

SPRINGER  
REFERENCE

Robert F. Schmidt  
William D. Willis  
*Editors*

# Encyclopedia of Pain





# Encyclopedia of Pain

With 713 Figures and 211 Tables



Professor em. Dr. Robert F. Schmidt  
Physiological Institute  
University of Würzburg  
Röntgenring 9  
97070 Würzburg  
Germany  
rfs@mail.uni-wuerzburg.de

Professor Dr. William D. Willis  
Department of Neuroscience and Cell Biology  
University of Texas Medical Branch  
301 University Boulevard  
Galveston  
TX 77555-1069  
USA  
wdwillis@utmb.edu

**ISBN-13: 978-3-540-43957-8 Springer Berlin Heidelberg New York**

This publication is available also as:  
Electronic publication under 978-3-540-29805-2 and  
Print and electronic bundle under ISBN 978-3-540-33447-7  
Library of Congress Control Number: 2006925866

This work is subject to copyright. All rights are reserved, whether the whole or part of the material is concerned, specifically the rights of translation, reprinting, reuse of illustrations, recitation, broadcasting, reproduction on microfilms or in other ways, and storage in data banks. Duplication of this publication or parts thereof is only permitted under the provisions of the German Copyright Law of September 9, 1965, in its current version, and permission for use must always be obtained from Springer-Verlag. Violations are liable for prosecution under the German Copyright Law.

Springer is part of Springer Science+Business Media  
springer.com

© Springer-Verlag Berlin Heidelberg New York 2007

The use of registered names, trademarks, etc. in this publication does not imply, even in the absence of a specific statement, that such names are exempt from the relevant protective laws and regulations and therefore free for general use.

Product liability: The publishers cannot guarantee the accuracy of any information about the application of operative techniques and medications contained in this book. In every individual case the user must check such information by consulting the relevant literature.

Editor: Thomas Mager, Andrea Pillmann, Heidelberg  
Development Editor: Michaela Bilic, Natasja Sheriff, Heidelberg  
Production Editor: Frank Krabbes, Heidelberg  
Cover Design: Frido Steinen-Broo, Spain

Printed on acid free paper

SPIN: 10877912 2109fk - 5 4 3 2 1 0

---

## Preface

As all medical students know, pain is the most common reason for a person to consult a physician. Under ordinary circumstances, acute pain has a useful, protective function. It discourages the individual from activities that aggravate the pain, allowing faster recovery from tissue damage. The physician can often tell from the nature of the pain what its source is. In most cases, treatment of the underlying condition resolves the pain. By contrast, children born with congenital insensitivity to pain suffer repeated physical damage and die young (see Sweet WH (1981) *Pain* 10:275).

Pain resulting from difficult to treat or untreatable conditions can become persistent. Chronic pain “never has a biologic function but is a malefic force that often imposes severe emotional, physical, economic, and social stresses on the patient and on the family...” (Bonica JJ (1990) *The Management of Pain*, vol 1, 2<sup>nd</sup> edn. Lea & Febiger, Philadelphia, p 19). Chronic pain can be considered a disease in its own right.

Pain is a complex phenomenon. It has been defined by the Taxonomy Committee of the International Association for the Study of Pain as “An unpleasant sensory and emotional experience associated with actual or potential tissue damage, or described in terms of such damage” (Merskey H and Bogduk N (1994) *Classification of Chronic Pain*, 2<sup>nd</sup> edn. IASP Press, Seattle). It is often ongoing, but in some cases it may be evoked by stimuli. Hyperalgesia occurs when there is an increase in pain intensity in response to stimuli that are normally painful. Allodynia is pain that is evoked by stimuli that are normally non-painful.

Acute pain is generally attributable to the activation of primary afferent neurons called nociceptors (Sherrington CS (1906) *The Integrative Action of the Nervous System*. Yale University Press, New Haven; 2<sup>nd</sup> edn, 1947). These sensory nerve fibers have high thresholds and respond to strong stimuli that threaten or cause injury to tissues of the body. Chronic pain may result from continuous or repeated activation of nociceptors, as in some forms of cancer or in chronic inflammatory states, such as arthritis.

However, chronic pain can also be produced by damage to nervous tissue. If peripheral nerves are injured, peripheral neuropathic pain may develop. Damage to certain parts of the central nervous system may result in central neuropathic pain. Examples of conditions that can cause central neuropathic pain include spinal cord injury, cerebrovascular accidents, and multiple sclerosis.

Research on pain in humans has been an important clinical topic for many years. Basic science studies were relatively few in number until experimental work on pain accelerated following detailed descriptions of peripheral nociceptors and central nociceptive neurons that were made in the 1960's and 70's, by the discovery of the endogenous opioid compounds and the descending pain control systems in the 1970's and the application of modern imaging techniques to visualize areas of the brain that are affected by pain in the 1990's. Accompanying these advances has been the development of a number of animal models of human pain states, with the goal of using these to examine pain mechanisms and also to test analgesic drugs or non-pharmacologic interventions that might prove useful for the treatment of pain in humans. Basic research on pain now emphasizes multidisciplinary approaches, including behavioral testing, electrophysiology and the application of many of the techniques of modern cell and molecular biology, including the use of transgenic animals.

The “Encyclopedia of Pain” is meant to provide a source of information that spans contemporary basic and clinical research on pain and pain therapy. It should be useful not only to researchers in these fields but also to practicing physicians and other health care professionals and to health care educators and administrators. The work is subdivided into 35 Fields, and the Field Editor of each of these describes the areas covered in the Fields in a brief review chapter. The topics included in a Field are the subject of a series of short essays, accompanied by key words, definitions,

illustrations, and a list of significant references. The number of authors who have contributed to the encyclopedia exceeds 550. The plan of the publisher, Springer-Verlag, is to produce both print and electronic versions of this encyclopedia. Numerous links within the electronic version should make comprehensive searches easy to manage. The electronic version will be updated at sufficiently short intervals to ensure that the content remains current.

The editors thank the staff at Springer-Verlag who have provided oversight for this project, including Rolf Lange, Thomas Mager, Claudia Lange, Natasja Sheriff, and Michaela Bilic. Working with these outstanding individuals has been a pleasure.

July 2006

ROBERT F. SCHMIDT  
Würzburg, Germany

WILLIAM D. WILLIS  
Galveston, Texas, USA

---

## Editors-in-Chief

ROBERT R. SCHMIDT  
Physiological Institute  
University of Würzburg  
Würzburg  
Germany  
rfs@mail.uni-wuerzburg.de

WILLIAM D. WILLIS  
Department of Neuroscience and Cell Biology  
University of Texas Medical Branch  
Galveston, TX  
USA  
wdrwillis@utmb.edu



---

## Field Editors

A. VANIA APKARIAN  
Department of Physiology  
Northwestern University Feinberg School of Medicine  
Chicago, IL  
USA  
a-apkarian@northwestern.edu

LARS ARENDT-NIELSEN  
Laboratory for Experimental Pain Research  
Center for Sensory-Motor Interaction  
Aalborg University  
Aalborg  
Denmark  
lan@hst.aau.dk

CARLOS BELMONTE  
Instituto de Neurociencias de Alicante  
Universidad Miguel Hernández-CSIC  
San Juan de Alicante  
Spain  
carlos.belmonte@umh.es

PHILLIP BERRYHILL  
PMG Cedar Neurosurgery  
Albuquerque, NM  
USA  
phillip.berryhill@mac.com

NIELS BIRBAUMER  
Institute of Medical Psychology and Behavioral  
Neurobiology  
University of Tübingen  
Tübingen  
Germany  
niels.birbaumer@uni-tuebingen.de

NIKOLAI BOGDUK  
Department of Clinical Research  
Royal Newcastle Hospital Newcastle  
University of Newcastle  
Newcastle, NSW  
Australia  
michelle.gillam@newcastle.edu.au

SIR MICHAEL R. BOND  
University of Glasgow  
Glasgow  
UK  
m.bond@admin.gla.ac.uk

KIM J. BURCHIEL  
Department of Neurological Surgery  
The Oregon Health Sciences University  
Portland, OR  
USA  
burchiek@ohsu.edu

KENNETH L. CASEY  
Department of Neurology and  
Department of Molecular and Integrative Physiology  
University of Michigan  
and  
Consultant in Neurology  
Veterans Administration Medical Center  
Ann Arbor, MI  
USA  
kencasey@umich.edu

JIN MO CHUNG  
Department of Neuroscience and Cell Biology  
University of Texas Medical Branch  
Galveston, TX  
USA  
jmchung@utmb.edu

MICHAEL J. COUSINS  
Department of Anesthesia and Pain Management  
Royal North Shore Hospital  
University of Sydney  
St. Leonards, NSW  
Australia  
mcousins@nsccha.health.nsw.gov.au

MARSHALL DEVOR  
Department of Cell and Animal Biology  
Institute of Life Sciences and  
Center for Research on Pain  
Hebrew University of Jerusalem  
Jerusalem  
Israel  
marshlu@vms.huji.ac.il

HANS-CHRISTOPH DIENER  
Department of Neurology  
University of Duisburg-Essen  
Essen  
Germany  
h.diener@uni-essen.de

JONATHAN O. DOSTROVSKY  
Department of Physiology  
Faculty of Medicine  
University of Toronto  
Toronto, ON  
Canada  
j.dostrovsky@utoronto.ca

RONALD DUBNER  
Department of Biomedical Sciences  
University of Maryland  
Baltimore, MD  
USA  
rdubner@umaryland.edu

HERTA FLOR  
Department of Neuropsychology at the  
University of Heidelberg  
Central Institute of Mental Health  
Mannheim  
Germany  
flor@zi-mannheim.de

GERALD F. GEBHART  
Department of Pharmacology  
University of Iowa  
Iowa City, IA  
USA  
gf-gebhart@uiowa.edu

GERD GEISSLINGER  
Institute for Clinical Pharmacology  
pharmazentrum frankfurt/ZAFES  
Clinical Centre of the Johann Wolfgang Goethe  
University Frankfurt am Main  
Frankfurt  
Germany  
geisslinger@em.uni-frankfurt.de

GLENN J. GIESLER JR.  
Department of Neuroscience  
University of Minnesota  
Minneapolis, MN  
USA  
giesler@mail.ahc.umn.edu

PETER J. GOADSBY  
Institute of Neurology  
The National Hospital for Neurology and  
Neurosurgery  
London  
UK  
peterg@ion.ucl.ac.uk

HERMANN O. HANDWERKER  
Department of Physiology and Pathophysiology  
University of Erlangen/Nürnberg  
Erlangen  
Germany  
handwerker@physiologie1.uni-erlangen.de

WILFRID JÄNIG  
Physiology Institute  
Christian Albrechts University Kiel  
Kiel  
Germany  
w.janig@physiologie.uni-kiel.de

MARTIN KOLTZENBURG  
Institute of Child Health and Institute of Neurology  
University College London  
London  
UK  
m.koltzenburg@ich.ucl.ac.uk

FRED A. LENZ  
Departments of Neurosurgery  
Johns Hopkins University  
Baltimore, MD  
USA  
flenzl@jhmi.edu

ROSS MACPHERSON  
Department of Anesthesia and Pain Management  
Royal North Shore Hospital  
University of Sydney  
St. Leonards, NSW  
Australia  
rmacpher@nscchahs.health.nsw.gov.au

PATRICIA A. MCGRATH  
Department of Anaesthesia  
Divisional Centre of Pain Management and Research  
The Hospital for Sick Children  
and  
Brain and Behavior Program  
Research Institute at The Hospital for Sick Children  
and  
Department of Anaesthesia  
University of Toronto  
Toronto, ON  
Canada

FRANK PORRECA  
Departments of Pharmacology and Anesthesiology  
University of Arizona  
Health Sciences Center  
Tucson, AZ  
USA  
frankp@u.arizona.edu



RUSSELL K. PORTENOY  
Department of Pain Medicine and Palliative Care  
Beth Israel Medical Center  
New York, NY  
USA  
rportenoy@chpnet.org

JAMES P. ROBINSON  
Department of Anesthesiology  
University of Washington School of Medicine  
Seattle, WA  
USA  
jimrob@u.washington.edu

HANS-GEORG SCHAIBLE  
Department of Physiology  
University of Jena  
Jena  
Germany  
hans-georg.schaible@mti.uni-jena.de

BARRY J. SESSLE  
Department of Physiology  
Faculty of Medicine  
and  
Faculty of Dentistry  
University of Toronto  
Toronto, ON  
Canada  
barry.sessle@utoronto.ca

BENGT H. SJÖLUND  
Rehabilitation and Research Centre for Torture  
Victims  
South Danish University  
Copenhagen  
Denmark  
bsj@rct.dk

DENNIS C. TURK  
Department of Anesthesiology  
University of Washington School of Medicine  
Seattle, WA  
USA  
turkdc@u.washington.edu

URSULA WESSELMANN  
Departments of Neurology  
Neurological Surgery and Biomedical Engineering  
The Johns Hopkins University School of Medicine  
Baltimore, MD  
USA  
pain@jhmi.edu

GEORGE L. WILCOX  
Department of Neuroscience  
Pharmacology and Dermatology  
University of Minnesota Medical School  
Minneapolis, MN  
USA  
george@umn.edu

ROBERT P. YEZIERSKI  
Department of Orthodontics  
Comprehensive Center for Pain Research and  
The McKnight Brain Institute  
University of Florida  
Gainesville, FL  
USA  
ryezierski@dental.ufl.edu



---

## List of Contributors

TIPU AAMIR  
The Auckland Regional Pain Service  
Auckland Hospital  
Auckland  
New Zealand  
bobl@adhb.govt.nz

CATHERINE ABBADIE  
Department of Pharmacology  
Merck Research Laboratories  
Rahway, NJ  
USA  
catherine\_abbadie@merck.com

FRANCES V. ABBOTT  
Department of Psychiatry and Psychology  
McGill University  
Montreal, QC  
Canada

HEATHER ADAMS  
Department of Psychology  
University of Montreal  
Montreal, QC  
Canada  
heather.adams@umontreal.ca

ROLF H. ADLER  
Prof. em. Medicine  
Kehrsatz  
Switzerland

CLAIRE D. ADVOKAT  
Department of Psychology  
Louisiana State University  
Baton Rouge, LA  
USA  
cadvoka@lsu.edu

SHEFALI AGARWAL  
Department of Anesthesiology and Critical Care  
Medicine  
The Johns Hopkins University School of Medicine  
Baltimore, MD  
USA

RETO M. AGOSTI  
Headache Center Hirslanden  
Zürich  
Switzerland  
reto.agosti@kopfwww.ch

HUGO VAN AKEN  
Clinic and Policlinic for Anaesthesiology and  
operative Intensive Medicine  
University Hospital Münster  
Münster  
Germany

ELIE D. AL-CHAER  
Neurobiology and Developmental Sciences  
College of Medicine  
University of Arkansas for Medical Sciences  
Center for Pain Research  
Pediatrics  
Little Rock, AR  
USA  
ealchaer@uams.edu

MARIE-CLAIRE ALBANESE  
Department of Psychology  
McGill University  
Montreal, QC  
Canada  
mclaire@bic.mni.mcgill.ca

KATHRYN M. ALBERS  
Department of Medicine  
University of Pittsburgh School of Medicine  
Pittsburgh, PA  
USA  
kaa2@pitt.edu

TERRY ALTILIO  
Department of Pain Medicine and Palliative Care  
Beth Israel Medical Center  
New York, NY  
USA  
taltilio@chpnet.org

RAINER AMANN  
Medical University Graz  
Graz  
Austria  
rainer.amann@meduni-graz.at

RON AMIR  
Institute of Life Sciences and  
Center for Research on Pain  
Hebrew University of Jerusalem  
Jerusalem  
Israel  
ronamir@pob.huji.ac.il

PRAVEEN ANAND  
Peripheral Neuropathy Unit  
Imperial College London  
Hammersmith Hospital  
London  
UK  
p.anand@imperial.ac.uk

OLE K. ANDERSEN  
Department of Health Science & Technology  
Center for Sensory-Motor Interaction  
Aalborg University  
Aalborg  
Denmark  
oka@hst.aau.dk

STAN ANDERSON  
Departments of Neurosurgery  
Johns Hopkins University  
Baltimore, MD  
USA

WILLIAM S. ANDERSON  
Department of Neurological Surgery  
Johns Hopkins Hospital  
Baltimore, MD  
USA  
wanderso@jhmi.edu

KARL-ERIK ANDERSSON  
Departments of Clinical Pharmacology  
Anesthesiology and Intensive Care  
Lund University Hospital  
Lund  
Sweden

FRANK ANDRASIK  
University of West Florida  
Pensacola, FL  
USA  
fandrasik@uwf.edu

A. VANIA APKARIAN  
Department of Physiology  
Feinberg School of Medicine  
Northwestern University  
Chicago, IL  
USA  
a-apkarian@northwestern.edu

LARS ARENDT-NIELSEN  
Laboratory for Experimental Pain Research  
Center for Sensory-Motor Interaction  
Aalborg University  
Aalborg  
Denmark  
lan@hst.aau.dk

KIRSTEN ARNDT  
CNS Pharmacology  
Pain Research  
Boehringer Ingelheim Pharma GmbH & Co. KG  
Biberach/Riss  
Germany  
kirsten.arndt@bc.boehringer-ingenheim.de

ERIK ASKENASY  
Health Science Center at Houston  
Neurobiology and Anatomy  
University of Texas  
Houston, TX  
USA

CHRISTOPH AUFENBERG  
Functional Neurosurgery  
Neurosurgical Clinic  
University Hospital  
Zürich  
Switzerland

BEATE AVERBECK  
Sanofi-Aventis Deutschland GmbH  
Frankfurt  
Germany  
beate.averbeck@sanofi-aventis.com

QASIM AZIZ  
Section of GI Sciences  
Hope Hospital  
University of Manchester  
Salford  
UK

F. W. BACH  
Danish Pain Research Center and  
Department of Neurology  
Aarhus University Hospital  
Aarhus  
Denmark

S. K. BACK  
Medical Science Research Center and Department of  
Physiology  
Korea University College of Medicine  
Seoul  
Korea

MISHA-MIROSLAV BACKONJA  
Department of Neurology  
University of Wisconsin-Madison  
Madison, WI  
USA  
backonja@neurology.wisc.edu

CARSTEN BANTEL  
Magill Department of Anaesthetics  
Chelsea and Westminster Campus  
Imperial College of Science  
Technology and Medicine  
London  
UK  
c.bantel@imperial.ac.uk

ALEX BARLING  
Department of Neurology  
Birmingham Muscle and Nerve Centre  
Queen Elizabeth Hospital  
Birmingham  
UK  
corisanderoad@aol.com

RALF BARON  
Department of Neurological Pain Research and  
Therapy  
Department of Neurology  
Christian Albrechts University Kiel  
Kiel  
Germany  
r.baron@neurologie.uni-kiel.de

GORDON A. BARR  
Department of Psychology  
Hunter College  
Graduate Center  
City University of New York  
and  
Department of Developmental Psychobiology  
New York State Psychiatric Institute  
Department of Psychiatry  
Medical Center  
Columbia University  
New York, NY  
USA  
gbarr@hunter.cuny.edu

JEFFREY R. BASFORD  
Department of Physical Medicine and Rehabilitation  
Mayo Clinic and Mayo Foundation  
Rochester, MN  
USA  
basford.jeffrey@mayo.edu

HEINZ-DIETER BASLER  
Institute of Medical Psychology  
University of Marburg  
Marburg  
Germany  
basler@med.uni-marburg.de

MICHELE C. BATTIÉ  
Department of Physical Therapy  
University of Alberta  
Edmonton, AB  
Canada  
michele.critesbattie@ualberta.ca

ULF BAUMGÄRTNER  
Institute of Physiology and Pathophysiology  
Johannes Gutenberg University  
Mainz  
Germany

JOLENE D. BEAN-LIJEWSKI  
Department of Anesthesiology  
Scott and White Memorial Hospital  
Temple, TX  
USA  
jbean-lijewski@swmail.sw.org

ALAIN BEAUDET  
Montreal Neurological Institute  
McGill University  
Montreal, QC  
Canada  
abeaudet@frsq.gouv.gc.ca

LINO BECERRA  
Brain Imaging Center  
McLean Hospital-Harvard Medical School  
Belmont, MA  
USA  
lbecerra@mclean.harvard.edu

YAAKOV BEILIN  
Department of Anesthesiology and Obstetrics  
Gynecology and Reproductive Sciences  
Mount Sinai School of Medicine  
New York, NY  
USA  
yaakov.beilin@mountsinai.org

ALVIN J. BEITZ  
Department of Veterinary and Biomedical Sciences  
University of Minnesota  
St. Paul, MN  
USA  
beitz001@tc.umn.edu

MILES J. BELGRADE  
Fairview Pain & Palliative Care  
University of Minnesota Medical Center  
and  
Department of Neurology  
University of Minnesota Medical School  
Minneapolis, MN  
USA  
mbelgra1@fairview.org

CARLO VALERIO BELLINI  
Neonatal Intensive Care Unit  
University Hospital  
Siena  
Italy  
bellieni@iol.it

CARLOS BELMONTE  
Instituto de Neurociencias de Alicante  
Universidad Miguel Hernández-CSIC  
San Juan de Alicante  
Spain  
carlos.belmonte@umh.es

ALLAN J. BELZBERG  
Department of Neurosurgery  
Johns Hopkins School of Medicine  
Baltimore, MD  
USA  
abelzber@jhmi.edu

FABRIZIO BENEDETTI  
Department of Neuroscience  
Clinical and Applied Physiology Program  
University of Turin Medical School  
Turin  
Italy  
fabrizio.benedetti@unito.it

ROBERT BENNETT  
Department of Medicine  
Oregon Health and Science University  
Portland, OR  
USA  
bennetrob1@comcast.net

DAVID BENNETT  
Department of Neurology  
King's College Hospital  
London  
UK  
dlhbennett@talk21.com

MAURICE F. BENSIGNOR  
Centre Catherine de Sienne  
Reze  
France  
dr.ben@wanadoo.fr

EDWARD BENZEL  
The Cleveland Clinic Foundation  
Department of Neurosurgery  
Cleveland Clinic Spine Institute  
Cleveland, OH  
USA  
benzele@ccf.org

DAVID A. BEREITER  
Department of Surgery  
Brown Medical School  
Providence, RI  
USA  
david\_bereiter@brown.edu

ELMAR BERENDES  
Clinic and Policlinic for Anaesthesiology and  
operative Intensive Medicine  
University Hospital Münster  
Münster  
Germany  
berendes@klinikum-krefeld.de

KAREN J. BERKLEY  
Program in Neuroscience  
Florida State University  
Tallahassee, FL  
USA  
kberkley@darwin.psy.fsu.edu

PETER BERLIT  
Department of Neurology  
Alfried Krupp Hospital  
Essen  
Germany  
peter.berlit@krupp-krankenhaus.de

JEAN-FRANÇOIS BERNARD  
Faculté de Médecine Pitié-Salpêtrière  
Institut National de la Santé et de la Recherche  
Médicale  
INSERM U-677  
Paris  
France  
jfbernar@ext.jussieu.fr

ANNE KJØRSVIK BERTELSEN  
Department of Neurology  
Haukeland University Hospital  
Bergen  
Norway  
anne.kjorsvik@biomed.uib.no

MARCELO E. BIGAL  
Department of Neurology  
Albert Einstein College of Medicine  
Bronx, NY  
and  
The New England Center for Headache  
Stamford, CT  
and  
Montefiore Headache Unit,  
Bronx, NY  
USA

YITZCHAK M. BINIK  
McGill University  
Montreal, QC  
Canada  
binik@ego.psych.mcgill.ca

NIELS BIRBAUMER  
Institute of Medical Psychology and Behavioral  
Neurobiology  
University of Tübingen  
Tübingen  
Germany  
niels.birbaumer@uni-tuebingen.de

FRANK BIRKLEIN  
Department of Neurology  
University of Mainz  
Mainz  
Germany  
birklein@neurologie.klinik.uni-mainz.de

THOMAS BISHOP  
Centre for Neuroscience  
King's College London  
London  
UK  
thomas.bishop@kcl.ac.uk

HENNING BLIDDAL  
The Parker Institute  
Frederiksberg Hospital  
Copenhagen  
Denmark  
hb@fh.hosp.dk

RONALD H. BLUM  
Beth Israel Medical Center  
New York, NY  
USA  
rblum@bethisraelny.org

JAMES A. BLUNK  
Clinic for Anaesthesiology  
University of Erlangen  
Erlangen  
Germany  
blunk@physiologie1.uni-erlangen.de

NIKOLAI BOGDUK  
Department of Clinical Research  
Royal Newcastle Hospital  
Newcastle, NSW  
Australia  
michelle.gillam@newcastle.edu.au

JÖRGEN BOIVIE  
Department of Neurology  
University Hospital  
Linköping  
Sweden  
jorgen.boivie@lio.se

SIR MICHAEL R. BOND  
University of Glasgow  
Glasgow  
UK  
m.bond@admin.gla.ac.uk

RICHARD L. BOORTZ-MARX  
Department of Neurosciences  
Gundersen Lutheran Health Care System  
La Crosse, WI  
USA  
rlboortz@gundluth.org

JAMES M. BOROWCZYK  
Department of Orthopaedics and Musculoskeletal  
Medicine  
Christchurch Public Hospital  
Christchurch Clinical School of Medicine and Health  
Sciences  
Christchurch  
New Zealand  
jmbor@clear.net.nz

DAVID BORSOOK  
Brain Imaging Center  
McLean Hospital-Harvard Medical School  
Belmont, MA  
USA

GEORGE S. BORSZCZ  
Department of Psychology  
Wayne State University  
Detroit, MI  
USA  
borszcz@wayne.edu

JASENKA BORZAN  
Department of Anesthesiology and  
Critical Care Medicine  
Johns Hopkins University  
Baltimore, MD  
USA  
jborzan1@jhmi.edu

REGINA M. BOTTING  
The William Harvey Research Institute  
The John Vane Science Centre  
Queen Mary University of London  
St Bartholomew's and the London School of  
Medicine and Dentistry  
London  
UK  
r.m.botting@qmul.ac.uk

DAVID BOWSHER  
Pain Research Institute  
University Hospital Aintree  
Liverpool  
UK  
pri@liv.ac.uk or bowsher@liv.ac.uk

EMMA L. BRANDON  
Royal Perth Hospital and  
University of Western Australia  
Crawley, WA  
Australia

HARALD BREIVIK  
Rikshospitalet University Hospital  
Rikshospitalet  
Norway  
harald.breivik@klinmed.uio.no

CHRISTOPHER R. BRIGHAM  
Brigham and Associates Inc.  
Portland, OR  
USA  
cbrigham@brighamassociates.com

STEPHEN C. BROWN  
Department of Anesthesia  
Divisional Centre of Pain Management and Pain  
Research  
The Hospital for Sick Children  
Toronto, ON  
Canada  
stephen.brown@sickkids.ca

JEFFREY A. BROWN  
Department of Neurological Surgery  
Wayne State University  
School of Medicine  
Detroit and Neurological Surgery  
NY, USA  
jbrown@neurosurgery.wayne.edu

EDUARDO BRUERA  
Department of Palliative Care and Rehabilitation  
Medicine  
The University of Texas M. D. Anderson Cancer  
Center  
Houston, TX  
USA  
ebruera@mdanderson.org

PABLO BRUMOVSKY  
Department of Neuroscience  
Karolinska Institute  
Stockholm  
Sweden  
and  
Neuroscience Laboratory  
Austral University  
Buenos Aires  
Argentina

KAY BRUNE  
Institute for Experimental and Clinical Pharmacology  
and Toxicology  
Friedrich Alexander University Erlangen-Nürnberg  
Erlangen  
Germany  
kay.brune@pharmakologie.uni-erlangen.de

MARIA BURIAN  
Pharmacological Center Frankfurt  
Clinical Center Johann-Wolfgang Goethe University  
Frankfurt  
Germany  
burian@em.uni-frankfurt.de

RICHARD BURSTAL  
John Hunter Royal Hospital  
Newcastle, NSW  
Australia  
richard.burstal@hnehealth.nsw.gov.au

DAN BUSKILA  
Rheumatic Disease Unit  
Faculty of Health Sciences  
Soroka Medical Center  
Ben Gurion University  
Beer Sheva  
Israel  
dbuskila@bgumail.bgu.ac.il

CATHERINE M. CAHILL  
Queen's University  
Kingston, ON  
Canada  
cahillc@post.queensu.ca

BRIAN E. CAIRNS  
Faculty of Pharmaceutical Sciences  
University of British Columbia  
Vancouver, BC  
Canada  
brcairns@interchange.ubc.ca

NIGEL A. CALCUTT  
Department of Pathology  
University of California San Diego  
La Jolla, CA  
USA  
ncalcutt@ucsd.edu



KATHARINE ANDREWS CAMPBELL  
Department of Anatomy and Developmental Biology  
University College London  
London  
UK  
k.campbell@ich.ucl.ac.uk

JAMES N. CAMPBELL  
Department of Neurosurgery  
The Johns Hopkins University School of Medicine  
Baltimore, MD  
USA  
jcampbel@jhmi.edu

ADAM CARINCI  
Department of Anesthesiology and Critical Care  
Medicine  
The Johns Hopkins University School of Medicine  
Baltimore, MD  
USA

GIANCARLO CARLI  
Department of Physiology  
University of Siena  
Siena  
Italy  
carlig@unisi.it

CHRISTER P.O. CARLSSON  
Rehabilitation Department  
Lunds University Hospital  
Lund  
Sweden  
akusyd@swipnet.se

SUSAN M. CARLTON  
Marine Biomedical Institute  
University of Texas Medical Branch  
Galveston, TX  
USA  
smcarlto@utmb.edu

KENNETH L. CASEY  
Department of Neurology  
University of Michigan  
and  
Neurology Research Laboratory  
VA Medical Center  
Ann Arbor, MI  
USA  
kencasey@umich.edu

CHRISTINE T. CHAMBERS  
Departments of Pediatrics and Psychology  
Dalhousie University and IWK Health Centre  
Halifax, NS  
Canada  
christine.chambers@dal.ca

SANDRA CHAPLAN  
Johnson & Johnson Pharmaceutical Research &  
Development  
San Diego, CA  
USA  
schaplan@prius.jnj.com

C. RICHARD CHAPMAN  
Pain Research Center  
Department of Anesthesiology  
University of Utah School of Medicine  
Salt Lake City, UT  
USA  
crc20@utah.edu

SANTOSH K. CHATURVEDI  
National Institute of Mental Health & Neurosciences  
Bangalore  
India  
chatur@nimhans.kar.nic.in

ANDREW C. N. CHEN  
Human Brain Mapping and Cortical Imaging  
Laboratory  
Aalborg University  
Aalborg  
Denmark  
ac@smi.auc.dk

ANDREA CHEVILLE  
Department of Rehabilitation Medicine  
University of Pennsylvania School of Medicine  
Philadelphia, PA  
USA  
acheville@aol.com

NAOMI L. CHILLINGWORTH  
Department of Physiology  
School of Medical Sciences  
University of Bristol  
Bristol  
UK

CATHERINE CHO  
Clinical Neurophysiology Laboratories  
Mount Sinai Medical Center  
New York, NY  
USA

EDWARD CHOW  
Toronto Sunnybrook Regional Cancer Center  
University of Toronto  
Toronto, ON  
Canada  
edward.chow@sw.ca

JULIE A. CHRISTIANSON  
University of Pittsburgh  
Pittsburgh, PA  
USA  
jcc26+@pitt.edu

MACDONALD J. CHRISTIE  
Pain Management Research Institute and Kolling  
Institute  
University of Sydney  
Sydney, NSW  
Australia  
macc@med.usyd.edu.au

KYUNGSOON CHUNG  
Department of Neuroscience and Cell Biology  
University of Texas Medical Branch  
Galveston, TX  
USA  
kchung@utmb.edu

JIN MO CHUNG  
Department of Neuroscience and Cell Biology  
University of Texas Medical Branch  
Galveston, TX  
USA  
jmchung@utmb.edu

W. CRAWFORD CLARK  
College of Physicians and Surgeons, Columbia  
University  
New York, NY  
USA  
USAclarkcr@pi.cpmc.columbia.edu

JUDY CLARKE  
Institute for Work & Health  
Toronto, ON  
Canada  
jclarke@iwh.on.ca

JAMES F. CLEARY  
University of Wisconsin Comprehensive Cancer  
Center  
Madison, WI  
USA  
jfcleary@wisc.edu

CHARLES S. CLEELAND  
The University of Texas M. D.  
Anderson Cancer Center  
Houston, TX  
USA  
ccleeland@mdanderson.org

JOHN DE CLERCQ  
Department of Rehabilitation Sciences and  
Physiotherapy  
Ghent University Hospital  
Ghent  
Belgium

TERENCE J. CODERRE  
Department of Anesthesia  
Neurology, Neurosurgery and Psychology  
McGill University  
Montreal, QC  
Canada  
terence.coderre@mcgill.ca

ROBERT C. COGHILL  
Department of Neurobiology and Anatomy  
Wake Forest University School of Medicine  
Winston-Salem, NC  
USA  
rcoghill@wfubmc.edu

ALAN L. COLLEDGE  
Utah Labor Commission  
International Association of Industrial Accident  
Boards and Commissions  
Salt Lake City, UT  
USA  
farmboyac@msn.com

BEVERLY J. COLLETT  
University Hospitals of Leicester  
Leicester  
UK  
beverly.collett@uhl.tr-nhs.uk

LESLEY A. COLVIN  
Department of Anaesthesia  
Critical Care and Pain Medicine  
Western General Hospital  
Edinburgh  
UK  
lesley.colvin@ed.ac.uk

KEVIN C. CONLON  
Trinity College Dublin  
University of Dublin  
and  
The Adelaide and Meath Hospital incorporating  
The National Children's Hospital  
Dublin  
Ireland  
profsurg@tcd.ie

BRIAN Y. COOPER  
Department of Oral and Maxillofacial Surgery  
University of Florida  
Gainesville, FL  
USA  
bcooper@dental.ufl.edu

CHRISTINE CORDLE  
University Hospitals of Leicester  
Leicester  
UK

MICHAEL J. COUSINS  
Department of Anesthesia and Pain Management  
Royal North Shore Hospital  
University of Sydney  
St. Leonards, NSW  
Australia  
mcousins@nscchahs.health.nsw.gov.au

VERNE C. COX  
Department of Psychology  
University of Texas at Arlington  
Arlington, TX  
USA

REBECCA M. CRAFT  
Washington State University  
Pullman, WA  
USA  
craft@wsu.edu

KENNETH D. CRAIG  
Department of Psychology  
University of British Columbia  
Vancouver, BC  
Canada  
kcraig@psych.ubc.ca

GEERT CROMBEZ  
Department of Experimental Clinical and  
Health Psychology  
Ghent University  
Ghent  
Belgium  
geert.crombez@ugent.be

JOAN CROOK  
Hamilton Health Sciences Corporation  
Hamilton, ON  
Canada

GIORGIO CRUCCU  
Department of Neurological Sciences  
La Sapienza University  
Rome  
Italy  
cruccu@uniroma1.it

MICHELE CURATOLO  
Department of Anesthesiology  
Division of Pain Therapy  
University Hospital of Bern  
Inselspital  
Bern  
Switzerland  
michele.curatolo@insel.ch

F. MICHAEL CUTRER  
Department of Neurology  
Mayo Clinic  
Rochester, MN  
USA  
cutrer.michael@mayo.edu

NACHUM DAFNY  
Health Science Center at Houston  
Neurobiology and Anatomy  
University of Texas  
Houston, TX  
USA  
nachum.dafny@uth.tmc.edu

JØRGEN B. DAHL  
Department of Anaesthesiology  
Glostrup University Hospital  
Herlev  
Denmark  
jbdahl@dadlnet.dk

YI DAI  
Department of Anatomy and Neuroscience  
Hyogo College of Medicine  
Hyogo  
Japan

STEFAN VAN DAMME  
Department of Experimental Clinical and  
Health Psychology  
Ghent University  
Ghent  
Belgium  
stefaan.vandamme@ugent.be

ALEXANDRE F. M. DASILVA  
Martinos Center for Biomedical Imaging  
Massachusetts General Hospital  
Harvard Medical School  
Charlestown, MA  
USA  
alexandr@nmr.mgh.harvard.edu

BRIAN DAVIS  
University of Pittsburgh  
Pittsburgh, PA  
USA  
davisb@dom.pitt.edu

KAREN D. DAVIS  
University of Toronto and the  
Toronto Western Research Institute  
University Health Network  
Toronto, ON  
Canada  
kdavis@uhnres.utoronto.ca

RICHARD O. DAY  
Department of Physiology and Pharmacology  
School of Medical Sciences  
University of New South Wales  
and  
Department of Clinical Pharmacology  
St Vincent's Hospital  
Sydney, NSW  
Australia  
r.day@unsw.edu.au

ISABELLE DECOSTERD  
Anesthesiology Pain Research Group  
Department of Anesthesiology  
University Hospital (CHUV) and Department  
of Cell Biology and Morphology  
Lausanne University  
Lausanne  
Switzerland  
isabelle.decosterd@chuv.ch

JOYCE A. DELEO  
Dartmouth Hitchcock Medical Center  
Dartmouth Medical School  
Lebanon, NH  
USA  
joyce.a.deleo@dartmouth.edu

A. LEE DELLON  
Johns Hopkins University  
Baltimore, MD  
USA  
aldellon@starpower.net

MARSHALL DEVOR  
Institute of Life Sciences and  
Center for Research on Pain  
Hebrew University of Jerusalem  
Jerusalem  
Israel  
marshlu@vms.huji.ac.il

DAVID DIAMANT  
Neurological and Spinal Surgery  
Lincoln, NE  
USA  
ddiamant@neb.rr.com

ANTHONY H. DICKENSON  
Department of Pharmacology  
University College London  
London  
UK  
anthony.dickenson@ucl.ac.uk

HANS-CHRISTOPH DIENER  
Department of Neurology  
University Hospital of Essen  
Essen  
Germany  
h.diener@uni-essen.de

ADAM VAN DIJK  
Department of Anesthesiology  
Queen's University  
Kingston General Hospital  
Kingston, ON  
Canada

NATALIA DMITRIEVA  
Program in Neuroscience  
Florida State University  
Tallahassee, FL  
USA  
dmitrieva@darwin.psy.fsu.edu

REGINALD J. DOCHERTY  
Wolfson Centre for Age-Related Diseases  
King's College London  
London  
UK  
reginald.docherty@kcl.ac.uk

LUCY F. DONALDSON  
Department of Physiology  
School of Medical Sciences  
University of Bristol  
Bristol  
UK  
lucy.donaldson@bris.ac.uk

HENRI DOODS  
CNS Pharmacology  
Pain Research  
Boehringer Ingelheim Pharma GmbH & Co.  
KG  
Biberach/Riss  
Germany

VICTORIA DORF  
Social Security Administration  
Baltimore, MD  
USA  
victoria.dorf@ssa.gov

MICHAEL J. DORSI  
Department of Neurosurgery  
Johns Hopkins School of Medicine  
Baltimore, MD  
USA

JONATHAN O. DOSTROVSKY  
Department of Physiology  
Faculty of Medicine  
University of Toronto  
Toronto, ON  
Canada  
j.dostrovsky@utoronto.ca

PAUL DREYFUSS  
Department of Rehabilitation Medicine  
University of Washington  
Seattle, WA  
USA  
pauldspine@aol.com

PETER D. DRUMMOND  
School of Psychology  
Murdoch University  
Perth, WA  
Australia  
p.drummond@murdoch.edu.au

RONALD DUBNER  
University of Maryland  
Department of Biomedical Sciences  
Baltimore, MD  
USA  
rdubner@umaryland.edu

ANNE DUCROS  
Headache Emergency Department and  
Institute National de la Santé et de la Recherche  
Médicale (INSERM)  
Faculté de Médecine Lariboisière  
Lariboisière Hospital  
Paris  
France  
anne.ducros@lrb.ap-hop-paris.fr

GARY DUNCAN  
Department of Psychology  
McGill University  
Montreal, QC  
Canada

MARY J. EATON  
Miller School of Medicine  
University of Miami  
Miami, FL  
USA  
meaton@miami.edu

ANDREA EBERSBERGER  
Department of Physiology  
Friedrich Schiller University of Jena  
Jena  
Germany  
andrea.ebersberger@mti.uni-jena.de

CHRISTOPHER ECCLESTON  
Pain Management Unit  
University of Bath  
Bath  
UK  
c.eccleston@bath.ac.uk

JOHN EDMEDS  
Sunnybrook and Woman's College Health  
Sciences Centre  
University of Toronto  
Toronto, ON  
Canada  
john.edmeads@sw.ca

ROBERT R. EDWARDS  
Department of Psychiatry and Behavioral Sciences  
The Johns Hopkins University School of Medicine  
Baltimore, MD  
USA  
redwar10@jhmi.edu

EVAN R. EISENBERG  
Department of Urology  
Long Island Jewish Medical Center  
New York, NY  
USA

JANET W. M. ELLIS  
Department of Anaesthesia  
Divisional Centre for Pain Management  
and  
Pain Research  
The Hospital for Sick Children  
Toronto, ON  
Canada  
joostjanet@rogers.com

JOYCE M. ENGEL  
Department of Rehabilitation Medicine  
University of Washington  
Seattle, WA  
USA  
knowles@u.washington.edu

MATTHEW ENNIS  
Department of Anatomy and Neurobiology  
University of Tennessee Health Science Center  
Memphis, TN  
USA  
mennis@utmem.edu

EDZARD ERNST  
Complementary Medicine  
Peninsula Medical School  
Universities of Exeter and Plymouth  
Exeter  
UK  
edzard.ernst@pms.ac.uk

LYDIA ESTANISLAO  
Clinical Neurophysiology Laboratories  
Mount Sinai Medical Center  
New York, NY  
USA

THOMAS EWERT  
Department of Physical Medicine and Rehabilitation  
Ludwig-Maximilians University  
Munich  
Germany

KERI L. FAKATA  
College of Pharmacy and Pain Management Center  
University of Utah  
Salt Lake City, UT  
USA  
keri.fakata@hsc.utah.edu

MARIE FALLON  
Department of Oncology  
Edinburgh Cancer Center  
University of Edinburgh  
Edinburgh  
Scotland  
marie.fallon@ed.ac.uk

GILBERT J. FANCIULLO  
Pain Management Center  
Dartmouth-Hitchcock Medical Center  
Lebanon, NH  
USA  
gilbert.j.fanciullo@hitchcock.org

ANDREW J. FARACI  
Virginia Mason Medical Center  
Seattle, WA  
USA

CHARLOTTE FEINMANN  
Eastman Dental Institute and Department of  
Psychiatry and Behavioural Sciences  
University College London  
London  
UK  
rejuce@ucl.ac.uk

ELIZABETH ROY FELIX  
The Miami Project to Cure Paralysis  
University of Miami Miller School of Medicine  
Miami, FL  
USA  
efelix@miamiproject.med.miami.edu

YI FENG  
Department of Anesthesiology  
Peking University People's Hospital  
Peking  
P. R. China  
yifeng65@263.net

ANDRES FERNANDEZ  
Departments of Neurosurgery  
Johns Hopkins University  
Baltimore, MD  
USA

ANTONIO VICENTE FERRER-MONTIEL  
Institute of Molecular and Cell Biology  
University Miguel Hernández  
Elche  
Alicante  
Spain  
aferrer@umh.es

MICHAEL FEUERSTEIN  
Department of Medical and Clinical Psychology  
Uniformed Services University of the Health  
Sciences  
Bethesda, MD  
and  
Department of Preventive Medicine & Biometrics  
USUHS  
Bethesda, MD  
and  
Georgetown University Medical Center  
Washington, DC  
USA  
mfeuerstein@usuhs.mil

VERONIKA FIALKA-MOSER  
Department of Physical Medicine and Rehabilitation  
University Vienna  
Vienna  
Austria  
Pmr.office@meduniwien.ac.at

PERRY G. FINE  
Pain Management and Research Center  
University of Utah  
Salt Lake City, UT  
USA  
fine@aros.net

DAVID J. FINK  
Department of Neurology  
University of Michigan and VA Ann Arbor  
Healthcare System  
Ann Arbor, MI  
USA  
dfink@pitt.edu

NANNA BRIX FINNERUP  
Department of Neurology and  
Danish Pain Research Centre  
Aarhus University Hospital  
Aarhus  
Denmark  
finnerup@ki.au.dk

DAVID A. FISHBAIN  
Department of Psychiatry and Department of  
Neurological Surgery and Anesthesiology  
University of Miami  
School of Medicine and H. Rosomoff Pain  
Center at South Shore Hospital  
Miami, FL  
USA  
dfishbain@miami.edu

PER FLISBERG  
Royal Perth Hospital  
University of Western Australia  
Perth, WA  
Australia

HERTA FLOR  
Department of Clinical and Cognitive Neuroscience  
University of Heidelberg  
Central Institute of Mental Health  
Mannheim  
Germany  
flor@zi-mannheim.de

CHRISTOPHER M. FLORES  
Drug Discovery  
Johnson and Johnson Pharmaceutical Research and  
Development  
Spring House, PA  
USA

WILBERT E. FORDYCE  
Department of Rehabilitation  
University of Washington School of Medicine  
Seattle, WA  
USA  
wfordyce@msn.com

ROBERT D. FOREMAN  
University of Oklahoma Health Sciences Center  
Oklahoma City, OK  
USA  
robert-foreman@ouhsc.edu

GARY M. FRANKLIN  
Department of Environmental and Occupational  
Health Sciences  
University of Washington  
Seattle, WA  
and  
Washington State Department of Labor and Industries  
Olympia, WA  
USA  
meddir@u.washington.edu

JAN FRIDÉN  
Department of Hand Surgery  
Sahlgrenska University Hospital  
Göteborg  
Sweden  
jan.friden@orthop.gu.se

ALLAN H. FRIEDMAN  
Division of Neurosurgery  
Duke University Medical Center  
Durham, NC  
USA

PERRY N. FUCHS  
Department of Psychology  
University of Texas at Arlington  
Arlington, TX  
USA  
fuchs@uta.edu

DEBORAH FULTON-KEHOE  
Department of Health Services  
University of Washington  
Seattle, WA  
USA

ARNAUD FUMAL  
Departments of Neurology and Neuroanatomy  
University of Liège  
CHR Citadelle  
Liege  
Belgium

ANDREA D. FURLAN  
Institute for Work & Health  
Toronto, ON  
Canada

VASCO GALHARDO  
Institute of Histology and Embryology  
Faculty of Medicine of Porto  
University of Porto  
Porto  
Portugal  
galhardo@med.up.pt

ANDREAS R. GANTENBEIN  
Headache & Pain Unit  
University Hospital Zurich  
Zurich  
Switzerland  
andy.gantenbein@gmx.ch

ELVIRA DE LA PEÑA GARCÍA  
Instituto de Neurociencias  
Universidad Miguel Hernández-CSIC  
Alicante  
Spain  
elvirap@umh.es



I. GARONZIK  
Johns Hopkins Medical Institutions  
Department of Neurosurgery  
Baltimore, MD  
USA

ROBERT GASSIN  
Musculoskeletal Medicine Clinic  
Frankston, VIC  
Australia  
rgassin@pen.hotkey.net.au

ROBERT J. GATCHEL  
Department of Psychology  
College of Science  
University of Texas at Arlington  
Arlington, TX  
USA  
gatchel@uta.edu

GERALD F. GEBHART  
Department of Pharmacology  
University of Iowa  
Iowa City, IA  
USA  
gf-gebhart@uiowa.edu

GERD GEISSLINGER  
Institute for Clinical Pharmacology  
pharmazentrum frankfurt/ZAFES  
Clinical Centre of the Johann Wolfgang Goethe  
University Frankfurt am Main  
Frankfurt  
Germany  
geisslinger@em.uni-frankfurt.de

ROBERT D. GERWIN  
Department of Neurology  
Johns Hopkins University  
Bethesda, MD  
USA  
gerwin@painpoints.com

MARIA ADELE GIAMBERARDINO  
Dipartimento di Medicina e Scienze  
dell'Invecchiamento  
University of Chieti  
Chieti  
Italy  
mag@unich.it

GLENN J. GIESLER JR  
Department of Neuroscience  
University of Minnesota  
Minneapolis, MN  
USA  
giesler@mail.ahc.umn.edu

PHILIP L. GILDENBERG  
Baylor Medical College  
Houston, TX  
USA  
hsc@stereotactic.net

MYRA GLAJCHEN  
Department of Pain Medicine and Palliative Care  
Beth Israel Medical Center  
New York, NY  
USA  
mglajchen@bethisraelny.org

PETER J. GOADSBY  
Institute of Neurology  
The National Hospital for Neurology and  
Neurosurgery  
London  
UK  
peterg@ion.ucl.ac.uk

HARTMUT GÖBEL  
Kiel Pain Center  
Kiel  
Germany  
hg@schmerzlinik.de

PHILIPPE GOFFAUX  
Faculty of Medicine  
Neurochirurgie  
University of Sherbrooke  
Sherbrooke, QC  
Canada  
philippe.goffaux@chus.qc.ca

ANA GOMIS  
Instituto de Neurociencias de Alicante  
Universidad Miguel Hernandez-CSIC  
San Juan de Alicante  
Spain  
agomis@umh.es

VIVEKANANDA GONUGUNTA  
The Cleveland Clinic Foundation  
Department of Neurosurgery  
Cleveland, OH  
USA

GILBERT R. GONZALES  
Department of Neurology  
Memorial Sloan-Kettering Cancer Center  
New York, NY  
USA



ALLAN GORDON  
Wasser Pain Management Centre  
Mount Sinai Hospital  
University of Toronto  
Toronto, ON  
Canada  
allan.gordon@utoronto.ca

LIESBET GOUBERT  
Ghent University  
Department of Experimental Clinical and  
Health Psychology  
Ghent  
Belgium  
liesbet.goubert@ugent.be

JAYANTILAL GOVIND  
Pain Clinic  
Department of Anaesthesia  
University of New South Wales  
Sydney, NSW  
Australia  
jaygovind@bigpond.com

RICHARD H. GRACELY  
Ann Arbor Veterans Administration Medical Center  
Departments of Medicine-Rheumatology and  
Neurology  
and Chronic Pain and Fatigue Research Center  
University of Michigan Health System  
Ann Arbor, MI  
USA  
rgracely@umich.edu

GARRY G. GRAHAM  
Department of Physiology and Pharmacology  
School of Medical Sciences  
University of New South Wales  
and  
Department of Clinical Pharmacology  
St. Vincent's Hospital  
Sydney, NSW  
Australia  
ggraham@stvincents.com.au

DAVID K. GRANDY  
Department of Physiology and Pharmacology  
School of Medicine  
Oregon Health and Science University  
Portland, OR  
USA  
grandyd@ohsu.edu

THOMAS GRAVEN-NIELSEN  
Laboratory for Experimental Pain Research  
Center for Sensory-Motor Interaction (SMI)  
Aalborg University  
Denmark  
tgn@hst.aau.dk

BARRY GREEN  
Pierce Laboratory  
Yale School of Medicine  
New Haven, CT  
USA  
green@jbpierce.org

PAUL G. GREEN  
NIH Pain Center (UCSF)  
University of California  
San Francisco, CA  
USA  
paul@itsa.ucsf.edu

JOEL D. GREENSPAN  
Department of Biomedical Sciences  
University of Maryland Dental School  
Baltimore, MD  
USA  
jgreenspan@umaryland.edu

JOHN W. GRIFFIN  
Department of Neurology  
Departments of Neuroscience and Pathology  
The Johns Hopkins University School of Medicine  
Johns Hopkins Hospital  
Baltimore, MD  
USA  
jgriffi@jhmi.edu

SABINE GRÖSCH  
Pharmacological Center Frankfurt  
Clinical Center Johann-Wolfgang Goethe University  
Frankfurt  
Germany  
groesch@em.uni-frankfurt.de

DOUGLAS P. GROSS  
Department of Physical Therapy  
University of Alberta  
Edmonton, AB  
Australia  
doug.gross@ualberta.ca

BLAIR D. GRUBB  
Department of Cell Physiology and Pharmacology  
University of Leicester  
Leicester  
UK  
bdg1@leicester.ac.uk

RUTH ECKSTEIN GRUNAU  
Centre for Community Child Health Research  
Child and Family Research Institute  
and  
University of British Columbia  
Vancouver, BC  
Canada  
rgrunau@cw.bc.ca

MICHEL GUERINEAU

Neurosurgery  
Hotel Dieu  
Nantes Cedex 1  
France

CHRISTOPH GUTENBRUNNER

Department of Physical Medicine and Rehabilitation  
Hanover Medical School  
Hanover  
Germany  
gutenbrunner.christoph@mh-hannover.de

MAIJA HAANPÄÄ

Department of Anaesthesiology and Department of  
Neurosurgery  
Pain Clinic  
Helsinki University Hospital  
Helsinki  
Finland

UTE HABEL

RWTH Aachen University  
Department of Psychiatry and Psychotherapy  
Aachen  
Germany  
uhabel@ukaachen.de

HEINZ-JOACHIM HÄBLER

FH Bonn-Rhein-Sieg  
Rheinbach  
Germany  
heinz-joachim.haebler@fh-bonn-rhein-sieg.de

THOMAS HACHENBERG

Clinic for Anaesthesiology and Intensive Therapy  
Otto-von-Guericke University  
Magdeburg  
Germany

NOUCHINE HADJIKHANI

Martinos Center for Biomedical Imaging  
Massachusetts General Hospital  
Harvard Medical School  
Charlestown, MA  
USA  
nouchine@nmr.mgh.harvard.edu

OLE HAEGG

Department of Orthopedic Surgery  
Sahlgren University Hospital  
Goteborg  
Sweden  
ollehagg@hotmail.com

BRYAN C. HAINS

The Center for Neuroscience and Regeneration  
Research  
Department of Neurology  
Yale University School of Medicine  
West Haven, CT  
USA  
bryan.hains@yale.edu

DARRYL T. HAMAMOTO

University of Minnesota  
Minneapolis, MN  
USA

DONNA L. HAMMOND

Department of Anesthesiology  
University of Iowa  
Iowa, IA  
USA  
donna-hammond@uiowa.edu

H. C. HAN

Medical Science Research Center and  
Department of Physiology  
Korea University College of Medicine  
Seoul  
Korea

HERMANN O. HANDWERKER

Department of Physiology and Pathophysiology  
University of Erlangen/Nürnberg  
Erlangen  
Germany  
handwerker@physiologie1.uni-erlangen.de

JING-XIA HAO

Karolinska Institute  
Stockholm  
Sweden

ELENI G. HAPIDOU

Department of Psychiatry and  
Behavioural Neurosciences  
McMaster University and Hamilton Health Sciences  
Hamilton, ON  
Canada  
hapidou@hhsc.ca

GEOFFREY HARDING

Sandgate, QLD  
Australia  
geoffharding@uq.net.au

LOUISE HARDING

Hospitals NHS Foundation Trust  
University College London  
London  
UK  
louise.harding@uclh.org

KENNETH M. HARGREAVES  
Department of Endodontics  
University of Texas Health Science Center  
at San Antonio  
San Antonio, TX  
USA  
hargreaves@uthscsa.edu

SARAH J. HARPER  
Royal Perth Hospital and  
University of Western Australia  
Perth, WA  
Australia

D. PAUL HARRIES  
Pain Care Center  
Samaritan Hospital Lexington  
Lexington, KY  
USA  
pharries@kypain.com

S. E. HARTE  
Department of Internal Medicine  
Chronic Pain and Fatigue Research Center  
Rheumatology University of Michigan Health System  
Ann Arbor, MI  
USA  
seharte@umich.edu

SAMUEL J. HASSENBUSCH  
The University of Texas M. D. Anderson Cancer  
Center  
Houston, TX  
USA  
samuel@neosoft.com

BRIDGET E. HAWKINS  
Department of Anatomy and Neurosciences  
University of Texas Medical Branch  
Galveston, TX  
USA  
behawkin@utmb.edu

JENNIFER A. HAYTHORNTHWAITE  
Johns Hopkins University  
Baltimore, MD  
USA  
jhaytho1@jhmi.edu

JOHN H. HEALEY  
Memorial Sloan Kettering Cancer Center and  
Weill Medical College of Cornell University  
New York, NY  
USA  
healeyj@mskcc.org

ALICIA A. HEAPY  
VA Connecticut Healthcare System and Yale  
University  
Westhaven, CT  
USA  
alicia.heapy@va.gov

ANNE M. HEFFERNAN  
The Adelaide and Meath Hospital incorporating  
The National Children's Hospital  
Dublin  
Ireland

MARY M. HEINRICHER  
Department of Neurological Surgery  
Oregon Health Science University  
Portland, OR  
USA  
heinricm@ohsu.edu

ROBERT D. HELME  
Centre for Pain Management  
St Vincent's Hospital  
Melbourne, VIC  
Australia  
rhelme@bigpond.net.au

ROBERT D. HERBERT  
School of Physiotherapy  
University of Sydney  
Sydney, NSW  
Australia  
r.herbert@fhs.usyd.edu.au

CHRISTIANE HERMANN  
Department of Clinical and Cognitive Neuroscience  
at the University of Heidelberg  
Central Institute of Mental Health  
Mannheim  
Germany  
chermann@zi-mannheim.de

JUAN F. HERRERO  
Department of Physiology  
Edificio de Medicina  
University of Alcalá  
Madrid  
Spain  
juanf.herrero@uah.es

AKI J. HIETAHARJU  
Department of Neurology and Rehabilitation  
Pain Clinic  
Tampere University Hospital  
Tampere  
Finland  
aki.hietaharju@pshp.fi

KARIN N. WESTLUND HIGH  
Department of Neuroscience and Cell Biology  
University of Texas Medical Branch  
Galveston, TX  
USA  
kwhigh@utmb.edu

MARITA HILLIGES  
Halmstad University  
Halmstad  
Sweden  
marita.hilliges@set.hh.se

MAX J. HILZ  
University of Erlangen-Nuernberg  
Erlangen  
Germany  
max.hilz@neuro.imed.uni-erlangen.de

BURKHARD HINZ  
Department of Experimental and Clinical  
Pharmacology and Toxicology  
Friedrich Alexander University Erlangen-Nürnberg  
Erlangen  
Germany  
hinz@pharmakologie.uni-erlangen.de

ANTHONY R. HOBSON  
Section of GI Sciences  
Hope Hospital  
University of Manchester  
Salford  
UK  
ahobson@fs1.ho.man.ac.uk

TOMAS HÖKFELT  
Department of Neuroscience  
Karolinska Institutet  
Stockholm  
Sweden  
tomas.hokfelt@neuro.ki.se

ANITA HOLDCROFT  
Imperial College London  
London  
UK  
aholdcro@imperial.ac.uk

SARAH V. HOLDRIDGE  
Department of Pharmacology and Toxicology  
Queen's University  
Kinston, ON  
Canada

KJELL HOLE  
University of Bergen  
Bergen  
Norway  
kjell.hole@fys.uib.no

GRAHAM R. HOLLAND  
Department of Cariology  
Restorative Sciences & Endodontics  
School of Dentistry  
University of Michigan  
Ann Arbor, MI  
USA  
rholland@umich.edu

ULRIKE HOLZER-PETSCHKE  
Department of Experimental and Clinical  
Pharmacology  
Medical University of Graz  
Graz  
Austria  
ulrike.holzer@meduni-graz.at

CHANG-ZERN HONG  
Department of Physical Medicine and Rehabilitation  
University of California Irvine  
Irvine, CA  
USA  
czhong88@ms49.hinet.net

S. K. HONG  
Medical Science Research Center and Department of  
Physiology  
Korea University College of Medicine  
Seoul  
Korea

MINORU HOSHIYAMA  
Department of Integrative Physiology  
National Institute for Physiological Sciences  
Okazaki  
Japan

FRED M. HOWARD  
Department of Obstetrics and Gynecology  
University of Rochester  
Rochester, NY  
USA  
fred\_howard@urmc.rochester.edu

SUNG-TSANG HSIEH  
Department of Anatomy and Cell Biology  
National Taiwan University  
and  
Department of Neurology  
National Taiwan University Hospital  
Taipei  
Taiwan  
sthsieh@ha.mc.ntu.edu.tw

JAMES W. HU  
Faculty of Dentistry  
University of Toronto  
Toronto, ON  
Canada  
james.hu@utoronto.ca

CLAIRE E. HULSEBOSCH  
Spinal Cord Injury Research  
University of Texas Medical Branch  
Galveston, TX  
USA  
cehulseb@utmb.edu

THOMAS HUMMEL  
Department of Otorhinolaryngology  
Smell and Taste Clinic  
University of Dresden Medical School  
Dresden  
Germany  
thummel@rcs.urz.tu-dresden.de

WALTER J. MEYER III  
Department of Psychiatry and Behavioral Science  
Shriners Hospitals for Children  
Shriners Burns Hospital  
Galveston, TX  
USA  
wmeyer@utmb.edu

ROSE-ANNE INDELICATO  
Department of Pain and Palliative Care  
Beth Israel Medical Center  
New York, NY  
USA

CHARLES E. INTURRISI  
Department of Pharmacology  
Weill Medical College of Cornell University  
ceintur@med.cornell.edu

KOJI INUI  
Department of Integrative Physiology  
National Institute for Physiological Sciences  
Okazaki  
Japan

SUHAYL J. JABBUR  
Neuroscience Program  
Faculty of Medicine  
American University of Beirut  
Beirut  
Lebanon

CAROL JAMES  
Department of Neurological Surgery  
Johns Hopkins Hospital  
Baltimore, MD  
USA

WILFRID JÄNIG  
Institute of Physiology  
Christian Albrechts University Kiel  
Kiel  
Germany  
w.janig@physiologie.uni-kiel.de

NORA JANJAN  
University of Texas M. D. Anderson Cancer Center  
Houston, TX  
USA

LUC JASMIN  
Department of Anatomy  
University of California San Francisco  
San Francisco, CA  
USA  
ucpain@itsa.ucsf.edu

ANNE JAUMEES  
Royal North Shore Hospital  
St. Leonards, NSW  
Australia

DANIEL JEANMONOD  
Functional Neurosurgery  
Neurosurgical Clinic  
University Hospital  
Zürich  
Switzerland  
daniel.jeanmonod@usz.ch

ANDREW JEFFREYS  
Department of Anaesthesia  
Western Health  
Melbourne, NSW  
Australia  
andrew.jeffreys@wh.org.au

TROELS S. JENSEN  
Danish Pain Research Center and  
Department of Neurology  
Aarhus University Hospital  
Aarhus  
Denmark  
tsj@akhpbd.au.dk

MARK P. JENSEN  
Department of Rehabilitation Medicine  
University of Washington  
Seattle, WA  
USA  
mjensen@u.washington.edu

MARK JOHNSON  
Musculoskeletal Physician  
Hibiscus Coast Highway  
Orewa  
New Zealand  
markjohn@ihug.co.nz

MARK I. JOHNSON  
School of Health and Human Sciences  
Faculty of Health  
Leeds Metropolitan University  
Leeds  
UK  
m.johnson@leedsmet.ac.uk

KURT L. JOHNSON  
Department of Rehabilitation Medicine  
School of Medicine  
University of Washington  
Seattle, WA  
USA  
kjohnson@u.washington.edu

MARK JOHNSTON  
Musculoskeletal Physician  
Hibiscus Coast Highway  
Orewa  
New Zealand  
markjohn@ihug.co.nz

DAVID S. JONES  
Division of Adolescent Medicine and Behavioral  
Sciences  
Vanderbilt University Medical Center  
Nashville, TN  
USA  
david.s.jones@vanderbilt.edu

EDWARD JONES  
Center for Neuroscience  
University of California  
Davies, CA  
USA  
ejones@ucdavis.edu

JEROEN R. DE JONG  
Department of Rehabilitation and Department of  
Medical Psychology  
University of Maastricht  
and  
Department of Medical, Clinical and  
Experimental Psychology  
Maastricht University  
Maastricht  
The Netherlands  
jdjo@smps.azm.nl

SVEN-ERIC JORDT  
Department of Pharmacology  
Yale University School of Medicine  
New Haven, CT  
USA  
sven.jordt@yale.edu

ELLEN JØRUM  
The Laboratory of Clinical Neurophysiology  
Rikshospitalet University  
Oslo  
Norway  
ellen.jorum@rikshospitalet.no

STEFAN JUST  
CNS Pharmacology  
Pain Research  
Boehringer Ingelheim Pharma GmbH & Co. KG  
Biberach/Riss  
Germany

NOUFISSA KABLI  
Department of Pharmacology and Toxicology  
Queen's University  
Kinston, ON  
Canada

RYUSUKE KAKIGI  
Department of Integrative Physiology  
National Institute for Physiological Sciences  
Okazaki  
Japan  
kakigi@nips.ac.jp

PETER C. A. KAM  
Department of Anaesthesia  
St. George Hospital  
University of New South Wales  
Kogarah, NSW  
Australia  
p.kam@unsw.edu.au

GIRESH KANJI  
Wellington  
New Zealand  
dr.kanji@actrix.co.nz

Z. KARIM  
Royal Perth Hospital and  
University of Western Australia  
Perth, WA  
Australia

ZAZA KATSARAVA  
Department of Neurology  
University Hospital of Essen  
Essen  
Germany  
zaza.katsarava@uni-essen.de

JOEL KATZ  
Department of Psychology  
McGill University  
Montreal, QC  
Canada

VALERIE KAYSER  
NeuroPsychoPharmacologie Médecine  
INSERM U677  
Faculté de Médecine Pitié-Salpêtrière  
Paris  
France  
kayser@ext.jussieu.fr

FRANCIS J. KEEFE  
Pain Prevention and Treatment Research  
Department of Psychiatry and Behavioral Sciences  
Duke University Medical Center  
Durham, NC  
USA  
keefe003@mc.duke.edu

LOIS J. KEHL  
Department of Anesthesiology  
University of Minnesota  
Minneapolis, MN  
USA  
lois@mail.ahc.umn.edu

WILLIAM N. KELLEY  
Department of Neurology  
The University of Pennsylvania Medical School  
Philadelphia, PA  
USA

STEPHEN KENNEDY  
Nuffield Department of Obstetrics and Gynaecology  
University of Oxford  
John Radcliffe Hospital  
Oxford  
UK  
stephen.kennedy@obs-gyn.ox.ac.uk

ELIZABETH VAN DEN KERKHOF  
Department of Community Health and Epidemiology  
Queen's University  
Kingston, ON  
Canada  
2anv1@qmlink.queensu.ca

ROBERT D. KERNS  
VA Connecticut Healthcare System and Yale  
University  
Westhaven, CT  
USA  
robert.kerns@med.va.gov

SANJAY KHANNA  
Department of Physiology  
National University of Singapore  
Singapore  
phsks@nus.edu.sg

KOK E. KHOR  
Department of Pain Management  
Prince of Wales Hospital  
Randwick, NSW  
Australia  
kekhor@bigpond.net.au

H. J. KIM  
Department of Life Science  
Yonsei University Wonju Campus  
Wonju  
Korea

Y. I. KIM  
Medical Science Research Center and Department  
of Physiology  
Korea University College of Medicine  
Seoul  
Korea

WADE KING  
Department of Clinical Research  
Royal Newcastle Hospital  
University of Newcastle  
Newcastle, NSW  
Australia  
wmbaking@tpg.com.au

K. L. KIRSH  
Markey Cancer Center  
University of Kentucky College of Medicine  
Lexington, KY  
USA

RICARDO J. KOMOTAR  
Department of Neurological Surgery  
Neurological Institute  
Columbia University  
New York, NY  
USA

RHONDA K. KOTARINOS  
Long Grove, IL  
USA  
rkotarinos@msn.com

KATALIN J. KOVÁCS  
Department of Veterinary and Biomedical Sciences  
University of Minnesota  
St. Paul, MN  
USA

MALGORZATA KRAJNIK  
St. Elizabeth Hospice  
Ipswich  
Suffolk  
UK



AJIT KRISHNANEY  
The Cleveland Clinic Foundation  
Department of Neurosurgery  
Cleveland, OH  
USA

GREGORY KROH  
Utah Labor Commission  
International Association of Industrial Accident  
Boards and Commissions  
Salt Lake City, UT  
USA

M. M. TER KUILE  
Department of Gynecology  
Leiden University Medical Center  
Leiden  
The Netherlands

ALICE KVÅLE  
Section for Physiotherapy Science  
Department of Public Health and Primary  
Health Care  
Faculty of Medicine  
University of Bergen  
Bergen  
Norway  
alice.kvale@isf.uib.no

ANTOON F. C. DE LAAT  
Department of Oral/Maxillofacial Surgery  
Catholic University of Leuven  
Leuven  
Belgium  
antoon.delaat@med.kuleuven.ac.be

JEAN-JACQUES LABAT  
Neurology and Rehabilitation  
Clinique Urologique  
Nantes Cedex 1  
France

GASTON LABRECQUE  
Faculty of Pharmacy  
Université Laval  
Quebec City  
Montreal, QC  
Canada  
gaston.labrecque@videotron.ca

MARCO LACERENZA  
Scientific Institute San Raffaele  
Pain Medicine Center  
Milano  
Italy

URI LADABAUM  
Division of Gastroenterology  
University of California  
San Francisco, CA  
USA  
uri.ladabaum@ucsf.edu

MARIE ANDREE LAHAIE  
McGill University  
Montreal, QC  
Canada

MIGUEL J. A. LÁINEZ-ANDRÉS  
Department of Neurology  
University of Valencia  
Valencia  
Spain  
jlainez@meditex.es

TIMOTHY R. LAIR  
Department of Anesthesiology  
University of Vermont College of Medicine  
Burlington, VT  
USA

ROBERT H. LAMOTTE  
Department of Anesthesiology  
Yale School of Medicine  
New Haven, CT  
USA  
robert.lamotte@yale.edu

JAMES W. LANCE  
Institute of Neurological Sciences  
Prince of Wales Hospital and University of  
New South Wales  
Sydney, NSW  
Australia  
jimlance@bigpond.com

ROBERT G. LARGE  
The Auckland Regional Pain Service  
Auckland Hospital  
Auckland  
New Zealand  
boblarge@actrix.co.nz

ALICE A. LARSON  
Department of Veterinary and Biomedical Sciences  
University of Minnesota  
St. Paul, MN  
USA  
larso011@umn.edu

PETER LAU  
Department of Clinical Research  
Royal Newcastle Hospital  
University of Newcastle  
Newcastle, NSW  
Australia  
peterclau@hotmail.com



STEFAN A. LAUFER  
Institute of Pharmacy  
Eberhard-Karls University of Tuebingen  
Tuebingen  
Germany  
stefan.laufer@uni-tuebingen.de

GILES J. LAVIGNE  
Facultés de Médecine Dentaire et de Médecine  
Université de Montréal  
Montréal, QC  
Canada  
gilles.lavigne@umontreal.ca

PETER G. LAWLOR  
Our Lady's Hospice  
Medical Department  
Dublin  
Ireland  
plawlor@olh.ie

MICHEL LAZDUNSKI  
Institut de Pharmacologie Moleculaire et Cellulaire  
Valbonne  
France

VINCENCO DI LAZZARO  
FENNSI Group  
National Hospital of Paraplégicos  
SESCAM Finca "La Peraleda"  
Toledo  
Spain

MAAIKE LEEUW  
Department of Medical  
Clinical and Experimental Psychology  
Maastricht University  
Maastricht  
The Netherlands  
m.leeuw@dmkep.unimaas.nl

SIRI LEKNES  
Pain Imaging Neuroscience (PaIN) Group  
Department of Physiology, Anatomy and Genetics  
and  
Centre for Functional Magnetic Resonance Imaging of  
the Brain  
Oxford University  
Oxford  
UK  
irene.tracey@anat.ox.ac.uk

TOBIAS LENIGER  
Department of Neurology  
University Essen  
Essen  
Germany  
tobias.leniger@uni-essen.de

FREDERICK A. LENZ  
Department of Neurosurgery  
Johns Hopkins Hospital  
Baltimore, MD  
USA  
flen1@jhmi.edu

PAULINE LESAGE  
Department of Pain Medicine and Palliative Care  
Beth Israel Medical Center and  
Albert Einstein College of Medicine  
New York, NY  
USA  
plesage@bethisraelny.org

ISOBEL LEVER  
Neural Plasticity Unit  
Institute of Child Health  
University College London  
London  
UK  
i.lever@ich.ucl.ac.uk

KHAN W. LI  
Department of Neurosurgery  
Johns Hopkins Hospital  
Baltimore, MD  
USA

ALAN R. LIGHT  
Department of Anesthesiology  
University of Utah  
Salt Lake City, UT  
USA  
alan.light@hsc.utah.edu

DEOLINDA LIMA  
Instituto de Histologia e Embriologia  
Faculdade de Medicina da Universidade do Porto  
Porto  
Portugal  
limad@med.up.pt

VOLKER LIMMROTH  
Department of Neurology  
University of Essen  
Essen  
Germany  
volker.limmroth@uni-essen.de

STEVEN J. LINTON  
Department of Occupational and  
Environmental Medicine  
Department of Behavioral, Social and Legal Sciences  
Örebro University Hospital  
Örebro  
Sweden  
steven.linton@orebroll.se

CHRISTINA LIOSSI  
School of Psychology  
University of Southampton and Great Ormond  
Street Hospital for Sick Children  
London  
UK  
cliossi@soton.ac.uk

ARTHUR G. LIPMAN  
College of Pharmacy and Pain Management  
Center  
University of Utah  
Salt Lake City, UT  
USA  
arthur.lipman@hsc.utah.edu

RICHARD B. LIPTON  
Departments of Neurology, Epidemiology and  
Population Health  
Albert Einstein College of Medicine  
and Montefiore Headache Unit  
Bronx  
New York, NY  
USA  
rlipton@aecom.yu.edu

KENNETH M. LITTLE  
Division of Neurosurgery  
Duke University Medical Center  
Durham, NC  
USA  
littl023@mc.duke.edu

SPENCER S. LIU  
Virginia Mason Medical Center  
Seattle, WA  
USA  
anessl@vmc.org

ANNE ELISABETH LJUNGGREN  
Section for Physiotherapy Science  
Department of Public Health and Primary Health Care  
Faculty of Medicine  
University of Bergen  
Bergen  
Norway  
elisabeth.ljunggren@isf.uib.no

JOHN D. LOESER  
Department of Neurological Surgery  
University of Washington  
Seattle, WA  
USA  
jdloeser@u.washington.edu

PATRICK LOISEL  
Disability Prevention Research and Training Centre  
Université de Sherbrooke  
Longueuil, QC  
Canada  
patrick.loisel@usherbrooke.ca

ELISA LOPEZ-DOLADO  
FENNSI Group  
National Hospital of Paraplégicos  
SESCAM Finca "La Peraleda"  
Toledo  
Spain

JÜRGEN LORENZ  
Hamburg University of Applied Sciences  
Hamburg  
Germany  
juergen.lorenz@rzbd.haw-hamburg.de

JÖRN LÖTSCH  
Institute for Clinical Pharmacology  
Pharmaceutical Center Frankfurt  
Johann Wolfgang Goethe University  
Frankfurt  
Germany  
j.loetsch@em.uni-frankfurt.de

DAYNA R. LOYD  
Center for Behavioral Neuroscience  
Georgia State University  
Atlanta, GA  
USA

DAVID LUSSIER  
McGill University  
Montreal, QC  
Canada  
david.lussier@muhc.mcgill.ca

STEPHEN LUTZ  
Blanchard Valley Regional Cancer Center  
Findlay, OH  
USA

BRUCE LYNN  
Department of Physiology  
University College London  
London  
UK  
b.lynn@ucl.ac.uk

ROSS MACPHERSON  
Department of Anesthesia and Pain Management  
University of Sydney  
Sydney, NSW  
Australia  
rmacpher@nscchahs.health.nsw.gov.au

MICHEL MAGNIN  
INSERM  
Neurological Hospital  
Lyon  
France

THORSTEN J. MAIER  
Pharmacological Center Frankfurt  
Clinical Center Johann-Wolfgang Goethe University  
Frankfurt  
Germany

STEVEN F. MAIER  
Department of Psychology and the Center for  
Neuroscience  
University of Colorado at Boulder  
Boulder, CO  
USA

CHRIS J. MAIN  
University of Manchester  
Manchester  
UK  
cjm@fs1.ho.man.ac.uk

MARZIA MALCANGIO  
Wolfson CARD King's College London  
London  
UK  
marzia.malcangio@kcl.ac.uk

PAOLO L. MANFREDI  
Essex Woodlands Health Ventures  
New York, NY  
USA  
ggonzales@ewhv.com

KAISA MANNERKORPI  
Department of Rheumatology and  
Inflammation Research  
Sahlgrenska Academy  
Göteborg University  
Göteborg  
Sweden  
kaisa.mannerkorpi@rheuma.gu.se

BARTON H. MANNING  
Amgen Inc.  
Thousand Oaks, CA  
USA  
bmanning@amgen.com

PATRICK W. MANTYH  
Department Prevential Science  
University of Minnesota  
Minneapolis, MN  
USA  
manty001@umn.edu

JIANREN MAO  
Pain Research Group  
MGH Pain Center  
and  
Department of Anesthesia and Critical Care  
Massachusetts General Hospital  
Harvard Medical School  
Boston, MA  
USA  
jmao@partners.org

SERGE MARCHAND  
Faculty of Medicine  
Neurochirurgie  
University of Sherbrooke  
Sherbrooke, QC  
Canada  
serge.marchand@usherbrooke.ca

PAOLO MARCHETTINI  
Pain Medicine Center  
Scientific Institute San Raffaele  
Milano  
Italy  
marchettini.paolo@hsr.it

PEGGY MASON  
Department of Neurobiology  
Pharmacology and Physiology  
University of Chicago  
Chicago, IL  
USA  
p-mason@uchicago.edu

SCOTT MASTERS  
Caloundra Spinal and Sports Medicine Centre  
Caloundra, QLD  
Australia  
scotty1@ozemail.com.au

LAURENCE E. MATHER  
Department of Anaesthesia and Pain Management  
University of Sydney at  
Royal North Shore Hospital  
Sydney, NSW  
Australia  
lmather@med.usyd.edu.au

MERVYN MAZE  
Magill Department of Anaesthetics  
Chelsea and Westminster Campus  
Imperial College of Science, Technology and  
Medicine, London, UK  
m.maze@imperial.ac.uk

BILL MCCARBERG  
Pain Services  
Kaiser Permanente and University of California  
School of Medicine  
San Diego, CA  
USA  
bill.h.mccarberg@kp.org

JOHN S. McDONALD  
Department of Anesthesiology  
Obstetrics and Gynecology  
Torrance, CA  
USA  
jsm5525@ucla.edu

PATRICIA A. MCGRATH  
Department of Anaesthesia  
Divisional Centre of Pain Management and Research  
The Hospital for Sick Children  
and  
Brain and Behavior Program  
Research Institute at The Hospital for Sick Children  
and  
Department of Anaesthesia  
University of Toronto  
Toronto, ON  
Canada  
patricia.mcgrath@sickkids.ca

BRIAN MCGUIRK  
Occupational (Musculoskeletal) Medicine  
Hunter Area Health Service  
Newcastle, NSW  
Australia  
mgillam@mail.newcastle.edu.au

GREG MCINTOSH  
Canadian Back Institute  
Toronto, ON  
Canada  
gmcintosh@cbi.ca

PETER MCINTYRE  
Department of Pharmacology  
University of Melbourne  
Melbourne, VIC  
Australia  
pmci@unimelb.edu.au

PETER A. MCNAUGHTON  
Department of Pharmacology  
University of Cambridge  
Cambridge  
UK  
pam42@cam.ac.uk

J. MARK MELHORN  
Section of Orthopaedics  
Department of Surgery  
University of Kansas School of Medicine  
Wichita, KS  
USA  
melhorn@ctdmap.com

RONALD MELZACK  
Department of Psychology  
McGill University  
Montreal, QC  
Canada  
rmelzack@ego.psych.mcgill.ca

LORNE M. MENDELL  
Department of Neurobiology and Behavior  
State University of New York at Stony Brook  
Stony Brook, NY  
USA  
lorne.mendell@sunysb.edu

GEORGE MENDELSON  
Department of Psychological Medicine  
Monash University and Caulfield Pain Management &  
Research Centre  
Caulfield General Medical Centre  
Caulfield, VIC  
Australia  
george.mendelson@med.monash.edu.au

DANIEL MENÉTREY  
CNRS  
Université René Descartes  
Biomédicale  
Paris  
France  
menetrey@biomedicale.univ-paris5.fr

SIEGFRIED MENSE  
Institute for Anatomy and Cell Biology III  
University Heidelberg  
Heidelberg  
Germany  
mense@urz.uni-heidelberg.de

SEBASTIANO MERCADANTE  
La Maddalena Cancer Pain Relief & Palliative  
Care Unit Center  
Palermo  
Italy  
terapiadeldolore@la-maddalena.it

SUSAN MERCER  
School of Biomedical Sciences  
University of Queensland  
Brisbane, QLD  
Australia  
susan.mercer@stonebow.otago.ac.nz

HAROLD MERSKEY  
Department of Psychiatry  
University of Western Ontario  
London, ON  
Canada

KARL MESSLINGER  
University of Erlangen-Nürnberg  
Nürnberg  
Germany  
messlinger@physiologie1.uni-erlangen.de

RICHARD A. MEYER  
Department of Neurosurgery  
School of Medicine  
Johns Hopkins University  
Baltimore, MD  
USA  
rmeyer@jhmi.edu

BJÖRN A. MEYERSON  
Department of Clinical Neuroscience  
Section of Neurosurgery  
Karolinska Institute/University Hospital  
Stockholm  
Sweden  
bjorn.meyerson@karolinska.se

MARTIN MICHAELIS  
Sanofi-Aventis Deutschland GmbH  
Frankfurt/Main  
Germany  
martin.michaelis@sanofi-aventis.com

JUDITH A. MIKACICH  
Department of Obstetrics and Gynecology  
University of California  
Los Angeles Medical Center  
Los Angeles, CA  
USA  
jmikacich@mednet.ucla.edu

KENSAKU MIKI  
Department of Integrative Physiology  
National Institute for Physiological Sciences  
Okazaki  
Japan

VJEKOSLAV MILETIC  
School of Veterinary Medicine  
University of Wisconsin-Madison  
Madison, WI  
USA  
vam@svm.vetmed.wisc.edu

ERIN D. MILLIGAN  
Department of Psychology and the  
Center for Neuroscience  
University of Colorado  
Boulder, CO  
USA  
emilligan@psych.colorado.edu

ADRIAN MIRANDA  
Division of Gastroenterology and Hepatology and  
Pediatric Gastroenterology  
Medical College of Wisconsin  
Milwaukee, WI  
USA

J. MOCCO  
Department of Neurological Surgery  
Neurological Institute  
Columbia University  
New York, NY  
USA

JEFFREY S. MOGIL  
Department of Psychology  
McGill University  
Montreal, QC  
Canada  
jeffrey.mogil@mcgill.ca

HARVEY MOLDOFSKY  
Sleep Disorders Clinic  
Centre for Sleep and Chronobiology  
Toronto, ON  
Canada  
h.moldofsky@utoronto.ca

ROBERT M. MOLDWIN  
Department of Urology  
Long Island Jewish Medical Center  
New York, NY  
USA

DEREK C. MOLLIVER  
Department of Medicine  
University of Pittsburgh School of Medicine  
Pittsburgh, PA  
USA

LENAIC MONCONDUIT  
INSERM  
University of Clermont-Ferrand  
Clermont-Ferrand  
France

JACQUELINE MONTAGNE-CLAVEL  
Inserm  
Paris  
France

ROBERT D. MOOTZ  
Department of Environmental and Occupational  
Health Sciences  
Washington State Department of Labor and Industries  
Olympia, WA  
USA

ANNE MOREL  
Functional Neurosurgery  
Neurosurgical Clinic  
University Hospital  
Zürich  
Switzerland

ANNE MORINVILLE  
Montreal Neurological Institute  
McGill University  
Montreal, QC  
Canada  
annemorinville@yahoo.ca

STEPHEN MORLEY  
Academic Unit of Psychiatry and Behavioral Sciences  
University of Leeds  
Leeds  
UK  
s.j.morley@leeds.ac.uk

DAVID B. MORRIS  
University of Virginia  
Charlottesville, VA  
USA  
dbm6e@virginia.edu

JOACHIM MÖSSNER  
Medical Clinic and Polyclinic II  
University Clinical Center Leipzig AöR  
Leipzig  
Germany  
moej@medizin.uni-leipzig.de

ERIC A. MOULTON  
Program in Neuroscience  
University of Maryland  
Baltimore, MD  
USA  
emoulton@mclean.harvard.edu

ANNE Z. MURPHY  
Center for Behavioral Neuroscience  
Georgia State University  
Atlanta, GA  
USA  
amurphy@gsu.edu

PAUL M. MURPHY  
Department of Anaesthesia and Pain Management  
Royal North Shore Hospital  
St. Leonard's, NSW  
Australia  
drpmurphy@hotmail.com

ALISON MURRAY  
Foothills Medical Center  
Calgary, AB  
Canada  
amurray@ucalgary.ca

H. S. NA  
Medical Science Research Center and  
Department of Physiology  
Korea University College of Medicine  
Seoul  
Korea  
hsna@korea.ac.kr

DAISUKE NAKA  
Department of Integrative Physiology  
National Institute for Physiological Sciences  
Okazaki  
Japan

YOSHIO NAKAMURA  
Pain Research Center  
Department of Anesthesiology  
University of Utah School of Medicine  
Salt Lake City, UT  
USA

MATTI V. O. NÄRHI  
Department of Physiology  
University of Kuopio  
Kuopio  
Finland  
matti.narhi@uku.fi

H.J. W. NAUTA  
University of Texas Medical Branch  
Galveston, TX  
USA  
hjnauta@utmb.edu

LUCIA NEGRI  
Department of Human Physiology and Pharmacology  
University "La Sapienza" of Rome  
Rome  
Italy  
lucia.negri@uniroma1.it

GARY NESBIT  
Department of Radiology  
Oregon Health and Science University  
Portland, OR  
USA  
nesbitg@ohsu.edu

TIMOTHY NESS  
Department of Anesthesiology  
University of Alabama at Birmingham  
Birmingham, AL  
USA  
loch@uab.edu

VOLKER NEUGEBAUER  
Department of Neuroscience and Cell Biology  
University of Texas Medical Branch  
Galveston, TX  
USA  
voneugeb@utmb.edu

LAWRENCE C. NEWMAN  
Albert Einstein College of Medicine  
New York, NY  
USA  
lnewman@chnpnet.org

CHARLES NG  
Musculoskeletal Medicine Specialist  
Australasian Faculty of Musculoskeletal Medicine  
Auckland  
New Zealand  
cng@xtra.co.nz

MICHAEL K. NICHOLAS  
Pain Management and Research Centre  
Royal North Shore Hospital  
University of Sydney  
St. Leonards, NSW  
Australia  
miken@med.usyd.edu.au

ELLEN NIEDERBERGER  
Pharmacological Center Frankfurt  
Clinical Center Johann-Wolfgang Goethe University  
Frankfurt  
Germany  
e.niederberger@em.uni-frankfurt.de

LONE NIKOLAJSSEN  
Department of Anaesthesiology  
Aarhus University Hospital  
Aarhus  
Denmark  
nikolajsen@dadlnet.dk

DONALD R. NIXDORF  
Department of Diagnostic and Biological Sciences  
School of Dentistry  
University of Minnesota  
Minneapolis, MN  
USA  
nixdorf@umn.edu

CARL E. NOE  
Baylor University Medical Center  
Texas Tech University Health Science Center  
Lubbock, TX  
USA

KOICHI NOGUCHI  
Department of Anatomy and Neuroscience  
Hyogo College of Medicine  
Hyogo  
Japan

RICHARD B. NORTH  
Neurosurgery  
The Johns Hopkins University School of Medicine  
Baltimore, MD  
USA  
RNorth@jhmi.edu

TURO J. NURMIKKO  
Department of Neurological Science and Pain  
Research Institute  
University of Liverpool  
Liverpool  
UK  
tjn@liv.ac.uk

ANNE LOUISE OAKLANDER  
Nerve Injury Unit  
Departments of Anesthesiology, Neurology and  
Neuropathology  
Massachusetts General Hospital  
Harvard Medical School  
Boston, MA  
USA  
aoaklander@partners.org

KOICHI OBATA  
Department of Anatomy and Neuroscience  
Hyogo College of Medicine  
Hyogo  
Japan  
noguchi@hyo-med.ac.jp

TIM F. OBERLANDER  
Division of Developmental Pediatrics  
Centre for Community Child Health Research and  
The University of British Columbia  
Vancouver, BC  
Canada  
toberlander@cw.bc.ca

BRUNO OERTEL  
Institute for Clinical Pharmacology  
Pharmaceutical Center Frankfurt  
Johann Wolfgang Goethe University  
Frankfurt  
Germany

ALFRED T. OGDEN  
Department of Neurological Surgery  
Neurological Institute  
Columbia University  
New York, NY  
USA

PETER T. OHARA  
Department of Anatomy  
University of California San Francisco  
San Francisco, CA  
USA  
pto@itsa.ucsf.edu

SHINJI OHARA  
Departments of Neurosurgery  
Johns Hopkins University  
Baltimore, MD  
USA

AKIKO OKIFUJI  
Department of Anesthesiology, Psychology and  
Clinical Pharmacy  
University of Utah  
Salt Lake City, UT  
USA  
akiko.okifuji@hsc.utah.edu

JEAN-LOUIS OLIVÉRAS  
Inserm  
Paris  
France  
jean-louis.oliveras@tolbiac.inserm.fr

ANTONIO OLIVIERO  
FENNSI Group  
National Hospital of Paraplégicos  
SESCAM Finca "La Peraleda" Toledo  
Toledo  
Spain  
antonio@sescam.jccm.es

GUNNAR L. OLSSON  
Pain Treatment Services  
Astrid Lindgren Children's Hospital/Karolinska  
Hospital  
Stockholm  
Sweden  
gunnar.olsson@ks.se

P. B. OSBORNE  
Pain Management Research Institute and  
Kolling Institute  
University of Sydney  
Sydney, NSW  
Australia

MICHAEL H. OSSIPOV  
Department of Pharmacology  
University of Arizona  
Health Sciences Center  
Tucson, AZ  
USA  
michaelo@u.arizona.edu

SEAN O'MAHONY  
Montefiore Medical Center and  
Albert Einstein College of Medicine  
Bronx  
New York, NY  
USA  
somahony@montefiore.org

DEBORAH A. O'ROURKE  
College of Nursing and Health Sciences  
University of Vermont  
Burlington, VT  
USA  
deborah.orourke@uvm.edu

JUDITH A. PAICE  
Division of Hematology-Oncology  
Northwestern University  
Feinberg School of Medicine  
Chicago, IL  
USA  
j-paice@northwestern.edu

JUAN A. PAREJA  
Department of Neurology  
Fundación Hospital Alcorcón  
Madrid  
Spain  
jpg03m@saludalia.com

ANA M. PASCUAL-LOZANO  
Clinical Hospital  
University of Valencia  
Valencia  
Spain

STEVEN D. PASSIK  
Markey Cancer Center  
University of Kentucky College of Medicine  
Lexington, KY  
USA  
spassik@uky.edu

GAVRIL W. PASTERNAK  
Department of Neurology  
Memorial Sloan-Kettering Cancer Center  
New York, NY  
USA  
pasterng@mskcc.org



S. H. PATEL  
Department of Neurosurgery  
Johns Hopkins Hospital  
Baltimore, MD  
USA

ELLIOT M. PAUL  
Department of Urology  
Long Island Jewish Medical Center  
New York, NY  
USA  
eliepaul@yahoo.com

KEVIN PAUZA  
Tyler Spine and Joint Hospital  
Tyler, TX  
USA  
kevinpauza@tyler.net

ERIC M. PEARLMAN  
Pediatric Education  
Mercer University School of Medicine  
Savannah, GA  
USA  
pearlmane@aol.com

ELVIRA DE LA PEÑA  
Instituto de Neurociencias de Alicante  
Universidad Miguel Hernández-CSIC  
Alicante  
Spain  
elvirap@umh.es

YUAN BO PENG  
Department of Psychology  
University of Texas at Arlington  
Arlington, TX  
USA

JOSE PEREIRA  
Foothills Medical Center  
Calgary, AB  
Canada  
pereiraj@ucalgary.ca

EDWARD PERL  
Department of Cell and Molecular Physiology  
School of Medicine  
University of North Carolina  
Chapel Hill, NC  
USA  
erp@med.unc.edu

ANTTI PERTOVAARA  
Department of Physiology  
University of Helsinki  
Helsinki  
Finland  
antti.pertovaara@helsinki.fi

PRAMIT PHAL  
Department of Radiology  
Oregon Health and Science University  
Portland, OR  
USA

ISSY PILOWSKY  
Emeritus Professor of Psychiatry  
University of Adelaide  
Adelaide, SA  
Australia  
issyp@med.usyd.edu.au

LEON PLAGHKI  
Cliniques Universitaires St. Luc  
Brussels  
Belgium  
plaghki@read.ucl.ac.be

MARKUS PLONER  
Department of Neurology  
Heinrich–Heine–University  
Düsseldorf  
Germany  
ploner@neurologie.uni-duesseldorf.de

ESTHER M. POGATZKI-ZAHN  
Department of Anesthesiology and Intensive Care  
Medicine  
University Muenster  
Muenster  
Germany  
pogatzki@anit.uni-muenster.de

K. M. POLLOCK  
Royal Perth Hospital and  
University of Western Australia  
Crawley, WA  
Australia

MICHAEL POLYDEFKIS  
Department of Neurology  
The Johns Hopkins University School of Medicine  
Baltimore, MD  
USA  
mpolyde@jhmi.edu

JAMES D. POMONIS  
Algos Therapeutics Inc.  
St. Paul, MN  
USA  
jpomonis@algosinc.com

DIETER PONGRATZ  
 Friedrich Baur Institute  
 Medical Faculty at the Neurological Clinic and  
 Policlinic  
 Ludwig Maximilians University  
 Munich  
 Germany  
 dieter.pongratz@fbs.med.uni-muenchen.de

FRANK PORRECA  
 Department of Pharmacology  
 College of Medicine  
 University of Arizona  
 Tucson, AZ  
 USA  
 frankp@u.arizona.edu

RUSSELL K. PORTENOY  
 Department of Pain and Palliative Care  
 Beth Israel Medical Center  
 New York, NY  
 USA  
 rportenoy@chpnet.org

IAN POWER  
 Anaesthesia Critical Care and Pain Medicine  
 University of Edinburgh  
 Edinburgh  
 UK  
 ian.power@ed.ac.uk

DONALD D. PRICE  
 Department of Oral and Maxillofacial Surgery  
 University of Florida  
 Gainesville, FL  
 USA  
 dprice@dental.ufl.edu

HERBERT K. PROUDFIT  
 Department of Anesthesiology  
 University of Iowa  
 Iowa, IA  
 USA  
 hk-proudfit@uiowa.edu

REBECCA W. PRYOR  
 Pain Prevention and Treatment Research  
 Department of Psychiatry and Behavioral Sciences  
 Duke University Medical Center  
 Durham, NC  
 USA

DARYL PULLMAN  
 Medical Ethics  
 Memorial University of Newfoundland  
 St. John's, NL  
 Canada  
 dpullman@mun.ca

CHAO QIN  
 Health Sciences Center  
 University of Oklahoma  
 Oklahoma City, OK  
 USA

YUNHAI QIU  
 Department of Integrative Physiology  
 National Institute for Physiological Sciences  
 Okazaki  
 Japan

MICHAEL QUITTAN  
 Department of Physical Medicine and Rehabilitation  
 Kaiser-Franz-Joseph Hospital  
 Vienna  
 Austria  
 michael.quittan@wienkav.at

RAYMOND M. QUOCK  
 Department of Pharmaceutical Sciences  
 Washington State University  
 Pullman, WA  
 USA  
 quockr@wsu.edu

GABOR B. RACZ  
 Baylor University Medical Center  
 Texas Tech University Health Science Center  
 Lubbock, TX  
 USA  
 gabor.racz@ttuhsc.edu

LUKAS RADBRUCH  
 Department of Palliative Medicine  
 University of Aachen  
 Aachen  
 Germany  
 lradbruch@ukaachen.de

ROBERT B. RAFFA  
 Department of Pharmacology  
 Temple University School of Pharmacy  
 Philadelphia, PA  
 USA  
 robert.raffa@temple.edu

VASUDEVA RAGHAVENDRA  
 Algos Therapeutics Inc.  
 Saint Paul, MN  
 USA  
 rvasudeva@algosinc.com

FRANCINE RAINONE  
 Montefiore Medical Center and Albert Einstein  
 College of Medicine  
 Bronx  
 New York, NY  
 USA  
 frainone@montefiore.org

PIERRE RAINVILLE  
Department of Stomatology  
University of Montreal  
Montreal, QC  
Canada  
pierre.rainville@umontreal.ca

SRINIVASA N. RAJA  
Department of Anesthesiology and  
Critical Care Medicine  
The Johns Hopkins University School of Medicine  
Baltimore, MD  
USA  
sraja@jhmi.edu

ALAN RANDICH  
University of Alabama  
Birmingham, AL  
USA  
arandich@uab.edu

ANDREA J. RAPKIN  
Department of Obstetrics and Gynecology  
University of California  
Los Angeles Medical Center  
Los Angeles, CA  
USA  
arapkin@mednet.ucla.edu

Z. HARRY RAPPAPORT  
Department of Neurosurgery  
Rabin Medical Center  
Tel-Aviv University  
Petah Tikva  
Israel  
zhr1@internet-zahav.net

MATTHEW N. RASBAND  
University of Connecticut Health Center  
Farmington, CT  
USA  
rasband@uchc.edu

DOUGLAS RASMUSSEN  
Department of Physiology and Biophysics  
Dalhousie University  
Halifax, NS  
Canada

JAMES P. RATHMELL  
Department of Anesthesiology  
University of Vermont College of Medicine  
Burlington, VT  
USA  
james.rathmell@vtmednet.org

K. RAVISHANKAR  
The Headache and Migraine Clinic  
Jaslok Hospital and Research Centre  
Lilavati Hospital and Research Centre  
Mumbai  
India  
dr\_k\_ravishankar@vsnl.com

KE REN  
Department of Biomedical Sciences  
University of Maryland  
Baltimore, MD  
USA  
kren@umaryland.edu

CIELITO C. REYES-GIBBY  
The University of Texas M. D. Anderson Cancer  
Center  
Houston, TX  
USA  
creyes@mdanderson.org

REBECCA PILLAI RIDDELL  
York University and  
The Hospital for Sick Kids  
Toronto, ON  
Canada  
rpr@yorku.ca

MATTHIAS RINGKAMP  
Department of Neurosurgery  
School of Medicine  
Johns Hopkins University  
Baltimore, MD  
USA  
platelet@jhmi.edu

MARGARITA SANCHEZ DEL RIO  
Neurology Department  
Hospital Ruber Internacional  
Madrid  
Spain  
msanchezdelrio@ruberinternacional.es

DANIEL RIRIE  
Department of Radiology  
Oregon Health and Science University  
Portland, OR  
USA

PIERRE J. M. RIVIÈRE  
Ferring Research Institute  
San Diego, CA  
USA  
pierre.riviere@ferring.com

ROGER ROBERT  
Neurosurgery  
Hotel Dieu  
Nantes Cedex 1  
France

JAMES P. ROBINSON  
University of Washington Pain Center  
University of Washington  
Seattle, WA  
USA  
jimrob@u.washington.edu

JOHN ROBINSON  
Pain Management Clinic  
Burwood Hospital  
Christchurch  
New Zealand  
jon.r@xtra.co.nz

HEATHER L. ROGERS  
Department of Medical and Clinical Psychology  
Uniformed Services University of the Health Sciences  
Bethesda, MD  
USA

DAVID ROSELT  
Aberdovy Clinic  
Bundaberg, QLD  
Australia  
drosel@aberdovy.com.au

SHLOMO ROTSHENKER  
Department of Anatomy & Cell Biology  
Faculty of Medicine  
Hebrew University of Jerusalem  
Jerusalem  
Israel  
rotsh@md.huji.ac.il

PAUL C. ROUSSEAU  
VA Medical Center  
Phoenix, AZ  
USA  
palliatiivedoctor@aol.com

RANJAN ROY  
Faculty of Social Work and  
Department of Clinical Health Psychology  
Faculty of Medicine  
University of Manitoba  
Winnipeg, MB  
Canada  
rroy@cc.umanitoba.CA

CAROLINA ROZA  
Institute of Neuroscience  
University Miguel Hernández-CSIC  
Alicante  
Spain  
croza@umh.es

TODD D. ROZEN  
Michigan Head-Pain and Neurological Institute  
Ann Arbor, MI  
USA  
tdrozmigraine@yahoo.com

ROMAN RUKWIED  
Department of Anaesthesiology and Intensive Care  
Medicine  
Faculty of Clinical Medicine Mannheim  
University of Heidelberg  
Mannheim  
Germany  
roman.rukwied@anaes.ma.uni-heidelberg.de

I. JON RUSSELL  
Division of Clinical Immunology and Rheumatology  
Department of Medicine  
The University of Texas Health Science Center  
San Antonio, TX  
USA  
russell@uthscsa.edu

NAYEF E. SAADÉ  
Neuroscience Program  
Faculty of Medicine  
American University of Beirut  
Beirut  
Lebanon  
nesaade@aub.edu.lb

MARY ANN C. SABINO  
Department Prevential Science  
University of Minnesota  
Minneapolis, MN  
USA

THOMAS E. SALT  
Institute of Ophthalmology  
University College London  
London  
UK  
t.salt@ucl.ac.uk

A. SAMDANI  
Department of Neurosurgery  
Johns Hopkins Medical Institutions  
Baltimore, MD  
USA

JÜRGEN SANDKÜHLER  
Department of Neurophysiology  
Center for Brain Research  
Medical University of Vienna  
Vienna  
Austria  
juergen.sandkuehler@meduniwien.ac.at

PETER S. SÁNDOR  
Headache & Pain Unit  
University Hospital Zurich  
Zürich  
Switzerland  
peter.sandor@usz.ch

JOHANNES SARNTHEIN  
Functional Neurosurgery  
Neurosurgical Clinic  
University Hospital  
Zürich  
Switzerland

SUSANNE K. SAUER  
Department of Physiology and Pathophysiology  
University of Erlangen  
Erlangen  
Germany  
sauer@physiology1.uni-erlangen.de

JANA SAWYNOK  
Department of Pharmacology  
Dalhousie University  
Halifax, NF  
Canada

JOHN W. SCADDING  
The National Hospital for Neurology and  
Neurosurgery  
London  
UK  
jwscadding@hotmail.com

M. SCHÄFER  
Clinic for Anesthesiology and  
Operative Intensive Medicine  
Charité-University Clinical Center Berlin  
Campus Benjamin Franklin  
Berlin  
Germany  
mischaefer@zop-admin.ukbf.fu-berlin.de

HANS-GEORG SCHAIBLE  
Department of Physiology  
Friedrich Schiller University of Jena  
Jena  
Germany  
hans-georg.schaible@mti.uni-jena.de

JÖRN SCHATTSCHEIDER  
Department of Neurology  
University Hospital Schleswig-Holstein  
Kiel  
Germany  
j.schattschneider@neurologie.uni-kiel.de

NEIL SCHECHTER  
Department of Pediatrics  
University of Connecticut School of Medicine and  
Pain Relief Program  
Connecticut Children's Medical Center  
Hartford, CT  
USA  
nschecht@stfranciscare.org

STEVEN S. SCHERER  
Department of Neurology  
The University of Pennsylvania Medical School  
Philadelphia, PA  
USA  
sscherer@mail.med.upenn.edu

MARTIN SCHMELZ  
Institute of Anaesthesiology  
Operative Intensive Medicine and Pain Research  
Faculty for Clinical Medicine Mannheim  
University of Heidelberg  
Mannheim  
Germany  
martin.schmelz@anaes.ma.uni-heidelberg.de

ROBERT F. SCHMIDT  
Institute of Physiology  
University of Würzburg  
Würzburg  
Germany  
rfs@mail.uni-wuerzburg.de

SUZAN SCHNEEWEISS  
The Hospital for Sick Children and  
The University of Toronto  
Toronto, ON  
Canada  
suzan.schneeweiss@sickkids.ca

FRANK SCHNEIDER  
RWTH Aachen University  
Department of Psychiatry and Psychotherapy  
Aachen  
Germany  
fschneider@ukaachen.de

ALFONS SCHNITZLER  
Department of Neurology  
Heinrich Heine University  
Düsseldorf  
Germany

JEAN SCHOENEN  
 Departments of Neurology and Neuroanatomy  
 University of Liège  
 CHR Citadelle  
 Liege  
 Belgium  
 jschoenen@ulg.ac.be

EVA SCHONSTEIN  
 School of Physiotherapy  
 Faculty of Health Science  
 The University of Sydney  
 Lidcombe  
 Sydney, NSW  
 Australia  
 e.schonstein@fhs.usyd.edu.au

JENS SCHOUENBORG  
 Section for Neurophysiology  
 Department of Physiological Sciences  
 Lund University  
 Lund  
 Sweden  
 Jens.Schouenborg@mphy.lu.se

STEPHAN A. SCHUG  
 Royal Perth Hospital and  
 University of Western Australia  
 Perth, WA  
 Australia  
 schug@cyllene.uwa.edu.au

ANTHONY C. SCHWARZER  
 Faculty of Medicine and Health Sciences  
 The University of Newcastle  
 Newcastle, NSW  
 Australia  
 msi5@ozemail.com.au

ZE'EV SELTZER  
 Centre for the Study of Pain  
 Faculty of Dentistry  
 University of Toronto  
 Toronto, ON  
 Canada

PETER SELWYN  
 Montefiore Medical Center and  
 Albert Einstein College of Medicine  
 Bronx  
 New York, NY  
 USA  
 selwyn@aecom.yu.edu

PATRICK B. SENATUS  
 Department of Neurological Surgery  
 Neurological Institute  
 Columbia University  
 New York, NY  
 USA

JYOTI N. SENGUPTA  
 Division of Gastroenterology and Hepatology and  
 Pediatric Gastroenterology  
 Medical College of Wisconsin  
 Milwaukee, WI  
 USA  
 sengupta@mcw.edu

MARIANO SERRAO  
 Department of Neurology and Otorinolaringoiatry  
 University of Rome La Sapienza  
 Rome  
 Italy  
 victor.m@mclink.it

BARRY J. SESSLE  
 Department of Physiology  
 Faculty of Medicine  
 and  
 Faculty of Dentistry  
 University of Toronto  
 Toronto, ON  
 Canada  
 barry.sessle@utoronto.ca

VIRGINIA S. SEYBOLD  
 Department of Neuroscience  
 University of Minnesota  
 Minneapolis, MN  
 USA  
 vseybold@umn.edu

T. SHAH  
 Royal Perth Hospital and  
 University of Western Australia  
 Crawley, WA  
 Australia

REZA SHAKER  
 Division of Gastroenterology and Hepatology and  
 Pediatric Gastroenterology  
 Medical College of Wisconsin  
 Milwaukee, WI  
 USA

YAIR SHARAV  
 Department of Oral Medicine  
 School of Dental Medicine  
 Hebrew University-Hadassah  
 Jerusalem  
 Israel  
 sharav@cc.huji.ac.il

MARNIE SHAW  
 Brain Imaging Center  
 McLean Hospital-Harvard Medical School  
 Belmont, MA  
 USA

S. MURRAY SHERMAN  
Department of Neurobiology  
State University of New York  
Stony Brook, NY  
USA  
s.sherman@sunysb.edu

YOSHIO SHIGENAGA  
Department of Oral Anatomy and Neurobiology  
Osaka University  
Osaka  
Japan  
sigenaga@dent.osaka-u.ac.jp

EDWARD A. SHIPTON  
Department of Anaesthesia  
Christchurch School of Medicine  
University of Otago  
Christchurch  
New Zealand  
shiptonea@xtra.co.nz

YORAM SHIR  
Pain Centre  
Department of Anesthesia  
McGill University Health Centre  
Montreal General Hospital  
Montreal, QC  
Canada  
yoram.shir@muhc.mcgill.ca

PETER SHRAGER  
Department of Neurobiology and Anatomy  
University of Rochester Medical Center  
Rochester, NY  
USA  
pshr@mail.rochester.edu

MARC J. SHULMAN  
VA Connecticut Healthcare System  
Yale University  
New Haven, CT  
USA  
marc.shulman@med.va.gov

DAVID M. SIBELL  
Comprehensive Pain Center  
Oregon Health and Science University  
Portland, OR  
USA  
sibelld@ohsu.edu

PHILIP J. SIDDALL  
Pain Management Research Institute  
Royal North Shore Hospital  
University of Sydney  
Sydney, NSW  
Australia  
phils@med.usyd.edu.au

STEPHEN D. SILBERSTEIN  
Jefferson Medical College  
Thomas Jefferson University and  
Jefferson Headache Center  
Thomas Jefferson University Hospital  
Philadelphia, PA  
USA  
stephen.silberstein@jefferson.edu

DONALD A. SIMONE  
University of Minnesota  
Minneapolis, MN  
USA  
simon003@umn.edu

DAVID G. SIMONS  
Department of Rehabilitation Medicine  
Emory University  
Atlanta, GA  
USA  
loisanddavesimons@earthlink.net

DAVID SIMPSON  
Clinical Neurophysiology Laboratories  
Mount Sinai Medical Center  
New York, NY  
USA  
david.simpson@mssm.edu

MARC SINDOU  
Department of Neurosurgery  
Hopital Neurologique  
Pierre Wertheimer University of Lyon  
Lyon  
France  
marc.sindou@chu-lyon.fr

SØREN HEIN SINDRUP  
Department of Neurology  
Odense University Hospital  
Odense  
Denmark  
s.sindrup@dadlnet.dk

BENGT H. SJÖLUND  
Rehabilitation and Research Centre for  
Torture Victims  
South Danish University  
Copenhagen  
Denmark  
bsj@rct.dk

CARSTEN SKARKE  
Institute of Clinical Pharmacology  
pharmazentrum frankfurt/ZAFES  
Institute of Clinical Pharmacology  
Johann-Wolfgang Goethe University  
Frankfurt  
Germany  
skarke@em.uni-frankfurt.de

KATHLEEN A. SLUKA  
Physical Therapy and Rehabilitation Science  
Graduate Program  
University of Iowa  
Iowa City, IA  
USA  
kathleen-sluka@uiowa.edu

INGRID SÖDERBACK  
Department of Public Health and Caring Sciences  
Uppsala University  
Uppsala  
Sweden  
ingrid.soderback@pubcare.uu.se

SEYMOUR SOLOMON  
Montefiore Medical Center  
Albert Einstein College of Medicine  
Bronx  
New York, NY  
USA  
ssolomon@montefiore.org

CLAUDIA SOMMER  
Department of Neurology  
University of Würzburg  
Würzburg  
Germany  
sommer@mail.uni-wuerzburg.de

LINDA S. SORKIN  
Anesthesia Research Laboratories  
University of California  
San Diego, CA  
USA  
lsorkin@ucsd.edu

MICHAEL SPAETH  
Friedrich-Baur-Institute  
University of Munich  
Munich  
Germany  
spaeth.m5@t-online.de  
michael.spaeth@lrz.uni-muenchen.de

PEREGRIN O. SPIELHOLZ  
SHARP Program  
Washington State Department of Labor and Industries  
Olympia, WA  
USA  
spip235@lni.wa.gov

BENJAMIN S. CARSON SR.  
Department of Neurological Surgery  
Johns Hopkins Hospital  
Baltimore, MD  
USA

PETER S. STAATS  
Division of Pain Medicine  
The Johns Hopkins University  
Baltimore, MD  
USA  
pstaats@jhmi.edu

BRETT R. STACEY  
Comprehensive Pain Center  
Oregon Health and Science University  
Portland, OR  
USA

WENDY M. STEIN  
San Diego Hospice and Palliative Care  
UCSD  
San Diego, CA  
USA  
wstein@sdhospice.org

CHRISTOPH STEIN  
Department of Anaesthesiology and  
Intensive Care Medicine  
Campus Benjamin Franklin  
Charité – University Medicine Berlin  
Berlin  
Germany  
christoph.stein@charite.de

MICHAEL STEINMETZ  
Department of Neurosurgery  
The Cleveland Clinic Foundation  
Cleveland, OH  
USA

JAIR STERN  
Functional Neurosurgery  
Neurosurgical Clinic  
University Hospital  
Zürich  
Switzerland

BONNIE J. STEVENS  
University of Toronto and  
The Hospital for Sick Children  
Toronto, ON  
Canada  
b.stevens@utoronto.ca

CARL-OLAV STILLER  
Division of Clinical Pharmacology  
Department of Medicine  
Karolinska University Hospital  
Stockholm  
Sweden  
carl-olav.stiller@ki.se



JENNIFER N. STINSON  
The Hospital for Sick Children and  
The University of Toronto  
Toronto, ON  
Canada  
jennifer.stinson@sickkids.ca

HENRY STOCKBRIDGE  
Health and Community Medicine  
University of Washington School of Public  
Seattle, WA  
USA  
stoh235@lni.wa.gov

CHRISTIAN S. STOHLER  
Baltimore College of Dental Surgery  
University of Maryland  
Baltimore, MD  
USA  
cstohler@dental.umaryland.edu

LAURA STONE  
Department of Neuroscience  
University of Minnesota  
Minneapolis, MN  
USA  
stone@med.umn.edu

R. WILLIAM STONES  
Princess Anne Hospital  
University of Southampton  
Southampton  
UK  
r.w.stones@soton.ac.uk

ANDREAS STRAUBE  
Department of Neurology  
Ludwig Maximilians University  
Munich  
Germany  
astraube@nefo.med.uni-muenchen.de

JENNY STRONG  
University of Queensland  
Brisbane, QLD  
Australia  
j.strong@uq.edu.au

GEROLD STUCKI  
Department of Physical Medicine and Rehabilitation  
Ludwig-Maximilians University  
Munich  
Germany  
gerold.stucki@med.uni-muenchen.de

CHERYL L. STUCKY  
Department of Cell Biology  
Neurobiology and Anatomy  
Medical College of Wisconsin  
Milwaukee, WI  
USA  
cstucky@mcw.edu

MATHIAS STURZENEGGER  
Department of Neurology  
University of Bern  
Bern  
Switzerland  
matthias.sturzenegger@insel.ch

YASUO SUGIURA  
Nagoya University School of Medicine  
Graduate School of Medicine  
Department of Functional Anatomy & Neuroscience  
Nagoya  
Japan  
ysugiura@med.nagoya-u.ac.jp

MARK D. SULLIVAN  
Psychiatry and Behavioral Sciences  
University of Washington  
Seattle, WA  
USA  
sullimar@u.washington.edu

MICHAEL J. L. SULLIVAN  
Department of Psychology  
University of Montreal  
Montreal, QC  
Canada  
michael.jl.sullivan@umontreal.ca

B. SUNG  
Medical Science Research Center and  
Department of Physiology  
Korea University College of Medicine  
Seoul  
Korea

RIE SUZUKI  
Department of Pharmacology  
University College London  
London  
UK  
ucklrsu@ucl.ac.uk

KRISTINA B. SVENDSEN  
Danish Pain Research Center  
Aarhus University Hospital  
Aarhus  
Denmark  
kristina@akphd.au.dk

PETER SVENSSON  
Department of Clinical Oral Physiology  
University of Aarhus  
Aarhus  
Denmark  
psvensson@odont.au.dk

NIGEL P. SYKES  
St. Christopher's Hospice and King's College  
University of London  
London  
UK  
nigelsykes@doctors.org.uk

A. TAGHVA  
Department of Neurosurgery  
Johns Hopkins Hospital  
Baltimore, MD  
USA

KERSI TARAPOREWALLA  
Royal Brisbane and Womens' Hospital  
University of Queensland  
Brisbane, QLD  
Australia  
Kersi\_taraporewalla@health.qld.gov.au

RONALD R. TASKER  
University of Toronto  
Toronto Western Hospital  
Toronto, ON  
Canada

IRMGARD TEGEDER  
Pharmacological Center Frankfurt  
Clinical Center Johann-Wolfgang Goethe University  
Frankfurt  
Germany  
tegeder@em.uni-frankfurt.de

ASTRID J. TERKELSEN  
Danish Pain Research Center and Department of  
Neurology  
Aarhus University Hospital  
Aarhus  
Denmark  
astrid@akhphd.au.dk

GREGORY W. TERMAN  
Department of Anesthesiology and the  
Graduate Program in Neurobiology and Behavior  
University of Washington  
Seattle, WA  
USA  
gwt@u.washington.edu

ALISON THOMAS  
Lismore, NSW  
Australia  
alison.thomas@crsrehab.gov.au

BEVERLY E. THORN  
University of Alabama  
Tuscaloosa, AL  
USA  
bthorn@bama.ua.edu

CINDY L. THURSTON-STANFIELD  
Department of Biomedical Sciences  
University of South Alabama  
Mobile, AL  
USA  
cthursto@usouthal.edu

ARNE TJØLSEN  
University of Bergen  
Bergen  
Norway  
arne.tjolsen@fys.uib.no

ANDREW J. TODD  
Spinal Cord Group  
Institute of Biomedical and Life Sciences  
University of Glasgow  
Glasgow  
UK  
a.todd@bio.gla.ac.uk

MAKOTO TOMINAGA  
Department of Cellular and Molecular Physiology  
Mie University School of Medicine  
Tsu Mie  
Japan  
tominaga@doc.medic.mie-u.ac.jp

IRENE TRACEY  
Pain Imaging Neuroscience (PaIN) Group  
Department of Physiology, Anatomy and Genetics  
and  
Centre for Functional Magnetic Resonance  
Imaging of the Brain  
Oxford University  
Oxford  
UK  
irene.tracey@anat.ox.ac.uk

TUAN DIEP TRAN  
Department of Neurology  
University of Michigan  
and  
Neurology Research Laboratory  
VA Medical Center  
Ann Arbor, MI  
USA  
and  
Department of Pediatrics  
University of Medicine and Pharmacy of Ho  
Chi Minh City  
Ho Chi Minh City  
Vietnam

DIEP TUAN TRAN  
Department of Integrative Physiology  
National Institute for Physiological Sciences  
Okazaki  
Japan

ROLF-DETLEF TREEDE  
Institute of Physiology and Pathophysiology  
Johannes Gutenberg University  
Mainz  
Germany  
treede@uni-mainz.de

JENNIE C. I. TSAO  
Pediatric Pain Program  
Department of Pediatrics  
David Geffen School of Medicine at UCLA  
Los Angeles, CA  
USA

JEANNA TSENER  
Department of Physical Medicine and Rehabilitation  
Hadassah University Hospital  
Jerusalem  
Israel

MAURITS VAN TULDER  
Institute for Research in Extramural Medicine  
Free University Amsterdam  
Amsterdam  
The Netherlands  
mw.vantulder@vumc.nl

ELDON TUNKS  
Hamilton Health Sciences Corporation  
Hamilton, ON  
Canada  
tunks@hhsc.ca

DENNIS C. TURK  
Department of Anesthesiology  
University of Washington  
Seattle, WA  
USA  
turkdc@u.washington.edu

JUDITH A. TURNER  
Department of Psychiatry and Behavioral Sciences  
University of Washington  
Seattle, WA  
USA

O. J. TWEEDIE  
Royal Perth Hospital and  
University of Western Australia  
Crawley, WA  
Australia

STEPHEN P. TYRER  
Royal Victoria Infirmary  
University of Newcastle upon Tyne  
Newcastle-on-Tyne  
UK  
s.p.tyrer@ncl.ac.uk

ALEXANDER TZABAZIS  
Department of Anesthesia  
University of Erlangen  
Erlangen  
Germany  
tzabazis@web.de

KENE UGOKWE  
Department of Neurosurgery  
The Cleveland Clinic Foundation  
Cleveland, OH  
USA

LINDSAY S. UMAN  
Department of Psychology  
Dalhousie University  
Halifax, NS  
Canada  
luman@dal.ca

ANITA M. UNRUH  
Health and Human Performance and  
Occupational Therapy  
Dalhousie University  
Halifax, NS  
Canada  
aunruh@dal.ca

CHRISTIANE VAHLE-HINZ  
Institute of Neurophysiology and Pathophysiology  
University Hospital Hamburg-Eppendorf  
Hamburg  
Germany  
vahle-hinz@uke.uni-hamburg.de

MUTHUKUMAR VAIDYARAMAN  
Division of Pain Medicine  
The Johns Hopkins University  
Baltimore, MD  
USA  
mvaidya2@jhmi.edu

TODD W. VANDERAH  
Department of Pharmacology  
College of Medicine  
University of Arizona  
Tucson, AZ  
USA  
vanderah@u.arizona.edu

GUY VANDERSTRAETEN  
Department of Rehabilitation Sciences and  
Physiotherapy  
Ghent University Hospital  
Ghent  
Belgium  
guy.vanderstraeten@ugent.be

HORACIO VANEGAS  
Instituto Venezolano de Investigaciones Cientificas  
(IVIC)  
Caracas  
Venezuela  
hvanegas@ivic.ve

JEAN-JACQUES VATINE  
Outpatient and Research Division  
Reuth Medical Center  
Tel Aviv  
Israel  
vatinejj@reuth.org.il

LINDA K. VAUGHN  
Department of Biomedical Sciences  
Marquette University  
Milwaukee, WI  
USA  
linda.vaughn@marquette.edu

LOUIS VERA-PORTOCARRERO  
Department of Pharmacology  
College of Medicine  
University of Arizona  
Tucson, AZ  
USA  
loverapo@email.arizona.edu

PAUL VERRILLS  
Metropolitan Spinal Clinic  
Prahran, VIC  
Australia  
verrills@bigpond.net.au

FÉLIX VIANA  
Instituto de Neurociencias de Alicante  
Universidad Miguel Hernández-CSIC  
San Juan de Alicante  
Spain

CHARLES J. VIERCK JR.  
Department of Neuroscience and  
McKnight Brain Institute  
University of Florida College of Medicine  
Gainesville, FL  
USA  
vierck@mbi.ufl.edu

LUIS VILLANUEVA  
INSERM  
University of Clermont-Ferrand  
Clermont-Ferrand  
France  
luis.villanueva@u-clermont1.fr

MARCELO VILLAR  
Neuroscience Laboratory  
Austral University  
Buenos Aires  
Argentina

DAVID VIVIAN  
Metro Spinal Clinic  
Caulfield, VIC  
Australia  
dvivian@metrospinal.com.au

JOHAN W. S. VLAEYEN  
Department of Medical, Clinical and Experimental  
Psychology  
Maastricht University  
Maastricht  
The Netherlands  
j.vlaeyen@dep.unimaas.nl

NICOLAS VOILLEY  
Institut de Pharmacologie Moleculaire et Cellulaire  
Valbonne  
France  
voilley@ipmc.cnrs.fr

ERNEST VOLINN  
Pain Research Center  
University of Utah  
Salt Lake City, UT  
USA  
epaulv@yahoo.com

LUCY VULCHANOVA  
Department of Veterinary and Biomedical Sciences  
University of Minnesota  
St. Paul, MN  
USA  
lucy@med.umn.edu

PAUL W. WACNIK  
Department of Pharmacology  
College of Medicine  
University of Minnesota  
Minneapolis, MN  
USA  
paul.w.wacnik@medtronic.com

GORDON WADDELL  
University of Glasgow  
Glasgow  
UK  
gordon.waddell@virgin.net

GARY A. WALCO  
Hackensack University Medical Center  
University of Medicine and Dentistry of New Jersey  
New Jersey Medical School  
Hackensack, NJ  
USA  
gwalco@humed.com

BARBARA WALKER  
Centre for Pain Management  
St Vincent's Hospital  
Melbourne, VIC  
Australia

SUELLEN M. WALKER  
University of Sydney Pain Management and  
Research Centre  
Royal North Shore Hospital  
St. Leonards, NSW  
Australia  
swalker@anatomy.usyd.edu.au  
suellen.walker@ucl.ac.uk

LYNN S. WALKER  
Division of Adolescent Medicine and  
Behavioral Sciences  
Vanderbilt University Medical Center  
Nashville, TN  
USA  
lynn.walker@vanderbilt.edu

VICTORIA C. J. WALLACE  
Department of Anaesthetics  
Pain Medicine and Intensive Care  
Chelsea and Westminster Hospital Campus  
London  
UK  
v.wallace@imperial.ac.uk

XIAOHONG WANG  
Department of Integrative Physiology  
National Institute for Physiological Sciences  
Okazaki  
Japan

FAY WARNOCK  
Children's and Women's Hospital and  
The University of British Columbia  
Vancouver, BC  
Canada  
warnock@nursing.ubc.ca

GUNNAR WASNER  
Department of Neurological Pain Research and  
Therapy  
Neurological Clinic  
Kiel  
Germany  
and  
Prince of Wales Medical Research Institute  
University of New South Wales  
Randwick, NSW  
Australia  
g.wasner@neurologie.uni-kiel.de

SHOKO WATANABE  
Department of Integrative Physiology  
National Institute for Physiological Sciences  
Okazaki  
Japan

LINDA R. WATKINS  
Department of Psychology and  
Center for Neuroscience  
University of Colorado at Boulder  
Boulder, CO  
USA  
lwatkins@psych.colorado.edu

CHRISTOPHER J. WATLING  
The University of Western Ontario  
London, ON  
Canada  
chris.watling@lhsc.on.ca

PAUL J. WATSON  
University Department of Anaesthesia  
University of Leicester  
Leicester  
UK  
pjw25@le.ac.uk

PETER N. WATSON  
University of Toronto  
Toronto, ON  
Canada  
peter.watson@utoronto.ca

JAMES WATT  
North Shore Hospital  
Auckland  
New Zealand  
jameswatt@clear.net.nz

STEPHEN G. WAXMAN  
Department of Neurology  
Yale School of Medicine  
New Haven, CT  
and  
VA Medical Center  
West Haven, CT  
USA  
stephen.waxman@yale.edu

CHRISTIAN WEIDNER  
Department of Physiology and Experimental  
Pathophysiology  
University Erlangen  
Erlangen  
Germany  
weidner@physiologie1.uni-erlangen.de

PH. TH. M. WEIJENBORG  
Department of Gynecology  
Leiden University Medical Center  
Leiden  
The Netherlands  
p.t.m.weijsborg@lumc.nl

ROBIN WEIR  
Hamilton Health Sciences Corporation  
Hamilton, ON  
Canada

NIRIT WEISS  
Departments of Neurosurgery  
Johns Hopkins University  
Baltimore, MD  
USA

URSULA WESSELMANN  
Departments of Neurology  
Neurological Surgery and Biomedical Engineering  
The Johns Hopkins University School of Medicine  
Baltimore, MD  
USA  
pain@jhmi.edu

DAGMAR WESTERLING  
Departments of Clinical Pharmacology  
Anesthesiology and Intensive Care  
Lund University Hospital  
Lund  
Sweden  
Dagmar.westerling@skane.se

KARIN N. WESTLUND  
Department of Anatomy and Neurosciences  
University of Texas Medical Branch  
Galveston, TX  
USA  
kwhigh@utmb.edu

THOMAS M. WICKIZER  
Department of Rehabilitation Medicine  
University of Washington  
Seattle, WA  
USA

EVA WIDERSTRÖM-NOGA  
The Miami Project to Cure Paralysis  
Department of Neurological Surgery  
University of Miami  
VAMC  
Miami, FL  
USA  
ewiderstrom-noga@miami.edu

JULIE WIESELER-FRANK  
Department of Psychology and Center for  
Neuroscience  
University of Colorado at Boulder  
Boulder, CO  
USA

ZSUZSANNA WIESENFELD-HALLIN  
Karolinska Institute  
Stockholm  
Sweden  
zsuzsanna.wiesenfeld-hallin@labmed.ki.se

ANN WIGHAM  
McCoull Clinic  
Prudhoe Hospital  
Northumberland  
UK  
ann\_wigham@hotmail.com

GEORGE L. WILCOX  
Department of Neuroscience  
Pharmacology and Dermatology  
University of Minnesota Medical School  
Minneapolis, MN  
USA  
george@umn.edu

OLIVER H. G. WILDER-SMITH  
Pain and Nociception Research Group  
Pain Centre  
Department of Anaesthesiology  
Radboud University Nijmegen Medical Centre  
Nijmegen  
The Netherlands  
o.wildersmith@anes.umcn.nl

KJERSTI WILHELMSSEN  
Section for Physiotherapy Science  
Department of Public Health and Primary Health Care  
Faculty of Medicine  
University of Bergen  
Bergen  
Norway  
kjersti.wilhelmsen@isf.uib.no

VICTOR WILK  
Brighton Spinal Group  
Brighton, VIC  
Australia  
vicwilk@tpg.com.au

W. A. WILLIAMS  
Royal Perth Hospital and  
University of Western Australia  
Perth, WA  
Australia

WILLIAM D. WILLIS  
Department of Neuroscience and Cell Biology  
University of Texas Medical Branch  
Galveston, TX  
USA  
wdwillis@utmb.edu

JOHN B. WINER  
Department of Neurology  
Birmingham Muscle and Nerve Centre  
Queen Elizabeth Hospital  
Birmingham  
UK  
j.b.winer@bham.ac.uk

CHRISTOPHER J. WINFREE  
Department of Neurological Surgery  
Neurological Institute  
Columbia University  
New York, NY  
USA  
cjw12@columbia.edu

JANET WINTER  
Novartis Institute for Medical Science  
London  
UK  
janet.winter@novartis.com

ALAIN WODA  
Faculté de Chirurgie Dentaire  
University Clermont-Ferrand  
Clermont-Ferrand  
France  
alain.woda@u-clermont1.fr

SUNG TAE KOO WONKWANG  
Korea Institute of Oriental Medicine  
Korea  
stkoo@klom.re.kr

LEE WOODSON  
Department of Anesthesiology  
University of Texas Medical Branch  
and  
Shriners Hospitals for Children  
Shriners Burns Hospital  
Galveston, TX  
USA

XIAO-JUN XU  
Karolinska Institute  
Stockholm  
Sweden

HIROSHI YAMASAKI  
Department of Integrative Physiology  
National Institute for Physiological Sciences  
Okazaki  
Japan

MICHAEL YELLAND  
School of Medicine  
Griffith University  
Logan, QLD  
Australia  
myelland@bigpond.com

S. YENNURAJALINGAM  
Department of Palliative Care and  
Rehabilitation Medicine  
The University of Texas M. D. Anderson Cancer  
Center  
Houston, TX  
USA

DAVID C. YEOMANS  
Department of Anesthesia  
Stanford University  
Stanford, CA  
USA  
dcyeomans@stanford.edu

ROBERT P. YEZIERSKI  
Comprehensive Center for Pain Research and  
Department of Neuroscience  
McKnight Brain Institute  
Gainesville, FL  
USA  
ryezierski@dental.ufl.edu

WAY YIN  
Department of Anesthesiology  
University of Washington  
Seattle, WA  
USA  
wyin@nospinepain.com

Y. W. YOON  
Medical Science Research Center and  
Department of Physiology  
Korea University College of Medicine  
Seoul  
Korea

ATSUSHI YOSHIDA  
Department of Oral Anatomy and Neurobiology  
Osaka University  
Osaka  
Japan  
yoshida@dent.osaka-u.ac.jp

JOANNA M. ZAKRZEWSKA  
Clinical Diagnostic and Oral Sciences  
Institute of Dentistry  
Barts and the London  
Queen Mary's School of Medicine & Dentistry  
University of London  
London  
UK  
j.m.zakrzewska@qmul.ac.uk

HANNS ULRICH ZEILHOFER  
Institute for Pharmacology and Toxicology  
University of Zürich  
Zürich  
Switzerland  
zeilhofer@pharma.unizh.ch

LONNIE K. ZELTZER  
Pediatric Pain Program  
Department of Pediatrics  
David Geffen School of Medicine at UCLA  
Los Angeles, CA  
USA  
lzeltzer@mednet.ucla.edu.

GIOVAMBATTISTA ZEPPELLA  
St. Clare Hospice  
Hastingwood  
UK  
jzeppetella@stclare-hospice.co.uk

YI-HONG ZHANG  
Department of Anatomy and Neurobiology  
University of Tennessee Health Science Center  
Memphis, TN  
USA  
yzhang32@utm.edu

XIJING J. ZHANG  
Department of Neuroscience  
University of Minnesota  
Minneapolis, MN  
USA  
zhang036@umn.edu

MIN ZHUO  
Department of Physiology  
University of Toronto  
Toronto, ON  
Canada  
min.zhuo@utoronto.ca

C. ZÖLLNER  
Clinic for Anesthesiology and Operative Intensive  
Medicine  
Charité-University Clinical Center Berlin  
Campus Benjamin Franklin  
Berlin  
Germany  
zoellner@zop-admin.ukbf.fu-berlin.de

KRINA ZONDERVAN  
Wellcome Trust Centre for Human Genetics  
Oxford  
UK

ZBIGNIEW ZYLICZ  
St. Elizabeth Hospice  
Ipswich  
Suffolk  
UK  
zzylicz@onetel.net



---

## A Afferent Fibers (Neurons)

### Definition

These are types of sensory afferent nerve fibers that are myelinated (encased in a myelin sheath), and are classified according to their conduction velocity and sensory modality.

A $\beta$  fibers are medium diameter afferent fibers with conduction velocities of 30–80 ms, and encode signals from non-noxious stimuli such as touch.

A $\delta$  fibers are smaller caliber afferent fibers with conduction velocities of 5–30 ms, and principally encode signals from noxious stimuli. They are commonly thought to be responsible for the rapid sensation of 'first pain' following injury.

It is often difficult to precisely identify the different classes of A fibers during development, as growth in fiber diameter and myelination occur slowly, so the eventual fate of fibers is not necessarily obvious at earlier stages of development.

- ▶ Infant Pain Mechanisms
- ▶ Insular Cortex, Neurophysiology and Functional Imaging of Nociceptive Processing
- ▶ Magnetoencephalography in Assessment of Pain in Humans
- ▶ Nociceptor, Categorization
- ▶ Spinothalamic Tract Neurons, in Deep Dorsal Horn

---

## A Fibers (A-Fibers)

### Definition

The terminology refers to compound action potential deflections; A fibers are the most rapidly conducting category representing activity of myelinated fibers. Most A fibers are afferent nerve fibers that carry non-noxious somatosensory information.

- ▶ A Afferent Fibers (Neurons)
- ▶ Opiates During Development

---

## A Beta( $\beta$ ) Afferent Fibers

- ▶ A Afferent Fibers (Neurons)

---

## A Delta( $\delta$ ) Afferent Fibers (Axons)

- ▶ A Afferent Fibers (Neurons)

---

## A Delta( $\delta$ )-Mechanoheat Receptor

- ▶ Polymodal Nociceptors, Heat Transduction

---

## A Delta( $\delta$ )-Mechanoreceptor

- ▶ Mechanonociceptors

---

## AAV

- ▶ Adenoassociated Virus Vectors

---

## Abacterial Meningitis

- ▶ Headache in Aseptic Meningitis

## Abdominal Skin Reflex

### Definition

Similar to the flexion withdrawal reflex, this reflex is a protective reflex of the trunk, and is intended to protect the abdominal organs from impact. In the adult, it is evoked by painful stimulation of the abdomen. However, in the infant, although more reliably elicited by noxious stimulation, it can also be elicited by innocuous stimuli such as calibrated monofilaments (von Frey hairs), its threshold in this age group being much lower than in the older child and adult. Nevertheless, above approximately one year of age, it is increasingly difficult to elicit the abdominal skin reflex using this type of stimulation.

- ▶ Infant Pain Mechanisms
- ▶ von Frey Hair

## Abduction

### Definition

Movement of a body part away from the midline of the body.

- ▶ Cancer Pain Management, Orthopedic Surgery

## Aberrant Drug-Related Behaviors

### Definition

Use of a prescription medication in a manner that violates expectations for responsible drug use. May be applied to verbal responses or actions. Occur on a continuum from relatively mild (e.g. unsanctioned dose escalation on one or two occasions) to severe (e.g. injecting oral formulations). Must be assessed to determine appropriate diagnosis (e.g. addiction, pseudoaddiction, other psychiatric disorder, etc).

- ▶ Cancer Pain, Evaluation of Relevant Comorbidities and Impact

## Ablation

### Definition

The basic definition of ablation is ‘elimination or removal’. Medically, it is a procedure involving destruction of brain tissue to decrease the activity of a brain structure, or interrupt information transmitted along a specific tract.

- ▶ Facet Joint Pain
- ▶ Pain Treatment, Intracranial Ablative Procedures

## Abnormal Illness Affirming States

### Definition

A group of psychiatric disorders (conversion disorder, hypochondriasis, somatization, pain disorder, factitious disorder, and malingering), where secondary gain is believed to be important to the production of some or all of the patient’s symptoms. It is to be noted that for factitious disorders and malingering, secondary gain is thought to operate on a conscious level, but at an unconscious level for the other illness affirming states.

- ▶ Abnormal Illness Behavior
- ▶ Malingering, Primary and Secondary Gain

## Abnormal Illness Behavior

### Definition

It is the persistence of an inappropriate or maladaptive mode of perceiving, evaluating, or acting in relation to one’s own state of health, despite the fact that the doctor has offered an accurate and reasonably lucid explanation about the illness, with opportunities for discussion, negotiations & clarifications, based on an adequate assessment of all biological, psychological, social & cultural factors.

- ▶ Abnormal Illness Affirming States
- ▶ Pain as a Cause of Psychiatric Illness
- ▶ Psychiatric Aspects of the Management of Cancer Pain

## Abnormal Illness Behaviour of the Unconsciously Motivated, Somatically Focussed Type

- ▶ Hypochondriasis, Somatoform Disorders and Abnormal Illness Behaviour

## Abnormal Temporal Summation

### Definition

Abnormal Temporal Summation is an abnormal, intense pain resulting from repetitive stimulation of a painful skin area in patients with neuropathic pain.

- ▶ Diagnosis and Assessment of Clinical Characteristics of Central Pain

## Abnormal Ureteric Peristalsis in Stone Rats

### Definition

A marked increase in amplitude of phasic contractions (such that the intraureter pressure reaches levels likely to be sufficient to activate ureteric nociceptors) associated with a decrease in rate of contractions, and a reduced basal tone compared to peristalsis seen in normal rats.

- ▶ Visceral Pain Model, Kidney Stone Pain

## Abscess

### Definition

An abscess is a circumscribed area of injury and inflammation in which considerable necrosis has occurred, and a fluid containing dead tissue and bacteria has collected. It may drain and be relatively comfortable, but if closed, tissue distension results in pain.

- ▶ Dental Pain, Etiology, Pathogenesis and Management

## Absolute Detection Threshold

### Definition

On a stimulus continuum: a, What is the minimum value of a stimulus that is “just detectable” by a subject? This value is called the ‘absolute threshold’.

- ▶ Pain Evaluation, Psychophysical Methods

## Absorption

### Definition

The absorption of a drug contains all events from the site of its administration to the site of the measurement. An essential requirement for absorption is that the drug is solved in a solvent.

- ▶ NSAIDs, Pharmacokinetics

## ACC

- ▶ Anterior Cingulate Cortex

## Accelerated Recovery Programs

- ▶ Postoperative Pain, Importance of Mobilisation

## Acceleration-Deceleration Injury

- ▶ Whiplash

## Accelerometer

### Definition

An instrument for measuring acceleration or change of velocity with respect to time

- ▶ Assessment of Pain Behaviors

## Accommodation (of a Nerve Fiber)

### Definition

The use dependant changes of action potential conduction and initiation of a nerve fiber, manifesting as conduction velocity, slowing or increasing the activation threshold.

- ▶ Mechano-Insensitive C-Fibres, Biophysics

## Acculturation

Acculturation is the ability to function with ease in another culture by learning the rules of that culture.

- ▶ Cancer Pain, Assessment of Cultural Issues

## Accuracy and Reliability of Memory

### Definition

The distinction between accuracy and reliability of memory is important for studies of pain memory. Reliability is determined by the correlation between the report of pain at the time of its occurrence, e.g. a score on a rating scale, and the estimate of that score at a later time (the remembered pain). In studies with a group of people, the correlation preserves the relative order of the magnitude of pain and its recall. Accuracy refers to the extent of agreement between records of the original event and the corresponding memory. Under certain conditions, it is possible to assess accuracy for an individual; which is not possible for reliability. Also, according to this distinction, memories may be reliable but not accurate.

- ▶ Pain Memory

## ACE-Inhibitors, Beta( $\beta$ )-Blockers

### Definition

Drugs used to lower blood pressure and relieve heart failure.

- ▶ Postoperative Pain, Acute Pain Management, Principles

## Acetaminophen

- ▶ Paracetamol
- ▶ Postoperative Pain, Paracetamol
- ▶ Simple Analgesics

## Acetylation

### Definition

The acetyl group of acetylsalicylic acid (aspirin) binds to serine 530 in the active site of COX-1, or serine 516 in the active site of COX-2. This prevents the access of arachidonic acid to the catalytic site of the cyclooxygenase.

- ▶ Cyclooxygenases in Biology and Disease

## Acetylcholine

### Synonyms

Ach; ACh

### Definition

Acetylcholine is a neurotransmitter synthesized from choline and acetyl coenzyme A. It is localized in large reticular formation neurons, and is the chemical mediator in the synapse of a motor endplate. The electrical signal of the motor nerve terminal causes release of many packets of acetylcholine. The packets are released into the synaptic cleft, where receptors in the postjunctional membrane of the striated muscle fiber membrane convert the chemical signal to an electrical signal (a propagated action potential), which can produce muscle contractile activity. Normally, an occasional acetylcholine packet is released spontaneously by the nerve terminal without a nerve signal. Each packet produces a miniature endplate potential in the muscle fiber, but its amplitude is too small to be propagated. Myofascial trigger points are associated with excessive spontaneous release of acetylcholine packets in affected endplates.

- ▶ Myofascial Trigger Points
- ▶ Thalamic Neurotransmitters and Neuromodulators

## Acetylcholine Receptors

### Definition

Receptors for the neurotransmitter acetylcholine, which can be distinguished into muscarinic (G protein coupled) and nicotinic (ion channel) receptors.

## Ach, ACh

- ▶ Acetylcholine

## Acidosis

### Definition

Acidosis is the disturbance of the acid-base balance, characterized by acidity (decreased pH) by accumulation of protons, caused by injury, inflammation or ischemia. Acidosis is an important source of pain. In humans, it produces non-adapting nociceptor excitation and contributes to hyperalgesia and allodynia in inflammation.

- ▶ Acid-Sensing Ion Channels
- ▶ TRPV1, Regulation by Protons

## Acid-Sensing Ion Channels

NICOLAS VOILLEY, MICHEL LAZDUNSKI  
Institut de Pharmacologie Moléculaire et Cellulaire,  
Valbonne, France  
voilley@ipmc.cnrs.fr

### Synonyms

ASIC; ASIC1a; brain sodium channel 2 (BNC2, BNaC2); ASIC1b; ASIC $\beta$ ; ASIC2a: mammalian degenerin 1 (MDEG1), brain sodium channel 1 (BNC1, BNaC1); ASIC2b: mammalian degenerin 2 (MDEG2); ASIC3: dorsal-root acid-sensing ion channel (DRASIC)

### Definition

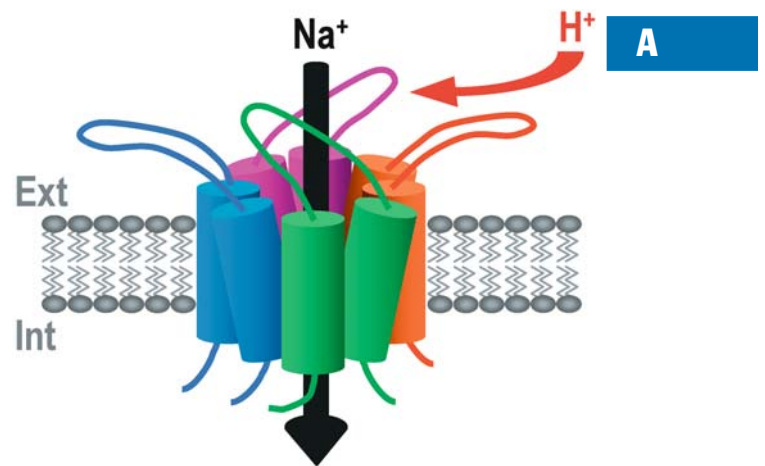
Acid-Sensing Ion Channels (ASICs) are membrane protein complexes that form depolarizing ion channels present on peripheral and/or central neurons. These channels are opened by extracellular protons. Their activation induces action potential triggering on neurons after an extracellular pH decrease to acidic values. Such tissue ▶ acidosis occurs during ▶ inflammation or ▶ ischemia, and is a major source of pain.

## Characteristics

ASICs are membrane protein complexes formed by four subunits among the six characterized isoforms (Fig. 1). The isoforms are coded by four different genes, two of them spliced in two variants: ASIC1a and ASIC1b, ASIC2a and ASIC2b, ASIC3 and ASIC4 (Chen et al. 1998; Garcia-Anoveros et al. 1997; Grunder et al. 2000; Lingueglia et al. 1997; Waldmann et al. 1997a; Waldmann et al. 1997b). Each subunit is 510 to 560 amino-acids long, with two transmembrane domains and a large extracellular loop, and belongs to the ENaC/DEG/ASIC family (Fig. 2) (Waldmann and Lazdunski 1998). The properties of the channels (i.e. activation and inactivation kinetics, pH sensitivity, ion selectivity) vary according to their subunit composition. For example, ASIC1a opens transiently for pH values from 7.2 and under with a  $\text{pH}_{50}$  of 6.2, and is sodium selective (Waldmann et al. 1997b) (Fig. 3). ASIC3 generates a biphasic current: the transient current is followed by a sustained current that lasts as long as the pH is low (Waldmann et al. 1997a) (Fig. 3). It has been associated with cardiac ischemic pain (Sutherland et al. 2001), and ASIC3-deficient mice display alterations in the modulation of high-intensity pain stimuli (Chen et al. 2002). Some isoforms have no activity when expressed alone: the isoform ASIC2b modifies the properties of the other subunits when present in heteromeric complexes (Lingueglia et al. 1997); the isoform ASIC4 has absolutely no activity, either alone or with other isoforms (Grunder et al. 2000). The association of ASIC3 and ASIC2b forms a channel with an ion selectivity and a pH sensitivity that is similar to those of an endogenous native current widely expressed on sensory neurons (Benson et al. 2002; Lingueglia et al. 1997), and that can participate in the sustained neuronal activity observed in lasting acidic pain states such as inflammatory and ischemic pain.

ASIC isoforms can be localized exclusively in sensory neurons and particularly nociceptors (ASIC1b and ASIC3), or in both sensory and central neurons (ASIC1a, ASIC2a and 2b). Their role as pH-sensors on sensory neurons occurs particularly in pathophysiological situations when tissue pH decreases. During inflammation, ischemia, around a fracture or a tumor, the extracellular pH can be lower than 6. This acidosis is directly responsible for pain feelings, and bicarbonate solutions used to be infused in arthritic joints to diminish pain.

ASIC currents are sensitive to amiloride but with relatively low affinities (around  $10\ \mu\text{M}$ ). ASIC1a is also potently inhibited by a peptidic toxin isolated from tarantula venom (Escoubas et al. 2000). It has been shown that NSAIDs directly block recombinant and native ASIC currents (Voilley et al. 2001). Ibuprofen and flurbiprofen inhibit ASIC1a-containing channels, and aspirin, salicylate and diclofenac inhibit ASIC3-containing chan-



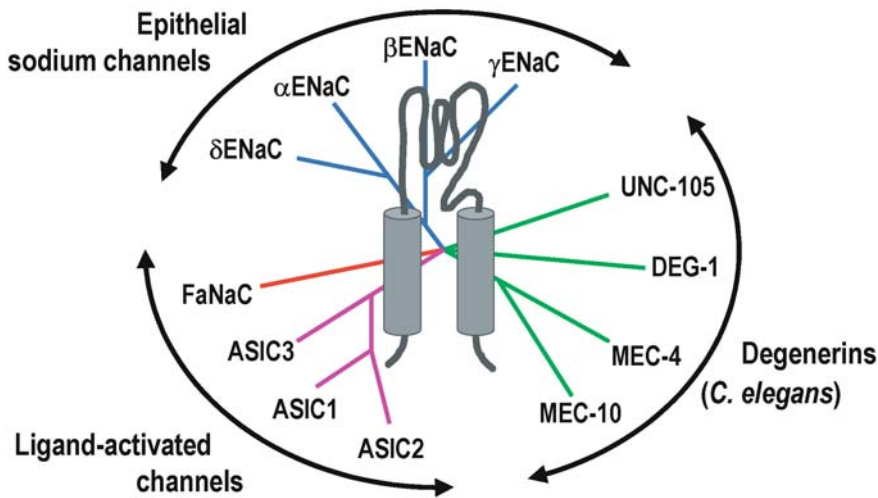
**Acid-Sensing Ion Channels, Figure 1** Model of the structure of the acid-sensing ion channel (ASIC) constituted by the assembling of 4 subunits in order to form a functional protein. The channel can be formed by 4 identical subunits (homomer) or by different subunits (heteromer). ASIC1a, 1b, 2a and 3 make functional channels as homomers or heteromers. ASIC2b and ASIC4 have no activity as homomers. However, ASIC2b modifies the current properties of the other subunits when present in a heteromer.

nels. The blocking action of these NSAIDs is direct on ASICs and is independent of cyclo-oxygenase inhibition (Voiley 2004). It prevents sensory neurons from triggering action potentials when submitted to acidic pH (Voilley et al. 2001). The effective concentrations are in the same range as the therapeutic doses necessary for analgesic effect. This pharmacology can explain some of the pain release observed with NSAIDs in experimental tissue acidosis and inflammation (Steen et al. 1996).

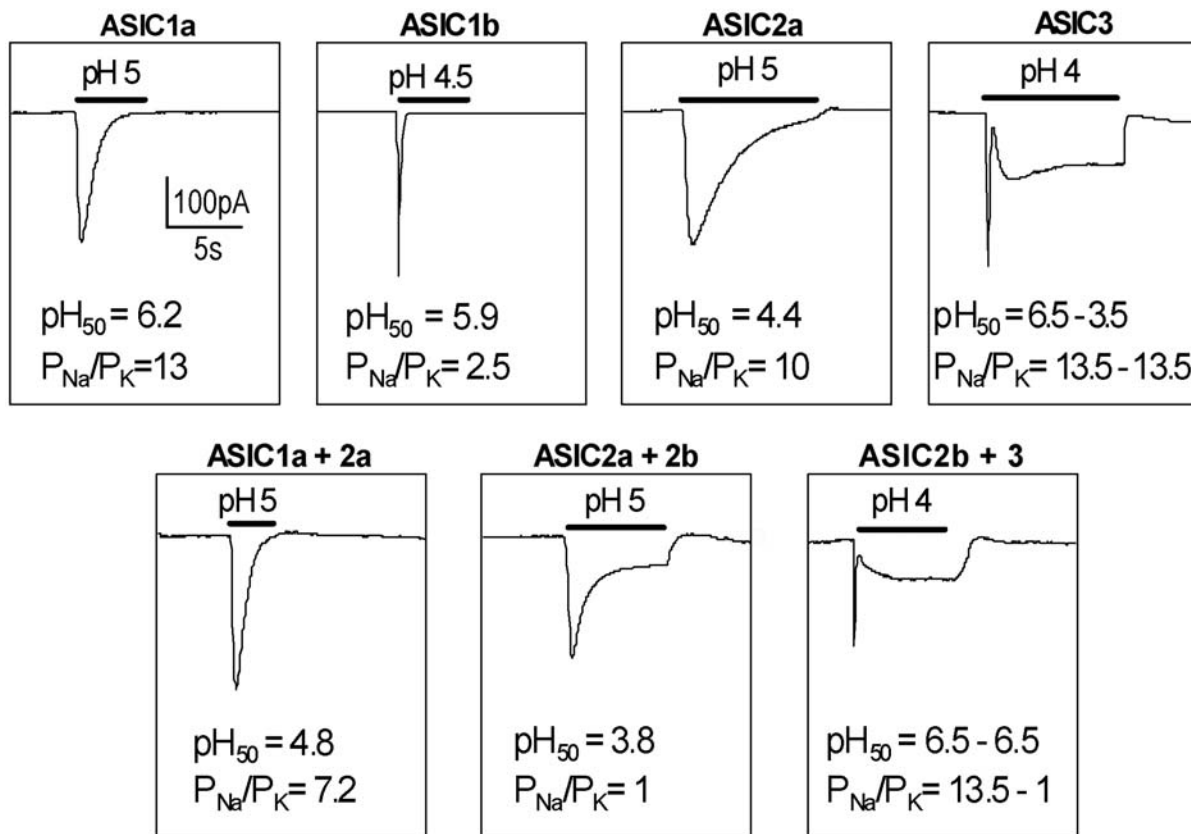
During inflammation, the mRNA levels of the ASICs are increased 6–15 fold, and this *in vivo* increase is completely abolished by treatments with glucocorticoids or NSAIDs (Voilley et al. 2001). This increase is correlated to a higher level of ASIC currents on sensory neurons, and leads to a greater excitability of these cells under pH variations (Mamet et al. 2002). Some pro-inflammatory mediators, and particularly NGF, are directly responsible for the observed increase in ASIC expression and activity. Indeed, NGF controls the expression and the transcriptional regulation of the ASIC3 encoding gene (Mamet et al. 2002; Mamet et al. 2003). Moreover, ASICs are also expressed *de novo* by a greater number of neurons, and participate in the recruiting of sensory fibers that become nociceptive neurons (Mamet et al. 2002; Voilley et al. 2001).

ASICs can also undergo post-translational regulations. Pro-inflammatory mediators like prostaglandins and bradykinin activate protein kinase cascades, which participate in sensory neuron sensitization. ASIC2a protein can be directly phosphorylated by protein kinase C (PKC). This phosphorylation, which is facilitated by an interaction with the PICK-1 protein, has a positive effect on the activity of the channel (Baron et al. 2002).

## The ENaC/DEG/ASIC family



**Acid-Sensing Ion Channels, Figure 2** Phylogenetic tree of the ENaC/DEG/ASIC family. The family is constituted mainly by the vertebrate epithelial sodium channel subunits (ENaC), the snail FMRF-amide activated sodium channel (FaNaC), the mammalian acid-sensing ion channels (ASICs) and the nematode *Caenorhabditis elegans* degenerins (MEC and DEG). The proteins share homologies in sequence and structure. Each member protein has a simple structure consisting of 2 transmembrane domains and a large extracellular loop.



**Acid-Sensing Ion Channels, Figure 3** Measurement by electrophysiology of the currents generated by ASIC cDNAs transfected in mammalian cells when an acidic stimulus is applied. ASIC1a, ASIC1b and ASIC2a display a transient activation. ASIC3 displays a transient current followed by a sustained phase. ASIC2b and ASIC4 do not bear any activity. In heteromers, ASIC2b confers a plateau phase with a cationic non-selective permeability. For each current type, the half-activation pH ( $pH_{50}$ ) and the sodium over potassium selectivity ( $P_{Na}/P_K$ ) are given; when the current is biphasic, both values (peak-plateau) are given.



ASICs present on sensory neurons are thus implicated in acidic pain sensing, neuron sensitization, and onset and maintenance of inflammatory hyperalgesia and allodynia.

## References

1. Baron A, Deval E, Salinas M et al. (2002) Protein Kinase C Stimulates the Acid-Sensing Ion Channel ASIC2a Via the PDZ Domain-Containing Protein PICK1. *J Biol Chem* 277:50463–50468
2. Benson CJ, Xie J, Wemmie JA et al. (2002) Heteromultimers of DEG/ENaC Subunits Form H<sup>+</sup>-Gated Channels in Mouse Sensory Neurons. *Proc Natl Acad Sci USA* 99:2338–2343
3. Chen CC, England S, Akopian AN et al. (1998) A Sensory Neuron-Specific, Proton-Gated Ion Channel. *Proc Natl Acad Sci USA* 95:10240–10245
4. Chen CC, Zimmer A, Sun WH et al. (2002) A Role for ASIC3 in the Modulation of High-Intensity Pain Stimuli. *Proc Natl Acad Sci USA* 99:8992–8997
5. Escoubas P, De Weille JR, Lecoq A et al. (2000) Isolation of a Tarantula Toxin Specific for a Class of Proton-Gated Na<sup>+</sup> Channels. *J Biol Chem* 275:25116–25121
6. Garcia-Anoveros J, Derfler B, Neville-Golden J et al. (1997) BNaC1 and BNaC2 Constitute a New Family of Human Neuronal Sodium Channels Related to Degenerins and Epithelial Sodium Channels. *Proc Natl Acad Sci USA* 94:1459–1464
7. Grunder S, Geissler HS, Bassler EL et al. (2000) A New Member of Acid-Sensing Ion Channels from Pituitary Gland. *Neuroreport* 11:1607–1611
8. Lingueglia E, Weille JR de, Bassilana F et al. (1997) A Modulatory Subunit of Acid Sensing Ion Channels in Brain and Dorsal Root Ganglion Cells. *J Biol Chem* 272:29778–29783
9. Mamet J, Baron A, Lazdunski M et al. (2002) Proinflammatory Mediators, Stimulators of Sensory Neuron Excitability Via the Expression of Acid-Sensing Ion Channels. *J Neurosci* 22:10662–10670
10. Mamet J, Lazdunski M, Voilley N (2003) How nerve growth factor drives physiological and inflammatory expressions of acid-sensing ion channel 3 in sensory neurons. *J Biol Chem* 278:48907–48913
11. Steen KH, Reeh PW, Kreysel HW (1996) Dose-Dependent Competitive Block by Topical Acetylsalicylic and Salicylic Acid of Low pH-Induced Cutaneous Pain. *Pain* 64:71–82
12. Sutherland SP, Benson CJ, Adelman JP et al. (2001) Acid-Sensing Ion Channel 3 Matches the Acid-Gated Current in Cardiac Ischemia-Sensing Neurons. *Proc Natl Acad Sci USA* 98:711–716
13. Voilley N (2004) Acid-sensing ion channels (ASICs): new targets for the analgesic effects of non-steroid anti-inflammatory drugs (NSAIDs). *Curr Drug Targets Inflamm Allergy* 3:71–79
14. Voilley N, de Weille J, Mamet J et al. (2001) Nonsteroid Anti-Inflammatory Drugs Inhibit Both the Activity and the Inflammation-Induced Expression of Acid-Sensing Ion Channels in Nociceptors. *J Neurosci* 21:8026–8033
15. Waldmann R, Bassilana F, de Weille J et al. (1997a) Molecular Cloning of a Non-Inactivating Proton-Gated Na<sup>+</sup> Channel Specific for Sensory Neurons. *J Biol Chem* 272:20975–20978
16. Waldmann R, Champigny G, Bassilana F et al. (1997b) A Proton-Gated Cation Channel Involved in Acid-Sensing. *Nature* 386:173–177
17. Waldmann R, Lazdunski M (1998) H(+)-Gated Cation Channels: Neuronal Acid Sensors in the NaC/DEG Family of Ion Channels. *Curr Opin Neurobiol* 8:418–424

## Acinar Cell Injury

- Visceral Pain Model, Pancreatic pain

## Acrylamide

An acrylic chemical used in industry and also in the laboratory (gel electrophoresis), with intoxication resulting in peripheral nerve disease (acrylamide neuropathy).

- Toxic Neuropathies

## Acting-Out

- Anger and Pain

## Action

A readiness to change stage, in which a person is taking concrete steps to change his or her behavior and/or environment.

- Motivational Aspects of Pain

## Action Potential

### Definition

Electrical potential actively generated by excitable cells. In nerve cells, the action potential is generated by a transient (less than 1 ms) increase in Na<sup>+</sup> and K<sup>+</sup> conductances, which brings the membrane potential to the equilibrium potential of Na<sup>+</sup>. Immediately afterwards, the membrane repolarizes and becomes more negative than before, generating an afterhyperpolarization. In unmyelinated axons, the action potential propagates along the length of the axon through local depolarization of each neighboring patch of membrane. In myelinated axons, action potential is generated only in the Ranvier nodes and jumps rapidly between nodes increasing markedly the propagation speed.

- Demyelination
- Molecular Contributions to the Mechanism of Central Pain
- Nociceptor Generator Potential

## Action Potential Conduction of C-Fibres

- Mechano-Insensitive C-Fibres, Biophysics

## Action Potential in Different Nociceptor Populations

- Nociceptors, Action Potentials and Post-Firing Excitability Changes

## Actiq®

### Definition

Actiq® is a transmucosal fentanyl system that produces more significant pain relief at 15, 30, 45, and 60 minutes following administration (over a recommended 15 minutes) in opioid tolerant cancer patients.

- ▶ [Postoperative Pain, Fentanyl](#)

## Activa®

### Definition

The Brand name (Medtronic, Minneapolis, USA) of a system of electrodes, connectors, and implantable pulse generators for the treatment of movement disorders, pain and epilepsy, by stimulation of the basal ganglia, mid-brain and thalamus.

- ▶ [Pain Treatment, Spinal Cord Stimulation](#)

## Activation Threshold

The current level needed to initiate an action potential in a nerve fiber.

- ▶ [Pain in Humans, Electrical Stimulation \(Skin, Muscle and Viscera\)](#)

## Activation/Reassurance

GEOFFREY HARDING  
Sandgate, QLD, Australia  
geoffharding@uq.net.au

### Synonyms

Reassurance and Activation

### Definition

Activation and reassurance are interventions that have been used for the treatment of acute low back pain. They involve having the practitioner gain the patient's confidence that they do not have a serious cause of pain, and that remaining active, or restoring activity, is beneficial for their recovery.

### Characteristics

Systematic reviews have shown that bed rest is neither appropriate nor effective for acute low back pain (Koes and van den Hoogen 1994; Waddell et al. 1997). Bed rest offers no therapeutic advantages, and is less effective than alternative treatments in terms of rate of recovery, relief of pain, return to daily activities, and time lost from work. By inference, these results support keeping patients active.

Nevertheless, patients may harbour fears or misconceptions about their pain, which may inhibit their resumption of activities. Explanation and reassurance are required to overcome these fears.

### Evidence

The study of Indahl et al. (1995) constitutes a landmark in the management of non-specific musculoskeletal conditions. It was the first rigorously controlled trial to demonstrate long-term efficacy for an intervention based on reassurance and activation, with no passive interventions. Patients were provided with a biological model of their painful condition. They were assured that light activity would not further injure the structures that were responsible for their pain, and was more likely to enhance the repair process. The link between emotions and musculoskeletal pain was explained as a muscular response. Patients were told that increased tension in the muscles for any reason would increase the pain and add to the problem. It was explained how long-standing pain and associated fear could create vicious cycles of muscular activity that caused pain to persist. It was strongly emphasised that the worst thing they could do would be to act in a guarded, over-cautious way.

Regardless of clinical and radiographic findings, all patients were told to mobilise the affected parts by light, non-specific exercise, within the limits of intense pain exacerbation. No fixed exercise goals were set, but patients were given guidelines and encouraged to set their own goals. Great emphasis was placed on the need to overcome fear about the condition and associated sickness behaviour. Misunderstandings about musculoskeletal pain were dealt with.

The principal recommendation was to undertake light, normal activities, moving as flexibly as possible. Activities involving static work for the regional muscles were discouraged. No restrictions were placed on lifting, but twisting when bending was to be avoided. Acute episodes of pain in the affected region were to be treated as acute muscles spasm, with stretching and further light activity. Instruction was reinforced at three months and at one year.

The actively treated patients exhibited a clinically and statistically significant difference from the control group with respect to decrease in sickness-leave. At 200 days, 60% in the control group, but only 30% in the intervention group, were still on sick-leave. A five-year follow-



up demonstrated that these differences were maintained (Indahl et al. 1998). Only 19% of the intervention group were still on sick-leave at five years, compared with 34% in the control group.

The results of Indahl et al. (1995) were corroborated by another study (McGuirk et al. 2001). The intervention was based on the principles set by Indahl, and focused on identifying the patient's fears, providing explanation, motivating patients to resume activities, and helping them maintain those activities. This approach achieved greater reductions in pain than did usual care, with fewer patients progressing to chronic pain, less use of other health care and greater patient satisfaction.

### Principles

Providing reassurance and motivating patients into activity are skills that have to be learnt. It is not enough to simply give information in the form of test results, diagnoses, prognoses or proposed treatments. The manner of the consultation and the doctor's ability to empathize with the anxious patient is a pre-requisite to any "motivational interview" (McDonald and Daly 2001). In order to develop empathy, a long consultation may be required. However, reassurance can nevertheless be achieved through a systematic series of shorter consultations (Roberts et al. 2002).

Interviewing techniques can be adapted to achieve an "educational outcome" (Arborelius and Bremberg 1994). The process of consulting or interviewing in a motivational way has been detailed (Kurtz et al. 2005), and is quite different from a normal medical interview that is geared towards collecting and collating information in as short a time as possible. Naturally, the educational (or motivational) interview demands more time from the practitioner. However, it is more effective in terms of changing behaviour towards self-motivation (Miller and Rollnick 2002).

The doctor must establish an initial rapport with the patient. In general, one should greet each patient as if they were a friend of a friend, not a complete stranger. The doctor should not give the impression of rushing.

The concerns with which patients present can be encapsulated by Watson's quartet (Watson 1999): "I hurt", "I can't move", "I can't work", and "I'm scared". The latter can be expanded to encompass: what has happened?; why has it happened?; why me?; why now?; what would happen if nothing were done about it?; what should I do about it, and who should I consult for further help?

It is useful to ask patients what they think has caused their problems – the answers given to this question are often surprising, and can sometimes hold the key to guiding patients through a complex biopsychosocial landscape. There are no routine responses to these issues and questions. The practitioner must be prepared to respond in an informed, convincing, and caring manner. One example of an explanation might be:

"Well, we don't actually know why you have developed this but there are many reasons, and some of them come down to just bad luck. It might be related to an event or an injury, but these are often hard to track down. At the end of the day I can say that there doesn't seem to be anything that you could have avoided, and the problem is one that is not serious – it is painful, but not harmful. It might happen again and it might not.

There are lots of people who will tell you that it's "this" or "that" which has caused it, but frankly this is speculation in most cases. Some people will tell you that it's because you have weak muscles, but you know that the fittest athletes in the world get injured from time to time, and there are many people out of condition who never get injuries. Others might say that it is your posture. But you have presumably not altered your posture in many years and you have never had the problem before. So trying to fix your posture in a major way might be pointless at this stage. I can say that there is no disease process going on and there are no broken bones or things that the surgeons have to fix. It's not something that you will pass onto your children and it will not shorten your lifespan. It might be that you will have to look at the type of work you do, but we will get more of an idea about that as time goes on."

This sort of explanation takes an enormous amount of time; but short-changing the patient will result in a less-than-effective consultation. The paradox of appearing to have shortage of time will result in no change accomplished, whereas appearing to have "all day" often results in a change occurring in a matter of minutes (Miller and Rollnick 2002).

As the patient raises issues, their narrative should be expanded, with the use of phrases such as: "tell me more about that". Terms and expressions used by the patient should be checked for meaning, so that the doctor understands what the patient is communicating.

Developing rapport relies on the appropriate use of eye contact, expressing concern and understanding, and dealing sensitively with the patient during the physical examination.

A thorough examination is a necessary pre-requisite for gaining the satisfaction (and thus the confidence) of the patient (McCracken et al. 2002). The reasons for examination procedures should be explained.

The practitioner can reassure patients by developing an "educational enterprise" (Daltroy 1993). Printed material is an effective reinforcer of tuition (see ► [Patient Education](#)). Models and pictures serve to explain concepts about normal structure and pathology. The language used should be appropriate to the patient and understood by them. Alarming and distressing terms should be avoided.

When recommending exercises, those exercises should be demonstrated, and the patient's ability to reproduce them should be observed and confirmed. The same confirmation should be obtained when advice is given about

how the patient will undertake their desired activities. Checking their understanding is what converts the consultation from one in which instructions are simply issued, to one in which the patient is confident about that instruction.

## References

1. Arborelius E, Bremberg S (1994) Prevention in Practice. How do General Practitioners Discuss Life-Style Issues with their Patients? *Patient Educ Couns* 23:23–31
2. Daltroy LH (1993) Consultations as Educational Experiences Doctor-Patient Communication in Rheumatological Disorders. *Baillieres Clin Rheumatol* 7:221–239
3. Indahl A, Velund L, Reikeraas O (1995) Good Prognosis for Low Back Pain when Left Untampered: A Randomized Clinical Trial. *Spine* 20:473–477
4. Indahl A, Haldorsen EH, Holm S et al. (1998) Five-Year Follow-Up Study of a Controlled Clinical Trial using Light Mobilization and an Informative Approach to Low Back Pain. *Spine* 23:2625–2630
5. Koes BW, Hoogen HMM van den (1994) Efficacy of Bed Rest and Orthoses of Low Back Pain. A Review of Randomized Clinical Trials. *Eur J Phys Med Rehabil* 4:96–99
6. Kurtz SM, Silverman JD, Benson J et al. (2005) Marrying content and process in clinical method teaching: enhancing the Calgary-Cambridge guides. *Acad Med* 78(8):802–9
7. McCracken LM, Evon D, Karapas ET (2002) Satisfaction with Treatment for Chronic Pain in a Specialty Service: Preliminary Prospective Results. *Eur J Pain* 6:387–393
8. McDonald IG, Daly J (2001) On Patient Judgement. *Intern Med J* 31:184–187
9. McGuirk B, King W, Govind J et al. (2001) The Safety, Efficacy, and Cost-Effectiveness of Evidence-Based Guidelines for the Management of Acute Low Back Pain in Primary Care. *Spine* 26:2615–2622
10. Miller WR, Rollnick S (2002) *Motivational Interviewing: Preparing People for Change*, 2<sup>nd</sup> edn. Guilford Press, New York
11. Roberts L, Little P, Chapman J et al. (2002) Practitioner-Supported Leaflets may Change Back Pain Behaviour. *Spine* 27:1821–1828
12. Waddell G, Feder G, Lewis M (1997) Systematic Reviews of Bed Rest and Advice to Stay Active for Acute Low Back Pain. *Brit J Gen Pract* 47:647–652
13. Watson P (1999) The MSM Quartet. *Australasian Musculoskeletal Medicine* 4:8–9

## Active

This refers to movement of a body part using power generated from one's own muscle action.

- ▶ [Cancer Pain Management, Orthopedic Surgery](#)

## Active Inhibition

### Definition

Active inhibition implies that nociceptive processing during the interphase of the formalin test is suppressed by specific inhibitory mechanisms, as opposed to simply reflecting the absence of excitatory input.

- ▶ [Formalin Test](#)

## Active Locus

### Synonyms

EPN locus

### Definition

The motor component of a Myofascial Trigger Point is the active locus, or endplate-noisy locus (EPN locus). From this locus, spontaneous electrical activity, known as endplate noise (EPN), can be recorded. It is related to taut band formation in skeletal muscle fibers.

- ▶ [Dry Needling](#)

## Active Myofascial Trigger Point

### Definition

An active trigger point is a myofascial trigger point that is causing, or contributing to, a clinical pain complaint. When it is compressed, the individual recognizes the induced referred pain as familiar and recently experienced.

- ▶ [Dry Needling](#)
- ▶ [Myofascial Trigger Points](#)

## Activities of Daily Living

### Definition

Activity: The execution of a task or action by an individual. Activities of daily living refers to normal physical activity such as getting out of bed, walking (initially with support), sitting, and personal toileting.

- ▶ [Physical Medicine and Rehabilitation, Team-Oriented Approach](#)
- ▶ [Postoperative Pain, Importance of Mobilisation](#)

## Activity

### Definition

Activity is described as the execution of a task or action by an individual. It represents the individual perspective of functioning. Difficulties an individual may have in executing activities are activity limitations.

- ▶ [Disability and Impairment Definitions](#)

## Activity Limitations

### Definition

Difficulties an individual may have in executing activities.

- ▶ Impairment, Pain-Related
- ▶ Physical Medicine and Rehabilitation, Team-Oriented Approach

## Activity Measurement

### Definition

A measure of personal activities of daily living (e.g. showering, dressing, toileting, feeding), independent activities of daily living (e.g. cleaning, cooking, shopping, banking), and discretionary activities of daily living (e.g. driving, visiting, leisure activities).

- ▶ Pain Assessment in the Elderly

## Activity Mobilization

### Definition

Strategies aimed at maximizing a chronic pain patient's participation in activities of daily living.

- ▶ Catastrophizing

## Activity-Dependent Plasticity

This is an alteration in neuronal structure or function due to activation of the neurons.

- ▶ Spinothalamic Tract Neurons, Role of Nitric Oxide

## Acupuncture

### Definition

A system of healing that is part of traditional Chinese medicine. It consists of the insertion of thin solid needles into specific points, usually into muscles, on the body that lie along channels or meridians, in order to treat different symptoms.

- ▶ Acupuncture Mechanisms
- ▶ Alternative Medicine in Neuropathic Pain
- ▶ Acupuncture Efficacy

## Acupuncture Efficacy

EDZARD ERNST

Complementary Medicine, Peninsula Medical School, Universities of Exeter and Plymouth, Exeter, UK  
edzard.ernst@pms.ac.uk

### Definition

▶ **Acupuncture** can be defined as the insertion of needles into the skin and underlying tissues at specific sites (acupuncture points) for therapeutic or preventative purposes (Ernst et al. 2001). Sometimes other forms of point stimulation are used, electrical current (electroacupuncture), pressure (acupressure), heat (moxibustion) or laser light (laser acupuncture). Acupuncture is part of the ancient Chinese medical tradition. In recent years, a new style (Western acupuncture) has emerged, which no longer adheres to the Taoist philosophies underpinning Chinese acupuncture but seeks explanations for its mode of action from modern concepts of neurophysiology and other branches of medical science.

### Characteristics

The evidence for or against the efficacy (or effectiveness) of acupuncture is highly heterogeneous and often contradictory. Thus single trials, even of good quality, may not provide a representative picture of the current evidence. The following section is therefore exclusively based on systematic reviews of controlled clinical trials, i.e. on the totality of the available trial data rather than on a possibly biased selection of it. Whenever more than one such publication is available, the most up to date one was chosen.

### Any Chronic Pain

One landmark paper summarised the results of 51 randomised clinical trials testing the efficacy of acupuncture as a treatment of all forms of chronic pain (Ezzo et al. 2000). Any type of acupuncture was considered. The studies were rated for methodological rigour using the Jadad score (Jadad et al. 1996). The results revealed a significant association between lower quality studies and positive outcomes. There was no clear evidence to demonstrate that acupuncture is superior to sham acupuncture or to standard treatment. Good evidence emerged that it is better than waiting list (i.e. no acupuncture). The quality of the review was rated "good" by independent assessors (Tait et al. 2002). Depending on one's viewpoint, one can interpret these findings differently. Acupuncture 'fans' would claim that they demonstrate acupuncture to be as good as standard treatments, while sceptics would point out that the data suggest that acupuncture has no more than a placebo effect. Pooling the data for all types of chronic pain is perhaps an approach too insensitive to tease out effects on more defined types of pain. Other

systematic reviews have therefore focussed on more specific targets.

### Dental Pain

Sixteen controlled trials were available, 11 of which were randomised (Ernst and Pittler 1998). All studies of manual or electroacupuncture were included. Their methodological quality was assessed using the Jadad score (Jadad et al. 1996). The collective evidence suggested that acupuncture can alleviate dental pain, even when compared against sham acupuncture. The strength of the conclusion was, however, limited through the often low quality of the primary data. The quality of the review was rated by independent assessors as “satisfactory” (Tait et al. 2002). Since effective and safe methods for relieving dental pain exist, the clinical relevance of acupuncture for dental pain may be limited.

### Headache

A Cochrane Review summarised the evidence from 26 randomised or quasi-randomised trials of any type of acupuncture (Linde et al. 2001). Their methodological quality was assessed using the Jadad score (Jadad et al. 1996). The overall results support the role of acupuncture for recurrent headaches but not for migraine or other types of headache. The conclusions were limited through the often low methodological quality of the primary studies. The review was independently rated to be of good quality (Tait et al. 2002).

### Neck Pain

Fourteen randomised clinical trials of all types of acupuncture were included in a systematic review (White and Ernst 1999). Their rigour was evaluated using the Jadad score (Jadad et al. 1996) and found to be mixed. About half of the trials generated a positive result while the other half could not confirm such a finding. Thus the efficacy of acupuncture was not deemed to be established. The quality of the review was rated “good” (Tait et al. 2002).

### Back Pain

A Cochrane Review assessed the effectiveness of manual acupuncture or electroacupuncture for non-specific back pain (van Tulder et al. 2001). Eleven randomised trials were included and evaluated according to the Cochrane Back Review Group criteria. The results were mixed, but overall acupuncture was not found to be of proven effectiveness, not least because the quality of the primary studies was found to be wanting. This review was rated as of good quality (Tait et al. 2002). Other systematic reviews of these data have drawn different conclusions, e.g. (Ernst and White 1998). An updated review on the subject including many new studies is now being conducted.

### Fibromyalgia

A systematic review included 4 cohort studies and 3 randomised clinical trials of any type of acupuncture (Berman et al. 1999). Their methodological quality as assessed using the Jadad score (Jadad et al. 1996) was mixed, but in some cases good. The notion that acupuncture alleviates the pain of fibromyalgia patients was mainly based on one high quality study and thus not fully convincing. The quality of the review was rated as “satisfactory” (Tait et al. 2002).

### Osteoarthritis

A systematic review of controlled acupuncture trials for osteoarthritis of any joint included 13 studies (Ernst 1997). Their methodological quality was evaluated using the Jadad score (Jadad et al. 1996) and found to be highly variable. The methodologically sound studies tended to yield negative results. Sham-acupuncture turned out to be as effective as real acupuncture in reducing pain. Thus it was concluded that acupuncture has a powerful placebo effect. Whether or not it generates specific therapeutic effects was deemed uncertain.

### Conclusion

These systematic reviews collectively provide tantalising but not convincing evidence for acupuncture’s pain reducing effects. The evidence is limited primarily by the paucity of studies and their often low methodological quality. The scarcity of research funds in this area is likely to perpetuate these problems. Since acupuncture is a relatively safe therapy (Ernst and White 2001), it deserves to be investigated in more detail and with more scientific rigour, e.g. using the novel sham needle devices (Park et al. 2002; Streitberger and Kleinhenz 1998) that have recently become available.

#### ► Acupuncture Mechanisms

### References

1. Berman B, Ezzo J, Hadhazy V et al. (1999) Is acupuncture effective in the treatment of fibromyalgia. *J Fam Pract* 48:213–218
2. Ernst E (1997) Acupuncture as a symptomatic treatment of osteoarthritis. *Scand J Rheumatol* 26:444–447
3. Ernst E, Pittler MH (1998) The effectiveness of acupuncture in treating acute dental pain: a systematic review. *Br Dent J* 184:443–447
4. Ernst E, White AR (1998) Acupuncture for back pain. A meta-analysis of randomized controlled trials. *Arch Intern Med* 158:2235–2241
5. Ernst E, White AR (2001) Prospective studies of the safety of acupuncture: a systematic review. *Am J Med* 110:481–485
6. Ernst E, Pittler MH, Stevinson C et al. (2001) The desktop guide to complementary and alternative medicine. Mosby, Edinburgh
7. Ezzo J et al. (2000) Is acupuncture effective for the treatment of chronic pain? A systematic review. *Pain* 86:217–225
8. Jadad AR et al. (1996) Assessing the quality of reports of randomized clinical trials – is blinding necessary? *Contr Clin Trials* 1996 17:1–12
9. Linde K et al. (2001) Acupuncture for idiopathic headache (Cochrane review). In: *The Cochrane Library*, Issue 2. Update Software, Oxford, pp 1–46



10. Park J, White A, Stevinson C et al. (2002) Validating a new non-penetrating sham acupuncture device: two randomised controlled trials. *Acupunct Med* 20:168–174
11. Streitberger K, Kleinhenz J (1998) Introducing a placebo needle into acupuncture research. *Lancet* 352:364–365
12. Tait PL, Brooks L, Harstall C (2002) Acupuncture: evidence from systematic reviews and meta-analyses. Alberta Heritage Foundation for Medical Research. Edmonton, Canada
13. van Tulder MW, Cherkin DC, Berman B et al. (2001) Acupuncture for low back pain. Available: <http://www.cochranelibrary.com>
14. White AR, Ernst E (1999) A systematic review of randomized controlled trials of acupuncture for neck pain. *Rheumatol* 38:143–147

## Acupuncture Mechanisms

CHRISTER P.O. CARLSSON

Rehabilitation Department, Lunds University Hospital, Lund, Sweden  
akusy@swipnet.se

### Definition

► **Acupuncture** is a traditional Chinese therapeutic method for the treatment of different symptoms including pain. Thin, solid needles are inserted into proposed specific points on the body, called acupuncture points. The needles are inserted through the skin to varying depths, often into the underlying musculature. The needles are often twirled slowly for a short time, 30–60 s and may be left in place for a varying time, 2–30 min. Many modifications of the method have been described and the concept of acupuncture is not well defined. The method of applying electrical stimulation *via* acupuncture needles, ► **electro-acupuncture (EA)**, was introduced in 1958.

The treatments are usually applied in series of 8–12 sessions, each treatment lasting 20–30 min and separated by ½–2 weeks. Needling is often performed with some needles near the source of pain (called local points), and some other needles on the forearms and lower legs (called distal points).

### Common Clinical Observations Concerning Therapeutic Acupuncture for Chronic Pain

After the first few acupuncture treatments there may be some hours of pain relief or nothing at all happens. Often pain relief starts 1–2 days after treatment. Some patients even get worse and have a temporary aggravation of their symptoms for some days before they start to improve. This aggravation can be seen for 2–3 days or even for a week. For those responding to acupuncture, usually both the degree and duration of the pain relief increase after each treatment, a clinical observation that has gained some experimental support (Price et al. 1984).

### Acupuncture Is a Form of Sensory Afferent Stimulation

As acupuncture needles are inserted into the tissue and mostly down to the muscular layer, they excite receptors and nerve fibres, i.e. the needles mechanically activate somatic afferents. Other forms of afferent sensory stimulation are trigger point needling or dry needling and transcutaneous electrical nerve stimulation (► **TENS**) as well as vibration. These methods may share some common features concerning mechanisms of action. A special method is painful sensory stimulation, which has been used through the centuries, an idea that a short but very painful stimulus would reduce pain. These methods have been called “► **counter irritation**” or “► **hyperstimulation analgesia**” and acupuncture is sometimes regarded as such. However, it is important to know that most patients who are treated with acupuncture describe the procedure as relaxing and pleasant but not painful.

The term ► **acupuncture analgesia (AA)** was used for electro-acupuncture (EA) used to get powerful and immediate pain relief during surgery, first used in China in 1958 but not described until 1973 (Foreign Languages Press, Beijing 1973). A success rate of 90% was claimed among those selected for the method. However, it soon became clear that only a minority of patients could develop so strong an analgesia as to tolerate surgery. Less than 10% of the patients showed a satisfactory response in acupuncture trials (Bonica 1974). Among these 10%, only one third had acceptable analgesia according to Western standards. Even so, patient selection and psychological preparations were crucial and often combinations with local anaesthetics or other drugs were used.

Felix Mann (1974) reported 100 observations on patients receiving AA. In only 10% of the experiments was the resulting analgesia considered adequate for surgery. He emphasised, that in ► **therapeutic acupuncture (TA)** to treat different symptoms, a mild stimulus was all that was usually required. This was in contrast to that needed to obtain AA where the stimulation had to be continued for at least 20 min and had to be painful to the maximum level the patient could tolerate. He concluded that usually, the stimulus required to achieve AA was so intense that the resulting pain would be unacceptable to most Western patients. For the main differences between AA and TA, see Table 1.

### Characteristics

The proposed AA effect on surgical pain initiated physiological research where the goal was to find an explanation for immediate and very strong analgesia. Consequently, physiological research during the last 25–35 years has concentrated on explaining a phenomenon that may only exist in about 3–10% of the population and that may have little in common with therapeutic acupuncture.

**Acupuncture Mechanisms, Table 1** Differences between acupuncture analgesia and therapeutic acupuncture

Acupuncture Analgesia	Therapeutic Acupuncture
Immediate and strong hypoalgesia is the goal.	Immediate hypoalgesia is not the goal.
Fast onset (minutes)	Slowly induced symptom relief after a number of treatments. The effects gradually increase after additional treatments.
Short-term = minutes	Long-term = days-weeks-months
The stimulation is felt very strongly. It is often painful and uncomfortable.	The stimulation is felt rather weakly. It is rarely painful and often relaxing.
Used most often in different physiological experiments and for surgical hypoalgesia. Often electro-acupuncture and pain threshold experiments on humans or animals.	Used for clinical pain relief and other symptom relief. Most often manual acupuncture but can also be electro-acupuncture.

The experimental acupuncture research has concentrated on very short-term effects (after a single treatment of EA) where pain thresholds and / or central neurochemicals (mostly endorphins) have been measured. The research groups have mostly used conscious animals where no special care has been taken to rule out stress-induced analgesia (► SIA) (Akil et al. 1984). In some studies it is explicitly noted that the animals showing obvious signs of discomfort during EA also had pain threshold elevations, but that this was not the case for those who were not distressed (e.g. Bossut and Mayer 1991; Galeano et al. 1979; Wang et al. 1992).

#### Conclusions from the Existing Acupuncture Experimental Data

Most acupuncture research on animals has been performed using (strong) EA, even though human therapeutic acupuncture is most often performed with gentle manual acupuncture. Much of the animal research on acupuncture probably only shows the consequences of nociceptive stimulation and the activation of ► SIA and ► DNIC. When manual acupuncture has been used in animal research, no pain threshold elevation has been described.

Pain threshold elevation in humans only seems to occur if the stimulation is painful and does not correspond at all with the clinical outcome after therapeutic acupuncture. Endorphins are partially involved in acupuncture analgesia in humans. Thus, AA in humans is believed to rely both on opioid and non-opioid mechanisms. However, whether endorphins are involved both locally (in the tissues) and within the central nervous system is not known (Price and Mayer 1995). Thus, the hitherto performed experimental acupuncture mechanism research is really only valid for acupuncture analgesia and not for therapeutic acupuncture.

#### Acupuncture Mechanisms – the Standard Neurophysiological Model

Several physiological mechanisms have been suggested to account for the pain relieving effect of acupuncture. Spinal and supraspinal endorphin release has been proposed, as has the activation of DNIC (diffuse noxious inhibitory control) through bulbospinal paths. The involvement of neurochemicals like serotonin, noradrenalin and different endorphins as well as hormones like ACTH and cortisone has been studied in detail. Acupuncture physiology is often summarised in the following manner (Han 1987; Pomeranz 2000): For acupuncture needles inserted within the segment of pain:

- Spinal gate-control mechanism (involving enkephalin and dynorphin)

#### For extrasegmental acupuncture:

- Activation of midbrain structures (PAG) and the descending pain relieving system (involving endorphins, serotonin and noradrenaline).
- Diffuse noxious inhibitory control (DNIC) is sometimes claimed to be involved.
- Activation of the HPA-axis (hypothalamic-pituitary-adrenal) with increased levels (in the blood) of  $\beta$ -endorphin and ACTH / cortisone.

#### Problems with the Standard Neurophysiological Model to Explain Clinical Observations

The model can only explain very short-term pain relief after each stimulation period. The gate-control mechanism is only active during stimulation and the descending inhibitory system for up to perhaps 8 h.

The model cannot explain why, in some patients, pain relief starts some days after the treatment whether the patient is first worse or not. The gate-control does not start some days after the stimulation and that does not hold for the descending pain inhibitory systems either. The model cannot explain why there seems to be more prolonged pain relief after additional treatments and why there seems to be long-term pain relief after a course of 8–12 treatments. Probably, the standard neurophysiological model can explain AA, but even so it should be realised that AA is mostly painful stimulation – and, if the gate-control mechanisms are implicated, then the stimulation should be non-painful. For a summary of probable acupuncture mechanisms for both TA and AA see Table 2 below.

#### Acupuncture Efficacy

In chronic pain patients the improvements are often incomplete with symptom relief for weeks or months. From the first Western descriptions of acupuncture, efficacy was claimed for a lot of different conditions, but mainly for musculoskeletal pain, headaches and nausea. Depending on the technique and the criteria employed,

Acupuncture Mechanisms, Table 2

Summary of probable mechanisms for acupuncture	Therapeutic acupuncture: mostly gentle manual Usual clinical use	Acupuncture Analgesia: high intensity electro-acupuncture Physiological experiments and surgical analgesia
Local events in the tissue (Local needles)	Axon reflexes in the tissue around needles and deeper through dichotomising fibres giving increased circulation and neuropeptide release. These can act as trophic factors (e.g. regeneration of glands). They can also have anti-inflammatory effects (like low dose of CGRP). Perhaps also release of local endorphins to local receptors.	Tissue trauma around the needles giving rise to more local pain (CGRP in higher doses has pro-inflammatory actions). Increased local pain for some days.
Segmental mechanisms and somato-autonomous reflexes (Regional needles)	Gate mechanism and perhaps long term depression (LTD). Sympathetic inhibition with increased segmental circulation.	(Gate mechanism) and perhaps LTD. Sympathetic stimulation with decreased segmental circulation.
Central mechanisms (Distal, regional and some local needles)	Sympathetic inhibition. Decreased levels of stress hormones, adrenaline and cortisone in plasma. Probably oxytocin is involved and induces long-term pain threshold elevations and anti-stress effects.	Sympathetic stimulation. Increased levels of the stress hormones, ACTH, adrenaline and cortisone in plasma. DNIC is activated. Descending pain inhibition from PAG with endorphins, serotonin and noradrenaline.

20–40% of patients in pain clinics have been said to benefit from acupuncture. In primary care or private clinics, where experienced practitioners choose who and what they treat, 60–70% of the patients have been reported to benefit. Because of inherent study design problems, especially with double blinding and the use of a proper placebo, the meta-analyses and systematic reviews are very difficult to interpret. However, from clinical research, in which the author has been involved, the conclusion has been drawn that clinically relevant long-term (> 6 months) pain relief from acupuncture can be seen in a proportion of patients with chronic nociceptive pain (Carlsson and Sjölund 1994; Carlsson and Sjölund 2001). For a full reference list to all sections of this chapter see (Carlsson 2002).

## References

- Akil H, Watson SJ, Young E et al. (1984) Endogenous opioids: Biology and function. *Ann Rev Neurosci* 7:223–255
- Bonica JJ (1974) Acupuncture anesthesia in the Peoples Republic of China. Implications for American medicine. *JAMA* 229:1317–1325
- Bossut DF, Mayer DJ (1991) Electroacupuncture analgesia in rats: naltrexone antagonism is dependent on previous exposure. *Brain Res* 549:47–51
- Carlsson C (2002) Acupuncture mechanisms for clinically relevant long-term effects –reconsideration and a hypothesis. *Acupunct Med* 20:82–99
- Carlsson CPO, Sjölund B (1994) Acupuncture and subtypes of chronic pain: assessment of long-term results. *Clin J Pain* 10:290–295
- Carlsson C, Sjölund B (2001) Acupuncture for Chronic Low Back Pain: A Randomized Placebo-Controlled Study With Long-Term Follow-Up. *Clin J Pain* 17:296–305
- Foreign Languages Press (1973) *Acupuncture anaesthesia*. Foreign Languages Press, Beijing
- Galeano C, Leung CY, Robitaille R et al. (1979) Acupuncture analgesia in rabbits. *Pain* 6:71–81
- Han JS (1987) The neurochemical basis of pain relief by acupuncture. A collection of Papers 1973–1987, Beijing
- Mann F (1974) Acupuncture analgesia. Report of 100 experiments. *Br J Anaesth* 46:361–364
- Pomeranz B (2000) *Acupuncture Analgesia –Basic Research*. In: Stux G, Hammerschlag R (eds) *Clinical Acupuncture*, Scientific Basis. Springer, Berlin, pp 1–28
- Price DD, Mayer DJ (1995) Evidence for endogenous opiate analgesic mechanisms triggered by somatosensory stimulation (including acupuncture) in humans. *Pain Forum* 4:40–43
- Price DD, Rafii A, Watkins LR et al. (1984) A psychophysical analysis of acupuncture analgesia. *Pain* 19:27–42
- Wang JQ, Mao L, Han JS (1992) Comparison of the antinociceptive effects induced by electroacupuncture and transcutaneous electrical nerve stimulation in the rat. *Intern J Neurosci* 65:117–129

## Acupuncture-Like TENS

### Definition

The delivery of TENS to generate activity in small diameter Group III muscle afferents, leading to the release of opioid peptides in a similar manner to that suggested for acupuncture. TENS is administered using low frequency train (1–4 Hz) bursts (5–8 pulses at 100Hz) at a high, but non-painful, intensity to stimulate selectively large diameter muscle efferents. This results in a 'strong but comfortable' muscle twitch that elicits Group III muscle afferent activity.

- ▶ [Transcutaneous Electrical Nerve Stimulation Outcomes](#)
- ▶ [Transcutaneous Electrical Nerve Stimulation \(TENS\) in Treatment of Muscle Pain](#)

## Acute Backache

- ▶ [Lower Back Pain, Acute](#)

## Acute Experimental Monoarthritis

- ▶ Arthritis Model, Kaolin-Carrageenan Induced Arthritis (Knee)

## Acute Experimental Synovitis

- ▶ Arthritis Model, Kaolin-Carrageenan Induced Arthritis (Knee)

## Acute Inflammatory Demyelinating Polyneuropathy

- ▶ Guillain-Barré Syndrome

## Acute Ischemia Test

- ▶ Tourniquet Test

## Acute Knee Joint Inflammation

- ▶ Arthritis Model, Kaolin-Carrageenan Induced Arthritis (Knee)

## Acute Lumbago

- ▶ Lower Back Pain, Acute

## Acute Pain in Children, Post-Operative

JOLENE D. BEAN-LIJEWSKI  
Department of Anesthesiology, Scott and White  
Memorial Hospital, Temple, TX, USA  
jbean-lijewski@swmail.sw.org

### Synonyms

Pediatric Post-Surgical Pain; Acute Post-Operative Pain in Children

### Definition

Children who have surgery experience significant postoperative pain for several days. Appropriate pain management should be initiated in the immediate post-operative period and continue until the pain resolves, whether the child is at home or in the hospital. Surgical trauma results from tissue destruction and musculoskeletal strain that causes the release of vaso- and immuno-reactive substrates that promote inflammation, hyperpermeability and pain.

Ineffective pain management increases the incidence of postoperative behavioral disorders in children and the risk of developing persistent or neuropathic pain. In preterm infants and neonates, this effect may be compounded by the lack of descending inhibitory pathways and enhanced neuroplasticity resulting in more extensive, persistent effects (Tachibana et al. 2001). Despite advances in the management of post-operative pain, nearly 70% of patients experience moderate or severe pain after surgery (Apfelbaum et al. 2003).

Effective post-surgical pain management reduces the stress response to surgery, promotes respiratory function, improves wound healing and permits faster return to normal functioning. Surgical invasiveness correlates with the intensity and duration of postoperative pain and analgesic requirements. As surgical invasiveness increases, the interventions employed to manage it escalate.

### Characteristics

Good pain management begins with informative preoperative teaching regarding the nature of the surgery, the anticipated level and duration of discomfort and strategies for reducing pain. This is particularly important as more children experience ambulatory surgery that requires parents to manage pain at home. Parents may fail to administer prescribed analgesics due to fear of side effects, addiction or difficulty with administration. Preoperative teaching, improves parental compliance with prescribed analgesic dosing and patient comfort post-operatively (Greenberg et al. 1999). Complementary, non-pharmacological techniques taught preoperatively also reduce anxiety and postoperative pain (Huth et al. 2004).

### Postoperative Pain Management Following Ambulatory Surgery

▶ **Local anesthetics** improve immediate postoperative comfort and hasten transition through the recovery process. A ▶ **field block**, ▶ **installation block** or direct peri-neural infiltration (▶ **peri-neural injection**) are the safest and easiest analgesic techniques available. Common peripheral nerve blocks employed in children include the ilioinguinal and iliohypogastric nerve block for inguinal herniorrhaphy, ▶ **penile block** for circumcision or phallic surgery, femoral, or the ▶ **fascia iliaca**



## Acute Pain

ROSS MACPHERSON, MICHAEL J. COUSINS  
Department of Anesthesia and Pain Management,  
Royal North Shore Hospital, University of Sydney,  
St. Leonards, NSW, Australia  
rmacpher@nscchahs.health.nsw.gov.au,  
mcousins@nscchahs.health.nsw.gov.au

### Why Should We Aim to Optimise the Management of Acute Pain?

Post-operative pain is a major marker of peri-operative morbidity and mortality and its effective treatment should be a goal in every hospital and institution. We should all aim to control pain, not only for humanitarian reasons, but also to attenuate the psychological and physiological stress with which it is associated following trauma or surgery. While it is now recognised that adequate pain control alone is not sufficient to reduce surgical morbidity, it remains an important variable and one that is perhaps more readily controlled (Kehlet and Holte 2001).

Adequate management of post-operative pain is vital to attenuate the stress response to surgery and the accompanying pathophysiological changes in metabolism, respiratory, cardiac, sympathetic nervous system and neuro-endocrine functions. These effects (summarised in Neuroendocrine and metabolic responses to surgery after NH&MRC 1999) are wide ranging and have significant impact on homeostasis. Effects on the respiratory system are most prominent, as persistent pain will result in a reduction in respiratory effort that then leads to hypoxaemia from significant ventilation / perfusion mismatching. Continuing hypoventilation predisposes to collapse of lung segments and the supervening infection that follows carries significant morbidity. Psychological and behavioural changes (e.g. yellow flags) also accompany pain states and may need to be recognised and managed. Not only will proper management of post-operative pain result in greater patient comfort and earlier discharge home, but the improved earlier mobilisation and return to function will also reduce serious post-operative complications such as venous thromboembolism.

### Neuroendocrine and Metabolic Responses to Surgery (after NH & MRC 1999)

#### Endocrine

- Catabolic – Due to increase in ACTH, cortisol, ADH, GH, catecholamines, renin, angiotensin II, aldosterone, glucagon, interleukin-1
- Anabolic – Due to decrease in insulin, testosterone

#### Metabolic

- Carbohydrate – hyperglycaemia, glucose intolerance, insulin resistance
- Due to increase in hepatic glycogenolysis (epinephrine, glucagon) – gluconeogenesis (cortisol, glucagon, growth hormone, epinephrine, free fatty acids)
- Due to decrease in insulin secretion / action
- Protein – muscle protein catabolism, increased synthesis of acute-phase proteins
- Due to increase in cortisol, epinephrine, glucagon, interleukin-1
- Fat – increased lipolysis and oxidation
- Due to increase in catecholamines, cortisol, glucagon, growth hormone
- Water and electrolyte flux – retention of H<sub>2</sub>O and Na<sup>+</sup>, increased excretion of K<sup>+</sup>, decreased functional extracellular fluid with shifts to intracellular compartments
- Due to increase in catecholamines, aldosterone, ADH, cortisol, angiotensin II, prostaglandins and other factors

However, despite the emergence of pain management as a specialty and the availability of a wide range of guidelines and templates for effective analgesia, pain continues to be poorly managed. Why this should be the case is a difficult question to answer, although there is clearly a wide range of possibilities (Cousins and Phillips 1986; Macintyre and Ready 1996).

As can be seen from “Reasons for ineffective analgesia (after NH&MRC 1999)”, in some cases it may be simply the result of inadequate knowledge or equipment, but sometimes there can be more disturbing reasons. Macintyre (2001) has pointed out that some health service personnel are still concerned that pain relief can be ‘too efficacious’ and thereby mask post-operative complications such as urinary retention, compartment syndrome or even myocardial infarction. Another barrier to providing effective analgesia is a view held in some quarters that maintaining the patient in pain is somehow a useful way to aid diagnosis – a concept that with no valid scientific basis (Attard et al. 1992; Zolte and Cust 1986).

#### Reasons for Ineffective Analgesia (After NH & MRC 1999)

- The common idea that pain is merely a symptom and not harmful in itself
- The mistaken impression that analgesia makes accurate diagnosis difficult or impossible
- Fear of the potential for addiction to opioids
- Concerns about respiratory depression and other opioid related side effects such as
- nausea and vomiting
- Lack of understanding of the pharmacokinetics of various agents

- Lack of appreciation of variability in analgesic response to opioids
- Prescriptions for opioids, which include the use of inappropriate doses and / or dose intervals.
- Misinterpretation of doctor's orders by nursing staff, including use of lower ranges of opioid doses and delaying opioid administration
- The mistaken belief that patient weight is the best predictor of opioid requirement
- The mistaken belief that opioids must not be given more often than 4 hourly
- Patients' difficulties in communicating their need for analgesia

### Mechanisms in Acute Pain

The manner in which pain signals are processed and modulated is a complex topic that is covered in detail elsewhere. However the following brief overview is provided as a background to the sections that follow. The traditional view of the processing of pain inputs is that they are first detected through non-specific polymodal nociceptors that respond to a range of stimuli, including thermal, chemical and mechanical alterations. It is a process designed to alert us to tissue damage. These inputs are then transmitted by A delta and C type fibres to the spinal cord at speeds of between 2 m / s in the case of the C type fibres and 10 m / s in the myelinated A delta fibres.

These peripheral nerves terminate in the dorsal horn of the spinal cord where they undergo considerable modulation both *via* neurotransmitters present at that site and through the action of descending tracts from higher centres, which usually have an inhibitory role. Following modulation, the nociceptive impulse is finally transmitted through tracts to supraspinal sites. Although a number of links are involved, the spinothalamic tract is perhaps the most prominent.

Having given this outline, it is now accepted that our nervous system is a "plastic" environment where stimuli or trauma in any one part of the body can invoke change within other body systems, especially that of the nervous system (Cousins and Power 1999). Changes in nerve function are particularly important and this plasticity can lead nerve fibres whose physiological role is not normally to transmit pain signals to act as nociceptors. For example, while A delta and C fibres are traditionally seen as primary nociceptive fibres, A beta fibres can become nociceptive under certain circumstances.

Coincident with this is the development of peripheral sensitisation. Trauma or other noxious stimuli to tissue results in a neurogenic inflammatory response that in turn leads to vasodilation, increased nerve excitability and the eventual release of a range of inflammatory mediators such as serotonin, substance P, histamine and

cytokines –the so called sensitising soup. This altered environment leads to a modification in the way that input signals are processed with innocuous stimuli being sensed as noxious or painful stimuli, leading to the phenomena of ► **hyperalgesia**.

### The Scope of Acute Pain Management

Acute pain management has developed into a subspecialty in its own right during the last decade with an ever-increasing range of activities. In the hospital setting, the major role of the acute pain team is in the area of post-operative pain management in the surgical patient, although their involvement must not be limited to these patients. In patients with burns, appropriate pain management will help in optimising pain control both in the early stages where skin grafting and debridement are being carried out and later when the patient requires assistance to undergo physiotherapy. In the patient with spinal cord injury, the initial phase following the injury is often complicated by acute neuropathic pain where early intervention is critical, while in the oncology patient, acute pain can complicate therapy, as in the patient who develops mucositis as a complication of treatment.

### Providing Comprehensive Acute Pain Management

Acute and post-operative pain is best managed by an acute pain team and there are a number of structural models of how these are best set up and operated (Rawal and Allvin 1998). While many are headed by consultant anaesthetists, this is not always the case and often the day to day running of the team is managed by a specialist pain nurse, with medical staff used only for back up when necessary. Acute pain teams need to have clearly defined guidelines and major goals, which will be dictated in part by their institution and circumstances (see Clinical practice guidelines for Acute Pain teams, Cousins and Power 1999). Irrespective of how the team is organised there must be an efficient method of referral of patients either from the operating theatre or from the various surgical teams.

### Clinical Practice Guidelines for Acute Pain Teams (Cousins and Power 1999)

#### Guidelines

- A collaborative, interdisciplinary approach to pain control, including all members of the healthcare team and input from the patient and the patient's family, when appropriate. An individualised proactive pain control plan developed preoperatively by patients and practitioners (since pain is easier to prevent than to treat)
- Assessment and frequent reassessment of the patient's pain

- Use of both drug and non-drug therapies to control and / or prevent pain
- A formal, institutional approach, with clear lines of responsibility

### Major Goals

- Reduce the incidence and severity of patients' post-operative or post-traumatic pain
- Educate patients about the need to communicate regarding unrelieved pain, so they can receive prompt evaluation and effective treatment
- Enhance patient comfort and satisfaction
- Contribute to fewer postoperative complications and, in some cases, shorter stays after surgical procedures

Where possible, the pain team should also be involved in ► [pre-operative education](#) of the elective surgical patient. At such a meeting, the patients' fears and anxieties about pain should be addressed, as there is considerable evidence to suggest that patients who have the opportunity to speak about their concerns about post-operative pain prior to surgery do better and use less medication than control groups. A number of studies have consistently pointed out that pain is usually the major fear of patients undergoing surgery. During pre-operative assessment, at least in the elective patient, it is important to obtain a full medication history especially in relation to use of analgesic agents and the duration of such therapy. Tolerance to opioids can develop quickly and identifying patients who attend for surgery with a history of oral opioid use is important, as they will most likely have different analgesic requirements when compared to the opioid naïve individual.

The acute pain team also needs to be responsible for the overall post-operative management of the patient. This includes ensuring that regular monitoring and recording of physiological parameters occurs. Details such as oxygen saturation, respiratory rate and pain status need to be recorded regularly and reviewed. Pain scores can be recorded either numerically or by descriptors. It is important to record pain levels both at rest and on movement, since treatment strategies for these problems will differ. Movement pain in particular is better treated with adjuvant agents rather than opioids.

Accurate recording of physiological data in patients being treated for acute pain is mandatory. Sedation scores and respiratory rate are important in reducing the incidence of opioid induced toxicity. Pain management records or electronic data apparatus should also allow for the recording of any associated ► [adverse events](#) (such as nausea and vomiting) and record data in a form allowing regular or on-going ► [audit](#). Such audits of acute pain patients should, where possible, al-

low not only for examination of the parameters already described but also for ► [outcome measures](#). The acute pain team should supervise the transition from a parenteral to an oral analgesic regime. Likewise, members of the acute pain service must recognise when a patient might be suffering a ► [Persistent Acute Pain](#) state or undergoing transition from an acute to a chronic pain state and need referral to chronic pain specialists.

Post-operative care also involves being alert for warning signs, so called "► [red flags](#)" that might indicate developing complications of the surgery or trauma. In patients previously well controlled using a particular analgesic regime, continuing episodes of unexpected pain requiring increasing doses of medication should alert the practitioner. Under these circumstances, an investigation should be made to elicit the cause of these events, which might be a result of complications of surgery or trauma. This should be diagnosed and treated directly, rather than merely increasing doses of analgesic drugs (Cousins and Phillips 1986).

### Pre-emptive Analgesia

Much has been made of the usefulness of ► [pre-emptive or preventive analgesia](#). The concept of providing analgesia prior to a surgical stimulus and thus reducing ► [central sensitisation](#) seems to be a logical and useful proposition and generated a great deal of initial enthusiasm (Dahl and Kehlet 1993; Woolf and Chong 1993). Unfortunately, subsequent controlled trials have failed to consistently demonstrate that any of the commonly used strategies are effective in reducing post-operative pain or analgesic use. These include the pre-operative administration of opioids, non-steroidal anti-inflammatory drugs and the provision of local analgesic neural blockade (Gill et al. 2001; Podder et al. 2000; Uzunkoy et al. 2001). Much research has been conducted in an effort to ascertain the reasons for this (Charlton 2002; Kehlet 1998; Kissin 1996). Some hypotheses that have been advanced include the suggestion that when local anaesthesia is employed in a pre-emptive setting, any failure to provide complete blockade will still allow sensitisation to occur (Lund et al. 1987). Another possibility is the timing between placement of the blockade and the commencement of surgery is critical, with a time interval of at least 30 min being required between drug administration and surgery (Senturk et al. 2002). One question that has not been fully answered is whether the use of pre-emptive analgesia might lead to a reduction in the number of patients progressing from acute to chronic pain states. Early studies such as that of Bach et al. (1988) suggested that this may well be the case and this has been supported by more recent reports (Obata et al. 1999).

### Treatment Strategies – General

The principles of management of acute nociceptive pain are generally ► **multi-modal**. This implies using a number of agents, sometimes given by different routes, to maximise pain control. While pain control after some minor procedures can be controlled by non-opioids alone, opioids remain the mainstay of moderate to severe pain management. The use of combinations of ► **adjuvant analgesics** also known as ► **balanced analgesia**, allows for a reduction in opioid dosage and thus side effects, which can be useful in managing some aspects of pain that can be less responsive to opioids alone.

With regard to the selection of a route of drug administration, whilst the use of the oral route might initially seem easiest, it is rarely used in the first instance. The variable bioavailability of oral products coupled with post-operative attenuation of gastrointestinal function and the possibility of superimposed vomiting, makes this route a poor choice initially. Parenteral administration is usually called for and the intravenous route is the preferred route of administration, often using ► **patient controlled analgesia** (PCA) devices.

### Patient Controlled Analgesia

PCA, as a means of drug administration has to a degree revolutionised modern pain management. Although purchase of the devices represents a significant financial outlay, there are savings to be made in terms of medical and nursing staff time, as well as less tangible benefits, such as reducing the number of needle stick injuries for example. Importantly, patients generally feel positive about using PCAs (Chumbley et al. 1999), with most studies suggesting that the feeling of “being in control” was the most common reason for the high level of satisfaction (Albert and Talbott 1988). However, despite a number of inbuilt safety mechanisms, overdosage can still occur with these devices, and strict post-operative monitoring is imperative (Macintyre 2001). While the intramuscular route can be used for intermittent analgesia, the pharmacokinetics are often unattractive, requiring repeated injections. Furthermore, intramuscular analgesia is most often prescribed on a p.r.n. or “as required” basis, which perforce implies that the patient must be in a pain state before they request the medication – a situation that should be avoided. Finally, every intramuscular (or indeed subcutaneous) injection given presents a possibility for a needlestick injury to occur – another situation best avoided.

### Epidural Analgesia

Much has been written about the risks and benefits associated with the use of epidural analgesia in the post-

operative period and interpreting the results of these myriad studies conducted under varying circumstances is extremely difficult. There is no doubt that epidural analgesia provides a number of real advantages. It allows the use of drug combinations, which can be delivered close to appropriate receptor sites in the spinal cord (Schmid et al. 2000), it reduces the requirements of opioid analgesics (Niemi and Breivik 1998) and generally allows for a faster return of physiological function, especially gastrointestinal and respiratory status in the post-operative period. The degree to which this occurs appears to be dependent, at least in part, on the nature of surgery performed (Young Park et al. 2001). However, more recently, despite the fact that there are considerable benefits associated with the use of epidural infusions, attention has focussed on the nature and incidence of complications associated with epidural infusions (Horlocker and Wedel 2000; Rigg et al. 2002; Wheatley et al. 2001). These complications can range from local or systemic infection through to haematoma formation and local or permanent neurological sequelae. The rates of the most serious complications of permanent nerve defects or paraplegia are quoted as between 0.005 and 0.03% (Aromaa et al. 1997; Dahlgren and Tornebrandt 1995). Again analysis of these data is difficult because of the number of variables involved. For example there is growing evidence that those people who develop epidural neurological complications frequently have significant pre-existing pathologies, which may predispose them to such complications. Lastly, there has been considerable debate about guidelines for epidural placement and removal in patients undergoing peri-operative anticoagulation. This is especially so when fractionated or low molecular weight heparin products are employed, because of the possibility of increased risk of development of epidural haematoma under these circumstances. Again, the evidence is conflicting (Bergqvist et al. 1992; Horlocker and Wedel 1998). Patient controlled epidural analgesia is a means of pain management that combines the efficacy of epidurally administered drugs with the convenience of patient control.

### Intrathecal Analgesia

The intrathecal route of drug administration can be useful both as a means of providing anaesthesia and for post-operative analgesia. Both opioids and local anaesthetic agents have been administered by this route. While the use of low doses of less lipophilic agents such as morphine is popular and gives prolonged post-operative care, the use of this route is not without risk, as there has been a rise in the number of cases of transient neurological symptoms following lignocaine use (Johnson 2000).



## Pharmacotherapies

### Opioids

With regard to the ► **opioids**, there has been an increase both in the range of drugs available and in their routes of administration. The traditional range of opioids such as morphine, pethidine and fentanyl has been augmented by drugs such as ► **oxycodone** and ► **hydromorphone**. None of these drugs are actually “new”, having been synthesised in some cases almost 100 years ago, but rather they have been re-discovered by a new generation of prescribers. Oxycodone in particular is available in a sustained release form that exhibits a useful biphasic pharmacokinetic profile. The role of pethidine (meperidine) in modern pain management continues to be problematic. While it still has a place under certain circumstances, it should be avoided as an agent for longer-term use, owing to its apparently increased abuse potential and the risk of accumulation of the excitatory metabolite norpethidine. The increased opioid armamentarium has also given scope for ► **opioid rotation**. Although this is a strategy primarily associated with chronic pain management, patients can develop a degree of tolerance to opioids even after a few days. Where continued opioid treatment is needed for whatever reason, switching opioids often results in enhanced pain control, often together with a reduction in dosage. Methadone is an interesting drug, which has generated some recent interest. Its unusual pharmacokinetic profile, with a long and unpredictable half-life of up to 72 h, makes it impracticable for use in the very early stages of acute pain. However it can be used in later stages where a long acting oral product is preferable. That the drug has activity at the NMDA receptor as well as the mu opioid receptor is well known. However it has always been difficult to assess to what, if any, extent this contributes to its analgesic effect and the fact that it has been shown to be of benefit in the treatment of other pain states such as phantom limb pain (Bergmans et al. 2002).

### Non-Opioids

The non-opioids are a diverse group of drugs with differing modes of action and means of administration. Most show clear synergism with the opioids. Members of this group include tramadol, the non-steroidal anti-inflammatory drugs (NSAIDs), COX-2 inhibitors and ketamine.

### Paracetamol

► **Paracetamol** should be almost the universal basis of acute and post-operative pain control. A number of well controlled trials have clearly demonstrated that regular paracetamol, when given in a dose of 1 gm q.i.d. clearly reduces opioid requirements by up to 30%. Side effects are minimal and the drug is very well tolerated. In most

countries it is available in both oral and rectal forms and in a small number a parenteral pro-drug propacetamol is also available.

The only real contraindication to the prescribing of paracetamol is impaired hepatic function, where the drug is probably best avoided. Much work has also been done on the efficacy of other drugs given in combination with paracetamol. In general, the analysis of trial data suggests that while the combination of codeine phosphate (60 mg) has benefits over paracetamol alone, the use of paracetamol with lower quantities seems to confer little benefit. Likewise, although the combination of paracetamol with dextropropoxyphene is widely used to treat more severe pain, many trials suggest that it too has little to offer above paracetamol alone.

### Tramadol

Tramadol is unique amongst analgesic agents in having a dual action. Its main activity probably lies in enhancing the action of noradrenaline and 5-hydroxytryptamine at the spinal cord level, while it also has a very weak agonist activity at the mu receptor at supraspinal sites. Tramadol is a very useful drug for the management of mild to moderate pain and the fact that it can be given orally or by the intravenous or intramuscular routes further adds to its versatility. Its low addiction potential makes it a good choice for long-term use. Because of risk of precipitating serotonin syndrome, tramadol is probably best avoided in combination with many of the different anti-depressant medications, especially the SSRIs, although in clinical practice the real risk seems quite low. Recent studies have confirmed that it possesses significant synergy when combined with paracetamol and indeed a combination product is now available in some countries (Fricke et al. 2002). There are few studies available on the usefulness of combination of tramadol with opioids, although initial results appear encouraging (Webb et al. 2002).

Tramadol is also attractive because of its low abuse potential. Certainly in comparison to strong opioids, the incidence of abuse, dependence and withdrawal is considerably lower (Cicero et al. 1999). However a number of such cases have been reported, almost all of which were in patients with a pre-existing history of drug or substance abuse (Brinker et al. 2002; Lange-Asschenfeldt et al. 2002).

In the management of post-operative pain, all efforts should be made to reduce the incidence of post-operative nausea and vomiting, which is not only uncomfortable for the patient, but can also lead to fluid imbalance, impaired respiratory function and electrolyte disturbances. In this regard the use of tramadol is somewhat problematic, as the incidence of nausea and vomiting is at least as high as with opioids (Sil-

vasti et al. 2000; Stamer et al. 1997). However, some strategies have been suggested to attenuate this response including administration of an intra-operative loading dose (Pang et al. 2000) and slow IV administration (Petrone et al. 1999). Should management of tramadol induced nausea and vomiting require pharmacological intervention, recent studies suggest that members of the butyrophenone class such as droperidol might be a better choice than 5HT<sub>3</sub> antagonists such as ondansetron, which might not only be less effective, but also antagonise tramadol's analgesic effects.

### Non-Steroidal Anti-Inflammatory Drugs

► **NSAIDs, Survey** (NSAIDs) are widely used in acute pain management (Merry and Power 1995). While they may be used as the sole agent in mild pain, they are primarily employed as adjunctive medications in combination with opioids in moderate to severe pain states. Here their action both at central and peripheral sites complements opioid activity and they are especially useful in the management of pain associated with movement. There have always been concerns associated with the use of NSAIDs in the surgical patient because of the risk of the development of serious complications, especially renal impairment. However, careful patient selection and monitoring, the use of a product with a short half-life and restricting the duration of treatment to about 3 days greatly reduces the danger. The discovery of the two isoforms of the cyclooxygenase (COX) enzyme has more recently led to the development of COX-2 specific inhibitors such as celecoxib and rofecoxib, with the aim of developing potent NSAIDs without significant associated gastrointestinal side effects. The majority of studies on these drugs have been conducted in outpatient populations and whether they offer any advantage over traditional NSAIDs in the management of post-operative pain is unclear. Even more recently, a parenteral COX-2 inhibitor (parecoxib) has been developed specifically for the management of post-operative pain and initial results of studies are encouraging.

Unfortunately, the cardiovascular safety of these products has recently come under scrutiny that has resulted in at least one (rofecoxib) being withdrawn from the market, owing to an increase in thrombo-embolic events associated with its use (Solomon et al. 2004). There is considerable discussion at present as to whether this constitutes an individual drug effect or a class effect. These setbacks have not however prevented the development and release of other members of this group with improved safety profiles.

### Ketamine

► **Ketamine** is an important second line drug in the pain physician's armamentarium. Well known as an anaes-

thetic agent, it has in the last decade or so found use as an analgesic product when used in sub-anaesthetic doses. The drug has some useful N-methyl-D-aspartate (NMDA) receptor antagonist activity and can also augment the action of opioids in the treatment of nociceptive pain. The usual psychomimetic effects of the drug are not usually a problem in the dosages employed, although the development and release of the S(+) might signal a resurgence in the interest of this drug.

### Neuropathic Pain

Comprehensive acute pain management also entails the recognition and management of ► **acute neuropathic pain**. Neuropathic pain is most frequently seen as a sequela of long-term pathological states such as diabetes or herpes zoster infection (Bowsher 1991). However this is not always the case and acute neuropathic pain can be seen immediately following surgical procedures where peripheral nerves have been disrupted, such as in the ► **post-thoracotomy syndrome**, following specific events such as acute spinal cord injury or as evidenced by ► **phantom limb pain** following amputation. It is important to be alert for the signs or symptoms of neuropathic pain in the acute or post-operative phase (see Features suggestive of neuropathic pain after NHMRC 1999). Failure to diagnose such a condition will result not only in prolonged pain, but also most probably in the patient being given increasing doses of opioid medication in a futile effort to control the condition (Hayes and Molloy 1997).

### Features Suggestive of Neuropathic Pain (After NH & MRC 1999)

- Pain can be related to an event causing nerve damage
- Pain unrelated to ongoing tissue damage
- Sometimes a delay between event and pain onset
  - The pain is described as burning, stabbing, pulsing or electric-shock like
  - Hyperalgesia
  - Allodynia (indicative of central sensitisation)
  - Dysaesthesia
- Poor response to opioids
- The pain is usually paroxysmal and often worse at night
- Pain persists in spite of the absence of ongoing tissue damage

Management of neuropathic pain can be complex and much has been written on the usefulness of various pain strategies. A wide range of drugs with differing pharmacological targets such as ► **anti-convulsant medications**, notably ► **gabapentin** and ► **carbamazepine**,

▶ anti-depressants and ▶ membrane stabilising agents such as ▶ Mexiletine/Mexitil have all been employed with varying success. Local anaesthetics such as lignocaine have all been found to be useful, especially in the acute case, where they can be administered as a subcutaneous infusion.

### Specific Acute Pain States

There are some acute pain states that have been subject to more extensive research and whose symptomatology and pathogenesis follows recognised patterns. These include acute lower back pain, pain following chest trauma or thoracic surgery, compartment syndrome and the acute presentation of ▶ complex regional pain syndrome. There have also been significant advances in our understanding of ▶ acute pain mechanisms and the differentiation between visceral or somatic (deep or superficial) pain.

### Summary

There have been a number of significant improvements in the management of acute and post-operative pain management during the past decade. To some degree this has been helped by the emergence of new drugs or, in some cases, whole new drug groups. However in the main, advances in acute and post-operative pain management have come about by recognising how to manage pain better with existing drugs, focussing on the use of drug combinations to maximise outcomes. There has also been a greater appreciation of the importance of diagnosing acute neuropathic pain, requiring a different approach. Those involved in pain management have embarked on a virtual crusade in an effort to convince health professionals that acute and post-operative pain can be and must be appropriately and successfully managed. Perhaps the most important lesson of all is an appreciation that all chronic pain must start as acute pain. Appropriate management of acute pain will therefore have the additional bonus of eventually reducing the worldwide burden of patients having to suffer debilitating chronic pain states.

### References

- Albert JM, Talbott TM (1988) Patient-controlled analgesia vs. conventional intramuscular analgesia following colon surgery. *Dis Colon Rectum* 31:83–86
- Aromaa U, Lahdensuu M, Cozantitis DA (1997) Severe complications associated with epidural and spinal anaesthesia in Finland 1987–1993. A study based on patient insurance claims. *Acta Anaesthesiol Scand* 41:445–452
- Attard AR, Corlett MJ, Kinder NJ et al. (1992) Safety of early pain relief for acute abdominal pain. *BMJ* 305:554–556
- Bach S, Noreng MF, Tjellend NU (1998) Phantom limb pain in amputees during the first 12 months following limb amputation, after preoperative lumbar epidural blockade. *Pain* 33:297–301
- Bergmans L, Snijdelaar DG, Katz J et al. (2002) Methadone for Phantom Limb Pain. *Clin J Pain* 18:203–205
- Bergqvist D, Lindblad B and Matzsch T (1992) Low molecular weight heparin for thromboprophylaxis and epidural / spinal anaesthesia: Is there a risk? *Acta Anaesthesiol Scand* 36:605–609
- Bowsher D (1991) Neurogenic pain syndromes and their management. *Br Med Bull* 47:644–666
- Brinker A, Bonnel R, Beitz J (2002) Abuse, dependence or withdrawal associated with Tramadol. *Am J Psychiatry* 159:881
- Charlton JE (2002) Treatment of Postoperative Pain. In: Giamberardino MA (ed) *Pain 2002 – An Updated Review: Refresher Course Syllabus*. IASP Press, Seattle
- Chumbley GM, Hall GM, Salmon P (1999) Why do patients feel positive about patient-controlled analgesia? *Anaesthesia* 54:38638–38639
- Cicero T, Adams E, Galler A (1999) Postmarketing surveillance program to monitor Ultram (tramadol hydrochloride) abuse in the United States. *Drug Alcohol Depend* 57:7–22
- Cousins MJ, Power I (1999) Acute and Post-Operative Pain. In: Wall PD, Melzack R (eds) *Textbook of Pain*, 4th edn. Churchill Livingstone, Edinburgh, pp 447–492
- Cousins MJ, Power I, Smith G (2000) 1996 Labat lecture: pain – a persistent problem. *Reg Anesth Pain Med* 25:6–21
- Dahl JB, Kehlet H (1993) The value of pre-emptive analgesia in the treatment of postoperative pain. *Br J Anaesth* 70:434
- Dahlgren N, Tornebrandt K (1995) Neurological complications after anaesthesia. A follow up of 18,000 spinal and epidural anaesthetics performed over three years. *Acta Anaesthesiol Scand* 39:872–880
- Fricke JJ, Karim R, Jordan D et al. (2002) A double-blind, single-dose comparison of the analgesic efficacy of tramadol / acetaminophen combination tablets, hydrocodone / acetaminophen combination tablets, and placebo after oral surgery. *Clin Ther* 24:953–968
- Gill P, Kiani S, Victoria B, Atcheson R (2001) Pre-emptive analgesia with local anaesthetic for herniorrhaphy. *Anaesthesia* 56:414–417
- Hayes C, Molloy AR (1997) Neuropathic pain in the perioperative period. In: Malloy AR, Power I (eds) *International anesthesiology clinics. Acute and chronic pain*. Lippincott-Raven, Philadelphia, pp 67–81
- Horlocker TT and Wedel DJ (1998) Neuraxial blockade and low molecular weight heparins: Balancing perioperative analgesia and thromboprophylaxis. *Reg Anesth Pain Med* 23(Suppl 2):164–177
- Horlocker TT, Wedel DJ (2000) Neurologic Complications of Spinal and Epidural Anesthesia. *Reg Anesth Pain Med* 25:83–98
- Johnson M (2000) Potential Neurotoxicity of Spinal Anesthesia with Lidocaine. *Mayo Clinic Proceedings* 75:921–932
- Kehlet H (1998) Modification of responses to surgery by neural blockade: clinical implications. In: Cousins MJ, Bridenbaugh PO (eds) *Neural blockade in clinical anesthesia and management of pain*. Lippincott-Raven, Philadelphia, pp 129–178
- Kehlet H, Holte K (2001) Effect of postoperative analgesia on surgical outcome. *Br J Anaesth* 87:62–72
- Kissin I (1996) Preemptive analgesia: why its effect is not always obvious. *Anesthesiology* 84:1015–1019
- Lange-Asschenfeldt C, Weigmann H, Hiemke C et al. (2002) Serotonin Syndrome as a result of Fluoxetine in a patient with Tramadol abuse: Plasma level-correlated symptomatology. *J Clin Psychopharmacol* 22:440–441
- Lund C, Selmar P, Hensen OB et al. (1987) Effect of epidural bupivacaine on somatosensory evoked potentials after dermatomal stimulation. *Anesth Analg* 66:343–348
- Macintyre PE, Ready LB (1996) *Acute Pain Management: A Practical Guide*. WB Saunders, London
- Macintyre PE (2001) Safety and efficacy of patient-controlled analgesia. *Br J Anaesth* 87:36–46
- Merry A, Power I (1995) Perioperative NSAIDs: towards greater safety. *Pain Rev* 2:268–291

30. NH&MRC (1999) National Health and Medical Research Council. Acute pain management: scientific evidence. Australian Government Printer
31. Niemi G, Breivik H (1998) Adrenaline markedly improves thoracic epidural analgesia produced by a low-dose infusion of bupivacaine, fentanyl and adrenaline after major surgery. *Acta Anaesthesiol Scand* 42:897–909
32. Obata H, Saito S, Fujita N (1999) Epidural block with mepivacaine before surgery reduces long-term post-thoracotomy pain. *Can J Anaesth* 46:1127–1132
33. Pang W-W, Mok M, Huang S et al. (2000) Intraoperative loading attenuates nausea and vomiting of tramadol patient-controlled analgesia. *Can J Anaesth* 47:968–973
34. Petrone D, Kamin M, Olson W (1999) Slowing the titration rate of tramadol HCl reduces the incidence of discontinuation due to nausea and / or vomiting: a double-blind randomized trial. *J Clin Pharm Ther* 24:115–123
35. Podder S, Wig J, Malhotra S et al. (2000) Effect of pre-emptive analgesia on self-reported and biological measures of pain after tonsillectomy. *Eur J Anaesthesiol* 17:319–324
36. Rawall N and Allvin R (1996) Epidural and intrathecal opioids for postoperative pain management in Europe –a 17 nation questionnaire study of selected hospitals. *Acta Anaesthesiol Scand* 63:583–592
37. Rigg JRA, Jarmrozki K, Myles PS et al. (2002) Epidural anaesthesia and analgesia and outcome of major surgery: a randomised trial. *Lancet* 359:1276–1282
38. Schmid RL, Sandler AN (2000) Use and efficacy of low-dose ketamine in the management of acute postoperative pain: review of current techniques and outcomes. *Pain* 82:111–125
39. Senturk M, Ozcan P-E, Talu G-K et al. (2002) The effects of three different analgesia techniques on long-term postthoracotomy pain. *Anesth Analg* 94:11–15
40. Silvasti M, Svartling N, Pitkanen M et al. (2000) Comparison of Intravenous patient-controlled analgesia with tramadol versus morphine after microvascular breast reconstruction. *Eur J Anaesthesiol* 17:448–455
41. Solomon DH, Glynn RJ, Levin R et al. (2004) Relationship between selective COX-2 inhibitors and acute myocardial infarction in older adults. *Circulation* 109:2068–73
42. Stamer U, Maier C, Grondt S et al. (1997) Tramadol in the management of post-operative pain: a double-blind, placebo and active drug-controlled study. *Eur J Anaesthesiol* 646–654
43. Uzunkoy A, Coskun A, Akinci O (2001) The value of pre-emptive analgesia in the treatment of postoperative pain after laparoscopic cholecystectomy. *Eur Surg Res* 33:39–41
44. Webb A, Leong S, Myles P et al. (2002) The addition of a Tramadol Infusion to Morphine Patient-Controlled Analgesia After Abdominal Surgery: A Double-Blinded, Placebo-Controlled Randomized Trial. *Anesth Analg* 95:1713–1718
45. Wheatley RG, Schug SA, Watson D (2001) Safety and efficacy of postoperative epidural analgesia. *Br J Anaesth* 87:47–61
46. Woolf CJ, Chong MS (1993) Preemptive analgesia –treating postoperative pain by preventing the establishment of central sensitization. *Anesth Analg* 77:362–379
47. Young Park W, Thompson JS, Lee KK (2001) Effect of Epidural Anesthesia and Analgesia on Perioperative Outcome: A Randomized, Controlled Veterans Affairs Cooperative Study. *Ann Surg* 234:560–571
48. Zolte N, Cust MD (1986) Analgesia in the acute abdomen. *Annals of the Royal College of Surgeons of England* 68:209–210

compartment block for lower extremity procedures and ► digital nerve blocks for toe or finger procedures. Peripheral nerve blocks provide analgesia of similar duration compared to plexus or epidural injections. The duration of the block is determined by the choice of local anesthetic, regional blood flow and use of vasoconstrictor (Table 1). Bupivacaine produces higher peak plasma concentrations in infants than ropivacaine but toxicity from these techniques is exceedingly low due to slow systemic absorption.

► Brachial plexus blockade can provide analgesia following surgery of the hand and / or arm and shoulder. The axillary approach (► axillary block) is most common in children and provides good analgesia of the hand. For surgeries involving the arm or shoulder, an ► interscalene block or ► infraclavicular block provides more reliable postoperative analgesia. The use of interscalene and infraclavicular injections has been limited in children, due to the risks of inadvertent neural or subarachnoid injections in anesthetized patients. The introduction of stimulating catheters and ultrasound guided placement of continuous interscalene and infraclavicular catheters may broaden their application in children undergoing upper extremity surgeries. Catheter techniques are considered safer when performing blocks on anesthetized patients, since catheters are less likely to penetrate the neural sheath and inject with difficulty when positioned within the nerve.

Single shot ► caudal epidural blocks are frequently employed for ambulatory lower abdominal, genitourinary and lower extremity surgeries. Bupivacaine 0.25% or ropivacaine 0.2% without epinephrine provide analgesia for 2–6 h and with the addition of 1:200,000 epinephrine 6–12 h. The inclusion of epinephrine improves the safety of the technique by providing an indicator for inadvertent intravascular or intraosseous injection. The addition of clonidine 1–2 mcg kg<sup>-1</sup> to the solution significantly prolongs the block but may delay discharge due to excessive duration (Farrar and Lerman 2002). Neuraxial morphine or hydromorphone should not be used for ambulatory patients due to the risk of delayed respiratory depression.

Systemic analgesic therapy must be initiated in order to prevent severe pain (prior to resolution of a local anesthetic block). Nonsteroidal anti-inflammatory agents (NSAIDs) and acetaminophen are the most commonly employed analgesics for children following ambulatory surgery. NSAIDs should be included in the analgesic regimen unless contraindicated (see Contraindications for the Use of NSAIDs) because they reduce the incidence of opioid related side effects and improve recovery characteristics and patient well being (Farrar and Lerman 2002; Gan et al. 2004; Watcha et al. 2003). In addition, they have been associated with a lower incidence of post-surgical behavioral disturbances in children (Kokki 2003).



**Acute Pain in Children, Post-Operative, Table 1** Local Anesthetic Maximal Recommended Doses and Usual Duration

Drug	Concentration	Without epinephrine [mg kg <sup>-1</sup> ]	Usual Duration w/o epinephrine	w / epinephrine [mg kg <sup>-1</sup> ]
Chloroprocaine	1–2%	8	½–1	10
Procaine	1–2%	7	½–1	8.5
Bupivacaine	0.25–0.5%	2	4–12 (peripheral Nn)	3
Levo-bupivacaine	0.25–0.5%	2	2–4 (s.c. / epidural)	3
Ropivacaine	0.2–0.5%	2	2–4 (s.c. / epidural)	3
Lidocaine	0.5–2%	5	1–2	7
Mepivacaine	1–1.5%	5	1.5–3	6

### Contraindications for the Use of NSAIDs

- Renal Impairment
- Liver Dysfunction
- Hypovolemia
- Thrombocytopenia
- Hypotension
- Coagulation Disorder
- Active Bleeding
- Hypersensitivity / Asthma precipitated by aspirin or other NSAID

A variety of NSAIDs are available for oral, intravenous and rectal administration (Table 2). Comparative trials in children are lacking, however when administered in appropriate doses little variation in their analgesic efficacy is expected with the exceptions of ketorolac and rofecoxib that appear to have stronger analgesic properties (Kokki 2003; Watcha et al. 2003). The volume of distribution and clearance of the NSAIDs are higher in children necessitating slightly higher or more frequent dosing regimens. A ceiling effect limits effectiveness of all NSAIDs. Children are less susceptible to the gastrointestinal side effects of NSAIDs. Caution is advised with renal impairment, asthma, dehydration and bleeding diatheses (Kokki 2003).

**Acute Pain in Children, Post-Operative, Table 2** Recommended Doses and Routes of Administration of NSAIDs in Infants >3 months and Children

Drug	Dose	Frequency [h]	Max Daily Dose [mg kg <sup>-1</sup> ]	Prepara- tions Available
Diclofenac	1 mg kg <sup>-1</sup>	8–12	3	i.v. / pr / PO
Ibuprofen	10 mg kg <sup>-1</sup>	6–8	4	PO
Flurbiprofen	1 mg kg <sup>-1</sup>	8–12	5	PO / i.v.
Ketoprofen	1– 2 mg kg <sup>-1</sup>	6–8	5	PO / i.v.
Ketorolac	0.3– 0.5 mg kg <sup>-1</sup>	6–8	2	i.v.

NSAIDs, especially ketorolac, are particularly effective analgesics following dental, oropharyngeal and genitourinary procedures but they are associated with an increased risk of bleeding that limits their use. Selective COX-2 inhibitors were designed to retain the analgesic and anti-inflammatory effects of NSAIDs while reducing the risk of gastric irritation and bleeding. Rofecoxib, 1 mg kg<sup>-1</sup> day<sup>-1</sup>, improved post-tonsillectomy pain when compared to placebo and hydrocodone. Evaluations of other COX-2-selective NSAIDs in children are lacking due to the absence of pediatric formulations. Chronic administration of COX-2-selective NSAIDs, in particular rofecoxib, has been associated with an increased incidence of heart attack or stroke in elderly patients. In appropriately selected patients, their short-term use in the peri-operative period has been shown to improve analgesia, recovery and return to normal levels of activity without increasing the risk of bleeding or asthma (Gan 2004).

The role of acetaminophen in the management of post-operative pain in children remains controversial. Confusion regarding the analgesic efficacy of acetaminophen is caused by the diversity of ages, procedures, doses, routes of administration and endpoints studied. Although the early administration of high dose (40–60 mg kg<sup>-1</sup>) acetaminophen is associated with a reduction in the incidence and severity of post-surgical pain, the result is inconsistent, especially following very painful surgeries. The risk: benefit ratio for escalating doses to achieve faster, higher effect compartment concentrations has not been established. Hepatic failure has occurred with doses lower than those recommended (Table 2) in the presence of dehydration, sepsis and malnutrition. Acetaminophen should be avoided in patients with hepatic dysfunction (Bremerich et al. 2001; Korpela et al 1999).

Opioid analgesics are frequently required following ambulatory surgeries in children. During the recovery phase, fentanyl 0.5–1 mcg kg<sup>-1</sup> intravenously, repeated every 5–10 min up to 2 mcg kg<sup>-1</sup>, provides rapid, brief analgesia. Fentanyl is associated with a lower incidence

and severity of postoperative nausea and vomiting (PONV) than morphine and permits the early initiation of oral analgesics so that the adequacy of pain relief can be assessed prior to discharge. Intravenous morphine 0.05–0.2 mg kg<sup>-1</sup> is employed when pain is more severe or persistent. When larger doses are required, inadequate pain relief after discharge is increasingly likely.

Codeine, the most common oral opioid for mild to moderate postoperative pain is less popular due to the high incidence of side effects. Codeine metabolism to morphine is responsible for its analgesia. Conversion to morphine is impaired in 10% of patients and absent in fetal liver microsomes, rendering it ineffective in 10% of the population and infants <1 month. The usual dose is 1 mg kg<sup>-1</sup> every 4 h and is limited by the high incidence of side effects including nausea, vomiting, sedation, urinary retention and constipation.

Hydrocodone, a synthetic opioid agonist, is available alone and in combination with acetaminophen and ibuprofen as an elixir or tablet. Twenty-five percent of the administered dose is converted to active metabolites including hydromorphone. Following ambulatory surgery, the incidence and severity of side effects is reduced when compared to codeine. Analgesia begins within 20–30 min of oral administration and lasts 3–6 h. The usual dose is 0.1–0.15 mg kg<sup>-1</sup> / dose or 0.6 mg kg<sup>-1</sup> day<sup>-1</sup> administered every 4–6 h.

The safety of oxycodone in children following ambulatory surgery has not been established but it is useful during transition from PCA or continuous epidural after major surgery as is hydrocodone.

#### Adjunctive Analgesics for Ambulatory Surgery

Post-tonsillectomy and genitourinary pain is significantly reduced by ► **dexamethasone**, 1 mg kg<sup>-1</sup> up to a maximum 20 mg, intravenously after induction of anesthesia. ► **Clonidine** is employed preoperatively at a dose of 1–2 mcg kg<sup>-1</sup> to reduce analgesic requirements. It has limited usefulness in outpatient surgery due its side effects of sedation, bradycardia and hypotension. ► **Tramadol** offers no advantage in the management of acute pediatric postoperative pain.

#### Postoperative Pain Management Following Major Surgery

Insertion of a catheter into the ► **epidural space** permits continuous infusion of opioid or local anesthetics. This provides patients with a baseline, prophylactic analgesic strategy. Studies in adults and most pediatric studies indicate that active pain following major thoracoabdominal, genitourinary, spinal and orthopedic surgeries is more effectively managed by neuraxial analgesia than PCA (Bozkurt 2002; Kokinsky and Thornbert 2003). In infants, catheters are frequently placed caudally and may often be threaded to the desired dermatomal level in most infants younger than 6 months. Caudally inserted catheters are at greater risk of dislodgement and contam-

ination than those placed at the lumbar or thoracic levels. Infection rates can be reduced and catheter longevity improved by tunneling the catheter to a separate exit site (Kost-Byerly 2002).

When epidural catheters are inserted in anesthetized patients, as in most pediatric situations, the risk of spinal cord or neural injury may be increased. Controversy exists over the safety of anesthetized placement, however, when inserted by experienced anesthesiologists in children, the risk appears to be acceptably low (Krane et al. 1998). Catheters can be placed under direct visualization during spinal instrumentation, so that the catheter tip is located at the level of injury. In addition, two catheter techniques have been employed for extensive spinal surgeries.

Bupivacaine 0.125% at 0.0625% and ropivacaine 0.1–0.2% are the most common solutions employed although 1% lidocaine or 0.125% levobupivacaine are employed in some hospitals. The addition of opioids like fentanyl, 2–10 mcg ml<sup>-1</sup>, acts synergistically to improve analgesia. At the recommended doses, these solutions provide a band of analgesia. Their safety is quite acceptable but high plasma concentrations can cause seizures and cardiac depression. Neonates are at increased risk of local anesthetic toxicity due to decreased ► **alpha-1-acid glycoprotein** binding and the accumulation of ► **amide local anesthetics**. Therefore, infusions should be terminated in infants younger than 3 months after 48 h unless lidocaine is employed and blood levels of lidocaine assessed daily to guide therapy (Kost-Byerly 2002). Motor blockade responds to dose reductions. Dosing guidelines are presented in Table 3. When neurosensory evaluation is necessary, e.g. following spinal instrumentation, where risk for compartment syndrome exists, or when the catheter tip cannot be located near the surgical site, neuraxial infusions of

Acute Pain in Children, Post-Operative, Table 3 Acetaminophen Dosing Guidelines

	Dose [mg kg <sup>-1</sup> ]	Frequency [h]	Max Daily [mg kg <sup>-1</sup> ]	Route
Acetaminophen				
Preterm Infants / Neonates 1–3 months	15	6	60	PO / pr
Infants > 3 months	15–20	6	75	PO / pr
Children [loading dose]	20–40			
	15–20	6	90–100	PO
Propacetamol				
Infants > 3 months / Children	30	6	120	i.v.

morphine or hydromorphone provide effective analgesia. Improvement of pain after rate adjustment or bolus requires *ca.* 45 min. Short-acting local anesthetics can be administered when prompt analgesia is needed. The incidence of nausea, pruritus and sedation are comparable to that of intravenous opioids (Kokinsky and Thornbert 2003). The risk of respiratory depression following neuraxial morphine ranges from 0.09–1.1% (Bozkurt 2002).

### Patient Controlled Analgesia

When neuraxial techniques are not employed following major surgery, opioids should be administered intravenously whenever possible. Intramuscular injections are painful and result in slow onset of analgesia that cannot be titrated. Nurses should be encouraged to seek painful behavior or elicit pain scores regularly to detect escalation of pain. Early treatment reduces the duration of severe pain, the dose of opioid required to achieve comfort and the risk of inadvertent overdose.

► **PCA** improves pain relief when compared to intermittent, scheduled dosing. Standard dosing regimens are provided in Table 4. Careful assessment of respiratory function is essential to the safety of this technique since the incidence of serious respiratory depression is between 0.1–1.7% (Bozkurt 2002). The inclusion of a basal infusion rate is associated with a higher incidence of hypoxemia and lower respiratory rates (McNeely and Trentadue 1997). Consideration should be given to provision of a basal infusion at night to improve sleep. Continuous infusion of opioids is recommended for infants and young children. Nurse or family member activation of the ► **PCA pump** for children who cannot activate it due to cognitive impairment or physical limitations is an innovation that circumvents the main design feature that insures safety. Appropriate monitoring for opioid induced respiratory depression is mandatory. Nurses trained to assess pain and opioid related side effects can safely employ PCA pumps as an alternative to intermittent bolus dosing. This promotes faster availability of the analgesic, lower incremental doses and improved pain relief. Monitoring protocols following bolus dosing and rate changes are required to maximize safety (Bozkurt 2002; Kokinsky and Thornbert 2003).

Caregivers can be trained to administer intermittent doses of parenteral opioids. Well-designed, training programs for caregivers and an appropriate level of nursing supervision are required to insure the safety of this innovation (Kost-Byerly 2002). Research regarding the safety of this approach in the acute, post-surgical setting is lacking.

The inclusion of NSAIDs, in particular ketorolac, reduces analgesic requirements and improves analgesia in children with epidurals or PCA (Kokki 2003). The use of NSAIDs following major orthopedic procedures remains controversial since prostaglandins induce lamellar bone formation and animal studies suggest that NSAIDs impair bone healing and fracture repair. No difference in the incidence of curve progression, hardware failure or back pain was found in adolescents following spinal fusion (Farrar and Lerman 2002). Since NSAIDs can result in renal dysfunction they are best avoided during the initial 24 h following major surgeries if ongoing third space losses are anticipated.

### References

1. Apfelbaum JL, Chen C, Mehta SS et al. (2003) Postoperative pain experience: results from a national survey suggest postoperative pain continues to be under managed. *Anesth Analg* 97:534–40
2. Bremerich DH, Neidhart G, Heimann K et al. (2001) Prophylactically administered rectal acetaminophen does not reduce postoperative opioid requirements in infants and small children undergoing elective cleft palate repair. *Anesth Analg* 92:907–912
3. Bozkurt P (2002) The analgesic efficacy and neuroendocrine response in paediatric patients treated with two analgesic techniques: using morphine-epidural and patient-controlled analgesia. *Paed Anes* 12:248–254
4. Farrar, MW, Lerman J (2002) Novel concepts for Analgesia in Pediatric Surgical Patients: cyclo-oxygenase-2 Inhibitors, alpha-2 agonists and opioids. *Anes Clin NA* 20:59
5. Gan TJ, Joshi GP, Viscusi E et al. (2004) Preoperative parenteral parecoxib and follow-up oral valdecoxib reduce length of stay and improve quality of patient recovery after laparoscopic cholecystectomy surgery. *Anesth Analg* 98:1665–1673
6. Greenberg RS, Billet C, Zahurak M et al. (1999) Videotape increases parental knowledge about pediatric pain management. *Anesth Analg* 89:899–903
7. Huth MM, Broome ME, Good M (2004) Imagery reduces children's post-operative pain. *Pain* 110:439–448
8. Kokinsky E, Thornbert E (2003) Postoperative pain control in children. A guide to drug dose. *Paediatr Drugs* 5:751–762
9. Kokki, Hannu (2003) Nonsteroidal anti-inflammatory drugs for postoperative pain. A focus on children. *Paediatr Drugs* 5:103–123
10. Korpela R, Korvenoja P, Meretoja OA (1999) Morphine-sparing effect of acetaminophen in pediatric day case surgery. *Anesthesiol* 91:442–447
11. Kost Byerly S (2002) New concepts in acute and extended postoperative pain management in children. *Anesthesiol Clin North America* 20:115–135
12. Krane EJ, Dalens BJ, Murat I et al. (1998) The safety of epidurals placed under general anesthesia. *Reg Anesth Pain Med* 23:433–438
13. McNeely JK, Trentadue NC (1997) Comparison of patient-controlled analgesia with and without nighttime morphine infusion following lower extremity surgery in children. *J Pain Symptom Manage* 13:268–273

**Acute Pain in Children, Post-Operative, Table 4** Opioid Infusion and PCA Dosing Guidelines

Medication	Loading Dose	Continuous / Basal Rate	PCA Bolus
Morphine 1 or 5 mg ml <sup>-1</sup>	0.03 mg– 0.05 mg kg <sup>-1</sup>	0.01– 0.03 mg kg <sup>-1</sup> h <sup>-1</sup>	0.01– 0.03 mg kg <sup>-1</sup>
Hydromorphone 100 mcg ml <sup>-1</sup>	5 mcg kg <sup>-1</sup>	3–5 mcg kg <sup>-1</sup> h <sup>-1</sup>	2–5 mcg kg <sup>-1</sup> h <sup>-1</sup>
Fentanyl 50 mcg ml <sup>-1</sup>	0.3 mcg kg <sup>-1</sup>	0.5–1 mcg kg <sup>-1</sup> h <sup>-1</sup>	0.2–1 mcg kg <sup>-1</sup> h <sup>-1</sup>

14. Tachibana T, Ling QD, Ruda MA (2001) Increased Fos induction in adult rats that experienced neonatal peripheral inflammation. *Neuroreport* 12:925–927
15. Watcha MF, Issioui T, Klein KW et al. (2003) Costs and effectiveness of rofecoxib, celecoxib and acetaminophen for preventing pain after ambulatory otolaryngologic surgery. *Anesth Analg* 96:987–994

## Acute Pain in Children, Procedural

CHRISTINA LIOSSI

School of Psychology, University of Southampton and Great Ormond Street Hospital for Sick Children, London, UK

cliossi@soton.ac.uk

### Synonyms

Pediatric Pharmacological Interventions; Pediatric Psychological Interventions; Pediatric Integrated Care for Painful Procedures; Acute Procedural Pain in Children

### Definition

Acute procedural pain refers to the pain that infants and children experience as a result of necessary ► **invasive** diagnostic and therapeutic procedures. Procedural pain management refers to the pharmacological, psychological and physical interventions used to prevent, reduce or eliminate pain sensations in children arising as a result of an invasive or aversive medical procedure.

### Characteristics

Acute procedural pain is a significant problem for infants and children and, regrettably, is currently undertreated in many centers. A recent survey of institutions in the Pediatric Oncology Group (Broome et al. 1996) found that 67% of institutions routinely used local anesthesia, 22% used systemic premedication and 11% used different relaxation techniques for management of painful procedures such as lumbar punctures (LPs) and bone marrow aspirations (BMAs). Children (this term refers to all individuals in the pediatric age range, i.e. neonates, infants and adolescents) and their families experience significant emotional and social consequences as a result of pain and the effects of inadequately managed procedure-related pain can be severe and long lasting (Kazak et al. 1997; Young et al. 2005).

The aims of pain management are to 1) optimize pain control during the procedure, recognizing that a pain-free procedure may not be achievable, 2) enhance the patient's physical well-being, 3) enhance the patient's self-esteem and self-efficacy and 4) minimize the short and long term psychological distress of the patient and his / her family.

### Invasive Procedures

Children undergo a variety of painful procedures in varied settings such as venipunctures, lumbar punctures, bone marrow aspirations, fracture reduction and orthodontic procedures. Painless procedures (such as CT scanning, MRI positioning for radiotherapy and ultrasonic examination, pelvic examination in young girls) that require patients to lie still, often on a cold, hard surface, may still be aversive and indirectly provoke pain and distress.

### Factors that Affect Procedural Pain

Acute procedural pain in children is the result of a dynamic integration of physiological processes, psychological factors and sociocultural context embedded within a developmental trajectory. Consequently, procedural pain management is most probably effective when all components of the child's pain experience are evaluated and addressed. Depending on the nature of the procedure and the characteristics and preferences of the child and his / her family, optimal pain control strategies will range from general anesthesia to ► **psychological strategies**. In all cases, a multimodal approach may reduce the potential for adverse effects arising from either escalating frequency or dosage levels of a single pharmacological modality (Lang et al. 2000).

In order to address all relevant factors, health care providers must assess the factors that affect a child's pain. A standard nomenclature and a multidimensional approach are essential components of a comprehensive procedural pain assessment. The description of the pain should include its temporal features, intensity, quality and exacerbating and relieving factors. Treatment strategies should be based on the findings of the assessment and should address the inciting and contributing factors. The specific approach to procedural pain is shaped according to the anticipated intensity and duration of expected pain, the type of procedure, the context and meaning as seen by the child and family, the coping style and temperament of the child, the child's history of pain and the available family support system (Lioffi 2002; McGrath 1990; Zeltzer et al. 1989).

Procedures that cause pain in a child should be performed by health care professionals with high technical competence, so that pain is minimized to the greatest possible extent. The child and his / her family should be included in the planning and decision-making process regarding the treatment plan. This provides families with control and health care providers with valuable insights into how the child understands and copes with pain. Children and parents should receive appropriate information about what to expect and appropriate preparation about how to minimize distress (Blount et al. 1994). A quiet environment, calm adults and clear, confident instructions increase the likelihood that the specific pain management strategy selected will be effective (McGrath 1990; Zeltzer et al. 1989).



### Pharmacological Interventions for Procedural Pain in Children

Local anesthesia is the standard analgesic intervention whenever tissue injury is involved. Topical anesthetics such as EMLA (eutectic mixture of local anesthetics) and amethocaine have recently revolutionized analgesic care but infiltration and regional nerve blocks with lidocaine, bupivacaine and ropivacaine remain in wide use (Finley 2001; Schechter et al. 2003).

For procedural pain that is predictably severe and for which local measures give inadequate relief, such as for bone marrow aspirations, the use of systemic agents is required to reduce or eliminate pain. The use of anxiolytics or sedatives (such as benzodiazepines, propofol, chloral hydrate or barbiturates) alone for painful procedures does not provide analgesia but makes a child less able to communicate distress. The child still experiences pain during the procedure and there are no data on the short- or long-term sequelae of this strategy. These agents are adequate as sole interventions only for nonpainful procedures such as CT or MRI scans (Finley 2001; Schechter et al. 2003).

When it is necessary to use sedation and analgesia for painful procedures, the guidelines issued by the AAP (American Academy of Pediatrics, Committee on Drugs 1992) should be followed. These AAP guidelines recommend that skilled supervision is necessary whenever systemic pharmacologic agents are used for conscious sedation (i.e. the patient maintains a response to verbal and physical stimuli), that sedation should be conducted in a monitored setting with resuscitative drugs and equipment available and that agents should be administered by a competent person. The guidelines further recommend that one person is assigned to monitor the child's condition and another qualified person is present to respond to medical emergencies. After the procedure, monitoring should continue until the patient is fully awake and has resumed the former level of function. Discharged patients should be accompanied by an adult for a time at least as long as two half-lives of the agents used. In contrast to conscious sedation, deep sedation (i.e. when the patient is not responsive to verbal or physical stimuli) is equivalent to general anesthesia and should be performed only under controlled circumstances by a professional trained in its use and skilled in airway management and advanced life support. Despite careful titration of sedative doses, individual responses are variable and patients may occasionally have respiratory compromise or loss of airway reflexes (Zeltzer et al. 1989). Nitrous oxide offers one more analgesic pharmacological option in the management of procedural pain. Its use requires availability of trained personnel and appropriate monitoring procedures. Administered by a mask or tent, nitrous oxide is a potent, short-acting inhalant analgesic. A significant drawback is the high degree of room air contamination, making occupational exposure a serious concern.

### Psychological Interventions for Procedural Pain in Children

A

Psychological interventions for procedural pain management include preparation, deep breathing, distraction, relaxation, play therapy, guided imagery, cognitive therapy and hypnosis. Of these interventions, cognitive therapy and hypnosis have achieved status as empirically validated, efficacious and possibly efficacious interventions respectively, in the management of pediatric procedure-related cancer pain (Lioffi 1999; Lioffi 2002; Powers 1999), according to the framework developed by the American Psychological Association Division 12 Task Force on Promotion and Dissemination of Psychological Procedures (Chambless and Hollon 1998). The focus in cognitive therapy is on the child's behavior, emotions, physiological reactions and cognitions (i.e. thoughts and visual images). The rationale for cognitive therapy is that a person's understanding of the pain or the illness / procedure causing their pain determines their emotional reactions; therefore it is possible by modifying negative and maladaptive cognitions to reduce pain and distress. Hypnosis is a psychological state of heightened awareness and focused concentration, in which critical faculties are reduced and susceptibility and receptiveness to ideas is greatly enhanced. In all studies conducted to date, cognitive therapy and hypnosis were effective in reducing the pain and anxiety of young patients during procedures (Lioffi 2002; Hilgard and LeBaron 1982).

Psychological strategies alone, however, often do not reduce pain sufficiently. A combination of psychological with pharmacological interventions is necessary. To this end, in 1998, the World Health Organization (WHO) developed and published guidelines for the management of pain in children with cancer. For all medical procedures, the use of a combination of a psychological with a pharmacological approach is supported and aggressive, preemptive approaches are emphasized. Preliminary empirical evidence for these guidelines has been offered in a recent randomized controlled clinical trial combining self-hypnosis with local anesthesia (Lioffi et al. 2006) and in the development and evaluation of a multidisciplinary psychological and pharmacological protocol for procedure pain in childhood leukemia (APPO) at the Children's Hospital of Philadelphia (Kazak and Kunin-Batson 2001). The general principles for pediatric procedural pain management are as follows:

#### Before the Procedure

- As far as possible treat procedure-related pain preemptively.
- Provide information regarding the time, frequency, and "clustering" of procedures, if more than one is to be required. For procedures that will be repeated, maximize treatment for the pain and anxiety of the first procedure to minimize the anticipatory anxiety before subsequent procedures.

- Provide the patient and his/her family with education regarding pain and pain management
- Tailor treatment options to the patient's and the family's needs and preferences, to the procedure and to the context.
- Provide adequate preparation of the patient and family. For children, discuss with the child and parents what can be expected and how the child might respond.
- Explore and address concerns regarding the procedure and pain management interventions.
- Minimize delays to prevent escalation of anticipatory anxiety.

#### During the Procedure

- Integrate pharmacological and nonpharmacological options in a complementary style.
- Allow parents to be with the child during the procedure, if parents choose to remain. Parents should be taught what to do, where to be and what to say to help their child through the procedure.

#### After the Procedure

- Debrief the patient and his / her family
- Encourage the use of coping skills
- Review with the patient and family their experiences and perceptions about the effectiveness of pain management strategies.

The list below provides an example of how psychological and pharmacological interventions can be integrated in the management of lumbar puncture pain for an older child (>6 years old):

#### Before the Procedure

- Teach the child self-hypnosis.
- Teach parents how to support their child in the use of self-hypnosis.
- Apply EMLA 60 min before the procedure.

#### During the Procedure

- Encourage the child to use self-hypnosis and their parents, if they wish, to coach them.

#### After the Procedure

- Encourage the use of self-hypnosis for the management of possible post lumbar puncture headache.

#### Summary

Innovations in acute pediatric procedural pain management do not need to be "high tech" In most cases, excellent analgesic results can be achieved through application of standard pharmacological and psychological approaches, continuous patient assessment and patient and family participation in treatment planning. Although financial pressures may slow the adoption of pain control

as a priority in acute patient care (and in this regard integrated care is particularly expensive), equally strong social trends demand treatments that enhance patient- and family-centered outcomes. Education of the public will increase societal awareness and support of children in pain and shape appropriate public policy, which in turn will speed up the bridging of the gap between theoretical developments, research evidence and current clinical practice in acute pediatric procedural pain management.

#### References

1. American Academy of Pediatrics Committee on Drugs (1992) Guidelines for monitoring and management of pediatric patients during and after sedation for diagnostic and therapeutic procedures. *Pediatrics* 89:1110–1115
2. Blount R, Powers SW, Cotter MW et al. (1994) Making the system work: training pediatric oncology patients to cope and their parents to coach them during BMA /LP procedures. *Behav Modif* 18:6–31
3. Broome M, Richtmeier A, Maikler V et al. (1996) Pediatric pain practices: a national survey of health professionals. *J Pain Symptom Manage* 11:312–320
4. Chambless DL, Hollon SD (1998) Defining empirically supported therapies. *J Consult Clin Psychol* 66:7–18
5. Finley GA (2001) Pharmacological management of procedure pain. In: Finley GA, McGrath PJ (eds) *Acute and Procedure Pain in Infants and Children. Progress in Pain Research and Management*, vol 20. IASP Press, Seattle
6. Hilgard J, LeBaron S (1982) Relief of anxiety and pain in children and adolescents with cancer: Quantitative measures and clinical observations. *Int J Clin Exp Hypn* 30:417–442
7. Kazak AE, Kunin-Batson A (2001) Psychological and integrative interventions in pediatric procedure pain. In: Finley GA, McGrath PJ (eds) *Acute and Procedure Pain in Infants and Children. Progress in Pain Research and Management*, vol 20. IASP Press, Seattle, pp 57–76
8. Kazak A, Barakat L, Meeske K et al. (1997) Posttraumatic stress, family functioning, and social support in survivors of childhood cancer and their mothers and fathers. *J Consult Clin Psychol* 65:120–129
9. Lang EV, Benotsch EG, Fick LJ et al. (2000) Adjunctive non-pharmacological analgesia for invasive medical procedures: a randomised trial. *Lancet* 29:1486–1490
10. Lioffi C (1999) Management of pediatric procedure-related cancer pain. *Pain Rev* 6:279–302
11. Lioffi C (2002) Procedure related cancer pain in children. Radcliffe Medical Press, Abingdon, Oxon, UK
12. Lioffi C, White P, Hatira P (2006) Randomised clinical trial of a local anaesthetic versus a combination of self-hypnosis with a local anaesthetic in the management of paediatric procedure-related pain. *Health Psychology* (in press)
13. McGrath PA (1990) *Pain in children: nature, assessment and treatment*. The Guilford Press, New York
14. Powers SW (1999) Empirically supported treatments in pediatric psychology: pediatric pain. *J Pediatr Psychol* 24:131–145
15. Schechter NL, Berde CB, Yaster M (2003) *Pain in infants, children, and adolescents*. Lippincott Williams & Wilkins, Philadelphia
16. World Health Organization (1998) *Cancer pain relief and palliative care in children*. World Health Organization, Geneva
17. Young KD (2005) Pediatric procedural pain. *Annals Emergency Med* 45:160–171
18. Zeltzer LK, Jay SM, Fisher DM (1989) The management of pain associated with pediatric procedures. *Pediatr Clin North Am* 36:941–964

## Acute Pain Management in Infants

REBECCA PILLAI RIDDELL<sup>1</sup>, BONNIE J. STEVENS<sup>2</sup>

<sup>1</sup>York University and The Hospital for Sick Kids,  
Toronto, ON, Canada

<sup>2</sup>University of Toronto and The Hospital for Sick  
Children, Toronto, ON, Canada

rpr@yorku.ca, b.stevens@utoronto.ca

### Synonyms

Infant pain treatment; Infant Pain Reduction/Therapy/Treatment; infant pain therapy; Pain Management in Infants

### Definition

Infant pain management is defined as any strategy or technique administered to an infant experiencing pain with the intention of lessening pain sensation and/or perception. Pain management strategies include the drugs described in the essay ► [pain management, pharmacotherapy](#) and varied nonpharmacological (contextual, psychological and physical) interventions described in this essay. Pain management during infancy has been almost exclusively focused on acute procedural (including post-operative) pain (although recent work is beginning to focus on assessment and treatment in prolonged and chronic pain), thus the emphasis throughout this essay will be on pain reduction strategies for acute procedural pain.

### Characteristics

#### Developmental and Caregiver Considerations

A sensitive appreciation of infants in pain and their complete reliance on their caregivers is a fundamental starting point for approaching infant pain management (Als et al. 1994). Infants have (a) greater sensitivity to noxious stimuli due to immature nervous system pathways, (b) immature cognitive ability to comprehend the purpose or predict the end of a painful procedure, (c) limited developmental motor competency to manage their pain and (d) minimal communication abilities to alert a caregiver who can alleviate their pain. However, even knowledgeable caregivers often do not recognize and / or adequately manage infants' pain (Simons et al. 2003). The caregivers' difficulty in discerning the state of an infant, the lack of specificity of infant responses to painful procedures and caregiver biases concerning pain assessment and management all contribute to this dilemma. Mixed results have been found regarding the strength of relationship between parental behaviors and infant pain reduction; however, researchers consistently suggest that the influence of parental behaviors on managing infant pain is mediated by the physiological and tem-

peramental qualities of the infant (e.g. Sweet et al. 1999).

#### An Integrated Approach to Acute Pain Management

Pain management during infancy should be multifaceted and integrated within every step of the decision-making process from deciding whether a particular procedure is warranted to determining the safest and most effective pain relieving strategy. While an informed understanding of drug therapy is a crucial facet of pain management, psychological, physical and environmental strategies and techniques are also important components and should be included in an integrated pain management approach.

#### Limit Exposure to Pain-inducing Procedures

Often the routine care of an ill infant necessarily includes the infliction of pain for diagnostic or therapeutic purposes. However, recent guidelines recommend that health care providers attempt to limit the number of painful procedures performed on infants (Joint Fetus and Newborn Committee of the Canadian Paediatric Society and American Academy of Pediatrics 2000). The number and frequency of painful procedures, particularly those often repeated during an infant's hospitalization (e.g. heel lance), should be carefully considered within the developmental stage and health status of the infant. Before subjecting an infant to a painful procedure, caregivers should determine whether the procedure is warranted in relation to the potential benefit to the child's health status. Unnecessary procedures should be avoided and alternative non-painful or less painful options should always be explored.

#### Select the Least Painful Diagnostic or Therapeutic Method

If a painful procedure is unavoidable, the least painful approach incorporating pharmacological (e.g. topical anesthetic), physical (e.g. ► [positioning](#)) and cognitive (e.g. distraction) interventions should be undertaken (see Anand et al. 2001 for a review). The onus is on clinicians to familiarize themselves with the current evidence and recommended clinical best practices to minimize procedural pain in infants. Databases such as the Cochrane Collaboration, CINAHL, MEDLINE and EMBASE provide systematic reviews and meta-analyses with recommendations for clinical practice. For example, venipuncture is recommended as less painful than heel lance for blood sampling in newborns (Shah and Olsson 2004). Other procedural examples may be found in the circumcision context. In addition to dorsal penile nerve blocks, the specific clamp used to hold the foreskin or the type of infant restraint can moderate pain and distress. For example, the Mogen clamp lessens pain in comparison to the Gomco clamp (Kurtis et al. 1999).

### Contextual Strategies to Manage Infant Pain

The context in which a painful procedure is conducted modifies behavioral and physiological aspects of infant pain. Context can refer to (a) the personal context of the infant, specifically that pain responses of infants are significantly increased with a history of numerous painful procedures and (b) the environmental context, most often the presence of stressful elements such as significant handling, unpredictable noises, multiple caregivers and bright lights. Preliminary research suggests that infants who are cared for in a developmentally sensitive manner (i.e. low noise and lighting, bundling of procedures to avoid over-handling) have lower pain reactivity (Stevens et al. 1996).

### Psychological Strategies

Despite extensive evidence of the value of inhibitory mechanisms in pain control with older children and adults, researchers have only begun to consider the inhibitory cognitive capabilities of the infant in relation to pain (e.g. distraction). ► **Distraction** in the form of play (such as encouraging infant attention to a mobile or mirror) (Cohen 2002) or the combination of music and non-nutritive sucking (Bo and Callaghan 2000) have both been shown to moderate both physiological and behavioral indicators of infant pain (i.e. cry, heart rate, facial grimacing). Another promising cognitive intervention for managing infant pain, adapted from work with older children and adults, was demonstrated by Derrickson et al. (1993). Based on a simple ► **signaling** paradigm, a 9 month old hospitalized infant was taught to predict the occurrence of painful and invasive procedures.

### Physical Strategies

Much of the interventional pain research on infants has been conducted within this domain. Common strategies involve ► **non-nutritive sucking** (NNS, e.g. pacifiers), ► **skin-to-skin contact** (e.g. kangaroo care), the administration of sweet substances such as sucrose that are thought to mimic opioid-mediated pain mechanisms or some combination of the above.

The most commonly researched strategy has been the administration of sucrose with and without NNS. Although exact dosage recommendations have not been clearly delineated (a dose range of 0.012 g to 0.12 g was identified), a recent systematic review of the efficacy of sucrose noted that for newborn infants sucrose decreased both physiological and behavioral indices of preterm and full-term infants in response to heel lance and venipuncture (Stevens et al. 2004). Pain responses are further decreased when sucrose and NNS are utilized together for heel lance with the speculation that the opioid-mediated orogustatory (e.g. sweet taste of sucrose), non-opioid-initiated orotactile (e.g. pacifier) and mechanoreceptor mechanisms are complementary in reducing pain (Gibbins and Stevens 2001). The administration of multisensory

saturation (i.e. massage, eye contact, gentle vocalization, soothing smell) has also been shown to significantly increase the analgesic efficacy of sucrose (Bellieni et al. 2002). It is noteworthy that the efficacy of sucrose for pain relief tends to decrease with age and is believed to no longer be effective after 6 months of age (Pasero 2004).

Breast milk has also been examined for analgesic properties but has not been found to be as effective as sucrose (Ors et al. 1999). Other physical techniques such as massage, rocking, holding and skin-to-skin contact have also been shown to successfully moderate pain responses through non-opioid mediated pathways (e.g. Johnston et al. 2003).

A further group of pain management strategies relate to the positioning or containing of the infant during painful procedures. ► **Swaddling**, positioning, ► **facilitative tucking**, all appear to have some limited efficacy as a pain management technique on their own but appear better as an adjuvant to increase the efficacy of more reliable pain-reducing strategies.

Other types of physical stimulation commonly utilized with children and adults, such as heat, cold, acupuncture, transcutaneous stimulation and acupressure have not yet been investigated adequately with infant populations.

### Summary

Understanding that unrelieved pain during infancy can irrevocably alter an individual's pain sensation and perception underscores the importance of infant caregivers' responsibility for being cognizant of the vast array of empirically supported strategies available to appropriately manage infant pain.

### References

1. Als H, Lawhon G, Duffy FH et al. (1994) Individualized developmental care for the very low-birth-weight preterm infant. Medical and neurofunctional effects. *JAMA* 272:853–858
2. Anand KJS and International Evidence-Based Group for Neonatal Pain (2001) Consensus statement for the prevention and management of pain in the newborn. *Arch Pediatr Adolesc Med* 155:173–180
3. Bellieni CV, Bagnoli F, Perrone S et al. (2002) Effect of multi-sensory stimulation on analgesia in term neonates: A randomized controlled trial. *Pediatr Res* 51:460–463
4. Bo LK, Callaghan P (2000) Soothing pain-elicited distress in Chinese neonates. *Pediatrics* 105:49
5. Cohen LL (2002) Reducing infant immunization distress through distraction. *Health Psychol* 21:207–211
6. Derrickson JG, Neef NA, Cataldo MF (1993) Effects of signaling invasive procedures on a hospitalized infant's affective behaviors. *J Appl Behav Anal* 26:133–134
7. Gibbins S, Stevens B (2001) Mechanisms of sucrose and non-nutritive sucking in procedural pain management in infants. *Pain Res Manag* 6: 21–28
8. Johnston CC, Stevens B, Pinelli J et al. (2003) Kangaroo care is effective in diminishing pain response in preterm neonates. *Arch Pediatr Adolesc Med* 157:1084–1088
9. Joint Fetus and Newborn Committee of the Canadian Paediatric Society and American Academy of Pediatrics (2000) Prevention and Management of Pain and Stress in the Neonate *Pediatrics* 105, pp 454–461



10. Kurtis PS, DeSilva HN, Bernstein BA et al. (1999) A comparison of the mogen and gomco clamps in combination with dorsal penile nerve block in minimizing the pain of neonatal circumcision. *Pediatrics* 103:E23
11. Ors R, Ozek E, Baysoy G et al. (1999) Comparison of sucrose and human milk on pain response in newborns. *European J Pediatrics* 158:63–66
12. Pasero C (2004) Pain relief for neonates. *Am J Nurs* 104:44–47
13. Shah V, Ohlsson A (2004) Venepuncture versus heel lance for blood sampling in term neonates. *Cochrane Database of Systematic Reviews* 4
14. Simons SHP, van Dijk M, Anand KS et al. (2003) Do we still hurt newborn babies?: A prospective study of procedural pain and analgesia in neonates. *Arch Pediatr Adolesc Med* 157:1058–1064
15. Stevens B, Johnston C, Franck L et al. (1999) The efficacy of developmentally sensitive interventions and sucrose for relieving procedural pain in very low birth weight neonates. *Nurs Res* 48:35–43
16. Stevens B, Petryshen P, Hawkins J et al. (1996) Developmental versus conventional care: A comparison of clinical outcomes for very low birth weight infants. *Can J Nurs Res* 28:97–113
17. Stevens B, Yamada J, Ohlsson A (2004) Sucrose for analgesia in newborn infants undergoing painful procedures (Updated Cochrane review). *The Cochrane Library* 3
18. Sweet SD, McGrath PJ, Symons D (1999) The roles of child reactivity and parenting context in infant pain response. *Pain* 80:655–661

## Acute Pain Mechanisms

PAUL M. MURPHY

Department of Anaesthesia and Pain Management,  
Royal North Shore Hospital, St Leonard's, NSW,  
Australia

drpmurphy@hotmail.com

### Definition

Acute pain is defined as “pain of recent onset and probable limited duration. It usually has an identifiable temporal and causal relationship to injury or disease” (Ready and Edwards 1992). The perception of acute pain requires transduction of noxious mechanical, thermal or chemical stimuli by nociceptive neurons, integration and modulation at the level of the spinal cord and ultimately transmission to cortical centres.

### Characteristics

#### Peripheral Nociception

► **Nociceptors** in the skin and other deeper somatic tissues such as periosteum are morphologically free nerve endings or simple receptor structures. A ► **noxious stimulus** activates the nociceptor depolarising the membrane *via* a variety of stimulus specific transduction mechanisms. C polymodal nociceptors are the most numerous of somatic nociceptors and respond to a full range of mechanical, chemical and thermal noxious stimuli. Polymodal nociceptors are coupled to unmyelinated C fibres. Electrophysiological activity in these slow conduction C fibres is characteristically perceived as dull, burning pain. Faster conducting A $\delta$  fibres are coupled to more

selective thermal and mechano-thermal receptors considered responsible for the perception of sharp or “stabbing” pain (Julius and Basbaum 2001).

#### Inflammatory Induced Peripheral Sensitization

A complex interaction of molecules produced during the inflammation acting on nociceptors results in functional, morphological and electrophysiological changes causing “primary hyperalgesia”. Nociceptors are sensitised due to changes in the absolute numbers of Na<sup>+</sup> and K<sup>+</sup> channels and their relative “open-closed” kinetics. This results in neuronal activation in response to innocuous stimuli and spontaneous ectopic discharges. Inflammatory mediators also act to increase the activity of “silent” nociceptors normally unresponsive to even noxious stimuli. There is an increase in many ion channel subtypes, (particularly the ► **tetrodotoxin** (TTX) resistant Na<sup>+</sup> channel) both on the axon and also in the dorsal root ganglion (DRG) (Kidd and Urban 2001). There is up-regulation of receptor expression, including substance P and brain derived growth factor (BDGF). Morphological changes including sprouting of unmyelinated nerve fibres have also been identified.

#### Spinal Cord Integration

The majority of somatic nociceptive neurons enter the dorsal horn spinal cord at their segmental level. A proportion of fibres pass either rostrally or caudally in ► **Lissauer's tract**. Somatic primary afferent fibres terminate predominantly in lamina I (marginal zone) and II (substantia gelatinosa) of the dorsal horn where they synapse with projection neurons and excitatory/inhibitory interneurons. Some A $\delta$  fibres penetrate more deeply into lamina V. Projection neurons are of three types classified as nociceptive specific (NS), low threshold (LT) and wide dynamic range neurons (WDR). The NS neurons are located predominantly in lamina I and respond exclusively to noxious stimuli. They are characterised by a small receptive field. LT neurons, which are located in laminae III and IV, respond to innocuous stimuli only. WDR neurons predominate in lamina V (also in I), display a large receptive field and receive input from wide range of sensory afferents (C, A $\beta$ ) (Parent 1996).

#### Spinal Modulation and Central Sensitisation

Glutamate and aspartate are the primary neurotransmitters involved in spinal excitatory transmission. Fast post-synaptic potentials generated *via* the action of glutamate on AMPA receptors are primarily involved in nociceptive transmission (Smullen et al. 1990). Prolonged C fibre activation facilitates glutamate-mediated activation of ► **NMDA receptors** and subsequent prolonged depolarization of the WDR neuron (termed “► **wind-up**”). This is associated with removal of a Mg<sup>+</sup> plug from the NMDA-gated ion channel. The activation of this voltage gated Ca<sup>+</sup> channel is associated

with an increase in intracellular  $\text{Ca}^{+}$  and up-regulated neurotransmission (McBain and Mayer 1994). The peptidergic neurotransmitters substance P and calcitonin G related peptide (CGRP) are co-produced in glutaminergic neurons and released with afferent stimulation. These transmitters appear to play a neuromodulatory role, facilitating the action of excitatory amino acids. A number of other molecules including glycine, GABA, somatostatin, endogenous opioids and ► **endocannabinoids** play modulatory roles in spinal nociceptive transmission (Fürst 1999).

### Projection Pathways

Nociceptive somatic input is relayed to higher cerebral centres *via* three main ascending pathways the spinothalamic, spinoreticular and spinomesencephalic tracts (Basbaum and Jessel 2000). The spinothalamic path originates in laminae I and V–VII and is composed of NS and WDR neuron axons. It projects to thalamus *via* lateral (► **neospinothalamic tracts**), and medial or ► **paleospinothalamic** tracts. The lateral tract passes to the ventro-postero-medial nucleus and subserves discriminative components of pain, while the medial tract is responsible for the autonomic and emotional components of pain. Additional fibres pass to reticular activating system, where they are associated with the arousal response to pain and the periaqueductal grey matter (PAG) where ascending inputs interact with descending modulatory fibres. The spinoreticular pathway originates in laminae VII and VIII and terminates on the medial medullary reticular formation. The spinomesencephalic tract originates in laminae I and V and terminates in the superior colliculus. Additional projections pass to the mesencephalic PAG. It appears that this pathway is not essential for pain perception but plays an important role in the modulation of afferent inputs.

### Cortical Representation

Multiple cortical areas are activated by nociceptive afferent input including the primary and secondary somatosensory cortex, the insula, the anterior cingulate cortex and the prefrontal cortex. Pain is a multidimensional experience with sensory-discriminative and affective-motivational components. Advances in functional brain imaging have allowed further understanding of the putative role of cortical structures in the pain experience (Treede et al. 1999).

#### 1. Localization

- a) primary somatosensory cortex
- b) secondary somatosensory cortex
- c) insula

#### 2. Intensity

- a) prefrontal cortex
- b) right posterior cingulate cortex

- c) brainstem
- d) periventricular grey matter

#### 3. Affective Component

- a) left anterior cingulate cortex

#### 4. Threshold

- a) cingulate cortex
- b) left thalamus
- c) frontal inferior cortex

### References

1. Basbaum AI, Jessel TM (2000) The perception of pain. In: Kandel ER, Schwartz JH, Jessel TM (eds) Principles of Neural Science. McGraw-Hill, New York, pp 472–91
2. Fürst S (1999) Transmitters involved in antinociception in the spinal cord. *Brain Res Bull* 48:129–41
3. Julius D, Basbaum AI (2001) Molecular mechanisms of nociception. *Nature* 413:203–7
4. Kidd BL, Urban L (2001) Mechanisms of Inflammatory Pain. *Br J Anaesth* 87:3–11
5. McBain CJ, Mayer ML (1994) N-methyl-D-aspartic acid receptor structure and function. *Physiol Rev* 74:723–60
6. Parent A (1996) *Carpenter's Human Neuroanatomy*. Williams & Wilkins, Baltimore
7. Ready LB, Edwards WT (1992) *Management of Acute Pain: A Practical Guide*. Taskforce on Acute Pain. IASP Publications, Seattle
8. Smullen DH, Skilling SR, Larson AA (1990) Interactions between Substance P, calcitonin G related peptide taurine and excitatory amino acids in the spinal cord. *Pain* 42:93–101
9. Treede R-D, Kenshalo DR, Gracely RH et al. (1999) The cortical representation of pain. *Pain* 79:105–11

## Acute Pain Service

### Synonyms

APS

### Definition

Poor perioperative pain management is remedied, not so much in the development of new techniques, but by the development of Acute Pain Services (APS) to exploit existing expertise. APSs have been established in many countries. Most are headed-up by anesthesiologists. An APS consists of anesthesiologist-supervised pain nurses and an ongoing educational program for patients and all health personnel involved in the care of surgical patients. The benefits of an APS include increased patient satisfaction and improved outcome after surgery. It raises the standards of pain management throughout the hospital. Optimal use of basic pharmacological analgesia improves the relief of post-operative pain for most surgical patients. More advanced approaches, such as well-tailored epidural analgesia, are used to relieve severe dynamic pain (e.g. when coughing). This

may markedly reduce risks of complications in patients at high risk of developing post-operative respiratory infections and cardiac ischemic events. Chronic pain is common after surgery. Better acute pain relief offered by an APS may reduce this distressing long-term complication of surgery.

► [Multimodal Analgesia in Postoperative Pain](#)

## Acute Pain Team

### Synonyms

APT

### Definition

A team of nurse(s) and doctors (usually anesthesiologist(s)) that specialize in preventing and treating acute pain after surgery, trauma, due to medical conditions, and in some hospitals also labor pain.

- [Postoperative Pain, Acute Pain Management, Principles](#)
- [Postoperative Pain, Acute Pain Team](#)

## Acute Pain, Subacute Pain and Chronic Pain

WADE KING

Department of Clinical Research, Royal Newcastle Hospital, University of Newcastle, Newcastle, NSW, Australia  
wmbaking@tpg.com.au

### Synonyms

Pain of Recent Origin; Persisting Pain; Subacute Pain; chronic pain

### Definition

Acute pain is pain that has been present for less than three months (Merskey 1979; Merskey and Bogduk 1994).

► **Chronic pain** is pain that has been present for more than three months (Merskey 1979; Merskey and Bogduk 1994). Subacute pain is a subset of acute pain: it is pain that has been present for at least six weeks but less than three months (van Tulder et al. 1997).

### Characteristics

Acute pain, subacute pain, and chronic pain are defined by units of time, but the concepts on which they are based are more fundamentally aetiological and prognostic. Acute pain was first defined by Bonica, as “a complex constellation of unpleasant sensory, perceptual and emotional experiences and certain associated autonomic, physiologic, emotional and behavioural responses”

(Bonica 1953). Bonica went on to say “invariably, acute pain and these associated responses are provoked by . . . injury and/or disease . . . or abnormal function.” Thus acute pain was originally defined as a biological phenomenon resulting from physiological responses to bodily impairment. Pain was recognised as playing the important pathophysiological role of making an individual aware of impairment so they could respond appropriately. Responses include withdrawal from the stimulus causing the pain, to avoid further impairment, and behaviours that minimise the impact of the impairment and facilitate recovery. For example, if a person suffers a fracture the resultant pain warns them to limit activities that might further deform the injured part. In this way, acute pain is fundamentally associated with the early stage of a condition, and with the healing process. It can be expected to last for as long as the healing process takes to restore the impaired tissue.

Chronic pain was defined by Bonica as “pain that persists a month beyond the usual course of an acute disease or . . . (beyond the) time for an injury to heal, or that is associated with a chronic pathologic process.” The implication is that if pain persists beyond the time in which an impaired tissue usually heals, the condition involves more than a simple insult to the tissue. One explanation for persistent pain would be that the original insult caused damage beyond the capacity of the natural healing process to repair. Another explanation would be that the insult was recurrent, with each recurrence renewing and prolonging the time required for healing. Yet another would be that the condition involved a chronic pathological process that continues to impair tissue over a long period. Other possible explanations invoke exogenous factors, such as inappropriate interventions applied for treatment, and/or endogenous factors such as cognitions and behaviours that inhibit recovery. Recognition of these endogenous factors lead Engel to develop the biopsychosocial model of chronic pain (Engel 1977), which although originally intended by its author to refer to only some types of chronic pain, is nowadays applied inappropriately by many to chronic pain in general.

The time factor ascribed by Bonica, i.e. one month longer than the usual time of recovery, would vary from condition to condition. In order to standardise the definitions of acute and chronic pain, attempts were made to ascribe finite durations to them. In 1974, Sternbach (Sternbach 1974) suggested six months as an arbitrary limit, such that pain present for up to six months would be classed as acute, whereas that present for more than six months would be deemed chronic. Others felt six months was too long, and discussion ensued. The International Association for the Study of Pain (IASP) formed a committee chaired by Harold Merskey to consider such issues and it determined, in 1979 in a publication defining pain terms, that “three months is the most convenient point of division. . .” (Merskey 1979).

Thus, we have the current definitions of acute and chronic pain as pain present for less than, and more than, three months. The three month period is arbitrary, but it operationalises the definitions so that pains can be classified readily and systematically as acute or chronic. The definition of subacute pain has not been addressed so deliberately. The term ‘subacute’ evolved to describe longer-lasting acute pain, and has been applied in the literature (van Tulder et al. 1997) to pain present for between six weeks and three months. As such, it forms a subset of acute pain. The main division between acute and chronic pain remains at three months.

The pragmatism of the time-based definitions should not be allowed to obscure the concept from which they were derived: that different types of condition give rise to acute and chronic pain. Acute pain should be considered primarily as pain due to a condition that is likely to resolve spontaneously by natural healing. Chronic pain should be considered as signifying a condition unlikely to resolve spontaneously by natural healing. The clinical significance of the three categories of pain flows from the implicit likelihood of spontaneous recovery, which is crucial to management and prognosis.

The management of acute pain is clear when the condition is understood and known to be likely to resolve within a short time by natural healing. By definition, no therapeutic intervention is necessary for recovery; so, rational management involves helping the patient understand the situation, reassuring them and simply allowing natural healing to proceed. The only active intervention that might be needed is something to ease the pain while healing occurs; and the least invasive measure for that purpose is to be preferred. Such an approach carries the least risk of iatrogenic disturbance of the healing process. It fits nicely with Hippocrates’s aphorism of “first, do no harm” (Hippocrates. *Of the Epidemics, I; II: VI*), to which doctors have (supposedly) subscribed for centuries. Cochrane promoted this approach in his farsighted work that led to the formal development of evidence-based medicine; he wrote of “the relative unimportance of therapy in comparison with the recuperative power of the human body” (Cochrane 1977), and wondered “how many things are done in modern medicine because they can be, rather than because they should be” (Cochrane 1977). The effectiveness of the approach has been shown by Indahl et al. (1995) in the management of subacute low back pain, and by McGuirk et al. (2001) in the management of acute low back pain. Rational management of chronic pain is quite different. As the circumstances giving rise to chronic pain will not resolve spontaneously, intervention is indicated in virtually every case. The key to the problem is accurate diagnosis. Psychosocial factors are important in chronic pain, but their roles are usually secondary to what began and often persists as a biological impairment. If the treating clinician can identify an underlying biological mechanism, many chronic conditions have specific treatments

that will control the pain effectively (Lord et al. 1996; Govind et al. 2003). Nevertheless, psychosocial factors must always be considered as well, and addressed if necessary in the management of the condition, but not to the exclusion of the fundamental (biological) cause.

Pursuing the diagnosis of a disorder so as to address its cause seems obvious and is standard practice in other fields of medicine, but for some reason it is controversial in pain medicine. Chronic low back and neck pain, in particular, are rarely managed as if precise diagnosis is possible, which these days it is in the majority of cases (Bogduk et al. 1996). If specific treatment is applied and the pain is controlled, associated psychosocial problems can also be expected to remit. There is sound evidence (Wallis et al. 1997) to show this happens, but no sound evidence to show that when pain is controlled effectively, related psychosocial problems persist.

## References

1. Bogduk N, Derby R, Aprill C, Lord S, Schwarzer A (1996) Precision Diagnosis of Spinal Pain. In: 8<sup>th</sup> World Congress on Pain, Refresher Course Syllabus. IASP Press, Seattle, pp 313–323
2. Bonica JJ (1953) *The Management of Pain*. Lea & Febiger, Philadelphia
3. Cochrane AL (1977) *Effectiveness and Efficiency. Random Reflections on Health Services*. Cambridge University Press, Cambridge, p 5
4. Engel G (1977) The Need for a New Medical Model: A Challenge for Biomedicine. *Science* 196:129–136
5. Govind J, King W, Bailey B, Bogduk N (2003) Radiofrequency Neurotomy for the Treatment of Third Occipital Headache. *J Neurol Neurosurg Psychiatr* 74:88–93
6. Hippocrates. *Of the Epidemics, I; II: VI* paraphrased by Galen, in *Commentaries*
7. Indahl A, Indahl A, Velund L, Reikerås O (1995) Good Prognosis for Low Back Pain when Left Untampered. *Spine* 20:473–477
8. Lord SM, Barnsley L, Wallis BJ, McDonald GJ, Bogduk N (1996) Percutaneous Radiofrequency Neurotomy for the Treatment of Chronic Cervical Zygapophysial Joint Pain: A Randomized, Double-Blind Controlled Trial. *N Engl J Med* 335:1721–1726
9. McGuirk B, King W, Govind J, Lowry J, Bogduk N (2001) Safety, Efficacy and Cost-Effectiveness of Evidence-Based Guidelines for the Management of Acute Low Back Pain in Primary Care. *Spine* 26:2615–2622
10. Merskey H (1979) Pain Terms: A List with Definitions and Notes on Usage Recommended by the IASP Subcommittee on Taxonomy. *Pain* 6:249–252
11. Merskey H, Bogduk N (1994) *Classification of Chronic Pain. Descriptions of Chronic Pain Syndromes and Definitions of Pain Terms*, 2nd edn. IASP Press, Seattle, p xi
12. Sternbach RA (1974) *Pain Patients: Traits and Treatment*. Academic Press, New York
13. van Tulder MW, Koes BW, Bouter LM (1997) Conservative Treatment of Acute and Chronic Nonspecific Low Back Pain. A Systematic Review of Randomized Controlled Trials of the most Common Interventions. *Spine* 22:2128–2156
14. Wallis BJ, Lord SM, Bogduk N (1997) Resolution of Psychological Distress of Whiplash Patients following Treatment by Radiofrequency Neurotomy: A Randomised, Double-Blind, Placebo-Controlled Trial. *Pain* 73:15–22

## Acute Painful Diabetic Neuropathy

### ► Diabetic Neuropathies



## Acute Pelvic Pain

- ▶ Gynecological Pain and Sexual Functioning

## Acute Phase Protein

### Definition

Liver proteins whose synthesis increases in inflammation and trauma.

- ▶ Pain Control in Children with Burns

## Acute Post-Operative Pain in Children

- ▶ Acute Pain in Children, Post-Operative

## Acute Postoperative Pain Therapy

### Definition

Acute postoperative pain therapy includes the postoperative pain service and pain management, patient controlled epidural analgesia and patient controlled intravenous analgesia.

- ▶ Postoperative Pain, Thoracic and Cardiac Surgery

## Acute Procedural Pain in Children

- ▶ Acute Pain in Children, Procedural

## Acute Salpingitis

- ▶ Chronic Pelvic Pain, Pelvic Inflammatory Disease and Adhesions

## Acute Sciatica

- ▶ Lower Back Pain, Acute

## Acute Stress Disorder

A

### Definition

A psychiatric disorder whose onset is within one month of exposure to trauma, and whose symptoms are similar to post traumatic distress. They include re-experiencing the event as with flashbacks and nightmares, dissociative symptoms like numbing, avoidance of any reminder of the trauma, and hyperarousal or increased generalized anxiety.

- ▶ Pain Control in Children with Burns

## Acute-Recurrent Pain

- ▶ Postoperative Pain, Acute-Recurrent Pain

## Adaptation

### Definition

Adaptation refers to a decrease in the firing rate of action potentials in the face of continuing excitation.

- ▶ Coping and Pain
- ▶ Mechanonociceptors

## Adaptation Phase

### Definition

A phase of the psychophysiological assessment designed to permit patients to become acclimated.

- ▶ Psychophysiological Assessment of Pain

## Adaptive Equipment

Equipment designed to increase the abilities of an individual with an impairment or disability.

- ▶ Chronic Pain in Children: Physical Medicine and Rehabilitation

## ADD Protocol

- ▶ Assessment of Discomfort in Dementia Protocol

## Addiction

### Definition

Addiction is the aberrant use of a substance in a manner characterized by: 1) loss of control over medication use, 2) compulsive use, 3) continued use despite physical, psychological or social harm, and 4) craving, often obtaining supply by deceptive or illegal means. This syndrome also includes a great deal of time used to obtain the medication, use the medication, or recover from its effects. Addiction is not the same as tolerance or dependence. Unlike the other two, which are physiological responses, addiction implies drug seeking behaviors and has a host of psychological factors. Addiction is rare among patients given opioids for the treatment of pain.

- ▶ [Cancer Pain, Evaluation of Relevant Comorbidities and Impact](#)
- ▶ [Cancer Pain Management](#)
- ▶ [Opioids, Clinical Opioid Tolerance](#)
- ▶ [Opioid Receptors](#)
- ▶ [Opioid Therapy in Cancer Patients with Substance Abuse Disorders, Management](#)
- ▶ [Postoperative Pain, Opioids](#)
- ▶ [Psychiatric Aspects of the Management of Cancer Pain](#)

## Adduction

### Definition

Movement of a body part toward the midline of the body.

- ▶ [Cancer Pain Management, Orthopedic Surgery](#)

## Adenoassociated Virus Vectors

### Synonyms

AAV

### Definition

Adenoassociated virus (AAV) based vectors are derived from a non-pathogenic parvovirus. AAV are thought to be naturally defective, because of their requirement for co-infection with a helper virus, such as Ad or HSV, for a productive infection. The single stranded 4.7 kB DNA genome is packaged in a 20 nm particle. AAV is not associated with any known disease and induces very little immune reaction when used as a vector. For applications requiring a relatively small transgene, AAV vectors are very attractive, but the small insert capacity limits their utility for applications requiring a large transgene.

- ▶ [Opioids and Gene Therapy](#)

## Adenoma

### Definition

Adenoma is a benign growth starting in the glandular tissue. Adenomas can originate from many organs including the colon, adrenal, thyroid, etc. In the majority of cases these neoplasms stay benign, but some transform to malignancy over time.

- ▶ [NSAIDs and Cancer](#)

## Adenomyosis

### Definition

The growth of endometrial glands and stroma into the uterine myometrium, to a depth of at least 2.5 mm from the basalis layer of the endometrium

- ▶ [Dyspareunia and Vaginismus](#)

## Adenosine 5' Triphosphate

### Synonyms

ATP

### Definition

ATP is one of the five nucleotides that serve as building blocks of nucleic acids. Structurally, adenine and guanine nucleotides are purines, whereas cytosine, thymine and uracil are pyrimidines. ATP is also the main energy source for cells. More recently it has been recognized that ATP, some of its metabolites, as well as some other nucleotides, play a role as extracellular signaling molecules by activating specific cell surface receptors.

- ▶ [Purine Receptor Targets in the Treatment of Neuropathic Pain](#)

## Adenoviral Vectors

### Definition

Adenoviral (Ad) vectors are based on a relatively non-pathogenic virus that causes respiratory infections. The 36 kb linear, double-stranded Ad DNA is packaged in a 100 nm diameter capsid. In first-generation Ad vectors, the early region 1 (E1) gene was deleted to generate a replication-defective vector, and to create space for an inserted gene coding for a marker or therapeutic protein. A cell line that complements the E1 gene deletion allows propagation of the viral vector in cultured cells. These first-generation Ad vectors can accommodate up to approximately 8 kb of insert DNA. In high capacity Ad

vectors, the entire Ad vector genome is ‘guttet’ (hence the alternative name, ‘guttet Ad vector’) removing all viral genes and providing 30 kb of insert cloning capacity.

- ▶ [Opioids and Gene Therapy](#)

## Adequate Stimulus

### Definition

A term coined by Sherrington in 1890’s to define the optimal stimulus for the activation of a particular nervous system structure. For nociceptive systems in humans it is simply defined as „a pain-producing stimulus“ – for animal studies it has been defined as a stimulus that produces, or threatens to produce, tissue damage. This is valid for studies of skin sensation, but may not be valid for deep tissues such as viscera.

- ▶ [Nocifensive Behaviors of the Urinary Bladder](#)
- ▶ [Visceral Pain Model, Urinary Bladder Pain \(Irritants or Distension\)](#)

## Adherence

### Definition

The active, voluntary, collaborative involvement of a patient in a mutually acceptable course of behavior to produce a desired therapeutic result.

- ▶ [Multidisciplinary Pain Centers, Rehabilitation](#)

## Adhesion Molecules

### Definition

Circulating leukocytes migrate to injured tissue directed by adhesion molecules. The initial step, rolling, is mediated by selectins on leukocytes (L-selectin) and endothelium (P- and E-selectin). The rolling leukocytes are exposed to tissue-derived chemokines. These up-regulate the avidity of integrins, which mediate the firm adhesion of cells to endothelium by interacting with immunoglobulin superfamily members such as intercellular adhesion molecule–1. Finally, the cells migrate through the vessel wall, directed by platelet-endothelial cell adhesion molecule-1 and other immunoglobulin ligands. Interruption of this cascade can block immunocyte extravasation.

- ▶ [Opioids in the Periphery and Analgesia](#)

## Adjunctive Drugs

### Definition

Adjunctive Drugs are medications employed in the course of therapy to assist in the treatment of side-effects from the prescribed therapy.

- ▶ [Analgesic Guidelines for Infants and Children](#)

## Adjusted Odds Ratio

### Definition

“Adjusted Odds Ratio” is the expression of probability after taking into account possible confounding variables.

- ▶ [Psychiatric Aspects of the Epidemiology of Pain](#)

## Adjustment Disorder

### Definition

Adjustment Disorder, defined by DSM–IV, includes significant depressive symptoms (with insufficient criteria for a mood disorder) after an identifiable stress, for example, a painful illness, injury, or hospitalization.

- ▶ [Somatization and Pain Disorders in Children](#)

## Adjuvant

### Definition

An additive that enhances the effectiveness of medical standard therapy.

- ▶ [Adjuvant Analgesics in Management of Cancer-Rated Bone Pain](#)
- ▶ [NSAIDs and Cancer](#)

## Adjuvant Analgesic

### Definition

Medications that have a primary indication other than pain, but are analgesic in some painful conditions. Examples include antidepressants and anticonvulsants. Adjuvant analgesic drugs are often added to opioids to augment their efficacy.

- ▶ [Analgesic Guidelines for Infants and Children](#)
- ▶ [Cancer Pain Management, Adjuvant Analgesics in Management of Pain Due To Bowel Obstruction](#)
- ▶ [Cancer Pain Management, Non-Opioid Analgesics](#)
- ▶ [Cancer Pain Management, Principles of Opioid Therapy, Drug Selection](#)
- ▶ [Opioid Rotation in Cancer Pain Management](#)

## Adjuvant Analgesics in Management of Cancer-Related Bone Pain

KERI L. FAKATA, ARTHUR G. LIPMAN  
College of Pharmacy and Pain Management Center,  
University of Utah, Salt Lake City, UT, USA  
keri.fakata@hsc.utah.edu, arthur.lipman@hsc.utah.edu

### Synonyms

Malignant Bone Pain; boney pain; cancer-related bone pain

### Definition

► **Adjuvant** ► **analgesics** in the management of cancer-related bone pain are supplemental treatments that are added to the primary analgesics, usually NSAIDs and opioids. These additional analgesic interventions include radiation, using either palliative ► **radiotherapy** or ► **radiopharmaceuticals**, and two classes of medications, ► **bisphosphonates** and steroids.

### Characteristics

Normal bone undergoes constant remodeling in which resorption or formation of bone occurs. The cells involved in these processes are ► **osteoblasts** and ► **osteoclasts**, respectively. These cells respond to signals from several types of mediators, including hormones, prostaglandins, and ► **cytokines**. Tumor cells invade bone and interrupt the balance between osteoblastic and osteoclastic activity, alter bone integrity and produce pain (Mercadante 1997).

Boney cancers can be exquisitely painful. The severity of pain does not always correlate with radiographic findings. Primary and metastatic bone tumors produce severe pain in about 90% of patients who develop such tumors. Therefore, aggressive and effective treatment of boney cancer pain is important to maintain patients' quality of life.

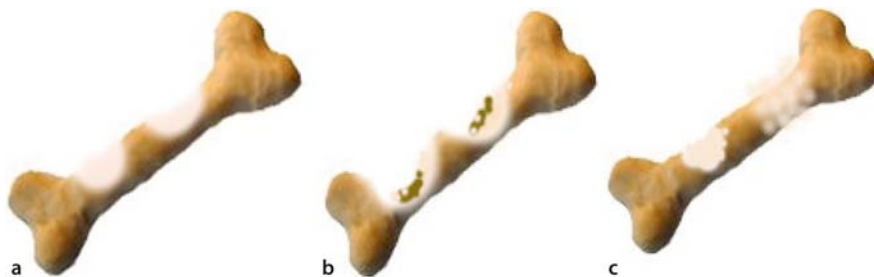
Boney metastases occur in approximately 60–85% of patients who develop metastatic disease from some of the more common cancers, e.g. breast, prostate, and lung. Bone is one of the most common metastatic sites. There are also primary bone cancers, e.g. myeloma, osteosarcoma, Ewing's sarcoma (Mercadante 1997).

When tumors metastasize to bone, they can either be osteolytic, causing boney destruction, or osteoblastic producing sclerotic boney changes (1). Figure 1 illustrates bone changes in cancer. Examples of these processes are prostatic cancer stimulating osteoblasts to lay down boney material, and breast cancer causing osteolysis from stimulation of osteoclasts. Mixed osteoblastic-osteoclastic states also can occur.

Chemical mediators, most notably prostaglandins and cytokines, are released in areas of tumor infiltration. These mediators stimulate osteoclasts or osteoblasts and nociceptors (Payne 1997). When tumor invasion occurs, the highly innervated periosteum that surrounds bone is disturbed and microfractures may occur within the trabeculae (Payne 1997). Nerve entrapment can also occur as disease progresses, due either to direct tumor effects or to collapse of the skeletal structure (Mercadante 1997; Payne 1997; Benjamin 2002).

Radiopharmaceuticals and bisphosphonates are very effective at treating boney pain; some clinicians consider these first line therapies. The combination of the two may be additive or synergistic in the treatment of bone pain and dose sparing to lessen dose-related complications of opioid therapy (Hoskin 2003).

Radiotherapy and radiopharmaceuticals are often underutilized therapies for treating bone pain. These two methods of delivering radionuclides have comparable efficacy as analgesics. A systematic review of 20 trials (12 using external field radiation and 8 using radioisotopes) showed that 1 in 4 patients received complete pain relief in one month, and 1 in 3 patients achieved at least 50% pain relief. For radiotherapy, no differences in efficacy or adverse events were reported with single or multiple fractional dosing in the external field trials. Radiotherapy has been reported to be up to 80% effective for the treatment of boney pain (McQuay et al. 2000). Radiation can be delivered by localized or widespread external beam radiation that can be localized or widespread, and also by systemic bone-seeking radioisotopes. For widespread painful boney metastases, external ► **hemibody radiation** may be administered. With radiation administered above the diaphragm, pneumonitis is a risk (Mercadante 1997). Below the diaphragm administration commonly causes nausea, vomiting, and diarrhea. If whole body radiation is the goal, a period of 4–6 weeks between



**Adjuvant Analgesics in Management of Cancer-Related Bone Pain, Figure 1** Cancer effects on bone. (a) Normal bone (balance between formation and remodeling). (b) Osteolytic bone (unbalanced – increase in osteoclastic activity). (c) Osteoblastic bone (unbalanced – increase in bone formation).



treatments must occur to allow bone marrow recovery.

An alternative to systemic delivery is the use of radioisotopes that target bone. There are four such agents available:  $^{89}\text{Sr}$ ,  $^{32}\text{P}$ ,  $^{186}\text{Re}$ , and  $^{153}\text{Sm}$ .  $^{89}\text{Sr}$  is the most commonly used due to its greater specificity for bone. All of these agents target osteoblastic activity. They emit beta particles and are associated with less systemic toxicity than hemibody radiation. However, bone marrow suppression is still a risk. Use of these radiopharmaceuticals is limited due to the expense of the drugs and by storage and disposal requirements (Hoskin 2003). Current radioisotope research is focusing on low energy electron emitters over the current energetic  $\beta$  emitters to produce therapeutic benefit without bone marrow suppression (Bouchet et al. 2000).

Local irradiation is the treatment of choice for localized bone pain, because this method is associated with a low incidence of local toxicity and virtually no systemic toxicity. Radiotherapy often provides relatively prompt pain relief, which is probably due to reduced effects of local inflammatory cells responsible for the release of inflammatory mediators, not tumor regression alone.

Bisphosphonates are another form of systemic treatment for bone pain. A recent meta-analysis of 30 randomized controlled trials, to evaluate relief of pain from bone metastases, supports the use of bisphosphonates as adjunct therapy when primary analgesics and/or radiotherapy are inadequate to treat the pain (Wong and Wiffen 2002). Evidence is lacking for the use of bisphosphonates as first line therapy for immediate relief of bone pain.

Two bisphosphonates are currently approved for the treatment of painful bony metastasis in the United States; pamidronate and zoledronic acid. Both are intravenous preparations. Doses of 90 mg pamidronate administered over two to four hours and 4 mg zoledronic acid administered over 15 min every three to four weeks have comparable effectiveness in reducing the need for radiotherapy, decreasing the occurrence of fractures, and reducing pain scores (Lucas and Lipman 2002). The most common adverse effects of both agents include bone pain, anorexia, nausea, myalgia, fever, and injection site reaction. Bisphosphonates have been associated with renal toxicity. Bisphosphonates bind strongly to the bone surface and are taken up by osteoclasts during bone resorption. The osteoclasts are then inhibited and apoptosis is induced. The reduction in the number of osteoclasts inhibits bony metastasis. The bisphosphonates also have an anti-tumor effect, possibly due to drug uptake in tumor cells (Green and Clezardin 2002).

Although NSAIDs are generally considered first-line drugs for mild cancer pain, their specific role in bony pain is currently being investigated. A recent study in mice evaluated a cyclooxygenase-2 (COX-2) selective

NSAID on movement-evoked cancer bone pain and tumor burden. A decrease of ongoing and movement-evoked pain was seen in acutely treated mice (day 14 post tumor implantation), and the same decrease in pain was expressed as well as decreased tumor burden, osteoclastogenesis, and bone destruction, by 50% of chronically treated mice (day 6 post tumor implantation) (Sabino et al. 2002). Tumors that invade bone express COX-2, possibly as a mechanism for implantation. This work supports the inhibition of prostaglandin synthesis as being the mechanism of action of the drugs in cancer-related bone pain.

Systemic steroids can also be useful adjuvants in cancer-related bone pain due to broad-spectrum anti-inflammatory properties. They are most commonly used for spinal cord compression due to collapse of vertebrae or pressure by the tumor itself. Approximately 90% of prostatic metastases involve the spine, with the lumbar region most commonly affected. Early diagnosis of spinal cord compression is critical. It presents as localized back pain in 90–95% of patients; muscle weakness, autonomic dysfunction and sensory loss will follow if untreated (Benjamin 2002). Intravenous dexamethasone is a steroid of choice due to its high potency, low mineralocorticoid activity and low cost.

When primary analgesics, i.e. nonsteroidal anti-inflammatory drugs (NSAIDs) and opioids, no longer control bone pain adequately, adjuvants should be considered. Local radiation should be used when pain is localized and fractures are ruled out. Pain due to solid tumors tends to respond greater to radiotherapy than bisphosphonates. Generally, as the disease progresses patients will have received both of these modalities. The role of their use together has yet to be evaluated. To forestall neurological complications of spinal cord compression, steroids are indicated and should be started promptly upon suspicion.

## References

1. Benjamin R (2002) Neurologic complications of prostate cancer. *Am Fam Physician* 65:1834–1840
2. Bouchet LG, Bolch WE, Goddu SM et al. (2000). Considerations in the Selection of Radiopharmaceuticals for Palliation of Bone Pain from Metastatic Osseous Lesions. *J Nucl Med* 41:682–687
3. Green JR, Clezardin P (2002) Mechanisms of Bisphosphonate Effects on Osteoclasts, Tumor Cell Growth, and Metastasis. *Am J Clin Oncol* 25:3–9
4. Hoskin PJ (2003) Bisphosphonates and Radiation Therapy for Palliation of Metastatic Bone Disease. *Cancer Treat Rev* 29:321–327
5. Lucas LK, Lipman AG (2002) Recent Advances in Pharmacotherapy for Cancer Pain Management. *Cancer Pract* 10:14–20
6. McQuay HJ, Collins SL, Carroll D et al. (2000) Radiotherapy for the Palliation of Painful Bone Metastases. *Cochrane Database Syst Rev*:CD001793
7. Mercadante S (1997) Malignant Bone Pain: Pathophysiology and Treatment. *Pain* 69:1–18
8. Payne R (1997) Mechanisms and Management of Bone Pain. *Cancer* 80:1608–1613

9. Sabino MA, Ghilardi JR, Jongen JL et al. (2002) Simultaneous Reduction in Cancer Pain, Bone Destruction, and Tumor Growth by Selective Inhibition of Cyclooxygenase-2. *Cancer Res* 62:7343–7349
10. Wong R, Wiffen PJ (2002) Bisphosphonates for the Relief of Pain Secondary to Bone Metastases. *Cochrane Database Syst Rev*:CD002068

## Adjuvant Analgesics in Management of Cancer-Related Neuropathic Pain

DAVID LUSSIER<sup>1</sup>, RUSSELL K. PORTENOY<sup>2</sup>

<sup>1</sup>McGill University, Montreal, QC, Canada

<sup>2</sup>Department of Pain and Palliative Care, Beth Israel Medical Center, New York, NY, USA

david.lussier@muhc.mcgill.ca, rportenoy@chpnet.org

### Definition

An adjuvant analgesic (see ► [adjuvant analgesics](#)) is any drug that has a primary indication other than pain, but is analgesic in some painful conditions.

### Characteristics

Cancer pain caused by neuropathic mechanisms is relatively less responsive to opioid drugs than pain caused by nociceptive mechanisms (Cherny et al. 1994). However, when adjuvant analgesics are appropriately combined with opioid and non-opioid analgesics (anti-inflammatory drugs, acetaminophen), it is possible to obtain a degree of analgesia similar to the one achieved in nociceptive pain (Grond et al. 1999). Several classes of adjuvant analgesics can be used in neuropathic pain. Some are useful in a variety of pain syndromes (nociceptive pain, bone pain, myofascial pain) and are, therefore, termed multipurpose adjuvant analgesics, whereas others are used specifically for neuropathic pain. Although adjuvant analgesics are used extensively to treat cancer-related pain, the scientific evidence is often limited and data from nonmalignant pain must be extrapolated.

### Anticonvulsants

Nowadays, anticonvulsants are often favored in the treatment of cancer-related neuropathic pain. Due to its proven analgesic effect, its good tolerability and paucity of drug-drug interactions, gabapentin is now recommended as a first-line agent, especially in the medically ill population (Farrar and Portenoy 2001). It should be started at 100–300 mg at bedtime, and titrated up until analgesia is obtained, which usually occurs with a daily dose of 900–3600 mg. A daily dose higher than 300 mg should be divided into three separate doses. Adverse effects (somnolence, mental clouding, and dizziness) are usually minimal if the titration is gradual, and often abate within a few days.

Although evidence for the analgesic effect of newer anticonvulsants (lamotrigine, levetiracetam, oxcarbazepine, topiramate, pregabalin, tiagabine, zonisamide) is scarce, especially for cancer-related pain, a positive clinical experience justifies a trial of one of these when the pain does not respond to gabapentin (Farrar and Portenoy 2001). The older anticonvulsants, i.e. carbamazepine, phenytoin and valproic acid, can also be analgesic, but caution is required due to their frequent side effects (sedation, dizziness, nausea), narrow therapeutic window, numerous drug interactions and low tolerability in medically ill patients (Farrar and Portenoy 2001).

### Antidepressants

Along with anticonvulsants, antidepressants are the adjuvant analgesics most commonly used for neuropathic pain. The tricyclic antidepressants have been proven to be analgesic in several types of neuropathic and non-neuropathic pain (Portenoy 1998). Their frequent adverse effects, especially in elderly and medically ill patients, however, limit their use. The secondary amines (nortriptyline, desipramine) are less anticholinergic than the tertiary amines (amitriptyline, imipramine, doxepin, clomipramine) and are often better tolerated (see ► [anticholinergics](#)). All tricyclics are, however, contraindicated in patients with significant cardiac disease and closed angle glaucoma, and should be used with caution in patients with prostate hypertrophy.

The analgesic efficacy of newer antidepressants (selective serotonin reuptake inhibitors, e.g. paroxetine, selective norepinephrine and serotonin reuptake inhibitors, e.g. venlafaxine and desvenlafaxine, and others, e.g. bupropion) has been less well documented than for the tricyclics. However, due to their better tolerability, a few studies supporting their analgesic effect and a favorable clinical experience, a therapeutic trial is often justified (Farrar and Portenoy 2001).

### Local Anesthetics

Local anesthetics are known to have analgesic properties in neuropathic pain (Mao and Chen 2000). A brief intravenous infusion of lidocaine has been shown to be effective in nonmalignant neuropathic pain. Despite negative results obtained in randomized controlled trials in neuropathic cancer pain, clinical experience justifies considering its use. Lidocaine infusions can be administered at varying doses within the range of 1–5 mg/kg infused over 20–30 min and should be done under cardiac monitoring. Prolonged pain relief following a brief local anesthetic infusion may be possible. If the pain recurs, long-term systemic local anesthetic therapy is usually accomplished using an oral formulation of mexiletine. Systemic local anesthetics are generally considered second-line, reserved for the treatment of severe intractable or 'crescendo' neuropathic pain (Mao and Chen 2000).

The use of a lidocaine 5% patch is associated with very low systemic absorption and adverse effects. It has been shown to reduce pain and allodynia from postherpetic neuralgia, and clinical experience supports its use in a variety of other neuropathic pain conditions (Argoff 2000).

#### **N-Methyl-D-Aspartate Receptor Blockers**

The *N*-methyl-D-aspartate (NMDA) receptor is involved in the sensitization of central neurons following injury and the development of the 'wind-up' phenomenon, a change in the response of the central neurons that has been associated with neuropathic pain. Antagonists at the NMDA receptor may, therefore, offer another approach to the treatment of neuropathic pain in cancer patients.

Ketamine, administered by intravenous bolus or infusion, or orally, has been shown to be effective in relieving pain in cancer patients (Jackson et al. 2001; Mercadante et al. 2000). A subcutaneous or intravenous infusion can be initiated at low doses (0.1–0.15 mg/kg/h). The dose can be gradually escalated, with close monitoring of pain and side effects. Long-term therapy can be maintained using continuous subcutaneous infusion, repeated subcutaneous injections or oral administration. The side effect profile of ketamine can, however, be daunting, especially in medically ill patients, so only clinicians who are experienced in the use of parenteral ketamine should consider this option in patients with refractory pain.

Dextromethorphan is better tolerated, can be used on a long-term basis, and has been reported to reduce phantom limb pain in cancer amputees (Ben Abraham et al. 2003). A prudent starting dose is 45–60 mg/day, which can be gradually escalated until favorable effects occur, side-effects supervene, or a conventional maximal dose of 1 g is reached.

Amantadine and memantine, non-competitive NMDA antagonists, are other options. Amantadine, for example, has been shown to reduce pain, allodynia and hyperalgesia in surgical neuropathic pain in cancer patients (Pud et al. 1998).

#### **Corticosteroids**

By decreasing the peritumoral edema, corticosteroid drugs can relieve neuropathic pain from infiltration or compression of neural structures (Watanabe and Bruera 1994). They also have many other indications in cancer and palliative care, including improvement of appetite, nausea, malaise and overall quality of life, as well as treatment of metastatic bone pain. A high-dose regimen (e.g. initial dose of dexamethasone 40–100 mg followed by 16–96 mg/day in divided doses) can be given to patients who experience an acute episode of very severe pain not relieved adequately with opioids, such as that associated with a rapidly worsening malignant plexopathy. More often, a low-dose corticosteroid

regimen (e.g. dexamethasone 1–2 mg once or twice daily) is used for patients with advanced cancer who continue to have pain despite optimal dosing of opioid drugs. Although long-term treatment with relatively low doses is generally well tolerated, ineffective regimens should be tapered and discontinued.

#### **Alpha-2-Adrenergic Agonists**

Alpha-2-adrenergic agonists are nonspecific multipurpose adjuvant analgesics that can be considered after trials of other adjuvants, mainly antidepressants and anticonvulsants, have failed. Clonidine, administered orally or transdermally, can relieve neuropathic pain, and there is strong evidence that intraspinal administration of clonidine can be effective in neuropathic cancer pain. The occurrence of hypotension may limit its use in medically ill patients.

Tizanidine is an alpha-2-adrenergic receptor agonist with a better safety profile than oral clonidine. Although it is mainly used as an antispasticity agent, it can also be tried as a multipurpose adjuvant analgesic.

#### **Other Adjuvant Analgesics for Neuropathic Pain**

Baclofen, an agonist at the gamma aminobutyric acid type B (GABA<sub>B</sub>) receptor, can also be considered for cancer-related neuropathic pain, notwithstanding very limited evidence of efficacy (Fromm 1994). The effective dose range is very wide (20 to >200 mg daily), which necessitates careful titration.

Cannabinoids are analgesic, but their utility in the treatment of chronic pain is still uncertain (Campbell et al. 2001). A trial might be considered in refractory neuropathic pain.

Topical therapies may be very useful. The lidocaine patch was described previously. Numerous other drugs – NSAIDs, antidepressants, capsaicin and varied others – have been used. In the cancer population, local application of capsaicin cream can be effective in reducing neuropathic postsurgical pain (postmastectomy, postthoracotomy, postamputation) (Rowland et al. 1997).

#### **Selection of the Most Appropriate Adjuvant Analgesic**

When selecting the most appropriate adjuvant for treatment of pain in a cancer patient, a comprehensive assessment is always warranted (Portenoy 1998). This includes: 1) description of the pain, including its etiology and its relationship to the underlying disease, which allows inferences about the predominating type of pain pathophysiology (e.g. nociceptive or neuropathic); 2) assessment of the impact of pain on function and quality of life; 3) identification of any relevant comorbidities that may influence drug selection (e.g. antidepressants will be favored in a patient with concomitant depression); 4) identification of associated symptoms (e.g. corticosteroids may be most appropriate if pain is associated with fatigue, nausea or anorexia); 5) assessment

of the goals of care (e.g. sedation will be better accepted by the patient and family if the patient's comfort is the main objective); 6) evaluation of patient's other medications, looking for potential drug interactions (Bernard and Bruera 2000).

Once the most appropriate adjuvant analgesic has been identified, a few guidelines should be followed in the initial prescription and follow-up of this patient (Portenoy 1998): 1) optimize the opioid and non-opioid analgesic therapy before adding an adjuvant; 2) start only one adjuvant at a time, to decrease cumulative adverse effects; 3) titrate the dose gradually and carefully, according to pain relief and adverse effects; 4) if pain relief is not adequate, consider combining several adjuvant analgesics of different classes; 5) regularly reassess the pain relief as well as the response and adverse effects to analgesic medications and adjust the therapeutic regimen if necessary.

## References

- Argoff CE (2000) New Analgesics for Neuropathic Pain: The Lidocaine Patch. *Clin J Pain* 16:S62–S66
- Ben Abraham R, Marouani N, Weinbroum AA (2003) Dextromethorphan Mitigates Phantom Pain in Cancer Amputees. *Ann Surg Oncol* 10:268–274
- Bernard SA, Bruera E (2000) Drug Interactions in Palliative Care. *J Clin Oncol* 18:1780–1799
- Campbell FA, Tramer MR, Carroll D et al. (2001) Are Cannabinoids an Effective and Safe Treatment Option in the Management of Pain? A Qualitative Systematic Review. *Br Med J* 323:13–16
- Cherny NI, Thaler HT, Friedlander-Klar H et al. (1994) Opioid Responsiveness of Cancer Pain Syndromes Caused by Neuropathic or Nociceptive Mechanisms. *Neurol* 44:857–861
- Ellison N, Loprinzi CL, Kugler J et al. (1997) Phase III Placebo-Controlled Trial of Capsaicin Cream in the Management of Surgical Neuropathic Pain in Cancer Patients. *J Clin Oncol* 15:2974–2980
- Farrar JT, Portenoy RK (2001) Neuropathic Cancer Pain: The Role of Adjuvant Analgesics. *Oncol* 15:1435–1445
- Fromm GH (1994) Baclofen as an Adjuvant Analgesic. *J Pain Symptom Manage* 9:500–509
- Grond S, Radbruch L, Meuser T et al. (1999) Assessment and Treatment of Neuropathic Cancer Pain following WHO Guidelines. *Pain* 79:15–20
- Jackson K, Ashby M, Martin P et al. (2001) 'Burst' Ketamine for Refractory Cancer Pain: An Open-Label Audit of 39 Patients. *J Pain Symptom Manage* 23:60–65
- Mao J, Chen LL (2000) Systemic Lidocaine for Neuropathic Pain Relief. *Pain* 87:7–17
- Mercadante S, Arcuri E, Tirelli W et al. (2000) Analgesic Effect of Intravenous Ketamine in Cancer Patients on Morphine Therapy: A Randomized, Controlled, Double-Blind, Crossover, Double-Dose Study. *J Pain Symptom Manage* 20:246–252
- Portenoy RK (1998) Adjuvant Analgesics in Pain Management. In: Doyle D, Hanks GW, MacDonald N (eds) *Oxford Textbook of Palliative Medicine*, 2<sup>nd</sup> edn. Oxford University Press, Oxford, pp 361–390
- Pud D, Eisenberg E, Spitzer A et al. (1998) The NMDA Receptor Antagonist Amantadine Reduces Surgical Neuropathic Pain in Cancer Patients: A Double Blind, Randomized, Placebo-Controlled Trial. *Pain* 75:349–354
- Rowland et al. (1997)
- Watanabe S, Bruera E (1994) Corticosteroids as Adjuvant Analgesics. *J Pain Symptom Manage* 9:442–445

## Adjuvant Arthritis

- ▶ Arthritis Model, Adjuvant-Induced Arthritis

## ADLs

- ▶ Activities of Daily Living

## Adrenergic Agonist

### Definition

An adrenergic agonist is a ligand that binds to adrenergic receptors.

- ▶ Adrenergic Antagonist
- ▶ Sympathetically Maintained Pain, Clinical Pharmacological Tests

## Adrenergic Antagonist

### Definition

An adrenergic antagonist is a drug that prevents ligands from binding to adrenergic receptors.

- ▶ Adrenergic Agonist
- ▶ Sympathetically Maintained Pain, Clinical Pharmacological Tests

## Adrenoceptors

### Definition

Adrenoceptors are receptors that are located pre- and postganglionically on effector tissues, most of which are innervated by postganglionic sympathetic fibers, and are activated by release of norepinephrine, epinephrine, and various adrenergic drugs.

- ▶ Sympathetically Maintained Pain in CRPS I, Human Experimentation

## Adult Respiratory Distress Syndrome

- ▶ ARDS

## Adverse Effects

### Definition

Unwanted side effects of drug treatment.

- ▶ NSAIDs, Adverse Effects

## Adverse Neural Tension

### Definition

Adverse neural tension is defined as abnormal physiological and mechanical responses created by the nervous system components, when their normal range of motion and stretch capabilities are tested.

- ▶ Chronic Pelvic Pain, Physical Therapy Approaches and Myofascial Abnormalities

## Adverse Selection

### Definition

When worse than average risks are most likely to acquire insurance.

- ▶ Disability Incentives

## Aerobic Exercise

- ▶ Exercise

## Affective

### Definition

Category of experiences associated with emotions that range from pleasant to unpleasant.

- ▶ McGill Pain Questionnaire

## Affective Analgesia

### Definition

Affective Analgesia is the preferential suppression of the emotional reaction of humans and animals to noxious stimulation.

- ▶ Thalamo-Amygdala Interactions and Pain

## Affective Component (Aspekt, Dimension) of Pain

A

### Definition

Refers to that quality of the pain experience that causes pain to be unpleasant or aversive. It may be involved in the „suffering“ component of persistent pain, and could also involve separate neural pathways in the brain than those involved in the sensory-discriminative component of pain (discrimination and localization of a painful stimulus).

- ▶ Amygdala, Pain Processing and Behavior in Animals
- ▶ Hypnotic Analgesia
- ▶ Primary Somatosensory Cortex (S1), Effect on Pain-Related Behavior in Humans
- ▶ Primary Somatosensory Cortex (SI)
- ▶ Thalamo-Amygdala Interactions and Pain

## Affective Responses

### Definition

Changes in mood or emotion-related behaviors elicited by noxious stimuli. Examples of these responses include aggressive behavior and freezing.

- ▶ Spinothalamic Tract, Anatomical Organization and Response Properties
- ▶ Spinothalamic Neuron

## Affective-Motivational

### Definition

Relating to affect and forces that drive behavior.

- ▶ Secondary Somatosensory Cortex (S2) and Insula, Effect on Pain Related Behavior in Animals and Humans

## Affective-Motivational Dimension of Pain

### Definition

A component of the pain experience that signals the unpleasant hedonic qualities and emotional reactions to noxious stimulation; and generates the motivational drive to escape from or terminate such stimulation. This corresponds to the subjective experience of the immediate unpleasantness of pain and the urge to respond behaviorally.

- ▶ Nociceptive Processing in the Cingulate Cortex, Behavioral Studies in Humans
- ▶ Thalamo-Amygdala Interactions and Pain



## Afferent Fiber / Afferent Neuron

### Definition

Afferent fibers are any of the nerve fibers that bring information to a neuron. The cell bodies of afferent fibers in the peripheral nerves reside in the dorsal root and trigeminal ganglion. An afferent neuron is also known as a sensory neuron.

- ▶ Postsynaptic Dorsal Column Projection, Functional Characteristics
- ▶ Visceral Nociception and Pain

## Afferent Projections

### Definition

In nervous systems, afferent signals or nerve fibers carry information toward the brain or a particular brain structure. A touch or painful stimulus, for example, creates a sensation in the brain, only after information about the stimulus travels there via afferent nerve pathways. Efferent nerves and signals carry information away from the brain or a particular brain structure.

- ▶ Amygdala, Pain Processing and Behavior in Animals

## Afferent Signal

### Definition

An afferent signal is a neurologic signal that comes from the site of the bone (or any other site of the body) abnormality, and goes towards the central nervous system.

- ▶ Cancer Pain Management, Orthopedic Surgery

## Afterdischarge(s)

### Definition

Afterdischarge is the continued nerve response after the stimulus, or inciting event, has ceased. This usually refers to both nerve hypersensitivity and prolonged reactivity.

- ▶ Molecular Contributions to the Mechanism of Central Pain
- ▶ Spinal Cord Injury Pain Model, Contusion Injury Model
- ▶ Trigeminal Neuralgia, Diagnosis and Treatment

## Afterhyperpolarisation

### Synonyms

AHP

### Definition

For many neuronal cells, an action potential or a burst of action potentials is followed by a hyperpolarisation, where the neuronal membrane potential is lower than the neuron's normal resting membrane potential. In various models, different parts of this AHP with different time constants and different pharmacology have been described and molecular mechanisms, most of them different potassium channels, have been suggested.

- ▶ Mechano-Insensitive C-Fibres, Biophysics
- ▶ Molecular Contributions to the Mechanism of Central Pain

## After-Pains, Postnatal Pain

- ▶ Postpartum Pain

## Age and Chronicity

- ▶ Pain in the Workplace, Risk Factors for Chronicity, Demographics

## Age Regression

### Definition

This refers to the use of hypnotic suggestion to return to an earlier time of life in imagination. This technique is used in the context of psychotherapy utilizing hypnosis and may be an exploratory or therapeutic technique. Studies suggest that age regression is extremely unreliable in retrieving accurate information about the past, but that it can be considered part of the individual's life narrative.

- ▶ Therapy of Pain, Hypnosis

## Age-Related Pain Diagnoses

### Definition

Pain diagnoses that are more frequent in the elderly, like osteoarthritis, zoster, arteriitis, polymyalgia rheumatica or arterosclerotic peripheral vascular disease.

- ▶ Psychological Treatment of Pain in Older Populations



## Aggression

- ▶ Anger and Pain

## Agonist

### Definition

An agonist is an endogenous or exogenous substance that can interact with and activate a receptor, initiating a physiological or a pharmacological response characteristic of that receptor.

- ▶ Postoperative Pain, Appropriate Management

## Agreed Medical Examination

- ▶ Independent Medical Examinations

## AHP

- ▶ Afterhyperpolarisation

## AIDS and Pain

- ▶ Pain in Human Immunodeficiency Virus Infection and Acquired Immune Deficiency Syndrome

## Alcock's Canal

### Definition

This is the space within the obturator internis fascia lining the lateral wall of the ischiorectal fossa that transmits the pudendal vessels and nerves.

- ▶ Clitoral Pain

## Alcohol-Induced Pancreatitis

- ▶ Visceral Pain Model, Pancreatic pain

## Alcoholism

- ▶ Metabolic and Nutritional Neuropathies

## Alfentanil

### Definition

This is a short acting very potent opioid.

- ▶ CRPS-1 in Children

## Algesia

- ▶ Hyperalgesia

## Algesic Agent / Algesic Chemical

### Definition

A chemical substance that elicits pain when administered (or released from pathologically altered tissue) in a concentration that excites nociceptors. Examples are: serotonin (5-hydroxytryptamine) and bradykinin (a nonapeptide).

- ▶ Sensitization of Muscular and Articular Nociceptors
- ▶ Visceral Pain Model, Angina Pain

## Algodystrohy

- ▶ Complex Regional Pain Syndromes, Clinical Aspects
- ▶ Complex Regional Pain Syndromes, General Aspects
- ▶ Neuropathic Pain Models, CRPS-I Neuropathy Model
- ▶ Sympathetically Maintained Pain in CRPS I, Human Experimentation

## Algogen

### Definition

Chemical substance with the ability to induce pain and hyperalgesia.

- ▶ Polymodal Nociceptors, Heat Transduction
- ▶ UV-Induced Erythema

## Allogenic Actions of Protons

### Definition

Lowering muscle pH causes acute ischemia pain since protons produce non-adapting excitation of muscle nociceptors.

- ▶ Tourniquet Test

## Algotometer

### Definition

An algometer is a calibrated device that can apply painful stimuli of graded intensities. A commonly used device is the pressure algometer, which is used to evaluate deep tissue pain threshold (i.e. muscle, tendon, periosteum).

- ▶ [Threshold Determination Protocols](#)

## Alice-in-Wonderland Syndrome

### Definition

A disorder of perception where visual disturbances occur. It was given its name due to the fact that the syndrome's symptoms are remarkably similar to the distortions in body image and shape as experienced by the main character in Lewis Carroll's 1865 novel "Alice in Wonderland" Objects either appear to be much larger (macropsia) or smaller (micropsia) than normal, and there is also usually an impaired perception of time and place.

- ▶ [Migraine, Childhood Syndromes](#)

## ALIF

### Synonyms

Anterior Lumbar Interbody Fusion

### Definition

Anterior lumbar interbody fusion are graft/cages placed between the vertebral bodies by anterior approach.

- ▶ [Spinal Fusion for Chronic Back Pain](#)

## Allele Dosage Study

- ▶ [Association Study](#)

## Alleles

### Definition

Alternate forms of a gene or genetic locus; the basic unit of genetic variability. Organisms inherit two alleles (maternal and paternal) of every gene, which may or may not be identical. Different alleles may produce protein isozymes (i.e. proteins with different amino acid sequences), alter expression levels of proteins, or have no effect whatsoever.

- ▶ [Cell Therapy in the Treatment of Central Pain](#)

- ▶ [Heritability of Inflammatory Nociception](#)
- ▶ [Opioid Analgesia, Strain Differences](#)

## Allocortex

### Definition

The allocortex is a 3-layered cortex. In the hippocampus, the three layers are the stratum oriens, the stratum pyramidale and the molecular zone consisting of the stratum radiatum, and stratum lacunosum-moleculare.

- ▶ [Nociceptive Processing in the Hippocampus and Entorhinal Cortex, Neurophysiology and Pharmacology](#)

## Allodynia

### Definition

Allodynia is a nociceptive reaction and/or pain due to a stimulus that does not normally evoke pain („allo“ – „other“; „dynia“ – pain), like mild touch or moderate cold. The definition of allodynia by the International Association for the Study of Pain (IASP) is: "Pain induced by stimuli that are not normally painful" If this definition is taken literally, it means that any drop in pain threshold is allodynia, whereas increases in pain to suprathreshold stimuli are hyperalgesia. Allodynia is based on sensitized central neurons with increased excitability to A-beta fiber input, and is critically dependent on the ongoing activity of nociceptive afferent units, particularly mechano-insensitive C-fibers. It is one of the most distressing symptoms of neuropathic pain.

- ▶ [Allodynia and Allodynia](#)
- ▶ [Anesthesia Dolorosa Model, Autotomy](#)
- ▶ [Calcium Channels in the Spinal Processing of Nociceptive Input](#)
- ▶ [Chronic Pelvic Pain, Musculoskeletal Syndromes](#)
- ▶ [Clitoral Pain](#)
- ▶ [Cognitive Behavioral Treatment of Pain](#)
- ▶ [Complex Regional Pain Syndromes, Clinical Aspects](#)
- ▶ [CRPS-1 in Children](#)
- ▶ [CRPS, Evidence-Based Treatment](#)
- ▶ [Deafferentation Pain](#)
- ▶ [Descending Circuits in the Forebrain, Imaging](#)
- ▶ [Diagnosis and Assessment of Clinical Characteristics of Central Pain](#)
- ▶ [Dietary Variables in Neuropathic Pain](#)
- ▶ [Drugs Targeting Voltage-Gated Sodium and Calcium Channels](#)
- ▶ [Drugs with Mixed Action and Combinations, Emphasis on Tramadol](#)
- ▶ [Freezing Model of Cutaneous Hyperalgesia](#)
- ▶ [Functional Changes in Sensory Neurons Following Spinal Cord Injury in Central Pain](#)

- ▶ Human Thalamic Response to Experimental Pain (Neuroimaging)
- ▶ Hyperaesthesia, Assessment
- ▶ Hyperalgesia
- ▶ Hyperpathia
- ▶ Hyperpathia, Assessment
- ▶ Inflammatory Neuritis
- ▶ Metabotropic Glutamate Receptors in Spinal Nociceptive Processing
- ▶ Neuropathic Pain Model, Tail Nerve Transection Model
- ▶ Nociceptive Circuitry in the Spinal Cord
- ▶ Nociceptive Processing in the Amygdala, Neurophysiology and Neuropharmacology
- ▶ Opioid Receptor Trafficking in Pain States
- ▶ Pain Modulatory Systems, History of Discovery
- ▶ Percutaneous Cordotomy
- ▶ PET and fMRI Imaging in Parietal Cortex (SI, SII, Inferior Parietal Cortex BA40)
- ▶ Postherpetic Neuralgia, Etiology, Pathogenesis and Management
- ▶ Postherpetic Neuralgia, Pharmacological and Non-Pharmacological Treatment Options
- ▶ Post-Stroke Pain Model, Thalamic Pain (Lesion)
- ▶ Psychiatric Aspects of Visceral Pain
- ▶ Purine Receptor Targets in the Treatment of Neuropathic Pain
- ▶ Satellite Cells and Inflammatory Pain
- ▶ Spinal Cord Injury Pain Model, Contusion Injury Model
- ▶ Sympathetically Maintained Pain in CRPS II, Human Experimentation
- ▶ Thalamotomy, Pain Behavior in Animals
- ▶ Thalamus, Dynamics of Nociception
- ▶ Transition from Acute to Chronic Pain

## Allodynia (Clinical, Experimental)

ROLF-DETLEF TREEDE

Institute of Physiology and Pathophysiology, Johannes Gutenberg University, Mainz, Germany  
treede@uni-mainz.de

### Synonyms

Touch Evoked Pain; dynamic mechanical hyperalgesia; obsolete: hyperaesthesia

### Definition

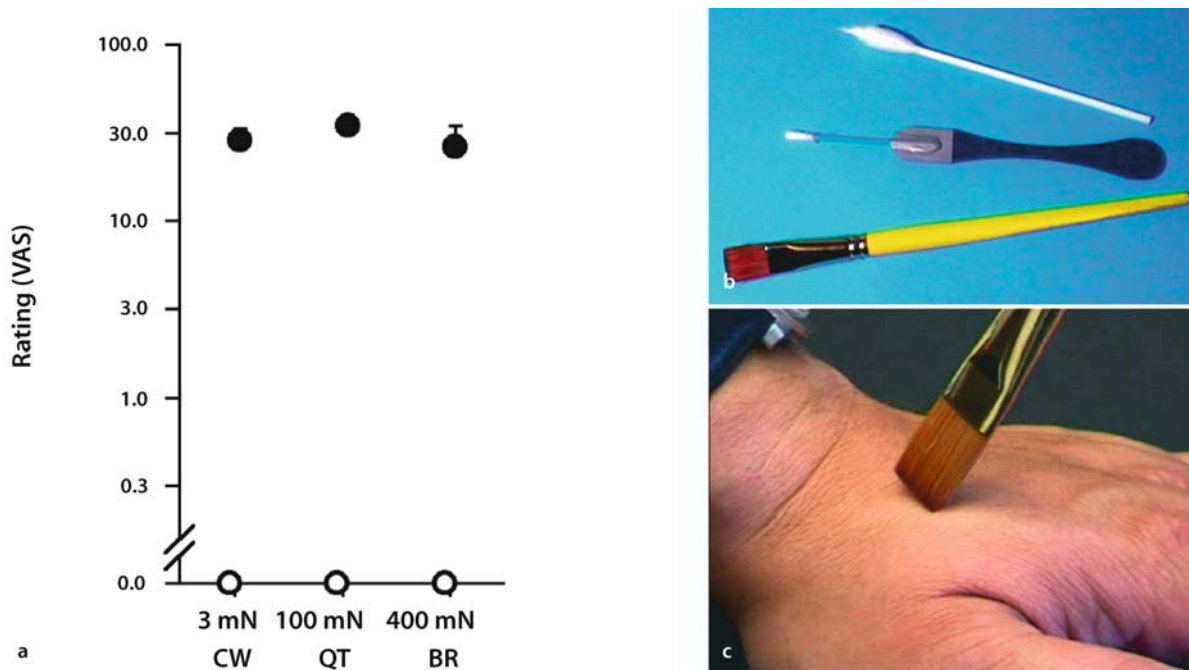
The term “allodynia” was introduced to describe a puzzling clinical phenomenon; in some patients, gentle touch may induce a pronounced pain sensation (“touch evoked pain”). In the current taxonomy of the International Association for the Study of Pain (IASP), allodynia is defined as: Pain induced by stimuli that are not normally painful.

If taken literally, this definition means that any reduction in pain threshold would be called “allodynia”. According to the IASP taxonomy, increases in pain to suprathreshold stimuli are called “▶ hyperalgesia”. Because the neural mechanisms of ▶ sensitization typically cause a leftward shift in the stimulus-response-function that encompasses both reduced thresholds and increased suprathreshold responses, these definitions have been controversial ever since their introduction. Moreover, behavioral studies in animals often use withdrawal threshold measures without any suprathreshold tests, leading to an inflationary use of the term “allodynia” in studies that often bear no resemblance to the initial clinical phenomenon. An alternative definition that captures the spirit of the original clinical observations (Merskey 1982; Treede et al. 2004) defines allodynia as: Pain due to a non-nociceptive stimulus. This definition implies that allodynia is pain in the absence of the adequate stimulus for ▶ nociceptive afferents (touch is not a “▶ nociceptive stimulus”). Operationally, the presence of mechanical allodynia can be tested with stimulators that do not activate nociceptive afferents (e.g. a soft brush). The situation is less clear for other stimulus modalities such as cooling stimuli. For those cases, where it is not clinically possible to determine whether or not the test stimuli activate nociceptive afferents, “hyperalgesia” is useful as an umbrella term for all types of increased pain sensitivity.

### Characteristics

Some patients – particularly after peripheral nerve lesions – experience pain from gentle touch to their skin, a faint current of air or mild cooling from evaporation of a drop of alcohol. Touch-evoked pain may adapt during constant skin contact, but is readily apparent for all stimuli applied in a stroking movement across the skin (Fig. 1). Touch-evoked pain is also called dynamic mechanical allodynia (Ochoa and Yarnitsky 1993). Reaction times of touch-evoked pain are too short for C-fiber latencies and it can be abolished by an A-fiber conduction block (Campbell et al. 1988). Moreover, both mechanical and electrical pain thresholds in those patients are often identical to the normal tactile detection thresholds (Gracely et al. 1992). These lines of evidence suggest that this strange pain sensation is mediated by Aβ-fiber low-threshold mechanoreceptors (touch receptors).

It was difficult to find the correct term to describe this clinical phenomenon. Because of the altered perceived quality of tactile stimuli, it was called “painful tactile dysesthesia” Due to the increased perception in response to a tactile stimulus it was also called “hyperesthesia” defined as “a state in which a stimulus, which does not cause pain in normally innervated tissues, does cause pain in the affected region” (Noordenbos 1959; quoted from Loh and Nathan 1978, who added that this was typically a very slight stimulus). This definition, however, ignored



**Allodynia (Clinical, Experimental), Figure 1** Assessment of dynamic mechanical allodynia. A 57-year-old male patient with a plexus lesion following abdominal surgery on the left side. (a) Gentle tactile stimuli that do not activate nociceptive afferents were moderately painful on the affected left leg (filled circles), whereas they elicited normal non-painful touch sensation on the unaffected right leg (open circles). Note that the intensity of allodynia was independent of the pressure exerted by the three stimulators that were stroked across the skin at the same speed. CW cotton wisp, QT cotton-tipped applicator, BR brush. Mean  $\pm$  SEM across five measurements. (b) Photograph of the three stimulators used for the assessment of dynamic mechanical allodynia in the quantitative sensory testing (QST) protocol of the German Research Network on Neuropathic Pain (Rolke et al. 2006) and video of their mode of application.

the change in perceived quality (from tactile to painful). According to the perceived quality, this phenomenon should have been called “mechanical hyperalgesia”.

At the time when most of the clinical characteristics of allodynia had been established, the only known neurobiological mechanism of hyperalgesia was peripheral sensitization of nociceptive afferents (Raja et al. 1999), leading to heat hyperalgesia at an injury site (primary hyperalgesia). Peripheral sensitization differs from the clinical phenomenon described above in many characteristics; it is spatially restricted to injured skin and the enhanced sensitivity is for heat stimuli, not for mechanical stimuli. The concept of central sensitization was introduced much later than the concept of peripheral sensitization (Woolf 1983). Thus, hyperalgesia also appeared to be an inadequate term at that time. As a consequence, a new word was introduced, “allodynia” indicating “a different type of pain” (Merskey 1982).

Dynamic mechanical allodynia occurs in a variety of clinical situations, secondary hyperalgesia surrounding an injury site, postoperative pain, joint and bone pain, visceral pain and delayed onset muscle soreness, as well as many [neuropathic pain](#) states.

### Mechanisms of Allodynia

The fact that both nociceptive and tactile primary afferents converge on one class of central nociceptive

neurons (WDR: wide dynamic range), led to the proposal that central sensitization of WDR neurons to their normal synaptic input may be the mechanism behind dynamic mechanical allodynia. These mechanisms were elucidated in an experimental surrogate model ([secondary hyperalgesia](#) surrounding a site of capsaicin injection). Parallel experiments in humans and monkeys showed that capsaicin injection induced dynamic mechanical allodynia (LaMotte et al. 1991) without any changes in the mechanical response properties of nociceptive afferents (Baumann et al. 1991). The responses of spinal cord WDR neurons to brushing, however, were increased following capsaicin injection; in addition, nociceptive specific HT neurons became responsive to brushing stimuli (Simone et al. 1991). Thus, [central sensitization](#) consisted of enhanced responses of central nociceptive neurons to a normal peripheral input. This was confirmed in humans by electrical microstimulation of tactile A $\beta$ -fibers that evoked a sensation of touch in normal skin but touch plus pain in hyperalgesic skin (Torebjörk et al. 1992). Central sensitization resembles long-term potentiation of excitatory synaptic transmission in other neural systems (Sandkühler 2000). High-frequency electrical stimulation patterns that induce long-term potentiation of synaptic transmission in the dorsal horn also induce mechanical allodynia in human subjects that may out-

last the conditioning stimulus for several hours (Klein et al. 2004). Chronic maintenance of the central sensitization leading to allodynia however, appears to depend on a continuous peripheral nociceptive input that can be dynamically modulated, e.g. by heating and cooling the skin (Gracely et al. 1992, Koltzenburg et al. 1994).

### Conflicting Terminology and the Inflationary Use of “Allodynia”

After the introduction of the word “allodynia” there were two terms that could describe a state of increased pain sensitivity, hyperalgesia and allodynia. Researchers and clinicians alike started to wonder, when to use which term. The 1994 edition of the IASP pain taxonomy addressed this issue by reserving the word “hyperalgesia” for an enhanced response to a stimulus that is normally painful. Pain induced by stimuli that are not normally painful was to be called “allodynia” Technically, this means that any reduction in pain threshold shall be called “allodynia” (Cervero and Laird 1996).

Table 1 illustrates why this definition was controversial ever since its introduction. ► **Peripheral sensitization** leads to a leftward shift of the stimulus response function for heat stimuli, consisting of both a reduction in threshold and an increase in response to suprathreshold stimuli (Raja et al. 1999). The psychophysical correlate, ► **primary hyperalgesia** to heat, now needs to be described with two different terms, simply depending on how it is being tested; if a researcher decides to determine heat pain threshold, its reduction is called “heat allodynia” if the researcher decides to use suprathreshold stimuli, the increase in perceived pain is called “heat hyperalgesia” Thus, the 1994 IASP taxonomy led to the paradoxical situation that two different names are used to describe a unitary phenomenon, the psychophysical correlate of peripheral sensitization. Likewise, secondary hyperalgesia to pinprick stimuli as a psychophysical correlate of central sensitization to A-fiber nociceptor

input is also characterized by reduced pain threshold plus increased suprathreshold pain (Treede et al. 2004). The 1994 IASP taxonomy was only reluctantly accepted in the scientific community, since time-honored terms such as primary and secondary hyperalgesia (for review see Treede et al. 1992) were artificially fractionated. In the recent past, allodynia was used for an increasing number of phenomena, particularly in animal studies, simply because it is often less difficult to obtain a threshold measure than a suprathreshold measure. This excessive use of the term allodynia however, has distracted from its original clinical implications. The mechanisms of reduced heat pain threshold have nothing in common with touch-evoked pain, yet both are being called allodynia. In fact, most of the animal studies that use the term “allodynia” are irrelevant for clinical allodynia, because they study reduced withdrawal thresholds for nociceptive stimuli (heat or pinprick). Instead of artificially dividing two sub-phenomena that by mechanisms of sensitization are intimately linked (threshold and suprathreshold changes), the terms allodynia and hyperalgesia should provide guidance towards a mechanism-based classification of pain. Contrary to the intentions of the authors of the IASP taxonomy, the inflationary use of “allodynia” was also counterproductive for furthering the understanding of the clinical phenomenon that it was originally conceived for, touch-evoked pain.

### Clinical Implications and a Unifying Proposal

Semantically, the term ‘allodynia’ implies pain by a stimulus that is alien to the nociceptive system (αλλοσ, Greek for ‘other’). Thus, allodynia should only be used when the mode of testing allows inference to a pain mechanism that relies on activation of a non-nociceptive input (e.g. low-threshold mechanoreceptors). If pain is reported to stroking the skin with gentle tactile stimuli, this mechanism is strongly implied and such tests are

**Allodynia (Clinical, Experimental), Table 1** Peripheral and central sensitization, allodynia and hyperalgesia

Clinical phenomenon	Input	Peripheral sensitization	Central sensitization	IASP taxonomy 1994		Proposed taxonomy	
				allodynia	Hyperalgesia	allodynia	hyperalgesia
touch evoked pain	tactile Aβ-fibers		X	X		X	(X <sup>a</sup> )
reduced threshold to pinprick pain	Aδ-nociceptors		X	X			X
increased response to pinprick pain	Aδ-nociceptors		X		X		X
reduced threshold to heat pain	Aδ- and C-nociceptors	X		X			X
increased response to heat pain	Aδ- and C-nociceptors	X			X		X

<sup>a</sup>Hyperalgesia is proposed to be used as an umbrella term for all types of enhanced pain sensitivity



easily employed in clinical trials as well as in daily practice. The distinction whether enhanced pain sensitivity is due to facilitation of nociceptive or non-nociceptive input is less clear for other stimuli. For example, pain due to gentle cooling, which is a frequent finding in some neuropathic pain states, is still enigmatic and so is the distinction of whether it should be called hyperalgesia or allodynia to cold. Peripheral sensitization of nociceptive afferents, central sensitization to non-nociceptive cold fiber input or central disinhibition by selective loss of a sensory channel specific for non-noxious cold that exerts a tonic inhibition of nociceptive channels are valid alternatives (Wasner et al. 2004).

Thus, in many cases, the mechanism of enhanced pain sensitivity may be unknown and it will not be evident whether or not a test stimulus activates nociceptive afferents. For these situations it is useful to have an umbrella term that does not imply any specific mechanism. Hyperalgesia traditionally was such an umbrella term, corresponding to the leftward shift in the stimulus response function relating magnitude of pain to stimulus intensity. Parallel to the definition of sensitization, hyperalgesia was characterized by a decrease in pain threshold, increased pain to suprathreshold stimuli and spontaneous pain. We have therefore suggested the reinstatement of hyperalgesia as the umbrella term for increased pain sensitivity in general (as the antonym to ► [hypoalgesia](#)) and returning the term allodynia to its old definition, i.e. describing a state of altered somatosensory signal processing wherein activation of non-nociceptive afferents causes pain (Treede et al. 2004).

## References

- Baumann TK, Simone DA, Shain CN et al. (1991) Neurogenic hyperalgesia: the search for the primary cutaneous afferent fibers that contribute to capsaicin-induced pain and hyperalgesia. *J Neurophysiol* 66:212–227
- Campbell JN, Raja SN, Meyer RA et al. (1988) Myelinated afferents signal the hyperalgesia associated with nerve injury. *Pain* 32:89–94
- Cervero F, Laird JMA (1996) Mechanisms of touch-evoked pain (allodynia): a new model. *Pain* 68:13–23
- Gracely RH, Lynch SA, Bennett GJ (1992) Painful neuropathy: altered central processing, maintained dynamically by peripheral input. *Pain* 51:175–194
- Klein T, Magerl W, Hopf HC et al (2004) Perceptual correlates of nociceptive long-term potentiation and long-term depression in humans. *J Neurosci* 24:964–971
- Koltzenburg M, Torebjörk HE, Wahren LK (1994) Nociceptor modulated central sensitization causes mechanical hyperalgesia in acute chemogenic and chronic neuropathic pain. *Brain* 117:579–591
- LaMotte RH, Shain CN, Simone DA et al. (1991) Neurogenic hyperalgesia: psychophysical studies of underlying mechanisms. *J Neurophysiol* 66:190–211
- Loh L, Nathan PW (1978) Painful peripheral states and sympathetic blocks. *J Neurol Neurosurg Psychiatry* 41:664–671
- Merskey H (1982) Pain terms: a supplementary note. *Pain* 14:205–206
- Ochoa JL, Yarnitsky D (1993) Mechanical hyperalgesias in neuropathic pain patients: dynamic and static subtypes. *Ann Neurol* 33:465–472
- Raja SN, Meyer RA, Ringkamp M et al. (1999) Peripheral neural mechanisms of nociception. In: Wall PD, Melzack R (eds) *Textbook of Pain*, 4th edn. Churchill Livingstone, Edinburgh, pp 11–57
- Rolke R, Magerl W, Campbell KA et al. (2006) Quantitative sensory testing: a comprehensive protocol for clinical trials. *Eur J Pain* 10:77–88
- Sandkühler J (2000) Learning and memory in pain pathways. *Pain* 88:113–118
- Simone DA, Sorkin LS, Oh U et al. (1991) Neurogenic hyperalgesia: Central neural correlates in responses of spinothalamic tract neurons. *J Neurophysiol* 66:228–246
- Torebjörk HE, Lundberg LER, LaMotte RH (1992) Central changes in processing of mechanoreceptive input in capsaicin-induced secondary hyperalgesia. *J Physiol* 448:765–780
- Treede RD, Meyer RA, Raja SN et al. (1992) Peripheral and central mechanisms of cutaneous hyperalgesia. *Prog Neurobiol* 38:397–421
- Treede RD, Handwerker HO, Baumgärtner U et al. (2004) Hyperalgesia and allodynia: taxonomy, assessment, and mechanisms. In: Brune K, Handwerker HO (eds) *Hyperalgesia: Molecular Mechanisms and Clinical Implications*. IASP Press, Seattle, pp 1–15
- Wasner G, Schattschneider J, Binder A et al. (2004) Topical menthol – a human model for cold pain by activation and sensitization of C nociceptors. *Brain* 127:1159–1171
- Woolf CJ (1983) Evidence for a central component of post-injury pain hypersensitivity. *Nature* 306:686–688

## Allodynia and Alloknesis

ROBERT H. LAMOTTE

Department of Anesthesiology, Yale School of Medicine, New Haven, CT, USA

robert.lamotte@yale.edu

## Synonyms

Alloknesis and Allodynia

## Definition

Allodynia and alloknesis are abnormal sensory states wherein normally innocuous stimuli elicit unpleasant sensations or aversive responses.

► **Allodynia** is the ► **nociceptive** sensation or aversive response evoked by a stimulus that is normally non-nociceptive (“allo” – “other”; “dynia” - pain). For example, a light stroking of the skin produced by the lateral motion of clothing, or the heat produced by the body are stimuli that do not elicit nociceptive sensations or responses under normal circumstances. However, these stimuli may become nociceptive after a cutaneous injury produced, for example, by sunburn. In contrast, ► **hyperalgesia** is defined as the abnormal nociceptive state in which a normally painful stimulus such as the prick of a needle elicits a greater than normal duration and/or magnitude of pain.

► **Alloknesis** is the itch or ► **pruriceptive** sensation (from the Latin word *prurire*, to itch) or scratching behavior evoked by a stimulus that is normally non-pruriceptive (“allo”, and “knesis”, an ancient Greek



word for itching). For example, a light stroking of the skin normally evokes the sensation of touch and perhaps tickle but not itch. However, when cutaneous alloknesis develops within the vicinity of a mosquito bite, or is present in an area of dermatitis, a light stroking of the skin can evoke an itch or exacerbate an ongoing itch. In contrast, ► **hyperknesis** is defined as the abnormal prurceptive state in which a normally pruritic stimulus (such as a fine diameter hair which can elicit a prickle sensation followed by an itch) elicits a greater than normal duration and/or magnitude of itch. The cutaneous areas of enhanced itch (alloknesis and hyperknesis) are also referred to as “► **itchy skin.**”

The abnormal sensory states of allodynia, alloknesis, hyperalgesia and hyperknesis that are initiated by an inflammatory or irritating stimulus can exist both within the area directly exposed to the stimulus (in which case they are termed “primary”) and can sometimes extend well beyond the area (in which case the sensory states outside the area are termed “secondary”). For example, when the skin receives a local, first-degree burn, primary allodynia and hyperalgesia may exist within the burned skin and secondary allodynia and hyperalgesia in the skin immediately surrounding the burn.

### Characteristics

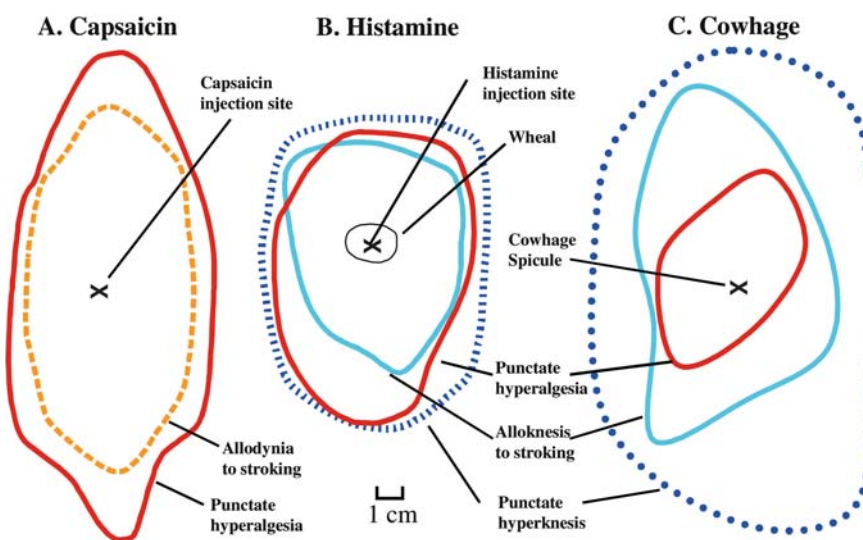
Allodynia is exhibited in a variety of forms such as the tenderness of the skin to combing the hair during a migraine headache, the discomfort of normal movements of the gut with irritable bowel syndrome, the soreness of muscles accompanying musculoskeletal inflammation or trauma and the chronic tenderness to touch or to gentle warming of the skin associated with trauma or inflammatory diseases of the peripheral or central nervous system. Allodynia can also be experimentally produced by the application of a noxious or irritant thermal, mechanical

or chemical stimulus to the skin. For example, an intradermal injection into the forearm of capsaicin, the irritant agent in hot peppers, elicits not only a burning pain in the immediate vicinity of the injection site but allodynia and hyperalgesia to mechanical stimulation in the surrounding skin not in contact with the irritant (LaMotte et al. 1991) (Fig. 1a).

### Alloknesis

Itchy skin and/or itch are characteristic of many cutaneous disorders such as atopic, allergic and irritant contact dermatitis and can accompany such systemic diseases as renal insufficiency, cholestasis, Hodgkin's disease, polycythemia vera, tumors and HIV infection.

Alloknesis can be experimentally produced in human volunteers by the iontophoresis (Magerl et al. 1990) or intradermal injection (Simone et al. 1991b) of histamine into the skin. The histamine evokes a sensation of itch accompanied by local cutaneous reactions consisting of a flare (redness of the skin mediated by a local axon reflex wherein vasodilatory neuropeptides are released by collaterals of activated nerve endings) and a wheal (local edema) (Simone et al. 1991b) (Fig. 1B). Within the wheal and within the surrounding skin that is not exposed to histamine, there develops alloknesis to lightly stroking the skin and hyperknesis and hyperalgesia to mechanical indentation of the skin with a fine prickly filament (Simone et al. 1991b; Atanassoff et al. 1999). Itch and alloknesis can also be produced in the absence of a flare or wheal by single spicules of cowhage (*Mucuna pruriens*), a tropical legume (Shelley and Arthur 1957; Graham et al. 1951) (Fig. 1C). Because the wheal and flare are elicited in response to histamine, the absence of these reactions in response to cowhage suggests that itch and itchy skin can be elicited by histamine-independent mechanisms, as is the case in most kinds of clinical pruritus.



**Allodynia and Alloknesis, Figure 1** Abnormal sensory states produced by algesic or pruritic chemicals applied to the volar forearm in human. (A) The borders of punctate hyperalgesia and allodynia to stroking after an intradermal injection of capsaicin (100  $\mu$ g). (B) The wheal and the borders of hyperalgesia and hyperknesis to punctate stimulation and alloknesis to stroking after an intradermal injection of histamine (20  $\mu$ g). (C) The borders of hyperknesis, hyperalgesia and alloknesis after the insertion a few cowhage spicules into the skin. Capsaicin and histamine evoked a flare (not shown) but cowhage did not. A different subject was used in each experiment.

### Interactions Between Pain and Itch

Pain and hyperalgesia have an inhibitory effect on itch and itchy skin. The enhanced itch and itchy skin resulting from injecting histamine into an anesthetic bleb of skin (as opposed to a bleb of saline) have been explained on the basis of a reduced activation of histamine responsive nociceptive neurons (Atanassoff et al. 1999). In contrast, histamine induced itch and itchy skin are absent or attenuated in the hyperalgesic skin surrounding a capsaicin injection (Brull et al. 1999). Thus, even though alloknesis and hyperknesis co-exist with the area of mild hyperalgesia induced by histamine (Fig. 1B), they are suppressed or prevented from developing when the hyperalgesia becomes sufficiently intense, as is the case after the injection of capsaicin. Similarly, cowhage spicules produced neither itch nor alloknesis within an area of hyperalgesia produced by a heat injury of the skin (Graham et al. 1951). Observations such as these confirm the existence of functional interactions between pruriceptive and nociceptive neural systems and lend support to the hypothesis that the mechanisms of itch and itchy skin are inhibited centrally by mechanisms that underlie pain and hyperalgesia (Brull et al. 1999; Nilsson et al. 1997; Ward et al. 1996).

### Neural Mechanisms of Allodynia and Alloknesis

Allodynia and hyperalgesia from an intradermal injection of capsaicin are believed to be initiated as a result of activity in a subpopulation of mechanically insensitive nociceptive afferent peripheral neurons (MIAs) (LaMotte 1992; Schmelz et al. 2003). A working model of the neural mechanisms of capsaicin induced allodynia and hyperalgesia posits that capsaicin responsive MIAs release neurochemicals that sensitize nociceptive neurons in the dorsal horn of the spinal cord. These neurons, in turn, receive convergent input from a) low-threshold primary afferents with thickly myelinated axons mediating the sense of touch and b) nociceptive afferents with thinly myelinated axons mediating the sense of mechanically evoked pricking pain. The sensitized neurons exhibit a *de novo* or greater than normal response to innocuous tactile stimuli, as well as an enhanced response to noxious punctate stimulation, thereby accounting for allodynia and hyperalgesia respectively. In support of this is the reported sensitization of nociceptive spinothalamic tract (STT) neurons, recorded electrophysiologically in animals, to innocuous touch and to noxious punctate stimulation after an intradermal injection of capsaicin (Simone et al. 1991a) via a mechanism called ► **central sensitization** (see also Fig. 2 in ► **ectopia, spontaneous** regarding possible chronic central sensitization leading to allodynia and hyperalgesia after injury of peripheral sensory neurons). Alloknesis and hyperknesis might be explained using a similar mechanistic model (LaMotte 1992). That is, there may exist pruriceptive STT neurons that can become sensitized to light mechanical touch and to

punctate stimulation with a fine filament, after an application of histamine or cowhage to the skin, thereby accounting for alloknesis and hyperknesis respectively. Subpopulations of mechanosensitive nociceptive peripheral neurons with unmyelinated axons respond, in humans, to histamine (Handwerker et al. 1991) and, in the cat, to cowhage spicules (Tuckett and Wei 1987). Histamine also activates a subpopulation of MIAs with unmyelinated axons in humans (Schmelz et al. 1997). Some of these neurons in human and cat exhibited responses that were comparable in time course to the sensation of itch reported by humans in response to the same stimuli. In addition, a few STT neurons with properties similar to the histamine sensitive MIAs were identified in the superficial dorsal horn of the cat (Andrew and Craig 2000). Similarly, a subpopulation of mechanically sensitive, ventrolateral spinal axons with nociceptive properties in the cat responded to cutaneous insertion of cowhage spicules (Wei and Tuckett 1991). However, the primary sensory neurons and spinal neurons responsive to histamine or to cowhage also responded to nociceptive stimuli that do not elicit itch in humans (Schmelz et al. 2003).

In the absence of itch-specific peripheral sensory neurons, it is possible that itch is encoded by pruriceptive central neurons, for example in the spinal dorsal horn, that are activated by peripheral neurons responsive to both pruritic and nociceptive stimuli but inhibited by interneurons that are activated only by noxious but not pruritic stimuli. Such interneurons may well receive input from known nociceptive specific afferents that respond to noxious stimuli such as capsaicin, heat or mechanical stimuli but do not respond to pruritic stimuli such as histamine. This “occlusion theory of itch” (Handwerker 1992) suggests that itch is felt only in the absence of activity in nociceptive neurons that would occlude or inhibit activity in the pruriceptive neurons. Presumably, the pruriceptive neurons would also be inhibited by sensitized central neurons responsible for maintaining a state of allodynia.

### References

1. Atanassoff PG, Brull SJ, Zhang JM et al. (1999) Enhancement of experimental pruritus and mechanically evoked dysesthesias with local anesthesia. *Somatosens Mot Res* 16:299–303
2. Brull SJ, Atanassoff PG, Silverman DG et al. (1999) Attenuation of experimental pruritus and mechanically evoked dysesthesias in an area of cutaneous allodynia. *Somatosens Mot Res* 16:291–298
3. Graham DT, Goodell H, Wolff HG (1951) Neural mechanisms involved in itch, “itchy skin,” and tickle sensations. *J Clin Invest* 30:37–49
4. Handwerker HO, Forster C, Kirchoff C (1991) Discharge properties of human C-fibres induced by itching and burning stimuli. *J Neurophysiol* 66:307–315
5. Handwerker HO (1992) Pain and allodynia, itch and alloknesis: an alternative hypothesis. *Am Pain Soc J* 1:135–138
6. LaMotte RH, Shain CN, Simone DA et al. (1991) Neurogenic hyperalgesia: Psychophysical studies of underlying mechanisms. *J Neurophysiol* 66:190–211

7. LaMotte RH (1992) Subpopulations of “nocifensor neurons” contributing to pain and allodynia, itch and allodynia. *Amer Pain Soc J* 1:115–126
8. Magerl W, Westerman RA, Mohnher B et al. (1990) Properties of transdermal histamine iontophoresis: differential effects of season, gender and body region. *J Invest Dermatol* 94:347–352
9. Nilsson H-JA, Levinsson A, Schouenborg J (1997) Cutaneous field stimulation (CFS) – a new powerful method to combat itch. *Pain* 71:49–55
10. Schmelz M, Schmidt R, Bickel A et al. (1997) Specific C-receptors for itch in human skin. *J Neurosci* 17:8003–8008
11. Schmelz M, Schmidt R, Weidner C et al. (2003) Chemical response pattern of different classes of C-nociceptors to pruritogens and algogens. *J Neurophysiol* 89:2441–2448
12. Shelley WB, Arthur RP (1957) The neurohistology and neurophysiology of the itch sensation in man. *Arch Dermatol* 76:296–323
13. Simone DA, Oh U, Sorokin LS et al. (1991a) Neurogenic hyperalgesia: Central neural correlates in responses of spinothalamic tract neurons. *J Neurophysiol* 66:228–246
14. Simone DA, Alreja M, LaMotte RH (1991b) Psychophysical studies of the itch sensation and itchy skin (“alloknesis”) produced by intracutaneous injection of histamine. *Somatosens Motor Res* 8:271–279
15. Tuckett RP, Wei JY (1987) Response to an itch-producing substance in cats, II. Cutaneous receptor populations with unmyelinated axons. *Brain Res* 413:87–94
16. Ward L, Wright E, McMahon SB (1996) A comparison of the effects of noxious and innocuous counterstimuli on experimentally induced itch and pain. *Pain* 64:129–138
17. Wei JY, Tuckett RP (1991) Response of cat ventrolateral spinal axons to an itch-producing stimulus (cowhage). *Somatosens Motor Res* 8:227–239

## Allodynia in Fibromyalgia

### Definition

A lowered pain threshold characterizes the examination findings in fibromyalgia. Allodynia can be caused in animal systems by strategic manipulation of nociceptive neurochemicals. Studies of the nociceptive neurochemicals in FMS spinal fluid have found them to be abnormal in concentration and/or correlated with the symptoms. As a result, FMS can now be identified as chronic, widespread allodynia. These observations change the way FMS is viewed, and identify it as a remarkably interesting human syndrome of chronic central neurochemical pain amplification.

► **Muscle Pain, Fibromyalgia Syndrome (Primary, Secondary)**

## Allodynia Test, Mechanical and Cold Allodynia

KYUNGSOON CHUNG

Department of Anatomy and Neurosciences, University of Texas Medical Branch, Galveston, TX, USA  
kchung@utmb.edu

### Synonym

Mechanical Allodynia Test; cold allodynia test

### Definition

Allodynia is defined as “pain due to a stimulus which does not normally provoke pain” by the International Association for the Study of Pain (Lindblom et al. 1986). It is important to recognize that allodynia involves a change in the quality of a sensation, since the original modality is normally non-painful but the response is painful. There is, thus, a loss of specificity of a sensory modality.

### Characteristics

Because allodynia is an evoked pain, testing requires an external stimulation of non-painful quality. Two different types of stimulation have been used to test allodynia in animal models of neuropathic pain: mechanical and cold. All testing methods rely on foot withdrawal response to stimulus, based on the premise that the animal’s avoidance of touching or cooling is an allodynic reaction.

### Mechanical Allodynia Test: Foot Withdrawal Response to Von Frey Filament Stimulus

Since mechanical allodynia is a major complaint of neuropathic pain patients, testing for signs of mechanical allodynia is an important aspect of behavioral tests for neuropathic pain. Mechanical allodynia, is often tested by quantifying mechanical sensitivity, using a set of von Frey filaments (a series of nylon monofilaments of increasing stiffness that exert defined levels of force as they are pressed to the point where they bend; Stoelting Co., Wood Dale, IL). Mechanical sensitivity is quantified either by determining mechanical threshold (Baik et al. 2003; Chaplan et al. 1994; Tal and Bennett 1994), or by measuring response frequency (Hashizume et al. 2000; Kim and Chung 1992).

### Measurement of Mechanical Thresholds

Although there are several ways of measuring mechanical thresholds, we measure foot withdrawal thresholds to mechanical stimuli by using the up-down method (Baik et al. 2003; Chaplan et al. 1994). The rats are placed under a transparent plastic dome (85x80x280mm) on a metal wire mesh floor. A series of 8 von Frey (VF) filaments with approximately equal logarithmic incremental (0.22) VF values (3.65, 3.87, 4.10, 4.31, 4.52, 4.74, 4.92, and 5.16) are used to determine the threshold stiffness required for 50% paw withdrawal. Because VF values are logarithmically related to gram (g) values [ $VF = \log(1000 \times g)$ ], the chosen VF numbers are equivalent to 0.45, 0.74, 1.26, 2.04, 3.31, 5.50, 8.32, and 14.45 in gram value, respectively. Starting with filament 4.31, VF filaments are applied perpendicular to the plantar surface of the hind paw and depressed



until they bent for 2 to 3 seconds. Whenever a positive response to a stimulus occurs, the next smaller VF filament is applied. Whenever a negative response occurs, the next higher one is applied. The test is continued until the response of 6 stimuli, after the first change in response, has been obtained or until the test reaches either end of the spectrum of the VF set. The 50% threshold value is calculated by using the formula of Dixon:  $50\% \text{ threshold} = X + kd$ , where X is the value of the final VF filament used (in log units), k is the tabular value for the pattern of positive/negative responses, and d is the mean difference between stimuli in log units (0.22). In the case where continuous positive or negative responses are observed all the way out to the end of the stimulus spectrum, values of 3.54 or 5.27 are assigned, respectively, by assuming a value of  $\pm 0.5$  for k. The outcome of behavioral data are expressed as VF values (maximum range, 3.54 to 5.27) and plotted in a linear scale. Because VF values are logarithmically related to gram values, plotting in gram values requires logarithmic plots. The mechanical threshold for foot withdrawal in a normal rat is usually a VF value of 5.27 (18.62 g) (Baik et al. 2003). After L5 spinal nerve ligation, mechanical thresholds decline to around the 3.54 (0.35 g) range by the 3<sup>rd</sup> day, and this level is maintained for weeks (Park et al. 2000). Since thresholds of most nociceptors are higher than 1.5 g (Leem et al. 1993), foot withdrawals elicited lower than this value can be assumed to be mechanical allodynia.

Another method has also been used to determine mechanical thresholds based on foot withdrawal reflex responses to VF filament stimulation. In this experimental paradigm, a series of VF filaments whose stiffness are within a non-painful stimulus range are selected, based on the testing locations. The VF filaments are applied perpendicular to the skin and depressed until they bend, flexor withdrawal reflexes are then observed. Starting from the weakest filament, the von Frey filaments are tested in order of increasing stiffness. The minimum force required to elicit a flexor withdrawal reflex is recorded as the mechanical threshold. Depending on each specific experiment, the number of applications with each VF filament, times of intervals between stimuli, and the criteria of threshold determination were somewhat variable. For example, the first filament in the series that evoked at least 1 response from 5 applications was designated as the threshold by Tal & Bennett (1994), while Ma & Woolf (1996) determined that the minimum force required to elicit a reproducible flexor withdrawal reflex on each of 3 applications of the VF filaments would be recorded as the threshold.

#### Measurements of Paw Withdrawal Frequencies

The general method of stimulus application with VF filaments, and recording positive or negative withdrawal reflex responses, are the same as the method used for the threshold measurement. The differences are:

1. Sensitivity testing is done by repeated stimuli with each defined VF filament
2. Frequency of positive response is measured and used as an indicator of tactile sensitivity.

In one experiment, mechanical stimuli are applied to the plantar surface of the hind paw with 6 different von Frey filaments ranging from 0.86 to 19.0 g (0.86, 1.4, 2.5, 5.6, 10.2, 19.0 g). The 0.86 g and 19.0 g filaments produce a faint sense of touch and a sense of pressure, respectively, when tested on our own palm. A single trial of stimuli consisted of 6–8 applications of a von Frey filament within a 2–3 sec period; each trial is repeated 5 times at approximately 3 min. intervals on each hind paw. The occurrence of foot withdrawal in each of 5 trials was expressed as a percent response frequency [ $\text{number of foot withdrawals}/5 \text{ (number of trials)} \times 100 = \% \text{ response frequency}$ ], and this percentage is used as an indication of mechanical sensitivity. For a given test day, the same procedure is repeated for the remaining 5 different von Frey filaments, in ascending order starting from the weakest. In the sham operated control rat, the strongest VF filament (19.0 g) produces a 10% response, but none of the other filaments produced any response (0%). Seven days after L5/6 spinal nerve ligation, response frequency increases to 40% and 80% by stimuli with 0.86 g and 19.0 g filaments, respectively (Kim and Chung 1992).

In another experimental paradigm, rats are subjected to three sequential series of ten tactile stimulations to the plantar surface of the hind paw using 2 and 12 g VF filaments. Mechanical allodynia is assessed by recording the total number of responses elicited during three successive trials (ten stimulations/each filament), separated by at least 10 min for a total possible score of 30. The terms for the allodynic condition are defined based on the average responses to 12 g von Frey stimulation in each group as follows: minimal (0–5), mild (5–10), moderate (10–15), robust (15 and more) (Hashizume et al. 2000).

#### Cold Allodynia Test: Foot Withdrawal Response to Acetone or Cold Plate

Two different methods have been used for cold allodynia testing in animal models of neuropathic pain: the acetone test and the cold plate test.

##### Acetone Test

The rat is placed under a transparent plastic dome on a metal mesh floor and acetone is applied to the plantar surface of the foot. Application of acetone is done by an acetone bubble formed at the end of a piece of polyethylene tubing (1/16" ID), which is connected to a syringe. The bubble is then gently touched to the heel. The acetone quickly spreads over the proximal half of the plantar surface of the foot and evaporates. On our own volar surface of the forearm, this stimulus produces a strong but non-painful cooling sensation as the acetone evaporates. Normal rats either ignore the stimulus, or it produces a very brief and small withdrawal reflex. After L5/6 spinal

nerve ligation, rats briskly withdraw the hind foot after some delay (about 0.2–0.3 sec) and subsequently shake, tap, or lick the hind paw in response to acetone application to the affected paw. For quantification of cold allodynic behavior, acetone is applied 5 times (once every 5 min) to each paw. The frequency of foot withdrawal is expressed as a percent: (number of trials accompanied by brisk foot withdrawal) x 100/(number of total trials). As a control, warm water (30°C) is applied in the same manner as acetone. A significant increase in the frequency of foot withdrawals in response to acetone application was interpreted as cold allodynia (Choi et al. 1994). In another experiment, 0.15 ml of acetone was sprayed onto the plantar surface of the hind paw for assaying cold allodynia. As in the acetone bubble test, normal rats either ignore the stimulus or it produces a very brief and small withdrawal reflex. Rats with sciatic neuritis reacted with a large and prolonged withdrawal response. Approximately one-half of the neuritic rats displayed cold allodynia while almost all rats with chronic constriction injury to the sciatic nerve showed cold allodynia (Bennett 1999).

### Cold Plate Test

In the cold plate test, rats are confined beneath an inverted, clear plastic cage (18x28x13 cm) placed upon a metal floor (e.g. aluminum plate), which is chilled to 4°C by an underlying water bath. While exposed to the cold floor for 20 min, the animals' behavior is noted, and the frequency of hind paw withdrawals and the duration the hind paw is held above the floor (i.e., hind paw withdrawals related to stepping are not counted) are measured. The 4°C floor does not produce any pain when our volar forearms are immobilized on it for 20 min, and it does not evoke any pain-related responses from unoperated control rats. In neuropathic rats with sciatic chronic constriction injury, the average frequency and cumulative duration of hind paw withdrawals on the nerve-damaged side increases about 5 and 2-fold, respectively, compared to that of normal rats. In addition, some rats also demonstrate vague, scratching-like movements and also lick the affected hind paw (Bennett and Xie 1988). This method is based on the premise that the animal's avoidance of touching the cold plate is an allodynic reaction. However, complete denervation of the foot does not change this behavior (Choi et al. 1994), making it questionable that the foot lift behavior is related to allodynia, since allodynia would require the presence of functioning sensory receptors.

### References

1. Baik EJ, Chung JM, Chung K (2003) Peripheral Norepinephrine Exacerbates Neuritis-Induced Hyperalgesia. *J Pain* 4:212–221
2. Bennett GJ (1999) Does a Neuroimmune Interaction Contribute to the Genesis of Painful Peripheral Neuropathies? *Proc Natl Acad Sci USA* 96:7737–7738

3. Bennett GJ, Xie Y-K (1988) A Peripheral Mononeuropathy in Rat that Produces Disorders of Pain Sensation like those Seen in Man. *Pain* 33:87–107
4. Bonica JJ (1990) Causalgia and Other Reflex Sympathetic Dys-trophies. In: Bonica JJ (ed) *The Management of Pain*. Lea & Febiger, Philadelphia, pp 220–243
5. Chaplan SR, Bach FW, Pogrel JW, Chung JM, Yaksh TL (1994) Quantitative Assessment of Tactile Allodynia in the Rat Paw. *J Neurosci Methods* 53:55–63
6. Choi Y, Yoon YW, Na HS, Kim SH, Chung JM (1994) Behavioral Signs of Ongoing Pain and Cold Allodynia in a Rat Model of Neuropathic Pain. *Pain* 59:369–376
7. Dixon WJ (1980) Efficient Analysis of Experimental Observations. *Ann Rev Phar Tox* 20:441–462
8. Hashizume H, Rutkowski MD, Weinstein JN, DeLeo JA (2000) Central Administration of Methotrexate Reduces Mechanical Allodynia in an Animal Model of Radiculopathy/Sciatica. *Pain* 87:159–169
9. Kim SH, Chung JM (1992) An Experimental Model for Peripheral Neuropathy Produced by Segmental Spinal Nerve Ligation in the Rat. *Pain* 50:355–363
10. Leem JW, Willis WD, Chung JM (1993) Cutaneous Sensory Receptors in the Rat Foot. *J Neurophysiol.* 69:1684–1699
11. Lindblom U, Merskey H, Mumford JM, Nathan PW, Noordenbos W, Sunderland S (1986) Pain Terms, A Current List with Definitions and Notes on Usage. *Pain Suppl* 3:215–221
12. Ma Q-P, Woolf CJ (1996) Progressive Tactile Hypersensitivity: An Inflammation-Induced Incremental Increase in the Excitability of the Spinal Cord. *Pain* 67:97–106
13. Park SK, Chung K, Chung JM (2000) Effects of Purinergic and Adrenergic Antagonists in a Rat Model of Painful Peripheral Neuropathy. *Pain* 87:171–179
14. Tal M, Bennett GJ (1994) Extra-Territorial Pain in Rats with a Peripheral Mononeuropathy: Mechano-Hyperalgesia and Mechano-Allodynia in the Territory of an Uninjured Nerve. *Pain* 57:375–382

## Alloknesis

### Definition

This is the itchy or pruriceptive sensation (from the Latin word *prurire*, to itch) evoked by a stimulus that is normally non-pruriceptive („allo“, and „knesis“, an ancient Greek word for itching), also referred to as “itchy skin”. For example, a light stroking of the skin normally evokes the sensation of touch, and perhaps tickle, but not itch. However, when cutaneous alloknesis develops within the vicinity of a mosquito bite, or is present in an area of dermatitis, a light stroking of the skin can evoke an itch or exacerbate an ongoing itch.

- ▶ Allodynia and Alloknesis
- ▶ Spinothalamic Tract Neurons, Central Sensitization

## Alloknesis and Allodynia

- ▶ Allodynia and Alloknesis

## Allostasis

### Definition

Maintaining stability (or homeostasis). Different situations require variations in physiological set points, for which regulatory changes throughout the body are necessary in order to maintain optimal levels of biological function.

- ▶ Stress and Pain

## Alpha( $\alpha$ ) 1-Adrenergic Receptor

### Definition

The  $\alpha^1$ -Adrenergic Receptor is a monoamine neurotransmitter receptor with maximum sensitivity to noradrenaline and blocked by the agonist, phenylephrine.

- ▶ Complex Regional Pain Syndrome and the Sympathetic Nervous System

## Alpha( $\alpha$ ) 2-Adrenergic Agonist

### Definition

Drugs that stimulate alpha 2 adrenergic receptor subtype of the catecholamine neurotransmitter, norepinephrine (adrenaline) on nerve endings and inhibit norepinephrine release, resulting in sedative and analgesic actions

- ▶ Opioids and Reflexes
- ▶ Pain Control in Children with Burns

## Alpha( $\alpha$ ) 2-Adrenergic Receptor Agonists

- ▶ Alpha( $\alpha$ ) 2-Adrenergic Agonists in Pain Treatment

## Alpha( $\alpha$ ) 2-Adrenoceptor Agonists

### Definition

A drug acting on  $\alpha_2$ -adrenoceptors.

- ▶ Alpha ( $\alpha$ ) 2-Adrenergic Agonists in Pain Treatment

## Alpha( $\alpha$ ) 2-Adrenoceptors

### Definition

$\alpha_2$ -Adrenoceptors are G protein coupled receptors, which inhibit accumulation of cyclic adenosine monophosphate (cAMP), inhibit N-type and P/Q-type calcium channels, and activate potassium channels and  $\text{Na}^+/\text{H}^+$  antiporter. Three receptor subtypes have so far been identified:  $\alpha_{2A}$ ,  $\alpha_{2B}$  and  $\alpha_{2C}$ .

- ▶ Alpha ( $\alpha$ ) 2-Adrenergic Agonists in Pain Treatment

## Alpha( $\alpha$ ) 2-Adrenergic Agonists in Pain Treatment

CARSTEN BANTEL<sup>1</sup>, MERVYN MAZE<sup>1</sup>,  
LAURA STONE<sup>2</sup>, GEORGE WILCOX<sup>2</sup>

<sup>1</sup>Magill Department of Anaesthetics, Chelsea and Westminster Campus, Imperial College of Science, Technology and Medicine, London, UK

<sup>2</sup>Department of Neuroscience, University of Minnesota, Minneapolis, MN, USA

c.bantel@imperial.ac.uk, m.maze@imperial.ac.uk,  
stone@med.umn.edu, george@umn.edu

### Synonyms

Alpha( $\alpha$ ) 2-Agonists;  $\alpha_2$ -adrenoceptor agonists;  $\alpha_2$ -receptor agonists;  $\alpha_2$ -adrenergic agonists; Alpha( $\alpha$ ) 2-Adrenergic Receptor Agonists;  $\alpha$ -agonists

### Definition

Alpha<sub>2</sub>-adrenergic agonists are drugs that mediate their analgesic (antinociceptive) effects by acting on  $\alpha_2$ -adrenoceptors ( $\alpha_{2A}$ ,  $\alpha_{2B}$ ,  $\alpha_{2C}$ ) in the peripheral and central nervous system.

### Characteristics

#### Indications and Patients

Alpha<sub>2</sub>-adrenoceptor ( $\alpha_2$ AR) agonists are used for treatment of acute (intra- and post-operative) as well as chronic (neuropathic) pain states. They are effective in patients of all age groups.  $\alpha_2$ AR agonists have also been safely used in pregnancy, labour and during caesarean sections. Furthermore, there is evidence that they provide haemodynamic stability in patients with co-existing cardiovascular diseases during phases of noxious stimulation (e.g. orotracheal intubation) by attenuating the sympathetic response.

#### Dose and Route of Administration (Table 1)

With ▶ clonidine being the prototypical  $\alpha_2$ AR agonist, these drugs have been administered in different doses and by a wide variety of routes: systemic, peripheral, regional, neuraxial and central. They have been used as



**Alpha( $\alpha$ ) 2-Adrenergic Agonists in Pain Treatment, Table 1** Alpha2-adrenergic drug dosing: Clonidine

Route		dose	duration
Premedication			
	children	2–4 $\mu\text{g}/\text{kg}$	
	elderly patients	1–2 $\mu\text{g}/\text{kg}$	
Perioperative Analgesia			
intrathecal	with opioid	max 1 $\mu\text{g}/\text{kg}$	long; dose dependent
epidural	with mepivacaine	up to 75 $\mu\text{g}$	up to 24 h
caudal		1–4 $\mu\text{g}/\text{kg}$	
peripheral nerve block Bier block		0.75–3 $\mu\text{g}/\text{kg}$ 0.1–0.5 $\mu\text{g}/\text{kg}$ 1–2 $\mu\text{g}/\text{kg}$	
Postoperative Analgesia			
epidural	clonidine alone	1–4 $\mu\text{g}/\text{kg}$ 100–150 $\mu\text{g}/\text{hour}$	
Analgesia for Labour Pain			
intrathecal	with bupivacaine	50–200 $\mu\text{g}$	
epidural	with bupivacaine + fentanyl	max 1 $\mu\text{g}/\text{kg}$ 30–150 $\mu\text{g}$ 75 $\mu\text{g}$	
Chronic Pain			
epidural	Infusion	100–900 $\mu\text{g}$ 30 $\mu\text{g}/\text{h}$	8 h up to 2 weeks

premedication, in combination with other drugs, or as sole analgesic during and after surgery, and in the treatment of chronic pain either by bolus or continuous infusions or as part of a ► [patient controlled analgesia](#) (PCA) regimen.

### Drug Interactions

Pre-clinical and clinical studies investigating the antinociceptive effect of  $\alpha_2$ AR agonists and their interactions with other drug classes have demonstrated synergistic interaction with opioids as well as opioid-sparing effects. Furthermore,  $\alpha_2$ AR agonists have been demonstrated to reduce the ► [minimal alveolar concentration](#) (MAC) of volatile anaesthetics and attenuate the pain from propofol injection. Numerous studies have shown that combining  $\alpha_2$ AR agonists with local anaesthetics both prolong the sensory blockade and also improve the quality of the block. Therefore,  $\alpha_2$ AR agonists may be considered as an adjuvant therapy for both general and local anaesthesia.

### Other Effects

Compared to opioids, far less respiratory depression is seen with  $\alpha_2$ AR agonists. Drugs of this class produce sedation by an action that originates in the brainstem and converges on the endogenous pathways responsible for non-REM sleep. Dose-dependent effects of  $\alpha_2$ AR agonists are also noted in the cardiovascular system. At low doses these drugs induce hypotension through actions on locus coeruleus and nucleus tractus solitarius, which

results in a decrease in sympathetic outflow. At higher doses,  $\alpha_2$ AR agonists induce vasoconstriction in the periphery and can result in a rise in systemic blood pressure. A combination of sympatholytic and vagomimetic actions of  $\alpha_2$ AR agonists cause a decrease in heart rate. Additional features that are useful in the perioperative period include the ability of  $\alpha_2$ AR agonistic drugs to produce xerostomia (dry mouth) and anxiety.

### Analgesic (Antinociceptive) Sites of Action

$\alpha_2$ ARs are present on peripheral nerves, in the spinal cord and at supraspinal pain-modulating centres. They have therefore been applied to all parts of the nervous system in an effort to generate analgesia in patients or antinociception in animals.

### Periphery

Although in pre-clinical models peripheral injections of  $\alpha_2$ AR agonists appeared promising for pain control, the utility of local peripheral administration has proven to be inconsistent in clinical studies. These inconsistencies may be due to the patient population examined, as topical clonidine has been shown to be antihyperalgesic in the subset of neuropathic pain patients with sympathetically maintained pain.

Peripheral  $\alpha_2$ ARs are found on sympathetic and sensory nerves, where they have been proposed to act as autoreceptors to inhibit neuronal excitability and transmitter release. There is a growing body of evidence that an inflammatory response might be prerequisite for the

peripheral site of action of  $\alpha_2$ AR receptor agonists. This has been hypothesised because of the demonstration of  $\alpha_2$ ARs on inflammatory cells, especially macrophages. Peri-neural application of the  $\alpha_2$ AR agonist clonidine reduced nerve injury-induced release of the pro-inflammatory cytokine TNF $\alpha$ , and the time course of this action was paralleled by a clear antinociceptive effect in an animal model of **▶ neuropathic pain**. Hence, it is now suggested that macrophages invade the site of traumatic nerve damage, and contribute to an inflammation-maintained pathogenic mechanism through the release of pro-inflammatory cytokines, and that  $\alpha_2$ AR agonists attenuate this process by reducing the inflammatory response rather than by direct action on peripheral nerves (Lavand'homme and Eisenach 2003).

### Spinal Cord

From recent data, the spinal cord dorsal horn has clearly emerged as a pivotal site of  $\alpha_2$ AR analgesic action. Administration of  $\alpha_2$ AR agonists result in antinociception and analgesia in animal models and human subjects by both pre- and post-synaptic actions. These spinal analgesic actions of  $\alpha_2$ AR agonists are largely mediated by the  $\alpha_{2A}$ AR subtype, and presynaptic  $\alpha_{2A}$ ARs on primary afferent nociceptive **▶ A $\delta$ - and C-fibres** are positioned to directly modulate pain processing through attenuation of excitatory synaptic transmission (Stone et al. 1997; Stone et al. 1998). This has been supported by results showing an inhibitory effect of  $\alpha_2$ AR on spinal glutamate release in synaptosomal and electrophysiological experiments (Kawasaki et al. 2003; Li and Eisenach 2001). Direct hyperpolarization of post-synaptic spinal neurons by  $\alpha_2$ AR agonists may also play an important role in the spinal analgesic action of  $\alpha_2$ AR agonists (Sonohata et al. 2004). These direct actions are concerted with indirect mechanisms by descending noradrenergic pathways, which release noradrenaline that may act via  $\alpha_{2B}$ ARs, thought by some to be on spinal ascending nociceptive pathways and interneurons.

There is also a growing body of evidence showing plasticity in the analgesic effects of  $\alpha_2$ AR agonists, especially in **▶ hypersensitivity-maintained pain** states. For example,  $\alpha_2$ AR agonists have a greater efficacy under circumstances of neuropathic pain. This may be due to the upregulation of the  $\alpha_{2C}$ AR subtype following nerve injury, resulting in an alteration of the  $\alpha_2$ AR-agonist site of action, and the involvement of different pathways in the generation of  $\alpha_2$ AR-induced antinociception (Duffo et al. 2002; Paqueron et al. 2003; Stone et al. 1999).

It has been suggested that the antihyperalgesic effect of  $\alpha_2$ AR-agonists in hypersensitivity-maintained pain states (e.g. neuropathic pain) is mediated, at least in part, through non- $\alpha_{2A}$ ARs. Furthermore, under those conditions, antihyperalgesia against mechanical but not thermal stimuli seems to be dependent on cholinergic mechanisms. This is supported by most recent data indicating that  $\alpha_2$ AR-agonists exert their action via

cholinergic neurons, which have been modulated by the interaction of **▶ nerve growth factor** (NGF) with its low-affinity p75 receptor. It has further been hypothesised that  $\alpha_2$ -adrenergic agonists facilitate the release of acetylcholine (ACh). The released ACh has been shown to act mainly on muscarinic and to a lesser extent on nicotinic **▶ acetylcholine receptors**, to induce the release of nitric oxide (NO) and thereby antinociception (Pan et al. 1999).

### Supraspinal Sites

The catecholaminergic cell groups A5, A6 (Locus Coeruleus, LC) and A7 in the dorsolateral pons of the brainstem have been identified as the most important supraspinal sites for  $\alpha_2$ AR-mediated antinociception. These areas express  $\alpha_2$ ARs and send and receive projections to and from other pain-modulating parts of the brain, for instance the periaqueductal gray (PAG) and the rostral ventromedial medulla (RVM). Therefore, they act as important relay stations for pain-modulating pathways. They are also centres from which **▶ descending inhibitory noradrenergic (NA) pathways** originate. These pathways terminate in parts of the spinal cord dorsal horn that modulate spinal pain processing.

Normally, tonic firing in LC neurons suppresses activity in A5/7 cell groups; consequently, the noradrenergic outflow through the descending NA pathways is inhibited (Bie et al. 2003; Nuseir and Proudfit 2000). Activation of  $\alpha_2$ ARs in the LC can inhibit activity in certain cells resulting in behavioural changes, which are in accordance with antinociceptive actions of the injected drugs. These effects could be completely reversed by **▶ intrathecal** application of an  $\alpha_2$ AR antagonist, suggesting a mechanism of action involving increased spinal NA release in response to the supraspinal agonist injection (Dawson et al. 2004).

From these results it has been suggested that  $\alpha_2$ AR agonists, in decreasing the activity of LC neurons, disinhibit the A5/A7 cell groups, and therefore indirectly activate the descending inhibitory NA pathways with the resultant increased spinal NA release. Evidence from recent studies suggests that the released NA acts on  $\alpha_{2B}$ ARs in the spinal cord, which are not located on primary afferents; instead, these may be located on interneurons or ascending excitatory pathways to mediate antinociception (Dawson et al. 2004; Kingery et al. 2002). In addition to antinociception, the LC also mediates the sedative actions of  $\alpha_2$ AR agonists by inhibition of cell firing in some LC neurons.

The possible importance of these noradrenergic pathways under circumstances of chronic pain has also recently been suggested. Data obtained from an animal model of neuropathic pain, for example, showed an increased expression of key enzymes of catecholamine synthesis, tyrosine hydroxylase and dopamine  $\beta$ -hydroxylase, in the LC and spinal cord. This increased expression has been interpreted as a reflection of an

enhanced activity in the descending NA system, with an increased noradrenaline turnover in response to the ongoing activity in nociceptive pathways (Ma and Eisenach 2003).

► [Thalamic Neurotransmitters and Neuromodulators](#)

## References

1. Bie B, Fields HL, Williams JT et al. (2003) Roles of Alpha<sup>1</sup> and Alpha<sup>2</sup>-adrenoceptors in the Nucleus Raphe Magnus in Opioid Analgesia and Opioid Abstinence-Induced Hyperalgesia. *J Neurosci* 23:7950–7957
2. Dawson C, Ma D, Chow A et al. (2004) Dexmedetomidine Enhances Analgesic Action of Nitrous Oxide: Mechanisms of Action. *Anesthesiology* 100:894–904
3. Duffo F, Li X, Bantel C et al. (2002) Peripheral Nerve Injury Alters the Alpha<sup>2</sup> Adrenoceptor Subtype Activated by Clonidine for Analgesia. *Anesthesiology* 97:636–641
4. Kawasaki Y, Kumamoto E, Furue H et al. (2003) Alpha<sup>2</sup> Adrenoceptor-Mediated Presynaptic Inhibition of Primary Afferent Glutamatergic Transmission in Rat Substantia Gelatinosa Neurons. *Anesthesiology* 98:682–689
5. Kingery WS, Agashe GS, Guo TZ et al. (2002) Isoflurane and Nociception: Spinal Alpha<sup>2A</sup> Adrenoceptors Mediate Antinociception while Supraspinal Alpha<sup>1</sup> Adrenoceptors Mediate Pronociception. *Anesthesiology* 96:367–374
6. Lavand'homme PM, Eisenach JC (2003) Perioperative Administration of the Alpha<sup>2</sup>-Adrenoceptor Agonist Clonidine at the Site of Nerve Injury Reduces the Development of Mechanical Hypersensitivity and Modulates Local Cytokine Expression. *Pain* 105:247–254
7. Li XH, Eisenach JC (2001)  $\alpha$ 2A-Adrenoceptor Stimulation Reduces Capsaicin-Induced Glutamate Release from Spinal Cord Synaptosomes. *J Pharmacol Exp Ther* 299:939–944
8. Ma W, Eisenach JC (2003) Chronic Constriction Injury of Sciatic Nerve Induces the Up-Regulation of Descending Inhibitory Noradrenergic Innervation to the Lumbar Dorsal Horn of Mice. *Brain Res* 970:110–118
9. Nuseir K, Proudfoot HK (2000) Bidirectional Modulation of Nociception by GABA Neurons in the Dorsolateral Pontine Tegmentum that Tonicly Inhibit Spinally Projecting Noradrenergic A7 Neurons. *Neuroscience* 96:773–783
10. Pan HL, Chen SR, Eisenach JC (1999) Intrathecal Clonidine Alleviates Allodynia in Neuropathic Rats: Interaction with Spinal Muscarinic and Nicotinic Receptors. *Anesthesiology* 90:509–514
11. Paqueron X, Conklin D, Eisenach JC (2003) Plasticity in Action of Intrathecal Clonidine to Mechanical but not Thermal Nociception after Peripheral Nerve Injury. *Anesthesiology* 99:199–204
12. Sonohata M, Furue H, Katafuchi T et al. (2004) Actions of Noradrenaline on Substantia Gelatinosa Neurons in the Rat Spinal Cord Revealed by *In Vivo* Patch Recording. *J Physiol* 555:515–526
13. Stone LS, Macmillan L, Kitto KF et al. (1997) The  $\alpha$ <sub>2</sub> a-adrenergic Receptor Subtype Mediates Spinal Analgesia Evoked by  $\alpha$ <sub>2</sub> Agonists and is Necessary for Spinal Adrenergic/Opioid Synergy. *J Neurosci* 17:7157–7165
14. Stone LS, Broberger C, Vulchanova L et al. (1998) Differential Distribution of Alpha<sup>2A</sup> and Alpha<sup>2C</sup> Adrenergic Receptor Immunoreactivity in the Rat Spinal Cord. *J Neurosci* 18:5928–5937
15. Stone LS, Vulchanova L, Riedl MS, Wang J, Williams FG, Wilcox GL, Elde R (1999) Effects of Peripheral Nerve Injury on Alpha<sup>2A</sup> and Alpha<sup>2C</sup> Adrenergic Receptor Immunoreactivity in the Rat Spinal Cord. *Neuroscience* 93:1399–1407

## Alpha( $\alpha$ ) 2-Agonists

► [Alpha\( \$\alpha\$ \) 2-Adrenergic Agonists in Pain Treatment](#)

## Alpha( $\alpha$ )-Adrenoceptors

A

### Definition

The sympathetic nervous system is an involuntary system that plays an important role in normal physiological functions, such as control of body temperature and regulation of blood flow to various tissues in the body. These nerves release a chemical called norepinephrine that activates specific receptors, called adrenergic receptors or adrenoceptors. There are two main subtypes of adrenoceptors – one of which is the alpha adrenoceptors.

► [Sympathetically Maintained Pain in CRPS II, Human Experimentation](#)

## Alpha( $\alpha$ )-Delta( $\delta$ ) Sleep

### Definition

Simultaneous recordings of delta and alpha brainwaves during sleep.

► [Fibromyalgia](#)

## Alpha( $\alpha$ )-D Galactose

### Definition

Lectins are proteins that bind to the carbohydrate portion of glycoproteins and glycolipids. The isolectin Griffonia simplicifolia I–B<sub>4</sub> (IB<sub>4</sub>) binds specifically to terminal  $\alpha$ -galactose, the terminal sugar on galactose- $\alpha$ 1,3-galactose carbohydrates on glycoproteins and glycolipids. The IB<sub>4</sub> lectin labels about one half of the small- and medium-diameter DRG neurons in rat and mouse. It is not yet clear which proteins or lipids in DRG neurons account for the majority of labeling by IB<sub>4</sub> binding.

► [Immunocytochemistry of Nociceptors](#)

## Alpha( $\alpha$ ) EEG Wave Intrusion

### Definition

The intrusion of fast-frequency EEG Alpha (7.5 – 11 Hz) activity into slow wave sleep (SWS). The SWS is dominated by large and slow EEG waves of Delta type (0.5 – 4.0 Hz); it also characterizes sleep stages 3 & 4.

► [Orofacial Pain, Sleep Disturbance](#)

## Alpha( $\alpha$ )-I-Acid Glycoprotein

### Definition

The most important serum binding protein for opioids and local anesthetics.

- ▶ Acute Pain in Children, Post-Operative

## AL-TENS

- ▶ Acupuncture-Like TENS

## Alternative Medicine

- ▶ Alternative Medicine in Neuropathic Pain

## Alternative Medicine in Neuropathic Pain

MILES J. BELGRADE

Fairview Pain & Palliative Care, University of Minnesota Medical Center, Minneapolis, MN, USA  
mbelgra1@fairview.org

### Synonyms

Complementary Medicine; Alternative Medicine; Holistic Medicine; Unconventional Medicine; Non-Traditional Medicine; Alternative Therapies; Complementary Therapies

### Definition

In 1993, Eisenberg utilized a working definition of alternative medicine as interventions that are not taught widely in medical schools and that are not generally available in U.S. hospitals (Eisenberg et al. 1993). However, there has been a rise in availability of complementary medical practices in Western-based medical institutions and more medical schools are incorporating unconventional therapies into their curricula. A broader definition of alternative and complementary medicine would be those medical systems, practices, interventions, applications, theories or claims that are not part of the dominant or conventional medical system of that society (National Institutes of Health on Alternative Medical systems and Practices in the United States). This definition is flexible in that it recognizes alternative and complementary medicine as culturally based. This definition also allows for changes in what constitutes alternative or complementary practices as a society evolves or changes.

The concept of alternative medicine implies practices used instead of conventional medical practice, whereas complementary medicine refers to practices that are

integrated with conventional care. Neither of these terms accurately reflects the most common way in which unconventional practices are incorporated into treatment. Most of the time, physicians are unaware of their patients' use of alternative health practices that are applied simultaneously with conventional treatment. Thus, these practices are neither instead of, nor integrated with, conventional treatment. They are simply a separate, dual track of care.

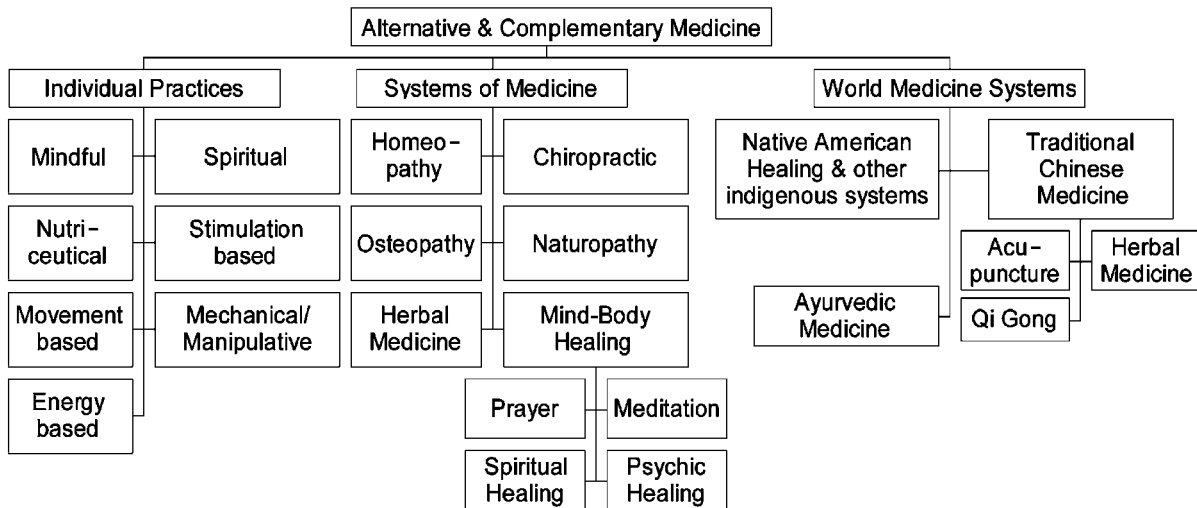
### Characteristics

Medical conditions that have effective and well-tolerated treatments generally do not motivate a search for alternatives – especially when such alternatives may be based on theoretical constructs that are foreign to the patient and their physician. Complex pain problems, like chronic neuropathic pain, that have multiple mechanisms are hard to treat even with the availability of newer pharmacological modulators. Many of the conventional therapies for neuropathic pain have adverse effects that interfere substantially with quality of life. It is not surprising that patients suffering from neuropathic pain would look outside conventional medicine for more effective and better-tolerated treatments.

▶ Acupuncture, ▶ chiropractic, ▶ homeopathy, herbal medicine, traditional Chinese medicine, massage, ▶ biofeedback, the list of complementary and alternative therapies is seemingly limitless. Just as we categorize conventional medical practice into pharmacological, surgical, physical rehabilitative and behavioral techniques, it is helpful to organize the broad array of alternative medicine practices into categories that allow practitioners to better understand the options available and how they differ from each other. It is convenient to separate all of CAM into three broad groups (Fig. 1):

1. World medicine systems
2. Other comprehensive systems of medicine that are not culturally based
3. Individual therapies

A system of medicine such as homeopathy or chiropractic consists of both a diagnostic and a therapeutic approach to a wide array of symptoms, illnesses and diseases. It is based on a philosophy of health and disease that gives rise to the types of treatments that are utilized. A world medicine system like traditional Chinese medicine or Ayurvedic medicine is a system of medicine that is based on the traditions and philosophy of a world culture. Individual therapies are not linked to a culture or a complete medical system and are generally used to treat a certain subset of symptoms or problems. Examples include biofeedback, massage and vitamin therapy. All therapies can be further subdivided into one or more of seven functional groups:



Alternative Medicine in Neuropathic Pain, Figure 1 Organizational chart of alternative and complementary therapies from Belgrade 2003.

1. Meditative / mindful
2. Spiritual
3. Energy based
4. Stimulation based
5. Movement based
6. Mechanical or manipulative
7. ▶ Nutriceutical

Mindful or meditative therapies utilize the mind to produce changes in physical and emotional status. Meditation, hypnosis and yoga can fall into this category. Spiritual therapies on the other hand, utilize a letting go of the mind and giving up control to a higher power as in prayer. Energy-based therapies rely on a construct of vital energy or an energy field that must be in proper balance to maintain health. Traditional acupuncture, healing touch and yoga all use the concept of vital energy. Acupuncture can also be considered a stimulation-based therapy. Thus, many practices fall into more than one functional category (Table 1).

**Prevalence and Cost**

Several large surveys in the United States, Europe and Australia demonstrate extensive use of alternative and complementary therapies by the public. Prevalence es-

timates are confounded by what practices are included as unconventional. For example, are ice, heat and prayer to be included when they are so commonly utilized? Aside from such universal practices, 42% of the U.S. population made use of alternative treatments as of 1997 (Eisenberg et al. 1998). Fifteen percent of Canadians visited an alternative health practitioner in the previous 12 months (Millar 1997). In Europe, prevalence of alternative health care use varies from 23% in Denmark to 49% in France (Fisher and Ward 1994). Alternative medicine use in Australia has also been estimated to be 49% (MacLennon et al. 1996).

Brunelli and Gorson surveyed 180 consecutive patients with peripheral neuropathy about their use of complementary and alternative medicine (CAM) (Brunelli and Gorson 2004). Forty-three percent of patients reported using at least one type of CAM. Patients with burning neuropathic pain used CAM at a significantly higher rate than those without such pain. Diabetic neuropathy patients were also significantly more likely to use CAM. Other predictors of CAM use were younger age and college educated. Types of treatments employed by patients were megavitamins (35%), magnets (30%), acupuncture (30%), herbal remedies (22%) and chiropractic (21%). Lack of pain control was the most common reason for

Alternative Medicine in Neuropathic Pain, Table 1 Examples of complementary and alternative therapies organized into functional groups (from Belgrade 2003)

Mindful	Spiritual	Energy based	Stimulation based	Movement based	Mechanical/manipulative	Nutriceutical
Hypnosis	Prayer	Massage	TENS	Exercise	Chiropractic	Vitamins
Imagery	Spiritual healing	Therapeutic touch	Acupuncture	Dance therapy	Osteopathy	Diet
Meditation	Psychic healing	Homeopathy	Massage	Alexander technique	Massage	Herbal Medicine
Relaxation	Yoga	Acupuncture	Aromatherapy	Tai Chi	Cranio-sacral therapy	Homeopathy
Biofeedback		Qi Gong	Therapeutic touch	Qi Gong	therapy	Aromatherapy
Yoga		Yoga	Music	Yoga	Rolfing	



CAM use and nearly half of the patients did not discuss it with their physician.

The United States spends \$27 billion each year on alternative medicine. That figure reflects out-of-pocket expenses alone and is nearly equal to the cost of physician services and triple the cost of hospitalizations (Eisenberg et al. 1998). Health benefit payers are facing the quandary of determining which alternative services are worthy of coverage and to what extent. The question of standards of care for the various alternative forms of therapy represents a quagmire that confronts everyone, patients, physicians, health benefit administrators and the alternative practitioners themselves.

#### Acupuncture and Other Stimulation-based Therapies

Acupuncture is one component of traditional Chinese medicine. As such, it has its theoretical roots in Taoist ideas about the universe, living systems, health and disease. Modern scientific scrutiny has already yielded more information about acupuncture mechanisms than for any other alternative therapy. The discovery of opioid receptors and ► **endorphins** has led to a large number of investigations into the role these receptors and ► **ligands** play in producing acupuncture analgesia. Nearly all such studies support the conclusion that acupuncture analgesia is mediated in part by the opioid system. Acupuncture analgesia can be reversed with administration of ► **naloxone** (Meyer et al. 1977; Pomeranz and Cheng 1979; Tsunoda et al. 1980). Increased levels of endogenous opioid following acupuncture have been directly measured in humans (Clement-Jones et al. 1980; Pert et al. 1984). Antiserum to opioid receptors applied to the periaqueductal gray matter has been shown to block experimental acupuncture analgesia in primates.

Han and Terenius reviewed a number of studies that demonstrate the importance of biogenic amines in acupuncture analgesia (Han and Terenius 1982). Ablating the ► **descending inhibitory pathway for pain** at the dorsal and medial raphe nuclei blunted acupuncture analgesia. Blocking serotonin receptors in rabbits and rats also diminished acupuncture analgesia. Administering a serotonin precursor potentiates acupuncture analgesia. Serotonin and its by-products are increased in the lower brainstem during acupuncture analgesia. Other neurochemical mediators of experimental acupuncture analgesia have been implicated in preliminary investigations including ► **substance P**, ► **CGRP**, ► **CCK** and ► **C-fos** (Belgrade 1994).

That stimulation of tissue, including neural tissue, produces analgesia has only recently gained acceptance in conventional medicine. Neurosurgeon Norman Shealy pioneered the use of transcutaneous electrical nerve stimulation (TENS) in the 1970s – less than a decade after Melzack and Wall published their gate

theory of pain modulation that postulated a competitive inhibition of pain by non-noxious stimuli. Wallin and colleagues showed that spinal cord stimulation inhibits ► **long-term potentiation** of spinal ► **wide dynamic range neurons** (Wallin 2003). Hanai (2000) demonstrated a similar response to peripheral nerve stimulation.

#### Clinical Studies

In one extensive multicenter randomized controlled trial of acupuncture, amitriptyline or placebo for HIV-related neuropathic pain, no differences were found between groups; but all groups showed significant reductions in pain (Shlay et al. 1998). Using an electroacupuncture-like treatment, Hamza and colleagues showed a substantial reduction in pain scores and analgesic use and improvement in quality of life measures among patients with Type II diabetes and painful neuropathy in a sham-controlled crossover trial of 50 patients (Hamza et al. 2000).

In a multicenter randomized placebo controlled study using static magnetic fields in the form of magnetized insoles for diabetic peripheral neuropathy, Weintraub et al. showed statistically significant reductions in burning, numbness and tingling after 3 to 4 months (Weintraub et al. 2003). Cortical stimulation for neuropathic pain has also been reported. In a small case series, Rainov and Heidecke report a sustained >50% reduction in trigeminal and glossopharyngeal neuralgia for 72 months with motor cortex stimulation using a quadripolar electrode contralateral to the side of pain (Rainov and Heidecke 2003).

Although clinical studies are lacking for specific neuropathic pain conditions, meditative and mindful therapies such as hypnosis have been utilized for pain management for more than a century. Rainville and colleagues used PET scanning in normal subjects to show that pain unpleasantness is mediated in the anterior cingulate and anterior insula and posterior cerebellum (Rainville et al. 1997). He used hypnosis to reduce the unpleasantness of an experimental pain stimulus and to distinguish it from pain intensity, localizing the two components functionally in the brain. The growing understanding of unpleasantness as distinct from pain intensity leads one to conclude that many non-specific therapies that “quiet” the nervous system’s emotional, anticipatory component of pain can play just as important a role as analgesics. In this way many alternative and complementary therapies can be beneficial. Obviously, much clinical research is needed to define the scope and value of these therapies as well as their mechanisms of action. In the meantime, the prevalence and popularity of CAM among patients with neuropathic pain requires that the physician be acquainted with these therapies and guide patients toward the better studied, safest and most appropriate techniques for the neurological condition.



## References

1. Belgrade M (1994) Two decades after ping-pong diplomacy: Is there a role for acupuncture in American Pain Medicine? *APS Journal* 3:73–83
2. Belgrade M (2003) Alternative and Complementary Therapies. In: Rice A, Warfield CA, Justins D, Eccleston C (eds) *Clinical Pain Management*, 1st edn. Chronic Pain Part 2. Arnold Press, London
3. Brunelli B, Gorson KC (2004) The use of complementary and alternative medicines by patients with peripheral neuropathy. *J Neurol Sci* 218:59–66
4. Clement-Jones V, McLoughlin L, Tomlin S et al. (1980) Increased beta-endorphin but not met-enkephalin levels in human cerebrospinal fluid after acupuncture for recurrent pain. *Lancet* 2:946–949
5. Eisenberg DM, Kessler RC, Foster C et al. (1993) Unconventional medicine in the United States. *New Engl J Med* 328:246–252
6. Eisenberg DM, Davis RB, Ettner et al. (1998) Trends in alternative medicine use in the United States, 1990–1997: Results of a follow-up national survey. *JAMA* 280:1569–1575
7. Fisher P, Ward A (1994) Complementary medicine in Europe. *BMJ* 309:107–111
8. Hamza MA, White PF, Craig WF et al. (2000) Percutaneous electrical nerve stimulation: a novel analgesic therapy for diabetic neuropathic pain. *Diabetes Care* 23:365–370
9. Han JS, Terenius L (1982) Neurochemical basis of acupuncture analgesia. *Ann Rev Pharmacol Toxicol* 22:193–220
10. Hanai F (2000) Effect of electrical stimulation of peripheral nerves on neuropathic pain. *Spine* 25:1886–1892
11. MacLennon AH, Wilson DH, Taylor AW (1996) Prevalence and cost of alternative medicine in Australia. *Lancet* 347:569–573
12. Meyer DJ, Price DD, Rafii A (1977) Antagonism of acupuncture analgesia in man by the narcotic antagonist naloxone. *Brain Res* 121:368–372
13. Millar WJ (1997) Use of alternative health care practitioners by Canadians. *Can J Public Health* 88:154–158
14. National Institutes of Health on Alternative Medical systems and Practices in the United States (1994) *Alternative medicine: Expanding horizons: A report to the National Institutes of Health on Alternative Medical systems and Practices in the United States*. US Government Printing Office, Washington DC (017-040-00537-7)
15. Pert A, Dionne R, Ng L et al. (1984) Alterations in rat central nervous system endorphins following transauricular electroacupuncture analgesia in the periaqueductal gray of the rabbit. *Brain Res* 322:289–296
16. Pomeranz B, Cheng R (1979) Suppression of noxious responses in single neurons of cat spinal cord by electroacupuncture and reversal by the opiate antagonist naloxone. *Exp Neurol* 64:327–349
17. Rainov NG, Heidecke V (2003) Motor cortex stimulation for neuropathic facial pain. *Neurological Research* 25:157–161
18. Rainville P, Duncan GH, Price DD et al. (1997) Pain affect encoded in human anterior cingulate but not somatosensory cortex. *Science* 277:968–971
19. Shlay JC, Chaloner K, Max MB et al. (1998) Acupuncture and amitriptyline for pain due to HIV-related peripheral neuropathy: a randomized controlled trial. *JAMA* 280:1590–1595
20. Tsunoda Y, Sakahira K, Nakano S et al. (1980) Antagonism of acupuncture analgesia by naloxone in unconscious man. *Bull Tokyo Med Dent Univ* 27:89–94
21. Wallin J, Fiska A, Tjolsen A et al. (2003) Spinal cord stimulation inhibits long-term potentiation of spinal wide dynamic range neurons. *Brain Res* 973:39–43
22. Weintraub MI, Wolfe GI, Barohn RA et al. (2003) Static magnetic field therapy for symptomatic diabetic neuropathy: a randomized, double-blind, placebo-controlled trial. *Arch Phys Med Rehab* 84:736–746

## Alternative Rat Models of Ureteric Nociceptive Stimulation In Vivo

A

### Definition

Nociceptive stimulation in the ureter has also been obtained with modalities other than stones in past studies. One modality was electrical stimulation of the ureter in the unanesthetized rat (Giamberardino et al. 1988, *Neurosci Lett* 87:29). This model offered the advantage of a stimulus that could be controlled and modulated in intensity; unfortunately, the aversive reactions of the animals (nocifensive behavior, referred muscle hyperalgesia) were inconstant; furthermore, the stimulation adopted was not natural.

Another modality was distension of the renal pelvis after cannulation of the ureteric-pelvic junction; this produced rather variable pseudo-affective responses that were unrelated to stimulus intensity (Brasch and Zetler 1982, *Arch Pharmacol* 319:161).

A further modality of stimulation was acute distension of the ureter via a catheter in a preparation involving the anesthetized rat: the ureter was cannulated close to the bladder and graded stimuli applied. Roza and Laird (1995, *Neurosci Lett* 197:1) have characterized the effects of these stimuli using cardiovascular changes as a measure of the nociceptive reactions. Responses to stimuli less than 25 mmHg were never observed, suprathreshold pressures evoked responses proportional to the stimulus intensity. The stimulus response curve was dose-dependently attenuated by morphine in a naloxone reversible manner. The authors concluded that the characteristics of the responses observed correlated well with pain sensations in man, and with the properties of ureteric primary afferent neurones in animals. This model fulfils most of the criteria proposed as ideal for a noxious visceral stimulus: the experiments are reproducible, the results consistent and the responses proportional to stimulus intensity. However, the procedure is invasive and can only be applied to the anesthetized rat; it is therefore not suitable for behavioral studies. On the other hand, it is ideal for electrophysiological studies, not only in normal animals but also in calculus rats, allowing the comparison of the neural processing of acute visceral noxious stimulation on normal animals with that of animals with chronic visceral pain and referred hyperalgesia using the same stimulation technique.

► [Visceral Pain Model, Kidney Stone Pain](#)

## Alternative Therapies

► [Alternative Medicine in Neuropathic Pain](#)

## Ambiguity

- ▶ Impairment Rating, Ambiguity
- ▶ Impairment Rating, Ambiguity, IAIABC System

## Amelioration

### Definition

The improvement or bettering of the meaning of a word through semantic change. The opposite of pejoration.

- ▶ Lower Back Pain, Physical Examination

## Amenorrhea

### Definition

Amenorrhea is the absence of menstruation, which is normal before puberty, during pregnancy, or after menopause. Congenital abnormalities of the reproductive tract, metabolic disorders (such as diabetes or obesity), and endocrine disorders (including altered pituitary, thyroid or ovarian function) are the most common causes of amenorrhea. Medications that alter hormonal status, including opioids, can also lead to amenorrhea. In some cases, emotional disorders can lead to a cessation of menses.

- ▶ Cancer Pain Management, Opioid Side Effects, Endocrine Changes and Sexual Dysfunction

## American Society of Anesthesiologists' Status Category

### Definition

Each Status Category/Class gives an overall impression of the complexity of the patient's medical condition. If the procedure is performed as an emergency, an 'E' is added to the Category/Class

Class 1 – a healthy patient

Class 2 – a patient with mild systemic disease

Class 3 – a patient with severe systemic disease that limits activity but is not incapacitating

Class 4 – a patient with incapacitating systemic disease that is a constant threat to life

Class 5 – a moribund patient not expected to survive 24 hours with or without surgery

- ▶ Postoperative Pain, Preoperative Education

## Amide Anesthetic

### Definition

A member of one of the two major chemical classes of local anesthetics, differentiated by the intermediate chain linking a lipophilic group and an ionizable group (usually a tertiary amine). The pharmacologic class of agents comprised of lidocaine, bupivacaine, ropivacaine, mepivacaine, prilocaine and etidocaine.

The other major class is ester anesthetic.

- ▶ Acute Pain in Children, Post-Operative
- ▶ Drugs with Mixed Action and Combinations, Emphasis on Tramadol
- ▶ Postoperative Pain, Methadone

## Amide Local Anesthetic

- ▶ Amide Anesthetic

## Aminobisphosphonate

### Definition

A class of drugs that block bone resorbing cells (osteoclasts) and prevent bone loss.

- ▶ Cancer Pain Management, Orthopedic Surgery

## Aminomethyl-Cyclohexane-Acetic Acid

- ▶ Postoperative Pain, Gabapentin

## Amitriptyline

### Definition

A tricyclic antidepressant drug utilized for the treatment of chronic pain, particularly effective in the craniofacial region. Its antinociceptive effect is independent of its antidepressive activity. Amitriptyline controls chronic facial pain in a relatively low dose (10–25 mg/day), and is also used as a prophylactic drug for migraine.

- ▶ Atypical Facial Pain, Etiology, Pathogenesis and Management
- ▶ Fibromyalgia, Mechanisms and Treatment
- ▶ Migraine, Preventive Therapy

## AMPA Glutamate Receptor (AMPA Receptor)

### Definition

A type of ionotropic glutamate receptor that is activated by the specific agonist *alpha*-Amino-3-hydroxy-5-methyl-4-isoxazolepropionate (AMPA). AMPA receptors comprise of several subunits (GluR1, GluR2, GluR3, GluR4) that form a heteromeric receptor-ion-channel complex, the composition of which affects the kinetic properties of the receptor-ion-channel. AMPA receptors mediate the majority of fast synaptic transmission in the central nervous system.

- ▶ Metabotropic Glutamate Receptors in the Thalamus
- ▶ Nociceptive Neurotransmission in the Thalamus
- ▶ Opiates During Development

## Amphibian Peptides

### Definition

Amphibian skin contains a wide variety of peptides that are often homologous or even identical to the gastrointestinal hormones and neurotransmitters of the Mammalia.

Striking examples are cerulein, the amphibian counterpart of mammalian cholecystokinin and gastrin; physalemin and kassinin, counterparts of the mammalian neuropeptides substance P and neurokinins; the amphibian bombesins and litorins, which heralded the discovery of the gastrin-releasing peptides (mammalian bombesin) and neuromedin B; finally sauvagine, whose structure elucidation preceded that of the analogous, hypothalamic corticotropin releasing hormone. Other peptide families common to amphibian skin and mammalian tissues are bradykinins, angiotensins, somatostatins and the thyrotropin-releasing hormone. Opioid peptides have so far only been in the skin of the hylid frog of the Phyllomedusine stock. During his long scientific life, the pharmacologist Vittorio Erspamer sought biologically active molecules in more than 500 amphibian species from all over the world, and showed that the amphibian skin and its secretions offer an inexhaustible supply of biologically active peptides for pharmacological research.

- ▶ Opioid Peptides from the Amphibian Skin

## Amphipathic

### Definition

An amphipathic segment is a segment with opposing hydrophobic and hydrophilic faces, oriented spatially along the axis of the segment.

- ▶ Capsaicin Receptor
- ▶ Thalamus, Clinical Pain, Human Imaging

A

## Amygdala

### Definition

A prominent group of neurons forming an almond shaped structure at the level of the temporal cortex in primates, and form part of the limbic system. In the rat, the amygdala is ventrolateral, close to both the temporal and perirhinal cortices. It is divided schematically into four groups: cortical & basal (main olfactory), medial (accessory olfactory), central (autonomic), basolateral & lateral (frontotemporal & temporal cortices). The precise role of this region remains incompletely understood. It seems that one of its roles is to mark perceptions with an affective label that provides an appropriate significance in the environment of the species. In the framework of pain, it triggers an aversive reaction and fear that causes the organism to avoid dangerous stimuli. It also plays a role in the development of memories with an emotional component.

- ▶ Amygdala, Pain Processing and Behavior in Animals
- ▶ Arthritis Model, Kaolin-Carrageenan Induced Arthritis (Knee)
- ▶ Parabrachial Hypothalamic and Amygdaloid Projections

## Amygdala, Functional Imaging

UTE HABEL, FRANK SCHNEIDER  
RWTH Aachen University, Department of Psychiatry and Psychotherapy, Aachen, Germany  
uhabel@ukaachen.de, fschneider@ukaachen.de

### Synonyms

Positron emission tomography (PET); functional magnetic resonance imaging (fMRI)

### Definition

The amygdala is an essential key structure in the cerebral limbic network underlying emotion processing. As such, it is suggested to be part of the brain circuit involved in the processing of pain, which is known to include strong affective components. Neuroimaging studies pointing to amygdala involvement during pain processing are currently increasing. The amygdala is a small almond shape structure in the anterior temporal lobe with a variety of functions for emotion processing together with learning and memory. It is supposed to execute an evaluative associative function, combining external cues with internal responses, thereby assessing and defining the valence, relevance and significance of stimuli. It is its extensive

connectivity with various cortical and subcortical areas that enables fast automatic, but also more conscious deliberate, responses. Its role in pain processing is however less clear.

### Characteristics

Negative affect is typically evoked by acute pain. Key structures of the ► **limbic system** have been identified that play an important role in regulating affective behavior; among the most important are the subcortical and cortical areas, the anterior cingulate, the insula and the prefrontal cortex. Most notably, assessment of emotional valence of stimuli and the provocation of distinct emotional reactions are mediated by the amygdala. This central role in emotion processing can be executed due to a broad cortical and subcortical network in which the amygdala is located and which is able to provide it with raw information *via* the short thalamus route but also with highly processed polymodal input from sensory cortices. Finally, the amygdala is not a unitary structure, but consists of several nuclei exerting different functions. It is believed to have a major role in pain because of the strong association and interaction between pain and emotion, but also because of the specific nociceptive inputs to the latero-capsular part of the central nucleus, the major output system within the amygdala, indicating that, within this accumulation of nuclei, this part may represent the “nociceptive amygdala” (Neugebauer et al. 2004). For ► **fMRI**, mapping of activation within this region is, however, critical posing technical and methodological problems, which often call into question the validity and reliability of imaging results reporting amygdala activation. This may possibly be one of the reasons, why early neuroimaging findings mostly failed to demonstrate clear amygdala activation during pain perception. fMRI of this deep subcortical region is confronted with a set of difficulties, such as movement, respiratory, inflow and susceptibility artefacts (see ► **inflow artefacts**) and nonetheless the rapid habituation of amygdala responses to repeated stimulus presentations. This is of special relevance for experimental pain studies, which mostly rely on the application of ► **block designs**, which are especially prone to habituation. Recent methodological advances in neuroimaging may have partly overcome these inherent mapping difficulties, accounting for the increase in pain studies successfully demonstrating amygdala participation (Bingel et al. 2002; Bornhövd et al. 2002). Alternatively, it is also conceivable that the majority of pain stimulation techniques failed to evoke pain that provoked strong emotional responses, hence falling short of observing amygdala involvement. The frequent failure of these early studies to report changes in autonomic arousal during painful stimulation corroborates this assumption. In an attempt to model acute traumatic nociceptive pain, a ► **PET** study used intracutaneous injection of ethanol (Hsieh et al. 1995). Affective and heart

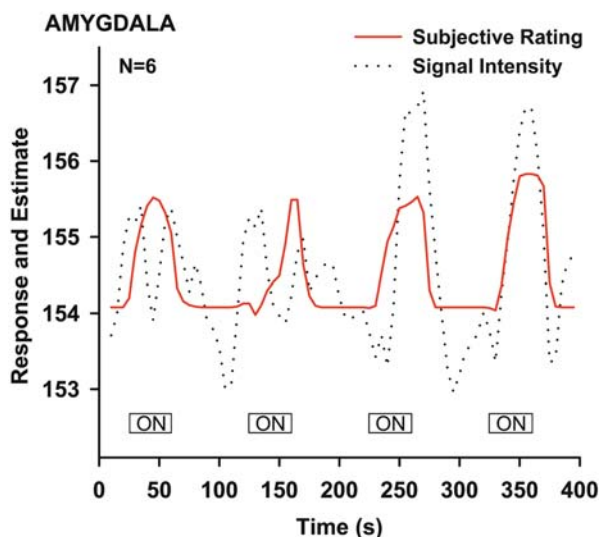
rate changes were described in subjects and cerebral activation was found in subcortical structures, specifically the hypothalamus and the periaqueductal gray. These regions are taken to constitute the brain defense system which functions as a modulator for aversive states. Although signal increases in the amygdala were detected by the authors, they failed to be significant.

Despite more recent neuroimaging findings reporting amygdala involvement in pain processing, a full characterization of its function during pain perception is still lacking and at first sight results seem to be equivocal, pointing to activations as well as deactivations of the amygdala in this context (Table 1).

One fMRI investigation applied painful stimulation with a strong affective component to measure pain related changes in cerebral activity (Schneider et al. 2001). By inflating an indwelling balloon catheter, a dorsal foot vein of healthy volunteers was stretched to a noxious distress physical level, which induced vascular pain associated with a particularly strong negative affect. Since the sensory innervation of veins exclusively subserves nociception, non-painful co-sensations were excluded. Additionally, brief stimulations of only a few minutes produce vascular pain that escapes adaptation and is generally reported as particular aching in character. During noxious stimulation, the subjects continuously rated perceived pain intensity on a pneumatically coupled visual analogue scale, which was used as permanent feedback to adjust balloon expansion so that the pain intensity could be kept at intended values at all times. The analysis strategy that focused primarily on correlations of signal changes with these subjective ratings, rather than the generally applied signal variations to a stimulation based reference function (► **boxcar design**), facilitated producing evidence for amygdala activation (Fig. 1). Hence, these results indicated a relevant role of the amygdala in the subjective component of painful experiences and suggested that in the widespread cerebral network of pain perception, the limbic system and especially the amygdala may be instrumental in the affective aspects of pain. Supporting evidence for these conclusions come from neuroimaging findings during air hunger (Evans et al. 2002) or fundus balloon distension (Lu et al. 2004). Dyspnea was induced in healthy subjects by mechanical ventilation until a sensation of “urge to breathe” and “starved for air” was reached and compared to mild hypocapnia. This pain is also very afflicted with strong negative affect. Correspondingly, a network of limbic and paralimbic nodes was activated, including anterior insula, anterior cingulate, operculum, thalamus, cerebellum, basal ganglia and also amygdala, that is the majority of regions forming part of the limbic network also involved in emotion processing. Similarly, moderate gastric pain was induced in 10 healthy subjects using fundus balloon distension (Lu et al. 2004) and resulted in a widespread activation pattern of subcortical as well as cortical regions, among

**Amygdala, Functional Imaging, Table 1** Overview of pain studies reporting amygdala activation

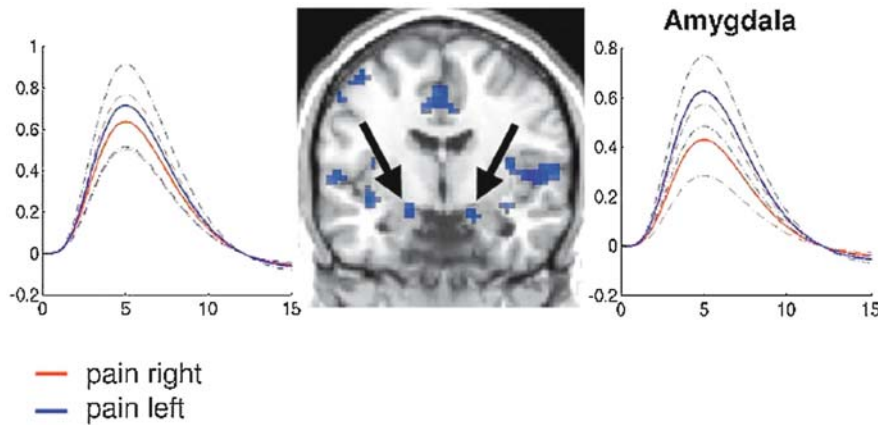
Author	Imaging Method	Painful stimulation	Number of subjects	Amygdala activation/deactivation
Becerra et al. 1999	fMRI (1,5 T)	Thermal stimulation (Peltier based thermode) 46°C	2 groups of 6 healthy subjects	Deactivation of the amygdala
Becerra et al. 2001	fMRI (1,5 T)	Thermal stimulation (Peltier based thermode) 46°C compared to 41°C	8 healthy subjects	Activation in the sublenticular extended amygdala in the early phase
Bingel et al. 2002	fMRI (1,5 T)	YAG infrared laser stimulation	14 healthy subjects	Bilateral activation to unilateral stimulation
Bornhövd et al. 2002	fMRI (1,5 T)	YAG infrared laser stimulation	9 healthy subjects	Activation increasing with stimulus intensity
Derbyshire et al. 1997	PET (H <sub>2</sub> <sup>15</sup> O)	CO <sub>2</sub> laser (mild/moderate pain vs. warm)	12 healthy subjects	Decreased rCBF
Evans et al. 2002	fMRI (1,5 T)	Mechanical ventilation at 12–14 breaths/min Air hunger vs. baseline	6 healthy subjects	Activation
Hsieh et al. 1995	PET ( <sup>15</sup> O Butanol)	Intracutaneous injection of a minute amount of ethanol vs. saline	4 healthy subjects	Non-significant activation
Lu et al. 2004	fMRI (3 T)	Fundus balloon distension (17.0 +/- 0.8 mmHg) vs. baseline	10 healthy subjects	Activation
Petrovic et al. 2004	PET (H <sub>2</sub> <sup>15</sup> O)	Cold pressure test (0–1°C water with ice or glycol) vs. cold water (19°C)	10 healthy subjects	Deactivation in response to context manipulations increasing anticipated pain duration
Schneider et al. 2001	fMRI (1,5 T)	Balloon dilatation of a dorsal foot vein	6 healthy subjects	Amygdala activation correlated with subjective online pain ratings
Wilder-Smith et al. 2004	fMRI (1,5 T)	Rectal balloon distension alone or with painful heterotopic stimulation of the foot with ice water	10 patients with irritable bowel syndrome, 10 healthy subjects	Amygdala activation in patients with irritable bowel syndrome (constipation) during heterotopic stimulation

**Amygdala, Functional Imaging, Figure 1** Individual signal intensities in the amygdala following correlation with subjective ratings of the six individual participants (from Schneider et al. 2000).

them insula and amygdala. This may once again point especially to the strong affective component of visceral pain. Since visceral pain may be indicative of an urgent and marked system imbalance possible endangering survival, strong affective responses with the objective of initiating adequate adaptations and reactions seem to have an evolutionary purpose and be necessary.

Amygdala activation is however not restricted to visceral pain, but also visible during other kinds of painful stimulation in animals as well as humans (Bingel et al. 2002). Unilateral laser evoked painful stimuli of either side, which also avoided concomitant tactile stimulation and anticipation as well as habituation, successfully demonstrated bilateral amygdala activation, most probably representing the affective pain component (Fig. 2). In contrast, basal ganglia and cerebellum displayed corresponding unilateral activation and may probably be related to defensive and withdrawal behavior. RCBF (regional cerebral blood flow) changes were also found in limbic structures of rats during noxious formalin nociception (Morrow et al. 1998).

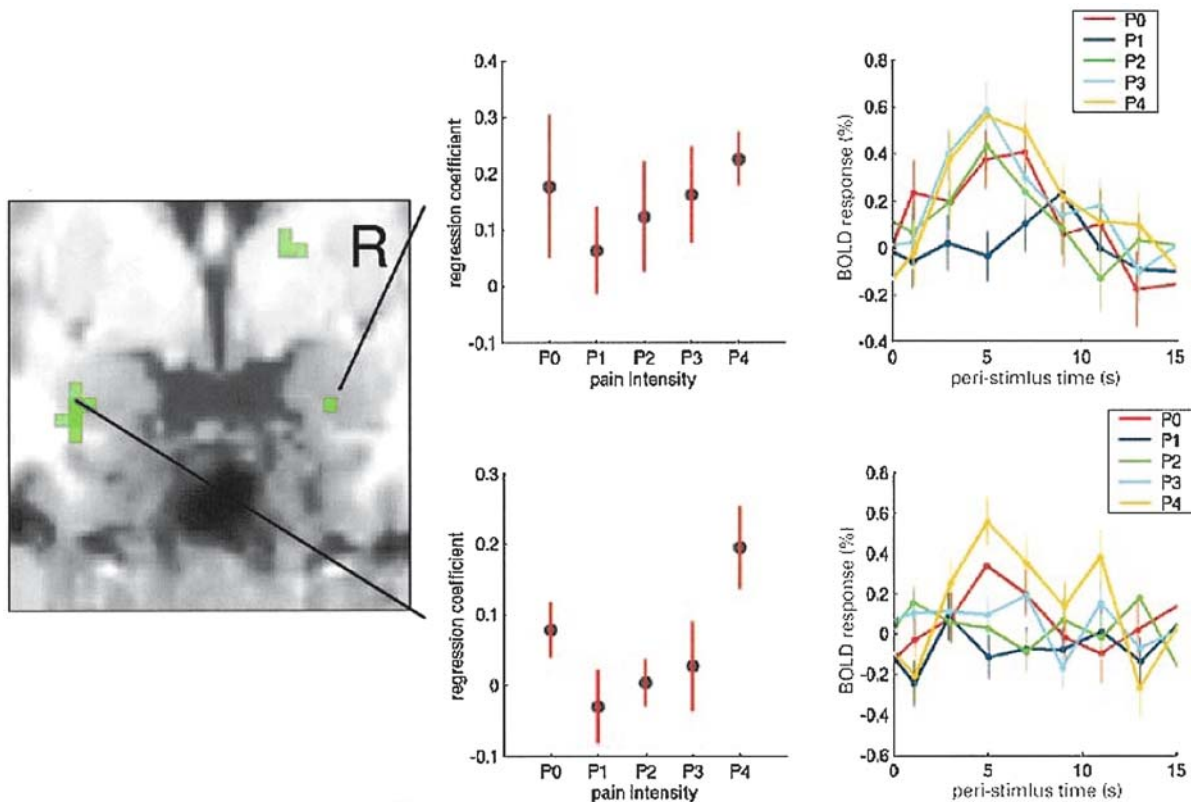




**Amygdala, Functional Imaging, Figure 2** Amygdala activation emerged bilaterally in response to painful unilateral laser stimulation. Left: Fitted responses applied to the left (blue line) or right (red line) hand for the left (left graph) and right (right graph) hemispheres. The dotted lines show the standard error of the mean (SEM) (from Bingel et al. 2002).

Hence, the role of the amygdala as a “sensory gateway to the emotions” (Aggleton and Mishkin 1986) with an evaluative function seems to extend to pain perception as well. An increasing number of studies supported the notion of a common evaluative system with a central role of the amygdala in the processing of painful but also non-painful or novel stimuli. The amygdala not only demonstrated coding of the pain amount by showing a linearly increasing response to augmenting painfulness (Fig. 3) but also significant responses during uncertain

trials in which the stimulus was not perceived and hence a judgment on the nature and valence is required (Bornhövd et al. 2002). Furthermore, the amygdala, here more specifically the sublenticular extended amygdala, seems to be characterized by early responses (to noxious thermal stimuli) in contrast to regions activated later and associated specifically to somatosensory processing, such as thalamus, somatosensory cortex and insula (Becerra et al. 2001) (Fig. 4). This is in accordance with the activation characteristic of the amygdala during



**Amygdala, Functional Imaging, Figure 3** Picture: Bilateral amygdala activation ( $p = 0.001$ ) on a coronal slice. Graphs: Left side entails regression coefficients indicating amount of response for each trial (P0–P4). Right side depicts amount of signal change in the amygdala as a function of peristimulus time separately for all stimuli (P0–P4; from Bornhövd et al. 2002).

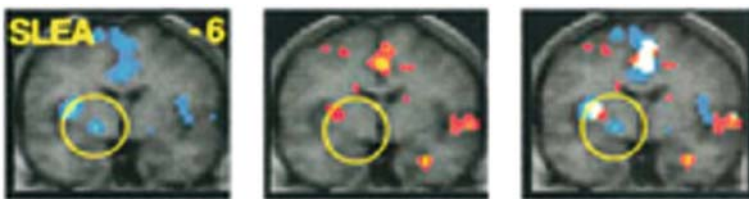


► **classical conditioning** (Büchel et al. 1998), in which a rapid adaptation to the conditioned stimulus has been observed, pointing to a major role of the amygdala during the early phase of learning, during the establishment of an association between the neutral stimulus and the (un)conditioned response. Hence, the early response during pain seems to reflect the association between the painful stimulus and an adequate internal response determining the negative valence of the stimulus. However, sometimes deactivation as opposed to activation has been observed in the amygdala during painful stimulation, for example with fMRI in response to thermal stimuli (45°C) (Becerra et al. 1999). In this study only 6 subjects were investigated and changes were low-level. Similar deactivations have also been reported using PET during mild or moderate pain due to CO<sub>2</sub> laser stimulation compared to non-painful warm sensations (Derbyshire et al. 1997). Hence, a possible moderating variable for activations and deactivations may be the specific thermal pain sensation, which was similar during both experiments. Alternatively, the deactivation may reflect another functional activation characteristic of the amygdala under certain circumstances. Hence, the deactivation may simply be the consequence of the nature of the experimental pain stimulus. An early activation in the amygdala for purposes of evaluation and affective judgment may be followed by a deactivation, possibly representing the attempt to regulate and cope with the affective aspects of the painful experience as well as the painful sensation itself that cannot be escaped in this special experimental setup. This interpretation is supported by recent PET findings. Petrovic et al. (2004) investigated the influence of context manipulations before the painful stimulation on the activation pattern during noxious (cold pressure) stimulation. Subjects were informed prior to stimulation if it was going to be painful or not and if it would last for 1 or 2 min. Anticipating that the pain was going to last longer was accompanied by a decrease in amygdala activation and changes in autonomic parameters, but also cognitive processes in the majority of subjects that consisted of strategies to cope with the stressful but unavoidable pain. This amygdala deactivation was paralleled by activation in the anterior cingulate, pointing to interactions within this limbic network constituting the brain's pain matrix responsible for the development and modulation as well

as coverage and termination of the affective noxious events.

This study also highlights some methodological problems of pain imaging studies in general and those with a special focus on the amygdala. Anticipation may alter amygdala response characteristics and may lead to deactivations instead of activations. Furthermore, the individual variability in pain responses and several methodological factors, such as imaging method, data analysis, control condition used for comparison with pain condition etc. influence results as well as their interpretation. However, further indications that the amygdala serves coping functions during pain perception come from clinical trials. Here, visceral pain hypersensitivity is discussed as a possible relevant pathogenic factor in various chronic pain syndromes, such as ► **irritable bowel syndrome** (IBS). Reduced signals in the amygdala (as well as in further limbic network nodes such as insula and striatum) have also been observed in patients with irritable bowel syndrome during rectal pain stimulation (Bonaz et al. 2002) and are in accordance with the interpretation of deactivations found in healthy controls. It may be suggested that deactivations in patients may correspond to the effort to modulate and control the strong affective components of the painful experiences. Unfortunately this study failed to include healthy controls and hence, a conclusion on the dysfunctional or compensatory aspects of these activations in patients remains elusive. Interestingly, a recent fMRI study (Wilder-Smith et al. 2004) investigating rectal pain alone or accompanied by painful foot stimulation (ice water, activating endogenous pain inhibitory mechanisms) in patients with irritable bowel syndrome as well as healthy controls found differential activations between groups in the amygdala (activation in constipated patients) as well as further affective-limbic regions (hippocampus, insula, anterior cingulate, prefrontal cortex etc.) during heterotopic stimulation.

Hence, the amygdala is not only implicated in the affective aspects of pain processing, including both the appraisal of a painful stimulation with the initiation of adequate responses, and the experiential affective aspects, such as stress, fear or anxiety but also the modification, attenuation and coping of these affective experiential aspects. This multiple functionality is supported by behavioral findings demonstrating amygdala activation during enhancement as well as inhibition of pain (Neugebauer et al. 2004). First, it may be a protective mechanism



**Amygdala, Functional Imaging, Figure 4** Coronal slices showing ► **sublenticular extended amygdala** (SLEA) activation in the early (left) and late phases (middle) in response to a noxious thermal stimulation (46°C). Overlap (white) of early (yellow/red) and late (blue) phases (right).

to detect a possible harmful stimulus, hence amplifying the painful experience; however, in case of unavoidable harm or pain, it may be the most suitable response to reduce the painfulness by inhibition (for example *via* the periaqueductal gray). Finally, the central role in pain and emotion makes it highly likely that it may also be involved in the dysfunctional aspects of chronic (visceral) pain. For example, the involvement of the amygdala during memory and learning may be relevant facets for the development of chronic pain.

However, the diversity of functions exerted by the amygdala as indicated by the different imaging studies on experimental and chronic pain, such as affective painful experience but also modulation of this experience as an evolutionary sensible warning and evaluative survival system, including an effective adaptation mechanism in case of inescapable painful stimulation, suggests the involvement of other brain regions as well. Hence, the function of the amygdala cannot be determined alone but only within a greater cortical and subcortical network. Despite its relevance, it is only the continuous and intensive interconnections, interactions and feedback mechanisms with other brain regions that account for the complex and intact function of this structure in pain and emotion.

## References

- Aggleton JP, Mishkin M (1986) The amygdala: sensory gateway to the emotions. In Plutchik R, Kellermann H (eds) *Emotion: Theory, research, and experience*, vol 3. Academic Press, New York, pp 281–299
- Beccera LR, Breiter HC, Stojanovic M et al. (1999) Human brain activation under controlled thermal stimulation and habituation to the noxious heat: an fMRI study. *Magn Res Med* 41:1044–1057
- Beccera L, Breiter HC, Wise R et al. (2001) Reward circuitry activation by noxious thermal stimuli. *Neuron* 32:927–946
- Bingel U, Quante M, Knab R et al. (2002) Subcortical structures involved in pain processing: evidence from single-trial fMRI. *Pain* 99:313–321
- Bonaz B, Bacin M, Papillon E et al. (2002) Central processing of rectal pain in patients with irritable bowel syndrome: an fMRI study. *Am J Gastroenterol* 97:654–661
- Bornhövd K, Quante M, Glauche V et al. (2002) Painful stimuli evoke different stimulus-response functions in the amygdala, prefrontal, insula and somatosensory cortex: a single-trial fMRI study. *Brain* 125:1326–1336
- Büchel C, Morris J, Dolan RJ et al. (1998) Brain systems mediating aversive conditioning: an event-related fMRI study. *Neuron* 20:947–957
- Derbyshire SW, Jones AK, Gyulai F et al. (1997) Pain processing during three levels of noxious stimulation produces differential patterns of central activity. *Pain* 73:431–445
- Evans KC, Banzett RB, Adams L et al. (2002) BOLD fMRI identifies limbic, paralimbic, and cerebellar activation during air hunger. *J Neurophysiol* 88:1500–1511
- Hsieh JC, Stähle-Bäckdahl M, Hägermark Ö et al. (1995) Traumatic nociceptive pain activates the hypothalamus and the periaqueductal gray: a positron emission tomography study. *Pain* 64:303–314
- Lu CL, Wu YT, Yeh TC et al. (2004) Neuronal correlates of gastric pain induced by fundus distension: a 3T-fMRI study. *Neurogastroenterol Motil* 16:575–587
- Morrow TJ, Paulson PE, Danneman PJ et al. (1998) Regional changes in forebrain activation during the early and late phase of formalin nociception: analysis using cerebral blood flow in the rat. *Pain* 75:355–365
- Neugebauer V, Li W, Bird GC et al. (2004) The amygdala and persistent pain. *Neuroscientist* 10:221–234
- Petrovic P, Carlsson K, Petersson KM et al. (2004) Context-dependent deactivation of the amygdala during pain. *J Cogn Neurosci* 16:1289–1301
- Schneider F, Habel U, Holthusen H et al. (2001) Subjective ratings of pain correlate with subcortical-limbic blood flow: an fMRI study. *Neuropsychobiol* 43:175–185
- Wilder-Smith CH, Schindler D, Lovblad K et al. (2004) Brain functional magnetic resonance imaging of rectal pain and activation of endogenous inhibitory mechanisms in irritable bowel syndrome patient subgroups and healthy controls. *Gut* 53:1595–1601

## Amygdala, Nociceptive Processing

- ▶ [Nociceptive Processing in the Amygdala, Neurophysiology and Neuropharmacology](#)

## Amygdala, Pain Processing and Behavior in Animals

BARTON H. MANNING  
Amgen Inc., Thousand Oaks, CA, USA  
bmanning@amgen.com

### Synonyms

Amygdaloid Complex; nociceptive processing in the amygdala, behavioral and pharmacological studies

### Definition

The ▶ [amygdala](#) is an almond shaped structure in the ventromedial temporal lobe that constitutes part of the brain's limbic system. It comprises several neuroanatomically and functionally distinct nuclei with widespread connections to and from a variety of cortical and subcortical brain regions.

### Characteristics

In a general sense, the amygdala plays a prominent role in the coordination of defense reactions to environmental threats (LeDoux 2003). The hypothesized role of the amygdala in emotional information processing represents one component in this overall role. Clearly, environmental threats are diverse and include the animate (e.g. extraspecies predators, intraspecies rivals) and inanimate (e.g. thorns or spines on plants). Stimuli signaling the presence of threats can be “natural” elicitors of the psychological state of fear such as a sudden, novel sound or the presence of a larger animal. Or previously “neutral” stimuli (discrete sensory cues or distinct environmental contexts) can come to elicit defense reactions following occasions in which they coincided in time with an occurrence of injury or the presence of a natural threat (i.e. through ▶ [classical](#)

conditioning processes). Such “conditioned” stimuli can elicit either acute fear or the qualitatively different state of ► **anxiety**, which is a more future-oriented psychological state that readies the animal for a potential environmental threat.

The amygdala is well connected to coordinate reactions to stimuli that signal potential danger. By way of incoming neuroanatomical connections to its central and basolateral subdivisions, the amygdala receives information from the organism’s internal environment (► **viscerosensation**) and information from the external environment consisting of simple sensory inputs and complex ► **multi-sensory perceptions**. This information already has already been highly processed by various subcortical and cortical brain structures (e.g. cortical sensory association areas) but the amygdala serves the purpose of attaching emotional significance to the input. By way of its outgoing neuroanatomical connections, the amygdala communicates with brain areas involved in motor preparation / action and autonomic responses. When sensory information arrives relating to environmental danger, the amygdala probably is involved both in the generation of emotional states (e.g. fear, anxiety) and the coordination of appropriate ► **autonomic** and behavioral changes that enhance the chance of survival (e.g. defensive fight or flight, subsequent avoidance behaviors, submissive postures, tonic immobilization, autonomic arousal and ► **hypoalgesia** or ► **hyperalgesia**).

Since pain can signal injury or the potential for injury, it should not be surprising that the processing of nociceptive information by the amygdala can be one of the triggers of these events. Electrophysiological studies show that individual amygdala neurons, particularly in the central nucleus of the amygdala (CeA), respond to brief nociceptive thermal and mechanical stimulation of the skin and or nociceptive mechanical stimulation of deeper (knee joint) tissue (Bernard et al. 1996; Neugebauer et al. 2004). Many CeA neurons have large receptive fields, with some neurons being excited by and others inhibited by nociceptive stimulation. The lateral capsular and, to a lesser extent, the lateral division of the CeA have been termed the “nociceptive amygdala” and receive nociceptive input from lamina I of the spinal and trigeminal ► **dorsal horns**. This lamina I input arrives at the CeA *via* several different routes (Gauriau and Bernard 2002): 1) indirectly, from relays in the lateral and external medial areas of the brainstem parabrachial complex (lamina I → PB → CeA), 2) indirectly, from the posterior triangular nucleus of the thalamus (PoT) to the amygdalostriatal transition area (AStr), which overlaps partly with the CeA (lamina I → PoT → AStr / CeA), 3) indirectly, from the ► **insular cortex** by way of the PoT (lamina I → PoT → IC → CeA) and 4) to a much lesser extent, from direct, monosynaptic projections (lamina I → CeA). The basolateral complex of the amygdala also probably receives highly processed

nociceptive information from unimodal and polymodal sensory areas of the cerebral cortex (Shi and Cassell 1998).

Human functional ► **neuroimaging** studies have supported a role for the amygdala in nociceptive processing by correlating changes in neural activity in the amygdala with the perception of brief painful stimuli. In a manner analogous to the different responses of individual CeA neurons described above, presentation of a painful thermal stimulus to skin of healthy human subjects can result in increases or decreases in neural activity in the amygdala as measured by ► **positron emission tomography** (PET) or functional ► **magnetic resonance imaging** (fMRI), depending on the stimulation parameters employed. These changes appear to be linearly related to stimulus intensity (Bornhovd et al. 2002; Derbyshire et al. 1997).

In addition to brief pain, neuroplastic changes in amygdala neurons may contribute to the induction and maintenance of ► **chronic pain** states. Rodent studies utilizing indirect measures of neuronal activation in the forebrain (e.g. ► **immediate early gene** expression or changes in regional cerebral blood flow) have suggested increases in neural activity in the amygdala that correlate with behavioral indices of persistent pain. Several groups have analyzed patterns of Fos protein-like immunoreactivity (Fos-LI) in the rat forebrain after hind paw injection of formalin (i.e. the formalin test). The formalin test involves injecting a small volume of dilute formalin into a hind paw, resulting in an array of pain-related behaviors (paw lifting, licking and flinching) that persists for 1½–2 h. Behavioral indices of formalin-induced ► **nociception** correlate with appearance of Fos-LI in the basolateral amygdala (Nakagawa et al. 2003). Fos-LI also appears in the basolateral amygdala and CeA following stimulation of the trigeminal ► **receptive field** in conscious rats with ► **capsaicin** (Ter Horst et al. 2001) or after prolonged, nociceptive colonic distension (Monnikes et al. 2003). In a rat model of ► **neuropathic pain** (the chronic constriction injury, or CCI, model), a significant increase in regional cerebral blood flow (rCBF) is seen in the basolateral amygdala after 8 or 12 weeks, but not 2 weeks following CCI surgery (Paulson et al. 2002).

The response characteristics of individual CeA neurons have been studied *in vivo* in rats with or without experimental arthritis in a knee joint (Neugebauer et al. 2004). Prolonged nociception produced by injection of ► **carrageenan** and ► **kaolin** into the knee joint results in enhancement of both receptive field size and responsiveness to mechanical stimulation of a subset of CeA neurons. Infusion, by ► **microdialysis**, of a selective ► **NMDA receptor** antagonist (AP5) or an mGluR1 receptor antagonist (CPCCOEt) into the CeA inhibits the increased responses to nociceptive and normally innocuous mechanical stimuli more potently in the arthritic *vs.* the control condition. By contrast, infusion

of a non-NMDA (AMPA / kainate) receptor antagonist (NBQX) or an mGluR5 receptor antagonist (MPEP) inhibits background activity and evoked responses under both normal control and arthritic conditions. These data suggest a change in mGluR1 and NMDA receptor function and activation in the amygdala during pain-related sensitization, whereas mGluR5 and non-NMDA receptors probably are involved in brief as well as prolonged nociception.

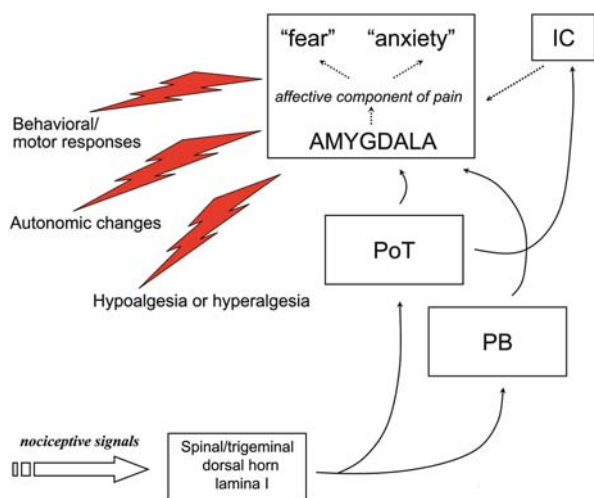
*In vitro* brain slice ► **electrophysiology** has provided additional insights (Neugebauer et al. 2004). It is possible to study properties of synaptic transmission (using ► **whole-cell patch-clamp recordings**) in brain slices taken from control rats *vs.* rats with persistent pain. In the nociceptive CeA of such rats, it is possible to study ► **monosynaptic** excitatory post-synaptic currents (EPSCs) evoked by electrical stimulation of afferents from the parabrachial complex or from the basolateral amygdala. In rats with experimental arthritis, enhanced synaptic transmission (larger amplitude of evoked monosynaptic EPSCs) is observed at both the nociceptive PB-CeA ► **synapse** and the polymodal (including nociceptive) BLA-CeA synapse as compared with control rats. CeA neurons from arthritic rats also develop an increase in excitability. Induction of experimental ► **colitis** (by intra-colonic injection of ► **zymosan**) produces similar effects, except for the fact that enhanced synaptic transmission is observed only at the nociceptive PB-CeA synapse. In the arthritis model, synaptic plasticity in the amygdala is accompanied by an increase in ► **presynaptic** mGluR1 function. Both the selective mGluR1 antagonist CPCCOEt and the group III mGluR agonist LAP4 decrease the amplitude of EPSCs more potently in CeA neurons from arthritic rats than in control animals. The selective group III mGluR antagonist UBP1112 reverses the inhibitory effect of LAP4. During the application of LAP4, paired-pulse facilitation was increased, while no significant changes in slope conductance and action potential firing rate of CeA neurons were observed. These data suggest that presynaptic mGluR1 receptors and group III mGluRs regulate synaptic plasticity in the amygdala in a rat model of arthritis.

Human neuroimaging studies have provided additional supporting evidence by correlating changes in neural activity in the amygdala with the perception of persistent pain. In patients suffering from ► **irritable bowel syndrome** (IBS), Wilder-Smith et al. (2005) demonstrated a bilateral decrease in neural activity in the amygdala during episodes of experimentally induced rectal pain. Neuroimaging techniques, measurement of immediate early gene responses and *in vivo* electrophysiological studies are useful for identifying brain regions with activity that co-varies with the presence or absence of pain or nociception, but such studies are limited with respect to mechanistic insights and determining cause *vs.* effect. On the contrary, rodent behavioral studies

have been highly informative in this regard. Such studies provide evidence that the amygdala is involved in encoding the affective or aversive component of pain. Hebert et al. (1999) used an alley-shaped apparatus with an array of protruding, sharp pins situated in the middle of the alley to investigate this issue. During 10 min test sessions, the behavioral patterns of normal rats were characterized by voluntary contact with the pins followed by periods of avoidance and risk assessment (referred to by the investigators as “stretch attend” and “stretch approach” behaviors). Of the group of normal rats tested, few actually crossed the array of pins. In contrast, rats with bilateral lesions of the amygdala showed a significant increase in both the number of crossings of the pin array and the amount of time spent on the pins as compared with normal rats. The results suggest that the aversive quality of the painful mechanical stimulation imparted by the pin array is encoded at least partly by the amygdala.

The affective / aversive quality of pain in rodents also has been studied using a variation of the place-conditioning paradigm. In 2001, Johansen et al. introduced the formalin-induced condition place avoidance model (F-CPA). By pairing the experience of formalin-induced pain with a distinct environmental context / compartment within a place-conditioning apparatus, the investigators hoped to establish a behavioral endpoint that is directly related to the negative ► **affective component of pain**. After two pairings of formalin-induced pain (1 h) with the compartment, rats learned to avoid the compartment and spend most of their time in the other two compartments of the apparatus. Lesions of the rostral anterior cingulate cortex (rACC) blocked the acquisition of F-CPA but did not affect the expression of acute formalin-induced pain behaviors (paw lifting, paw licking, etc.). The results suggested that the rACC lesions reduced the affective salience, but not the sensory-discriminative component of formalin-induced pain (Johansen et al. 2001). Using the F-CPA model, a similar pattern of results was obtained after bilateral lesions of either the CeA or basolateral amygdala (Tanimoto et al. 2003). The results provide strong causal data suggesting that the processing of nociceptive information in the amygdala and rACC relates to encoding of the affective component of pain. Furthermore, the results fit with the role in defense reactions ascribed to the amygdala at the beginning of this essay. By attaching emotional significance to a stimulus signaling danger (in this case the pain associated with formalin), the amygdala sets the stage for coordination of appropriate acute and delayed responses to the stimulus by way of its multitude of connections with other brain regions and neural circuitry (Fig. 1). These responses include acute protective behaviors and autonomic responses followed by avoidance of the environment in which the pain was experienced.





**Amygdala, Pain Processing and Behavior in Animals, Figure 1** A simplified illustration of major nociceptive pathways to the amygdala and possible consequences of stimulation of these pathways. Abbreviations: IC, insular cortex; PB, parabrachial complex; PoT, posterior triangular nucleus of the thalamus.

**References**

- Bernard JF, Bester H, Besson JM (1996) Involvement of the spino-parabrachio-amygdaloid and -hypothalamic pathways in the autonomic and affective emotional aspects of pain. *Prog Brain Res* 107:243–255
- Bornhovd K, Quante M, Glauche V et al. (2002) Painful stimuli evoke different stimulus-response functions in the amygdala, prefrontal, insula and somatosensory cortex: a single-trial fMRI study. *Brain* 125:1326–1336
- Derbyshire SW, Jones AK, Gyulai F et al. (1997) Pain processing during three levels of noxious stimulation produces differential patterns of central activity. *Pain* 73:431–445
- Gauriau C, Bernard JF (2002) Pain pathways and parabrachial circuits in the rat. *Exp Physiol* 87:251–258
- Hebert MA, Ardid D, Henrie JA et al. (1999) Amygdala lesions produce analgesia in a novel, ethologically relevant acute pain test. *Physiol Behav* 67:99–105
- Johansen JP, Fields HL, Manning BH (2001) The affective component of pain in rodents: direct evidence for a contribution of the anterior cingulate cortex. *Proc Natl Acad Sci USA* 98:8077–8082
- LeDoux J (2003) The emotional brain, fear, and the amygdala. *Cell Mol Neurobiol* 23:727–738
- Monnikes H, Ruter J, Konig M et al. (2003) Differential induction of c-fos expression in brain nuclei by noxious and non-noxious colonic distension: role of afferent C-fibers and 5-HT3 receptors. *Brain Res* 966:253–264
- Nakagawa T, Katsuya A, Tanimoto S et al. (2003) Differential patterns of c-fos mRNA expression in the amygdaloid nuclei induced by chemical somatic and visceral noxious stimuli in rats. *Neurosci Lett* 344:197–200
- Neugebauer V, Li W, Bird GC et al. (2004) The amygdala and persistent pain. *Neuroscientist* 10:221–234
- Paulson PE, Casey KL, Morrow TJ (2002) Long-term changes in behavior and regional cerebral blood flow associated with painful peripheral mononeuropathy in the rat. *Pain* 95:31–40
- Shi C-J, Cassell MD (1998) Cascade projections from somatosensory cortex to the rat basolateral amygdala via the parietal insular cortex. *J Comp Neurol* 399:469–491
- Tanimoto S, Nakagawa T, Yamauchi Y et al. (2003) Differential contributions of the basolateral and central nuclei of the amygdala in the negative affective component of chemical somatic and visceral pains in rats. *Eur J Neurosci* 18:2343–2350

- Ter Horst GJ, Meijler WJ, Korf J et al. (2001) Trigeminal nociception-induced cerebral Fos expression in the conscious rat. *Cephalalgia* 21:963–975
- Wilder-Smith CH, Schindler D, Lovblad K et al. (2005) Brain functional magnetic resonance imaging of rectal pain and activation of endogenous inhibitory mechanisms in irritable bowel syndrome patient subgroups and healthy controls. *Gut* 53:1595–1601

**Amygdaloid Complex**

► [Amygdala, Pain Processing and Behavior in Animals](#)

**Anaerobic Glycolysis**

**Definition**

Glycolysis is a metabolic process that yields energy by converting glucose into lactic acid. It occurs in skeletal muscle when the blood supply is not sufficient for aerobic metabolism. The process is less effective than the aerobic metabolism (yields less ATP per mol. of glucose).

► [Muscle Pain Model, Ischemia-Induced and Hypertonic Saline-Induced](#)

**Analgesia**

**Definition**

A reduced or absent sense of pain response to stimulation that would normally be painful. Can be seen as a decrease in nociceptive threshold or a decrease in pain perception. It can also be described as a situation in which the intensity of the stimulus required to evoke an escape or avoidance response is increased above normal, or the time required for an animal to respond to a noxious stimulus is increased above normal. Analgesia is measured in the uninjured stated.

► [Cancer Pain, Assessment in the Cognitively Impaired](#)  
 ► [Cytokine Modulation of Opioid Action](#)  
 ► [Descending Circuitry, Opioids](#)  
 ► [Lateral Thalamic Lesions, Pain Behavior in Animals](#)  
 ► [Postsynaptic Dorsal Column Projection, Anatomical Organization](#)

**Analgesia During Labor and Delivery**

YAAKOV BEILIN  
 Department of Anesthesiology, and Obstetrics, Gynecology and Reproductive Sciences, Mount Sinai School of Medicine, New York, NY, USA  
 yaakov.beilin@mountsinai.org

## Characteristics

► **Analgesia for labor and delivery** is now safer than ever. Anesthesia related maternal mortality has decreased from 4.3 per million live births during the years 1979–1981 to 1.7 per million live births during the years 1988–1990. The increased use of regional anesthesia for the parturient is in part responsible for this decrease in mortality (Hawkins et al. 1997). Safety is the first and foremost goal of obstetrical anesthesia. For labor analgesia, a secondary goal is to minimize or eliminate maternal lower extremity muscle weakness associated with epidural and subarachnoid ► **local anesthetics**. Patients with less motor block are more satisfied with their anesthetic experience and decreasing motor block may improve obstetric outcome. Although controversial, motor blockade related to labor epidural analgesia has been implicated as a cause of forceps deliveries and cesarean delivery. Minimizing the motor block may attenuate or eliminate these effects (Chestnut 1997). In addition to ► **epidural analgesia** (see epidural anesthesia), anesthesiologists are now providing ► **spinal anesthesia** and the combined spinal-epidural technique for labor analgesia. The purpose of this article is to review analgesic techniques that are currently used to provide labor analgesia.

Epidural analgesia has been the most popular technique for the relief of labor pain. Its popularity is related to its efficacy and safety. Women can obtain almost complete relief from the pain of labor. From the anesthesiologist's perspective, because a catheter is threaded into the epidural space, it is also a versatile technique. During the earlier stages of labor, dilute solutions of local anesthetic can be used to achieve analgesia. As labor progresses, a more concentrated solution of local anesthetic can be used, or an adjunct, such as an ► **opioid**, can be added. Additionally, the epidural catheter can be utilized to maintain a low ► **dermatomal level** of analgesia for labor (thoracic 10–lumbar 10/lumbar 1) and, if needed, the dermatomal level can be raised to thoracic 4 for cesarean delivery.

The agent most commonly utilized for labor epidural analgesia is a local anesthetic. Opioids are often added to the local anesthetic to decrease the motor block. But, unless large doses of opioids are used, they do not on their own confer adequate analgesia for labor pain. Continuous infusions of epidural local anesthetic combined with an opioid are frequently employed during labor. Continuous infusions provide a more stable level of analgesia than that provided by intermittent bolus techniques. This effect translates into decreased workload for the anesthesiologist and better analgesia for the mother. Furthermore, without the frequent bolus injections there may be less risk of maternal hypotension. Currently used continuous infusion solutions contain 0.04–0.125% of a local anesthetic (bupivacaine or ropivacaine or levobupivacaine) plus an opioid (fentanyl or sufentanil).

Some anesthesiologists use ► **patient controlled epidural analgesia** (PCEA). This technique allows the patient to self-medicate, controlling their analgesia. Because there are few well-controlled studies regarding PCEA, the optimal dosing regimens have not been determined. Compared with continuous infusion or intermittent bolus techniques, PCEA is associated with fewer anesthesiologist interventions and less motor block. Less anesthetic also decreases the frequency of maternal hypotension. The total dose of local anesthetic used is less with PCEA, and maternal satisfaction greater than with standard epidural analgesia techniques (Gambling et al. 1990). A commonly used PCEA regimen is bupivacaine 0.0625% with fentanyl  $2 \mu\text{g cc}^{-1}$  at the following PCEA settings 10 ml h<sup>-1</sup> basal rate, 5 ml bolus dose, 10 min lockout and a 30 ml h<sup>-1</sup> maximum limit. This author is not aware of any reported complications to the parturient with PCEA use. But theoretical risks include those that have been seen in the general surgical patient, including high dermatomal level or overdose from excessive self-administration, from a helpful family member or secondary to a catheter that has migrated into the subarachnoid space.

The safety of epidural opioids has been well documented. Despite decreased neonatal ► **neurobehavioral scores** shortly after delivery, epidural fentanyl has not been linked to any long-term (4 years) developmental effects (Ounsted et al. 1978). The clinical relevance of lower neurobehavioral scores around the time of delivery is unknown, but some have suggested that epidural fentanyl may impact on the ability of the neonate to breast-feed (Walker 1997). Although, Halpern et al. did not find any difference in breast-feeding success among neonates whose mothers received epidural fentanyl vs. those who did not (Halpern et al. 1999), at least one other study found different results. A recent prospective randomized study (Beilin et al. 2005) found that multiparous women who received >150  $\mu\text{g}$  of epidural fentanyl during labor were more likely to report breastfeeding difficulty on postpartum day one and to have stopped breastfeeding at 6 weeks than women who received less fentanyl or no fentanyl. Respiratory depression in the neonate is also of little concern with epidural fentanyl. Respiratory parameters of neonates whose mothers received epidural fentanyl (up to 400  $\mu\text{g}$ ) are similar to neonates whose mothers did not receive any fentanyl. There are a number of problems with labor epidural analgesia that have prompted some to seek alternative techniques. First, the time from epidural catheter placement until the patient is comfortable is variable, but depending on the local anesthetic used can take up to 30 min. Other disadvantages of labor epidural analgesia include maternal hypotension, inadequate analgesia (15–20% of cases) and, even with the very dilute local anesthetic solutions, motor block.

Subarachnoid opioids offer rapid, intense analgesia with minimal changes in blood pressure or motor func-



tion. The opioid is usually administered as part of a ► **combined spinal epidural (CSE) technique**. After locating the epidural space in the usual manner, a long small gauge spinal needle with a pencil point design is inserted through the epidural needle into the subarachnoid space. A subarachnoid opioid either alone or in combination with local anesthetic is injected. The spinal needle is removed and an epidural catheter threaded for future use. Analgesia begins within 3–5 min and lasts 1–1.5 h. A continuous epidural infusion of dilute local anesthetic / opioid solution is immediately started after securing the epidural catheter. Starting the epidural infusion immediately, *vs.* waiting for pain to recur, prolongs the spinal medication by approximately 60 min with minimal side effects (Beilin et al. 2002). It would be tempting to thread a catheter into the subarachnoid space to enable administration of repeated doses of opioid into this space. Unfortunately, there may be a risk of cauda equina syndrome when placing subarachnoid catheters, especially microcatheters. A study is currently underway to evaluate the safety of subarachnoid microcatheters.

Fentanyl or sufentanil are the most commonly utilized subarachnoid opioid with the CSE technique. Differences between the two drugs are subtle and choice of one over the other is based on personal preference. However, the cost of sufentanil is greater than that of fentanyl. Most anesthesiologists use between 10 and 25 µg of fentanyl and between 2 and 5 µg of sufentanil. Adding 1 ml of bupivacaine 0.25% to either fentanyl or sufentanil prolongs the duration by about 20 min for fentanyl and 30 min for sufentanil. Side effects of adding bupivacaine are minimal and may protect the patient from developing pruritus (Asokumar et al. 1998). Whether this added duration is worthwhile is based on personal preference. At Mount Sinai we commonly use fentanyl 25 µg with 1 ml of bupivacaine 0.25% for the subarachnoid dose.

There are several advantages to the CSE technique. The primary advantage is the rapid (3–5 min) onset of analgesia. Additionally, patients have less motor block and greater patient satisfaction with the CSE technique *versus* the “standard” epidural technique of bupivacaine 0.25%. The greater satisfaction is related to the faster onset of action and less motor block. There are some concerns about the CSE technique, most of which are only theoretical. There is no increased risk of subarachnoid catheter migration of the epidural catheter and metallic particles are not produced as a result of passing one needle through another. The incidence of ► **post dural puncture headache (PDPH)** is not increased with the CSE technique. An increase in end-tidal carbon dioxide has been reported in women who received subarachnoid sufentanil, but the risk of clinically significant respiratory depression is extremely rare. The risk of hypotension is also not greater with the CSE technique than with standard epidural regimens. The

most common side effect of subarachnoid opioids is pruritus, with a reported incidence as great as 95%, that is easily treated with either an antihistamine or naloxone.

It is possible that the epidural catheter may not actually be in the epidural space after the CSE technique is performed, and this may not be detected until the analgesia from the subarachnoid opioid has dissipated (1–2 h). If, during this time period, the woman requires an emergent cesarean delivery, the catheter may fail and the patient may require a general anesthetic. Norris et al. (Norris et al. 1998) found that the risk of failed epidural catheters was lower in women who received CSE analgesia than those who received epidural analgesia. However, it is prudent not to use the CSE technique in a woman who is a poor risk for general analgesia, e.g. one with a bad airway or obesity, so that the epidural catheter can be immediately tested.

Clarke et al. (1994) reported fetal bradycardia associated with uterine hypertonus after subarachnoid opioid injection. One proposed theory for increased uterine tone is related to the rapid decrease in maternal catecholamines associated with the onset of pain relief. With the decrease in circulating beta-adrenergic agonists, there is a predominance of alpha activity that leads to uterine contractions. Most studies prospective and retrospective do not find any difference in the incidence of fetal heart rate abnormalities with CSE *vs.* epidural analgesia (Albright and Forster 1997; Palmer et al. 1999). If hypertonus occurs, treatment should include subcutaneous terbutaline or intravenous nitroglycerin.

There have been several recent prospective studies evaluating the effects of the CSE technique on the cesarean delivery rate. Nageotte et al. (Nageotte et al. 1997) randomized women to three groups: group 1 received CSE with sufentanil 10 µg, group 2 received the same technique and medication as those in group 1 but were encouraged to ambulate and group 3 received epidural analgesia. They did not find any difference in the cesarean delivery rate between the three groups of patients. Gambling et al. (Gambling et al. 1998) compared women who received CSE analgesia *vs.* those who received intravenous meperidine during labor and they too did not find any difference in the cesarean delivery rate between the 2 groups.

The term ► **walking epidural** has become popular especially in the lay community. The term walking epidural refers to any epidural or spinal technique that allows ambulation. Some have suggested that ambulating or the upright position is associated with a shorter first stage of labor, less pain in early labor and decreased analgesia requirements. These findings have not been confirmed in prospective and randomized studies (Bloom et al. 1998). In most centers, few patients want to ambulate. Most want to rest or sleep once they have pain relief. However, even if patients do not want to ambulate, using a technique that produces minimal motor blockade will

improve maternal satisfaction. Both epidural analgesia using dilute local anesthetic / opioid solutions or a CSE technique can achieve this goal. Several precautions should be taken before allowing a parturient to walk during epidural or CSE analgesia. These women should be candidates for intermittent fetal heart rate monitoring. Maternal blood pressure and fetal heart rate should be monitored for 30–60 min after induction. Even small doses of subarachnoid and epidural local anesthetics can produce some motor deficits. Assess motor function by having the parturient perform a modified deep knee bend or stepping up and down on a stool. The patient must have an escort at all times. Fetal heart rate and maternal blood pressure should be reassessed at least every 30 min.

In summary, techniques and drugs available to the modern day obstetric anesthesiologist approach the objectives of an ideal labor anesthetic. The future of obstetric anesthesia lies in refining these drugs and techniques to make obstetric anesthesia even safer and more efficacious so we can better care for our patients.

## References

- Albright GA, Forster RM (1997) Does combined spinal-epidural analgesia with subarachnoid sufentanil increase the incidence of emergency cesarean delivery? *Reg Anesth* 22:400–405
- Asokumar B, Newman LM, McCarthy RJ et al. (1998) Intrathecal bupivacaine reduces pruritus and prolongs duration of fentanyl analgesia during labor: a prospective, randomized controlled trial. *Anesth Analg* 87:1309–1315
- Beilin Y, Nair A, Arnold I et al. (2002) A comparison of epidural infusions in the combined spinal/epidural technique for labor analgesia. *Anesth Analg* 94:927–932
- Bloom SL, McIntire DD, Kelly MA et al. (1998) Lack of effect of walking on labor and delivery. *N Engl J Med* 339:76–79
- Beilin Y, Bodian CA, Weiser J et al. (2005) Effect of epidural analgesia with and without fentanyl on infant breast-feeding. A prospective, randomized, double-blind study. *Anaesthesiol* 103:1211–17
- Chestnut DH (1997) Does epidural analgesia during labor affect the incidence of cesarean delivery? *Reg Anesth* 22:495–499
- Clarke VT, Smiley RM, Finster M (1994) Uterine hyperactivity after intrathecal injection of fentanyl for analgesia during labor: a cause of fetal bradycardia? *Anesthesiology* 81:1083
- Gambling DR, McMorland GH, Yu P et al. (1990) Comparison of patient-controlled epidural analgesia and conventional intermittent “top-up” injections during labor. *Anesth Analg* 70:256–261
- Gambling DR, Sharma SK, Ramin SM et al. (1998) A randomized study of combined spinal-epidural analgesia versus intravenous meperidine during labor: impact on cesarean delivery rate. *Anesthesiology* 89: 1336–1344
- Halpern SH, Levine T, Wilson DB et al. (1999) Effect of labor analgesia on breastfeeding success. *Birth* 26:83–88
- Hawkins JL, Koonin LM, Palmer SK et al. (1997) Anesthesia-related deaths during obstetric delivery in the United States, 1979–1990. *Anesthesiology* 86:277–284
- Nageotte MP, Larson D, Rumney PJ et al. (1997) Epidural analgesia compared with combined spinal-epidural analgesia during labor in nulliparous women. *N Engl J Med* 337:1715–1719
- Norris MC, Fogel ST, Dalman H (1998) Labor epidural analgesia without an intravascular “test dose” *Anesthesiology* 88:1495–1501
- Ounsted MK, Boyd PA, Hendrick AM et al. (1978) Induction of labour by different methods in primiparous women. II. Neuro-behavioural status of the infants. *Early Hum Dev* 2:241–253
- Palmer CM, Maciulla JE, Cork RC et al. (1999) The incidence of fetal heart rate changes after intrathecal fentanyl labor analgesia. *Anesth Analg* 88:577–581
- Walker M (1997) Do labor medications affect breastfeeding? *J Hum Lact* 13:131–137

## Analgesia for Labor and Delivery

### Definition

Pain relief during labor and delivery can be administered intravenously or via the neuraxis as an epidural or spinal block. Intravenous medication is usually not adequate, as it only attenuates the pain but does not eliminate the pain. Epidural or spinal analgesia, generally administered by an anesthesiologist, virtually eliminates labor pain without a loss of consciousness.

► [Analgesia During Labor and Delivery](#)

## Analgesic Effect of Oxycodone

### Definition

The analgesic effect of oxycodone is mainly mediated by the parent compound.

► [Postoperative Pain, Oxycodone](#)

## Analgesic Gap

### Definition

The increase in pain levels sometimes associated with withdrawal of high-level input (usually via a Pain Service) to analgesic strategies.

► [Postoperative Pain, Transition from Parenteral to Oral](#)

## Analgesic Guidelines for Infants and Children

STEPHEN C. BROWN

Department of Anesthesia, Divisional Centre of Pain Management and Pain Research, The Hospital for Sick Children, Toronto, ON, Canada  
stephen.brown@sickkids.ca

### Synonyms

Drug Guidelines; Pediatric Dosing Guidelines

### Definition

The goal of administering analgesia is to relieve pain without intentionally producing a sedated state.

## Characteristics

### Oral Analgesics

Analgesics include acetaminophen, non-steroidal anti-inflammatory drugs and opioids. While acetaminophen and opioids remain the cornerstone for providing analgesia for our youngest patients, the scope and diversity of drugs expand as those patients grow older. ► **Adjuvant analgesics** include a variety of drugs with analgesic properties that were initially developed to treat other health problems. These adjuvant analgesics (such as anticonvulsants and antidepressants) have become a cornerstone of pain control for children with chronic pain, especially when pain has a neuropathic component.

Pain control should include regular pain assessments, appropriate analgesics and adjuvant analgesics administered at regular dosing intervals, adjunctive drug therapy for symptom and side-effects control and non-drug therapies to modify the situational factors that can exacerbate pain and suffering. The guiding principles of analgesic administration are ► **‘by the ladder’, ‘by the clock’, ‘by the child’ and ‘by the mouth’**. By the ladder’ refers to a three-step approach for selecting drugs according to their analgesic potency based on the child’s pain level—acetaminophen to control mild pain, codeine to control moderate pain and morphine for strong pain (World Health Organization 1990). The ladder approach was based on our scientific understanding of how analgesics affect pain of nociceptive origins (► **nociceptive pain**). If pain persists despite starting with the appropriate drug, recommended doses and dosing schedule, move up the ladder and administer the next more potent analgesic. Even when children require opioid analgesics, they should continue to receive acetaminophen (and non-steroidal anti-inflammatory drugs, if appropriate) as supplemental analgesics. The analgesic ladder approach is based on the premise that acetaminophen, codeine and morphine should be available in all countries and that doctors and health-care providers can relieve pain in the majority of children with a few drugs. However, increasing attention is focusing on ‘thinking beyond the ladder’ in accordance with our improved understanding of pain of neuropathic origins (Krane et al. 2003). Children should receive adjuvant analgesics to more specifically target neuropathic mechanisms. Regrettably, two of the main classes of adjuvant analgesics, antidepressants and anticonvulsants, have unfortunate names. Proper education of health care providers, parents and children should lead to a wider acceptance and use of these medications for pain management. For example, amitriptyline may require 4–6 weeks to affect depression, but often requires only 1–2 weeks to affect pain. The newer classes of antidepressants, the selective serotonin reuptake inhibitors (SSRI’s), may be beneficial to treat depression in a child with pain, but have not been shown to be beneficial for pain management. The

other main class of adjuvant analgesics is the anticonvulsants. The two principal medications used for this purpose in pediatrics are carbamazepine and gabapentin. With gabapentin, the main dose limiting side effect is sedation, so that a slow titration to maximal dose is required. Because of its greater number of significant side effects, the use of carbamazepine has decreased recently and the use of gabapentin has increased. We still await published studies to support the wide use of gabapentin. Non-steroidal anti-inflammatory drugs (NSAIDs) are similar in potency to aspirin. NSAIDs are used primarily to treat inflammatory disorders and to lessen mild to moderate acute pain. They should be used with caution in children with hepatic or renal impairment, compromised cardiac function, hypertension (since they may cause fluid retention and edema) and a history of GI bleeding or ulcers. NSAIDs may also inhibit platelet aggregation and thus must be monitored closely in patients with prolonged bleeding times. NSAIDs have been used for many years in pediatrics and with their minimal side effects and many advantages (no effect on ventilation, no physical dependence, morphine sparing effect, etc) their use should be encouraged.

The specific drugs and doses are determined by the needs of each child. The drugs listed in this chapter are based on guidelines from our institution (The Hospital for Sick Children 2004–2005). Recommended starting doses for analgesic medications to control children’s disease-related pain are listed in Table 1 and Table 2; starting doses for adjuvant analgesic medications to control pain, drug related side effects and other symptoms are listed in Table 3. (For further review of analgesics and adjuvant analgesics in children, see (McGrath and Brown 2004; Schechter et al. 2003).

### Oral Analgesic Dosing Schedules

Children should receive analgesics at regular times, ‘by the clock’, to provide consistent pain relief and prevent breakthrough pain. The specific drug schedule (e.g. every 4 or 6 h) is based on the drug’s duration of action and the child’s pain severity. Although breakthrough pain episodes have been recognized as a problem in adult pain control, they may represent an even more serious problem for children. Unlike adults, who generally realize that they can demand more potent analgesic medications or demand more frequent dosing intervals, children have little control, little awareness of alternatives and fear that their pain cannot be controlled. They may become progressively frightened, upset and preoccupied with their symptoms. Thus, it is essential to establish and maintain a therapeutic window of pain relief for children.

Analgesic doses should be adjusted ‘by the child’. There is no one dose that will be appropriate for all children with pain. The goal is to select a dose that prevents children from experiencing pain before they receive the next dose. It is essential to monitor the child’s pain regularly and adjust analgesic doses as necessary to

**Analgesic Guidelines for Infants and Children, Table 1** Non-opioid drugs to control pain in children

Drug	Dosage	Comments
Acetaminophen	10–15 mg kg <sup>-1</sup> PO, every 4–6 h	Lacks gastrointestinal and hematological side-effects; lacks anti-inflammatory effects (may mask infection-associated fever) Dose limit of 65 mg kg <sup>-1</sup> day <sup>-1</sup> or 4 g day <sup>-1</sup> , whichever is less
Ibuprofen	5–10 mg kg <sup>-1</sup> PO, every 6–8 h	Anti-inflammatory activity Use with caution in patients with hepatic or renal impairment, compromised cardiac function or hypertension (may cause fluid retention, edema), history of GI bleeding or ulcers, may inhibit platelet aggregation Dose limit of 40 mg kg <sup>-1</sup> day <sup>-1</sup> ; max dose of 2400 mg day <sup>-1</sup>
Naproxen	10–20 mg kg <sup>-1</sup> day <sup>-1</sup> PO, divided every 12 h	Anti-inflammatory activity. Use with caution and monitor closely in patients with impaired renal function. Avoid in patients with severe renal impairment Dose limit of 1 g day <sup>-1</sup>
Diclofenac	1 mg kg <sup>-1</sup> PO, every 8–12 h	Anti-inflammatory activity. Similar GI, renal and hepatic precautions as noted above for ibuprofen and naproxen Dose limit of 50 mg / dose

Note: Increasing the dose of non-opioids beyond the recommended therapeutic level produces a 'ceiling effect', in that there is no additional analgesia but there are major increases in toxicity and side effects. Abbreviations: PO, by mouth; GI, gastrointestinal (Reprinted from McGrath and Brown 2004)

**Analgesic Guidelines for Infants and Children, Table 2** Opioid analgesics: Usual starting doses for children

Drug	Equianalgesic Dose (parenteral)	Starting Dose IV	IV: PO Ratio	Starting Dose PO / Transdermal	Duration of action
Morphine	10 mg	Bolus dose = 0.05–0.1 mg kg <sup>-1</sup> every 2–4 h Continuous infusion = 0.01–0.04 mg kg <sup>-1</sup> h <sup>-1</sup>	1:3	0.15–0.3 mg kg <sup>-1</sup> / dose every 4 h	3–4 h
Hydromorphone	1.5 mg	0.015–0.02 mg kg <sup>-1</sup> every 4 h	1:5	0.06 mg kg <sup>-1</sup> every 3–4 h	2–4 h
Codeine	120 mg	Not recommended		1.0 mg kg <sup>-1</sup> every 4 h (dose limit 1.5 mg kg <sup>-1</sup> / dose)	3–4 h
Oxycodone	5–10 mg	Not recommended		0.1–0.2 mg kg <sup>-1</sup> every 3–4 h	3–4 h
Meperidine <sup>a</sup>	75 mg	0.5–1.0 mg kg <sup>-1</sup> every 3–4 h	1:4	1.0–2.0 mg kg <sup>-1</sup> every 3–4 h (dose limit 150 mg)	1–3 h
Fentanyl <sup>b</sup>	100 µg	1–2 µg kg <sup>-1</sup> h <sup>-1</sup> as continuous infusion		25 µg patch	72 h (patch)

Note: Doses are for opioid naïve patients. For infants under 6 months, start at one-quarter to one-third the suggested dose and titrate to effect. Principles of opioid administration:

1. If inadequate pain relief and no toxicity at peak onset of opioid action, increase dose in 50% increments.
2. Avoid IM administration.
3. Whenever using continuous infusion, plan for hourly rescue doses with short onset opioids if needed. Rescue dose is usually 50–200% of continuous hourly dose. If greater than 6 rescues are necessary in 24 h period, increase daily infusion total by the total amount of rescues for previous 24 h ÷ 24. An alternative is to increase infusion by 50%.
4. To change opioids - because of incomplete cross-tolerance, if changing between opioids with short duration of action, start new opioid at 50% of equianalgesic dose. Titrate to effect.
5. To taper opioids - anyone on opioids over 1 week must be tapered to avoid withdrawal - taper by 50% for 2 days and then decrease by 25% every 2 days. When the dose is equianalgesic to an oral morphine dose of 0.6 mg kg<sup>-1</sup> day<sup>-1</sup>, it may be stopped. Some patients on opioids for prolonged periods may require much slower weaning.

<sup>a</sup>Avoid use in renal impairment. Metabolite may cause seizures.

<sup>b</sup>Potentially highly toxic. Not for use in acute pain control.

Abbreviations: PO, by mouth; I.V., intravenous

(Modified from McGrath and Brown 2004)

control the pain. The effective opioid dose to relieve pain varies widely among different children or in the same child at different times. Some children require large opioid doses at frequent intervals to control their

pain. If such doses are necessary for effective pain control and the side effects can be managed by adjunctive medication (► [adjunctive drugs](#)) so that children are comfortable, then the doses are appropriate. Children

**Analgesic Guidelines for Infants and Children, Table 3** Adjuvant analgesics: doses for children

Drug Category	Drug, Dosage	Indications	Comments
Antidepressants	Amitriptyline, 0.2–0.5 mg kg <sup>-1</sup> PO. Titrate upward by 0.25 mg kg <sup>-1</sup> every 2–3 days. Maintenance: 0.2–3.0 mg kg <sup>-1</sup> Alternatives: nortriptyline, doxepin, imipramine.	► <b>Neuropathic pain</b> (i.e., vincristine-induced, radiation plexopathy, tumor invasion, CRPS-1). Insomnia.	Usually improved sleep and pain relief within 3–5 days. Anticholinergic side effects are dose limiting. Use with caution for children with increased risk for cardiac dysfunction.
Anticonvulsants	Gabapentin, 5 mg kg <sup>-1</sup> day <sup>-1</sup> PO. Titrate upward over 3–7 days. Maintenance: up to 15–50 mg kg <sup>-1</sup> day <sup>-1</sup> PO divided TID. Carbamazepine, Initial dosing: 10 mg kg <sup>-1</sup> day <sup>-1</sup> PO divided OD or BID. Maintenance: up to 20–30 mg kg <sup>-1</sup> day <sup>-1</sup> PO divided every 8 h. Increase dose gradually over 2–4 weeks. Alternatives: phenytoin, clonazepam.	Neuropathic pain, especially shooting, stabbing pain.	Side effects: gastrointestinal upset, ataxia, dizziness, disorientation, and somnolence. Monitor for hematological, hepatic and allergic reactions with carbamazepine.
Sedatives, hypnotics, anxiolytics	Diazepam, 0.025–0.2 mg kg <sup>-1</sup> PO every 6 h. Lorazepam, 0.05 mg kg <sup>-1</sup> /dose SL Midazolam, 0.5 mg kg <sup>-1</sup> /dose PO administered 15–30 min prior to procedure; 0.05 mg kg <sup>-1</sup> /dose IV for sedation.	Acute anxiety, muscle spasm. Premedication for painful procedures.	Sedative effect may limit opioid use. Other side effects include depression and dependence with prolonged use.
Antihistamines	Hydroxyzine, 0.5 mg kg <sup>-1</sup> PO every 6 h. Diphenhydramine, 0.5–1.0 mg kg <sup>-1</sup> PO/IV every 6 h.	Opioid-induced pruritus, anxiety, nausea.	Sedative side effects may be helpful.
Psychostimulants	Dextroamphetamine, Methylphenidate, 0.1–0.2 mg kg <sup>-1</sup> BID. Escalate to 0.3–0.5 mg kg <sup>-1</sup> as needed.	Opioid-induced somnolence. Potentiation of opioid analgesia.	Side effects include agitation, sleep disturbance and anorexia. Administer second dose in afternoon to avoid sleep disturbances.
Corticosteroids	Prednisone, prednisolone, and dexamethasone dosage depends on clinical situation (i.e. dexamethasone initial dosing: 0.2 mg kg <sup>-1</sup> I.V. Dose limit 10 mg. Subsequent dose 0.3 mg kg <sup>-1</sup> day <sup>-1</sup> I.V. divided every 6 h.)	Headache from increased intracranial pressure, spinal or nerve compression; widespread metastases.	Side effects include edema, dyspeptic symptoms and occasional gastrointestinal bleeding.

Abbreviations: CRPS-1 = Complex Regional Pain Syndrome, Type 1; PO, by mouth; I.V., intravenous; SL, sublingual (Modified from McGrath and Brown 2004)

receiving opioids may develop altered sleep patterns so that they are awake at night fearful and complaining about pain and sleep intermittently throughout the day. They should receive adequate analgesics at night with antidepressants or hypnotics as necessary to enable them to sleep throughout the night. To relieve ongoing pain, opioid doses should be increased steadily until comfort is achieved, unless the child experiences unacceptable side effects, such as somnolence or respiratory depression (Table 4).

'By the mouth' refers to the oral route of drug administration. Medication should be administered to children by the simplest and most effective route, usually by mouth. Since children are afraid of painful injections they may deny that they have pain or they may not request medication. When possible, children should receive medications through routes that do not cause additional pain. Although optimal analgesic administration for children requires flexibility in selecting routes according to children's needs, parenteral administration is often the most efficient route for providing

direct and rapid pain relief. Since intravenous, intramuscular and subcutaneous routes cause additional pain for children, serious efforts have been expended on developing more pain-free modes of administration that still provide relatively direct and rapid analgesia. Attention has focused on improving the effectiveness of oral routes.

#### Intravenous Analgesia

Many hospitals have restricted the use of intramuscular injections because they are painful and drug absorption is not reliable; they advocate the use of intravenous lines into which drugs can be administered directly without causing further pain. Topical anesthetic creams should also be applied prior to the insertion of intravenous lines in children. The use of ► **portacatheters** has become the gold standard in pediatrics, particularly for children with cancer under the care of the physician, who require administration of multiple drugs at weekly intervals. Continuous infusion has several advantages over intermittent subcutaneous, intramuscular or intravenous



**Analgesic Guidelines for Infants and Children, Table 4** Opioid side effects

Side-effect	Management
Respiratory depression	Reduction in opioid dose by 50%, titrate to maintain pain relief without respiratory depression
Respiratory arrest	Naloxone, titrate to effect with 0.01 mg kg <sup>-1</sup> / dose I.V./ETT increments or 0.1 mg kg <sup>-1</sup> / dose I.V./ETT, repeat PRN. Small frequent doses of diluted naloxone or naloxone drip are preferable for patients on chronic opioid therapy to avoid severe, painful withdrawal syndrome. Repeated doses are often required until opioid side effect subsides
Drowsiness/sedation	Frequently subsides after a few days without dosage reduction; methylphenidate or dextroamphetamine (0.1 mg kg <sup>-1</sup> administered twice daily, in the morning and mid-day so as not to interfere with night-time sleep). The dose can be escalated in increments of 0.05–0.1 mg kg <sup>-1</sup> to a maximum of 10 mg / dose for dextroamphetamine and 20 mg / dose for methylphenidate
Constipation	Increased fluids and bulk, prophylactic laxatives as indicated
Nausea/vomiting	Administer an antiemetic (e.g. ondansetron, 0.1 mg kg <sup>-1</sup> I.V./PO every 8 h) Antihistamines (e.g. dimenhydrinate 0.5 mg kg <sup>-1</sup> / dose every 4–6 h I.V./PO) may be used. Pre-chemotherapy, Nabilone 0.5–1.0 mg PO and then every 12 h may also be used
Confusion, nightmares, hallucinations	Reassurance only, if symptoms mild. A reduced dosage of opioid or a change to a different opioid or add neuroleptic (e.g. haloperidol 0.1 mg kg <sup>-1</sup> PO/I.V. every 8 h to a maximum of 30 mg day <sup>-1</sup> )
Multifocal myoclonus; seizures	Generally occur only during extremely high dose therapy; reduction in opioid dose indicated if possible. Add a benzodiazepine (e.g. clonazepam 0.05 mg kg <sup>-1</sup> day <sup>-1</sup> divided BID or TID increasing by 0.05 mg kg <sup>-1</sup> day <sup>-1</sup> every 3 days PRN up to 0.2 mg kg <sup>-1</sup> day <sup>-1</sup> . Dose limit of 20 mg day <sup>-1</sup> )
Urinary retention	Rule out bladder outlet obstruction, neurogenic bladder and other precipitating drug (e.g. tricyclic antidepressant). Particularly common with epidural opioids. Change of opioid, route of administration and dose may relieve symptom. Bethanechol or catheter may be required

I.V., intravenous; PO, by mouth; ETT, endotracheal tube; PRN, as needed.  
(Reprinted from McGrath and Brown 2004)

routes. This method circumvents repetitive injections, prevents delays in analgesic drug administration and provides continuous levels of pain control without children experiencing increased side effects at peak level and pain breakthroughs at trough level. Continuous infusion should be considered when children have pain for which oral and intermittent parenteral opioids do not provide satisfactory pain control, when intractable vomiting prevents the use of oral medications and when intravenous lines are not desirable. Children receiving a continuous infusion should continue to receive 'rescue doses' to control breakthrough pain, as necessary. As outlined in Table 2, the rescue doses should be 50–200% of the continuous infusion hourly dose. If children experience repeated breakthrough pain, the basal rate can be increased by 50% or by the total amount of morphine administered through the rescue doses over a 24 h period (divided by 24 h).

### Patient-controlled Analgesia

► **Patient-controlled analgesia (PCA)** enables children to administer analgesic doses according to their pain level. PCA provides children with a continuum of analgesia that is prompt, economical, not nurse dependent and results in a lower overall narcotic use (Rodgers et al. 1988; Schechter et al. 2003). It has a high degree of safety, allows for wide variability between patients and removes delay in analgesic administration (for review, see (Berde and Solodiuk 2003).) It can now be

regarded as a standard for the delivery of analgesia in children aged >5 years (McDonald and Cooper 2001). However, there are opposing views about the use of ► **background infusions** with PCA. Although they may improve efficacy, they may increase the occurrence of adverse effects such as nausea and respiratory depression. In a comparison of PCA with and without a background infusion for children having lower extremity surgery, the total morphine requirements were reduced in the PCA only group and the background infusion offered no advantage (McNeely and Trentadue 1997). In another study comparing background infusion and PCA, children between 9 and 15 achieved better pain relief with PCA while children between 5 and 8 showed no difference (Bray et al. 1996). Our current standard is to add a background infusion to the PCA if the pain is not controlled adequately with PCA alone. The selection of opioid used in PCA is perhaps less critical than the appropriate selection of parameters such as bolus dose, lockout and background infusion rate. The opioid choice may be based on adverse effect profile rather than efficacy. Clearly, patient controlled analgesia offers special advantages to children who have little control and who are extremely frightened about uncontrolled pain. PCA is, as it states, patient controlled analgesia. When special circumstances require that alternate people administer the medication, we do allow both nurse and parent controlled analgesia. Under these circumstances, parents require our



nurse educators to fully educate them on the use of PCA. In a recent alert by the Joint Commission on Accreditation of Health Care Organizations (JCAHO), they advise that serious adverse events can result when family members, caregivers or clinicians who are not authorized become involved in administering the analgesia for the patient “by proxy” (Sentinel Event Alert 2004).

### Transdermal Fentanyl

Fentanyl is a potent synthetic opioid, which like morphine binds to mu receptors. However, fentanyl is 75–100 × more potent than morphine. The intravenous preparation of fentanyl has been used extensively in children. A ► **transdermal** preparation of fentanyl was introduced in 1991 for use with chronic pain. This route provides a noninvasive but continuously controlled delivery system. Although limited data is available on transdermal fentanyl (TF) in children, its use is increasing for children with pain. In a 2001 study, TF was well tolerated with effective pain relief in 11 of 13 children and provided an ideal approach for children where compliance with oral analgesics was problematic (Noyes and Irving 2001). In another study, when children were converted from oral morphine doses to TF, the investigators noted diminished side effects and improved convenience with TF (Hunt et al. 2001). The majority of parents and investigators considered TF to be better than previous treatment. No serious adverse events were attributed to fentanyl, suggesting that TF was both effective and acceptable for children and their families. Similarly, no adverse effects were noted in a study of TF for children with pain due to sickle cell crisis (Christensen et al. 1996). This study showed a significant relationship between TF dose and fentanyl concentration; pain control with the use of TF was improved in 7 of 10 patients in comparison to PCA alone. In a multicenter crossover study in adults, TF caused significantly less constipation and less daytime drowsiness in comparison to morphine, but greater sleep disturbance and shorter sleep duration (Ahmedzai and Brooks 1997). Of those patients able to express a preference, significantly more preferred fentanyl patches. As with all opioids, fatal adult complications have been noted with the use of multiple transdermal patches.

### Summary

I have guided you through the basics of the administration of analgesics for the pediatric patient from the oral route, through to intravenous and the PCA route and finally discussed a fairly recently employed analgesic administered by the transdermal route. By the use of these drugs as examples and with the simple principles discussed to apply them, we can hopefully attain the goal of decreasing the intensity of pain in children – no matter what the setting.

### References

- Ahmedzai S, Brooks D (1997) Transdermal fentanyl versus sustained-release oral morphine in cancer pain: preference, efficacy, and quality of life. The TTS-Fentanyl Comparative Trial Group. *J Pain Symptom Manage* 13:254–261
- Berde CB, Solodiuk J (2003) Multidisciplinary Programs for Management of Acute and Chronic Pain in Children. In: Schechter NL, Berde CB, Yaster M (eds) *Pain in Infants, Children, and Adolescents*, 2nd edn. Lippincott Williams and Wilkins, Philadelphia, pp 471–486
- Bray RJ, Woodhams AM, Vallis CJ et al. (1996) A double-blind comparison of morphine infusion and patient controlled analgesia in children. *Paediatr Anaesth* 6:121–127
- Christensen ML, Wang WC, Harris S et al. (1996) Transdermal fentanyl administration in children and adolescents with sickle cell pain crisis. *J Pediatr Hematol Oncol* 18: 372–376
- Hunt A, Goldman A, Devine T et al. (2001) Transdermal fentanyl for pain relief in a paediatric palliative care population. *Palliat Med* 15:405–412
- Krane EJ, Leong MS, Golianu B et al. (2003) Treatment of pediatric pain with nonconventional analgesics. In: Schechter NL, Berde CB, Yaster M (eds) *Pain in Infants, Children, and Adolescents*, 2nd edn. Lippincott Williams and Wilkins, Philadelphia, pp 225–241
- McDonald AJ, Cooper MG (2001) Patient-controlled analgesia: an appropriate method of pain control in children. *Paediatr Drugs* 3: 273–284
- McGrath PA, Brown SC (2004) Paediatric palliative medicine - Pain control. In: Doyle D, Hanks G, Cherny N et al. (eds) *Oxford Textbook of Palliative Medicine*, 3rd edn. Oxford University Press, Oxford, pp 775–789
- McNeely JK, Trentadue NC (1997) Comparison of patient-controlled analgesia with and without nighttime morphine infusion following lower extremity surgery in children. *J Pain Symptom Manage* 13:268–273
- Noyes M, Irving H (2001) The use of transdermal fentanyl in pediatric oncology palliative care. *Am J Hosp Palliat Care* 18:411–416
- Rodgers BM, Webb CJ, Stergios D et al. (1988) Patient-controlled analgesia in pediatric surgery. *J Pediatr Surg* 23:259–262
- Schechter NL, Berde CB, Yaster M (2003) *Pain in infants, children, and adolescents*, 2nd edn. Lippincott Williams & Wilkins, Philadelphia
- Sentinel Event Alert (2004) Patient controlled analgesia by proxy: Joint Commission of Healthcare Organizations
- The Hospital for Sick Children (2005) *The 2004–2005 Formulary*, 23rd edn. The Hospital for Sick Children, Toronto
- World Health Organization (1990) *Cancer Pain Relief and Palliative Care*. World Health Organization, Geneva

## Analgesic Ladder

### Definition

In 1986 WHO proposed a three step analgesic ladder. Non-opioids (step 1) are administered in case of mild pain. If this is not enough, weak opioids (step 2) are being added. They may be exchanged by strong opioids (step 3). The analgesics from the ladder frequently need to be co-administered with other drugs aiming either reduction of adverse effects (e.g. laxatives) or increase of activity and widening the spectrum of analgesic activity (e.g. tricyclic antidepressants).

### ► Cancer Pain

## Analgesic Tolerance

- ▶ Opioids, Clinical Opioid Tolerance

## Analgesic Treatment

### Definition

A treatment used to reduce pain or its perception, without causing loss of consciousness.

- ▶ Adjuvant Analgesics in Management of Cancer-Related Bone Pain
- ▶ Cancer Pain Management, Cancer-Related Break-through Pain, Therapy

## Analgesics

### Definition

Analgesics are drugs (pharmacological agents) that provide pain relief.

- ▶ NSAIDs, COX-Independent Actions
- ▶ Opioids, Clinical Opioid Tolerance
- ▶ Opioids in Geriatric Application

## Analgesics, History

- ▶ History of Analgesics

## Analysis of Pain Behavior

- ▶ Assessment of Pain Behaviors

## Anaphylactic Reaction

### Synonyms

Anaphylaxis

### Definition

A severe allergic reaction that starts when the immune system mistakenly responds to a relatively harmless substance as if it were a serious threat.

- ▶ Diencephalic Mast Cells

## Anaphylaxis

- ▶ Anaphylactic Reaction

## Anesthesia

### Definition

Loss of sensation and usually of consciousness without loss of vital functions, artificially produced by the administration of one or more agents that block the passage of pain impulses along nerve pathways to the brain.

- ▶ Thalamic Nuclei Involved in Pain, Cat and Rat

## Anesthesia Dolorosa

### Definition

Spontaneous pain felt in a body part that has been denervated or deafferented, which is therefore numb and unresponsive to applied stimuli. It is usually the result of a surgical lesion of a peripheral nerve (usually the trigeminal) intended to relieve pain.

- ▶ Central Nervous System Stimulation for Pain
- ▶ Dorsal Root Ganglionectomy and Dorsal Rhizotomy
- ▶ Neuropathic Pain Model, Spared Nerve Injury
- ▶ Peripheral Neuropathic Pain

## Anesthesia Dolorosa Due to Plexus Avulsion

- ▶ Plexus Injuries and Deafferentation Pain

## Anesthesia Dolorosa Model, Autotomy

MARSHALL DEVOR

Institute of Life Sciences and Center for Research on Pain, Hebrew University of Jerusalem, Jerusalem, Israel

marshlu@vms.huji.ac.il

### Synonyms

Model of Spontaneous Neuropathic Pain; Neuroma Model of Neuropathic Pain; Denervation Model of Neuropathic Pain; deafferentation model of neuropathic pain; autotomy model of neuropathic pain

### Definition

“Anesthesia dolorosa” (“painful numbness”) is a seemingly paradoxical chronic pain state in which, despite the presence of ongoing pain, the painful body part is completely numb and insensate. Applied stimuli are not felt. To create this state in animals a limb is made insensate by either: 1) cutting all peripheral nerves that serve

it (► **denervation**), or 2) cutting the corresponding dorsal roots (► **deafferentation**). Hence the animal model of anesthesia dolorosa is actually a family of models. The presence of ongoing pain is inferred from the observation of “► **autotomy**” behavior or its consequences. Autotomy is a behavior pattern in which the animal licks, bites and chews its denervated limb (self mutilation). Quantification is usually based on the amount of tissue lost from the extremity as a function of time after the surgical denervation/deafferentation, or on the number of days required to reach a criterion amount of tissue loss (Wall et al. 1979). Anesthesia dolorosa differs from phantom limb pain in that the body part in which the pain is felt is still present; it has not been amputated. Since it is unlikely that the presence of the insensate limb contributes materially to the spontaneous pain, this model is also useful for studying amputation phantom pain, and spontaneous pain in neuropathy in general.

### Characteristics

Spontaneous ► **dysesthesia** and pain is probably the most common and troublesome element of painful neuropathies. It occurs in nearly all neuropathic pain patients, either as an isolated symptom or in combination with exaggerated response to applied stimuli (► **allodynia** and ► **hyperalgesia**). In addition to being of great clinical significance, the presence of pain in an insensate limb is paradoxical and represents a challenge for theoretical understanding. Since its development, the denervation/deafferentation model has proved to be an important tool in identifying the biological mechanism(s) underlying neuropathic pain, and in evaluating the mode of action of therapeutic agents (Devor and Seltzer 1999). Although in recent years it has been largely superseded by partial denervation models based on the evaluation of allodynia and hyperalgesia, autotomy remains the most important behavioral probe of ongoing painful dysesthesia in experimental animals.

### Background and Ethical Considerations

Although it had been recognized previously that animals, from rodents to primates, tend to lick, scratch and bite an insensate body part, this autotomy behavior was not recognized as a potential indicator of ongoing pain until the mid-1970s (Basbaum 1974, Wall et al. 1979). Actually, investigators rarely witness actual autotomy behavior. Rather, the accumulated amount of tissue loss is scored. Long-term observations and video monitoring indicate that autotomy usually occurs in brief “attacks”, separated by hours or days, in which no further tissue loss occurs. This suggests that autotomy may reflect paroxysmal pain events, perhaps overlaid on a continuous ongoing pain. Across-strains genetic analysis in mice indicates that autotomy behavior is part of a pain family (“type”) that includes thermal nociception (Mogil et al. 1999). Perhaps, in mice at least, the pain has a burning quality.

It is essential to understand that, since the limb is entirely numb, autotomy behavior *per se* is not painful, even when the self-inflicted tissue loss includes entire digits. Pain arises spontaneously in association with the underlying neural injury. The ongoing pain remains even when steps are taken to prevent autotomy itself, such as with the use of a protective ruff placed around the animal’s neck, or when a foul-tasting substance is painted on the limb (Devor and Seltzer 1999). If reports from human patients can serve as guidance, it is safe to assume that most animals that suffer allodynia and hyperalgesia in partially denervated limbs also have spontaneous pain. The only reason that autotomy does not occur along with allodynia and hyperalgesia in the partial nerve injury models, is that the very act of licking and biting the limb provokes pain. Autotomy is prevented by “sensory cover”. The absence of autotomy in a nerve injured animal with residual sensation in the limb should, therefore, not be taken as evidence for the absence of ongoing pain. In the chronic constriction injury (CCI) model of neuropathic pain, for example, there may be patches of complete skin denervation, and these are targets for autotomy behavior (Bennett and Xie 1988). Esthetic considerations aside, ethical constraints on the use of lesions that trigger autotomy are no different, in kind, from those associated with the use of other neuropathic pain models.

### Does Autotomy Behavior Reflect Pain?

Pain is a private experience (1st person) that cannot be felt by another, only inferred through context and the observation of nocifensive behavior (e.g. escape, distress vocalization, spoken language). Drawing inferences about ongoing pain from spontaneously emitted behavior, such as autotomy, is intrinsically more uncertain than concluding that pain is felt when an animal shows distress in response to an applied stimulus. Skeptics have questioned the proposition that autotomy reflects pain with two main arguments. First, anesthesia dolorosa does not typically trigger self-injurious behavior in human patients, and second, autotomy may reflect an animal’s attempt to rid itself of a useless, insensate, but pain-free limb. The first critique is weak, as socialization and the anticipation of consequences are expected to prevent self-mutilation in humans, but not in animals. Moreover, compulsive autotomy-like behavior does occur in some people with ongoing dysesthesias (including itch) and pain (Mailis 1996; Devor and Seltzer 1999). As for the second critique, rendering a limb numb by sustained local anesthetic nerve block does not trigger autotomy (Blumenkopf and Lipman 1991).

There are many positive indicators that autotomy reflects spontaneous pain. These include:

- Limb denervation and deafferentation frequently cause ongoing neuropathic pain in humans. As in

humans, palpating neuromas in rats evokes distress vocalization and struggling (Levitt 1985)

- Neural injuries that are followed by autotomy behavior trigger massive barrages of spontaneous discharge in injured afferents. There is a suggestive temporal correspondence between this discharge and autotomy, particularly for ectopia in nociceptive C-fibers (Devor and Seltzer 1999)
- Depletion of C-fibers with neonatal capsaicin treatment suppresses autotomy (Devor et al. 1982), and resecting neuromas in adults delays autotomy until a new spontaneously active neuroma reforms (Seltzer 1995)
- Different forms of nerve section (cut, freeze, cautery, crush etc.) produce identical anesthesia, but yield different degrees of autotomy, presumably because of differences in the resulting ectopia (Zeltser et al. 2000)
- Autotomy is suppressed in a dose-dependent manner by drugs that reduce ectopic firing and/or relieve neuropathic pain in humans (e. g. anticonvulsants, local anesthetics, opiates, corticosteroids, tricyclics, NMDA receptor antagonists). Likewise, analgesics minimally effective against neuropathic pain, such as NSAIDs, do not suppress autotomy (Coderre et al. 1986; Seltzer 1995; Kaupilla 1998; Devor and Seltzer 1999)
- Spinal injection of excitants such as strychnine, tetanus toxin, alumina cream, penicillin, and substance P, which almost certainly cause pain, induces scratching and biting of the corresponding limb, and sometimes frank autotomy (Coderre et al. 1986; Kaupilla 1998; Devor and Seltzer 1999)
- Blockade of descending antinociceptive control by appropriate brainstem or spinal tract lesions augments autotomy (Coderre et al. 1986; Saade et al. 1990), while midbrain or dorsal column stimulation, and dorsal root entry zone (DREZ) lesions, suppress it (Levitt 1985; Kaupilla and Pertovaara 1991; Rossitch et al. 1993; Devor and Seltzer 1999)
- Autotomy is accompanied by paw guarding, protective gait, sleep disturbances, sometimes weight loss, and stress-related increase in plasma corticosterone levels. It is augmented by stressful conditions such as isolation and cold stress, and reduced by taming and social contact (Coderre et al. 1986; Kaupilla and Pertovaara 1991; Seltzer 1995; Devor and Seltzer 1999; Raber and Devor 2002)
- There are consistent differences in autotomy behavior among inbred strains of mice and rodent selection lines, despite identical denervation and sensory loss. There is clear evidence that genes, as well as environmental factors, determine the level of autotomy. One such pain susceptibility gene is located on mouse chromosome 15 (Mogil et al. 1999; Devor and Seltzer 1999; Seltzer et al. 2001)

### Mechanisms of Ongoing Pain in the Denervation/Deafferentation Model

A limb may be rendered insensate by denervation or deafferentation and both situations may produce anesthesia dolorosa in humans and autotomy behavior in animals. The terms “denervation” and “deafferentation” are frequently confused and misused; they do not mean the same thing. Denervation, in the present context, refers to severing sensory axons that innervate the limb. Sensory endings rapidly degenerate in the process of anterograde (Wallerian) degeneration. Deafferentation refers to blocking the arrival of afferent impulses into the CNS by severing dorsal roots (dorsal ► [rhizotomy](#)). The sensory neurons in the dorsal root ganglion (DRG) survive, as do sensory endings in the skin. The limb is not denervated.

It is generally presumed that pain and the resulting autotomy due to denervation and deafferentation result from different mechanisms, although this conjecture has not been proved definitively.

Pain and autotomy after nerve injury is probably due to abnormal spontaneous afferent discharge generated ectopically at the nerve injury site, and in axotomized DRG neurons. There might also be a contribution by residual intact neurons that continue to innervate adjacent skin. The ectopic firing plays two roles. First, it constitutes a primary nociceptive afferent signal. Second, it probably triggers central sensitization in the spinal cord dorsal horn, and perhaps also in the brain. The sensitized CNS amplifies and augments pain sensation due to the spontaneous afferent discharge. It also renders light tactile input from residual neighboring afferents painful, yielding tactile allodynia in the skin bordering on the denervated zone (Devor and Seltzer 1999).

Pain and autotomy after deafferentation must be due to another mechanism, as dorsal rhizotomy does not trigger massive ectopia in axotomized afferents, and even if it did, the impulses would have no access to the CNS. Pain following rhizotomy is, therefore, presumed to be due to impulses that originate within the deafferented CNS itself. Deafferentation triggers many structural and neurochemical changes in the CNS, and abnormal bursting discharges have been recorded in deafferented spinal dorsal horn in animals and in humans. The possibility that deafferentation pain is indeed due to this activity, is supported by the observation that surgical destruction of the abnormal dorsal horn tissue by ► [DREZotomy](#) often relieves the pain (Rossitch et al. 1993; Devor and Seltzer 1999).

### References

1. Basbaum AI (1974) Effects of Central Lesions on Disorders Produced by Dorsal Rhizotomy in Rats. *Exp Neurol* 42:490–501
2. Bennett G, Xie Y-K (1988) A Peripheral Mononeuropathy in Rat that Produces Disorders of Pain Sensation Like Those Seen in Man. *Pain* 33:87–107



3. Blumenkopf B, Lipman JJ (1991) Studies in Autotomy: Its Pathophysiology and Usefulness as a Model of Chronic Pain. *Pain* 45:203–210
- 4.Coderre TJ, Grimes RW, Melzack R (1986) Deafferentiation and Chronic Pain in Animals: An Evaluation of Evidence Suggesting Autotomy is related to Pain. *Pain* 26:61–84
5. Devor M, Inbal R, Govrin-Lippmann R (1982) Genetic Factors in the Development of Chronic Pain. In: Lieblich I (ed) *The Genetics of the Brain*. Elsevier-North Holland, Amsterdam, pp: 273–296
6. Devor M, Seltzer Z (1999) Pathophysiology of Damaged Nerves in Relation to Chronic Pain. In: Wall PD and Melzack R (eds) *Textbook of Pain*, 4th edn, Churchill Livingstone, London pp: 129–164
7. Kauppila T, Pertovaara A (1991) Effects of Different Sensory and Behavioral Manipulations on Autotomy Caused by a Sciatic Lesion in Rats. *Experimental Neurology* 111:128–130
8. Kauppila T (1998) Correlation between autotomy-behavior and current theories of neuropathic pain. *Neurosci Biobehav Rev* 23:111–129
9. Levitt M (1985) Dysesthesias and Self-Mutilation in Humans and Subhumans: A Review of and Experimental Studies. *Brain Res Reviews* 10:247–290
10. Mailis A (1996) Compulsive Targeted Self-Injurious Behaviour in Humans with Neuropathic Pain: A Counterpart of Animal Autotomy? Four Case Reports and Literature Review. *Pain* 64:569–578
11. Mogil JS, Wilson SG, Bon K et al. (1999) Heritability of Nociception. II. “Types” of Nociception Revealed by Genetic Correlation Analysis. *Pain* 80:83–93
12. Raber P, Devor M (2002) Social variables affect phenotype in the neuroma model of neuropathic pain. *Pain* 97:139–150
13. Rossitch EJ, Abdulhak M, Olvelmen-Levitt J et al. (1993) The Expression of Deafferentation Dysesthesias Reduced by Dorsal Root Entry Zone Lesions in the Rat. *Journal of Neurosurgery* 78:598–602
14. Saadé NE, Atweh SF, Tabbur SJ and Wall PD (1990) Effects of Lesions in the anterolateral columns and dorsolateral funiculi on self-mutilation behavior in rats. *Pain* 42:313–321
15. Seltzer Z (1995) The Relevance of Animal Neuropathy Models for Chronic Pain in Humans. *Seminars in Neuroscience* 7:31–39
16. Seltzer ZWT, Max MB, Diehl SR (2001) Mapping a Gene for Neuropathic Pain-Related Behavior following Peripheral Neurectomy in the Mouse. *Pain* 93:101–106
17. Wall PD, Devor M, Inbal R et al. (1979) Autotomy following Peripheral Nerve Lesions: Experimental Anaesthesia Dolorosa. *Pain* 7:103–111
18. Zeltser R, Zaslansky R, Beilin B et al. (2000) Comparison of Neuropathic Pain Induced in Rats by Various Clinically-Used Neurectomy Methods. *Pain* 89:19–24

## Anesthesiological Interventions

- ▶ [Cancer Pain Management, Anesthesiologic Interventions, Neural Blockade](#)
- ▶ [Cancer Pain Management, Anesthesiologic Interventions, Spinal Cord Stimulation, and Neuraxial Infusion](#)

## Anesthesiologist

### Definition

A medical doctor specializing in preventing and treating pain during surgery (general anesthesia (sleeping patient) or local or regional anesthesia (with part of the

body made numb and feeling no pain)). Anesthesiologists also take care of critically ill patients in the intensive care units, in emergency and pre-hospital settings.

- ▶ [Postoperative Pain, Acute Pain Management, Principles](#)
- ▶ [Postoperative Pain, Acute Pain Team](#)

## Anesthetic Block

- ▶ [Cancer Pain Management, Anesthesiologic Interventions](#)

## Anesthetic Blockade

### Definition

Injection of local anesthetics in a nerve branch or plexus.

- ▶ [Deafferentation Pain](#)

## Aneurysm

### Definition

An aneurysm is a localized dilatation of a blood vessel, commonly an artery, which may cause symptoms by enlarging or bleeding.

- ▶ [Primary Cough Headache](#)

## Anger and Pain

AKIKO OKIFUJI

Department of Anesthesiology, Psychology and Clinical Pharmacy, University of Utah, Salt Lake City, UT, USA

akiko.okifuji@hsc.utah.edu

### Synonyms

Frustration; hostility; Aggression; Acting-Out; Anger-In

### Definition

Anger is an emotional experience involving cognitive appraisal and action tendency (Smedslund 1992). There have been numerous anecdotal reports since the early days of pain medicine, suggesting that anger may be an associated or resultant emotional experience of pain. There are several terms that are used interchangeably. For the purpose of clarification, in this chapter, the following definitions will be applied:

- Frustration: Affective state that arises when one's effort has been blocked, thwarted



- Anger: Strong feeling of displeasure associated with cognitive appraisal that injustice has occurred and action tendency to remedy the perceived injustice
- Hostility: Unfriendly attitudinal disposition with tendency to become angry
- Aggression: Behavioral actualization of the action tendency associated with anger

### Characteristics

Anger is a common emotional experience associated with pain, particularly chronic pain. Pain, by virtue of its aversive phenomenological nature, frequently brings on the perception of injustice and frustration. Additionally, the sense of injustice may come with having to undergo multiple diagnostic tests without finding fruitful findings. This often raises a question of legitimacy of pain, leading to interpersonal hardship. Functional limitations associated with chronic pain may severely impair the patient's ability to be a productive member of a workforce, enjoy the recreations they used to engage in, and nurture their personal relationships with friends and families.

### Parameters of Anger

Anger is a multidimensional construct. It involves the temporary parameters of the experience such as frequency, recurrence, and duration, intensity of the experience, expression styles, and target of the anger. The earlier studies mostly focused on anger levels, or one's tendency to become angry. Those earlier studies generally demonstrated the relationship between anger and pain severity in chronic pain patients (Wade et al. 1990). The directionality of the relationship has been a topic of much debate. Some early clinical studies with chronic pain patients suggest that high levels of anger exacerbate pain severity (Gaskin et al. 1992), whereas the experimental studies show higher frustration and hostility as a result of noxious stimulation (Berkowitz and Thorne 1987).

Another parameter of anger is how anger is experienced and expressed ("anger management style"). One of the two styles that have been most studied is "anger-in", in which people are aware of the presence of anger but the expression is suppressed. Various studies have shown that anger-in and pain intensity in chronic pain patients are positively related (e.g. Kerns et al. 1994). The other style is "anger out", in which angry feelings are overtly expressed. The high degree of anger-out suggests uncontrolled, excessive demonstrations of anger. Those who tend to readily express their anger and hostility may sabotage the effectiveness of rehabilitative effort (Fernandez and Turk 1995).

Finally, a target parameter of anger may be important in understanding pain patients. Anger is generally a provoked feeling and requires a specific target, object, or person with whom one feels angry. The degree to which

anger is related to pain may greatly differ, depending upon targets with which people experience anger. Self and healthcare providers appear to be common targets of anger among chronic pain patients. Interestingly, anger at self is related to depression, whereas anger at healthcare providers is related to the perceived level of functional disability (Okifuji et al. 1999). The results suggest that the assessment of specific targets with which patients experience anger, may be important in understanding the overall clinical picture of their pain condition.

### Mechanisms

#### Psychodynamic Model

The role of anger in medically unexplained somatic complaints plays a central role in a psychodynamic conceptualization. When a person experiences anger, the person's psyche classifies the emotion as unacceptable, and it channels the feeling into somatic symptoms. This psychodynamic concept of hysteria has been applied to pain conditions, when the conditions cannot be understood from the medical findings.

In the early days of research evaluating the etiology of chronic pain, the high prevalence of depressed mood in chronic pain patients led the psychodynamic paradigm to propose the notion of "masked depression", in which chronic pain was considered as a somatically expressed form of depression. Depression, in turn, was considered as "anger turned inward", with a person holding a self-depreciating view of self. However, empirical support for the psychodynamic model is limited to the correlational association between pain and negative moods.

#### Psychosocial-Behavioral Model

Behaviorally, anger, when it is poorly managed, may contribute to the suffering of a person living with pain. Functional limitations that often accompany their condition significantly compromise the quality of life, leading to frustration, and persistent irritability further compromises interpersonal relationships. Moreover, anger may interfere with how the person interacts with healthcare providers. Intense anger may jeopardize the cooperative relationship between the providers and the patient, or decrease the patient's willingness to comply with the regimen; as a result, the patient may not receive the optimal benefit from the treatment.

#### Psychophysiological-Neurological Model

Anger may also contribute to pain via autonomic activation. Anger is associated with the general elevation in the sympathetic responses. The orchestrated arousal of the sympathetic tone is analogous to what we experience in response to a stressor. Such stress responses, particularly muscle tension, is known to be potentially problematic for pain patients. Pain patients exhibit a greater level of muscle tension in the pain-afflicted region than in other non-affected areas in response to

a stressor (Flor and Turk 1989), suggesting that the elevation of muscle tension associated with anger may play a role in perpetuating the stress-tension-pain cycle. On the other hand, when patients re-experience/recall anger, chronic back patients who tended to suppress their anger, seemed to show reduced paraspinal muscle reactivity (Burns 1997). These results suggest that anger, stress response, and pain seem to form a complex relationship. Janssen et al. (2001) showed the positive relationship between cardiovascular reactivity in response to anger provocation and pain threshold, yet the participants reported increased pain reports under such conditions.

More recently, it has been suggested that the dysregulation in the endogenous opioid function may mediate the relationship between anger and pain. Expressed anger seems to compromise the endogenous opioid reactivity to experimentally induced pain (Bruehl et al. 2002, Bruehl et al. 2003). The mediation effect is modest and certainly does not completely explain the relationship; nevertheless, this line of research has just begun, and further research may help uncover the psychophysiological-neurological patterns associated with pain and anger.

#### Treatment Implications

Treatment of pain, particularly chronic pain, requires cooperation and active participation from patients. Anger, if not properly managed, is likely to interfere with treatment efficacy. It is reasonable to assume that angry patients may be reluctant to follow the regimen. Angry patients with suboptimal coping skills may also find it difficult to adaptively change their lifestyles to accommodate rehabilitation. At this time, very little is known about how anger interacts with rehabilitative efforts for pain patients. Burns et al. (1998) reported that male patients showed the inversed relationship between the pre-treatment level of anger suppression and improvement in mood and self-reported level of activity. The result from their subsequent study suggests (Burns et al. 1999) that patients with a high degree of anger-out may not develop a sense of rapport with their healthcare providers.

Anger is not necessarily maladaptive. Anger can be an adaptive emotional response to the injustice that patients perceive. However, the accumulation of research suggests that poorly managed anger exacerbates pain and disability, and interferes with the treatment efforts. Effective self-management of anger may be essential for the successful rehabilitative effort of pain patients. Psychoeducational approaches help patients to better understand the concept, and how poorly managed anger may contribute to their pain. Fernandez (2002) suggests several approaches to help patients acquire better anger coping skills via cognitive reappraisal, behavioral modification, and appropriate affective disclosure. Given the salient effects of poorly managed anger, future research

is warranted to evaluate the enhancement effects of such approaches for pain rehabilitation.

#### References

1. Berkowitz L, Thome P (1987) Pain, Expectation, Negative Affect, and Angry Aggression. *Motivation Emo* 11:183–193
2. Bruehl S, Burns JW et al. (2002) Anger and Pain Sensitivity in Chronic Low Back Pain Patients and Pain-Free Controls: The Role of Endogenous Opioids. *Pain* 99:223–233
3. Bruehl S, Chung OY et al. (2003) The Association between Anger Expression and Chronic Pain Intensity: Evidence for Partial Mediation by Endogenous Opioid Dysfunction. *Pain* 106:317–324
4. Burns J, Higdon L et al. (1999) Relationships among Patient Hostility, Anger Expression, Depression and the Working Alliance in a Work Hardening Program. *Annals Behav Med* 21:77–82
5. Burns JW (1997) Anger Management Style and Hostility: Predicting Symptom-Specific Physiological Reactivity among Chronic Low Back Pain Patients. *J Behav Med* 20:505–522
6. Burns JW, Johnson BJ et al. (1998) Anger Management Style and the Prediction of Treatment Outcome among Male and Female Chronic Pain Patients. *Behav Res Ther* 36:1051–1062
7. Fernandez E (2002) *Anxiety, Depression, and Anger in Pain*. Toronto, University of Toronto Press
8. Fernandez E, Turk DC (1995) The Scope and Significance of Anger in the Experience of Chronic Pain. *Pain* 61:165–175
9. Flor H, Turk DC (1989) Psychophysiology of Chronic Pain: Do Chronic Pain Patients Exhibit Symptom-Specific Psychophysiological Responses? *Psychol Bull* 105:215–259
10. Gaskin ME, Greene AF et al. (1992) Negative Affect and the Experience of Chronic Pain. *J Psychosom Res* 36(8):707–713
11. Janssen SA, Spinhoven P et al. (2001) Experimentally Induced Anger, Cardiovascular Reactivity, and Pain Sensitivity. *J Psychosom Res* 51:479–485
12. Kerns RD, Rosenberg R et al. (1994) Anger Expression and Chronic Pain. *J Behav Med* 17:57–67
13. Okifuji AD, Turk DC et al. (1999) Anger in Chronic Pain: Investigations of Anger Targets and Intensity. *J Psychosom Res* 47:1–12
14. Smedslund J (1992) How Shall the Concept of Anger be Defined? *Theory Psychol* 3:5–34
15. Wade JB, Price DD et al. (1990) An Emotional Component Analysis of Chronic Pain. *Pain* 40:303–310

## Anger-In

- Anger and Pain

## Angiitis of the CNS

- Headache Due to Arteritis

## Angina Pectoris

#### Definition

Severe chest discomfort usually caused by inadequate blood flow through the blood vessels of the heart as a result of cardiac disease resulting in myocardial ischemia (inadequate oxygen supply to the heart). It is often treated by medical means or by surgical or angioplasty

revascularization. It is rarely treated by spinal cord stimulation. Angina is often accompanied by shortness of breath, sweating, nausea and dizziness.

- ▶ Pain Treatment, Spinal Cord Stimulation
- ▶ Spinothalamic Tract Neurons, Visceral Input
- ▶ Thalamus
- ▶ Thalamus and Visceral Pain Processing (Human Imaging)
- ▶ Thalamus, Clinical Visceral Pain, Human Imaging
- ▶ Visceral Pain Model, Angina Pain

## Angina Pectoris, Neurophysiology and Psychophysics

STAN ANDERSON, SHINJI OHARA, NIRIT WEISS, FRED A. LENZ

Departments of Neurosurgery, Johns Hopkins University, Baltimore, MD, USA  
flenz1@jhmi.edu

### Synonyms

Visceral Sensation; interoceptive sensation; Sympathetic Afferents

### Definition

The role of the somatic sensory ▶ **thalamus** in angina related to cardiac disease is demonstrated by stimulation of thalamus in patients with a history of angina and by the presence of cells projecting to monkey thalamus that respond to cardiac stimulation.

### Characteristics

The sensory mechanisms of angina are poorly understood, although it is a common, clinically significant symptom. Recent evidence suggests that the perception of angina is correlated with central nervous system activity encoding cardiac injury. Noxious cardiac stimuli evoke activity in sympathetic afferent nerves (Foreman et al. 1986), in ascending spinal pathways (spinothalamic - ▶ **STT** and ▶ **dorsal column** pathways DC) and in cells of the principal sensory nucleus of the ▶ **thalamus** (Horie and Yokota 1990).

STT cells in the upper thoracic spinal cord projecting to the region of ▶ **VP** respond to coronary artery occlusion (Blair et al. 1984) and intracardiac injection of bradykinin (Blair et al. 1982). Cells at the posteroinferior aspect of VP in the cat respond to intracardiac injections of bradykinin (Horie and Yokota 1990) and to stimulation of cardiac sympathetic nerves (Taguchi et al. 1987). Neurons in the thalamic principal sensory nucleus also encode visceral inputs from gastrointestinal and genitourinary systems in monkeys (Bruggemann et al. 1998). Therefore experimental studies suggest that cells in the region of VP encode noxious visceral and cardiac stimuli

The spinothalamic tract sends a dense projection particularly to the posterior inferior lateral aspect of monkey VP (Apkarian and Hodge 1989). Projections from the spinothalamic tract are also found posterior and inferior to VP in the posterior nucleus and in the ventral posterior inferior nucleus. VP projects to primary somatosensory cortex while the region posterior and inferior to VP projects to secondary somatosensory cortex, insular and retroinsular cortex (Jones 1985).

Involvement of sympathetics in the perception of angina is based upon evidence that stimulation of the superior cervical ganglion produces pain and that lesions of the sympathetic ganglia and dorsal roots relieve angina (reviewed by Meller and Gebhart 1992). Involvement of thalamus in the sensation of angina is suggested by the case of a patient with angina successfully treated by balloon angioplasty (Lenz et al. 1994). During thalamic exploration for implantation of a stimulating electrode, micro-stimulation evoked a pain 'almost identical' to her angina, except that it began and stopped instantaneously with stimulation. This time course of this sensation was typical of sensations evoked by thalamic microstimulation but not those evoked by cardiac disease (Lenz et al. 1993). Stimulation-associated angina was not accompanied by the cardiac indices of angina in the setting of myocardial infarction.

The description of her typical angina and stimulation-evoked angina included words with a strong affective dimension from a questionnaire. In a similar setting the atypical chest pain of panic disorder was 'almost identical' to that produced by micro-stimulation in the same thalamic area as the present case (Lenz et al. 1995). Stimulation-evoked pain without an affective dimension was observed in a retrospective analysis of patients without experience of spontaneous chest pain with a strong affective dimension (Lenz et al. 1994; Lenz et al. 1995). Therefore, stimulation-evoked chest pain included an affective dimension as a result of conditioning by the prior experience of angina of cardiac origin.

The affective dimension of stimulation-associated pain might be analogous to emotional phenomena evoked by stimulation of amygdala in patients with epilepsy who have prior experience of these phenomena during the aura of their seizures (Halgren et al. 1978). The region posterior to Vc is linked to nociceptive cortical areas that project to the amygdala. Vcpc projects to anterior insular cortex (Mehler 1962) whereas Vcpor projects to the inferior parietal lobule, including the parietal operculum and secondary somatosensory cortex - SII (Locke et al. 1961) which project, directly or indirectly to the amygdala. Noxious sensory input to these cortical areas is demonstrated by evoked potentials in response to tooth pulp stimulation (Chatrian et al. 1975). Lesions of SII interfere with discrimination of noxious stimuli (Greenspan and Winfield 1992) while lesions of insula impair emotional responses to painful stimuli (Berthier

et al. 1988). Thus there is good evidence that cortical areas receiving input from Vcpc and Vcpor are involved in pain processing.

SII and insular cortical areas involved in pain processing also satisfy criteria for areas involved in corticolimbic connections (see ► [corticolimbic circuits](#)). In monkeys, a nociceptive sub-modality selective area has been found within SII (Dong et al. 1989). SII cortex projects to insular areas that project to the amygdala (Friedman et al. 1986). SII and insular cortex have bilateral primary noxious sensory input (Chatrian et al. 1975) and cells in these areas responding to noxious stimuli have bilateral representation (Dong et al. 1989; Chatrian et al. 1975). Therefore cortical areas receiving input from Vcpc and Vcpor may be involved in memory for pain through corticolimbic connections (Mishkin 1979).

## References

1. Apkarian AV, Hodge CJ (1989) Primate spinothalamic pathways: III. Thalamic terminations of the dorsolateral and ventral spinothalamic pathways. *J Comp Neurol* 288:493–511
2. Berthier M, Starkstein S, Leiguarda R (1988) Asymbolia for pain: a sensory-limbic disconnection syndrome. *Ann Neurol* 24:41–49
3. Blair RW, Weber N, Foreman RD (1982) Responses of thoracic spinothalamic neurons to intracardiac injection of bradykinin in the monkey. *Circ Res* 51:83–94
4. Blair RW, Ammons WS, Foreman RD (1984) Responses of thoracic spinothalamic and spinoreticular cells to coronary artery occlusion. *J Neurophysiol* 51:636–648
5. Bruggemann J, Shi T, Apkarian AV (1998) Viscerosomatic interactions in the thalamic ventral posterolateral nucleus (VPL) of the squirrel monkey. *Brain Res* 787:269–276
6. Chatrian GE, Canfield RC, Knauss TA et al. (1975) Cerebral responses to electrical tooth pulp stimulation in man. An objective correlate of acute experimental pain. *Neurology* 25:745–757
7. Dong WK, Salonen LD, Kawakami Y et al. (1989) Nociceptive responses of trigeminal neurons in SII-7b cortex of awake monkeys. *Brain Res* 484:314–324
8. Foreman RD, Blair RW, Ammons WS (1986) Neural mechanisms of cardiac pain. In: Cervero F, Morrison JFB (eds) *Progress in Brain Research*. Elsevier Science Publishers BV, New York, Amsterdam, Oxford, pp 227–243
9. Friedman DP, Murray EA, O'Neill JB et al. (1986) Cortical connections of the somatosensory fields of the lateral sulcus of macaques: evidence for a corticolimbic pathway for touch. *J Comp Neurol* 252:323–347
10. Greenspan JD, Winfield JA (1992) Reversible pain and tactile deficits associated with a cerebral tumor compressing the posterior insula and parietal operculum. *Pain* 50:29–39
11. Halgren E, Walter RD, Cherlow DG et al. (1978) Mental phenomena evoked by electrical stimulation of the human hippocampal formation and amygdala. *Brain* 101:83–117
12. Horie H, Yokota T (1990) Responses of nociceptive VPL neurons to intracardiac injection of bradykinin in the cat. *Brain Res* 516:161–164
13. Jones EG (1985) *The Thalamus*. Plenum, New York
14. Lenz FA, Seike M, Richardson RT et al. (1993) Thermal and pain sensations evoked by microstimulation in the area of human ventrocaudal nucleus. *J Neurophysiol* 70:200–212
15. Lenz FA, Gracely RH, Hope EJ et al. (1994) The sensation of angina can be evoked by stimulation of the human thalamus. *Pain* 59:119–125
16. Lenz FA, Gracely RH, Romanoski AJ et al. (1995) Stimulation in the human somatosensory thalamus can reproduce both the affective and sensory dimensions of previously experienced pain. *Nat Med* 1:910–913
17. Locke S, Angevine JB, Marin OSM (1961) Projection of magnocellular medial geniculate nucleus in man. *Anat.Rec* 139:249–250
18. Mehler WR (1962) The anatomy of the so-called “pain tract” in man: an analysis of the course and distribution of the ascending fibers of the fasciculus anterolateralis. In: French JD, Porter RW (eds) *Basic Research in Paraplegia*. Thomas, Springfield, pp 26–55
19. Meller ST, Gebhart GF (1992) A critical review of the afferent pathways and the potential chemical mediators involved in cardiac pain. *Neurosci* 48:501–524
20. Mishkin M (1979) Analogous neural models for tactual and visual learning. *Neuropsych* 17:139–151
21. Taguchi H, Masuda T, Yokota T (1987) Cardiac sympathetic afferent input onto neurons in nucleus ventralis posterolateralis in cat thalamus. *Brain Res* 436:240–252

## Angiogenesis

### Definition

Angiogenesis refers to the growth of new blood vessels, which is an important naturally occurring process in the organism, both in normal and tumor tissue. In the case of cancer, the new vessels provide oxygen and nutrition for the tumor cells and allow tumor cells to escape into the circulation and lodge into other organs (tumor metastases).

► [NSAIDs and Cancer](#)

## Angiography

### Definition

An Angiography is necessary for the diagnosis of CNS vasculitides.

► [Headache Due to Arteritis](#)

## Animal Models for Mononeuropathy

### Definition

Experimental procedures that produce partial lesion of the nerves supplying one appendage (fore leg or hind leg). Several animal models are available and are known to produce increased nociception.

► [Thalamotomy, Pain Behavior in Animals](#)

## Animal Models of Inflammatory Bowel Disease

JULIE A. CHRISTIANSON, BRIAN DAVIS  
University of Pittsburgh, Pittsburgh, PA, USA  
jcc26+@pitt.edu, davisb@dom.pitt.edu



## Animal Models and Experimental Tests to Study Nociception and Pain

JIN MO CHUNG

Department of Neuroscience and Cell Biology,  
University of Texas Medical Branch, Galveston,  
TX, USA  
jmchung@utmb.edu

### Introduction

Animal models and experimental tests are the fundamental tools that make studying nociception and pain possible. In fact, it would not be an exaggeration to say that progress in pain research has been made only to the degree that these essential research tools are available. Perhaps, the oldest and the most commonly used nociceptive test would be the ► [tail flick test](#) that was developed by D'Amour and Smith in 1941 (D'Amour and Smith 1941). Following this early test, which is a test for acute pain in normal rodents, many other tests and models for chronic or persistent pain using various animals have been developed. The availability of these new tests and models has made it possible for research on persistent pain to flourish during the last decade. The present section attempts to document the majority of commonly used animal models and experimental tests. Hence, this section would be a good reference source for those who want to know about these basic tools for pain research.

### Overview of Topics

#### Tests for Nociception and Pain

Nociceptive tests utilize observations of animal behavior after delivering noxious mechanical, heat or chemical stimuli to a defined body part. In the section, we will address a variety of tests used to study nociception and pain. Two of these tests, the ► [allodynia test, mechanical and cold allodynia](#) and the ► [Randall-Selitto paw pressure test](#), use a mechanical stimulus to elicit responses. The tail flick test, the ► [thermal nociception test](#) and the ► [Hot Plate Test \(Assay\)](#) use noxious heat as the stimulus. There are a number of ways to apply chemical stimuli to elicit pain behaviors. However, one of the most common methods is an injection of formalin into the paw of a rodent – the ► [formalin test](#).

The thermal hyperalgesia test and the allodynia test, in particular, have been widely used in recent years. The thermal hyperalgesia test, which was developed by Hargreaves et al. (1988), uses the latency of escape behaviors of a rodent after application of a noxious heat stimulus to estimate changes in the heat pain threshold. This test has hence been frequently used to quantify the development of heat hyperalgesia in various

painful conditions. The allodynia test in a neuropathic pain model using von Frey filaments was first conducted by Seltzer et al. (1990) and quantifies changes in mechanical threshold for pain behavior. Kim and Chung (1991; 1992) subsequently used von Frey filaments extensively to quantify mechanical allodynia in their model of neuropathic pain. All these tests are for quantification of pain behavior in various pain models.

### Animal Models

Numerous good animal models representing various pain syndromes have been developed in the past, particularly during the last decade. These include various musculoskeletal pain models (► [arthritis model, kaolin-carrageenan induced arthritis \(knee\)](#); ► [arthritis model, adjuvant-induced arthritis](#); ► [cancer pain model, bone cancer pain](#); ► [muscle pain model, ischemia-induced and hypertonic saline-induced](#); ► [Animal Models of Inflammatory Muscle Pain](#); ► [sprained ankle pain model](#)) and visceral pain models (pain originating from various parts of gastrointestinal tract, heart, kidney, pancreas, urinary bladder and female reproductive organs). In addition, there are a number of neuropathic pain models – produced by injuries to either the peripheral or the central nervous system.

In particular, there has been an explosion in the development of peripheral neuropathic pain models in recent years, as well as in studies conducted using them. The field of neuropathic pain was revolutionized by the initial development of a model by Bennett and Xie (1988), which was followed by other models (Seltzer et al. 1990; Kim and Chung 1992; Na et al. 1994; Decosterd and Woolf 2000). All these models have in common that they produce a partial nerve injury so that an area of the skin is partially denervated but a part of the innervation is left intact. Direct comparison of multiple models in a single study is rare, but Kim et al. (1997) compared 3 neuropathic pain models, the chronic constriction injury (CCI) (► [neuropathic pain model, chronic constriction injury](#)), partial sciatic nerve ligation (PSL) (► [neuropathic pain model, partial sciatic nerve ligation model](#)) and spinal nerve ligation (SNL) (► [neuropathic pain model, spinal nerve ligation model](#)) models. They found that these three models displayed similar behavioral patterns with minor differences in specific features, presumably due to the difference in populations and numbers of afferent fibers that are denervated *versus* those left intact in each model. For example, the CCI model showed a relatively larger magnitude of behavioral signs representing ongoing pain whereas the spinal nerve ligation (SNL) model displayed more robust mechanical allodynia. As far as the nature of injury is concerned, the SNL model is highly artificial in that it produces an injury to one



or two spinal nerves selectively, whereas the PSL model closely resembles the nerve injury produced by gun shot wounds, on which the description of classical causalgia was based (Mitchell 1872). On the other hand, if one wants to reduce the variability between animals, a stereotyped injury such as SNL would be beneficial. Therefore, having such a variety of models provides a good opportunity to select and use a model depending on the questions posed and the given circumstances. Another area of animal modeling that has flourished in recent years is the area of central neuropathic pain, particularly ► [spinal cord injury pain models](#). In the central nervous system, post-stroke pain models of the cerebral cortex as well as of the thalamus are available. In the spinal cord, we now have models for contusion, ischemic and focal injuries produced by mechanical as well as by chemical means.

Visceral pain is a clinically important topic. There are animal models representing pain arising from various visceral organs, ranging from the heart to the kidney, pancreas, urinary bladder and various parts of the gastrointestinal tract. All of these models attempt to imitate a clinical situation that causes pain, such as ischemia (e.g. angina), over-distension of the gastrointestinal tract or chemical/mechanical irritation of ductal structures.

#### Discussion and Future Direction

Although this section describes a number of animal models and experimental tests used to study nociception and pain, there are a large number of already developed tests and models that are not included here. We hope to be able to include them as their usage becomes more widespread. At the same time, there are a number of models and tests that need to be developed and these will be included in this Section as they become available. Therefore, this Section is expected to grow rapidly as we progress in pain research.

Ethical considerations in animal welfare are very important issues for all animal research, but this is especially important in pain studies because these require using painful stimuli yet the pain and stress of animals must be minimized. Therefore, although the nature of the studies calls for inducing some levels of painful stimuli, pain and stress must be kept at the minimal level. Fortunately, animals in most models do not display signs of severe chronic pain and discomfort as evidenced by normal weight gain and grooming. However, should the animal show signs of unbearable discomfort the experiment must be terminated by humanely euthanizing the animals. Maintaining pain and discomfort at the minimum level is important not only for the humane treatment of experimental animals but also for obtaining the most reliable scientific data without contamination by undesirable stress induced factors.

How to define what a good animal model is can be debatable. However, a good animal model should at least 1) replicate a human disease condition faithfully, 2) show little variability between investigators and between laboratories and 3) be easy to produce. Most of the models presented in this Section satisfy these criteria, however some are better in one aspect and worse in others and some are the other way around. A good model should also replicate the most important aspect of a human pain condition and employ animal tests most relevant to these aspects. A model may employ a testing method that is designed to be convenient for experimenters but which does not necessarily test the most relevant aspect of pain in patients. This is a shortcoming which should be corrected.

It is sometimes difficult to relate the results of tests in animal models to human diseases. For example, in the case of a disease with motor deficits, a question may arise as to whether motor deficits seen in animals would be the same as those seen in human patients. This is particularly a problem in pain research because animals cannot verbally express sensory experience and we have to rely on their behaviors and our interpretation of them. Such an indirect approach leaves much room for a subjective interpretation. Therefore, we must pay particular attention to this problem when we deal with animal models and testing in animals.

As mentioned above, animals in all the models described in this Section display pain behavior, but the intensity of the pain seems to be much less than the pain that is intended to be modeled. For example, although it is common for humans to lose their appetite and to lose weight while suffering from chronic pain, in most animal models of pain the animals seldom show signs of severe suffering for an extended period. Another example would be that many neuropathic pain sufferers have excruciating sensitivity to tactile stimuli so that even gentle movement of hair will cause pain. However, rats in all neuropathic pain models can be handled and the affected areas touched without too much of a response. Furthermore, these rats usually bear some weight during locomotion although they invariably have some motor deficits. Why is there such a difference in the intensity of pain? It is possible that none of the developed models truly represent a severe human pain condition. It is also possible that animals react differently from humans to the same intensity of pain and that the models may still be valid. We can argue for one or the other with no definite answer, but this is something we need to consider when we deal with animal models.

Frequently, most of the animals used in a given animal model may consistently show signs of pain. Such consistency is a good thing in a pain model since there will be less variability between animals. On the other hand, this can be viewed as a bad feature in a model that

represents a pain syndrome, since it is rare for all patients with a particular disease state to develop pain. For example, only 10–15% of patients with a peripheral nerve injury develop neuropathic pain, yet virtually all rats in neuropathic pain models show pain behaviors. Why is this true? Are these still good models? These are difficult questions to answer. One explanation commonly used is that a genetic factor may play a role so that some patients may have a genetic make-up prone to develop pain after peripheral nerve injury. In support of this contention, there are vast differences in pain behavioral responses to a peripheral nerve injury among different strains of rats or mice. However, there is no direct proof indicating that this is the true explanation. This is a factor we need to keep in mind as well when conducting studies of animal models.

Although animal models for many painful conditions are described in this Section, more good animal models are needed for common painful conditions, such as lower back pain, headaches and myofascial pain. The main reason for the lack of such models is that it is technically difficult to develop them. However, it is imperative to develop animal models for these clinically common painful conditions so that we can make scientific progress in understanding these important pain conditions.

### Conclusion

Many good clinically relevant animal models for various painful conditions are available now and their avail-

ability provides powerful tools for scientific studies, as well as for the development of new analgesic drugs. Undoubtedly, we will need to refine existing models and to develop new ones representing other painful conditions.

### References

1. Bennett GJ, Xie Y-K (1988) A peripheral mononeuropathy in rat that produces disorders of pain sensation like those seen in man. *Pain* 33:87–107
2. D'Amour FE, Smith DL (1941) A method for determining loss of pain sensation. *J Pharmacol Exp Ther* 72:74–79
3. Decosterd I, Woolf CJ (2000) Spared nerve injury: an animal model of persistent peripheral neuropathic pain. *Pain* 87:149–158
4. Hargreaves K, Dubner R, Brown F et al. (1988) A new and sensitive method for measuring thermal nociception in cutaneous hyperalgesia. *Pain* 32:77–88
5. Kim SH, Chung JM (1991) Sympathectomy alleviates mechanical allodynia in an experimental animal model for neuropathy in the rat. *Neurosci Lett* 134:131–134
6. Kim SH, Chung JM (1992) An experimental model for peripheral neuropathy produced by segmental spinal nerve ligation in the rat. *Pain* 50:355–363
7. Kim KJ, Yoon YW, Chung JM (1997) Comparison of three rodent neuropathic pain models. *Exp Brain Res* 113:200–206
8. Mitchell SW (1872) *Injuries of nerves and their consequences*. JB Lippincott, Philadelphia, pp 252–281
9. Na HS, Han JS, Ko KH et al. (1994) A behavioral model for peripheral neuropathy produced in rat's tail by inferior caudal trunk injury. *Neurosci Lett* 177:50–52
10. Seltzer Z, Dubner R, Shir Y (1990) A novel behavioral model of neuropathic pain disorders produced in rats by partial sciatic nerve injury. *Pain* 43:205–218

### Synonyms

Colitis; Crohn's Disease; Inflammatory Bowel Disease, Animal Models; Ulcerative Colitis

### Definition

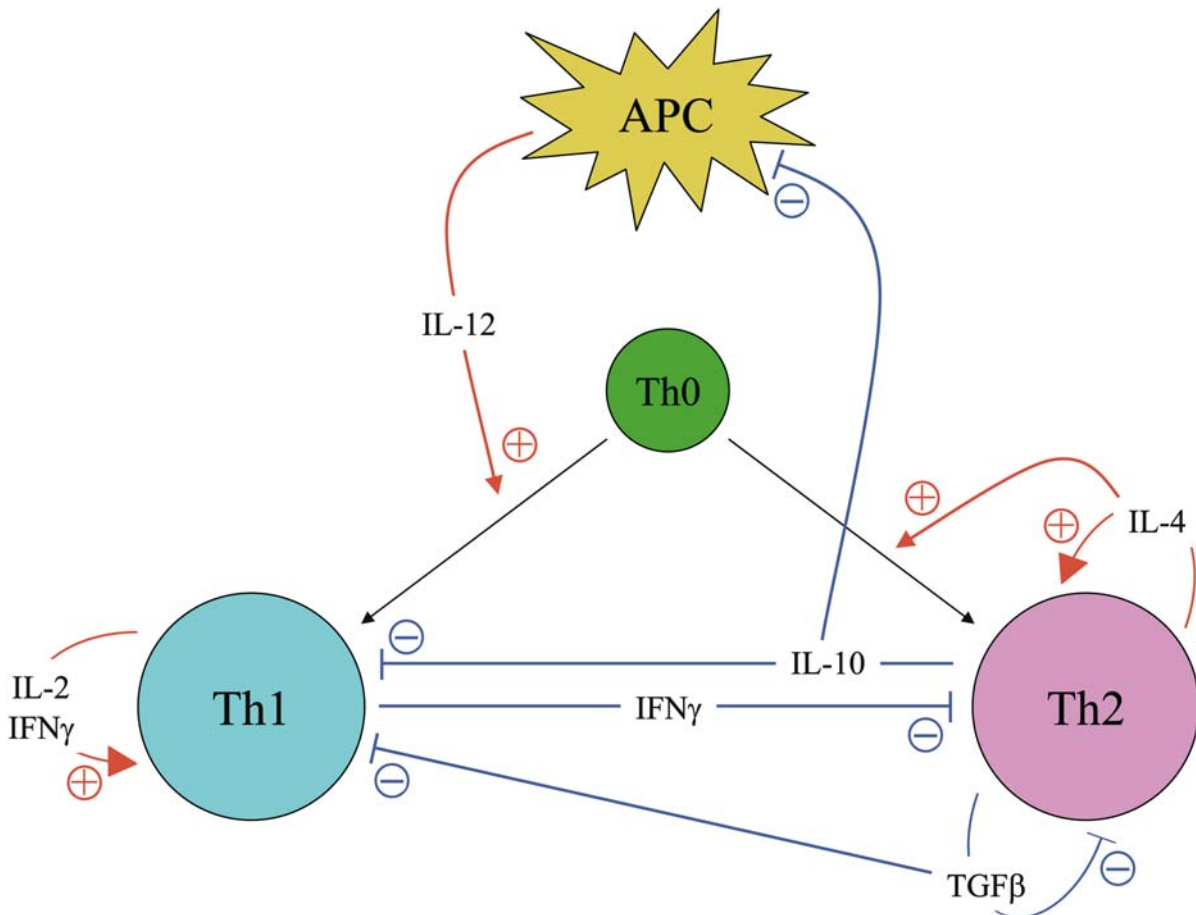
Inflammatory bowel disease (IBD) manifests as a complex chronic inflammatory disorder thought to be caused by a combination of environmental and genetic factors. Clinically, IBD presents as either ulcerative colitis (UC) or Crohn's disease (CD), which predominantly affect the colon and/or the distal small intestine, respectively (Hendrickson et al. 2002).

### Characteristics

Approximately 600,000 Americans suffer from IBD, with the majority of patients diagnosed with the disease during their third decade of life. The most common symptoms include diarrhea, abdominal pain, fever, weight loss, ► **arthralgias** and arthritis (Hendrickson et al. 2002). While the exact causes of IBD remain unknown, certain environmental and genetic factors

have been shown to play a role in the development of IBD. Environmental factors may include smoking, diet, physical activity, childhood infections, microbial agents and stress (Fiocchi 1998). The familial incidence of both CD and UC is remarkably high. The frequency of IBD in first-degree relations has been reported to be as high as 40%. Among populations, IBD is most common among whites of European descent, although it is present in all races and ethnic groups (Fiocchi 1998).

The onset of IBD is generally thought to arise from T lymphocytes infiltrating a weakened epithelial lining and thereby initiating a pathological immune response within the bowel (Bhan et al. 1999; Blumberg et al. 1999). For IBD, the focus of research has been on CD4 T cells, also known as T-helper cells. These cells are capable of secreting large amounts of ► **cytokine** or ► **growth factors** that affect other immune cells and interacting tissues. Mature CD4 cells can be divided into Th1 and Th2 cells based on the complement of cytokines they produce. Th1 cells secrete IL-2, IFN $\gamma$  and TNF, whereas Th2 cells secrete IL-4, IL-5, IL-13



**Animal Models of Inflammatory Bowel Disease, Figure 1** Imbalance between T-helper cells may contribute to CD and UC. T-helper cell type 1 (Th1) and T-helper cell type 2 (Th2) participate in cell-mediated immunity and antibody mediated immunity, respectively. Antigen presenting cells (APC) produce IL-12 in response to specific antigens and this induces undifferentiated T-helper cells (Th0) to become Th1 cells. The cytokine(s) responsible for inducing Th0 cells to become Th2 cells have not been identified. Th1 and Th2 cells both secrete specific cytokines that act through positive and negative feedback loops. Th1 cytokines (IL-2, IFN $\gamma$ ) enhance Th1 cell proliferation while also inhibiting Th2 cell proliferation. IFN $\gamma$  also functions to increase Th1 cell differentiation by up-regulating IL-12 production. Th2 cytokines both increase (IL-4) and decrease (TGF $\beta$ ) the proliferation of Th2 cells. TGF $\beta$  and IL-10 both suppress cytokine production by Th1 cells and IL-10 also decreases the differentiation of Th1 cells by down-regulating IL-12 production.

and TGF $\beta$  cytokines (Fig. 1). A balance between these two cell types appears to be required for immunological homeostasis, as disruption of this balance can lead to pathological inflammation. Interestingly, Th1 and Th2 cell types predominate in CD and UC, respectively, and because of this, many animal models of IBD employ genetic deficiencies or antibodies against the cytokines associated with Th1 or Th2 CD4 cells (Bhan et al. 1999; Blumberg et al. 1999).

The important role played by these immune cells does not mean that environmental factors do not contribute significantly to the onset of IBD. Multiple studies have shown that animals housed in a pathogen-free environment do not develop IBD (Kim and Berstad 1992; Wirtz and Neurath 2000). This indicates that while alterations in the immune system are important for development of IBD, in most cases the development of pathology requires an environmental trigger that may include pathogens, stress and nutrition.

#### Animal Models

Animal models of IBD can be separated into four main categories: spontaneous colitis, inducible colitis, adoptive transfer and genetically engineered. Each model offers a novel approach to studying IBD, however none presents an exact model of the human condition.

#### Spontaneous Colitis

Symptoms of IBD occur naturally and are studied in C3H/HeJBir mice, SAMP1/Yit mice, cotton top tamarins and juvenile rhesus macaques. C3H/HeJBir mice can develop inflammation in the colon that peaks between 3–6 weeks of age and generally resolves by 10–12 weeks of age (Wirtz and Neurath 2000; Hendrickson et al. 2002). In contrast, SAMP1/Yit mice develop inflammation in the distal small intestine and cecum by 20 weeks of age with increasing lesion severity and incidence (Blumberg et al. 1999; Wirtz and Neurath 2000; Hendrickson et al. 2002). Cotton top tamarins

and juvenile rhesus monkeys are both primate models of UC, hallmarked by mucosal inflammation occurring only in the colon (Kim and Berstad 1992; Ribbons et al. 1997; Wirtz and Neurath 2000). Considering the high frequency of familial IBD, spontaneous models of IBD are highly useful in the study of genetic susceptibility to IBD.

### Inducible Colitis

Interruption of the mucosal barrier of the bowel can lead to transient or chronic inflammation. Various agents can induce IBD in this manner including formalin, acetic acid, carrageenan, dextran sulfate sodium (DSS), 2,4,6-trinitrobenzene sulfonic acid (TNBS), dinitrobenzene sulfonic acid (DNBS), indomethacin, oxazolone or ethanol.

Intracolonic administration of dilute formalin or acetic acid induces a transient inflammation in the colon of rats or mice. Their effects occur very quickly and have been used extensively in the study of visceral pain (Kim and Berstad 1992). In contrast, chronic inflammation can be induced by oral ingestion of carrageenan or DSS, subcutaneous injection of indomethacin, or intracolonic administration of TNBS, DNBS, oxazolone or ethanol. Carrageenan induces an early mucosal inflammation of the cecum with subsequent mucosal inflammation of the colon of rodents (Kim and Berstad 1992). Ingestion of DSS initially results in lesions and crypt formation within the mucosal lining of the colon of both rats and mice. This is followed by a secondary inflammation and infiltration of cytokines (Kim and Berstad 1992; Mahler et al. 1998). In mice, rats and rabbits, intracolonic administration of TNBS or DNBS results in epithelial necrosis that leads to increased mucosal permeability and transmural inflammation (Kim and Berstad 1992; Elson et al. 1996). It is interesting to note that mouse strain differences exist regarding the susceptibility to either DSS or TNBS-induced IBD (Mahler et al. 1998). C3H/HeJ mice are highly susceptible to both DSS and TNBS, whereas C57Bl/6 and DBA/2 mice are less vulnerable to DSS and resistant to TNBS, again emphasizing the importance of genetic factors in the occurrence of IBD (Elson et al. 1996; Mahler et al. 1998). In rats, subcutaneous injection of indomethacin produces both an acute and a chronic inflammation within the small bowel, as well as epithelial injury measurable by mucosal permeability (Yamada et al. 1993). Mice or rats given intrarectal oxazolone develop a severe mucosal inflammation of the distal colon (Wirtz and Neurath 2000). Similarly, intrarectal ethanol results in destruction of the surface epithelium and necrosis extending throughout the mucosal layer of both mice and rats (Kamp et al. 2003). Inducible models are important in the study of IBD in that they establish a mechanical or chemical disruption of the mucosal barrier within the bowel, thereby providing an adequate model to study the chain of events that occur

during the initial activation of the mucosal immune system.

### Adoptive Transfer

IBD can be generated by transferring activated immune cells from normal animals into immunocompromised host animals. The most common model involves transferring CD4-positive T cells with a high expression of CD45RB (CD4<sup>+</sup>CD45RB<sup>high</sup>) from wild type animals into severe combined immunodeficient (SCID) or recombination activating gene (RAG) knockout mice (Wirtz and Neurath 2000; Hendrickson et al. 2002). CD4<sup>+</sup>CD45RB<sup>high</sup> T cells produce high levels of Th1 cytokines, which have been shown to play a role in the induction and maintenance of IBD, in particular CD (Bhan et al. 1999; Blumberg et al. 1999). IBD can also be induced by introducing activated hsp60-specific CD8<sup>+</sup> T cells into immunodeficient or T cell receptor (TCR)  $\beta$ -/- mice (Wirtz and Neurath 2000). This results in degeneration of the mucosal epithelium in the small bowel with massive leukocytic infiltration within the lamina propria and epithelial layers. The adoptive transfer models have provided an excellent paradigm for gaining a better understanding for the role of T cells in the development and maintenance of IBD.

### Genetically Engineered

The use of genetically altered mice has provided an excellent approach to studying the roles of specific immune cells and cytokines in IBD. As mentioned previously, an imbalance of Th1 and Th2 type cytokines has been shown to play a role in IBD (Bhan et al. 1999; Blumberg et al. 1999). Several transgenic and knockout mouse models have been generated to study the roles of Th1 and Th2 cytokines in IBD. Over-expression of HLA-B27 or STAT-4 both increase the production of Th1 type cytokines, including TNF $\alpha$  and IFN $\gamma$ , most likely through the activation of IL-12 (Wirtz and Neurath 2000; Hendrickson et al. 2002). Similarly, mice with a deletion of IL-2, IL-2R $\alpha$ , IL-10, CRF2-4, G $\beta$ 2, STAT-3 or the AURICH region of TNF overproduce Th1 cytokines and develop symptoms of IBD (Wirtz and Neurath 2000; Hendrickson et al. 2002). On the other hand, over-expression of IL-7 or a deletion of TCR- $\alpha$  results in a Th2 mediated IBD, mostly due to an increased production of Th1 cells (Wirtz and Neurath 2000).

Genetic models have also been generated to investigate aspects of IBD other than cytokine production. Disruption in the integrity of the intestinal epithelium has been implicated in IBD. This has been demonstrated in a mouse model that over-expresses a dominant negative form of N-cadherin using a small intestine-specific promoter (Wirtz and Neurath 2000). Similarly, deletion of the multiple drug resistant gene (*mdr1a*) resulted in IBD, solely due to the lack of *mdr1a* expression on intestinal epithelial cells (Wirtz and Neurath 2000). Intestinal trefoil factor (ITF) is lumenally secreted after



inflammation and is thought to aid in maintaining the barrier function of mucosal surfaces and facilitating healing processes after injury. Mice with a genetic deletion of ITF are significantly more susceptible to induction of IBD by DSS, indicated by increased colonic ulceration and morbidity (Mashimo et al. 1996; Wirtz and Neurath 2000). To investigate the role of enteric ganglia cells in IBD, a mouse model was developed that expresses herpes simplex virus (HSV) thymidine kinase (TK), driven by the glia-specific glial fibrillary acidic protein (GFAP) promoter. When the antiviral agent ganciclovir (GCV) is injected subcutaneously, the HSV-TK metabolizes the GCV into toxic nucleotide analogs that induce cell death within their host cells, in this case enteric glial cells. Disruption of ileal and jejunal glial cells resulted in overt inflammation of the small bowel, however the colon remained unaffected (Bush et al. 1998). Genetic models have provided an excellent tool for investigating the possible roles of specific cytokines and structural proteins in IBD.

### Implications for Pain Studies

As previously mentioned, patients with IBD often suffer from abdominal pain. Animal models, primarily models of inducible colitis, are often used to investigate changes in nociceptive processing that arise from IBD. The two most common methods for assessing visceral pain in animals are colorectal distension (CRD) and the acetic acid writhing test. CRD uses balloon distension of the distal colon to induce activation of both first and second order sensory afferents and contraction of abdominal muscles (visceromotor response), both of which can be quantifiably measured to determine visceral sensitivity (Kamp et al. 2003). In the writhing test, ► **intraperitoneal** injections of acetic acid induce abdominal contractions along the length of the torso with corresponding arching of the back (Martinez et al. 1999). The mechanisms underlying the acetic acid writhing test are relatively unknown; therefore CRD is a much more reliable and consequently more widely used test for visceral hypersensitivity.

Several studies have used CRD as a means to study the effects of acute and chronic colon inflammation in rodents. Intracolonic application of acetic acid or ethanol was shown to significantly increase the number of abdominal contractions, as well as the visceromotor response, during CRD (Martinez et al. 1999; Kamp et al. 2003). Similar results were observed in a TNBS-induced model of IBD (Sengupta et al. 1999). Visceral hyperalgesia has largely gone unstudied in genetic models of IBD. This is unfortunate as these models present an excellent opportunity for investigating the possible roles that cytokines and other molecules may play in the genesis of visceral hyperalgesia associated with IBD.

Animal models of IBD provide researchers with the tools to investigate specific aspects of the disease in an *in vivo* setting. While none of the models wholly represents the disease as it appears in humans, they each provide a use-

ful tool with which to study specific aspects of the disease, including the manifestation of visceral hyperalgesia.

### References

1. Bhan AK, Mizoguchi E, Smith RN et al. (1999) Colitis in transgenic and knockout animals as models of human inflammatory bowel disease. *Immunol Rev* 169:195–207
2. Blumberg RS, Saubermann LJ, Strober W (1999) Animal models of mucosal inflammation and their relation to human inflammatory bowel disease. *Curr Opin Immunol* 11:648–656
3. Bush TG, Savidge TC, Freeman TC et al. (1998) Fulminant jejuno-ileitis following ablation of enteric glia in adult transgenic mice. *Cell* 93:189–201
4. Elson CO, Beagley KW, Sharmanov AT et al. (1996) Hapten-induced model of murine inflammatory bowel disease: mucosa immune responses and protection by tolerance. *J Immunol* 157:2174–2185
5. Fiocchi C (1998) Inflammatory bowel disease: etiology and pathogenesis. *Gastroenterology* 115:182–205
6. Hendrickson BA, Gokhale R, Cho JH (2002) Clinical aspects and pathophysiology of inflammatory bowel disease. *Clin Microbiol Rev* 15:79–94
7. Kamp EH, Jones RC 3rd, Tillman SR et al. (2003) Quantitative assessment and characterization of visceral nociception and hyperalgesia in mice. *Am J Physiol Gastrointest Liver Physiol* 284:434–444
8. Kim HS, Berstad A (1992) Experimental colitis in animal models. *Scand J Gastroenterol* 27:529–537
9. Mahler M, Bristol IJ, Leiter EH et al. (1998) Differential susceptibility of inbred mouse strains to dextran sulfate sodium-induced colitis. *Am J Physiol* 274:G544–551
10. Martinez V, Thakur S, Mogil JS et al. (1999) Differential effects of chemical and mechanical colonic irritation on behavioral pain response to intraperitoneal acetic acid in mice. *Pain* 81:179–186
11. Mashimo H, Wu DC, Podolsky DK et al. (1996) Impaired defense of intestinal mucosa in mice lacking intestinal trefoil factor. *Science* 274:262–265
12. Ribbons KA, Currie MG, Connor JR et al. (1997) The effect of inhibitors of inducible nitric oxide synthase on chronic colitis in the rhesus monkey. *J Pharmacol Exp Ther* 280:1008–1015
13. Sengupta JN, Snider A, Su X et al. (1999) Effects of kappa opioids in the inflamed rat colon. *Pain* 79:175–185
14. Wirtz S, Neurath MF (2000) Animal models of intestinal inflammation: new insights into the molecular pathogenesis and immunotherapy of inflammatory bowel disease. *Int J Colorectal Dis* 15:144–160
15. Yamada T, Deitch E, Specian RD et al. (1993) Mechanisms of acute and chronic intestinal inflammation induced by indomethacin. *Inflammation* 17:641–662

## Animal Models of Inflammatory Muscle Pain

- Muscle Pain Model, Inflammatory Agents-Induced

## Animal Models of Inflammatory Myalgia

- Muscle Pain Model, Inflammatory Agents-Induced



## Ankylosing Spondylitis

### Definition

Ankylosing Spondylitis is an inflammatory joint disease that is characterized by enthesitis, an inflammation at points of attachment of tendons to bone. The vertebrae may become linked by bony bridging (bamboo spine).

- ▶ [Chronic Low Back Pain, Definitions and Diagnosis](#)
- ▶ [NSAIDs and their Indications](#)
- ▶ [Sacroiliac Joint Pain](#)

## Ankylosis

### Definition

Bony ankylosis occurs when bone remodeling as a result of inflammation or damage occurs, resulting in a fusion of the joint. This causes joint immobility. Fibrous ankylosis occurs when inflammation of fibrous or connective tissues of the joint results in proliferation of tissue, and results in reduced mobility or stiffness of the joint.

- ▶ [Arthritis Model, Adjuvant-Induced Arthritis](#)

## Annulus Fibrosus

### Definition

Annulus Fibrosus is an outer anatomical structure of the intervertebral disc composed of fibrocartilage and fibrous tissue, delimiting the nucleus pulposus. The annulus fibrosus has a nociceptive innervation.

- ▶ [Lumbar Traction](#)
- ▶ [Whiplash](#)

## Anorexia

### Definition

Loss of appetite.

- ▶ [Clinical Migraine with Aura](#)

## Antecedents and Consequences of Behaviour

### Definition

The set of factors that occurred temporally before and after a behavioral event or experience. The antecedents may contribute to an individual's expectations for the future, and the behavioral responses that are received in

close proximity to an event can serve to influence subsequent responses and experiences. Thus, the antecedents and consequences play a role in determining the onset, maintenance, and exacerbation of inappropriate behaviours, or contribute to appropriate and adaptive responses to similar situations and sensations in the future.

- ▶ [Psychological Assessment of Pain](#)

## Anterior Cingulate Cortex

### Synonyms

ACC

### Definition

The anterior cingulate cortex (ACC), a component of the limbic system, is an area of the brain located just above the corpus callosum. The ACC is involved in many functions, including attention, emotion, and response selection, among others. Its descending connections to the medial thalamic nuclei and the periaqueductal gray, along with evidence from brain imaging studies, also support a role for the ACC in the descending modulation of pain.

- ▶ [Cingulate Cortex, Nociceptive Processing, Behavioral Studies in Animals](#)
- ▶ [Descending Circuits in the Forebrain, Imaging](#)

## Anterior Lumbar Interbody Fusion

- ▶ [ALIF](#)

## Anterior Primary Ramus

### Definition

The anterior branch of a spinal nerve that provides the nerve supply to the extremities (e.g. brachial plexus) and the chest wall.

- ▶ [Pain Treatment, Spinal Nerve Blocks](#)

## Anterior Pulvinar Nucleus

### Definition

The Anterior Pulvinar Nucleus extends from the medial pulvinar and posterior nuclei, situated between the centre median and ventral posterior nuclei.

- ▶ [Thalamic Nuclei Involved in Pain, Human and Monkey](#)

## Anterior Spinothalamic Tract

- ▶ Paleospinothalamic Tract

## Anterograde Axonal Tracer (Anterograde Labeling)

### Definition

A substance (protein, enzyme) that is injected at the level of the neuronal soma. It is incorporated within the soma, then conveyed in an anterograde (orthodromic) direction in the axon up to the endings. The tracer is generally colored with a histochemical reaction, with or without an earlier immune amplification reaction.

- ▶ Parabrachial Hypothalamic and Amygdaloid Projections
- ▶ Spinal Dorsal Horn Pathways, Dorsal Column (Visceral)
- ▶ Spinohypothalamic Tract, Anatomical Organization and Response Properties

## Anterograde Transport

### Definition

Anterograde transport is the movement of proteins away from the cell body.

- ▶ Opioid Receptor Trafficking in Pain States

## Anterolateral Cordotomy

### Definition

Ablation of the spinothalamic tract by open surgical section or through the application of a thermal coagulation probe.

- ▶ Cancer Pain Management: Neurosurgical Interventions
- ▶ Percutaneous Cordotomy
- ▶ Spinothalamic Neuron

## Antiarrhythmics

- ▶ Drugs Targeting Voltage-Gated Sodium and Calcium Channels

## Anticholinergics

### Definition

A class of drugs also referred to as antimuscarinics that are used as smooth muscle antispasmodics and antisecretory drugs. Anticholinergic medications include the natural belladonna alkaloids (atropine and hyoscine) and synthetic and semisynthetic derivatives. The synthetic and semisynthetic derivatives are separated into tertiary amines (i.e. dicyclomine), and quaternary ammonium compounds, (i.e. hyoscine butylbromide and glycopyrrolate). The quaternary ammonium compounds are less lipid soluble than the natural alkaloids, and are therefore less likely to cross the blood-brain barrier and cause side effects such as agitation and hallucinations.

- ▶ Cancer Pain Management, Adjuvant Analgesics in Management of Pain Due To Bowel Obstruction

## Anticipatory Anxiety

### Definition

Anticipatory anxiety refers to the perceived dangerousness or threat-value of an impending situation or experience. In relation to experimental pain, anticipatory anxiety relates to a child's perception of the extent to which the upcoming pain stimulus may lead to harm or damage to one's physical integrity. With respect to pain, it tends to lead to hyperalgesia and to an attentional focus on pain.

- ▶ Experimental Pain in Children
- ▶ Respondent Conditioning of Chronic Pain

## Anticonvulsant (Agent)

### Definition

Antiepileptics. An agent that prevents or arrests seizures, which are primary used in the management of epilepsy.

- ▶ Drugs Targeting Voltage-Gated Sodium and Calcium Channels
- ▶ Migraine, Preventive Therapy
- ▶ Postoperative Pain, Anti-Convulsant Medications
- ▶ Post-Seizure Headache

## Antidepressant Analgesics in Pain Management

PETER N. WATSON<sup>1</sup>, HAROLD MERSKEY<sup>2</sup>

<sup>1</sup>Department of Medicine, University of Toronto, Toronto, ON, Canada

<sup>2</sup>Department of Psychiatry, University of Western Ontario, London, ON, Canada  
peter.watson@utoronto.ca

### Synonyms

Tricyclic-Type Antidepressants  
More noradrenergic (N): e.g. nortriptyline, desipramine, maprotiline (tetracyclic)  
More serotonergic (S): e.g. clomipramine  
Monoamine Oxidase Inhibitors  
Selective serotonin reuptake inhibitors (SSRIs) e.g. fluoxetine, fluvoxamine, sertraline, paroxetine  
Atypical Antidepressants  
Serotonin Norepinephrine Reuptake Inhibitors

### Definition

Antidepressants are a broad category of drugs originally aimed at treating depressed mood; however, there is an independent analgesic effect that occurs at lower doses than the antidepressant effect. They are categorized in different ways, based on structure (tricyclic, tetracyclic) and their putative mechanism of action (serotonin and norepinephrine reuptake inhibition, monoamine oxidase inhibition).

### Characteristics

#### Historical

There is a large body of scientific evidence that a variety of pain disorders are relieved by antidepressant therapy. The roots of this information have been neglected to-date, and historical studies of seminal importance have been omitted from reviews of these drugs. In the early 1960s, publications of case series in the French literature reported relief of pain (in some cases neuropathic), by injectable and oral imipramine. Although responses seemed most pronounced in patients with psychological disorders, a few were described as having no psychiatric diagnosis. The mechanism of action was unclear to these investigators, but a leucotomy-like action and an antihistaminic effect were suggested. Lance and Curran (1964) studied amitriptyline in chronic tension headache by controlled trial, and noticed that most patients were not depressed and stated that “there was no evidence that amitriptyline influenced selectively those patients who had some degree of depression” They said that “amitriptyline seems unlikely to exert a significant analgesic effect in tension headache” despite their finding of a lack of effect on depression. They thought that an effect on vasodilation may have resulted in the benefit seen. The French authors’ results with imipramine were referred to in a study of amitriptyline in postherpetic neuralgia (PHN) by Woodforde (1965) and appeared to have influenced him. Woodforde described the relief of PHN with amitriptyline in intractable cases of long duration and with prolonged

follow-up. He thought patients were depressed, and that pain relief was associated with relief of depression. Merskey and Hester (1972), aware of the 1964 Lance and Curran report, published a report of patients with chronic pain, including 7 patients with PHN treated successfully with a tricyclic (usually amitriptyline) and a phenothiazine (usually pericyazine). They stated that they thought that these drugs had an analgesic effect independent of a mood-altering action. Taub (1973, 1974) chose amitriptyline to treat PHN because of its sedative and antidepressant effect. He added a phenothiazine because of persistent pain and anxiety. He described eventually using perphenazine because of its better side effect profile. He observed that this latter drug seemed to him to be the pain-relieving agent in the combination. Taub’s regimen of amitriptyline 75 mg and perphenazine 1 mg TID came into widespread use in North America and, along with clinical experience, led Watson and others to conduct the initial randomized controlled trial (RCT) of amitriptyline alone vs placebo in PHN (Watson et al. 1982), and because of Merskey’s work (1972), to investigate the possibility of an independent analgesic action for this drug.

### Pharmacodynamics

The original reason for the treatment of chronic pain with antidepressants appears to have been for the relief of concomitant depression. A proportion of chronic pain patients have been shown to be depressed and show an increased incidence of familial depression and response to tricyclic antidepressants. RCTs have demonstrated that relief of pain occurs as well as depression relief with these agents. Pain relief, separate from the antidepressant effect, suggesting an analgesic action, has been reported since the 1960’s. RCTs have repeatedly and clearly demonstrated the separation of the analgesic and antidepressant effects.

The earliest concept of the mechanism of antidepressant analgesia was that this occurred via pain-inhibiting systems that descend from the brainstem onto the dorsal horn of the spinal cord. The earliest candidate involved an endorphin link from the periaqueductal gray area to the raphe nucleus in the mid-pons, and then a serotonergic (S) connection from the raphe to the dorsal horn of the spinal cord. Another inhibitory system extends from the locus coeruleus in the lateral pons to the dorsal horn which involves noradrenaline (N). RCTs have indicated that the selective S drugs appear either to be ineffective or less effective than N agents and those with a mixed effect on S + N. The N agent maprotiline has been shown to be effective, but comparative trials indicate that it is probably less effective than amitriptyline (S + N). The more effective antidepressants for chronic pain appear to be amitriptyline and its metabolite nortriptyline. A meta-analysis of 39 placebo-controlled trials of antidepressant analgesia in chronic pain has found that a larger effect size occurs with the agents that combine

**Antidepressant Analgesics in Pain Management, Table 1** Number needed to treat (NNT) data in some neuropathic pain conditions

DRUG	CONDITION			COMMENTS
	Postherpetic Neuralgia	Diabetic Neuropathy	Painful Pain	
<b>ANTIDEPRESSANTS</b>				
McQuay et al. 1996	2.3	3.0		1.7 systematic review
Sindrup and Jensen 1999	2.3	2.4		1.7 review
Collins et al. 2000	2.1	3.4		systematic review
Sindrup et al. 2003				
<b>IMIPRAMINE</b>				
Sindrup et al. 2003			2.7	RCT
<b>VENLAFAXINE</b>				
Sindrup et al. 2003			5.2	RCT
<b>GABAPENTIN</b>				
Sindrup and Jensen 1999	3.2	3.7		systematic review
<b>PREGABALIN</b>				
Dworkin et al. 2003	3.4			RCT
<b>OXYCODONE</b>				
Watson et al. 1998	2.5			RCT
Watson et al. 2003		2.6		RCT
<b>TRAMADOL</b>				
Sindrup and Jensen 1999			3.4	systematic review

N and S effects than the more specific drugs (Onghena and Van Houdenhove 1992). The older antidepressants are, however, relatively “dirty drugs” and act on multiple receptors and have multiple effects. It has been suggested that relief of pain might be due to an anxiolytic or sedative effect. This seems unlikely. Other actions that possibly could contribute are the anticholinergic effect, an antihistaminic effect, an anti-inflammatory effect due to the inhibition of prostaglandin synthetase or a calcium channel blocking action. Recent attractive ideas, in light of current thinking, are that these drugs may be n-methyl d-aspartate (NMDA) antagonists, or that they have a sodium channel blocking effect.

#### Evidence-Based Studies

In terms of the published RCTs, favourable trials are more likely to be found in arthritis headache, PHN, and painful diabetic neuropathy (PDN), in which all published trials are favourable. Only 40–50% of trials were positive in other kinds of chronic non-malignant pain such as fibromyalgia and low back pain. This finding may simply be due to a failure to report negative trials in some conditions. A summary of published literature on the effect of anti-depressants on pain is presented in Table 1.

#### Acute Pain Studies

The acute pain studies are few in number, with mainly negative studies of amitriptyline and desipramine in postoperative pain (Kerrick et al. 1993; Levine et al. 1986), although the potentiation of morphine by desipramine and not amitriptyline is of interest (Levine et al. 1986). The duration and dose may have been inadequate to show an effect in these trials. The solitary positive trial (Stein et al. 1996) was in acute low back pain and used a higher dose of amitriptyline than is commonly used for pain relief (150 mg).

#### Cancer Pain

The cancer pain RCTs were also few and notable because of the relief of neuropathic pain in breast cancer by amitriptyline (Kalso et al. 1995) and venlafaxine (Tasmuth et al. 2002), the amitriptyline dose in the favourable trial (Kalso et al. 1995) being higher (50–100 mg) than that in an unfavourable study in the same condition (30–50 mg) (Mercadante 2002).

#### Chronic Non-Malignant, Non-Neuropathic Pain

Results in a number of chronic nonmalignant, non-neuropathic disorders (CNMNNP) have demonstrated that a variety of antidepressants with a mixed effect

**Antidepressant Analgesics in Pain Management, Table 2** Comparative studies on the effect of anti-depressants on pain

Outcome of Trial	Author(s) of study
Effect on chronic, malignant, non-neuropathic disorders (CNMNNP)	
Only amitriptyline (N+S) relieved arthritic pain compared to desipramine(N) and trazodone(S)	Frank et al. (1988) <i>Journal of Rheumatology</i> 15:1632–1638
Combination of fluoxetine(S) and amitriptyline better than either alone in fibromyalgia; however, the dose of amitriptyline was low at 25 mg	Goldenberg (1996) <i>Arthritis and Rheumatism</i> 39:1852–1859
Fluoxetine (S) better than amitriptyline(S+N) in a variety of rheumatic conditions but again the dose of amitriptyline was only 25 mg	Usha et al. (1996) <i>Anaesthesia Analgesia</i> 83: 371–375
Effect on Neuropathic Pain	
Amitriptyline (S+N) is more effective than maprotiline (N)	Watson et al. (1992) <i>Pain</i> 48:29–36
Nortriptyline (N) has less significant adverse effects than amitriptyline	Watson et al. (1998) <i>Neurology</i> 51:1166–1171
Opioids thought to be more effective than tricyclic antidepressants in a comparative study in PHN	Raja et al. (2002) <i>Neurology</i> 59:1015–1021
Comparison RCTs in PDN indicate that amitriptyline (S+N) and desipramine (N) relieve pain but fluoxetine (S) does not.	Max et al. (1992) <i>New England Journal of Medicine</i> 326:1250–1256
In PDN, amitriptyline(S+N) appears more effective than maprotiline (N), an identical result to that in PHN	Vrethem et al. (1997) <i>Clinical Journal of Pain</i> 12:313–323
An RCT in PHN (Morello et al. 1999) has shown amitriptyline to be equal to gabapentin in pain relief and adverse events.	Morello et al. (1999) <i>Archives of Internal Medicine</i> 159:1931–1937
S agent clomipramine may be more effective than desipramine(N).	Sindrup et al. (1990) <i>Br J Clin Pharmacol</i> 30:683–691
Favourable response of NP to topical doxepin	McLeane (2000) <i>British Journal of Clinical Pharmacology</i> 49(6):574–579
Favourable response of NP to bupropion	Semenchuk et al. (2001) <i>Neurology</i> 57:1583–1588
Favourable response of NP to venlafaxine, although study indicated that venlafaxine is less effective than imipramine	Sindrup et al. (2003) <i>Neurology</i> 60:1284–1289
Favourable response of central pain to amitriptyline (S+N)	Leijon and Boivie (1989) <i>Pain</i> 36:27–36
Favourable response of central pain to clomipramine(S) and nortriptyline(N)	Panerai et al. (1990) <i>Acta Neurologica Scandinavica</i> 82:34–38
Negative trials in HIV neuropathy pain	Kieburts et al. (1998) <i>Neurology</i> 51:1683–1688 Shlay et al. (1998) <i>JAMA</i> 289:1590–1595
Negative trails of nortriptyline in cis-platinum neuropathy	Hammack et al. (2002) <i>Pain</i> 91:195–203

on S and N were associated with favourable results (amitriptyline, imipramine, trimipramine, dothiepin, dibenzepin), as was a drug with a predominantly N action (nortriptyline). More selective S agents were also more effective than placebo (fluoxetine, fluvoxamine, sertraline) (Watson et al. 2004). (For studies on the effect of antidepressants on CNMNNP, the reader is referred to Table 2).

The data in CNMNNP do not allow us to draw conclusions as to the relative effectiveness of different antidepressants, nor have they been compared to other analgesic drugs. Neither is there information about clinical meaningfulness such as number needed to treat (NNT) (Laupacis et al. 1988) information in these studies.

### Neuropathic Pain (NP)

Most of the antidepressant research in neuropathic pain (NP) has been carried out in PHN and painful diabetic neuropathy (PDN), both of which have proven to be

good clinical experimental models for antidepressant research (Watson 2000). The results in the two conditions have been reasonably similar, except that there is evidence of an effect of S agents in PDN; however, but there are no RCTs of these agents in PHN. In both PHN and PDN trials, amitriptyline (N+S) and the N agents, i.e. maprotiline, desipramine, and nortriptyline, have been repeatedly shown to be better than placebo. More of these drugs have been studied in PDN, and there are positive trials with imipramine (S+N), as well as S agents e.g. paroxetine, clomipramine, and citalopram in this disorder. There are also negative trials of mianserin (Sindrup et al. 1992) and fluoxetine(S) (Max et al. 1992). (For trials on the effect of antidepressants on neuropathic pain, the reader is referred to Table 2). What are we to conclude about the relative efficacy of these different antidepressants? It is probable that the mixed N and S agents amitriptyline and imipramine are more effective than the N agents desipramine and maprotiline (although nortriptyline appears equal in pain relief



but superior to amitriptyline in having less significant adverse effects). Selective S agents appear less effective in some cases or not effective at all. Recent studies indicate that opioids may be more effective than antidepressants (Raja et al. 2002), and that amitriptyline is equal to gabapentin in the relief of pain and in causing adverse effects is of interest. NNT data from systematic reviews and single RCTs (Table 1) may help to give us some insight as to the relative efficacy of antidepressants versus other agents, but probably must be interpreted with caution. A comparison of NNT is problematic, especially given the use of intent-to-treat analyses in the gabapentin trials but not in the crossover trials of tricyclic antidepressants and opioids (Dworkin et al. 2003). It is also probable that the generalization of these NNT data to clinical practice is problematic because of the selection that goes into RCTs.

### Practical Guidelines

Practical guidelines for the use of antidepressants and NP pain are to start with nortriptyline (less significant adverse events) or amitriptyline in a low dose, that is 10 mg in those over 65 and 25 mg in those under 65, and to slowly increase the dose every week or two by similar amounts until an end point of satisfactory pain relief or a significant adverse event occurs. The average dose is around 75 mg for appreciable pain relief, and this occurs in about 1/2 to 2/3 of patients. It may be helpful to try different antidepressants, moving from those with a mixed effect on S and N such as amitriptyline and imipramine to the more N ones such as desipramine and maprotiline, to an S agent. Individual differences in pain-inhibitory mechanisms may mean that one drug is more efficacious for an individual patient. It is important to try to deal with some side effects pre-emptively such as a mouth spray for dry mouth and stool softeners for constipation. Caution regarding possible weight gain is important as well. Combination therapy is reasonable, that is combining an antidepressant with an opioid and/or gabapentin and/or the lidocaine patch.

### Conclusions

In conclusion, antidepressants have repeatedly been shown to have an analgesic effect and to relieve different components of neuropathic pain, which is the stabbing pain, steady pain, and skin sensitivity, and that this effect is independent of an antidepressant action. Adverse events are often problematic and some can be dealt with pre-emptively. There is evidence that the drugs with a mixed effect on S and N such as amitriptyline and imipramine, may be more effective than the N agents desipramine and maprotiline (except for nortriptyline which seems equal to amitriptyline and to have less significant adverse events). S agents appear least efficacious, but may have an effect in individual instances. More comparative studies are needed to determine the relative efficacy of the antepres-

sants and how they compare with other agents such as gabapentin, pregabalin, and other anticonvulsants and opioids. Some agents require further study (topical doxepin, bupropion), clinical meaningfulness data such as NNT should be incorporated in future studies, and new drugs and approaches are needed.

### References

- Collins SL, Moore RA, McQuay JH (2000) Antidepressants and Anticonvulsants for Diabetic Neuropathy and Postherpetic Neuralgia: A Quantitative Systematic Review. *J Pain Symptom Manage* 20:449–458
- Dworkin RH, Corbin AE, Young JP (2003) Pregabalin for the Treatment of Postherpetic Neuralgia. *Neurology* 60:1274–1283
- Kalso E, Tasmuth T, Neuvonen PJ (1995) Amitriptyline Effectively Relieves Neuropathic Pain following Treatment of Breast Cancer. *Pain* 64:293–302
- Kerrick JM, Fine PG, Lipman AG et al. (1993) Low Dose Amitriptyline as an Adjunct to Opioids for Postoperative Orthopaedic Pain: A Randomized Controlled Trial. *Pain* 52:325–330
- Lance JW, Curran DA (1964) Treatment of Chronic Tension Headache. *Lancet* I:1236–1239
- Langohr HD, Stohr M, Petrucci F (1982) An Open End, Double-Blind, Crossover Study on the Efficacy of Clomipramine in Patients with Painful Polyneuropathies. *Eur Neurol* 21:309–317
- Laupacis A, Sackett DL, Roberts RS (1988) An Assessment of Clinically Useful Measures of the Consequences of Treatment. *New Engl J Med* 318:1728–1733
- Levine JD, Gordon NC, Smith R et al. (1986) Desipramine Enhances Opiate Postoperative Analgesia. *Pain* 27:45–49
- Max MB, Lynch SA, Muir J et al. (1992) Effects of Desipramine, Amitriptyline, and Fluoxetine on Pain in Diabetic Neuropathy. *New Engl J Med* 326:1250–1256
- McQuay H, Trainer M, Nye BA et al. (1996) A Systematic Review of Antidepressants in Neuropathic Pain. *Pain* 68:217–227
- Mercadante S, Arcuri E, Tirelli W et al. (2002) Amitriptyline in Neuropathic Cancer Pain in Patients on Morphine Therapy: A Randomized, Placebo-Controlled, Double-Blind, Crossover Study. *Tumori* 88:239–242
- Merskey H, Hester RA (1972) The Treatment of Pain with Psychotropic Drugs. *Postgraduate Medical Journal* 48:594–598
- Ongheena P, van Houdenhove B (1992) Antidepressant-Induced Analgesia in Chronic Non-Malignant Pain: A Meta-Analysis of 39 Placebo Controlled Studies. *Pain* 49:205–219
- Raja SN, Haythornethwaite JA, Pappagallo M et al. (2002) Opioids versus Antidepressants in Postherpetic Neuralgia: A Randomized, Placebo-Controlled Trial. *Neurology* 59:1015–1021
- Sindrup SH, Jensen TS (1999) Efficacy of Pharmacological Treatment of Neuropathic Pain: An Update and Effect Related to Mechanism of Drug Action. *Pain* 83:389–400
- Sindrup SH, Tuxen C, Gram LF et al. (1992) Lack of Effect of Mianserin on the Symptoms of Diabetic Neuropathy. *Eur J Clin Pharmacol* 43:251–255
- Sindrup SH, Bach FW, Madsen C et al. (2003) Venlafaxine versus Imipramine in Painful Neuropathy: A Randomized Controlled Trial. *Neurology* 60:1284–1289
- Stein D, Floman Y, Elizur A et al. (1996) The Efficacy of Amitriptyline and Acetaminophen in Acute Low Back Pain. *Psychosomatics* 37:63–70
- Tasmuth T, Brita H, Kalso E (2002) Venlafaxine in Neuropathic Pain following Treatment of Breast Cancer. *Eur J Pain* 6:17–24
- Usha PU, Naidi MUR, Prasad V (1996) An Evaluation of Antidepressants in Rheumatic Pain Conditions. *Anaesth Analg* 83:371–375
- Watson CPN, Vernich L, Chipman M et al. (1998) Amitriptyline versus Nortriptyline in Postherpetic Neuralgia. *Neurology* 51:1166–1171

22. Watson CPN, Evans RJ, Reed K et al. (1982) Amitriptyline versus Placebo in Postherpetic Neuralgia. *Neurology* 32:671–673
23. Watson CPN (2000) The Treatment of Neuropathic Pain: Antidepressants and Opioids. *Clin J Pain* 16:49–55
24. Watson CPN, Moulin D, Watt-Watson JH et al. (2003) Controlled Release Oxycodone Relieves Neuropathic Pain: A Randomized Controlled Trial in Painful Diabetic Neuropathy. *Pain* 105:71–78
25. Watson CPN, Chipman M, Monks RC (2004) *Textbook of Pain*, Churchill Livingstone Woodforde JM, Dwyer B, McEwen BW et al. (1965) The Treatment of Postherpetic Neuralgia. *Medical Journal of Australia* 2:869–872

## Antidepressant Drugs

### Definition

Antidepressant drugs are primarily used in the management of depressive disorders.

- ▶ Diabetic Neuropathy, Treatment
- ▶ Migraine, Preventive Therapy
- ▶ Postoperative Pain, Anti-Depressants

## Antidepressants in Neuropathic Pain

SØREN H. SINDRUP<sup>1</sup>, TROELS S. JENSEN<sup>2</sup>

<sup>1</sup>Department of Neurology, Odense University Hospital, Odense, Denmark

<sup>2</sup>Department of Neurology and Danish Pain Research Center, Aarhus University Hospital, Aarhus, Denmark  
soeren.sindrup@ouh.fyns-amt.dk, tsj@akphd.au.dk

### Definition

Neuropathic pain is pain caused by a lesion or dysfunction in the nervous system. In peripheral neuropathic pain, the lesion is located in the peripheral nervous system, and painful polyneuropathies (diabetic and non-diabetic), post-herpetic neuralgia and chronic pain after surgery (e.g. post-mastectomy pain syndrome) are prominent examples of this category of neuropathic pain. Post-stroke pain, pain after spinal cord injury, and pain in multiple sclerosis represent examples of central neuropathic pain conditions.

Antidepressants are drugs primarily developed to treat depression. The antidepressants that have been found to relieve neuropathic pain are ▶ tricyclic antidepressants (TCAs), serotonin noradrenaline reuptake inhibitors (SNRIs), selective serotonin reuptake inhibitors (SSRIs) and a dopamine noradrenaline reuptake inhibitor (DNRI). Within the pain field, the important drugs in these categories are TCAs: amitriptyline, imipramine, clomipramine, nortriptyline, desipramine and maprotyline; SNRIs: venlafaxine and duloxetine; SSRIs: paroxetine, fluoxetine and citalopram (see Table 1).

### Characteristics

TCAs were among the first ▶ evidence-based treatments for neuropathic pain and this drug class is still, together with anticonvulsants, the mainstay of treatment for this type of pain. TCAs have been tested in various peripheral and central neuropathic pain conditions and there are also some data on SNRIs, SSRIs and a DNRI (Sindrup et al. 2005).

### Pharmacology of Antidepressants

TCAs have a genuine analgesic effect, since 1) they have analgesic efficacy in experimental pain in humans and animals; 2) relieve neuropathic pain in patients both with and without concomitant depression; and 3) have a more prompt effect at lower doses in pain than in depression (Sindrup 1997). The pharmacological actions of TCAs are numerous (Table 1): inhibition of ▶ presynaptic reuptake of serotonin and noradrenaline, postsynaptic blockade of  $\alpha$ -adrenergic and NMDA receptors, and blockade of sodium and possibly also calcium channels (Baldessarini 2001; Sindrup et al. 2005). All of these actions have a potential for relief of neuropathic pain, due to the specific mechanisms of this type of pain (Woolf and Mannion 1999) (Fig. 1). However, it is thought that the pain-relieving effect is mainly attributed to the TCA action on monoamines and sodium channels. The more selective antidepressants, SNRIs, SSRIs and one DNRI (bupropion), have an effect on the reuptake of amines, apparently without other actions. Therefore, the latter drug classes may only interfere with parts of the neuropathic pain mechanisms (Table 1).

### Evidence

Numerous ▶ randomised, ▶ double-blind, placebo-controlled clinical trials have shown that TCAs relieve painful polyneuropathies and post-herpetic neuralgia, and a few trials have indicated that TCAs also have the potential to relieve central post-stroke pain and post-mastectomy pain syndrome (Sindrup et al. 2005). Lack of effect of the TCA amitriptyline in spinal cord injury pain in a single trial may have been caused by insufficient dosing, and a negative outcome in a study on amitriptyline in post-amputation pain could be related to inclusion of a number of patients with minimal pain. Thus, TCAs appear to be effective in central and peripheral neuropathic pain. The SNRIs venlafaxine and duloxetine relieve painful diabetic polyneuropathy, and SSRIs also apparently have a weak effect in this condition (Sindrup et al. 2005). In a study including a mixture of different types of peripheral neuropathic pain, bupropion provided astonishing pain relief (Semenchuck et al. 2001).

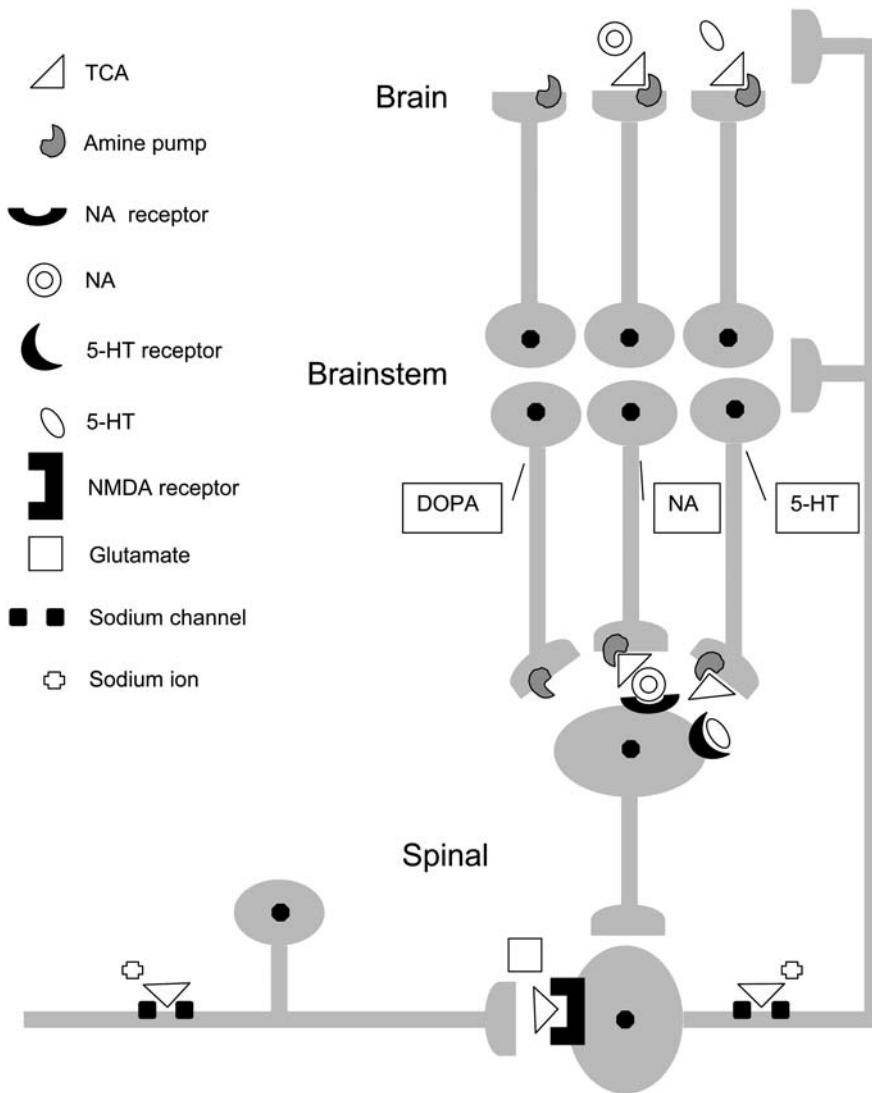
### Efficacy of Antidepressants in Neuropathic Pain

▶ Numbers needed to treat (NNT) to obtain one patient with more than 50% pain relief, calculated from pooled data from randomised placebo-controlled trials, is used

**A**

**Antidepressants in Neuropathic Pain, Table 1** Pharmacological profile of antidepressant drugs tried in neuropathic pain

		TCA		SNRI	DNRI	SSRI
		Amitriptyline Imipramine Clomipramine	Nortriptyline Desipramine Maprotiline	Venlafaxine Duloxetine	Bupropion	Fluoxetine Paroxetine Citalopram
Reuptake inhibition	Serotonin	+	-/(+)	+	-	+
	Noradrenaline	+	+	+	+	-
	Dopamine	-	-	-	+	-
Receptor Blockade	$\alpha$ -adrenergic	+	+	-	-	-
	H <sup>1</sup> -histaminergic	+	+	-	-	-
	Musc. cholinergic	+	+	-	-	-
	NMDA	+	+	-	?	-
Ion channel blockade	Sodium	+	+	-/(+)	?	-/(+)?
	Calcium	+	+	?	?	?



**Antidepressants in Neuropathic Pain, Figure 1** Mechanisms and sites of action of tricyclic antidepressants (TCA) in neuropathic pain on peripheral nerves, in the dorsal horn of the spinal cord and at supraspinal levels. NA, noradrenaline; 5-HT, serotonin; DOPA, dopamine; NMDA, N-methyl-D-aspartate.

**Antidepressants in Neuropathic Pain, Table 2** Efficacy of antidepressants in neuropathic pain as estimated by Numbers Needed to Treat (NNT) for one patient with more than 50% pain relief

	NNT	95% CI	N
Peripheral neuropathic pain			
TCA	2.3	2.1–2.7	397
Serotonergic and noradrenergic TCAs (Amitriptyline, imipramine, clomipramine)	2.2	1.9–2.6	232
Noradrenergic TCAs(desipramine, nortriptyline, maprotiline)	2.5	2.1–3.3	165
DNRI (bupropion)	1.6	1.3–2.1	41
SNRI (venlafaxine)	4.6	2.9–10.6	112
SSRI (fluoxetine, paroxetine, citalopram)	6.8	3.4–441	81
Central neuropathic pain			
TCA	4.0	2.6–8.5	59

TCA, Tricyclic antidepressants; DNRI, Dopamine and noradrenaline reuptake inhibitor; SNRI, Serotonin noradrenaline reuptake inhibitor; SSRI, Selective serotonin reuptake inhibitor; N, Number of patients exposed to active treatment in the underlying trials

to give a rough estimate of the efficacy of different antidepressants in peripheral and central neuropathic pain and some of their subcategories (Table 2) (Sindrup et al. 2005). For TCAs, the NNT is 4.0 (CI 2.6–8.5) in central pain and 2.3 (2.1–2.7) in peripheral neuropathic pain, and there are only minor differences between the efficacy of TCAs in different peripheral neuropathic pain conditions. The SNRI venlafaxine seems to have lower efficacy than TCA in painful polyneuropathy, whereas preliminary reports have indicated that duloxetine, another SNRI, has the potential to relieve painful diabetic polyneuropathy more efficiently. The SSRIs have been tested in painful diabetic polyneuropathy and appear to have rather low efficacy, with an NNT value of 6.8. A surprisingly low NNT of 1.6 was calculated for the DNRI bupropion in a group of patients with a range of different etiologies to their neuropathic pain. In general, the efficacy ranking in peripheral neuropathic pain is in line with the supposed mechanism of action of the different antidepressants, i.e. multiple mechanisms for TCAs versus more selective effects of the other antidepressants. Data on the effects of antidepressants on specific neuropathic pain symptoms are sparse. The TCA imipramine and the SNRI venlafaxine apparently relieve some ► [spontaneous pain](#) symptoms (constant deep aching pain and lancinating pain), and at least one type of ► [stimulus-evoked pain](#) (pain on pressure) in painful polyneuropathy (Sindrup et al. 2003). A general effect of TCAs on different pain symptoms has also been reported for amitriptyline and desipramine in postherpetic neuralgia (Kishore-Kumar et al. 1990; Max et al. 1988) and painful diabetic polyneuropathy (Max et al. 1987; Max et al. 1991).

#### Dosing of Antidepressants in Neuropathic Pain

TCAs exhibit a large interindividual variability in pharmacokinetics (Baldessarini 2001), and concentration-

response relations have been found for some of these drugs, e.g. imipramine and amitriptyline (Rasmussen 2004; Sindrup 2005). Thus, standard dosing may cause toxicity in some patients due to the relatively low therapeutic index of TCAs, and leave others at subtherapeutic drug levels. Dosing according to effect and side-effect is not expected to be successful, since side-effects are often present even at subtherapeutic concentrations, and not all patients will obtain a pain-relieving effect at all. Dosing guided by measurements of serum drug concentrations (► [therapeutic drug monitoring](#)) is suggested to improve therapeutic outcome, i.e. a start dose of 50 mg/d and dose adjustment according to a drug level measured after 2–3 weeks on the start dose.

The pharmacokinetics of SNRIs, DNRI and SSRIs show less interindividual variability and the therapeutic index is probably higher. Dosing according to effect and side-effects is therefore feasible. The studies on venlafaxine showed that a dose of 75 mg/d was ineffective, whereas 225 mg/d relieved pain (Rowbotham et al. 2004), and low serum drug levels were associated with non-response (Sindrup et al. 2003). This result fits with the experimental data showing that noradrenaline reuptake inhibition is first present at higher drug concentration, and the noradrenergic effect is expected to be important for the analgesic effect. The preliminary data on duloxetine indicate that 60–120 mg/d provides pain relief, whereas 20 mg/d is ineffective.

#### Side-Effects of Antidepressants in Neuropathic Pain

TCAs cannot be used in patients with cardiac conduction disturbances, cardiac compensation and epilepsy. Side-effects including dry mouth, sweating, dizziness, orthostatic hypotension, fatigue, constipation and problems with micturition are often bothersome and will lead to discontinuation of TCAs in a number of patients. The SSRIs and SNRI are better tolerated, but



drugs from these groups also cause side-effects. The SSRIs may induce nausea, vomiting and dyspepsia, and the same types of side-effects are seen with the SNRIs. Bupropion may cause gastric upset like the SNRIs and like the TCAs dry mouth. The SNRI venlafaxine may also lead to rising blood pressure.

Drop-outs due to side-effects during clinical trials with antidepressants in neuropathic pain can be used to calculate ▶ **Number Needed to Harm (NNH)**, as the reciprocal value of the difference in drop-out rates on active and placebo treatment, and this provides a rough estimate of tolerability of the drugs. The overall NNHs are 13.6 (9.8–22.5) for TCAs, 19 (8.1–∞) for SSRIs and 21.5 (11.2–270) for SNRIs and bupropion together. The somewhat better tolerability of SSRIs and SNRIs than of TCAs is reflected in these figures. Treatment discontinuation may be more frequent in daily clinical practice than in the setting of a clinical trial.

### Discussion and Conclusion

To summarize, TCAs and SNRIs are evidence-based treatments of peripheral neuropathic pain and TCAs appear to be more efficacious than SNRIs. SSRIs relieve peripheral neuropathic pain with low efficacy, whereas a limited amount of data indicates that the SNRI bupropion could be very effective for this type of pain. TCAs may work for central pain, whereas none of the other antidepressants have been tried for this category of neuropathic pain. Thus, antidepressants are, together with anticonvulsants, first line treatments for peripheral (TCAs and SNRIs) and central (TCAs) neuropathic pain. Our present knowledge does not allow us to predict which patients with neuropathic pain will respond to treatment with antidepressants.

### References

- Baldessarini RJ (2001) Drugs for the Treatment of Psychiatric Disorders. In: Goodman & Gilman's The Pharmacological Basis of Therapeutics. 10<sup>th</sup> edn. McGraw Hill, New York, pp 447–483
- Kishore-Kumar R, Max MB, Schafer SC et al. (1990) Desipramine Relieves Postherpetic Neuralgia. *Neurology* 47:305–312
- Max MB, Culnane M, Schafer SC et al. (1987) Amitriptyline Relieves Diabetic Neuropathy in Patients with Normal and Depressed Mood. *Neurology* 37:589–596
- Max MB, Schafer SC, Culnane M et al. (1988) Amitriptyline, but not lorazepam, Relieves Postherpetic Neuralgia. *Neurology* 38:1427–1432
- Max MB, Kishore-Kumar R, Schafer SC et al. (1991) Efficacy of Desipramine in Painful Diabetic Neuropathy: A Placebo-Controlled Trial. *Pain* 45:3–9
- Rasmussen PV, Jensen TS, Sindrup SH et al. (2004) TDM-Based Imipramine Treatment in Neuropathic Pain. *Ther Drug Monit* 26:352–360
- Rowbotham MC, Goli V, Kunz NR et al. (2004) Venlafaxine Extended Release in the Treatment of Painful Diabetic Polyneuropathy: A Double-Blind, Placebo-Controlled Study. *Pain* 110:697–706
- Semenchuk MR, Sherman S, Davis B (2001) Double-Blind, Randomized Trial of Bupropion SR for the Treatment of Neuropathic Pain. *Neurology* 57:1583–1588
- Sindrup SH (1997) Antidepressants as Analgesics In: Yaksh TL, Lynch C, Zapol WM et al. (eds). *Anesthesia. Biological Foundations*. Lippencott-Raven Publishers, Philadelphia, pp 987–997
- Sindrup SH, Bach FW, Madsen C et al. (2003) Venlafaxine versus Imipramine in Painful Polyneuropathy. A Randomized, Controlled Trial. *Neurology* 60:1284–1289
- Sindrup SH, Otto M, Finnerup NB et al. (2005) Antidepressants in Neuropathic Pain. *Basic Clin Pharmacol Toxicol* 96:399–409
- Woolf CJ, Mannion RJ (1999) Neuropathic Pain. Aetiology, Symptoms, Mechanisms and Management. *Lancet* 353:1959–1964

## Antidromic Activation/Invasion

### Definition

Eliciting action potentials in the axon of a neuron, which propagate toward the cell body to invade the soma and the dendrites, in an opposite direction to that observed when the neurons are naturally excited (orthodromic direction). The stimulation of an axonal ending triggers a potential that is conveyed in the antidromic direction. The recognition of an antidromic potential on three criterion (latency stability, ability to follow high frequency stimulation, and observation of collision between orthodromic and antidromic potential) permitted the identification of one projection of a recorded neuron.

- ▶ [Corticothalamic and Thalamocortical Interactions](#)
- ▶ [Nociceptor, Fatigue](#)
- ▶ [Nociceptors in the Orofacial Region \(Temporomandibular Joint and Masseter Muscle\)](#)
- ▶ [Parabrachial Hypothalamic and Amygdaloid Projections](#)
- ▶ [Spinothalamic Neuron](#)
- ▶ [Spinothalamic Tract, Anatomical Organization and Response Properties](#)

## Antidromic Microstimulation Mapping

### Definition

Antidromic microstimulation is a technique that can be used to map the locations of the cell bodies of origin of a nervous system pathway. An electrical stimulus is applied through a microelectrode that is inserted into a nervous system region of interest. The stimulus intensity is kept minimal to prevent stimulus spread. A series of microelectrode tracks are made transversely across a region suspected to contain the cells of origin of the pathway terminating near the stimulating electrode. Recordings are made through this electrode so that antidromically activated neurons can be identified. The stimulating and recording sites are reconstructed after the experiment, often with the assistance of electrolytic lesions or other types of marks made by passing current through the electrodes.

- ▶ [Spinothalamic Input, Cells of Origin \(Monkey\)](#)



## Antiepileptic Drugs (Agents)

### Definition

Antiepileptic drugs are primarily used in the management of epilepsy.

- ▶ Diabetic Neuropathy, Treatment
- ▶ Postoperative Pain, Anti-Convulsant Medications
- ▶ Postoperative Pain, Gabapentin

## Antihyperalgesic Effect

### Definition

An effect leading to the attenuation of hyperalgesia, usually produced by surgical or pharmacological methods.

- ▶ Muscle Pain Model, Inflammatory Agents-Induced
- ▶ NSAIDs, Mode of Action
- ▶ Opioid Modulation of Nociceptive Afferents in Vivo

## Anti-Inflammatories

- ▶ NSAIDs, Survey

## Anti-Inflammatory Cytokines

### Definition

Cytokines involved in negatively regulating the inflammatory response.

- ▶ Cytokines, Regulation in Inflammation

## Antinociception

### Definition

Attenuation of nociceptive processing in the nervous system, and the reduction of inhibition of nociceptive transmission. In animal models of pain, a decrease in a response to a stimulus that is perceived as painful to humans.

- ▶ Cell Therapy in the Treatment of Central Pain
- ▶ Cytokines, Effects on Nociceptors
- ▶ Dietary Variables in Neuropathic Pain
- ▶ GABA Mechanisms and Descending Inhibitory Mechanisms
- ▶ Nitrous Oxide Antinociception and Opioid Receptors
- ▶ Opioids in the Spinal Cord and Modulation of Ascending Pathways (*N. gracilis*)
- ▶ Secondary Somatosensory Cortex (S2) and Insula, Effect on Pain Related Behavior in Animals and Humans

- ▶ Stimulation Produced Analgesia
- ▶ Vagal Input and Descending Modulation

## Antinociceptive Effects of General Anesthetics

### Definition

Nociceptors are inhibited to varying degrees when under anesthesia.

- ▶ Thalamic Nuclei Involved in Pain, Cat and Rat

## Antinociceptive Models

### Definition

Animal models of experimental pain include the tail flick test, ▶ **Hot Plate Test (Assay)**, warm water tail withdrawal, abdominal constriction, paw pressure and others. In all cases, a measured nociceptive stimulus of a thermal, chemical or pressure nature is applied and the response of the animal is monitored. For instance, thermal stimuli typically produce a pre-determined response within a latency time; antinociception is determined by the prolongation of the latency time. A chemical stimulus such as phenylquinone or acetic acid typically induces abdominal constrictions, which can be suppressed by analgesic drugs.

- ▶ Nitrous Oxide Antinociception and Opioid Receptors

## Antiphospholipid Syndrome

### Definition

Diagnosis with the detection of lupus anticoagulant and IgG-anticardiolipin antibodies; primary or secondary in collagen vascular disease (SLE).

- ▶ Headache Due to Arteritis

## Antipyretic Analgesics

- ▶ NSAIDs and their Indications

## Antisense Oligonucleotide

### Synonyms

ASO

**Definition**

A DNA sequence, typically 15 to 25 nucleotides in length, designed to bind to a complementary sequence on a target RNA molecule. As a result, the protein product coded by that particular RNA is not synthesized. ASO can be delivered *in vitro* or *in vivo* to reversibly inhibit the synthesis of a protein of interest.

- ▶ [Purine Receptor Targets in the Treatment of Neuro-pathic Pain](#)

**Anxiety****Definition**

Anxiety is the subjective feeling of apprehension, dread, or foreboding ranging from excessive concern about the present or future to feelings of panic, accompanied by a variety of autonomic signs and symptoms, with or without a stressful situation. The focus of anticipated danger may be internal or external. The state of anxiety seems to place the defensive physiological mechanisms in a heightened state of preparedness, thereby facilitating and stimulating the fight-flight response only in case the threatening event occurs. Anxiety is often distinguished from fear in that fear is a more appropriate word to use when threat or danger exists in the real world. Anxiety is more reflective of a threat that is not apparent or imminent in the real world, at least not to an experienced degree.

- ▶ [Amygdala, Pain Processing and Behavior in Animals](#)
- ▶ [Fear and Pain](#)
- ▶ [Pain in the Workplace, Risk Factors for Chronicity, Psychosocial Factors](#)

**Anxiety Sensitivity****Definition**

Anxiety sensitivity refers to the fear of anxiety symptoms arising from the belief that anxiety has harmful somatic, psychological and social consequences.

- ▶ [Fear and Pain](#)

**Anxiolysis**

- ▶ [Minimal Sedation](#)

**Apamin****Definition**

Bee venom inhibiting some Ca dependant K channels (SK type).

- ▶ [Mechano-Insensitive C-Fibres, Biophysics](#)

**Apoplexy**

- ▶ [Headache Due to Intracranial Bleeding](#)

**Apoptosis****Synonyms**

Programmed Cell Death

**Definition**

Apoptosis is a type of cell death in which the cell uses a specialized cellular machinery to kill itself; it is also called programmed cell death. It is a physiological process of the organism to eliminate damaged or overaged cells.

- ▶ [NSAIDs and Cancer](#)
- ▶ [NSAIDs, COX-Independent Actions](#)

**Apoptotic Degeneration****Definition**

Programmed cell death, which involves a tightly controlled death pathway. It avoids tissue inflammation, which usually accompanies cell death though cell damage.

- ▶ [GABA and Glycine in Spinal Nociceptive Processing](#)

**Appraisal****Definition**

The mental act of evaluating the significance of a particular symptom, situation or outcome; or the assessment of the threat value of a particular symptom or stimulus.

- ▶ [Catastrophizing](#)
- ▶ [Psychology of Pain, Assessment of Cognitive Variables](#)

**APS**

- ▶ [Acute Pain Service](#)

## APT

- ▶ Acute Pain Team

## Arachadonic Acid

### Definition

Arachidonic Acid is a C<sub>20</sub> carboxylic acid with 4 isolated double bonds at positions 5, 8, 11 and 14. This esterified fatty acid is released from phospholipids in cell membranes by the action of phospholipase A<sub>2</sub>, activated by pro-inflammatory cytokines. Further enzymatic processing of arachadonic acid results in the production of a range of prostanoids (prostaglandins and thromboxanes). This includes PGE<sub>2</sub> (this has a role in limiting inflammation by inhibiting production of some cytokines such as interleukin-1), and TXA<sub>2</sub> (involved in platelet aggregation and haemostasis). Metabolites are named “eicosanoids“, referring to the common structural feature of 20 carbon atoms.

- ▶ Coxibs and Novel Compounds, Chemistry
- ▶ Cyclooxygenases in Biology and Disease
- ▶ NSAIDs, Chemical Structure and Molecular Mode of Action
- ▶ Postoperative Pain, COX-2 Inhibitors

## Arachnoid Membrane

### Definition

The arachnoid membrane is a delicate, non-vascular membrane that is closely attached to the outermost layer, the dura mater. The epidural space surrounds the dura mater sac.

- ▶ Postoperative Pain, Intrathecal Drug Administration

## Archispinothalamic Tract

### Definition

Part of the Paleo-spinothalamic tract, it is an intersegmental nerve fiber tract that travels for 2–4 segments.

- ▶ Parafascicular Nucleus, Pain Modulation

## ARDS

### Synonyms

Adult Respiratory Distress Syndrome

### Definition

ARDS is a severe form of acute lung failure requiring mechanical ventilation.

- ▶ Pain Control in Children with Burns

## Area Postrema

### Definition

One of the circumventricular organs interfacing between the brain and cerebral spinal fluid. Receives nerve fibers from the solitary nucleus, spinal cord and adjacent areas of the medulla.

- ▶ Brainstem Subnucleus Reticularis Dorsalis Neuron

## Area under the Curve

### Synonyms

AUC

### Definition

The area under the curve (AUC) is the integral of drug blood level over time from zero to infinity, and is a measure of the quantity of drug absorbed and in the body.

- ▶ NSAIDs, Pharmacokinetics

## Arousal

### Definition

Arousal is both a behavioral and an electroencephalographic response to a variety of strong stimuli, including painful ones. During arousal, there is a heightened level of conscious awareness.

- ▶ Spinothalamic Tract Neurons, Descending Control by Brainstem Neurons

## Arterial Spasm

### Definition

Arterial constriction, vasospasm.

- ▶ Primary Exertional Headache

## Arthralgias

### Definition

Neuralgic pain in a joint or joints.

- ▶ Animal Models of Inflammatory Bowel Disease

## Arthritis

### Definition

Arthritis is defined as inflammation of a joint, usually a synovial joint, which is characterized by specific features. Clinically, these features are often radiographic (that is, only detectable on radiograph) and include loss of bone in the joint, narrowing of the space between opposing bones in the joint, and thickening of the lining of the joint, the synovium. Histologically, features that are often present include inflammatory cell infiltrate, usually of monocytes, synovial hyperplasia and pannus formation, bone erosion and new bone formation, and in the more extreme situations, ankylosis of the joint. The two most common forms of arthritis are osteoarthritis and rheumatoid arthritis. Osteoarthritis is a degenerative condition characterized by progressive loss of cartilage, leading to joint pain and loss of motion. Weight bearing joints, particularly the hips and knees, commonly used joints, and hands (distal and proximal interphalangeal joints), are the most commonly affected. Importantly, the pain of osteoarthritis is worse with use and better with rest, and most common in older adults. Rheumatoid arthritis is an inflammatory polyarthritis that involves peripheral joints in a symmetric distribution. Characteristic signs are morning stiffness and pain that improves with movement, with joint swelling and tenderness.

- ▶ Arthritis Model, Adjuvant-Induced Arthritis
- ▶ Arthritis Model, Osteoarthritis
- ▶ Nocifensive Behaviors (Muscle and Joint)
- ▶ TRPV1, Regulation by Protons

## Arthritis Model, Adjuvant-Induced Arthritis

LUCY F. DONALDSON, NAOMI L. CHILLINGWORTH  
Department of Physiology, School of Medical Sciences, University of Bristol, Bristol, UK  
lucy.donaldson@bris.ac.uk

### Synonyms

Adjuvant Arthritis; adjuvant-induced arthritis

### Definition

Adjuvant-induced ▶ arthritis is a model of chronic immune-mediated joint inflammation that is induced by injection, usually sub- or intradermally, of a suspension of heat killed *Mycobacterium tuberculosis* (▶ *Mycobacterium Species*) in oil (▶ Freund's complete adjuvant or FCA).

### Characteristics

The classical model of adjuvant induced polyarthritis is induced in rats, using an intradermal injection of mycobacterium tuberculosis suspension in paraffin oil at the tail base. The reaction to adjuvant injection is generally one of systemic illness, with inflammation affecting tarsal, carpal, phalangeal and spinal joints after 11–16 days (Pearson and Wood 1959). Arthritis is accompanied by lesions of the eyes, ears, nose, skin and genitals, in addition to anorexia and profound weight loss. The disease follows a relapsing-remitting course after the initial two weeks and may persist for several months (Pearson and Wood 1959).

The appearance of the arthritis is very similar to that of rheumatoid arthritis in humans, and for this reason this model has been used as an animal model of rheumatoid arthritis, in studies of both disease mechanisms and in the development of potential analgesic drugs (Rainsford 1982). Gross lesions in animals with adjuvant arthritis are seen as oedematous swellings of multiple joints, particularly the tibiotarsal joints of the hind-paws. As the disease progresses, periarticular swellings develop in the hind limbs and tail. Persistent disease over several months may ultimately result in chronic joint deformation. Microscopic features of adjuvant arthritis are apparent before the gross lesions. As the disease progresses there are signs of joint destruction, with joints showing new bone formation, synovitis, inflammation of the bone marrow, and fibrous and bony ▶ ankylosis. Joint destruction is thought to be a result of the production of autoantibodies, possibly as a result of cross-reactivity of antibodies against mycobacterial proteins with host proteoglycans (van Eden et al. 1985) in response to the FCA injection.

Behaviourally rats show weight loss, reduced mobility, increased vocalisation and irritability (Pearson and Wood 1959; De Castro Costa et al. 1981). Animals also exhibit signs of chronic pain, such as altered ▶ nociceptive thresholds and increased self-administration of analgesic drugs (Colpaert et al. 1982). Adjuvant arthritis has also been used as a model of chronic stress as animals show increased corticosterone secretion, loss of diurnal rhythm of secretion and other parameters of increased physiological stress, such as increased adrenal and splenic weight, and decreased thymic weight (Sarlis et al. 1992).

Although classical adjuvant polyarthritis has been considered to be a good model of rheumatoid arthritis, the original model has been modified by several groups to reduce the severity of the disease, and hence the potential suffering of the animals, in line with ethical recommendations on the reduction in the severity of animal models of human disease.

Adjuvant arthritis has been modified by: a) reduction of the amount of mycobacterium injected, and b) the route of injection of the adjuvant. Injection of adjuvant into

one footpad has been used to induce a localised arthritis, but this model can result in more widespread inflammation if not carefully controlled. Refinement of classical adjuvant arthritis has led to definition of models of unilateral arthritis that affects only one joint, rather than the polyarthritis seen in the original model. This type of model has several advantages, in that principally it enables study of a limited arthritis without the complications of systemic disease seen in polyarthritis. The advantage of an internal uninflamed control joint contralateral to the arthritic joint was thought to be an added advantage of this model, until the limitations of this approach were identified (see below).

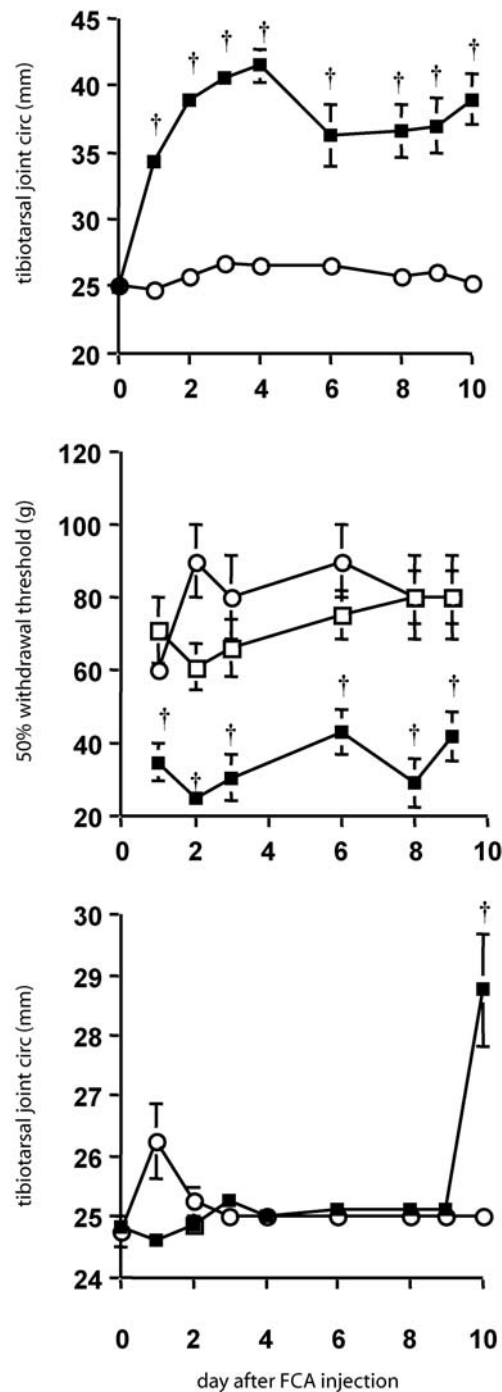
#### Modified Adjuvant-Induced Arthritis Models

One of the most commonly used refined models of adjuvant arthritis is that in which FCA is injected locally around a joint in which arthritis is to be induced (Donaldson et al. 1993). Intra-articular injection of FCA is also possible and also results in a stable and reliable monoarthritis (Butler et al. 1992), however, when the tibiotarsal joint is used, such intra-articular injection is complicated, as the joint space is small. Intra-articular injection of FCA in larger joints, such as the knee joint, also gives a reliable arthritis.

Injection of FCA into the skin around the tibiotarsal joint results in a reproducible arthritis after 14 days, which is maintained as a unilateral arthritis for at least 60 days post-injection (Donaldson et al. 1993). Gross features of this monoarthritis include tibiotarsal joint swelling, often resulting in a near doubling in the circumference of the joint (Fig. 1a), with cutaneous erythema and occasional breakdown of the skin over the joint. Mobility of the animals and use of the inflamed paw is only slightly altered, and most animals continue to show normal exploratory behaviours, although there is significant mechanical allodynia in the inflamed paw (Fig. 1b). Weight gain of the animals is also normal.

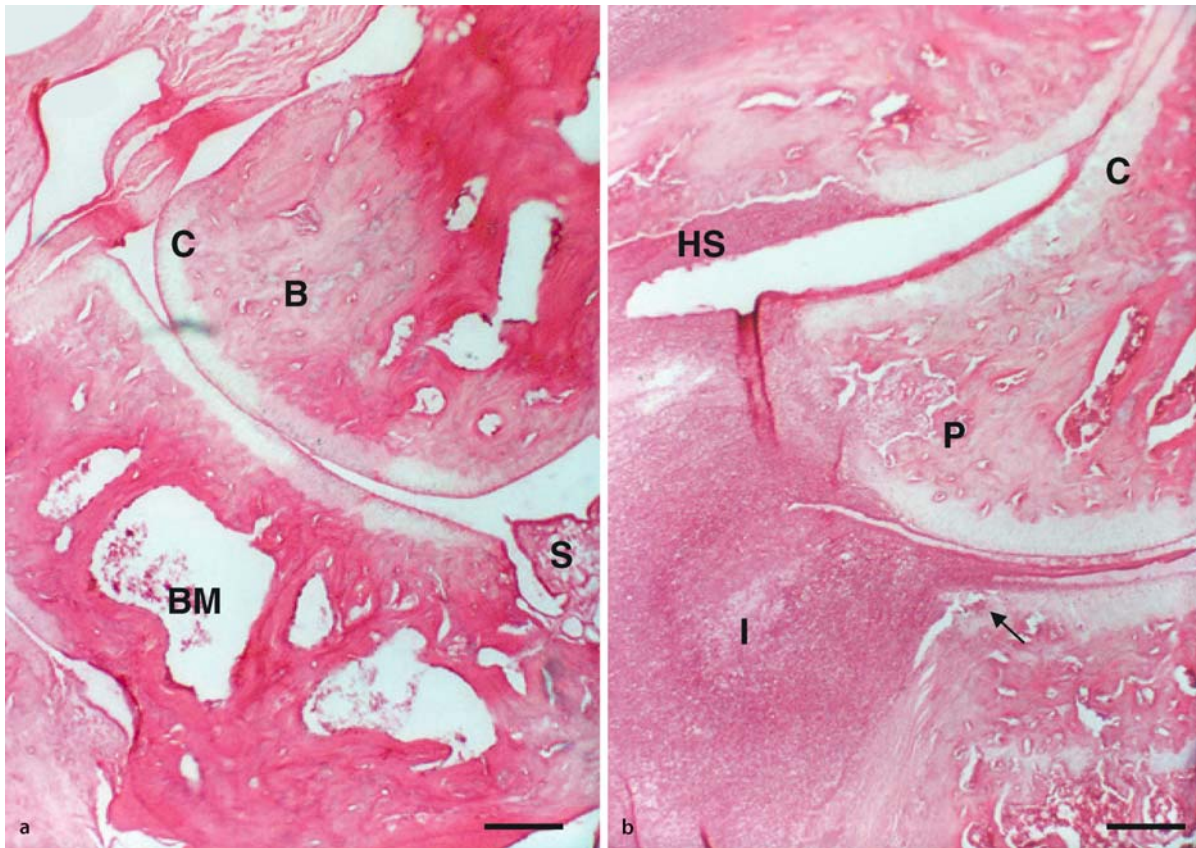
Histologically, the affected joint shows most of the features seen in classical adjuvant arthritis, except for the more severe aspects such as ankylosis. Inflammatory infiltrate into bone marrow, joint space and synovium is seen, as is synovial hyperplasia and **▶ pannus** (Fig. 2). There are no obvious changes in the contralateral tibiotarsal joint, either at the gross or histological level (but see also below).

This modified adjuvant monoarthritis also results in decreased mechanical nociceptive thresholds in the inflamed limb (Fig. 1b), but not in the contralateral limb, and thus this model has been used in studies of chronic pain. Not surprisingly, in an animal in chronic discomfort, rats do exhibit some signs of stress, but these are extremely mild, and only include a loss of diurnal variation in corticosterone secretion with no effect on other parameters associated with chronic hypothalamic-pituitary-adrenal axis activation (Donaldson et al. 1994).



**Arthritis Model, Adjuvant-Induced Arthritis, Figure 1** (a) Joint circumferences of rats injected with FCA around one tibiotarsal joint ( $\nu$ ) or control animals injected with vehicle ( $\mu$ ). FCA results in a significant increase in joint circumference ( $\dagger p < 0.001$ ) over the 10 days of study. (b) Change in 50% mechanical withdrawal threshold in FCA-induced monoarthritis. Graphs show the withdrawal thresholds in the FCA-injected joint ( $\nu$ ), the contralateral uninflamed paw ( $\theta$ ) and in control, uninjected rats ( $\mu$ ). There is a significant decrease in withdrawal threshold seen in FCA-induced arthritis ( $\dagger p < 0.001$ ). (c) Contralateral joint circumferences in rats with FCA-induced monoarthritis. The contralateral joint remains unaffected by arthritis until day 10, when there is a significant increase in joint swelling in FCA-injected ( $\nu$ ) but not vehicle injected rats ( $\mu$ ). Note that the degree of swelling is not as great as in the FCA injected limb ( $\dagger p < 0.001$ ).





A

**Arthritis Model, Adjuvant-Induced Arthritis, Figure 2** Histological appearance of FCA-induced monoarthritis and control joint. (a) Photomicrograph of the right (uninjected) tibiotarsal joint showing normal cartilage (C), subchondral bone (B), synovium (S). Bone marrow spaces (BM) can also be seen. (b) Photomicrograph of the left injected tibiotarsal joint showing hyperplastic synovium (HS) and inflammatory infiltrate in the joint (I). There is early cartilage and subchondral bone destruction evident (arrow) with more advanced pannus seen invading subchondral bone (P). Scale bars = 100µm.

Thus a modified adjuvant monoarthritis is a commonly used alternative to the classical adjuvant polyarthritis. Monoarthritis has similar features to polyarthritis and models rheumatoid arthritis well, but with fewer confounding features.

#### Neurogenic Inflammation in Adjuvant Arthritis

The injection of FCA into the tail base of rats results in arthritis that affects multiple joints. The spread of arthritis is not due to a spread of mycobacterium from the site of injection to the joints, but rather to an activation of the immune system resulting in a systemic delayed hypersensitivity reaction. Whole body irradiation and ablation of active T-lymphocytes delays the onset of adjuvant polyarthritis (Wakesman et al. 1960), but does not abolish it completely.

However, it has been hypothesised that immune activation alone cannot explain the precise symmetry often seen in both clinical and experimental arthritis. Damage to the peripheral nervous system in adjuvant polyarthritis can result in the sparing of specific joints, implying that the development of arthritis in this model is dependent on an interaction between an intact ner-

vous system and the immune system (Donaldson et al. 1995). This suggests that the involvement of multiple joints in the tail base model is not purely an immune mediated effect, but that ► **neurogenic inflammation** is involved in arthritis. The precise nervous pathway through which signals are transmitted, which results in the spread of arthritis from one joint to another, is not yet known. It is, however, known that in addition to the peripheral nerves being integral to this effect (Donaldson et al. 1995), spinal mechanisms are also important as damage to the appropriate spinal cord segment will also stop contralateral joint damage (Decaris et al. 1999).

In modified models of adjuvant arthritis, local injection of FCA around the joint can also result in neurogenic spread of arthritis to the contralateral tibiotarsal joint after 10–14 days (Fig. 1c). This effect is dependent on the amount of adjuvant injected, that is, greater amounts of adjuvant result in a more distant spread of disease (Donaldson et al. 1993). For this reason, the use of the contralateral limb/joint as an internal control is often inappropriate in monoarthritic models, as there may be covert arthritis in the contralateral joint that may

affect behavioural (pain behaviours) or physiological parameters (neuronal activity).

#### Adjuvant Arthritis in Other Experimental Animals

FCA is used as an immunological adjuvant in other species to enhance autoimmune reactions to co-injected antigens, such as in ovalbumin-induced arthritis in rabbits (Pettipher and Henderson 1988), where cell-mediated immunity is required for full development of the disease. Adjuvant polyarthritis or monoarthritis has been very difficult to induce in species other than the rat using FCA alone, rather than as an adjuvant for immunisation. Guinea pigs form granulomas at the site of adjuvant injection and do not develop polyarthritis, but do develop a monoarthritis when FCA is injected into the hindpaw (Hood et al. 2001).

The mouse is a species in which it has been notoriously difficult to induce adjuvant arthritis. There are very few reports of adjuvant arthritis in mice, and those that have attempted to induce arthritis in this species have had limited success. Tail base injection of FCA does not induce widespread arthritis in mice (Larson et al. 1986), and local FCA injection in mice does not reliably induce arthritis in all animals (Ratkay et al. 1994). In addition, altered nociception in adjuvant inflammation in mice is also inconsistent (Larson et al. 1986). Recent work has, however, defined an adjuvant arthritis model in mice that is reliable both in terms of the consistent induction of arthritis in all animals, and in which all animals exhibit thermal hyperalgesia and mechanical allodynia similar to that seen in rats (Chillingworth and Donaldson 2003; Gaudie et al. 2004). In adjuvant arthritis in mice, thermal hyperalgesia and mechanical allodynia develop very rapidly (within 24 hours), and are maintained for at least 15 days (Chillingworth and Donaldson 2003; Gaudie et al. 2004). This model requires the use of very much higher concentrations of FCA than those usually used to induce monoarthritis in rats, ( $25 \text{ mgkg}^{-1}$  in mice versus  $0.6 \text{ mgkg}^{-1}$  in rats). Probably as a result of the relative resistance of mice to immune stimulation by FCA, arthritis remains unilateral in mice for at least 20 days, despite the much higher concentration of FCA used, with no apparent signs of contralateral inflammation. The reasons for this apparent resistance in mice and other species to the arthritic effects of FCA are unknown, but it is probably attributable to differences in the immune reactions to the mycobacterium antigens (Audibert and Chedid 1976). Thus, a reliable model of adjuvant arthritis now also exists in mice that can be used for similar purposes as that in rats, but can also be used to extend studies on disease progression and modification to include the use of genetically modified mice.

Adjuvant polyarthritis is still used as a model of rheumatoid arthritis, but has confounding features such as poor animal health. Modifications of adjuvant polyarthritis to limit the disease to a single joint have improved this model, from both the animal welfare perspective and in

the ease of data interpretation. This model is now established in both rats and mice, allowing study of arthritis and inflammatory nociception in the two most commonly used experimental species.

#### References

- Audibert F, Chedid L (1976) Adjuvant Disease Induced by Mycobacteria, Determinants of Arthritogenicity. *Agents Actions* 6:75–85
- Butler SH, Godefroy F, Besson JM, Weil-Fugazza J (1992) A Limited Arthritic Model for Chronic Pain Studies in the Rat. *Pain* 48:73–81
- Chillingworth NL, Donaldson LF (2003) Characterisation of a Freund's Complete Adjuvant-Induced Model of Chronic Arthritis in Mice. *J Neurosci Meth* 128:45–52
- Colpaert FC, Meert T, De Witte P, Schmitt P (1982) Further Evidence Validating Adjuvant Arthritis as an Experimental Model of Chronic Pain in the Rat. *Life Sci* 31:67–75
- De Castro Costa M, De Sutter P, Gybels J, Van Hees J (1981) Adjuvant-Induced Arthritis in Rats: A Possible Animal Model of Chronic Pain. *Pain* 10:73–185
- Decaris E, Guingamp C, Chat M, Philippe L, Grillasca JP, Abid A, Minn A, Gillet P, Netter P, Terlain B (1999) Evidence for Neurogenic Transmission Inducing Degenerative Cartilage Damage Distant from Local Inflammation. *Arthritis Rheum* 42:1951–1960
- Donaldson LF, McQueen DS, Seckl JR (1994) Endogenous Glucocorticoids and the Induction and Spread of Monoarthritis in the Rat. *J Neuroendocrinol* 6:649–654
- Donaldson LF, McQueen DS, Seckl JR (1995) Neuropeptide Gene Expression and Capsaicin-Sensitive Primary Afferents: Maintenance and Spread of Adjuvant Arthritis in the Rat. *J Physiol* 486:473–482
- Donaldson LF, Seckl JR, McQueen DS (1993) A Discrete Adjuvant-Induced Monoarthritis in the Rat: Effects of Adjuvant Dose. *J Neurosci Methods* 49:5–10
- Gaudie SD, McQueen DS, Clarke CJ, Chessell IP (2004) A robust model of adjuvant-induced chronic unilateral arthritis in two mouse strains. *J Neurosci Meth* 139(2):281–29
- Hood VC, Cruwys SC, Urban L, Kidd BL (2001) The Neurogenic Contribution to Synovial Leucocyte Infiltration and Other Outcome Measures in a Guinea Pig Model of Arthritis. *Neurosci Lett* 299:201–204
- Larson AA, Brown DR, el-Atrash S, Walser MM (1986) Pain Threshold Changes in Adjuvant-Induced Inflammation: A Possible Model of Chronic Pain in the Mouse. *Pharmacol Biochem Behav* 24:49–53
- Pearson CM, Wood FD (1959) Studies of Polyarthritis and Other Lesions in Rats by Injection of Mycobacterial Adjuvant. I. General Clinical and Pathological Characteristics and some Modifying Factors. *Arthritis Rheum* 2:440–45
- Pettipher ER, Henderson B (1988) The Relationship between Cell-Mediated Immunity and Cartilage Degradation in Antigen-Induced Arthritis in the Rabbit. *Br J Exp Pathol* 69:113–122
- Rainsford KD (1982) Adjuvant Polyarthritis in Rats: Is this a Satisfactory Model for Screening Anti-Arthritic Drugs? *Agents Actions* 12:452–458.
- Ratkay LG, Tait B, Tonzetich J, Waterfield JD (1994) Lpr and MRL Background Gene Involvement in the Control of Adjuvant Enhanced Arthritis in MRL-lpr Mice. *J Autoimmun* 7:561–573
- Sarlis NJ, Chowdrey HS, Stephanou A, Lightman SL (1992) Chronic Activation of the Hypothalamo-Pituitary-Adrenal Axis and Loss of Circadian Rhythm During Adjuvant-Induced Arthritis in the Rat. *Endocrinology* 130:1775–1779
- van Eden W, Holoshitz J, Nevo Z, Frenkel A, Klajman A, Cohen IR (1985) Arthritis Induced by a T-Lymphocyte Clone that Responds to Mycobacterium Tuberculosis and to Cartilage Proteoglycans. *Proc Natl Acad Sci USA* 82:511701–5120
- Wakesman BH, Pearson CM, Sharp JT (1960) Studies of Arthritis and other Lesions Induced in Rats by Injection of Mycobacte-

rial Adjuvant. II. Evidence that the Disease is a Disseminated Immunologic Response to Exogenous Antigen. *Proc Natl Acad Sci USA* 85:403–417

## Arthritis Model, Kaolin-Carrageenan Induced Arthritis (Knee)

VOLKER NEUGEBAUER

Department of Neurosciences & Cell Biology,  
University of Texas Medical Branch, Galveston, TX,  
USA

voneugeb@utmb.edu

### Synonyms

Kaolin-Carrageenan induced arthritis; K/C Arthritis; Acute Experimental Monoarthritis; Acute Knee Joint Inflammation; Acute Experimental Synovitis

### Definition

Aseptic inflammatory monoarthritis induced by injections of kaolin and carrageenan into the synovial cavity of one knee joint, resulting in damage to the cartilage, inflammation of the synovia and synovial fluid exudates, as well as pain behavior and neuroplastic changes in the peripheral and central nervous system.

### Characteristics

The K/C arthritis is a well established model of an acute onset monoarthritis resembling osteoarthritis, which is characterized by degeneration of hyaline articular cartilage and subsequent inflammation and pain. The K/C arthritis model has been used in cats (Coggeshall et al. 1983; Schaible and Grubb 1993), monkeys (Dougherty et al. 1992), rats (Neugebauer et al. 1993; Sluka and Westlund 1993) and mice (Zhang et al. 2001) to study pain mechanisms in the peripheral and central nervous system. The K/C arthritis produces inflammation, behavioral changes and ► **neuroplasticity** with a distinct time course of acute onset (1–3 h) and plateau phase (after 5–6 h) that persists for at least 1 week.

### Induction of Arthritis

This experimental arthritis is induced in one knee by intraarticular injections of kaolin and carrageenan into the one knee joint. The inorganic kaolin (bolus alba, “China clay”), which is hydrated aluminum silicate ( $H_2Al_2Si_2O_8 \cdot H_2O$ ) (Merck 13, 5300), is used to inflict mechanical damage to the cartilage as in osteoarthritis and, as an adjuvant, to increase the effectiveness of the active inflammatory compound carrageenan. Lambda carrageenan type IV (name derived from the Irish coastal town of Carrageen) is a mixture of sulfated polysaccharides extracted from the red seaweed *Gigartina* (Merck 13, 1878). Although subcutaneous, intramuscular and intraarticular injections of each compound

alone can produce inflammation, the combination of kaolin and carrageenan results in a more robust and longer lasting inflammation with a more constant and highly reproducible time-course. Several experimental protocols exist for the induction of the K/C arthritis in different species.

### Cat

0.4–0.5 ml of a 4% kaolin suspension is injected into the synovial cavity through the lateral aspect of the knee joint. After alternating flexions and extensions of the knee for 15 min, 0.3 ml of a 2% carrageenan solution are injected intraarticularly, and the knee is flexed and extended for 5 min. The movements facilitate the damage to the cartilage and the development of inflammation (Coggeshall et al. 1983; Schaible and Grubb 1993).

### Monkey

0.5 ml of a solution containing 5% carrageenan plus 5% kaolin is injected into the knee joint cavity through the lateral aspect of the leg. The knee joint is then repeatedly flexed and extended for 15 min (Dougherty et al. 1992).

### Rat

Kaolin and carrageenan are injected either sequentially or together according to the following protocols: 1) 80–100  $\mu$ l of a 4% kaolin suspension are injected into the joint cavity through the patellar ligament. After repetitive flexions and extensions of the knee for 15 min, a carrageenan solution (2%, 80–100  $\mu$ l) is injected into the knee joint cavity and the leg is flexed and extended for another 5 min (Neugebauer et al. 1993). 2) 100  $\mu$ l of a solution of 3% kaolin and 3% carrageenan are injected into the knee joint cavity and the knee joint is flexed and extended for 1 min (14) or 5–10 min (Sluka and Westlund 1993), 50  $\mu$ l of a mixture of 3% kaolin and 3% carrageenan are injected into one knee joint.

### Histopathology

The intraarticular injections of kaolin and carrageenan cause a unilateral aseptic inflammation with the following characteristics: swelling of the knee joint (measured as increased circumference of the knee), increased intraarticular pressure, hyperthermia of the knee, and edema with marked cellular infiltration (polymorphnuclear leucocytes) (Schaible and Grubb 1993; Schaible et al. 2002; Sluka and Westlund 1993).

### Pain Behavior

The K/C arthritis is accompanied by spontaneous pain behavior in awake freely moving animals, including limping, guarding of the leg with the arthritic knee, avoidance of joint movements, decreased weight bearing on the leg with the arthritic knee and reduced exploratory behavior (Neugebauer et al. 2003; Schaible and Grubb 1993; Sluka and Westlund 1993). Awake arthritic animals also show increased evoked pain behavior (Neugebauer et al. 2003; Schaible et al. 2002;



Sluka 1996; Sluka and Westlund 1993; Urban et al. 1999; Yang et al. 1996; Yu et al. 2002; Zhang et al. 2001): primary mechanical ► **allodynia** (reduced vocalization threshold to mechanical stimulation of the arthritic knee); secondary allodynia and ► **hyperalgesia** (reduced paw withdrawal threshold and latency, respectively) for mechanical and thermal stimuli applied to the hindpaw. Whereas in the acute stage of the K/C arthritis evoked pain behavior is strictly unilateral, secondary allodynia and hyperalgesia can occur bilaterally in the more chronic phase (> 1 week).

### Neurochemical Changes

Inflammatory mediators, neuropeptides and excitatory amino acids accumulate in the inflamed tissue of the knee and the synovial fluid (Lawand et al. 2000; Schaible and Grubb 1993; Schaible et al. 2002). Sources include immune cells, inflammatory cells, serum (plasma extravasation) and articular nerve fibers (neurogenic component). These substances play an important role in the “► **peripheral sensitization**” of articular afferent nerve fibers (see below and Fig. 1), which results in the enhanced production and release of various neurotransmitters (amino acids) and neuromodulators (peptides) into the spinal cord. Changes and mechanisms in the K/C arthritis pain model are listed below:

#### Inflammation

- Edema (increased knee joint circumference ipsilateral but not contralateral)
- Increased intraarticular pressure
- Increased temperature of arthritic (but not contralateral) knee
- Cellular infiltration (neutrophils)

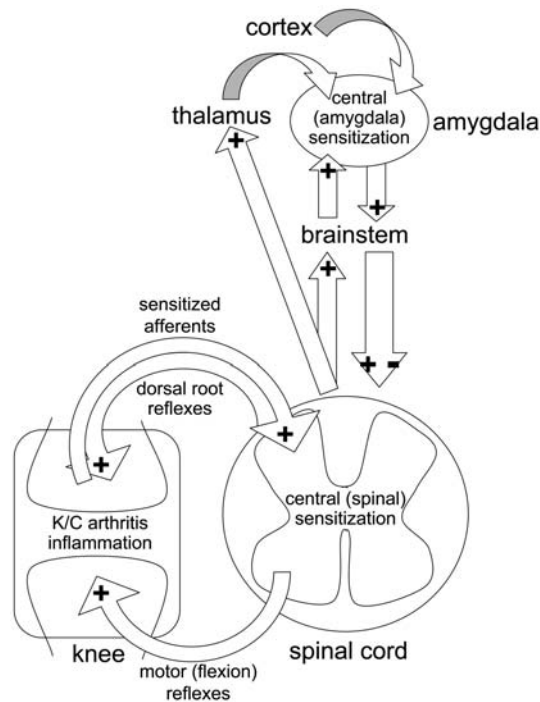
#### Pain Behavior

- Spontaneous pain behavior
- Primary allodynia (mechanical)
- Secondary hyperalgesia (mechanical and thermal)
- Secondary allodynia (mechanical and thermal)

#### Neurochemistry

##### • Periphery

Prostaglandins (PGE2, PGI2)  
 Bradykinin  
 Leukotrienes  
 Histamine  
 Serotonin  
 Excitatory amino acids (EAA; glutamate but not aspartate)  
 Nitric oxide (NO) metabolites (arginine, citrulline)  
 Substance P  
 Calcitonin gene-related peptide (CGRP)  
 Galanin  
 NPY  
 Somatostatin (SST)



**Arthritis Model, Kaolin-Carrageenan Induced Arthritis (Knee), Figure 1** Peripheral and central pain mechanisms in the K/C arthritis model. The knee joint inflammation causes sensitization of articular afferent nerve fibers, which results in enhanced input to the spinal cord, dorsal root reflexes back to the arthritic knee, increased flexion reflexes, and central sensitization of spinal neurons. Sensitized spinal neurons send their enhanced signals through pain pathways to the brainstem and brain to cause central sensitization of amygdala neurons (plasticity in other brain areas has not yet been analyzed in the K/C model) and enhanced descending control of spinal nociceptive processing.

##### • Spinal Cord

EAA (Glutamate, glutamine, aspartate)  
 NO metabolites (citrulline)  
 Substance P  
 NKA  
 Calcitonin gene-related peptide (CGRP)  
 Prostaglandins (PGE2)

#### Electrophysiology

##### • Periphery

Sensitization of groups II, III, and IV ( $A\beta$ ,  $A\delta$ , and C) articular afferent nerve fibers, including silent nociceptors  
 Dorsal root reflexes in groups II, III, and IV ( $A\beta$ ,  $A\delta$ , and C) articular afferent fibers

##### • Spinal Cord

Sensitization of spinal neurons in the superficial and deep dorsal horn and in the ventral horn (nociceptive specific, wide-dynamic-range, inhibited, non-responsive types)

- **Brainstem/Brain**

Increased descending inhibition and facilitation  
Sensitization of neurons in the central nucleus of the amygdala (multi-receptive and non-responsive but not nociceptive-specific)

**Pharmacology**

- **Periphery**

Excitatory: NMDA receptor, Non-NMDA receptor, Neurokinin 1 (NK1) receptor, Neurokinin 2 (NK2) receptor, NO/NOS

Inhibitory: Galanin receptor, Opioid receptors ( $\mu$ ,  $\kappa$ , ORL1), Somatostatin receptor

- **Spinal Cord**

Excitatory: NMDA receptor, Non-NMDA receptor, Metabotropic glutamate receptor (mGluR) group I, Neurokinin 1 (NK1) receptor, Neurokinin 2 (NK2) receptor, Calcitonin gene-related peptide (CGRP1) receptor, Calcium channels (L-, N-, P-type), Prostaglandins, Nicotinic cholinergic receptor

Inhibitory: GABA<sub>A</sub> (but not GABA<sub>B</sub>) receptor

- **Amygdala**

Excitatory: NMDA receptor (but not non-NMDA receptor), Metabotropic glutamate receptor (mGluR) group I, II and III

**Peripheral Sensitization**

Physical (increased intraarticular pressure; increased temperature) and chemical (low pH, inflammatory mediators, peptides, and amino acids) factors lead to the enhanced excitability and responsiveness of articular afferent nerve fibers to mechanical and chemical stimuli (sensitization). Some low-threshold non-nociceptive articular afferents (groups II and III or A $\beta$  and A $\delta$  fibers, respectively) show enhanced responses to mechanical compression and movements of the knee joint. Numerous high-threshold nociceptive groups III and IV (A $\delta$  and C fibers, respectively) become activated by normally ► **Innocuous Input/Stimulus** compression (see ► **innocuous input/stimulus**) and movements of the knee joint. Importantly, initially mechano-insensitive articular afferent fibers (► **silent nociceptors**) become responsive to mechanical stimulation of the knee joint (Schaible and Grubb 1993; Schaible et al. 2002). A variety of pharmacological receptor blockers or agonists can prevent or reduce the sensitization (see above list), which is believed to contribute to primary allodynia/hyperalgesia. The enhanced afferent inflow into the spinal cord, as a consequence of the peripheral sensitization, causes enhanced activation of spinal dorsal horn circuitry (Dougherty et al. 1992; Neugebauer et al. 2003) and excess primary afferent depolarization in the dorsal horn, leading to ► **dorsal root reflexes** in articular afferents. As a positive feedback loop, signals would travel

back out to the periphery; release substances in the knee joint and contribute to the inflammation (Sluka et al. 1995). Importantly, the sympathetic nervous system does not seem to contribute to the inflammatory, behavioral and peripheral electrophysiological changes in the K/C arthritis pain model (Schaible and Grubb 1993; Schaible et al. 2002; Sluka 1996).

**Central Sensitization**

Enhanced incoming signals in articular afferents from the arthritic knee result in the intraspinal release of various substances (transmitters, modulators), and trigger the development of neuroplastic changes of spinal neurons (Dougherty et al. 1992; Neugebauer et al. 1993). The responses of ► **wide dynamic range neurons** to innocuous and ► **noxious** compression (see ► **noxious stimulus**) of the arthritic joint increase gradually. The threshold of ► **nociceptive-specific neurons** is lowered, such that they are activated by normally innocuous stimuli. Typically, the receptive fields of these neurons expand, and their responses to stimulation of non-inflamed tissue remote from the arthritic knee also increase; both are considered evidence for central sensitization, i.e. spinal pain mechanisms that are not simply a reflection of the peripheral sensitization (Schaible and Grubb 1993; Schaible et al. 2002; Sluka 1996). Central sensitization is generated and maintained through a variety of neurotransmitters, modulators and their receptors (see above list) at pre- and postsynaptic sites in the spinal cord, but the signal transduction pathways involved are largely unknown in the K/C arthritis model. The excitability of spinal neurons is not only regulated by peripheral mechanisms but also through tonic descending inhibitory and excitatory supraspinal controls, which exert enhanced effects on spinal neurons in the K/C arthritis model (Schaible and Grubb 1993; Urban et al. 1999). Among the spinal neurons that become sensitized in the arthritis state, are those that send their axons to various brain areas including the thalamus (spinothalamic tract cells) (Dougherty et al. 1992). K/C arthritis pain-related changes in the brain have only been studied in the ► **amygdala**, a temporal lobe structure, which as part of the ► **limbic system** plays a key role in emotionality and negatively affective states, and is believed to be a neural substrate of the reciprocal relationship between emotion and pain. Two major subpopulations of neurons in the latero-capsular part of the central nucleus of the amygdala (“nociceptive amygdala”) develop nociceptive plasticity in the K/C arthritis pain model: multi-receptive neurons (comparable to spinal wide-dynamic-range neurons) and non-responsive neurons without a receptive field, but not nociceptive-specific neurons (Neugebauer and Li 2003). Synaptic transmission and neuronal excitability are enhanced in amygdala neurons in brain slices from rats with K/C arthritis, suggesting that plasticity in the amygdala can be maintained independently of



afferent input from the arthritic knee (Neugebauer et al. 2003). Both purely nociceptive inputs from the spino-parabrachio-amygdaloid pain pathway, and highly integrated polymodal inputs from the fear/anxiety-circuitry in the lateral and basolateral amygdala are required to produce these plastic changes, which is consistent with a role of the amygdala as the interface between pain and affect (Neugebauer and Li 2003; Neugebauer et al. 2003). Enhanced nociceptive processing and increased neuronal excitability in the amygdala in the K/C arthritis model critically depend on the upregulation of presynaptic G-protein-coupled metabotropic glutamate receptors of the mGluR1 subtype, and enhanced function of postsynaptic N-methyl-D-aspartate (NMDA) receptors through protein kinase A (PKA)-dependent phosphorylation. The amygdala is closely interconnected with other forebrain structures and brainstem centers known to be part of the endogenous pain control system. Pain-related plasticity in these areas, however, remains to be studied in the K/C arthritis model.

## References

- Coggeshall RE, Hong KA, Langford LA et al. (1983) Discharge Characteristics of Fine Medial Articular Afferents at Rest and during Passive Movements of Inflamed Knee Joints. *Brain Res* 272:185–188
- Dougherty PM, Sluka KA, Sorkin LS et al. (1992) Neural Changes in Acute Arthritis in Monkeys. I. Parallel Enhancement of Responses of Spinothalamic Tract Neurons to Mechanical Stimulation and Excitatory Amino Acids. *Brain Res Rev* 55:1–13
- Lawand NB, McNearney T, Westlund KN (2000) Amino Acid Release into the Knee Joint: Key Role in Nociception and Inflammation. *Pain* 86:69–74
- Neugebauer V, Li W (2003) Differential Sensitization of Amygdala Neurons to Afferent Inputs in a Model of Arthritic Pain. *J Neurophysiol* 89:716–727
- Neugebauer V, Li W, Bird GC et al. (2003) Synaptic Plasticity in the Amygdala in a Model of Arthritic Pain: Differential Roles of Metabotropic Glutamate Receptors 1 and 5. *J Neurosci* 23:52–63
- Neugebauer V, Lucke T, Schaible H-G (1993) N-methyl-D-aspartate (NMDA) and Non-NMDA Receptor Antagonists Block the Hyperexcitability of Dorsal Horn Neurons during Development of Acute Arthritis in Rat's Knee Joint. *J Neurophysiol* 70:1365–1377
- Schaible H-G, Grubb B (1993) Afferent and Spinal Mechanisms of Joint Pain. *Pain* 55:5–54
- Schaible H-G, Ebersberger A, von Banchet GS (2002) Mechanisms of Pain in Arthritis. *Ann N Y Acad Sci* 966:343–354
- Sluka KA (1996) Pain Mechanisms Involved in Musculoskeletal Disorders. *J Orthop Sports Phys Ther* 24:240–254
- Sluka KA, Rees H, Westlund KN et al. (1995) Fiber Types Contributing to Dorsal Root Reflexes Induced by Joint Inflammation in Cats and Monkeys. *J Neurophysiol* 74:981–989
- Sluka KA, Westlund KN (1993) Behavioral and Immunohistochemical Changes in an Experimental Arthritis Model in Rats. *Pain* 55:367–377
- Urban MO, Zahn PK, Gebhart GF (1999) Descending Facilitatory Influences from the Rostral Medial Medulla Mediate Secondary, but not Primary Hyperalgesia in the Rat. *Neurosci* 90:349–352
- Yang LC, Marsala M, Yaksh TL (1996) Characterization of Time Course of Spinal Amino Acids, Citrulline and PGE<sub>2</sub> Release after Carrageenan/Kaolin-Induced Knee Joint Inflammation: A Chronic Microdialysis Study. *Pain* 67:345–354
- Yu YC, Koo ST, Kim CH et al. (2002) Two Variables that can be used as Pain Indices in Experimental Animal Models of Arthritis. *J Neurosci Methods* 115:107–113
- Zhang L, Hoff AO, Wimalawansa SJ et al. (2001) Arthritic Calcitonin/[alpha] Calcitonin Gene-Related Peptide Knockout Mice have Reduced Nociceptive Hypersensitivity. *Pain* 89:265–273

## Arthritis Model, Osteoarthritis

JAMES D. POMONIS

Algos Therapeutics Inc., St. Paul, MN, USA

jpomonis@algosinc.com

### Synonyms

Degenerative Joint Disease; Arthritis; Osteoarthritis Model

### Definition

Osteoarthritis is a condition in which physical or biological damage to the cartilage of ► [synovial joints](#) leads to destruction of the ► [cartilage](#) and remodeling of the bone underneath the affected cartilage.

### Characteristics

Osteoarthritis (OA) and other degenerative joint diseases affect almost one third of all adults, equaling nearly 70 million adults in the United States and 34 million adults in Europe. It is the leading cause of disability in the United States. The most important risk factor for OA is age (Elders 2000), and as the aging population is dramatically increasing, the prevalence of the disease is likewise expected to increase. OA is distinct from rheumatoid arthritis, which is a systemic inflammatory disease, and is much less prevalent.

OA is frequently associated with severe pain, but the sources of this pain are not fully understood, which has presented many obstacles for its treatment and the development of novel therapies. The generation and maintenance of OA-related pain is so poorly understood largely because OA itself is not a single disease entity, but rather a group of diseases with different origins that share a common pathology. This pathology is characterized by damage of the cartilage in synovial joints, alterations in the physiology of ► [chondrocytes](#), and profound changes in the ► [subchondral bone](#) including sclerosis, cyst formation, and the formation of bony spurs beneath the affected cartilage. Over time, these changes lead to radiologic evidence for the presence of OA, and in fact, this is the primary method for diagnosis of OA in humans. OA tends to be most common in specific joints, namely the knees, hips, small joints of the hands, and the cervical and lumbar spine (Cushnaghan et al. 1990). Aside from the radiological evidence for the presence of the disease, the main symptom of the disease is pain, in particular, pain associated with use of the affected joint. Current treatment for OA-related pain can be divided

into three categories: physical/occupational therapy and devices, pharmacological treatment, and surgical intervention. The use of physical therapy can maintain muscle strength around the joint and can assist by increasing joint stability. Therapeutic intervention is most commonly achieved by using ► **NSAIDs, Survey** (NSAIDs). Although these drugs have been shown clinically to provide pain relief in OA patients, this pain relief is often incomplete (Altman et al. 2000), and they are often accompanied by unwanted side effects including the induction of ulcers (Scheiman 2003). However, the relatively recent development of selective ► **Cyclooxygenase-2 Inhibitors** such as rofecoxib and celecoxib, has led to equal or superior pain relief with a lower incidence of gastrointestinal toxicity (Scheiman 2003). Other pharmacological therapies include injections of steroids or high molecular weight hyaluronate into the affected joints. Finally, surgical intervention has grown rapidly over the past 25 years, but is only considered when the pain associated with OA has become intractable.

Several animal models of OA have been developed over the years. Just as OA itself has multiple distinct origins, different types of animal models have been developed. These animal models can be broadly classified as one of three types. The first type is a ‘chemical’ model of osteoarthritis and will be the focus of this chapter. Briefly, chemical models involve injection of one of a number of substances into a joint (typically the knee), which ultimately results in perturbations of the cartilage of the joint. The second type of model is a surgical model and mimics OA that develops secondary to an injury. These models typically involve severing one or more ligaments in the knee, but can also involve damaging the ► **meniscus**. The third type of model involves specific strains of mice or other animals that are prone to spontaneously develop OA. Each type of model has its own benefits and limitations, but like the human disease shares a similar pathology, namely damage to the cartilage and subchondral bone.

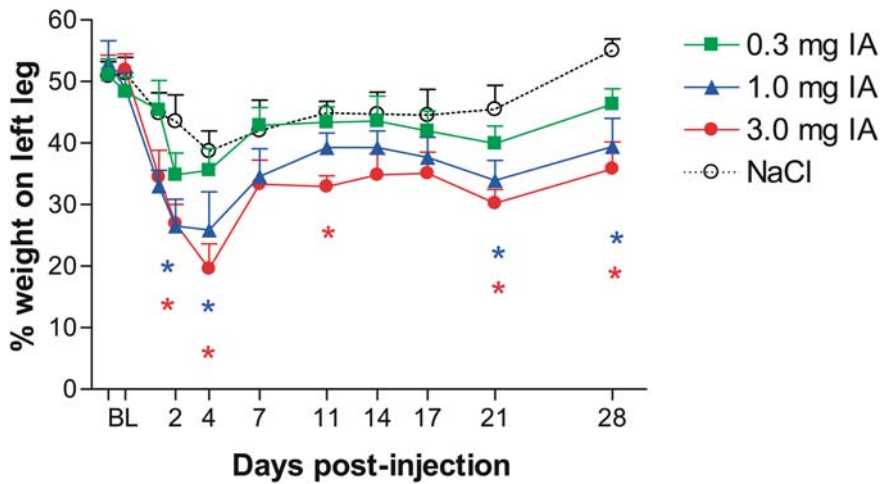
Initial studies using these models focused primarily on the biological processes that mediate the development of the disease, but they rarely addressed the pain associated with the disease. As the pain associated with OA significantly decreases the quality of life for OA sufferers, treatment of this pain has become of significant interest to the research community. Thus, these models have become the subject of recent investigation for studying the potential of novel therapeutics for OA-related pain. The monosodium iodoacetate (MIA) model in particular has received considerable attention for studying OA related pain. MIA is a metabolic inhibitor that blocks the activity of glyceraldehyde-3-phosphate dehydrogenase, preventing ► **glycolysis**. This inhibition ultimately leads to the death of the affected cells. When injected into a joint space, MIA preferentially acts on chondrocytes, causing damage to the cartilage of the joint. As the cartilage that normally protects the underlying bone

is destroyed, subsequent damage to this bony tissue occurs, and a pathology similar to that seen in humans develops. This is evident by histological analysis showing significant loss of cartilage and death of chondrocytes as well as alterations in the subchondral bone, and infiltration of inflammatory cells (van der Kraan et al. 1989; Guingamp et al. 1997; Guzman et al. 2003). The pathology is also evident when the knee joint is visualized using x-rays, which show severe damage to the bones in the knee joint (Fig. 1). Similarly, injection of MIA results in a concentration-dependent decrease in bone mineral

A



**Arthritis Model, Osteoarthritis, Figure 1** Radiograph showing the effect of iodoacetate on the bones of the rat knee joint. Injection of 3 mg iodoacetate (bottom panel) leads to profound deformation of the bones relative to saline-injected control of the knee joint (top panel). These changes are present as rough edges of the bone, apparent loss of bone density, and displacement of the patella (kneecap), indicating joint swelling.

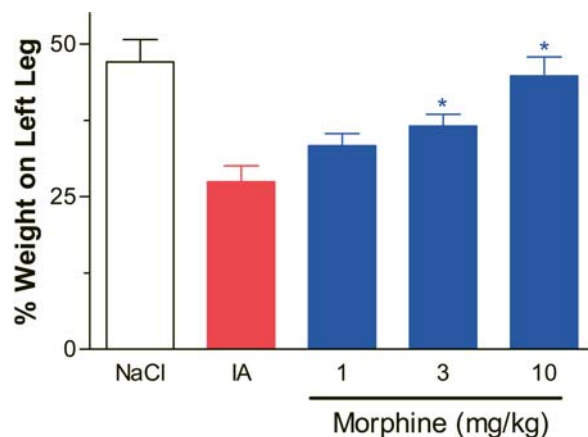


**Arthritis Model, Osteoarthritis, Figure 2** Injection of iodoacetate (IA) into the left knee of male rats leads to a concentration dependent alteration in hind limb weight bearing, indicative of joint pain. Note the biphasic nature of the response, and the critical late phase that begins around day 11, and does not appear to resolve. Asterisks denote significant differences between treatment groups for the respective colors compared to saline (NaCl)-injected control rats.

density in the affected joint (Pomonis et al. 2005) and marked joint swelling (Fernihough et al. 2004). Although the MIA model of OA has been used for some time to study the pathology associated with the model, its use to study pain associated with OA has only recently been investigated. Injection of MIA results in a concentration-dependent decrease in spontaneous activity in rats (Guingamp et al. 1997). However, this study did not investigate whether compounds that are known to provide pain relief altered these behaviors, and as such, it was unclear whether the decreased activity actually reflected the pain associated with the disease. Subsequent advances in behavioral assessment more conclusively demonstrated the utility of the MIA model for studying OA-associated pain. Several investigators have begun to measure hind limb weight bearing (WB) as a measure of OA-associated pain in rats. This technique simultaneously measures the weight borne by each hind limb of a rat. Rats with experimentally-induced OA show profound alterations in WB in a concentration-dependent manner (Bove et al. 2003; Kobayashi et al. 2003; Pomonis et al. 2005). As shown in Figure 2, the alterations in WB are biphasic in nature, with an intense acute phase that lasts approximately 4 days, followed by a period of restored WB. Eventually, a chronic phase of altered WB emerges that does not appear to resolve (Pomonis et al. 2005). The alterations in WB can be reversed upon administration of pain relieving agents such as morphine (Fernihough et al. 2004; Pomonis et al. 2005), acetaminophen, naproxen, rofecoxib (Bove et al. 2003), and celecoxib (Pomonis et al. 2005). The reversal of the MIA-induced alterations in WB is important, as it demonstrates that these behaviors are pain-related (and do not simply reflect alterations in joint stability). This also indicates that this technique is amenable to testing novel therapeutic agents for the treatment of OA-associated pain. Assessment of altered WB has not been the only reported pain behaviors observed in the MIA model, as mechanical

hypersensitivity has been reported in the corresponding hind paw (Fernihough et al. 2004), although these behaviors have not been observed by all experimenters (Pomonis et al. 2005).

Measurement of alterations in WB has also allowed other experimental models of OA to be examined for pain behaviors. Surgical transection of the meniscus leads to alterations in WB and mechanical hypersensitivity, but to a lesser extent than what is seen with MIA injection, despite similar changes in joint pathology (Fernihough et al. 2004). Intra-articular injection of papain (a protease derived from papaya) leads to concentration-dependent alterations in WB, but the alterations are relatively short-lasting and not as robust as those seen with injection of MIA (Pomonis et al. 2005). While the implications of the differences in pain behaviors in the various models of OA are not completely clear, it appears that several factors including the



**Arthritis Model, Osteoarthritis, Figure 3** Morphine reverses pain associated with experimental osteoarthritis. Twenty one days after an injection of 1 mg iodoacetate (IA), rats received a single dose of morphine or vehicle, and hind limb weight bearing was assessed one hour later. Asterisks denote that the 3 and 10 mg/kg doses of morphine produced significant reversal of IA-induced pain. Adapted from Pomonis et al. (2005).



region of damage to the joint, the source of pathology, and the extent of the pathology can all have profound effects on the subsequent pain behaviors. This suggests that there may be distinct mechanisms responsible for the generation and maintenance of OA-associated pain, and that considerable work will need to be done to more fully understand these mechanisms.

## References

1. Altma R, Hochberg M, Moskowitz RW, Schnitzer TJ (2000) Recommendations for the Medical Management of Osteoarthritis of the Hip and Knee: 2000 Update. *Arthritis and Rheumatism* 43:1905–1915
2. Bove S, Calcaterra S et al. (2003) Weight Bearing as a Measure of Disease Progression and Efficacy of Anti-Inflammatory Compounds in a Model of Monosodium Iodoacetate-Induced Osteoarthritis. *Osteoarthritis and Cartilage* 11:821–830
3. Cushnaghan J, Cooper C et al. (1990) Clinical Assessment of Osteoarthritis of the Knee. *Annals of the Rheumatic Diseases* 49:768–770
4. Elders MJ (2000) The Increasing Impact of Arthritis on Public Health. *J Rheumatol* 60:6–8
5. Fernihough J, Gentry C et al. (2004) Pain Related Behaviour in Two Models of Osteoarthritis in the Rat Knee. *Pain* 112:83–93
6. Guingamp C, Gefout-Pottie P et al. (1997) Mono-Iodoacetate-Induced Experimental Osteoarthritis: A Dose-Response Study of Loss of Mobility, Morphology, and Biochemistry. *Arthritis and Rheumatism* 40:1670–1679
7. Guzman R, Evans M et al. (2003) Mono-Iodoacetate-Induced Histologic Changes in Subchondral Bone and Articular Cartilage of Rat Femorotibial Joints: An Animal Model of Osteoarthritis. *Toxicologic Pathology* 31:619–624
8. Kobayashi K, Imaizumi R et al. (2003) Sodium Iodoacetate-Induced Experimental Osteoarthritis and Associated Pain Model in Rats. *J Vet Med Sci* 65(11):1195–1199
9. Pomonis JD, Boulet J et al. (2005) Development and Pharmacological Characterization of a Rat Model of Osteoarthritis Pain. *Pain*: 114:339–346
10. Scheiman JM (2003) Gastrointestinal Safety of Cyclooxygenase-2 Inhibitors. *Current Pharmaceutical Design* 9:2197–206
11. van der Kraan P, Vitters E et al. (1989) Development of Osteoarthritic Lesions in Mice by “Metabolic” and “Mechanical” Alterations in the Knee Joints. *Am J Pathol* 135:1001–1014

## Arthritis Urethritica

- ▶ Reiter’s Syndrome

## Arthritogenic Pain

- ▶ Muscle Pain in Systemic Inflammation (Polymyalgia Rheumatica, Giant Cell Arteritis, Rheumatoid Arthritis)

## Articular

### Definition

Pertaining to the joints.

- ▶ Sacroiliac Joint Pain

## Articular Afferents, Morphology

**A**

KARL MESSLINGER

University of Erlangen-Nürnberg, Erlangen, Germany  
messlinger@physiologie1.uni-erlangen.de

### Synonyms

Articular Sensory Receptors; Sensory Endings in Joint Tissues

### Definition

Afferent nerve fibers innervating articular tissues, in a narrow sense the sensory endings of afferent fibers in joint tissues, particularly in joint capsules and articular ligaments. Thick myelinated afferents form corpuscular nerve endings, thin myelinated and unmyelinated afferents are without a corpuscular end structure (non-corpuscular endings, free nerve endings).

### Characteristics

#### Remarks on the Classification of Sensory Endings

Sensory receptors are either classified according to their morphological appearance, which is thought to be correlated with functional properties, or according to the electrophysiological properties of their sensory axons within peripheral nerves. The velocity of action potentials running along the afferent fiber is used for a basic classification, dividing the afferents into slowly conducting (A $\delta$  or group III, and C or group IV) and fast conducting groups (A $\beta$  or group II). Whereas the A $\beta$  fibers possess corpuscular nerve endings, the thinly myelinated A $\delta$  and the unmyelinated C fibers terminate as so-called “free nerve endings” in peripheral tissues. This term has been used since the late 19<sup>th</sup> century, when new staining techniques enabled anatomists to visualize fine nerve endings that were obviously not enclosed or accompanied by specific cellular end structures (Hinsey 1927). In the middle of the 20<sup>th</sup> century researchers combined psychophysiological and histological methods, and found that spot-like areas in human skin and deep tissues, the noxious stimulation of which was painful, contained nothing more than “free nerve endings” (Weddell and Harpman 1940). This led to the general conclusion that “free nerve endings” are the sensory end structures of nociceptors. Subsequent studies have shown, however, that sensory receptors signaling (innocuous) warm and cold, as well as many low-threshold mechanoreceptors, are also slowly conducting. New trials to correlate electrophysiological and histological data on slowly conducting afferents have not been much more conclusive with respect to morpho-functional characteristics (see below), whereas many additional structural details have been acquired by selective marking and high resolution techniques such as confocal and electron microscopy. We now know that those (previously described) unmyelinated peripheral

nerve fibers and “free nerve endings”, which are visible with the light microscope, are usually Remak bundles composed of several unmyelinated sensory axons and Schwann cells.

### Composition of Articular Nerves

The distribution of different types of nerve fibers has been studied in detail in the medial and posterior articular nerves (MAN and PAN) innervating the knee joint in cat, rat and mouse, using electron microscopy (Langford and Schmidt 1983; Hildebrand et al. 1991; Salo and Theriault 1997; Ebinger et al. 2001). The composition of these nerves is similar, with a proportion of about 80% being unmyelinated fibers, although the total number of nerve fibers differs between the three species (e.g. in the PAN: cat about 1200, rat 400–600, mouse about 200). Comparisons between normal and sympathectomized animals have revealed that up to 50% of unmyelinated fibers are afferent (Langford and Schmidt 1983; Salo and Theriault 1997). The diameters of myelinated sensory axons range from 1 to 8  $\mu\text{m}$  in the rat (Hildebrand et al. 1991), and from 1 to 18  $\mu\text{m}$  in the cat. The majority of myelinated fibers in the MAN have diameters below 6  $\mu\text{m}$  (belonging to group III), whereas in the PAN, thicker nerve fibers (group II) predominate (Heppelmann et al. 1988).

### Neuropeptide Content of Articular Afferents

The proportion of neuropeptide-containing **dorsal root ganglion** (DRG) cells innervating the cat knee joint has been determined with retrograde labeling techniques and immunohistochemistry. **Calcitonin gene-related peptide** (CGRP) immunoreactivity was found in 35% and **substance P** (SP) immunoreactivity in 17% of labeled afferents from the MAN (Hanesch et al. 1991). In the PAN, the proportions are similar. Whereas all SP immunoreactive DRG neurons were found to be small or medium-sized cells, CGRP immunoreactivity was also detected in some large neurons with a diameter of more than 50  $\mu\text{m}$  (Hanesch et al. 1991). **Somatostatin** (Som) seems to be colocalized with SP in nearly all MAN afferents (Hanesch et al. 1995). An acute experimental arthritis caused significant upregulation of the number of CGRP - but not SP-positive neurons (Hanesch et al. 1997). In the rat knee joint, the proportion of CGRP and SP immunoreactive afferents was 33% and 10%, respectively (Salo and Theriault 1997). In the dog, the respective proportions were 29% for CGRP and 17% for SP, while in 10% of afferents these two neuropeptides seemed to be colocalized (Tamura et al. 1998).

### Ultrastructure of Fine Sensory Endings in Articular Tissues

The fine sensory innervation of the cat knee joint has been studied by electron microscopy followed by quantitative analysis of structures and 3D-reconstruction (Heppelmann et al. 1990, 1995) and reviewed with respect to their presumptive functional role (Messlinger

1996, Heppelmann 1997). In this paragraph general ultrastructural features are discussed that probably apply to all non-corpusecular sensory endings in deep tissues. As fine sensory endings lack a corpusecular structure, the only morphological landmark that may indicate the end of the conductive part of the nerve fibers, and the beginning of the sensory endings, is the termination of the perineurial sheath surrounding the peripheral nerve. In group III fibers, an additional transition zone exists in which the nerve fibers have lost their myelin sheath but are still enclosed by the perineurium. Distal to the perineurial sheath, the sensory axons maintain their accompanying **Schwann cells**. Individual group III fibers are usually encased by their own Schwann cell, whereas several group IV axons are frequently bound together sharing a common Schwann cell, as is the case within the peripheral nerve (Remak bundles). These bundles of group IV, as well as the individual group III fibers, ramify several times to form tree-like sensory endings. Apart from the larger mean diameter of group III compared to group IV fibers, the sensory endings of group III fibers can be identified by a characteristic “neurofilament core”, a bundle of centrally arranged neurofilaments that run along the whole length of the sensory axon up to their terminal branches. There is morphological evidence that the afferents are receptive along their entire tree-like sensory endings, which can measure up to several hundred  $\mu\text{m}$  in length. Each sensory axon forms periodically arranged varicose segments that are characterized by bare areas, where there are gaps in the cover formed by the Schwann cell so that the axon membrane is partly exposed to the surrounding tissue. Membrane channels may be concentrated here and exposed to the extracellular space. Accumulated mitochondria, glycogen particles and some vesicles are regularly found in the varicosities. The axoplasm beneath the bare areas has an electron dense substructure, which has been described as a “receptor matrix” in various types of sensory nerve endings (Andres and von Düring 1973). These specialized areas, presumably receptive in nature, stretch along the whole sensory branches of non-corpusecular endings.

### Topography of Fine Sensory Endings in the Knee Joint

Sensory endings of group III and group IV fibers are found in nearly all tissues of the cat knee joint, in particular the articular capsule, the superficial layers of the ligaments, and the tendons and muscles that insert at the joint. Most of the fine sensory endings are located within vascularized layers of the articular capsule running along venous vessels, whilst others extend into dense connective tissue or between fat cells. In search of a functional consequence of this differential topography, trials have been made to combine electrophysiological and morphological techniques (Messlinger et al. 1995). In these experiments, the sensory endings of functionally characterized group



III units were marked with fine needles within their receptive fields, the positioning of which was guided by impulse responses to the needles. The results of this study were fairly conclusive with respect to the mechanical and chemical sensitivity of units. The sensory endings of high-threshold afferents that can be regarded as mechano-nociceptors were most frequently located in structures of dense connective tissue (ligaments, tendons, collagenous layers of the articular capsule), whereas the endings of low-threshold afferents were usually found innervating vascularized and soft connective tissues. Secondly, nociceptors that terminated in dense connective tissues were clearly less chemosensitive to the close arterial application of bradykinin or prostaglandins compared to the low mechanical threshold afferents that innervated vascularized tissues. It is not yet clear if these functional differences are determined by intracellular modifications, differences in the receptor equipment of the sensory endings, or whether they are simply dependent on the surrounding tissues. It has been hypothesized that the sensitivity of fine sensory receptors is reflected by the number of energy-providing mitochondria within the sensory axons, which is significantly different between individual sensory group III endings (Heppelmann et al. 1994).

#### Corpuscular Nerve Endings in Articular Tissues

Corpuscular sensory endings in the joint are Ruffini- and Pacini-like corpuscles that have been classified as type I and type II endings in early morphological studies (Freeman and Wyke 1967). Ruffini-like corpuscles are found in the fibrous joint capsule and within ligaments in different joints, while Golgi tendon organs (type III) can be found in muscles inserting at the joint (review by Zimny 1988). Morphologically these two types are very similar. Ruffini-like corpuscles have a globular or ovoid shape, are enclosed by a capsule of several cell layers and are supplied by a myelinated nerve fiber of 5–8  $\mu\text{m}$  in diameter. One nerve fiber can innervate up to 6 corpuscles. Within the capsule, the sensory axon ramifies forming several unmyelinated branches that wind around bundles of collagen fibers. The intracapsular collagen fibers may be connected with the extracapsular network of collagen to conduct mechanical distension to the corpuscle (Andres and von Düring 1973). According to ultrastructural data from different species including man, there is a broad variety of corpuscular form and size, and there are also transient corpuscle types, for which the corpuscle may be incomplete or absent (Halata et al. 1985). Functionally, Ruffini-like corpuscular receptors are low-threshold, slowly adapting mechanoreceptors that respond to distension of articular structures. Pacini-like corpuscles (type II endings) are localized in the joint capsule and in periarticular fatty tissue (Freeman and Wyke 1967). They have an oval or longish form, a capsule composed of many cell layers (derived from

fibroblasts and perineurial cells) and they are supplied by a thick myelinated nerve fiber, which is not ramified but runs through the long axis of the corpuscle as a central cylinder. Detailed electron microscopic studies were made on Pacini-like corpuscles in the knee joint of different species including man (Halata et al. 1985). Functionally, Pacini-like corpuscles are rapidly adapting mechanoreceptors with a very low threshold for movement and vibratory stimuli. Corpuscular sensory endings play only a minor, if any, role in articular nociception and pain. It is likely, however, that they regulate reflexes and posture programs that are modulated by nociceptive inputs.

#### References

1. Andres KH, von Düring M. (1973) Morphology of Cutaneous Receptors. In: Iggo A (ed) *Handbook of Sensory Physiology*, vol 2, Somatosensory System. Springer, Berlin, pp 3–28
2. Ebinger M, Schmidt RF, Heppelmann B (2001) Composition of the Medial and Posterior Articular Nerves of the Mouse Knee Joint. *Somatosens Mot Res* 18:62–65
3. Freeman MAR, Wyke B (1967) The Innervation of the Knee Joint. An Anatomical and Histological Study in the Cat. *J Anat* 101:505–532
4. Halata Z, Rettig T, Schulze W (1985) The Ultrastructure of Sensory Nerve Endings in the Human Knee Joint Capsule. *Anat Embryol* 172:265–275
5. Hanesch U, Heppelmann B, Schmidt RF (1991) Substance P- and Calcitonin Gene-Related Peptide Immunoreactivity in Primary Afferent Neurons of the Cat's Knee Joint. *Neuroscience* 45:185–193
6. Hanesch U, Heppelmann B, Schmidt RF (1995) Somatostatin-Like Immunoreactivity in Primary Afferents of the Medial Articular Nerve and Colocalization with Substance P in the Cat. *J Comp Neurol* 354:345–352
7. Hanesch U, Heppelmann B, Schmidt RF (1997) Quantification of Cat's Articular Afferents Containing Calcitonin Gene-Related Peptide or Substance P Innervating Normal and Acutely Inflamed Knee Joint. *Neurosci Lett* 233:105–108
8. Heppelmann B (1997) Anatomy and Histology of Joint Innervation. *J Peripher Nerv Syst* 2:5–16
9. Heppelmann B, Heuss C, Schmidt RF (1988) Fiber Size Distribution of Myelinated and Unmyelinated Axons in the Medial and Posterior Articular Nerves of the Cat's Knee Joint. *Somatosens Res* 5:273–281
10. Heppelmann B, Messlinger K, Neiss WF et al. (1990) Ultrastructural Three-Dimensional Reconstruction of Group III and Group IV Sensory Nerve Endings ("Free Nerve Endings") in the Knee Joint Capsule of the Cat: Evidence for Multiple Receptive Sites. *J Comp Neurol* 292:103–116
11. Heppelmann B, Messlinger K, Neiss WF et al. (1994) Mitochondria in Fine Afferent Nerve Fibres of the Knee Joint in the Cat: A Quantitative Electron-Microscopical Examination. *Cell Tissue Res* 275:493–501
12. Heppelmann B, Messlinger K, Neiss WF et al. (1995) Fine Sensory Innervation of the Knee Joint Capsule by Group III and Group IV Nerve Fibers in the Cat. *J Comp Neurol* 351:415–428
13. Hildebrandt C, Oqvist G, Brax L et al. (1991) Anatomy of the Rat Knee Joint and Fibre Composition of a Major Articular Nerve. *Anat Rec* 229:545–555
14. Hinsey JC (1927) Some Observations on the Innervation of Skeletal Muscle of the Cat. *J Comp Neurol* 44:87–195
15. Langford LA, Schmidt RF (1983) Afferent and Efferent Axons in the Medial and Posterior Articular Nerves of the Cat. *Anat Rec* 206:71–78
16. Messlinger K, Pawlak M, Steinbach H et al. (1995) A New Combination of Methods for Localization, Identification, and Three-

- Dimensional Reconstruction of the Sensory Endings of Articular Afferents Characterized by Electrophysiology. *Cell Tissue Res* 281: 283–294
17. Messlinger K (1996) Functional Morphology of Nociceptive and other Fine Sensory Endings ("Free Nerve Endings") in Different Tissues. In: Kumazawa T, Kruger L, Mizumura K (eds) *The Polymodal Receptor – a Gateway to Pathological Pain – Progress in Brain Research*, vol 113. Elsevier, Amsterdam, pp 273–298
  18. Salo PT, Theriault E (1997) Number, Distribution and Neuropeptide Content of Rat Knee Joint Afferents. *J Anat* 190:515–522
  19. Tamura R, Hanesch U, Schmidt RF et al. (1998) Examination of Colocalization of Calcitonin Gene-Related Peptide- and Substance P-Like Immunoreactivity in the Knee Joint of the Dog. *Neurosci Lett* 254:53–56
  20. Weddell G, Harpman JA (1940) The Neurohistological Basis for the Sensation of Pain Provoked from Deep Fascia, Tendon, and Periosteum. *J Neurol Neurosurg Psychiat* 3:319–328
  21. Zimny ML (1988) Mechanoreceptors in Articular Tissues. *Am J Anat* 182:16–32

## Articular Nociceptors

HANS-GEORG SCHAIBLE  
 Department of Physiology, Friedrich-Schiller-  
 University of Jena, Jena, Germany  
 Hans-Georg.Schaible@mti.uni-jena.de

### Synonyms

Joint nociceptors

### Definition

► **Articular nociceptors** are primary afferent neurons in joint nerves (or primary afferent neurons supplying joints) that signal and encode the impact of noxious stimuli to joints. In the normal joint, articular nociceptors are mainly or exclusively activated by noxious mechanical stimuli applied to the joint. Articular nociceptors are sensitized for mechanical stimulation in the process of joint inflammation.

### Characteristics

#### Pain in Joints

Pain in a normal joint is commonly elicited by twisting or hitting the joint. In conscious humans, pain in the normal joint can be elicited when noxious mechanical or chemical stimuli are applied to the fibrous structures, such as ligaments and fibrous capsule. No pain is elicited by stimulation of cartilage. Stimulation of normal synovial tissue rarely evokes pain. Stimulation of fibrous structures with innocuous mechanical stimulation can evoke pressure sensations.

Joint inflammation is characterized by hyperalgesia and persistent pain at rest. Noxious stimuli cause stronger pain than normal, and pain is even evoked by mechanical stimuli whose intensity does not normally elicit pain, i.e. movements in the working range and gentle pressure, e.g. during palpation. Discharge properties of joint nociceptors correspond to these characteristic phenomena of joint pain (Schaible and Grubb 1993; Schaible 2005).

### Anatomy of Joint Innervation

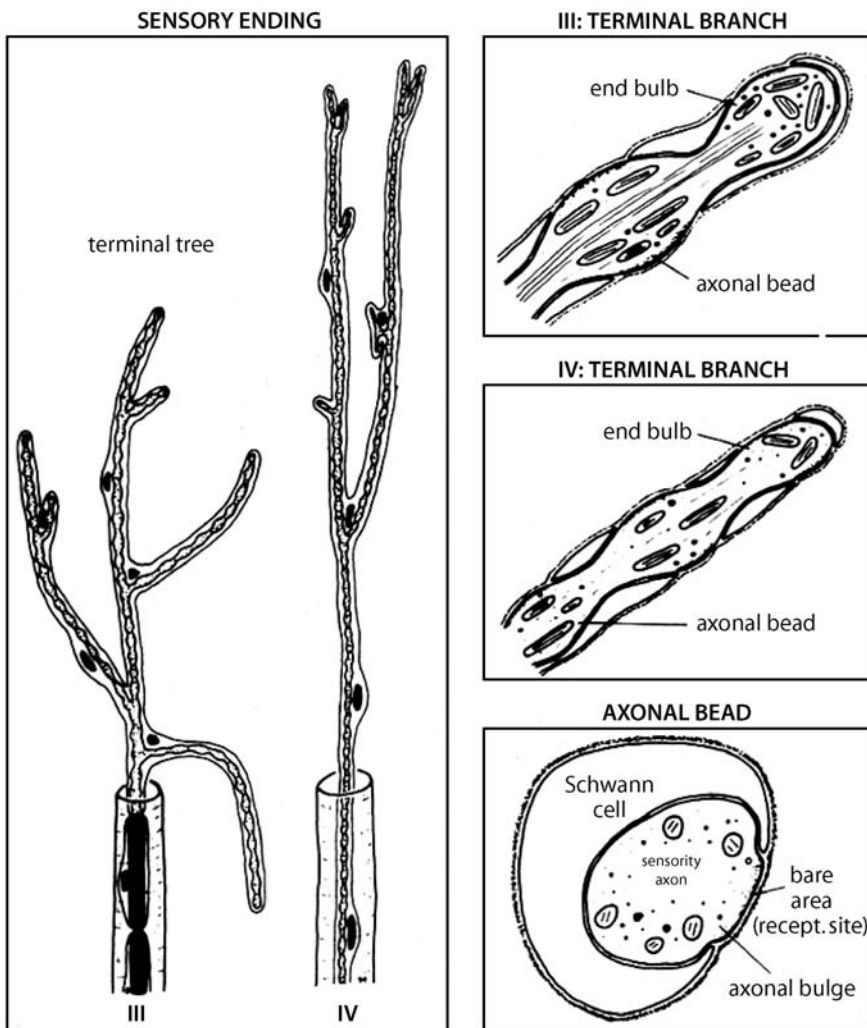
Joints are innervated by branches descending from main nerve trunks or their muscular, cutaneous and periosteal branches. A typical joint nerve contains thick myelinated A $\beta$  (group II), thinly myelinated A $\delta$  (group III), and a high proportion (~ 80%) of unmyelinated C (group IV) fibres. The latter are either sensory afferents or sympathetic efferents (each ~ 50%). While A $\beta$  fibres with corpuscular endings of the Ruffini-, Golgi- and Pacini-type in fibrous capsule, articular ligaments, menisci and adjacent periosteum are not nociceptive, numerous articular A $\delta$  and C fibres are nociceptive. A $\delta$  and C fibres terminate as unencapsulated ("free") nerve endings in the fibrous capsule, adipose tissue, ligaments, menisci, and the periosteum. Using staining for nerve fibres and neuropeptides, endings were also identified in the synovial layer. The major neuropeptides in joint nerves are ► **substance P**, ► **CGRP**, and ► **somatostatin**. Neurokinin A, ► **galanin**, enkephalins, and ► **neuropeptide Y** have also been localized in joint afferents. The cartilage is not innervated (Schaible and Grubb 1993; Schaible 2005).

Figure 1 shows the reconstruction of peripheral nerve endings of joint afferents of cat's knee joint. Typical nerve endings of joint afferents are ensheathed by ► **Schwann cells**, and only some sites are not covered. These exposed areas appear as a string of beads. It is assumed that these exposed areas are receptive sites along the fibres (Heppelmann et al. 1990).

### Mechanosensitivity of Joint Afferents

Joint afferents have been mainly recorded in articular nerves supplying cat knee and rat knee and ankle joints. They were characterized by their responses to innocuous and noxious mechanical stimuli. Light to moderate pressure applied to the joint, and movements within the working range of the joint, are innocuous stimuli which are not normally painful. Noxious stimuli are strong pressure at intensities that are felt as pain, and movements exceeding the working range of the joint, such as twisting against the resistance of the tissue (Schaible and Schmidt 1983a; Schaible and Schmidt 1983b).

Figure 2 shows four typical joint afferents of cat's knee joint with different sensitivities to movements. Figure 2a displays a low threshold A $\delta$  fibre. This fibre had two receptive fields in the fibrous capsule (dots). It responded phasically to extension (ext) of the knee, and it was strongly activated by inward rotation (IR) within the working range of the knee joint. This fibre was thus activated by innocuous movements, i.e. the threshold was in the innocuous range. However, the strongest responses were elicited by noxious movements such as noxious inward rotation (n.IR). Typically, these neurons are also activated by light pressure applied to the receptive field. Such a response pattern is also seen in many low threshold A $\beta$  fibres in the fibrous capsule and in ligaments, including the anterior cruciate ligament.

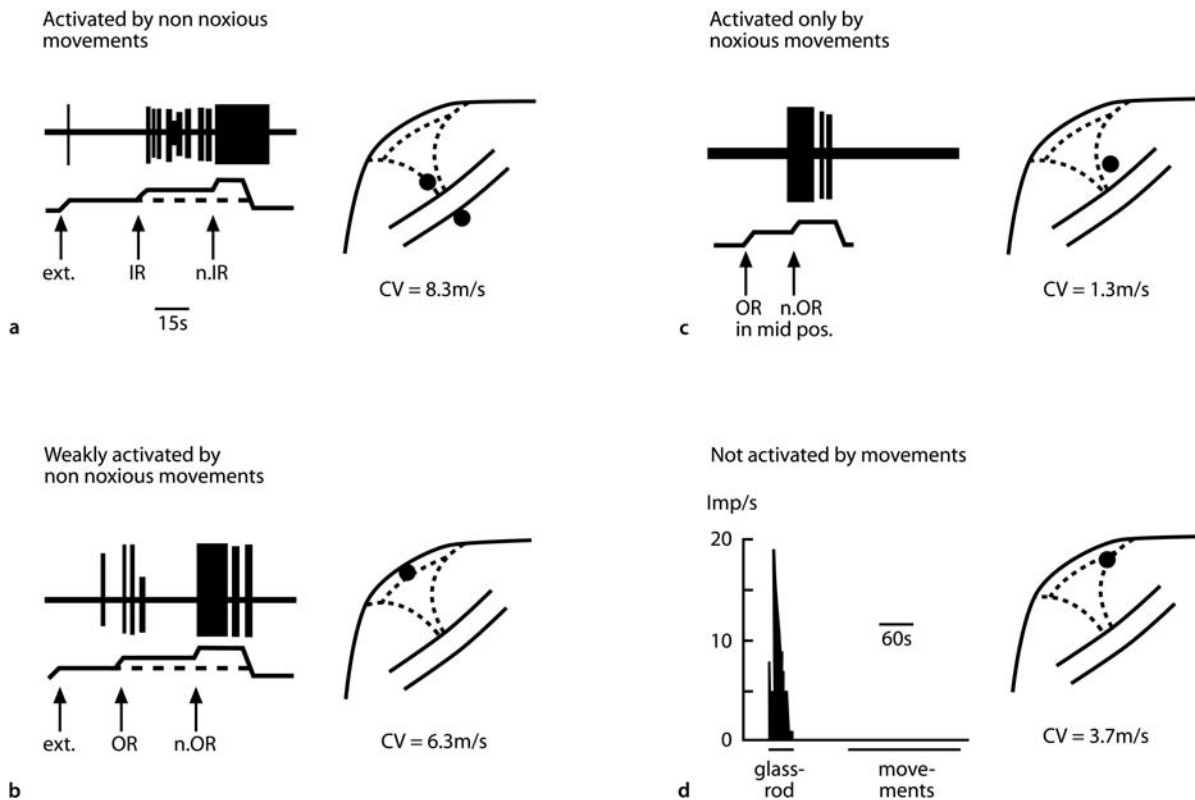


**Articular Nociceptors,**  
**Figure 1** Schematic drawings of a group III (A $\delta$ ) and group IV (C) fibre sensory ending in the knee joint capsule of the cat. A terminal tree is formed by several long and short branches. The sensory axons consist of periodically arranged thick and thin segments forming spindle-shaped beads. The axolemma is not completely unmyelinated by its accompanying Schwann cells; the bare areas are presumably receptive sites. From Heppelmann et al. (1990).

Although these units have their strongest response in the noxious range, they are not considered nociceptive neurons. The discharge rate seems to encode the strength of a stimulus from the innocuous to the noxious range, but it does not encode the presence of a noxious stimulus *per se*. In fact, the most adequate innocuous mechanical stimulus can evoke a stronger response than a noxious mechanical stimulus, e.g. a noxious movement in another direction.

The other fibre types shown in Figure 2 respond mainly or exclusively to noxious mechanical stimuli. Figure 2b shows an A $\delta$  fibre with a receptive field in the patellar ligament (dot). This unit responded weakly, with only a few spikes during outward rotation in the working range (OR), but it had a strong response to noxious outward rotation (n.OR). The C fibre in Figure 2C, with a receptive field in the fibrous capsule, was exclusively activated by noxious movements. It did not respond to any innocuous movement, but showed pronounced responses when the joint was twisted (noxious outward rotation, n.OR). These neurons also require high

pressure intensity to elicit a response by probing the receptive field. Figure 2D displays an A $\delta$  fibre with a receptive field in the anterior capsule that did not respond to any innocuous or noxious movement, but responded to noxious pressure onto the receptive field. Not shown in Figure 2 are sensory neurons which are mechanoinensitive under normal conditions. These neurons can be identified by electrical stimulation of the joint nerve, but under normal conditions no receptive field is found, and no response is elicited by innocuous or noxious movement. They respond to injection of KCl into the joint artery, and some seem to respond to inflammatory mediators. However, a proportion of these neurons is rendered mechanosensitive during inflammation in the joint (see below), and therefore these units were called silent nociceptors. It is estimated that about one third of the sensory C fibres and a small proportion of A $\delta$  fibres in the joint nerve are mechanoinensitive. The proportion of silent nociceptors can be different in different joint nerves. For example, the posterior articular nerve of cat's knee seems to contain



**Articular Nociceptors, Figure 2** Four different articular afferents of cats knee joint exemplifying classes of afferents according to their responses to passive movements. Dots in the insets: receptive fields identified by probing the joint. Ext, extension; IR, inward rotation (pronation); OR, outward rotation (supination); n.IR and n.OR, noxious IR and OR; mid pos, mid (resting) position. From Schaible and Grubb (1993).

many more silent nociceptors than the medial articular nerve.

Figure 3 displays the medial articular nerve of cat's knee joint, and the proportions of A $\beta$ , A $\delta$  and C fibres in the categories defined in Figure 2. Only those neurons that had a detectable receptive field, and that were activated by innocuous and/or noxious mechanical stimuli applied to the normal joint (initially mechanosensitive sensory neurons are not included) are included. It is shown that most A $\beta$  fibres were either strongly or weakly activated by innocuous stimuli. More than 50% of the A $\delta$  fibres and about 70% of the sensory C fibres were classified as high threshold units (Schaible and Grubb 1993; Schaible 2005).

#### Changes of Mechanosensitivity of Joint Afferents during Inflammation

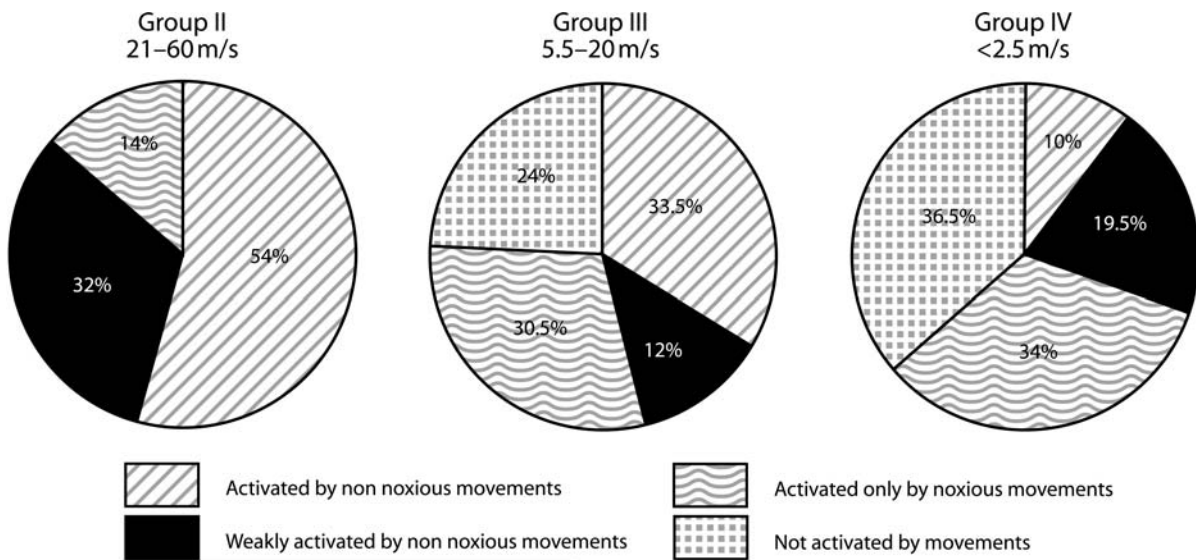
It has been pointed out above that an inflamed joint hurts during movements in the working range and during palpation, and that pain may occur under resting conditions. It is a characteristic feature of joint nociceptors that their mechanosensitivity is increased during inflammation. Many low threshold A $\delta$  and C fibres show increased responses to movements in the working range. Most strikingly, a large proportion of high threshold afferents (see Figs. 2c and d) are sensitized,

such that they respond to movements in the working range of the joint (Schaible and Schmidt 1985). Increased mechanosensitivity has also been found during chronic forms of arthritis, suggesting that mechanical sensitization is an important neuronal basis for chronic persistent hyperalgesia of the inflamed joint (Guilbaud et al. 1985). Furthermore, initially mechanosensitive afferents (silent nociceptors) are sensitized and become mechanosensitive (Schaible and Schmidt 1988). Thus, silent nociceptors are recruited for the encoding of noxious events during an inflammatory process.

#### Chemosensitivity of Joint Afferents

The vast majority of sensory A $\delta$  and C fibres in the joint nerve are chemosensitive for endogenous compounds that are produced and released during pathophysiological conditions. Mediators are able to excite and/or sensitize primary afferent neurons for mechanical stimuli and for chemical stimuli. These mediators also usually produce vascular and other changes in the tissue (i.e. they contribute to the inflammatory process itself). Concerning chemosensitivity, the following aspects should be noted: first, these mediators only affect A $\delta$  and C fibres of the joint nerve, not A $\beta$  fibres, second, an effect is typically elicited only in subpopulations of the articular units (i.e. not all units express the full range of





**Articular Nociceptors, Figure 3** Mechanosensitivity of primary afferent neurons supplying normal cat's knee joint. The graph shows the proportions of A $\beta$ , A $\delta$ , and C fibres in the different sensitivity classes. From Schaible and Grubb (1993).

chemosensitivity), and third, high threshold (nociceptive) as well as low threshold A $\delta$  and C articular afferents (not nociceptive-specific) are affected or not affected by a certain mediator. Thus, the chemosensitivity of a unit is not strictly correlated to its mechanosensitivity (Schaible and Grubb 1993; Schaible 2005).

Effects of mediators can be described as follows. Some mediators can induce firing of neurons and/or an increase of their responses to movements. Such effects have been observed for bradykinin, prostaglandins E<sub>2</sub> and I<sub>2</sub>, and serotonin. However, after bolus injections of the compounds into the joint artery, differences in the pattern of effects were noted. The excitatory effect of bradykinin on joint afferents is short (less than 1 min), whereas the sensitization for mechanical stimuli of joint afferents lasts minutes, even when bradykinin did not excite the neuron. Both PGE<sub>2</sub> and PGI<sub>2</sub> cause ongoing discharges and/or sensitization to mechanical stimulation of the joint. The effect of PGE<sub>2</sub> has a slow onset and duration of minutes, whereas the action of PGI<sub>2</sub> begins quickly and has a short duration. In the rat ankle joint, PGI<sub>2</sub> excites and sensitizes a much larger proportion of units than PGE<sub>2</sub>. In addition, these PGs sensitize joint afferents to the effects of bradykinin, regardless of whether they have an excitatory effect by themselves. PGE<sub>2</sub> and bradykinin together can cause a stronger sensitization to mechanical stimulation than bradykinin or PGE<sub>2</sub> alone. Serotonin also sensitizes A $\delta$  and C fibres of the joint nerve to excitation by mechanical stimuli (Schaible and Grubb 1993; Schaible 2005). Excitation of articular afferents has also been observed following administration of capsaicin, ATP and adenosine (Dowd et al. 1998a; Dowd et al. 1998b). Effects have also been found for neuropeptides. While sub-

stance P increased (Herbert and Schmidt 2001) and somatostatin reduced mechanosensitivity in numerous afferents (Heppelmann and Pawlak 1997), the peptides galanin (Heppelmann et al. 2000), neuropeptide Y (Just et al. 2001), and nociceptin (McDougall et al. 2000) sensitized some neurons and reduced responses in other neurons. Whether the different patterns of peptide effects (excitation or inhibition) are dependent on the functional state of the neuron is not known at the moment. In general, it was proposed that the simultaneous presence of different neuropeptides regulates excitability of the afferent fibres.

## References

1. Dowd E, McQueen DS, Chessell IP, Humphrey PPA (1998a) P2X Receptor-Mediated Excitation of Nociceptive Afferents in the Normal and Arthritic Rat Knee Joint. *Br J Pharmacol* 125:341–346
2. Dowd E, McQueen DS, Chessell IP, Humphrey PPA (1998b) Adenosine A1 Receptor-Mediated Excitation of Nociceptive Afferents Innervating the Normal and Arthritic Rat Knee Joint. *Br J Pharmacol* 125:1267–1271
3. Guilbaud G, Iggo A, Tegner R (1985) Sensory Receptors in Ankle Joint Capsules of Normal and Arthritic Rats. *Exp Brain Res* 58:29–40
4. Heppelmann B, Messlinger K, Neiss W, Schmidt RF (1990) Ultrastructural Three-Dimensional Reconstruction of Group III and Group IV Sensory Nerve Endings (Free Nerve Endings) in the Knee Joint Capsule of the Rat: Evidence for Multiple Receptive Sites. *J Comp Neurol* 292:103–116
5. Heppelmann B, Just S, Pawlak M (2000) Galanin Influences the Mechanosensitivity of Sensory Endings in the Rat Knee Joint. *Eur J Neurosci* 12:1567–1572
6. Heppelmann B, Pawlak M (1997) Inhibitory Effect of Somatostatin on the Mechanosensitivity of Articular Afferents in Normal and Inflamed Knee Joints of the Rat. *Pain* 73:377–382
7. Herbert MK, Schmidt RF (2001) Sensitisation of Group III Articular Afferents to Mechanical Stimuli by Substance P. *Inflamm Res* 50:275–282



8. Just S, Heppelmann B (2001) Neuropeptide Y Changes the Excitability of Fine Afferent Units in the Rat Knee Joint. *Br J Pharmacol* 132:703–708
9. McDougall JJ, Pawlak M, Hanesch U, Schmidt RF (2000) Peripheral Modulation of Rat Knee Joint Afferent Mechanosensitivity by Nociceptin/Orphanin FQ. *Neurosci Lett* 288:123–126
10. Schaible H-G (2005) Basic Mechanisms of Deep Somatic Pain. In: McMahon SB, Koltzenburg M (eds) *Textbook of Pain* (in press)
11. Schaible H-G, Grubb BD (1993) Afferent and Spinal Mechanisms of Joint Pain. *Pain* 55:5–54
12. Schaible H-G, Schmidt RF (1983a) Activation of Groups III and IV Sensory Units in Medial Articular Nerve by Local Mechanical Stimulation of Knee Joint. *J Neurophysiol* 49:35–44
13. Schaible H-G, Schmidt RF (1983b) Responses of Fine Medial Articular Nerve Afferents to Passive Movements of Knee Joint. *J Neurophysiol* 49:1118–1126
14. Schaible H-G, Schmidt RF (1985) Effects of an Experimental Arthritis on the Sensory Properties of Fine Articular Afferent Units. *J Neurophysiol* 54:1109–1122
15. Schaible H-G, Schmidt RF (1988) Time Course of Mechanosensitivity Changes in Articular Afferents during a Developing Experimental Arthritis. *J Neurophysiol* 60:2180–2195

## Articular Nociceptors, Sensitization

- ▶ Sensitization of Muscular and Articular Nociceptors

## Articular Sensory Receptors

- ▶ Articular Afferents, Morphology

## As Needed Dosage Regimen

### Definition

A method of dose titration where the dose of drug is fixed and the interval between administered doses is determined by the response of the patient.

In analgesic therapy using “as needed” regimen, the dose of an opioid is not repeated until the patient reports the return of some intensity of pain.

- ▶ Opioid Rotation

## Aseptic Meningitis

- ▶ Headache in Aseptic Meningitis

## ASICs

### Synonyms

Acid sensing ion channels

### Definition

A family of proteins combined to form acid sensing ion channels (ASIC) of the degenerin family. The channels are gated by acidity (threshold pH 6.8), and are often found in nociceptive afferents. There are several subtypes of ASICs including ASIC1, ASIC2, ASIC3 and ASIC4. ASICs are expressed throughout the central and peripheral nervous system. ASIC channels are related to epithelial sodium channels in the kidney (ENaC), and to degenerins in the model organism *C. elegans*. ASIC channels may play a role in mediating cardiac ischemic pain by sensing extracellular acidification. Mice and *C. elegans* worms, deficient in ASIC subunits, show deficits in mechanosensation.

- ▶ Acid-Sensing Ion Channels
- ▶ Nociceptors in the Orofacial Region (Skin/Mucosa)
- ▶ TRPV1, Regulation by Protons
- ▶ Visceral Pain Model, Esophageal Pain

## ASO

- ▶ Antisense Oligonucleotide

## Aspartate

### Definition

Aspartate is an excitatory amino-acid neurotransmitter.

- ▶ Somatic Pain

## Aspirin-Like Drugs

- ▶ Non-Steroidal Anti-Inflammatory Drugs (NSAIDs)
- ▶ NSAIDs and their Indications
- ▶ NSAIDs, Mode of Action

## Assessment

### Definition

An assessment is a comprehensive description of a patient’s condition designed to constitute a basis for treating or otherwise managing that condition. One systematic approach to assessment requires identifying the patient’s physical, psychological, social, and vocational complaints, problems or disabilities. Having been identified, these may be targeted individually and separately, or collectively, for treatment.

An assessment may be formulated in the absence of a diagnosis, and is thereby a substitute for a diagnosis; but

## Ascending Nociceptive Pathways

GLENN J. GIESLER JR

Department of Neuroscience, University of Minnesota, Minneapolis, MN, USA  
giesler@mail.ahc.umn.edu

Nociceptive neurons in the spinal cord and trigeminal nuclei send their axons to terminate within a large number of regions in the upper cervical spinal cord, brainstem and diencephalon. The precise roles of each of these pathways in nociception have not yet been established with certainty and it is likely that their roles vary among species. This overview presents a summary of prominent findings on several of the most thoroughly examined ascending nociceptive projections. Many specific topics are dealt with in more detail by individual contributors to the Encyclopedia of Pain. These are referred to throughout this overview.

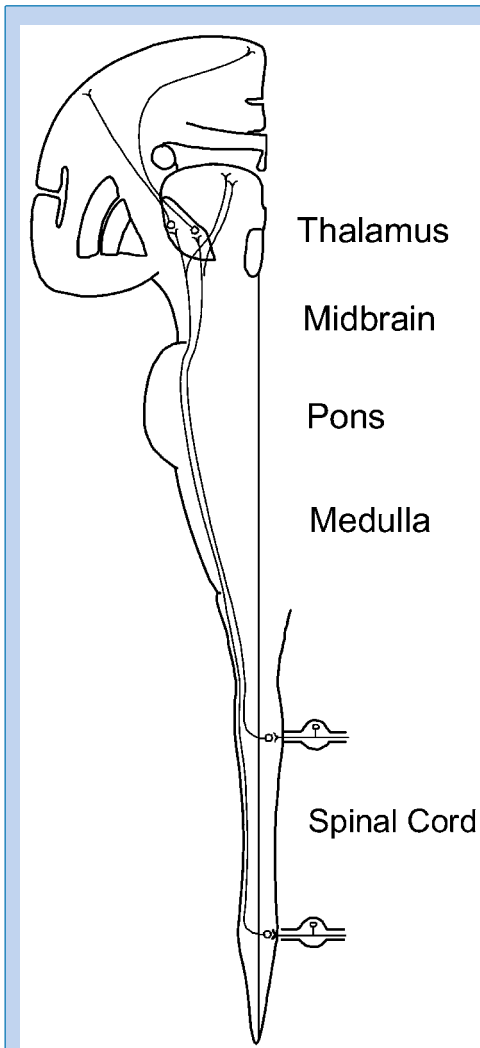
### Spinothalamic Tract

The most widely studied ascending nociceptive pathway originating in the spinal cord is the spinothalamic tract. Nearly 100 years ago, anatomical studies indicated that lesions of the spinal cord caused the degeneration of axons within the thalamus. These early studies were performed in a variety of species including primates. The first description of spinothalamic tract axons in humans has been attributed to Edinger (Willis and Coggeshall 2004). In the early 1970s antidromic activation techniques were first used to identify and functionally characterize spinothalamic tract neurons. These methods have been used in a large number of studies in the intervening years to examine many facets of the function and organization of this pathway. Both anterograde and retrograde tracing techniques have also been used extensively to determine the locations and numbers of the cells of origin of the spinothalamic tract in several species as well as the areas of termination of spinothalamic tract axons. Several of the prominent features of the spinothalamic tract are schematically illustrated in Fig. 1. The cells of origin of this pathway are found within the spinal gray matter at all levels of the cord. STT neurons comprise a small percentage of spinal cord neurons. It has been estimated, based on retrograde tracing studies, that there are between 10 and 20 thousand STT neurons in the spinal cord of primates (Apkarian and Hodge 1989; Willis and Coggeshall 2004). Particularly high concentrations have been described in upper cervical segments. Within the gray matter, STT neurons are concentrated in the marginal zone (see ► [spinothalamic tract neurons, morphology](#)) and within the deep dor-

sal horn (lamina V; see ► [spinothalamic tract neurons in deep dorsal horn](#)). A sizeable number of STT neurons are also located within the intermediate gray zone and the ventral horn (Andrew and Craig 2001; Craig et al. 1994; Willis et al. 1979). STT cell bodies and dendrites receive glutamatergic (see ► [spinothalamic tract neurons, glutamatergic input](#)) and several types of peptidergic inputs (see ► [spinothalamic tract neurons, peptidergic input](#)). Nitric oxide appears to play an important role in modulating the activity of STT neurons (see ► [spinothalamic tract neurons, descending control by brainstem neurons](#)). Axons of STT neurons decussate at a level near the cell body and the majority turn and ascend within the ventral half of the lateral funiculus. Several groups of investigators have shown that STT axons originating in marginal zone neurons ascend in a position that is dorsal to STT axons originating in neurons within the deep dorsal horn. Within thoracic levels, STT axons of marginal zone neurons are generally located dorsal to the denticulate ligament in the dorsal lateral funiculus, whereas the axons of lamina V neurons are found within the ventral part of the lateral funiculus (Apkarian and Hodge 1989; Zhang et al. 2000). There is also a somatotopic organization of STT axons. Axons from lumbosacral levels ascend on the periphery of the lateral funiculus, whereas STT axons from rostral levels are located closer to the gray matter (Applebaum et al. 1975).

STT axons ascend through the lateral and ventral brainstem. Collateral branches are frequently given off by these axons, supplying nociceptive sensory information to a number of nuclei, particularly within the reticular formation, throughout the length of the brainstem. Several early clinical cases in which injury to the spinal cord had blocked the sense of pain in patients indicated that the axons carrying nociceptive information crossed within the spinal cord and ascended within the ventral or anterior half (see ► [cordotomy effects on humans and animal models](#)) (Willis and Coggeshall 2004). These observations led to the first surgical attempts to relieve chronic pain by cutting the anterolateral quadrant of the spinal cord, the area that carries the overwhelming majority of spinothalamic tract axons. This procedure, cordotomy, can very effectively produce pain relief for patients, but the positive effects are short lived and pain frequently returns within a few months or a year. It is not known which tracts begin to carry the nociceptive information following a cordotomy. More studies are needed on this important phenomenon.

Although cordotomies are infrequently used now in the United States to relieve pain (they have generally been replaced with the use of opiates), they continue to be used by neurosurgeons in many countries. In the early years, laminectomies were performed to allow the



**Ascending Nociceptive Pathways, Figure 1** Schematic representation of spinothalamic tract and thalamic projection to primary somatic sensory cortex from the ventral posterior lateral nucleus of thalamus.

lesions to be made. Cordotomies are now frequently done percutaneously under local anesthesia.

STT axons terminate in three principle regions of the thalamus including the ventral posterior lateral (VPL), central lateral and adjacent parts of the medial dorsal nucleus, and posterior thalamic nuclei (Cliffer et al. 1989; Craig 2004; Graziano and Jones 2004; Mehler 1969; Craig et al. 1994; Willis et al. 1979). STT terminations within VPL are somatotopically organized. Axons ascending from lumbosacral levels terminate within the lateral part of VPL; those from cervical levels end within the medial part of the nucleus. Within the VPL of primates, STT terminals are concentrated within small areas that are surrounded by large regions that are dominated by the endings of medial lemniscal axons. In carnivores, STT axons are concentrated within the periphery of VPL. It has been shown that a

high percentage of nociceptive neurons within the primate VPL can be antidromically activated from SI parietal cortex, indicating that nociceptive input to VPL neurons *via* STT axons is transmitted to the cortex.

A second area of termination of the STT is the central lateral nucleus and the adjacent lateral region of the medial dorsal nucleus. There does not appear to be a somatotopic organization to this termination. Many of the nociceptive neurons within this area of the thalamus have large, bilateral, even whole body receptive fields (Giesler et al. 1981). Thus it is unlikely that this region is involved in localization of nociceptive stimuli. It appears more likely that STT inputs and thalamic neurons within this region are involved in the production of affective / emotional responses to nociceptive stimulation. It has been shown that STT neurons that project to this region are frequently located within the intermediate zone and ventral horn of the spinal cord. Many of these STT neurons have whole body receptive fields including the face.

Responses of STT neurons to a variety of somatic and visceral stimuli have been examined (Willis and Coggeshall 2004). In primates, the vast majority of STT neurons have been classified as nociceptive, responding either preferentially (wide dynamic range, WDR) or specifically (high threshold, HT) to noxious stimuli. In most (but not all) studies, higher percentages of HT-STT neurons have been found in the marginal zone and more WDR neurons within the deep dorsal horn. Receptive fields of neurons in the marginal zone tend to be smaller, sometimes being restricted to a single toe. The receptive fields of deeper neurons often cover much of the ipsilateral leg. Many STT cells are powerfully activated by noxious thermal stimulation of their receptive fields. Response thresholds to noxious heat stimuli are often between 45 and 55°C (Kenshalo et al. 1979). Repeated applications of noxious heat stimuli lead to sensitization, including reduced response thresholds, increased responses to identical noxious heat stimuli and the production of ongoing activity (see ► [spinothalamic tract neurons, central sensitization](#)). STT neurons also receive nociceptive input from muscles and joints (Foreman et al. 1979) and they are activated by stimulation with noxious chemicals (► [spinothalamic tract neurons, responses to chemical stimulation](#)). Nociceptive information originating from receptors on the face in the oral and nasal cavities is carried to the ventral posterior medial nucleus of thalamus by trigeminothalamic tract projections (see ► [trigeminothalamic tract projections](#)).

In a large number of studies, STT neurons at a number of levels of the spinal cord have been examined for possible input from visceral structures. It has been shown that STT neurons can be activated by noxious stimulation of the heart, esophagus, urinary bladder, testicles,

vagina, colon, rectum, gall bladder and bile duct (see ► [spinothalamic tract neurons, visceral input](#)). In almost all cases, STT neurons that respond to stimulation of a visceral organ have somatic receptive fields as well. Frequently the somatic receptive fields were found to be located in areas in which noxious stimulation of the examined organ produced referred pain in human studies. These findings indicate that STT axons are capable of carrying nociceptive visceral information and that the convergence of somatic and visceral nociceptive input probably contributes to the production of referred pain.

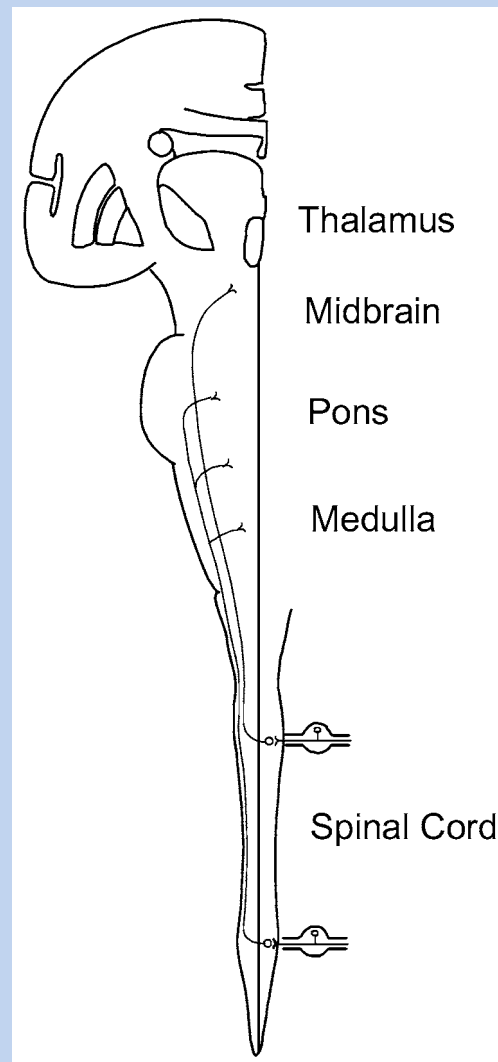
### Spinohypothalamic Tract

In the late 1980's, Burstein et al. (1987) noted that spinal cord neurons could be antidromically activated using small amplitude current pulses delivered through electrodes located within the hypothalamus of rats. In addition, injections of anterograde tracers into the spinal cord labeled axons within several areas of the hypothalamus including the lateral, posterior and ventromedial hypothalamus. Injections of retrograde tracers that were restricted to the hypothalamus labeled thousands of neurons within the spinal cords of rats. SHT cell bodies are located in the marginal zone and the deep dorsal horn. SHT axons have been shown to ascend to the posterior thalamus, then turn ventrally and laterally entering the supraoptic decussation. These axons continue to ascend in a position just dorsal to the optic tract and enter the hypothalamus. Many SHT axons ascend to the level of the optic chiasm where they decussate, turn posteriorly and descend within the supraoptic decussation on the side ipsilateral to the cell body. SHT axons have been shown to end in the ipsilateral hypothalamus, posterior thalamus and brainstem. Some have even been shown to descend as far as the level of the medulla (Zhang et al. 1995). SHT neurons are frequently nociceptive. Some also receive an apparent input from innocuous thermoreceptors. It has been suggested that through their complex, bilateral projections and frequent branches, SHT axons could provide nociceptive input to a variety of areas of the brainstem and forebrain that are involved in nociceptive processing (see ► [spinothalamic tract, anatomical organization and response properties](#)). SHT neurons have also been identified and characterized in monkeys. Large numbers of neurons within all divisions of the trigeminal complex and upper cervical segments also send axonal projections to the hypothalamus (see ► [trigeminothalamic tract](#)).

### Spinoreticular Tract (SRT)

The SRT is a direct projection from spinal cord neurons to the reticular formation of medulla, pons and midbrain (Fig. 2) (see ► [spinomesencephalic tract](#)).

Regions that receive these direct spinal afferent fibers include the nucleus gigantocellularis and the nucleus dorsalis, both within the medulla and the cuneiform nucleus of the midbrain. Since several of these regions in the reticular formation in turn send ascending nociceptive projections to the forebrain, it is believed that the SRT is part of a multisynaptic projection system to the thalamus and is probably involved in providing nociceptive information that is used in producing cortical arousal (Villanueva et al. 1990).



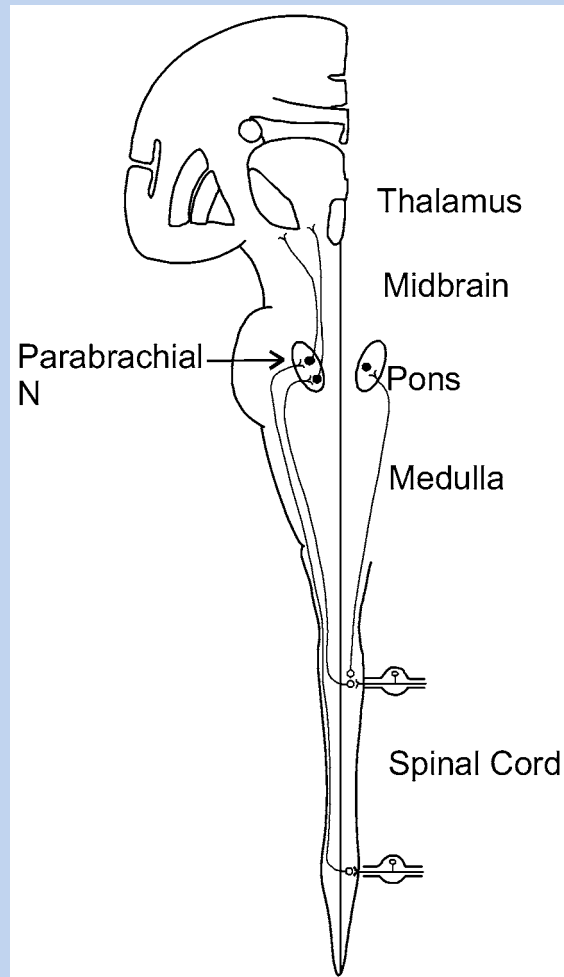
**Ascending Nociceptive Pathways, Figure 2** Schematic illustration of spinoreticular tract.

It is difficult to identify the cells of origin of this projection with certainty since it is known that at least some axons ascending to higher levels of the brainstem or diencephalon pass through or near the reticular formation without giving off collaterals within it. Such

axons would not be considered as part of the SRT since they do not provide information to neurons within the reticular formation. Injections of retrograde tracers into the reticular formation could be taken up by such axons as well as by SRT axons. In addition, such axons may be activated in studies in which antidromic activation techniques are used to examine SRT neurons. Measures have been taken, such as stimulating with high amplitude current pulses at higher levels of the neuraxis, to insure that examined axons do not ascend beyond the area of interest. Studies in which antidromic methods have been used have shown that many SRT neurons are nociceptive (Fields et al. 1975; Haber et al. 1982; Yeziarski and Schwartz 1986). These neurons have frequently been recorded deep within the spinal gray matter and have large complex receptive fields, often including the face. Retrograde tracing studies indicate that SRT neurons are found within the marginal zone and deep dorsal horn, but a large percentage are located within the intermediate zone and ventral horn (Menetrey et al. 1983).

### Spinoparabrachial Tract

Somatic sensory and nociceptive information ascends directly from the spinal cord to several sub-nuclei of the parabrachial nucleus, which is located lateral to the superior cerebellar peduncle within the rostral pons and caudal midbrain (Fig. 3) (see ► [spinoparabrachial tract](#) and ► [parabrachial hypothalamic and amygdaloid projections](#)). The locations of the cells of origin of the spinoparabrachial tract have been established using electrophysiological and anatomical techniques. Injections of retrograde tracers that are restricted to the parabrachial nucleus label a large number of spinal neurons at all levels of the spinal cord of rats and cats. Although spinoparabrachial tract neurons are found throughout much of the gray matter, the fact that they are highly concentrated within the marginal zone has attracted a great deal of interest in this projection. Anterograde tracing studies indicate that neurons in the marginal zone send a large projection *via* the dorsal part of the lateral funiculus to the parabrachial nuclei on both sides (Bernard et al. 1995). Studies in which antidromic activation has been used to identify spinoparabrachial tract neurons in cats indicate that the overwhelming majority are activated by noxious stimuli (Hylden et al. 1986; Light et al. 1993). The parabrachial nuclei are known to have large projections to several areas of the forebrain that are involved in nociception including the hypothalamus and the amygdala (Bernard et al. 1989) (see ► [parabrachial hypothalamic and amygdaloid projections](#)). Therefore, this projection appears well suited for providing nociceptive information that is used for producing cognitive, emotional or affective responses to pain.



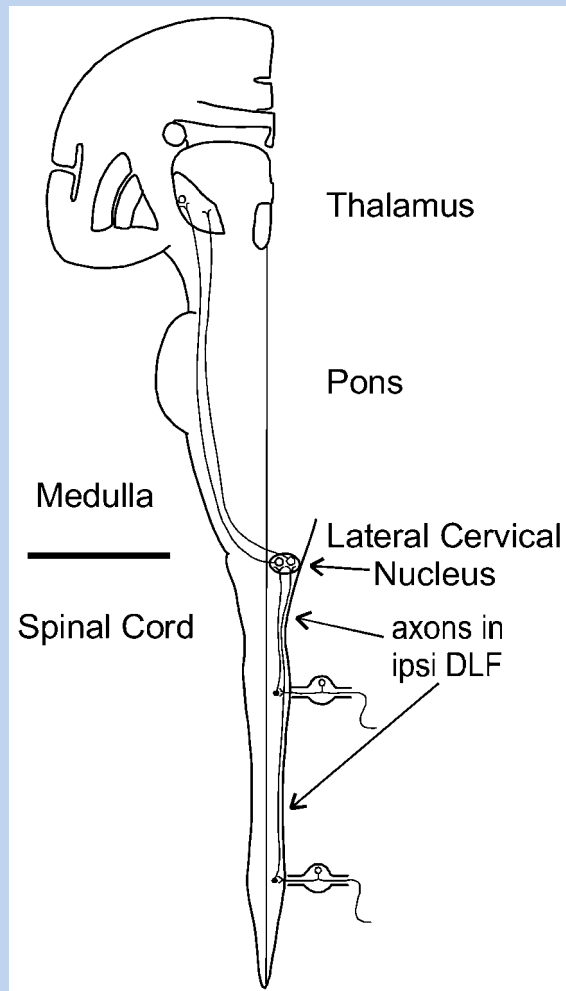
**Ascending Nociceptive Pathways, Figure 3** Schematic representation of spinoparabrachial tract projection.

### Spinocervicothalamic Tract

The spinocervicothalamic projection is schematically depicted in Fig. 4. Spinocervical tract neurons are located throughout the length of the spinal cord (Craig 1978). These neurons send their ascending axons into the dorsal part of the ipsilateral lateral funiculus. SCT axons ascend to upper cervical segments where they terminate within the lateral cervical nucleus, an island of neurons located with the dorsal lateral funiculus. The LCN extends from segment C3 through C1. The number of neurons that form the LCN varies greatly among species. The LCN is a large prominent nucleus in carnivores (Truex et al. 1970) and can contain as many as 10,000 neurons. In cats, lesions of the dorsal lateral funiculus have been reported to reduce nociceptive responses. A. G. Brown and colleagues (1981) performed an elegant and thorough series of studies of SCT neurons in cats.



SCT neurons are located in the deep dorsal horn (laminae III–V). Many receive a powerful afferent input from innocuous mechanoreceptors. Evidence from a number of studies indicates that as many as half of SCT neurons also receive a nociceptive input (Brown 1981; Cervero et al. 1977; Kniffki et al. 1977). These SCT neurons respond to noxious mechanical and thermal stimuli.



**Ascending Nociceptive Pathways, Figure 4** Schematic representation of postsynaptic dorsal column projection.

In rodents, the LCN has been shown to be at least an order of magnitude smaller. The LCN is also comparatively small in monkeys although precise cell counts are not available. The LCN has been examined in humans and it has been reported to be highly variable. Truex et al. (1970) reported that some individuals appear to have a prominent LCN on one side and few if any LCN neurons on the other. No evidence in Nissl stained material could be found for an LCN in several other individuals. Other individuals appeared to have

a clear LCN on both sides. These findings suggest a lesser, variable role for the spinocervicothalamic tract in nociception in individual humans.

Physiological studies have indicated that roughly half of LCN neurons in carnivores are nociceptive (Kajander and Giesler 1987). LCN neurons have been shown to respond specifically or preferentially to noxious mechanical stimuli. Many of these neurons can also be activated by noxious heat stimuli. LCN neurons that receive mechanoreceptive or nociceptive input are somatotopically organized; neurons in the lateral LCN receive input from lumbosacral segments, whereas neurons in the medial LCN receive input from cervical levels. Craig and Tapper (1978) reported that a small number of neurons in the medial LCN have nociceptive whole body receptive fields. Axons of LCN decussate in upper cervical spinal cord and ascend to terminate in the contralateral VPL (Boivie 1970). As many as half of the ascending axons of LCN neurons give off branches that terminate within the midbrain.

#### Postsynaptic Dorsal Column Projection

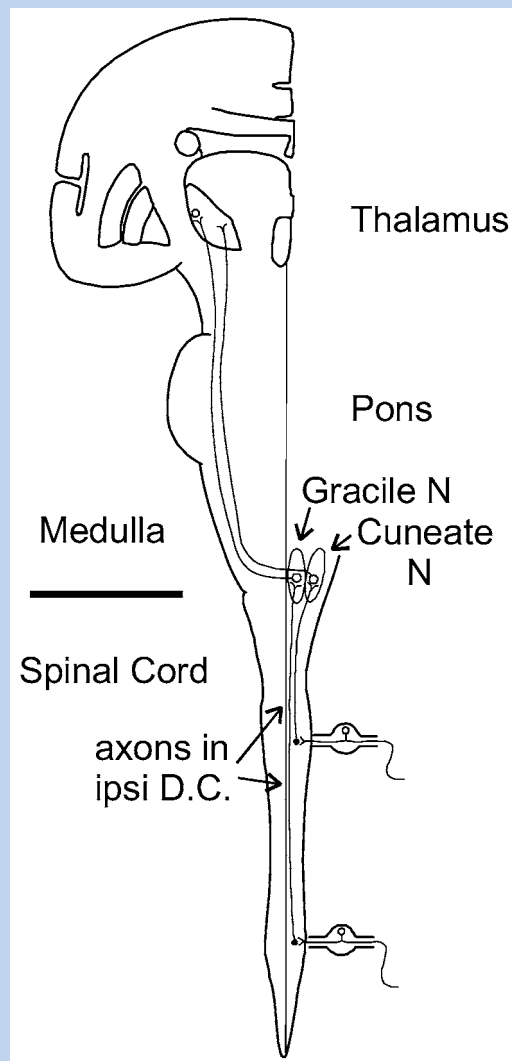
Early evidence for the existence of the PSDC projection was discovered in electrophysiological experiments by Uddenberg (1968). He noted that some axons that were recorded in the dorsal columns responded to stimulation of ipsilateral peripheral nerves with multiple spike discharges, an indication that at least one synapse intervened between the stimulated and recorded axons. A schematic drawing illustrating the basic organization of this projection is illustrated in Fig. 5. Injections of retrograde tracers into the dorsal column nuclei of cats, rats and monkeys label large numbers of neurons throughout the length of the spinal cord (Bennett et al. 1983; Giesler et al. 1984). Many of these are located in nucleus proprius or laminae III and IV. A smaller number are found near the central canal (see ► [postsynaptic dorsal column projection, functional characteristics](#)). Anterograde tracing studies indicate that most axons of this type ascend within the ipsilateral dorsal columns but some appear to ascend within the dorsal lateral funiculus (Cliffer and Giesler 1989). Such studies also show that the terminals of this projection were somewhat separated from the endings of primary afferent axons within the dorsal column nuclei. In cats, PSDC axons frequently terminate in the periphery of the nuclei and primary afferent fibers often terminate in the cores of the two nuclei. In rats, the terminations of these projections appear to overlap more substantially. It is difficult to determine the frequencies with which PSDC axons terminate on neurons within the dorsal column nuclei that project to the contralateral VPL. In cats, several electrophysiological studies have shown that roughly half of the PSDC neurons can

be driven exclusively by innocuous mechanical stimulation and the remainder can be classified as WDR neurons (Angaut-Petit 1975; Uddenberg 1968), indicating that this projection in cats is capable of conveying nociceptive information. These cells have been shown to be powerfully activated by noxious mechanical and heat stimuli. PSDC neurons have not been systematically examined in monkeys but the presence of nociceptive neurons within the dorsal column nuclei in monkeys is consistent with the idea that PSDC neurons are nociceptive in primates. Accurate functional classification in rats is less clear. In one early study it was concluded that few, if any, PSDC neurons were conclusively nociceptive in rats. On the other hand, several lines of evidence indicate that nociceptive visceral information is carried by this projection in rats, monkeys and possibly humans. Willis, Al-Chaer and colleagues (Al-Chaer et al. 1996, 1998; see ► [postsynaptic dorsal column neurons, responses to visceral input](#)) have performed an elegant series of studies showing that PSDC neurons convey nociceptive visceral information that reaches the thalamus. They have also pointed out that surgical section of the medial area of the dorsal columns can relieve chronic visceral pain in patients. This result would appear to indicate that axons carrying nociceptive visceral information within the lateral funiculus (e.g. spinothalamic, spinoreticular, spinothalamal tract axons) are not sufficient to maintain visceral nociception, since these axons are spared when the dorsal columns are sectioned. This seems unlikely since many spinothalamic tract axons carry nociceptive visceral information and anterolateral cordotomies have been used for nearly 100 years to relieve chronic visceral pain. More studies are needed to resolve the precise roles of these pathways in carrying nociceptive information from the viscera, particularly in primates including humans.

### Spinosolitary Tract

Several types of information indicate that a number of spinal cord neurons send a direct projection to the solitary nucleus in the medulla. Injections of anterograde tracers into the spinal cord gray matter label small numbers of axons within the solitary nucleus (Cliffer et al. 1989). Injections of retrograde tracers restricted to the solitary nucleus label neurons at all segmental levels in rats (Esteves et al. 1993; Menetrey and Basbaum 1987). Spinosolitary neurons were found in the marginal zone, lamina V and the area around the central canal, the primary areas of the spinal gray matter in which nociceptive processing occurs. At this time, the neurons in the spinal cord that project to the solitary nuclei have not been physiologically identified and characterized. Therefore, it has not been established beyond doubt that they carry nociceptive information.

Thus, the role of this projection is not certain. Many neurons within the solitary nuclei have ascending projections, suggesting that this polysynaptic projection could contribute to nociceptive processing.



**Ascending Nociceptive Pathways, Figure 5** Schematic depiction of spinothalamal projection.

### References

1. Al-Chaer ED, Lawand NB, Westlund KN et al. (1996) Pelvic visceral input into the nucleus gracilis is largely mediated by the postsynaptic dorsal column pathway. *J Neurophysiol* 76:2675–2690
2. Al-Chaer ED, Feng Y, Willis WD (1998) A role for the dorsal column in nociceptive visceral input into the thalamus of primates. *J Neurophysiol* 79:3143–3150
3. Andrew D, Craig AD (2001) Spinothalamic lamina I neurons selectively sensitive to histamine: a central neural pathway for itch. *Nat Neurosci* 4:72–77
4. Angaut-Petit D (1975) The dorsal column system: II. functional properties and bulbar relay of the postsynaptic fibres of the cat's fasciculus gracilis. *Exp Brain Res* 22:471–493

5. Applebaum AE, Beall JE, Foreman RD et al. (1975) Organization and receptive fields of primate spinothalamic tract neurons. *J Neurophysiol* 38:572–586
6. Apkarian AV, Hodge CJ (1989) Primate spinothalamic pathways: I. a quantitative study of the cells of origin of the spinothalamic pathway. *J Comp Neurol* 288:447–473
7. Bennett GJ, Seltzer Z, Lu G-W et al. (1983) The cells of origin of the dorsal column postsynaptic projection in the lumbosacral enlargement of cats and monkeys. *Somatosens Res* 1:131–149
8. Bernard J., Peschanski M, Besson JM (1989) A possible spino(trigemino)-ponto-amygdaloid pathway for pain. *Neurosci Letters* 100:83–88
9. Bernard JF, Dallel R, Raboisson P et al. (1995) Organization of the efferent projections from the spinal cervical enlargement to the parabrachial area and periaqueductal gray: A PHA-L study in the rat. *J Comp Neurol* 353:480–505
10. Boivie J (1970) The termination of the cervicothalamic tract in the cat. An experimental study with silver impregnation methods. *Brain Res* 19:333–360
11. Brown AG (1981) *Organization in the Spinal Cord: The Anatomy and Physiology of Identified Neurones*. Springer-Verlag, Berlin, pp 17–72
12. Burstein R, Cliffer KD, Giesler GJ Jr (1987) Direct somatosensory projections from the spinal cord to the hypothalamus and telecephalon. *J Neurosci* 7:4159–4161
13. Cervero F, Iggo A, Molony V (1977) Responses of spinocervical tract neurones to noxious stimulation of the skin. *J Physiol* 267:537–558
14. Cliffer KD, Giesler GJ Jr (1989) Postsynaptic dorsal column pathway of the rat. III. distribution of ascending afferent fibers. *J Neurosci* 9:3146–3168
15. Craig AD Jr (1978) Spinal and medullary input to the lateral cervical nucleus. *J Comp Neurol* 181:729–744
16. Craig AD (2004) Distribution of trigeminohthalamic and spinothalamic lamina I terminations in the Macaque monkey. *J Comp Neurol* 477:119–148
17. Craig AD Jr, Tapper DN (1978) Lateral cervical nucleus in the cat: Functional organization and characteristics. *J Neurophysiol* 41:1511–1534
18. Craig AD, Bushnell MC, Zhang ET et al. (1994) A thalamic nucleus specific for pain and temperature sensation. *Nature* 372:770–773
19. Esteves F, Lima D, Coimbra A (1993) Structural types of spinal cord marginal (lamina I) neurons projecting to the nucleus of the tractus solitarius in the rat. *Somatosensory and Motor Res* 10:203–216
20. Fields HL, Wagner GM, Anderson SD (1975) Some properties of spinal neurons projecting to the medial brainstem reticular formation. *Exp Neurol* 47:118–134
21. Foreman RD, Schmidt RF, Willis WD (1979) Effects of mechanical and chemical stimulation of fine muscle afferents upon primate spinothalamic tract cells. *J Physiol* 286:215–231
22. Giesler GJ Jr, Yezierski RP, Gerhart KD et al. (1981) Spinothalamic tract neurons that project to medial and / or lateral thalamic nuclei: evidence for a physiologically novel population of spinal cord neurons. *J Neurophysiol* 46:1285–1308
23. Giesler GJ Jr, Nahin RL, Madsen AM (1984) Postsynaptic dorsal column pathway of the rat. I. Anatomical studies. *J Neurophysiol* 51:260–275
24. Graziano A, Jones EG (2004) Widespread thalamic terminations of fibers arising in the superficial medullary dorsal horn of monkeys and their relation to calbindin immunoreactivity. *J Neurosci* 24:248–256
25. Haber LH, Moore BD, Willis WD (1982) Electrophysiological response properties of spinoreticular neurons in the monkey. *J Comp Neurol* 207:75–84
26. Hylden JHK, Hayashi H, Dubner R et al. (1986) Physiology and morphology of the lamina I spinomesencephalic projection. *J Comp Neurol* 247:505–515
27. Kajander KC, Giesler GJ Jr (1987) Responses of neurons in the lateral cervical nucleus of the cat to noxious cutaneous stimulation. *J Neurophysiol* 57:1686–1702
28. Kniffki K-D, Mense S, Schmidt RF (1977) The spinocervical tract as a possible pathway for muscular nociception. *J Physiol* 73:359–366
29. Kenshalo DR, Leonard RB, Chung JM et al. (1979) Responses of primate spinothalamic neurons to graded and to repeated noxious heat stimuli. *J Neurophysiol* 42:1370–1389
30. Light AR, Sedivec MJ, Casale EJ et al. (1993) Physiological and morphological characteristics of spinal neurons projecting to the parabrachial region of the cat. *Somatosensory and Motor Res* 10:309–325
31. Mehler WR (1969) Some neurological species differences –A posteriori. *Ann NY Acad Sci* 167:424–468
32. Menetrey D, Basbaum AI (1987) Spinal and trigeminal projection to the nucleus of the solitary tract: A possible substrate for somatovisceral and viscerovisceral reflex activation. *J Comp Neurol* 255:439–450
33. Menetrey D, Roudier F, Besson JM (1983) Spinal neurons reaching the lateral reticular nucleus as studied in the rat by retrograde transport of horseradish peroxidase. *J Comp Neurol* 220:439–452
34. Truex RC, Taylor MJ, Smythe MQ et al. (1970) The lateral cervical nucleus of the cat, dog, and man. *J Comp Neurol* 139:93–104
35. Uddenberg N (1968) Functional organization of long, second-order afferents in the dorsal funiculus. *Exp. Brain Res* 4:377–382
36. Villanueva L, Cliffer KD, Sorkin LS et al. (1990) Convergence of heterotopic nociceptive information onto neurons of caudal medullary reticular formation in monkey (*Macaca fascicularis*). *J Neurophys* 63:1118–1127
37. Willis WD Jr, Coggeshall RE (2004) *Sensory Mechanisms of the Spinal Cord*, 3rd edn. Kluwer Academic / Plenum, New York
38. Willis WD, Kenshalo DR Jr, Leonard RB (1979) The cells of origin of the primate spinothalamic tract. *J Comp Neurol* 188:543–573
39. Yezierski RP, Schwartz RH (1986) Response and receptive-field properties of spinomesencephalic tract cells in the cat. *J Neurophys* 55:76–95
40. Zhang X, Kostarczyk E, Giesler GJ Jr (1995) Spinohypothalamic tract neurons in the cervical enlargement of rats: Descending axons in the ipsilateral brain. *J Neurosci* 15:8393–8407
41. Zhang X, Wenk HN, Honda CN et al. (2000) Locations of spinothalamic tract axons in cervical and thoracic spinal cord white matter in monkeys. *J Neurophysiol* 83:2869–2880

it can also complement a diagnosis. In some instances, although a diagnosis may be available, it may not be possible to cure or to rectify the condition responsible for a patient's pain. In that event, formulating an assessment allows treatment to target the pain and its consequences instead of the actual cause.

Some practitioners might prefer to restrict the term – assessment, to apply to the act or process of obtaining information about a patient, and use the term – formulation to apply to the actual description that results from this process.

► [Psychological Assessment of Pain](#)

## Assessment of Discomfort in Dementia Protocol

### Synonyms

ADD Protocol

### Definition

Assessment of Discomfort in Dementia Protocol is an algorithm approach involving exclusion of common physical causes for discomfort in adults with dementia.

► [Cancer Pain, Assessment in the Cognitively Impaired](#)

## Assessment of Hypoalgesia

► [Hypoalgesia, Assessment](#)

## Assessment of Pain Behaviors

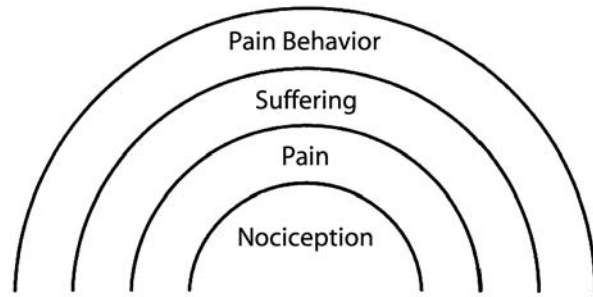
FRANCIS J. KEEFE, REBECCA W. PRYOR  
Pain Prevention and Treatment Research, Department of Psychiatry and Behavioral Sciences, Duke University Medical Center, Durham, NC, USA  
keefe003@mc.duke.edu

### Synonyms

Analysis of Pain Behavior; Observation of Pain Behavior; Recording of Pain Behavior

### Definition

Patients who have pain exhibit a variety of behaviors that serve to communicate the fact that pain is being experienced. These behaviors have been termed pain behaviors (Fordyce 1976). Pain behaviors can be verbal (e.g. verbal descriptions of the intensity, location, and quality of pain; vocalizations of distress; moaning, or complaining) or nonverbal (e.g. withdrawing from activities, taking pain medication, or pain related body postures or facial expressions). Fordyce (1976) was one of the first to address the importance of pain behaviors. According to Fordyce's operant behavioral model, pain behaviors that initially occur in response to acute injury are sometimes maintained over much longer periods of time because they lead to reinforcing consequences. For example, a brief period of bed rest can be adaptive in response to ► [acute pain](#), but when pain persists, excessive bed rest can promote deconditioning and decrease a person's tolerance for pain. In addition, attention from a concerned spouse may initially be helpful for someone coping with pain, but if that spouse becomes overly ► [solicitous](#) such behavior may actually increase physical and psychological disability in the person experiencing pain (Fordyce



**Assessment of Pain Behaviors, Figure 1** Fordyce's (1979) behavioral model of pain.

1976; Keefe and Lefebvre 1994). Pain behavior assessment allows one to identify problem pain behaviors and analyze the variables controlling those behaviors.

In the operant behavioral model (depicted in Fig. 1, adapted from Fordyce 1979), pain behaviors reflect the influence of three important factors:

1. nociception: nervous system responses that produce aversive input,
2. pain: the conscious perception of nociception, and
3. suffering: the negative emotional responses to Nociception and Pain.

This model has several important implications. First, the model maintains that pain and pain behavior may be related and influence each other, but are not necessarily synonymous. Thus, careful assessments of persons with pain should focus not only on underlying biological factors (e.g. nociception), but also on overt behaviors (e.g. verbalizations of pain, time spent in bed, or pain-related body postures). Second, the model serves to guide treatment efforts designed to improve adjustment to persistent pain by modifying pain behavior. Behavioral treatments based on this model include graded activation programs in which:

- patients learn to gradually increase their activity level, and time-contingent medication scheduling, and
- pain medications are switched from a ► [pro re nata](#) (prn) basis to time-contingent basis.

Behavioral treatment protocols based on these methods have been found to be effective in randomized clinical trials (see Turner 1996 for a review of this literature). Recently, behavioral theorists (e.g. Keefe and Lefebvre 1999) have developed more comprehensive models of pain behavior based on ► [systems theory](#). As illustrated by Fig. 2, these models maintain that pain behavior can influence and be influenced by an array of environmental, psychological, and behavioral factors. For example, social reinforcement for engaging in exercise (an environmental factor) could increase ► [self-efficacy](#) (a psychological factor), which, in turn, could decrease emotional arousal (a biological factor) related to engaging in painful activities. Consistent with this model,





**Assessment of Pain Behaviors, Figure 2** Keefe and Lefebvre's (1994) systems model of pain behavior.

researchers have identified a number of psychological and social variables related to pain behaviors. Patients who are depressed, for example, have been shown to exhibit higher levels of pain behavior (Keefe et al. 1986), while those who report a high degree of self-efficacy or confidence in their ability to control pain exhibit lower levels of pain behavior (Buckelew et al. 1994).

### Characteristics

There are three basic methods of pain behavior assessment: self-monitoring, automated recording, and direct observation.

#### Self-Monitoring

In self-monitoring, a patient directly records their own behavior including key, pain-related behaviors. This is often done using a daily diary, similar to that initially used by Fordyce (1976), which asked the individual to record on an hourly basis the amount of time they spent sitting, standing or walking, and reclining, along with their pain medication intake. Diary data can often be examined and analyzed in treatment sessions using simple graphs. A patient, for example, who shows a very low level of uptime (time spent up and out of the reclining position) may benefit from behavioral and physical therapy interventions designed to increase their level and range of activity. One concern about using self-monitoring is the degree to which these records are reliable and valid. However, recent research indicates that high quality data can be obtained from daily diary recording methods if patients receive systematic training (Keefe et al. 1997). The major strengths of self-monitoring are that it: is simple and inexpensive, can be used over long time periods, provides a better real-time measure of behavior than retrospective reports or questionnaires, and can increase a patient's awareness of his or her own behavior.

#### Automated Recording

Several electromechanical devices have been developed to automatically record important behaviors such as time spent up and out of bed or activity level. Recently, actigraphy has been used to monitor activity level (Sugimoto et al. 1997). A commercially available device, the Actigraph, monitors activity level by using an advanced [accelerometer](#) to detect motion, and a microprocessor to control how data on such motion is

collected and stored. The device can be worn by patients in their natural environment to provide continuous, objective information concerning their overall activity level (Sugimoto et al. 1997).

#### Direct Observation

In direct observation, observers who are trained in the coding of pain behavior, carefully watch patients as they engage in daily activities and record the pain behaviors that are observed. Two approaches to direct observation have been used: standard behavior sampling, and naturalistic observation.

#### Standard Behavior Sampling

Clinical observations suggest that the level of pain behavior varies depending on what activities a patient is engaged in. To standardize the conditions under which pain behavior is sampled, researchers have asked patients to engage in a series of standard activities, and then observed the pain behaviors that occur. A good example of this strategy is the observation method developed by Keefe and Block (1982) for recording pain behavior in chronic low back pain patients. Patients participated in a 10-min session in which they were asked to sit, stand, walk, and recline for 1–2 min, each in randomized order. The session was videotaped and then scored by trained observers using an interval recording strategy, in which the observer watches for 20 s and records for 10 s. The observers coded five pain behaviors:

1. guarding: abnormally slow stiff, interrupted or rigid movement,
2. bracing: stiff pain avoidant static position,
3. rubbing-touching or holding of pain area,
4. grimacing: obvious pain-related facial expression, and
5. sighing.

Standard behavioral sampling can yield data that is both highly reliable and highly valid. Keefe and Block (1982) tested and found high interobserver [reliability](#) (independent observers showed a high percentage of agreement on the behaviors observed), construct [validity](#) (behavior observed correlated significantly with pain ratings of naïve observers), and discriminate validity (the measures discriminated between the low back pain patients and pain-free controls). The procedure used by Keefe and Block has been modified to record the pain behaviors of arthritis patients, and has been shown to be similarly reliable and valid (McDaniel et al. 1986).

Standard behavior sampling is a useful method of pain behavior assessment. Pain behaviors have been shown to be more frequently observed when a patient is moving, than when in a static position (Keefe and Block 1982). One can thus structure a standardized situation to elicit more pain behaviors than might otherwise be observed. Clinicians can use standard behavior sampling to eval-



uate treatment effects, by comparing the pain behaviors observed before and after treatment is received. By standardizing the situation under which pain behavior is observed, it is possible to analyze the social and psychological variables that contribute to those behaviors. For example, a patient who reports higher levels of pain when in the room with their spouse, as opposed to a neutral observer, may have an overly solicitous spouse who contributes to their display of pain behaviors. Romano et al. (1992) videotaped 50 chronic pain patients and their spouses as they jointly preformed specified tasks. It was found that spouse solicitous behaviors were significantly more likely than chance to both precede and follow non-verbal pain behaviors.

### Naturalistic Observation

It is often desirable to observe and record pain behavior in naturalistic clinical settings such as an inpatient unit or physical examination. Keefe et al. (1987) developed an observation method for recording the pain behaviors and activity level of patients in inpatient pain management units. Their method was designed to be performed by the nursing staff as part of their normal duties. Daily graphs of activity level and pain behavior generated from these observations were used to identify problem behaviors, make treatment decisions, and evaluate patient progress. Pain behavior assessment can also be conducted during a physical examination. For example, Keefe et al. (1984) recorded the pain behavior exhibited by low back pain patients during a physical examination. A higher level of pain behavior was significantly correlated with a greater number of mechanical and neurological findings.

It is possible to combine elements of naturalistic and standard behavior sampling. For example, Richards et al. (1982) designed a standardized observation method, the University of Alabama at Birmingham (UAB) Pain Behavior Scale, which is intended to be used in a naturalistic setting. During morning rounds, the patient is briefly observed walking, standing, and moving from sitting to standing and from standing to sitting. Behaviors are recorded and rated as to their frequency and severity on a three-point scale. Reliability between observers is generally quite high, and the method requires minimal training.

In sum, over the past 25 years, clinical researchers have developed and refined a number of methods for pain behavior assessment. These methods have been shown to be reliable and valid, and are now being widely used in the assessment of patients suffering from ► **chronic pain** and persistent, disease-related pain. In clinical settings, pain behavior assessment is an important component of any comprehensive assessment of patients suffering from chronic pain.

### References

1. Buckelew SP, Parker JC, Keefe FJ et al. (1994) Self-Efficacy and Pain Behavior among Subjects with Fibromyalgia. *Pain* 56:191–201

2. Fordyce WE (1976) *Behavioral Methods for Chronic Pain and Illness*. CV Mosby, Saint Louis
3. Fordyce WE (1979) Environmental Factors in the Genesis of Low Back Pain. In: Bonica JJ, Liebeskind JE, Albe-Fessard DG (eds) *Proceedings of the Second World Congress on Pain*. *Advances in Pain Research and Therapy*, vol 3. Raven Press, New York, pp 659–666
4. Keefe FJ, Affleck G, Lefebvre JC et al. (1997) Coping Strategies and Coping Efficacy in Rheumatoid Arthritis: A Daily Process Analysis. *Pain* 69:43–48
5. Keefe FJ, Block AR (1982) Development of an Observation Method for Assessing Pain Behavior in Chronic Low Back Pain Patients. *Behav Ther* 13:363–375
6. Keefe FJ, Crisson JE, Trainor M (1987) Observational Methods for Assessing Pain: A Practical Guide. In: Blumenthal JA, McKee DC (eds) *Applications for Behavioral Medicine and Health Psychology*. Professional Resources Exchange, Sarasota, pp 67–94
7. Keefe FJ, Lefebvre J (1994) Pain Behavior Concepts: Controversies, Current Status, and Future Directions. In: Gebhart G, Hammond DL, Jensen TS (eds) *Proceedings of the VIIth World Congress on Pain*. Elsevier, New York, pp 127–148
8. Keefe FJ, Lefebvre J (1999) Behavioral Therapy. In: Melzack R, Wall P (eds) *Textbook of Pain* fourth edition. Churchill Livingstone, London, pp 1445–1461
9. Keefe FJ, Wilkins RH, Cook WA (1984) Direct Observations of Pain Behavior in Low Back Pain Patients during Physical Examination. *Pain* 20:59–68
10. Keefe FJ, Wilkins RH, Cook WA et al. (1986) Depression, Pain, and Pain Behavior. *J Consult Clin Psychol* 54:665–669
11. McDaniel LK, Anderson KO, Bradley LA et al. (1986) Development of an Observation Method for Assessing Pain Behavior in Rheumatoid Arthritis Patients. *Pain* 24:185–184
12. Richards R, Nepomuceno C, Riles M et al. (1982) Assessing Pain Behavior: The UAB Pain Behavior Scale. *Pain* 14:393–398
13. Romano JM, Turner JA, Friedman LS et al. (1992) Sequential Analysis of Chronic Pain Behaviors and Spouse Responses. *J Consult Clin Psychol* 60:777–782
14. Sugimoto A, Hara Y, Findley TW et al. (1997) A Useful Method for Measuring Daily Physical Activity by a Three-Direction Monitor. *Scand J Rehabil Med* 29:37–42
15. Turner JA (1996) Educational and Behavioral Interventions for Back Pain in Primary Care. *Spine* 21:2851–2857

---

## Assimilation

### Definition

Giving up the values, beliefs, material culture and practices of their native group, and adopting those of the host culture.

► [Cancer Pain, Assessment of Cultural Issues](#)

---

## Association Study

### Synonyms

Allele Dosage Study

### Definition

Also known as an allele dosage study, this involves comparing the frequencies of alleles of genes or DNA markers between different phenotypic groups (e.g. those with

a disease versus those without). If allele frequencies differ between the groups, the gene examined (or one very nearby) is implicated in the trait in question.

- ▶ Alleles
- ▶ Opioid Analgesia, Strain Differences

## Astrocytes

### Definition

Astrocytes are star-shaped glial cells integrally involved in synaptic communication by providing nutrients, support and insulation for neurons of the central nervous system. As immunocompetent cells, astrocytes can be activated by bacteria and viruses to release classical immune products. Current studies suggest that astrocytes maintain exaggerated pain in pathological pain models.

- ▶ Cord Glial Activation
- ▶ Diencephalic Mast Cells

## Asymmetric Junctions

### Definition

Gray (1962) divided the central synapse into two types, based on the differences in synaptic density between the pre- and post-synaptic membranes, asymmetric (type I) and symmetric (type II).

- ▶ Trigeminal Brainstem Nuclear Complex, Anatomy

## Ataxia

### Definition

Imbalance and poor control of various parts of the body; may reflect damage to the large sensory neurons that subserve joint position sense and coordination.

- ▶ Diabetic Neuropathies

## Atenolol

### Definition

Beta-blocker.

- ▶ Migraine, Preventive Therapy

## At-Level Neuropathic Pain

A

### Definition

Neuropathic pain located in the segments adjacent to the level of the spinal cord lesion. Also referred to as border reaction, end zone, segmental or radicular pain.

- ▶ Spinal Cord Injury Pain Model, Contusion Injury Model

## At-Level Phenomena

### Definition

Alterations in sensations or spontaneous sensations that are referred to the body region, which is represented by the region of the spinal cord that is damaged by spinal injury.

- ▶ Spinal Cord Injury Pain Model, Cordotomy Model

## ATP

- ▶ Adenosine 5' Triphosphate

## ATP-Dependent Na<sup>+</sup>/K<sup>+</sup> Pump

### Definition

The principal primary active transport system in neurons, the Na/K-ATPase utilizes energy to maintain cation cellular concentrations by extruding Na and accumulating K ions, thus creating an electrical potential across the neuronal cell membrane. It is estimated that 25 to 40% of brain energy utilization may be related to Na/K-ATPase activity. Abnormalities in the pump may lead to neuronal dysfunction, although the exact relationship to familial hemiplegic migraine is not known.

- ▶ Migraine, Childhood Syndromes

## ATrP

- ▶ Attachment Trigger Point

## Attachment Trigger Point

### Synonyms

ATrP

**Definition**

An attachment trigger point is pathogenetically distinct from, and secondary to, a central myofascial trigger point. It is a region of inflammatory-type reaction (an enthesopathy) at the musculotendinous junction, or at the bony attachment of the muscle where the taut band fibers attach and produce increased sustained tension.

► [Myofascial Trigger Points](#)

**Attentional Bias****Definition**

The tendency to selectively attend to threatening information in comparison to neutral information.

► [Hypervigilance and Attention to Pain](#)

**Attentional Mechanisms****Definition**

Attentional mechanisms are cognitive processes that focus sensory processing on particular inputs and de-emphasize other inputs.

► [Spinothalamic Tract Neurons, Descending Control by Brainstem Neurons](#)

**Attributable Effect**

► [Effect Size](#)

**Attributable Effect and Number Needed to Treat**

NIKOLAI BOGDUK  
University of Newcastle, Department of Clinical Research, Royal Newcastle Hospital, Newcastle, NSW, Australia  
nbogduk@mail.newcastle.edu.au

**Synonyms**

Efficacy; effectiveness; number needed to treat; NTT

**Definition**

The ► **Attributable Effect** of a treatment is the extent to which it achieves its outcomes, beyond that achieved by non-specific effects of the intervention. It is the extent to which outcomes can be attributed to the specific components of a treatment by which it is purported to work. The ► **number needed to treat** (NNT) is a measure of how effective a treatment is. Specifically, it is the number of patients who must achieve a particular outcome before one of those patients, on average, can be claimed to have responded because of the specific effects of the treatment (as opposed to having responded to the non-specific effects of treatment). As a measure of the power of a treatment, NNT effectively discounts the apparent power by the extent to which outcomes are achieved by non-specific effects. The larger the number, the more the treatment works by non-specific effects. The smaller the number, the more the treatment has a specific effect.

**Characteristics**

The attributable effect is derived from categorical data. It requires data on whether the treatment has worked or not, in comparison with a control treatment, in the form shown in Table 1. Ideally, the control treatment should be one with no specific effects, i.e. a ► **placebo**.

For the purposes of the initial explanation, it does not matter what the definitions are of success or failure; that comes later. All that is important is that (somehow) a decision is made as to whether the treatment has been successful or not.

The proportion of patients who succeeded with the index treatment is  $a/(a+b)$ . Let this proportion be  $P_{\text{index}}$ , which is expressed as a decimal.

The proportion of patients who succeeded with the control treatment is  $c/(c+d)$ . Let this proportion be  $P_{\text{control}}$ , which is expressed as a decimal.

The attributable effect (AE) of the index treatment is the extent to which its success rate exceeds that achieved by the control treatment. The argument is that the control treatment provides non-specific effects, but these are also a component of the index treatment. The attributable effect of the index treatment is what remains when the success rate of the index treatment is discounted for these non-specific effects.

Mathematically:

$$AE = P_{\text{index}} - P_{\text{control}}$$

**Attributable Effect and Number Needed to Treat, Table 1** The categorical results of a clinical trial of an index treatment

TREATMENT	RESULT	
	SUCCESS	FAILURE
INDEX	a	b
CONTROL	c	d



Since  $P_{\text{index}}$  and  $P_{\text{control}}$  are both proportions, AE is also a proportion. It stipulates the proportion of patients treated, whose successful outcome can be legitimately attributed to the effects of the index treatment, above and beyond any non-specific effects.

Thus, if  $N$  patients are subjected to the index treatment, one would expect that  $(N \times P_{\text{index}})$  patients would have a successful outcome. However,  $(N \times P_{\text{control}})$  of these patients would, on average, have responded because of non-specific effects of the treatment.

Therefore, only  $N(P_{\text{index}} - P_{\text{control}})$  would have responded because of the specific effects of the treatment, i.e.  $(N \times \text{AE})$ . In other words, when  $N$  patients are treated, only  $(N \times \text{AE})$  patients respond to the attributable effect of the treatment.

Any group of patients who achieve a successful outcome will consist of those who responded to the attributable effect of the treatment, and those who responded to non-specific effects of treatment. There is no way of determining which particular patient or patients responded to the attributable effect or to non-specific effects, but outcome data from large samples of patients can be used to show how many, on average, would have responded to the attributable effect. The number needed to treat (NNT) is used to indicate this proportion.

Let  $N_S$  be the number of patients who achieve a successful outcome. This number consists of two types of patient: those whose outcome was due to the attributable effect ( $N_{\text{AE}}$ ), and those who had non-specific responses ( $N_{\text{NS}}$ ), i.e.

$$N_S = N_{\text{AE}} + N_{\text{NS}}$$

But

$$N_{\text{AE}} = N_S \times \text{AE}$$

And

$$N_{\text{NS}} = N_S \times (1 - \text{AE})$$

Wherefore,

$$N_S = [N_S \times \text{AE}] + [N_S \times (1 - \text{AE})]$$

In large studies,  $N_S$  will be large, and both  $[N_S \times \text{AE}]$  and  $[N_S \times (1 - \text{AE})]$  will be large. In small studies,  $N_S$  will be small, and both  $[N_S \times \text{AE}]$  and  $[N_S \times (1 - \text{AE})]$  will be correspondingly small. Nevertheless, the proportion between  $[N_S \times \text{AE}]$  and  $N_S$  will be the same.

Clearly, that proportion is mathematically simply the attributable effect, i.e.

$$[N_S \times \text{AE}] / N_S = \text{AE}$$

However, this is an abstract number, with no immediate, apparent relationship to clinical practice.

A way of expressing the proportion more meaningfully, is to express it in terms of whole patients.

Since  $[N_S \times \text{AE}]$  will always be smaller than  $N_S$ , the smallest sample size in which the proportion can be expressed in terms of whole patients is one in which  $[N_S \times \text{AE}]$  equals 1,

$$[N_S \times \text{AE}] = 1$$

In which case,

$$N_S = 1 / \text{AE}$$

Under these conditions,  $N_S$  becomes the number needed to treat, (Cook and Sackett 1995, Laupacis et al. 1988) i.e.

$$\text{NNT} = 1 / \text{AE}$$

Under these conditions, for every NNT patient with a successful outcome, 1 will have responded to the attributable effect, and the remainder will have responded to non-specific effects. All that is required to determine the ratio between attributable and non-specific effects, is a knowledge of the attributable effect.

For example, if an index treatment has a success rate of 78%, and a control treatment has a success rate of 45%,

$$P_{\text{index}} = 0.78$$

$$P_{\text{control}} = 0.45$$

$$P_{\text{index}} - P_{\text{control}} = 0.33$$

$$\text{AE} = 0.33$$

$$1 / \text{AE} = 3$$

$$\text{NNT} = 3$$

Thus, for every 3 patients with a successful outcome, 1 can be attributed to the specific effects of the treatment, while the other 2 outcomes were due to non-specific effects. If 30 patients were to have a successful outcome, 10 would be due to the attributable effect, and 20 due to non-specific effects.

Consider another example, in which the success rate of a treatment is 56%, and that of the control treatment is 36%.

$$P_{\text{index}} = 0.56$$

$$P_{\text{control}} = 0.36$$

$$P_{\text{index}} - P_{\text{control}} = 0.20$$

$$\text{AE} = 0.20$$

$$1 / \text{AE} = 5$$

$$\text{NNT} = 5$$

For every 5 patients with a successful outcome, 1 is due to the specific effects of treatment, and 4 are due to non-specific effects.

Clearly, the larger the NNT, the weaker the treatment is, for a greater proportion of patients who appear to respond, do so because of non-specific effects. Conversely, the smaller the NNT, the more powerful the treatment is. As a benchmark, an NNT of 3 or less is considered to be good.

However, NNT is not a measure of how effective a treatment is over all. It is a measure of how much a particular outcome is due to specific effects of the treatment, compared with non-specific effects. In these terms, a powerful treatment is one in which much, or most, of the outcome is due to specific effects, i.e. the attributable effect, as opposed to non-specific effects. Less powerful treatments may nevertheless be effective, but their outcomes are due less to the attributable effect, and more to non-specific effects. NNT reveals the proportion between these two types of effect.

The implication of a large NNT is that most of the outcome observed is due to non-specific effects, and could be achieved without using the index treatment at all. Accordingly, NNT is an index of the utility of a treatment.

If a treatment is costly, or carries a high risk of complications, and has a large NNT, its use can be called into question. The large NNT indicates, that because most of the effect is non-specific, the cost and risk of the index treatment may not be justified, because the same, or similar, outcome might be achieved by other means.

If the NNT is high, it means that doctors will need to treat large numbers of patients before they get an attributable effect. This consumes time and effort. The doctors might consider if this large effort is worthwhile; and whether their efforts might not be better spent using another treatment.

A large NNT also means that funds are being expended on large numbers of patients in order to get gains in a minority. Doctors might reflect as to whether these funds might be better spent differently; or if as good a result might be achieved, on average, by using less expensive treatments.

For example, the NNT for epidural steroids is about 11 (McQuay and Moore 1996). Effectively, this means that for every 11 patients who get a successful outcome, only one can be claimed to have responded to the specific effects of the injections. The cost of that one success is not just the time and expense required for that one case, but the also the costs incurred for the other 10 patients.

### Subscripts

The NNT is not a single measure of all of the effects of a treatment. It measures the power of a treatment only with respect to the outcomes specified in the original table of data from which the NNT was derived. Therefore, the pedantic but accurate use of NNT requires that the outcome be specified. This might be done as a subscript, but is usually omitted in practice because of the typographic impositions incurred. Nevertheless, the concept is conveyed by this notation.

If the success in question is “ability to walk 1 km in 10 minutes” the NNT for that outcome would be recorded as

$NNT_{\text{ability to walk 1 km in 10 minutes}}$ .

If the success in question is “achieving a reduction of at least 50% in VAS score” the NNT for that outcome would be

$NNT_{\text{reduction in VAS by 50\%}}$ .

No-one uses this notation, but it is taken as understood. Readers should understand that authors leave this implicit. They expect readers to have noticed what outcome they are addressing. Therefore, readers should consult the methods and results sections of any study to find out what the subscript would have been, had the authors used this complete notation.

This is not an example of academic pedantry or an idiosyncrasy. It is an important realisation lest NNT be abused. As a number, an NNT might look good, and might be used to extol a treatment as successful and useful. However, the treatment might not be as good as

it sounds, if the reader realises that the NNT pertains to an unconvincing or unconvincing outcome.

For example, the NNT for many drug therapies in pain medicine is about 3, which is considered a good score. Readers might, however, care to ask – exactly what was the outcome measure? The risk is of readers being lulled into believing that with an NNT of 3, they could expect that for every three patients that they treat, one will be totally cured. This is not the case, for the NNT in question actually refers to “patients lowering their VAS by 50%”. It says nothing about patients being completely relieved. In actual fact, in this instance, an NNT of 3 means that for every three patients who obtained greater than 50% relief of their pain, only one achieved this because of the effects of the drug used.

For NNT to be meaningful, the subscript must be specified. For a complete picture of how powerful a treatment is, authors should indicate the NNT for each outcome, e.g.  $NNT_{\text{complete relief}}$ ;  $NNT_{50\% \text{ relief}}$ ; and  $NNT_{\text{return to work}}$ .

### References

1. Cook RJ, Sackett DL (1995) The Number Needed to Treat: A Clinically Useful Measure of Treatment Effect. *BMJ* 310:452–454
2. Laupacis A, Sackett DL, Roberts RS (1988) An Assessment of Clinically Useful Measures of the Consequences of Treatment. *New Engl J Med* 318:1728–1733
3. McQuay HS, Moore A (1996) Epidural Steroids for Sciatica. *Anaesth Intens Care* 24:284–286

## Atypical Antidepressants

### ▶ Antidepressant Analgesics in Pain Management

## Atypical Facial Neuralgia

### ▶ Atypical Facial Pain, Etiology, Pathogenesis and Management

### ▶ Trigeminal, Glossopharyngeal, and Geniculate Neuralgias

## Atypical Facial Pain, Etiology, Pathogenesis and Management

YAIR SHARAV

Department of Oral Medicine, School of Dental Medicine, Hebrew University-Hadassah, Jerusalem, Israel

sharav@cc.huji.ac.il



## Synonyms

Atypical Facial Neuralgia; atypical odontalgia; Phantom Tooth Pain; Stomatodynia; burning mouth syndrome; Idiopathic Orofacial Pain; complex regional pain syndrome

## Definition

This ill-defined chronic facial pain condition is employed as a “wastebasket” definition, applied by elimination, of facial pain “not fulfilling other criteria”. Recently, attempts have been made to define atypical facial pain in a more positive way and not merely by elimination (Sharav 1999; Woda and Pionchon 1999). Atypical facial pain can be described as chronic facial pain of constant intensity, which usually has a burning quality, and occasionally intensifies to produce a throbbing sensation. Pain does not wake the patient from sleep and is not triggered by remote stimuli, but may be intensified by stimulation of the painful area itself. No local signs are present that can be related to the pain. No etiological factors are identifiable in the orofacial region.

## Characteristics

This chronic intraoral or facial pain may start in one quadrant of the mouth and often spreads across the midline. Changes in pain location are frequent and may result in extensive dental work, alcohol nerve blocks and surgery that do not usually alleviate the pain. Pain location is often ill-defined. Pain is usually constant, of moderate intensity, and has a burning quality that occasionally intensifies to produce a throbbing sensation. However, pain does not wake the patient from sleep. The pain is not triggered by remote stimuli, but may be intensified by stimulation of the painful area itself. Accompanying ► [autonomic phenomena](#) are not observed. Typically, there is a lack of objective signs in most of these patients. The age range at examination is wide (20–82 years), the mean age of patients with ► [atypical odontalgia](#) is around 45–50 years (Marbach 1978; Vickers et al. 1998), and of patients with ► [burning mouth syndrome](#) is around 55 years (Grushka et al. 1987a). All reports of atypical oral and facial pain indicate an overwhelming majority are females (82–100%). Atypical facial pain should be differentiated from pains associated with a causative lesion. The symptoms of chronic atypical facial pain may be observed secondary to a slow-growing cerebellopontine angle tumor. The most common intraoral presentations of atypical facial pain are atypical odontalgia and burning mouth syndrome, and these are therefore discussed separately below.

## Etiology

There is no identifiable uniform etiology of atypical oral and facial pain (Loeser 1989). Several underlying

mechanisms have been proposed. A number of reports have suggested that atypical facial pain is a psychiatric disorder (Feinmann et al. 1984). Depression is considered the most likely diagnosis, and is explained based on the catecholamine hypothesis of affective disorders. However, Sharav et al. (1987) showed that only two of their 28 patients with chronic facial pain were cortisol non-suppressors on the dexamethasone suppression test, and that half the patients were not depressed at all. Grushka et al. (1987a) conclude that the personality characteristics of patients with burning mouth syndrome are similar to those seen in other chronic pain patients, and that these personality disturbances tend to increase with increased pain. Vickers et al. (1998) suggested a possible neuropathic pain mechanism, but pointed out that it cannot explain all cases, and suggested that some may fit the diagnosis of ► [complex regional pain syndrome](#).

## Treatment

While various treatment modalities are used for atypical oral and facial pain, the predominant trends are clear. All authors firmly recommend avoiding surgical or dental interventions for the relief of pain (Loeser 1989). Since such interventions usually exacerbate the condition, reassurance, psychological counseling and the use of antidepressants, particularly from the tricyclic group, have been found to be a very promising mode of therapy. Two double-blind controlled studies demonstrated that tricyclic antidepressant drugs were superior to placebo in reducing chronic facial pain (Feinmann et al. 1984; Sharav et al. 1987). Furthermore, Sharav et al. (1987) showed that ► [amitriptyline](#) was effective, for most chronic facial pain states, in a daily dose of 30 mg or less, and that the relief of pain was independent of the antidepressant activity.

## References

1. Feinmann C, Harris M, Cawley R (1984) Psychogenic Facial Pain: Presentation and Treatment. *BMJ* 288:436–438
2. Grushka M, Sessle BJ, Miller R (1987a) Pain and Personality Profiles in Burning Mouth Syndrome. *Pain* 28:155–167
3. Loeser JD (1989) Tic Douloureux and Atypical Facial Pain. In: Wall PD, Melzack R (eds) *Textbook of Pain*, 2nd edn. Churchill Livingstone, pp 535–543
4. Marbach JJ (1978) Phantom tooth pain. *Journal of Endodontics* 4:362–372
5. Sharav Y, Singer E, Schmidt E, Dionne RA, Dubner R (1987) The Analgesic Effect of Amitriptyline on Chronic Facial Pain. *Pain* 31:199–209
6. Sharav Y (1999) Orofacial pain. In: Wall PD, Melzack R (eds) *Textbook of Pain*, 4<sup>th</sup> edn. Churchill Livingstone, pp 711–738
7. Vickers ER, Cousins MJ, Walker S, Chisholm K (1998) Analysis of 50 Patients with Atypical Odontalgia. *Oral Surgery, Oral Medicine, Oral Pathology, Oral Radiology and Endodontics* 85:24–32
8. Woda A, Pionchon PA (1999) Unified Concept of Idiopathic Orofacial Pain: Clinical Features. *J Orofac Pain* 13:172–184

## Atypical Odontalgia

YAIR SHARAV

Department of Oral Medicine, School of Dental Medicine, Hebrew University-Hadassah, Jerusalem, Israel  
sharav@cc.huji.ac.il

### Definition

Atypical odontalgia may be defined as pain of dental origin without a definitive organic cause (Woda and Pionchon 1999).

### Characteristics

Pain is localized to a tooth, or sometimes more than one tooth, which shows no dental pathology. Pain may be spontaneous or evoked by hot or cold foods, is usually strong and may throb (Czerninsky et al. 1999).

### Etiology

Marbach (1978) postulated that pain is the result of previous trauma, such as tooth extraction or tooth pulp extirpation, which interferes with the central nervous system pain modulatory mechanisms and coined the name “phantom tooth pain”. This idea is supported by the observation that experimental tooth extraction produces brainstem lesions in the trigeminal nucleus caudalis, and that more extensive tooth pulp injury is associated with heightened excitability changes of trigeminal brainstem neurons (Hu et al. 1990). Although far from proven, a ► [deafferentation](#) associated with peripheral nerve injury may be responsible for some types of atypical facial pain. Vascular changes are other possible underlying mechanisms for atypical facial pain. ► [Vascular orofacial pain](#) (VOP) may be especially relevant to the diagnosis of atypical intraoral pain (atypical odontalgia). VOP, possibly a new diagnostic entity (Sharav 1999), shares many of the signs and symptoms common to other ► [vascular-type craniofacial pain](#). It was found to be associated with atypical toothache (Benoliel et al. 1997) and to mimic ► [pulpitis](#) (Cherninsky et al. 1999). The onset of VOP is around 40–50 years of age, and it affects females at a rate of 2.5 times more than males.

### Treatment

While pulp extirpation may eliminate the pain for a short time, pain tends to recur in another tooth (Czerninsky et al. 1999). The prophylactic use of beta-blockers or tricyclic antidepressants is usually beneficial (Benoliel et al. 1997, Czerninsky et al. 1999).

► [Atypical Facial Pain](#)

► [Atypical Facial Pain, Etiology, Pathogenesis and Management](#)

## References

1. Benoliel R, Elishoov H, Sharav Y (1997) Orofacial Pain with Vascular-Type Features. *Oral Surgery, Oral Medicine, Oral Pathology, Oral Radiology and Endodontics* 84:506–512
2. Hu JW, Sharav Y, Sessle BJ (1990) Effect of One- or Two-Stage Deafferentation of Mandibular and Maxillary Tooth Pulp on the Functional Properties of Trigeminal Brainstem Neurons. *Brain Research* 516:271–279
3. Marbach JJ (1978) Phantom tooth pain. *Journal of Endodontics* 4:362–372
4. Sharav Y (1999) Orofacial pain. In: Wall PD, Melzack R (eds) *Textbook of Pain*, 4<sup>th</sup> edn. Churchill Livingstone, pp 711–738
5. Woda A, Pionchon PA (1999) Unified Concept of Idiopathic Orofacial Pain: Clinical Features. *J Orofac Pain* 13:172–184

## Atypical Trigeminal Neuralgia

► [Trigeminal Neuralgia, Etiology, Pathogenesis and Management](#)

## AUC

► [Area Under the Curve](#)

## Audit Report

### Definition

An audit report refers to conclusions made by grouping data according to criteria, so that inferences can be made from them.

► [Postoperative Pain, Data Gathering and Auditing](#)

## Aura

### Definition

Aura is a transient disturbance in neurological function that may precede an attack of migraine headache. These disturbances usually last 20–30 minutes, but may persist for as long as 1 hour. The classical migraine aura that precede attacks in about 30% of migraine sufferers is visual, and characterized by an arc of brightly colored lights that flicker and change shapes. These visual disturbances often surround an area of dimmed or absent vision.

► [Hemicrania Continua](#)

► [Migraine, Pathophysiology](#)

► [New Daily Persistent Headache](#)

## Autacoids

► [Prostaglandins, Spinal Effects](#)

## Autobiographical Memory

### Definition

Autobiographical memory is memory of one's life. It is central to the establishment and maintenance of the self concept and one's personal and social identity, i.e. the sense of who you are. Autobiographical memory is considered to comprise of two types of memories: memories about specific experiences at specific times, and knowledge of facts relevant to the self, e.g. one's date of birth, information about family relationships, schooling, historical events that have occurred in one's lifetime.

- ▶ Pain Memory

## Autogenic Feedback

### Definition

A combination of autogenic training and thermal biofeedback, used for the purpose of promoting hand warming and generalized relaxation.

- ▶ Biofeedback in the Treatment of Pain

## Autogenic Training

### Definition

A form of relaxation training where verbal cues (e.g. „my hands are heavy and warm“) are paired with physiological aspects of the relaxation process.

- ▶ Relaxation in the Treatment of Pain
- ▶ Relaxation Training
- ▶ Therapy of Pain, Hypnosis

## Autologous Graft

### Definition

Transplant tissue or cell source that is taken from the same or genetically identical individual.

- ▶ Cell Therapy in the Treatment of Central Pain

## Autologous Thrombocyte Injection as a Model of Cutaneous Pain

JAMES A. BLUNK<sup>1</sup>, MARTIN SCHMELZ<sup>2</sup>

<sup>1</sup>Clinic for Anaesthesiology, University of Erlangen, Erlangen, Germany

<sup>2</sup>Faculty for Clinical Medicine in Mannheim, University of Heidelberg, Mannheim, Germany

blunk@physiologie1.uni-erlangen.de,  
martin.schmelz@anaes.ma.uni-heidelberg.de

A

### Synonyms

Blood Platelets; Intracutaneous Injection Pain; hyperalgesia; Cutaneous Pain Model

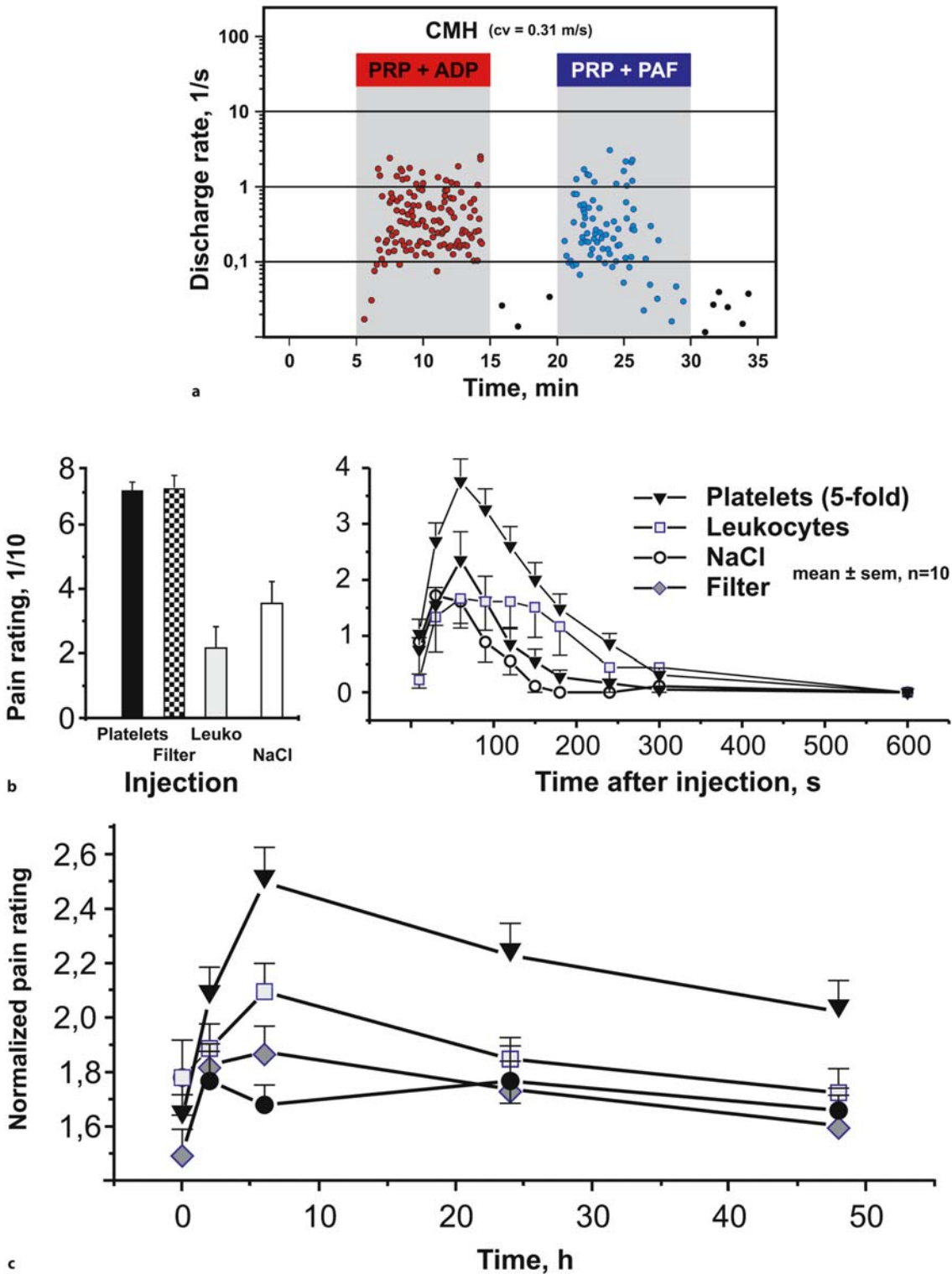
### Definition

Thrombocytes are usually associated with the hemostasis or with vascular inflammatory processes. Little is known about the role of corpuscular components like white blood cells or platelets in the excitation and sensitization of nociceptors in human tissue. Injections of autologous preparations of human thrombocytes into the dermal layer of the skin are able to directly excite nociceptors and to induce an inflammatory ▶ **induration**, showing prolonged primary mechanical and thermal hyperalgesia (▶ **primary hyperalgesia**). Neuronal and vascular reactions following platelet injections have been assessed by videography, ▶ **Laser-Doppler Flowmetry** (LDF), and various other psychophysical methods to measure primary hyperalgesia. Injections of platelet preparations into the skin are intended to further increase the pathophysiological relevance of hyperalgesia models.

### Characteristics

Inflammatory processes are often associated with pain and hyperalgesia (Koltzenburg and Torebjörk 1995). Even though a multitude of algogenic substances, such as ▶ **bradykinin**, could be identified as mediators in inflammatory processes (Reeh and Kress 1995), little is known about the origin of mechanical hyperalgesia in inflamed tissue. A variety of algogenic substances and combinations of mediators have been thoroughly tested in various cutaneous pain models. Nevertheless, only a very few models inducing subacute or chronic inflammatory pain in humans exist. All of these models are based on the physical or noxious stimulation of the skin (heat, UV-irradiation, ▶ **capsaicin** injection) (Bickel et al. 1998; LaMotte et al. 1992). Yet, there is only limited information about the role of corpuscular elements in the activation and sensitization of nociceptors in these models. Every trauma, be it a laceration, scalding (Lofgren et al. 1997), UV-irradiation, blunt tissue injury or even inflammatory, immunological diseases (Alstergren and Kopp 1997; Maeda et al. 1998), usually results in the disruption, or at least in the alteration, of the vascular system, inducing the activation of the coagulation system.

The first electrophysiological studies employing *in vitro* skin nerve preparations of the rat hind paw have verified acute activation of nociceptive C-fibers exposed to activated platelets (Ringkamp et al. 1995). These studies clearly show, that only activated human



**Autologous Thrombocyte Injection as a Model of Cutaneous Pain, Figure 1** Platelet injections as cutaneous pain model. Effects of thrombocyte superfusion of in vivo rat skin and of injections of autologous platelet preparations into human skin of volunteers. (a) In a nerve-skin preparation activated platelets (ADP and PAF) induce severe discharge of a mechano-heat sensitive C-unit (CMH), reversible during washout periods. (b) In humans, injections of platelet preparations induced pronounced injection pain (rated on a numerical rating scale of 0 “no pain” to 10 “most severe pain”), which gradually receded over the observation period of 10 minutes. (c) Six hours after the injection, mechanical hyperalgesia developed directly at the induration at the injection site. This was significantly increased for 3 days. Filtered platelets were only able to induce severe injection pain. Hyperalgesia did not develop. Leukocytes, like saline injections, produced unspecific effects.



platelets were able to excite these isolated nociceptive units. Platelets contain a considerable amount of ► **serotonin**, an algogenic substance that is secreted upon activation of the cell fragment. This substance is known to activate nociceptive nerve endings (Reeh and Kress 1995). Further studies employing serotonin antagonists and prostaglandin inhibitors underlined that serotonin discharged from activated thrombocytes was not the crucial mediator (Ringkamp et al. 1994b). The activation of platelets not only resulted in the activation of nociceptive nerve endings in the rat, but was equally able to induce dose dependent pain and ► **axon reflex** flare reactions after the injection of autologous platelet preparations into the skin of human subjects (Schmelz et al. 1997). The pain subsided within minutes after the injection, but, within only a few hours, a local induration developed. This induration was hypersensitive to mechanical and thermal stimuli and gradually dissolved after about three days. This hyperalgesic reaction was linked to membrane bound mediators, as injection of filtered platelets did evoke acute pain, but no hyperalgesia (Blunk et al. 1999). Therefore, acute pain is probably induced by the secretion of a water-soluble algogenic substance, whereas the development of mechanical and thermal primary hyperalgesia is probably due to a cyto-attractant substance bound to the platelet membrane. The activation of platelets and subsequent release of ► **Beta(β)-Thromboglobulin** (Blunk et al. 1998) in the human burn model has already been shown by intracutaneous microdialysis, suggesting a role for platelets in this pain and hyperalgesia model. Interestingly, activated platelets have also been proposed to be linked to myocardial pain (Fu and Longhurst 2002), whereas the proposed link to migraine might not be valid (Migraine Pathophysiology 2004). Injections of pure leukocyte preparations do not have an algogenic effect on nociceptors, but synergistically enhance the ability of platelets to induce pain and inflammation in the skin (Blunk et al. 1999). The interaction of platelets and leukocytes is of major interest, as it is the basis of transcellular synthesis resulting in mediators such as lipoxins (Kantarci and Van Dyke 2003). In summary, platelets are a most interesting source of mediators that can excite and sensitize nociceptors in the human.

## References

1. Alstergren P, Kopp S (1997) Pain synovial fluid concentration of serotonin in arthritic temporomandibular joints. *Pain* 72:137–143
2. Bickel A, Dorfs S, Schmelz M et al. (1998) Effects of antihyperalgesic drugs on experimentally induced hyperalgesia in man. *Pain* 76:317–325
3. Blunk J, Schmelz M (1998) Beta-thromboglobulin is secreted by platelets in heat-induced skin inflammation. Abstract in *Pflügers Archiv, Eur J Physiol, Suppl* 435:25–5
4. Blunk J, Osiander G, Nischik M et al. (1999) Pain and inflammatory hyperalgesia by intradermal injections of human platelets and leukocytes. *Eur J Pain* 3:247–259
5. Fu LW, Longhurst JC (2002) Activated platelets contribute to stimulation of cardiac afferents during ischaemia in cats: role of 5-HT(3) receptors. *J Physiol* 544:897–912
6. Kantarci A, Van Dyke TE (2003) Lipoxins in chronic inflammation. *Crit Rev Oral Biol Med* 14:4–12
7. Koltzenburg M, Torebjörk HE (1995) Pain and hyperalgesia in acute inflammatory and chronic neuropathic conditions. *Lancet* 345:1111
8. LaMotte RH, Lundberg LER, Torebjörk HE (1992) Pain, hyperalgesia and activity on nociceptive-C units in humans after intradermal injection of capsaicin. *J Physiol Lond* 448:749–764
9. Lofgren O, Gazelius B, Lundeberg T (1997) Acute microcirculatory changes after scalding of the rat hind paw. *Acta Physiol Scand* 161:289–294
10. Maeda M, Kachi H, Mori S (1998) Ultrastructural observations of platelets from patients with progressive systemic sclerosis (PSS). *J Dermatol* 25:222–230
11. Reeh PW, Kress M (1995) Effects of classical algogens. *Semin Neurosci* 7:221–226
12. Ringkamp M, Schmelz M, Kress M et al. (1994a) Activated human platelets in plasma excite nociceptors in rat skin, in vitro. *Neurosci Lett* 170:103–106
13. Ringkamp M, Schmelz M, Allwang M et al. (1994b) Nociceptor excitation by platelets is not due to 5-HAT or prostanoids released. *Soc Neurosci Abstr* 20:1569
14. Schmelz M, Osiander G, Blunk J et al. (1997) Intracutaneous injections of platelets cause acute pain and protracted hyperalgesia. *Neurosci Lett* 226:171–174
15. No authors listed (2004) Migraine Pathophysiology. *Headache* 44:735–739

## Autonomic

### Definition

Pertaining to the part of the vertebrate nervous system that regulates involuntary action, as of the intestines, heart, and glands. This is divided into the sympathetic nervous system and the parasympathetic nervous system.

► [Psychiatric Aspects of Visceral Pain](#)

## Autonomic Dominant Cramping Disease

### Definition

Familial forms of idiopathic cramps. In most cases, a central, neuronal origin of the cramps at the level of the motoneuron somata has been hypothesized.

► [Muscular Cramps](#)

## Autonomic Dysreflexia

### Definition

Autonomic dysreflexia is the inappropriate autonomic function that results from spinal cord injury at or above the level of T6

► [Spinal Cord Injury Pain](#)



## Autonomic Features

### Definition

A variety of symptoms referable to activation of the autonomic nervous system. When activated, symptoms include ptosis, miosis, lacrimation, conjunctival injection, nasal congestion and rhinorrhea. These autonomic symptoms classically accompany attacks of cluster headache, but also occur during painful exacerbations of hemicrania continua.

- ▶ [Hemicrania Continua](#)

## Autonomic Functions

### Definition

Nervous regulation of the homeostasis of blood pressure, cardiac rhythm, blood circulation, blood fluid balance, respiration, pupil diameter, visceral motility, exocrine and neuroendocrine secretions, energy metabolism and internal temperature. This is achieved by a constant interaction between the central and peripheral nervous systems.

- ▶ [Hypothalamus and Nociceptive Pathways](#)
- ▶ [Pain Processing in the Cingulate Cortex, Behavioral Studies in Humans](#)

## Autonomic Nervous System

### Definition

The autonomic nervous system is that part of the nervous system that controls body functions not under our direct voluntary control, such as the blood pressure, pulse rate, operation of the bowel and bladder and body temperature. It includes the sympathetic, parasympathetic and enteric nervous system.

- ▶ [Amygdala, Pain Processing and Behavior in Animals](#)
- ▶ [Diabetic Neuropathies](#)
- ▶ [Hereditary Neuropathies](#)

## Autonomic Phenomena

### Definition

Signs and symptoms associated with vascular-type craniofacial pain. Local autonomic signs include: tearing, redness of eye, nasal congestion and rhinorrhea, cheek swelling and redness. Symptoms include: nausea, photophobia and phonophobia.

- ▶ [Atypical Facial Pain](#)

## Autonomic Reactions/Symptoms

### Definition

Variation of blood pressure, cardiac rhythm, blood circulation, respiration, pupil diameter, visceral motility and visceral secretion triggered by a noxious stimulus.

- ▶ [Autonomic Functions](#)
- ▶ [Hypnic Headache](#)
- ▶ [Parabrachial Hypothalamic and Amygdaloid Projections](#)

## Autoregulation of the Cerebral Vessels

### Definition

Autoregulation of the cerebral vessels refers to the capability of the cerebral vascular system to hold the cerebral perfusion stable during a wide range of systemic blood pressure.

- ▶ [Primary Exertional Headache](#)

## Autotomy

### Definition

Self-injurious behavior in which a body part, usually denervated or deafferented, is compulsively licked, bitten and chewed (self mutilation), and is commonly observed in animals following neurectomy. In the animal model of peripheral neurectomy, animals typically begin biting off nails and digits on the denervated paw within a few days following nerve injury.

- ▶ [Anesthesia Dolorosa Model, Autotomy](#)
- ▶ [Dietary Variables in Neuropathic Pain](#)

## Autotraction

- ▶ [Lumbar Traction](#)

## Avocado-Soybean-Unsaponifiables

- ▶ [Nutraceuticals](#)

## Avoidance Behavior

### Definition

Behavior aimed at avoiding or postponing undesirable situations or experiences. In chronic low back pain patients, avoidance behavior often consists of avoiding those activities that are believed to promote pain and/or (re)injury.

- ▶ Disability, Fear of Movement
- ▶ Hypervigilance and Attention to Pain
- ▶ Muscle Pain, Fear-Avoidance Model

## Avulsion

### Definition

Avulsion refers to the traumatic disconnection of nerve root from the spinal cord.

- ▶ Plexus Injuries and Deafferentation Pain

## Avulsion Fracture

### Definition

A fracture caused by a muscle pulling off a piece of bone from the area of the muscle's attachment.

- ▶ Cancer Pain Management, Orthopedic Surgery

## Awakening

### Definition

An increase in EEG and heart rate frequency with a rise in muscle tone that lasts more than 10 seconds. Subjects remain in sleep and are not usually aware of external influences. They could complain of non-refreshing sleep on the following day.

- ▶ Orofacial Pain, Sleep Disturbance

## Awareness

- ▶ Consciousness and Pain

## Axillary Block

### Definition

Injection of local anesthetic into the axillary brachial plexus sheath resulting in sensory blockade of the hand. The forearm and inner aspect of the arm may be incompletely blocked due to inadequate blockade of the musculocutaneous and median nerves.

- ▶ Acute Pain in Children, Post-Operative

## Axolemma

### Definition

Membrane around the nerve cell; the membranous sheath that encloses the long thin extension of a nerve cell (axon).

- ▶ Perireceptor Elements

## Axon

### Definition

A process (and its eventual collaterals) of a neuron that conducts electrical impulses (action potentials) away from the soma (orthodromically) to its presynaptic ending(s) (forming synaptic contacts with other neurons, muscles or glands). Axons and their sheaths are called nerve fibers.

- ▶ Nociceptors, Action Potentials and Post-Firing Excitability Changes
- ▶ Spinothalamic Tract Neurons, Morphology
- ▶ Toxic Neuropathies
- ▶ Wallerian Degeneration

## Axon Reflex

### Definition

The activation of a nociceptive C-fiber results not only in the transmission of action potentials towards the CNS, but also along its branching fibers back towards the skin. This leads to the release of the vasoactive substances CGRP (calcitonin-gene-related peptide) and substance P. These neuropeptides subsequently induce protein extravasation and vasodilation, which is reddening and weal formation of the skin (neurogenic inflammation).

- ▶ Autologous Thrombocyte Injection as a Model of Cutaneous Pain
- ▶ Nociceptor, Axonal Branching
- ▶ Nociceptors in the Dental Pulp

## Axonal Arborization

### Definition

Terminal domain of an axon, exhibiting numerous branches and varicosities where the synaptic events take place.

- ▶ Spinothalamic Tract Neurons, Morphology

## Axonal Degeneration

### Definition

The pathologic term to describe destruction of nerve fibers (axons).

- ▶ Toxic Neuropathies

## Axonal Sprouting

- ▶ Sympathetic and Sensory Neurons after Nerve Lesions, Structural Basis for Interactions

## Axonal/Axoplasmic Transport

### Definition

Anterograde axonal (or axoplasmic) transport is the energy-dependent mechanism by which materials synthesized in the cell body are moved to distal regions of neuronal processes. It is broadly divided into fast axonal transport, which involves the movement of materials within vesicles such as neurotransmitters, and slow axonal transport, incorporating movement of cytoskeletal proteins and cytoplasmic constituents. Retrograde axonal transport is the movement of materials such as proteins destined for degradation, or molecules acquired from the external environment back to the cell body. Impaired axonal transport has been implicated

in many neuropathies, including diabetic neuropathy, as it would be likely to starve peripheral parts of the axons of critical materials and also disrupt the delivery of factors from the environment back to the cell body.

- ▶ Dietary Variables in Neuropathic Pain
- ▶ Neuropathic Pain Model, Diabetic Neuropathy Model
- ▶ Opioids and Inflammatory Pain
- ▶ Toxic Neuropathies

## Axotomy

### Definition

When the axon of a neurone is transected, the neurone is said to be axotomized. This occurs when the nerve trunk is cut, crushed, ligated or frozen. The stump of the axon becomes swollen with accumulated organelles originally destined for the nerve terminals. The soma responds within ~ 6 hours, by changing the synthesis of proteins from transmitter synthesizing enzymes, to those associated with regeneration of axonal membrane and other structural components. If regeneration is prevented by scar formation or another impediment, a neuroma forms. Axotomy of the sciatic nerve, particularly in rats or mice, is frequently used as an animal model for nerve injury and neuropathic pain.

- ▶ Immunocytochemistry of Nociceptors
- ▶ Peptides in Neuropathic Pain States
- ▶ Retrograde Cellular Changes after Nerve Injury
- ▶ Sympathetic and Sensory Neurons after Nerve Lesions, Structural Basis for Interactions

## Azathioprine

### Definition

Azathioprine is an immunosuppressant agent, purine derivative. Steroid sparing agent in cranial arteritis; treatment of choice in Behçet's disease.

- ▶ Headache Due to Arteritis
- ▶ Vascular Neuropathies

## Back Pain

- ▶ Chronic Back Pain and Spinal Instability
- ▶ Radiculopathies

## Back Pain in the Workplace

JOHN D. LOESER  
 Department of Neurological Surgery, University of  
 Washington, Seattle, WA, USA  
 jdloeser@u.washington.edu

### Synonyms

Work intolerance; nonspecific low back pain

### Definition

Report of the International Association for the Study of Pain Taskforce on Back Pain in the Workplace chaired by Professor Wilbert E. Fordyce.

### Characteristics

The International Association of the Study of Pain (IASP), under the leadership of its President, Michael J. Cousins, established a Taskforce on Back Pain in the Workplace in 1989. Wilbert E. Fordyce was the Chairperson; Professor Cousins appointed twenty-five Taskforce members from a wide variety of professions: medicine, physical therapy, economics, labor, business, insurance, and administration. All were from developed countries including the United States, Australia, Canada, United Kingdom and Sweden. The Taskforce report was approved by the IASP Council and published in 1995. The 77 page Report consisted of an introduction and eight chapters, along with an extensive bibliography. Professor Fordyce composed the final draft of the report, after multiple reviews and contributions by all of the Taskforce members. The final paragraph of the report was:

“We conclude that existing disability programs are a major contributor to the explosion in disability ascribed to nonspecific low back pain. We call for a new paradigm

for the assessment and management of disability ascribed to low back pain. The new program should have a primary goal of reducing worker pain, suffering, and loss of economic and personal rewards of gainful employment. We believe that the costs of such a program should accrue to both worker and employer in a fashion that provides appropriate incentives for each to reduce injuries and disability. Major changes are also needed in health care delivery for low back pain. Disability has complex social, personal, and physical antecedents. It is time to change our strategies for containment.” (Fordyce 1995)

The first chapter set the stage for the succeeding sections, by identifying nonspecific low back pain (NSLBP) as the focus of the report. It defined this condition and other terms such as disability and impairment, and emphasized that disability is always based upon the interaction between the person and his or her environment. The second chapter reviewed the literature on the epidemiology of NSLBP and its costs. The third chapter built upon Loeser’s model of pain (Loeser 1980) and elucidated the bio-medical and biopsychosocial models of pain. The fourth chapter discussed the ambiguities associated with the diagnosis and treatment of chronic low back pain and the medicalization of suffering. The fifth chapter looked at disability programs and their intent and distinguished physical from psychological factors that can cause disability. The sixth chapter discussed the prevention of disability in the workplace. The seventh chapter excerpted the treatment guidelines from the United States Agency for Health Care Policy and Research (AHCPR) Guidelines (1994), and a similar report from the UK (1994). It emphasized the need for rehabilitation rather than cure. The eighth chapter proposed changes in disability systems, and the ninth chapter contained a proposal for the management of long-term disability.

The Taskforce Report called for new approaches to the treatment of non-specific low back pain and the disability that was ascribed to it. It called for the recognition of NSLBP as a problem of activity intolerance, not a bio-medical issue. It made heavy use of the diagnostic and treatment guidelines that had recently been published in the United States and the United Kingdom. Medical management was to be on a time-contingent, not pain-contingent basis. The focus of interventions

for NSLBP should be shifted from the clinic to the worksite. The Report called for comprehensive reevaluation of any worker whose function was not restored within six weeks. Those who failed to return to work with restoration of function after six weeks should be classified as unemployed, and not medically disabled, due to NSLBP. Other recommendations included the limitation of permanent disability status to those who had clear-cut impairment that was irremediable; temporary disability status should not require permanent impairment. The authors also stated that, psychological and psychiatric conditions ascribed to chronic pain should not lead to disability ascribed to pain. A strong emphasis on vocational rehabilitation permeated this report. Finally, a complete overhaul of all of the existing administrative policies, relating to disability and impairment from NSLBP, was recommended.

No other publication of the IASP Press has stirred up so much controversy, and certainly none has led to actions such as the changes in disability policies that have been implemented in many countries and states in the US. The report succeeded in threatening those with vested interests in many aspects of the disability process, especially those who earned their living providing interminable health care to people with NSLBP who rarely seemed to return to work. Labor interests claimed that the report was an attempt to take away benefits that had been earned through difficult negotiations. Business interests thought that costs to them could be increased by such a plan. Insurance companies worried about their costs and administrators saw their empires threatened. Vituperative and erroneous letters to the editors of pain journals persisted for several years. The members of the Taskforce in general, and its chairperson in particular, were called to task for even thinking such thoughts, let alone publishing them. IASP Council members, every one of whom had been sent a draft copy of the report prior to its publication, were chastised for approving its publication.

The primary argument leveled against the Report was, the idea that its plan would deprive injured working people of health care, and that labeling them as unemployed after six weeks would damage both their self-esteem and financial well-being. Some felt that "work intolerance" was not a valid concept, and that all of the workers who complained of back pain harbored an occult disease, which was amenable to more therapy of the sort that they provided. The authors of this report were accused of having no sympathy for injured working people who were entitled to whatever benefits they now received, as if such benefits were decreed by some higher being. The Report did suggest that changing from a biomedical model to a biopsychosocial model would reduce health care costs and hasten return to gainful employment, which would be an advantage to both the worker and the employer, as well as those who fund disability systems.

Eight years later, what has been the effect of this Taskforce report? Some governmental agencies have attempted to implement its recommendations with mixed results. Some have returned to the old systems. Not many health care providers have changed their concepts of NSLBP, but the entity is at least more visible in debates about how to solve the disability crisis. Western societies have not come to grips with the huge impact of NSLBP on their economies, in part because of the political impact of shifting many of those who are said to be disabled by low back pain to the group of those that are considered unemployed. To do so would more than double the unemployment rate in most countries! Those who earn a living providing health care to patients with NSLBP, have not accepted the rather conclusive evidence that none of their interventions have been shown to improve the outcome from an episode of acute low back pain.

Nonetheless, this report has had a perceptible effect upon thinking about the management of low back pain and disability. First, it served as yet another resource for those who have long been concerned about the excessive amounts of useless health care that have been provided to sufferers with non-specific low back pain. By concurring with US and UK expert reports (and other countries later), a much more cogent argument in favor of a new approach to NSLBP has been generated. The need for evidence that a treatment was effective was also strongly supported. Many compensation systems have moved away from acute symptomatic interventions, to comprehensive, multidisciplinary approaches to patients with chronic non-specific low back pain. Second, it has served as a focus for a debate on what disability programs are designed to accomplish, and how they should be constructed. The principle behind the Taskforce recommendations was, that a properly constructed disability program should facilitate return to gainful employment, not impede it. The incorporation of behavioral principles into the fabric of health care and disability programs was seen as a step toward better outcomes at lower costs.

Third, it demonstrated that multidisciplinary, multinational scientific organizations, such as the IASP, could generate meaningful reports that could serve as a focal point for discussion and lead to social change.

Change comes slowly in social and political issues, such as the award of disability status to those who claim to be unable to work because of NSLBP. It is unlikely that a cataclysmic event will occur, in spite of mounting costs and additional evidence, that the way Western societies handle this problem is counterproductive for both the worker and society. The specifics of the proposal set forth in this report are not too important; the conceptual changes that it called for are the primary reason for its value. For those who look back on health care and disability programs in 50 years, I predict that it will be seen as prescient.



## References

1. Back Pain: Report of a CSAG Committee on Back Pain (1994) Clinical Standards Advisory Group, HMSO London
2. Bigos SJ (1994) Acute Low Back Problems in Adults, Clinical Practice Guideline, AHCPR Publication no. 95-0642, U.S. Department of Health and Human Services, Public Health Service, Agency for Health Care Policy and Research, Rockville, MD
3. Fordyce WE (1995) Back Pain in the Workplace. IASP Press, Seattle, p 67
4. Loeser JD (1980) Perspectives on Pain. In: Turner P (ed) Proceedings of the First World Congress on Clinical Pharmacology and Therapeutics. Macmillan, London, pp 316–326

## Back Schools

- ▶ Information and Psychoeducation in the Early Management of Persistent Pain

## Background Activity / Firing

### Definition

Background Activity is the spontaneous discharge of neurons that is independent of afferent input or any other direct stimulation.

- ▶ Molecular Contributions to the Mechanism of Central Pain
- ▶ Postsynaptic Dorsal Column Projection, Functional Characteristics

## Background Infusion

### Definition

Background infusion is a constant intravenous infusion of an analgesic medication that can be used in conjunction with a PCA.

- ▶ Analgesic Guidelines for Infants and Children

## Baclofen

### Definition

Baclofen is an agonist at G-protein coupled GABA<sub>B</sub> receptors.

- ▶ GABA and Glycine in Spinal Nociceptive Processing

## Bad Back

- ▶ Lower Back Pain, Acute

## Balanced Analgesia

- ▶ Multimodal Analgesia
- ▶ Multimodal Analgesia in Postoperative Pain

## Balanced Analgesic Regime

### Definition

This term refers to the use of a mixture of analgesics with different mechanisms of action. It can also be referred to as “multimodal analgesia“. There is evidence that this can improve pain relief and reduce adverse effects. There has been particular interest in using this as part of an overall approach to hasten recovery rates after surgery and to reduce in-patient stay (Wilmore DW, Kehlet H. 2001).

- ▶ Postoperative Pain, COX-2 Inhibitors

### References

1. Wilmore DW, Kehlet H. (2001) Management of Patients in Fast Track Surgery. British Medical Journal; 322:473–476

## Balneotherapy

### Definition

The term comes from the Latin balneum (bath).

- ▶ Spa Treatment

## Baricity

### Definition

Baricity is the ratio comparing the density of one solution to another. In order to make a drug hypobaric to cerebrospinal fluid (CSF), it must be less dense than the CSF, having a baricity less than 1.0000 or a specific gravity appreciably less than 1.0069 (the mean value of CAF specific gravity). Intrathecal local anesthetic solutions can be hypobaric, isobaric or hyperbaric. The predictability of the spread of intrathecal local anesthesia can be improved by altering both the baricity of the solution and the position of the patient during the intrathecal local anesthetic injection.

- ▶ Postoperative Pain, Intrathecal Drug Administration

## Barotraumas

### Definition

Barotraumas are lung injuries due to high airway pressure.

- ▶ Pain Control in Children with Burns

## Barreloids

### Definition

Groups of neurons in the thalamus that are responsive to whisker stimulation. Individual barreloids are driven by specific whiskers.

- ▶ [Thalamic Plasticity and Chronic Pain](#)

## Basal Ganglia

### Definition

The basal ganglia belong to subcortical structures of the brain, and comprise of a group of nuclei associated with motor control, motivation and learning functions.

- ▶ [Functional Imaging of Cutaneous Pain](#)

## Basal Lamina

### Definition

Extracellular matrix characteristically found under epithelial cells. The basal lamina, immediately adjacent to the cells, is a product of the epithelial cells themselves and contains collagen type IV.

- ▶ [Perireceptor Elements](#)

## Basal Ventral Medial Nuclei

### Synonyms

VM, VMb

### Definition

Part of the Ventral posterior complex.

- ▶ [Spinothalamic Terminations, Core and Matrix](#)
- ▶ [Thalamic Nuclei Involved in Pain, Human and Monkey](#)

## Baseline Phase

### Definition

A phase of the psychophysiological assessment involving collection of initial data to help design treatment targets and assess progress over time.

- ▶ [Psychophysiological Assessment of Pain](#)

## Basic Body Awareness Therapy

### Definition

A method that focuses on stability in postural function combined with freedom of movement, breathing, and body experiences are considered crucial for total self-identity. The aim of the therapy is to increase sensory motor awareness and locomotor control, through exercise that focuses on a stable relation to the ground, posture, gait and truncal positioning, and the maintenance of balance related to the central axis of the body.

- ▶ [Body Awareness Therapies](#)

## Basic Work Activities

### Definition

The abilities and aptitudes necessary to do most jobs. Basic work activities include physical functions, such as walking, standing, sitting, lifting, pushing, pulling, reaching, carrying, or handling; the capacities for seeing, hearing, and speaking; and the mental abilities for understanding, carrying out, and remembering simple instructions, use of judgment; responding appropriately to supervision, co-workers and usual work situations; and dealing with changes in a routine work setting.

- ▶ [Disability Evaluation in the Social Security Administration](#)

## Basilar-Type Migraine

### Definition

Migraine aura in which the clinical symptoms can be attributed to brainstem dysfunction. The symptoms can last from 5 to 60 minutes and may include ataxia, vertigo, diplopia, bitemporal or binasal visual field loss, dysarthria, tinnitus, hyperacusia, bilateral sensory changes and alterations in consciousness, but no motor weakness in peripheral limbs. Originally, this was felt to be due to constriction of the basilar artery, hence the name basilar migraine. The International Classification of Headache Disorders II has classified this condition as basilar-type migraine preserving the historical link, but acknowledging the fact that the basilar artery may not be involved at all in the pathogenesis of this condition.

- ▶ [Migraine, Childhood Syndromes](#)
- ▶ [Migraine Without Aura](#)

## Bcl-2

### Definition

Bcl-2 is a proto-oncogene, activated by chromosome translocation in human B-cell lymphomas. It encodes for a plasma membrane protein. The gene product inhibits programmed cell death (apoptosis).

- ▶ NSAIDs and Cancer

## BDNF

- ▶ Brain Derived Neurotrophic Factor

## Bed Nucleus of the Stria Terminalis

### Definition

Group of neurons located in the forebrain, chiefly at the end of the stria terminalis, a fasciculus that links this nucleus with the amygdala. The lateral portion of this nucleus has a functional relationship with the central nucleus of the amygdala (central extended amygdala). It may play a critical role in autonomic reactions linked to diffuse stress.

- ▶ Nociceptive Processing in the Amygdala, Neurophysiology and Neuropharmacology
- ▶ Parabrachial Hypothalamic and Amygdaloid Projections

## Behçet's Disease

### Definition

Systemic vasculitis of the veins presenting with iridocyclitis, oral and genital ulcers.

- ▶ Headache Due to Arteritis

## Behavior

### Definition

Exercise and activity are behaviors; not attitudes, traits, or interests. The methods are designed to change (increase or decrease) behavior; not something else.

- ▶ Training by Quotas

## Behavior Modification

### Definition

Involves helping parents learn strategies to promote well behaviors and extinguish the child's overt pain behaviors such as crying, guarding, limping, and restricting activities due to the pain.

- ▶ Complex Chronic Pain in Children, Interdisciplinary Treatment

## Behavior Therapies

### Definition

Systematic application of learning theory principles to treat behavioral problems or disorders. Treatment focus is on observable and measurable physiological or environmental events and on the patient's resultant behaviors.

- ▶ Psychiatric Aspects of the Management of Cancer Pain

## Behavioral

### Definition

Pertaining to the outwardly observed behavior of the individual.

- ▶ Pain as a Cause of Psychiatric Illness
- ▶ Psychological Treatment in Acute Pain

## Behavioral Assessment

### Definition

Evaluation of the response of an individual, group, or species to its environment.

- ▶ Disability, Functional Capacity Evaluations

## Behavioral Descriptions of Symptoms

- ▶ Non-Organic Symptoms and Signs

## Behavioral Experiments

### Definition

A behavioral experiment is a therapeutic tool in order to test the dysfunctional beliefs or misconceptions about the relation between certain stimuli and aversive consequences. The goal is to decrease the subjective credibility of the dysfunctional interpretations and to increase the credibility of the alternative interpretations.

- ▶ Disability, Fear of Movement
- ▶ Fear Reduction through Exposure In Vivo

## Behavioral Pain Scale

### Definition

Indirect measure of pain in which presence or intensity of pain is inferred by noting changes from baseline levels for certain observable behaviors such as crying, facial expression and limb movements rate.

- ▶ Pain Assessment in Children

## Behavioral Responses to Examination

- ▶ Non-Organic Symptoms and Signs

## Behavioral Self-Management

### Definition

Skills that are employed by the patient to increase positive adaptation to the experience of pain (e.g. exercise, appropriate use of analgesic medication).

- ▶ Psychological Treatment of Headache

## Behavioral Therapies to Reduce Disability

MICHAEL J.L. SULLIVAN  
University of Montreal, Montreal, QC, Canada  
michael.jl.sullivan@umontreal.ca

### Synonyms

Pain Management Programs; Operant Conditioning Approaches to Chronic Pain; Graded Activity Approaches to Chronic Pain; Exposure Techniques for Reducing Activity Avoidance

### Definition

Behavior therapy refers to a host of techniques that are based on principles of learning theory. Behavior therapy approaches to pain and disability proceed from the assumption that disability is a form of behavior, which is governed by the same environmental forces that influence all forms of human behavior. Current approaches vary with respect to their relative emphasis on different components of learning theory such as ▶ **classical conditioning**, ▶ **instrumental conditioning**, and ▶ **social learning**. Disability is typically construed as a reduction in physical or psychological capacity, from a pre-injury or pre-illness level. The primary goal of behavior therapy is to modify environmental contingencies such that disability is minimized.

### Characteristics

According to the principles of operant conditioning, behaviors are influenced by their consequences. A particular behavior (e.g. moaning) that is followed by a positive consequence (e.g. empathic attention) will have a higher probability of being emitted in the future, regardless of the level of pain. In this case, 'moaning' becomes instrumental in achieving empathic attention.

The association between physical activity and pain symptoms has also been discussed, as a significant factor in the development and maintenance of pain behavior (Philips 1987; Vlaeyen and Linton 2000). Individuals with musculoskeletal pain conditions typically experience increases in pain following activity, and decreases in pain upon activity cessation. This relation between activity and pain sets a stage, ideal for the learning of escape or avoidance behavior (Vlaeyen et al. 1995). Activity cessation or activity avoidance is reinforced by the reduction in experienced pain. Since activity cessation and activity avoidance essentially define 'disability', learning principles have been discussed as fundamental to the development of disability associated with pain (Vlaeyen and Linton 2000). It has been suggested that disability can persist solely on the basis of an individual's expectation that a certain behavior will result in pain (Philips 1987). Since avoidance of activity does not allow for disconfirmation of the individual's expectation or belief that pain will result from activity, disability can be maintained long after a pain condition has resolved (Turk et al. 1983; Vlaeyen and Linton 2000).

Behavior therapy initially emerged from empirical research on the determinants of learning (Skinner 1953). In the 1960s and 1970s, William Fordyce and his colleagues applied the concepts of learning theory to the problem of chronic pain (Fordyce 1976; Fordyce et al. 1968). The focus of Fordyce's approach to treatment was not on reducing the experience of pain, but on reducing the overt display of pain. The targets selected for treatment were pain behaviors such as distress vocalizations,

facial grimacing, limping, guarding, medication intake, activity withdrawal and activity avoidance.

The first behavioral approaches to the management of pain and disability were conducted within inpatient settings, which permitted systematic observation of pain behaviors, as well control over environmental contingencies influencing pain behavior (Fordyce 1976). Staff were trained to monitor pain behavior, and to selectively reinforce 'well behaviors' and selectively ignore 'pain behaviors'. Results of several studies revealed that the manipulation of reinforcement contingencies could exert powerful influence on the frequency of display of pain behaviors (Fordyce et al. 1985). The manipulation of reinforcement contingencies was also applied to other domains of pain-related behavior, and shown to be effective in reducing medication intake, reducing downtime and maximizing participation in goal-directed activity.

A number of clinical trials on the efficacy of behavioral treatments, for the reduction of pain and disability, yielded positive findings (Sanders 1996). However, given the significant resources required to implement contingency management interventions, issues concerning the cost-efficacy of behavioral therapy for pain and disability were raised. Concern was also raised over the maintenance of treatment gains, since reinforcement contingencies outside the clinic setting could not be readily controlled. In order to increase access and reduce costs, behavioral treatments were modified to permit their administration on an outpatient basis. This change in delivery format compromised, to some degree, the control over environmental contingencies, and required greater reliance on self-monitoring and self-report measures (Sanders 1996).

There have been a number of other behavior therapies that have been applied to individuals with persistent pain conditions (Turk et al. 1983). Two techniques that have received considerable research attention are relaxation and biofeedback. These techniques were not addressed in this article, since they have as their primary objective, the reduction in the subjective experience of pain as opposed to the reduction of disability.

The early work of Fordyce and his colleagues was at once novel and contentious, with its focus on reducing pain behavior as opposed to ameliorating the pain condition. Critics voiced their concerns that behavioral treatments might only be effective in training stoicism, and were not dealing with the underlying problem. In response to critics, Fordyce pointed to literature indicating that the magnitude of the relation between pain and disability was modest at best, and that treatments aimed at reducing pain often had no appreciable effect on level of disability (Fordyce et al. 1985). According to Fordyce, to effectively treat disability, disability had to be targeted directly.

There has been a recent resurgence of interest in the application of behavioral interventions for the management of pain-related disability. Emerging programs

differ from traditional approaches, with greater emphasis on increasing activity involvement and reducing avoidance and escape behaviors. Recent programs have also tended to adopt return to work as the primary goal of the intervention (Sullivan and Stanish 2003).

Vlaeyen and his colleagues have developed a behavioral treatment program designed to reduce fears of pain, movement and re-injury. The treatment program is based on the premise that pain-related disability arises from an individual's fears, that movement or activity may precipitate increases in pain or injury exacerbation. Clients enrolled in this treatment are first asked to rate the intensity of their fears of engaging in a variety of different physical activities (Kugler et al. 1999). A **fear hierarchy** is then established, and exposure techniques are used to desensitize the individual to the feared activities. A number of clinical research reports have been published highlighting the efficacy of this approach for reducing pain-related fear, and minimizing the degree of disability associated with pain (Vlaeyen et al. 2002a; Vlaeyen et al. 2002b).

Another recent behavioral treatment for disability is the Pain-Disability Prevention (PDP) Program (Sullivan and Stanish 2003). The PDP Program is a community-based behavioral intervention, which aims to increase activity involvement and minimize psychological risk factors for prolonged disability. The treatment Program targets known risk factors for chronicity including: (1) fear of movement/re-injury, (2) catastrophizing, (3) perceived disability, and (4) depression. The PDP Program begins with behavioral strategies (e.g. goal setting, pacing, graded activity exposure) aimed at maximizing participation in daily activities. The goals of these activity mobilization techniques include reducing fears of movement, and challenging the clients' beliefs about their level of disability. Midway through the Program, cognitive strategies (e.g. cognitive restructuring, positive self-statements) are introduced to reduce catastrophic thinking and depressive symptoms. Outcome studies on the impact of the PDP Program reveal significant reductions in risk factors for prolonged disability and return to work rates ranging from 60–68% (Sullivan and Stanish 2003).

In summary, the literature reveals a wide range of interventions that have been developed to modify pain behaviors associated with disability. Behavior therapies for reducing disability have enjoyed a resurgence of interest in recent years. This interest is partly borne out of current clinical perspectives, emphasizing the importance of targeting disability as the primary goal of intervention. The interest in behavioral therapy for persistent pain conditions is likely to be maintained, as clinical studies continue to yield positive results in terms of observable outcomes such as increased activity and return to work. Such outcomes are being increasingly recognized as potentially more meaningful, whether assessed in terms of personal, social or societal benefit,



than subjective outcomes such as pain reduction or subjective well-being.

## References

1. Fordyce WE (1976) Behavioral Methods in Chronic Pain and Illness. CV Mosby, St. Louis
2. Fordyce WE, Fowler RS, Lehmann JF, De Lateur BJ (1968) Some Implications of Learning in Problems of Chronic Pain. *J Chron Dis* 21:179–190
3. Fordyce WE, Roberts AH, Sternbach RA (1985) The Behavioral Management of Chronic Pain: A Response to Critics. *Pain* 22:113–125
4. Kugler K, Wijn J, Geilen M et al. (1999) The Photograph Series of Daily Activities (PHODA). CD ROM version 1.0. Institute for Rehabilitation Research and School for Physiotherapy, Heerlen, The Netherlands
5. Philips HC (1987) Avoidance Behavior and its Role in Sustaining Chronic Pain. *Behav Res Ther* 25:273–279
6. Sanders SH (1996) Operant Conditioning with Chronic Pain: Back to Basics. In: Gatchel RJ, Turk DC (eds) *Psychological Approaches to Pain Management: A Practitioner's Handbook*. Guilford Press, New York, pp 112–130
7. Skinner BF (1953) *Science and Human Behavior*. MacMillan, New York
8. Sullivan MJL, Stanish WD (2003) Psychologically Based Occupational Rehabilitation: The Pain-Disability Prevention Program. *Clin J Pain* 19:97–104
9. Turk DC, Meichenbaum D, Genest M (1983). *Pain and Behavioral Medicine. A Cognitive-behavioral Perspective*. Guilford Press, New York
10. Vlaeyen JWS, de Jong J, Geilen M, Heuts PHTG, van Breukelen G (2002a) The Treatment of Fear of Movement/Re-Injury in Chronic Low Back Pain: Further Evidence on the Effectiveness of Exposure *In Vivo*. *Clin J Pain* 18:251–261
11. Vlaeyen JWS, De Jong J, Onghena P, Kerckhoffs-Hanssen M, Kole-Snijders AMJ (2002b) Can Pain-Related Fear be Reduced? The Application of Cognitive-Behavioral Exposure *In Vivo*. *Pain Res Manag* 7:144–153
12. Vlaeyen JWS, Linton SJ (2000). Fear-Avoidance and its Consequences in Chronic Musculoskeletal Pain: A State of the Art. *Pain* 85:317–332

## Behavioral Treatment

- ▶ Operant Treatment of Chronic Pain
- ▶ Psychological Treatment of Headache

## Behavioral/Cognitive Perspective

- ▶ Cognitive-Behavioral Perspective of Pain

## Below-Level Neuropathic Pain

### Definition

Neuropathic pain occurring in a more diffuse distribution below the level of the spinal cord lesion. Also referred to as central dysaesthesia syndrome, remote, or phantom pain.

- ▶ Cognitive Behavioral Treatment of Pain
- ▶ Spinal Cord Injury Pain Model, Contusion Injury Model

## Benign Cough Headache

- ▶ Primary Cough Headache

## Bennett Model

- ▶ Neuropathic Pain Model, Chronic Constriction Injury
- ▶ Retrograde Cellular Changes after Nerve Injury

## Beri Beri Disease

- ▶ Metabolic and Nutritional Neuropathies

## Beta(β) Blockers

### Definition

Beta adrenergic receptor antagonists.

- ▶ Migraine, Preventive Therapy

## Beta(β)-Adrenergic Sympathetic System

### Definition

It belongs to the autonomic nervous system and is typically activated during stress, including pain.

- ▶ Placebo Analgesia and Descending Opioid Modulation

## Beta(β)-Endorphin

### Definition

β-Endorphin is a 31 amino acid peptide produced from proopiomelanocortin, a pituitary precursor also found in the arcuate nucleus of the hypothalamus.

- ▶ Opiates During Development

## Beta( $\beta$ )-Thromboglobulin

### Definition

Constituent of platelet alpha-granules that is secreted from the platelet upon stimulation. This protein has been considered platelet specific. It is involved in the negative regulation of normal and pathologic megakaryocytopoiesis, and seems to have chemotactic activity for human fibroblasts.

- ▶ Autologous Thrombocyte Injection as a Model of Cutaneous Pain

## BFB

- ▶ Biofeedback

## BGT

### Definition

BGT is a plasma membrane GABA transporter; also transports betaine.

- ▶ GABA and Glycine in Spinal Nociceptive Processing

## Bias

### Definition

Systematic deviations of the results from the truth.

- ▶ Lumbar Traction

## Bicuculline

### Definition

Antagonist at GABA<sub>A</sub> receptors.

- ▶ GABA and Glycine in Spinal Nociceptive Processing

## Binding Medical Examination

- ▶ Independent Medical Examinations

## Binding Studies

### Definition

Receptor binding studies may serve as an indirect indicator of release. Specific radioligand binding is of a competitive nature, and if opioids induce endogenous release of CCK a decreased binding of a CCK-radioligand could be expected.

- ▶ Opioid-Induced Release of CCK

## Bioavailability

### Definition

The bioavailability is defined as a measure of the extent and rate of active drug that reaches the systemic circulation, and its subsequent availability at the site of action after administration of a dosage. It is the fraction of the administered dose that has reached the system and is then available to exert effects. Factors that may influence the bioavailability of a drug are the release from the pharmaceutical product, the absorption from the gastrointestinal tract, the transformation due to the hepatic first-pass metabolism, and last but not least, the degradation processes prior to reaching system circulation.

- ▶ NSAIDs, Pharmacokinetics

## Biobehavioral Factors

- ▶ Stress and Pain

## Biobehavioral Model

- ▶ Diathesis-Stress Model of Chronic Pain

## BiobraneRx

### Definition

BiobraneRx is a bilaminate biosynthetic temporary skin substitute wound dressing, which incorporates a collagen coating of a silastic semi-permeable membrane bonded to a nylon fabric material. It is made by Winthrop Pharmaceuticals, New York New York.

- ▶ Pain Control in Children with Burns

## Biofeedback

### Synonyms

BFB

## Definition

Biofeedback refers to a group of nonpharmacological interventions that, by providing external (computer-aided) feedback about physiological responses (such as blood pressure, hand temperature, or muscle tension he or she would not normally be aware of), aims at improving self-regulation of physiological responses that typically are not voluntarily perceived and controlled. The success of BFB in the treatment of chronic pain has been attributed to physiological and/or psychological factors. Physiological accounts are based on the assumption that a dysregulation of specific physiological processes (e.g. elevated muscle tension) underlies the pain problem. Hence, learned control of the relevant physiological process should lead to corresponding pain relief. Yet, empirical studies have not provided consistent and convincing support for this hypothesis. The literature on biofeedback for headache and back-pain suggests that cognitive factors, such as an increase in perceived self-efficacy and a decrease in negative pain-related cognitions, may mediate the effectiveness of biofeedback in the treatment of chronic pain.

- ▶ [Alternative Medicine in Neuropathic Pain](#)
- ▶ [Biofeedback in the Treatment of Pain](#)
- ▶ [Chronic Back Pain and Spinal Instability](#)
- ▶ [Chronic Pain In Children, Physical Medicine And Rehabilitation](#)
- ▶ [Complex Chronic Pain In Children, Interdisciplinary Treatment](#)
- ▶ [Dyspareunia and Vaginismus](#)
- ▶ [Impact of Familial Factors on Children's Chronic Pain](#)
- ▶ [Migraine, Preventive Therapy](#)
- ▶ [Modeling, Social Learning in Pain](#)
- ▶ [Motivational Aspects of Pain](#)
- ▶ [Psychological Treatment of Headache](#)
- ▶ [Psychological Treatment of Pain in Children](#)
- ▶ [Psychology of Pain, Efficacy](#)

---

## Biofeedback in the Treatment of Pain

FRANK ANDRASIK<sup>1</sup>, BEVERLY E. THORN<sup>2</sup>

<sup>1</sup>Institute for Human and Machine Cognition,  
University of West Florida, Pensacola, FL, USA

<sup>2</sup>Department of Psychology, University of Alabama,  
Tuscaloosa, AL, USA

fandrasik@ihmc.us, bthorn@bama.ua.edu

### Synonym

Self-Regulation; self-control; voluntary control; Pain Therapy, Biofeedback in the Treatment of Pain

### Definition

▶ **Biofeedback** is a ▶ **nonpharmacological treatment** that uses electrical instruments to help people become

aware of, and then exert control over, physiological responses (Andrasik and Lords 2004). It involves: (1) detecting and amplifying a biological response by using certain measurement devices (or transducers) and electronic amplifiers; (2) converting these bioelectrical signals to a form that can be easily understood and processed by the patient; and (3) providing relatively immediate feedback of the signal to enable the patient to influence the response. The feedback signal is most often presented in visual and/or auditory modalities, in either binary (signal on or signal off at a specified threshold) or continuous proportional fashion (as muscle tension decreases, the tone or click rate decreases, signaling progress at the goal of lowering); on occasion, combinations of both are used. Several theories have been used to account for biofeedback, ranging from operant learning to cognitive and expectancy models (Schwartz and Schwartz 2003). In all cases, the goal of biofeedback is to acquire the ability to regulate the targeted physiology in the desired direction (e.g. decrease excessive muscle tension, increase blood flow).

## Characteristics

### Approaches to Biofeedback

Three different rationales have been advanced for the use of biofeedback in the treatment of pain (Andrasik 2005; Andrasik and Lords 2004; Belar and Kibrick 1986; Flor 2001). For simplicity we term them *general*, *specific*, and *indirect*.

### General Approach to Biofeedback

The “general” approach employs biofeedback (and related procedures, such as relaxation; see Thorn and Andrasik this volume) to lower overall arousal, and promote a generalized state of relaxation. Several assumptions underlie this use: (1) Reducing general arousal results in a concurrent reduction in central processing of peripheral sensory inputs; (2) The second assumption derives from the observed relationship between negative affect and pain, wherein negative affect is associated with decreased pain tolerance and increased reports of pain (Fernandez 2002). Achieving a more relaxed state leads to reductions in negative affect, which in turn enhances pain tolerance and decreases pain reports. (3) A final consideration is based on the association of stress and pain, which Melzack (1999) has discussed in detail. Prolonged activation of the stress system increases cortisol levels, which is related to a number of physiological changes that can give rise to pain. Stress is also directly linked to the negative affective triad. Based on these considerations, a case can be made that most pain patients could benefit from some form of relaxation and arousal reduction, especially when the pain is associated with increased muscle tension. This approach is probably the most common (and it also requires the least technical proficiency).

### Examples of Biofeedback as a General Aid to Relaxation

Any response modality indicative of heightened arousal can theoretically serve as a target for promoting relaxation, but three are used most often – muscle tension (electromyographic or EMG), skin conductance (or sweat gland activity), and peripheral temperature. These modalities, termed as the “workhorses” of the biofeedback general practitioner (Andrasik and Lords 2004), are easily collected, quantified, and interpreted and are discussed below. Other responses, such as heart rate, respiration, blood volume, and electroencephalogram can be useful, but these are not commonly employed and will not be addressed further (see Flor 2001, for discussion).

#### EMG-Assisted Relaxation

The rationale for employing muscle tension feedback to facilitate relaxation is straightforward. The basis of the EMG signal is the small electrochemical changes that occur when a muscle contracts, and these changes can be monitored by placing a series of electrodes along the muscle fibers (to assess the muscle action potentials associated with the ion exchange across the membrane of the muscles). When EMG is used for generalized relaxation, sensors are usually placed on the forehead, neck, or shoulders. When other sites remain tense (such as arms), clinicians may also provide training for them.

#### Skin Conductance-Assisted Relaxation

Electrical activity of the skin or sweating has long been thought to be associated with arousal. It was used in the late 1800’s to facilitate understanding when working with cases of hysterical anesthetics, and Carl Jung used it in the early 1900’s as a way to “read the mind” in word-association experiments. Sensors are placed on body surface areas that are most densely populated with “eccrine” sweat glands (such as the palm of the hand or the fingers), as these respond primarily to psychological stimulation and are innervated by the sympathetic branch of the autonomic nervous system (Boucsein 1992; Stern et al. 2001). Conductance measures are preferred in clinical application because they have a linear relationship to the number of sweat glands that are activated. This permits a straightforward explanation to patients (as arousal increases, so does skin conductance; focusing on decreasing skin conductance helps to lower arousal and to achieve a state of relaxation).

#### Skin-Temperature-Assisted Relaxation

Peripheral skin temperature is of value because it provides an indirect measure of blood flow and of sympathetic nervous activity (constriction of peripheral blood flow is under control of the sympathetic branch of the nervous system, decreases in sympathetic outflow lead to increased vasodilation and a resultant rise in peripheral temperature due to the warmth of the blood). Thus,

temperature feedback may best be thought of at the moment as yet another way to facilitate general relaxation. When used for purposes of general relaxation, it is typically augmented by components of autogenic training, leading to a procedure termed “▶ autogenic feedback.” Recent research with functional MRI has shown that distraction, a common component of relaxation, leads to significant activation within the periaqueductal gray region, a site recognized for higher cortical control of pain (Tracey et al. 2002). Thus, these treatments may be impacting central mechanisms as well.

These approaches have been used extensively and successfully with pain patients (see Andrasik, in press; Andrasik and Lords 2004).

#### Specific Approach

When utilizing the specific approach, a detailed ▶ [psychophysiological assessment](#) is conducted first to identify the physiological dysfunction or response modalities assumed to be relevant to the pain condition, and to do so under varied stimulus conditions (psychological and physical) that mimic work and rest (reclining, bending, stooping, lifting, working a keyboard, simulated stressors, etc.) in order to guide treatment efforts and gauge progress. It typically incorporates the following phases: adaptation, resting baseline, self-control baseline, stress induction, stress recovery, etc. This approach is described more fully in Andrasik, Thorn, and Flor (▶ [psychophysiological assessment of pain](#)), as well as in Arena and Schwartz (2003), and Flor (2001). When biofeedback-assisted relaxation is the main focus, the psychophysiological assessment is much briefer, if done at all.

#### Examples of the Specific Application

Most research and practice has focused on biofeedback as a general approach to decrease stress, tension, and pain. With patients with certain characteristics, more specific approaches are emerging as either alternative or preferred treatments. A brief example is provided here for purposes of illustration.

Arena (cited within Arena and Blanchard 2002) describes a straightforward approach to a more individualized biofeedback treatment for chronic low back pain. Treatment begins with EMG biofeedback-assisted relaxation, initially from the frontal or forehead area, which is then followed by feedback of the trapezius muscles, all performed with the patient seated comfortably. As the patient becomes proficient, positions are changed in order to facilitate generalization of training effects. Now, practice is performed in a comfortable office chair (with arms supported), then moves to an office chair without arm support, and then to a standing position. This phase of training continues for 12–16 sessions.

If improvement is insufficient and the patient has not had a prior course of general relaxation training, then this

may be pursued (► [relaxation in the treatment of pain](#)). If this is unwarranted or has been unsuccessful, then an abbreviated psychophysiological assessment, based on the logic of biomechanical theory, is conducted to analyze the problem further. EMG sensors are placed bilaterally on the paraspinals (L4–L5) and the biceps femoris (back of the thigh). Recordings are made in at least two positions: sitting with back supported in a recliner and standing with arms by the side. These sites are used because they have been found to provide greater information than other sites (such as quadriceps femoris or gastrocnemius) in prior examinations.

The data will reveal one of three patterns of abnormality: 1) unusually low muscle tension levels (which Arena states most typically occurs when nerve damage and muscle atrophy are present) 2) unusually high muscle tension levels (which Arena states is the most common finding), or 3) left-right asymmetry, wherein one side has normal muscle values and the other side is either abnormally high or low. Treatment focuses on returning EMG values to normal levels. Arena notes that much can be learned by examining gait and posture, and also by correcting faulty positions. Sella (2002) has also commented on these postural aspects.

The approach that Arena describes is appealing because of its simplicity. The difficulty is in determining normal versus abnormal values. Experience with a considerable number of patients is necessary for this. Some researchers have been approaching this problem in a more systematic manner, and have developed detailed normative data banks for multiple muscle sites to help identify aberrant values, as these may be suggestive of bracing or favoring of a position or posture, and, thus, targets for EMG treatment.

In this more expanded approach, multiple bilateral recordings need to be made in fairly rapid succession. To make this feasible, Cram (1990) uses two hand-held “post” electrodes to obtain brief (around 2 seconds per site) sequential bilateral recordings while the patient is sitting and standing (rather than having to apply multiple leads or apply and reapply the same set of leads). Although seemingly straightforward, this approach is actually complex because a number of factors can influence the results (angle and force of sensor application, amount of adipose tissue present, as fat acts as an insulator and dampens the signal, and the exactness of sensor placement). Further, results will vary as a function of bandpass settings, making it difficult to compare across data sets with different settings.

### Indirect Approach

Belar and Kibrick (1986) describe what they term the “indirect” approach to biofeedback. This approach is based more upon clinical than empirical foundations, and it involves using biofeedback as a means for facilitating psychosomatic therapy. Consider a patient who steadfastly holds to a purely somatic view, refus-

ing to accept the notion that other factors (emotional, behavioral, or environmental) may be precipitating, perpetuating, or exacerbating pain and somatic symptoms. In this instance, a referral for biofeedback is likely to be less threatening (it is construed as a “physical” treatment for a “physical” problem), and to at least open the door for help. As “physiological insight” is acquired, the patient may begin to grasp the broader picture; i.e., the interplay of physical and psychological factors. It is not uncommon for this type of patient, who denies psychological factors upon entry to therapy, to make a request like the following after just a few sessions of biofeedback: “Doc, how about turning off the biofeedback equipment today. I want to talk about a few things.” From this point on, session time may be divided between biofeedback and psychotherapy.

### Some Clinical Consideration

Few difficulties have been reported when using biofeedback as a general relaxation procedure. A small portion of clients may experience what has been termed “► [relaxation-induced anxiety](#),” noted to be a sudden increase in anxiety during deep relaxation, which can range from mild to moderate intensity and approach the level of a minor panic attack (► [relaxation in the treatment of pain](#)). It is important for the therapist to remain calm, reassure the patient that the episode will pass, and, when possible, have the patient sit up for a few minutes or even walk about the office when this happens. With patients who are believed to be at risk for relaxation-induced anxiety, it may be helpful to instruct them to focus more on the somatic aspects as opposed to the cognitive aspects of training (Arena and Blanchard 1996). See Schwartz, Schwartz and Monastra (2003) for discussion of other problems and solutions.

### References

1. Andrasik F (2005) Relaxation and Biofeedback Self-Management for Pain. In: Boswell MV, Cole BE, Weiner RS (eds) *Weiner's Pain Management: A Practical Guide for Clinicians*, 7<sup>th</sup> edn. CRC Press, Boca Raton
2. Andrasik F, Lords AO (2004) Biofeedback. In: Freeman L (ed) *Mosby's Complementary & Alternative Medicine: A Research-Based Approach*, 2<sup>nd</sup> edn. Elsevier Science, Philadelphia, pp 207–235
3. Arena JG, Blanchard EB (2002) Biofeedback Training for Chronic Pain Disorders: A Primer. In: Gatchel RJ, Turk DC (eds) *Psychological Approaches to Pain Management: A Practitioner's Handbook*, 2<sup>nd</sup> edn. Guilford Press, New York, pp 159–187
4. Arena JG & Schwartz MS (2003) Psychophysiological Assessment and Biofeedback Baselines: A Primer. In: Schwartz MS & Andrasik F (eds). *Biofeedback: A Practitioner's Guide*, 3<sup>rd</sup> edn, Guilford Press, New York, pp 128–158
5. Belar CD & Kibrick SA (1986) Biofeedback in the Treatment of Chronic Back Pain. In: Holzman AD & Turk DC (eds). *Pain Management: A Handbook of Psychological Treatment Approaches*. Pergamon Press, New York, pp 131–150
6. Cram JR (1990) EMG Muscle Scanning and Diagnostic Manual for Surface Recordings. In: Cram JR and Associates (eds) *Clinical*



- EMG for Surface Recordings, vol 2. Clinical Resources, Nevada City, pp. 1–141
7. Fernandez E (2002) Anxiety, Depression, and Anger in Pain: Research Findings and Clinical Options. Advanced Psychological Resources, Dallas, TX
  8. Flor H (2001) Psychophysiological Assessment of the Patient with Chronic Pain. In: Turk DC, Melzack R (eds) Handbook of Pain Assessment, 2<sup>nd</sup> edn. Guilford, New York, pp 76–96
  9. Melzack R (1999) Pain and Stress: A New Perspective. In: Gatchel RJ, Turk DC (eds) Psychosocial Factors and Pain: Critical Perspectives, Guilford Press, New York, pp 89–106
  10. Schwartz NM, Schwartz MS (2003) Definitions of Biofeedback and Applied Psychophysiology. In: Schwartz MS, Andrasik F (eds) Biofeedback: A Practitioner's Guide, 3<sup>rd</sup> edn. Guilford Press, New York, pp 27–39
  11. Schwartz MS, Schwartz NM, Monastra VJ (2003) Problems with Relaxation and Biofeedback-Assisted Relaxation, and Guidelines for Management. In: Schwartz MS, Andrasik F (eds) Biofeedback: A practitioner's Guide, 3<sup>rd</sup> edn. Guilford Press, New York, pp 251–264
  12. Sella GE (2003) Neuropathology Considerations: Clinical and SEMG/Biofeedback Applications. Appl Psychophysiol Biofeedback 28:93–105
  13. Tracey I, Proghaus A, Gati JS, Clare S, Smith S, Menon RS, Matthews PM (2002) Imaging Attentional Modulation of Pain in the Periaqueductal Gray in Humans. J Neurosci 22:2748–2752.

## Biogenic Amine Theory

### Definition

Biogenic amine theory of the relationship between chronic pain and depression hypothesizes that both mood and pain regulation are mediated by bioamine systems including dopaminergic, noradrenergic, and serotonergic neurotransmitter systems in the periaqueductal grey, in particular.

- ▶ Depression and Pain

## Biological Clock

### Definition

An area of the brain thought to be the hypothalamus that dictates biological rhythms such as the sleep-wake cycle and menstruation.

- ▶ Hypnic Headache

## Biological Rhythms

### Definition

Biological rhythms are periodic and predictable-in-time variations of biological phenomena.

- ▶ Diurnal Variations of Pain in Humans

## Biomagnetometer

- ▶ Magnetoencephalography in Assessment of Pain in Humans

B

## Biopsy

### Definition

Necessary for most vasculitides; leptomeningeal and parenchymal biopsy necessary for the diagnosis of IAN; temporal artery biopsy mandatory for the diagnosis of temporal arteritis.

- ▶ Headache Due to Arteritis

## Biopsychosocial

### Definition

Is the term coined by George L. Engel in his classic 1977 article in Science, „The Need for a New Medical Model: A Challenge for Biomedicine.“ As an alternative to the biomedical model, it recommends a new approach that understands illness as a confluence of biological, psychological, and social processes.

- ▶ Ethics of Pain, Culture and Ethnicity

## Biopsychosocial Model

### Definition

In contrast to the biomedical model that emphasizes physical pathology and disease, the biopsychosocial model acknowledges the complex interaction of psychological and social factors as well as biological (physical) ones in the understanding and expression of disease and illness. From this perspective on medical problems, the diversity in illness expression is accounted for by the interrelationships among biological changes, psychological states, and social and cultural contexts. All of these shape the individual's perception of and response to physiological perturbations.

- ▶ Diathesis-Stress Model of Chronic Pain
- ▶ Multiaxial Assessment of Pain
- ▶ Multidisciplinary Pain Centers, Rehabilitation
- ▶ Psychological Treatment of Chronic Pain, Prediction of Outcome

## Biopsychosocial Perspective

### Definition

In contrast to the traditional but outdated biomedical model and its emphasis on disease, the more heuristic biopsychosocial perspective focuses on illness, which is the result of the complex interaction of physiological, psychological and social variables.

- ▶ [Disability Assessment, Psychological / Psychiatric Evaluation](#)
- ▶ [Psychological Treatment of Chronic Pain, Prediction of Outcome](#)

## Bischof Myelotomy

- ▶ [Midline Myelotomy](#)

## Bisphosphonates

NIKOLAI BOGDUK  
Department of Clinical Research, Royal Newcastle Hospital Newcastle, University of Newcastle, Newcastle, NSW, Australia  
nik.bogduk@newcastle.edu.au

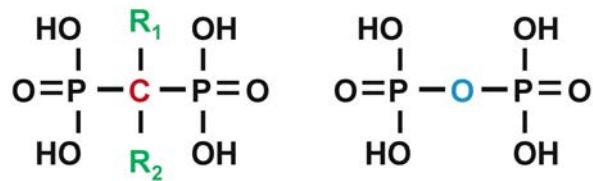
### Definition

Bisphosphonates are chemicals with a structure similar to that of the mineral pyrophosphate, which occurs in bone. As drugs, they are used to treat a variety of bone diseases, some of which are associated with pain.

### Characteristics

Bisphosphonates were discovered in the 19<sup>th</sup> century, and were used as corrosion inhibitors and complexing agents in the textile, oil, and fertilizer industries. Their potential for use in Medicine arose when it was recognized that pyrophosphate inhibited precipitation of calcium. Pyrophosphate was, therefore, considered as a drug that might be used to control calcium metabolism; but was found not to be active orally, and was rapidly hydrolysed if administered parenterally. The similar chemical structure of bisphosphonates to pyrophosphate (Fig. 1) made them a suitable substitute for pyrophosphate as a drug.

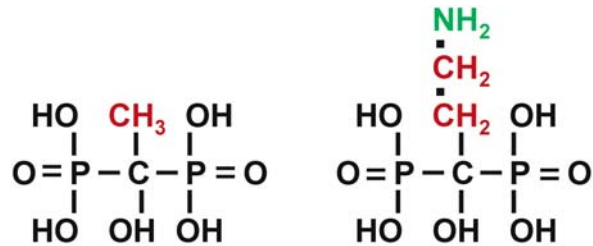
A substantial number of bisphosphonates have been developed. These include pamidronate, clodronate, etidronate, tiludronate, alendronate, and ibandronate. They each share the same basic chemical structure, but differ in their substitution radicles (Fig. 2.) Pharmacologically they differ in their relative potencies for different conditions.



### Bisphosphonates

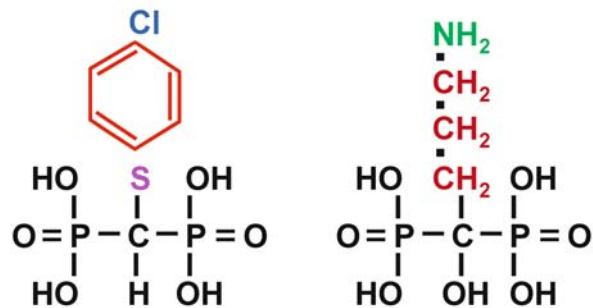
### Pyrophosphate

**Bisphosphonates, Figure 1** The structural formulae of bisphosphonates and pyrophosphate. Instead of oxygen, carbon is the central atom of the bisphosphonate molecule; and it subtends two radicles ( $R_1$  and  $R_2$ ).



### Etidronate

### Pamidronate



### Tiludronate

### Alendronate

**Bisphosphonates, Figure 2** The structural formulae of a selection of bisphosphonates.

### Mechanism

Upon being absorbed into bone, bisphosphonates inhibit the release of calcium from the bone matrix, and are toxic to osteoclasts. By both mechanisms, bisphosphonates prevent bone resorption.

### Applications

Due to their ability to inhibit bone resorption, bisphosphonates have been used in the treatment of disease in which bone resorption is a major feature. Their principal application has been as a treatment for osteoporosis. They have also been used to treat Paget's disease of bone.

### Cancer Pain

In Pain Medicine, bisphosphonates were first used to treat painful tumours of bone, in which osteolysis

was a feature. They have been particularly effective for reducing the pathological effects of myeloma and metastases, such as fractures (Ross et al. 2004; Djulbegovic et al. 2002). In these conditions, bisphosphonates both inhibit the progression of the cancer, and relieve its pain. For cancer bone pain, they have proved to be a valuable adjunctive therapy (Wong and Wiffen 2002). Bisphosphonates may be used orally or as an intravenous infusion. Intravenous infusions appear to be more effective; and are administered once every one or two weeks. Relief of pain usually occurs within one week of starting treatment. During that period, other analgesics, such as ► **opioids**, need to be used to provide relief of pain; but as and once the effect of bisphosphonates occurs, other analgesics can be tapered.

### CRPS

Focal, juxta-articular osteoporosis is a feature of ► **Complex Regional Pain Syndromes, General Aspects** (CRPS). This feature prompted the exploration of bisphosphonates for the treatment of CRPS. However, although they were used to treat the osteoporosis, they had a fortuitous effect on pain.

Open studies announced good relief of pain following treatment with pamidronate (Cortet et al. 1997; Kubalek et al. 2001). Indeed, one study reported that 86% of patients treated with oral pamidronate for three days were completely relieved of pain within 1–5 weeks (Kubalek et al. 2001). Controlled trials have verified this ► **effectiveness**. Intravenous alendronate (Adami et al. 1997) and intravenous clodronate (Varenna et al. 2000) are both significantly more effective than placebo. Following treatment with clodronate, patients achieved an average of 93% reduction in pain (Varenna et al. 2000). Intravenous pamidronate is more effective than placebo, but its efficacy seems to be less than that of other bisphosphonates (Robinson et al. 2004).

### Side Effects

Due to their actions, bisphosphonates can lower serum calcium levels. Oral preparations can cause gastric ulceration. Intravenous preparations can cause fever, bone pain, and transient lymphopaenia. Intravenous pamidronate can cause anterior uveitis, which resolves after cessation of treatment.

### References

- Adami S, Fossaluzza V, Gatti D, Fracassi E, Braga V (1997) Bisphosphonate Therapy of Reflex Sympathetic Dystrophy Syndrome. *Ann Rheum Dis* 56:201–204
- Cortet B, Flipa RM, Coquerelle P, Duquesnoy B, Delcambre B (1997) Treatment of Severe, Recalcitrant Reflex Sympathetic Dystrophy: Assessment of Efficacy and Safety of the Second Generation Bisphosphonate Pamidronate. *Clin Rheumatol* 16:51–56
- Djulbegovic B, Wheatley K, Ross J, Clark O, Bos G, Goldschmidt H, Cremer F, Alsina M, Glasmacher A (2002) Bisphosphonates in Multiple Myeloma. *Cochrane Database Syst Rev* 4:CD003188
- Kubalek I, Fain O, Paries J, Kettaneh A, Thomas M (2001) Treatment of Reflex Sympathetic Dystrophy with Pamidronate: 29 Cases. *Rheumatology* 40:1394–1397
- Robinson JN, Sandom J, Chapman PT (2004) Efficacy of Pamidronate in Complex Regional Pain Syndrome Type 1. *Pain Med* 5:276–280
- Ross JR, Saunders Y, Edmonds PM, Wonderling D, Normand C, Broadley K (2004) A Systematic Review of the Role of Bisphosphonates in Metastatic Disease. *Health Technol Assess* 8:1–176.
- Varenna M, Zucchi F, Ghiringhelli D, Binelli L, Bevilacqua M, Bettica P, Sinigaglia L (2000) Intravenous Clodronate in the Treatment of Reflex Sympathetic Dystrophy Syndrome. A Randomized, Double Blind, Placebo Controlled Study. *J Rheumatol* 27:1477–1483
- Wong R, Wiffen PJ (2002) Bisphosphonates for the Relief of Pain Secondary to Bone Metastases. *Cochrane Database Syst Rev* 2:CD002068

B

### BK

- **Bradykinin**

### Black Disc Disease

- **Discogenic Back Pain**

### Black Flags

#### Definition

Black Flags refer to organizational obstacles to recovery including objective work characteristics and conditions of employment. Black Flags are not a matter of perception, and affect all workers equally. They include both nationally established policy concerning conditions of employment and sickness policy, and working conditions specific to a particular organization.

- **Blue Flags**
- **Yellow Flags**

### Blink Reflex

#### Definition

Excitatory reflex elicited in the orbicularis oculi muscle by innocuous stimuli in the supraorbital region and consisting of an early (R1) and late (R2) component.

- **Jaw-Muscle Silent Periods (Exteroceptive Suppression)**

### Block Design

#### Synonyms

Boxcar Design

**Definition**

Experimental design, in which stimuli are presented in a fixed sequence independently of subjective responses of the subject, resulting in a fixed sequence of baseline and activation periods repeated frequently. For data analysis each block is regarded as a unit, hence all stimuli or tasks of this block should pertain to only one condition.

- ▶ Amygdala, Functional Imaging

**Blocking Threshold****Definition**

The current level at which an action potential is blocked due to positive potentials distant from the cathode.

- ▶ Pain in Humans, Electrical Stimulation (Skin, Muscle and Viscera)

**Blood Brain Barrier****Definition**

A cellular barrier that separates blood from brain and protects the latter from the chemical messenger systems flowing around the body, s. also Blood Nerve Barrier.

- ▶ Blood Nerve Barrier
- ▶ Diencephalic Mast Cells

**Blood Clot**

- ▶ Deep Venous Thrombosis

**Blood Clot in Brain**

- ▶ Headache Due to Intracranial Bleeding

**Blood Nerve Barrier****Definition**

A naturally occurring barrier created by the modification of capillaries (as by reduction in fenestration and formation of tight cell-to-cell contacts) that prevents many substances from leaving the blood and crossing the capillary walls into the nervous system, s. also Blood Brain Barrier.

- ▶ Blood Brain Barrier
- ▶ Cytokines, Regulation in Inflammation

**Blood Oxygenation Level Dependent**

- ▶ BOLD

**Blood Patch****Definition**

Epidural injection of 10-15ml of the patient's own blood. Improves low pressure headaches immediately by simple volume replacement, and subsequently by sealing spinal leaks.

- ▶ Headache due to Low Cerebrospinal Fluid Pressure

**Blood Platelets**

- ▶ Autologous Thrombocyte Injection as a Model of Cutaneous Pain

**Blue Flags****Definition**

Blue Flags are perceived features of work, generally associated with higher rates of symptoms, ill-health and work loss. They are characterized by features such as high demand/low control, unhelpful management style, poor social support from colleagues, perceived time pressure and lack of job satisfaction.

- ▶ Black Flags
- ▶ Yellow Flags

**BMS**

- ▶ Burning Mouth Syndrome

**Body Awareness****Definition**

An overall concept for the awareness between body and mind. It includes body consciousness, body management, and deepened body experience.

- ▶ Body Awareness Therapies

## Body Awareness Therapies

ALICE KVÅLE, ANNE ELISABETH LJUNGGREN  
Section for Physiotherapy Science, Department of  
Public Health and Primary Health Care, Faculty of  
Medicine, University of Bergen, Bergen, Norway  
alice.kvale@isf.uib.no, elisabeth.ljunggren@isf.uib.no

### Synonyms

Basic body awareness therapy; body-mind approaches; psychomotor physiotherapy; psychosomatic and psychiatric physiotherapy; relaxation therapy

### Definition

The term ► **body awareness** is applied as an overall concept to the awareness between body and mind. It includes body consciousness, body management and deepened body experience. Body awareness therapies focus on the whole person, rather than on separate parts. The body is seen as a functional and interacting entity and psyche and soma are considered indivisible. Through body awareness techniques, the aim is to reduce tension and guarded movements and to increase sensory motor awareness and locomotor control. The techniques range through relaxation, massage and active exercises, in order to improve and normalise muscular control and help the patient to become aware of how the mind and body interact.

### Characteristics

Body awareness therapies are based upon an assumption that the body reacts to both physical and psychological strain, over time affecting flexibility and ability to relax, muscle tension, respiration and posture (Bunkan and Thornquist 1990; Sundsvold and Vaglum 1985). A healthy person generally has a good ability to perceive the whole of his body as well as parts of it and has intact and good body awareness. The healthy person has a realistic self-image, adequate muscle tension, good stability and balance, flexibility in movements, unrestricted respiration and the ability to listen to signals from the body. Many patients are unaware of how they hold and use their body, ways that may perpetuate and worsen their problems, over time resulting in a number of secondary physical aberrations. Fear of movement in the early stages of pain may lead to avoidance behaviour, resulting in reduced activities and guarded movement patterns (Vlaeyen and Linton 2000).

Patients with long-lasting musculoskeletal pain conditions have been found to have postural and respiratory changes, as well as reduced flexibility and ability to relax and palpable changes in muscles and skin (Kvåle et al. 2003). Furthermore, a close relationship between physical and psychological aberrations has been documented, most prominently in patients with widespread pain (Kvåle et al. 2001). Posture, respiration, movements and muscles function interactively and a common

pitfall is to overlook this in treatment, only concentrating upon the body part that the patient has reported as most painful. In patients with long-lasting pain conditions, the whole body should therefore be examined and treated, because changes in one region may have widespread effects in the rest of the body. Furthermore, promotion of the body-mind mutuality may enable a person to gain a new perspective over the health problem, leading to less helplessness, better coping and pain relief.

Treatments that focus on pathoanatomical aspects and on single physiotherapy interventions have been shown to have few or no long-term effects in patients with long-lasting musculoskeletal pain conditions (van Tulder et al. 1997). Multidisciplinary rehabilitation interventions including cognitive and behavioural approaches have been found to be superior to many other treatment interventions in persistent pain problems (van Tulder et al. 2001). Most of these programs include elements common to body awareness therapies, such as ► **body awareness training** and relaxation. However, it is unclear which type and part of such programs are most effective. Outcome studies and randomised controlled trials have become the golden standard for examining the efficiency of therapies. However, within treatment of long-lasting pain problems, a dilemma still exists between experience based knowledge and so-called evidence based knowledge. Likewise, knowledge of the effect of body awareness used alone or as part of other therapies is still limited. Patients with pain disorders represent a heterogeneous group; in such a group the effect of the treatment on one sub-group may not be visible when patients with several different characteristics are pooled (Haldorsen et al. 2002).

### Body and Mind Therapies

#### Psychomotor Physiotherapy

Since the late 1940's a branch of physiotherapy has developed in the Scandinavian countries, called ► **psychomotor physiotherapy** or ► **psychosomatic and psychiatric physiotherapy** (Bunkan and Thornquist 1990). This direction recognises the body as a functional and interacting entity and considers psyche and soma as indivisible. Posture and respiration may express repressed emotions and give an indication of the general tension of the person, aspects that are taken into account during treatment. Flexibility of movement and elasticity of muscles bear the key to proper functioning, physically as well as psychologically. Excessive muscular work when carrying out movements, poor co-ordination and restrained respiration may result from both pain and strain, with negative consequences for body flow and rhythm. Through psychomotor physiotherapy body awareness techniques, the aim is to improve and normalise muscular control and help the patient to become aware of how the mind and body interact. During therapy, patient contact is mainly obtained through the



body, listening and talking being secondary. Different techniques ranging from stimulating massage to active exercise are part of the therapy sessions. Common to all approaches is teaching the patient to register tension and to notice the difference between contracted and relaxed muscles. Furthermore, the therapy focuses on how respiration can influence muscle tension and guarded movements. Body sensitivity training can be done individually or in small groups, depending on the individual's degree of problem and needs. Exercises can focus directly or indirectly on respiration, they can include rhythmic swinging and exercises with rotation and exercises in sitting, standing and walking. Included in the therapy, is teaching the patients relaxation techniques (see below).

Some therapists integrate special exercises such as Feldenkrais, Pilates, Laban or Alexander techniques (Braverman et al. 2003) into psychomotor physiotherapy and some might occasionally add music. If music is used, the therapist must ensure that it does not distract attention from body consciousness. Common to the above mentioned techniques is the re-education of the body to interrupt poor posture and movement patterns, to develop smooth coordinated actions and to perform functional energy efficient tasks without unnecessary muscular contractions and restricted breathing.

In Norway, physiotherapists (PTs) must take 2 years of additional education at post-graduate level in order to qualify as licensed psychomotor physiotherapists to work with psychiatric patients. Parts of these body and mind techniques are, however, included in basic physiotherapy education in the Scandinavian countries. Further experience in the techniques is often offered as shorter post-graduate courses for qualified PTs. For PTs working with pain patients, this is considered adequate. As body-mind therapies influence the way patients feel and behave, appropriate training and ethical practice are necessary and essential.

#### **Basic Body Awareness Therapy (Basic BAT)**

Inspired by the French movement therapist and psychotherapist Dropsy (Dropsy 1993), the Swedish physiotherapist Roxendal, developed a method called ▶ **basic body awareness therapy** (Roxendal 1985), which is widely used today in Scandinavia in patients with pain problems (Gyllensten 2001; Malmgren-Olsson 2002). Stability in postural function combined with freedom of movement and breathing are also essential elements in this therapy approach and the body experiences are considered crucial for total self-identity. In therapy, the aim is to increase sensory motor awareness and locomotor control, through exercise that focuses on a stable relation to the ground, posture, gait and truncal positioning and the maintenance of balance related to the central axis of the body. The emphasis is in particular on the development of the mental presence and awareness that underlies all that is practised in the

movement exercises. The exercises consist of simple basic movements of daily living such as lying, sitting, standing and walking, used to normalise postural control and co-ordination, breathing and muscular tension. Patients are usually instructed in small groups. Sometimes different massage techniques can be used by the therapist or in pair exercises in the group. During the sessions the patients have the opportunity to talk about their experience of movements and to reflect on the interaction between pain and environmental factors. Elements from T'ai-chi and Zen meditation as well as those from Feldenkrais, Laban and other body oriented programmes are often integrated when practising basic BAT and in the promotion of awareness of muscular tension and muscular relaxation (Gyllensten 2001).

#### **The Mensendieck System (MS)**

In the Netherlands, Denmark, Norway, Sweden and the United States, another direction of body awareness program has been in use for many decades. This method, developed by the Dutch American physician Bess Mensendieck in the early 1900s, is a pedagogically designed system of functional exercises based on an analysis of human anatomy, physiology and biomechanics (Mensendieck 1937). The MS is taught primarily to individuals with musculoskeletal problems attributable to imbalances in muscle function with primary or secondary muscular tension and pain. The aims of MS are to improve the individual's functional capacity in daily life by increasing the understanding of anatomically and physiologically correct movements and improving the ability to interpret body signals.

Only small studies of the mentioned therapies are available and unfortunately often without control groups. In a recent study, BAT and Feldenkrais approaches were found to be more beneficial for patients with non-specific musculoskeletal disorders than individual physiotherapy (Malmgren-Olsson 2002). This is in line with what has been found concerning cognitive behavioural treatment. In another study concerning patients with fibromyalgia, a MS intervention was found to be more effective than a BAT intervention and had a significant effect on pain, function and coping at an 18 months follow-up too (Kendall et al. 2000).

#### **Relaxation and Meditation Programs**

Standardised instructions or meditative techniques are used to elicit a relaxation response, characterised by generalised decrease in the sympathetic nervous system and metabolic activity and an altered state of consciousness, described as a subjective experience of well-being (Kabat-Zinn et al. 1985). The techniques include autogenic training (patients are taught to achieve feelings of heaviness and warmth in their limbs), transcendental meditation or yoga (deep relaxation accompanied by subjective experiences such as peace of mind and a sense of well-being) and Jacobson's method of progressive

relaxation (people are taught to relax individual muscle groups in progression, after first contracting them). Yoga may also incorporate flexibility and strengthening exercises, as well as awareness of how nutrition, physical health practices and ethical and social conduct affect the body and mind.

One review of several stress management studies showed that relaxation and behavioural skills are helpful and that such group methods are both more cost-effective and more beneficial than individual counselling (Sims 1997). In a few studies, relaxation techniques are compared with other forms of conservative treatments. In one small study, patients with chronic low back pain were randomly assigned to three different kinds of treatment. Eight sessions with relaxation training, consisting of progressive relaxation, breathing techniques, autogenic training and visual imagery, gave better results in reducing EMG and pain and in increasing relaxation and activity, than either EMG biofeedback alone or placebo (Stuckey et al. 1986). Relaxation training should, however, be used in addition to exercise and be combined with coping skills training and stress management (Sandstrom and Keefe 1998).

### Final Remarks

Since the gate control theory became known, cognitive-behavioural and body awareness therapies seem to have gained increasing acceptance as part of conventional pain management programmes (Braverman et al. 2003). Although there is a need for more evidence based support for the effect of body awareness therapies, combination of therapies may provide patients with long-lasting pain conditions, with the skills and knowledge needed to increase the sense of control over pain and possible perpetuating factors. The integration of physiotherapy, psychological techniques and, if necessary, appropriate pharmacotherapeutic regimens maximises effectiveness in managing long-lasting pain.

### References

1. Braverman DL, Erickson JJ, Shah RV et al. (2003) Interventions in chronic pain management. 3. New frontiers in pain management: Complementary techniques. *Arch Phys Med Rehab* 84:45–49
2. Bunkan BH, Thornquist E (1990) Psychomotor therapy: an approach to the evaluation and treatment of psychosomatic disorders. In: Hegna T, Sveram M (eds) *International perspectives in physical therapy 5: Psychological and psychosomatic problems*. Churchill Livingstone, London, pp 45–74
3. Drosy J (1993) *Leva i sin kropp. Kroppsuttryck och mänsklig kontakt. (Vivre dans son corps)*. Natur och Kultur, Stockholm
4. Gyllensten AL (2001) *Basic Body Awareness Therapy –assessment, treatment and interaction*. Doctoral thesis. Lund University, Sweden, Lund
5. Haldorsen EMH, Grasdahl AL, Skouen JS et al. (2002) Is there a right treatment for a particular patient group? Comparison of ordinary treatment, light multidisciplinary treatment, and extensive multidisciplinary treatment for long-term sick-listed employees with musculoskeletal pain. *Pain* 95:49–63
6. Kabat-Zinn J, Lipworth L, Burney R (1985) The clinical use of mindfulness meditation for the self-regulation of chronic pain. *J Behav Med* 8:163–190
7. Kendall SA, Brolin-Magnusson K, Sören B et al. (2000) A pilot study of body awareness programs in the treatment of fibromyalgia syndrome. *Arthritis Care Res* 13:304–311
8. Kvåle A, Ellertsen B, Skouen JS (2001) Relationships between physical findings (GPE-78) and psychological profiles (MMPI-2) in patients with long-lasting musculoskeletal pain. *Nord J Psychiatry* 55:177–184
9. Kvåle A, Skouen JS, Ljunggren AE (2003) Discriminative validity of the Global Physiotherapy Examination (GPE-52) in patients with long-lasting musculoskeletal pain versus healthy persons. *J Musculoske Pain* 11:23–35
10. Malmgren-Olsson E-B (2002) A comparison between three physiotherapy approaches with regard to health-related factors in patients with non-specific musculoskeletal disorders. *Disabil Rehabil* 24:181–189
11. Mensendieck BM (1937) *The Mensendieck system of functional exercises*. Southworth-Anthoensen Press, Portland
12. Roxendal G (1985) *Body Awareness Therapy and the Body Awareness Scale, treatment and evaluation in psychiatric physiotherapy*. Doctoral thesis. Gothenburg University, Gothenburg, Sweden
13. Sandstrom MJ, Keefe FJ (1998) Self-management of fibromyalgia: the role of formal coping skills training and physical exercise training programs. *Arthritis Care Res* 11:432–447
14. Sims J (1997) The evaluation of stress management strategies in general practice: an evidence-led approach. *Br J Gen Pract* 47:577–582
15. Stuckey SJ, Jacobs A, Goldfarb J (1986) EMG biofeedback training, relaxation training, and placebo for the relief of chronic back pain. *Percept Mot Skills* 63:1023–1036
16. Sundsvold MØ, Vaglum P (1985) Muscular pains and psychopathology: evaluation by the GPM method. In: Michel TH (ed) *International Perspectives in Physical Therapy. 1: Pain*. Churchill Livingstone, London, pp 18–47
17. van Tulder MW, Koes BW, Bouter LM (1997) Conservative treatment of acute and chronic nonspecific low back pain. A systematic review of randomized controlled trials of the most common interventions. *Spine* 22:2128–2156
18. van Tulder MW, Ostelo R, Vlaeyen JWS et al. (2001) Behavioral treatment for chronic low back pain - A systematic review within the framework of the Cochrane Back Review Group. *Spine* 26:270–281
19. Vlaeyen JW, Linton SJ (2000) Fear-avoidance and its consequences in chronic musculoskeletal pain: a state of the art. *Pain* 85:317–332

## Body Awareness Training

### Definition

Includes different body awareness techniques, also called body-mind approaches, which focus on the whole person, rather than on separate body parts. The body is seen as a functional and interacting entity, and psyche and soma are considered indivisible. The aims of the awareness training are to reduce tension and guarded movements, and to increase sensory motor awareness and locomotor control. Techniques range from relaxation, massage and active exercises, in order to improve and normalize the muscular control and help the patient to become aware of how the mind and body interact.

► [Body Awareness Therapies](#)

## Body Dysmorphic Disorder

- ▶ Somatization and Pain Disorders in Children

## Body Functions

### Definition

The physiological functions of body systems (including psychological functions).

- ▶ Disability and Impairment Definitions
- ▶ Physical Medicine and Rehabilitation, Team-Oriented Approach

## Body of the Clitoris

### Definition

The body is the portion of the clitoris, 2–3 cm in length, consisting of erectile tissue, and hangs downward from the pubic bone, connecting the glans and the crura.

- ▶ Clitoral Pain

## Body Structures

### Definition

Body structures are anatomical parts of the body such as organs, limbs and their components.

- ▶ Disability and Impairment Definitions

## Body-Mind Approaches

### Definition

Includes a variety of methods focusing on body consciousness, body management and body experience, and is defined synonymously with Body Awareness Therapies.

- ▶ Body Awareness Therapies

## Body-Self Neuromatrix

### Definition

A model proposed by R. Melzack to explain how acute and/or long term stress responses modulate the multi-dimensional pain experience. Three parallel neural networks, which contribute to the sensory-discriminative, affective-motivational, and evaluative-cognitive dimensions of the pain experience, receive input from a number

of sources, including somatic, visual, cognitive, emotional, as well as the stress-regulation systems (including endocrine, immune, opioid, HPA and LC-NE).

- ▶ Stress and Pain

## BOLD

### Synonyms

Blood Oxygenation Level Dependent

### Definition

The BOLD signal arises due to the higher ratio of oxy- to deoxyhaemoglobin in local draining venules and veins in response to neuronal activity.

- ▶ Thalamus, Clinical Pain, Human Imaging

## Bone Marrow

### Definition

The soft sponge-like material that is found inside bones and that produces blood cells from immature cells called stem cells.

- ▶ Diencephalic Mast Cells

## Bone Metastases

### Definition

Spread of cancer to bone.

- ▶ Cancer Pain Management, Radiotherapy

## Bone Pain

### Definition

Bone pain is frequently caused by growth of blood-borne tumor cells in the bone. Primary bone tumors can also cause pain. Tumors most often producing painful bone metastases are cancer of breast, prostate, bronchus and kidney. Tumor cells release a number of osteoclast activating factors (OAFs) which include prostaglandins, kinins, substance P and parathyroid-hormone related peptides. OAFs are responsible not only for bone destruction but also for sensitization of the nerve endings and pain. Bone pain consists of inflammatory, instability and neuropathic components. Bone pain causes in the spinal cord similar activation of the glial astrocytes as seen in neuropathic pain. The bone pain is usually sensitive to prostaglandin inhibitors, and only partially sensitive to opioids. Bisphosphonates may be helpful in restoring bone integrity and reducing pain.

- ▶ Adjuvant Analgesics in Management of Cancer-Related Bone Pain
- ▶ Cancer Pain
- ▶ Cancer Pain Management, Orthopedic Surgery
- ▶ Cancer Pain Model, Bone Cancer Pain Model

## Bone Scan

PETER LAU  
Department of Clinical Research, Royal Newcastle Hospital, University of Newcastle, Newcastle, NSW, Australia  
peterclau@hotmail.com

### Synonyms

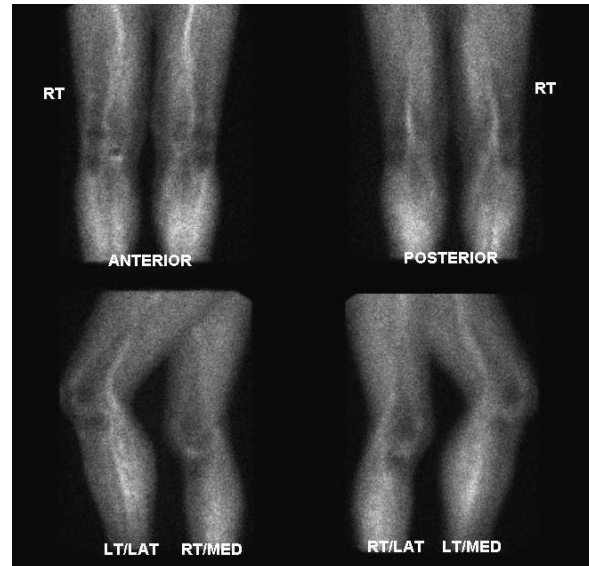
Bone Scintigraphy

### Definition

Bone scan is a diagnostic test to detect focal changes in bone metabolism. It involves administering a radioactive substance that accumulates in bone in proportion to its metabolism. The emitted radiation constitutes the basis for the scan.

### Characteristics

If bone metabolism is increased, it will draw a greater than normal supply of blood. If a substance that is used by bone is rendered radioactive, and is administered into the bloodstream, a greater than normal concentration of the substance will accumulate in the region of bone that has the increased blood supply and increased metabolic activity. The focal concentration of the substance can be detected from the increased radiation that it emits from where it is concentrated. Any disease process that increases blood flow will result in a positive bone scan. Conversely, if a disease decreases bone metabolism, it will be manifest as less than normal radioactive activity. Because of its similarity to pyrophosphate, technetium-99m methylene diphosphonate (MDP) is a radioactive tracer that is absorbed by bone. If injected intravenously it accumulates in all bones. The radiation that it emits can be detected by a scanner and an image can be produced of the distribution and concentration of the tracer. In a normal bone, the tracer is distributed reasonably uniformly throughout the bone and the radiation emitted will cast a photographic image of the shape of the bone on a digital detector. Increased uptake of radioisotope is seen as a "hot" spot and decreased uptake as a "cold" spot. There are three phases of the bone scan study. The initial phase occurs immediately after the intravenous injection of the radioactive tracer. During this phase, the tracer is distributed into the bloodstream. During the second phase, the tracer is delivered to bone through the arterial system (Fig. 1). Scans obtained during this phase reflect the perfusion of bones by blood. The third phase reflects



**Bone Scan, Figure 1** The arterial phase of a bone scan. Radioactive tracer is seen flowing through the arteries of the lower limbs and into the peripheral tissues. Images provided by courtesy of Dr John Booker of Hunter Imaging Group and Sonic Health, Newcastle, Australia.

the accumulation of the tracer in the bone and its binding to it. Uptake is maximal at 2 h. At this time, a significant proportion of the unbound tracer will have been excreted by the kidneys.

The extent to which a lesion accumulates the tracer is a function of both the local blood flow and the extraction efficiency, i.e. the rate at which the bone removes tracer from the blood. The extent to which these two factors contribute to accumulation differs in different conditions.

### Application

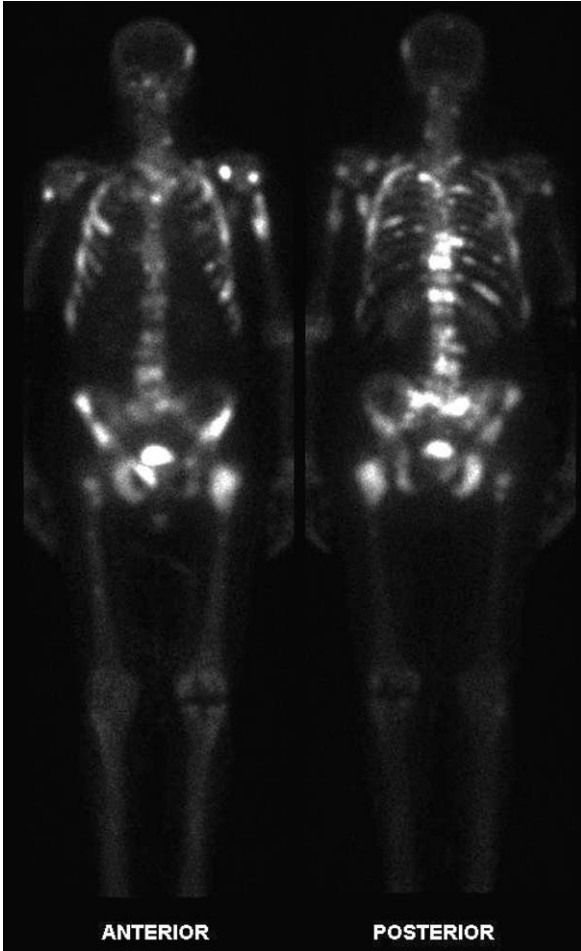
Increased uptake of radioactive tracer can be observed in benign conditions, such as fracture, osteomyelitis and myositis ossificans, in which local inflammation stimulates an increased blood flow. Increased uptake occurs in malignant, primary bone lesions such as osteogenic sarcomas. Metastases can manifest as either increased or decreased uptake, depending on the nature of the tumour (Fig. 2).

Decreased uptake occurs in disorders such as Perthe's disease and avascular necrosis (e.g. of the femur, lunate or scaphoid). In Paget's disease there is characteristically an increased radioisotope concentration in the extracellular fluid by passive diffusion as well as increased vascularity. This results in an intense uptake of technetium (Fig. 3).

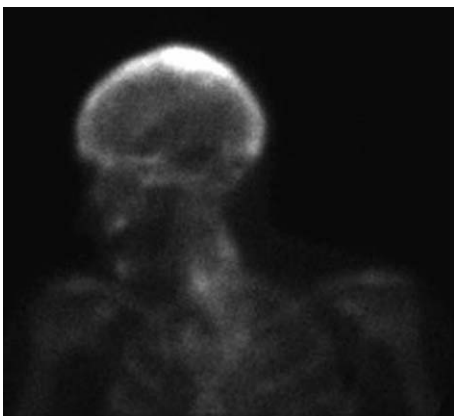
### Stress Fractures

The application of bone scanning in pain medicine lies in the detection of stress fractures in patients with leg pain and foot pain precipitated by prolonged activity, and in athletes with back pain. The particular advantage of

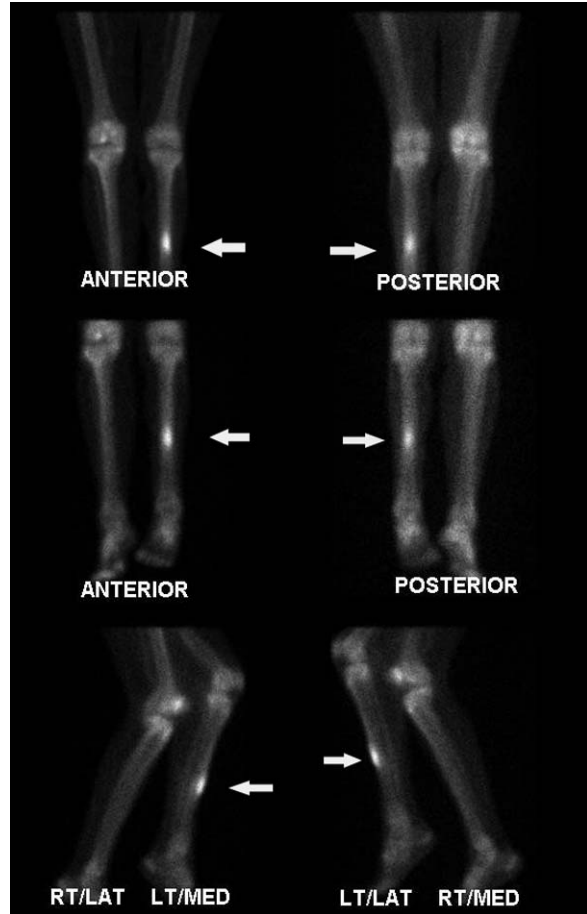




**Bone Scan, Figure 2** A whole-body bone scan. The white areas are sites of increased uptake of tracer throughout the skeletal system, indicative of disseminated metastases. Images provided by courtesy of Dr John Booker of Hunter Imaging Group and Sonic Health, Newcastle, Australia.



**Bone Scan, Figure 3** A bone scan of Paget's disease. There is increased uptake of tracer in the bones of the skull. Image provided by courtesy of Dr John Booker of Hunter Imaging Group and Sonic Health, Newcastle, Australia.



**Bone Scan, Figure 4** A bone scan of the lower limbs showing a stress reaction in the left tibia, which appears as a white spot of increased uptake of tracer (arrow). Images provided by courtesy of Dr John Booker of Hunter Imaging Group and Sonic Health, Newcastle, Australia.

bone scanning is that it can detect stressed bone before it actually fractures. The appearance on the scan is referred to as a stress reaction (Fig. 4). Early detection allows rest for the offending activity to be implemented, with good chances of averting fracture.

The utility of bone scanning once a fracture has occurred is more contentious. Classical teaching maintains that a positive scan would indicate a recent fracture, which would implicate the fracture as the source of pain. However, in the case of fractures of the pars interarticularis of lumbar vertebrae, the relationships between bone scan, pars defect, and symptoms are imperfect, although a positive scan is likely to be associated with pain. The scan is negative in the majority of patients with pain (Lowe et al. 1984). In patients with a radiologically evident pars fracture, the bone scan is just as likely to be negative as positive (Elliot et al. 1988).

**Necrosis**

Bone infarction and aseptic necrosis can affect the femoral head, humeral head, and tibia. These are be-



nign lesions, but may cause pain. Although uncommon, they are an important differential diagnosis of pain in the hip, shoulder and knee. Early detection is paramount so that surgical treatment can be implemented before the joint is irreparably damaged. Plain radiography in the early stage may be normal or show only minor periosteal reaction but a bone scan will typically show decreased uptake. The differential diagnosis includes osteomyelitis or bone tumour.

To distinguish avascular necrosis from infection of bone, a gallium scan may be used. Not to be confused with a bone scan, a gallium scan uses radioactive gallium citrate as the tracer. It usually takes a few days to accumulate gallium citrate in the areas of the body tissues where white blood cells accumulate. If the problem is caused by infection, certain inflammatory diseases, or neoplasms such as lymphoma, the accumulated gallium will show up on the scan as a “hot” spot.

### Metastases

Metastatic bone disease is a common cause of bone pain in cancer patients. Breast, lung and prostate cancer accounts for more than 50% of the primary cancer that commonly has extensive bony metastasis. More than 50% of patients with this primary cancer will eventually develop bone metastasis (Malawer and Delaney 1993). Lymphoma can also involve bone. Pain may arise from the bone because of the invasion by tumour or it may arise because of pathological fracture.

Malignancy is more common in elderly patients, but age-related degenerative changes may confound the diagnosis. In the spine, symmetry of findings is the basis for distinguishing tumour from asymptomatic degenerative changes. Symmetrical uptake around the zygapophysial joints is more likely to be due to osteoarthritis. Focal, increased uptake in the vertebral bodies or pedicles is highly specific for metastatic spine disease. Nevertheless, plain radiography and CT or MRI is required to confirm the diagnosis.

Bone scan is definitely more sensitive than skeletal X-ray in detecting metastatic bone disease, except in myeloma, renal cell carcinoma and thyroid cancer. The metastases of these latter tumours are purely lytic. Therefore, they are clearly apparent on plain radiographs. Meanwhile, they are not associated with significant new bone formation, which renders them difficult to detect on bone scan.

With advances in chemotherapy and hormonal treatment, patients with breast or prostate cancer can have a prolonged life expectancy. As a result, their chances of developing bony metastasis are high compared with those of patients with lung cancer, from which the survival rate is less than 6 months.

### Post-Operative Fusion

Spinal fusion is used to treat spinal pain. A pronounced focal increase in uptake within the fusion mass, at more

than 1 year post-operatively, is a highly suspicious sign for pseudoarthrosis. Bone scan has a sensitivity of 78% and a specificity of 83% in the detection of pseudoarthrosis, which is superior to plain radiography (43% and 50%, respectively) (Even-Sapir et al. 1994; Lusins et al. 1989). Such abnormalities, however, are not a sign of pain, for they have also been identified in asymptomatic patients.

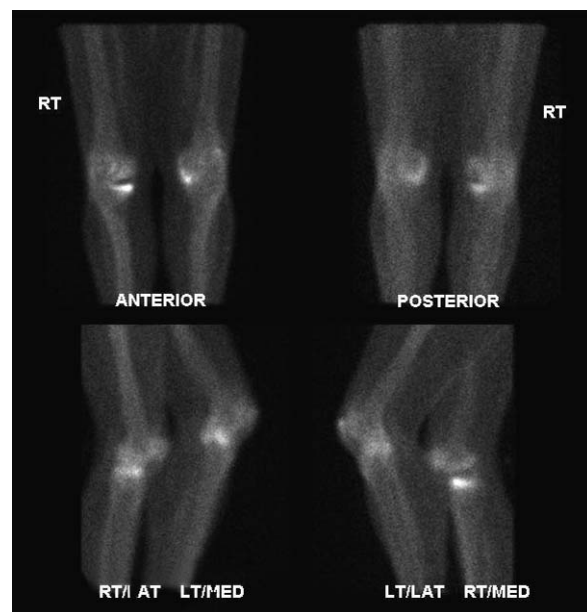
Asymmetric uptake in the sacroiliac region has also been frequently noted in patients who have undergone spinal fusion (up to 75% of cases). It occurs on the side from which the bone graft has been harvested. Increased uptake can occur in the sacroiliac joints themselves and has been inferred to reflect alterations in spinal mechanics (Even-Sapir et al. 1994; Lusins et al. 1989).

### Joint Prostheses

Increased uptake can occur around joint prostheses (Fig. 5). This can be due to aseptic loosening or to infection. *Staphylococcus epidermidis* and *S. aureus* are the most common organisms (Love et al. 2001). Septic prostheses require resection arthroplasty, a long course of antibiotics and a lengthy hospitalisation. In aseptic loosening, the patient typically undergoes a single stage revision arthroplasty. Differentiation between infection and aseptic loosening is difficult, but extremely important.

With cemented hip prostheses, if the uptake about the acetabular component of the prosthesis exceeds that of

B



**Bone Scan, Figure 5** A bone scan of the lower limbs showing increased uptake of tracer in the upper right tibia, indicative of loosening of a knee prosthesis. Images provided by courtesy of Dr John Booker of Hunter Imaging Group and Sonic Health, Newcastle, Australia.

the activity of the iliac crest, loosening is strongly suspected.

With porous coated prostheses the distinction between infection and loosening can be very difficult. Nevertheless bone scan is useful as a screening test because a negative bone scan excludes a sinister lesion. A sensitivity of 65% and a specificity of 70% have been quoted for infected prosthesis (Love et al. 2001).

Indium scanning with In-111<sup>I</sup>-WBC (white blood cells) is used to differentiate aseptic loosening and hip prosthesis loosening. Abnormalities with activity greater than that in the iliac crest should be considered suspicious for infection (Rand and Brown 1990).

### Knee Prostheses

Bone scan is not sensitive for infected prostheses of the knee, because 60% of the femoral components and 90% of the tibial components demonstrate increased periprosthetic activity more than 1 year after surgery in asymptomatic patients (Palestro 1995). However, white blood cell imaging has a sensitivity, specificity and accuracy of approximately 85% in the diagnosis of infected knee prosthesis (Love et al. 2001). False positive examinations have been reported in association with active rheumatoid arthritis and with massive osteolysis of the adjacent femur and tibia (Love et al. 2001).

### References

1. Elliot S, Huitson A, Wastie ML (1988) Bone scintigraphy in the assessment of spondylolysis in patients attending a sports injury clinic. *Clin Radiol* 39:269–272
2. Even-Sapir E, Martin RH, Mitchell MJ et al. (1994) Assessment of painful late effects of lumbar spinal fusion with SPECT. *J Nucl Med* 35:416–422
3. Love C, Thomas MB, Marwin SE et al. (2001) Role of nuclear medicine in diagnosis of the infected joint replacement. *Radiographics* 21:12290–1238
4. Lowe J, Schachner E, Hirschberg E et al. (1984) Significance of bone scintigraphy in symptomatic spondylolysis. *Spine* 9:654–655
5. Lusins JO, Danielski EF, Goldsmith SJ (1989) Bone SPECT in patients with persistent back pain after lumbar spine surgery. *J Nucl Med* 30:490–496
6. Malawer MM, Delaney TF (1993) Treatment of metastatic cancer to bone. In DeVita VT, Hellman S, Rosenberg SA (eds) *Cancer: Principles and Practice of Oncology* 4th edn. JB Lippincott Company, Philadelphia, pp 2225–2245
7. Palestro CJ (1995) Radionuclide imaging after skeletal interventional procedures. *Semin Nucl Med* 25:3–14
8. Rand JA, Brown ML (1990) The value of indium 111 leukocyte scanning in the evaluation of painful or infected total knee arthroplasties. *Clin Orthop* 259:179–182

## Bone Scintigraphy

- ▶ Bone Scan

## Borderline Leprosy

### Definition

Borderline leprosy is an immunologically unstable form of leprosy, which is transitional between the tuberculoid and lepromatous forms, and has clinical and histological features of both types.

- ▶ Hansen's Disease

## Botox<sup>®</sup>™

- ▶ Botulinum Toxin

## Bottom of Form

### Definition

Validity – the extent to which a measurement, test, or study measures what it claims to measure.

- ▶ Assessment of Pain Behaviors

## Botulinum Toxin

JAYANTILAL GOVIND

Pain Clinic, Department of Anaesthesia, University of New South Wales, Liverpool Hospital, Sydney, NSW, Australia

[jaygovind@bigpond.com](mailto:jaygovind@bigpond.com)

### Synonyms

Botox<sup>®</sup>™

### Definition

Botulinum neurotoxin (Botox<sup>®</sup>™, BoNT) is a purified neurotoxin derived from the anaerobic spore-forming bacterium, *Clostridium botulinum*. The toxin has been advocated for the treatment of acute and chronic pain occurring in a heterogeneous group of disorders.

Eight immunologically distinct serotypes have been identified, each produced by a distinct strain of *Clostridium botulinum*. With the exception of C2, A–G inclusive are all neurotoxins. To date, only type A and type B have been introduced into clinical practice.

## Characteristics

### Mechanism

Botulinum toxin is well-known for its effects on the motor system, where it inhibits the release of acetylcholine (ACh) from cholinergic terminals of motor neurons (Simpson 2000). It also inhibits release of ACh from pre-ganglion sympathetic and parasympathetic neurons, and post-ganglionic parasympathetic nerves (Simpson 2000). It produces a flaccid paralysis in the motor system (Humeau et al. 2000). Elsewhere, it produces autonomic dysfunction and various disturbances of central nervous system function (Hatheway 1995; Tyler 1963; Santini et al. 1999), which can occur during botulism or following peripheral administration of the toxin.

The effect is temporary. Whilst synaptic activity is eradicated, nerve endings are preserved. Recovery of neurotransmission does occur eventually. Blockade by botulinum toxin at the neuromuscular junction induces the formation of an extensive network of nerve terminal sprouts, and a number of other proteins essential for neurotransmission, including voltage sensitive sodium and calcium channels for action potential conduction and nerve evoked transmitter release. Sprouting is rapid and the sprouts are only transitory, because a second distinct phase of recovery occurs with the return of synaptic activity to the original nerve terminals, accompanied by elimination of the then superfluous sprouts (Paiva et al. 1999). The original terminals remain unable to undergo measurable exocytosis until almost two months after injection of toxin A (Paiva et al. 1999).

The mechanism of botulinum toxin in the management of pain is not known. Proponents of its use in pain are actively pursuing a mechanism distinct from its effects on motor nerves. Although cholinergic neurons are believed to mediate nociceptive pathways in the central nervous system, a central action of botulinum toxin seems unlikely, because its effectiveness appears to be related to local administration at the site of pain.

### Technique

The agent is administered either by subcutaneous, intradermal or intramuscular injection. (For dosage schedule, the reader is advised to consult with the manufacturer's recommendations. With respect to potency, the neurotoxins are not interchangeable given the lack of international units.)

### Applications

In certain jurisdictions, the toxin has been approved for the treatment of blepharospasm, spasticity due to juvenile cerebral palsy, cervical dystonia (spasmodic torticollis), hemifacial spasm, glabellar lines and primary hyperhidrosis of the axilla. This is consistent with its known mechanisms of action.

For the treatment of pain, the use of BoNT is still considered off-label in certain jurisdictions and, therefore, cannot be publicly recommended.

### Indications

The toxin has been actively promoted for the management of a number of diverse conditions including achalasia, anismus, benign prostatic hypertrophy, dysphonia, essential tremor, migraine, tension-type headaches, myofascial pain, pancreatitis, pelvic floor disorders, rectal fissures, temporomandibular joint syndrome, and urinary sphincter dysfunction (Munchau and Bhatia 2000).

### Efficacy

Advocating BoNT for a diverse and heterogeneous group of disorders presupposes a common pain pathophysiology. Published observational studies suffer severe methodological flaws including small sample size, lack of randomisation, poor outcome measures and construct validity.

In the treatment of ► **chronic low back pain**, BoNT ostensibly relieves pain due to muscle spasm. A randomised double-blind study, in which fifteen patients received the toxin, 60 % reported at least 50 % pain relief at eight weeks, compared to 12 % who received saline (Foster et al. 2001). The study is limited by its small sample size and large confidence intervals. None of the recipients reported complete relief of pain. The results attenuate over time, and its efficacy beyond eight weeks is not known. Whilst it may offer temporary palliation, its short duration of action limits its utility.

Two randomised, placebo-controlled trials showed that BoNT was not clinically beneficial for the treatment of neck pain and whiplash associated disorders. Statistically significant effects were not achieved in a study of 15 participants (Freund and Schwartz 2000). In a subsequent study of 25 participants, no specific benefits could be identified. Participants treated with normal saline showed comparable outcomes to those treated with BoNT over four months (Wheeler et al. 2001).

No studies have been reported that establish either the ► **effectiveness** or the ► **efficacy** of the toxin for the treatment of myofascial pain syndrome or ► **fibromyalgia** (Smith et al. 2002).

Contradictory results have been reported for the treatment of headache. Silberstein et al. (2000) enrolled 123 patients with episodic migraine to randomly receive either 25 units or 75 units of BoNT, or placebo, injected at multiple fixed symmetrical pericranial sites. At three months, post injection patients receiving 25 units showed significant reduction in headache frequency, headache severity, acute medication use and migraine associated vomiting compared to placebo. However, the outcomes of participants receiving 75 units did differ from those receiving placebo. Thirteen cases of ptosis and two cases of diplopia were reported. It is possible

the study may not have been truly double-blinded, and whether the toxin exerted a true anti-migraine effect remains speculative.

Evaluating the studies published thus far according to evidence-based medicine criteria, Evers et al. (2002), reported no sufficient positive evidence for the general treatment of idiopathic and cervicogenic headaches with BoNT.

### Contraindications

Known contraindications include hypersensitivity to any ingredient in the formulation, myasthenia gravis, amyotrophic lateral sclerosis, infection or the Eaton Lambert syndrome. The toxin may be potentiated by aminoglycoside antibiotics, spectinomycin or any other drug that might interfere with the neuromuscular transmission e.g. tubocurarine, tetracyclines, lincomycin or drugs that interfere with the intraneuronal concentrations of calcium (Dysport, Botox 2002).

### Side Effects and Complications

The product information provided by manufacturers lists a variety of possible side-effects and complications (Dysport, Botox 2002). These include: skin reactions, gastrointestinal disturbances, respiratory symptoms, and neurological, cardiovascular, and ocular disturbances. The product also contains a small amount of human albumin and hence, the risk of transmission of viral infection cannot be excluded with absolute certainty.

### References

1. Botox (2002) Product Information. Allergan Australia Pty Ltd. Gordon, New South Wales, Australia
2. Dysport. Product Information. IPSEN Pty Ltd, Glen Waverley, Victoria, Australia
3. Evers S, Rahmann A, Vollmer-Haase J, Husstedt IW (2002) Treatment of Headache with Botulinum Toxin A – A Review According to Evidence-Based Medicine Criteria. *Cephalalgia* 22:699–710
4. Foster L, Clapp L, Erickson M, Jabbari B (2001) Botulinum Toxin A and Chronic Low Back Pain. A Randomised, Double-Blind Study. *Neurology* 56:1290–1293
5. Freund B, Schwartz M (2000) Treatment of Whiplash Associated with Neck Pain with Botulinum Toxin-A: A Pilot Study. *J Rheumatol* 27:481–484
6. Hatheway CL (1995) Botulism: The Present Status of the Disease. *Curr Top Microbiol Immunol* 195:53–75
7. Humeau Y, Doussau F, Grant NJ, Poulain B (2000) How Botulinum and Tetanus Neurotoxins Block Neurotransmitter Release. *Biochimie* 82:427–446
8. Munchau A, Bhatia KP (2000) Uses of Botulinum Toxin Injection in Medicine Today. *BMJ* 320:161–165
9. Paiva A, Meunier FA, Molgo J, Aoki KR, Dolly J (1999) Functional Repair of Motor Endplates after Botulinum Neurotoxin Type-A Poisoning: Biphasic Switch of Synaptic Activity between Nerve Sprouts and their Parent Terminals. *Proc Natl Acad Sci USA* 96:3200–3205
10. Santini M, Fabri S, Sagnelli P, Manfredi M, Francia A (1999) Botulism: A Case Associated with Pyramidal Signs. *Eur J Neurol* 6:91–93
11. Silberstein S, Mathew N, Saper J, Jenkins S (2000) Botulinum Toxin Type-A as a Migraine Preventive Treatment. *Headache* 40:445–50
12. Simpson LL (2000) Identification of the Characteristics that Underlie Botulinum Toxin Potency: Implication for Designing Novel Drugs. *Biochimie* 82:943–953
13. Smith HS, Audette J, Royal MA (2002). Botulinum Toxin in Pain Management of Soft Tissue Syndromes. *Clin J Pain* 18:S147–S154
14. Tyler HR (1963) Botulinum Toxin: Effect on the Central Nervous System of Man. *Science* 139:847–848
15. Wheeler AH, Goolkasian P, Gretz SS (2001) Botulinum Toxin A for the Treatment of Chronic Neck Pain. *Pain* 94:255–260

## Boxcar Design

- ▶ Block Design

## Brachial and/or Lumbal Plexopathy

### Definition

Pain that emerges after compression, entrapment, infiltration or other lesion to the nerves of the plexus. In all disorders the pain is increased by motion, use of the shoulder or leg and, in the case of brachial plexopathy: deep inspiration. The pain usually radiates down to the limb. In oncological patients, brachial plexopathy may be caused by the Pancoast tumor growing in the lung top. Suprascapular nerve entrapment and accompanying shoulder pain are frequently seen in cachectic cancer patients. Lumbar plexopathy in cancer patients is more often caused by metastases to the lumbal and pelvic region.

- ▶ Cancer Pain

## Brachial Plexus

### Definition

The lowest four cervical and first thoracic spinal cord nerve roots (C5 – T1) unite that innervate the upper extremity and branch to form the brachial plexus in the lower part of the neck and behind the clavicle.

- ▶ Acute Pain in Children, Post-Operative
- ▶ Plexus Injuries and Deafferentation Pain
- ▶ Postoperative Pain, Regional Blocks

## Brachial Plexus Avulsion

### Definition

Traumatic lesion consisting of detachment of cervical root(s) corresponding to the brachial plexus (that is C5 to Th1) from the spinal cord; main mechanism is stretching. Frequently results in a syndrome of constant burning or aching pain punctuated by paroxysms of crushing pain.



- ▶ Brachial Plexus Avulsion and Dorsal Root Entry Zone
- ▶ DREZ Procedures

## Brachial Plexus Avulsion and Dorsal Root Entry Zone

MARC SINDOU

Department of Neurosurgery, Hopital Neurologique, Pierre Wertheimer University of Lyon, Lyon, France  
marc.sindou@chu-lyon.fr

### Synonyms

Brachial plexus injury; cervical root avulsion; dorsal root entry zone and brachial plexus avulsion; dorsal root – spinal cord junction; Neurosurgery for Pain in the DREZ; DREZ lesions; Microsurgical DREZotomy

### Definition

The vast majority of Brachial Plexus Avulsion (BPA) occur as a consequence of motorcycle accidents. In most BPA injuries, structures of the plexus are stretched down and laterally (Sunderland 1968), resulting in multiple lesions along the neural fibers, within their extra-and/or intra-spinal portions, at the entry-zone into the spinal cord, up to the Lissauer's tract and the superficial layers of the dorsal horn. This leads to the appearance of intramedullary hemorrhages and necrosis, then to gliosis and microcysts, intra-operatively observed. BPA injuries are followed by secondary chronic pain in the deafferented area of the upper limb in 30% to 90% of the patients, according to publications (Wynn-Parry 1980). In the particular group of patients with severe supraganglionic lesions, that is with avulsion, the rate of patients with pain has been reported at as much as 90% (Narakas 1988). Microelectrode recordings of Dorsal Horn neurons in animal models (Guenot et al. 2002), and also in humans, during surgery (Guenot et al. 1999; Jeanmonod et al. 1989) have evidenced spontaneous electrophysiological hyperactivities, which are hypothesized to be due to deafferentation phenomena, together with ectopic generation of spikes in the gliotic scar tissue. The resulting neuropathic pain represents a clinical stereotype: a continuous pain background described as burning, throbbing and/or aching sensations, associated to electrical shooting – like paroxysms.

### Characteristics

Topography of pain most frequently cover several dermatomes of the upper limb. In most patients, pain distribution is predominant in the lowest radicular territories, which is in the hand and forearm. This is well in concordance with the observed anatomical lesions. According to a recent study in our series, dorsal root damages extended to all five roots from C5 to Th1 in 43% of the patients, from C6 to Th1 in 14%, C7 to Th1 in 14%, C8

and Th1 in 4%, and were diversely grouped in the other 25%. C8 was the most frequently (in 90%) and severely (avulsion almost always) damaged DR. C5 was the less frequently (in 50%) and less severely (avulsion in only 25%) damaged root. Interesting, lesions in the ventral roots were quite similarly distributed, with the exception of the C5 root level, where it appeared that the ventral root was more frequently and more severely impaired than the corresponding C5 dorsal root.

After BPA, level of pain intensity is generally between 7/10 and 10/10 on the VAS scoring system, in spite of analgesic medications at maximum doses.

Direct repair or neurotization with donor nerves (accessory, intercostal descending cervical plexus) have been reported to may have a more or less preventing effect on appearance of pain. Direct reimplantation of avulsed roots into the spinal cord itself is still in the preliminary phase of clinical trials. Medical treatments, whatever the therapeutic class used - including anti-convulsants and antidepressants – are usually irrelevant with time. Transcutaneous and Spinal Cord Stimulation techniques are ineffective; as a matter of fact, after avulsion the fibers to stimulate degenerate up to the brain stem nuclei (Sindou et al. 2003). Deep Brain Stimulation generally does not give lasting pain relief. Classical ablative procedures - namely cervical Antero-lateral Cordotomy, Spino-thalamic mesencephalic Tractomy - reveal very little effective, and not exempt from side-effects. First trials of the recently introduced Motor Cortex Stimulation does not seem to have the same promising results in pain after BPI as for pain after stroke.

▶ **Surgery in the DREZ** introduced in the seventies (Sindou 1972; Sindou et al. 1974; Nashold and Ost Dahl 1979) demonstrates efficacy along time for relieving pain in the patients with BP, avulsion as well as in patients affected with segmentally-generated pain, after ▶ **Spinal cord Injury** (Sindou et al. 2001). Therefore, DREZ-surgery is currently used for those indications in dedicated centers. Detailed descriptions of the ▶ **Microsurgical DREZotomy** procedure have recently been given in several books on Neurosurgical Techniques (Sindou 2002). Briefly, after ipsilateral hemilaminectomy and dural opening over the avulsed segments of the cervical spinal cord, the cord is freed from (often strong) arachnoid adhesions. Incision of the dorso-lateral sulcus is made with a micro-knife, 2 mm in depth and oriented at 35° medially and ventrally, that is the axis of the dorsal horn. Then dotted micro-coagulations are performed inside the dorsal horn down to approximately the Vth layer of the Rexed classification, which is at 3 to 4 mm deep. The microcoagulations are made under magnified vision with a sharp graduated bipolar forceps. Special care must be taken to locate the microcoagulations strictly inside the deafferented dorsal horn, in between the Cuneate fasciculus of the dorsal column, on the medial side, and the Cortico-spinal tract, on the lateral



side. Important is avoidance of impairment of the sensory and motor pathways, respectively (Jeanmonod and Sindou 1993).

A recent survey of our 55 patients, with a follow-up ranging from 1 to 18 years (6 years on average), showed the following results (Sindou et al. 2005). 66% had their pain relieved (34.2% without the need of any medical treatment, 31.8% with additional moderate doses of (non-opioid analgesics). 71% benefited from an improvement in their activity level. Mortality was nil. Neurological complications consisted of long-tract deficits: there were 2 cases of permanent ataxia (3.6%) and 2 other cases of motor weakness (3.6%) in the ipsilateral lower limb, and 1 case of genito-urinary disturbances (1.3%).

Our results are approximately the same as those reported in the literature with other DREZ-lesion makers, namely, RF-Thermocoagulation (Nashold and Ostdahl 1979), Laser-beam (Levy et al. 1983) and Ultrasonic probe (Dreval 1993).

### Conclusions

1. Gross anatomical lesions, observed in patients referred for pain after severe ► **brachial plexus injury**, are mostly supraganglionic. In our series, 78% of the dorsal roots corresponding to the brachial plexus (that is C5 to Th1) were found impaired. Of those, 79% were totally avulsed and 7.5% avulsed partially; 13.5% had their rootlets present but with an important atrophic aspect. These findings correspond to a clear-cut deafferentation state of the spinal cord, and constitute a consistent substrate for considering neuropathic pain after BPA as pain from deafferentation origin.
2. Study of long-term outcomes after therapeutic DREZ-lesioning shows that surgery is able to obtain lasting pain relief in two-thirds of the patients.
3. The positive effects of destructive surgery on the DREZ target favors the hypothesis that the main mechanism of pain after BPA is the appearance of pain generators in the neurons, and/or imbalance in fiber circuitry of the Dorsal Horn at the level of the avulsed cervical segments.

### References

1. Dreval ON (1993) Ultrasonic DREZ-Operations for Treatment of Pain Due to Brachial Plexus Avulsion. *Acta Neurochir* 122:76–81
2. Guenot M, Hupe JM, Mertens P et al. (1999) A New Type of Microelectrode for Obtaining Unitary Recordings in the Human Spinal Cord. *J Neurosurg* 91:25–32
3. Guenot M, Bullier J, Sindou M (2002) Clinical and Electrophysiological Expression of Deafferentation Pain Alleviated by Dorsal Root Entry Zone Lesions in Rats. *J Neurosurg* 97:1402–1409
4. Jeanmonod D, Sindou M (1993) Somatosensory Function Following Dorsal Root Entry Zone Lesions in Patients with Neurogenic Pain or Spasticity. *J Neurosurg* 74:916–932
5. Jeanmonod D, Sindou M, Magnin M et al. (1989) Intra-Operative Unit Recording in the Human Dorsal Horn with a Simplified Floating Microelectrode. *Electroencephalogr Clin Neurophysiol* 74:450–454

6. Levy WJ, Nutkiewicz A, Ditmore M et al. (1983) Laser-Induced Dorsal Root Entry Zone Lesions for Pain Control. Report of Three Cases. *J Neurosurg* 59:884–886
7. Narakas A (1988) Pain Syndromes in Brachial Plexus Injuries. In: Brunelli G (ed) *Textbook of Microsurgery*. Masson, Paris, pp 809–816
8. Nashold BS Jr, Ostdahl RH (1979) Dorsal Root Entry Zone Lesions for Pain Relief. *J Neurosurg* 51:59–69
9. Sindou M (1972) Study of the Dorsal Root Entry Zone. The Selective MicroDREZotomy for Pain Surgery. University Med Thesis Press, Lyon
10. Sindou M, Quoex C, Baleyrier C (1974) Fiber Organization at the Posterior Spinal Cord-Rootlet Junction in Man. *J Comp Neurol* 153:15–26
11. Sindou M, Mertens P, Wael M (2001) Microsurgical DREZotomy for Pain Due to Spinal Cord and/or Cauda Equina Injuries: Long-Term Results in a Series of 44 Patients. *Pain* 92:159–171
12. Sindou (2002) Dorsal Root Entry Zone Lesions. In: Burchiel KJ (ed) *Surgical management of pain*. Thieme, New York, pp 701–713
13. Sindou M, Mertens P, Bendavid U et al. (2003) Predictive Value of Somato-Sensory Evoked Potentials (Central Conduction Time) for Patients' Selection to Spinal Cord Stimulation for Neuro-pathic Pain. *Neurosurgery* 52:1374–1384
14. Sindou M, Blondet E, Emery E, Mertens P (2005) Microsurgical lesioning in the dorsal root entry zone for pain due to brachial plexus avulsion: a prospective series of 55 patients. *J Neurosurg* 102:1018–1028
15. Sunderland S (1968) Nerves and Nerve Injuries. The Painful Sequelae of Injuries to Peripheral Nerves. Causalgia. Churchill-Livingstone, Edinburgh, pp 411–430
16. Wynn-Parry CB (1980) Pain in Avulsion Lesions of the Brachial Plexus. *Pain* 9:41–53

## Brachial Plexus Avulsion Injury

- **Brachial Plexus Avulsion and Dorsal Root Entry Zone Plexus Injuries and Deafferentation Pain**

## Brachial Plexus Compression

- **Thoracic Outlet Syndrome**

## Brachial Plexus Injury

### Definition

Traumatism occurring at any level of the brachial plexus, from spinal cord to peripheral branches; may be due to direct aggression or indirectly to stretching.

- **Brachial Plexus Avulsion and Dorsal Root Entry Zone**

## Brachialgia

- **Radicular Pain, Diagnosis**

## Bradykinin

### Definition

A potent inflammatory peptide messenger, consisting of 9-amino acids, which is generated from a protein precursor (kallidin) through the action of specific enzyme kallikrein. Bradykinin is released from damaged tissue during injury or inflammation. It is also released from mast cell, and also produced in the blood, where it serves as a vasodilator and increases vessel permeability. It also stimulates prostacyclin formation. BK not only excites a high percentage of nociceptors, but also sensitizes them to other noxious stimuli through activation of B1 and B2 receptors. One of the most potent pain-producing substances.

- ▶ Autologous Thrombocyte Injection as a Model of Cutaneous Pain
- ▶ ERK Regulation in Sensory Neurons during Inflammation
- ▶ Mechanonociceptors
- ▶ Nociceptors in the Orofacial Region (Skin/Mucosa)
- ▶ Postsynaptic Dorsal Column Projection, Anatomical Organization
- ▶ Satellite Cells and Inflammatory Pain
- ▶ Spinal Dorsal Horn Pathways, Dorsal Column (Visceral)
- ▶ TRPV1 Modulation by p2Y Receptors
- ▶ TRPV1, Regulation by Protons
- ▶ Visceral Pain Model, Angina Pain

## Bradykinin Receptors

### Definition

Two types of molecular receptors for bradykinin are known presently, namely the B2 and B1 receptor. Both receptors are coupled to a G protein, i.e. they do not control an ion channel, but are involved in the synthesis of second messengers in the axoplasm of the nociceptive ending. In intact tissue, BKN binds to the B2 receptor. If the tissue is inflamed or otherwise pathologically altered, the B1 receptor molecule is synthesized in the soma of the nociceptor and transported to the ending where the receptor is built in the membrane. The de-novo synthesis of the B1 receptor is an important aspect of the sensitization of the ending.

- ▶ Muscle Pain Model, Ischemia-Induced and Hypertonic Saline-Induced

## Brain Derived Neurotrophic Factor

### Synonyms

BDNF

### Definition

A member of the neurotrophin family that signals via the trkB receptor. BDNF is upregulated in trkA-expressing DRG neurons that are exposed to inflammatory mediators such as NGF. BDNF has roles in neuronal survival and development, and has been suggested to function as a neuromodulator of synaptic transmission and spinal nociception, especially during inflammatory states. BDNF, synthesized in the DRG, is transported to the central terminals of the primary afferents, released into the spinal dorsal horn, and binds to trkB receptors on second-order sensory neurons.

- ▶ ERK Regulation in Sensory Neurons during Inflammation
- ▶ Nerve Growth Factor, Sensitizing Action on Nociceptors
- ▶ Spinal Cord Nociception, Neurotrophins

## Brain Electrode

- ▶ Deep Brain Stimulation

## Brain Sodium Channel 2 (BNC2, BNaC2)

- ▶ Acid-Sensing Ion Channels

## Brain Stimulation Analgesia

- ▶ Stimulation-Produced Analgesia

## Brain-Gut Axis

### Definition

The relationship between events that affect the function of the central nervous system, and the influence these factors ultimately have on the function of the intestines via the enteric nervous system through the interconnection between the two systems.

- ▶ Recurrent Abdominal Pain in Children

## Brainstem

### Definition

The brainstem is the area from the top of the spinal cord including the medulla, pons and midbrain. It contains the PAG and RVM and controls many basic and unconscious functions, including gating or modulating sensory input.

**B**

- ▶ Descending Circuitry, Transmitters and Receptors
- ▶ Forebrain Modulation of the Periaqueductal Gray
- ▶ Migraine, Pathophysiology

## Brainstem Respiratory Centers

### Definition

Brainstem Respiratory Centers are neuron assemblies located in the Pons and Medulla that control involuntary respiration.

- ▶ Pain Treatment, Implantable Pumps for Drug Delivery

## Brainstem Subnucleus Reticularis Dorsalis Neuron

LENAIC MONCONDUIT, LUIS VILLANUEVA  
INSERM, University of Clermont-Ferrand, France  
luis.villanueva@u-clermont1.fr

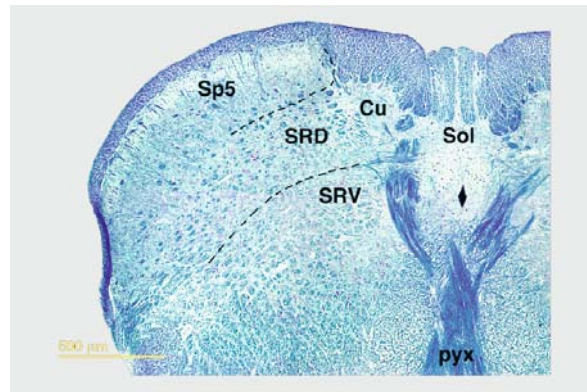
### Definition

Neuron whose cell body and dendrites are located in the medullary subnucleus reticularis dorsalis (SRD) and whose axon issues collaterals to both the thalamus and the dorsal horn of the spinal cord. SRD neurons respond selectively to and encode noxious stimuli from any part of the body. Because the SRD innervates several areas involved in motor processing and receives strong, direct influences from several cortical regions, it could provide a structural basis for the processing of nociceptive and motor activities.

### Characteristics

Several groups have shown that widespread areas throughout the brainstem reticular formation contain neurons responsive to noxious stimuli (Bowsher 1976; Villanueva et al. 1996) and that focal stimulation of some bulbar reticular areas can elicit escape behavior (Casey 1969). However, the way in which the reticular structures participate in the processing of nociceptive information was not clear. This was because reticular units activated by noxious stimulation showed irregular responses and changes in excitability, had receptive fields that were difficult to define and presented some degree of heterosensory convergence. As a result, it was stated that the reticular formation did not play a specific role in the processing of pain.

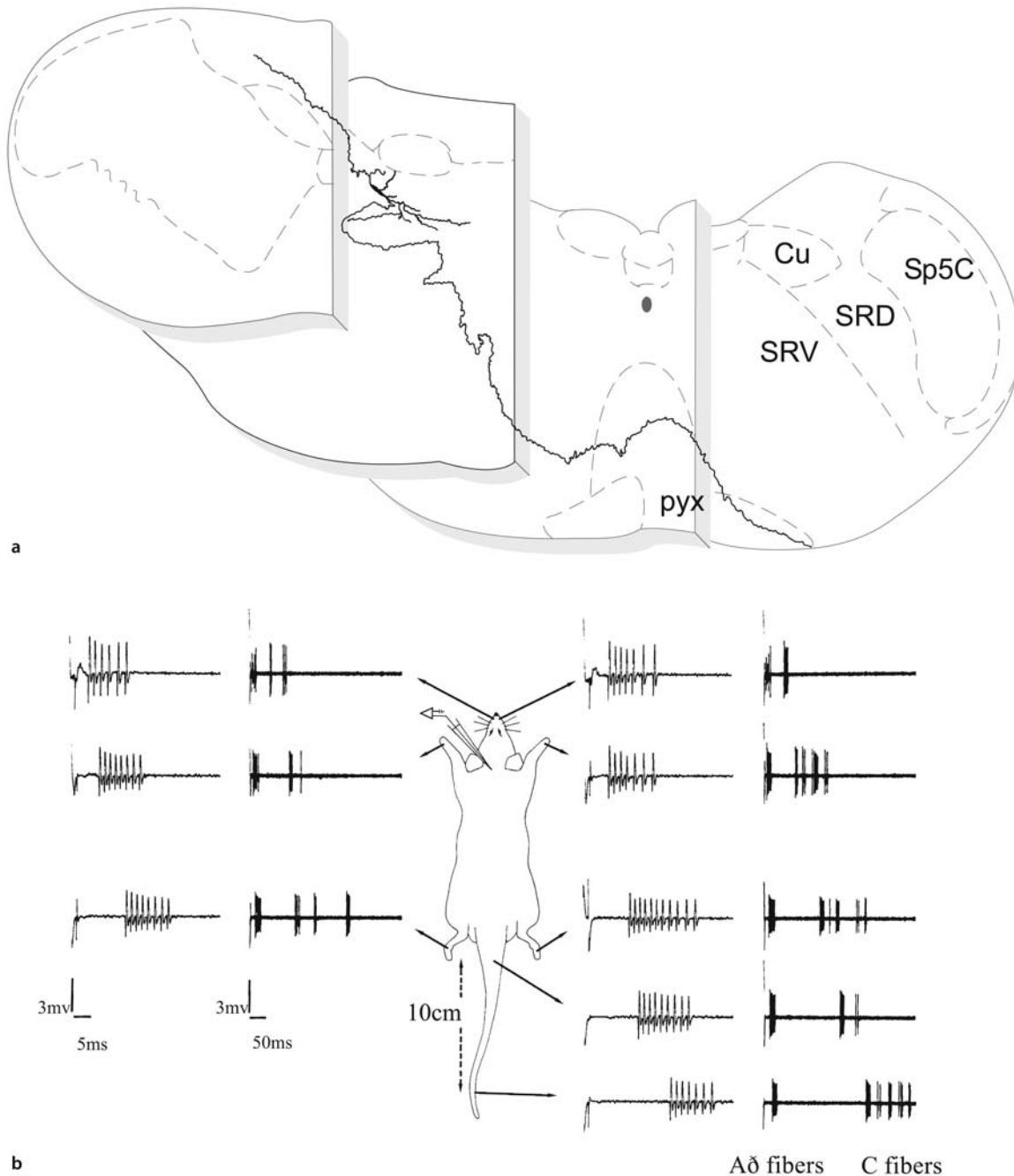
This proposal has been challenged by data obtained in the rat showing that a well-delimited area within the caudal-most aspect of the medulla, the subnucleus reticularis dorsalis (SRD), can play a selective role in processing cutaneous and visceral nociceptive inputs (Villanueva et al. 1996). The SRD region extends



**Brainstem Subnucleus Reticularis Dorsalis Neuron, Figure 1** Bright field image of a section of the medulla caudal to the obex stained with the Kluver and Barrera technique. The dotted line represents the delimitation of the SRD area with regard to the surrounding trigeminal (Sp5), cuneate (Cu), nucleus of the solitary tract (Sol) and subnucleus reticularis ventralis (SRV) regions. Pyx, pyramidal decussation.

caudo-rostrally from the spinomedullary junction to the level of the ▶ **area postrema** and lies ventral to the ▶ **cuneate nucleus**, medial to the magnocellular layer of ▶ **trigeminal nucleus caudalis** and is separated from the ▶ **subnucleus reticularis ventralis** by an acellular boundary extending from the solitary tract to the dorsal border of the lateral reticular nucleus (Fig. 1). The SRD contains neurons that respond to and encode selectively noxious stimuli from any part of the body (Fig. 2; Villanueva et al. 1996) and their C-fiber components exhibit the ▶ **wind-up phenomenon** during repetitive stimulation. Additional data obtained in the monkey have demonstrated that there are neurons with similar features to those described in the rat SRD. Medullary units recorded in monkeys exhibited convergence of nociceptive inputs from widespread areas of the body and encoded the intensities of peripheral noxious stimuli (Villanueva et al. 1990). Thus, in different species, dorsal medullary reticular neurons constitute a morphofunctional entity that processes nociceptive inputs.

SRD neurons regulate the flow of sensory information in spinal and thalamic nociceptive pathways and project to several areas of the central nervous system that are involved in motor processing. These areas include the deep dorsal horn and the more dorsal part of the ventral horn at all levels of the spinal cord (Villanueva et al. 1995), brainstem motor nuclei, the gigantocellular and parvocellular reticular formation (Bernard et al. 1990) and motor-related areas of the forebrain such as the ▶ **ventromedial nuclei**, parafascicular thalamic nuclei and the ventral ▶ **zona incerta** (Villanueva et al. 1998). Conversely, various regions of the deep dorsal horn (laminae V–VII) that contain neurons that respond to noxious cutaneous and / or visceral stimuli provide the main input to the dorsal-most aspect of the SRD (Lima 1990; Raboisson et al. 1996). The SRD, *via* its reciproc-



**Brainstem Subnucleus Reticularis Dorsalis Neuron, Figure 2** (a) Camera lucida drawing from successive frontal sections of a SRD neuron labeled with a juxtacellular injection of biotin-dextran. Note that its axonal processes give both an ascending and descending collateral (adapted from Monconduit et al. 2002). (b) Single sweep recordings showing A $\delta$ - and C-fiber evoked responses of a SRD neuron following supramaximal percutaneous electrical stimulation (square-wave pulses, 2 ms duration) of different areas of the body (arrows). Note that massive A $\delta$ - and C-fiber responses were evoked from all body areas (adapted from Villanueva et al. 1988).

cal connections, exerts both inhibitory (Bouhassira et al. 1992) and excitatory (Dugast et al. 2001) influences on spinal cord outflow. Behavioral studies in rats have shown modifications of motor responses, such as decreases in the latency of tail-flick withdrawal reactions,

following glutamate injections in the SRD. Moreover, the same studies showed that lesions that included the dorsal aspect of the SRD induced an increase in the latencies of the hot plate, tail-flick and formalin-elicited withdrawal reactions (Almeida et al. 1999).



Interestingly, SRD neurons receive strong, direct influences from numerous cortical regions (Desbois et al. 1999) and provide monosynaptic connections to both the thalamus and spinal cord (Monconduit et al. 2002). From a general point of view, it has been suggested that the pyramidal system might implement and refine basic motor patterns generated by brainstem reticulospinal circuits and this could apply to those relayed at the level of the SRD. Various corticofugal influences could, *via* SRD collaterals, reach rostral and caudal sites in the CNS almost simultaneously. Perhaps one of the advantages conferred by single SRD cells projecting to two different CNS regions is that it allows for more precise temporal synchrony between the two target areas. The SRD is a medullary substrate for the processing of nociceptive and motor activities. The cortex might, *via* pyramidal influences onto SRD neurons, co-ordinate the nociceptive information that ascends to it. Corticofugal mechanisms could allow the cortex to select its own input by suppressing or augmenting transmission of signals through SRD-hindbrain / forebrain pathways or by coordinating activities in spino-SRD-spinal circuits and thus selecting the relevant information caused by the noxious stimulus itself.

## References

- Almeida A, Storkson R, Lima D et al. (1999) The medullary dorsal reticular nucleus facilitates pain behaviour induced by formalin in the rat. *Eur J Neurosci* 11:110–122
- Bernard JF, Villanueva L, Carroue J et al. (1990). Efferent projections from the subnucleus reticularis dorsalis (SRD): A Phaseolus Vulgaris leucoagglutinin study in the rat. *Neurosci Lett* 122:257–262
- Bouhassira D, Villanueva L, Bing Z et al. (1992) Involvement of the subnucleus reticularis dorsalis in diffuse noxious inhibitory controls in the rat. *Brain Res* 595:353–357
- Bowsher D (1976) Role of the reticular formation in responses to noxious stimulation. *Pain* 2:361–378
- Casey KL (1969) Somatosensory responses of bulbotreticular units in the awake cat: relation to escape producing stimuli. *Science* 173:77–80
- Desbois C, Le Bars D, Villanueva L (1999) Organization of cortical projections to the medullary subnucleus reticularis dorsalis: a retrograde and anterograde tracing study in the rat. *J Comp Neurol* 410:178–196
- Dugast C, Almeida A, Lima D (2003) The medullary dorsal reticular nucleus enhances the responsiveness of spinal nociceptive neurons to peripheral stimulation in the rat. *Eur J Neurosci* 18:580–588
- Lima D (1990) A spinomedullary projection terminating in the dorsal reticular nucleus of the rat. *Neuroscience* 34:577–590
- Monconduit L, Desbois C, Villanueva L (2002) The integrative role of the rat medullary subnucleus reticularis dorsalis in nociception. *Eur J Neurosci* 16:937–944
- Raboisson P, Dallel R, Bernard JF et al. (1996) Organization of efferent projections from the spinal cervical enlargement to the medullary subnucleus reticularis dorsalis and the adjacent cuneate nucleus: a PHA-L study in the rat. *J Comp Neurol* 367:503–517
- Villanueva L, Bouhassira D, Bing Z et al. (1988) Convergence of heterotopic nociceptive information onto subnucleus reticularis dorsalis neurons in the rat medulla. *J Neurophysiol* 60:980–1009
- Villanueva L, Cliffer KD, Sorkin L et al. (1990) Convergence of heterotopic nociceptive information onto neurons of the caudal medullary reticular formation in the monkey (*Macaca fascicularis*). *J Neurophysiol* 63:1118–1127
- Villanueva L, Bernard JF, Le Bars D (1995) Distribution of spinal cord projections from the medullary subnucleus reticularis dorsalis and the adjacent cuneate nucleus: a Phaseolus vulgaris leucoagglutinin (PHA-L) study in the rat. *J Comp Neurol* 352:11–32
- Villanueva L, Bouhassira D, Le Bars D (1996) The medullary subnucleus reticularis dorsalis (SRD) as a key link in both the transmission and modulation of pain signals. *Pain* 67:231–240
- Villanueva L, Desbois C, Le Bars D et al. (1998) Organization of diencephalic projections from the medullary subnucleus reticularis dorsalis and the adjacent cuneate nucleus: a retrograde and anterograde tracer study in the rat. *J Comp Neurol* 390:133–160

## Breakthrough Pain (BP)

### Definition

Pain flares that are experienced as exacerbations in otherwise acceptable analgesia are defined as breakthrough pain (BP). It typically has a rapid onset of less than 3 minutes and short duration (median 30 minutes). Different definitions of breakthrough pain may be used in different countries, with some defining breakthrough pain as occurring only after background pain is controlled. Most frequently, BP is encountered during voluntary or involuntary movements. Some BP are spontaneous, not related to pain and sometimes not to any other precipitating factor. Yet another category of BP is the end-of-dose pain. Pain appearing at the end of the dose interval of analgesics. The cause of BP should be vigorously investigated and specifically treated. Episodic pain or temporary pain are used as synonyms.

- ▶ [Cancer Pain](#)
- ▶ [Cancer Pain Management, Anesthesiologic Interventions, Neural Blockade](#)
- ▶ [Cancer Pain Management, Principles of Opioid Therapy, Dosing Guidelines](#)
- ▶ [Evoked and Movement-Related Neuropathic Pain](#)
- ▶ [Incident Pain](#)
- ▶ [Opioids in Geriatric Application](#)
- ▶ [Opioid Responsiveness in Cancer Pain Management](#)
- ▶ [Opioid Therapy in Cancer Pain Management, Route of Administration](#)
- ▶ [Rest and Movement Pain](#)

## Brennan Pain Model

- ▶ [Nick Model of Cutaneous Pain and Hyperalgesia](#)

## Brodmann Areas

### Definition

A system developed by Brodmann for the classification of brain cortical areas based on the specific organiza-



tion of neurons. When examined perpendicular to its surface, the cerebral cortex can be subdivided into layers, each containing subpopulations of neurons that can be distinguished based on their morphology and connectivity with other cortical and sub-cortical areas. Different Brodmann areas are distinguished by the relative importance of each cortical layer.

- ▶ Cingulate Cortex, Functional Imaging
- ▶ Nociceptive Processing in the Cingulate Cortex, Behavioral Studies in Humans
- ▶ Pain Processing in the Cingulate Cortex, Behavioral Studies in Humans

## Bruxism

### Definition

Grinding movements of the teeth leading to lesions of the teeth and pain in the masticatory muscles or the temporomandibular joint.

- ▶ Orofacial Pain, Movement Disorders
- ▶ Sensitization of Muscular and Articular Nociceptors

## Bulbospinal Modulation of Nociceptive Inputs

- ▶ Descending Facilitation and Inhibition in Neuro-pathic Pain

## Bulbospinal Pathways

- ▶ Descending Circuitry, Opioids

## Buprenorphine

### Definition

A semi-synthetic opiate possessing both narcotic agonist ( $\mu$  opioid receptor) and antagonist ( $\kappa$  opioid receptor) activity. It has limited activity and low intrinsic efficacy at the  $\mu$  opioid receptor in comparison to full opioid receptor agonists. Buprenorphine displays a ceiling effect to analgesia.

- ▶ Opioids and Inflammatory Pain

## Burn Pain Control in Children

- ▶ Pain Control in Children with Burns

## Burning Feet Syndrome

- ▶ Diabetic Neuropathies

## Burning Mouth Syndrome

YAIR SHARAV

Department of Oral Medicine, School of Dental Medicine, Hebrew University-Hadassah, Jerusalem, Israel

sharav@cc.huji.ac.il

### Synonyms

BMS

### Definition

The ▶ **burning mouth syndrome** (BMS) is an intraoral pain disorder not accompanied by distinct clinical signs. Its vague definition and unknown etiology warrant its inclusion under atypical oral and facial pain. Inclusion criteria of patients with BMS may differ in different studies, e.g. the presence of systemic disorders may or may not be an exclusion criterion (Grushka 1987). The term “symptomatic” burning mouth refers to symptoms associated with local or systemic causes, and is distinguished from the “idiopathic” BMS presently discussed.

### Characteristics

Burning pain often occurs at more than one oral site, with the anterior two-thirds of the tongue, the anterior hard palate and the mucosal aspect of the lower lip most frequently affected (Grushka et al. 1987a). The pain is as intense as toothache but differs from toothache in pain quality. Burning pain is constant throughout the day or begins by mid-morning and reaches maximum intensity by early evening, but is usually not present at night and does not disturb sleep (Grushka 1987). Grushka (1987) reported no significant difference between BMS and controls in any clinical oral features including number of teeth, oral mucosal conditions, presence of *Candida* infection and parafunctional habits.

The prevalence of BMS is in the range of 1.5–2.5% of the general population, but usually affects women more than men are, and can be as high as 15% in women over 40 years of age (Grushka 1987).

### Psychophysical Assessment

There is evidence for taste dysfunction in BMS, especially in those individuals with self-reported dysgeusia. Sweet thresholds were significantly higher for BMS than control subjects. No differences were found between BMS and control subjects in somatosensory modalities such as two-point discrimination, temperature perception and stereognostic ability (Grushka et al. 1987b). Grushka et al. (1987b) did, however, find

that heat pain tolerance was significantly reduced at the tip of the tongue of BMS subjects, and suggested that hyperalgesia in these patients may depend on prolonged temporal or spatial central summation.

Jaaskelainen et al. (1997) studied the blink reflex (BR) in 11 patients with BMS, who demonstrated higher stimulus thresholds for the R1 component of the BR, indicating altered tactile sensory processing. These findings were explained as correlates of allying, and the patients demonstrated changes on the BR similar to other atypical facial pain subjects.

### Etiology

The etiology of BMS is not clear. Many possible etiologies have been suggested and include local, intraoral factors as well as general, systemic ones. However, once a clear causative factor can be identified, and its elimination stops the burning symptoms, the condition is no more that of idiopathic BMS. Looking for these factors is therefore essential before the condition can be defined as BMS.

### Local Factors

These include galvanic currents, denture allergy and mechanical irritation and decreased salivary secretion or change in saliva composition. Most studies have not supported an allergic or mechanical irritation cause for BMS. Most salivary flow rate studies have not demonstrated a significant decrease in salivary output. On the other hand, some studies found significant alterations in salivary components such as proteins, immunoglobulins and phosphates, as well as differences in saliva pH buffering capacity. Whether these alterations in salivary composition are a causal or a coincidental event in BMS is unknown.

### Systemic Factors

Among these are menopause and hormonal imbalance, nutritional deficiencies and psychogenic factors. Significantly, more oral discomfort was found in menopausal women, however, oral discomfort was not associated with any of the vasomotor symptoms of menopause, nor did it show any relationship to mucosal health. The presence of oral discomfort bore no relationship to follicle-stimulating hormone (FSH) or oestradiol levels measured in menopausal women. In spite of the conflicting data on the effect of menopause and oestrogen replacement therapy on oral discomfort, the high frequency of oral complaints in menopausal women clearly indicates a significant, although poorly understood, association between menopause and BMS. Numerous studies have used psychological questionnaires and psychiatric interviews to demonstrate psychological disturbances such as depression, anxiety and irritability in patients with BMS (Grushka et al. 1987a). BMS patients showed elevation in certain personality characteristics similar to those seen in other

chronic pain patients (Grushka et al. 1987a). However, it is unclear whether depression and other personality characteristics are causative or the result of the pain.

In conclusion, there is no clear etiology of BMS available today, and it is possible that a further sub-classification of this 'syndrome' is needed. A more rigorous definition of inclusion and exclusion criteria may help in future studies of etiology and possible therapy.

### Treatment

Before treatment is instigated, local and systemic underlying factors should be ruled out and treated. Unfortunately, in many instances these corrections may not improve the burning sensation and oral discomfort. Symptomatic treatment with psychotropic drugs, such as amitriptyline or clonazepam, may be of some benefit, but no good controlled studies are available to demonstrate a real effect of these drugs. The local application of various medications was recently examined. Interestingly, burning sensation increased after local application of topical anesthesia, while dysgeusia symptoms were more likely to decrease (Ship et al. 1995). Ship et al. (1995) suggested a centrally based neuropathic condition for the burning sensation, and that the topical anesthesia may be releasing peripheral inhibition of central sensory pathways. Application of ► **capsaicin** to oral mucosa was beneficial in about 50% of patients in an open study, but double-blind controlled studies are warranted before this treatment can be recommended for BMS.

► **Atypical Facial Pain, Etiology, Pathogenesis and Management**

► **Nociception in Nose and Oral Mucosa**

### References

1. Grushka M (1987) Clinical Features of Burning Mouth Syndrome. *Oral Surgery* 63:30–36
2. Grushka M, Sessle BJ, Miller R (1987a) Pain and Personality Profiles in Burning Mouth Syndrome. *Pain* 28:155–167
3. Grushka M, Sessle BJ, Howley TP (1987b) Psychophysical Assessment of Tactile Pain and Thermal Sensory Functions in Burning Mouth Syndrome. *Pain* 28:169–184
4. Jaaskelainen SK, Forssell H, Tenovuoto O (1997) Abnormalities of the Blink Reflex in Burning Mouth Syndrome. *Pain* 73:455–460
5. Ship J, Grushka M, Lipton J, Mott AE, Sessle BJ, Dionne RA (1995) Burning Mouth Syndrome: An Update. *Journal of the American Dental Association* 126:842–853

## Burning Pain

### Definition

Burning pain is felt as intensely hot and from the skin. It occurs as a result of stimulation of heat-sensitive nociceptors, including those supplied by A-delta and C afferent axons.

► **First and Second Pain Assessment (First Pain, Pricking Pain, Pin-Prick Pain, Second Pain, Burning Pain)**

## Bursitis

### Definition

A painful bursae, usually resulting from unaccustomed physical activity, injury to the area, or constant pressure for extended periods of time such as the weight of sleeping on a specific structure. Classified as a localized STP.

► **Muscle Pain, Fibromyalgia Syndrome (Primary, Secondary)**

## Burst Activity in Thalamus and Pain

JONATHAN O. DOSTROVSKY

Department of Physiology, University of Toronto,  
Toronto, ON, Canada  
j.dostrovsky@utoronto.ca

### Synonyms

Bursting activity; Thalamic Bursting Activity; Calcium Spike Bursts; low threshold calcium spike (LTS) burst

### Definition

Thalamic neurons normally fire in two distinct modes – the tonic mode and the bursting mode. The latter firing mode is usually only observed during sleep. This “► **bursting activity**” is due to the intrinsic membrane properties of thalamic neurons. When they are in a hyperpolarized state, T-type calcium channels become de-inactivated and can then lead to calcium entry (a ► **low threshold calcium spike LTS**) when they are activated. This calcium spike gives rise to a short high frequency burst of action potentials. Several studies have reported the existence of LTS bursting activity in awake chronic pain patients, and have suggested that this activity may be related to their pain.

### Characteristics

Deafferentation and damage to CNS regions involved in the somatosensory system have been reported to give rise to abnormal bursting firing patterns in some neurons at various levels of the somatosensory system (Albe-Fessard and Longden 1983; Black 1974; Loeser et al. 1968; Lombard and Larabi 1983). These early observations have led investigators to propose that such spontaneous bursting activity is due to pathology, and may give rise to chronic central pain (e.g. see Boivie 1994; Lenz and Dougherty 1997).

Thalamocortical neurons are characterized by several intrinsic voltage- and time- dependent ionic conductances that give rise to two major firing states. During sleep, thalamic neurons tend to fire in a characteristic bursting firing pattern (the burst mode) which ceases during wakefulness to be replaced by a more regular firing pattern (the tonic mode) (see Steriade et al.

1997). This bursting activity occurs when the cell is in a hyperpolarized state which results in deinactivation of low-threshold T-type calcium channels, and which subsequently open when the cell depolarizes slightly, thus generating a low-threshold calcium spike (LTS) associated with a burst of sodium-generated action potentials. The burst of action potentials induced by the LTS has a very characteristic pattern, which consists of progressively increasing interspike intervals in each burst, and a first interspike interval that decreases with increasing burst size and thus can be identified in extracellular recordings (Domich et al. 1986). This type of bursting, which has been extensively studied in experimental animals, has also been shown to occur in the lateral thalamus of patients when they fall asleep (Tsoukatos et al. 1997; Zirh et al. 1998).

It is generally assumed that LTS-induced bursting normally occurs only during sleep and drowsiness, and thus that its presence in an awake patient signifies a pathological condition. Several groups have reported the existence of thalamic neurons in chronic pain patients, which fire in a bursting pattern similar to the low-threshold calcium spike-mediated bursting activity that has been reported during sleep in animal and human studies (Jeanmonod et al. 1996; Lenz and Dougherty 1997; Lenz et al. 1994; Rinaldi et al. 1991). Although such activity is common in medial thalamus it is also observed in lateral thalamus, including ► **Vc** (► **VPL** and ► **VPM**). It has been proposed that such firing may give rise to, or at least contribute to, the patients' chronic pain (Lenz and Dougherty 1997; Llinas et al. 1999). In support of this, it has been reported that in pain patients with central pain secondary to spinal cord transection, there is a higher likelihood of finding bursting activity in the border zone/anesthetic area of the deafferented somatosensory representation in Vc. This is an attractive hypothesis but difficult to prove since the bursting neurons do not have receptive fields, and so it is unclear whether they are part of the nociceptive system. Furthermore, bursting activity in the awake patient is by no means limited to pain patients, and has been reported in movement disorder and epilepsy patients, and can be found in regions that are unlikely to be related to the somatosensory system (Radhakrishnan et al. 1999). Rhythmic LTS bursting activity in thalamus has been proposed by Llinas et al. (1999) to be the basis of many neurological disorders including pain and has been termed thalamocortical dysrhythmia.

### References

1. Albe-Fessard D, Longden A (1983) Use of an Animal Model to Evaluate the Origin of and Protection against Deafferentation Pain. In: Bonica JJ, Lindblom U, Iggo A (eds) *Advances in Pain Research and Therapy*. Raven Press, New York, pp 691–700
2. Black RG (1974) A Laboratory Model for Trigeminal Neuralgia. *Adv Neural* 4:651–659
3. Boivie J (1994) Central pain. In: Wall PD (ed) *Textbook of Pain*. Churchill Livingstone, Philadelphia, pp 871–902

4. Domich L, Oakson G, Steriade M (1986) Thalamic Burst Patterns in the Naturally Sleeping Cat: A Comparison between Cortically Projecting and Reticularis Neurones. *J Physiol* 379:429–449
5. Jeanmonod D, Magnin M, Morel A (1996) Low-Threshold Calcium Spike Bursts in the Human Thalamus. Common Pathology for Sensory, Motor and Limbic Positive Symptoms. *Brain* 119:363–375
6. Lenz FA, Dougherty PM (1997) Pain Processing in the Human Thalamus. In: Steriade M, Jones EG, McCormick DA (eds) *Thalamus, Vol II, Experimental and Clinical Aspects*. Elsevier, Amsterdam, pp 617–652
7. Lenz FA, Kwan HC, Martin R et al. (1994) Characteristics of Somatotopic Organization and Spontaneous Neuronal Activity in the Region of the Thalamic Principal Sensory Nucleus in Patients with Spinal Cord Transection. *J Neurophysiol* 72:1570–1587
8. Llinas RR, Ribary U, Jeanmonod D et al. (1999) Thalamocortical Dysrhythmia: A Neurological and Neuropsychiatric Syndrome Characterized by Magnetoencephalography. *Proc Natl Acad Sci USA* 96:15222–15227
9. Loeser JD, Ward AAJ, White LE Jr (1968) Chronic Deafferentation of Human Spinal Cord Neurons. *J Neurosurg* 29:48–50
10. Lombard MC, Larabi Y (1983) Electrophysiological Study of Cervical Dorsal Horn Cells in Partially Deafferented Rats. In: Bonica JJ, Lindblom U, Iggo A (eds) *Advances in Pain Research and Therapy*. Raven Press, New York, pp 147–154
11. Radhakrishnan V, Tsoukatos J, Davis KD et al. (1999) A Comparison of the Burst Activity of Lateral Thalamic Neurons in Chronic Pain and Non-Pain Patients. *Pain* 80:567–575
12. Rinaldi PC, Young RF, Albe-Fessard D et al. (1991) Spontaneous Neuronal Hyperactivity in the Medial and Intralaminar Thalamic Nuclei of Patients with Deafferentation Pain. *J Neurosurg* 74:415–421
13. Steriade M, Jones EG, McCormick DA (1997) *Thalamus*. Elsevier Science, Oxford
14. Tsoukatos J, Kiss ZH, Davis KD et al. (1997) Patterns of Neuronal Firing in the Human Lateral Thalamus during Sleep and Wakefulness. *Exp Brain Res* 113:273–282
15. Zirh TA, Lenz FA, Reich SG et al. (1998) Patterns of Bursting Occurring in Thalamic Cells during Parkinsonian Tremor. *Neuroscience* 83:107–121

---

## Burst Firing Mode

### Definition

A pattern of spontaneous action potential firing, demonstrated by thalamic neurons in which a clear pattern of interspike intervals exists.

- ▶ [Burst Activity in Thalamus and Pain](#)
- ▶ [Spinothalamocortical Projections to Ventromedial and Parafascicular Nuclei](#)

---

## Bursting Activity

### Definition

A neuronal firing pattern characterized by short clusters of high frequency firing (short interspike intervals), in comparison to the mean firing rate of the neuron interspersed by time periods with minimal activity. In thalamus, bursting activity is usually caused by a low threshold calcium spike, with the interspike intervals typically ranging from 2 to 5 ms.

- ▶ [Burst Activity in Thalamus and Pain](#)
- ▶ [Central Pain, Human Studies of Physiology](#)
- ▶ [Chronic Pain](#)
- ▶ [Corticothalamic and Thalamocortical Interactions](#)
- ▶ [Thalamic Bursting Activity](#)
- ▶ [Thalamic Plasticity and Chronic Pain](#)

---

## Butterfly Erythema

### Definition

Of the face, typical symptom of systemic lupus erythematosus (SLE).

- ▶ [Headache Due to Arteritis](#)

---

## By the Ladder, by the Clock, by the Child and by the Mouth

### Definition

“By the ladder, by the clock, by the child and by the mouth” describes the World Health Organization (WHO) philosophy of varying level of strengths of analgesics that should be prescribed in an increasing ladder style approach, to be taken orally, when requested by the child and at regularly prescribed intervals.

- ▶ [Analgesic Guidelines for Infants and Children](#)

## C Afferent Axons/Fibers

### Synonyms

C Fibers

### Definition

One kind of fiber in the peripheral nerve; unmyelinated thin fibers. These high-threshold sensory afferents conduct very slowly (less than 2 m/s), and are thought to be responsible for the sensation of deep, burning pain that follows 'first pain' after injury. Although C fibers mature earlier than low-threshold A $\beta$  fibers, anatomically and neurochemically, other aspects of their function are delayed, for example, the phenomenon of neurogenic edema, and the development of functional central connections within the spinal cord.

- ▶ A Fibers (A-Fibers)
- ▶ Alpha( $\alpha$ ) 2-Adrenergic Agonists in Pain Treatment
- ▶ Infant Pain Mechanisms
- ▶ Insular Cortex, Neurophysiology and Functional Imaging of Nociceptive Processing
- ▶ Magnetoencephalography in Assessment of Pain in Humans
- ▶ Morphology, Intraspinal Organization of Visceral Afferents
- ▶ Nociceptor, Categorization
- ▶ Nociceptors in the Orofacial Region (Temporomandibular Joint and Masseter Muscle)
- ▶ Nociceptor(s)
- ▶ Opiates During Development
- ▶ Spinothalamic Tract Neurons, in Deep Dorsal Horn
- ▶ Thalamus, Dynamics of Nociception
- ▶ Vagal Input and Descending Modulation

## C and A Fibers

### Definition

Nociceptive input is conveyed from the peripheral terminals to the spinal cord, predominantly by two classes of primary afferent fibers. Of these, the slowly-conducting, thinly-myelinated A $\delta$ -fibers mediate thermal and mechanical nociception, whereas the unmyeli-

nated, polymodal C-fibers are activated by a variety of high-intensity mechanical, chemical, hot and cold stimuli. In addition, low threshold fibers (A $\beta$ ) that normally only transfer innocuous sensations like touch, can contribute to neuropathic pain following nerve damage.

- ▶ Opioids in the Periphery and Analgesia

## Cachexia

### Definition

General ill health and malnutrition that presents as muscle wasting, dehydration and reduced behavioral activities in untreated diabetic animals.

- ▶ Neuropathic Pain Model, Diabetic Neuropathy Model

## CACNA1A

### Definition

CACNA1A is a gene encoding the  $\alpha$ 1A subunit of a voltage sensitive calcium channel abundantly expressed in neuronal tissue. It is activated by high voltage and gives rise to P/Q-type calcium currents. Mutations in the human gene are related to diseases like spinocerebellar ataxia type 6, familial hemiplegic migraine and episodic ataxia type 2. In mice, mutations in the orthologous gene are responsible for the "leaner" and "tottering" phenotypes.

- ▶ Calcitonin Gene-Related Peptide and Migraine Headaches

## Calbindin

### Definition

Vitamin D-dependent calcium-binding protein that is present in specific sensory neuronal cell types.

- ▶ Spinothalamic Terminations, Core and Matrix
- ▶ Thalamus, Receptive Fields, Projected Fields, Human



## Calbindin D-28k

### Definition

A member of the EF-hand family calcium binding proteins, which buffer intracellular calcium concentration and mediate a variety of cellular functions. Calbindin D-28k has six EF-hand domains, but only four of them bind to calcium. Calbindin D-28k has been used as a marker of nerve cells in neuroanatomical studies, since it selectively distributes in subpopulations of central nervous system neurons in specific regions. In the monkey thalamus, calbindin D-28k antibodies selectively label the matrix domain of the medial ventroposterior nucleus of the thalamus, which is related to trigeminothalamic projection from the caudal spinal trigeminal nucleus subnucleus caudalis.

- ▶ Trigeminothalamic Tract Projections

## Calbindin-Immunoreceptive Matrix Cells

### Definition

Sensory neurons that stain positively for the presence of vitamin D-dependent calcium-binding protein.

- ▶ Thalamic Nuclei Involved in Pain, Human and Monkey

## Calcitonin Gene-Related Peptide

### Synonyms

CGRP

### Definition

CGRP is a 37-amino acid peptide that is produced by tissue-specific processing of the calcitonin gene. It belongs to the Calcitonin/CGRP family which includes other peptides like calcitonin, amylin, adrenomedullin and intermedin. CGRP is comprised of at least two forms:  $\alpha$ CGRP and  $\beta$ CGRP. Whereas  $\alpha$ CGRP is found in DRG neurons of all sizes,  $\beta$ CGRP is localized to small- and medium-sized neurons. CGRP functions primarily as a neuromodulator and signals via a heterodimeric receptor complex consisting of a G-protein coupled receptor (calcitonin-like receptor) and a receptor activity modifying protein (RAMP1) and stimulates cAMP formation intracellularly. Release of CGRP from the peripheral terminals of DRG neurons contributes to neurogenic inflammation. During this process, CGRP is the most potent vasodilator in the microcirculation identified so far and acts by relaxing small arteries and arterioles. Furthermore, CGRP acts together with substance P to potentiate plasma extravasation where

proteins from the blood stream pass into the surrounding tissue. Release of CGRP from the central terminals of DRG neurons modulates spinal cord neurons, in part by enhancing the actions of substance P. It also plays a role in pain processing.

- ▶ Alternative Medicine in Neuropathic Pain
- ▶ Calcitonin Gene-Related Peptide and Migraine Headaches
- ▶ Clinical Migraine without Aura
- ▶ Immunocytochemistry of Nociceptors
- ▶ Migraine, Pathophysiology
- ▶ Neuropeptide Release in the Skin
- ▶ Nociceptor, Categorization
- ▶ Nociceptors in the Orofacial Region (Meningeal/Cerebrovascular)
- ▶ Opioids in the Periphery and Analgesia
- ▶ Opioid Modulation of Nociceptive Afferents In Vivo
- ▶ Spinal Cord Nociception, Neurotrophins
- ▶ Thalamus, Visceral Representation

## Calcitonin Gene-Related Peptide and Migraine Headaches

KIRSTEN ARNDT, STEFAN JUST, HENRI DOODS  
CNS Pharmacology, Pain Research, Boehringer  
Ingelheim Pharma GmbH & Co. KG, Biberach/Riss,  
Germany  
kirsten.arndt@bc.boehringer-ingelheim.de

### Synonym

CGRP

### Definition

▶ **Migraine** is a complex, multi-symptom disease affecting 10–16% of the western population. It has a higher prevalence in women than in men. Migraine characteristics are its episodic appearance and symptoms such as unilateral headache, phono- and/or photo-phobia, facial mechanical allodynia and nausea and vomiting (Headache Classification Subcommittee of the International Headache Society 2004). Preceding the headache, 20–30% of the patients experience focal neurological symptoms termed aura. Based on the presence or absence of an aura, migraines are classified as either “classical” migraine (migraine with aura), or “common” migraine (migraine without aura). Generally, a migraine attack can be subdivided into different phases that include the premonitory phase, headache and the postdrome. The prevalence of the different symptoms varies over the phases with e.g. being tired and weary as approximately equally prominent in all phases and “stiff neck” being most prevalent in the headache and postdrome phases. Typically, a migraine attack lasts from 4 to 72 hours.

► **Calcitonin gene-related peptide (CGRP)** is a neuropeptide and important vasodilator. It is released during migraine attacks. Blockade of CGRP receptors in humans alleviates migraine pain.

## Characteristics

### Underlying Causes of a Migraine Attack

Despite many approaches to understand the initiation of migraine attacks, “the migraine trigger” or the physiological starting point has not yet been identified. To date it is also not possible to come up with a primary underlying cause for migraines and probably there is more than one. Several genetic factors have been discussed as rendering a person more susceptible to developing migraines, as well as disturbances of central neuronal function or cranial changes in vasodynamics. Many of these hypotheses evolved from studies of one subtype of migraine patients, the ones experiencing classical migraines. Potential genetic defects which might cause classical migraines include e.g. missense mutations in the ► **CACNA1A** gene encoding the  $\alpha 1$  subunit of the voltage dependent P/Q type calcium channel, which accounts for 50% of an autosomal disease called familial hemiplegic migraine (FHM1). Missense mutations in the **ATP1A2** gene, which encodes the  $\alpha 2$  isoform of the enzyme Na, K-ATPase, have been shown to be responsible for additional cases of FHM.

Besides the genetic factors, local disturbances of central neuronal function, i.e. the cortical spreading depression (CSD) of Leão or activity changes in brainstem/ midbrain neuronal systems have been hypothesized to be a main cause underlying migraine attacks. In the forebrain, CSD is a wave of excitation that propagates across the cortex, followed by a wave of suppression. Recent evidence suggests that CSD is the physiological phenomenon causing the aura phenomenon of classical migraines (Hadjikhani et al. 2001). Whether CSDs also occur in common migraines is not yet known. Neuronal dysfunction of brainstem/ midbrain neuronal systems involved in pain inhibition/facilitation has also been suggested (Knight and Goadsby 2001; May 2003). Human fMRI studies during migraine attacks indicate changed neuronal activity in certain brainstem and midbrain areas (Weiller et al. 1995). The anatomical location suggests that the function of these regions is associated with adjusting nociceptive information entering the brain by either inhibiting or facilitating the responses of neurons and sensory terminals in the brainstem trigeminal nucleus caudalis (TNC). Furthermore, extensive changes in vasodynamics have long been implicated in the pathogenesis of migraines, e.g. alterations in intracranial vessel diameters followed by reactive changes in extracranial vessel diameters were already investigated in 1938 by Graham and Wolff. Also, the first specific treatment employed, the ergotamines, work as vasoconstrictors. More recent support for the importance of vasodilata-

tion is coming from observations employing transcranial laser Doppler measurements, which suggest that migraine attacks are associated with intracranial large arterial dilatation on the headache side.

Together the possible causes described above provide links to the observed migraine symptomatology and potential underlying mechanisms. They deliver the biological “hardware” which contributes to migraine pathogenesis. The focus is on the cranial vasculature and the trigeminal sensory system controlling the vasculature and transmitting information to brainstem and midbrain nuclei, which in turn monitor and adjust the incoming information. During a migraine attack, adjustments made by these systems might be reflected by certain symptoms. As an example, the symptom unilateral throbbing pain at the temples seems to be caused by mechanisms like sensitization of sensory afferents in the periphery. In addition, facial mechanical allodynia might be initiated by neuronal sensitization processes advancing from sensory to central neurons (Burstein et al. 2000). Understanding migraine symptoms and the potential mechanisms driving an attack is an important basis for understanding the disease and getting a handle on the essential molecular drivers that direct the biological systems towards a migraine attack.

### The Neuropeptide CGRP, an Important Molecular Player in Migraine Attacks

Several molecules have been identified that trigger headache responses fulfilling the criteria of migraine attacks. Among them are NO released from glyceryl trinitrate (GTN), histamine, prostaglandin E1 and CGRP. These molecules have in common that they induce vasodilatation and affect sensory neuron function. The 37 amino acid neuropeptide CGRP has been shown to be one of the most potent vasodilators in human and animal tissues and is widely distributed throughout the body. Two isoforms,  $\alpha$  and  $\beta$  CGRP are known, which originate from different genes. The isoforms differ by only 1 and 3 amino acids in rats and humans, respectively. The peptides are expressed by primary afferent neurons, which mostly fire in the C- and A $\delta$  fiber range, as well as by motor neurons, the autonomous nervous system and central neurons. The CGRP receptor mediating CGRP function consists of three components, a G protein coupled seven transmembrane receptor element known as calcitonin-like receptor (CLR) a receptor associated membrane protein 1 (RAMP1) and a protein termed receptor component protein (RCP) (Poyner et al. 2002). While CLR and RAMP1 are membrane constituents, RCP is a cytoplasmic protein shown to be crucial for the efficient intracellular coupling of the G protein and adenylate cyclase and thus for the production of cAMP. Constituents of the CGRP receptor have been shown to be expressed by peripheral and central neurons as well as by smooth muscle cells in the vascular system.

Ample evidence that CGRP could play an important role in migraine pathophysiology comes from various studies investigating the transmitter content of external jugular vein blood during migraine attacks (Goadsby and Edvinsson 1994, Sarchielli et al. 2000). These studies demonstrate that levels of CGRP normally found to be in the lower pM range and below are approximately 2-fold increased during acute migraine attacks. Also, increasing the plasma levels by a short infusion of CGRP triggers immediate headaches followed by a delayed severe headache in migraineurs. The symptoms of the delayed headache are indistinguishable from that of a migraine. Furthermore, current gold standard migraine treatment with sumatriptan, a 5HT<sub>1B/1D</sub> agonist, reduces blood levels of CGRP in humans and in animal experiments. A relationship between pain intensity and plasma CGRP levels has been suggested. Finally, more direct evidence for the contribution of CGRP to migraine pain was introduced by a recent phase II clinical trial. Olesen et al. (2004) investigated the effectiveness of the small molecule CGRP antagonist BIBN4096 in reducing migraine pain. In this multicenter, double blind, randomized clinical trial, a dose dependent relief from migraine pain was observed after BIBN4096 intravenous administration. The 2.5 mg dose represented the dose group with the highest patient number. It displayed a response rate of approximately 66% over 27% for placebo (Fig. 1). A general pain relieving effect was already observed 30 min after application of BIBN4096. Significant efficacy over placebo was also observed in other migraine specific secondary endpoints, including the pain-free rate, the 24 hr recurrence rate and typical migraine associated symptoms like nausea and phono- and/or photo-phobia. The drug was well tolerated and no serious adverse events were observed.

In summary, evidence like increased CGRP levels during an attack, the induction of migraine attacks by infusion of CGRP, CGRP levels showing a relationship to

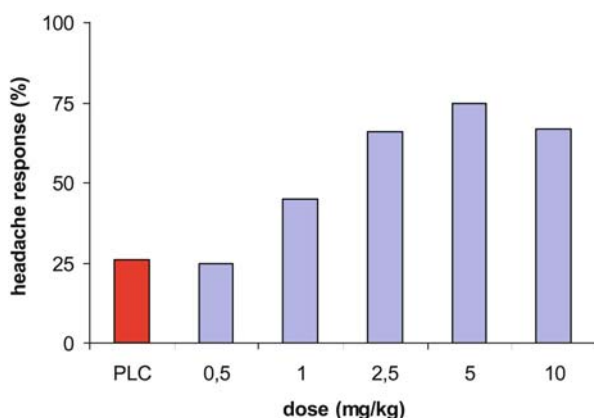
pain intensity and high CGRP levels detected early in an attack, as well as current and future treatment affecting CGRP function, point to a significant contribution of the neuropeptide to the pathogenesis of migraines. CGRP might be not only a marker but also an important driver of processes underlying migraine symptomatology. Nevertheless, to date its mechanism of action in the migraine setting is still not fully understood.

#### Potential Function of CGRP in Migraine

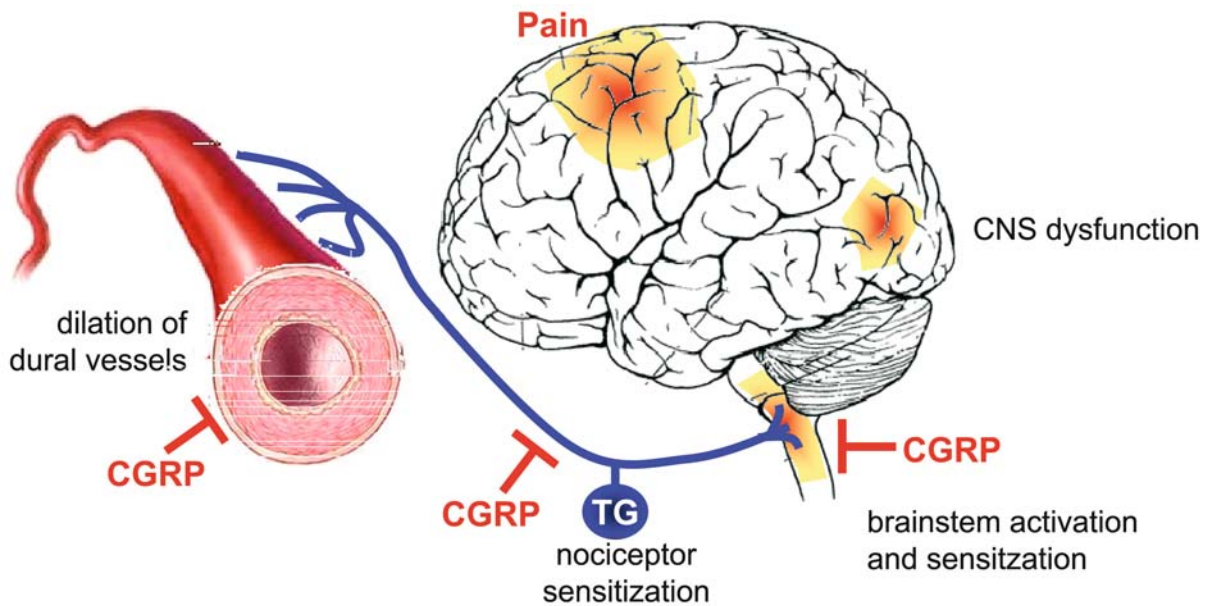
Some insights into the potential function of CGRP come from animal studies investigating the activity of the highly selective and competitive CGRP antagonist BIBN4096 in the vascular and neuronal system. BIBN4096 has a high affinity for the human CGRP receptor (14.4 pM) and potently reverses CGRP-induced vasodilatation in various rat and guinea pig vascular tissues as well as human cerebral arteries (Doods 2001). Furthermore, in an *in vivo* model where an increase in facial blood flow is induced by unilateral electrical stimulation of the trigeminal ganglion, BIBN4096 dose dependently reduces the evoked blood flow with an ID<sub>50</sub> of 0.003 mg/kg in marmoset monkeys. Recent detailed investigations into the mechanism of action of the antagonist in humans showed that in healthy volunteers BIBN4096 prevented CGRP-induced extracranial dilatation and concomitantly reduced CGRP-induced headaches (Petersen et al. 2005). Together these data support the significance of CGRP-induced vasodynamic changes in migraine headaches.

CGRP and its receptor system are not only expressed by the vasculature but also by trigeminal and second order neurons in the brainstem TNC. It therefore might well be that during migraine attacks increased CGRP levels influence trigeminal neuronal information processing besides affecting vasodynamics. Unfortunately, the role of CGRP is not very well explored in the trigeminal system. This is especially true for the primary afferent. In the central portion, direct application of  $\alpha$ CGRP into the TNC increased the firing rate of the neurons. In this setting, intravenous administration of the CGRP antagonist BIBN4096 dose dependently inhibited increased activity of TNC neurons. Because the selective CGRP antagonist BIBN4096 is able to reduce central neuronal activity, the data suggest that CGRP participates in increasing the activity of and/or sensitizing second order neurons in the TNC under these experimental conditions. Whether CGRP sensitizes central second order neurons directly or increases the firing rate of trigeminal neurons that then drive central sensitization or both has still to be demonstrated.

In summary, these experimental animal studies suggest that CGRP can affect nociceptive processing in the trigeminal system. Increased CGRP levels being present during migraine attacks could imply a role of CGRP in sensitization of primary and/or central neurons



**Calcitonin Gene-Related Peptide and Migraine Headaches, Figure 1** Two hr headache response after intravenous administration of several doses BIBN4096 in the phase II clinical trial.



**Calcitonin Gene-Related Peptide and Migraine Headaches, Figure 2** Possible points of action of CGRP in migraine pathogenesis.

besides inducing vasodynamic changes in the cranial vasculature (Fig. 2).

Although migraine pathogenesis still offers vagueness with respect to the trigger(s) and numerous hypotheses on causes and the biological processes behind the symptoms, the testing of new molecular principles like that of the CGRP antagonist BIBN4096 opens new paths for the understanding of underlying mechanisms and the identification of important contributors to this complex disease.

## References

- Burstein R, Yarnitsky D, Goor-Aryeh I et al. (2000) An association between migraine and cutaneous allodynia. *Ann Neurol* 47:614–624
- Doods H (2001) Development of CGRP antagonists for the treatment of migraine. *Curr Opin Investig Drugs* 9:1261–1268
- Goadsby PJ, Edvinsson L (1994) Neuropeptides in migraine and cluster headache. *Cephalalgia* 14:320–327
- Graham JR, Wolff HG (1938) Mechanism of migraine headache and action of ergotamine tartrate. *Arch Neurol Psychiatry* 39:737–763
- Hadjikhani N, Sanchez Del Rio M, Wu O et al. (2001) Mechanisms of migraine aura revealed by functional MRI in human visual cortex. *Proc Natl Acad Sci USA* 98:4687–4692
- Headache Classification Subcommittee of the International Headache Society (2004) The international classification of Headache disorders. *Cephalalgia* 24:9–160
- Knight YE, Goadsby PJ (2001) The periaqueductal grey matter modulates trigeminovascular input: a role in migraine? *Neuroscience* 106:793–800
- May A (2003) Headache: lessons learned from functional imaging. *Br Med Bull* 65:223–234
- Olesen J, Diener HC, Husstedt IW et al. (2004) BIBN 4096 BS Clinical Proof of Concept Study Group. Calcitonin gene-related peptide receptor antagonist BIBN 4096 BS for the acute treatment of migraine. *N Engl J Med* 350:1104–1110
- Petersen KA, Lassen LH, Birk S et al. (2005) BIBN4096BS antagonizes human alpha-calcitonin gene related peptide-induced headache and extracerebral artery dilatation. *J Clin Pharmacol Ther* 77:202–213
- Poyner DR, Sexton PM, Marshall I et al. (2002) International Union of Pharmacology. XXXII. The mammalian calcitonin gene-related peptides, adrenomedullin, amylin, and calcitonin receptors. *Pharmacol Rev* 54:233–246
- Sarchielli P, Alberti A, Codini M et al. (2000) Nitric oxide metabolites, prostaglandins and trigeminal vasoactive peptides in internal jugular vein blood during spontaneous migraine attacks. *Cephalalgia* 20:907–918
- Weiller C, May A, Limmroth V et al. (1995) Brain stem activation in spontaneous human migraine attacks. *Nat Med* 1:658–660

## Calcium Channel Blockers

### Definition

A class of drugs with the capacity to prevent calcium ions from passing through biologic membranes. These agents are used to treat hypertension, angina pectoris and cardiac arrhythmias; examples include nifedipine, diltiazem, verapamil, amlodipene.

► [Headache Attributed to a Substance or its Withdrawal](#)

## Calcium Channels in the Spinal Processing of Nociceptive Input

HORACIO VANEGAS

Instituto Venezolano de Investigaciones Científicas (IVIC), Caracas, Venezuela and Institute for Physiology, Friedrich Schiller University, Jena, Germany

hvanegas@ivic.ve



## Synonyms

Voltage-Dependent Calcium Channels; VDCCs; voltage-sensitive calcium channels; VSCCs, high-threshold calcium channels; High-Threshold VDCCs; High-Voltage Calcium Channels; HVCCs; Low-Threshold Calcium Channels; Low-Threshold VDCCs; Low-Voltage Calcium Channels; LVCCs; hyperalgesia; allodynia; spinal dorsal horn; spinal nociceptive transmission

## Definition

Calcium channels that open upon depolarization (voltage-dependent calcium channels, VDCCs) enable calcium ions to enter neurons. VDCCs are thereby involved in synaptic transmission, changes in membrane excitability, intracellular regulation of second and third messengers and expression of genes. Spinal VDCCs that are opened by relatively large depolarizations (high-threshold VDCCs) or by small depolarizations (low-threshold VDCCs) are involved in normal nociception as well as in the hyperalgesia and allodynia that result from inflammatory and mechanical lesions of peripheral tissues or from lesions of primary afferents fibers.

## Characteristics

### Voltage-Dependent Calcium Channels

VDCCs are classified according to their electrophysiological properties and their sensitivity to specific antagonists (Miljanich and Ramachandran 1995). L-, N-, P/Q- and R-type are high-threshold whereas T-type are low-threshold VDCCs. Most of what is known regarding the role of spinal VDCCs in pain (see Vanegas and Schaible 2000 for a comprehensive review) derives from studies based on the use of specific channel antagonists or blockers (Table 1). By definition, there are no specific blockers for R-type VDCCs; their role in pain mechanisms is therefore unclear. One and the same neuron may express several types of VDCC. An antagonist to only one channel type therefore blocks only a fraction of the

VDCCs present in a neuron or a neuronal ensemble such as the spinal cord, but the effect of one antagonist may be additive to the effect of antagonists to other channel types.

### Animal Models for the Study of VDCCs in Nociception

On the one hand there are the models for “acute” nociception, in which brief and intense stimuli are applied to normal tissues (see Vanegas and Schaible 2000). These stimuli include noxious heat or noxious pressure as applied to skin or joints, application or injection of algogenic substances such as capsaicin, mustard oil, formalin or acetic acid, and noxious distension of hollow viscera. Upon stimulus application, withdrawal reflexes and other protective behaviors can be measured or the response of dorsal spinal nociceptive neurons can be recorded prior to and during the action of specific VDCC antagonists. Also spinal neuronal responses to electrical stimulation of nociceptive primary afferent fibers may serve as a measure of nociception.

On the other hand, animal models of persistent damage include inflammation of skin or joints, surgical wounds, long-lasting hyperexcitability induced by application or injection of capsaicin, mustard oil or formalin, ligation of peripheral nerves, and diabetic neuropathy (see Vanegas and Schaible 2000). These manipulations induce peripheral and central sensitization and the experimental animals thus respond in an exaggerated manner to the “acute” stimuli mentioned above. This is akin to ► hyperalgesia and ► allodynia, and the effect of specific VDCC antagonists on these exaggerated responses can be investigated.

It is now possible to generate mice that lack one of the molecular subunits of specific calcium channels and to study their nociceptive responses both under normal and under sensitized conditions. The VDCC defect in these animals, however, is not restricted to the spinal cord.

### Role of Spinal VDCCs in Nociception

#### Normal Nociception

In awake and in anesthetized rats, L- and N-type antagonists may or may not depress responses to mechanical innocuous or noxious, thermal noxious and visceral noxious stimuli, or responses to electrical stimulation of nociceptive afferents (e.g. Malmberg and Yaksh 1994; Neugebauer et al. 1996). Blockade of spinal P/Q-type channels causes a slight increase in neuronal responses, thus suggesting that they normally participate in predominantly inhibitory mechanisms (Matthews and Dickenson 2001a; Nebe et al. 1999). Finally, blockade of spinal T-type channels causes an inhibition of spinal neuronal responses to electrical stimulation of nociceptive afferents as well as to low- and high-intensity mechanical and thermal stimuli (Matthews and Dickenson 2001b).

Mice with a genetically induced lack of N-type VDCCs may or may not show decreased responses to

**Calcium Channels in the Spinal Processing of Nociceptive Input, Table 1** Some antagonists to voltage-dependent calcium channels

channel type	antagonist
L	<i>Benzothiazepines</i> : diltiazem <i>Dihydropyridines</i> : nifedipine, nifedipine, nimodipine, nitrendipine <i>Phenylalkylamines</i> : verapamil
N	$\omega$ - <i>Conopeptides</i> : <i>natural</i> : $\omega$ -conotoxin-GVIA, $\omega$ -conotoxin-C1VD (AM336) <i>synthetic</i> : SNX-111 (equivalent to $\omega$ -conotoxin-MVIIA), SNX-124 (equivalent to $\omega$ -conotoxin-GVIA), SNX-159, SNX-239
P/Q	$\omega$ - <i>Agapeptide</i> : $\omega$ -agatoxin-IVA
T	<i>ethosuximide</i>



“acute” thermal and/or mechanical noxious stimuli (Hatakeyama et al. 2001; Kim et al. 2001; Murakami et al. 2002; Saegusa et al. 2001). Mice that lack the  $\alpha_{1E}$  subunit (which may be part of the R- or the T-type channel) have normal responses to thermal and mechanical noxious stimuli (Saegusa et al. 2000).

### Sensitized Nociception

In animal models that utilize nociceptive stimulation by means of capsaicin or mustard oil (see Vanegas and Schaible 2000), blockade of spinal N-type channels always prevents the subsequent exaggeration of responses (primary and secondary hyperalgesia and allodynia) to “acute” test stimuli. Also, blockade of spinal L- or P/Q-type channels generally prevents secondary hyperalgesia and allodynia.

As regards responses to test stimuli during inflammation or inflammation-like processes such as surgical wounds, blockade of N-type channels in animals has never failed to prevent or attenuate primary hyperalgesia, secondary hyperalgesia and allodynia or the late, “inflammatory” response to formalin injection (see Vanegas and Schaible 2000). The most effective doses of N-type antagonists, however, cause motor disturbances after 30–60 min. In human patients, one intrathecally administered N-type channel blocker alleviated postsurgical pain but produced severe adverse effects (Atanassoff et al. 2000). On the other hand, blockade of spinal L-type channels has generally prevented the late phase of the formalin response and has attenuated primary and secondary mechanical hyperalgesia and allodynia (but not thermal hyperalgesia) due to knee inflammation. Finally, blockade of spinal P/Q-type channels before and during induction of inflammation prevents the exaggeration of responses to stimulation of the inflamed knee or the uninflamed ankle. However, blockade of P/Q-type channels when central sensitization is already established attenuates only responses to stimulation of the sensitized nociceptors in the knee (primary hyperalgesia and allodynia) but has no influence upon responses to stimulation of normal nociceptors in the uninflamed ankle (Nebe et al. 1997). The effect of a given compound on the prevention of a painful condition may therefore be different from its effect on the alleviation of the already established condition.

Mice with a genetically induced lack of either N-type VDCCs or the  $\alpha_{1E}$  subunit of VDCCs show an attenuation of the late phase of the formalin response (Hatakeyama et al. 2001; Kim et al. 2001; Saegusa et al. 2000; Saegusa et al. 2001). The writhing response to intraperitoneal acetic acid, a model of visceral nociception, may (Kim et al. 2001) or may not (Saegusa et al. 2000; Saegusa et al. 2001) be attenuated.

In animals with peripheral nerve damage, spinal application of antagonists to either L- or P/Q-type VDCCs does not alter the hyperalgesia and allodynia, nor the increased spinal neuronal responses to noxious heat,

pressure or electrical stimulation of nociceptive afferents (Matthews and Dickenson 2001a; see Vanegas and Schaible 2000). In contrast, spinal application of N-type channel antagonists has proven effective against neuropathic nociceptive behavior in animals (see Vanegas and Schaible 2000) and against the increased spinal neuronal responses to noxious heat, pressure or electrical stimulation of nociceptive afferents induced by nerve damage (Matthews and Dickenson 2001a). Also, mice with a genetically induced lack of N-type VDCCs fail to develop neuropathic behavioral responses after peripheral nerve damage (Saegusa et al. 2001). Intrathecal administration of one N-type antagonist alleviated neuropathic pain and allodynia in human patients, although with considerable adverse effects (Brose et al. 1997; Penn and Paice 2000). Finally, the inhibition by a T-type VDCC antagonist of spinal neuronal responses to noxious heat, pressure or electrical stimulation of nociceptive afferents remains unaltered after development of neuropathy (Matthews and Dickenson 2001b).

### In Summary

Pharmacological or genetic reduction of VDCC function may or may not have an effect upon normal nociceptive mechanisms. In situations where inflammation or inflammation-like processes have induced an enhancement of spinal nociceptive phenomena (central sensitization), the participation of VDCCs in the spinal processing of nociceptive input becomes more obvious and reduction of L-, P/Q-, T- and, particularly, N-type VDCC function attenuates the exaggeration of responses to noxious and innocuous stimulation. N-type VDCC antagonists also attenuate the spontaneous pain, the hyperalgesia and the allodynia that result from damage to primary afferents, yet with considerable adverse effects.

### Potential Therapeutic Use of VDCC Antagonists

Any hope of using VDCC antagonists for alleviating hyperalgesia and allodynia in a clinical setting must reckon with several drawbacks. All studies with spinal VDCC antagonists have used the intrathecal route of administration, which is problematic, especially for compounds of low water solubility. On the other hand, systemically administered VDCC antagonists may have undesirable effects on a variety of organs. Sufficiently beneficial effects with VDCC antagonists are attained mostly with doses that already cause unwanted effects. At the same time, VDCC antagonists have some positive attributes. They may block the synaptic release of several mediators involved in nociceptive transmission, hyperalgesia and allodynia. This would be an advantage over the use of individual antagonists to, e.g. glutamate, **▶ substance P**, neurokinin A and **▶ CGRP**. In contrast with opioids, which may also decrease synaptic release, VDCC antagonists do not seem to give rise to tolerance. In some cases, normal somethesia and motricity have been spared by doses that are effective against hyperalgesia and allody-

nia. Specific antagonists to various VDCC types can be combined in submaximal doses to achieve a summated effect. Finally, VDCC antagonists may synergize with, e.g. opiates and local anesthetics.

## References

1. Atanassoff PG, Hartmannsgruber MW, Thrasher J et al. (2000) Ziconotide, a new N-type calcium channel blocker, administered intrathecally for acute postoperative pain. *Reg Anesth Pain Med* 25:274–278
2. Brose WG, Gutlove DP, Luther RR et al. (1997) Use of intrathecal SNX-111, a novel, N-type, voltage-sensitive, calcium channel blocker, in the management of intractable brachial plexus avulsion pain. *Clin J Pain* 13:256–259
3. Hatakeyama S, Wakamori M, Ino M et al. (2001) Differential nociceptive responses in mice lacking the  $\alpha_{1B}$  subunit of N-type  $Ca^{2+}$  channels. *NeuroReport* 12:2423–2427
4. Kim C, Jun K, Lee T et al. (2001) Altered nociceptive responses in mice deficient in the  $\alpha_{1B}$  subunit of the voltage-dependent calcium channel. *Mol Cell Neurosci* 18:235–245
5. Malmberg AB, Yaksh TL (1994) Voltage-sensitive calcium channels in spinal nociceptive processing: blockade of N- and P-type channels inhibits formalin-induced nociception. *J Neurosci* 14:4882–4890
6. Matthews EA, Dickenson AH (2001a) Effects of spinally delivered N- and P-type voltage-dependent calcium channel antagonists on dorsal horn neuronal responses in a rat model of neuropathy. *Pain* 92:235–246
7. Matthews EA, Dickenson AH (2001b) Effects of ethosuximide, a T-type  $Ca^{2+}$  channel blocker, on dorsal horn neuronal responses in rats. *Eur J Pharmacol* 415:141–149
8. Miljanich GP, Ramachandran J (1995) Antagonists of neuronal calcium channels: structure, function, and therapeutic implications. *Annu Rev Pharmacol Toxicol* 35:707–734
9. Murakami M, Fleischmann B, De Felipe C et al. (2002) Pain perception in mice lacking the  $\beta_3$  subunit of voltage-activated calcium channels. *J Biol Chem* 277:40342–40351
10. Nebe J, Vanegas H, Neugebauer V et al. (1997)  $\omega$ -Agatoxin IVA, a P-type calcium channel antagonist, reduces nociceptive processing in spinal cord neurons with input from the inflamed but not from the normal knee joint -An electrophysiological study in the rat in vivo. *Eur J Neurosci* 9:2193–2201
11. Nebe J, Ebersberger A, Vanegas H et al. (1999) Effect of  $\omega$ -agatoxin IVA, a P-type calcium channel antagonist, on the development of spinal neuronal hyperexcitability caused by knee inflammation in rats. *J Neurophysiol* 81:2620–2626
12. Neugebauer V, Vanegas H, Nebe J et al. (1996) Effects of N- and L-type calcium channel antagonists on the responses of nociceptive spinal cord neurons to mechanical stimulation of the normal and inflamed knee joint *J Neurophysiol* 76:3740–3749
13. Penn RD, Paice JA (2000) Adverse effects associated with the intrathecal administration of ziconotide. *Pain* 85:291–296
14. Saegusa H, Kurihara T, Zong S et al. (2000) Altered pain responses in mice lacking the  $\alpha_{1E}$  subunit of the voltage-dependent  $Ca^{2+}$  channel. *Proc Natl Acad Sci USA* 97:6132–6137
15. Saegusa H, Kurihara T, Zong S et al. (2001) Suppression of inflammatory and neuropathic pain symptoms in mice lacking the N-type  $Ca^{2+}$  channel. *EMBO J* 20:2349–2356
16. Vanegas H, Schaible H-G (2000) Effects of antagonists to high-threshold calcium channels upon spinal mechanisms of pain, hyperalgesia and allodynia. *Pain* 85:9–18

## Calcium Spike Bursts

- Burst Activity in Thalamus and Pain

## Calculus

- Visceral Pain Model, Kidney Stone Pain

## CAMs

- Cellular Adhesion Molecules

## Cancer Pain

ZBIGNIEW ZYLICZ, MAŁGORZATA KRAJNIK  
St. Elizabeth Hospice, Ipswich, Suffolk, UK  
zzylicz@onetel.net

### Synonyms

Malignant pain; Pain Due to Cancer; oncological pain

### Definition

'Cancer pain' is a conglomerate name for all kinds of pain symptoms experienced in the course of a malignant disease. The common denominator of pain associated with cancer is that the suffering experienced by the patient is a combination of many different kinds of pain, for example, other symptoms of the disease as well as psychological, spiritual and existential factors.

### Characteristics

Pain is experienced by 20–50% of cancer patients at the time of diagnosis. This prevalence increases up to 75% in the case of patients with advanced stages of the disease. Within these statistics half of the patients normally experience moderate or severe pain, whereas 20–30% experience very severe or excruciating pain (Anonymous 1990).

Usually, cancer patients experience pain of more than one quality and in more than one location. Only 20% of patients experience one single location of pain. In one third of patients there are three or more pain locations (Twycross et al. 1996).

According to Grond et al. (1996) cancer pain may be related to:

- tumor growth: 85%
- tumor treatment: 17%
- progressive debility: 9%
- concurrent disorder: 9%

Cancer pain may originate in many locations and have multiple, inter-twined mechanisms. The top 10 pains among 211 patients (Twycross 2003) with advanced cancer were:

- bone
- visceral

- neuropathic
- soft tissue
- immobility
- constipation
- myofascial
- cramp
- esophagitis
- degeneration of the spine

It therefore follows that careful evaluation and examination is necessary to make a diagnosis of cancer pain. Evaluation of pain is based primarily on probability and pattern recognition. Factors that may be helpful in the diagnosis of cancer pain are:

The natural history of the disease (e.g. breast cancer often causes bone metastases and ► **bone pain**, ovarian cancer may rarely cause brain metastases and headache). A time course of the pain symptoms may be important. ► **Brachial or lumbal plexopathy** that resulted in pain even before radiation therapy is probably caused by the growth of the tumor, but may be exacerbated by the radiation therapy. Lack of pain two or three weeks after irradiation may be not related to the opioids administered, but to the radiation therapy.

Plain radiographic imaging is helpful in discovering the origin of bone pain. Pain originating in soft tissues and neural tissues needs more sophisticated techniques (MRI). Some types of pain (e.g. ► **neuropathic pain**) may be “invisible” to radiographic imaging. Neuropathic pain may frequently be a component of another pain (Portenoy et al. 1999), it may be a complication of therapy, but may also be a paraneoplastic symptom. An evaluation of neurological deficit may frequently lead to better understanding and diagnosis of pain. ► **Spinal cord compression** (SCC) occurs in 3% of all cancer patients.

► **Nerve compression** or entrapment usually gives a specific syndrome (e.g. vertebral collapse may cause nerve root compression).

► **Response to analgesics** may often give a clue to the type of pain (e.g. nociceptive pain responds readily to opioids, while neuropathic pain may be resistant to this treatment). Full history of the pharmacological and non-pharmacological treatment of the pain should be taken. Emotional, social and spiritual factors may make the precise diagnosis of pain difficult, and should be recognized and addressed specifically.

A distinction should be made between pain whilst at rest and pain during movement. Pain may have a circadian distribution. Many types of cancer pains are constant, but some may appear to have an exploding character (► **breakthrough pain**), even when the optimal analgesia is provided (Portenoy et al. 1999).

Patients who describe their pain as throbbing, lancinating and burning, and exacerbated by light touch during examination, may appear to have ► **mechanical allodynia**.

**Cancer Pain, Table 1** The WHO analgesic ladder

Step 1	Step 2	Step 3
Non-opioids	weak opioids	strong opioids
paracetamol, various NSAIDs	Codeine, tramadol, low dose oxycodone	morphine, fentanyl, oxycodone, methadone

C

Knowledge of the so called ► **referred pain** syndromes (Giamberardino and Vecchiet 1995) can be helpful in establishing diagnosis (e.g. unilateral facial or ear pain may be associated with mediastinal involvement by bronchial carcinoma or reflux esophagitis. Right shoulder pain may be due to an enlarged liver. Metastases in the lower lumbar region may result in pain localized in the sacroiliacal joint.

Most types of cancer pain respond readily to analgesics. Principles of cancer pain treatments were elaborated by the WHO (1990). In specialist centers, 95–98% of pain symptoms can be successfully treated.

Cancer pain is not usually the only symptom of the disease. It is frequently accompanied by other symptoms like: ► **delirium**, nausea and vomiting, weakness, fatigue, weight loss, dyspnea, dry mouth, constipation or diarrhea, pruritus and probably many others. Treatment of pain alone may decrease its intensity but increase intensity of other symptoms. So cancer pain should always be seen in the context of other symptoms and in the context of the whole person.

Cognitive failure progressing to delirium, but also some other adverse effects that emerge in the course of treatment, may compromise the patients quality of life more seriously than pain. So the aim of the treatment is the balanced control of all symptoms, not only pain control. Sometimes making pain and other symptoms bearable, but not alleviating them fully, is the only viable option. The principles of WHO are as follows:

- preferably give the medication by mouth
- give the next dose of analgesics before the effect of the previous dose ceases
- give drugs according to the ► **analgesic ladder**
- use adjuvant drugs, either to alleviate the adverse effects of analgesics or to enhance them, analgesia therapy should be individualized (Anonymous 1990)

Cancer pain is usually a dynamic and complex phenomenon that should be assessed regularly. Prolonged use of analgesics may induce plastic changes in the central nervous system which are similar to those induced by pain itself. Also, prolonged use of opioid drugs for pain may induce tolerance, while the adverse effects may increase. To prevent this, more and more combinations of the various drugs are used. With proper choice of drugs, continuous assessment and adjustment

**Cancer Pain, Table 2** Analgesic adjuvants

indication	drugs used
insufficient analgesic effects	ketamine
neuropathic pain	amitriptyline, venlafaxine, gabapentin
nerve entrapment, compression	dexamethasone, NSAIDs
reflux esophagitis	proton pump inhibitors
abdominal cramp, bladder cramp	butyl-scopolamine
muscle cramp	benzodiazepine, baclofen
respiratory depression, breathlessness, sedation, tiredness	methylphenidate
constipation	lactulose and sennosides, or macrogol
nausea and vomiting	metoclopramide, haloperidol, levomepromazine, cyclizine
dry mouth	pilocarpine
pruritus	paroxetine

of medication, it is possible to control pain with optimal preservation of alertness in most cancer patients. Controlling cancer pain is of importance for the dying patient, as well as for the family of the dying who need to carry on normal living insofar as that is possible, and to adapt to the loss of a loved one.

- ▶ [Cancer Pain Management, Treatment of Neuropathic Components](#)
- ▶ [Pain Treatment, Intracranial Ablative Procedures](#)
- ▶ [Psychiatric Aspects of the Management of Cancer Pain](#)

### References

1. Anonymous (1990) Cancer Pain Relief and Palliative Care. Report of a WHO Expert Committee. World Health Organ Tech Rep Ser 804:1–75
2. Giamberardino MA, Vecchiet L (1995) Visceral Pain, Referred Hyperalgesia and Outcome: New Concepts. *Eur J Anaesthesiol Suppl* 10:61–66
3. Grond S, Zech D, Diefenbach C et al. (1996) Assessment of Cancer Pain: A Prospective Evaluation in 2266 Cancer Patients Referred to a Pain Service. *Pain* 64:107–114
4. Portenoy RK, Payne D, Jacobsen P (1999) Breakthrough Pain: Characteristics and Impact in Patients with Cancer Pain. *Pain* 81:129–134
5. Twycross R (2003) Cancer Pain Syndromes. In: Sykes N, Fallon MT, Patt RB (eds) *Clinical Pain Management*. Cancer Pain. London, Arnold, pp 3–19
6. Twycross R, Harcourt J, Bergl S (1996) A Survey of Pain in Patients with Advanced Cancer. *J Pain Symptom Manage* 12:273–282

## Cancer Pain, Animal Models

MARY ANN C. SABINO, PATRICK W. MANTYH  
 Department Prevential Science, University of  
 Minnesota, Minneapolis, MN, USA  
 manty001@umn.edu

### Definition

Cancer pain, distinguished from non-malignant pain, arises from tumor cells which invade soft tissue and/or bony structures, or occur as a result of therapies used to treat cancer.

### Characteristics

Although there is significant variability in the type, severity and evolution of this pain, two major components are generally recognized. The first component, known as ▶ [ongoing pain](#), is most often the first to present, described as a dull ache or throbbing in character and usually increases in severity with disease progression. A second component of bone cancer pain frequently emerges over time and is more acute in nature. This second pain is known as ▶ [incident](#) or ▶ [breakthrough pain](#), as it frequently occurs either spontaneously, with intermittent exacerbations of pain or by movement of the cancerous bone (Mercadante and Arcuri 1998). For many patients, pain is the first sign of cancer and 30–50% of all cancer patients will experience moderate to severe pain. Cancer-associated pain can be present at any time during the course of the disease, but the frequency and intensity of cancer pain tends to increase with advancing stages of cancer. 75–95% of patients with metastatic or advanced stage cancer will experience significant amounts of cancer-induced pain (Portenoy et al. 1999).

The first animal model of bone cancer pain involved the injection of murine osteolytic sarcoma cells into the intramedullary space of the murine femur (Fig. 1). A critical component of this model is that the tumor cells are confined within the marrow space of the injected femur, and the tumor cells do not invade adjacent soft tissues (Schwei et al. 1999). Following tumor injection, the fluorescent cancer cells proliferate, and both



## Cancer Pain and Pain in HIV / AIDS

RUSSELL K. PORTENYO

Department of Pain Medicine and Palliative Care,  
Beth Israel Medical Center, New York, NY, USA  
rportenoy@chpnet.org

### Synonyms

Cancer-related pain; HIV / AIDS-related pain; Pain in HIV / AIDS

### Definition

The terms “cancer pain” and “pain in HIV / AIDS” refer to the assessment and management of acute or chronic pain syndromes that are either directly related to a malignant neoplasm or to HIV infection respectively or to the treatments that are used to manage these diseases.

### Introduction

Chronic pain, a highly prevalent symptom in populations with cancer or HIV / AIDS, may be associated with loss of function, compromised quality of life and profound suffering. Although there are important differences between cancer and HIV / AIDS, and each disorder itself is extraordinarily diverse, there are broad commonalities in the approach to pain assessment and management. The specific issues encountered in the management of HIV / AIDS are addressed in the essay on ► [Pain in HIV / AIDS](#). The remaining essays in this section, which focus on cancer pain may be understood to apply to both the cancer and HIV / AIDS populations.

### Epidemiology

Studies of cancer pain epidemiology reveal that approximately 30–50% of patients undergoing antineoplastic therapy and 75–90% of patients with advanced disease have chronic pain severe enough to warrant opioid therapy (Vainio and Auvinen 1996). Although the prevalence of pain in HIV / AIDS has probably declined with the advent of highly active anti-retroviral therapy, recent surveys suggest that chronic pain affects about half of this population (Dobalian et al. 2004).

It is widely accepted that a large majority of patients with cancer pain can attain satisfactory relief with available therapies. Unfortunately, surveys indicate a high rate of undertreatment (Anderson et al. 2004). Undertreatment is a complex phenomenon that may result from a variety of patient-related barriers and clinician-related barriers or from distortions in the health care system that limit access to treatment. Recent studies underscore the influence on these barriers of cultural

factors, and race and ethnicity (Anderson et al. 2004; Green et al. 2003). Education of patients, families and professional staff, and system level strategies such as quality improvement activities are needed to address the problem of undertreatment.

### Models of Care

In populations with life-threatening illnesses, the management of pain should be incorporated into a broader effort to ameliorate the physical, psychosocial and spiritual issues that undermine quality of life or worsen suffering for the patient or family. The therapeutic approach that addresses these issues is known as palliative care. The relationship between cancer pain and palliative care (see ► [Cancer Pain Management, Interface between Cancer Pain Management and Palliative Care](#)) must be understood to optimize the care of these patients, particularly those with advanced disease.

Palliative care is a therapeutic approach to the care of patients with life-threatening illnesses and their families. It is focused on maintaining quality of life throughout the course of the illness and addressing the challenging needs of patients who are approaching the end of life. The goals of this model include control of pain and other symptoms; management of psychological distress, comorbid psychiatric disorders and spiritual distress; support for effective communication and decision making; provision of practical help in the home; and ongoing support for the family and management of the dying process in a manner that allows a comfortable and dignified death and effective grieving on the part of the family.

Palliative care is now considered an approach that should be implemented at a generalist level by every physician who cares for those with serious medical illness. It should also be available at a specialist level for those patients and families who warrant this level of care. The need for specialist level palliative care, which typically occurs in the setting of advanced illness is being met in the United States by a growing number of institution-based palliative care programs ([www.nationalconsensusproject.org](http://www.nationalconsensusproject.org)) and by more than 3300 hospice programs providing palliative care at the end of life. All of these programs are underutilized and poorly understood by patients, families and professional staff.

### Evaluation of Pain

The goals ► [of pain assessment](#) include characterization of the pain complaint, evaluation of the etiology, syndrome and putative mechanisms sustaining the pain and the assessment of the impact of the pain and relevant comorbidities.



### Pain Characteristics

A comprehensive evaluation should begin with an assessment of the pain characteristics. The temporal features comprise onset, duration, course and fluctuation. Most patients with chronic pain related to a progressive illness experience pain that begins insidiously and fluctuates broadly, but gradually progresses. Periodic short-lived flares of pain, or “▶ breakthrough pain” (Caraceni et al. 2004), are very common and should be separately assessed.

Topographic features include primary location and radiation. Pain may be referred from any structure, including nerve, bone, muscle, soft tissue and viscera, and knowledge of pain referral patterns is needed to guide the evaluation. For example, pain in the inguinal crease may require evaluation of numerous structures to identify the underlying lesion, including the pelvic bones and hip joint, pelvic sidewall, paraspinal gutter at an upper lumbar spinal level and intraspinal region at the upper lumbar level.

Measurement of pain intensity may be accomplished using a numeric scale (0–10), verbal rating scale, (none, mild, moderate, severe) or a visual analogue scale. Pictorial scales are particularly useful when assessing pain in the pediatric cancer (see ▶ [Cancer Pain, Assessment in Children](#)) population and pain in the cognitively impaired (see ▶ [Cancer Pain, Assessment in the Cognitively Impaired](#)). The particular scale is less important than its consistent use to monitor and document the status of a specific pain (e.g. “worst pain during the past week”) over time. In assessing pain intensity, it also is important to obtain information about factors that increase or decrease the pain. The quality of the pain is assessed using verbal descriptors, such as aching, sharp, throbbing, burning or stabbing. Combined with other information, these descriptors allow broad inferences about the type of pathophysiology that sustains the pain.

### Inferred Pathophysiology, Etiology and Syndromes

Characterization of the pain complaint must be complemented by a physical examination and appropriate laboratory tests and imaging to provide the information necessary to elucidate the likely etiology of the pain, the pain syndrome and the inferred type of pathophysiology sustaining the pain. In populations with cancer or HIV / AIDS, the etiology often relates to an identifiable structural lesion, such as neoplastic invasion of bone. Identification of the etiology often informs the overall treatment of the patient by defining the extent of disease.

Numerous pain syndromes have been characterized in the cancer (Caraceni et al. 1999) and HIV / AIDS (Hewitt et al. 1997) populations. Syndrome identification

helps to define the underlying etiology and prognosis and also may suggest the need for additional testing or specific therapies.

Although inferences about the type of pathophysiology sustaining the pain represent a simplification of very dynamic processes occurring in both the periphery and in the central nervous system, these inferences have been incorporated into clinical practice because they have utility when deciding on a treatment strategies. The labels that are applied to the pathophysiological categories include nociceptive, neuropathic, psychogenic and mixed.

Nociceptive pain refers to pain that is believed to be sustained by ongoing activation of pain sensitive primary afferent neurons by injury to tissue. In the setting of cancer, nociceptive pain usually is due to direct invasion by the neoplasm (Caraceni et al. 1999). When somatic structures are involved, the pain is termed “somatic pain” and the pain is typically aching, throbbing, stabbing and familiar. Bone pain is the most common type. “Visceral pain” occurs when the nociceptive lesion involves visceral structures; it is usually gnawing or crampy when arising from obstruction of a hollow viscus and aching or stabbing when arising from damage to organ capsules.

Pain is labeled neuropathic if it is believed to be sustained by abnormal somatosensory processing in the peripheral or central nervous systems (CNS). Neuropathic mechanisms are involved in approximately 40% of cancer pain syndromes and may be caused by disease or by treatment (Caraceni et al. 1999). Dysesthesia, or abnormal uncomfortable sensations that may be described using words such as “burning”, “shock-like” or “electrical” are suggestive of neuropathic mechanisms, as is the presence of abnormal findings on the sensory examination, such as allodynia (pain induced by non-painful stimuli) or hyperalgesia (increased perception of painful stimuli).

The term “psychogenic pain” is a generic label referring to pain that is believed to be sustained predominantly by psychological factors. Pain of this type may be more precisely characterized through the widely accepted taxonomy of somatoform disorders proposed by the American Psychiatric Association (1994). These pains share an assessment that reveals positive evidence for the psychopathology that is believed to causally related to the pain. Although psychological influences are profoundly important in the presentation of the pain and the patient’s ability to adapt and function, psychogenic pain itself appears to be distinctly uncommon in the cancer and HIV / AIDS populations.

Occasionally, pain occurs that defies clinical characterization according to a clear etiology or syndrome. In the absence of positive evidence for any distinctive

type of pain, it is usually best to label the symptom as “idiopathic.” In the setting of progressive medical illnesses, idiopathic pains require regular reassessment in the hope that an explanatory process will become clear over time.

#### Impact and Comorbidities

The pain evaluation also must include an assessment of impact and relevant comorbidities (see ► [Cancer Pain, Evaluation of Relevant Comorbidities and Impact](#)). The impact of the pain may be considered from the perspective of varied physical, psychosocial and spiritual domains. As appropriate, these domains and specific medical and psychiatric comorbidities must be specifically assessed to fully understand the targets for treatment.

#### Pain Management

The overall treatment strategy (see ► [Cancer Pain Management, Overall Strategy](#)) should proceed from the broader therapeutic perspective of palliative care. The multidimensional assessment guides treatment that is often multimodal and best implemented through the efforts of professionals in varied disciplines. The immediate goal of pain relief should be pursued in tandem with interventions that address other sources of distress.

Analgesic approaches can be broadly divided into 1) primary therapies directed against the etiology of the pain and 2) symptomatic therapies. Primary treatments for the pain include antineoplastic therapies – ► [radiotherapy](#), ► [chemotherapy](#), immunotherapy and surgery (see ► [Palliative Surgery in Cancer Pain Management](#)) – and other interventions directed at structural pathology. Orthopedic surgery interventions (see ► [Cancer Pain Management, Orthopedic Surgery](#)) to address bony metastases exemplify the potential for primary therapy directed at specific structural pathology. In the HIV / AIDS population, primary treatment may include anti-retroviral therapy and other interventions. If it is feasible and clinically appropriate to provide a primary therapy that can effectively treat the source of the pain, the analgesic consequences can be profound. Most patients have pain that cannot be addressed solely by a primary disease modifying approach. The most important symptomatic therapy is an opioid-based analgesic drug regimen, which may be complemented by a large number of other treatments.

#### Pharmacotherapy

Prospective trials indicate that more than 70% of patients can achieve adequate relief of cancer pain using a pharmacologic approach (Schug et al. 1990). Effective pain management requires expertise in the use of the nonsteroidal anti-inflammatory drugs (NSAIDs),

opioid analgesics and adjuvant analgesics. The term “adjuvant analgesic” is applied to a diverse group of drugs, most of which have primary indications other than pain, but can be effective analgesics in specific disorders such as neuropathic pain.

There is a broad consensus in favor of an approach to cancer pain management that was developed by an expert panel of the World Health Organization almost two decades ago and was termed the “analgesic ladder” (1996). This approach has been highly influential, reinforcing the consensus view that persistent moderate to severe cancer pain should be treated with an opioid-based drug regimen. The details of the model have evolved over time, but it remains a useful as a tool for educating clinicians and policymakers.

According to the analgesic ladder approach, mild to moderate cancer pain is first treated with a nonopioid analgesic (see ► [Cancer Pain Management, Nonopioid Analgesic](#)), such as acetaminophen or a nonsteroidal anti-inflammatory drug (NSAID). This drug is combined with an adjuvant drug that can be selected either to provide additional analgesia (i.e. an adjuvant analgesic) or to treat a side effect of the analgesic or a coexisting symptom. Patients who present with moderate to severe pain or who do not achieve adequate relief after a trial of a NSAID should be treated with an opioid, often combined with a NSAID or adjuvant drugs.

#### Nonsteroidal Anti-Inflammatory Drugs

NSAIDs appear to be especially useful in patients with bone pain or pain related to grossly inflammatory lesions and relatively less useful in patients with neuropathic pain (Wallenstein and Portenoy 2002). These drugs may have an opioid sparing effect that can limit the potential for dose-related opioid side effects. The use of the NSAIDs may be limited by their toxicities and a maximal efficacy that is insufficient to address most cancer pain. All NSAIDs have the potential for nephrotoxicity, with effects that range from peripheral edema to acute or chronic renal failure. All these drugs increase the risk of gastrointestinal ulcers and bleeding. The selective cyclo-oxygenase (COX)-2 inhibitors have a relatively reduced risk of these outcomes and many clinicians recommend these drugs as first line therapy for all patients at relatively high risk of ulcer, including the elderly, those concurrently receiving a corticosteroid and those with a prior history of peptic ulcer disease or NSAID-induced gastroduodenopathy (Wallenstein and Portenoy 2002). The risk is also reduced by co-administration of a proton pump inhibitor, the prostaglandin analogue misoprostol and possibly high dose H2 blockers. Recent data that have raised concerns about an increased risk of cardiovascular events among those treated with the selective

COX-2 inhibitors (Solomon et al. 2004), but the relative risks and benefits compared to nonselective drugs in medically ill populations have yet to be defined. There are also no data in the medical ill from which to judge the relative outcomes associated with administration of selective COX-2 inhibitors alone *versus* nonselective NSAIDs plus a gastroprotective agent. At the present time, the approach is a matter of clinical judgment.

### Adjuvant Analgesics

The adjuvant analgesics comprise numerous drugs in diverse classes (Lussier and Portenoy 2004). Treatment with one of these drugs is generally considered if an optimally administered opioid regimen fails to provide a satisfactory balance between pain relief and side effects. These drugs are particularly useful in the treatment of neuropathic pain, bone pain and pain related to bowel obstruction.

Corticosteroids are multipurpose adjuvant analgesics and also are used to improve anorexia, nausea and fatigue. In populations with cancer pain or pain due to HIV / AIDS, the first-line adjuvant analgesics for neuropathic pain (see ► [Adjuvant Analgesics in Management of Cancer-Related Neuropathic Pain](#)) are the corticosteroids, anticonvulsants and antidepressants. Use of the anticonvulsants and antidepressants is supported by numerous controlled trials in varied populations (Lussier and Portenoy 2004). Other drugs considered for neuropathic pain comprise the GABA agonist baclofen, alpha-2 adrenergic agonists and various N-methyl-D-aspartate inhibitors. Topical agents, such as the lidocaine patch, represent another strategy for these pain syndromes.

The most commonly used adjuvant analgesics for bone pain (see ► [Adjuvant Analgesics in Management of Bone-Related Pain](#)) are the bisphosphonates. These drugs also have been demonstrated to reduce skeletal morbidity, such as fractures. Other drugs used for bone pain include radiopharmaceuticals and calcitonin. Adjuvant analgesics for bowel obstruction (see ► [Cancer Pain Management, Adjuvant Analgesics in Management of Pain Due to Bowel Obstruction](#)) can often control pain and other symptoms and obviate the need for drainage procedures. Treatment usually involves the combination of anticholinergic drugs, octreotide and corticosteroids (Lussier and Portenoy 2004).

### Opioid Analgesics

Opioid pharmacotherapy is the mainstay approach for the management of moderate to severe pain in populations with cancer or HIV / AIDS. Guidelines for opioid selection (see ► [Cancer Pain Management, Principles of Opioid Therapy, Drug Selection](#)) have evolved from the WHO analgesic ladder approach, which orig-

inally labeled some opioids as “weak” (for moderate pain) and some as “strong” (for severe pain) (1996). This distinction is based on conventional practice and not pharmacology. In the U.S., drugs typically administered to address moderate pain in the opioid naïve patient include codeine, hydrocodone (combined with acetaminophen or ibuprofen), dihydrocodeine (combined with aspirin), oxycodone (combined with aspirin, acetaminophen or ibuprofen), propoxyphene and occasionally, meperidine. Tramadol, a unique centrally acting analgesic with a mechanism that is partly opioid is also generally included in this group. These drugs are conventionally used for moderate pain either because of dose dependent toxicity or because the combination products contain a nonopioid analgesic with a maximum safe dose.

Opioids conventionally selected for severe pain, particularly when patients have already been exposed to the short acting drugs on the first rung of the analgesic ladder, include morphine, fentanyl, oxycodone (without acetaminophen or aspirin), hydromorphone, oxymorphone, levorphanol and methadone. Historically, morphine was described as the preferred first line drug, but there is large variation in the response to different opioids and it is best to select an initial trial based on the available formulations, cost and prior experience. Although the role of methadone has expanded in recent years because of its low cost, long half life and unexpectedly high potency (presumably related to the D-isomer in the racemate, which is a N-methyl-D-aspartate blocker), it poses challenges in dose selection, dose adjustment and monitoring that are not shared by the other pure mu agonist opioids. Experience is needed to use this drug safely.

Opioids may be delivered by any of numerous routes of administration (see ► [Opioid Therapy in Cancer Pain Management, Route of Administration](#)). Long-term dosing is best accomplished by an oral or transdermal route. Numerous oral formulations are available, including modified release forms of morphine, oxycodone or hydromorphone. Other drugs, such as oxymorphone may become available. The latter drugs provide effective analgesia with a prolonged dosing interval, increasing convenience and potentially adherence to therapy. The transdermal route is available for fentanyl and offers a 48–72 h dosing interval. Other transdermal formulations are in development. The oral transmucosal form of fentanyl has been shown to be safe and efficacious when used to treat breakthrough pain in cancer patients (Christie et al. 1998). Rectal formulations of many opioids, such as oxymorphone, hydromorphone and morphine are available, but are seldom used for long-term administration.

Long-term parenteral dosing is possible for patients who are poor candidates for oral or transdermal for-

mulations. Continuous subcutaneous infusion or continuous intravenous infusion (if the patient has an indwelling central venous port) can be implemented with any opioid available in an injectable formulation. Opioids and other drugs may also be delivered into the epidural or intrathecal spaces. The strongest indication for neuraxial infusion is the presence of intolerable somnolence or confusion during systemic opioid therapy.

The most important principle of opioid administration is individualization of the dose (Jacox et al. 1994). In all cases, the dose of an opioid should be gradually increased until acceptable analgesia is produced or unmanageable side effects supervene. The absolute dose of the opioid is immaterial as long as the balance between analgesia and side effects remains acceptable to the patient. Most patients achieve a favorable outcome and remain on a stable dose until pain recurs as a result of disease progression. Recurrent pain following a period of dose stability usually requires re-evaluation of the patient and another period of dose titration.

For persistent or frequently recurring pain, the best outcome is achieved by a fixed, around the clock dosing schedule. Long acting opioids are often used because of the convenience and the likelihood that treatment adherence will be better than with frequent daily doses. Breakthrough pain commonly is managed by coadministration of short acting, as needed, “rescue doses.”

Dose titration usually yields a favorable balance between analgesia and side effects. In some cases, however, treatment-limiting side effects occur and render the treatment ineffective. This scenario is known as poor ► [opioid responsiveness](#), a phenomenon that should be viewed as individual to the patient, the drug and route and the moment in time.

Patients with pain that is poorly responsive to the opioid therapy must undergo a change in treatment. There are no comparative trials to guide clinical practice. Four strategies should be considered and a specific approach selected based on the assessment and clinical judgment. Given the individual variation in the response to different drugs, one strategy is to switch to an alternative opioid, an approach called ► [opioid rotation](#). A second strategy is to co-administer one or more treatments for the side effect that limits dose escalation. Sophisticated approaches are now available to address ► [cognitive dysfunction](#) and gastrointestinal effects (see ► [Cancer Pain Management, Gastrointestinal Dysfunction as Opioid Side Effects](#)), the two most common types of opioid-related toxicity. A third strategy involves the use of a pharmacological approach that would potentially allow reduction in the requirement for the systemic opioid. Coadministration of a NSAID or adjuvant analgesic or a trial of neuraxial infusion might be considered. Finally, a strategy using a

non-pharmacological approach that would potentially reduce the opioid requirement might be considered. This might involve an invasive therapy, such as neural blockade or any of a variety of other approaches. Patients who are treated for a prolonged period with opioids must be continually reassessed for side effects. In addition to common toxicities, opioids may produce a variety of uncommon effects (see ► [Cancer Pain Management, Opioid Side Effects, Uncommon Side Effects](#)) or outcomes that are yet poorly recognized. For example, endocrine changes (see ► [Cancer Pain Management, Opioid Side Effects, Endocrine Changes and Sexual Dysfunction](#)) associated with opioid use, such as hypogonadism may be associated with fatigue, sexual dysfunction or osteoporosis and should be assessed in some populations.

Opioids are potentially abusable drugs and the clinicians who prescribe them for chronic pain should be familiar with the principles of addiction medicine. Although abuse and addiction during opioid therapy for pain are very uncommon in the population of cancer patients with no prior history of substance abuse, these outcomes should always be assessed and are significant concerns in subpopulations with substance use disorders. Understanding the special considerations posed by ► [opioid use in patients with substance use disorders](#) (see ► [Opioid Therapy in Cancer Patients with Substance Abuse Disorders, Management](#)) provides essential information that must be applied in the treatment of all patients.

#### Other Approaches in the Management of Chronic Pain

There are numerous alternative strategies that may be considered in the treatment of pain related to cancer or HIV / AIDS. In almost every situation, the use of these approaches has been extrapolated from experience in the populations with chronic non-cancer pain syndromes. Noninvasive analgesic strategies can be broadly categorized into psychological interventions, rehabilitative treatments and complementary or alternative medicine approaches. Specific psychological approaches have been applied successfully in the management of pain and related symptoms (Breitbart et al. 2004). Treatments include relaxation training, distraction, hypnosis and biofeedback. Although many of these techniques require experienced personnel to implement, several forms of relaxation training can be taught by the non-specialist. Behavioral interventions, like the use of an activities diary to improve physical functioning have achieved wide acceptance in the management of non-cancer pain and are occasionally considered for medically ill patients. A variety of psychoeducational and psychotherapeutic approaches may be implemented in an effort to improve coping, adaptation, family integrity, functioning and quality of life.



Rehabilitative therapies (see ► [Cancer Pain Management, Rehabilitative Therapies](#)), such as therapeutic exercise, use of orthotics, and modalities such as heat, cold and electrical stimulation, may be useful in selected patients. Refractory, movement-induced pain, such as that related to bone metastases may be partially relieved by bracing the painful part and a well fitting prosthesis may reduce stump pain. Therapeutic exercise may lessen pain associated with immobility, trigger points in muscle, and ankylosis. Although all the rehabilitative approaches remain inadequately studied, clinical experience is favorable.

Complementary and alternative medicine (CAM) approaches are commonly pursued by medically ill patients. Some of these interventions, such as meditation and other mind-body approaches, nutritional support, acupuncture and massage, are widely used for pain and are generally considered mainstream strategies (Pan et al. 2000). Others, such as homeopathy and naturopathy have little scientific support. Clinicians should provide whatever data are available about these approaches and support informed decision-making.

Invasive strategies for pain include neurosurgical interventions (see ► [Cancer Pain Management, Neurosurgical Interventions](#)), such as cordotomy; a variety of injection therapies, including neural blockade; and the implantable therapies of neuraxial infusion and spinal cord stimulation. Although the injection therapies and implants are sometimes described as anesthesiological therapies (see ► [Cancer Pain Management, Anesthesiologic Interventions, Neural Blockade](#)), they are now performed by pain specialists in a variety of disciplines.

► [Neural Blockade](#) includes a diverse group of procedures that transiently or permanently block sympathetic nerves, somatic nerves or both (Swarm et al. 2004). Injections may be diagnostic, prognostic or therapeutic. The solutions injected may be local anesthetics, in which case the effects typically are short-lived only or neurolytic substances. Neurolytic blockade generally is seldom employed and considered in the context of advanced illness. One exception is the celiac plexus blockade for pancreatic cancer, experience with which is sufficiently favorable to apply early in the treatment of pain.

In medically ill populations, neuraxial infusion and stimulation (see ► [Cancer Pain Management, Anesthesiologic Interventions, Spinal Cord Stimulation, and Neuraxial Infusion](#)) are seldom considered. The role of neuraxial infusion may evolve as a result of a controlled trial that demonstrated benefits of an implanted pump for intrathecal drug delivery over conventional systemic opioid therapy in a population with cancer (Smith et al. 2002). Other techniques for neuraxial infusion include a tunneled percutaneous epidural catheter and an implanted epidural catheter connected

to a subcutaneous portal. The latter techniques are usually preferred for patients with life expectancies shorter than 3 months.

### Conclusion

Pain is a common complication of cancer and HIV / AIDS. Treatment of pain from a broader perspective of palliative care is likely to yield the best outcomes. Relatively simple therapeutic approaches can provide effective pain relief in a large majority of patients. Pain relief must be considered an aspect of best clinical practice for all clinicians who treat patients with these illnesses.

### References

1. American Psychiatric Association (1994) Somatoform disorders. In: Diagnostic and statistical manual of mental disorders (DSM-IV), 4th edn. American Psychiatric Association, Washington, pp 445–471
2. Anderson KO, Mendoza TR, Payne R et al. (2004) Pain education for underserved minority cancer patients: a randomized controlled trial. *J Clin Oncol* 22:4918–4925
3. Breitbart W, Payne D, Passik S (2004) Psychological and psychiatric interventions in pain control. In: Doyle D, Hanks G, Cherny NI et al. (eds) *Oxford Textbook of Palliative Medicine*, 3rd edn. Oxford University Press, Oxford, pp 424–438
4. Caraceni A, Portenoy RK, and a Working Group of the IASP Task Force on Cancer Pain (1999) An international survey of cancer pain characteristics and syndromes. *Pain* 82:263–274
5. Caraceni A, Martini C, Zecca E et al. (2004) Breakthrough pain characteristics and syndromes in patients with cancer pain. An international survey. *Palliat Med* 18:177–183
6. Christie JM, Simmonds M, Patt R et al. (1998) A dose-titration, multicenter study of oral transmucosal fentanyl citrate (OTFC) for the treatment of breakthrough pain in cancer patients using transdermal fentanyl for persistent pain. *J Clin Oncol* 16:3238–3245
7. Dobalian A, Tsao JC, Duncan RP (2004) Pain and the use of outpatient services among persons with HIV: results from a nationally representative survey. *Med Care* 42:129–138
8. Green CR, Anderson KO, Baker TA et al. (2003) The unequal burden of pain: confronting racial and ethnic disparities in pain. *Pain Med* 4:277–294
9. Hewitt DJ, McDonald M, Portenoy RK et al. (1997) Pain syndromes and etiologies in ambulatory AIDS patients. *Pain* 70:117–124
10. Jacox A, Carr DB, Payne R et al. (1994) Management of Cancer Pain. AHCPR Publication No. 94-0592: Clinical Practice Guideline No. 9. Rockville, MD, U.S. Department of Health and Human Services, Public Health Service
11. Lussier D, Portenoy RK (2004) Adjuvant analgesics. In: Doyle D, Hanks G, Cherny NI et al. (eds) *Oxford Textbook of Palliative Medicine*, 3rd edn. Oxford University Press, Oxford, pp 349–377
12. Pan CX, Morrison RS, Ness J et al. (2000) Complementary and alternative medicine in the management of pain, dyspnea, and nausea and vomiting near the end of life. A systematic review. *J Pain Symptom Manage* 20:374–387
13. Schug SA, Zech O, Dorr U (1990) Cancer pain management according to WHO analgesic guidelines. *J Pain Symptom Manage* 5:27–32
14. Smith TJ, Staats PS, Stearns LJ et al. (2002) Randomized clinical trial of an implantable drug delivery system compared with comprehensive medical management for refractory cancer pain: impact on pain, drug-related toxicity, and survival. *J Clin Oncol* 19:4040–4049



15. Solomon DH, Schneeweiss S, Glynn RJ et al. (2004) Relationship between selective cyclooxygenase-2 inhibitors and acute myocardial infarction in older adults. *Circulation* 109:2068–2073
16. Swarm, RA, Karanikolas M, Cousins MJ (2004) Anaesthetic techniques for pain control In: Doyle D, Hanks G, Cherny NI et al. (eds) *Oxford Textbook of Palliative Medicine*, 3rd edn. Oxford University Press, Oxford, pp 378–395
17. Vainio A, Auvinen A (1996) Prevalence of symptoms among patients with advanced cancer: an international collaborative study. *J Pain Symptom Manage* 12:3–10
18. Wallenstein DJ, Portenoy RK (2002) Nonopioid and adjuvant analgesics. In: Berger AM, Portenoy RK, Weissman DE (eds) *Principles and Practice of Palliative Care and Supportive Oncology*. Lippincott-Raven, Philadelphia, pp 84–97
19. World Health Organization (1996) *Cancer pain relief*, 2nd edn. World Health Organization, Geneva
20. [www.nationalconsensusproject.org](http://www.nationalconsensusproject.org)

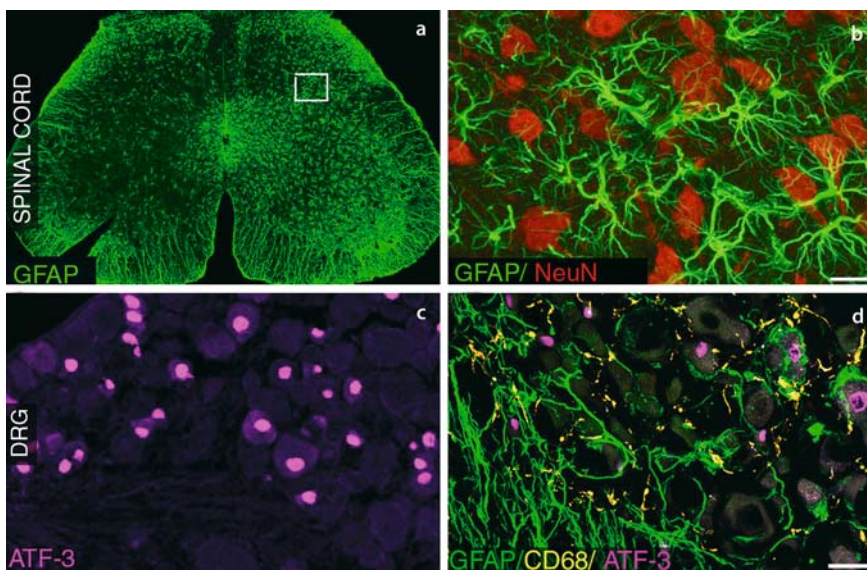
C



**Cancer Pain, Animal Models, Figure 1** Bone cancer pain animal model. (a) Radiograph of lower half of adult mouse demonstrating the femur through which osteolytic fluorescent sarcoma cells were injected. Tumor cells are confined within the intramedullary space by placement of an amalgam plug (arrow). Two weeks later, femurs can be assessed at the whole bone level for extraosseous invasion (none noted in b), tumor burden (using excitation filters to visualize green fluorescent protein expressed by tumor cells, c) and bone destruction (high power radiographic imaging, arrow denotes extensive bone destruction, d).

ongoing and movement-evoked pain related behaviors increase in severity as the tumor develops. These pain behaviors correlate with the progressive tumor-induced bone destruction that ensues, which appears to mimic the condition seen in patients with primary or metastatic bone cancer. In this model, peripheral nerve destruction as well as alterations in neurochemical markers implicated in pain transmission has been observed (Fig. 2).

Following the publication of the first animal model of cancer pain, several rodent models of soft tissue and bone cancer pain have been described. A rat model of bone cancer pain was developed (Medhurst et al. 2002) whereby MRMT-1 mammary carcinoma cells were injected into the tibiae of syngeneic rats. Morphine-reversible pain behaviors and ▶ osteolysis were evident 2–3 weeks following inoculation. Mouse models of soft tissue sarcoma (Wacnik et al. 2001) and rat models



**Cancer Pain, Animal Models, Figure 2** Neurochemical changes in the spinal cord and dorsal root ganglia (DRG) in bone cancer pain. (a) confocal imaging of glial fibrillary acidic protein (GFAP) expressed by astrocytes in a spinal cord of a tumor-bearing mouse. Note increased expression only on side ipsilateral to tumorous limb. (b) High power magnification of spinal cord showing hypertrophy of astrocytes (green) without changes in neuronal numbers (red, stained with neuronal marker, NeuN). (c) Confocal image of dorsal root ganglia labeling injured neurons labeled with activating transcription factor 3 (magenta, ATF-3). (d) Non-myelinating schwann cells (green, GFAP) and macrophage infiltration (yellow, CD68) can also be seen.

of neuropathic cancer (Eliav et al. 2004) were also developed, and involved growth of tumor cells in soft tissues surrounding bones and alongside sciatic nerves, respectively. Mechanical and thermal **▶ hyperalgesia**, demyelination, progressive tumor infiltration and nerve destruction were seen in these models.

Given the development of animal models of cancer pain, significant advances have been made in understanding the molecular and cellular mechanisms which drive cancer pain (Fig. 3). Cancer cells and tumor associated macrophages have both been shown to express high levels of COX-2, leading to high levels of **▶ prostaglandins**. Prostaglandins have been shown to be involved in the sensitization and/or direct excitation of **▶ nociceptors**, by binding to several prostanoid receptors expressed by nociceptors that sensitize or directly excite nociceptors (Vasko 1995). Treatment of cancer animals with selective COX-2 inhibitors resulted in significant attenuation of pain behaviors, as well as many of the neurochemical changes, suggestive of both **▶ peripheral sensitization** and central sensitization (Medhurst et al. 2002; Sabino et al. 2003).

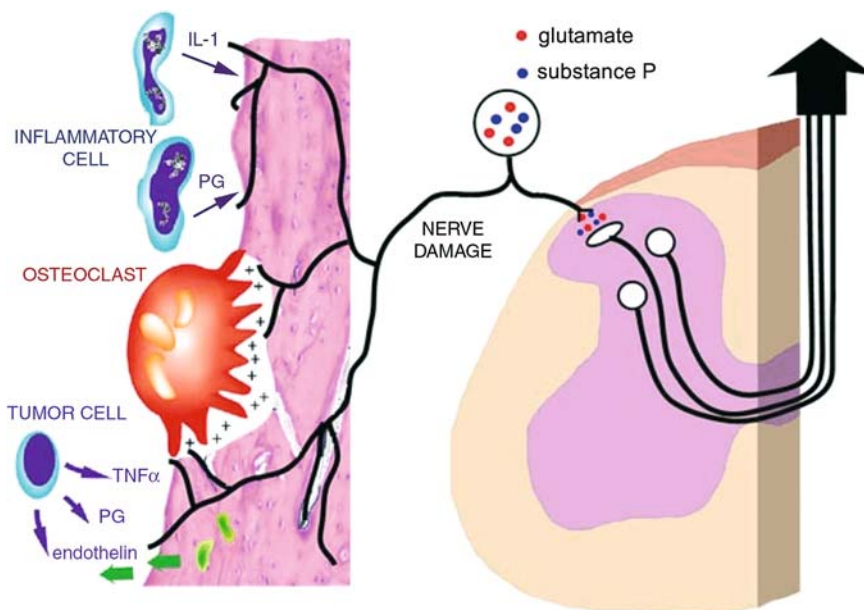
**▶ Endothelins** have been found in cancer patients (Nelson et al. 1995) and in cancer-bearing mice (Wacnik 2001), and their levels have been correlated with the severity of pain (Nelson et al. 1995). Endothelins could contribute to cancer pain by directly sensitizing or exciting nociceptors, as a subset of small unmyelinated primary afferent neurons express endothelin A receptors (Pomonis et al. 2001). Furthermore, direct application of endothelin to peripheral nerves induces activation of primary afferent fibers and an induction of pain behaviors (Davar et al. 1998). These findings indi-

cate endothelin antagonists may be useful in inhibiting cancer pain.

**▶ Osteoclasts**, the body's principal bone resorbing cell, play an essential role in cancer-induced bone loss, and contribute to the etiology of bone cancer pain (Honore et al. 2000; Luger et al. 2001; Sabino et al. 2002; Sevcik 2004). Osteoprotegerin (OPG) is a secreted soluble receptor that prevents the activation and proliferation of osteoclasts. Bisphosphonates induced osteoclast apoptosis have been reported to reduce pain in cancer patients and in animal models of bone cancer pain (Sevcik 2004). Both anti-resorptive compounds were highly potent in reducing both cancer-induced bone destruction and the development of pain-related behaviors, suggesting an important role for osteoclasts in the development and maintenance of bone cancer pain.

Cancer pain in advanced cancer patients is typically recalcitrant to both non-steroidal anti-inflammatory agents and opioids, and typically requires adjuvants such as gabapentin for adequate management. Gabapentin is also commonly used to treat neuropathic pain patients who are unresponsive to opioids. In several cancer pain models, peripheral nerve destruction within skin (Cain et al. 2001) and bone (Peters et al. 2005) have been observed. Likewise, sensitization of unmyelinated primary afferent fibers and damage to small and medium sized sensory neurons suggest that a neuropathic component exists in cancer pain.

Insights into the mechanisms that induce cancer pain are now coming from animal models. These models have begun to provide a glimpse into the mechanisms by which tumors cause pain and how this sensory information is processed. Chemicals derived from tumor cells,



**Cancer Pain, Animal Models, Figure 3** Sensory neurons and detection of noxious stimuli due to tumor cells. Nociceptors use a diversity of signal transduction mechanisms to detect noxious physiological stimuli, and many of these mechanisms may be involved in driving cancer pain. Thus, when nociceptors are exposed to products of tumor cells, tissue injury or inflammation, their excitability is altered and this nociceptive information is relayed to the spinal cord and then to higher centers of the brain. Some of the mechanisms that appear to be involved in generating and maintaining cancer pain include activation of nociceptors by factors such as extracellular protons (+), endothelin-1 (ET-1), interleukins (ILs), prostaglandins (PG), and tumor necrosis factor (TNF).

inflammatory cells and cells derived from bone appear to be simultaneously involved in driving this frequently difficult to control pain state. Understanding the mechanisms involved in the pathophysiology of cancer pain will improve our ability to provide mechanism-based treatments and therapies, and improve the quality of life of cancer patients. Insights such as this promise to fundamentally change the way cancer pain is controlled.

## References

1. Cain DM, Wacnik PW, Turner M et al. (2001) Functional Interactions between Tumor and Peripheral Nerve: Changes in Excitability and Morphology of Primary Afferent Fibers in a Murine Model of Cancer Pain. *J Neurosci* 21:9367–9376
2. Davar G, Hans G, Fareed MU et al. (1998) Behavioral Signs of Acute Pain Produced by Application of Endothelin-1 to Rat Sciatic Nerve. *Neuroreport* 9:2279–2283
3. Eliav E, Tal M, Benoliel R (2004) Experimental Malignancy in the Rat Induces Early Hypersensitivity Indicative of Neuritis. *Pain* 110:727–737
4. Honore P, Luger NM, Sabino MA et al. (2000) Osteoprotegerin Blocks Bone Cancer-Induced Skeletal Destruction, Skeletal Pain and Pain-Related Neurochemical Reorganization of the Spinal Cord. *Nat Med* 6:521–528
5. Luger NM, Honore P, Sabino MA et al. (2001) Osteoprotegerin Diminishes Advanced Bone Cancer Pain. *Cancer Res* 61:4038–4047
6. Medhurst SJ, Walker K, Bowes M et al. (2002) A Rat Model of Bone Cancer Pain. *Pain* 96:129–140
7. Mercadante S, Arcuri E (1998) Breakthrough Pain in Cancer Patients: Pathophysiology and Treatment. *Cancer Treat Rev* 24:425–432
8. Nelson, JB, Hedican SP, George DJ et al. (1995) Identification of Endothelin-1 in the Pathophysiology of Metastatic Adenocarcinoma of the Prostate. *Nat Med* 1:944–949
9. Peters C M, Ghilardi JR, Keyser CP et al. (2005) Tumor-Induced Injury of Primary Afferent Sensory Nerve Fibers in Bone Cancer Pain. *Exp Neurol* 193:85–100
10. Pomonis JD, Rogers SD, Peters CM et al. (2001) Expression and Localization of Endothelin Receptors: Implication for the Involvement of Peripheral Glia in Nociception. *J Neurosci* 21:999–1006
11. Portenoy RK, Payne D, Jacobsen P (1999) Breakthrough Pain: Characteristics and Impact in Patients with Cancer Pain. *Pain* 81:129–134
12. Sabino MA, Ghilardi JR, Jongen JL et al. (2002) Simultaneous Reduction in Cancer Pain, Bone Destruction, and Tumor Growth by Selective Inhibition of Cyclooxygenase-2. *Cancer Res* 62:7343–7349
13. Sabino MA, Luger NM, Mach DB et al. (2003) Different Tumors in Bone Each Give Rise to a Distinct Pattern of Skeletal Destruction, Bone Cancer-Related Pain Behaviors and Neurochemical Changes in the Central Nervous System. *Int J Cancer* 104:550–558
14. Schwei MJ, Honore P, Rogers SD et al. (1999) Neurochemical and Cellular Reorganization of the Spinal Cord in a Murine Model of Bone Cancer Pain. *J Neurosci*: 19:10886–10897
15. Sevcik MA, Luger NM, Mach DB et al. (2004) Bone Cancer Pain: The Effects of the Bisphosphonate Alendronate on Pain, Skeletal Remodeling, Tumor Growth and Tumor Necrosis. *Pain* 111:169–180
16. Vasko MR (1995) Prostaglandin-Induced Neuropeptide Release from Spinal Cord. *Prog Brain Res* 104:367–380
17. Wacnik PW, Eikmeier LJ, Ruggles TR et al. (2001) Functional Interactions between Tumor and Peripheral Nerve: Morphology, Algogen Identification, and Behavioral Characterization of a New Murine Model of Cancer Pain. *J Neurosci* 21:9355–9366

## Cancer Pain, Assessment in Children

GARY A. WALCO

The David Center for Children's Pain and Palliative Care, University Medical Center Hackensack, NJ, USA

gwalco@humed.com

C

### Definition

Cancer pain in children is associated with three major etiologies: (a) ► **procedural distress**, (b) ► **iatrogenic effects** of treatment, and (c) disease-related pain. Chronic pain among long-term cancer survivors (see ► **cancer survivorship**) is increasingly recognized as surveillance of these patients continues. Each has unique components that dictate the nature of the assessments to be made and treatments that may ensue.

### Characteristics

#### Procedural Distress

For many of the cancers most common in the pediatric population (e.g. leukemia, lymphoma), invasive procedures are integral to the diagnostic and treatment process. Included here are bone marrow aspirations and biopsies, for diagnostic purposes, and lumbar punctures, both for diagnostic purposes as well as to deliver intrathecal chemotherapy as prophylaxis against or treatment for central nervous system disease (Balis et al. 2002). The latter occurs on a recurrent basis over the course of several months of treatment. Among survivors of pediatric cancer, the trauma of undertreated procedural distress is often the most disturbing element of their entire cancer experience, sometimes severe enough to leave children and parents with post-traumatic stress symptoms (Stuber et al. 1998). Interventions combining sedating and analgesic agents along with preparatory and cognitive-behavioral strategies (see ► **Cognitive-Behavioral Treatment of Pain**) have greatly reduced the pain and anxiety associated with invasive procedures (Berde et al. 2002; Conte et al. 1999). Assessment strategies involve three modalities: self-report of the child, behavioral observations, and physiological indicators of stress (Walco et al. 2005). As these do not necessarily correlate with one another, it is imperative to specify the target outcome(s) of the intervention (Walco et al. 2005). Ultimately the goal would be to implement an algorithm optimizing the match between patient needs and available interventions, so that comfort may be assured while risk and cost are minimized.

#### Iatrogenic Effects

Treatments for cancer involve chemotherapy, radiation, surgery, and stem cell transplantation. Each potentially leads to iatrogenic pain problems (Collins and Weisman 2003). Symptoms resulting from chemotherapeutic and radiation treatment most commonly include



nausea and vomiting, fatigue, neutropenia and related vulnerability to infection, and pain. Common iatrogenic pain syndromes in pediatric cancer are related to mucositis, infectious process, and ► **neuropathic pain** (from ► **peripheral neuropathy**) associated with agents such as vincristine. Pain secondary to radiation is also seen in some instances. Painful sequelae of surgical interventions occur, including ► **phantom limb pain** related to amputations. Acute abdominal pain, severe enough to require administration of opioids, has been noted among patients who have undergone allogeneic bone marrow transplantation. Finally, as follow-up programs for long-term survivors of childhood cancer provide data, it appears that chronic pain syndromes may be of concern. For example, aseptic necrosis of the bone is a known long-term effect of high dose steroid usage, and does not manifest until well after the child has completed standard treatment protocols.

### Disease-Related Pain

Disease-related pain in pediatric cancer is not as common as in neoplasms common in the adult population. Pain may be present at the time of diagnosis, as pain in the long bones is associated with leukemia, severe headache is a symptom of brain tumors, solid tumors may elicit somatic pain in the focal area of tumor growth or infiltration, and abdominal tumors may generate visceral pain. In contrast to adult patients with such tumors, children with cancer usually experience a significant remission of pain within two weeks of beginning treatment (Miser et al. 1987). Unfortunately, the other circumstance where pain is problematic is in advanced illness, often in the context of end-of-life care. Thus, many of the same types of syndromes seen at presentation, where pain is of high intensity and often unrelenting, recur in advanced illness and should be addressed in service of maximizing quality of life (Wolfe and Grier 2002).

### Assessment Strategies

Specific pain assessment strategies depend on the age or ► **developmental level** of the child and the nature of the pain in question (McGrath and Gillespie 2001). Whenever possible, it is optimal to use patients' verbal reports to assess their pain experience, skills that emerge in children between the ages of 3 and 7 years (American Academy of Pediatrics Committee on Psychosocial Aspects of Child and Family Health, American Pain Society Task Force on Pain in Infants, Children, and Adolescents 2001). In preverbal children, pain is assessed through physiological indicators of distress (Sweet and McGrath 1998), through specific behavioral indicators (McGrath 1998; Lilley et al. 1997), or through some combination thereof (Franck et al. 2000). During the toddler and preschool years, as children begin to use language meaningfully, increased emphasis may be placed on verbal report, but one must take care to use language and terminology that is familiar to the

child. Parental ratings of pain may also be helpful in preverbal children.

For procedural distress, assessment strategies should include two major components, anxiety and pain. The term "distress" is used as a way to represent the combined effect of these two factors, as they are separable only in concept, not in practice. Behavior rating instruments typically define specific behaviors, and frequency of occurrence, duration, or intensity is scored during a specified period. Typically, this includes a segment prior to, during, and after the procedure. Likewise, physiological indicators, including heart rate, blood pressure, vagal tone, and cortisol responses have been used as indicators of acute distress. Self-report measures focus on the subjective experience of the child and typically encompass concerns about pain, anxiety, and perceived self-efficacy in coping (Walco et al. 2005).

For pain related to both disease and the iatrogenic effects of treatment, self report measures help ascertain the location of pain, intensity, sensory, affective, and evaluative components, as well as the impact of pain on functioning. Especially when confronting pain that is more chronic or recurrent in nature, assessing the contextual factors associated with the pain experience (developmental level, temperament, characteristic pain responsiveness, family issues, impact of pain, etc.) becomes very important.

### References

1. American Academy of Pediatrics Committee on Psychosocial Aspects of Child and Family Health, American Pain Society Task Force on Pain in Infants, Children, and Adolescents (2001) Policy Statement: The Assessment and Management of Acute Pain in Infants, Children and Adolescents (0793). *Pediatrics* 108:793–797
2. Balis FM, Holcenberg JS, Blaney SM (2002) General Principles of Chemotherapy. In: Pizzo PA, Poplack DG (eds) *Principles and Practice of Pediatric Oncology*, 4<sup>th</sup> edn. Lippincott, Williams & Wilkins, Philadelphia, pp 237–308
3. Berde CB, Billett AL, Collins JJ (2002) Symptom Management in Supportive Care. In: Pizzo PA, Poplack DG (eds) *Principles and Practice of Pediatric Oncology*, 4<sup>th</sup> edn. Lippincott, Williams & Wilkins, Philadelphia, pp 1301–1332
4. Collins JJ, Weisman SJ (2003) Management of Pain in Childhood Cancer. In: Schechter NL, Berde CB, Yaster M (eds) *Pain in Infants, Children, and Adolescents*, 2<sup>nd</sup> edn. Lippincott, Williams & Wilkins, Philadelphia, pp 517–538
5. Conte PM, Walco GA, Sterling CM et al. (1999) Procedural Pain Management in Pediatric Oncology: A Review of the Literature. *Cancer Investigation* 17:448–459
6. Franck LS, Greenberg CS, Stevens B (2000) Pain Assessment in Infants and Children. *Pediatric Clinics of North America* 47:487–512
7. Lilley CM, Craig KD, Grunau RE (1997) The Expression of Pain in Infants and Toddlers: Developmental Changes in Facial Action. *Pain* 72:161–70
8. McGrath PJ (1998) Behavioral Measures of Pain. In: Finley GA, McGrath PJ (eds) *Measurement of Pain in Infants and Children*. Progress in Pain Research and Management, vol 10. IASP Press, Seattle, Washington, pp 83–102
9. McGrath PA, Gillespie J (2001) Pain Assessment in Children and Adolescents. In: Turk DC, Melzack R (eds) *Handbook of Pain Assessment*, 2<sup>nd</sup> edn. Guilford, New York, pp 97–118
10. Miser A, Dothage J, Wesley R et al. (1987) The Prevalence of Pain in a Pediatric and Young Adult Cancer Population. *Pain* 29:73–83

11. Stuber ML, Kazak AE, Meeske K et al. (1998) Is Posttraumatic Stress a Viable Model for Understanding Responses to Childhood Cancer? *Child and Adolescent Psychiatric Clinics of North America* 7:169–182
12. Sweet SD, McGrath PJ (1998) Physiological Measures of Pain. In: Finley GA, McGrath PJ (eds) *Measurement of Pain in Infants and Children*. Progress in Pain Research and Management, vol 10. IASP Press, Seattle, Washington, pp 59–81
13. Walco GA, Conte PM, Labay LE et al. (2005) Procedural distress in children with cancer: self-report, behavioral observations, and physiological parameters. *Clin J Pain* 21:484–90
14. Wolfe J, Grier HE (2002) Care of the Dying Child. In: Pizzo PA, Poplack DG (eds) *Principles and Practice of Pediatric Oncology*, 4<sup>th</sup> edn. Lippincott, Williams & Wilkins, Philadelphia, pp 1477–1493

## Cancer Pain, Assessment in the Cognitively Impaired

WENDY M. STEIN

San Diego Hospice and Palliative Care, UCSD, San Diego, CA, USA  
wstein@sdhospice.org

### Synonyms

Cognitive Impairment; dementia; delirium

### Definition

Cognitive impairment or altered mental state is a change in the patient's usual premorbid state of mind, which can include delirium and dementia as well as altered emotions and behaviors (8).

### Characteristics

This section will focus on the challenging assessment of cancer pain in the communicative and non-communicative cognitively impaired patient. Acute and subacute changes in mental status have been well documented in as many as 20–30% of medical inpatients and 50–90% of nursing home residents (Folstein and Folstein 1994b), and can substantially impair a patient's ability to participate actively in both the initial pain assessment and subsequent evaluation of treatment efficacy. The initial step is to establish the patient's premorbid mental status, and the nature and association of any clinical changes that may have occurred. Vision and hearing impairments can further complicate both the assessment and treatment of pain in the cognitively impaired and need to be adequately compensated.

Population-based studies of community dwelling elderly have shown a two-fold increase in pain problems significant enough to impair daily function among those over age 60 (Crook et al. 1984). Older patients have a higher prevalence of a number of specific pain syndromes including most types of cancer, peripheral vascular disease, ► **temporal arteritis** and ► **polymyalgia rheumatica**, ► **peripheral neuropathies**, ► **herpes zoster**

and subsequent ► **postherpetic neuralgia**. One might then reasonably expect that individuals suffering from dementia and delirium would also be disproportionately affected by these syndromes, resulting in a large number of cognitively impaired elderly in desperate need of aggressive and appropriate pain assessment and treatment.

In addition, older patients as a group are at high risk for undertreatment of cancer pain. Cleeland et al. showed that those over the age of 70 were at higher risk of receiving inadequate pain management (Cleeland 1998). Bernabei et al. documented significant numbers of nursing home patients with cancer suffering from daily pain, and those over age 85 were at particular risk of having no ► **analgesia** at all (Bernabei et al. 1998).

### Dementia versus Delirium

Folstein and Folstein define dementia as “a syndrome characterized by a decline in multiple cognitive functions occurring in clear consciousness” (Folstein and Folstein 1994b). Dementia has been estimated in 10–15% of elderly surgical patients, one-third of elderly medical inpatients, and more than 50% of nursing home residents (Folstein and Folstein 1994b). Delirium, on the other hand, is noted for its acute or subacute presentation with waxing and waning levels of consciousness, global cognitive impairment, and disorganized wake-sleep cycles. Delirium has been well described in the medical literature in patients with cancer (Derogatis et al. 1983); however, it also occurs commonly in the elderly, especially in those with underlying dementias. Rates of delirium have ranged as high as 50% in hospitalized patients with previously diagnosed dementia (Ouslander et al. 1997); in reality the figures may be even larger, as in the community dementia is often well hidden by well meaning family and friends who compensate for gradually increasing mental deficits over time.

### Studies of Pain in the Communicative Cognitively Impaired

The reader should keep in mind that most pain studies of assessment in the cognitively impaired have not focused specifically on cancer pain, but on all types of pain in general. Parmalee et al. (1996) studied self-reported pain in 758 elders with mild to moderate levels of cognitive impairment. This study showed that pain complaints decreased with increasing levels of cognitive impairment over time, i.e. that patients became less good at reporting their pain. However, when cognitively impaired individuals reported pain, their pain complaints were no less valid. Ferrell et al. (1995) studied patients with moderate to severe degrees of cognitive impairment in 10 community nursing homes. The researchers presented five commonly used pain scales in enlarged format and with adequate amounts of light, and with hearing augmentation if required. Of those presented, the ► **Present Pain Intensity Subscale (PPI)** had the highest rate of comple-



tion (65%). Although only 32% could complete all five scales presented, 83% of these patients with significant cognitive impairment could complete at least one of the scales presented. These findings validate the utility of offering a variety of scales when using standardized measures with the cognitively impaired, and then continuing with what works best for that patient.

#### **Pain in Non-Communicative Cognitively Impaired Patients**

Unfortunately, many early studies of pain assessment in this population focused on the use of pediatric instruments, and specifically those developed for neonates, without first establishing data in this population. These tools were developed to measure acute, and often externally induced procedure related pain. In the cognitively impaired elderly, clinicians are most often evaluating chronic, or acute on chronic pain, which is likely to present differently. There have now been multiple studies to validate the use of standardized tools specifically adapted and/or developed for use in this population such as the ► **Faces Pain Scale** (Herr et al. 1998). However, global evaluations of a combination of nonverbal behavior, vocalizations, changes in function, and caregiver reports are most often used as indicators of pain in the non-communicative cognitively impaired elderly (AGS Panel on Chronic Pain in Older Persons 2002). Marzinski (1991) studied 60 patients living in a dementia unit, of which 43% had potentially painful conditions based on chart review. The most clinically interesting finding of this study was that the nursing staff could clearly identify what amounted to normative behavior for individual patients, and once aberrations were identified, to act upon them.

Several studies have sought to link assessment with initiating pain interventions empirically in non-communicative cognitively impaired elders. The most comprehensive project of this nature is that of Kovach et al. (1999). The research team worked with 104 non-communicative demented elderly who had signs or symptoms of pain or discomfort at 32 nursing homes. The nursing staffs were instructed in the use of the ► **Assessment of Discomfort in Dementia (ADD) Protocol** if a patient displayed signs or symptoms of distress. After excluding common physical causes for discomfort such as occult infection, or impaction by thorough physical assessment, and review of history including consultations with family and/or physicians, nonpharmacologic comfort interventions were undertaken. If unsuccessful, the nurses were educated to administer 'as needed' non-opioid analgesics, and continue up the WHO ladder depending on response and discussion with physicians. The sample population decreased behavioral symptoms associated discomfort from an average of 32.85–23.47 symptoms on protocol, which was a statistically significant change. Of note was the fact that 88% of the staff felt that the protocol was beneficial.

#### **General Recommendations**

The clinician needs to create an optimal environment in order to adequately assess pain in the communicative cognitively impaired. Limited attention span may demand dividing up the initial assessment into several shorter sessions. Additional time should be allowed for the patient to assimilate questions to allow for receptive or expressive aphasia. Ensuring that large print cards, adequate lighting, and hearing aids or pocket amplification devices and refractive lenses are available is vital. Qualitative descriptions of pain should bear equal weight and be encouraged. If using standardized tools, multiple tools should be presented upon initial assessment so as to discern which is easiest for that particular patient, document this in the clinical record, and communicate this with the care team (Stein 1996). Copies of this tool can be made available (without identifying data on it) on the chart and at the bedside, ensuring that each subsequent assessment is performed exactly the same way regardless of the team member asking the questions. As the cognitively impaired elderly are often unable to report on previous pain, assessment should be conducted more frequently than would be necessary with a cognitively intact patient (Stein 2001). Family members and caregivers can assist in this process by helping to journal the patient's pain when they visit, thus providing a comprehensive picture.

Deviation from what is considered baseline or 'normal' behavior for the non-communicative cognitively impaired patient remains the clinical imperative (Stein 2001). This should trigger a comprehensive bedside physical examination coupled with laboratory and imaging studies, consistent with the benefits and burdens likely to be incurred and the patient and/or family's wishes. Physical examination should specifically focus on occult sources or atypical presentations of infection such as pneumonia or urinary tract infection, as well as fecal impaction. The clinical involvement of the entire interdisciplinary team should be sought to elicit alterations in sleeping, eating or elimination as sources of change in behavior. Chart review should exclude changes in medications, doses or dose intervals as potential causes. After all of the above have been carefully completed and reviewed with family members and staff, and informed consent obtained from involved family members, there may be a role for a well-defined empiric trial of short-acting pain medication with consistent and continual reassessment (Stein 2001).

#### **References**

1. AGS Panel on Chronic Pain in Older Persons (2002) The Management of Chronic Pain in Older Persons. *JAGS* 50:1–20
2. Bernabei R, Gambassi G, Lapane K et al. (1998) Management of Pain in Elderly Patients with Cancer. SAGE Study Group. Systematic Assessment of Geriatric Drug Use via Epidemiology. *JAMA* 279:1877–1882
3. Cleeland CS (1998) Undertreatment of Cancer Pain in the Elderly. *JAMA* 279:1914–1915

4. Crook J, Rideout E, Browne G (1984) The Prevalence of Pain Complaints among a General Population. *Pain* 18:299–314
5. Derogatis LR, Morrow GR, Fetting J et al. (1983) The Prevalence of Psychiatric Disorders among Cancer Patients. *JAMA* 249:751–757
6. Ferrell BA, Ferrell BR, Rivera L (1995) Pain in Cognitively Impaired Nursing Home Patients. *J Pain Symptom Manage* 10:591–598
7. Folstein MF, Folstein SE (1994a) Neuropsychiatric Assessment of Syndromes of Altered Mental State. In: Hazzard WB, Bierman EL, Blass JP et al. (eds) *Principles of Geriatric Medicine and Gerontology*. McGraw-Hill, pp 221–228
8. Folstein MF, Folstein SE (1994b) Syndromes of Altered Mental State. In: Hazzard WB, Bierman EL, Blass JP et al. (eds) *Principles of Geriatric Medicine and Gerontology*. McGraw-Hill, pp 1197–1204
9. Herr KA, Mobily PR, Kohout FJ et al. (1998) Evaluation of the Faces Pain Scale for Use with the Elderly. *Clin J Pain* 14:29–38
10. Kovach CR, Weissman DE, Griffi J et al. (1999) Assessment and Treatment of Discomfort for People with Late-Stage Dementia. *J Pain Symptom Management* 18:412–419
11. Marzinski LR (1991) The Tragedy of Dementia: Clinically Assessing Pain in the Confused, Nonverbal Elderly. *J Gerontological Nursing* 17:25–28
12. Ouslander JG, Osterweil D, Morley J (1997) Delirium and Dementia. In: *Medical Care in the Nursing Home*. McGraw-Hill, pp 147–162
13. Parmalee PA (1996) Pain in Cognitively Impaired Older Persons. In: Ferrell BA, Saunders WB (eds) *Clinics In Geriatric Medicine*, pp 473–485
14. Stein WM (1996) Cancer Pain in the Elderly. In: Ferrell BR, Ferrell BA (eds) *Pain in the Elderly*. IASP Press, Seattle, pp 69–80
15. Stein WM (2001) Assessment of Symptoms in the Cognitively Impaired. In: *Topics in Palliative Care*. Oxford University Press 5:123–133

## Cancer Pain, Assessment of Cultural Issues

TERRY ALTILIO

Department of Pain Medicine and Palliative Care, Beth Israel Medical Center, New York, NY, USA  
taltilio@chpnet.org

### Definition

Culture is defined as learned values, beliefs, behaviors and systems of meaning which guide a worldview and inform decisions. Culture is constantly redefined and negotiated and respectful, comprehensive care requires combining theoretical knowledge with a meaningful exploration of the “patients unique history, family constellation and socioeconomic status” (Koenig and Gates-Williams 1995).

### Characteristics

Although knowledge of specific cultures can be instructive, cultural identification alone is not predictive of specific behaviors, values or beliefs. Intracultural variation emanating from such factors as gender, age, geographic location, ties to country of origin, ► **assimilation** and ► **acculturation** contribute to the dynamic nature of culture. Culture infuses the experience of the patient and

family, and practitioners are more or less influenced by the culture of the health care system, the disease and the larger society. It is at this interface that understanding, collaboration and negotiation needs to occur (Koenig and Gates-Williams 1995; Kagawa-Singer and Blackhall 2001; Kagawa-Singer 1996).

Studies of the relationship of culture and pain date back to 1950 and include both clinical and laboratory research. Studies have focused on such varied aspects as pain threshold, pain perception and description, attitudes and behaviors, undertreatment in minority patients, coping strategies, use of opioid medications, beliefs, ascribed meaning and outcomes (Edwards et al. 2001; Zatzick and Dimsdale 1990). As far back as 1952, Zborowski studied the influence of ► **ethnicity** on pain response patterns, attitudes, beliefs and meaning (Zborowski 1952). In 1966, Zola studied interethnic differences in the response and attitudes toward symptoms such as pain (Zola 1966).

Cultural aspects of pain such as meaning, attribution, description and health seeking behaviors become increasingly relevant as research points to the importance of these factors on outcomes. For example, a study of chest pain in a population from the Southern United States revealed that cultural differences resulted in atypical descriptions, which have the potential to mislead clinicians who depend on the description of the character of chest pain as they triage for ischemic heart disease (Summers et al. 1999). A study of indigenous and non-indigenous people with persistent chest pain in the Northern Territory of Australia revealed that delays in presentation affected both rural and urban indigenous peoples, as well as rural non-indigenous people; these delays influence management options for acute myocardial infarction (Ong and Weeramanthri 2000). Such information assists clinicians and health educators to know that signs and symptoms, and pain-related behaviors, may not be the same for all cultural groups. Pain related to a diagnosis of cancer becomes complicated by the values and beliefs surrounding the disease itself, which may vary among optimism, hopelessness, shame or acceptance. These findings can provide direction to culturally informed assessment, education and outreach efforts.

Within available research, there is considerable variation in study populations, theoretical formulations, study design and findings. There is much opportunity for ongoing research in this rich and complex topic. Assessment and study challenges include cross-cultural validity of behavioral cues to indicate pain level, cross-cultural validity of assessment tools, and expanding study designs to include variables such as intracultural differences and influence of clinician culture on outcome. Assessment tools such as the Brief Pain Inventory and McGill Pain Questionnaire have been validated and translated into languages other than English. In addition, acceptance of unique cultures requires understanding

that linear assessment tools may have little relevance in cultures where numbers have no relationship to pain rating, or where narrative or pictures are essential to communication (Kagawa-Singer and Blackhall 2001, Hallenbeck and Goldstein 1999).

Consideration of cultural issues in the health care setting means that practitioners have to reconcile the possibility that their personal beliefs and values, and the values of the medical system, may not be shared by the patient and family (Hallenbeck 2002). Consequently, clinicians need to develop an awareness of the culture and traditions of the population they treat. This awareness becomes a hypothesis and serves only as background to guide inquiry and exploration. The subjective nature of pain requires that each patient's pain description, report and behaviors be explored and understood in the context of cultural variation related to pain. Clinicians bring their own personal and professional cultural perspectives into the medical setting and it is at this interface that the assessment of pain, clinical judgement and related treatment interventions take place. As early as 1977, Davitz et al. reported on the emergency room care of a 45-year-old male whose pain behaviors were observed by three nurses of different **ethnic group** backgrounds (Davitz et al. 1977). Each nurse had different reactions and judgments of his expression of pain. A nurse from Northern Europe described the patient as very emotional and overreactive. A nurse from Puerto Rico felt the patient's outbursts were understandable and an American nurse expected that an adult male of his age and background would be stronger and more stoic. A follow-up study found that nurses from various countries differed in their judgments about the degree of patient suffering. These findings are an alert to all disciplines of the importance of self awareness, as clinician beliefs and values can significantly impact on attitudes and practice (Bonham 2001). Characteristics of pain assessment and management may be influenced by culture. While categorized as discrete aspects, these variables are integrated and overlapping, and related to the larger historical/political, class and socioeconomic issues (Koenig and Gates-Williams 1995). For example, in some countries, the experience of marginalization and discrimination of minority patients creates an environment of mistrust and/or hopelessness, which requires clinicians to spend additional time and ongoing effort to establish beginning rapport and credibility. The undertreatment of pain, including cancer pain, in minority populations has been identified in a variety of studies, and further work is needed to isolate the multidimensional factors that influence these outcomes (Zborowski 1969).

#### Expression and Language of Pain

Pain complaints can be conveyed using verbal, facial or body language. For many, how one expresses and responds to pain is learned through childhood experience and either reinforced in adulthood or modified by other

experience, such as a diagnosis of a life threatening illness. Culture influences how, if and to whom the subjective pain experience is expressed and whether it is described in direct, substitute or metaphoric terms. In cultures where control is valued, endurance and stoicism would be expected and outward expression of pain viewed as a sign of weakness, possibly resulting in guilt or shame. Similar behaviors are not always based in the same value system. For example, stoicism may reflect a reluctance to impose or disrupt others rather than a sign of endurance. This is especially important with a diagnosis of cancer, where historically emphasis has been on curing the disease and pain, and quality of life issues have been perceived as a distraction from that primary goal. Expressions of pain, such as crying, cursing or moaning, can be the learned and expected way to express distress and seek care, and are not always correlated with the degree of pain. These behaviors may relate to feared consequences rather than the pain itself (Mims 1989). In patients with cancer, emerging or increasing pain may be interpreted as a sign of progressing disease, and the symbolic significance of the pain becomes a source of suffering and distress. Dramatic expressions of pain can serve an important purpose in systems and situations where people have to compete for care, or where healthcare professional have minimized or challenged reports of pain. Cultures that value patience and choose not to disrupt others need outreach from health care staff to create an environment where patients feel their comfort to be an important focus of care. Another variable that influences the expression of pain and related content is time orientation. In societies that are future-oriented, patients may project ahead, and rather than focus on the sensation of pain and relief, will anticipate and worry about the future impacts of pain and disease (Mims 1989).

#### Meaning of Pain

The meaning of pain may have an important relationship to response, behaviors and coping. Cultural traditions often prepare individuals to anticipate pain in certain situations, which can increase feelings of control and lessen anxiety and distress related to the unknown. Pain that has been experienced before has different meaning than pain that is related to a life-threatening illness, or is unexpected, and all will be integrated in accordance with personal and cultural beliefs and values. The narratives and descriptions not only reflect pain but also attempt to make sense of it within a cultural context and within the context of a known diagnosis (Hallenbeck 2002; Davitz et al. 1977; Lipson et al. 2000). Health may be considered a gift from God or a reflection of internal equilibrium. Cancer and pain may be interpreted as a sign of internal imbalance, divine displeasure, a curse, witchcraft, or perhaps, the result of transgressions in prior life. If pain is considered part of God's plan, a test of faith or an opportunity for character building and redemption, then



acceptance and the manner of coping may be a demonstration of courage and faith. Where pain is an extension of God's will, or when suffering is felt to be an expected part of life, there may be a feeling of fatalism that results in a feeling of powerlessness with no expectation or acceptance of treatment (Hallenbeck 2002; Davitz et al. 1977; Lipson et al. 2000).

### Expectations of Health Care Professionals

The expectations of healthcare professionals are highly influenced by cultural variables. Respect for clinicians may be expressed by behaviors such as not making direct eye contact and not challenging or questioning practitioners. Many traditions support a hierarchical system, and patients do not expect a consultative model where they are asked for feedback and given options. Expecting to be guided by experts, patients may interpret the consultative approach as a reflection of incompetence. Health care relationships are a reflection of the larger culture, which may be high or low-context. Low-context culture, similar to Western biomedicine, places emphasis on individuality and a more linear verbal communication, whereas a high-context environment emphasizes the relational aspects that are important to care, decision making and inclusion of family and community (Hallenbeck 2002; Davitz et al. 1977). Consultation with a health care professional may follow the primary healing efforts of family or healers. Acknowledging and integrating these traditional interventions can be signs of respect for patients and their support systems and may enhance outcome. In situations where the language of patient and clinician differ, perceptions of patient and family about the use of medical translators need to be explored. Family members are untrained in the use of medical terminology and when acting as interpreters may experience role conflict and confusion (Zhou et al. 1993). Clinicians are in the unique position of being unaware of the actual content and accuracy of the communication when family and friends translate through their own cognitive and emotional filters.

### Response to and Acceptance of Treatments

Treatment response is based on a range of values and beliefs. In addition to the ongoing investigation of interethnic differences in drug response, culture impacts acceptance of medications, interventions and side effects. Sedation and cognitive impairment may be very troubling to patients whose clarity of mind and contact with others are essential to spiritual, emotional and philosophical well being. Treatments that are internal, such as pills or injections, may be preferred by some, while external interventions, such as massage and salves, may be preferable to others. In cultures where acupuncture equates with positive outcome, the sensation of insertion of needles may have positive association. Certain medications, such as morphine or methadone, may have symbolic significance and be

associated with addiction or death. When medications are feared, patients may discontinue them quickly. In high context cultures, treatment plans and options may need to be discussed with family and community, which may include healers, elders or clergy (Hallenbeck and Goldstein 1999).

### Caregiver Responses

The responses of caregivers are multifaceted and often relate to how care is provided to a sick family or community member. The expected roles and responses of patients, parents, siblings, family and community may evolve from an acute illness model. For some, a cancer diagnosis may yield helplessness and passivity as the accepted and expected response to illness and pain (Hallenbeck and Goldstein 1999). Transition to a chronic disease state can challenge traditional beliefs and behaviors, as the support must become long-term, and there is a need to accommodate to a person who receives ongoing treatments and may or may not be disabled (Lipson et al. 2000). Traditional beliefs, which encourage rest and dependence can be very responsive to situations of pain in life threatening illness and less helpful in chronic settings, where goals of care include recovering function and encouraging participation beyond the role of patient. The convergence of culture, pain and the diagnosis of cancer provides a rich and challenging opportunity for clinicians to individualize assessment and intervention, and maximize the support, comfort and continuity that comes from cultural beliefs and sustains patients and families through medical and life transitions, crises and beyond.

### References

1. Bonham VL (2001) Race, Ethnicity and Pain Treatment: Striving to Understand the Causes and Solutions to the Disparities in Pain Treatment. *J Law Med Ethics* 29:52–68
2. Davitz LL, Davitz JR, Higuchi Y (1977) Cross-Cultural Inferences of Physical Pain and Psychological Distress. *Nursing Times* 73:521–558
3. Edwards CL, Fillingim RB, Keefe F (2001) Race, Ethnicity and Pain – Topical Review. *Pain* 94:133–137
4. Groce NE, Zola IK (1993) Multiculturalism, Chronic Illness and Disability. *Pediatrics* 91:1048–1055
5. Hallenbeck JL (2002) Cross-Cultural Issues. In: Berger AM, Portenoy RK, Weissman DE (eds) *Principles and Practice of Palliative Care*. Lippincott, Williams & Wilkins, Philadelphia, pp 661–672
6. Hallenbeck JL, Goldstein MK (1999) Decisions at the End of Life – Cultural Considerations beyond Medical Ethics. *Generations* Spring:24–29
7. Koenig BA, Gates-Williams J (1995) Understanding Cultural Differences in Caring for Dying Patients. *West J Med* 163:244–249
8. Kagawa-Singer M (1996) Cultural Systems. In: McCorkle R, Grant M, Frank-Stromborg M (eds) *Cancer Nursing*, 2<sup>nd</sup> edn. WB Saunders, Philadelphia, pp 38–52
9. Kagawa-Singer M, Blackhall LJ (2001) Negotiating Cross-Cultural Issues at the End of Life “You Got to Go Where he Lives.” *JAMA* 286:2993–3001

10. Lipson JG, Dibble SL, Minarik PA (eds) (2000). *Culture & Nursing Care: A Pocket Guide*. California: UCSF Nursing Press, pp 3–4
11. Mims BC (1989) Sociologic and Cultural Aspects of Pain. In: Tolison CD (ed) *Handbook of Chronic Pain Management*. Williams and Wilkins, Baltimore, pp 17–25
12. Ong MA, Weeramanthri TS (2000) Delay Times and Management of Acute Myocardial Infarction in Indigenous and Non-Indigenous People in the Northern Territory. *Med J Australia* 173:173–174
13. Summers RL, Cooper GJ, Carlton FB et al. (1999) Prevalence of Chest Pain Descriptions in a Population from the Southern United States. *Amer J Medical Science* 318:142–145
14. Zatzick DF, Dimsdale JE (1990) Cultural Variation in Response to Painful Stimuli. *Psychosom Med* 52:544–557
15. Zborowski M (1952) Cultural Components in Responses to Pain. *J Social Issues* 8:16–30
16. Zborowski M (1969) *People in Pain*. Jossey-Bass, San Francisco, pp 30–41
17. Zhou HH, Sheller JR, Nu H et al. (1993) Ethnic Differences in Response to Morphine. *Clin Pharmacol Ther* 54:507–513
18. Zola J (1966) Culture and Symptoms, an Analysis of Patients Presenting Complaints. *Am Sociol Rev* 31:615

---

## Cancer Pain, Epidemiology

CIELITO C. REYES-GIBBY, CHARLES S. CLEELAND  
The University of Texas M. D., Anderson Cancer  
Center, Houston, TX, USA  
ccleeland@mdanderson.org

### Definition

Epidemiology provides a framework for measuring the prevalence, incidence, and risks associated with pain in cancer patients. Epidemiology provides research methods that can be used to answer the following questions: What is the occurrence of pain in people with cancer? At what stage of the disease does pain become a problem? Are cancer patients at a higher risk for pain compared to patients with chronic conditions such as diabetes or cardiovascular disease? To what extent does the prevalence of cancer pain vary by age, gender, or race? What factors are associated with the prevalence or incidence of pain? What proportion of patients receives adequate treatment for pain?

### Characteristics

Although many studies have attempted to answer these basic questions, consistent results have been difficult to obtain. Estimates of the number of cancer patients experiencing pain vary widely, mainly because of a lack of uniformity (or standardization) in the definitions and assessment measures used (i.e. there is no gold standard) and the heterogeneity of pain conditions (nociceptive vs. neuropathic). Other factors contributing to the wide variability of results include, but are not limited to, the heterogeneity of cancer types (breast, lung, etc.), the stage of disease, and the type of treatment settings (outpatient vs. inpatient or palliative) in

which studies were conducted. In many instances, the issue of potential confounding factors has not been adequately addressed. There is also non-distinction on the various measures of disease occurrence and risk used in measuring the distribution, determinants, and natural history of pain. For example, prevalence measures (which quantify the proportion of a population with a condition at a given point in time (point prevalence rate), the proportion of persons affected by the condition during a defined period of time (period prevalence rate), or the proportion of a population affected over their lifetime (lifetime prevalence rate)) are commonly confused with incidence measures (which quantify the probability or rate of onset of a condition among persons with no prior history). A recent report of the National Cancer Institute (Patrick et al. 2004), while emphasizing the need for better symptom epidemiologic studies, elaborates the methodological issues and challenges facing researchers who study the epidemiology of pain. In this essay, we report on studies of the prevalence of pain among cancer patients and the risk factors associated with pain and its undertreatment, and offer recommendations for future studies on the epidemiology of pain.

### Prevalence of Cancer Pain

Pain is prevalent for large numbers of patients with cancer (Cleeland et al. 1997; Cleeland et al. 1994; Portenoy et al. 1994; Von Roenn et al. 1993). Approximately 55% of outpatients with metastatic cancer have disease-related pain, and 36% have pain of sufficient severity to impair their functioning and quality of life. Significant pain is rarely a problem at diagnosis, but as disease becomes metastatic, a majority of patients will have pain (Daut and Cleeland 1982). Pain prevalence and severity obviously varies with the adequacy of pain management. However, despite the existence of national and international pain management guidelines, many patients with pain are not prescribed an analgesic appropriate to the severity of their pain. Multicenter studies indicate that approximately 40% of patients with cancer pain are not prescribed analgesics potent enough to manage their pain, with additional patients receiving insufficient doses of the analgesic prescribed. Studies of pain related to specific cancers show pain as highly prevalent. For example, a study of breast cancer patients (stages II, III, and IV breast cancer) showed 47% had severe pain (Gaston-Johansson et al. 1999). In a study of pancreatic cancer patients, at least 44% were found to have severe pain (Brescia et al. 1992). A review of studies of lung cancer patients document that as many as 85% experienced severe pain (Potter and Higginson 2004). Studies of pain following surgical treatment show pain as prevalent treatment sequelae. Despite the thousands of cancer patients who are treated with curative surgery, very little is known about the prevalence, duration,



and functional impact of pain in this patient population. Patients not only suffer from the side effects of the chemotherapy or radiotherapy before surgery for their cancer, but may also develop serious post-surgical symptoms.

Among breast cancer patients, 41% of those who had conservative breast surgery with radiotherapy reported pain as a consequence of treatment. Pain generally started within three months after the completion of therapy, was localized in the axillary region, and was intermittent (Amichetti and Caffo 2003). The pain was mainly described as aching (59%), tender (51%), and cramping (43%). In comparison to the patients who did not experience pain, those who suffered from pain had significantly worse scores in physical, psychological, and other quality-of-life measures.

It is less recognized that many cancer patients continue to experience pain well after treatment has ended. Chaplin and Morton (1999) assessed 93 head and neck cancer patients and found that 48% had head and neck pain when first seen, and that 25% and 26% had pain that persisted at 12 and 24 months, respectively. The prevalence of shoulder and arm pain was greater after treatment, increasing from 14% at diagnosis to 37% at 12 months and 26% at 24 months. Any pain (pain in either the head and neck or shoulder and arm or both) at 24 months was strongly predicted by earlier post-treatment pain (at three months or at 12 months). Shoulder and arm pain at 24 months was strongly correlated with surgical treatment of the neck, although no difference in pain experience was noted between those who had radical neck dissections and those who had more conservative procedures.

Studies have examined the prevalence of pain among cancer patients in advanced stage. As part of the SUPPORT studies, McCarthy et al. (2000) evaluated over 1,000 cancer patients during the three days before death, at one to three months before death, and three to six months before death. As expected, as patients progressed toward death, their six-month prognosis deteriorated significantly and the severity of their disease worsened. Cancer patients experienced significantly more pain and confusion as death approached. Severe pain was common; more than one quarter of patients with cancer experienced significant pain three to six months before death, and more than 40% were in significant pain during their last three days of life.

While it is recognized that pain is prevalent for the majority of cancer patients, evidence suggests that the elderly and patients from minority groups may have an even greater risk for pain and poor pain management (Cleeland et al. 1997; Anderson et al. 2000). Undertreatment of pain was shown to be higher among minority patients seen at clinics serving minority clients, with minority patients three times more likely to be undermedicated with analgesics than patients treated in non-minority community treatment settings (Cleeland

et al. 1994). Patients treated at university centers and at centers seeing primarily African Americans, Hispanics, or both, were more likely to receive inadequate analgesia than patients treated in non-minority community treatment settings (77% vs. 52%, respectively). Minority patients had the severity of their pain underestimated by their physicians, reported that they needed stronger pain medication, and felt that they needed to take more analgesics than their doctors had prescribed. Assessing differences between minority groups, more Hispanic patients reported lower levels of pain relief than did African Americans.

Although few disagree that painful conditions should be treated regardless of age, studies document undertreatment of cancer pain in older populations. In a study of 4,003 elderly cancer patients (24%, 29%, and 38% of those aged 85 years or older, 75–84 years, and 65–74 years, respectively), Bernabei and colleagues (1998) found that more than a quarter (26%) of patients experiencing daily pain received no analgesic agent. Patients aged 85 years or older were less likely to receive morphine or other strong opiates than those aged 65–74 years (13% vs. 38%, respectively), and were more likely to receive no analgesia at all. African American elderly patients were also at a higher risk for undertreatment, suggesting the disparity in pain treatment is compounded for elderly minority patients. A study that looked at undertreatment of pain for ambulatory patients with metastatic cancer (Cleeland et al. 1994) also showed that older age (70 years or older) was a significant predictor of inadequate analgesia, according to the World Health Organization guidelines (World Health Organization 1986) for treatment of patients with cancer pain.

#### Factors Associated with Inadequate Treatment and Control of Pain

Undertreatment of pain is a major factor in the prevalence and severity of pain. A number of factors predict poor control or undertreatment of pain. Poor pain assessment remains the most salient barrier. Cleeland et al. (1994) found the degree of discrepancy between physician estimate and patient report of pain severity was a major predictor of undertreatment. However, although quantitative pain assessment has demonstrated its feasibility and validated pain assessment tools are available, data from a community-based oncology setting (Rhodes et al. 2001) show a virtual absence of documentation of quantitative pain assessment (only 0–5% of medical and radiation oncology physicians' notes contained any such documentation). Twenty-eight percent of patients with significant pain had no mention of pain in the physicians' notes, and 48% had no documented analgesic treatment. These findings point to the critical role of adequate assessment and monitoring for the control of pain and other symptoms.

Many cancer specialists recognize that pain control is often suboptimal. Medical oncologists were surveyed about their treatment of cancer pain in a study conducted by the Eastern Cooperative Oncology Group (ECOG) (Von Roenn et al. 1993). Only half of the physicians surveyed indicated that cancer pain control was “good” or “very good” in their practice setting. Seventy-five percent of the physicians indicated that the most important barrier to cancer pain management was inadequate pain assessment. Over 60% reported that physicians’ reluctance to prescribe analgesics and patient unwillingness to report pain or take opioids were barriers to adequate pain treatment. Inadequate knowledge about cancer pain management was reported by over 50% of the ECOG physicians surveyed. The survey documents that a substandard level of education about cancer pain management and a reluctance to address it in practice existed at all levels of professional health care. Cleeland and colleagues (2000) repeated the ECOG study format with physician members of the Radiation Therapy Oncology Group. Although there has been some improvement in the use of stronger analgesics, many barriers to good pain control remain, and poor pain assessment is still seen as the major barrier to good pain management.

#### Improving Control of Cancer Pain

In spite of the recent concerns over symptom management, there is substantial evidence that symptoms that could, in principle, be well managed are nonetheless undertreated. Pain could be more adequately controlled if we systematically applied the knowledge that we now have about its management.

There is at least preliminary evidence that improving pain assessment can improve pain management, and may improve the management of other symptoms as well. Trowbridge et al. (1997) conducted a randomized controlled trial of 320 patients and 13 oncologists. Patients were asked while in the clinic to complete assessments of their pain, their pain treatment regimens, and the degrees of relief received. Follow-up was conducted four weeks later by mail-in survey. The intervention group’s clinical charts contained a summary of the completed pain scales, and the oncologists who treated these patients were instructed to review the summary sheet prior to an evaluation. This summary was not available for the oncologists treating the patients in the control group. Results showed a significant difference ( $P = 0.016$ ) in the physicians’ prescription patterns. In the control group, prescriptions for 86% of the patients did not change, without any increase in analgesic prescriptions. In the intervention group, analgesic prescriptions changed for 25% of the patients, decreasing for 5% and increasing for 20%. A decrease in the incidence of pain described as “more than life’s usual aches and pains” was found at follow-up for the

intervention group ( $P = 0.05$ ). The findings from this study suggest that standardized pain assessment leads to improved cancer pain management.

Beginning with the publication of the World Health Organization’s Cancer Pain Management guidelines in 1986 (World Health Organization 1986), several guidelines for the practice of cancer pain management have been issued. There is, however, only one published study that evaluates the effectiveness of adherence to a pain management guideline for cancer pain (Du Pen et al. 1999). In this study, 81 cancer patients were enrolled in a prospective, longitudinal, randomized controlled study from 26 medical oncologist outpatient clinics in western Washington. A multilevel treatment algorithm based on the AHRQ Guidelines for Cancer Pain Management was compared with standard-practice (control) therapies for pain and symptom management used by community oncologists. Patients randomized to the pain algorithm group achieved a statistically significant reduction in pain intensity when compared with standard community practice.

A recently completed Eastern Cooperative Oncology Group study (Cleeland et al. 2005) found that the institutional use of a protocol for pain management improved pain control in lung and prostate cancer patients, but failed to improve the pain management of other patients (breast cancer and myeloma patients) in the same institutions who were not specifically treated by the pain protocol. Forty-eight percent of patients with lung and prostate cancer in the institutions that used a protocol for pain management reported a statistically significant reduction in moderate and severe pain ( $P < 0.02$ ), compared with 15% of lung and prostate patients treated as usual in the control institutions.

More recently, a system improvement approach was used to improve pain management in a national health-care system (Cleeland et al. 2003), with some reported success. The focus of the project, a collaborative initiative of the Veterans Health Administration and the Institute for Healthcare Improvement (VHA-IHI), was to achieve rapid improvements in pain management in the clinical and operational areas in the national VHA system. An underlying premise was the spread of existing knowledge to multiple sites. A total of 70 teams were formed and were asked to identify their goals and to implement changes in their practice setting. Importantly, faculty involved in the initiative developed the attributes of an ideal pain management system. Changes that were implemented included the development of new assessment forms to increase the number of patients with documented assessment and follow-up for treatment plan; development of guidelines and/or protocols; formation of one-on-one, group-provider, or computer-based educational methods to improve both assessment and follow-up, and/or ways to effectively link provider education with other system changes such as drug ordering or assessment processes; and develop-

ment of innovative ways to link primary care physicians with pain specialists.

The following outcomes were reported: moderate or severe pain on study units dropped from 24% to 17%; pain assessment increased from 75% to 85%; pain care plans for patients with at least mild pain increased from 58% to 78%; and the number of patients provided with pain educational materials increased from 35% to 62%. The results of these studies, taken together, suggest that improved assessment should improve symptom management for cancer patients.

### Future Directions

Overall, studies of the incidence, prevalence, severity, and treatment of cancer-related pain have shortcomings that need to be addressed and remedied. Pain is often evaluated and reported without stratifying for heterogeneity with respect to pain type, disease type and stage, disease treatment, and response to disease treatment. Although pain may endure for days, months, or years, assessments are often performed cross-sectionally rather than longitudinally, thus failing to assess patterns and trajectories.

Moreover, we need to explore whether pain and other symptoms experienced by cancer patients differ quantitatively and qualitatively with those of non-cancer populations. Cohort studies that will provide clinicians with information regarding the incidence, severity, and duration of these symptoms after a diagnosis of cancer should also be useful in determining the epidemiology of cancer pain. Finally, we need to identify the current adequacy of care for these symptoms, including identifying what factors (e.g. patient-related, clinician-related, and system-related) are predictive of poor symptom management.

### References

- Amichetti M, Caffo O (2003) Pain after quadrantectomy and radiotherapy for early-stage breast cancer: incidence, characteristics and influence on quality of life. Results from a retrospective study. *Oncology* 65:23–28
- Anderson KO, Mendoza TR, Valero V et al. (2000) Minority cancer patients and their providers: Pain management attitudes and practice. *Cancer* 88:1929–1938
- Bernabei R, Gambassi G, Lapane K et al. (1998) Management of pain in older adult patients with cancer. SAGE Study Group. Systematic Assessment of Geriatric Drug Use via Epidemiology. *JAMA* 279:1877–1882
- Brescia FJ, Portenoy RK, Ryan M et al. (1992) Pain, opioid use, and survival in hospitalized patients with advanced cancer. *J Clin Oncol* 10:149–155
- Chaplin JM, Morton RP (1999) A prospective, longitudinal study of pain in head and neck cancer patients. *Head Neck* 21:531–537
- Cleeland CS, Gonin R, Baez L et al. (1997) Pain and treatment of pain in minority patients with cancer. The Eastern Cooperative Oncology Group Minority Outpatient Pain Study. *Ann Intern Med* 127:813–816
- Cleeland CS, Gonin R, Hatfield AK et al. (1994) Pain and its treatment in outpatients with metastatic cancer. *N Engl J Med* 330:592–596
- Cleeland CS, Janjan NA, Scott CB et al. (2000) Cancer pain management by radiotherapists: a survey of radiation therapy oncology group physicians. *Int J Radiat Oncol Biol Phys* 47:203–208
- Cleeland CS, Portenoy RK, Rue M, et al. (2005) Does an oral analgesic protocol improve pain control for patients with cancer? An intergroup study coordinated by the Eastern Cooperative Oncology group. *Ann Oncol* 16:972–980
- Cleeland CS, Reyes-Gibby CC, Schall M et al. (2003) Rapid improvement in pain management: the Veterans Health Administration and the institute for healthcare improvement collaborative. *Clin J Pain* 19:298–305
- Daut RL, Cleeland CS (1982) The prevalence and severity of pain in cancer. *Cancer* 50:1913–1918
- Du Pen SL, Du Pen AR, Polissar N et al. (1999) Implementing guidelines for cancer pain management: results of a randomized controlled clinical trial. *J Clin Oncol* 17:361–370
- Gaston-Johansson F, Fall-Dickson JM, Bakos AB et al. (1999) Fatigue, pain, and depression in pre-autotransplant breast cancer patients. *Cancer Pract* 7:240–247
- McCarthy EP, Phillips RS, Zhong Z et al. (2000) Dying with cancer: patients' function, symptoms, and care preferences as death approaches. *J Am Geriatr Soc* 48:S110–S121
- Patrick DL, Ferketich SL, Frame PS et al. (2004) National Institutes of Health State-of-the-Science Panel National Institutes of Health State-of-the-Science Conference Statement: Symptom management in cancer: pain, depression, and fatigue, July 15–17, 2002. *J Natl Cancer Inst Monogr* 32:9–16
- Portenoy RK, Thaler HT, Kornblith AB et al. (1994) Symptom prevalence, characteristics and distress in a cancer population. *Qual Life Res* 3:183–189
- Potter J, Higginson IJ (2004) Pain experienced by lung cancer patients: a review of prevalence, causes and pathophysiology. *Lung Cancer* 43:247–257
- Rhodes DJ, Koshy RC, Waterfield WC et al. (2001) Feasibility of quantitative pain assessment in outpatient oncology practice. *J Clin Oncol* 19:501–508
- Trowbridge R, Dugan W, Jay SJ et al. (1997) Determining the effectiveness of a clinical-practice intervention in improving the control of pain in outpatients with cancer. *Acad Med* 72:798–800
- Von Roenn JH, Cleeland CS, Gonin R et al. (1993) Physician attitudes and practice in cancer pain management. A survey from the Eastern Cooperative Oncology Group. *Ann Intern Med* 119:121–126
- World Health Organization (1986) Cancer pain relief. World Health Organization, Geneva

C

## Cancer Pain, Evaluation of Relevant Comorbidities and Impact

MYRA GLAJCHEN

Department of Pain Medicine and Palliative Care, Beth Israel Medical Center, New York, NY, USA  
mglajchen@bethisraelny.org

### Definition

The assessment of patients with cancer pain often reveals the existence of important physical or psychiatric comorbidities. These comorbidities may or may not contribute to the pain. They often influence the selection of pain therapy, and may be independent problems in need of management in the broad strategy to improve quality of life.

## Characteristics

In some cases, a comorbid condition is both an independent medical issue and a potential etiology of the pain. For example, major depression may be expressed, in part, by persistent pain. Under these circumstances, treatment for the depression must be given priority and included among the analgesic strategies pursued. In other circumstances, a comorbid condition may be unrelated to the pain itself, but may impair function and negatively affect treatments intended to restore functioning. This is commonly encountered in the cancer patient with persistent gastrointestinal distress following chemotherapy.

A useful taxonomy for evaluating the impact of relevant comorbidities on cancer pain is listed below. The coexisting symptom or condition should be evaluated for its: direct contribution to the pain, predisposition to cause adverse treatment effects, compromise of rehabilitative efforts, ability to independently undermine quality of life, and ability to increase risk of serious adverse medical outcomes.

Fatigue is a common comorbidity, affecting 14-96% of people with cancer (Cella et al. 2002; Vogelzang et al. 1997). Generally, fatigue is characterized by a decrease in energy, distress and decreased functional status (Pickard-Holley 1991; Stone et al. 1998). Fatigue in cancer patients can result from the course of the disease, preexisting physical or psychological conditions, effects of medication, or lack of exercise. Fatigue may also result from surgery, chemotherapy, and radiation therapy. As fatigue can severely undermine the sense of well being, activities of daily living, relationships with family and friends, and treatment compliance, prompt diagnosis and treatment are recommended.

Gastrointestinal complications (constipation, impaction, bowel obstruction, nausea, vomiting and diarrhea) are common in oncology patients. The growth and spread of cancer, as well as related treatment, contribute to these conditions. Despite advances in management, nausea and vomiting remain among the most distressing side effects for patients and families (Wickham 1999). In addition, gastrointestinal comorbidities undermine quality of life and interfere with treatment (Pisters and Kris 1998).

Alterations in nutritional status begin at diagnosis, and may proceed through treatment. ► **Protein-calorie malnutrition** (PCM) is common and can lead to progressive wasting, weakness, and debilitation. Anorexia, the loss of appetite, is present in 15-25% of patients at diagnosis and may also occur as a treatment side effect (Vigano et al. 1994). Depression, loss of hope and anxiety are all associated with anorexia (Ross 1990). Anorexia can hasten the course of cachexia, a progressive wasting syndrome (Ross 1990) marked by weakness and progressive loss of body weight, fat, and muscle. Pain treatment in the context of anorexia and cachexia is complex.

About 44% of cancer patients report anxiety during treatment, while 23% report high anxiety (Nordin and Glimelius 1999; Pereira et al. 1997). Anxiety that is unusually intense or persistent may suggest an adjustment disorder or anxiety disorder in need of targeted treatment. Factors that increase the likelihood of developing adjustment disorders include pain, a history of anxiety disorders, functional limitations, advancing disease and absence of social support (Breitbart 1995; Schag and Heinrich 1989; Stark et al. 2002). Patients can become immobilized by anxiety, and be unable to comply with treatment. Therefore, prompt diagnosis and early intervention are optimal.

Depression is a disabling condition affecting 15-25% of cancer patients (Breitbart et al. 2000; Nelson et al. 2002). While some sadness is normal in reaction to cancer, it is important to distinguish normal sadness from an adjustment disorder with depressed mood or a depressive disorder (Block 2000). Clinicians should assess mood carefully and have a low threshold for initiating therapies. Early intervention is indicated if symptoms persist or recur, or if patients present with a history of depression, poor social support, a poor prognosis and higher levels of disability. A combination of psychotherapy and antidepressant drugs represents the most effective strategy for pain-related depression. Antidepressants with established analgesic effectiveness may be preferred (Breitbart 1995).

Delirium, agitation and cognitive impairment occur in 28-48% of patients with advanced cancer (Pereira et al. 1997; Lawlor et al. 2000). The causes of delirium are multifactorial, and may include direct effects of the disease on the CNS, metabolic or electrolyte disturbances, treatment and medications (Lawlor et al. 2000; Morita et al. 2002). The presence of delirium poses a major barrier to doctor-patient communication, family distress and treatment adherence (Fainsinger et al. 1993). Prompt diagnosis and treatment are therefore optimal.

Nearly one-third of the population of the United States has used illicit drugs, and an estimated 6-27% have a ► **substance abuse** problem of some type (see ► **aberrant drug-related behaviors** and ► **pseudoaddiction**) (Colliver and Kopstein 1991). Although problematic drug use is sometimes related to undertreatment (Weissman and Haddox 1989), primary abuse or ► **addiction** may be encountered in the oncology setting. A history of substance abuse can increase the risk of morbidity or mortality among those with progressive life-threatening disease, and undermine treatment adherence. This can be mitigated by a therapeutic strategy that addresses drug-taking behavior while implementing other therapies. Knowledge about the basic concepts of addiction medicine and collaboration with addiction specialists is needed (Substance Abuse and Mental Health Services Administration 2002).



The goal of a comprehensive approach to the patient with cancer pain is to organize a therapeutic strategy, which can enhance comfort and function and ameliorate comorbidities – all in an effort to reduce suffering and improve quality of life.

## References

- Block SD (2000) Assessing and Managing Depression in the Terminally Ill Patient. ACP-ASIM End-of-Life Care Consensus Panel. American College of Physicians – American Society of Internal Medicine. *Ann Intern Med* 132: 209–218
- Breitbart W (1995) Identifying Patients at Risk for, and Treatment of Major Psychiatric Complications of Cancer. *Support Care Cancer* 3:45–60
- Breitbart W, Rosenfeld B, Pessin H et al. (2000) Depression, Hopelessness, and Desire for Hastened Death in Terminally Ill Patients with Cancer. *JAMA* 284:2907–2911
- Cella D, Lai JS, Chang CH et al. (2002) Fatigue in Cancer Patients Compared with Fatigue in the General United States Population. *Cancer* 94:528–538
- Colliver JD, Kopstein AN (1991) Trends in Cocaine Abuse Reflected in Emergency Room Episodes Reported to DAWN. *Public Health Rep* 10:59–68
- Fainsinger RL, Tapper M, Bruera E (1993) A Perspective on the Management of Delirium in Terminally Ill Patients on a Palliative Care Unit. *J Palliat Care* 9:4–8
- Lawlor PG, Gagnon B, Mancini IL et al. (2000) Occurrence, Causes, and Outcome of Delirium in Patients with Advanced Cancer: A Prospective Study. *Arch Intern Med* 160:786–294
- Morita T, Tei Y, Tsunoda J et al. (2002) Underlying Pathologies and their Associations with Clinical Features in Terminal Delirium of Cancer Patients. *J Pain Symptom Manage* 23:107–113
- Nelson CJ, Rosenfeld B, Breitbart W et al. (2002) Spirituality, Religion, and Depression in the Terminally Ill. *Psychosomatics* 43:213–220
- Nordin K, Glimelius B (1999) Predicting Delayed Anxiety and Depression in Patients with Gastrointestinal Cancer. *Br J Cancer* 79:525–529
- Pereira J, Hanson J, Bruera E (1997) The Frequency and Clinical Course of Cognitive Impairment in Patients with Terminal Cancer. *Cancer* 79:835–842
- Pickard-Holley S (1991) Fatigue in Cancer Patients. A Descriptive Study. *Cancer Nurs* 14:13–19
- Pisters KM, Kris MG (1998) Treatment-Related Nausea and Vomiting. In: Berger A, Portenoy RK, Weissman DE (eds) *Principles and Practice of Supportive Oncology*. Lippincott-Raven Publishers, Philadelphia, pp 165–178
- Ross BT (1990) Cancer's Impact on the Nutrition Status of Patients. In: Bloch AS (ed) *Nutrition Management of the Cancer Patient*. Aspen Publishers, Rockville, MD
- Schag CA, Heinrich RL (1989) Anxiety in Medical Situations: Adult Cancer Patients. *J Clin Psychol* 45:20–27
- Stark D, Kiely M, Smith A et al. (2002) Anxiety Disorders in Cancer Patients: Their Nature, Associations, and Relation to Quality of Life. *J Clin Oncol* 20:3137–3148
- Stone P, Richards M, Hardy J (1998) Fatigue in Patients with Cancer. *Eur J Cancer* 34:1670–1676
- Substance Abuse and Mental Health Services Administration: Results From the 2001 National Household Survey on Drug Abuse: Volume I. Summary of National Findings (2002) SAMHSA, Office of Applied Studies, DHHS, Rockville, MD
- Vigano A, Watanabe S, Bruera E (1994) Anorexia and Cachexia in Advanced Cancer Patients. *Cancer Surv* 21:99–115
- Vogelzang NJ, Breitbart W, Cella D et al. (1997) Patient, Caregiver, and Oncologist Perceptions of Cancer-Related Fatigue: Results of a Tripart Assessment Survey. The Fatigue Coalition. *Semin Hematol* 34:4–12
- Weissman DE, Haddox JD (1989) Opioid Pseudoaddiction – An Iatrogenic Syndrome. *Pain* 36:363–366
- Wickham R (1999) Nausea and Vomiting. In: Yarbo CH, Frogge MH, Goodman M (eds) *Cancer Symptom Management*, 2<sup>nd</sup> edn. Jones and Bartlett Publishers, Sudbury, MA, pp 228–263

C

## Cancer Pain, Goals of a Comprehensive Assessment

PAULINE LESAGE

Department of Pain Medicine and Palliative Care, Beth Israel Medical Center and Albert Einstein College of Medicine, New York, NY, USA  
plesage@bethisraelny.org

### Definition

The assessment of cancer pain requires an understanding of the disease and its extent, in addition to its diverse comorbidities, to clarify the nature of the pain and its physical, psychological, and social disturbances. The list below describes a stepwise assessment of patients with cancer pain. This understanding will guide the treatment plan, focused on providing comfort and improving quality of life.

### Step 1: Data Collection

- Pain-related history
  - Other relevant history
  - Disease related
  - Other symptoms
  - Psychiatric history
  - Social resources
- Concurrent quality-of-life concerns
  - Other symptoms
  - Concerns in physical, psychological, social, and spiritual domains
  - Other concerns (e.g. financial)
  - Assessment of the family
- Available laboratory and imaging data
  - Radiographs and scans
  - Tumor markers
  - Hematologic parameters
  - Biochemical parameters

### Step 2: Interpret the Findings

- Pain-related constructs
  - Etiology
  - Inferred pathophysiology
  - Syndrome identification
- Extent of disease



- Goals of care
  - Prolonging survival
  - Optimizing function
  - Optimizing comfort

### Step 3: Formulating a Treatment Strategy

- Further evaluation, if needed
- Multimodality approach to the pain
- Treatment of the pain etiology, if possible
- Treatments for concurrent concerns
- Patient/family education

### Characteristics

The comprehensive assessment of pain characteristics should include information about: 1) temporal characteristics (onset and duration); 2) course (stable, improving, worsening, or widely fluctuating); 3) severity (both average and worst); 4) location; 5) quality, and 6) provocative and palliative factors.

Acute pain usually has a well-defined onset and a readily identifiable cause (e.g. surgical incision). It may be associated with anxiety, overt pain behaviors (moaning or grimacing), and signs of sympathetic hyperactivity (including tachycardia, hypertension, and diaphoresis). In contrast, chronic pain is usually characterized by an ill-defined onset and association with persistent focus of pathology. The course of the pain may be linked to the disease, and may change with the response to primary antineoplastic therapies. With chronic pain, overt pain behaviors and sympathetic hyperactivity are typically absent, and vegetative signs, including lassitude, sleep disturbance, and anorexia, may be present. A clinical depression evolves in some patients.

Most patients with chronic cancer pain also experience periodic flares of pain, or breakthrough pain (Patt and Ellison 1999). An important subtype of breakthrough pain is known as ► **incident pain**. Diagnosis of breakthrough pain may suggest specific interventions, such as the use of supplemental medication that specifically targets the cause.

Pain may be focal, multifocal, referred or generalized. Pain may be referred from a lesion involving any of a large group of structures, including nerve, bone, muscle or other soft tissue, and viscera (Ness and Gebhart 1990; Torebjork et al. 1984). Various subtypes of ► **referred pain** can be distinguished. Pain may be referred anywhere along the course of an injured peripheral nerve (such as pain in the thigh or knee from a lumbar plexus lesion) or nerve root (known as radicular pain). Pain may also be referred to a site remote from a nociceptive lesion and outside the dermatome affected by the lesion (e.g. shoulder pain from diaphragmatic irritation).

Measurement of pain intensity is an essential element in the pain assessment. Intensity may be monitored using a numeric scale (0–10), verbal rating scale (none, mild,

moderate, severe), or a visual analogue scale. The particular scale used is less important than its regular use to record the status of the pain over time.

### Interpreting the Assessment

The pain history, combined with the information gleaned from a physical examination and appropriate imaging and laboratory studies, usually provides sufficient data to generate meaningful conclusions concerning the etiology of the pain, its pathophysiology, and its defining syndrome. The latter constructs are very useful in clarifying the need for additional evaluation, prognosticating outcomes, and developing an efficient therapeutic strategy.

### Etiology

The etiology of acute pain is usually clear-cut. Further evaluation to determine the underlying lesion is not indicated unless the course varies from the expected. In contrast, the etiology of chronic cancer-related pain may be more difficult to characterize. In most cases, pain is due to direct invasion of pain-sensitive structures by the neoplasm (Cherny et al. 1994; Foley 1996). The structures most often involved are bone and neural tissue, but pain can also occur when there is an obstruction of hollow viscus, distention of organ capsules, distortion or occlusion of blood vessels, and infiltration of soft tissues. In about one-quarter of patients, the etiology relates to an antineoplastic treatment, and fewer than 10% have pain unrelated to the neoplasm or its treatment (Cherny et al. 1994; Foley 1996). Many patients, particularly those with advanced illness, have multiple etiologies and several sources of pain.

Given the association between pain and the underlying neoplasm, clarification of the specific relationship between the pain and the disease is an essential element of the assessment. A survey of patients referred to a pain service in a major cancer hospital noted, that previously unsuspected lesions were identified in 63% of patients (Gonzalez et al. 1991). This outcome altered the known extent of disease in virtually all patients, changed the prognosis for some, and provided an opportunity for a primary antineoplastic therapy in approximately 15%.

### Pathophysiology

Although inferences about the predominating mechanisms underlying pain are certainly gross simplifications of very complex and dynamic processes, and can never be proved in the clinical setting, this classification has utility in treatment planning. Pain syndromes may be labeled nociceptive, neuropathic, psychogenic and mixed (Merskey and Bogduk 1994).

The quality of somatic ► **nociceptive pain** is typically described as aching, stabbing, throbbing, or pressure-like. The quality of visceral nociceptive pain is usually gnawing or crampy when related to obstruction of hol-

low viscous, and aching or stabbing when associated with injury to other visceral structures.

Neuropathic mechanisms are involved in approximately 40% of cancer pain syndromes and can be disease-related (e.g. tumor invasion of nerve plexus) or treatment-related (e.g. postmastectomy syndrome or chemotherapy-induced painful polyneuropathy) (Caraceni and Portenoy RK, and a working group of the IASP Task Force on Cancer Pain 1999). Among those with metastatic disease, ► **neuropathic pain** usually results from neoplastic injury to peripheral nerves (peripheral neuropathic pain). Other, less common, subtypes include: 1) those sustained by CNS processes (sometimes generically termed deafferentation pain); and 2) those in which the pain is believed to be maintained by efferent activity in the sympathetic nervous system (so-called sympathetically-maintained pain) (Galer 1995).

Neuropathic pain is diagnosed on the basis of the patient's verbal description of the pain, the findings on examination, and evidence of nerve injury. If patients describe pain in dysesthetic terms, such as "burning," "shock-like," or "electrical," this is suggestive of neuropathic mechanisms (Grond et al. 1999). Likewise, the existence of neuropathic pain may be inferred by the findings of abnormal sensations on physical examination, most notably ► **allodynia** and ► **hyperalgesia**.

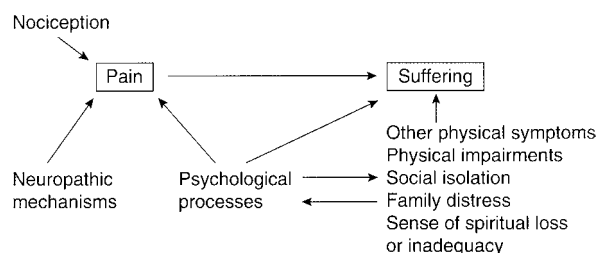
Pain may be labeled psychogenic if there is positive evidence from the assessment that psychological factors predominate in sustaining the symptom. ► **Psychogenic pain** may be more formally characterized according to the widely-accepted taxonomy of the American Psychiatric Association (one of the Somatoform Disorders described in the Diagnostic and Statistical Manual, 4<sup>th</sup> Revision). Although psychological factors commonly influence the expression and severity of pain in the cancer population, it is rare to identify a pain as psychogenic. If a credible pathophysiologic diagnosis is not apparent, and there is no strong evidence of a predominating psychological cause, it is best to label the pain idiopathic.

### Assessment of Related Constructs

Chronic cancer-related pain is best addressed with consideration of a set of broader constructs, including suffering, quality of life, symptom distress, and the goals of care. These understandings continually inform decision-making about interventions to manage pain.

### Pain and Suffering

Suffering, a global construct intricately related to the experience of pain (Fig. 1), has been described as a perceived threat to the integrity of the person, as a type of "total pain," or as overall impairment in quality of life (Cassell 1982). Suffering may be primarily related to symptoms such as pain or physical losses; to psychiatric disorders such as depression or psychological processes such as disturbed body image; to social issues such as



**Cancer Pain, Goals of a Comprehensive Assessment, Figure 1** Distinctions and interactions between nociception, pain, and suffering. (Reproduced with permission from Portenoy RK (1992) Cancer pain: pathophysiology and syndromes. *Lancet* 339:1026).

loss of role functioning, familial disruption, or tension in the relationship with a significant other; or to spiritual concerns such as loss of faith. Other factors, such as financial concerns, may be prominent. Psychosocial and spiritual strengths and weaknesses that long predated the cancer may be important.

Comprehensive pain assessment must address issues related to suffering. An understanding of the physical, psychological, social and spiritual issues important to the patient is fundamental to this process. A therapeutic approach focused only on pain may not meaningfully benefit a patient whose suffering is caused by other disturbances.

### Pain and Quality of Life

Quality of life is related to the construct of suffering but has been more formally characterized for a research context. Numerous instruments have been created to measure quality of life, and these have been developed from the perspective of two major characteristics: subjectivity and multidimensionality (Skeel 2002).

The inherent subjectivity of quality of life has implications for assessment. Although clinicians commonly make inferences about patients' well-being, or rely on proxy evaluation by family or others, the likelihood of inaccuracy in such appraisals must be appreciated (Grossman et al. 2001). For the evaluation of quality of life, and each of its contributing concerns, including pain, the "gold standard" of assessment is self-report. Like pain itself, quality of life is multidimensional. Although a single question can screen for overall well-being, a fuller understanding of the factors that must be addressed to improve quality of life requires probing of issues related to physical, psychological, social, and spiritual functioning.

### Pain and Symptom Distress

Most patients with chronic cancer pain experience other symptoms concurrently. Studies have demonstrated that pain, fatigue, and psychological distress are most prevalent across populations with advanced cancer. Global symptom distress is a useful construct that characterizes overall symptom burden (Portenoy et al. 1994).

## Goals of Care

In developing a therapeutic approach to address pain and other quality-of-life concerns in patients with cancer, it is essential to clarify the goals of care. At any point in time, treatment may be guided by one or more overriding goals: 1) to cure or prolong life; 2) to maintain function; and 3) to provide comfort. These goals are strongly influenced by many factors, including the status of the disease, the availability and burdens of therapy, psychosocial comorbidity, and the degree of spiritual or existential distress. Goals are very dynamic, and often evolve over time with the vagaries of the disease, the availability of treatment and optimal palliative care. Current goals continually influence therapeutic decision-making.

## References

1. Caraceni A, Portenoy RK, and a working group of the IASP Task Force on Cancer Pain (1999) An international survey of cancer pain characteristics and syndromes. *Pain* 82:263–274
2. Cassell EJ (1982) The nature of suffering and the goals of medicine. *N Engl J Med* 306:639–645
3. Cherny NI, Coyle N, Foley KM (1994) Suffering in the advanced cancer patient: a definition and taxonomy. *J Palliat Care* 10:57–70
4. Foley KM (1996) Pain syndromes in patients with cancer. In: Portenoy RK, Kranner RM (eds) *Pain management: Theory and practice*. FA Davis, Philadelphia, pp 191
5. Galer BS (1995) Neuropathic pain of peripheral origin: advances in pharmacologic treatment. *Neurology* 45:S17–25
6. Gonzalez GR, Elliott KJ, Portenoy RK, Foley KM (1991) The impact of a comprehensive evaluation in the management of cancer pain. *Pain* 47:141–144
7. Grond S, Radbruch L, Meuser T et al. (1999) Assessment and treatment of neuropathic cancer pain following WHO guidelines. *Pain* 79:15–20
8. Grossman SA, Sheidler VR, Sweden K et al. (2001) Correlation of patient and caregiver ratings of cancer pain. *J Pain Symptom Manage* 6:53–57
9. Merskey H, Bogduk N (1994) *Classification of chronic pain: descriptions of chronic pain syndromes and definitions of pain terms*, 2<sup>nd</sup> edn. IASP Press, Seattle
10. Ness TJ, Gebhart GF (1990) Visceral pain: a review of experimental studies. *Pain* 41:167–234
11. Patt RB, Ellison N (1999) Breakthrough pain. In: Aronoff GM (ed) *Evaluation and treatment of chronic pain*, 3<sup>rd</sup> edn. Williams & Wilkins, Baltimore, pp 377
12. Portenoy RK, Thaler HT, Kornblith AB et al. (1994) Patients with cancer: The Memorial Symptom Assessment Scale: an instrument for the evaluation of symptom prevalence, characteristics and distress. *Eur J Cancer* 30A:1326–1336
13. Skeel RT (2002) Measurement of outcomes in supportive care: Quality of life. In: Berger AM, Portenoy RK, Weissman DE (eds) *Principles and practice of palliative care and supportive oncology*. Lippincott Williams & Wilkins, Philadelphia, pp 1107–1122
14. Torebjork HE, Ochoa JL, Schady W (1984) Referred pain from intraneural stimulation of muscle fascicles in the median nerve. *Pain* 18:145–156

## Cancer Pain, Palliative Care in Children

STEPHEN C. BROWN

Department of Anesthesia, Divisional Centre of Pain Management and Pain Research, The Hospital for Sick Children, Toronto, ON, Canada  
stephen.brown@sickkids.ca

## Synonyms

Pain Control in Children with Cancer; Palliative Care in Children; End of Life Care; Dying Child

## Definition

Pain control is an integral component of caring for all children with cancer. Children with cancer may experience many different types of pain from invasive procedures, the cumulative effects of toxic therapies, progressive disease or from psychological factors. While the goal in cancer care is to minimize morbidity on the road to cure, at times even with the best of care, we fail to achieve this goal and thus we also address the issue of palliative pain management. ► **Palliative care** is the management of patients with active, progressive, far-advanced disease, for whom prognosis is limited and the focus of care is the quality of life.

## Characteristics

Pediatric cancer pain encompasses four broad etiologic categories – procedural pain, the cumulative effects of toxic therapies, progressive disease and psychological factors. Children’s cancer pain is often complex with multiple sources, comprised of nociceptive and neuropathic components (Collins and Weisman 2003; McGrath and Brown 2004; Miaskowski et al. 2005; World Health Organization 1998). In addition, several ► **situational factors** usually contribute to children’s pain, distress and disability. Thus, to treat pain in these children adequately, we must evaluate the primary pain sources and also ascertain which situational factors are relevant for which children and families. Treatment emphasis should shift accordingly from an exclusive disease-centered framework to a more child-centered focus.

In 1993 the World Health Organization (WHO) and the International Association for the Study of Pain (IASP) invited experts in the fields of oncology, palliative care, anesthesiology, neurology, pediatrics, nursing, palliative care, psychiatry, psychology and pastoral care to write guidelines for the management of pediatric cancer pain and palliative care, resulting in the 1998 publication “Cancer pain relief and palliative care in children”.

A child-centered framework is required for understanding and controlling pain for these children. Pain control should include regular pain assessments, appropriate analgesics administered at regular dosing intervals, adjunctive drug therapy for symptom and side effects control and non-drug interventions to modify the situational factors that can exacerbate pain and suffering. Parents concerned about medication centered on their children’s comfort are calling for improved communication, standardization of nursing procedures and techniques and a guide for a clear understanding of what to expect and from whom (Sobo et al. 2002).

Basic information on pathophysiology, pharmacology, analgesic guidelines for children and management of procedural pain is presented in other essays in this Encyclopedic Reference of Pain. This essay provides a complementary focus by describing the unique nature of children's cancer pain including the primary factors that affect their pain and quality of life, providing references to guidelines for selecting and administering drug therapy in accordance with the nociceptive and neuropathic components and recommending practical non-drug therapies for integration within a hospital, home or hospice setting.

### The Nature of a Child's Cancer Pain

Throughout the last decade, we have gained an increasing appreciation of the ► [plasticity](#) and complexity of a child's pain. As with adults, a child's pain is often initiated by tissue damage caused by noxious stimulation, but the consequent pain is neither simply nor directly related to the amount of tissue damage. Perhaps even more than in adults, differing pain responses to the same tissue damage are noted. The eventual pain evoked by a relatively constant noxious stimulus can be different depending on children's expectations, perceived control or the significance that they attach to the pain. Children do not sustain tissue damage in an isolated manner, devoid of a particular context, but actively interpret the strength and quality of any pain sensations, determine the relevance of any hurting and learn how to interpret the pain by observing the general environment, especially the behavior of other people. Children's perceptions of pain are defined by their age and cognitive level, their previous pain experiences against which they evaluate each new pain, the relevance of the pain or disease causing pain, their expectations for obtaining eventual recovery and pain relief and their ability to control the pain themselves. While plasticity and complexity are critical features for all pain perception, plasticity seems an even more important feature for controlling children's pain. Much research has been conducted to identify the critical factors responsible for the plasticity of pain perception. Recent PET and functional MRI studies have demonstrated that painful stimulation activates different cortical regions – depending on an individual's expectations and attention (Price and Bushnell 2004). Human studies evaluating the impact of environmental and psychological factors on the perception of experimentally induced pain have been conducted primarily in adults. However, results from the few laboratory studies conducted with children are consistent with those from adult studies (see ► [Experimental Pain in Children](#)). In addition, much compelling evidence about the powerful mediating role of psychological factors in children's pain derives from clinical studies of acute, recurrent and chronic pain. These studies highlight the need to recognize and evaluate the mediating impact of these factors in order to optimally control children's pain.

Certain child factors are stable such as gender, temperament and cultural background, while other factors change progressively such as age, cognitive level, previous pain experience and family learning. These child characteristics shape how children generally interpret and experience the various sensations caused by tissue damage. In contrast, various cognitive, behavioral and emotional factors are not stable. They represent a unique interaction between the child and the situation in which the pain is experienced. These situational factors can vary dynamically throughout the course of a child's illness, depending on the specific circumstances in which children experience pain. For example, a child receiving treatment for cancer will have repeated injections, central port access and lumbar punctures – all of which may cause some pain (depending on the analgesics, anesthetics or sedatives used). Even though the tissue damage from these procedures is the same each time, the particular set of situational factors for each treatment is unique for a child – depending on a child's (and parent's) expectations, a child's (and parent's and staff's) behaviors and on a child's (and family's) emotional state. Although the causal relationship between an injury and a consequent pain seems direct and obvious, what children understand, what they do and how they feel all affect their pain. Certain factors can intensify pain, exacerbate suffering or affect adversely a child's quality of life. While parents and health care providers may be unable to change the more stable child characteristics, they can modify situational factors and dramatically improve children's pain and lives.

### The Impact of Situational Factors on a Child's Pain

Cognitive factors include children's understanding about the pain source, their ability to control what will happen, their expectations regarding the quality and strength of pain sensations that they will experience, their primary focus of attention (that is distracted away from or focused primarily on the pain) and their knowledge of pain control strategies. In general, children's pain can be lessened by providing accurate age-appropriate information about pain, for example emphasizing the specific sensations that children will experience (such as the stinging quality of an injection, rather than the general hurting aspects), by increasing their control and choices, by explaining the rationale for what can be done to reduce pain and by teaching them some independent pain reducing strategies (Brown and McGrath 2005). Behavioral factors refer to the specific behaviors of children, parents and staff when children experience pain and also encompass parents' and children's wider behaviors in response to a course of repeated painful treatments, chronic pain or progressive illness. Common behavioral factors include children's distress or coping reactions (e.g. crying, using a pain control strategy, withdrawing from life) and parents' and health staff's subsequent reactions to them (e.g. dis-



playing frustration, calmly providing encouragement for children to use pain control strategies, engaging them in conversation and activities). Emotional factors include parents' and children's feelings in response to pain and to the daily effects of the underlying illness or condition. Children's emotions affect their ability to understand what is happening, their ability to cope positively, their behaviors and ultimately their pain.

There are dynamic interactions among cognitive, behavioral and emotional factors. Health staff can significantly lessen children's pain, not only by administering potent analgesics but also by increasing children's understanding and control, by decreasing their emotional distress and by teaching children some simple physical, behavioral and cognitive methods to complement analgesic medications and further reduce their pain.

If the disease progresses and treatment emphasis shifts from curative to palliative, cognitive and emotional factors become the most salient situational factors that affect pain for children. Children probably have endured a prolonged period of intermittent pain, physical disability and multiple aversive treatments. Children receiving curative therapies are more focused on the future consequences of their disease. Their thoughts, behaviors and feelings change if their care becomes palliative. If this should happen, the type of support, information and guidance children require changes. While the impact of palliation is profound for all children and families, each child and family is unique with respect to their specific psychological, medical, social and spiritual needs. All families experience anguish and grief, but they may also experience denial, anxiety, anger, guilt, frustration and depression. It is essential that health professionals listen attentively and observe carefully, not only to ensure that all the needs of both the child and family are met, but also to resolve the myriad factors that can exacerbate children's pain and suffering. The primary situational factors in pediatric palliative care are listed (see below).

### Situational Factors in Pediatric Palliative Care

#### Cognitive Factors

- Meaning of death
- Inaccurate understanding: impact of situational factors on pain and quality of life
- Course of disease
- Palliative *versus* curative therapy
- Little independent control over pain
- Limited choices
- Expectation for continuing pain and suffering
- Misunderstanding of drug therapy: opioids
  - dosing and administration
  - criteria for evaluating effectiveness

#### Behavioural Factors

- Social withdrawal
- Physical inactivity

- Passive approach to pain control
- Secondary gains: stress reduction
  - emotional denial
  - parent or staff attention
- Inappropriate drug management: choice or mode of drug administration
- Failure to treat opioid-related side-effects aggressively
- Failure to evaluate pain sources and document pain level
- Failure to use effective non-drug therapies

#### Emotional

- Anxiety about: dying and death
  - suffering
  - meaning of life
- Fear of: separation
  - inadequate pain control
  - increasing adverse symptoms
  - impact on family
- Anger
- Sadness or depression
- Distancing by staff and friends

A shift in care from curative to palliative therapies may signify to some children and families that health professionals are giving up on the child. Children and families must understand that stopping ineffective therapies is not giving up, but represents a rational decision based on children's best interests. Pain control is an essential component of cancer care and of palliative care (Chaffee 2001; Galloway and Yaster 2000; Goldman 1998; Goldman et al. 2003). Children and parents should not fear that health professionals have given up on controlling pain and aversive symptoms. Pain and all symptoms must be treated aggressively from the dual perspective of targeting the primary source of tissue damage and modifying the secondary contributing factors. Although most children receive accurate information about their disease and required treatments, few children or their parents receive concrete information about their pain, the factors that can attenuate or exacerbate it, a rationale for the interventions they receive and training in effective non-pharmacological pain control techniques. The latter may be particularly important for children in palliative care, who have diminishing control in their lives. Children and their parents do not know that prescribed pain control treatments may vary in efficacy at different times throughout their treatment due to variations in disease activity or situational factors. Without this knowledge, their confidence in certain therapies can decrease, even



though these therapies would effectively alleviate pain at another time. The fear of inadequate pain control places an enormous emotional burden on an already distressed child and family and can create a situation in which their pain and disability intensifies.

Children seem to know intuitively, even when dying has not been discussed directly with them. They fear separation and abandonment; some children may fear that their illness is a punishment. Dying children may feel frightened, isolated and guilty unless they are able to openly express and resolve their concerns. Many observers have noted that children who are dying have a level of maturity far beyond their years. It is essential to acknowledge and resolve their fears. Children should receive accurate information, consistent with their religious beliefs, presented in a calm reassuring manner. They may need concrete reassurance that they will not suffer when they die, that they will not be alone and that their families will remember them. Unresolved emotions add anguish and may intensify their pain.

### Treating a Child's Pain

A treatment algorithm illustrating a practical approach for treating a child's pain is illustrated in Fig. 1. Pain assessment is an integral component of diagnosis and treatment. The differential diagnosis of a child's pain is a dynamic process that guides clinical management. We should select specific therapies to target the responsible central and peripheral mechanisms and to mitigate the pain-exacerbating impact of situational factors, recognizing that the multiple causes and contributing factors will vary over time. Drug therapies – analgesics, adjuvant analgesics and anesthetics - are essential for pain control, but non-drug therapies – cognitive, physical and behavioral - are also essential. As we monitor the child's improvement in response to the therapies initiated, we refine our pain diagnosis and treatment plan accordingly. Drug therapies are covered in the essay Analgesic Guidelines for Children; anesthetic blocks are covered in the essay Post-operative Pain Control in Children and acute procedural pain is covered in the essay by Lioffi.

The optimal relief of pain in pediatric palliative care begins with the recognition that you are assessing and treating an individual child with pain, not managing pain as a symptom apart from the child. A thorough medical history, physical examination and assessment of pain characteristics and contributing factors are necessary to establish a correct clinical diagnosis. Specific interventions should be selected and administered to children as part of a comprehensive pain programme, in the same manner as the most appropriate analgesics are selected and administered in adequate doses, at regular dosing intervals, through the most efficient routes.

Children seem to possess an enhanced ability to absorb themselves completely in a task, game or imagined event and thus might be more able than adults to trigger endogenous pain-inhibitory mechanisms. Even very

young children can easily learn to use a variety of practical pain control methods to lessen their anxiety, distress and pain. The specific methods depend on the age of the child, the type of pain experienced and the resources available. Deep breathing, alternately tightening and relaxing their fists, squeezing their mother's hand, listening to stories or music and imagining that they are in a pleasant setting can be very effective for reducing procedural-related pain, when used with appropriate analgesics. Families should understand that what they think, how they behave and how they feel affects their children's pain. Then they can begin to work independently and with staff to create additional non-drug pain control methods based on the child's interest, the cultural setting and the availability of resources.

### Summary

Optimal pain control for children with cancer and for children receiving palliative care requires an integrated treatment plan with both drug and non-drug therapies (Frager 1997; Hooke et al. 2002; McGrath and Brown 2004). Comprehensive care includes curative therapies when available, pain and symptom management and compassionate support for children and their families. It is essential to focus not only on the medical management of children's disease but also on the psychosocial and spiritual factors that affect children's pain and suffering. Specific interventions must be selected after determination of the primary and secondary sources of noxious stimulation and after a thorough assessment of the unique situational, behavioral, emotional and familial factors that affect a child's pain. All analgesics should be selected 'by the ladder' and administered 'by the clock', 'by the child' and by an effective and painless route. Dosing intervals should be frequent enough to control pain adequately, so that children do not experience an alternating cycle of pain, drowsy analgesia, pain, etc. Special problems in palliative pain control may arise when children die at home, unless parents and medical and nursing teams communicate openly about the availability of potent analgesics and the flexibility of dosing routes and regimens. The choice for pain control is not merely 'drug *versus* non-drug therapy', but rather a therapy that mitigates both the causative and contributing factors for pain. We have the knowledge and thus the obligation to ensure that children receive adequate pain control from the time that they are diagnosed with cancer throughout their treatment protocol, including those cases that proceed to palliative care.

### References

1. Brown SC, McGrath PA (2005) Pain In Children. In: Pappagallo M (ed) The Neurological Basis of Pain. McGraw-Hill, New York
2. Chaffee S (2001) Pediatric palliative care. *Prim Care* 28:365–390
3. Collin, JJ, Weisman SJ (2003) Management of pain in childhood cancer. In: Schechter NL, Berde CB, Yaster M (eds) Pain in Infants, Children, and Adolescents. Lippincott Williams & Wilkins, Philadelphia, pp 517–538

### 1. Evaluate the Child with Pain

- Assess sensory characteristics of pain
- Conduct medical examination and appropriate diagnostic tests
- Evaluate probable involvement of nociceptive and neuropathic mechanisms
- Appraise situational factors contributing to child's pain

### 2. Diagnose the Primary and Secondary Causes

- Current nociceptive and neuropathic components
- Attenuating physical symptoms
- Relevance of key cognitive, behavioural, and emotional factors

### 3. Select Appropriate Therapies

#### Drugs

- Analgesics
- Adjunct analgesics
- Anesthetics

#### Non-Drugs

- Psychological
- Physical
- Behavioural

### 4. Implement Pain Management Plan

- Provide feedback on causes and contributing factors to parents (and child)
- Provide rationale for integrated treatment plan
- Measure child's pain regularly
- Evaluate effectiveness of treatment plan
- Revise plan as needed

**Cancer Pain, Palliative Care in Children, Figure 1** Treatment algorithm for pain management.

4. Doyle D, Hanks GWC, Cherny NI et al. (eds) (2004) Oxford Textbook of Palliative Medicine 3rd edn. Oxford University Press, Oxford, pp 775–789
5. Frager G (1997) Palliative care and terminal care of children. *Child Adolesc Clin North Am* 6:889–909
6. Galloway KS, Yaster M (2000) Pain and symptom control in terminally ill children. *Pediatr Clin North Am* 47:711–747
7. Goldman A (1998) ABC of palliative care. Special problems of children. *BMJ* 316: 49–52
8. Goldman A, Frager G, Pomietto M (2003) Pain and Palliative Care. In: Schechter NL, Berde CB, Yaster M (eds) *Pain in Infants, Children, and Adolescents*. Lippincott Williams & Wilkins, Philadelphia, pp 539–562
9. Hooke C, Hellsten MB, Stutzer C et al. (2002) Pain management for the child with cancer in end-of-life care: APON position paper. *J Pediatr Oncol Nurs* 19:43–47
10. McGrath PA, Brown SC (2004) Paediatric palliative medicine – Pain control. In: Doyle D, Hanks G, Cherny N et al (eds) *Oxford Textbook of Palliative Medicine*, 3rd edn. Oxford University Press, Oxford, pp 775–789
11. Miaskowski C, Cleary J, Burney J et al (2005) Guideline for the Management of Cancer Pain in Adults and Children, APS Clinical Practice Guidelines Series, No. 3. American Pain Society, Glenview, Illinois
12. Price DD, Bushnell MC (2004) *Psychological Modulation of Pain: Integrating Basic Science and Clinical Perspectives*. IASP Press, Seattle
13. Sobo EJ, Billman G, Lim L et al. (2002) A rapid interview protocol supporting patient-centered quality improvement: hearing the parent's voice in a pediatric cancer unit. *Jt Comm J Qual Improv* 28:498–509
14. World Health Organization (1998) *Cancer pain relief and palliative care in children*. World Health Organization, Geneva

## Cancer Pain Management

### Definition

A disciplined approach to assessment, pharmacological, and nonpharmacological treatment aimed at reducing or

eliminating pain in patients who have a diagnosis of cancer.

- ▶ Cancer Pain Management, Adjuvant Analgesics in Management of Pain Due To Bowel Obstruction
- ▶ Cancer Pain Management, Anesthesiologic Interventions, Neural Blockade
- ▶ Cancer Pain Management, Anesthesiologic Interventions, Spinal Cord Stimulation, and Neuraxial Infusion
- ▶ Cancer Pain Management, Cancer-Related Breakthrough Pain, Therapy
- ▶ Cancer Pain Management, Chemotherapy
- ▶ Cancer Pain Management, Gastrointestinal Dysfunction as Opioid Side Effects
- ▶ Cancer Pain Management, Interface between Cancer Pain Management and Palliative Care
- ▶ Cancer Pain Management, Neurosurgical Interventions
- ▶ Cancer Pain Management, Nonopioid Analgesics
- ▶ Cancer Pain Management, Opioid Side Effects, Cognitive Dysfunction
- ▶ Cancer Pain Management, Opioid Side Effects, Endocrine Changes and Sexual Dysfunction
- ▶ Cancer Pain Management, Opioid Side Effects, Uncommon Side Effects
- ▶ Cancer Pain Management, Orthopedic Surgery
- ▶ Cancer Pain Management, Overall Strategy
- ▶ Cancer Pain Management, Palliation of Upper GI Cancer
- ▶ Cancer Pain Management, Patient-Related Barriers
- ▶ Cancer Pain Management, Principles of Opioid Therapy, Dosing Guidelines
- ▶ Cancer Pain Management, Principles of Opioid Therapy, Drug Selection
- ▶ Cancer Pain Management, Radiotherapy
- ▶ Cancer Pain Management, Rehabilitative Therapies
- ▶ Cancer Pain Management, Treatment of Neuropathic Components
- ▶ Cancer Pain Management, Undertreatment and Clinician-Related Barriers
- ▶ Pain Management, Cancer-Related Breakthrough Pain Therapy

## Cancer Pain Management, Adjuvant Analgesics in Management of Pain Due To Bowel Obstruction

PAUL C. ROUSSEAU  
VA Medical Center, Phoenix, AZ, USA  
palliatidoctor@aol.com

### Definition

Non-opioid analgesics utilized in the management of pain and colic in malignant bowel obstruction.

Three types of medication are commonly used: 1) anticholinergics; 2) corticosteroids; and 3) the synthetic ▶ **somatostatin** analogue octreotide.

### Characteristics

The pharmacological management of pain associated with ▶ **malignant bowel obstruction** addresses three critical pathophysiological mechanisms: 1) intestinal distention and resultant bowel ischemia; 2) paroxysmal intestinal hypermotility; and 3) increased intestinal secretions that perpetuate a vicious cycle of distention-intestinal secretion-peristalsis (Basson et al. 1989; Rousseau 1998).

Opioids are the mainstay of pain management in malignant bowel obstruction, and frequently assuage the pain associated with intestinal distention and bowel ischemia. The pain that occurs secondary to intestinal hypermotility is often referred to as colic, and is precipitated by paroxysms of increased peristalsis that thrust against the mechanical resistance of a malignant obstruction (Baines 1998). Colicky pain often requires the use of anticholinergic medications in addition to opioids to mitigate the excruciating discomfort of intestinal hypermotility (Rousseau 1998; Baines 1998; Krouse et al. 2002; Lublin and Schwartzentruber 2002; Ripamonti et al. 2000; Ripamonti et al. 2001).

Anticholinergic medications decrease peristalsis of the gastrointestinal tract through a competitive inhibition of the muscarinic receptors of intestinal smooth muscle, and an impairment of ganglionic neural transmission in the bowel wall (Mercadante 1997; Baines 1994). Although there are few well-controlled studies evaluating their efficacy in reducing abdominal colic in malignant bowel obstruction, anecdotal experience supports their ability to relieve malignant colic, and they are commonly used in the management of bowel obstruction. Recommended medications include glycopyrrolate, hyoscine butylbromide, scopolamine, hyoscyamine sulfate, and atropine. Glycopyrrolate, a quaternary ammonium anticholinergic, and hyoscine butylbromide (not available in the United States) both exhibit limited lipid solubility (Rousseau 1998; Krouse et al. 2002; Davis and Furste 1999). They penetrate the blood-brain barrier less than other anticholinergics, and as a result, reduce central nervous system side effects such as agitation and hallucinations (Rousseau 1998; Baines 1998; Mercadante 1997). Aside from agitation and hallucinations, anticholinergic drugs can cause dry mouth and eyes, drowsiness, tachycardia, hypotension, and urinary retention; dry mouth can be reduced by sucking ice cubes and drinking small sips of water, while dry eyes can be alleviated with physiologic eye drops.

Corticosteroids have been used empirically in malignant bowel obstruction to reduce peritumor and perineural inflammatory edema (Rousseau 1998; Baines 1998; Krouse et al. 2002; Mercadante 1997), and thereby improve gastrointestinal transport and colicky pain

(Ripamont 1994). They act both as antiemetics and analgesics, the latter ostensibly due to prostaglandin inhibition, suppression of migration of polymorphonuclear leukocytes, and reversal of increased capillary permeability. In an inclusive meta-analysis of published articles and studies on the use of corticosteroids in malignant bowel obstruction, secondary to advanced gynecological and gastrointestinal cancers, Feur and Broadley noted a trend for improvement in bowel obstruction for patients treated with corticosteroids, but this trend did not reach statistical significance. Although corticosteroids did appear to improve the symptoms of bowel obstruction, Feur and Broadley did not explicitly mention their ability to relieve pain (Feur and Broadley 1999). In another study on the benefits of corticosteroids in malignant bowel obstruction, 68% of patients without a nasogastric tube prescribed corticosteroids, versus 33% without a nasogastric tube prescribed a placebo, achieved symptom relief ( $p = 0.047$ ); however, in patients who already had a nasogastric tube in place, the results were less significant (60% versus 33%,  $p = 0.080$ ). Unfortunately, the sample size of this study was small, and while the authors mentioned colic as a symptom in 62% of study participants, they did not specify if colic was relieved with corticosteroids (Laval et al. 2000). Side effects of corticosteroids are minimal when used in malignant bowel obstruction, with oral candidiasis the most commonly reported adverse event (Mercadante 1997).

Octreotide, a synthetic analogue of somatostatin, reduces the gastrointestinal secretion of gastrin, vasoactive intestinal peptide (VIP), insulin, pepsin, glucagon, and pancreatic bicarbonate and enzymes; reduces mesenteric blood flow (Mercadante 1997, Pandha and Waxman 1996); exhibits a proabsorptive effect on water and ions (Rousseau 1998); and inhibits intestinal motility (Rousseau 1998; Baines 1998; Krouse et al. 2002; Pandha and Waxman 1996). By reducing intestinal secretions and inhibiting gastrointestinal motility, octreotide positively modulates gastrointestinal function and controls emesis in 70–100% of patients (Baines 1998; Krouse et al. 2002). Abdominal distention and colic are similarly controlled in a significant number of patients (Baines 1998). These statistics are supported by a prospective randomized controlled trial comparing the antisecretory effects of octreotide and hyoscine butylbromide in patients with inoperable malignant bowel obstruction who have nasogastric tubes. In this study, octreotide was very effective in reducing the amount of gastrointestinal secretions in patients with nasogastric tubes, and as an implicit consequence, though not specifically stated, reducing colicky pain (Ripamonti et al. 2000). The toxicity and side effect profile of octreotide is excellent (aside from discomfort at the site of injection), with no major side effects reported, even at a dose of 1.2 mg daily (Riley and Fallon 1994).

**Cancer Pain Management, Adjuvant Analgesics in Management of Pain Due To Bowel Obstruction, Table 1** ▶ Adjuvant Analgesics in Malignant Bowel Obstruction\*

Drug	Dose
glycopyrrolate**	1–2 mg tid-qid OR
	0.1–0.2 mg tid-qid SC/IV
hyoscine butylbromide	40–120 mg daily SC/IV
Scopolamine	400–800 mcg OR every 4–6 h
	1–2 TDP every 48–72 h
Atropine	0.8–2 mg via CSI every 24 h
	1–2 drops ophthalmic solution SL every 4 h
	0.4 mg OR every 4 h
Dexamethasone	0.4 mg SC every 4 h
	4–8 mg daily OR
	2–8 mg every 6 h SC/IV
Prednisone	2–12 mg via CSI every 24 h
	5–20 mg every 4–6 h
Octreotide	150 mcg tid SC
	0.2–0.9 mg via CSI every 24 h

\*List is not inclusive, dosages are suggested initial doses that may be prescribed as scheduled and/or prn doses, may need to be titrated to effect dependent upon patient's clinical condition and expected life expectancy  
\*\*Reduce dose in renal insufficiency

OR, oral; SC, subcutaneous; IV, intravenous; TDP, transdermal patch; SL, sublingual; CSI, continuous subcutaneous infusion; prn, as needed

## References

- Baines M (1994) Intestinal Obstruction. In: Hanks GW (ed) Palliative Medicine: Problem Areas in Pain and Symptom Management. Cold Spring Harbor Laboratory Press, Plainview, New York, pp 147–156
- Baines MJ (1998) The Pathophysiology and Management of Malignant Intestinal Obstruction. In: Doyle D, Hanks GWC, Macdonald N (eds) Oxford Textbook of Palliative Medicine, 2<sup>nd</sup> edn. Oxford University Press, Oxford, pp 526–534
- Basson MD et al. (1989) Does Vasoactive Intestinal Polypeptide Mediate the Pathophysiology of Bowel Obstruction? *Am J Surg* 157:109–115
- Davis MP, Furste A (1999) Glycopyrrolate: A Useful Drug in the Palliation of Mechanical Bowel Obstruction. *J Pain Symptom Manage* 18:153–154
- Feur DJ, Broadley KE (1999) Systematic Review and Meta-Analysis of Corticosteroids for the Resolution of Malignant Bowel Obstruction in Advanced Gynaecological and Gastrointestinal Cancers. *Ann Oncol* 10:1035–1041
- Krouse RS et al. (2002) When the Sun can Set on an Unoperated Bowel Obstruction: Management of Malignant Bowel Obstruction. *J Am Coll Surg* 195:117–128
- Laval G et al. (2000) The Use of Steroids in the Management of Inoperable Intestinal Obstruction in Terminal Cancer Patients: Do They Remove the Obstruction? *Palliat Med* 14:3–10
- Lublin M, Schwartzentruber DJ (2002) Bowel Obstruction. In: Berger A, Portenoy RK, Weissman DE (eds) Principles &



- Practice of Palliative Care & Supportive Oncology. Lippincott Williams & Wilkins, Philadelphia, pp 250–263
9. Mercadante S (1997) Assessment and Management of Mechanical Bowel Obstruction. In: Portenoy RK, Bruera E (eds) Topics in Palliative Care, vol 1. Oxford University Press, New York, pp 113–130
  10. Pandha HS, Waxman J (1996) Octreotide in Malignant Intestinal Obstruction. *Anti-Cancer drugs* 7:5–10
  11. Riley J, Fallon MT (1994) Octreotide in Terminal Malignant Obstruction of the Gastrointestinal Tract. *Eur J Palliat Care* 1:23–25
  12. Ripamonti C (1994) Management of Bowel Obstruction in Advanced Cancer Patients. *J Pain Symptom Manage* 9:193–200
  13. Ripamonti C et al. (2000) Role of Octreotide, Scopolamine Butylbromide, and Hydration in Symptom Control of Patients with Inoperable Bowel Obstruction and Nasogastric Tubes: A Prospective Randomized Trial. *J Pain Symptom Manage* 19:23–34
  14. Ripamonti C et al. (2001) Clinical-Practice Recommendations for the Management of Bowel Obstruction in Patients with End-Stage Cancer. *Support Care Cancer* 9:223–233
  15. Rousseau PC (1998) Management of Malignant Bowel Obstruction in Advanced Cancer: A Brief Review. *J Palliat Med* 1:65–72

## Cancer Pain Management, Anesthesiologic Interventions

PAUL A. SLOAN

Department of Anesthesiology, University of Kentucky, Lexington, KY, USA  
paulsloan1956@yahoo.com

### Synonyms

Nerve block; anesthetic block

### Definition

Information about noxious events is transmitted to the brain via neurons of the peripheral and central nervous system. Blockade of this nerve conduction using applied local anesthetics to temporarily block pain transmission, spinal medications (e.g. opioids) to modulate pain transmission, or neurolytic substances to destroy the pain-transmitting nerves is the domain of anesthesiologic interventions for cancer pain management.

### Characteristics

Most patients with cancer pain can have their pain well managed using standard opioids and other analgesics via the oral or parenteral routes. However, approximately 15% of cancer patients with pain will experience severe pain resistant to traditional analgesic therapies (Sloan and Melzack 1999). For these unfortunate patients, anesthesiologic techniques often provide welcome pain relief. The use of alcohol to destroy nerve tissue in the treatment of painful conditions is almost 75 years old, and, along with phenol, became popular in the 1950's and 1960's for the treatment of cancer pain (Maher 1955). With more recent acceptance and use of chronic opioid therapy for cancer pain, the current role of neuroablative techniques has chiefly been for patients with terminal disease and pain unresponsive to traditional analgesics.

The use of local anesthetics and spinal opioids to modulate pain transmission has gained popularity in the past decade, because of the low risk involved and the ability to reverse the treatment course at any time.

The use of local anesthetics to provide long-term pain relief for cancer patients has principally involved infiltration around peripheral nerves, and ► **epidural** or ► **intrathecal** administration. Local anesthetics injected close to a peripheral nerve or the spinal cord will block nerve impulses and provide degrees of nociceptive, sensory, or motor nerve blockade. Anesthesiologists have searched for the correct combination of local anesthetic concentration, infusion site, and rate of infusion to achieve analgesia without the significant side effects of motor or sensory blockade. Two common sites of peripheral nerve block with local anesthetic infusion are the brachial plexus (Fig. 1) and lumbar plexus. Tumors originating in lung, head and neck, or other sites may invade the brachial plexus, resulting in severe neuropathic pain, and pelvic tumors may similarly invade the lumbar plexus. The percutaneous insertion of catheters for the infusion of local anesthetics has provided excellent and long-term pain relief among such cancer patients (Vranken et al. 2001; Douglas and Bush 1999). A basal infusion may be physician prescribed, and augmented by the use of patient-controlled boluses for breakthrough pain. Portable infusion pumps (small enough to be worn on the body) allow the patient to return home for as long as possible. Typical local anesthetics used are bupivacaine (1–5 mg/ml), lidocaine (5–10 mg/ml) or ropivacaine (1–5 mg/ml), with infusion rates of 3–8 ml/h.

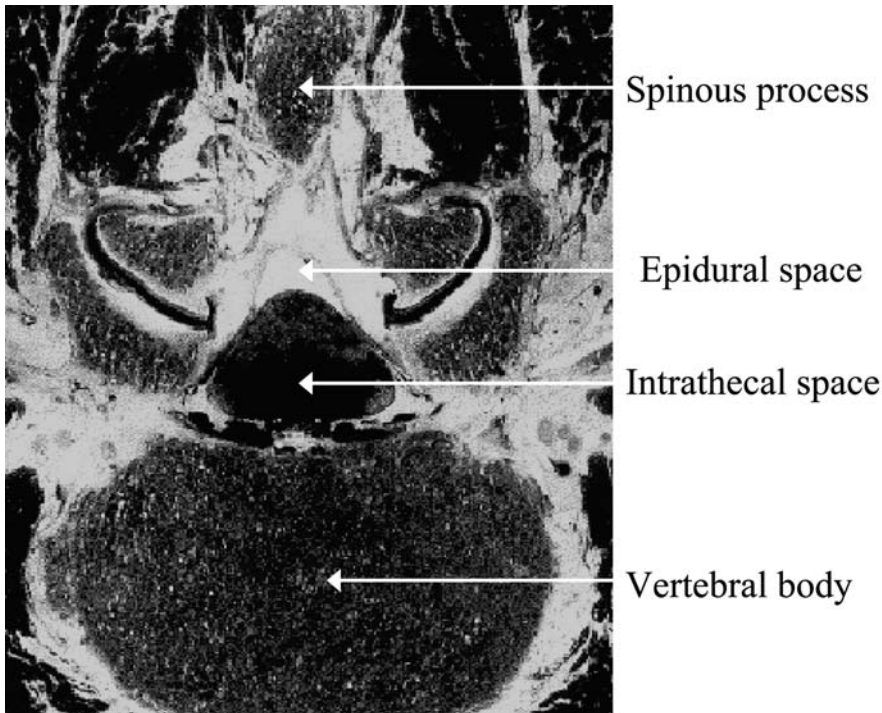
The spinal cord is bathed by cerebrospinal fluid (CSF) that is contained in a strong protective membrane, the dura mater. Local anesthetics applied outside the dura mater (epidural) or within the CSF (intrathecal) have been used to control cancer pain (Fig. 2). A catheter is usually placed percutaneously into the epidural



**Cancer Pain Management, Anesthesiologic Interventions, Figure 1** Interscalene approach to brachial plexus block.

C





**Cancer Pain Management, Anesthesiologic Interventions, Figure 2** Cross-section through a lumbar vertebrae.

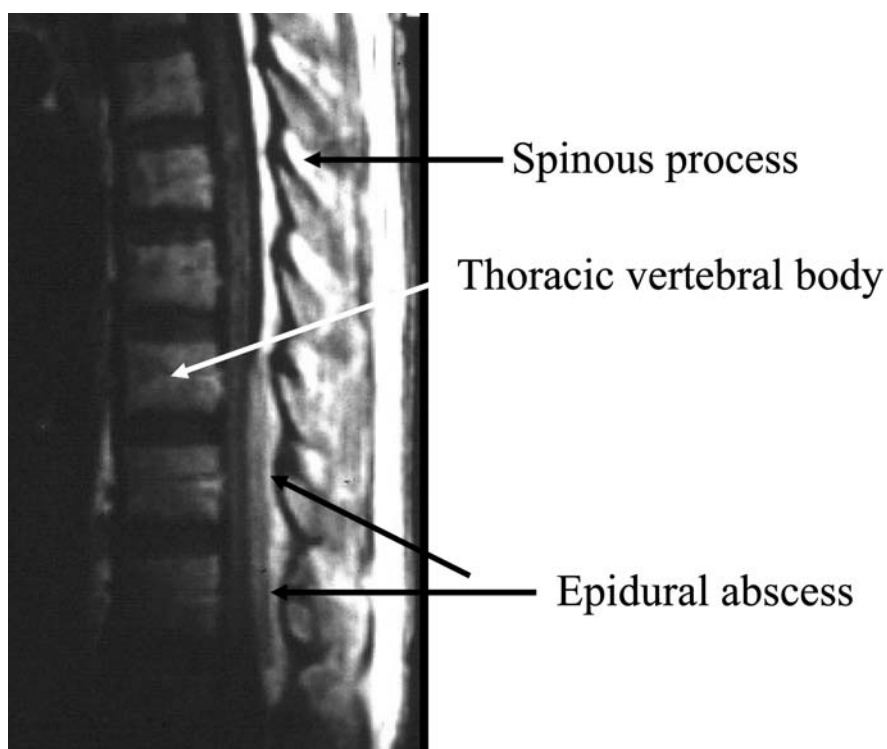
or intrathecal space for the chronic infusion of local anesthetics. The catheter may be tunneled under the skin and exit to an external portable pump, or remain buried and attached to an implanted pump. These procedures are usually performed using local anesthesia and intravenous sedatives. The pumps allow for the constant infusion of local anesthetics such as bupivacaine (Dahm et al. 2000). Cancer patients with lower extremity or truncal pain to the waist are best suited to these approaches. Possible complications include local anesthetic toxicity (uncommon), hypotension, tachyphylaxis, infection, and motor weakness. Despite the side effect potential, most patients tolerate chronic infusion of anesthetics without difficulty and can be monitored at home. In addition to spinal administration, anesthetics have been infused chronically into the pleural space via a percutaneous catheter for the relief of refractory lung cancer pain (Aguilar et al. 1992).

Spinal administration of opioids for pain relief was first applied to patients in 1979 (Behar et al. 1979), and has been advocated for the relief of intractable cancer pain. Spinal opioids can be given by both the epidural and intrathecal routes of administration, with the epidural dose being approximately 10 times the intrathecal dose. It is believed that spinally applied opioids modulate pain transmission by direct action on specific opioid receptors in the dorsal horn of the spinal cord (Bedder 1997). In this way, there may be fewer and/or less intense systemic opioid side effects and a better quality of analgesia may be obtained. Many opioids have been used to

achieve successful analgesia, with morphine remaining the most common. A single injection of spinal morphine will provide 12–24 h of pain relief. However, a continuous infusion of opioid is often used and can be managed safely at home (Samuelsson et al. 1995). The effective dose is titrated to analgesia or intolerable side effects. A useful starting dose for epidural morphine is 20% of the current daily oral morphine dose, and the final daily epidural doses reported in the literature have ranged from 2 to over 1000 mg.

The combination of opioids and local anesthetics applied to the spinal cord in animals has resulted in a synergistic effect (Akerman et al. 1988), and led to the clinical practice of combining spinal analgesics to achieve powerful analgesia with the fewest possible side effects. The co-administration of these drugs has gained widespread acceptance and has been shown to limit morphine dose progression during long-term spinal infusion (Dongen et al. 1999). Other spinal drugs that have provided some analgesia include alpha-adrenergic agonists (clonidine, dexmedetomidine) and NMDA receptor antagonists (ketamine).

Complications (10% of all patients) associated with spinal analgesics include local infection, CSF leak, pain on injection, mechanical problems with catheter function, headache, meningitis and epidural hematoma (Basta and Sloan 1999) or abscess (Fig. 3). Local infection can usually be managed with antibiotics and catheters can remain in place for months. The typical side effects of opioids may be seen, including nausea and vomiting, sedation, urinary retention, and pruritus.



C

**Cancer Pain Management, Anesthesiologic Interventions, Figure 3** MRI of low thoracic epidural abscess in a patient treated with chronic epidural analgesics.

Patient accommodation to these side effects of opioids typically occurs.

The historic “nerve block” using neurolytic agents to physically modify nerve tissue to produce analgesia has now become the least prevalent anesthesiologic procedure for the management of cancer pain. Nonetheless, among terminally ill patients with pain not well controlled by other measures, certain neurolytic injections can provide excellent pain relief with a minimum of complications. The destruction of the celiac plexus in the upper abdomen is the most common neurolytic block performed. Upper abdominal pain associated with cancer of the pancreas, distal esophagus, stomach or liver may be treated using a simple percutaneous technique. Imaging studies (x-ray, CT scan, ultrasound) guide accurate needle placement, and the injection of 25–50 ml of alcohol or phenol results in destruction of nociceptive neurons passing through the celiac plexus, thus producing pain relief in the majority of patients that may last for many months (Rykowski and Hilgier 2000). While significant complications (paraplegia, pneumothorax) are infrequent and have been reduced by radiographic needle placement, they have not been entirely eliminated. Common complications include postural hypotension and diarrhea.

Additional neurolytic blocks occasionally used to treat cancer pain include lumbar sympathetic block for urologic pain, superior hypogastric block for pelvic pain, subarachnoid block for chest wall pain, subarachnoid saddle block for perineal pain, and cranial nerve block

for head or neck pain. Noninvasive ► [gamma knife](#) destruction of the pituitary has also been tried for intractable bilateral cancer pain (Sloan et al. 1996).

Other innovations may prove valuable in the future. Ziconotide, a neuronal-specific calcium channel blocker, will be available for intrathecal use and has been shown to be an effective analgesic in controlled trials. The percutaneous injection of adrenal medullary allografts, obtained from organ donors, into the lumbar CSF presents an exciting possibility for interventional management of cancer pain. These cells produce met-enkephalin, and both studies in animals and small surveys in humans (Lazorthes et al. 2000) have yielded positive findings. Anesthetic interventions for pain are well established and new therapies are evolving. The appropriate use of anesthesiologic interventions to help manage acute and chronic pain among cancer patients will ensure pain relief and improved quality of life.

#### References

1. Aguilar JL, Montes A, Samper D et al. (1992) Interpleural Analgesia through a DuPen Catheter for Lung Cancer Pain. *Cancer* 70:2621–2623
2. Akerman B, Arwestrom E, Post C (1988) Local Anesthetics Potentiate Spinal Morphine Antinociception. *Anesth Analg* 67:943–948
3. Basta M, Sloan PA (1999) Epidural Hematoma following Epidural Catheter Placement in a Patient with Chronic Renal Failure. *Can J Anesth* 46:271–274
4. Bedder MD (1997) Neuraxial Analgesic Blockade: Physiology, Pharmacology, and Complications. In: Parris WCV, Foster HW, Melzack R (eds) *Cancer Pain Management: Principles and Practice*. Butterworth-Heinemann, Newton, MA, pp 171–180

5. Behar M, Magora F, Olshwang D et al. (1979) Epidural Morphine in Treatment of Pain. *Lancet* 1:527–529
6. Dahm P, Lundborg C, Janson M et al. (2000) Comparison of 0.5% Intrathecal Bupivacaine with 0.5% Intrathecal Ropivacaine in the Treatment of Refractory Cancer and Noncancer Pain Conditions: Results from a Prospective, Crossover, Double-Blind, Randomized Study. *Reg Anesth Pain Med* 25:480–487
7. Dongen RT van, Crul BJ, Egmond J van (1999) Intrathecal Coadministration of Bupivacaine Diminishes Morphine Dose Progression during Long-Term Intrathecal Infusion in Cancer Patients. *Clin J Pain* 15:166–172
8. Douglas I, Bush D (1999) The Use of Patient-Controlled Boluses of Local Anaesthetic Via a Psoas Sheath Catheter in the Management of Malignant Pain. *Pain* 82:105–107
9. Lazorthes Y, Sagen J, Sallerin B et al. (2000) Human Chromaffin Cell Graft into the CSF for Cancer Pain Management: A Prospective Phase II Clinical Study. *Pain* 87:19–32
10. Maher RM (1955) Relief of Pain in Incurable Cancer. *Lancet* 1:18
11. Rykowski JJ, Hilgier M (2000) Efficacy of Neurolytic Celiac Plexus Block in Varying Locations of Pancreatic Cancer: Influence on Pain Relief. *Anesth* 92:347–354
12. Samuelsson H, Malmberg F, Eriksson M et al. (1995) Outcomes of Epidural Morphine Treatment in Cancer Pain: Nine Years of Clinical Experience. *J Pain Symptom Manage* 10:105–112
13. Sloan PA, Hodes J, John W (1996) Radiosurgical Pituitary Ablation for Cancer Pain. *J Palliat Care* 12:51–53
14. Sloan PA, Melzack R (1999) Long-Term Patterns of Morphine Dosage and Pain Intensity among Cancer Patients. *Hospice J* 14:35–47
15. Vranken JH, Vejt MH van der, Zuurmond WW et al. (2001) Continuous Brachial Plexus Block at the Cervical Level using a Posterior Approach in the Management of Neuropathic Cancer Pain. *Reg Anesth Pain Med* 26:572–575

## Cancer Pain Management, Anesthesiologic Interventions, Neural Blockade

HARALD BREIVIK

Department of Anesthesiology, Rikshospitalet University Hospital, University of Oslo, Oslo, Norway  
harald.breivik@medisin.uio.no

### Synonyms

Anesthesiological Interventions; Neural Blockade

### Definition

Anesthesiologic interventions are transient or long lasting interruptions of pain impulse conduction in peripheral nerves, nerve roots, or the spinal cord. This will hinder the conscious perception of pain and lessen the suffering associated with cancer and its destruction of normal tissues.

### Characteristics

Anesthesiologic interventions may be performed with ► **local anesthetic drugs**, which stop pain impulse conduction along nerves for up to several hours, or with ► **neurolytic drugs**, which block transmission for up to several months. These interventions will remove pain from the locally anesthetized part of the body, which

may become numb and partly paralyzed. Interruptions of pain impulses conducted through visceral nerves, e.g. the celiac plexus of the upper abdomen; do not cause numbness or skeletal muscle weakness. Severe forms of cancer pain can be relieved effectively by skillfully applied anesthesiologic interventions (Breivik 2000). The risk of adverse effects exists and must be understood when considering these approaches.

### Reversible Blockade of Pain Impulses by Local Anesthetic Drugs

Infiltration of a painful primary or metastatic tumor, or the peripheral nerves innervating a painful cancerous growth, with a local anesthetic drug results in local or regional anesthesia and pain relief lasting from 1–12 h. The duration can be prolonged with repeated injections or infusion into ► **perineural catheters**. Local anesthetic infiltrations and ► **simple nerve blocks** should be used liberally (Twycross 1994). Relief of acute, overwhelmingly intense ► **breakthrough pain** from a pathological fracture or an acute tumor infarct can be relieved effectively with a ► **regional anesthetic block**. Local anesthetic nerve blocks should not be used to predict the effect of neurolytic blocks or other neurodestructive treatment, such as ► **thermocoagulation** or ► **surgical denervation** (Hogan and Abrams 1997).

### Spinal Cord Analgesia by Epidural or Subarachnoid Catheter Infusion of Drugs

#### Epidural Analgesia

Potent pain relief can occur when low concentrations of a local anesthetic drug, an opioid, and an adrenergic drug are administered epidurally (Breivik 2002a). With an epidural catheter at the appropriate ► **spinal cord segmental level** (cervical to the upper lumbar), a reliable infusion pump and trained nurses, analgesia can be maintained for prolonged periods at home, in a hospice or palliative care institution. Stable and sterile drug mixtures are needed (Breivik 2002a). Details of epidural catheter placement and maintenance, monitoring and prevention and management of complications are described in textbooks (Breivik 2002a).

#### Prolonged Infusion into the Spinal Subarachnoid Space

Insertion of a catheter into the subarachnoid space allows infusion of a local anesthetic solution containing an opioid and donidine or adrenaline directly into the ► **cerebrospinal fluid**. This may give satisfactory analgesia when most other methods have failed (Nitescu et al. 2002). Prolonged, effective, and safe pain relief is possible, even when the patient is living at home (Nitescu et al. 2002).

#### Inflammatory Pain Treated with Injections of Local Anesthetic and Corticosteroid Drugs

Corticosteroids have analgesic effects when administered epidurally, perineurally or intralesionally. These

are in part systemic effects, in part local effects on nociceptive nerve endings, and in part effects on inflammatory or neurogenic pain mechanisms (Breivik 2000, Twycross 1994).

Segmental epidural applications of local anesthetic drugs combined with methylprednisolone, dexamethasone or triamcinolone may relieve ► **radicular nerve root pain** (Breivik 2000), including that caused by a tumor impinging on spinal nerve roots (Twycross 1994). Perineural injections of a mixture of a local anesthetic and a corticosteroid may cause immediate and prolonged pain relief in nerves made hyperexcitable from local trauma, infiltration of tumor or inflammatory reactions (Twycross 1994).

Intralesional injection of local anesthetics and depot corticosteroids similarly may cause immediate, and in some patients, prolonged pain relief, e.g. in multiple myeloma lesions or metastases from breast cancer in ribs (Twycross 1994).

#### Neurolytic Nerve Blocks with Ethanol or Phenol

The advantage of neurolytic blocks is apparent when a single intervention can replace or reduce the need for daily administration of multiple drugs. However, a misplaced injection or injection of an inappropriate dose may cause severe complications. Duration of analgesia after a neurolytic block is limited. However, some blocks can be repeated with success. Due to the possibility of severe post-denervation neuropathic pain, neurolytic blocks of peripheral nerves should be reserved for patients with life expectancy of less than about one year. ► **Visceral sympathetic blocks** may be considered in patients with longer life expectancy.

#### Celiac Plexus Block

Celiac plexus block relieves pain from cancer in the upper part of the abdomen (Breivik 2000). One double-blind, randomized, placebo-controlled study of intraoperative celiac plexus neurolysis demonstrated improved pain control, reduction in opioid analgesic consumption, and significantly prolonged survival (Lillemo et al. 1993). The block can be repeated with success if pain recurs after weeks to months. Pneumothorax and shoulder pain from ethanol irritation of the diaphragmatic peritoneum are short-lived side effects. The sympatholysis that results may cause ► **orthostatic hypotension** and diarrhea for a few days. However, paraplegia and intestinal infarction may result if the neurolytic solution is injected into arteries. Severely misplaced epidural, paravertebral, and subarachnoid injections have been reported, with tragic consequences (Breivik 2000).

#### Indications for Celiac Plexus Block

Cancer of the pancreas is the classic indication. However, cancer of the stomach, duodenum, liver, gallbladder, and choledocal duct causing visceral type pain in the

upper abdomen are indications as well. When abdominal wall involvement occurs, pain impulses will also travel through somatic afferent nociceptor fibers of the intercostal nerves. Neurolytic block of the visceral afferent nociceptor fibers passing through the celiac plexus will not relieve this pain.

#### Techniques of Celiac Plexus and Splanchnic Nerve Blockade

The celiac plexus is the prevertebral sympathetic plexus that supplies the upper abdominal viscera with sympathetic innervations. It is located in the retroperitoneal tissue space, anterior to the body of the first lumbar and twelfth thoracic vertebrae. The aorta lies behind, and the inferior vena cava and right renal vessels lie in front of the celiac plexus. The greater, the lesser, and the least ► **splanchnic nerves** connect the celiac plexus via the spinal nerve roots to the thoracic spinal cord. These nerves can be interrupted by radiofrequency denervation in the thoracic region, an approach favored by some (Medicis and Leon-Casasola 2002).

The celiac plexus can be injected intraoperatively when the surgeon has determined that the tumor is unresectable (Lillemo et al. 1993). However, the block has most often been performed with needles through the skin from the back, or with an anterior approach with needle-guidance from computerized tomography scanning (CT) (Medicis and Leon-Casasola 2002). In the traditional technique (Breivik 2000, Breivik 2002b) (Fig. 1), the patient is prone and a needle is inserted on each side under the midpoint of the 12<sup>th</sup> rib. With local anesthetic infiltration, the needle is advanced towards the anterolateral corner of the body of the first lumbar vertebra. When this bone is contacted, the depth marker is moved 1.5–2 cm from the skin level towards the hub of the needle. The needle is now withdrawn to the subcutaneous tissue, redirected, and advanced 1.5–2 cm beyond the anterolateral corner of the vertebral body. If the aorta is punctured on the left side, or the vena cava on the right side, the needle is withdrawn until blood stops coming on aspiration. At this point, 5 ml of lidocaine 20 mg/ml is injected in each needle. The patient is soon able to tell whether his pain has disappeared. He will also be able to inform the anesthesiologist of any signs of intraspinal or intravascular injection. This is sufficient information to be able to go ahead with an injection of 50 ml of 50% ethanol (96% ethanol diluted with bupivacaine 2.5 mg/ml) in each of the two needles. It should be noted that radiographic imaging of the needle position is no guarantee that the injected neurolytic agent will not cause somatic neurological deficit. Two reported cases of paraplegia following celiac plexus block in spite of radiographic needle control underscore this important point (Breivik 2000). If this block is performed with the patient under general anesthesia, the indications of correct needle positioning from a test dose of a small, concentrated dose of local anesthetic



are lost. Some of the reports of poor or short lasting pain relief from celiac plexus block may be due to an insufficient injected volume or concentration of ethanol, which should not be less than 50 ml of 50%.

#### Side Effects of Celiac Plexus Block with Ethanol

An immediate side effect of celiac plexus block is a drop in blood pressure and also orthostatic hypotension for some time following the block. If this occurs, it may be treated with ephedrine and intravenous colloid-containing fluids. Due to the sympathetic denervation of the major part of the gastrointestinal tract, diarrhea may also result, often a desirable effect in patients who have been on oral opioids for some time. The patient should be warned that transient shoulder pain may be a result of the ethanol reaching the diaphragm. Too rapid a discontinuation of morphine may cause withdrawal symptoms. Some patients may need a reduced dose of oral morphine for residual pain, or for pain stemming from tumor invasion of the abdominal wall (Breivik 2000).

#### Superior Hypogastric Plexus Block and Bilateral Lumbar Sympathetic Block

Phenol blocks of the superior hypogastric plexus or bilateral lumbar sympathetic block may relieve patients with visceral pain from pelvic organs and sigmoid colon (Breivik 2000, Medicis and Leon-Casasola 2002). Local pelvic infiltration of cervical or prostatic carcinoma can cause somatic nociceptive pains that limit the effectiveness of sympathetic blocks. The same is true for perineal pain, when mainly of somatic origin and pain impulses travel via sacral and pudendal nerves.

#### Subarachnoid Spinal Nerve Root Neurolytic Block

Segmental, one-sided denervation of sacral nerve roots can be obtained by spinal puncture close to the affected nerve roots, followed by subarachnoid injection of 0.3–0.6 ml of hypobaric ethanol (96%) with the patient's painful side up, or hyperbaric phenol (5% in glycerol) with the painful side down. This technique is used less nowadays due to the dissatisfaction with the degree and duration of relief, and because of risks of severe side effects (Breivik 2000, Twycross 1994). Continuous catheter infusion of local anesthetics with opioids is an alternative that is more effective and has less risk of severe complications (Nitescu et al. 2002). However, under circumstances with very limited resources, where other pain relief is unavailable, the simple methods of subarachnoid ethanol or phenol block may still have a place. It can be performed at the bedside with a spinal needle and a syringe (Stovner and Endresen 1972). It is superior to no pain relief at all in a terminally ill cancer patient who is suffering from excruciating pain (Swerdlow 1983, Kuzucu et al. 1966, Drechsel 1984).

#### Subdural and Epidural Neurolytic Blockade with Phenol

These techniques have been used for cancer pain in the cervical and upper thoracic region where subarachnoid block is less effective (Breivik 2000).

#### Neurolytic Blocks of Selected Peripheral and Paravertebral Nerves (Hill 2002)

Trigeminal nerve block may be indicated for pain from head and neck cancer with trigeminal nerve involvement. Less than 0.5 ml ethanol 96% is needed to anesthetize an appropriate branch (Swerdlow 1983). Glossopharyngeal nerve block may give good pain relief when pharmacological therapy fails in painful conditions of the mouth and throat. Ethanol is injected at the jugular foramen and may easily also block the vagus, accessory and hypoglossal nerves, causing dysphagia if bilateral block is required (Montgomery and Cousins 1972).

Intercostal nerve block with 1.0 ml of ethanol 96% or phenol 5–6% often gives excellent pain relief, lasting up to a few weeks.

#### Paravertebral Spinal Nerve Blocks

For well-localized somatic pain, a paravertebral spinal nerve block can be performed, with needle insertion 2–3 cm lateral to the spinous process (of the same vertebra in the lumbar region, but of the vertebra above the segmental nerve to be blocked in the thoracic region). After contact with the transverse process, the needle is redirected below the transverse process, and 3–5 ml of the solution is injected. Pain relief may be good, but the duration is unpredictable. The block can be considered in debilitated and bedridden patients with severe pain not responding well to pharmacological treatment. Unintended subarachnoid injection, or injection into a radicular artery to the spinal cord, may cause severe neurological complications (Breivik 2000).

#### Sacral Nerve Blocks (Posterior Transsacral Blocks)

When pelvic metastases cause nerve compression pain which is not well controlled by pharmacological means, sacral nerve blocks may be useful. The second sacral foramen lies 1 cm below and medial to the posterior superior iliac spine. The fifth sacral foramen lies 1 cm inferior and lateral to the sacral cornua. The 3<sup>rd</sup> and 4<sup>th</sup> foramina lie on the line between the 1<sup>st</sup> and the 5<sup>th</sup> (Hill 2002). The needle is advanced 0.5–1.5 cm beyond the opening of the foramina and about 3 ml of the solution is injected at each site.

#### References

1. Breivik H (2000) Nerve Blocks – Simple Injections, Epidurals, Spinals and More Complex Blocks. In: Simpson KH, Budd K (eds) *Cancer Pain Management. A Comprehensive Approach*. Oxford University Press, Oxford, pp 84–98
2. Breivik H (2002a) Epidural Analgesia. In: Breivik H, Campbell W, Eccleston C (eds) *Clinical Pain Management. Practical Applications and Procedures*. Arnold, London, pp 409–416



3. Breivik H (2002b) Sympathetic Blocks. In: Breivik H, Campbell W, Eccleston C (eds) *Clinical Pain Management. Practical Applications and Procedures*. Arnold, London, pp 233–246
4. Drechsel U (1984) Treatment of Cancer Pain with Neurolytic Agents. *Recent Results of Cancer Research* 89:137–147
5. Hill D (2002) Peripheral Nerve Blocks. In: Breivik H, Campbell W, Eccleston C (eds) *Clinical Pain Management. Practical Applications and Procedures*. Arnold, London, pp 197–232
6. Hogan QH, Abrams SE (1997) Neural Blockade for Diagnosis and Prognosis: A Review. *Anesthesiology* 86:216–241
7. Kuzucu EY, Derrick WS, Wilber SA (1966) Control of Intractable Pain with Subarachnoid Alcohol Block. *J American Med Ass* 195:541–544
8. Lillemo KD, Cameron JL, Kaufman HS et al. (1993) Chemical Splanchnicectomy in Patients with Unresectable Pancreatic Cancer. *Annals of Surgery* 217:447–457
9. Medicis E de, Leon-Casasola de O (2002) Neurolytic Blocks. In: Breivik H, Campbell W, Eccleston C (eds) *Clinical Pain Management. Practical Applications and Procedures*. Arnold, London, pp 247–254
10. Montgomery W, Cousins MJ (1972) Aspects of Management of Chronic Pain Illustrated by Ninth Nerve Block. *British Journal of Anaesthesia* 44: 383–385
11. Nitescu PV, Apelgren L, Curelaru IA (2002) Long-Term Intrathecal and Intracisternal Treatment of Malignant and Nonmalignant Pain Using External Pumps. In: Breivik H, Campbell W, Eccleston C (eds) *Clinical Pain Management. Practical Applications and Procedures*. Arnold, London, pp 285–306
12. Stovner J, Endresen R (1972) Intrathecal Phenol for Cancer Pain. *Acta Anaesthesiol Scand* 16:17–21
13. Swerdlow M (1983) *Relief of Intractable Pain*, 3<sup>rd</sup> edn. Excerpta Medica, Amsterdam
14. Twycross R (1994) *Pain Relief in Advanced Cancer*. Churchill Livingstone, Edinburgh

## Cancer Pain Management, Anesthesiologic Interventions, Spinal Cord Stimulation, and Neuraxial Infusion

MUTHUKUMAR VAIDYARAMAN, PETER S. STAATS  
Division of Pain Medicine, The Johns Hopkins  
University, Baltimore, MD, USA  
mvaidya2@jhmi.edu, pstaats@jhmi.edu

### Synonyms

Anesthesiological Interventions; spinal cord stimulation; neuraxial infusion

### Definitions

Anesthesiologic interventions, ► [spinal cord stimulation](#) and ► [neuraxial infusion](#) are types of interventional therapies that may be used in the treatment of cancer pain.

### Characteristics

Cancer is the second-most frequent cause of death in the United States. Cancer patients fear pain more than other symptoms, and at least a third suffer pain at the time of diagnosis (Jacox et al. 1994). Pain is heterogeneous (Bonica 1990), and the prevalence and complexity of pain increases in populations with advanced disease.

Humane treatment demands aggressive treatment of cancer pain. To this end, the World Health Organization (World Health Organization 1990), and the Agency for Health Care Policy and Research (Jacox et al. 1994) have published guidelines on the management of cancer-related pain. These guidelines, however, either fail to mention or minimize the importance of the role of interventional therapy. Although opioids continue to be a mainstay of cancer pain treatment, patients frequently experience side effects, such as sedation and constipation. Many experience only imperfect cancer pain relief.

### The Role of Interventional Therapies

Interventional therapies include neural blockade, spinal drug delivery, and spinal cord stimulation (Staats 1998). Clinicians should consider using these therapies in cancer patients who suffer intractable opioid side effects, or in whom opioids provide inadequate relief. Altering pain conduction with neural blockade techniques or delivering lower doses of agents directly to the spinal cord can often improve the balance between analgesia and side effects. Interventional therapies may also be cost-effective (Erdine and Talu 1998); for example, long-term (more than three months) administration of high-dose opioids delivered at home via patient-controlled-analgesia, is much more expensive on a strictly medical cost basis than implantable drug delivery. In appropriate patients, interventional therapies can make it possible to achieve the goal of decreasing pain and the side effects associated with higher doses of systemic therapy while also reducing health care and associated costs.

### Neural Blockade

The effect of a nerve block can be short-term (using local anesthetics) or long-term (with chemical, thermal, or surgical applications). Nerve blocks can be peripheral, visceral, or intraspinal. Intraspinal blocks are now rarely performed because advances in spinal analgesia offer alternatives, and increased life expectancy in cancer patients makes the risk of its associated complications unacceptable.

Short-acting local anesthetic blocks carry a very low risk and are usually diagnostic, guiding clinical decisions about the use of longer-acting methods. For example, the physician may anesthetize the painful areas prior to a neurodestructive technique. This offers the patient the opportunity to experience the feeling of a permanent procedure. If anesthesia is not associated with pain relief, it also helps the physician prognosticate the permanent neurolytic procedure. In some cases, a series of blocks with local anesthetic (e.g. sympathetic blockade) can achieve lasting relief of neuropathic pain. Although clinicians commonly refer to neurodestructive blocks as permanent, the nerve may regenerate, leading

to a return of pain. Neurolysis typically provides three to six months of relief.

### Anatomic Location of Nerve Blocks

Among the many possible peripheral nerve blocks, clinicians most frequently block intercostal (Bolotin et al. 2000) and trigeminal nerves to treat somatic pain. A visceral nerve block can be performed to address visceral pain. The most common is the celiac plexus block (Polati et al. 1998). The superior hypogastric plexus block is indicated for the visceral pain that may be prominent in patients with various pelvic organ cancers, even in advanced stages (Leon-Casasola et al. 1993; Plancarte et al. 1997), and ganglion impar (Walther's) blockade mitigates the burning visceral pain in the perineal area and can have a beneficial impact on urgency (Plancarte et al. 1990).

### Neuromodulation

#### Spinal Cord Stimulation (SCS)

SCS may be efficacious in patients whose pain has a neuropathic component (Grabow et al. 2003) and may benefit certain cancer patients, for example, those with post-thoracotomy pain, postherpetic neuralgia, and/or radicular lower extremity pain. With this approach, an electrical current is applied to the dorsal aspect of the spinal cord through an implanted wire. The current is created either by an implanted generator or an external generator that transmits to an implanted antenna. There have been no controlled trials of SCS in cancer patients, but anecdotal experience has been favorable in carefully selected patients.

#### Neuraxial Infusion

Epidural delivery of morphine with an external pump is widely used to treat cancer pain, especially in the postoperative setting. The timing of doses of epidural analgesia can be patient-controlled, and patients may continue to use this method of pain control after they are discharged from the hospital.

Compared with epidural delivery, intrathecal delivery of opioids has the advantages of providing analgesia with a much smaller dose of the drug, and a reduced chance of infection with implanted systems. Intrathecal drug delivery should be considered in those patients with chronic pain inadequately relieved by maximum medical management, or relieved at the expense of intolerable side effects (Paice et al. 1996). Only preservative-free morphine is approved to treat pain intrathecally. Additional widely-used agents include hydromorphone, fentanyl, clonidine, and bupivacaine. Ziconotide, a novel n-type calcium channel blocker, is under investigation and has been demonstrated to be efficacious in a controlled trial (Staats et al. 2004). Screening for intrathecal treatment includes assessment and treatment of co-morbid psychological conditions (Olson 1992) and a trial with a single bolus dose, epidural delivery, or

intrathecal delivery of half of the oral opioid dose converted to its intrathecal equivalent. The remaining oral dose should be replaced with an equivalent intrathecal dose titrated over the next few days (Krames 1993). If the pain decreases by half with no intolerable side effects, the patient receives an external pump with a percutaneous catheter (for treatment duration of  $\leq$  three months) or an implanted constant flow-rate or programmable pump.

### Pain Treatment and Survival in Cancer Patients

Investigators are beginning to report findings of increased survival rates in cancer patients whose pain is controlled in a manner that reduces side effects and improves quality of life. In one study, patients with unresectable pancreatic cancer who received an alcohol celiac block survived longer than those who received a placebo block (Staats et al. 2001). Another study that compared optimal medical management alone with optimal medical management plus intrathecal drug delivery, in a randomized trial involving 200 patients with refractory cancer pain, intrathecal therapy reduced the incidence of drug-related toxicity and reliance on systemic analgesics while improving pain scores, quality of life for patients and caregivers, and survival rates (Smith et al. 2002). The possibility that controlling pain will lengthen the life of terminally-ill patients is intriguing, and should add to our urgency in promoting the consideration of pain as a disease that must be treated as aggressively as possible.

### References

1. Bolotin G, Lazarovici H, Uretzky G et al. (2000) The Efficacy of Intraoperative Internal Intercostal Nerve Block during Video-Assisted Thoracic Surgery on Postoperative Pain. *Ann Thorac Surg* 70:1872-1875
2. Bonica JJ (1990) Cancer Pain. In: Bonica JJ (ed) *The Management of Pain*, vol 1, 2<sup>nd</sup> edn. Lea and Febiger, Philadelphia, pp 200-460
3. Erdine S, Talu GK (1998). Cost Effectiveness of Implantable Devices versus Tunneled Catheters. *Current Review of Pain* 2:157-162
4. Grabow TS, Tella PK, Raja SN (2003) Spinal Cord Stimulation for Complex Regional Pain Syndrome: An Evidence-Based Medicine Review of the Literature. *Clin J Pain* 19:371-383
5. Jacox A, Carr DB, Payne R (1994) New Clinical Practice Guidelines for the Management of Cancer Pain. *N Engl J Med* 330:169-173
6. Krames ES (1993). Intrathecal Infusion Therapies for Intractable Pain: Patient Management Guidelines. *J Pain Symptom Manage* 8:36
7. Leon-Casasola de OA, Kent E, Lema MJ (1993) Neurolytic Superior Hypogastric Plexus Block for Chronic Pelvic Pain Associated with Cancer. *Pain* 54:145-151
8. Olson K (1992) An Approach to Psychological Assessment of Chronic Pain Patients. *NCS Assessments*, Minneapolis
9. Paice JA, Penn RD, Shott S (1996) Intraspinal Morphine for Chronic Pain: A Retrospective Multicenter Study. *J Pain Symptom Manage* 11:71
10. Plancarte R, Amescua C, Patt RB (1990) Presacral Blockade of the Ganglion of Walther (Ganglion Impar). *Anesthesiology* 73:A751

11. Plancarte R, de Leon-Casasola OA, El-Helaly M et al. (1997) Neurolytic Superior Hypogastric Plexus Block for Chronic Pelvic Pain Associated with Cancer. *Reg Anesth* 22:562–568
12. Polati E, Finco G, Gottin L et al. (1998) Prospective Randomized Double-Blind Trial of Neurolytic Celiac Plexus Block in Patients with Pancreatic Cancer. *Br J Surg* 85:199–201
13. Smith TJ, Staats PS, Pool G et al. (2002) Randomized Clinical Trial of an Implantable Drug Delivery System Compared to Comprehensive Medical Management for Refractory Cancer Pain: Impact on Pain, Drug-Related Toxicity, and Survival. *J Clin Oncol* 20:4040–4049
14. Staats PS (1998) Cancer Pain: Beyond the Ladder. *J Back Musculoskeletal Rehabilitation* 10:69–80
15. Staats PS, Hekmat H, Sauter P, Lillemoe K (2001) The Effects of Alcohol Celiac Plexus Block, Pain, and Mood on Longevity in Patients with Unresectable Pancreatic Cancer: A Double-Blind, Randomized, Placebo-Controlled Study. *Pain Med* 2:28–34
16. Staats PS, Yearwood T, Charapata S et al. (2004) Intrathecal Ziconotide in the Treatment of Refractory Malignant Pain: A Controlled Clinical Trial. *JAMA* 291:63–70
17. World Health Organization (1990) Cancer Pain Relief. World Health Organization, Geneva

## Cancer Pain Management, Cancer-Related Breakthrough Pain, Therapy

GIOVAMBATTISTA ZEPPELELLA  
St. Clare Hospice, Hastingwood, UK  
jzppetella@stclare-hospice.co.uk

### Definition

Breakthrough pain is a transient increase in pain intensity over background pain. It occurs commonly in cancer patients and is a heterogeneous phenomenon that may be incapacitating or debilitating, or significantly impact quality of life. Breakthrough pain is a distinct component of cancer pain and requires specific management.

### Characteristics

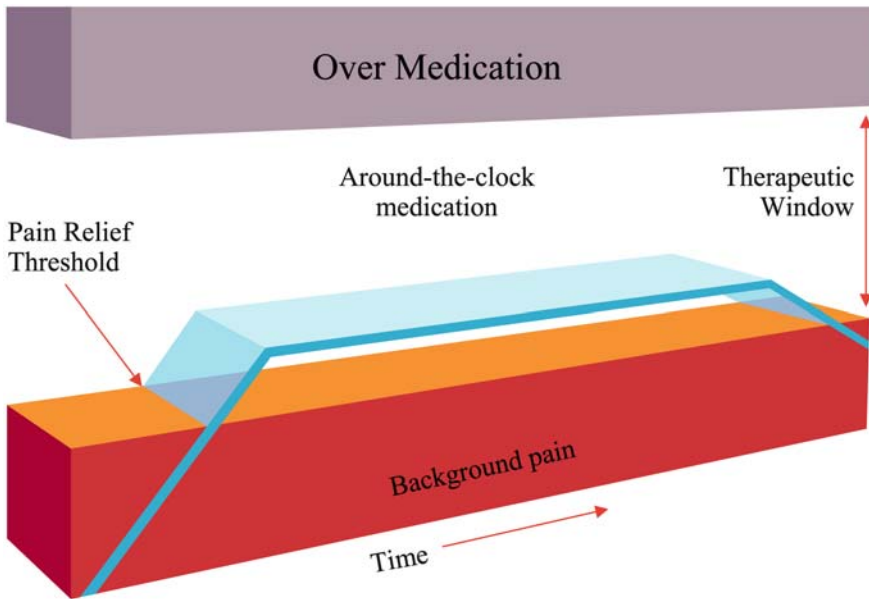
People with cancer-related pain often report that their pain varies during the course of the day. Two patterns of pain can be identified: continuous background pain, which may respond well to around-the-clock (ATC) ► **analgesics** (Fig. 1), and transitory exacerbations of pain, which break through the ATC analgesics (Fig. 2). Transient increases in pain in a cancer patient who has stable persistent pain treated with ► **opioids** may be defined as breakthrough pain (Portenoy and Hagen 1990). The definition of breakthrough pain has been the subject of much discussion, with some investigators classifying episodic pains as breakthrough pain irrespective of the analgesic regimen, and others classifying episodic pains in this way irrespective of whether background pain is controlled. Even the term ‘breakthrough’ is not one that is universally accepted (Mercadante et al. 2002). A number of studies have evaluated the characteristics of breakthrough pain in patients attending cancer centers

or pain clinics, and in hospice inpatients or outpatients. These studies have varied in their sampling procedures, and in inclusion and exclusion criteria. Breakthrough pain is usually characterized according to its location, severity, temporal characteristics, relationship to regular ► **analgesia**, precipitating factors, predictability, pathophysiology, etiology and palliative factors (Portenoy 1997). The reported prevalence of breakthrough pain has varied from 20 to 95% (Zeppetella and Ribeiro 2003). Pain is typically of fast onset, short duration and feels similar to background pain, except that it may be more severe. Like background pain, the pathophysiology of breakthrough pain may be visceral, somatic or neuropathic, and the etiology may be related directly to cancer or cancer treatment, or unrelated to the cancer.

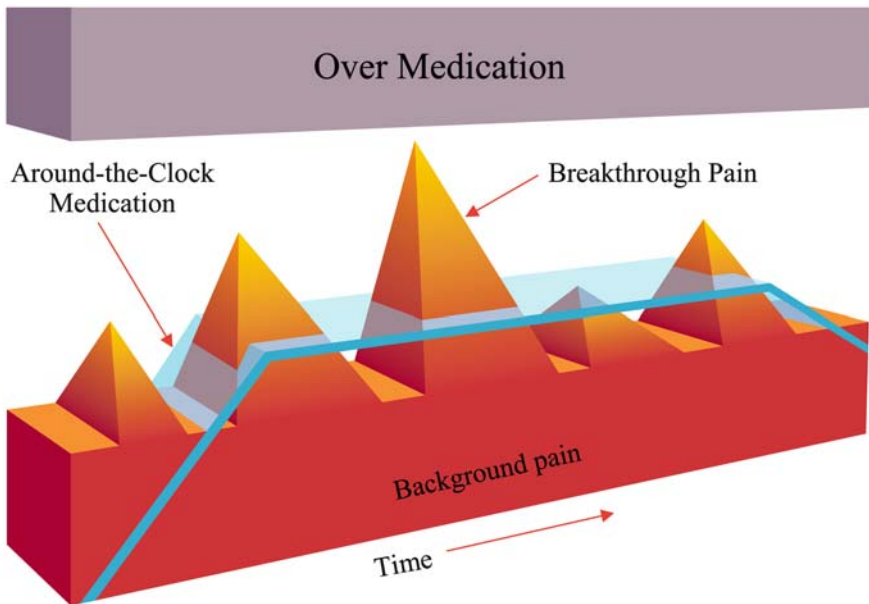
Breakthrough pain is a heterogeneous phenomenon that may be different for each patient; patients may have more than one pain type. Two types of breakthrough pain have been described; incident pain, which is precipitated by volitional factors such as movement or non-volitional such as bladder spasm; and spontaneous pain, which occurs in the absence of a specific trigger. End-of-dose failure is sometimes included as a breakthrough pain subtype. It occurs either because the analgesic is described at an inadequate dose or the interval between administrations is too long. As background pain is not controlled, end-of dose pain is not breakthrough pain.

Despite the self-limiting nature of breakthrough pain, it can have a profound impact on both patients’ and carers’ quality of life. Patients with breakthrough pain are often less satisfied with their analgesic therapy, have decreased functioning because of their pain and have an increased level of anxiety and depression (Portenoy et al. 1999). Unrelieved breakthrough pain also increases economic burden placed on the healthcare system (Fortner et al. 2002). Effective management is, therefore, essential and can only be achieved through meticulous assessment, good communication, and patient and caregiver participation. Failure to take these factors into account can lead to ineffective analgesia, unwanted adverse effects and poor adherence to therapy.

Management of breakthrough pain should be part of a holistic framework and appropriate to the stage of the patient’s disease. A combination of pharmacological and non-pharmacological treatment strategies may be required. Three principles of management have been proposed (Portenoy 1997). First, implementation of primary therapies can lead to improvement in both background and breakthrough pain. These interventions include those that modify the pathological process (e.g. radiotherapy, chemotherapy, and surgery), and those that manage reversible problems (e.g. antitussives for cough, laxatives for constipation and antispasmodics for bladder spasm). Second, optimizing of the scheduled analgesic regimen using the World Health Organization analgesic ladder as a basis for therapy (World Health



**Cancer Pain Management, Cancer-Related Breakthrough Pain, Therapy, Figure 1** Background pain. Successful management of background pain with regular analgesia and without serious adverse effects.



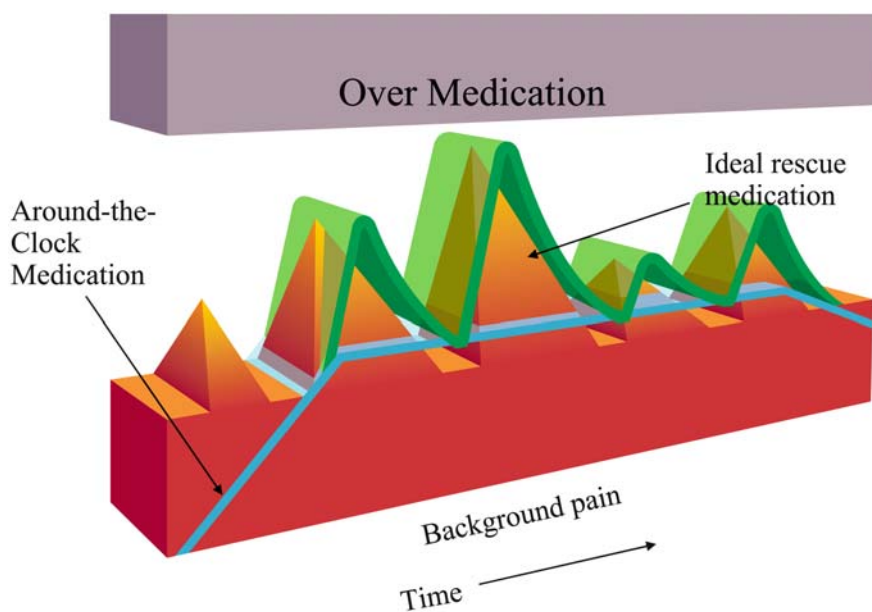
**Cancer Pain Management, Cancer-Related Breakthrough Pain, Therapy, Figure 2** Breakthrough pain. A transient increase over background pain that breaks through the regular analgesia; pain may vary in frequency, intensity and duration.

Organization 1996). Patients may require a combination of opioid and non-opioid analgesics and, in some cases, ► **adjuvant analgesics** such as antidepressants, anticonvulsants, bisphosphonates and corticosteroids. Third, use of specific non-pharmacological or pharmacological interventions for breakthrough pain. Non-pharmacological interventions include physiotherapy, cognitive techniques and orthopedic procedures. Pharmacological management is usually in the form of supplemental analgesia also known as rescue medication. End-of dose failure responds best to increasing ATC medication, whereas other breakthrough pain subtypes are usually managed with rescue medication, as increasing the ATC medication to cover all incident and

spontaneous breakthrough pains can lead to adverse effects.

Successful use of rescue medication requires adequate analgesia to be obtained without excessive adverse effects. When using rescue medication, a number of issues should be considered (What do we give? How much, when in relation to the pain? By what route and how frequently?). Rescue medication is best administered before or soon after the onset of breakthrough pain. As breakthrough pain is typically of fast onset and short duration, rescue medication should ideally be potent, absorbed and excreted rapidly, easy to administer and produce minimal adverse effects (Fig. 3). Opioids are most commonly used, and the current approach involves giv-





C

**Cancer Pain Management, Cancer-Related Breakthrough Pain, Therapy, Figure 3** Ideal rescue medication. The plasma level of medication follows the profile of breakthrough pain without excessive adverse effects.

ing an additional dose based on the patient's ATC analgesia. Opioids may be administered by several routes, including oral, oral transmucosal, rectal, intravenous, subcutaneous and intraspinal (intrathecal and epidural). The route of administration is important, as this can influence the onset of analgesia and duration of effect. Oral medication is generally used as it is convenient and often the most acceptable (Walker et al. 2003). When using morphine as rescue medication, the 'normal-release' formulation (which has a four-hourly duration of action) is used; the current recommendation by the European Association for Palliative Care is to use the same as the four-hourly dose of normal-release morphine (approximately 16% of the daily dose) when necessary (Hanks et al. 2001). However, as breakthrough pain can vary in etiology, intensity and duration, the dose of rescue medication may also vary (Fig. 3).

Patients with advanced disease may require more than one route of drug administration due to difficulty in swallowing, nausea or other gastrointestinal problems (Coyle et al. 1990). Furthermore, the onset of effect with most currently available opioids does not match the rapid onset of a typical breakthrough pain episode. Parenteral opioids (subcutaneous, intravenous or intramuscular) achieve a peak effect more rapidly than oral opioids but are invasive, inconvenient, costly, and can be uncomfortable; the same is true of intraspinal opioids. Sublingual administration allows rapid absorption and is convenient, accessible, and generally well accepted, but absorption can be poor or irregular. Rectal administration, although generally safe, effective and inexpensive, may be inconvenient and unacceptable to some patients, and absorption can be unreliable. Oral transmucosal administration provides a simple and convenient route, which offers the potential for more rapid absorption and

onset of action than the oral route and avoids hepatic first pass metabolism. Oral transmucosal fentanyl citrate (OTFC) is a fentanyl-impregnated lozenge, specifically developed for the management of breakthrough pain. OTFC is rapidly absorbed through the oral mucosa and in controlled studies has been shown to be safe and effective (Coluzzi et al. 2001; Farrar et al. 1998). OTFC should be individually titrated to a successful dose that is not predicted from the ATC opioid dose.

#### References

1. Coluzzi PH, Schwartzberg L, Conroy JD et al. (2001) Breakthrough Cancer Pain: A Randomized Trial Comparing Oral Transmucosal Fentanyl Citrate (OTFC) and Morphine Sulphate Immediate Release (MSIR) *Pain* 91:123–130
2. Coyle N, Adelhardt J, Foley KM et al. (1990) Character of Terminal Illness in the Advanced Cancer Patient: Pain and Other Symptoms during the Last Four Weeks of Life. *J Pain Symptom Manage* 5:83–93
3. Farrar JT, Cleary J, Rauch R et al. (1998) Oral Transmucosal Fentanyl Citrate: Randomized, Double-Blind, Placebo-Controlled Trial for the Treatment of Breakthrough Pain in Cancer Patients. *J Natl Cancer Inst* 90:611–616
4. Fortner BV, Okon TA, Portenoy RK (2002) A Survey of Pain-Related Hospitalizations, Emergency Department Visits, and Physician Office Visits Reported by Cancer Patients With and Without History of Breakthrough Pain. *J Pain* 3:38–44
5. Hanks GW, De Conno F, Cherny N et al. (2001) Morphine and Alternative Opioids in Cancer Pain: The EAPC Recommendations. *Br J Cancer* 84:587–93
6. Mercadante S, Radbruch L, Caraceni A et al. (2002) Episodic (Breakthrough) Pain: Consensus Conference of an Expert Working Group of the European Association for Palliative Care. *Cancer* 94:832–839
7. Portenoy RK (1993) A combination of pharmacological and non-pharmacological treatment strategies may be required and three principles of management have been proposed
8. Portenoy RK (1997) Treatment of Temporal Variations in Chronic Cancer Pain. *Semin Oncol* 24:S16–7–S16–12
9. Portenoy RK, Hagen NA (1990) Breakthrough Pain: Definition, Prevalence and Characteristics. *Pain* 41:273–281



10. Portenoy RK, Payne D, Jacobsen P (1999) Breakthrough Pain: Characteristics and Impact in Patients with Cancer Pain. *Pain* 81:129–134
11. Walker G, Wilcock A, Manderson C et al. (2003) The Acceptability of Different Routes of Administration of Analgesia for Breakthrough Pain. *Palliat Med* 17:219–221
12. World Health Organization (1996) *Cancer Pain Relief*. WHO, Geneva
13. Zeppetella G, Ribeiro MDC (2003) The Pharmacotherapy of Episodic Pain. *Expert Opin Pharmacother* 4:493–502

## Cancer Pain Management, Chemotherapy

RONALD H. BLUM

Beth Israel Medical Center, New York, NY, USA

rblum@bethisraelny.org

### Synonyms

Chemotherapy

### Definition

Chemotherapy, the use of chemicals as therapy, is, along with surgery and radiation, one of the most common treatments for cancer. Chemotherapy is generally administered intravenously, but oral agents are becoming increasingly available.

### Characteristics

Over the last generation, chemotherapy has evolved based on the principles of cytotoxicity in cellular systems, empiric observation in preclinical models, and incremental improvements achieved with clinical trials. Chemotherapeutic agents can be classified by their presumed mechanism of action, e.g. alkylator of DNA, antimetabolite, mitotic inhibitor, and repair enzyme inhibitor. Chemotherapy indications are based on clinical trials data, with the optimum therapeutic ratio determined by establishing the dose based on maximum therapeutic benefit with acceptable toxicity. Many chemotherapeutic agents are schedule-dependent, both for efficacy and toxicity. Combination therapy usually has a therapeutic advantage over single agent treatments. Optimum benefit for cancer treatment is achieved with a basic understanding of the tumor site-specific clinical characteristics, including prognostic factors and patterns of spread, coupled with knowledge of the role and sequencing of the treatment modalities. Depending on the tumor type and the presentation of the disease in an individual patient, multidisciplinary planning results in treatment that might involve a single modality, such as surgery; the concurrent use of radiation and/or chemotherapy; or sequential treatments, such as surgery followed by the addition of radiation and/or chemotherapy.

Prospective clinical trials, often randomized, have established standards of practice. Therapeutic endpoints vary.

In clinical situations where cure is the expected outcome, survival is conventionally used as the therapeutic endpoint. In clinical situations where cure is a less likely outcome, then clinical endpoints such as progression-free survival, symptom-free interval, or overall survival are commonly used. The ► **RECIST** criteria have been established as an objective reproducible measurement of reduction in tumor; these criteria generally correlate with improvements in quality of life and survival.

When the therapeutic intent is predominantly palliative, then other therapeutic endpoints are used. Commonly used palliative clinical trials endpoints include a > 50% decrease in pain score (measured using validated methodologies), > 50% decrease in opioid usage, and improvement in performance scale, all lasting more than four weeks.

Cancer chemotherapy with established benefits is unfortunately associated with what can be significant toxicities. With the increasing availability of interventions to manage symptoms, chemotherapy can be better tolerated. Fatigue is one of the most commonly encountered chemotherapy-associated toxicities. Although often multifactorial, fatigue associated with chemotherapy is often caused by anemia. There is a strong body of evidence demonstrating the value of the ► **erythropoietins** to increase the hemoglobin in patients receiving chemotherapy. This erythropoietin-induced increase in hemoglobin is correlated with improvement in quality of life and reversal of fatigue associated with the cancer and cancer treatment.

► **Granulocytopenia** is also a common chemotherapy toxicity. With the availability of recombinant hematopoietic growth factors, the associated morbidities of fever, sepsis, and antibiotic use, which may require hospitalization, are significantly reduced.

Chemotherapy-induced nausea and vomiting, formerly a dose-limiting toxicity, is almost always preventable or at least greatly reduced by treatment. An array of effective antiemetic agents is now available, including ► **Serotonin Blockers**, benzodiazepines, steroids, and the recently available ► **NK1 blockers**.

In addition to these chemotherapy-associated toxicities, consideration needs to be given to the effects of chemotherapy-associated organ damage. Examples are the cumulative myocardial damage associated with anthracycline chemotherapy, the pulmonary toxicity associated with bleomycin, the nephrotoxicity associated with the platinols, and the peripheral neuropathy associated with the vinca alkaloids. Other considerations for patients receiving chemotherapy revolve around the establishment of safe and easy venous access for the administration of chemotherapy and the maintenance of nutrition.

### Clinical Decision-Making

Given the reality that chemotherapy is often of limited benefit and associated with significant toxicities, clinical

decision-making is critically important. The decision whether or not to use chemotherapy for palliative intent must consider a number of important perspectives. From the provider perspective, medical decisions are usually based on both evidence and the “expert” opinion of the provider. The provider preferences are influenced by many factors, including what could be globally defined as self-serving interests, practical issues, and issues surrounding reimbursement. From the patient perspective, preferences are influenced by the understanding and expectation of outcomes, by psychosocial issues including developmental stage and beliefs, and by practical and financial issues. Financial issues include not only reimbursement for medical expenses, but what can be burdensome, out-of-pocket expenses for such things as transportation and parking, and the loss of income because of the patient or care partner not being able to work. Clinical decision-making should be a shared medical decision-making process, which assumes that both provider and patient develop an understanding of the relative balance between the autonomy of the physician and the preferences of the patient.

A recent study (Koedoot et al. 2002) used clinical vignettes to identify variables that influence provider preference for “watchful waiting,” that is, deferring the introduction of palliative chemotherapy. Based on information gathered from questionnaires administered to more than 1000 oncologists, age was the strongest predictor, followed by the patient’s wish to be treated, and the expected survival gain. One of the conclusions of this study is that oncologists’ recommendations are consistent and based on objective criteria (Koedoot et al. 2002).

Probably the most important determinant of provider preference is the available evidence of palliative benefit of chemotherapy for a specific cancer diagnosis. Although high level evidence from clinical trials is limited, these trials form the basis for the general assumption that chemotherapy can be a standard of care for palliation of symptoms associated with most malignancies. The risk/benefit determination of treatment versus no treatment must be highly individualized and based on the tumor type, the symptoms associated with the tumor, overall clinical status and, of course, coupled with patient preference.

#### **Pancreatic Cancer**

Perhaps the strongest argument for an evidence basis for the palliative benefit of chemotherapy is for pancreatic cancer. In a landmark prospective study that led to the licensing of gemcitabine, 126 symptomatic pancreas cancer patients were enrolled in a study that began with a lead-in period during which patients were stabilized with analgesics. Patients were then randomized to receive what was at that point the experimental agent gemcitabine, or what was at that time a standard of care, 5-fluorouracil. The primary

endpoints of the study were pain intensity and related analgesic consumption, Karnofsky performance status, and weight. In order to meet the criteria of objective benefit, the required improvement in these symptoms had to be sustained for at least four weeks, without worsening of any symptom during the observation period. The symptom improvement was correlated to objective tumor response, time to tumor progression, and survival. There was evident clinical benefit in 24% of patients who received gemcitabine and 5% treated with 5-fluorouracil ( $P = 0.0022$ ); median survival durations were 6 vs. 4 months ( $P = 0.0025$ ), and the 12-month survival rate was 18% vs. 2% (Burriss et al. 1997).

#### **Colon Cancer**

Patients with progressive metastatic colon cancer were randomized to test supportive care with or without the chemotherapeutic agent irinotecan. The primary endpoint of survival demonstrated an improvement from 14% at one year to 36% ( $P = 0.001$ ). Palliative benefit was evident with demonstration in the secondary endpoints, with a longer duration of pain-free survival, longer duration to any significant decrease in performance status, and time to more than 5% weight loss. Corroborating data was evident in the results of quality-of-life assessments (Cunningham et al. 1998).

#### **Breast Cancer**

The hypothesis that there is a relationship between tumor shrinkage and improvement in disease-related symptoms was evaluated in a prospective randomized trial of 300 women with metastatic breast cancer, during which symptoms were assessed for change over time associated with the cancer chemotherapy (Geels et al. 2000). Utilizing established quality-of-life questionnaires and what are now known as the **Common Toxicity Criteria**, the authors were able to demonstrate a clear correlation between patients’ symptoms and objective tumor response.

#### **Lung Cancer Chemotherapy**

For non-small cell lung cancer, the benefits of palliative chemotherapy are evident from a meta-analysis of 52 randomized clinical trials of chemotherapy. Comparing best supportive care to chemotherapy in a group of patients who had not had prior chemotherapy for metastatic disease, there was a 10% absolute improvement and survival at one year with chemotherapy; expressed as a hazard ratio, this was equal to 0.73 (Thongprasert et al. 1999). In a specific chemotherapy trial of docetaxel versus best supportive care in a group of 103 patients who had had previous treatment with platinum-based chemotherapy, there was a significant difference between the two groups in their requirement for opioid analgesics and other medications for symptom management (Shepherd et al. 2000).

### Prostate

For prostate cancer, the best evidence is from a prospective randomized trial of prednisone with or without the chemotherapeutic agent, mitoxantrone, in 161 men with metastatic prostate cancer. The primary endpoints were improvement in health-related quality of life assessed by questionnaire. Both groups demonstrated improvement in quality of life, but the important parameters of physical functioning and pain were significantly better in the mitoxantrone group, with longer duration of response compared to the prednisone alone group (Tannock et al. 1996).

### Ovary Cancer

For ovarian cancer, the data are not as well established, but implied from objective response data. Among 27 women, only seven achieved an objective response, and there were improvements in symptom endpoints (Doyle et al. 2001).

### References

1. Burris HA III, Moore MJ, Anderson J et al. (1997) Improvements in Survival and Clinical Benefit with Gemcitabine as First Line Therapy for Patients with Advanced Pancreas Cancer: A Randomized Trial. *J Clin Oncol* 15:2403–2413
2. Cunningham D, Pyrohonon S, James RD et al. (1998) Randomised Trial of Irinotecan plus Supportive Care versus Supportive Care alone after Fluorouracil Failure for Patients with Metastatic Colorectal Cancer. *Lancet* 352:1413–1418
3. Doyle C, Crump M, Pintilie M et al. (2001) Does Palliative Chemotherapy Palliate? Evaluation of Expectations, Outcomes, and Costs in Women Receiving Chemotherapy for Advanced Ovarian Cancer. *J Clin Oncol* 19:1266–1274
4. Geels P, Eisenhauer E, Bezjak A et al. (2000) Palliative Effect of Chemotherapy: Objective Tumor Response is Associated with Symptom Improvement in Patients with Metastatic Breast Cancer. *J Clin Oncol* 18:2395–2405
5. Koedoot CG, Haes JC de, Heisterkamp SH et al. (2002) Palliative Chemotherapy or Watchful Waiting? A Vignettes Study among Oncologists. *J Clin Oncol* 20:3658–3664
6. Shepherd F, Dancey J, Ramlau R et al. (2000) Prospective Randomized Trial of Docetaxel versus Best Supportive Care in Patients with Non-Small Cell Lung Cancer Previously Treated with Platinum-Based Chemotherapy. *J Clin Oncol* 18:2095–2103
7. Tannock IF, Osoba D, Stockler MR et al. (1996) Chemotherapy with Mitoxantrone plus Prednisone or Prednisone Alone for Symptomatic Hormone-Resistant Prostate Cancer: A Canadian Randomized Trial with Palliative End Points. *J Clin Oncol* 14:1756–1764
8. Thongprasert S, Sanguanmitra P, Juthapan W et al. (1999) Relationship between Quality of Life and Clinical Outcomes in Advanced Non-Small Cell Lung Cancer: Best Supportive Care (BSC) versus BSC plus Chemotherapy. *Lung Cancer* 24:17–24

## Cancer Pain Management, Gastrointestinal Dysfunction as Opioid Side Effects

NIGEL P. SYKES

St. Christopher's Hospice and King's College,  
University of London, London, UK  
nigelsykes@doctors.org.uk

### Synonyms

Opioid-Induced Bowel Dysfunction; opioid-related bowel dysfunction; Narcotic Bowel Syndrome

### Definition

A constellation of symptoms resulting from the effects of opioid analgesics on intestinal function. The most common and enduring of these symptoms is constipation. The other principal symptoms referable to opioid-induced gastrointestinal dysfunction are nausea and vomiting.

### Characteristics

Gastrointestinal dysfunction due to opioids is important because of the impact upon patients' quality of life, an impact that is sometimes rated higher than that of pain itself. Nausea affects up to 70% of patients with advanced cancer, and vomiting 10 to 30%. In advanced disease, opioids are probably the single most important identifiable cause of constipation, but many other factors such as impaired mobility and reductions or changes in dietary intake are involved. Thus 63% of cancer patients' not taking opioids need laxatives, but with opioids this rises to 87% (Sykes 1998).

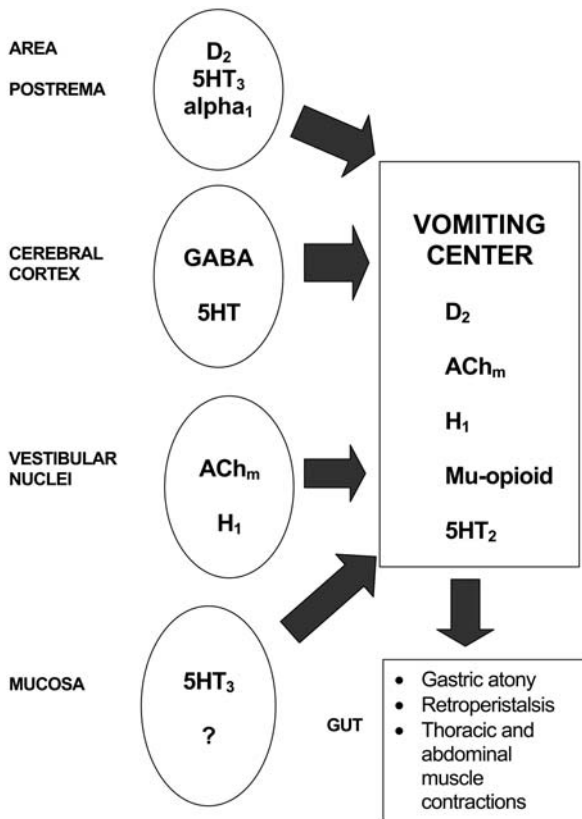
### Nausea and Vomiting

Opioids act in at least three ways to cause nausea and vomiting (Fig. 1):

- Detection by the chemoreceptor trigger area in the region of the area postrema and nucleus tractus solitarius.
- Slowing of gastrointestinal transit and, in particular, gastric emptying
- Increase of vestibular sensitivity.

A first step in management is to ensure that the patient is actually vomiting rather than regurgitating, as the latter will not be helped by antiemetics. Undigested food eaten in a current or immediately past meal, returned in small volumes with little or no prodromal nausea, suggests regurgitation. In any confirmed case of nausea or vomiting, the existence of exacerbating factors such as strong smells, anxiety and, of course, constipation, must be considered and addressed. At least 30% of cancer patients receiving morphine do not need an antiemetic, but around 10% will need a combination of two or more antiemetics (Twycross and Lack 1986). The logical choice of antiemetic depends on which of the three mechanisms of opioid-induced emesis appears to be acting most strongly (Table 1). In practice, vestibular stimulation can be ignored unless the patient has to take a journey, as movement *per se* is not usually the sole stimulus to nausea and vomiting in this patient group.

Delayed gastric emptying is suggested by large volume vomits, containing little or no bile, occurring suddenly



**Cancer Pain Management, Gastrointestinal Dysfunction as Opioid Side Effects, Figure 1** Receptor Activity of Commonly-Used Antiemetics

with little or no preceding nausea. There may be complaints of hiccups and heartburn, and there is often undigested food in the vomit from meals taken more than six hours previously. In this situation, metoclopramide is the rational first choice of antiemetic because of its prokinetic action on the upper gut. Metoclopramide has been

shown to overcome opioid-related upper gut slowing and associated vomiting (Stewart et al. 1976).

The chemoreceptor areas involved in emetogenesis are rich in D<sub>2</sub> dopamine receptors. In the absence of evidence of gastric hold-up, it is appropriate to use a drug with antidopaminergic activity for opioid-related nausea or vomiting. The most potent and specific antidopaminergics are droperidol and haloperidol. Droperidol is short-acting, but haloperidol has a half-life of about 18 hours, rendering it suitable initially to be given once a day, usually in the evening because of its somewhat sedative effect. A systematic review of the use of haloperidol as an antiemetic in palliative care found evidence of effectiveness in nausea and vomiting due to a variety of causes, including morphine (Critchley et al. 2001). Extrapyramidal or Parkinsonian effects of haloperidol can be dose-limiting.

Levomopromazine (methotrimeprazine) is a popular antiemetic for use in advanced disease in Britain, because its broad spectrum of receptor actions can cover the mixed etiology of vomiting characteristic of this patient group. It is effective at much lower doses than previously assumed (from 6.25 mg/day orally, or 2.5 mg/day subcutaneously), allowing the avoidance of sedation. Extrapyramidal effects are less than with haloperidol, but not absent.

Cyclizine is an H<sub>1</sub> antihistamine offering receptor activity complementary to that of haloperidol. It has been shown to have efficacy comparable with that of droperidol in nausea and vomiting associated with patient-controlled opioid analgesia (Walder and Aitkenhead 1995). Its receptor activity suggests a role at vagal level, which would be relevant where nausea was associated with gut distension. The efficacy of any antiemetic in a vomiting patient is likely to be better if administered by continuous subcutaneous infusion, and all the drugs mentioned can be administered in this way, alone or in combination with morphine.

**Cancer Pain Management, Gastrointestinal Dysfunction as Opioid Side Effects, Table 1** Receptor Activity of Commonly-Used Antiemetics

	D <sub>2</sub>	ACh <sub>m</sub>	H <sub>1</sub>	5HT <sub>3</sub>	5HT <sub>4</sub>
Hyoscine	-	+++	-	-	-
Cyclizine	-	+	+++	-	-
Haloperidol	+++	-	-	-	-
Chlorpromazine	++	+	++	-	-
Metoclopramide	++	-	-	+	++
Domperidone	++	-	-	-	-
Ondansetron	-	-	-	+++	+
Levomopromazine	++	+	+	+	-
Droperidol	+++	-	-	-	-

+++ indicates strong antagonism; - indicates little or no activity

C



Among newer drugs, the place of 5HT<sub>3</sub> antagonists in opioid-induced vomiting remains unclear. Moreover, clinical trials of NK<sub>1</sub> receptor antagonists indicate poor effectiveness in this indication (Loewen 2002).

Public interest in non-drug approaches to anti-emesis, notably acupuncture and acupressure, is strong. There is controlled trial evidence that acupuncture or acupressure at the P6 point (just above the wrist) is effective for nausea and vomiting due to opioid premedication.

### Constipation

Constipating effects of opioids on the bowel include:

- Reduction of peristalsis
- Increase in sphincter tone
- Increased water absorption
- Impairment of rectal sensation

These actions are predominantly mediated through mu<sub>2</sub> receptors in the gut itself. Mu<sub>2</sub> actions, such as delay of intestinal transit, show less tolerance than mu<sub>1</sub> mediated analgesia (Ling et al. 1989). In contrast to nausea and vomiting caused by opioids, which usually subsides within 7 to 10 days, opioid-induced constipation is often persistent.

In general, opioids differ little in their ability to constipate. Oxycodone has not shown constipating effects significantly different from those of morphine and neither has hydromorphone. Reduction in laxative use has been reported after changing from morphine to methadone, but only on a case history basis (Daeninck and Bruera 1999). However, there is now good evidence that transdermal fentanyl is significantly less constipating than morphine (Radbruch et al. 2000), presumably because the gut is also exposed to relatively lower levels of the drug.

Functional definitions of constipation exist, but are unhelpful in patients whose constipation is related to opioid use, where the condition's importance is as a symptom not a disease entity. Normal bowel habit is highly variable, and it is crucial to obtain a history of how bowel function has altered for the individual who is complaining of constipation. The most important differential diagnosis is intestinal obstruction by tumor or adhesions. The distinction is important, as attempts to clear 'constipation' which is actually obstruction by use of stimulant laxatives can cause severe pain.

It is better to prevent constipation rather than to treat it after it has occurred. Potential prophylactic measures include:

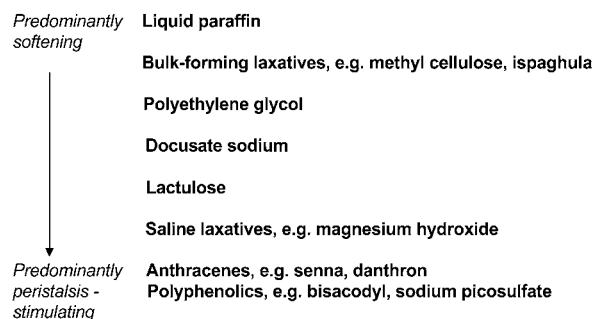
- Good general symptom control, without which no other measures are possible.
- Encouragement and facilitation of physical activity.
- An adequate fluid intake.
- Increased dietary fiber. However, fiber alone will not correct severe constipation, and the priority remains that food should be as attractive as possible to the person who is expected to eat it.

- Awareness of which drugs are likely to cause constipation, e.g. vinca alkaloids and 5HT<sub>3</sub> antagonist antiemetics, as well as opioid analgesics. If avoidance is impracticable, a laxative should be prescribed from the outset, without waiting until constipation is established.
- In institutions, ensure privacy for defecation.

Despite prophylaxis, most patients taking opioids will require a laxative. The basic division of laxatives is between ► **stimulant** s and ► **softener** s (Fig. 2). This division seems useful in clinical practice, although in fact any drug that stimulates peristalsis will accelerate transit, allow less time for water absorption and so produce a softer stool. Similarly, softening the stool involves increasing its bulk, which will result in increased distension of the intestinal wall, and a consequent stimulation of reflex enteric muscle contraction. Most trials of laxative drugs have been carried out in gastroenterology or in geriatrics. The results do not allow a clear recommendation of one agent over another because of the small size of the studies, the number of different preparations, and the various endpoints and conditions involved. However:

- Systematic review evidence suggests that any kind of laxative can increase stool frequency by about 1.4 bowel actions per week compared with placebo (Pettigrew et al. 1997).
- A volunteer trial using loperamide as a source of opioid-induced constipation, concluded that the optimal combination of effectiveness with minimum adverse effects and medication burden was achieved by using a combination of stimulant and softening laxatives, rather than either alone (Sykes 1997).
- Laxative preparations vary significantly in price and physical characteristics. Given the lack of major differences in efficacy, cost and individual patient acceptability should both be strong influences in prescribing choice (NHS Center for Reviews and Dissemination 2001).

Most patients prefer oral laxatives to rectal, so the use of suppositories and enemas should be minimized by opti-



**Cancer Pain Management, Gastrointestinal Dysfunction as Opioid Side Effects, Figure 2** Cancer Pain Management, opioid side effects, gastrointestinal dysfunction .



mizing laxative treatment by mouth. There is, however, a particular role for enemas and suppositories in the relief of fecal impaction and in bowel management in patients whose neurological dysfunction is resulting in fecal incontinence. Evidence to guide their use is even scantier than that for oral laxatives. Anything introduced into the rectum can stimulate defecation via the anocolonic reflex, but among rectal laxatives, only bisacodyl suppositories have a pharmacological stimulant action. Glycerine suppositories, and arachis or olive oil enemas, soften and lubricate the stool, as do proprietary mini-enemas which contain mixtures of surfactants.

## References

1. Critchley P, Plach N, Grantham M, Marshall D, Taniguchi A, Latimer E (2001). Efficacy of Haloperidol in the Treatment of Nausea and Vomiting in the Palliative Patient: A Systematic Review. *J Pain Symptom Manage* 22:631–634
2. Daeninck PJ, Bruera E (1999) Reduction in Constipation and Laxative Requirements following Opioid Rotation to Methadone. *J Pain Symptom Manage* 18:303–309
3. Ling GS, Paul D, Simontov R, Pasternak GW (1989) Differential Development of Acute Tolerance. *Life Sciences* 45:1627–1636
4. Loewen PS (2002) Anti-Emetics in Development. *Expert Opinion on Investigational Drugs* 11:801–805
5. NHS Center for Reviews and Dissemination (2001) Effectiveness of Laxatives in Adults. *Effective Health Care* 7:1–12
6. Petticrew M, Watt I, Sheldon T (1997) Systematic Review of the Effectiveness of Laxatives in the Elderly. *Health Technology Assessment* 1:1–52
7. Radbruch L, Sabatowski R, Loick G, Kulbe C, Kasper M, Grond S, Lehmann KA (2000) Constipation and the Use of Laxatives: A Comparison between Transdermal Fentanyl and Oral Morphine. *Palliative Medicine* 14:111–119
8. Stewart JJ, Weisbrodt NW, Burko TF (1976) Intestinal Reverse Peristalsis Associated with Morphine-Induced Vomiting. In: Kosterlitz HW (ed) *Opiates and Endogenous Opioid Peptides*. Elsevier, Amsterdam, pp 46–58
9. Sykes NP (1997) A Volunteer Model for the Comparison of Laxatives in Opioid-Induced Constipation. *J Pain Symptom Manage* 11:363–369
10. Sykes NP (1998) The Relationship between Opioid Use and Laxative Use in Terminally Ill Cancer Patients. *Palliative Medicine* 12:375–382
11. Twycross RG, Lack SA. Control of Alimentary Symptoms in Far Advanced Cancer. Churchill Livingstone, Edinburgh, pp 153
12. Walder AD, Aitkenhead AR (1995) A Comparison of Droperidol and Cyclizine in the Prevention of Postoperative Nausea and Vomiting Associated with Patient-Controlled Analgesia. *Anaesthesia* 50:654–656

## Cancer Pain Management, Interface between Cancer Pain Management and Palliative Care

PETER G. LAWLOR

Our Lady's Hospice, Medical Department, Dublin, Ireland  
plawlor@olh.ie

## Synonyms

Hospice care; supportive care; Palliative Care and Cancer Pain Management

## Definition

The recently revised World Health Organization definition of palliative care reads: “Palliative care is an approach that improves the ► **quality of life** of patients and their families facing the problems associated with life-threatening illness, through the prevention and relief of ► **suffering** by means of early identification and impeccable assessment and treatment of pain and other problems, physical, psychosocial and spiritual” (<http://www.who.int/cancer/palliative/en/>).

## Characteristics

### Cancer Pain and Palliative Care: A Global Perspective and Introductory Outline

Cancer is one of those life-threatening illnesses referred to in the WHO definition of palliative care. Approximately one-third of the population in developed countries will be diagnosed with cancer. The estimated worldwide number of new cases each year is expected to rise from 10 million in the year 2000 to 15 million in 2020. The number of annual worldwide cancer related deaths is expected to rise from 6 to 10 million over the same period (World Health Organization and International Union against Cancer 2003). Much of the projected increase in cancer mortality relates to an increase in the elderly population, whose age is associated with an increased risk of developing cancer, and who are likely to have multiple comorbidities and increasing general care needs. Despite a survival rate of approximately 50% in developed countries for all cancers combined, about 70% of all cancer patients are estimated to need palliative care. In developing countries, this proportion rises to around 80% (World Health Organization 2002). Hence, for the majority of cancer patients, treatment with a curative outcome proves to be either ultimately elusive or an unrealistic goal from the time of diagnosis.

Pain is present in 20–50% of cancer patients at diagnosis and in at least 75% of those patients with advanced disease, often in association with other distressing symptoms such as fatigue and anorexia (Donnelly and Walsh 1995; World Health Organization 1997). A survey of cancer patients suggested that pain was directly related to the cancer in 85%, anti-cancer treatments such as surgery, chemotherapy and radiotherapy in 17%, and other comorbidities in 9% (Grond et al. 1996).

A consensus exists among pain management specialists regarding the multidimensional nature of cancer pain, and scientific evidence supports the concept (World Health Organization 1997; Lawlor 2003; Ahles et al. 1983; Portenoy and Lesage 1999). The ultimate expression of pain intensity represents not only the perception of the basic physiological input from peripheral nociceptor activation but varying levels of multiple other inputs, which may relate to psychological state, cognitive status (the presence of delirium or dementia),

the meaning of pain (for example, fears of disease progression), cultural norms, and distress of an existential and spiritual nature. The multidisciplinary palliative care model with its broad holistic principles recognizes these dimensions, and embodies a multidimensional assessment approach as an integral part of cancer pain management (Lawlor 2003).

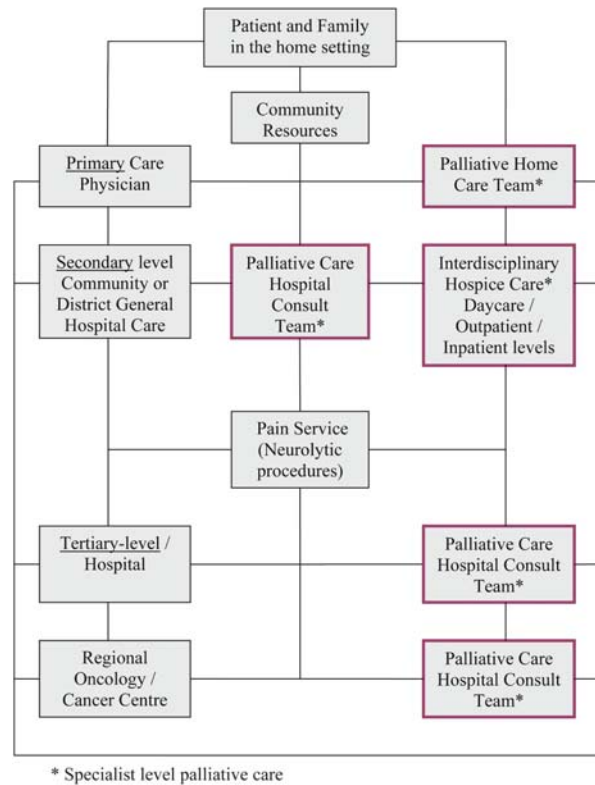
To enable the reader to appreciate the special role of palliative care, and to assist in understanding interactive roles in the interfaces of palliative care and cancer pain management, four broad aspects are described: firstly, the historical background of the palliative care model and its interfaces; secondly, the fundamental practice principles and service delivery levels of modern palliative care; thirdly, issues in palliative care delivery in the interface with other specialties and health care personnel at the various locations and stages of cancer care; and fourthly, bridging strategies at the aforementioned interfaces.

**Palliative Care Interfaces: Historical Background**

Palliative care originated from the hospice model of care (MacDonald 1993). Although the term “hospice” has medieval origins referring to a place of shelter or rest, its 19<sup>th</sup> century use referred mainly to a site of care, but in addition many of these sites also included “hospice for the dying” as part of their name. Historically, “hospice” therefore has a strong association with the terminal phase of illness, and the terms **hospice care** and terminal care have been used interchangeably. Up to the 20<sup>th</sup> century, most medical care interventions were not curative but provided symptom relief, and as such were essentially palliative. Medical advances in the first half of the 20<sup>th</sup> century resulted in a shift to obtaining a cure and waging a “war” against cancer. The biomedical aspects of care largely became the focus of care, often at the cost of ignoring the total illness experience from the patient and family perspective, an experience that invariably generates substantial psychosocial and spiritual needs. The more modern hospice movement, incorporating the bulk of today’s palliative care principles, and typified by St Christopher’s Hospice in London, was born in the late 1960’s mainly to address these needs (MacDonald 1993). In the US, hospice care eligibility is restricted by requirements for an estimated 6-month prognosis and willingness to forego life prolonging treatment. Generally, palliative care is broader in its scope than either hospice or **supportive care**, and is advocated earlier in the disease trajectory. **Palliative medicine** now has medical specialty status in the UK, Australia, and Ireland.

**Practice Principles and Service Delivery Levels of Modern Palliative Care**

The complex web of palliative care with its broad holistic purview is summarized through a schematic matrix in Fig. 1. For many patients with cancer pain, progres-



**Cancer Pain Management, Interface between Cancer Pain Management and Palliative Care, Figure 1** Cancer pain and the multidisciplinary palliative care approach (Adapted from reference 7).

sion of the disease process affects functioning in the physical, psychological, spiritual, and social domains, thereby reducing overall quality of life (QOL). Examples of problems in the QOL domains include: reduced mobility; loss of independence; depression; anger; fear; anxiety; guilt; anticipatory grieving; financial hardship; family stress and exhaustion. The palliative care approach recognizes the distress generated in the main QOL domains, and aims to support patients and families in coping with the burden of advancing disease, in striving to achieve optimal QOL, and in adjusting over time to their inevitable demise. This recognition and intervention is especially important in the case of suffering (Cassell 1982) or **total pain** (Kearney 1996), where the expression of pain is attributable only in part to nociceptor activation, but perhaps in greater proportion to psychosocial and spiritual distress.

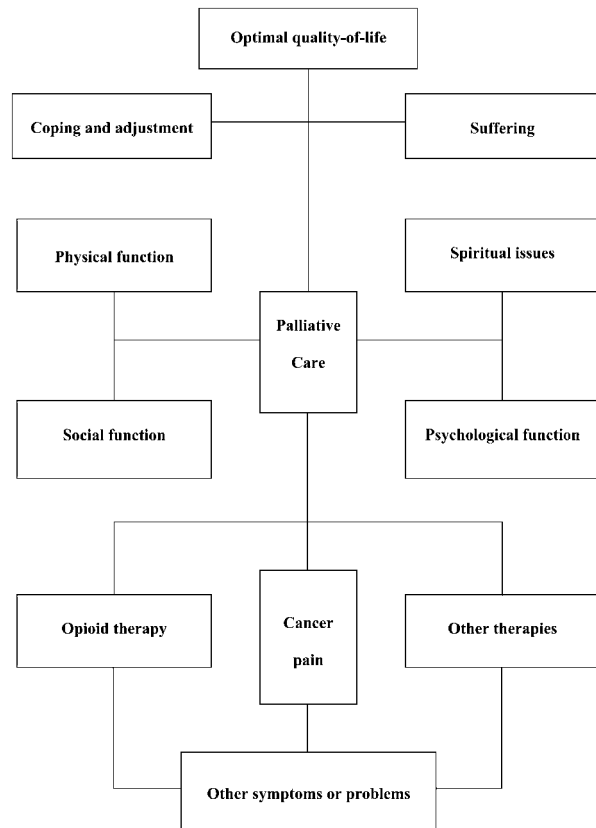
The WHO definition of palliative care states that it is “applicable early in the course of illness, in conjunction with other therapies that are intended to prolong life, such as chemotherapy or radiation therapy, and includes those investigations needed to better understand and manage distressing clinical complications” (World Health Organization 2002). This distinguishes the modern palliative care approach as being active and not necessarily passive. Nonetheless, the stigma of passivity often persists

and probably reflects the more traditional origins of palliative care, especially hospice care. In developed countries, especially those where palliative medicine is recognized as a specialty, palliative care services are often tiered from level one to three on the basis of the specialization level and expertise of the professionals delivering palliative care (National Advisory Committee on Palliative Care 2001). Level one refers to the practice of the basic “palliative care approach”. This embodies a set of principles with which all health care professionals should be familiar and be capable of adopting in their practice. Level two or generalist palliative care refers to that delivered by professionals who are not practicing full-time in palliative care, but who have some additional training in palliative care. Level three refers to **specialist palliative care**. Patients with more complex and demanding care needs, for example those patients with neuropathic pain, substance abuse histories, and features of “total pain” are referred to specialist palliative care services (Bruera et al. 1995). Consequently, these services are more resource intensive, and are akin to secondary or tertiary healthcare services. For the healthcare professional, ease of access to specialist palliative care advice as needed is essential. Healthcare delivery models should ensure that patients have access to the level of palliative care expertise most appropriate to their needs in a seamless and integrated fashion (MacDonald 1993; National Advisory Committee on Palliative Care 2001).

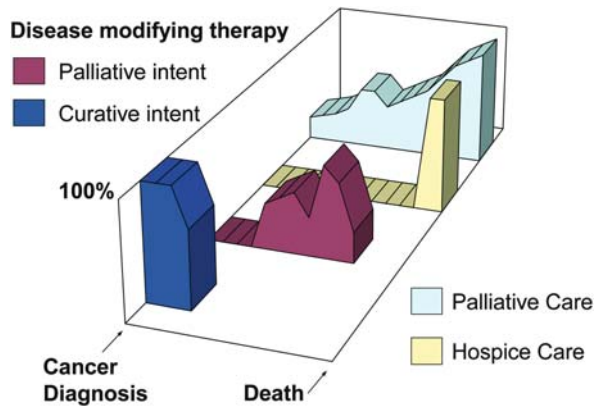
**Palliative Care and Cancer Pain Management: Clinical and Other Interface Issues**

The interface between cancer pain management and palliative care refers to the boundaries either real or notional between palliative care and the many locations of care delivery, and the temporal changes in the degree of involvement of palliative care during the course of the cancer disease trajectory. The location or institutional interfaces are represented in an ideal, generic, developed world model in Fig. 2, which shows each level of health care from primary to tertiary, and each with a direct link to specialist palliative care services. In this model, some international or geographic differences may occur regarding the level of interaction between and within various levels, and also regarding the degree of provision of specialist palliative care.

The temporal interface of palliative care and disease modifying therapies, and their respective levels of use in the progressive disease trajectory (from diagnosis to death) of a hypothetical cancer patient is represented in schematic form in Fig. 3. Disease modifying therapies such as surgery, chemotherapy, and radiation can be offered depending on the relative burden/benefit associated with the treatment. This is done with either curative or palliative intent depending on the stage of disease. The curative intent phase for this patient is relatively brief, is followed by a phase where there is modest use



**Cancer Pain Management, Interface between Cancer Pain Management and Palliative Care, Figure 2** Interface of palliative care and specific sites and levels of medical care during the cancer disease trajectory.



**Cancer Pain Management, Interface between Cancer Pain Management and Palliative Care, Figure 3** Palliative care and its temporal involvement compared to other therapies in the cancer disease trajectory.

of palliative disease modifying interventions such as radiation therapy. This phase ends rather abruptly prior to a short terminal or hospice phase of care. The role of palliative or supportive care progressively increases in association with disease progression, and finally envelops the hospice contribution to the terminal phase of care.

Although the high level of need for palliative care is generally well recognized in advanced cancer, its delivery to patients and their families is often inadequate. This shortfall may be associated with various health service delivery factors of a political and/or financial nature, especially in the case of developing countries, where palliative care services are often only rudimentary or sometimes non-existent (World Health Organization 2002). In developed countries, the shortfall in palliative care delivery may relate to professional factors such as lack of knowledge of pain management; multiple boundary issues such as the fear of losing or separating from the patient, or fear that exposure to palliative care in itself will hasten a patient's demise, or concern that the patient could feel abandoned if palliative care are consulted; and a state of relative denial of disease progression. This denial is often reflected by the relentless pursuit of burdensome treatments, whose outcomes often have a deleterious effect on quality of life, and are perceived as being unnecessarily aggressive by the palliative care professional. In addition, patient and caregiver denial may result in varying degrees of reticence to accept the palliative care approach. Cultural norms may result in a "conspiracy of silence" (denial reflected by non discussion of disease status), or a "conspiracy of words" (denial reflected by limited discussion and use of euphemistic terms, for example, "spot" or "shadow" to evasively describe the presence of cancer). This must be sensitively recognized as a potential challenge to both the delivery and acceptance of palliative care in its most idealistic format (World Health Organization 1997).

#### **Palliative Care and Cancer Pain Management: Interface Bridging Strategies**

A number of strategies can allow a functionally smooth and readily traversable interface between palliative care and other specialties in the management of cancer pain and associated symptoms (MacDonald 1993).

Firstly, the need for mutual appreciation of each others roles is of pivotal importance, for example, the palliative care physician needs to appreciate the potential palliative benefit associated with chemotherapy, radiation or surgery, and the oncologist or surgeon needs to appreciate the benefit of early palliative care involvement for symptom control advice, support for adjustment to disease progression, and assistance with the planning of care, such as instituting palliative home care support or discussing hospice placement. Such a premise will often allow a shared care model, and thereby the shared goal of achieving optimal QOL for patients and their families rightly takes precedence over "patient ownership" or territorial concerns.

Secondly, consistently good communication is essential. The shared, systematic use of validated, low burden assessment tools for pain and other symptoms through-

out all levels of health service delivery is of great assistance in communication regarding cancer pain management (MacDonald 1993; Chang et al. 2000). Other ways to facilitate communication include person to person corridor conversations, joint rounds or joint clinics, and user friendly technology. For the purpose of maintaining continuity of care, both the mutual appreciation and enhanced communication paradigms should ensure that the patient's general practitioner or family physician, and palliative home nurse are not disenfranchised, especially in the case of patients who are discharged to the community.

Other valuable bridging strategies include mutually shared research agendas; mutually shared educational rounds, ideally with some multidisciplinary input; integrated treatment sites; integrated administrative input, for example, shared participation in regional council bodies that might advise on care delivery and its development; and shared use of resources. The benefits for the patient with cancer pain as a result of smooth negotiation across the palliative care interfaces include ease of access to services, for example, fast-tracking of radiation oncology referrals; integration and continuity of care, which diminishes the risk of a sense of abandonment, a perception held by some patients when curative therapy is no longer possible.

#### **Summary and Conclusions**

In conclusion, a multidimensional assessment of cancer pain is paramount and constitutes an integral component of the palliative care approach. Optimal cancer pain management must recognize unique individual patient and family care needs, whatever the location and wherever this may occur in the cancer disease trajectory. Although the need for specialist palliative care services varies in relation to the temporal trajectory and location of cancer care, the basic palliative care approach is a fundamental requisite that essentially spans all stages and sites of care. Although various political, cultural, geographical, administrative and financial factors will clearly influence the degree of development and support of the palliative care model in different areas, healthcare planning must aim to achieve a seamless integration of the different aspects of palliative care service delivery and other areas of cancer care, and to offer flexibility for patients to access the different levels of care (each level with a link to specialist palliative care services) as determined by their individual and specific needs.

#### **References**

1. Ahles TA, Blanchard EB, Ruckdeschel JC (1983) The Multidimensional Nature of Cancer-Related Pain. *Pain* 17:277-288
2. Bruera E, Schoeller T, Wenk R et al. (1995) A Prospective Multi-center Assessment of the Edmonton Staging System for Cancer Pain. *J Pain Symptom Manage* 10:348-355
3. Cassell EJ (1982) The Nature of Suffering and the Goals of Medicine. *N Engl J Med* 306:639-645



4. Chang VT, Hwang SS, Feuerman M (2000) Validation of the Edmonton Symptom Assessment Scale. *Cancer* 88:2164–2171
5. Donnelly S, Walsh D (1995) The Symptoms of Advanced Cancer. *Semin Oncol* 22:67–72
6. Grond S, Zech D, Diefenbach C et al. (1996) Assessment of Cancer Pain: A Prospective Evaluation in 2266 Cancer Patients Referred to a Pain Service. *Pain* 64:107–114
7. <http://www.who.int/cancer/palliative/en/> Accessed November 4<sup>th</sup> 2003
8. Kearney M (1996) *Mortally Wounded. Stories of Soul Pain, Death, and Healing*. Scribner, New York
9. Lawlor PG (2003) Multidimensional Assessment: Pain and Palliative Care. In: Bruera E, Portenoy RK (eds) *Cancer Pain*. Cambridge University Press, New York, pp 67–88
10. MacDonald N (1993) The Interface between Oncology and Palliative Medicine In: Doyle D, Hanks GWC, MacDonald N (eds) *Oxford Textbook of Palliative Medicine*. Oxford University Press, Oxford, pp 11–17
11. National Advisory Committee on Palliative Care (2001) *Palliative Care – An Overview*. In: Report of the National Advisory Committee on Palliative Care. Department of Health and Children, Dublin
12. Portenoy RK, Lesage P (1999) Management of Cancer Pain. *Lancet* 353:1695–1700
13. World Health Organization and International Union against Cancer (2003) *Global Action against Cancer*. WHO and UICC, Geneva, pp 1–24
14. World Health Organization (1997) *Looking Forward to Cancer Pain Relief for All. International Consensus on the Management of Cancer Pain*. WHO, Oxford, pp 1–70
15. World Health Organization (2002) *Pain Relief and Palliative Care*. WHO, Geneva, pp 83–91

## Cancer Pain Management, Neurosurgical Interventions

RICHARD B. NORTH<sup>1</sup>, SAMUEL J. HASSENBUSCH<sup>2</sup>  
<sup>1</sup>The Johns Hopkins University, Baltimore, ML, USA  
<sup>2</sup>The University of Texas M. D. Anderson Cancer Center, Houston, TX, USA  
 rnorth@jhmi.edu, samuel@neosoft.com

### Definition

Cancer pain arises from the presence, progression, or treatment of cancer or from an unidentifiable source in patients with cancer. Cancer pain may be nociceptive, neuropathic, or a mixture of both.

A neurosurgical intervention uses an ablative, augmentative, or anatomic surgical technique, or a combination of these techniques, to relieve pain.

### Characteristics

In humans, cancer assumes many guises, can affect every physiologic system and tissue, and strikes with various degrees of virulence. Cancer and its treatment cause pain in most patients, with the severity and impact of this pain dictated by a host of influences (Patt 2002).

Medical management, which is often sufficient to treat cancer pain, sometimes fails to provide adequate relief or results in side effects that substantially reduce the quality of the patient's life (nausea, constipation, vomiting,

incontinence, mood changes, sedation, diarrhea, confusion, etc.) (McNicol et al. 2003). It might seem reasonable to wait until medical management fails before pursuing neurosurgical intervention, but in certain cases, for example when a patient foreseeably will need an implanted device, neurosurgeons should intervene before the patient's condition deteriorates too far to support the intervention.

When neurosurgical techniques result in pain relief, they can enhance a patient's quality of life by increasing functional capacity and offering freedom from troublesome side effects. Compared with medical management, neurosurgical techniques can improve continuity of relief, reduce the patient's and physician's time spent adjusting dosages, and minimize the development of tolerance or adverse effects from opioids. It is possible that, in some patients, neurosurgical intervention for pain relief will prolong survival (Smith et al. 2002).

### Patient Selection

Patient selection for neurosurgical intervention is based on a consideration of the nature of the disease, the impact of the disease on the patient's life, and the nature of the pain. One major factor in assessing disease impact and therapeutic options is the patient's prognosis, which involves quantitative and qualitative factors, such as age, life expectancy, type of cancer, the intervention's cost effectiveness, risk/benefit ratio, duration of effect and the patient's functional capacity, personal values/wishes, and living/family conditions. A multimodal assessment will reveal if a patient has a good (expected to survive at least a year and to be active for most of that time) or a poor prognosis (expected to survive less than six months and to be inactive). Pain type and severity are also important indicators of the appropriate intervention. Relative contraindications for interventional pain therapy include the presence of an untreated comorbid psychological disorder or current drug abuse (North 2002; Levy 2002).

### Treatment Options

Interventional treatment options range from simple injections of short-acting local anesthetics (and, occasionally, of an adjuvant steroid or lytic agent) to complex anatomic, ablative, and augmentative neurosurgical techniques

Anatomic procedures address structural problems causing pain – for example, tumor removal or debulking. Spinal reconstructive surgery (decompression, stabilization) for metastatic disease is a common example. To the extent that this addresses the cause of pain directly, it has obvious appeal; but the cause of pain may not be completely clear, and there may be alternatives (such as radiation therapy alone). Patients with advanced disease and limited life expectancy may not be candidates for reconstructive surgery.



Ablative procedures destroy portions of the peripheral or central nervous system to block pain transmission. This may be achieved through chemical (the direct application of alcohol or phenol), thermal (► [cryoablation](#) or radiofrequency, see ► [radiofrequency ablation](#)), surgical (cutting) or radiosurgical means.

Peripheral ablative procedures are applicable to pain generators in the distribution of specific peripheral nerves, if they may be sacrificed without incurring an unacceptable deficit. For example, a peripheral ► [neurectomy](#) might relieve the pain in the distribution of the supra- or infraorbital nerve. Percutaneous radiofrequency or open ► [dorsal rhizotomy](#) has a role in cases where a tumor involves the chest wall. ► [Sympathetic ganglionectomy](#) involving several adjacent levels will denervate somatic and/or visceral tissue in the trunk or abdomen or in a limb. All of these may be emulated by reversible local anesthetic injections, to predict the results of a permanent procedure and thereby aid in patient selection.

Intraspinal ablative techniques interrupt input or rostral transmission of nociceptive signals in patients with severe pain and a poor prognosis. These techniques include open or percutaneous ► [anterolateral cordotomy](#) for intermittent and/or evoked neuropathic pain affecting one, or sometimes, two limbs (Tasker 1995), and ► [midline commissural myelotomy](#) for diffuse lower body pain. Cordotomy is associated with significant risks, especially with bilateral application for midline or axial pain. Cordotomy is often ruled out when pain is above C5 or the patient suffers from pulmonary dysfunction. Myelotomy addresses bilateral and midline pain in a single procedure and is best reserved for cancer patients with bladder, bowel, and sexual dysfunction. Most patients achieve nearly complete pain relief after cordotomy and myelotomy, but some experience recurrent pain months later.

Intracranial ablative therapies interrupt or change the perception of pain transmission. ► [Stereotactic cingulotomy](#) is appropriate for severe pain in diffuse areas of the body and provides at least three months relief for most cancer patients (Hassenbusch 1996). The less-frequently used ► [stereotactic medial thalamotomy](#) relieves pain for as many as 50% of patients with a good or poor prognosis and severe, otherwise intractable, nociceptive pain that is widespread, midline, bilateral, or located in the head or neck; it also may help approximately 30% with neuropathic pain (intermittent and evoked neuropathic pain responds more readily than continuous pain). ► [Hypophysectomy](#) is an appropriate treatment for diffuse pain associated with widespread cancer, and provides relief through an unknown mechanism of action in 45–95% of patients. These procedures may be performed not only by stereotactic probe placement but also by radiosurgery (see ► [stereotactic radiosurgery](#)).

Augmentative procedures modulate activity in the intact nervous system by electrical stimulation or continuous drug infusion to change pain perception. They have the advantages of reversibility, titration of dose, and of a trial or test phase which emulates the definitive procedure exactly. This is not the case for anatomic or ablative procedures. Due to the high initial expense, physicians reserve implanted devices for patients expected to survive at least three months.

The usual indication for somatosensory stimulation is neuropathic pain restricted to a specific area, and this stimulation can target the spinal cord, a peripheral nerve, or the thalamus (to treat continuous neuropathic pain, such as ► [post-radiation plexopathy](#)). The goal of such electrical stimulation is to induce a ► [paresthesia](#) that covers the painful area, effectively replacing the pain with a tolerable, non-noxious sensation. Nociceptive pain may also be treated by periaqueductal or periventricular grey stimulation.

The best-established indication for continuous drug infusion, in particular morphine, is diffuse midline or bilateral nociceptive cancer pain. The infusion catheter enters the epidural, intrathecal, or intraventricular space, and the drug delivery system includes an implanted or an external pump (Staats and Luthardt 2004).

## References

1. Hassenbusch SI (1996) Intracranial Ablative Procedures for Pain. In: Youmans JR (ed) *Neurological Surgery*, 4<sup>th</sup> edn. WB Saunders, Philadelphia, pp 3541–3551
2. Levy RM (2002) Intrathecal Opioids: Patient Selection. In: Burchiel K (ed) *Surgical Management of Pain*. Thieme, New York, pp 469–484
3. McNicol E, Horowicz-Mehler N, Fisk RA et al. American Pain Society (2003) Management of Opioid Side Effects in Cancer-Related and Chronic Noncancer Pain: A Systematic Review. *J Pain* 4:231–256
4. North RB (2002) Spinal Cord Stimulation: Patient Selection. In: Burchiel K (ed) *Surgical Management of Pain*. Thieme, New York, pp 469–484
5. Patt RB (2002) Cancer Pain. In: Burchiel K (ed) *Surgical Management of Pain*. Thieme, New York, pp 469–484
6. Smith TJ, Staats PS, Pool G et al. (2002) Randomized Clinical Trial of an Implantable Drug Delivery System Compared to Comprehensive Medical Management for Refractory Cancer Pain: Impact on Pain, Drug-Related Toxicity, and Survival. *J Clin Oncol* 20:4040–4049
7. Staats PS, Luthardt F (2004) Intrathecal Therapy for Cancer Pain. *Just the Facts Pain Medicine*. McGraw Hill, New York
8. Tasker RR (1995) Percutaneous Cordotomy. In: Schmidek HH, Sweet WH (eds) *Operative Neurosurgical Techniques: Indications, Methods and Results*. WB Saunders, Philadelphia, pp 1595–1611

## Cancer Pain Management, Nonopioid Analgesics

ALISON MURRAY, JOSE PEREIRA  
Foothills Medical Center, Calgary, AB, Canada  
amurray@ucalgary.ca, pereiraj@ucalgary.ca

## Definition

Nonopioid analgesics comprise of all those medications prescribed for pain relief that do not fall into the opioid class. These include paracetamol (acetaminophen), aspirin (acetylsalicylic acid), and the nonsteroidal anti-inflammatory drugs (NSAIDs). Paracetamol is an analgesic-antipyretic with weak anti-inflammatory activity. Aspirin is a derivative of salicylic acid and has analgesic, antipyretic and anti-inflammatory activity. Nonsteroidal anti-inflammatory drugs are a heterogeneous group of compounds. They share the same therapeutic action and side-effect profile as aspirin. Nonopioid analgesics are recommended for use in the case of mild cancer pain, as described in Step I of the World Health Organization Analgesic Ladder for the treatment of cancer pain (World Health Organization 1986). Nonopioids were used on 11% of treatment days in a large prospective study involving 2118 cancer patients, while the so-called “weak opioids” (WHO Step II) were used on 31% of days and the so-called “strong” opioids (Step III) on 49% of treatment days (Zech et al. 1995). In another study, 52% of cancer patients started on a nonopioid analgesic needed to be switched to a weak or strong opioid because of escalating pain (Ventafridda et al. 1987). Nonopioid analgesics are also used as adjuvant medications to opioids for the management of moderate to severe pain (Step II and III of the ► [WHO Analgesic Ladder](#)).

## Characteristics

### Paracetamol (Acetaminophen)

#### Mode of Action

Paracetamol has analgesic and antipyretic effects but only weak anti-inflammatory effects. Its mechanism of action is unknown, although it is thought to act centrally rather than peripherally (Flower et al. 1980). Paracetamol may be given orally or rectally.

#### Pharmacokinetics

It is metabolized by the liver.

#### Efficacy

Paracetamol is considered to be a weak analgesic without anti-inflammatory effects. There is little evidence supporting the use of paracetamol alone in cancer pain, although there are some studies which support its use when combined with an opioid (codeine or oxycodone) (Carlson et al. 1990). Paracetamol 600 mg plus codeine 60 mg has been found to be equivalent to ketorolac 10 mg, and superior to placebo in reducing cancer pain in a double-blind randomized controlled study.

#### Adverse Effects

Side effects include rash, urticaria and nausea. Paracetamol may induce hepatotoxicity after acute ingestion of large doses (> 10 g) or chronic ingestion of daily doses exceeding 4 g. Other serious but rare side effects

include: nephrotoxicity, blood dyscrasias, pancreatitis and angioedema. Caution should be used in patients with impaired liver function/chronic alcohol use, or impaired renal function (Flower et al. 1980). Most clinicians will consider paracetamol safe to use in patients with liver metastases on the condition that overt hepatic failure is not present. There are no studies to support or refute this practice.

## Nonsteroidal Anti-Inflammatory Drugs (NSAIDs)

### Mode of Action

NSAIDs inhibit peripheral prostaglandin synthesis through the inhibition of cyclo-oxygenase enzymes, COX-1 (found in normal cells) and COX-2 (induced during the inflammatory process). Inhibition of COX-2 produces anti-inflammatory effects: decreased release of inflammatory mediators (such as substance P and cytokines), which leads to decreased stimulation of peripheral ► [nociceptors](#) (Jenkins and Bruera 1999). COX-1 inhibition can lead to many of the known side effects of NSAIDs, in particular gastrointestinal ulceration and inhibition of platelet aggregation. It has also been suggested that NSAIDs may have a central effect on pain perception by reducing NMDA-mediated hyperalgesia (Jenkins and Bruera 1999).

The older generation of NSAIDs (including aspirin) has variable effects on both COX-1 and COX-2. A new generation of NSAIDs (etodolac, meloxicam, nabumetone, celecoxib, valdecoxib, and rofecoxib) show COX-2 selective inhibition (Jenkins and Bruera 1999), and those created most recently (the coxibs celecoxib, valdecoxib, rofecoxib, and others in development) are highly COX-2 selective.

### Pharmacokinetics

NSAIDs are given by the oral or the rectal route, with the exception of ketorolac, which is also available in a parenteral preparation. NSAIDs are metabolized by the liver and excreted in the urine and faeces (Flower et al. 1980).

### Efficacy

In multiple dose trials, NSAIDs have been found to be as effective as weak opioids or weak opioid/paracetamol preparations (Goudas et al. 2001). No individual NSAID or class of NSAID has been shown to be more effective in the control of pain (Goudas et al. 2001; Mercadante 2001). NSAIDs appear to have a dose-response relationship with respect to analgesic efficacy (Eisenberg et al. 1994), and they also demonstrate a ceiling effect (supramaximal doses do not demonstrate superiority over recommended doses) (Eisenberg et al. 1994). The efficacy of NSAIDs does not vary with the route of administration (Tramer et al 1998). It has been common practice to prescribe NSAIDs for certain cancer pain syndromes (in particular, metastatic bone pain), but the

evidence to support this is largely lacking (Goudas et al. 2001; Mercadante 2001; Eisenberg et al. 1994). There are no current trials available involving the use of COX-2 selective inhibitors in cancer pain. Data from the non-malignant pain literature (largely osteoarthritis and rheumatoid arthritis populations) demonstrate that coxibs are as effective as nonselective NSAIDs in terms of pain relief (Kuritzky and Weaver 2003). When NSAIDs are coadministered with opioids as ► **adjuvant analgesics**, they produce an opioid sparing effect, but there is no consistent reduction in side effects (Jenkins and Bruera 1999; Goudas et al. 2001; Mercadante 2001). It is difficult to evaluate the opioid sparing effects of NSAIDs, given that they have an equally significant side effect profile of their own.

### Side Effects

The incidence of side effects with NSAIDs demonstrates a dose-response relationship and rises significantly after multiple dosing over 7–10 days (Eisenberg et al. 1994). One of the major side effects of nonselective NSAIDs is gastrointestinal ulceration (resulting in clinically significant gastrointestinal bleeding) (Mercadante 2001). The majority of studies have been performed in non cancer populations. NSAID users have three times the risk of gastrointestinal ulceration compared to non-users (Jenkins and Bruera 1999). Advanced age, history of peptic ulcer disease, and concurrent corticosteroid or anticoagulant therapy are known risk factors for NSAID-induced gastrointestinal bleeding and perforation (Hernandez-Diaz and Rodriguez 2000). Omeprazole has been shown to decrease the incidence of NSAID induced gastrointestinal ulceration. Eradication of helicobacter pylori prior to NSAID administration may reduce the risk in the general population (Jenkins and Bruera 1999). In uncontrolled studies of cancer populations, dyspepsia has been reported by 7–13% of users, and 5–20% of users discontinued NSAIDs due to an adverse event (Goudas et al. 2001). In cancer patients, advanced disease and the presence of liver disease (primary cancer or metastases) have been associated with a higher rate of gastrointestinal bleeding events (Mercadante et al. 2000).

A second side effect is impaired renal function. Acute renal dysfunction is usually reversible and improves after discontinuation of the NSAID. It is caused by a decrease in prostaglandin dependent renal plasma flow. Older age, hypertension, concomitant use of diuretics, pre-existing renal failure, diabetes and dehydration are risk factors for acute NSAID-induced renal failure (De Broe and Elseviers 1998). Chronic and permanent renal failure secondary to NSAIDs is much rarer, and is probably due to acute tubular necrosis (Mercadante 2001).

Other known side effects of NSAIDs include platelet inhibition, blood dyscrasias, hepatic damage and CNS toxicity (tinnitus, visual disturbances, dizziness etc.) (Mercadante 2001).

There are no trials comparing the side effects of COX-2 inhibitors compared to nonselective NSAIDs in cancer populations (Goudas et al. 2001). The use of COX-2 inhibitors is associated with fewer endoscopic ulcers and fewer gastrointestinal events compared to nonselective NSAIDs in the general population (Laine 2003), but they have a similar rate of nephrotoxic events. Coxibs do not inhibit platelet function as nonselective NSAIDs do. There is controversy about whether coxibs are associated with an increased risk of cardiovascular events (DeMaria and Weir 2003).

### Dipyrone

Dipyrone has anti-inflammatory, anti-pyretic and analgesic effects. Its mechanism of action is unknown. It is used in Europe, but it is not available in North America due to concerns about agranulocytosis (Flower et al. 1980).

### References

1. Carlson RW, Borrisson RA, Sher HB et al. (1990) A Multi-Institutional Evaluation of the Analgesic Efficacy and Safety of Ketorolac Tromethamine, Acetaminophen plus Codeine, and Placebo in Cancer Pain. *Pharmacotherapy* 10:211–216
2. De Broe ME, Elseviers MM (1998) Analgesic Nephropathy. *N Engl J Med* 338:446–452
3. DeMaria AN, Weir MR (2003) Coxibs – Beyond the GI tract: Renal and Cardiovascular Issues. *J Pain Symptom Manage* 25:41–49
4. Eisenberg E, Berkey CS, Carr D et al. (1994) Efficacy and Safety of Nonsteroidal Anti-Inflammatory Drugs for Cancer Pain: A Meta-Analysis. *J Clin Oncol* 12:2756–2765
5. Flower RJ MS, Vane JR, Moncada S (1980) Analgesic-Antipyretics and Anti-Inflammatory Agents; Drugs Employed in the Treatment of Gout. In: Goodman and Gilman's The Pharmacological Basis of Therapeutics, 6<sup>th</sup> edn. MacMillan publishing Company Inc., New York
6. Goudas L, Carr DB, Bloch R et al. (2001) Management of Cancer Pain. *Evid Rep Technol Assess* 35:1–5
7. Hernandez-Diaz S, Rodriguez LA (2000) Association between Nonsteroidal Anti-Inflammatory Drugs and Upper Gastrointestinal Tract Bleeding/Perforation: An Overview of Epidemiologic Studies Published in the 1990's. *Arch Intern Med* 160:2093–2099
8. Jenkins CA, Bruera E (1999) Nonsteroidal Anti-Inflammatory Drugs as Adjuvant Analgesics in Cancer Patients. *Palliat Med* 13:183–196
9. Kuritzky L, Weaver A (2003) Advances in Rheumatology: Coxibs and Beyond. *J Pain Symptom Manage* 25:6–20
10. Laine L (2003) Gastrointestinal Effects of NSAIDs and Coxibs. *J Pain Symptom Manage* 25:32–40
11. Mercadante S (2001) The Use of Anti-Inflammatory Drugs in Cancer Pain. *Cancer Treat Rev* 27:51–61
12. Mercadante S, Barresi L, Cassucio A et al. (2000) Gastrointestinal Bleeding in Advanced Cancer Patients. *J Pain Symptom Manage* 19:160–162
13. Tramer MR, Williams JE, Carroll D et al. (1998) Comparing Analgesic Efficacy of Non-Steroidal Anti-Inflammatory Drugs Given by Different Routes in Acute and Chronic Pain: A Qualitative Systematic Review. *Acta Anaesthesiol Scand* 42:71–79
14. Ventafridda V, Tamburini M, Caraceni A et al. (1987) A Validation Study of the WHO Method for Cancer Pain Relief. *Cancer* 59:850–856
15. World Health Organization (1986) Cancer Pain Relief. World Health Organization, Geneva
16. Zech DF, Grond S, Lynch J et al. (1995). Validation of World Health Organization Guidelines for Cancer Pain Relief: A 10-Year Prospective Trial. *Pain* 63:65–76

## Cancer Pain Management, Opioid Responsiveness

### ► Opioid Responsiveness in Cancer Pain Management

## Cancer Pain Management, Opioid Side Effects, Cognitive Dysfunction

S. YENNURAJALINGAM, EDUARDO BRUERA  
Department of Palliative Care and Rehabilitation  
Medicine, The University of Texas M. D. Anderson  
Cancer Center, Houston, TX, USA  
ebruera@mdanderson.org

### Definition

► **Cognitive dysfunction** refers to changes in consciousness, higher cortical functions, mood, or perception that may be induced by any of numerous neurological or systemic diseases, or by ingestion of substances, including drugs, that have the potential for central nervous system toxicity.

### Characteristics

Pain in cancer patients is not yet treated effectively. Many studies have described undertreatment in this population. For example, a 1995 study of outpatients who had metastatic cancer found that pain occurred in 67% of the patients, yet 42% had not been prescribed adequate analgesic therapy (Cleeland et al. 1994). Similarly, a 2000 study found that 65% of minority patients with cancer reported severe pain despite having received analgesics (Anderson et al. 2000).

Pain is multidimensional and can be described in terms of location, radiation, character, intensity, frequency, and syndromal presentation. Pain can also be described in terms of its relationship to other symptoms. Prevalence rates of the many symptoms reported by palliative care patients vary: pain 41–76%, depression 33–40%, anxiety 57–68%, nausea 24–68%, constipation 65%, sedation/confusion 46–60%, dyspnea 12–58%, anorexia 85% and asthenia 90% (Cleeland et al. 1994; Anderson et al. 2000; Bruera 1998; Chang et al. 2000; Hopwood and Stephens 2000).

Due to the multidimensional nature of pain, health care professionals assessing a patient's level of pain should keep in mind the "production-perception-expression"-model of symptoms (Bruera 1998). This cascade model addresses the different levels of symptom development resulting in an individual rating of the patient's suffering. This model applies well to the symptoms of sedation, mental clouding, confusion or related phenomena. These cognitive disturbances characterize diverse types of encephalopathy, including delirium and dementia

(Pereira et al. 1997; Manfredi et al. 2003; Farrell et al. 1996). Cognitive impairment may result from any of numerous disorders, including drug toxicity. Opioid therapy may cause cognitive disturbances that undermine the positive effects of the drug, or render assessment of the pain more difficult. Since a patient's expression of distress requires cognition, a self-report by the patient should not be requested if the degree of cognitive impairment is sufficient to compromise communication.

### Management of Cancer Pain

Opioid-based pharmacotherapy is the mainstay in ► **cancer pain management** and should be considered for all cancer patients with moderate or severe pain. Other approaches can be used in addition to the opioid-based pharmacotherapy, based on the goals of care. Pure opioid agonists used as a single agent are preferred for treating pain in cancer patients. Partial agonists and mixed agonists-antagonists have limited use in the management of cancer pain due to mixed receptor activity, side effects, and dose-related ceiling effects. Once an opioid and route of delivery is selected, effective therapy depends on adjustment of the dose. There is no maximum recommended dose of opioids in cancer pain management. The dose should be gradually escalated until effects are favorable or side effects impose a maximum tolerated dose. Management of opioid side effects is an essential aspect of opioid therapy, which can allow opioid dose titration to effective levels and directly improve the comfort of the patient.

### Opioid-Induced Cognitive Dysfunction

#### Sedation

Opioid-induced sedation usually occurs when opioid dosing is initiated or when the dose is increased. Approximately 7–10% of patients receiving strong opioids for cancer pain have persistent sedation related to opioid medication (Bruera et al. 1995). In some cases, this sedation is multifactorial; the opioid may contribute but may not be the primary cause. Some patients, however, appear to have a very narrow or non-existing therapeutic window, and the persistent sedation can be ascribed directly to the drug.

Persistent opioid-induced sedation can sometimes be managed by adding an opioid-sparing analgesic, either an NSAID or an adjuvant analgesic, such as a corticosteroid. Alternatively, psychostimulants, such as dextroamphetamine, methyphenidate or modafinil may help to counteract the effect. Patients who are not candidates for psychostimulant therapy may be tried on an anticholinesterase inhibitor, such as donepezil (Slatkin et al. 2001). In patients with persistent sedation, a change of opioid may also be helpful.

#### Opioid-Induced Neurotoxicity

Opioid-induced neurotoxicity may take the form of a syndrome that may include, in addition to severe seda-



tion, cognitive impairment, hallucinosis, delirium, myoclonus, and even seizures. Generalized ▶ **hyperalgesia** and ▶ **allodynia** may also occur. This syndrome, which may occur in milder and partial forms, appears to be dose-related and also potentially associated with preexisting cognitive impairment or delirium, or metabolic disturbances such as dehydration or renal failure. When these changes occur in morphine-treated patients, accumulation of morphine metabolites, specifically morphine-3-glucuronide (M3G), may be causative.

The management of severe neurotoxicity related to opioids incorporates the same strategies considered when the side effects are less severe. This begins with a detailed assessment to identify treatable causes.

Therapeutic approaches include hydration, opioid switching (▶ **opioid rotation**), opioid dose reduction, and discontinuation of contributing drugs like hypnotics. Symptomatic treatment with haloperidol or another neuroleptic may be needed.

## References

- American Psychiatric Association (1994) Delirium, Dementia, and Amnesic and Other Cognitive Disorders. In: American Psychiatric Association, Diagnostic and Statistical Manual of Mental Disorders, 4<sup>th</sup> edn. (DSM-IV) American Psychiatric Association, Washington DC, pp 123–133
- Anderson KO, Mendoza TR, Valero V et al. (2000) Minority Cancer Patients and their Providers: Pain Management Attitudes and Practice. *Cancer* 88:1929–1938
- Bruera E (1998) Research into Symptoms other than Pain. In: Doyle D, Hanks GW, MacDonald N (eds) *Oxford Textbook of Palliative Medicine*, 2<sup>nd</sup> edn. Oxford University Press, New York: pp 179–185
- Bruera E, Watanabe S, Faisinger RL et al. (1995) Custom-Made Capsules and Suppositories of Methadone for Patients on High Dose Opioids for Cancer Pain. *Pain* 62:141–146
- Chang VT, Hwang SS, Feuerman M (2000) Validation of the Edmonton Symptom Assessment Scale. *Cancer* 88:2164–2171
- Cleeland CS, Gonin R, Hatfield AK et al. (1994) Pain and its Treatment in Outpatients with Metastatic Cancer. *N Engl J Med* 330:592–596
- Farrell KR, Ganzini L (1995) Misdiagnosing Delirium as Depression in Medically Ill Elderly Patients. *Arch Intern Med* 155:2459–2464
- Farrell MJ, Katz B, Helme RD (1996) The Impact of Dementia on the Pain Experience. *Pain* 67:7–15
- Hopwood P, Stephens RJ (2000) Depression in Patients with Lung Cancer: Prevalence and Risk Factors Derived from Quality-of-Life Data. *J Clin Oncol* 18:893–903
- Lawlor PG, Bruera ED (2002) Delirium in Patients with Advanced Cancer. *Hematol Oncol Clin N Am* 16:701–714
- Manfredi PL, Breuer B, Meier DE et al. (2003) Pain Assessment in Elderly Patients with Severe Dementia. *J Pain Symptom Manage* 25:48–52
- Mercadante S, Casuccio A, Fulfaro F et al. (2001) Switching from Morphine to Methadone to Improve Analgesia and Tolerability in Cancer Patients: A Prospective Study. *J Clin Oncol* 19:2898–2904
- Pereira J, Hanson J, Bruera E (1997) The Frequency and Clinical Course of Cognitive Impairment in Patients with Terminal Cancer. *Cancer* 79:835–842
- Ripamonti C, Bruera E (1991) Rectal, Buccal, and Sublingual Narcotics for the Management of Cancer Pain. *J Palliat Care* 7:30–35
- Slatkin NE, Rhiner M, Maluso Bolton T (2001) Donepezil in the Treatment of Opioid-Induced Sedation: Report of Six Cases. *J Pain Symptom Manage* 21:425–438

## Cancer Pain Management, Opioid Side Effects, Endocrine Changes and Sexual Dysfunction

JUDITH A. PAICE

Division of Hematology-Oncology, Northwestern University; Feinberg School of Medicine, Chicago, IL, USA

j-paice@northwestern.edu

### Definition

Endocrine changes associated with opioid use include altered concentrations of sex hormones (e.g. ▶ **testosterone**, ▶ **prolactin**). These changes alter ovulation and menstruation patterns in women and cause hypogonadism in men. The resultant sexual dysfunction encompasses reduction in ▶ **libido** (see also ▶ **sexual response**) in both men and women, limited engorgement and subsequent excitation and orgasm in women, and inability to obtain and maintain erection and ejaculation in males.

### Characteristics

Opioids alter libido and sexual performance in animal models, individuals with addictive disease using heroin, and persons in methadone maintenance programs (Cicero et al. 1975; Wiesenfeld-Hallin and Sdersten 1984). Opioids have also been shown to produce ▶ **galactorrhea**, inhibit ovulation, and trigger ▶ **amenorrhea** in animal models and in women attending methadone clinics (Johnson and Rosecrans 1980; Packman and Rothchild 1976; Pelosi et al. 1974). Little attention has been given to these effects in persons prescribed opioids for the treatment of chronic pain. However, recent case reports document these reactions (i.e. diminished libido, sexual dysfunction, and amenorrhea) in persons being treated with spinal or systemic opioids for chronic pain (Abs et al. 2000; Daniell 2002; Finch et al. 2000; Paice et al. 1994).

Evidence that the sexual dysfunction is due to opioids, rather than psychological mechanisms common in chronic pain, is provided by the reversibility of this phenomenon when the antagonist naloxone is administered or when the opioid is discontinued (Packman and Rothchild 1976). The underlying endocrine changes leading to sexual dysfunction appear to be multifactorial. Opioids significantly suppress plasma testosterone levels in persons using heroin, methadone, or other opioids (Finch et al. 2000; Paice et al. 1994; Mendelson et al. 1975). These suppressed testosterone levels



return to normal after stopping opioid therapy (Finch et al. 2000). Although pain may contribute to altered testosterone levels, Abs and colleagues compared these levels with case-matched chronic pain patients not receiving opioids and found that individuals treated with intraspinal opioids have lower testosterone levels (Abs et al. 2000). These data provide additional support for opioids being the causative agent in sexual dysfunction, rather than chronic pain alone leading to changes in testosterone and performance.

Reduced testosterone levels are likely to be a result of increased prolactin levels. Prolactin levels are increased in heroin use (Ellingboe et al. 1980), in normal subjects given intravenous injections of morphine (Delitala et al. 1983; Zis et al. 1984), and in cancer patients given intraventricular injections of morphine (Su et al. 1987). Normally, the hypothalamus releases dopamine to tonically suppress prolactin release from the anterior pituitary. Opioids disinhibit this suppression, leading to elevations in prolactin. Prolactin reduces levels of luteinizing hormone (LH) and follicle stimulating hormone (FSH), which subsequently depress testosterone. In females, prolactin stimulates lactation, and reduces LH and FSH levels, leading to depressed libido and cessation of menses.

Clinical experience suggests that testosterone replacement, either by injection, gel, or patch, may improve sexual function in persons treated with opioids who have depressed serum testosterone (Abs et al. 2000). In women with postmenopausal changes in libido, an oral combination of estrogen and testosterone (Estratest) is being used “off label” to relieve sexual dysfunction, as is methyltestosterone gel applied to the vulva (Fleming and Paice 2001). Neither of these therapies has been systematically evaluated in the relief of opioid-induced sexual dysfunction.

When decreased testosterone is also associated with increased prolactin levels, testosterone replacement alone may not be sufficient to restore sexual function, as elevated prolactin levels prevent the body from responding normally to testosterone. Treatment for hyperprolactinemia with bromocriptine (Parlodel), pergolide (Permax) or cabergoline (Dostinex) normalizes serum prolactin levels to restore normal sensitivity to the sexual effects of testosterone (Fleming and Paice 2001). However, the safety and efficacy of these drugs have not been studied in persons with sexual dysfunction due to opioids administered for pain and further research is needed.

► **Sildenafil** (Viagra) has been anecdotally described as being effective in relieving opioid-induced sexual dysfunction in both men and women, although controlled trials are warranted to establish efficacy and safety in this population. Non-pharmacologic approaches, including cognitive-behavioral techniques, may be useful to distract attention from pain, theoretically allowing reductions in opioid dose. Sex therapy may provide couples

with alternative positions that are less likely to elevate pain levels, as well as education to facilitate sexual pleasure.

Additional research is needed to determine the prevalence of opioid-induced sexual dysfunction, as well as the long-term effects of testosterone suppression. Suppression of testosterone may lead to chronic fatigue and osteoporosis, of particular concern to cancer survivors and individuals with non-cancer pain who might be treated with opioids for extended periods. Finally, studies to confirm the safety and efficacy of androgen replacement and other therapies designed to relieve sexual dysfunction due to opioids are indicated.

## References

1. Abs R, Verhelst J, Maeyaert J et al. (2000) Endocrine Consequences of Long-Term Intrathecal Administration of Opioids. *J Clin Endocrinol Metab* 85:2215–2222
2. Cicero TH, Bell RD, Wiest WG et al. (1975) Function of the Male Sex Organs in Heroin and Methadone Users. *N Engl J Med* 292:882–887
3. Daniell HW (2002) Hypogonadism in Men Consuming Sustained-Action Oral Opioids. *J Pain* 3:377–384
4. Delitala G, Grossman A, Besser GM (1983) The Participation of Hypothalamic Dopamine in Morphine-Induced Prolactin Release in Man. *Clin Endocrinol* 19:437–444
5. Ellingboe J, Mendelson JH, Kuehne JC (1980) Effects of Heroin and Naltrexone on Plasma Prolactin Levels in Man. *Pharmacol Biochem Behav* 12:163–165
6. Finch PM, Roberts LJ, Price L et al. (2000) Hypogonadism in Patients Treated with Intrathecal Morphine. *Clin J Pain* 16:251–254
7. Fleming MP, Paice JA (2001) Sexuality and Chronic Pain. *J Sex Educ Ther* 26:204–214
8. Johnson JH, Rosecrans JA (1980) Blockade of Ovulation by Methadone in the Rat: A Central Nervous System-Mediated Acute Event. *J Pharmacol Exp Ther* 213:110–113
9. Mendelson JH, Meyer RE, Ellingboe J et al. (1975) Effects of Heroin and Methadone on Plasma Cortisol and Testosterone. *J Pharmacol Exp Ther* 195:296–302
10. Packman PM, Rothchild JA (1976) Morphine Inhibition of Ovulation: Reversal by Naloxone. *Endocrinology* 99:7–10
11. Paice JA, Penn RD, Ryan W (1994) Altered Sexual Function and Decreased Testosterone in Patients Receiving Intraspinal Opioids. *J Pain Symptom Manage* 9:126–131
12. Pelosi MA, Sama JC, Caterini H et al. (1974) Galactorrhea-Amenorrhea Syndrome Associated with Heroin Addiction. *Am J Obstet Gynecol* 118:966–970
13. Su CF, Liu MY, Lin MT (1987) Intraventricular Morphine Produces Pain Relief, Hypothermia, Hyperglycaemia and Increased Prolactin and Growth Hormone Levels in Patients with Cancer Pain. *J Neurol* 235:105–108
14. Wiesenfeld-Hallin Z, Sdersten P (1984) Spinal Opiates Affect Sexual Behavior in Rats. *Nature* 309:257–258
15. Zis AP, Haskett RF, Albala AA et al. (1984) Morphine Inhibits Cortisol and Stimulates Prolactin Secretion in Man. *Psychoneuroimmunology* 9:423–427

## Cancer Pain Management, Opioid Side Effects, Uncommon Side Effects

CHRISTOPHER J. WATLING

The University of Western Ontario, London, Ontario, Canada

chris.watling@lhsc.on.ca

## Definition

► **Opioid analgesics** are the mainstay of cancer pain treatment. Opioid analgesia is mediated by interaction with specific receptors in the brain and spinal cord. In addition to the desired clinical effect of pain relief, opioids may also produce a variety of unwanted adverse effects that may compromise their usefulness. Common side effects, including constipation, nausea, vomiting, and sedation are well-recognized and predictable. Other adverse effects, including respiratory depression, pruritus, sweating, urinary retention, and headache, are less common, but may occasionally have important clinical implications in the cancer patient with pain.

## Characteristics

### Respiratory Depression

All opioids in clinical use, given in sufficient doses, may decrease respiratory rate, tidal volume, or both, as a result of their direct depressant effects on brainstem respiratory centers (Duthie and Nimmo 1987). Although perhaps the most feared of opioid side effects, clinically significant respiratory depression is very rarely encountered in practice, particularly in opioid-tolerant patients. Pain stimulates respiration, acting as a physiologic antagonist to the respiratory depressant effects of opioids in an intensity-dependent fashion (Borgbjerg et al. 1996). Two situations may arise in cancer pain management where the risk of respiratory depression is higher and merits special caution. First, the neuraxial administration of opioids (see ► **Neuraxial Infusion** and ► **Spinal (Neuraxial) Opioid Analgesia**), either epidural or intrathecal, may be complicated by respiratory depression due to supraspinal migration of the drug. Although respiratory depression may occur within minutes of spinal opioid administration, its appearance may be delayed for hours (Chaney 1995). Risk factors for clinically significant respiratory depression after spinally administered opioids include advanced age, coexisting medical or respiratory problems, lack of opioid ► **tolerance**, and concurrent administration of parenteral opioids. Rarely, however, patients with no identifiable risk factors will develop life-threatening respiratory depression (Etches et al. 1989). Careful monitoring of respiration and level of consciousness is therefore necessary when initiating therapy with spinal opioids.

Second, patients on long-term opioid treatment may experience respiratory depression following complete relief of pain by other methods. Opioid-treated cancer patients undergoing neural blockade or ► **cordotomy**, for example, are at risk of developing respiratory depression following the pain-relieving procedure (Wells et al. 1984). This effect, and the need to rapidly adjust opioid dosing post-procedure, must be anticipated.

### Pruritus

Pruritus, when it occurs as an opioid side effect, is often only a minor nuisance and may only be elicited by direct questioning. For occasional patients, however, it is so severe that opioid therapy must be modified. Itch is considered an uncommon side effect of systemically-administered opioids, though may affect up to 17% of patients (Friedman et al. 2001). In contrast, itch is common after neuraxial opioid administration, with a reported incidence of 30–100% (Szarvas et al. 2003). Even with neuraxial opioid administration, however, severe pruritus is rare, probably affecting less than 1% of individuals (Chaney 1995). Itch is not generally associated with skin rash, which is distinctly uncommon with opioid administration. Pruritus after systemic opioid administration is generalized, while that after neuraxial opioid administration is often localized to the face, neck, or upper thorax (Chaney 1995).

The pathophysiology of opioid-induced pruritus is uncertain. Although opioids may induce histamine release from mast cells in the periphery, it is not clear that this mechanism is important to the generation of pruritus. Rather, it is likely that a central mechanism is involved, a hypothesis supported by the reversibility of neuraxial opioid-induced pruritus with naloxone (Friedman and Dello Buono 2001).

In spite of the lack of evidence for histamine release being an important etiologic factor in opioid-induced pruritus, antihistamines may sometimes be an effective treatment, perhaps as a result of their sedative properties. Infusions of the opioid antagonists ► **naloxone** and nalbuphine may prevent or reduce itch with neuraxial opioids (Kendrick et al. 1996), while the oral opioid antagonist methylnaltrexone has been shown to reduce pruritus when co-administered with morphine (Yuan et al. 1998). The long-term use of opioid antagonists for chronic opioid-induced pruritus has not been evaluated. Other potential treatments for opioid-induced pruritus include ► **NSAIDs**, **Survey** (NSAIDs), the 5-HT<sub>3</sub> receptor antagonist ondansetron (Szarvas et al. 2003), and the opioid agonist-antagonist butorphanol (Duntzman et al. 1996). Opioid rotation is also a simple and potentially effective strategy for managing opioid-induced pruritus (Katcher and Walsh 1999).

### Sweating

Sweating may be a significant problem in some cancer patients treated with opioids. Though the prevalence of sweating has been reported to range from 14–28% in this population, numerous non-opioid factors may also be causative, including effects of the neoplasm itself, coexisting infection, and other drugs (Mercadante 1998). As such, the incidence of true opioid-induced sweating is difficult to estimate. Clearly, however, there are uncommon instances where intense sweating occurs secondary to opioid therapy, and has a significantly adverse effect on quality of life. Numerous agents have

been used to control sweating, including NSAIDs, corticosteroids, benzodiazepines, H<sub>2</sub>-receptor blockers, thioridazine, and anticholinergic drugs such as hyoscine hydrobromide or butylbromide, with varying degrees of success (Mercadante 1998). Like many unwanted opioid side effects, the problem may also respond to opioid rotation.

### Urinary Retention

Urinary retention is a frequent effect of spinally administered opioids, but less commonly may be observed after oral, parenteral, or transdermal opioid administration. This effect is likely to be mediated by interaction with opioid receptors in the lower spinal cord (Rawal et al. 1983). Caution should be exercised, however, in attributing urinary retention in a cancer patient to opioid therapy, particularly when the symptom appears in a patient on chronic, stable doses of opioid, as neoplastic involvement of the spinal cord or cauda equina may also compromise bladder emptying.

### Headache

Occasionally cancer patients report that opioids cause headaches, even as the pain for which the opioids are prescribed resolves. The etiology of this seemingly paradoxical phenomenon is uncertain. Headache specialists have long recognized drug-induced or analgesic rebound headaches, often resulting from the frequent use of short-acting opioids. One could speculate that susceptible patients prescribed opioids for cancer pain may develop such rebound headaches. The frequent use of analgesics may transform previously episodic headache syndromes into chronic daily headaches (Silberstein et al. 1998), but it is possible that some individuals without a prior headache history may also develop rebound headaches when exposed to frequent doses of opioid analgesics. Whether the use of long-acting opioids is associated with a lower risk of rebound headaches than short-acting opioids is not known. Headaches in the cancer setting may have many causes, of course, including brain or meningeal metastases, and should not be attributed to opioid therapy without diligent evaluation of other possibilities.

### References

- Borgbjerg FM, Nielsen K, Franks J (1996) Experimental Pain Stimulates Respiration and Attenuates Morphine-Induced Respiratory Depression: A Controlled Study in Human Volunteers. *Pain* 64:123–128
- Chaney MA (1995) Side Effects of Intrathecal and Epidural Opioids. *Can J Anaesth* 42:891–903
- Duntzman E, Karanikolas M, Filos KS (1996) Transnasal Butorphanol for the Treatment of Opioid-Induced Pruritus Unresponsive to Antihistamines. *J Pain Symptom Manage* 12:255–260
- Duthie DJR, Nimmo WS (1987) Adverse Effects of Opioid Analgesic Drugs. *Br J Anaesth* 59:61–77
- Etches RC, Sandler AN, Daley MD (1989) Respiratory Depression and Spinal Opioids. *Can J Anaesth* 36:165–185
- Friedman JD, Dello Buono FA (2001) Opioid Antagonists in the Treatment of Opioid-Induced Constipation and Pruritus. *Ann Pharmacother* 35:85–91
- Katcher J, Walsh D (1999) Opioid-Induced Itching: Morphine Sulfate and Hydromorphone Hydrochloride. *J Pain Symptom Manage* 17:70–72
- Kendrick WD, Woods AM, Daly MY et al. (1996) Naloxone versus Nalbuphine Infusion for Prophylaxis of Epidural Morphine-Induced Pruritus. *Anesth Analg* 82:641–647
- Mercadante S (1998) Hyoscine in Opioid-Induced Sweating. *J Pain Symptom Manage* 15:214–215
- Rawal N, Möllefors K, Axelsson K et al. (1983) An Experimental Study of Urodynamic Effects of Epidural Morphine and of Naloxone Reversal. *Anesth Analg* 62:641–647
- Silberstein SD, Lipton RB, Goadsby PJ (1998) Headache in Clinical Practice. Isis Medical Media Ltd, Oxford, pp 106–107
- Szarvas S, Harmon D, Murphy D (2003) Neuraxial Opioid-Induced Pruritus: A Review. *J Clin Anesth* 15:234–239
- Wells CJ, Lipton S, Lahuerta J (1984) Respiratory Depression after Percutaneous Cervical Anterolateral Cordotomy in Patients on Slow-Release Oral Morphine. *Lancet* 1:739
- Yuan CS, Foss JF, O'Connor M et al. (1998) Efficacy of Orally Administered Methylnaltrexone in Decreasing Subjective Effects after Intravenous Morphine. *Drug Alcohol Depend* 52:161–165

## Cancer Pain Management, Orthopedic Surgery

JOHN H. HEALEY

Memorial Sloan Kettering Cancer Center and Weill Medical College of Cornell University, New York, NY, USA

healeyj@mskcc.org

### Definition

Orthopedic cancer pain includes biologic or mechanical pain that affects the musculoskeletal system, and compromises the function and independence of cancer patients. Bone pain has a different neurochemical basis than either inflammatory or neuropathic pain. It is often multifactorial in origin and requires treatment of all contributing factors. Pain treatment includes the surgical stabilization of fractured bones and often of impending fractures.

### Characteristics

Bone pain can be multifactorial and requires a multi-pronged approach for accurate diagnosis and effective treatment. ► **Afferent signals** come from stimuli that are inherently mechanical or biologic. Exclusion of remote causes, such as referred and radicular pain, and other distant causes, must be done in each case to optimize treatment and avoid missing concomitant disease such as spinal cord compression. Comprehensive management of bone pain requires specific treatment to address each cause.

One type of referred pain comes from an insult affecting the same dermatome. Typically, this comes from a lesion affecting the same bone proximal to the symptomatic site. The most common example is distal femur and knee pain due to a proximal femur or hip lesion. A careful physical examination is the

best way to make the diagnosis clinically. The limp that is due to a knee problem differs significantly from that of a hip problem, and should alert the clinician to problems “upstream” from the reported site of the pain. Certain provocative tests have compelling diagnostic value. For example, ► [passive ► abduction](#) or ► [active ► adduction](#) of the hip isolates the adductor musculature and its pubic origin as the source of pain. This can point away from intrinsic hip pathology and can avoid an unnecessary hip replacement operation. Another common problem is an ► [avulsion fracture](#) of the anterior inferior iliac spine. Since this is the origin for the rectus femoris, activities that stress it, such as straight leg raising from a supine position, provoke pain, whereas hip flexion from the seated position does not. Once again, identification of the pathologic pain generator focuses treatment and prevents ill-advised surgical or medical treatment.

Radicular pain is common from cervical tumors and causes periscapular or arm pain that is often improperly ascribed to other sources. Similarly, lumbar tumors cause buttock or lower limb pain that may or may not be associated with neurologic symptoms of a sensory or motor nature.

Alternative sources of pain must also be excluded. For example, degenerative arthritis of the hip, knee, spine, or shoulder is common in older cancer patients. Avascular necrosis, particularly of the hip or shoulder, may develop from steroids, chemotherapy, or radiation therapy used to treat the underlying cancer. Simple radiographs are the best way to look for these traditional, non-oncologic causes of bone pain in the cancer patient. Occasionally, ► [paraneoplastic syndromes](#) may cause bone or joint pain and elude usual diagnostic tests. This problem can occur from any cancer, but seems to be most common in patients with small cell lung cancer and with HIV-related malignancies. In the midst of chemotherapy, ► [granulocyte colony stimulating factor](#) (G-CSF) is commonly used and will produce localized and diffuse bone pain. The cause is poorly defined, but it seems to be due to acute pressure developing in the bone marrow from marrow expansion, and possibly from the evolution of nociceptors and cytokines in response to the G-CSF. Finally, infection must be excluded, particularly in patients who have hematologic malignancies or ► [treatment-related neutropenia](#).

Mechanical pain characterizes orthopedic cancer pain. Excess force or weight bearing bends the mechanically insufficient bone (strain). This stretches the periosteum, stimulates pain receptors, and produces pain. Before fracture occurs, normal stimuli such as walking can trigger lower extremity pain, and lifting or forceful activity cause upper extremity pain. In the extreme condition, these forces result in fractures that are associated with periosteal tears, hemorrhage and tissue trauma. Local cytokines are released and further stimulate the nociceptors.

Bone is weakest and most likely to fracture when strained in torque (twisting on a firmly planted foot, for example.) It is relatively stronger when the stress is axial and the forces are in compression or distraction (tension). Metastases and erosions weaken the bone to well defined degrees. A 50% cortical defect in the femur causes 60–90% reduction in bone strength. The fracture risk posed by a bone lesion can be characterized in different ways. Bone mineral density alone explains 80–90% of the fracture risk in cadaveric models of lytic bone lesions of the femur (Michaeli et al. 1999). Usually, but not always, these lesions are associated with pain. Conversely, bone pain is usually associated with such a bony defect. The presence of either a critical bone lesion or mechanical pain constitutes an impending fracture. Mechanical treatment is mandatory for such a lesion. This can comprise of external support (crutches) or internal reinforcement of the bone (implant). A common error is to treat the mechanical pain with antineoplastic agents or radiation and analgesics, without addressing the mechanical component.

Plain radiographs remain the most efficient way to assess the global integrity of bone and determine whether surgery is a consideration to treat the mechanical pain (Hipp et al. 1995). Three-dimensional imaging such as CT scans or MRI scans are occasionally needed to diagnose occult lesions or plan surgeries, since they can identify bony defects that must be bypassed. The mere presence of a bone lesion or metastasis does not mean that is the source of pain nor that it requires explicit treatment. Most bone lesions are asymptomatic. Rapidly growing lesions may evade diagnosis. Plain radiographs appear normal until 30% of the mineral is lost, and bone scintigraphy primarily identifies areas of bone reaction. If the host bone has not had sufficient time to respond, these studies may yield false negative results, so a high index of suspicion is needed.

Biologically rapidly growing tumors raise intraosseous pressure by blocking venous blood return, expanding within a closed space, and releasing pain-mediating substances. Many neural transmitters and nerve fibers have been identified within bone. They are involved in normal development and pathologic conditions (Sisask et al. 1995, Bergstrom et al. 2003). ► [Substance P](#), ► [calcitonin gene-related product](#) (CGRP), vasointestinal peptide, and other compounds that stimulate nociceptors, augment local perfusion, and have direct metabolic effects on the bone contribute to the pain generating milieu. Nerve fibers that stain for CGRP are widely distributed in bone, periosteum and marrow. They directly regulate local bone remodeling during growth, and repair by elevating the CGRP concentration in the microenvironment around bone cells (Irie et al. 2002). The connection between brain function and bone metabolism has recently been postulated to occur due to leptin and mediated by noradrenaline acting on  $\beta_2$  adrenergic receptors on osteoblasts (Takeda et al. 2002).



Bone pain has a different profile of neurotransmitters than either inflammatory or neuropathic pain (Clohisy and Mantyh 2003; Schwei et al. 1999). For example, substance P and calcitonin gene-related peptide are both ► **up-regulated** in inflammatory pain, ► **down-regulated** in neuropathic pain, and unchanged in models of bone metastasis (Honore et al. 2000a). On the other hand, GFAP (glial fibrillary acidic protein) is massively up-regulated in the spinal cord in bone cancer pain, but not in inflammatory or neuropathic pain. Several other changes occur in the spinal cord. There is up-regulation of c-FOS, reflecting increased neuronal activity, dynorphin, and the development of astrocytosis. These chemical and morphologic changes indicate a central reorganization of the neural system in cases of orthopedic oncologic pain.

Cancers encourage the recruitment of osteoclasts that reabsorb bone. This bone resorption contributes to pain due to biologic and mechanical reasons. Blocking the osteoclastic action with agents such as osteoprotogenin prevents pain in animal models of bone cancer (Honore et al. 2000b). Once the cortex is breached, the advancing cancer mechanically and biologically irritates the periosteum. Weak bone incurs greater strain, and pain ensues.

Prevention of bone resorption prevents bone pain and improves patient quality of life. Clinical studies have proven that ► **aminobisphosphonates** reduce bone resorption, pain, and the need for radiation therapy. Meta-analysis of 95 randomized studies with more than six months follow up has shown that these agents significantly reduced the odds ratio for fractures (vertebral 0.69, 95% confidence interval 0.57–0.84,  $P < 0.0001$ ; non-vertebral 0.65, 0.54–0.79,  $P < 0.0001$ ; combined 0.65, 0.55–0.78,  $P < 0.0001$ ), radiotherapy (0.67, 0.57–0.79,  $P < 0.0001$ ), and hypercalcemia (0.54, 0.36–0.81,  $P = 0.003$ ) but not for orthopedic surgery (0.70, 0.46–1.05,  $P = 0.086$ ) or spinal cord compression (0.71, 0.47–1.08,  $P = 0.113$ ). The reduction in orthopedic surgery was significant in studies that lasted over a year 0.59, 0.39–0.88,  $P = 0.009$  (Ross et al. 2003).

Despite the clear benefits of optimal medical management, many patients will still have bone pain and sustain fractures. Mechanical pain responds to the relieving of loads on the bone, externally or internally (Healey and Brown 2000). External support and protection comes from protected weight bearing with a walking aid (e.g. a cane, crutches, or walker) or brace (e.g. a lumbar support or functional cast brace for the humerus). Internal fixation reinforces the bone with metal, bypassing the bony defect and sharing the stress with the intact bone. Fixation of an orthopedic implant in normal bone is needed proximal and distal to the deficiency. When the defect is close to the end of the bone and it is impossible to meet the goal of rigid fixation through the metaphysis or epiphysis, the joint must be sacrificed and a

hemiarthroplasty replacement is needed. This surgery is very successful in alleviating mechanical cancer pain acutely. It works well long-term if antitumor therapies prevent local bone destruction and destabilization of the implant.

Treatment consists of reinforcing the bone, stopping the cancer progression, and preventing new sites of symptomatic disease involvement.

C

## References

1. Bergstrom J, Ahmed M, Kreicbergs A et al. (2003) Purification and Quantification of Opioid Peptides in Bone and Joint Tissues – A Methodological Study in the Rat. *J Orthop Res* 21:465–469
2. Clohisy D, Mantyh PW (2003) Bone Cancer Pain. *Cancer* 97:866–873
3. Healey JH, Brown HK (2000) Complications of Bone Metastases: Surgical Management. *Cancer* 88:2940–2951
4. Hipp JA, Springfield DS, Hayes WC (1995) Predicting Pathologic Fracture Risk in the Management of Metastatic Bone Defects. *Clin Orthop* 312:120–135
5. Honore P, Rogers SD, Schwei MG et al. (2000a) Murine Models of Inflammatory, Neuropathic and Cancer Pain Each Generate a Unique Set of Neurochemical Changes in the Spinal Cord and Sensory Neurons. *Neuroscience* 98:585–598
6. Honore P, Luger NM, Sabino MA et al. (2000b) Osteoprotogenin Blocks Bone Cancer-Induced Skeletal Destruction, Skeletal Pain, and Pain Related to the Structural Reorganization of the Spinal Cord. *Nat Med* 6:521–528
7. Irie K, Hara-Irie F, Ozawa H et al. (2002) Calcitonin Gene-Related Peptide (CGRP)-Containing Nerve Fibers in Bone Tissue and their Involvement in Bone Remodeling. *Microsc Res Tech* 58:85–90
8. Michaeli DA, Inoue K, Hayes WC et al. (1999) Density Predicts the Activity-Dependent Failure Load of Proximal Femora with Defects. *Skeletal Radiol* 28:90–95
9. Ross JR, Saunders Y, Edmonds PM et al. (2003) Systematic Review of Role of Bisphosphonates on Skeletal Morbidity in Metastatic Cancer. *BMJ* 327:469
10. Schwei MG, Honore P, Rogers SD et al. (1999) Neurochemical and Cellular Reorganization of the Spinal Cord in a Murine Model of Bone Cancer Pain. *J Neurosci* 19:10886–10897
11. Sisask G, Bjurholm A, Ahmed M et al. (1995) Ontogeny of Sensory Nerves in the Developing Skeleton. *Anat Rec* 243:234–240
12. Takeda S, Eleftheriou F, Levasseur R et al. (2002) Leptin Regulates Bone Formation Via the Sympathetic Nervous System. *Cell* 111:305–317

## Cancer Pain Management, Overall Strategy

GILBERT J. FANCIULLO  
Pain Management Center, Dartmouth-Hitchcock  
Medical Center, Lebanon, NH, USA  
gilbert.j.fanciullo@hitchcock.org

### Definition

Pain is an experience unique to each individual and based on perception, mood, and current and past experiences. Cancer pain, even more so than chronic or acute pain, is multidimensional, and has emotional, social, and spiritual vectors that must be assessed and addressed. Given



the multidimensional nature of cancer pain, a team or multidisciplinary approach geared towards assessment and treatment is required to ensure the best care. Good cancer pain treatment is labor intensive, requires highly specialized knowledge and skill, can change the lives of cancer patients and their loved ones, and can be the most fulfilling part of a pain clinicians practice.

## Characteristics

### Epidemiology and Impact

About half a million people in the United States and about 6.6 million people worldwide die of cancer each year (American Cancer Society 2003; World Health Organization 1996). Lifetime probability of developing cancer is approximately 1 in 2 for men and 1 in 3 for women (American Cancer Society 2003). The survival rate for adults is approximately 62% and for children is 97% (American Cancer Society 2003). Roughly 40% of newly diagnosed cancer patients and 75% of advanced cancer patients suffer from pain (Sykes et al. 2003).

The prevalence of pain varies with the type of cancer. Pain in patients with head and neck cancer, genitourinary, prostate, and esophageal cancer is far more common than in patients with leukemia (Portenoy 1989; Sykes et al. 2003). Patients with metastatic disease have more frequent pain complaints than those with nonmetastatic cancer (Sykes et al. 2003). One-third of patients with advanced cancer have two sites of pain and two-thirds have three or more sites of pain (Grond et al. 1996). Seventeen percent of pain in patients with cancer is treatment related and 9% is due to a concomitant disease (Grond et al. 1996).

The influence of uncontrolled cancer pain is dramatic. The severity and impact of pain caused by cancer is believed to be greater than pain in patients without cancer. Beliefs about the meaning of pain in cancer pain patients have been shown to increase the severity of pain as well as levels of depression, anxiety, somatization, and hostility (Ahles et al. 1983). Severe, uncontrolled pain in patients with cancer is a major risk factor in cancer related suicide (Chochinov and Breitbart 2000). Pain, depression, ► [delirium](#) and lack of social support have all been associated with an increased desire for a hastened death in cancer patients (Chochinov and Breitbart 2000). Many of these symptoms can be treated and pain can almost always be well controlled, often with simple and noninvasive remedies. Psychological distress is often lessened and psychiatric symptoms can resolve with good pain treatment and relief (Chochinov and Breitbart 2000).

Special patient populations can be especially challenging and include children and infants, elderly patients, patients with concomitant preexisting personality or other psychiatric disorders, patients with preexisting chronic pain, patients who suffer from addiction, poverty, who live in rural locations, are poorly educated or illiterate,

are non-English speaking, have no support network, or who are in denial.

### Characterization of Pain

Cancer pain can be caused by direct effects of tumor, side effects of treatment, ► [paraneoplastic syndromes](#), or be related to a preexisting or concomitant condition. Pain can be characterized as neuropathic, somatic or visceral, or can be mixed. Diagnosis is based on history and physical examination, and pharmacological treatment decisions will vary based on the characteristics and etiology of the pain.

Cancer pain related to direct effects of tumor can manifest as somatic, visceral or ► [neuropathic pain syndromes](#). Bony, particularly vertebral body and rib metastases are common and often cause localized ► [somatic pain](#) but can cause neuropathic symptoms particularly with spinal cord, cauda equina, or nerve root involvement or ► [Visceral Nociception and Pain syndromes](#) such as pleuritic pain with rib metastases. Spinal cord compression occurs in approximately 3% of all cancer patients (Kramer 1992). Thoracic radiculopathic pain patterns are common and may be easily misdiagnosed. Brachial and lumbar plexopathy, meningeal carcinomatosis (► [meningeal carcinomatous](#)) and base of skull metastasis are frequent direct tumor effect causes of neuropathic pain. Pleuritic pain, hepatic capsular stretch pain, and bowel obstruction pain are examples of visceral pain syndromes requiring special attention and skill to treat well.

► [Mucositis](#) is an extremely prevalent, difficult to treat, and severe and debilitating pain syndrome caused by cancer treatment. Peripheral neuropathy pain can occur as a paraneoplastic syndrome in up to 5% of patients with lung cancer, or can occur as often as 82% in patients being treated with chemotherapy (Smith et al. 2002). Postthoracotomy pain syndrome can occur in greater than 50% of patients undergoing thoracotomy (Perkins and Kehlet 2000). Fifty percent of woman undergoing breast surgery for cancer have pain one year after surgery, and 30–80% of patients undergoing amputation continue to suffer chronic pain (Perkins and Kehlet 2000). Radiation ► [plexopathy](#) or myelopathy are not uncommon pain syndromes in cancer survivors, nor is avascular necrosis secondary to corticosteroid treatment.

### Assessment

A pain history should incorporate questioning about multiple sites of pain since this information is often not volunteered by the patient. Cancer patients are frequently reluctant to report increasing pain, perhaps fearing progressive disease. The character, location, intensity, frequency and relationship of pain to activities should all be investigated. Pain syndromes that existed prior to cancer diagnosis should be identified. Patients with a long history of chronic pain, such as low back

pain or fibromyalgia, which has never been adequately controlled even with long-term opioid treatment, may be at risk of poorly-controlled pain as more aggressive treatments for cancer pain are administered. At the same time, it is not unusual for chronic pain syndromes to resolve or assume diminished importance within the context of a life threatening illness.

A pain history should include an understanding of the characteristics of the cancer type, including diagnosis, histology, extent of disease, and prognosis. History of antineoplastic treatment is important in order to assess peripheral neuropathy pain that might be secondary to a paraneoplastic syndrome, chemotherapy or radiation treatment. Prognosis and treatment may vary based on etiology. Knowledge of specific cancer pain syndromes can help in diagnosis and in selecting treatments. For example, radiation therapy may be more effective in treating intermittent pain due to bone metastasis than analgesics. A history of remote or concurrent alcoholism or drug addiction can be important in prioritizing therapy. For example, an analgesic intrathecal infusion system may be selected for treatment earlier in the paradigm, rather than oral opioids. A social and emotional history is an essential part of the cancer pain history. An assessment of cognitive ability, educational level, dementia or delirium should all be part of the history.

A thorough physical examination combined with a complete history will almost always provide sufficient information to formulate a good therapeutic plan. Review of upcoming procedures is also important, because painful procedures in adults are too commonly overlooked as a treatable component of cancer pain. Many cancer centers have “pain free” systems in place to ensure that infants and children can undergo bone marrow biopsy, MRI exams, and line and tube placement comfortably, but these same options are not typically available for adults. Clinicians should offer analgesic guidance for procedures to ensure that they are not painful and anticipated with dread and fear.

The ability to review and interpret laboratory tests, radiographs, MRI and CT scans, and to understand oncologic nomenclature, are important and useful skills when addressing the problem of cancer pain.

### Treatment

Cancer pain treatment can be divided into five strategies: drugs, interventional approaches (surgery and injections), behavioral medicine approaches, physical medicine approaches, and complementary and alternative approaches.

Acetaminophen and nonsteroidal anti-inflammatory drugs; opioids; and adjuvant analgesics, such as anti-convulsants, antidepressants, topical agents (e.g. lidocaine patch), and bisphosphonates are the backbone of therapy and will be effective for the large majority of patients with cancer pain. The World Health Organization ladder approach to treatment selection can be a

useful model upon which to guide therapy, but it must be remembered that cancer patients with severe pain should not be forced to fail treatment with NSAIDs before having an opioid added to their regimen (Sykes et al. 2003). Patients with severe pain due to cancer should almost always have therapy initiated with a single entity, pure mu agonist opioid at the time they are first seen. Routes of administration, such as intravenous, subcutaneous, oral, rectal, buccal, and intranasal or inhaled, should be considered in special circumstances. Drugs such as ketamine or local anesthetics can be infused intravenously for refractory pain syndromes.

The potential effectiveness of neural blockade in carefully selected patients is exemplified by the neurolytic ► **celiac plexus block**. This injection is still the most useful of injection therapies for cancer pain, and can provide good to excellent analgesia in 85% of patients with localized pain secondary to pancreatic carcinoma. It should be an early option for patients with pain from this disease or other intraabdominal cancer (Patt and Cousins 1998). Epidural, intrathecal, and regional nerve blocks can be done using neurolytic agents such as alcohol or phenol and can be individualized in special circumstances. Analgesia from neurolytic blocks will typically last for 6 months.

Patients with severe pain refractory to noninvasive treatments should also be considered for treatment with intrathecal analgesics. Drugs routinely infused into the intrathecal space include morphine, hydromorphone, bupivacaine, and clonidine. Intrathecal infusions can be successfully employed and should be considered in patients with severe neuropathic pain, incident pain, or opioid tolerance or refractoriness. Patients with an estimated life expectancy of 3 months or less can have a percutaneous system connected to a mobile infusion pump. If life expectancy is greater than 6 months, a programmable, implanted pump can be used and will typically need to be refilled only every 90 days. Analgesic infusion systems can be a useful option, and there is now extensive experience supporting efficacy and safety; these systems are labor intensive, however, and may require frequent medication or rate adjustments.

Neurosurgical procedures such as anterolateral ► **cordotomy**, medial ► **myelotomy**, ► **dorsal root entry zone** lesioning, and other neurodestructive procedures are options for carefully selected patients and can provide excellent relief of pain in otherwise refractory situations. They, too, should be considered in cancer pain patients whose pain does not respond to nondestructive remedies (Burchiel 2002).

Behavioral interventions, such as coping skill training and pacing, learning about the differences between hurt and harm, reduction of catastrophizing, relaxation techniques, self-hypnosis, biofeedback and other psychological interventions are an essential component of any cancer pain reduction plan. Patients should be assessed for denial, anger, and depression. When severe,

these problems should be managed by a behavioral medicine specialist. Astute pain medicine specialists should possess enough skill and knowledge in this area to enable them to provide this care to the majority of cancer pain patients. Preexisting or concomitant psychiatric illness may make treating cancer pain more challenging, but can also increase the rewards of successful therapy to the patient, his or her family, and all providers involved.

Physical medicine interventions should be considered in all patients with cancer, but especially those with pain. Pain from immobility can be relieved with a prescribed regimen of physical activity, even if a patient is bed-bound or has advanced disease. Maintaining the highest functional capacity possible will ensure the best quality of life for the majority of patients with cancer pain. Modalities used for acute pain, such as fluidotherapy, heat, and massage, can be very useful in patients suffering from cancer pain. Physical medicine specialists with special skill in cancer rehabilitation should be called upon early to help care for cancer patients.

Complementary and alternative pain management strategies should be employed whenever they might be useful. Thirty percent of cancer patients worldwide use complementary medicine approaches to help manage their cancer and complications (Ernst and Cassileth 1998). A patient who specifically asks about acupuncture may be likely to find acupuncture a useful adjunct, whether there is a true therapeutic effect or placebo effect alone. Patient's belief in efficacy of complementary and alternative treatments and their high therapeutic index should not be overlooked.

Attention to spirituality and cultural beliefs is extremely important in managing patients with cancer pain. Spiritual beliefs may influence the patients understanding of their illness and suffering, and may affect treatment decision making. Spiritual beliefs may assist coping skills. Providers should respect the beliefs of their patients and appreciate the often profound importance of these beliefs. This appreciation itself can be therapeutic, and enable the provider to help his or her patient take full advantage of the power of these beliefs (Berger et al. 2002).

### Summary

Pain in patients with cancer cannot be treated in a vacuum, as a hard-wired nociceptive sensation. It is best treated in context, taking advantage of the special skills and knowledge of other professionals. Pain physicians' superior knowledge of the treatment of refractory cancer pain can be enhanced by the palliative physicians' superior knowledge of communication skills; management of symptoms other than pain; ability to address social, spiritual, and emotional conditions; and importantly, ability to organize and prioritize the efforts of oncologists, surgeons, primary providers, nurses and pain physicians. Good cancer pain medicine is more

than providing a paradigm for the administration of medications and procedures.

Treatment of patients with cancer pain can be challenging, requires special skills and knowledge, is best accomplished in a multidisciplinary setting and can be extraordinarily rewarding. Attention to other symptoms and to the social, emotional, and spiritual needs of cancer patients should be a routine part of cancer pain management and can be addressed by pain specialists with interests and skill in those areas, or may require the special talents of palliative medicine providers working in conjunction with pain providers.

### References

- Ahles TA, Blanchard EB, Ruckdeschel JC (1983) The Multidimensional Nature of Cancer-Related Pain. *Pain* 17:277–288
- American Cancer Society (2003) [http://www.cancer.org/docroot/stt/stt\\_0.asp](http://www.cancer.org/docroot/stt/stt_0.asp)
- Berger AM, Portenoy RK, Weissman, eds (2002) *Principles and Practice of Palliative Care and Supportive Oncology*. Lippincott Williams & Wilkins, Philadelphia
- Burchiel K (2002) *Surgical Management of Pain*. Thieme, New York
- Chochinov HM, Breitbart W (2000) *Handbook of Psychiatry in Palliative Medicine*. Oxford University Press, Oxford, pp 57–58
- Ernst E, Cassileth B (1998) The Prevalence of Complementary/Alternative Medicine in Cancer. *Cancer* 83:777–782
- Grond S, Zech D, Diefenbach et al. (1996) Assessment of Cancer Pain: A Prospective Evaluation in 2266 Cancer Patients Referred to a Pain Service. *Pain* 64:107–114
- Kramer JA (1992) Spinal Cord Compression in Malignancy. *Palliative Med* 6:202–211
- Smith EL, Whedon MB, Bookbinder M (2002) Quality Improvement of Painful Peripheral Neuropathy. *Seminars in Oncology Nursing* 18:36–43
- Patt RB, Cousins MJ (1998) Techniques for Neurolytic Neural Blockade. In: *Neural Blockade in Clinical Anesthesia and Management of Pain* (Cousins MJ, Bridenbaugh PO, Eds). Lippincott-Raven, Philadelphia. pp 1036–1037
- Perkins FM, Kehlet H (2000) Chronic Pain as an Outcome of Surgery. A Review of Predictive Factors. *Anesthesiology* 93:1123–1133
- Portenoy RK (1989) Cancer Pain: Epidemiology and Syndromes. *Cancer* 63:2298–2307
- Sykes N, Fallon MT, Patt RB (2003) *Cancer Pain*. Arnold Publishers, London, p 22
- World Health Organization (1996) *Cancer Pain Relief and Palliative Care*, 2<sup>nd</sup> edn. World Health Organization, Geneva

## Cancer Pain Management, Palliation of Upper GI Cancer

### ► Palliative Surgery in Cancer Pain Management

## Cancer Pain Management, Patient-Related Barriers

CIELITO REYES-GIBBY

The University of Texas MD Anderson Cancer Center, Houston, TX, USA

[creyes@mdanderson.org](mailto:creyes@mdanderson.org)

## Definition

Patient-related barriers refer to patients' limited knowledge of, beliefs about, and attitudes towards pain and pain treatment that detract from optimal pain management.

## Characteristics

Patients, as consumers of health care, play an important role in the successful management of pain. Critical components for the successful clinical management of pain include the patients' ability to communicate their need for pain control, provide feedback on the effectiveness of treatment, and compliance with the requirements of therapy. Patients' limited knowledge of, beliefs about and attitudes towards pain and pain treatment may, therefore, detract from optimal pain management. Several barriers (Cleeland et al. 1997; Ward et al. 1993; Cleeland 1987) to the practice of good pain management have been identified. They include those associated with patients (reluctance to report pain and to take pain medications), the health care system (low priority given to pain control), and health care professionals (inadequate knowledge, reluctance to treat, fear of controlled-substance regulations).

Among cancer patients, studies have shown that patients' reluctance to report pain is a primary reason for inadequate pain control. Von Roenn et al. (1993), Larson et al. (1993), and Cleeland (1987) have demonstrated that both oncologists and oncology nurses identified patient reluctance to report pain as one of the major barriers to the adequate control of cancer pain.

Patients are reluctant to report pain to their physicians or nurses for many reasons. Fear of addiction and dependence is often rated as a number one concern is. Opioids are the cornerstone of cancer pain therapy. First described in the World Health Organization's guidelines for cancer pain relief (World Health Organization 1986), the protocol for pain treatment provides simple recommendations for the use of oral analgesics and adjuvants: Non-opioids and adjuvants for mild pain; so-called "weak" opioids, often combined with a non-opioid and adjuvants, for moderate pain; and so-called "strong" opioids, combined with adjuvants, for moderate to severe pain. There is, however, a common misconception among patients that opioids cause addiction. Often, patients and their family caregivers mistake the signs of withdrawal for addiction rather than physical dependence, perpetuating the belief that addiction is a sequela of taking opioids. Family members also fear that the patient will be thought of as an addict, adding substantial pressure on the patient to refrain from taking opioids.

The mistaken notion that pain medications taken early will not be effective when pain gets worse further compounds the problem. Some patients believe that if they take pain medication they will become tolerant to the ef-

fects of analgesics when their disease progresses (Cleeland et al. 1997; Cleeland 1987). Due to this fear of drug tolerance, many withhold or "save" their medication until they can no longer tolerate their pain.

Concern about side effects from pain medicines is another commonly reported barrier to adequate pain management. Many believe that side effects from analgesics are even more bothersome than the pain itself. In a study of underserved cancer patients, Anderson and colleagues (Anderson et al. 2002) found that a majority (75%) reported problems with side effects from pain medicines. Commonly reported side effects include constipation, sedation, and nausea.

Belief that increasing pain signifies disease progression causes patients who are unwilling to face this possibility to deny their cancer pain. Patients are also afraid to bother their health care providers with symptoms they consider to be an expected part of their disease. Due to the belief that pain is an inevitable part of cancer and that nothing can be done about it, patients are willing to accept and endure pain. In a population-based survey conducted several years ago (Levin et al. 1985), approximately 50% of the respondents considered cancer to be an extremely painful disease. Approximately 40% believed that cancer treatment is extremely painful, and 37% rated cancer treatment as moderately painful. Furthermore, over 70% thought that cancer pain could be so severe that one would consider suicide, and more than 60% believed that cancer patients usually die a painful death. These findings document the misconceptions surrounding cancer pain.

Patients also think that if they complain of symptoms, their health care providers will be distracted from their efforts to cure the disease. A recent study specifically investigated whether patients' self-reports of pain vary by treatment setting (Reyes-Gibby et al. 2003), in this case an outpatient chemotherapy clinic and an outpatient breast clinic. Medical charts of patients seen during the same day in both the outpatient chemotherapy clinic and the outpatient breast clinic were reviewed and pain ratings were abstracted. Statistically significant differences in patients' self-reports of pain were observed in the two treatment settings. Fifty-one percent of patients' self-reports of pain differed between the two treatment settings, with 38% reporting a pain score > 4 in the outpatient breast clinic, and 0 in the outpatient chemotherapy clinic. The authors suggested that the results may indicate that patients were reluctant to report pain in the chemotherapy clinic to avoid delaying their treatment. Another possible explanation for this finding is that patients may have believed that the chemotherapy clinic was not set up for pain intervention (to contact a physician for pain medication), and were thus reluctant to distract the clinic health care professionals from administering chemotherapy.

Wanting to be labeled as "good patients" and not as "complainers" also influences patients' reporting of



pain. Many patients think that their behavior will influence the quality of their care. Families may compound the problem by trying to work out with the patient what is important to tell their physicians (Cleeland 1987).

Not surprisingly, other frequently reported barriers are forgetting to take pain medications and the belief that one should be able to tolerate pain without medication (Thomason et al. 1998).

While most of the studies on patient-related barriers to pain were conducted with non-Hispanic whites, studies in recent years explored the influence of sociocultural factors on patient-related barriers to adequate pain management. There are many definitions of culture, but one that is helpful for understanding the effects of culture on pain was offered by Hellman (1990). He defined culture as “a set of guidelines (both explicit and implicit) that individuals inherit as members of a particular society, that tells them how to view the world, how to experience it emotionally, and how to behave in it in relation to other people, and to natural and supernatural forces.” Helman offered specific propositions as to the pervasive effects of culture on pain: 1) Not all social or cultural groups respond to pain in the same way, 2) How people perceive and respond to pain, both in themselves and in others, can be largely influenced by their cultural background, and 3) How, and whether, people communicate their pain to health professionals and to others can also be influenced by cultural factors. These propositions underlie the commonly held assertion that there may be significant cultural and linguistic differences in the way people feel, view, and report pain.

Although recent research suggests that culture does not affect pain thresholds or pain intensity ratings, culture probably does impact people’s behavioral responses to pain and their interpretations of the meaning of pain. A study by Cleeland and colleagues (Cleeland et al. 1997) of Hispanics and African-Americans who attended minority outpatient clinics, showed that Hispanics reported more concerns about taking too much pain medication and more concerns about possible side effects from analgesics, as compared to African American patients.

A recent study by Anderson and colleagues (Anderson et al. 2002) noted that, although the reasons for not taking pain medications do not significantly vary among African-Americans and Hispanic patients, differences exist between the two groups in terms of the meaning of cancer pain. African-Americans talked about the sensory component of pain, describing pain as “hurt” and as limited activity and impaired function. In contrast, Hispanics tended to focus more on the emotional component of pain, describing pain as “emotional suffering.” In terms of patient-related barriers to cancer pain management, commonly stated barriers for both groups were: the need to be strong and not lean on pain medications; concern about addiction and the possible development of tolerance to pain medications; concern about side effects; and family reactions to their use of pain medica-

tions. Another important finding of this study was that a majority of patients in both ethnic groups would wait until their pain severity was a 10 on a 10-point scale before calling their health care provider.

Other studies have identified religious beliefs, folk healers, non-drug interventions, and assistance from family members as important for pain management. A study of patients receiving analgesics from home health or hospice agencies, found that Hispanic patients were more likely than Caucasian patients to report beliefs (e.g. take pain medicines only when pain is severe) that could hinder effective pain management (Juarez et al. 1998a). A qualitative study of Hispanic cancer patients receiving home health or hospice care also found that many patients believed that pain should be approached with stoicism (Juarez et al. 1998b).

While not directly related to patients’ attitudes and beliefs, other notable barriers patients face includes the cost and limited availability of analgesics. Difficulty with co-payments or incidental costs associated with obtaining their prescriptions is especially relevant for those who lack insurance coverage or who have a limited income. In terms of availability, a study of pharmacies in New York found that only 25% of pharmacies in minority communities stocked sufficient opioids for pain management, compared to 72% of pharmacies in non-minority communities (Morrison et al. 2000).

When patients’ attitudes and beliefs interfere with effective pain management, patients can benefit from a number of interventions. Educational interventions that provide accurate information about pain and pain treatments have shown some positive results. Rimer and colleagues (Rimer et al. 1987) used a randomized Solomon Four-Group design to assess the effectiveness of a patient education intervention among 230 cancer patients. The intervention consisted of nurse counseling and printed materials. Results showed that one month later, patients in the experimental group were more likely to have taken their pain medicine on the correct schedule and to have taken the correct dosage. The experimental group was significantly less likely to have reported stopping the medicine when they felt better, and were significantly less worried about tolerance and addiction to pain medicines as compared to the control group. The results of this study provide support for the importance of educational interventions, augmented with brief health care professional contact, in changing pain-related beliefs and improving pain management.

## References

1. Anderson KO, Richman SP, Hurley J et al. (2002) Cancer Pain Management among Underserved Minority Outpatients: Perceived Needs and Barriers to Optimal Control. *Cancer* 94:2295–2304
2. Cleeland CS (1987) Barriers to the Management of Cancer Pain. *Oncology* 1:19–26
3. Cleeland CS, Gonin R, Baez L et al. (1997) Pain and Treatment of Pain in Minority Patients with Cancer. *The Eastern Cooperative*



- Oncology Group Minority Outpatient Pain Study. *Ann Intern Med* 127:813–816
4. Hellman C (1990) *Culture, Health and Illness: An Introduction for Health Professionals*. Wright, London
  5. Juarez G, Ferrell B, Borneman T (1998a) Influence of Culture on Cancer Pain Management in Hispanic Patients. *Cancer Pract* 6:262–269
  6. Juarez G, Ferrell B, Borneman T (1998b) Perceptions of Quality of Life in Hispanic Patients with Cancer. *Cancer Pract* 6:318–324
  7. Larson PJ, Viele CS, Coleman S et al. (1993) Comparison of Perceived Symptoms of Patients Undergoing Bone Marrow Transplant and the Nurses Caring for Them. *Oncol Nurs Forum* 20:81–87
  8. Levin DN, Cleeland CS, Dar R (1985) Public Attitudes toward Cancer Pain. *Cancer* 56:2337–2339
  9. Morrison RS, Wallenstein S, Natale DK et al. (2000) “We Don’t Carry That”- Failure of Pharmacies in Predominantly Non-White Neighborhoods to stock Opioid Analgesics. *N Engl J Med* 342:1023–1026
  10. Reyes-Gibby CC, McCrory LL, Cleeland CS (2003) Variations in Patients’ Self-Report of Pain by Treatment Setting. *J Pain Symptom Manage* 25:444–448
  11. Rimer B, Levy MH, Keintz MK et al. (1987) Enhancing Cancer Pain Control Regimens through Patient Education. *Patient Educ Couns*:267–277
  12. Thomason TE, McCune JS, Bernard SA et al. (1998) Cancer Pain Survey: Patient-Centered Issues in Control. *J Pain Symptom Manage* 15:275–284
  13. Von Roenn JH, Cleeland CS, Gonin R et al. (1993) Physician Attitudes and Practice in Cancer Pain Management. A Survey from the Eastern Cooperative Oncology Group. *Ann Intern Med* 119:121–126
  14. Ward SE, Goldberg N, Miller-McCauley et al. (1993) Patient-Related Barriers to Management of Cancer Pain. *Pain* 52:319–324
  15. World Health Organization (1986) *Cancer Pain Relief*. WHO, Geneva

## Cancer Pain Management, Principles of Opioid Therapy, Dosing Guidelines

JAMES F. CLEARY

University of Wisconsin Comprehensive Cancer Center, Madison, WI, USA  
jfcleary@wisc.edu

### Characteristics

► **Opioids** are the mainstay of cancer pain management. All patients with moderate to severe cancer pain should have access to opioids (Cleary 2000). The primary goal of opioid dosing is to establish pain relief with regular dosing within a therapeutic window, the dose that maximises pain control with minimal side effects. Opioids can be administered by various routes: oral (immediate-release or modified-release products); transdermal; transmucosal; intravenous; subcutaneous or intraspinal.

### Initial Dosing

In most cases, the initial treatment with opioids begins with short-acting formulations. This may be in the form of opioid-only products (codeine, oxycodone or

morphine) or oral combination products (e.g. hydrocodone/acetaminophen or oxycodone/acetaminophen). The dose-limiting factor in these combination products is acetaminophen. The total daily dose should be limited to 4 grams, placing a limitation of 8–12 tablets per day, depending on the dose of acetaminophen. Short-acting opioids are normally administered every 3–4 h, but products such as immediate-release oxycodone or morphine may be given as often as hourly in the situation of uncontrolled pain.

Modified- or slow-release opioid products should be used cautiously as an initial opioid treatment, given the potential for side effects and the longer elimination with these compounds. This is particularly true with the elderly and those with renal impairment, in whom opioid clearance may be decreased, causing increased and prolonged side effects with low doses of these products (Osborne et al. 1986).

### Around-the-Clock Dosing

The routine administration of opioids at regular intervals has been an important part of cancer pain management (Saunders 1963). In registration studies, investigators have found analgesic equivalence between immediate-release products and modified-release products at identical daily doses (Walsh et al. 1992). Improved patient compliance, and, therefore, improved pain control, is anticipated with modified-release products. However, in the situation of limited resources, patients can be prescribed regularly-administered, immediate-release oral products with the anticipation of satisfactory pain control.

Patients can be converted from immediate-release products to modified-release products. Some modified-release products have a biphasic release mechanism that results in both immediate and more sustained pain relief. The dose of the modified-release formulation should be calculated by converting the daily dose of immediate-release opioids (including those administered parenterally) to the modified-release formulation, which is then administered over the 24-h period according to the medication’s dosing schedule.

There are now oral opioids approved for daily and twice daily dosing. The transdermal fentanyl patch has a duration of 2–3 days. With modified-release compounds, dose escalation is usually best accomplished by increasing the dose rather than shortening the dosing interval. However, a careful history should be taken to explore the concept of “end of dose failure.” A patient may report effective analgesia for 8–10 h following the administration of a modified-release opioid on a twice daily schedule. Rather than increasing the dose and therefore increasing the risk of side effects, it may be preferable to decrease the dosing interval to every 8 h. This also applies to once daily oral products, with which twice daily dosing may be necessary. With the transdermal fentanyl patch, patients may report only one good day out of three despite

increases in the dose delivered per hour. Changing the patch every 48 h may result in more effective pain control (Payne et al. 1995)

► **Breakthrough pain** can usually be managed by providing a short-acting drug at a dose equal to 10–15% of 24-h daily dosing (Portenoy and Hagen 1990). Experience with oral transmucosal fentanyl citrate, however, suggests that there is not a clear correlation between the around-the-clock opioid dose and the breakthrough pain dose (Farrar et al. 1998).

### Dose Escalation

If pain is not well controlled and side effects are not severe, the dose of opioid should be increased. The percentage escalation should be based on the severity of the pain, the side effects, and other medical factors. If pain is moderate, the increase should be 25–50% of the daily dose (Jacox et al. 1994). If pain is severe, a dose escalation of 50–100% of the daily dose should be made. With most oral products, this escalation can safely take place every 24 h. In the case of the transdermal fentanyl patch, dose escalation should not take place more often than every 48 h, although in inpatient settings with close clinical supervision, dose increases have been safely made every 24 h when needed (Payne et al. 1995). When opioid infusions are used in the treatment of pain, dose escalations should take place no more often than the time required for four half-lives, unless there is careful monitoring. In the case of morphine, this is every 10–16 h. Escalating the infusion rate more often than this may result in increased drug toxicity. Patients may use patient-controlled analgesia together with clinician-administered boluses to effect better pain control, but it will still require 4–5 half lives to reach steady-state.

### Pain Emergency

In the case of a pain emergency, a loading dose may be the most effective way to treat the pain (Davis 2004). The loading dose should be established with frequent dosing administered either intravenously or subcutaneously. Many clinicians commence an opioid infusion alone, but it will require 4–5 half-lives before maximal pain relief can be achieved. With the half life of morphine being 2.5–4 h, it would take 10–16 h to reach steady state, and therefore potentially leave the patient with uncontrolled pain. If a loading dose is added to an opioid infusion, the ongoing opioid dose should be the sum of the previous opioid regimen together with that calculated from the loading dose.

### Dosing in Special Situations

In the presence of renal impairment (Osborne et al. 1986) and in the elderly (Cleary and Carbone 1997), the clearance of either primary drug or metabolites may be decreased. Therefore, both more cautious titration and longer dosing intervals may be necessary. Near the end

of life, it may also be appropriate to decrease the dose of morphine administered to reduce the risk of toxicity.

### References

1. Cleary JF (2000) Cancer Pain Management *Cancer Control* 7:120–131
2. Cleary JF, Carbone PP (1997) Palliative Medicine in the Elderly. *Cancer* 80:1335–1347
3. Davis MP (2004) Acute Pain in Advanced Cancer: An Opioid Dosing Strategy and Illustration. *Am J Hosp Palliat Care* 21:47–50
4. Farrar JT, Cleary J, Rauck R et al. (1998) Oral Transmucosal Fentanyl Citrate: Randomized, Double-Blinded, Placebo-Controlled Trial for Treatment of Breakthrough Pain in Cancer Patients *J Natl Cancer Inst* 90: 611–616
5. Jacox A, Carr DB, Payne R et al. (1994) Management of Cancer Pain: Clinical Practice Guideline No 9. Agency for Health Care Policy and Research. US Dept of Health and Human Services, Public Health Service AHCPublication 94-052
6. Osborne RJ, Joel SP, Slevin ML (1986) Morphine Intoxication in Renal Failure: The Role of Morphine-6-Glucuronide. *BMJ* 292:1548–1549
7. Payne R, Chandler S, Einhaus M (1995) Guidelines for the Clinical Use of Transdermal Fentanyl. *Anticancer Drugs* 6:50–53
8. Portenoy RK, Hagen NA (1990) Breakthrough Pain: Definition, Prevalence and Characteristics. *Pain* 41:273–281
9. Saunders C (1963) The Treatment of Intractable Pain in Terminal Cancer. *Proc R Soc Med* 56:195–197
10. Walsh TD, MacDonald N, Bruera E et al. (1992) A Controlled Study of Sustained-Release Morphine Sulfate Tablets in Chronic Pain from Advanced Cancer. *Am J Clin Oncol* 15:268–272

## Cancer Pain Management, Principles of Opioid Therapy, Drug Selection

MARIE FALLON

Department of Oncology, Edinburgh Cancer Center, University of Edinburgh, Edinburgh, Scotland  
marie.fallon@ed.ac.uk

### Definition

► **Opioid** is a general term that includes naturally occurring, semisynthetic, and synthetic drugs that produce their effects by combining with opioid receptors and are stereospecifically antagonized by naloxone. Opioid drugs are the mainstay in the treatment of moderate to severe cancer pain.

### Characteristics

Although concurrent use of other approaches and interventions may be appropriate in many patients, and necessary in some, analgesic drugs are needed in almost every patient with cancer pain. The keystone of cancer pain management is a good assessment. Insight into the complex multidimensional features of cancer pain, and an appreciation of the patient's clinical and psychosocial characteristics, are fundamental for the success of any pain management strategy, pharmacological or otherwise. Drugs whose primary clinical action is the relief of pain are conventionally classified on the basis of their activity at opioid receptors, as either opioid or non-opioid

analgesics. A third class, ► **adjuvant analgesics**, are drugs with other primary indications that can be effective analgesics in specific circumstances. The major group of drugs used in cancer pain management are the opioid analgesics.

Analgesic therapy with opioids, non-opioids and adjuvant analgesics is developed for the individual patient through a process of continuous evaluation, so that a favorable balance between pain relief and adverse pharmacological effects is maintained. The World Health Organization (WHO) structured approach to drug selection for cancer pain, known as the ► **WHO analgesic ladder**, when combined with appropriate dosing guidelines is capable of providing adequate relief to 70–90% of patients (World Health Organization 1986; Ventafridda et al. 1987; Takeda 1990; Walker et al. 1983; Schug et al. 1990; Zech et al. 1995). This approach emphasizes that the intensity of pain, rather than its specific etiology, should be the prime consideration in analgesic selection.

The WHO ladder was never intended to be used in isolation. Rather, it should be integrated with other approaches to cancer pain management such as radiotherapy, chemotherapy, anesthetic interventions, physiotherapy and relaxation techniques.

The WHO ladder approach advocates three basic steps (Fig. 1): Patients with mild cancer-related pain should be treated with a non-opioid analgesic (also known as a ► **simple analgesic**), which should be combined with adjuvant drugs, if a specific indication for these exists. For example, a patient with mild to moderate

arm pain caused by radiation-induced brachial plexopathy may benefit when a tricyclic antidepressant is added to paracetamol (acetaminophen) (McQuay and Moore 1997; Kalso et al. 1998).

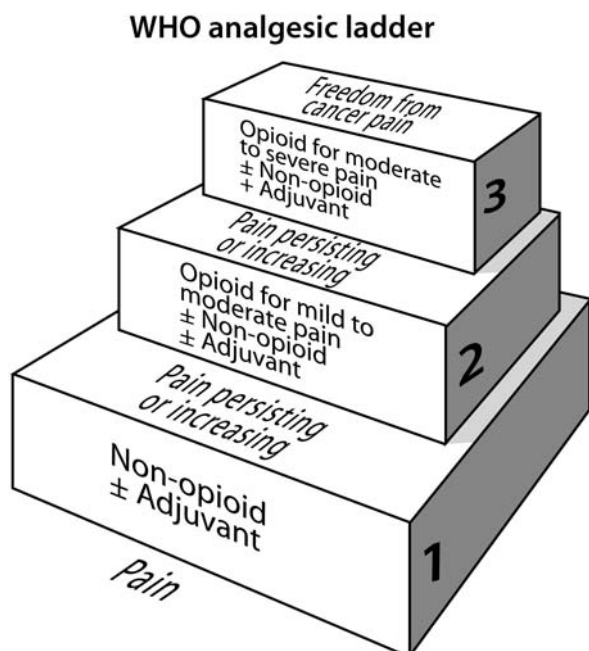
Patients who are relatively non-tolerant and present with moderate pain, or who fail to achieve adequate relief after a trial of a non-opioid analgesic, should be treated with an opioid conventionally used for mild to moderate pain (formerly known as a “weak” opioid). This treatment is typically accomplished using a combination product containing a non-opioid (e.g. aspirin or paracetamol (acetaminophen)) and an opioid (such as codeine, oxycodone or propoxyphene). This combination can also be coadministered with an adjuvant analgesic. The doses of these combination products can be increased until the maximum dose of the non-opioid analgesic is attained (e.g. 4000–6000 mg paracetamol (acetaminophen)); beyond this dose, the opioid contained in the combination product could be increased as a single agent, or the patient could be switched to an opioid conventionally used in Step 3.

Patients who present with severe pain, or who fail to achieve adequate relief following appropriate administration of drugs on the second step of the analgesic ladder, should receive an opioid conventionally used for moderate to severe pain (formerly known as a “strong” opioid). This group includes morphine, diamorphine, fentanyl, oxycodone, phenazocine, hydromorphone, methadone, levorphanol, and oxymorphone. These drugs may also be combined with a non-opioid analgesic or an adjuvant drug. Clearly, the boundary between opioids used in the second and third steps of the analgesic ladder is somewhat artificial, since low doses of morphine or other opioids for severe pain can be less effective than high doses of codeine or propoxyphene. Accordingly, some debate surrounds the usefulness of Step 2 of the WHO ladder. This is currently being examined in clinical studies.

According to the WHO guidelines, a trial of opioid therapy should be given to all patients with chronic pain of moderate or greater severity. This approach has been subject to criticism concerning its evidence base and its use over time. Much of the evidence is based on components of the ladder examined in nonmalignant pain, e.g. an opioid combined with a non-opioid is more effective than either alone, or systematic reviews of adjuvant analgesics (which appear to suggest that the number needed-to-treat [NNT] for most of the commonly-used drugs is about three (McQuay and Moore 1998)).

Some of the criticism may be related to the common misconception that the WHO ladder is a ‘recipe’ for cancer pain management. In fact, it is a set of principles that need to be applied appropriately with other non-pharmacological treatments to each individual situation.

The morphine-like agonist drugs are widely used to manage cancer pain. Although they may differ from mor-



**Cancer Pain Management, Principles of Opioid Therapy, Drug Selection, Figure 1** WHO analgesic ladder.

phine in quantitative characteristics, they qualitatively mimic the pharmacological profile of morphine, including both desirable and undesirable effects.

Comparative trials of opioids in cancer pain are extremely difficult to perform. While good quality randomized trials to provide evidence for pharmacotherapy of cancer pain are preferred, clinical decisions are currently based on limited trial evidence; basic pharmacology of the opioid and particular properties relating to renal, hepatic and cognitive impairment; and progress in basic science which gives foundation to our belief of genetic variability in response to opioid analgesia (Rossi et al. 1997). No strong evidence speaks for the superiority of one opioid over another. For this reason, the aforementioned factors, along with practical clinical issues such as possible routes of drug administration, determine drug selection.

Although most cancer pain is responsive to opioid analgesia to some extent, the side effects experienced by an individual are the practical limiting factors in what is termed “▶ opioid-responsiveness.” While pure opioid agonists have no pharmacological ceiling dose, a “▶ opioid pseudo-pharmacological ceiling dose” exists in some situations because of dose-limiting side effects. The common side effects of all opioids are constipation, dry mouth, sedation, nausea and vomiting. The first two often persist, but tolerance usually develops to sedation, nausea and vomiting. Sedation, however, tends to be the common limiting factor during ▶ opioid dose titration, particularly in genetically susceptible individuals, or in pain syndromes that usually require larger doses of opioid e.g. neuropathic pain (Portenoy et al. 1990).

In individuals troubled with side effects, especially sedation, with one opioid, a switch to an alternative opioid may result in an improved balance between analgesia and unwanted side-effects (Fallon 1997). It is impossible to predict such an improvement, but clinical experience with opioids makes this an acceptable strategy. In the case of neuropathic pain, use and titration of an appropriate adjuvant analgesic would seem another critical step in improving the balance between analgesia and side effects.

There are no good data that examine a route switch rather than an ▶ opioid switch as a beneficial strategy in the management of ▶ opioid adverse effects. Clinically, the main benefit in switch to the spinal route of delivery is the possibility of adding drugs to manage neuropathic pain and incident pain, such as local anesthetic.

The transdermal route can be useful in patients having swallowing difficulties and in some cases of resistant constipation with oral opioids. Studies with transdermal fentanyl show a trend towards less constipation (Wong et al. 1997).

There is one randomized, controlled trial comparing oxycodone favorably with morphine with regard to hallucinations, however, the numbers are small and larger

trials would be needed to say there is good evidence for the superiority of oxycodone (Kalso and Vainio 1990). Hydromorphone is another alternative to morphine if toxicity or drowsiness is problematic, but again, there is no high quality evidence suggesting that one drug is superior to another.

Methadone is a synthetic opioid with unusual qualities and different pharmacological properties from the other opioids used in cancer pain. Steady-state plasma concentration is usually reached at one week, but may take up to 28 days. Serious adverse effects are avoided if the initial period of dosing is accomplished with “as needed” administration, which is not the usual recommendation in cancer pain dosing regimens. When steady-state has been achieved, scheduled dose frequency should be determined by the duration of analgesia following each dose.

The ▶ equianalgesic dose ratio of morphine to methadone has been the subject of controversy. Recent data suggest that the ratio correlates with the total opioid dose administered before switching to methadone. Among patients receiving low doses of morphine the ratio is 4:1. In contrast, for patients receiving more than 300 mg of oral morphine, the ratio is approximately 10:1 or 12:1 (Ripamonti et al. 1998).

The therapeutic armamentarium for opioids has expanded over time, and familiarity with a range of opioid agonists and with the use of equianalgesic tables to convert doses if switching opioids, is necessary (Table 1). It is clear that patients are at risk of under- or over-dosing by virtue of individual sensitivities; hence, a logical, systematic approach to reassessment of the entire clinical situation is the key to managing opioid adverse effects and/or uncontrolled cancer pain, rather than an automatic switch to another opioid.

## References

1. Fallon MT (1997) Opioid Rotation – Does It Have a Role? *Palliat Med* 11:176–178
2. Kalso E, Tramer MR et al. (1998) Systemic Local Anaesthetic-Type Drugs in Chronic Pain: A Systematic Review. *Eur J Pain* 2:3–14
3. Kalso E, Vainio A (1990) Morphine and Oxycodone Hydrochloride in the Management of Cancer Pain. *Clin Pharmacol Ther* 47:639–646
4. McQuay HJ, Moore RA (1997) Antidepressants and Chronic Pain. *BMJ* 314:763–764
5. McQuay H, Moore A (1998) *An Evidence-Based Resource for Pain Relief*. Oxford Medical Publications, Oxford
6. Portenoy RK, Foley KM, Inturrisi CE (1990) The Nature of Opioid Responsiveness and its Implications for Neuropathic Pain: New Hypotheses Derived from Studies of Opioid Infusions. *Pain* 43:273–286
7. Ripamonti C, De Conno F et al. (1998) Equianalgesic Dose/Ratio between Methadone and other Opioid Agonists in Cancer Pain: Comparison of Two Clinical Experiences. *Ann Oncol* 9:79–83
8. Rossi GC, Leventhal L, Pan YX et al. (1997) Antisense Mapping of MOR-1 in Rats. Distinguishing between Morphine and Morphine-6 Beta-Glucuronide Antinociception. *J Pharmacol Exp Ther* 281:109–114



**Cancer Pain Management, Principles of Opioid Therapy, Drug Selection, Table 1** Opioid analgesics (pure mu agonists) used for the treatment of chronic pain

Morphine-like agonists	Equi-analgesic doses <sup>a</sup>	Half-life (hr)	Peak Effect (hr)	Duration (hr)	Toxicity	Comments	Oral Bioavailability (%)	Active metabolites
Morphine	10 s.c. 20–60 p.o. <sup>b</sup>	2–3 2–3	0.5–1 1.5–2	3–6 4–7	Constipation, nausea, sedation most common; respiratory depression rare in cancer patients	Standard comparison for opioids; multiple routes available	20–30	M6G
Controlled-release morphine	20–60 p.o. <sup>b</sup>	2–3	3–4	8–12			20–30	M6G
Sustained-release morphine	20–60 p.o. <sup>b</sup>	2–3	4–6	24		Once-a-day morphine approved in some countries	20–30	M6G
Hydromorphone	1.5 s.c. 7.5 p.o.	2–3 2–3	0.5–1 1–2	3–4 3–4	Same as morphine	Used for multiple routes	35–80	No
Oxycodone	20–30	2–3	1	3–6	Same as morphine	Combined with aspirin or acetaminophen, for moderate pain in USA; available orally without coanalgesic for severe pain	60–90	oxymorphone
Controlled-release oxycodone	20–30	2–3	3–4	8–12				oxymorphone
Oxymorphone	1 s.c. 10 p.r.	– –	0.5–1 1.5–3	3–6 4–6	Same as morphine	No oral formulation		glucuronides
Meperidine (pethidine)	75 s.c.	2–3	0.5–1	3–4	Same as morphine + CNS excitation; contraindicated in those on MAO inhibitors	Not used for cancer pain due to toxicity in higher doses and short half-life	30–60	norpethidine
Diamorphine	5 s.c.	0.5	0.5–1	4–5	Same as morphine	Analgesic action due to metabolites, predominantly morphine; only available in some countries		Morphine
Levorphanol	2 s.c. 4 p.o.	12–16	0.5–1	4–6	Same as morphine	With long half-life, accumulation occurs after beginning or increasing dose		No
Methadone <sup>c</sup>	10 s.c. 20 p.o. (see text)	12 ≥150	0.5–1.5	4–8	Same as morphine	Risk of delayed toxicity due to accumulation; useful to start dosing on p.r.n.	60–90	No
Codeine	130 s.c. 200 p.o.	2–3	1.5–2	3–6	Same as morphine	Usually combined with non-opioid	60–90	morphine
Propoxyphene HCl (Dextro-propoxyphene)	–	12	1.5–2	3–6	Same as morphine plus seizures with overdose	Toxic metabolite accumulates but not significant at doses used clinically; usually combined with non-opioid	40	norpropoxyphene
Propoxyphene napsylate (Dextro-propoxyphene)	–	12	1.5–2	3–6	Same as hydrochloride	Same as hydrochloride	40	norpropoxyphene

C



Cancer Pain Management, Principles of Opioid Therapy, Drug Selection, Table 1 (continued)

Morphine-like agonists	Equi-analgesic doses <sup>a</sup>	Half-life (hr)	Peak Effect (hr)	Duration (hr)	Toxicity	Comments	Oral Bioavailability (%)	Active metabolites
Hydrocodone	–	2–4	0.5–1	3–4	Same as morphine	Only available combined with acetaminophen; only available in some countries		hydromorphone
Dihydrocodone	–	2–4	0.5–1	3–4	Same as morphine	Only available combined with aspirin or acetaminophen in some countries	20	morphine
Fentanyl	–	3–12	–	–	Same as morphine	Can be administered as a continuous I.V. or S.C. infusion; based on clinical experience, 100 mcg/hr is roughly equianalgesic to morphine 4 mg/hr I.V.	25/buccal <2/oral	No
Fentanyl Transdermal System	–	13–22	–	48–72	Same as morphine	Based on clinical experience 100 mcg/hr is roughly equianalgesic to morphine 4 mg/hr; recent study indicates a ratio of oral morphine: transdermal fentanyl of 100:1	90/transdermal	No

<sup>a</sup>Dose that provides analgesia equivalent to 10 mg i.m. morphine. These ratios are useful guidelines when switching drugs or routes of administration

<sup>b</sup>Extensive survey data suggest that the relative potency of i.m.:p.o. or s.c.:p.o., morphine of 1:6 changes to 1:2–3 with chronic dosing

<sup>c</sup>When switching from another opioid to methadone, the potency of methadone is much greater than indicated on this table

- Schug SA, Zech D et al. (1990) Cancer Pain Management According to WHO Analgesic Guidelines. *J Pain Symptom Manage* 5:27–32
- Takeda F (1990) Japan's WHO Cancer Pain Relief Program. In: Foley KM, Bonica JJ, Ventafridda V et al. (eds) *Advances in Pain Research and Therapy*, vol 16. Raven Press, New York, pp 475–483
- Ventafridda V, Tamburini M, Caraceni A et al. (1987) A Validation Study of the WHO Method for Cancer Pain Relief. *Cancer* 59:851–856
- Walker VA, Hoskin PJ et al. (1983) Evaluation of WHO Analgesic Guidelines for Cancer Pain in a Hospital-Based Palliative Care Unit. *J Pain Symptom Manage* 3:145–149
- Wong JO, Chui GL, Tsao CJ et al. (1997) Comparison of Oral Controlled-Release Morphine with Transdermal Fentanyl in Terminal Cancer Pain. *Acta Anaesthesiol Sin* 35:25–32
- World Health Organization (1986) *Cancer Pain Relief*. World Health Organization, Geneva
- Zech DFJ, Grond S, Lynch J et al. (1995) Validation of World Health Organization Guidelines for Cancer Pain Relief. A 10 Year Prospective Study. *Pain* 63:65–76

## Definition

Radiation is used to treat cancer and other diseases. The radiation dose is described in terms of centigray (cGY) or Gray (Gy) (100 cGy = 1 Gy). For curative radiation, 5000–8000 cGy are generally prescribed over 5 treatments each week for 5–8 weeks of radiation. This means that 180 cGy to 200 cGy of radiation are given each day for a total of 25–40 fractions or treatments. When radiation is given with palliative intent, the dose usually ranges from a single 8 Gy fraction to 15 fractions of 2.5 Gy over 3 weeks.

There are many ways that radiation can be administered, which are broadly classified as external radiation and brachytherapy. External radiation and brachytherapy each have many forms of treatment. The goal of any type of radiation treatment is to limit the radiation dose only to the involved areas.

## External Beam Radiation

External radiation treats the site of disease by using different types of x-ray beams derived from a machine called a linear accelerator, which is built on the principles used in an x-ray machine. This is the most common way that radiation is administered. Through the use of specialized blocks, a linear accelerator focuses the radiation only on the area to be treated with millimeter precision, and blocks radiation from affecting adjacent tissues.

Radiation loses energy as it passes through tissue, and the characteristic of a radiation beam is described by the

## Cancer Pain Management, Radiotherapy

EDWARD CHOW<sup>1</sup>, STEPHEN LUTZ<sup>2</sup>, NORA JANJAN<sup>3</sup>

<sup>1</sup>Toronto Sunnybrook Regional Cancer Center, University of Toronto, Toronto, ON, Canada

<sup>2</sup>Blanchard Valley Regional Cancer Center, Findlay, Ohio, USA

<sup>3</sup>University of Texas M. D. Anderson Cancer Center, Houston, TX, USA

edward.chow@sw.ca

amount of energy that is lost as it passes through the tissue. The term *D<sub>max</sub>* refers to the depth of the tissue where 100% of the radiation dose is deposited. Only 50% of the prescribed radiation dose from a single beam may penetrate to a tumor located 10 cm from the skin surface. To overcome this, many beams of radiation are routinely used to treat a tumor. The sum of the radiation doses at the tumor gives a high total radiation dose.

The choice of the type of radiation used in a radiation treatment plan depends on the location of the tumor and critical structures near the tumor. The concept of integral dose is used to describe the selection of the type of radiation in order to maximize the radiation dose in the tumor, yet minimize treatment of uninvolved adjacent tumors.

Newer forms of radiation treatment planning, like three-dimensional conformal radiation therapy and intensity modulated radiation therapy, apply the principles of integral dose by targeting the tumor through multiple low-dose radiation beams. All the radiation energy from these beams adds to give the tumor a very high radiation dose, but the radiation dose from the individual beams is so low that there are minimal effects from the radiation in the adjacent normal tissues.

There are many types of external beam radiation that are derived from a linear accelerator. These types of radiation include gamma rays and electron beam radiation. Gamma rays are used to treat tumors located deep in the body, while electron beam radiation treats superficial cancers.

### Gamma Rays

Gamma rays are penetrating forms of x-rays, and many energy levels of gamma rays are available for treatment (Tables 1 and 2). In general:

- High-energy gamma rays deeply penetrate the tissues but spare the skin from radiation reactions like erythema and moist desquamation. This type of radiation is used to treat deep-seated tumors in the abdominal and pelvic areas. Due to the characteristics of high-energy gamma rays, the skin receives little to no dose.
- An example of a high-energy gamma radiation beam is an 18 MV photon beam [a photon is a package of energy]. If 100 cGy is prescribed from one radiation beam, 100 cGy is deposited 3.5 cm from the skin surface [*D<sub>max</sub>*] and 85% of the radiation dose [85 cGy] is deposited at 10 cm of tissue below the skin surface.
- Low-energy gamma rays do not penetrate the tissues well and cause more skin reactions. This type of radiation is used to treat head and neck cancers and breast cancers where there may be tumor infiltration of the skin.
- An example of a low energy gamma radiation beam is a Cobalt-60 beam or a 6 MV photon beam. If 100 cGy is prescribed from one 6 MV radiation beam, 100 cGy is deposited 1.5 cm from the skin surface [*D<sub>max</sub>*], and

60% of the radiation dose [60 cGy] is deposited at 10 cm of tissue below the skin surface.

### Electron Beam Radiation

Electron beam radiation is used to treat cancers located in the superficial tissues, like lymph nodes in the neck, the chest wall after a mastectomy, and skin cancers. It provides an important alternative to gamma rays, because underlying critical structures like the heart and spinal cord may not receive any radiation at all from electron beam therapy.

- The depth of penetration in centimeters of tissue from an electron beam energy can be generalized by the following rule (Table 1):
- 80% of the radiation dose will be deposited if the electron beam energy is divided by three, and 95% of the radiation dose will be deposited if the electron beam energy is divided by two.
  - For example, a 9 MeV electron beam deposits 80% of the dose 3 cm from the skin surface and 95% of the dose 4.5 cm from the skin surface.

External beam treatment planning involves the specific selection of radiation beams to target the tumor and minimize treatment of adjacent normal tissues. Limiting the dose of radiation to adjacent tissues is critical to avoid side effects from radiation. These treatment-related side effects, especially those to mucosal surfaces that result in mucositis, nausea and diarrhea, can significantly impact on the functional status of the patient. This is of particular concern in patients who are already debilitated from their disease.

### Brachytherapy

Brachytherapy is the placement of radioactive sources in or adjacent to a tumor bed. These radioactive sources can be permanently implanted in a tumor or placed temporarily near the tumor location. Permanently implanted radiation sources are used to treat prostate cancer. The radiation dose gradually decays until no further radiation is emitted. For lung cancer, radioactive sources that are placed in a catheter are temporarily adjacent to a tumor blocking the bronchus for a prescribed amount of time to deliver a specific radiation dose. After the prescribed amount of time, the radiation sources are removed. Brachytherapy also uses high-dose rate [a very strong radioactive source that gives radiation over a few minutes] and low-dose rate [a radioactive source that gives a low-dose of radiation over several hours]. The choice of brachytherapy used primarily depends on the tumor location. The radiation dose is extremely localized because of the Inverse Square Law [Radiation dose =  $1/d^2$ ]. Applying this principle, the radiation dose drops off rapidly as the distance from the radiation source increases. For example, the radioactive dose 2 cm away from the radioactive source is only one-fourth the radia-

**Cancer Pain Management, Radiotherapy, Table 1** Gamma Radiation – Prescribing 100 cGy for a tumor located 10 cm below the skin

Type of Gamma Beam	Dmax [cm below skin surface]	% Depth Dose at 10 cm below the skin surface	Dose of radiation [cGy] needed to give 100 cGy @ 10 cm below the skin	Dose of radiation at Dmax with each radiation fraction	Total dose of radiation to the skin at Dmax [20 radiation fractions]
Cobalt-60	0.5 cm	57%	175 cGy	175 cGy	3500 cGy $\cong$ 0.5 cm
6 MV photons	1.5 cm	65%	154 cGy	154 cGy	3080 cGy $\cong$ 1.5 cm
18 MV photons	3.5 cm	80%	125 cGy	125 cGy	2500 cGy $\cong$ 3.5 cm

Dmax is the depth in cm below the skin surface where 100% of the prescribed radiation dose is given. The % depth dose at 10 cm is the % of the prescribed radiation that penetrates to a tumor located 10 cm below the skin surface = 100 cGy/% depth dose. 2000 cGy will be given to the tumor [located 10 cm from the skin surface] from an anterior radiation field. Another 2000 cGy will be given to the tumor from a posterior radiation field. This will deliver 4000 cGy to the tumor. Each radiation fraction will equal 200 cGy [100 cGy from the anterior and 100 cGy from the posterior field] and 20 fractions will be required to give a total radiation dose of 4000 cGy. 18 MV photons are more effective in treating abdominal and pelvic tumors and they cause little skin reaction. Cobalt-60 and 6 MV photons are effective in treating more superficial tumors like head and neck and breast cancers that may have tumor infiltration of the skin; in this case a higher radiation dose to the skin is essential to control the tumor.

**Cancer Pain Management, Radiotherapy, Table 2** Electron Beam Radiation - Radiation is deposited over a short distance from the skin's surface

Type of Electron Beam	Dmax [cm below skin surface]	80% of radiation dose deposited within	95% of radiation dose deposited within
6 MeV	1.5 cm	2 cm	3 cm
9 MeV	2.3 cm	3 cm	4.5 cm
12 MeV	3 cm	4 cm	6 cm

As an example, if a 100 cGy of radiation is administered with 6 MeV electron beam, 100 cGy would be given at 1.5 cm below the skin, only 20 cGy would be delivered 2 cm below the skin surface [80% of the radiation dose deposited within 2 cm of the skin surface] and only 5 cGy would be delivered 3 cm below the skin surface [95% of the radiation dose delivered within 3 cm of the skin surface]. Therefore, 80% of the radiation dose is given between 1.5 cm and 2 cm from the skin surface. Less than 5% of the radiation dose reaches structures more than 3 cm from the skin surface.

tion dose next to the source. Brachytherapy is an important option in palliative care, because it can deliver radiation over a few minutes to days instead of several weeks. As the radiation is well localized, brachytherapy can be used to re-irradiate tissues that have previously been irradiated. Treatment-related side effects with brachytherapy are limited.

Radioactive isotopes, which have affinity to specific areas like the bone or thyroid, can also be injected into the blood stream and are a form of brachytherapy. The effects of the radiation are localized to the site of deposition and little radiation is administered to adjacent tissues. Like more conventional brachytherapy, ► **radioisotopes** allow re-irradiation of previously irradiated areas because the radiation dose is concentrated in the site of disease.

Radiotherapy results in damage to cellular DNA. Radiotherapy causes both direct and indirect damage to the reproductive DNA material of the cell. Direct damage takes place in the form of base deletions, single and double strand breaks in the DNA chain. Indirect damage occurs by the interaction of radiotherapy with water molecules in the cell, which releases toxic free radicals.

### Mechanisms of Action

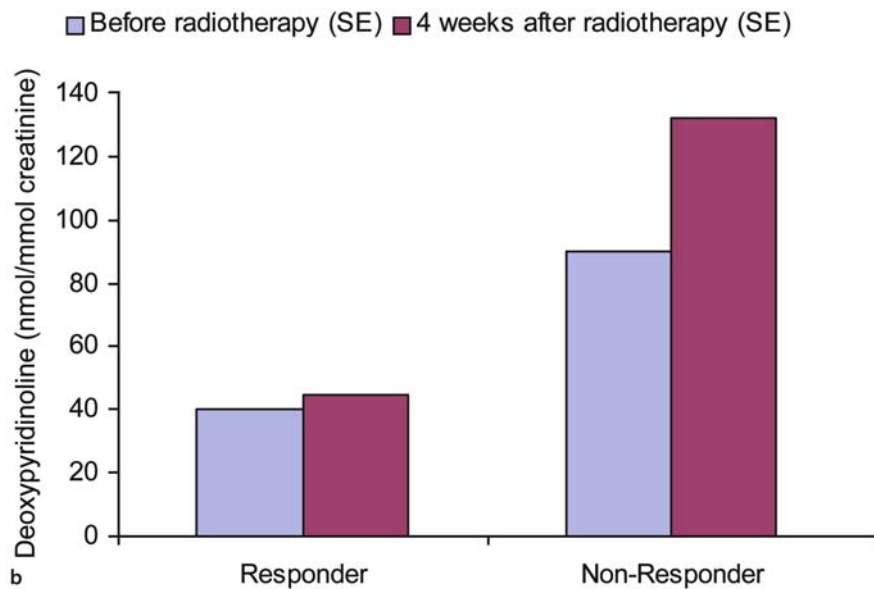
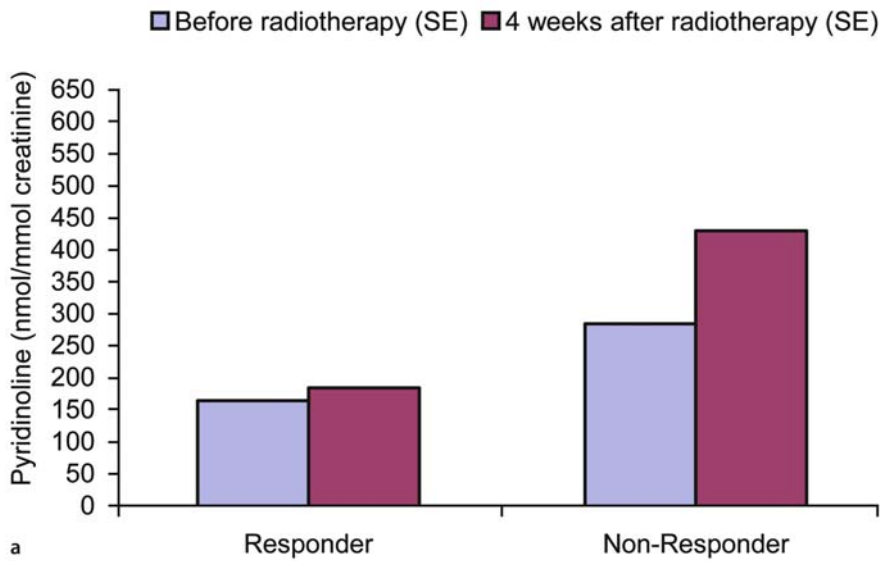
► **Palliative radiotherapy** is well established for the treatment of symptomatic ► **bone metastases**. The ex-

act mechanism of its action is still uncertain, although tumor cell kill may be an important reason. However, the absence of a dose-response relationship, rapid responses, and poor correlation of symptomatic relief with radiosensitivity suggest that an effect on host mechanisms of ► **pain** could also be important.

Markers of bone remodeling have been shown to be suppressed by anti-resorptive therapy, and the response of these bone markers has been applied to monitoring therapy for bone metastases.

In the recent UK Bone Pain Radiotherapy Trial (Bone Pain Trial Working Party 1999), 22 patients were entered into a supplementary study to establish the effects of local radiotherapy for metastatic bone pain on markers of osteoclast activity, particularly the pyridinium crosslinks pyridinoline and deoxypyridinoline, the latter being specific for bone turnover. Urine samples were collected before and one month after radiotherapy. Patients were treated with either a single 8 Gy or 20 Gy in 5 daily fractions. Pain response was scored with validated pain charts completed by patients.

Urinary pyridinium concentrations were correlated with pain response. In patients who did not respond to palliative radiation (non-responders), baseline concentrations of both pyridinoline and deoxypyridinoline were higher than those who responded (responders), and rose further after treatment, whereas in responders, the



**Cancer Pain Management, Radiotherapy, Figure 1** Effect of Radiotherapy on Urinary Markers of Osteoclast Activity Related to Pain Response. Total: 22 patients, 8 with breast cancer and 14 with prostate cancer; 5 patients showed no response, 9 a partial response and 8 a complete response.

mean values remained unchanged (Fig. 1). This resulted in significant differences between responders and non-responders for both indices after treatment ( $P = 0.027$ ). The authors concluded that radiotherapy-mediated inhibition of bone resorption, and thus osteoclastic activity, could be a predictor for pain response. They also proposed that tumor cell killing reduces the production of osteoclast-activating factors, or there is a direct effect upon osteoclasts within the radiation volume, distinct from tumor shrinkage. Their study supports the results from randomized trials that high dose radiotherapy is not necessary for pain relief, and that single low-doses of treatment are more than adequate for most patients (Hoskin et al. 2000).

## Characteristics

### External Beam Local Radiotherapy

Radiation therapy has long been employed in the management of bone metastases, including relief of bone pain, prevention of impending fractures and promotion of healing in ► **pathological fractures**. Stabilization of bony destruction occurs in 80% and re-ossification takes place in 50% of patients after radiotherapy. Palliation of bone metastases comprises a significant workload in the specialty of radiation oncology. External beam radiation therapy is effective and cost-effective in relieving symptomatic bone metastases. The most commonly employed schemes to treat bone metastases

include a single 8 Gy, 20 Gy in 5 daily fractions, 30 Gy in 10 daily fractions and 40 Gy in 20 daily fractions. Numerous randomized trials have been conducted on dose-fractionation schedules of palliative radiotherapy. Despite that, there is still no uniform consensus on the optimal dose fractionation scheme.

Retrospective series have documented prompt improvement in pain in 80–90% of patients with various dose fractionations, without causing significant hematological or gastrointestinal side effects. One of the first randomized studies on bone metastases was conducted by the Radiation Therapy Oncology Group (RTOG). The initial analysis of this trial (RTOG 74-02) concluded that a low dose short-course schedule was as effective in pain relief as more aggressive high-dose protracted schedules (Tong et al. 1982). However, this study was criticized for using physician-based pain assessment. A re-analysis of the same set of data, grouping solitary and multiple bone metastases, using the endpoint of pain relief and taking into account analgesic intake and re-treatment, concluded that the number of radiation fractions was significantly associated with complete pain relief. This conclusion was directly contrary to the initial report (Blitzer 1985), making the choice of endpoints very important in defining the outcome of clinical trials (Chow et al. 2002).

Several prospective randomized trials have subsequently been performed that compared the efficacy of different dose-fractionation schedules. They included the recent large-scale multicenter trials comparing the efficacy of a single 8 Gy treatment against multiple treatments. The UK Bone Pain Working Party found no difference in the degree and duration of pain relief in a study of 765 patients randomized to receive either a single treatment or 5 fractionated treatments (Bone Pain Trial Working Party 1999). The Dutch Bone Metastases Study included 1171 patients, and found no difference in pain relief or the quality of life following a single 8 Gy or 24 Gy in 6 daily radiation treatments (Steenland et al. 1999).

One critical review on the subject of radiation dose-fractionation suggested that protracted fractionated radiotherapy, given over 2–4 weeks, results in more complete and durable pain relief (Ratanatharathorn et al. 1999). This review was performed because of concerns regarding the influence of length of survival on the durability of pain relief. It was unclear whether higher radiation doses were necessary for durable pain relief in patients who survived longer. A recent meta-analysis showed no significant difference in complete and overall pain relief between single and multi-fraction palliative radiotherapy for bone metastases. No dose-response relationship could be detected. The meta-analysis reported that the complete response rates (absence of pain after radiotherapy) were 33.4% and 32.3% after single and multi-fraction radiation treatment, respectively, while the overall response rates were 62.1% and 58.7%,

respectively. The latter became 72.7% and 72.5%, respectively, when the analysis was restricted to evaluated patients alone (Wu et al. 2002). Most patients will experience pain relief in the first two to four weeks after radiotherapy, be it single or multiple fractionations.

How, then, are radiation oncologists to prescribe treatment? Despite the equivalence of single and multiple fractionations, recent surveys on the patterns of practice of radiation oncologists do not suggest the implementation of employing single fractionation in daily practice (Ben-Josef et al. 1998; Chow et al. 2000; Roos 2000).

There is no doubt that in patients with short life expectancy, protracted schedules are a burden. However, in patients with a longer expected survival, such as breast and prostate cancer patients with bone metastases only, other parameters need to be taken into account. Since re-treatment rates are known to be higher following a single versus multiple fractions, about 25% versus 10% respectively, patients with good performance status may wish to share the decision-making process. A recent survey of patients with bone metastases suggested that patients are not prepared to trade off long-term outcomes in favor of a shorter treatment course. Durability of pain relief was more important than short-term “convenience” factors. Patients prefer multiple treatments upfront in hopes of avoiding re-treatment (Barton et al. 2001). However, they need to be aware of the potential physician bias of more readiness to retreat after single fraction, accounting for the difference in re-treatment rates in the trials.

The anatomic location to be treated may also influence the radiation schedule that is used. Smaller daily doses of radiation [250–300 cGy] are generally better tolerated when larger treatment fields are needed over mucosal surfaces like those in the head and neck region, esophagus, abdomen and pelvis.

### Re-Irradiation

As effective systemic treatment and better supportive care result in improved survival, certain subsets of patients with bone metastases have longer life expectancies than before. An increasing number of patients outlive the duration of the benefits of initial palliative radiotherapy for symptomatic bone metastases, requiring re-irradiation of the previously treated sites. Additionally, some patients fail to respond initially but may benefit from re-irradiation.

Among the radiation trials comparing single versus multiple fractionation schemes, re-irradiation rates varied from 11–42% following single fraction, and 0–24% following multiple-fraction schedules. There are at least three scenarios of “failure” where re-irradiation may be considered. Response to re-irradiation may be different for each of these scenarios: 1) no pain relief or pain progression after initial radiotherapy; 2) partial response with initial radiotherapy and the hope to achieve



further pain reduction with more radiotherapy, and 3) partial or complete response with initial radiotherapy but subsequent recurrence of pain.

Available data support the re-irradiation of sites of metastatic bone pain following initial irradiation, particularly where this follows an initial period of response. There is also limited evidence that a proportion of non-responders would respond to re-irradiation. However, there remains a small group of patients who appear to be non-responsive to any amount of palliative radiotherapy. Although the data do support the clinical practice of re-irradiation, the preferred dose-fractionation at the time of re-irradiation is unknown.

#### Wide-Field/Half-Body External Beam Radiation (HBI)

Patients with bone metastases can have multiple sites of disease and present with diffuse symptoms affecting several sites. ► **Wide-field radiation**/half-body external beam radiation (HBI) has been used to treat patients with multiple painful bone metastases. Single fraction HBI has been shown to provide pain relief in 70–80% of patients. Pain relief is apparent within 24–48 h. Toxicities include minor bone marrow suppression and gastrointestinal side effects, such as nausea and vomiting in upper-abdominal radiation. Pulmonary toxicity is minimal provided the lung dose is limited to 6 Gy (corrected dose). Fractionated HBI was investigated in a phase II study that compared a single fraction ( $n = 14$ ) with fractionated HBI (25–30 Gy in a 9–10 fractions) ( $n = 15$ ). Pain relief was achieved in over 94% of patients. At 1 year, 70% in the fractionated and 15% in the single fraction group had pain control; re-treatment was required in 71% and 13% for the single and fractionated group, respectively. A randomized trial of 499 patients compared local radiation alone versus local radiation plus a single fraction of HBI. The study documented a lower incidence of new bone metastases (50% vs. 68%), and fewer patients requiring further local radiotherapy at 1 year after HBI (60% vs. 76%) (Poulter et al. 1992).

#### Systemic Radiation – Radioisotopes

An alternative approach to the palliation of multiple bone metastases is the administration of a bone seeking radioactive isotope that is taken up at sites of bone metastases with osteoblastic activity. The isotopes deliver the radiation dose through the release of beta particles; their range of radiation is only a few millimeters, thereby concentrating their dose within the bone metastases and delivering little dose to the adjacent normal bone marrow. The radiation half-life is about 50 days in the metastasis and only 14 days in the normal bone marrow. Some radioisotopes also have a gamma component, so that the uptake can be measured by conventional bone scan techniques.

Systemic radiation using radioisotopes such as strontium, samarium and rhenium has been increasingly used

to palliate bone pain and improve the quality of life in these patients. These agents are particularly useful among patients with multiple symptomatic metastases. As the radiation is localized to the metastases, radioisotopes can be used for re-irradiation when there are concerns about normal tissue tolerance to further external beam radiation. Also, improved outcomes and cost-effectiveness have been demonstrated when radioisotopes have been combined with external beam radiation. The Trans-Canada Study, comparing external beam radiation alone or in combination with Strontium-89 for bone metastases, demonstrated better pain relief and a reduced need for external beam radiation to other sites in the latter group (Porter et al. 1993). Convenience to the patient is the other key advantage, because radioisotope therapy is administered as a single injection. With normal bone marrow parameters, re-treatment with radioisotope therapy is also possible because the adjacent normal tissues do not receive any radiation dose.

A flare of pain, like that seen with hormonal therapy in breast cancer, may precede the relief of symptoms. It may take up to 1 to 2 months before there is relief of symptoms. Due to this, patients should have a life expectancy that allows the benefit of the relief of symptoms. Contraindications to bone-seeking radioisotopes include compromised bone marrow tolerance defined as a platelet count  $< 60,000/\text{mL}$ , white blood cell count  $< 2.5 \times 10^3/\text{mL}$ , disseminated intra-vascular coagulation, or myelo-suppressive chemotherapy within previous month. As bone-seeking radioisotopes do not penetrate to soft tissues, they are also contraindicated for treatment of soft tissue metastases or epidural extension with ► **spinal cord compression**. As with external beam radiation, an impending pathological fracture should be evaluated for surgical stabilization. Impending or established pathological fractures and cord compressions are acute emergencies to be managed by surgical or radiation oncology teams. Once the fracture or compression is stabilized, radioisotopes may be appropriate therapy for on-going palliation of pain.

#### Controlling Side Effects of Treatment

Radiation treatment planning is the most critical aspect of reducing radiation side effects. Management of the acute effects of radiotherapy requires attentive medical management that prevents expected side effect. Radiation side effects are specific to the area treated. No side effects are observed when a femoral bone metastasis is treated by radiation. Careful radiation treatment planning that avoids critical structures like mucosal surfaces can prevent most side effects.

Patients should be reassured that the unavoidable side effects that they experience will resolve following the completion of radiotherapy. Skin reactions are usually minimal during radiotherapy for bone metastases and

are limited only to the radiation portal. Nausea and vomiting, resulting from a radiation portal that includes the abdomen, will usually respond to antiemetic therapy. Diarrhea, resulting from abdominopelvic radiation, will also usually respond to treatment. Local irritation from mucositis of the oropharyngeal region may be relieved by soluble aspirin, analgesics or benzydamine mouthwashes. Secondary infections, like Candida, should be treated.

The side effects of electron beam radiation are more limited because they only treat superficial structures like the ribs, skin lesions, and superficial lymph nodes. Underlying structures are spared with the selection of the proper electron beam energy. This characteristic is especially important with re-irradiation to avoid injury to critical structures like the spinal cord. The most prominent side effect of electron beam radiation is an erythematous skin reaction and possible moist desquamation. Other side effects listed above do not occur with electron beam radiation because the radiation beam does not penetrate to these structures.

No side effects, other than a possible flare of pain in the first two weeks after administration, are observed with systemic radioisotope therapy because all the radiation is localized to the bone. This is a significant consideration for patients who have symptoms of the disease or other treatments. Side effects from external beam radiation are also more severe when the radiation fields are large because more normal tissues are treated. Systemic radioisotopes can have significant advantage over large external beam radiation fields by reducing the risk for side effects like nausea and diarrhea.

### Radiotherapy for Complications of Bone Metastases

#### Pathological and Impending Fractures

Pathological fractures are handled with orthopedic stabilization whenever possible. Surgery rapidly controls pain and returns the patient to mobility. As elective orthopedic stabilization has reportedly resulted in good pain relief and sustained mobility in up to 90% of patients, early identification of patients with a high risk of fracture is especially important. Prophylactic orthopedic fixation is often advised to avoid the trauma of a pathological fracture.

The criteria often used to determine fracture risk in long bones include:

- Persistent or increasing local pain despite radiotherapy, particularly when aggravated by functional loading
- A solitary, well-defined lytic lesion greater than 2.5 cm
- A solitary, well-defined lesion circumferentially involving more than 50% of the cortical bone
- Metastatic involvement of the proximal femur associated with a fracture of the lesser trochanter

Although radiotherapy provides pain relief and tumor control, it does not restore bone stability. Postoperative radiotherapy is usually recommended after surgical stabilization of a pathologic fracture. Patients who are without visceral metastases and who have a relatively long expected survival (e.g. > 3 months), are more likely to benefit from post-op radiotherapy. As the entire bone is at risk for microscopic involvement and the procedure involved in rod placement may seed the bone at other sites, the length of the entire rod used for bone stabilization should be included in the radiation field. When the radiation fields are more limited, instability of the rod, resulting in pain and need for re-operation, can result from recurrent osteolytic metastases outside the radiation portal.

#### Spinal Cord Compression and Cauda Equina Compression

Malignant spinal cord and cauda equina compression is a devastating compression of advanced malignancy. Early diagnosis is essential. Presenting symptoms include radicular pain, paresis, paralysis, paresthesia and bowel/bladder dysfunction. Surgery, radiation and steroids are the standard treatment options in this condition (Loblaw et al., Group at CCOPGIN-ODS 2003). Radiotherapy results in pain relief in over 75% of patients.

Radiotherapy is indicated in patients without spinal instability or bone compression, when surgery is medically hazardous or technically difficult, and in patients who refuse surgery.

Pre-existing co-morbidity, pre-treatment ambulatory status, the presence of bone compression and spinal instability, and patient preferences should be considered in clinical decision making.

The outcome of treatment depends mostly on the speed of diagnosis and neurological status at initiation of treatment. Over seventy percent of patients are still ambulatory following radiation if they are ambulatory on presentation. However, for those who are paralyzed when they present for treatment, less than 30% will regain neurologic function.

#### Conclusion

Many forms of radiation therapy are possible in the treatment of bone metastases. Meeting the goal of palliative care, suffering can be effectively and efficiently relieved with the use of radiation. Ongoing trials continue to refine therapeutic approaches to determine the optimal radiation schedule and modalities used. Treatment-related side effects can be minimized through the use of radiation treatment planning, and anticipating and preventing known side effects.

Compared to other approaches, like systemic chemotherapy, hormonal therapy and bisphosphonates, that administer treatment on an ongoing basis, all forms of radiation therapy are completed within a day to several

weeks with durable control of symptoms. Cost-benefit analyses demonstrate the benefit of radiation over other forms of therapy for bone metastases. Furthermore, there is no evidence to support a survival benefit for the administration of systemic chemotherapy, hormonal therapy or bisphosphonates in metastatic disease. Considering quality of life issues of time spent under therapy, toxicities of therapy and socioeconomic cost, radiotherapy continues to be under-utilized in the treatment of bone metastases.

## References

1. Barton MB, Dawson R, Jacob S et al. (2001) Palliative Radiotherapy of Bone Metastases: An Evaluation of Outcome Measures. *J Eval Clin Pract* 7:47–64
2. Ben-Josef E, Shamsa F, Williams A et al. (1998) Radiotherapeutic Management of Osseous Metastases: A Survey of Current Patterns of Care. *Int J Radiat Oncol Phys* 40:915–921
3. Blitzer P (1985) Reanalysis of the RTOG Study of the Palliation of Symptomatic Osseous Metastases. *Cancer* 55:1468–1472
4. Bone Pain Trial Working Party (1999) 8 Gy Single Fraction Radiotherapy for the Treatment of Metastatic Skeletal Pain: Randomized Comparison with Multi-Fraction Schedule over 12 Months of Patient Follow-Up. *Radiother Oncol* 52:111–121
5. Chow E, Danjoux C, Wong R et al. (2000) Palliation of Bone Metastases: A Survey of Patterns of Practice among Canadian Radiation Oncologists. *Radiother Oncol* 56:305–314
6. Chow E, Wu JS, Hoskin P et al. (2002) International Consensus on Palliative Radiotherapy Endpoints for Future Clinical Trials in Bone Metastases. *Radiother Oncol* 64:275–280
7. Hoskin PJ, Stratford MRL, Folkes LK et al. (2000) Effect of Local Radiotherapy for Bone Pain on Urinary Markers of Osteoclast Activity. *The Lancet* 355:1428–1429
8. Loblaw DA, Laperriere NJ, Chambers A et al., Group at CCOPGIN-ODS (2003) Diagnosis and Management of Malignant Epidural Spinal Cord Compression (Evidence Summary Report No. 9-9). *Cancer Care Ontario*; <http://www.ccopebc.ca/neucpg.html>. Accessed: April 4, 2003
9. Porter A, McEwan A, Powe J (1993) Results of a Randomized Phase III Trial to Evaluate the Efficacy of Strontium-89 Adjuvant to Local Field External Beam Irradiation in the Management of Endocrine Resistant Metastatic Prostate Cancer. *Int J Radiat Oncol Biol Phys* 25:805–813
10. Poulter C, Cosmatos D, Rubin P et al. (1992) A Report of RTOG 8206: A Phase III Study of Whether the Addition of Single Dose Hemibody Irradiation to Standard Fractionated Local Field Irradiation is More Effective than Local Field Irradiation Alone in the Treatment of Symptomatic Osseous Metastases. *Int J Radiat Oncol Biol Phys* 23:207–214
11. Ratanatharathorn V, Powers W, Moss W et al. (1999) Bone Metastasis: Review and Critical Analysis of Random Allocation Trials of Local Field Treatment. *Int J Radiat Oncol Biol Phys* 44:1–18
12. Roos D (2000) Continuing Reluctance to use Single Fractions of Radiotherapy for Metastatic Bone Pain: An Australian and New Zealand Practice Survey and Literature Review. *Radiother Oncol* 56:315–322
13. Steenland E, Leer J, van Houwelingen H et al. (1999) The Effect of a Single Fraction Compared to Multiple Fractions on Painful Bone Metastases: A Global Analysis of the Dutch Bone Metastasis Study. *Radiother Oncol* 52:101–109
14. Tong D, Gillick L, Hendrickson F (1982) The Palliation of Symptomatic Osseous Metastases: Final Results of the Study by the Radiation Therapy Oncology Group. *Cancer* 50:893–899
15. Wu J, Wong R, Johnston M, Bezjak A, Whelan T (2002) Meta-Analysis of Dose-Fractionation Radiotherapy Trials for the Palliation of Painful Bone Metastases. *Int J Radiat Oncol Biol Phys* 55:594–605

## Cancer Pain Management, Rehabilitative Therapies

ANDREA CHEVILLE

Department of Rehabilitation Medicine, University of Pennsylvania School of Medicine, Philadelphia, PA, USA

acheville@aol.com

C

### Definition

The potential role of rehabilitation in pain management is often overlooked. Rehabilitative techniques include modalities that can directly influence pain (e.g. topical cold and desensitization techniques), and interventions that preserve and restore function. The latter are the focus of this essay.

### Characteristics

#### Rehabilitative Goal Setting in Pain Management

As with any clinical intervention, the therapeutic goals of rehabilitation must be established prior to the initiation of therapy to facilitate reassessment at future time points. Dietz developed a structured approach to goal setting in cancer rehabilitation that is extremely useful and applicable in pain management (Dietz 1985). He identified four broad categories of rehabilitation goals that can be used to define the purpose of interventions and to guide their strategic integration for optimal results. As outlined in Table 1, these include: 1) preventative rehabilitation that attempts to preclude or mitigate functional morbidity resulting from pain, the pathophysiological process driving it, or its treatment; 2) restorative rehabilitation that describes the effort to restore the patient to a pre-morbid level of function when little or no long-term impairment is anticipated; 3) supportive rehabilitation that attempts to maximize function when long-term impairment, disability, and handicap result from the pain, its source, or its treatment; and 4) palliative rehabilitation, which decreases dependency in mobility and self-care in association with the provision of comfort and emotional support. Many interventions (e.g. resistive and aerobic exercise) may fall into more than one category, depending on the motivation for their use. For example, resistive exercise can be used preventatively to avoid deconditioning, restoratively to reverse it, and supportively to minimize it. The specifics of the therapeutic prescription and anticipated duration of therapy may vary widely, contingent on goal definition.

The effort to precisely define how these four general types of goals may apply to each patient is critical for a number of reasons. It ensures that potentially beneficial therapies will not be overlooked. It clarifies for both the clinician and the patient the purpose for which therapies are prescribed. This allows objective future assessment of whether a therapy has been successful. If therapeutic goals have not been met after an

**Cancer Pain Management, Rehabilitative Therapies, Table 1** Examples of goals and interventions that can be classified within the general therapeutic categories of preventive, restorative, supportive, and palliative rehabilitation

Preventative Rehabilitation	The effort to restore the patient to a pre-morbid level of function when little or no long-term impairment is anticipated.	
	Goal	Possible Intervention
	Avoid development of secondary pain generators	Normalize motor recruitment patterns
	Minimize adverse effects of immobility	
	a.) deconditioning	aerobic & resistive exercise
	b.) contractures	stretching, positioning
Restorative Rehabilitation	The effort to restore the patient to a pre-morbid level of function when little or no long-term impairment is anticipated.	
	Goal	Possible Intervention
	Eliminate musculoskeletal pain generators	Myofascial release techniques
	Restore power postoperatively to compromised muscle groups	Progressive resistive exercises
	c.) osteopenia	strategic loading of axial and appendicular structures
	Correct maladaptive biomechanical patterns	posture & gait modification
Supportive Rehabilitation	The attempt to maximize function when long-term impairment, disability, and handicap are anticipated.	
	Goal	Possible Intervention
	Optimize mobility status	Provide patient with can, walker, etc.
	Optimize ADL independence	Instruction in compensatory strategies
Palliative Rehabilitation	The effort to decrease dependency in mobility and self-care in association with the provision of comfort and support.	
	Goal	Possible Intervention
	Reduce dependency in toileting and grooming	Provide appropriate ADL assistive devices
	Preserve community integration	Prescription of wheelchair or scooter

adequate trial, the rationale for discontinuation can be made evident to the patient. Definition of goals is also useful in justifying therapy to third party payers, and in anticipating the duration of therapy. The profound heterogeneity of presentation encountered in pain management confounds a rigidly algorithmic approach to the prescription of rehabilitative therapies. The four broad categories of clinical goals offer practitioners a flexible structure in which to develop a comprehensive and integrated therapeutic plan for functional preservation.

#### Rehabilitation, the Musculoskeletal System, and Pain

The musculoskeletal system is the primary focus of virtually all pain-oriented rehabilitation approaches. Dysfunction in the musculoskeletal system can: 1) produce a primary pain generator; 2) function as a primary pain generator; 3) produce secondary pain generators; 4) function as secondary pain generators; or 5) have no role in the pain syndrome, but undermine patients'

functional status. Examples of the first four situations are given in Table 2. It is important to note that many musculoskeletal structures (e.g. the rotator cuff) can function in each of these categories. Rehabilitation is based on the fact that muscles, fascia, and bones respond to external forces that can be manipulated with therapeutic intent. For example, muscles can be stretched, strengthened, aerobically conditioned, or rendered more proprioceptively responsive, depending on the therapeutic demands to which they are subjected. The correct choice of type, location and intensity of pressure(s) requires accurate identification, not only of the involved anatomy and pathophysiological processes, but determination of precisely how these may be contributing to a patient's global pain experience and functional decline. It is critical that permissive factors (e.g. laxity, contractures, biomechanical malalignment) be identified and definitively addressed in order to prevent recurrence of the primary and development of secondary pain generators.



**Cancer Pain Management, Rehabilitative Therapies, Table 2** Examples of musculoskeletal structures functioning as: 1) primary pain generators; 2) contributors to primary pain generator; 3) secondary pain generators; and 4) contributors to secondary pain generators Effects of Inactivity

Primary pain generator	Contributor to primary pain generator	Secondary pain generator	Contributor to secondary pain generator
Structures that become painful due to trauma, overuse, or inflammation	Permissive factors (e.g. muscle weakness or tightness, or dysfunctional biomechanics) that impose stress on the primary pain generator.	Structures that become painful due to spasm, overuse or inflammation related to the primary pain generator	Permissive biomechanical factors that arise consequent to the primary pain generator
Rotator cuff tendonitis	Weakness of scapular stabilizers	Trapezius myofascial pain	Premature upper trapezius recruitment
Osteoarthritis of the hip joint	Flexibility deficits of hip muscles	Greater trochanteric bursitis	Iliotibial band tightness
Myofascial pain of scapular retractors	Pectoralis muscle tightness	Rotator cuff tendonitis	Altered scapular biomechanics
Discogenic lumbar nerve root compression	Weakness of the abdominal muscles	Lumbar paraspinal muscle spasm	Lumbar hyperextension to reduce pain

C

Pain, particularly if associated with movement, engenders inactivity. The many adverse consequences of inactivity have been well documented. They include: reduced cardiovascular endurance, diminished muscle strength and stamina, osteopenia with reduced fracture threshold, reduced peri-articular distensibility, articular cartilage degeneration, compromise of neural patterns required for coordinated activity, reduced plasma volume, diminished proprioceptive acuity, and chemical alterations in connective tissue (e.g. ligaments, tendons) causing failure with reduced loading. Studies characterizing these physiological parameters have found that the rate of loss far exceeds the rate of recovery once therapeutic activity has been initiated (Saltin et al. 1968; Noyes et al. 1974; Beckman and Buchanan 1995). Some changes, particularly those in articular cartilage, may be irreversible. As inactivity has such profound and widespread adverse effects, and because its consequences may be slow and difficult to reverse, it is essential that patients preserve their activity levels within the limits imposed by their pain. The prescription of preventative rehabilitation strategies can greatly facilitate this goal.

### Scope of Rehabilitation

Rehabilitative interventions encompass a broad and highly varied collection of therapies. Most can be used with supportive, restorative, preventive, or palliative intent. The overarching goal of rehabilitation is functional restoration and preservation. However, many approaches can be used to definitively address pain generators, as with manual techniques for myofascial pain. Interventions can be grouped into the following categories: modalities, manual approaches, therapeutic exercise, provision of assistive devices, education in compensatory strategies, and orthotics.

### Modalities

Although few blinded, prospective, randomized clinical trials have been conducted to establish the efficacy of most modalities, their routine integration into rehabilitative programs is the current standard of care. A review of the few randomized controlled trials and the many observational studies (Philadelphia Panel 2001) found evidence in support of a small, transient treatment effect from the application of heat. The delivery of therapeutic heat is often characterized by depth of penetration (superficial and deep), or mechanism of transmission (conduction, convection, radiation, evaporation, and conversion). Superficial heat increases the temperature in skin and subcutaneous fat to a depth of approximately 1 cm. Superficial modalities include hot packs, heating pads, fluidotherapy, and paraffin baths. Deep heating modalities increase temperature at a depth of approximately 3.5–7.0 cm and can, therefore, influence muscles, tendons, ligaments, and bones, while sparing the skin and subcutaneous fat. Although ultrasound is the most commonly used deep heating modality, reviews offer little support of its efficacy, and its clinical utility remains a subject of debate (Baker et al. 2001; Robertson and Baker 2001).

Cryotherapy is a second modality used in the treatment of cancer pain (Lehmann 1990). The majority of cryotherapeutic modalities use superficial conduction. Cold packs come in the form of ice packs, hydrocollator packs, and endothermic packs that rely on chemical reactions to lower temperature. Ice massage is the application of ice directly to the skin's surface. The phases of reaction are coolness, aching, hypesthesia, and analgesia. Cold (5–13°C) water immersion is a convection modality and vapocoolant sprays rely on evaporative cooling. Medical contraindications to cold therapy include, but are not limited to, arterial insufficiency, Raynaud's phenomenon, cryoglobulinemia, cold



hypersensitivity, and paroxysmal cold hemoglobinuria.

Hydrotherapy involves the external application of water of any temperature to achieve therapeutic goals. Hydrotherapeutic modalities are often used for wound or skin debridement and cleansing, as well as in the supportive and palliative care of pain related to arthritis, chronic inflammatory states, and myofascial syndromes.

Traction, the use of strategic displacing force to stretch soft tissue and separate articular surfaces, has been used for nonmalignant conditions, particularly those associated with nerve root impingement. Despite decades of research regarding the clinical benefits of spinal traction, there is no consensus regarding its utility. Primary malignancies of bone or spinal cord, osteomyelitis or discitis, unstable spinal fractures, end-stage osteoporosis, central disc herniations, carotid or vertebral artery disease, rheumatoid arthritis (cervical), and pregnancy (lumbar) are absolute contraindications to the use of traction.

Functional electrical stimulation (FES) applies electrical stimulation via pad electrodes to depolarize motor nerves, at either the axon or neuromuscular junction. It has been used in patients with potentially painful conditions such as spinal cord injury (SCI), peripheral nerve injury, spasticity, and cardiopulmonary deconditioning. It has not been used in the management of cancer pain. Transcutaneous electrical nerve stimulation (TENS) influences pain by stimulating large diameter, myelinated A $\beta$  nerve fibers. There is a large clinical experience suggesting that a subgroup does benefit. Multiple electrode and stimulation configurations must be tested to ensure an adequate trial. Studies of the technique have yielded inconsistent results (Fargas-Babjak 2001). For theoretical reasons, patients are cautioned against stimulating directly over tumors.

Iontophoresis allows charged molecules to penetrate cell membranes and enter tissue through the application of an electric field. Negative, positive and ground electrodes are secured to the patient, and a 10–30 m current is used to transfer medication from the electrode into the surrounding tissues. This modality creates the potential for medication delivery in the treatment of spasticity, chronic inflammatory states, and myofascial pain syndromes. There is no experience in the use of this approach in medically ill patients.

Phonophoresis also facilitates the transdermal delivery of topical medications, but uses ultrasound to facilitate medication delivery. The technique has been used to treat soft tissue inflammation. Again, there is no experience in the cancer pain population.

### Manual Therapies

Manual therapies refer to a vast array of hands on techniques designed to normalize soft tissue and joint mobility. Types of manual therapies include everything from massage to myofascial release, acupressure and

joint range of motion. Common manual techniques include:

- Massage
- Myofascial release
- Soft tissue mobilization
- Manual lymphatic drainage
- Acupressure
- Shiatsu
- Roling
- Reflexology
- Craniosacral therapy
- Osteopathic manipulation
- Joint mobilization
- Muscle energy techniques
- Passive range of motion

The benefits of manual approaches are generally short-lived if patients do not comply with a concurrent stretching, strengthening, and conditioning regimen. Physical therapists, osteopathic physicians, massage therapists, acupuncturists, as well as a host of complementary and alternative practitioners, use manual techniques for pain control.

When chronic pain affects the musculoskeletal system, a pain-spasm cycle begins. Nociception causes reflexive muscle contraction, which in turn increases nociception, and the cycle is set in motion leading ultimately to painful, chronic muscle hypertonicity. This results in muscle weakness, joint contractures, aberrant biomechanics, and dysfunctional kinesthetic patterns. As patients attempt to perform normal daily activities, the compromised system becomes overused, exacerbating the pain cycle and producing secondary pain generators. By normalizing joint and soft tissue physiology, manual techniques can be used to break this pain cycle and reestablish function biomechanics. Ideally, patient referral for manual techniques should not be delayed until the pain-muscle spasm cycle is well established.

Massage focuses on decreasing pain through increased circulation and mechanical movement of tissues. Techniques vary in the variety of hand strokes, applied pressure, and direction of force. Many beneficial physiological effects have been associated with massage (Field 2002). In addition to its use in pain management, it has been adapted to the treatment of lymphedema and contractures.

Myofascial release is a technique that purportedly facilitates normal movement within the fascial system. Fascia is the connective tissue that provides support throughout the body, and fascia that is injured or contracted could contribute to pain. Practitioners use vigorous “hands on” compression and stretching techniques to alter the mobility of affected tissues.

Several manual techniques are used to affect joint physiology and normalize accessory movement. The most basic technique is passive range of motion (PROM).

A practitioner using PROM will move a joint through its physiologic range of motion in an effort to maintain and/or restore motion. In addition, PROM also stretches the soft tissues surrounding a joint and normalizes accessory movements in a joint. By restoring normal joint mechanics on the accessory level, normal physiologic motion can follow. There are five grades of joint mobilization based on the amplitude of movement through the full range of accessory movement. Grades I and II provide the smallest amount of movement. These techniques are used to prevent contractures and pain relief. Grades III and IV provide increased pressure within the joint's range of normal motion. These techniques can help to promote normal physiologic motion as well as providing pain relief. Grade V joint mobilization is known as a "manipulation." Grade V manipulations are performed at high velocity and intensity to the end of the accessory range of motion. Physical therapists, osteopathic physicians and chiropractors use joint mobilization. In most cases, only chiropractors use manipulations.

Muscle energy techniques (MET) are used to restore normal joint and soft tissue movement through patients' own force. METs are based on the theory of joint mobilization to facilitate movement, but recruit patients' own muscular force. The practitioner places the patient in a specific position, the patient is asked to push against the practitioner's counterforce in order to facilitate movement in joints and soft tissues.

Acupressure involves the strategic application of pressure to trigger points and derives from the theories of acupuncture. The use of pressure to relieve trigger points has been incorporated into many soft tissue techniques.

### Therapeutic Exercise

The strategic use of exercise to enhance strength, coordination, stamina, and flexibility is perhaps the most powerful intervention in rehabilitation medicine. The fact that muscles and fascia respond predictably to imposed external demands underlies this therapeutic approach. Muscle changes that can be achieved through therapeutic exercise include: increased capillary density, enhanced neuromuscular responsiveness, normalization of muscle length-tension relationships, altered resting tone, and increased elaboration of mitochondrial and sarcoplasmic proteins (de Lateur 1996).

For optimal benefit, the type, intensity, and frequency of exercise must be rationally chosen following a comprehensive clinical examination. The exercise prescription will be determined by the presence, severity, and distribution of flexibility and strength deficits, the degree of deconditioning, and the presence abnormal segmental biomechanics. An exercise program combining stretching, aerobic conditioning, and strengthening should be tailored to each patient's unique requirements.

Patients may protest that the intensity of their pain precludes participation in an exercise program. Even

minimal resistive exercises, however, can lead to significant improvements in strength and functional status. Brief isometric muscle contractions can be performed in bed or in a chair against gravity or with gravity eliminated. One brief isometric contraction per day was demonstrated to prevent loss of strength in bed-ridden rheumatoid arthritis patients (Atha 1981).

Stretching, or flexibility activities, can influence muscles by altering their length-tension relationships and resting tone. Stretching is an integral part of the treatment of myofascial pain (Travell and Simons 1983) and pain associated with muscle spasms. It is commonly used to achieve adequate range of motion for performance of daily activities. Flexibility assessment must consider patients' overall level of muscle tightness, their required range of motion given their activity profile, and the impact of contracture-related asymmetry on movement patterns. Two stretching techniques predominate in rehabilitation medicine: ballistic and static. Ballistic stretching involves repetitious bouncing movements at the end-range of joint range. Static stretching, in contrast, involves slow, steady soft tissue distension, which is maintained for several seconds. Comparisons suggest that static is superior to ballistic stretching, and that meaningful benefit can be achieved through three to five sessions per week (Sady et al. 1982). Pain patients require a slowly progressive approach to static stretching. Ballistic stretching is indicated only in unusual cases and should be performed under the care of a physical medicine and rehabilitation specialist.

Resistive exercise is used to strengthen selected muscles or muscle groups by forcing them to contract repeatedly against resistance. Resistive training can be utilized with restorative, supportive and/or preventative intent. Goals must consider patients' current level of conditioning, the prognosis for their pain and related medical comorbidities, their past fitness histories, and the rigor of their anticipated activity profile (e.g. vocational, avocational). To induce strength gains, an intensity of at least 60% of the one-repetition maximum must be used. Table 3 outlines common parameters utilized in prescribing resistive exercise for generalized or focal weakness.

Aerobic conditioning differs from resistive exercise in its emphasis on continuous rhythmic contraction of large muscle groups. Jogging and cycling are common examples. Aerobic training allows patients to perform daily activities with less effort, maintain greater independence, and enjoy an enhanced sense of well-being (NIH Consensus Developments Panel on Physical Activity and Cardiovascular Health 1996). If the medical condition permits, regular physical activity may improve the ability to perform physical activities and attenuate the psychological morbidity associated with chronic pain. A prescription for exercise should consider baseline fitness levels, associated motor impairments and comorbidities, and patient tolerance. For deconditioned patients with chronic pain, the initial aerobic training

**Cancer Pain Management, Rehabilitative Therapies, Table 3** Considerations in prescription of therapeutic resistive exercise

Exercise Parameter	Considerations and Recommendations
Choice of exercise	Exercises strength deficient muscle groups in multiple planes and across a range of length-tension relationships
Order of exercise	Begin with large muscle group exercises. For circuit training start with legs
Number of sets	Begin with one set and progress to three or more sets of each exercise
Rest between sets	3 min for heavy resistance, 2–3 for moderate resistance, 1–2 light resistance
Intensity	60% one repetition maximum, 6–15 repetitions
Rate of progression	Increase 2.5–5% when level of resistance is perceived as “moderate”
Program variation	Variations in intensity, positioning, order of exercises, choice of exercise should be adopted weekly to avoid overtraining
Speed specificity	Intermediate velocity unless training goals involve rapid or slow velocity activities
Contraction specificity	Isotonic training unless joint pain is prohibitive, then initiate training with isometric activities. Isometrics can be used to prevent loss of strength.
Joint angle specificity	Loading should be maintained throughout entire functional range.

may entail walking slowly for 5–10 min. Exercise can also be used to enhance coordination, posture, proprioception, balance, and the performance of integrated movement patterns. Much of the literature establishing the value of exercise for these applications derives from sports and performing arts medicine. Techniques to improve proprioception include use of a tilt or wobble board, sideways walking or running, and agility drills. Balance enhancing activities include tossing and catching a ball while standing on heels, toes, or one leg. Therapy balls can be utilized to address deficits in truncal stability. Generally, patients sit on the ball while shifting their weight in different directions or lifting their legs. There are many variations on balance activities. Their selection should consider the patients' deficits and desired activity profile. The adage that the best training for an activity is the activity itself also holds true for coordination training.

### Orthotics

Orthotics are braces designed to alter articular mechanics when their integrity has been compromised by pain, weak muscles, impaired sensation, or other anatomical disruption. Orthotics may be used therapeutically to provide support, restore normal alignment, protect vulnerable structures, address soft-tissue contractures, substitute for weak muscles, or maintain joints in positions of least pain. Many orthotics are available pre-fabricated, “off-the-shelf.” While such braces often suffice, patients may require more expensive custom orthoses for optimal benefit. Orthotics can be used to address pathology in virtually any articular structure. The use of these devices for pain patients must be tempered by concern for engendering long-term dependency and validating patients' impairments. Orthotics are most often used in pain management on a transient basis, to keep joints in a fixed

position, to allow resolution of local inflammation, or to rest painful muscles and/or tendons that act on the joint. They also can be used preventatively, when joints or osseous structures are at risk of injury or contracture, and patients are incapable, despite resistive exercise and proprioceptive enhancement, of protecting them. Such circumstances often arise in the context of systemic illness. For example, spinal extension orthoses such as the Jewett or Cash brace limit spinal flexion, and thereby prevent excessive loading and compression fracture of the anterior vertebral bodies. Palliative splinting is used to optimize comfort when function is no longer a primary concern. An excellent example is the use of slings to keep flaccid upper extremities tethered near the body and out of harm's way. Referral to an orthotist or physical medicine and rehabilitation specialist will ensure that patients receive appropriate orthoses. However, many of these professionals lack experience with pain patients. It is important to communicate the goals of treatment and the precise reason(s) why the orthotic is being prescribed to the rehabilitation professional. In this way, patients have the best chance of receiving an orthotist suited to their unique requirements.

Many patients with chronic pain, particularly pain related to chronic medical illness, require adaptive devices to enhance their safety, comfort and autonomy while moving about the home or community. Ready access to such devices is essential if pain patients are to remain socially integrated within their communities. Adaptive equipment designed to augment mobility ranges from prefabricated single-point canes to complex motorized wheelchair systems. Hand-held assistive devices are generally variations on canes, crutches and walkers. Devices can be customized to distribute weight bearing onto intact structures to minimize the pain. Patients with severe deconditioning, paresis, osseous instabil-

ity, or other sources of impaired mobility may require a wheelchair or scooter. Even when deficits are presumed transient, a wheelchair can sustain community integration and fragile social connections. Wheelchair tolerance and utilization depend on the prescription of an appropriate model.

Assistive devices have also been developed to maximize patients' independence and reduce pain during performance of activities of daily living (ADLs). Dependence for self-care has been shown to erode quality of life across many medical diagnoses. Devices are available to assist patients with independent dressing, grooming, toileting, as well as performance of more complex activities such as cooking and housekeeping.

### Conclusion

Clinicians must become discriminating consumers of rehabilitation services if they are to optimally benefit their patients. This need arises from the fact that the delivery of rehabilitation services occurs within a socioeconomic context that imposes fiscal pressures upon its providers. It is essential that clinicians question patients regarding the particulars of their treatment and relay any concerns to the treating therapist. Including specific requirements on the therapy prescription can also help to ensure that patients receive appropriate care. Clinicians must recognize that rehabilitation professionals vary widely in their levels of experience, biomechanical acumen, interpersonal skill, and mastery of manual techniques. Ideally, clinicians should refer patients to therapists with whom they are familiar and can readily enter into clinical dialogue. Most therapists welcome guidance from physicians and nurses and are highly motivated to cultivate the skills required to optimally serve pain patients.

### References

1. Atha J (1981) Strengthening Muscle. *Exerc Sport Sci Rev* 9:1–73
2. Baker K, Robertson V, Duck F (2001) A Review of Therapeutic Ultrasound: Biophysical Effects. *Phys Ther* 81:1351–1358
3. Beckman S, Buchanan T (1995) Ankle Inversion Injury and Hypermobility: Effect on Hip and Ankle Muscle Electromyography Onset Latency. *Arch Phys Med Rehabil* 76:1138–1143
4. de Lateur BJ (1996) Therapeutic Exercise, pp 401–419
5. Dietz JJ (1985) Rehabilitation of the Patient with Cancer. In: Calabresi P, Schein PS, Rosenberg SA (eds) *Medical oncology*. Macmillan Publishing, New York, pp 1501–1522
6. Fargas-Babjak A (2001) Acupuncture, Transcutaneous Electrical Nerve Stimulation, and Laser Therapy in Chronic Pain. *Clin J Pain* 17:105–113
7. Field T (2002) Massage Therapy. *Med Clin North Am* 86:163–171
8. Lehmann JF (1990) *Therapeutic Heat and Cold*. Williams & Wilkins, Baltimore
9. NIH Consensus Developments Panel on Physical Activity and Cardiovascular Health (1996) *Physical Activity and Cardiovascular Health*. *JAMA* 276:241–246
10. Noyes FR, Torvik PJ, Hyde WB et al. (1974) Biomechanics of Ligament Failure II. An Analysis of Immobilization, Exercise, and Reconditioning Effects in Primates. *J Bone Joint Surg* 56:1406–1418
11. Philadelphia Panel (2001) Philadelphia Panel Evidence-Based Clinical Practice Guidelines on Selected Rehabilitation for Knee Pain. *Phys Ther* 81:1675–1700
12. Robertson V, Baker K (2001) A Review of Therapeutic Ultrasound: Effectiveness Studies. *Phys Ther* 81:1339–1350
13. Sady S, Wortman M, Blanke D (1982) Flexibility Training: Ballistic, Static or Propriospic Neuromuscular Facilitation? *Arch Phys Med Rehabil* 63:261–263
14. Saltin B, Blomqvist G, Mitchell JH et al. (1968) Response to Exercise after Bed Rest and after Training: A Longitudinal Study of Adaptive Changes in Oxygen Transport and Body Composition. *Circulation* 38:VIII–78
15. Travell J, Simons D (1983) *Myofascial Pain and Dysfunction. The Trigger Point Manual*. Williams and Wilkins, Baltimore

C

## Cancer Pain Management, Treatment of Neuropathic Components

PAUL W. WACNIK<sup>1</sup>, RICHARD L. BOORTZ-MARX<sup>2</sup>

<sup>1</sup>Department of Pharmacology, College of Medicine, University of Minnesota, Minneapolis, MN, USA

<sup>2</sup>Department of Neurosciences, Gundersen Lutheran Health Care System, La Crosse, WI, USA

paul.w.wacnik@medtronic.com,

rlboortz@gundluth.org

### Definitions

Pain due to pathological functioning of either the peripheral nervous system (PNS) or the central nervous system (CNS) is classified as neuropathic. These processes may directly stimulate the pain system or damage nociceptive pathways to shift the balance between painful and nonpainful inputs to the CNS (Merskey and Bogduk 1994). Neurological symptoms of ► **neuropathic pain** in cancer include continuous, burning, itching, aching and cramping or pain evoked by mechanical or thermal stimuli. Such symptoms can be accounted for by an intact, normally functioning nervous system sensing a noxious stimulus (in this case a ► **tumor**) manifesting as ► **somatic pain** or by a component of the nervous system damaged by the impact of previous antineoplastic therapies, such as surgery, chemotherapeutic agents or radiation oncology or by progression of the disease (Portnoy 1991). Distinguishing between the two etiologies is often problematic.

### Characteristics

Pain is but one symptom of many experienced with cancer. However, if uncontrolled, the pain can profoundly compromise quality of life and may interfere with anti-neoplastic treatment (Portnoy and Lesage 1999). Pain in cancer can be either constant or variable in character, owing to the inevitability that cancer will involve tumor growth and progression, changes in the tissue surrounding the tumor and therapeutic interventions intended to control tumor growth. Although no overall “cure” exists for most cancers, advances in anti-neoplastic therapies have allowed patients to live longer with their disease,



making long-term ► **cancer pain** therapy a consideration of increasing importance. The incidence of cancer pain is high in patients with advanced disease as well as in patients undergoing active treatment for solid tumors (30–50% Portenoy and Lesage 1999). The intensity of this pain is often overwhelming. In a multi-site cancer pain study, two-thirds of patients rated their worst pain, using an 11 point numerical rating scale during a given day, at 7 out of a maximum 10, with an average pain level of 4.7 throughout the day, even though 91% of these patients were receiving opioid analgesics (Caraceni and Portenoy 1999). This observation demonstrates that most patients, even those receiving analgesic therapy, live with moderate to severe daily pain. One complication in understanding and treating cancer pain is its variable and complex nature (see Table 1). More than 25% of patients have nerve injury that occurs in tandem with damage to other structures and the pain has a mixed pathophysiology with more than one type of pain, most frequently somatic-nociceptive pain. ► **Nociceptive pain** involves direct ongoing activation of intact nociceptors (pain sensitive neurons) in either somatic or visceral tissue. In essence, this is the intact, normally functioning nervous system sensing a noxious stimulus (in this case a tumor). On the other hand, pain due to pathological function of either the peripheral or central nervous system is classified as neuropathic. In this case, the presence of cancer induces a phenotypic change in the pain sensing system, increasing sensitivity of nerves to normally innocuous stimuli or exaggerating the response to noxious stimuli.

The findings of Boortz-Marx's group in 2004 were similar with 15% of cancer patients having neuropathic pain, 25% showing somatic-nociceptive pain and 60% showing mixed pain characteristics. This outcome underscores the complexity of the alterations in pain

sensing systems in cancer. Although pain due to the neoplasm is the focus of much investigation and treatment, there are considerable instances of pain observed in cancer patients related to noxious interventions, including pain associated with diagnostic interventions, therapeutic interventions, lumbar puncture, analgesic techniques, ► **chemotherapy** toxicity, hormonal therapy and radiotherapy as well as post-operative pain. The fact that cancer pain can evolve from one form to another with progression of the disease implies that analgesic treatment regimens must also evolve to match a changing etiology.

#### Diagnoses of Neuropathic Components of Cancer Pain

The diagnosis of neuropathic cancer pain is a clinical diagnosis. Based on the clinical presentation of the character and quality of pain, one is led to a provisional diagnosis of neuropathic cancer pain, which appropriately initiates therapeutic options, possibly including anti-neuropathic pharmacotherapy. Some types of neuropathic injury produce aching, stabbing or throbbing pain, but these syndromes often present with an unfamiliar quality or sensory distortion. Burning, shooting and tingling are suggestive of nerve involvement, but not sufficient to make the diagnosis. Accompanying abnormal sensations are often found on examination, including hypesthesia (increased threshold), hyperesthesia (decreased threshold), paresthesias (spontaneous non-painful threshold), dysesthesia (spontaneous pain threshold), hyperpathia (prolonged stimulus response) and allodynia (pain from a normally innocuous stimulus). The presence of changes in small fibers on biopsy of the skin or peripheral nerves may be a useful confirmation, but has proven largely unnecessary in several clinical studies.

#### Pharmacological Treatment of Neuropathic Components of Cancer Pain

Traditionally opioids have been utilized in the treatment of cancer pain. However, their efficacy for neuropathic pain states is controversial (McQuay 1999). The "mixed pain" state lends itself to effective treatment with opioids (several preparations of long- and short-acting opioids to be administered by different routes). These routes of administration include oral, submucosal, subcutaneous, transdermal, rectal, parenteral, epidural and intrathecal. Undesirable side effects of opioids (cognitive impairment, somnolence, constipation, fatigue, hallucinations and myoclonus) may present without adequate analgesia being achieved.

The adjuvant group of analgesics (pharmacotherapy designed for other purposes, but producing analgesia in certain circumstances) has proved to be effective in the treatment of neuropathic cancer pain. Traditionally, the tricyclic antidepressants (amitriptyline, nortriptyline, imipramine, desipramine and doxepin) have demonstrated efficacy in the treatment of neuropathic pain

**Cancer Pain Management, Treatment of Neuropathic Components, Table 1** A compilation of pain types due to cancer from a multi-site study (Adapted from Caraceni and Portenoy 1999)

Cancer pain pathophysiology	% Occurrence
Somatic nociceptive only	32.2
Somatic and neuropathic	23.3
Visceral nociceptive only	15.2
Somatic and visceral	10.8
Neuropathic only	7.7
Somatic, visceral, and neuropathic	5.2
Visceral and neuropathic	3.6
Unknown only	1.7
Other with psychogenic	1.5
Psychogenic only	0.3



states. The side effect profile of this group has led individuals not to consider these medications as first line therapy. The predominance of anticholinergic side effects (dry mouth, somnolence, cognitive impairment, cardiac arrhythmias, urinary retention and constipation) is often dose related, but can have advantages in patients afflicted with disrupted sleep architecture. Often doses needed for treatment of neuropathic pain states are much lower than those needed for the treatment of depression. Other antidepressants such as the serotonin selective reuptake inhibitors (SSRIs), atypical antidepressants and monoamine oxidase inhibitors (MAOIs) have not proven efficacious unless predominant depression accompanies the neuropathic pain state. Most recently, a selective norepinephrine reuptake inhibitor (SNRI) received approval for treatment of painful diabetic peripheral neuropathy. One of the authors (RB-M) has not experienced added benefit with this class of drugs in the treatment of painful neuropathic pain states related to cancer.

Several anticonvulsant medications constitute the mainstay in the treatment of most neuropathic pain states, including neuropathic pain accompanying cancer. The traditional anticonvulsants (phenytoin, carbamazepine and valproate) have fallen from favor because of their toxic side effects related to bone marrow suppression; this side effect is particularly unwelcome in a patient population that has already received a toxic impact from chemotherapeutic agents used in the treatment of their disease state. A newer class of anticonvulsants has recently evolved that employs varying modes of activity relating to voltage gated channels (alpha-2/delta subunit of voltage gated calcium channels and voltage gated sodium channels) and glutamate gated channels of the AMPA subtype. These agents include pregabalin and gabapentin, which target the calcium channels, topiramate, tiagabine, levetiracetam, lamotrigine, oxcarbazepine and zonisamide, which target the sodium channels and glutamate receptors. Drugs such as gabapentin have few drug-drug interactions, are well tolerated (starting at a low dose and escalating slowly) and have produced favorable outcomes.

Other adjuvant medications used or tested in the treatment of neuropathic cancer pain have included alpha-2 adrenergic agonists (tizanidine and clonidine) administered orally, epidurally or intrathecally, local anesthetics (lidocaine, mexiletine, bupivacaine, ropivacaine, tetracaine) administered perineurally (conductive block of major nerve trunks), parenterally, epidurally, intrathecally or orally, NMDA receptor antagonists (dextromethorphan and ketamine) administered orally or parenterally or (ketamine only) intrathecally, GABA agonists (e.g. baclofen) or facilitators (e.g. diazepam) administered orally or intrathecally, corticosteroids (prednisone and dexamethasone) administered parenterally or orally, topical agents (EMLA, gabapentin, morphine, lidocaine and capsaicin) and phenol or alco-

hol (chemical neurolysis in specific cases) administered around nerves or ganglia (Chong 1997; Eisenach 1995; Stubhaug 1997; Rowbotham 1994; Galer 1999; Watson 1988).

Most recently Boortz-Marx and colleagues published results of a multicenter study looking at the impact of intrathecal drug delivery on cancer pain (Smith et al. 2002). Mixtures of drugs including opioid agonists, local anesthetics and alpha-2 adrenergic agonists were applied as intrathecal preparations. Patients enrolled in this study reported reduced pain, reduced toxic side effects, improved quality of life and a trend toward extended life expectancy.

### Non-Pharmacological Treatment of Neuropathic Components of Cancer Pain

Non-pharmacological treatment options serve as a successful adjunct in the treatment of neuropathic cancer pain. The International Association for the Study of Pain (IASP) has characterized chronic pain as a “bio-psycho-social-spiritual” process. Chronic pain affects all patients at all stages of their cancer disease. Non-pharmacological strategies including patient psychoeducation, supportive psychotherapy and cognitive-behavioral interventions have been demonstrated to be effective in the cancer pain patient. These therapies lead to patient empowerment, improved stress management and improved patient recognition and modification of factors contributing to physical and emotional distress (Thomas and Weiss 2000). Other major non-pharmacological modalities that have demonstrated efficacy include therapeutic touch, massage, aromatherapy, reflexology, relaxation, guided imagery, visualization, meditation, biofeedback, acupuncture and music therapy (O’Callaghan 1996; Penson and Fisher 1995).

### Modeling Aspects of Persistent Cancer Pain

In order to understand the basic mechanisms involved in cancer pain and ultimately to provide insight into mechanism based therapies, several groups have developed rodent models of tumor induced hyperalgesia. The classification of pain in cancer can be either neuropathic or nociceptive (somatic), but is often mixed (Caraceni and Portenoy 1999). This distinction is a familiar theme, not only clinically, but also in pain models. ► [Neuropathic pain models](#) in rodents have mostly focused on mechanical trauma to the sciatic or spinal nerves; similarly, in animal models of cancer pain, the tumor mass itself may impose structural damage on nearby nerve bundles.

### Neural Plasticity in Cancer Pain Models

Plasticity in pain processing within the CNS can lead to pathological pain states that manifest not only as increased nociceptive sensitivity at the injury site, but also as secondary hyperalgesia and referred pain. In models of cancer pain, the potential for both peripheral

and central plasticity is likely, particularly when tumor cells are implanted into the distal femur, where hyperalgesia both at the tumor site (Schwei et al. 1999) and secondarily in the paw (Wacnik et al. 2001) are measurable. Schwei et al. (1999) and Shimoyama et al. (2005) found increased immunoreactivity for dynorphin and c-fos protein in the dorsal horn correlated with tumor growth, possibly signaling neuroplastic changes. In a rat model of cancer pain where tumors are implanted in the tibia, Urch et al. (2003) demonstrated increased responses to mechanical, thermal and electrical (A beta, C-fiber and post-discharge evoked response) stimuli in wide dynamic range dorsal horn neurons in tumor bearing animals, but no changes in nociceptive specific neurons. Tumor induced peripheral neuropathies include aberrant firing of peripheral nociceptors adjacent to the tumor, identified by spontaneous activity in 34% of cutaneous C-fibers and an increase in epidermal nerve branching concomitant with a decrease in the actual number of fibers in skin overlying the tumor (Cain et al. 2001). Furthermore, immunohistochemical analysis of tumors revealed innervation of tumors with CGRP-immunoreactive nerve fibers. The density of these tumor-nerve appositions was positively correlated with the level of hyperalgesia, whereas that of blood vessels was inversely correlated (Wacnik et al. 2005).

#### Models of Chemotherapy Induced Neuropathic Pain

In cancer patients, neuropathic pain is frequently associated with direct tumor invasion of the peripheral nerve or spinal cord or secondarily caused by cancer chemotherapy. Several rodent models have been developed to model painful chemotherapy induced neuropathy, using for example, vincristine or paclitaxel. In the periphery, vincristine has been shown to enhance C-fiber responsiveness and to induce structural changes to large diameter sensory neurons and myelinated axons (Topp et al. 2000). In the CNS, vincristine promotes central sensitization in the dorsal horn of the spinal cord, as indicated by increased spontaneous activity, increased responsiveness to C- and A $\delta$ -fiber activity and abnormal "wind-up" in response to afferent C-fiber activity (Weng et al. 2003).

#### Conclusions

Pain categories say little about the actual underlying mechanisms. Whether the category is neuropathic or nociceptive, the tumor or antecedent chemotherapy is ultimately the genesis of the pain. Damage to several different tissue types is part of tumorigenesis, and this damage in turn may make different contributions to the resulting pain. There is a high likelihood that a tumor could damage the nerve through compression, stretching or infiltration (i.e. neuropathic), as well as by invading somatic or visceral structures and releasing mediators that activate nociceptive fibers (i.e. nocicep-

tive somatic/visceral). Although the malignant mass begins as a single entity, it may manifest pain *via* several means and *via* complex interactions. Accordingly, work towards a mechanistic classification of cancer pain must take these various means and interactions into account.

#### References

1. Bruera E, Roca E, Cedaro L (1985) Action of Oral Methylprednisolone in Terminal Cancer Patients: A Perspective Randomized Double-blind Study. *Cancer Treat Rep* 69:751–754
2. Caraceni A, Portenoy R (1999) An international survey of cancer pain characteristics and syndromes. *Pain* 82:263–274
3. Chong SF, Bretsher ME, Mailliard JA, et al. (1997) Pilot Study Evaluating Local Anesthetics Administered Systemically for Treatment of Pain in Patient with Advanced Cancer. *J Pain Symptom Manage* 13:112–117
4. Cain DM, Wacnik PW, Turner M et al. (2001) Functional interactions between tumor and peripheral nerve: changes in excitability and morphology of primary afferent fibers in a murine model of cancer pain. *J Neurosci* 21:9367–9376
5. Eisenach JC, DuPen S, Dubois M et al. (1995) Epidural Clonidine Analgesia for Intractable Cancer Pain. The Epidural Clonidine Study Group. *Pain* 61:391–399
6. Foley KM (2000) Controlling cancer pain. *Hosp Pract (Off Ed)* 35:101–108, 111–102
7. Galer BS, Rowbotham MC, Pender J et al. (1999) Topical Lidocaine Patch Release Post-Herpetic Neuralgia More Effectively than a Vehicle Topical Patch: Results of an Enriched Enrollment Study. *Pain* 80:533–538
8. McQuay, H (1999) Opioids in Pain Management. *Lancet* 353:2229–2232
9. Merskey H, Bogduk N (1994) Classification of Chronic Pain, 2nd edn. IASP Press, Seattle
10. O'Collaghan CC (1996) Complimentary Therapies in Terminal Care: Pain, Music, Creativity, and Music Therapy in Palliative Care. *Am J Hospice Palliative Care* 13:43–49
11. Penson J, Fisher R (1995) Complimentary Therapies in Palliative Care for People with Cancer. Arnold, London, pp 233–245
12. Portenoy RK (1991) Cancer Pain General Design Issues. In: Max M, Portenoy R, Laska E (eds) *Advances in Pain Research and Therapy*. Raven Press, New York, pp 233–266
13. Rowbotham MC (1994) *Pharmacological Approaches to the Treatment of Chronic Pain: New Concepts in Critical Issues*. IASP Press, Seattle
14. Schwei MJ, Honore P, Rogers SD et al (1999) Neurochemical and cellular reorganization of the spinal cord in a murine model of bone cancer pain. *J Neurosci* 19:10886–10897
15. Shimoyama M, Tatsuoka H, Ohtori S et al. (2005) Change of dorsal horn neurochemistry in a mouse model of neuropathic cancer pain. *Pain* 114:221–230
16. Smith TJ, Staats PS, Pool G et al. (2002) An implantable drug delivery system for refractory cancer pain improves pain control, drug-related toxicity, and survival compared to comprehensive medical management. *American Society of Clinical Oncology*, May 2002. *Proceedings of the American Society of Clinical Oncology* 21:360a
17. Stubhaug A, Breivik H (1997) Long-term Treatment of Chronic Neuropathic Pain with NMDA (N-Methyl-D-Aspartate) Receptor Antagonists Ketamine. *Acta Anaesthesiol Scand* 41:329–331
18. Thomas EM, Weiss SM (2000) Non-pharmacological Interventions with Chronic Cancer Pain in Adults. *Cancer Control* 7:157–164
19. Urch CE, Donovan-Rodriguez T, Dickenson AH (2003) Alterations in dorsal horn neurones in a rat model of cancer-induced bone pain. *Pain* 106:347–356
20. Wacnik PW, Eikmeier LJ, Ruggles TR et al. (2001) Functional interactions between tumor and peripheral nerve: morphology, algogen identification, and behavioral characterization of a new murine model of cancer pain. *J Neurosci* 21:9355–9366

21. Wacnik PW, Baker C, Blazar BR et al. (2005) Tumor-induced mechanical hyperalgesia involves CGRP receptors and altered innervation and vascularization of DsRed2 fluorescent hindpaw tumors. *Pain* 115:95–106
22. Weng HR, Cordella JV, Dougherty PM (2003) Changes in sensory processing in the spinal dorsal horn accompany vincristine-induced hyperalgesia and allodynia. *Pain* 103:131–138

## Cancer Pain Management, Undertreatment and Clinician-Related Barriers

SEAN O'MAHONY

Montefiore Medical Center and Albert Einstein College of Medicine, Bronx, New York, NY, USA  
somahony@montefiore.org

### Definitions

Cancer pain is pain that can be attributed to a malignancy, or complication of a malignancy, or its treatment.

### Characteristics

Cancer pain affects 17 million people worldwide (Coyle et al. 1990; Daut and Cleeland 1982). Prevalence rates of 30–40% are reported for patients receiving active treatment, and 70–90% for patients with advanced cancer (Kelsen et al. 1995). Cancer pain occurs at multiple sites; in one study of 2266 cancer patients, 70% of patients had pain at 2 or more sites (Zeppetella et al. 2000). The duration of cancer pain varies, but it can extend to several months or years (Petzke et al. 1999). In the U.S., an Eastern Cooperative Oncology Group survey of 1308 ambulatory cancer patients found that 67% reported recent pain, and 36% reported their pain severity as sufficient to interfere with their function (Von Roenn et al. 1994).

### Undertreatment of Cancer Pain

Although reviews of the literature confirm that cancer pain may be relieved in 70–90% of patients, an increasing body of evidence suggests that cancer pain remains undertreated internationally. Deficits in the treatment of cancer pain extend across specialty and level of experience. A French national questionnaire study of general practitioners and specialists indicated that only 10% of patients treated by general practitioners, and 21% of patients treated by specialists, were receiving treatment regimens appropriate to their pain severity (Vainio 1995). An analysis of the computerized medical records of more than one million German patients revealed that only 1.9% of patients with cancer were receiving prescriptions for strong opioid medications, and many patients with cancer were receiving medications at inappropriate intervals and often on an “as needed” basis (Zenz et al. 1995).

Fear of addiction and respiratory depression appear to limit physician's use of strong opioids. In a study

of 13,625 US nursing home residents with cancer and daily pain, factors that were predictive of undertreatment included poor cognitive status, polypharmacy, and advanced age (age > 85) (Bernabei et al. 1998). Factors that were predictive of undertreatment of pain in the ECOG study of ambulatory oncology patients included minority status, discrepancy between patient and physician rating of pain severity, age, female sex and poor performance status.

### Undertreatment of Cancer Pain in Special Populations

#### Elderly and Minority Patients

Undertreatment of cancer pain has been reported in minorities and the elderly in ambulatory patients, hospitalized patients and residents of nursing homes (Von Roenn et al. 1994; Bernabei et al. 1998). Elderly patients with cancer pain often have comorbidities. In conjunction with polypharmacy, this can account for a greater susceptibility of adverse drug events. Cognitive impairment and impaired communication also render some elderly patients with pain susceptible to undertreatment.

Despite the high prevalence of cancer pain in the elderly, they tend to be excluded from analgesic trials. Between 1987 and 1990, 83 randomized clinical trials of anti-inflammatory drugs in 10,000 patients included only 203 patients over the age of 65. The occurrence of complications of cancer pain in the elderly has not been extensively studied, including gait disturbance, falls, delayed rehabilitation, malnutrition, polypharmacy and cognitive impairment.

Ambulatory cancer patients treated at centers that predominantly treat minority patients in the U.S., have been reported to be three times less likely than patients treated elsewhere to receive adequate cancer pain management (Von Roenn et al. 1994). Access to analgesic medication is impaired by lower availability of opioid medications in pharmacies located in predominantly minority neighborhoods. Clinician adherence to racial stereotypes is implicated in reports of disparities in morphine equivalent doses for different ethnic groups

#### Cancer Pain in the Developing World

It has been predicted that 10 of the 15 million new cases of cancer worldwide in the year 2015 will occur in the Third World; as many as 90% of these will continue to present with advanced disease. The World Health Organization assesses progress in cancer pain management by national **per capita morphine consumption**. Fifty percent of countries use little or no morphine (U.N. **International Narcotics Control Board** (United Nations International Narcotics Control Board 1992). The ten countries consuming 57% of all morphine in 1991 have ranked highest in morphine consumption for many years. However, 100 of the poorest countries with the majority of the world's population used just 14% of all morphine. Many of these countries lack economic

resources and medical infrastructure to produce and distribute oral opioid medications. Restrictions exist on the duration that a patient can receive oral morphine or the locations where opioid medications can be received. When available orally, the available formulations of morphine (e.g. 10 mg controlled-release formulations in the Philippines) may predispose to underdosing.

### Barriers to Effective Pain Management

#### Clinician Educational Needs

Barriers to effective pain management are often conceptualized in terms of healthcare provider, patient, family, institutional and societal factors. About 50% of physicians are reported as having erroneous assumptions about the use of opioids for cancer pain (Fife et al. 1993). These misconceptions include concerns about tolerance, addiction, the role of various routes of administration and the prevalence and management of side effects. As many as 20% of physicians are reported to regard cancer pain as inevitable and something that cannot be effectively managed (Fife et al. 1993). These misconceptions extend across disciplines and medical specialties. More than one-third of doctors and nurses in a U.S. survey of 971 clinicians believed that the use of opioid medications should be restricted based on the stage of a patient's illness (Elliott and Elliott 1992). Knowledge deficits do not appear to correlate with the level of exposure to cancer pain and training in palliative care. Despite their widespread availability, physicians continue to be reluctant to use validated assessment instruments.

#### Patient and Family Barriers

Many patients and families have unrealistic concerns about the use of pain medications, and inadequate knowledge of cancer pain management. Patients often regard opioids as a last resort to be reserved for intolerable pain, which they believe will be an inevitable sequela of their illness. Patient barriers are stronger in older patients and in patients with lower educational and income levels.

#### Economic Considerations

Internationally, reimbursement of patients for analgesic medications is limited. Reimbursement by prevailing medical payers also does not cover operational costs for the provision of comprehensive cancer pain management services. Palliative care is funded, in most countries, through a combination of public and private funding sources. However, there is heavy dependence on philanthropy and community fund-raising. In an attempt to limit the impact on healthcare systems of soaring costs for medications, many health care insurance benefits limit coverage of medications or place restrictions on the number of refills on prescriptions, the number of dosage units of a medication, or the number of medications that a patient can receive. An

unintentional effect of such policies may be the premature admission of chronically ill patients to skilled long term nursing care facilities (Soumerai et al. 1987). In many countries, oral opioids and long-acting formulations of opioid medications, in particular, are prohibitively expensive when consideration is given to average incomes.

Even in wealthy countries, availability of inpatient palliative care beds is limited. In Germany, it was estimated in 1996 that the national need for palliative care beds was about 4000 beds. Only 230 were available, and at the same time patients described spending an average of 2 years with cancer pain prior to having access to a pain clinic (Strumpf et al. 1996).

Historically, in the U.S., healthcare insurance companies have paid for procedures at the expense of comprehensive medication coverage. Medicare, the prevailing carrier for patients with chronic illness and for the elderly, will pay for the cost of home infusions of opioid medications at a cost of US \$250–300 per day. However, the same medications administered orally are often not reimbursed (Witteveen et al. 1999).

Inconsistent access to effective pain management resources commonly result in unnecessary hospital admissions for pain and symptom management. At one hospital alone, it was reported that 4% of the hospital's admissions were for uncontrolled pain, at an annual cost of US \$5.1 million. Little work exists on the impact of ► **cost shifting** to patients and their families, in terms of family income or lost work days for cancer pain management in the community.

The rising cost of opioid medications, for long-acting formulations in particular, may place severe strains on the budgets of hospice organizations. Hospices may also be negatively impacted by requirements to destroy opioid medications after a patient dies. Recommended changes include alterations in federal guidelines to enable pharmacies to partially dispense if a patient is resident in a long-term care facility or has a documented terminal illness.

### References

1. Bernabei R, Gambassi I, Lapane KF (1998) Pain Management in Elderly Patients with Cancer. *JAMA* 279(23): 1877–1882
2. Coyle N, Adelhardt J, Foley KM et al. (1990) Character of Terminal Illness in the Advanced Cancer Patient: Pain and Other Symptoms in the Last 4 Weeks of Life. *J Pain Symptom Manage* 5:83–93
3. Daut RL, Cleeland CS (1982) The Prevalence and Severity of Pain in Cancer. *Cancer* 50:13–18
4. Elliott TE, Elliott BA (1992) Physician Attitudes and Beliefs about Use of Morphine for Cancer Pain. *J Pain Symptom Manage* 7:141–148
5. Fife BL, Irick N, Painter JD (1993) A Comparative Study of the Attitudes of Physicians and Nurses towards the Management of Cancer Pain. *J Pain Symptom Manage* 8:132–139
6. Kelsen DP, Portenoy RK, Thaler HT et al. (1995) Pain and Depression in Patients with Newly Diagnosed Pancreas Cancer *J Clin Oncol* 13:748–755
7. Petzke F, Radbruch L, Zech D, Loick G, Grond S (1999) Temporal Presentation of Chronic Cancer Pain: Transitory Pains on



- Admission to a Multidisciplinary Pain Clinic. *J Pain Symptom Manage* 17:391–401
8. Soumerai SB, Avorn J, Ross-Degnan D et al. (1987) Payment Restrictions for Prescription Medications under Medicaid. *N Engl J Med* 317:550–556
  9. Strumpf M, Zenz M, Donner B (1996) Germany: Status of Cancer Pain and Palliative Care. *J Pain Symptom Manage* 12:109–111
  10. United Nations International Narcotics Control Board (1992) *Narcotic Drugs: Estimated World Requirements for 1993, Statistics for 1991*. United Nations, Vienna
  11. Vainio A (1995) Treatment of Terminal Cancer Pain in France: A Questionnaire Study. *Pain* 62:155–162
  12. Von Roenn JH, Cleeland CS, Gonin R et al. (1994) Pain and its Treatment in Outpatients with Metastatic Cancer. *N Engl J Med* 330:592–596
  13. Witteveen PO, Van Groenestijn MAC, Blijham GH et al. (1999) Use of Resources and Costs of Palliative Care with Parenteral Fluids and Analgesics in the Home Setting for Patients with End-Stage Cancer. *Annals Oncology* 10:161–165
  14. Zenz M, Zenz T, Tryba M et al. (1995) Severe Under-Treatment of Cancer Pain: A 3 Year Survey of the German Situation. *J Pain Symptom Manage* 10:187–190
  15. Zeppetella G, O'Doherty CA, Collins S (2000) Prevalence and Characteristics of Breakthrough Pain in Cancer Patients Admitted to a Hospice. *J Pain Symptom Manage* 20:87–95

## Cancer Pain Model

### Definition

A clinically relevant model used to study the mechanisms and neurobiology of cancer-induced pain. Often, but not exclusively, these models are developed in rodents or mammalians.

- ▶ [Cancer Pain, Animal Models](#)
- ▶ [Cancer Pain Management, Treatment of Neuropathic Components](#)
- ▶ [Cancer Pain Model, Bone Cancer Pain Model](#)

## Cancer Pain Model, Bone Cancer Pain Model

DARRYL T. HAMAMOTO, DONALD A. SIMONE  
University of Minnesota, School of Dentistry, Moos Tower, Minneapolis, MN, USA  
hamam001@umn.edu, simon003@umn.edu

### Definition

Bone is the third most common site for tumor metastases (Rubens 1998), and pain is the most frequent symptom for patients with metastatic bone cancer (Pecherstorfer and Vesely 2000). Bone cancer pain is often difficult to treat (Mercadante 1997). Animal models have recently been developed to elucidate the underlying mechanisms of bone cancer pain. A better understanding of these mechanisms may lead to the development of novel and more effective approaches to treating bone cancer pain.

### Characteristics

Animal models of bone cancer pain have only been developed in rodents (i.e. mice and rats). One advantage of murine models is that mice are commonly used to study cancer biology, so that many cancer cell lines are available for use in mice. Many strains of mice have been genetically modified, and these strains may be used to determine the role of specific biochemicals in bone cancer pain. The advantage of using rats in a model of bone cancer pain is that rats are commonly used in pain research, so their nociceptive systems have been well studied. Many ▶ [nocifensive behavioral](#) assays used to test rodents with bone cancer pain were initially developed in rats and have been used in models of inflammatory and neuropathic pain. Thus, comparisons between the mechanisms underlying inflammatory, neuropathic, and bone cancer pain can be made more easily. Finally, because of its larger size, it is easier to perform surgical procedures on a rat than a mouse.

In these rodent models of bone cancer pain, tumor cells are implanted into different bones. In three of the four models, tumor cells are implanted into bones of the hind limb, specifically the femur, tibia, and calcaneus bones. Use of the hind limb is advantageous because many behavioral tests of ▶ [nociception](#) apply the stimulus to the hind paw of rats, and thus the responses to these stimuli have been well characterized. It is easier to apply stimuli to the hind paw than the forepaw in rodents because the hind paw is larger and away from the animal's line of sight. The lumbar enlargement of the spinal cord is easier to access than the cervical enlargement, and so it is easier to apply drugs to or record ▶ [electrophysiological](#) activity from ▶ [dorsal horn neurons](#). The lumbar and cervical enlargements are where ▶ [primary afferents/neurons](#) that innervate the hind limb and forelimb terminate, respectively. As a result, the electrophysiological responses and neurochemical characteristics of the dorsal horn neurons that have receptive fields on the hind limb have been better characterized than those innervating the forelimb. As the hind limb is longer than the forelimb in rodents, surgical preparation for electrophysiological recording from primary afferent fibers is easier. Thus, the electrophysiological responses of the primary afferent fibers that innervate the hind paw, and the neurochemical characteristics of their associated ▶ [dorsal root ganglion](#) neurons, have been better studied.

### Femur Model

The first reported animal model of bone cancer pain used NCTC 2472 cells, derived from a spontaneous connective tissue tumor, which were implanted through an arthrotomy in the knee joint into the medullary cavity of one femur of C3H/He mice (Schwei et al. 1999). The hole in the articular surface of the distal femur, through which the sarcoma cells are implanted, is sealed to



keep the cells within the medullary cavity (Honore et al. 2000a). Implantation of sarcoma cells produces an increase in both the number of osteoclasts and in osteoclast activation, which results in osteolytic lesions in the implanted femur and invasion of the sarcoma cells into the adjacent soft tissues (Clohisy et al. 1996). Mice with sarcoma cells implanted into the femur exhibit spontaneous guarding and flinches, movement-evoked nocifensive behaviors during spontaneous or forced ambulation, and mechanical **▶ allodynia**, as evidenced by flinching, guarding, fighting, and vocalization produced by normally non-noxious palpation of the affected limb (Schwei et al. 1999; Honore et al. 2000a; Luger et al. 2001). The frequency of palpation-induced nocifensive behaviors was correlated with the extent of bone destruction (Schwei et al. 1999).

One feature of this model is that the sarcoma cells are sealed in the bone. This is similar to the clinical situation in which tumor cells metastasize to the medullary cavity of a bone. Also, nociceptive stimuli are applied to the distal femur, the location where the sarcoma cells erode through the bone, suggesting that the nociceptive behaviors are due to excitation of nociceptors in the area. However, it is not clear whether excitation of nociceptors located in bone, muscle, or skin is responsible for evoking the nocifensive behaviors. Interestingly, implantation of sarcoma cells into the femur also produced mechanical allodynia at the plantar surface of the hind paw, as shown by a decrease in the threshold force required to evoke a hind paw withdrawal (Honore et al. 2000b). This finding suggests that the sarcoma cells may be injuring nerve trunks passing through the area, resulting in a neuropathic pain condition as well as releasing potential algogens. Alternatively, excitation of nociceptors located near the sarcoma cells might produce sensitization of dorsal horn neurons (i.e. **▶ central sensitization**) that also have cutaneous receptive fields on the hind paw.

#### Tibia Model

A model of bone cancer pain in rats was developed in which mammary gland carcinoma cells (MRMT-1) were implanted through an incision in the skin into the tibia, 5 mm distal to the knee joint of one hind limb in female (Medhurst et al. 2002) or male (Urch et al. 2003) Sprague-Dawley rats. The hole through which the breast carcinoma cells were implanted is sealed. Implantation of these breast carcinoma cells produces an increase in the number of osteoclasts-like cells and time-dependent bone destruction. Tumor bearing rats exhibit mechanical **▶ hyperalgesia** (i.e. paw pressure) and allodynia (i.e. von Fey stimulation to the plantar surface of the hind paw), cold allodynia (i.e. acetone applied to the plantar surface of the hind paw), a decrease in weight bearing on the implanted limb, and ambulatory-evoked pain (i.e. limping and guarding on a Rotarod treadmill) (Medhurst et al. 2002; Urch et al. 2003). Thus, this model of bone cancer pain in rats produces histological and behavioral

changes that were similar to those found in the femur model in mice.

A murine model of bone cancer pain, produced by implantation of NCTC 2472 sarcoma cells through a skin incision into the tibia of C3H/He mice, has also been reported (Menendez et al. 2003). The hole in the tibia through which the sarcoma cells are implanted is not sealed. Implantation of sarcoma cells results in an increase in the number of osteoclasts. At the time when the sarcoma cells erode through the bone and grow into the surrounding soft tissue, mice exhibit thermal hypoalgesia (i.e. increased paw withdrawal latencies when on a hot plate). As the tumor mass grows, and the extent of bone destruction increases, mice exhibit thermal hyperalgesia.

In both of these models, test stimuli are applied to the hind paw, a site distant from the location of the tumor cells. Increased responses to stimuli applied distant to the site of implantation of the tumor cells suggesting a neuropathic injury or central sensitization may underlie these tumor-evoked behaviors.

#### Calcaneus Model

Implantation of NCTC 2472 sarcoma cells percutaneously into and around the calcaneus bone of C3H/He mice produces osteolysis and evokes mechanical hyperalgesia (Wacnik et al. 2001). Mechanical hyperalgesia was observed upon stimulation of the plantar surface of the ipsilateral hind paw with **▶ von Frey monofilaments**. These mice also exhibited cold hyperalgesia (i.e. enhanced paw withdrawal responses when placed on a 5°C plate). Histological examination shows that sarcoma cells are found under the skin of the plantar surface of the hind paw, and that the number of nerve fibers in the epidermis (i.e. epidermal nerve fibers) above the tumor decreases (Cain et al. 2001). Interestingly, the proportion of neuropeptide containing primary afferent fibers increases suggesting that the sarcoma cells affect subclasses of primary afferent fibers differently.

One advantage of this model of bone cancer pain is that the effect of the sarcoma cells on the electrophysiological responses of primary afferent fibers innervating the tissue near the tumor can be determined. In fact, a proportion of nociceptive C-fibers innervating the plantar surface of the hind paw exhibit spontaneous activity, which may produce central sensitization and contribute to the mechanical hyperalgesia observed (Cain et al. 2001). Thus, interactions between the sarcoma cells and primary afferent fibers can be examined using both histological and electrophysiological methods.

This model differs from the models using the femur and tibia in that the sarcoma cells are not sealed in the bone but are implanted both in and around the calcaneus bone. As a practical issue, the calcaneus bone in mice is small and the volume of its medullary cavity is low, making it difficult to keep the cell suspension within the medullary cavity. Additionally, sarcoma cells are

implanted without making an incision through the skin. To seal the hole would require an incision to expose the calcaneus bone, which might produce inflammation and mechanical hyperalgesia. Moreover, implantation of sarcoma cells into the tissues around the calcaneus bone produced less mechanical and cold hyperalgesia than when the sarcoma cells were implanted into the bone (Wacnik et al. 2001). These findings suggest that interaction of the sarcoma cells with the calcaneus bone is important for full development of the mechanical and cold hyperalgesia observed in this model.

### Humerus Model

Movement-related cancer pain is thought to be a predictor of poor response to routine pharmacotherapy in cancer patients (Mercadante et al. 1992). Thus, a model of deep tissue cancer pain may be ideal for studying this specific characteristic of cancer pain. Implantation of NCTC 2472 sarcoma cells through the proximal end of each humerus bone in C3H/he mice produces movement-related hyperalgesia, observed as a reduction in forelimb ► [grip force](#) (Wacnik et al. 2003) (see ► [Muscle Pain Model, Inflammatory Agents-Induced](#)). This reduction in grip force can be attenuated with morphine (Wacnik et al. 2003), and is possibly due to sensitization of nociceptors in the triceps muscles. An interesting advantage of the humerus model is that the effectiveness of an analgesic treatment is indicated by an increase in response. That is, as the tumor grows, mice exhibit a decrease in grip force that is reversed by effective analgesics. In other nocifensive behavioral tests, the animal shows an increase in responsiveness with tissue injury that is reversed by effective analgesic treatment. However, a decrease in paw withdrawal response or vocalization could also be due to sedation or motor effects of the test treatment. In the humerus model, sedation and motor impairment would be likely to produce a decrease in grip force, resulting in the analgesic effects of a treatment being more easily separated from any sedative effects or motor impairment.

### References

- Cain DM, Wacnik PW, Turner M et al. (2001) Functional Interactions between Tumor and Peripheral Nerve: Changes in Excitability and Morphology of Primary Afferent Fibers in a Murine Model of Cancer Pain. *J Neurosci* 21:9367–9376
- Clohisey DR, Ogilvie CM, Carpenter RJ et al. (1996) Localized, Tumor-Associated Osteolysis Involves the Recruitment and Activation of Osteoclasts. *J Orthop Res* 14:2–6
- Honore P, Luger NM, Sabino MA et al. (2000a) Osteoprotegerin Blocks Bone Cancer-Induced Skeletal Destruction, Skeletal Pain and Pain-Related Neurochemical Reorganization of the Spinal Cord. *Nat Med* 6:521–528
- Honore P, Rogers SD, Schwei MJ et al. (2000b) Murine Models of Inflammatory, Neuropathic and Cancer Pain each Generates a Unique Set of Neurochemical Changes in the Spinal Cord and Sensory Neurons. *Neuroscience* 98:585–598
- Luger NM, Honore P, Sabino MA et al. (2001) Osteoprotegerin Diminishes Advanced Bone Cancer Pain. *Cancer Res* 61:4038–4047
- Medhurst SJ, Walker K, Bowes M et al. (2002) A Rat Model of Bone Cancer Pain. *Pain* 96:129–140
- Menendez L, Lastra A, Fresno MF et al. (2003) Initial Thermal Heat Hypoalgesia and Delayed Hyperalgesia in a Murine Model of Bone Cancer Pain. *Brain Res* 969:102–109
- Mercadante S (1997) Malignant Bone Pain: Pathophysiology and Treatment. *Pain* 69:1–18
- Mercadante S, Maddaloni S, Roccella S et al. (1992) Predictive Factors in Advanced Cancer Pain Treated only by Analgesics. *Pain* 50:151–155
- Pecherstorfer M, Vesely M (2000) Diagnosis and Monitoring of Bone Metastases: Clinical Means. In: Body J-J (ed) *Tumor Bone Diseases and Osteoporosis in Cancer Patients*. Marcel Dekker Inc., New York, pp 97–129
- Rubens RD (1998) Bone Metastases - The Clinical Problem. *Eur J Cancer* 34:210–213
- Schwei MJ, Honore P, Rogers SD et al. (1999) Neurochemical and Cellular Reorganization of the Spinal Cord in a Murine Model of Bone Cancer Pain. *J Neurosci* 19:10886–10897
- Urch CE, Donovan-Rodriguez T, Dickenson AH (2003) Alterations in Dorsal Horn Neurons in a Rat Model of Cancer-Induced Bone Pain. *Pain* 106:347–356
- Wacnik PW, Eikmeier LJ, Ruggles TR et al. (2001) Functional Interactions between Tumor and Peripheral Nerve: Morphology, Algogen Identification, and Behavioral Characterization of a New Murine Model of Cancer Pain. *J Neurosci* 21:9355–9366
- Wacnik PW, Kehl LJ, Trempe TM et al. (2003) Tumor Implantation in Mouse Humerus Evokes Movement-Related Hyperalgesia Exceeding that Evoked by Intramuscular Carrageenan. *Pain* 101:175–186

C

## Cancer Survivorship

### Definition

The period of time during which an individual's life is defined from the moment of diagnosis with cancer until death. Often in pediatric oncology the focus is long-term survivorship, defined as a specified period of time after treatment during which the individual is disease free.

► [Cancer Pain, Assessment in Children](#)

## Cancer Therapy

### Definition

Refers to anti-cancer chemotherapy, radiation treatment, surgery or endocrine/hormonal treatment to cure or control cancer and its progression.

► [Cancer Pain Management](#)

► [Psychiatric Aspects of the Management of Cancer Pain](#)

## Cannabinoid

### Definition

Cannabinoids are derivatives of  $\Delta^9$ -tetrahydrocannabinol ( $\Delta^9$ -THC), the constituent of marijuana that is responsible for its psychoactive effects.

► [Evoked and Movement-related Neuropathic Pain](#)

## Cannabinoid Receptors

### Definition

Receptors that are activated by the active constituent of *cannabis sativa*,  $\Delta^9$ -tetrahydrocannabinol ( $\Delta^9$ -THC). These receptors can also be activated by endogenous ligands such as anandamide (so-called „endocannabinoids“). Two types of receptor have been identified, CB1 and CB2, which are G-protein coupled. CB1 receptors are found in several brain areas.

- ▶ Nociceptive Neurotransmission in the Thalamus

## Capacity

### Definition

An individual's ability to execute a task or an action, the highest probable level of functioning that a person may reach in a given domain, at a given moment.

- ▶ Disability, Functional Capacity Evaluations

## Capitated Care

### Definition

A provider receives a set fee for each patient assigned to the practice through an insurance carrier. The fee is often called a per-member-per-month, and is independent of the care the patient requires.

- ▶ Disability Management in Managed Care System

## Capsaicin

### Definition

The pungent ingredient of chili peppers (8-methyl N-vanillyl 6-nonenamide) from the *capsicum* family, which can be used to selectively activate nociceptive sensory neurones via its activation of a ligand-gated cation channel TRPV1 (originally called the VR1 channel, which can also be stimulated with heat and physical abrasion, permits cations to pass), present on these neurones. Stimulation of the cutaneous peripheral terminals of these nerve fibers with capsaicin can be used to produce neurogenic inflammation. It is also applied to the skin in order to treat neuropathic pain such as post herpetic neuralgia. Suggested mechanism of action is by activation of C fiber mechano-heat nociceptors, causing depletion of its neurotransmitters, e.g. substance P, thus stopping the function of the neuron. Plants produce the compound to deter predation. Capsaicin is classified among the secondary metabolites.

The substance is widely used as an experimental model of cutaneous hyperalgesia

- ▶ Amygdala, Pain Processing and Behavior in Animals
- ▶ Atypical Facial Pain, Etiology, Pathogenesis and Management
- ▶ Autologous Thrombocyte Injection as a Model of Cutaneous Pain
- ▶ Exogenous Muscle Pain
- ▶ Freezing Model of Cutaneous Hyperalgesia
- ▶ Human Thalamic Response to Experimental Pain (Neuroimaging)
- ▶ Inflammation, Modulation by Peripheral Cannabinoid Receptors
- ▶ Mechano-Insensitive C-Fibres, Biophysics
- ▶ Muscle Pain Model, Ischemia-Induced and Hypertonic Saline-Induced
- ▶ Nociceptors in the Orofacial Region (Skin/Mucosa)
- ▶ Opioid Modulation of Nociceptive Afferents In Vivo
- ▶ PET and fMRI Imaging in Parietal Cortex (SI, SII, Inferior Parietal Cortex BA40)
- ▶ Polymodal Nociceptors, Heat Transduction
- ▶ Sensitization of Muscular and Articular Nociceptors
- ▶ Species Differences in Skin Nociception
- ▶ Spinothalamic Tract Neurons, Glutamatergic Input
- ▶ Spinothalamic Tract Neurons, Role of Nitric Oxide
- ▶ Sympathetically maintained Pain and Inflammation, Human Experimentation
- ▶ Toxic Neuropathies
- ▶ TRPV1 Modulation by p2Y Receptors
- ▶ TRPV1, Regulation by Nerve Growth Factor
- ▶ TRPV1, Regulation by Protons

## Capsaicin Receptor

ANTONIO VICENTE FERRER-MONTIEL  
Institute of Molecular and Cell Biology, University Miguel Hernández de Elche, Alicante, Spain  
aferrer@umh.es

### Synonyms

TRPV1; vanilloid receptor subunit 1; Heat Sensor

### Definition

The capsaicin receptor is a calcium permeable non-selective cation channel that is gated by noxious heat ( $\geq 42^\circ\text{C}$ ), vanilloid compounds such as capsaicin and protons. As a molecular sensor of painful stimuli at the peripheral endings of nociceptive, primary sensory neurons, the capsaicin receptor transduces noxious chemical and thermal signals into action potentials. Thus, the capsaicin receptor is a key molecular component of the pain pathway.

## Characteristics

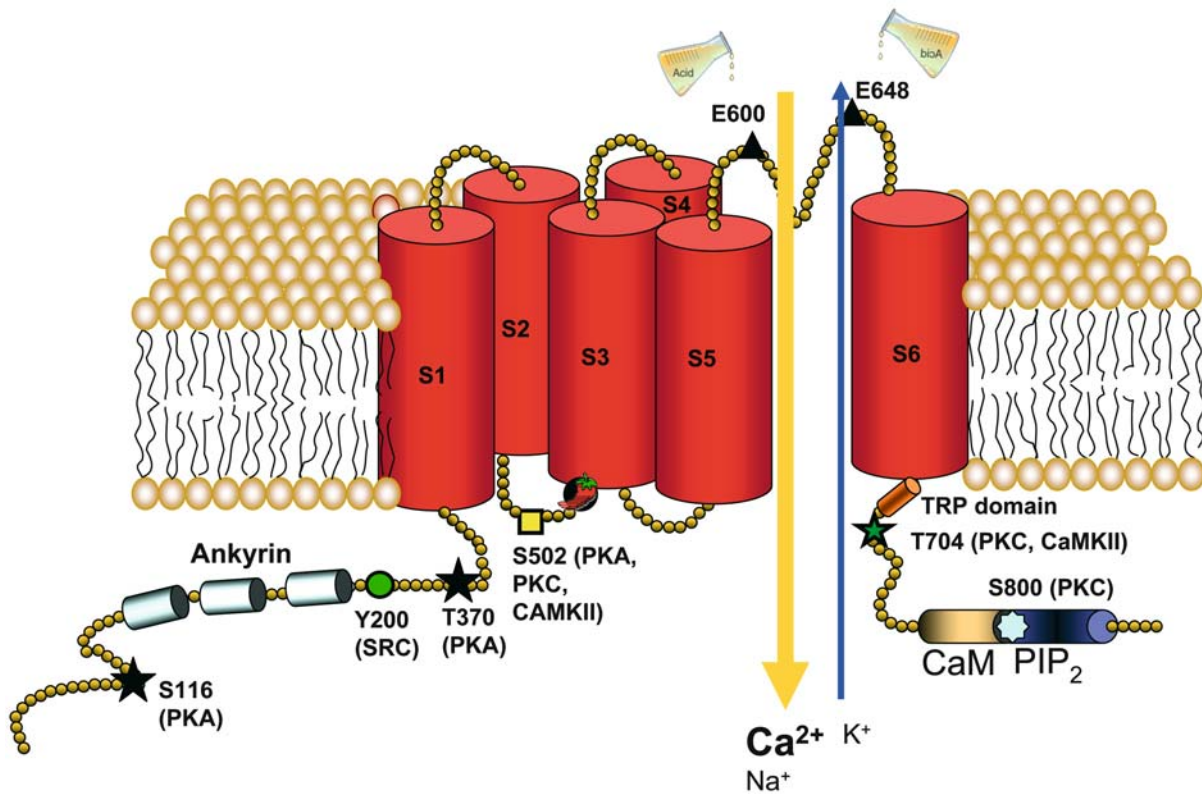
The capsaicin receptor is a member of the transient receptor potential (TRP) mammalian gene superfamily (Caterina and Julius 2001). These channels are considered molecular gateways in sensory systems, since several of these proteins transduce chemical and physical stimuli into neuronal activity, i.e. membrane potential changes. The capsaicin receptor gave its name to the vanilloid subfamily (TRPV) of TRP channels. This sensory receptor is an integrator of noxious thermal stimuli as well as of irritant chemicals such as vanilloids, protons and pro-algesic substances (Caterina and Julius 2001; Szallasi and Appendino 2004). Temperature gates the channel by shifting the voltage-dependent activation towards the neuronal resting potential (Voets et al. 2004). In contrast, chemical activators of the receptor such as capsaicinoid and vanilloid-like molecules and acidosis act as gating modifiers, reducing the temperature threshold of channel gating from 42°C to below body temperature (36°C). This is the underlying mechanism for the characteristic pungency of capsaicin and related molecules.

Molecularly, the functional channel is a tetrameric membrane protein with four identical subunits assembled around a central aqueous pore. Each receptor subunit displays a membrane domain composed of six transmembrane segments (S1–S6) with an ► **amphipathic** region between the fifth and sixth segment that forms the channel conductive pore (Caterina and Julius 2001; Ferrer-Montiel et al. 2004). The protein also has cytoplasmic N- and C-termini (Fig. 1). In the N-terminus, TRPV1 channels exhibit three ankyrin domains that mediate protein-protein interactions with cytosolic proteins and consensus sequences for protein kinases. The protein displays a cytosolic C-terminus domain containing phosphoinositide, and calmodulin binding (CAM) domains, as well as phosphorylation sites (Caterina and Julius 2001; Ferrer-Montiel et al. 2004; Nagy et al. 2004). In addition, the C-end has a TRP-like motif that functions as an association domain for receptor subunits (Garcia-Sanz et al. 2004). The receptor has two abundant single nucleotide ► **polymorphisms** that produce amino acid substitutions, one in codon 315 (Met<sup>315</sup> Ile) at the N-terminus domain and the other at amino acid 585 (Ile<sup>585</sup> Val) located in the fifth transmembrane segment. Interestingly, gender, ethnicity and temperament seem to contribute to individual variation in thermal and cold pain sensitivity by interactions in part with these TRPV1 single nucleotide polymorphisms (Kim et al. 2004).

The capsaicin receptor is widely expressed in neuronal and non-neuronal cells of both endodermal and mesodermal origin, implying that the receptor is involved in diverse physiological functions. These include thermosensory transduction, as well as chemical signalling presumably mediated by ► **endovanilloid** compounds.

*In situ* hybridisation, immunocytochemical analysis and drug binding assays have shown TRPV1 expression in ≈50% of dorsal root and trigeminal ganglion neurons, in the dorsal horn of the spinal cord and in the caudal nucleus of the spinal trigeminal complex. The majority of TRPV1 positive neurons also colocalise with the nerve growth factor (NGF) receptor *trkA*, the lectin IB4 and the neuropeptides involved in nociceptive transmission such as substance P (SP) and calcitonin gene related peptide (CGRP) (Caterina and Julius 2001; Nagy et al. 2004; Szallasi and Appendino 2004). Vanilloid sensitive nociceptors are peptidergic, small diameter neurons that give rise to unmyelinated C fibres, although some Aδ fibres are responsive to vanilloid derivatives (Nagy et al. 2004; Szallasi and Appendino 2004). Somatic and visceral primary afferents express TRPV1 at both the spinal and peripheral terminals. In addition to a subset of nociceptors, the capsaicin receptor is present in neurons of the central nervous system and in non-neuronal cells. For instance, TRPV1 mRNA or protein is widely expressed in brain regions such as the olfactory nuclei, cerebral cortex, dentate gyrus, central amygdala, striatum, centromedian and paraventricular thalamic nuclei, hypothalamus, substantia nigra, reticular formation, locus coeruleus, inferior olive and cerebellar cortex (Nagy et al. 2004). Furthermore, the receptor is expressed in a variety of epithelial tissues such as the skin, human hair follicles, lungs, uroepithelium of the urinary bladder, the vascular system and the inner ear (Nagy et al. 2004). Taken together, all these observations underscore the notion that TRPV1 is a widely expressed protein whose function is critical for diverse physiological conditions. The pivotal role of TRPV1 in nociceptive transduction has suggested a contribution of the channel to diverse pathophysiological processes. In particular, cumulative evidence is substantiating the tenet that ► **nociceptor sensitisation** by pro-inflammatory agents is primarily achieved by the capsaicin receptor. This protein is the endpoint target of intracellular signalling cascades triggered by inflammatory mediators that lead to remarkable potentiation of its channel activity which, in turn, promotes the hyperexcitability of nociceptors (Planells-Cases et al. 2005; Julius and Basbaum 2001; Davis et al. 2000). Enhancement of TRPV1 function by pro-algesic agents may be accomplished either by direct activation of the channel or by its posttranslational modification by intracellular metabolic cascades (Planells-Cases et al. 2005; Julius and Basbaum 2001). Direct activation of TRPV1 responses has been reported for lipid mediators such as arachidonic acid metabolites including anandamide, N-arachidonyl-dopamine (NADA) and N-oleoyldopamine. Similarly, several eicosanoids, particularly those derived from the enzymatic action of 5-lipoxygenase or 12-lipoxygenase, are capable of activating TRPV1. In particular, 12-(hydroperoxy)eicosatetraenoic acid (12-HPETE) and leukotriene B<sub>4</sub> (LTB<sub>4</sub>) have exhibited the





**Capsaicin Receptor, Figure 1** Molecular model of the capsaicin receptor subunit. The figure displays a membrane domain composed of six transmembrane segments (S1–S6) with an *amphipathic* region between the fifth and sixth segment that forms the channel conductive pore, which also contains the glutamic acids (E600 and E648) responsible for the pH-induced channel gating. The protein also has cytoplasmic N- and C-termini. In the N-terminus, TRPV1 channels exhibit three ankyrin domains and consensus sequences for PKA and Src. The capsaicin-binding site is located at the N-end of the S3 segment, near S502, a serine residue phosphorylated by PKA, PKC and CaMKII. The protein displays a cytosolic C-terminus domain containing phosphoinositide (PIP<sub>2</sub>), and calmodulin binding (CAM) domains and phosphorylation sites for PKC (T704, S800) and CaMKII (T704). In addition, the C-end has a TRP domain that may contribute to the association of receptor subunits. The higher Ca<sup>2+</sup> permeability with respect to Na<sup>+</sup> and K<sup>+</sup> is also depicted.

most potent agonistic activity. In addition, the acidosis that develops in inflamed tissues is also a direct activator of the TRPV1 channel activity (van der Stelt and Di Marzo 2004). The potency and efficacy of each singular mediator is quite low but in inflammatory conditions several of these modulators are simultaneously released and act synergistically. Therefore, direct gating of TRPV1 responses by inflammatory agents acting as channel agonists notably increases the excitability of nociceptors, resulting in a hyperalgesic condition. Prolonged activation of the receptor, leads to an intracellular [Ca<sup>2+</sup>] rise that, in turn, activates intracellular signalling that triggers the release of pro-inflammatory agents at peripheral terminals. This dual action further increases the excitability of the nociceptors. In addition, inflammation-evoked activation of intracellular protein networks results in TRPV1 phosphorylation, release of tonically inhibited receptors and an increment in the surface expression of functional channels, all being major events underlying the nociceptor activation and sensitisation that leads to ► [hyperalgesia](#) (Planells-Cases et al. 2005). Indeed, TRPV1 expres-

sion is up-regulated in tissue samples from patients with inflammatory bowel disease and Crohn's disease and also in patients with rectal hypersensitivity, as well as in those affected by vulvodynia (see ref. in Nagy et al. 2004; Szallasi and Appendino 2004; Planells-Cases et al. 2005). Thus, TRPV1 receptors are critical determinants of the sensitisation of primary afferents after injury or inflammation. The involvement of TRPV1 in heat hypersensitivity is underscored by the reduced thermal hyperalgesia of TRPV1 null mice (Caterina et al. 2000), and by the attenuation of this inflammatory associated phenomenon by non-competitive antagonists of the TRPV1 channel (Garcia-Martinez et al. 2002). Accordingly, the important contribution of TRPV1 receptor to the onset and maintenance of neurogenic inflammation has validated it as a therapeutic target for inflammatory pain management and a tremendous effort is being carried out to develop clinically useful modulators of the receptor dysfunction characteristic of human diseases (Szallasi and Blumberg 1999).

- [Polymodal Nociceptors, Heat Transduction](#)
- [TRPV1 Receptor, Species Variability](#)



- ▶ TRPV1, Regulation by Nerve Growth Factor
- ▶ TRPV1, Regulation by Protons

## References

1. Caterina MJ, Julius D (2001) The vanilloid receptor: A molecular gateway to the pain pathway. *Annu Rev Neurosci* 24:487–517
2. Caterina MJ, Leffler A, Malmberg AB et al. (2000) Impaired nociception and pain sensation in mice lacking the capsaicin receptor. *Science* 288:306–313
3. Davis JB, Gray J, Gunthorpe MJ et al. (2000) Vanilloid receptor-1 is essential for inflammatory thermal hyperalgesia. *Nature* 405:183–187
4. Ferrer-Montiel A, Garcia-Martinez C, Morenilla-Palao C et al. (2004) Molecular architecture of the vanilloid receptor. Insights for drug design. *Eur J Biochem* 271:1820–1826
5. García-Martínez C, Humet M, Planells-Cases R et al. (2002). Attenuation of thermal nociception and hyperalgesia by VR1 blockers. *Proc Natl Acad Sci USA* 99:2374–2379
6. Garcia-Sanz N, Fernández-Carvajal A, Morenilla-Palao C et al. (2004) Identification of tetramerization domain in the C-terminus of the vanilloid receptor. *J Neurosci* 24:5306–5314
7. Julius D, Basbaum AI (2001) Molecular mechanisms of nociception. *Nature* 413:203–210
8. Kim H, Neubert JK, San Miguel A et al. (2004) Genetic influence on variability in human acute experimental pain sensitivity associated with gender, ethnicity and psychological temperament. *Pain* 109:488–496
9. Nagy I, Sántha P, Jancsó G et al. (2004) The role of the vanilloid (capsaicin) receptor (TRPV1) in physiology and pathology. *Eur J Pharmacol* 500:351–369
10. Planells-Cases R, García-Sanz N, Morenilla-Palao C et al. (2005) Functional aspects and mechanisms of TRPV1 involvement in neurogenic inflammation that leads to thermal hyperalgesia. *Pflugers Arch Eur J Physiol* 21 May, Epub ahead of print. PMID 15909179
11. Stelt M van der, Di Marzo V (2004) Endovanilloids. Putative endogenous ligands of transient receptor potential vanilloid 1 channels. *Eur J Biochem* 271:1827–1834
12. Szallasi A, Appendino G (2004) Vanilloid receptor TRPV1 antagonists as the next generation of painkillers. Are we putting the cart before the horse? *J Med Chem* 47:1–7
13. Szallasi A, Blumberg PM (1999) Vanilloid (capsaicin) receptors and mechanisms. *Pharmacol Rev* 51:159–211
14. Voets T, Droogmans G, Wissenbach U et al. (2004) The principle of temperature-dependent gating in cold- and heat-sensitive TRP channels. *Nature* 430:748–754

## Capsazepine

### Definition

Capsazepine is a classical capsaicin antagonist, identified by a combinatorial chemical screen. Interacts with TRPV1, the capsaicin receptor.

- ▶ Capsaicin Receptors
- ▶ TRPV1, Regulation by Protons

## Carbenoxolone

### Definition

Carbenoxolone is a gap junction decoupler. When administered over the spinal cord, it disrupts gap junctions

among astrocytes. In addition to decoupling gap junctions, carbenoxolone can also exert non-specific effects, including inhibition of 1<sup>β</sup>-hydroxysteroid dehydrogenase, at higher doses. Peri-spinal administration of carbenoxolone blocks mirror-image pain.

- ▶ Cord Glial Activation

## Cardiac Stress Response

- ▶ Postoperative Pain, Pathophysiological Changes in Cardiovascular Function in Response to Acute Pain

## Cardiac Surgery

### Definition

All cardiac surgical procedures performed with or without cardiopulmonary bypass.

- ▶ Postoperative Pain, Thoracic and Cardiac Surgery

## Career Assessment

- ▶ Vocational Assessment in Chronic Pain

## Caregiver

### Definition

Any person who assesses and provides care to the individual experiencing pain (health care professionals, family member, friend). As it pertains to the newborn infants, the maternal caregiving relationship during infancy is considered a key mediator and moderator of risk factors on infant development.

- ▶ Pain Assessment in Neonates

## Carotid Arteries

### Definition

The common carotid artery divides into the internal and external carotid arteries in the neck. The former supplies the forebrain with blood and the latter supplies the face and scalp.

- ▶ Primary Cough Headache

## Carotidynia

### Definition

A poorly defined syndrome with unilateral anterolateral cervical pain and local tenderness.

- ▶ [Headache due to Dissection](#)

## Carpal Tunnel Syndrome

### Definition

Chronic compression of the median nerve as it passes through the carpal tunnel in the wrist. The pressure placed on the median nerve could be caused by excessive pressure due to tendon or tissue inflammation and excessive fluid in the wrist. The condition normally results in reduced nerve conduction velocity, and pain and numbness in the thumb, index and middle fingers, sometimes the ring finger, but not the little finger. With use of the hand, these symptoms can become disturbing during the daytime. Carpal tunnel syndrome has been associated with repetitive work and frequent forceful exertions, as well as several systemic health conditions such as diabetes and pregnancy. The symptoms are over the palmar side of the hand, and not the dorsum. These include night-time awakening with numbness or tingling.

- ▶ [Carpal Tunnel Syndrome](#)
- ▶ [Ergonomics Essay](#)
- ▶ [Neuropathic Pain Model, Chronic Constriction Injury](#)

## Carpal Tunnel Syndrome

A. LEE DELLON

Department of Plastic Surgery and Neurosurgery,  
Johns Hopkins University, Baltimore, MD, USA  
aldellon@erols.com

### Synonyms

Median nerve compression at the wrist; Entrapment Neuropathies, Carpal Tunnel Syndrome

### Definition

▶ **Carpal tunnel syndrome** is a combination of patient complaints related to chronic compression of the median nerve within the carpal tunnel. Since the carpal tunnel is at the wrist, the painful symptoms of which the patient complains are related to the small and large myelinated nerve fibers that supply the palmar, but not thenar, skin along an axis that is radial to the longitudinal axis of the ring finger, and the distal dorsal tips of the index and middle finger. The thenar skin is innervated by the palmar cutaneous branch of the median nerve, which arises 5 cm

proximal to the wrist, and therefore abnormal sensibility of the thenar skin is not included in the definition of carpal tunnel syndrome. Motor symptoms include complaints of clumsiness in the use of the thumb, as the median nerve's motor branch innervates the abductor pollicis brevis, the opponens pollicis, and the short head of the flexor pollicis brevis. When the wrist is flexed, pressure increases upon the median nerve, causing decreased blood flow within the median nerve, and the resulting ischemia causes transmission of neural impulses interpreted as numbness or tingling (paresthesia), and, in some patients, actually as pain, causing them to awaken at night. Acute onset of pain in the distribution of the median nerve is not included in the definition of carpal tunnel syndrome, and indicates acute compression with axonal loss, rather than chronic compression and demyelination.

### Characteristics

Carpal tunnel syndrome is the most common example of chronic nerve compression, with a prevalence of at least 2% in the general population, 14% in diabetics without peripheral neuropathy, and 30% in diabetics with peripheral neuropathy (Perkins et al. 2003). The physical examination findings required to confirm a diagnosis in the first patient reported to have a carpal decompression were blisters on the tips of the thumb, index and middle finger, due to anesthesia, and wasting of the thenar muscles (Woltman 1941). The patient was an acromegalic with hypertrophic neuropathy as the cause of the compression of the median nerve, and James Learmonth, a neurosurgeon at the Mayo Clinic, divided the transverse carpal ligament. In 1950, George Phalen, a surgeon in Cleveland, described a series of patients with carpal tunnel syndrome, which has become the classic description. Today a history of numbness or paresthesias in the thumb and index finger, associated with night time awakening has become the classic history. The classic physical examination findings are a positive Phalen sign (symptoms provoked with wrist flexion for 1 min) or a positive Tinel sign (distally radiating sensory phenomenon when the median nerve is tapped at the wrist) (Mackinnon and Dellon 1988). It is unusual today for a patient to have sufficient chronicity of symptoms or severity of compression to have thenar muscle wasting at the time of presentation.

Documentation of carpal tunnel syndrome requires either ▶ **electrodiagnostic testing** (EDT) or ▶ **neurosensory testing** (NST). EDT is objective, but remains with significant number of false negative findings, such that a meta-analysis done by the American Neurologic Association (AAEM 1993) found that just 66% of patients using clinical symptoms and findings as the gold standard had positive EDT. In contrast, quantitative sensory testing has been demonstrated to be valid, reliable, correlate well with patient symptoms, and to be painless (Arezzo et al. 1993). Thermal threshold testing docu-

ments the presence of small nerve fiber pathology, and does not become abnormal until late in the pathology of carpal tunnel syndrome. Vibratory threshold testing documents the presence of large fiber pathology, but, because the stimulus is a wave, it can give ambiguous information when used to stimulate the index finger or the thumb: these fingers are innervated by both the radial sensory and the median nerve, both of which will be stimulated by the waveform. NST is a form of quantitative sensory testing that measures the cutaneous pressure threshold for one and two-point moving and static-touch. This testing found a clear distinction between the 99% upper confidence limit in the normal age-matched population, from those patients with even a mild degree of carpal tunnel syndrome (Dellon and Keller 1997), suggesting that this methodology would have a high sensitivity in evaluating patients with chronic nerve compression. This was confirmed in a blinded, prospective study evaluating the ability of EDT versus NST with the Pressure-Specified Sensory Device to identify patients with carpal tunnel syndrome from an asymptomatic population (Weber et al. 2000). That study found that the sensitivity of NST vs. EDT was 92% vs. 81%, and the specificity of NST vs. EDT was 82% vs. 77%. Since NST is painless, the patient is willing to have repeated studies in those clinical situations in which they may be necessary, e.g. when non-operative treatment is first prescribed, or there is workplace environment modification (ergonomics), treatment failure, or evaluation of impairment for a disability rating.

Another indication for NST is the differential diagnosis of failure to improve following carpal tunnel decompression, in which a proximal source of median nerve compression, such as the pronator syndrome, is considered. EDT has a high false negative percentage with this nerve compression, with up to 75% false negative in many studies, whereas NST, by measuring the cutaneous pressure threshold of the thenar eminence, can document this proximal site of compression (Rosenberg et al. 2001). Evaluation of the cutaneous pressure threshold over the dorsoradial aspect of the hand can identify the presence of radial sensory nerve entrapment, another nerve compression to be considered in the differential diagnosis of “failed carpal tunnel decompression”. In those patients in whom a C6 radiculopathy is being considered in the differential diagnosis, the electromyographic component of EDT is still the critical method required for documentation. The treatment of carpal tunnel syndrome is clearly defined based upon staging the degree of compression (Dellon 2001). Measurement of peripheral nerve function permits a numerical grading system which incorporates both the motor and sensory systems, and can be applied to other upper extremity nerve compressions like the ulnar nerve at the elbow, cubital tunnel syndrome, or the lower extremity tibial nerve compression,

the tarsal tunnel syndrome. This numerical grading system permits statistical comparison of treatment options for the wide range of clinical symptoms and findings usually seen in carpal tunnel syndrome, or other nerve entrapment syndromes. For the mild degrees of compression, non-operative treatment is appropriate with splinting of the wrist in a neutral position, non-steroidal anti-inflammatory medication, change of activities of daily living, and cortisone injection. Failure of this approach, manifested by persistence or progression of symptoms is an indication for surgical decompression of the median nerve at the wrist. Another indication for surgery is if more severe degrees of compression are present initially, such as the axonal loss associated with abnormal two-point discrimination or muscle atrophy. Randomized prospective studies (Gerritsen et al. 2001; Trumble et al. 2002), in general, agree that 80–90% of patients can achieve good to excellent symptomatic relief through either a traditional open or the newer endoscopic approach. In experienced hands, the complications for each procedure are similar. These complications include failure of the procedure to achieve the desired result, injury to the median nerve or its branches, and a painful incision. For certain occupations, the endoscopic approach appears to permit a slightly earlier return to work.

Based upon pre-operative staging, a routine intra-operative internal neurolysis does not improve results (Mackinnon et al. 1991), however, adding an internal microsurgical neurolysis based upon intra-operative pathology, has not been evaluated in a prospective study. An **▶ internal neurolysis** may be indicated, therefore, and is utilized by this author, for intraneural fibrosis typically identified in the setting or recurrent median nerve entrapment (Chang and Dellon 1993), or that observed in diabetics with superimposed nerve compression (Aszmann et al. 2000; Dellon 1992). Results of median nerve decompression in diabetics give excellent results in the majority of patients. In the presence of neuropathy, EDT cannot reliably identify the presence of carpal tunnel syndrome, and clinical decision making, based upon the presence of the Phalen and Tinel sign, is still considered valid (Perkins et al. 2002).

## References

1. AAEM Quality Assurance Committee (1993) Literature Review of the Usefulness of Nerve Conduction Studies and Electromyography for the Evaluation of Patients with Carpal Tunnel Syndrome. *Muscle Nerve* 16:1392–1414
2. Arezzo JC, Bolton CF, Boulton A et al. (1993) Quantitative Sensory Testing: A Consensus Report from the Peripheral Neuropathy Association. *Neurol* 43:1050–1052
3. Aszmann OC, Kress K, Dellon AL (2002) Results of Decompression of Peripheral Nerves in Diabetics: A Prospective, Blinded Study Utilizing Computer-Assisted Sensorimotor Testing. *Plast Reconstr Surg* 106:816–822
4. Chang B, Dellon AL (1993) Surgical Management of Recurrent Carpal Tunnel Syndrome. *J Hand Surg* 18:467–470

5. Dellon AL (1992) Treatment of Symptoms of Diabetic Neuropathy by Peripheral Nerve Decompression. *Plast Reconstr Surg* 89:689–697
6. Dellon AL (2001) Clinical Grading of Peripheral Nerve Problems. *Neurosurg Clinics N Amer* 12:229–240
7. Dellon AL, Keller KM (1997) Computer-Assisted Quantitative Sensory Testing in Carpal and Cubital Tunnel Syndromes. *Ann Plast Surg* 38:493–502
8. Gerritsen AAM, Uitdehaag BMJ, Geldere D van et al. (2001) Systematic Review of Randomized Clinical Trials of Surgical Treatment for Carpal Tunnel Syndrome. *Br J Surg* 88:1285–1295
9. Mackinnon SE, Dellon AL (1988) Carpal Tunnel Syndrome. In: Mackinnon and Dellon (eds) *Surgery of the Peripheral Nerve*. Thieme, New York, pp 149–170
10. Mackinnon SE, McCabe S, Murray JF et al. (1991) Internal Neurolysis Fails to Improve Results of Primary Carpal Tunnel Decompression. *J Hand Surg* 16:211–216
11. Perkins BA, Olaaleye D, Bril V (2002) Carpal Tunnel Syndrome in Patients with Diabetic Polyneuropathy. *Diabetes Care* 25:565–569
12. Rosenberg D, Conolley J, Dellon AL (2001) Thenar Eminence Quantitative Sensory Testing in Diagnosis of Proximal Median Nerve Compression. *J Hand Therap* 14:258–265
13. Trumble TE, Diao E, Abrams RA et al. (2002) Single-Portal Endoscopic Carpal Tunnel Release Compared with Open Release. *J Bone Joint Surgery* 84:1107–1115
14. Weber R, Weber RA, Schuchmann JA et al. (2000) A Prospective Blinded Evaluation of Nerve Conduction Velocity versus Pressure-Specified Sensory Testing in Carpal Tunnel Syndrome. *Ann Plast Surg* 45:252–257
15. Woltman HW (1941) Neuritis Associated with Acromegaly. *Arch Neurol Psych* 45:680–682

---

## Carrageenan

### Definition

A colloidal extract from carrageen seaweed and other red algae, s. also Carrageenan Inflammation.

- ▶ [Amygdala, Pain Processing and Behavior in Animals](#)

---

## Carrageenan Inflammation

### Definition

Carrageenan is an inflammatory irritant utilized to mimic inflammatory pain. Carrageenan can be injected into the paw, muscle or joint. Carrageenan inflammation is associated with heat and mechanical hyperalgesia.

- ▶ [Arthritis Model, Kaolin-Carrageenan Induced Arthritis \(Knee\)](#)
- ▶ [TENS, Mechanisms of Action](#)

---

## Cartilage

### Definition

Connective tissue that surrounds the ends of bones as they meet to form a joint. The cartilage serves to form a smooth surface around the bones, providing for cushioning and allowing for smooth and easy movement of

the joint. Degradation of cartilage is a key characteristic of osteoarthritis.

- ▶ [Arthritis Model, Osteoarthritis](#)

---

## Case Control Study

### Definition

A study that starts with the identification of persons with the disease (or outcome variable) of interest, and a suitable control (comparison) group of persons without the disease (Last, 1988).

- ▶ [Prevalence of Chronic Pain Disorders in Children](#)

---

## Case Rate

### Definition

Flat fee paid for a patient's treatment, based on the diagnosis and/or presenting problem.

- ▶ [Disability Management in Managed Care System](#)

---

## Caspases

### Definition

Caspases are a family of cysteine proteases that cleave proteins after aspartic acid residues. They are the main executors of apoptosis or programmed cell death (PCD), and cause the characteristic morphological changes of the cell during apoptosis such as shrinkage, chromatin condensation and DNA fragmentation.

- ▶ [NSAIDs and Cancer](#)

---

## CAT Scan

- ▶ [CT Scanning](#)

---

## Catabolism, Destructive Metabolism

- ▶ [Postoperative Pain, Pathophysiological Changes in Metabolism in Response to Acute Pain](#)

---

## Catalogue

- ▶ [Taxonomy](#)



## Catastrophic Cognitions

- ▶ Catastrophizing

## Catastrophic Thinking

- ▶ Catastrophizing

## Catastrophizing

MICHAEL J.L. SULLIVAN, HEATHER ADAMS  
 Department of Psychology, University of Montreal,  
 Montreal, QC, Canada  
 michael.jl.sullivan@umontreal.ca,  
 heather.adams@umontreal.ca

### Synonyms

Catastrophic thinking; catastrophic cognitions; maladaptive coping

### Definition

Pain catastrophizing has been defined as an exaggerated negative ‘mental set’ that is brought to bear during an actual or anticipated pain experience (Sullivan et al. 2001). Pain catastrophizing is considered to be a multidimensional construct that includes elements of ▶ **rumination** (i.e. excessive focus on pain sensations), ▶ **magnification** (i.e. exaggerating the threat value of pain sensations), and ▶ **helplessness** (i.e. perceiving oneself as unable to cope with pain symptoms).

### Characteristics

#### Catastrophizing, Pain and Disability

To date, approximately 200 studies have been published documenting a relation between catastrophizing and pain. A relation between catastrophizing and pain has been observed in diverse clinical and experimental populations (Sullivan et al. 2001). Catastrophizing has been associated with increased pain and ▶ **pain behavior**, increased use of health care services, longer hospital stays, increased use of analgesic medication, and higher rates of unemployment. In samples of chronic pain patients, catastrophizing has been associated with heightened disability, predicting the risk of chronicity and the severity of disability better than illness-related variables or pain itself (Sullivan et al. 2001; Buer and Linton 2002; Picavet et al. 2002). A relation between catastrophizing and pain-related outcomes has been observed in children as young as 7 years (Gil et al. 1993). For a comprehensive review of current research and theory on pain catastrophizing, the reader is referred to Sullivan et al. (2001) and Vlaeyen and Linton (2000).

Most of the research demonstrating an association between catastrophizing and pain has been correlational in design, thus precluding the nature of causal inferences that can be drawn. However, a few studies have shown that measures of catastrophizing prospectively predict pain outcomes. Keefe et al. (1989) assessed catastrophizing and various pain-related outcomes in a sample of patients with rheumatoid arthritis at two points in time, separated by a 6-month interval. Catastrophizing predicted pain and functional disability even when controlling for initial pain and disability. In a sample of injured workers, Sullivan and Stanish (2003) showed that treatment-related reductions in catastrophic thinking were associated with increased probability of returning to work. In several experimental studies, Sullivan and colleagues showed that catastrophizing, measured in a pain-free state, prospectively predicted pain responses to painful procedures conducted as long as 6 weeks following initial assessment of catastrophizing (Sullivan et al. 2001). Although these findings do not rule out the possibility that catastrophizing may be reactive to variations in pain experience, they do nevertheless highlight that the assessment of catastrophizing can permit prediction of future pain and pain-related disability.

### Functions of Catastrophizing

Early conceptualizations of pain catastrophizing appealed to cognitive constructs such as ▶ **appraisals**, ▶ **cognitive errors** and ▶ **schema activation** to account for the relation between catastrophizing and pain (Sullivan et al. 1995). It was suggested that, as a function of a learning history characterized by heightened pain experience, catastrophizers may develop expectancies about the high threat value of painful stimuli (i.e. primary appraisal), and about their inability to effectively manage the stress associated with painful experiences (i.e. secondary appraisal). Once activated, catastrophizers’ ‘pain schema’ could influence emotional or cognitive functioning in a manner that contributed to heightened pain experience.

More recently, it has been suggested that catastrophizers might engage in exaggerated displays of their pain-related distress as a means of coping with pain (Sullivan et al. 2001). This ‘communal coping’ model of pain catastrophizing draws on recent theoretical discussions of the interpersonal dimensions of coping, suggesting that individuals differ in the degree to which they adopt social or relational goals in their efforts to cope with stress. Catastrophizers’ expressive displays of distress might be used, consciously or unconsciously, to maximize proximity, or to solicit assistance or empathic responses from others in their social environment (Sullivan et al. 2004a).

### Mechanisms of Action: Catastrophizing and Pain

The role of attentional factors has been discussed as one mechanism through which catastrophic thinking might



exert its influence on the pain experience. For example, several investigations have shown the rumination subscale of the PCS is more strongly correlated to pain intensity ratings than the magnification or helplessness subscales (Sullivan et al. 2001). In other words, the endorsement of items, such as ‘I keep thinking about how much it hurts’ and ‘I can’t seem to keep it out of my mind’ is associated with higher pain ratings.

Crombez et al. (1997) found that, in anticipation of a pain stimulus, catastrophizers showed greater interference on an attention-demanding task than non-catastrophizers. Heyneman et al. (1990) reported that pain catastrophizers were unsuccessful in using attention diversion coping strategies to reduce their pain. Other investigations have provided data suggesting that catastrophizers may be impaired in their ability to divert attention away from pain (Sullivan et al. 2001; Van Damme et al. 2002).

#### Mechanism of Action: Catastrophizing and Disability

The role of emotional factors, specifically fear, has been discussed as one mechanism through which catastrophic thinking might exert its influence on pain-related disability. It has been suggested that following injury, individuals who engage in catastrophic thinking are likely to develop heightened fears of pain, movement and re-injury (Vlaeyen and Linton 2000). By contributing to the development of pain-related fears, catastrophizing might heighten the risk for different aspects of disability, such as activity discontinuation and activity avoidance (Picavet et al. 2002). Research suggests that pain-related fears do not mediate the relation between catastrophizing and pain experience, but do mediate the relation between catastrophizing and disability (Sullivan et al. 2004b; Picavet et al. 2002).

#### Assessment

Several assessment instruments have been developed to assess pain catastrophizing. Considerable research on catastrophizing has used the Coping Strategies Questionnaire (CSQ) (Rosenstiel and Keefe 1983). The CSQ consists of 7 coping subscales, including a 6-item catastrophizing subscale. Respondents are asked to rate the frequency with which they use the different strategies described by scale items. The catastrophizing subscale of the CSQ contains items reflecting pessimism and helplessness in relation to coping with pain (i.e. “It’s terrible and it’s never going to get any better”, “There’s nothing I can do to reduce the intensity of the pain”).

The Pain Catastrophizing Scale (PCS) (Sullivan et al. 1995) is another commonly used measure of catastrophizing that adopts a multidimensional view of the construct. The PCS is a 13-item self-report questionnaire that assesses three dimensions of catastrophizing: rumination (“I can’t stop thinking about how much it hurts”), magnification (“I worry that something serious may happen”), and helplessness (“It’s awful and I feel that it overwhelms me”).

Self-report measures have also been developed for assessing catastrophizing in children and adolescents (Gil et al. 1993; Crombez et al. 2003). Interview methods have also been used; however, their application to clinical settings has been limited.

#### Treatment

The robust relation between catastrophizing and pain has prompted a growing number of clinicians and researchers to identify catastrophizing as a central factor in the clinical management of disabling pain conditions. Following multidisciplinary treatment for pain, reductions in catastrophizing are often noted (Burns et al. 2003). Recently, intervention programs have been developed that specifically target catastrophic thinking as a primary goal of treatment. Thorn et al. (2002) have described a 10-week, cognitive behavioral intervention designed to reduce catastrophic thinking in headache sufferers. In this treatment program, thought recording and ► [cognitive restructuring techniques](#) are used as a means of monitoring and modifying catastrophic thoughts. Sullivan and Stanish (2003) described a 10-week, cognitive-behavioral program designed to facilitate return-to-work following occupational injury. In the latter program, ► [activity mobilization](#) strategies and cognitive restructuring are used to minimize catastrophic thinking and facilitate progress toward occupational re-integration.

- [Cognitive-Behavioral Perspective of Pain](#)
- [Coping and Pain](#)
- [Ethics of Pain, Culture and Ethnicity](#)
- [Psychological Aspects of Pain in Women](#)
- [Psychological Treatment in Acute Pain](#)
- [Psychological Treatment of Headache](#)

#### References

1. Buer N, Linton SJ (2002) Fear-Avoidance Beliefs and Catastrophizing: Occurrence and Risk Factor in Back Pain and ADL in the General Population. *Pain* 99:485–491
2. Burns JW, Kubilus A, Bruehl S, Harden RN, Lofland K (2003) Do Changes in Cognitive Factors Influence Outcome following Multidisciplinary Treatment for Chronic Pain? A Cross-Lagged Panel Analysis. *J Consult Clin Psychol* 71:81–91
3. Crombez G, Bijttebier P, Eccleston E, Mascagni GM, Goubert L, Verstraeten K (2003) The Child Version of the Pain Catastrophizing Scale (PCS-C): A Preliminary Validation. *Pain* 104:639–646
4. Crombez G, Eccleston C, Baeyens F, Eelen P (1997) When Somatic Information Threatens, Catastrophic Thinking Enhances Attentional Interference. *Pain* 74:230–237
5. Gil KM, Thompson RJ, Keith BR, Tota-Faucette M, Noll S, Kinney TR (1993) Sickle Cell Disease Pain in Children and Adolescents: Change in Pain Frequency and Coping Strategies Over Time. *J Ped Psychol* 18:621–637
6. Heyneman NE, Fremouw WJ, Gano D, Kirkland F, Heiden L (1990) Individual Differences and the Effectiveness of Different Coping Strategies for Pain. *Cog Ther Res* 14:63–77
7. Keefe FJ, Brown GK, Wallston KA, Caldwell DS (1989) Coping with Rheumatoid Arthritis: Catastrophizing as a Maladaptive Strategy. *Pain* 37:51–56
8. Picavet HS, Vlaeyen JW, Schouten JS (2002) Pain Catastrophizing and Kinesiophobia: Predictors of Chronic Low Back Pain. *Am J Epidemiol* 156:1028–1034

9. Rosenstiel AK, Keefe FJ (1983) The Use of Coping Strategies in Chronic Low Back Pain Patients: Relationship to Patient Characteristics and Current Adjustment. *Pain* 17:33–44
10. Sullivan MJL, Adams H, Sullivan ME (2004a) Communicative Dimensions of Pain Catastrophizing: Social Cueing Effects on Pain Behaviour and Coping. *Pain* 107:220–226
11. Sullivan MJL, Bishop, SR, Pivik J (1995) The Pain Catastrophizing Scale: Development and Validation. *Psychological Assessment* 7:524–532
12. Sullivan MJL, Stanish WD (2003) Psychologically Based Occupational Rehabilitation: The Pain-Disability Prevention Program. *Clin J Pain* 19:97–104
13. Sullivan MJL, Thorn B, Haythornthwaite JA, Keefe FJ, Martin M, Bradley LA, Lefebvre JC (2001) Theoretical Perspectives on the Relation between Catastrophizing and Pain. *Clin J Pain* 17:52–64
14. Sullivan MJL, Thorn B, Rodgers W, Ward C (2004b) Path Model of Psychological Antecedents of Pain Experience: Experimental and Clinical Findings. *Clin J Pain* 20:164–173
15. Thorn BE, Boothby J, Sullivan MJL (2002) Targeted Treatment of Catastrophizing in the Management of Chronic Pain. *Cogn Behav Pract* 9:127–138
16. Van Damme S, Crombez G, Eccleston C (2002) Retarded Disengagement from Pain Cues: The Effects of Pain Catastrophizing and Pain Expectancy. *Pain* 100:111–118
17. Vlaeyen JWS, Linton SJ (2000) Fear-Avoidance and its Consequences in Chronic Musculoskeletal Pain: A State of the Art. *Pain* 85:317–332

## Categorization of Nociceptors

- ▶ Nociceptor, Categorization

## Cauda Equina

### Definition

A syndrome of fluctuating weakness and sensory loss caused by ischemia of the lumbosacral roots in a narrow spinal canal. It also refers to a collection of spinal roots descending from the lower spinal cord and occupying the vertebral canal below the cord.

- ▶ Chronic Back Pain and Spinal Instability
- ▶ Radiculopathies

## Caudal Analgesia or Anesthesia

### Definition

Regional anesthesia by injection of local anesthetic solution or other drugs into the epidural space via sacral hiatus.

- ▶ Postoperative Pain, Epidural Infusions

## Caudal Epidural Blocks

### Definition

Sensory and motor block of the thoracic, lumbar or sacral nerves achieved by injecting local anesthetic (0.5–1 mg/kg) via needle or catheter inserted through the sacral hiatus into the epidural space.

- ▶ Acute Pain in Children, Post-Operative

## Caudal Epidural Steroids

- ▶ Epidural Steroid Injections

## Caudal Injection

- ▶ Epidural Steroid Injections for Chronic Back Pain

## Caudate Nucleus

### Definition

One of the main nuclei of the basal ganglia; part of the striatum connected principally with prefrontal and other association areas of cortex.

- ▶ Nociceptive Processing in the Nucleus Accumbens, Neurophysiology and Behavioral Studies
- ▶ Parafascicular Nucleus, Pain Modulation

## Causalgia

### Definition

A syndrome of sustained burning pain, allodynia, and hyperpathia after a traumatic nerve lesion, often combined with vasomotor and sudomotor dysfunction and later trophic changes.

- ▶ Causalgia, Assessment
- ▶ Complex Regional Pain Syndrome and the Sympathetic Nervous System
- ▶ Complex Regional Pain Syndromes, General Aspects
- ▶ Sympathetically Maintained Pain in CRPS II, Human Experimentation

## Causalgia, Assessment

ELLEN JØRUM

The Laboratory of Clinical Neurophysiology,  
Rikshospitalet University, Oslo, Norway  
ellen.jorum@rikshospitalet.no

### Definition

► **Causalgia** is defined as “A syndrome of sustained burning pain, ► **allodynia** and ► **hyperpathia** after a traumatic ► **nerve lesion**, often combined with ► **vasomotor** and ► **sudomotor dysfunction** and later trophic changes.” (Classification of chronic pain 1994) This is an old term and causalgia will now be called ► **complex regional pain syndrome type 2 – CRPS–II** (with nerve lesion).

Causalgia, or complex regional pain syndrome, is as the name implies a complex pain syndrome, being characterized by the presence of ► **spontaneous pain**, alterations in sensibility including allodynia and hyperpathia, as well as symptoms and signs of autonomic dysfunction.

Since this chapter will be dealing with “assessments” the complicated neurophysiological mechanisms will not be mentioned. The aetiology is given, since we are talking about a traumatic nerve lesion. This may occur in relation to all sorts of injuries.

### Characteristics

#### Assessment of Nerve Lesion

This is a pain syndrome occurring after a traumatic nerve lesion, and much emphasis will have to be put on the identification of a specific nerve lesion.

The best way to detect and to assess a peripheral nerve lesion is to perform a detailed clinical neurological examination of the patient, including investigation of motor and sensory function and myotatic reflexes. Since pain may arise following either a sensory or a mixed motor and sensory nerve, a detailed mapping of motor and sensory deficits is crucial. In most cases, there will be a lesion of sensory nerve fibres, and a careful study of the innervation territory of sensory deficit is warranted. However, because of the involvement of central sensitization-mechanisms, the sensory deficit may sometimes exceed the innervation territory of the nerve; one may proceed by admitting the patient to a clinical neurophysiologist for EMG (electromyography) and neurography. By neurography, measurements of conduction velocities and other variables such as distal delay, motor and sensory amplitudes and latency of late volleys such as the H– and F– wave are measured. Nerve conduction studies play an important role in precisely delineating the extent and distribution of a peripheral nerve lesion, and give some indication of nerve-root pathology (by evaluation of late reflexes) (Jørum and

Arendt-Nielsen 2003). ► **Electrodiagnostic studies** are capable of demonstrating the peripheral nerve injury of causalgia or CRPS–II (Devor 1983). Neurography does not evaluate the function of thin nerve fibres such as A  $\delta$  mediating cold/sharp pain and C-fibres mediating the sensation of heat, heat pain and some forms of tactile pain. These nerve fibres may be evaluated by quantitative sensory testing (QST) (Gracely et al. 1996). It is important to note that the number of nerves available for neurography is restricted. Neurography will routinely be performed on the major nerves of the upper extremity (median, ulnar and radial nerves) and in the lower extremity (peroneal, tibial and sural nerves); it is also possible, to some extent, to perform neurography of a few proximal sensory nerves in both upper and lower extremity. EMG is also a helpful method in evaluating neurogenic affection of muscles, and since it may be performed in a large extent of muscles, more nerves may hereby be examined.

#### Assessment of Clinical Pain

The pain in causalgia will have the same possible characteristics as pain following neuropathic pain in general, including the presence of spontaneous and evoked pain. Although pain following nerve lesions has often been described as burning, there are no pain descriptors which are specific to neuropathic pain (and thereby to causalgia).

Pain in causalgia may be described by a large number of adjectives, of which burning, throbbing, aching are only a few examples. Spontaneous pain may be ongoing and/or paroxysmal, and the intensity may be evaluated by a visual analogue score (0–10 cm) or (0–100 mm), where 0 represents no pain and 10 or 100 the worst thinkable pain. Pain intensity may spontaneously vary in intensity, but is often aggravated by physical activity and exposure to cold. Lightly touching the painful area will, in most cases, provoke a severe pain, but pain may also be evoked by thermal stimuli (frequently cold, not so frequently heat.)

#### Assessment of Allodynia/Hyperpathia

Since causalgia may be characterized by the presence of allodynia and hyperpathia, an assessment of these phenomena is important. Both are described elsewhere, but it is briefly repeated here that allodynia is defined as “pain due to a stimulus which does not normally provoke pain” and hyperpathia as “a painful syndrome characterized by an abnormally painful reaction to a stimulus, especially a repetitive stimulus, as well as an increased threshold” (Classification of chronic pain 1994). Allodynia and hyperpathia to both ► **tactile stimuli** and ► **thermal stimuli** may be tested. In clinical practice, allodynia to light touch is the easiest to perform. One may apply a cotton swab or a brush, gently moving it over the painful area, and record whether this normally non-painful stimulus evokes pain or not. Hyperpathia

to light touch may also be present, but in general the two phenomena may coexist. For the determination of allodynia and hyperpathia to thermal stimuli, special equipment is generally needed. One may obtain some indication of the presence or not of allodynia to cold or heat by applying thermorollers over the skin, rollers which are set at fixed temperatures, i.e. 25 and 40°C. The rollers are first and foremost manufactured for testing reduced sensibility, and since heat pain is normally perceived at temperatures around 42–43°C, it may be difficult to conclude with heat allodynia if pain is perceived at 40°C. Cold allodynia, on the other hand, may be easier to demonstrate. In the upper extremity, cold pain will normally be seen at a threshold of 10–15°C, while in the lower extremity, it will be below 10°C. For more accurate determinations of thresholds for cold allodynia or heat allodynia, quantitative sensory testing (QST) may be performed with the use of a thermotest. Cold allodynia will be the most prominent finding, and will not be different from cold allodynia in other cases of neuropathic pain (Jørum et al. 2003).

Heat allodynia may exist, but is seen less frequently. Hyperalgesia/hyperpathia to pinprick may also be demonstrated, and as for allodynia to light touch, it may be of value to map the area, by moving the von Frey hair or a needle from normal skin centripetally towards the area of hyperalgesia.

#### Assessment of Vasomotor and Sudomotor Dysfunction

The inclusion of possible vasomotor and sudomotor dysfunction is essential for the diagnosis of CRPS–II or causalgia. The clinician should look for signs like oedema (Fig. 1), sweat dysregulation (usually increased sweating, but also possibly reduced sweating), alterations in skin temperature (cooler or warmer) reflecting vasomotor changes, and trophic changes of the skin, hair and nails. The diagnosis of a full developed CRPS is not difficult. However, the diagnosis of milder cases may prove difficult, especially since the patients' clinical picture may change over time (vasodilatation at first, then vasoconstriction and finally dystrophic changes),

and the dynamic alterations may also include diurnal fluctuations. The evaluation of autonomic dysfunction may in most cases be performed by a clinical examination, but laboratory tests may prove helpful. These can measure changes in autonomic function with higher sensitivity and more objectivity. Most laboratory studies of autonomic dysfunction in patients with CRPS have been conducted on patients with CRPS type 1 (formerly reflex sympathetic dystrophy). One must add that a general assumption is that CRPS–I or CRPS–II, do not differ in the changes believed to be dependent on the sympathetic nervous system (Stanton-Hicks et al. 1995). Various tests may be employed to assess the function of the autonomic nervous system, both well validated routine tests as well as more experimental procedures. For the assessment of sudomotor function, sympathetic skin response and quantitative sudomotor axon reflex test (QSART) may be employed. Recordings of skin potentials from the foot or hand may be made following a stimulus such as electric shock, a noise, a cough or an inspiratory gasp. The advantage of this method is that it is easy to perform in a routine clinical neurophysiological laboratory. The disadvantage is its large variability, the tendency of the responses to habituate, and that it has little sensitivity, especially compared with the more sophisticated QSART. In the latter test, the sweat output in response to iontophoretic application of 10% acetylcholine is recorded by a sudorometer. The major advantage is that the test is sensitive and reproducible in controls and in patients with neuropathy (Low 2003). The disadvantage is that the equipment has only recently become commercially available and is not yet represented in many laboratories. In a study of 102 patients with CRPS–I by Sandroni and co-workers (1998), they found that some of the indices that correlated most reliably with clinical data, and with each other, were QSART and skin temperature reductions. The authors computed the sudomotor index from the change in sweat volume, latency and persistent sweat activity. QSART was positive at a single site if the affected side

C



**Causalgia, Assessment,**  
**Figure 1** Oedema in the right hand  
 in a patient with CRPS.



showed changes 50% greater than the non-affected side.

The assessment of vasomotor (vasoconstriction/vasodilatation) dysfunction may be performed by indirect methods, such as measuring of skin temperature or thermography and by more sophisticated laser doppler-examinations. The measurement of skin temperature is an easy but indirect way to detect changes in vasomotor function, where a difference between the affected and non-affected extremity exceeding 1°C will be regarded as significant. Thermography is also easy to perform, but has the disadvantage that it will be regarded as an indirect way of testing vasomotor function. Laser doppler investigations are also easy to perform, by measuring flow at a limited area or by scanning a larger area, but interpretations of data related to pathophysiology may be difficult. Elegant examinations are performed with laser doppler examination, as described in a paper by Weber et al. (2001), in combination with transcutaneous electrical stimulation. They found that the vasodilatation as a response to electrical stimulation of the skin increased significantly (more pronounced vasodilatation) in a group of mainly CRPS type 1 patients compared to normal controls. There have been many critical comments to the IASP diagnostic criteria for CRPS in general, and many authors have questioned the specificity of the criteria.

In a study by Bruehl and co-workers (1999) of 117 patients meeting the IASP criteria for CRPS, and 43 patients with neuropathic pain from diabetic neuropathy, they found that signs or symptoms of oedema versus colour changes versus sweat dysregulation satisfied three criteria, and discriminated between the groups. Although diagnostic sensitivity was high at 98%, specificity was poor at 36%. The diagnosis of CRPS was likely to be correct in only 40% of the cases, and the results of this study suggested that the criteria used by IASP had inadequate specificity and were likely to lead to over-diagnosis. However, it was again emphasized that this study was performed on patients with CRPS of both type 1 (approximately two thirds) and type 2.

## References

1. Bruehl S, Harden RN, Galer BS, Saltz S, Betram M, Backonja M, Gayles R, Rudin N, Bhugra MK, Stanton-Hicks M (1999) External Validation of IASP Diagnostic Criteria for Complex Regional Pain Syndrome and Proposed Research Diagnostic Criteria. *Pain* 81:147–154
2. Merskey H, Bogduk N (1994) Classification of Chronic Pain. IASP Press, Seattle
3. Devor M (1983) Nerve Pathophysiology and Mechanisms of Pain in Causalgia. *J Autonom Nerv Syst* 7:371–384
4. Gracely RH, Price DD, Rogers WJ, Bennett GJ (1996) Quantitative Sensory Testing in Patients with Complex Regional Pain Syndrome (CRPS) I and II. In: Jänig W, Stanton-Hicks M (eds) *Reflex Sympathetic Dystrophy: A Reappraisal, Progress in Pain Research and Management*, vol 6. IASP Press, Seattle, p 151
5. Jørum E, Arendt-Nielsen L (2002) Sensory Testing and Clinical Neurophysiology. In: Breivik H, Campell W, Eccleston C (eds) *Textbook of Clinical Pain Management*. Arnold, London, pp 27–38
6. Jørum E, Warncke T, Stubhaug A (2003) Cold Allodynia and Hyperalgesia in Neuropathic Pain: The Effect of N-methyl-D-aspartate (NMDA) Receptor Antagonist Ketamine: A Double-Blind, Cross-Over Comparison with Alfentanil and Placebo. *Pain* 101:229–235
7. Low P (2003) Testing the Autonomic Nervous System. *Seminars in neurology* 23:407–421
8. Sandroni P, Low PA, Ferrer T, Opfer-Gehrking T, Willner C, Wilson PR (1998) Complex Regional Pain Syndrome (CRPS 1): Prospective Study and Laboratory Evaluation. *Clin J Pain* 14:282–289
9. Stanton-Hicks M, Jänig W, Hassenbusch S et al. (1995) Reflex Sympathetic Dystrophy: Changing Concepts and Taxonomy. *Pain* 63:127–133
10. Weber M, Birklein F, Neundörfer B, Schmelz M (2001) Facilitated Neurogenic Inflammation in Complex Regional Pain Syndrome. *Pain* 91:251–257

---

## Cawthorne and Cookseys' Eye-Head Exercises

- ▶ Coordination Exercises in the Treatment of Cervical Dizziness

---

## CBT

- ▶ Cognitive-Behavioral Therapy

---

## CCI

- ▶ Chronic Constriction Injury
- ▶ Chronic Constriction Injury Model
- ▶ Neuropathic Pain Model, Chronic Constriction Injury

---

## CCK

- ▶ Cholecystokinin

---

## CDH

- ▶ Chronic Daily Headache in Children



## Celiac Plexus Block

### Definition

The celiac plexus is involved in nociceptive pain transmission from intraabdominal organs from the distal esophagus to the transverse, and sometimes to the descending colon. Interruption of nociceptive signals by injection of phenol or alcohol onto the plexus may provide excellent and prolonged pain relief for patients suffering particularly from gastric and pancreatic carcinoma.

- ▶ Cancer Pain Management, Anesthesiologic Interventions, Neural Blockade
- ▶ Cancer Pain Management, Overall Strategy

## Cell Adhesion

### Definition

An intercellular connection by which cells stick to other cells or non-cellular components of their environment. Cell adhesion generally requires special protein complexes at the surface of cells.

- ▶ NSAIDs and Cancer

## Cell Grafts

- ▶ Cell Therapy in the Treatment of Central Pain

## Cell Minipumps

- ▶ Cell Therapy in the Treatment of Central Pain

## Cell Therapy in the Treatment of Central Pain

MARY J. EATON

Miller School of Medicine at the University of Miami,  
Miami, FL, USA  
meaton@miami.edu

### Synonyms

Cell Transplantation; Cell Grafts; Cell Minipumps

### Definition

Cell therapy is the use of transplanted cells from primary or immortalized sources to reverse or reduce symptoms or causes of pain arising from injury to the central nervous system. Cell grafts used in this therapy can be placed near the original injury, such as in or near the spinal cord, or further away, depending on the intended mechanism to be targeted for therapeutic intervention. Primary cell sources are derived from a single cohort donor and cannot be expanded or kept *in vitro* for extended periods. Immortalized cell sources are derived from any animal or human source, but have been engineered to be, or are naturally, expandable *in vitro*.

### Characteristics

Even with continuous improvements in surgical management, physical therapy and the availability of newer pharmacological agents, many patients following injury to the central nervous system continue to suffer from difficult to treat chronic pain. Newer treatments to modulate and reduce ▶ **central pain** are likely to include cell grafts that release antinociceptive molecules synthesized by transplanted cells. Cell therapy to treat neuropathic pain after spinal cord injury (SCI) is in its infancy, but the development of cellular strategies that would replace or be used as an adjunct to current pharmacological treatments for ▶ **neuropathic pain** have progressed tremendously over the past 20 years. One strategy involves the placement of grafts in the spinal cord where a variety of antinociceptive substances are released. Presumably, these cell grafts act as “cellular minipumps” that are able to release neuroactive ▶ **antinociceptive** molecules in the spinal cord and effect pain processing pathways. Cell lines, rather than primary cell grafts, can also offer a renewable and possibly safe to use source of cells. Grafts of either primary or immortalized sources could be expected to reduce or eliminate side effects associated with large doses of pharmacological agents typically required for centrally acting pain reducing agents, such as opioids or antidepressants.

The earliest studies using cell transplants for pain therapy were developed with the idea of mimicking descending or local spinal inhibitory ▶ **neurotransmitter** modulation of sensory information. In these studies agents released by cell grafts after injury resulted in ▶ **antinociception**. A variety of neurotransmitters, peptides and more recently ▶ **neurotrophins**, have been implicated in spinal inhibition. These include the endogenous neurotransmitters serotonin (5-HT), noradrenaline and  $\gamma$ -aminobutyric acid (GABA), the endogenous opioid  $\beta$ -endorphin, enkephalins, endogenous peptides such galanin and neurotrophins such as brain derived neurotrophic factor (BDNF). Many of the commonly used pharmacological therapies target receptors and re-uptake mechanisms of these substances

in order to increase or mimic their presence in acute and chronic pain. In the early 1980's it was recognized that these agents could be supplied by grafts of autologous primary adrenal medullary chromaffin cells after nerve injury (► [autologous graft](#)). Chromaffin cells contain a cocktail of antinociceptive agents, peptides and neurotrophins (Wilson et al. 1981). To use chromaffin cell therapy in humans, adrenal chromaffin cell grafts were prepared from xenogenic bovine sources and tested for antinociception after nerve injury (Sagen et al. 1993). There have also been a number of animal studies using primary medullary tissue or dissociated chromaffin cultures placed in the ► [subarachnoid space](#) to reduce behavioral hypersensitivity in models of SCI-induced pain (Brewer and Yeziarski 1998). Unfortunately, non-human, xenogenic tissue sources are not likely to be used clinically, even if they are more abundant, given their increased risk of antigenicity and rapid rejection by the human host. Adult human chromaffin tissue has been transplanted and tested in humans for terminal cancer pain (Pappas et al. 1997), which is often neuropathic pain in nature. In these studies when the immune response in the human host was examined after graft placement, it was concluded that further purification or ► [immunoisolation](#) of grafts would be needed in order to use such tissues in multiple transplants, given the antigenicity of the diverse cell sources. Chromaffin cells from primary tissue sources are not likely to be homogeneous, since they are often obtained from multiple donors. The ability to use and manipulate immortalized cell lines as a defined and stable source of cells will most probably permit the implementation of cell therapy for pain in a clinical setting.

A number of immortalized cell lines have been derived from the rat brainstem to model how such cell line grafts might function in models of pain after grafting near the spinal cord. A common feature of these cells is the expression of an oncogene, such as the temperature sensitive ► [allele](#) of large T antigen (tsTag) that confers ► [immortalization](#) and allows for the expansion of cells at low temperatures *in vitro*. This oncogene is down-regulated at higher transplant temperatures in the animal. One of these rat neural precursor cell lines was isolated from embryonic day 12.5 rat brainstem and immortalized with the tsTag sequence. This cell line has been made to synthesize and secrete the neurotrophin BDNF by the addition of the sequence for rat BDNF to its ► [genome](#), causing these cells to have improved survival *in vitro* and *in vivo* and develop a permanent serotonergic phenotype. Since additional 5-HT was postulated to have a beneficial effect on neuropathic pain, cells were placed in a lumbar subarachnoid space after sciatic nerve injury. Grafts of these serotonergic cells placed 1 week after nerve injury and the development of severe hypersensitivity to thermal and tactile stimuli were able to permanently reverse the symptoms of neu-

ropathic pain (Eaton et al. 1997). Transplants of similar murine cell lines genetically engineered to synthesize and secrete potentially antinociceptive molecules such as the inhibitory peptide galanin, the neurotrophin BDNF and the inhibitory neurotransmitter GABA have been tested successfully in the same partial nerve injury pain model (Eaton 2000).

The same bioengineered rat serotonergic cell line mentioned above has been successfully used to reduce neuropathic pain and improve locomotor function following SCI (Hains et al. 2001). Pain reduction requires that cells be placed in the subarachnoid space, where they can affect dorsal horn pathways and reduce spinal neuronal hyperexcitability (Hains et al. 2003), probably modulated through specific 5-HT receptors. A similar bioengineering approach was used to immortalize primary embryonic rat and bovine chromaffin cells, using the tsTag for immortalization. Grafts of these cells placed in the subarachnoid space in a model of neuropathic pain after nerve injury reduced pain without forming tumors in the host animal (Eaton et al. 2000). For such an approach to be completely safe as a clinical method for cell therapy, it will be necessary to remove the oncogene completely before grafting. The next advance in the creation of cell lines for therapeutic use has been the development of reversibly immortalized cell lines, as modeled by rat chromaffin cell lines with an excisable oncogene.

Studies exploiting site specific ► [DNA recombination](#) and Cre/lox excision have suggested that cells can be targeted *in vitro* and *in vivo* for removal of deleterious genes, including the large T antigen. Reversible immortalization with Tag and Cre/lox technology was first reported in human fibroblasts by Westerman and Leblouch (1996) and more recently in human myogenic cells and hepatocytes (Kobayashi et al. 2000). Introduction of the gene for Cre recombinase into a cell's ► [genome](#) allows for Cre to excise any recombinant sequences present that are flanked by small loxP sequences. Using this strategy, rat chromaffin cells have been immortalized with an oncogenic tsTag construct, utilizing retroviral infection of these early chromaffin precursors with the tsTag construct flanked by loxP sequences (floxed). Following isolation of immortalized cells, they were further infected with a retrovirus expressing the CrePR1 gene, which encodes for a fusion protein that combines Cre activity with the mutant human steroid receptor, hPRB891. After incubation of the cells with the synthetic steroid RU486, the fusion protein is translocated to the cell nucleus, allowing Cre to excise the tsTag oncogene and effectively dis-immortalize the cells *in vitro*. Such reversibly immortalized chromaffin cells, which express many features of the primary chromaffin cell, are able to reverse neuropathic pain after spinal cord transplantation in a nerve injury model (Eaton et al. 2002). Such studies model the use of reversibly immortalized cell lines in humans.

An entirely different approach with cell lines is the use of human neural lines that contain an oncogene that can be down-regulated with agents such as retinoic acid (RA). An example of such a human neural cell line is the NT2 line (Andrews 1984), which after ► **differentiation** with RA for more than 2 weeks *in vitro*, differentiates into stable human neural cells that never form tumors after grafting and have been used to ameliorate a variety of traumatic and neurodegenerative conditions (Trojanowski et al. 1997). Such cells represent immortalized stem cells or neural progenitors that have been spontaneously immortalized and only differentiate after RA into the non-tumor, neural phenotype. These cells offer great potential for the treatment of ► **central pain**, since they appear safe and can be easily used in the clinical setting, being placed *via* spinal tap into the subarachnoid space. Finally, there are no published successful methods for treating human central pain with stem cells or precursors. The promise of this strategy lies in the future and will probably require a degree of genetic or laboratory manipulation. Regenerative medicine and the use of human embryonic stem cells also currently engender ethical considerations. But, with rapid advances in knowledge about the basic biology of and ability to manipulate embryonic stem and precursor cells derived from CNS and other tissues, the future will probably have a place for the use of cell therapy. For example, adrenal chromaffin progenitors can be kept proliferating by growth factors *in vitro* (Bes and Sagen 2002), suggesting that they might provide an alternative source for cell therapy, different from bioengineered, immortalized chromaffin cell lines. The near future will probably provide new challenges for the implementation of cell therapy for those who suffer chronic pain. Some of the challenges common to all forms of cell transplantation include immune rejection *versus* long-term survival and efficacy in the human host, dependable, well characterized cell sources for grafts, cells that can safely integrate into or near the CNS without danger of tumors or significant deleterious effects, ability to control the antinociceptive output of cell grafts, ideally increasing with the cyclic episodes of pain, and efficacy in a wide variety of pain causalities. Cell therapy for the treatment of pain offers much promise as a replacement or adjunct to current clinical methodologies. The efficacy of this strategy will depend on a better understanding of the mechanisms of pain, so that such bio-engineered cellular tools can be used appropriately.

## References

- Andrews PW (1984) Retinoic acid induces neuronal differentiation of a cloned human embryonal carcinoma cell line *in vitro*. *Dev Biol* 103:285–293
- Bes JC, Sagen J (2002) Dissociated human embryonic and fetal adrenal glands in neural stem cell culture system: open fate for neuronal, nonneuronal, and chromaffin lineages? *Ann N Y Acad Sci* 971:563–572
- Brewer KL, Yeziarski RP (1998) Effects of adrenal medullary transplants on pain-related behaviors following excitotoxic spinal cord injury. *Brain Res* 798:83–92
- Eaton MJ (2000) Emerging cell and molecular strategies for the study and treatment of painful peripheral neuropathies. *J Peripher Nerv Syst* 5:59–74
- Eaton MJ, Dancausse HR, Santiago DI et al. (1997) Lumbar transplants of immortalized serotonergic neurons alleviates chronic neuropathic pain. *Pain* 72:59–69
- Eaton MJ, Martinez M, Frydel B et al. (2000) Initial characterization of the transplant of immortalized chromaffin cells for the attenuation of chronic neuropathic pain. *Cell Transplant* 9:637–656
- Eaton MJ, Herman JP, Jullien N et al. (2002) Immortalized chromaffin cells disimmortalized with Cre/lox site-directed recombination for use in cell therapy for pain. *Exp Neurol* 175:49–60
- Hains BC, Johnson KM, McAdoo DJ et al. (2001) Engraftment of immortalized serotonergic neurons enhances locomotor function and attenuates pain-like behavior following spinal hemisection injury in the rat. *Exp Neurol* 171:361–378
- Hains BC, Johnson KM, Eaton MJ et al. (2003) Serotonergic neural precursor cell grafts attenuate bilateral hyperexcitability of dorsal horn neurons after spinal hemisection in rat. *Neurosci* 116:1097–1110
- Kobayashi N, Miyazaki M, Fukaya K et al. (2000) Treatment of surgically induced acute liver failure with transplantation of highly differentiated immortalized human hepatocytes. *Cell Transplant* 9:733–735
- Pappas GD, Lazorthes Y, Bes JC et al. (1997) Relief of intractable cancer pain by human chromaffin cell transplants: experience at two medical centers. *Neurol Res* 19:71–77
- Sagen J, Wang H, Tresco PA et al. (1993) Transplants of immunologically isolated xenogenic chromaffin cells provide a long-term source of pain-reducing neuroactive substances. *J Neurosci* 13:2415–2423
- Trojanowski JQ, Kleppner SR, Hartley RS et al. (1997) Transfectable and transplantable postmitotic human neurons: potential “platform” for gene therapy of nervous system diseases. *Exp Neurol* 144:92–97
- Westerman KA, Leboulch P (1996) Reversible immortalization of mammalian cells mediated by retroviral transfer and site-specific recombination. *Proc Nat Acad Sci USA* 93:8971–8976
- Wilson S, Chang K, Viveros O (1981) Opioid peptide synthesis in bovine and human adrenal chromaffin cells. *Peptides* 2 Suppl:83–88

## Cell Transplantation

- [Cell Therapy in the Treatment of Central Pain](#)

## Cell-Mediated Immunity

### Definition

An arm of the immune system that recognizes cell-associated antigens and consists of T-cells, phagocytes and NK cells as cellular effectors.

- [Viral Neuropathies](#)

## Cellular Adhesion Molecules

### Synonyms

CAMs

**Definition**

Cellular adhesion molecules (CAMs) are cell surface proteins involved in the binding of cells, usually leukocytes, to each other, to endothelial cells, or to extracellular matrix. Most of the CAMs characterized so far fall into three general families of proteins: the immunoglobulin (Ig) superfamily, the integrin family, or the selectin family. The Ig superfamily of adhesion molecules, including ICAM-1, ICAM-2, ICAM-3, VCAM-1, and MadCAM-1, bind to integrins on leukocytes and mediate their flattening onto the blood vessel wall, with their subsequent extravasation into the surrounding tissue.

► Cytokine Modulation of Opioid Action

**Cellular Targets of Substance P****Definition**

Possible sources of NK1 receptor stimulated NGF biosynthesis including mast cells, which have been reported to be prominent sources of skin NGF, although the expression of NK1 receptors on these cells is unsure. There are only a few reports suggesting the presence of NK1 receptors on mast cells. However, it has to be taken into account that, depending on anatomic site, mast cells show variations in cell size, cytoplasmic granule ultrastructure, mediator content, sensitivity to stimulation by secretagogues, and in their susceptibility to various pharmacological agents. Thus, it has been shown recently that functional NK1 receptors are induced by IL-4 and stem cell factor, suggesting that under certain conditions, like those accompanying inflammation, mast cells could gain increased responsiveness to NK1 agonists. Keratinocytes have been shown to express beta adrenoceptors and to produce NGF in response to substance P. However, there are diverging reports as to the type of tachykinin receptor primarily expressed by murine keratinocytes. Other possible sources of NGF include macrophages/monocytes that express NK1 receptors and can be stimulated by substance P to produce cytokines.

► NGF, Regulation during Inflammation

**Cementum****Definition**

Cementum is the mineralized tissue that covers the root of a tooth. At the level where it abuts the enamel of the crown it is very thin and often abraded, exposing the underlying sensitive dentin.

► Dental Pain, Etiology, Pathogenesis and Management

**Central Changes after Peripheral Nerve Injury**

MARSHALL DEVOR

Department of Cell and Animal Biology, Institute of Life Sciences, and Center for Research on Pain, Hebrew University of Jerusalem, Jerusalem, Israel  
marshlu@vms.huji.ac.il

**Synonyms**

Transsynaptic Changes after Peripheral Nerve Injury; central sensitization; central hyperexcitability state; Centralization; CNS Changes after Peripheral Nerve Injury

**Definition**

Following nerve injury, including injury associated with chronic pain, numerous structural, neurochemical and electrophysiological parameters are altered in the central nervous system (CNS), especially in the spinal cord and brainstem areas that receive direct primary afferent input. This has led to the conviction that at least some of these central changes contribute to chronic neuropathic pain either directly, by generating ectopic pain-signaling impulses, or indirectly, by amplifying or otherwise modulating pain signals generated in the peripheral nervous system (PNS). In most instances we do not know with confidence whether or not a particular central change plays an important part in neuropathic pain.

**Characteristics****Central Sensitization and Pain Centralization**

“Central sensitization” refers to an altered state of central neural processing in which nociceptive signals that enter the CNS from the periphery are amplified, or in which signals carried centrally by low threshold mechanoreceptor afferents (afferents that normally provoke a sensation of touch) instead provoke a sensation of pain (Campbell et al. 1988; Devor et al. 1991; Woolf 1983). The concept that pain hypersensitivity in inflamed tissue and in neuropathy may be due, at least in part, to abnormal signal processing in the CNS, has a long history in neurology. The idea was promoted in particular by Hardy, Wolf and Goodell in the 1950s (Hardy et al. 1952), but was marginalized at the time, with most investigators favoring the alternative hypothesis of hyperexcitable nociceptive afferent endings in the periphery (Lewis 1942). The conviction that the CNS makes an important contribution was revived in the 1980s, partly under the influence of Melzack and Wall’s “Gate control theory” and partly due to the appearance of a great deal of new data based on experimental observations in humans and animal preparations.

When first introduced, the term central sensitization referred to a spinal pain hypersensitivity state triggered



by afferent input entering the CNS on nociceptive C-afferents, and perhaps also nociceptive A $\delta$ -afferents. This hypersensitivity state comes on rapidly following onset of the nociceptive stimulus (seconds or minutes), and on cessation of the stimulus rapidly dissipates (minutes or hours). It can be maintained indefinitely, however, by continuous barrages of nociceptive input such as may occur in chronic inflammatory conditions and neuropathy. Thus, as originally conceived, central sensitization is a labile, dynamic state dependent on an ongoing barrage of nociceptive afferent input (Gracely et al. 1992; Ji et al. 2003; Koltzenburg et al. 1994; Torebjork et al. 1992).

Research into neural mechanisms that might underlie central sensitization, however, revealed that a large variety of candidate processes are triggered by peripheral inflammation and neuropathy, and that some of these are neither transient and rapidly reversible, nor apparently dependent on ongoing afferent input. The discovery of such durable central changes coincided with the revival of another classical concept, “► [pain centralization](#)” Believers in pain centralization claim that persistent severe pain can “burn itself into” the CNS, in the same way that a torrential stream can carve a canyon through solid rock. Persistent pain thus creates a central hyperexcitability state that becomes independent of afferent input from the periphery. If true, this is an important matter, because it implies that pain relief has a deadline; if it is not relieved soon enough it centralizes and may become intractable, permanent (Kalso 1997).

It is unlikely that pain, per se, can in fact cause permanent changes in central somatosensory processing. If it did, then severe pain would persist after removal of a clear peripheral source such as passage of a kidney stone, childbirth, or replacement of an osteoarthritic hip. Peripheral nerve injury, in contrast, may well induce permanent CNS changes and intractable pain. In the context of neuropathy, the idea of durable centralization has merged with the original dynamic concept of central sensitization. Thus, “central sensitization” has become an umbrella term that covers all peripherally evoked central changes that contribute to neuropathic pain, labile and durable. This will be the use of the term in the present essay. Note that central changes underlying neuropathic pain probably encompass some processes that are not involved in central sensitization evoked by acute noxious events, or by peripheral tissue inflammation.

Central sensitization was originally conceived of as being regionally circumscribed. For example, following a localized burn, allodynia and hyperalgesia spread somewhat beyond the area of primary injury into a surrounding zone termed the area of “► [secondary hyperalgesia](#)”. Likewise, if the precipitating injury is to a particular nerve or sensory ganglion, central sensitization can cause the pain to extend into the distribution of neighboring nerves, or nearby dermatomes. Pain extending beyond the triggering source is sometimes

given the dissonant name “extraterritorial pain” The concept can be extended still further. Pathology in one organ, for example, can cause hyperesthesia in neighboring ones, and meningeal inflammation in migraine can cause tenderness on the scalp. Some authors have gone even further, positing that broad expanses of the central somatosensory representation can become persistently hyperexcitable. This is a popular explanation for widely distributed global pain symptoms such as in fibromyalgia (Banic et al. 2004; McDermid et al. 1996).

### Varieties of Central Change

Numerous central changes have been documented in animal models of neuropathic (and inflammatory) pain. In principle, it ought to be possible to determine the relative contribution of each such change by spinal delivery of agents that counter the changes, one at a time. Each such agent should block a fraction of the neuropathic pain symptoms, and the appropriate combination of agents should block the pain entirely. In practice, however, this approach has not produced clear results. In many cases, appropriate blocking drugs are not available. In others, the application of drugs intended to reverse individual central changes has been claimed to eliminate neuropathic pain entirely. This suggests that experimental results might have been exaggerated, or perhaps tested under highly specific, idiosyncratic circumstances. Alternatively, pain symptoms may have a threshold such that partial suppression of many independent processes indeed yields complete pain suppression.

Another problem is with the agents themselves. Pharmacological agents that show a high degree of specificity when tested under specific *in vitro* conditions, often prove to have unanticipated effects when tested in complex behavioral paradigms, *in vivo*. This also extends to newer transgenic technologies. Finally, few authors check whether the agents they deliver to the spinal cord actually act there. Ectopic impulse discharge originating in the ► [DRG](#) is thought to play an important role in the initiation and maintenance of central sensitization, particularly in animal models of neuropathy. Since the DRG shares the epidural and the intrathecal space with the spinal cord, spinally delivered drugs access primary sensory neurons as well as CNS neurons. It is essential to document that the spinally administered drug being tested does not silence peripheral ectopia because this alone would be expected to relieve pain symptoms, without regard to the central process being tested. Such confirmation is rarely done.

What follows is a list of central changes induced by peripheral nerve injury that might reasonably be predicted to affect pain processing. Most have been documented in one, or only a few neuropathic pain models, or are inferred from models of inflammation, and are not necessarily universal. Some may appear paradoxical. For example, a priori one might presume that depletion of an excitatory transmitter, or increased expression of an



inhibitory one, is unlikely to cause pain. However, since these transmitters might be acting on inhibitory interneurons in the spinal cord, a contribution to pain hypersensitivity by such changes cannot be ruled out. The list below is presented with a minimum of annotation (and without references due to editorial limitations imposed on all essays in this volume). It is almost certainly incomplete at the time of writing, and new changes are being identified at a rapid rate. Some changes may overlap, be redundant, or describe the same process using alternative functional markers.

### Changes in the Neurochemistry of Primary Afferent Terminals in the Spinal Cord after Peripheral Nerve Injury

- Levels of the excitatory peptide neurotransmitter/neuromodulator ► **substance P** (SP), and expression of its precursor gene preprotachykinin, are reduced in small diameter nociceptive DRG neurons and their central terminals. However, there is a concomitant increase in medium and large diameter DRG neurons.
- Expression of the excitatory peptide neurotransmitter/neuromodulator ► **CGRP** is decreased in small diameter DRG neurons and their central terminals.
- Expression of the inhibitory peptide neurotransmitter/neuromodulator galanin is increased.
- Cellular content of the excitatory peptide neurotransmitters/neuromodulators ► **neuropeptide Y** (NPY) and vasoactive intestinal peptide (VIP) is increased, as is that of a variety of proinflammatory cytokines.
- Expression of the  $\mu$  opioid morphine receptor gene (MOR) is reduced in DRG neurons and  $\mu$  receptor is depleted in afferent terminals
- The  $\text{Ca}^{2+}$  channel subunit  $\alpha 2\delta$ -1 is upregulated in axotomized primary afferent neurons, perhaps enhancing synaptic release.
- Expression of the transducer/ion channels ► **TRPV1** and **P2X3** is depressed in afferent terminals
- Tissue plasminogen activator is induced in primary afferent neurons by axotomy and released from their terminal endings. This increases the excitability of dorsal horn neurons.
- Expression of the ► **TTX**-S  $\text{Na}^+$  channel Nav1.3 is upregulated in axotomized DRG neurons while that of TTX-R Nav1.8 and Nav1.9 is downregulated. All three channels contribute to the membrane excitability of primary afferent neurons and their central terminals.
- The preceding are high-profile examples of changes in gene expression in DRG neurons, and in gene product density in afferent terminals, following axotomy. Recent studies using ► **oligonucleotide arrays** indicate that more than one thousand transcripts are up- or down-regulated in axotomized DRG neurons (Costigan et al. 2002; Xiao et al. 2002), and that “intact” neighboring neurons that have not been axotomized also undergo changes in gene expression. All of these are candidates, but few have been subjected to even minimal functional analysis.

### Changes in the Neurochemistry and Gene Expression of CNS Neurons and Glia after Peripheral Nerve Injury

- A number of activity-regulated immediate early genes are upregulated in postsynaptic neurons in the dorsal horn including c-fos and jun-B. These tend to be ► **transcription factors** and hence probably affect the expression of numerous other, still unidentified, downstream genes.
- Many transmembrane and intracellular signaling cascades in postsynaptic neurons are activated by the phosphorylation of protein kinases such as ERK, MAPK, and CREB. More than 500 protein kinase genes are present in the mammalian genome (Manning et al. 2002).
- Levels of cyclooxygenase (COX-1 and COX-2) in the dorsal horn are altered with consequent changes in arachidonic acid metabolites including (excitatory) prostanoids and leukotrienes.
- Expression of certain  $\text{Na}^+$  channel types is upregulated in postsynaptic spinal neurons following nerve injury. Such changes are expected to increase the excitability of the affected neurons.
- A decrease in  $\mu$  opiate receptors on postsynaptic dorsal horn neurons following nerve injury may occasion decreased intrinsic spinal inhibition.
- P2X4 receptors are upregulated in dorsal horn microglia, potentially enhancing response to the excitatory neurotransmitter ATP.
- There is an increase in the spinal content of proinflammatory cytokines including IL1 $\beta$ , IL6, TNF $\alpha$ , but also in the anti-inflammatory cytokine IL10. These compounds are synthesized in activated astrocytes and microglia and are released into the extracellular space. Some may also be produced in neurons. Proinflammatory cytokines can sensitize and directly excite postsynaptic dorsal horn neurons.
- There is an alteration in the content of many neurotransmitters in postsynaptic dorsal horn neurons, some inhibitory (e.g. 5-HT, NA, GABA, glycine) and some prohyperalgesic (e.g. dynorphin). There is also an increase in the spinal content of many bioactive molecules of uncertain function in pain processing such as certain lectins and GAP43
- Increased nocistatin decreases spinal GABA inhibition.
- As with primary sensory neurons, studies using oligonucleotide arrays suggest that very large numbers of transcripts are up- or down-regulated in the spinal cord as a consequence of nerve injury. Few of these have been subjected to even minimal functional analysis.

### Structural Changes in the CNS after Peripheral Nerve Injury

- Central terminals of axotomized primary afferent neurons show a morphologically distinct “degeneration atrophy”. The functional significance is uncertain, but the change might be associated with altered synaptic release or even degeneration.
- There are reports that intraspinal terminals of low threshold mechanoreceptive A $\beta$  afferents enter a growth mode, extending sprouts dorsally into spinal laminae 1 and 2, where they may form ectopic synaptic contacts with pain signaling spinal neurons. This finding is controversial, however, as it might simply reflect axotomy-induced enhancement of the visualization of afferent connections present normally.
- There is a loss of neurons that immunolabel for the inhibitory neurotransmitters glycine and GABA. This may reflect permanent loss of inhibitory interneurons.
- Time-dependent loss of many functionally unidentified neurons in the dorsal horn has been reported (neuronal degeneration), but the magnitude and significance of this effect has been disputed.
- Transsynaptic atrophy and cell loss has been reported in somatotopically appropriate supraspinal projection systems including the primary somatosensory cortex (in long term amputees).
- Large numbers of astrocytes and microglia in the dorsal horn are “activated”, shortly after nerve injury, showing hypertrophy, increased numbers (hyperplasia), and altered expression of neuroactive molecules including proinflammatory cytokines.
- Immune cells from the peripheral circulation, including macrophages and lymphocytes, invade the dorsal horn grey matter. They may release excitatory cytokines and activate dorsal horn neurons.
- ATP, an excitatory neurotransmitter, is released from astroglia activated following nerve injury. ATP is also hydrolysed into the inhibitory neuroactive transmitter adenosine.

### Electrophysiological and Functional Changes in the CNS after Peripheral Nerve Injury

- The dorsal root potential (DRP) and primary afferent depolarization (PAD), two measures of spinal **presynaptic inhibition**, are suppressed following nerve injury. Reduced inhibition increases spinal response.
- Receptive fields (RF) of dorsal horn neurons expand, increasing the RF overlap between neighboring neurons. A given peripheral stimulus now activates more spinal cord neurons.
- The overall impulse volley that ascends in the spinal cord towards the brain upon electrical stimulation of a peripheral nerve is reduced by about 50% beginning 1–2 weeks following nerve injury. However, it is pos-

sible that some specific components of the ascending volley are enhanced.

- NMDA type glutamate receptors on postsynaptic dorsal horn pain signaling neurons are normally blocked and non-functional at resting membrane potential. Primary afferent nociceptive input produces a prolonged, shallow depolarization, probably due to the release of SP (and other peptides) which relieves the block, enables the NMDA-Rs, and enhances postsynaptic response to A $\beta$  touch input.
- Nociceptive afferent input induces PKC-dependent phosphorylation of NMDA-R subunits contributing to spinal pain hypersensitivity.
- There is also activation of non-NMDA glutamate receptors (kainate receptors) in the spinal cord following nociceptive afferent input.
- Since the nociceptive mediators SP, NPY, and BDNF come to be expressed in low threshold mechanoreceptive A $\beta$  afferents, activity in these afferents might come to directly activate pain signaling dorsal horn neurons.
- For the same reason, these afferents may acquire the ability to trigger and maintain central sensitization.
- There is increased release of the excitatory neurotransmitter glutamate in the dorsal horn.
- “Glycine spillover” facilitates the response of NMDA receptors to glutamate, including glutamate released from A $\beta$  touch afferents.
- Suppression of the Cl<sup>-</sup> pump, and the consequent depolarizing shift of the Cl<sup>-</sup> reversal potential, can cause the normally inhibitory neurotransmitter GABA to yield excitation.
- Many synapses present on dorsal horn neurons are relatively ineffective at driving the postsynaptic neuron (“silent synapses”). These can be strengthened by a variety of mechanisms, opening new functional pathways including A $\beta$  access to ascending nociceptive circuitry.
- BDNF released from afferent terminals, and perhaps synthesized locally, sensitizes postsynaptic neurons in the superficial dorsal horn.
- Elevated background afferent activity (ectopia) depolarizes neurons, bringing them closer to spike threshold. This increases the level of spontaneous activity generated within the dorsal horn, and enhances the response of dorsal horn neurons to weak residual inputs from the periphery.
- Repetitive stimulation at low frequency reveals homosynaptic facilitation (“windup”). This is augmented after nerve injury.
- Long term potentiation (LTP) is facilitated by nerve injury.
- The duration of spinal postsynaptic potentiation is augmented by nerve injury.
- Injury discharge triggered by acute transection of primary afferent axons may selectively damage inhibitory spinal interneurons, perhaps by the sudden

release of high levels of glutamate (excitotoxic cell death).

- Nerve injury is associated with reduced GABA release in the dorsal horn following electrical nerve stimulation.
- Spontaneous discharge, particularly in a bursty mode, is augmented in dorsal horn postsynaptic neurons and also in supraspinal relays. Some of this activity may be generated within the CNS, rather than reflecting elevated peripheral drive.
- Brainstem descending inhibition may be reduced following nerve injury.
- Brainstem descending facilitation may be enhanced following nerve injury.
- The gate control theory predicts that selective loss of large diameter low threshold afferent neurons will bias the spinal gate towards augmented nociception.

#### How Does Nerve Injury Trigger Central Change?

Little is known with confidence about how peripheral nerve injury triggers and maintains central sensitization. There are three fundamental possibilities:

##### Depolarization due to Impulse Traffic per se

The resting potential of postsynaptic neurons is determined, in part, by the constant barrage of excitatory and inhibitory postsynaptic potentials impinging on their dendritic arbor (spatial and temporal summation). Ectopic afferent activity in neuropathy enhances the barrage, depolarizes the neuron, and brings resting potential closer to firing threshold. This increases spontaneous firing and response to normal and ectopic afferent input.

##### Other Actions of Transmitters Released by Afferent Impulse Traffic

Neurotransmitter and neuromodulator molecules released from afferent terminals during spike activity may have postsynaptic effects beyond the moment to moment modulation of the membrane potential. Coupling may be via ligand-gated ion channels (and consequent membrane depolarization), or transmembrane signaling pathways that are independent of membrane potential.

##### Trophic Interactions

More speculatively, nerve injury might bring about central changes completely independent of impulse traffic and synaptic release. During embryonic development, the very survival of primary sensory and second order CNS neurons is dependent on mutual neurotrophic interactions. Beyond a critical period the neurons lose their acute dependence on neurotrophic support, but even in adulthood neuronal phenotype is altered by changes in the provision of developmental neurotrophins (Boucher et al. 2001). Both soluble and membrane bound recognition molecules could be involved (neurotrophins, NCAMs, ephrin). Amounts of

these signaling molecules released or incorporated into the membrane might be regulated by spike-evoked exocytosis, or perhaps by constitutive processes unrelated to afferent impulse traffic (Battaglia et al. 2003; Fields et al. 2001).

#### Perspective

Only a generation ago there was little concept of the processes that might underlie neuropathic pain. The situation has since reversed so that today we are awash with candidate theories. It is a high priority to develop strategies for prioritizing central changes in terms of their relative contribution to pain symptomatology. Likewise, it is essential to establish the mechanism(s) by which nerve injury triggers CNS changes. If all or most central changes are due to abnormal primary afferent input, it may be possible to prevent or reverse the central changes by controlling afferent input. Alternatively, key central changes might offer opportunities for direct therapeutic intervention.

#### Acknowledgements

Thanks to Linda Watkins and Zsuzsanna Wiesenfeld-Hallin for helpful comments on the manuscript. I wish to apologize to the numerous colleagues whose work was noted in this essay but not specifically cited because of editorial restrictions on the number of references permitted.

#### References

1. Banic B, Petersen-Felix S, Andersen OK et al. (2004) Evidence for Spinal Cord Hypersensitivity in Chronic Pain after Whiplash Injury and in Fibromyalgia. *Pain* 107:7–15
2. Battaglia AA, Sehayek K, Grist J et al. (2003) EphB Receptors and Ephrin-B Ligands Regulate Spinal Sensory Connectivity and Modulate Pain Processing. *Nat Neurosci* 6:339–340
3. Campbell JN, Raja SN, Meyer RA et al. (1988) Myelinated Afferents Signal the Hyperalgesia Associated with Nerve Injury. *Pain* 32:89–94
4. Costigan M, Befort K, Karchewski L et al. (2002) Replicate High-Density Rat Genome Oligonucleotide Microarrays Reveal Hundreds of Regulated Genes in the Dorsal Root Ganglion after Peripheral Nerve Injury. *BMC Neurosci* 3:16–28
5. Devor M, Basbaum A, Bennett G et al. (1991) Mechanisms of Neuropathic Pain following Peripheral Injury. In: Basbaum A, Besson J-M (eds) *Towards a New Pharmacology of Pain*, Chichester: Dahlem Konferenzen, Wiley, pp 417–440
6. Fields RD, Eshete F, Dudek S et al. (2001) Regulation of Gene Expression by Action Potentials: Dependence on Complexity in Cellular Information Processing. *Novartis Found Symp* 239:160–172
7. Gracely R, Lynch S, Bennett G (1992) Painful Neuropathy: Altered Central Processing, Maintained Dynamically by Peripheral Input. *Pain* 51:175–194
8. Hardy JD, Wolf HG, Goodell H (1952) *Pain Sensations and Reactions*. William and Wilkins, New York
9. Ji RR, Kohno T, Moore KA et al. (2003) Central Sensitization and LTP: Do Pain and Memory Share Similar Mechanisms? *Trends Neurosci* 26:696–705
10. Kalso E (1997) Prevention of Chronicity. In: Jensen TS, Turner JA, Wiesenfeld-Hallin ZH (eds), *Proceedings of the 8<sup>th</sup> World Congress on Pain*. Progress in Pain Research and Management, vol 8. IASP Press, Seattle, pp 215–230

11. Koltzenburg M, Torebjork, H, Wahren L (1994) Nociceptor Modulated Central Sensitization Causes Mechanical Hyperalgesia in Acute Chemogenic and Chronic Neuropathic Pain. *Brain* 117:579–591
12. Lewis T (1942) *Pain*. MacMillan, New York
13. Manning G, Whyte DB, Martinez R et al. (2002) The Protein Kinase Complement of the Human Genome. *Science* 298:1912–1934
14. McDermid AJ, Rollman GB, McCain GA (1996) Generalized Hypervigilance in Fibromyalgia: Evidence of Perceptual Amplification. *Pain* 66:133–144
15. Torebjork H, Lundberg L, LaMotte R (1992) Central Changes in Processing of Mechanoreceptive Input in Capsaicin-Induced Secondary Hyperalgesia in Humans. *J Physiol* 448:765–780
16. Woolf CJ (1983) Evidence for a Central Component of Post-Injury Pain hypersensitivity. *Nature* 306:686–688
17. Xiao HS, Huang QH, Zhang FX et al. (2002) Identification of Gene Expression Profile of Dorsal Root Ganglion in the Rat Peripheral Axotomy Model of Neuropathic Pain. *Proc Natl Acad Sci USA*: 998360–998365

## Central Gray/Central Grey

- ▶ Opioid Electrophysiology in PAG

## Central Hyperexcitability

- ▶ Central Changes after Peripheral Nerve Injury
- ▶ Visceral Pain Model, Esophageal Pain

## Central Lateral Nucleus (CL)

### Definition

The intralaminar complex is a group of thalamic nuclei composed of neurons that are located within the internal medullary lamina, a nerve fiber sheet that can be used to subdivide different parts of the thalamus. The central lateral nucleus is one of the rostral group of intralaminar nuclei of the primate thalamus. It receives input from the spinothalamic tract and projects broadly to the sensorimotor cortex, as well as to the striatum.

- ▶ Spinothalamic Input, Cells of Origin (Monkey)
- ▶ Spinothalamic Terminations, Core and Matrix
- ▶ Thalamotomy for Human Pain Relief
- ▶ Thalamus, Visceral Representation

## Central Lobe

- ▶ Insular Cortex, Neurophysiology and Functional Imaging of Nociceptive Processing

## Central Medial Nucleus (CM)

### Definition

A nucleus within the internal medullary lamina, located ventrally to the central lateral nucleus and lateral to the parafascicular nucleus.

- ▶ Thalamus, Visceral Representation

C

## Central Nervous System Map

### Definition

The organization of locations on or in the brain or spinal cord that represent the characteristics of a stimulus, such as the receptive field, or of motor output, such as stimulation evoked movement.

- ▶ Thalamus, Receptive Fields, Projected Fields, Human

## Central Nervous System Portion of a Cranial Nerve

### Definition

The proximal portion of a cranial nerve over which myelin is associated with glial (oligodendroglial) cells rather than with the Schwann cells, which are associated with myelin in the periphery.

- ▶ Trigeminal, Glossopharyngeal, and Geniculate Neuralgias

## Central Nervous System Stimulation for Pain

LUC JASMIN<sup>1, 2</sup>, PETER T. OHARA<sup>2, 3</sup>

<sup>1</sup>Department of Surgery, Division of Neurosurgery, University of Texas Medical Branch, Galveston, TX, USA

<sup>2</sup>Department of Anatomy and,

<sup>3</sup>the W.M. Keck Foundation Center for Integrative Neuroscience, University of California San Francisco, San Francisco, CA, USA

ucpain@itsa.ucsf.edu, peter.ohara@ucsf.edu

### Synonyms

CNS Stimulation in Treatment of Neuropathic Pain



## Definition

Electrical stimulation of the central nervous system is a non-destructive and reversible therapy for certain forms of difficult to treat chronic pain. Candidates have to fail a trial of the more conventional therapies. An electrode is placed over the spinal cord, cerebral cortex or in the thalamus, hypothalamus or central gray matter. Analgesia is produced when a small current is delivered through this electrode and usually persists for some time after the current is turned off.

## Characteristics

Both clinical and experimental studies have determined that electrical stimulation of the spinal cord or brain is analgesic. Considering the complexity of chronic pain, it is often perplexing that such a simple technique results in relieving pain syndromes often deemed “intractable”, while complex pharmaceutical approaches, often because of their side effects, end in failure. Since the 1960s the technology associated with electrical stimulation for pain has remained essentially the same, although the quality of the components has improved. The two main components are the electrode and the current generator, both of which are internalized (i.e. all inside the patient). The electrode (4 to 8 contacts) is usually placed over the dorsal aspect (dorsal columns) of the spinal cord, in the brain parenchyma (thalamus, hypothalamus or ► [periaqueductal gray matter](#) [PAG]), or over the surface of the motor cortex. The current generator, which is presently about the size of a pacemaker (4 cm × 4 cm × 1 cm), is concealed under the skin and connected to the electrode through subcutaneous wires. The current generator (including a rechargeable battery) is programmed by telemetry using a handheld computer and an antenna laid over the appropriate skin area. Voltage, frequency, pulse width and times of the day the system is on can be adjusted after the system is implanted.

## Spinal Cord Stimulation (SCS)

Spinal cord stimulation (SCS) was first performed in 1967 and since then several hundred thousand patients have received this treatment worldwide. About 10,000 individuals will be implanted in the United States this year alone. While the mechanism remains to be fully elucidated, a widely regarded explanation is the ► [gate control theory](#). This theory, dating from the 1960s suggests that nociceptive information entering the CNS is reduced by the activity of innocuous (low threshold large fibers) sensory afferents or brain activity. The effect of electrically stimulating neural pathways capable of inhibiting nociceptive information is to “close the gate” on the noxious input and result in analgesia. Accordingly, the electrode is positioned at the level of the spinal cord corresponding to the ► [dermatome](#) or ► [viscerotome](#) where the pain is felt. Interestingly, the analgesia produced by stimulation often lasts long after

the cessation of the electric current (minutes to hours). This persistent analgesia is thought to depend not only on an effect on neurons adjacent to the stimulating electrode, but also on long neural loops linking the spinal cord to the brain. The result is the inhibition of spinothalamic projection neurons (Gerhart et al. 1984). Clearly, when the underlying disease involves a loss of large fiber activity (as in multiple sclerosis or post-► [cordotomy](#) ► [dysesthesia](#)), stimulation is less likely to work. Another often cited mechanism is that spinal cord stimulation blocks sympathetic nervous system fibers. This latter action would explain the favorable results obtained in ► [complex regional pain syndrome](#) (CRPS) and in angina pectoris. Other indications are neuropathic leg pain (not back pain) associated with ► [failed back syndrome](#), diabetic neuropathy, ischemic leg pain not treatable by vascular surgery, phantom limb pain, post-herpetic neuralgia, spinal cord injury pain, ► [tabes dorsalis](#) and spinal cord injury pain. Long term, moderate relief can be obtained in many patients.

In spite of the use of electrical stimulation to control pain in large number of patients, there have been only a few placebo-controlled evaluations of this treatment (Mailis-Gagnon et al. 2004). A significant placebo effect might exist in patients utilizing SCS, and the relief might be related to the distraction of stimulation. Testing of this possibility is undermined by the difficulty in controlling for placebo response in a therapy that depends on the production of a sensory phenomenon to work (i.e. patients feel a tingling or paresthesia in the stimulated area when the current generator is on). Although it is important to understand the exact mechanism of pain relief, it will probably not matter to the patient whether it is *via* placebo or some other mechanism. While all agree that better clinical studies are needed to confirm the effectiveness of SCS, especially since the benefits appear moderate, its continued use appears justified since it decreases the cost of treating pain (Taylor et al. 2005).

## Deep Brain Stimulation (DBS)

Deep brain stimulation (DBS) has been out of favor since 1999 when Medtronic (Medtronic Inc. Minneapolis, MN) decided not to pursue FDA approval for this therapy due to the lack of conclusive clinical data (Coffey 2001). In spite of this, DBS is still used “off-label” here and in other countries for selected patients (Nandi and Aziz 2004). Electrodes are implanted in the ventropostero-lateral thalamus, posterior limb of the internal capsule, periventricular gray including the posterior hypothalamus or PAG. Stimulation in these areas is reported as fairly successful in patients with failed back syndrome, trigeminal neuropathy other than *tic douloureux*, certain forms of ► [central pain](#) (post-stroke pain), peripheral neuropathy, ► [anesthesia dolorosa](#) and post-cordotomy dysesthesia.



As with dorsal column stimulation, the neural mechanisms underlying DBS-induced analgesia are a matter of speculation. Marchand and colleagues (Marchand et al. 2003) studied the effect of placebo stimulation in patients with thalamic electrodes installed for pain control. Their key finding is that placebo analgesia is a significant element of DBS and that this is reinforced by the degree of paresthesia felt during the stimulation. The study of Marchand and colleague supports the contention that further controlled investigations are needed to understand the mechanisms by which stimulation of the central nervous system produces analgesia.

Recently DBS has experienced a rebirth based on the finding that stimulation of the hypothalamus can reduce the occurrence of cluster headaches (Horton's headaches). Cluster headaches are a vascular type of pain, occurring more commonly in males and characterized by unilateral headaches lasting 30 to 90 minutes and recurring 1 to 6 times a day for several weeks. Between attacks, patients can be asymptomatic for months. The pain is reported as excruciating and characteristically located around the eye, which is visibly congested and tearing. While some measures, such as avoiding alcohol and tobacco, reduce the frequency of the attacks, in many patients the prevention and treatment of cluster headaches presents a challenge. In 1998 the positron emission tomography (PET) observation that the symptomatic phase of cluster headaches was accompanied by the activation of a region of the ipsilateral medio-caudal hypothalamus led to the idea that stimulation of this area might be of therapeutic value (Ekbom and Waldenlind 2004, Leone et al. 2004). Unilateral or bilateral electrodes and high frequency stimulation have been effective in reducing the occurrence and duration of the attacks. PET imaging in cluster headache has revealed that during hypothalamic stimulation, some pain activated areas such as the ipsilateral anterior cingulate, primary somatosensory cortices and the insular cortex bilaterally are inactive (May et al. 2003). While, DBS does not bring a cure to individuals with cluster headaches, for some it is the best treatment available. For neuroscientists, it is a further indication of the validity of electrical stimulation for pain and an incentive to pursue basic research in this field as a means of understanding pain mechanisms.

### Motor Cortex Stimulation (MCS)

Motor cortex stimulation (MCS) has also yielded positive results in treating patients with central pain following ischemic brain or spinal injury and with ► **deafferentation** pain in the trigeminal or spinal territories. Here an electrode is laid over the part of the motor cortex (usually over the dura rather than directly on the pia mater) that corresponds to the area where the pain is felt on the opposite side of the body (according to the homunculus).

The rationale that guided surgeons to attempt cortical stimulation was based on the results of many decades of experimentation, which demonstrated that electrical stimulation of the cerebral cortex affects spinal and trigeminal afferent sensory transmission and that this effect is, in part, presynaptic on somatic afferents, including nociceptive afferents (Abdelmoumene et al. 1970). The effect of stimulation of the cerebral cortex on spinothalamic neurons however, can be inhibitory, excitatory or both (Yeziarski et al. 1983). Because the latency of excitation is significantly shorter than the latency of inhibition, inhibition could be polysynaptic *via* inhibitory interneurons and/or presynaptic processes on primary afferent terminals. Finally, experimentation in cats has also shown that motor cortex stimulation blocks spontaneous burst activity induced by spinothalamic deafferentation (Tsubokawa et al. 1991).

The most common indication for cortical stimulation is central pain syndrome. Dejerine recognized the syndrome a century ago while an intern at the Salpêtrière hospital in Paris. Because all of his patients with this previously unrecognized pain syndrome were found to have strokes in the posterolateral thalamic area at autopsy, Dejerine and Roussy, coined the term "thalamic syndrome" A complete thalamic syndrome is uncommon and subsequently the term "thalamic pain" was used for all pain conditions that arose from both thalamic and non-thalamic CNS lesions. Since the majority of central pain syndromes occur after an ischemic stroke, the designation 'central post-stroke pain' (CPSP) is often employed. The current definition of central pain has become quite broad and accommodates etiologies of central pain such as Parkinson's disease or epilepsy, in which there is no thalamic lesion or interruption of thalamic afferents. It should be noted that "central pain" differs from "centralized pain", which is considered to result from remodeling of the CNS as a consequence of a peripheral injury. One example of centralized pain for which cortical stimulation has recently been shown to be successful is trigeminal deafferentation pain (Brown and Pilitsis 2005).

Although it is important to optimize patient selection for motor cortex stimulation, there is no unequivocal way to separate the responders from the non-responders preoperatively. Only patients with an intact motor cortex and corticospinal projections should be chosen. In patients with large lesions of the motor cortex or pyramidal tract on the side opposite to the symptoms, stimulation of the ipsilateral motor cortex has been shown to produce analgesia. Stimulation is usually ineffective, however, in subjects with profound sensory loss. Imaging studies have also been recommended prior to surgery in order to confirm the presence of cortical hypoperfusion and ascertain the site of implantation, since cortical stimulation is associated with a cortical reperfusion. Finally, a trial of non-invasive stimulation using a transcranial magnetic

coil over the motor cortex could also be a helpful way of selecting the potential responders.

### Vagal Nerve Stimulation (VNS)

Vagal nerve stimulation (VNS) acts indirectly to stimulate the CNS through sensory afferents to the caudal brainstem. VNS is currently used to treat certain forms of epilepsy and is under investigation as possible therapy for depression. It might also become an accepted method for treating cluster headaches and migraine (Mauskop 2005) and possibly other pain disorders. Because it can decrease the nociceptive threshold in depressed individuals (Borckardt et al. 2005) and depression often accompanies pain, patient selection for this technique will be critical.

### Conclusion

Further clinical studies are needed to validate CNS stimulation as an effective treatment of pain, mainly because most of the evidence is anecdotal or retrospective. Basic research is critically needed to establish the mechanism of action and it is possible that stimulation induced analgesia might open the door to a new, unforeseen understanding of the means by which pain operates. DBS is currently gaining popularity for the treatment of movement disorders, a field where much greater understanding of the neural circuitry has fostered unique cooperation between clinicians and basic scientists. The same type of teamwork could benefit the development of new ideas and advances in the field of pain.

### References

1. Abdelmoumene M, Besson JM, Aleonard P (1970) Cortical areas exerting presynaptic inhibitory action on the spinal cord in cat and monkey. *Brain Res* 20:327–329
2. Borckardt JJ, Kozel FA, Anderson B et al. (2005) Vagus nerve stimulation affects pain perception in depressed adults. *Pain Res Manag* 10:9–14
3. Brown JA, Pilitsis JG (2005) Motor cortex stimulation for central and neuropathic facial pain: a prospective study of 10 patients and observations of enhanced sensory and motor function during stimulation. *Neurosurgery* 56:290–297; discussion 290–297
4. Coffey RJ (2001) Deep brain stimulation for chronic pain: results of two multicenter trials and a structured review. *Pain Med* 2:183–192
5. Ekblom K, Waldenlind E (2004) Cluster headache: the history of the Cluster Club and a review of recent clinical research. *Funct Neurol* 19:73–81
6. Gerhart KD, Yezierski RP, Wilcox TK et al. (1984) Inhibition of primate spinothalamic tract neurons by stimulation in periaqueductal gray or adjacent midbrain reticular formation. *J Neurophysiol* 51:450–466
7. Leone M, Franzini A, Broggi G et al. (2004) Long-term follow-up of bilateral hypothalamic stimulation for intractable cluster headache. *Brain* 127:2259–2264
8. Mailis-Gagnon A, Furlan AD, Sandoval JA et al. (2004) Spinal cord stimulation for chronic pain. *Cochrane Database Syst Rev*:CD003783
9. Marchand S, Kupers RC, Bushnell MC et al. (2003) Analgesic and placebo effects of thalamic stimulation. *Pain* 105:481–488
10. Mauskop A (2005) Vagus nerve stimulation relieves chronic refractory migraine and cluster headaches. *Cephalalgia* 25:82–86
11. May A, Leone M, Boeker H et al. (2003) Deep brain stimulation in cluster headache: preventing intractable pain by activating the pain network. *Cephalalgia* 23:656
12. Nandi D, Aziz TZ (2004) Deep brain stimulation in the management of neuropathic pain and multiple sclerosis tremor. *J Clin Neurophysiol* 21:31–39
13. Taylor RS, Van Buyten JP, Buchser E (2005) Spinal cord stimulation for chronic back and leg pain and failed back surgery syndrome: a systematic review and analysis of prognostic factors. *Spine* 30:152–160
14. Tsubokawa T, Katayama Y, Yamamoto T et al. (1991) Treatment of thalamic pain by chronic motor cortex stimulation. *Pacing Clin Electrophysiol* 14:131–134
15. Yezierski RP, Gerhart KD, Schrock BJ et al. (1983) A further examination of effects of cortical stimulation on primate spinothalamic tract cells. *J Neurophysiol* 49:424–441

## Central Neuropathic Pain

DAVID BOWSHER

Pain Research Institute, University Hospital Aintree,  
Liverpool, UK

pri@liv.ac.uk or bowsher@liv.ac.uk

### Synonyms

Dejerine and Roussy (1906) described three cases of pain following strokes involving the thalamus, and named the condition “thalamic syndrome” – a name that has, unfortunately, remained in the literature – because it was later shown that similar pain follows infarction of other, non-thalamic, telencephalic areas such as the cortex (Foix et al. 1927). Infarction in brainstem or the anterolateral medulla oblongata can also cause pain in the condition known as Wallenberg’s syndrome (Ajuriaguerra 1937).

The onset of pain following central lesions is not restricted to supraspinal pathology. Central pain in syringomyelia has been reported by Spiller (1923) and was indistinguishable from central pain of cerebral origin. Unfortunately, recognition of the fact that central pains following spinal cord damage, such as anterolateral cordotomy (White and Sweet 1969), and of course spinal cord injury (SCI) are similar to those of supraspinal origin was slow to develop.

### Definition

Leijon et al. (1989) proposed the name “Central Post-Stroke Pain” (CPSP) to cover all these contingencies – however, this name does not encompass cases caused by conditions other than stroke. The post-mortem anatomical pathology of eleven cases in which lesions of the central nervous system, including cortical lesions, two tumours and one multiple aneurysm, resulted in the onset of pain was described in detail by Davison and Schick (1935). Subarachnoid haemorrhage, multiple sclerosis, tumour, cerebral abscess, Behçet’s disease, Parkinson’s disease, and arteriovenous aneurysm have all been implicated as causes of central pain. It is well-known that syringomyelia is associated with central

pain (Madsen et al. 1994), and central pain caused by spinal cord injury (SCI) has been described in a number of reports (Yeziarski 1996). Painful post-cordotomy dysaesthesia was recognised by White and Sweet (1955), who stated that 20 % of patients undergoing anterolateral cordotomy and surviving for more than a year developed painful dysaesthesia. Siddal et al. (1999) concluded that 50 % of patients with spinal cord injury (SCI) suffer central neuropathic pain, as do most patients with syringo/hydro-myelia.

It can convincingly be argued that the seat of pathophysiology in neuropathic pains due to insult of peripheral nerves (e.g. painful diabetic neuropathy, complex regional pain syndromes, and postherpetic neuralgia) is in the central nervous system; the symptomatology certainly fulfils the criterion enunciated in the next paragraph. However, they will not be dealt with in detail in this chapter. Thus, it would perhaps be better to recognise a category of central neuropathic pain (CNP), due to (unspecified) damage to any part of the neuraxis. That such pains be recognised as neuropathic requires one more criterion: the pain occurs in an area of sensory change (total or, much more frequently, partial deficit).

#### Incidence

While it has long been known that not all cases of spinal cord injury or Wallenberg's syndrome necessarily suffer spontaneous neuropathic pain, it is important to emphasise the findings of Bogousslavsky and his colleagues (1988): only 25 % of patients with thalamic infarcts involving the thalamic somatosensory relay nucleus (VPL, Vc) actually develop pain. In a prospective study, Andersen et al. (1995) reported that about 8 % of all surviving stroke patients develop CNP. In a population of 250 million (e.g. USA), there are 250,000 strokes p.a., of whom about 170,000 survive. Thus, the annual incidence of CPSP is approximately 11,000 new cases. Since most patients with CPSP do not have very severe or life-threatening motor impairment (only 8 % of 111 of our CPSP patients were plegic, and only 29 % paretic), the prevalence must be very much higher. At least 30 % of MS patients have central pain, and in spinal cord injury (SCI) CNP is present in about two thirds of patients. SCI pain has been subdivided into pain at, above, and below the level of injury in an attempt to develop a more meaningful taxonomy (Siddal and Loeser 2001). Thus, despite the fact that far from all patients with injury to the CNS develops CNP, the overall prevalence is very high – yet it is regarded as a rarity by most members of the medical and allied professions.

#### Characteristics

Central pain is greatly influenced by autonomic factors. Seventy-nine CPSP patients were asked to identify factors that exacerbated or alleviated their pain: 59 % found their pain was exacerbated by cold and 57 % by emo-

tional stress; while 38 % were alleviated by relaxation (which is why most patients with CNP can fall asleep without difficulty, even though they may wake in pain) and 15 % by warmth (Bowsher 1996a). The most important feature of CNP, as noted above, is that it occurs in an area of sensory change (partial or total deficit of one or more somatosensory modalities); this is indeed an essential criterion. The pain is experienced within the area of sensory change, i.e. it is smaller than the area exhibiting sensory change. Of course patients do not present with sensory loss, but with pain; so this will be dealt with first. About 40 % of CPSP patients begin to experience pain immediately after their stroke; the other 60 % have a later onset, which may be up to 2 years after stroke, but the median is 3 months (Bowsher 1996a). In the case of spinal cord injury, a similar pattern is observed: pain is immediate in about a third of cases, with later onsets up to 2 years, but a median of 3 months (Widerström-Noga 2003).

Early descriptions emphasised burning pain as a prominent characteristic of central pain. Close interrogation reveals that this is most frequently paradoxical burning (ice-burn). While this type of pain, when it occurs, is indeed characteristic of central pain, and is much emphasised because patients say “It's like nothing I ever experienced before”, burning pain is not a sine qua non of neuropathic pain. Only 47 % of 111 personal CPSP patients complained of burning pain (Bowsher 1996a). Others experienced aching or throbbing pain (35 %) or shooting/stabbing pain (7 %); no type of pain was perceived to be more intense than any other (► [Visual Analogue Scale](#), VAS). Background pain was exacerbated by emotional stress or environmental cold in about half of patients (28 % by both). Following spinal cord injury, burning and aching pain were found in almost equal proportions (Widerström-Noga 2002).

#### Sensory Change

Some somatosensory modalities may be entirely lost, while in others the sensation may still be present, but with a raised threshold compared to the mirror-image area on the unaffected side. There is frequently dissociation between various somatosensory submodalities. From the point of view of spontaneous pain in CPSP, the modalities most concerned appear to be those subserving innocuous thermal sensations (Bowsher 1996b) and sharpness discrimination (tested with weighted needles); pain intensity correlated with thermal (particularly warmth) and sharpness discrimination threshold elevation. Patients with aching pain had a significantly higher perception threshold for tactile (von Frey) stimuli than those with burning pain, while the latter had much higher thresholds for innocuous warmth and cold (but not for painful heat). Both had higher thresholds for sharpness and innocuous thermal modalities than patients suffering from strokes with sensory loss but no pain; and additionally patients with burning pain,

but not those with aching pain, had a very much higher threshold for warmth than did pain-free stroke patients (Bowsher 1996a).

Eide et al. (1996) found that CNP in SCI patients was correlated with intensity of sensory deficit. Central pain does not accompany loss of only A $\beta$  modalities (touch, innocuous pressure, vibration), as those subserved by smaller peripheral fibres (A $\delta$ , C) are also compromised. It was noted that in cordotomised patients with malignant disease, where non-neuropathic pain due to the neoplasm returned, pinprick (sharpness) threshold also returned towards that on the unaffected side, while in those patients who developed neuropathic post-cordotomy pain, the deficit in sharpness sensation remained (Lahuerta et al. 1994). Indeed, so far as central pain is concerned, it is irrelevant whether or not sensations subserved by A $\beta$  fibres are affected. Contrarily, stroke patients with sensory deficits but no pain frequently have a very marked tactile deficit, but much less extensive thermal and sharpness deficits.

► **Allodynia** is defined as pain produced by innocuous stimulation. As it only occurs in patients with peripheral or central neuropathic pain, it is pathognomonic when found. However, unfortunately for the diagnostician, it is found in only about half of patients with supraspinal CNP. By far the commonest form of allodynia is dynamic mechanical or tactile: allodynia caused by a moving tactile stimulus, subserved by A $\beta$  fibres. The provoking stimulus may be the movement of clothes across the skin or a breeze on the face. Other forms of stimulus that may produce allodynia are thermal (particularly cold, which unlike other forms of allodynia is twice as common in males as in females; warmth-provoked allodynia is rare). The threshold for innocuous warmth is significantly higher in CPSP patients with allodynia (all forms) than in those without. Movement related allodynia also occurs in CPSP, provoked by active or passive movement, so presumably initiated from stretch receptors.

While the pain of allodynia usually occurs in the area stimulated, it may occur in a remote area, even one which itself is neither spontaneously painful nor allodynic. When somatosensory thresholds in patients with mechanical allodynia are compared with thresholds in pain-free stroke patients, it is found that the significance of the difference in thresholds between affected and unaffected mirror-image areas between the two groups is 0.02 for sharpness, 0.007 for warmth, 0.047 for cold, and 0.004 for heat pain; but is non-significant for mechanical modalities (Bowsher 1996a).

### Treatment

The mainstay of treatment until recently has been adrenergically-active ► **tricyclic antidepressants**, i.e. principally ami- or nor- tryptiline, in relatively low doses (Leijon and Boivie 1989). Spontaneous recovery undoubtedly occurs (usually unreported), sometimes

as a result of a further stroke (which may also suppress other neurogenic pains such as postherpetic neuralgia). Successful treatment with tricyclic antidepressants (TCAs) is time-dependent, as with several other neuropathic pains – i.e. if treatment is initiated within 6 months of pain onset (NOT of stroke occurrence), 89 % of our patients gained relief; within 12 months, 67 %; but thereafter less than 50 %. Ami- and nor- tryptiline are poorly tolerated, and produce disagreeable side-effects. Success has been reported with a more recent and less noxious antidepressant, venlafaxine. This is also adrenergically active; it should be noted that selective serotonergic reuptake inhibitors (SSRIs), which have no SNRI activity, are ineffective in neuropathic pains (e.g. Max et al. 1992). Unlike peripheral neuropathic pain (PHN), the presence or absence of allodynia does not influence the therapeutic response to tricyclics.

Older ► **Anticonvulsant (Agent)**, notably carbamazepine, have proven themselves ineffective (Leijon and Boivie 1989) in the treatment of central neuropathic pain. Membrane-stabilising drugs such as lignocaine (infusions) and mexiletine (Awerbuch and Sandyk (1990) have been effective; mexiletine added to a TCA has been shown to be beneficial in CPSP (Bowsher 1995b) in some cases unresponsive to TCAs alone. Lignocaine (lidocaine) is a local anaesthetic that blocks sodium channels. Boas et al. (1982) reported its analgesic effect when given systemically (I.V.) in conditions with neuropathic pain. Among newer anticonvulsants, which do not block sodium channels, gabapentin monotherapy is now widely used, though no statistics are yet available. Lamotrigine has also shown promise, perhaps especially when added to a TCA. Of the opioids, dextromethorphan, in combination with gabapentin, is the most widely used; favourable claims have also been made for methadone. NMDA receptor antagonists (a minor additional property of dextromethorphan and methadone) are said to be effective, as shown by use of the short-acting ketamine; relief of CPSP by oral ketamine has been reported (Vick and Lamer 2001), and there is a report of relief of syringomyelic pain by intravenous ketamine (Cohen and DeJesus 2004).

Surgical treatment has varied from thalamic lesioning to the implantation of stimulating electrodes – thalamic, periaqueductal, or spinal; and more recently on the motor cortex (Tsubokawa et al. 1993), which is the most promising of the stimulation methods, with a reported success rate of 60–70 %. Additional treatments of pain associated with spinal cord injury are dealt with in the volume edited by Yeziarski and Burchiel (2002). Relaxation therapy, which has a known beneficial effect, should not be overlooked in all forms of CNP.

### Possible Mechanisms of Neuropathic Pain

We have to explain a condition that differentially and variably affects somatosensory submodalities and autonomic function; which follows insult to the central or pe-



ripheral nervous system, but not ineluctably – indeed, in only a minority of cases; and in which the sensory change may or may not be accompanied by neuropathic pain (although, as discussed above, the presence or absence of pain does appear to depend on the intensity of innocuous thermal loss, particularly for warmth).

It strikes the present author that the cardinal fact about neuropathic pain (central or peripheral) is that only a minority of individuals who suffer apparently appropriate insult to the central or peripheral nervous system actually develop neuropathic pain. This is equally true, it would seem, of nerve ligation experiments in animals, by no means all of which show signs or symptoms of neuropathic pain.

It was suggested earlier (Bowsher 1995b) that the best-fit theoretical model for central pain would appear to be one in which a widely-distributed transmitter/ligand in the central nervous system, and/or its specific receptors may become depleted; possible changes in receptor function were also mentioned by Siddall and Loeser (2001), specifically in relation to spinal cord injury. It has been known for a long time that some transmitters, such as serotonin, have both a global function, disturbance of which may be reflected in some psychiatric disorders, and a specific one, disturbance of which is seen in particular “focal” conditions such as migraine; enhanced pain sensitivity following injury may be regulated by spinal NK1 receptor expressing neurons (Suzuki et al. 2002), while spinal 5HT<sub>3</sub> receptors mediate descending excitatory controls on spinal neurones activated in some neuropathic pain states (McCleane et al. 2003). Although we still have little idea what the transmitter(s) or receptor(s) concerned with central pain may be, recent developments in the field lend some support to this type of argument. For example, it has been shown in the NMDA system that presynaptic transmitters and postsynaptic receptors may be present in varying quantities (concentrations, densities) in the central nervous system (Yu and Salter 1999). Another relevant observation is that ubiquitous C-terminal hydrolase is upregulated in rats with sciatic nerve constriction injuries (Moss et al. 2002). Wang et al. (2002) have described as many as 148 genes which are up- or down-regulated in the dorsal root ganglia of neuropathic rats.

It may, therefore, be suggested that changes in transmitter concentration and/or receptor density, as either up- or down- regulation, may occur following nervous system injury. Following appropriate insult, transmitters and/or receptors may undergo sudden and massive depletion, leading to immediate onset of CNP; or one or other or both may deplete slowly, giving rise to later onset of pain; they may recover their original levels/concentrations/density, so that the pain “spontaneously” disappears; fluctuant recovery may account for fluctuating degrees of CNP.

However, if this hypothesis is even partly valid, there are a number of unexplained phenomena, among which are:

- a) Why, in what is apparently the same condition, does one form of therapy succeed in some cases but fail in others, in which another form of therapy (a different drug) is effective? (e.g. TCAs, which act on serotonergic and adrenergic systems, versus gabapentin, which acts on subunits of voltage-dependent Ca<sup>++</sup> channels)
- b) It is fairly widely reported that patients with CPSP may have their pain alleviated by a second stroke; we have also seen the pains of both post-herpetic and trigeminal neuralgias relieved by a subsequent stroke. Such events are hardly going to increase levels of Transmitter X or densities of Receptor Y!

Although progress has been made in understanding the mechanisms responsible for central pain, there are clearly additional questions to address, the answers to which will hopefully provide new insights into more effective treatment strategies.

#### ► Spinal Cord Injury Pain Model, Hemisection Model

### References

1. Ajuriaguerra J de (1937) *La Douleur dans les Affections du Système Nerveux Central*. Doin, Paris
2. Andersen G (1995) Incidence of Central Post-Stroke Pain. *Pain* 61:187–194
3. Awerbuch GI, Sandyk R (1990) Mexiletine for Thalamic Pain Syndrome. *Int J Neurosci* 55:129–133
4. Boas RA, Covino BG, Shanharian A (1982) Analgesic Response to I. V. Lignocaine. *Br J Anaesth* 54:501–505
5. Bogousslavsky J, Regli F, Uske A (1988) Thalamic Infarcts: Clinical Syndromes, Etiology, and Prognosis. *Neurol* 38:837–848
6. Bowsher (1995a) The management of central post-stroke pain. *Postgrad Med J* 71:598–604
7. Bowsher D (1995b) Central Pain. *Pain Rev* 2:175–186
8. Bowsher D (1996a) Central Pain: Clinical and Physiological Characteristics. *J Neurol Neurosurg Psychiatr* 61:62–69
9. Bowsher, D (1996b) Central Pain of Spinal Origin. *Spinal Cord* 34:707–710
10. Bowsher D, Leijon G, Thomas K-A (1998) Central Post-Stroke Pain: Correlation of Magnetic Resonance Imaging with Clinical Pain Characteristics and Sensory Abnormalities. *Neurology* 51:1352–1358
11. Cohen SP, DeJesus M (2004) Ketamine Patient-Controlled Analgesia for Dysesthetic Central Pain. *Spinal Cord* 42:425–428
12. Davison C, Schick W (1935) Spontaneous Pain and other Sensory Disturbances. *Arch Neurol Psychiatr (Chicago)* 34:1204–1237
13. Dejerine J, Roussy J (1906) Le Syndrome Thalamique. *Rev Neurol* 14: 521–532
14. Eide PK, Jörum E, Stenejhem AE (1996) Somatosensory Findings in Spinal Cord Injury Patients with Central Dysaesthesia Pain. *J Neurol Neurosurg Psychiatr* 60:411–415
15. Foix C, Chavany J-A, Lévy M (1927) Syndrome pseudo-thalamique d'origine pariétale. Lésion de l'artère du sillon interpariétal (Pa P1P2 antérieures, petit territoire insulo-capsulaire). *Rev Neurol (Paris)* 35:68–76
16. Lahuerta J, Bowsher D, Buxton PH, Lipton S (1994) Percutaneous cervical cordotomy: A review of 181 operations in 146 patients, including a study on the location of “pain fibers” in the second cervical spinal cord segment of 29 cases. *J Neurosurg* 80:975–985
17. Leijon G, Boivie J, Johansson I (1989) Central Post-Stroke Pain – A Study of the Mechanisms through Analyses of the Sensory Abnormalities. *Pain* 37:173–185
18. Madsen PW, Yeziarski RP, Holets VR (1994) Syringomyelia: Clinical Observations and Experimental Studies. *J Neurotrauma* 11:241–254



19. Max M, Lynch SA, Muir J et al. (1992) Effects of Desipramine, Amitriptyline, and Fluoxetine on Pain in Diabetic Neuropathy. *New Eng. J Med* 326:1250–1256
20. McCleane GJ, Suzuki R, Dickenson AH (2003) Does a Single Intravenous Injection of 5HT<sub>3</sub> Receptor Antagonist Ondansetron have an Analgesic Effect in Neuropathic Pain? A Double-Blinded, Placebo-Controlled Cross-Over Study. *Anesth Analg* 97:1474–1478
21. Moss A, Blackburn-Munro G, Garry EM et al. (2002) A Role of the Ubiquitin-Proteasome System in Neuropathic Pain. *J Neurosci* 22:1363–1372
22. Siddall PJ, Loeser JD (2001) Pain following Spinal Cord Injury. *Spinal Cord* 39:63–73
23. Siddall PJ, Taylor DA, McClelland JM et al. (1999) Pain Report and the Relationship of Pain to Physical Factors in the First 6 Months following Spinal Cord Injury. *Pain* 81:187–197
24. Suzuki R, Morcuende S, Webber M et al. (2002) Superficial NK<sup>1</sup>-Expressing Neurons Control Spinal Excitability through Activation of Descending Pathways. *Nat Neurosci* 5:1319–1326
25. Taylor CP, Gee NS, Su T-Z et al. (1998) A Summary of Mechanistic Hypotheses of Gabapentin Pharmacology. *Epilepsy Res* 29:233–249
26. Tsubokawa T, Katayama Y, Yamamoto T, Hirayama T, Koyama S (1993) Chronic motor cortex stimulation in patients with thalamic pain. *J Neurosurg* 78:393–401
27. Vick PG, Lamer TJ (2003) Treatment of Central Post-Stroke Pain with Oral Ketamine. *Pain* 92:311–313
28. Wang H, Sun H, Della Penna K et al. (2002) Chronic Neuropathic Pain is accompanied by Global Changes in Gene Expression and Shares Pathobiology with Neurodegenerative Diseases. *Neurosci* 114:529–546
29. White JC, Sweet WH (1955) *Pain: Its Mechanisms and Neurosurgical Control*. CC Thomas, Springfield Ill
30. Widerström-Noga EG (2002) Evaluation of Clinical Characteristics of Pain and Psychosocial Factors after Spinal Cord Injury. In: Yezierski RP, Rurchiel KJ (eds) *Spinal Cord Injury Pain: Assessment, Mechanisms, Management*. IASP Press, Seattle, pp 53–82
31. Widerström-Noga EG (2003) Chronic Pain and Non-Painful Sensations following SCI: Is there a Relationship? *Clin J Pain* 19:39–47
32. Yezierski RP (1996) Pain following Spinal Cord Injury: The Clinical Problem and Experimental Studies. *Pain* 73:115–119
33. Yezierski RP, Burchiel KJ (2002) *Spinal Cord Injury Pain: Assessment, Mechanisms, Management*. IASP Press, Seattle
34. Yu X-M, Salter MW (1999) Src, A Molecular Switch Governing Gain Control of Synaptic Transmission Mediated by N-methyl-D-aspartate Receptors. *Proc-Natl Acad Sci USA* 96:7697–7704

## Central Neuropathic Pain from Spinal Cord Injury

PHILIP SIDDALL

Pain Management Research Institute, University of Sydney, Royal North Shore Hospital, Sydney, NSW, Australia  
 phils@med.usyd.edu.au

### Definition

Central pain from spinal cord injury (SCI) refers to ► **neuropathic pain** that occurs following traumatic or atraumatic injury to the spinal cord. It may be due to dysfunction occurring at spinal and/or supraspinal levels. Two main types of central neuropathic pain are described following SCI. These are ► **at-level neuropathic pain** and ► **below-level neuropathic pain** (Siddall et al. 2002).

## Characteristics

### Prevalence

The prevalence of central neuropathic pain following SCI is relatively high. In the first six months following SCI, it has been reported that 35 % of patients have at-level neuropathic pain and 25 % of patients have below-level neuropathic pain. At five years following injury, there is little change in these numbers, with 42 % having at-level neuropathic pain and 34 % having below-level neuropathic pain (Siddall et al. 2003). This increase in numbers of people reporting pain reflects the lack of success in alleviating the pain. It also reflects the late onset of neuropathic pain, even years following injury, in many people. The prospective study by Siddall et al. (2003) also indicates a strong correlation between the presence of both types of neuropathic pain within six months and at five years following injury. This unfortunately suggests that if either of these pain types is present at six months, then there is a strong likelihood that it will be present at 5 years.

### Diagnosis

A taxonomy of pain following SCI was proposed by the International Association for the Study of Pain (IASP) Task Force on SCI pain, and identifies five main types of pain that occur following SCI (Siddall et al. 2002). These are: musculoskeletal, visceral, above-level neuropathic, at-level neuropathic and below-level neuropathic pains. The presence of neuropathic pain is suggested by descriptors such as electric, shooting and burning with pain located in or adjacent to a region of sensory loss. Central neuropathic pain will usually present at or below the level of injury and will therefore fall into the last two groups. Above-level neuropathic pain usually refers to neuropathic pain arising from damage to peripheral nerves above the level of injury. Therefore, many types of above-level neuropathic pain are peripheral in origin. However, some types of above-level neuropathic pain may be central in origin. For example, syringomyelia may give rise to central neuropathic pain that is located in dermatomes above the level of injury.

At-level neuropathic pain occurs as a band of pain in the dermatomes adjacent to the level of injury, and is therefore sometimes referred to as segmental, end-zone or border zone pain. It may be due to damage to nerve roots and therefore be a form of peripheral neuropathic pain. However, animal models have clearly demonstrated that at-level neuropathic pain may occur in the absence of nerve root damage, and therefore it may be central in origin.

Below-level neuropathic pain occurs more diffusely, in a bilateral distribution below the level of the spinal cord lesion in the region of sensory disturbance, and is sometimes referred to as central dysesthesia syndrome. It is most likely due to changes in the spinal cord and brain

following SCI. Therefore, below-level neuropathic pain is generally regarded as a central neuropathic pain.

### Mechanisms

At-level neuropathic pain may be due to nerve root compression. The mechanisms of pain associated with nerve root compression are similar to other forms of peripheral neuropathic pain and are described elsewhere. However, at-level neuropathic pain may also be due to changes within the spinal cord itself as a consequence of injury. The specific mechanisms underlying both at-level and below-level neuropathic pain are incompletely understood. However, there are a number of secondary changes that occur as a consequence of spinal cord damage, which may result in the generation or amplification of nociceptive signals (Vierck et al. 2000, Yeziarski 2003). These include:

1. Damage to the spinal cord may result in increased levels of glutamate which activates N-methyl D-aspartate (NMDA), non-NMDA and metabotropic glutamate receptors. This activation of glutamate receptors results in activation of a cascade of secondary processes within neurons, which ultimately result in increased neuronal excitability.
2. Alternatively, increased neuronal excitability may be a consequence of reduced inhibition within the spinal cord. Several mechanisms have been proposed, including reduced function of inhibitory neurotransmitters and receptors such as  $\gamma$  aminobutyric acid (GABA) and glycine. This may occur through reduction in inputs from surrounding regions that normally exert an inhibitory action on the region, which has lost inputs (inhibitory surround). Loss of inhibition may also occur through disruption to inhibitory neurotransmitter production, release or uptake as a consequence of spinal cord damage. A reduction in inhibition may also be due to a decrease in the levels of inhibitory controls exerted by descending antinociceptive pathways.
3. Injury to the spinal cord will also initiate inflammatory and immune responses, which will have both direct and indirect effects on the long-term integrity of spinal cord structures, as well as functional changes in sensory processing.

Both increased excitation and loss of inhibition may give rise to a population of neurons close to the site of injury that have an increased responsiveness to peripheral stimulation and may even fire spontaneously. These alterations in the properties of spinal neurons may give rise to the phenomenon of hyperaesthesia (► **allodynia** and ► **hyperalgesia**) and spontaneous pain, respectively. As well as alterations at a spinal level, alterations in the chemistry and firing properties of supraspinal neurons have also been demonstrated. The main site that has been investigated is the thalamus (Ralston et al. 2000; Ohara et al. 2002).

### Treatment

There are relatively few studies that have specifically examined the effectiveness of treatments for pain following SCI, and in these situations subject numbers are generally low. Therefore, there is little definitive evidence to guide management. In the few randomized controlled trials that have been done, many of the treatments were no more effective than the placebo, and therefore adequate control of central neuropathic SCI pain is generally difficult (Finnerup et al. 2001). Principles of treatment are derived largely from the treatment of other neuropathic pain conditions.

It is traditionally stated that opioids are relatively ineffective for the treatment of neuropathic pain. However, there is increasing evidence that they may be effective if an appropriate dose is used. A randomized controlled trial of intravenous morphine (9–30 mg) found a significant reduction in brush-evoked allodynia, but no significant effect on spontaneous neuropathic SCI pain (Attal et al. 2002). Long term use of opioids may also be a problem because of side effects such as constipation, which may be more of an issue in individuals with SCI. Although there is little direct evidence in SCI pain, tramadol may also be an option because of its serotonergic and noradrenergic effects, which may provide an advantage in the treatment of neuropathic pain.

Intravenous or subcutaneous infusion of local anaesthetics such as lidocaine (lignocaine), are also widely used for the treatment of neuropathic pain and may be effective for neuropathic SCI pain. One of the actions of local anaesthetics is to produce sodium channel blockade. This reduces the amount of ectopic impulses generated by activity at these receptors. Relatively low concentrations of local anaesthetic are required to reduce ectopic neural activity in damaged nerves. There is evidence from a randomized controlled trial supporting the efficacy of intravenous lidocaine in treating neuropathic SCI pain (Attal et al. 2000). Although its mode of action is different from local anaesthetics, propofol is another agent that may be administered systemically and has been shown to provide effective relief of neuropathic SCI pain (Canavero et al. 1995).

As mentioned above, SCI may result in an increased release of glutamate and activation of NMDA receptors, resulting in central neuronal hyperexcitability. NMDA receptor antagonists such as ketamine have been used as a treatment for neuropathic pain following SCI (Eide et al. 1995). Administration is generally by infusion via the intravenous or subcutaneous route. One of the main problems with the use of ketamine is the occurrence of disturbing side effects such as hallucinations, although benzodiazepines may help reduce these symptoms. Although careful monitoring can help to minimize the rate of occurrence of these side effects, they can be distressing to the person when they do occur.

Oral rather than systemic administration of a number of drugs is also possible, and may be preferred. Unfortunately, most studies suggest that these oral agents are less effective than drugs used systemically. Most of the evidence for the effectiveness of opioids for the treatment of neuropathic pain comes from studies using acute intravenous administration. Local anaesthetics are not available in oral form, and the local anaesthetic congener mexiletine does not appear to be as effective as lidocaine in reducing neuropathic SCI pain (Chiou Tan et al. 1996). Similarly, ketamine is difficult to administer orally and other NMDA antagonists available for administration via the oral route, such as dextromethorphan, are also not as effective.

Several agents that are used widely for the treatment of persistent neuropathic pain are not available for systemic administration but are available in the oral form. These include the tricyclic antidepressants such as amitriptyline, prothiaden and nortriptyline and anticonvulsants such as carbamazepine, valproate, lamotrigine and gabapentin. However, specific evidence of efficacy in the treatment of neuropathic SCI pain is limited. Randomised controlled trials of trazodone (Davidoff et al. 1987) and amitriptyline (Cardenas et al. 2002) both failed to find an effect greater than placebo, although numbers in the trazodone study were low and the amitriptyline study contained subjects who had both musculoskeletal and neuropathic pains. A randomised controlled trial of sodium valproate also failed to demonstrate a significant analgesic effect (Drewes et al. 1994). Lamotrigine has been demonstrated to be effective, but only for the evoked component of neuropathic SCI pain (Finnerup et al. 2002).

Consideration may be given to spinal administration of drugs if oral approaches are unsuccessful. Intrathecal administration of morphine and clonidine has been helpful in some people with neuropathic SCI pain (Siddall et al. 2000).

Spinal cord injury requires a major psychological adjustment. Awareness of these issues is important in the evaluation of the person with pain. As with any pain condition, psychological factors may contribute to the perception and expression of pain. Pain report may be an expression of difficulty in adjustment, and therefore psychological approaches that attempt to deal with these issues may be helpful. Utilisation of pain management strategies and cognitive behavioural therapy (CBT) may be helpful in achieving optimal pain management (Umlauf 1992).

## References

1. Attal N, Guirimand F, Brasseur L, Gaude V, Chauvin M, Bouhasira D (2002) Effects of IV Morphine in Central Pain – A Randomized Placebo-Controlled Study. *Neurology* 58:554–563
2. Attal N, Gaudé V, Brasseur L et al. (2000) Intravenous Lidocaine in Central Pain: A Double-Blind, Placebo-Controlled, Psychophysical Study. *Neurology* 54:564–574
3. Canavero S, Bonicalzi V, Pagni CA et al. (1995) Propofol Analgesia in Central Pain - Preliminary Clinical Observations. *J Neurol* 242:561–567
4. Cardenas DD, Warms CA, Turner JA, Marshall H, Brooke MM, Loeser JD (2002) Efficacy of Amitriptyline for Relief of Pain in Spinal Cord Injury: Results of a Randomized Controlled Trial. *Pain* 96:365–373
5. Chiou Tan FY, Tuel SM, Johnson JC, Priebe MM, Hirsh DD, Strayer JR (1996) Effect of Mexiletine on Spinal Cord Injury Dysesthetic Pain. *Am J Phys Med Rehabil* 75:84–87
6. Davidoff G, Guarracini M, Roth E, Sliwa J, Yarkony G. (1987) Trazodone Hydrochloride in the Treatment of Dysesthetic Pain in Traumatic Myelopathy: A Randomized, Double-Blind, Placebo-Controlled Study. *Pain* 29:151–161
7. Eide PK, Stubhaug A, Stenehjem AE (1995) Central Dysesthesia Pain after Traumatic Spinal Cord Injury is Dependent on N-methyl-D-aspartate Receptor Activation. *Neurosurgery* 37:1080–1087
8. Finnerup NB, Zezierski RP, Sang CN, Burchiel KJ, Jensen TS (2001) Treatment of Spinal Cord Injury Pain. *Pain Clinical Updates* 9:1–6
9. Finnerup NB, Sindrup SH, Flemming WB, Johannesen IL, Jensen TS (2002) Lamotrigine in Spinal Cord Injury Pain: A Randomized Controlled Trial. *Pain* 96:375–383
10. Ohara S, Garonzik I, Hua S, Lenz FA (2002) Microelectrode Studies of the Thalamus in Patients with Central Pain and in Control Patients with Movement Disorders. In: Zezierski RP, Rurchiel KJ (eds) *Spinal Cord Injury Pain: Assessment, Mechanisms, Management*. IASP Press, Seattle, pp 219–236
11. Siddall PJ, Molloy AR, Walker S, Mather LE, Rutkowski SB, Cousins MJ (2000) Efficacy of Intrathecal Morphine and Clonidine in the Treatment of Neuropathic Pain Following Spinal Cord Injury. *Anesth Analg* 91:1493–1498
12. Siddall PJ, Zezierski RP, Loeser JD (2002) Taxonomy and Epidemiology of Spinal Cord Injury Pain. In: Zezierski RP, Rurchiel KJ (eds) *Spinal Cord Injury Pain: Assessment, Mechanisms, Management*. IASP Press, Seattle, pp 9–24
13. Siddall PJ, McClelland JM, Rutkowski SB, Cousins MJ (2003) A Longitudinal Study of the Prevalence and Characteristics of Pain in the First 5 Years Following Spinal Cord Injury. *Pain* 103:249–257
14. Ralston DD, Dougherty PM, Lenz FA, Weng HR, Vierck CJ, Ralston HJ (2000) Plasticity of the Inhibitory Circuitry of the Primate Ventrobasal Thalamus Following Lesions of Somatosensory Pathways. In: Devor M, Rowbotham MC, Wiesenfeld-Hallin Z (eds) *Proceedings of the 9th World Congress on Pain*, IASP Press, Seattle, pp 427–434
15. Umlauf RL (1992) Psychological Interventions for Chronic Pain Following Spinal Cord Injury. *Clin J Pain* 8:111–118
16. Vierck CJ, Siddall PJ, Zezierski RP (2000) Pain Following Spinal Cord Injury: Animal Models and Mechanistic Studies. *Pain* 89:1–5
17. Zezierski RP (2002) Pathophysiology and Animal Models of Spinal Cord Injury Pain. In: Zezierski RP, Rurchiel KJ (eds) *Spinal Cord Injury Pain: Assessment, Mechanisms, Management*. IASP Press, Seattle, pp 117–136

## Central Pain

### Definition

Central pain is defined by the International Association for the Study of Pain (IASP) as: „Regional pain caused by a primary lesion or dysfunction in the central nervous system, usually associated with abnormal sensibility to temperature and to noxious stimulation“.

- ▶ [Cell Therapy in the Treatment of Central Pain](#)
- ▶ [Central Nervous System Stimulation for Pain](#)
- ▶ [Central Pain, Diagnosis and Assessment of Clinical Characteristics](#)



- ▶ Central Pain, Human Studies of Physiology
- ▶ Central Pain in Multiple Sclerosis
- ▶ Central Pain, Outcome Measures in Clinical Trials
- ▶ Central Pain, Pharmacological Treatments
- ▶ Central Pain Syndrome
- ▶ Diagnosis and Assessment of Clinical Characteristics of Central Pain
- ▶ DREZ Procedures
- ▶ Functional Changes in Sensory Neurons Following Spinal Cord Injury in Central Pain
- ▶ Pain Treatment, Motor Cortex Stimulation
- ▶ Percutaneous Cordotomy
- ▶ Post-Stroke Pain Model, Thalamic Pain (Lesion)
- ▶ Secondary Somatosensory Cortex (S2) and Insula, Effect on Pain Related Behavior in Animals and Humans
- ▶ Stimulation Treatments of Central Pain

## Central Pain and Cancer

PAOLO L. MANFREDI<sup>1, 2</sup>, GILBERT R. GONZALES<sup>1</sup>  
<sup>1</sup>Department of Neurology, Memorial Sloan-Kettering Cancer Center, New York, NY, USA  
<sup>2</sup>Essex Woodlands Health Ventures, New York, NY, USA  
 manfredp@mskcc.org, ggonzales@ewhv.com

### Definition

In order to be diagnosed with Central Pain (CP) associated with cancer, patients must have a lesion within the Central Nervous System (CNS) caused by cancer or its treatment, pain in a distribution compatible with the CNS lesion, and no other lesions that could potentially cause pain in the same area (Casey 1991; Gonzales and Casey 2003; Gonzales et al. 2003).

This definition includes pathology in the spinal cord, brainstem, or cerebral hemispheres. Lesions in the peripheral nervous system can produce CNS changes, but these are secondary CNS changes and are not categorized as CP syndromes (Casey 1991; Gonzales and Casey 2003). The most common causes of CNS injuries that result in CP are stroke, spinal cord trauma and multiple sclerosis (Casey 1991). However, cancer and its treatment can also cause CP (Gonzales et al. 2003).

### Characteristics

Although CP occurs infrequently, over 15% of patients with systemic cancer have metastases to the brain or spinal cord (Clouston et al. 1992), making it possible for some of these patients to go on and develop CP. Central pain caused by cancer is mostly described through case reports, such as the study of thalamic tumors by Cheek and Taveras (Cheek et al. 1966). Pagni and Canavero (1993), and Gan and Choksey (2001) have reported CP from extra-axial tumors such as meningiomas. Delattre and colleagues have reported CP caused by

leptomeningeal disease (Delattre et al. 1989). A more recent study by Gonzales et al. described the prevalence and causes of central pain in patients with cancer (Gonzales et al. 2003). In this study conducted in a cancer center, a relatively high number of general oncology patients admitted to the Neurology Service (2%) or seen in consultation by the Pain Service (4%) were found to have CP. It is important to underscore that the prevalence of central pain seen in these patients is not representative of the true prevalence of central pain in hospitalized patients with cancer, as these patients were selected by their referral to the pain service or admission to the neurology ward. In this study, spinal cord lesions were by far more likely to cause CP compared to brain and brainstem lesions, as is the case in patients with non-cancer causes of central pain (Gonzales et al. 2003).

When a patient with cancer has radiological documentation of a lesion within the CNS, pain in a distribution compatible with the CNS lesion, and no other lesions that could potentially cause pain in the same area, a diagnosis of CP can be made. In order to be classified as CP related to cancer the inciting CNS lesion must be caused by cancer or its treatment.

Pain descriptors suggestive of CP such as burning, numb, cold, pins and needles, electric shock can also help with the diagnosis.

On physical examination it may be possible to elicit different neurological abnormalities, depending on the location and size of the CNS lesion. The finding of altered temperature sensation in the painful area is consistently seen in all CP patients with cancer, as expected from the experience with non-malignant causes of CP (Gonzales and Casey 2003; Gonzales et al. 2003). A detailed sensory examination is therefore essential.

Central pain may be delayed by days to years after CNS injury (Gonzales 1995). In one cancer patient, CP was found to be delayed by up to 6 years after the diagnosis and treatment of the spinal cord tumor (Gonzales et al. 2003). This is much longer than the delay usually seen in non-malignant causes of spinal cord CP.

The treatment strategies in patients with cancer and CP may include anti-tumor therapies such as radiation, chemotherapy, surgical resection and steroids to decrease edema. Aside from addressing the treatment of the tumor, the treatment of CP in patients with cancer can be approached as with non-malignant CP (Gonzales and Casey 2003; Gonzales et al. 2003) and include antidepressants, anticonvulsants, opioids, clonidine, baclofen, acetaminophen, and NSAIDs.

### References

1. Casey KL (1991) Pain and Central Nervous System Disease: A Summary and Overview. In: Casey KL ed. Pain and Central Nervous System Disease: The Central Pain Syndromes. Raven Press, New York
2. Cheek WR, Taveras JM (1966) Thalamic Tumors. *J Neurosurg* 24:505–513

3. Clouston PD, DeAngelis LM, Posner J (1992) The Spectrum of Neurological Disease in Patients with Systemic Cancer. *Ann Neurol* 31:268–273
4. Delattre JY, Walker RW, Rosenblum MK (1989) Leptomeningeal Gliomatosis with Spinal Cord or Cauda Equina Compression: A Completion of Supratentorial Gliomas in Adults. *Acta Neurol Scand* 79:133–139
5. Gan YC, Choksey MS (2001) Parafalcine Meningioma Presenting with Facial Pain: Evidence for Cortical Theory or Pain? *Br J Neurosurg* 15:350–352
6. Gonzales GR (1995) Central Pain: Diagnosis and Treatment Strategies. *Neurology* 45:11–16
7. Gonzales GR, Casey KL (2003) Central Pain Syndromes. In: Rice ADS, Washeld CA, Justins D et al. (eds) *Clinical Pain Management Chronic Pain*. Arnold Press, London
8. Gonzales GR, Tuttle S, Thaler HT et al. (2003) Central Pain in Patients with Cancer. *J Pain* 4:351–354
9. Pagni CA, Canavero S (1993) Paroxysmal Perineal Pain Resembling Tic Douloureux, only Symptom of a Dorsal Meningioma. *Ital J Neurol Sci* 14:323–324
10. Tasker RR, DeCorvalho G, Dostrovosky JO (1991) The History of Central Pain Syndromes, with Observations Concerning Pathophysiology and Treatment. In: Casey KL (ed) *Pain and Central Nervous System Disease: The Central Pain Syndromes*. Raven Press, New York, pp 31–58

## Central Pain, Diagnosis

DAVID VIVIAN

Metro Spinal Clinic, Caulfield, VIC, Australia  
dvivian@metrospinal.com.au

### Synonyms

Thalamic Pain; Dejerine-Roussy Syndrome; deafferentation pain

### Definition

Central pain is pain whose source lies in the central nervous system, i.e. the brain, brainstem, or spinal cord. The cardinal defining feature is that the pain is not evoked by neural activity in peripheral nerves.

### Characteristics

In terms of clinical features, central pain has particular characteristics. The pain is typically spontaneous and burning in quality, associated with abnormal sensations. The latter may include:

- hyperaesthesia (increased sensitivity to touch)
- hyperalgesia (increased sensitivity to noxious stimuli)
- allodynia (touch and brush are perceived as painful)
- paraesthesiae (sensation of pins and needles)
- formication (sensation of ants crawling on skin) and
- diminished topoesthesia (ability to locate a sensation somatotopically)

In these respects central pain resembles neuropathic pain, and the taxonomic distinction between the two conditions is not always clear. Some forms of neuropathic pain are likely to be central in origin rather than

arising from the damaged peripheral nerve. The distinction is most clear when the precipitating injury of disease is obviously in the central nervous system. In such cases the term –central pain, applies unambiguously.

### Examples

Classical examples of central pain are the pain of brachial plexus avulsion, spinal cord injury pain, pain after stroke, and pain due to infarction of ► **thalamic nuclei**. The latter is known as thalamic pain syndrome or the Dejerine-Roussy syndrome. Complex regional pain syndrome is the most florid example of central pain.

Others examples include postherpetic neuralgia, peripheral nerve injury, and painful peripheral neuropathy. The latter, however, are contentious, for it is not always evident the extent to which the pain is central in origin or due to peripheral mechanisms such as neuroma, or ectopic impulse generation in peripheral nerves or their ► **dorsal root ganglia**.

### Mechanism

Central pain is believed to result from deafferentation: when neurons in the central nervous system lose their accustomed afferent input, either from a peripheral nerve or from an ascending sensory tract. In particular, partial deafferentation is considered most likely to be associated with the development of central pain.

Deafferentation seems to induce plastic changes in the central nervous system. Numerous theories describe these plastic changes in terms of: removal of local inhibition, changes in neuronal membrane excitability, and synaptic reorganisation. These changes occur rapidly after central nervous system damage. However, it is typical for central pain to occur some time after such an injury (days to weeks).

Experiments in animals have been conducted in which recordings are established from dorsal horn neurons that respond to input from particular peripheral nerves. If those nerves are then severed, the dorsal horn neurons no longer respond to peripheral stimuli but exhibit a variety of changes (Anderson et al. 1971; Macon 1979; 3). They become spontaneously active, and eventually no longer become responsive to typical neurotransmitters. These features suggest that their membranes become unstable, and the neurons no longer maintain receptors when denied their accustomed input. The latter feature probably underlies the notorious resistance of central pain to pharmacological therapy.

Spontaneous activity has been confirmed in humans with central pain. When subjects with spinal cord injury pain have been explored with electrodes, spontaneously active neurons have been found in the spinal cord immediately above the level of injury (Loeser et al. 1968). Similar activity has been recorded after experimental spinal cord injury in cats (Loeser and Ward 1967).



The abnormal sensations associated with central pain are most likely due to disinhibition. Sensory perception is normally subject to a variety of central excitatory and inhibitory controls. These are mediated by the dorsolateral tract and by tracts in the anterior funiculus of the spinal cord. When peripheral nerves are severed, the balance between these central modulating influences is disturbed, sometimes with contrasting effects.

Disinhibition results in sensitization of ► **Second Order Neurons**. Sensations mediated by intact nerves become exaggerated. This is manifest in the form of hyperaesthesia, hyperalgesia, and allodynia.

In experimental animals, the effects of sectioning the trigeminal nerve (Denny-Brown et al. 1973), spinal nerves (Denny-Brown and Yanagisawa 1973) or the spinal cord (Denny-Brown 1979), can be modulated pharmacologically and surgically. Discrete sectioning of the lateral portion of the dorsolateral tract results in shrinkage of the area of sensory nerve loss (Denny-Brown and Yanagisawa 1973; Denny-Brown et al. 1973). Conversely, sectioning the medial portion of the dorsolateral tract increases the area (Denny-Brown and Yanagisawa 1973; Denny-Brown et al. 1973). Sectioning both anterior funiculi reverses the sensory loss caused by spinothalamic tractotomy, but the restored sensation is hyperaesthetic (Denny-Brown 1979). Administering L-dopa reduces sensory loss (Denny-Brown et al. 1973), as does a subconvulsive dose of strychnine: an antagonist of the inhibitory transmitter – glycine (Denny-Brown 1979; Denny-Brown and Yanagisawa 1973; Denny-Brown et al. 1973).

In humans who have undergone dorsal root section for pain but whose pain recurs, administration of L-dopa increases their pain but decreases the area of cutaneous anaesthesia (Hodge and King 1976). Reciprocally, administration of methyl-dopa decreases pain but increases numbness. Similarly, tryptophan – a serotonin precursor – reduces pain but increases anaesthesia (King 1980). These phenomena indicate that the effects of deafferentation are not fixed, but are subject to a complex variety of controls. Release of these controls, following peripheral nerve injury or central nervous injury, underlies the varied appearance of pain and altered sensations associated with central pain.

For the central pain of thalamic syndrome, a variety of explanations have been advanced; but they, too, revolve around deafferentation and disinhibition. Cells in the ventroposterior thalamic nuclei become spontaneously active, and produce pain in the area of the body that they subtend (Lenz et al. 1987; Lenz et al. 1989). Experimental stimulation of these cells evokes pain in the deafferented region (Lenz et al. 1988). The abnormal activity is believed to arise because of loss of inhibition of medial thalamic nuclei by the reticular nucleus (Cesaro et al. 1991; Mauguier and Desmedt 1988). Damage to the spinothalamic tract seems to be the precipitating factor for these changes.

## Diagnosis

The diagnosis of central pain rests largely on the recognition of the clinical features and history of the pain. Spontaneous burning pain associated with abnormal, exaggerated sensations implies a central mechanism. If the history indicates disease or injury to the central nervous system, the diagnosis is confirmed. The diagnosis is less certain if injury to the central nervous system is not evident, or when the injury or disease affects peripheral nerves.

A presumptive test for central pain is the administration of lignocaine by systemic intravenous infusion. Such an infusion is believed to suppress the spontaneous activity in the central nervous system believed to be responsible for central pain.

## Treatment

Central pain is notoriously difficult to treat. Standard analgesics seem to have little or no effect, which correlates with the lack of receptors found in animals with spontaneously active neurons after deafferentation.

Agents that suppress ectopic activity, or which stabilize nerve-cell membranes, are more likely to relieve central pain, provided that side-effects can be tolerated. Such agents include local anaesthetic agents, administered either by systemic infusion or orally; and membrane-stabilizing agents such as gabapentin and lamotrigine. Otherwise, central pain can be treated, with reasonable success, by neuroaugmentive surgical procedures such as dorsal column stimulation, dorsal root entry zone lesioning, and deep brain stimulation.

## References

1. Anderson LS, Black RG, Abraham J et al. (1971a) Neuronal Hyperactivity in Experimental Trigeminal Deafferentation. *J Neurosurg* 35:444–451
2. Anderson LS, Black RG, Abraham J et al. (1971b) Neuronal Hyperactivity in Experimental Trigeminal Deafferentation. *J Neurosurg* 35:444–451
3. Cesaro P, Mann MW, Moretti JL et al. (1991) Central Pain and Thalamic Hyperactivity: A Single Photon Emission Computerized Tomographic Study. *Pain* 47:329–336
4. Denny-Brown D (1979) The Enigma of Crossed Sensory Loss with Cord Hemisection. In: Bonica JJ et al. (eds) *Advances in Pain Research and Therapy*, vol 3. Raven Press, New York, pp 889–895
5. Denny-Brown D, Kirk EJ, Yanagisawa N (1973a) The Tract of Lissauer in Relation to Sensory Transmission in the Dorsal Horn of Spinal Cord in the Macaque Monkey. *J Comp Neurol* 151:175–199
6. Denny-Brown D, Yanagisawa N (1973b) The Function of the Descending Root of the Fifth Nerve. *Brain* 96:783–814
7. Hodge CJ, King RB (1976) Medical Modification of Sensation. *J Neurosurg* 44:21–28
8. King RB (1980) Pain and Tryptophan. *J Neurosurg* 53:44–52
9. Lenz FA, Tasker RR, Dostrovsky JO (1987) Abnormal Single Unit Activity Recorded in the Somatosensory Thalamus of a Quadriplegic Patient with Central Pain. *Pain* 31:225–236
10. Lenz FA, Dostrovsky JO, Tasker RR et al. (1988) Single-Unit Analysis of the Human Ventral Thalamic Nuclear Group: Somatosensory Responses. *J Neurophysiol* 59:299–316
11. Lenz FA, Kwan HC, Dostrovsky JO et al. (1989) Characteristics of the Bursting Pattern of Action Potential that Occurs in the Thalamus of Patients with Central Pain. *Brain Res* 496:375–360

12. Loeser JD, Ward AA (1967) Some Effects of Deafferentation on Neurons of the Cat spinal cord. *Arch Neurol* 17:629–636
13. Loeser JD, Ward AA, White LE (1968) Chronic Deafferentation of Human Spinal Cord Neurons. *J Neurosurg* 29:48–50
14. Macon JB (1979) Deafferentation Hyperactivity in the Monkey Spinal Trigeminal Nucleus: Neuronal Responses to Amino Acid Iontophoresis. *Brain Research* 161:549–554
15. Manguiere F, Desmedt JE (1988) Thalamic Pain Syndrome of Dejerine-Roussy: Differentiation of Four Subtypes Assisted by Somatosensory Evoked Patients Data. *Arch Neurol* 45:1312–1320

## Central Pain, Diagnosis and Assessment of Clinical Characteristics

- ▶ [Diagnosis and Assessment of Clinical Characteristics of Central Pain](#)

## Central Pain, Functional Changes in Sensory Neurons Following Spinal Cord Injury

- ▶ [Functional Changes in Sensory Neurons Following Spinal Cord Injury in Central Pain](#)

## Central Pain, Human Studies of Physiology

A. TAGHVA, S.H. PATEL, A. FERNANDEZ,  
N. WEISS, FREDERICK A. LENZ  
Department of Neurosurgery, Johns Hopkins Hospital,  
Baltimore, MD, USA  
flenzl@jhmi.edu

### Definition

Spontaneous thalamic cellular activity is often categorized as either ▶ [bursting activity](#) (▶ [spike-bursts](#), bursting mode) or as ▶ [tonic firing mode](#) (tonic mode) (Steriade et al. 1990). Many studies have suggested that increased spike-bursting occurs in the thalamus of patients with chronic neuropathic pain (Jeanmonod et al. 1994; Lenz et al. 1994, 1998; Rinaldi et al. 1991). Thalamic bursting has also been reported in monkeys with interruption of the ▶ [spinothalamic tract](#) (STT), which sometimes develop sensory abnormalities similar to those seen in patients with similar lesions (Weng et al. 2000). This bursting is certainly associated with lesions of the somatic sensory pathways to thalamus, and is perhaps associated with the pain that develops following such lesions.

## Characteristics

### The Thalamic Region of Vc and its Importance in Pain Processing

Several lines of evidence demonstrate that the ventral caudal nucleus of the human sensory thalamus (Vc), the human analog of monkey ventral posterior (VP) nucleus (Hirai and Jones 1989), is an important component in human pain-signaling pathways. Studies of patients at autopsy following lesions of the STT show the densest STT termination in the Vc region including: posterior and inferior subnuclei of Vc, supragenulate, and posterior subnuclei (Bowsher 1957; Mehler 1962; Walker 1943). In monkeys, the STT originating in dorsal horn lamina I, in part, terminates in Vmpo (Craig et al. 1994; Graziano and Jones 2004). In humans, cells responding to noxious and temperature stimuli can be located in all of these areas (Davis et al. 1999; Lee et al. 1999; Lenz et al. 1993). Thus, both anatomic and physiologic data demonstrates the presence of a distributed group of thalamic nuclei with pain related activity.

### Is Thalamic Functional Mode Altered in Chronic Pain States?

Spike-bursting activity refers to a particular pattern of ▶ [interspike intervals](#) (ISI) between action potentials, such that a spike-burst begins after a relatively long ISI, and is comprised of a series of action potentials with a short ISI (typically < 6 ms) (Lenz et al. 1994; Steriade et al. 1990). Thereafter, the ISIs progressively increase in length so that the cell's firing decelerates throughout the spike-burst.

In patients with spinal transection, the highest rate of bursting occurs in cells that do not have peripheral receptive fields, and that are located in the thalamic representation of the anesthetic part of the body. Since the pain is also in the anesthetic part of the body, this bursting may be due to loss of sensory input or be the cause of pain or both. These cells also have the lowest firing rates in the interval between bursts (principal event rate) (Lenz et al. 1994). The low firing rates suggest that these cells have decreased tonic excitatory drive and are hyperpolarized, perhaps due to loss of excitatory input from the STT (Blomqvist et al. 1996; Dougherty et al. 1996; Eaton and Salt 1990). Therefore, the available evidence suggests that thalamic cells deafferented by spinal transection (lesions) are dominated by spike-bursting and low firing rates between bursts, consistent with membrane hyperpolarization (Lenz et al. 1998; Steriade et al. 1990).

Spike-bursting activity is maximal in the region posterior and inferior to the core nucleus of Vc (Table 4 in Lenz et al. 1994). Stimulation in this area may evoke the sensation of pain more frequently than does stimulation in the core of Vc (Dostrovsky et al. 1991; Hassler 1970; Ohara and Lenz 2003). Thus, increased spike-bursting activity may be correlated with some aspects of abnormal sensations (e.g. dysesthesia or pain) that these patients expe-

rience. However, in patients with spinal transection, the painful area and the area of sensory loss overlap (Lenz et al. 1994). Thus, the bursting activity might be related to deafferentation of the thalamus from the input from the STT, rather than to pain.

These findings about spike-bursting activity in spinal patients have been called into question by a recent study in patients with chronic pain (Radhakrishnan et al. 1999). It has been reported that the number of bursting cells per trajectory in patients with movement disorders (controls) is not different from that in patients with chronic pain. However, there are significant differences between the two studies (Lenz et al. 1994; Radhakrishnan et al. 1999) in terms of: (1) patient population (spinal cord injury vs. mixed chronic pain); (2) location of cells studied (Vc vs. anterior and posterior to Vc); and (3) analysis methods (incidence of bursting cells vs. bursting parameters). Clearly, the increase in bursting activity demonstrated in the earlier study is more applicable to the region of the principal somatic sensory nucleus in patients with central pain from spinal transection (Lenz et al. 1994). Further support for increased spike-bursts occurring in spinal cord injured patients is found in thalamic recordings from monkeys with thoracic anterolateral cordotomies (Weng et al. 2000). Some of these animals showed increased responsiveness to electrocutaneous stimuli, and thus may represent a model of central pain (Vierck 1991). The most pronounced changes in firing pattern were found in thalamic multi-receptive cells, which respond to both cutaneous brushing and compressive stimuli, with activity that is not graded into the noxious range. In comparison with normal controls, multi-receptive cells in monkeys with cordotomies showed significant increases in the number of bursts occurring spontaneously or in response to brushing or compressive stimuli. The changes in bursting behavior were widespread, occurring in the thalamic representation of upper and lower extremities, both ipsilateral and contralateral to the cordotomy.

Although there is an increase in spike-burst activity in central pain secondary to spinal injury, there does not appear to be a direct relationship between spike-burst firing and pain. Spike-bursts are also found in the thalamic representation of the monkey upper extremity and of the representation of the arm and leg ipsilateral to the cordotomy. Pain is not typically experienced in these parts of the body in patients with thoracic spinal cord transection or cordotomy (Beric et al. 1988). Spike-bursts are increased in frequency during slow wave sleep and drowsiness in all mammals studied (Steriade et al. 1990) including man in the absence of pain (Zirh et al. 1997). However, such bursting could cause pain if stimulation in the vicinity of the bursting cells produced the sensation of pain. This finding has been reported in a study of sensations evoked by stimulation of the region of Vc in patients with central pain, including those with spinal cord injuries (Lenz et al. 1998). Thus, there is evidence

from both human and animal studies for a correlation between central pain following spinal cord injury and an altered thalamic neuronal action potential firing pattern. It appears that there is an increase in spike-burst firing in patients with pain following spinal injury. The exact physiologic relationships which link the pattern of thalamic firing to the human perception of pain in this condition are still unclear.

C

### Acknowledgement

Supported by grants to FAL from the NIH: NS39498 and NS40059.

### References

- Beric A, Dimitrijevic MR, Lindblom U (1988) Central Dysesthesia Syndrome in Spinal Cord Injury Patients. *Pain* 34:109–116
- Blomqvist A, Ericson AC, Craig AD et al. (1996) Evidence for Glutamate as a Neurotransmitter in Spinothalamic Tract Terminals in the Posterior Region of Owl Monkeys. *Exp Brain Res* 108:33–44
- Bowsher D (1957) Termination of the Central Pain Pathway in Man: The Conscious Appreciation of Pain. *Brain* 80:606–620
- Craig AD, Bushnell MC, Zhang ET et al. (1994) A Thalamic Nucleus Specific for Pain and Temperature Sensation. *Nature* 372:770–773
- Davis KD, Lozano AM, Manduch M et al. (1999) Thalamic Relay Site for Cold Perception in Humans. *J Neurophysiol* 81:1970–1973
- Dostrovsky JO, Wells FEB, Tasker RR (1991) Pain Evoked by Stimulation in Human Thalamus. In: Szigjenaga Y (ed) *International Symposium on Processing Nociceptive Information*. Elsevier, Amsterdam, pp 115–120
- Dougherty PM, Li YJ, Lenz FA et al. (1996) Evidence that Excitatory Amino Acids Mediate Afferent Input to the Primate Somatosensory Thalamus. *Brain Res* 278:267–273
- Eaton SA, Salt TE (1990) Thalamic NMDA Receptors and Nociceptive Sensory Synaptic Transmission. *Neurosci Lett* 110:297–302
- Graziano A, Jones EG (2004) Widespread Thalamic Terminations of Fibers Arising in the Superficial Medullary Dorsal Horn of Monkeys and their Relation to Calbindin Immunoreactivity. *J Neurosci* 24:248–256
- Hassler R (1970) Dichotomy of Facial Pain Conduction in the Diencephalon. In: Walker AE (ed) *Trigeminal Neuralgia*. Saunders, Philadelphia, pp 123–138
- Hirai T, Jones EG (1989) A New Parcellation of the Human Thalamus on the Basis of Histochemical Staining. *Brain Res Rev* 14:1–34
- Jeanmonod D, Magnin M, Morel A (1994) A Thalamic Concept of Neurogenic Pain. In: Gebhart GF, Hammond DL, Jensen TS (eds) *Proceedings of the 7th World Congress on Pain*. Progress in Pain Research and Management, vol 2. IASP Press, Seattle, pp 767–787
- Lee J-I, Antezanna D, Dougherty PM et al. (1999) Responses of Neurons in the Region of the Thalamic Somatosensory Nucleus to Mechanical and Thermal Stimuli Graded into the Painful Range. *J Comp Neurol* 410:541–555
- Lenz FA, Gracely RH, Baker FH et al. (1998) Reorganization of Sensory Modalities Evoked by Stimulation in the Region of the Principal Sensory Nucleus (Ventral Caudal-Vc) in Patients with Pain Secondary to Neural Injury. *J Comp Neurol* 399:125–138
- Lenz FA, Kwan HC, Martin R et al. (1994) Characteristics of Somatotopic Organization and Spontaneous Neuronal Activity in the Region of the Thalamic Principal Sensory Nucleus in Patients with Spinal Cord Transection. *J Neurophysiol* 72:1570–1587
- Lenz FA, Seike M, Lin YC et al. (1993) Neurons in the Area of Human Thalamic Nucleus Ventralis Caudalis Respond to Painful Heat Stimuli. *Brain Res* 623:235–240



17. Lenz FA, Zirh AT, Garonzik IM et al. (1998) Neuronal Activity in the Region of the Principle Sensory Nucleus of Human Thalamus (Ventralis Caudalis) in Patients with Pain Following Amputations. *Neurosci* 86:1065–1081
18. Mehler WR (1962) The Anatomy of the So-Called "Pain Tract" in Man: An Analysis of the Course and Distribution of the Ascending Fibers of the Fasciculus Anterolateralis. In: French JD, Porter RW (eds) *Basic Research in Paraplegia*. Thomas, Springfield, pp 26–55
19. Ohara S, Lenz FA (2003) Medial Lateral Extent of Thermal and Pain Sensations Evoked by Microstimulation in Somatic Sensory Nuclei of Human Thalamus. *J Neurophysiol* 90:2367–2377
20. Radhakrishnan V, Tsoukatos J, Davis KD et al. (1999) A Comparison of the Burst Activity of Lateral Thalamic Neurons in Chronic Pain and Non-Pain Patients. *Pain* 80:567–575
21. Rinaldi PC, Young RF, Albe-Fessard DG et al. (1991) Spontaneous Neuronal Hyperactivity in the Medial and Intralaminar Thalamic Nuclei in Patients with Deafferentation Pain. *J Neurosurg* 74:415–421
22. Steriade M, Jones EG, Llinas RR (1990) *Thalamic Oscillations and Signaling*. Wiley, John & Sons, New York
23. Vierck CJ (1991) Can Mechanisms of Central Pain Syndromes be Investigated in Animal Models? In: Casey KL (ed) *Pain and Central Nervous System Disease: the Central Pain Syndromes*. Raven Press, New York, pp 129–141
24. Walker AE (1943) Central Representation of Pain. *Res Publ Assoc Res Nerv Ment Dis* 23:63–85
25. Weng HR, Lee J-I, Lenz FA et al. (2000) Functional Plasticity in Primate Somatosensory Thalamus Following Chronic Lesion of the Ventral Lateral Spinal Cord. *Neurosci* 101:393–401
26. Zirh AT, Lenz FA, Reich SG et al. (1997) Patterns of Bursting Occurring in Thalamic Cells during Parkinsonian Tremor. *Neurosci* 83:107–121

## Central Pain in Multiple Sclerosis

JÖRGEN BOIVIE

Department of Neurology, University Hospital,  
Linköping, Sweden  
jorgen.boivie@lio.se

### Synonyms

Central neuropathic pain in multiple sclerosis. Previously equated with dysesthetic pain, since there was a belief that all central pain in multiple sclerosis (MS) was of dysesthetic quality, this has been shown to be incorrect.

### Definition

► **Central pain** (CP) is neuropathic pain caused by primary lesions (e.g. MS lesions) in the central nervous system (CNS), either in the brain or spinal cord.

### Characteristics

#### Epidemiology

Contrary to what was previously claimed in the literature, several studies from the last two decades have shown that many patients with MS have pain, and that pain is a major problem for many MS patients. In the early literature it was recognized that a small minority of MS patients have ► **trigeminal neuralgia** (TN) and even fewer ► **painful tonic seizures**. Furthermore, some MS

patients have pain caused by spasticity; while others report pain is not a common problem. According to recent research, however, 44%–79% of all MS patients have problems with pain (Ehde et al. 2003; Österberg 2005; Svendsen 2003), and about half of these patients have central pain, according to the only study in which central pain has been specifically investigated (Österberg et al. 2005).

In two postal surveys about pain, responses were received from 442 and 508 MS patients (Ehde et al. 2003; Svendsen et al. 2003). In the American study 44% reported persistent, bothersome pain as a result of MS. Pain was of moderate to severe intensity in 63%, and interfered with life moderately or severely in 49% (Ehde et al. 2003). In the Danish study, no significant difference in the total proportion of individuals with pain were found between MS patients and controls (79% and 75%), but when responses were analyzed it became clear that pain was more severe in MS patients (Svendsen et al. 2003). In this study the impact of pain on daily life ranged from moderate to severe in 45% and 7% of the patients, respectively. Results from studies over the last twenty years in which neurologists have interviewed and examined MS with regard to pain point in the same direction. Seven studies from the last 20 years have shown the prevalence of pain in MS patients has been found to be 54%–86% (Table 1).

In a systematic study of central pain in MS, the prevalence of CP in a population of 364 MS patients was found to be 27.5%, including 4.9% with TN (Österberg et al. 2005). An additional 15 patients had possible CP. If the patients with probable CP had been included the outcome would have been a prevalence of 31.6%. These figures compare well with results of previous studies (Moulin et al. 1988; Moulin 1989; Vermonte et al. 1986).

### Features of Central Pain

In the study by Österberg et al. (2005) many aspects of CP in MS were investigated, including:

- The prevalence of CP increased with age and disease duration with peaks between 40 and 60 years-of-age and 10–20 years of disease duration, but not with a higher degree of disability. The prevalence of CP was as high as 31% ten years after onset of MS, and almost the same after 11–20 years of disease, thereafter the prevalence of CP decreased to 14% – 18%. Thus, it appears that neither age nor duration of MS increases the risk of developing CP. This partly contradicts the results of previous studies, where it was found that the pain prevalence increased with age (Clifford and Trotter 1984; Moulin et al. 1988; Stenager et al. 1991), disease duration (Kassirer and Osterberg 1987) and disability (Stenager et al. 1995). Prospective studies are needed to give more reliable information on these matters.



**Central Pain in Multiple Sclerosis, Table 1** Results from prevalence studies on pain in MS. Ages and durations in years. Prevalence in percent of the total population. The prevalence figures for central pain are estimates made from descriptions of pain, and were not calculated by the authors themselves.

Study	Vermote 1986	Kassirer 1987	Moulin 1988	Stenager 1991	Indaco 1994	Stenager 1995	Österberg 2005
Nr of pats	83	28	159	117	122	49	364
Mean age	-	49	47	43	38	-	54
MS duration	-	29	13	8	13	-	23
All pain	54	75	55	65	57	86	65
CP incl. TN	31	64*	29	-	-	-	28
TN	3,6	18**	5,9	3	9***	14	4,9
Dysaesthetic pain	-	-	29	-	22	20	-
Pain in extremities	15	64	-	22	-	55	21
Spasm induced pain	-	53	13	21	19	4	1
Non-trig. paroxysmal pain	4	-	5	7	5	41	2
Pain qualities	Burning Pricking Stabbing Dull	Burning Tingling	Burning Tingling Aching	-	-	-	Aching Burning Pricking Stabbing Smarting Squeezing

TN=trigeminal neuralgia. \*Neurogenic origin, \*\*Including atypical facial pain, \*\*\*Neuralgic pain (face and head)

- There was a large span in the time interval between clinical onset of MS and the onset of CP, ranging from 7 years before other symptoms to 25 years after other symptoms. In 57% of patients with CP, pain started within 5 years of onset of the disease, and after 10 years the figure was 73%.
- In some patients, CP was the first symptom of MS before any other symptom, while in others CP appeared together with other symptoms. CP preceded other symptoms in 6% of patients, and it was part of the onset symptoms in 20% of these patients and in 5.5% of all MS patients.
- A large majority of patients experienced daily pain (88%); only 30% had pain-free moments, lasting minutes to hours.
- The intensity of pain varied somewhat, and 44% of patients experienced a constant intensity. This and the irritating quality of the pain, contribute to the fact that patients rate their pain as a heavy burden (Ehde et al. 2003).
- More than one third of patients experienced CP in two to four separate pain loci, often with differing modality, time of onset and intensity (TN excluded).
- The most common location of CP was in the lower extremities (87%) and in the upper extremities (31%).
- Half the patients experienced pain both superficially in skin and in deeper parts of the body, which is similar to that found in central post-stroke pain (Leijon et al. 1989).
- More than 80% of MS patients with CP experienced two or more pain qualities, which is similar to that found by Leijon et al. (1989) for central post-stroke pain. The most common qualities were burning (40%) and aching (40%). Thus, no pain qualities or combination of pain qualities are pathognomonic for CP in MS.
- Out of 364 patients only 2% had pain caused by spasticity. Instead, it was found that many patients with CP also have spasticity, but it was not the cause of pain. This conclusion is shared by many clinicians.

As for other MS symptoms, CP can be one of several symptoms in a relapse, or the only symptom. Clifford and Trotter (1984) reported this phenomenon, in two patients with temporary burning pain during a relapse of MS. The distribution of the three forms of MS in patients with CP does not generally differ among MS patients (relapsing-remitting, secondary progressive, primary progressive). From the literature it is known that emotional stress, light touch, cold and physical activity can increase CP (Boivie 1999). This aspect has not been systematically studied in MS, but it has been noted that many MS patients experience worse pain after physical activity. Some patients with MS who have pareses, spasticity and dyscoordination of movement will develop nociceptive musculoskeletal pain. In a recent study, 21% of MS patients were found to have nociceptive pain (Österberg et al. 2005), which is in the same range found in pre-

vious studies (14%–39%; Kassirer and Osterberg 1987, Moulin 1989; Vermote et al. 1986).

### Sensory Abnormalities

The most common neurological sign in patients with non-trigeminal CP is sensory disturbance. Almost all patients have at least one abnormal finding in the sensory examination, with a decrease in sensibility to cold occurring more often than any other sub-modalities (Österberg and Boivie, in preparation). In this study of 62 patients with non-trigeminal CP, both clinical and quantitative methods were used to test sensibility. There was a large variation between patients with regard to degree and submodality of abnormalities. Some patients had severe defects in all submodalities, whereas only one or two were affected in others. In the quantitative tests, all patients except two (97%) had abnormal sensibility to temperature and/or pain. Significant differences in abnormalities were found between regions with CP and regions without CP for the following perception thresholds: difference limen (i.e. innocuous temperature), warmth, cold, cold pain. No significant differences were found in the thresholds for heat pain.

Among patients who did not perceive non-noxious warmth at all, but could feel heat pain, the burning sensation of heat struck patients suddenly and with high intensity as the temperature reached threshold. This was observed in 19% of patients. A corresponding sensation did not appear with cold. Eight patients had noxious cold evoked paradoxical heat pain. Non-painful dysesthesias were commonly evoked by noxious heat or cold.

The results from the sensory tests indicate that most MS patients with CP have lesions affecting the spinothalamic pathways (temperature and pain), but to a lesser degree affect the medial lemniscal pathways (tactile, position sense and vibration).

### Mechanisms

The cellular mechanisms underlying central pain in general, and definitely for MS, are largely unknown. Several investigators have reported that CP develops as a result of lesions affecting the spino- and quinothalamic pathways, i.e. pathways most important for the sensibility of pain and temperature. Furthermore, lesions of these pathways can be located at any level of the neuraxis (for references see Boivie 1999). The results from examination of the sensibility in MS patients with CP support this hypothesis. It has been proposed that the crucial lesion is one that affects neospinothalamic projections, i.e. projections to the ventroposterior thalamic region (Bowsher 1996). The effects of such a lesion involve neurones of the spinothalamic pathway which become hyperexcitable due to reduced tonic inhibition.

Based on results from experimental studies, Craig (1998) proposed a similar hypothesis about the mech-

anisms of central pain stating that “central pain is due to the disruption of thermosensory integration and the loss of cold inhibition of burning pain”, which in turn is caused by a lesion of the spinothalamic projection activated by cold receptors in the periphery. The disrupted fibres are thought to tonically inhibit nociceptive thalamocortical neurones, increasing discharge and producing pain. Like several other hypotheses, this might be applicable in some patients, but not others, because of the location of the lesions and character of the pain.

One can only speculate about the location of lesions responsible for the development of CP in MS, because, as shown with MRI, practically all patients have disseminated lesions in both the brain and spinal cord. However, based on clinical grounds, it is proposed that much of the CP located in the lower extremities is due to lesions in the spinal cord. The bilateral nature of pain supports this idea.

### Treatment

The treatment of MS with interferons and similar substances do not appear to have any symptomatic effect on central pain, or on any other symptom.

Several treatment modalities are used in the management of CP in general, but almost no controlled clinical trials have been performed in MS, and only a few in other forms of CP. The only exception is the study of oral cannabinoid dronabinol in 28 MS patients. A statistically significant, but weak effect was found (Svensden et al. 2004).

Treatments that are used for CP are listed above, but most of them are based on clinical experience and tradition, rather than on results from controlled clinical trials. This means that no evidence based recommendations can be made for the management of CP in MS. Tricyclic antidepressants have been found to be effective for many patients with central post-stroke pain (see essay on this pain condition), but the experience is that many MS patients get severe side effects from these drugs.

### Treatment Modalities Used for Central Pain

Among antidepressants and antiepileptics, the most frequently used are listed.

- Antidepressant drugs (AD)
  - Amitriptyline
  - Desipramine
  - Doxepine
  - Imipramine
  - Nortriptyline
- Antiepileptic drugs (AED)
  - Carbamazepine
  - Gabapentin
  - Lamotrigine

- Oxcarbazepine
- Pregabalin
- Analgesics
  - Morphine
  - Oxycodone
  - Codeine
- Sensory stimulation
  - Transcutaneous electrical stimulation (TENS)
  - Spinal cord stimulation (SCS)
  - Deep brain stimulation (DBS)
  - Motor cortex stimulation (MCS)

Among the antiepileptic drugs, carbamazepine is effective for trigeminal neuralgia associated with MS, but does not appear to relieve non-trigeminal central pain (Österberg and Boivie, in preparation). Lamotrigine was shown to relieve CP in stroke, but it has not been tested in MS patients. Many neurologists have tried gabapentin with some success in non-trigeminal CP, but in the literature only case reports support its use.

In one study with I.V. morphine, ten patients with CP from MS, and five patients from stroke were tested. Only a trend to pain relief was found, and during the following 12 weeks open treatment period only three patients experienced a positive effect (Attal 2002). From clinical experience it appears that some MS patients obtain long-term relief from weak opioids, but no systematic observations support this. The experience with TENS for CP is meagre and positive results have not been reported. The same is true for spinal cord stimulation and deep brain stimulation.

## References

1. Boivie J (1999) Central Pain. In: Wall PD, Melzack R (ed) *Textbook of Pain* 4<sup>th</sup> edn. Churchill Livingstone, Edinburgh, pp 879–914
2. Bowsher D (1996) Central Pain: Clinical and Physiological Characteristics. *J Neurol Neurosurg Psychiatr* 61:62–69
3. Clifford DB, Trotter JL (1984) Pain in Multiple Sclerosis. *Arch Neurol* 41:1270–1272
4. Craig AD (1998) A New Version of the Thalamic Disinhibition Hypothesis of Central Pain. *Pain Forum* 7:1–14
5. Ehde DM, Gibbons LE, Chwastiak L (2003) Chronic Pain in a Large Community Sample of Persons with Multiple Sclerosis. *Multiple Sclerosis* 9:605–611
6. Indaco A, Iachetta C, Nappi C (1994) Chronic and Acute Pain Syndromes in Patients with Multiple Sclerosis. *Acta Neurol (Napoli)* 16:97–102
7. Kassirer M, Osterberg D (1987) Pain in Chronic Multiple Sclerosis. *J Pain Symptom Manag* 2:95–97
8. Moulin DE (1989) Pain in Multiple Sclerosis. *Neurologic Clinics* 7:321–331
9. Österberg A, Boivie J, Thuomas K-Å (2005) Central Pain in Multiple Sclerosis – Prevalences, Clinical Characteristics and Mechanisms. *Eur J Pain* 9:531–542
10. Stenager E, Knudsen L, Jensen K (1991) Acute and Chronic Pain Syndromes in Multiple Sclerosis. *Acta Neurol Scand* 84:197–200
11. Stenager K, Knudsen L, Jensen K (1995) Acute and Chronic Pain Syndromes in Multiple Sclerosis. A 5-Year Follow-Up Study. *Ital J Neurol Sci* 16:629–632
12. Svendsen K, Jensen T, Bach F (2004) Does the Cannabinoid Dronabinol Reduce Central Pain in Multiple Sclerosis? Randomised Double Blind Controlled Crossover Trial. *Br Med J* 329:253
13. Svendsen K, Jensen T, Overvald K (2003) Pain in Patients with Multiple Sclerosis: A Population-Based Study. *Arch Neurol* 60:1089–1094
14. Vermote R, Ketelaer P, Carton H (1986) Pain in Multiple Sclerosis Patients. *Clin Neurol Neurosurg* 88: 87–93

C

## Central Pain Mechanisms, Molecular Contributions

- ▶ [Molecular Contributions to the Mechanism of Central Pain](#)

## Central Pain Model

- ▶ [Spinal Cord Injury Pain Model, Ischemia Model](#)

## Central Pain, Outcome Measures in Clinical Trials

EVA WIDERSTRÖM-NOGA  
The Miami Project to Cure Paralysis, Department of Neurological Surgery University of Miami, VAMC, Miami, FL, USA  
ewiderstrom-noga@miami.edu

### Synonyms

Effectiveness Measure

### Definition

An outcome measure is a performance indicator that assesses patient health status subsequent to, and resulting from, a health care treatment, procedure, or other therapeutic interventions.

### Characteristics

Central neuropathic pain (CNP) is a result of trauma or neurological disease involving the central nervous system (CNS) (Bowsher et al. 1998). This type of pain can be a prominent feature in the complex clinical picture associated with disease or trauma involving the CNS, e.g. ▶ [stroke](#), ▶ [multiple sclerosis](#), ▶ [epilepsy](#), tumors, ▶ [syringomyelia](#), brain or spinal cord trauma, or ▶ [Parkinson's disease](#) (Boivie 2003). CNP is commonly associated with both spontaneous non-painful sensations and evoked pain (Widerström-Noga 2002), which further contribute to its unpleasant character.

Due to the refractory nature of CNP (Bowsher 1999), there is an obvious risk for a significantly decreased health-related ► [quality of life](#) (HRQOL). Therefore, ► [clinical trials](#) examining treatments, or combinations of treatments, which may lead to more effective strategies for pain management in these patient populations are urgently needed. Although CNP is common in specific syndromes, the prevalence in the general population is relatively low (Boivie 2003). However, with increased awareness and more advanced diagnostic procedures this number can be expected to increase.

The low numbers of people who experience CNP make it difficult to obtain sufficient numbers of participants for definitive clinical trials. Consequently, few large scale, randomized, controlled clinical trials have been conducted in persons with CNP. This further emphasizes the need for clinical trial designs that permit comparisons between trials. To achieve this goal, it is particularly important to evaluate outcomes of treatments in a comprehensive and consistent manner. The use of standard sets of outcome measures in clinical trials involving people with CNP would greatly facilitate the interpretation and application of research results to the management of CNP.

In a recent report, the Initiative on Methods, Measurement, and Pain Assessment in Clinical Trials (IMMPACT) (Turk et al. 2003) recommended that clinical trials designed to evaluate the effectiveness of a therapy in relieving chronic pain, should consider including a core set of 6 outcome domains. The combination of these domains would generate more complete reports of results, and therefore facilitate the overall risk-benefit evaluation. The suggested domains include:

1. Pain
2. Physical functioning
3. Emotional functioning
4. Participants ratings of improvement and satisfaction with treatment
5. Symptoms and adverse effects
6. Participant disposition.

The authors emphasized those complementary measures appropriate for specific patient populations should be added as needed. Below is a brief description of the six domains recommended to be included in the design of clinical trials for chronic pain.

### **Pain**

Ratings of pain intensity, or pain severity by means of ► [numerical rating](#) or ► [visual analogue scales](#), are the most widely used primary outcome measures in clinical pain trials (Farrar et al. 2001). However, other clinical features of pain (i.e. location, quality temporal pattern) commonly evaluated in the ► [pain history](#) (Wincent et al. 2003) may also be useful for the evaluation of treatment outcome. The differentiation of pain types is based

on a combination of clinical characteristics, and signs and symptoms of neurological dysfunction. This evaluation is particularly relevant for people who have CNP, since they frequently experience different types of pain simultaneously, with presumably different mechanisms. Even though a clinical trial may be designed primarily to target CNP, an improvement in physical and emotional function may be caused by a decrease in the severity of less refractory pain types, rather than a direct effect on central pain. Different types of pain may also influence pain-related impairment and function to various degrees (Marshall et al. 2002). Therefore, it is important to differentiate between the consequences of different pain types to determine treatment effects on specific types of pains.

In central pain, the evaluation of neurological dysfunction includes the quantification and determination of sensory, motor, and autonomic function (Cruccu et al. 2004). This evaluation is of primary importance for the diagnosis, and thus provides a basis for mechanism-based tailored treatments. However, the role of these types of assessments as outcome measures in clinical trials is less clear. Specifically, more research is needed to establish reliability of the various ways of assessing and quantifying neurological dysfunction. In addition, the relationship between neurological dysfunction and improvement in spontaneous neuropathic pain needs to be further elucidated.

### **Physical Functioning**

Because CNP is associated with neurological disease or trauma, physical functioning is often impaired. Although a general measure applicable to various pain populations would allow for better comparisons, physical functioning in chronic pain populations afflicted with neurological disease or trauma may be influenced more by the neurological impairment per se, than by chronic pain. One of the commonly used measures for the evaluation of function in disabled populations is the Functional Independence Measure (FIM). The FIM was developed to provide a uniform measurement of disability (Granger 1998) and assesses independent performance in self-care, sphincter control, transfers, locomotion, communication, and social cognition. However, the usefulness of this measure in CNP populations needs to be determined. Moreover, the relative contribution of CNP to the overall perceived disability in physically impaired central pain populations is not clear, and is also an important area for future research. Pain Interference measures may provide more useful alternatives or complements to instruments that assess general functional disability. For example, the extent to which pain hinders or interferes with daily activities may provide more specific information in populations afflicted with physical impairment (Widerström-Noga et al. 2002). These measures can be used as comparisons to samples of able-bodied chronic pain patients.



### Emotional Functioning

Emotional distress (e.g. depressed mood, anxiety, anger, irritability) is intimately linked to the experience of chronic pain, although no consistent causal relationship has been proven. In neurological disease or trauma, such as in traumatic brain injury (Jorge et al. 2004), depression and anxiety levels are often elevated. Similar to physical functioning, it is not clear to what extent pain itself contributes to affective distress in the complicated clinical syndromes associated with a neurological injury. Since affective distress is an important factor in the pain experience, this may have a significant impact on HRQOL, and additional research in this area is warranted.

### Participants Ratings of Global Improvement and Satisfaction with Treatment

Related to the risk-benefit ratio, is the participant's personal estimation of how beneficial a treatment intervention is, namely, participants rating of global improvement and satisfaction with treatment. Although this rating can be influenced by a variety of factors that are difficult to control for (e.g. social desirability, recall bias, etc.), it still provides valuable and useful information (Farrar et al. 2001), incorporating the patient's own unique view about the benefit and overall meaning of a treatment.

### Symptoms and Adverse Effects

The assessment of adverse effects in a clinical trial aims to determine the risk-benefit of the treatment. Adverse effects can be directly caused by the treatment, or indirectly by worsening an underlying illness or compromising previously impaired function. In people with CNP, the latter scenario may need special consideration, since adverse effects that have a relatively minor impact in able-bodied populations can cause significant problems when there are pre-existing impairments. For example, a decrease in cognitive function in a person with cognitive impairment due to a traumatic brain injury, or constipation in a person who has impaired bowel function due to spinal cord injury, may cause difficulties that hinder adequate dosing as well as adherence to treatment. Therefore, it is important to monitor not only severity of adverse effects, but also impact on pre-existing problems associated with the neurological disease or trauma.

### Participant Disposition

To adequately interpret the results of a trial and to determine whether obtained results are representative and applicable to larger population, details concerning participants screened for enrollment (e.g. reasons for drop-out and non-compliance etc.) need to be provided (for details see the ► [CONSORT statement](#) (Moher et al. 2001). This is particularly important in CNP populations, since the reasons for withdrawal and non-adherence may be

disease-specific and related to other sequela of neurological disease and trauma.

### Health Related Quality of Life

In CNP, complete remission of pain is unlikely to occur either spontaneously or due to treatment (Bowsher 1999). Therefore, measures that assess factors that may influence HRQOL are of particular interest. HRQOL is a subjective concept, which is based on personal preferences and values concerning multiple dimensions of life, including well-being and enjoyment of life. HRQOL in diverse populations has been categorized into the following groups:

1. Physical functioning
2. Social functioning
3. Role limitations due to physical problems
4. Role limitations due to emotional problems
5. Mental health
6. Vitality
7. Bodily pain
8. General Health (Ware and Sherbourne 1992).

The IMMPACT group (Turk et al. 2003) suggested that assessing some of these HRQOL dimensions (e.g. physical and emotional functioning and pain severity) would provide a basis for a multidimensional evaluation of pain. However, in CNP populations with physical impairments, the inclusion of additional dimensions (i.e. changed roles due to physical problems and general health) may be needed to determine the relative contribution of CNP to the perception of HRQOL. Furthermore, increased understanding of the interaction between the various domains may improve management of these complex pain syndromes.

### Conclusion

The assessment domains recommended by the IMMPACT appear to also be appropriate for CNP populations. Due to the fact that people who have CNP frequently have varying degrees of physical impairment, specific assessment of pain-related interference with physical and emotional functioning may be more useful than general measures of physical and emotional function. A set of core outcome measures in combination with more disease specific measures would be useful for the purpose of comparison of clinical trials in these populations. In the selection of specific instruments to be used as core outcome measures, not only validity and reliability must be considered, but also whether the instrument can be used with diverse CNP populations associated with a variety of diseases and traumas.

### References

1. Boivie J (2003) Central Pain and the Role of Quantitative Sensory Testing (QST) in Research and Diagnosis. *Eur J Pain* 7:339–343

2. Bowsher D, Leijon G, Thuomas KA (1998) Central Poststroke Pain: Correlation of MRI with Clinical Pain Characteristics and Sensory Abnormalities. *Neurology* 51:1352–1358
3. Bowsher D (1999) Central Pain Following Spinal and Supraspinal Lesions. *Spinal Cord* 37:235–238
4. Cruccu G, Anand P, Attal N et al. (2004) EFNS Guidelines on Neuropathic Pain Assessment. *Eur J Neurol* 11:153–162
5. Farrar JT, Young JP Jr, LaMoreaux Le et al. (2001) Clinical Importance of Changes in Chronic Pain Intensity Measured on an 11-Point Numerical Pain Rating Scale. *Pain* 94:149–158
6. Granger CV (1998) The Emerging Science of Functional Assessment: Our Tool for Outcomes Analysis. *Arch Phys Med Rehabil* 79:235–240
7. Jorge RE, Robinson RG, Moser D et al. (2004) Major Depression Following Traumatic Brain Injury. *Arch Gen Psychiatry* 61:42–50
8. Marshall HM, Jensen MP, Ehde DM et al. (2002) Pain Site and Impairment in Individuals with Amputation Pain. *Arch Phys Med Rehabil* 83:1116–1119
9. Moher D, Schulz KF, Altman DG (2001) The CONSORT Statement: Revised Recommendations for Improving the Quality of Reports of Parallel-Group Randomised Trials. *Lancet* 357:1191–1194
10. Turk DC, Dworkin RH, Allen RR et al. (2003) Core Outcome Domains for Chronic Pain Clinical Trials: IMMPACT Recommendations. *Pain* 106:337–345
11. Ware JE Jr, Sherbourne CD (1992) The MOS 36-Item Short-Form Health Survey (SF-36). I. Conceptual Framework and Item Selection. *Med Care* 30:473–483
12. Widerström-Noga EG (2003) Chronic Pain and Nonpainful Sensations after Spinal Cord Injury: Is there a Relation? *Clin J Pain* 19:39–47
13. Widerström-Noga EG, Duncan R, Felipe-Cuervo E et al. (2002) Assessment of the Impact of Pain and Impairments Associated with Spinal Cord Injuries. *Arch Phys Med Rehabil* 83:395–404
14. Wincent A, Liden Y, Arner S (2003) Pain Questionnaires in the Analysis of Long Lasting (Chronic) Pain Conditions. *Eur J Pain* 7:311–321

## Central Pain Pathways

### Definition

The pathways that carry information about noxious stimuli to the brain, includes the spinalthalamic tract and trigeminal system.

- ▶ **Thalamic Nuclei Involved in Pain, Human and Monkey**

## Central Pain, Pharmacological Treatments

NANNA BRIX FINNERUP<sup>1</sup>, SØREN HEIN SINDRUP<sup>2</sup>  
<sup>1</sup>Department of Neurology and Danish Pain Research Centre, Aarhus University Hospital, Aarhus, Denmark  
<sup>2</sup>Department of Neurology, Odense University Hospital, Odense, Denmark  
 finnerup@ki.au.dk, s.sindrup@dadlnet.dk

### Definition

- ▶ **Central pain** can be a consequence of different diseases and includes central post-stroke pain (CPSP),

central pain in spinal cord injury (SCI), multiple sclerosis, perhaps Parkinson's and Huntington's disease, AIDS, and brain trauma. In spinal cord injury, central neuropathic pain is experienced at and/or below the level of a lesion, and may be difficult to separate from peripheral neuropathic pain components caused by root lesions. Pain associated with this pathology is generally felt at the level of injury. Since different types of SCI pain are usually not separated, this review includes all trials on the treatment of pain associated with spinal cord injury.

Any lesion along the spinothalamicocortical pathway may lead to central pain, and ▶ **neuronal hyperexcitability** caused by increased excitation and/or decreased inhibition is an additional mechanism, which provides the mechanistic basis for the use of drugs for neuropathic pain. Most pharmacological agents developed for treatment of this condition act by depressing neuronal activity, modulating sodium or calcium channels, increasing inhibition with  $\gamma$ -aminobutyric acid (GABA), serotonergic, noradrenergic, or enkephalinergic agonists, or decreasing activation via glutamate receptors, especially the N-methyl-D-aspartate (NMDA) receptor.

### Characteristics

To suggest an evidence-based treatment algorithm based on ▶ **randomized** ▶ **double-blind** placebo-controlled trials on central pain is difficult, considering the fact that although new trials are emerging, there are still only a few, small sized studies on central pain (Table 1 and 2). ▶ **Number needed to treat** (NNT) and number needed to harm (NNH) (in this text defined as treatment-related withdrawals) are used to compare efficacy and harm of individual drugs.

### Antidepressants

Tricyclic antidepressants block the reuptake of norepinephrine or serotonin, but activation on NMDA receptors and sodium channels may also play a role in their analgesic actions. The tricyclic antidepressant amitriptyline has been studied in two controlled trials. In a three-way cross-over study, amitriptyline 75 mg daily was effective in relieving pain (Leijon and Boivie 1989). The pain-relieving effect correlated well with total plasma concentration a with high number of responders, b having plasma concentrations exceeding 300 nmol/L. In patients with SCI, amitriptyline 10–125 mg daily had no effect on different types of pain, including nociceptive pain (Cardenas et al. 2002), but the average amitriptyline dose was low, as were serum concentrations (mean 92 ng/ml), i.e. below the level associated with response in CPSP. The heterocyclic antidepressant trazodone 150 mg daily had no effect on neuropathic pain in spinal injury (Davidoff et al. 1987). The possibility of preventing CPSP was studied using amitriptyline (10 mg the first day after the onset of stroke was diagnosed, titrated to 75 mg within

**Central Pain, Pharmacological Treatments, Table 1** Randomized, double-blind, placebo-controlled trials on oral drugs in central pain

Active drug, daily dose	Study	Condition	Design, no. of patients	Outcome	NNT (95% CI)	NNH (95% CI)
Amitriptyline 75 mg	Leijon and Boivie 1989	CPSP	Cross-over 15	Ami > pla	1.7 (1.2–3.1)	∞
Amitriptyline 10–125 mg	Cardenas et al. 2002	SCI pain	Parallel 84	Ami = pla	-	9.2 (4.2–∞)
Trazodone 150 mg	Davidoff et al. 1987	SCI pain	Parallel 18	Tra = pla	-	NA
Carbamazepine 800 mg	Leijon and Boivie 1989	CPSP	Cross-over 15	Carb = pla	-	15.0 (5.2–∞)
Lamotrigine 200 mg	Vestergaard et al. 2001	CPSP	Cross-over 30	Ltg > pla	NA	10.0 (4.8–∞)
Lamotrigine 200–400 mg	Finnerup et al. 2002	SCI pain	Cross-over 22	Ltg = pla	-	∞
Valproate 600–2400 mg	Drewes et al. 1994	SCI pain	Cross-over 20	Val = pla	-	∞
Gabapentin up to 1800 mg	Tai et al. 2002	SCI pain	Cross-over 7	Gab = pla	-	14.0 (4.8–∞)
Gabapentin up to 3600 mg	Levendoglu et al. 2004	SCI pain	Cross-over 20	Gab > pla	NA	∞
Mexiletine 450 mg	Chiou-Tan et al. 1996	SCI pain	Cross-over 11	Mex = pla	-	∞
Dronabinol 5–10 mg	Svendsen et al. 2004	Multiple sclerosis	Cross-over 24	Dro > pla	3.4 (1.8–23.4)	∞

CPSP, central post-stroke pain; SCI, spinal cord injury; CI, confidence interval

three weeks) or placebo administered to 39 stroke patients for one year (Lampl et al. 2002). Within this year, CPSP developed in three patients receiving amitriptyline (VAS 5.0), and in four receiving placebo (VAS 5.4). Two patients in the amitriptyline group and three patients in the placebo group developed allodynia. With an expected 8% incidence of CPSP, this sample size is probably too small to detect an effect, but this was the first study of its kind and more are encouraged.

### Antiepileptic Drugs

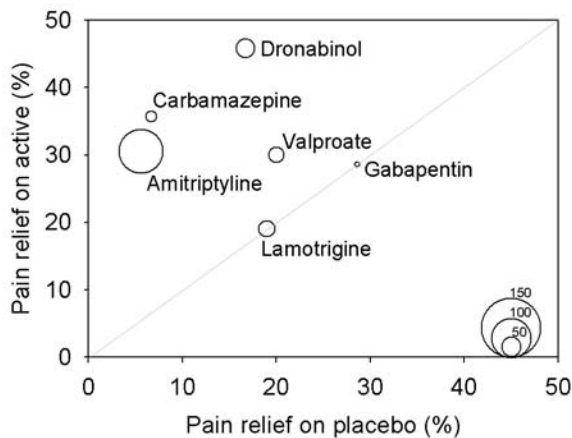
Antiepileptic drugs include a broad spectrum of drugs used in the management of epilepsy, and exert their analgesic actions through multiple mechanisms, by either reducing excitation and/or enhancing inhibition. Carbamazepine blocks voltage dependent sodium channels, and may have minor effects on calcium channels and serotonergic systems. In a three-way cross-over study of amitriptyline, carbamazepine 800 mg and placebo, carbamazepine did not reduce CPSP compared to placebo (Leijon and Boivie 1989). However, both amitriptyline and carbamazepine treatments gave a 20% lower mean pain intensity score during the last week of treatment. Based on the relatively small number of patients in this study, a significant effect of carbamazepine in CPSP cannot be excluded. Valproate has several pharmacological effects, including GABAergic and anti-glutamatergic

actions. The effect of valproate 600–2400 mg daily was examined in a cross-over study in patients with spinal injury (Drewes et al. 1994). Although a trend toward improvement was observed, valproate was not significantly better than placebo in relieving pain. Lamotrigine inhibits voltage dependent sodium channels to stabilize neuronal membranes and inhibits release of excitatory amino acids, principally glutamate. In CPSP, lamotrigine 200 mg daily reduced pain with a mean reduction of 30% (Vestergaard et al. 2001). Lamotrigine also reduced cold evoked **▶ allodynia** assessed by an acetone droplet. In spinal cord injury pain (SCIP), lamotrigine 200–400 mg daily was not more effective than placebo in reducing pain, although a subgroup of patients with incomplete injury and evoked pain reported an effect on spontaneous pain (Finnerup et al. 2002). Gabapentin, which is thought to exert its analgesic actions by binding to an  $\alpha_2\delta$  subunit of voltage gated calcium channels, has been studied in two cross-over trials in SCIP. In a small study with seven patients, gabapentin up to 1800 mg had no significant effect on pain intensity (Tai et al. 2002). There was, however, a trend toward improvement, and a significant effect on unpleasant feeling. In another study, gabapentin up to 3600 mg reduced the intensity and frequency of pain and several pain descriptors in 20 paraplegics with complete SCI (Levendoglu et al. 2004). Gabapentin in

**Central Pain, Pharmacological Treatments, Table 2** Randomized, double-blind, placebo-controlled trials on non-oral drugs in central pain

Active drug, dose administration	Study	Condition	Design, no. of patients	Outcome
Lidocaine IV 5 mg/kg	Attal et al. 2000	CPSP/ SCI pain	Cross-over 16	Lid > pla
Lidocaine IV 2.5 mg/kg	Kvarnström et al. 2004	SCI pain	Cross-over 10	Lid = pla
Lidocaine SA 50–100 mg	Loubser and Donovan 1991	SCI pain	Cross-over 21	Lid > pla
Ketamine IV 60 µg/kg + 6 µg/kg/min	Eide et al. 1995	SCI pain	Cross-over 9	Ket > pla
Ketamine IV 0.4 mg/kg	Kvarnström et al. 2004	SCI pain	Cross-over 10	Ket > pla
Alfentanil IV 7 µg/kg + 0.6 µg/kg/min	Eide et al. 1995	SCI pain	Cross-over 9	Alf > pla
Propofol IV 0,2 mg/kg	Canavero and Bonicalzi 2004	CPSP/ SCI pain	Cross-over 44	Pro > pla
Morphine IV 9-30 mg	Attal et al. 2002	CPSP/ SCI pain	Cross-over 15	Mor = pla
Morphine IT 0.2–1.5 mg Clonidine IT 50–100 µg or 300–500 µg	Siddall et al. 2000	SCI pain	Cross-over 15	Mor = pla Clo = pla Mor + clo > pla
Naloxone IV up to 8 mg	Bainton et al. 1992	CPSP	Cross-over 20	Nal = pla
Baclofen 50 µg	Hermann et al. 1992	SCI pain	Cross-over 6	Bac > pla

CPSP, central post-stroke pain; SCI, spinal cord injury; IV, intravenous; SA, subarachnoidal; IT, intrathecal



**Central Pain, Pharmacological Treatments, Figure 1** L'Abbé plot of controlled trials in central pain. Number of patients receiving active and placebo treatments are indicated by circle sizes (lower right corner). Note that the two trials showing a pain relieving effect of lamotrigine (Vestergaard et al. 2001) and gabapentin (Levendoglu et al. 2004) are not included in the figure because dichotomized data were not provided.

combination with the NMDA antagonist dextromethorphan was found to be superior to placebo, and to either component alone, in patients with neuropathic pain following spinal injury (Sang et al. 2001). Pregabalin

(similar mechanism as gabapentin) reduced SCIP in a large study which is not yet published (Siddall et al. 2005). Oxcarbazepine (similar mechanism as carbamazepine), and other newer anticonvulsants such as tiagabine, levetiracetam, and zonisamide, have not been tested in controlled trials in central pain.

#### Other Oral Drugs

The cannabinoid dronabinol (a synthetic  $\delta$ -9-tetrahydrocannabinol) has been studied in 24 patients with central pain caused by multiple sclerosis. It significantly relieved central pain (Svendsen et al. 2004). Mexiletine, a sodium channel blocker, did not relieve pain in eleven patients with SCIP in doses of 450 mg daily (Chiou-Tan et al. 1996).

#### Non-Oral Drugs

Sodium channel blockers may play a role in the treatment of central pain. Lidocaine in doses of 2.5 mg/kg, administered intravenously over 40 minutes, had no pain relieving effect on pain in spinal cord injury patients (Kvarnstrom et al. 2004), while 5 mg/kg administered intravenously over 30 minutes significantly decreased spontaneous ongoing pain, brush-evoked allodynia, and static mechanical **▶ hyperalgesia**, but was no better



than placebo against thermal allodynia and hyperalgesia in patients with CPSP or SCIP (Attal et al. 2000). It was also found that lidocaine 5 mg/kg over 30 minutes relieved spontaneous pain in spinal cord injury patients with (n=12) and without (n=12) evoked pain, and that lidocaine relieved pain felt at and below the level of injury (Finnerup et al. 2005). Subarachnoid infusion of lidocaine was significantly better than placebo in relieving SCIP (Loubser and Donovan 1991). Adequate spinal anesthesia, proximal to the level of spinal injury, seems important for a positive response to lidocaine, suggesting the existence of a 'pain generator' in the spinal cord of some patients.

NMDA receptor antagonists given intravenously were reported to relieve SCIP in two studies (Eide et al. 1995; Kvarnstrom et al. 2004). Studies on opioids in central pain trials have yielded diverging results. Intravenous morphine was reported to have an effect on brush-evoked allodynia, but not on spontaneous pain in CPSP and SCIP patients (Attal et al. 2002), intravenous alfentanil was effective in relieving SCIP (Eide et al. 1995), and finally, morphine given intrathecally was effective in SCIP patients, but only in combination with clonidine (an  $\alpha_2$ -adrenergic agonist) (Siddall et al. 2000). No effect of naloxone in CPSP was found (Bainton et al. 1992). Propofol, a GABA<sub>A</sub>-receptor agonist, injected as a single intravenous bolus of 0.2 mg/kg, relieved spontaneous pain and allodynia in 44 patients with spinal cord injury and post-stroke pain (Canavero and Bonicalzi 2004). Intrathecal baclofen, a GABA<sub>B</sub> receptor agonist, was also reported to relieve dysesthesia in six patients with SCI or multiple sclerosis (Herman et al. 1992).

### Conclusions

Tricyclic antidepressants, sodium channel blockers, NMDA antagonists, GABA agonists, calcium channel blockers, and cannabinoids, are shown to relieve central pain. In randomized controlled trials on oral treatment, amitriptyline, lamotrigine, gabapentin, and dronabinol have been effective in relieving pain, but large scale randomized controlled studies are lacking, and the

treatment algorithm for central pain is still based on effective treatments for peripheral neuropathic pain. Antidepressants and anticonvulsants (Table 3) are first-line drugs for central pain. In many cases, treatment provides only partial or no relief, and other types of drugs, combination therapy, intrathecal therapy, and different non-pharmacological approaches may be considered in these cases.

C

### References

- Attal N, Gaude V, Brasseur L, Dupuy M, Guirimand F, Parker F, Bouhassira D (2000) Intravenous Lidocaine in Central Pain: A Double-Blind, Placebo-Controlled, Psychophysical Study. *Neurology* 54:564–574
- Attal N, Guirimand F, Brasseur L, Gaude V, Chauvin M, Bouhassira D (2002) Effects of IV Morphine in Central Pain: A Randomized Placebo-Controlled Study. *Neurology* 58:554–563
- Bainton T, Fox M, Bowsler D, Wells C (1992) A Double-Blind Trial of Naloxone in Central Post-Stroke Pain. *Pain* 48:159–162
- Canavero S, Bonicalzi V (2004) Intravenous Subhypnotic Propofol in Central Pain: A Double-Blind, Placebo-Controlled, Crossover Study. *Clin Neuropharm* 27:182–186
- Cardenas DD, Warms CA, Turner JA, Marshall H, Brooke MM, Loeser JD (2002) Efficacy of Amitriptyline for Relief of Pain in Spinal Cord Injury: Results of a Randomized Controlled Trial. *Pain* 96:365–373
- Chiou-Tan FY, Tuel SM, Johnson JC, Priebe MM et al. (1996) Effect of Mexiletine on Spinal Cord Injury Dysesthetic Pain. *Am J Phys Med Rehabil* 75:84–87
- Davidoff G, Guarracini M, Roth E, Sliwa J, Yarkony G (1987) Trazodone Hydrochloride in the Treatment of Dysesthetic Pain in Traumatic Myelopathy: A Randomized, Double-Blind, Placebo-Controlled Study. *Pain* 29:151–161
- Drewes AM, Andreassen A, Poulsen LH (1994) Valproate for Treatment of Chronic Central Pain after Spinal Cord Injury. A double-blind cross-over study. *Paraplegia* 32:565–569
- Eide PK, Stubhaug A, Stenehjem AE (1995) Central Dysesthesia Pain after Traumatic Spinal Cord Injury is Dependent on N-methyl-D-aspartate Receptor Activation. *Neurosurgery* 37:1080–1087
- Finnerup NB, Sindrup SH, Bach FW, Johannesen IL, Jensen TS (2002) Lamotrigine in Spinal Cord Injury Pain: A Randomized Controlled Trial. *Pain* 96:375–383
- Finnerup NB, Biering-Sorensen F, Johannesen IL et al. (2005) Intravenous lidocaine relieves spinal cord injury pain: a randomized controlled trial. *Anesthesiology* 102:1023–30
- Herman RM, D'Luzansky SC, Ippolito R (1992) Intrathecal Baclofen Suppresses Central Pain in Patients with Spinal Lesions. A Pilot Study. *Clin J Pain* 8:338–345

**Central Pain, Pharmacological Treatments, Table 3** First-line treatment options for central pain

Drug class and name	Dosage	Common side effects and cautions
Tricyclic antidepressants e.g. imipramine or amitriptyline	25 mg daily initially, increasing by 25 mg every two weeks, usually up to 150 mg daily in one to two divided doses. Plasma drug levels should be monitored (optimal plasma levels of imipramine plus desipramine is 300–750 nM).	Dry mouth, constipation, and urinary retention, orthostatic hypotension, sedation, and increased spasticity is reported. Contraindicated in patients with heart failure, cardiac conduction blocks (ECG before start) and epilepsy.
Gabapentin	300 mg daily initially, increasing by 300 mg every third day, to 1800–4800 mg daily.	Dizziness, sedation, ataxia, and occasional peripheral edema. Renal impairment requires dosage adjustment.
Lamotrigine	25 mg daily initially, increasing the dose with 25 mg every two weeks, later with 50 mg every week to 400 mg daily	Dizziness, sedation, ataxia diplopia, and nausea. Risk of rash and potentially life-threatening hypersensitivity reactions requires slow dose escalation

13. Kvarnström A, Karlsten R, Quiding H, Gordh T (2004) The Analgesic Effect of Intravenous Ketamine and Lidocaine on Pain after Spinal Cord Injury. *Acta Anaesthesiol Scand* 48:498–506
14. Lampl C, Yazdi K, Röper C (2002) Amitriptyline in the Prophylaxis of Central Poststroke Pain. *Stroke* 33:3030–3032
15. Leijon G, Boivie J (1989) Central Post-Stroke Pain – A Controlled Trial of Amitriptyline and Carbamazepine. *Pain* 36:27–36
16. Levendoglu F, Ögün CÖ, Özerbil Ö, Ögün TC, Ugurlu H (2004) Gabapentin is a First Line Drug for the Treatment of Neuropathic Pain in Spinal Cord Injury. *Spine* 29:743–751
17. Loubser PG, Donovan WH (1991) Diagnostic Spinal Anaesthesia in Chronic Spinal Cord Injury Pain. *Paraplegia* 29:25–36
18. Sang CN, Dobosh L, Miller V, Brown R (2001) Combination Therapy for Refractory Pain following Spinal Cord Injury Using the Low Affinity N-methyl-D-aspartate (NMDA) Receptor Antagonist Dextromethorphan and Gabapentin. Abstract 20<sup>th</sup> Annual Scientific Meeting APS. *J Pain* 2:10
19. Siddall PJ, Molloy AR, Walker S, Rutkowski SB (2000) The Efficacy of Intrathecal Morphine and Clonidine in the Treatment of Pain after Spinal Cord Injury. *Anesth Analg* 91:1–6
20. Siddall PJ, Cousins M et al. (2005) Pregabalin safely and effectively treats chronic central neuropathic pain after spinal cord injury. *Abstr IASP 11<sup>th</sup> World Congress on Pain*
21. Svendsen KB, Jensen TS, Bach F (2004) Does the cannabinoid dronabinol reduce central pain in multiple sclerosis? Randomised double blind placebo controlled crossover trial. *BMJ* 329:253–258
22. Tai Q, Kirshblum S, Chen B, Millis S et al. (2002) Gabapentin in the Treatment of Neuropathic Pain after Spinal Cord Injury: A Prospective, Randomized, Double-Blind, Cross-over Trial. *J Spinal Cord Med* 25:100–105
23. Vestergaard K, Andersen G, Gottrup H, Kristensen BT, Jensen TS (2001) Lamotrigine for Central Poststroke Pain: A Randomized Controlled Trial. *Neurology* 56:184–190

---

## Central Pain Syndrome

### Definition

A neurological condition caused by damage to or dysfunction of the central nervous system, most commonly following a thalamic stroke, s. also ► [Central Pain](#).

► [Lateral Thalamic Lesions, Pain Behavior in Animals](#)

---

## Central Pattern Generator

### Definition

Cellular networks in the brainstem that are organized to initiate and maintain motor activity through pattern generation and rhythm generation.

► [Orofacial Pain, Movement Disorders](#)

---

## Central Sensitization

### Definition

Central sensitization is an umbrella term for a number of phenomena, all of which are characterized by an increase in the responsiveness of nociceptive neurons in the central nervous system, best characterized in

the spinal dorsal horn, to sensory stimulation. Central sensitization may be induced by conditioning noxious stimulation such as trauma, inflammation, nerve injury or electrical stimulation of sensory nerves at C-fiber strength. It is considered to contribute to afferent-induced forms of hyperalgesia and allodynia. Proposed spinal mechanisms include reduced inhibition, excessive primary afferent depolarization (PAD), and enhanced strength at excitatory synapses in pain pathways (synaptic long-term potentiation: LTP).

- [Arthritis Model, Kaolin-Carrageenan Induced Arthritis \(Knee\)](#)
- [Cancer Pain Model, Bone Cancer Pain Model](#)
- [Central Changes after Peripheral Nerve Injury](#)
- [Chronic Pelvic Pain, Musculoskeletal Syndromes](#)
- [Drugs Targeting Voltage-Gated Sodium and Calcium Channels](#)
- [Exogenous Muscle Pain](#)
- [Formalin Test](#)
- [GABA Mechanisms and Descending Inhibitory Mechanisms](#)
- [Gynecological Pain, Neural Mechanisms](#)
- [Hypersensitivity Maintained Pain](#)
- [Long-Term Potentiation and Long-Term Depression in the Spinal Cord](#)
- [Metabotropic Glutamate Receptors in Spinal Nociceptive Processing](#)
- [Muscle Pain Model, Inflammatory Agents-Induced](#)
- [Pain Modulatory Systems, History of Discovery](#)
- [Postherpetic Neuralgia, Pharmacological and Non-Pharmacological Treatment Options](#)
- [Postoperative Pain, Acute Neuropathic Pain](#)
- [Psychiatric Aspects of Pain and Dentistry](#)
- [Psychological Treatment of Headache](#)
- [Quantitative Sensory Testing](#)
- [Referred Muscle Pain, Assessment](#)
- [Restless Legs Syndrome](#)
- [Spinothalamic Neuron](#)
- [Spinothalamic Tract Neurons, Role of Nitric Oxide](#)
- [Transition from Acute to Chronic Pain](#)

---

## Central Sulcus

### Synonyms

Rolandic Sulcus

### Definition

The convolutions of the cerebral cortex have a general organization that is similar for all humans. One constant and readily recognizable sulcus is the central sulcus (of Rolando), and marks the division between the frontal and parietal lobes.

► [Motor Cortex, Effect on Pain-Related Behavior](#)

## Central Trigger Point

### Synonyms

CTrP

### Definition

Clinically, central trigger point is characteristically a very tender, circumscribed nodule-like spot in the mid-portion of a palpable taut band of skeletal muscle fibers and it usually refers pain when compressed. This trigger point may be active or latent and can induce attachment trigger points.

- ▶ Myofascial Trigger Points

## Centralization

- ▶ Central Changes after Peripheral Nerve Injury

## Central-Peripheral Distal Axonopathy

### Definition

Peripheral nerve disorders beginning from degeneration of the most terminal parts of both central and peripheral processes of neurons, the major pathology of toxic neuropathies; also dying-back neuropathy and distal axonopathy.

- ▶ Toxic Neuropathies

## Centrifugal Control of Nociceptive Processing

- ▶ GABA Mechanisms and Descending Inhibitory Mechanisms
- ▶ Spinothalamic Tract Neurons, Descending Control by Brainstem Neurons

## Centrifugal Control of Sensory Inputs

### Definition

Regulation of the access of sensory information to the central nervous system is carried out by the action of neural pathways that inhibit or facilitate sensory processing. Such regulatory pathways can be intrinsic to the spinal cord (and trigeminal nuclei) or can originate from a variety of structures in the brain.

- ▶ Spinothalamic Tract Neurons, Descending Control by Brainstem Neurons

## Cephalalgia

- ▶ Headache

## Ceramide

### Definition

An intracellular signaling molecule liberated by activation of the sphingomyelin pathway. This pathway is activated by NGF via its action on the p75 receptor.

- ▶ Nerve Growth Factor, Sensitizing Action on Nociceptors

## Cerebellum

### Definition

The cerebellum is located dorsal to the brainstem and pons, and inferior to the occipital lobe. It mainly serves sensory-motor integration, by providing constant feedback signals to adapt fine-tune movements according to momentary muscle length and tone and body posture.

- ▶ Functional Imaging of Cutaneous Pain

## Cerebral Cortex

### Definition

The cerebral cortex is the thin, convoluted surface layer of nerve cell bodies (also called gray matter) of the cerebral hemispheres responsible for receiving and analyzing sensory information, for the execution of voluntary muscle movement, thought, reasoning and memory.

- ▶ Cingulate Cortex, Functional Imaging
- ▶ Clinical Migraine with Aura
- ▶ Descending Circuitry, Transmitters and Receptors
- ▶ Nociceptive Processing in the Cingulate Cortex, Behavioral Studies in Humans
- ▶ PET and fMRI Imaging in Parietal Cortex (SI, SII, Inferior Parietal Cortex BA40)

## Cerebrospinal Fluid

### Synonyms

CSF

## Definition

Fluid within the 4 brain ventricles, mainly produced by the choroid plexus. The average pressure (in lateral recumbent position) is 150–250mmH<sub>2</sub>O, depending on CSF secretion & absorption, intracranial arterial and venous pressure, hydrostatic pressure, brain bulk and status of surrounding coverings.

- ▶ [Cancer Pain Management, Anesthesiologic Interventions, Neural Blockade](#)
- ▶ [Headache due to Low Cerebrospinal Fluid Pressure](#)

## Cervical Discogram

- ▶ [Cervical Discography](#)

## Cervical Discography

DAVID DIAMANT  
Neurological and Spinal Surgery, Lincoln, NE, USA  
ddiamant@neb.rr.com

### Synonyms

Cervical Discogram; Provocation Discogram; provocative discography

### Definition

Cervical discography is a diagnostic procedure designed to determine if a cervical intervertebral disc is the source of a patient's neck pain. It involves injecting contrast medium into the disc in an attempt to reproduce the patient's pain.

### Characteristics

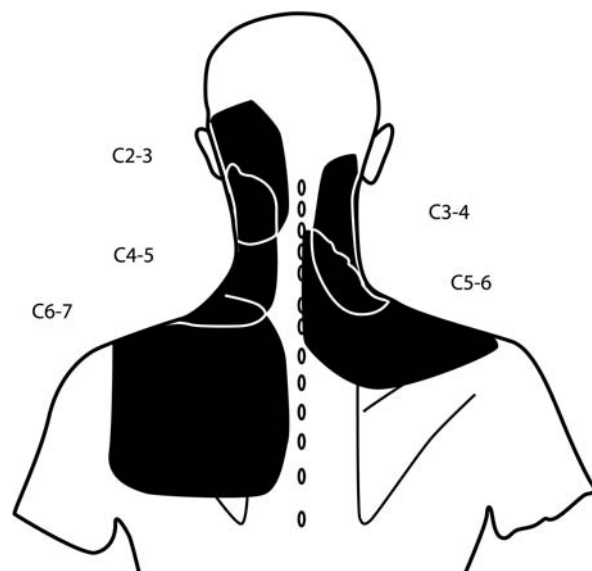
#### Principles

The cervical intervertebral discs are innervated by nociceptive fibers from the cervical sinuvertebral nerves, the vertebral nerves, and the cervical sympathetic trunks (Bogduk et al. 1989; Groen et al. 1990; Mendel et al. 1992). Being endowed with a nerve supply, the cervical discs are potentially a source of neck pain. There are no conventional means by which to determine if a patient's neck pain arises from a cervical intervertebral disc. There are no signs on [musculoskeletal examination](#) by which this can be established, and no signs on medical imaging. Abnormalities evident on [magnetic resonance imaging](#) (MRI) correlate poorly with whether the disc is painful or not (Parfenchuck and Janssen 1994; Schellhas et al. 1996). Furthermore, fissures that may be present across the posterior aspect of cervical discs are a normal age change (Oda et al. 1988), and do not constitute a painful lesion (Parfenchuck and Janssen 1994; Schellhas et al. 1996).

Provocation discography is the only means by which to test if a cervical disc is painful or not. The procedure involves injecting contrast medium into the nucleus pulposus of the disc, in an effort to reproduce the patient's pain. Although the contrast medium outlines the internal structure of the disc, this is not seminal to the diagnosis. The critical component of the procedure is reproduction of the patient's pain.

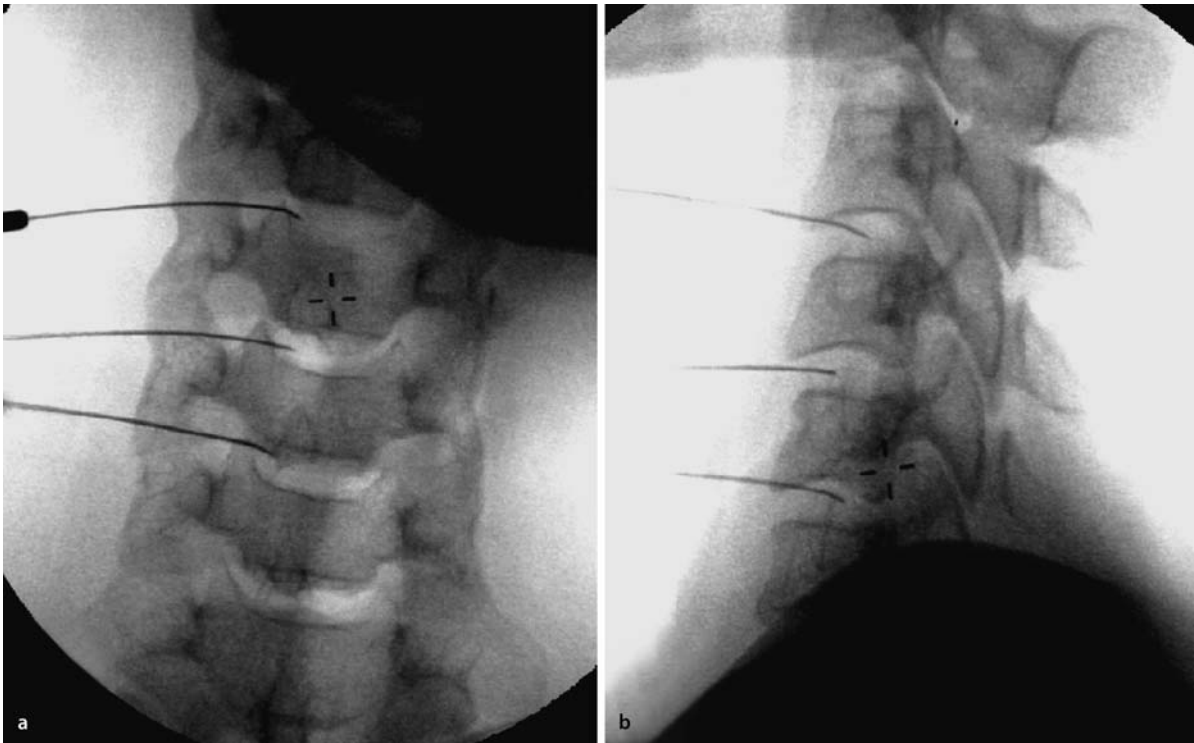
Studies in normal volunteers and in patients have demonstrated that cervical discs can produce neck pain, under experimental conditions (Schellhas et al. 1996; Cloward 1959; Grubb and Kelly 2000). Referred pain patterns encompass areas that are topographically separated from the site of pathology. Furthermore, discs at particular segmental levels produce pain in fairly consistent regions (Schellhas et al. 1996; Grubb and Kelly 2000) (Fig. 1). The C2–3 disc typically refers to the occiput. The C3–4 disc typically refers to the area of the C7 spinous process, with spread toward the side of the neck. The C4–5 disc typically refers toward the superior angle of the scapula, but may spread from the base of the neck to the top of the shoulder. The C5–6 disc refers to the center of the scapular border, and the C6–7 disc refers to the inferior angle of the scapula, but both may spread over the entire scapula, across the shoulder and into the proximal upper limb. These pain patterns can be used to plan which segmental levels should be targeted for investigation.

If stimulation of the disc reproduces the patient's pain pattern (concordant pain), it may be presumed that such is their pain generator. If stimulating the disc is not painful, or produces an atypical (non-concordant) pain pattern, this disc is presumed not to be the pain generator.

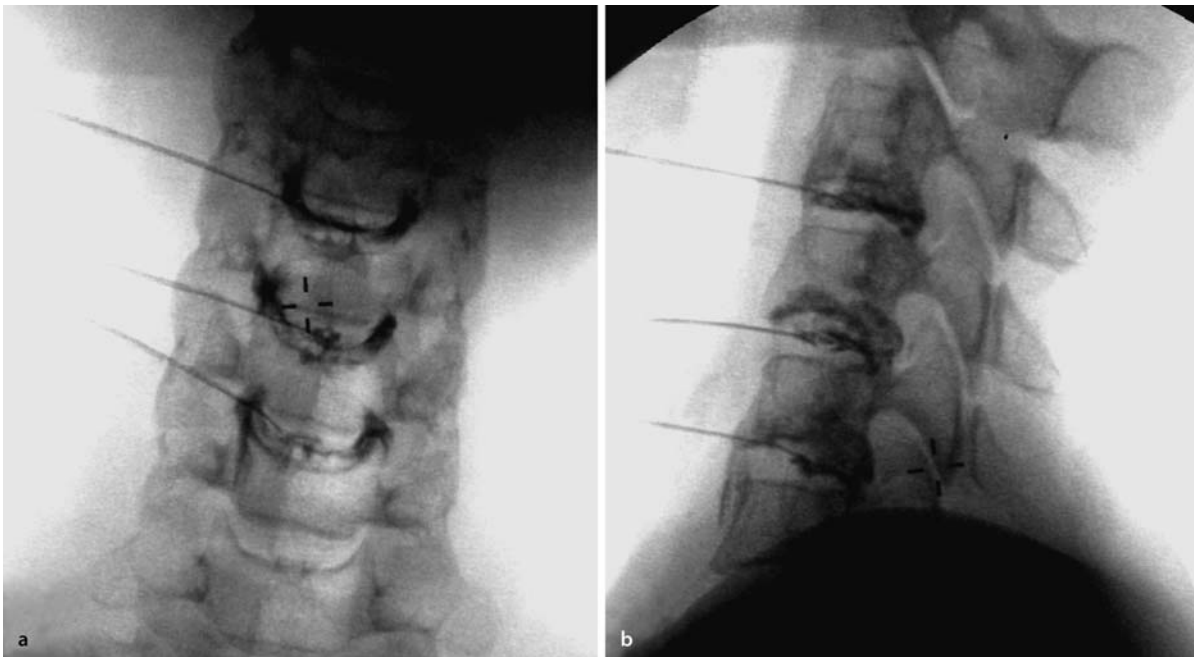


**Cervical Discography, Figure 1** Patterns of distribution of pain after stimulation of cervical intervertebral discs at the segments indicated. Re-produced courtesy of the International Spinal Intervention Society.





**Cervical Discography, Figure 2** Radiographs showing needles placed into cervical intervertebral discs in preparation for discography. (a) Anterior view. (b) Lateral view. Reproduced courtesy of the International Spinal Intervention Society.



**Cervical Discography, Figure 3** Radiographs of cervical discography after injecting of contrast medium. (a) Anterior view. (b) Lateral view. Reproduced courtesy of the International Spinal Intervention Society.

### Technique

The patient lies supine and the neck is prepared for an aseptic procedure. The operator inserts a needle through the skin of the neck and into the anterolateral aspect of

the target disc, until it reaches the centre of the nucleus (Fig. 2). Thereupon, contrast medium is injected, both to verify correct placement (Fig. 3), and to test for reproduction of pain. The nucleus pulposus of a typical

cervical intervertebral disc will admit 0.2–0.4cc of injectate (Kambin et al. 1980). Whether the patient develops concordant pain or not is the critical component of the procedure.

### Validity

In order to be valid, the International Association for the Study of Pain (Merskey and Bogduk 1994) recommends that cervical discography be subjected to anatomical controls. Not only does provocation of the intervertebral disc need to reproduce the individual's pain concordantly, but also provocation at adjacent levels must not reproduce such pain. Additional criteria have been recommended by the International Spinal Intervention Society (2004) pertaining to the intensity of the pain produced during disc stimulation, and the potential role of other structures in the generation of pain.

Cervical discs in normal, asymptomatic volunteers can be made to hurt by discography (Schellhas et al. 1996). However, in such individuals the evoked pain is not severe. They rate the pain as typically less than 6 on a 10–point scale. In contrast, patients with disc pain report reproduction of moderate or severe pain, which they typically rate as greater than 7, Schellhas et al. 1996). Accordingly, it is recommended that for cervical disc stimulation to be considered positive, the evoked pain must have an intensity of 7 or greater (International Spinal Intervention Society 2004). This criterion serves to prevent minor pain from an asymptomatic disc, being considered positive.

Provocation of the intervertebral disc may elicit concordant pain, yet other sources of such pain can be the actual pain generator. As such, the issue of diagnostic specificity of this procedure is questionable. As they share a similar segmental innervation, the cervical zygapophysial joints can refer pain to similar regions as the intervertebral discs (Bogduk and Aprill 1993). Consequently, cervical discography can be false-positive in patients whose pain originates from the zygapophysial joints at the same segment as the disc stimulated. Some 40% of patients with positive responses to discography have their pain relieved by blocks of the cervical zygapophysial joints (see ► [Cervical Medial Branch Blocks](#)), which is not compatible with the disc being the primary source of their pain. Accordingly, it has been recommended that cervical discography be undertaken only when the cervical zygapophysial joints, at the areas of concern, have been excluded as the source of the patient's pain (International Spinal Intervention Society 2004).

Additionally, there are other pitfalls that may compromise the validity of cervical discography. Technical errors will compromise the diagnostic validity of cervical discography. The needle tip must be in the nucleus pulposus—otherwise, stimulation of the annulus fibrosus will be likely to yield a painful response, regardless of whether that disc is the pain generator or not.

### Applications

The primary purpose of cervical discography is to determine if cervical discs are the source of patient's neck pain. It is indicated, therefore, in patients whose cause of pain cannot be established by other means, who have not benefited from conservative therapy, and for whom a diagnosis is desired or required.

A secondary purpose of cervical discography is to help physicians plan interventional management. One treatment option is anterior cervical discectomy and fusion. For this procedure, surgeons are not only interested in if a disc hurts, but also if other discs hurt. The greater the numbers of discs that appear painful, the less inclined surgeons are to undertake surgery. Not only is multi-level fusion more technically demanding for the surgeons, and more hazardous to the patient, its outcomes are less favorable than fusion at a single level.

### Utility

Cervical discography was originally developed with the prospect of finding one, or perhaps only two, discs that were painful, so that fusion might be undertaken to relieve the patient's pain. Accordingly, cervical discography was expected to have positive predictive value. Subsequent studies, however, have thwarted this aspiration. It has become evident that cervical discs are infrequently symptomatic at single levels (Grubb and Kelly 2000). More commonly, discs at three levels, and even four or more levels, are symptomatic. This pattern essentially precludes surgical therapy. Consequently, in practice, cervical discography has more of a negative predictive value. It serves far more often to prevent surgery than to encourage it. Indeed, in one series, only 10% of patients proceeded to surgery in the light of their responses to cervical discography (Grubb and Kelly 2000).

### References

1. Bogduk N, Aprill C (1993) On the Nature of Neck Pain, Discography and Cervical Zygapophysial Joint Blocks. *Pain* 54:213–217
2. Bogduk N, Windsor M, Inglis A (1989) The Innervation of the Cervical Intervertebral Discs. *Spine* 13:2–8
3. Cloward RB (1959) Cervical Diskography. A Contribution to the Aetiology and Mechanism of Neck, Shoulder and Arm Pain. *Ann Surg* 130:1052–1064
4. Groen GJ, Baljet B, Drukker J (1990) Nerves and Nerve Plexuses of the Human Vertebral Column. *Am J Anat* 188: 282–296
5. Grubb SA, Kelly CK (2000) Cervical Discography: Clinical Implications from 12 Years of Experience. *Spine* 25:1382–1389
6. International Spinal Intervention Society (2004). Cervical Discography. In: Bogduk N (ed) Practice Guidelines for Spinal Diagnostic and Treatment Procedures (2004) International Spinal Intervention Society, San Francisco
7. Kambin P, Abda S, Kurpicki F (1980) Intradiskal Pressure and Volume Recording: Evaluation of Normal and Abnormal Cervical Disks. *Clin Orthop* 146: 144–147
8. Mendel T, Wink CS, Zimny ML (1992) Neural Elements in Human Cervical Intervertebral Discs. *Spine* 17:132– 135
9. Merskey H, Bogduk N (1994) Classification of Chronic Pain. Descriptions of Chronic Pain Syndromes and Definition of Pain Terms, 2nd ed. IASP Press Seattle, p 108

10. Oda J, Tanaka H, Tsuzuki N (1988) Intervertebral Disc Changes with Aging of Human Cervical Vertebra from the Neonate to the Eighties. *Spine* 13:1205–1211
11. Parfenchuck TA, Janssen ME (1994) A Correlation of Cervical Magnetic Resonance Imaging and Discography/Computed Tomographic Discograms. *Spine* 19:2819–2825
12. Schellhas KP, Smith MD, Gundry CR, Pollei SR (1996) Cervical Discogenic Pain. Prospective Correlation of Magnetic Resonance Imaging and Discography in Asymptomatic Subjects and Pain Sufferers. *Spine* 21:300–312

## Cervical Facet Blocks

- ▶ Cervical Medial Branch Blocks

## Cervical Facet Denervation

- ▶ Cervical Medial Branch Neurotomy

## Cervical MBBs

- ▶ Cervical Medial Branch Blocks

## Cervical Medial Branch Blocks

JAYANTILAL GOVIND

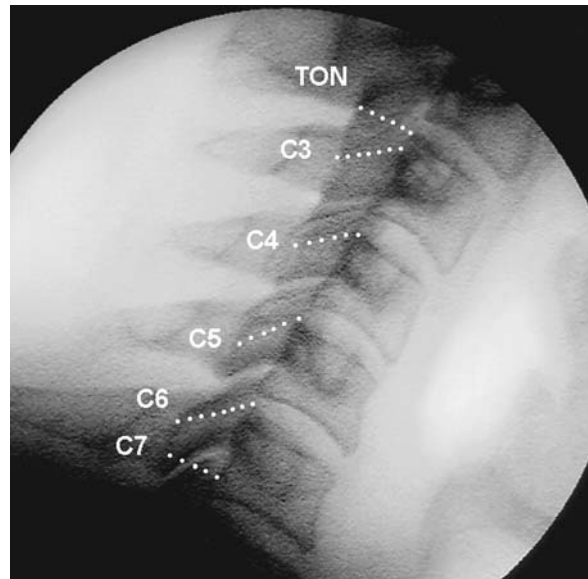
Department of Anaesthesia, Pain Clinic, Liverpool Hospital, University of New South Wales, Sydney, NSW, Australia  
jaygovind@bigpond.com

### Synonyms

Cervical Zygapophysial Joint Blocks; Cervical Facet Blocks; Cervical MBBs; Z Joint Blocks

### Definition

Cervical medial branch blocks (MBBs) are a diagnostic test to determine if a patient's neck pain is mediated by one or more of the medial branches of the cervical dorsal rami. This is achieved by anaesthetising the target nerve with a minute volume of local anaesthetic. In the absence of evidence to the contrary, a positive response to MBBs implies that the patient's pain stems from the zygapophysial joint innervated by the nerves anaesthetised.



**Cervical Medial Branch Blocks, Figure 1** A lateral radiograph of the cervical spine. The course of the third occipital nerve and the medial branches of the C3 to C7 dorsal rami across the articular pillars is indicated with dotted lines.

### Characteristics

#### Rationale

At typical cervical levels, the medial branches of the cervical dorsal rami pass across the waist of the ipsilateral articular pillar (Fig. 1). They innervate the zygapophysial joints above and below, before supplying the posterior muscles of the neck (Bogduk 1982). The third occipital nerve and the C7 medial branch cross the joint that they supply.

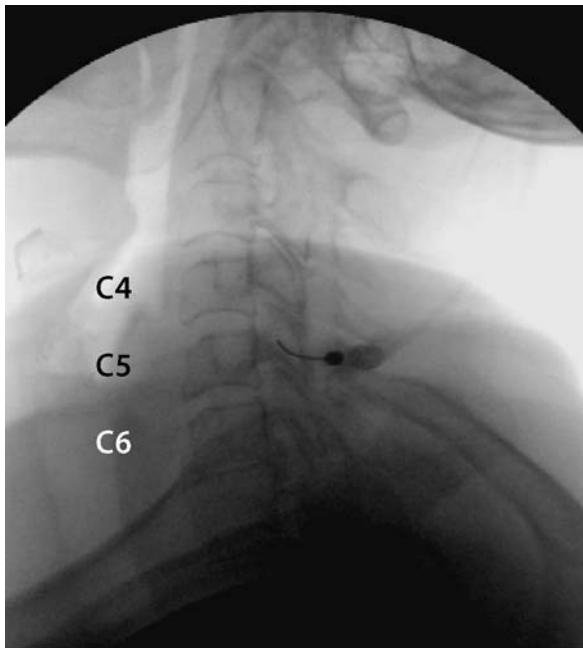
The zygapophysial (“Z”) joints are the only structures supplied by these nerves that are affected by disorders that can be a source of chronic pain (Barnsley and Bogduk 1993). These disorders cannot be diagnosed by musculoskeletal examination or by medical imaging. Diagnostic blocks are the only validated means by which the Z joints can be implicated or excluded as the source of pain. In order to anaesthetise a given joint, both nerves that innervate it must be blocked.

#### Technique

The blocks are performed with the patient lying in a comfortable position, prone, supine, or on their side. Under fluoroscopic guidance, a fine needle is inserted through the skin and muscles of the neck and onto the articular pillar where the target nerve lies (Fig. 2). The nerve can be anaesthetised with as little as 0.3 ml of local anaesthetic.

#### Principles

The primary objective of cervical MBBs is to establish if anaesthetising the target nerves relieves the patient's pain. If the pain is not relieved, the targeted joint can be



**Cervical Medial Branch Blocks, Figure 2** A lateral radiograph of a cervical spine, showing a needle in position for a C5 medial branch block.

excluded as the source of pain, and a new source considered, such as a joint at another segmental level, or an intervertebral disc. If pain is relieved, the response constitutes *prima facie* evidence that the targeted nerves are mediating the patient's pain, and that it arises from the joint that they supply.

In order to be positive, the blocks must produce complete relief of pain. Partial reduction of pain does not constitute a positive response.

In some patients, however, their pain may arise from more than one joint. They may experience pain from both joints at the same segment, from consecutive joints on the same side, or from joints at separate and displaced segments. Typical patterns are: C5–6 on both sides, C5–6 and C6–7 ipsilaterally, and C5–6 and C2–3 on the same side.

In such patients, anaesthetising one joint will not relieve all of their pain. However, blocking that joint will completely relieve pain in the particular region to which that joint refers its pain. Similarly, blocking the other joint will relieve pain in the remaining area. The subtlety of the diagnostic criterion is that the patient obtains complete relief of pain in a particular topographical distribution. This is not the same as the patient obtaining partial relief of their pain overall (International Spinal Intervention Society 2004).

#### Validity

Cervical MBBs are target-specific, and the use of minute volumes of local anaesthetic precludes other structures being anaesthetised (Barnsley and Bogduk 1993). To avoid false-positive responses, the blocks must be con-

trolled. Single diagnostic blocks are associated with an unacceptably high rate of false-positive responses (Barnsley et al. 1993a). Although placebo controls can be used, these may not be practical under conventional circumstances, but comparative local anaesthetic blocks can be used (International Spinal Intervention Society 2004; Barnsley et al. 1993b; Lord et al. 1995). On separate occasions, the same block is repeated using local anaesthetics with different durations of action. The test is negative if the repeat block fails to relieve pain. If both blocks relieve the pain, the relief may be concordant or discordant, and can be either prolonged or not (Barnsley et al. 1993b).

Concordant relief is short-lasting relief when a short-acting agent is used and long-lasting relief when a long-acting agent is used. When relief is longer after the short-acting agent is used, the response is classed as discordant. If the relief substantially outlasts the expected duration of action of either agent, the response is classed as prolonged. Discordant and prolonged responses are probably due to local anaesthetics, particularly lignocaine, acting on "open" sodium channels (Butterworth and Strichartz 1990).

Concordant responses are the ideal. They have a sensitivity of 54% and specificity of 88% (Lord et al. 1995). The high specificity means that concordant responses are very unlikely to be false. The low sensitivity, however, means that not all patients with zygapophysial joint pain will be detected.

If discordant responses are accepted as positive, the sensitivity rises to 100% but the specificity drops to 65% (Lord et al. 1995). Thus, all patients with zygapophysial joint pain will be detected, but some will be false-positive.

#### Epidemiology

The zygapophysial joints are the single-most common source of chronic neck pain. They are the source of pain in at least 50% (Barnsley et al. 1995; Lord et al. 1996a), and up to 88% (Gibson et al. 2000), of patients with neck pain after whiplash. In 53% of patients with headache after whiplash, the pain can be traced to the C2–3 joint (Lord et al. 1994).

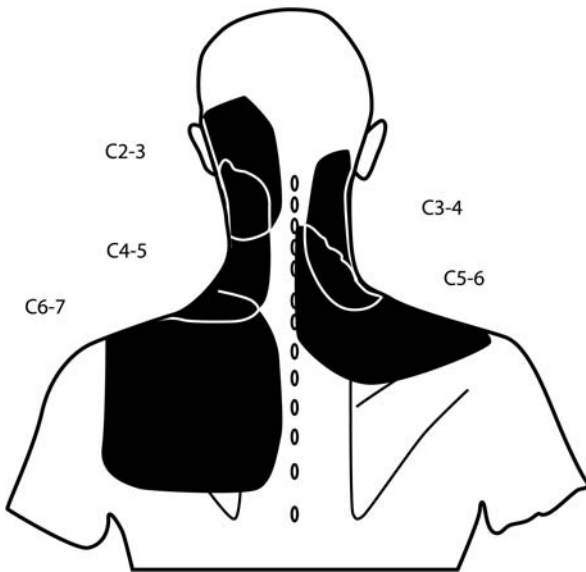
#### Indications

Neck pain for which a diagnosis is required is the primary indication for cervical MBBs. To date, they have been used only for the investigation of patients with chronic neck pain, but their judicious application in patients with sub-acute pain would be worthy of exploration. Isolating the source of pain and instituting appropriate treatment expeditiously could serve to prevent chronicity.

#### Patient Selection

Studies in normal volunteers (Dwyer et al. 1990) and in patients (Fukui et al. 1996) have shown that the cervical zygapophysial joints generate somatic referred pain





**Cervical Medial Branch Blocks, Figure 3** A map of the referred pain patterns from cervical zygapophysial joints at the segments indicated.

in characteristic regions, specific to the segmental location of the joint stimulated (Fig. 3). These patterns can be used to select the joints and nerves most likely to respond to blocks (International Spinal Intervention Society 2004; Aprill et al. 1990).

To optimise their efficiency, MBBs should be performed in patients with discrete areas of neck pain, which correspond to one or more of these areas of referred pain. Patients with more diffuse patterns of pain are less likely to have identifiable joints as the source of pain.

#### Contraindications

Absolute contraindications include localised or systemic infection, a bleeding diathesis, and possible pregnancy. Relative contraindications may include an allergy to contrast media or local anaesthetics, the concurrent treatment with non-steroidal anti-inflammatory medication including aspirin and neurological signs. ► **Radicular pain** and chronic neck pain may co-exist. Whilst cervical medial branch blocks may alleviate neck pain and any ► **somatic referred pain**, they will not relieve radicular pain.

#### Evaluation

The value of diagnostic blocks lies in the information that they provide (International Spinal Intervention Society 2004). For the blocks to be valid, the patient must be able to cooperate fully. They must understand that the procedure is a diagnostic one, and it is neither designed nor intended to be therapeutic. When multiple sources of pain are suspected, patients should understand that relief may occur in only a particular topographic area; and they must be able to determine if they obtain relief in a discrete area. They should also understand the use of a visual analogue scale or numerical pain rating scale.

Blocks should not be performed when the patient's pain is minimal, lest they be unable to distinguish the effects of a block from natural fluctuations in pain. Cervical MBBs are not recommended in patients whose typical pain is less than 40 on a 100 mm scale.

The response to diagnostic blocks should be evaluated immediately after the procedure and for some time afterwards, at the location at which the block was performed, and by an independent observer using validated and objective instruments and tools. Doing so avoids potential errors such as observer bias, patient or operator's expectations, and recall bias. For a response to be judged positive, relief of pain should be accompanied by restoration of activities that are normally limited by pain.

#### Utility

Cervical MBBs have diagnostic utility, in that they can pinpoint the source of the patient's pain. Establishing a firm diagnosis prevents the futile pursuit of a diagnosis by other means. MBBs also have therapeutic utility. A positive response to blocks predicts a favourable outcome from ► **radiofrequency neurotomy** (Lord et al. 1996b).

#### References

1. Aprill C, Dwyer A, Bogduk N (1990) Cervical Zygapophysial Joint Pain Patterns – II: A Clinical Evaluation. *Spine* 15:458–461
2. Barnsley L, Bogduk N (1993) Medial Branch Blocks are Specific for the Diagnosis of Cervical Zygapophysial Joint Pain. *Reg Anaesth* 18:343–350
3. Barnsley L, Lord S, Wallis B, Bogduk N (1993a) False-Positive Rates of Cervical Zygapophysial Joint Blocks. *Clin J Pain* 9:124–130
4. Barnsley L, Lord S, Bogduk N (1993b) Comparative Local Anaesthetic Blocks in the Diagnosis of Cervical Zygapophysial Joint. *Pain* 55:99–106
5. Barnsley L, Lord SM, Wallis BJ, Bogduk N (1995) The Prevalence of Chronic Cervical Zygapophysial Joint Pain after Whiplash. *Spine* 20:20–26
6. Bogduk N (1982) The Clinical Anatomy of the Cervical Dorsal Rami. *Spine* 7:319–330
7. Butterworth JF, Strichartz GR (1990) Molecular Mechanisms of Local Anesthesia: A Review. *Anesthesiology* 72:711–734
8. Dwyer A, Aprill C, Bogduk N (1990) Cervical Zygapophysial Joint Pain Patterns – I: A Study in Normal Volunteers. *Spine* 15:453–457
9. Fukui S, Ohseto K, Shiotani M et al. (1996) Referred Pain Distribution of the Cervical Zygapophysial Joints and the Cervical Dorsal Rami. *Pain* 68:79–83
10. Gibson T, Bogduk N, MacPherson J, McIntosh A (2000) Crash Characteristics of Whiplash Associated Chronic Neck Pain. *J Musculoskeletal Pain* 8:87–95
11. International Spinal Intervention Society (2004) Cervical Medial Branch Blocks. In: Bogduk N (ed) *Practice Guidelines for Spinal Diagnostic and Treatment Procedures*. International Spinal Intervention Society, San Francisco
12. Lord SM, Barnsley L, Bogduk N (1995) The Utility of Comparative Local Anaesthetic Blocks versus Placebo Controlled Blocks for the Diagnosis of Cervical Zygapophysial Joint Pain. *Clin J Pain* 11:208–213
13. Lord S, Barnsley L, Wallis B, Bogduk N (1994) Third Occipital Nerve Headache: A Prevalent Study. *J Neurol Neurosurg Psychiatry* 57:1187–1190
14. Lord S, Barnsley L, Wallis BJ, Bogduk N (1996a) Chronic Cervical Zygapophysial Joint Pain after Whiplash: Placebo Controlled Prevalence Study. *Spine* 21:1737–1745

15. Lord SM, Barnsley L, Wallis BJ, McDonald GJ, Bogduk N (1996b) Percutaneous Radiofrequency Neurotomy for Chronic Cervical Zygapophyseal Joint Pain. *N Eng J Med* 335:1721–1726

## Cervical Medial Branch Neurotomy

JAYANTILAL GOVIND

Department of Anaesthesia, Pain Clinic, Liverpool Hospital, University of New South Wales, Sydney, NSW, Australia  
jaygovind@bigpond.com

### Synonyms

Cervical Facet Denervation; Cervical Radiofrequency Neurotomy

### Definition

Cervical medial branch neurotomy is a treatment for neck pain or headache, stemming from one or more of the zygapophysial joints of the cervical spine. It involves coagulating the nerves that innervate the painful joint, or joints, with an electrode inserted onto the nerves through the skin and muscles of the back of the neck.

### Characteristics

#### Mechanism

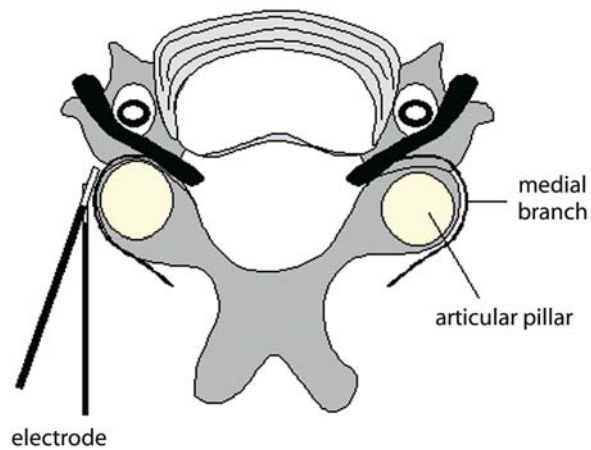
Medial branch neurotomy achieves relief of pain by interrupting the transmission of nociceptive information from a painful zygapophysial joint, by generating a heat lesion in the nerves that mediate the pain (see ► [Electrophysiological Principles of Radiofrequency Neurotomy](#)).

#### Indications

Cervical medial branch neurotomy is not a treatment for any form of neck pain. It is explicitly and solely designed to relieve pain from the zygapophysial joints. Therefore, the singular indication for the procedure is complete, or near complete, relief of pain following controlled, ► [diagnostic blocks](#) of the nerves from the painful joint or joints, i.e. ► [cervical medial branch blocks](#). These blocks must be controlled, because the false-positive rate of uncontrolled blocks is such that responses to single blocks will be false in up to 30% of patients, and those patients will not benefit from the denervation procedure (Barnsley et al. 1993; Bogduk and Holmes 2000).

#### Technique

A detailed protocol has been produced by the International Spinal Injection Society (International Spinal Intervention Society 2004). In essence, the procedure is performed under local anaesthesia, in a room equipped with a fluoroscope and the necessary equipment to gen-

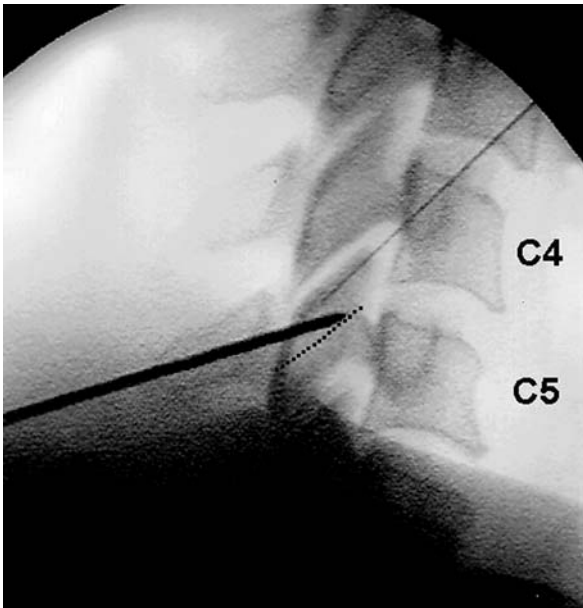


**Cervical Medial Branch Neurotomy, Figure 1** A sketch of a top view of the course of a cervical medial branch. As the nerve follows a curved path around the articular pillar, electrodes must be introduced along a sagittal plane and along a 30° oblique plane.

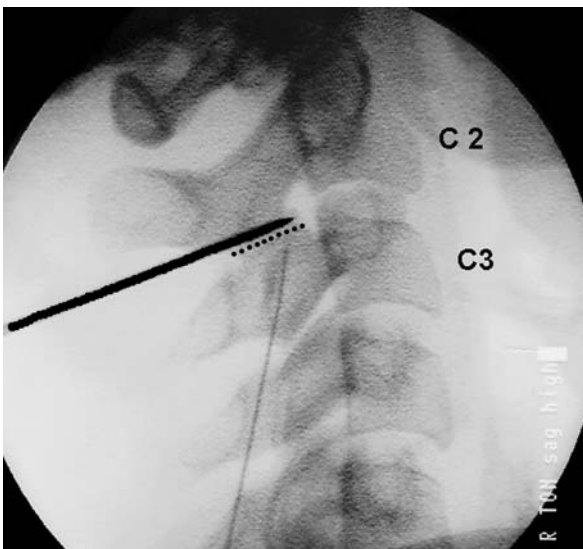
erate the lesions. Sedation should be avoided so that the patient can be alert to any problems that might occur during the procedure, and which threaten their safety. The objective is to make a lesion as long as possible along the course of the target nerve. In order to capture the curved course of each cervical medial branch, the electrode must be introduced in both of two ways (Fig. 1). An oblique pass, about 30° lateral from the sagittal plane is used to reach the proximal part of the nerve, where it lays anterolaterally to the articular pillar (or anterolaterally to the C2/3 zygapophysial joint, in the case of the third occipital nerve). The second pass is along the sagittal plane to reach the nerve where it lies laterally to the articular pillar.

Along both the oblique pass and the sagittal pass, the electrode is introduced through the skin and muscles of the posterior neck, so that its tip lies parallel to the target nerve and against the articular pillar (or the C2–3 joint). At typical cervical levels, this requires inserting the electrode upwards from below the target level, for the nerves course downwards as well as backwards (Fig. 2). The third occipital nerve runs transversely and so, can be approached along a transverse plane instead of an inclined one (Fig. 3).

At each target point, two or three lesions need to be made, in order to accommodate possible variations in the course of the nerve (International Spinal Intervention Society 2004; Lord et al. 1998). Each lesion is made by increasing the heating current gradually by about 1°C per second. Raising the temperature slowly provides time for both the patient and the physician to react if any untoward sensations arise, either because the electrode has dislodged or because the target site has not been adequately anaesthetized; and for the physician to respond before any injury occurs to the patient. Once a temperature of 80°–85°C has been achieved, it



**Cervical Medial Branch Neurotomy, Figure 2** Lateral radiograph of an electrode, inserted along a sagittal path, in position to coagulate a C5 medial branch. The course of the nerve is depicted by a dotted line.



**Cervical Medial Branch Neurotomy, Figure 3** Lateral radiograph of an electrode, inserted along a sagittal path, in position to coagulate the third occipital nerve. The course of the nerve is depicted by a dotted line.

is maintained for about 90 seconds to ensure adequate coagulation of the nerve.

The procedure is repeated for all nerves that were anaesthetized, in order to produce relief of pain during the prior conduct of diagnostic cervical medial branch blocks.

#### Variants

The optimal technique requires that the electrode be placed parallel to the target nerves, and that multiple lesions be made to accommodate variations in the course of the nerve (International Spinal Intervention Society

2004; Lord et al. 1998; Lord et al. 1996a; McDonald et al. 1999). Only this technique has been tested and shown to produce complete and lasting relief of pain.

Variants are used by some operators, ostensibly in the belief that the procedure is faster or easier. These variants, however, have not been tested; and their efficacy is not known (Bogduk 2002).

#### Efficacy

A controlled trial has shown that the effects of cervical medial branch neurotomy cannot be attributed to a placebo response (Lord et al. 1996a). When correctly performed, the efficacy of cervical medial branch neurotomy is genuine.

Provided that patients are correctly selected using controlled cervical medial branch blocks, and provided that the optimal technique is used, good outcome can be expected from cervical medial branch neurotomy. All patients should obtain relief of their pain, which should be evident as soon as the anaesthesia for the procedure wears off, and any postoperative pain abates. If such immediate relief is not evident, an error will have occurred either during the diagnostic blocks or in the conduct of the procedure; both of which should then be reviewed. When neck pain is the target complaint, and joints below C2/3 are treated, some 70% of patients obtain complete relief of their pain (Lord et al. 1998; Lord et al. 1996a; McDonald et al. 1999). When headache is the target complaint, and the third occipital nerve is targeted, some 85% of patients obtain complete relief (Govind et al. 2003). The cardinal reasons for initial failures are suboptimal placement of electrodes or failure, during the conduct of diagnostic blocks, to recognize a source of pain from an adjacent joint.

If complete relief of pain is achieved, it is attended by restoration of activities of normal living, and no need for other health care for the pain (Lord et al. 1998; Lord et al. 1996a; McDonald et al. 1999; Govind et al. 2003). Furthermore, it is associated with complete resolution of psychological distress, without any need for psychological treatment (Wallis et al. 1997). The procedure is equally effective in patients who have compensation claims as those who do not (McDonald et al. 1999; Bogduk 2002; Govind et al. 2003; Sapir and Gorup 2001).

Relief of pain is not permanent. In time, the coagulated nerves regenerate and may again transmit nociceptive information from the painful joint or joints. The time that it takes for this regeneration to occur, depends on how accurately and how thoroughly the nerves were coagulated. After medial branch neurotomy at typical cervical levels, patients can expect complete relief of pain for at least 9 months, and up to 12 months or longer (Lord et al. 1998; Lord et al. 1996a; McDonald et al. 1999). The duration of relief after third occipital neurotomy for headache is, on the average, slightly shorter; some patients may maintain relief for only



6 months, although durations longer than 12 months have been reported (Govind et al. 2003).

Pain usually returns gradually; although it may not return to its former intensity. If pain recurs and becomes sufficiently intense again as to warrant treatment, cervical medial branch neurotomy can be repeated in order to reinstate relief. Patients can have multiple repetitions without prejudicing their response (Lord et al. 1998; McDonald et al. 1999; Govind et al. 2003).

### Complications

Provided that the correct technique is used, no complications are associated with this procedure. Side-effects are uncommon when the procedure is performed at typical cervical levels (Lord et al. 1998); but are more common when the third occipital nerve is coagulated. They include dysaesthesiae when medial branches with cutaneous distributions are coagulated; and ataxia when the third occipital nerve is coagulated. The dysaesthesiae are self-limiting and do not require treatment, as a rule. The ataxia is accommodated by the patient relying on visual cues for balance; and is readily tolerated in exchange for the relief from headache.

Whereas it may be believed by some that denervating a joint will create a neuropathic joint (Charcot's arthropathy), there is no evidence that this occurs, and no grounds for believing that it would occur (Lord and Bogduk 1997). Charcot's arthropathy occurs in limbs that have been completely denervated, in which potentially unstable joints are not protected by muscle activity. In contrast, the zygapophysial joints are intrinsically stable; they are stabilized further by the intervertebral disc, and most of the muscles that act on the affected segment remain functional.

### Utility

Cervical medial branch neurotomy is the singular means by which pain from cervical zygapophysial joints can be eliminated. No other forms of treatment have been shown to be as effective for the treatment of proven cervical zygapophysial joint pain. No other form of treatment has been shown to consistently provide complete relief of neck pain or cervicogenic headache.

Given that the prevalence of cervical zygapophysial joint pain is in excess of 50% in patients with chronic neck pain after whiplash (Lord et al. 1994; Barnsley et al. 1995; Lord et al. 1996b; Gibson et al. 2000), and given that no other form of treatment has been shown to be effective for these patients, cervical medial branch neurotomy has a potentially enormous application in practice.

### References

- Barnsley L, Lord S, Wallis B, Bogduk N (1993) False-Positive Rates of Cervical Zygapophysial Joint Blocks. *Clin J Pain* 9:124–130
- Barnsley L, Lord SM, Wallis BJ, Bogduk N (1995) The Prevalence of Chronic Cervical Zygapophysial Joint Pain after Whiplash. *Spine* 20:20–26
- Bogduk N (2002) Radiofrequency Treatment in Australia. *Pain Practice* 2:180–182
- Bogduk N, Holmes S (2000) Controlled Zygapophysial Joint Blocks: The Travesty of Cost-Effectiveness. *Pain Med* 1:25–34
- Gibson T, Bogduk N, Macpherson J, McIntosh A (2000) Crash Characteristics of Whiplash Associated Chronic Neck Pain. *J Musculoskeletal Pain* 8:87–95
- Govind J, King W, Bailey B, Bogduk N (2003) Radiofrequency Neurotomy for the Treatment of Third Occipital Headache. *J Neurol Neurosurg Psychiatry* 74:88–93
- International Spinal Intervention Society (2004) Cervical Medial Branch Neurotomy. In: Bogduk N (ed). *Practice Guidelines for Spinal Diagnostic and Treatment Procedures*. International Spinal Intervention Society, San Francisco
- Lord S, Barnsley L, Wallis B, Bogduk N (1994) Third Occipital Nerve Headache: A Prevalence Study. *J Neurol Neurosurg Psychiatry* 57:1187–1190
- Lord S, Barnsley L, Wallis BJ, Bogduk N (1996b) Chronic Cervical Zygapophysial Joint Pain after Whiplash: A Placebo-Controlled Prevalence Study. *Spine* 21:1737–1745
- Lord SM, Barnsley L, Wallis B, McDonald GM, Bogduk N (1996a) Percutaneous Radio-Frequency Neurotomy for Chronic Cervical Zygapophysial Joint Pain. *N Engl J Med* 335:1721–1726
- Lord SM, Bogduk N (1997) Treatment of Chronic Cervical Zygapophysial Joint Pain. *N Engl J Med* 336:1531
- Lord SM, McDonald GJ, Bogduk N (1998) Percutaneous Radiofrequency Neurotomy of the Cervical Medial Branches: A Validated Treatment for Cervical Zygapophysial Joint Pain. *Neurosurgery Quarterly* 8:288–308
- McDonald GJ, Lord SM, Bogduk N (1999) Long Term Follow-Up of Patients Treated with Cervical Radiofrequency Neurotomy for Chronic Neck Pain. *Neurosurgery* 45:61–68
- Sapir DA, Gorup JM (2001) Radiofrequency Medial Branch Neurotomy in Litigant and Non-Litigant Patients with Cervical Whiplash. *Spine* 26:E268–E273
- Wallis BJ, Lord SM, Bogduk N (1997) Resolution of Psychological Distress of Whiplash Patients following Treatment by Radiofrequency Neurotomy: A Randomised, Double-Blind, Placebo-Controlled Trial. *Pain* 73:156–162

## Cervical Periradicular Epidural Steroid Injection

- ▶ Cervical Transforaminal Injection of Steroids

## Cervical Radiofrequency Neurotomy

- ▶ Cervical Medial Branch Neurotomy

## Cervical Root Avulsion

### Definition

Traumatic lesion of ventral and/or dorsal root, at the cervical level, consisting of detachment of the constituting rootlets of the root from the spinal cord; main mechanism is stretching.

- ▶ Brachial Plexus Avulsion and Dorsal Root Entry Zone



## Cervical Selective Nerve Root Injection

- ▶ Cervical Transforaminal Injection of Steroids

## Cervical Transforaminal Injection of Corticosteroids

### Definition

The directed deposition of corticosteroid into the cervical intervertebral neuroforamen.

- ▶ Cervical Transforaminal Injection of Steroids

## Cervical Transforaminal Injection of Steroids

TIMOTHY R. LAIR, JAMES P. RATHMELL  
Department of Anesthesiology, University of Vermont  
College of Medicine, Burlington, VT, USA  
james.rathmell@vtmednet.org

### Synonyms

Cervical Periradicular Epidural Steroid Injection; Cervical Selective Nerve Root Injection

### Definition

▶ Cervical transforaminal injection of corticosteroids is a treatment for cervical ▶ radicular pain in which corticosteroids are delivered into a cervical intervertebral neuroforamen.

### Characteristics

Cervical radicular pain affects about one person per 1,000 of population, per year (Radhakrishnan et al. 1994), and is most often caused by a disc herniation or foraminal stenosis. Its natural history can be favorable (Bogduk et al. 1999), but not all patients recover naturally. For relieving cervical radicular pain, conservative therapy, typically including graduated exercise and oral analgesics, is supported only by observational studies, which have not controlled for natural history or non-specific effects of treatment. The controlled studies that have been conducted have shown no significant benefit for traction or exercises (British Association of Physical Medicine 1966; Goldie and Landquist 1970; Klaber et al. 1990). Surgery is the mainstay of treatment if conservative therapy fails (Chestnut et al. 1992; Ahlgren and Garfin 1996). Surgery, however, is not without risks, and constitutes a major undertaking for patients.

CTFIS constitutes an option for treatment, instead of surgery, when conservative therapy does not result in resolution of symptoms, and pain is the sole indication for treatment.

### Rationale

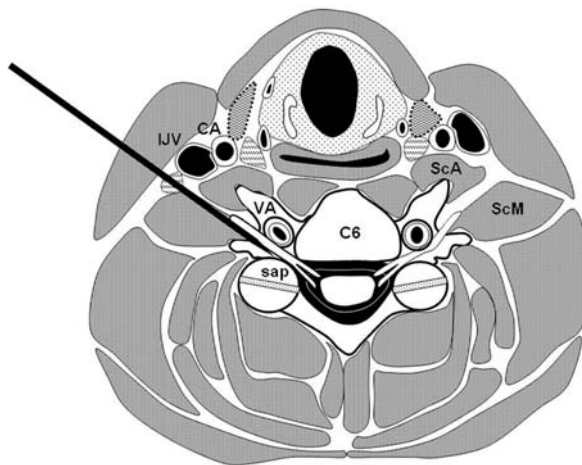
The rationale for injecting steroids is that they suppress inflammation of the nerve, which is believed to be the basis for radicular pain. The rationale for using a transforaminal route of injection, rather than an interlaminar route, is that the injectate is delivered directly onto the target nerve. This ensures that the medication reaches the target area in maximum concentration at the site of the suspected pathology.

### Indications

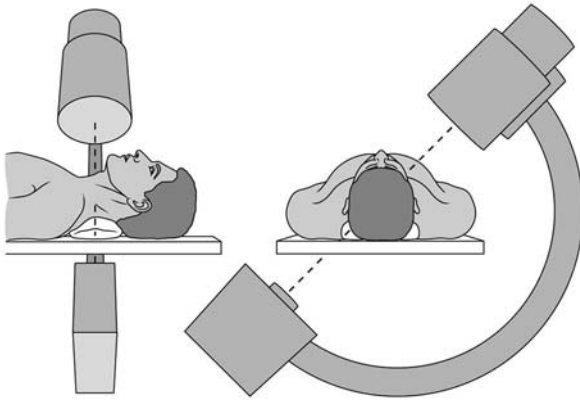
Cervical radicular pain is the only indication for cervical transforaminal injection of steroids. Radicular pain is recognized by its dermatomal distribution, which is distinctly different from the ▶ dermatomes of the same nerve (Slipman et al. 1998). Confidence in the diagnosis is enhanced if the patient also has ▶ radiculopathy, although this may not always be evident. Paraesthesiae, segmental numbness, weakness, and loss of reflexes are reliable and valid signs of radiculopathy that allow the diagnosis to be made clinically, without recourse to investigations. Disc protrusion and foraminal stenosis are the most common causes, but diagnostic imaging is required to exclude tumors and other infrequent causes such as infection, trauma, or inflammatory arthritides (Boyce and Wang 2003).

### Anatomy

The C3–C8 spinal nerves lie in the lower half of their respective intervertebral foramina. These foramina face anterolaterally. The vertebral artery lies just anterior to the exiting nerve (Fig. 1). Radicular branches from the



**Cervical Transforaminal Injection of Steroids, Figure 1** A drawing of an axial view of the cervical intervertebral foramen and adjacent structures at the level of C6, with a needle inserted parallel to the axis of the foramen along its posterior wall. Note the proximity of adjacent structures, IJV, internal jugular vein; CA, common carotid artery; VA, vertebral artery; C6, vertebral body of C6; ScA, anterior scalene muscle, ScM, middle scalene muscle; sap, superior articular process of C5–6 zygapophysial joint. (Reproduced with permission from Rathmell et al. 2004).



**Cervical Transforaminal Injection of Steroids, Figure 2** A sketch showing patient position and fluoroscope orientation to obtain an oblique view of the cervical intervertebral foramina.

vertebral artery lie adjacent to the spinal nerve and its roots to the spinal cord.

#### Technique (Rathmell et al. 2004)

The patient lies supine, and a correct oblique view of the target foramen is obtained with a fluoroscope (Fig. 2). The correct oblique view is critical because, in less oblique views, the vertebral artery may lie along the course of the needle.

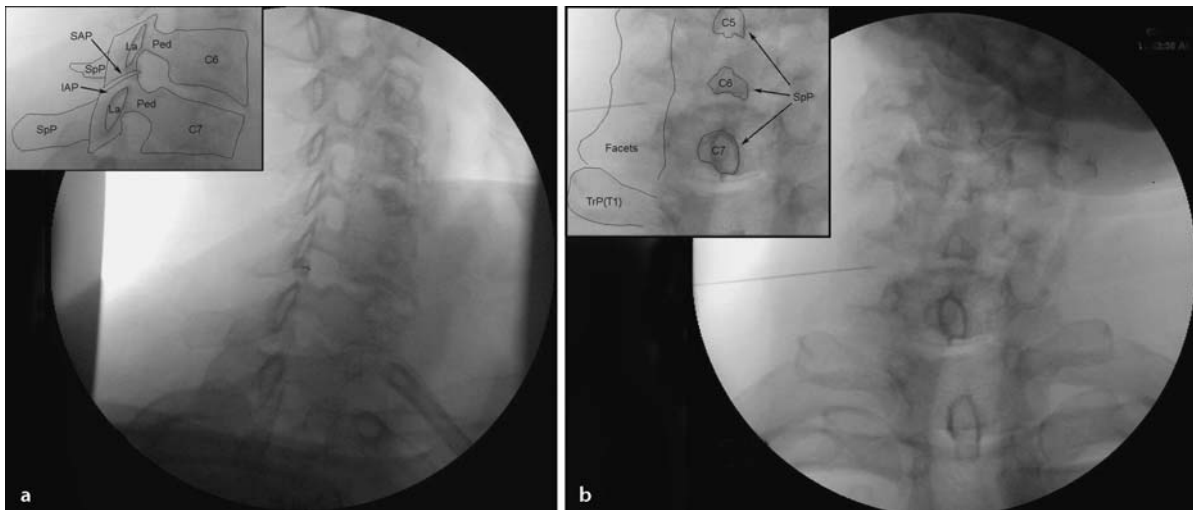
Through a puncture point overlying the posterior half of the target foramen, a 25 gauge,  $2\frac{1}{2}$  –  $3\frac{1}{2}$  inch needle is passed into the neck, and then carefully readjusted to enter the foramen immediately in front of the anterior aspect of the superior articular process, at the midpoint of the foramen (Fig. 3a). Above this level, the nee-

dle may encounter veins; below it, the needle may encounter the spinal nerve and its arteries. The needle must stay in contact with the posterior wall to avoid the vertebral artery. On anteroposterior view, the tip of the needle should not be advanced past the midpoint of the articular pillar (Fig. 3b). Insertion beyond this depth risks puncturing the dural sleeve or thecal sac.

Under direct, real-time fluoroscopy, a small volume of non-ionic contrast medium (1.0 ml or less) is injected. The solution should outline the proximal end of the spinal nerve and spread centrally toward the epidural space (Fig. 4). Real-time fluoroscopy is essential to check for inadvertent intra-arterial injection, which may occur even if the needle is correctly placed. Intra-arterial injection is manifested by very rapid clearance of the injected contrast material. In a vertebral artery, the contrast material will streak in a cephalized direction. In a radicular artery, it will blush briefly in a transverse direction medially towards the spinal cord. In either instance, the needle should be withdrawn and the procedure should be postponed until after a period long enough for the puncture to have healed.

Sometimes the contrast medium may fill epidural veins. These are recognized by the slow clearance of the contrast medium, characteristic of venous flow. In that event, the needle should be adjusted by either slightly withdrawing the needle, or redirecting it to a position slightly lower on the posterior wall of the foramen.

Only a small volume of contrast medium (1.0 ml or less) is required to outline the dural sleeve of the spinal nerve. As it spreads onto the thecal sac, the contrast medium will assume a linear configuration (Fig. 4). Rapid dilution of the contrast medium implies subarachnoid



**Cervical Transforaminal Injection of Steroids, Figure 3** (a) Right anterior oblique radiograph demonstrating a needle in position along the posterior aspect of the right C6–7 intervertebral foramen. Inset of mid portion of image with bony structures labeled: SAP, Superior Articular Process; La, Lamina; Ped, Pedicle; IAP, Inferior Articular Process; SpP, Spinous Process; C6, C6 vertebral body; C7, C7 vertebral body. (b) Anteroposterior radiograph demonstrating needle in final position within the right C6–7 intervertebral foramen. The needle lies halfway between the medial and lateral borders of the articular pillars. Inset of mid portion of image with bony structures labeled: SpP, Spinous Processes of C5, C6, and C7; Facets, medial and lateral aspect of the facet column; TrP (T1), Transverse Process of T1. (Reproduced with permission from Rathmell et al. 2004).



**Cervical Transforaminal Injection of Steroids, Figure 4** Anteroposterior radiograph demonstrating needle in final position within the right C6–7 intervertebral foramen after injection of 1 ml of radiographic contrast medium (iohexol 180 mg/ml). Contrast outlines the spinal nerve and extends along the lateral aspect of the epidural space above the foramen (arrows). (Reproduced with permission from Rathmell et al. 2004).

spread, which may occur if the needle has punctured the thecal sac or a lateral dilatation of the dural root sleeve into the **▶ intervertebral foramen**. In that event, the procedure should be abandoned and rescheduled to avoid potential subarachnoid deposition of local anesthetic or steroid. Once the target nerve has been correctly outlined, a small volume of a short-acting local anesthetic (lidocaine 1%, 0.5 to 1.5 ml) is injected in order to anaesthetize the target nerve. While ensuring that the needle has not displaced, the procedure is completed by injecting a small dose of corticosteroid (betamethasone, 3–6 mg, or triamcinolone 20–40 mg).

### Complications

A case report has detailed fatal spinal cord infarction following CTFIS (Brouwers et al. 2001). Another report referred to several unpublished cases in Australia, Europe, and the USA in which patients suffered severe neurologic sequelae (Rathmell et al. 2004). Injection of corticosteroid into a radicular artery is one plausible mechanism for neurologic injury to occur (Baker R et al. 2002). Meticulous attention to real-time fluoroscopic imaging is required to avoid such complications (Rathmell et al. 2004; Baker et al. 2002).

### Outcomes

There are no randomized controlled trials comparing CTFIS to placebo or other treatments. The literature is limited to three small observational studies.

Bush and Hillier (1996) treated patients with three different forms of injection therapy: cervical or brachial plexus block, CTFIS, and x-ray guided, interlaminar epidural steroid injection. They reported that 76% of patients achieved complete relief of arm pain, but it is not possible from their report to derive what proportion responded to transforaminal injections.

Slipman et al. (2000) reported good or excellent results, at 12–45 month follow-up, in 60% of 20 patients treated with an average of 2.2 injections. They did not, however, provide separate results for each category of outcome. Vallee et al. (2001) studied 34 patients with cervical radiculopathy with refractory symptoms after two months of medical management. Good or excellent results were reported in 53% of 32 patients at six months, after an average of 1.3 injections. At three months, 29% of patients had complete relief of pain. This proportion persisted at six months, but diminished to 20% at 12 months.

These studies appear to paint an encouraging picture of the role for CTFIS. However, this sentiment must be tempered by the relatively low level of evidence these studies provide.

### Caveats

CTFIS is an emerging therapy whose efficacy has not been corroborated by controlled studies. Yet it is associated with serious complications whose incidence is not properly known. Although a possible option for cervical radicular pain, it should only be undertaken by operators familiar with the relevant anatomy, with sufficient experience and skill to maximize the safety of the procedure.

### References

1. Ahlgren BR, Garfin SR (1996) Cervical Radiculopathy. *Orthop Clin North Am* 27:253–263
2. Baker R, Dreyfuss P, Mercer S, Bogduk N (2002) Cervical Transforaminal Injection of Corticosteroids into a Radicular Artery: A Possible Mechanism for Spinal Cord Injury. *Pain* 103:211–215
3. Bogduk N (1999) Medical Management of Acute Cervical Radicular Pain. An Evidence-Based Approach. Newcastle Bone and Joint Institute, Newcastle Australia
4. Boyce BH, Wang JC (2003) Evaluation of Neck Pain, Radiculopathy, and Myelopathy: Imaging, Conservative Treatment, and Surgical Indications. *Instr Course Lect* 52:489–95
5. British Association of Physical Medicine (1966) Pain in the Neck and Arm: A Multicentre Trial of the Effects of Physiotherapy. *Brit Med J* 1:253–258
6. Brouwers PJAM, Kottnik EJBL, Simon MAM, Prevo RL (2001) A Cervical Anterior Spinal Artery Syndrome after Diagnostic Blockade of the Right C6-Nerve Root. *Pain* 91:397–399
7. Bush K, Hillier S (1996) Outcome of Cervical Radiculopathy Treated with Periradicular/Epidural Corticosteroid Injections: A Prospective Study with Independent Clinical Review. *Eur Spine J* 5:319–325
8. Chestnut RM, Abithol JJ, Garfin SR (1992) Surgical Management of Cervical Radiculopathy. *Orthop Clin North Am* 23:461–474
9. Goldie I, Landquist A (1970) Evaluation of the Effects of Different Forms of Physiotherapy in Cervical Pain. *Scand J Rehab Med* 2–3:117–121
10. Klaber Moffett JA, Hughes GI, Griffiths P (1990) An Investigation of the Effects of Cervical Traction. Part 1: Clinical Effectiveness. *Clin Rehab* 4:205–211

11. Radhakrishnan K, Litchy WJ, O'Fallon WM, Kurland LT (1994) Epidemiology of Cervical Radiculopathy. A Population-Based Study of Rochester, Minnesota, 1976–1990. *Brain* 117:325–335
12. Rathmell JP, Aprill C, Bogduk N (2004) Cervical Transforaminal Injection of Steroids. *Anesthesiology* 100:1595–1600
13. Slipman CW, Lipetz JS, Jackson HB, Rogers DP, Vresilovic EJ (2000). Therapeutic Selective Nerve Root Block in the Non-Surgical Treatment of Atraumatic Cervical Spondylotic Radicular Pain: A Retrospective Analysis with Independent Clinical Review. *Arch Phys Med Rehabil* 81:741–746
14. Slipman CW, Plasteras CT, Palmitier RA, Huston CW, Sterenfeld EB (1998) Symptom Provocation of Fluoroscopically Guided Cervical Nerve Root Stimulation. Are Dermatomal Maps Identical to Dermatomal Maps? *Spine* 23:2235–42
15. Vallee JN, Feydy A, Carlier RY, Mutschler C, Mompont D, Vallee CA (2001) Chronic Cervical Radiculopathy: Lateral Approach Periradicular Corticosteroid Injection. *Radiology* 218:886–892

## Cervical Zygapophysial Joint Blocks

- ▶ Cervical Medial Branch Blocks

## CFA

### Synonyms

Complete Freund's Adjuvant

### Definition

Complete Freund's Adjuvant is used in animal experiments to induce inflammation.

- ▶ Complete Freund's Adjuvant
- ▶ Substance P Regulation in Inflammation

## C Fiber

- ▶ C Afferent Axons/Fibers

## c-Fos

### Definition

A gene that codes for a transcription factor (Fos). *c-fos* can be switched on rapidly as a result of various stimuli, and its product regulates the expression of various other genes in the cell. Fos protein, which can be detected by immunocytochemistry, can be used to demonstrate that a neuron has been activated, and, is therefore used as a marker to map neuronal recruitment to stimuli, including noxious stimuli. In addition, c-Fos may play a role in activating 'late response' genes.

- ▶ Alternative Medicine in Neuropathic Pain
- ▶ c-Fos Immediate-Early Gene Expression

- ▶ Freezing Model of Cutaneous Hyperalgesia
- ▶ Nociceptive Processing in the Hippocampus and Entorhinal Cortex, Neurophysiology and Pharmacology
- ▶ Opioid Receptors at Postsynaptic Sites
- ▶ Spinothalamic Tract Neurons, Role of Nitric Oxide

## c-Fos Immediate-Early Gene Expression

### Definition

*c-Fos* is one of a family of genes, called „immediate-early genes,“ which are expressed very soon after a salient environmental event (e.g. pain). The proteins encoded by immediate-early genes act as transcription factors to affect the expression of other genes. By using immunohistochemistry for Fos, the protein product of *c-fos*, one can identify with single cell resolution those neurons that „responded“ to the noxious stimulus, s. also c-Fos.

- ▶ c-Fos
- ▶ Heritability of Inflammatory Nociception

## CFS

- ▶ Cutaneous Field Stimulation

## CGRP

- ▶ Calcitonin Gene Related Peptide
- ▶ Calcitonin Gene-Related Peptide and Migraine Headaches
- ▶ CGRP and Spinal Cord Nociception

## CGRP and Spinal Cord Nociception

ANDREA EBERSBERGER

Department of Physiology, Friedrich Schiller University of Jena, Jena, Germany  
andrea.ebersberger@mti.uni-jena.de

### Synonym

Calcitonin gene-related peptide and spinal cord nociception; Spinal Cord Nociception and CGRP



## Definition

► **Calcitonin gene-related peptide (CGRP)** is a 37 amino acid peptide of the calcitonin family with two isoforms,  $\alpha$  and  $\beta$  CGRP, with similar biological functions (Poyner 1992). The neuropeptide is synthesized in up to 50% of the small- and medium-sized dorsal root ganglion neurons (DRGs) and is transported along the axon to the peripheral endings (Donnerer et al. 1992) and to the central endings of the neuron in the dorsal horn of the spinal cord. In addition to its role in nociception, CGRP is involved in a number of other functions including vasodilation.

## Characteristics

### Localization of Spinal CGRP

Fibers showing CGRP-immunoreactivity are located in the dorsal horn of the spinal cord in laminae I and II at high density and in lamina V at lower density (Wiesenfeld-Hallin et al. 1984). CGRP-like immunoreactivity and CGRP mRNA are also localized in motoneurons of the ventral horn.

### Localization of CGRP Receptors

The density of CGRP receptors is highest in the superficial and deep dorsal horn, but there are also receptors in the ventral horn. The distribution of CGRP binding sites is thus similar to the distribution of CGRP positive fibers but they may even be located at sites where no CGRP-containing fibers are terminating. These receptors might be reached by the neuropeptide by diffusion within the tissue.

Immunostaining of RCP, an essential component of the CGRP receptor complex, corroborated the distribution of CGRP receptors in the spinal cord. The distribution of the CGRP receptor subtypes, CGRP<sub>1</sub>-receptor (corresponding to CRLR/RAMP1) and CGRP<sub>2</sub>-receptor in the spinal cord has not been investigated.

Under pathophysiological conditions such as peripheral inflammation, increases and decreases in binding sites for CGRP have been observed (Galeazza et al. 1992). Not only the receptor but also its accessory protein (RCP) can be regulated in inflammatory or neuropathic pain states (Ma et al. 2003).

### Release of CGRP

There is a high basal release of CGRP from central endings of afferents in the spinal cord, which was shown with antibody-coated microprobes (Schaible et al. 1994; Morton and Hutchison 1989). This release is not influenced by activating peripheral afferents with innocuous stimuli or motor activity in the physiological range. Noxious mechanical stimuli, however, increase this basal release (Morton and Hutchison 1989). The situation changes during peripheral inflammation. During acute knee inflammation, mechanical stimuli of innocuous intensity to the knee induce spinal CGRP release (Schaible et al. 1994). This is probably caused

by a sensitization of the afferents to mechanical stimuli. Additionally basal release is much higher in inflamed than in normal animals (Collin et al. 1993). This may result from an up-regulation of the synthesis of CGRP that has been observed in the acute and chronic stage of inflammation.

### CGRP Receptor Agonists and Antagonists

There are two CGRP receptor subtypes, namely CGRP<sub>1</sub> and CGRP<sub>2</sub>, which both bind the endogenous ligands CGRP $\alpha$  and CGRP $\beta$ . The subtypes are characterized by the abilities of the fragment CGRP<sub>8-37</sub> to antagonize the effect of CGRP (CGRP<sub>1</sub>) and the linear agonistic analog [Cys(ACN)<sup>2,7</sup>]hCGRP $\alpha$  to mimic the effect of CGRP (CGRP<sub>2</sub>). BIBN4096BS, the first potent non-peptide antagonist preferentially binds to the CGRP<sub>2</sub> receptor (Watling 2001).

### Effect of Spinal CGRP

Released CGRP can exert its action directly by binding to CGRP receptors. However, it also interacts with the release and metabolism of substance P. CGRP can facilitate release of substance P and, in addition, CGRP controls the amount of substance P by inhibiting the enzymatic degradation of substance P (Duggan et al. 1992).

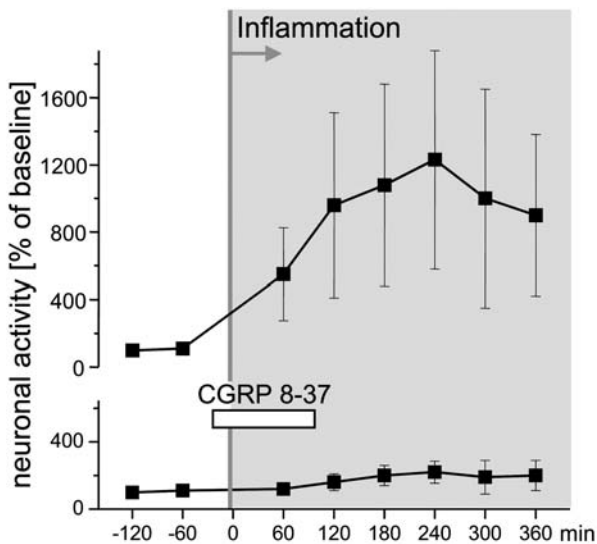
#### Behavioral Experiments

In behavioral experiments, intrathecally applied CGRP facilitated the responses to noxious stimulation (e.g. Wiesenfeld-Hallin et al. 1984) and antagonization of endogenous CGRP with CGRP<sub>8-37</sub>, a CGRP<sub>1</sub> receptor antagonist, was antinociceptive. CGRP was also shown to support the generation and maintenance of ► **mechanical allodynia** and ► **hyperalgesia** in rats. CGRP<sub>8-37</sub> alleviated mechanical and ► **thermal allodynia** in chronic central pain. Thus CGRP has a role in normal nociception but it is also involved in pain states (reviewed by Schaible et al. 2004).

### Effect on Neuronal Activity

Application of CGRP in the vicinity of spinal cord neurons caused no, or only weak, excitation of the neurons (Ryu et al. 1988). But CGRP has a facilitatory effect on evoked activity in spinal cord neurons, e.g. activities evoked by innocuous or noxious mechanical stimulation or substance P (Biella et al. 1991). CGRP is also involved in the development and maintenance of spinal hyperexcitability. This effect was shown in a model of knee joint inflammation where CGRP or the antagonist CGRP<sub>8-37</sub> had been ionophoretically applied in the vicinity of spinal cord neurons that responded to mechanical stimulation of the leg (Fig. 1).

Since ► **glutamate receptors** are of major importance in the excitation of spinal nociceptive neurons, a possible interaction between the responses of spinal cord neurons to CGRP and ► **NMDA** or ► **AMPA** was investigated. Coadministration of CGRP and AMPA or NMDA enhanced the responses to the excitatory amino acids



**CGRP and Spinal Cord Nociception, Figure 1** The development of knee joint inflammation is paralleled by the development of spinal hyperexcitability measured as an increase in neuronal responses to repetitive noxious pressure applied to the knee joint (upper trace). When CGRP<sub>8-37</sub> was ionophoretically applied during and 90 min after induction of inflammation in the vicinity of the recorded neurons the development of spinal hyperexcitability was prevented (Neugebauer et al. 1996).

(Ebersberger et al. 2000). Thus one explanation for the spinal effect of CGRP is its influence on ► **glutamatergic** neuronal transmission.

## References

1. Biella G, Panara C, Pecile A, Sotgiu ML (1991) Facilitatory role of calcitonin gene-related peptide (CGRP) on excitation induced by substance P (SP) and noxious stimuli in rat spinal dorsal horn neurons. *Brain Res* 559:352–356
2. Donnerer J, Schuligoi R, Stein C (1992) Increased content and transport of substance P and calcitonin gene-related peptide in sensory nerves innervating inflamed tissue: evidence for a regulatory function of nerve growth factor in vivo. *Neuroscience* 49:693–698
3. Duggan AW, Schaible HG, Hope PJ, Lang CW (1992) Effect of peptidase inhibition on the pattern of intraspinally released immunoreactive substance P detected with antibody microprobes. *Brain Res.* 579:261–269
4. Ebersberger A, Charbel Issa P, Venegas H, Schaible HG (2000) Differential effects of calcitonin gene-related peptide and calcitonin gene-related peptide<sub>8-37</sub> responses to N-methyl-D-aspartate or (R,S)- $\alpha$ -amino-3-hydroxy-5-methylisoxazole-4-propionate in spinal nociceptive neurons with knee joint input in the rat. *Neuroscience* 99:171–178
5. Galeazza MT, Stucky CL, Seybold VS (1992) Changes in 125IhCGRP binding sites in rat spinal cord in an experimental model of acute, peripheral inflammation. *Brain Res* 591:198–208
6. Ma W, Chabot J-G, Powell KJ et al. (2003) Localization and modulation of calcitonin gene-related peptide-receptor component protein-immunoreactive cells in the rat central and peripheral nervous system. *Neuroscience* 120:677–694
7. Morton CR, Hutchison WD (1989) Release of sensory neuropeptides in the spinal cord: studies with calcitonin-gene related peptide and galanin. *Neuroscience* 31:807–815
8. Neugebauer V, R umenapp P, Schaible H-G (1996) Calcitonin gene related peptide is involved in the generation and maintenance of hyperexcitability of dorsal horn neurons observed during

development of acute inflammation in rat's knee joint. *Neuroscience* 71: 1095–1109

9. Poyner DR (1992) Calcitonin gene related peptide: multiple actions, multiple receptors. *Pharmac Ther* 56:23–51
10. Ryu PD, Gerber G, Murase K, Randic M (1988) Actions of calcitonin gene-related peptide on rat spinal dorsal horn neurons. *Brain Res.* 441:357–361
11. Schaible H-G, Freudenberger U, Neugebauer V et al. (1994) Intraspinally release of immunoreactive calcitonin gene-related peptide during development of inflammation in the joint in vivo – a study with antibody microprobes in cat and rat. *Neuroscience* 62:1293–1304
12. Schaible H-G et al. (2004) Involvement of CGRP in nociceptive processing and hyperalgesia: Effects of CGRP on spinal and dorsal root ganglion neurons. In: Brune K, Handwerker HO (eds) *Hyperalgesia: Molecular Mechanisms and Clinical Implications*. Progress in Brain Research and Management, vol 30. IASP Press, Seattle, pp 201–227
13. Watling KJ (2001) The Sigma-RBI handbook of receptor classification and signal transduction. Sigma-RBI, Natick, pp 82–83
14. Wiesenfeld-Hallin S, H okfelt T, Lundberg JM et al. (1984) Immunoreactive calcitonin-gene related peptide and substance P coexist in sensory neurons in the spinal cord and interact in spinal behavioral responses of the rat. *Neurosci Lett* 52:199–204

## Channel Inactivation

### Definition

A period of silencing (due to the inability to re-open) after an ion channel opens and then closes.

- [Painful Channelopathies](#)

## Channelopathies

### Definition

Channelopathies are disorders in which absence of ion channels, abnormal function of ion channels, or deployment of an aberrant of ensemble of ion channels produce clinical symptoms.

- [Migraine, Pathophysiology](#)
- [Painful Channelopathies](#)

## Charcot-Marie-Tooth Disease

### Synonyms

CMT

### Definition

CMT is any inherited neuropathy that is not part of a syndrome.

- [Hereditary Neuropathies](#)

## C-Heat Receptor

- [Polymodal Nociceptors, Heat Transduction](#)

## Chemesthesis

### Definition

Sensitivity to all chemicals that produce sensations other than (or in addition to) taste or smell.

- ▶ [Nociception in Nose and Oral Mucosa](#)

## Chemical Lesion

### Definition

Selective lesion of neuronal cell bodies of the CNS. It consists of injecting a concentrated solution of an excitatory amino-acid that can normally excite the neurons at high concentration. At high concentration, the amino acid (glutamic, kainic, quisqualic, ibotenic acids) can produce selective neuronal death (cell bodies only sparing nerve fibers) by excitotoxicity.

- ▶ [Thalamotomy, Pain Behavior in Animals](#)

## Chemical Sympathectomy

- ▶ [Sympathetic Blocks](#)

## Chemical Transmitter

- ▶ [Nociceptive Neurotransmission in the Thalamus](#)

## Chemoattractants

### Definition

Chemoattractants have been divided into two categories. One category is represented by the classical chemoattractants like platelet activating factor (PAF), leukotriene B<sub>4</sub> (LTB<sub>4</sub>), formyl-methionyl-leucyl-phenylalanine (FMLP), and complement protein C5a. The second category consists of compounds belonging to the chemokine group. Both classical chemoattractants and chemokines act on target cells through seven-transmembrane domain receptors that are coupled to heteromeric G-proteins and elicit chemotactic responses.

- ▶ [Neutrophils in Inflammatory Pain](#)

## Chemokines

### Synonyms

Chemotactic Cytokines

### Definition

Chemokines are cytokines with chemoattractant properties, inducing cells with the appropriate receptors to migrate towards the source of the chemokines, which includes the family of proinflammatory activation-inducible cytokines. These proteins are mainly chemotactic for different cell types. Based on chromosomal locations of individual genes, two different sub-families of chemokines are distinguished as CXC-chemokines (CXCL; also known as alpha-chemokines or 4q chemokine family) and CC-chemokines (CCL; also known as beta-chemokines or 17q chemokine family). In the earliest phases of inflammation, chemokines are released and induce direct chemotaxis in nearby responsive cells. Together with intercellular adhesion molecules, chemokines and their receptors serve to localize and enhance the inflammatory reaction at the site of tissue damage.

- ▶ [Cytokines as Targets in the Treatment of Neuropathic Pain](#)
- ▶ [Cytokines, Effects on Nociceptors](#)
- ▶ [Cytokine Modulation of Opioid Action](#)
- ▶ [Neutrophils in Inflammatory Pain](#)

## Chemosensation

### Definition

Sensations initiated through chemicals, e.g. gustatory or olfactory mediated sensations or sensations mediated through the intranasal trigeminal nerves.

- ▶ [Nociception in Nose and Oral Mucosa](#)

## Chemosensitive Sympathetic Afferent Fibers

### Definition

Afferent fibers that transmit information resulting from a variety of chemicals that are released during myocardial ischemia.

## Chemotactic

### Definition

A chemical (sodium morrhuate) used in prolotherapy solutions, which acts by attracting inflammatory cells.

- ▶ [Prolotherapy](#)

## Chemotactic Cytokines

- ▶ [Chemokines](#)

## Chemotherapy

### Definition

Treatment with drugs that kill cancer cells that may be given by one or more of the following methods: orally, by venous or arterial injection (through a catheter or port), or topically.

- ▶ [Cancer Pain Management, Chemotherapy](#)
- ▶ [Cancer Pain Management, Treatment of Neuropathic Components](#)

## Chemotherapy-Induced Neuropathy

### Definition

A group of drugs used in chemotherapy are associated with a peripheral neuropathy. Vincristine was the first drug in this group. The most commonly used chemotherapy agents that produce a painful neuropathy, which is also associated with a sensory loss, are Cisplatin (and Carboplatin) and Taxol. These two drugs bind to tubulin in the axoplasm and reduce the anterograde slow component of axoplasmic transport. This makes the nerves susceptible to chronic compression, which can be helped by decompression of the involved nerves. The most recent drug to be used for chemotherapy that has an associated neuropathy is Thalidomide.

- ▶ [Ulceration, Prevention by Nerve Decompression](#)

## Chest Pain

### Definition

Chest pain is often caused by coronary artery disease, but can originate from non-cardiac structures such as the esophagus. The most prominent feelings are pressure, squeezing and/or crushing on the chest.

- ▶ [Visceral Pain Model, Angina Pain](#)

## Chiari Type I Malformation

### Definition

This is a protrusion of the cerebellar tonsils, below the foramen magnum, which can cause a valve-like obstruction to the flow of cerebrospinal fluid.

- ▶ [Primary Cough Headache](#)

## Childhood Migraine

- ▶ [Migraine, Childhood Syndromes](#)

## Childhood Sexual Abuse

### Definition

Any child below the age of consent may be deemed to have been sexually abused when another sexually mature person has, by design or by neglect of their usual societal or specific responsibilities in relation to that child, engaged or permitted the engagement of that person in any activity of a sexual nature that is intended to lead to the sexual gratification of the sexually mature person. This definition pertains whether or not it involves genital contact or physical contact, and whether or not there is discernible harmful outcome in the short-term.

- ▶ [Chronic Pelvic Pain, Physical and Sexual Abuse](#)

## Chiropractic

### Definition

Therapeutic manipulation of the spine to treat a wide variety of conditions by correcting dysfunction in spinal alignment.

- ▶ [Alternative Medicine in Neuropathic Pain](#)
- ▶ [Spinal Manipulation, Characteristics](#)
- ▶ [Spinal Manipulation, Pain Management](#)

## Chloride Transporter

### Synonyms

Cl<sup>-</sup> Transporter

### Definition

A chloride transporter is a membrane protein that assists in the movement of ions across the surface membrane of a neuron. The result can be a greater concentration of chloride ions on one or the other side of the membrane.

- ▶ [GABA Mechanisms and Descending Inhibitory Mechanisms](#)

## Chloro-phenyl-2-methylaminocyclohexanone-hydrochloride

- ▶ [Postoperative Pain, Ketamine](#)

## Cholecystokinin

### Synonyms

CCK



**Definition**

An eight amino acid peptide present in the gastrointestinal tract and in the nervous system that modulates pain sensation as well as other neuronal processes. It was named for its effects on the gall bladder, but also thought to have pro-nociceptive effects in the spinal cord.

- ▶ [Alternative Medicine in Neuropathic Pain](#)
- ▶ [Pain Modulatory Systems, History of Discovery](#)
- ▶ [Peptides in Neuropathic Pain States](#)
- ▶ [Placebo Analgesia and Descending Opioid Modulation](#)

**Chondrocytes****Definition**

Chondrocytes are cells that produce cartilage by secretion of the cartilaginous matrix. The secretion of the matrix by chondrocytes leads to their encapsulation in this matrix where they eventually undergo programmed cell death, or apoptosis. As a consequence, new chondrocytes constantly arise from their precursor cells. Chondrocytes arise from chondroblasts, which arise from mesenchymal cells.

- ▶ [Arthritis Model, Osteoarthritis](#)

**Chromosomes****Definition**

Chromosomes contain the cell's genetic information, and are structured as compact intertwined molecules of DNA located in the nucleus of cells.

- ▶ [NSAIDs, Pharmacogenetics](#)

**Chronic Abdominal Pain of Childhood**

- ▶ [Recurrent Abdominal Pain in Children](#)

**Chronic Back Pain and Spinal Instability**

KENE UGOKWE<sup>1</sup>, AJIT KRISHNANEY<sup>1</sup>,  
MICHAEL STEINMETZ<sup>1</sup>, EDWARD BENZEL<sup>1,2</sup>

<sup>1</sup>The Cleveland Clinic Foundation, Department of Neurosurgery, Cleveland, OH, USA

<sup>2</sup>The Cleveland Clinic Foundation, Cleveland Clinic Spine Institute, Cleveland, OH, USA  
benzele@ccf.org

**Synonyms**

Dysfunctional Segmental Motion; Mechanical Low Back Pain; Lumbago; Back Pain; Myofascial pain syndrome; Muscle Spasm; Discogenic pain; Painful Disc Syndrome

**Definition**

Chronic back pain is defined as pain in the dorsal aspect of the trunk (from the neck to the pelvis) that persists for more than twelve weeks (Gatchel 1986). It may be related to degenerative, neoplastic, traumatic or infectious conditions. Chronic back pain may also be related to spinal ▶ [instability](#). Spinal instability is defined as the inability of the spine to limit patterns of movement or displacement that may lead to deformity or pain. Other entities that are particularly worthy of definition are mechanical back pain and myofascial pain syndrome, discogenic pain, pain of soft tissue injury origin and pain of bony tissue injury origin:

- Mechanical back pain – a deep and agonizing pain that increases with activity, such as the assumption of the upright posture (loading) and decreases with inactivity, such as assuming the supine position (unloading).
- Myofascial pain syndrome – synonymous with muscle spasm or strain. It is usually self-limiting. There often exists an underlying cause.
- Discogenic low back pain – pain that originates from the intervertebral disc and the disc space.
- Pain of soft tissue injury origin – such pain originates from the damage or destruction of richly innervated soft tissue. It may occur after surgery and is also seen with muscle tear.
- Pain of bony tissue destruction origin – pain that is associated with bony distortion. It is usually associated with weakened bone, as may be seen with tumor, infection, or trauma.

**Characteristics**

Chronic back pain is common. Eighty five percent of cases are idiopathic. Potential anatomical sources of back pain include muscle, ligaments, tendons, bones, ▶ [facet joints](#) and discs. In many cases, it is difficult to determine the exact cause of back pain because of significant overlap in the nerve supply to the aforementioned structures. Approximately 80% of Americans experience clinically-significant back pain. Eighty to ninety percent of the attacks resolve within 6 weeks (Bigos 1994). It is the second most common reason for which people seek medical attention (Cypress 1983). Back pain accounts for 15% of all sick leave and it is the most common cause of disability for people less than 45 years of age (Cunningham 1984).

Spinal instability is a common cause of back pain. Some of the causes of spinal instability include age related

degenerative changes, prior spinal surgery, physically dependent occupations, sedentary lifestyles, obesity, poor posture and certain sporting activities. In a patient with chronic back pain, a diagnosis to consider is spinal tumor. Pain at night that is relieved by aspirin may be suggestive of an osteoid osteoma or a benign ► **osteoblastoma**. Infections such as discitis (an infection of the disc space between the vertebral bodies) must also be ruled out. Spinal ► **compression fractures** may also be the source of severe back pain, particularly in the elderly. Other potential etiologies of chronic back pain include:

#### Degenerative Conditions

- Degenerative spondylolisthesis: slippage of one vertebral body over another (Percy 1983).
- ► **Spinal stenosis**
- Lateral recess syndrome: the lateral recess is the channel alongside the pedicle where the exiting nerve root resides.

#### Spondyloarthropathies

- Paget's disease: this is a condition characterized by areas of abnormal bone growth and an increased rate of bone resorption.
- Ankylosing spondylitis: this is a connective tissue disease characterized by inflammation of the spine and joints resulting in pain and stiffness.

It is important to note that all of the aforementioned conditions contribute to or cause spinal instability. Certain patients, however, have no organic disease and their back pain is ► **psychogenic** in nature. This may be as a result of secondary gain, i.e. financial or emotional gain (Waddell 1980).

#### Spinal Instability

There are two categories of spinal instability: (1) Acute spinal instability, and (2) Chronic spinal instability. Acute spinal instability may be further divided into overt and limited instability, while chronic instability is subcategorized into glacial instability and dysfunctional segmental motion (Benzel 2001). Denis described the three-column concept of identifying criteria for instability of the spine (Denis 1983).

#### The Three Column Concept of Spinal Integrity and Stability

The spine is divided into three columns.

- Anterior column – composed of the ventral half of the disc and the vertebral body, including the anterior longitudinal ligament.
- Middle column – composed of the dorsal half of the disc and vertebral body and the posterior longitudinal ligament
- Posterior column – the dorsal bony complex (posterior arch) and the dorsal ligamentous complex, in-

**Chronic Back Pain and Spinal Instability, Table 1** Quantitation of Acute Instability for Subaxial Cervical, Thoracic, and Lumbar Injuries (The Point System)

Condition	Points Assigned
Loss of integrity of anterior and middle column	2
Loss of integrity of posterior columns	2
Acute resting translational deformity	2
Acute resting angulation deformity	2
Acute dynamic translation deformity exaggeration	2
Acute dynamic angulation deformity exaggeration	2
Neural element injury	3
Acute disc narrowing at the level of suspected pathology	1
Dangerous loading anticipated	1

(Panjabi 1994; White 1990)

cluding the supraspinous and interspinous ligaments and the ligamentum flavum.

Many authors have used a point system approach to quantify the extent of acute instability. White and Panjabi described the accumulation of 5 or more points as being indicative of spinal instability (Panjabi 1994; White 1990) (Table 1). They also described a stretch test in which the progressive addition of cervical traction weight was accompanied by clinical assessments and radiographs. The test was positive for instability when a disc interspace separation of greater than 1.7 mm, or a change in angle greater than 7.5 degrees between pre and post stretch measurements, was observed. Most clinicians do not employ this method due to the risks involved and its cumbersome nature. Flexion and extension radiographs or MRI (Dvorak 1991) may also be helpful in determining the degree of instability.

#### Acute Instability

##### Overt Instability

Overt instability is defined as the inability of the spine to support the torso during normal activity. This is usually acute in nature, e.g. after a trauma. It also has a chronic component, and may also occur in the setting of tumor, infection, or ► **degenerative disease**. It is characterized by circumferential loss of spinal integrity. Treatment may involve surgical stabilization, with or without decompression. The back pain experienced with overt instability is usually associated with soft tissue injury and muscle spasms (Fig. 1a).

##### Limited Instability

Limited instability is characterized by loss of either ventral or dorsal spinal integrity. Posterior column disruption is not always associated with instability, unless the



C

**Chronic Back Pain and Spinal Instability, Figure 1** (a) Fracture dislocation in the thoracolumbar spine representative of overt instability. (b) Wedge compression fracture elucidating limited instability.

posterior longitudinal ligament and the middle column are disrupted. Failure of the middle column represents an unstable injury (Denis 1983). Chronic forms of both overt and limited instability exist, especially when overt and limited forms do not heal adequately (Fig. 1b).

### Chronic Instability

#### Glacial Instability

Glacial instability is defined as spinal instability that is neither overt nor limited. It does not pose a significant risk for the rapid development of a spinal deformity. The deformity progresses gradually; like a glacier moving down a mountain. Glacial instability is associated with pain that is mechanical in nature. In managing this type of instability, one must factor in the degree of progression of deformity and the subjective complaint of pain. Causes include trauma, tumors and congenital defects (Fig. 2a).

#### Dysfunctional Segmental Motion

Dysfunctional segmental motion is a type of instability that is related to disc interspace or vertebral body degenerative changes, tumor, or infection. A deep and agonizing pain that is usually worsened by activity and improved by inactivity usually characterizes dysfunctional segmental motion. This type of pain is similar to that observed with glacial instability. This pain results from the exaggeration of reflex muscle activity, which picks up the slack from the inadequate intrinsic stability from the spine. The associated pain syndrome, as described here, is commonly known as mechanical low back pain (Fig. 2b).

### Treatment

When patients present with chronic low back pain, the initial management usually consists of non-surgical therapy; except in the presence of ► **cauda equina** syndrome, progressive neurologic deficit or profound motor weakness. Also, one may proceed directly to surgery in the presence of severe pain that is not sufficiently controlled with pain medications

#### Non-Surgical Treatment

- Bed rest helps reduce pressure on nerve roots and intradiscal pressure, which is lowest in the supine semi-Fowler position (Nachemson 1992). This, however, has been shown in subsequent studies to be a relatively ineffective form of treatment (Malmivaara 1995).
- Exercise, including physical therapy with low stress aerobic exercise, may help relieve symptoms and strengthen back muscles. Low stress aerobic exercise can minimize debility due to inactivity. Conditioning exercises for trunk muscles are also helpful if symptoms persist.
- Analgesics (e.g. NSAIDS) in the initial short-term period may be helpful. Opioids may be required for more intense pain.
- Muscle relaxants, such as cyclobenzaprine and methocarbamol, may help with pain of muscle spasm origin (myofascial component of pain).
- Epidural steroid injections may be of assistance in some cases of chronic pain.
- Modality (physical) treatments, including transcutaneous electrical nerve stimulation (TENS) and traction, qualify as physical treatments but may only pro-



**Chronic Back Pain and Spinal Instability, Figure 2** (a) Spondylolisthesis in the lumbar spine which is an example of glacial instability. (b) Lumbar canal stenosis and degenerative disc disease showing dysfunctional segmental motion.

vide minor relief for some patients. ► **Biofeedback** has been advocated for chronic low back pain (Bush 1985).

- Injection therapy, including trigger point and ligament injections, are controversial and are of equivocal efficacy. Acupuncture has been studied in randomized clinical trials for chronic low back pain. The studies have been mostly contradictory. This, however, should not discount the fact that they may be effective for a subset of people.

### Surgical Treatment

In patients with compressive lesions, surgery (decompression; e.g. ► **laminectomy**) is the next step when conservative therapy fails (Holdsworth 1963). Fusion instrumentation is appropriate in the refractory patient with mechanical low back pain. The goal of surgical intervention for mechanical low back pain is stabilization of unstable spinal segments. Spinal fusion is an accepted therapy for fracture/dislocation or acute instability that may result from tumor or infection. It also may be used in selected patients with glacial instability or dysfunctional segmental motion. It is important to note that the use of spinal instrumentation increases the fusion rate (Lorenz 1991), but not necessarily the clinical outcome.

### References

1. Benzel EC (2001) Biomechanics of Spine Stabilization: Stability and Instability of the Spine. AANS Press, pp 29–43
2. Bigos S, Bowyer O, Braen G et al. (1994) Acute Low Back Problems in Adults. Clinical Practice Guideline 14. AHCPR Publication No. 95-0642. Agency for Healthcare Policy and Research, Public Health Service, U.S. Department of Health and Human Services, Rockville, MD
3. Bush C, Ditto B, Feuerstein M (1985) A Controlled Evaluation of Paraspinal EMG Biofeedback in the Treatment of Chronic Low Back Pain. *Health Psychol* 4:307–321
4. Cunningham LS, Kelsey JL (1984) Epidemiology of Musculoskeletal Impairments and Associated Disability. *Am J Public Health* 74:574–579
5. Cypress BK (1983) Characteristics of Physician Visits for Back Symptoms: A National Perspective. *Am Journal of Public Health* 73:389–395
6. Denis F (1983) The Three Column Spine and its Significance in the Classification of Acute Thoracolumbar Spine Injuries. *Spine* 8:817–831
7. Dvorak J, Panjabi MM (1991) Functional Radiographic Diagnosis of the Lumbar Spine: Flexion-Extension and Lateral Bending. *Spine* 16:562–571
8. Gatchel RJ, Mayer TG, Capra P et al. (1986) Quantification of Lumbar Function, VI: The Use of Psychological Measures in Guiding Physical Functional Restoration. *Spine* 11:36–42
9. Holdsworth FW (1963) Fractures, Dislocations, and Fracture-Dislocations of the Spine. *J Bone Joint Surg* 45B:6–20
10. Lorenz M, Zindrick M (1991) A Comparison of Single Level Fusion With and Without Hardware. *Spine* 16:455–458
11. Malmivaara A, Hakkinen U, Aro T (1995) The Treatment of Acute Low Back Pain – Bed Rest, Exercises, or Ordinary Activity? *N Engl J Med* 322:351–355
12. Nachemson AL (1992) Newest Knowledge of Low Back Pain. A Critical Look. *Clin Orthop* 279:8–20
13. Panjabi MM, Lydon C (1994) On the Understanding of Clinical Instability. *Spine* 19:2642–2650
14. Percy M, Shepherd J (1983) Is there Instability in Spondylolisthesis? *Spine* 10:461–473
15. Waddell G, McCulloch JA, Kummel E et al. (1980) Non-organic Physical Signs in Low Back Pain. *Spine* 5:117–25
16. White AA, Panjabi MM (1990) *Clinical Biomechanics of the Spine*, 2<sup>nd</sup> edn. Lippincott, Philadelphia, pp 30–342

## Chronic Central Pain Models

- **Spinal Cord Injury Pain Model, Hemisection Model**



## Chronic Constriction Injury Model

### Synonyms

CCI Model

### Definition

This is a nerve injury model of persistent pain. It consists of a partial nerve injury, mostly used in rodents, that is produced by tying several ligatures around a nerve, such that these ligatures slightly constrict the nerve. This induces an incomplete nerve injury that entails behavioral signs of hyperalgesia in the animals.

- ▶ [Neuropathic Pain Model, Chronic Constriction Injury](#)
- ▶ [Neuropathic Pain Model, Partial Sciatic Nerve Ligation Model](#)
- ▶ [Nociceptive Processing in the Hippocampus and Entorhinal Cortex, Neurophysiology and Pharmacology](#)
- ▶ [Peptides in Neuropathic Pain States](#)
- ▶ [Purine Receptor Targets in the Treatment of Neuropathic Pain](#)

## Chronic Daily Headache

- ▶ [New Daily Persistent Headache](#)

## Chronic Daily Headache in Children

PATRICIA A. MCGRATH  
The Hospital for Sick Children and University of  
Toronto, Toronto, ON, Canada  
patricia.mcgrath@sickkids.ca

### Synonyms

Headache; CDH; Transformed Migraine

### Definition

Chronic daily headache (CDH) is an almost continual headache in the absence of organic pathology (Holden et al. 1994). This relatively new diagnostic category was created to characterize individuals who did not meet the criteria for episodic tension or migraine headaches, but instead presented with chronic daily pain.

### Characteristics

In 1994, Silberstein and colleagues proposed a new set of diagnostic criteria for chronic daily headache that included 4 types seen in clinical practice, ▶ [transformed migraine headache](#), ▶ [chronic tension type headache](#), ▶ [new daily persistent headache](#) and ▶ [hemicrania continua headache](#), as defined below (Silberstein et al. 1994). Gladstein and Holden (1996) evaluated whether these new criteria were adequate for diagnosing a clinical sample of 37 children with CDH. Almost half the

children (45%) did not fit within the four types of CDH. Instead, these children had a pattern of intermittent migraines with an underlying daily tension headache, thus leading the authors to propose a fifth diagnostic category of ▶ [comorbid headache](#).

### Proposed Diagnostic Classification for Pediatric Chronic Daily Headache

#### Transformed Migraine

A chronic daily (or near daily) headache that developed gradually over time from a pre-existing, well-defined migraine headache. Headache is longer than 4 h per day, can include a mixture of autonomic and tension-type symptoms and symptoms have progressed with increasing frequency and decreasing severity over at least 3 months.

#### Chronic Tension-type

Very frequent headaches (>180 episodes per year) that developed gradually over at least 3 months from pre-existing tension-type headache. Pain has pressing or squeezing quality, bilateral location and there is a relative absence of autonomic nervous system symptoms.

#### New Daily Persistent

Abrupt onset of head pain that continues on a daily basis, with no history of pre-existing migraine or tension-type headache. Pain episodes last longer than 4 h per day and have been present for greater than one month.

#### Hemicrania Continua

Daily unilateral headache for at least 1 month. Pain is continuous but fluctuating, moderately severe, lacks precipitating triggers and responds positively to indomethacin.

#### Comorbid Headache

Daily tension-type headache, accompanied by intermittent and less frequent episodes of well-defined migraine headache.

Large descriptive studies should be conducted for children to establish age and sex-related data on the clinical features of CDH in children. At present, our knowledge of CDH in children is derived primarily from a few case series (Esposito and Gherpelli 2004; Gladstein et al. 1993; Hershey et al. 2001). Such studies indicate that CDH typically has a bifrontal, rather than uni-lateral location. Children and adolescents often describe the headache as diffuse, e.g. “All over, or around my head”, instead of a specific region. Headache episodes vary widely in length from lasting only a few minutes to almost continuously. In my clinical experience, children usually report that the headache “lasts all day”. They do not know exactly when they first notice the headache in the morning – some children describing noticing it when they first open their eyes in bed, while other children notice the headache when they are brushing their teeth, eating breakfast, or dressing for school.

Children have similar difficulty in determining exactly when the headache ends each day – often noting that it is present until they fall asleep. Children rarely report that the headache disturbs their sleep at night.

Headache intensity also varies considerably among children. Some children report a consistently mild pain, while other children describe a severe and incapacitating headache. Some children report that the pain intensity varies throughout the day, while other children report that the pain is constant, regardless of the time of day or their activities. Some of the children, who rate their headache as very strong, do not appear distressed by their continual pain – almost exhibiting “► *la belle in-difference*”. They explain that the pain does not bother them because they have learned to adjust to it.

### Prevalence of CDH in Children

Prevalence estimates of headache in children range from 1.4–27% for migraine headache and from 6.3–49% for other types of headache (McGrath 2001). These estimates differ widely due to differences among epidemiological studies in the sampling method used to identify children, the age and sex of children studied, the diagnostic criteria used to classify headache, the country of origin and the presentation and analysis of data.

At present, we do not know the prevalence of CDH for children and adolescents in the general population according to age, gender and the diagnostic categories listed above. The overall rate of CDH has been estimated as low (<1%) in community samples (Abu-Arefeh and Russell 1994; Sillanpää et al. 1991), but this rate may underestimate the actual prevalence because most epidemiological studies of childhood headache have not determined prevalence by headache frequency (McGrath 2001). The prevalence of CDH for children who seek treatment at specialized pediatric clinics is not known, although in my experience approximately 15% of children with headache have CDH with half of these children experiencing an associated emotional problem. Rossi and colleagues (1992) describe a prevalence rate of 4.6% for children with daily headache and psychological problems in their clinical sample.

### Pathophysiology

Many questions remain about the pathophysiology of recurrent headache in children, especially CDH (Holden et al. 2001). As noted previously in the section on diagnostic classification, CDH has different expressions in children and adults and the different expressions may reflect several different etiologies or a developmental continuum. Most childhood headaches, including CDH, are not caused by an underlying disease or disorder. While a positive family history predisposes children to develop headache, many environmental, biological and psychological processes are relevant. Despite widely held beliefs that many environmental

and physical stimuli (e.g. foods, weather conditions and activities) can trigger recurrent headache attacks, the evidence base for these presumed triggers is negligible. Heredity is important, but certain cognitive, behavioral and emotional factors are critical for triggering attacks, increasing pain, prolonging disability or maintaining a cycle of almost daily headache (McGrath and Hillier 2001).

While CDH in children probably involves both central and peripheral nervous systems, the specific interplay of systems is not known. Similarly, the extent to which vascular and muscular components are involved is unknown and may differ according to the type of CDH. To date, no studies have examined the pathophysiology of CDH in children, so that our understanding is presumed rather than documented and based primarily on extrapolation from adult studies. For some cases with migraine features, presumed mechanisms include a neurogenic inflammatory cascade, vascular reactivity and serotonin (5-HT), while for other cases, mechanisms may include pericranial muscle tenderness or musculoskeletal abnormalities as noted recently for adults (Holden et al. 2001; Lipchik et al. 1996). Serotonergic dysregulation has been postulated as a common point of neurotransmitter abnormality in anxiety, depression and migraine (Rossi et al. 1992). In view of the association between CDH and features of depression and anxiety in a subset of children, serotonin dysfunction may also play a role in CDH.

### Risk Factors and Impact

Almost all studies of childhood headache evaluate demographic and psychosocial factors in an effort to identify potential risk factors that may predispose children to develop headache. However, only a few studies have focused on CDH. Holden and colleagues (1994) compared 3 groups of children (CDH, migraine and both CDH and migraine) with respect to the impact of headache, children’s coping and headache disability. Children with CDH had higher rates of concurrent psychiatric diagnoses, missed more school days and tended more to blame others as a coping mechanism in comparison to children with migraine headache. Galli and colleagues (2004) noted psychiatric disorders in approximately 64% of children with CDH, especially sleep and anxiety disorders. From my clinical experience, a subset of children with CDH also have long-standing emotional problems suggestive of mood disorders, anxiety disorders and somatoform disorders. Many of these children satisfy the existing IHS diagnostic criteria outlined for chronic tension-type headache unassociated with disorder of pericranial muscles (previously described as chronic psychogenic headache), even though these children do not necessarily satisfy the criteria for a DSM-IV diagnosis (as required for coding anxiety, etc. as a causative factor). At present, we do not know whether this subset of CDH is associated with

a particular one (or more) of the diagnostic categories listed above.

### Management of CDS

#### Drug Therapy

Drug therapies for treating children's headache include analgesics, ergot derivatives, serotonin receptor agonists, antiemetics,  $\beta$ -blockers, serotonin antagonists, tricyclic antidepressants, antihistamines, calcium channel blockers and antiepileptics (Levin 2001). Yet their efficacy has generally been accepted on the basis of studies with adults rather than demonstrated in controlled trials with children and adolescents. At present, we lack data about which drugs are best for children with CDH or its subtypes.

Dosing guidelines for prophylactic medication for children with CDH are based on their use for children with frequent migraine. Holden and colleagues (2001) recommend that only those children with severe headache who exhibited significant functional disability should be considered for prophylaxis. Rothner (2001) recommends that if effective, children should use prophylactic medication for 4–6 months and then be weaned. If not effective, the medication should be discontinued after 6–10 weeks and another medication tried. The dosing guidelines for the common prophylactic medications used for childhood headache are listed in Table 1. Randomized controlled trials are needed to evaluate the efficacy of the varied drug therapies for treating CDH in children and adolescents. In my clinical experience, many children benefit from a combined drug and non-drug protocol, including a low dose schedule of amitriptyline, a tricyclic antidepressant, combined with a cognitive-behavioral pain management program.

#### Nondrug Therapy

A diverse array of nondrug therapies are used to treat children's headache, including counseling, guided imagery, hypnosis, biofeedback, behavioral management, acupuncture, massage, chiropractic manipulation, homeopathic remedies, naturopathic approaches and herbal medicines (McGrath and Hillier 2001).

#### Cognitive-behavioral Therapies

Cognitive therapy, designed to modify an individual's beliefs, expectations and coping abilities, is an intrinsic component of all headache treatment. Health care providers educate families about the circumstances that cause headache, often counseling them about how they can alter those circumstances (e.g., lifestyle management, diet, sleep, exercise). In addition, children may learn specialized stress management techniques as part of a treatment program and families may receive guidance about how to minimize headache related disability. In some programs, therapists teach children how to use individual cognitive pain control methods,

such as attention and distraction, guided imagery and hypnosis to lessen their pain.

Behavior therapy, often used in combination with cognitive therapy, is targeted either for children themselves or for the adults who respond to them when they experience headache. At the initial consultation, health care providers may assess whether children's behaviors or those of key adults (parents, teachers or coaches) are influencing the pattern and severity of headache attacks. If so, they recommend how they should change their behaviors to improve pain control and lessen disability. Strong and consistent evidence supports the efficacy of most cognitive and behavioral therapies for relieving children's headache. However, all studies have focused on either migraine or general recurrent headache, so that we lack definitive evidence about the efficacy of these cognitive-behavioral therapies specifically for CDH. Alternatively, psychologists and therapists counsel families about the impact of their behaviors and assist families to make required changes using operant conditioning programs.

Many of these cognitive-behavioral therapies share a common "child-centered" focus, addressing the unique causative and contributing factors for each child's headache. Although the evidence base supporting their efficacy for relieving childhood headache is strong, there are no controlled trials evaluating their efficacy for children with CDH.

#### Physical Techniques

Physical techniques include thermal stimulation, visual modulation, transcutaneous nerve stimulation (TENS), acupuncture, massage and chiropractic or osteopathic manipulation. Although each technique has been used to treat headache in children, almost no studies have been conducted to evaluate their efficacy objectively. Instead, physical techniques are recommended primarily on the basis of clinical experience and anecdotal information.

#### Summary

CDH is a relatively new diagnostic category that describes an almost continual headache in the absence of organic pathology. The management of CDH in children is exceptionally challenging. The current principles guiding our management of CDH in children and adolescents are extrapolated from the existing literature on childhood headache, CDH in adults and our clinical experience.

A child-centered focus is particularly important in the treatment of CDH because it is not caused by an underlying disease or disorder. Optimal treatment of CDH begins with the differential diagnosis and a comprehensive pain assessment to identify relevant causative and contributing factors. These factors may vary among children, even children presenting with seemingly identical headache symptoms. In our experience, children benefit from a combined drug and nondrug regimen.

**Chronic Daily Headache in Children, Table 1** Drugs used in the prophylaxis of childhood headache

Drug	Dosage	Comments
Beta-blockers		
Propranolol	1–3 mg kg <sup>-1</sup> day <sup>-1</sup> as b.i.d.	Side effects: fatigue, bradycardia, hypotension, depression. Contraindications: asthma, heart block, bradyarrhythmias, diabetes, congestive heart failure. Avoid abrupt withdrawal.
Tricyclic antidepressants		
Amitriptyline	0.2–2.0 mg kg <sup>-1</sup> day <sup>-1</sup> as t.i.d. dose	Side effects: weight gain, drowsiness, anticholinergic effects. Contraindication: cardiac disease.
Serotonin antagonists		
Pizotifen	0.5 mg t.i.d. (may use 0.5–1.5 mg kg <sup>-1</sup> as t.i.d. dose)	Side effects: sedation, weight gain. Start small dose at night and increase at weekly intervals to t.i.d. dose.
Methysergide	2–6 mg day <sup>-1</sup>	Side effects: retroperitoneal fibrosis. Discontinue for 1 month every 3–6 months. Use in adolescents only.
Calcium channel blockers		
Flunarizine	5 mg day <sup>-1</sup>	Side effects: bradycardia, hypotension, weight gain, drowsiness. Contraindications: depression, extrapyramidal disorders.
Antihistamines		
Cyproheptadine	Age 2–6 yr: 2 mg q8–12 h (max 12 mg day <sup>-1</sup> ) Age 7–14 yr: 4 mg q8–12 h (max 16 mg day <sup>-1</sup> )	Side effect: drowsiness
Antiepileptics		
Valproate	10–50 mg kg <sup>-1</sup> day <sup>-1</sup> as b.i.d. dose	Side effects: hepatotoxicity, thrombocytopenia. Start at low dose and increase at weekly intervals.
Gabapentin	300–400 mg t.i.d.	Start at 100 mg t.i.d. and increase daily by 100 mg t.i.d. to maximum dose.

Abbreviations: b.i.d., twice a day; t.i.d., three times a day; q 8–12 h, every 8–12 h (Levin 2001)

Although the specific drug(s) are selected in accordance with the needs of individual children, our clinical experience has led us to begin treatment with a combined protocol of amitriptyline concurrent with a cognitive-behavioral pain management program. Children learn specific nondrug pain strategies to complement the drug therapy, while a therapist assists them to identify and address any contributing factors (e.g. unresolved situation-specific stressors, excessive disability and emotional problems). Some children may also receive a formal psychiatric evaluation.

Although special effort should be expended towards studying children and adolescents with CDH, a dual challenge for the future is to integrate a child-centered approach more efficiently into clinical practice. We need to evaluate therapies according to individual children, beginning by identifying which children respond optimally (i.e. immediately or with a major improvement) to drug, nondrug and multimodal therapies. Future studies should be designed to identify the child characteristics that should enable us to better match treatments to individual children, as well as to headache type.

## References

1. Abu-Arefeh I, Russell G (1994) Prevalence of headache and migraine in schoolchildren. *Bmj* 309:765–769
2. Esposito SB, Gherpelli JL (2004) Chronic daily headaches in children and adolescents: a study of clinical characteristics. *Cephalalgia* 24:476–482
3. Galli F, Patron L, Russo PM et al. (2004) Chronic daily headache in childhood and adolescence: clinical aspects and a 4-year follow-up. *Cephalalgia* 24:850–858
4. Gladstein J, Holden EW (1996) Chronic daily headache in children and adolescents: a 2-year prospective study. *Headache* 36:349–351
5. Gladstein J, Holden EW, Peralta L et al. (1993) Diagnoses and symptom patterns in children presenting to a pediatric headache clinic. *Headache* 33 497–500
6. Hershey AD, Powers SW, Benti AL et al. (2001) Characterization of chronic daily headaches in children in a multidisciplinary headache center. *Neurology* 56:1032–1037
7. Holden EW, Gladstein J, Trulsen M et al. (1994) Chronic daily headache in children and adolescents. *Headache* 34:508–514
8. Holden EW, Bachanas P, Kullgren K et al. (2001) Chronic Daily Headache in Children and Adolescents. In: McGrath PA, Hillier LM (eds) *The Child with Headache: Diagnosis and Treatment*. IASP Press, Seattle, pp 221–241
9. Levin SD (2001) Drug Therapies for Childhood Headache. In: McGrath PA, Hillier LM (eds) *The Child with Headache: Diagnosis and Treatment*. IASP Press, Seattle, pp 109–127



10. Lipchik GL, Holroyd KA, France CR et al. (1996) Central and peripheral mechanisms in chronic tension-type headache. *Pain* 64:467–475
11. McGrath PA, Hillier LM (2001) *The Child with Headache: Diagnosis and Treatment*. IASP Press, Seattle
12. Rossi LN, Cortinovis I, Bellettini G et al. (1992) Diagnostic criteria for migraine and psychogenic headache in children. *Dev. Med Child Neurol* 34:516–523
13. Rothner AD (2001) Differential Diagnosis of Headaches in Children and Adolescents. In: McGrath PA, Hillier LM (eds) *The Child with Headache: Diagnosis and Treatment*. IASP Press, Seattle, pp 57–76
14. Silberstein SD, Lipton RB, Solomon S et al. (1994) Classification of daily and near-daily headaches in the headache clinic. Proposed revision to the International Headache Society criteria. In: Olesen J (ed) *Frontiers in Headache Research: Headache Classification and Epidemiology*, vol 4. Raven Press, New York, pp 117–126
15. Sillanpää M, Piekkala P, Kero P (1991) Prevalence of headache at preschool age in an unselected child population. *Cephalalgia* 11:239–242

## Chronic Gynaecological Pain, Doctor-Patient Interaction

R. WILLIAM STONES  
Princess Anne Hospital, University of Southampton,  
Southampton, UK  
r.w.stones@soton.ac.uk

### Synonyms

Doctor-Patient Communication; Therapeutic Relationships

### Definition

The proposition that patient outcomes in ► **chronic pelvic pain** are influenced by the quality of interaction between patient and doctor.

### Characteristics

While it is a truism that across the spectrum of illness and disease, patients link their outcomes to experiences in consultations with particular doctors, there are specific factors to consider in the case of chronic gynaecological pain. The nature of the condition and associated symptoms mean that women are often distressed and anxious about associated issues such as fertility and sexuality. Women frequently report unsatisfactory and dismissive attitudes during consultations for pain (Grace 1995) and this has been ascribed to inappropriately persistent mechanistic views of pain causation (Grace 1998). Gynaecologists trained into a technical diagnostic and therapeutic role experience a dissonance between patient expectations for explanation and support and their own approach of detecting disease and disengaging once its apparent absence is established, despite patients' ongoing symptoms of pain.

### What Do Doctors Think About Women with Pelvic Pain? (Selfe et al. 1998a)

To obtain primary data on medical attitudes, focus group discussions were conducted with groups of general practitioners, gynaecologists and patients. Themes common to all groups were expression of the need to find a pathological cause for the pain, something that would provide a diagnosis. Issues relating to time were discussed by all groups and this was particularly related by hospital gynaecologists and GPs to aspects of communication. Both groups of doctors were aware of the possible stress related and psychological influences of pain, although patients seemed to avoid direct discussion of psychological factors which may have been related to their pain. Themes particular to general practitioners were diagnosis by exclusion, especially with respect to ► **irritable bowel syndrome (IBS)** and ► **pelvic inflammatory disease (PID)**. They stated that the lack of a firm diagnosis meant that dealing with patients with CPP could be difficult, particularly those patients who have experienced a 'negative' laparoscopy. If no visible pathology was seen at laparoscopy to account for the pain, GPs found it difficult to know how to proceed with persistent patients. A provisional diagnosis, even if it was considered imprecise, could provide a label by which to justify the patient's symptoms. This applied especially to IBS and "pelvic congestion"

GPs recognised the value of effective communication, but acknowledged that a good rapport with a patient was unlikely to develop after one short visit. GPs also commented on the complexity of a complaint in which it was necessary to sort out "the emotional components of the problem"

Hospital gynaecologists implied that identifying pathology would somehow validate the pain as 'real'. When visible pathology had been excluded by previous referrals to other specialities such as gastroenterology, comments included "some patients are going to be afraid that you're going to think it's a psychological problem" and "they [the patients] come in and they say, I'm not mad you know" There was a clear awareness that an anxious patient may make diagnosis difficult and that patients are alarmed by the suggestion of a psychological diagnosis, because they will be 'labelled'. Hospital gynaecologists were acutely aware of the time sometimes necessary to deal effectively with patients suffering from CPP. Development of rapport was found to be "difficult to establish in one outpatient session" If needed, consultation time was extended, but doctors were concerned that "you're filling up the waiting room" and there was anxiety that if, for example, a patient starts to divulge adverse psychosexual experiences, it may well become a lengthy consultation; the doctor thinks "Oh hell! I've got three patients in the waiting room" After a negative laparoscopy hospital gynaecologists felt the need to look for other causes, asking the question "Have I missed something"?

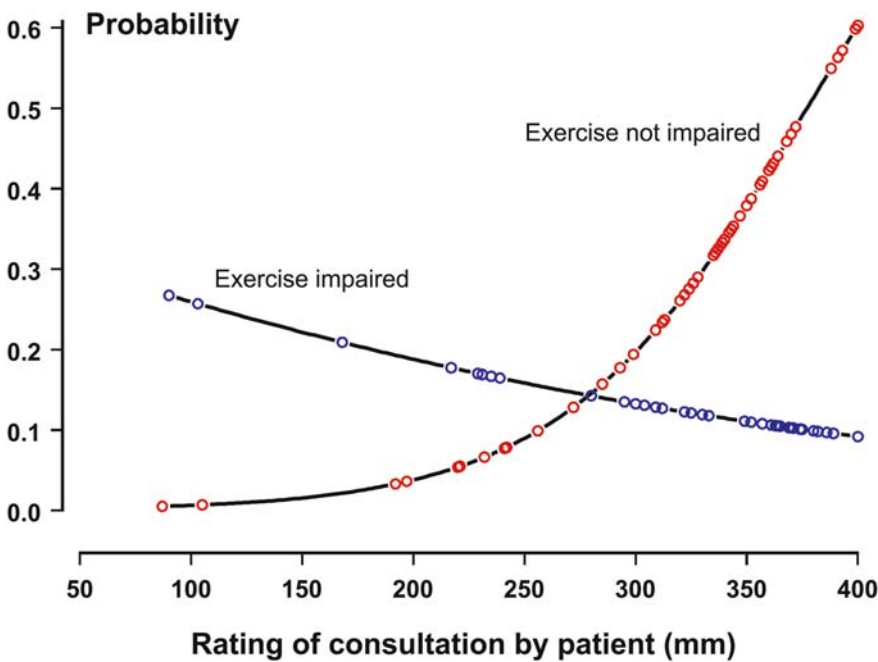
They recognised this as problematic, as the patient is disheartened by not having a diagnosis, a 'label' by which to define her problem.

It was hypothesised that a propensity to inwardly directed ► **hostility** might underlie some of the difficulty experienced by some patients in establishing rapport (Fry and Stones 1996). However, further work highlighted the importance of the individual clinician and consultation in influencing outcomes. Disease factors are of course also important; in statistical models the interaction between disease states and the consultation setting was identified. In women referred to a hospital gynaecology department for symptoms present for at least 6 months, continuing pain 6 months after an initial consultation was predicted by the presence of endometriosis, but also by the patient's initial report of pain interfering with exercise, her rating of the initial medical consultation as less satisfactory and the individual clinician undertaking the consultation. Interestingly, the outcomes were not affected by the doctor's grade or gender (Selfe et al. 1998b), although there has been much attention in women's health literature to the gender imbalance among gynaecologists and the mismatch with women's preference to see a female doctor in many countries. In this study there was an interaction between the impact of pain on exercise and the extent to which the patient's rating of the quality of the consultation was associated with probability of pain resolution. For the group where exercise was not impaired, there was a significant association, whereas this was not the case among those in whom exercise was impaired by pain (Fig. 1). It may be that those with

less impairment are more amenable to the therapeutic effect of a good consultation.

#### Lasting Influences of Consultations

The dimensions within which women recalled consultations 6 months later were examined. Lasting impressions of the doctor-patient interaction that had taken place could be characterised in terms of the constructs "affect", "expectation" and "cognition" (Stones et al. 2006). The first describes social interaction and the emotional response felt by the patient. It relates to whether the doctor is recalled as approachable and expressing a friendly interest in and concern for the patient. Opposite recollections would not necessarily mean that the doctor had been unpleasant or rude to the patient, but may simply reflect a businesslike manner, a hurried consultation or the use of technical jargon. The construct "cognition" relates to memory and understanding, a pre-requisite for adherence to treatment. Often patients do not understand what they have been told, are afraid to ask questions and forget much of what has been said during a consultation. Under such circumstances it is not unreasonable that patients who were given little information or could not remember much of the detail of the encounter would find it unsatisfactory. The items loading to the subscale denoted "expectation" relate to the patient's wish to understand her problem and what the implications may be for the future. Women expected to be given a diagnosis and as a result a cure. If this expectation was not fulfilled, patients described the situation as 'disappointing' or felt that they had been 'fobbed off'. In the present study, the item "I have re-



**Chronic Gynaecological Pain, Doctor-Patient Interaction, Figure 1** Fitted probabilities of pain resolution and women's rating of initial consultation, with and without exercise impairment. (Reproduced with permission from Selfe et al. 1998b).

ceived enough information about my condition” loaded to “expectation” rather than to “cognition”. This suggests that, rather than the quantity, the appropriateness of information given in relation to expectations is important in determining satisfaction.

Lower current levels of pain at follow up were associated with highly significantly more favourable recall of the original consultation in terms of the “expectation” subscale. However, the impact of an initial consultation rated positively by the patient on the subscales “affect” and “expectation”, but not “cognition”, was still evident after controlling for current pain intensity. Thus, the experience of the initial consultation appeared to have an influence on the patient 6 months later irrespective of pain outcome. It is concluded that the doctor’s affect and the extent to which expectations were met rather than simple information provision are the elements of communication through which this influence is mediated.

#### Reassurance

Relief of symptoms by provision of reassurance is likely to be one of the doctor’s aims following negative investigations such as laparoscopy, but can also arise from explanation of normal findings at an initial consultation, for example where a careful history and physical examination indicates a minimal likelihood of infection or endometriosis. However, there are mixed findings from research on the impact of assessment as therapy. In a randomised trial design, an ultrasound scan used as a basis for counselling about normal findings was found to be helpful in relieving symptoms (Ghaly 1994). The reassuring effect of laparoscopy has been reviewed (Price and Blake 1999). However, this approach can be counterproductive, as shown in a study where women were shown photographs of laparoscopic findings in order to reinforce counselling, where no benefit was seen (Onwude et al. 2004).

In conclusion, doctors need to be aware of the importance of establishing a therapeutic relationship through effective consulting behaviour that meets patients’ expectations and exploits opportunities for provision of reassurance and support.

#### References

1. Fry RPW, Stones RW (1996) Hostility and doctor-patient interaction in chronic pelvic pain. *Psychother Psychosom* 65:253–257
2. Ghaly AFF (1994) The psychological and physical benefits of pelvic ultrasonography in patients with chronic pelvic pain and negative laparoscopy. A random allocation trial. *J Obstet Gynaecol* 14:269–271
3. Grace VM (1995) Problems of communication, diagnosis, and treatment experienced by women using the New Zealand health services for chronic pelvic pain: a quantitative analysis. *Health Care Women Int* 16:521–535
4. Grace VM (1998) Mind / body dualism in medicine: The case of chronic pelvic pain without organic pathology –A critical review of the literature. *Int J Health Serv* 28:127–151
5. Onwude JL, Thornton JG, Morley S et al. (2004) A randomised trial of photographic reinforcement during postoperative counselling after diagnostic laparoscopy for pelvic pain. *Eur J Obstet Gynecol Reprod Biol* 112:89–94

6. Price JR, Blake F (1999) Chronic pelvic pain: The assessment as therapy. *J Psychosom Res* 46:7–14
7. Selfe SA, van Vugt M, Stones RW (1998a) Chronic gynaecological pain: an exploration of medical attitudes. *Pain* 77:215–225
8. Selfe SA, Matthews Z, Stones RW (1998b) Factors influencing outcome in consultations for chronic pelvic pain. *J Womens Health* 7:1041–1048
9. Stones RW, Lawrence WT, Selfe SA (2006) Lasting impressions: influence of the initial hospital consultation for chronic pelvic pain on dimensions of patient satisfaction at follow-up. *J Psychosom Res* 60:163–167

C

## Chronic Illness Problem Inventory

### Definition

The Chronic Illness Problem Inventory is a 65-item instrument developed to measure patient functioning in the areas of physical limitations, psychosocial functioning, health care behaviors, and marital adjustment.

► Pain Inventories

## Chronic Inflammatory Demyelinating Polyneuropathy

### Synonym

CIDP; chronic relapsing polyneuropathy

### Definition

Chronic inflammatory demyelinating polyneuropathy is caused by demyelination due to an immune reaction. It is characterized by progressive weakness and impaired sensory function in the arms and legs. It is related to Guillain Barré syndrome, and is sometimes considered to be the chronic version of that disease.

► Inflammatory Neuritis

## Chronic Low Back Pain, Definitions and Diagnosis

CHRISTOPHER J. WINFREE

Department of Neurological Surgery, Neurological Institute, Columbia University, New York, NY, USA  
cjw12@columbia.edu

### Synonyms

Ankylosing spondylitis; Chronic pain; CT myelography; Diagnostic block; Discogenic pain; Facet joint; Fibromyalgia; Internal disc disruption; Intervertebral disc; Low back pain; Paget’s disease; Pathological fracture; Provocative discography; Reiter’s syndrome; Sacroiliac joint; Spondyloarthropathy; Spondylolisthesis; Zygapophyseal joint

## Definition

Chronic ► **low back pain** is defined as pain localized to the region bordered by L1 above, S1 below, and the erector spinae muscles laterally (Merskey 1994), which lasts for more than 3 months (Merskey 1986). Chronic low back pain is often associated with pain radiating to the buttock or legs; however, it is useful to distinguish between these distinct pain syndromes, as they are typically treated differently.

## Characteristics

### General

Men and women are affected equally, most commonly during the 4–6<sup>th</sup> decades (Deyo 2001). Chronic low back pain is the most costly of the work-related disabilities (Andersson 1999). The lumbar spine is a complex anatomical region, with a number of structures that may serve as pain generators to be discussed below.

### History

The initial assessment of the chronic low back pain patient includes a careful medical history. The duration and severity of symptoms, predisposing factors, exacerbating factors, alleviating factors, and treatments may all be explored in the patient interview. Information regarding occupational history, disability, litigation, psychosocial influences, and secondary gain may also be gleaned during the initial discussion. It is important to inquire about neurological function, such as weakness, bowel and bladder function, and sexual function, to establish whether neurological compromise is present, as treatment of these patients will likely proceed in a more urgent manner. It is also important to document a baseline level of pain upon which to judge efficacy of interventions, if any.

### Physical Exam

The physical exam is generally helpful but not typically sensitive or specific in the setting of chronic low back pain. The astute observer may discern peculiar movements or postures characteristic of the back pain patient. For example, these patients sometimes sit bent forward at the waist, as hyperextension often aggravates low back symptoms. Some patients fail to get comfortable, and spend the time during the interview switching positions, or alternating standing and sitting.

### Imaging

Conventional roentgenography is rapid, inexpensive, and best suited for inspection of the osseous structures. Vertebral fracture, osteoporosis, loss of disc height, end plate changes, facet hypertrophy, and alignment deformity are all readily seen on conventional X-rays. Characteristic bony changes of selected spondyloarthropathies are also readily identifiable with this modality. The typical static images include anteroposterior and lateral lumbar and sacral views, left and right lateral lumbar

oblique (for inspection of the neural foraminae), and a cone down lateral sacral view. Dynamic images to assist in the evaluation of spinal stability include lateral flexion and extension views. Magnetic resonance imaging is the best modality available for evaluation of the soft tissue structures of the spine. The ► **intervertebral discs**, ligaments, neural structures, and osseous structures are all well seen. Typically, non-contrast imaging is all that is required; however, the use of contrast may be useful in the setting of tumor, malignancy, or previous surgery. Caution must be exercised in the interpretation of positive findings on MRI, as over half of asymptomatic subjects will have at least one abnormality on MR imaging (Jensen 1994). CT scanning is a vital part of ► **provocative discography**, providing detailed anatomical data on the morphology of the intervertebral discs in question. ► **CT myelography** provides the optimum contrast between neural and non-neural structures. Subtle nerve root compression or spinal canal encroachment invisible on MRI may be obvious on CT myelography. Bone scanning has limited but specific uses in the imaging of chronic back pain. It may be useful in the evaluation of suspected pseudoarthrosis at a previous fusion site, or also of malignancy or infection.

### Discogenic Pain

► **Discogenic pain** is defined as pain from the disc itself and not surrounding structures compressed by the disc. It is probably the most common cause of chronic low back pain, with ► **internal disc disruption** present in approximately 40% of cases (Schwarzer 1995a). These patients often describe pain localized to the low back, often accompanied by pain referred to the hip, buttock, or groin. Pain that radiates to the lower extremities may be patchy or “sclerotomal” in nature rather than dermatomal, as seen in herniated discs. These patients typically report that their pain is aggravated by standing or sitting and relieved by lying down, presumably since this position takes the pressure off the intervertebral discs. The intervertebral disc receives innervation along at least the outer third of the annulus (Coppes 1997). The disc may become painful when it undergoes disruption; however, nonspecific degenerative changes are not thought to be specifically painful (Moneta 1994). These changes may be obvious on conventional imaging studies, and include loss of height, rupture, end plate changes, and dehydration. Other, subtler changes, such as internal disc disruption (IDD), may only be revealed as small radial fissures on CT imaging following discography (Vanharanta 1988). Provocative discography consists of both physiologic and radiographic assessment, and is used to establish whether a degenerated disc is a pain generator in the chronic low back pain patient. It involves the fluoroscopic placement of a needle into the intervertebral disc of the awake patient, and subsequent injection of contrast dye. Intradiscal insertion and injection pressures are measured. A positive discogram



occurs when the patient's back pain is reproduced when dye is injected into a particular disc at modest pressures. A negative discogram occurs when the pain on injection only occurs at extremely high pressures, or does not match the patient's normal pain. A complete discogram always includes the injection of a normal control disc, to exclude the possibility of non-specific patient pain responses to injection. Once the procedure is complete, high resolution CT scanning is performed to illustrate the morphology of the injected discs. Typically, positive discs show some evidence of internal disruption, with extravasation of contrast beyond the inner confines of the annulus. The key diagnostic criteria are the presence of concordant pain in a radiographically demonstrated degenerated disc. When careful technique is performed using these rigid criteria, the false positive rate for provocative discography approaches 0% (Walsh 1990).

### Zygapophyseal Joint Pain

The lumbar ► **facet joints**, or ► **zygapophyseal joints**, are synovial joints that receive their segmental innervation from the medial facet branch of the posterior division of the respective spinal nerve (Bogduk 1979). The role of facet joint arthropathy in the pathogenesis of low back pain was recognized early in the 20<sup>th</sup> Century (Ghormley 1933). These patients typically have low back pain that may radiate across the buttock or thigh. One estimate of its incidence in a low back pain population was 15%, based upon diagnostic blockade (Schwarzer 1994). As in other forms of low back pain, there are no reliable, reproducible diagnostic criteria (Jackson 1988; Schwarzer 1994). Injection of the joint or its innervating fibers using a double block technique to help reduce the influence of the placebo effect, and to increase the sensitivity and specificity, may represent the most reliable diagnostic method (Schwarzer 1994). This technique involves the injection of facet joint (or the medial facet branch) on one visit, followed by a second confirmatory injection at a separate visit. A positive response occurs when the patient reports >50% relief with both blocks.

### Sacroiliac Joint Pain

The ► **sacroiliac joint** is a diarthrodial joint with limited mobility, receiving its innervation from the lumbosacral roots. Thought to be an important contributor to chronic low back pain, one estimate of its incidence in a selected population of low back pain was 19% (Maigne 1996). Pain may be located across the low back with radiation to the buttock or groin, as in other forms of low back pain. Some patients have tenderness over the sacroiliac joint. Despite the myriad of specific physical maneuvers designed to provoke a positive response in patients with sacroiliac joint pain, no test alone or in combination with others is reliable when compared with diagnostic blockade of the joint itself (Dreyfuss

1996). Radiographic imaging is likewise unhelpful (Schwarzer 1995b).

### Spinal Instability

► **Spondylolisthesis** consists of facet joint arthropathy combined with disc degeneration, resulting in one vertebral body subluxing over another (Mardjetko 1994). Common at L4-5 and L5-S1, such movement may be due to trauma, degenerative changes, congenital defects, or ► **pathological fracture**. X-rays readily demonstrate spondylolisthesis, and may further show movement of the vertebral bodies in relation to each other on dynamic views.

### Other Causes

The spondyloarthropathies are a group of rheumatologic diseases that typically generate chronic low back pain that is worst upon awakening, and improves with activity (McCowin 1991). ► **Ankylosing spondylitis** commonly affects young adult males, causes low back pain, decreased spinal range of motion, and has characteristic bony changes on spine imaging. ► **Reiter's syndrome**, another common cause of arthritis and low back pain in men, consists of the triad of arthritis, conjunctivitis, and urethritis. ► **Paget's disease** is a common cause of back pain in the elderly (Mazanec 1999). Characteristic findings on history are deep, arthritic pain, and on imaging are localized bony overgrowths. ► **Fibromyalgia** is a common disorder causing back pain, associated with other conditions such as headache and irritable bowel syndrome. Radiographic investigations are typically normal. Diagnosis is based upon the symptoms of widespread pain and discreet trigger points (Mazanec 1999).

### ► Disability, Fear of Movements

### References

1. Andersson GBJ (1999) Epidemiologic Features of Chronic Low Back Pain. *Lancet* 354:581–585
2. Bogduk N, Long DM (1979) The Anatomy of the so-called "Articular Nerves" and their Relationship to Facet Denervation in the Treatment of Low-Back Pain. *J Neurosurg* 51:172–177
3. Coppes MH, Tamaki T, Hayashi N et al. (1997) Innervation of "Painful" Lumbar Discs. *Spine* 22:2342–2350
4. Deyo RA, Weinstein JN (2001) Low Back Pain. *N Engl J Med* 344:363–370
5. Dreyfuss et al. (1996) The Value of Medical History and Physical Examination in Diagnosing Sacroiliac Joint Pain. *Spine* 21:2594–2602
6. Ghormley RK (1933) Low Back Pain: With Special Reference to the Articular Facets, with Presentation of an Operative Procedure. *JAMA* 101:1773–1777
7. Jackson RP, Jacobs RR, Montesano PX (1988) Facet Joint Injection in Low-Back Pain: A Prospective Statistical Study. *Spine* 13:966–971
8. Jensen MC, Brant-Zawadzki MN, Obuchowski N et al. (1994) Magnetic Resonance Imaging of the Lumbar Spine in People without Back Pain. *N Engl J Med* 331:69–73
9. Maigne J-Y, Aivaliklis A, Pfefer F (1996) Results of Sacroiliac Joint Double Block and Value of Sacroiliac Pain Provocation Tests in 54 Patients with Low Back Pain. *Spine* 21:1889–1892

10. Mardjetko SM, Connolly PJ, Shott S (1994) Degenerative Lumbar Spondylolisthesis: A Meta-Analysis of Literature 1970–1993. *Spine* 19:2256–2265
11. Mazanec DJ (1999) Evaluating Back Pain in the Elderly. *Clev Clin J Med* 66:89–99
12. McCowin PR, Borenstein D, Wiesel SW (1991) The Current Approach to the Medical Diagnosis of Low Back Pain. *Ortho Clin North Am* 22:315–325
13. Merskey H (1986) Classification of Chronic Pain: Descriptions of Chronic Pain Syndromes and Definitions of Pain Terms. *Pain* 3:1–225
14. Merskey H, Bogduk N (1994) Classification of Chronic Pain: Descriptions of Chronic Pain Syndromes and Definitions of Pain Terms, 2<sup>nd</sup> edn. IASP Press, Seattle, pp 11–36
15. Moneta GB, Videman T, Kaivanto K et al. (1994) Reported Pain during Lumbar Discography as a Function of Annular Ruptures and Disc Degeneration: A Re-Analysis of 833 Discograms. *Spine* 19:1968–1974
16. Schwarzer AC, Aprill CN, Derby R et al. (1994) Clinical Features of Patients with Pain Stemming from the Lumbar Zygapophysial Joints: Is the Lumbar Facet Syndrome a Clinical Entity? *Spine* 19:1132–1137
17. Schwarzer AC et al. (1995a) The Prevalence and Clinical Features of Internal Disc Disruption in Patients with Chronic Low Back Pain. *Spine* 20:1878–1883
18. Schwarzer AC, Aprill CN, Bogduk N (1995b) The Sacroiliac Joint in Chronic Low Back Pain. *Spine* 20:31–37
19. Vanharanta H, Sachs BL, Spivey M et al. (1988) A Comparison of CT/Discography, Pain Response and Radiographic Disc Height. *Spine* 13:321–324
20. Walsh TR, Weinstein JN, Spratt KF et al. (1990) Lumbar Discography in Normal Subjects: A Controlled, Prospective Study. *J Bone Joint Surg Am* 72A:1081–1088

## Chronic Migraine

### Definition

Migraine headache occurring more than 15 days per month. Typically, a patient has a remote history of episodic migraine which slowly increases in frequency over time to a near daily headache with migraine features. In many instances the patient is overusing analgesics.

- ▶ New Daily Persistent Headache

## Chronic Neural Sensitization

- ▶ Visceral Pain Model, Irritable Bowel Syndrome Model

## Chronic Neuropathic Pain

### Definition

Chronic pain caused by dysfunction of or damage to the nervous system.

- ▶ Pain Treatment, Implantable Pumps for Drug Delivery

## Chronic Pain

### Definition

Pain that persists on a constant basis for three months or more. Some researchers and clinicians use a timeline of six months or more. Chronic pain rarely has a known cause, and may be hard to localize in the body. Treatment is usually limited to general measures of pain control. Emotive symptoms are commonly an important component of the suffering associated with chronic pain. The character of a chronic pain signal is often misinterpreted or grossly distorted. There is often a measurable imbalance between pronociceptive and antinociceptive forces consistent with the perception of pain. No definition of chronic pain exists for newborns, but prolonged pain has been defined as that lasting several hours or days.

- ▶ Acute Pain, Subacute Pain and Chronic Pain
- ▶ Amygdala, Pain Processing and Behavior in Animals
- ▶ Assessment of Pain Behaviors
- ▶ Chronic Low Back Pain, Definitions and Diagnosis
- ▶ Depression and Pain
- ▶ Impact of Familial Factors on Children's Chronic Pain
- ▶ Muscle Pain, Fibromyalgia Syndrome (Primary, Secondary)
- ▶ Pain Assessment in Neonates
- ▶ Pain in the Workplace, Risk factors for Chronicity, Job Demands
- ▶ Pain Inventories
- ▶ Pain Treatment, Intracranial Ablative Procedures
- ▶ Pain Treatment, Motor Cortex Stimulation
- ▶ Physical Exercise
- ▶ Postoperative Pain, Persistent Acute Pain
- ▶ Prevalence of Chronic Pain Disorders in Children
- ▶ Psychiatric Aspects of Pain and Dentistry
- ▶ Psychological Treatment of Chronic Pain, Prediction of Outcome
- ▶ Thalamus, Clinical Pain, Human Imaging

## Chronic Pain Disorder Prevalence in Children

- ▶ Prevalence of Chronic Pain Disorders in Children

## Chronic Pain in Children, Physical Medicine and Rehabilitation

JOYCE M. ENGEL<sup>1</sup>, DEBORAH A. O'ROURKE<sup>2</sup>  
<sup>1</sup>Department of Rehabilitation Medicine, University of Washington, Seattle, WA, USA  
<sup>2</sup>College of Nursing and Health Sciences, University of Vermont, Burlington, VT, USA

knowles@u.washington.edu,  
deborah.orourke@uvm.edu

### Synonyms

Pediatric Physical Therapy; Occupational Therapy in Children; Pediatric Physiotherapy

### Definition

Physical medicine and rehabilitation are core components of current multimodal and multidisciplinary approaches to chronic pain management and include the disciplines of physical therapy and occupational therapy. Physical therapists apply a wide range of physical and behavioral interventions to reduce pain, prevent impairment and disability as well as to promote function. Occupational therapists are primarily concerned with the psychosocial and environmental factors that contribute to pain and have an impact on an individual's daily activities and participation (Engel and Kartin 2004; International Association for the Study of Pain ad hoc Subcommittee for Occupational Therapy / Physical Therapy Curriculum 1994).

### Characteristics

Physical therapists and occupational therapists are primarily, although not exclusively, involved in rehabilitation programs for children with chronic musculoskeletal pain. Many diseases, injuries and disabling conditions are associated with chronic musculoskeletal pain (Engel and Kartin 2004). These include pain associated with physical diseases (e.g. arthritis), pain that is secondary to a physical disability (e.g. cerebral palsy (CP) and pain that may occur without an identifiable cause (e.g. complex regional pain syndrome).

### Rehabilitation Conceptual Models

Rehabilitation interventions are based on the biopsychosocial model of health, functioning and pain. As an example, Loeser and Fordyce's biopsychosocial model (1983) of pain is conceptualized into four domains, nociception, pain, suffering and pain behavior. A child may experience some, but not all, domains. Some children with chronic pain may experience pain and suffering and demonstrate pain behaviors in the absence of nociception. Developmental aspects are also critical to consider for the clinical assessment and management of chronic pain in children. The ability to describe and self-report pain and suffering is limited in young children and in children with cognitive or communication impairments, so that it is important to evaluate and monitor a child's overt pain behaviors. For some children with physical disabilities (e.g. CP), the range of potential pain behaviors may also be reduced secondary to paralysis, muscle ► [contractures](#), ► [joint deformities](#) and communication impairments. In this situation, family members and caregivers help to identify and interpret pain behaviors.

The World Health Organization (WHO) International Classification of Functioning, Disability, and Health (ICF; 2001) classification system uses a biopsychosocial framework to describe functioning at three levels, the body, the individual and the individual within a broad social context. Biological aspects include body structures and body functions, while individual aspects include participating in daily activities and social aspects encompass overall functioning in society. Pain related disability and optimal functioning are not simply linked to particular pain conditions. Instead, they depend on interactions among the specific child characteristics, the specific pain condition and the environmental or contextual factors in which the child experiences pain. According to this model, chronic pain impairs body function due to various health conditions that often result in additional impairments, activity limitations and participation restrictions (i.e., secondary disabilities). The child's environment (family, physical, social, cultural) and their personal characteristics interact with and determine functioning and disability in a dynamic way. A comprehensive assessment of the child's impairments, activities, participation and contextual factors is needed to guide intervention. Clarity about the goals of rehabilitation, the levels of intervention, the specific treatment techniques or modalities and expected outcomes is essential.

### Interventions

Interventions for children with chronic pain are typically multimodal. Physical therapists and occupational therapists follow the principles of ► [family-centered care](#) when developing a treatment plan. In collaboration with the child, family and other health care providers, they carefully identify all impairments, activity limitations and participation restrictions, pain frequency, pain intensity and the child's stage in development. Rehabilitation interventions reduce impairments at the body structure and function level, promote activity and participation level functioning, and address environmental or personal barriers to health and functioning. At the body structure and function level, interventions include electrotherapy modalities and physical agents. Electrotherapy modalities (e.g. ► [transcutaneous electrical nerve stimulation \(TENS\)](#) and ► [physical agents](#) (e.g. ► [cryotherapy](#), hydrotherapy, ► [manual therapy](#), massage, therapeutic exercise) are not widely used to relieve chronic pain in children, but may have a place, especially in preparing the child for physical retraining. Possible clinical indications for TENS in children may include chronic low back pain, arthritis, inflammatory disorders of soft tissues and procedural pain (McCarthy et al. 2003). Cryotherapy has been used successfully in reducing chronic muscle spasm and inflammation associated with arthritis (Bell and Prentice 2002). Careful monitoring of the child's skin is necessary with both of these interventions. ► [Hydrotherapy](#) (e.g. whirlpool)

promotes muscle relaxation and can be a medium for exercise. Manual therapy techniques such as therapeutic massage and ► **mobilization** can induce muscle relaxation, help lessen muscle spasm and increase range of motion.

► **Therapeutic exercise** is a primary component of rehabilitation of adults and children with chronic pain (Eccleston and Eccleston 2004). Children with chronic pain do not move or exercise as much as their healthy peers and this can result in decreased aerobic capacity, muscle strength, and flexibility. This pattern of inactivity can result in a vicious cycle of additional inactivity, greater deconditioning and further reductions in muscle strength and flexibility (Anthony and Schanberg 2003). Aerobic conditioning exercises can lessen chronic pain in children with arthritis (Klepper 1999) and in children with complex regional pain syndrome (CRPS) (Sherry et al. 1999). For children with CRPS, exercise and other forms of physical activity play an important role in recovery of function (Lee et al. 2002). Research is needed to determine the frequency, type and duration of exercise in combination with other forms of treatment required to achieve optimum outcomes in this group of children (Berde 2005). Clearly, exercises for children with chronic pain must be developmentally appropriate and as enjoyable as possible.

Exercises to improve muscle strength and flexibility are another important component of therapeutic exercise. Muscle strengthening exercises appear to increase physical functioning in children with and without disabilities (Damiano et al. 2002). Research is needed to examine whether muscle-strengthening exercises reduce pain. Flexibility exercises such as passive range of motion and stretching exercise must be individualized to each child to address potential biomechanical limitations and other constraints. A recent study reported that children with significant physical disabilities demonstrated pain behaviors during passive stretching exercises (Hadden and von Baeyer 2002). In contrast, this particular form of therapeutic exercise has been advocated as a pain reducing intervention in children with musculoskeletal pain associated with other diagnoses. Meticulous attention to assessment findings and family knowledge of pain triggers is essential when therapists are working with children who are nonverbal. For children who have the ability to self-report, muscle strengthening and stretching exercises can be progressed in an incremental manner to tolerance. Other forms of therapeutic exercise include activities to improve posture and increase balance and coordination. Often these exercises can be addressed through games and age-appropriate physical activities.

Activity and participation level interventions are essential components in rehabilitation. Interventions at this level include graded tasks, mobility training, self-care training and education. For example, children with chronic musculoskeletal pain often demonstrate

problems walking and may benefit from rehabilitation interventions to correct gait deviations and increase walking capabilities. Chronic pain may also compromise the child's usual level of participation in social interactions, school participation and community recreation and play or leisure activities. Physical therapists and occupational therapists use a variety of developmentally appropriate strategies to promote the child's capacity to resume their typical activities and participation. For example, therapists often work in collaboration with school personnel to identify activities that are interesting and socially engaging for a child with chronic pain.

Attention to contextual factors is also an essential component of physical rehabilitation. An assessment of the child's environment may yield information about physical or social factors that can be modified to reduce chronic pain in addition to impairment and associated disability. Interventions at this level include products and technology as well as social support systems. For example, for children with limited mobility due to significant physical disability, modification of the physical environment is important and may include the prescription of postural support systems, mobility devices and ► **adaptive equipment** to promote comfort and improve access to and interaction with the environment. Assessment of the social environment is critical and interventions may be warranted at home, at school and in the community to address assumptions, attitudes and beliefs about chronic pain, its impact and its management. Education and counseling are often required. Finally, personal factors represent the second contextual factor and these characteristics are prominent in determining appropriate rehabilitation interventions. The child's age, cognitive skills and communication capabilities will determine whether physical therapists and occupational therapists can incorporate cognitive and behavioral strategies along with rehabilitative interventions. For young children and children with significant cognitive and communication impairments, this might not be possible.

The occupational therapist and physical therapist may use cognitive behavioral strategies as adjuncts to the above-described interventions. Personal factors treatments consist of relaxation training, distraction and contingency management. Relaxation techniques may consist of diaphragmatic breathing, autogenic training, progressive muscle relaxation or guided imagery. The benefits of relaxation techniques include alleviation of skeletal muscle tension, lessening of fatigue, distraction and enhancement of other pain relief measures. Numerous studies support the use of relaxation and distraction in the treatment of arthritic pain, headache disorders and burn wound care (McGrath et al. 2003). An infrequent and mild side effect of relaxation training is a child feeling out of control when relaxation occurs. Relaxation training may be done in conjunction



with ► **biofeedback**. Some research supports the use of biofeedback in children with arthritis and children with headaches (Engel and Kartin 2004). Distraction has been effective in reducing pain and distress in youths with burn injuries (Hoffman et al. 2000). ► **Contingency management** procedures for the treatment of children with recurrent abdominal pain, burn injuries or headaches have resulted in increased activity levels and participation, in addition to reduced pain frequency and pain behaviors (Engel and Kartin 2004). In summary, the roles of the physical therapist and occupational therapist on the pediatric pain management team are emerging. Physical therapists and occupational therapists use their knowledge of anatomy, physiology, kinesiology, psychology and human development and function to develop and implement comprehensive evaluations and interventions for the child with chronic pain. A variety of activity-based and family-centered interventions are available. Evidence to support these interventions, however, is greatly needed.

## References

- Ad Hoc Committee OT / PT Pain Curriculum (1994) Pain curriculum for students in occupational therapy or physical therapy. IASP Newsletter, International Association for the Study of Pain, Seattle
- Anthony KK, Schanberg LE (2003) Pain in children with arthritis: a review of the current literature. *Arthritis Rheum* 49:272–279
- Bell GW, Prentice WE. (2002) Therapeutic modalities for physical therapists, 2nd edn. McGraw-Hill, New York
- Berde CB, Lebel A (2005) Complex regional pain syndromes in children and adolescents. *Anesthesiology* 102:252–255
- Damiano DL, Dodd K, Taylor NF (2002) Should we be testing and training muscle strength in cerebral palsy? *Dev Med Child Neurol* 44:68–72
- Eccleston Z, Eccleston C (2004) Interdisciplinary management of adolescent chronic pain: developing the role of physiotherapy. *Physiotherapy* 90:77–81
- Engel JM, Kartin D (2004) Pain in youth: a primer for current practice. *Critical Reviews™ in Physical and Rehabilitation Medicine* 16:53–76
- Hadden KL, von Baeyer CL (2002) Pain in children with cerebral palsy: Common triggers and expressive behaviors. *Pain* 99:281–288
- Hoffman HG, Doctor JN, Patterson DR et al. (2000) Virtual reality as an adjunctive pain control in wound care in adolescent patients. *Pain* 85:305–309
- Klepper SE (1999) Effects of an eight-week physical conditioning program on disease signs and symptoms in children with chronic arthritis. *Arthritis Care Res* 12:52–60
- Lee BH, Scharff L, Sethna NF et al. (2002) Physical therapy and cognitive-behavioral treatment for complex regional pain syndromes. *J Pediatr* 141:135–140
- Loeser JD, Fordyce WE (1983) Chronic pain. In: Carr JE, Dengerink HA (eds) *Behavioral science in the practice of medicine*. Elsevier, New York
- McCarthy CF, Shea AM, Sullivan P (2003) Physical therapy management of pain in children. In: Schechter NL, Berde CB, Yaster M (eds) *Pain in Infants, Children and Adolescents*, 2nd edn. Lippincott Williams and Wilkins, Philadelphia, pp 434–448
- McGrath PA, Hiller LM (2003) Modifying the psychological factors that intensify children's pain and prolong disability. In: Schechter NL, Berde CB, Yaster M (eds) *Pain in Infants, Children, and Adolescents* 2nd edn. Lippincott, Williams and Wilkins, Philadelphia, pp 85–104
- Sherry DD, Wallace CA, Kelley C et al. (1999) Short and long-term outcomes of children with complex regional pain syndrome type I treated with exercise therapy. *Clin J Pain* 15:218–223
- World Health Organization (2001) *International Classification of Functioning Disability and Health*. World Health Organization, Geneva, pp 3–20

C

## Chronic Pain, Patient-Therapist Interaction

MARK P. JENSEN

Department of Rehabilitation Medicine, University of Washington, Seattle, WA, USA  
mjensen@u.washington.edu

### Synonyms

Relationship; Therapeutic Alliance

### Definition

► **Patient-therapist interaction** refers to the verbal and nonverbal interactions between healthcare providers and their patients or clients. These interactions may include, but are not necessarily limited to, communication and negotiations concerning the patient's history, diagnosis, and clinical care.

### Characteristics

#### Patient-Therapist Interaction and Pain Treatment Satisfaction

Research shows that pain intensity has only a weak to moderate association with pain treatment satisfaction, due primarily to the fact that patients tend to report relatively high levels of satisfaction with pain management care, regardless of pain severity levels (Miaskowski et al. 1994; Ward and Gordon 1996; Dawson et al. 2002). On the other hand, factors related to the interactions between patients and clinicians show consistent associations with treatment satisfaction across measures and samples. For example, Sherwood and colleagues (Sherwood et al. 2000) found that treatment satisfaction with pain treatment was higher when patients felt that their pain was addressed with the patient as an informed partner, and was lower when the providers appeared uncaring, were slow to respond to pain complaints, or were perceived to lack knowledge and skills. Similarly, Dawson and colleagues (Dawson et al. 2002) found that many patients who reported severe pain, and who still reported that they were satisfied with pain care, attributed their satisfaction to their belief that their healthcare provider was making efforts to provide pain relief. Riley and colleagues (Riley et al. 2001) found that patient-perceived quality of caregiver communication predicted satisfaction with individualized pain treatment plans in a sample of 107 patients seen in an orofacial pain clinic. McCracken and colleagues (McCracken et al. 1997) identified confidence and trust in the treatment provider, pain reduction, and time

spent waiting in the clinic as predictors of satisfaction with chronic pain treatment. In short, patients who are satisfied with their pain care seem to be those who see themselves as having a collaborative relationship with a treatment provider who works collaboratively with the patient to address the pain problem. While pain reduction may be associated with treatment satisfaction in some instances, pain reduction does not appear to be necessary for patients to be satisfied with their care.

#### **Patient-Therapist Interaction and Treatment Adherence and Outcomes**

Research also shows that ► **treatment adherence** is related to patient-therapist interactions; in particular, the existence of a collaborative relationship between the patient and clinician. While very little of this research has been performed in samples of persons with chronic pain (for an exception, see discussion of Alamo et al. 2002, below), this finding is consistent across a wide variety of patient populations and treatments (Cruz and Pincus 2002). For example, Gavin et al. (2002) showed that a measure of ► **treatment alliance** (measuring the extent to which patients and clinicians agree on treatment goals and hold each other in positive regard) was associated with medication adherence and treatment outcome in a sample of adolescents with severe asthma. Weiss et al. (2002) similarly found that a measure of ► **working alliance** (which assessed patient-therapist agreement of treatment goals and the tasks to be used to work toward these goals, and the degree to which a bond exists between the therapist and patient) was associated with future medication adherence and treatment outcome in a sample of patients with psychotic disorders. In a sample of patients with schizophrenia, Frank and Gunderson (1990) found that patients who were able to form a good treatment alliance with their therapists within the first six months of treatment, adhered more to their medication regimen and achieved better outcomes after two years (with less medication) than patients who did not form a good treatment alliance.

Alamo and colleagues (Alamo et al. 2002) found evidence for the efficacy of a ► **patient-centered** approach in a sample of patients with chronic pain. In this study, a group of family physicians were trained in the use of a patient-centered approach to pain treatment, which included the following components, among others: listening to the patient without interrupting in the first moments of the consultation, being supportive and ► **empathic**, allowing and encouraging patients to ask questions, trying to reach an agreement about the nature of the problem, and trying to find common ground about the management plan. Patients of the physicians who were trained in and used the patient-centered approach reported significantly greater improvements after one year in psychological distress and number of tender points, than the patients of family physicians not trained in the patient-centered approach. Although not

statistically significant, there was also a trend for patients in the patient-centered condition to report greater decreases in pain intensity than patients who received usual care.

#### **Implications for Improving Pain Management Care**

The findings briefly reviewed above support the conclusion that patient-therapist interaction factors play a role in patient treatment satisfaction and adherence, as well as in long-term treatment outcome. Clinicians would therefore be wise to make any appropriate changes in the way they interact with patients to maximize therapeutic alliance. Attention to three specific areas may be particularly useful: (1) communicate efforts to manage pain; (2) make an effort to build and maintain rapport; (3) encourage a collaborative relationship.

#### **Communicate Efforts to Manage Pain**

Most patients come to realize, by the time their pain becomes chronic, that there is no quick fix for their pain problem. However, these patients may still hope that a new treatment will be discovered that will provide pain relief. Also, there exist many treatments for pain that subgroups of patients may find effective, even if these treatments are not necessarily effective for the majority of patients (Engel et al. 2002). Clinicians could improve their relationships with patients, and increase patient treatment satisfaction, if they communicated that (1) they are vigilant in their efforts to identify effective pain treatments as these treatments are reported in the research literature and (2) they are willing to work with the patient to find the specific combination of treatments and approaches that are most effective for each individual patient.

#### **Make an Effort to Build and Maintain Rapport**

One of the most effective ways to build rapport is to incorporate ► **reflective listening** in interactions with patients. Reflective listening involves making statements that indicate that you understand what the patient is saying. Such statements differ substantially from usual clinician responses, such as questions that call for or require a response or statements that merely provide information (Miller and Rollnick 2002; Rollnick et al. 1999). Examples of reflective responses to the statement, "I am sick and tired of this pain" would include, "You are frustrated that it is taking so long for us to find an approach that effectively reduces your pain" or "You are ready to try something new to get this pain under better control." The immediate concern of some clinicians, when they consider using reflective listening during a patient encounter, is that such statements might open a Pandora's Box of patient talking, which may then use up the (limited) time devoted to the encounter. However, clinicians need not make every statement a reflective one. Moreover, encounters that include reflective listening can actually be more efficient than encounters that do not, be-

cause once patients feel understood, they may feel less compelled to interrupt and ask questions. In support of this, one study found that being responsive to patient concerns (as opposed to ignoring patient concerns) was associated with a decrease in the time of the encounter (Levinson et al. 2000).

### Encourage a Collaborative Relationship

For the most part, adequate management of chronic pain involves active patient participation and involvement, and good long-term adjustment depends much more on what patients do, than on what is done to them (Jensen et al. 2003). As reviewed above, patients are more likely to actively participate in treatment and adhere to treatment recommendations when there is a good therapeutic alliance and when there is a collaborative patient-therapist relationship. Developing and maintaining a collaborative relationship with patients does not have to involve any special skills, other than a willingness to avoid lecturing patients or telling them what to do, and a willingness to provide the patient with options and choices.

Lecturing patients can create resentment and ► **resistance** (Miller and Rollnick 2002). It is more effective to provide guidance, options, and advice, while at the same time communicating the expectation that the patient can decide which parts of the recommended treatment plan he or she will follow. As choice increases adherence, the collaborative clinician offers patients choices whenever possible (Miller and Rollnick 2002). For example, if both the clinician and patient decide that a graduated exercise program is worth trying, the patient should then be offered different methods for starting and maintaining such a program. The patient could be offered sessions with a physical therapist who could help them to develop a home program. Another option would be to allow the patient to develop a simple reactivation program at home, under the guidance of his or her physician, without the need to visit a physical therapist. The home program could be highly structured, with a series of specific exercises that the patient decides to engage in on a daily basis; or it could be less structured, with the patient setting goals to increase general activity levels by a certain percent every week. As there are so many paths that may be taken to reach any one treatment goal, a treatment plan can, and should, be developed that is tailored to the patient's own situation, goals, and interests, and that is developed in close collaboration with the patient. Such collaboration will increase the chances that the patient will adhere to the treatment plan, and ultimately increase the chances of a successful treatment outcome.

### References

1. Cruz M, Pincus HA (2002) Research on the Influence that Communication in Psychiatric Encounters has on Treatment. *Psychiatr Serv* 53:1253–1265

2. Dawson R, Spross JA, Jablonski ES et al. (2002) Probing the Paradox of Patients' Satisfaction with Inadequate Pain Management. *J Pain Symptom Manage* 23:211–220
3. Engel JM, Kartin D, Jensen MP (2002) Pain Treatment and Health Care in Persons with Cerebral Palsy: Frequency and Helpfulness. *Am J Phys Med Rehabil* 81:291–296
4. Frank AF, Gunderson JG (1990) The Role of the Therapeutic Alliance in the Treatment of Schizophrenia. *Arch Gen Psychiatry* 47:228–236
5. Gavin LA, Wamboldt MZ, Sorokin N et al. (1999) Treatment Alliance and its Association with Family Functioning, Adherence, and Medical Outcome in Adolescents with Severe, Chronic Asthma. *J Pediatr Psychol* 24:355–365
6. Jensen MP, Nielson WR, Kerns RD (2003) Toward the Development of a Motivational Model of Pain Self-Management. *J Pain* 4:477–492
7. Levinson W, Gorawara-Bhat R, Lamb J (2000) A Study of Patient Clues and Physician Responses in Primary Care and Surgical Settings. *JAMA* 284:1021–1027
8. McCracken LM, Klock PA, Mingay DJ et al. (1997) Assessment of Satisfaction with Treatment for Chronic Pain. *J Pain Symptom Manage* 14:292–299
9. Miaskowski C, Nichols R, Brody R et al. (1994) Assessment of Patient Satisfaction Utilizing the American Pain Society's Quality Assurance Standards on Acute and Cancer-Related Pain. *J Pain Symptom Manage* 9:5–11
10. Miller W, Rollnick S (2002) *Motivational Interviewing: Preparing People to Change*, 2<sup>nd</sup> edn. Guilford Press, New York
11. Riley JL, Meyers CD, Robinson ME, Bulcough B et al. (2001) Factors Predicting Orofacial Pain Patient Satisfaction with Improvement. *J Orofac Pain* 15:29–35
12. Rollnick S, Mason P, Butler C (1999) *Health Behavior Change: A Guide for Practitioners*. Churchill Livingstone, Edinburgh
13. Sherwood G, Adams-McNeill J, Starck PL et al. (2000) Qualitative Assessment of Hospitalized Patients' Satisfaction with Pain Management. *Res Nurs Health* 23:486–495
14. Ward SE, Gordon DB (1996) Patient Satisfaction and Pain Severity as Outcomes in Pain Management: A Longitudinal View of one Settings' Experience. *J Pain Symptom Manage* 11:242–251
15. Weiss KA, Smith TE, Hull JW et al. (2002) Predictors of Risk of Non-Adherence in Outpatients with Schizophrenia and Other Psychotic Disorders. *Schizophr Bull* 28:341–349

C

## Chronic Pain, Thalamic Plasticity

- Thalamic Plasticity and Chronic Pain

## Chronic Paroxysmal Hemicrania

### Synonyms

CPH

### Definition

Chronic paroxysmal hemicrania is a trigemino-autonomic syndrome with frequent repeated facial pains, each lasting for 3 minutes or more. Attacks can recur over >1 year without remission periods or with remission periods lasting <1 month.

- Paroxysmal Hemicrania
- Primary Stabbing Headache

## Chronic Pelvic Inflammatory Disease

- ▶ Chronic Pelvic Pain, Pelvic Inflammatory Disease and Adhesions

## Chronic Pelvic Pain

### Definition

In woman, chronic pelvic pain is intermittent or constant pain in the lower abdomen or pelvis of at least 6 months' duration, not occurring exclusively with menstruation or intercourse and not associated with pregnancy.

- ▶ Chronic Gynaecological Pain, Doctor-Patient Interaction
- ▶ Chronic Pelvic Pain, Physical and Sexual Abuse
- ▶ Gynecological Pain and Sexual Functioning
- ▶ Gynecological Pain, Neural Mechanisms

## Chronic Pelvic Pain, Endometriosis

FRED M. HOWARD  
University of Rochester, Rochester, NY, USA  
fred\_howard@urmc.rochester.edu

### Synonyms

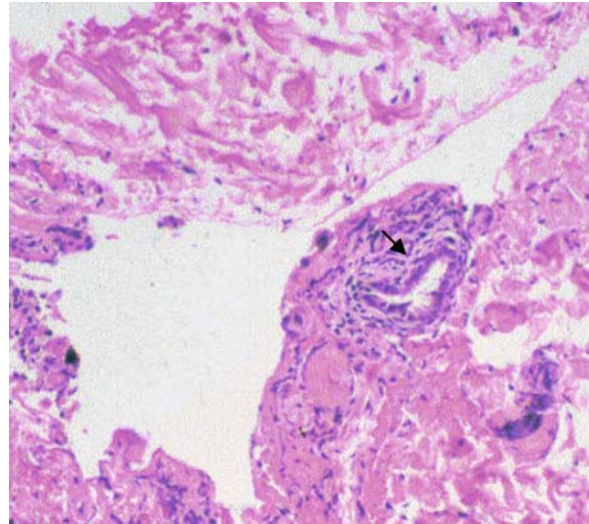
Endometriosis Externa

### Definition

Endometriosis is the presence of ectopic endometrial glands and stroma, that is endometrium located outside the endometrial cavity (Fig. 1). Occasionally only endometrial glands are present in cases of endometriosis. Hemosiderin-laden macrophages may be present also, but their solitary presence without endometrial glands or stroma does not confirm endometriosis. Sampson first applied the name "endometriosis" to ectopic endometrium in 1921 (Sampson 1921).

### Characteristics

Endometriosis is most often found within the peritoneal cavity in the pelvis, but may also occur in numerous other, even remote, locations (Table 1). There is still a great deal about it that is unclear and controversial and it remains an enigmatic disorder in that the etiology, the natural history and the precise mechanisms by which it causes pain are not completely understood. In some patients it behaves almost like a malignancy, spreading rapidly and widely, yet in others it is a seemingly irrelevant, insignificant, incidental histological diagnosis. Grossly, endometriosis has a variety of appearances; it may be red, purple, blue, white, yellow, brown, clear or black lesions, peritoneal pockets or windows, adhesions



**Chronic Pelvic Pain, Endometriosis, Figure 1** Endometriosis of the pelvic peritoneum.

**Chronic Pelvic Pain, Endometriosis, Table 1** Possible sites of endometriosis

Common sites	Less common or rare sites
Ovaries	Umbilicus
Round ligaments	Laparotomy scars
Broad ligaments	Hernial sacs
Uterosacral ligaments	Small intestine
Rectovaginal septum	Rectum
Appendix	Sigmoid
Pelvic peritoneum	Ureters
Bladder	Vulva
Pelvic lymph nodes	Extremities
Cervix	Pleural cavity
Vagina	Lung
Fallopian tubes	Nasal mucosa

or chocolate cysts. Endometriosis is primarily a disease of women of reproductive age.

### Prevalence

As endometriosis is accurately diagnosed only by surgical biopsy with histological confirmation, accurate prevalence is difficult to determine, but is estimated to be about 7% (Barbieri 1990). In women who undergo a laparoscopy to evaluate chronic pelvic pain (CPP) the prevalence of endometriosis is about 33% (Howard 1993). In patients undergoing laparoscopy for infertility the prevalence is about 40%. Additionally it appears that about 70% of women with endometriosis have some type of pelvic pain symptoms. It has been observed that the severity of pain frequently does not correlate with the severity of endometriosis (Vercellini 1991).



## Etiology

None of several theories of etiology alone explain the protean manifestations of endometriosis or the predilection of some women but not others to develop symptomatic endometriosis. Sampson's theory is that endometriosis is due to retrograde flow of menstrual effluent through the fallopian tubes into the peritoneal cavity. However, most women experience some degree of retrograde menstruation, so there is more to the development of endometriosis than just retrograde flow. Metaplasia of coelomic epithelium, the epithelium from which the mullerian duct is derived, can result in endometrium. Metaplasia needs an induction phenomenon or factor, which might be menstrual debris, estrogen or progesterone. The theory of lymphatic and vascular metastases is invoked to explain the occurrence of endometriosis in remote locations such as the pleura, nose and spinal column. It has been reported that endometriosis is present in pelvic lymph nodes in 30% of women with pelvic endometriosis, which supports this theory. A defect of the immunological system is supported by a good deal of research and helps to explain why not all women develop endometriosis secondary to retrograde menstruation. It also ties into the theory of genetic predisposition, as an immunologic disorder may be inherited. Finally, recent research has focused on the endometrial cells that are present in endometriosis and found a number of abnormalities that may contribute either to initiation or development of endometriosis. For example, endometriosis cells have been found to have abnormal production of aromatase cytochrome P<sub>450</sub>, an enzyme that is not present in normal endometrium and is integral to the conversion of androstenedione and testosterone to estrogen. This ability to produce estrogen locally may directly stimulate the growth of endometrial cells of endometriotic lesions. Endometriosis cells have also been observed to have increased amounts of vascular endothelial growth factor and interleukin-6.

It is worthwhile to especially note the role of estrogen, as there are several clinical observations that suggest that the development and persistence of endometriosis are estrogen dependent. First, endometriosis is rare before puberty or after menopause unless the woman is on estrogen replacement therapy. Second, bilateral oophorectomy typically results in regression of endometriotic lesions. Third, decreased levels of estradiol *via* GnRH agonist treatment results in regression of endometriosis. Fourth, endometriosis can develop in the prostatic utricle of a male with DES treatment for prostatic cancer. Finally, immunohistochemical studies show virtually all endometriosis lesions contain estrogen receptors.

The etiology of symptoms in some women but not in others is also not understood. Endometriosis might produce symptoms due to swelling of the tissue with hormonal stimulation, plus extravasation of blood and

menstrual debris into surrounding tissues, with production of prostaglandins as possible chemical mediators of pain and inflammation. It is also hypothesized that lesions produce prostaglandins and cause functional pain symptoms, like dysmenorrhea, *via* direct production of prostaglandins (Vernon 1985). Finally, it has been suggested that lesions cause pain *via* nociceptor stimulation by mechanical pressure or by stretching tissue. Such a mechanism would predict that larger lesions and more deeply infiltrating lesions would cause more frequent or more severe pain (Cornillie 1990).

## Symptoms and Signs

Classically the woman with endometriosis presents with one or more of the following, an adnexal mass (endometrioma), infertility, pelvic pain or dysmenorrhea. Estimates are that up to 40% of women with endometriosis have chronic pelvic pain. Pelvic pain most often starts as dysmenorrhea and at least 75% of women with endometriosis-associated pelvic pain have dysmenorrhea as an initial component of their pain. Dyspareunia with deep penetration is also a frequent component of endometriosis-associated pain, occurring in about 33% of cases. Although CPP, dyspareunia and dysmenorrhea are significantly more common in women with endometriosis than in women with a normal pelvis, these pain symptoms are not as specific nor diagnostic for endometriosis as is commonly thought and by themselves do not justify a diagnosis of endometriosis.

Intestinal involvement, usually of the appendix, rectosigmoid or anterior rectum, may cause abdominal pain, dyspareunia, tenesmus, dyschezia, constipation, diarrhea, low back pain and, rarely, hematochezia or symptoms of bowel obstruction. Urinary tract involvement, most often at the bladder peritoneum and anterior cul-de-sac, may cause frequency, pressure, dysuria or hematuria. Involvement of the distal one-third of the ureter may lead in rare cases to symptoms of ureteral obstruction. With lung involvement, endometriosis may rarely cause dyspnea on exertion, pleural effusion and lung collapse. Catamenial hemothorax has been reported. A cyclically bleeding or a cyclically tender mass in an incisional scar may also occur with endometriosis. The physical examination is often normal, but there is tenderness, especially during the menses, in many women with endometriosis-associated pelvic pain. A fixed retroverted uterus with posterior tenderness is particularly suggestive of endometriosis. Tender nodularity of the uterosacral ligaments and cul-de-sac is a classically described finding with endometriosis. Narrowing of the posterior vaginal fornix or lateral deviation of the position of the cervix may rarely be present. In patients with endometriomas a tender adnexal mass may be noted.

### Diagnostic Studies

At the present time an accurate diagnosis can only be made by surgical and histological confirmation. Before the introduction of diagnostic laparoscopy, this required an exploratory laparotomy. Laparoscopy is a much less invasive procedure and is currently the recommended diagnostic procedure for any patient suspected of having endometriosis.

A preoperative ultrasound is worthwhile as 15–20% of women with endometriosis have endometriomas. These generally range from 3 to 8 cm in size and are not always palpable by physical examination. Measurement of serum Ca-125 levels has a low sensitivity and specificity, although it is more reliable for advanced stage disease (Lanzone 1991). Ca-125 levels are also elevated with cancers of the ovary, endometrium, gastrointestinal tract, fallopian tube and breast as well as pelvic inflammatory disease, pregnancy, menses and leiomyomata. Adolescents with endometriosis should be evaluated for obstructive anomalies of the reproductive system using magnetic resonance imaging, ultrasound and hystero-graphy. About 10% will have such an anomaly.

In patients in whom intestinal endometriosis is suspected, evaluation of the intestinal tract is usually normal, as most patients have involvement of the serosa or muscularis, not the mucosa. Sigmoidoscopy may show a bluish submucosal mass in some of these cases. Mucosal lesions may be diagnosed by sigmoidoscopy, colonoscopy or barium enema studies, but these evaluations are certainly not necessary on a routine basis.

In patients with suspected urinary tract involvement, cystoscopy and intravenous pyelography or computerized tomography of the kidney, ureters and bladder may be indicated.

### Medical Treatment

There are many options for medical and surgical treatment of endometriosis-associated pelvic pain (see list below).

#### General treatment options for women with endometriosis-associated pelvic pain

- Observation with palliative treatment
- Conservative surgery
- Hormonal suppression
- Combined medical and surgical treatments
- Definitive extirpative surgery (radical surgery)

Danazol, a 17-ethinyl-testosterone derivative, was approved by the FDA for treatment of endometriosis in 1976 (Greenblatt et al. 1971). It is mildly androgenic and anabolic, properties that account for many of its side effects. Side effects include acne, edema, weight gain, hirsutism, voice changes, hot flushes, abnormal uterine bleeding, decreased breast size, decreased libido, vaginal dryness, nausea, weakness and muscle cramps. Danazol does not significantly affect LH and

FSH levels in premenopausal women, but lowers estrogen levels by directly inhibiting steroidogenesis at the ovarian and adrenal levels. Sixty to 83% of patients obtain significant relief of pelvic pain with danazol therapy and the number needed to treat is 1.7 (Barbieri et al. 1982). Danazol is contraindicated in patients with abnormal uterine bleeding, pregnancy, breastfeeding or impaired renal, cardiac or hepatic function.

Gonadotropin releasing hormone (GnRH) agonists are analogues of naturally occurring gonadotropin-releasing hormone and are the most commonly prescribed medical treatment for endometriosis in the U.S.A. Examples of GnRH agonists are nafarelin, leuprolide and goserelin. They all work at the hypothalamic-pituitary level to shut down LH and FSH production and release, resulting in a dramatic decline in estradiol levels. Pain relief with GnRH agonists is about the same as with danazol. Side effects of the GnRH agonists are loss of bone density, hot flashes, vaginal dryness, decreased libido, headaches, emotional lability, acne and reduced breast size (Bergqvist et al. 1998; Kennedy et al. 1990; Wheeler et al. 1992). Because of concerns about loss of bone density, add-back therapy with 5 mg day<sup>-1</sup> of norethindrone acetate, with or without 0.625 conjugated equine estrogen, is recommended for up to 1 year of treatment (Hornstein et al. 1998). After discontinuation of treatment, symptoms tend to recur in most patients, with mean time to recurrence between 8 to 11 months.

A number of progestagens, particularly medroxyprogesterone acetate and norethindrone acetate, are used to treat endometriosis. Breakthrough bleeding, prolonged amenorrhea, mood changes, depression, weight gain and irritability are common side effects. Gestrinone, a 19-nortestosterone derivative with mostly progestagenic and low androgenic activity, has also been used to treat endometriosis (not available in the US) (The Gestrinone Italian Study Group 1996).

Oral contraceptives are commonly used to treat endometriosis. They appear to be less effective than GnRH agonists in relieving dysmenorrhea and dyspareunia, but comparable in relief of non-menstrual pelvic pain (Vercellini et al. 1993). Side effects are weight gain, breast tenderness, nausea, chloasma, abnormal uterine bleeding, enlargement of myomas, thrombophlebitis and thromboembolism, increased appetite, irritability, depression, edema, hypertension and increased vaginal discharge. They are contraindicated in women with a history of or high risk of thrombosis or a history of breast cancer and relatively contraindicated with diabetes, collagen vascular disease or hypertension.

### Surgical Treatment

Surgical treatment of endometriosis may be conservative (i.e. without extirpation of the uterus, tubes or ovaries) or radical (i.e. with extirpation of the uterus

or one or both ovaries). Radical surgery appears to be more effective in achieving pain relief, but conservative surgery is more appropriate in younger women, especially if preservation of reproductive potential is important. Also, conservative surgery can be done at the time of laparoscopic diagnosis (Howard 1994). The core of either conservative or radical surgical treatment is the removal or destruction of all endometriotic lesions. A randomized clinical trial of conservative surgery for endometriosis shows that on average there is a 50% decrease of pain 6 months postoperatively and the number needed to treat is 2.5 (Sutton et al. 1994).

Both presacral neurectomy (resection of the superior hypogastric plexus) and uterosacral neurectomy (transection of the uterosacral ligament) have been recommended for relief of CPP associated with endometriosis, but results of randomized clinical trials show efficacy only for presacral neurectomy, (Candiani et al. 1992; Zullo et al. 2003) not uterosacral neurectomy (Sutton et al. 2001; Vercellini et al. 2003). Presacral neurectomy is most effective for the treatment specifically of midline dysmenorrhea. There appears to be a small effect, if any, on non-menstrual pelvic pain or dyspareunia.

If fertility is not desired, then hysterectomy, with or without bilateral salpingo-oophorectomy, is often recommended for endometriosis-associated pelvic pain. There is no consensus as to the advisability of removal of both ovaries if one or both are not directly involved by endometriosis, but recurrence of pain when one or both ovaries are preserved has been reported to be increased (relative risk for pain recurrence of 6.1, confidence interval 2.5 to 14.6) (Namnoum et al. 1995). Although uncommon, endometriosis has been reported to recur after hysterectomy and bilateral salpingo-oophorectomy, with and without estrogen replacement therapy. Finally, currently available data do not allow a conclusion as to whether medical or conservative surgical treatment is more effective in the treatment of endometriosis associated pelvic pain.

#### Combined Medical and Surgical Treatment

There are no clinical trials of preoperative medical treatment. There are however, at least three randomized, placebo-controlled clinical trials of postoperative medical treatment (Hornstein et al. 1997; Parazzini et al. 1994; Telimaa et al. 1987). These trials suggest that pain is decreased with postoperative medical treatment while patients are on the medications, but within 6–12 months after discontinuation of medications pain levels are similar in postoperative patients whether or not they received medical treatment. A reasonable way to apply these data is to initiate medical treatment after conservative surgical debulking therapy if patients have persistent or recurrent pain, rather than treat all patients postoperatively.

#### References

1. Barbieri RL (1990) Etiology and epidemiology of endometriosis. *Am J Obstet Gynecol* 162:565–567
2. Barbieri RL, Evans S, Kistner RW (1982) Danazol in the treatment of endometriosis: analysis of 100 cases with 4-year follow-up. *Fertil Steril* 37:737–746
3. Bergqvist A, Bergh T, Hogstrom L et al. (1998) Effects of triptorelin versus placebo on the symptoms of endometriosis. *Fertil Steril* 69:702–708
4. Candiani GB, Fedele L, Vercellini P et al. (1992) Presacral neurectomy for the treatment of pelvic pain associated with endometriosis: a controlled study. *Am J Obstet Gynecol* 167:100–103
5. Cornillie FJ, Oosterlynck D, Lauweryns JM et al. (1990) Deeply infiltrating pelvic endometriosis: Histology and clinical significance. *Fertil Steril* 53:978–983
6. Greenblatt RB, Dmowski WP, Mahesh VB et al. (1971) Clinical studies with an antigonadotropin – danazol. *Fertil Steril* 22:102–112
7. Hornstein MD, Hemmings R, Yuzpe AA et al. (1997) Use of nafarelin versus placebo after reductive laparoscopic surgery for endometriosis. *Fertil Steril* 68:860–864
8. Hornstein MD, Surrey ES, Weisberg GW et al. for the Lupron Add-Back Study Group (1998) Leuprolide acetate depot and hormonal add-back in endometriosis: a 12-month study. *Obstet Gynecol* 91:16–24
9. Howard FM (1993) The role of laparoscopy in chronic pelvic pain: promise and pitfalls. *Obstet Gynecol Survey* 48:357–387
10. Howard FM (1994) Laparoscopic evaluation and treatment of women with chronic pelvic pain. *J Amer Assoc Gynecol Laparosc* 1:325–331
11. Kennedy SH, Williams IA, Brodribb et al. (1990) A comparison of nafarelin acetate and danazol in the treatment of endometriosis. *Fertil Steril* 53:998–1003
12. Lanzone A, Marane R, Muscatello R et al. (1991) Serum Ca-125 levels in the diagnosis and management of endometriosis. *J Reprod Med* 36:603
13. Namnoum AB, Hickman TN, Goodman SB et al. (1995) Incidence of symptom recurrence after hysterectomy for endometriosis. *Fertil Steril* 64:898–902
14. Parazzini F, Fedele L, Busacca M et al. (1994) Postsurgical medical treatment of advanced endometriosis: results of a randomized clinical trial. *Am J Obstet Gynecol* 171:1205–1207
15. Sampson JA (1921) Perforating hemorrhagic (chocolate) cysts of the ovary. *Arch Surg* 3:245
16. Sutton CJG, Ewen SP, Whitelaw N et al. (1994) Prospective, randomized, double-blind trial of laser laparoscopy in the treatment of pelvic pain associated with minimal, mild, and moderate endometriosis. *Fertil Steril* 62:696–700
17. Sutton C, Pooley AS, Jones KD et al. (2001) A prospective, randomized, double-blind controlled trial of laparoscopic uterine nerve ablation in the treatment of pelvic pain associated with endometriosis. *Gynaecol Endoscopy* 10:217–222
18. Telimaa S, Ronnberg L, Kauppila A (1987) Placebo-controlled comparison of danazol and high-dose medroxyprogesterone acetate in the treatment of endometriosis after conservative surgery. *Gynecol Endocrinol* 1:363–371
19. The Gestrinone Italian Study Group (1996) Gestrinone versus a gonadotropin-releasing hormone agonist for the treatment of pelvic pain associated with endometriosis: a multicenter, randomized, double-blind study. *Fertil Steril* 66:911–919
20. Vercellini P, Bocciolone L, Vendola N et al. (1991) Peritoneal endometriosis: morphologic appearance in women with chronic pelvic pain. *J Reprod Med* 36:533
21. Vercellini P, Trespidi L, Colombo A et al. (1993) A gonadotrophin-releasing hormone agonist versus a low-dose oral contraceptive for pelvic pain associated with endometriosis. *Fertil Steril* 60:75–79
22. Vercellini P, Aimi G, Busacca M et al. (2003) Laparoscopic uterosacral ligament resection for dysmenorrhea associated

- with endometriosis: results of a randomized, controlled trial. *Fertil Steril* 80:310–319
23. Vernon MW, Beard JS, Graves K et al. (1985) Classification of endometriotic implants by morphological appearance and capacity to synthesize prostaglandin F. *Fertil Steril* 46:801–806
  24. Wheeler JM, Knittle JD, Miller JD (1992) Depot leuprolide versus danazol in treatment of women with symptomatic endometriosis. I. Efficacy results. *Am J Obstet Gynecol* 167:1367–1371
  25. Zullo F, Palomba S, Zupi E et al. (2003) Effectiveness of presacral neurectomy in women with severe dysmenorrhea caused by endometriosis who were treated with laparoscopic conservative surgery: A 1<sup>st</sup> year prospective randomized double-blind trial. *Am J Obstet Gynecol* 189:5–10

## Chronic Pelvic Pain, Epidemiology

### ► Epidemiology of Chronic Pelvic Pain

## Chronic Pelvic Pain, Interstitial Cystitis

### ► Interstitial Cystitis and Chronic Pelvic Pain

## Chronic Pelvic Pain, Laparoscopic Pain Mapping

FRED M. HOWARD

Department of Obstetrics and Gynecology, University of Rochester, Rochester, NY, USA  
fred\_howard@urmc.rochester.edu

### Synonyms

Conscious Laparoscopic Pain Mapping; Pain Mapping; Conscious Pain Mapping; Patient Assisted Laparoscopy; Laparoscopy (for Pain) under Local Anesthesia; Laparoscopic Pain Mapping

### Definition

Laparoscopic pain mapping is a diagnostic laparoscopy under local anesthesia, with or without conscious sedation, performed with the goal of identifying sources or generators of pain in women with chronic pelvic pain. It has been suggested that laparoscopic pain mapping can lead to the treatment of subtle or atypical areas of disease that might have been overlooked if the procedure had been done under general anesthesia (Almeida and Val-Gallas 1997). Also, it may help to avoid surgical interventions when there are no surgically treatable pain generators present. However, there are limited data confirming these potential benefits (Demco 1997).

Laparoscopy under local anesthesia is not new, but its use as a diagnostic modality to localize areas of tenderness potentially responsible for chronic pelvic pain is a relatively new technique. It was first described in 1996 in a series of eleven patients with pelvic pain, ten

**Chronic Pelvic Pain, Laparoscopic Pain Mapping, Table 1** Visual analogue scores (VAS) of various anatomic structures at the time of laparoscopic pain mapping

Anatomic Structure	Median VAS When Structure is Not Site of Pain	Median VAS When Structure is Site of Pain
Uterus	2	9
Ovaries	3	8
Fallopian Tubes	2	-
Round Ligaments	1	-
Uterosacral Ligaments & Cul-de-sac	1	9
Intestines	1	-

Unpublished data courtesy of P. Reginald

of whom were found to have diffuse visceroperitoneal ► **tenderness** (Palter and Olive 1996). It has also been used to evaluate women with endometriosis-associated pelvic pain (Demco 1998).

The technique used to map the pelvis is a gentle probing or tractioning of tissues and organs with a blunt probe or forceps passed through a secondary cannula site. During a systematic evaluation of the entire pelvis, the patient is asked to note the presence or absence of tenderness and pain and to rate its severity when present. In particular, the patient is to note if there is replication of her usual or presenting pain. Diagnosis of an etiologic lesion or organ should be based on the severity and quality of pain elicited, especially reproduction of the patient's presenting pain. It has been suggested that applying or injecting local anesthetic to sites of focal tenderness may block the pain response and possibly improve the predictability that surgical excision will be therapeutic. Also, ► **superior hypogastric plexus** block can be done at the time of laparoscopic pain mapping and may help to predict the efficacy of presacral neurectomy (Steege 1998).

It has been shown that when laparoscopy is done under local anesthesia in women without pelvic pain, there is no significant pain or tenderness to probing of the uterus, ovaries, omentum or bowel (Zupi et al. 1999). Table 1 summarizes the pain levels of viscera in women with chronic pelvic pain in one unpublished series of laparoscopies under local anesthesia.

### Characteristics

Not all women with chronic pelvic pain are candidates for laparoscopic pain mapping. Patients who are morbidly obese (BMI greater than 30), have significant anesthesia risk, have anxiety disorders or psychiatric disease or are known or suspected to have severe adhesive disease are not ideal candidates for the procedure. Counseling and preparation of the patient is also cru-



cial, because chronic pelvic pain patients experience greater pain with laparoscopy under local anesthesia than non-pain patients. Intolerable pain is the most common reason for failures with laparoscopic pain mapping. Other reasons for failures may include adhesions that obliterate the visual field, inability to access the peritoneal cavity and inability to visualize the entire pelvis. Published success rates range from 70–100%.

As with traditional diagnostic laparoscopy, endometriosis and adhesions are the most common diagnoses made with laparoscopic pain mapping; i.e. they are the lesions that most frequently elicit pain and tenderness at the time of pain mapping. However, even in patients with tender endometriosis or adhesions, other endometriotic lesions or adhesions may not be tender to probing at the time of laparoscopic pain mapping.

Other less common lesions found to map pain at the time of laparoscopic pain mapping include sciatic hernia, leiomyoma, hernia repair site, postoperative peritoneal cyst, colon carcinoma, chronic ileal disease, staple at the ureter, pseudo stone secondary to gallbladder spillage, peritoneal puckering, two with ovary, herniorrhaphy site and peritoneal scarring. Individual pelvic viscera have also been mapped as painful, including the uterus, ovary, fallopian tube, round ligament, appendix, bladder and vaginal apex.

#### Endometriosis

In one published series there were 15 cases with successful conscious pain mapping and a visual diagnosis of endometriosis and in these cases endometriotic lesions were mapped as painful sites in seven. In all seven of these cases there was histological confirmation of the diagnosis. In the remaining eight successfully mapped cases in which endometriotic lesions did not map positively, there was histological confirmation of the diagnosis in only two cases. Thus seven of nine cases with histologically confirmed endometriosis mapped pain to endometriotic lesions, *versus* none of six cases in which the visual diagnosis of endometriosis was not histologically confirmed ( $P = 0.007$ , Fischer's exact test). These findings emphasize the importance of the histologically confirmed presence of endometrial glands and stroma to generation of pain by suspected endometriotic lesions. Another published series correlating the appearance of endometriotic lesions with tenderness showed that 84% of red lesions, 76% of clear lesions, 44% of white scar lesions and 22% of black lesions are painful (Demco 1998). Findings at laparoscopic pain mapping have also suggested that up to as much as a 3 cm area of normal-appearing peritoneum surrounding endometriotic lesions may be tender.

#### Adhesions

Whether adhesions can produce pain is controversial. All of the published series of conscious pain mapping have shown that adhesions can be tender and that their

stimulation can reproduce a patient's pain. This strongly supports the hypothesis that some adhesions cause abdominopelvic pain. As appears to be the case with endometriosis, these data also suggest that adhesions are not always a source of pain in women with chronic pelvic pain and adhesions.

#### Chronic Visceral Pain

Laparoscopic pain mapping not infrequently shows generalized pelvic visceral and peritoneal hypersensitivity, suggesting such patients may have chronic visceral pain syndrome of visceral neuropathic etiology. We believe that our finding of patients with diffuse pelvic visceral and peritoneal tenderness may represent a way to confirm the diagnosis of chronic visceral pain syndrome, a diagnosis that has been suggested for chronic pain syndromes believed to be of visceral origin (Wesselman 1999). Unpublished data suggest that reproductive viscera tend to be tenderer than peritoneum or intestines at the time of laparoscopic pain mapping. It may be that many of the patients with no apparent diagnosis at the time of diagnostic laparoscopy under general anesthesia may have chronic visceral pain syndrome. Clearly further evaluations are needed to confirm these proposals.

#### Summary

Chronic pelvic pain is a multifactorial and complicated disorder. It is premature to assume that the findings with laparoscopic pain mapping translate directly into cause and cure. For example, comparing series of patients from our center who were evaluated with traditional diagnostic laparoscopy to those evaluated with laparoscopic pain mapping showed similar prevalences of endometriosis and adhesions in both groups (endometriosis in 38% versus 40% and adhesions in 34% versus 54%, respectively) (Howard 1994). Treatment based on the findings at the time of laparoscopic pain mapping did not change the outcomes however, compared to the outcomes based on traditional diagnostic laparoscopy. With laparoscopic evaluation and treatment without pain mapping, 78% of patients had decreased pain and 45% were pain-free. With laparoscopic pain mapping, 44% had decreased pain and 16% were pain-free. The patients in the two groups were not identical, as only one-half of the patients in the traditional diagnostic laparoscopy series had undergone prior evaluations and treatments for chronic pelvic pain, compared to all of the patients evaluated by laparoscopic pain mapping. The clinical value of conscious pain mapping both diagnostically and therapeutically cannot be stated yet, as only observational studies are available. Current data suggest it does help to avoid unnecessary operative laparoscopies in some cases. Whether it improves outcomes in women with chronic pelvic pain by leading to more specific medical and surgical treatments requires

more study and probably a prospective, randomized trial.

## References

1. Almeida Jr OD, Val-Gallas JM (1997) Conscious pain mapping. *J Am Assoc Gynecol Laparosc* 4:587–590
2. Demco LA (1997) Effect on negative laparoscopy rate in chronic pelvic pain patients using patient assisted laparoscopy. *J Soc Laparoendosc Surg* 1:319–321
3. Demco LA (1998) Mapping the source and character of pain due to endometriosis by patient-assisted laparoscopy. *J Am Assoc Gynecol Laparosc* 5:241–245
4. Howard FM (1994) Laparoscopic evaluation and treatment of women with chronic pelvic pain. *J Amer Assoc Gynecol Laparosc* 1:325–31
5. Metha PV (1989) A total of 250,136 laparoscopic sterilizations by a single operator. *Br J Obstet Gynaecol* 96:1024–1034
6. Palter SF, Olive DL (1996) Office microlaparoscopy under local anesthesia for chronic pelvic pain. *J Am Assoc Gynecol Laparosc* 3:359–364
7. Steege JF (1998) Superior hypogastric block during microlaparoscopic pain mapping. *J Am Assoc Gynecol Laparosc* 5:265–267
8. Wesselman U (1999) A call for recognizing, legitimizing, and treating chronic visceral pain syndromes. *Pain Forum* 8:146–150
9. Zupi E, Sbracia M, Marconi D et al. (1999) Pain mapping during minilaparoscopy in infertile patients without pathology. *J Am Assoc Gynecol Laparosc* 6:51–54

## Chronic Pelvic Pain Model

- ▶ [Visceral Pain Models, Female Reproductive Organ Pain](#)

## Chronic Pelvic Pain, Musculoskeletal Syndromes

ROBERT D. GERWIN  
Department of Neurology, Johns Hopkins University,  
Bethesda, MD, USA  
gerwin@painpoints.com

### Synonyms

Viscerosomatic pain syndromes; myofascial pain syndromes; myofascial trigger points.

### Definition

Chronic pelvic pain syndromes (CPPS) and even acute pelvic pain syndromes (APPS) can have both visceral and a body wall (somatic) representations, referred to as viscerosomatic and musculoskeletal or myofascial pain syndromes respectively.

### Characteristics

Pain can arise from a disorder of a visceral organ, as in inflammatory bowel disease or endometriosis, ureteral calculus or interstitial cystitis. The presenting complaint

however, can be ▶ [somatic pain](#), such as lower abdominal wall pain in irritable bowel syndrome, celiac disease or colitis, flank pain in renal colic and pelvic floor or pelvic region ▶ [myofascial pain syndromes](#) in interstitial cystitis or endometriosis. The visceral component can be difficult to identify or can be overlooked, because visceral pain is diffuse and poorly localized. One must have a high degree of suspicion in order to identify the visceral component of pain when the complaint is somatic pain like a myofascial pelvic floor muscle pain syndrome. The visceral syndromes that are common in women include endometriosis and interstitial cystitis, irritable bowel syndrome and irritable bladder syndrome, whereas prostatitis or ▶ [prostadynia](#), interstitial cystitis and irritable bowel syndrome are common in men (Vecchiet et al. 1992; Wesselmann 1999; Lukban et al. 2001; Verne et al. 2001; Nadler 2002).

Myofascial pain syndromes can also refer pain to a region where visceral pain is common, either as local or as referred pain. The attendant trigger point formation and the referred pain can cause or aggravate visceral organ dysfunction. This is readily seen in bladder or bowel dysfunction in the presence of trigger points in the levator ani and other pelvic floor muscles. Abdominal wall and pelvic floor trigger points can persist long after an initiating visceral insult has passed. This is seen very strikingly when abdominal wall ▶ [triggerpoints](#) form (in the abdominal oblique muscles) in response to ureteral colic and persist for weeks after the stone has passed, or recur weeks or months later like renal colic, when in fact there is only somatic trigger point pain. Treatment of the trigger points eliminates the local and the referred pain.

### Visceral Pain

▶ [Visceral Nociception and Pain](#) can result from such non-tissue injuring mechanisms as distention or increased capsular pressure or from inflammation, ischemia or obstruction. Thus, visceral pain can arise from conditions that produce or threaten tissue destruction or from conditions that are benign. Interstitial cystitis, irritable bowel syndrome, chronic prostatitis and endometriosis are common causes of pelvic pain with pelvic region muscular pain representation. As many as 20–30% of cases of chronic prostatic related pain conditions are not due to inflammatory or infectious causes (Krieger et al. 2002; Schaeffer et al. 2002) and could be called prostadynia, a condition largely related to pelvic floor myofascial pain syndromes. Vulvadynia and vulvar vestibulitis are not visceral pain syndromes, in the strict sense that they do not arise from hollow viscera, but they are non-muscular sources of chronic pelvic pain that are associated with musculoskeletal pain syndromes.

Pain from pelvic region visceral and genital structures is transmitted to the central nervous system through the visceral afferent sensory fibers of both sympathetic

nerves (the splanchnic nerves) and parasympathetic nerves (the pelvic nerve), involving both the parasympathetic and sympathetic nerves in the superior and inferior hypogastric plexuses. Transmission of pelvic region pain is by both the dorsal spinal column to the thalamus, and *via* the lateral columns to the medullary lateral reticular nucleus (Ness 2000). Pseudoaffective responses associated with heart rate and blood pressure changes are mediated *via* the lateral column.

In addition to direct ► **nociceptive** pathways from visceral organs as well as from muscle to the spinal cord and brain, there are psychophysiological responses as well. These responses are associated with central and perhaps peripheral sensitization. They are not uniformly found in all hollow viscera. Rectal distention does not result in an accelerated response with repeated stimulation as is found in the colon or in the urinary bladder. Repeated stimulation of the urinary bladder by a distending stimulus results in lowering of the pressure threshold needed to evoke sensory responses and an acceleration of autonomic responses (Ness et al. 1998). The same effect has been noted following repeated distention of the colon. Moreover, the area of sensitization or the region of the body where discomfort is experienced widens with successive stimulation.

#### Referred Pain from Viscera

Studies of subjects exposed to repeated distention of hollow organs (colon, urinary bladder) have shown that pain from visceral organs is experienced in the body wall. Referred pain from the gall bladder to the right shoulder area, esophageal pain to the chest and cardiac pain to the neck and arm are well known, as are prostatic and labor pains referred to the perineum. Visceral organs in general have both a somatic representation and a cutaneous representation. These representations are related to the local spread of incoming nociceptive stimulation to the spinal cord. Thus, referred pain from genitourinary structures is felt in pelvic region musculoskeletal structures rather than thoracic or lower extremity structures.

The mechanisms underlying central sensitization have been well studied over the past quarter century. Cutaneous pain and somatic referred pain are both clinically experienced. Pelvic floor pain, lower abdominal and flank pain and proximal thigh pain are all examples of myofascial referred pain syndromes. There is an interaction between primary visceral pain, primary myofascial pain and referred pain to and from these regions. Pain that originates as a myofascial pain syndrome from non-visceral causes can be experienced as visceral pain with symptoms characteristic of interstitial cystitis, irritable bowel syndrome or genital dysfunction. As discussed above, visceral pain can result in muscular pain. In other words, the symptoms of referred pain go in both directions, visceral to somatic and somatic to visceral (Gerwin 2002). Both the visceral and somatic

(muscular) pain syndromes need to be treated in order to produce a positive outcome.

The mechanisms of visceral induced hypersensitization include both peripheral nerve and central nervous system activation. Sensitization lowers the pain threshold, magnifies pain and results in a larger area of the body being perceived to be painful. An example of a mechanism resulting in peripheral sensitization is the increase in rectal nerve fibers that are immunoreactive to the heat and capsaicin receptor vanilloid receptor 1 (Chan et al. 2003). ► **Central sensitization** results in part through activation of the dorsal horn neuron by such means as N-methyl D-aspartate receptor activation or by the convergence of two afferent nociceptive nerve fibers on one dorsal horn neuron. A recently discovered mechanism of central hypersensitization is the increase in the number of spinal lamina 1 neurons that express substance P receptor, seen in both non-inflamed distended rat colon and in the inflamed rat colon (Honoré et al. 2002). Visceral inflammation markedly increased the number and the rostro-caudal extent of lamina 1 substance P receptor neurons that were activated by normally non-noxious and noxious distention of the colon. Neuroplastic changes in the central nervous system take place very rapidly in response to nociceptive afferent input from viscera and from muscle, resulting in ► **hypersensitivity**, ► **allodynia** and an increase in the receptive fields of individual dorsal horn neurons. Tenderness develops in response to non-nociceptive stimulation, increased perceived pain in response to nociceptive stimulation and this is perhaps part of the basis for referred pain.

Another phenomenon that is important for pain referred from viscera to somatic tissues and from abdominal and pelvic myofascial trigger points to viscera is the extent of spread of afferent input in the spinal cord. Spinal cord spread of non-nociceptive sensory afferent fibers in the classical sensory system is over about 4 segments, 2 segments upwards and 2 segments downward. Spinal cord spread of nociceptive sensory afferent fibers is 7–10 segments in extent. The more extensive spread of nociceptive sensory afferent fibers increases the possibility of referred pain at a greater distance from the source of the nociceptive stimulus. Nociceptive neuronal activation in the dorsal horn spreads from neuron to neuron through the excitation of cell surface receptors and the unmasking and activation of inactive or non-functional afferent connections from normally non-functional receptive fields. Activating these quiescent afferent connections results in a given dorsal horn neuron responding to stimulation of receptive fields that normally belong to other dorsal horn neurons. Thus, chronic painful stimulation from either pelvic region viscera or from abdominal and pelvic region myofascial trigger points results in pain referral either to the somatic muscles or to visceral structures or regions respectively. Viscerosomatic pain referral is segmental and is most common locally. Thus, pain

from interstitial cystitis is most often felt in the pubic region and in the ventral portion of the pelvic floor muscles, like the levator ani muscle. Pain from endometriosis is often felt in the suprapubic and pubic region and in the low back. Pain in irritable bowel syndrome is often felt in the dorsal or posterior portion of the levator ani and other pelvic floor muscles like the piriformis muscles. Trophic changes can also be seen in the region of referred pain from visceral trigger points. Neurogenic plasma extravasation causing cutaneous edema was seen in the region of referred pain in the rat in which uterine inflammation was produced (Wesselmann and Lai 1997).

#### Abdominal and Pelvic Floor Myofascial Pain Syndromes

Myofascial trigger points are painful areas within muscle that are composed of tender regions or zones on tight or taut bands of muscle that can be palpated in accessible muscles (Simons et al. 1999). The trigger zones within the muscle can be quiescent and not painful until the muscle is activated by use or they can be spontaneously painful even at rest. A property of myofascial trigger points that arises from central sensitization of dorsal horn neurons in the spinal cord is the development of referred pain zones in a predominantly localized, segmental manner, similar to the segmental spread of referred pain from viscera. Trigger points in the muscles discussed below are relevant to chronic pelvic pain syndromes when stimulation of the trigger points reproduces symptoms commonly experienced by the patient. Visceral dysfunction, such as bladder or bowel irritability or dyspareunia, can occur as a result of myofascial trigger points. The classical chronic pelvic pain triad of endometriosis or prostatic dyspareunia together with interstitial cystitis and irritable bowel syndrome is usually accompanied by abdominal and pelvic floor muscle trigger points that serve to perpetuate and aggravate the pelvic visceral syndromes.

The following muscle trigger point referred patterns are of importance in pelvic visceral pain syndromes.

1. Lateral abdominal wall myofascial trigger points refer pain to the lower abdominal quadrant and to the groin. These muscles are affected by chronic colitis, Crohn's disease and renal and ureteral chronic pain conditions and can be associated with abdominal cramping pain, diarrhea or constipation.
2. Thoracolumbar paraspinal muscle trigger points, especially the lower thoracic, lumbar and multifidi muscle trigger points, refer pain to the buttock, sacral and coccygeal region and are associated with both rectal-colonic dysfunction and genitourinary dysfunction.
3. Pelvic floor muscles, including the pubococcygeous and iliococcygeous muscles of the levator ani, are associated with pelvic organ dysfunction, the anterior or ventral portion with genitourinary dysfunction, the posterior or dorsal portion with colon and rectal/anal dysfunction. The bulbospongiosus, ischiocavernosus and transverse perineal muscles develop trigger points in association with genital dysfunction and give rise to ► **dyspareunia** in women and penile, scrotal and prostatic pain in men.
4. Obturator internus trigger points often accompany chronic pelvic pain conditions involving bowel, bladder and genital organs, but are particularly associated with rectal pain.
5. The gluteal muscles, including the gluteus maximus, gluteus medius, gluteus minimus and the piriformis muscle, give rise to trigger points in association with pain from any of the pelvic organs.
6. Adductor magnus medial thigh muscle trigger points refer pain deep within the pelvis and can simulate genital, bladder or rectal pain.

Diagnosis of these myofascial pain syndromes is made by palpation of the appropriate muscles for hardened or taut bands within the muscle. These bands generally run from one tendinous insertion to the other, will be tender to palpation and may refer pain to areas commonly experienced as painful by the patient. Referred pain phenomena usually take about 5–10 seconds of firm pressure to develop.

#### Treatment

Treatment is directed towards inactivating the myofascial trigger points and preventing their return. Inactivation of trigger points requires reducing or eliminating the pain from the trigger point and restoring normal length to the shortened, contracted, taut or hard band of muscle that harbors the trigger point. This can be done manually through the use of trigger point compression, local stretching and then stretching the entire muscle. In chronic pelvic pain conditions, this may involve working within the pelvis through the vagina or the rectum, even though the majority of manual work can be done externally.

Trigger points can be reduced and pain relieved by physical therapy modalities such as electrical stimulation, including percutaneous electrical stimulation. Ultrasound may release superficial trigger points, but does not penetrate far enough to be effective in most deep trigger points. Trigger point injection with local anesthetic or needling the trigger zone with an acupuncture needle without instilling local anesthetic is a highly effective way of inactivating trigger points. A local twitch response elicited from the trigger zone (which is followed by partial or complete relaxation of the taut or hardened band and a reduction in trigger point tenderness) is the confirmatory sign that the trigger zone has actually been entered and injected. There is no evidence to support the injection of substances other than local anesthetics, such as steroids, cyanocobalamin or ketorolac. Injection or dry needling can be



done diagnostically to see if a trigger point is indeed causing a problem, to treat acute pain and to facilitate physical therapy. Trigger point injections in the pelvic region can almost always be done externally, including injections of the levator ani, piriformis and obturator internus muscles. Only rarely is it actually necessary to inject vaginally.

Conditions that create or perpetuate pelvic pain and pelvic region myofascial trigger points must be addressed and corrected. Thus, vulvar vestibulitis, interstitial cystitis and structural factors such as pelvic torsion, pubic symphysis shear and sacroiliac joint dysfunction must be treated and corrected. Muscle energy techniques are often adequate for the correction of the structural perpetuating factors. Treatment of trigger points in the muscles that refer pain to the pelvis will often result in dramatic improvement of chronic pelvic pain states and of pelvic organ dysfunction.

## References

1. Chan CHL, Facer P, Davis JB et al. (2003) Sensory fibres expressing capsaicin receptor TRPV1 in patients with rectal hypersensitivity and faecal urgency. *Lancet* 361:385–391
2. Gerwin RD (2002) Myofascial and visceral pain syndromes: visceral-somatic pain representations. *J Musculoskel Pain* 10:165–175
3. Honoré P, Kamp EH, Rogers SD, Gebhart GF, Mantyh PW (2002) Activation of lamina 1 spinal cord neurons that express the substance P receptor in visceral nociception and hyperalgesia. *J Pain* 3:3–11
4. Krieger JN, Ross SO, Deutsch L et al. (2002) The NIH Consensus concept of chronic prostatitis/chronic pelvic pain syndrome compared with traditional concepts of nonbacterial prostatitis and prostatodynia. *Curr Urol Rep* 3:301–306
5. Lukban JC, Parkin JV, Holzberg AS et al. (2001) Interstitial cystitis and pelvic floor dysfunction: a comprehensive review. *Pain Medicine* 2:60–71
6. Nadler RB (2002) Bladder training biofeedback and pelvic floor myalgia. *Urology* 60 (S6):42–43
7. Ness TJ (2000) Evidence for ascending visceral nociceptive information in the dorsal midline and lateral spinal cord. *Pain* 87:83–88
8. Ness TJ, Richter HE, Varner RE et al. (1998) A psychophysiological study of discomfort produced by repeated filling of the urinary bladder. *Pain* 76:61–69
9. Schaeffer AJ, Knauss JS, Landis JR et al. (2002) Chronic Prostatitis Collaborative Research Network Study Group. Leukocyte and bacterial counts do not correlate with severity of symptoms in men with chronic prostatitis: the National Institutes of Health Chronic Prostatitis Cohort Study. *J Urology* 168:1048–1053
10. Simons DG, Travell JG, Simons LS (1999) Myofascial Pain and Dysfunction: The trigger point manual, 2nd edn. Williams and Wilkins, Baltimore, pp 11–93
11. Vecchiet L, Giamberardino MA, de Bigontina (1992) Referred Pain from Viscera. In: Sicuteri F, Tenenius L, Vecchiet L et al. (eds) Pain versus Man, Advances in Pain Research and Therapy, vol 20. Raven Press, New York, pp 101–110
12. Verne GN, Robinson ME, Price DD (2001) Hypersensitivity to visceral and cutaneous pain in the irritable bowel syndrome. *Pain* 93:7–14
13. Wesselmann U (1999) Pain - the neglected aspect of visceral disease. *Eur J Pain* 3:189–191
14. Wesselmann U, Lai J (1997) Mechanisms of referred visceral pain: uterine inflammation in the adult virgin rat results in neurogenic plasma extravasation in the skin. *Pain* 73:309–317

## Chronic Pelvic Pain, Pelvic Inflammatory Disease and Adhesions

FRED M. HOWARD

Department of Obstetrics and Gynecology, University of Rochester, Rochester, NY, USA  
fred\_howard@urmc.rochester.edu

C

### Synonyms

Acute Salpingitis; Salpingitis-Oophoritis-Peritonitis; Chronic Pelvic Inflammatory Disease; Tubo-Ovarian Complex; pelvic inflammatory disease

### Definition

Pelvic inflammatory disease (PID) comprises a spectrum of inflammatory disorders of the upper female genital tract, including any combination of endometritis, salpingitis, tuboovarian abscess and pelvic peritonitis (Centers for Disease Control 1998). Chronic abdominopelvic pain (CPP) and adhesive disease are significant sequelae of pelvic inflammatory disease (Safrin et al. 1992).

PID is most often due to ascent of organisms from the vagina and cervix, but it may also be from contiguous spread of organisms (e.g. from appendicitis) or from lymphatic or hematogenous spread (e.g. tuberculosis). PID may be iatrogenic after invasive diagnostic or therapeutic procedures, but more often it is spontaneously associate with sexual activity. Infection with gonococcus or chlamydia increases the risk of PID.

In the United States there are an estimated 1.2 million visits per year to physicians' offices (Curran 1980) and about 280,000 women per year are hospitalized for PID (Jones 1980; Washington 1984). In addition, an estimated 150,000 surgical procedures are performed annually for complications of salpingitis. The estimated incidence of PID is 14.2 per 100 women.

### Characteristics

#### Etiology

PID is a polymicrobial infection. Microorganisms that have been recovered from the upper genital tracts of women with PID include *N. gonorrhoeae*, *C. trachomatis*, mycoplasmas, anaerobic and aerobic bacteria from the endogenous vaginal flora such as *Bacteroides*, *Peptostreptococcus*, *Gardnerella vaginalis*, *Escherichia coli*, *Haemophilus influenzae* and aerobic *Streptococci* (Eschenbach et al. 1975; Monif et al. 1976). PID is often precipitated by gonococcal or chlamydial infections of the cervix.

Chronic pelvic pain develops in 18–36% of women subsequent to PID and may occur in up to 67% after three or more episodes of PID (Haggerty 2003; Westrom 1980). (The etiology of CPP after PID is not known, but is generally thought to be due to adhesive disease and to injury of the fallopian tubes and ovaries by the infection

**Chronic Pelvic Pain, Pelvic Inflammatory Disease and Adhesions, Table 1** Peritubal adhesions and distal tubal pathology among PID patient with chronic pain

Women with chronic pain	Total women	Number	Rate (%)
<b>ADHESIONS</b>			
None	57	5	9
Slight	23	3	13
Moderate	40	25	63
Extensive	32	29	91
<b>FIMBRIATED ENDS</b>			
Normal	74	23	31
Phimotic	18	8	44
Clubbed	41	23	56

(Westrom 1988)). One possible mechanism for CPP may be related to chronic inflammation due to host immunological responses to the acute infection. Another may be recurrent infections due to repeated infectious exposures and weakened host defenses secondary to previous damage (Moller et al. 1995; Patton et al. 1983). At second-look laparoscopy, 88% of post-PID women with CPP had morphological changes in the fallopian tubes or ovaries or both and the severity of chronic pelvic pain was highly correlated with the extensiveness of pelvic adhesions (Table 1) (Westrom 1992).

### Signs and Symptoms

PID is difficult to diagnosis because of wide variation in symptoms and signs. Overall, the clinical diagnosis of symptomatic PID has a positive predictive value of 65 to 90%, yet many patients with mild symptoms may go unrecognized. Even though PID is an infectious disease, 30–50% of patients are afebrile. Lower abdominal and pelvic pain are usually present and of less than 2 weeks duration. Physical examination usually shows bilateral lower abdominal tenderness, bilateral adnexal tenderness and cervical motion tenderness. Abnormal cervical or vaginal discharge is characteristic. Laboratory testing may show elevated erythrocyte sedimentation rate, elevated C-reactive protein, leukocytosis and positive cultures for *N. gonorrhoeae* or *C. trachomatis*. There is a strong correlation between exposure to sexually transmitted organisms and PID.

Laparoscopy is the current gold standard for the diagnosis of acute PID. However, routine laparoscopy is logistically and economically impractical for all patients suspected of having acute PID. Other useful studies for diagnosing acute PID include histopathological evidence of endometritis on endometrial biopsy (Paavonen et al. 1985) and transvaginal sonography or other imaging techniques showing thickened fluid

filled tubes with or without pelvic fluid or tubo-ovarian complex (Cacciatore et al. 1992).

CPP associated with prior PID is generally thought to be due to adhesions or tubal disease, but usually there are no specific findings on examination that allow a diagnosis of adhesions or tubal damage. Occasionally with dense uterine adhesions the uterus is found in a fixed, immobile retroverted position. With hydrosalpinges or tubo-ovarian complexes, a tender adnexal mass may be palpable. Laparoscopy for CPP may show fallopian tubes that are tortuous, clubbed or phimotic and may show tubo-ovarian adhesions in women with prior PID. In many patients laparoscopic findings may be normal.

### Treatment

Acute PID should be treated empirically with broad-spectrum antibiotics to cover the variety of likely aerobic and anaerobic pathogens. Oral versus parenteral treatment does not appear to alter outcomes nor change the likelihood of developing CPP. Hospitalization should occur if the diagnosis is uncertain and the patient seems ill, the patient is pregnant, the patient does not respond clinically to oral antimicrobial therapy, the patient is unable to follow or tolerate an outpatient oral regimen, the patient has severe illness, nausea and vomiting or high fever, the patient has a tubo-ovarian abscess or the patient is immunodeficient.

The ideal treatment of women with CPP secondary to PID is not known. Empirical antibiotic therapy is often tried in women with CPP in whom prior, chronic or recurrent PID is suspected. Unfortunately there are no studies supporting efficacy for this approach. Surgical treatment by adhesiolysis or even removal of severely damaged organs, such as hydrosalpinges, is utilized for conservative management, but only observational and anecdotal data are available to support this approach. Hysterectomy with bilateral salpingo-oophorectomy is commonly performed for CPP with pelvic findings suggestive of prior PID, although there is not much published information documenting efficacy for relief of CPP.

### References

- Cacciatore B, Leminen A, Ingman-Friberg S et al. (1992) Transvaginal sonographic findings in ambulatory patients with suspected PID. *Obstet Gynecol* 80:912–916
- Centers for Disease Control (1997) 1998 guidelines for treatment of sexually transmitted diseases. *MMWR Recomm Rep* 47:79–86
- Curran JW (1980) Economic consequences of pelvic inflammatory disease in the United States. *Am J Obstet Gynecol* 1080:138–905
- Eschenbach DA, Buchanan T, Pollock HM et al. (1975) Polymicrobial etiology of acute pelvic inflammatory disease. *N Engl J Med* 293:166
- Haggerty CL, Schulz R, Ness RB (2003) Lower Quality of Life Among Women With Chronic Pelvic Pain After Pelvic Inflammatory Disease. *Obstet Gynecol* 102:934–939
- Jones OG, Saida AA, St John RK (1980) Frequency and distribution of salpingitis and pelvic inflammatory disease in short stay in hospitals in the United States. *Am J Obstet Gynecol* 138–905

7. Moller BR, Krostiansen FV, Thorsen P et al. (1995) Sterility of the uterine cavity. *Acta Obstet Gynecol Scand* 74:216–219
8. Monif GRG, Welkos SL, Baer H et al. (1976) Cul-de-sac isolates from patients with endometritis, salpingitis, peritonitis and gonococcal endocervicitis. *Am J Obstet Gynecol* 126:158
9. Paavonen J, Aine R, Teisala K et al. (1985) Comparison of endometrial biopsy and peritoneal fluid cytology with laparoscopy in the diagnosis of acute PID. *Am J Obstet Gynecol* 151:645–650
10. Patton DL, Halbert SA, Kuo CC et al. (1983) Host response to Chlamydia trachomatis infection of the fallopian tube in pig-tailed monkeys. *Fertil Steril* 40:829–840
11. Safrin S, Schachter J, Dahrouge D et al. (1992) Long-term sequelae of acute PID. *Am J Obstet Gynecol* 166:1300–1305
12. Washington AE, Cates W, Sadi AA (1984) Hospitalizations for pelvic inflammatory disease. Epidemiology and trends in the United States 1975 and 1981. *JAMA* 251:2529–2533
13. Westrom L (1980) Incidence, prevalence and trends of acute pelvic inflammatory disease and its consequences in industrialized countries. *Am J Obstet Gynecol* 138:880–892
14. Westrom L (1988) Chronic pain after acute PID. In: Belfort P, Piatti JA, Eskes TKAB, (eds) *Advances in gynecology and obstetrics*. Proc XII<sup>th</sup> World Congress Gynecol Obstet. Rio de Janeiro, October 1988, vol 6, pp 265–272
15. Westrom LV, Berger GS (1992) In: Berger GS, Westrom LV (eds) *Consequences of pelvic inflammatory disease*. Raven Press, New York, pp 101–114

## Chronic Pelvic Pain, Physical and Sexual Abuse

BEVERLY J. COLLETT, CHRISTINE CORDLE  
University Hospitals of Leicester, Leicester, UK  
beverly.collett@uhl.tr-nhs.uk

### Definition

#### Physical Abuse

Hitting, shaking, throwing, poisoning, burning or scalding, drowning, suffocating, or otherwise causing physical harm to another person (DoH 2000a).

#### Sexual Abuse

Forcing or enticing another person to take part in sexual activities, whether or not they are aware of what is happening. The activities may involve physical contact, including penetrative (e.g. rape or buggery) and non-penetrative acts. They may include non-contact activities, such as involving another person in looking at, or in the production of, pornographic material or watching sexual activities or encouraging another person to behave in sexually inappropriate ways (DoH 2000a).

The issue of defining sexual abuse in practice is both complex and problematical.

### Characteristics

The role of abusive experiences in ► **chronic pelvic pain** began to be the focus of investigation in the early 1980's. Since then, there has been growing documentation of prevalence rates for sexual and ► **physical abuse** during

childhood and adulthood, in patients presenting with a variety of chronic medical conditions including chronic pelvic pain. Much of the published research comes from North America, and how well these findings generalise to other countries is not clear.

More attention has been given to ► **sexual abuse** than physical abuse in the literature. Reported prevalence rates for sexual abuse in patients with chronic pelvic pain range from 26% to 64% (Collett et al. 1998; Reiter and Gambone 1990; Toomey et al. 1993; Walker et al. 1988; Walling et al. 1994), and from 11% to 50% for physical abuse (Rapkin et al. 1990; Toomey et al. 1993). This wide range is a reflection of the significant methodological problems characterising this area of research. One of the main problems is with definitions. Sexual abuse is defined in various ways by different investigators. Some studies have only included contact sexual abuse, whereas others have used a wider definition of sexual abuse and have included episodes of threatened or attempted abuse without any direct genital contact. Other studies have excluded isolated incidents of abuse. Some have distinguished between childhood abuse (usually below the age of 14 years) and abuse in adulthood, whereas others have not made this distinction.

Similar problems exist with definitions of physical abuse. Some studies only include life threatening abuse, where there is intent to seriously harm or kill, whereas others have defined it as any pattern of physical discipline or punishment, performed by a more powerful other individual to a person aged under 18 years, resulting in physical injury such as marks, bruises and welts.

It is clearly important for investigators to define sexual and physical abuse in a more uniform way, taking into account the age at the time of abuse, the nature, the range and duration of the abuse, and the relationship of the perpetrator to the abused person. There are also problems with defining chronic pelvic pain, which represents a very heterogeneous group of patients. It has been suggested that certain subgroups of patients with chronic pelvic pain have a higher prevalence of sexual trauma (Reiter et al. 1991).

The other factor known to influence reported prevalence rates is the method of data collection. Most data is collected using face-to-face interviews or self-administered questionnaires. It has been suggested that lengthy interviews carried out in a certain style are more likely to result in abuse disclosure (Wyatt and Peters 1986).

Many of the early studies did not include control groups, and although this has been addressed in more recent research, there is still lack of agreement over what constitutes an appropriate control group. Groups are rarely matched for such factors as chronicity of pain and age. Age may have a role in abuse reporting. Briere found that older women reported less sexual abuse than younger women, and this was attributed to the

older woman's discomfort with speaking about sexuality (Briere 1992). Many studies are limited by small sample sizes and are based on a population of patients referred to speciality pain clinics. The findings from such clinics may not be generalisable to patients seen in routine gynaecology clinics or in the primary care setting. There is a need for prospective studies with larger sample groups, although these are very difficult to carry out. The methodological problems in this area of research make it difficult to draw conclusions from the data presented.

A number of controlled studies, comparing women with chronic pelvic pain with women with pain in a different site and women with no pain, have demonstrated an increased prevalence of lifetime sexual abuse in the chronic pelvic pain group (Collett et al. 1998). In one study, this association only held for women who had been abused as an adult, whether or not they had also been abused as a child (Jamieson 1997). She also found that recent abuse was more likely to be associated with pain syndromes.

There is much less information about physical abuse and chronic pelvic pain. One often quoted study by Rapkin (1990), found that women with chronic pelvic pain were significantly more likely to report a history of childhood physical abuse than women receiving routine gynaecology care or women with pain in another site. This finding has not been replicated, although other workers have suggested that a history of physical abuse may be more relevant than a history of sexual abuse in women with chronic pelvic pain (Walling et al. 1994).

There has been considerable speculation in the literature as to the possible mechanisms linking abuse with chronic pelvic pain. It has been suggested by several workers that any type of childhood trauma, including violence, separations, illnesses and neglect, would be a predictor for pain proneness in adulthood. It is argued that traumatised individuals are more likely to feel vulnerable about their body and their health. Some psychologists conceptualise the pain amongst victims of sexual abuse as a defence against the overwhelming emotions connected to the traumatic experience. Linton (1996) suggested an indirect relationship in that abuse may affect pain by altering perception and one's ability to cope with pain. Support for this model comes from the knowledge that abused patients have higher levels of depression and affective distress, and lower levels of perceived control, compared to non-abused patients. It may be that women with an abuse history have a tendency to report more symptoms of any kind as a function of psychological disturbance. Although the data are consistent with the idea that abuse may be instrumental in the development of chronic pain problems, we do not understand the mechanisms involved with this. It has been pointed out that abuse may be a correlate rather than a causal variable, since abuse may be related to many lifestyle risk factors (Fry 1993).

A recent prospective investigation of childhood sexual and physical abuse and neglect found no association with adult pain symptoms. However, unexplained pain symptoms were found to be associated with retrospective self-reports of all types of childhood victimisation. Perhaps patients who recall childhood abuse and neglect perceive themselves to be trapped by a history that they cannot undo, and this in turn leads to helplessness and passivity (Raphael 2001).

In view of the high prevalence of lifetime abuse in women with chronic pelvic pain, it has been argued that such women should be routinely asked about any abuse history as part of their assessment. A number of studies have shown that women with chronic pelvic pain are rarely asked about assault, and only a small minority of women volunteer this information to a gynaecologist or physician. When women were asked whether they thought they should be asked, 90 per cent answered in the affirmative (Robohm and Buttenheim 1996). In addition to asking about any past abuse history, it is important to ensure that the women are not involved in any ongoing abuse. Interpersonal sensitivity in treating these women is particularly important. Concerns about trust in the doctor-patient relationship are common, and women with a history of ► [childhood sexual abuse](#) report more anxiety, embarrassment and vulnerability associated with a gynaecological examination than other women (Robohm and Buttenheim 1996).

Linton found that more than 85 percent of the women in his sample did not believe that their history of abuse affected their pain or their sex lives. Interventions, therefore, oriented directly towards abuse may be difficult to incorporate into general pain treatment. Specific therapy for the abuse may be the best way to deal with the problem if the patient has unresolved issues around the abuse, which are affecting her current functioning.

In summary, there are complex interactions between child and adult abuse, depression, stressful life events and the occurrence of chronic pelvic pain, and clinicians need to take these psychosocial factors into consideration when assessing and treating women with chronic pelvic pain.

Little research into physical and sexual abuse amongst patients with chronic vulvar pain syndromes or ► [vulvodynia](#) has been undertaken. However, studies that have been undertaken show that there is a significantly higher incidence of sexual abuse and psychological distress in chronic pelvic pain patients, compared to women with chronic vulvar pain and to gynaecological controls (Bodden-Heidrich et al. 1999, Reed et al 2000).

## References

1. Bodden-Heidrich R, Kupperts V, Beckmann MW, Rechenberger I, Bender HG (1999) Chronic Pelvic Pain Syndrome (CPPS) and Chronic Vulvar Pain Syndrome (CVPS): Evaluation of Psychosomatic Aspects. *J Psychosom Obstet Gynecol* 20:145-151



2. Briere J (1992) *Child Abuse Trauma. Theory and Treatment of the Lasting Effects.* SAGE Publications, London
3. Collett BJ, Cordle CJ, Stewart CR, Jagger C (1998) A Comparative Study of Women with Chronic Pelvic Pain, Chronic Non-Pelvic Pain and Those with no History of Pain Attending General Practitioners. *Br J Obstetrics Gynaecology* 105:87–92
4. Department of Health (2000a) *Working Together to Safeguard Children in Need and Their Families.* The Stationary Office, London, p 5
5. Fry RP, Crisp AH, Beard RW, McGuigan S (1993) Psychosocial Aspects of Chronic Pelvic Pain with Special Reference to Sexual Abuse. A study of 164 women. *Postgrad Med J* 69:566–574
6. Glaser D & Frosch S (1988) *Child Sexual Abuse.* Macmillan, London, p 5
7. Jamieson DJ, Steege JF (1997) The Association of Sexual Abuse with Pelvic Pain Complaints in a Primary Care Population. *Am J Obstet Gynecol* 177:1408–1412
8. Linton SJ, Larden M, Gillow AM (1996) Sexual Abuse and Chronic Musculoskeletal Pain: Prevalence and Psychological Factors. *Clinical Journal of Pain* 12:215–221
9. Raphael KG, Widom CS, Lange G (2001) Childhood Victimization and Pain in Adulthood: A Prospective Investigation. *Pain* 92:283–293
10. Rapkin AJ, Kames LD, Darke LL, Stamper FM, Nabiloff BD (1990) History of Physical and Sexual Abuse in Women with Chronic Pelvic Pain. *Obstet Gynecol* 76:92–95
11. Reed BD, Haefner HK, Punch MR, Roth RS, Gorenflo DW, Gillespie BW (2000) Psychosocial and Sexual Functioning in Women with Vulvodynia and Chronic Pelvic Pain. *J Reprod Med* 45:624–632
12. Reiter RC, Gambone JC (1990) Demographic and Historic Variables in Women with Idiopathic Chronic Pelvic Pain. *Obstet Gynecol* 75:428–432
13. Reiter RC, Shakerin LR, Gambone JC, Milburn AR (1991) Correlation Between Sexual Abuse and Somatisation in Women with Somatic and Nonsomatic Chronic Pelvic Pain. *Am J Obstet Gynecol* 165:104–109
14. Robohm JS, Bottenheim M (1996) The Gynaecological Care Experiences of Adult Survivors of Childhood Sexual Abuse: A Preliminary Investigation. *Women Health* 24:59–75
15. Toomey TC, Hernandez JT, Gittelman DF, Hulka JF (1993) Relationship of Sexual and Physical Abuse to Pain and Psychological Assessment Variables in Chronic Pelvic Pain. *Pain* 53:105–109
16. Walker E, Katon W, Harrop-Griffiths J, Holm L, Russo J, Hickok LR (1988) Relationship of Chronic Pelvic Pain to Psychiatric Diagnoses and Childhood Sexual Abuse. *Am J Psychiatry* 145:75–80
17. Walling MK, Reiter RC, O'Hara MW, Milburn AK, Lilly G, Vincent SD (1994) Abuse History and Chronic Pain in Women: Prevalence of Sexual Abuse and Physical Abuse. *Obstet Gynecol* 84:193–199
18. Wyatt GE, Peters SD (1986) Methodological Considerations in Research on the Prevalence of Child Sexual Abuse. *Child Abuse Negl* 10:241–251

## Chronic Pelvic Pain, Physical Therapy Approaches and Myofascial Abnormalities

RHONDA K. KOTARINOS  
Long Grove, IL, USA  
rkotarinos@msn.com

### Synonyms

Myofascial trigger point; myofascial pain syndrome

### Definition

A ► **myofascial trigger point** is a hyper-irritable spot within a taut band of skeletal muscle or muscle fascia which is painful on compression and gives rise to characteristic referral pain patterns, tenderness and autonomic phenomena. (Travell and Simons 1983) ► **Myofascial pain syndrome** has had various definitions over the years. An early definition identifies it as a regional muscle pain disorder that is characterized by tender spots in taut bands of muscle that refer pain to areas overlying or distant to the tenderness. (Travell 1990) The sensory, motor and autonomic phenomenon caused by myofascial trigger points is the currently acceptable definition. (Simons et al. 1999) In diagnosing a myofascial pain syndrome, the specific muscle or muscle group must be specified.

### Characteristics

Chronic pelvic pain has many definitions. At this time, there is not a universally accepted definition of chronic pelvic pain, which mirrors the problems with defining myofascial pain syndrome. In 1989, the American College of Obstetricians and Gynecologists defined chronic pelvic pain as pain that had persisted for six months or longer and of such severity that it significantly impacted the ability to function and relationships. (Steege 1989) Six common characteristics associated with chronic pelvic pain were: duration of 6 months or longer, incomplete relief by most previous treatments, significantly impaired function at home or work, signs of depression, pain out of proportion to pathology and altered family roles” (Steege 1989). Over time, defining chronic pelvic pain evolved to be based on the duration, the anatomical and physical basis or psychological characteristics of the pain. (Steege et al. 1993) Chronic pelvic pain in the absence of obvious pathology is defined by the International Association for the Study of Pain as chronic or recurrent pelvic pain that appears to have a gynecologic origin but without a definitive lesion or cause (Mersky and Bogduk 1994).

Many pain syndromes are included within the domain of chronic pelvic pain. Vulvodynia, vulvar vestibulitis, urethral syndrome, interstitial cystitis, penile pain, orchialgia, perineal pain, chronic prostatitis, prostatic dysnia, proctalgia fugax, are a few of the pain syndromes associated with chronic pelvic pain.

Confusion in defining chronic pelvic pain has not been limited to medical management of the female. In 1995, the National Institutes of Health (NIH) proposed that the definition of Chronic Pelvic Pain Syndrome in men would be based on “the presence of genito urinary pain and the absence of uropathogenic bacteria by standard microbiological methodology.” (Kreiger et al. 1999) Chronic Abacterial Prostatitis/Chronic Pelvic Pain Syndrome is a new category (Category III) established by NIH. The specific definition being discomfort of pain

in the pelvic region (for at least three months, variable voiding and sexual symptoms with no demonstrable infection).

Chronic pelvic pain in both sexes continues to be a diagnostic and therapeutic challenge. Musculoskeletal dysfunction is emerging as a common denominator in the manifestation of chronic pelvic pain in both men and women.

Two major categories of musculoskeletal dysfunction associated with chronic pelvic pain are myofascial dysfunction and ► **somatic dysfunction** (Grunman 1989). Several studies have investigated the most common components of the somatic dysfunction. Somatic dysfunction describes dysfunction within the musculoskeletal system that is characterized by skeletal asymmetry, altered articular mobility and tissue texture abnormality. In a retrospective study performed at the University of Tennessee, 75 % of 132 patients were found to have a “typical pelvic pain posture.” (King et al. 1991) A lordosis of the lumbar spine with an anterior pelvic tilt were the common components of the typical pelvic pain posture. Other common musculoskeletal dysfunctions identified in the typical pelvic pain posture patients included decreased iliopsoas length, decreased range of motion of lumbar spine flexion, decreased range of motion of hip rotation and increased pelvic floor muscle tone.

Individualized physical therapy treatment plans were developed and executed for each patient. Physical therapy treatment included active and passive stretching, active and passive lumbar flexion exercises, abdominal muscle strengthening, and joint mobilization. Other physical therapy modalities included massage, external supports, moist heat and electrotherapy. Education as to proper posturing for lifestyle factors was included in the physical therapy management. Complete or significant relief was achieved in 70 % of the chronic pelvic pain patients that received physical therapy treatment. Adler investigated musculoskeletal structure as sources of undiagnosed pelvic and / or abdominal pain. (Adler 2003) Twenty women that had continued pain after hysterectomy for pelvic / abdominal pain were referred to physical therapy, primarily for concomitant low back pain. During the comprehensive orthopedic physical therapy evaluation, the subjects were to inform the therapist if their chief complaint could be reproduced by palpation of various musculoskeletal structures. A positive result was documented when their pain was reproduced to a level of 80 % or higher.

Seventeen of the twenty subjects (85 %) reported that their pain was reproduced during the physical therapy evaluation. Mechanical dysfunctions, poor postural habits and myofascial trigger points were musculoskeletal factors that were determined to be elements of pelvic and / or abdominal pain.

Two major categories of musculoskeletal dysfunction associated with chronic pelvic pain, myofascial disor-

ders and skeletal malalignment, have been described. (Punch et al. 1994) Within each category the specific diagnostic criteria, typical muscle groups implicated for each category and the therapeutic treatment plan for the dysfunction was delineated. (Table 1)

Punch et al. found that 35 women of 160 that were referred to their university hospital clinic had a musculoskeletal cause for their chronic pelvic pain. Physical therapy management as described (Table 1) and trigger point injections, being determined on an individual basis, was administered to the subjects. Sixty-nine percent reported total or significant pain relief.

Pelvic floor dysfunction is well established as being a factor in many of the syndromes associated with chronic pelvic pain. Weiss performed a retrospective study of 52 patients that presented to him with a diagnosis of either interstitial cystitis or urgency-frequency syndrome. (Weiss 2001) Manual physical therapy to the pelvic floor includes trigger point release techniques with and without injections, active and passive stretching, and neuromuscular reeducation. Eighty-three percent of the patients with urgency-frequency syndrome had moderate to complete resolution of their symptoms. Of the patients with a diagnosis of interstitial cystitis, 70 % had marked or moderate improvement.

Another retrospective study investigated musculoskeletal pelvic pain in a pediatric and adolescent gynecology setting. (Schroeder et al. 2000) To be included in the study, the subject had to have a diagnosis of pelvic pain not explained by a standard gynecologic work up or no response to standard treatments for known endometriosis. Of the sixty three patients who met the inclusion criteria, 50 % had a final diagnosis of musculoskeletal pain with 10 % having trigger points as a causative factor. Physical therapy management resulted in complete resolution in 20 / 21 (95.24 %) who completed treatment. Five subjects underwent trigger point injections with 4/5 (80 %) responding positively.

In the past, pelvic pain complaints in most men have been attributed to prostate pathology, even when no pathology could be demonstrated. More recent studies are now demonstrating that there is a high incidence of musculoskeletal dysfunction in men who present with chronic pain syndrome type III A and III B. (Hetrick et al. 2003) This study compared pelvic muscle function in 62 men with chronic pelvic pain syndrome III to 89 healthy men without pelvic pain. Increased pelvic muscle tenderness, increased pelvic floor muscle tone, greater incidence of pelvic floor muscle spasm and a greater incidence of substitution of other muscles when an isolated pelvic floor contraction was attempted was found in the subjects with a diagnosis of chronic pelvic pain syndrome III A & III B.

Musculoskeletal dysfunction is slowly, but surely, being established as one of many contributing factors associated with chronic pelvic pain in men and women. Simultaneously, health care professionals are learning that

**Chronic Pelvic Pain, Physical Therapy Approaches and Myofascial Abnormalities, Table 1** Assessment of Musculoskeletal Dysfunction (Punch et al 1994).



<b>1. Typical Muscle Groups Affecting Pelvic Function (most common muscles emphasized)</b>	
Pelvic Floor	Levator Ani Coccygeous
Anterior Action	Abdominal Wall Iliopsoas Rectus Femoris Sartorius Quadratus Femoris Gracilis
Posterior Action	Gluteus Maximus Hamstrings Quadratus Lumborum Piriformis Lateral Rotators
Medial Action	Adductor Magnus Adductor Longus Adductor Brevis Pectineus
Lateral Action	Tensor Fascia Latae Gluteus Medius Gluteus Minimus
<b>2. Articular Dysfunctions Relevant to Pelvic Pain</b>	
Pubic Symphysis	
Sacroiliac Joints	
Lumbosacral Junction	
Lumbar Spine	
<b>3. Screening for Musculoskeletal Dysfunctions</b>	
Clinical Picture	Exacerbated by Movement, Postures or Positioning Stiffness Poorly Localized Deep Ache, Tightness or Burning May become more Diffuse Over Time
<b>4. Treatment of Musculoskeletal Dysfunction</b>	
Restore ROM for involved muscles with Stretching protocol emphasizing Twice Daily Home Exercises and Duration of Stretch (15–30 Seconds)	
Modalities to facilitate ROM	Ice Heat Fluorimethane Spray Ultrasound Trigger Point Injections
Post Re-education	
Progressive Strengthening Program	

a multidisciplinary approach is more likely to be effective in managing chronic pelvic pain. (Wesselman 1998) A comprehensive multidisciplinary pain clinic should include representation from gynecologists, urogynecologists, urologists, anesthesiologists, gastroenterologist, colorectal surgeons, physical therapists and various alternative medicine disciplines.

Physical therapy is developing into an essential service in treating chronic pelvic pain. All patients should be evaluated for musculoskeletal dysfunction and then managed with an individualized treatment plan that addresses the skeletal and myofascial dysfunctions noted. A comprehensive physical therapy evaluation would include a postural evaluation, gait analysis, muscle strength assessment, articular range of motion of the trunk and extremities, and muscle length.

A soft tissue evaluation should also be done. The tissues to be assessed with this evaluation are the connective, muscle and neural tissues. Neural tissue assessment would be looking for ► **adverse neural tension**. Pain symptoms can develop from neural tissue that has impaired movement and elasticity. (Butler 1991) The physical therapist should also perform a thorough pelvic floor exam. An internal exam would include a localized soft tissue assessment, as well as assessment of the pelvic floor strength and range of motion. An instrumented evaluation of the pelvic floor with EMG or pressure biofeedback can be useful, but is not required. The individualized treatment plan would address all dysfunctions noted. Treatment could include postural corrective exercise, active and passive stretching, neuromuscular reeducation, progressive strengthening, and joint mobilization. Manual therapy techniques would be employed to address the soft tissue dysfunctions. They could include ► **myofascial manipulation**, ► **connective tissue manipulation**, neural mobilization / stretching, muscle energy techniques, and ► **myofascial release**. Adjunctive management with modalities of physical therapy could include ice, heat, ultrasound, diathermy, electrical stimulation (TENS, high volt pulsed galvanic, interferential, etc.), biofeedback, and trigger point injections.

## References

- Adler T, Personius W, Lamb R et al. (2003) Abstract Presentation. Musculoskeletal Symptoms Mimicking Pathological Pelvic Pain in Women. The International Pelvic Pain Society 10<sup>th</sup> Scientific Meeting on Chronic Pelvic Pain
- Butler D (1991) Mobilization of the Nervous System. Churchill Livingstone, Melbourne, p vii
- Greenman P (1989) Principles of Manual Medicine. Williams & Wilkins, Baltimore
- Hetrick D, Ciol M, Rothman I et al. (2003) Musculoskeletal Dysfunction in Men with Chronic Pelvic Pain Syndrome Type III: A Case Control Study. J Urol 170:828–831
- King P, Myers L, Ling F et al. (1991) Journal of Psychosomatics, Obstetrics and Gynecology 12:87–98
- Kreiger JN, Nyberg L, Nickel J (1999) NIH Consensus Definition and Classification of Prostatitis. Journal of American Medical Association
- Mersky H, Bogduk N (1994) Classification of Chronic Pain. IASP Press
- Punch MR, Roth RS, Pominville L (1994) Musculoskeletal Origins of Chronic Pelvic Pain in Women. American Society for Psychosomatic Obstetrics and Gynecology, 22<sup>nd</sup> Annual Meeting. San Diego, California. Poster Presentation
- Shroeder B, Sanfilippo J, Hertweck S (2000) Musculoskeletal Pelvic Pain in a Pediatric and Adolescent Gynecology Practice. Journal of Pediatric and Adolescent Gynecology 13:90
- Simons D, Travell J, Simons L (1999) Myofascial Pain and Dysfunction: The Trigger Point Manual, vol 1, 2<sup>nd</sup> edn
- Steege J (1989) Chronic Pelvic Pain. ACOG Technical Bulletin 129:1–6
- Steege J, Stout A, Somkuti S (1993) Chronic Pelvic Pain in Women: Toward and Integrated Model. Obstetric and Gynecology Survey 48:95–110
- Travell J, Simons D (1983) Myofascial Pain and Dysfunction: The Trigger Point Manual, vol 1, 1<sup>st</sup> edn
- Travell JG (1990) Chronic Myofascial Pain Syndromes Advances in Pain Research and Therapy 17:129–137
- Weiss J (2001) Pelvic Floor Myofascial Trigger Points: Manual Therapy for Interstitial Cystitis and the Urgency-Frequency Syndrome. J Urol 166: 2226–2231
- Wesselmann U (1998) Management of Chronic Pelvic Pain. In: Arnoff G (ed) Evaluation and Treatment of Chronic Pain. Williams & Wilkins, Baltimore, pp 269–279

## Chronic Postoperative Pain

- **Iatrogenic Causes of Neuropathy**

## Chronic Post-Surgical Neuralgia

- **Iatrogenic Causes of Neuropathy**

## Chronic Post-Surgical Pain Syndromes

### Definition

A pain lasting more than three months, persisting after healing from a surgical procedure. Chronic post surgical pain syndromes are most often the consequence of a peripheral nerve injury directly or indirectly caused by the surgical intervention. Proper identification of the injured nerve is crucial for adequate pain management.

- **Iatrogenic Causes of Neuropathy**

## Chronic Relapsing Polyneuropathy

- **Chronic Inflammatory Demyelinating Polyneuropathy**



## Chronic Tension-Type Headache

### Definition

Classification of International Headache Society describing a subtype of chronic daily headache as very frequent headaches ( $\geq 15$  days per month for at least 3 months,  $\geq 180$  days per year). Pain has 2 of the following characteristics: pressing or tightening quality, mild or moderate intensity, bilateral location, and not aggravated by routine physical activity. Headache has only one of the following: photophobia, phonophobia or nausea and does not have moderate or severe nausea and no vomiting. Headache is not attributed to another disorder, an individual's use of analgesics or other acute medication, and is  $\leq 10$  days per month.

- ▶ Chronic Daily Headache in Children
- ▶ New Daily Persistent Headache

## Chronic Vulvar Pain

- ▶ Gynecological Pain and Sexual Functioning

## Chronic Widespread Allodynia

### Definition

The fibromyalgia syndrome can now be viewed physiologically as the classical human model for chronic, widespread allodynia.

- ▶ Allodynia
- ▶ Muscle Pain, Fibromyalgia Syndrome (Primary, Secondary)

## Chronic Widespread Pain

### Synonyms

CWP

### Definition

Chronic widespread pain refers to pain in the left side of the body, pain in the right side of the body, pain above the waist, and pain below the waist. In addition, axial pain (cervical, thoracic or low back) must be present and pain must have persisted for at least three months (Wolfe F, Smythe H, Yunus M, et al. 1990).

- ▶ Physical Exercise
- ▶ Fibromyalgia

### Reference

Wolfe F, Smythe H, Yunus M, et al. (1990) The American College of Rheumatology. Criteria for the Classification of Fibromyalgia. Report of the Multicenter Criteria Committee. *Arthritis Rheum* 33:160-172

C

## Chronicity, Prevention

MICHAEL K. NICHOLAS

University of Sydney, Royal North Shore Hospital, St. Leonards, NSW, Australia  
miken@med.usyd.edu.au

### Synonyms

Secondary Prevention

### Definition

Interventions aimed at reducing the risk of a recently injured person developing chronic pain and disability.

### Characteristics

The natural history of pain following injury, especially non-specific injuries like low back pain, is that such pain typically eases to minimal levels within 1–12 weeks. If pain persists beyond 12 weeks it has been reclassified as 'chronic' (Merskey and Bogduk 1994) and may last for prolonged periods. However, recurrences of low back pain, once it has settled, are common. A systematic review of published evidence by Pengel et al. (2003) found that recurrences of low back pain in the first year after initial onset were in the region of 70%. Epidemiological findings of chronic pain, using the 3-month definition, indicate that around 20% of adults in western industrialised countries report experiencing such pain (e.g. Blyth et al. 2001). Importantly, however, at least half of this group report that persisting pain was having little impact on their lives, indicating that having persisting pain does not, by itself, mean that the person will be disabled by it. In contrast, the remaining half of those with persisting pain reported that it was interfering in their lives to some degree, a proportion reporting substantial impact on their lifestyles due to pain.

Given the evidence that the transition from acute to chronic pain, and the concurrent development of disability, can be modulated by psychological and environmental (or social) factors, a number of studies have described attempts to modify these psychosocial factors to prevent the development of secondary disability. Some interventions have addressed psychological risk factors, such as beliefs, fears, coping strategies, and avoidance and escape behaviours. Other interventions have addressed environmental or social risk factors, such as workplace arrangements, or compensation

factors. A number of controlled treatment studies, addressing these risk factors in people with acute and sub-acute musculoskeletal pain conditions, have now been reported.

Waddell and Burton (2000), in their systematic review of the treatment literature for acute and sub-acute low back pain, concluded that there is strong evidence that advice to continue ordinary activities of daily living as normally as possible despite the pain, can give equivalent or faster symptomatic recovery from acute symptoms, and leads to shorter periods of work loss, fewer recurrences and less work loss the following year than "traditional" medical treatment. Specifically, they reported that interventions containing education (aimed at managing pain and disability, as opposed to simply anatomy/physiology), reassurance and advice (to stay active), progressive fitness exercises, and pain management advice (using behavioural principles) were likely to reduce the risks of developing chronic, disabling pain. Waddell and Burton also found that there was moderate evidence that such approaches were more effective, if they were combined with organisational (workplace) arrangements aimed at facilitating return to work.

Since that review, a number of randomised controlled studies have provided further evidence that interventions aimed at psychosocial risk factors were effective at preventing the development of chronic disability. For example, Linton and Anderson (2001) demonstrated that a brief (six 2-hour group sessions) cognitive-behavioural pain management (conducted by a clinical psychologist) intervention, for workers (who were still working but increasingly missing days at work due to back pain) with sub-acute low back pain (defined by them as 6–8 months), was more effective than standard rehabilitation and information provision (via booklets) in terms of lost sick days and reduced use of healthcare. These effects were still present a year later, and there was a 9-fold advantage for the cognitive-behavioural approach over the alternative interventions in terms of lost work days.

Haldorsen et al. (2002) compared three different treatment modalities with a large sample of injured workers with a range of musculoskeletal conditions who still had jobs, but had been sick-listed for at least 8-weeks in the previous 2-years. The patients were first classified according to three prognostic categories for likely return to work (based on a combination of questionnaire evaluation of psychosocial factors and physiotherapy assessment). Patients in each category were then randomly assigned to one of the different treatments. The treatments consisted of 'ordinary treatment' (referral to a general practitioner combined with some physiotherapy); 'light multidisciplinary treatment' (like a light mobilisation program or encouragement to resume normal activities, similar to that reported by Indahl et al. 1995); and 'extensive multidisciplinary treatment' (4-weeks of an intensive program similar to that de-

scribed by Bendix et al. 1998). Patients were followed up 14-months post-treatment.

The results reported by Haldorsen et al. indicated that injured workers assessed to have a good prognosis of return to work achieved good outcomes, regardless of whichever level of intervention they received. While those with only medium prognostic profiles benefited equally from the light and intensive multidisciplinary programs, but not from 'standard or ordinary' care. However, those assessed to have a poor prognosis responded best to the intensive multidisciplinary treatment, with significantly better return to work rates up to 14-months post-treatment than light mobilisation (55 vs. 37%). Recently, Schonstein et al. (2003) reported the results of a systematic review of randomised and controlled physiotherapy exercise programs for injured workers. This review concluded that there is evidence that the programs "that include a cognitive-behavioural approach can reduce the number of sick days lost for workers with chronic back pain" (p. 5). They also concluded that "there is no evidence for or against specific exercises which are not accompanied by a cognitive-behavioural approach being effective" (p. 5) (in terms of sick days lost, for both acute and chronic back pain cases). Thus, there is strong evidence that encouragement to resume normal activities or exercises, using cognitive-behavioural methods, such as goal setting, consistent reinforcement for progress, and graduated increments in activities and exercises can limit secondary disability due to persisting musculoskeletal pain.

## References

1. Bendix BT, Bendix A, Labriola M, Boekgaard P (1998) Functional Restoration for Chronic Low Back Pain. Two Year Follow-Up of Two Randomized Clinical Trials. *Spine* 23:717–725
2. Blyth FM, March LM, Brnabic AJM, Jorm LR, Williamson M, Cousins MJ (2001) Chronic Pain in Australia: A Prevalence Study. *Pain* 89:127–134
3. Haldorsen EM, Grasdahl AL, Skouen JS, Risa AE, Kronholm K, Ursin H (2002) Is There a Right Treatment for a Particular Patient Group? Comparison of Ordinary Treatment, Light Multidisciplinary Treatment, and Extensive Multidisciplinary Treatment for Long-Term Sick-Listed Employees with Musculoskeletal Pain. *Pain* 95:49–63
4. Indahl A, Velund L, Reikeraas O (1995) Good Prognosis for Low Back Pain when Left Untampered: A Randomized Clinical Trial. *Spine* 20:473–477
5. Linton SJ, Andersson T (2000) Can Chronic Disability be Prevented? A Randomized Trial of a Cognitive-Behavioral Intervention and Two Forms of Information for Spinal Pain Patients. *Spine* 25:2825–2831
6. Merskey H, Bogduk N (1994) Classification of Chronic Pain. Descriptions of Chronic pain Syndromes and Definitions of Pain Terms, 2<sup>nd</sup> edn. IASP Press, Seattle
7. Pengel LH, Herbert R, Maher CG, Refshauge KM (2003) Acute Low Back Pain: Systematic Review of its Prognosis. *BMJ* 327:323–327
8. Schonstein E, Kenny DT, Keating J, Koes BW (2003) Work Conditioning, Work Hardening and Functional Restoration for Workers with Back and Neck Pain. Meta-Analysis. *Cochrane Database of Systematic Reviews* (1)
9. Waddell G, Burton K (2000) Evidence Review. In: Carter JT, Birrell LN (eds) *Occupational Health Guidelines for the Manage-*

ment of Low Back Pain at Work – Principal Recommendations.  
Faculty of Occupational Medicine, London

## Chung Model

- ▶ Animal Models and Experimental Tests to Study Nociception and Pain
- ▶ Neuropathic Pain Model, Spinal Nerve Ligation Model
- ▶ Retrograde Cellular Changes after Nerve Injury
- ▶ Spinal Nerve Ligation Model

## CIDP

- ▶ Chronic Inflammatory Demyelinating Polyneuropathy

## Cingulate Cortex

### Definition

Cortical tissue also referred to as Limbic Cortex or Cingulate Gyrus that encircles the hippocampus and other structures of the limbic region. It is sometimes interrupted as treatment for obsessive compulsive disorder or pain.

- ▶ Cingulate Cortex, Nociceptive Processing, Behavioral Studies in Animals
- ▶ Pain Treatment, Intracranial Ablative Procedures

## Cingulate Cortex, Effect on Pain-Related Behavior in Humans

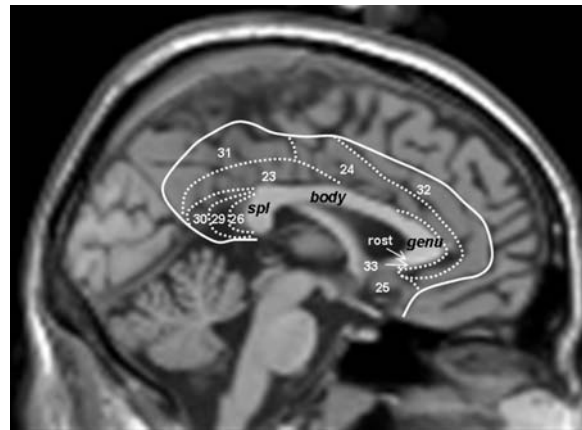
- ▶ Pain Processing in the Cingulate Cortex, Behavioral Studies in Humans

## Cingulate Cortex, Functional Imaging

PIERRE RAINVILLE  
Department of Stomatology, Faculty of Dental Medicine, University of Montreal, Montreal, QC, Canada  
pierre.rainville@umontreal.ca

### Definition

The cingulate cortex is a part of the medial frontal and parietal ▶ **cerebral cortices** situated immediately above the ▶ **corpus callosum** and curving around its most anterior part. The human cingulate cortex can be subdivided into several sub-regions as shown in Fig. 1. Histologically, the anterior cingulate cortex



**Cingulate Cortex, Functional Imaging, Figure 1** Anatomy of the human cingulate cortex. The cingulate cortex is delimited ventrally by the corpus callosum. The cingulate cortex is delimited ventrally by the corpus callosum. The full line corresponds to its approximate anterior, posterior and dorsal borders. The sub-regions of the cingulate cortex are delimited by dotted lines according to the corresponding Brodmann areas identified by numbers. Regions of the cingulate cortex can also be divided based on their location relative to the body of the corpus callosum (dorsal = supracallosal; ventral = subcallosal) and to the anterior (rost = rostrum and genu) or posterior (spl = splenium) parts of the corpus callosum. The subgenual area corresponds to BA25, the perigenual area corresponds to BA33 and to the anterior part of BA24 and BA32 and the retrosplenial area corresponds to BA26, BA29 and BA30.

(ACC) comprises ▶ **Brodmann area 25** (BA25) below the rostrum of the corpus callosum and BA24, BA32 and BA33 above the body and curving around the genu of the corpus callosum. The posterior region of the cingulate gyrus corresponds to BA23, BA31, BA30, BA29 and BA26. Traditionally, the cingulate cortex is considered part of the ▶ **limbic system**, which is associated with emotions. Furthermore, functional brain imaging studies have shown that sub-regions of the cingulate cortex, in particular within the anterior cingulate cortex (ACC), are activated in response to painful stimuli and therefore may be involved in pain related functions. Seeking to explain these findings, several theoretical models have placed the cingulate cortex at the interface of the sensory, affective, cognitive, skeletomotor and visceromotor systems (e.g. Vogt 2005).

### Characteristics

#### Nociceptive Activation of the Cingulate Cortex

Almost all functional brain-imaging studies of pain using ▶ **positron emission tomography** (PET) or ▶ **functional magnetic resonance imaging** (fMRI) have found pain related activation of the ACC (Apkarian et al. 2005). In these studies, experimental pain is produced using noxious thermal, mechanical, electrical or chemical stimuli applied to the skin or viscera of normal human volunteers. Peaks of activation are found most reliably in the caudal part of the supracallosal ACC and occasionally in the perigenual area. This activation is consistent with the projection of nociceptive neurons from the medial and intralaminar nuclei of the thalamus to BA24 (Vogt 2005).

### Functional Role of the ACC in Pain and Pain Modulation

Pain is a complex experience described along ► **sensory-discriminative** and ► **affective-motivational dimensions** influenced by cognitive processes and associated with somato-motor and visceromotor responses. The ACC may contribute to each of these aspects. Levels of activation in the supracallosal ACC have been correlated with the subjective reports of pain (Coghill et al. 2003). More specifically, activity in certain regions of the ACC may reflect the ► **affective-motivational dimension of pain**, as the modulation of pain unpleasantness, independently of pain intensity, changes ACC activity (Rainville 2002). Furthermore, the affective-motivational dimension of pain is strongly influenced by cognitive-evaluative processes shown to be highly dependent upon the function of the ACC (Price 2000). The supracallosal ACC is part of higher order systems involved in the voluntary regulation of behavioral and motor responses. Therefore, pain related activation in this area probably reflects motivational aspects of pain behaviors and conscious processes involved in pain related responses. Similarly, the perigenual region of the ACC is involved in physiological arousal, a fundamental aspect of emotion and a critical component of pain related affective responses. Changes in activity within the perigenual area have been associated with physiological arousal during emotional experiences, the performance of motor and cognitive tasks and the anticipation of pain (see Rainville 2002). However, the precise nature of the relationship between pain related activity in the ACC and physiological arousal remains to be demonstrated. Finally, posterior regions of the cingulate cortex may be involved in the representation of viscerosomatic changes, but the functional role of this area in pain is unclear. The ACC is also critically involved in cognitive processes, as demonstrated by innumerable brain imaging studies showing activation in this area during the performance of cognitive tasks (see Rainville 2002). However, this activation is typically observed in a more dorsal region, within BA32, whereas pain related activation is more ventral, in BA24. Nonetheless, regions of the ACC involved in cognitive processes may be involved in the modulation of pain. Studies investigating the modulation of pain by hypnosis (Rainville et al. 1999), placebo analgesia (Petrovic et al. 2002; Wager et al. 2004) and distraction (Valet et al. 2004) have in fact shown some activation in the dorsal anterior region of the ACC (typically in BA32). This activation is associated with a decrease in the response to painful stimuli in other pain related areas such as the somatosensory cortices and is consistent with a reduction in the pain reported by subjects. In some of these studies, activation of the ACC has also been found to correlate with activity in the brain stem, consistent with the activation of the periaqueductal grey area (PAG), a key structure of descending pain inhibitory mechanisms.

A role for the ACC in pain modulation is also supported by studies investigating the opioid system. The  $\mu$ -opioid receptor is found in many brain areas including the ACC. In a PET study, the systemic administration of the  $\mu$ -opioid agonist fentanyl increased activity in the ACC in a control condition without pain and reduced pain evoked activity within the thalamus and cortical areas, including the ACC (Casey et al. 2000). This decrease in pain related ACC activity was associated with a decrease in reported pain intensity and pain unpleasantness, as well as with pain related heart rate responses. Endogenous activation of the  $\mu$ -opioid system in the ACC and other areas has also been associated with decreased affective ratings of pain (Zubieta et al. 2001) and suggested as an underlying mechanism of placebo analgesia (Petrovic et al. 2002).

### Beyond Nociception: the ACC and the Mental Representation of Pain

In addition to its roles in the experience of pain and in the modulation of pain, the ACC may also be activated in the context of pain, in the absence of a noxious stimulus. This has been suggested by studies showing that ACC activation may occur during the anticipation of pain, prior to the presentation of a painful stimulus (Rainville 2002). However, pain related activation of the ACC may also be observed when the subject is merely thinking about, but not expecting or anticipating, an actual painful stimulus to the self. For example, ACC activity has been reported in response to visual stimuli depicting a hand or foot receiving a painful stimulus (Morrison et al. 2004; Jackson et al. 2005), videos showing a patient displaying pain behaviors (Botvinick et al. 2005) or cues indicating that a loved one is receiving a painful stimulus (Singer et al. 2004). ACC activation during both pain experiences and in response to cues signaling impending pain in the self or pain in others may reflect a general involvement of this structure in the mental representation of pain.

### A Multifunctional and Integrative Role for the ACC in Pain

From this brief overview of brain imaging studies, it is clear that the role of the ACC in pain is multifaceted. The ACC receives ascending nociceptive input and is in an excellent position to integrate this information with signals related to the motivational, emotional and underlying viscerosomatic state of the organism. The ACC is also well positioned to modify cognitive and behavioral priorities based on the biological significance of pain signals. In addition, the ACC may contribute to higher order processes involved in pain modulation. Finally, the ACC may play a critical role in the mental representation of pain in self and in others. This may provide a fundamental neurobiological basis for social interactions and pain empathy.

### References

1. Apkarian AV, Bushnell MC, Treede RD, Zubieta JK (2005) Human brain mechanisms of pain perception and regulation in health and disease. *Eur J Pain* 9(4):463–484



2. Botvinick M, Jha AP, Bylsma LM et al. (2005) Viewing facial expressions of pain engages cortical areas involved in the direct experience of pain. *Neuroimage* 25:312–319
3. Casey KL, Svensson P, Morrow TJ et al. (2000) Selective opiate modulation of nociceptive processing in the human brain. *J Neurophysiol* 84:525–533
4. Coghill RC, McHaffie JG, Yen YF (2003) Neural correlates of interindividual differences in the subjective experience of pain. *Proc Natl Acad Sci USA* 100:8538–8542
5. Jackson PL, Meltzoff, AN, Decety J (2005) How do we perceive the pain of others? A window into the neural processes involved in empathy. *Neuroimage* 24:771–779
6. Morrison I, Lloyd D, di Pellegrino G et al. (2004) Vicarious responses to pain in anterior cingulate cortex: is empathy a multisensory issue? *Cogn Affect Behav Neurosci* 4:270–278
7. Petrovic P, Kalso E, Petersson KM et al. (2002) Placebo and opioid analgesia—imaging a shared neuronal network. *Science* 295:1737–1740
8. Price DD (2000) Psychological and neural mechanisms of the affective dimension of pain. *Science* 288:1769–1772
9. Rainville P (2002) Brain mechanisms of pain affect and pain modulation. *Curr Opin Neurobiol* 12:195–204
10. Rainville P, Hofbauer RK, Paus T et al. (1999) Cerebral mechanisms of hypnotic induction and suggestion. *J Cogn Neurosci* 11:110–125
11. Singer T, Seymour B, O’Doherty J et al. (2004) Empathy for pain involves the affective but not sensory components of pain. *Science* 303:1157–1162
12. Valet M, Sprenger T, Boecker H et al. (2004) Distraction modulates connectivity of the cingulo-frontal cortex and the midbrain during pain—an fMRI analysis. *Pain* 109:399–408
13. Vogt BA (2005) Pain and emotion interactions in subregions of the cingulate gyrus. *Nat Rev Neurosci* 6:533–544
14. Wager TD, Rilling JK, Smith EE et al. (2004) Placebo-induced changes in fMRI in the anticipation and experience of pain. *Science* 303:1162–1167
15. Zubieta JK, Smith YR, Bueller JA et al. (2001) Regional mu opioid receptor regulation of sensory and affective dimensions of pain. *Science* 293:311–315

## Cingulate Cortex, Nociceptive Processing, Behavioral Studies in Animals

PERRY N. FUCHS, VERNE C. COX  
 Department of Psychology, University of Texas at  
 Arlington, Arlington, TX, USA  
 fuchs@uta.edu

### Synonyms

Anterior cingulate cortex; pain affect; Nociceptive Processing in the Cingulate Cortex, Behavioral Studies in Animals

### Definition

Nociceptive processing in the ► [cingulate cortex](#) is believed to reflect the affective component of pain and is probably a critical structure in the neural network that contributes to the suffering that accompanies persistent pain states. Behavioral studies in animals have utilized paradigms that measure escape and / or avoidance of a noxious stimulus. It is assumed that escape / avoidance behavior is evidence that animals find the noxious stimulus aversive. With the use of these paradigms, the precise

nature of the neuroanatomical and neurochemical mechanisms underlying the processing of higher order pain processing in rodents is beginning to be understood.

### Characteristics

The experience of pain consists of affective and sensory components. It is the affective component that underlies the suffering that accompanies many persistent pain states. An understanding of the neural substrates mediating the affective processing of nociceptive stimulation is essential for the development of successful pain therapies. The ► [anterior cingulate cortex \(ACC\)](#) is one brain region that has been implicated in the affective component of pain with relatively little involvement in sensory processing (Vogt 1985). For instance, ACC neuronal activity increases in direct response to and / or anticipation of noxious, but not nonnoxious chemical, mechanical and thermal stimuli (Hutchison et al. 1999; Koyama et al. 2001). Surgical cingulotomy and cingulectomy, or transection of the cingulum bundle and cingulate cortex respectively, decrease the affective response to noxious stimuli but do not alter ability to localize the unpleasant stimulus. Brain imaging studies consistently report increased ACC neuronal activity preceding and during the presentation of an acute noxious stimulus or during persistent pain conditions. Hypnotic suggestions to selectively decrease pain affect prior to and during noxious stimulation resulted in decreased ratings of pain unpleasantness but not pain intensity (Rainville et al. 1997). Manipulating pain unpleasantness by hypnotic suggestion also changed the regional cerebral blood flow (rCBF) in the ACC but not in the somatosensory cortex, providing evidence that the ACC is involved in the processing of pain-related affect but not in the sensory processing of noxious stimulation (Rainville et al. 1997).

Most of the studies that have examined supraspinal focal brain stimulation or ► [microinjection](#) of drugs into discrete nuclei have measured reflexive behavioral response to acute noxious stimulation. Indeed, activation of various subcortical, brainstem and spinal cord systems produces antinociception, as revealed by an increase in the threshold or latency to respond to noxious stimulation. In most studies, it is assumed that manipulations of limbic system structures alter pain processing through selective modulation of pain affect (Donahue et al. 2001). However, the majority of past and current behavioral paradigms cannot provide definitive information about the aversive and unpleasant qualities of a persistent pain condition. Thus, it has been difficult to examine the affective / motivational and sensory / discriminative components of pain processing in animal models. In addition, any study that attempts to examine higher order processing of noxious input in animals must address the exact nature of pain affect. For instance, the affective (i.e. worrisome, cruel, fearful, terrifying, etc.) nature of chronic pain in humans is dissociable from the sensory (i.e. shooting, stabbing,

pinching, cramping, etc.) nature of the condition by the descriptors that patients select on the ► [McGill Pain Questionnaire](#). In animal studies, the precise nature of pain affect is more difficult to define. Affect, as it relates to noxious input, is most certainly a negative hedonic state that can be identified in one way as aversion to a noxious stimulus.

With this in mind, a number of investigators have developed new behavioral methodologies to study the complexity of nociceptive processing in the ACC of animals. The underlying feature of these methodologies is that escape and/or avoidance of a noxious stimulus are clear indications that animals find the stimulus aversive (Fuchs 2000). For instance, Johansen et al. (2001) utilized the ► [formalin test](#) with the place-conditioning paradigm. In this paradigm, formalin injection elicits an acute nociceptive response and induces conditioned place avoidance (F-CPA) to the compartment of the apparatus that is associated with the formalin injection. Another recent paradigm utilizes place escape / avoidance in which animals must associate the application of the mechanical stimulus to the hyperalgesic paw with the preferred dark area of the test chamber (LaBuda and Fuchs 2000). Escape / avoidance behavior is measured as a shift from the preferred dark area of the chamber to increased time spent within the non-preferred light area of the chamber. In both instances, damage to the ACC, by either neurotoxic or electrolytic procedures, decreases behavioral evidence that the noxious stimulus is aversive (Johansen et al. 2001; LaGraize et al. 2004). At this time, the most parsimonious explanation of the behavioral studies in rodents is that the ACC is involved in the modulation and processing of pain affect and that manipulations of the ACC decrease the affective component of pain processing.

Behavioral paradigms that permit the separate assessment of affective and sensory components of the pain experience have led to examination of the underlying neurochemical processes that might be involved in modulating pain affect. One possible mechanism of action by which the ACC selectively modulates pain affect is *via* the mu-opioid receptor system. The ACC has a high density of opioid receptors and activation of the ACC mu-opioid receptor system during sustained pain is negatively correlated with McGill Pain Questionnaire affective scores (Zubieta et al. 2001). In animals, morphine microinjection into the ACC produces a selective decrease in escape / avoidance to mechanical stimulation of the hyperalgesic paw (LaGraize et al., 2006). Additional contributions of the NMDA (Lei et al. 2004), cholecystokinin (Erel et al. 2004), and glutamatergic (Johansen et al. 2004) systems have been reported.

It is unlikely that the above findings can be attributed to the role of the ACC in learning and memory processes, that is the possibility that ACC manipulation interferes with acquisition and retention of an escape / avoidance response rather than a change in the negative hedonic

value of the mechanical stimulus. Morphine has been found to impair performance in various tests of memory such as the ► [Morris water maze](#) and the ► [radial arm maze](#). However, the effect of morphine on the radial arm maze requires chronic high dose administration (up to 40 mg / kg) that almost certainly is associated with sedation and impairment in task performance rather than with interference in memory. Other investigators report biphasic results in rats such that lower doses of morphine enhance, while higher doses impair, memory. Anatomically, impairment of learning and memory function is typically associated with manipulations to the more posterior regions of the cingulate cortex.

It is inappropriate to examine the role of the ACC in nociceptive processing in animals with the use of reflexive behaviors to examine the aversive nature of persistent pain conditions. Experiments using only quantified mechanical thresholds or acute formalin injection behaviors can lead to the erroneous conclusion that the ACC does not effect supraspinal pain processing. Clearly, functional alterations of the ACC by lesion and neurochemical methods reduce the avoidance of noxious mechanical hind paw stimulation as measured using the place escape / avoidance paradigm and the formalin conditioned place avoidance paradigm. Sensory mechanisms of pain processing are clearly important but fail to highlight the mechanisms underlying the affect that accompanies many persistent pain conditions. Clinically, the sensation of pain can be treated by reducing the sensory input as well as by manipulating affective-motivational and cognitive factors (Melzack and Casey 1968). Therefore, an understanding of the neural substrates mediating the affective processing of nociceptive stimulation should advance our knowledge of pain processing and contribute to advances in therapeutic interventions to reduce the affective component of pain that accounts for the suffering so frequently seen in clinical conditions.

## References

1. Donahue RR, LaGraize SC, Fuchs PN (2001) Electrolytic lesion of the anterior cingulate cortex decreases inflammatory, but not neuropathic pain in rats. *Brain Res* 897:131–138
2. Erel U, Arborelius L, Brodin E (2004) Increased cholecystokinin release in the rat anterior cingulate cortex during carrageenan-induced arthritis. *Brain Res* 1022:39–46
3. Fuchs PN (2000) Beyond reflexive measures to examine higher order pain processing in rats. *Pain Res Manag* 5:215–219
4. Hutchinson WD, Davis KD, Lozano AM et al. (1999) Pain-related neurons in human cingulate cortex. *Nat Neurosci* 2:403–405
5. Johansen JP, Fields HL (2004) Glutamatergic activation of anterior cingulate cortex produces an aversive teaching signal. *Nat Neurosci* 7:398–403
6. Johansen JP, Fields HL, Manning BH (2001) The affective component of pain in rodents: direct evidence for a contribution of the anterior cingulate cortex. *Proc Natl Acad Sci USA* 98:8077–8082
7. Koyama T, Kato K, Tanaka YZ et al. (2001) Anterior cingulate activity during pain-avoidance and reward tasks in monkeys. *Neurosci Res* 39:421–430

8. LaBuda CJ, Fuchs PN (2000) A behavioral test paradigm to measure the aversive quality of inflammatory and neuropathic pain in rats. *Exp Neurol* 163:490–494
9. LaGraize SC, LaBuda CJ, Rutledge MA et al. (2004) Differential effect of anterior cingulate cortex lesion on mechanical hypersensitivity and escape / avoidance behavior in an animal model of neuropathic pain. *Exp Neurol* 188:139–148
10. LaGraize SC, Borzan J, Peng YB et al. (2006) Selective regulation of pain affect following activation of the opioid anterior cingulate cortex system. *Exp Neurol* 197:22–30
11. Lei L-G, Sun S, Gao Y-J et al. (2004) NMDA receptors in the anterior cingulate cortex mediate pain-related aversion. *Exp Neurol* 189:413–421
12. Melzack R, Casey KL (1968) Sensory, motivational, and central control determinants of pain. In: Kenshalo DR (ed) *The Skin Senses*. CC Thomas, Springfield, pp 423–439
13. Rainville P, Duncan GH, Price DD et al. (1997) Pain affect encoded in human anterior cingulate but not somatosensory cortex. *Science* 277:968–971
14. Vogt BA (1985) Cingulate cortex. In: Peters A, Johns EG (eds) *Cerebral Cortex*. Plenum Publishing Corporation, New York, pp 80–149
15. Zubieta J-K, Smith YR, Bueller JA et al. (2001) Regional mu opioid receptor regulation of sensory and affective dimensions of pain. *Science* 293:311–315

## Cingulotomy

### Definition

The creation of lesions in the cingulate gyrus, usually for the relief of intractable pain and in the treatment of psychiatric disorders and addiction.

- ▶ Pain Processing in the Cingulate Cortex, Behavioral Studies in Humans
- ▶ Pain Treatment, Intracranial Ablative Procedures

## CIPA

- ▶ Congenital Insensitivity to Pain with Anhidrosis

## Circadian Rhythms/Variations

### Definition

Rhythms of parameters with a frequency close to, but not exactly, 24-hr.

- ▶ Diurnal Variations of Pain in Humans

## Circadian Variations in Pain Level

- ▶ Diurnal Variations of Pain in Humans

## Circumventricular Brain Structures

### Definition

Specific regions within the brain where the blood brain barrier is weak or absent.

- ▶ Proinflammatory Cytokines

## Cl<sup>-</sup> Transporter

- ▶ Chloride Transporter

## Classical Conditioning

### Synonyms

Pavlovian conditioning; respondent conditioning

### Definition

Also called “Pavlovian conditioning” or “respondent conditioning” it is a type of learning that results from the association of stimuli with reflex responses, whereby a neutral stimulus (usually called the conditioned stimulus, CS) acquires the response eliciting properties of a previously potent stimulus (the unconditioned stimulus, US). Through repeated pairings of the CS (e.g. tone) with the US (e.g. shock) stimulus, the CS can be used to elicit the same or similar response, the conditioned response (CR, e.g. withdrawal) as the US.

- ▶ Amygdala, Functional Imaging
- ▶ Amygdala, Pain Processing and Behavior in Animals
- ▶ Behavioral Therapies to Reduce Disability
- ▶ Muscle Pain, Fear-Avoidance Model
- ▶ Pavlovian Conditioning
- ▶ Psychology of Pain and Psychological Treatment
- ▶ Respondent Conditioning of Chronic Pain

## Classical Massage

- ▶ Massage and Pain Relief Prospects

## Classical Migraine

- ▶ Clinical Migraine with Aura

## Classification

- ▶ Taxonomy

## Claudication

### Definition

Claudication is characterized by leg pain and weakness brought on by walking, with the disappearance of the symptoms following a brief rest.

► [Vascular Neuropathies](#)

## Clearance

### Definition

The clearance describes the hypothetical volume of fluid that is cleared from the unchanged drug per unit of time by any elimination pathway. The clearance can be further categorized as the total clearance (CL) (all elimination pathways) or the organic clearance (e.g. renal clearance (CL<sub>R</sub>), hepatic clearance (CL<sub>H</sub>), etc.).

► [NSAIDs, Pharmacokinetics](#)

## Clinical Migraine With Aura

F. MICHAEL CUTRER

Department of Neurology, Mayo Clinic, Rochester, MN, USA

cutrer.michael@mayo.edu

### Synonyms

Classical Migraine; classic migraine; Complex Migraine; Complicated Migraine; Migraine Accompanying; Migraine Ophthalmic; Migraine With Aura; Migraine Optical; Migraine Hemiparesthetic; Migraine Aphasic; Migraine Hemiplegic

### Definition

Migraine aura is a disorder during which episodes of transient focal neurological symptoms develop over a period of 5–20 minutes and resolve within 60 minutes (IHS 2004). Most commonly, these symptoms occur within 60 minutes of the onset of a migraine headache (i.e. unilateral throbbing headache of moderate to severe intensity, lasting 4–72 hours and associated with nausea, vomiting, ► [photophobia](#), ► [phonophobia](#) and worsening with routine exertion). Less commonly, the aura may occur during the course of a headache, in association with a headache which does not have all of the features of a migraine headache or in the absence of headache altogether. The aura is distinct from the term “prodrome” which refers to often vague symptoms that occur hours to a day prior to the onset of headache and which include both vegetative symptoms such as fatigue, pallor, yawning, ► [anorexia](#), nausea, light or

sound sensitivity or neck stiffness or affective symptoms namely depression, euphoria and concentration difficulties.

### Characteristics

#### General Characteristics

It has been estimated that migraine with aura occurs in about 4% of the general population each year (Rasmussen and Stewart 2000) suggesting that it occurs in up to one third of migraine sufferers. Many patients who have attacks of migraine with aura also have attacks of migraine without aura. Aura symptoms are clinically localizable to the ► [cerebral cortex](#) or brainstem and resolve fully in between attacks. In addition, no static changes in conventional anatomical neuroimaging occur as a result of the migraine aura. Although the duration of a single migraine aura is limited to 60 minutes, an individual patient may within a single attack have more than one type of aura. When the auras occur in sequence, their total time may extend beyond 60 minutes up to as much as 60 minutes for each aura type and still be considered aura. When the aura types occur in sequence, the most common order is visual, then sensory followed by language or motor symptoms although the order may vary. There are two general characteristics of the aura that seem to distinguish it from ischemia. 1. There is a tendency for the symptoms to spread or migrate slowly with time and 2. there is bimodal progression in which positive symptoms (tingling or visual shimmering) are followed by negative symptoms (numbness or visual scotoma).

#### Aura Types

Traditionally, four types of migraine aura have been recognized. These include visual, sensory, language and motor. However, the most recent International Headache Society (IHS 2004) diagnostic criteria consider motor aura a separate migraine subtype, as recent genetic data suggest the possibility of a distinct pathophysiology in motor aura. The three remaining aura types, visual, sensory and language auras are collectively termed “typical aura”.

#### Visual Aura

Visual aura consists of episodes of visual disturbance, which although frequently stereotypical within a given individual, may differ from one individual to another. In the classical progression, the aura begins as a small area of visual disturbance often just lateral to central fixation. This visual phenomenon, generally described as either a shimmering or sparkling light or as a crawling geometric or zigzagging pattern, is very characteristic of the aura of migraine. Within a few minutes of onset, the area of visual dysfunction begins to expand from its original central location slowly outward often in a crescent-like pattern to involve as much as a quarter or half of the visual field in both eyes. The expanding shimmering margin of



the aura leaves in its wake an area in which there is no image. This area is termed a ► **scotoma**. The scotoma is usually not a particular color but has been likened to the blind spot left in the visual field after having looked at a flashing light. The rate of the shimmering or flickering observed by the patient during aura seems to increase as the aura spreads toward the periphery. Gradually vision is restored, first centrally and then in areas of peripheral vision as the aura moves out of the visual field. The spread is usually quite slow taking from 40–60 minutes, but may be much more rapid, sometimes being completed in less than 15 minutes. Fragments of the aura (scotoma with shimmering or *vice versa*) maybe recalled as well as differences in the direction of expansion implying variability from one patient to another or within the same patient from one attack to another. The shimmering component of the aura is usually seen when the eyes are closed and passive movement of the eyeball through the eyelid does not change the position of the aura, implying that the abnormality occurs outside the eyeball itself. The visual aura is by far the most common form of migraine aura.

### Sensory Aura

Sensory aura is the second most common aura type and generally first manifests as a tingling sensation or paresthesia on one side of the face or in an arm or leg. Just as the visual aura expands or migrates, the sensory disturbance may march along the arm or leg only to jump upward to affect the face, gradually moving across it and then inside the mouth to affect the gums and/or tongue on one side. The involvement of half the tongue is quite suggestive of migraine and not typical for ischemia. Also indicative of migraine is the sensory aura's bimodal wave of paresthesias, which leaves in its wake a mild to moderate numbness that persists for up to an hour.

### Language Aura

Language aura is the least common of the typical aura forms but can be quite disturbing to patients when they first experience it. This aura type is actually a dysfunction of language, which makes it difficult for the patient to choose the correct words or speak them in a coherent fashion. The language aura may also disrupt reading or writing. It is clearly distinct from slurring of speech, which may occur with sensory aura if half the tongue is numb. Because thought is generally in conducted in a given language, patients are often distressed by an inability to think clearly.

### Motor Aura

Motor aura is now considered as a separate entity by the International Headache Society because single gene mutations have been identified as the cause of hemiplegic migraine in several families. Patients with hemiplegic migraine report unilateral weakness involving the face and/or an extremity. The duration of the motor aura dif-

fers from other typical aura types in that it is sometimes longer than 1 hour and may actually persist after resolution of the headache. This would argue for a distinct pathophysiology. However, most patients who experience hemiplegic migraine also report other aura types that may occur within the same attack.

### Pathophysiology

The slow spreading nature of the scintillating disturbance in migraine visual aura led to early speculation that aura may be caused by the phenomenon of cortical spreading depression (CSD) (Lashley 1941). CSD is an electrically measurable wave of neuro-glial excitation that causes a brief disruption in local ionic ► **homeostasis** and is followed by a resultant depression of activity (Leao 1944). The wave appears and then migrates over the cortex in experimental animals at a slow rate of 3–4 mm per minute after mechanical or chemical perturbation. Functional magnetic resonance imaging (fMRI) techniques including perfusion weighted (Cutrer et al. 1998) and blood oxygen level dependent (BOLD) imaging (Hadjikhani et al. 2001) applied during spontaneous migraine visual auras in humans have shown that CSD and visual aura share many characteristics. 1. Both CSD and the migraine visual aura are characterized by an initial ► **hyperemia** lasting 3–4.5 minutes. 2. The hyperemia signal spreads across the affected cortex at a slow rate (2–5 mm/min) 3. The hyperemia in both CSD and migraine aura is followed by mild hypoperfusion lasting 1–2 hours. 4. Evoked visual responses during CSD and during aura are suppressed and take about 15 minutes to recover. 5. The BOLD signal complexes during both aura and induced CSD in animals halt at major ► **sulci**. 6. In CSD and migraine aura, the first affected area is the first to recover normal response to standard visual stimuli. Thus far, factors that render over 25% of migraineurs vulnerable to a CSD-like phenomenon are poorly understood and may be genetically determined. One recent report found that prolonged visual symptoms associated with migraine headaches are not associated with the perfusion defects seen in typical migraine visual aura. (Jager et al. 2005) At this point, the relationship between the aura and migraine headache is incompletely understood. There is experimental evidence that events intrinsic to the cerebral cortex such as CSD are capable of exerting effects on trigeminal perivascular nociceptive neurons, thereby activating headache. Immunohistochemical studies in rodents have shown that CSD is capable of activating the expression of the immediate early gene *c-fos*, a non-specific marker of neuronal activation within the nuclei of neurons of the superficial laminae of the trigeminal nucleus caudalis (second order nociceptive neurons) (Moskowitz et al. 1993). In addition, ► **laser speckle imaging** studies (Bolay et al. 2002) recently demonstrated that CSD could initiate long lasting dilation within pain sensitive middle meningeal artery branches

by a brainstem reflex dependent on intact trigeminal primary afferent and parasympathetic efferent neurons. It may well be that the aura represents one of several mechanisms by which the headache is activated, as it is clear that migraine headache may occur without aura and the aura may occasionally occur with activation of headache.

### References

1. Bolay H, Reuter U, Dunn AK et al. (2002) Intrinsic brain activity triggers trigeminal meningeal afferents in a migraine model. *Nat Med* 8:136–142
2. Cutrer FM, Sorensen AG, Weisskoff RM et al. (1998) Perfusion-Weighted Imaging Defects During Spontaneous Migrainous Aura. *Ann Neurol* 43:25–31
3. Hadjikhani N, Sanchez Del Rio M, Wu O et al. (2001) Mechanisms of migraine aura revealed by functional MRI in human visual cortex. *Proc Natl Acad Sci USA* 10:98:4687–4692
4. Headache Classification Subcommittee of the International Headache Society (2004) The International Classification of Headache Disorders, 2nd edn. *Cephalalgia* 24:24–30
5. Jager HR, Taylor MN, Theodossy T et al. (2005) MR imaging-guided interstitial photodynamic laser therapy for advanced head and neck tumors. *Am J Neuroradiol* 26:1193–200
6. Lashley KS (1941) Patterns of cerebral integration indicated by the scotomas of migraine. *Archives of Neurology and Psychiatry (Chicago)* 46:331
7. Leao AAP (1944) Spreading depression of activity in the cerebral cortex. *J Neurophysiol* 7:359–390
8. Moskowitz MA, Nozaki K, Kraig RP (1993) Neocortical spreading depression provokes the expression of c-fos protein-like immunoreactivity within trigeminal nucleus caudalis via trigemino-vascular mechanisms. *J Neurosci* 13:1167–1177
9. Rasmussen BK and Stewart WF (2000) Epidemiology of Migraine. In: Olesen J, Tfelt-Hansen P, Welch KMA (eds) *The Headaches*, 2nd edn. Lippincott Williams & Wilkins, Philadelphia, pp 231–232

## Clinical Migraine Without Aura

► Migraine Without Aura

## Clinical Pain

### Definition

„Physiological“ pain is pain felt in the intact, non-injured organism. „Clinical“ pain is pain felt after a tissue injury has induced sensitization of the peripheral and central nervous system.

► Postoperative Pain, Pre-Emptive or Preventive Analgesia

## Clinical Signs

### Definition

Clinical signs are abnormal responses elicited by clinicians during the physical examination.

► Hypoalgesia, Assessment

## Clinical Trial

### Definition

A clinical trial is a research study designed to test the safety and/or effectiveness of drugs, devices, treatments, or preventive measures in humans. Clinical trials can usually be divided into four categories or “phases”

► Central Pain, Outcome Measures in Clinical Trials

## Clitoral Pain

ALLAN GORDON

Wasser Pain Management Centre, Mount Sinai Hospital, University of Toronto, Toronto, ON, Canada  
allan.gordon@utoronto.ca

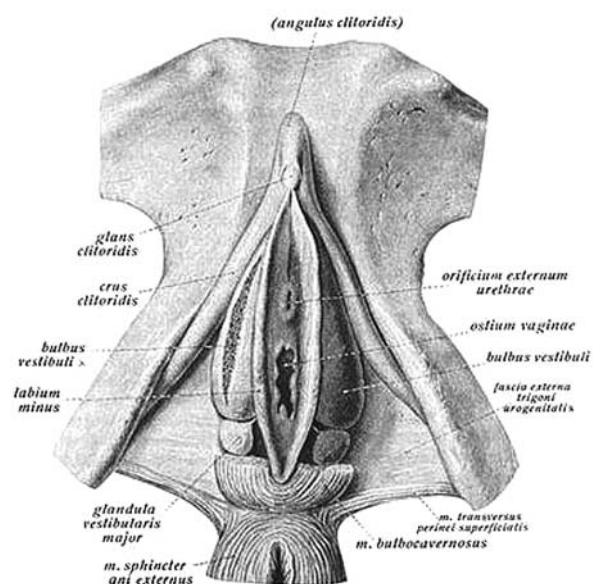
### Characteristics

#### Introduction

“Why is it that the very places in my body that should give me pleasure give me pain”  
Quote from a woman with a painful clitoris and painful nipples (The NPC Syndrome).

#### Description of the Clitoris

The best place to find out about the clitoris is the website [www.the-clitoris.com](http://www.the-clitoris.com). Here the clitoris is described in clear terms with excellent graphics. The major parts are the ► **prepuce** or hood, the ► **glans**, the body and the crura (O’Connell et al. 1998; [www.the-clitoris.com](http://www.the-clitoris.com)) (see Fig. 1). The major function is sexual pleasure and orgasm. The clitoris has up to 8000 nerve endings making it extremely sensitive ([www.the-clitoris.com](http://www.the-clitoris.com)).



Clitoral Pain, Figure 1 The Clitoris.

The clitoris is innervated by the dorsal nerve of the clitoris off the pudendal nerve. That transmits somatic sensation including pain, temperature, vibration, and proprioception. The clitoris also receives sympathetic and parasympathetic fibers for sexual function.

### What is Clitoral Pain?

Clitoral pain is pain either present at rest and/or induced by touch or pressure on the glans, ► [body of the clitoris](#) or ► [crura of the clitoris](#). Occasionally pain is felt in or next to the clitoral hood or just posterior to the glans and body. It may be there on its own or more commonly associated with vulvar pain or urethral pain and also deeper muscular pain. The pain may be referred into the urethra from other sites e.g. the urethra.

One definition is a “specific subset of vulvodynia produced by neuralgia of the anterior division of the pudendal nerve” (Perry 2004). However, that may be too exclusive a definition since there is such a variety of causes possible.

Many women with genital pain including vulvodynia and vulvar vestibulitis, may not mention their clitoral pain unless they have been so involved with the healthcare system that they lose their reserve. More importantly, many practitioners do not ask or examine for it. For instance, many women with fibromyalgia or irritable bowel may also have vulvar pain and/or clitoral pain, but do not volunteer it or are not asked about it. This is certainly the case in our pain clinic where such pain is described mainly upon direct questioning.

Some women have a ‘sensitive’ clitoris that is uncomfortable at rest or to touch but it does not interfere with sexual activity. Others may have a true pain in the clitoris, enough so that they do not like it touched. These terms need to be better defined in further population health studies.

In an internet survey of 423 women with vulvar pain only 3.3% had clitoral pain, and none had it alone (Gordon et al. 2003).

### Literature and Internet Search

Wesselman and Burnett (Wesselmann and Burnett 1999) refer to very few cases and talk mainly about pain post- ritualistic clitoral excision. It is not mentioned in “Chronic Pelvic Pain: An Integrated approach” (Steege et al. 1998).

The International Pelvic Pain Society website <http://www.pelvicpain.org> (Perry 2004) contains an article on Clitoral Pain that was also published in a textbook (Perry 2000) and in the Fall 2000 edition of the National Vulvodynia Association Newsletter. Perry mentions metabolic (e.g. diabetes), violent stimulation, tight clothing, or laser vaporization as known causes of clitoral pain

A Pub Med search for key words “Clitoris Pain” yields articles on FGM (female genital mutilation) (Okonofy et al. 2002), painful priapism (Medina 2002), clitoral neu-

roma (Fernandes-Aguilar and Noel 2003), hair tourniquet (Kuo et al. 2002), and phimosis (Munarriz et al. 2002) as well as various tumors. The author’s paper in 2002 represents the only significant collection of cases (Gordon 2002), which reports the clinical features of 21 women with clitoral pain.

An Internet search, however, will pick up information on chat line discussions, sex information sites and/or sites that appear pornographic.

### My Patient Population

In our paper (Gordon 2002) we reported on 21 individuals, 7 from my own practice and 14 who had contacted the author online through various sources. We have added to the numbers and are in the process of reporting a larger group of 26 patients, and more than 40 who sought and supplied information via the internet. Some patients were followed for up to 4 years. The National Vulvodynia Association also referred women patients. The following represents information from the paper and personal observations and communication.

### Clinical Points

- The rest pain is often described as mild to severe and to be burning, stinging or aching. All our examined clinic patients have rest pain.
- There is pain on touching or contacting the clitoris, and the pain is moderate to severe in intensity. The women examined may have ► [allodynia](#), hyperalgesia or pain on firmer touch or pressure. The allodynia and hyperalgesia suggests a neuropathic pain process.
- Allodynia of the clitoris and introitus often coexist as well as periurethral touch induced pain.
- Intercourse is almost always painful even with the use of techniques to avoid touching the clitoris. This interferes greatly with intimate relations.
- ► [Primary anorgasmia](#) is relatively uncommon (Gordon 2002), and secondary anorgasmia may occur because of the pain and unwillingness to try because of pain. Most continue to be orgasmic, some also achieving orgasm through a vaginal approach.
- Many women avoid intercourse or sexual activity because of the pain. Sexual desire may not be decreased despite the pain but more commonly desire is suppressed. Non-penetrative sex may also be painful.
- The pain may be part of established diseases including ► [Lichen Sclerosus](#). Our article describes 5 such patients (Gordon 2002).
- Some patients have had it for 10 or more years, up to 18 years in practice and 25 years online.
- In others it was much shorter in duration, sometimes just months.
- Relapse and remissions may occur and spontaneous recovery may also occur.
- We know of at least 4 women who had remission with pregnancy, with the remission persisting in four post partum. Another one worsened after pregnancy.

- We had at least 10 women who complained of painful or very highly sensitive nipples associated with the clitoral pain (Gordon 2000, 2002). The reason for this association is unclear.
- Clitoral pain may be associated with vulvar pain, vaginismus, urethral pain, and occasionally anal pain as well as interstitial cystitis, painful urethral syndromes and ► [urethral dyssynergia](#).
- There is often a fruitless search for infections.
- Other c-morbidities include endometriosis, fibromyalgia, anorexia, and back pain including spondylolisthesis. Depression was common in at least 14 of our own patients.
- Painful clitoral priapism was seen in 2 of our patients.
- Clitoral pain may rarely be associated with a constant state of arousal.
- Clitoral pain may be the presenting feature in some, and the most disconcerting, but more commonly there are other genital pain issues.
- Women with clitoral pain can be desperate for explanations and relief, are concerned about being labeled as psychogenic, and look back in regret to events, particularly traumatic or surgical events that may have precipitated or aggravated their condition.

#### Causes of Clitoral Pain in our Groups

1. Direct 'sexual' trauma (e.g. vigorous masturbation; vigorous cunnilingus; a slipped' vibrator; vigorous sexual intercourse were all reported to us)
2. Direct 'non sexual' trauma (e.g. doing the splits on a beam while doing gymnastics; injury during car accident from direct trauma)
3. Injury to lumbar spine and/or coccyx and possible lower sacral root irritation
4. Pelvic fracture and indirect trauma
5. Multiple Sclerosis with other urogenital complaints of pain, altered libido and voiding dysfunction due to central plaques
6. Post-hysterectomy especially with vascular misadventure (2 with recurrent engorgement)
7. Post spinal fusion procedure with insertion of a cage
8. Peripheral polyneuropathy
9. Part of a unilateral or bilateral ► [pudendal neuralgia syndrome](#)
10. Associated with Lichen Sclerosis with deforming tissue destruction
11. Following explained or unexplained infection, such as yeast, vaginosis, or herpes
12. Primary clitoral pain of unknown cause
13. Part of unexplained genital pain syndrome involving clitoris, urethra, vulva, and anus
14. Part of a severe chronic pelvic pain disorder with diffuse muscle and genital pain
15. Related to sexual abuse
16. A feature of vulvodynia

#### Common Mechanism

While yeast or other infections might suggest an acute nociceptive mechanism, most patients have evidence of a chronic neuropathic pain. There is clitoral allodynia and at times hyperalgesia. While documented or undocumented pudendal nerve entrapment may present in some in ► [Alcock's canal](#), this would not explain pain seen in direct trauma. Clitoral pain seems to be an example of neuropathic pain and seen in central pain (MS), polyneuropathy or Lichen Sclerosis. Ultimately, whatever the insult, there must be peripheral and central sensitization. Clitoral pain deserves more study as an example of neuropathic pain derived from many basic causes, be it post-infectious, post-traumatic, iatrogenic, direct injury, or chronic nerve entrapment

#### Clinical Evaluation

This must include:

- Clinical history
- Sexual History
- Psychosocial history and evaluation
- Alcohol, addiction and abuse history
- Treatments tried
- Neurological, musculoskeletal and gynecological exam
- Detailed vulvar exam including Q tip and pain and temperature and retraction of prepuce
- Pelvic and rectal exam checking for deeper pain and anal pain
- Pelvic and spinal imaging when clinically appropriate with ultrasound, CT scan or magnetic resonance scan
- Pudendal nerve latencies if available
- Quantitative sensory testing of genital area
- Cultures of vulva, vagina and urine
- Urogynecological evaluation if urinary symptoms

#### Treatment

The treatment depends upon clinical diagnosis and co-morbidity. There are no published clinical trials and even very few anecdotal reports on clitoral pain. Awareness of the condition, asking the right questions in the right way, and validating the patients pain are key, and a detailed multidisciplinary or transdisciplinary examination is necessary: Management is best in a multidisciplinary pain clinic where chronic pelvic region pain is regularly treated.

#### Treatments to Try and Comments

1. Oral tricyclic antidepressants such as amitriptyline. Occasionally effective
2. Oral anticonvulsants such as gabapentin. Variable results
3. Topical medications such as amitriptyline, gabapentin, ketamine and even capsaicin (which burns). More



studies needed with these agents. Clinical trials are needed

4. Opiates. They are often tried because of other comorbid pain conditions, and experience suggests that they are not particularly effective in clitoral pain
5. Topical cocaine. Usually associated with addictive behavior
6. Anesthetic block of dorsal nerve of clitoris. No literature studies (Perry 2004)
7. Pudendal nerve block. Of diagnostic value in pudendal neuralgia and no specific studies for clitoral pain.
8. Pudendal nerve decompression. Must be well documented and in experienced hands only.
9. Physical therapy May have through therapy of spine, internal and external muscle.
10. Specific treatment of underlying, associated or comorbid conditions such as vulvodynia, Lichen Sclerosus and depression.
11. Psychological therapies including cognitive behavioral therapy.
12. Pelvic floor surface EMG. Only if evidence of pelvic floor disturbance and probe does not hurt.
13. Sexual therapies. Assists in developing alternate techniques and exploring attitudes, preferences and experiences.
14. Cannabis: No trials but anecdotal reports from patients does suggest some benefit

### Conclusion

Clinical trials will clearly be necessary in order to understand what really works. In the meantime, conservative multimodal treatments should be considered. The relative rarity of clitoral pain, the many associated conditions, and the fact that most practitioners are not prepared to evaluate these patients has meant that trials are not carried out. However, it is also clear that we need to know more about the clinical and natural history of clitoral pain, as well as understand more about the pathophysiology and the various associated and/or co-morbid features. That can be achieved by detailed study including the use of neurophysiologic techniques and the creation of an observational database.

Clitoral pain is reframed as an example of neuropathic pain, and studied in the same way as other forms of neuropathic pain.

### References

1. Fernandes-Aguilar S, Noel JC (2003) Neuroma of the Clitoris after Female Genital Cutting *Obstet Gynecol* 101:1053–1054
2. Gordon AS (2000) The PNPC Syndrome. Platform presentation at PUGO Special Interest Group meeting (Sept 23, 2000) Hamburg, Germany
3. Gordon AS (2002) Clitoral Pain: The Great Unexplored Pain in Women. *J Sex Marital Ther* 28:181–185
4. Gordon AS, Panahian-Jand M, McComb F et al. (2003) Characteristics of Women with Vulvar Pain Disorders: Response to a Web Based Survey. *J Sex Marital Ther* 29:25.58
5. Kuo JH, Smith LM, Berkowitz CD (2002) A Hair Tourniquet Resulting in Strangulation and Amputation of the Clitoris. *Obstet Gynecol* 99:939–941
6. Medina CA (2002) Clitoral Priapism: A Rare Condition Presenting as a Cause of Vulvar Pain. *Obstet Gynecol* 100:1089–1091
7. Munarriz R, Talakoub L, Kuohung W et al. (2002) The Prevalence of Phimosis of the Clitoris in Women Presenting to the Sexual Dysfunction Clinic: Lack of Correlation to Disorders of Desire, Arousal and Orgasm. *J Sex Marital Ther* 28:181–185
8. O'Connell HM, Hutson JM, Anderson CR et al. (1998) Anatomical Relationship between Urethra and Clitoris. *J Urol* 159:1892–1897
9. Okonofy FE, Larsen U, Oronsaye F et al. (2002) The Association between Female Genital Cutting and Correlates of Sexual and Gynecological Morbidity in Edo State, Nigeria. *BJOG* 109:1089–1096
10. Perry CP (2000) Vulvodynia. In: Howard FM, Perry CP, Carter JE et al. (eds) *Pelvic Pain: Diagnosis and Management*. Lippincott Williams & Wilkins, Philadelphia, pp 204–210
11. Perry CP (2004) Clitoral Pain. <http://www.pelvicpain.org/>
12. Steege JF, Metzger DA, Levy BS (eds) (1998) *Chronic Pelvic Pain: An Integrated Approach*. WB Saunders Company, Philadelphia
13. Wessellmann U, Burnett AL (1999) Genitourinary Pain. In: Wall P, Melzack R (eds) *Textbook of Pain*, 4<sup>th</sup> edn. Churchill Livingstone, Edinburgh, pp 689–709
14. [www.the-clitoris.com](http://www.the-clitoris.com), Copyright 1998–2004 Fox Internet Services

## Clofazimine

### Definition

Clofazimine is a substituted iminophenazine dye with antibacterial properties, which is used in the treatment of leprosy; it is administered orally.

► [Hansen's Disease](#)

## Clonidine

### Definition

Clonidine is a prototypical  $\alpha_2$ -adrenoceptor agonist with potent sympatholytic effects. It activates neuronal cell membrane potassium channels causing hyperpolarization, reducing the rate of neuronal firing. It also inhibits neurotransmitter release by inhibiting calcium conductance through N-type calcium channels. Clinically, it has antihypertensive, sedative, anxiolytic and analgesic actions, which may also be useful in the management of complex pain states.

- [Acute Pain in Children, Post-Operative](#)
- [Alpha\( \$\alpha\$ \) 2-Adrenergic Agonists in Pain Treatment](#)
- [Postoperative Pain, Appropriate Management](#)

## Cluster Analysis

- [Multidimensional Scaling and Cluster Analysis Application for Assessment of Pain](#)

- ▶ Pain Measurement by Questionnaires, Psychophysical Procedures and Multivariate Analysis

## Cluster Headache

### Definition

An uncommon headache disorder with a striking male predilection. They are called cluster headaches because attacks occur in a group or “cluster” during which time patients suffer from 1–8 headaches daily. Individual headaches last between 20–180 minutes each, are excruciatingly severe, and are associated with one or more autonomic features such as conjunctival injection, lacrimation, nasal congestion, rhinorrhea, forehead and facial sweating, miosis, ptosis, eyelid edema. Cluster cycles last 2–8 weeks each and are followed by remission periods of 6–12 months, during which time patients are pain-free. Attacks are strictly unilateral orbitally, supraorbitally and/or temporally.

- ▶ Hemicrania Continua
- ▶ Human Thalamic Response to Experimental Pain (Neuroimaging)
- ▶ Paroxysmal Hemicrania

## Clustering

- ▶ Trafficking and Localization of Ion Channels

## C-Mechanoheat Receptor

- ▶ Polymodal Nociceptors, Heat Transduction

## C-Mechanoreceptor

- ▶ Mechanonociceptors

## CM-PF Complex

- ▶ Parafascicular Nucleus, Pain Modulation

## CMT

- ▶ Charcot-Marie-Tooth Disease

## CNS Changes after Peripheral Nerve Injury

- ▶ Central Changes after Peripheral Nerve Injury

## CNS Stimulation in Treatment of Neuropathic Pain

- ▶ Central Nervous System Stimulation for Pain

## CNV

- ▶ Contingent Negative Variation

## CO Staining

- ▶ Cytochrome Oxidase Staining

## CO<sub>2</sub> Laser

### Definition

CO<sub>2</sub> laser is frequently used as a pain (heat) stimulator. Since it is a heat beam, tactile receptors are not excited, and the time-lock is extremely good.

- ▶ Magnetoencephalography in Assessment of Pain in Humans

## Cochlea

### Definition

The cochlea is the coiled structure within the inner ear where vibrations caused by sound are transduced into neural impulses by the Organ of Corti.

- ▶ Perireceptor Elements

## Cognition

### Definition

Cognition is the mental act or process by which knowledge may be acquired or analyzed. A distinction is typically made between the content of cognition such as beliefs, attitudes, or memories; and the process of cognition involving acts such as perception, interpretation, inference, retrieval, or problem solving.

- ▶ Pain Assessment in the Elderly

- ▶ Psychology of Pain, Assessment of Cognitive Variables

## Cognitive

### Definition

Pertaining to the internal thoughts, images and constructs of the individual.

- ▶ Pain as a Cause of Psychiatric Illness
- ▶ Psychological Treatment in Acute Pain

## Cognitive Appraisal

### Definition

Cognitive appraisal is an evaluation of environmental stimuli. Resources available to cope with a potential stressor, and their ability to offset the threatening stimuli, determines the degree and intensity of the stress response.

- ▶ Stress and Pain

## Cognitive Aspect of Pain

### Definition

Perceptual component of pain perception including pain-related learning and memory and the recognition of the painful nature of the stimulus.

- ▶ Primary Somatosensory Cortex (S1), Effect on Pain-Related Behavior in Humans

## Cognitive Assessment

- ▶ Psychology of Pain, Assessment of Cognitive Variables

## Cognitive-Behavior Modification

- ▶ Cognitive-Behavioral Treatment of Pain

## Cognitive-Behavioral Model

### Definition

In the context of bodily sensations, this model states that (mis)interpretations (cognitions) of bodily sensations have a profound impact upon how patients perceive their body, cope and behave. Often a vicious circle is assumed between bodily sensations, cognitions and behavior.

- ▶ Muscle Pain, Fear-Avoidance Model

## Cognitive-Behavioral Model of Chronic Low Back Pain

### Definition

Cognitive behavioral models of chronic low back pain state that catastrophic misinterpretations in response to acute pain lead to fear of movement/(re)injury. As a consequence, a vicious cycle develops in which subsequent avoidance of activities and hypervigilance lead to an increase of functional disability, pain, depression and a decrease of physical fitness, thereby further advancing chronicity.

- ▶ Disability, Fear of Movement
- ▶ Fear and Pain

## Cognitive-Behavioral Perspective of Pain

DENNIS C. TURK

Department of Anesthesiology, University of Washington, Seattle, WA, USA  
turkdc@u.washington.edu

### Synonyms

Cognitive Model of Pain; Behavioral/Cognitive Perspective

### Definition

The Cognitive-Behavioral (CB) model of pain incorporates pain sufferers' fear avoidance and ▶ contingencies of reinforcement, but suggests that ▶ cognitive factors, in particular, and expectations rather than conditioning factors are of central importance. Thus, the model is a hyphenated one – CB. It does not ignore the important role of contextual factors and principles of learning theory, but rather incorporates them within an integrated perspective on pain sufferers and pain management. The CB model proposes that so-called conditioned reactions are largely self-activated on the basis of learned expectations rather than automatically evoked. The critical factor for the CB model, therefore, is not that events occur together in time or are operantly reinforced, but that

people learn to predict them based on experiences and information processing. They filter information through their preexisting knowledge, and organized representations of knowledge (Turk and Salovey 1985), and react accordingly. Their responses, consequently, are based not on objective reality but their idiosyncratic interpretations of reality. As interaction with the environment is not a static process, attention is given to the ongoing reciprocal relationships among physical, cognitive, affective, social, and behavioral factors.

### Characteristic

According to the CB model then, it is the pain sufferer's perspective, based on their idiosyncratic attitudes, beliefs, appraisals, and expectations that filter and interact reciprocally with emotional factors, social influences, behavioral responses, as well as sensory phenomena. Moreover, patients' behaviors elicit responses from significant others (including health care professionals) that can reinforce both adaptive and maladaptive modes of thinking, feeling, and behaving.

There are five central assumptions that characterize the CB perspective on pain (Turk and Okifuji 1999). The first assumption is that all people are active processors of information rather than passive reactors to environmental contingencies. People attempt to make sense of stimuli from the external environment by filtering information through organized schema derived from their prior learning histories, and by general strategies that guide the processing of information. People's responses (overt as well as covert) are based on appraisals and subsequent expectations and are not totally dependent on the actual consequences of their behaviors (i.e. positive and negative reinforcements and punishments). Thus, from this perspective, anticipated consequences are as important in guiding behavior as actual consequences.

A second assumption is that one's thoughts (e.g. appraisals, attributions, expectancies) can elicit or modulate affect and physiological arousal, both of which may serve as impetuses for behavior. Conversely, affect, physiology, and behavior can instigate or influence one's thinking processes. Thus, the causal priority is dependent upon where in the cycle one chooses to begin. Causal priority may be less of a concern than the view of an interactive process that extends over time.

Unlike orthodox behavioral models (operant and respondent conditioning) that emphasize the influence of the environment on behavior, the CB perspective focuses on the reciprocal effects of the person on the environment, as well as the influence of environment on behavior. The third assumption of the CB perspective, therefore, is that both the environment and the individual reciprocally determine behavior. People not only passively respond to their environment but elicit environmental responses by their behavior. In a very real sense, people create their environments. The person who becomes aware of physical events (symptoms) and

decides the symptom requires attention from a health care provider, initiates a set of circumstances different from the person with the same symptom who chooses to self-manage (► [self-management](#)).

A fourth assumption is that if people have learned maladaptive ways of thinking, feeling, and responding, then successful interventions designed to alter behavior should focus on maladaptive thoughts, feelings, physiology, and behaviors, and not one to the exclusion of the others. There is no expectancy that changing thoughts, feelings, or behaviors will necessarily result in the other two following suit.

The final assumption of the CB perspective is that in the same way as people are instrumental in developing and maintaining maladaptive thoughts, feelings, and behaviors, they can, are, and should be considered active agents of change of their maladaptive modes of responding. People with chronic pain, no matter how severe, despite their common beliefs to the contrary, are not helpless pawns of fate. They can and should become instrumental in learning and carrying out more effective modes of responding to their environment and their plight.

From the CB perspective, people with pain are viewed as having negative expectations about their own ability to control certain motor skills without pain. Moreover, pain patients tend to believe they have limited ability to exert any control over their pain. Such negative, maladaptive appraisals about the situation and personal efficacy may reinforce the experience of demoralization, inactivity, and overreaction to nociceptive stimulation. These cognitive appraisals and expectations are postulated as having an effect on behavior, leading to reduced efforts and activity that may contribute to increased psychological distress (► [helplessness](#)) and subsequently physical limitations. If we accept that pain is a complex, subjective phenomenon that is uniquely experienced by each person, then knowledge about idiosyncratic beliefs, appraisals, and ► [coping repertoire](#)s become critical for optimal treatment planning, and for accurately evaluating treatment outcome (Turk et al. 1983).

Biomedical factors that may have initiated the original report of pain play less and less of a role in disability over time, although secondary problems associated with deconditioning may exacerbate and serve to maintain the problem. Inactivity leads to increased focus on and preoccupation with the body and pain, and these cognitive-attentional changes increase the likelihood of misinterpreting symptoms, overemphasis on symptoms, and the perception of oneself as being disabled. Reduction of activity, fear of re-injury, pain, loss of compensation, and an environment that, perhaps, unwittingly supports the pain-patient role can each impede alleviation of pain, successful rehabilitation, reduction of disability, and improvement in adjustment. As has been noted, cognitive factors may not only affect the patient's behavior and indirectly their pain, but may actually have a direct effect



of physiological factors believed to be associated with the experience of pain (e.g. Flor et al. 1985).

People respond to medical conditions in part based on their subjective representations of illness and symptoms (► [cognitive schemata](#)). When confronted with new stimuli, the person engages in a meaning analysis that is guided by the schemata that best match the attributes of the stimulus. It is on the basis of the person's idiosyncratic schema that incoming stimuli are interpreted, labeled, and acted on.

People build fairly elaborate representations of their physical state, and these representations provide the basis for action plans and coping. Beliefs about the meaning of pain and one's ability to function despite discomfort are important aspects of the cognitive schemata of pain. These representations are used to construct causal, co-variational, and consequential information from their symptoms. For example, a cognitive schema that one has a very serious, debilitating condition, that disability is a necessary aspect of pain, that activity is dangerous, and that pain is an acceptable excuse for neglecting responsibilities will likely result in maladaptive responses. Similarly, if patients believe they have a serious condition that is quite fragile and a high risk for re-injury, they may fear engaging in physical activities. Through a process of stimulus generalization, patients may avoid more and more activities, become more physically deconditioned, and more disabled.

People's beliefs, appraisals, and expectations about pain, their ability to cope, social supports, their disorder, the medicolegal system, the health care system, and their employers are all important as they may facilitate or disrupt the patient's ► [sense of control](#). These factors also influence patients' investment in treatment, acceptance of responsibility, perceptions of disability, support from significant others, expectancies for treatment, acceptance of treatment rationale, and adherence to treatment.

Cognitive interpretations will also affect how patients present symptoms to significant others, including health care providers and employers. Overt communication of pain, suffering, and distress will enlist responses that may reinforce pain behaviors and impressions about the seriousness, severity, and uncontrollability of the pain. That is, reports of pain may lead physicians to prescribe more potent medications, order additional diagnostic tests, and, in some cases perform surgery. Family members may express sympathy, excuse the patient from usual responsibilities, and encourage passivity thereby fostering further ► [physical deconditioning](#). It should be obvious that the CB perspective integrates the operant conditioning emphasis on external reinforcement and the respondent's view of learned avoidance within the framework of information processing.

People with persistent pain often have negative expectations about their own ability and responsibility to exert

any control over their pain, and they avoid activities that they believe will exacerbate their pain or contribute to additional injury (Vlaeyen et al. 1995). Moreover, they often view themselves as helpless. Such negative, maladaptive appraisals about their condition, situation, and their personal efficacy in controlling their pain and problems associated with pain serve to reinforce their overreaction to nociceptive stimulation, inactivity, and experience of demoralization. These cognitive appraisals are posed as having an effect on behavior; leading to reduced effort, reduced perseverance in the face of difficulty and activities and increased psychological distress.

The specific thoughts and feelings that patients experience prior to exacerbations of pain, during an exacerbation or intense episode of pain, as well as following a pain episode can greatly influence the experience of pain and subsequent pain episodes (e.g. Jensen et al. 1994; Turk and Okifuji 2002). Moreover, the methods patients use to control their emotional arousal and symptoms are important predictors of both cognitive and behavioral responses.

The CB perspective on pain management focuses on providing patients with a repertoire of techniques to help them gain a sense of control over the effects of pain on their lives, as well as actually modifying the affective, behavioral, cognitive, and sensory facets of the experience. Behavioral experiences help to show patients that they are capable of more than they assumed, increasing their sense of personal competence. Cognitive techniques (e.g. problem solving and coping skills training) help to place affective, behavioral, cognitive, and sensory responses under the patient's control. The assumption is that long-term maintenance of behavioral changes will only occur if the patient has learned to attribute success to his or her own efforts. There are suggestions that these treatments can result in changes of beliefs about pain, coping style, and reported pain severity, as well as direct behavior changes. Further, treatment that results in increases in perceived control over pain and decreased ► [catastrophizing](#) also are associated with decreases in pain severity ratings and functional disability (Sullivan et al. 2001; Turner and Aaron 2001). The most important factor in poor coping may be the presence of catastrophizing, rather than differences in the nature of specific adaptive coping strategies (Jensen et al. 1999; Jensen et al. 1994).

In summary, people have prior learning histories that precede the development of their current pain. Based on these experiences, they have developed cognitive schema that consist of all information acquired over their lifetime. These cognitive schemata serve as the filters through which all subsequent experiences are perceived and to which they are responded. Thus, it is essential that people with chronic pain be viewed as integrated wholes, not body parts that are damaged and requiring repair. Failure to attend to cognitive and affective influences either by a narrow focus on

physiology and anatomy, as is the case in the traditional medical model, or exclusively on environmental influences, as is emphasized in operant models, will prove to be inadequate. People are more than physical parameters or pawns of reinforcement contingences. Rather, they observe, anticipate, and interpret internal and external stimuli. Moreover, people exist in a social environment and contextual factors also play an important role in the pain experience. Since chronic pain is by virtue of its sole defining characteristic chronic, and since there is no cure, it is essential that treatment focuses on their adaptation to the symptoms and accompanying problems and not just the symptoms.

### References

1. Flor H, Turk DC, Birbaumer N (1985) Assessment of Stress-Related Psychophysiological Responses in Chronic Back Pain Patients. *J Consult Clin Psychology* 54:354–364
2. Jensen MP, Romano JM, Turner JA et al. (1999). Patient Beliefs Predict Patient Functioning: Further Support for a Cognitive-Behavioral Model of Chronic Pain. *Pain* 81:95–104
3. Jensen MP, Turner JA, Romano RM et al. (1994) Relationship of Pain-Specific Beliefs to Chronic Pain Adjustment. *Pain* 57:301–309
4. Sullivan MJL, Thom B, Haythornthwaite JA et al. (2001) Theoretical Perspectives on the Relation between Catastrophizing and Pain. *Clin J Pain* 17:52–64
5. Turk DC, Meichenbaum D, Genest M (1983) *Pain and Behavioral Medicine: A Cognitive-Behavioral Perspective*. New York, Guilford, 1983
6. Turk DC, Okifuji A (1999) A Cognitive-Behavioral Approach to Pain Management. In: Wall PD, and Melzack R (eds) *Textbook of Pain*, 4<sup>th</sup> edn. Churchill-Livingstone, London, pp 1431–1444
7. Turk DC, Okifuji A (2002) Psychological Factors in Chronic Pain: Evolution and Revolution. *J Consult Clin Psychol* 70:678–690
8. Turk DC, Salovey P (1985) Cognitive Structures, Cognitive Processes, and Cognitive-Behavioral Modification: I. Client Issues. *Cogn Ther Res* 9:1–17
9. Turner JA, Aaron LA (2001) Pain-Related Catastrophizing: What Is It? *Clin J Pain* 17:65–71
10. Vlaeyen JWS, Kole-Snijders A, Boeren R et al. (1995) Fear of Movement/(Re) Injury in Chronic Low Back Pain and its Relation to Behavioral Performance. *Pain* 62:363–372

## Cognitive-Behavioral Programs

- ▶ [Interdisciplinary Pain Rehabilitation](#)

## Cognitive-Behavioral Theories

### Definition

Cognitive-behavioral theories of the relationship between pain and depression suggest that a persons'

negative cognitive appraisals of pain may contribute to the development of depression.

- ▶ [Depression and Pain](#)

## Cognitive-Behavioral Therapy

### Synonyms

CBT

### Definition

Cognitive behavioral therapy refers to a class of psychotherapy incorporating a wide range of techniques, and which is capable of addressing a range of psychological problems including chronic pain e.g. anxiety, depression, specific symptoms of psychosis. A central assumption of CBT is that a person's emotional and behavioral reactions to adverse circumstances are determined by their cognitive representation of the circumstances, and their appraisal of them, thus being able to influence a person's mood or behaviour. The main aim of therapy is therefore to change the way in which the individual represents the circumstance and their appraisals. This is achieved through active elicitation of a person's thoughts and beliefs, and active behavioral and cognitive tasks that are designed to enable the person to re-evaluate their circumstances in a manner that is likely to be beneficial for them.

- ▶ [Cognitive-Behavioral Perspective of Pain](#)
- ▶ [Cognitive-Behavioral Treatment of Pain](#)
- ▶ [Coping and Pain](#)
- ▶ [Dyspareunia and Vaginismus](#)
- ▶ [Impact of Familial Factors on Children's Chronic Pain](#)
- ▶ [Premenstrual Syndrome](#)
- ▶ [Psychiatric Aspects of Visceral Pain](#)
- ▶ [Psychological Treatment in Acute Pain](#)
- ▶ [Psychological Treatment of Headache](#)
- ▶ [Psychological Treatment of Pain in Children](#)
- ▶ [Psychology of Pain, Efficacy](#)
- ▶ [Recurrent Abdominal Pain in Children](#)
- ▶ [Relaxation in the Treatment of Pain](#)

## Cognitive-Behavioral Transactional Model of Family Functioning

### Definition

Cognitive-behavioral transactional model of family functioning emphasizes the role of cognitions and beliefs in the appraisal of pain and pain-related behavioral interactions.

- ▶ [Spouse, Role in Chronic Pain](#)

## Cognitive-Behavioral Treatment of Pain

DENNIS C. TURK

Department of Anesthesiology, University of Washington, Seattle, WA, USA  
turkdc@u.washington.edu

### Synonyms

Cognitive-Behavioral Therapy (CBT); Cognitive-Behavior Modification; Cognitive Therapy

### Definition

Cognitive-Behavioral Therapy (CBT) or cognitive-behavior modification (CBM) are generic terms that incorporate a wide-range of treatment modalities (e.g. stress management, distraction, relaxation, problem-solving, cognitive restructuring), all of which are designed to enhance coping, facilitate self-management, and improve emotional and physical functioning. The primary goals are to help patients understand the effects that thoughts, feelings, and behaviors have on pain, the potential of patients to exert some control over their symptoms, and education and practice in the use of cognitive and behavioral coping skills.

### Characteristics

The cognitive-behavioral (CB) approach to pain management evolved from research on a number of mental health problems (e.g. anxiety, depression and phobias). Following the initial empirical research on CB techniques in the early 1970s, there have been a large number of research and clinical applications. The common denominators across different CB approaches include:

1. Interest in the nature and modification of a patient's thoughts, feelings and beliefs, as well as behaviors;
2. Some commitment to behavior therapy procedures in promoting change (such as graded practice, homework assignments, relaxation, relapse prevention training, social skills training) (Turk et al. 1983).

In general, the CB therapist is concerned with using environmental manipulations, as are behavior (operant conditioning) therapists, but for the CB therapist such manipulations represent informational feedback trials that provide an opportunity for the patient to question, reappraise, and acquire self-control over maladaptive thoughts, feelings, behaviors and physiological responses. Although the CB approach was originally developed for the treatment of mental health disorders, the perspective has much in common with the multidimensional conceptualizations of pain, which emphasize the contributions of cognitive and affective, as well as sensory phenomena (Melzack and Wall 1965). The CB perspective emphasizes the important contribution of

psychological variables such as the perception of control, the meaning of pain to the patient, and dysphoric affect (Turk and Flor 1999).

It is important to differentiate the CB perspective from CB treatments. The CB perspective is based on five central assumptions, and can be superimposed upon any treatment approach used with chronic pain patients:

- People are active processors of information and not passive reactors
- Thoughts (e.g. appraisals, expectancies, beliefs) can elicit and influence mood, affect physiological processes, have social consequences and can also serve as an impetus for behavior; conversely, mood, physiology, environmental factors, and behavior can influence the nature and content of thought processes
- Behavior is reciprocally determined by both the individual and environmental factors
- People can learn more adaptive ways of thinking, feeling, and behaving
- People should be active collaborative agents in changing their maladaptive thoughts, feelings, and behaviors

In many cases, the perspective is as important as the content of the therapeutic modalities employed, somatic as well as psychological (Turk 1997).

The application of the CB perspective to the treatment of chronic pain involves a complex clinical interaction and makes use of a wide range of tactics and techniques. Despite the specific techniques used, all CB treatment approaches are characterized by being present, focused, active, time limited, and structured. Therapists are not simply conveyers of information acting on passive patients, but serve as educators, coaches, and trainers. They work in concert with the patient (and sometimes family members) to achieve mutually agreed upon goals.

A growing body of research has demonstrated the important roles that cognitive factors (appraisals, beliefs, expectancies) play in exacerbating pain and suffering, contributing to disability and influencing response to treatment (Turk and Rudy 1992). Thus, CB interventions are designed to help patients identify maladaptive patterns and acquire, develop and practice more adaptive ways of responding. Patients are encouraged to become aware of, and monitor, the impact that negative pain-engendering thoughts and feelings play in the maintenance of maladaptive overt and covert behaviors. Additionally, patients are taught to recognize the connections linking cognitions, affective, behavioral, and physiological responses together with their joint consequences. Finally, patients are encouraged to undertake 'personal experiments', and to test the effects of their appraisals, expectations, and beliefs by means of selected homework assignments.

The CB therapist is concerned not only with the role that patients' thoughts play in contributing to their disorders but, equally important, with the nature and adequacy

of the patients' behavioral repertoire, since this affects resultant intrapersonal and interpersonal situations. A CB treatment program for pain patients is multifaceted. Treatment may be conducted for individuals or groups on an inpatient or outpatient basis.

The CB perspective should be considered not merely as a set of methods designed to address the psychological components of pain and disability, but as an organizing strategy for more comprehensive rehabilitation (Turk 1997). For example, patients' difficulties arising during physical therapy may be associated not only with physical limitations, but also with the fear engendered by anticipation of increased pain or concern about injury. Therefore, from a CB perspective, physical therapists need to address not only the patient's performance of physical therapy exercises and the accompanying attention to body mechanics, but also the patient's expectancies and fears as they will affect the amount of effort, perseverance in the face of difficulties and adherence with the treatment plan (Meichenbaum and Turk 1987). These cognitive and affective processes, including self-management concerns, may be impediments to rehabilitation and thus need to be considered and addressed, along with traditional instructions regarding the proper performance of exercise. The attention paid to the individual's thoughts and expectancies by a psychologist should be adopted by all members of the interdisciplinary treatment team. In short, CB treatment should not be viewed as totally scripted. Therapists must realize that flexibility and clinical skills have to be brought to bear throughout the treatment program.

The CB treatment consists of five overlapping phases:

1. Initial assessment
2. Collaborative reconceptualization of the patient's views of pain
3. Skills acquisition and skills consolidation, including cognitive and behavioral rehearsal
4. Generalization, maintenance, and relapse prevention
5. Booster sessions and follow-up

Although the five treatment phases are listed separately, it is important to appreciate that they overlap. The distinction between phases is designed to highlight the different components of the multidimensional treatment. Moreover, although the treatment, as presented, follows a logical sequence, it should be implemented in a flexible, individually tailored fashion. Patients proceed at varying paces and the therapist must be sensitive to these individual differences.

The CB treatment is not designed to eliminate patients' pain *per se*, although the intensity and frequency of their pain may be reduced as a result of increased activity, physical reconditioning achieved during physical therapy, and the acquisition of various cognitive and behavioral coping skills. Rather, the treatment is designed to help patients learn to live more effective and satisfying

lives, despite the presence of varying levels of discomfort that may persist. Other goals include the reduction of excessive reliance on the healthcare system, reduced dependence on analgesic medications, increased functional capacity and, whenever feasible, return to employment or usual household activities. The primary objectives of CB treatment are:

- To combat demoralization by assisting patients to change their view of their pain and suffering from overwhelming to manageable
- To teach patients that there are coping techniques and skills that can be used to help them to adapt and respond to pain and the resultant problems
- To assist patients to reconceptualize their view of themselves from being passive, reactive and helpless to being active, resourceful and competent
- To help patients learn the associations between thoughts, feelings and their behavior, and subsequently to identify and alter automatic, maladaptive patterns
- To teach patients specific coping skills and, moreover, when and how to utilize these more adaptive responses
- To bolster self-confidence and to encourage patients to attribute successful outcomes to their own efforts
- To help patients anticipate problems proactively and generate solutions, thereby facilitating maintenance and generalization

The over-riding message of the CB approach is that people are not helpless in dealing with their pain, nor need they view pain as an all-encompassing determinant of their lives. Rather, a variety of resources are available for confronting pain, and pain will come to be viewed by patients in a more differentiated manner. The treatment encourages patients to maintain a problem-solving orientation and to develop a sense of resourcefulness, instead of the feelings of helplessness and withdrawal that revolve around bed, physicians, and pharmacists.

The CB approach offers promise for use with a variety of chronic pain syndromes across all developmental levels (Turk and Okifuji 1999). CB approaches have been evaluated in a number of clinical pain studies. The results tend to support the effectiveness of CB therapy in reducing pain and improving functional activities (Morley et al. 1999). The American Psychological Association Task Force on Treatment Efficacy designated CBT for chronic pain as one of 20 applications of psychological treatments for which there was significant empirical support. CBT is frequently used as a complement to other treatment modalities including information, exercise, and medication in the treatment of FMS patients, and is incorporated within interdisciplinary and multidisciplinary programs (Flor et al. 1992).

Taken as an aggregate, the available evidence suggests that the CB approach has a good deal of potential as a treatment approach by itself and in conjunction with



other treatments. The CB perspective is a reasonable way for healthcare providers to think about and deal with their patients, regardless of the therapeutic modalities utilized.

## References

1. Flor H, Fydrich T, Turk DC (1992) Efficacy of Multidisciplinary Pain Treatment Centers: A Meta-Analytic Review. *Pain* 49:221–230
2. Meichenbaum D, Turk DC (1987) *Facilitating Treatment Adherence: A Practitioner's Guidebook*. Plenum Press, New York
3. Melzack R, Wall PD (1965) Pain Mechanisms: A New Theory. *Science* 150:971–979
4. Morley S, Eccleston C, Williams AC de (1999) Systematic Review and Meta-Analysis of Randomized Controlled Trials of Cognitive Behavior Therapy and Behavior Therapy for Chronic Pain in Adults, Excluding Headache. *Pain* 80:1–13
5. Turk DC (1997) Psychological Aspects of Pain. In: Bakule P (ed) *Expert Pain Management*. Springhouse, pp 124–178
6. Turk DC, Rudy TE (1992) Cognitive Factors and Persistent Pain: A Glimpse into Pandora's Box. *Cognitive Therapy and Research* 16:99–122
7. Turk DC, Flor H (1999) Chronic Pain: A Biobehavioral Perspective. In: Gatchel RJ, Turk DC (eds) *Psychosocial Factors in Pain*. Guilford Press, New York, pp 18–34
8. Turk DC, Okifuji (1999) A Cognitive-Behavioral Approach to Pain Management. In: Wall PD, Melzack R (eds). *Textbook of Pain*, 4<sup>th</sup> edn. Churchill Livingstone, London, pp 1431–1444
9. Turk DC, Meichenbaum D, Genest M (1983) Pain and Behavioral Medicine: A Cognitive-Behavioral Perspective. Guilford Press, New York

## Cognitive Coping Training

### Definition

Cognitive Coping Training includes, but is not limited to, attention diversion strategies, reinterpreting pain sensations, calming self-statements, and imagery techniques.

- ▶ [Psychological Treatment of Headache](#)

## Cognitive Dysfunction

### Definition

Changes in consciousness, higher cortical functions, mood, or perception that may be induced by any of numerous neurological or systemic diseases, or by ingestion of substances, including drugs, that have the potential for central nervous system toxicity.

- ▶ [Cancer Pain Management, Opioid Side Effects, Cognitive Dysfunction](#)

## Cognitive Error

### Definition

A discrepancy between actual and perceived aspects of a particular situation.

- ▶ [Catastrophizing](#)

## Cognitive Factors

### Definition

Cognitive factors are the beliefs, appraisals, expectations, and meaning through which individuals filter information. These cognitive factors will have an influence on emotional and physiological arousal and behavior.

- ▶ [Cognitive-Behavioral Perspective of Pain](#)
- ▶ [Psychological Assessment of Pain](#)

## Cognitive Impairment

- ▶ [Cancer Pain, Assessment in the Cognitively Impaired](#)

## Cognitive Model of Pain

- ▶ [Cognitive-Behavioral Perspective of Pain](#)

## Cognitive Modulation of Pain

- ▶ [Descending Circuits in the Forebrain, Imaging](#)

## Cognitive Restructuring

### Definition

Cognitive restructuring is a process whereby patients are taught to monitor their thoughts and feelings, and to evaluate whether these are appropriate in light of the circumstances and evidence available. Patients are encouraged to become aware of their automatic responses and to consider the accuracy of the assumptions on which these responses are based. They are instructed to evaluate the assumptions that result in specific behaviors and to consider alternatives that may be more adaptive.

- ▶ [Catastrophizing](#)
- ▶ [Multidisciplinary Pain Centers, Rehabilitation](#)
- ▶ [Psychological Treatment of Headache](#)

## Cognitive Schemata

### Definition

Cognitive schemata are models that people create to assist them to structure and make sense of life circumstances, constructs, and categories. These are efficient templates that help people navigate in their world and filter new information. Newly acquired information must be assimilated into these existing cognitive structures

or will contribute to a modification (accommodation) of the schemata to incorporate the new data of experience.

- ▶ Cognitive-Behavioral Perspective of Pain

## Cognitive Tasks

### Definition

Procedures used to engage participants in a particular cognitive activity. These include (but are not restricted to) tasks such as the retrieval of words or memories, reaction times to identify specific stimulus features or to complete different mental operations, or the interpretation of ambiguous stimuli. The operation of specific cognitive processes is typically inferred on the basis of different patterns of cognitive task performance.

- ▶ Psychology of Pain, Assessment of Cognitive Variables

## Cognitive Therapy

- ▶ Cognitive-Behavioral Treatment of Pain

## Cohort

### Definition

Cohort refers to a group, band, or body of people who are followed over time.

- ▶ Prevalence of Chronic Pain Disorders in Children

## Cohort Study

Longitudinal Study

- ▶ Longitudinal Study

## Coital Pain

- ▶ Dyspareunia and Vaginismus

## Cold Allodynia

### Definition

Pain produced by a normally non-painful cold stimulus.

- ▶ Neuropathic Pain Model, Partial Sciatic Nerve Ligation Model
- ▶ Neuropathic Pain Model, Tail Nerve Transection Model

## Cold Allodynia Test

### Definition

One or two drops of acetone are thrown on the plantar aspect of the leg. In rats, this procedure does not produce a significant reaction (score  $\leq 0.5$ ), however, in rats with mononeuropathy a vigorous reaction is induced by acetone-drops for a period up to 20 s.

- ▶ Allodynia Test, Mechanical and Cold Allodynia
- ▶ Thalamotomy, Pain Behavior in Animals

## Cold Hyperalgesia

### Definition

Pain induced abnormally, or exacerbated, by low temperature. A common symptom in many neuropathic pain patients.

- ▶ Nociceptors, Cold Thermotransduction

## Cold Nociception

- ▶ Nociceptors, Cold Thermotransduction

## Cold Nociceptors

DONALD A. SIMONE

Department of Diagnostic and Biological Sciences,  
University of Minnesota, School of Dentistry,  
Minneapolis, MN, USA  
simon003@umn.edu

### Definition

Nociceptors are sensory receptors located on peripheral nerve endings that are excited by noxious or painful stimuli. Subgroups of nociceptors are excited by cold and encode the intensity of cold stimuli.

### Characteristics

In humans, reduction of skin temperature to approximately 15°C or less evokes a sensation of pain. Interestingly, pain from noxious cold can have different qualities, including cold, burning, pricking and aching, depending on the intensity, duration, rate of stimulation and location of the cold stimulus (Chery-Croz 1983; Davis and Pope 2002; Kunkle 1949). This suggests that different classes of nociceptors are excited by noxious cold stimuli.

Early studies documented that a portion of cutaneous A $\delta$  and C nociceptors that are responsive to mechanical stimuli are excited by noxious cold (Bessou and Perl 1969; Burgess and Perl 1967; Georgopoulos 1976;

LaMotte and Thalhammer 1982; Saumet et al. 1985). Many of the nociceptors excited by cold are also excited by heat, and are considered to be polymodal nociceptors. However, the exact proportion of A $\delta$  and C nociceptors excited by cold varied among the studies because stimulus temperatures and species used varied. For example, nociceptors in monkeys were not excited by stimuli to 15°C (Perl 1968), whereas 78% of A $\delta$  and C nociceptors were excited by the application of ice to the skin (LaMotte and Thalhammer 1982). In an extensive study of the response properties of the various subtypes of nociceptors in rats, Leem et al. (1993) found that approximately 10% or less of A $\delta$  and C nociceptors were excited by cold. Using stimulus temperatures between 27 and 12°C, they found response thresholds of nociceptors were between 22 and 12°C. However, when a wider range of stimulus temperatures was used, it was found that nearly all mechanosensitive nociceptors in rat hairy skin were excited by noxious cold (Simone and Kajander 1996; Simone and Kajander 1997). Response thresholds for A $\delta$  nociceptors ranged from 14 to -18°C; 79% of A $\delta$  nociceptors had cold response thresholds at or below 0°C. Most C nociceptors exhibited response thresholds above 0°C and thresholds ranged from 12 to -6°C. A wide range of cold response thresholds was also observed for nociceptors in mouse skin (Cain et al. 2001).

Sensitivity of nociceptors to cold has also been described in humans (Campero et al. 1996; Torebjrk 1974). Using stimulus intensities between 19 and 0°C, it was found that 40% of C nociceptors that were sensitive to mechanical and heat stimuli were also excited by noxious cold stimuli.

A few studies have examined the intensity encoding properties of nociceptors for noxious cold stimuli (Georgopoulos 1977; Simone and Kajander 1996; Simone and Kajander 1997). Using a range of stimulus temperatures from 20 to -12°C (or sometimes to -12°C), each for a duration of 10 seconds, it was found that responses of A $\delta$  and C nociceptors in rats increased as stimulus temperature decreased (Simone and Kajander 1996; Simone and Kajander 1997). The number of evoked impulses, the average discharge rate and the peak discharge rate each increased as stimulus temperature decreased. Discharge rates evoked by stimulus temperatures greater than 0°C were typically low (less than 1 impulse per second) and increased with colder temperatures. Power functions were generated to determine the stimulus-response relationship for A $\delta$  nociceptors and the slopes of the power functions ranged from 0.12 to 2.28.

In summary, the majority of cutaneous nociceptors that are excited by mechanical stimuli, including polymodal nociceptors, are excited by noxious cold stimuli. Cutaneous nociceptors exhibit a wide range of cold response thresholds and encode stimulus intensity.

## References

1. Bessou P, Perl ER (1969) Response of cutaneous sensory units with unmyelinated fibers to noxious stimuli. *J Neurophysiol* 32:1025–1043
2. Burgess PR, Perl ER (1967) Myelinated afferent fibres responding specifically to noxious stimulation of the skin. *J Physiol* 190:541–562
3. Cain DM, Khasabov SG, Simone DA (2001) Response properties of mechanoreceptors and nociceptors in mouse glabrous skin: an in vivo study. *J Neurophysiol* 85:1561–1574
4. Campero M, Serra J, Ochoa JL (1996) C-polymodal nociceptors activated by noxious low temperature in human skin. *J Physiol* 497:565–572
5. Chéry-Croze S (1983) Painful sensation induced by a thermal cutaneous stimulus. *Pain* 17:109–137
6. Davis KD, Pope GE (2002) Noxious cold evokes multiple sensations with distinct time courses. *Pain* 98:179–185
7. Georgopoulos A (1977) Stimulus-response relations in high-threshold mechanothermal fibers innervating primate glabrous skin. *Brain Res* 128:547–552
8. Kunkle EC (1949) Phasic pains induced by cold. *J App Physiol* 1:811–824
9. LaMotte RH, Thalhammer JG (1982) Response properties of high-threshold cutaneous cold receptors in the primate. *Brain Research* 244:279–287
10. Leem JW, Willis WD, Chung JM (1993) Cutaneous sensory receptors in the rat foot. *J Neurophysiol* 69:1684–1699
11. Perl ER (1968) Myelinated afferent fibers innervating the primate skin and their response to noxious stimuli. *J Physiol (Lond)* 197:593–615
12. Saumet J-L, Chéry-Croze S, Duclaux R (1985) Response of rat skin mechanothermal nociceptors to cold stimulation. *Brain Res Bull* 15:529–532
13. Simone DA, Kajander KC (1996) Excitation of rat cutaneous nociceptors by noxious cold. *Neurosci Lett* 213:53–56
14. Simone DA, Kajander KC (1997) Responses of cutaneous A-fiber nociceptors in noxious cold. *J Neurophysiol* 77:2049–2060
15. Torebjrk HE (1974) Afferent C units responding to mechanical, thermal and chemical stimuli in human non-glabrous skin. *Acta Physiol Scand* 92:374–390

C

## Cold Pressor Test

### Definition

The cold pressor test is a widely used experimental pain procedure to determine a person's pain threshold and pain tolerance. Subjects are asked to immerse their right or left lower arm (up to the elbow) or foot into a basin of water, which is kept at a constant given temperature between 0°C and 10°C. Pain threshold is defined as the elapsed time between arm immersion and the first report of a pain sensation. Pain tolerance is defined as the elapsed time until voluntary withdrawal of the hand. Since the cold pressor test induces pronounced sympathetic activation and vasoconstriction, the maximum duration of limb immersion is typically restricted by the experimenter in order to prevent vascular problems.

- ▶ [Experimental Pain in Children](#)
- ▶ [Modeling, Social Learning in Pain](#)
- ▶ [Pain in Humans, Thermal Stimulation \(Skin, Muscle, Viscera\), Laser, Peltier, Cold \(Cold Pressure\), Radiant, Contact](#)
- ▶ [Pain in Humans, Thresholds](#)

- ▶ Psychological Aspects of Pain in Women
- ▶ Psychology of Pain, Self-Efficacy

## Cold Therapy

- ▶ Therapeutic Heat, Microwaves and Cold

## Cold Thermoreceptor

### Definition

In biophysical terms, a cold thermoreceptor is a nerve ending excited only, or preferentially, by a cold temperature stimulus. They should be distinguished from „spurious“ thermoreceptors like slowly adapting mechanoreceptors that also respond to thermal stimulation.

- ▶ Cold Nociceptors
- ▶ Nociceptors, Cold Thermotransduction

## Cold Thermotransduction

- ▶ Cold Nociceptors
- ▶ Nociceptors, Cold Thermotransduction

## Cold-Induced Hyperalgesia

- ▶ Freezing Model of Cutaneous Hyperalgesia

## Colitis

### Definition

Inflammation of the large intestine, or colon, often caused by a primary disease, irritation of the bowel, antibiotic use, or ulceration. Acute colitis can be produced experimentally by the introduction of an irritant, such as mustard oil, zymosan or capsaicin into the lumen of the colon. Symptoms may include abdominal pain or bloating, diarrhea, dehydration, and increased intestinal gas.

- ▶ Amygdala, Pain Processing and Behavior in Animals
- ▶ Animal Models of Inflammatory Bowel Disease
- ▶ Visceral Pain Model, Lower Gastrointestinal Tract Pain

## Collateral Sprouting

### Definition

Induction of new axonal sprouts from an intact nerve by nerve growth factor. The sprouts grow into an area of an adjacent, injured, degenerating, peripheral nerve. Cortical sensations related to this phenomenon can be related to either the injury itself, or the response to dividing the injured peripheral nerve to treat a painful neuroma. Collateral sprouting pain can be misinterpreted as failure of the original treatment for the painful scar or painful neuroma.

- ▶ Painful Scars

## Colorectal Distension

### Synonyms

CRD

### Definition

Controlled innocuous or noxious visceral stimulus applied by distension of a balloon placed in the lumen of the descending colon and rectum. In humans under normal conditions, distension pressures below 40 mmHg are felt as non-painful, whereas distension pressures greater than 40 mmHg are felt as painful.

- ▶ Descending Modulation of Visceral Pain
- ▶ Postsynaptic Dorsal Column Neurons, Responses to Visceral Input
- ▶ Spinal Dorsal Horn Pathways, Dorsal Column (Visceral)
- ▶ Visceral Pain Model, Lower Gastrointestinal Tract Pain

## Colposcopy

### Definition

Colposcopy is a diagnostic tool aimed at verifying the cause of abnormalities found in Pap smears. It involves a visual examination of the cervix, genitals, and vagina as well as the application of acetic acid to identify abnormal cells.

- ▶ Dyspareunia and Vaginismus

## Combined Spinal Epidural (CSE) Technique

### Definition

An anesthetic technique where both spinal and epidural anesthesia is administered to the same patient as one



technique. It offers the advantages of a spinal anesthetic (intense analgesia) with the advantages of an epidural anesthetic (flexibility and long duration of action).

- ▶ Analgesia During Labor and Delivery

## Common Fears

### Definition

More specific fears directed at an apparent object (such as spider phobia, agoraphobia, fear of pain). They arise as the result of an interaction between the fundamental fears and learning experiences, and can thus be logically derived from these three fundamental fears.

- ▶ Fear and Pain

## Common Migraine

- ▶ Migraine Without Aura

## Common Toxicity Criteria

### Definition

WHO and National Cancer Institute method of assessing the morbidity associated with cancer and cancer treatment by organ system.

- ▶ Cancer Pain Management, Chemotherapy

## Communication Limitations or Neurological Impairment

- ▶ Pain in Children with Disabilities

## Comorbid Headache

### Definition

Classification proposed by Gladstein and Holden (1996), describing a subtype of chronic daily headache in children as a daily tension-type headache, accompanied by intermittent and less frequent episodes of well-defined migraine headache.

- ▶ Chronic Daily Headache in Children

### Reference

Gladstein J, Holden EW (1996) Chronic daily headache in children and adolescents: a 2-year prospective study. *Headache* 36:349-351

## Comorbidity

### Definition

Comorbidity defines an association between two or more disorders or diagnoses at one time that are more than coincidental.

- ▶ Migraine, Preventive Therapy
- ▶ Psychiatric Aspects of the Epidemiology of Pain

C

## Compartmental Syndrome

- ▶ Postoperative Pain, Compartment Syndrome

## Competitive Agonist or Antagonist

### Definition

Compound that interacts with the endogenous ligand-binding site of the receptor.

- ▶ Nociceptive Processing in the Amygdala, Neurophysiology and Neuropharmacology
- ▶ Spinal Cord Nociception, Glutamate Receptor (Metabotropic)

## Complement

### Definition

Non-specific mediator of humoral immunity. Many agents (antigens) trigger the complement cascade, which may ultimately result in the generation of membrane attack complex and lysis of cells presenting the triggering agent.

- ▶ Inflammatory Neuritis

## Complementary Medicine

- ▶ Alternative Medicine in Neuropathic Pain

## Complementary Therapies

- ▶ Alternative Medicine in Neuropathic Pain

## Complete Freund's Adjuvant

### Synonyms

CFA

## Compensation, Disability, and Pain in the Workplace

JAMES P. ROBINSON, DENNIS C. TURK  
 Department of Anesthesiology, University of  
 Washington School of Medicine, Seattle, WA, USA  
 jimrob@u.washington.edu,  
 turkdc@u.washington.edu

### Introduction

Pain is the epitome of a private experience. Only the person with pain has direct access to the experience. At the same time however, pain has a public face, because people in pain communicate their suffering to others either verbally or by non-verbal behavior and often request assistance. Observers of someone in pain are challenged because they are not able to experience the other's pain directly. Thus, they are forced to make inferences and may well have difficulty interpreting the communications of the pain sufferer.

Social interactions related to pain occur in both formal and informal settings. As an example of the latter, a person with pain will communicate his or her suffering to family members. Research has demonstrated that the family members, in turn, respond to the pain sufferer in fairly predictable ways (Romano et al. 1995). But not only family members respond to the behavior of those who experience pain. Co-workers and supervisors and health care providers are also asked to respond by making work place accommodations in the case of the former and prescribing treatment in the latter. Health care providers are also frequently asked to make recommendations regarding the impairments of individuals who report incapacitation because of pain. These may serve as the basis for financial compensation and accommodations on the job. The present field of this volume addresses social interactions related to pain that occur in a formal context – in particular, it addresses interactions between pain sufferers and 1) health care providers who offer treatment and make decisions about disability and 2) societal agencies that provide benefits for work disability. Examples of such societal agencies include workers' compensation programs (which compensate individuals only if their medical problems were caused by work) and programs such as the United States Social Security Administration (which compensate disabled people regardless of the cause of their disability).

The problems of impairment and disability (these 2 inter-related concepts are defined and differentiated below) secondary to pain are elusive and yield conflicts and contradictions at multiple levels of analysis. The central problem relates to the fact that there is currently no objective measure of pain. As a con-

sequence, decisions regarding the presence and impact of pain are based on inferences derived from prior experience and assumptions related to the amount of pain that might be expected given objective indications of pathology or disease. At a clinical level, conflicts and distrust frequently develop between disability applicants and the health care provider and disability adjudicators who are involved in their claims. Independent medical examiners and attorneys often become participants in these conflicts. People experiencing pain often feel that physicians and others discount their reports; physicians and adjudicators may experience doubt or outright skepticism about reports of pain in the absence of corroborating physical findings. The essay ► [Ethics of Pain-Related Disability Evaluations](#) explores ethical and conceptual issues related to the task of making inferences about the pain of another person.

### Disability Systems

Communities frequently provide assistance to people who are incapacitated. This type of helping behavior can be seen not only in modern societies, but also in primitive ones and even in communities of infrahuman primates (Fabrega 1997). Tolerance toward and care of the sick, infirm, injured and disabled appears to be a fundamental feature of society dating back to prehistoric times (Ranavaya and Rondinelli 2000). Formal disability compensation systems were recorded as many as 4000 years ago by the Babylonians, who provided compensation for loss of life or a body part incurred in the service of the state. During the time of the ancient Egyptians and Greeks, the state provided compensation for injuries caused by a wrongful act or occurring in the context of military service, respectively. Contemporary approaches to the issue of assistance for incapacitated people can be traced back to social insurance programs instituted in Germany in the late 19<sup>th</sup> century (Ritter 1983).

The social insurance programs that are most relevant to the present field of this volume are those that provide income maintenance benefits (also referred to as “wage replacement” or “time loss” benefits) for persons who are incapacitated from work. As noted in a comprehensive survey of social insurance programs in 138 countries and territories, programs to assist citizens who are incapacitated exist in most countries (Social Security Administration, Office of Research, Evaluation and Statistics 1999). Several of these are discussed as illustrations in the essays ► [impairment rating, ambiguity](#); ► [impairment rating, ambiguity, IA-IABC system](#); ► [disability evaluation in the social security administration](#) and ► [rating impairment due to pain in a workers' compensation system](#).

Among income maintenance programs, a basic distinction can be made between work injury (or workers' compensation) programs and disability programs. Workers' compensation programs provide benefits for individuals who are disabled because they have sustained injuries or developed diseases "out of and in the course of employment" (p. 10) (Williams 1991). Disability programs in contrast provide benefits for people who are incapable of working for any reason. Thus, both workers' compensation programs and disability programs provide income maintenance only if an individual is judged to be unable to work because of a medical condition, but workers' compensation programs impose an additional criterion – that the medical condition was caused by the person's work activities.

A central thesis of this field in the *Encyclopedic Reference of Pain* is that important problems and significant ambiguities emerge as individuals with painful disorders interact with agencies that administer income maintenance programs. A corollary of this thesis is that the problems that emerge in these interactions will depend on specific features of disability programs. It is beyond the scope of this essay to discuss the complexities of disability programs, but even a cursory review of them reveals enormous variation from country to country in the manner in which programs are financed and integrated into a network of social security programs, and in the eligibility criteria and procedures they use to evaluate applicants (Social Security Administration, Office of Research, Evaluation and Statistics 1999). Some of the essays (e.g. the ones on patient credibility and pain behavior; see ► [credibility, assessment](#) and ► [nonorganic symptoms and signs](#)) are relevant to any system of income maintenance for persons who allege work incapacity because of pain. However, many of the other essays discuss attempts by specific disability agencies to address problems presented by pain related incapacitation. These essays should be viewed as providing examples of ways in which specific disability agencies have addressed problems associated with pain, rather than as comprehensive discussions of the ways in which these problems might be addressed.

At an administrative level, bureaucracies that have specific imperatives operate disability programs. For example, the Social Security Administration in the United States, which operates the 2 largest disability programs, strives for uniformity, objectivity and cost containment in its disability evaluation procedures (Derthick 1990). One of the essays, ► [impairment, pain related](#), points out that however sensible these goals are from a bureaucratic standpoint, they are often at odds with the clinical realities of patients with chronic pain (Osterweis et al. 1987; Robinson et al. 2004).

At a societal level, additional concerns and perspectives emerge. As noted previously, disability programs

reflect an ethical commitment to support citizens who are incapable of working. If a program is too restrictive, it may consign needy and worthy applicants to poverty; if it is too lax, it may encourage disability applications from people who are actually capable of working. Even if a program is meeting its ethical mandate quite well, it may strain the financial resources of the payer to the breaking point. This is precisely the concern that is now being voiced about many of the programs run by the Social Security Administration in the United States.

At a scientific level, issues related to disability are usually unanswerable, because the research underpinnings for "disability evaluation science" are so meager. Moreover, the search for scientifically valid conclusions about disability may be compromised by the adversarial settings in which disability evaluations are conducted, and the enormous financial stakes involved (see ► [independent medical examinations](#)).

Finally, at a philosophical level, the problem of disability evaluation in chronic pain rests on an epistemological dilemma – the information available to an individual suffering pain is fundamentally different from the information available to any external observer who attempts to assess the pain. Scarry succinctly captured this dilemma when she asserted: "To have great pain is to have certainty; to hear that another person has pain is to have doubt." (p. 7) (Scarry 1985).

In clinical situations, patients frequently communicate the sense that they are severely incapacitated by pain and ask health care providers to support their claims. Typically, the health care providers who evaluate these patients cannot identify tissue damage or organ pathology that makes the limitations communicated by the patient seem inevitable, proportional or even plausible. The health care provider then has the dilemma of integrating the patient's subjective report with the objective evidence of tissue damage and organ pathology to establish some final judgment about the extent to which the patient really is incapacitated. At one extreme, a health care provider might simply ignore a patient's self-assessments and make a disability determination based strictly on objective findings of tissue damage or organ pathology. At the opposite extreme, the health care provider might accept the patient's description of the situation, and provide a disability rating that is congruent with the patient's self-assessment. Adjudicators at disability agencies face the same dilemma when they decide whether or not to award benefits to disability applicants. It has proved extremely difficult to find some intermediate position in which both objective evidence and self-assessments by patients can be incorporated into disability evaluations (see ► [impairment rating, ambiguity](#); ► [impairment rating, ambiguity, IAIABC system](#); ► [impairment, pain-related](#) and ► [independent medical examinations](#)).

The issues discussed in this field are particularly relevant to 5 groups of professionals: 1) clinicians who treat patients with chronic pain, 2) physicians who conduct independent medical examinations (see ► [independent medical examinations](#)), 3) allied professionals who participate in disability mitigation programs (e.g. vocational ► [rehabilitation](#) counselors) 4) individuals involved in disability policy and 5) psychologists interested in the study of interpersonal perception and the ways in which social interactions influence pain.

### Definitions: Disability and Impairment

“Disability” and “impairment” are fundamental concepts that provide the conceptual cornerstones for disability programs. Disability can be informally defined as the inability to carry out certain activities because of a medical problem (an abnormality in the structure or function of an organ or body part). There are different kinds of disability, since there are different types of activities that might be affected by a physical disorder. For example, a person might be disabled in the sense of being unable to work, in the sense of being unable to manage his or her personal finances or in the sense of being unable to perform activities of daily living independently. The current field focuses specifically on work disability – the inability to engage in substantial, gainful employment.

Unfortunately, there is no unique formal definition of work disability, since various agencies that administer disability programs define the term slightly differently. These differences reflect a fundamental reality about disability agencies and the criteria used for making decisions. For a disability agency, definitions serve the practical function of identifying the criteria that applicants must meet in order to be eligible for benefits. Thus, agencies have different definitions, because they have different mandates and different eligibility criteria.

The United States Social Security Administration defines disability as: “the inability to engage in any substantial gainful activity...by reason of any medically determinable physical or mental impairment that can be expected to result in death or that has lasted or can be expected to last for a continuous period of not less than 12 months” (p. 2) (SSA Publication 1994). This definition reflects 3 facts about eligibility criteria for the Social Security Disability Insurance and Supplemental Security Income programs: 1) applicants must be totally disabled from work; 2) the work disability must be “permanent” (or at least long-term); 3) causation is irrelevant – that is, an individual is eligible for benefits regardless of how or why he or she became disabled. In contrast, the American Medical Association’s Guides to the Evaluation of Permanent Impairment, 5th edition

(AMA Guides) defines disability as “an alteration of an individual’s capacity to meet personal, social or occupational demands or statutory or regulatory requirements because of an impairment” (p. 8) (Cocchiarella and Andersson 2001). This very broad definition reflects the fact that the AMA Guides describe an evaluation system that is relevant to many kinds of disability (rather than just work disability) and that permits gradations in disability to be identified (rather than just the 2 categories of totally disabled vs. non-disabled.)

An impairment can best be understood as a deficiency in the functioning of an organ or body part that leads to incapacitation or disadvantage in various arenas (such as inability to work or inability to do routine activities at home). “Impairment” is defined in a similar way by different disability agencies and expert panels. As an example, the formal definition of impairment given in the AMA Guides is: “a loss, loss of use or derangement of any body part, organ system or organ function” (p. 2) (Cocchiarella and Andersson 2001). Thus, one might say: “Mr. Jones’ heart has been impaired since he suffered a myocardial infarction” or “Mrs. Brown’s right hand is impaired because of her carpal tunnel syndrome.” The essay ► [impairment, pain-related](#) addresses problems that arise when the AMA Guides construct of impairment is applied to individuals who report incapacitation because of pain. Additional discussions of the definitions and the relationships among body function and structures, activities and participation as conceptualized by the World Health Organization are included in the essays ► [disability and impairment definitions](#) and ► [WHO system on impairment and disability](#).

Disability agencies assume significant linkages between impairment and disability. First, they construe impairment as a necessary condition for disability. The logic underlying this requirement is simple. Disability programs are designed to assist people who are incapable of competing in the workplace because of a medical condition. In essence, disability programs attempt to partition persons who fail in the workplace into 2 large groups, ones who fail because of a medical condition and ones who fail for other reasons (e.g. lack of demand for their skills). Therefore, disability programs require evidence that an applicant actually has a medical problem underlying his or her workplace failure. Impairment provides the necessary evidence, since it can be viewed as a marker that an individual has a medical problem that diminishes his or her capability. Conversely, if a person has no apparent impairment, this means that he or she does not have limitations due to a medical condition.

Disability agencies typically assume that the severity of a person’s impairment is highly correlated with the severity (or probability) of his or her being disabled



from work. Thus, even when an agency grants awards only on the basis of work disability, the agency will often seek information about a person's impairment in order to rationalize its decision about whether or not to award disability benefits. Studies have shown, however, that the association between physical impairments and work disability is far from perfect (Waddell 1987). As the above discussion suggests, the practical question facing a disability agency is to determine whether or not an applicant is sufficiently incapacitated to be eligible for disability benefits. Impairment evaluation should be viewed as an intermediate step in making this determination. Many of the essays in the field of compensation, disability and pain in the workplace focus on disability and disability determination.

### When Should a Disorder Be Construed as a Pain Problem?

Pain occurs in a wide range of medical disorders. It is usually conceptualized as a "component" of a disorder that is typically inextricably interwoven with other manifestations of disease or injury. From this perspective, it is somewhat arbitrary to abstract pain from other manifestations of disorders, just as it would be arbitrary to isolate fevers from malaria or shortness of breath from myocardial infarction.

A related point is that many painful disorders are treated by specialists of an affected organ system rather than by pain specialists. For example, chest pain is a cardinal symptom of cardiac ischemia, but a patient with chest pain of cardiac origin is much more likely to be treated by a cardiologist or a thoracic surgeon rather than by a pain specialist. Specialists in organ pathology typically view pain as a symptom of a biological abnormality that is important as a guide to appropriate diagnosis and treatment. In this model, symptoms and signs are used to diagnose disorders and treatment is directed toward the abnormal pathophysiology that comprises a disorder, rather than toward the symptoms of the disorder *per se*. The assumption is that once the underlying biological abnormality has been corrected, the symptoms – including pain – will abate.

The discussion in the previous paragraph raises a practical question. When should disorders that occur in the workplace be construed as pain problems? Two related criteria are suggested. A disorder is appropriately construed as a pain problem when either 1) patients report pain, but do not demonstrate structural or functional abnormalities that unequivocally explain their pain or 2) patients demonstrate limitations in activities that are not inevitable consequences of biological abnormalities, but rather appear to be consequences of pain that the patients experience as they engage in activities. One or both of these circumstances occur sufficiently fre-

quently to warrant a thorough discussion of pain in the workplace.

### Basic Problems Involving the Interface between Disability Systems and Injured Workers with Chronic Pain

#### Objective Factors

Disability agencies strive to use disability evaluation procedures that are based on objective findings of incapacitation. This administrative objective seems innocuous enough; however, it has profound implications. In essence, disability agencies must make significant simplifying assumptions about disability in order to achieve their administrative goal. The most fundamental simplifying assumption is that impairment and disability should be "transparent" to an experienced physician, namely that activity limitations as described or demonstrated by patients should be highly correlated with evidence of tissue damage or organ dysfunction that can be objectively assessed by a physician. This assumption underlies the routine demand that disability adjudicators make for physicians to rely on "objective findings" when they proffer conclusions about activity limitations of claimants.

The assumption that impairment and disability can be objectively assessed is so pervasive that most physicians – and essentially all disability adjudicators – accept it without question. The assumption is valid for certain medical conditions. For example, physicians have tools to quantify impairment stemming from amputations or complete spinal cord injuries. However, in many medical conditions – including most chronic pain syndromes – physicians cannot objectively identify impairments that rationalize the activity limitations that patients report. In a monograph on the disability programs administered by the Social Security Administration in the United States, Osterweis et al. (1987) summarize the problem as follows.

The notion that all impairments should be verifiable by objective evidence is administratively necessary for an entitlement program. Yet this notion is fundamentally at odds with a realistic understanding of how disease and injury operate to incapacitate people. Except for a very few conditions, such as the loss of a limb, blindness, deafness, paralysis or coma, most diseases and injuries do not prevent people from working by mechanical failure. Rather, people are incapacitated by a variety of unbearable sensations when they try to work (p. 28).

In essence, this statement indicates that in many medical disorders disability is related to subjective factors – especially pain – rather than to objectively measurable "mechanical failure" of body parts or organs. As discussed in several essays (► [impairment rating, ambiguity](#) ► [impairment rating, ambiguity, IAIABC system](#)

► [disability evaluation in the social security administration](#) ► [disability, effect of physician communication](#) ► [rating impairment due to pain in a workers' compensation system](#)), disability agencies have developed different solutions to the problem of reconciling the administrative imperative of basing disability determinations on objective findings with the reality that subjective factors are the proximate cause of work incapacitation for many patients.

### Credibility

Many disability agencies have at least implicitly accepted the premise that determinations about eligibility for disability benefits should rely, at least in part, on claimants' reports about pain and other subjective experiences. To the extent that disability determination relies on subjective reports by claimants about the difficulties they have when working, agencies must be concerned about how to assess the integrity of these reports. In the extreme case, it is possible for malingerers to simulate incapacitation and receive disability benefits when they have essentially no work limitations. The problem of malingering is addressed in ► [malingering, primary and secondary gain](#).

A more common scenario is that claimants report dramatic activity restrictions because of pain, and demonstrate severe functional limitations during physical examination. Examining physicians and disability agencies face a quandary when evaluating these patients, since, as noted above, it is often not possible to identify evidence of organ damage that makes the alleged activity restrictions seem inevitable, proportional or even plausible. The essay ► [credibility, assessment](#) addresses general problems in the assessment of credibility and veracity among patients with chronic pain. In ► [nonorganic symptoms and signs](#), the assessment of "non-organic signs" on physical examination is specifically addressed, namely the assessment of examination findings that indicate something other than well-described organic pathology.

### Severity of Impairment and Disability

As discussed, disability agencies attempt to base decisions on objective evidence of organ or body part dysfunction. The assessment of disability secondary to pain is in conflict with this administrative imperative. People with chronic pain typically attribute their pain and activity limitations to dysfunction of an organ or body part. But these subjective reports are difficult to assess precisely because examination of the involved organ or body part often does not identify abnormalities that make the pain reports inevitable (Robinson et al. 2004). It often appears to an examiner that the affected organ or body part is capable of functioning, but that the claimant does not use it normally because of pain. Thus, the examiner has the challenge of determining

how much weight to place on the claimant's subjective reports, as opposed to objective findings of organ or body part dysfunction (see ► [impairment, pain-related](#) and ► [disability evaluation in the social security administration](#) for discussions of attempts to integrate subjective reports with objective evidence in impairment / disability determination).

A comparison between rheumatoid arthritis (RA) and fibromyalgia syndrome (FMS) provides a dramatic example of the difficulty of assessing severity of impairment-disability in a person with chronic pain. People with RA and FMS typically report comparably severe activity limitations. However, the former typically have observable evidence of joint inflammation or destruction, whereas physical and laboratory examinations for the latter are often completely normal (except for tenderness to palpation). The question for a disability agency is should the activity limitations reported by people diagnosed with FMS be given as much weight as those reported by people with RA for purposes of awarding disability benefits? This type of dilemma occurs routinely when claimants allege incapacitation secondary to pain. Three essays in this field cover specific examples of syndromes in which patients complain of severe pain, but have little or no evidence of tissue pathology that rationalizes the complaints – low back pain (► [epidemiology of work disability, back pain](#)), FMS (► [disability in fibromyalgia patients](#)), and upper extremity injuries (► [disability, upper extremity](#)).

### Causation

Causation is important when a person is seeking disability benefits from an agency that is responsible only for medical conditions that arise in certain circumstances. In particular, workers' compensation carriers are responsible only for conditions that arise out of employment. The assessment of causation is thorny at both the conceptual (Kramer and Lane 1992; Lakoff and Johnson 1999) and practical levels. The difficulty in determining whether a medical condition has been caused by work is by no means limited to painful conditions. For example, controversy rages about whether and when hearing loss should be construed as work related (Dembe 1996). However, issues of causation are often particularly vexing for painful conditions that are commonly attributed to work. The difficulty stems in part from the fact that many disorders that are commonly attributed to work (e.g. non-radicular low back pain) often reflect a combination of degenerative changes and inciting physical loads. As a result, it is difficult to weigh the influence of work exposures with non-work exposures. But another reason for the difficulty is that an examiner typically has no objective method for determining the severity of incapacitation

in a patient with LBP. The claimant may allege that his LBP started or became worse during the course of activities at work, but the examiner will not be able to confirm or deny such a statement on the basis of objective medical information. Thus, the problem of determining causation in people with chronic pain overlaps with the problem of determining severity of disability – in both instances, the examiner must decide how much weight to assign to claimants' reports.

Disability agencies differ significantly in the standard they set for establishing causation. Some agencies follow the principle that in order for an index injury to be accepted as the cause of a claimant's impairment, the injury must be the significant factor contributing to the impairment. Others adopt a much lower standard of causation that has been described as "lighting up". When this standard applies, an index injury may be viewed as the cause of an impairment even when the injury is minor and impairment is severe. For example, consider a person with a multiply operated knee who falls at work, develops an effusion in the knee and is told by an orthopedist that he needs a total knee replacement. If the individual's workers' compensation carrier operated under the "lighting up" standard of causation, this person's knee symptoms and need for a total knee replacement would be viewed as caused by his slip and fall. The differences between disability agencies in the criteria required for establishing causation highlight the general point that the rules and regulations of different disability agencies vary greatly.

### Iatrogenesis

Most clinicians who treat injured workers believe that some of them report symptoms that are not explained biologically, but rather reflect influences of the disability system as filtered by psychological tendencies. The term "disability syndrome" is often used to describe these people. A disability syndrome is conceptualized as a set of dysfunctional attitudes and beliefs that evolves over time following an injury (Robinson et al. 1997). One probable contributor to a disability syndrome is the injured worker's adaptation to non-work roles; for example, an injured worker might take over childcare duties, while his wife enters the work force to make up for family income losses. Another likely contributor is the dysfunctional interactions that may occur between an injured worker and a disability agency.

As Hadler (1996) has pointed out, injured workers who claim ongoing work disability must run a gauntlet of challenges by their claims manager, threats to their benefits and independent medical examinations. In these situations, they must convincingly portray themselves as incapacitated in order to maintain their benefits. Hadler argues that after trying so hard to convince others of their incapacity, injured workers are likely to have difficulty conceptualizing themselves as fit for work or

to approach return to work with confidence. In addition, workers may develop resentment toward the disability agency with which they interact and thereby become more resistant to rehabilitation.

The disability syndrome construct is difficult to prove empirically. For example, it is possible that injured workers who fail to recover in a timely way had medical or psychosocial risk factors that existed at the time of their injury, but were recognized only after the workers showed a delayed recovery (Mustard and Hertzmann 2001). However, the construct provides a plausible explanation for the common observation that an injured worker, who seems straightforward and highly motivated just after an injury, often becomes more resistant to rehabilitation at a later point.

The possibility that disability policies and agencies inadvertently promote disability is a cause for great concern. The concern is similar to that expressed by critics of welfare programs in the United States during the 1990s. The criticism of those programs was that by providing long-term financial support for unemployed, indigent members of the society, welfare programs actually promoted continued indigence and unemployment.

### Epidemiology of Pain in the Workplace

As discussed above, there is ambiguity about the circumstances in which it is appropriate to label a medical disorder as a pain disorder. This ambiguity clouds the interpretation of data on the epidemiology of pain in the workplace. The ambiguity is increased further by the fact that the databases of workers' compensation systems and disability agencies generally do not provide data in a manner that highlights the role that pain plays in various injuries.

However, a few simplifying assumptions make it possible to obtain at least approximate data regarding the frequency of work related disorders in which pain is a major problem, but objective evidence of biological injury is either minimal or bears an equivocal relation to the pain that injured workers report. First, many musculoskeletal disorders meet these criteria. The discussion below will focus on these disorders, and in particular on 2 types of musculoskeletal problems – LBP and upper extremity disorders associated with repetitive motion (see ► [epidemiology of work disability, back pain](#) and ► [disability, upper extremity](#)). Second, although sprains can be associated with unequivocal evidence of a ► [structural lesion](#) (e.g. a complete tear of the anterior cruciate ligament would be coded as a sprain), workers' compensation carriers routinely use the designation sprain / strain to describe musculoskeletal complaints in the absence of definite evidence of a significant structural lesion. Thus, the designation "sprain or strain" in a workers' compensation database can be

taken as a proxy for a disorder characterized primarily by musculoskeletal pain in the absence of a definite structural lesion. Third, many of the disorders coded as upper extremity repetitive motion disorders meet the above criteria, since they are not associated with definite evidence of structural lesions (Miller and Topliss 1988).

### Common Work Injuries and Illness

Workers' compensation carriers generally distinguish between work injuries and occupational illnesses (Blessmann 1991). Conceptually, an injury involves a single event, whereas an illness arises gradually as a consequence of repeated work exposures. The distinction between a work injury and an occupational illness is obvious if a logger who is crushed by a tree is compared to a carpenter who develops a mesothelioma after years of exposure to asbestos. However, the distinction becomes opaque when it is applied to musculoskeletal disorders. For example, episodes of LBP are coded as injuries, whereas carpal tunnel syndrome and other upper extremity disorders associated with repetitive motion are coded as occupational illnesses. Tables 1 and 2 provide unpublished data about injuries that occurred among workers covered by the Department of Labor and Industries in Washington State of the United States in 1988. Table 1 provides a break down of injuries according to the mechanism of injury. Column 1 indicates that the largest proportion of injuries were classified as contusions, bruises, cuts, lacerations, punctures, scratches or abrasions. The second largest

group consisted of sprains and strains. Table 2 provides a breakdown of conditions (injuries and illnesses combined) according to the body part affected. The most commonly affected body part is the hand or fingers. However, over 27,000 injuries involved the back, with an additional 8,427 involving the back and neck. Approximately 90% of the back injuries were diagnosed as sprains or strains.

Data from the Bureau of Labor Statistics in the United States (U.S. Department of Labor 1995) indicate that approximately 7% of all claims filed during 1992 were for occupational illnesses rather than injuries. Approximately 60% of the claims for illnesses involved repetitive trauma, usually of the upper extremity. (Carpal tunnel syndrome is a subset of upper extremity illnesses caused by repetitive trauma.) The second and third largest groups are skin disorders (14%) and respiratory conditions due to toxic agents (5%). The most frequent types of repetitive activities associated with occupational illnesses are repetitive grasping or moving of objects (other than tools) and repetitive use of tools. As one would expect from the types of repetitive activities that produce occupational illnesses, the overwhelming majority of them occur in manufacturing jobs. In fact, the 25 industries with the highest rates of repetitive trauma occupational illnesses are all in the manufacturing sector, with meat packing plants and manufacturers of motor vehicles leading the way. The Bureau of Labor Statistics also identifies keyboarding as a significant cause of repetitive trauma induced occupational illnesses, but it is much less important than repetitive grasping or repetitive use of tools.

Compensation, Disability, and Pain in the Workplace, Table 1 1988 Washington State injury profile by nature of injury

Nature of injury	I All Claims (% of total claims)	II % of Claims in Column 1 that lead to time loss > 120 days	III # of Claims with time loss > 120 days (% of total claims with time loss > 120 days)
Contusions, Bruises, Cuts, Lacerations, Punctures, Scratches, Abrasions	75,713 (47.6%)	0.8%	644 (9.6%)
Sprains, Strains	59,729 (37.6%)	7.5%	4456 (66.1%)
Fractures	7,424 (4.7%)	11.9%	882 (13.1%)
Burns	5,777 (3.6%)	0.6%	38 (0.6%)
Multiple Injuries	2,689 (1.7%)	10.2%	273 (4.0%)
Dislocations	1,483 (0.9%)	19.0%	282 (4.2%)
Amputations	237 (0.1%)	18.1%	43 (0.6%)
Other	5,918 (3.7%)	2.1%	123 (1.8%)
Totals	158,970 (100%)	—	6,741 (100%)

Washington State Department of Labor and Industries (unpublished)



**Compensation, Disability, and Pain in the Workplace, Table 2** 1988 Washington State injury and illness profile by body part

Body part	I All Claims (% of total claims)	II % of Claims in Column 1 that lead to time loss > 120 days	III # of Claims with time loss > 120 days (% of total claims with time loss > 120 days)
Finger	29,721 (17.7%)	0.7%	207 (2.8%)
Back	27,196 (16.2%)	9.6%	2598 (34.6%)
Eyes	17,981 (10.7%)	0.1%	19 (0.2%)
Hand/Wrist	17,444 (10.4%)	3.7%	643 (8.5%)
Back & Neck	8427 (5.0%)	8.7%	734 (9.8%)
Knee	7478 (4.4%)	8.1%	609 (8.1%)
Foot	6611 (3.9%)	2.6%	173 (2.3%)
Multiple	5583 (3.3%)	10.2%	571 (7.6%)
Other	47,616 (28.3%)	4.1%	1945 (25.9%)
Totals	168,057 (100%)	–	7499 (100%)

Washington State Department of Labor and Industries (unpublished)

**The Effect of Work Place Factors**

An enormous amount of research has been conducted to determine work place factors that affect the probability that workers will become injured. The essay ► [pain in the workplace, risk factors for chronicity, workplace factors](#) reviews many of the work place factors that have been investigated. The essay ► [ergonomics](#) provides a historical overview of the field of ergonomics and summarizes research on risk factors for upper extremity work related musculoskeletal disorders and LBP. This research has supported the conclusion that the risk of upper extremity musculoskeletal disorders increases when jobs require forceful, repetitive motions, especially when workers are also subjected to vibration and have to maintain awkward positions. Research has also found 4 factors associated with an increased risk of LBP, 1) lifting and forceful movements, 2) awkward postures, 3) heavy physical work and 4) whole body vibration.

The essay ► [Pain in the workplace, risk factors for chronicity, job demands](#) also addresses work place factors that influence the frequency of work injuries. It considers ergonomic factors briefly and also reviews several psychosocial work place factors that influence injury rates, including monotonous work, lack of personal control and job dissatisfaction.

**Conditions Associated with Prolonged Time Off Work**

Bureau of Labor Statistics data (U.S. Department of Labor 1995) in the United States indicate that 66% of all workers who filed injury or occupational illness claims in 1992 did not miss time from work. Among claims

that are associated with work disability, it is important to distinguish ones associated with short periods off work vs. ones associated with prolonged time loss. Although any injured worker who reports that he or she is unable to work must be viewed with concern, most injuries involving time off work end uneventfully with the worker returning to his or her job after a short time period. For example, among workers in 1992 who went off work because of a back injury, the median time off work was 7 days (U.S. Department of Labor 1995). As far as long term work disability is concerned, Column 1 of Table 1 shows that contusions, bruises, cuts, lacerations, punctures, scratches and abrasions represented the largest category of industrial injuries in Washington State during 1988, but Column 2 indicates that only 0.8% of patients with these conditions lost more than 120 days from work. As a result, these patients represented only 9.6% of the total of patients with time loss of more than 120 days (column 3). Further examination of Columns 2 and 3 reveals that the probability of protracted time loss is high for dislocations, amputations, fractures and multiple injuries. It is moderately high for sprains and strains. However, since sprains and strains are relatively common to begin with, patients with these conditions represent 66% of the total number of patients with time loss greater than 120 days.

Columns 2 and 3 of Table 2 provide similar information for industrial conditions in Washington State as a function of affected body part (injuries and illnesses are combined in this table). Inspection reveals that 9.6% of patients with back disorders remain off work more than 120 days. Since back problems occur frequently,

fully 34.6% of the group who miss more than 120 days from work do so because of back problems.

### Skewed Recovery Curves

A major problem is that the recovery curves for some of the most important industrial conditions are highly skewed. For example, although most workers with LBP return to work within several days (if they go off work at all), a small proportion go on to very extended or even permanent work incapacity. In a representative study, Cheadle et al. (1994) examined 28,473 claims among Washington State workers between 1987 and 1989. All workers with claims involving more than 3 days off work were included. Approximately 86% of the back pain claimants returned to work within 4 months of injury. After that, however, the recovery curve flattened out, so that only about 5% of patients returned to work during months 5–8 following injury. Similar results have been reported by Spitzer et al. (1987) and others (Clinical Standards Advisory Group (1994).

A few points about the skewed recovery curve deserve emphasis. First, the curve is by no means descriptive only of LBP. In fact, Cheadle et al. (1994) found similarly skewed curves for carpal tunnel syndrome, fractures and unspecified other industrial injuries. Second, the costs of claims with delayed recoveries are staggering. In Washington State, almost 80% of work injuries do not lead to any time off work. Of people who go off work because of injuries, more than three-fourths return to their jobs within 120 days. Thus, injuries associated with the loss of more than 120 days from work represent less than 5% of the total number of injuries. However, fully 84% of the total payments made to injured workers are paid to this small group (Washington State Department of Labor and Industries 1994). Third, the flattening of the recovery curve demonstrated by Cheadle et al. and other investigators (Waddell 1987) indicates that a worker who has been on disability for a prolonged time is at great risk of continuing on disability indefinitely. In a recent literature synthesis, the Clinical Standards Advisory Group (1994) constructed an estimated long-term recovery curve for LBP patients. It indicates that the probability of ever returning to work is about 25% for a person who has been off work 1 year and about 10% for a person who has been off work 2 years.

### Predictors of Delayed Recovery

Data provided above indicate that prevalent musculoskeletal conditions, particularly LBP and carpal tunnel syndrome, are sometimes associated with the protracted disability. But the data are only of limited value, because of the enormous variation in outcomes among injured workers with these conditions. The clinician's job would be much easier if he or she could identify

factors that permitted predictions to be made about which workers are most likely to become chronically disabled. Research directed toward several of the factors that have been investigated is briefly summarized here. Specifically, the essays ► [Pain in the workplace, risk factors for chronicity, demographics](#) ► [Pain in the workplace, risk factors for chronicity, psychosocial factors](#) ► [Pain in the workplace, risk factors for chronicity, workplace factors](#), and ► [Pain in the Workplace, Compensation and Disability Management](#) discuss the roles of demographic, psychosocial, and workplace factors in predicting prolonged disability. A more extended discussion can be found a recent review by Krause et al. (2001a).

### Severity of Injury

At the extremes, the expected relation between injury severity and duration of disability has been demonstrated. For example, Cheadle et al. found that injured workers with "catastrophic injuries" (i.e., ones hospitalized within 28 days of injury) were off work about 2.5 times as long as ones without catastrophic injuries (Cheadle et al. 1994). However, only 6% of the workers in their sample had catastrophic injuries. Thus, the finding that patients with catastrophic injuries are disabled for prolonged time periods does little to help the physician make predictions among the much larger group of people who do not sustain catastrophic injuries.

### Diagnosis

Statistics clearly demonstrate that the risk of protracted disability is much greater for some types of injuries than for others. For example, workers with lacerations or abrasions only rarely have protracted disability, whereas ones with sprains or strains account for fully 66% of claims with more than 120 days of time loss (Table 1). In particular, since back strains have a high incidence rate and a moderately high associated probability of protracted time loss, they account for approximately 35% of all protracted time loss claims (Cheadle et al. 1994).

### Specific Diagnosis Within an Injury Category

It is a difficult task to predict the duration of disability among patients with a common problem such as LBP. Making predictions within LBP patients is important for an obvious reason. Since the outcomes of injuries are highly variable, a physician who can predict which patients are likely to become chronic can focus on rehabilitating them (see ► [epidemiology of work disability, back pain](#)). Unfortunately, predictions based on detailed medical information have been only modestly successful. Several studies have shown that patients with sciatica have more prolonged disability than ones only with low back pain (Andersson et al. 1983).

Also, there is evidence that injured workers given a specific diagnosis within 1 week of injury (such as sciatica, disc injury or facet joint syndrome) are more likely to demonstrate prolonged disability than ones given a non-specific diagnosis such as lumbar strain (Abenhaim et al. 1995). This suggests that physicians can identify some high-risk patients on the basis of a history and physical examination. However, since only 8.9% of the patients in Abenhaim et al.'s study received a specific diagnosis, the study is not helpful in identifying predictors among the remaining 91% of patients who were given non-specific diagnoses. In a similar vein, Franklin et al. (1994) studied injured workers who underwent lumbar spinal fusions. Although these patients ended up having very protracted disability, most of them were initially given non-specific diagnoses such as lumbar strain.

**Age**

Data from the Bureau of Labor Statistics indicate that older workers are less likely than younger ones to sustain work related injuries, but are at greater risk for protracted disability if they do sustain an injury. Several studies have confirmed the fact that among patients who sustain disabling injuries, older ones are more likely to experience prolonged disability (Cheadle et al. 1994; Rossignol et al. 1988). See the essay ► [Pain in the workplace, risk factors for chronicity, demographics](#) for a more extended discussion of age as well as other demographic factors in predicting prolonged disability.

**The Effect of Work Place Factors**

Multiple factors associated with the work place affect the duration of work injuries, which is considered in the essay ► [Pain in the Workplace, Compensation and Disability Management](#). At the level of the physical demands of work, there is good evidence that workers who do physically demanding work are more likely to demonstrate protracted disability after a back injury than ones with lighter work (Krause et al. 2001b). However, as pointed out in ► [Pain in the Workplace, Compensation and Disability Management](#), psychosocial aspects of the work environment – including the extent to which employers invest resources to encourage return to work – also affect the duration of work injuries.

**Disability Evaluation –General**

**The Biopsychosocial Model**

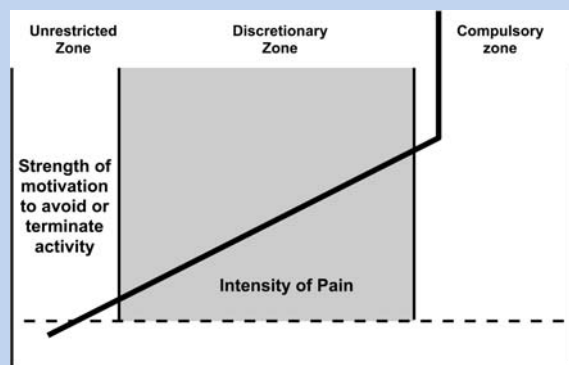
Virtually all experts agree that one must use a biopsychosocial model (Waddell 1987; Waddell 1998) to evaluate disabling musculoskeletal disorders in the workplace. Within this model, it is appropriate to distinguish among 3 broad groups of factors that might

contribute to disability. All of them need to be included in a comprehensive review of pain in the workplace and in a comprehensive evaluation of an individual injured worker.

**Medical Factors**

These, of course, vary with the specific disorder under consideration. Several essays (► [disability assessment, psychological / psychiatric evaluation](#); ► [yellow flags](#); ► [ethics of pain-related disability evaluations](#)) state (or imply) that medical factors are not as important as psychosocial factors in determining which workers become disabled by musculoskeletal injuries. A few general observations on this issue are worthwhile. First, the role of medical factors in the outcome of a musculoskeletal injury depends on the severity of the injury. Severe musculoskeletal injuries (fractures, amputations and any injuries requiring immediate hospitalization) are associated with a high risk of protracted work disability. However, the bulk of low back injuries and upper extremity disorders that lead to disability are not associated with obvious markers of severe biological dysfunction. As a consequence, an analysis that attempts to predict length of disability on the basis of severity of biological injury is hampered by restriction in the range of the independent variable. Second, most of the painful disorders that occur in the workplace can be construed as making it more difficult for an individual to continue working, but not completely precluding work.

The relation between pain severity and strength of motivation to avoid or discontinue activity limitation is illustrated in Fig. 1. As the figure indicates, people with no or minimal pain are described as being in an unrestricted zone as far as activities are concerned, whereas as ones with extremely severe pain are described as being in a compulsory zone, such that it is virtually impossible for them to continue with normal activities. But most people with musculoskeletal pain are in what is described as a discretionary zone – they can continue



Compensation, Disability, and Pain in the Workplace, Figure 1 Motivational consequences of activity-related pain.

to engage in important activities, but only with significant effort. The behavior of patients with pain in the discretionary zone will depend on psychological factors such as their resourcefulness in finding alternative ways to accomplish tasks and their ability to manage emotional distress provoked by pain.

### Psychological Factors

As discussed in the essays on ► [disability assessment, psychological / psychiatric evaluation](#) ► [yellow flags](#), and ► [Psychological assessment of pain](#), individuals with psychological vulnerabilities are relatively likely to succumb to disability following musculoskeletal injury. In particular, the risk of disability has been found to be elevated among individuals with anxiety disorders, depressive disorders, personality disorders or problems with chemical dependency. In addition, persons who are somatically focused (as manifested, for example, by elevated scores on the hypochondriasis scale of the Minnesota multiphasic personality inventory [MMPI]) are at risk, even if they do not warrant a psychiatric diagnosis.

### Situational and Social Factors

Another theme that emerges from several of the essays in this field (e.g. ► [Pain in the workplace, risk factors for chronicity, psychosocial factors](#) and ► [Pain in the Workplace, Compensation and Disability Management](#)) is that the likelihood of prolonged disability among injured workers is affected by their satisfaction with their jobs and the efforts that their employers make to reintegrate them into the work force.

### Assessing Credibility

As indicated, disability assessment in painful conditions poses a challenge because an examiner must rely on the verbal and nonverbal pain behaviors of an injured worker in order to assess the extent to which pain affects the worker's ability to function. Some disability agencies attempt to finesse this dilemma by mandating that decisions about disability should rely almost entirely on objective findings. However, if an agency permits subjective data from injured workers to be considered in disability evaluations, it must immediately confront the issue of assessing the credibility of patients with pain problems. Issues related to patient credibility are often poorly formulated and emotionally tinged.

As a point of departure in clarifying these issues, it is worth considering the type of presentation by a patient that an examiner would find highly credible. The table listed below lists a set of findings that would convince most examiners that an examinee was highly credible (see Characteristics associated with high patient credibility). The areas mentioned cover a wide range – including the nature of the injury, the biologic response of

claimants, claimants' current symptoms and reported activity limitations, their physical findings on a single physical examination, the consistency of their findings over repeated examinations, the presence or absence of acute or chronic psychiatric conditions, their apparent motivation to return to productivity and various incentives or disincentives for continued disability. As a metaphor, we can visualize very high claimant credibility as analogous to a mountaintop, with various pathways leading "downward" to questionable credibility. An assumption in discussions of credibility is that, in a highly credible patient, there is a relatively direct path from injury through tissue damage to present signs, symptoms and reported activity limitations. Another way to state the assumption is that the presentation of a highly credible patient is determined almost exclusively by abnormal biology. In contrast, the factors that compromise patient credibility are usually construed as being in the psychosocial sphere. The question then becomes what are the psychological processes that underlie the behavior of claimants whose credibility is suspect? Some investigators have emphasized the role of somatic anxiety as a factor underlying claimants' verbal statements about their abilities and their behavior during a physical examination (see ► [disability, fear of movement](#)). For example, if claimants are extremely anxious about hurting themselves during a physical examination, they might well demonstrate exaggerated pain behaviors such as guarding and pain-inhibited weakness.

Another possibility is that claimants exaggerate their reports about their incapacity and demonstrate limitations on examination as a deliberate strategy to maximize the disability payments they are awarded. That is, they are malingerers. A more subtle analysis posits "secondary gain" as a determinant of a patient's behavior. In effect, this analysis indicates that money acts as a reinforcer that influences a claimant's behavior. However, it allows for the possibility that the influence occurs at an unconscious level, namely that the claimant is not necessarily maliciously and deliberately misleading an examiner (as occurs in the case of malingering). The essay ► [malingering, primary and secondary gain](#) deals specifically with the issues of secondary gain and malingering and adds an important concept to the lexicon related to patient credibility when it discusses "secondary losses" (i.e., the types of reinforcers that a person is less likely to receive if he is severely disabled). As pointed out in ► [malingering, primary and secondary gain](#), for most injured workers the financial losses associated with protracted disability far outweigh the gains associated with disability payments (Reno et al. 1997; Reville et al. 2000).

In principle, information bearing on the credibility of claimants can be gleaned from several sources, includ-



**Compensation, Disability, and Pain in the Workplace, Table 3** Characteristics Associated with High Patient Credibility (Robinson JP “Psychological Aspects of Disability.” Presented to Employer Advisory Group, Valley Medical Center, Renton WA, June, 1997)

Characteristics Associated with High Patient Credibility
No pre-existing condition
No medical co-morbidities
Definite stimulus – e.g. crushed by a tree
Definite tissue damage – e.g. fracture
Symptoms, signs, activity limitations – fit expectations for the medical problem
Consistent findings over repeated examinations
No exaggerated pain behavior
No inconsistencies between symptoms / signs noted in MD’s office and behavior outside the office
No chronic psychiatric disorders or long-term psychosocial risk factors
No reactive psychiatric problems – e.g. anxiety disorder, depression
Patient motivated to return to productivity
Job opportunities exist
No incentives for disability

ing information about the individual’s injury, examination of records of health practitioners who have seen him in the past, statements by the patient about his current symptoms and activity restrictions and observation of claimants’ behavior during a physical examination. The essay ► [credibility, assessment](#) discusses the significance of these types of data.

The essay ► [nonorganic symptoms and signs](#) deals with a specific issue related to credibility – the behavior of a patient during a physical examination. In particular, a set of “non-organic” signs have been developed that can sometimes be observed by an examiner during the physical examination of a patient with LBP. Extensive research on the “Waddell signs” suggests that they are primarily indicators of somatic anxiety on the part of patients with LBP.

The interpretation of Waddell signs is far from obvious (see ► [malingering, primary and secondary gain](#)). Although Waddell described them as “non-organic” signs in his initial publication on them, recent research suggests that they could be manifestations of altered nervous system functioning in response to pain (Banic et al. 2004; Curatolo et al. 2004). That is, they might be construed as manifestations of a genuine medical disorder rather than solely as indicators of psychological dysfunction (see ► [dysfunctional pain and the international classification of function](#).)

**Rehabilitation of Pain Related Disability**

During the interval shortly after a worker sustains a disabling injury, the focus of attention is typically on medical or surgical treatment of his injury. If disability persists, various evaluations and interventions may-

be performed to manage the worker’s disability (i.e. to foster return to work). If the worker’s disability becomes protracted, the focus of evaluations subtly shifts toward issues related to the extent of permanent impairment and disability and the financial liability of an insurer or disability agency in the event of permanent work disability. Sometimes an evaluation can serve a dual purpose, namely, it can be used either to facilitate return to work or to establish the severity of disability for purposes of long-term compensation. The ► [Pain in the Workplace, Compensation and Disability Management](#); ► [ethics of pain-related disability evaluations](#) and ► [impairment, pain-related](#) essays deal with evaluations and interventions that are often used to manage disability by facilitating return to work. One crucial element in disability management is the assessment of a worker’s risk for long-term disability. The essay on ► [yellow flags](#) addresses this important issue.

Another crucial issue for a worker who is unlikely to return fully to his pre-injury status is the assessment of his residual physical capacities. Although disability agencies routinely ask treating physicians to provide detailed information about a patient’s activity tolerances and activity restrictions, the examinations that a physician conducts in an office setting generally do not provide relevant data to make such judgments. As discussed in the essay ► [disability, functional capacity evaluations](#), physical capacities evaluations can provide detailed data about the ability of a patient to perform a range of physical tasks over periods of time ranging from a few hours to a few days.

Another crucial input for disability management is a realistic assessment of the workers’ vocational options, especially if the probability is high that they will not

be able to return to the job they had when they were injured. As discussed in ► [vocational assessment in chronic Pain](#), the role of the vocational rehabilitation counselor is to identify vocational options and to facilitate communication among physicians, employers and the worker to maximize the probability that the worker will be able to return to gainful employment.

As far as treatment of disability is concerned, the ► [disability, effect of physician communication](#) essay highlights the importance of communication between physicians and injured workers. Effective communication that enables patients to cope with their injuries is not usually thought of as a treatment, but expert opinion and at least some empirical evidence (Catchlove and Cohen 1982; Hall et al. 1994) support the conclusion that such communication can substantially influence the outcome of work injuries.

Many workers receive physical therapy as a component of the treatment they receive for their work injuries. Although such treatment is often helpful, workers who are sliding into protracted disability often report lack of benefit from physical therapy. Ineffective physical therapy can occur for a variety of reasons. One common problem is that physical therapists sometimes focus excessively on passive treatments such as diathermy or massage, rather than on active functional restoration. Even when progressive exercise is emphasized in physical therapy, patients may fail to benefit because they are fearful that physical activity will cause reinjury or will delay their recovery (see ► [disability, fear of movement](#)). As discussed in ► [physical conditioning programs](#), structured physical conditioning or work hardening programs may be helpful in this situation. These programs are structured in the sense that they emphasize progressive exercise and that they require patients to attend treatment sessions several times per week.

It is noteworthy that a recent extensive review of literature on structured physical conditioning programs revealed that such programs were reliably effective only when they were combined with psychosocial support (Schonstein et al. 2002) (see ► [physical conditioning programs](#) and ► [multidisciplinary pain centers](#)). This finding supports the logic underlying the most aggressive rehabilitation programs for workers with chronic, disabling pain – multidisciplinary pain center or functional restoration treatments. As discussed by Turk in his essay ► [multidisciplinary pain centers](#), these programs have demonstrated efficacy in the treatment of selected injured workers. However, there is often reluctance by third party payers to provide coverage and reimbursement for these treatments.

Managed care organizations in the United States have particular difficulties when it comes to treatment of people they cover that experience work related disabili-

ties. The essay ► [disability management in managed care system](#) describes the interaction between managed care organizations and injured workers.

Finally, as discussed ► [Pain in the Workplace, Compensation and Disability Management](#), there is persuasive evidence that initiatives by employers can reduce the incidence of work injury claims and the duration of disability for claims that are filed. These initiatives include programs for rotating activity schedules for workers and promoting early return to modified work following a work injury. The essay ► [Pain in the Workplace, Compensation and Disability Management](#) also cites data supporting the importance of programs to promote a positive psychosocial environment in the workplace. In particular, it describes research demonstrating that workers are relatively likely to return to work quickly following injury if they have good rapport with their supervisors and if their supervisors express concern about them following an injury.

#### **Assessing Permanent Impairment / Disability Associated with Pain**

As noted previously, if a worker fails to recover fully from an injury, the agencies involved with his claim need to make some determination regarding his permanent impairment and his ability to work. Decisions regarding these issues determine the agencies' financial obligations to the worker. Logically, the starting point for a system to evaluate impairment and disability in an injured worker is a set of concepts that links the many interacting factors that contribute to disability following a work injury. The essays ► [disability and impairment definitions](#) and ► [WHO system on impairment and disability](#) describe the current WHO conceptual system. Key concepts in it are body functions, body structures, impairments, activity-activity limitations, participation-participation limitations and disability. The essay ► [dysfunctional pain and the international classification of function](#) describes how sensory changes that are postulated to occur in chronic pain syndromes can be conceptualized within the WHO framework.

At a practical level, the essay ► [impairment rating, ambiguity](#) describes several issues that make it difficult for agencies to evaluate impairment and disability in an efficient, equitable manner. The essays are not limited to the evaluation of painful conditions, but emphasize the difficulty of determining impairment or disability in such conditions. The companion essay ► [impairment rating, ambiguity, IAIABC system](#) describes the recently developed impairment rating system of the International Association of Industrial Accident Boards and Commissions. For the most part, this system does not specifically address impairment secondary to chronic

pain, but does do so in selected disorders (such as phantom limb pain).

Essays on ► [disability evaluation in the social security administration](#) ► [rating impairment due to pain in a workers' compensation system](#) and ► [impairment, pain-related](#) describe the approaches to the assessment of impairment-disability associated with chronic pain taken by the Social Security Administration, the Washington State workers' compensation system, the California workers' compensation system and the AMA Guides. The Social Security Administration system emphasizes the potential importance of pain to disability and provides fairly specific guidelines for adjudicators to follow as they gather information from applicants regarding their pain. The California system also emphasizes the potential importance of pain to disability, but does not give specific guidelines regarding its assessment. The AMA Guides devote a chapter to the assessment of pain-related impairment, but fail to integrate the concepts elaborated in the chapter into the overall impairment assessment system and contain multiple inconsistencies related to the assessment of impairment secondary to pain. The Washington State system specifically excludes chronic pain as a basis for impairment. These essays are presented as representative; however, there are wide variations in compensation systems within and between countries. The only conclusion one can reach with confidence from reading the essays ► [disability evaluation in the social security administration](#) ► [rating impairment due to pain in a workers' compensation system](#) and ► [impairment, pain-related](#) is that there is a striking lack of consensus about how to incorporate pain into impairment and disability evaluations.

### Paradigm Shifts; Systemic Changes

It is safe to say that no system has solved the problems of how to assess, rehabilitate and compensate people who report chronic pain following work injuries. In this unsatisfactory situation, it is appropriate to consider strategies for improving the ways in which disability agencies conceptualize and evaluate chronic pain and disability. Two essays in this field discuss concepts that need to be considered in any systemic change in workers' compensation systems or disability systems in general. ► [Disability incentives](#) addresses the influences of incentives and "moral hazards" on the behavior of both injured workers and the health professionals who treat them. It does not propose specific changes in current disability systems, but it strongly suggests that a successful disability system needs to be based on a careful consideration of incentives and disincentives to disability. The essay ► [disability prevention](#) reviews a wealth of data on factors associated with long-term dis-

ability following non-traumatic work injuries. It makes a convincing case that we have sufficient data to craft programs that focus on disability prevention rather than treatment and long-term wage replacement following the development of disability. ► [Disability prevention](#) addresses protracted disability in general rather than chronic pain specifically. However, it is highly relevant to an understanding of work related chronic pain, since chronic pain is a major cause of protracted disability following a work injury.

The essay ► [back pain in the workplace](#) describes a monograph about work related low back pain. The monograph, entitled *Back Pain in the Workplace* (Fordyce 1995) focuses on problems associated with our current concepts regarding low back pain and work disability. In essence, the authors argue that impairment cannot be assessed validly in nonspecific LBP, because 1) an examiner's assessment of impairment from LBP depends on the performance of a patient during an examination and 2) a back pain patient's performance during an examination is determined not only by the severity of the anatomic and physiological functional loss he or she has sustained, but also by a variety of psychosocial factors. In the authors' words: "Not all potential impairments can be confirmed by verifiable measures of their presence independent of performance by the person purported to be impaired. Because performance is also "effort-related" as well as related to anatomical or physiological capabilities, it is inevitably linked to and influenced by such factors as attitudes, motivation and personality" (p. 28).

The authors of the *Back Pain in the Workplace* report go on to promote the idea that people with nonspecific LBP should be classified as "unemployed" rather than disabled if they "persist... in activity intolerance beyond the allotted time for medical treatment and temporary disability status" (p. 59). Thus, people with persistent nonspecific LBP would, for benefits purposes, be classified with healthy people who are unable to find work.

It is important to note that *Back Pain in the Workplace* makes recommendations for disability policy only in relation to nonspecific LBP; they do not consider any other chronic pain conditions. Also, although their recommendations about disability policy rest on their pessimistic view of the ability of physicians to determine impairment in patients with nonspecific LBP, they do not provide any data to buttress this view. In essence, their monograph is a consensus document rather than a presentation of empirical data. However, in view of the eminence of its authors, *Back Pain in the Workplace* is a provocative work that has been read widely and, as documented in ► [back pain in the workplace](#), has generated a heated debate.

## Summary

Many vexing and inter-related issues are associated with the assessment and compensation of individuals who develop painful conditions in the workplace. The essays included in this field were designed to be evocative and to offer insightful perspectives on the important nuances that come into play when judgments are made about such individuals. Some of the essays describe efforts that selected disability agencies have made to address problems associated with the assessment of impairment and disability in injured workers with painful conditions. But rather than providing clear and definitive answers to the difficult issues surrounding pain in the workplace, the essays should sensitize readers to the complexities and ambiguities in this area.

## References

1. Abenheim L, Rossignol M, Gobeille D et al. (1995) The prognostic consequences in the making of the initial medical diagnosis of work-related back injuries. *Spine* 20:791–795
2. Andersson GB, Svensson HO, Oden A (1983) The intensity of work recovery in low back pain. *Spine* 8:880–884
3. Banic B, Petersen-Felix S, Andersen OK et al. (2004) Evidence for spinal cord hypersensitivity in chronic pain after whiplash injury and in fibromyalgia. *Pain* 107:7–15
4. Blessman JE (1991) Differential treatment of occupational disease v occupational injury by workers' compensation in Washington State. *J Occup Med* 33:121–126
5. Catchlove R, Cohen K (1982) Effects of a directive return to work approach in the treatment of workman's compensation patients with chronic pain. *Pain* 14:181–191
6. Cheadle A, Franklin G, Wolfhagen C et al. (1994) Factors influencing the duration of work-related disability: a population-based study of Washington state workers' compensation. *Am J Publ Health* 84:190–196
7. Clinical Standards Advisory Group (1994) *Back Pain*. HMSO, London
8. Cocchiarella L, Andersson GBJ (2001) *Guides to the Evaluation of Permanent Impairment*, 5th edn. AMA Press, Chicago
9. Curatolo M, Arendt-Nielsen L, Petersen-Felix S (2004) Evidence, mechanisms, and clinical implications of central hypersensitivity in chronic pain after whiplash injury. *Clin J Pain* 20:469–476
10. Dembe AE (1996) *Occupation and Disease*. Yale University Press, New Haven
11. Derthick M (1990) *Agency under stress*. The Brookings Institution, Washington, DC
12. Fabrega HJ (1997) *Evolution of Sickness and Healing*. University of California Press, Berkeley
13. Fordyce WE (1995) *Back Pain in the Workplace*. IASP Press, Seattle
14. Franklin GM, Haug J, Heyer NJ et al. (1994) Outcome of lumbar fusion in Washington state workers' compensation. *Spine* 19:1897–1904
15. Hadler NM (1996) If you have to prove you are ill, you can't get well. The object lesson of fibromyalgia. *Spine* 21:2397–2400
16. Hall H, McIntosh G, Melles T et al. (1994) Effect of discharge recommendations on outcome. *Spine* 19:2033–2037
17. Kramer MS, Lane DA (1992) Causal propositions in clinical research and practice. *J Clin Epidemiol* 45:639–649
18. Krause N, Frank JW, Dasinger LK et al. (2001a) Determinants of duration of disability and return-to-work after work-related injury and illness; challenges for future research. *Am J Ind Med* 40:464–484
19. Krause N, Dasinger LK, Deegan LJ et al. (2001b) Psychosocial job factors and return-to-work after compensated low back injury: a disability phase-specific analysis. *Am J Ind Med* 40:374–392
20. Lakoff G, Johnson M (1999) *Philosophy in the Flesh*. Basic Books, New York
21. Miller MH, Topliss DJ (1988) Chronic upper limb pain syndrome (repetitive strain injury) in the Australian workforce: a systematic cross sectional rheumatological study of 229 patients. *J Rheumatol* 11:1705–1712
22. Mustard C, Hertzman C (2001) Relationship between health services outcomes and social and economic outcomes in workplace injury and disease: data sources and methods. *Am J Ind Med* 40:335–343
23. Osterweis M, Kleinman A, Mechanic D (eds) (1987) *Pain and Disability*. National Academy Press, Washington, DC
24. Ranavaya MI, Rondinelli RD (2000) The Major U.S. Disability and Compensation Systems: Origins and Historical Overview. In: Rondinelli RD, Katz RT (eds) *Impairment Rating and Disability Evaluation*. WB Saunders, Philadelphia, pp 3–16
25. Reno VP, Mashaw JL, Gradison B (1997) *Disability*. National Academy of Social Insurance, Washington, DC
26. Reville RT, Polich S, Seabury S, Gidens E (2000) Permanent disability at private, self-insured firms. (MR-1268-ICJ). RAND, Santa Monica
27. Ritter GA (1983) *Social Welfare in Germany and Britain*. Berg, New York
28. Robinson JP, Rondinelli RD, Scheer SJ (1997) Industrial rehabilitation medicine 1: Why is industrial rehabilitation medicine unique? *Arch Phys Med Rehabil* 78:3–9
29. Robinson JP, Turk DC, Loeser JD (2004) Pain, impairment, and disability in the AMA Guides. *J Law Med Ethics* 32:315–326
30. Romano JM, Turner JA, Jensen MP et al. (1995) Chronic pain patient-spouse behavioral interactions predict patient disability. *Pain* 63:353–360
31. Rossignol M, Suissa S, Abenheim L (1988) Working disability due to occupational back pain: Three-year follow-up of 2,300 compensated workers in Quebec. *J Occup Med* 30:502–505
32. Scarry E (1985) *The Body in Pain*. Oxford University Press, New York
33. Schonstein E, Kenny DT, Keating J et al. (2002) Work conditioning, work hardening and functional restoration for workers with back and neck pain. The Cochrane Database of Systematic Reviews 2002, issue 4. Art No.: CD001822. DOI: 10.1002/14651858. CD001822
34. Social Security Administration, Office of Research, Evaluation and Statistics (1999) *Social security programs throughout the world –1999*. (SSA Publication no. 13-11805). Government Printing Office, Washington, DC
35. Spitzer WO et al. (1987) Scientific approach to the assessment and management of activity-related spinal disorders. *Spine* 12:1–57
36. SSA Publication No. 64-039 (1994) *Disability evaluation under social security*. Government Printing Office, Washington, DC
37. U.S. Department of Labor, Bureau of Labor Statistics (1995) *Occupational Injuries and Illnesses: Counts, Rates, and Characteristics, 1992*. Government Printing Office, Washington, DC
38. Waddell G (1987) Volvo award in clinical sciences. A new clinical model for the treatment of low-back pain. *Spine* 12:632–644
39. Waddell G (1998) *The back pain revolution*. Churchill Livingstone, Philadelphia
40. Washington State Department of Labor and Industries (1994) *Long-term disability prevention pilots*. Annual Report to the Legislature
41. Williams CA (1991) *An International Comparison of Workers' Compensation*. Kluwer, Boston



## Definition

An oil emulsion that contains a dead mycobacterium that elicits an inflammatory and immune response *in vivo*. Injection of CFA into the skin of the hind paw is frequently used as an experimental model of peripheral inflammation in mice or rats.

- ▶ CFA
- ▶ IB4-Positive Neurons, Role in Inflammatory Pain
- ▶ Nerve Growth Factor Overexpressing Mice as Models of Inflammatory Pain

## Complex Adaptive System

### Definition

A complex adaptive system is a large set of units that interact with each other, and with an external environment, to produce overall patterns that are significantly more complex than the behaviors of the individual entities comprising the system.

- ▶ Consciousness and Pain

## Complex Chronic Pain in Children, Interdisciplinary Treatment

JENNIFER N. STINSON

The Hospital for Sick Children and The University of Toronto, Toronto, ON, Canada  
jennifer.stinson@sickkids.ca

### Synonyms

Multidisciplinary treatment; Paediatric Chronic Pain Management; Pain-Related Disability

### Definition

Chronic pain in children is defined as any recurring (e.g. headaches, abdominal and limb pain) or persistent pain (e.g. back pain, cancer pain, ▶ [complex regional pain syndrome](#)) that lasts a minimum of 3 months (McGrath 1999). While most children with chronic pain function quite well, some develop more complex chronic pain conditions with associated distress and disability (McGrath and Finley 1999). These children typically present with subjective ratings of pain out of proportion to the objective physical findings and are more disabled than one would expect.

The pain adversely affects all aspects of children's lives. They stop going to school, refrain from exercising or playing sports for fear of increasing the pain and withdraw from their peers. These children often have impaired sleep, suffer from anxiety and or depression and have disrupted family relationships (Bursch et al 1998; Dahlquist and Switkin 2003). The pain becomes the focus of the children's lives and a vicious cycle

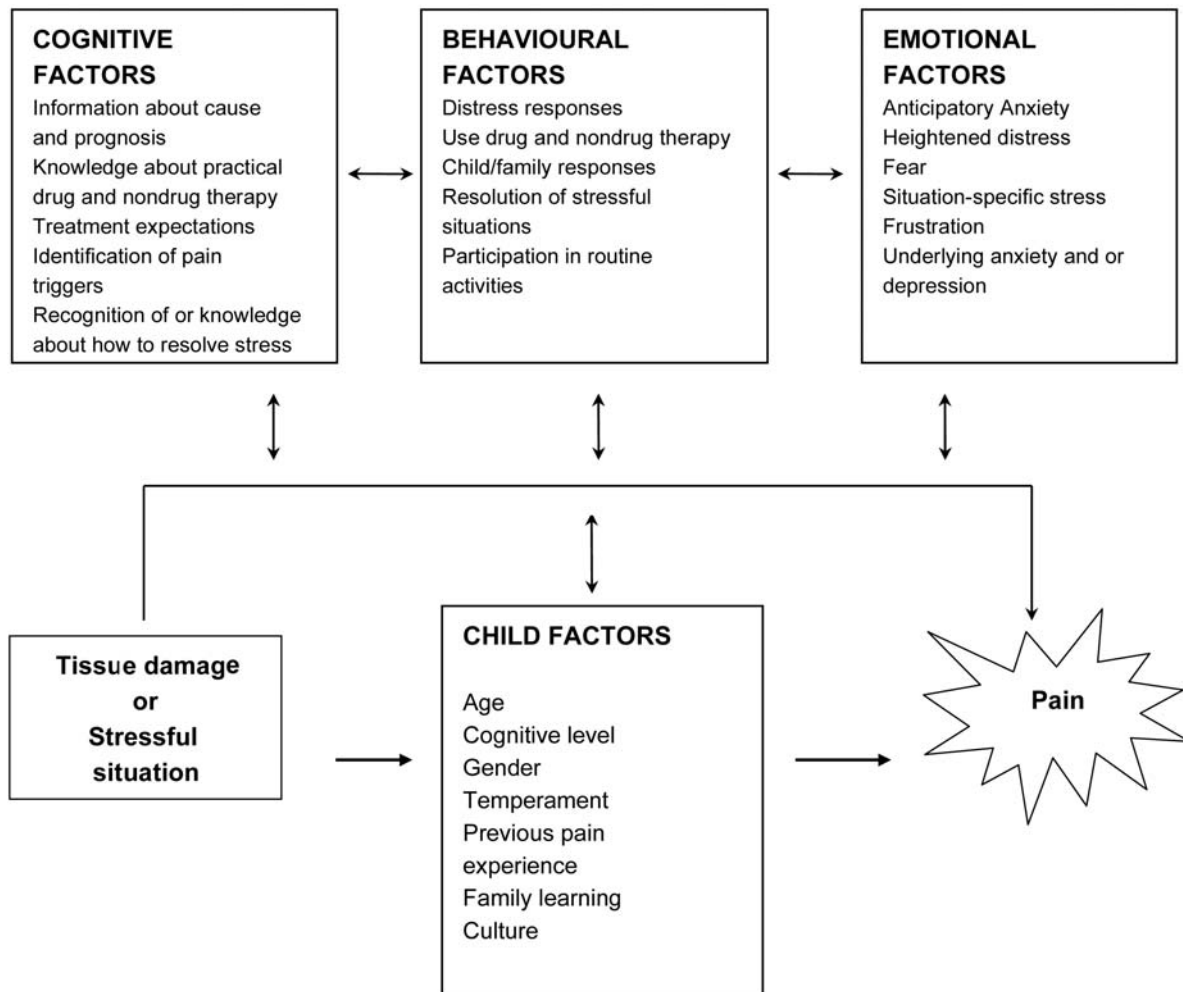
of pain and disability develops. Furthermore, many factors such as how the child thinks, feels and behaves in response to the pain can intensify the pain and distress and prolong the disability. Some of the common situational and child factors that intensify pain and prolong disability are outlined in Fig. 1 (McGrath and Hillier 2003). These children also tend to have components of ▶ [nociceptive](#) (normal pain) and ▶ [neuropathic](#) (nerve pain), which make them more difficult to treat. Therefore, ▶ [interdisciplinary](#) chronic pain teams are necessary to treat complex chronic pain conditions adequately in order to ensure that assessments and interventions are child-centred (e.g. tailored to the needs of the individual child) rather than just focused on the underlying disease or condition.

### Characteristics

Given that these complex chronic pain conditions have multiple causes, children must be treated from an interdisciplinary, ▶ [multimodal](#), rehabilitation perspective. Drug, physical and psychological therapies should be incorporated into a flexible, child-friendly program with particular attention to the cognitive, behavioural and emotional factors contributing to the underlying problem. Because of the complexity of chronic pain, no single discipline has the expertise to assess and manage it independently. Therefore, specialised interdisciplinary chronic pain teams are now considered the standard of care for children with complex chronic pain conditions.

### Composition of Interdisciplinary Pain Teams

Chronic pain teams for children generally include specialised physicians (e.g. anaesthesiologists, neurologists, psychiatrists), nurses, psychologists and physical therapists. More recently, teams may also include complementary and alternative therapists (e.g. acupuncturists, massage therapists). The specific team members involved in any one case depend on the individual needs of the child and family. A child's initial consultation includes either a joint team interview and physical examination or separate interviews with each healthcare professional. Comprehensive physical and psychosocial assessment may typically last a few hours to a full day, depending on the child's previous diagnostic tests and the team's core assessment battery (i.e. standardised sensory testing, questionnaires). The team then meets to formulate the child's pain diagnosis and treatment plan. The treatment plan should include: the diagnosis (underlying causes and contributing factors), rationale for a rehabilitative approach with a clear description of the specific treatment options and an opportunity for the family to help fine-tune the plan. It is essential to educate children and their families about the nature of chronic pain (e.g. different from acute pain where there is a single cause and a single treatment) and the factors that intensify it, as well as the drug and non-



**Complex Chronic Pain in Children, Interdisciplinary Treatment, Figure 1** Model of situational and child factors that modify pain and disability.

drug strategies they can use to control the pain. Some children's clinics also offer inpatient, day or residential treatment programs (Berde and Solodiuk 2003).

#### Goals of Interdisciplinary Chronic Pain Treatment

Interdisciplinary chronic pain programs use a rehabilitative approach where children's pain is treated with the most appropriate drug therapy and where the team assists children and their parents to improve children's function despite their pain. In some instances, teams work with families to help them understand that their child's pain might not be eradicated fully, so that efforts are directed towards improving function and quality of life. Interdisciplinary treatment goals include:

- Comprehensive physical and psychosocial assessment of the child with pain and their family to evaluate aetiology and contributing factors.
- Design and implementation of a flexible child-centred treatment approach that addresses all causative factors.
- The treatment plan typically including pharmacological, psychological and physical therapies and in some cases medical (e.g. nerve blocks) intervention.
- The specific goals of the treatment plan including: (a) increasing independent function in terms of activities of daily living, school, social and physical activity; (b) facilitating adaptive problem solving, communication and coping skills; (c) treating specific problems identified from the comprehensive assessment (e.g. depression, anxiety) and (d) helping children and their families to understand the nature of pain, the pain condition and its treatment from a holistic perspective.
- Ongoing assessment and re-evaluation of the treatment plan. One way to monitor children with chronic pain is through the use of electronic pain diaries. Stinson and colleagues (2005; 2006) have developed and are testing a new electronic (PDA-based) multidimensional chronic pain measure for children called the e-Ouch.

### Pharmacological Therapies

Pharmacologic methods are an important component of an integrated, flexible approach that combines psychological and physical strategies. The choice of medication depends in part on the source of pain (e.g. nociceptive, neuropathic or mixed). Pain medications are tailored to the individual needs of each child based on the results of their assessment. Drug therapies are divided broadly into analgesics and adjuvant medication. Analgesics are administered in a stepwise approach and are recommended for pain conditions with characteristics of nociceptive or mixed pain. Simple analgesics, such as acetaminophen and non-steroidal anti-inflammatory drugs (e.g. ibuprofen) in adequate doses, are effective for some children. Opioids may be added to the analgesics regimen when these mild analgesics do not alleviate the pain. In contrast, pain conditions with characteristics of neuropathic pain are often resistant to drug therapies that typically relieve nociceptive pain (e.g. opioids). Therefore, adjuvant pain medications such as anti-convulsants and tricyclic anti-depressants are used. Gabapentin is the most commonly used anti-convulsant, as it is safe and well tolerated. Amitriptyline is the most commonly used tricyclic anti-depressant and is often recommended for children whose sleep is disturbed. Antidepressants are also helpful for children who have chronic pain and who are depressed (Sethna 1999) (see ► [Analgesic guidelines for infants and children](#)).

### Psychological Therapies

Many psychological therapies are available to treat chronic pain in children. These treatments include counselling, ► [relaxation therapy](#), ► [biofeedback](#), ► [behavioural modification](#) and cognitive strategies including ► [hypnosis](#) and ► [psychotherapy](#) (McGrath et al. 2003). Often these therapies are integrated into a comprehensive cognitive-behavioural therapy (CBT) program that is directed at identifying and ameliorating the thinking, behaving and feeling factors that affect a child's pain and disability. A recent systematic review documented the efficacy of CBT for chronic headache and abdominal pain in children (Eccleston et al. 2002). CBT is often organized into a program of therapy that is delivered by various members of the chronic pain team. The content of the programs varies across clinics but usually includes teaching children specific pain and life coping skills, encouraging positive family responses for resuming typical activities, reframing or changing the family's beliefs that may impede rehabilitation, exercise therapy, education and self-management strategies. The goal of these psychological therapies is to help children regain their lives and take back control from the pain. Finally, there is strong evidence that these psychological treatments can be effective without a therapist being physically present, using alternative models of service delivery such as the Internet (Elgar and McGrath 2003). We are currently developing a web-enabled distance

treatment program for children with chronic pain. These types of programs might help to overcome some of the traditional barriers to treatment (e.g. stigma associated with these therapies, acceptability and accessibility).

### Physical Therapies

Chronic pain often leads a child to avoid physical activity due to fear of re-injury or because it exacerbates the pain. Lack of muscle use leads to loss of muscle strength, flexibility and endurance and overall deconditioning. Therefore, physical therapies are an integral component, and in certain instances the cornerstone, of treatment for children with complex chronic pain problems. Exercise therapy, physiotherapy, thermal (heat and cold) and sensory (► [desensitization](#), ► [transcutaneous electrical nerve stimulation](#) or TENS) stimulation and massage are the most commonly used physical modalities. They are frequently used in combination. Regular exercise (e.g. 20 min 3 × per week) should help improve sleep, mood, self-esteem and energy levels. However, maintaining normal daily activities such as school, sports and play are often as effective as a formal exercise program. Some children will benefit from intensive physiotherapy. Physiotherapy is usually administered on an outpatient basis with the ultimate goal of teaching the child to execute the program at home. A program the child enjoys (e.g. swimming) and one where the amount of time spent in the activity is gradually increased is one the child is more likely to continue with (McCarthy et al. 2003).

### Summary

In summary, children with complex chronic pain conditions experience prolonged suffering and disability. The pain adversely impacts all aspects of children's lives in terms of physical, psychological, social and role functioning. Many sensory, cognitive, behavioural and emotional factors may intensify the pain and prolong pain related disability. Moreover, these complex pain conditions tend to have components of nociceptive and neuropathic pain, which makes them more difficult to treat. Given this complexity, unidisciplinary and unimodal treatments are rarely successful. Therefore, children with complex chronic pain conditions must be treated from an interdisciplinary, multi-modal, rehabilitation perspective. Pharmacological, physical and psychological therapies should be incorporated into a flexible, child-centred program.

### References

1. Berde CB, Solodiuk J (2003) Multidisciplinary programs for management of acute and chronic pain in children. In: Schechter NL, Berde CB, Yaster M (eds) *Pain in Infants, Children and Adolescents*. Lippincott Williams and Wilkins, Philadelphia, pp 471–486
2. Bursch B, Walco GA, Zeltzer L (1998) Clinical assessment and management of chronic pain and pain-associated disability syndrome. *Dev Behav Pediatr* 19:45–53

3. Dahlquist LM, Switkin MC (2003) Chronic and recurrent pain. In: Schechter NL, Berde CB, Yaster M (eds) *Pain in Infants, Children and Adolescents*. Lippincott Williams and Wilkins, Philadelphia, pp 198–215
4. Eccleston C, Morley S, Williams A et al. (2002) Systematic review of randomised controlled trials of psychological therapy for chronic pain in children and adolescents, with a subset meta-analysis of pain relief. *Pain* 99:157–165
5. Elgar FJ, McGrath PJ (2003) Self-administered psychosocial treatments for children and families. *J Clin Psychol* 59:321–339
6. McGrath PA (1999) Chronic pain in children. In: Crombie IK (ed) *Epidemiology of Pain*. IASP Press, Seattle, pp 81–101
7. McGrath PJ, Finley GA (1999) Chronic and recurrent pain in children and adolescents. In: McGrath PJ, Finley GA (eds) *Chronic and recurrent pain in children and adolescents*. Progress in Pain Research and Management, vol 13. IASP Press, Seattle, pp 1–4
8. McGrath PA, Hillier LM (2003) Modifying the psychological factors that intensify children's pain and prolong disability. In: Schechter NL, Berde CB, Yaster M (eds) *Pain in Infants, Children and Adolescents*. Lippincott Williams and Wilkins, Philadelphia, pp 85–104
9. McGrath PJ, Dick B, Unruh AM (2003) Psychologic and behavioural treatment in pain in children and adolescents. In: Schechter NL, Berde CB, Yaster M (eds) *Pain in Infants, Children and Adolescents*. Lippincott Williams and Wilkins, Philadelphia, pp 303–328
10. McCarthy CF, Shea AM, Sullivan P (2003) Physical therapy management of pain in children. In: Schechter NL, Berde CB, Yaster M (eds) *Pain in Infants, Children and Adolescents*. Lippincott Williams and Wilkins, Philadelphia, pp 434–448
11. Sethna NF (1999) Pharmacotherapy in long-term pain: Current experience and future direction. In: McGrath PJ, Finley GA (eds) *Chronic and Recurrent Pain in Children and Adolescents*. Progress in Pain Research and Management, vol 13. IASP Press, Seattle, pp 243–264
12. Stinson J, Petroz G, Stevens B et al. (2005) e-Ouch electronic pain diary for adolescents with arthritis: A pilot test. International Association for the Study of Pain 11<sup>th</sup> World Congress, Sydney Australia, August 21–26
13. Stinson J, Petroz G, Tait G et al. (2006) e-Ouch: Usability testing of an electronic chronic pain diary for adolescents with arthritis. *Clin J Pain* 22:295–305

## Complex Migraine

- ▶ [Clinical Migraine with Aura](#)

## Complex Regional Pain Syndrome

### Synonymss

CRPS; Complex Regional Pain Syndrome Type I (CRPS I)

### Definition

CRPS is a medical syndrome characterized by chronic regionalized STP, edema, blood flow changes, sudomotor changes, dysfunction, and bone turnover disproportionate in response to what is often a recognized noxious inciting event. The CRPS designation is a new name for this kind of disorder. The name applies to CRPS–1, which was formerly known as sympathetic dystrophy without nerve injury, and to CRPS–2, formerly known

as causalgia. Whether it exists in the facial region is still a matter of debate.

- ▶ [Adrenergic Agonist](#)
- ▶ [Atypical Facial Pain, Etiology, Pathogenesis and Management](#)
- ▶ [Causalgia, Assessment](#)
- ▶ [Central Nervous System Stimulation for Pain](#)
- ▶ [Complex Chronic Pain In Children, Interdisciplinary Treatment](#)
- ▶ [Complex Regional Pain Syndrome and the Sympathetic Nervous System](#)
- ▶ [Complex Regional Pain Syndromes, General Aspects](#)
- ▶ [CRPS-1 in Children](#)
- ▶ [Muscle Pain, Fibromyalgia Syndrome \(Primary, Secondary\)](#)
- ▶ [Sympathetically maintained Pain and Inflammation, Human Experimentation](#)
- ▶ [Sympathetically Maintained Pain, Clinical Pharmacological Tests](#)
- ▶ [Sympathetically Maintained Pain in CRPS I, Human Experimentation](#)
- ▶ [Sympathetically Maintained Pain in CRPS II, Human Experimentation](#)

## Complex Regional Pain Syndrome and the Sympathetic Nervous System

JAMES N. CAMPBELL  
Johns Hopkins University School of Medicine,  
Baltimore, MD, USA  
jcampbel@jhmi.edu

### Synonyms

Reflex Sympathetic Dystrophy; Sympathetically-maintained pain; Causalgia

### Definition

▶ [Sympathetically maintained pain \(SMP\)](#) refers to pain that is dependent on neural activity in the sympathetic nervous system and is present in some patients with ▶ [complex regional pain syndrome \(CRPS\)](#).

### Characteristics

Activity in nociceptors induces an increase in sympathetic discharge. It is in this way, in part, that noxious (painful) stimuli induce a rise in blood pressure. Usually, the converse is not true: sympathetic activity does not impact the discharge of nociceptive neurons. In certain patients with pain, however, nociceptors acquire sensitivity to norepinephrine released by sympathetic efferents. Pain dependent on activity in the sympathetic nervous system is referred to as sympathetically maintained pain (SMP).

This linkage with the sympathetic nervous system may, in some patients, be a dominant mechanism for pain.



SMP, in particular, is noted in many cases of complex regional pain syndrome (CRPS). CRPS typically occurs after trauma that may or may not result in nerve injury. The distal extremities, areas rich in sympathetic innervation, are usually affected. The patients present with edema (at least in the early stages) and striking hyperalgesia. Patients with CRPS often have motor disability with difficulty moving the affected painful body parts, regardless of an intact sensory/motor pathway. The skin may be very cool and sweaty, or sometimes very warm compared to the opposite normal side. The disorder appears to spread in some patients from distal to proximal parts of the extremity, and may in fact spread to other extremities as well.

### SMP is a Receptor Disorder

The dramatic relief of pain that occurs with selective blockage of the sympathetic nervous system defines SMP. Three general ideas have been advanced to explain this phenomenon: 1) the anesthetic blocks “pain” fibers that course with the sympathetic efferent fibers; 2) the sympathetic nervous system is overactive and thus induces pain; 3) the sympathetic nervous system acquires the capacity to activate nociceptors and hence induce pain. Evidence from both human and animal studies supports the latter hypothesis.

Stimulation of the sympathetic chain induces pain in patients with causalgia (Walker and Nulson 1948; White and Sweet 1969), even when the sympathetic chain is disconnected from the spinal cord. Thus, efferent actions of the sympathetic nervous system account for SMP. Injection of noradrenaline around stump neuromas or skin in patients with postherpetic neuralgia induces an increase in spontaneous pain (Chabal et al. 1992; Raja et al. 1998; Choi and Rowbotham 1997). In patients relieved of pain after a sympathetic block, intradermal injection of norepinephrine into the previously hyperalgesic area in physiological concentrations induces pain (Ali et al. 2000). Norepinephrine injected into normal subjects evokes little or no pain. This evidence strongly suggests that SMP does not arise from an excess of epinephrine, but rather from the presence of adrenergic receptors coupled to cutaneous nociceptors. Therefore, in SMP, norepinephrine that is normally released from the sympathetic terminals acquires the capacity to evoke pain by activating nociceptors.

### Nerve Injury Induces Catechol Sensitization in Nociceptors

In a primate model, the L6 root was lesioned leaving the dorsum of the foot partly denervated (Ali et al. 1999). Intact nociceptors from adjacent uninjured roots developed spontaneous activity and a response to an  $\alpha_1$ -adrenergic agonist, phenylephrine, applied to the receptive field. In monkeys where no spinal nerve lesion was applied, little or no catechol sensitivity and spontaneous activity was present. Using a somewhat different model, studies in rats have also demonstrated catechol

sensitization of intact nociceptors after nerve injury of companion fibers (Sato and Perl 1991). C-fibers ending in a neuroma also display adrenergic sensitivity (Devor and Jänig 1981; Häbler et al. 1987; Wall and Gutnick 1974; Scadding 1981). These data indicate that SMP is likely to arise from expression of  $\alpha_1$ -adrenergic receptors on the terminals of nociceptors.

### Phentolamine Infusion as a Test for SMP

The gold standard for diagnosing SMP has been determination of the response to blockade of the appropriate level of the sympathetic chain with local anesthetic. Phentolamine, given systemically, has proven to be safe and is now considered (by some at least) to be a more specific way to diagnose SMP. After infusion of saline to hydrate the patient, and after administration of 1–2 mg of propranolol to block the development of reflex tachycardia, phentolamine in a dose of 1 mg/kg is given over 10 minutes. Skin temperature is monitored. If the skin temperature does not rise, then a higher dose of phentolamine may have to be given. The test can be blinded, such that the patient does not know when the drug is given. A positive result is the finding that systemic phentolamine and  $\alpha$ -adrenergic antagonist relieve pain when given to patients with SMP (Raja et al. 1991; Arner 1991).

### Alpha 1 or Alpha 2 Adrenergic Receptors

To sort out the adrenergic mechanisms in humans, further investigators have applied topical clonidine, an  $\alpha_2$ -adrenergic agonist, to the painful skin in patients with SMP. Relief of hyperalgesia in the painful area resulted (Davis et al. 1991). Activation of  $\alpha_2$ -adrenergic receptors, located on sympathetic terminals, blocks norepinephrine release. Thus, clonidine appears to relieve pain by blocking norepinephrine release. When phenylephrine, a selective  $\alpha_1$ -adrenergic agonist, was applied to the clonidine-treated area, pain was rekindled in patients with SMP (Davis et al. 1991). Thus, clinical data, as with the primate physiological data, suggest that the  $\alpha_1$ -adrenergic receptor plays a pivotal role in SMP. Whether a phenotypic change or other change explains this nociceptor chemical sensitization is unanswered. It is of interest that the density of  $\alpha_1$ -adrenoceptors in the epidermis of hyperalgesic skin of patients with complex regional pain syndrome is increased (Drummond et al. 1996).

### Treatment of Sympathetically Maintained Pain

By definition, SMP is relieved by performance of a sympathetic block. It has been frequently observed, that in some patients the pain relief outlives the pharmacological action of the anesthetic block. A similar long-lasting pain relief has also been reported following systemic phentolamine infusion (Galer et al. 1992). A series of sympathetic blocks may lead to successful resolution of the pain problem.

In cases where sympathetic blockade fails to provide enduring pain relief other strategies are needed. Surgical ► **sympathectomy** provides permanent sympathetic denervation and offers lasting pain relief (Singh et al. 2003). In the case of the upper extremity, the T2, 3, 4 ganglia are removed. The stellate ganglion provides no innervation of the hand, and injury of this ganglion is avoided in order to prevent development of a Horner's syndrome. The thoraco-endoscopic approach affords excellent visualization of the sympathetic chain, and provides a minimally invasive technique by which to achieve a thoracic sympathectomy. For the lumbar area, it is necessary to remove the sympathetic chain from L1 to L5. Typically, at least three ganglia are removed, and the length of the excised chain is 10 cm.

Signs of sympathetic innervation to the foot may return after weeks or months. This may be due to crossed innervation. In other words, sympathetic fibers from the contralateral side may reach the foot and provide sufficient innervation that the SMP returns. The test for this is to perform a contralateral sympathetic block. The block should lead to a striking increase in temperature in the contralateral foot (this does not occur customarily), and be associated with pain relief for at least the duration of the block. In this case, a contralateral lumbar sympathectomy may be performed, which will provide enduring pain relief.

Complications of sympathectomy include new pain attributable to the surgery. These patients appear to have a vulnerability to develop new pain with trauma. Compensatory hyperhidrosis may develop, but this is more of a problem in patients in whom the sympathectomy is done to treat hyperhidrosis.

Spinal cord electrical stimulation is an alternative treatment for SMP (Kemler et al. 2000). Of course ► **spinal cord stimulation** may be effective for treatment of sympathetically independent pain as well. The advantage of this technique is that the morbidity is low. The disadvantage is that continued stimulation and maintenance of the device is required to maintain the therapeutic effect. Notably, use of one modality does not preclude the later use of the other modality.

## References

1. Ali Z, Raja S N, Wessellmann U et al. (2000) Intradermal Injection of Norepinephrine Evokes Pain in Patients with Sympathetically Maintained Pain. *Pain* 88:161–168
2. Ali Z, Ringkamp M, Hartke T V et al. (1999) Uninjured C-Fiber Nociceptors Develop Spontaneous Activity and Alpha Adrenergic Sensitivity Following L6 Spinal Nerve Ligation in the Monkey. *J Neurophysiol* 81:455–466
3. Arner S (1991) Intravenous Phentolamine Test: Diagnostic and Prognostic use in Reflex Sympathetic Dystrophy. *Pain* 46:17–22
4. Chabal C, Jacobson L, Russell L C et al. (1992) Pain Response to Perineuronal Injection of Normal Saline, Epinephrine, and Lidocaine in Humans. *Pain* 49:9–12
5. Choi B, Rowbotham M C (1997) Effect of Adrenergic Receptor Activation on Post-Herpetic Neuralgia Pain and Sensory Disturbances. *Pain* 69:55–63
6. Davis K D, Treede R-D, Raja S N et al. (1991) Topical Application of Clonidine Relieves Hyperalgesia in Patients with Sympathetically Maintained Pain. *Pain* 47:309–317
7. Devor M, Jänig W (1981) Activation of Myelinated Afferents Ending in a Neuroma by Stimulation of the Sympathetic Supply in the Rat. *Neurosci Lett* 24:43–47
8. Drummond P D, Skipworth S, Finch P M (1996) Alpha<sup>1</sup>-Adrenoceptors in Normal and Hyperalgesic Human Skin. *Clin Sci (Colch)* 91:73–77
9. Galer B S, Rowbotham M C, Von Miller K et al. (1992) Treatment of Inflammatory, Neuropathic and Sympathetically Maintained Pain in a Patient with Sjögren's Syndrome. *Pain* 50:205–208
10. Häbler H-J, Jänig W, Koltzenburg M (1988) A Novel Type of Unmyelinated Chemosensitive Nociceptor in the Acutely Inflamed Urinary Bladder. *Agents Actions* 25:219–221
11. Kemler M A, Barendse G A, van Kleef M et al. (2000) Spinal Cord Stimulation in Patients with Chronic Reflex Sympathetic Dystrophy. *N Engl J Med* 343:618–624
12. Raja S N, Abatzis V, Frank S (1998) Role of  $\alpha$ -Adrenoceptors in Neuroma Pain in Amputees. *American Society of Anesthesiologists Abstracts*
13. Raja S N, Treede R-D, Davis K D et al. (1991) Systemic Alpha-Adrenergic Blockade with Phentolamine: A Diagnostic Test for Sympathetically Maintained Pain. *Anesthesiology* 74:691–698
14. Sato J, Perl E R (1991) Adrenergic Excitation of Cutaneous Pain Receptors Induced by Peripheral Nerve Injury. *Science* 251:1608–1610
15. Scadding J W (1981) Development of Ongoing Activity, Mechanosensitivity and Adrenaline Sensitivity in Severed Peripheral Nerve Axons. *Experimental Neurology* 73:345–364
16. Singh B, Moodley J, Shaik A S et al. (2003) Sympathectomy for Complex Regional Pain Syndrome. *J Vasc Surg* 37:508–511
17. Walker A E and Nulson F (1948) Electrical Stimulation of the Upper Thoracic Portion of the Sympathetic Chain in Man. *Archives of Neurology and Psychiatry* 59:559–560
18. Wall P D and Gutnick M (1974) Ongoing Activity in Peripheral Nerves: The Physiology and Pharmacology of Impulses Originating from a Neuroma. *Experimental Neurology* 43:580–593
19. White J C, Sweet W H (1969) Pain and the Neurosurgeon: A Forty Year Experience. Charles C. Thomas, Springfield

## Complex Regional Pain Syndrome Type I

- **Sympathetically Maintained Pain in CRPS I, Human Experimentation**

## Complex Regional Pain Syndrome Type I (CRPS I) and Type II (CRPS II)

- **Complex Regional Pain Syndrome**

## Complex Regional Pain Syndromes, General Aspects

KOK E. KHOR  
 Department of Pain Management, Prince of Wales  
 Hospital, Randwick, NSW, Australia  
 kekhor@bigpond.net.au

## Synonyms

### CRPS

CRPS Type 1: Reflex sympathetic dystrophy; algodystrophy; Sudeck's Atrophy; Traumatic Angiospasm; Shoulder-Hand Syndrome; Post-Infarction Sclerodactyly

CRPS Type 2: Causalgia

## Definition

CRPS Type 1 is a syndrome that usually develops after an initiating noxious event. It consists of spontaneous pain or allodynia/hyperalgesia, in a regional distribution not limited to the territory of a single peripheral nerve, and disproportionate in severity to the inciting event, associated at some point with evidence of oedema, changes in skin blood flow or abnormal sudomotor activity in the region of pain (Complex regional pain syndromes 1994). CRPS Type 2 is the same as Type 1, but the syndrome develops in association with a partial nerve injury (Complex regional pain syndromes 1994).

## Characteristics

### Clinical Manifestations

CRPS can be initiated by events ranging from minor injuries to surgical lesions, visceral diseases (e.g. myocardial infarction) and central neurological disorders (e.g. acute stroke). Various stages of CRPS have been proposed, but have not been corroborated in population studies (Veldman et al. 1993).

Pain is the essential feature and is disproportionate to the severity of the injury (Complex regional pain syndromes 1994). It can be burning, aching, prickling, shooting or tearing, and felt distally, diffusely and deeply in the affected region. It can be spontaneous or evoked by light touch, thermal stimulation, dependent position, palpation and joint movements (Walker and Cousins 1997; Birklein et al. 2000; Ribbers et al. 1995; Bogduk 2001). If the pain is relieved by ► **Sympathetic Nerve Block** or ► **intravenous infusions** of an  $\alpha$ -adrenoceptor antagonist, it is considered to be sympathetically maintained pain (SMP) (Complex regional pain syndromes 1994). If not so relieved, it is considered to be sympathetically independent pain (SIP).

Skin changes range from warm and red to cold and cyanotic, and are associated with swelling and increased or decreased sweating (Walker and Cousins 1997). Trophic changes include increased or decreased nail and hair growth, thin shiny skin, muscle wasting and fibrosis, and osteoporosis (Walker and Cousins 1997). Motor impairments include weakness, tremor, dystonia, myoclonic jerks, joint stiffness, and difficulty initiating movements (Walker and Cousins 1997; Ribbers et al. 1995). These vasomotor, sudomotor, and trophic changes distinguish CRPS from other painful conditions due to neuropathy, musculoskeletal injury or visceral diseases (Fig. 1).



**Complex Regional Pain Syndromes, General Aspects, Figure 1** Patient with complex regional pain syndrome (CRPS). The patient developed CRPS following a crush injury to the right foot.

Somatization, anxiety, depression and fear avoidance behaviours found in patients with CRPS are identical to those of patients with chronic pain, and are a result, rather than a cause, of pain (Walker and Cousins 1997). The diagnosis of CRPS is based solely on clinical criteria. Investigations are used only to confirm clinical impressions about autonomic, sensory and motor dysfunction. These include bone scintigraphy, quantitative sensory testing and tests for autonomic function (Baron and Wasner 2001).

### Demographics

CRPS affects women more often (66%), and most often the upper limb (73%) (Birklein et al. 2000). The mean age of patients is 50.4 years, but CRPS also occurs in children—mainly adolescent females and affecting lower limbs—but carries a more favourable prognosis (Walker and Cousins 1997). CRPS 1 is 5 times more common than CRPS 2.

CRPS occurs in 2–5% patients with peripheral nerve injuries, and in 1–2% of patients who sustain fractures, although the incidence is higher following Colles' frac-



ture (Walker and Cousins 1997). In 10–26% of patients no significant precipitant cause is found (Ribbers et al. 1995). A genetic predisposition to CRPS had also been suggested (Walker and Cousins 1997).

### Natural History

Symptoms tend to improve in about two-thirds of patients. After Colles' fracture, although most patients improve rapidly, pain and swelling persist in some 20–30% patients at 6 months (Walker and Cousins 1997). In patients who are unresponsive to treatment during the acute stage, pain may become refractory and associated with significant impairment in activities of daily living, recreational activities, work and mood (Ribbers et al. 1995). Recurrence or spread to another region occurs in 10% of patients.

### Mechanisms

As the features of CRPS 1 and CRPS 2 are identical, it is likely that CRPS 1 involves an undetected nerve injury. CRPS is thus a form of ► **neuropathic pain** (Baron and Wasner 2001; Bennett 1999). The underlying mechanism of CRPS has not been explicitly elucidated (Bogduk 2001). Multiple mechanisms appear to be involved, with somatosensory dysfunctions interacting with the sympathetic nervous system and peripheral inflammatory reactions (Bogduk 2001; Bennett 1999). Peripheral and central mechanisms for pain generation have been invoked (Bennett 1999).

Injury of a peripheral nerve may result in a neuroma formation or constriction of the nerve. These can generate ectopic activity in the A $\delta$  and C fibres, which excites nociceptive neurons in the dorsal horn, resulting in central hyperexcitability (Bogduk 2001; Bennett 1999). This becomes the basis for neurogenic pain, mechanical hyperalgesia, and allodynia. Sprouting of sympathetic efferent fibres onto dorsal root ganglia (DRG), and production of  $\alpha$ -adrenoreceptors in the DRG and nerve terminals, renders the affected nerves more responsive to noradrenaline (NA) and sympathetic stimulation (Bogduk 2001; Baron and Wasner 2001; Bennett 1999).

Deafferentation following peripheral nerve injury can result in disinhibition of dorsal horn neurons, and consequent spontaneous activity and facilitation of nociceptive neurons (Bogduk 2001). CRPS following lesions in the central nervous system might also be due to disinhibition of central nociceptive pathways (Bogduk 2001). It remains uncertain if the so-called sympathetic features are caused by abnormalities in sympathetic nerve activity, by inflammatory changes, or a combination of both, at different phases of CRPS.

In the early phase, central sympathetic activity is functionally reduced, with reduced release of NA and relative vasodilatation. Antidromic activity in C fibres may liberate inflammatory mediators and enhance vasodilatation. In the advanced phase, central sympathetic activity

returns but vasoconstrictor innervation disappears, because some sympathetic postganglionic neurons degenerate. Blood vessels develop denervation hypersensitivity with increased  $\alpha$ -adrenoceptor density, leading to increased vasoconstriction with manifestation of chronically cold, bluish limbs (Bogduk 2001; Baron and Wasner 2001; Bennett 1999).

Inflammatory responses, with proliferation of immune cell infiltrates and liberation of proinflammatory cytokines, accompany nerve injury. These chemicals can sensitise sensory neurones, resulting in mechanical allodynia and hyperalgesia (Bennett 1999). The excessive production of free oxygen radicals by activated phagocytes in inflamed tissues may also play a role (Baron and Wasner 2001; Veldman 1999).

### Treatment

Although CRPS has attracted treatment with a variety of agents and interventions, used alone or in combination, systematic and pragmatic reviews have shown that few interventions have been vindicated by controlled trials (Kingery 1997; Robinson 2002; Hord and Oaklander 2003). The management of CRPS, therefore, rests largely on recommendations (Stanton-Hicks et al. 1998) rather than strong evidence.

Early recognition and treatment are associated with the best chance of a good outcome. Comprehensive management entails physical therapy and functional restoration, coupled with behavioural therapy, and drugs or injections to reduce pain (Stanton-Hicks et al. 1998).

Recommended, but unproven, interventions include dynamic splinting, exercises, and stress-loading programs in order to maintain limb function and minimise secondary effects due to disuse (Walker and Cousins 1997; Hord and Oaklander 2003). Although cognitive behavioural therapy may be effective for chronic pain in general (Walker and Cousins 1997; Hord and Oaklander 2003), its efficacy for CRPS has not been demonstrated.

► **Sympathetic nerve blocks** have been a traditional intervention for CRPS, but a systematic review showed that the response rates were no better than what could be expected from a placebo effect (Cepeda et al. 2002).

► **Sympathetic blocks** or ► **epidural infusions** may be used to facilitate physical therapy, but their utility remains unproven. Bretylium and ketanserin delivered as ► **regional intravenous infusions** have been vindicated in controlled trials, but phentolamine and guanethidine have effects no greater than placebo (Robinson 2002; Hord and Oaklander 2003). Clonidine may be effective by intravenous, transdermal, or epidural application (Hord and Oaklander 2003). Nifedipine and phenoxybenzamine may be effective in recent onset CRPS (Hord and Oaklander 2003).

There is some evidence that oral corticosteroids may be effective (Kingery 1997; Hord and Oaklander 2003). There is emerging evidence that ► **bisphosphonates** can



relieve the pain of CRPS (Robinson 2002; Hord and Oaklander 2003). Topical dimethylsulfoxide cream, which acts as a free radical scavenger, may reduce the signs of CRPS (Veldman 1999).

Gabapentin, lamotrigine, subcutaneous and transdermal lignocaine appear to be effective in open label trials, but there have been no published trials of oral opioids, anticonvulsants, mexiletine, ketamine, or amitriptyline (Robinson 2002; Hord and Oaklander 2003). The efficacy of NSAIDs (Baron and Wasner 2001) and acupuncture (Hord and Oaklander 2003) has not been demonstrated. Amitriptyline and ► TENS appear to be effective in children (Hord and Oaklander 2003).

For intractable CRPS, some authorities advocate neuro-modulation with peripheral nerve stimulator and epidural spinal cord stimulator (Hord and Oaklander 2003; Stanton-Hicks et al. 1998), but a controlled trial showed that although spinal cord stimulation did relieve pain, it did not improve function (Kemler et al. 2000). For dystonia associated with CRPS, intrathecal baclofen has been effective (Hord and Oaklander 2003). Intrathecal administration of morphine can also be considered, although efficacy has only been reported in case series (Hord and Oaklander 2003).

## References

- Baron R, Wasner G (2001) Complex Regional Pain Syndromes. *Curr Pain Headache Rep* 5:114–123
- Bennett G (1999) Scientific Basis for the Evaluation and Treatment of RSD/CRPS Syndromes: Laboratory Studies in Animals and Man. In: Max M (ed) *Pain 1999 – An updated review. Refresher Course Syllabus*. IASP Press, Seattle, pp 331–337
- Birklein F, Riedl N, Sieweke N et al. (2000) Neurological Findings in Complex Regional Pain Syndromes – Analysis of 145 Cases. *Acta Neurol Scand* 101:262–269
- Bogduk N (2001) Mechanisms of Complex Regional Pain Syndromes. *Aust Musculoskeletal Med* 6:88–102
- Cepeda MS, Lau J, Carr B (2002) Defining the Therapeutic Role of Local Anesthetic Sympathetic Blockade in Complex Regional Pain Syndrome: A Narrative and Systematic Review. *Clin J Pain* 18:216–233
- Complex Regional Pain Syndromes (1994) In: Merskey H, Bogduk N (eds) *Classification of Chronic Pain: Descriptions of Chronic Pain Syndromes and Definition of Pain Terms*, 2nd edn. IASP Press, Seattle, pp 40–43
- Hord E, Oaklander A (2003) Complex Regional Pain Syndrome: A Review of Evidence-Supported Treatment Options. *Curr Pain Headache Rep* 7:188–196
- Kemler MA, Barendse GAM, van Kleef M, de Vet HCW, Rijks CPM, Furnee CA, van den Wildenberg FAJM (2000) Spinal Cord Stimulation in Patients with Chronic Reflex Sympathetic Dystrophy. *New Engl J Med* 343:618–624
- Kingery WS (1997) A Critical Review of Controlled Clinical Trials for Peripheral Neuropathic Pain and Complex Regional Pain Syndromes. *Pain* 73:123–139
- Ribbers G, Geurts A, Mulder T (1995) The Reflex Sympathetic Dystrophy Syndrome: A Review with Special Reference to Chronic Pain and Motor Impairments. *Int J Rehab Res* 18:277–295
- Robinson J (2002) The Treatment of Complex Regional Pain Syndrome Type I. *Aust Musculoskeletal Med* 7:101–105
- Stanton-Hicks M, Baron R, Boas R, Gordh T, Harden N, Hendler N, Koltzenburg M, Raj P, Wilder R (1998) Complex Regional Pain Syndromes: Guidelines for Therapy. *Clin J Pain* 14:155–166
- Veldman P (1999) Inflammatory Aspects of RSD. In: Max M (ed) *Pain 1999 – An Updated Review. Refresher Course Syllabus*. IASP Press, Seattle, pp 343–345
- Veldman P, Reynen H, Arntz E et al. (1993) Signs and Symptoms of Reflex Sympathetic Dystrophy: Prospective Study of 829 Patients. *Lancet* 342:1012–1016
- Walker S, Cousins M (1997) Complex Regional Pain Syndromes: Including “Reflex Sympathetic Dystrophy” and “Causalgia”. *Anaesth Intens Care* 25: 113–125

## Complex Regional Pain Syndromes, Clinical Aspects

RALF BARON

Clinic for Neurology, Christian Albrechts University  
Kiel, Kiel, Germany

r.baron@neurologie.uni-kiel.de

### Synonyms

CRPS; reflex sympathetic dystrophy; causalgia; Morbus Sudeck; algodystrophy

### Definition

The “IASP classification of chronic pain” redefined pain syndromes formerly known as reflex sympathetic dystrophy and causalgia. The term Complex Regional Pain Syndrome describes, “a variety of painful conditions following injury which appear regionally having a distal predominance of abnormal findings, exceeding in both magnitude and duration the expected clinical course of the inciting event often resulting in significant impairment of motor function, and showing variable progression over time”. These chronic pain syndromes comprise of different additional clinical features including ► spontaneous pain, ► allodynia, ► hyperalgesia, oedema, autonomic abnormalities and trophic signs. In ► CRPS type I (reflex sympathetic dystrophy), minor injuries or fractures of a limb precede the onset of symptoms. ► CRPS type II (causalgia) develops after injury to a major peripheral nerve (Merskey and Bogduk 1995; Harden et al. 2001; Janig and Baron 2003).

### Characteristics

#### CRPS Type I (Reflex Sympathetic Dystrophy)

The most common precipitating event is a trauma affecting the distal part of an extremity (65%), especially fractures, postsurgical conditions, contusions and strain or sprain. Less common occurrences are central nervous system lesions, like spinal cord injuries and cerebrovascular accidents as well as cardiac ischemia (Allen et al. 1999).

CRPS I patients develop asymmetrical distal extremity pain and swelling without presenting with a demonstrable nerve lesion. These patients often report a spontaneous burning pain felt in the distal part of the affected extremity. Characteristically, the pain is disproportionate in intensity to the inciting event. The pain

usually increases when the extremity is in a dependent position. Stimulus-evoked pains are a striking clinical feature; they include ► **mechanical allodynia** and ► **thermal allodynia** and/or hyperalgesia. These sensory abnormalities often appear early, are most pronounced distally, and have no consistent spatial relationship to individual nerve territories or to the site of the inciting lesion (Sieweke et al. 1999). Movement of, and pressure on, the joints (deep somatic allodynia) can elicit pain, even if the inciting lesion does not directly affect these. Autonomic abnormalities include swelling and changes in sweating and skin blood flow (Chelimsky et al. 1995; Birklein et al. 1998; Wasner et al. 2002; Wasner et al. 2001). In the acute stages of CRPS I, the affected limb is often warmer than the contralateral limb. Sweating abnormalities, either hypohidrosis or, more frequently, hyperhidrosis are present in nearly all CRPS I patients. The acute distal swelling of the affected limb depends very critically on aggravating stimuli. Since it diminishes after sympathetic blocks, it is likely that it is maintained by sympathetic activity.

Trophic changes such as abnormal nail growth, increased or decreased hair growth, fibrosis, thin glossy skin and osteoporosis may be present, particularly in chronic stages. Restrictions of passive movement are often present in long-standing cases, and may be related to both functional motor disturbances and trophic changes of joints and tendons.

Weakness of all muscles of the affected distal extremity is often present. Small accurate movements are characteristically impaired. Nerve conduction and electromyography studies are normal, except in patients in very chronic and advanced stages. About half of the patients have a postural or action tremor representing an increased physiological tremor (Deuschl et al. 1991). In about 10 % of cases, dystonia of the affected hand or foot develops (Bhatia et al. 1993).

#### CRPS Type II (Causalgia)

The symptoms of CRPS II are similar to those of CRPS I. The only exception is that a lesion of peripheral nerve structures and subsequent focal deficits are mandatory for the diagnosis. The symptoms and signs spread beyond the innervation territory of the injured peripheral nerve and often occur remote from the site of injury, however, a restriction to the territory is not in conflict with the current definition.

#### Sympathetically Maintained Pain (SMP)

On the basis of experience and recent clinical studies the term ► **sympathetically maintained pain** was re-defined: Neuropathic pain patients presenting with similar clinical signs and symptoms can clearly be divided into two groups, by the negative or positive effect of selective sympathetic blockade, selective activation of sympathetic activity or antagonism of alpha adrenoceptor mechanisms (Raja et al. 1991; Baron et al. 2002).

The pain component that is relieved by specific sympatholytic procedures is considered "sympathetically maintained pain" (SMP). Thus, SMP is now defined to be a symptom or the underlying mechanism in a subset of patients with neuropathic disorders and not a clinical entity. The positive effect of a sympathetic blockade is not essential for the diagnosis. On the other hand, the only possibility of differentiating between SMP and "sympathetically independent pain" (SIP) is the efficacy of a correctly applied sympatholytic intervention (Stanton-Hicks et al. 1995).

#### Diagnostic Procedure

The diagnosis of CRPS I and II follows the IASP clinical criteria (Stanton-Hicks and Jänig 1996). If two clinical signs are joined by "or", if either sign is present or both, the condition of the statement is satisfied.

#### CRPS Type I

Type I is a syndrome that develops after an initiating noxious event.

Spontaneous pain or allodynia/hyperalgesia occurs, is not limited to the territory of a single peripheral nerve, and is disproportionate to the inciting event.

There is or has been evidence of oedema, skin blood flow abnormality, or abnormal sudomotor activity in the region of the pain since the inciting event.

This diagnosis is excluded by the existence of conditions that would otherwise account for the degree of pain and dysfunction.

#### CRPS Type II

Type II is a syndrome that develops after nerve injury. Spontaneous pain or allodynia/hyperalgesia occurs and is not necessarily limited to the territory of the injured nerve.

There is or has been evidence of oedema, skin blood flow abnormality, or abnormal sudomotor activity in the region of the pain since the inciting event.

This diagnosis is excluded by the existence of conditions that would otherwise account for the degree of pain and dysfunction.

Pain is essential for the diagnosis, whereby 'spontaneous' indicates pain without external cause. Motor symptoms and findings are not included in this classification, although they are common, and can include tremor, dystonia and weakness.

Possible inciting events of CRPS include:

#### CRPS I

- Peripheral tissues
  - fractures and dislocations
  - soft-tissue injury
  - fasciitis
  - tendonitis
  - bursitis
  - ligamentous strain

- arthritis
- mastectomy
- deep vein thrombosis
- immobilization

- Idiopathic

CRPS often follows minor trauma that could not be remembered by the patient. Also some patients negate any inciting event

- Viscera

- abdominal disease
- myocardial infarction

- Central nervous system

- spinal cord lesions
- head injury
- cerebral infarction
- cerebral tumor

## CRPS II

- Peripheral nerve and dorsal root

- peripheral nerve trauma
- brachial plexus lesions
- root lesions

### Treatment Algorithm

Treatment should be immediate and most importantly directed toward restoration of full function of the extremity. This objective is best attained in a comprehensive interdisciplinary setting, with particular emphasis on pain management and functional restoration (treatment algorithm see (Stanton-Hicks et al. 1998)). The pain specialists should include neurologists, anesthesiologists, orthopedics, physiotherapists, psychologists and the general practitioner.

Destructive surgery on the peripheral or central afferent nervous system in cases of CRPS always implicates further deafferentation, and thereby provides an increased risk for persistent deafferentation type of pain.

The severity of the disease determines the therapeutical regime. The reduction of pain is the precondition that all other interventions have to comply with. At the acute stage of CRPS, when the patients still suffer from severe pain, it is often impossible to carry out intensive active therapy. Painful interventions, and in particular vigorous physical therapy, at this stage leads to deterioration. Therefore, immobilization of the affected extremity and careful contralateral physical therapy should be the acute treatment of choice and pain treatment should be initiated immediately. There are only a few controlled treatment studies on CRPS. The first choice analgesic drugs, in which efficacy has been shown by

clinical studies on other neuropathic pain syndromes, include opioids, tricyclic antidepressants, gabapentin, pregabalin and carbamazepine. Additionally, systemic corticosteroids treatment is frequently used. Calcium-regulating agents (calcitonin, bisphosphonates) are used in case of refractory pain. Sympatholytic procedures for SMP testing, preferably sympathetic ganglion blocks, are used if no or an insufficient pain relief is achieved and should be perpetuated in case of efficacy. If resting pain subsides, first passive physical therapy, later active isometric followed by active isotonic training should be performed in combination with sensory desensitization programmes until restitution of complete motor function. Psychological treatment has to flank the regime to strengthen coping strategies and discover contributing factors. In refractory cases spinal cord stimulation could be considered. If refractory dystonia develops intrathecal baclofen application is worth considering.

### References

1. Allen G, Galer BS, Schwartz L (1999) Epidemiology of Complex Regional Pain Syndrome: A Retrospective Chart Review of 134 Patients. *Pain* 80:539–544
2. Baron R, Schattschneider J, Binder A, Siebrecht D, Wasner G (2002) Relation Between Sympathetic Vasoconstrictor Activity and Pain and Hyperalgesia in Complex Regional Pain Syndromes: A Case-Control Study. *Lancet* 359:1655–1660
3. Bhatia KP, Bhatt MH, Marsden CD (1993) The Causalgia-Dystonia Syndrome. *Brain* 116(Pt 4):843–851
4. Birklein F, Riedel B, Neundörfer B, Handwerker HO (1998) Sympathetic Vasoconstrictor Reflex Pattern in Patients with Complex Regional Pain Syndrome. *Pain* 75:93–100
5. Chelmsky TC, Low PA, Naessens JM, Wilson PR, Amadio PC, O'Brien PC (1995) Value of Autonomic Testing in Reflex Sympathetic Dystrophy. *Mayo Clin Proc* 70:1029–1040
6. Deuschl G, Blumberg H, Lücking CH (1991) Tremor in Reflex Sympathetic Dystrophy. *Arch Neurol* 48:1247–1252
7. Harden RN, Baron R, Jänig W (2001) Complex Regional Pain Syndrome. IASP Press, Seattle
8. Janig W, Baron R (2003) Complex Regional Pain Syndrome: Mystery Explained? *Lancet Neurol* 2:687–697
9. Merskey H, Bogduk N (1995) Classification of Chronic Pain Descriptions of Chronic Pain Syndromes and Definition of Terms. IASP press, Seattle
10. Raja SN, Treede RD, Davis KD, Campbell JN (1991) Systemic Alpha-Adrenergic Blockade with Phentolamine: A Diagnostic Test for Sympathetically Maintained Pain. *Anesthesiology* 74:691–698
11. Sieweke N, Birklein F, Riedel B, Neundorfer B, Handwerker HO (1999) Patterns of Hyperalgesia in Complex Regional Pain Syndrome. *Pain* 80:171–177
12. Stanton-Hicks M, Janig W, Hassenbusch S, Haddock JD, Boas R, Wilson P (1995) Reflex Sympathetic Dystrophy: Changing Concepts and Taxonomy. *Pain* 63:127–133
13. Stanton-Hicks M, Jänig W (1996) Reflex Sympathetic Dystrophy: A Reappraisal. IASP Press, Seattle, pp 1–249
14. Stanton-Hicks M, Baron R, Boas R, Gordh T, Harden N, Hendler N, Koltzenburg M, Raj P, Wilder R (1998) Complex Regional Pain Syndromes: Guidelines for Therapy. *Clin J Pain* 14:155–166
15. Wasner G, Schattschneider J, Baron R (2002) Skin Temperature Side Differences – A Diagnostic Tool for CRPS? *Pain* 98:19–26
16. Wasner G, Schattschneider J, Heckmann K, Maier C, Baron R (2001) Vascular Abnormalities in Reflex Sympathetic Dystrophy (CRPS I): Mechanisms and Diagnostic Value. *Brain* 124:587–599

## Compliance

### Definition

The extent to which patients are obedient and follow the instructions and prescriptions of a health care provider.

- ▶ [Multidisciplinary Pain Centers, Rehabilitation](#)

## Complicated Migraine

- ▶ [Clinical Migraine with Aura](#)

## Comprehensive Assessment

- ▶ [Multiaxial Assessment of Pain](#)

## Compression Fracture

### Definition

Compression failure of the anterior column of the spine with an intact middle and posterior column.

- ▶ [Chronic Back Pain and Spinal Instability](#)

## Computed Radiography

- ▶ [Plain Radiography](#)

## Computerised Axial Tomography

- ▶ [CT Scanning](#)

## Conditioned Analgesia

### Definition

Conditioned Analgesia is a learned activation of pain-inhibitory systems.

- ▶ [Pain Modulatory Systems, History of Discovery](#)

## Conditioned Place Avoidance

### Definition

In this paradigm, the animal received aversive footshock in one chamber (shock chamber) of a two chamber apparatus (Selden et al. 1991). On a subsequent day, the animal was placed in the non-shock (safe) chamber and the time spent in this chamber was recorded. Hippocampus lesioned animals spent less time in the safe chamber as compared to control animals.

- ▶ [Nociceptive Processing in the Hippocampus and Entorhinal Cortex, Neurophysiology and Pharmacology](#)

## Conditioning

### Definition

Mechanism through which repeated associations between two stimuli induces a new learned response. In particular, by pairing a neutral stimulus (conditioned stimulus) with an unconditioned stimulus (that induces a physiological response) many times, the neutral stimulus alone will be capable of producing a conditioned physiological response.

- ▶ [Operant Perspective of Pain](#)
- ▶ [Placebo Analgesia and Descending Opioid Modulation](#)

## Conductance

### Definition

Passage of ions such as  $\text{Na}^+$ ,  $\text{K}^+$ ,  $\text{Cl}^-$  or  $\text{Ca}^{++}$  through channels in the plasma membrane. Entry of positively charged ions depolarizes a neuron and leads to the generation of action potentials, whereas their exit can cause hyperpolarization and a suppression of action potentials. Conductances may be activated by ligands binding to their receptor, such as in the case of  $\gamma$ -aminobutyric acid, or by changes in resting membrane potential.

- ▶ [Descending Circuitry, Opioids](#)

## Conduction Velocity

### Definition

Speed of propagation of an action potential along a nerve fiber.

- ▶ [Nociceptor, Categorization](#)



## Confidence in Coping Abilities

- Psychology of Pain, Self-Efficacy

## Confusional Migraine

### Definition

An unusual migraine aura that consists of a sudden onset of agitation, confusion and disorientation. It may be associated with dysarthria or aphasia. The episode lasts from a few minutes to an hour and is followed by headache consistent with migraine. The individual is usually amnesic for the period of confusion. It often occurs in teenagers, and may be triggered by mild head trauma or can occur spontaneously. The differential diagnosis includes complex partial seizure, intoxication/drug ingestion and encephalitis.

- Migraine, Childhood Syndromes

## Congener

### Definition

A congener is one of two or more things of the same kind, as of animal or plant, with respect to classification.

- Headache Attributed to a Substance or its Withdrawal

## Congenital Hypomyelinating Neuropathy

- Hereditary Neuropathies

## Congenital Insensitivity to Pain with Anhidrosis

MAX J. HILZ

University of Erlangen-Nuernberg, Erlangen, Germany  
max.hilz@neuro.med.uni-erlangen.de

### Synonyms

Hereditary Sensory and Autonomic Neuropathy Type IV, HSAN IV, HSAN 4; CIPA; Congenital Sensory Neuropathy with Anhidrosis; Familial Dysautonomia Type II

### Definition

Congenital Insensitivity to pain with anhidrosis (CIPA) is a rare autosomal recessive disorder characterized by a lack of pain sensation, recurrent episodes of high, unexplained fever, anhidrosis, i.e. absence of sweating, self-mutilating behavior and mental retardation (Swanson 1963; Pinsky and DiGeorge 1966; Dyck 1993; Axelrod 2002; Hilz et al. 1999)

### Characteristics

CIPA is the second most frequent among the five HSANs classified by Ohta and Dyck (Dyck 1993). The combination of distinctive anhidrosis and insensitivity to deep as well as superficial pain, with manifestation already in early childhood, is among the most prominent findings differentiating CIPA from the other HSANs, in particular from the most common of the five disorders, HSAN III, also called Riley-Day-syndrome or familial dysautonomia. Familial dysautonomia is characterized by excessive sweating during autonomic crises and by significantly impaired perception of superficial pain but preserved deep pain perception (Axelrod 2002).

CIPA manifests in infancy or early childhood with frequent bouts of extreme, at first sight unexplained, fever and heat intolerance.

Anhidrosis is present on the trunk and upper extremities in all CIPA patients while other body parts may be variably affected. Particularly with high environmental temperatures, anhidrosis induces hyperpyrexia, which in turn can lead to recurrent febrile convulsions and has been reported to account for death within the first three years in up to 20 percent of CIPA children (Axelrod 2002; Indo 2002).

Anhidrosis also contributes to the development of a calloused, thickened skin with lichenification, i.e. a leathery induration and thickening of the epidermis with exaggeration of normal skin lines, giving it a bark-like appearance and hyperkeratosis particularly at palms and soles (Fig. 1) (Indo 2002). The skin is dry and warm and frequently shows deep and persistent ulcers at the heels (Fig. 2), nails are dystrophic (Axelrod 2002; Indo 2002; Pinsky and DiGeorge 1966).

Initially insensitivity to pain may not be apparent. Yet with increasing mobility, children sustain severe, frequently unrecognized injuries without complaint. They incur repeated bruises or inadvertently self-inflicted burn injuries and cuts and multiple scars. Insensitivity to pain also accounts for, often self-inflicted corneal scarring with opacities and even perforation of the cornea (Axelrod 2002, Indo 2002). With dentition, children start to bite their tongue, lips and fingers, leading to a mutilated, bifid tongue with decubital ulcers or absent tip of the tongue, mutilated lips (Fig. 3), jaw malformation with edentate areas due to self-extraction of teeth (Bodner et al. 2002), or to amputated finger tips. Open wounds with poor healing, continuous self-mutilation



**Congenital Insensitivity to Pain with Anhidrosis, Figure 1** Hyperkeratosis and leathery induration of the skin with exaggeration of normal skin lines in the palm of a CIPA patient. Fingernails are dystrophic. Fingertips show signs of chronic inflammation due to repeated self-mutilation.



**Congenital Insensitivity to Pain with Anhidrosis, Figure 2** Deep persistent ulcer and chronic inflammation at the area of the heel in a CIPA patient.

and frequent, often unnoticed fractures and joint injuries lead to osteomyelitis and - over the years - to grotesque joint deformities with neurogenic arthropathy (Fig. 3) or amputations (Axelrod 2002). Even with active or passive movement of fractured joints or bones, there is no tenderness or discomfort (Swanson 1963). Radiograms frequently show numerous fractures, particularly of the weight-bearing bones with neuropathic Charcot joints (Indo 2002).



**Congenital Insensitivity to Pain with Anhidrosis, Figure 3** Neuropathic ankle joint (Charcot joint) due to repetitive fractures. Tissue swelling as a result of chronic inflammation and osteomyelitis. Chronic ulcer at the bottom of the heel. Mutilation of lower left lip due to repeated lip biting.

Chronic inflammation may lead to secondary amyloidosis (Axelrod 2002; Indo 2002). Local and systemic infections often induce sepsis, which accounted for 20% fatalities in one patient group (Shorer et al. 2001).

Most CIPA children are mentally retarded and have learning problems. 50% show irritability, hyperactivity and a tendency to rages and tantrums (Axelrod 2002). Clinical examination confirms the absence of responses to superficial or deep, visceral pain, e.g. with electrical shock during neurophysiologic examination, intramuscular injection or urinary catheterization (Swanson 1963). Moreover, temperature perception and discrimination between hot and cold stimuli is impaired (Indo 2002). Similarly, discrimination of sharp and dull stimuli is compromised while light touch, vibration and position senses are normal. Deep tendon reflexes are preserved and there are no pathological reflexes. Corneal reflexes may be inconsistent. In contrast to HSAN III, emotional tear flow and fungiform papillae of the tongue are present (Axelrod 2002).

Motor and sensory nerve conduction, somatosensory, visual or brainstem evoked potentials are usually normal, while quantitative sensory testing of warm, cold or heat perception is highly abnormal. The ► [sympathetic skin response](#) (SSR) is abnormal in all CIPA patients (Hilz et al. 1999; Shorer et al. 2001).

Intradermal injection of diluted histamine does not induce the typical ► [triple response](#) of a C-nerve fiber axon reflex mediated vasodilatation with diffuse erythema and itching pain, but only results in a circumscribed wheal at the site of injection (Axelrod 2002; Indo 2002). Similarly, local sweating cannot be induced by injection of pilocarpine or methacholine (Pinsky and DiGeorge 1966).

Apart from anhidrosis, autonomic dysfunction is not a predominant characteristic of CIPA, though present. There may be orthostatic hypotension with preserved reflex tachycardia, and supersensitivity to exogenous

vasopressor drugs (Pinsky and DiGeorge 1966). Pupillary responses to cocaine are absent, yet preserved with epinephrine instillation into the conjunctival sac, also suggesting sympathetic denervation (Indo 2002). Subcutaneous injection of cholinergic methacholine or neostigmine in a dosage that would normally induce tearing does not result in lacrimation in CIPA patients although emotional tearing is preserved (Pinsky and DiGeorge 1966).

The deficiency in pain and temperature perception and in sweating can be explained by the bioptic findings of absence of small myelinated and unmyelinated nerve fibers in the cutaneous branch of the radial nerve and a significant reduction of these fibers in the sural nerve (for review see Indo 2002).

Skin biopsies show preserved sweat glands but absent innervation with loss of unmyelinated sudomotor fibers (for review see Indo 2002).

Absence of intradermal C- and A-delta fibers appears to be the morphological basis of insensitivity to pain and anhidrosis (for review see Indo 2002).

Verzé et al. found no nerve branches or endings in the epidermis and only a few nerve fibers in deeper layers of the dermis (for review see Indo 2002).

Autopsy of one CIPA patient showed absence of small neurons in dorsal root ganglia, absence of small nerve fibers in the dorsal roots, absence of Lissauer's tract and paucity of small fibers in the spinal tract of the trigeminal nerve (Swanson et al. 1965), i.e. lack of afferent pain and temperature mediating structures (Swanson 1963).

The genetic basis for CIPA are not mutations in the genes encoding ► **neurotrophins**, but mutations in the gene encoding the ► **tyrosine kinase A receptor** (TRKA/NTRK1) located on chromosome 1 (1q21-q22) (Indo et al. 1996).

So far, 37 mutations have been identified in CIPA patients of various ethnicities (Indo 2002).

The similarities of anatomical and clinical changes in TrkA knockout mice and in CIPA patients led Indo and co-workers to the discovery that mutations of the trkA (NTRK1) gene are the genetic basis of CIPA. Defect NGF signal transduction at the trkA receptor causes failure to survive and probably apoptosis of developing small nerve fiber neurons (Indo et al. 1996; Indo 2002). The only tool for prenatal diagnosis of CIPA is the identification of trkA (NTRK1) mutations (Indo 2002) but there are numerous mutations which prevents simple DNA diagnosis of the disease (Axelrod 2002).

There is no specific therapy, but treatment remains supportive and attempts to control hyperthermia, to prevent injuries, self-mutilation and orthopedic or dental complications and to modify behavioral problems such as hyperactivity or rages (Axelrod 2002).

## References

1. Axelrod FB (2002) Hereditary sensory and autonomic neuropathies. Familial dysautonomia and other HSANs. Clin Auton Res 12 Suppl 1:1/2-1/14

2. Bodner L, Woldenberg Y, Pinsky V et al. (2002) Orofacial manifestations of congenital insensitivity to pain with anhidrosis: a report of 24 cases. ASDC J Dent Child 69:293-296
3. Dyck PJ (1993) Neuronal atrophy and degeneration predominantly affecting peripheral sensory and autonomic neurons. In: Dyck PJ, Griffin PK, Low PA et al. (eds) Peripheral Neuropathy. WB Saunders, Philadelphia, pp 1065-1093
4. Hilz MJ (2002) Assessment and evaluation of hereditary sensory and autonomic neuropathies with autonomic and neurophysiological examinations. Clin Auton Res 12 Suppl 1:133-143
5. Hilz MJ, Stemper B, Axelrod FB (1999) Sympathetic skin response differentiates hereditary sensory autonomic neuropathies III and IV. Neurology 52:1652-1657
6. Indo Y (2002) Genetics of congenital insensitivity to pain with anhidrosis (CIPA) or hereditary sensory and autonomic neuropathy type IV. Clinical, biological and molecular aspects of mutations in TRKA (NTRK1) gene encoding the receptor tyrosine kinase for nerve growth factor. Clin Auton Res 12 Suppl 1:120-132
7. Indo Y, Tsuruta M, Hayashida Y et al. (1996) Mutations in the TRKA/NGF receptor gene in patients with congenital insensitivity to pain with anhidrosis. Nat Genet 13:485-488
8. Pinsky L, DiGeorge AM (1966) Congenital familial sensory neuropathy with anhidrosis. J Pediatr 68:1-13
9. Shorer Z, Moses SW, Hershkovitz E et al. (2001) Neurophysiologic studies in congenital insensitivity to pain with anhidrosis. Pediatr Neurol 25:397-400
10. Swanson AG (1963) Congenital insensitivity to pain with anhidrosis. Arch Neurol 8:299-306
11. Swanson AG, Buchan GC, Alvord EC (1965) Anatomic changes in congenital insensitivity to pain. Arch Neurol 12:12-18

C

## Congenital Sensory Neuropathy with Anhidrosis

- Congenital Insensitivity to Pain with Anhidrosis

## Conjunctival Injection

### Definition

Redness of the conjunctiva (white) of the eye.

- Hemicrania Continua

## Connective Tissue Disease

### Definition

The autoimmune disease is characterized by an abnormal structure or function of one or more of the elements of connective tissue, i.e. collagen, elastin, or the mucopolysaccharides, including, for example, rheumatoid arthritis, systemic lupus erythematosus, scleroderma.

- Vascular Neuropathies

## Connective Tissue Manipulation

### Definition

A superficial form of myofascial manipulation is the simple definition of connective manipulation. It involves manipulating the skin and superficial connective tissues above muscle to achieve reflex and local effects, which is believed to be based on a viscerocutaneous reflex. Reflex reactions include vasodilatation and diffuse or localized increase in sudomotor activity.

- ▶ [Chronic Pelvic Pain, Physical Therapy Approaches and Myofascial Abnormalities](#)

## Conscious Laparoscopic Pain Mapping

- ▶ [Chronic Pelvic Pain, Laparoscopic Pain Mapping](#)

## Conscious Pain Mapping

- ▶ [Chronic Pelvic Pain, Laparoscopic Pain Mapping](#)

## Consciousness and Pain

C. RICHARD CHAPMAN, YOSHIO NAKAMURA  
Pain Research Center, Department of Anesthesiology,  
University of Utah School of Medicine, Salt Lake City,  
UT, USA  
crc20@utah.edu

### Synonym

Awareness

### Definitions

#### Pain as Conscious Experience

Pain is the unique meaning of a tissue injury event that the brain, as a ▶ [complex adaptive system](#), constructs. Pain emerges from large scale patterns of brain activity that reflect sensory, emotional and cognitive processing. As it is an aspect of consciousness, pain is distinct from ▶ [nociception](#).

#### Consciousness

Consciousness is an emergent, self-organizing feature of brain activity that makes complex, adaptive interactions with the internal and external environments and self-reference in those environments possible (Chapman and Nakamura 2003).

### Complex Adaptive System

A complex adaptive system is a large set of units that interact with each other and with an external environment, to produce overall patterns that are significantly more complex than the behaviors of the individual entities comprising the system. A complex adaptive system changes according to three key principles: order is emergent as opposed to predetermined, the system's history is irreversible, and the system's future is often unpredictable. Simpler complex systems nest within more elaborate complex systems (Morowitz and Singer 1995; Dooley 1996).

The essence of a complex adaptive system is that it organizes itself to optimize its adaptation to its environment. Its dynamic instability gives it the flexibility it needs to accommodate quickly to environmental change. Complex adaptive systems are dynamic in that they constantly change and adjust to disturbances. Such a system does not always undergo linear changes when it reorganizes to accommodate a disturbance; instead, it may demonstrate abrupt transitions in organizational patterns known as state transitions.

### Self-Organization

▶ [Self-organization](#) is a process whereby a pattern at the global level of a system emerges solely from interactions among lower-level components of the system. The global pattern is an emergent property of the system itself. A self-organizing, adaptive system tends to take on life-like qualities such as self-directedness, self-correction, self-preservation, and intelligence (Camazine et al. 2001).

### Emergence

▶ [Emergence](#) is the process by which a system of interacting elements spontaneously acquires a qualitatively new pattern and structure, which is unpredictable from knowledge of the individual elements (Camazine, et al. 2001). For example, combining hydrogen and oxygen gases at room temperature produces liquidity.

### Intentionality

A complex adaptive system has ▶ [intentionality](#) when it exhibits directedness toward some future state or goal. Intent comprises the endogenous initiation, construction and direction of perception, action and goal-directed behavior (Freeman 1995; 2000).

### Schemata

A ▶ [schema](#) is a perceptual hypothesis that serves as the fundamental unit for constructing awareness (Marcel 1983). ▶ [Schemata](#) are fuzzy, preconscious and dynamical patterns, roughly related to dynamically stable patterns in neural networks (Rumelhart et al. 1986). The brain, as a complex adaptive system, adapts to the world and the body in which it dwells, by constantly forming, evaluating, and refining these global perceptual hypotheses. Ongoing awareness of the body and the



world depends upon a continual process of reconstruction based on schemata. Simpler schemata nest within more complex schemata (for review see Martin 1994).

## Characteristics

### Pain and Nociception

Pain is an unpleasant, compelling aspect of somatic awareness. Like other aspects of consciousness, it is emergent, dynamic, intentional and constructed. Also, like other aspects of consciousness, pain is the product of the brain operating as a pattern forming, self-organized complex adaptive system.

Nociceptive traffic within the nervous system has many consequences (Willis and Westlund 1997; Craig 2003). Nociception is a reflexive motor stimulus and a trigger for autonomic arousal. In addition to activating sensory processes, nociceptive traffic activates the limbic brain via multiple pathways. Functional brain imaging studies reveal that complex patterns of processing occur in mesencephalic, limbic and cortical structures during the emergence of pain as a conscious experience. These processes appear to be complex, dynamic self-organization that makes the construction of subjective experience possible (Kelso and Fuchs 1995). Nociception is normally necessary, but not sufficient, for pain, which as an aspect of consciousness is an emergent feature of brain activity.

Properties of consciousness in general are also properties of pain. These properties include the following. Consciousness:

- Is personal, with a necessarily limited point of view;
- Has mental contents that are stable for short periods and vary over longer intervals;
- Has mental contents that are unified at any one moment and continuous over time;
- Is selective, with a foreground and background, and has a limited capacity at a given moment;
- Is intentional because it is directed at the world or the body.

### Pain and the Construction of Consciousness

The brain deals, not with reality as the physical sciences study it, but rather with an internal, autonomous representation of reality that it builds and revises from moment to moment, using sensory information and schemata that involve networks of association in memory. Subjective reality undergoes constant self-organized revision, which integrates sensory information, emotion, ratiocination and other aspects of cognition to produce meaning. Therefore, brain representations of external objects and bodily events are dynamic constructions, not replications, of the external world or the body (Mountcastle 1998). Pain is not a static entity that an individual possesses, but rather a dynamic construction of bodily awareness, typically based on nociception.

The construction of consciousness, at any given moment, proceeds in response to the intentional and situational imperatives of each person. The intentionality of the person perceiving, feeling and emoting constrains and drives the construction of consciousness (Freeman 2000). This process involves integrating sensory signals, memory and prior experience, expectations, and immediate and long-term goals and plans. It weaves all of these into a coherent, stable macro-emergent-pattern that seems to underlie awareness of the world and one's self. Far from being a passive entity that merely registers information coming in from various sensory channels, the brain is an active, adaptive system that constantly models the world and the body in which it dwells. This modeling can change gradually from moment to moment or in abrupt state transitions.

### Acute versus Chronic Pain

In the consciousness studies framework, pain is a state of the brain. Nociceptive signaling from acute tissue injury can perturb the complex adaptive system and force non-stable reorganization. It tends to provoke a state transition from ordinary purposeful activity focused on immediate goals or needs, to somatic preoccupation and protection. However, the system will tend to return to its normal, habitual patterns when the nociception decreases or terminates.

When pain becomes chronic, the complex adaptive system undergoes reorganization to a stable, global state characterized by low dynamic instability that makes the system resistant to change. The stable state is a complex adaptation to the physical health of the body, the social environment and role expectations, interpersonal relationships, and mood. Patients tend to demonstrate somatic preoccupation, conservation of energy, and illness behavior.

The consciousness studies perspective holds that chronic pain is difficult to treat, because an effective intervention must do more than eliminate the element of nociceptive signaling. It must disturb the complex adaptive system sufficiently to permit adaptive reorganization to a stable state of well-being, normal function and optimal somatic awareness. The termination of nociceptive activity often fails to disturb the system sufficiently to enable reorganization in the desired direction. Psychological intervention, social adjustments and increased physical activity are often necessary adjuncts for chronic pain therapy, because the synergistic effect of these combined has a better chance of perturbing the complex adaptive system than a single intervention alone.

### Individual Differences

Individuals differ markedly from one another in the pain they experience in response to virtually identical tissue trauma. Although this stems in part from genetic factors that influence nociceptive transduction

and/or transmission, most inter-individual variance reflects each individual's unique construction of the pain experience. Personal past experience and personal interpretation of the immediate situation generate highly varied schemata, and these in turn construct highly individual personal experiences of pain. Put more simply, pain is the unique meaning of a tissue injury event that the brain, as a complex adaptive system, constructs. Different people construct different meanings in highly similar tissue injury situations.

### Culture and Pain

Conscious experience is subject to cultural influences because the brain, as a complex adaptive system, is embedded within larger social and cultural complex adaptive systems. Consequently, cultural meaning systems may determine the possible range of states of consciousness. Some cultures may predispose those they influence to experience pain differently than others in a particular situation.

### Pain Measurement

As pain is a personal experience, subjective report is the only way to access it. Conventional [▶ pain measurement](#) practice assumes that patients and research subjects can exercise introspection to gauge the magnitude of some feature of pain, assign numbers accordingly, and report such numbers without bias. In principle, different people reporting pain should use a common scale. From the consciousness studies perspective, pain is the meaning of an injury event that the brain constructs. In contrived research contexts, pain reports behave more or less as conventional practice requires, albeit with substantial measurement error. It is less clear if clinical pain states, as personal meanings, possess the assumed feature of numerical scalability. Future progress in pain measurement must reexamine conventional assumptions about pain measurement, recognize the uniqueness of conscious individual experience as meaning, and evolve improved methods for pain assessment (Nakamura and Chapman 2002).

### References

1. Camazine S, Deneubourg J, Franks NR, Sneyd J, Theraulaz G, Bonabeau E (2001) *Self-Organization in Biological Systems*. Princeton Univ Press
2. Chapman CR, Nakamura Y (2003) Feeling Pain: A Constructivist Perspective. In: Kalso E, Estlander A, Klockars M (eds) *Psyche, Soma and Pain*. The Signe and Ane Gyllenberg Foundation, Helsinki, Finland, pp 115–123
3. Craig AD (2003) Interoception: The Sense of the Physiological Condition of the Body. *Curr Opin Neurobiol* 13:500–505
4. Dooley K (1996) A Nominal Definition of Complex Adaptive Systems. *The Chaos Network* 8:2–3
5. Freeman WJ (1995) *Societies of Brains: A Study in the Neuroscience of Love and Hate*. Erlbaum L (ed) Hillsdale, New Jersey.
6. Freeman WJ (2000) *How Brains Make Up Their Minds*. Columbia University Press, New York
7. Kelso JAS (1995) *Dynamic Patterns: The Self-Organization of Brain and Behavior*. MIT Press, Cambridge, MA
8. Marcel A (1983) Conscious and Unconscious Perception: Experiments on Visual Masking and Word Recognition. *Cognitive Psychology* 15:197–237
9. Martin B (1994) The Schema. In: Cowan G, Pines D, Meltzer D (eds) *Complexity: Metaphors, Models and Reality*. Addison-Wesley, Reading, MA, pp 263–285
10. Morowitz HJ, Singer JL (1995) *The Mind, the Brain, and Complex Adaptive Systems*. Morowitz H, Singer JL (eds) Addison-Wesley Pub. Co., Reading, Mass, p 237
11. Mountcastle VB (1998) Brain Science at the Century's Ebb. *Daedalus* vol 127:1–36
12. Nakamura Y, Chapman CR (2002) Measuring Pain: An Introspective Look at Introspection. *Conscious Cognition* 11:582–592
13. Rumelhart DD, Smolensky P, McClelland JL, Hinton GE (1986) Schemata and Sequential Thought Processes in PDP Models. In: McClelland JL, Rumelhart DE (eds) *Parallel Distributed Processing: Explorations in the Microstructure of Cognition*, vol 2: Psychological and Biological Models. MIT press, Cambridge, MA, pp 7–57
14. Willis WD, Westlund KN (1997) Neuroanatomy of the Pain System and the Pathways that Modulate Pain. *J Clin Neurophysiol* 14:2–31

## Consolidated Standards of Reporting Trials Statement

- ▶ [CONSORT Statement](#)

## CONSORT Statement

### Synonyms

Consolidated standards of reporting trials statement

### Definition

A group of scientists and editors developed the CONSORT (Consolidated Standards of Reporting Trials) statement to improve the quality of reporting of clinical trials. The statement consists of a checklist and flow diagram that authors can use for reporting a trial. Many leading medical journals and major international editorial groups have adopted the CONSORT statement. The CONSORT statement facilitates critical appraisal and interpretation of trials by providing guidance to authors about how to improve the reporting of their trials.

- ▶ [Central Pain, Outcome Measures in Clinical Trials](#)

## Constitutive Gene

### Definition

A gene that is continuously expressed without regulation, i.e. the transcription can be neither suppressed nor encouraged. Constitutive genes often encode proteins with housekeeping functions.

- ▶ [COX-1 and COX-2 in Pain](#)
- ▶ [NSAIDs, Adverse Effects](#)

## Construction of Consciousness

### Definition

The construction of consciousness, at any given moment, proceeds in response to the intentional and situational imperatives of each person. The intentionality of the person perceiving, feeling and emoting constrains and drives the construction of consciousness. This process involves integrating sensory signals, memory and prior experience, expectations, and immediate and long-term goals and plans. Far from being a passive entity that merely registers information coming in from various sensory channels, the brain is an active, adaptive system that constantly models the world and the body in which it dwells.

- ▶ [Consciousness and Pain](#)

## Contact Stimulator

### Definition

The most commonly used heat/cold contact stimulators rely on the Peltier principle (a thermoelectric effect in which passage of an electric current through a junction between two different solids causes heat to be produced or absorbed at that junction, according to the direction of current).

- ▶ [Pain in Humans, Thermal Stimulation \(Skin, Muscle, Viscera\), Laser, Peltier, Cold \(Cold Pressure\), Radiant, Contact](#)

## Contemplation

### Definition

A readiness to change stage, in which a person recognizes the potential importance of making a change in behavior, but has not yet made a commitment to changing behavior.

- ▶ [Motivational Aspects of Pain](#)

## Contextual Factors

### Definition

Contextual factors consist of two components: Environmental factors and personal factors. Contextual factors are factors that together constitute the complete context of an individual's life, and in particular the background against which health states are classified in ICF.

- ▶ [Disability and Impairment Definitions](#)

## Contingencies

### Definition

Contingencies are events that occur in response to behavior. According to the operant model, contingencies can be reinforcing, punishing, or neutral with respect to their effects on behavior. Reinforcing contingencies strengthen (increases the probability of future occurrence of) behavior, punishing contingencies weaken behavior, and neutral contingencies have no impact on the future occurrence of behavior.

- ▶ [Cognitive-Behavioral Perspective of Pain](#)
- ▶ [Motivational Aspects of Pain](#)

## Contingencies of Reinforcement

### Definition

The nature of the responses that the behaviors of individuals elicit from significant people in their environment. Patterns of reinforcement will influence the occurrence or nonoccurrence of behaviours, with reinforcement leading to an increase in the behaviors and punishment contributing to a reduction in behaviors. The proximity, strength, desirability, and frequency of responses by others will influence the behaviors.

- ▶ [Cognitive-Behavioral Perspective of Pain](#)
- ▶ [Motivational Aspects of Pain](#)

## Contingency Management

### Definition

A system in which an individual's successful task completion is consistently rewarded.

- ▶ [Chronic Pain in Children, Physical Medicine and Rehabilitation](#)
- ▶ [Training by Quotas](#)

## Contingent Negative Variation

### Synonyms

CNV

### Definition

The CNV is a negative slow cortical potential that is typically observed between a warning signal and a following imperative signal requiring a response. The CNV reflects attention, arousal, expectancy and response preparation. For time intervals between the warning and the imperative signal that exceed 3 sec, an early CNV component during the first 500 ms after the warning signal,

and a late CNV component starting at about 1 sec prior to the imperative signal, can be distinguished. The early CNV component presumably reflects an orienting response and contingency processing, while the late CNV is closely related to response preparation. In migraine, an enhanced CNV amplitude and an impaired habituation of the CNV have been observed, which has been interpreted as evidence for abnormal cortical information processing in migraine.

- ▶ [Modeling, Social Learning in Pain](#)
- ▶ [Psychological Treatment of Pain in Children](#)

---

## Continuous Video-Tape Recordings

### Definition

Non-stop recordings of animals' spontaneous behavior via a telecamera connected to a time-lapse videotape with a wide range (3-960 hr/tape) of recording/reading speeds. This system allows a detailed analysis of animals' movements. An infrared lighting system permits filming during the dark phase (8:00 p.m. – 8:00 a.m.) (Giamberardino et al. 1995)

- ▶ [Visceral Pain Model, Kidney Stone Pain](#)

---

## Contract-Release

### Definition

Contract-release is a manual technique used for the treatment of myofascial trigger points that can serve as a patient self-treatment. It is a repeated series of brief (2 or 3 seconds), gentle (10% of maximum effort), voluntary contractions of the muscle harboring the trigger point. This is followed immediately by either passive or active stretching of the same muscle.

- ▶ [Myofascial Trigger Points](#)

---

## Contracture

### Definition

Involuntary muscle contractions are called contracture. There are three types of contractures: antalgic contractures, painful contractures and myotactic contractures. Antalgic contractures mainly consist of a compensating phenomenon, related to a polysynaptic reflex, secondary to pain (for example the contracture of paraspinal muscles due to discal herniation), and usually last from several days to weeks. By contrast, painful contractures (also called contractures) include various types of cramps.

- ▶ [Chronic Pain in Children, Physical Medicine and Rehabilitation](#)
- ▶ [Muscular Cramps](#)

---

## Contralateral

### Definition

On or relating to the opposite side of the body. The output of the primary motor cortex is principally to the opposite side of the body. Thus, to relieve pain restricted to one side of the motor cortex, the opposite side is stimulated.

- ▶ [Motor Cortex, Effect on Pain-Related Behavior](#)
- ▶ [Opioid Receptor Trafficking in Pain States](#)
- ▶ [PET and fMRI Imaging in Parietal Cortex \(SI, SII, Inferior Parietal Cortex BA40\)](#)
- ▶ [Spinothalamocortical Projections from SM](#)

---

## Controlled Trial

### Definition

A clinical trial that compares the effect of the drug to be tested with either a standard treatment or a placebo treatment.

- ▶ [Antidepressants in Neuropathic Pain](#)

---

## Contusion

### Definition

A hematoma or bruise.

- ▶ [Spinal Cord Injury Pain Model, Contusion Injury Model](#)

---

## Conus medularis DREZ

- ▶ [DREZ Procedures](#)

---

## Conventional TENS

### Definition

The delivery of TENS to stimulate selectively large diameter non-noxious cutaneous afferents, without concurrently activating small diameter nociceptive afferents or muscle efferents. This is achieved by high frequency (50 – 120 Hz), low (sensory) intensity pulsed currents to generate a 'strong but comfortable' non-painful electrical paresthesia.



- ▶ Transcutaneous Electrical Nerve Stimulation Outcomes
- ▶ Transcutaneous Electrical Nerve Stimulation (TENS) in Treatment of Muscle Pain

## Convergent

### Definition

Characteristic of the receptive field size increase at each synaptic relay level, because ascending projections converge onto a single neuron in the subsequent synaptic relay. Like a single ganglion cell receives input from several primary afferents.

- ▶ Postsynaptic Dorsal Column Projection, Functional Characteristics

## Conversion Disorder

### Definition

One or more symptoms occur, involving voluntary motor or sensory functions that suggest a neurological or general medical condition (e.g. inability to move an arm or leg). The beginning or worsening of the symptoms must be linked to a psychological stressor. In children, pseudoseizures are the most common conversion disorder manifestation. Conversion Disorders occur more frequently in girls than boys, and more frequently post-puberty than pre-puberty. Unlike adults with Conversion Disorder who show La Belle Indifference, children show concern for their symptoms.

- ▶ Somatization and Pain Disorders in Children

## Coordination Exercises in the Treatment of Cervical Dizziness

KJERSTI WILHELMSSEN, ANNE E. LJUNGGREN  
Section for Physiotherapy Science, Department of Public Health and Primary Health Care, Faculty of Medicine, University of Bergen, Bergen, Norway  
kjersti.wilhelmsen@isf.uib.no,  
elisabeth.ljunggren@isf.uib.no

### Synonyms

Vestibular rehabilitation; Cawthorne and Cookseys' Eye-Head Exercises; vestibular compensation; vestibular adaptation exercises; vestibular habituation exercises

### Definitions

▶ **Vestibular rehabilitation** (VR) is a physiotherapy program for persons with symptomatic lesions of the vestibular system (Foster 1994). The program is designed to decrease ▶ **dizziness**, improve balance function and increase activity level. It is based on exercises to promote central ▶ **vestibular compensation** (Herdman and Whitney 2000).

▶ **Vertigo** is an illusory sensation of motion (rotational, translational or tilting of the visual environment) of either the self or the surroundings (Wrisley et al. 2000). Dizziness is a non-specific term that describes an altered orientation in space, reflecting a discrepancy between internal sensation and external reality, creating sensory conflicts. The conflicts can occur between any of the vestibular, visual or somatosensory systems, or dizziness may be caused by central problems involving the integration and weighting of the different modalities and their relation to memory (Berthoz and Viaud-Delmon 1999). Dizziness may include sensations of light-headedness, faintness, giddiness, unsteadiness, imbalance, falling, waving or floating (Wrisley et al. 2000).

Cervical vertigo can be defined as a syndrome of imbalance arising from disturbance of the cervical joint receptors and associated with a sensation of dizziness (Brown 1992). Cervical dizziness is a non-specific sensation of altered orientation in space and disequilibrium originating from abnormal afferent activities in the neck (Wrisley et al. 2000).

### Characteristics

#### Cervical Vertigo

A large number of patients seek physiotherapy for neck-associated disorders (Clendaniel 2000). Different synonyms exist, but commonly used terms are cervical vertigo and cervical dizziness. According to the definitions given, the two concepts seem to reflect the same type of functional problems from the patient's point of view. Cervical vertigo is described as a condition of dizziness following neck trauma, usually caused by flexion-extension movement of the neck (cf. whiplash trauma). Neck pain is associated with the injury and precedes all other symptoms (Brown 1992; Wrisley et al. 2000). True vertigo, which is found in patients with acute vestibular conditions, is rare in patients with cervical vertigo (Brown 1992). The sensation of dizziness is vague and non-specific in character; the same type of dizziness is often described by patients with chronic vestibular deficits and by patients with neurological disorders (Clendaniel 2000). Patients may use words like light-headedness, faintness, giddiness, unsteadiness, imbalance, falling, waving and floating. Other symptoms are disequilibrium, ataxia, limited range of motion in the cervical region (Clendaniel 2000) and disturbance of vision (Tjell 2001). It is a common

experience to find that head movements and / or movements in the environment, aggravate the visual problem. Headache and tinnitus as well as hearing loss may also be present (Brown 1992; Clendaniel 2000). According to some authors, cervical vertigo is classified as a central vestibular disorder (Whitney and Rossi 2000). There is dispute as to whether the condition exists as an independent diagnosis; no definite diagnostic test is available (Wrisley et al. 2000). Diagnosis is inferred from the patient's history in conjunction with exclusion of other causes.

The cause of cervical vertigo is still debated (Clendaniel 2000). It has been proposed to be a subset of post-concussion syndrome (Brown 1992). Patients with cervical dizziness usually have normal responses on vestibular function tests, with the exception of posturography (Clendaniel 2000; Wrisley et al. 2000). There seems to be consensus regarding the neck's contribution to postural control and balance (Brown 1992; Clendaniel 2000; Karlberg et al. 1996), but controversies as to whether cervical mechano-receptor dysfunction contributes to dizziness and influences the function of the vestibular system (Brown 1992; Clendaniel 2000). Neck receptors have a role in eye-head co-ordination through the cervico-ocular reflex and in the perception of balance, according to Brown (1992). Focus on dizziness and balance may therefore be of interest for patients with cervical vertigo.

Traditionally, treatment of cervical vertigo has been directed towards relieving pain and consequences of pain (Furman and Whitney 2000). Karlberg et al (1996) have shown that an intervention consisting of traditional physiotherapy aimed at reducing cervical discomfort, also managed to decrease the frequency and intensity of dizziness. Exercises intended to reduce dizziness may enhance these effects.

### Vestibular Rehabilitation (VR)

VR was developed in England in the 1940s by Cawthorne and Cooksey. Patients with post-concussion syndrome and vestibular deficiencies were introduced to exercises designed to train the eyes, muscle and joint sense to compensate for vestibular dysfunction and to restore balance (Cooksey 1946). The program incorporated head and neck exercises, which the patient practiced in different starting positions (Dix 1974).

Today's approaches can be traced back to the treatment principles developed in England. Increased knowledge of the brain's ability to compensate for deficient structures, along with development of theories of motor control and learning, have given rise to an understanding of the vestibular compensatory mechanisms as learning processes. Vestibular compensation is the process by which vestibular symptoms are brought to resolution. The patient may take advantage of different strategies in the compensatory process. The overall goal of the process is to achieve stability of gaze and postural control,

in static as well as more challenging dynamic situations. Complete recovery depends on the restoration of symmetry between the incoming signals to the different components constituting the balance system, i.e. vision, somatosensory and vestibular systems (Luxon 1997).

The central compensatory process seems to involve both physical and chemical changes in the brain. It can be divided into acute and chronic stages (Herdman and Whitney 2000). Four neurophysiological mechanisms are described. ► **Tonic rebalancing** (spontaneous, physiological process by which the system tries to restore symmetry at the level of the vestibular nuclei) is the most important process in the acute stage. Vestibular adaptation (the long-term adjustments in the basic vestibulo-ocular and vestibulo-spinal reflexes) and vestibular habituation (the long-term reduction in the neurological responses to a noxious stimulus) (Shepard and Telian 1996) are compensatory processes in the chronic phase. Vestibular adaptation and habituation are facilitated by error signals, i.e. dizziness, which can be brought on in different ways. The facilitating stimulus in adaptation is termed ► **retinal slips**, i.e. movements of images across the retina. The error signal is brought on by a combination of visual fixation and head movements. The brain tries to minimize the error signal by increasing the gain of the vestibulo-ocular reflexes (Herdman and Whitney 2000). With habituation, dizziness is provoked by repeated exposure to movements provoking it, that is performance of certain movements will produce dizziness (Shepard and Telian 1996). The last mechanism described is substitution, i.e. alternative strategies are chosen to compensate for deficient vestibular functions. The latter mechanism comes into action when optimal compensation is lacking.

In the acute phase, compensation (the tonic rebalancing process) is a pathophysiological process occurring independently of the patient's activities. In the so-called chronic phase, activities and exposure to visual input are necessary pre-requisites in order to keep up the recovery process. For some patients, a systematic and structured program of exercises often referred to as vestibular rehabilitation (VR), may be required to enhance the compensatory process in the chronic stages. Based on the underlying neurophysiological understanding of compensatory processes, two major approaches to VR can be identified. The exercise strategies are founded on either adaptation or habituation, but in clinical practice there are no clear-cut borders between the two approaches. Basically, if there is a visually provoked vertigo, exercises that promote adaptation might be choice number one, while habituation may be used with patients whose dizziness primarily is produced by a change in head and / or bodily positions.

Examples of gaze adaptation exercises are: Exercise 1: look at a stationary target placed on the wall. Move the head from side to side as fast as possible, keeping the target in focus. Repeat after a short rest, moving the head up

and down, and Exercise 2: hold a card in the hand at arm-length. Move the head and card in opposite directions, again keeping the target in focus. Exercise 1 can also be performed holding a card in the hand. This reduces the distance between the eyes and target and stresses another part of the visual-vestibular system. Varying the tasks with regards to tempo, starting-positions and surroundings are ways to progress, the guiding lines should always be the patient's ability to keep the visual target in focus (Herdman and Whitney 2000).

A program of habituation exercises involves exposing the patient to positional changes that cause dizziness. Systematic assessment of various positional changes should be carried out and movements provoking the dizziness make up the program. If, in lying, turning from supine and on to the side provokes dizziness, this movement should be included in the patient's program. The actual number of movements included should not exceed 3–4 at the time (see Shepard and Telian 1996). There seem to be only a few articles describing the use of VR in the treatment of cervical vertigo. Wrisley et al. (2000) present the successful treatment of two patients with cervical dizziness having used a combination of traditional physiotherapy (such as ice treatment, massage, mobilisation and exercises) to decrease pain and increase the range of movement, VR in the form of adaptation (exercises 1 and 2 as presented above) and balance exercises. Tjell (2001) uses a habituation approach in the treatment of whiplash-associated disorders. The program comprises gaze and walk-gaze exercises and progression is based on the patient's experience of pain following each treatment session. It is a slow process, but improvement in pain and dizziness is reported. A program with special focus on eye-neck coordination was administered to a group of patients with chronic neck pain (Revel et al. 1994). The aim of the program was to improve neck proprioception and to decrease pain and discomfort. The program included passive and active movements of eye and head, gaze stability and cervical repositioning exercises. The exercises were performed in different starting positions over a period of 8 weeks. The authors suggest that the program could be useful for patients with cervical vertigo.

It is our experience that a comprehensive approach is needed in the rehabilitation of patients with cervical vertigo. Reports from patients indicate optimal compensation in situations with few challenges, i.e. settings where the head and thus vision can be kept stable. In more dynamic and thus demanding surroundings, the impression of a condition of disablement still exists and many patients choose a sedentary lifestyle to avoid the dizziness. A rehabilitation program should therefore challenge dizziness through specific as well as general activity. Our program consists of group treatment based on a cognitive behavioural approach promoting direct and indirect learning processes (Bandura 1986). Adaptation, habituation and balance exercises as well

as relaxation techniques are included. Every-day activities that provoke dizziness are emphasised as important and necessary premises for compensation. The significance of having a focus on body awareness as described elsewhere in this volume (see ► [Body Awareness Therapies](#)), is stressed throughout the program. Alteration in body alignment in general as well as specifically in the cervical region might be a pre-requisite for allowing changes in the other systems responsible for balance.

## References

1. Bandura A (1986) Models of human nature and causality. Social foundation of thought and action, a social cognitive theory. Prentice-Hall, New Jersey, pp 1–46
2. Berthoz A, Viaud-Delmon I (1999) Multisensory integration in spatial orientation. *Curr Opin Neurobiol* 9:708–712
3. Brown JJ (1992) Cervical contribution to balance: cervical vertigo. In: Berthoz W, Graf P, Vidal P (eds) *The head-neck sensory motor system*. Oxford University Press, New York, pp 644–647
4. Clendaniel RA (2000) Cervical vertigo. In: Herdman SJ (ed) *Vestibular rehabilitation*. F.A. Davies, Philadelphia, pp 494–509
5. Cooksey FS (1946) Rehabilitation in vestibular injuries. *Proc R Soc Med* 39:273–277
6. Dix MR (1974) Treatment of vertigo. *Physiotherapy* 60:380–384
7. Foster CA (1994) Vestibular rehabilitation. *Baillieres Clin Neurol* 3:577–592
8. Furman JM, Whitney SL (2000) Central causes of dizziness. *Phys Ther* 80:179–187
9. Herdman SJ, Whitney SL (2000) Treatment of vestibular hypofunction. In: Herdman SJ (ed) *Vestibular rehabilitation*. F.A. Davies, Philadelphia, pp 387–423
10. Karlberg M, Magnusson M, Malmstrom EM et al. (1996) Postural and symptomatic improvement after physiotherapy in patients with dizziness of suspected cervical origin. *Arch Phys Med Rehabil* 77: 874–882
11. Luxon L (1997) Vestibular compensation. In: Luxon L, Davies R (eds) *Handbook of vestibular rehabilitation*. Singular Publishing Group, San Diego, pp 17–29
12. Revel M, Minguet M, Gregoy P et al. (1994) Changes in cervicoccephalic kinesthesia after a proprioceptive rehabilitation program in patients with neck pain: a randomized controlled study. *Arch Phys Med Rehabil* 75:895–899
13. Shepard NT, Telian SA (1996) Vestibular rehabilitation programs. In: Shepard NT, Telian SA (eds) *Practical management of the balance disorder patient*. Singular, San Diego, pp 169–185
14. Tjell C (2001) Cervicogenic vertigo: with special emphasis on whiplash-associated disorder. In: Vernon H (ed) *The cranio-cervical syndrome Mechanisms, assessment and treatment*. Butterworth-Heinemann, Oxford, pp 231–243
15. Whitney SL, Rossi MM (2000) Efficacy of vestibular rehabilitation. *Otolaryngol Clin North Am* 33:659–672
16. Wrisley DM, Sparto PJ, Whitney SL et al. (2000) Cervicogenic dizziness: a review of diagnosis and treatment. *J Orthop Sports Phys Ther* 30:755–766

## Coping

### Definition

Psychological or behavioral strategies invoked in order to minimize the impact of specific stressors on an individual's physical or emotional well-being.

- [Catastrophizing](#)
- [Coping and Pain](#)

- ▶ Psychological Assessment of Pain
- ▶ Psychology of Pain, Assessment of Cognitive Variables

## Coping and Pain

JENNIFER A. HAYTHORNTHWAITE  
 Johns Hopkins University, Baltimore, MD, USA  
 jhaytho1@jhmi.edu

### Synonyms

Adaptation; coping strategies; coping style

### Definition

Cognitive and behavioral efforts to manage pain or pain-related experiences, such as disability or negative mood.

### Characteristics

How individuals cope with pain is a consistent predictor of various aspects of pain, including physical function and psychological adaptation, with ▶ **catastrophizing** being by far the most consistent correlate of pain-related phenomena. Much of the pain coping literature has a strong theoretical foundation in the larger literature examining how individuals cope with stress. Coping is usually defined as “constantly changing cognitive and behavioral efforts to manage specific external and/or internal demands that are appraised as taxing or exceeding the resources of the person” (Lazarus and Folkman 1984, p 141). Note that this definition suggests that intention underlies the efforts made by the individual, and emphasizes a process that may or may not be successful. Complex issues arise in determining the “adaptive” or “maladaptive” nature of any coping strategy used to manage pain, and, when pain becomes chronic, coping attempts necessarily broaden to encompass not only pain itself but also negative emotions, social connectedness, and pain-related disability across multiple domains of function. A seemingly maladaptive coping strategy at one point in time may be adaptive at another time; similarly, an adaptive strategy in one domain (e.g. physical function) may be maladaptive in another domain (e.g. social function). For example, the person with low back pain who spends the weekend in bed during a pain flare may experience less pain in the short run, but may also become de-conditioned if this use of rest persists across weeks or months. Time spent in bed may reduce pain, but may endanger employment or social relationships.

### Style vs. Strategy

Specific coping styles – assimilative (active attempts to alter the situation to accomplish personal goals) vs. accommodative (revision of personal goals to accommodate limitations or losses) – can interact with pain cop-

ing strategies and moderate important outcomes such as disability and depression (Schmitz et al. 1996). In addition to these clearly dispositional processes, much of the existing literature uses measures of pain coping strategies that encompass an indeterminate time frame, and thereby measure general use of a strategy-style – as opposed to specific use of a coping strategy at a given point in time. While this approach has provided valuable data on stylistic use of pain coping strategies, the loss of information about the dynamic process of coping may explain the inconsistencies in the literature. Recent technological developments have offered improved methods for assessing specific use of pain coping strategies with the distinct possibility of determining short-term impact. Since coping is inherently a dynamic process, daily diaries (Keefe et al. 1997), and more recently electronic diaries (Peters et al. 2000), are just starting to yield valuable information about the interplay of coping, pain, mood, and disability over time. This technology also offers the potential for identifying social interactions and environmental characteristics that influence these evolving processes.

### Active vs. Passive Coping

Early conceptualizations of pain coping in rheumatoid arthritis distinguished between active and passive coping. Active coping strategies are strategies used to directly control pain or pain-related dysfunction (e.g. distracting one’s attention), whereas passive strategies relinquish control to others or limit activities (Brown and Nicassio 1987; e.g. the use of rest). Although originally conceptualized as adaptive (active) vs. maladaptive (passive), more recent work has refined this characterization to include more detailed coping strategies that are associated with both positive and negative adjustment, although the distinction between active and passive coping remains valuable (Jensen et al. 2001).

### Specific Pain Coping Strategies

#### Distraction, Ignoring Pain, or Distancing

Distraction – directing attention to something other than pain – may be more useful for managing acute pain than chronic pain (Boothby et al. 1999). Even with acute pain, however, distraction may not relieve the severe levels of pain often seen in clinical settings (Haythornthwaite et al. 2001). Although some studies indicate distraction can improve function and well-being, others suggest distraction correlates with greater pain, pain-related interference and distress. Ignoring pain is conceptually similar to distraction but focuses more on blocking out the pain; it has been associated with lower ratings of pain and improved pain-related functioning (Boothby et al. 1999), as well as with perceptions that pain is controllable (Haythornthwaite et al. 1998). Ignoring pain is reported more frequently in individuals with



a longer duration of chronic pain (Peters et al. 2000), suggesting that this strategy may be one that increases as individuals gain experience dealing with the challenges of chronic pain. Distancing includes thinking of the pain as outside one's body (Robinson et al. 1997) and overlaps with reinterpreting pain as another sensation (e.g. numbness). Although inconsistently related to positive outcomes, distancing may contribute to the perception that pain is controllable (Haythornthwaite et al. 1998). Increases in the use of these strategies as seen following multidisciplinary treatment (Jensen et al. 2001), are consistent with the cognitive-behavioral formulation that these strategies are generally adaptive, and contribute to the individual's perception that pain is controllable.

### Positive Coping Statements

Coping self-statements refers to the positive, encouraging thoughts people use to manage pain. Certain studies have found positive self-statements to be associated with the perception that pain is controllable (Haythornthwaite et al. 1998); however, the positive impact of coping self-statements is not consistent across studies. Recent reviews have concluded that positive coping self-statements do not generally show a consistent relationship with reduced pain or improved functioning (Boothby et al. 1999). However, these coping self-statements are an integral component of most psychological interventions for pain management, and show changes with treatment (Jensen et al. 2001).

### Spirituality/Religiosity

Although spiritual beliefs and religious activities are often used to cope with stress and painful chronic illnesses, this domain has generally received surprisingly little attention in the pain literature. Historically, the primary method of measuring this domain has relied on a subscale of the Coping Strategies Questionnaire (Rosenstiel and Keefe 1983) that assesses passive prayer and hope. Higher scores on this scale are consistently associated with greater pain severity, disability, and distress across a number of studies. The measurement of praying and hoping has been empirically linked to catastrophizing, probably due to the shared passive quality of these scales. Since this strategy may be a response to difficult times, longitudinal or diary studies are needed to confirm its "maladaptive" function. In fact, more detailed assessments of day-to-day spirituality as a coping strategy, have found that daily spiritual experiences and positive spiritual coping are associated with greater positive mood and lower negative mood, but this coping strategy does not impact on pain reports (Keefe et al. 2001). Further research investigating the spiritual dimensions of coping may discover that actively seeking spiritual experiences forms a key dimension of accepting pain.

### Social Support

When social interactions, including some expressions of pain, are intended to elicit help in managing pain or pain-related difficulties, these social interactions are conceptualized as coping strategies. The measurement of social support usually focuses on the individual's overall perceptions of support, typically incorporating two primary domains: *instrumental support* – the perception that the social environment provides resources or information, completes tasks to help the individual, or facilitates problem-solving; and *emotional support* – the perception that the social network provides sympathy, distraction, and sources of positive affect. As is the case with other coping strategies, the beneficial and/or harmful effects of social support may differ across domains of functioning and may interact with other coping strategies, such as catastrophizing. Recent prospective analyses have indicated that perceived social support predicted reductions in pain-related disability and depression over 5 months following a limb amputation (Jensen et al. 2002). Diary analyses provide further details about the process by which these changes may transpire. Provision of social support is associated with lower same-day negative mood and lower next-day pain (Feldman et al. 1999). In the context of high pain, social support reduced depressed mood on the next day, suggesting a buffering role for social support. Very little research has examined what happens during these supportive exchanges, but qualitative information suggests that the sources of support are affirming their commitment to help, encouraging active coping – coping self-statements in particular – and discouraging helplessness and catastrophizing (Feldman et al. 1999). These responses contrast with more general social responses to pain that derive from the operant literature and are conceptualized as negative, or punishing, responses to pain expression (i.e., anger, irritation or ignoring) from a significant other, or attentive and solicitous responses (i.e., encouraging rest or taking over responsibilities), the latter being associated with poorer adaptation following a limb amputation (Jensen et al. 2002).

### Rest

Resting in response to pain is a pain coping strategy that derives largely from the operant pain literature, and has been consistently related to poorer outcomes (Jensen et al. 1991) when studied in heterogeneous samples of patients, typically seen in multidisciplinary specialty clinics. Most of the studies examining the deleterious effects of rest on pain-related interference and mood are cross-sectional (Jensen et al. 2002). Although use of rest following a limb amputation is not prospectively associated with poorer function (Jensen et al. 2002), reductions in rest are seen following multidisciplinary treatment and remain an important target for these interventions (Jensen et al. 2001).

To date, coping research has focused on pain coping strategies that influence pain and pain-related outcomes. Little attention, however, has been paid to the possibility that strategies for managing pain-related disability or negative mood are likely to differ from strategies for managing pain, or that people suffering from chronic pain may not report use of these strategies when oriented to describe how they cope with pain. Recent data indicating that the use of pain coping strategies differs by pain duration (Peters et al. 2000) and site of pain (Heinberg et al. 2004), highlight the difficulties of summarizing this complex literature across these, and other yet to be identified, dimensions.

## References

1. Boothby JL, Thorn BE, Stroud MW, Jensen MP (1999) Coping with Pain. In: Gatchel RJ, Turk DC (eds) *Psychosocial Factors in Pain*. Guilford Press, New York, pp 343–359
2. Brown GK, Nicassio PM (1987) Development of a Questionnaire for the Assessment of Active and Passive Coping Strategies in Chronic Pain Patients. *Pain* 31:53–64
3. Feldman SI, Downey G, Schaffer-Neitz R (1999) Pain, Negative Mood, and Perceived Support in Chronic Pain Patients: A Daily Diary Study of People with Reflex Sympathetic Dystrophy Syndrome. *J Consult Clin Psychol* 67:776–785
4. Haythornthwaite JA, Lawrence JW, Fauerbach JA (2001) Brief Cognitive Interventions for Burn Pain. *Ann Behav Med* 23:42–49
5. Haythornthwaite JA, Menefee LA, Heinberg LJ, Clark MR (1998) Pain Coping Strategies Predict Perceived Control Over Pain. *Pain* 77:33–39
6. Heinberg LJ, Fisher BJ, Wesselmann U, Reed J, Haythornthwaite JA (2004) Psychological Factors in Pelvic/Urogenital Pain: The Influence of Site of Pain versus Sex. *Pain* 108:88–94
7. Jensen MP, Ehde DM, Hoffman AJ, Patterson DR, Czerniecki JM, Robinson LR (2002) Cognitions, Coping and Social Environment Predict Adjustment to Phantom Limb Pain. *Pain* 95:133–142
8. Jensen MP, Turner JA, Romano JM (2001) Changes in Beliefs, Catastrophizing, and Coping are Associated with Improvement in Multidisciplinary Pain Treatment. *J Consult Clin Psychol* 69:655–662
9. Jensen MP, Turner JA, Romano JM, Karoly P (1991) Coping with Chronic Pain: A Critical Review of the Literature. *Pain* 47:249–283
10. Keefe FJ, Affleck G, Lefebvre J, Underwood L, Caldwell DS, Drew J, Egert J, Gibson J, Pargament K (2001) Living with Rheumatoid Arthritis: The Role of Daily Spirituality and Daily Religious and Spiritual Coping. *J Pain* 2:101–110
11. Keefe FJ, Affleck G, Lefebvre JC, Starr K, Caldwell DS, Tenen H (1997) Pain Coping Strategies and Coping Efficacy in Rheumatoid Arthritis: A Daily Process Analysis. *Pain* 69:35–42
12. Lazarus RS, Folkman S (1984) *Stress, Appraisal, and Coping*. Springer Publishing Company, New York
13. Peters ML, Sorbi MJ, Kruijsen DA, Kerssens JJ, Verhaak PF, Bensing JM (2000) Electronic Diary Assessment of Pain, Disability and Psychological Adaptation in Patients Differing in Duration of Pain. *Pain* 84:181–192
14. Robinson ME, Riley JL, III, Myers CD, Sadler IJ, Kvaal SA, Geisser ME, Keefe FJ (1997) The Coping Strategies Questionnaire: A Large Sample, Item Level Factor Analysis. *Clin J Pain* 13:43–49
15. Rosenstiel AK, Keefe FJ (1983) The Use of Coping Strategies in Chronic Low Back Pain Patients: Relationship to Patient Characteristics and Current Adjustment. *Pain* 3:1–8
16. Schmitz U, Saile H, Nilges P (1996) Coping with Chronic Pain: Flexible Goal Adjustment as an Interactive Buffer Against Pain-Related Distress. *Pain* 67:41–51

## Coping Repertoire

### Definition

Resources that individuals have for responding to problems and sources of stress and distress. These consist of methods to change the situation, adjust to emotional arousal and uncontrollable circumstances, and acceptance of limitations. The coping repertoire includes the internal resources, the external supports that are available, and the instrumental means that facilitate response such as financial means to assist in accommodation.

► [Cognitive-Behavioral Perspective of Pain](#)

## Coping Strategy/Style

### Definition

A cognitive-behavioral response to a stressor (e.g. problem solving, recruiting social support) that mediates a person's response to a stressor and can impact the stress-pain relationship.

► [Coping and Pain](#)

► [Stress and Pain](#)

## Coprevalence

### Definition

Coprevalence refers to the rates of co-occurrence of two specific disorders or clinical problems.

► [Depression and Pain](#)

## Cord Glial Activation

JULIE WIESELER-FRANK, ERIN D. MILLIGAN,  
STEVEN F. MAIER, LINDA R. WATKINS

Department of Psychology and Center for Neuroscience, University of Colorado at Boulder, Boulder, CO, USA

lwatkins@psych.colorado.edu

### Synonyms

Spinal Cord Astrocyte; Microglia Activation

### Definition

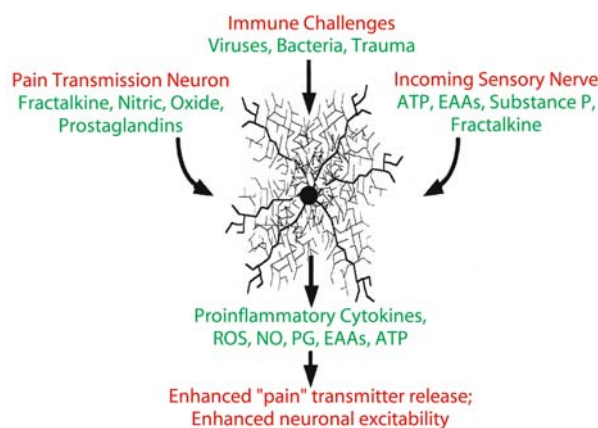
Cord glial activation refers to the activation of dorsal spinal cord ► [microglia](#) and ► [astrocytes](#), which induces exaggerated pain via the release of substances that excite nociceptive neurons (reviewed in Watkins et al. 2001). Activation is evidenced by upregulation of immunohistochemically-detectable cell-type specific activation markers, and increased release of neuroactive

glial products including ► **proinflammatory cytokines**, ► **excitatory amino acids** (EAA), ► **nitric oxide** (NO), adenosine triphosphate (ATP), and prostaglandins. These released substances then act on neurons, thereby amplifying the pain response. Some evidence points to the activation of microglia leading to the activation of astrocytes (Raghavendra et al. 2003).

### Characteristics

Glia are non-neuronal cells traditionally thought of as “supportive cells” for neurons (Araque et al. 1999). Many of their functions involve the release of growth factors, protecting neurons from excitotoxicity, regulating extracellular ion concentrations, and removal of cellular debris (Fig. 1).

As discussed here, the term glia refers to astrocytes and microglia. While these are distinct cell types, most studies investigating exaggerated pain and glia are not able to isolate the individual contribution of the two cell types. The glia in the dorsal spinal cord differ from glia in other regions of the central nervous system (CNS). Several lines of evidence point to a striking heterogeneity among glial cells, which is influenced by the regional biochemical milieu. That is, spinal cord glia express receptors not found on glia derived from various brain regions and vice versa. For example, spinal cord is one of the few CNS regions in which glia express receptors for substance P (Beaujouan 1990). Differences have also been reported between dorsal spinal cord and ventral spinal cord, and even between superficial dorsal horn and the remainder of the gray matter (Ochalski et al. 1997).

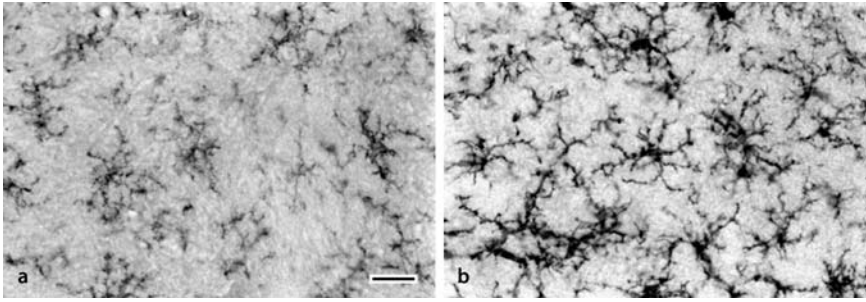


**Cord Glial Activation, Figure 1** Glia are activated by three sources: 1) bacteria and viruses which bind specific activation receptors expressed by microglia and astrocytes, 2) substance P, excitatory amino acids (EAAs), and adenosine triphosphate (ATP) released by either A-delta or C fiber presynaptic terminals or by brain to spinal cord pain enhancement pathways, and 3) nitric oxide (NO), prostaglandins (PGs), and fractalkine released from pain transmission neurons. Following activation, microglia and astrocytes cause pain transmission neuron hyperexcitability and exaggerated release of substance P and EAAs from presynaptic terminals. These changes are created by the glial release of NO, EAAs, PGs, reactive oxygen species (ROS), and proinflammatory cytokines. Reprinted with permission from Watkins et al. 2001.

Glia, specifically astrocytes, are intimately entangled with neurons insofar as they encapsulate neuronal synapses, as well as wrap their processes around neuronal somas, axons and dendrites (Araque et al. 1999). This proximity puts astrocytes in a unique position to modulate the activity of nociceptive neurons. Garrison et al. were the first to investigate the relationship between exaggerated pain and ► **glial activation** (1994). Using the sciatic chronic constriction injury (CCI) model, they compared the expression of CCI-induced hyperalgesia and immunohistochemical markers of astrocyte activation (Garrison et al. 1991). In addition, they evaluated whether CCI-induced astrocyte activation would be affected by an ► **N-methyl-D-aspartate (NMDA) receptor** antagonist (MK801), known to inhibit CCI-induced hyperalgesia (Garrison et al. 1994). They found that 1) hyperalgesia induced by CCI is associated with astrocyte activation, and 2) this glial activation (like CCI-induced hyperalgesia) is inhibited by MK801. Thus, these studies revealed a predictive relationship between glial activation and exaggerated pain. Since then, positive correlations between exaggerated pain and activation of spinal cord microglia (see caption of Fig. 2 for discussion) and astrocytes have been revealed by diverse animal models of exaggerated pain, including those induced by inflammation and/or trauma to tissues, peripheral nerves, spinal roots, and/or spinal cord (DeLeo and Colburn 1999; Watkins et al. 2001). Such data naturally raise the question of whether glial activation is necessary and/or sufficient for induction and maintenance of exaggerated pain.

That glial activation plays a prominent role in the induction of exaggerated pain has been demonstrated using glial inhibitors. ► **Fluorocitrate** selectively blocks glial metabolic activity by inhibiting aconitase, a Krebs cycle enzyme (Paulsen et al. 1987; Hassel 1992). Blocking the activation of spinal cord glial cells with fluorocitrate blocks exaggerated pain states, including thermal and mechanical hyperalgesia and mechanical allodynia (Meller et al. 1994; Milligan et al. 2000). Recently, a similar pattern has also been observed with the microglia specific inhibitor, ► **minocycline**. Minocycline selectively inhibits the release of several neuroexcitatory substances from microglia, including inflammatory mediators. Administration of minocycline attenuates the development of mechanical allodynia and thermal hyperalgesia in response to spinal nerve transection, peripheral nerve inflammation, or spinal cord inflammation (Raghavendra et al. 2003). Thus microglial activation plays a significant role in the development of exaggerated pain. Intriguingly, minocycline failed to reverse, or minimally reversed, these exaggerated pain states once they were fully expressed. These data, supported by parallel analyses of glial activation markers, revealing upregulation of GFAP (astrocyte activation marker), suggest that microglial activation may lead to astrocyte activation. Astrocytes may then play a more





**Cord Glial Activation, Figure 2** Example of microglial activation in response to a stimulus that creates exaggerated pain states. Peri-spinal administration of HIV-1 envelope glycoprotein gp120 creates exaggerated responses to both thermal and touch/pressure stimuli. Disruption of glial activation abolishes the pain changes. Furthermore, these pain changes are correlated with anatomical evidence of activation of both astrocytes and microglia. An example of such microglial activation is illustrated here. Panel A illustrates the dorsal horn of a rat injected peri-spinally with vehicle. Panel B is identical except that the rat received peri-spinal HIV-1 gp120 at a dose that creates exaggerated pain states. These photomicrographs are from the tissues collected for analysis reported in Milligan et al. 2001. Activation of microglia induces these cells to upregulate their expression of complement type 3 receptors. Thus enzyme labeled antibodies directed against complement receptor type 3 (OX-42 monoclonal antibodies) can be used to detect microglial activation by light microscopy. In the photomicrographs shown here, the bound enzyme labeled antibodies catalyzed a reaction leading to precipitation of a colored reaction product. Thus, more antibodies bound (and hence more colored reaction product produced) reflects upregulation of the complement receptor type 3 microglial activation marker. By this method, activated microglia appear darker and more densely stained in accordance with their increased expression of OX-42 antibody bound receptors. Scale bar, 25  $\mu\text{m}$  in (a) and (b). (Reproduced from Milligan et al. 2001 with permission).

significant role in the maintenance of the pain facilitatory process. Taken together, these data suggest that glial activation is important for both the induction and maintenance of exaggerated pain.

It is important to note another key finding from studies of minocycline and fluorocitrate. That is, glia are not involved in normal pain processing (Milligan et al. 2000). Normally, glia are quiescent, releasing nothing that enhances pain. However, in situations leading to exaggerated pain states, glia become activated. Once activated, they begin releasing substances that contribute to the amplification of pain. Therefore the involvement of glia in pain is determined by their state of activation.

The data strongly suggest the glial activation is important for the expression of exaggerated pain, but is it sufficient? To assess this question, glia alone need to be directly activated. While glia can be activated by classical pain neurotransmitters, including EAA, NO, prostaglandins and extracellular ATP, these substances also activate neurons. To activate spinal cord glia without activating neurons, the portions of bacteria and viruses that bind to and activate the immune-like glial cells have been used. Administration of these substances induces mechanical allodynia and thermal hyperalgesia (Meller et al. 1994; Milligan et al. 2000). Thus, taken together, spinal cord glial activation is implicated in both the creation and maintenance pain facilitation.

#### Bidirectional Neuron-Glia Communication

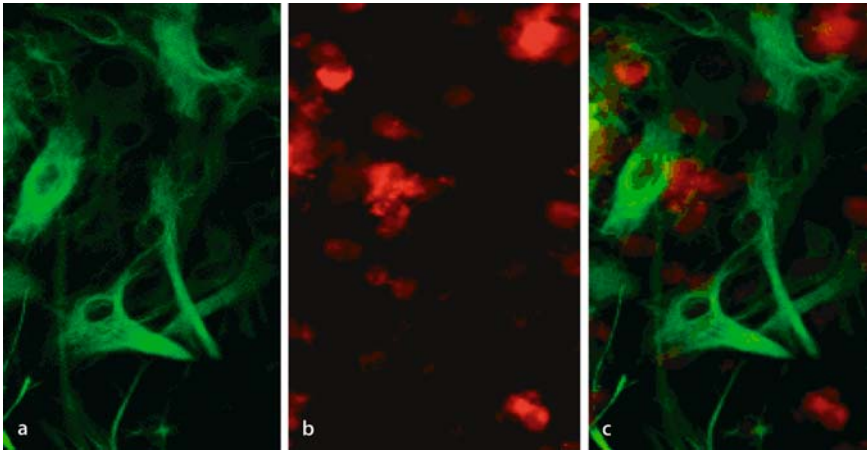
The discussion above describes glia as integral to the creation and maintenance of exaggerated pain. The question remains as to what signal from the periphery induces glial activation in the dorsal horn of the spinal cord, thereby inducing exaggerated pain. As described, one way is via the release of classical pain neurotransmitters/ neuromodulators including EAA,

substance P, prostaglandins, ATP, and NO among others, by incoming sensory neurons and/or by intrinsic dorsal horn neurons in proximity to glia. While each of these substances excites spinal cord neurons in the pain pathway, they also activate astrocytes and microglia. Thus these traditional neuronal mediators may exert their pain modulating effects, at least in part, via glial activation

Once glia are activated, the question becomes what signal(s) maintains the persistent glial activation. One possible answer is that the signal is something released from dying or degenerating neurons associated with some models of chronic pain (Sugimoto et al. 1990; Coggeshall et al. 2001; Moore et al. 2002). It is well known that neuronal injury and degeneration activate glia via different pathways. Degenerating neurons have porous membranes, through which proteins such as heat-shock proteins can pass. These proteins may serve as signals of dying cells, thereby activating glia. Additionally, neurons inhibit glial activation via cell-to-cell contact (Chang et al. 2001; Neumann 2001). When a neuron dies, this contact is disrupted leading to glial activation. Thus it seems possible that persistent glial activation may be the end result.

There are a number of peripheral signals that may potentially trigger glial activation, such as altered neuronal activity, transported molecules from sensory neurons, or the removal of tonic inhibitory signals. However, little is known about the signal resulting in glial activation. One signal currently being explored is the putative neuron-to-glia signal ► **fractalkine**, a protein expressed on the extracellular surface of sensory neurons as well as dorsal horn neurons. Fractalkine is tethered to neuronal membranes by a mucin stalk (Chapman 2000). When neurons are sufficiently activated, the mucin stalks break, releasing fractalkine into the extracellular fluid.





C

**Cord Glial Activation, Figure 3** Mixed astrocyte and microglia culture from neonatal rat pups showing selectivity of fractalkine for microglia. (a) Astrocytes labeled with glial fibrillary acidic protein (GFAP) visualized by a fluorescent antibody conjugated to Alexa 488. GFAP is a cytoskeletal protein that is highly specific to astrocytes. Note, that despite these astrocytes being in a mixed culture containing microglia, no microglia are labeled for GFAP. (b) Microglia labeled with fractalkine, which is directly conjugated to the Cy3b fluorochrome. In the dorsal spinal cord, fractalkine receptors are found exclusively on microglia. Note that, despite these microglia being in a culture containing astrocytes, no astrocytes are labeled by fractalkine. (c) Overlay of (a) and (b) to provide the true picture of the mixed culture.

Within the spinal cord, only microglia express receptors for fractalkine, supporting the concept of fractalkine as a neuron-to-glia signal (Fig. 3).

Spinal administration of fractalkine induces mechanical allodynia and thermal hyperalgesia, while spinal administration of a fractalkine receptor antagonist blocks exaggerated pain, including neuropathic pain (Watkins and Maier 2003). Whether fractalkine-induced microglial activation leads, in turn, to astrocyte activation is a question that remains to be explored.

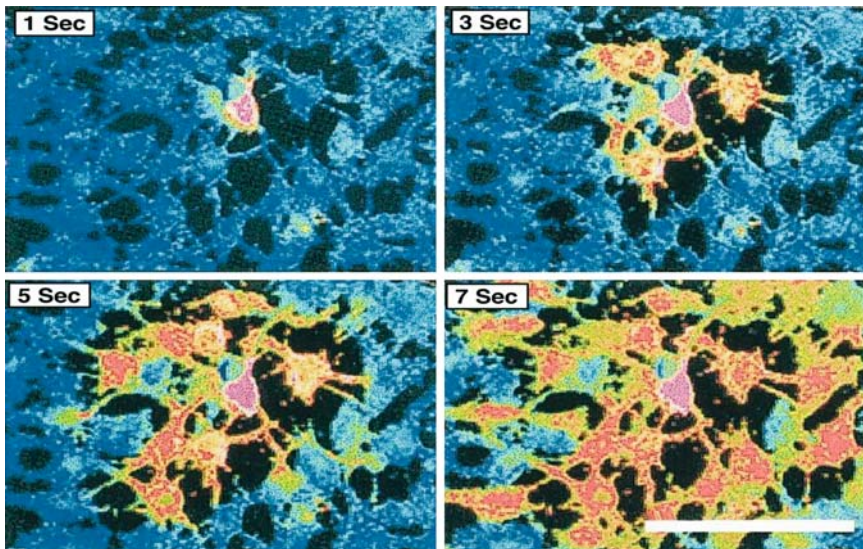
These neuron-to-glia signals point to a means by which sensory nociceptive neurons and dorsal horn neurons communicate to glia, thereby inducing activation. In response to neuron-to-glia signals, glia release substances that then excite other glia and neurons. For example, microglial binding of fractalkine rapidly induces the release of the neuro- and glial-excitatory substances (including interleukin-1beta and nitric oxide) from dorsal spinal cord (Watkins and Maier 2003). The release of these excitatory substances induces exaggerated pain.

As ► **immunocompetent cells**, activated glia release classical immune products in response to neuronal signals. These include proinflammatory cytokines such as interleukin-1beta, interleukin-6, and ► **tumor necrosis factor alpha** (TNF- $\alpha$ ) reduced. In their role as classical immune signals, these cytokines are “proinflammatory” because they orchestrate the early immune response to infection and damage by recruiting immune cells to the site and activating them. In spinal cord, these proinflammatory cytokines are signal molecules that activate neurons as well as glia, via binding to specific receptors on these cells. This is one means by which glia can signal neurons. Proinflammatory cytokines are not constitutively released in the spinal cord, and

pharmacologically blocking their activity does not alter normal pain responsivity. However, in conditions leading to exaggerated pain, including CCI, sciatic inflammatory neuropathy (SIN), and spinal nerve transection, blocking proinflammatory cytokine activity in spinal cord blocks mechanical allodynia and thermal hyperalgesia (reviewed in DeLeo and Colburn 1999). Proinflammatory cytokines are, therefore, necessary for these exaggerated pain states. Mechanical allodynia and mechanical and thermal hyperalgesia are induced by spinal administration of proinflammatory cytokines (reviewed in Watkins et al. 2001). Thus, proinflammatory cytokines are sufficient for exaggerated pain.

In addition to released signals acting on glia, astrocytes are also able to communicate with other astrocytes via ► **gap junctions**. This spread of excitation leads to the activation of distant glia (Fig. 4) and their release of neuroexcitatory substances (Araque et al. 1999).

The importance of this type of astrocyte-to-astrocyte communication, causing excitation of distant glia, raises the question of whether gap junctions may potentially provide an explanation for the spread of human pain beyond the original site of trauma; that is, mirror image pain and extraterritorial pain. Such a communication network could, theoretically at least, lead to release of pain enhancing substances by newly activated glia distant from the initial site of gap junctional activation. While no data yet exist in humans, the spread of pain in animal models is indeed blocked by spinal administration of the gap junction decoupler ► **carbenoxolone**. Carbenoxolone blocks the spread of mechanical allodynia in CCI and SIN (Spataro et al. 2003). Control studies, using glycyrrhetic acid, verify that carbenoxolone-induced disruption of CCI and SIN-induced mirror



**Cord Glial Activation, Figure 4** Illustration of the spread of a calcium wave among astrocytes. Astrocytes are electrically coupled by gap junctions into vast networks. These electrical couplings allow astrocytes to rapidly communicate with one another over widespread areas. These images show a sequence of time-lapse photographic images, illustrating the rapid spread of excitation that occurs after the activation of a single glial cell at time 0. These newly activated, distant cells can then release pain-enhancing substances, thereby activating nearby pain neurons. Such gap junctional spread of excitation has recently been linked to pain facilitation, especially to mirror-image pain. (Modified from Araque et al. 1999. Reprinted with permission.)

image pains are indeed due to its disruption of gap junctions. This is the first example of gap junctions, most likely of glial origin, being implicated in pain. Thus, gap junctional communication among astrocytes provides an intriguing and novel explanation for pain that arises in otherwise healthy body parts. In summary, cord glial activation is integrally involved in diverse exaggerated pain phenomena. The powerful role that glia play in pain facilitation suggests that drugs targeting this non-neuronal cell type may hold promise for effective clinical pain control.

## References

- Araque A, Parpura V, Sanzgiri RP, Haydon PG (1999) Tripartite Synapses: Glia, The Unacknowledged Partner. *Trends in Neurosci* 22:208–215
- Beaujouan JC, DaguetteMontety MC, Torrens Y, Saffroy M, Diel M, Glowinski J (1990) Marked Regional Heterogeneity of 125I-Bolton Hunter Substance P Binding and Substance P-Induced Activation of Phospholipase C in Astrocyte Cultures from the Embryonic or Newborn Rat. *J Neurochem* 54:669–675
- Chang RC, Chen W, Hudson P, Wilson B, Han DS, Hong JS (2001) Neurons Reduce Glial Responses to Lipopolysaccharide (LPS) and Prevent Injury of Microglial Cells from Over-Activation by LPS. *J Neurochem* 76:1042–1049
- Chapman GA, Moores K, Harrison D, Campbell CA, Steward BR, Stribos PJLM (2000) Fractalkine Cleavage from Neuronal Membranes Represents an Acute Event in the Inflammatory Response to Excitotoxic Brain Damage. *Journal of Neuroscience* 20: RC87 pp 81–85
- Coggeshall RE, Lekan HA, White FA, Woolf CJ (2001) A-Fiber Sensory Input Induces Neuronal Cell Death in the Dorsal Horn of the Adult Rat Spinal Cord. *J Comp Neurol* 435:276–282
- DeLeo JA, Colburn RW (1999) Proinflammatory Cytokines and Glial Cells: Their Role in Neuropathic Pain. In: Watkins L (ed) *Cytokines and Pain*. Birkhauser, Basel, pp 159–182
- Garrison CJ, Dougherty PM, Carlton SM (1994) GFAP Expression in Lumbar Spinal Cord of Naive and Neuropathic Rats Treated with MK-801. *Exp Neurol* 129:237–243
- Garrison CJ, Dougherty PM, Kajander KC, Carlton SM (1991) Staining of Glial Fibrillary Acidic Protein (GFAP) in Lumbar Spinal Cord Increases Following a Sciatic Nerve Constriction Injury. *Brain Res* 565:1–7
- Hassel B, Paulsen RE, Johnson A, & Fonnum F (1992) Selective Inhibition of Glial Cell Metabolism by Fluorocitrate. *Brain Res* 249:120–124
- Meller ST, Dykstra C, Grzybycki D, Murphy S, Gebhart GF (1994) The Possible Role of Glia in Nociceptive Processing and Hyperalgesia in the Spinal Cord of the Rat. *Neuropharmacology* 33:1471–1478
- Milligan ED, Mehmert KK, Hinde JL, Harvey LO, Martin D, Tracey KJ, Maier SF, Watkins LR (2000) Thermal Hyperalgesia and Mechanical Allodynia Produced by Intrathecal Administration of the Human Immunodeficiency Virus-1 (HIV-1) Envelope Glycoprotein, gp120. *Brain Res* 861:105–116
- Moore KA, Kohno T, Karchewski LA, Scholz J, Baba H, Woolf CJ (2002) Partial Peripheral Nerve Injury Promotes a Selective Loss of GABAergic Inhibition in the Superficial Dorsal Horn of the Spinal Cord. *J Neurosci* 22:6724–6731
- Neumann H (2001) Control of Glial Immune Function by Neurons. *Glia* 36:191–199
- Ochalski PA, Frankenstein UN, Hertzberg EL, Nagy JI (1997) Connexin-43 in Rat Spinal Cord: Localization in Astrocytes and Identification of Heterotypic Astro-Oligodendrocytic Gap Junctions. *Neuroscience* 76:931–945
- Paulsen RE, Contestabile A, Villani L, Fonnum F (1987) An *In Vivo* Model for Studying Function of Brain Tissue Temporarily Devoid of Glial Cell Metabolism: The Use of Fluorocitrate. *J Neurochem* 48:1377–1385
- Raghavendra V, Tanga F, DeLeo JA (2003) Inhibition of Microglial Activation Attenuates the Development but not Existing Hypersensitivity in a Rat Model of Neuropathy. *J Pharmacol Exp Ther* 306:624–630
- Spataro LE, Sloane E, Milligan ED, Maier SF, Wieseler-Frank J, Schoeniger D, Jekrich BM, Barrientos RM, Watkins LR (2004) Spinal gap junctions: potential involvement in pain facilitation. *J Pain* 5:392–405
- Sugimoto T, Bennett GJ, Kajander KC (1990) Transsynaptic Degeneration in the Superficial Dorsal Horn after Sciatic Nerve Injury: Effects of a Chronic Constriction Injury, Transection, and Strychnine. *Pain* 42:205–213
- Watkins LR, Maier SF (2003) Glia: A Novel Drug Discovery Target for Clinical Pain. *Nature Reviews Drug Discovery* 2:973–985
- Watkins LR, Milligan ED, Maier SF (2001) Glial Activation: A Driving Force for Pathological Pain. *Trends Neurosci* 24:450–455

## Cordotomy

### Definition

Originally anterolateral chordotomy, referring to the geometric term “chord” to indicate interruption of white matter. Cordotomy was developed as a surgical procedure, to sever the spinothalamic tract at a spinal level above dermatomes to which extreme chronic pain was referred. It is generally performed percutaneously at the cervical level, which interrupts the ascending lateral spinothalamic tract. Cordotomy is most useful in the management of intractable, unilateral lower extremity cancer pain. Cordotomy tends to be more effective for nociceptive pain syndromes than for neuropathic syndromes. Unilateral pain is a better indication than bilateral pain, and midline pain tends to respond poorly even to bilateral cordotomy.

- ▶ [Cancer Pain Management, Opioid Side Effects, Uncommon Side Effects](#)
- ▶ [Cancer Pain Management, Overall Strategy](#)
- ▶ [Central Nervous System Stimulation for Pain](#)
- ▶ [Postherpetic Neuralgia, Pharmacological and Non-Pharmacological Treatment Options](#)
- ▶ [Spinal Cord Injury Pain Model, Cordotomy Model](#)
- ▶ [Thalamus, Receptive Fields, Perceptive Fields, Human](#)

## Cordotomy Effects on Humans and Animal Models

CHARLES J. VIERCK<sup>1</sup>, ALAN R. LIGHT<sup>2</sup>

<sup>1</sup>Department of Neuroscience, McKnight Brain Institute, University of Florida College of Medicine, Gainesville, FL, USA

<sup>2</sup>Department of Anesthesiology, University of Utah, Salt Lake City, UT, USA  
vierck@mbi.ufl.edu

### Definition

Cordotomy is a surgical procedure introduced in the early 1900s for reduction of chronic intractable pain in humans. An anterolateral column of spinal white matter is cut or coagulated at a spinal level above and contralateral to a source of clinical pain, intentionally interrupting the ▶ [spinothalamic tract](#). For weeks, months or years after successful interruption of ascending pathways in the anterolateral column, pain and temperature sensations are diminished contralaterally over dermatomes beginning several segments below (caudal) to the lesion. The reduction of pain is apparent for clinical pain and for nociceptive stimulation of humans, other primates and mammals (Vierck et al. 1986; Vierck et al. 1995; White and Sweet 1969).

### Characteristics

The intent of surgical section of anterolateral spinal white matter is to interrupt axons of the spinothalamic tract that originate predominantly in the contralateral gray matter in spinal segments below the lesion. The targeted projection cells receive input from nociceptive peripheral afferents selectively sensitive to stimuli that elicit pain or temperature sensations, and some are excited by non-nociceptive afferents. Other axons situated posteriorly in the spinal white matter, ipsilateral to their cells of origin, convey non-nociceptive information that subserves sensations of touch and ▶ [proprioception](#). Therefore, cordotomy reduces pain and temperature sensitivity without producing clinically relevant deficits of touch or proprioception. Sensations reported to be lost or diminished by cordotomy are pain, itch, discrimination of sharpness with or without a painful quality, wetness, cold, warmth and voluptuous sensations elicited by genital stimulation (Vierck et al. 1986). It is important to recognize that these effects of cordotomy probably result from combined interruption of ascending pathways to cerebral sites that include numerous thalamus nuclei, the hypothalamus and the amygdaloid complex (Giesler et al. 1994).

Often chronic clinical pain is referred to deep tissues and appears to be particularly attenuated by cordotomy (Nathan and Smith 1979). The upper segmental levels for reduction of clinical pain and of pain from deep pressure stimulation have been reported to be well correlated and lower than the upper level of ▶ [hypoalgesia](#) for cutaneous stimulation. Similarly, visceral pain is reported to be well controlled by cordotomy (White and Sweet 1969), but the upper level of visceral pain reduction can differ from the upper level of diminished pain elicited by cutaneous pin prick testing. These differences in “sensory level” for deep and superficial pain are probably based on different entry levels for visceral and somatic afferents and on a more extensive rostrocaudal dispersion in the spinal cord of afferent input from deep somatic structures. The effectiveness of anterolateral cordotomy for attenuation of visceral pain is surprising in view of evidence that interruption of a pathway located in the dorsal spinal columns can attenuate visceral pain (Nauta et al. 2000). It appears that different aspects (qualitative features?) of visceral sensation depend on rostral conduction by dorsal and ventral spinal pathways.

The dorsoventral and mediolateral extents of lateral and ventral column damage are important determinants of the sensory effects of cordotomy. A somatotopic organization exists dorsoventrally, with sacral dermatomes dorsal and rostral dermatomes ventral. Accordingly restriction of cordotomy to the anterolateral column can miss the most dorsal spinothalamic axons and result in sacral sparing. In addition, there are differences in dorsoventral distribution of rostrally projecting axons with distinguishable origins. For example, spinotha-



lamic axons originating in the deep dorsal horn are more ventrally located in the anterolateral and ventral column, relative to cells from the superficial dorsal horn (Zhang et al. 2000). This appears to be the case in general for cells originating in the superficial and deep dorsal horn, which have overlapping, but differential, functional properties and projections to targets in the brain stem and thalamus (e.g. Craig 1998). These relationships could influence the long-term effects of a cordotomy.

For the mediolateral dimension of the anterolateral column, clinical investigators have postulated that pain from mechanical stimulation of the skin depends upon peripherally located axonal projections, while temperature sensations and pain from stimulation of deep tissues depend upon more medially located axons (Walker 1940). These suppositions encouraged a clinical strategy involving medially extensive anterolateral cordotomy, in order to maximally attenuate pain from deep tissues. Given this surgical approach, the expectation is that a successful unilateral cordotomy would produce contralateral analgesia, particularly for cutaneous stimulation. However, human and animal studies involving nociceptive cutaneous stimulation within dermatomes maximally affected by cordotomy indicate that pain sensitivity is not eliminated (King 1957; Vierck et al. 1990; Vierck et al. 1995; Vierck and Luck 1979).

Not only is pain sensitivity partially preserved contralaterally, but chronic pain returns and pain sensitivity increases over time for some but not all cases after an initially successful cordotomy. Early on, the explanation for this was that the anterolateral lesion for cases of recovery was incomplete dorsally, ventrally or medially. However this possibility is contradicted by human and animal studies with histological confirmation of highly restricted lesions (superficially located in the anterolateral column) that produced very long-term hypoalgesia (Nathan and Smith 1979; Vierck and Luck 1979). Direct comparisons of cordotomy effects in monkeys indicate that recovery of pain sensitivity over time is more substantial for extensive lesions (primarily medially) than for superficial lesions (Vierck et al. 1990). Explanations for these results may be 1) that all spinothalamic axons shift laterally with ascension of the spinal cord (Zhang et al. 2000) and 2) that the more extensive lesions partially damage spinal projection systems other than the spinothalamic tract (Fig. 1) (see ► [Spinal Cord Injury Pain Model, Cordotomy Model](#)).

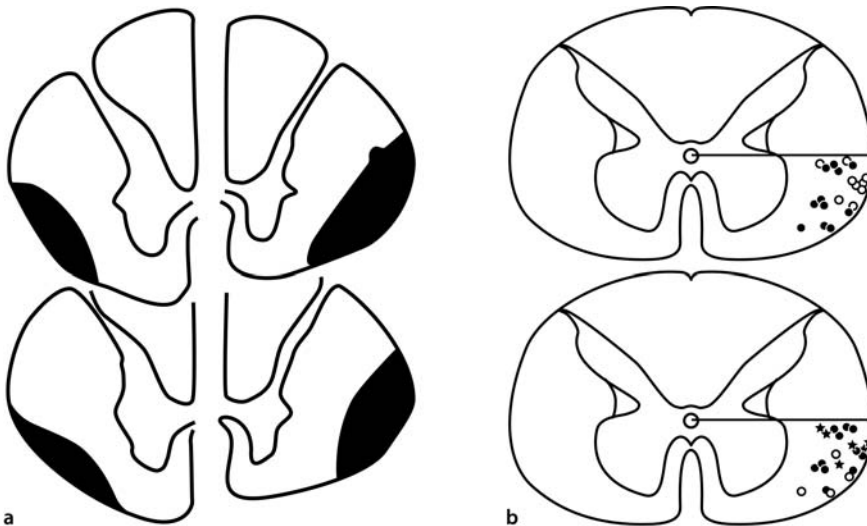
When chronic pain returns after cordotomy, it appears to be qualitatively distinct from that experienced before surgery. Discrimination between qualitative features of chronic pain is difficult, but recovered pain can be more diffuse in character and bilaterally distributed (White and Sweet 1969). Several possible mechanisms for this are related to 1) ► [deafferentation](#) of neurons normally receiving input from rostrally projecting axons sec-

tioned by cordotomy, and 2) enhanced transmission of nociception by diffusely projecting ascending pathways spared by cordotomy.

Return of clinical pain and of painful sensations elicited by stimulation after cordotomy is consistent with development of chronic pain that can occur following strokes that produce deficits of elicited pain and temperature sensations and, by implication, damage the spinothalamic tract at some level of the neuraxis (Boivie et al. 1989). Numerous human studies involving thalamic recording have demonstrated abnormal spontaneous activity in regions deafferented by these and other lesions (Lenz 1992). The presence of abnormally high levels of activity among populations of neurons that previously received nociceptive input can potentially be interpreted as pain. If this occurs, the distribution of pain would be expected to involve much of the deafferented region, rather than the more restricted site of pain experienced before cordotomy. Furthermore, recordings from the thalamus of monkeys after medially extensive cordotomy have shown that abnormal spontaneous activity is not restricted to the region of primary deafferentation within the nucleus ventralis posterolateralis (Weng et al. 2000). That is, the effects of deafferentation can extend beyond the somatotopically appropriate region of a principal target of spinothalamic projections to the thalamus.

Other clues relevant to an eventual return of clinical pain and pain sensitivity are offered by the stimuli capable of eliciting pain sensations after cordotomy. Thresholds for elicitation of pain are clearly elevated, but strong suprathreshold stimulation is perceived as painful (King 1957). This is apparent for electrical stimulation of the skin or a peripheral nerve, which progressively activates A-delta and C afferents as nociceptive stimulus intensity increases. A cordotomy that eliminates pain elicited by stimulation of A-delta afferents can preserve pain from electrical stimulation at intensities sufficient to excite C nociceptors (Collins et al. 1960). Similarly, pain elicited by the standard pinprick test involving single stimuli can be eliminated by a cordotomy, but repetitive pinprick stimulation at the same location produces pain (Nathan and Smith 1979; Walker 1940), presumably because of temporal summation. Temporal summation by repetitive stimulation has been shown to depend upon stimulation of C nociceptors (e.g. Vierck et al. 1997). Also, when pain from application of focal pressure to deep tissues is eliminated by cordotomy, pain from muscular cramps can be perceived (White 1968). In this example, spatial summation from simultaneous stimulation of many C nociceptors may be responsible for break through pain. The varieties of pain retained after cordotomy suggest that pathways of rostral projection outside the contralateral lateral column are particularly sensitive to C nociceptor input. The following evidence indicates that this conduction system is diffusely distributed in the antero-





C

**Cordotomy Effects on Humans and Animal Models, Figure 1** (a) Diagrams of 4 unilateral cervical cordotomies in humans that produced enduring reductions of chronic clinical pain and sensitivity to nociceptive stimulation. Note that the lesions are restricted to the peripheral portions of the anterolateral white matter (after Nathan and Smith, 1979). (b) Plots of the uniformly peripheral distribution of anterolateral axons (at the C2 segment of monkeys) that project to the ipsilateral thalamus from cells of origin in the contralateral gray matter. Upper diagram: solid circles: axons from cells in the superficial dorsal horn; open circles: axons from cells in the deep dorsal horn. Overall, axons from superficial cells are distributed more dorsally, especially at thoracic levels (not shown). Lower diagram: cells with input from different populations of peripheral afferents: solid circles: wide dynamic range neurons; open circles: low threshold neurons; stars: high threshold neurons (from Zhang et al. 2000).

lateral and ventral spinal cord and is responsible for return of pain sensitivity after cordotomy. Bilateral cordotomy does not prevent recovery of pain or eliminate pain that has developed after interruption of one anterolateral column (White and Sweet 1969). Therefore, it is unlikely that sparing of spinothalamic axons underlies the return of pain after cordotomy. Also, secondary lesions of dorsal spinal pathways in monkeys do not attenuate pain sensitivity that has returned after cordotomy (Vierck and Luck 1979). However, complete interruption of both ventral spinal quadrants (ventral hemisection) appears to eliminate pain sensitivity without recovery (Vierck and Luck 1979). Obvious candidates for diffuse rostral pain transmission are the spinoreticular pathways, with bilateral relays to cerebral systems involved in pain coding and modulation (e.g. spinomesencephalic and spinoreticulothalamic).

In summary, clinical and laboratory animal studies with histological verification of spinal lesions indicate that interruption of spinothalamic axons located superficially in the anterolateral spinal column effectively reduces chronic pain and pain sensitivity, long term. However, partial interruption of diffuse ventral spinal projection systems by more extensive lesions can initiate a recovery process with adverse effects on pain sensitivity. Complete interruption of the bilateral ventral projection system and the spinothalamic tract produces analgesia, in contrast to the hypoalgesia produced by anterolateral cordotomy. Unfortunately, ventral hemisection also produces profound motor deficits by interrupting a number of descending spinal pathways. Therefore, when employment of spinal surgery is considered for

alleviation of chronic, intractable pain, available evidence favors interruption of superficial axons in the anterolateral column.

## References

1. Boivie J, Leijon G, Johansson I (1989) Central post-stroke pain - a study of the mechanisms through analyses of the sensory abnormalities. *Pain* 37:173-185
2. Collins W, Nulsen F, Randt C (1960) Relation of peripheral nerve fibre size and sensation in man. *Arch Neurol* 5:381-385
3. Craig, AD (1998) A new version of the thalamic disinhibition hypothesis of central pain. *Pain Forum* 7:1-14
4. Giesler GJ Jr, Katter JT, Dado RJ (1994) Direct spinal pathways to the limbic system for nociceptive information. *TINS* 17:244-250
5. King RB (1957) Postcordotomy studies of pain threshold. *Neurology* 7:610-614
6. Lenz FA (1992) The ventral posterior nucleus of thalamus is involved in the generation of central pain syndromes. *APS Journal* 1:42-51
7. Nathan PW, Smith MC (1979) Clinico-anatomical correlation in anterolateral cordotomy. *Adv Pain Res Ther* 3:921-926
8. Nauta HJW, Soukup VM, Fabian RH et al (2000) Punctate midline myelotomy for the relief of visceral cancer pain. *J Neurosurg* 92:125-130
9. Vierck CJ Jr, Luck MM (1979) Loss and recovery of reactivity to noxious stimuli in monkeys with primary spinothalamic chordotomies, followed by secondary and tertiary lesions of other cord sectors. *Brain* 102:233-248
10. Vierck CJ Jr, Greenspan JD, Ritz LA et al (1986) The spinal pathways contributing to the ascending conduction and the descending modulation of pain sensations and reactions. In: Yaksh TL (ed) *Spinal systems of afferent processing*. Plenum Press, New York, pp 275-329
11. Vierck CJ Jr, Greenspan JD, Ritz LA (1990) Long term changes in purposive and reflexive responses to nociceptive stimulation in monkeys following anterolateral chordotomy. *J Neurosci* 10:2077-2095

12. Vierck CJ Jr, Lee CL, Willcockson HH et al. (1995) Effects of anterolateral spinal lesions on escape responses of rats to hindpaw stimulation. *Somatosens Motor Res* 12:163–174
13. Vierck CJ Jr, Cannon RL, Fry G et al. (1997) Characteristics of temporal summation of second pain sensations elicited by brief contact of glabrous skin by a preheated thermode. *J Neurophysiol* 78:992–1002
14. Walker AE (1940) The spinothalamic tract in man. *Arch Neurol Psychiat* 43:284–298
15. Weng H-R, Lee J, Lenz F et al. (2000) Functional plasticity in primate somatosensory thalamus following chronic lesion of the ventral lateral spinal cord. *Neurosci* 101:393–401
16. White JC, Sweet WH (1969) Pain and the neurosurgeon: A forty-year experience. Thomas CC, Springfield
17. White J (1968) Operations for the relief of pain in the torso and extremities: Evaluation of their effectiveness over long periods. In: Soulaïrac A, Cahn J, Charpentier J (eds) *Pain*. Academic Press, New York, pp 503–519
18. Zhang X, Honda C, Giesler GJ Jr (2000) Position of spinothalamic tract axons in upper cervical spinal cord of monkeys. *J Neurophysiol* 84:1180–1185

---

## Core and Matrix

- ▶ Spinothalamic Terminations, Core and Matrix

---

## Coronary Artery Disease

- ▶ Visceral Pain Model, Angina Pain

---

## Coronary Insufficiency

- ▶ Visceral Pain Model, Angina Pain

---

## Corpus Callosum

### Definition

The largest bundle of fibers connecting the two hemispheres. The corpus callosum is subdivided into four sub-regions with the splenium located in the most posterior region, the body extending anterior from the splenium, the genu consisting in the most anterior part, and the rostrum below the genu. Each region of the corpus callosum connects specific regions of one hemisphere of the cerebral cortex to the homologous area in the other hemisphere.

- ▶ Cingulate Cortex, Functional Imaging
- ▶ Nociceptive Processing in the Cingulate Cortex, Behavioral Studies in Humans
- ▶ Pain Processing in the Cingulate Cortex, Behavioral Studies in Humans

---

## Correct Rejection

### Definition

Correct rejection is the probability of response „B“ when event B has occurred.

- ▶ Statistical Decision Theory Application in Pain Assessment

---

## Correlation

### Definition

The degree to which variables change together.

- ▶ Pain in the Workplace, Risk factors for Chronicity, Job Demands

---

## Cortex and Pain

### Definition

Cortical areas (anterior cingulate, parietal operculum, insula, primary somatic sensory cortex) that show pain-related activity, usually based on imaging studies.

- ▶ Pain Treatment, Motor Cortex Stimulation

---

## Cortical Feedback

### Definition

Back projections from cortical regions that receive forward projections from the thalamus.

- ▶ Thalamic Plasticity and Chronic Pain

---

## Cortical Information Flow

- ▶ Thalamocortical Loops and Information Processing

---

## Cortical Plasticity

### Definition

Flexible organization of the cortical textures and circuits adapting to input variability and regulated by 'experience', i.e. preferential use increase/reduction of definite pathways. At the synaptic level, strengthening or weakening of the synaptic connections depending on a correlation principle.

- ▶ Deafferentation Pain

## Cortical and Limbic Mechanisms Mediating Pain and Pain-Related Behavior

KENNETH L. CASEY

Department of Neurology, Department of Molecular and Integrative Physiology, University of Michigan, and Consultant in Neurology, Veterans Administration Medical Center, Ann Arbor, MI, USA

kencasey@umich.edu

### Scope of This Review

This article will briefly review pain related functions of the cerebral cortex and limbic system. For the purposes of this review, the limbic system is defined as the medial and orbital portions of the frontal, parietal and temporal lobes that form a ring around the upper brainstem and diencephalon. The cingulate gyrus is a defining structure of the limbic system, the major components of which have direct or oligosynaptic connections with cingulate cortex (see also ► [cingulate cortex, functional imaging](#); ► [pain processing in the cingulate cortex, behavioral studies in humans](#); ► [cingulate cortex, nociceptive processing, behavioral studies in animals](#)) and with the hypothalamus (MacLean 1955; Papez 1937). The subcortical limbic structures such as the amygdala (see also ► [amygdala, functional imaging](#); ► [nociceptive processing in the amygdala, neurophysiology and neuropharmacology](#)), which is covered thoroughly in the essay in this Section by Volker Neugebauer, will not be discussed. Modulatory mechanisms mediated by pathways descending from the cortex and brainstem are discussed elsewhere in this volume and will not be discussed here.

The neurobiological response to injury complicates the analysis of cortical function during pain. Peripheral or central nervous system injuries trigger complex biochemical mechanisms that result in varying degrees of anatomical and functional reorganization of the cerebral cortex (Kaas et al. 1997). In this review, cortical functions will be considered only as mediated normally in the absence of clinically significant reorganization.

### Conceptual Issues

“Function” refers to the mix of psychological, behavioral and physiological manifestations of cerebral cortical activity, including somatic and autonomic responses that may be independent of the fully developed sensation of pain and the sensory, affective-motivational and cognitive components of pain (Melzack and Casey 1968; Price 1988; Price 1999) as recognized by the International Association for the Study of Pain (IASP) (Merskey and Bogduk 1994) and

in recent reviews of the cerebral cortical mechanisms mediating pain (Treede et al. 1999).

### Spatial Distribution of Function

The clinical observation that pain can be relieved, at least partially, by spinothalamic tractotomy (Spiller and Martin 1912) supports the concept of an anatomically distinct pain pathway, but subsequent clinical and neurosurgical experience has emphasized the long-term unpredictability of the results obtained following most ablative procedures, especially those involving cerebral structures (Sweet 1982). Current methods of analyzing brain function show that all cortical and limbic functions are mediated by networks of interconnected cortical areas, each with a specific, although incompletely characterized, neuronal function. This concept is in accord with the results of current functional imaging studies of pain (Casey 1999; Casey 2000; Davis 2000; Derbyshire 2000; Peyron et al. 2000) and the contemporary view that distributed parallel systems mediate cortical functions (Mesulam 1990).

### Temporal Distribution of Function

Cortical and limbic functions are also distributed over time. This concept is important for considering cortical functions as they affect both acute and chronically painful conditions. How cortical functions influence the perception of pain and pain related behavior may change with time from injury or, in the experimental setting, with time following a noxious stimulus. Some temporal variance may be due to the sequential activation of different cortical areas. Imaging studies of pain, for example, show that changes in the cortical response to noxious stimulation occur over a time span of approximately 45 s (Casey et al. 2001). Other temporal variation in cortical influence may occur simply because an injury or the context surrounding the injury has changed over time, so that the perceptual and behavioral impact of that function changes. All cortical areas are active to some degree throughout all time periods during which pain is experienced. Neurophysiological and functional brain imaging studies (cited below) show that each of the cortical structures listed here is active within milliseconds following a noxious stimulus. However, the clinically relevant impact of specific cortical structures on pain and pain behaviors deserves emphasis within particular time frames. Figure 1 is intended to summarize this hypothesized temporal distribution of the influence and impact of cortical and limbic functions over time. Unfortunately, information about cortical and limbic function over periods ranging from hours to years is available only in the clinical setting and only when long-term follow-up is available.

	EARLY (msec)	INT.MED. (msec—min)	LATE (min—years)
S1	X	x	x
S2	X	x	x
AI	X	x	x
ACC	X	X	X
PCC	X	X	?
IPL	x	X	x
PrMot	x	X	x
PI	x	X	x
MPC	x	X	X
OFC	x	X	X
HIPP	x	X	X
DLPFC	x	X	X

SENSORY	AFFECTIVE	COGNITIVE

**Cortical and Limbic Mechanisms Mediating Pain and Pain-Related Behavior, Figure 1** Relative influence of cortical function on pain and pain-related behavior. The figure summarizes the distribution of the influence of cerebral cortical and limbic functions on pain perception and pain related behavior over time. All structures listed in the left column have some influence on pain and behavior throughout the experience of pain, but the degree of this influence and its clinical and behavioral impact varies over time as indicated by the size and boldness of the X marks. The sensory-discriminative function (blue) is largely limited to the primary (S1) somatosensory cortex. Affective function is indicated by shades of red and cognitive function by green. Hippocampal (and entorhinal cortex) function is a mixture of affective and cognitive elements. S1, primary somatosensory cortex; S2, secondary somatosensory cortex; AI, anterior insula; ACC, anterior cingulate cortex; PCC, posterior cingulate cortex; IPL, inferior parietal lobule; Pr.Mot., premotor cortex; PI, posterior insula; MPC, medial prefrontal cortex; OFC, orbitofrontal cortex; HIPP, hippocampus and entorhinal cortex; DLPFC, dorsolateral prefrontal cortex.

### Early Cortical and Limbic Processing (Milliseconds)

#### Primary Somatosensory Cortex (S1)

The S1 cortex (see also ► [Primary Somatosensory Cortex \(S1\), Effect on Pain-Related Behavior in Humans](#)) within the postcentral gyrus is composed of Brodmann areas 1, 2, 3a and 3b, the latter two areas lying in the depths of the central sulcus and generally considered to be the major recipient of spatially refined cutaneous somatosensory input.

#### Lesions

There is evidence from clinical, neurophysiological and functional brain imaging that the S1 cortex is a major site for identifying noxious stimuli along the temporo-spatial and intensity domains. Early clinical analysis based on wartime missile wounds suggested that small lesions within the S1 cortex could produce a somatotopically restricted hypoalgesia along

with an impairment of somesthetic spatial and temporal discriminative functions (Marshall 1951; Russell 1945). However, direct anatomical corroboration was not available at the time and subsequent studies have shown that even relatively modest impact trauma to the cortex can result in otherwise unrecognized and clinically significant subcortical lesions that could interrupt deep nociceptive pathways (Lighthall 1988; Lighthall et al. 1989).

Selective surgical lesions of S1 cortex for the relief of clinical pain have produced poor results over time (Sweet 1982). Furthermore, infarctions limited to the territory of the postcentral gyrus and superior-posterior parietal region produce a somatotopically limited impairment of tactile and kinesthetic discriminative functions with sparing of pain and temperature sensations (Bassetti et al. 1993). This suggests that the S1 cortex is not essential for mediating the perceptual aspects of clinically relevant chronic pain states.

#### Stimulation

Despite the strong evidence for nociceptive information reaching the S1 cortex (see below), electrical stimulation of the postcentral gyrus rarely, if ever, evokes pain in the conscious or partially sedated human (Nii et al. 1996; Sweet 1982). However, these stimuli do not typically activate neurons in the sulcal depths of S1 cortex, where nociceptive neurons may be located.

#### Electrophysiology

The detailed somatotopic organization of neurons responding to tactile stimuli (Whitsel et al. 1971) has been confirmed in numerous investigations (Kaas et al. 1979; Kaas 1993). Single cell recordings from the monkey reveal that there are nociceptive neurons within S1 cortex and that these have restricted receptive fields and responses that could mediate thermal nociceptive discrimination in the monkey (Kenshalo and Isensee 1983; Kenshalo et al. 1988; Kenshalo et al. 2000). In humans, the earliest nociceptive information to reach the cerebral cortex, as determined by magnetoencephalographic (MEG) (see also ► [Insular Cortex, Neurophysiology and Functional Imaging of Nociceptive Processing](#)) and evoked potential (EP) (see also ► [insular cortex, neurophysiology and functional imaging of nociceptive processing](#), ► [nociceptive processing in the hippocampus and entorhinal cortex, neurophysiology and pharmacology](#)) studies with noxious laser or brief mechanical stimulation, arrives nearly simultaneously in the primary somatosensory (S1), secondary somatosensory (S2) (see also ► [secondary somatosensory cortex \(S2\) and insula, effect on pain related behavior in animals and humans](#)), anterior insular (AI) (see also



► [insular cortex, neurophysiology and functional imaging of nociceptive processing](#)) and the rostral anterior cingulate cortex (ACC) (see also ► [cingulate cortex, nociceptive processing, behavioral studies in animals](#), ► [pain processing in the cingulate cortex, behavioral studies in humans](#), ► [cingulate cortex, functional imaging](#)) (Arendt-Nielsen et al. 1999; Kakigi et al. 1995; Ploner et al. 1999; Schnitzler and Ploner 2000). Kanda and colleagues used recordings from the scalp and from implanted subdural electrodes to show that painful infrared laser stimulation evokes a potential with a peak latency of 220 ms in human S1 cortex (Kanda et al. 2000). A recent MEG study with laser evoked selective stimulation of C fibers found nearly simultaneous responses within approximately 750 ms in both the S1 and S2 cortices (Tran et al. 2002).

### Functional Imaging

Functional imaging studies support the concept that the S1 cortex participates in the sensory-discriminative aspect of pain although cognitive variables modify the intensity of the response significantly (Bushnell et al. 1999; Hofbauer et al. 2001). High-resolution optical imaging studies show unique and possibly specific responses to noxious heating in subdivisions of area 3a (Tommerdahl et al. 1996). However, functional magnetic resonance imaging (fMRI) studies (see also ► [PET and fMRI imaging in parietal cortex \(Si, Sii, inferior parietal cortex BA40\)](#)) show that responses to noxious stimuli are also likely to be obtained from area 1 of the S1 cortex (Gelnar et al. 1999), a finding in general agreement with the results of cellular recording (Kenshalo and Isensee 1983; Kenshalo et al. 1988). In summary, the weight of evidence from a variety of sources favors the view that S1 cortical neurons are specialized to engage in the earliest processes mediating the discriminative aspects of somatic sensation, including pain. Clinical observations suggest that these neurons are essential for nociceptive discriminative functions, but are less likely to be essential for mediating or modulating the affective or cognitive aspects of chronically painful conditions.

### Secondary Somatosensory Cortex (S2)

The S2 cortex occupies the posterior parietal operculum over the lateral (Sylvian) fissure and is adjacent to the posterior insula (see also ► [insular cortex, neurophysiology and functional imaging of nociceptive processing](#), ► [secondary somatosensory cortex \(s2\) and insula, effect on pain related behavior in animals and humans](#), ► [nociceptive processing in the secondary somatosensory cortex](#)). Because the S2 cortex receives input via the spinothalamic tract (Stevens et al. 1993) and has strong projections to the insula, it is in a position to transmit nociceptive information to limbic cortical structures, such as the cingulate, medial

prefrontal (see also ► [prefrontal cortex, effects on pain-related behavior](#)) and orbital frontal cortices, *via* insular connections (Mesulam and Mufson 1982a; Mesulam and Mufson 1982b).

### Lesions

Lesions involving the human S2 cortex or the adjacent subcortical white matter have been associated with a central pain syndrome and a clinically detectable contralateral hypalgesia (Horiuchi et al. 1996; Schmahmann and Leifer 1992), but a contributing effect of injury to the insular cortex could not be completely eliminated. Greenspan and colleagues (1999) found that lesions involving the posterior opercular (S2) cortex were associated with a clinically detectable elevation of pain threshold in humans, while patients with lesions sparing S2 cortex had normal heat pain thresholds even when the lesion also involved the insula (Greenspan et al. 1999).

### Stimulation

Recent studies using imaging methods to confirm the location of implanted depth electrodes have not thus far reported pain sensations or pain related behavior during direct stimulation of the S2 cortex in humans (Ostrowsky et al. 2000; Ostrowsky et al. 2002). However, these investigations were focused on stimulation of the insular cortex, so a more definitive assessment awaits a systematic exploration of the human S2 cortex.

### Electrophysiology

Cellular recordings from S2 cortex in anesthetized primates reveal very few neurons that respond to noxious stimuli. The somatotopic organization of primate S2 is quite coarse compared to that of S1 cortex and the receptive fields are typically large - often bilateral or covering most of a single limb (Burton et al. 1995). In contrast with the observations in recordings from animals, noxious stimulation regularly evokes distinctive electrical and magnetic responses in human S2 cortex (Arendt-Nielsen et al. 1999; Bromm 2001; Kakigi et al. 2000; Ploner et al. 2002). Nociceptive information arrives nearly simultaneously at the human S2 and S1 cortex (approximately 150–200 ms to peak) but, following a brief stimulus, the duration of neuronal activity is significantly longer in S2 than in the S1 cortex (Inui et al. 2003; Kanda et al. 2000; Ploner et al. 2002). Selective C fiber stimulation also evokes MEG and EP responses in S2 cortex (Opsommer et al. 2001; Tran et al. 2002). Frot and colleagues (2001) revealed differences in the latency and amplitude of S2 cortical responses to innocuous electrical and noxious (laser) stimulation during depth electrode recording in humans, suggesting that this cortex integrates both tactile and nociceptive inputs (Frot et al. 2001).

### Functional Imaging

The S2 cortex is one of the most consistently activated structures in positron emission tomographic (PET) and fMRI studies (see also ► [PET and fMRI imaging in parietal cortex \(SI, SII, inferior parietal cortex BA40\)](#)) designed to distinguish among responses to noxious and innocuous stimuli (Burton et al. 1993; Casey 1999; Davis 2000; Derbyshire 2003; Peyron et al. 2000). An fMRI study revealed a coarse somatotopic organization within the S2 cortex (Ruben et al. 2001). However, Peyron and colleagues (2002), using a multi-modality approach involving PET, fMRI, and scalp LEP recording with dipole localization in the same subjects, could not determine whether the pain related activations they obtained were localized to the S2 cortex, the insula or both structures. Their results led the authors to suggest the term “operculoinsular” cortex to refer to responses within the S2-insular region (Peyron et al. 2002). However, the recent results obtained from detailed depth recording favor the interpretation that both the S2 and insular cortices are independent generators of responses to noxious stimuli (Frot and Mauguiere 2003).

In summary, the evidence supports the view that human S2 cortex is a critical component of the cortical network mediating pain. Although there is a crude somatotopic organization within this cortex, it seems unlikely that it is critical for spatial discrimination. Rather, the S2 cortex appears to be involved in the early identification of noxious events that are combined with the localizing information provided through the S1 cortex and transmitted to other cortical areas for further analysis.

### Anterior Insula

The anterior insula (see also ► [insular cortex, neurophysiology and functional imaging of nociceptive processing](#), ► [secondary somatosensory cortex \(s2\) and insula, effect on pain related behavior in animals and humans](#), ► [nociceptive processing in the secondary somatosensory cortex](#)) lies rostral to the most lateral point of the central sulcus, which also approximately defines the vertical plane extending through the anterior commissure perpendicular to the sagittal plane. The cortex of the anteroventral part of the insula is agranular, receives input from entorhinal cortex (see also ► [nociceptive processing in the hippocampus and entorhinal cortex, neurophysiology and pharmacology](#), ► [hippocampus and entorhinal complex, functional imaging](#)) and sends projections to limbic cortical structures such as the entorhinal, periamygdaloid and anterior cingulate cortices (Augustine 1996).

### Lesions

There are no studies of the effects of localized anterior insular lesions specifically on pain perception.

Greenspan and colleagues, however, identified 2 patients with lesions involving the anterior insula, both of whom had normal heat pain thresholds. Their 3 patients with anterior insular sparing and involvement of both S2 and posterior insula however, had contralateral elevated thresholds for heat or mechanically induced pain (Greenspan et al. 1999). These observations suggest that the anterior insula is not an essential component of the cortical network mediating pain.

### Stimulation

In a study confirming the site of stimulation in conscious humans, stimulation of the anterior insula produced visceral sensory experiences and visceral motor responses, but not reports of pain (Ostrowsky et al. 2000).

### Electrophysiology

A neurophysiological study directed specifically at the anterior (granular) portion of the primate insula found that all responsive neurons had large receptive fields and were excited by innocuous somatic stimuli; however, the investigators searched for responses only with innocuous stimuli (Schneider et al. 1993).

### Functional Imaging

PET imaging shows that the anterior insula is active during the early phase of a series of repetitive noxious heat stimuli, but not after the stimulation continues for 45 s (Casey et al. 2001). This is consistent with the findings of Ploghaus and colleagues who showed, using fMRI, that the anterior insula was active specifically during the anticipation of experimentally induced pain rather than during the experience of pain itself (Ploghaus et al. 1999). However, Porro and colleagues showed that activity in the anterior insula, together with the S1, anterior cingulate, and medial prefrontal cortices, increases during the anticipation of pain and is also correlated with perceived pain intensity (Porro et al. 2002). Nonetheless, a recent fMRI study reveals that the anterior insula is among the frontal and temporal brain structures responding specifically to stimulus novelty (Downar et al. 2002). These results confirm and elaborate on earlier imaging studies showing pain related activity in the anterior insula (Casey et al. 1996; Coghill et al. 1994; Davis et al. 1998; Hsieh et al. 1994; Svensson et al. 1997).

In summary, the results suggest that the anterior insula is an essential component of the cortical network mediating some early aspects of pain perception including the anticipation of pain. Because anticipation implies the influence of past experience with pain, the anatomical connections of the anterior insula with limbic structures, such as the entorhinal cortex of the temporal lobe (see also ► [hippocampus and entorhinal](#)

► complex, functional imaging ► nociceptive processing in the hippocampus and entorhinal cortex: neurophysiology and pharmacology) are likely to be of critical importance in mediating this function.

### Cingulate Cortex

Based on clinical observations and recent experimental studies, Vogt and colleagues have proposed that the anterior cingulate cortex (ACC; rostral to the plane of the anterior commissure) mediates primarily executive functions related to the emotional control of visceral, skeletal and endocrine outflow; the posterior cingulate cortex (PCC) (see also ► cingulate cortex, nociceptive processing, behavioral studies in animals, ► pain processing in the cingulate cortex, behavioral studies in humans, ► cingulate cortex, functional imaging), however, is thought to subserve evaluative functions such as monitoring sensory events and personal behavior in relation to spatial orientation and memory (Vogt et al. 1992). The results of a more recent PET study suggested further that increased responses (activation) in subdivisions of the ACC signal participation in response selection and affective elaboration, while reduced responses (deactivation) in the PCC may reflect disengagement from visually guided processes (Vogt et al. 1996). However, other studies have shown strong neurovascular (Gelnar et al. 1999) and laser evoked responses (► insular cortex, neurophysiology and functional imaging of nociceptive processing, ► nociceptive processing in the secondary somatosensory cortex) in the PCC (Bentley et al. 2003).

Anatomical data shows that sectors of the ACC and a mid-cingulate area just below the supplementary motor area are strongly connected to the ventral horns of the spinal cord, thus providing direct access to motor mechanisms and the direct modulation of voluntary responses to noxious stimuli (Dum and Strick 1993; Hutchins et al. 1988).

### Anterior Cingulate Cortex (ACC)

#### Lesions

Anterior cingulate lesions do not interfere with the ability of humans to recognize or respond to acute noxious stimuli. This is most clearly demonstrated in clinical cases. There are very few studies in which the location and extent of the lesion is known to be confined to the anterior cingulate cortex and the response to pain is tested specifically. However, Cohen and colleagues (Cohen et al. 1999) examined 12 patients, all with normal neurological examinations except for peripheral findings related to their pain syndrome. Each underwent cingulotomy (see also ► cingulate cortex, nociceptive processing, behavioral studies in animals, ► pain processing in the cingulate cortex, behavioral studies in humans, ► cingulate cortex, func-

tional imaging) for intractable pain and was examined pre- and post-operatively. The lesions were limited to the supracallosal mid-anterior cingulate cortex. The response to acute experimental pain was not tested. However, the patients reported only a modest relief of the intensity of their clinical pain but a significant reduction in the degree to which the pain interfered with their daily behavior and social function

Animal studies of rostral ACC lesions reveal deficits in avoidance learning and nociceptively conditioned place avoidance, but the normal response to acute pain appears unimpaired (Gabriel et al. 1991; Johansen et al. 2001). Lesions involving the rodent mid-anterior, but not the pregenual cingulate cortex however, impair the execution of escape responses to gradually increasing heat, while sparing other nocifensive behaviors (Pastoriza et al. 1996).

Overall, the results show that different sectors of the ACC participate in the acquisition of learned responses to noxious stimuli, the association of negative hedonic attributes with acute noxious stimuli and the execution of motor responses to acute noxious stimuli. The longer-term effects of ACC lesions will be considered in subsequent sections of this review.

#### Stimulation

The most consistent responses during electrical stimulation in humans are visceromotor changes associated with nausea, sensations of fullness, changes in blood pressure and heart rate and cutaneous flushing (Talairach et al. 1973). Unpleasant emotional reactions are occasionally reported (Laitinen 1979; von Cramon and Jurgens 1983). In the rodent, biochemical stimulation of the rostral ACC (see also ► cingulate cortex, nociceptive processing, behavioral studies in animals, ► pain processing in the cingulate cortex, behavioral studies in humans, ► cingulate cortex, functional imaging) produced conditioned avoidance and biochemical suppression of the same site impairs conditioned avoidance learning (Johansen and Fields 2004). Overall, the results suggest a negative affective state that must be associated with noxious stimuli for the normal experience of pain.

#### Electrophysiology

Several evoked potential and single cell recording studies show that noxious stimuli evoke neuronal responses within the rostral and mid-anterior sectors of the ACC of humans and experimental animals. In the human, nociceptive responses appear within 300 ms of a noxious laser stimulus (Inui et al. 2003; Kakigi et al. 2000; Lenz et al. 1998). Neurophysiological studies show that the ACC becomes active nearly simultaneously with the S1 and S2 cortices, indicating that spatio-temporal and intensity analysis begins in parallel with the process-

ing of affective related information (Ploner et al. 2002; Schnitzler and Ploner 2000). The early parallel processing of affective and sensory information is consistent with the concept that noxious stimuli have an intrinsic, primary unpleasantness (Fields 1999; Melzack and Casey 1968; Price 2000).

The limited sample of cellular recordings from human subjects shows that some mid-anterior ACC neurons responded only to noxious thermal (heat or cold) stimuli but also responded in anticipation of noxious stimulation (Hutchison et al. 1999); the receptive field size could not be determined. In experimental animals, nociceptively responding cells had large receptive fields (Sikes and Vogt 1992; Yamamura et al. 1996). In the conscious monkey, neurons in the ACC and in the anatomically associated caudate nucleus responded during the anticipation of pain in a pain avoidance task (Koyama et al. 1998; Koyama et al. 2000, 2001).

### Functional Imaging

Reviews of functional imaging studies show that either the rostral or mid-anterior or both sectors of the ACC are activated consistently during pain (Bushnell et al. 1999; Casey 1999; Derbyshire 2000, 2003). Davis and colleagues showed that a sector of the ACC rostral to that responding during pain is activated specifically by a pain independent attention-demanding task (Davis et al. 1997). Rainville and colleagues (1997) showed that an anterior, supragenual area of this cortex participates specifically in the affective coding of pain (Rainville 2002; Rainville et al. 1997). During prolonged, repetitive heat stimulation, the most rostral sector of the ACC is active only during the early phase, while activation of the more caudal part of the ACC appears during the later phase (Casey et al. 2001). This result is in accord with the observation that the most rostral sector of the ACC is associated with the anticipation of pain (Ploghaus et al. 1999).

### Posterior Cingulate Cortex (PCC)

Nociceptive information arrives at the PCC within approximately 200–250 ms of the application of a noxious laser stimulus (Bentley et al. 2003; Bromm 2001), so, like the ACC, it is involved in the earliest stages of nociceptive analysis. As noted above in the general discussion of the cingulate cortex, there is neurophysiological and functional imaging (Gelnar et al. 1999) evidence that the PCC participates in both the sensory and behavioral aspects of pain processing.

### Intermediate Cortical and Limbic Processing (Milliseconds–Minutes)

As the nociceptive identification process is sustained, it leads to the allocation of attentional resources and the distraction from competing stimuli. Ward and col-

leagues presented evidence that, in the visual system, the application of attentional mechanisms requires up to 500 ms (Ward et al. 1996). Following this very early stage, there is an elaboration of the identity of the stimulus so that its location, physical property and affective qualities are recognized more clearly and begin to form the basis for further analysis and response. This early identification of the affective component of a noxious stimulus is probably identical to the “primary unpleasantness” of Fields (Fields 1999) and the “immediate pain unpleasantness” of Price (Price 2000) and is closely tied to perceived stimulus intensity.

Somatic, visceral and autonomic responses may be reflexive and preconscious at the earliest stages of cortical engagement, but may be facilitated or prolonged by the action of specific cortical mechanisms. Immediate withdrawal from the stimulus and the facilitation of flexion reflexes is an example of an early somatomotor response that may be modified quickly to include more elaborate voluntary escape maneuvers. Early cognitive reactions at this stage may include the recognition of tissue injury, the experience of fear or anger and the development of immediate defensive actions. Cortical connections with the amygdala are important for these affective and autonomic responses (LeDoux 2000; Neugebauer et al. 2004).

### Inferior Parietal Lobule (B40)

Lesions involving the inferior parietal lobule (IPL) (see also ► [PET and fMRI imaging in parietal cortex \(SI, SII, inferior parietal cortex BA40\)](#)), particularly of the right hemisphere, are associated classically with hemibody neglect syndromes (Adams and Victor 1993; De-Jong 1979; Mesulam 1990). In humans, lesions involving this cortical area, which includes the posterior parietal operculum and Brodmann’s area 40, have clinically obvious deficits in detecting and responding to noxious stimuli (Bassetti et al. 1993). Neurons responding to noxious stimulation or the visual threat of noxious stimulation have been recorded from the posterior parietal (7b) cortex of monkeys and a lesion in this same area was associated with contralateral hypalgesia (Dong et al. 1994, 1996). Functional imaging studies have frequently revealed activity in this lateral posterior parietal cortex during pain, particularly when the task involves attending specifically to the painful stimulation (Coghill et al. 2001; Duncan and Albanese 2003; Peyron et al. 1999; Peyron et al. 2000; Svensson et al. 1997) or during simulated pathological pain states (Baron et al. 1999; Hsieh et al. 1994; Hsieh et al. 1995a). However, Karnath (Karnath 2001; Karnath et al. 2001) has presented and summarized evidence that pure spatial neglect follows lesions of the superior temporal gyrus (STG) and that lesions involving the human IPL are more likely to reflect deficits in organizing



movements directed within extrapersonal, body oriented hemispace. Downar and colleagues showed that activation of the cortex at the temporo-parietal junction, which includes the inferior parietal lobule and superior temporal gyrus, is associated with the perceived salience of both painful and painless stimuli (Downar et al. 2002; Downar et al. 2003). In summary, there is substantial evidence that the cortex in the area of the temporo-parietal junction, including the IPL (B40) and STG, participates in attentional mechanisms that are likely to be critical for the normal perception of and attention to injurious stimuli. This interpretation is of interest in view of the strong connections between this cortex and the premotor cortical areas (see below).

#### Premotor Cortex (B6)

The premotor cortex (see also ► [prefrontal cortex, effects on pain-related behavior](#)) is active during pain as shown in many functional imaging studies of normal human subjects (Casey 1999; Casey et al. 2001; Coghill et al. 1999; Ladabaum et al. 2000; Tracey et al. 2000), including those focused on the related sensation of itch (Drzezga et al. 2001; Hsieh et al. 1994). Fibromyalgia patients who show a high degree of catastrophizing about their pain have an increased response in the medial premotor cortex (B6) to somatic pressure stimuli (Gracely et al. 2004).

There is a strong anatomical and functional relationship between the parietal and frontal motor (see also ► [prefrontal cortex, effects on pain-related behavior](#), ► [PET and fMRI imaging in parietal cortex \(SI, SII, inferior parietal cortex BA40\)](#)) areas of the monkey and human brain (Rizzolatti et al. 1998). The circuits connecting predominantly somatosensory posterior parietal association areas with the dorsal and ventral premotor cortex are important for nociceptive processing in the cortex. For example, a component of the dorsal premotor circuit is involved in motor planning based primarily on somatosensory information (Rizzolatti et al. 1998). A functional imaging study has now shown that the both the ventral and dorsal premotor cortex participate in the development of the sense of ownership of a body part (Ehrsson et al. 2004). Therefore, it is possible that the premotor cortex contributes to stimulus recognition and identification in addition to participating in the development of a motor response to a stimulus.

#### Posterior Insula

##### Lesions

The recent observations by Greenspan and colleagues show that lesions involving the posterior insula may not attenuate pain threshold but are associated with a significant increase in pain tolerance as assessed by the cold pressor test (Greenspan et al. 1999). Clinical

observations also show that lesions involving the deep parasyllvian cortex are associated with significant hypalgesia (Bassetti et al. 1993; Davison and Schick 1935; Greenspan and Winfield 1992; Horiuchi et al. 1996; Schmammann and Leifer 1992). Involvement of the insula also leads to the clinical phenomenon of pain asymbolia, in which the patient fails to recognize or respond to the threat of noxious stimuli (Berthier et al. 1988).

##### Stimulation

Ostrowsky and colleagues (Ostrowsky et al. 2000, 2002) explored the insular cortex in 43 patients undergoing evaluation for epilepsy surgery and were able to verify the location of the stimulating electrodes with MR imaging. Stimulation within the posterior insula evoked painful sensations in the upper posterior insular cortex at 17 of 93 (18.2%) insular stimulation sites in 14 patients. The patients described the stimulus-evoked sensations as burning, stinging or disabling, located either contralaterally or bilaterally and rarely outlasting the stimulation. Non-painful somatosensory sensations, described as warmth, cold or tingling, were also evoked in 21 of these 93 insular sites (37.2%). The pain related region shows a striking overlap with the dorsal posterior insular site activated by heat pain (Craig et al. 2000). Although these electrical stimuli did not evoke after-discharge, it is likely that other cortical areas were activated during the insular stimulation and may have participated in the elaboration of the sensory experiences.

##### Electrophysiology

A small number of neurons responding to noxious stimuli have been recorded from the posterior insula (Robinson and Burton 1980). Zhang and colleagues recorded single insular neurons that responded to both innocuous and noxious somatic stimuli; some of these cells were localized to the more posterior granular area and also responded to baroreceptor stimulation (Zhang et al. 1999). In addition, numerous electrophysiological studies in humans have shown insular responses to painful cutaneous stimulation (Kakigi et al. 2000; Kakigi et al. 2003; Treede et al. 2000).

##### Functional Imaging

The anterior insula is activated early in the course of repetitive stimulation with noxious heat, but this response is replaced by a shift of the peak activity caudally to the mid-posterior insula as the stimulation continues (Casey et al. 2001). The mid- and posterior-insula is among the most regularly responsive regions found among a variety of functional imaging studies (Casey 1999; Craig et al. 2000; Peyron et al. 2000; Peyron et al. 2002). Derbyshire (2003) has reviewed

evidence showing that visceral distention activates both the anterior and posterior insula, but the intensity, timing and duration of stimulation varied across studies (Derbyshire 2003).

#### Anterior and Posterior Cingulate Cortex

The more rostral perigenual sectors of the ACC are active only early in the course of prolonged repetitive heat stimulation. Such stimulation is followed by sustained activity more caudally within Brodmann area 24 (Casey et al. 2001). Both attentional mechanisms and the perception of pain activate adjacent but separate sectors of the ACC (Davis et al. 1997). Gelnar and colleagues showed that the posterior cingulate cortex, which receives input from thalamic targets of the spinothalamic tract (Apkarian and Shi 1997), responds specifically during painful heat stimulation (Gelnar et al. 1999); the PCC also participates in identifying the salience of prolonged (1 minute) noxious stimuli (Downar et al. 2003).

#### Long-Term Cortical and Limbic Processes (Minutes—Years)

Unlike the preceding responses, which generally occur over periods of seconds or less, a more detailed evaluation of an injury proceeds over time periods ranging from minutes to years and, especially in the case of chronic pain, may change over time. The qualitative evaluation includes mnemonic processes such as a comparison of present and past experiences with injurious physical stimuli such as heat, mechanical distortions and chemical changes in the tissue. Most critically, a global assessment of the environment and the context in which the noxious event occurred is an important determinant of the perceived severity of the noxious stimulation or injury. The affective component of the experience may vary over time but is fully developed at this stage; it is probably related to what Fields has called “secondary unpleasantness” (Fields 1999) and Price refers to as “secondary pain unpleasantness” (Price 2000). Cognitive mechanisms are engaged at this stage and these may include mnemonic functions, adjustments to daily living and planning for the future. Overall, this aspect of pain related cortical function is closely related to the concept of pain as a “need-state” (Wall 1979) or a homeostatic function (Craig 2002).

#### Anterior Cingulate Cortex

Patients with lesions specifically confined to the ACC have an attenuation of the affective component of pain that is sustained for many months and, where information is available, for years (Cohen et al. 1999; Hurt and Ballantine 1973). Unfortunately, these patients may also show impairment of sustained attention and spontaneous behavioral responses (Cohen et al. 1999). A

patient with a surgical lesion confined to the right mid-anterior cingulate gyrus had impaired executive control of manual but not verbal responses; responses to noxious stimuli were not tested (Turken and Swick 1999). Surgical lesions within the more rostral, pregenual (“affective”) sector of the ACC are associated with affective blunting and a reduction of concern about clinical pain, but the responses to acute experimentally induced pain are generally not described in detail (Foltz and White 1962; Hornak et al. 2003; Hurt and Ballantine 1973); the same is true of an extensively analyzed case of medial prefrontal damage (Damasio et al. 1994). There is insufficient data to warrant comment on the long-term pain related effects of posterior cingulate lesions in humans.

#### Medial Prefrontal Cortex (B9, 10, 11)

Although the medial prefrontal cortex participates in the elaboration of emotional and high order cognitive states that are independent of noxious somatic and visceral stimuli (Ramnani and Owen 2004; Simpson et al. 2001; Wager et al. 2003), a significant minority of functional imaging studies have shown that this cortex is active during experimental somatic or visceral pain (Derbyshire 2003; Peyron et al. 2000; Wager et al. 2004) or simulated pathological states (Hsieh et al. 1995b; Iadarola et al. 1998). Extensive lesions of the human mesial prefrontal cortex extending rostral to the cingulate gyrus (see also ► [cingulate cortex, nociceptive processing, behavioral studies in animals](#), ► [pain processing in the cingulate cortex, behavioral studies in humans](#), ► [cingulate cortex, functional imaging](#)) are associated with profound and lasting neurological deficits ranging from blunting of emotional responses (abulia) to the syndrome of akinetic mutism and motor neglect (Damasio et al. 1994; Mochizuki and Saito 1990; Kumral et al. 2002; Minagar and David 1999; Mochizuki and Saito 1990). Although extensive damage to this cortex precludes an unbiased examination of pain sensations, it is likely that it participates in the long-term evaluation of the emotional impact of pain and the need to apply cognitive strategies to adapt accordingly.

#### Orbitofrontal Cortex (OFC)

The orbitofrontal cortex (see also ► [hypothalamus and nociceptive pathways](#), ► [prefrontal cortex, effects on pain-related behavior](#)) is the major cortical output to the hypothalamus (see also ► [hypothalamus and nociceptive pathways](#)) and also has direct efferent connections to the amygdala and periaqueductal gray matter (Ongur et al. 1998). Functional imaging studies of pain show OFC activation during experimental pain studies of heat (Craig et al. 2000), visceral stimulation (Derbyshire 2003) and simulated pathological pain

states (Lorenz et al. 2002). Other imaging investigations show that the OFC plays a critical role in assigning affective valence to sensory information and in establishing the rewarding or punishing value of experiences including pain (Rolls et al. 2003), which in turn guide behavioral responses (Rolls 2000). In studying 43 patients with a variety of prefrontal cortical lesions, Hornack and colleagues (Hornak et al. 2003) identified 6 patients with bilateral circumscribed surgical lesions involving the OFC. These patients had difficulty identifying emotions and impairments in their subjective emotional states. Therefore, the greatest long-term clinical significance of OFC participation in pain related behavior may be a sustained impairment of the ability to recognize pain as a primary reinforcer, which, in turn, leads to adaptive behaviors and emotional responses to injury (Kringelbach and Rolls 2004).

#### **Dorsolateral Prefrontal Cortex (DLPFC; B9, 46)**

The DLPFC (see also ► [prefrontal cortex, effects on pain-related behavior](#)) is active during executive processes involving shifts of attention between or among tasks (Smith and Jonides 1999). Cortical activations that include the DLPFC are observed in a majority of neuroimaging studies of pain (Peyron et al. 2000). However, as Peyron and colleagues have shown, the activation appears to be due to the participation of attentional and executive processes involved in attempting to attend to or ignore the painful stimulation, rather than an analysis of the sensory or affective dimensions of the stimulus (Peyron et al. 1999). Thus, during the pain of heat allodynia (Lorenz et al. 2002), a high level of activation intensity in the left DLPFC is correlated with reduced pain unpleasantness and reduced functional connectivity between the midbrain and medial thalamus; right DLPFC activity however, is associated with a reduced correlation of anterior insular activity with both pain unpleasantness and intensity (Lorenz et al. 2003). The DLPFC also appears to be an active agent in mediating placebo analgesia, because the intensity of DLPFC activity correlates with and predicts the intensity of expected pain relief in the placebo condition (Wager et al. 2004). The DLPFC thus participates in mediating acute pain, but the current author suggests that the sustained pain modulatory effects of DLPFC activity are most strongly engaged following the initial sensory and hedonic analysis of injuries and during chronic pain states, where the impairment of frontal lobe function would have clinically significant impact on the recruitment of pain coping strategies (Stuss and Benson 1986).

#### **Hippocampus and Entorhinal Cortex**

The hippocampus (see ► [nociceptive processing in the hippocampus and entorhinal cortex, neurophysiology](#)

and pharmacology) and its major input, the entorhinal cortex, are part of a cortical network, including the DLPFC and anatomically related frontal cortices, for the encoding, storage and retrieval of polymodal sensory information emanating from parietal association areas (Sakai 2003; Simons and Spiers 2003). In the rodent, the synaptic excitability of hippocampal pyramidal neurons undergoes a prolonged, cholinergically dependent depression following noxious stimulation; this evoked depression shows a marked habituation to repeated stimulation (Khanna and Sinclair 1989; Khanna and Sinclair 1992). Noxious stimuli also activate immediate early genes in neurons within the same hippocampal sector (Khanna et al. 2004), further suggesting a role in mnemonic circuitry. Prolonged increases in neuronal activity are also seen in the rodent entorhinal cortex (Frank and Brown 2003). Hippocampal or entorhinal activation or deactivation is rarely seen in most neuroimaging studies, but appears in studies in which the stimulus intensity increases during the scan period (Derbyshire et al. 1997) or when painful, but not painless, stimulation is unexpected (Ploghaus et al. 2000). When the expectation of a noxious stimulus is manipulated so as to produce anxiety, there is an anxiety related increase in pain and in the pain response in the entorhinal cortex (Ploghaus et al. 2001). Together, these findings show that these medial temporal lobe structures participate in elaborating the experience of pain based on emotional state, expectation and past experience. The author suggests that this elaboration follows the earlier sensory identification and affective labeling of the noxious stimulation and that its sustained clinical impact is on the ability of patients to interpret the long-term significance of internal states, including clinically painful conditions. A well-studied example of this rare but important condition has been presented by Hebben and colleagues (Hebben et al. 1985).

#### **References**

1. Adams RD, Victor M (1993) Principles of Neurology, 5th edn. McGraw-Hill, New York
2. Apkarian AV, Shi T (1997) Thalamocortical connections of the cingulate and insula in relation to nociceptive inputs to the cortex. In: Ayrapietian S, Apkarian AV (eds) Pain Mechanisms and Management. IOS Press, Amsterdam, pp 212–220
3. Arendt-Nielsen L, Yamasaki H, Nielse, J et al. (1999) Magnetoencephalographic responses to painful impact stimulation. *Brain Res* 839:203–208
4. Augustine JR (1996) Circuitry and functional aspects of the insular lobe in primates including humans. *Brain Res Rev* 22:229–244
5. Baron R, Baron Y, Disbrow E et al. (1999) Brain processing of capsaicin-induced secondary hyperalgesia: A functional MRI study. *Neurology* 53:548
6. Bassetti C, Bogousslavsky J, Regli F (1993) Sensory syndromes in parietal stroke. *Neurology* 43:1942–1949

7. Bentley DE, Derbyshire SWG, Youell PD et al. (2003) Caudal cingulate cortex involvement in pain processing: an inter-individual laser evoked potential source localisation study using realistic head models. *Pain* 102:265–271
8. Berthier M, Starkstein S, Leiguarda R (1988) Asymobolia for pain: A sensory-limbic disconnection syndrome. *Annals Neurol* 24:41–49
9. Bromm B (2001) Brain Images of Pain. *News Physiol Sci* 16:244–249
10. Burton H, Videen TO, Raichle ME (1993) Tactile-vibration-activated foci in insular and parietal-opercular cortex studied with positron emission tomography: Mapping the second somatosensory area in humans. *Somatosens Mot Res* 10:297–308
11. Burton H, Fabri M, Alloway K (1995) Cortical areas within the lateral sulcus connected to cutaneous representations in areas 3b and 1: A revised interpretation of the second somatosensory area in macaque monkeys. *J Comparative Neurol* 355:539–562
12. Bushnell MC, Duncan GH, Hofbauer RK et al. (1999) Pain perception: Is there a role for primary somatosensory cortex? *Proc Natl Acad Sci USA* 96:7705–7709
13. Casey KL (1999) Forebrain mechanisms of nociception and pain: Analysis through imaging. *Proc Natl Acad Sci USA* 96:7668–7674
14. Casey KL (2000) The Imaging of Pain: Background and Rationale. In: Casey KL, Bushnell MC (eds) *Pain Imaging*. IASP Press, Seattle, pp 1–29
15. Casey KL, Minoshima S, Morrow TJ et al. (1996) Comparison of human cerebral activation patterns during cutaneous warmth, heat pain, and deep cold pain. *J Neurophysiol* 76:571–581
16. Casey KL, Morrow TJ, Lorenz J et al. (2001) Temporal and spatial dynamics of human forebrain activity during heat pain: analysis by positron emission tomography. *J Neurophysiol* 85:951–959
17. Coghill RC, Talbot JD, Evans AC et al. (1994) Distributed processing of pain and vibration by the human brain. *J Neurosci* 14:4095–4108
18. Coghill RC, Sang CN, Maisog JH et al. (1999) Pain intensity processing within the human brain: A bilateral, distributed mechanism. *J Neurophysiol* 82:1934–1943
19. Coghill RC, Gilron I, Iadarola MJ (2001) Hemispheric lateralization of somatosensory processing. *J Neurophysiol* 85:2602–2612
20. Cohen RA, Kaplan RF, Moser DJ et al. (1999) Impairments of attention after cingulotomy. *Neurology* 53:p 819
21. Craig AD (2002) How do you feel? Interoception: the sense of the physiological condition of the body. *Nat Rev Neurosci* 3:655–666
22. Craig AD, Chen K, Bandy D et al. (2000) Thermosensory activation of insular cortex. *Nature Neurosci* 3:184–190
23. Damasio H, Grabowski T, Frank R et al. (1994) The return of Phineas Gage: Clues about the brain from the skull of a famous patient. *Science* 264:1102–1105
24. Davis KD (2000) The neural circuitry of pain as explored with functional MRI. *Neurological Res* 22:313–317
25. Davis KD, Taylor SJ, Crawley AP et al. (1997) Functional MRI of pain- and attention-related activations in the human cingulate cortex. *J Neurophysiol* 77:3370–3380
26. Davis KD, Kwan CL, Crawley AP et al. (1998) Functional MRI study of thalamic and cortical activations evoked by cutaneous heat, cold, and tactile stimuli. *J Neurophysiol* 80:1533–1546
27. Davison C, Schick W (1935) Spontaneous pain and other subjective sensory disturbances. *AMA Arch Neurol Psychiat* 34:1204–1237
28. DeJong RN (1979) *The Neurologic Examination*, 4th edn. Harper and Row, Hagerstown
29. Derbyshire SW (2000) Exploring the pain “neuromatrix” *Curr Rev Pain* 4:467–477
30. Derbyshire SWG (2003) A systematic review of neuroimaging data during visceral stimulation. *Am J Gastroenterol* 98:12–20
31. Derbyshire SW, Jones AK, Gyulai F et al. (1997) Pain processing during three levels of noxious stimulation produces differential patterns of central activity. *Pain* 73:431–445
32. Dong WK, Chudler EH, Sugiyama K et al. (1994) Somatosensory, multisensory, and task-related neurons in cortical area 7b (PF) of unanesthetized monkeys. *J Neurophysiol* 72:542–564
33. Dong WK, Hayashi T, Roberts VJ et al. (1996) Behavioral outcome of posterior parietal cortex injury in the monkey. *Pain* 64:579–587
34. Downar JD, Crawley AP, Mikulis DJ et al. (2002) A cortical network sensitive to stimulus salience in a neutral behavioral context across multiple sensory modalities. *J Neurophysiol* 87:615–620
35. Downar J, Mikulis DJ, Davis KD. (2003) Neural correlates of the prolonged salience of painful stimulation. *Neuroimage* 20:1540–1551
36. Drzezgza A, Darsow U, Treede RD et al. (2001) Central activation by histamine-induced itch: analogies to pain processing: a correlational analysis of O-15 H<sub>2</sub>O positron emission tomography studies. *Pain* 92:295–305
37. Dum RP, Strick PL (1993) Cingulate Motor Areas. In: Vogt BA, Gabriel M (eds) *Neurobiology of Cingulate Cortex and Limbic Thalamus: A Comprehensive Handbook*. Birkhauser, Boston
38. Duncan GH, Albanese MC (2003) Is there a role for the parietal lobes in the perception of pain? *Adv Neurol* 93:69–86
39. Ehrsson HH, Spence C, Passingham RE (2004) That’s My Hand! Activity in Premotor Cortex Reflects Feeling of Ownership of a Limb. *Science* 305:875–877
40. Fields HL (1999) Pain: an unpleasant topic. *Pain* 6: 61–69
41. Foltz EL, White LE (1962) Pain “relief” by frontal cingulotomy. *J Neurosurgery* 19:89–100
42. Frank LM, Brown EN (2003) Persistent activity and memory in the entorhinal cortex. *Trends in Neurosci* 26:400–401
43. Frot M, Mauguere F (2003) Dual representation of pain in the operculo-insular cortex in humans. *Brain* 126:438–450
44. Frot M, Garcia-Larrea L, Guenet M et al. (2001) Responses of the supra-sylvian (SII) cortex in humans to painful and innocuous stimuli: A study using intra-cerebral recordings. *Pain* 94:65–73
45. Gabriel M, Kubota Y, Sparenborg S et al. (1991) Effects of cingulate cortical lesions on avoidance learning and training-induced unit activity in rabbits. *Experimental Brain Res* 86:585–600
46. Gelnar PA, Krauss BR, Sheeche PR et al. (1999) A Comparative fMRI Study of Cortical Representations for Thermal Painful, Vibrotactile, and Motor Performance Tasks. *Neuroimage* 10:460–482
47. Gracely RH, Geisser ME, Giesecke T et al. (2004) Pain catastrophizing and neural responses to pain among persons with fibromyalgia. *Brain* 127:835–843
48. Greenspan JD, Winfield JA (1992) Reversible pain and tactile deficits associated with a cerebral tumor compressing the posterior insula and parietal operculum. *Pain* 50:29–39
49. Greenspan JD, Lee RR, Lenz FA (1999) Pain sensitivity alterations as a function of lesion location in the parasylvian cortex. *Pain* 81:273–282
50. Hebben N, Corkin S, Eichenbaum H et al. (1985) Diminished ability to interpret and report internal states after bilateral medial temporal resection: case H.M. *Behavioral Neurosci* 99:1031–1039
51. Hofbauer RK, Rainville P, Duncan GH et al. (2001) Cortical representation of the sensory dimension of pain. *J Neurophysiol* 86:402–411
52. Horiuchi T, Unoki T, Yokoh A et al. (1996) Pure sensory stroke caused by cortical infarction associated with the secondary somatosensory area. *J Neurol Neurosurg Psychiatry* 60:588–589
53. Hornak J, Bramham J, Rolls ET et al. (2003) Changes in emotion after circumscribed surgical lesions of the orbitofrontal and cingulate cortices. *Brain* 126:1691–1712



54. Hsieh J-C, Hagermark O, Stahle-Backdahl M et al. (1994) Urge to scratch represented in the human cerebral cortex during itch. *J Neurophysiol* 72:3004–3008
55. Hsieh J-C, Belfrage M, Stone-Elander S et al. (1995a) Central representation of chronic ongoing neuropathic pain studied by positron emission tomography. *Pain* 63:225–336
56. Hsieh J-C, Belfrage M, Stone-Elander S et al. (1995b) Central representation of chronic ongoing neuropathic pain studied by positron emission tomography. *Pain* 63:225–236
57. Hurt RW, Ballantine HT (1973) Stereotactic anterior cingulate lesions for persistent pain: A report on 68 cases. *Clin Neurosurg* 21:334–351
58. Hutchins KD, Martino AM, Strick PL (1988) Corticospinal projections from the medial wall of the hemisphere. *Experimental Brain Res* 71:667–672
59. Hutchison WD, Davis KD, Lozano AM et al. (1999) Pain-related neurons in the human cingulate cortex. *Nat Neurosci* 2:403–405
60. Iadarola MJ, Berman KF, Zeffiro TA et al. (1998) Neural activation during acute capsaicin-evoked pain and allodynia assessed with PET. *Brain* 121:931–947
61. Inui K, Tran TD, Qiu Y et al. (2003) A comparative magnetoencephalographic study of cortical activations evoked by noxious and innocuous somatosensory stimulations. *Neurosci* 120:235–248
62. Johansen JP, Fields HL (2004) Glutamatergic activation of anterior cingulate cortex produces an aversive teaching signal. *Nat Neurosci* 7:398–403
63. Johansen JP, Fields HL, Manning BH (2001) The affective component of pain in rodents: Direct evidence for a contribution of the anterior cingulate cortex. *Proc Natl Acad Sci USA* 98:8077–8082
64. Kaas JH (1993) The functional organization of somatosensory cortex in primates. *Ann. Anat* 175:509–518
65. Kaas JH, Nelson RJ, Sur M et al. (1979) Multiple representations of the body within the primary somatosensory cortex of primates. *Science* 204:521–523
66. Kaas JH, Florence SL, Neeraj J (1997) Reorganization of sensory systems of primates after injury. *The Neuroscientist* 3:123–130
67. Kakigi R, Koyama S, Hoshiyama M et al. (1995) Pain-related magnetic fields following painful CO<sub>2</sub> laser stimulation in man. *Neurosci Letters* 192:45–48
68. Kakigi R, Watanabe S, Yamasaki H (2000) Pain-Related somatosensory evoked potentials. *J Clinical Neurophysiol* 17:295–308
69. Kakigi R, Tran TD, Qiu Y et al. (2003) Cerebral responses following stimulation of unmyelinated C-fibers in humans: electro- and magneto-encephalographic study. *Neurosci Res* 45:255–275
70. Kanda M, Nagamine T, Ikeda A et al. (2000) Primary somatosensory cortex is actively involved in pain processing in human. *Brain Research* 853:282–289
71. Karnath HO (2001) New insights into the functions of the superior temporal cortex. *Nat Rev Neurosci* 2:568–576
72. Karnath HO, Ferber S, Himmelbach M (2001) Spatial awareness is a function of the temporal not the posterior parietal lobe. *Nature* 411:950–953
73. Kenshalo DR, Isensee O (1983) Responses of primate S1 cortical neurons to noxious stimuli. *J Neurophysiol* 50:1479–1496
74. Kenshalo DR, Chudler EH, Anton F et al. (1988) S1 nociceptive neurons participate in the encoding process by which monkeys perceive the intensity of noxious thermal stimulation. *Brain Res* 454:378–382
75. Kenshalo DR, Iwata K, Sholas M et al. (2000) Response properties and organization of nociceptive neurons in Area I of monkey primary somatosensory cortex. *J Neurophysiol* 84:719–729
76. Khanna S, Sinclair JG (1989) Noxious stimuli produce prolonged changes in the CA1 region of the rat hippocampus. *Pain* 39:337–343
77. Khanna S, Sinclair JG (1992) Responses in the CA1 region of the rat hippocampus to a noxious stimulus. *Exp Neurol* 117:28–35
78. Khanna S, Seong Chang L, Jiang F et al. (2004) Nociception-driven decreased induction of Fos protein in ventral hippocampus field CA1 of the rat. *Brain Res* 1004:167–176
79. Koyama T, Tanaka YZ, Mikami A (1998) Nociceptive neurons in the macaque anterior cingulate activate during anticipation of pain. *Neuroreport* 9:2663–2667
80. Koyama T, Kato K, Mikami A (2000) During pain-avoidance neurons activated in the macaque anterior cingulate and caudate. *Neurosci Letters* 283:17–20
81. Koyama T, Kato K, Tanaka YZ et al. (2001) Anterior cingulate activity during pain-avoidance and reward tasks in monkeys. *Neurosci Res* 39:421–430
82. Kringelbach ML, Rolls ET (2004) The functional neuroanatomy of the human orbitofrontal cortex: evidence from neuroimaging and neuropsychology. *Prog Neurobiol* 72:341–372
83. Kumral E, Bayulkem G, Evyapan D et al. (2002) Spectrum of anterior cerebral artery territory infarction: clinical and MRI findings. *Eur J Neurol* 9:615–624
84. Ladabaum U, Minoshima S, Owyang C (2000) Pathobiology of visceral pain: Molecular mechanisms and therapeutic implications v. Central nervous system processing of somatic and visceral sensory signals. *Am J Physiol Gastrointest Liver Physiol* 279:1–6
85. Laitinen LV (1979) Emotional responses to subcortical electrical stimulation in psychiatric patients. *Clin Neurol Neurosurg* 81:148–157
86. LeDoux JE (2000) Emotion circuits in the brain. *Ann Rev Neurosci* 23:155–184
87. Lenz FA, Rios M, Zirh A et al. (1998) Painful stimuli evoke potentials recorded over the human anterior cingulate gyrus. *J Neurophysiol* 79:2231–2234
88. Lighthall JW (1988) Controlled cortical impact: a new experimental brain injury model. *J Neurotrauma* 5:1–15
89. Lighthall JW, Dixon CE, Anderson TE (1989) Experimental models of brain injury. *J Neurotrauma* 6:83–97
90. Lorenz J, Cross D, Minoshima S et al. (2002) A unique representation of heat allodynia in the human brain. *Neuron* 35:383–393
91. Lorenz J, Minoshima S, Casey KL (2003) Keeping pain out of mind: the role of the dorsolateral prefrontal cortex in pain modulation. *Brain* 126:1079–1091
92. MacLean PD (1955) The limbic system ("visceral brain") in relation to the central gray and reticulum of the brain stem. *Psychosom Med* 17:355–366
93. Marshall J (1951) Sensory disturbances in cortical wounds with special reference to pain. *J Neurol Neurosurg Psychiat* 14:187–204
94. Melzack R, Casey KL (1968) Sensory, Motivational and Central Control Determinants of Pain. In: Kenshalo DR (ed) *The Skin Senses*. CC Thomas, Springfield, pp 423–439
95. Merskey H, Bogduk N (1994) Classification of Chronic Pain: Descriptions of Chronic Pain Syndromes and Definitions of Pain Terms, 2nd edn. IASP Press, Seattle
96. Mesulam MM (1990) Large-scale neurocognitive networks and distributed processing for attention, language, and memory. *Ann Neurol* 28:597–613
97. Mesulam MM, Mufson EJ (1982a) Insula of the old world monkey. II. Afferent cortical input and comments on the claustrum. *J Comparative Neurol* 212:23–37
98. Mesulam MM, Mufson EJ (1982b) Insula of the old world monkey. III. Efferent cortical input and comments on function. *J Comparative Neurol* 212:38–52
99. Minagar A, David NJ (1999) Bilateral infarction in the territory of the anterior cerebral arteries. *Neurol* 52:886–888

100. Mochizuki H, Saito H (1990) Mesial frontal lobe syndromes: correlations between neurological deficits and radiological localizations. *Tohoku J Exp Med* 161:231–239
101. Neugebauer V, Li W, Bird GC et al. (2004) The Amygdala and Persistent Pain. *The Neuroscientist*
102. Nii Y, Uematsu S, Lesser RP et al. (1996) Does the central sulcus divide motor and sensory functions? Cortical mapping of human hand areas as revealed by electrical stimulation through subdural grid electrodes. *Neurol* 46:360–367
103. Ongur D, An X, Price JL (1998) Prefrontal cortical projections to the hypothalamus in macaque monkeys. *J Comp Neurol* 401:480–505
104. Opsommer E, Weiss T, Plaghki L et al. (2001) Dipole analysis of ultralate (C-fibres) evoked potentials after laser stimulation of tiny cutaneous surface areas in humans. *Neurosci Letters* 298:41–44
105. Ostrowsky K, Isnard J, Ryvlin P et al. (2000) Functional mapping of the insular cortex: clinical implication in temporal lobe epilepsy. *Epilepsia* 41:681–686
106. Ostrowsky K, Magnin M, Ryvlin P et al. (2002) Representation of Pain and Somatic Sensation in the Human Insula: a Study of Responses to Direct Electrical Cortical Stimulation. *Cerebral Cortex* 12:376–385
107. Papez JW (1937) A proposed mechanism of emotion. *Archives of Neurological Psychiatry* 38:725–743
108. Pastoriza LN, Morrow TJ, Casey KL (1996) Medial frontal cortex lesions selectively attenuate the hot plate response: possible nocifensive apraxia in the rat. *Pain* 64:11–17
109. Peyron R, Garcia-Larrea L, Gregoire MC et al. (1999) Haemodynamic brain responses to acute pain in humans: sensory and attentional networks. *Brain* 122:1765–1780
110. Peyron R, Laurent B, Garcia-Larrea L (2000) Functional imaging of brain responses to pain. A review and meta-analysis. *Neurophysiol Clin* 30:263–288
111. Peyron R, Frot M, Schneider F et al. (2002) Role of Operculoinsular Cortices in Human Pain Processing: Converging Evidence from PET, fMRI, Dipole Modeling, and Intracerebral Recordings of Evoked Potentials. *Neuroimage* 17:1336–1346
112. Ploghaus A, Narain C, Beckmann CF et al. (2001) Exacerbation of pain by anxiety is associated with activity in a hippocampal network. *J Neurosci* 21:9896–9903
113. Ploghaus A, Tracey I, Gati JS et al. (1999) Dissociating pain from its anticipation in the human brain. *Science* 284:1979–1981
114. Ploghaus A, Tracey I, Clare S et al. (2000) Learning about pain: the neural substrate of the prediction error for aversive events. *Proc Natl Acad Sci USA* 97:9281–9286
115. Ploner M, Schmitz F, Freund HJ et al. (1999) Parallel activation of primary and secondary somatosensory cortices in human pain processing. *J Neurophysiol* 81:3100–3104
116. Ploner M, Gross J, Timmermann L et al. (2002) Cortical representation of first and second pain sensation in humans. *Proc Natl Acad Sci USA* 99:12444–12448
117. Porro CA, Baraldi P, Pagnoni G et al. (2002) Does Anticipation of Pain Affect Cortical Nociceptive Systems? *J Neurosci* 22:3206–3214
118. Price DD (1988) *Psychological and Neural Mechanisms of Pain*. Raven Press, New York
119. Price DD (1999) *Psychological Mechanisms of Pain and Analgesia*. IASP Press, Seattle
120. Price DD (2000) Psychological and Neural Mechanisms of the Affective Dimension of Pain. *Science* 288:1769–1772
121. Rainville P (2002) Brain mechanisms of pain affect and pain modulation. *Curr Opin Neurobiol* 12:195–204
122. Rainville P, Duncan GH, Price DD et al. (1997) Pain affect encoded in human anterior cingulate but not somatosensory cortex. *Science* 277:968–971
123. Ramnani N, Owen AM (2004) Anterior Prefrontal Cortex: Insights into Function from Anatomy and Neuroimaging. *Nat Rev Neurosci* 5:184–194
124. Rizzolatti G, Luppino G, Matelli M (1998) The organization of the cortical motor system: new concepts. *Electroencephalogr Clin Neurophysiol* 106:283–296
125. Robinson CJ, Burton H (1980) Organization of somatosensory receptive fields in cortical areas 7b, retroinsula, postauditory and granular insula of *M. fascicularis*. *J Comp Neurol* 192:69–92
126. Rolls ET (2000) The orbitofrontal cortex and reward. *Cereb Cortex* 10:284–294
127. Rolls ET, O'Doherty J, Kringelbach ML et al. (2003) Representations of Pleasant and Painful Touch in the Human Orbitofrontal and Cingulate Cortices. *Cereb Cortex* 13:308–317
128. Ruben J, Schwiemann J, Deuchert M, et al. (2001) Somatotopic organization of human secondary somatosensory cortex. *Cereb Cortex* 11:463–473
129. Russell WR (1945) Transient disturbances following gunshot wounds of the head. *Brain* 68:79–97
130. Sakai K (2003) Reactivation of memory: role of medial temporal lobe and prefrontal cortex. *Rev Neurosci* 14:241–252
131. Schmähmann JD, Leifer D (1992) Parietal pseudothalamic pain syndrome: Clinical features and anatomic correlates. *Arch Neurol* 49:1032–1037
132. Schneider RJ, Friedman DP, Mishkin M (1993) A modality-specific somatosensory area within the insula of the rhesus monkey. *Brain Res* 621:116–120
133. Schnitzler A, Ploner M (2000) Neurophysiology and functional neuroanatomy of pain perception. *J Clin Neurophysiol* 17:592–603
134. Sikes RW, Vogt BA (1992) Nociceptive neurons in area 24 of rabbit cingulate cortex. *J Neurophysiol* 68:1720–1732
135. Simons JS, Spiers HJ (2003) Prefrontal and medial temporal lobe interactions in long-term memory. *Nat Rev Neurosci* 4:637–648
136. Simpson JR Jr, Drevets WC, Snyder AZ et al. (2001) Emotion-induced changes in human medial prefrontal cortex: II. During anticipatory anxiety. *Proc Natl Acad Sci USA* 98:688–693
137. Smith EE, Jonides J (1999) Storage and Executive Processes in the Frontal Lobes. *Science* 283:1657–1661
138. Spiller WG, Martin E (1912) The treatment of persistent pain of organic origin in the lower part of the body by division of the anterolateral column of the spinal cord. *J Am Med Association* 58:1489–1492
139. Stevens RT, London SM, Apkarian AV (1993) Spinothalamic cortical projections to the secondary somatosensory cortex (SII) in squirrel monkey. *Brain Res* 631:241–246
140. Stuss DT, Benson DF (1986) *The Frontal Lobes*. Raven, New York
141. Svensson P, Minoshima S, Beydoun A et al. (1997) Cerebral processing of acute skin and muscle pain in humans. *J Neurophysiol* 78:450–460
142. Sweet WH (1982) Cerebral localization of pain. In: Thompson RA, Green JR (eds) *New Perspectives in Cerebral Localization*. Raven Press, New York, pp 205–242
143. Talairach J, Bancaud J, Geier S et al. (1973) The cingulate gyrus and human behaviour. *Electroencephalogr Clin Neurophysiol* 34:45–52
144. Tommerdahl M, Delemos KA, Vierck CJ Jr et al. (1996) Anterior parietal cortical response to tactile and skin-heating stimuli applied to the same skin site. *J Neurophysiol* 75:2662–2670
145. Tracey I, Becerra L, Chang I et al. (2000) Noxious hot and cold stimulation produce common patterns of brain activation in humans: a functional magnetic resonance imaging study. *Neurosci Lett* 288:159–162
146. Tran TD, Inui K, Hoshiyama M et al. (2002) Cerebral activation by the signals ascending through unmyelinated C-fibers in humans: a magnetoencephalographic study. *Neuroscience* 113:375–386
147. Treede RD, Kenshalo DR, Gracely RH et al. (1999) The cortical representation of pain. *Pain* 79:105–111

148. Treede RD, Apkarian AV, Bromm B et al. (2000) Cortical representation of pain: functional characterization of nociceptive areas near the lateral sulcus. *Pain* 87:113–119
149. Turken, A. U. and Swick, D. (1999) Response selection in the human anterior cingulate cortex. *Nat Neurosci* 2:920–924
150. Vogt BA, Derbyshire S, Jones AKP et al. (1996) Pain processing in four regions of human cingulate cortex localized with co-registered PET and MR imaging. *Eur J Neurosci* 8:1461–1473
151. Vogt BA, Finch DM, Olson CR (1992) Functional heterogeneity in cingulate cortex: the anterior executive and posterior evaluative regions. *Cereb Cortex* 2:435–443
152. von Cramon D, Jurgens U (1983) The anterior cingulate cortex and the phonatory control in monkey and man. *Neurosci Biobehav Rev* 7:423–425
153. Wager TD, Phan KL, Liberzon I et al. (2003) Valence, gender, and lateralization of functional brain anatomy in emotion: a meta-analysis of findings from neuroimaging. *Neuroimage* 19:513–531
154. Wager TD, Rilling JK, Smith EE et al. (2004) Placebo-induced changes in fMRI in the anticipation and experience of pain. *Science* 303:1162–1167
155. Wall PD (1979) On the relation of injury to pain the John J. Bonica Lecture. *Pain* 6:253–264
156. Ward R, Duncan J, Shapiro K (1996) The Slow Time-Course of Visual Attention. *Cog Psychol* 30:79–109
157. Whitsel BL, Dreyer DA, Roppolo JR (1971) Determinants of body representation in postcentral gyrus of macaques. *J Neurophysiol* 34:1018–1034
158. Yamamura H, Iwata K, Tsuboi Y et al. (1996) Morphological and electrophysiological properties of ACC nociceptive neurons in rats. *Brain Res* 735:83–92
159. Zhang ZH, Dougherty PM, Oppenheimer SM (1999) Monkey insular cortex neurons respond to baroreceptive and somatosensory convergent inputs. *Neurosci* 94:351–360

C

## Cortical Projections

- ▶ Corticothalamic and Thalamocortical Interactions

## Cortical Reorganization

### Definition

A functional or structural change in the primary sensorimotor areas of the cortex that can also occur in the adult nervous system but was long thought possible only in the developing organism.

- ▶ Phantom Limb Pain, Treatment

## Cortical Spreading Depression

### Definition

A wave of activation followed by deactivation that moves across the surface of the brain typically at 2–6 mm/min. It is widely considered to be the animal equivalent of migraine aura.

- ▶ Migraine, Pathophysiology

## Cortical Stimulation for Relief of Pain

- ▶ Pain Treatment, Motor Cortex Stimulation

## Cortic limbic Circuits

### Definition

Pathway through parietal opercular cortex, including SII, and insula cortex to the medial temporal lobe including amygdala and hippocampus

- ▶ Angina Pectoris, Neurophysiology and Psychophysics

## Corticortical Pathways

- ▶ Thalamocortical Loops and Information Processing

## Corticospinal Tract

### Definition

A motor pathway originating in the motor cortex and terminating in brainstem and spinal motor nuclei. Injury of this pathway can lead to paresis of the ipsilateral lower limb.

- ▶ Percutaneous Cordotomy

## Corticosteroid Injections

- ▶ Steroid Injections

## Corticothalamic and Thalamocortical Interactions

EDWARD JONES

Center for Neuroscience, University of California,  
Davies, CA, USA  
ejones@ucdavis.edu

### Synonyms

Bursting activity; 40 Hz oscillations; Reticular Nucleus Inputs from Cortex; Cortical Projections; Thalamic Projections; Thalamocortical and Corticothalamic Interactions

### Definition

Cortical projections to dorsal thalamic nuclei and to thalamic reticular nucleus, together with projections from the thalamus to the cortex form the basic thalamocortical- corticothalamic loop. Neuronal connectivity in these loops, involved neurotransmitters and synaptic mechanisms define distinct dynamical states of this network.

### Characteristics

► **Corticothalamic fibers** arise in every area of the cerebral cortex and every dorsal thalamic nucleus receives the terminations of corticothalamic fibers. The cells of origin of these fibers form two distinct classes. Both are a form of ► **pyramidal neuron**, with spiny dendrites and utilize glutamate as the transmitter. One class, with soma located in layer VI is characterized by small size, a thin ascending apical dendrite that devolves into a tuft of branches in layer IV where it receives monosynaptic inputs from thalamic fibers and strongly recurrent, columnar axon collaterals (Fig. 1). The thin primary axon of these cells returns to the thalamic nucleus from which the cortical area in which it lies receives thalamic input, giving off collateral branches to the ► **thalamic reticular nucleus en route** (Fig. 2). A second class, with soma located in layer V is larger, with an apical dendrite that ascends to layer I, ending there in a tuft of spiny branches and a set of lengthy horizontal axon collaterals that connect extensive stretches of layers III and V (Fig. 1). The relatively thick primary axon of these cells descends and sends branches to multiple subcortical sites, such as the spinal cord, brainstem, tectum, basal ganglia and thalamus. The thalamic branches traverse the reticular nucleus without giving off collaterals and end primarily in nuclei other than the primary sensory nuclei, especially in those characterized by a high density of matrix cells (see ► **Spinothalamic terminations, core ans matrix**) (Fig. 2).

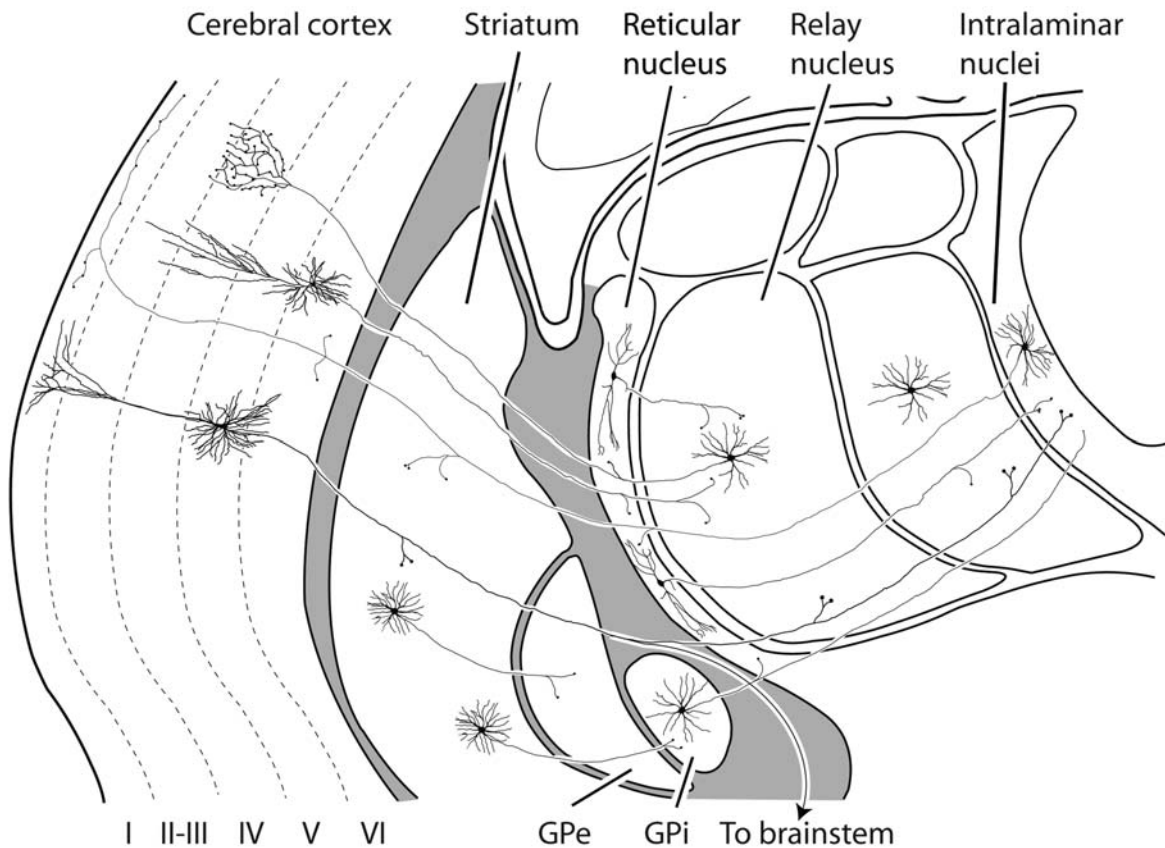
The reticular nucleus, which is innervated by the collaterals of the layer VI corticothalamic cells, occupies a key place in the circuitry connecting thalamus and cortex; it is also innervated by collaterals of thalamocortical axons

arising in the underlying dorsal thalamus. Because of the differences in the diameters of the corticothalamic and ► **thalamocortical fibers** that provide collateral inputs to the reticular nucleus, it is possible physiologically to identify the two kinds of collateral synapse. A brief electrical stimulus applied to the cerebral cortex or underlying white matter elicits short latency ► **EPSCs** in reticular nucleus cells due to ► **antidromic invasion** of thalamocortical collaterals and longer latency EPSCs due to ► **orthodromic activation** of the slower corticothalamic fibers (Golshani et al. 2001; Liu et al. 2001). EPSCs attributable to collateral corticothalamic synapses have a consistent amplitude, reflecting their small size and a single vesicle release site, but a wide range of rise times, reflecting their wide distribution over the dendritic tree of reticular nucleus cells (Liu et al. 2001). Unitary EPSCs attributable to collateral thalamocortical synapses tend to have large, although more variable amplitudes, reflecting their large size and multiple release sites, but very consistent rise times, reflecting their proximal location on the dendritic tree.

In the dorsal thalamus, more than 40% of the synapses on a thalamic relay cell are derived from layer VI corticothalamic fibers and are concentrated on secondary and especially on tertiary dendrites (Liu et al. 1995a). Less than 20% are derived from medial lemniscal or optic tract or other subcortical fibers and are concentrated on proximal dendrites. These terminals tend to have multiple points of synaptic contact, including on dendritic protrusions and the parent shafts. The remaining 40% of synapses are inhibitory and tend to be concentrated on proximal and second order dendrites and on the soma. The majority of these terminals are derived from axons of the reticular nucleus (Liu et al. 1995b). A lesser number are derived from the presynaptic dendrites of intrinsic interneurons in animals that possess these neurons. The terminals of layer V-originating corticothalamic fibers end in large terminals concentrated proximally, in numbers that have not yet been quantified.

The glutamatergic nature of corticothalamic synapses is evidenced by the ability to record ► **NMDA** -, ► **AMPA** - and ► **metabotropic glutamate** receptor-based EPSCs in relay cells and in reticular nucleus cells under appropriate conditions (McCormick and Von Krosigk 1992; Kao and Coulter 1997; Turner and Salt 1998, 1999; Golshani et al. 1998; Zhang and Jones 2004). However, corticothalamic stimulation can also engender a powerful disynaptic, feed-forward inhibition of relay cells, resulting from co-activation of the reticular nucleus. The importance of this corticothalamic-induced inhibition of the relay cells is that it drives them towards the burst-firing mode. As they recover from this inhibition, the ► **low threshold calcium conductance**,  $I_T$ , is de-inactivated and the cells fire a burst of action potentials. This has the effect of re-exciting, *via* the collaterals of thalamocortical fibers, the reticular nucleus cells, which then fire a new burst of action potentials. These re-inhibit the relay





C

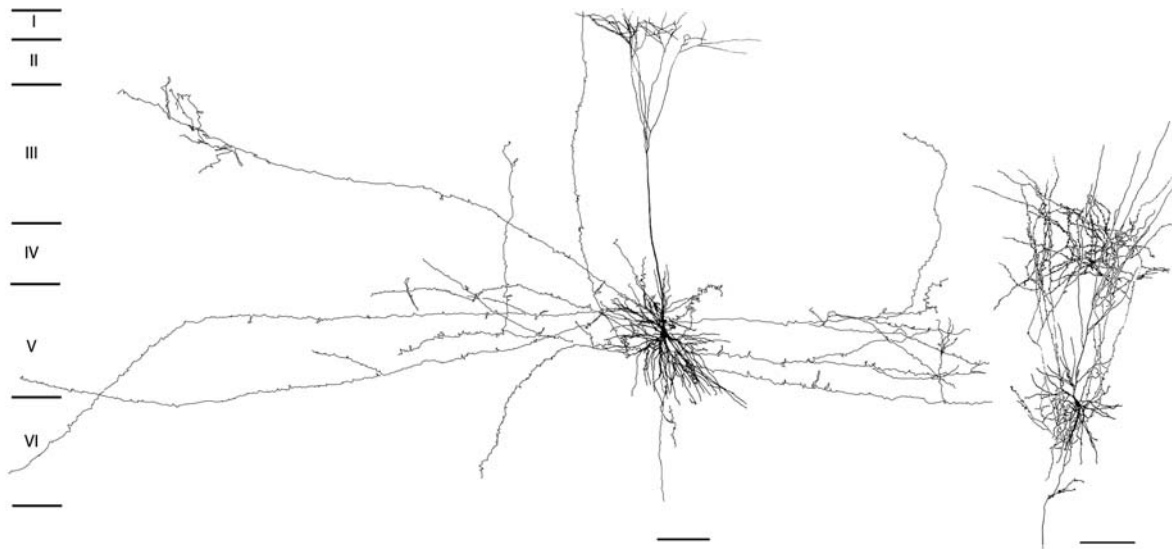
**Corticothalamic and Thalamocortical Interactions, Figure 1** Schematic view of the background matrix (left) of the ventral posterior complex, with its input from the spinothalamic and spinal trigeminothalamic systems and widespread projection to superficial layers of the cerebral cortex, contrasted with the core, restricted to the VPM and VPL nuclei, with its input from the lemniscal system and topographically-organized projection to middle layers of the primary somatosensory cortex. Based on Jones (2006). Abbreviations: Vmb, basal ventral medial nucleus; VPI, ventral posterior inferior nucleus; VPL, ventral posterior lateral nucleus; VPM, ventral posterior medial nucleus.

cells, which burst again on recovering and so the cycle continues at 7–14 Hz, the spindle frequency. Recordings made simultaneously from reticular nucleus and relay cells in the underlying dorsal thalamus clearly demonstrate synchrony of their discharges at spindle frequencies, a result of the synaptic interplay between the two sets of cells.

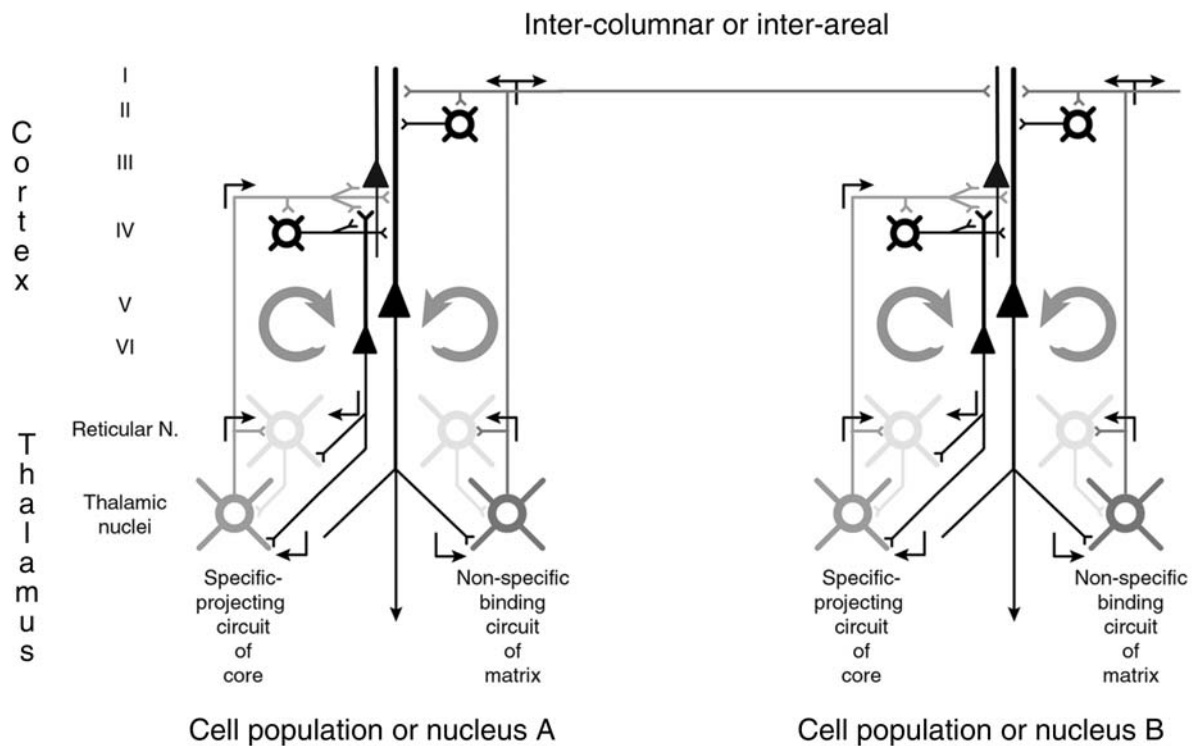
Apart from causing repetitive burst firing in relay cells, a reticular nucleus cell, by reason of the widespread terminations of its axon within the dorsal thalamus, has the effect of distributing the disynaptic inhibitory effects of corticothalamic stimulation across many relay cells, thus helping to promote synchrony throughout the whole thalamo-cortico-thalamic network. Spread of corticothalamic effects across many reticular nucleus cells and recruitment of others by collateral inputs from the thalamocortical axons of bursting relay cells will also serve to spread spindle oscillations across most of the thalamus and cortex. The simultaneous onset of spindles throughout cortex and thalamus implies rapid diffusion of reticular nucleus effects on relay cells and equally rapid collateral excitation of widespread

sections of the reticular nucleus by bursting relay cells (Steriade and Amzica 1996). Although the corticothalamic system is particularly powerful in inducing spindle oscillations, it is the reticular nucleus that is the prime mover in synchronizing the oscillations of virtually all cells in the network. Its capacity to do this is enhanced when the weak inhibitory effects of one reticular nucleus cell on another are removed (Sohal et al. 2000).

The power of the corticothalamic projection to induce ► **low frequency oscillations** in the spindle range clearly depends upon the capacity of the disynaptic inhibitory effect of the reticular nucleus to overcome the direct, monosynaptic excitatory effect of corticothalamic fibers upon the relay cells of the dorsal thalamus. To effect this, the strength of the corticothalamic input to the reticular nucleus is stronger than that to the relay cells. Corticothalamic EPSCs in the reticular nucleus cells are nearly three times larger than in relay cells (Golshani et al 2001). The basis for this difference in AMPA-receptor based synaptic strength depends upon the presence of nearly three times as many GluR<sub>4</sub> receptor subunits at the corticothalamic synapses on the reticular nucleus



**Corticothalamic and Thalamocortical Interactions, Figure 2** Photomicrographs of adjacent frontal sections through the thalamus of a macaque monkey, showing the parvalbumin immunoreactive core of the ventral posterior nucleus (a) and the calbindin immunoreactive matrix (b). Bar 500  $\mu$ m. s, enhanced matrix region of VPM; CL, central lateral nucleus; CM, centre median nucleus; other abbreviations as in Fig 1. Arrow indicates region of parvalbumin and calbindin overlap in medial VPM. From Jones (2005).



**Corticothalamic and Thalamocortical Interactions, Figure 3** Laminar and areal projections of neurons in the ventral posterior nucleus of monkeys. Core regions (gray) receiving inputs from different classes of peripheral mechanoreceptors project to middle layers of specific cortical fields. Matrix regions (crosses) receiving inputs from the spinothalamic and spinal trigeminothalamic systems project to superficial layers of all fields. From Jones (2006).

cells than at corticothalamic synapses on relay cells (Liu et al. 2001). Increases in channel opening time consequent upon this enrichment should account for the larger EPSCs in the reticular nucleus cells.

Unlike the corticothalamic synapses at which GluR<sub>4</sub> receptor subunits are enriched in comparison with other AMPA receptor subunits, notably GluR<sub>3</sub>, the larger col-lateral thalamocortical synapses in the reticular nucleus

possess GluR<sub>4</sub> and GluR<sub>3</sub> subunits in equal proportions. The collateral thalamocortical synapses provide the capacity for the powerful ► **re-entrant excitation** of the reticular nucleus cells by bursts of action potentials in relay cells during the course of spindle oscillations. When thalamic relay cells are relatively depolarized, as in the alert attentive state, they tend to display intrinsic membrane oscillations at 20–50 Hz (Pedroarena and Llinás, 1997). Under these circumstances, with the disinhibitory inhibition of the reticular nucleus rendered less effective, corticothalamic stimulation tends to promote oscillatory activity at ~40 Hz in the connected thalamo-cortico-thalamic network. ► **Forty Hz Oscillations** is an accompaniment of attention, perception and higher cognitive states.

In cooperation with the corticothalamic system, the cells of the thalamic matrix form a basis for dispersion of activity across larger areas of cortex than those of the core with their focused projections to an individual area. Within an area, the terminations of matrix cell axons on distal dendrites in superficial layers and of matrix cell axons on more proximal dendrites in middle layers should serve as a coincidence detection circuit leading to a high degree of temporal integration (Llinás and Paré 1997) (Fig. 3). This in turn should promote synchronous activity in the cells of individual cortical columns and in a group of columns activated by the same stimulus. Oscillatory activity in these cortical columns should be fed back by layer VI corticothalamic cells to the thalamic nucleus from which they receive input, serving to reinforce the synchrony. Synchronous activity would be spread across other cortical columns in the same cortical area and in adjacent cortical areas by the diffuse projections of matrix cells in the thalamic nucleus. However, other thalamic nuclei and, through their matrix cells, other cortical areas should also be recruited into large scale coherent activity by the diffuse intracortical and corticothalamic projections of layer V corticothalamic neurons. This is thought to be a key to the binding together of the various elements of a cognitive event.

## References

- Golshani P, Warren RA, Jones EG (1998) Progression of change in NMDA, non-NMDA, and metabotropic glutamate receptor function at the developing corticothalamic synapse. *J Neurophysiol* 80:143–154
- Golshani P, Liu X-B, Jones EG (2001) Differences in quantal amplitude reflect GluR<sub>4</sub>- subunit number at corticothalamic synapses on two populations of thalamic neurons. *Proc Natl Acad Sci USA* 98:4172–4177
- Jones, EG (2005) *The Thalamus – Revisited*. Cambridge University Press, Cambridge
- Kao CQ, Coulter DA (1997) Physiology and pharmacology of corticothalamic stimulation- evoked responses in rat somatosensory thalamic neurons *in vitro*. *J Neurophysiol* 77:2661–2676
- Liu X-B, Warren RA, Jones EG (1995a) Synaptic distribution of afferents from reticular nucleus in ventroposterior nucleus of cat thalamus. *J Comp Neurol* 352:187–202
- Liu X-B, Honda CN, Jones EG (1995b) Distribution of four types of synapse on physiologically identified relay neurons in the ventral posterior thalamic nucleus of the cat. *J Comp Neurol* 352:69–91
- Liu X-B, Bolea S, Golshani P et al. (2001) Differentiation of corticothalamic and thalamocortical collateral synapses on mouse reticular nucleus neurons by EPSC amplitude and AMPA receptor subunit composition. *Thalamus Related Systems* 1:15–29
- Llinás R, Paré D (1997) Coherent oscillations in specific and non-specific thalamocortical networks and their role in cognition. In: Steriade M, Jones EG, McCormick DA (eds) *Thalamus Volume II Experimental and Clinical Aspects*. Elsevier, Amsterdam, pp 501–516
- McCormick DA, von Krosigk M (1992) Corticothalamic activation modulates thalamic firing through glutamate “metabotropic” receptors. *Proc Natl Acad Sci USA* 89:2774–2778
- Pedroarena C, Llinás R (1997) Dendritic calcium conductances generate high-frequency oscillation in thalamocortical neurons. *Proc Natl Acad Sci USA* 94:724–728
- Sohal VS, Huntsman MM, Huguenard JR (2000) Reciprocal inhibitory connections regulate the spatiotemporal properties of intrathalamic oscillations. *J Neurosci* 20:1735–1745
- Steriade M, Amzica F (1996) Intracortical and corticothalamic coherency of fast spontaneous oscillations. *Proc Natl Acad Sci USA* 93:2533–2538
- Turner JP, Salt TE (1998) Characterization of sensory and corticothalamic excitatory inputs to rat thalamocortical neurones *in vitro*. *J Physiol* 510:829–843
- Turner JP, Salt TE (1999) Group III metabotropic glutamate receptors control corticothalamic synaptic transmission in the rat thalamus *in vitro*. *J Physiol* 519:481–491
- Zhang L, Jones EG (2004) Corticothalamic inhibition in the thalamic reticular nucleus. *J Neurophysiol* 91:759–766

## Corticothalamic Fibers

### Definition

Axons with cell bodies located in the cortex with terminations in the thalamus.

► **Corticothalamic and Thalamocortical Interactions**

## Cortisol

### Definition

Hormone released by the adrenal glands. It is regulated by many endogenous substances, e.g. the serotonin 5-HT<sub>1</sub> receptors, which induce a biphasic response. In fact, 5-HT<sub>1</sub> agonists first induce a cortisol increase, followed by a decrease.

► **Placebo Analgesia and Descending Opioid Modulation**

## Cost Shifting

### Definition

Cost shifting can be said to occur in health care when changes in the reimbursement for the delivery of health services, or alterations in the parameters of health benefits displace part of the cost of health care expenditures from one sphere of healthcare to another, or from

healthcare institutions to patients and/or their families. Examples of this would include attempts by state governments to attempt to restrict reimbursement for medications to cheaper non-brand name medications, or to limit access to categories of medications such as the Cox B anti-inflammatory medications. This cost is displaced onto underinsured consumers. Often as a result of inability to absorb such costs, patients are hospitalized or placed in skilled nursing facilities.

- ▶ [Cancer Pain Management, Undertreatment and Clinician-Related Barriers](#)

## Costoclavicular Syndrome

- ▶ [Thoracic Outlet Syndrome](#)

## Co-Transmission

### Definition

Many neurons synthesize two different types of neurotransmitters. Small molecule neurotransmitters such as glutamate and acetylcholine, are recycled or synthesized at the level of the nerve terminal and stored in small synaptic vesicles. Peptidergic transmitters are synthesized as part of large precursor proteins on the rough endoplasmic reticulum in the cell body and transported into the Golgi apparatus where they are packaged into large, dense-core vesicles that are transported to the nerve terminal. Transmitters released from small clear vesicles generate rapid synaptic responses, because small vesicles are located closest to the voltage-dependent  $Ca^{2+}$  channels that provide the influx of  $Ca^{2+}$  that activates the release process, and small molecule transmitters in synaptic vesicles activate ionotropic receptors. As large, dense-core vesicles are located at a greater distance from the site of  $Ca^{2+}$  influx, higher firing frequencies are required to initiate release of transmitter from these vesicles. Peptidergic transmitters activate metabotropic receptors that couple to intracellular signaling pathways. Thus, peptidergic transmission is capable of modulating neurotransmission of small molecule transmitters.

- ▶ [Spinothalamic Tract Neurons, Peptidergic Input](#)

## Cotrimoxazol

### Definition

Treatment of choice in the limited stage of WG (combination of 2 x 800 mg sulfamethoxazol and 2 x 160 mg trimethoprim).

- ▶ [Headache Due to Arteritis](#)

## Cotunnus Disease

- ▶ [Sciatica](#)

## Counterirritation

### Definition

The mechanisms by which any kind of intense and noxious stimulus elicits an analgesic effect distant from the site of the pain producing effect.

- ▶ [Acupuncture Mechanisms](#)
- ▶ [Tourniquet Test](#)

## Coupling Media of Ultrasound

### Definition

Coupling media are mineral oil or several commercially available coupling gels. They have similar transmissivities to the reference standard of distilled degassed water.

- ▶ [Ultrasound Therapy of Pain from the Musculoskeletal System](#)

## Coupling of Sympathetic Postganglionic Neurons onto Primary Afferent Nerve Fibers

- ▶ [Sympathetic-Afferent Coupling in the Afferent Nerve Fiber, Neurophysiological Experiments](#)

## COX

- ▶ [Cyclooxygenases](#)
- ▶ [Cyclooxygenases in Biology and Disease](#)
- ▶ [NSAIDs, COX-Independent Actions](#)
- ▶ [NSAIDs, Mode of Action](#)
- ▶ [COX-1 and COX-2 in Pain](#)

## COX Isozymes

### Definition

Are subsets of the cyclooxygenase enzymes that catalyze the conversion of arachidonic acid to prostaglandins and other products involved in pain signaling.

- ▶ [Drugs with Mixed Action and Combinations, Emphasis on Tramadol](#)



## COX-1

### ► COX-1 and COX-2 in Pain

## COX-1 and COX-2 in Pain

IRMGARD TEGEDER

Center of Pharmacology, University Clinic Frankfurt, Frankfurt, Germany  
tegeder@em.uni-frankfurt.de

### Synonyms

Cyclooxygenase-1; Cyclooxygenase-2; COX-1; COX-1; PGHS-1; PGHS-2; prostaglandin endoperoxide synthase 1; prostaglandin endoperoxide synthase 2; Ptg1; Ptg2

### Definition

The isoenzymes ► **Cyclooxygenases** -1 and -2 (COX-1 and COX-2) catalyze the conversion of arachidonic acid (AA) to prostaglandin H<sub>2</sub> (PGH<sub>2</sub>) which is the rate limiting step in the biosynthesis of various ► **prostaglandins** and ► **thromboxanes**. The subsequent specific step is accomplished by various prostaglandin synthases which convert PGH<sub>2</sub> to PGE<sub>2</sub>, PGD<sub>2</sub>, PGF<sub>2</sub>α, PGI<sub>2</sub> and TXA<sub>2</sub>. Prostaglandin E<sub>2</sub> (PGE<sub>2</sub>) plays a particularly important role in pain signaling (Fig. 1).

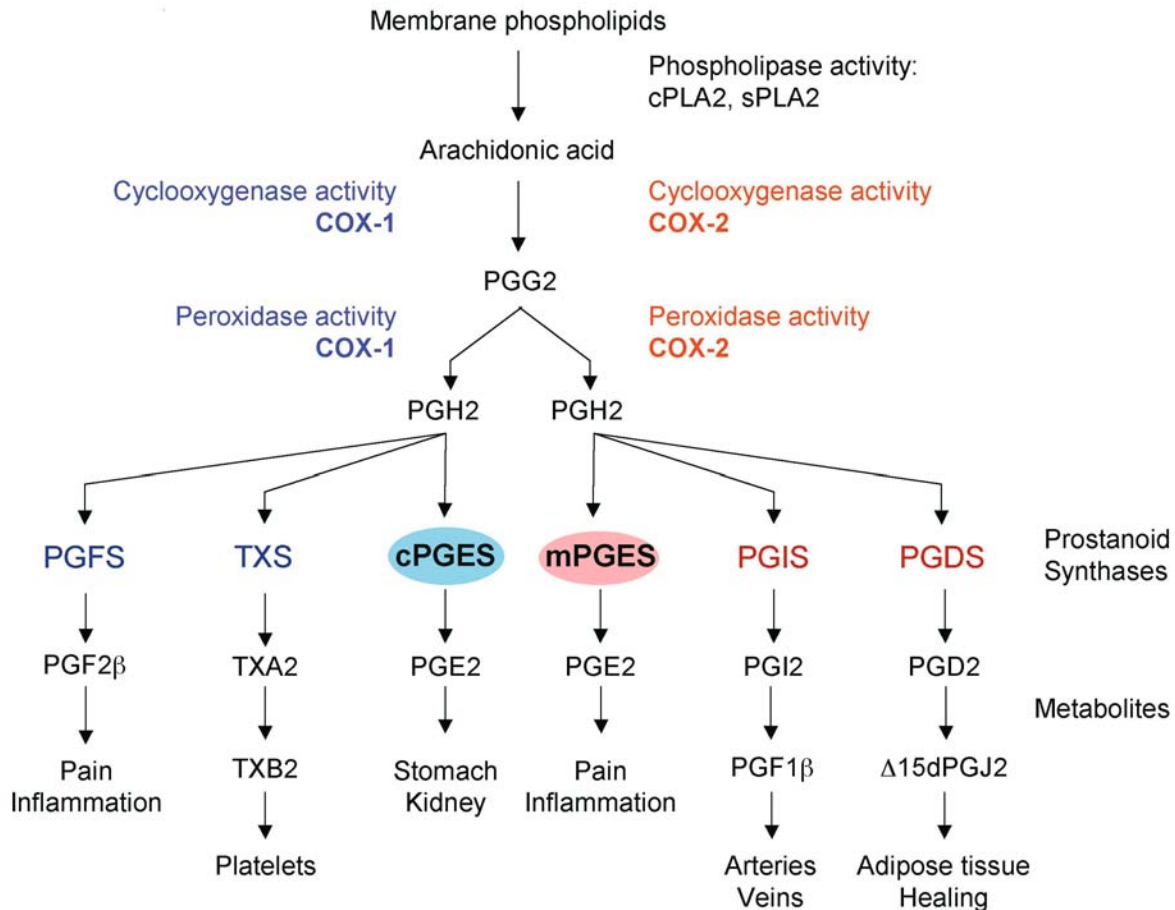
### Characteristics

COX-1 and COX-2 are the key enzymes in the prostaglandin and thromboxane biosynthetic pathway. Although the structure and enzymatic activity of both enzymes are very similar, COX-1 and COX-2 perform different tasks which is allowed for by a different localization and regulation. COX-1 is expressed in all tissues in certain cell types, and produces prostaglandins and thromboxanes that are needed for the maintenance of physiological functions such as regulation of blood flow, platelet aggregation and mucus production in the stomach. On the other hand, COX-2 is not normally expressed in “healthy” tissue but only occurs following adequate stimulation, which may be any kind of tissue damage such as trauma, ischemia, infection or inflammation. Such stimuli result in activation of COX-2 regulating ► **transcription factors** including nuclear factor kappa B (NFκB), activator protein-1 (AP-1), CCAAT Enhancer-binding protein-1 (C/EBPβ) and cAMP response element binding protein (CREB), which translate the stimulus into COX-2 ► **upregulation** and excessive prostaglandin production. PGE<sub>2</sub> is particularly involved in the activation and ► **sensitization of the nociceptive system**. This effect is mediated by stimulation of ► **nociceptors** in the periphery, and direct ► **depolarization** of postsynaptic nociceptive

neurons in the spinal cord, which is mediated through prostaglandin E (EP<sub>2</sub>) receptors (Baba et al. 2001). In addition, PGE<sub>2</sub> causes a dys-inhibition of nociceptive neurons by suppressing inhibitory glycinergic synaptic transmission in the spinal cord (Ahmadi et al. 2002). Enhanced or mal-controlled PGE<sub>2</sub> release results in spontaneous pain and ► **hyperalgesia**, i.e. increased sensitivity to painful stimuli. The functional disparity of COX-1 and COX-2 has encouraged the development of COX-2 selective inhibitors. These drugs are supposed to inhibit only the “pain”-related PG synthesis without affecting physiological prostaglandins. Multiple clinical trials have demonstrated that COX-2 selective inhibitors cause somewhat less gastrointestinal toxicity than unselective agents, and are equally effective in the treatment of arthritis (pain and function) and postoperative pain in clinical studies. However, there are some exceptions from the COX-1/COX-2 rule, in that COX-2 is also constitutively expressed in some tissues and COX-1 might contribute to pain-associated PG-release.

### Contribution of COX-1 Derived Prostaglandins to Nociception

Some experimental studies suggest that COX-1 is involved in the “injury”-induced immediate release of PGE<sub>2</sub> in the spinal cord and periphery, and thereby contributes to the activation and sensitization of nociceptive neurons (Teleder et al. 2001a; Wallace et al. 1998). However, this is contradicted by others (Ghilardi et al. 2004; Yaksh et al. 2001). The debate is primarily fuelled by a controversy about the exact localization of constitutive COX-2 and the time needed for its upregulation. For example, constitutive COX-2 expression was observed in motor neurons of the ventral horn, but neither in dorsal horn sensory neurons nor glial cells (Maihofner et al. 2000). In line with the lack of baseline expression of COX-2 in nociceptive neurons, celecoxib (COX-2 inhibitor, injected i.p.) had no antinociceptive effect in a model of acute nociception, whereas a COX-1 inhibitor was effective (Teleder et al. 2001a). Another study, however, reported a constitutive expression of COX-2 in dorsal horn sensory neurons and radial glial cells (Ghilardi et al. 2004). In this study, the COX-2 inhibitor reduced acute nociceptive behavior and the COX-1 inhibitor was ineffective (Ghilardi et al. 2004). In this study, the drugs were delivered onto the lumbar spinal cord via a chronically implanted spinal catheter. The catheter may by itself cause an activation of radial glia and COX-2 upregulation in the dorsal horn. Hence, the nociceptive system might have been pre-activated in this study, which would explain the antinociceptive effect of the COX-2 inhibitor. The studies generally agree upon the COX-2 upregulation in dorsal horn neurons following inflammatory or nociceptive stimulation (Beiche et al. 1996; Dolan et al. 2003; Ghilardi et al. 2004; Samad et al. 2001; Teleder et al. 2001b).



COX-1 and COX-2 in Pain, Figure 1 Synthesis of prostaglandins and thromboxanes.

### COX-1 and COX-2 in Clinical Pain

In clinical studies, COX-2 inhibitors were generally as effective as traditional NSAIDs in the treatment of arthritis, postoperative pain, gout, migraine, dental pain, dental surgery and dysmenorrhea. Thus, selective COX-2 inhibitors not only reduce chronic inflammatory pain caused, for example, by chronic arthritis, but also “acute” pain, although COX-2 is not constitutively expressed in most peripheral human tissues or in human sensory neurons in the spinal cord (Maihofner et al. 2003). Hence, the potential contribution of COX-1 derived prostaglandins to “acute” clinical pain is apparently of minor importance. This is explained by the fact that even “acute” pain (such as postoperative pain, acute gout, dental pain, dysmenorrhea) that requires treatment with non-opioid analgesics lasts for at least several hours, and hence, COX-2 is going to be upregulated in the course of the affection and contributes to PG-production. The onset of effects will probably depend more on pharmacokinetic issues than on the speed of COX-2 upregulation.

### COX-2 in Higher Brain Regions

Results of some clinical studies, however, cannot be satisfactorily explained by COX-2 upregulation. For example, preemptive treatment with a COX-2 inhibitor before starting surgery resulted in a reduction of postoperative pain, although the time from the skin incision to the first pain assessment was very short and no pain was reported before surgery. This suggests that prostaglandin release from constitutively expressed COX-2 in higher brain regions also contributes to nociception. This idea is supported by experimental data showing that COX-2 derived prostaglandins in the pre-optic hypothalamus mediate lipopolysaccharide (LPS) induced hyperalgesia in rats (Abe et al. 2001). An experimental pain study in humans also suggests an involvement of constitutive brain COX-2 (Koppert et al. 2004). This study employed electrically evoked non-inflammatory pain, where the electrical current directly stimulated axons without affecting the nociceptive nerve terminals. Intravenous parecoxib (prodrug of valdecoxib) reduced secondary hyperalgesia and allodynia within 30 min after starting

the stimulation, so that COX-2 upregulation at any site was highly unlikely. The analgesic effects are therefore probably caused by inhibition of constitutive COX-2 in higher brain regions such as hypothalamus or cortex.

### Peripheral versus Central Effects in Humans

In light of the growing evidence for central effects of COX-inhibitors, it is interesting to dissect the relative contributions of peripheral and central effects, particularly because NSAID gels and creams that only provide COX inhibition in the skin and directly underlying tissue are very popular in some countries. A recent clinical study has addressed this question, employing local and systemic diclofenac in the ► [freeze lesion](#) model (Burian et al. 2003). In this study, diclofenac gel significantly reduced mechanical hyperalgesia. However, overall pain relief with systemic diclofenac was stronger with equal tissue concentrations. Thus, both peripheral and central effects do contribute to the analgesic efficacy in this inflammatory model. The relative contribution of peripheral versus central effects, however, may vary depending on the type and source of pain.

### Neuropathic Pain

The role of prostaglandins in ► [neuropathic pain](#) is highly controversial and depends on the model used. It has recently been suggested that COX-1 plays a significant role because an increase of its expression in the spinal cord was observed. However, COX-1 is expressed in microglial cells in the spinal cord. These cells proliferate in response to a peripheral nerve injury. Thus, the observed COX-1 “upregulation” is probably caused by an increase in the number of microglial cells, rather than an increase of its transcription in the individual cell. The role of microglia proliferation for neuropathic pain is still elusive. COX-2 is not upregulated in the spinal cord in response to a peripheral nerve injury, suggesting that its contribution, if any, to neuropathic pain is of minor importance. In support, inhibitors of cyclooxygenase activity (traditional NSAIDs and selective COX-2 inhibitors) are generally considered to be ineffective in reducing neuropathic pain in clinical practice.

### References

1. Abe M, Oka T, Hori T et al. (2001) Prostanoids in the Preoptic Hypothalamus Mediate Systemic Lipopolysaccharide-Induced Hyperalgesia in Rats. *Brain Res* 916:41–49
2. Ahmadi S, Lippross S, Neuhuber WL et al. (2002) PGE(2) Selectively Blocks Inhibitory Glycinergic Neurotransmission onto Rat Superficial Dorsal Horn Neurons. *Nat Neurosci* 5:34–40
3. Baba H, Kohno T, Moore KA et al. (2001) Direct Activation of Rat Spinal Dorsal Horn Neurons by Prostaglandin E2. *J Neurosci* 21:1750–1756
4. Beiche F, Scheuerer S, Brune K et al. (1996) Up-Regulation of Cyclooxygenase-2 mRNA in the Rat Spinal Cord following Peripheral Inflammation. *FEBS Lett* 390:165–169
5. Burian M, Tegeeder I, Seegel M et al. (2003) Peripheral and Central Antihyperalgesic Effects of Diclofenac in a Model of Human Inflammatory Pain. *Clin Pharmacol Ther* 74:113–120
6. Dolan S, Kelly JG, Huan M et al. (2003) Transient Up-Regulation of Spinal Cyclooxygenase-2 and Neuronal Nitric Oxide Synthase following Surgical Inflammation. *Anesthesiology* 98:170–180
7. Ghilardi JR, Svensson CI, Rogers SD et al. (2004) Constitutive Spinal Cyclooxygenase-2 Participates in the Initiation of Tissue Injury-Induced Hyperalgesia. *J Neurosci* 24:2727–2732
8. Koppert W, Wehrfritz A, Korber N et al. (2004) The Cyclooxygenase Isozyme Inhibitors Parecoxib and Paracetamol Reduce Central Hyperalgesia in Humans. *Pain* 108:148–153
9. Maihofner C, Probst-Cousin S, Bergmann M et al. (2003) Expression and Localization of Cyclooxygenase-1 and -2 in Human Sporadic Amyotrophic Lateral Sclerosis. *Eur J Neurosci* 18:1527–1534
10. Maihofner C, Tegeeder I, Euchenhofer C et al. (2000) Localization and Regulation of Cyclooxygenase-1 and -2 and Neuronal Nitric Oxide Synthase in Mouse Spinal Cord. *Neuroscience* 101:1093–1108
11. Samad TA, Moore KA, Sapirstein A et al. (2001) Interleukin-1beta-Mediated Induction of Cox-2 in the CNS Contributes to Inflammatory Pain Hypersensitivity. *Nature* 410:471–475
12. Tegeeder I, Niederberger E, Vetter G et al. (2001a) Effects of Selective COX-1 and -2 Inhibition on Formalin-Evoked Nociceptive Behaviour and Prostaglandin E(2) Release in the Spinal Cord. *J Neurochem* 79:777–786
13. Tegeeder I, Niederberger E, Israr E et al. (2001b) Inhibition of NF- $\kappa$ B and AP-1 Activation by R- and S-flurbiprofen. *FASEB J* 15:2–4
14. Wallace JL, Bak A, McKnight W et al. (1998) Cyclooxygenase-1 Contributes to Inflammatory Responses in Rats and Mice: Implications for Gastrointestinal Toxicity. *Gastroenterology* 115:101–109
15. Yaksh TL, Dirig DM, Conway CM et al. (2001) The Acute Antihyperalgesic Action of Nonsteroidal, Anti-Inflammatory Drugs and Release of Spinal Prostaglandin E2 is Mediated by the Inhibition of Constitutive Spinal Cyclooxygenase-2 (COX-2) but not COX-1. *J Neurosci* 21:5847–5853

C

## COX-1 Inhibitor

### Definition

A drug that inhibits type 1 of the enzyme cyclo-oxidase, which takes part in production of prostaglandins that cause inflammation and pain, cause blood platelets to become sticky and stop bleeding, protect the gastric mucosal cells (and also have many other physiologic functions).

- [COX-1 and COX-2 in Pain](#)
- [Postoperative Pain, Acute Pain Management, Principles](#)

## COX-2

- [COX-1 and COX-2 in Pain](#)

## COX-2 Inhibitor

### Synonyms

Coxib; NSAIDs

## Definition

Non-steroidal anti-inflammatory drugs (NSAIDs) are increasingly used for postoperative analgesia. While lacking some of the troublesome adverse effects of opioids, non-selective NSAIDs may cause bleeding, gastric ulceration, and renal injury as a result of their inhibitory effects on cyclo-oxygenase-1 (COX-1). Cyclo-oxygenase-2 (COX-2) is normally present in small concentrations, but is induced peripherally under conditions of inflammation. Cyclo-oxygenase-2 (COX-2) is constitutively expressed in the brain and spinal cord and is further up-regulated after persistent noxious inputs. Spinal COX-2 inhibition may be an important mechanism for reducing post-injury hyperalgesia. For this reason, COX-2-selective inhibitors (COXIBS) could uncouple the therapeutic and adverse effects of the non-selective NSAIDs. COX-2-selective inhibitors are effective for the treatment of preoperative and postoperative pain and reduce post-surgical requirements for opioids. They have similar analgesic efficacy to the non-selective NSAIDs. Data from large multi-centre, multi-dose comparative studies are needed to establish whether COX-2-selective inhibitors are more efficacious, cost-effective and safe compared to the non-selective NSAIDs with respect to gastric, renal and coagulation problems, and whether COX-2-selective inhibitors confer greater cardiovascular risk in the perioperative setting.

- ▶ [Multimodal Analgesia in Postoperative Pain](#)
- ▶ [Postoperative Pain, Acute Pain Management, Principles](#)
- ▶ [Postoperative Pain, Cox-2 Inhibitors](#)

## Coxibs

### Definition

Structural heterogenous class of compounds inhibiting COX-2, more or less selectively.

- ▶ [COX-2 Inhibitor NSAIDs](#)
- ▶ [COX-1 and COX-2 in Pain](#)
- ▶ [COX-2 Inhibitor](#)
- ▶ [Coxibs and Novel Compounds, Chemistry](#)
- ▶ [NSAIDs, Chemical Structure and Molecular Mode of Action](#)
- ▶ [Postoperative Pain, COX-2 Inhibitors](#)

## Coxibs and Novel Compounds, Chemistry

STEFAN A. LAUFER  
 Institute of Pharmacy, Eberhard-Karls University of Tuebingen, Tuebingen, Germany  
 stefan.lauffer@uni-tuebingen.de

## Synonyms

NSAIDs and Coxibs; Cyclooxygenase Inhibitors, Chemistry

### Definition

As most ▶ [NSAID](#)s are believed to act *via* a substrate analogue of ▶ [arachidonic acid](#) mechanism at the active site of the molecular target, ▶ [Cyclooxygenases](#) (COX), chemical structure and biological activity are closely linked. Acidic groups and  $\pi$ -electron systems of NSAIDs mimic key structural features of the genuine substrate, arachidonic acid. COX-1/COX-2 selectivity is mainly determined by different conformational requirements rather than specific interactions.

### Characteristics

#### Unselective COX Inhibitors

#### Structure and Metabolic Function of COX-1

COX-1 is a 70 kD enzyme, catalyzing the reaction of arachidonic acid to PGG<sub>2</sub> (cyclooxygenase reaction) and consecutively PGG<sub>2</sub> to PGH<sub>2</sub> (peroxidase reaction) as outlined in Fig. 1.

There are distinct active sites for the cyclooxygenase and peroxidase reactions (Fig. 2).

#### Inhibitors

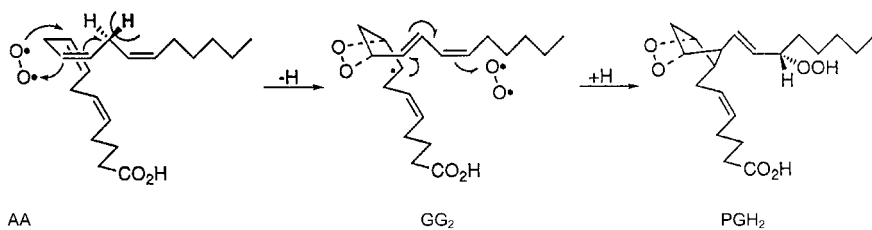
Different chemical classes can provide the structural features necessary to mimic arachidonic acid at the active site. The substrate, arachidonic acid is a C<sub>20</sub> carboxylic acid with 4 isolated double bonds at positions 5, 8, 11 and 14. For the enzyme reaction, arachidonic acid must adapt to a “folded” conformation, allowing the oxygen to insert between C<sub>9</sub> and C<sub>11</sub> and the ring closure between C<sub>8</sub> and C<sub>12</sub> (Fig. 3). To fix arachidonic acid in such a conformation, several interactions to the active site of the enzyme are necessary, e.g. ionic interaction (a salt bridge) between the carboxylic group and arginine 120,  $\pi$ - $\pi$  interactions between the double bonds of arachidonic acid and aromatic amino acids and numerous hydrophobic interactions (Fig. 4).

All these structural features can be identified in many NSAIDs. Most acidic NSAIDs are therefore believed to mimic arachidonic acid in its folded conformation at the active site of COX. The structure activity relationship follows these structural constrictions closely. The activity against COX-1 clearly correlates with torsion angles around the  $\pi$ -electron systems and the overall lipophilicity of the molecule (Moser et al. 1990).

Two classes of compounds however have a distinctly different molecular mode of action,

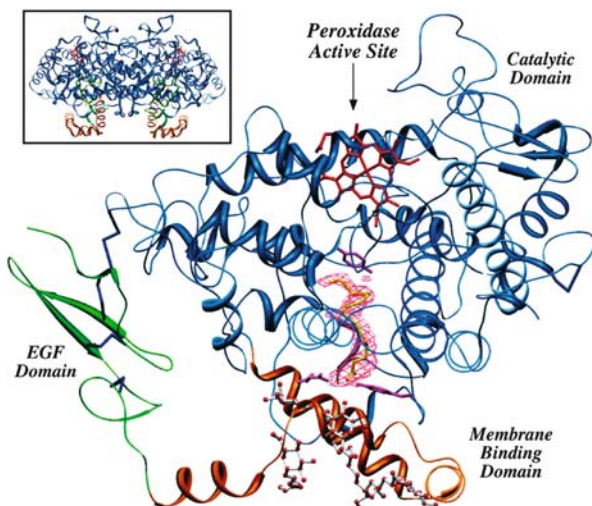
- ASS irreversibly acetylates Ser 530 at the active site of the enzyme
- The oxicames are believed to interfere with the peroxidase active site, which also explains their structural difference.





**Coxibs and Novel Compounds, Chemistry, Figure 1** Reactions catalyzed by COX enzymes.

C



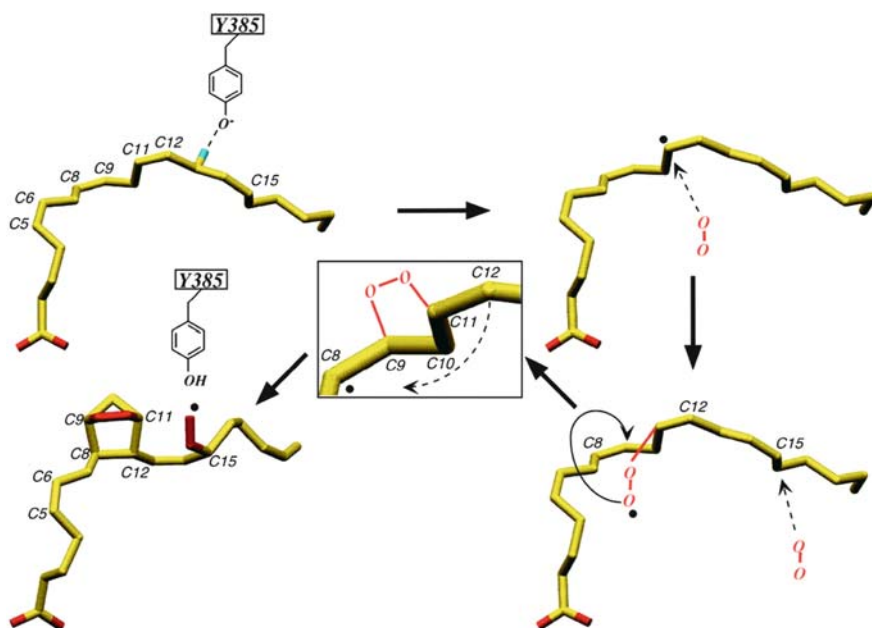
**Coxibs and Novel Compounds, Chemistry, Figure 2** A ribbon representation of the Co<sup>3+</sup>-oPGHS-1 monomer with AA bound in the COX channel. The EGF domain, MBD and catalytic domain are shown in green, orange and blue, respectively; Co<sup>3+</sup>-protoporphyrin IX is depicted in red, disulfide bonds (Cys36-Cys47, Cys37-Cys159, Cys4<sup>1</sup>-Cys57, Cys59-Cys69 and Cys569-Cys575) in dark blue and side chain atoms for COX channel residues Arg120, Tyr355 and Tyr385 in magenta (from Malkowski et al. (2000)).

Most of the currently used NSAIDs, including diclofenac, ibuprofen, naproxen, piroxicam and indomethacin for instance, may produce full inhibition of both COX-1 and COX-2 with relatively poor selectivity under therapeutic conditions (Warner et al. 1999). Acidic NSAIDs like diclofenac accumulate particularly in blood, liver, milt and bone marrow, but also in tissues with acidic extracellular pH values. Such tissues are mainly inflamed tissues, such as gastric tissue and the manifolds of the kidney. In inflamed tissue, NSAIDs inhibit the pathological overproduction of prostaglandins. In contrast neutral NSAIDs (paracetamol) and weakly acidic NSAIDs (metamizol) distribute themselves quickly and homogeneously in the organism. They also penetrate the blood-brain-barrier.

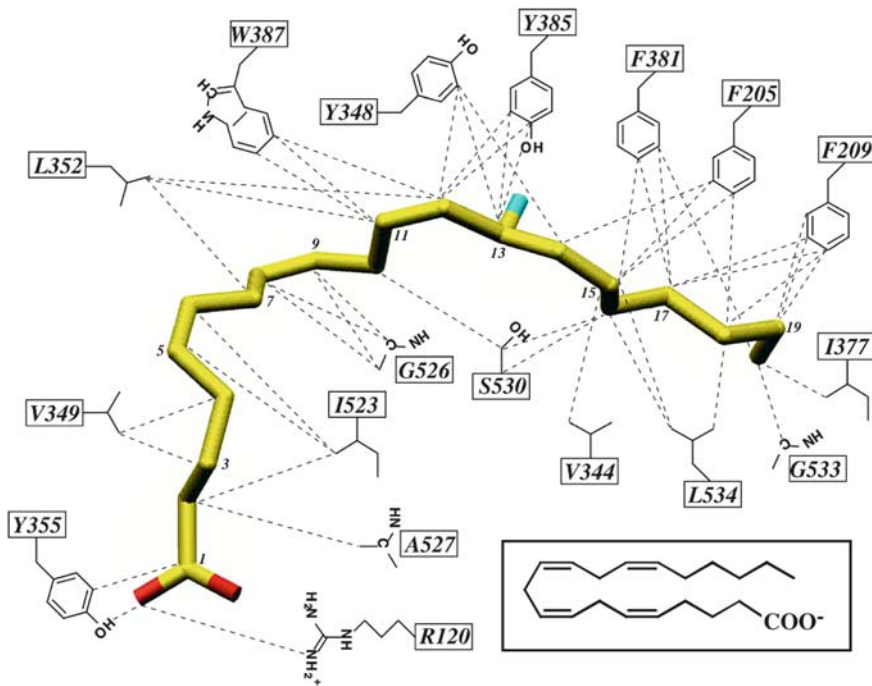
### Fenamate Group

The core structure is 2-aminobenzoic acid (anthranilic acid). The 2-amino group is substituted with aromatic residues.

- flufenamic acid
- mefenamic acid
- meclofenamic acid
- niflumonic acid (core structure, 2-amino-pyridyl-3-carboxylic acid). For topical application, the



**Coxibs and Novel Compounds, Chemistry, Figure 3** Mechanistic sequence for converting AA to PGG<sub>2</sub>. Abstraction of the 13-proS hydrogen by the tyrosyl radical leads to the migration of the radical to C-11 on AA. An attack of molecular oxygen, coming from the base of the COX channel, occurs on the side interfacial to the hydrogen abstraction. As the 11R-peroxyl radical swings over C-8 for an R-side attack on C-9 to form the endoperoxide bridge, C-12 is brought closer to C-8 *via* rotation about the C-10/C-11 bond, allowing the formation of the cyclopentane ring. The movement of C-12 also positions C-15 optimally for addition of a second molecule of oxygen, formation of PGG<sub>2</sub> and the migration of the radical back to Tyr385 (from Malkowski et al. (2000)).



**Coxibs and Novel Compounds, Chemistry, Figure 4** A schematic of interactions between AA and COX channel residues. Carbon atoms of AA are yellow, oxygen atoms red and the 13proS hydrogen blue. All dashed lines represent interactions within 4.0 Å between the specific side chain atom of the protein and AA (from Malkowski et al. (2000)).

carboxylic acid group is esterified with diethyleneglycol

- etofenamate

#### Fenac Group

The core structure is 2-aminophenylacetic acid. The 2-amino group is substituted with aromatic residues.

- diclofenac
- felbinac (only used topically)

#### Heteroaryl Acetic Acid Group

- indomethacin
- acetaminophen
- proglumetacin
- tolmetin (and its ring closed analog ketorolac)
- ionazolin

#### Profene Group

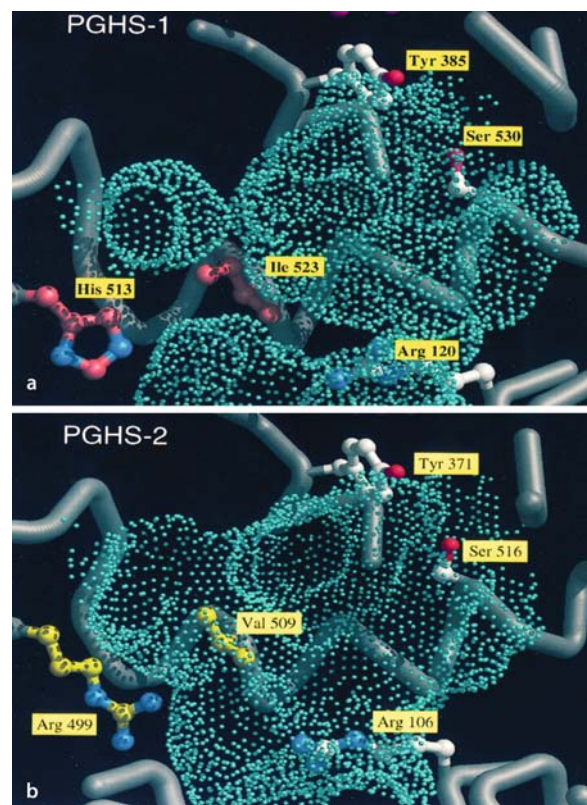
Core structure: 2-arylpropionic acid

- ibuprofen
- ketoprofen
- thiaprofen
- naproxen
- ketorolac (can be seen formally as a ring closed profene)

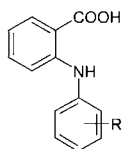
#### Oxicame Group

Core structure: 1,2-benzothiazine

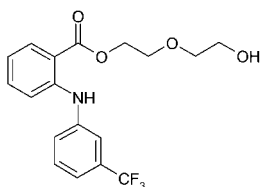
- piroxicam
- tenoxicam



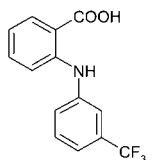
**Coxibs and Novel Compounds, Chemistry, Figure 5** Comparison of the active sites of COX-1 (PGHS-1) and COX-2 (PGHS-2) (from Wong et al. (1997)).



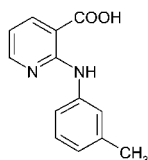
**Fenamate  
core structure**



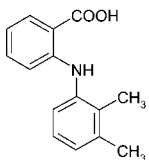
**Etofenamat**



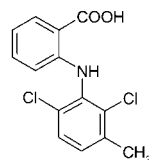
**Flufenamic acid**



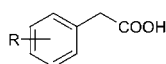
**Niflumnic acid**



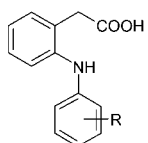
**Mefenamic acid**



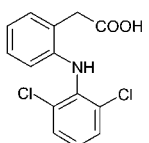
**Meclofenamic acid**



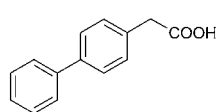
**Phenylacetic acid  
derivatives**



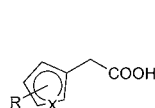
**Fenac group**



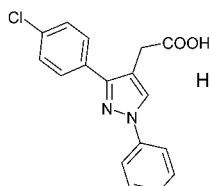
**Diclofenac**



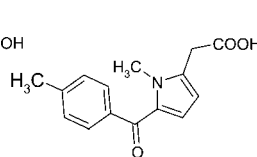
**Felbinac**



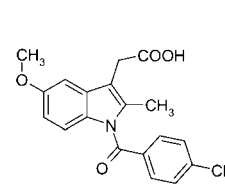
**Heteroaryl-acetic  
acid group**



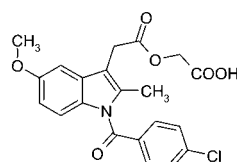
**Lonazolac**



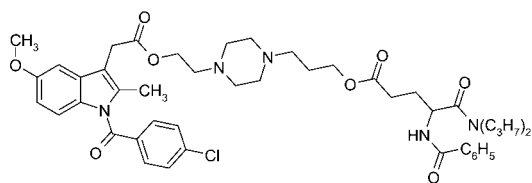
**Tolmetine**



**Indometacine**

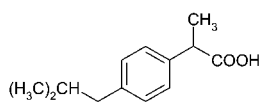


**Acemetacine**

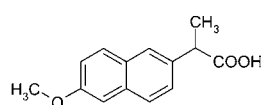


**Proglumetacine**

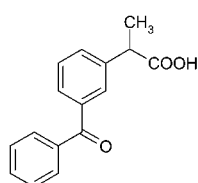
**Profene group**



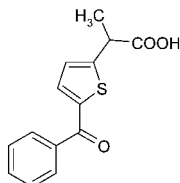
**Ibuprofene**



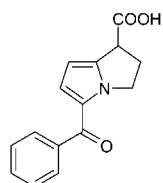
**Naproxene**



**Ketoprofene**



**Thiaprofene**



**Ketorolac**

**Coxibs and Novel Compounds,  
Chemistry, Figure 6** Chemical  
structures of NSAIDs and coxibs.

- lornoxicam
- droxicam
- cinoxicam
- sudoxicam
- meloxicam

### Pyrazolone Group

The mode of action of the pyrazolones remains unclear. It is thought that they may not be involved in the inhibition of COX-1 or COX-2. The compounds of the pyrazol-3-on series at least are neutral molecules with no acidity. A central mode of action is suggested. They also act antispasmodically and they are effective against visceral pain. In the past, pyrazolones were among the nonsteroidal anti-inflammatory drugs used very frequently. They show a high plasma protein binding and therefore have a high rate of interaction with other pharmaceuticals. Agranulocytosis is a rare but severe side effect.

The core structure is 3*H*-pyrazol-3-on

- propyphenazone
- metamizol-Na
- phenazone

### Pyrazolidindione

The core structure is pyrazolidin-3,5-dion

- phenylbutazone
- mofebutazone

### COX-2 Selective Inhibitors

Isoform 2 of the COX enzyme catalyzes the identical reaction, AA to PGG<sub>2</sub>; the active site however is slightly different from that of COX-1 (Fig. 5).

Isoleucine 523 is replaced by valine 509, making the active site of COX-2 more “spacious”. This difference can be used to generate COX-2 selective inhibitors, as this active site tolerates more bulky molecules. Celecoxib is capable of producing full inhibition of COX-1 and COX-2. However it shows a preferential selectivity toward COX-2 (>5 fold). The newer coxibs like rofecoxib strongly inhibit COX-2 with only weak activity against COX-1 (Warner et al. 1999).

A common pharmacophore cannot be identified; however vicinal diaryl systems (celecoxib, rofecoxib, valdecoxib) and sulfone or sulphonamide groups seem to be advantageous (Dannhardt and Laufer 2000). Lumiracoxib is an excellent example of the fact that spatial demanding substituents (bulky groups) alone are sufficient to generate selectivity, even with a diclofenac-like pharmacophore.

### Structural Features of Selective COX-2 Inhibitors

Sulfonamide Structure

- celecoxib
- valdecoxib

Methylsulfone Structure

- rofecoxib
- etoricoxib

Aryl Acetic Acid

- lumiracoxib

Others:

- parecoxib (water soluble prodrug for parenteral application, rapidly metabolized to valdecoxib)

### References

1. Dannhardt G, Laufer S (2000) Structural approaches to explain the selectivity of COX-2 inhibitors: Is there a common pharmacophore? *Current Med Chem* 7:1101–1112
2. Malkowski M, Ginell SL, Smith WL, Garavito RM (2000) The Productive Conformation of Arachidonic Acid Bound to Prostaglandin Synthase. *Science* 289:1933–1937
3. Moser P, Sallmann A, Wiesenberg L (1990) Synthesis and quantitative structure-activity relationships of diclofenac analogues. *J Med Chem* 33:2358–2368
4. Warner T, Giuliano F, Vojnovic I et al. (1999) Nonsteroid drug selectivities for cyclo-oxygenase-1 rather than cyclo-oxygenase 2 are associated with human gastrointestinal toxicity: A full in vitro analysis. *Proc. Natl Acad Sci USA* 96:7563–7568
5. Wong E, Bayly E, Waterman HL et al. (1997) Conversion of prostaglandin G/H synthase-1 into an enzyme sensitive to PGHS-2-selective inhibitors by a double His<sup>513</sup> → Arg and Ile<sup>523</sup> → Val mutation. *J Biol Chem* 272:9280–9286

## CPH

- ▶ Chronic Paroxysmal Hemicrania

## Cranial Arteritis

- ▶ Headache Due to Arteritis
- ▶ Temporal Arteritis

## Cranial Nerve Neuralgia

### Definition

A family of chronic neuropathic pain states associated with injury or dysfunction of a cranial nerve, most often in the trigeminal or glossopharyngeal nerve. Ongoing pain and/or hypersensitivity is felt primarily in the distribution of the injured nerve.

- ▶ Tic and Cranial Neuralgias



## Cranial Nerves

### Definition

The 12 pairs of nerves originating from the brain that provide motor, sensory, and autonomic function to the structures of the head and neck. The N. vagus (X) also innervates the viscera.

- ▶ Diabetic Neuropathies

## Cranial Neuralgias

- ▶ Tic and Cranial Neuralgias

## Craniomandibular Disorders

- ▶ Temporomandibular Joint Disorders

## Cranium

### Definition

The skull and its associated soft tissues.

- ▶ Orofacial Pain, Taxonomy/Classification

## CRD

- ▶ Colorectal Distension

## CREB

- ▶ Cyclic Adenosine Monophosphate-Responsive Element-Binding Protein

## Credibility Finding

### Definition

An adjudicative finding of the extent to which a person's statements about the intensity, persistence, and functional effects of his or her symptoms can be believed and accepted as true. The credibility finding takes into consideration the objective medical evidence and the other evidence in the case record, to include the person's statements, the statements and other evidence provided by physicians and psychologists who have treated or examined the person, evidence from other health care professionals, and statements from other persons, to include the person's spouse, family members, neighbors, friends, co-workers, etc.

- ▶ Disability Evaluation in the Social Security Administration

## Credibility, Assessment

C

KENNETH D. CRAIG

University of British Columbia, Vancouver, BC, Canada

krcraig@psych.ubc.ca

University of British Columbia, Vancouver, BC, Canada

### Synonyms

Deception; malingering

### Definition

Pain reports and disability are regularly subjected to scrutiny to establish their veracity, with contextual factors, self-report, nonverbal behavior, the reports of significant others, and medical information variably useful as determinants of judgments.

### Characteristics

Pain enmeshes people in complex social transactions, with the credibility of complaints invariably subjected to careful appraisal by others. A substantial range of caregiving resources may be available, whether motivated by sympathy, professional responsibility, contractual obligation (e.g. disability insurance), legislated entitlement (e.g. workers' compensation benefits) or court order. In all instances, optimal caregiving and prudent stewardship of resources require judgments about the legitimacy of the representations of the person in distress. In health-care settings, it would be ideal if norms of trust were to prevail, and negotiation of care did not require patients to persuade health care practitioners of the legitimacy of their concerns. However, patients sometimes warrant and often encounter distrust, particularly when physical pathology is not manifestly obvious. Patients are likely to be scrutinized to discover whether financial incentives, efforts to obtain illicit drugs, or avoidance of onerous responsibilities are involved. Werner and Malterud (2003) describe women with medically unexplained disorders encountering skepticism, lack of comprehension, rejection, being blamed for their condition, and suffering feelings of being ignored or belittled.

The real incidence and costs of various forms of deception is unknown, because people work hard to avoid discovery of dishonesty (Craig et al 1999). Denial of pain to avoid noxious treatments or imposition of sick roles is an often ignored but widespread form of deception, because its immediate effects do not usually inflict demands on others, despite the potential for collapse of personal health and long-term medical costs. Opportunistic feigning or exaggeration of minor pain is relatively common and may be approved by others (e.g. sick days), despite substantial costs (e.g. to employers). Flagrant,

planned fraud is generally estimated to be rare; nevertheless systems costs to employers, health care providers, insurance companies, and social service could mount dramatically.

Decisions that another is malingering require a judgment of intentional production of false symptoms to obtain financial incentives or other privileges. Many clinicians eschew providing reports on credibility because they perceive them inconsistent with their role as patient advocate. Challenging patients is also fraught with a substantial risk of reprisal and angry, emotional confrontations. Patients reasonably perceive serious consequences, including denial of treatment, loss of income, or criminal investigations.

Regrettably, universally acceptable and valid measures of neither pain nor deception are available, and judgments require inferences based upon information that has demonstrable limitations. Efforts to detect deception generally appear not to be particularly effective. There are considerable individual differences in detecting deception. Hill and Craig (2004) reported that success rates in accurately differentiating genuine and faked or suppressed facial expressions of pain varied across individuals between 18 and 63%.

#### Strategies for Assessing Credibility

Useful information often emerges during pain assessments, when listening to complaints, symptoms, and personal histories, observing nonverbal manifestations of distress and disability, examining standardized questionnaires and physical examinations, and studying archival documents and reports of significant others, including reports of laboratory tests. Assessors usually look at matches between their personal conceptions as to how one should behave and the actual behavior of the individual, with inconsistencies indicative of deception. We know more about cues that have “illusory correlations” with deception than about sensitive and specific cues to honest or dishonest representations. Erroneous cues to deception, not unique to pain, include signs of nervousness, clearing the throat, faltering speech, and biting the lips (Porter et al 2002). Concerning pain, people who respond to placebos have been misconstrued as not experiencing “real” pain, despite clear evidence that placebos can dramatically reduce pain instigated by injury and surgery.

#### Contextual Analysis

The contexts in which people present themselves to be in pain are important. Sometimes a discrete, precipitating event may be required to legitimize work-related injuries, or engineering reports must describe substantial physical forces in motor vehicle accidents, but these are controversial as pain onset can occur without trauma. Analyses of the settings in which people lead their lives may disclose circumstances leading to deception, for example, work dissatisfaction or domestic distress. Of

course, disincentives for assuming the life of a person with persistent pain also must be considered (e.g. loss of employment or impaired family and friendship relationships). The American Psychiatric Association diagnostic manual (2000) implicates malingering when there is a medicolegal context, a strong discrepancy between claimed stress and disability and objective findings, or limited cooperation with assessment or lack of compliance in treatment. However, these are commonplace and their use can cast inappropriate aspersions on people.

#### Use of Self-Report

Capitalizing on the unique capacity of humans to use sophisticated language to describe subjective states, self-report has been favored as a communication medium for the measurement of pain. Guidelines on pain management often assert, “Pain is what the patient says it is.” But self-report is also a prime medium for dissembling pain. Distrust of self-report in reality is widespread. Scarry (1985) captures the suspicion in the observation that, “To have great pain is to have certainty, to hear that another person has pain is to have doubt”. Nevertheless, analyses of the content of verbal statements can disclose useful information. Mendelson and Mendelson (2004) reviewed questionnaire studies contrasting people genuinely in pain with people coached to pretend they were in pain, finding that simulators exaggerated the genuine pattern of response. However, cutting scores yielded substantial numbers of misidentified false positives and negatives. A review of the MMPI-2 (Arbisi and Butcher 2004) concluded that it is useful in detecting inconsistent and inaccurate self-report responding, uncooperative responding, unusually positive or virtuous self-presentation, and general defensiveness.

#### Biomedical Approaches

The biomedical model of pain requires physical lesions to account for pain complaints. The model persists because it is adequate for painful conditions arising from serious injury or surgery, provided there is some allowance for variability related to the individual and the situation. However, patients encounter medical distrust and resistance when physicians cannot find evidence of physical pathology. The reality is that medically unexplained pain is common and a serious health care problem. Some patients do not receive adequate medical examinations or expert use of diagnostic tests, but even when used properly these are not as reliable and valid as might be expected (Hunt et al 2001). Controlled diagnostic blocks serve as useful diagnostic tools when a specific source of pain can be posited and is subject to being anaesthetized (e.g. spinal pain) (Bogduk 2004).

#### Nonverbal Cues

Nonverbal information weighs heavily when people make judgments about others’ reports of pain, includ-

ing their credibility. Painful distress can be manifest in facial expression, qualities of speech, guarded posture, protective movements, and other actions as people engage their daily lives. Reflexive, automatic reactions are less subject to ongoing self-monitoring and personal control than voluntary actions. The latter provide the basis for misrepresenting pain, but require ongoing careful scrutiny. Inconsistencies with self-report and failure to match the reflexive pattern can disclose misrepresentation (Hill and Craig 2002).

Several illustrations of spurious use of cues presumed indicative of deception are available. Evidence that pain behavior can be controlled by social consequences (e.g. release from responsibilities, potent medication, sympathy) has been taken to suggest, incorrectly, that the behavior represented voluntary dishonesty or efforts to secure incentives. However, environmental contingencies can operate on behavior without consciousness

There have been similar misinterpretations of diagnostic signs related to low back pain that could not have a basis in physical pathology, as we understand current anatomy and physiology (e.g. nonanatomic or superficial tenderness). Main and Waddell (1998) and Fishbain et al (2004) concluded that there was little evidence of an association between these signs and secondary gain or malingering. Main and Waddell (1998) warn that these signs “are not on their own a test of credibility or faking” and consider inferences based on that supposition to be misuse, both clinically and medico-legally.

Other measures have pursued observations that people who sincerely exercise effort in strength testing appear less likely to be misrepresenting themselves. Displays of weakness and decreased range and velocity of motion have been interpreted as conscious attempts to deceive. Investigations of a variety of indices of this type led Robinson and Dannecker (2004) to conclude “that the current ‘state of the art’, while promising in some instances, does not warrant the clinical application of muscle testing as a means of sincerity of effort”. Problems arise because performance is also influenced by fear of injury, pain, medications and other motivational and cognitive factors, and discriminating maximal and submaximal effort remains a problem.

#### Reports of Significant Others

Reports of family members, friends, colleagues and others can provide valuable collateral information able to confirm or disconfirm patient self-report. Collusion would be possible, but contradiction seems more likely, unless there has been very careful grooming. Unobtrusive behavioral observation can be undertaken using covert surveillance, to provide photographic or video records of people claiming to have severely disabling pain engaging in vigorous physical activity. While this appears to represent flagrant abuse, careful analysis often suggests the need for income or commitments to

family and others can lead people to engage in vigorous activities, despite severe immediate or delayed pain.

#### Conclusion

Assessment of credibility is an evolving process. Those who would deceive can be well motivated and well tutored by prior personal experience, or instructional models in their families. In turn, those interested in assessing credibility must use a broad range of information sources that will hopefully improve in sensitivity and specificity to deceptive behavior. Sequential, progressive evaluation seems the best strategy, using broad screening approaches to trigger suspicion, followed by progressively more rigorous methods.

#### References

1. American Psychiatric Association (2000) *Diagnostic and Statistical Manual of Mental Disorders*. Fourth edition. Text revision. Washington, DC
2. Arbisi PA and Butcher JN (2004) Psychometric Perspectives on Detection of Malingering of Pain: Use of the MMPI-2. *Clin J Pain* 20:383–391
3. Bogduk N (2004) Diagnostic blocks: A Truth Serum for Malingering. *Clin J Pain* 20:409–414
4. Craig KD, Hill ML, McMurtry B. Detecting Deception and Malingering. In A.R. Block AR, Kramer EF, Fernandez E (1999) *Handbook of Chronic Pain Syndromes: Biopsychosocial Perspectives*. Mahwah NJ: Lawrence Erlbaum Associates, pp 41–58
5. Fishbain DA, Cutler RB, Rosomoff HL, Rosomoff RS (2004). Is There a Relationship Between Non-Organic Physical Findings (Waddell Signs) and Secondary Gain/Malingering? *Clin J Pain* 20:399–408
6. Hill ML, Craig KD (2002) Detecting Deception in Pain Expressions: The Structure of Genuine and Deceptive Facial Displays. *Pain* 98:135–144
7. Hill ML, Craig KD (2004) Detecting Deception in Facial Expressions of Pain: Accuracy and Training. *Clin J Pain* 20:415–422
8. Hunt DG, Zuberbier OA, Kozlowski A, Robinson J, Berkowitz J, Schultz IZ, Milner RA, Crook JM, Turk DC (2001) Reliability of the Lumbar Flexion, Lumbar Extension and Passive Straight Leg Raise Test in Normal Populations Embedded within a Complete Physical Examination. *Spine* 26:2714–2718
9. Main CJ, Waddell G (1998) Behavioral Responses to Examination: A Reappraisal of the Interpretation of “Nonorganic Signs”. *Spine* 23:2367–2371
10. Mendelson G, Mendelson D (2004) Malingering Pain in the Medico-Legal Context. *Clin J Pain* 20:423–432
11. Porter S, Campbell MA, Stapleton J, Birt AR (2002) The Influence of Judge, Target, and Stimulus Characteristics on the Accuracy of Detecting Deceit. *Can J Behav Sci* 34:172–185
12. Robinson ME, and Dannecker EA (2004) Critical Issues in the Use of Muscle Testing for the Determination of Sincerity of Effort. *Clin J Pain* 20:392–398
13. Scarry E (1985) *The Body in Pain*. Oxford University Press, New York
14. Werner A and Malterud K (2003) It is Hard Work Behaving as a Credible Patient: Encounters between Women with Chronic Pain and their Doctors. *Social Science and Medicine* 57:1409–1419

## Creep

#### Definition

Creep is a physiologic property of collagenous tissue. In response to the application of a constant force, collagen

starts to deform (stretch). However, this deformation is not directly proportional to time. Initially, the deformation is small, but the longer the constant force is applied, the more rapidly collagen will deform (and weaken), even if the magnitude of the force remains constant. This phenomenon is defined as creep and may lead to complete failure of the collagen fibre.

- ▶ [Ergonomic Counseling](#)

## Criterion-Referenced Assessment

### Definition

In criterion-referenced assessment, the critical aspects of a job are analyzed to determine standards essential for the worker's adequate performances of a job. The results are stated in terms of skills mastered, e.g. Method Time Methods (MTM) (the time it would take the average, well-trained worker to complete the work sample tasks if they were carried out over the eight-hour work day in a typical industrial context), and the Worker Qualification Profiles given in Jist's Enhanced DOT.

- ▶ [Vocational Counselling](#)

## Crohn's Disease

- ▶ [Animal Models of Inflammatory Bowel Disease](#)

## Cross Excitation

### Definition

Electrophysiological phenomenon whereby neurotransmitter molecules, and probably also  $K^+$  ions, are released into the extracellular space from active neurons. These diffuse towards neighboring neurons and excite them. Cross excitation occurs within sensory ganglia and at sites of nerve injury.

- ▶ [Pain Paroxysms](#)

## Cross Sectional Study

### Definition

A research methodology that examines relationships between variables at one point in time.

- ▶ [Pain in the Workplace, Risk factors for Chronicity, Job Demands](#)

## Cross-Excitatory Discharge

### Definition

Excitation evoked within the dorsal root ganglion between repetitively discharging neurons and their passive neighbors. This excitatory interaction between neurons is believed to be chemically and not electrically mediated.

- ▶ [Ectopia, Spontaneous](#)

## Cross-System Viscero-Visceral Interactions

- ▶ [Gynecological Pain, Neural Mechanisms](#)

## Cross-System Viscero-Visceral or Viscero-Somatic Convergence

### Definition

A connective situation in which neurons in the CNS receive converging input from different organs (viscero-visceral), sometimes in different functional systems (e.g. reproductive and urinary), and from different types of structures such as skin, muscle, and internal organs (viscero-somatic).

- ▶ [Gynecological Pain, Neural Mechanisms](#)

## CRPS

- ▶ [Complex Regional Pain Syndrome](#)
- ▶ [Complex Regional Pain Syndromes, Clinical Aspects](#)
- ▶ [Complex Regional Pain Syndromes, General Aspects](#)
- ▶ [Sympathetically Maintained Pain, Clinical Pharmacological Tests](#)

## CRPS, Evidence-Based Treatment

ANNE LOUISE OAKLANDER

Nerve Injury Unit, Departments of Anesthesiology, Neurology, and Neuropathology, Massachusetts General Hospital, Harvard Medical School, Boston, MA, USA

aoaklander@partners.org

### Synonyms

- Complex regional pain syndrome (CRPS): term designated by International Association for the Study of Pain (IASP) in 1994



- Reflex sympathetic dystrophy (RSD): term first used by Evans in 1946
- Algodystrophy: most common designation in Europe
- Shoulder-hand syndrome: refers specifically to CRPS originating in hand, spreading to shoulder
- Causalgia: from Greek, *causos* = heat; *algia* = pain (Oxford English Dictionary first use: S. Weir Mitchell 1872)
- Sudeck's atrophy (1901)
- Major or minor causalgia
- Post-traumatic dystrophy
- Pourfour du Petit syndrome
- Postinfarctional sclerodactylia
- Traumatic angiospasm
- Peripheral acute trophoneurosis
- Post-traumatic neuralgia

### Definition

Because the biological cause of CRPS is unknown, the definition is currently based on the presence of various non-specific symptoms. Many investigators create their own definitions, hampering comparison of study results. The International Association for the Study of Pain (IASP) formulated consensus definitions in 1994 (see below) (Merskey and Bogduk 1994). "Type I" classifies patients without diagnosed nerve injury; "type II" classifies those with known neural injuries. This dichotomy depends more on the skill of the examiner than the patient and contributes to the confusion. Although flawed, the use of IASP criteria is encouraged until a better definition is developed. More rigorous definitions proposed for research use require visual confirmation of autonomic dysfunction. This improves specificity, but at the cost of reducing sensitivity. Rigorous diagnostic criteria may limit study to severely affected patients, who do not represent the overall population and who may be least likely to improve in clinical trials. This author suggests adopting the hierarchy of definitions used for other neurological research (definite CRPS, probable CRPS and possible CRPS) to permit greater or less sensitivity and specificity for use in individual research projects.

### IASP Diagnostic Criteria for CRPS-I (Reflex Sympathetic Dystrophy)

1. The presence of an initiating noxious event or a cause of immobilization.
2. Continuing pain, ► **allodynia**, or ► **hyperalgesia** in which the pain is disproportionate to any inciting event.
3. Evidence at some time of edema, changes in skin blood flow or abnormal sudomotor activity in the region of the pain.
4. This diagnosis is excluded by the existence of conditions that would otherwise account for the degree

of pain and dysfunction. **Note:** Criteria 2–4 must be satisfied (Merskey and Bogduk 1994)

### IASP Diagnostic Criteria for CRPS-II (Causalgia)

1. The presence of continuing pain, allodynia or hyperalgesia after a nerve injury, not necessarily limited to the distribution of the injured nerve.
2. Evidence at some time of edema, changes in skin blood flow or abnormal sudomotor activity in the region of the pain.
3. This diagnosis is excluded by the existence of conditions that would otherwise account for the degree of pain and dysfunction. **Note:** All three criteria must be satisfied (Merskey and Bogduk 1994)

### Characteristics

CRPS is a "pain plus" syndrome comprising regional neuralgia plus additional symptoms. Most cases follow trauma, but symptoms persist after apparent healing of injuries. Autonomic dysregulation (hyperhidrosis, vasomotor instability causing edema, abnormal skin color or temperature) is part of the definition. Motor abnormalities are common and increasingly recognized. Some patients have mild or transient symptoms; others are chronically disabled. CRPS was first characterized in Weir Mitchell's astute descriptions of Civil War soldiers with ► **causalgia** after penetrating wounds. It is not known why rare nerve injury patients develop CRPS-II and why identical symptoms develop without obvious cause in CRPS-I. The fundamental lesion in CRPS-I appears to involve specific peripheral axons, the small diameter unmyelinated and thinly myelinated axons that subserve pain and some autonomic functions (van der Laan et al. 1998; Albrecht et al. 2006; Oaklander et al. 2006). Relative sparing of motor and large fiber sensory axons can preserve enough function to give some patients a misleadingly normal appearance.

### Treatments for Recent Onset CRPS

Early on, medications must be secondary to and supportive of efforts to mobilize the affected limb and to restore its function. Several trials have evaluated treatments for CRPS symptoms present for less than 6 months. Inflammation and remodeling from the original trauma may still be present and the final effects of injury on the CNS may not yet have occurred, making it possible to find treatments to modify the disease course (provide permanent cure or improvement) rather than merely alleviate symptoms. It has not been examined whether these early treatments are also effective for chronic CRPS, and their mechanisms are completely unknown. Two small, unblinded trials (Braus et al. 1994) support the use of oral corticosteroids. Systematic meta-analysis (Perez et al. 2001) of several placebo controlled randomized controlled trials (RCT) of intranasal calcitonin (100–400 IU) support its use.

Calcitonin is a neuropeptide with direct antihyperalgesic effects independent of its effects on bone (Braga 1994). Use of bisphosphonates, which also inhibit osteoclast mediated bone resorption, is supported by several small RCT (Varena et al. 2000). One study found pamidronate (30 mg daily for 3 days) effective in 35 patients with acute or chronic CRPS. Single RCTs support the efficacy of topical dimethylsulfoxide, and of oral vitamin C in CRPS-I. The alpha-adrenergic antagonist phenoxybenzamine was effective in small trials in early CRPS (Muizelaar et al. 1997) and various neuralgias including CRPS-II.

#### Conservative Treatments for Established CRPS

Rehabilitation is essential. In addition to preventing secondary problems including deconditioning, contractures, weight gain and depression, it now appears that abnormal cortical reorganization in CRPS may be ameliorated by aggressive restoration of function. Psychotherapy and/or psychotropic medications are indicated for many patients who develop reactive depression or other psychological difficulties caused by their chronic pain and disability. The limited evidence suggests that acupuncture, magnets, and other alternative treatments are ineffective.

#### Medical Treatments for Established CRPS

Pharmacotherapy becomes the major treatment for patients whose symptoms do not improve substantially despite aggressive rehabilitation. Few pharmaceutical companies consider CRPS a suitable condition for clinical trials and so there are no strong drug trials in chronic CRPS. Clinicians must currently extrapolate from the results of well-designed and conclusive trials for related conditions (primarily painful diabetic neuropathy and postherpetic [neuralgia](#) (PHN)). No medication has a U.S. Food and Drug Administration indication for CRPS. Regardless, most chronic CRPS patients take medications, of necessity "off label".

Randomized, controlled, clinical trials studying the treatment of neuralgia have established the efficacy and safety of four classes of medication. There are not enough data to support the use of one class over another and efficacy data must be tempered with consideration of possible adverse effects and cost. Standard principles should be applied, namely selection of medication based not only on the patient's symptoms, but also on their overall medical, social and financial situations. Each medication should be tried in an adequate dose and for long enough (1 to 2 months for tricyclics). If ineffective or ill tolerated, a medication should be tapered, discontinued and then replaced with the next choice. Multiple medications are indicated only when each provides added benefit and there are no adverse interactions. Usually, a selection of medications from different classes is required. Polytherapy is common in CRPS because pain relief is often elusive.

#### Topical Local Anesthetics

The most important characteristic of topically applied medications (whose active ingredient remains in the skin) is the low incidence of adverse effects. These are available in various forms including gels, creams and sprays. The 5% lidocaine patch is probably the most commonly topical medication prescribed for CRPS. The patch itself protects allodynic skin from contact and the local anesthetics within reduce hyperalgesia. An RCT of 40 patients with focal [neuropathic pain](#) including CRPS documents its efficacy (Meier et al. 2003), as does an earlier uncontrolled open label add on study of six CRPS patients.

#### Tricyclic Antidepressants (TCA)

TCAs that augment noradrenergic neurotransmission are perhaps the most effective option for treating neuralgia. Generic forms are available. TCAs have several mechanisms that contribute to efficacy, including potentiation of descending inhibitory pathways to decrease dorsal horn hyperactivity,  $\mu$ -opioid receptor activation and cation channel blockade. There are no studies specifically documenting the efficacy of TCAs in CRPS, but their efficacy in neuralgias including diabetic neuropathy (Max et al. 1992) and PHN is better documented than for any other medications. TCAs that increase norepinephrine are effective; those with serotonergic effects only are not, whereas those that increase both may work best. Adverse effects, which limit TCA use, are more common with amitriptyline than nortriptyline (Watson et al. 1998) or desipramine (Max et al. 1992). CRPS patients are often younger than other neuralgia patients and thus may tolerate TCAs better.

#### Antiepileptic Drugs (AED)

AEDs decrease central neuronal hyperexcitability to treat neuralgic pain as well as seizures. Gabapentin, well studied in PHN and diabetic neuropathy, is a primary option. It binds to the  $\alpha_2\delta$  subunit of voltage gated calcium channels and decreases calcium-mediated release of excitatory neurotransmitters. Gabapentin has no drug interactions and serum levels do not usually need to be monitored. Serious adverse effects appear to be less common than with TCAs, though this may not be true for minor ones. In CRPS, gabapentin was useful in an open label uncontrolled study of nine adult patients given 600 mg/day (a lower dose than is now used) (Mellick and Mellick 1997) and in a single pediatric case. Carbamazepine, FDA-approved for trigeminal neuralgia, is supported by a single small, uncontrolled study adding it to spinal cord stimulation (Harke et al. 2001).

#### Opioids

Reluctance to prescribe is common, though some CRPS patients do benefit from opioid treatment and remain on

stable doses. Like other options, opioids help some but not all sufferers and usually provide only partial relief. Physical ▶ [dependence](#) or ▶ [tolerance](#) do not always develop and can usually be managed by avoiding dose escalation and sudden withdrawal. There are inadequate data to support preference for any particular opioid, although methadone is attractive because of its low cost. Direct evidence from CRPS patients is almost nil; the rationale for use is based largely on the results of well-designed studies in other neuralgic conditions (Raja et al. 2002). An add-on study of morphine in CRPS patients with spinal cord stimulators did not demonstrate efficacy, but the subjects were too unique to generalize its conclusions. Current or former substance abuse is the major contraindication to opioid use, although they can sometimes be prescribed for abusers with severe pain if they are rigorously monitored.

### Other Medications to Consider

Systemic local anesthetics are sometimes efficacious but require invasive or subcutaneous administration. Such use was supported by the results of a small RCT in 16 patients with CRPS-I and -II (Raja et al. 2002) and a case series. Administration must be carefully monitored to prevent seizures or cardiac arrest. The evidence supporting clonidine is weak. A case series of four CRPS patients screened by regional and systematic sympathetic blocks found that the antihyperalgesic effect was restricted to skin directly under the clonidine patch (Davis et al. 1991). Thalidomide, which inhibits release of TNF-alpha, is under evaluation.

### Surgical Treatments for Established CRPS

If medications have not provided significant relief after adequate trials, two surgical options deserve consideration and one does not, namely cutting nerves or neural structures transmitting pain sensations from the affected areas. Ablative neurosurgery has a simplistic appeal and occasionally provides a pain-free interval to terminal patients; it is not indicated for most CRPS patients who have largely preserved motor function and long life expectancy. Limb amputation is still occasionally performed and may very rarely be indicated for serious complications such as gangrene, but it should not be performed for pain control. CRPS pain is almost certainly maintained by CNS abnormalities not addressed by peripheral ablation.

In contrast, the possibility of nerve entrapment or compression should more often be considered. Surgical decompression can provide dramatic cures in these situations (Thimineur and Saberski 1996). Occasionally, unexpected causes of CRPS such as leprosy, tumors or vascular malformations are diagnosable only by exploratory surgery. The single most powerful treatment for severe established CRPS is implantation of a bipolar neural stimulator. Properly selected patients can achieve dramatic pain relief permitting discontinuation

of medications and major functional gains. Experienced clinicians have noted that, unlike medications, stimulators can have disease modifying effects, such as pain relief that persists for longer and longer periods after the stimulator is turned off. Similar properties have also been documented after CNS stimulation in other diseases. Stimulation of the dorsal column is the most common procedure, because the electrode can be placed percutaneously. Although device trials are difficult to control for, there is at least one well-designed study (Kemler et al. 2000) and several case series that demonstrate efficacy in about half of implanted CRPS patients. Expense and not infrequent complications are the major limitations. For patients whose CRPS is due to single nerve damage, surgically implanted peripheral nerve stimulators have had even higher efficacy in a prospective trial (Hassenbusch et al. 1996).

### References

1. Albrecht PJ, Hines S, Eisenberg E et al. (2006) Pathologic alterations of cutaneous innervation and vasculature in affected limbs from patients with complex regional pain syndrome. *Pain* 120:244–266
2. Braga PC (1994) Calcitonin and its antinociceptive activity: animal and human investigations 1975–1992. *Agents Actions* 41:121–131
3. Braus DF, Krauss JK, Strobel J (1994) The shoulder-hand syndrome after stroke: a prospective clinical trial. *Ann Neurol* 36:728–733
4. Davis KD, Treede RD, Raja SN et al. (1991) Topical application of clonidine relieves hyperalgesia in patients with sympathetically maintained pain. *Pain* 47:309–317
5. Harke H, Gretenkort P, Ladleif HU et al. (2001) The response of neuropathic pain and pain in complex regional pain syndrome I to carbamazepine and sustained-release morphine in patients pretreated with spinal cord stimulation: a double-blinded randomized study. *Anesth Analg* 92:488–495
6. Hassenbusch SJ, Schoppa D, Walsh JG et al. (1996) Long-term results of peripheral nerve stimulation for reflex sympathetic dystrophy. *J Neurosurg* 84:415–423
7. Kemler MA, Barendse GA, van Kleef M et al. (2000) Spinal cord stimulation in patients with chronic reflex sympathetic dystrophy. *N Engl J Med* 343:618–624
8. Max MB, Lynch SA, Muir J et al. (1992) Effects of desipramine, amitriptyline, and fluoxetine on pain in diabetic neuropathy. *N Engl J Med* 326:250–256
9. Meier T, Wasner G, Faust M et al. (2003) Efficacy of lidocaine patch 5 % in the treatment of focal peripheral neuropathic pain syndromes: a randomized, double-blind, placebo-controlled study. *Pain* 106:151–158
10. Mellick GA, Mellick LB (1997) Reflex sympathetic dystrophy treated with gabapentin. *Arch Phys Med Rehabil* 78:98–105
11. Merskey H, Bogduk N (1994) Classification of chronic pain: Descriptions of chronic pain syndromes and definitions of pain terms, 2nd edn. IASP Press, Seattle
12. Muizelaar JP, Kleyer M, Hertogs IA et al. (1997) Complex regional pain syndrome (reflex sympathetic dystrophy and causalgia): management with the calcium channel blocker nifedipine and/or the alpha-sympathetic blocker phenoxybenzamine in 59 patients. *Clin Neurol Neurosurg* 99:26–30
13. Oaklander AL, Rissmiller JG, Gelman LB et al. (2006) Evidence of focal small-fiber axonal degeneration in complex regional pain syndrome-I (reflex sympathetic dystrophy). *Pain* 120:235–243
14. Perez RS, Kwakkel G, Zuurmond WW et al. (2001) Treatment of reflex sympathetic dystrophy (CRPS type 1): a research synthesis of 21 randomized clinical trials. *J Pain Symptom Manage* 21:511–526

15. Raja SN, Haythornthwaite JA, Pappagallo M et al. (2002) Opioids versus antidepressants in postherpetic neuralgia: a randomized, placebo-controlled trial. *Neurology* 59:1015–1021
16. Thimineur MA, Saberski L (1996) Complex regional pain syndrome type I (RSD) or peripheral mononeuropathy: A discussion of three cases. *Clin J Pain* 12:145–150
17. van der Laan L, ter Laak HJ, Gabreels-Festen A et al. (1998) Complex regional pain syndrome type I (RSD): pathology of skeletal muscle and peripheral nerve. *Neurology* 51:20–25
18. Varena M, Zucchi F, Ghiringhelli D et al. (2000) Intravenous clodronate in the treatment of reflex sympathetic dystrophy syndrome. A randomized, double blind, placebo controlled study. *J Rheumatol* 27:1477–1483
19. Watson CPN, Vernich L, Chipman M et al. (1998) Nortriptyline versus amitriptyline in postherpetic neuralgia: a randomized trial. *Neurology* 51:1166–1171

## CRPS Type-I

### Definition

Pain syndrome that develops after minor injuries or fractures of a limb

- ▶ [Complex Regional Pain Syndromes, Clinical Aspects](#)
- ▶ [Postoperative Pain, Acute Presentation of Complex Regional Pain Syndrome](#)
- ▶ [Sympathetically Maintained Pain in CRPS I, Human Experimentation](#)

## CRPS Type-II

### Definition

Complex regional pain syndrome type 2, previously called causalgia. A pain syndrome that develops after injury to a major peripheral nerve.

- ▶ [Complex Regional Pain Syndromes, Clinical Aspects](#)
- ▶ [Postoperative Pain, Acute Presentation of Complex Regional Pain Syndrome](#)
- ▶ [Sympathetically Maintained Pain in CRPS II, Human Experimentation](#)

## CRPS-1 in Children

GUNNAR L. OLSSON

Pain Treatment Services, Astrid Lindgren Children's Hospital/Karolinska Hospital, Stockholm, Sweden  
gunnar.olsson@ks.se

### Synonyms

Complex regional pain syndrome; Reflex Sympathetic Dystrophy; RSD

### Definition

The diagnostic criteria for ▶ [CRPS -1](#) were established in 1995 (Stanton-Hicks et al. 1995):

1. An eliciting event, but no demonstrable injury to a peripheral nerve
2. Pain, spontaneous or evoked, often with evidence of ▶ [allodynia](#) in a limb
3. ▶ [Dysautonomic](#) signs
4. No other explanations for the pain

CRPS occurs more frequently in girls, than boys. The most common age of onset is approximately 10–14 years of age. The site of CRPS-1 is predominantly in the lower extremities. The cause is unknown but children have often had a history of psychosocial stress, such as bullying in school. However, the most common stress factor is that children have atypically high expectations for achievement in school and / or sports.

Harden et al. performed a factor analysis of symptoms and signs associated with CRPS-1 and proposed another diagnostic classification: 1. pain, 2. vasomotor disturbances, 3. oedema and sweating changes, 4. motor changes (Harden et al. 1999; Wilson et al. 2005). They suggested that the criteria of an eliciting event should be dropped because no eliciting trauma could be identified in 8% of the cases in a large case series in adults.

### Characteristics

#### Age and Gender

CRPS-1 is much more common in girls; approximately 85% of affected children are girls (Bernstein et al. 1978; Olsson et al. 1997; Wilder et al. 1992; Sherry et al. 1999). It is most commonly reported for children in the pre-teen or early teen years (11–14 years of age), although there are case reports on children as young as 3 years old (Kozin et al. 1977).

#### Localisation

The foot is the most commonly affected site, followed by other parts of the leg and then the upper extremities, including hands, elbows and shoulders. Although the diagnosis of CRPS-1 in other regions is controversial, I have treated a girl with CRPS-1 in the forehead.

#### Dysautonomic Signs

For adults with CRPS-1, the skin temperature often increases initially so that the affected region feels warm; later a cold dystrophic phase ensues. In contrast, children usually first experience a lower temperature in the affected region. An infrared skin thermometer is of great value in the clinical setting for temperature determination. Discoloration is usually bluish, blue and red or pale and appears intermittently rather than consistently. Oedema may be very soft and subcutaneous and may also recur intermittently. Many children have had a MRI before their referral to the pain clinic. In several of our cases the radiologist has described a





C

**CRPS-1 in Children, Figure 1** An 11 year old girl with a severe CRPS-1 including contractures of knee and hip. She was successfully treated with spinal stimulation.

bone marrow oedema, but its relevance is not known. In the more classic cases of CRPS-1 the child's extremity is continuously cold, swollen, blue-reddish and very allodynic (Fig. 1).

#### Motor Disturbances

Some motor weakness and even paresthesias may be attributed to reflexes associated with pain. However, even active motor disturbances are sometimes involuntary movements and contractures due to predominance of flexors or extensors.

#### Psychosocial Stress

Certain chronic pain syndromes in children are associated with high levels of psychosocial stress. Child abuse and bullying in school is not uncommon among girls with CRPS. However the most typical stress factor seems to be a child's unrealistically high expectations of performance in school and athletics.

#### Diagnosis

First, physicians must determine whether the pain arises from a known cause. This determination is often difficult. CRPS-1 is classified as a neurogenic pain syndrome. Although there is no identified lesion in the nervous system, there is a dysfunction of the sympathetic nervous system and pain transmission. CRPS-1 does not respond to traditional analgesics, even to opioids in normal doses. Thus, pharmacological testing is a valuable diagnostic tool to investigate the presences of ongoing noxious stimulation. We often administer a course of oral NSAIDs in a reasonably high dose, e.g. diclofenac or ibuprofen, for 1 week where children have not had any analgesics. We assess pain by self-report 3 × a day and note the time of day when children experience their worst pain. Sometimes we per-

form an intravenous ▶ **alfentanil** test in a standardised double blind manner. CRPS-1 children who typically experience spontaneous pain do not experience relief, while children with nociceptive pain usually experience complete pain relief.

According to the criteria from 1995, a history of dysautonomia was sufficient for a CRPS-1 diagnosis when a child had pain without any other explanation. Dysautonomic signs may also prevail in connection with acute trauma. However, such signs usually resolve when wounds and fractures have healed. An updated review of CRPS in adults and children has recently been published as a proceeding from a meeting of the Special Interest Group on Pain and the Sympathetic Nervous system in Budapest August 2003 (Wilson et al. 2005).

#### Treatment

Children and families require reassurance that the pain is not a sign of continuing damage and that the pain is not a symptom of correlating injury. Many children require psychological counselling in order to be able to resume their previous activities.

#### Physiotherapy

Physiotherapy (PT) is a mainstay in the treatment of CRPS-1. Bernstein and colleagues described the first case series in children; they treated the children as inpatients with intensive physiotherapy including massage and "towelings" (Bernstein 1978). More recently, Sherry advocated 6 h daily PT, including desensitisation and touching allodynic areas, for a large case series of 103 children. However, in the only randomized controlled trial evaluating PT for children with CRPS-1, Lee et al. (2002) used a more intense PT treatment (3 × weekly) that was not more effective than a weekly program. The positive effect of PT is probably due to the increased

activity of affected extremities (i.e. increasing normal sensory input) and to the increased overall activity of the children (i.e. resuming normal social and physical activities), rather than avoiding activity due to fear of pain and further injury.

### Drugs

Analgesics do not relieve pain associated with CRPS-1. There are no published studies evaluating the effect of other drugs in childhood CRPS, despite clinical practice in which tricyclic antidepressants (TCA) are widely used and effective in certain cases (Olsson 2003). However TCA's may have adverse effects, the drug must be very slowly titrated and the child must be closely monitored to ensure compliance. Common side effects include sedation, dry mouth, nightmares, dizziness and occasional nausea. The effective dose is not known, with some physicians prescribing a maximum dose of 10 mg. In our centre, we slowly increase the dose from 10 mg until the child benefits or there are adverse effects, to a maximum of 100 mg. There are no published studies indicating effects of other drugs used for neurogenic pain such as gabapentin or other antiepileptic drugs in children.

### Sympathetic Blocks

Some children obtain pain relief by a sympathetic block (Olsson 1990; Olsson 2003). In Europe, this block is often performed as an intravenous regional block using guanethidine. Paravertebral blocks using local anaesthetics seldom have long-lasting effects. Epidural analgesia with an indwelling catheter may provide longer relief in severe cases. The long-term effect of this treatment is not well documented. Sympathectomy should not be used in children due to the nature of the procedure and the tendency to improve non-surgically.

### Dorsal Column Stimulation

Neurogenic pain can often be treated with spinal stimulation. In our centre, we have applied ► [dorsal column stimulation](#) to seven children with severe CRPS (Olsson 2003) and achieved good pain relief for most children. However, this therapy is very invasive, expensive and usually performed on conscious patients, so it should be considered only in very special, severe, selected cases.

### Psychological Treatment

Psychological treatments are an important component in the treatment of CRPS-1. Specific therapies range from reassurance and education to sophisticated programs of cognitive behavioural therapy. There are no published studies proving the efficacy of CBT in CRPS although it is included in the treatment program in many studies (Lee et al. 2002; Wilder et al. 1992). In our centre, we use a well-defined form of CBT called acceptance and commitment therapy (Robinson et al. 2004) based on acceptance, fear / avoidance, activation and exposure to valued life.

### Prognosis

The long-term prognosis for CRPS in children is unknown and studies to date yield contradictory information. CRPS-1 in childhood seems to be milder, with less atrophy and with a good short-term prognosis, in comparison to CRPS-1 in adults. Veldman and Goris (1997) reported 118 cases of recurrence in 1183 consecutive patients, in a predominantly adult sample. Recurrences occurred especially in younger patients, often not only in the originally affected limb. In a 5 year follow up at our centre, 25% of children continued to experience pain (Olsson et al. 1991). Only 50% of 70 children with CRPS in the Boston series were free from pain (Wilder et al. 1992). In a series of 1006 RSD patients aged 10–84 years, 7% developed severe complications such as infection, ulcers, chronic oedema, dystonia and / or myoclonus. Patients affected were younger and more often female. The skin temperature at onset was in these patients lower than in non-complicated cases (van der Laan et al. 1998). The long-term prognosis has to be further evaluated in children.

### References

- Bernstein BH, Singen BH, Kent JT et al. (1978) Reflex neurovascular dystrophy in childhood. *J Pediatr* 93:211–215
- Harden RN, Bruehl S, Galer BS et al. (1999) Complex regional pain syndrome: are the IASP diagnostic criteria valid and sufficiently comprehensive? *Pain* 83:211–219
- Kozin F, Haughton V, Ryan L (1977) The reflex sympathetic dystrophy syndrome in a child. *J Pediatr* 90:417–419
- Lee BH, Scharff L, Sethna NF et al. (2002) Physical therapy and cognitive-behavioral treatment for complex regional pain syndromes. *J Pediatr* 141:135–140
- Olsson GL (2003) The effect of i.v. regional sympathetic block in children with CRPS-1. *SIG Pain in Childhood ISPP2003*, Sydney
- Olsson GL, Arnér S, Hirsch G (1991) Reflex sympathetic dystrophy in children. *Advances in Pain research and therapy* 15:323–331
- Olsson GL, Linderöth B, Meyerson B (2003) Spinal cord stimulation as a treatment option in severe cases of complex regional pain syndrome. *SIG Pain in Childhood ISPP2003*, Sydney
- Robinson P, Wicksell R, Olsson GL (2004) ACT with chronic pain patients. In: Hayes S, Strosahl KD (eds) *A practical guide to acceptance and commitment therapy*. Springer New York
- Sherry DD, Wallace CA, Kelley C et al. (1999) Short- and long-term outcomes of children with complex regional pain syndrome type I treated with exercise therapy. *Clin J Pain* 15:218–23
- Stanton-Hicks M, Janig W, Hassenbusch S et al. (1995) Reflex sympathetic dystrophy: changing concepts and taxonomy. *Pain* 63:127–33
- van der Laan L, Veldman PH, Goris RJ (1998) Severe complications of reflex sympathetic dystrophy: infection, ulcers, chronic edema, dystonia, and myoclonus. *Arch Phys Med Rehabil* 79:424–429
- Veldman PH, Goris RJ (1997) Multiple reflex sympathetic dystrophy. Which patients are at risk for developing a recurrence of reflex sympathetic dystrophy in the same or another limb. *Pain* 71:207–208
- Wilder RT, Berde CB, Wolohan M et al. (1992) Reflex sympathetic dystrophy in children. Clinical characteristics and follow-up of seventy patients. *J Bone Joint Surg Am* 74:910–919
- Wilson PR, Stanton-Hicks M, Harden RN (2005) *CRPS: Current diagnosis and therapy*. IASP Press, Seattle

## Crura of Clitoris

### Definition

The crura or bulbs extend posteriorly and horizontally as two cylinders of erectile tissue arising from the body of the clitoris where it meets the pubic bone for up to 9 cm.

- ▶ Clitoral Pain

## Cryoablation

### Definition

The use of sub-zero temperatures to destroy tissue.

- ▶ Cancer Pain Management, Neurosurgical Interventions

## Cryoglobulinemia

### Definition

Condition wherein cryoglobulins, a class of immunoglobulins that precipitate when cooled and re-dissolve when heated, are present in the blood.

- ▶ Viral Neuropathies

## Cryotherapy

### Definition

Application of cold to body surfaces.

- ▶ Chronic Pain in Children, Physical Medicine and Rehabilitation

## CSF

- ▶ Cerebrospinal Fluid

## CSF Examination

### Definition

Shows pleocytosis, elevation of protein, or oligoclonal banding in Neuro-Behcet, collagen vascular disease, systemic vasculitides and the isolated angiitis of the central nervous system.

- ▶ Headache Due to Arteritis

## CSF Leak

- ▶ Spontaneous Cerebrospinal Fluid (CSF) Leak

## CT Myelography

### Definition

Imaging of the spinal cord using computerized analysis of cross-sectional scans (tomograms) after injection of a contrast agent into the spinal fluid.

- ▶ Chronic Low Back Pain, Definitions and Diagnosis

## CT Scanning

PETER LAU

Department of Clinical Research, Royal Newcastle Hospital, University of Newcastle, Newcastle, NSW, Australia

petercplau@hotmail.com

### Synonyms

CAT Scan; Helical CT; Spiral CT; Multichannel CT; Computerised Axial Tomography

### Definition

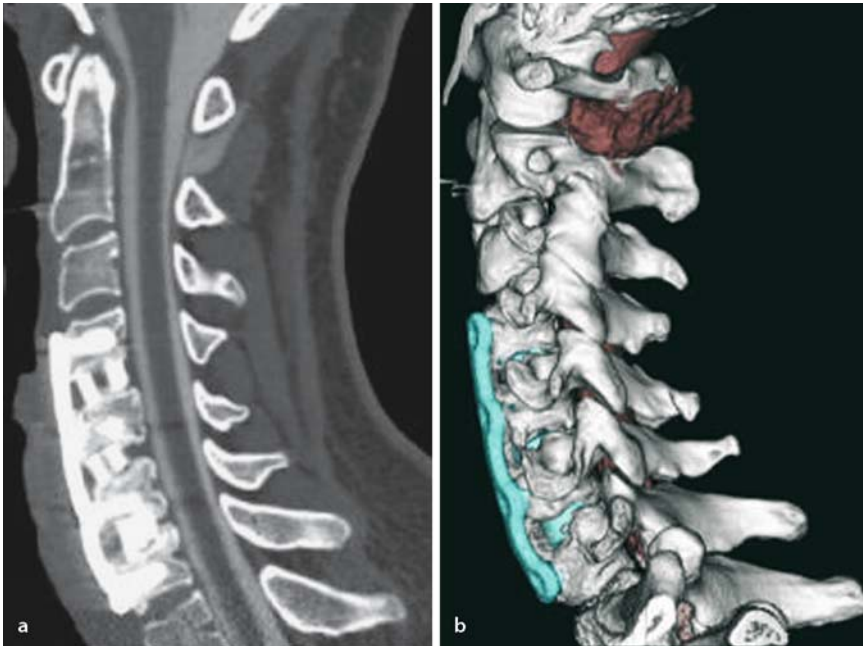
Computerised axial tomography (CAT or CT) is a means by which images of the internal structure of the body can be obtained in selected planes and at selected depths.

### Characteristics

#### Principles

In CT scanning, a computer is used to synthesise images based on X-ray absorption data. The object to be scanned is placed at the centre of a circular gantry, around which an X-ray camera and its receiver rotate. As the camera rotates, X-rays are beamed through the object along multiple, selected diameters. Along each diameter the X-ray shadows (see ▶ Plain Radiography) of the object and its internal structure are transmitted to the receiver and stored by a computer. Using an iterative program, the computer then analyses the stored information to generate a synthetic image of what the internal, three-dimensional structure of the object must be, in order to account for all of the different patterns of X-ray absorption obtained along each of the diameters across which the object was viewed.

The plane across which the object is studied is typically transverse to the long axis of the object; but this plane can be varied by tilting the gantry. Also, the object can be translated relative to the gantry so that it can be studied across multiple, selected sections, also referred to as "slices". By scanning across its entire length, images of



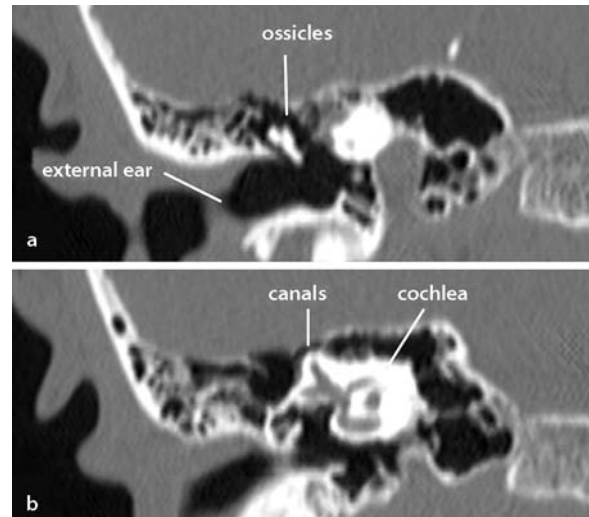
**CT Scanning, Figure 1** Sagittal CT scans of the cervical spine in which the vertebrae C4 to C7 have been fused with interbody grafts and an anterior metal plate. (a) Midline section. (b) 3-D reconstruction. Reproduced courtesy of Toshiba Medical.

the entire object can be synthesized. By using special computer programs, images can be synthesized to view the object from any angle or perspective, at any depth. The images can be planar, i.e. depicting the appearance of a single, selected slice through the object (Fig. 1a) or they can be simulated, three-dimensional reconstructions of the internal structure of the object (Fig. 1b).

#### Capabilities

The first generation scanner took about 7 min to perform a single scan. Since then, the technology involved has been improved greatly, through at least five generations of development. Today, with multi-slice or multichannel, slip-ring CT systems, which allow continuous scanner gantry motion, coupled with synchronous table feed provide the basis for so-called helical or spiral CT scanning (Fox et al. 1998). Ultra-fast scanners are capable of performing as many as 32 scans in half a second which is the time taken per rotation of the gantry. This is achieved by unique design of detectors, isotropic scanning and fast reconstruction. Sub-millimetre thin and ultra-thin slices can be obtained. There is now commercially available CT scanner capable of more than 64 slices per half a second.

In the past, using slow scanners, CT provided images of all but the smallest of soft tissues. Today with sub-millimetre, micro-voxel scanning (Pretorius and Fishman 1999), the smallest structures in the body, particularly small bony structures such as those of the middle and inner ear, can be well demonstrated (Fig. 2). The cardinal advantage of CT is that it allows observers to “see inside” cavities such as the chest, abdomen, skull and vertebral canal (Fig. 3). The ability to demonstrate soft tissues allows CT to detect displacement and distor-



**CT Scanning, Figure 2** ACT scan through the temporal bone, showing the external ear and contents of the middle and internal ear. (a) Transverse section showing the ossicles of the middle ear. (b) Transverse section showing the cochlea and semicircular canals.

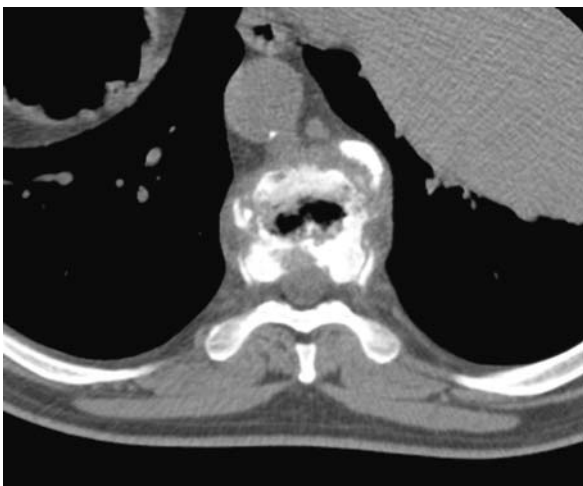
tion of these structures by tumours, infiltration, infection and inflammation (Fig. 4). Of particular relevance to pain medicine is the ability of CT to demonstrate intracranial pathology in patients with headaches and the relationship between spinal nerves and the vertebral column in patients with radicular pain.

However, CT still relies on detecting the X-ray shadows of internal structures. Consequently, although CT can demonstrate the location, shape and density of tissues it cannot reveal their internal architecture, although hollow or permeable structures can be indirectly visu-





**CT Scanning, Figure 3** Sagittal CT scan of the abdomen showing internal viscera and vessels. a aorta. l liver. m superior mesenteric artery. c colon. s small intestine. Reproduced courtesy of Toshiba Medical.



**CT Scanning, Figure 4** Axial CT scan of the thoracic spine showing osteomyelitis of a vertebral body.

alised by injection or infusion of radio-opaque agents, which localise in targeted tissues. Thus, injection of contrast medium will outline the lumen of hollow organs and blood vessels, joint cavities and the subarachnoid space (Fig. 5). The internal structure of the intervertebral disc

can be visualised by injection of contrast into the nucleus (Fig. 6) and intravenous infusion of a rapidly excreted contrast medium will enhance the structure of the kidney and urinary tract.

Multichannel techniques have had a significant impact on the style and quality of spine CT. Coverage is no longer limited by practical problems. Lumbar studies routinely extend from T12 to S1 and cervical spine studies from C2 to T2. With a 64-channel scanner, the full spine scan may be obtained in the duration of one breath-hold, which is easier for patients to tolerate than MRI scans.

### Applications

Microvoxel volumetric acquisition techniques provide a significant boost in spatial and contrast resolution. They can be used to create exquisite sagittal images of the intervertebral foramina in patients with radicular pain, especially in those with persisting pain after surgery, when missed foraminal stenosis is a major source of chronic pain.

With the advent of fine, sub-millimetre technology, CT is becoming the modality of choice for the assessment of failed back surgery syndrome. Artifacts from intervertebral metal cages or pedicular screws can be minimised, which allows for assessment of failure of spinal fixation hardware by loosening or metal fracture and fatigue.

CT can demonstrate the progress of healing in the skeletal system and can detect pseudoarthrosis in the spine after attempted arthrodesis. Similar techniques can be used for the assessment of joint replacement in the hip, shoulder and knee. Microvoxel scan techniques minimise partial volume artefact and allow evaluation of the state of bone surrounding hardware implants, as well as evaluation of possible loosening and migration of the prosthesis as a chronic source of pain.

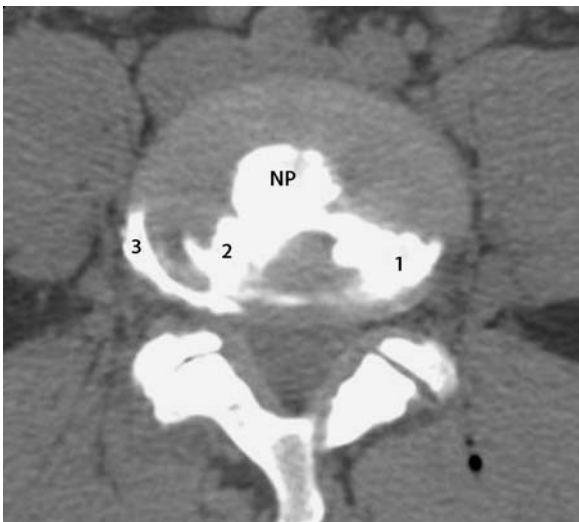
With the advent of 32 and 64 slice scanners, dynamic, real-time imaging of joint movements and spinal movement in order to assess biomechanical abnormalities is possible.

Real time fluoroscopy-CT is used to perform pain interventional procedures. It enables drugs to be injected accurately and safely. It enables the accurate and safe delivery of ablation devices, such as radio-frequency electrodes, to deep sites that were considered difficult, unsafe and inaccurate in the past. This opens up a new arena of oncological pain management by using radiofrequency ablation to destroy pain-producing tumours that have invaded nerve plexuses e.g. metastatic carcinoma of the rectum with invasion of the lumbo-sacral plexus. Ablation of painful bone tumours, such as osteoid osteoma, is another avenue of application of CT in pain management.

High-contrast resolution and the seamless multi-planar capability of the latest multi-channel CT imagers have their greatest application in musculoskeletal pain after



**CT Scanning, Figure 5** Parasagittal and sagittal CT scans of the entire spine. Contrast medium has been injected into the subarachnoid space, which appears white (sa), and outlines the spinal cord (sc), which appears dark. Reproduced courtesy of Toshiba Medical.



**CT Scanning, Figure 6** An axial CT scan of a lumbar intervertebral disc. Contrast medium fills the nucleus pulposus (NP), a left posterolateral radial fissure (1) that extends into the annulus fibrosus and a right posterolateral fissure (2) that has a circumferential extension (3).



**CT Scanning, Figure 7** A sagittal CT scan of the ankle, showing an oblique fracture (arrow) through the posterior tibia, extending into the talocrural joint. Reproduced courtesy of Toshiba Medical.

trauma. Fractures are now delineated easily in any plane while the patient is situated comfortably on the table. Positioning during the scan is not critical, as any plane can be created from the volumetric data. Trauma series are typically performed in less than 30 s, minimizing the likelihood of patient motion (Tanenbaum 2003). Treatment can be better planned when CT demonstrates the

presence and extent of subtle cortical fractures, fracture fragments, intra-articular loose bodies and articular surface offset / depression; this was not possible by plain radiography (Fig. 7).

Whereas magnetic resonance imaging is superior for the delineation of the extent of tumours in medullary bone, CT is better able to delineate cortical bone, calcifications

in the matrix of lesions and periosteal new bone formation.

#### Utility

The utility of CT emerges from a tension between what can be seen with CT and what is relevant and valid. Although CT can provide detailed images of the internal structure of the body, abnormalities demonstrated by CT are not necessarily the cause of a patient's pain. In the context of pain medicine, CT is useful as a diagnostic test only if and when it reliably shows the cause of pain.

#### Reliability

For major and obvious lesions, the reliability of radiologists using CT has not been questioned. Such lesions, however, are rarely pertinent to pain medicine. Of greater relevance are minor abnormalities that are sometimes reported in scans of patients with pain. Conspicuously, reliability data are largely lacking in the radiology literature. There has been a tradition to assume that all radiologists agree on what they report. When this has been studied, however, the converse emerges.

In reading CT scans of the lumbar spine, radiologists fail to agree on the presence of such features as spinal stenosis, degenerative joint disease and even herniated nucleus pulposus (Wiesel et al. 1986). Unfortunately, data have not been presented in a manner from which kappa scores can be calculated.

#### Validity

In the joints of the appendicular skeleton, CT can show abnormalities of joint space, subchondral bone and even internal and external ligaments. However, there are no data that incriminate these abnormalities as the cause of pain (Bogduk 2003).

In CT scans of the lumbar spine, abnormalities, such as degenerative joint disease, disc bulges and disc herniations are the most commonly encountered abnormalities. These abnormalities, however, also frequently occur in asymptomatic individuals (Wiesel et al. 1986). Indeed, some 20–30% of asymptomatic individuals exhibit herniated lumbar intervertebral discs. These figures warn that finding such abnormalities in symptomatic patients does not necessarily prove that they are the cause of pain.

Tumours and infections are assumed to be valid causes of pain but they are rare causes of either acute or chronic pain. The same applies for conditions, such as osteonecrosis. For most patients with pain, there is nothing demonstrable by CT that has actually been proven to be a cause of pain. Even pseudoarthrosis following spine surgery has not been validated as a cause of pain.

#### Future Trends

Improvements in the technology of CT are likely to continue. There is an urgent need, however, for clinical science to catch up with the technology. Urgently needed

are studies in which the presence and absence of morphological abnormalities are correlated with the presence and absence of pain. Such studies are necessary lest abnormalities simply be assumed to be relevant to the diagnosis of pain.

Another opportunity lies in the fusion of morphological CT technology with physiological imaging techniques such as [positron emission tomography \(PET\)](#) (Erickson 2003). Already PET-CT can produce the physiological properties of certain neoplasms combined with anatomical imaging. In the same way, it may become possible to demonstrate the physiology of lesions, seen on CT, that are suspected of being causes of pain.

#### References

1. Bogduk N (2003) Diagnostic procedures in chronic pain. In: Jensen TS, Wilson PR, Rice ASC (eds) *Clinical Pain Management: Chronic Pain*. Arnold, London, pp 125–144
2. Erickson JE (2003) TRIP 3-Possible Future Technologies. Paper presented at the 89<sup>th</sup> Annual Meeting of the Radiological Society of North America. Chicago, Illinois, November 2003
3. Fox SH, Tanenbaum LN, Ackelsberg S et al. (1998) Future directions in CT technology. *Neuroimaging Clin N Am* 8:497–513
4. Pretorius ES, Fishman EK (1999) Volume-rendered three-dimensional spiral CT: musculoskeletal application. *Radiographics* 19:1143–1160
5. Tanenbaum LN (2003) Multichannel helical CT of the musculoskeletal system. *Appl Radiol* 32:15–22
6. Wiesel SW, Tsourmas N, Feffer HL et al. (1986) A study of computer-assisted tomography. 1. The incidence of positive CAT scans in an asymptomatic group of patients. *Spine* 9:549–551

## CT Scans

### Definition

CT (computed tomography), sometimes called CAT scan (computed axial tomography), uses x-ray images taken at different angles around the body, and then by computer processing of the information produces two- or three-dimensional slice images.

► [Motor Cortex, Effect on Pain-Related Behavior](#)

## CTDs

► [Disability, Upper Extremity](#)

## CTrP

► [Central Trigger Point](#)

## Cuban Neuropathy Fabry's Disease

► [Metabolic and Nutritional Neuropathies](#)

## Cumulative Trauma Disorders

### Definition

A descriptive term used to label pain associated with repetitive activities.

- ▶ [Disability, Upper Extremity](#)

## Cuneate Nucleus

### Definition

A nucleus at the upper cervical spinal cord where the first synapse of the dorsal columns occurs. Discriminative sensory information from cutaneous regions from the upper half of the body is relayed to this nucleus.

- ▶ [Brainstem Subnucleus Reticularis Dorsalis Neuron](#)
- ▶ [Postsynaptic Dorsal Column Projection, Anatomical Organization](#)

## Cutaneous

### Definition

Relating to, or affecting, the skin.

- ▶ [Psychiatric Aspects of Visceral Pain](#)

## Cutaneous Allodynia

### Definition

Pain elicited by a non-noxious stimulus that is not normally painful.

- ▶ [Migraine Without Aura](#)

## Cutaneous Field Stimulation

JENS SCHOUENBORG

Section for Neurophysiology, Department of Physiological Sciences, Lund University, Lund, Sweden

Jens.Schouenborg@mphy.lu.se

### Synonyms

CFS

### Definition

Cutaneous field stimulation (CFS) allows topographically restricted and tolerable electrical stimulation of thin (A $\delta$  and C) cutaneous fibers for the symptomatic relief of ▶ [itch](#) and pain.

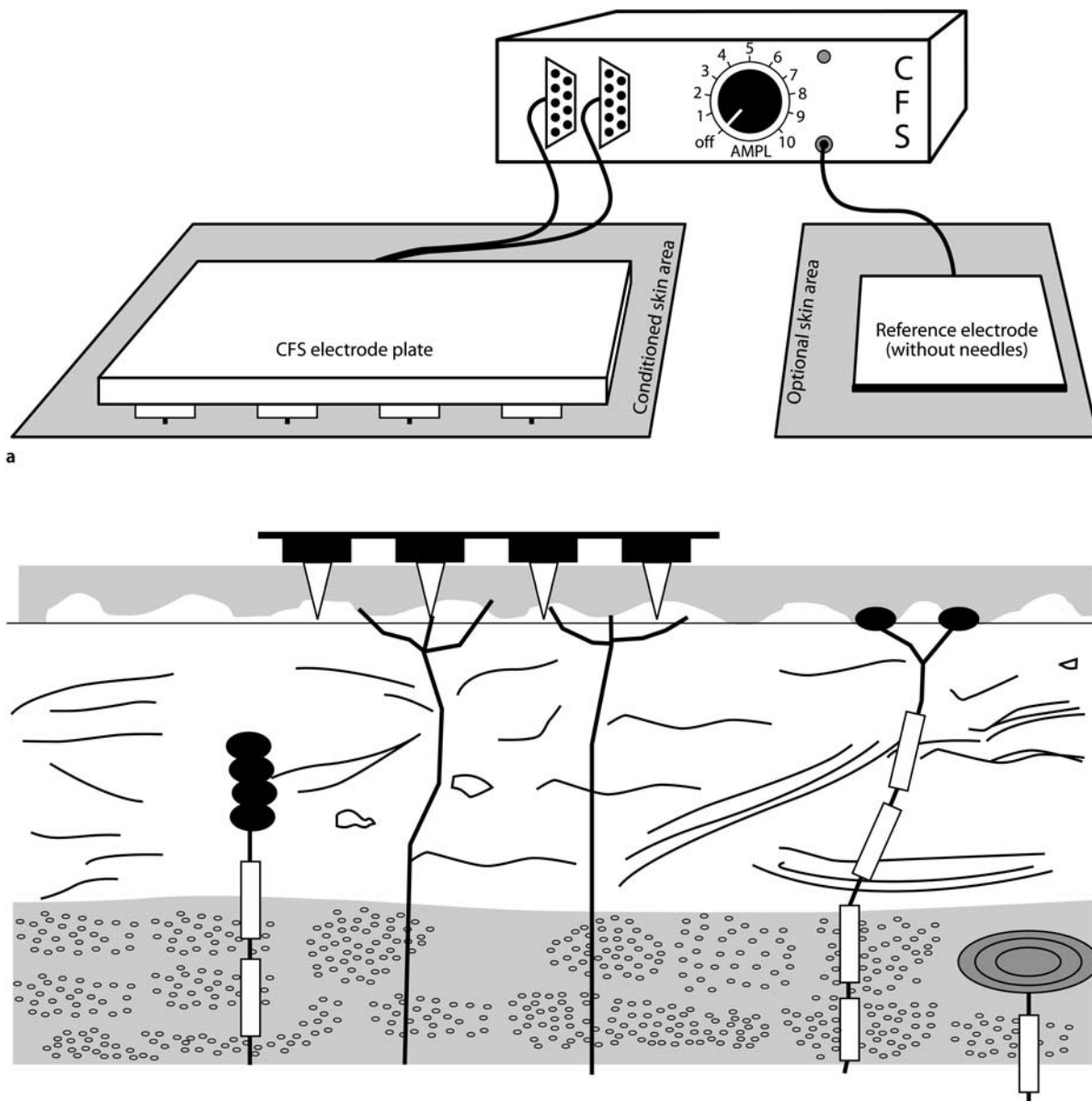
## Characteristics

The CFS technology is based on the organization of endogenous intermodality interactions and allows tolerable stimulation of cutaneous A $\delta$  and C afferent fibers (McMahon and Koltzenburg 1992; Ward et al. 1996). For example, mechanical stimulation inhibits ongoing pain (Bromm et al. 1995; Sjölund et al. 1990; Wall and Cronly-Dillon 1960; Ward et al. 1996). In fact, particularly strong interactions are found between submodalities of the nociceptive system (here including itch), e.g. low frequency electrical stimulation of A $\delta$  fibers may cause a durable depression of nociceptive C fiber transmission both *in vivo* (Sjölund 1985; Sjölund 1988) and *in vitro* spinal preparations (Sandkühler et al. 1997) and noxious mechanical stimulation, such as scratching, reduces itch. These interactions occur at several levels in the somatosensory system, the dorsal horn of the spinal cord (Cervero et al. 1979; Melzack and Wall 1965), the dorsal column nuclei (Saade et al. 1985) and the thalamus (Olausson et al. 1994) and are often topographically well organized. To use these interactions for the symptomatic relief of itch and pain, a new technique, termed cutaneous field stimulation (CFS), was introduced (Nilsson et al. 1997). CFS allows topographically restricted and tolerable electrical stimulation of thin (A $\delta$  and C) cutaneous fibers.

CFS uses a flexible rubber plate with multiarray needle-like electrodes regularly fixed at 2 cm intervals (Fig. 1). Each electrode is surrounded by a “stop-device” 2.0 mm in diameter that protrudes 2.0 mm from the plate. The electrode tip protrudes 0.3 mm from the stop-device. When the electrode plate is gently pressed against the skin, the electrode tips are introduced close to the receptors in the epidermis and the superficial part of dermis. Since the electrodes traverse the electrically isolating horny layer of the epidermis and the current density is high near the sharp electrode tips, the voltage and current necessary to stimulate cutaneous nerve fibers are small, typically less than 10 V and up to 0.8 mA, respectively. As the current density decreases rapidly with distance, localized stimulation is achieved. The electrodes are stimulated consecutively with a constant current stimulator (64 pulses / s), each electrode with a frequency of 1–10 Hz (pulse duration 1.0 ms). Treatment duration is 5–45 min. A self-adhesive surface (TENS) electrode serves as anode and is placed about 5–30 cm away from the needle electrode plate.

Several pieces of evidence demonstrate that CFS acts *via* stimulation of nociceptive A $\delta$  and C fibers (Nilsson et al. 1997; Nilsson et al. 2003). 1) The needle-like electrodes of the CFS plate are introduced close to the dermo-epidermal junction, known to be richly innervated by thin afferent fibers (Fundin et al. 1994; Kruger et al. 1985), 2) CFS evokes a sensation of pricking and slightly burning pain of weak / moderate intensity, indicating an activation of nociceptive A $\delta$ - and / or

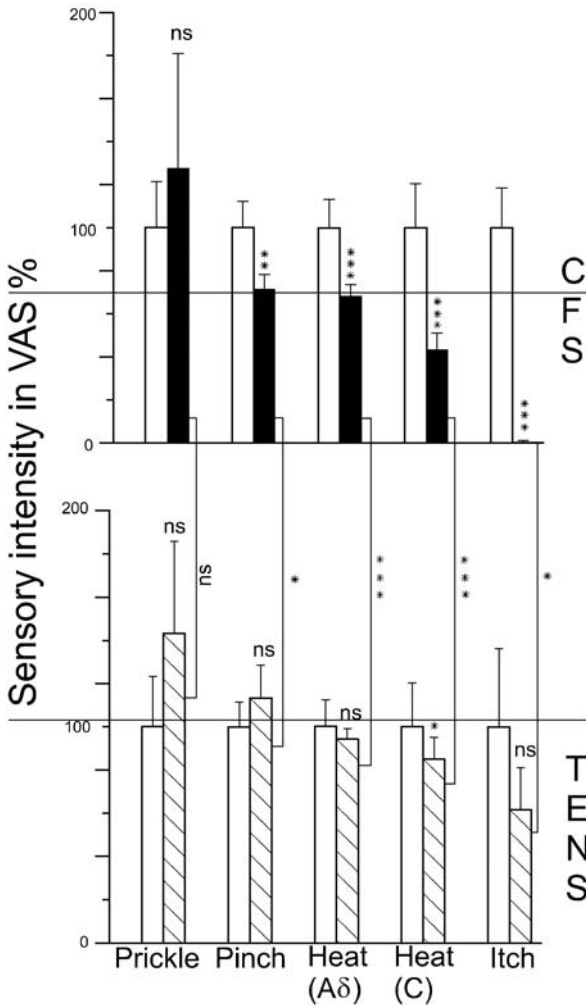




**Figure 1** (a) Schematic of CFS apparatus with electrodes. (b) The needle-like electrodes are inserted into the dermo-epidermal junction, permitting stimulation of thin nerve fibers with low electrical voltage and current.

C-fibers, respectively (Bromm and Treede 1987), 3) during a selective blockade of the impulse conduction in A fibers, CFS still produces a burning sensation, known to be due to heat sensitive nociceptive C fibers and 4) a flare, known to be caused by nociceptive C fibers (Kenins 1981), develops around the CFS electrodes. It should be noted that while A $\beta$ -fibers are presumably also activated by CFS due to their low electrical threshold, the stimulation frequencies used for CFS are very low for A $\beta$  fibers (but relatively high for C fibers). CFS acts preferentially on nociceptive senses, since homo- but not hetero-topical (with respect to testing

sites) CFS, abolishes itch evoked by histamine in normal humans and reduces CO<sub>2</sub>-laser evoked A $\delta$ - and C-fiber mediated heat pain and pinch evoked pain (Nilsson and Schouenborg 1999) but has no effect on fabric evoked prickle (assumed to be mediated by high threshold mechanoreceptive A $\delta$  and C fibers; Garnsworthy et al. 1988) (Fig. 2). The relative potency of CFS on nociceptive skin senses is thus, in a descending order, itch, secondary heat pain, primary heat pain, pinch-evoked pain and prickle. Regarding innocuous senses, CFS increases the warm and cold thresholds somewhat but has no effect on tactile sensibility.

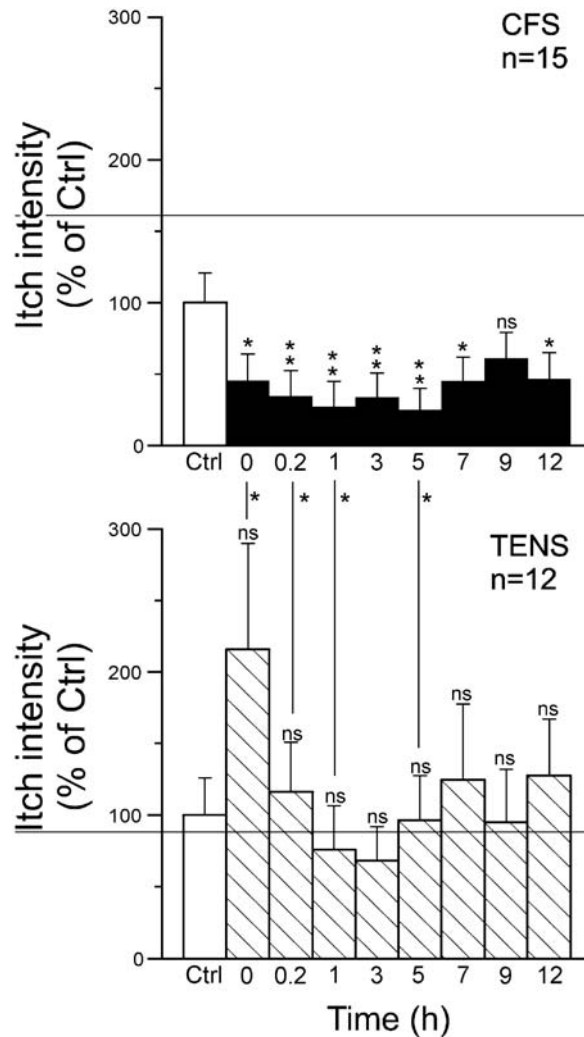


**Cutaneous Field Stimulation, Figure 2** Differential effect on different sensory qualities of nociception after CFS (n = 10 subjects except for itch where n = 7 subjects) and lack of effect after conventional high frequency TENS (n = 10 subjects except for itch where n = 7 subjects). The conditioning stimulations and all sensory testings were performed on the right volar forearm. The mean magnitude of sensation after CFS (black bars) or TENS (hatched bars) is indicated as percentage of control (unfilled bars). Top diagram shows effects after CFS, bottom diagram shows effects after TENS. Statistical comparisons (Wilcoxon's signed ranks test, 2-tailed) were made both between control values and values obtained after conditioning stimulation and also between values obtained after CFS and TENS respectively. Normalized visual analogue scale (VAS) on the vertical axes. \* P<0.05, \*\* P<0.01, \*\*\* P<0.001; ns, non-significant. Error bars indicate +S.E.M. (From Nilsson et al. 1997, 1999).

CFS causes a dramatic reduction in histamine-induced itch. In fact, all subjects tested have reported a complete or near complete inhibition of itch evoked by histamine. This inhibitory effect lasts 4–8 h and extends 10–20 cm along the same dermatome, but appears to be more restricted in a direction across dermatomal borders (Nilsson et al. 1997). Maximal effects are reached already after 8–10 min and more prolonged CFS stimulation (up to 45 min tested) does not appear to add to the inhibitory effect (Nilsson et al. 2003). The optimal stimulation fre-

quency appears to be around 4 Hz per electrode (Nilsson et al. 2003). Notably, the effective stimulation parameters are similar to those known to cause long-term depression (LTD) (Sandkuhler et al. 1997) – a memory-like mechanism – in the spinal cord and elsewhere.

Figure 3 shows the results from a randomized controlled clinical study on chronic itch due to localized atopic dermatitis (n = 27; Nilsson et al. 2004). As can be seen, CFS depresses itch significantly for more than 7 h. Peak inhibitory effect (down to about 25% of control) is reached between 1 and 5 h postconditioning. Similar results have recently been reached for chronic itch due to neurodermatitis (n = 30; Bäck et al, in preparation). In the latter



**Cutaneous Field Stimulation, Figure 3** Effects of CFS (top diagram) and TENS (bottom diagram) on chronic itch due to atopic dermatitis. For comparison, the mean VAS values were normalized with respect to control (unfilled bars). The mean sensory intensities after CFS (black bars, n = 15) and TENS (hatched bars, n = 12) are shown. ANOVA repeated measures with Dunnett's *post hoc* test was applied for matched comparisons within a group, whereas the Mann-Whitney U test was used when comparing effects of the two treatments; ns, non-significant, \* p<0.05, \*\* p<0.01. Error bars indicate + S.E.M. (From Nilsson et al. 2004).

single-blind study, CFS was compared to conventional TENS over a treatment period of 2 weeks (two treatments a day). It was found that CFS provided effective relief of itch in practically all patients and also markedly improved the skin condition. The improvement of the skin condition may be due to a reduced urge to scratch the skin (or care not to scratch the treated skin), thus stopping the vicious itch–scratch circle that may sustain this type of condition. Other workers have reported similar findings on the relief of chronic itch by CFS in various dermatoses (Wallengren 2002; Wallengren and Sundler 2001). In addition, a normalized innervation of the skin may result from CFS (Wallengren and Sundler 2001). No adverse effects of CFS have been reported (Wallengren 2002).

CFS not only affects cutaneous nociception but also musculoskeletal nociception. In a recent study on 142 TENS resistant patients with chronic musculoskeletal pain (i.e. a group of patients that received no pain relief from established treatments of electrostimulation), 30% received clinically relevant pain relief from CFS (Martinsson and Sjölund, in preparation). The group studied consisted of 91 patients with nociceptive pain and 51 patients with neuropathic pain according to established criteria. 33 / 91 patients with nociceptive pain and 10 / 51 with neuropathic pain got clinically relevant pain relief from CFS for more than 3 months. In conclusion, CFS preferentially affects nociceptive senses *via* endogenous inhibitory memory-like mechanisms and has no significant adverse side effects. The findings that CFS causes a strong inhibitory effect on itch and that skin conditions improve considerably and the lack of adverse side effects demonstrate that CFS is a useful itch therapy. Moreover, CFS is clearly worth trying for the treatment of chronic musculoskeletal pain.

## References

- Bäck O, Svensson Å, Thelin I et al. (2004) Chronic itch in neurodermatitis is dramatically reduced by Cutaneous Field Stimulation (CFS). In manuscript
- Bromm B, Scharein E, Darsow U et al. (1995) Effects of menthol and cold on histamine-induced itch and skin reactions in man. *Neurosci Lett* 187:157–160
- Bromm B, Treede R-D (1987) Human cerebral potentials evoked by CO<sub>2</sub> laser stimuli causing pain. *Exp Brain Res* 67:153–162
- Cervero F, Iggo A, Molony V (1979) An electrophysiological study of neurones in the substantia gelatinosa rolandi of the cat's spinal cord. *Quart J Exp Physiol* 64:297–314
- Fundin BT, Rice FL, Pfaller K et al. (1994) The innervation of the mystacial pad in the adult rat studied by anterograde transport of HRP-conjugates. *Exp Brain Res* 99:233–246
- Garnsworthy RK, Gully PL, Kenins P et al. (1988) Identification of the physical stimulus and the neural basis of fabric-evoked prickle. *J Neurophysiol* 59:1083–1097
- Kenins P (1981) Identification of the unmyelinated sensory nerves which evoke plasma extravasation in response to antidromic stimulation. *Neurosci Lett* 25:137–141
- Kruger L, Sampogna SL, Rodin BE et al. (1985) Thin-fiber cutaneous innervation and its intraepidermal contribution studied by labelling methods and neurotoxin treatment in rats. *Somatosens Res* 2:335–356
- Martinsson K, Sjölund BH (2004) Cutaneous field stimulation (CFS) in TENS-resistant chronic pain. In manuscript
- McMahon SB, Koltzenburg M (1992) Itching for an explanation. *Trends in Neurosci* 15 / 12:497–501
- Melzack R (1975) Prolonged relief of pain by brief, intense transcutaneous somatic stimulation. *Pain* 1:357–373
- Melzack R, Wall PD (1965) Pain mechanisms: a new theory. A gate control system modulates sensory input from the skin before it evokes pain perception and response. *Science* 150:971–979
- Nilsson H-J, Schouenborg J (1999) Differential inhibitory effect on human nociceptive skin senses induced by local stimulation of thin cutaneous fibers. *Pain* 80:103–112
- Nilsson H-J, Levinsson A, Schouenborg J (1997) Cutaneous Field Stimulation (CFS) – a new powerful method to combat itch. *Pain* 71:49–55
- Nilsson H-J, Psouni E, Schouenborg J (2003) Long term depression of human nociceptive skin senses induced by thin fibre stimulation. *Eur J Pain* 7:225–233
- Nilsson H-J, Psouni E, Carstam R et al. (2004) Profound inhibition of chronic itch induced by stimulation of thin cutaneous nerve fibres. *J Eur Acad Dermatol Venereol* 18:37–43
- Olausson B, Xu Z-Q, Shyu B-C (1994) Dorsal column inhibition of nociceptive thalamic cells mediated by gamma-aminobutyric acid mechanisms in the cat. *Acta Physiol Scand* 152: 239–247
- Saade NE, Dajani BM, Atweh SF et al. (1985) Inhibition of dorsal column nuclei by stimulation of trigeminal afferents in decerebrate-decerebellate cats. *Brain Res* 348:405–407
- Sandkühler J, Chen JG, Cheng G et al. (1997) Low-frequency stimulation of afferent Aδ-fibers induces long-term depression at primary afferent synapses with substantia gelatinosa neurons in the rat. *J Neurosci* 17:6483–6491
- Sjölund B H (1985) Peripheral nerve stimulation suppression of C-fiber-evoked flexion reflex in rats. Part 1: parameters of continuous stimulation. *J Neurosurg* 63:612–616
- Sjölund B H (1988) Peripheral nerve stimulation suppression of C-fiber-evoked flexion reflex in rats. Part 2: parameters of low-rate train stimulation of skin and muscle afferent nerves. *J Neurosurg*. 68:279–283
- Sjölund BH, Eriksson M, Loeser JD (1990) Transcutaneous and implanted electric stimulation of peripheral nerves. In: Bonica J (ed), *Management of Pain*, 2nd edn. Lea & Febiger, Philadelphia, pp 1852–1861
- Wall PD, Cronly-Dillon JR (1960) Pain, itch, and vibration, A.M.A. *Archives of Neurology* 2:365–375
- Wallengren J, Sundler F (2001) Cutaneous field stimulation in the treatment of severe itch. *Arch Dermatol* 137:1323–1325
- Wallengren J (2002) Cutaneous field stimulation of sensory nerve fibers reduces itch without affecting contact dermatitis. *Allergy* 57:1195–1199
- Ward L, Wright E, McMahon SB (1996) A comparison of the effects of noxious and innocuous counterstimuli on experimentally induced itch and pain. *Pain* 64:129–138

C

## Cutaneous Freeze Trauma

- ▶ Freezing Model of Cutaneous Hyperalgesia

## Cutaneous Hyperalgesia

- ▶ Freezing Model of Cutaneous Hyperalgesia

## Cutaneous Mechanoreception

### Definition

Neuronal responses to mechanical stimuli applied to the skin are transduced by specialized receptive endings of afferent nerve fibers.

- ▶ Postsynaptic Dorsal Column Projection, Anatomical Organization

## Cutaneous Pain Model

- ▶ Autologous Thrombocyte Injection as a Model of Cutaneous Pain

## Cutaneous Stimulation

### Definition

Chemical, thermal, or mechanical input delivered to the skin to activate one or more superficial or cutaneous sensory receptor types.

- ▶ Postsynaptic Dorsal Column Projection, Functional Characteristics

## CWP

- ▶ Chronic Widespread Pain

## Cyclic Adenosine Monophosphate-Responsive Element-Binding Protein

### Synonyms

CREB

### Definition

CREB is a transcription factor that is activated by the cAMP signal transduction pathway. It is phosphorylated by protein kinase A, enters the nucleus of a neuron and can alter gene expression.

- ▶ Spinothalamic Tract Neurons, Role of Nitric Oxide

## Cyclic Alternating Pattern

### Definition

Repetition of micro-arousal every 20–60 s as a sentinel that allows for a „reset“ of physiological functions (e.g. heart rate, respiration, muscle tone), or prepares the body for an appropriate response if an event could be potentially disrupting.

- ▶ Orofacial Pain, Sleep Disturbance

## Cyclic Pain

### Definition

Cyclic pain occurs with definite association to the menstrual cycle, generally 1–2 days prior to the onset of or during menses.

- ▶ Dyspareunia and Vaginismus

## Cyclooxygenase Inhibitors

- ▶ NSAIDs, Adverse Effects
- ▶ NSAIDs and Cancer
- ▶ NSAIDs and Cardio-Vascular Effects
- ▶ Postoperative Pain, Non Steroidal Anti-Inflammatory Drugs

## Cyclooxygenase Inhibitors, Chemistry

- ▶ Coxibs and Novel Compounds, Chemistry

## Cyclooxygenase-2 Inhibitors

### Definition

A class of drugs related to non-steroidal anti-inflammatory drugs (NSAIDs) that prevent the synthesis of prostaglandins by the enzyme cyclooxygenase-2. These drugs are relatively new additions to the standard treatment regimen of osteoarthritis, and include Celebrex<sup>®</sup> and Vioxx<sup>®</sup>.

- ▶ Arthritis Model, Osteoarthritis
- ▶ Postoperative Pain, COX-2 Inhibitors

## Cyclooxygenases

### Synonyms

COX



### Definition

COX is a 70–72 kD enzyme, catalyzing the reaction of Arachidonic acid to PGG<sub>2</sub> (cyclooxygenase reaction) and consecutively PGG<sub>2</sub> to PGH<sub>2</sub> (peroxidase reaction). Prostaglandin H<sub>2</sub> (PGH<sub>2</sub>) is further converted into various prostaglandins and thromboxanes. There is a distinct active site for both cyclooxygenase and peroxidase reaction. There are at least 3 isoforms, COX1, COX2 and COX3, which are also slightly different at the active site, explaining particular selectivities of inhibitors. Prostaglandins are involved in pain, inflammation and fever, but also in cytoprotection in the stomach and blood flow regulation in the kidneys. NSAIDs (non steroidal anti-inflammatory drugs) are therapeutic agents that block this enzyme and thus act as pain killers, antipyretic and anti-inflammatory drugs.

- ▶ COX-1 and COX-2 in Pain
- ▶ Coxibs and Novel Compounds, Chemistry
- ▶ Cyclooxygenases in Biology and Disease
- ▶ NSAIDs, Adverse Effects
- ▶ NSAIDs and Cancer
- ▶ NSAIDs, Chemical Structure and Molecular Mode of Action
- ▶ NSAIDs, COX-Independent Actions
- ▶ NSAIDs, Mode of Action
- ▶ Wind-Up of Spinal Cord Neurons

## Cyclooxygenases in Biology and Disease

REGINA M. BOTTING

The William Harvey Research Institute, The John Vane Science Centre, Queen Mary University of London, St Bartholomew's and the London School of Medicine and Dentistry, Charterhouse Square, London, UK  
r.m.botting@qmul.ac.uk

### Synonyms

Cyclooxygenase; COX; Prostaglandin Endoperoxide Synthase; PtgS

### Definition

Cyclooxygenases are enzymes which synthesise prostaglandins.

### Characteristics

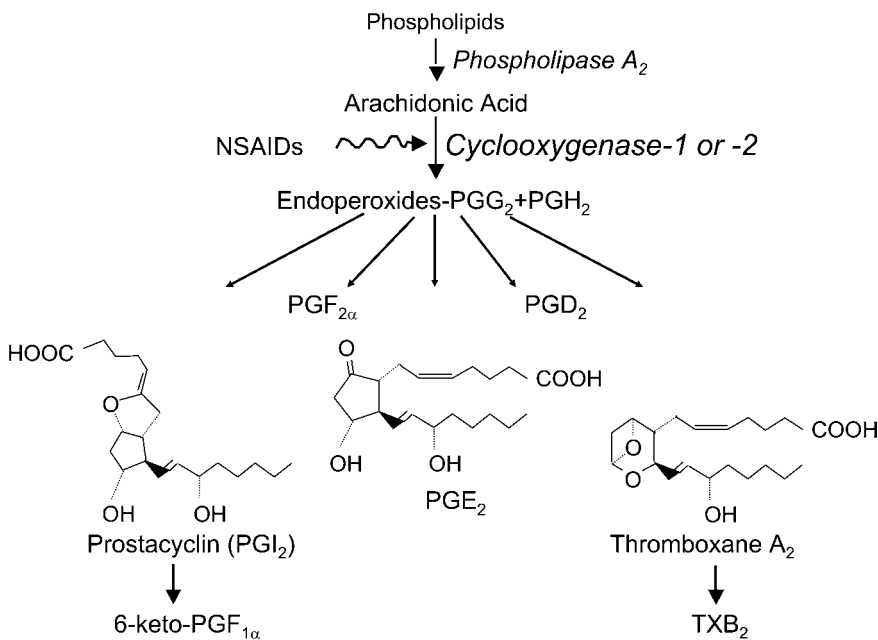
Three isoenzymes of cyclooxygenase have been characterised: cyclooxygenase-1 (COX-1; PtgS-1), cyclooxygenase-2 (COX-2; PtgS-2) and a putative cyclooxygenase-3 (COX-3; PtgS-3), which is currently under investigation.

### Cyclooxygenase-1

In the 1930s, Goldblatt in England (Goldblatt 1935) and von Euler in Sweden (von Euler 1934) found that seminal

fluid contained activity that contracted uterine smooth muscle, and also caused a fall in blood pressure. Von Euler identified the active principle as a lipid-soluble acid, which he named 'prostaglandin' (PG) because he thought it originated from the prostate gland. In the 1960's, technical advances allowed the characterisation of the PGs as a family of lipid compounds with a unique structure. They proved to be 20-carbon unsaturated carboxylic acids with a cyclopentane ring, and in 1964, PGE<sub>2</sub> was synthesised using ▶ [arachidonic acid](#) and an enzyme preparation from ram seminal vesicles (Bergström et al. 1964). Prostaglandins and related compounds are some of the most prevalent of autocooids and can be released from every tissue except red blood cells. As local hormones, they produce, in minute concentrations, an incredibly broad spectrum of effects that modulate almost every biological function. They derive mostly from the 20-carbon fatty acid, arachidonic acid (C<sub>20</sub>:<sub>4</sub>ω<sub>6</sub>), and almost 100 different derivatives have been identified, including lipoxins and isoprostanes. Prostaglandins are important to inflammatory processes, as evidenced by the anti-inflammatory effects of drugs that interfere with their synthesis, such as the steroid and non-steroid anti-inflammatory drugs (NSAIDs). The discovery 15 years ago of a second cyclooxygenase (COX-2), inducible by cytokines, has led to an important clarification of the roles of PGs as mediators of inflammation. COX-2 is induced in inflammation and makes PGs locally, whereas COX-1 is a 'housekeeping' enzyme involved in the modulation of physiological events.

Cyclooxygenase had long been studied in preparations from ram seminal vesicles and a homogeneous, enzymatically active prostaglandin endoperoxide synthase was isolated in 1976 (Hemler et al. 1976), and cloned in 1988 (DeWitt and Smith 1988). This membrane-bound haemo- and glycoprotein, with a molecular weight of 71kDA, is found in greatest amounts in the endoplasmic reticulum of prostanoid-forming cells. It both cyclizes arachidonic acid and adds the 15-hydroperoxy group to form PGG<sub>2</sub>. The hydroperoxy group of PGG<sub>2</sub>, is reduced to the hydroxy group of PGH<sub>2</sub>, by a peroxidase (in the same enzyme protein) that utilizes a wide variety of compounds to provide the requisite pair of electrons. The ▶ [hydroperoxides](#) also drive the cyclooxygenase reaction by maintaining a 'hydroperoxide tone'. The three dimensional structure of COX-1 was determined in 1994 (Picot et al. 1994). This enzyme consists of three independent folding units: an epidermal growth factor-like domain, a membrane-binding section and an enzymatic domain. The sites for peroxidase and cyclooxygenase activity are adjacent but spatially distinct. Three of the helices of the COX-1 structure form an entrance channel to the active site, which is a long, hydrophobic channel. Since the enzyme integrates into only a single leaflet of the membrane lipid bilayer, the position of the cyclooxy-



**Cyclooxygenases in Biology and Disease, Figure 1** The arachidonic acid cascade. Cyclooxygenase-1 (COX-1) and cyclooxygenase-2 (COX-2) utilise arachidonic acid to form the unstable endoperoxide intermediates, prostaglandin G<sub>2</sub> (PGG<sub>2</sub>) and prostaglandin H<sub>2</sub> (PGH<sub>2</sub>). From these intermediates the more stable prostaglandins are synthesised by individual synthases. Prostaglandin E<sub>2</sub> (PGE<sub>2</sub>) is mostly involved in pain, fever and inflammation, prostaglandin F<sub>2α</sub> (PGF<sub>2α</sub>) in labour and parturition and prostaglandin D<sub>2</sub> (PGD<sub>2</sub>) is a mediator in brain and mast cells. Prostacyclin (PGI<sub>2</sub>) with a half life of 3 minutes, protects the stomach mucosa from damage and prevents aggregation of blood platelets. It breaks down spontaneously to inactive 6-keto-PGF<sub>1α</sub>. Thromboxane A<sub>2</sub> is mainly found in blood platelets and promotes clotting of blood by inducing platelet aggregation. It has a half life of 30 seconds and breaks down to inactive thromboxane B<sub>2</sub>. The activity of COX-1 and COX-2 is inhibited by aspirin and similar drugs, the non steroid anti-inflammatory drugs (NSAIDs), thereby preventing formation of prostanoids.

genase channel allows arachidonic acid to gain access to the active site from the interior of the bilayer.

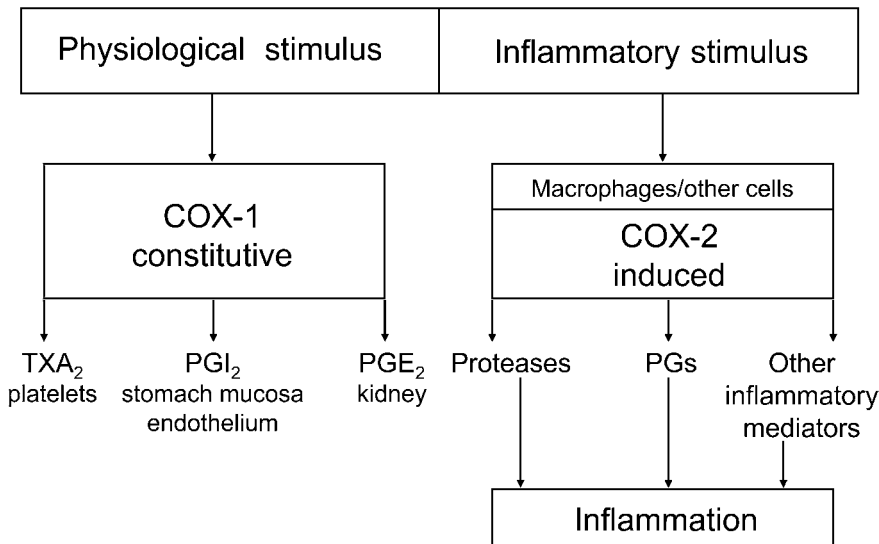
Most NSAIDs compete with arachidonic acid for binding to the active site (Fig. 1). ► **Flurbiprofen**, for example, inhibits COX-1 by excluding arachidonic acid from the upper portion of the channel, and blocking its access to tyrosine (Tyr) 385 and serine (Ser) 530 at the apex of the long active site. Uniquely, aspirin irreversibly inhibits COX-1 by acetylation of (Ser) 530, thereby excluding access for the arachidonic acid to (Tyr) 385 by steric hindrance.

Before 1971, many biochemical effects of the NSAIDs had been reported, and there were many hypotheses about the mechanism of action of these drugs. However, in 1971, John Vane elegantly demonstrated that aspirin, salicylate and indomethacin inhibited COX of guinea pig lung homogenates, and thus prevented the formation of PGs (Vane 1971). Two other reports from the same laboratory, that aspirin prevented the release of prostanoids from aggregating human platelets and that NSAIDs blocked PG release from the perfused isolated spleen of the dog, lent support to and extended his finding.

COX-1 is constitutively expressed in most tissues, and performs a ‘housekeeping’ function to synthesize PGs which regulate normal cell activity (Fig. 2). The PGs produced are therefore protective to the organ-

ism. The concentration of the enzyme remains largely stable, but small 2- to 4-fold increases can occur in response to stimulation with hormones or growth factors. COX-1 has clear physiological functions (Vane and Botting 2001). Its activation leads, for instance, to the production of prostacyclin (PGI<sub>2</sub>), which when released by endothelial cells is antithrombogenic, and when released by the gastric mucosa, is cytoprotective. However, it is likely that in humans endothelial PGI<sub>2</sub> is also synthesised by COX-2, induced by ► **Shear Stress** on endothelial cells. Release of PGI<sub>2</sub> and PGE<sub>2</sub> made by COX-1 also sensitises nociceptors on peripheral sensory nerve terminals and thus acutely amplifies ► **painful stimulation**. Since COX-2 is induced by inflammatory stimuli and by cytokines in migratory and other cells, it appears likely that the anti-inflammatory actions of NSAIDs are due to the inhibition of COX-2, whereas the unwanted side effects such as irritation of the stomach lining are due to the inhibition of the constitutive enzyme, COX-1.

The inhibition of PG synthesis explains all the actions of the NSAIDs. They prevent the pathological overproduction of PGs by COX-2 which contribute to the inflammatory process (therapeutic effects), and prevent the physiological formation of prostanoids by COX-1 (side effects). For instance, the ulcerogenic activity of aspirin arises from the inhibition of prostacyclin



C

**Cyclooxygenases in Biology and Disease, Figure 2** Physiological and pathological functions of COX-1 and COX-2. Cyclooxygenase-1 (COX-1) functions as a constitutive enzyme and produces prostaglandins which are involved in physiological processes. For example, thromboxane A<sub>2</sub> (TXA<sub>2</sub>) made by platelets promotes the clotting of blood when required, prostacyclin (PGI<sub>2</sub>) made by the stomach mucosa protects it from damage by gastric acid and PGE<sub>2</sub> made in kidney cells is involved in kidney function. PGI<sub>2</sub> made by COX-1 in vascular endothelial cells inhibits aggregation of platelets and the clotting of blood. PGI<sub>2</sub> is also formed by COX-2 induced in endothelial cells by shear stress produced by laminar blood flow. Cyclooxygenase-2 is mainly induced in inflammation and by mitogens and growth factors. It is induced in macrophages and other inflammatory cells by bacterial lipopolysaccharide and cytokines. It forms mainly PGE<sub>2</sub>, which with other inflammatory mediators causes pain and fever. Some constitutive COX-2 is also expressed, particularly in the brain. In pain, PGE<sub>2</sub> is hyperalgesic, sensitising peripheral sensory nerve terminals to nociceptive stimuli.

production, which has an important cytoprotective function in the gastric mucosa. Administration of various PGs reverses or prevents experimental gastric ulcers, and some of these PG derivatives are available for clinical use. In addition, the inhibition of COX-1 by NSAIDs correlates with their capacity to erode the gastric mucosa. NSAIDs also inhibit the aggregation of blood platelets, by preventing the formation of the potent pro-aggregatory and vasoconstrictor eicosanoid, thromboxane A<sub>2</sub> (TXA<sub>2</sub>), synthesised by COX-1 in platelets. Aspirin irreversibly inhibits COX-1 in platelets by acetylation of the enzyme, thus completely preventing synthesis of TXA<sub>2</sub> until new platelets are produced after 8-11 days.

The inhibition of PG synthesis by NSAIDs has been demonstrated in a wide variety of cell types and tissues, ranging from whole animals and humans to microsomal enzyme preparations. For example, the concentration of PGE<sub>2</sub> is about 20 ng/ml in the synovial fluid of patients with rheumatoid arthritis. This decreases to zero in patients taking aspirin; a good demonstration of the effect of this drug on PG synthesis clinically. Several classes of NSAIDs have been identified, and at least 12 major chemical series are known to affect PG production by COX-1 and COX-2.

### Cyclooxygenase-2

The cloning of COX-1 from sheep seminal vesicles provided useful probes for the study of the relationship between PG production and COX mRNA induction.

Many of these studies revealed a lack of correlation between COX activity and the induction of COX mRNA. For example, the levels of 2.8 kb COX-1 mRNA in epithelial cells of sheep trachea stimulated with growth factors, did not reflect the increase in enzyme activity. However, a second mRNA (4.0 kb) recognised by the COX-1 cDNA probes and formed from a separate gene increased in parallel with PG production. Dexamethasone inhibited only the inducible COX activity in human IL-1 treated dermal fibroblasts, and in human bacterial lipopolysaccharide (LPS)-stimulated monocytes (Masferrer et al. 1990). Basal levels of COX were not affected by dexamethasone.

The presence of the gene encoding for a second COX enzyme was discovered by Xie et al. while characterising 'immediate early' genes, switched on by expression of the *v-src* oncogene in chicken embryo fibroblasts (Xie et al. 1991). This new COX isoenzyme was also induced by serum, tetradecanoyl phorbol acetate (TPA) or forskolin in established murine fibroblast cell lines. The chicken and mouse COX-2 gene, at 8.3 kb, is similar to the COX-2 gene of human, but smaller than the 22 kb human COX-1 gene. The gene products also differ, with the size of the mRNA for COX-2 being approximating 4.5 kb and that for COX-1 being 2.8 kb. At the amino acid level, the protein sizes of COX-1 and COX-2 enzymes from different sources are approximately 80-90% identical, with just over 600 amino acids, of which 63% are in an identical sequence. Both enzymes have a molecular weight of 71 kDa and similar K<sub>m</sub> and V<sub>max</sub> values for

metabolism of arachidonic acid. Both enzymes also have similar active sites for the attachment of arachidonic acid or NSAIDs, although the active site of COX-2 is larger than that of COX-1 and can accept a wider range of structures as substrates.

The residues that form the substrate binding channel, the catalytic sites, and the residues immediately adjacent are all identical in COX-1 and COX-2 except for two small variations. The primary sequence difference in the active site itself is the valine 523 side chain in COX-2, which is smaller by a single methyl group than the isoleucine side chain that it replaces in COX-1. This opens up access to a side pocket off the main substrate channel in COX-2, allowing an enzyme inhibitor to react with arginine 513, which replaces histidine in COX-1. Another sequence difference is situated outside, but close to, the active site, and can indirectly influence its conformation. The large residue, phenylalanine 503, in COX-1 is replaced by the smaller leucine in COX-2. This allows leucine 384, which borders the active site, to re-orientate its methyl side chain out of the active site, and thus leave more space available for a larger inhibitor molecule in COX-2 than in COX-1.

The importance of the discovery of the inducible COX-2 is highlighted by the differences in pharmacology of the two enzymes (Warner et al. 1999). Aspirin, indomethacin and ibuprofen are much less active against COX-2 than against COX-1. Indeed, the strongest inhibitors of COX-1 such as aspirin, indomethacin and piroxicam are the NSAIDs which cause the most damage to the stomach. The spectrum of activities of some ten standard NSAIDs against the two enzymes ranges from a high selectivity towards COX-1 (166-fold for aspirin), through to equiactivity on both (for example, diclofenac). The range of activities of NSAIDs against COX-1 compared with COX-2 explains the variations in the side effects of NSAIDs at their anti-inflammatory doses. Drugs which have a high potency against COX-2 and a low COX-2/COX-1 activity ratio will have potent anti-inflammatory activity with few side effects on the stomach and kidney. Published epidemiological data on the side effects of NSAIDs reported that piroxicam and indomethacin in anti-inflammatory doses showed high gastrointestinal toxicity. These drugs have a much higher potency against COX-1 than against COX-2.

The discovery of COX-2, induced by inflammatory stimuli and cytokines in migratory and other cells, stimulated several laboratories to develop highly selective inhibitors of this enzyme (Fig. 2). Monsanto/Searle (now Pfizer) are marketing celecoxib and its successor, ► **valdecoxib**, whereas Merck and Company developed the selective COX-2 inhibitors, rofecoxib and etoricoxib. Early trials of celecoxib (Silverstein et al. 2000) and of rofecoxib (Bombardier et al. 2000) demonstrated good analgesia and anti-inflammatory activity, with less adverse effects on the stomach mucosa than

comparator drugs. Millions of arthritic patients were then prescribed these drugs. However, the rofecoxib trial revealed that 4 times as many patients receiving rofecoxib suffered a myocardial infarction than those treated with naproxen. This was interpreted as a protective effect of naproxen, which would inhibit aggregation of platelets and therefore prevent heart attacks. Following these initial trials, Merck and Pfizer began large scale trials of rofecoxib and celecoxib in patients with recurrent neoplastic ► **polyps** of the large bowel, a precancerous condition preceding colorectal neoplasia. These trials were instituted since cancer cells have high levels of COX-2, while surrounding healthy colon cells have none. In these anti-cancer trials, the effects of rofecoxib and celecoxib were compared with patients receiving placebo treatment. Both trials were terminated after eighteen months, when it became clear that the incidence of adverse cardiovascular events, primarily myocardial infarctions and ischemic cerebrovascular events, was greater in the patients receiving selective COX-2 inhibitors. At this stage, Merck decided to withdraw rofecoxib from the market. The most plausible explanation for this increase in heart attacks is that selective COX-2 inhibitors prevent synthesis of anti-aggregatory prostacyclin in the vascular endothelium. Since these drugs do not affect TXA<sub>2</sub> synthesis by COX-1 in blood platelets, the aggregatory action of TXA<sub>2</sub> progresses unopposed and thrombotic emboli form to cause myocardial infarctions.

### Cyclooxygenase-3

► **Paracetamol** (acetaminophen) has potent analgesic and antipyretic actions but very little anti-inflammatory activity. Its mechanism of action has remained a mystery for many years, since it is only a weak inhibitor of PG biosynthesis by either COX-1 or COX-2 *in vitro*, but inhibits PG biosynthesis *in vivo*. Reduction of PG biosynthesis by paracetamol varies in different tissues, and COX activity in brain is particularly sensitive to inhibition (Flower and Vane 1972). In 2002, Simmons and colleagues cloned, characterised and expressed a variant of COX-1 from dog and human brain, which they named COX-3 (Chandrasekharan et al. 2002). This enzyme, expressed in insect cells, was sensitive to inhibition with low concentrations of paracetamol and other related antipyretic analgesic drugs, such as antipyrine and aminopyrine. However, significantly increased concentrations of paracetamol were needed to inhibit COX-1 and COX-2 under the same experimental conditions. COX-3 was also sensitive to inhibition with low concentrations of non-selective NSAIDs, which may explain the antipyretic action of these drugs.

Similarly to COX-1 and COX-2, COX-3 was shown to possess COX and peroxidase active sites and to have the same cellular localisation. COX-3 was also shown



to be glycosylated and to have the capacity to metabolise arachidonic acid, leading to the formation of PGE<sub>2</sub>. The major difference between COX-3 and COX-1 is that at the mRNA level, COX-3 retains intron-1, which encodes a 30aa sequence inserted into the N-terminal hydrophobic signal peptide of the enzyme. Although in canine COX-3 mRNA, intron-1 is within frame, in the human there is a frameshift in intron-1 of the COX-3 transcript. The conversion of COX-3 mRNA into enzyme protein in humans requires further investigation.

## References

1. Bergström S, Danielsson H, Samuelsson B (1964) The Enzymatic Formation of Prostaglandin E<sub>2</sub> from Arachidonic Acid. Prostaglandins and related factors 32. *Biochim Biophys Acta* 90:207–210
2. Bombardier C, Laine L, Reicin A, Shapiro D, Burgos-Vargas R, Davis B et al. (2000) Comparison of Upper Gastrointestinal Toxicity of Rofecoxib and Naproxen in Patients with Rheumatoid Arthritis. *N Engl J Med* 343:1520–1528
3. Chandrasekharan NV, Dai H, Roos KLT, Evanson NK, Tomsik J, Elton TS, Simmons DL (2002) COX-3, A Cyclooxygenase-1 Variant Inhibited by Acetaminophen and Other Analgesic/Antipyretic Drugs: Cloning, Structure and Expression. *Proc Natl Acad Sci USA* 99:13926–13931
4. DeWitt DL, Smith WL (1988) Primary Structure of Prostaglandin G/H Synthase from Sheep Vesicular Gland Determined from the Complementary DNA Sequence. *Proc Natl Acad Sci USA* 85:1412–1416
5. Flower RJ, Vane JR (1972) Inhibition of Prostaglandin Synthetase in Brain Explains the Antipyretic Activity of Paracetamol (4-acetamidophenol). *Nature* 240:410–411
6. Goldblatt MW (1935) Properties of Human Seminal Plasma. *J Physiol (Lond)* 84:208–218
7. Hemler M, Lands WEM, Smith WL (1976) Purification of the Cyclooxygenase that Forms Prostaglandins: Demonstration of Two Forms of Iron in the Holoenzyme. *J Biol Chem* 251:5575–5579
8. Masferrer JL, Zweifel BS, Seibert K, Needleman P (1990) Selective Regulation of Cellular Cyclooxygenase and Endotoxin in Mice. *J Clin Invest* 86:1375–1379
9. Picot D, Loll PJ, Garavito RM (1994) The X-ray Crystal Structure of the Membrane Protein Prostaglandin H<sub>2</sub> Synthase-1. *Nature* 367:243–249
10. Silverstein FE, Faich G, Goldstein JL, Simon LS, Pincus T, Whelton A et al. (2000) Gastrointestinal Toxicity with Celecoxib vs. Nonsteroidal Anti-Inflammatory Drugs for Osteoarthritis and Rheumatoid Arthritis: The CLASS Study: A Randomised Controlled Trial. Celecoxib Long-term Arthritis Safety Study. *J Am Med Assoc* 284:1247–1255
11. Vane JR (1971) Inhibition of Prostaglandin Synthesis as a Mechanism of Action for the Aspirin-Like Drugs. *Nature* 231:232–235
12. Vane JR, Botting RM (2001) Formation and Actions of Prostaglandins and Inhibition of their Synthesis. In: Vane JR, Botting RM (eds) *Therapeutic Roles of Selective COX-2 Inhibitors*. William Harvey Press, London, pp 1–47
13. von Euler US (1934) Zur Kenntnis der Pharmakologischen Wirkung von Nativsekreten und Extracten Männlicher Accessorischer Geschlechtsdrüsen. *Arch Exp Path Pharmacol* 175:78–84
14. Warner TD, Giuliano F, Vojnovic I, Bukasa A, Mitchell JA, Vane JR (1999) Nonsteroid Drug Selectivities for Cyclooxygenase-1 Rather than Cyclooxygenase-2 are Associated with Human Gastrointestinal Toxicity: A Full *In Vitro* Analysis. *Proc Natl Acad Sci USA* 96:7563–7568
15. Xie W, Chipman JG, Robertson DL, Erikson RL, Simmons DL (1991) Expression of a Mitogen-Responsive Gene Encoding Prostaglandin Synthase is Regulated by mRNA Splicing. *Proc Natl Acad Sci USA* 88:2692–2696

## Cyclophosphamide

### Definition

An alkylating agent frequently used as immunosuppressant. The treatment of choice, in combination with steroids, in systemic vasculitides like WG.

- ▶ Headache Due to Arteritis
- ▶ Vascular Neuropathies

C

## Cyclosporin, Methotrexate

### Definition

Drugs used to suppress immune functions in organ-transplanted patients and in patients with diseases with disturbances in immune functions, e.g. rheumatoid arthritis, psoriasis.

- ▶ Postoperative Pain, Acute Pain Management, Principles

## Cystitis Models

- ▶ Visceral Pain Model, Urinary Bladder Pain (Irritants or Distension)

## Cytoarchitectural

### Definition

Pertaining to the cellular composition of bodily structure.

- ▶ Pain Processing in the Cingulate Cortex, Behavioral Studies in Humans

## Cytochrome Oxidase Staining

### Synonyms

CO staining

### Definition

Type of staining that reflects mitochondrial activity in neurons.

- ▶ Spinothalamic Terminations, Core and Matrix
- ▶ Thalamus, Receptive Fields, Projected Fields, Human

## Cytokine Modulation of Opioid Action

VASUDEVA RAGHAVENDRA<sup>1</sup>, JOYCE A. DELEO<sup>2</sup>

<sup>1</sup>Algos Therapeutics Inc., Saint Paul, MN, USA

<sup>2</sup>Dartmouth Hitchcock Medical Center, Dartmouth Medical School, Lebanon, NH, USA

rvasudeva@algosinc.com,

joyce.a.deleo@dartmouth.edu

### Synonyms

Opioid Modulation by Cytokines

### Definition

A conceptual framework has recently emerged to support the hypothesis that an **opioid** may, in fact, be broadly defined as a **cytokine**. This is due to the presence of opioid receptors on immune cells, and the ability of opioids to mediate interactions between cells and regulate processes in the extracellular environment. In addition, it has been demonstrated that a bidirectional interaction exists among endogenous opioids and classically defined cytokines. In the central nervous system (CNS), cytokines appear to be modulated by endogenous opioids, and the neural effects of opioids altered by cytokines. In particular, cytokines modulate opioid regulation of neuronal activity, sensory motor function, body temperature, food intake and regulation of hypothalamic-pituitary-adrenocortical axis functions. Recently, the role of cytokines in modulating opioid **analgesia**, tolerance and **hyperalgesia** has also been reported.

### Characteristics

Opioids are a class of the most effective analgesics for treating many forms of acute and chronic pain. In addition to the known adverse effects, the clinical utility of opioid analgesics is often hampered by the development of analgesic tolerance, hyperalgesia and physical dependence. A wide range of neurotransmitters and neuromodulators play a role in the development of tolerance and dependence to opioids. Recent studies have demonstrated that cytokines are also capable of modulating opioid-induced analgesia, and play a role in the development of opioid tolerance and withdrawal-induced hyperalgesia.

### Cytokines

Cytokines, e.g. IL-1 $\beta$ , IL-6, IL-10, interferons, and chemokines have the ability to modulate the analgesic action of opioids. For example, the proinflammatory cytokine, IL-1 $\beta$  directly attenuates opioid analgesia (Gul et al. 2000). IL-1 $\beta$  also plays a role in the anti-analgesic activity of dynorphin and ligands of the peripheral benzodiazepine receptor (Laughlin et al. 2000; Rady and Fujimoto 2001). The role of IL-6 in modulating opioid analgesia is more complicated. Although IL-6 is known

to induce hyperalgesia in animals, IL-6 knock-out mice showed reduced morphine analgesia and an early development of morphine tolerance (Bianchi et al. 1999). We have shown that neutralizing or blocking IL-6, IL-1 $\beta$  and TNF- $\alpha$  spared the analgesic action of morphine in rats following a peripheral nerve injury (Raghavendra et al. 2002). A sickness-inducing agent such as lipopolysaccharide or lithium chloride, which induces proinflammatory cytokine release, reduces morphine analgesia (Johnston and Westbrook 2003). Proinflammatory cytokines also play a role in the development of morphine tolerance and withdrawal-induced hyperalgesia. Chronic administration of heroin or morphine to mice or rats resulted in increased peripheral and central expression of proinflammatory cytokines (Raghavendra et al. 2002; Jolan et al. 2003). The central expression of proinflammatory cytokines after chronic morphine treatment, exhibited a temporal correlation with the development of analgesic tolerance and withdrawal-induced hyperalgesia in rats (Raghavendra et al. 2002). Conversely, IL-10, an anti-inflammatory cytokine, spared the analgesic actions of opioids in dynorphin treated rats (Laughlin et al. 2000). Interferon-alpha (IFN- $\alpha$ ), which exhibits structural and functional similarities to endorphins, induces opioid receptor-mediated analgesia and prevents the development of tolerance to opioids (Dafny 1984).

### Chemokines

**Chemokines** (chemotactic cytokines) also influence the perception of pain by interacting with G-protein-coupled opioid receptors. Recent studies have shown that cross-desensitization between opioid and chemokine receptors has significant implications in the regulation of leukocyte trafficking, progression of inflammatory disease and regulation of opioid receptor function in the CNS (Steele et al. 2002). The direct administration of chemokines, particularly CXCL12 and CCL5, into the periaqueductal gray matter, inhibited opioid-induced analgesia by cross desensitizing  $\mu$  opioid receptors (Szabo et al. 2002). Opioid enhancement of chemokine up-regulation is also responsible for enhanced HIV infection and progression to AIDS in opioid abusers (Peterson et al. 1998).

### Glial Component

Major sources of proinflammatory cytokines and chemokines in the CNS are activated **glial cells**. The presence of opioid receptors on microglia and astrocytes is well documented, and priming these cells with opioids induces enhanced secretion of proinflammatory cytokines and chemokines (Peterson et al. 1998). Activation of spinal proinflammatory cytokines by chronic opioid treatment may be caused by its interaction with glial cells (Raghavendra et al. 2002). Attenuation of glial activation using the methylxanthine, propentofylline, restored opioid analgesia, prevented the development of

morphine tolerance and morphine withdrawal-induced hyperalgesia, and opioid-induced neuroimmune activation (Raghavendra and DeLeo 2004). This reduction in neuroimmune activation by propentofylline included decreased microglial, astrocytic activation and cytokine expression in the lumbar spinal cord following morphine administration in a peripheral nerve injury in a rat model of neuropathy.

### Intracellular Signaling Cascades

Mitogen-activated protein (MAP) kinase or protein kinase C (PKC) pathways may be involved in opioid-induced activation of proinflammatory immune responses. MAP kinase and PKC are intriguing, because they are key players in the intracellular signaling cascade leading to the development of morphine tolerance and production of proinflammatory immune activation (Raghavendra et al. 2002). Since proinflammatory cytokines and chemokines induce hyperalgesia in animals, it is possible that activation of pro-nociceptive pathways by these mediators could counteract opioid analgesia.

### Cellular Adhesion Molecules

The immune system has the capacity to modulate pain directly at the site of tissue injury by liberating opioid peptides from immune cells. In an inflammatory pain model, the peripheral analgesic activity of opioids is modulated by **selectins** and intracellular adhesion molecule-1 (ICAM-1). ICAM-1, expressed on vascular endothelium, recruits immunocytes containing opioids to promote the local control of inflammatory pain. Anti-selectin or anti-ICAM-1 treatment strongly reduces endogenous peripheral opioid analgesia, apparently by blocking the extravasation of immune cells containing  $\beta$ -endorphin, and by the consequent decrease of the  $\beta$ -endorphin level in the inflamed tissue (Machelska et al. 1998; Machelska et al. 2002). Therefore, the immune control of opioid action may demonstrate a dichotomous action in the periphery as compared with the central nervous system.

### Clinical Relevance

One of the reasons for decreased opioid analgesia in neuropathic pain conditions may be an enhanced expression of proinflammatory cytokines and chemokines in the CNS, which is evoked following peripheral nerve injury. It is well-established that exaggerated pain states occur as a part of an inflammatory stress reaction. Pre-clinical studies demonstrated that neutralizing proinflammatory cytokines restored the analgesic action of opioids in neuropathic conditions, induced either by experimental diabetes or by L5 nerve transection in rats (Gul et al. 2000; Raghavendra et al. 2002). Pathological pain is the result of a dynamic interplay between hyperalgesic and analgesic mediators. During tissue injury or inflammation, both hyperalgesic and

anti-hyperalgesic/analgesic mediators are produced by activated immune cells. Hyperalgesic mediators, such as proinflammatory cytokines and chemokines, and anti-hyperalgesic mediators, such as anti-inflammatory cytokines and adhesion molecules, modulate opioid analgesia. Drugs such as immunosuppressants that influence this interplay may also modulate endogenous or exogenously administered opioid analgesia.

### Conclusions

Of particular clinical interest, the glial modulating agent, propentofylline, was shown to prevent opioid tolerance and hyperalgesia in a rat model of neuropathy (Raghavendra and DeLeo 2004; Raghavendra et al. 2003). Together, these data offer a novel clinical therapy for the prevention or delay of opioid tolerance and hyperalgesia: the co-administration of cytokine inhibitors and/or glial modulators with opioids. Recognizing that opioids remain the gold standard for the treatment of acute pain, improvement of their untoward side-effect profile would enhance their clinical efficacy.

### References

1. Bianchi M, Maggi R, Pimpinelli F, Rubino T, Parolaro D, Poli V, Ciliberto G, Panerai AE, Sacerdote P (1999) Presence of a Reduced Opioid Response in Interleukin-6 Knock-Out Mice. *Eur J Neurosci* 11:1501–1507
2. Dafny N (1984) Interferon: A Candidate as the Endogenous Substance Preventing Tolerance Dependence to Brain Opioids. *Prog Neuropsychopharmacol* 8:351–357
3. Gul H, Yildiz O, Dogrul A, Yesilyurt O, Isimer A (2000) The Interaction between IL-1 $\beta$  and Morphine: Possible Mechanism of the Deficiency of Morphine-Induced Analgesia in Diabetic Mice. *Pain* 89:39–45
4. Holan V, Zajikova A, Krulova M, Blahoutova V, Wilczek H (2003) Augmented Production of Proinflammatory Cytokines and Accelerated Allograft Rejection in Heroin-Treated Mice. *Clin Exp Immunol* 132:40–45
5. Johnston IN, Westbrook RF (2003) Acute and Conditioned Sickness Reduces Morphine Analgesia. *Behav Brain Res* 142:89–97
6. Laughlin TM, Bethea JR, Yezierski RP, Wilcox GL (2000) Cytokine Involvement in Dynorphin-Induced Allodynia. *Pain* 84:159–167
7. Machelska H, Cabot, PJ, Mousa SA, Zhang Q, Stein C (1998) Pain Control in Inflammation Governed by Selectins. *Nat Med* 4:1425–1428
8. Machelska H, Mousa SA, Brack A, Schopohl JK, Rittner HL, Schafer M, Stein C (2002) Opioid Control of Inflammatory Pain Regulated by Intracellular Adhesion Molecule-1. *J Neurosci* 22:5588–5596
9. Peterson PK, Molitor TW, Chao CC (1998) The Opioid-Cytokine Connection. *J Neuroimmunol* 83:63–69
10. Rady JJ, Fujimoto JM (2001) Confluence of Antianalgesic Action of Diverse Agents through Brain Interleukin-1 $\beta$  in Mice. *J Pharmacol Exp Ther* 299:659–665
11. Raghavendra V, DeLeo JA (2004) The Role of Astrocytes and Microglia in Persistent Pain. In: Hertz L (eds) *Non-Neuronal Cells in the Nervous System: Function and Dysfunction*. Elsevier, Amsterdam, pp 951–966
12. Raghavendra V, Rutkowski MD, DeLeo JA (2002) The Role of Spinal Neuroimmune Activation in Morphine Tolerance/Hyperalgesia in Neuropathic and Sham Operated Rats. *J Neurosci* 22:9980–9989
13. Raghavendra V, Tanga F, Rutkowski MD, DeLeo JA (2003) Anti-Hyperalgesic and Morphine-Sparing Actions of Propentofylline following Peripheral Nerve Injury in Rats: Mechanistic

Implications of Spinal Glia and Proinflammatory Cytokines. *Pain* 104:657–665

14. Steele AD, Szabo I, Bednar F, Rogers TJ (2002) Interaction between Opioid and Chemokine Receptors: Heterologous Desensitization. *Cytokine Growth Factor Rev* 13:209–222
15. Szabo I, Chen XH, Xin L, Adler MW, Howard OM, Oppenheim JJ, Rogers TJ (2002) Heterologous Desensitization of Opioid Receptors by Chemokines Inhibits Chemotaxis and Enhances the Perception of Pain. *Proc Natl Acad Sci USA* 99:10276–10281

## Cytokines

### Definition

Any of several small regulatory proteins (25 kDa), such as the interleukins and lymphokines, that are released by cells of the immune system and act as intercellular mediators in the generation of immune and inflammatory responses. They can act in an autocrine, paracrine, and endocrine manner. Interleukins, interferons and tumor necrosis factor (TNF) alpha are typical members of the cytokine family.

- ▶ Adjuvant Analgesics in Management of Cancer-Related Bone Pain
- ▶ Animal Models of Inflammatory Bowel Disease
- ▶ Cytokines as Targets in the Treatment of Neuropathic Pain
- ▶ Cytokine Modulation of Opioid Action
- ▶ Cytokines, Regulation in Inflammation
- ▶ Inflammatory Neuritis
- ▶ Muscle Pain in Systemic Inflammation (Polymyalgia Rheumatica, Giant Cell Arteritis, Rheumatoid Arthritis)
- ▶ Neutrophils in Inflammatory Pain
- ▶ Vascular Neuropathies
- ▶ Wallerian Degeneration

## Cytokines as Targets in the Treatment of Neuropathic Pain

CLAUDIA SOMMER<sup>1</sup>, LINDA S. SORKIN<sup>2</sup>

<sup>1</sup>Department of Neurology, University of Würzburg, Würzburg, Germany

<sup>2</sup>Anesthesiology Research, University of California, San Diego, CA, USA

sommer@mail.uni-wuerzburg.de, lsorkin@ucsd.edu

### Synonyms

NA; interleukins; Lymphokines; chemokines

### Definition

Extracellular signaling proteins within the immune system and between the immune system and nervous system.

## Characteristics

### Cytokines

▶ **Cytokines** are a heterogeneous group of proteins that were originally found to mediate activation of the immune system and inflammatory responses. They are produced by white blood cells and a variety of other cells including neurons, Schwann cells and other glial cells. Most cytokines act on a variety of tissues, including the peripheral and central nervous systems. Cytokines are extracellular signaling proteins that form part of a bi-directional circuit between the immune system and the nervous system, acting at hormonal concentrations through high-affinity receptors, and producing endocrine, paracrine and autocrine effects. In contrast to circulating hormones, they exert their effects over short distances onto nearby cells. *In vivo* concentrations are in the range of a few pg to ng per ml. Due to local cytokine effects at low concentrations, serum levels may not reliably reflect activity. Cytokines are called 'pleiotropic', due to a broad range of redundant, frequently overlapping functions. Their activation or dysregulation is implied in a variety of disease states like sepsis, rheumatoid arthritis, Crohn's disease, multiple sclerosis, skin diseases, and many more. Some cytokines are labeled 'pro-inflammatory' or 'Th1', others 'anti-inflammatory' or 'Th2', depending on their effects on immune cells, in particular on lymphocytes.

### Cytokines and Pain

#### Evidence from Experimental Studies

Numerous experimental studies provide evidence that proinflammatory cytokines induce or facilitate inflammatory as well as neuropathic pain and hyperalgesia. Direct receptor-mediated actions of cytokines on afferent nerve fibers have been reported, as well as cytokine effects involving downstream mediators. The first indications of a hyperalgesic effect of cytokines came from studies using intraplantar cytokine injections in the rat; interleukin-1 $\beta$  (▶ IL-1 beta) and ▶ tumor necrosis factor alpha (TNF- $\alpha$ ) reduced mechanical nociceptive thresholds in a cyclooxygenase-dependent process. Cytokine antagonists reduced hyperalgesia in this animal model, indicating that the cytokines were activated in a classical sequence (TNF $\Rightarrow$ IL-1 $\Rightarrow$  ▶ IL-6), and that activation of this pro-inflammatory cytokine cascade is an important step in the development of inflammatory pain (for review see Poole et al. 1999).

After nerve injury, cytokine production in the injured nerve is upregulated, and blockade of the proinflammatory cytokines TNF $\alpha$  and IL-1 $\beta$  reduces behavioral signs of hyperalgesia in experimental animals (for review see Sommer 2001). The mechanisms by which proinflammatory cytokines induce hyperalgesia have not yet been fully elucidated.

IL-1 $\beta$ , among its other actions involving secondary production of nitric oxide, bradykinin or prostaglandins, has



a direct excitatory action on nociceptive fibers, which are activated within one minute by IL-1 $\beta$  application (Fukuoka et al. 1994). In a skin-nerve *in vitro* preparation, brief exposure of the corium to IL-1 $\beta$  results in a facilitation of heat-evoked calcitonin gene-related peptide release from peptidergic neurons (Oprea and Kress 2000). The short latency of the effect, and the absence of the neuronal cell soma in the preparation, indicate that the heat sensitization is independent of changes in gene expression or receptor up-regulation. Further experiments showed that IL-1 $\beta$  can act directly on sensory neurons to increase their sensitivity to noxious heat via a mechanism involving IL-1 receptor I, tyrosine kinase and protein kinase C (Obreja et al. 2002).

TNF $\alpha$  has been shown to lower mechanical activation thresholds in C nociceptors of the rat sural nerve when injected subcutaneously (Junger and Sorokin 2000). While mechanisms of this action are unknown, the acute TNF-induced decrease in K<sup>+</sup> conductance may play an important role (Diem et al. 2001). *In vitro* perfusion of TNF $\alpha$  to dorsal root ganglia (DRG) elicits neuronal discharges in both A and C-fibers. Firing frequency is markedly higher and the discharge longer-lasting after nerve injury, indicating an increased sensitivity of injured afferent neurons to TNF $\alpha$  (Schäfers et al. 2003). Furthermore, DRG neurons with injured afferents, and neighboring neurons attached to intact afferents running within the same peripheral nerve, have an increased immunoreactivity to TNF $\alpha$  (probable increased TNF $\alpha$  protein), and both display increased sensitivity to TNF $\alpha$  (Schäfers et al. 2003, 2003a). Injection or perfusion of TNF $\alpha$  into/onto rat DRGs *in vivo* induces allodynia. Subthreshold quantities of TNF $\alpha$ , injected into a DRG at the same time that its spinal nerve was ligated resulted in a synergy that manifests as faster onset of allodynia and increased spontaneous pain behavior (Schäfers et al. 2003). Thus, there is strong *in vivo* and *in vitro* evidence that injury results in increased endogenous TNF $\alpha$ , and that injured nerve fibers are sensitized to the excitatory effects of TNF $\alpha$ .

► **Nucleus pulposus**, the material within the vertebral discs, is highly enriched with a variety of pro-inflammatory cytokines. Subsequent to disc herniation, it is likely that this material comes into contact with the dorsal roots. Application of autologous nucleus pulposus to dorsal roots, or experimental disc herniation in animals, results in pain behavior as well as both ongoing and enhanced evoked activity in spinal nociceptive neurons (Onda et al. 2003). Animals treated with either neutralizing antibodies to TNF $\alpha$  directly on the nerve root or with systemic TNF $\alpha$  antagonists, showed a marked reduction of both the neuronal activity (Onda et al. 2003) and the pain behavior, implicating a role for TNF $\alpha$  in the process.

Increased spinal cord expression of TNF $\alpha$ , IL-1 $\beta$ , or IL-6 is associated with pain. Protein and mRNA levels of all three cytokines increase in the spinal cord following

nerve injury in animal models (Winkelstein et al. 2001). Spinal administration of exogenous TNF $\alpha$  and IL-1 $\beta$  produces pain behavior and neuronal sensitization *in vivo*, with IL-1 being the more effective (Reeve et al. 2000). In animals with nerve injury and pain behavior, spinal administration of TNF $\alpha$  antagonists prevents or reduces allodynia and hyperalgesia. Whereas spinal IL-1 $\beta$  antagonists alone are seemingly without effect in nerve injury models, they synergize with TNF $\alpha$  antagonists causing a further reduction of allodynia. Interestingly, while this combination treatment reduces the spinal cord expression of the pro-inflammatory cytokine IL-6, spinal expression of the anti-inflammatory cytokine ► IL-10 was unaffected.

Anti-inflammatory cytokines like ► IL-4 and IL-10 seem to have anti-hyperalgesic actions in animal models of pain (Wagner et al. 1998). IL-10 pretreatment reduces the hyperalgesic responses to intraplantar injections of carrageenan, IL-1 $\beta$ , IL-6 and TNF $\alpha$  (Poole et al. 1999). Systemic IL-10 down-regulates local levels of IL-1 $\beta$ , TNF $\alpha$ , and nerve growth factor (NGF) after endotoxin injection into the hindpaw, and reduces thermal and mechanical hyperalgesia. IL-4, delivered by a viral vector, reduces behavioral signs of pain in an animal model of neuropathic pain.

### Clinical Applications

The most striking correlation between cytokine levels and neuropathic pain comes from leprosy, where a subgroup of patients has elevated serum levels of TNF $\alpha$  and IL-1; these patients suffer from excruciating pain. Treatment with thalidomide reduces TNF $\alpha$  secretion in peripheral blood mononuclear cells by >90% and greatly reduces pain in the patients (Barnes et al. 1992). In other human neuropathies, preliminary data also point to a correlation between cytokine expression and pain. Not all patients with elevated cytokine levels in their sural nerve biopsy had pain, but cytokine levels were increased more often in patients with painful neuropathies (Lindenlaub and Sommer 2003), indicating that at least a subgroup of patients with painful neuropathies might benefit from cytokine inhibition. Occasionally, inflammatory neuropathies have been treated with TNF $\alpha$  inhibitors, but data on pain are lacking in these reports. One remarkable case report describes remission of long standing complex regional pain syndrome (CRPS) after treatment with thalidomide for Behçet's disease (Ching et al. 2003).

Anti-TNF $\alpha$  strategies have been used in various non-neuropathic painful conditions like AIDS-associated proctitis, rheumatoid arthritis, and HIV-associated aphthous ulcers. Many other reports have followed since the advent of ► etanercept and ► infliximab : for example, a controlled trial showing a beneficial effect of etanercept in ankylosing spondylitis, and a prospective study with historical controls using infliximab in low back pain.

Several studies have reported increased levels of cytokines in the vicinity of herniated discs and a correlation of their presence to sciatica (Brisby et al. 2002). Inhibitors of TNF $\alpha$  have been used successfully for patients with chronic nerve root pain, but up to now only data from case reports and uncontrolled studies have been available.

In summary, evidence from numerous preclinical studies and preliminary data in humans point to a possible beneficial role of cytokine inhibition in patients with painful neuropathy or radiculopathy. Randomized controlled trials are needed to determine whether cytokine inhibitors have a role in the treatment of neuropathic pain.

## References

- Barnes PF, Chatterjee D, Brennan et al. (1992) Tumor Necrosis Factor Production in Patients with Leprosy. *Infect Immun* 60:1441–1446
- Brisby H, Olmarker K, Larsson K et al. (2002) Proinflammatory Cytokines in Cerebrospinal Fluid and Serum in Patients with Disc Herniation and Sciatica. *Eur Spine J* 11:62–66
- Ching DWT, McClintock A, Beswick F (2003) Successful Treatment with Low-Dose Thalidomide in a Patient with Both Behcet's Disease and Complex Regional Pain Syndrome Type I. *J Clin Rheumatology* 9:96–98
- Diem R, Meyer R, Weishaupt JH et al. (2001) Reduction of Potassium Currents and Phosphatidylinositol 3-Kinase-Dependent AKT Phosphorylation by Tumor Necrosis Factor-(alpha) Rescues Axotomized Retinal Ganglion Cells from Retrograde Cell Death *In Vivo*. *J Neurosci* 21:2058–2066
- Fukuoka H, Kawatani M, Hisamitsu T et al. (1994) Cutaneous Hyperalgesia Induced by Peripheral Injection of Interleukin-1 $\beta$  in the Rat. *Brain Res* 657:133–140
- Junger H, Sorkin LS (2000) Nociceptive and Inflammatory Effects of Subcutaneous TNF $\alpha$ . *Pain* 85:145–151
- Lindenlaub T, Sommer C (2003) Cytokines in Sural Nerve Biopsies from Inflammatory and Non-Inflammatory Neuropathies. *Acta Neuropathol* 105:593–602
- Obreja O, Rathee PK, Lips KS et al. (2002) IL-1 Beta Potentiates Heat-Activated Currents in Rat Sensory Neurons: Involvement of IL-1RI, Tyrosine Kinase, and Protein Kinase C. *FASEB J* 16:1497–1503
- Olmarker K, Nutu M, Storkson R (2003) Changes in Spontaneous Behavior in Rats Exposed to Experimental Disc Herniation are Blocked by Selective TNF-Alpha Inhibition. *Spine* 28:1635–1641
- Onda A, Yabuki S, Kikuchi S (2003) Effects of Neutralizing Antibodies to Tumor Necrosis Factor-Alpha on Nucleus Pulposus-Induced Abnormal Nociceptive Responses in Rat Dorsal Horn Neurons. *Spine* 28:967–972
- Oprea A, Kress M (2000) Involvement of the Proinflammatory Cytokines Tumor Necrosis Factor-Alpha, IL-1Beta, and IL-6 but not IL-8 in the Development of Heat Hyperalgesia: Effects on Heat-Evoked Calcitonin Gene-Related Peptide Release from Rat Skin. *J Neurosci* 20:6289–6293
- Poole S, Cunha FQ, Ferreira SH (1999) Hyperalgesia from Subcutaneous Cytokines. In: Watkins LR, Maier SF (eds) *Cytokines and Pain*. Birkhäuser, Basel, pp 59–87
- Reeve AJ, Patel S, Fox A et al. (2000) Intrathecally Administered Endotoxin or Cytokines Produce Allodynia, Hyperalgesia and Changes in Spinal Cord Neuronal Responses to Nociceptive Stimuli in the Rat. *Eur J Pain* 4:247–257
- Schäfers M, Geis C, Svensson CI et al. (2003) Selective Increase of Tumour Necrosis Factor-Alpha in Injured and Spared Myelinated Primary Afferents after Chronic Constrictive Injury of Rat Sciatic Nerve. *Eur J Neurosci* 17:791–804
- Schäfers M, Lee DH, Brors D et al. (2003a) Increased Sensitivity of Injured and Adjacent Uninjured Rat Primary Sensory Neurons to Exogenous Tumor Necrosis Factor-Alpha after Spinal Nerve Ligation. *J Neurosci* 23:3028–3038
- Sommer C (2001) Cytokines and Neuropathic Pain. In: Hansson P, Fields H, Hill R et al. (eds) *Neuropathic Pain: Pathophysiology and Treatment*. IASP Press, Seattle, pp 37–62
- Wagner R, Janjigian M, Myers RR (1998) Anti-Inflammatory Interleukin-10 Therapy in CCI Neuropathy Decreases Thermal Hyperalgesia, Macrophage Recruitment, and Endoneurial TNF-Alpha Expression. *Pain* 74:35–42
- Winkelstein BA, Rutkowski MD, Sweitzer SM et al. (2001) Nerve Injury Proximal or Distal to the DRG Induces Similar Spinal Glial Activation and Selective Cytokine Expression but Differential Behavioral Responses to Pharmacologic Treatment. *J Comp Neurol* 439:127–139

## Cytokines, Effects on Nociceptors

VICTORIA C. J. WALLACE

Department of Anaesthetics, Pain Medicine and Intensive Care, Chelsea and Westminster Hospital Campus, London, UK  
v.wallace@imperial.ac.uk

### Synonyms

Immunocytokines

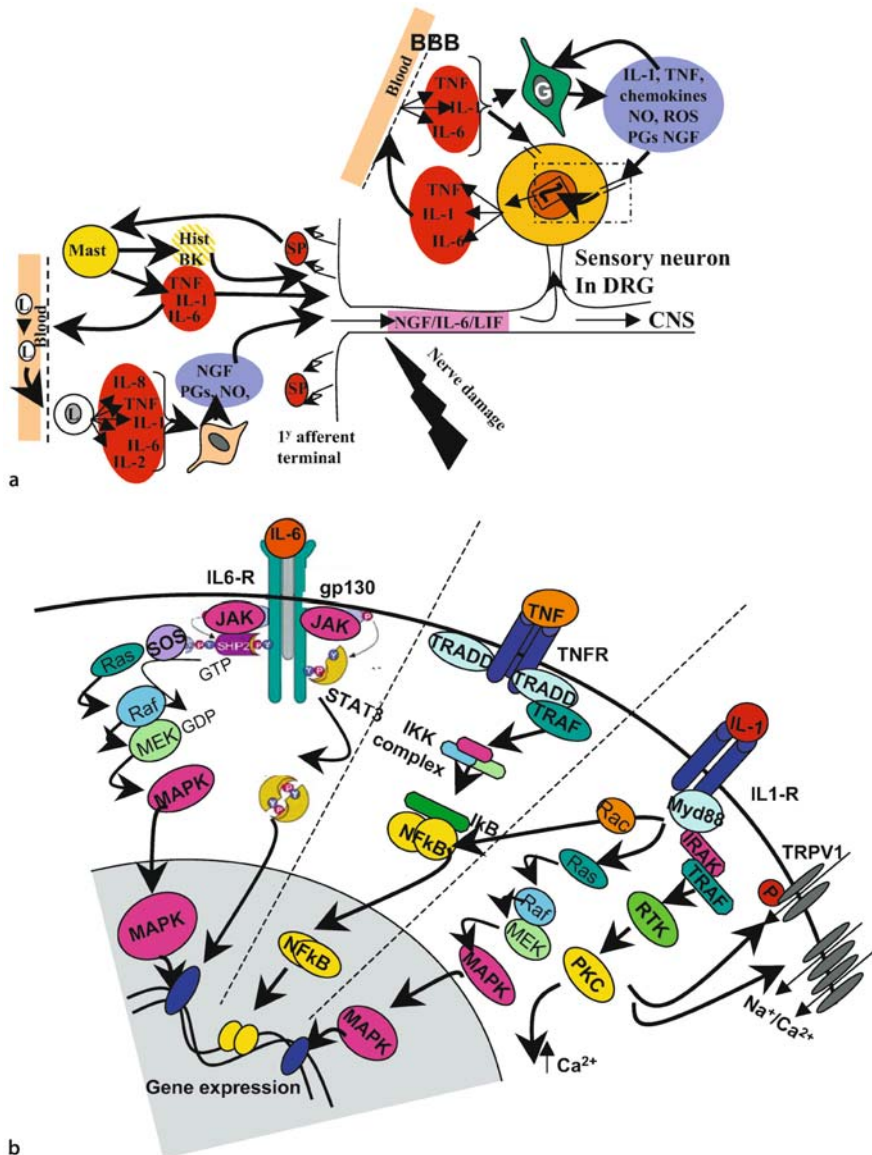
### Definition

Cytokines are a family of growth factor proteins secreted primarily from ► **leukocytes** as part of the immune and inflammatory response.

### Characteristics

#### Interactions with Peripheral Nociceptive Terminals

Proinflammatory cytokines, such as IL-1, TNF- $\alpha$  and IL-6, as well as other inflammatory mediators that cytokines influence as part of the inflammatory response, can directly stimulate and sensitise peripheral terminals of small diameter ► **nociceptors** (C-fibres) influencing transduction and transmission of the nociceptive signal contributing to ► **peripheral sensitisation** (Fig 1a). For example, a subcutaneous injection of IL-1, TNF- $\alpha$  or IL-6 has been shown to directly excite peripheral nociceptive fibres (Poole et al. 1999). Also, TNF- $\alpha$ , which causes the subsequent release of IL-1, produces thermal hyperalgesia and mechanical allodynia, as well as endoneurial inflammation, demyelination, and axonal degeneration whilst lowering C-fibre thresholds and inducing ectopic activity in single primary afferent nociceptive fibers (Junger 2000). Such stimulation of nociceptors not only results in signalling to the spinal cord, leading to sensation/perception of pain, but also to a local axon reflex. Importantly, SP acts directly via surface expressed NK1 receptors, to degranulate mast cells causing release of histamine, which further sensitise nociceptive terminals, and proinflammatory cytokines, thus inducing a SP-cytokine positive-feedback loop.



**Cytokines, Effects on Nociceptors, Figure 1** (a) Interactions of cytokines with nociceptors at their peripheral terminals and in the DRG. Injurious stimuli induce immune and inflammatory cells to release cytokines and chemokines, which stimulate further release of cytokines and non-cytokine inflammatory mediators such as prostaglandins (PGs), NGF and nitric oxide (NO) from various tissue cells. Cytokines and various inflammatory mediators such as histamine (Hist) and bradykinin (BK) can activate nociceptor terminals to release neurotransmitters such as SP leading to neurogenic inflammation. Retrogradely transported signal proteins cause the release of cytokines and other factors from blood, neurones and glia (G) into the DRG which can activate intracellular cascades (see 1b) regulating gene transcription, cell phenotype and excitability and therefore sensory transmission to the spinal cord. (b) Highlighted region in (1a) (dashed line) representing examples of some of the intracellular mechanisms of proinflammatory cytokine-induced cell change. IL-1 via the IL-1R activates a number of protein kinase cascades including; protein tyrosine kinase (PTK), and protein kinase C (PKC) inducing intracellular Ca<sup>++</sup> increase and phosphorylation of ion channels such as TRPV1 and others inducing changes in Na<sup>+</sup> and Ca<sup>++</sup> currents. Early events in all cascades involve MyD88, IL-1 receptor-associated kinase (IRAK-1) and a TNF receptor-associated factor (TRAF). Ras activation of p38 MAP kinase (MAPK) and Rac mediated transactivation of gene expression by NFκB regulation also occur. The IL-6/L-6R complex activates; JAK which recruits STAT3 to the phosphorylated receptor, gp130, and activates the Ras/MAP kinase pathway via the SHP-2 pathway ultimately affecting nuclear transcription factors such as CREB, c-fos, and c-jun. In contrast to such kinase signalling, the TNF/TNFR complex is regulated by intracellular adaptor proteins (TRADD and TRAF), via which it activates the IKK complex to phosphorylate IκB, liberating NFκB to the nucleus (see Hanada et al. 2002; Obreja et al. 2002; Heinrich et al. 2003).

Proinflammatory cytokines can also modulate nociceptors indirectly, by stimulating the release of a variety of pronociceptive inflammatory mediators such as; BK, which directly stimulates nociceptor terminals via BK

receptors (Dray 1997), also upregulated by proinflammatory cytokines; prostaglandins, such as PGE<sub>2</sub>, which can be produced by almost all types of cells and is a well known key player in the inflammatory cascade and

inflammatory hyperalgesia (Samad et al. 2002); and ► **chemokines** (small chemottractant cytokines) such as IL-8 (CXCL8) which in turn stimulate the production of ► **sympathomimetic amines** capable of directly sensitising nociceptors (Sachs et al. 2001).

Another major pronociceptive target of cytokine function is NGF, which is released by a variety of cells at the site of infection/inflammation in response to proinflammatory cytokines, and plays a role in exaggerated pain states (Woolf et al. 1994) via direct (binding to TrkA receptors on nociceptive fibers) and indirect (via cytokine-like actions, causing immune cells to accumulate and release their cellular contents exciting nociceptive fibers) actions on the nociceptive function.

Peripheral stimulation of nociceptive afferents can also produce an axon reflex, in which ► **prodromic nerve impulses** travelling up the sensory axon initiate ► **antidromic impulses** in neighbouring axons. This results in a release of ► **neuropeptides** and ► **neurogenic inflammation** at sites distant from the original stimuli increasing the area of sensitivity.

Such cytokine driven, neurogenic inflammatory loops stimulate and sensitise nociceptors in the absence of further peripheral stimulation, which could, in theory, create enough 'drive' to create and maintain spinal cord sensitisation, resulting in persisting pain.

#### Influences in the DRG

Cytokines can also have direct and indirect effects on nociceptor function, at the level of the DRG, resulting in excitability and phenotypic changes. This contributes to altered synaptic transmission in the spinal cord (central sensitisation) involved in the development of hyperalgesia and persistent pain (Fig. 1a). Levels of cytokines can increase in the DRG following inflammation and nerve damage in response to signal proteins produced at the site of damage, such as the cytokines LIF and IL-6 as well as cytokine induced NGF, which are retrogradely transported by both intact and injured axons (Watkins and Maier 2000). Such signals can initiate the recruitment of immune cells to the DRG and induce proliferation and activation of satellite (glial) cells, resulting in the release of a variety of growth factors, including cytokines, into the extracellular fluid of the DRG where they modulate sensory neuron, and/or glial cell function via differentially expressed cytokine receptors. For example, the proinflammatory cytokines IL-1 and TNF- $\alpha$  bind directly to neuronally expressed receptors inducing rapid increases in sensory neuronal excitation, facilitating pain transmission to the spinal cord. On the other hand, the primary receptor for IL-6 (IL6-R) is predominantly expressed by glial cells and therefore IL-6, although produced by DRG neurons, likely affects nociceptor function indirectly (such as via Schwann cell release of IL-1 and TNF- $\alpha$ ), although receptor expression is likely to change under pathological conditions (De Jongh 2003). In fact, even in the absence of nerve dam-

age or of any action at receptors expressed by peripheral nerve terminals, proinflammatory cytokines acting in the DRG can rapidly induce aberrant responses in peripheral nociceptors (Sorkin et al. 1997, Watkins and Meier 2000).

Retrogradely transported signals can also induce phenotypic changes in primary sensory neurons, such as increased expression of BDNF, TRPV1, Nav1.8, CGRP, SP, and galanin (Watkins and Meier 2002), all of which can change the properties of nociceptive neurons.

In the DRG, ► **G-protein coupled**, chemokine ► **receptors** are expressed by small diameter nociceptors, suggesting a direct involvement of chemokines in nociceptive signal transduction and the pathogenesis of pain. This is supported by the fact that endogenous chemokines such as SDF1 $\alpha$ /CXCL12, MDC/CCL22 and RANTES/CCL5 or exogenous factors such as the HIV-1 coat protein gp120, which is a ligand at the chemokine receptors CXCR4 and CCR5, have been shown to produce powerful excitatory effects on sensory neurons via increased calcium mobilization and the lowering of the threshold for action potential generation (Oh et al. 2001). Chemokine receptors are also expressed by glial cells, the activation of which enhances the release of neuroactive substances, including NGF, NO, glutamate and other chemokines, which can further affect nociceptor activity and even lead to neurotoxicity.

#### Intracellular Mechanisms

Cytokines modulate nociceptor activity contributing to ► **neural plasticity** and pain, via the initiation of intracellular cascades of phosphorylation of constitutively expressed signal proteins involved in nociception and pain such as PKC, MAP kinase, Ras/Raf c-jun, c-fos and STAT (Fig 1b). As a result there are alterations to the transcription rate and/or posttranslational changes in proteins involved in the pain pathway, which ultimately lead to a modification of transduction, conduction and transmission functionality of these neurons. For example, IL-1 binds to the specific cell surface receptors, IL-1RI and IL-1RII; members of the Toll-like receptor superfamily of which IL-1R1 are expressed by nociceptive neurons. IL-1RI-mediated mechanisms, involving activation of tyrosine kinases and PKC associated phosphorylation, lead to long lasting increases in voltage-sensitive sodium and calcium channel conductance, increasing excitability of the cell as well as changes in specific receptor function (Obreja et al. 2002). In nociceptors, this may include phosphorylation of heat-transducing vanilloid receptors; TRPV1 or TRPV1-1, supported by evidence that IL-1 $\beta$  directly sensitises rat sensory neurons to heat. Downstream pathways of IL-1Rs and TNF- $\alpha$  receptors (TNFRI and TNFRII) ultimately activate NF $\kappa$ B, which modulates the expression of a variety of proteins implicated in nociceptor sensitivity and pain,



including growth factors and inducible enzymes such as cyclooxygenase 2 (COX2) and inducible nitric oxide synthase (iNOS) (Hanada 2002). NF $\kappa$ B also promotes further proinflammatory cytokine and chemokine production, potentiating cytokine-mediated mechanisms of nociceptor excitability and signalling. In addition to receptor function, the TNF- $\alpha$  molecule itself may cause changes in neuronal excitability due to pH facilitated insertion into lipid membranes, to form a central pore-like region forming voltage-dependent sodium channels, which may not only be associated with the generation of neuronal hyperexcitability, but may interact with endogenous sodium and calcium channels to increase membrane conductance (Kagan et al. 1992). In contrast, IL-6 signalling occurs via binding to the  $\alpha$ -subunit non-signalling receptor IL-6R (gp80), which leads to homodimerisation of the transmembranous signalling transducer receptor gp130, which signals intracellularly via the JAK/STAT pathways to influence gene expression via MAPK (Heinrich et al. 2003). IL-6R and gp130 are expressed predominantly on glial cells; however, although peripheral nociceptors lack IL-6R subunits under normal physiological conditions, they do express gp130 molecules, and the expression patterns of each have been reported to change following nerve damage (De Jongh et al. 2003).

#### Antinociceptive Functions

In addition to the anti-inflammatory and antinociceptive function of cytokines, such as IL-10, IL-4 and IL-13 (Vale et al. 2003), there is evidence of the direct interaction of cytokines with nociceptors in an antinociceptive manner. For example, IL-2 induces peripheral ► [antinociception](#) via the IL-2R specific receptor, which is expressed in small and medium (i. e. nociceptive) primary sensory neurons of DRG, and is transported to the peripheral axon terminals (Song et al. 2000). The mechanism underlying cytokine-induced antinociception may include inhibition of neurotransmitter release, due to Ca<sup>2+</sup> channel blocking properties decreasing nociceptor activity.

#### References

1. De Jongh RF, Vissers KC, Meert TF, Boon LH, De Deyne CS, Heylen RJ (2003) The Role of Interleukin-6 in Nociception and Pain. *Anesth Analg* 96:1096–103
2. Dray A (1997) Kinins and their Receptors in Hyperalgesia. *Can J Physiol Pharmacol* 75:704–712
3. Hanada T, Yoshimura A (2002) Regulation of Cytokine Signaling and Inflammation. *Cytokine Growth Factor Rev* 13:413–421
4. Heinrich PC, Behrmann I, Haan S, Hermanns HM, Müller-Newen G, Schaper F (2003) Principles of Interleukin (IL)-6-type Cytokine Signalling and its Regulation. *Biochem J* 374:1–20
5. Junger H, Sorkin LS (2000) Nociceptive and Inflammatory Effects of Subcutaneous TNF- $\alpha$ . *Pain* 85:145–151
6. Kagan BL, Baldwin RL, Munoz D, Wisniewski BJ (1992) Formation of Ion-Permeable Channels by Tumor Necrosis Factor- $\alpha$ . *Science* 255:1427–1430
7. Obreja O, Rathee PK, Lips KS, Distler C, Kress M (2002) IL-1 Beta Potentiates Heat-Activated Currents in Rat Sensory Neu-

rons: Involvement of IL-1RI, Tyrosine Kinase and Protein Kinase C. *FASEB J* 16:1497–1503

8. Oh SB, Tran PB, Gillard SE, Hurley RW, Hammond DL, Miller RJ (2001) Chemokines and Glycoprotein120 Produce Pain Hypersensitivity by Directly Exciting Primary Nociceptive Neurons. *J Neurosci* 21:5027–5035
9. Poole S, Cunha FDQ, Ferreira SH (1999) Hyperalgesia from Subcutaneous Cytokines. In: Watkins LR, Maier SF (eds) *Cytokines and Pain*. Birkhauser, Basel, pp 59–88
10. Samad TA, Sapirstein A, Woolf CJ (2002) Prostanoids and Pain: Unraveling Mechanisms and Revealing Therapeutic Targets. *Trends Mol Med* 8:390–396
11. Song J, Jang YY, Shin YK, Lee C, Chung S (2000) N-Ethylmaleimide Modulation of Tetrodotoxin-Sensitive and Tetrodotoxin-Resistant Sodium Channels in Rat Dorsal Root Ganglion Neurons. *Brain Res* 855:267–273
12. Sorkin LS, Xiao WH, Wagner R, Myers RR (1997) Tumour Necrosis Factor- $\alpha$  Induces Ectopic Activity in Nociceptive Primary Afferent Fibres. *Neuroscience* 81:255–262
13. Watkins LR, Maier SF (2000) The Pain of Being Sick: Implications of Immune-to-Brain Communication for Understanding Pain. *Annu Rev Psychol* 51:29–57
14. Watkins LR, Maier SF (2002) Beyond Neurons: Evidence that Immune and Glial Cells Contribute to Pathological Pain States. *Physiol Rev* 82:981–1011
15. Woolf CJ, Safieh-Garabedian B, Ma QP, Crilly P, Winter J (1994) Nerve Growth Factor Contributes to the Generation of Inflammatory Sensory Hypersensitivity. *Neuroscience* 62:327–331

C

## Cytokines, Regulation in Inflammation

VICTORIA WALLACE

Department of Anaesthetics, Pain Medicine and Intensive Care, Chelsea and Westminster Hospital Campus, London, UK  
v.wallace@imperial.ac.uk

#### Synonyms

Immunocytokines

#### Definition

► **Cytokines** are a large family of growth factor proteins (MW 8–30 kD) secreted primarily from leukocytes (as well as a variety of cells) as part of the immune and inflammatory response.

#### Characteristics

Over 150 cytokines have been cloned, which may be grouped into various sub-families, based upon functional properties and receptor utilisation, although nomenclature is somewhat confusing and arbitrary (Vilcek 1998). Cytokines that are particularly involved in regulation of inflammation are termed the ► **proinflammatory cytokines** (which can also encompass the inflammatory chemokines) and the ► **anti-inflammatory cytokines**.

#### Proinflammatory Cytokines

The major proinflammatory cytokines include tumour necrosis factor- $\alpha$  (TNF- $\alpha$ ), interleukin-1 $\alpha$  and  $\beta$  (IL-1 $\alpha$

and  $\beta$ ) and interleukin-6 (IL-6), which are secreted in a sequential cascade (TNF- $\alpha$ >IL-1>IL-6), by a variety of immune and inflammatory cells, in response to inflammation. A wealth of literature supports a role for proinflammatory cytokines in the production of inflammation associated pain and hyperalgesia. For example, pain associated with signs of inflammation after peripheral nerve injury in rodents correlates with the number of proinflammatory cytokine-producing cells at the injury site; and thermal hyperalgesia and mechanical allodynia can be reduced via the blockade of IL-1 or TNF- $\alpha$  (Watkins and Meier 2000). Furthermore, an intraplantar injection of TNF- $\alpha$  results in hyperalgesia, which lasts for several hours and can be associated with a cascade of cytokine involvement, including IL-1 followed by IL-6, as well as the activation of IL-8 (Junger et al. 2000). TNF- $\alpha$ , a member of the TNF family of cytokines is produced primarily by macrophages, and acts via the TNFR1 and TNFR2 receptors (Orlinick and Chao 1998). Binding of TNF- $\alpha$  triggers intracellular signalling cascades to induce changes in gene expression, mainly via the activation of NF $\kappa$ B. Effects can include the upregulation of; proinflammatory cytokines, adhesion molecules, chemokines, growth factors, inducible enzymes such as cyclooxygenase 2 (COX2) and inducible nitric oxide synthase (iNOS) (Hanada 2002), all of which can have effects on mechanisms of nociception. Importantly, TNF- $\alpha$  induces production of IL-1, a member of the interleukin family, which is produced in two molecular forms ( $\alpha$  and  $\beta$ ) by many cell types including mononuclear cells, fibroblasts, synoviocytes, macrophages, keratinocytes, mast cells, glial cells, and neurons (Bianchi 1998). Additionally, the inactive precursor of IL-1 (pro-IL-1) is constantly produced by keratinocytes and fibroblasts in the skin, and in increasing amounts following tissue damage, during which degranulation of mast cells releases the enzyme, chymase, which cleaves the IL-1 precursor to its active form. IL-1 binds to the specific cell surface receptors, IL-1RI and IL-1RII, which are members of the Toll-like receptor superfamily. Like TNF- $\alpha$ , the proinflammatory and pronociceptive actions of IL-1 are mediated via complex intracellular signalling cascades that ultimately activate NF $\kappa$ B. In the context of pain, IL-1 is likely to be the most important proinflammatory cytokine, with many outcomes of other proinflammatory cytokine actions occurring via IL-1 release. In most cell types, IL-1 and TNF- $\alpha$  induce the release of IL-6, a member of the neuropoetic cytokine family. IL-6 plays a minimal role in inducing inflammatory mediators or other inflammatory cytokines in tissues, although may play a role in inducing chemokine production. IL-6 binds to the  $\alpha$ -subunit non-signalling receptor, IL-6R (gap80), leading to homodimerisation of the transmembranous signal transducer receptor, gp130, and an intracellular cascade of phosphorylation (De Jongh 2003). This affects cell activity and initiates the

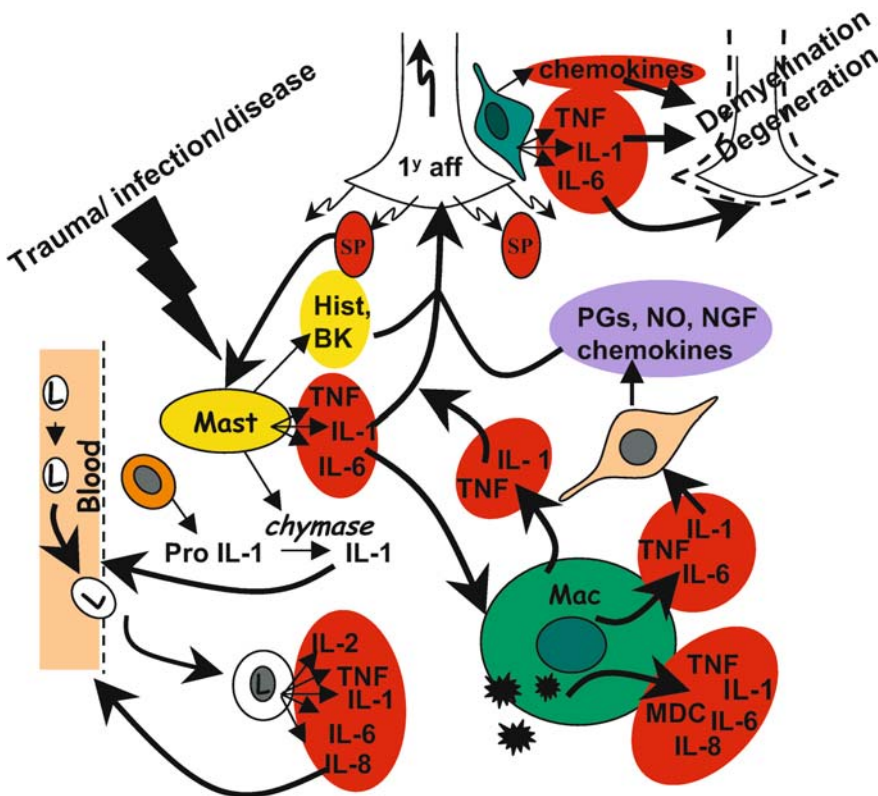
release of many cell specific ► [neuroactive substances](#) and inflammatory substances.

In general, proinflammatory cytokines act to increase vascular endothelial membrane permeability, and induce upregulation of endothelial adhesion molecules and thus leukocyte adhesion, migration and extravasation. Due to a self-promoting cytokine loop, there is a rapid accumulation of proinflammatory cytokines at the site of damage, ensuring a rapid onset of the inflammatory response (Fig. 1).

In the context of pain, which is a key component of the inflammatory response designed to prevent further insult to the damaged site, it is important to note that proinflammatory cytokines are released from and act upon neurones and glial cell, via which they signal to the brain that infection or injury has occurred (Watkins and Maier 2000; Watkins and Maier 2002). This ► [neuroimmune interaction](#) can influence mechanisms implicated in the development of hyperalgesia and persistent pain, which are associated with many inflammatory conditions. For example, cytokines released in damaged tissue can activate peripheral terminals of primary sensory neurones either directly, via neuronally expressed cytokine receptors, or indirectly via the stimulation of other substances that have relevance to the production of pain such as prostaglandins, nitric oxide and nerve growth factor (NGF) (see ► [cytokines, effects on nociceptors](#) ). Such activation enhances the release of neuroactive transmitters, such as ► [substance P](#) (SP), enhancing neurogenic inflammation leading to sensitisation and increased excitability of sensory primary afferents (Fig. 1) (Black 2002). Inflammation of, or damage to, the peripheral nerve itself causes the activation of recruited and resident macrophages, fibroblasts, mast cells, dendritic cells, and endothelial cells, all of which can release proinflammatory cytokines which, due to their induction of oedema-associated disruption of the ► [blood nerve barrier](#), can lead to further immune invasion of the nervous system. Furthermore, activated Schwann cells, which myelinate peripheral nerves, release proinflammatory cytokines (as well as many other damaging substances such as NO, ROS, PGs and ATP). This can damage myelin, with resulting demyelination and/or nerve degeneration (► [Wallerian degeneration](#)), all of which can be associated with the development of pain.

### Chemokines

Chemokines are a family of small chemoattractant cytokines (MW 8-10kDa) that have potent leukocyte activation and/or chemotactic activity. Over 50 have been identified so far, the majority of which are classed into the CC group or CXC group based in their cysteine residues. Via actions on their specific G-protein coupled receptors, chemokines are intimately involved in the orchestration of inflammatory responses, by inducing cell migration across a concentration gradient.



C

**Cytokines, Regulation in Inflammation, Figure 1** A representation of the network of cytokine production in tissue, following typical injurious stimuli. Degranulation of local and infiltrating mast cells releases proinflammatory cytokines which stimulate further cytokine release from macrophages (Mac) attracted to the site of injury to phagocytose pathogens (\*), a process which in itself triggers cytokine production. Cytokines act to increase vascular permeability inducing leukocyte extravasation and further stimulating release of cytokines and non-cytokine inflammatory mediators such as PGs, growth factors and NO from various tissue cells (TC). IL-1 is also formed from its precursor pro-IL1 and chemokines are secreted enhancing further leukocyte migration from the bloodstream. Cytokines and various inflammatory mediators such as histamine and BK can activate primary sensory neurons to release neurotransmitters such as SP. Activation of Schwann cells causes further cytokine and chemokine release which can cause demyelination and degeneration of 1y afferents.

Although most pain research related to neuroimmune function has focussed on proinflammatory cytokines, the involvement of chemokines in inflammatory pain and hyperalgesia has become more apparent (Boddeke 2001). In addition to immune cells, many nervous system cells (neuronal and glial) are capable of synthesising chemokines and express a variety of chemokine receptors, suggesting that chemokines act as messengers between peripheral immune cells and sensory afferent neurons from inflamed sites. Evidence supports a role for a number of chemokines in inflammation and pain such as IL-8/CXCL8 (Boddeke 2001), SDF1 $\alpha$ /CXCL12, MDC/CCL22 and RANTES/CCL5 (Oh et al. 2001), which may act to increase intracellular calcium and, therefore, cell excitability and release.

#### Limiting Actions of Cytokines

Since cytokines are potent mediators of potentially damaging tissue responses, several mechanisms exist to ensure that the effects of these cytokines are restricted, thereby limiting the inflammatory response.

For example, the IL-1 receptor antagonist (IL-1ra), a member of the interleukin cytokine family, is up-regulated during inflammation and prevents binding of IL-1 to its receptors (Hopkins 2003). Additionally, the cellular receptors for both IL-1 and TNF- $\alpha$  exist in soluble forms, and are able to bind and neutralise their cytokine ligands after being cleaved from the cell surface. Some cytokines, such as IL-10, IL-4 (Hamilton et al. 2002) and LIF (see Gadiant and Patterson 1999), have anti-inflammatory activity and are able to down-regulate expression of pro-inflammatory cytokines. The actual role of LIF is however controversial, and has been implicated as a proinflammatory cytokine (McKenzie et al. 1996) and as an anti-inflammatory and analgesic cytokine (Banner et al. 1997). It is likely that the increased activation of leukocytes and, therefore, release of proinflammatory cytokines, characteristic of chronic inflammation and associated persistent pain, involves a dysfunction of these negative regulatory mechanisms leading to sustained positive feedback cytokine-neural interactions.

## References

1. Banner LR, Patterson PH, Allchorne A, Poole S, Woolf CJ (1998) Leukemia Inhibitory Factor is an Anti-Inflammatory and Analgesic Cytokine. *J Neurosci* 18:5456–5462
2. Bianchi M, Dib B, Panerai AE (1998) Interleukin-1 and Nociception in the Rat. *J Neurosci Res* 53:645–650
3. Black PH (2002) Stress and the Inflammatory Response: A Review of Neurogenic Inflammation. *Brain Behav Immun* 16:622–653
4. Boddeke EW (2001) Involvement of Chemokines in Pain. *Eur J Pharmacol* 429:115–119
5. De Jongh RF, Vissers KC, Meert TF, Booij LH, De Deyne CS, Heylen RJ (2003) The Role of Interleukin-6 in Nociception and Pain. *Anesth Analg* 96:1096–103
6. Gadiant RA, Patterson PH (1999) Leukemia Inhibitory Factor, Interleukin 6, and Other Cytokines Using the GPI30 Transducing Receptor: Roles in Inflammation and Injury. *Stem Cells* 17:127–137
7. Hamilton TA, Ohmori Y, Tebo J (2002) Regulation of Chemokine Expression by Anti-Inflammatory Cytokines. *Immunol Res* 25:229–245
8. Hanada T, Yoshimura A (2002) Regulation of Cytokine Signaling and Inflammation. *Cytokine Growth Factor Rev* 13:413–421
9. Hopkins SJ (2003) The Pathophysiological Role of Cytokines. *Leg Med (Tokyo)* 5 Suppl 1:S45–S57
10. Junger H, Sorkin LS (2000) Nociceptive and Inflammatory Effects of Subcutaneous TNFalpha. *Pain* 85:145–151
11. Oh SB, Tran PB, Gillard SE, Hurley RW, Hammond DL, Miller RJ (2001) Chemokines and Glycoprotein120 Produce Pain Hypersensitivity by Directly Exciting Primary Nociceptive Neurons. *J Neurosci* 21:5027–5035
12. Orlinick JR, Chao MV (1998) TNF-Related Ligands and Their Receptors. *Cell Signal* 10:543–551
13. Vilcek J (1998). The cytokines: an overview. In: Thomson A (ed) *The Cytokine Handbook*, 3rd edn. Academic Press, San Diego, pp 1–20
14. Watkins LR, Maier SF (2000) The Pain of Being Sick: Implications of Immune-to-Brain Communication for Understanding Pain. *Annu Rev Psychol* 51:29–57
15. Watkins LR, Maier SF (2002) Beyond Neurons: Evidence that Immune and Glial Cells Contribute to Pathological Pain States. *Physiol Rev* 82:981–1011

---

## Cytoprotection

### Definition

As applied to the gastrointestinal tract, cytoprotection indicates the development of mechanisms that protect the tract from damage from the digestive enzymes and, in the stomach and duodenum, from the acidic contents.

► [NSAIDs and their Indications](#)

---

## Cytoskeleton

### Definition

The scaffold structures of cells, also cytoskeletal system.

► [Toxic Neuropathies](#)



---

## Daily Persistent Headache

- ▶ New Daily Persistent Headache

---

## DAMGO

### Definition

DAMGO is a  $\mu$  opioid receptor selective enkephalin derivative: [D-Ala<sup>2</sup>,N-Me-Phe<sup>4</sup>,Gly<sup>5</sup>-ol]-enkephalin.

- ▶ Opioids and Inflammatory Pain

---

## Dapsone

### Definition

Dapsone is an antibacterial, belonging to a group of sulfonamide-like sulfones. It is used especially in the treatment of leprosy; administered orally.

- ▶ Hansen's Disease

---

## Dark Disc Disease

- ▶ Discogenic Back Pain

---

## Data

### Definition

Data can be described in one of two of the following ways:

- Pieces of numerical or other information.
  - A set of facts from which conclusions can be drawn.
- ▶ Postoperative Pain, Data Gathering and Auditing

---

## Data Auditing/Collection/ Gathering/Management/Security

- ▶ Postoperative Pain, Data Gathering and Auditing

---

## DBS

- ▶ Deep Brain Stimulation

---

## Deactivation

### Definition

Many fMRI experiments show regions of cortex that seem to respond in antiphase with the primary stimulus. This negative BOLD (blood oxygenated level dependent) response or deactivation is spatially and temporally linked to reductions in blood flow, and has been shown to be primarily due to neuronal inhibition.

- ▶ Hippocampus and Entorhinal Complex, Functional Imaging
- ▶ Nociceptor, Fatigue

---

## Dead Sea

### Definition

This region in Israel is a major spa area for patients with various types of arthritis.

- ▶ Spa Treatment

---

## Deafferentation

### Definition

Deafferentation means interruption of afferent sensory input due to nerve injury. This may be associated with chronic pain mainly due to mechanisms of peripheral and central sensitization. Although the lesion is usually peripheral, lesions of ascending somatosensory pathways will lead to deafferentation of their target nuclei.

- ▶ Anesthesia Dolorosa Model, Autotomy
- ▶ Atypical Facial Pain, Etiology, Pathogenesis and Management
- ▶ Atypical Odontalgia
- ▶ Central Nervous System Stimulation for Pain

- ▶ Cordotomy Effects on Humans and Animal Models
- ▶ Dorsal Root Ganglionectomy and Dorsal Rhizotomy
- ▶ Hyperpathia, Assessment
- ▶ Peripheral Neuropathic Pain
- ▶ Plexus Injuries and Deafferentation Pain
- ▶ Thalamic Plasticity and Chronic Pain
- ▶ Thalamus, Dynamics of Nociception

## Deafferentation Pain

### Definition

Neuropathic pain generated in the central nervous system, and secondary to interruption of afferent sensory pathways, projecting onto the concerned central structure. The existence of hyperactive neurons in the deafferented dorsal horn (DH) has been proven by microelectrode recordings of the DH neurons, in humans as well as in animal experiments. Deafferentation pain may develop after avulsion of the brachial plexus, dorsal root rhizotomy or ganglionectomy, or other types of lesions of peripheral nerves, or because of pathology of the central nervous system.

- ▶ Anesthesia Dolorosa Model, Autotomy
- ▶ Brachial Plexus Avulsion and Dorsal Root Entry Zone
- ▶ Central Pain, Diagnosis
- ▶ Dietary Variables in Neuropathic Pain
- ▶ Dorsal Root Ganglionectomy and Dorsal Rhizotomy

## Deception

- ▶ Credibility, Assessment

## Decerebrated

### Definition

Cerebral brain function (in an animal) and its impact on lower brain and spinal cord can be eliminated experimentally by removing the cerebrum, cutting across the brain stem, or severing certain arteries in the brain stem.

- ▶ Postsynaptic Dorsal Column Projection, Anatomical Organization

## Decidualization

### Definition

Forming of the deciduas, which is the changed endometrium (the lining of the uterus), after the blastocyst (fertilized ovum after 4–9 days of development) is implanted onto the endometrium.

- ▶ NSAIDs, Adverse Effects

## Decision Theory

- ▶ Statistical Decision Theory Application in Pain Assessment

## Deconditioned

### Definition

Deconditioned refers to a state of poor physical conditioning brought on by inactivity.

It is usually used to refer to a deterioration of physical conditioning, secondary to a reduction in an individual's level of activity. The deconditioning may involve loss of strength, loss of flexibility, and reduced cardiovascular function.

- ▶ Disability, Effect of Physician Communication

## Deep Brain Stimulation

N. WEISS, I. GARONZIK, A. SAMDANI, S. OHARA, F. A. LENZ

Johns Hopkins Medical Institutions, Department of Neurosurgery, Baltimore, MD, USA  
flenzl@jhmi.edu

### Synonyms

DBS; Brain electrode

### Definition

Electrical stimulation of subcortical structures in the brain including peri-ventricular grey; ▶ [internal capsule](#) ▶ [somatic sensory and intralaminar nuclei of thalamus](#) is a therapy for some patients with chronic pain.

### Characteristics

#### Introduction

The electrical stimulation of subcortical brain structures for the treatment of chronic pain was first reported in the 1950s, when hypothalamic nuclei were stimulated for pain control (Tulane University School of Medicine, Dept. of Psychiatry and Neurology 1954; Pool et al. 1956). Over the next few decades, the sensory ▶ [thalamus](#) and ▶ [periaqueductal gray \(PAG\)](#) became the most frequent targets for deep brain stimulation (DBS). This transition followed the observation of stimulation-evoked analgesia, first in animals and subsequently in humans (Hosobuchi et al. 1977; Richardson and Akil 1977).

Chronic pain is pain that occurs daily over a 6-month period. Nociceptive refers to pain produced by activation of peripheral nociceptors and transmitted to the central nervous system through intact somatosensory

pathways. Examples of nociceptive pain include pain of acute trauma and cancer pain secondary to invasion of bone. This pain responds well to ► **opiates**. ► **Neuropathic pain** refers to pain arising from injury to the nervous system either peripherally (deafferentation pain, e.g. diabetic neuropathy) or centrally (central pain, e.g. post-stroke pain) (Portenoy 1989). It has been proposed that this type of pain does not respond to opiates (Arner and Meyerson 1988), although this proposal is not universally accepted (Vecht 1989; DelleMijn 1999).

### Mechanisms of Action

The mechanisms of action of deep brain stimulation of the PAG and sensory thalamus are not completely understood. Evidence supports the role of ► **endogenous opioid** release in PAG stimulation: focal stimulation of the PAG attenuates nociceptive responses to painful stimuli (Reynolds 1969), an effect that is reversed by opioid antagonists (Hosobuchi et al. 1977), and which is associated with increased endogenous opioid levels in the third ventricle (Akil et al. 1978; Hosobuchi et al. 1979). Several lines of evidence also suggest that the mechanism of analgesia in PAG stimulation involves spinal connections (Basbaum and Fields 1984; Maciewicz and Fields 1986). PAG neurons synapse upon neurons in the medullary nucleus raphe magnus (NRM), which, in turn, sends a strong serotonergic projection to the dorsal horn. This analgesic effect is also abolished by cutting the descending pathways to the spinal cord. The PAG, medullary NRM and dorsal horn all contain high levels of opiates and opiate receptors. Due to the important role apparently played by opioids, PAG stimulation is usually indicated in chronic nociceptive pain conditions.

The mechanism by which sensory thalamic stimulation provides pain relief is less clearly understood. The target nucleus for this type of stimulation is the principal somatosensory nucleus, known as ventral caudal (Vc) in humans and ventral posterior (VP) in other species. Stimulation of rat VP inhibits responses to noxious stimulation through an opioid-independent pathway (Benabid et al. 1983). The effects of somatosensory thalamic stimulation on pain modulation may be due to an inhibitory effect on Rexed's laminae I to V ► **spinothalamic tract** (STT) neurons, most likely through serotonergic pathways (Gerhart et al. 1984). Due to the relative independence of the opioid pathways, somatosensory thalamic stimulation is indicated in cases of chronic neuropathic pain.

### Patient Selection

The issue of patient selection for placement of DBS for the treatment of pain has been addressed in a number of published studies (Young and Rinaldi 1997; Levy et al. 1987; Hosobuchi 1986). These patients experienced chronic pain, unresponsive to medical or surgical therapies over several years, and failed treatment adminis-

tered during an admission to a pain clinic. Often, they underwent psychosocial assessment, and were selected for stimulation if there is no evidence of psychological or secondary gain issues. In many published studies, patients have been subjected to intravenous morphine infusion tests, based on the hypothesis that nociceptive but not neuropathic pain responds to opioids. Reversibility of analgesia with naloxone is taken as further evidence of a nociceptive pain condition. If the patient's pain was likely to be nociceptive in origin, PAG stimulation was performed. If the pain appeared to be neuropathic, the patient underwent thalamic stimulation.

### Intraoperative Targets

Localization of the surgical target for PAG has been determined using different means by different authors. All targets were determined relative to the anterior commissure-posterior commissure (AC-PC) line, a third ventricular radiologic landmark with a relatively fixed anatomic relationship to subcortical structures. Levy and co-workers targeted a point 1 mm below and 1 mm posterior to the posterior commissure, and 3 mm lateral to the lateral wall of the third ventricle (Levy et al. 1987). Young and Rinaldi targeted a point 2 to 3 mm below the AC-PC line, 12 to 14 mm posterior to the midpoint (MC) of the AC-PC line and 2 to 3 mm lateral to the midline (Young and Rinaldi 1997). Hosobuchi targeted a site at the level of the opening of the aqueduct into the third ventricle and 3 mm lateral to the midline (Hosobuchi 1986). The correct target was identified by stimulation-evoked warmth, oscillopsia, loss of up-gaze, elevation of both heart rate and blood pressure, or pain relief. If the electrode is implanted more ventrally and posterior – in periaqueductal grey, fear and anxiety are evoked by stimulation (Hosobuchi 1986). ► **Periventricular gray**, which is slightly rostral to PAG, has been targeted as an alternative site to PAG in some studies. The periventricular gray is located 10 mm posterior to MC, at the vertical level of the AC-PC line, and 3 to 4 mm lateral to the midline (Young and Rinaldi 1997).

Levy and co-workers described sites of thalamic targets for treatment of deafferentation pain (Young and Rinaldi 1997). Targets for facial deafferentation pain in the medial Vc (facial representation of Vc) were chosen 8 mm posterior to the MC point, 8 mm lateral to the midline, and 1 to 3 mm above the MC point. Deafferentation pain of the extremities was treated by stimulation of lateral Vc (representation of the extremities), defined as a point 9 mm posterior to MC, 10 to 12 mm lateral, and 2 to 3 mm above the MC point. In other studies, targets were calculated from standard atlas maps. All studies included a period of postoperative testing with the electrode attached to an externalized lead. Patients were stimulated at different electrode combinations, voltages, pulse widths, and frequencies until the optimal stimulation parameters for pain relief were determined. The results of this period

of postoperative testing were used to decide whether to implant the stimulator permanently.

### Results

Three large studies have reported the results of deep brain stimulation for the treatment of pain. Young et al. retrospectively reviewed 178 patients over 14 years who had DBS for chronic pain (Young and Rinaldi 1997). Early in their experience, they relied on screening tests, such as response of pain to opiates and reversal of pain relief with naloxone, to determine the surgical target of DBS. Later in their experience, electrodes were implanted in both PAG and Vc in most patients, and the ideal stimulation parameters were determined through post-operative DBS programming. Of the 89 patients with permanent implants, 62% experienced long-term pain relief. Long-term pain relief was obtained in 70% of patients with nociceptive pain, and in 50% of patients with neuropathic pain.

Another study reported the results of DBS for chronic pain in 161 patients over 80 months. Patients given pain relief with morphine infusion and reversal with naloxone had PAG stimulation, those who had no response had Vc stimulation, and those with a mixed response had electrodes placed in both locations. Success was measured by regular use of the electrode at initial (6 weeks) and long term (>6 weeks) follow-up. Overall, there was a 61% initial success rate and a 30% long-term success rate. Patients with nociceptive pain had a 56% initial success rate and a 32% long-term success rate, while patients with neuropathic pain experienced 20–50% success rates (Levy et al. 1987). In a third study, 122 patients had thalamic DBS placed for chronic pain, with 68% initial and 57% long-term success rates (Hosobuchi 1986). A meta-analysis of 13 studies (1114 patients) evaluating DBS for the treatment of chronic pain reported that 50% of all patients experienced long term pain relief. Patients with nociceptive pain experienced a 60% long-term relief of pain with PAG stimulation. Patients with neuropathic pain experienced a 56% long-term success rate with Vc stimulation.

### Complications

Hemorrhage is the most serious complication of DBS, occurring in 14/441 cases and leading to 3 deaths. This has been attributed to the design of the electrode, which has since been modified (Levy et al. 1987; Hosobuchi 1986; Young and Rinaldi 1997). Neurologic sequelae of stimulation were reported in 7% of cases, including diplopia, vertical gaze paresis, blurred vision, oscillopsia, hemineglect and hemiparesis. In one study, persistent headache occurred in 50% of cases; however, this was not mentioned in others (Young and Rinaldi 1997). Infections occurred in 5–12% of cases (Young and Rinaldi 1997; Levy et al. 1987; Hosobuchi 1986), with staphylococcus species being the majority of causative organisms. Stitch and subgaleal infections were most

common, and were usually treated adequately with antibiotics. Removal of the hardware system and intravenous antibiotics were successful in treating the hardware infections. Ventriculitis (*Propionobacterium*) and subdural empyema (*Staphylococcus aureus*) rarely occurred.

Technical failures were reported in all studies, including electrode migration (2–10%) and insulation fracture (3–4%). Skin erosion was reported in 2% of cases. The technical complication rate has decreased with the newly designed electrode.

- ▶ Pain Treatment, Motor Cortex Stimulation
- ▶ Postherpetic Neuralgia, Pharmacological and Non-Pharmacological Treatment Options
- ▶ Stimulation Treatments of Central Pain

### References

1. Akil H, Richardson DE, Hughes J, Barchas JD (1978) Enkephalin-Like Material Elevated in Ventricular Cerebrospinal Fluid of Pain Patients after Analgetic Focal Stimulation. *Science* 201:463–465
2. Arner S, Meyerson BA (1988) Lack of Analgesic Effect of Opioids on Neuropathic and Idiopathic Forms of Pain. *Pain* 33:11–23
3. Basbaum AI, Fields HL (1984) Endogenous Pain Control Systems: Brainstem Spinal Pathways and Endorphin Circuitry. *Ann Rev Neurosci* 7:309–338
4. Benabid AL, Henriksen SJ, McGinty JF, Bloom FE (1983) Thalamic Nucleus Vento-Postero-Lateralis Inhibits Nucleus Parafascicularis Response to Noxious Stimuli through a Non-Opioid Pathway. *Brain Res* 280:217–231
5. Dellemijn P (1999) Are Opioids Effective in Relieving Neuropathic Pain? *Pain* 80:453–462
6. Gerhart KD, Yeziarski RP, Wilcox TK, Willis WD (1984) Inhibition of Primate Spinothalamic Tract Neurons by Stimulation in Periaqueductal Gray or Adjacent Midbrain Reticular Formation. *J Neurophysiol* 51:450–466
7. Hosobuchi Y, Adams JE, Linchitz R (1977) Pain Relief by Electrical Stimulation of the Central Gray Matter in Humans and its Reversal by Naloxone. *Science* 197:183–186
8. Hosobuchi Y, Rossier J, Bloom FE, Guillemin R (1979) Stimulation of Human Periaqueductal Gray for Pain Relief Increases Immunoreactive Beta-Endorphin in Ventricular Fluid. *Science* 203:279–281
9. Hosobuchi Y (1986) Subcortical Electrical Stimulation for Control of Intractable Pain in Humans. Report of 122 cases (1970–1984). *J Neurosurg* 64:543–553
10. Lenz FA, Kwan HC, Martin R, Tasker RR, Richardson RT, Dostrovsky JO (1994) Characteristics of somatotopic organization and spontaneous neuronal activity in the region of the human principal sensory nucleus in patients with spinal cord transection. *J Neurophysiol* 72:1570–1587
11. Lenz FA, Zirh AT, Garonzik IM, Dougherty PM (1998) Neuronal Activity in the Region of the Principle Sensory Nucleus of Human Thalamus (Ventralis Caudalis) in Patients with Pain Following Amputations. *Neuroscience* 86:1065–1081
12. Levy RM, Lamb S, Adams JE (1987) Treatment of Chronic Pain by Deep Brain Stimulation: Long Term Follow-up and Review of the Literature. *Neurosurgery* 21:885–893
13. Maciewicz R, Fields HL (1986) Pain pathways. In: Asbury AK, McKhann GM, McDonald WI (eds) *Diseases of the Nervous System. Clinical Neurobiology*. W.B. Saunders Company, Philadelphia, London, pp 930–940
14. Pool JL, Clark WK, Hudson P, Lombardo M (1956) Hypothalamic-Hypophysial Dysfunction in Man. Laboratory and Clinical Assessment. In: Guillemin R, Guillemin R, Carton CA (eds) *Hypothalamic-Hypophysial Interrelationships*. Thomas, Springfield, pp 114–124



15. Boivie J (1994) Central pain. In: Wall PD, Melzack R (eds) Textbook of Pain. Churchill Livingstone, Edinburgh, pp 871-902
16. Radhakrishnan V, Tsoukatos J, Davis KD, Tasker RR, Lozano AM, Dostrovsky JO (1999) A Comparison of the Burst Activity of Lateral Thalamic Neurons in Chronic Pain and Non-Pain Patients. Pain 80:567-575
17. Reynolds DV (1969) Surgery in the Rat During Electrical Analgesia Induced by Focal Brain Stimulation. Science 164:444-445
18. Richardson DE, Akil H (1977) Pain Reduction by Electrical Brain Stimulation in Man: Part II: Chronic Self Administration in the Periaqueductal Gray Matter. J Neurosurg 47:184-194
19. Tulane University, School of Medicine. Dept. of Psychiatry and Neurology (1954) Studies in Schizophrenia. A Multidisciplinary Approach to Mind-Brain Relationships. Harvard University Press, Cambridge
20. Turk DC, Okifuji A (2001) Pain Terms and Taxonomies of Pain. In: Loeser JD (ed) Bonica's Management of Pain. Lippincott Williams & Wilkins, Philadelphia, Baltimore, New York, London, Buenos Aires, Hong Kong, Sydney, Tokyo, pp 17-25
21. Vecht ChJ (1989) Nociceptive Nerve Pain and Neuropathic Pain. Pain 39:243-244
22. Young RF, Rinaldi PC (1997) Brain stimulation. In: North RB, Levy RM (eds) Neurosurgical management of pain. Springer-Verlag, New York, Berlin, Heidelberg, pp 283-301

## Deep Dyspareunia

### Definition

Lower abdominal pain exclusively during intercourse.

- ▶ Gynecological Pain and Sexual Functioning

## Deep Sedation

### Definition

A drug-induced state of depressed consciousness during which patients are not easily aroused and may need airway and ventilatory assistance, although they purposefully respond to repeated or painful stimulation.

- ▶ Pain and Sedation of Children in the Emergency Setting

## Deep Somatic Pain

- ▶ Spinal Dorsal Horn Pathways, Muscle and Joint

## Deep Venous Thrombosis

### Synonyms

Blood clot; DVT

### Definition

Commonly affects the lower leg and can present as a pain syndrome mimicking sciatica with primarily distal extremity pain.

- ▶ Postoperative Pain, Venous Thromboembolism
- ▶ Sciatica

**D**

## Default Value

### Definition

Values attributed to a variable or data as a base value, which remains unless replaced by the user.

- ▶ Postoperative Pain, Data Gathering and Auditing

## Definition of Disability (Adults)

### Definition

The inability to engage in any substantial gainful activity by reason of any medically determinable physical or mental impairment or combination of impairments, which is expected to result in death or that has lasted or can be expected to last for a continuous period of not less than 12 months.

- ▶ Disability Evaluation in the Social Security Administration

## Definition of Disability for Individuals under Age 18 (SSI Program Only)

### Definition

A medically determinable physical or mental impairment or impairments that result in marked and severe functional limitations and that meet the duration requirement.

- ▶ Disability Evaluation in the Social Security Administration

## Degenerative Disease

### Definition

A biomechanical and pathologic condition caused by degeneration, inflammation, or infection.

- ▶ Chronic Back Pain and Spinal Instability

## Degenerative Joint Disease

- ▶ Arthritis Model, Osteoarthritis

## Dejerine-Roussy Syndrome

- ▶ Central Pain, Diagnosis

## Dejerine-Sottas Syndrome (Neuropathy)

### Synonyms

DSN

### Definition

A severe form of inherited neuropathy that is clinically detected during infancy.

- ▶ Hereditary Neuropathies

## Delayed Muscle Soreness

- ▶ Delayed Onset Muscle Soreness

## Delayed Onset Muscle Soreness

JAN FRIDÉN

Department of Hand Surgery, Sahlgrenska University Hospital, Göteborg, Sweden  
jan.friden@orthop.gu.se

### Synonyms

Delayed Muscle Soreness; Exercise-Induced Muscle Soreness; DOMS

### Definition

Delayed onset muscle soreness (DOMS) is the sensation of muscular discomfort and pain during active contractions that occurs 24–48 h after strenuous exercise. The initial symptoms are most evident at the muscle tendon junction and thereafter spread throughout the entire muscle. Muscle soreness and injury are associated with intense exercise and are more pronounced if the exercise performed is new to the individual.

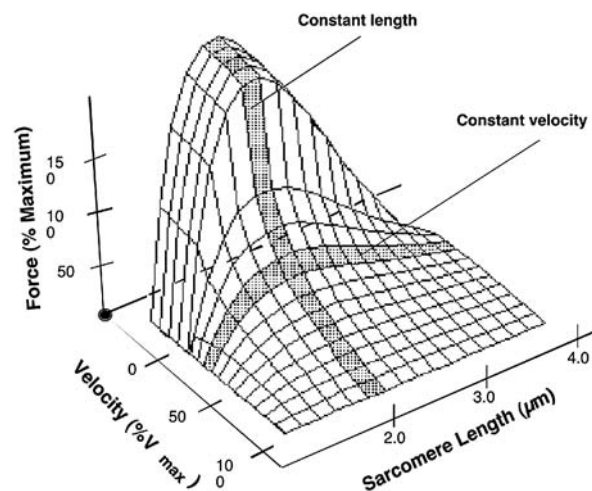
### Characteristics

Sore muscles after exercise are stiff, tender and aching, symptoms that are aggravated by active muscle contractions. The symptoms of DOMS develop during the first 24–48 h, peak between 24 and 72 h and usually disappear without intervention within 5–7 days (Armstrong 1984; Ebbeling and Clarkson 1989; Fridén 1981). The soreness has been reported by some to be localized at the muscle-tendon junction, while others describe the pain as being diffusely spread throughout the muscle. Regardless of the exact location, palpation, passive stretching and renewed activity aggravate the

pain. Some controversy exists regarding the relation between maximum voluntary force and symptoms of soreness. Ebbeling and Clarkson suggested that there is no, or very little, relationship between the development of soreness and decrease of muscle strength (Ebbeling and Clarkson 1989). Return of maximum muscle strength to pre-exercise levels takes between 24 h and 2 weeks.

Bobbert and co-workers (Bobbert et al. 1986) reported an increase in limb volume 24–72 h after eccentric activity of the calf. Intramuscular edema of the biceps, as verified by magnetic resonance imaging, is maximized at 72 h after eccentric activity. The stiffness and swelling associated with DOMS is probably an effect due to edema occurring in the perimuscular connective tissue. Regardless of whether the swelling is intra- or extra-cellular, an increase in the intramuscular pressure is implicated. In addition to increased tenderness during palpation, the examiner will find prolonged strength loss, a reduced range of motion and elevated levels of creatine kinase in the blood. Frequently, muscle cramps accompany DOMS.

DOMS is primarily associated with the eccentric component of exercise (Asmussen 1952). During an eccentric action, a contracted muscle is forced to elongate while producing tension. Its counterpart, concentric action, produces tension during muscle shortening. The intermediate, isometric contraction, produces tension while the muscle remains essentially at the same length (Fig. 1). All three actions are common components of daily movement. The tension generated during eccentric action is higher than that for either of the other actions (Katz 1939) although fewer motor units are recruited (Bigland-Ritchie 1976).



**Delayed Onset Muscle Soreness, Figure 1** Generalized relationship between muscle length, force and velocity. Note the very high forces occurring at "negative" velocities (from Fig. 6, Fridén and Lieber 1992, *Med Sci Sports Exerc* 24:521–530).

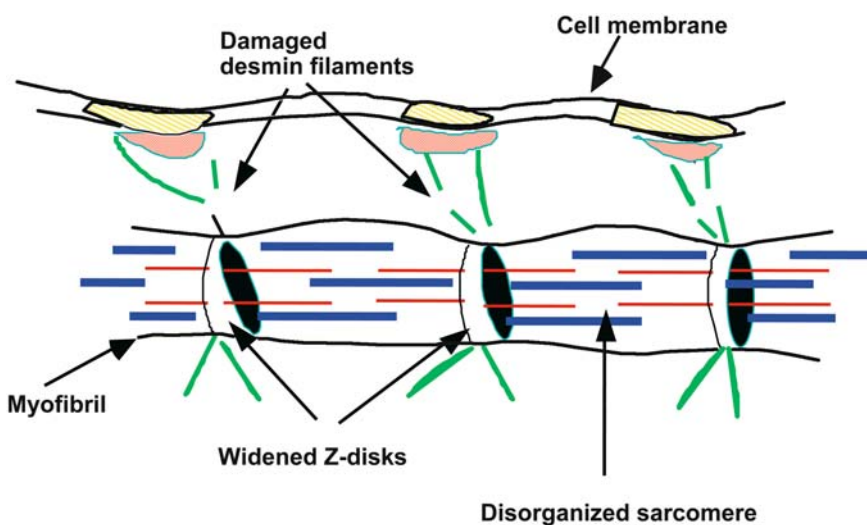
Due to the nature of an eccentric action, the tension generating mechanism can be expressed in two phases; the muscle contracts to generate tension and then the muscle is passively stretched by an external force while generating additional tension.

It is still unknown whether the initial decline of strength after eccentric contractions (EC) is because of injury or fatigue or a combination of both. Some authors have referred the immediate loss of strength to overstretch of sarcomeres resulting in a non-optimal overlap between actin and myosin filaments. It has been suggested that during eccentric exercise some sarcomeres are stretched beyond overlap and thereby injured, while others maintain their length. Despite the great force loss after eccentric contractions, the resting membrane potentials of isolated muscles fatigued by eccentric or isometric contractions were similar (Warren et al. 1993). Since there is no evidence of excitation failure, the ability to produce action potentials is expected to be unaffected. Lieber and Fridén showed that it is not high force *per se* which causes muscle damage following eccentric contraction, but the magnitude of the active strain, i.e. strain during active lengthening (Lieber and Fridén 1993). The active strain hypothesis is described in terms of the interaction between the myofibrillar cytoskeleton, the sarcomere and the sarcolemma.

It is generally agreed that the initial force decline is due to mechanical injury. A number of mechanical factors such as muscle length, force and velocity seem to play roles in the consequences of eccentric contractions. Newham and colleagues found more pronounced strength loss after eccentric exercise at a long muscle length compared to a short muscle length (Newham et al. 1988). Although the nature of morphological injury to the muscle has been well documented and reported, the mechanism of the injury is not fully understood. Strenuous exercise causes a disturbance of the muscle's homeostasis. Although muscle tissue is extremely plas-

tic, destructive changes in muscle ultrastructure may occur in response to unusual demands. DOMS and ultrastructural disruptions are selectively associated with exercise involving EC (Fridén 1984; Fridén et al. 1981) and have been reported in both animal and human models. Such changes may require several weeks to resolve and often lead to muscle hypertrophy and strengthening. In previous studies, two pieces of mechanical evidence suggested that ► **desmin** plays a direct mechanical role in the force loss after EC (Fig. 2). Desmin immunostaining was rapidly lost, as fast as 15 min into a single bout of EC (Lieber et al. 1996) and a strong linear correlation was seen between the magnitude of desmin loss and loss of muscle force generated after EC. Recently, it has been hypothesized that there is a relationship between force loss, desmin immunostaining, transcriptional up-regulation and the ultimate increase in desmin content per sarcomere (Barash et al. 2002; Peters et al. 2003). Direct mechanical data demonstrated that reinforced sarcomeres are highly resistant to EC-induced injury.

In addition to injuries to muscle fibers, there is evidence of disturbance to muscle sense organs and of proprioception after eccentric exercise. The peripheral contribution to perturbations of force perception after eccentric exercise is, however, small and the centrally derived sense of effort plays the most important role. Proske and Morgan made the common observation that a second period of exercise, for example 1 week after the first, produces much less damage (Proske and Morgan 2001). One proposed mechanism for this adaptation may be an increase in sarcomere number in muscle fibers. It is postulated that the adaptation is likely to lead to a secondary shift in the muscle's optimum length for active tension. The authors conclude that the ability of muscle to adapt quickly after damage from a single bout of eccentric exercise implies the use in clinical applications of mild eccentric exercise for protecting a muscle against more major injuries.



**Delayed Onset Muscle Soreness, Figure 2** Schematic depiction of eccentric contraction-induced muscle damage. Muscle fiber strain results in disruption of the intermediate filament network. Disruption of the intermediate filaments causes loss of the sarcomere's structural integrity and misalignment of striated bands.

- ▶ Nocifensive Behaviors, Muscle and Joint
- ▶ Stretching

### References

1. Armstrong RB (1984) Mechanisms of exercise-induced delayed onset muscular soreness: a brief review. *Med Sci Sports Exerc* 16: 529–538
2. Asmussen E (1952) Positive and negative muscular work. *Acta Physiol Scand* 28:364–382.
3. Barash IA, Peters D, Fridén J et al. (2002) Desmin cytoskeletal modifications after a bout of eccentric exercise in the rat. *Am J Physiol* 283:958–563
4. Bigland-Ritchie B, Woods JJ (1976) Integrated electromyogram and oxygen uptake during positive and negative work. *J Physiol* 260:267–277
5. Bobbert MF, Hollander AP, Huijing PA (1986) Factors in delayed onset muscular soreness of man. *Med Sci Sports Exerc* 18:75–81
6. Ebbeling CB, Clarkson PM (1989) Exercise-induced muscle damage and adaptation. *Sports Med* 7:207–234
7. Fridén J (1984) Changes in human skeletal muscle induced by long term eccentric exercise. *Cell & Tissue Res* 236:365–372
8. Fridén J, Sjöström M, Ekblom B (1981) A morphological study of delayed muscle soreness. *Experientia* 37:506–507
9. Katz B (1939) The relation between force and speed in muscular contraction. *J Physiol* 96:45–64
10. Lieber RL, Fridén J (1993) Muscle injury is not a function of muscle force but active muscle strain. *J Appl Physiol* 74:520–526
11. Lieber RL, Thornell LE, Fridén J (1996) Muscle cytoskeletal disruption occurs within the first 15 minutes of cyclic eccentric contraction. *J Appl Physiol* 80:278–284
12. Newham DJ, Jones DA, Ghosh G et al. (1988) Muscle fatigue and pain after eccentric contractions at long and short length. *Clin Sci* 74:553–557
13. Peters D, Barash I, Burdi M et al. (2003) Asynchronous functional, cellular and transcriptional changes after a bout of eccentric exercise in the rat. *J Physiol* 553:947–957
14. Proske U, Morgan DL (2001) Muscle damage from eccentric exercise: mechanism, mechanical signs, adaptation and clinical applications. *J Physiol* 537:333–345
15. Warren GW, Hayes D, Lowe DA et al. (1993) Mechanical factors in the initiation of eccentric contraction-induced injury in rat soleus muscle. *J Physiol* 464:457–475

## Delayed Severe Respiratory Depression

### Definition

Severe slowing or arrest of spontaneous breathing, usually caused by morphine administered close to the spinal cord (epidurally or directly into the cerebrospinal fluid)

- ▶ Postoperative Pain, Acute Pain Team

## Delirium

### Definition

An acute or subacute syndrome with waxing and waning levels of consciousness, global cognitive impairment, a reduced ability to focus attention, sustain attention or to shift attention and disorganized wake-sleep cycle.

- ▶ Cancer Pain, Assessment in the Cognitively Impaired
- ▶ Cancer Pain Management, Overall Strategy

## Delta( $\delta$ ) Opioid Receptor(s)

### Synonyms

OP1 receptors; DOP

### Definition

Receptors that preferentially bind enkephalins and enkephalin-like drugs. It was originally named for its discovery in the mouse *vas deferens*. The receptor was cloned in 1992. They are present throughout the telencephalon and spinal cord. Agonists are associated with spinal analgesia.

- ▶ Opiates During Development
- ▶ Opioid Receptors
- ▶ Postoperative Pain, Transition from Parenteral to Oral

## Delta( $\delta$ ) Sleep

### Definition

Delta sleep refers to stages 3 and 4 of non-REM (rapid eye movement) sleep.

- ▶ Fibromyalgia

## Demand Characteristics

### Definition

This term refers to the demands of the situation that must be considered in the context of introducing hypnosis. Experimental subjects tend to guess at the experimenter's objectives and then behave accordingly in order to be socially compliant and co-operative. This tendency is clearly important in any therapeutic interaction where the patient may be trying to please the doctor.

- ▶ Therapy of Pain, Hypnosis

## Dementia

### Definition

A syndrome characterized by a decline in multiple cognitive functions occurring in clear consciousness.

- ▶ Cancer Pain, Assessment in the Cognitively Impaired

## Demographic

### Definition

Statistical characteristics of populations such as age, educational attainment or income.

- ▶ Pain in the Workplace, Risk Factors for Chronicity, Demographics



## Demyelination

MATTHEW N. RASBAND<sup>1</sup>, PETER SHRAGER<sup>2</sup>

<sup>1</sup>University of Connecticut Health Center, Farmington, CT, USA

<sup>2</sup>Department of Neurobiology and Anatomy, University of Rochester, Rochester, NY, USA

rasband@uchc.edu, pshr@mail.rochester.edu

### Definition

A large percentage of the axons in the nervous system are ensheathed by a lipid rich membrane called myelin. This sheath is essential for rapid and efficient conduction of electrical signals along axons. Demyelination is the loss of the myelin sheath and results from disease or injury.

### Characteristics

Proper nervous system function depends on the transmission of electrical signals (► [action potentials](#)) along axons and over relatively long distances. In order to facilitate conduction in a rapid and efficient manner, vertebrates have developed a lipid rich sheath, called ► [myelin](#), which confers several passive electrical properties onto axons. These properties include high ► [membrane resistance](#) and low ► [membrane capacitance](#). Myelin also plays several active roles that determine axonal excitability. For example, myelin-axon interactions restrict ► [sodium \(Na<sup>+</sup>\) channels](#) to regularly spaced gaps in the myelin sheath called nodes of Ranvier (Fig. 1a, arrow), and compact myelin regulates the kinds of Na<sup>+</sup> channels expressed in axons (for a more comprehensive review, see Salzer 2003). Together, these active and passive properties facilitate rapid and efficient action potential conduction by decreasing loss of electrical charge in regions covered by myelin, and by regenerating the action potential at each node of Ranvier.

Myelin is made by glial cells: Schwann cells in the peripheral nervous system (PNS) and oligodendrocytes in the central nervous system (CNS). Demyelination, or loss of the myelin sheath, is most commonly associated with autoimmune diseases (e.g. multiple sclerosis (MS) in the CNS and Guillain-Barre syndrome in the PNS) or traumatic injury (e.g. spinal cord crush), but may also be a consequence of mutations in a variety of myelin proteins (e.g. various types of Charcot-Marie-Tooth disease). In most cases of demyelination in the PNS, Schwann cells are able to remyelinate axons. In contrast, in the CNS, oligodendrocytes are much less efficient at remyelination. This is thought to be a consequence of differences between the PNS and CNS extracellular environments, as well as intrinsic differences between ► [Schwann cells](#) and oligodendrocytes.

Subsequent to demyelination, the passive electrical properties of axons are dramatically altered, resulting in failure to conduct action potentials through de-

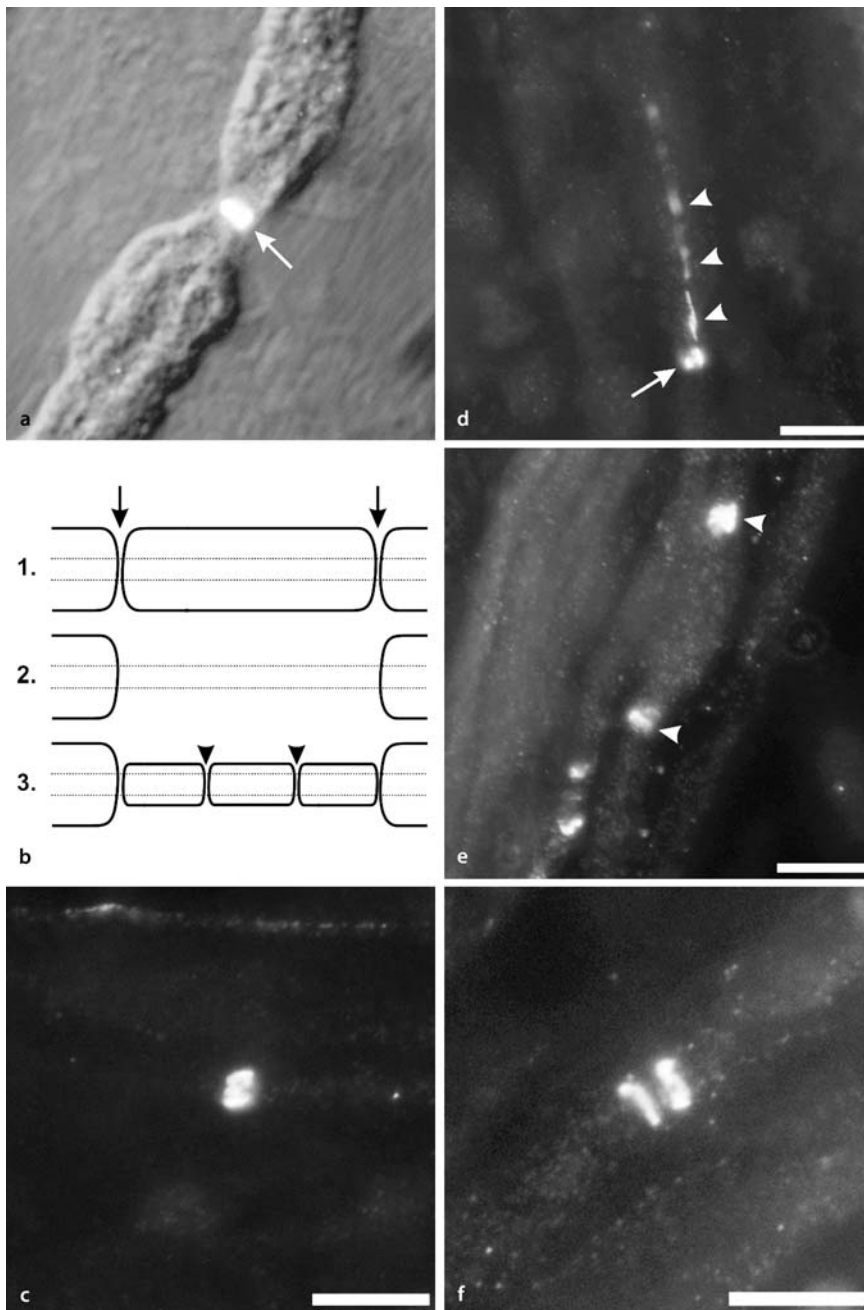
myelinated zones. In particular, demyelination causes a striking increase in the axonal membrane capacitance. Thus, as electrical signals propagate down an axon, the current available to trigger the next group of Na<sup>+</sup> channels is reduced due to capacitative charging of the axonal membrane. Demyelination also results in dysregulation of myelin's 'active' properties. It may be that disruption of these 'active' properties contributes to the generation of neuropathic pain following demyelination.

While alterations to the passive properties of axons after demyelination are well understood, the consequences for the active properties of myelin are mostly unknown. As a result, recent work has focused on how myelin-axon interactions regulate the excitable properties of axons. For example, a variety of experimental models have been used to investigate the consequences of demyelination and remyelination on Na<sup>+</sup> channel clustering and expression.

### Acute Demyelination

Peripheral demyelination has been shown to dramatically influence the localization of ion channels. For example, injection of the weak detergent lyssolecithin into a peripheral nerve causes a transient, focal demyelinated lesion about 1 week after the injection. This lesion can be remyelinated by Schwann cells during the second and third weeks post-injection. However, the architecture of this new myelin is somewhat different than before: sheaths are thinner and shorter (Fig. 1b) (Dugandzija-Novakovic et al. 1995). Therefore, in order to support action potential conduction, new nodes of Ranvier with high densities of Na<sup>+</sup> channels must be formed in regions that were formerly covered by compact myelin and characterized by a low density of channels (Fig. 1b, arrowheads) (Shrager 1989). This model has permitted a careful analysis of Na<sup>+</sup> channel localization subsequent to acute demyelination and during remyelination (Dugandzija-Novakovic et al. 1995). Specifically, regions of demyelinated axon can be seen to retain Na<sup>+</sup> channel clusters. Some of these clusters even appear indistinguishable from those found in normal axons (Fig. 1c), suggesting that in the absence of overlying myelinating Schwann cells, neurons have intrinsic mechanisms that cause clusters of Na<sup>+</sup> channels to be retained. In other places, Na<sup>+</sup> channel clusters (Fig. 1d, arrow) can be seen to have a 'tail' of immunoreactivity leading away from the main cluster (Fig. 1d, arrowheads). This situation is most often seen adjacent to heminodes (where the myelin on one side of a node has been lost and the sheath on the other side remains intact). As remyelination occurs, single axons can be seen to have multiple Na<sup>+</sup> channel clusters between remyelinating Schwann cells (Fig. 1e; the two Na<sup>+</sup> channel clusters identified by the arrowheads are found in the same axon and are only about 25 μm apart). As remyelination progresses, these clusters appear to be 'pushed' ahead of the myelinating Schwann cell

D



**Demyelination, Figure 1**  $\text{Na}^+$  channel clusters in myelinated, demyelinated, and remyelinating peripheral axons. (a) A node of Ranvier (arrow) labeled for  $\text{Na}^+$  channels. The outline of the myelin sheath can also be seen. (b) Cartoon illustrating that remyelinated axons have shorter and thinner sheaths with new nodes of Ranvier in formerly internodal zones. (c) A  $\text{Na}^+$  channel cluster in a demyelinated axon. (d) A heminode with a  $\text{Na}^+$  channel cluster (arrow) and 'tail' of  $\text{Na}^+$  channel immunoreactivity (arrowheads). (e) Two  $\text{Na}^+$  channel clusters (arrowheads), located on the same remyelinating axon. (f) Two  $\text{Na}^+$  channel clusters just before they fuse to form a new node of Ranvier. Scalebars = 10  $\mu\text{m}$ .

until they finally fuse and form a new node of Ranvier. Figure 1f shows two  $\text{Na}^+$  channel clusters (11 days after lysolecithin injection) just before they fuse at a nascent node of Ranvier.

#### Chronic Demyelination

One major difference between lysolecithin mediated demyelination and many forms of disease or injury related demyelination is that the latter forms are usually chronic. As a result, lessons learned from acute demyelination may not be generally applicable to chronic demyelination. To date, few studies have focused on

the consequences of chronic demyelination for  $\text{Na}^+$  channel expression and localization. Some of the first experiments relied on mutant dysmyelinating mice to assess these characteristics. For example, we showed that the localization of  $\text{Na}^+$  channels was dramatically disrupted in axons of the hypomyelinated mouse mutant *Shiverer* (Rasband et al. 1999). Further, Westenbroek et al. (1992) showed that the expression of one particular type of brain  $\text{Na}^+$  channel (Nav1.2) was dramatically increased in these mice. However, subsequent studies demonstrated that during normal development, Nav1.2 is found in premyelinated and actively myelinating

axons (Boiko et al. 2001). Therefore, the differences in Na<sup>+</sup> channel expression and localization seen in *Shiverer* may be related to developmental defects, rather than a consequence of demyelination.

To directly address whether chronic demyelination can influence the kinds of Na<sup>+</sup> channels present in CNS axons, Craner et al. (2003) examined the localization of Nav1.2 and Nav1.6 in an inflammatory mouse model of CNS demyelination [► [experimental allergic encephalitis](#) (EAE)], and Rasband et al. (2003) examined localization and expression levels of these same Na<sup>+</sup> channels in a genetic, adult onset model of chronic CNS demyelination. Each of these studies showed essentially the same result: that chronic demyelination results in a loss of clustered Na<sup>+</sup> channels, but a concomitant increase in Nav1.2 expression levels. Indeed, Rasband et al. (2003) showed a 6-fold increase in their model of the amount of Nav1.2 found in chronically demyelinated optic nerve axons. These Nav1.2 channels were found diffusely distributed throughout the axon rather than in clusters. Together, these studies suggest that, in addition to altering the passive electrical properties of axons and the active clustering of Na<sup>+</sup> channels to nodes of Ranvier, myelin also regulates the kinds of channels present in CNS axons. The axon-glia signaling that mediates this regulation of channel expression, trafficking, and/or localization is an active area of investigation.

#### Demyelination and Neuropathic Pain

A very common symptom associated with MS is the presence of acute and/or chronic pain (e.g. ► [trigeminal neuralgia](#)). Similarly, some forms of Charcot-Marie-Tooth disease, characterized by ► [segmental demyelination](#) of PNS axons, also have as symptoms the development of ► [hyperalgesia](#), spontaneous pain, and ► [allodynia](#). Unfortunately, very little is known about the molecular and cellular mechanisms linking demyelination and neuropathic pain. Since the expression and localization of Na<sup>+</sup> channels appears to depend on interactions with myelinating glial cells, and Na<sup>+</sup> channels are obvious candidates to modulate neuronal hyperexcitability, one intriguing possibility is that pain associated with demyelination is a consequence of loss of neuroglial interactions.

Recently, Wallace et al. (2003) showed that acute PNS demyelination by lysolecithin results in the development of both allodynia and hyperalgesia. The development of the neuropathic pain coincided with detection of Nav1.3 Na<sup>+</sup> channels in formerly myelinated axons – a surprising result since Nav1.3 is not normally found in myelinated nerve fibers, or anywhere else in the adult nervous system. Further, spontaneous action potentials were measured during the remyelination phase. These results suggest that peripheral demyelination may lead to aberrant Na<sup>+</sup> channel subtype expression and activity, and the switching of receptor modality from proprioceptor or mechanoreceptor to nociceptor.

Although very little is known about the development of neuropathic pain as a consequence of demyelination, future studies designed to determine the molecular and cellular mechanisms underlying control of both Na<sup>+</sup> channel localization and expression may lead to the ability to directly modulate neuronal activity. However, one thing is clear: in the arena of neuropathic pain, myelinating cells such as Schwann cells and oligodendrocytes are not simply bystanders, but instead play active roles by modulating the excitable properties of sensory neurons.

D

#### References

1. Boiko T, Rasband MN, Levinson SR et al. (2001) Compact Myelin Dictates the Differential Targeting of Two Sodium Channel Isoforms in the Same Axon. *Neuron* 30:91–104
2. Craner MJ, Lo AC, Black JA et al. (2003) Abnormal Sodium Channel Distribution in Optic Nerve Axons in a Model of Inflammatory Demyelination. *Brain* 126:1552–1561
3. Dugandzija-Novakovic S, Koszowski AG, Levinson SR et al. (1995) Clustering of Na<sup>+</sup> Channels and Node of Ranvier Formation in Remyelinating Axons. *J Neurosci* 15:492–503
4. Rasband MN, Kagawa T, Park EW et al. (2003) Dysregulation of Axonal Sodium Channel Isoforms after Adult-Onset Chronic Demyelination. *J Neurosci Res* 73:465–470
5. Rasband MN, Peles E, Trimmer JS et al. (1999) Dependence of Nodal Sodium Channel Clustering on Paranodal Axoglial Contact in the Developing CNS. *J Neurosci* 19:7516–7528
6. Salzer JL (2003) Polarized Domains of Myelinated Axons. *Neuron* 40:297–318
7. Shrager P (1989) Sodium Channels in Single Demyelinated Mammalian Axons. *Brain Res* 483:149–154
8. Wallace VC, Cottrell DF, Brophy PJ et al. (2003) Focal Lysolecithin-Induced Demyelination of Peripheral Afferents Results in Neuropathic Pain Behavior that is Attenuated by Cannabinoids. *J Neurosci* 23:3221–3233
9. Westenbroek RE, Noebels JL, Catterall WA (1992) Elevated Expression of Type II Na<sup>+</sup> Channels in Hypomyelinated Axons of Shiverer Mouse Brain. *J Neurosci* 12:2259–2267

## Dendrite

#### Definition

Dendrite refers to the post-synaptic element of a neuron.

► [Opioid Receptor Trafficking in Pain States](#)

## Dendritic Spines

#### Definition

Small protrusions of the dendritic shafts specialized at the reception and processing of incoming signals at synapses. They most often look like pedicled knobs, but may also assume other configurations such as sessile knobs, rose spines, or bunches of knobs connected to a sole pedicle.

► [Spinothalamic Tract Neurons, Morphology](#)

## Dendritic Topography

### Definition

Spatial distribution of the dendritic tree with respect to the cell body and gray matter regions located around it.

- ▶ Spinothalamic Tract Neurons, Morphology

## Dendritic Tree

### Definition

Ensemble of neuronal processes ramifying around the cell body and specialized to receive input (chemical or electrical signals) from other neurons.

- ▶ Spinothalamic Tract Neurons, Morphology

## Dendrogram

### Definition

A dendrogram hierarchically organizes stimulus objects, subclusters, clusters, etc. on the basis of their relative similarities.

- ▶ Multidimensional Scaling and Cluster Analysis Application for Assessment of Pain

## Denervation

### Definition

Situation where a limb (or an organ or part of it) is rendered insensitive to applied stimuli by severing sensory axons that innervate the limb. Sensory endings rapidly degenerate in the process of anterograde (Wallerian) degeneration.

- ▶ Anesthesia Dolorosa Model, Autotomy
- ▶ Facet Joint Pain

## Denervation Model of Neuropathic Pain

- ▶ Anesthesia Dolorosa Model, Autotomy

## Densocellular Subnucleus of the Mediodorsal Nucleus

### Synonyms

MDdc

### Definition

Envelops MD laterally and posteriorly. Its neurons resemble those of the central lateral nucleus (CL). MDdc receives input from many of the same subcortical sites as CL, and projects to the striatum and to premotor cortical areas.

- ▶ Spinothalamic Terminations, Core and Matrix

## Dental Pain, Etiology, Pathogenesis and Management

GRAHAM R. HOLLAND

Department of Cariology, Restorative Sciences & Endodontics, School of Dentistry, University of Michigan, Michigan, MI, USA  
rholland@umich.edu

### Synonyms

Toothache; pulpitis; Pulpalgia; dentin sensitivity

### Definition

A noxious experience that originates or appears to originate from a tooth.

### Characteristics

Pain is not experienced from an entirely healthy tooth under normal physiological conditions, but can be induced by a cold stimulus at 0°C or below. It is more readily felt in otherwise normal teeth in which the ▶ **dentin** beneath the ▶ **enamel** of the crown or the ▶ **cementum** of the root is exposed. Then hot stimuli may, and osmotic and cold stimuli will, induce pain. This pain is sharp and lasts only for the duration of the stimulus. If the ▶ **dental pulp**, the soft tissue within the dentin and responsible for its production, is inflamed, the pain to an applied stimulus will be strong, dull and throbbing. It may continue beyond the duration of the stimulus and may be present spontaneously. As the majority of nociceptors in the uninjured pulp are inactive they can be classified as silent. No sensations other than pain can be experienced from the tooth pulp in response to non-electrical stimuli, a property that has been utilized in a number of experimental studies. The stimuli capable of inducing pain from inflamed pulps would not be in the noxious range when applied to intact, healthy skin. It is difficult to elicit pain from a freshly cut cavity in dentin, but the tooth becomes much more responsive if bacteria are allowed to inhabit the cavity for a week to allow the underlying pulp to become inflamed (Anderson et al. 1967). The intensity of pain felt from a tooth with an inflamed pulp is highly variable but it has been ranked using the McGill pain questionnaire as similar to the pain experienced from arthritis or a bone fracture but substantially less than that associated with childbirth (Melzack 1984).



The descriptors most commonly applied to it are throbbing, boring, sharp, sickening, annoying, constant and rhythmic (Melzack 1975).

### Etiology

Dental caries is the predominant cause of pulpal inflammation and the pain associated with it. Toxins from the bacteria contained in a carious lesion permeate the dentin and induce inflammation in the pulp long before the bacteria themselves invade the pulp. Some dental restorative materials are potentially irritating but pain from restored teeth without overt dental caries is often due to the micro leakage of bacteria beneath the filling and the penetration of their toxins to the dental pulp. While carious teeth are commonly painful, in almost a third of cases, the inflammation may progress to necrosis without the patient experiencing discomfort (Michaelson and Holland 2002). When the dental pulp is heavily inflamed or becomes necrotic inflammatory mediators as well as bacteria and toxins may spread into the tissues around the apex of the tooth root. This tissue may be painful especially when the tooth is tapped but is often not noticed by the patient. If the inflammation around the tooth apex progresses to ► **necrosis**, ► **abscess** formation may occur and this can be acutely painful due to swelling, tissue distension and the spread of inflammatory mediators. In contrast to pain limited to the pulp, pain originating from the tissue around the tooth is easily localized.

### Pathogenesis

The pulp has a dense afferent innervation of ► **C fibres** and A $\delta$  fibers, which are a dedicated component of the pain system with a smaller number of A $\beta$  fibers that may be recruited during inflammation. The A $\delta$  fibers may be those which respond to cold stimuli applied to an uninjured tooth. The C fibers may be silent and only become active in inflammation, causing the dull throbbing pain characteristic of symptomatic pulpitis (Narhi et al. 1992). The stimuli which initiate dental pain when applied to the dentin, do so mainly by causing fluid movement in the narrow (approx. 1–2  $\mu$ m in diameter) tubules which make up the tissue (Matthews et al. 1994). This movement rapidly deforms and activates the exposed axonal membranes of the nociceptors which are abundant in the dental pulp, and present to a limited extent within the tubules of the dentin. Chemicals may also diffuse more slowly and act directly on the ► **nociceptors** (Matthews et al. 1994). Once inflammation is initiated in the pulp, a large number of cytokines and inflammatory mediators are released some of which activate (e.g. ► **bradykinin**) or sensitize (► **prostaglandins**) nociceptive terminals. Inflammation also leads to sprouting and increases in the neuropeptide content of pulpal nerves (Byers et al. 1990). The neuropeptide ► **substance P** is found within a subpopulation of nociceptive afferent nerve fibers. The expression of substance P within pulpal nerves

undergoes dynamic changes during the inflammation induced by dental caries (Rodd et al. 2000; Bowles et al. 2003). The initiation of inflammatory pain in the dental pulp is essentially similar to that elsewhere, as far as is yet determined, but differs in that it takes place in a rigid non-compliant environment where high extracellular tissue fluid pressures prevail. This may contribute to nociceptor activation, given that the pulpal nociceptors are, apparently, exquisitely sensitive to small, localized pressure changes.

The pulpal nociceptors are the terminals of afferent fibers carried in the mandibular and maxillary divisions of the trigeminal nerve with cell bodies in the trigeminal ganglion. They relay at various levels in the trigeminal nuclear complex and contribute to the central ascending pathways.

The variability in the presentation of pulpal pain may, in part, be due to variations in the extent of inflammation but peripheral and central mechanisms of pain suppression and hyperalgesia are also involved. For example, pulpal inflammation leads to gene product Fos expression (Chattipakorn et al. 2002) as well as central sensitization (Chiang et al. 1998) in the ► **trigeminal subnucleus caudalis**. Opioid peptides and receptors have been found in the dental pulp (Jaber et al. 2003). The pulp also has a sympathetic innervation, and activity in this may modulate nociceptive output perhaps by effecting neuropeptide release (Hargreaves et al. 2003).

### Management

The diagnosis of dental pain is often complicated by its referral to other teeth and sometimes to extra-oral structures. Central mechanisms and sensitization may explain this (Sessle et al. 1986). Conversely pain in extra-oral structures such as the masticatory apparatus and bony sinuses may be referred to the teeth. Pain of cardiac muscle may sometimes be referred to the teeth. Thus, the first step in management is to determine that the pain is of dental origin and from which tooth it originates. This is done by using cold (ice or solid CO<sub>2</sub>) and sometimes hot stimuli to test all the teeth in both upper and lower arches on the side indicated by the patient. The patient will experience greater pain when an affected tooth is stimulated. In some circumstances ► **selective anesthesia** of individual teeth may help. If serious uncertainty exists, symptoms usually become clearer with time.

If a patient reports only occasional brief discomfort to hot and cold drinks and it is determined that the discomfort is due to exposed dentin in an otherwise healthy tooth, the sensitivity can be reduced or eliminated by blocking the dentinal tubules. Patent tubules are a characteristic of sensitive dentin (Yoshiyama et al. 1989). Rubbing the surface with a wood stick creates a smeared layer of dentin which occludes many tubules. Some salt solutions, such as potassium oxalate and sodium fluoride induce precipitation within

the tubules. These may be applied in a dental office setting. ► [Desensitizing toothpastes](#) for home use usually incorporate fluoride compounds and potassium nitrate. The potassium ions released from these pastes may permeate the dentin and inactivate nociceptors by altering the ionic composition of the extracellular fluid. Sometimes attaching an adhesive restoration to the surface of the dentin may by occluding the dentinal tubules be successful.

If the cause of the pain is pulpal inflammation resulting from dental caries this must be dealt with by removing the infected dentin and replacing it with a filling material that does not itself induce inflammation, and also has surface margins that prevent the migration of bacteria onto the dentinal surface. With the causative factor removed, the inflammation in the dental pulp should gradually subside and the symptoms with it. When the dentin is severely infected or bacteria themselves rather than just their toxins have reached the pulp the inflammatory process may be irreversible and the only solution is to remove the pulp followed by ► [root canal therapy](#) or, alternatively, to extract the tooth. Unfortunately, it is difficult to diagnose the extent of inflammation in an affected pulp. No clear correlation has ever been established between symptoms and the inflammatory condition of the pulp though spontaneously painful teeth usually have extensively inflamed pulps. The most consistent finding in examining the pulps that have been removed from symptomatic teeth is that substance P is present in greater amounts in painful teeth than in normal teeth (Rodd et al. 2000; Bowles et al. 2003). Currently, the most accepted standard for determining the presence of irreversible pulpal inflammation is the presence of spontaneous pain or pain that is prolonged well beyond the removal of a cold stimulus. Convincing evidence supporting this relationship is meager. In the acute management of dental pain, analgesics are of great value in relieving symptoms. As toothache is predominantly of inflammatory origin, ► [NSAIDs, Survey](#) are likely to be more effective than centrally acting analgesics. One presentation of toothache, which provides a special treatment challenge, is a condition often known as ► [hot tooth syndrome](#). This presents as an intense and spontaneous pain in a tooth which is difficult to anesthetize with local anesthetics. When other signs of effective local anesthesia are present, the tooth remains painful. Regional block anesthesia and direct local infiltration may prove incompletely effective. Resolution is often only achieved by removing the pulp from the tooth with less than total anesthesia, a trial for both patient and practitioner. In these cases long-standing inflammation and nociceptors stimulation has led to central sensitization (Hu et al. 1968; Chiang et al. 1998). The principal features of this are the recruitment of A $\beta$  axons, hyperalgesia, allodynia and spontaneous pain. A combination of peripherally acting anti-inflammatory drugs and centrally acting analgesics would best control symptoms. Drugs developed specif-

ically to reduce or eliminate central sensitization may find application here.

## References

1. Anderson DJ, Matthews B (1967) Osmotic Stimulation of Human Dentine and the Distribution of Dental Pain Thresholds. *Arch Oral Biol* 12:417–426
2. Bowles WR, Withrow JC, Lepinski AM, Hargreaves KM (2003) Tissue Levels of Immunoreactive Substance P are Increased in Patients with Irreversible Pulpitis. *J Endod* 29:265–267
3. Byers MR, Taylor PE, Khayat BG, Kimberly CL (1990) Effects of Injury and Inflammation on Pulpal and Periapical Nerves. *J Endod* 16:78–84
4. Chattipakorn SC, Sigurdsson A, Light AR, Narhi M, Maixner W (2002) Trigeminal c-Fos Expression and Behavioral Responses to Pulpal Inflammation in Ferrets. *Pain* 99:61–69
5. Chiang CY, Park SJ, Kwan CL, Hu JW, Sessle BJ (1998) NMDA Receptor Mechanisms Contribute to Neuroplasticity Induced in Caudalis Nociceptive Neurons by Tooth Pulp Stimulation. *J Neurophysiol* 80:2621–2631
6. Hargreaves KM, Bowles WR, Jackson DL (2003) Intrinsic Regulation of CGRP Release by Dental Pulp Sympathetic Fibers. *J Dent Res* 82:398–401
7. Hu JW, Dostrovsky JO, Lenz YE, Ball GJ, Sessle BJ (1986) Tooth Pulp Deafferentation is Associated with Functional Alterations in the Properties of Neurons in the Trigeminal Spinal Tract Nucleus. *J Neurophysiol* 56:1650–1668
8. Jaber L, Swaim WD, Dionne RA (2003) Immunohistochemical Localization of Mu-opioid Receptors in Human Dental Pulp. *J Endod* 29:108–110
9. Matthews B, Vongsavan N (1994) Interactions Between Neural and Hydrodynamic Mechanisms in Dentine and Pulp. *Arch Oral Biol* 39:87S–95S
10. Melzack R (1975) The McGill Pain Questionnaire: Major Properties and Scoring Methods. *Pain* 1:277–299
11. Melzack R (1984) The Myth of Painless Childbirth (the John J. Bonica lecture). *Pain* 19:321–337
12. Michaelson PL, Holland GR (2002) Is Pulpitis Painful? *Int Endod J* 35:829–832
13. Narhi M, Jyvasjarvi E, Virtanen A, Huopaniemi T, Ngassapa D, Hirvonen T (1992) Role of Intradental A- and C-type Nerve Fibres in Dental Pain Mechanisms. *Proc Finn Dent Soc* 88:507–516
14. Rodd HD, Boissonade FM (2000) Substance P Expression in Human Tooth Pulp in Relation to Caries and Pain Experience. *Eur J Oral Sci* 108:467–474
15. Sessle BJ, Hu JW, Amano N, Zhong G (1986) Convergence of Cutaneous, Tooth Pulp, Visceral, Neck and Muscle Afferents onto Nociceptive and Non-Nociceptive Neurons in Trigeminal Subnucleus Caudalis (Medullary Dorsal Horn) and its Implications for Referred Pain. *Pain* 27:219–235
16. Yoshiyama M, Masada J, Uchida A, Ishida H (1989) Scanning Electron Microscopic Characterization of Sensitive vs. Insensitive Human Radicular Dentin. *J Dent Res* 68:1498–1502

## Dental Pulp

### Definition

The dental pulp is a loose connective inside the dentin of the tooth. It contains a large number of afferent and sympathetic nerve fibers, an extensive vascular plexus and supports the cells lining the dentin, the odontoblasts, responsible for its formation and repair.

- [Dental Pain, Etiology, Pathogenesis and Management](#)
- [Nociceptors in the Dental Pulp](#)
- [Orofacial Pain, Taxonomy/Classification](#)

## Dentin

### Definition

Dentin is a mineralized tissue similar in hardness to bone. It forms the bulk of a tooth, but is covered by the harder enamel (that forms the crown and visible part of the tooth) and the cementum that binds it to the bony socket. It is made up of many thousands of small (1–2  $\mu\text{m}$ ) tubules running from the dental pulp on its inside to its outer surface in contact with the enamel and cementum.

- ▶ [Dental Pain, Etiology, Pathogenesis and Management](#)
- ▶ [Nociceptors in the Dental Pulp](#)

## Dentinal Tubules

### Definition

Fluid-filled thin tubules (diameter: 1–2  $\mu\text{m}$ ) in dentin, which extend all the way from the dental pulp to the dentin-enamel border. There are 30,000–40,000 tubules/ $\text{mm}^2$  of dentin.

- ▶ [Nociceptors in the Dental Pulp](#)

## Dependence

### Definition

Dependence is a state in which an abstinence syndrome may occur following abrupt withdrawal, dose reduction or administration of an antagonist. Although usually associated with opioids, this is common with many classes of medication including anti-hypertensives and anti-convulsants. It is seen in all subjects chronically given a dependence inducing drug.

- ▶ [CRPS, Evidence-Based Treatment](#)
- ▶ [Opioid Receptors](#)
- ▶ [Postoperative Pain, Opioids](#)

## Depolarisation

### Definition

A loss of polarity in general. Depolarisation is a change in the electrical charge between the inside and the outside of a membrane. Specifically in cells, the response of a cell membrane to a stimulus, which leads to a loss of the negativity of the membrane potential beyond the resting potential, and thereby the generation of an action potential.

- ▶ [COX-1 and COX-2 in Pain](#)
- ▶ [Mechanoreceptors](#)
- ▶ [Transition from Acute to Chronic Pain](#)

## Depression

### Definition

A state of lowered mood, often accompanied by disturbances of sleep, energy, appetite, concentration, interests, and sexual drive. There are also associated depressive thoughts like ideas of hopelessness, worthlessness, helplessness, low self esteem, and being fed up with life. The term depression can be used to denote a mood state, a symptom or a disorder (Major Depressive Disorder).

- ▶ [Depression and Pain](#)
- ▶ [Pain in the Workplace, Risk Factors for Chronicity, Psychosocial Factors](#)
- ▶ [Psychiatric Aspects of the Management of Cancer Pain](#)

## Depression and Pain

ROBERT D. KERNS, ALICIA A. HEAPY  
VA Connecticut Healthcare System and Yale University, Westhaven, CT, USA  
robert.kerns@med.va.gov, alicia.heapy@med.va.gov

### Synonyms

Depression, Major Depressive Disorder

### Definition

▶ [Depression](#) is characterized by sadness and loss of interest or pleasure in previously enjoyed activities. The term depression can be used to denote a mood state, a symptom or a disorder (Major Depressive Disorder). Depression qualifies as a disorder when it is intense, frequent, or enduring enough to result in dysfunction and/or concern for the person, his or her significant others, or society, more generally. The formal diagnosis of ▶ [Major Depressive Disorder](#) (MDD), as defined by the Diagnostic and Statistical Manual of Mental Disorders 4<sup>th</sup> ed. (DSM-IV) (American Psychiatric Association 1994), is the presence of a collection of symptoms that must include depressed mood or loss of interest or pleasure in most activities lasting at least 2 weeks. Additional symptoms include fatigue, feelings of excessive or inappropriate worthlessness or guilt nearly every day, significant weight loss or gain, insomnia or hypersomnia, diminished concentration or ability to make decisions, frequent thoughts of death, suicidal ideation or suicide attempt. In order to meet criteria for MDD, symptoms must cause distress or impairment in functioning. ▶ [Chronic pain](#) is characterized as non-cancer pain lasting 6 or more months.

### Characteristics

The presence of at least transient experiences of depressed mood among persons with chronic pain is

thought to be understandable, and even expected, and in fact, a high ► [co-prevalence](#) between the experience of chronic pain and ► [depressive symptom severity](#) has been noted, both clinically and in formal empirical investigations for many years. However, estimates of the prevalence of MDD among persons with chronic pain vary widely depending on the manner of assessment, population selection, and the definition of depression that is used (Banks and Kerns 1996). MDD may be assessed with varying levels of stringency, and when standard diagnostic criteria are not used, persons with significant depressive symptoms, but not MDD, may be included in the depressed category, thereby providing a misleading picture of the true comorbidity of chronic pain and MDD. Further complicating the picture, several symptoms of MDD and pain overlap (e.g. sleep disturbance, loss of energy, change in appetite), which may inflate estimates of depression in populations with chronic pain. Use of standardized semi-structured interview methods, such as the Structured Clinical Interview for DSM-III-R (SCID, Spitzer 1992) and DSM-IV criteria, is encouraged to ensure reliable and valid diagnosis of MDD in persons with chronic pain. When these criteria are used a majority of studies report ► [point prevalence](#) rates ranging from 30 % to 54 % (Banks and Kerns 1996). Even when these criteria are employed, however, MDD appears to occur more frequently in chronic pain than in other common, chronic medical conditions (Banks and Kerns 1996). Studies also suggest that the presence of chronic pain may interfere with the detection of depression in primary care settings (Bair et al. 2003). Patient emphasis on somatic complaints in chronic pain conditions, which may be exacerbated in the context of depression, are thought to interfere with physician detection of depression, particularly milder cases of depression. While depression and pain appear to frequently co-occur, the temporal association between the two, and possible causal mechanisms underlying the comorbidity, have not been identified. Three hypotheses have been asserted: (1) pain precedes depression, (2) depression precedes pain and (3) the two occur simultaneously. Many proponents of the first hypothesis, that pain precedes depression, argue that depression is largely a psychological reaction to pain, mediated by cognitive factors, behavioral factors or a combination of both (e.g. Fordyce 1976; Rudy et al. 1988; Sullivan and D'Eon 1990). Those that assert that depression precedes pain point to mood-induction studies, that have demonstrated increased self-focus of attention and increased reports of aches and pain, as well as decreased tolerance for laboratory-induced pain in response to depressed mood (Ingram and Smith 1984, Salovey and Birnbaum 1989). Finally, evidence for the simultaneous occurrence of depression and pain is rooted in nervous system biogenic ► [monoamines](#) such as serotonin and norepinephrine, which have been implicated in both

the development of depression and the modulation of pain (Ward et al. 1982). This theory hypothesizes that depression and pain symptoms both use the descending pathways of the central nervous system. Specifically, the periaqueductal gray, the limbic structures and the rostral-ventromedial medulla modulate attention and affective response to peripheral pain stimuli, typically suppressing these stimuli in favor of attending to outside stimuli. However, in the context of depression and its concomitant depletion of serotonin and epinephrine, attention and affective responses to these peripheral signals are enhanced, providing a potential explanation for the high comorbidity of pain and depression, and the effectiveness of antidepressant medication for chronic pain complaints (Bair et al. 2003). Efforts to fully describe the temporal development of pain and depression have been hampered by lack of longitudinal studies and other methodological shortcomings. The reliability and validity of retrospective patient reports of the temporal emergence of pain and depression have been questioned due to the subjective nature of pain and depression, the difficulty identifying the exact onset of depression, which is usually gradual, and the difficulty in determining when acute pain can be classified as chronic (Banks and Kerns 1996).

Several theories have been asserted to explain the frequent co-occurrence of depression and pain. These models are variations of major ► [cognitive-behavioral theories](#), and hypothesize that an individual's pattern of cognitive assessment of pain and pain experience, and their behavior in response to pain, contribute to the development and maintenance of depression. Beck's cognitive distortion model (Beck 1976) contends that certain individuals, by virtue of preexisting negative cognitive schemas, are particularly vulnerable to developing depression and depressive symptomatology in response to the challenges of living with chronic pain. Once these negative schemas are activated, they serve to elicit negative thoughts about the self, the world and the future. In turn, these negative thoughts produce negative mood, which in turn leads to other symptoms of depression such as decreased activity and suicidal ideation. Learned helplessness theory (Seligman 1975) asserts that when individuals are exposed to uncontrollable negative outcomes like chronic pain, they develop an attitude of helplessness or expectation that other future outcomes are also uncontrollable. These individuals do not attempt to alter future outcomes, even when those outcomes are amenable to their efforts, due to an erroneous belief in their own helplessness, thereby maintaining the circumstances that contribute to depression. Behavioral models posit that an individual with chronic pain faces greatly reduced opportunities for rewards and, consequently, is at higher risk of developing depression. Specifically, persons with chronic pain experience pain as a result of performing previously rewarding activities like work,



social interactions and physical activity, which leads to withdrawal from these activities. Additionally, fear of reinjury may also result in a reduction in activities and consequent reinforcement.

The preceding models, although widely accepted for explaining depression in general, are less able to account for the elevated levels of depression found in chronic pain compared with other chronic diseases or conditions. The cognitive and behavioral vulnerabilities that are thought to precipitate depression should be equally distributed across populations with other chronic illnesses, and the presence of a chronic illness could be conceptualized as a stressor capable of triggering the vulnerabilities necessary to set off depression. If these models are correct, the prevalence of depression would be approximately equal among persons with various chronic medical conditions. Banks and Kerns (1996) have asserted that pain has several unique qualities that make it a particularly potent stressor. First, chronic pain is a symptomatic condition and the symptoms provide a constant reminder on the condition. Second, pain is typically a signal of danger and tissue damage and as a result often produces anxiety. Third, pain is often associated with a variety of losses resulting in impairment and disability. Secondary losses are especially prominent. Pain can interfere with employment, leisure activities, sexual function, and interpersonal relationships. Financial consequences can include high medical expenses, diminished capacity to work and unemployment. The combination of the many losses experienced by persons with chronic pain can lead to feelings of social isolation, meaninglessness, uncertainty about the future, loss of self-concept, self-esteem and family role. Finally, due to the frequent discrepancy between structural pathology and pain severity, impairment, and disability, patients may experience a disconnection between their own experience and the messages they receive from the health care system. Persons with chronic pain may be told that there is no medical basis for their pain or that there is a medical basis, but there is nothing more that can be done. The conflicting messages between what a person is told by the health care system and their own experience can lead to self-doubt, distrust of healthcare providers, confusion, frustration and affective distress (e.g. Goldman 1991; Reid et al. 1991).

Negative mood states, including depressive symptoms and MDD, have been shown to hinder pain treatment (Haythornthwaite et al. 1991) and exacerbate chronic pain conditions. Somatic focus and amplification, autonomic arousal and misinterpretation of symptoms are all mechanism through which negative mood states are thought to influence pain experience and outcomes (Dersh et al. 2002). The frequent correlation of pain and depression, and the effect of depression on pain treatment, argue for the importance of identification and treatment of depression for improving chronic pain treatment outcomes.

## References

1. American Psychiatric Association (1994) Diagnostic and Statistical Manual of Mental Disorders, 4<sup>th</sup> edn. APA, Washington DC
2. Bair MJ, Robinson RL, Katon W et al. (2003) Depression and Pain Comorbidity: A Literature Review. *Arch Intern Med* 163:2433–2455
3. Banks SM, Kerns RD (1996) Explaining the High Rates of Depression in Chronic Pain: A Diathesis Stress Framework. *Psychol Bull* 119:95–110
4. Beck AT (1976) *Cognitive Therapy and the Emotional Disorders*. International Universities Press, New York
5. Fordyce WE (1976) *Behavioral Methods for Chronic Pain and Illness*. Mosby, St. Louis, MO
6. Goldman B (1991) Chronic Pain Patients Must Cope with Chronic Lack of Physician Understanding. *CMAJ* 144:1492–1497
7. Haythornthwaite JA, Sieber, WJ, Kerns RD (1991) Depression and the Chronic Pain Experience. *Pain* 46:177–184
8. Ingram RE, Smith TS (1984) Depression and Internal versus External Locus of Attention. *Cogn Therapy Res* 8:139–152
9. Reid J, Ewan C, Lowy E (1991) Pilgrimage of Pain: The Illness Experience of Women with Repetition Strain Injury and the Search for Credibility. *Soc Sci Med* 32:601–612
10. Rudy TE, Kerns RD, Turk DC (1988) Chronic Pain and Depression: Toward a Cognitive-Behavioral Mediation Model. *Pain* 35:129–140
11. Salovey P, Birnbaum D (1989) Influence of Mood on Health-Relevant Cognitions. *J Pers Soc Psychol* 57:539–551
12. Seligman MEP (1975) *Helplessness: On Depression, Development, and Death*. Freeman, San Francisco
13. Spitzer RL (1992) History and Rationale and Development of SCID for DSM-III-R. *Arch Gen Psychiatry* 49:624–629
14. Sullivan MJL, D'Eon JL (1979) Relation between Catastrophizing and Depression in Chronic Pain Patients. *J Abnorm Psychol* 99:260–263
15. Ward NG, Bloom VL, Dworkin S (1982) Psychobiological Markers in Coexisting Pain and Depression: Toward a Unified Theory. *J Clin Psychiatry* 43:32–41

D

## Depression, Major Depressive Disorder

► [Depression and Pain](#)

## Depressive Symptom Severity

### Definition

Depressive symptom severity refers to the prevalence and intensity of symptoms of depressive disorders.

► [Depression and Pain](#)

## Dermatomal Level

### Definition

A dermatome is an area on the body supplied by a single nerve root. The dermatomal level is used to describe the

highest level of anesthesia provided by either a spinal or epidural anesthetic. A thoracic 4 level of anesthesia is typically needed to provide pain relief for cesarean delivery.

- ▶ Analgesia During Labor and Delivery

## Dermatomes

### Definition

Dermatomes are the areas of skin that are innervated by single dorsal roots of the spinal cord, or trigeminal nerve in the case of the oral-facial region. Dermatomes are labeled by the spinal segment with which they are associated, such as C<sub>1</sub>, C<sub>2</sub>, (cervical), T<sub>1</sub>, T<sub>2</sub>, (thoracic), and L<sub>1</sub>, L<sub>2</sub> (lumbar).

- ▶ Central Nervous System Stimulation for Pain
- ▶ Cervical Transforaminal Injection of Steroids
- ▶ Dorsal Root Ganglionectomy and Dorsal Rhizotomy
- ▶ Pain in Humans, Psychophysical Law

## Dermatomyositis

### Definition

Immunogenic myositis, mainly with characteristic additional skin lesions. A paraneoplastic cause should be considered in adult cases. The development of muscle symptoms, especially in proximal muscles, is acute or subacute. Muscle pain is frequent. Muscle biopsies confirm the diagnosis.

- ▶ Myositis

## Descending Anti-Analgesic Systems

- ▶ Descending Circuitry, Opioids
- ▶ Descending Facilitatory Systems

## Descending Circuitry, Molecular Mechanisms of Activity-Dependent Plasticity

KE REN

Department of Biomedical Sciences, Dental School, University of Maryland, Baltimore, MD, USA  
kren@umaryland.edu

### Synonyms

Pain Modulatory Circuitry and Endogenous Pain Control; cellular and receptor mechanisms underlying the development of persistent pain

### Definition

In the context of pain, the descending circuitry refers to a neural network between the brain stem and spinal cord, which provides supraspinal modulation of nociceptive transmission at the spinal and trigeminal level (Fields and Basbaum 1999, for further details). Plastic changes occur after tissue or nerve injury within the descending pain modulatory circuitry. Such changes involve transcriptional, translational and post-translational modulation of the receptors, lead to enhanced synaptic strength and altered net descending modulation, and contribute to the development of persistent pain.

### Characteristics

#### Changing Role of Descending Circuitry after Injury

The potency, efficacy and net effect of the descending circuitry are subject to modulation by the functional status of the organism. Rats with inflammatory hyperalgesia exhibit an increased sensitivity to opioid analgesics (Neil et al. 1986). Parallel changes in the net effect of descending modulation are observed at the spinal level, where an enhanced descending inhibition of spinal nociceptive neurons has been demonstrated in animals with inflammation (Schaible et al. 1991; Ren and Dubner 2002). The source of the increased sensitivity to opioids, and enhanced descending inhibition after inflammation, can be traced to supraspinal structures. The antihyperalgesic and analgesic potency of the mu and delta opioid receptor agonists microinjected into the rostral ventromedial medulla (RVM), a pivotal site in the descending pain modulatory circuitry (Fields and Basbaum 1999), is progressively enhanced after adjuvant-induced hindpaw inflammation (Hurley and Hammond 2000). Local anesthesia of the nucleus raphe magnus, leads to a further increase in dorsal horn nociceptive neuronal activity in inflamed, but not noninflamed rats (Ren and Dubner 2002). Focal lesions of the RVM and locus coeruleus are followed by an increase in spinal Fos protein expression and hyperalgesia after inflammation (Tsuruoka and Willis 1996; Ren and Dubner 2002). Stimulation of the periaqueductal gray produces an increased antinociception in the inflamed paw in rats (Morgan et al. 1991).

The descending circuitry can also actively facilitate abnormal pains. The selective destruction of the nucleus reticularis gigantocellularis with a soma-selective neurotoxin, ibotenic acid, leads to an attenuation of hyperalgesia and a reduction of inflammation-induced spinal Fos expression (Ren and Dubner 2002). There is an enhancement of the C-fiber wind-up, and the novel A-fiber wind-up, during inflammation, which also depends on

input from supraspinal circuitry (Herrero and Cervero 1996). A descending facilitatory drive contributes to the pathogenesis of secondary hyperalgesia and experimental neuropathic pain (Porreca et al. 2002). The tactile allodynia after nerve injury is dependent upon a tonic activation of net descending facilitation from supraspinal sites. Lesions of the RVM inhibit secondary hyperalgesia, produced by topical application of mustard oil (Urban and Gebhart 1999). Hindpaw formalin-induced hyperalgesia is prevented by RVM lesion (Wiertelak et al. 1997). Spinalization blocks mustard oil-produced secondary mechanical allodynia and mechanical hyperexcitability of spinal nociceptive neurons (Mansikka and Pertovaara 1997). Finally, immune activation produces hyperalgesia that depends on a supraspinal facilitatory input (Watkins et al. 1995).

The injury-induced plasticity in the descending circuitry is dynamic and time-dependent. Following inflammation, brainstem-descending pathways become progressively more involved in suppressing incoming nociceptive signals in primary hyperalgesic zones. The dynamic nature of descending pain modulation after inflammation has been examined over time, by monitoring antinociceptive responses in lightly anesthetized rats during RVM stimulation (Ren and Dubner 2002). In these studies, hindpaw inflammation induces temporal changes in synaptic activation in the brain stem. Early (up to 3 h) in the development of inflammation, there is an increased descending facilitation (also see Urban and Gebhart 1999), which reduces the net effect of the inhibition. Over time, the level of descending inhibition increases, or descending facilitation decreases, leading to a net enhancement of antinociception. In nerve injured rats, lesions of the ► **dorsolateral fasciculus**, local anesthetic block of the RVM and lesions of RVM mu-opioid receptor expressing cells do not prevent the onset, but reverse the later maintenance, of tactile and thermal hypersensitivity (Burgess et al. 2002).

#### Activity-Dependent Synaptic Plasticity in Descending Circuitry

Synaptic transmission within the descending circuitry involves multiple neurotransmitters and receptors (Fields and Basbaum 1999). The role of ► **excitatory amino acid** receptors, or ► **glutamate receptors**, has gained most attention in searching for supraspinal mechanisms of persistent pain. Excitatory amino acid receptors have been shown to activate pain modulatory neurons in the RVM and mediate morphine analgesia (Heinricher et al. 2001). Glutamatergic synapses in descending circuitry also play a critical role in response to injury. N-methyl-D-aspartate (► **NMDA**), the prototype NMDA receptor agonist, microinjected into the RVM, produces effects that are dependent upon the post-inflammatory period. At 3 h post-inflammation, low doses of NMDA produce facilitation of the response to noxious heat of the inflamed and non-inflamed hindpaws and tail, indicating that descending facilitatory effects

are NMDA dependent and occur early after inflammation (Urban and Gebhart 1999; Ren and Dubner 2002). Higher doses of NMDA at 3 h post-inflammation only produce inhibition. At 24 h post-inflammation, NMDA produces only inhibition. Alpha-amino-3-hydroxy-5-methyl-4-isoxazole propionic acid (AMPA), a selective AMPA receptor agonist, produces greater antinociception at 24 h, as compared to 3 h after inflammation. These findings suggest a change in synaptic strength and potency of RVM excitatory amino acid neurotransmission after inflammation. The increase in potency of NMDA and AMPA receptor agonists parallels the time-dependent enhancement of net descending inhibition produced by RVM electrical stimulation. Thus, injury-induced glutamatergic synaptic plasticity may underlie the mechanisms of time-dependent changes in descending modulation.

#### Activity-Dependent Changes in Gene Expression and Protein Phosphorylation in Descending Circuitry

The molecular mechanisms of activity-dependent plasticity in descending circuitry are largely unknown. Correlate changes in gene transcription and protein translation have been found in the descending circuitry after injury. Williams and Beitz (1993) have shown that adjuvant-induced hindpaw inflammation increased neurotensin mRNA expression in the ► **periaqueductal gray** and the lateral tegmental nuclei, from which neurotensinergic neurons project to the RVM. The increased sensitivity of excitatory amino acid receptors in the descending circuitry, during the development of inflammatory hyperalgesia, is related to transcriptional and translational modulation of the receptors (Ren and Dubner 2002). Examination of the mRNA expression of the NR1, NR2A and NR2B subunits of the NMDA receptor in the RVM reveals an upregulation that parallels the time course of the RVM excitability changes. This is accompanied by an increase in NMDA receptor protein.

AMPA receptor subunits (GluR1-4) exist in the two 'flip' and 'flop' isoforms, which differentially affect the desensitization properties of the receptor. Reverse transcription polymerase chain reaction analysis, indicates that inflammation induces a significant upregulation of mRNAs encoding the GluR1-flip (5 h–24 h post-inflammation), GluR2-flip (24 h post-inflammation) and GluR2-flop (24 h post-inflammation) isoforms in the RVM, whereas the levels of GluR1-1 flop mRNAs do not exhibit significant changes (Guan et al. 2003). Western blots demonstrate that the GluR1 protein levels are significantly upregulated at 24 h to 3 days post-inflammation, compared to that of naive animals. GluR2 protein levels remain unchanged. Immunohistochemistry of RVM tissues localizes the increase in GluR1 proteins to RVM neurons. The effect of GluR1 overexpression in RVM neurons on nociceptive behavior has been examined (Bai et al. 2002). GluR1

proteins are introduced into RVM neurons through conjugation with green fluorescent protein (GFP), and by using sindbis pseudovirus as a vector (sin-GFP-GluR1). Microinjection of sin-GFP-GluR1 into rat RVM results in an overexpression of the GFP-GluR1 in RVM neurons, as early as 7 h post-injection. The inflammatory hyperalgesia is significantly attenuated in animals receiving sin-GFP-GluR<sup>1-flip</sup>, but not sin-GFP-GluR<sup>1-flop</sup>. These results suggest that GluR1 flip-dominant AMPA receptors (► [Flip-flop isoform of AMPA receptors](#)) contribute to descending inhibition of nociception in inflamed animals.

Protein phosphorylation is a major mechanism for regulation of receptor function. The native NMDA receptor is a likely tetramer, which consists of two NR1 and two NR2 subunits. Phosphorylation of multiple sites in the cytoplasmic C-termini of the NR1 and NR2 subunits, including tyrosine, serine and threonine residues, is known to modulate NMDA receptor activity and affect synaptic transmission. To examine tyrosine phosphorylation of the NR2 subunits, protein samples from RVM were first immunoprecipitated with anti-NR2A or anti-NR2B antibodies. The eluted NR2A or NR2B proteins were then incubated with an anti-phosphotyrosine antibody, 4G-10. The tyrosine phosphorylation, as indicated by the immunoblot against 4G-10, was associated with a band of 180 kDa in RVM tissues. There was an increase in the intensity of the 4G-10 bands after immunoprecipitation with anti-NR2A, but not NR2B antibodies after inflammation, as compared to naïve noninflamed rats (Turnbach et al. 2003). Interestingly, inflammation induces an increase in NR2B, but not NR2A subunit tyrosine phosphorylation in the spinal cord. Using an antibody that selectively recognizes the phosphoserine residues on the receptor subunit, a time-dependent increase in NR1 and GluR1 serine phosphorylation has also been identified in the RVM after hindpaw inflammation. A common feature of the changes in glutamate receptor phosphorylation is that it occurs rapidly, as early as 10–30 min. after inflammation, and persists for up to a week. The time course of changes in glutamate receptor phosphorylation in the RVM correlates well with changes in excitability in descending circuitry after inflammation.

These findings indicate that excitatory amino acid receptors in the RVM undergo selective transcriptional, translational and posttranslational modulation following inflammation, and may contribute to activity-dependent plasticity in descending pain modulatory systems after prolonged noxious input. The activity-induced plasticity in descending circuitry complements the activity-dependent neuronal plasticity in ascending pain transmission pathways. The spinal and brain stem plasticity is dependent upon increased activation of nociceptors at the site of injury, and its initiation and maintenance is dependent upon modulation of glutamatergic, opioidergic, neurotensinergic and presumably GABAergic neurons. The activity-dependent

plasticity at the spinal and brain stem levels share similar but not identical, and yet to be elucidated, molecular mechanisms.

## References

- Bai G, Guan Y, Zhuang ZY et al. (2002) Overexpression of GluR1 Subunit of AMPA Receptors in the Brain Stem RVM Enhanced Descending Inhibition in Rats. *Soc Neurosci Abstr* 28:351.13
- Burgess SE, Gardell LR, Ossipov MH et al. (2002) Time-Dependent Descending Facilitation from the Rostral Ventromedial Medulla Maintains, but Does Not Initiate, Neuropathic Pain. *J Neurosci* 22:5129–5136
- Fields HL, Basbaum AI (1999) Central Nervous System Mechanisms of Pain Modulation. In: Wall PD, Melzack R (eds) *Textbook of Pain*. Churchill Livingstone, Edinburgh, pp 309–329
- Guan Y, Guo W, Zou SP et al. (2003) Inflammation-Induced Upregulation of AMPA Receptor Subunit Expression in Brain Stem Pain Modulatory Circuitry. *Pain* 104:401–413
- Heinricher MM, Schouten JC, Jobst EE (2001) Activation of Brainstem N-methyl-D-aspartate Receptors is Required for the Analgesic Actions of Morphine Given Systemically. *Pain* 92:129–138
- Herrero JF, Cervero F (1996) Supraspinal Influences on the Facilitation of Rat Nociceptive Reflexes Induced by Carrageenan Monoarthritis. *Neurosci Lett* 209:21–24
- Hurley RW, Hammond DL (2000) The Analgesic Effects of Supraspinal Mu and Delta Opioid Receptor Agonists are Potentiated During Persistent Inflammation. *J Neurosci* 20:1249–1259
- Mansikka H, Pertovaara A (1997) Supraspinal Influence on Hindlimb Withdrawal Thresholds and Mustard Oil-Induced Secondary Allodynia in Rats. *Brain Res Bull* 42:359–365
- Morgan MM, Gold MS, Liebeskind JC et al. (1991) Periqueductal Gray Stimulation Produces a Spinally Mediated, Opioid Antinociception for the Inflamed Hindpaw of the Rat. *Brain Res* 545:17–23
- Neil A, Kayser V, Gacel G et al. (1986) Opioid Receptor Types and Antinociceptive Activity in Chronic Inflammation: Both Kappa and Mu Opiate Agonistic Effects are Enhanced in Arthritic Rats. *Eur J Pharmacol* 130:203–208
- Porreca F, Ossipov MH, Gebhart GF (2002) Chronic Pain and Medullary Descending Facilitation. *Trends Neurosci* 25:319–325
- Ren K, Dubner R (2002) Descending Modulation in Persistent Pain: An update. *Pain* 100:1–6
- Schaible H-G, Neugebauer V, Cervero F et al. (1991) Changes in Tonic Descending Inhibition of Spinal Neurons with Articular Input During the Development of Acute Arthritis in the Cat. *J Neurophysiol* 66:1021–1032
- Tsuruoka M, Willis WD (1996) Bilateral Lesions in the Area of the Nucleus Locus Coeruleus Affect the Development of Hyperalgesia During Carrageenan-Induced Inflammation. *Brain Res* 726:233–236
- Turnbach ME, Guo W, Dubner R et al. (2003) Inflammation Induces Tyrosine Phosphorylation of the NR2A Subunit and Serine Phosphorylation of NR1 Subunits in the Rat Rostral Ventromedial Medulla. *Soc Neurosci Abstr* 29
- Urban MO, Gebhart GF (1999) Supraspinal Contributions to Hyperalgesia. *Proc Natl Acad Sci USA* 96:7687–7692
- Watkins LR, Maier SF, Goehler LE (1995) Immune Activation: The Role of Pro-Inflammatory Cytokines in Inflammation, Illness Responses and Pathological Pain States. *Pain* 63:289–302
- Wiertelak EP, Roemer B, Maier SF et al. (1997) Comparison of the Effects of Nucleus Tractus Solitarius and Ventral Medial Medulla Lesions on Illness-Induced and Subcutaneous Formalin-Induced Hyperalgesias. *Brain Res* 748:143–150
- Williams, FG, Beitz, AJ (1993) Chronic Pain Increases Brainstem Proneurotensin/Neuromedin-N mRNA Expression: A Hybridization-Histochemical and Immunohistochemical Study using Three Different Rat Models for Chronic Nociception. *Brain Res* 611:87–102



## Descending Circuitry, Opioids

DONNA L. HAMMOND, HERBERT K. PROUDFIT  
Department of Anesthesiology, University of Iowa,  
Iowa, IA, USA  
Donna-hammond@uiowa.edu, hk-proudfit@uiowa.edu

### Synonyms

Bulbospinal Pathways; Pain Modulatory Pathways

### Definition

Descending circuitry is a generic term for neurons in the medulla, pons or midbrain that modulate the evoked and spontaneous activity of neurons in the dorsal horn of the spinal cord. These neurons may project directly to the spinal cord or they may project to other brainstem nuclei that in turn project to and terminate in the spinal cord. They are an important component of the neural circuitry by which opioid receptor agonists such as morphine act to produce ► [analgesia](#) or to alleviate ► [hyperalgesia](#) or ► [allodynia](#).

### Characteristics

#### Background

The observation that direct injection of morphine into the cerebral ventricles of rodents produces analgesia provided some of the earliest evidence that opioid receptor agonists act in the brain to produce analgesia. Mapping studies subsequently demonstrated that direct injection of small microgram doses of morphine into many different nuclei in the midbrain, pons or medulla was sufficient to produce analgesia (Yaksh and Rudy 1978). Indeed, activation of opioid receptors in any one of these nuclei was sufficient to produce analgesia. These findings were further supported by others that determined that the analgesic effects of systemically administered morphine were reduced in rats in which specific nuclei had been selectively inactivated by chemical or electrolytic lesions or by injection of an opioid receptor antagonist or local anesthetic. These studies were undertaken at the same time as other studies that demonstrated that supraspinal nuclei exert strong inhibitory and excitatory influences on the synaptic transmission of sensory information in the spinal cord. Indeed, chemical activation or electrical stimulation of many of the same nuclei at which morphine acted to produce analgesia was demonstrated to suppress the responses of dorsal horn neurons to noxious stimuli in anesthetized animals and to produce analgesia in conscious animals. Collectively, these data indicate that neurons in the lateral reticular nucleus in the ventrolateral medulla, the nucleus raphe magnus and nucleus reticularis gigantocellularis pars alpha in the rostral ventromedial medulla, the ventrolateral periaqueduc-

tal gray in the midbrain, the locus coeruleus and A7 catecholamine nuclei in the pons and the hypothalamus and amygdala in the diencephalon are involved in the modulation of nociception and in the production of analgesia by opioids. The development of new neuroanatomical methods for tracing the efferent projections of neurons subsequently confirmed that many of these nuclei project either directly or indirectly, *via* other nuclei, to the spinal cord. Hence, the term descending circuitry or bulbospinal pain modulatory pathways was coined as a generic term for a collection of supraspinal neurons that modulate synaptic transmission of sensory information in the spinal cord and that are implicated in the production of analgesia by opioid receptor agonists.

#### Redundant or Complementary Pathways

Neurons in the nucleus raphe magnus and nucleus reticularis gigantocellularis pars alpha, which include serotonergic neurons among others, project directly to the spinal cord. They also receive direct projections from many other, more rostrally-situated nuclei that are also implicated in the modulation of pain sensitivity. Neurons in these two midline nuclei therefore comprise a final common efferent pathway to the spinal cord and, not surprisingly, have been the subject of intense investigation. However, neurons in the more laterally situated locus coeruleus and the A7 catecholamine cell group, which include noradrenergic neurons in the dorsolateral pontine tegmentum, also project directly to the spinal cord dorsal horn and similarly receive afferent projections from more rostral nuclei implicated in pain modulation. For reasons that remain unclear, these nuclei have not been as extensively studied as those in the rostral ventromedial medulla. Yet, the literature reveals many instances in which experimental manipulations that produce analgesia, including local application of opioid receptor agonists at supraspinal sites, is attenuated not only by ► [intrathecal](#) administration of serotonin receptor antagonists, but also by noradrenergic receptor antagonists (Jensen and Yaksh 1986). Furthermore, coincident release of serotonin and norepinephrine in the spinal cord has been documented after microinjection of morphine at supraspinal sites. Thus, there appear to be several efferent pain modulatory pathways at which opioid receptor agonists can act to produce analgesia.

These bulbospinal pathways may or may not function in concert, but their presence suggests complementary and possibly redundant means by which sensitivity to painful stimuli can be regulated and by which opioids can produce analgesia. Systemically administered opioids like morphine, meperidine or fentanyl that cross the blood-brain barrier readily distribute throughout the brain and are therefore likely to act at multiple supraspinal sites to produce analgesia. Thus, spinally projecting neurons in the rostral ventromedial medulla and in the dorsolateral pontine tegmentum could be

recruited independently and possibly in a redundant manner. However, it is also highly likely that these pathways are recruited in a concordant or coordinated manner. For example, neurons in the periaqueductal gray, an important site of opioid action, project to neurons in the rostral ventromedial medulla and to neurons in the dorsolateral pontine tegmentum. Thus, both pathways are recruited by an action of opioids limited solely to the periaqueductal gray. Furthermore, neurons in the rostral ventromedial medulla project to and activate neurons in the locus coeruleus and A7 catecholamine cell group. Thus, even though the rostral ventromedial medulla does not contain noradrenergic neurons, microinjection of opioid receptor agonists in this region produces an analgesia that can be reversed by intrathecal administration of either serotonergic or noradrenergic receptor antagonists (Hurley et al. 2003). The latter finding is concordant with a recruitment of spinally projecting noradrenergic neurons in the locus coeruleus or A7 catecholamine cell group.

#### Evolving Concepts: Disinhibition and Inhibition

The finding that local application of glutamate, an excitatory amino acid, or electrical stimulation of brainstem nuclei produced analgesia led to the proposal that analgesia results from the activation of brainstem neurons that then inhibit the transmission of sensory information in the spinal cord. However, opioid receptor agonists are almost exclusively inhibitory. They suppress synaptic transmission by acting at postsynaptic receptors to increase  $K^+$  ► **conductance** resulting in ► **hyperpolarization** or by acting at presynaptic receptors to decrease  $Ca^{++}$  conductance thereby inhibiting neurotransmitter release. At first glance, the inhibitory effects of opioid receptor agonists are difficult to reconcile with the data that suggested that activation of neurons in brainstem nuclei was necessary for the production of analgesia. However, neurons in the rostral ventromedial medulla and the locus coeruleus and A7 catecholamine cell group express  $\gamma$ -aminobutyric acid ( $GABA_A$ ) and  $GABA_B$  receptors and receive inputs from local GABAergic interneurons that appear to be tonically active. These GABAergic neurons express opioid receptors. Thus, the idea was put forth that opioid receptor agonists produced analgesia by a process of ► **disinhibition**, rather than by direct excitation. Specifically, it was proposed that opioid receptor agonists inhibited the activity of tonically active GABAergic neurons, thereby releasing spinally projecting neurons in the rostral ventromedial medulla or A7 neurons from inhibition, resulting in their excitation. The concept of disinhibition by opioids as a means by which spinally projecting brainstem neurons were activated to produce analgesia dominated the literature for over a decade (Fields and Basbaum 1999).

Careful examination of the literature suggested, however, that brainstem neurons were also able to facilitate

synaptic transmission of sensory information in the spinal cord dorsal horn. For example, microinjection of glutamate or electrical stimulation in these same nuclei could also produce ► **hyperalgesia**, in addition to analgesia (Zhuo and Gebhart 1990). This set of findings introduced the concept that brainstem nuclei contain pain facilitatory neurons, as well as pain inhibitory neurons. Sensitivity to painful stimuli or the analgesic effects of opioid receptor agonists therefore reflects the net sum activity in these opposing bulbospinal pathways. Thus, it was proposed that opioid receptor agonists may not only produce analgesia by disinhibition of pain inhibitory neurons, but also by direct inhibition of bulbospinal pain facilitatory neurons (Marinelli et al. 2002).

#### Evolving Concepts: Bimodal Regulation

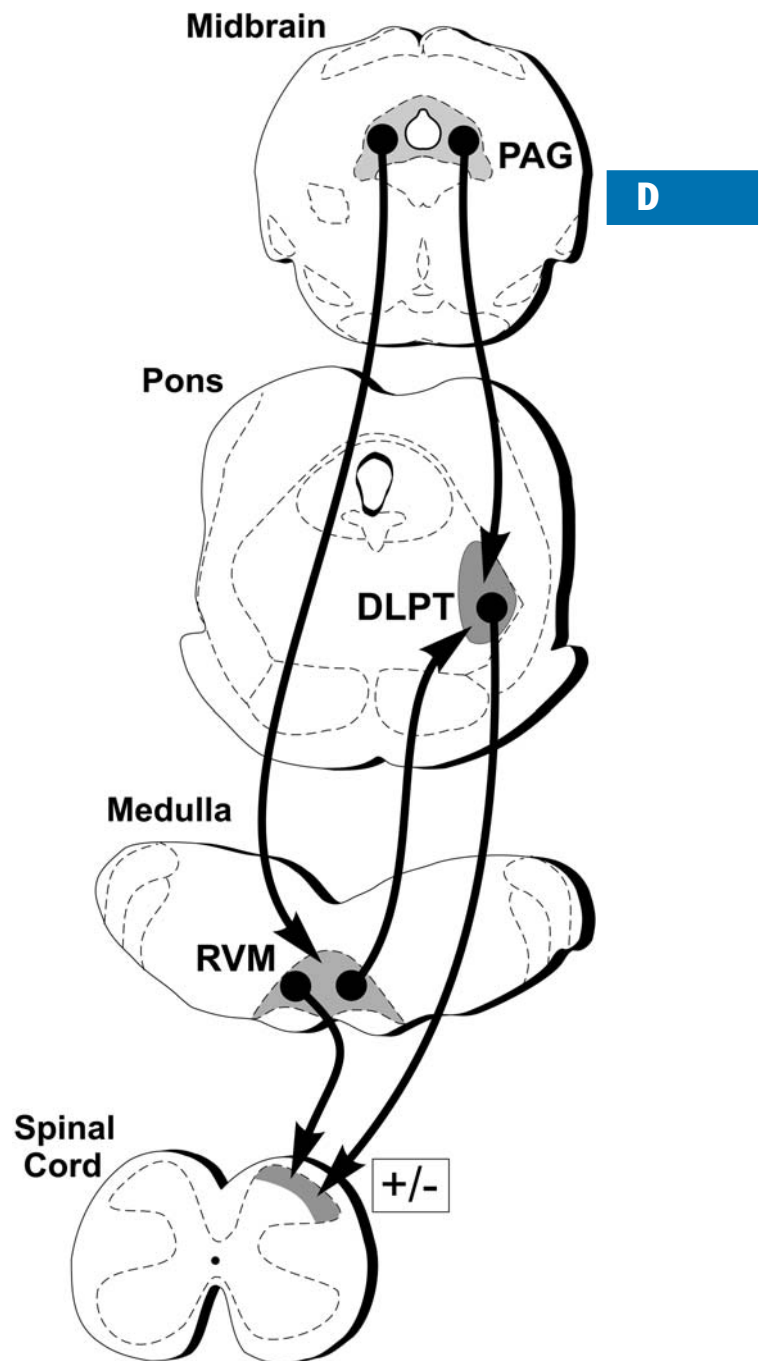
Sensitivity to painful stimuli is regulated or maintained through a process of bimodal regulation. Homeostasis reflects a balance of activity in bulbospinal pain facilitatory and pain inhibitory neurons. The apparent potency and efficacy of opioid receptor agonists is also dependent on this balance of activity. Recent data suggest that opioid receptor agonists may disinhibit pain facilitatory and pain inhibitory neurons in concert and that the analgesia produced by opioids represents the sum of that activity. For example, microinjection of morphine in the A7 catecholamine cell group results in analgesia that is enhanced by antagonism of spinal  $\alpha_1$  noradrenergic receptors and diminished by antagonism of spinal  $\alpha_2$  noradrenergic receptors (Holden et al. 1999). This finding requires further elaboration of the concept of pain inhibitory and pain facilitatory pathways. Neurons in the rostral ventromedial medulla and the dorsolateral pontine tegmentum can synapse directly on spinoreticular and spinothalamic tract neurons. In this instance, the functional effect of activation of the bulbospinal projection will be dictated by the postsynaptic receptor. For example, activation of  $\alpha_1$  noradrenergic receptors depolarizes dorsal horn neurons, whereas activation of  $\alpha_2$  noradrenergic receptors hyperpolarizes these neurons. Thus, activation of bulbospinal noradrenergic neurons of the locus coeruleus or the A7 catecholamine cell group can respectively facilitate or inhibit synaptic transmission of nociceptive information in the spinal cord. However, other neurons in these same nuclei synapse on interneurons in the dorsal horn that may be excitatory (i.e. contain substance P or glutamate) or inhibitory (i.e. contain ► **enkephalin**, glycine or ► **GABA**). In this instance, the identity of the interneuron will dictate the functional consequence of activation or inhibition of the bulbospinal neuron. For example, ► **serotonin** ( $5HT$ )<sub>3</sub> receptors are excitatory and cause depolarization of neurons. Serotonergic neurons of the rostral ventromedial medulla are postulated to inhibit synaptic transmission and produce analgesia *via* their projections to GABAergic interneurons that express

a 5HT<sub>3</sub> receptor (Alhaider et al. 1991). Excitation of the GABAergic interneuron in turn inhibits the activity of spinothalamic or spinoreticular tract neurons and produces analgesia. However, serotonergic neurons in the rostroventromedial medulla are also proposed to facilitate pain *via* their direct projections to spinothalamic and spinoreticular neurons that also express the excitatory 5HT<sub>3</sub> receptor (Suzuki et al. 2002).

#### Evolving Concepts: Plasticity in Opioid Actions

The vast majority of studies investigating the brainstem neural circuitry by which opioids modulate nociceptive sensitivity limited their investigation to naïve, uninjured rats and used acute measures of pain. Thus, it was not until very recently that it was understood that the bulbospinal efferent pain modulatory pathways exhibit substantial plasticity in terms of their physiological and pharmacological properties (Ren and Dubner 2002) or that these changes had important ramifications for the actions of opioid receptor agonists. For example, the anti-hyperalgesic and antinociceptive effects of  $\mu$  and  $\delta$  opioid receptor agonists applied directly into the rostral ventromedial medulla are enhanced under conditions of persistent inflammatory nociception. In addition, persistent inflammation increases the levels of enkephalins, endogenous opioid peptides that have preferential affinity for  $\delta$  opioid receptors, in the rostral ventromedial medulla. The enhancement of the antinociceptive effects of  $\mu$  opioid receptor agonists appears to occur as a consequence of an additive or synergistic interaction of the  $\mu$  opioid receptor agonist with the enhanced release of enkephalins that act preferentially at  $\delta$  opioid receptors (Hurley and Hammond 2001). These results suggest that endogenous opioids such as enkephalin can be recruited in persistent inflammatory pain states as part of a compensatory response on the part of brainstem pain modulatory pathways to mitigate the behavioral pain state and enable the organism to derive maximum benefit from systemic opioid pharmacotherapies.

Figure 1 summarizes the complementary pain modulatory pathways that arise from neurons in the rostral ventromedial medulla, comprised of the nucleus raphe magnus and nucleus reticularis gigantocellularis pars alpha and the dorsolateral pontine tegmentum, which includes the locus coeruleus and A7 catecholamine cell group. The strain and stock of Sprague-Dawley rat will determine whether the noradrenergic pathways in the dorsolateral pontine tegmentum that modulate nociceptive sensitivity arise from the locus coeruleus (e.g. Harlan Sprague-Dawley rats) or the A7 catecholamine cell group (Sasco or Charles River Sprague-Dawley rat) (Clark and Proudfit 1992). Neurons in the rostral ventromedial medulla and in the dorsolateral pontine tegmentum express several different types of opioid receptor although the  $\mu$  opioid receptor predominates. Opioid receptor agonists can act directly in each nucleus



**Descending Circuitry, Opioids, Figure 1** Schematic illustrating the interconnections among nuclei in the midbrain, pons and medulla that mediate the antinociceptive, anti-allodynic and anti-hyperalgesic effects of opioid receptor agonists such as morphine. Neurons in these nuclei may function to either facilitate or inhibit (+/-) the synaptic transmission of nociceptive information in the dorsal horn of the spinal cord. Although not illustrated for the sake of clarity, more rostrally situated nuclei implicated in opioid mediated antinociception, such as the hypothalamus and amygdala, send afferent projections to the periaqueductal gray. PAG, periaqueductal gray; DLPT, dorsolateral pontine tegmentum; RVM, rostral ventromedial medulla.

to produce analgesia either by disinhibition of spinally projecting pain inhibitory neurons or by direct inhibition of pain facilitatory neurons. Figure 1 also illustrates the interconnections among these nuclei that can support concordant recruitment of these bulbospinal pain modulatory neurons, even when the action of an opioid is limited to just one nucleus. Finally, Fig. 1 illustrates the efferent projections of the periaqueductal gray, which also contains opioid receptors, to neurons in both the rostral ventromedial medulla and the dorsolateral pontine tegmentum that can also support concordant recruitment of pain modulatory pathways in these nuclei. Although not illustrated, more rostrally situated nuclei, such as the hypothalamus and amygdala, which are implicated in nociception and opioid-mediated analgesia send afferent projections to the periaqueductal gray.

### Current Conundrums and Challenges

Substantial evidence has accrued that the antinociceptive effects of opioid receptor agonists are mediated by the activation of serotonergic bulbospinal neurons in the rostral ventromedial medulla. For example, the antinociceptive effects of opioid receptor agonists can be reversed by intrathecal administration of serotonergic receptor antagonists and opioid administration results in an increased release of serotonin in the spinal cord. Yet, electrophysiological recordings from serotonergic neurons (or neurons categorized as serotonergic based on their physiological response properties) in the rostral ventromedial medulla could document no consistent increase or decrease in their firing rate after administration of morphine (Gao et al. 1998). These results are difficult to reconcile with the results of earlier pharmacological and neurochemical investigations unless one proposes that opioids may increase the release of serotonin from the spinal terminals of these neurons in the absence of a direct excitation of the neuron or that tonically released serotonin exerts a modulatory effect at the spinal terminations of other bulbospinal pathways.

A principal challenge at present concerns the development of methods to reliably identify pain facilitatory and pain inhibitory neurons in the unanesthetized, awake behaving animal. Although a classification scheme has been developed whereby neurons in the rostral ventromedial medulla are characterized as on (pain facilitatory), off (pain inhibitory) or neutral (no response) cells based on their response to painful stimulation, the vast majority of this work has been conducted in anesthetized animals. Similar studies in conscious animals have suggested that this classification scheme and the function of these neurons may be more tightly linked to and reflective of behavioral state than originally envisioned (Mason 2001; Fields 2004). Advances in understanding the neural circuitry that mediates the analgesic, anti-allodynic and anti-hyperalgesic effects

of opioids will require a means to identify pain inhibitory and pain facilitatory neurons on the basis of their neurotransmitter contents and receptor expressions, their afferent and efferent projections and their responses to a variety of nociceptive stimuli and pharmacological agents. Although definition of the neural circuitry that regulates pain sensitivity and mediates the actions of different drug classes requires a systems-based analysis, it is not complete without complementary investigations that address these same hypotheses using cellular and molecular approaches. Therefore, concordance is required so that classification schemes that are developed can be uniformly applied under both *in vivo* and *in vitro* conditions.

### References

- Alhaider AA, Lei S, Wilcox GL (1991) Spinal 5-HT<sub>3</sub> receptor-mediated antinociception: possible release of GABA. *J Neurosci* 11:1881–1888
- Clark FM, Proudfit HK (1992) Anatomical evidence for genetic differences in the innervation of the rat spinal cord by noradrenergic locus coeruleus neurons. *Brain Res* 591:44–53
- Fields H (2004) State-dependent opioid control of pain. *Nat Rev Neurosci* 5:565–575
- Fields HL, Basbaum AI (1999) Central nervous system mechanisms of pain modulation. In: Wall PD, Melzack R (eds) *The Textbook of Pain*, 4th edn. Churchill Livingstone, Edinburgh, pp 309–329
- Gao K, Chen DO, Genzen JR et al. (1998) Activation of serotonergic neurons in the raphe magnus is not necessary for morphine analgesia. *J Neurosci* 18:1860–1868
- Holden JE, Schwartz EJ, Proudfit HK (1999) Microinjection of morphine in the A7 catecholamine cell group produces opposing effects on nociception that are mediated by  $\alpha^1$ - and  $\alpha^2$ -adrenoceptors. *Neurosci* 91:979–990
- Hurley RW, Hammond DL (2001) Contribution of endogenous enkephalins to the enhanced analgesic effects of supraspinal  $\mu$  opioid receptor agonists after inflammatory injury. *J Neurosci* 21:2536–2545
- Hurley RW, Banfor P, Hammond DL (2003) Spinal pharmacology of antinociception produced by microinjection of mu or delta opioid receptor agonists in the ventromedial medulla of the rat. *Neurosci* 118:789–796
- Jensen TS, Yaksh TL (1986) II. Examination of spinal monoamine receptors through which brainstem opiate-sensitive systems act in the rat. *Brain Res* 363:114–127
- Marinelli S, Vaughan CW, Schnell SA et al. (2002) Rostral ventromedial medulla neurons that project to the spinal cord express multiple opioid receptor phenotypes. *J Neurosci* 22:10847–10855
- Mason P (2001) Contributions of the medullary raphe and ventromedial reticular region to pain modulation and other homeostatic functions. *Annu Rev Neurosci* 24:737–777
- Ren K, Dubner R (2002) Descending modulation in persistent pain: an update. *Pain* 100:1–6
- Suzuki R, Morcuende S, Webber M et al. (2002) Superficial NK<sup>1</sup>-expressing neurons control spinal excitability through activation of descending pathways. *Nat Neurosci* 5:1319–13126
- Yaksh TL, Rudy TA (1978) Narcotic analgesics: CNS sites and mechanisms of action as revealed by intracerebral injection techniques. *Pain* 4:299–359
- Zhuo M, Gebhart GF (1990) Characterization of descending inhibition and facilitation of spinal nociceptive transmission from the nuclei reticularis gigantocellularis and gigantocellularis pars alpha in rat. *Pain* 42:337–350



## Descending Circuitry, Transmitters and Receptors

ALVIN J. BEITZ

Department of Veterinary and Biomedical Sciences,  
University of Minnesota, St. Paul, MN, USA  
beitz001@tc.umn.edu

### Synonyms

Transmitters in the Descending Circuitry; Receptors in the Descending Circuitry

### Definition

► **Neurotransmitters** can be defined as chemicals released from nerve cells, which convey information from one neuron to another or to non-neuronal target cells such as muscle. Following their release, transmitters typically affect postsynaptic neurons by binding to specialized proteins located in their neuronal membrane called receptors. Once a transmitter binds to its receptor, it either facilitates opening of an intrinsic ion channel or activates a second messenger system, such as cyclic GMP, which ultimately leads to a response in the postsynaptic neuron. The descending circuitry associated with modulation of spinal nociceptive processing utilizes a wide variety of transmitters and receptors.

### Characteristics

Descending pain modulatory circuitry can either facilitate or inhibit nociceptive signaling from the spinal cord to higher brain regions by interacting with the terminals of primary afferent fibers, with projection neurons, intrinsic spinal cord interneurons or terminals of other descending pathways. There is no absolute anatomical separation between brain regions that give rise to descending pathways that inhibit nociceptive transmission, versus those that give rise to pathways that facilitate nociceptive transmission. The difference between whether a pathway facilitates or inhibits spinal nociceptive processing is dependent in most cases on the transmitters and ► **receptors** associated with that particular pathway (Milan 2002). For instance, neurons in the rostroventral medulla, including the nucleus raphe magnus, give rise to descending ► **serotonergic** (5-HT) pathways, which can produce inhibition or facilitation of spinal cord dorsal horn neurons (Fields and Basbaum 1999; Porreca et al. 2002), based in part on the type of 5-HT receptor that is activated upon 5-HT release. Thus 5-HT activation of 5-HT<sub>1B</sub>, 1D, or 3 receptors inhibits dorsal horn nociceptive transmission, while activation of 5-HT<sub>1A</sub>, 2A, 2C, 3, 4, or 7 receptors facilitates nociceptive transmission (Milan 2002). Similarly, descending dopaminergic, cholinergic and noradrenergic pathways can facilitate or inhibit dorsal horn nociceptive transmission, by differential actions on dopaminergic, cholinergic or noradrenergic receptor subtypes.

Since there are multiple pathways that descend from the brain into the spinal cord to modulate incoming nociceptive information, it is not surprising that there are a myriad of neurotransmitters and receptors associated with these pathways. The major descending pathways and their transmitters and receptors are summarized in Table 1. This list is by no means definitive, and the reader is referred to the comprehensive review by Milan (2002) for an in-depth summary of these pathways, transmitters and receptors.

### Cortical and Subcortical Pathways

The anterior cingulate gyrus, agranular insular cortex and the frontal/parietal cortical areas have direct projections to the spinal cord, but each of these regions also affects the spinal cord indirectly via relays to brainstem nuclei, including the ► **rostroventral medulla** (RVM). All three pathways utilize ► **glutamate** as a major transmitter, but the anterior cingulate gyrus and the agranular insular cortex facilitate nociception, while the frontal/parietal cortex inhibits nociception, perhaps by acting on different glutamate receptor subtypes or by affecting different brainstem circuits or spinal interneurons. Based on these differential effects, the ► **cerebral cortex** has been proposed to modulate pain by acting on both pronociceptive and antinociceptive circuits, to change the set-point of pain threshold (Jasmin et al. 2003). The ► **amygdala** is a subcortical structure that also projects directly to the ► **spinal cord**. It utilizes ► **GABA** and several peptides as neurotransmitters, and has both an inhibitory and facilitatory effect on nociception at the spinal cord level. The amygdala participates together with the agranular ► **insular cortex**, and other cortical areas, in setting the pain threshold at the level of the spinal cord, and an imbalance in the output from the cortex and amygdala is likely to underlie some chronic pain states.

### Hypothalamus

The ► **hypothalamus** has direct projections to the spinal cord but is also extensively linked to the ► **periaqueductal gray** (PAG), nucleus of the solitary tract and RVM, and thus can influence spinal cord nociception indirectly. For example, the paraventricular nucleus (PVN) of the hypothalamus provides the major source of oxytocin- and vasopressin-containing axons to the dorsal horn, and release of these peptides inhibits nociception by activation of VP<sub>1a</sub> and oxytocin receptors on spinal cord inhibitory interneurons. A number of other peptides and transmitters have been identified in paraventricular hypothalamospinal projections, as summarized in Table 1. The posterior periventricular nucleus and the tuberomammillary nucleus are the major sources of ► **dopamine** and ► **histamine**, respectively, to the spinal cord. Dopamine acts at spinal cord D2 receptors to inhibit nociception and at D1 receptors to facilitate nociception, while histamine acts at H1 receptors to fa-

**Descending Circuitry, Transmitters and Receptors, Table 1** Overview of the descending pathways that modulate nociception in the spinal cord dorsal horn

Brain Structure	Primary Transmitter	Other Transmitters	Inhibits Nociception	Facilitates Nociception
Anterior Cingulate Gyrus	Glutamate	?	-	++
Frontal/Parietal	Glutamate	?	++	-
Amygdala	GABA	Somatostatin, Neurotensin, VIP	++	+
Paraventricular Nucleus/Hypothalamus	Vasopressin/Oxytocin-Corticotrophin-Releasing Factor	Dynorphin, Enkephalin, Neuropeptide F/Nitric Oxide	VP <sub>1a</sub> /OTCRF <sub>1</sub> K-opioid	-
Posterior Peri-ventricular nucleus (A <sub>11</sub> )/Hypothalamus	Dopamine	Ramide related peptides, CGRP	D <sub>2</sub>	D <sub>1</sub>
Tuberomammillary Nucleus/Hypothalamus	Histamine	GABA, Galanin, Enkephalin	-	H <sub>1</sub>
Arcuate Nucleus/Hypothalamus	B-endorphin/Melanocortin-Neuropeptide Y	CART	μ-opioid/NPY <sub>1</sub>	MC <sub>4</sub>
Lateral Hypothalamus	Orexin	Dynorphin/Glutamate	orexin-1 receptor	-
Periaqueductal Gray	Glutamate, CCK/Substance P	Serotonin/Neurotensin-Enkephalin	NMDA/5-HT <sub>3</sub>	CCK <sub>2</sub> /NK <sub>1</sub>
Parabrachial Nucleus	Glutamate/Acetylcholine	Somatostatin, Enkephalin/GABA	++	+
Pedunculopontine Nucleus	Acetylcholine	Dynorphin, Vasopressin	++	-
A5, A6, A7 Nuclei	Noradrenaline	GABA, Glutamate, Neuropeptide Y	α <sub>2A</sub> , α <sub>2B</sub>	α <sub>1A</sub> , α <sub>1B</sub>
Nucleus Raphe Magnus	Serotonin	GABA, Glutamate, Enkephalin, Galanin, CCK	5-HT <sub>1B,1D,3</sub>	5-HT <sub>1A,2A,2C,3,4,7</sub>
Rostroventral Medulla	Acetylcholine, GABA	Glycine, CCK, Enkephalin	Muscarinic/Nicotinic	Nicotinic
Nucleus of the Solitary Tract	Glutamate	Somatostatin, Orphanin FQ, CCK	++	+
Dorsal Reticular Nucleus	Glutamate	?	+	++

A summary of the major descending pathways that synapse in the spinal cord dorsal horn and the transmitters and receptors associated with each pathway that inhibit or facilitate nociception. The primary transmitters of each pathway are listed in the second column, while additional transmitters (neuromodulators) are listed in the third column. The identity of other transmitters for corticospinal pathways and some reticulospinal pathways remain to be determined. The specific receptor subtypes involved in antinociceptive or pronociceptive actions are also listed. In cases where the specific receptors that facilitate or inhibit nociception have yet to be identified with certainty, the antinociceptive or pronociceptive effect of stimulating the pathway is indicated by pluses (++) or minuses (-). A single "+" indicates that the evidence is controversial and a lack of evidence is indicated by a minus sign. It is important to note that while the structures listed in this table have direct projections to the spinal cord, they may also influence nociception indirectly by activating other brain regions, particularly medullary and pontine nuclei, that in turn project directly to the spinal cord. Receptor Abbreviations: α, Adrenergic; CCK, Cholecystokinin; CRF, corticotropin releasing factor; D, Dopamine; H, Histamine; MC, Melanocortin; NK, Neurokinin; NMDA, N-Methyl-D-Aspartate; OT, oxytocin; 5-HT, serotonergic; VP, Vasopressin

facilitate nociception. The hypothalamic arcuate nucleus contains a large number of neuroactive peptides, as indicated in table 1, and sends projections directly to the spinal cord, where these neuroactive peptides are either antinociceptive or pronociceptive, depending on the neuropeptide receptors that are activated. Finally, the lateral hypothalamus provides a direct orexin projection to the spinal cord, which is thought to play a role in descending antinociceptive mechanisms, by activating inhibitory interneurons in the spinal cord dorsal horn (Grudt et al. 2002).

### Brain Stem Nuclei

The periaqueductal gray (PAG) is a midbrain structure with a vast number of neurotransmitters and neuropeptides, and has a rich history as a key component in the descending pain modulation system (Beitz 1995). While glutamate appears to be the key transmitter of descending projections from this region to the spinal cord and to other brainstem nuclei (Beitz 1995), a number of other transmitters including 5-HT, cholecystokinin, substance P and neurotensin are present in descending PAG projections (Beitz 1982; Beitz et al. 1987). Neu-

rotenin released from the PAG has a dual effect in the rostroventral medulla (RVM): facilitation predominates at low (picomolar) doses of neurotensin injected into the RVM, whereas higher doses (nanomolar) produce antinociception (Smith et al. 1997). It is also worth noting that stimulation of  $\mu$ -**▶ opioid** receptors in the PAG with **▶ morphine** or other  $\mu$ -opioid receptor agonists activates a descending antinociceptive circuit with a delta-opioid receptor link in the RVM (Hirakawa et al. 1999). While a significant portion of the PAG's effect on spinal nociception is mediated via relays in other nuclei, like the RVM and A7 nucleus, direct descending pathways from this region can inhibit nociception at the spinal cord level via actions at NMDA receptors on spinal interneurons, and facilitate nociception via activation of neurokinin and cholecystokinin receptors. The pons contains a number of noradrenergic cell groups including the locus coeruleus (A6), the A5 group in the ventrolateral brainstem and the A7 group, whose axons project directly to the spinal cord dorsal horn. The bulbospinal axons arising from these cell groups release **▶ noradrenaline**, which inhibits nociception by acting on  $\alpha_2$ -adrenergic receptors on primary afferent terminals, to reduce the release of glutamate and substance P, and by increasing the release of inhibitory neurotransmitters from lamina II interneurons (Kawasaki et al. 2003). Noradrenaline released from these descending fibers can also facilitate nociception, by acting at spinal cord  $\alpha_{1A}$ - and  $\alpha_{1B}$ -adrenergic receptors. In addition to these noradrenergic cell groups, the pons provides a major cholinergic projection to the spinal cord, arising from the pedunculopontine nucleus and the parabrachial nucleus (PBN), as well as a glutamatergic projection arising from the parabrachial nucleus. The pedunculopontine nucleus inhibits nociception via release of acetylcholine, dynorphin and vasopressin, while the PBN can inhibit nociception via activation of **▶ glutamate receptors** located on spinal inhibitory interneurons or via the direct release of GABA and enkephalin.

The medulla provides a rich contribution of descending projections to the spinal cord, which includes a major source of **▶ serotonin**, glutamate, GABA and neuropeptide input. The 5-HT innervation of the spinal cord dorsal horn arises in large part from the nucleus raphe magnus. This descending serotonergic projection can both inhibit and facilitate nociception via activation of different 5-HT receptors, as summarized in table 1. It should be noted that descending 5-HT axons also contain a number of other neuropeptides and transmitters including glutamate (Hokfelt et al. 2000), and thus it is likely that additional neuroactive substances are co-released with 5-HT in the spinal cord dorsal horn, causing a wide spectrum of post- (and pre-) synaptic action. The rostroventral medulla consists of several subnuclei, including the nucleus gigantocellularis pars alpha and the lateral paragigantocellular nucleus, which provide both a GABAergic and cholinergic projection

to the spinal cord. This region can inhibit nociception, via activation of muscarinic and nicotinic cholinergic receptors, and can facilitate nociception via activation of nicotinic receptors. Descending projections from the RVM also contain glycine, CCK, enkephalin and 5-HT (Milan 2002). These neurotransmitters also appear to modulate spinal nociception, but the precise action of each transmitter and the specific receptor subtypes activated within the dorsal horn remain to be adequately defined. The nucleus of the solitary tract (NTS) plays a crucial role in processing visceral information, and like the PBN, it serves as an interface between the autonomic and sensory branches of the nervous system. Stimulation of the NTS has both antinociceptive and pronociceptive effects, which appear to be mediated by glutamatergic bulbospinal projections, with contributions from a peptidergic component consisting of somatostatin, CCK and orphanin FQ-containing axons. Since the NTS contains a myriad of neuropeptides and transmitters, it is likely that other NTS neuropeptides and transmitters may also contribute to nociceptive modulation at the spinal level. The dorsal reticular nucleus is located in the dorsal portion of the medulla, adjacent and lateral to the NTS, and stimulation of this region has been shown to enhance the responsiveness of spinal nociceptive neurons to peripheral stimulation (Dugast et al. 2003). Neurons in this region are activated by noxious stimuli, contain a high level of GABA<sub>B</sub> receptors, and send glutamatergic projections to the spinal cord to modulate nociception.

Given the information summarized above, it is clear that there are a large number of transmitters and receptors associated with the descending circuitry that modulates spinal nociceptive processing. An understanding of the role that each transmitter and receptor plays in pain modulation is complicated by the fact that a single transmitter and even a single receptor class can exert differential effects on nociception, at both spinal and supraspinal sites. Nonetheless, extensive progress has been made in defining the roles of many of the neuroactive substances listed above, and knowledge of the mechanisms by which descending pathways modulate nociception has increased dramatically in recent years, which should lead to improved management of pain.

## References

1. Beitz AJ (1982) The Sites of Origin of Brain Stem Neurotensin and Serotonin Projections to the Rodent Nucleus Raphe Magnus. *J Neurosci* 2:829–842
2. Beitz AJ (1995) Periaqueductal Gray. In: Paxinos G (ed) *The Rat Nervous System*, 2<sup>nd</sup> ed. Academic Press, San Diego, pp 173–182
3. Beitz AJ, Clements JR, Ecklund LJ et al. (1987) The Nuclei of Origin of Brainstem Enkephalin and Cholecystokinin Projections to the Spinal Trigeminal Nucleus of the Rat. *Neuroscience* 1987 20:409–425
4. Dugast C, Almeida A, Lima D (2003) The Medullary Dorsal Reticular Nucleus Enhances the Responsiveness of Spinal Nociceptive Neurons to Peripheral Stimulation in the Rat. *Eur J Neurosci* 18:580–588

5. Fields, HL and Basbaum AI (1999) Central Nervous System Mechanisms of Pain Modulation. In: Wall PD, Melzac R (eds) *Textbook of Pain*, 4<sup>th</sup> edn. Churchill Livingstone, Edinburgh, pp 309–329
6. Grudt TJ, van den Pol AN, Perl ER (2002) Hypocretin-2 (orexin-B) Modulation of Superficial Dorsal Horn Activity in Rat. *J Physiol* 538(Pt 2):517–525
7. Hirakawa N, Tershner SA and Fields HL (1999) Highly  $\delta$  Selective Antagonists in the RVM Attenuate the Antinociceptive Effect of PAG DAMGO. *Neuroreport* 10:3125–3129
8. Hokfelt T, Arvidsson U, Cullheim et al. (2000) Multiple Messengers in Descending Serotonin Neurons: Localization and Functional Implications. *J Chem Neuroanat* 18:75–86
9. Jasmin L, Rabkin SD, Granato A et al. (2003) Analgesia and Hyperalgesia from GABA-Mediated Modulation of the Cerebral Cortex. *Nature* 424:316–320
10. Kawasaki Y, Kumamoto E, Furue H et al. (2003) Alpha 2 Adrenoceptor-Mediated Presynaptic Inhibition of Primary Afferent Glutamatergic Transmission in Rat Substantia Gelatinosa Neurons. *Anesthesiology* 98:682–689
11. Milan MJ (2002) Descending Control of Pain. *Prog Neurobiol* 66:355–474
12. Porreca F, Ossipov MH, Gebhart GF (2002) Chronic Pain and Medullary Descending Facilitation. *Trends Neurosci* 25:319–325
13. Smith DJ, Hawranko AA, Monroe PJ et al. (1997) Dose-Dependent Pain-Facilitatory and -Inhibitory Actions of Neurotensin are Revealed by SR 48692, a Nonpeptide Neurotensin Antagonist: Influence on the Antinociceptive Effect of Morphine. *J Pharmacol Exp Ther* 282:899–908

## Descending Circuits in the Forebrain, Imaging

ELIZABETH ROY FELIX

The Miami Project to Cure Paralysis, University of Miami Miller School of Medicine, Miami, FL, USA  
 efelix@miamiproject.med.miami.edu

### Synonyms

Functional Imaging of Descending Modulation; Cognitive Modulation of Pain; imaging descending circuits in the forebrain

### Definition

Functional brain imaging techniques have been used as *in vivo* methods for examining which brain regions may be involved in or reflective of the modulation of pain. Current evidence using ► [positron emission tomography](#) (PET) and ► [functional magnetic resonance imaging](#) (fMRI) methodologies supports roles for the perigenual- and mid- ► [anterior cingulate cortices](#) (ACC) and portions of the ► [prefrontal cortex](#) in modulating input from nociceptive afferent pathways *via* descending projections.

### Characteristics

Utilization of brain imaging techniques to study the descending modulation of pain is not straightforward and thus the results from these studies must be considered together with results derived from other methodologies.

One pitfall in the interpretation of functional imaging data is that increases in the oxygenation level of the blood (as is commonly measured in fMRI experiments) or metabolism (as measured with PET) can represent increased activity in either excitatory or inhibitory neurons (or both) within the area of interest, making it hard to distinguish the net neurophysiological outcome of the measured activity. A second caution when interpreting imaging results involves the distinction between changes that occur in each “active” area as a source of modulation and changes that occur as a result of such modulation (through the influence of other brain areas). Without supporting research from other methodologies, hypotheses based on results from imaging studies alone are speculative.

Given these caveats, the great advantage of functional brain imaging is that responsiveness in a number of brain regions can be looked at simultaneously to examine how these areas are affected by particular manipulations that occur within short experimental sessions and with relatively few subjects. This allows for a comprehensive assessment of the areas that may be involved in descending modulation of pain.

The regions most consistently activated by nociceptive stimulation alone, measured with PET and fMRI, have been well studied using various types of peripheral stimulation. The recognition that brain imaging techniques could bring special insight regarding which of these areas exhibited changes in activity that were correlated with changes in pain perception measured psychophysically has led to another level of investigation, one which examines the mechanisms of nociceptive modulation in the forebrain.

A first approach to understanding the mechanisms of pain modulation is the investigation of responsiveness to the presentation of the effective manipulation itself, in the absence of nociceptive stimulation. PET studies are especially useful in this regard and have provided a starting point for evaluating the possible mechanisms of descending modulation. Manipulations involving suggestions of pain relief (► [placebo](#) : Petrovic et al. 2002; hypnosis: Faymonville et al. 2000) result in increased regional cerebral blood flow (rCBF) in areas of the ACC compared to a resting condition. Administration of fentanyl (Adler et al. 1997; Casey et al. 2000) or remifentanyl (Petrovic et al. 2002), both opioid agonists, also results in increased rCBF in the perigenual- and mid-ACC regions. Similarly, increased activations in prefrontal regions during placebo (Petrovic et al. 2002) or opioid administration (Firestone et al. 1996; Petrovic et al. 2002), support inclusion of prefrontal areas in the circuitry responsible for descending modulation of pain.

Perhaps a more direct way to implicate regional involvement in descending modulation of pain is to examine the nociceptive specific changes that occur in forebrain activity during manipulations aimed at altering pain per-



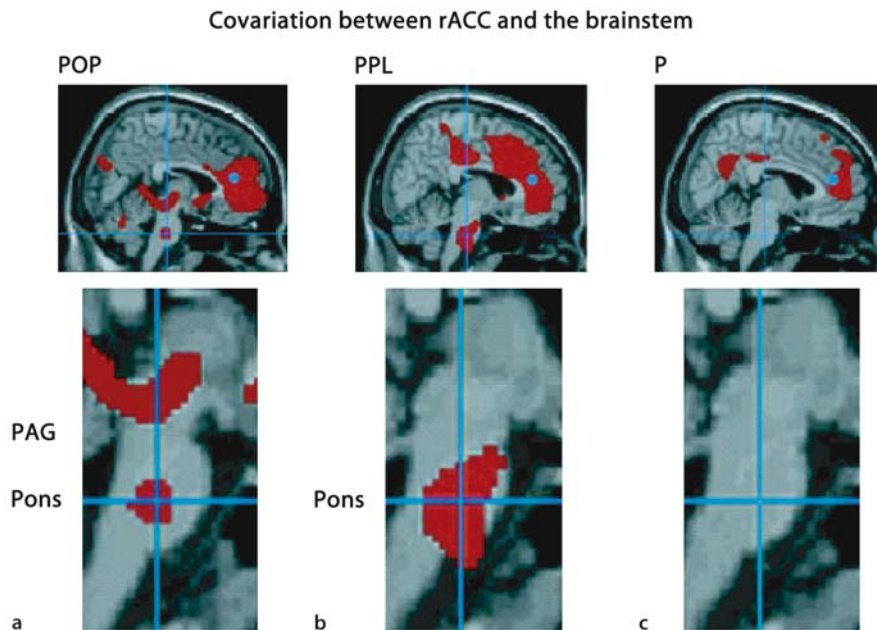
ception. Indeed, several cortical and sub-cortical areas have been shown to modulate their level of responsiveness to painful stimuli in the presence of cognitive and pharmacological manipulations that modify the perception of such stimuli. One of the most frequently identified areas related to this type of modulation in human subjects is the ACC. Although the exact location and polarity of the changes in activity within the ACC during cognitive modulation of pain are not in full agreement among all such studies, the most consistent effect in this area suggests that manipulations that cause decreases in pain perception (compared to equal intensity stimuli presented outside the cognitive modulation context) result in increased stimulus induced activation here (Bantick et al. 2002; Frankenstein et al. 2001; Petrovic et al. 2002). In addition, a study that prompted increased pain perceptual ratings by increasing the anxiety associated with an impending noxious stimulus was correlated with decreased activation in this area of the ACC (Porro et al. 2002), suggesting that the direction of change in ACC modulatory activity can be reversed if the situation calls for increased vigilance.

Although the mechanisms underlying the relationship between the modulation of pain and activity in the perigenual/rostral ACC seen in brain imaging studies are far from fully elucidated, the evidence cited above demonstrates that this area is a likely candidate for the modulation of pain in certain contexts. Taken together, these studies suggest that increased activation in this area of the ACC serves to suppress incoming nociceptive information, causing decreases in pain perception. In fact, Petrovic and colleagues (2002) (see Fig. 1) have shown that, during administration of either remifentanyl (an opioid receptor agonist) or placebo (administered with suggestions of pain relief), there is increased correlation between activation in rostral ACC and areas of the pons and the ▶ **periaqueductal gray** (PAG) in the brainstem (when compared with correlated stimulus induced activation of these areas in the absence of pain modulation). A recent fMRI study (Bingel et al. 2006) supports this finding, identifying significant covariation of placebo-dependent activation between rostral ACC and the PAG, and between rostral ACC and bilateral amygdalae, as well. These results implicate the ACC as a possible source of cortical nociceptive modulation, exerting control of activity in brainstem areas known to be involved in the descending modulation of pain. Despite the differences in the vehicle of modulation (administration of an opioid agonist or cognitive suggestions accompanying placebo administration), both means of manipulating pain perception resulted in activation of similar brain circuits, suggesting at least some common mechanisms for modulation of pain at the cortical level. Additionally, fMRI has been used to further suggest the engagement of the PAG during modulation of pain *via* attentional mechanisms (Tracey et al. 2002).

Many prefrontal areas have also been implicated as possible sources of descending modulatory control. Changes similar to those seen in the perigenual/rostral ACC have been reported in the prefrontal cortex when the subjective perception of a noxious stimulus is decreased due to distraction or administration of pharmacological agents or when nociceptive specific increases in activation of prefrontal regions are evident (Adler et al. 1997; Bantick et al. 2002; Frankenstein et al. 2001; Petrovic et al. 2000). Administration of opioidergic agents in the absence of pain stimulation also increases activation in prefrontal areas (Firestone et al. 1996; Petrovic et al. 2002), further suggesting that such activation may serve to inhibit forthcoming nociceptive signals.

Experiments involving evoked increases in pain perception due to increased anticipatory anxiety however, report positive correlations between ratings of pain and activity in prefrontal areas (Hsieh et al. 1999; Porro et al. 2002). These results imply that the prefrontal cortex may work as a coding mechanism for pain intensity – simply a reflection of changes in pain perception – rather than a source of such modulation. Similarly, peripheral stimulation with capsaicin, which sets up conditions of ▶ **allodynia** and ▶ **secondary hyperalgesia** (mediated by central mechanisms), also results in increases in positive correlations between prefrontal activation and measures of pain intensity (Iadorola et al. 1998; Lorenz et al. 2002). The current evidence regarding the prefrontal cortex and its modulatory role in pain perception then, suggests a complex relationship, involving increases in activation of this area under contexts that cause reductions in pain (during distraction and opioid administration) and those that cause increases in pain sensitivity (during anxiety and stimulus induced allodynia and hyperalgesia).

The insular cortex is another area that is consistently reported to show changes in its level of stimulus-induced activation under cognitive and pharmacological conditions that alter pain sensitivity. Manipulations resulting in increases in pain result in increases in activity in the insula (Hofbauer et al. 2001; Porro et al. 2002) and manipulations that result in decreases in pain perception correlate with similar decreases in this area (Brooks et al. 2002; Bantick et al. 2002; Petrovic et al. 2002). To date, there is little evidence from functional imaging studies that the insula has any direct influence over incoming nociceptive input. Instead, it may serve as a coding mechanism for the level of the sensory experience. Likewise, other areas involved in pain processing during baseline or control conditions (thalamus, primary and secondary somatosensory cortex) show changes in responsiveness that positively correlate with the direction of the perceptual changes (Bantick et al. 2002; Casey et al. 2000; Hofbauer et al. 2001; Lorenz et al. 2003; Petrovic et al. 2000) and are not implicated as sources of the cognitive or pharmacological modulation of pain.



**Descending Circuits in the Forebrain, Imaging, Figure 1** Covariation of activity in brainstem regions with activity in the rACC (denoted by the blue sphere) in different pain conditions. (a) Activity in the rostral ACC covaried with activity in the PAG and in the lower pons/medulla during the pain + opioid condition. These covariations were significantly greater during the pain + opioid condition compared with the pain alone condition. (b) A similar covariation between the rostral ACC and the lower pons/medulla was observed during the pain + placebo condition. This covariation was significantly greater during pain + placebo as compared with pain alone. (c) No such regressions were observed during the pain alone condition. The activations are presented on an SPM99-template and a more detailed image of the brainstem indicating the approximate position of the PAG and the pons. The threshold of activation is at  $p = 0.005$  (from Petrovic et al. 2002).

Although the spatial and temporal resolution of PET and fMRI may not always be fine enough to resolve direct relationships between different brain structures known to exhibit descending pain modulation definitively, these methods do allow us access to the inter-related nature of the forebrain during such modulation. Functional brain imaging in human subjects has allowed the evaluation, not only of pharmacological effects, but also of complex psychological manipulations on changes in activation of particular brain areas that correspond with changes in pain perception. Current research, indicating increased activity levels in the ACC and in prefrontal regions during decreased pain perception due to experimental manipulation, points to these areas as the best candidates for exerting descending control over nociceptive signaling. Many other areas responsive to pain, including the insular cortex, the primary and secondary somatosensory cortices and the thalamus, may also be found to be involved in the descending modulation of pain, but current functional imaging results do not strongly support such roles.

## References

- Adler LJ, Gyulai FE, Diehl DJ et al. (1997) Regional brain activity changes associated with fentanyl analgesia elucidated by positron emission tomography. *Anesth Analg* 84:120–126
- Bantick SJ, Wise RG, Ploghaus A et al. (2002) Imaging how attention modulates pain in humans using functional MRI. *Brain* 125:310–319
- Bingel U, Lorenz J, Schoell E, Weiller C, Büchel C (2006) Mechanisms of placebo analgesia: rACC recruitment of a subcortical antinociceptive network. *Pain* 120:8–15
- Brooks JCW, Nurmiikko TJ, Bimson WE et al. (2002) fMRI of thermal pain: Effects of stimulus laterality and attention. *NeuroImage* 15:293–301
- Casey KL, Svensson P, Morrow TJ et al. (2000) Selective opiate modulation of nociceptive processing in the human brain. *J Neurophysiol* 84:525–533
- Faymonville ME, Laureys S, Degueldre C et al. (2000) Neural mechanisms of antinociceptive effects of hypnosis. *Anesthesiology* 92:1257–1267
- Firestone LL, Gyulai F, Mintun M et al. (1996) Human brain activity response to fentanyl imaged by positron emission tomography. *Anesth Analg* 82:1247–1251
- Frankenstein UN, Richter W, McIntire MC et al. (2001) Distraction modulates anterior cingulate gyrus activations during the cold pressor test. *NeuroImage* 14:827–836
- Hofbauer RK, Rainville P, Duncan GH et al. (2001) Cortical representation of the sensory dimension of pain. *J Neurophysiol* 86:402–411
- Hsieh J-C, Stone-Elander S, Ingvar M (1999) Anticipatory coping of pain expressed in the human anterior cingulate cortex: a positron emission tomography study. *Neurosci Lett* 262:61–64
- Iadorola MJ, Berman KF, Zeffiro TA et al. (1998) Neural activation during acute capsaicin-evoked pain and allodynia assessed with PET. *Brain* 121:931–947
- Lorenz J, Cross DJ, Minoshima S et al. (2002) A unique representation of heat allodynia in the human brain. *Neuron* 35:383–393
- Lorenz J, Minoshima S, Casey KL (2003) Keeping pain out of mind: the role of the dorsolateral prefrontal cortex in pain modulation. *Brain* 126:1079–1091
- Petrovic P, Petersson KM, Ghatan PH et al. (2000) Pain-related cerebral activation is altered by a distracting cognitive task. *Pain* 85:19–30

15. Petrovic P, Kalso E, Petersson KM et al. (2002) Placebo and opioid analgesia – imaging a shared neuronal network. *Science* 295:1737–1740
16. Porro CA, Baraldi P, Pagnoni G et al. (2002) Does anticipation of pain affect cortical nociceptive systems? *J Neurosci* 22:3206–3214
17. Tracey I, Ploghaus A, Gati JS et al. (2002) Imaging attentional modulation of pain in the periaqueductal gray in humans. *J Neurosci* 22:2748–2752

## Descending Control

- ▶ Descending Modulation of Nociceptive Processing

## Descending Control of Hyperalgesia

- ▶ Descending Modulation of Nociceptive Transmission during Persistent Damage to Peripheral Tissues

## Descending Excitatory Modulation

- ▶ Descending Facilitatory Systems

## Descending Facilitation

- ▶ Descending Facilitatory Systems
- ▶ Descending Modulation of Visceral Pain

## Descending Facilitation and Inhibition in Neuropathic Pain

MICHAEL H. OSSISOV, FRANK PORRECA  
Department of Pharmacology, University of Arizona,  
Health Sciences Center, Tucson, AZ, USA  
michaelo@u.arizona.edu, frankp@u.arizona.edu

### Synonyms

Spinopetal Modulation of Pain; Bulbosplinal Modulation of Nociceptive Inputs

### Definitions

Neuropathic pain refers to the set of behavioral signs and symptoms that are associated with pain following injury

to peripheral nerves. Nerve injury may be due to physical trauma, a consequence of a disease state or a result of cancer chemotherapy or other medications. Abnormal nerve injury induced pain states are often characterized by spontaneous burning pain, paroxysmal pain, allodynia and hyperalgesia. Neuropathic pain is resistant to common protocols for treatment of chronic pain. Allodynia refers to the condition when normally non-noxious stimuli are perceived as noxious. Hyperalgesia refers to enhanced perception of and responses to noxious stimuli.

It is generally accepted that specific regions of the brain exert modulatory control over incoming pain signals. As such influences descend from the brain to the spinal cord, this process is referred to as descending modulation. Descending inhibition is the activation of inhibitory systems arising from discrete brain loci and projecting to the dorsal horns of the spinal cord that modulate nociceptive inputs at that level (for review see Fields and Basbaum 1999). Accordingly, electrical stimulation of discrete regions of the brain has produced robust antinociception in many species. Although several brain sites have been identified as important in the descending modulation of pain, considerable anatomical evidence indicates that the rostroventromedial medulla (RVM) is an integral relay in the processing of bulbospinal pain modulation (Fields and Basbaum 1978). The RVM includes, but is not limited to, the midline nucleus raphe magnus (NRM). It is defined anatomically as the region of the medulla between the pyramids, from the ventral surface to the top of the facial nucleus and extending rostro-caudally from the caudal aspect of the superior olive to the rostral aspect of the inferior olive. Projections from the RVM to the spinal cord course principally along the dorsolateral funiculus (DLF).

### Characteristics

#### Descending Modulation of Pain

Convincing evidence that specific regions of the brain exert a control over incoming pain signals at the level of the spinal cord was first demonstrated when focal electrical stimulation in the midbrain periaqueductal gray (PAG) of the conscious rat produced a profound analgesia. Electrical stimulation of the PAG has also relieved intractable cancer pain in man. Other sites, including the locus coeruleus and the thalamus, also produce robust antinociception in several species when stimulated (for review see Fields and Basbaum 1999). These sites coincide with those that produce antinociception after the microinjection of morphine (Fields and Basbaum 1999). The interpretation that the RVM functions as a critical brainstem relay in the modulation of descending nociceptive controls is supported by observations that interruption of the activity of the RVM by either lidocaine microinjections or lesions blocked antinociception elicited

by stimulation of the PAG (Gebhart et al. 1983). More recent studies show that the RVM may give rise to a facilitatory pathway that promotes pain as well. For example, nociceptive inputs may activate pain facilitatory neurons of the RVM, thus promoting further nociception, setting the stage for the maintenance of a chronic pain state (Porreca et al. 2002). An illustration of this concept is observed when hyperalgesia induced by a variety of means, including naloxone precipitated opiate withdrawal, inflammation or nerve injury is reversed by intra-RVM lidocaine or electrolytic lesion (Pertovaara 1998). Electrical stimulation of the RVM at low intensities has facilitated dorsal horn neuronal activity and the spinal nociceptive tail flick reflex, further demonstrating the existence of nociceptive facilitation arising from this region (Zhuo and Gebhart 1997).

In order to describe how the RVM may mediate apparently physiologically contradictory functions, it should be remembered that the RVM is considered to contain three types of cells, which have been extensively characterized by Fields and colleagues (Fields and Heinricher 1985). Based on response characteristics to nociception, these cells are described as “on”-cells, “off”-cells and neutral cells. The physiologic function of the neutral cells is undetermined. The off-cells are tonically active, pause in their firing immediately before a withdrawal response occurs to noxious stimuli and are believed to be responsible for descending inhibition of nociceptive inputs (see Fields and Basbaum 1999). The on-cells accelerate firing immediately before the nociceptive reflex occurs and are likely to be the source of descending facilitation of nociceptive inputs and thus can mediate hyperalgesia (Fields and Basbaum 1999). Accordingly, manipulations that increase nociceptive responsiveness, thus indicating facilitation, also increase on-cell activity. Naloxone precipitated opioid withdrawal is associated with hyperalgesia and also with increased activity of RVM on-cells, which is in turn blocked by RVM lidocaine (for reviews see Fields and Basbaum 1999; Porreca et al. 2002).

It is now generally accepted that a spino-bulbo-spinal loop may be important in the development and maintenance of exaggerated pain behaviors produced by noxious (i.e. hyperalgesia) and non-noxious (i.e. allodynia) peripheral stimuli (Fields and Basbaum 1999; Porreca et al. 2002). Behavioral signs of tactile hypersensitivity and thermal hyperalgesia were produced by CCK injected into the RVM and this effect was blocked by the CCK<sub>2</sub> receptor antagonist L365,260 (Kovelowski et al. 2000). Furthermore, microinjection of L365,260 or of lidocaine into the RVM blocked behavioral signs of neuropathic pain in rats with spinal nerve ligation (SNL) (Kovelowski et al. 2000; Pertovaara et al. 1996). Persistent noxious input from an injection of formalin into the hind paw has facilitated the nocifensive tail flick reflex through an NMDA-mediated mechanism within the RVM (Wiertelak et al. 1994). RVM lido-

caine or ibotenic acid also blocked hyperalgesia and increased WDR cell activity of inflammatory origin (Pertovaara 1998). In the light of these considerations, it is believed that behavioral manifestations of neuropathic pain result in part from supraspinal neuroplastic changes in response to abnormal, persistent afferent inputs resulting from the nerve injury. These changes appear to induce the activation of medullospinal facilitatory pathway(s) that result in further increase in afferent input. These changes lead to a self-generating feed forward mechanism that perpetuates sensations of neuropathic pain, even after the original injury has been resolved.

The spinopetal projections from the RVM travel along the dorsolateral funiculus (DLF) to synapse with either interneurons or nerve terminals of primary afferent fibers in the dorsal horn of the spinal cord (Fields and Basbaum 1999). Ablation of the DLF ipsilateral to spinal nerve ligation abolished injury induced tactile hypersensitivity, whereas contralateral DLF lesions or sham DLF lesions had no effect on neuropathic pain (Ossipov et al. 2000). The maintenance, but not the initiation, of nerve injury induced pain appear to require supraspinal neuroplastic changes that ultimately activate descending facilitation from the RVM. RVM lidocaine, selective lesions of mu-opioid receptor expressing neurons of the RVM and DLF lesions blocked tactile and thermal hypersensitivity elicited by nerve injury, but only beyond the 3<sup>rd</sup> day post-injury (Burgess et al. 2002). At day 3, these manipulations were without effect (see below).

The up-regulation of spinal dynorphin may provide a means through which enhanced afferent inputs may be maintained. Considerable evidence has demonstrated that dynorphin is pronociceptive and tactile and thermal hypersensitivity elicited by nerve injury was reversed by the spinal injection of dynorphin antiserum (Wang et al. 2001). Furthermore, spinal dynorphin content is maximally elevated within 10 days after nerve injury, although behavioral signs of abnormal pain occur as early as 3 days after the injury (Wang et al. 2001). This observation suggests that spinal dynorphin elevations may be a result of neuroplastic changes over a period of several days. This suggestion was supported by the observation that in mice tested within 2 days of SNL, tactile hypersensitivity was reversed by spinal injections of MK-801, but not by antiserum to dynorphin. In contrast, on the 10<sup>th</sup> day after SNL, both spinal injections of MK-801 and antiserum to dynorphin blocked signs of neuropathic pain (Wang et al. 2001). Accordingly, spinal dynorphin content was not elevated on the second day, but was elevated on the 10<sup>th</sup> day (Wang et al. 2001). Furthermore, mice with deletions of the prodynorphin gene (dynorphin knockout; KO) developed behavioral signs of neuropathic pain within 2 days of SNL that were blocked by MK-801. These signs spontaneously resolved over a 10 day period, whereas those of the wild type littermates did not (Wang et al. 2001). These studies



taken together suggest that elevated spinal dynorphin may not be critical to the initiation of increased pain, but is a necessary component for the long-term maintenance of abnormal pain after nerve injury.

The precise mechanisms through which elevated spinal dynorphin promotes neuropathic pain remain to be elucidated. However, there is considerable evidence that increased spinal dynorphin promotes the further release of excitatory amino acids from primary afferent neurons, in this way provoking a positive feedback loop that amplifies further sensory input. Microdialysis studies have demonstrated localized, dose-dependent release of glutamate and aspartate elicited by exogenous dynorphin in the hippocampus and spinal cord (Skilling et al. 1992). More recently, it was demonstrated that capsaicin-stimulated release of CGRP was potentiated by dynorphin in spinal cord slices *in vitro* (Gardell et al. 2003). In recent studies, spinal cord sections obtained from rats with SNL demonstrated elevated capsaicin-induced release of CGRP and this effect was blocked by antiserum to dynorphin (Gardell et al. 2003). Dynorphin antiserum did not alter capsaicin-induced release of CGRP in spinal cord tissue from sham-operated rats (Gardell et al. 2003). These observations are consistent with previous reports of dynorphin facilitation of capsaicin-evoked substance P release from trigeminal nuclear slices, an effect blocked by MK-801, but not by opioid antagonists (see Gardell et al. 2003). Thus, dynorphin may contribute to amplification of nociceptive input at the level of the spinal cord by promoting NMDA-mediated sensory input. Initial afferent discharges lead to release of excitatory neurotransmitters and activation of descending facilitation. Constant facilitation results in neuroplastic changes, including increased dynorphin release. In turn, spinal dynorphin promotes further release of excitatory neurotransmitters in the spinal cord. In this way, dynorphin may maintain a facilitated pain state initiated by the original increased discharge of the injured nerve and promoted by this feed forward mechanism.

In summary, initial nerve injury may result in increased neuronal hyperexcitability, predominantly of large diameter A $\beta$  afferent fibers. This excitation results in supraspinal neuroplastic changes, ultimately leading to the development of descending facilitation arising from the RVM. Furthermore, this underlying abnormal pain state may be the reason why opioid requirements to produce a consistent level of analgesia increase after nerve injury. Finally, it is proposed that these neuroplastic changes lead to elevations in spinal dynorphin expression and that these pathologically elevated levels exhibit a pronociceptive effect. Consequently, elevated spinal dynorphin further promotes nociceptive input and contributes to a positive feed forward cycle that serves to maintain an abnormally sensitized pain state. Manipulations that interrupt this self-perpetuating cycle may be exploited as targets for rational novel therapies

for the treatment of neuropathic pain states. These would include local anesthetic application at the site of injury, antagonists of excitatory neurotransmitters (e.g. CCK antagonists or NMDA antagonists), interruption of spinal neurotransmitter release or blockade of the neurotransmitter receptors and prevention of the up-regulation of spinal dynorphin.

D

## References

1. Burgess SE, Gardell LR, Ossipov MH et al. (2002) Time-dependent descending facilitation from the rostral ventromedial medulla maintains, but does not initiate, neuropathic pain. *J Neurosci* 22:5129–36
2. Fields HL, Basbaum AI (1978) Brainstem control of spinal pain-transmission neurons. *Annu Rev Physiol* 40:217–48
3. Fields HL, Basbaum AI (1999) Central nervous system mechanisms of pain modulation. In: Wall PD, Melzack R (eds) *Textbook of pain*. Churchill Livingstone, Edinburgh, pp 309–329
4. Fields HL, Heinricher MM (1985) Anatomy and physiology of a nociceptive modulatory system. *Philos Trans R Soc Lond B Biol Sci* 308:361–74
5. Gardell LR, Vanderah TW, Gardell SE et al. (2003) Enhanced evoked excitatory transmitter release in experimental neuropathy requires descending facilitation. *J Neurosci* 23:8370–9
6. Gebhart GF, Sandkuhler J, Thalhammer JG et al. (1983) Inhibition of spinal nociceptive information by stimulation in mid-brain of the cat is blocked by lidocaine microinjected in nucleus raphe magnus and medullary reticular formation. *J Neurophysiol* 50:1446–59
7. Kovelowski CJ, Ossipov MH, Sun H et al. (2000) Supraspinal cholecystokinin may drive tonic descending facilitation mechanisms to maintain neuropathic pain in the rat. *Pain* 87:265–73
8. Ossipov MH, Hong Sun T, Malan P Jr et al. (2000) Mediation of spinal nerve injury induced tactile allodynia by descending facilitatory pathways in the dorsolateral funiculus in rats. *Neurosci Lett* 290:129–32
9. Pertovaara A (1998) A neuronal correlate of secondary hyperalgesia in the rat spinal dorsal horn is submodality selective and facilitated by supraspinal influence. *Exp Neurol* 149:193–202
10. Pertovaara A, Wei H, Hamalainen MM (1996) Lidocaine in the rostroventromedial medulla and the periaqueductal gray attenuates allodynia in neuropathic rats. *Neuroscience Letters* 218:127–30
11. Porreca F, Ossipov MH, Gebhart GF (2002) Chronic pain and medullary descending facilitation. *Trends Neurosci* 25:319–25
12. Skilling SR, Sun X, Kurtz HJ et al. (1992) Selective potentiation of NMDA-induced activity and release of excitatory amino acids by dynorphin: possible roles in paralysis and neurotoxicity. *Brain Res* 575:272–8
13. Wang Z, Gardell LR, Ossipov MH et al. (2001) Pronociceptive actions of dynorphin maintain chronic neuropathic pain. *J Neurosci* 21:1779–86
14. Wiertelak EP, Furness LE, Horan R et al. (1994) Subcutaneous formalin produces centrifugal hyperalgesia at a non-injected site via the NMDA-nitric oxide cascade. *Brain Res* 649:19–26
15. Zhuo M, Gebhart GF (1997) Biphasic modulation of spinal nociceptive transmission from the medullary raphe nuclei in the rat. *J Neurophysiol* 78:746–58

## Descending Facilitatory Systems

MIN ZHUO

Department of Physiology, University of Toronto,  
Toronto, ONT, Canada  
min.zhuo@utoronto.ca

## Synonyms

Descending Excitatory Modulation; Descending Anti-Analgesic Systems

## Definition

Descending facilitation systems are the descending projection functional neuronal networks originating from supraspinal structures to the spinal cord. Activation of these systems enhances or increases evoked responses of spinal sensory neurons to peripheral sensory stimulation, including noxious and non-noxious stimuli. Reduction in the neuronal threshold to sensory stimuli contributes to the facilitatory effects. These systems are likely to be active in physiological conditions, to enhance the detection, localization and reaction to potentially dangerous or noxious stimuli. In pathological conditions, activation of descending facilitatory systems contributes to persistent pain related to inflammation or nerve injury.

## Characteristics

Brain activity is able to affect sensory transmission in the spinal cord through descending modulatory systems (Basbaum and Fields 1984). Descending modulation is biphasic, including descending inhibitory and facilitatory systems. Descending projection pathways derive directly or indirectly from central nuclei, including the ► **anterior cingulate cortex** (ACC), periaqueductal gray (PAG), and brainstem rostroventral ► **medulla** (RVM). As the last step of relay nuclei, neurons in the RVM play important roles in descending inhibition and facilitation of spinal sensory transmission. Biphasic modulation of spinal nociceptive transmission from the RVM offers fine regulation of spinal sensory thresholds and responses.

Integrative approaches have been used to investigate the mechanisms for descending facilitation, including electrophysiological, pharmacological, behavioral, and biochemical studies. The key evidence for descending facilitation is from electrophysiological recording of spinal sensory dorsal horn neurons (Zhuo and Gebhart 1991; Zhuo and Gebhart 1997; Zhuo et al. 2002; Zhuo and Gebhart 2003). Through focally delivered electrical stimulation or ► **glutamate** into brain regions, it has been shown that responses of spinal dorsal horn neurons to peripheral sensory stimulation are enhanced or increased. No significant effects on spontaneous activity of spinal sensory neurons have been found. There are four major characteristics of descending facilitatory systems:

1. They affect spinal sensory transmission from both cutaneous and visceral inputs
2. They reduce the neuronal threshold to nociceptive stimulation
3. They are intensity-dependent, and stimulation at lower intensities usually leads to facilitation

4. They have longer latencies for the onset of descending facilitatory systems as compared to that of descending inhibitory systems. Descending inhibition from the RVM has a latency of 90 ms, while facilitation is 232 msec.

Descending facilitatory systems affect animals' behavioral withdrawal reflexive responses to noxious stimuli (Zhuo and Gebhart 1990; Zhuo and Gebhart 2002; Zhuo and Gebhart 1991). In the spinal nociceptive tail-flick reflex, activation of descending facilitatory systems reduces the response latency to noxious heating of the tail. In visceromotor responses to colorectal distention (noxious visceral stimuli), descending facilitatory systems enhance responses to noxious visceral stimuli. These results consistently indicate that facilitation of spinal sensory neurons' responses lead to changes in behavioral reflexive responses in intact animals. Most 5-HT-containing nerve fibers in the spinal cord originate from the RVM. Pharmacological studies, using intrathecal drug administration, found that spinal 5-HT receptors mediate descending facilitatory modulation (Zhuo and Gebhart 1991). It is likely that certain brain activity leads to the release of 5-HT at the level of the spinal cord, 5-HT binds to postsynaptic and presynaptic 5-HT receptors, and enhances responses of spinal sensory neurons to peripheral sensory (noxious and non-noxious) stimuli. The enhanced neuronal activities in spinal dorsal horn neurons, also contribute to the shortening of behavioral withdrawal response latencies by reducing the threshold.

It is important to point out that, in the case of cutaneous sensory transmission, descending facilitation is often small or difficult to elicit. This is because spinal sensory transmission receives tonic descending inhibitory modulation under normal physiological conditions. Removal of tonic descending inhibition (e. g. by lesioning the dorsolateral funiculi) often increases the chance of observing descending facilitation (Zhuo and Gebhart 1991). Recent studies from the ACC show that descending facilitation may have stronger influences in pain perception at cortical levels. Activation of neurons in the ACC, leads to pure facilitation of the spinal nociceptive tail-flick reflex in adult animals, without any significant inhibition (Calejese et al. 2000).

The cellular mechanism for descending facilitation is provided by *in vitro* spinal cord slice studies. Application of a low dose of 5-HT, or a selective 5-HT<sub>2</sub> receptor agonist, induces facilitation of fast EPSCs in the lumbar spinal cord (Li and Zhuo 1998). 5-HT at low doses could facilitate fast EPSCs in the presence of an NMDA receptor antagonist AP-5, indicating that the facilitatory effect is NMDA receptor independent. Furthermore, the facilitatory effect induced by 5-HT at low doses persists during the washout of 5-HT. While the activation of 5-HT receptors is important for the induction of the facilitation, continuous activation of these receptors is not

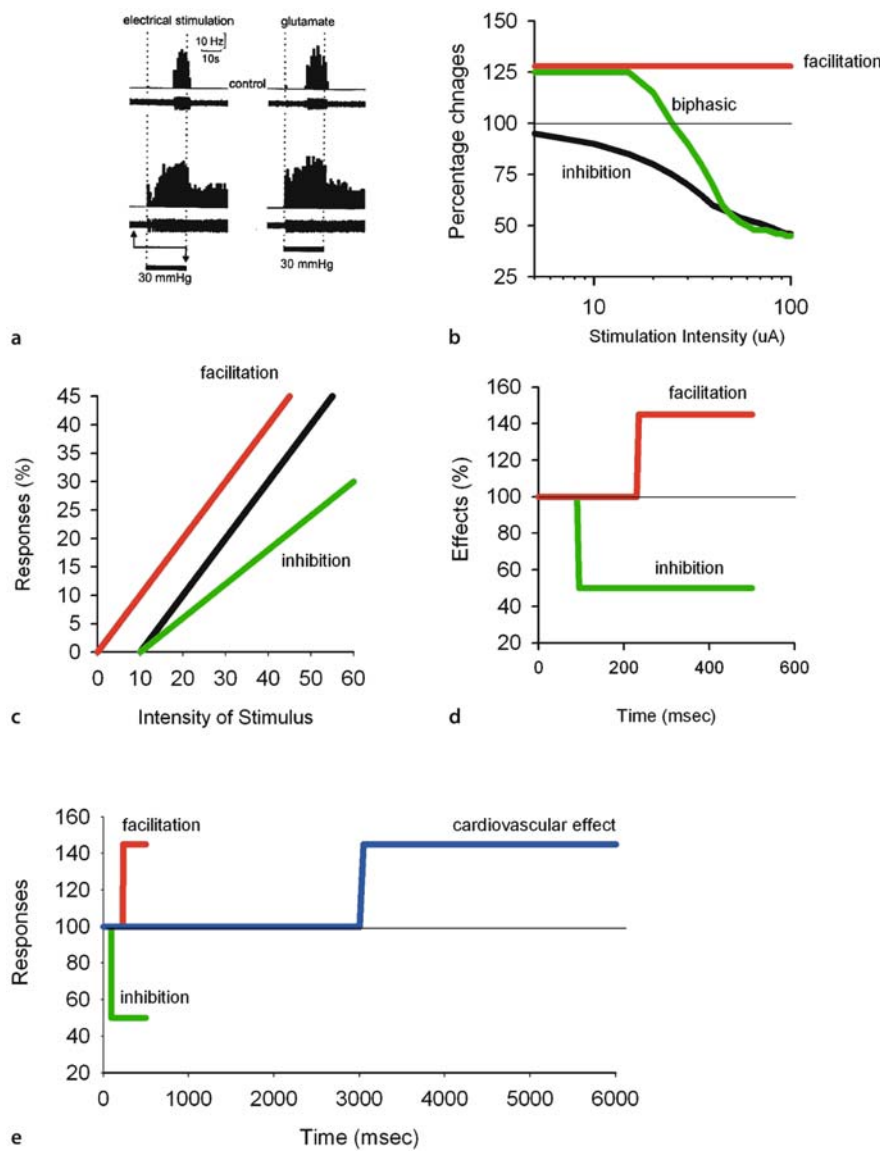
necessary for the expression of the facilitation. Application of methysergide after the 5-HT receptor agonist DOI fails to reverse the facilitatory effect (Li and Zhuo 1998).

One synaptic mechanism for the 5-HT produced facilitation is due to the recruitment of silent glutamatergic synapses. Application of 5-HT (5  $\mu$ M) causes typically fast EPSCs to appear at synapses initially lacking AMPA/kainate receptor-mediated responses. 5-HT may affect spinal sensory transmission, by acting on presynaptic or postsynaptic receptors. Postsynaptic application of G protein inhibitors, introduced through the recording pipette, abolish the effect of 5-HT to facilitate synaptic transmission, suggesting that postsynaptic 5-HT receptors are critical for the facilitatory effect. In support of this notion, postsynaptic  $Ca^{2+}$ -dependent processes are required for 5-HT-induced facilitation. In

experiments with BAPTA (1,2-bis-(o-aminophenoxy) ethane-N,N,N',N'-tetracetic acid) in the pipette solution, the facilitatory effect of 5-HT is abolished, indicating that an increase in postsynaptic  $Ca^{2+}$  is required. Additional evidence against a mechanism of 5-HT-induced synaptic facilitation, involving modulation of presynaptic glutamate release, comes from the observation that while 5-HT application clearly causes  $\blacktriangleright$  AMPA receptor mediated EPSCs, NMDA receptor mediated EPSCs are significantly decreased by 5-HT in the same neurons (Li and Zhuo 1998). This result suggests that postsynaptic enhancement of AMPA receptor mediated currents by 5-HT are selective.

One possible mechanism for the recruitment of silent synapses is the interaction of glutamate AMPA receptors and proteins containing postsynaptic density-95/Discs large/zona occludens-1 (PDZ) domains. GluR2 and

**D**



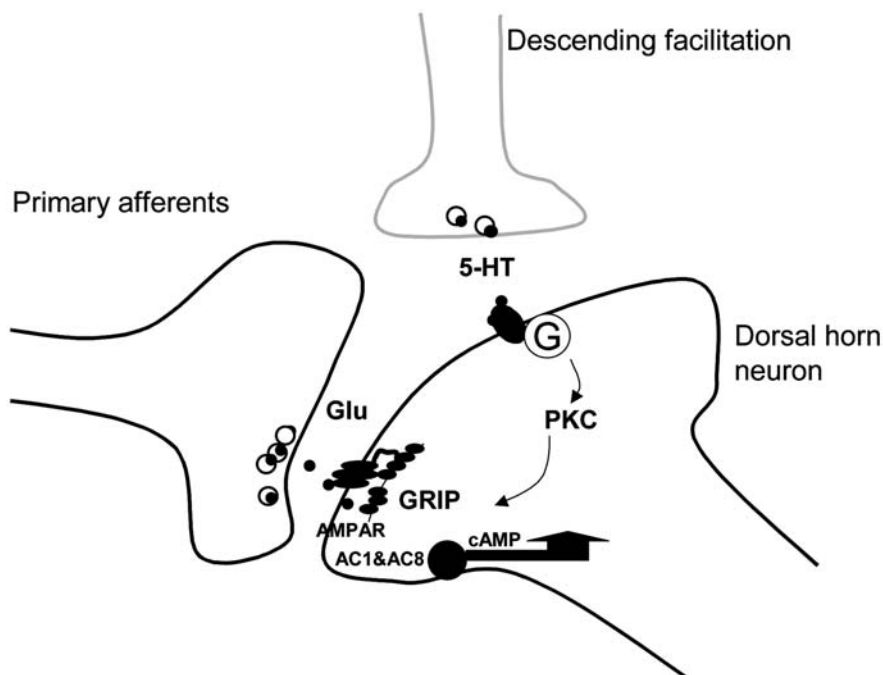
**Descending Facilitatory Systems, Figure 1** Descending Facilitatory Systems. (a) Example of facilitation of spinal visceral transmission produced by electrical stimulation and glutamate in the nucleus raphe magnus (NRM). Peristimulus time histograms (1-s binwidth) and corresponding oculographic records, in the absence (top histograms) and presence (bottom histograms) of, electrical stimulation (25  $\mu$ A) and glutamate (5 nmoles) given in the same site in NRM. The intensity and duration of colorectal distension is illustrated below; the period of electrical stimulation (25 s) is indicated by the arrows. (b) Model of intensity-dependent biphasic modulation of spinal nociceptive transmission. (c) Model of different effects of facilitatory vs. inhibitory modulation on the SRFs of spinal dorsal horn neurons. (d) Model of the latency for descending facilitatory vs. inhibitory effects from the RVM. (e) Model of electrical stimulation in the RVM on the latencies of cardiovascular vs. neuronal effects.

-3 are widely expressed in sensory neurons in the superficial dorsal horn of the spinal cord. Glutamate receptor-interacting protein (GRIP), a protein with 7 PDZ domains that bind specifically to the C-terminus of GluR2/3, is also expressed in spinal dorsal horn neurons. A synthetic peptide corresponding to the last 10 amino acids of GluR2 ("GluR2-SVKI": NVY-GIESVKI), which disrupts binding of GluR2 to GRIP (Li et al. 1999) blocks the facilitatory effect of 5-HT. Experiments with different control peptides consistently indicate that the interaction between the c-terminus of GluR2/3 and GRIP/ABP (or called GRIP1 and GRIP2) is important for 5-HT induced facilitation.

Possible developmental factors have been raised, because silent experiments require a good space clamp in neurons, thus, most are performed in young neurons. In adult mouse spinal cord dorsal horn, some synaptic responses (26.3 % of a total of 38 experiments) between primary afferent fibers and dorsal horn neurons are almost completely mediated by NMDA receptors (Wang and Zhuo 2002). Dorsal root stimulation does not elicit any detectable AMPA/kainate receptor mediated responses in these synapses. Unlike young spinal cord, 5-HT alone does not produce any long-lasting synaptic enhancement in adult spinal dorsal horn neurons. Activation of adenylyl cyclases by forskolin also

does not significantly affect synaptic responses induced by dorsal root stimulation. However, Co-application of 5-HT and forskolin produces long-lasting facilitation of synaptic responses. Possible contributors to the increases in the cAMP levels are the calcium-sensitive adenylyl cyclases. The facilitatory effect induced by 5-HT and forskolin is completely blocked in mice lacking AC1 or AC8 (Wang and Zhuo 2002). One possible scenario for regulation of two different signaling pathways, under physiological or pathological conditions, is that postsynaptic increases in cAMP levels by sensory transmitters may favor 5-HT-induced facilitation.

Descending facilitatory systems play important roles in physiological and pathological conditions. One important physiological function for descending facilitation is that the activation of descending facilitatory systems increases the input of sensory information to enhance the detection, localization and reaction to potentially dangerous or noxious stimuli. Imbalance between the descending facilitatory systems and the inhibitory systems contribute to chronic pain in pathological conditions. The recruitment of silent or ineffective synapses could significantly enhance spinal sensory transmission, including nociceptive transmission. AMPA receptors are expressed in the [▶ dorsal horn](#) neurons both at synapses receiving high- and low-



**Descending Facilitatory Systems, Figure 2** Cellular Model for Descending Facilitation at the Spinal Cord Dorsal Horn. Peripheral tissue injury activates nociceptors and causes the release of glutamate (filled circles) as well as substance P, CGRP and other putative transmitters (not shown) from the central terminals in the spinal dorsal horn. [▶ Serotonin](#) released from descending projection terminals binds to its receptors and activates protein kinase C (PKC) by G-protein coupled receptors. Activation of PKC activated a series of intracellular signaling pathways and caused long-term facilitation of AMPA receptor mediated responses. The interaction between AMPA receptors and the PDZ protein glutamate receptor-interacting protein (GRIP) are likely to contribute to the recruitment of functional AMPA responses. In adult dorsal horn neurons, the activity of adenylyl cyclase subtype 1 and 8 is required for 5-HT produced facilitatory effects. Abbreviations: Glu: glutamate; AMPARs:  $\alpha$ -amino-3-hydroxy-5-methyl-4-isoxalepropionate receptors; 5-HT: serotonin; GRIP: glutamate receptor interacting protein; AC1 and AC8: adenylyl cyclase subtype 1 and 8.



threshold inputs. Activation of silent synapses with low-threshold afferents might cause the dorsal horn neurons to exhibit an increased firing rate in response to non-noxious stimuli. Increases in postsynaptic AMPA receptor density and activation of silent synapses, could contribute to plastic changes in the electrophysiological properties of dorsal horn sensory neurons, including ascending spinothalamic tract projecting neurons. These include increased receptive fields, enhanced responses to noxious and non-noxious stimuli, decreased firing thresholds, and increased background activity. There are two pieces of evidence that indirectly support the notion that alterations to descending serotonergic influences and spinal glutamate AMPA receptors may contribute to persistent pain: first, descending serotonergic systems from the RVM to the spinal cord have been implicated in different types of hyperalgesia after tissue injury (Calejesan et al. 1998; Urban and Gebhart 1999). Second, formalin-induced inflammation causes increases in activity of 5-HT containing neurons in the RVM for up to two hours (Robinson et al. 2002). Third, changes in the expression of AMPA receptors on spinal dorsal horn neurons after tissue injury has been reported. Therefore, activation of silent synapses could serve as an important cellular mechanism underlying two features of chronic pain: hyperalgesia, where the intensity of responses to noxious stimuli is increased over baseline; and allodynia, where the nociceptive threshold is decreased, and a normally non-noxious stimulus, such a gentle touch, can induce pain.

## References

1. Basbaum AI, Fields HL (1984) Endogenous Pain Control Systems: Brainstem Spinal Pathways and Endorphin Circuitry. *Annu Rev Neurosci* 7:309–338
2. Calejesan AA, Ch'ang MHC, Zhuo M (1998) Spinal Serotonergic Receptors Mediate Facilitation of a Nociceptive Reflex by Subcutaneous Formalin Injection into the Hindpaw in Rats. *Brain Res* 798:46–54
3. Calejesan AA, Kim SJ, Zhuo M (2000) Descending Facilitatory Modulation of a Behavioral Nociceptive Response by Stimulation in the Adult Rat Anterior Cingulate Cortex. *Eur J Pain* 4:83–96
4. Li P, Zhuo M (1998) Silent Glutamatergic Synapses and Nociception in Mammalian Spinal Cord. *Nature* 393:695–698
5. Li P et al. (1999) AMPA Receptor-PDZ Interactions in Facilitation of Spinal Sensory Synapses. *Nat Neurosci* 2:972–977
6. Robinson DA, Calejesan AA, Zhuo M (2002) Long-Lasting Changes in Rostral Ventral Medulla Neuronal Activity Following Inflammation in the Adult Rat. *J Pain* 3:292–300
7. Urban MO, Gebhart GF (1999) Supraspinal Contributions to Hyperalgesia. *Proc Natl Acad Sci USA* 96:7687–7692
8. Wang GD, Zhuo M (2002) Synergistic Enhancement of Glutamate-Mediated Responses by Serotonin and Forskolin in Adult Mouse Spinal Dorsal Horn Neurons. *J Neurophysiol* 87:732–739
9. Zhuo M, Gebhart GF (1991) Characterization of Descending Facilitation and Inhibition of Spinal Nociceptive Transmission from the Nuclei Reticularis Gigantocellularis and Gigantocellularis Pars Alpha in the Rat. *J Neurophysiol* 67:1599–1614
10. Zhuo M, Gebhart GF (1997) Biphasic Modulation of Spinal Nociceptive Transmission from the Medullary Raphe Nuclei in the Rat. *J Neurophysiol* 78:746–758
11. Zhuo M, Sengupta JN, Gebhart GF (2002) Biphasic Modulation of Spinal Visceral Nociceptive Transmission from the Rostroventral Medial Medulla in the Rat. *J Neurophysiol* 87:2225–2236
12. Zhuo M, Gebhart GF (2003) Modulation of Noxious and Non-Noxious Spinal Mechanical Transmission from the Rostroventral Medial Medulla in the Rat. *J Neurophysiol* 88:2928–2941
13. Zhuo M, Gebhart GF (1990) Characterization of Descending Inhibition and Facilitation from the Nuclei Reticularis Gigantocellularis and Gigantocellularis Pars Alpha in the Rat. *Pain* 42:337–350
14. Zhuo M, Gebhart GF (2002) Biphasic Modulation of a Visceral Nociceptive Reflex from the Rostroventral Medial Medulla in the Rat. *Gastroenterology* 122:1007–1019
15. Zhuo M, Gebhart GF (1991) Spinal Serotonin Receptors Mediate Descending Facilitation of a Nociceptive Reflex from the Nuclei Reticularis Gigantocellularis and Gigantocellularis Pars Alpha in the Rat. *Brain Res* 550:35–48

D

## Descending Inhibition

### Definition

There are three types of opioid receptors,  $\mu$ ,  $\delta$ , and  $\kappa$ . These are located peripherally, in the spinal cord and in areas involved in descending inhibition, including the nucleus raphe magnus in the rostral ventral medulla (RVM) and the periaqueductal gray (PAG). The PAG sends projection to the RVM, which in turn sends projections to the spinal dorsal horn. Stimulation of the PAG or the RVM produces inhibition of dorsal horn neurons including spinothalamic tract cells. It is commonly accepted that opioid mediated inhibition produces its effects through activation of the PAG-RVM pathway. Further, the RVM pathway utilizes serotonin as a neurotransmitter. Another common inhibitory pathway is from the pontine noradrenergic cells groups, A6 (locus coeruleus) and A7 (locus subcoeruleus). These pontine neurons utilize the neurotransmitter noradrenaline and activate  $\alpha$ -2 receptors spinally to produce inhibition of dorsal horn neurons.

► [Descending Modulation of Visceral Pain](#)

► [TENS, Mechanisms of Action](#)

## Descending Inhibition/Facilitation

### Definition

Refers to the ability of certain brain areas to inhibit dorsal horn neuronal responses to nociceptive stimuli and to inhibit the sensation of pain. Descending facilitation refers to the ability of brain areas to produce a heightened sensation of pain.

► [Forebrain Modulation of the Periaqueductal Gray](#)

## Descending Inhibitory Fibers

### Definition

These fibers comprise of descending tracts in the dorsolateral funiculus (DLF) from cell bodies located in brain stem nuclei, including the nucleus raphe magnus and adjacent reticular formation, but other brain stem nuclei are also responsible for tonic descending inhibition. The fibers from these descending tracts synapse onto nociceptive neurons in the dorsal horn of the spinal cord, and inhibit their responses to noxious stimuli. The main neurotransmitter involved in this process is serotonin. Although the growth of descending inhibitory projections to the dorsal horn is well-advanced comparatively early in development, physiological maturity occurs some time later, possibly due to insufficient levels of serotonin or other neurochemicals in DLF axon terminals, or delayed maturation of dorsal horn interneurons involved in this pathway. This functional immaturity appears to be one of the reasons for much lower reflex thresholds in the infant as compared to the older child and adult.

- ▶ [Descending Modulation and Persistent Pain](#)
- ▶ [Descending Modulation of Nociceptive Processing](#)
- ▶ [Infant Pain Mechanisms](#)

## Descending Inhibitory Mechanisms and GABA Mechanisms

- ▶ [Descending Modulation and Persistent Pain](#)
- ▶ [Descending Modulation of Nociceptive Processing](#)
- ▶ [GABA Mechanisms and Descending Inhibitory Mechanisms](#)

## Descending Inhibitory Noradrenergic Pathways

### Definition

Pathways originating from noradrenergic nuclei in the brainstem to modulate (inhibit) incoming (painful) stimuli in the spinal cord.

- ▶ [Alpha\( \$\alpha\$ \) 2-Adrenergic Agonists in Pain Treatment](#)

## Descending Inhibitory Pathway for Pain

### Definition

A pain modulating pathway originating in the forebrain and terminating in the dorsal horn of the spinal cord.

- ▶ [Alternative Medicine in Neuropathic Pain](#)

## Descending Modulation and Persistent Pain

ANTTI PERTOVAARA

Department of Physiology, University of Helsinki, Helsinki, Finland

antti.pertovaara@helsinki.fi

### Synonyms

Persistent Pain and Descending Modulation

### Definition

Ascending nociceptive pathways carry information about potentially harmful peripheral events from the spinal cord to the brain, and these ascending signals may eventually evoke the sensation of pain. The magnitude of the ascending nociceptive signal and the consequent pain sensation can be greatly influenced by descending pathways originating in the brainstem and terminating in the spinal cord. In conditions that cause persistent pain, such as inflammation or injury, the function of descending pathways may change. This change may contribute to suppression or facilitation of pain sensitivity, depending among other things on the pathophysiological condition, the brainstem-spinal pathway, time course of the injury, and the type of pain.

### Characteristics

Multiple descending pathways originate in several different brainstem nuclei, release different neurotransmitters from their axonal endings at the spinal cord, and have different functional characteristics. Those descending pathways that terminate in the spinal dorsal horn, a critical relay for ascending nociceptive signals, contribute to pain modulation (Fields and Basbaum 1999). Descending pain modulatory pathways are involved in mediating the ▶ [top-down](#) and ▶ [feedback control of pain](#). This includes the optimal setting of gain for ascending signals according to various behavioral needs. In healthy animals, descending pathways predominantly suppress pain, as shown by increased spinal responses to noxious heat following inactivation of descending pathways, e.g. by a cold block at a midthoracic level (Fields and Basbaum 1999). However, descending pathways may also facilitate pain, and the same brainstem site may be a source of descending facilitation as well as inhibition. This was shown by the finding that a low concentration of glutamate, or low electrical stimulus intensity in the ▶ [rostromedial medulla](#) (RVM), produced facilitation of spinal nociception in healthy animals, whereas a high glutamate concentration or high electrical stimulus intensity in the same brainstem site suppressed spinal nociception (Urban and Gebhart 1999).

### Enhanced Inhibitory Controls

In conditions causing persistent pain, such as following injury or inflammation, the function of descending pathways may change. The first observations on the pathophysiological function of descending pain control systems indicated that the inhibitory effect of descending pathways on responses of spinal pain-relay neurons was stronger in animals with experimental arthritis than in controls (Schaible et al. 1991). Enhanced descending inhibitory controls have been observed in not only experimental arthritis, but also following paw inflammation or formalin-treatment of the skin (Ren and Dubner 2002). The enhanced inhibitory controls required a few days to develop in inflamed animals. It was accompanied by an increased inhibitory efficacy of glutamate, via action on medial medullary ► **N-methyl-D-aspartate** (NMDA) and alpha-amino-3-hydroxy-5-methyl-4-isoxazole propionic acid (AMPA) receptors, and by a phenotypic switch in the response profile of RVM neurons (Ren and Dubner 2002). These results suggest that following inflammation, the RVM and its glutamatergic receptors exhibit activity-dependent plasticity leading to enhanced inhibitory controls. Additionally, the noradrenergic ► **locus coeruleus** nucleus in the pontomesencephalic junction has an important role in the enhanced inhibition, as shown by a stronger inflammation-induced decrease of a heat-evoked spinal withdrawal latency in animals with a bilateral lesion of the locus coeruleus than in sham-operated animals (Tsuruoka and Willis 1996). Enhanced descending inhibition provides a feedback control of pain, which helps to maintain the capacity to use an injured and painful body part for fight or flight in case of emergency, giving potential evolutionary benefits

### Enhanced Facilitatory Controls

An opposite effect to the enhanced descending inhibitory controls has also been described in conditions causing persistent pain. Namely, hypersensitivity induced by inflammation or nerve injury was attenuated following brainstem lesions or a blockade of descending pathways (Herrero and Cervero 1996; Pertovaara et al. 1996; Urban et al. 1996; Wiertelak et al. 1994). This finding indicates that descending spinal pathways may contribute to hypersensitivity by facilitating nociception at the spinal cord level. Thus, persistent pain may induce not only enhanced inhibitory controls, but also enhanced facilitatory controls, or concurrently both. There is evidence suggesting that the net effect of descending controls may critically depend on whether nociceptive signals originate in the site of injury (► **primary hyperalgesia** predominantly due to peripheral mechanisms), or adjacent to it (► **secondary hyperalgesia** predominantly due to central mechanisms) (Urban and Gebhart 1999). Enhanced inhibitory controls were reported in experiments in which primary hyperalgesia was studied (Schaible et al. 1991), whereas

descending facilitation was the net effect in experiments in which secondary hyperalgesia was studied (Pertovaara 1998; Urban et al. 1996; Wiertelak et al. 1994). The net effect of descending controls may also depend on the sub-modality of pain, since it was reported that particularly mechanical and cold hypersensitivity were dependent on intact medullospinal pathways (Kauppila et al. 1998). Furthermore, the net effect of descending controls may vary from facilitation to inhibition as time progresses from the start of the injury (Ren and Dubner 2002).

### Neurocircuitry and Neurochemistry Underlying Descending Facilitation

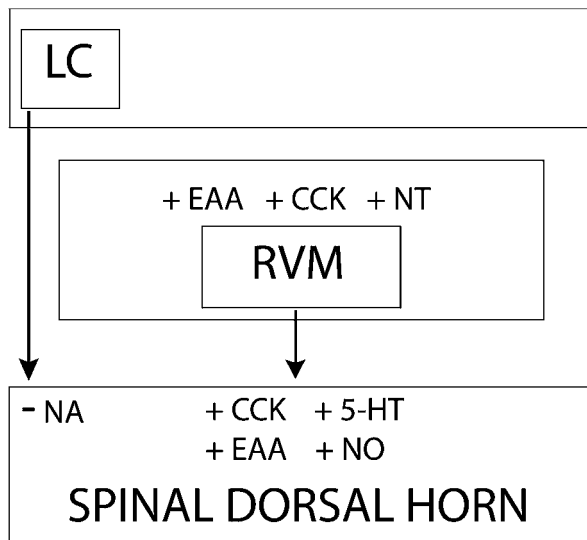
The dorsal column is at least partly involved in carrying the ascending injury signal to the brainstem level that maintains the descending facilitation, since a lesion of this ascending pathway selectively attenuated hypersensitivity in neuropathic animals (Porreca et al. 2002). The RVM, an important relay for many descending inhibitory pathways, is also a major link for mediating the facilitatory effect to the spinal cord level. Attenuation of hypersensitivity following micro-administration of a local anesthetic into the RVM or following a lesion of the dorsolateral funiculus, a major conduit of descending projections from the RVM (Urban and Gebhart 1999) demonstrates this. Glutamatergic NMDA, neurotensin and cholecystokinin B (CCK-B) receptors in the RVM are involved in the maintenance of descending facilitation, since micro-administrations of antagonists of these receptors into the RVM reduced hypersensitivity induced by neurogenic inflammation or nerve injury (Porreca et al. 2002). The finding that a single dose of an NMDA receptor antagonist microinjected into the RVM, prior to but not after a nerve injury, delayed the development of hypersensitivity, suggests that medullary NMDA receptors trigger central changes that contribute to descending facilitation (Pertovaara 2000). However, attenuation of neuropathic symptoms by local anesthesia near the injury site indicates that central changes alone are not sufficient to maintain hypersensitivity, but continuous injury discharge from the periphery is of critical importance for the sustained facilitatory action of medullo-spinal pathways (Porreca et al. 2002). From the RVM, the facilitatory action may be mediated downwards by a class of mu-opioid receptor-expressing neurons called ON-cells, which typically discharge prior to a ► **noxious stimulus** - induced withdrawal, and are considered to have a role in the induction of protective (pain) reflexes. This is suggested by the finding that immunocytochemical destruction of these RVM neurons reduced hypersensitivity, and attenuated spinal upregulation of dynorphin, a pronociceptive substance, in neuropathic animals (Porreca et al. 2002). The contribution of increased ON-cell discharge to hypersensitivity is further supported by the finding that, neurogenic inflammation-induced hy-

perreflexia was accompanied by an increase of ON-cell activity in the RVM, and these effects were reversed in parallel by an NMDA receptor antagonist (Heinricher et al. 2003). Unexpectedly, the response properties of medullary ON-neurons were not markedly changed in animals with a fully developed ▶ neuropathy (Pertovaara et al. 2001). However, a lack of change in response properties of medullary ON-neurons during the chronic phase of neuropathy, does not exclude the possibility that the afferent barrage at the time of nerve injury would have caused long-term changes in the synaptic efficacy of the spinal terminals of the RVM neurons. This spinal change would not be revealed by characterization of neuronal response properties at the medullary level. The finding that intrathecal administration of a serotonin receptor antagonist (Pertovaara et al. 2001), a CCK-B receptor antagonist (Urban et al. 1996), an NMDA receptor antagonist and a nitric oxide synthesis inhibitor (Wiertelak et al. 1994) selectively attenuated hypersensitivity suggests that serotonin, CCK, glutamate through action on NMDA receptors, and nitric oxide are involved in mediating the descending facilitatory action on spinal nociceptive neurons. Following a block of descending pathways, hypersensitivity in nociceptive spinal neurons was attenuated, but still significant (Pertovaara 1998). This finding indicates that medullary descending facilitation augments spinal segmental mechanisms, which alone

may induce significant hyperalgesia following inflammation or injury. From the evolutionary point of view, enhanced facilitation of pain might help the healing process by promoting immobilization and protection of the injured region. However, under human clinical conditions this type of pain-enhancing loop may contribute to chronic hypersensitivity and persistent pain that serves no useful purpose. Further characterization of the neurochemical basis of this facilitatory circuitry may provide novel targets for selective suppression of chronic hyperalgesia, without influence on the physiological pain mechanisms that help to protect tissues.

## References

1. Fields HL, Basbaum AI (1999) Central Nervous System Mechanisms of Pain Modulation. In: Wall PD, Melzack R (eds) *Textbook of Pain*, 4<sup>th</sup> edn. Churchill Livingstone, Hong Kong, pp 309–329
2. Heinricher MM, Pertovaara A, Ossipov MH (2003) Descending Modulation after Injury. *Prog Pain Res Manag* 24:251–260
3. Herrero JF, Cervero F (1996) Supraspinal Influences on the Facilitation of Rat Nociceptive Reflexes Induced by Carrageenan Monoarthritis. *Neurosci Lett* 209:21–24
4. Kaupilla T, Kontinen VK, Pertovaara A (1998) Influence of Spinalization on Spinal Withdrawal Reflex Responses Varies Depending on the Submodality of the Test Stimulus and the Experimental Pathophysiological Condition. *Brain Res* 797:234–242
5. Pertovaara A (1998) A Neuronal Correlate of Secondary Hyperalgesia in the Rat Spinal Dorsal Horn is Submodality Selective and Facilitated by Supraspinal Influence. *Exp Neurol* 149:193–202
6. Pertovaara A (2000) Plasticity in Descending Pain Modulatory Systems. *Prog Brain Res* 129:231–242
7. Pertovaara A, Wei H, Hämäläinen MM (1996) Lidocaine in the Rostromedial Medulla and the Periaqueductal Gray Attenuates Allodynia in Neuropathic Rats. *Neurosci Lett* 218:127–130
8. Pertovaara A, Keski-Vakkuri U, Kalmari J et al. (2001) Response Properties of Neurons in the Rostromedial Medulla of Neuropathic Rats: Attempted Modulation of Responses by [IDMe]NPYF, a Neuropeptide FF Analogue. *Neuroscience* 105:457–468
9. Porreca F, Ossipov MH, Gebhart GF (2002) Chronic Pain and Medullary Descending Facilitation. *Trends Neurosci* 25:319–325
10. Ren K, Dubner R (2002) Descending Modulation in Persistent Pain: An Update. *Pain* 100:1–6
11. Schaible HG, Neugebauer V, Cervero F et al. (1991) Changes in Tonic Descending Inhibition of Spinal Neurons with Articular Input during the Development of Acute Arthritis in the Cat. *J Neurophysiol* 66:1021–1032
12. Tsuruoka M, Willis WD (1996) Bilateral Lesions in the Area of the Nucleus Locus Coeruleus Affect the Development of Hyperalgesia during Carrageenan-Induced Inflammation. *Brain Res* 726:233–236
13. Urban MO, Gebhart GF (1999) Supraspinal Contributions to Hyperalgesia. *Proc Nat Acad Sci USA* 96:7687–7692
14. Urban MO, Jiang MC, Gebhart GF (1996) Participation of Central Descending Nociceptive Facilitatory Systems in Secondary Hyperalgesia Produced by Mustard Oil. *Brain Res* 737:83–91
15. Wiertelak EP, Furness LE, Horan R et al. (1994) Subcutaneous Formalin Produces Centrifugal Hyperalgesia at a Non-Injected Site via the NMDA-Nitric Oxide Cascade. *Brain Res* 649:19–26



**Descending Modulation and Persistent Pain, Figure 1** A schematic diagram showing one example of enhanced descending inhibitory controls and one of enhanced descending facilitatory controls in inflamed and/or nerve-injured conditions. LC: noradrenergic locus coeruleus nucleus in the pons. RVM: rostromedial medulla. - indicates inhibitory and + a facilitatory effect. NA, noradrenaline; EAA, excitatory amino acid; CCK, cholecystokinin; NT, neurotensin; 5-HT, serotonin; NO, nitric oxide. It should be noted that the RVM is also an important source of descending inhibitory controls.



## Descending Modulation of Nociceptive Processing

RONALD DUBNER

University of Maryland, Department of Biomedical Sciences, Baltimore, MD, USA  
rdubner@umaryland.edu

### Synonyms

Pain Modulation; Descending Control; pain inhibitory systems; pain facilitatory systems; endogenous analgesia systems; Supraspinal Pain Control Systems; descending pain modulation

### Definition

Information about the condition of injured peripheral tissues enters the spinal cord and then ascends to higher centers in the ► **brain stem**, thalamus and ► **cerebral cortex**, ultimately being elaborated as a complex sensory experience. What we perceive depends not only on the features of the stimulus, but is also related to its meaning, based on previous exposure to pain, its influence on our emotional state and its relevance to our survival. ► **Descending modulation of pain** refers to how the pain experience is modified at supraspinal sites in the brainstem and forebrain. It is an important component of the sensory processing of pain because it provides the neural networks by which attention, motivation and cognition modulate what we perceive.

### Characteristics

Our knowledge of the existence of endogenous descending pain modulatory systems (see ► **Pain Modulatory Systems, History of Discovery**) spans at least three decades (for comprehensive reviews, see Fields and Basbaum 1999; Millan 2002). The first line of evidence to support endogenous pain control came from the study of Reynolds (1969) who demonstrated that focal brain stimulation of the ► **periaqueductal gray** (PAG) produced sufficient analgesia to permit abdominal surgery. Liebeskind and colleagues confirmed this finding and concluded that stimulation of the PAG activated a normal function of the brain, pain inhibition (Mayer et al. 1971; Mayer and Liebeskind 1974). They labeled the phenomenon, ► **stimulation-produced analgesia** (SPA). These early studies found SPA to be specifically ► **antinociceptive** – producing no generalized sensory, attentional, emotional or motoric deficits. They also showed that SPA could outlast the period of brain stimulation and that it occurred in a restricted peripheral field, such that noxious stimuli applied outside that field elicited normal defensive reactions. They reported that during stimulation the sensation of light touch was intact, there was no indication

of seizure activity and animals were still capable of eating. The analgesia produced by electrical stimulation of the PAG was of rapid onset and as potent as high doses of morphine – completely inhibiting withdrawal responses to even the most severe noxious stimuli.

An important final common descending modulatory site in the brain stem is the ► **RVM** or ► **rostral ventromedial medulla**, whose major component is the ► **nucleus raphe magnus** (NRM). The RVM receives signals directly from the PAG and indirectly from ► **forebrain** sites such as the prefrontal cortex, the amygdala and the anterior cingulate gyrus (Bandler and Shipley 1994). The descending PAG-RVM circuit is involved in the emotional, motivational and cognitive factors that modulate the sensation of pain. Numerous anatomical studies have demonstrated that PAG afferents arise predominantly in the forebrain. PAG receives significant innervation from a number of cortical and subcortical sites involved in nociception. These forebrain projections terminate with a high degree of topographical specificity, forming sets of longitudinal input columns extending focally throughout the rostrocaudal extent of PAG. Several of these same forebrain structures send parallel projections to the RVM. These sites include the medial preoptic area (MPO), central nucleus of the amygdala (CNA) and certain medial prefrontal cortical fields. Thus the PAG is ideally positioned to integrate information from sensory systems in the brainstem / spinal cord with information from higher processing in the forebrain and is thought to modulate a number of homeostatic processes including fear, anxiety, cardiovascular tone and vocalization. The descending nociceptive modulation from PAG appears to be normally under tonic ► **Gamma( $\gamma$ )-Aminobutyric Acid** (GABA) inhibitory control. Endogenous and exogenous opiates acting within the PAG probably produce analgesia *via* inhibition of inhibitory GABA containing interneurons and thereby activate (disinhibit) PAG output neurons.

Besson and colleagues were the first to show that electrical stimulation of the nucleus raphe magnus in the RVM suppressed behavioral responses to a strong pinch of the tail or the limbs as well as modifying the threshold of the jaw opening reflex (Oliveras et al. 1975). Perhaps the most important finding concerning SPA was that analgesia induced by brain stimulation shared several characteristics with analgesia from opiate drugs. Areas of the brain from which SPA could be elicited were rich in opiate receptors and microinjection of morphine into these brain regions produced analgesia, indicating that common brain sites support both SPA and opiate analgesia. Tsou and Jang (1964) discovered that the most sensitive sites for the analgesic action of ► **morphine** were located in the PAG and the adjacent hypothalamic periventricular area. This led

to the hypothesis that opiate drugs like morphine acted by binding to a receptor in the brain (Pert and Snyder 1973) and that there were probably endogenous ligands or chemical mediators whose actions were mimicked by opiates. These findings led to the discovery of the ► **endogenous opioid peptides** (Goldstein et al. 1979; Hughes et al. 1975) and subsequently to the cloning of the three major subtypes of ► **opioid receptors**, mu, delta and kappa (Chen et al. 1993; Evans et al. 1992; Kieffer et al. 1992; Thompson et al. 1993).

Electric shock, restraint, rotation, forced swim and intruder threat can all produce analgesia in laboratory animals without producing identifiable tissue damage (Hayes et al. 1978). Since the same environmental influences are known to produce stress and activate the hypothalamic-pituitary-adrenal (HPA) axis, this has been called "► **stress-induced analgesia** (SIA). Timing, severity and location of a single stressor were all eventually reported to differentially produce opioid and nonopioid SIA (Terman et al. 1984). Some forms of opioid SIA, although depending on descending pain inhibitory pathways, appear to be activated entirely by the physical properties of the stressor and can be elicited even in the surgically anesthetized animal (Terman et al. 1984). On the other hand, other forms of opioid SIA depend on learning mechanisms and can be blocked by decerebration, muscarinic antagonists, amygdala lesions and pentobarbital anesthesia. Placing rats in a cage where foot shock was previously received, but is not currently administered, can also elicit analgesia ("► **conditioned analgesia**"). Evidently, animals can not only activate their intrinsic pain inhibitory systems in the presence of stress, but they can also learn to activate them in anticipation of such stimuli. Unconditioned expectations also appear capable of activating opioid descending pain inhibitory substrates. The scent of an animal's natural predator for instance can induce analgesia.

#### **Bidirectional Descending Control**

Early studies established the presence of a descending inhibitory pain modulatory circuit linking the brain stem PAG and RVM with the ► **spinal cord** (see Basbaum and Fields 1984; Fields and Basbaum 1999; Gebhart 1986; Millan 2002, for reviews). However, we now know that there are parallel ► **descending facilitatory mechanisms** (see Gebhart 2004; Ren and Dubner 2002, for reviews). Brain stem descending pathways also facilitate nociceptive transmission at the spinal cord level. Excitation and inhibition of dorsal horn neurons can be produced by stimulation of the ► **dorsolateral funiculus** of the spinal cord (Dubuisson and Wall 1979; McMahon and Wall 1988), NRM (Dubuisson and Wall 1980) and nucleus reticularis gigantocellularis (NGC) (Haber et al. 1980). In the NGC, low intensity electrical stimulation or microinjection of a low dose of

► **glutamate** or neurotensin produce facilitation of behavioral and spinal dorsal horn neuronal responses to noxious stimulation (Thomas et al. 1995; Urban and Gebhart 1999; Zhou et al. 2002; Zhuo and Gebhart 1992). RVM neurons may exert bi-directional control of nociception through descending serotonergic pathways and ► **descending noradrenergic pathways** (Holden et al. 1999; Zhuo and Gebhart 1991). Descending inhibitory influences from the RVM travel mainly in the dorsolateral funiculus whereas descending facilitatory effects reach the spinal cord *via* the ventral and ► **ventrolateral funiculi** (Zhuo et al. 2002).

#### **Descending Modulation of Visceral Pain**

Descending modulation of visceral pain processing at the spinal level is also under the control of both facilitatory and inhibitory influences. Activation of neurons in the RVM attenuates responses to inflammation of the viscera (Coutinho et al. 1998; Urban et al. 1999). Electrical stimulation or glutamate microinjection into the PAG, RVM or the NGC inhibits the activity of dorsal horn neurons responsive to visceral afferent fiber stimulation or noxious ► **colorectal distension** (CRD) (Ammon et al. 1984; Cervero et al. 1985; Ness and Gebhart 1987). Other studies have shown that spinal visceral input is subject to facilitation from descending brain stem sites (Zhou et al. 2002). These descending effects are intensity dependent with facilitation produced by the lowest levels of electrical stimulation or drug doses and higher levels of stimulation accounting for descending inhibition at RVM and PAG sites. In addition, multiple transmitters may exert different actions depending on the type of neurons stimulated and the receptors activated (Park and Al-Chaer 2002). In addition, stimulus dependent vagal afferent stimulation has also been shown to produce facilitation and inhibition of the nociceptive tail flick reflex as well as dorsal horn nociceptive neuronal activity (Randich and Gebhart 1992). Vagal afferents transmit signals from the esophagus, lower airways, heart, gastrointestinal tract, liver, gallbladder and pancreas to the nucleus tractus solitarius in the medulla oblongata. Pharmacological activation of vagal afferents with intravenous administration of serotonin or low dose opioids also inhibits spinal nociceptive reflexes and the response of ► **spinothalamic neurons** to noxious stimuli.

#### **Functional Properties of RVM Neurons**

In the RVM, two types of cells have been identified by Fields and colleagues (Fields et al. 1991) as pain modulatory neurons. ► **On-cells** are characterized by a sudden increase in activity before the initiation of a nocifensive behavior, in this case, a tail flick to a transient noxious heat stimulus. ► **Off-cells** exhibit a pause in activity just prior to the initiation of the tail flick.

While off-cells are usually associated with the inhibition of ► [nocifensive behavior](#), on-cells are correlated with a facilitation of nocifensive behavior. A third type of cell, the ► [neutral cell](#), was also identified but its activity was not correlated with nocifensive behavior in response to transient stimuli.

The RVM also contains serotonergic cell types. Serotonergic cells comprise about 15% of the cells in RVM. Most serotonergic RVM cells send unmyelinated axons through the dorsolateral funiculus into the spinal cord. Most serotonergic cells contain at least one and often several co-transmitters, including excitatory and inhibitory amino acids and a plethora of neuropeptides (Bowker et al. 1982). Since decreasing the availability of serotonin or antagonizing the activation of serotonergic receptors strongly attenuates antinociception, serotonergic RVM cells were originally thought to be the antinociceptive output cell of the RVM. However, serotonergic RVM cells are not activated by midbrain periaqueductal gray stimulation or opioid administration that evokes analgesia. Further, supraspinal opioid administration that causes analgesia does not consistently evoke serotonin release in the spinal cord. Serotonergic RVM cells fire at their highest rates when an animal is active and moving about, fire progressively more slowly as an animal proceeds from drowsy to slow wave sleep and are silent during rapid eye movement sleep. Within the dorsal horn, serotonin is likely to primarily function by presynaptically modulating the release of glutamate and other transmitters (Li and Zhuo 1998).

A second neurochemically distinct monoamine descending system involves noradrenergic neurons whose cell bodies are in A5, A6 and A7 cell groups in the brainstem. Several studies indicate that a descending norepinephrine (NE) system can mediate analgesia and dorsal horn inhibition and that the NE descending system is critical for opiate induced analgesia. Blockade of PAG SPA by intrathecal  $\alpha_2$  adrenergic antagonists (Graham et al. 1997) emphasizes the importance of noradrenergic systems in descending nociceptive modulation.

#### **Persistent Pain and Descending Modulation**

Earlier studies of descending modulation mainly focused on responses to acute or transient stimuli. In contrast, recent studies have examined the effects of persistent pain on descending modulation following tissue damage or nerve injury. These persistent, or chronic, pain conditions are associated with prolonged functional changes in the nervous system, evidenced by the development of dorsal horn hyperexcitability and ► [activity dependent plasticity](#), also commonly referred to as spinal ► [central sensitization](#) (for reviews see Dubner and Ruda 1992; Woolf and Salter 2000).

There is evidence of enhanced net descending inhibition after inflammation at sites of ► [primary hyperalgesia](#). Primary hyperalgesia involves increased sensitivity of primary afferent neurons (peripheral sensitization) as well as central sensitization. Descending inhibition is greater in neurons with input from an inflamed knee as compared to a non-inflamed knee (Schaible et al. 1991). In rats with hind paw inflammation, spinal cord lidocaine block leads to an enhanced activity of dorsal horn nociceptive neurons that is greater in inflamed than that in non-inflamed rats (Ren and Dubner 1996). Similar findings are found using Fos protein expression (see ► [c-Fos](#)) as a marker of neuronal activation. There are more inflammation induced Fos-immunoreactive neurons in the dorsal horn in spinally transected or dorsolateral funiculus lesioned rats as compared to sham-operated inflamed rats (Ren and Ruda 1996; Wei et al. 1998). Kauppila et al. (1998) showed that thermal but not mechanical nociceptive responses were further enhanced in hind paw inflamed and spinal nerve ligated rats after midthoracic spinalization. Finally, hyperalgesia is intensified in rats with lesions of the dorsal lateral quadrant of the spinal cord after inflammation or formalin injection (Abbott et al. 1996; Ren and Dubner 1996). These studies reveal the net descending inhibitory effects of activation of multiple supraspinal sites. The findings suggest that injury induced dorsal horn hyperexcitability and primary hyperalgesia are dampened by descending pathways, due to enhancement of descending net inhibitory effects. The source of the enhanced net inhibition can be found in the brain stem. Local anesthesia of the RVM results in a further increase in dorsal horn nociceptive neuronal activity in hind paw inflamed rats (Ren and Dubner 1996). Focal lesions of the RVM and ► [locus coeruleus](#) produce an increase in spinal Fos expression and hyperalgesia after inflammation (Tsuruoka and Willis 1996a; Tsuruoka and Willis 1996b; Wei et al. 1999b). It appears that both RVM and locus coeruleus descending pathways are major sources of enhanced net inhibition in inflamed animals.

After inflammation, descending facilitation parallels inhibition but can also dominate it, resulting in a net enhancement of activity or hyperalgesia. The selective destruction of the NGC with a soma selective neurotoxin, ibotenic acid, leads to an attenuation of hyperalgesia and a reduction of inflammation induced spinal Fos expression (Wei et al. 1999a). A descending facilitatory effect may also originate from the medullary dorsal reticular nucleus (Lima and Almeida 2002) and other brain sites such as the ► [anterior cingulate cortex](#) (Calejesan et al. 2000).

A descending facilitatory drive contributes to the pathogenesis of certain types of persistent pain, particularly those associated with ► [secondary hyperalgesia](#)

or nerve injury (Porreca et al. 2002; Ren and Dubner 2002). Spinalization blocks mustard oil produced secondary mechanical allodynia and mechanical hyperexcitability of spinal nociceptive neurons (Mansikka and Pertovaara 1997). Hind paw formalin induced hyperalgesia is prevented by RVM lesions (Wiertelak et al. 1997). RVM lesions inhibit secondary hyperalgesia produced by topical application of mustard oil (Urban and Gebhart 1999). The same phenomenon occurs in models of ► [neuropathic pain](#). The tactile allodynia after nerve injury is dependent upon a tonic activation of net descending facilitation from supraspinal sites (Ossipov et al. 2000). In nerve injured rats, lesions of the dorsolateral funiculus, local anesthetic block of the RVM and lesions of RVM mu-opioid receptor expressing cells do not prevent the onset, but reverse the later maintenance of tactile and thermal hyperalgesia (Burgess et al. 2002; Porreca et al. 2001). These observations point to an ascending-descending loop that is activated in response to prolonged stimulation and resulting in facilitation at the spinal level. Although most of the above studies have concluded that the hyperalgesia is dependent completely on facilitatory influences from the brain stem, it should be noted that the same effects can be produced by a reduction in descending facilitation leading to a dominance of descending inhibition. Thus, inflammatory secondary hyperalgesia and neuropathic hyperalgesia may be dependent on a net descending facilitatory effect. Both facilitatory and inhibitory circuitry may be activated by ascending input after injury (Gozariu et al. 1998; Herrero and Cervero 1996; Terayama et al. 2000). There is an increase in on- and off-cell activity after inflammation (Miki et al. 2002). What appears to be important then is the balance between synaptic excitation and inhibition under different conditions. It has been shown previously that the NGC plays a role in descending facilitation of nociceptive transmission after transient noxious stimuli (Zhuo and Gebhart 1992). Lesions of the NGC produce an attenuation of hyperalgesia and spinal Fos expression after inflammation (Wei et al. 1999). However, combined NGC and NRM lesions reverse the opposite NGC or NRM lesion induced effects. It appears that severe persistent pain may be enhanced when the descending facilitatory drive overrides the descending inhibitory drive.

#### **Dynamic Shifts in Descending Modulation after Injury**

Studies indicate that the enhancement of descending inhibition in response to tissue injury appears to build up gradually (Danziger et al. 1999; Dubner and Ren 1999; Hurley and Hammond 2000; Ren and Dubner 1996; Ren and Ruda 1996; Schaible et al. 1991). An effect of Freund's adjuvant on the spinal cord contralateral to tissue injury may also be subject to the

inhibitory control of descending inputs as suggested by a clear contralateral increase in Fos-positive cells in transected rats after inflammation (Ren and Ruda 1996). It appears that following inflammation, brain-stem descending pathways become progressively more involved in suppressing incoming nociceptive signals in primary hyperalgesic zones. Injury related primary afferent input is probably responsible for triggering this ascending-descending feedback circuit. This enhancement of descending inhibition appears to be present when the animal is subject to continuous, persistent noxious stimulation.

Persistent inflammation induces dramatic changes in the excitability of RVM pain modulating circuitry, suggesting that there are dynamic temporal changes in synaptic activation in the brain stem after inflammation (Guan et al. 2002; Terayama et al. 2000). Early (up to 3 h) in the development of inflammation there is an increased descending facilitation as shown previously (Urban and Gebhart 1999), which reduces the net effect of the inhibition. Over time, the level of descending inhibition increases, or descending facilitation decreases, leading to a net enhancement of antinociceptive behavior. Direct stimulation of the dorsolateral funiculus that bypasses brain stem synaptic mechanisms does not produce a dynamic change in excitability, indicating that the changes are due to supraspinal mechanisms at the level of the RVM or higher.

What are the cellular mechanisms that underlie these changes? ► [Excitatory amino acids](#) (EAAs) have previously been shown to mediate descending modulation in response to transient noxious stimulation and early inflammation (Heinricher et al. 1999; Urban and Gebhart 1999 for review;) and they appear to be involved in the development of RVM excitability associated with inflammation and persistent pain (Guan et al. 2002; Miki et al. 2002; Terayama et al. 2000). At 3 h post-inflammation, low doses of NMDA, a prototype NMDA receptor agonist, microinjected into the RVM produces facilitation of the response to noxious heat of the inflamed hind paw, supporting previous findings (Urban and Gebhart 1999). Higher doses of NMDA at 3 h post-inflammation only produce inhibition. At 24 h post-inflammation, NMDA produces only inhibition. All of these effects are blocked by administration of NMDA receptor antagonists. AMPA, a selective AMPA receptor agonist, produces dose- and time-dependent inhibition at 3 and 24 h post-inflammation that is blocked by an AMPA receptor antagonist. The above findings indicate that there is an increase in the potency of the dose-response curves of NMDA- and AMPA-produced inhibition at 24 h post-inflammation as compared to 3 h. The leftward shift of the dose-response curves of EAA receptor agonists parallels the time dependent enhancement of net descending



inhibition produced by RVM electrical stimulation. The results suggest that the time dependent functional changes in descending modulation are mediated in part by enhanced EAA neurotransmission.

Rats with inflammatory hyperalgesia exhibit an increased sensitivity to ► **opioid analgesics** (Neil et al. 1986). Typically, there is a leftward shift of the dose-response curve for opioids from the inflamed hyperalgesic paw when compared to the non-inflamed paw (Hylden et al. 1991). Kayser et al. (1991) suggesting that this increased opioid sensitivity in inflamed animals is related to a peripheral mechanism, as it is significantly attenuated after local injections of very low doses (0.5–1 µg) of naloxone. Recent observations indicate that the increased opioid sensitivity after inflammation may also reflect changes in central pain modulating pathways. Hurley and Hammond (2000, 2001) have demonstrated enhancement and plasticity of the descending inhibitory effects of mu and delta-2 opioid receptor agonists microinjected into the RVM during the development and maintenance of inflammatory hyperalgesia. It is likely that opioid peptide activation or GABA ► **disinhibition** (Fields and Basbaum 1999) are also important in the initiation and maintenance of RVM plasticity.

#### **Molecular Mechanisms of Plasticity in the RVM**

What are the molecular and cellular mechanisms of this increased potency leading to enhanced synaptic activity and increases in descending net inhibition associated with primary hyperalgesia? Recent studies have examined whether transcriptional, translational and posttranslational changes occur in the RVM after inflammation and may underlie the changes in EAA receptor sensitivity observed. Examination of the mRNA expression of the NR1, NR2A and NR2B subunits of the NMDA receptor in the RVM revealed an up-regulation that parallels the time course of the RVM excitability changes (Miki et al. 2002). This is accompanied by an increase in NMDA receptor protein. There is also an increase in receptor phosphorylation of the NR2A subunit of the NMDA receptor in the RVM after inflammation (Turnbach et al. 2003). Western blot analysis revealed a time dependent increase in the AMPA receptor GluR1 subunit levels in the RVM at 5 h and 24 h post-inflammation as compared to naïve animals (Guan et al. 2004). Western blots also demonstrated that GluR1 phosphoprotein levels were increased as early as 30 min and were time dependent, suggesting that posttranslational receptor phosphorylation may also contribute to the enhanced AMPA transmission (Guan et al. 2004). These findings support the hypothesis that activity dependent plasticity takes place at the RVM level and involves both changes in excitatory amino acid receptor gene

and protein expression and increased phosphorylation of these receptors.

This activity induced plasticity in pain modulating circuitry after inflammation complements the activity dependent neuronal plasticity in ascending pain transmission pathways (Dubner and Ruda 1992; Ren and Dubner 2002). Inflammation leads to ► **peripheral sensitization** of nociceptors and central sensitization or activity dependent plasticity of spinal nociceptive neurons. The increased neuronal barrage at the spinal level activates spinal projection neurons, which leads to activation of glutamatergic, opioidergic and GABAergic neurons at the brain stem level and a similar, but not identical, form of activity dependent plasticity.

#### **Phenotypic Changes in the RVM after Inflammation**

The time dependent plasticity in descending pain modulatory circuitry also involves changes in the response profiles of RVM neurons. Miki et al. (2002) used paw withdrawal latency as a behavioral correlate to assess the relationship between nocifensive behavior and RVM neural activity after inflammation. Similar to the findings of Fields et al. (1991), who correlated tail flick responses to RVM neural activity after transient noxious thermal stimuli, Miki et al. (2002) observed on-like, off-like and neutral-like cells based on the relationship of their responses to paw withdrawal behavior during the development of inflammation. They found that some neutral-like cells changed their response profile and were reclassified as on- or off-like cells during continuous recordings of 5 h or more. The change in the response profile of RVM neurons correlated with the temporal changes in excitability in the RVM after inflammation (Terayama et al. 2000). This phenotypic switch of RVM neurons was verified in a population study which showed that there was a significant increase in the percentage of on-like and off-like cells, and a decrease in the neutral-like cell population 24 h after inflammation. There was also a greater increase in the magnitude of the responses of on-like cells after inflammation as compared to on-like responses in naïve controls, suggesting an increase in facilitatory drive in the RVM. In contrast, off-like responses were reduced after inflammation, suggesting an increase in inhibitory descending activity originating in the RVM. However, it is difficult to predict the net effect of descending facilitation and inhibition from changes in single neuronal activity without recording from very large populations of neurons.

Although the on and off cell classification system explains much of the existing data, a number of unanswered questions remain. For instance, cells that are excited by noxious stimulation are not inhibited by morphine in the conscious animal (Martin et al. 1992). After inflammation, some cells have different response

properties depending upon the site of peripheral stimulation (Ren and Dubner, unpublished). In conscious animals, the function of these neurons may be more tightly linked to behavioral state than other aspects of the stimulus conditions (Fields 2004). RVM neurons clearly participate in a number of processes in addition to pain modulation. How individual RVM neurons contribute to multiple modulatory functions is part of the future challenge in this field.

#### Placebo Analgesia and Hypnosis: Role of Descending Effects

► **Placebo analgesia** is that component of the reduction of pain due to an inert treatment (or the nonactive component of an active treatment) administered to a subject who expects that it will reduce pain. Thus, the context in which a placebo is administered and the expectation of the subject influence the level of analgesia produced. Conditioning stimulation can also influence the level of analgesia, but such conditioning effects appear to involve ► **cognitive** functions and are not merely reflex effects. The neural mechanisms of the placebo effect are unclear. There are numerous studies that suggest that the placebo effect, in part, involves ► **endogenous opioid pathways** and descending modulation. Studies using ► **positron emission tomography (PET)** have shown that the brain regions in the cerebral cortex and in the brainstem influenced by a placebo manipulation are also those activated by opioids, suggesting similar mechanisms in placebo induced and opioid induced analgesias (Petrovic et al. 2002). The areas activated include the rostral anterior cingulate cortex, the orbitofrontal cortex and the brain stem. In addition, there are several pharmacological studies which show that placebo analgesia is attenuated or reversed by the opioid receptor antagonist naloxone (Amanzio and Benedetti 1999; Grevert et al. 1983; Levine et al. 1978, Levine and Gordon 1984), providing further evidence for the involvement of opioid mechanisms. It is important to note that placebo analgesia can also be insensitive to opioid receptor antagonists, suggesting that chemical mediators other than opioids may be involved (Amanzio and Benedetti 1999; Gracely et al. 1983).

Hypnotically induced reductions in pain are induced by suggestions and facilitated by alterations of consciousness (Hilgard and Hilgard 1983; Price and Barrell 1990; Raineville and Price 2003). ► **Hypnosis** can alter the sensory discriminative component of pain (see ► **Pain in Humans, Sensory-Discriminative Aspects**) as well as the ► **affective dimension**. The efficacy of ► **hypnotic analgesia** depends on several factors including the pain dimension that is measured, baseline pain intensity, the maintained presence of the hypnotist or hypnotic suggestions and finally hypnotic ability (Price and Barber 1987). The neural mechanisms

underlying hypnotic analgesia are poorly understood though it is thought that both ascending and descending nociceptive pathways are involved.

#### Clinical Implications

Descending modulation and activity dependent plasticity are normal functions of the brain and presumably are activated to protect the organism from further environmental injury. Ren and Dubner (2002) propose that after inflammatory primary hyperalgesia, the early facilitation may function to enhance nociceptive escape behavior, whereas the dominant late inhibition may provide a mechanism by which movement of the injured site is suppressed or reduced to aid in healing and recuperation. In contrast, Gebhart (2004) provides an anthropomorphic explanation in which the need to escape from a predator requires enhanced control of pain and thus more descending inhibition (e.g. the football player who breaks an ankle but continues to run in order to score a touchdown). The Gebhart proposal is supported by opioid and nonopioid mechanisms of stress induced analgesia seen in animals (Hayes et al. 1978), but is not consistent with the enhanced descending facilitation found at sites of secondary hyperalgesia. Gebhart hypothesizes that descending facilitation is necessary to maintain secondary hyperalgesia as the tissue heals and to protect the injured tissue from further insult. It is clear that enhanced modulation includes shifts in the balance between inhibitory and facilitatory components. Recuperation from an injury involves the need for this balance, which may shift depending upon the behavioral state of the animal, which has other survival needs besides the control of pain. Present evidence suggests that there is a different balance in neural networks receiving input from zones of secondary hyperalgesia where there is no primary injury. The balance towards facilitatory influences appears to be maintained for longer periods after permanent types of nerve injury. Activation of these sites would lead to an enhancement of movement behavior that could also be protective.

The imbalance between these modulatory pathways may also be one mechanism underlying variability in other persistent or ► **chronic pain** conditions, especially those involving deep tissues such as muscle and viscera. Inputs from deep tissues produce more robust dorsal horn hyperexcitability and plasticity than inputs from cutaneous tissues. Primary afferent and spinal neurons originating from muscle and viscera are often multimodal and responsive to innocuous as well as noxious stimuli. An imbalance of descending modulatory systems in which there is an increase in endogenous facilitation could lead to innocuous input being perceived as painful. For patients suffering from deep pains, such as ► **temporomandibular disorders**,

► fibromyalgia, ► irritable bowel syndrome and ► low back pain, the diffuse nature and amplification of persistent pain may in part be the result of a net increase in endogenous descending facilitation.

## References

- Abbott FV, Hong Y, Franklin KB (1996) The effect of lesions of the dorsolateral funiculus on formalin pain and morphine analgesia: a dose-response analysis. *Pain* 65:17–23
- Amanzio M, Benedetti F (1999) Neuropharmacological dissection of placebo analgesia: expectation-activated opioid systems versus conditioning-activated specific sub-systems. *J Neurosci* 19:484–494
- Ammon WS, Blair RW, Foreman RD (1984) Raphe magnus inhibition of primate T<sup>1</sup>-T<sub>2</sub> spinothalamic cells with cardiopulmonary visceral input. *Pain* 20:247–260
- Bandler R, Shipley MT (1994) Columnar organization in the midbrain periaqueductal gray: modules for emotional expression? *Trends Neurosci* 17:379–389
- Basbaum AI, Fields HL (1984) Endogenous pain control systems: brainstem spinal pathways and endorphin circuitry. *Annu Rev Neurosci* 7:309–338
- Bowker RM, Westlund KN, Sullivan MC et al. (1982) Transmitters of the raphe-spinal complex: immunocytochemical studies. *Peptides* 3:291–298
- Burgess SE, Gardell LR, Ossipov MH et al. (2002) Time-dependent descending facilitation from the rostral ventromedial medulla maintains, but does not initiate, neuropathic pain. *J Neurosci* 22:5129–5136
- Calejesan AA, Kim SJ, Zhuo M (2000) Descending facilitatory modulation of a behavioral nociceptive response by stimulation in the adult rat anterior cingulate cortex. *Eur J Pain* 4:83–96
- Cervero F, Lumb BM, Tattersall JEH (1985) Supraspinal loops that mediate visceral inputs to thoracic spinal cord neurons in the cat: involvement of descending pathways from raphe and reticular formation. *Neurosci Lett* 56:189–194
- Chen Y, Mestek A, Liu J et al. (1993) Molecular cloning and functional expression of a mu-opioid receptor from rat brain. *Mol Pharmacol* 44:8–12
- Coutinho SV, Urban MO, Gebhart GF (1998) Role of glutamate receptors and nitric oxide in the rostral ventromedial medulla in visceral hyperalgesia. *Pain* 78:59–69
- Danziger N, Weil-Fugazza J, Le Bars D et al. (1999) Alteration of descending modulation of nociception during the course of monoarthritis in the rat. *J Neurosci* 19:2394–2400
- Dubner R, Ren K (1999) Endogenous mechanisms of sensory modulation. *Pain* 6:45–53
- Dubner R, Ruda MA (1992) Activity-dependent neuronal plasticity following tissue injury and inflammation. *Trends Neurosci* 15:96–103
- Dubuisson D, Wall PD (1979) Medullary raphe influences on units in laminae 1 and 2 of cat spinal cord. *J Physiol* 300:33
- Dubuisson D, Wall PD (1980) Descending influences on receptive fields and activity of single units recorded in laminae 1, 2 and 3 of cat spinal cord. *Brain Res* 199:283–298
- Evans CJ, Keith DE Jr, Morrison H et al. (1992) Cloning of a delta opioid receptor by functional expression. *Science* 258:1952–1955
- Fields H (2004) State-dependent opioid control of pain. *Nat Rev Neurosci* 5:565–575
- Fields HL, Basbaum AI (1999) Central nervous system mechanisms of pain modulation. In: Wall PD, Melzack R (eds) *Textbook of Pain*. Churchill Livingstone, London, pp 309–329
- Fields HL, Heinricher MM, Mason P (1991) Neurotransmitters in nociceptive modulatory circuits. *Annu Rev Neurosci* 14:219–245
- Gebhart GF (1986) Modulatory effects of descending systems on spinal dorsal horn neurons. In: Yaksh TL (ed) *Spinal Afferent Processing*. Plenum, New York, pp 391–416
- Gebhart GF (2004) Descending modulation of pain. *Neurosci Bio Behav Rev* 729–737
- Goldstein A, Tachibana S, Lowney LI et al. (1979) Dynorphin-(1-13), an extraordinarily potent opioid peptide. *Proc Natl Acad Sci USA* 76:6666–6670
- Goziaru M, Bouhassira D, Willer JC et al. (1998) The influence of temporal summation on a C-fibre reflex in the rat: effects of lesions in the rostral ventromedial medulla (RVM). *Brain Res* 792:168–172
- Graham BA, Hammond DL, Proudfit HK (1997) Differences in the antinociceptive effects of alpha-2 adrenoceptor agonists in two substrains of Sprague-Dawley rats. *J Pharmacol Exp Ther* 283:511–19
- Gracely RH, Dubner R, Wolskee PJ et al. (1983) Placebo and naloxone can alter postsurgical pain by separate mechanisms. *Nature* 306:264–265
- Grevert P, Albert LH, Goldstein A (1983) Partial antagonism of placebo analgesia by naloxone. *Pain* 16:129–143
- Guan Y, Terayama R, Dubner R et al. (2002) Plasticity in excitatory amino acid receptor-mediated descending pain modulation after inflammation. *J Pharmacol Exp Ther* 300:513–520
- Guan Y, Guo W, Robbins, MT et al. (2004) Changes in AMPA receptor phosphorylation in the rostral ventromedial medulla after inflammatory hyperalgesia in rats. *Neurosci Lett* 366:201–205
- Haber LH, Martin RF, Chung JM, Willis WD (1980) Inhibition and excitation of primate spinothalamic tract neurons by stimulation in region of nucleus reticularis gigantocellularis. *J Neurophysiol* 43:1578–1593
- Hayes RL, Bennett GJ, Newlon PG et al. (1978) Behavioral and physiological studies of non-narcotic analgesia in the rat elicited by certain environmental stimuli. *Brain Res* 155:69–90
- Heinricher MM, McGaraughty S, Farr DA (1999) The role of excitatory amino acid transmission within the rostral ventromedial medulla in the antinociceptive actions of systemically administered morphine. *Pain* 81:57–65
- Herrero JF, Cervero F (1996) Supraspinal influences on the facilitation of rat nociceptive reflexes induced by carrageenan monoarthritis. *Neurosci Lett* 209:21–24
- Hilgard ER, Hilgard JR (1983) *Hypnosis in the relief of pain*. William Kaufmann, Los Altos, pp 294
- Holden JE, Schwartz EJ, Proudfit HK (1999) Microinjection of morphine in the A7 catecholamine cell group produces opposing effects on nociception that are mediated by alpha<sup>1</sup>- and alpha<sup>2</sup>-adrenoceptors. *Neuroscience* 91:979–990
- Hughes J, Smith TW, Kosterlitz HW et al. (1975) Identification of two related pentapeptides from the brain with potent opiate agonist activity. *Nature* 258:577–580
- Hurley RW, Hammond DL (2000) The analgesic effects of supraspinal mu and delta opioid receptor agonists are potentiated during persistent inflammation. *J Neurosci* 20:1249–1259
- Hurley RW, Hammond DL (2001) Contribution of endogenous enkephalins to the enhanced analgesic effects of supraspinal mu opioid receptor agonists after inflammatory injury. *J Neurosci* 21:2536–2545
- Hylden JLK, Thomas DA, Iadarola MJ et al. (1991) Spinal opioid analgesic effects are enhanced in a model of unilateral inflammation/hyperalgesia: possible involvement of noradrenergic mechanisms. *Eur J Pharmacol* 194:135–143
- Kauppila T, Kontinen VK, Pertovaara A (1998) Influence of spinalization on spinal withdrawal reflex responses varies depending on the submodality of the test stimulus and the experimental pathophysiological condition in the rat. *Brain Res* 797:234–242

41. Kayser V, Chen YL, Guilbaud G (1991) Behavioural evidence for a peripheral component in the enhanced antinociceptive effect of a low dose of systemic morphine in carragenin-induced hyperalgesic rats. *Brain Res* 560:237–244
42. Kieffer BL, Befort K, Gaveriaux-Ruff C et al. (1992) The delta-opioid receptor: isolation of a cDNA by expression cloning and pharmacological characterization. *Proc Natl Acad Sci USA* 89:12048–12052
43. Levine JD, Gordon NC (1984) Influence of the method of drug administration on analgesic response. *Nature* 312:755–756
44. Levine JD, Gordon NC, Fields HL (1978) The mechanisms of placebo analgesia. *Lancet* 2:654–657
45. Li P and Zhuo M (1998) Silent glutamatergic synapses and nociception in mammalian spinal cord. *Nature* 393:695–698
46. Lima D, Almeida A (2002) The medullary dorsal reticular nucleus as a pronociceptive centre of the pain control system. *Prog Neurobiol* 66:81–108
47. Mansikka H, Pertovaara A (1997) Supraspinal influence on hindlimb withdrawal thresholds and mustard oil-induced secondary allodynia in rats. *Brain Res Bull* 42:359–365
48. Martin G, Montagne CJ, Oliveras JL (1992) Involvement of ventromedial medulla “multimodal, multireceptive” neurons in opiate spinal descending control system: a single-unit study of the effect of morphine in the awake, freely moving rat. *J Neurosci* 12:1511–1522
49. Mayer DJ, Liebeskind JC (1974) Pain reduction by focal electrical stimulation of the brain: an anatomical and behavioral analysis. *Brain Res* 68:73–93
50. Mayer DJ, Wolfle TL, Akil H et al. (1971) Analgesia from electrical stimulation in the brainstem of the rat. *Science* 174:1351–1354
51. McMahon SB, Wall PD (1988) Descending excitation and inhibition of spinal cord lamina I projection neurons. *J Neurophysiol* 59:1204–1219
52. Miki K, Zhou QQ, Guo W et al. (2002) Changes in gene expression and neuronal phenotype in brain stem pain modulatory circuitry after inflammation. *J Neurophysiol* 87:750–760
53. Millan MJ (2002) Descending control of pain. *Prog Neurobiol* 66:355–474
54. Neil A, Kayser V, Gacel G et al. (1986) Opioid receptor types and antinociceptive activity in chronic inflammation: both kappa and mu opiate agonistic effects are enhanced in arthritic rats. *Eur J Pharmacol* 130:203–208
55. Ness TJ, Gebhart GF (1987) Quantitative comparison of inhibition of visceral and cutaneous spinal nociceptive transmission from the midbrain and medulla in the rat. *J Neurophysiol* 58:850–865
56. Oliveras JL, Redjemi F, Guilbaud G et al. (1975) Analgesia induced by electrical stimulation of the inferior centralis nucleus of the raphe in the cat. *Pain* 1:139–145
57. Ossipov MH, Hong Sun T, Malan P Jr et al. (2000) Mediation of spinal nerve injury induced tactile allodynia by descending facilitatory pathways in the dorsolateral funiculus in rats. *Neurosci Lett* 290:129–132
58. Park Y, Al-Chaer ED (2002) Thalamic stimulation differentially modifies spinal neuronal responses to colorectal distension in rats with chronic visceral pain. *J Pain* 3:31; American Pain Society Abstract 722
59. Pert CB, Snyder SH (1973) Opiate receptor: demonstration in nervous tissue. *Science* 179:1011–1014
60. Petrovic P, Kalso E, Petersson KM et al. (2002) Placebo and opioid analgesia – Imaging a shared neuronal network. *Science* 295:1737–1740
61. Porreca F, Burgess SE, Gardell LR et al. (2001) Inhibition of neuropathic pain by selective ablation of brainstem medullary cells expressing the micro-opioid receptor. *J Neurosci* 21:5281–5288
62. Porreca F, Ossipov MH, Gebhart GF (2002) Chronic pain and medullary descending facilitation. *Trends Neurosci* 25:319–325
63. Price DD, Barber J (1987) An analysis of factors that contribute to the efficacy of hypnotic analgesia. *J Abnorm Psychol* 96:46–51
64. Price DD, Barrell JJ (1990) The structure of the hypnotic state: a self-directed experiential study. In: Barrell JJ (ed) *The Experiential Method: Exploring the Human Experience*. Copely Publishing Group, Massachusetts, pp 85–97
65. Rainville P, Price DD (2003) Hypnosis phenomenology and the neurobiology of consciousness. *Int J Clin Exp Hypn* 51:105–129
66. Randich A, Gebhart GF (1992) Vagal afferent modulation of nociception. *Brain Res Brain Res Rev* 17:77–99
67. Ren K, Dubner R (1996) Enhanced descending modulation of nociception in rats with persistent hindpaw inflammation. *J Neurophysiol* 76:3025–3037
68. Ren K, Dubner R (2002) Descending modulation in persistent pain: an update. *Pain* 100:1–6
69. Ren K, Ruda MA (1996) Descending modulation of Fos expression after persistent peripheral inflammation. *Neuroreport* 7:2186–2190
70. Reynolds DV (1969) Surgery in the rat during electrical analgesia induced by focal brain stimulation. *Science* 164:444–445
71. Schaible HG, Neugebauer V, Cervero F et al. (1991) Changes in tonic descending inhibition of spinal neurons with articular input during the development of acute arthritis in the cat. *J Neurophysiol* 66:1021–1032
72. Terayama R, Dubner R, Ren K (2000) The roles of NMDA receptor activation and nucleus reticularis gigantocellularis in the time-dependent changes in descending inhibition after inflammation. *Pain* 97:171–181
73. Terman GW, Shavit Y, Lewis JW et al. (1984) Intrinsic mechanisms of pain inhibition: activation by stress. *Science* 226:1270–1277
74. Thomas DA, McGowan MK, Hammond DL (1995) Microinjection of baclofen in the ventromedial medulla of rats: antinociception at low doses and hyperalgesia at high doses. *J Pharmacol Exp Ther* 275:274–284
75. Thompson RC, Mansour A, Akil et al. (1993) Cloning and pharmacological characterization of a rat mu opioid receptor. *Neuron* 11:903–913
76. Tsou K, Jang CS (1964) Studies on the site of analgesic action of morphine by intracerebral microinjections. *Sci Sin* 13:1099–1109
77. Tsuruoka M, Willis WD (1996a) Bilateral lesions in the area of the nucleus locus coeruleus affect the development of hyperalgesia during carrageenan-induced inflammation. *Brain Res* 726:233–236
78. Tsuruoka M, Willis WD (1996b) Descending modulation from the region of the locus coeruleus or nociceptive sensitivity in a rat model of inflammatory hyperalgesia. *Brain Res* 743:86–92
79. Turnbach ME, Guo W, Dubner R et al. (2003) Inflammation induces tyrosine phosphorylation of the NR2A subunit and serine phosphorylation of the NR1 subunits in the rat rostral ventromedial medulla. *Society for Neuroscience Abstracts* 2003, vol 29:695.13
80. Urban MO, Gebhart GF (1999) Supraspinal contributions to hyperalgesia. *Proc Natl Acad Sci USA* 96:7687–7692
81. Urban MO, Coutinho SV, Gebhart GF (1999) Biphasic modulation of visceral nociception by neurotensin in rat rostral ventromedial medulla. *J Pharmacol Exp Ther* 290:207–213
82. Wei F, Ren K, Dubner R (1998) Inflammation-induced Fos protein expression in the rat spinal cord is enhanced following dorsolateral or ventrolateral funiculus lesions. *Brain Res* 782:136–141
83. Wei F, Dubner R, Ren K (1999a) Nucleus reticularis gigantocellularis and nucleus raphe magnus in the brain stem exert opposite effects on behavioral hyperalgesia and spinal Fos protein expression after peripheral inflammation. *Pain* 80:127–141



84. Wei F, Dubner R, Ren K (1999b) Laminar-selective noradrenergic and serotonergic modulation includes spinoparabrachial cells after inflammation. *NeuroReport* 10:1757–1761
85. Wiertelak EP, Roemer B, Maier SF et al. (1997) Comparison of the effects of nucleus tractus solitarius and ventral medial medulla lesions on illness-induced and subcutaneous formalin-induced hyperalgesias. *Brain Res* 748:143–150
86. Woolf CJ, Salter MW (2000) Neuronal plasticity: Increasing the gain in pain. *Science* 288:1765–1768
87. Zhuo M, Gebhart GF (1991) Spinal serotonin receptors mediate descending facilitation of a nociceptive reflex from the nuclei reticularis gigantocellularis and gigantocellularis pars alpha in the rat. *Brain Res* 550:35–48
88. Zhuo M, Gebhart (1992) Characterization of descending facilitation and inhibition of spinal nociceptive transmission from the nuclei reticularis gigantocellularis and gigantocellularis pars alpha in the rat. *J Neurophysiol* 67:1599–1614
89. Zhuo M, Sengupta JN, Gebhart GF (2002) Biphasic modulation of spinal visceral nociceptive transmission from the rostroventral medial medulla in the rat. *J Neurophysiol* 87:2225–2236

D

## Descending Modulation of Nociceptive Transmission during Persistent Damage to Peripheral Tissues

HORACIO VANEGAS

Istituto Venezolano de Investigaciones Cientificas (IVIC), Caracas, Venezuela  
hvanegas@ivic.ve

### Synonyms

Descending Pain Control; Descending Control of Hyperalgesia

### Definition

Inhibitory or facilitatory influences which brain stem structures exert upon the spinal transmission of pain messages that arise from inflamed peripheral tissues or damaged peripheral nerves. Animal models show that persistent nociception induces changes in the activity of brain stem structures, and these in turn facilitate or inhibit spinal circuits responsible for ► [hyperalgesia](#) and ► [allodynia](#).

### Characteristics

Transmission of pain messages in the spinal cord is modulated by the descending pain-control system (Fields and Basbaum 1999). In its simplest form this system is pictured as follows: The gray matter around the sylvian aqueduct (periaqueductal gray, PAG) is connected to the ► [rostral ventromedial medulla](#) (RVM), which contains the nucleus raphe magnus and other reticular nuclei. Neurons in RVM in turn send their axons to the spinal dorsal horn, where they increase or decrease transmission of nociceptive messages along spinal reflex circuits, as well as along pathways that ascend towards the brain stem, the thalamus and the cerebral cortex. PAG and RVM receive messages from vast areas of the central nervous system, which thereby can influence nociceptive transmission. Importantly, exogenous opiate and non-opiate analgesic drugs act upon PAG and RVM by imitating, or interacting with, endogenous opioids, and this contributes to their analgesic action.

The descending pain-control system is modified by, and in turn modifies, persistent nociception caused by inflammation or nerve damage. In animal models of these two types of chronic pain, application of noxious stimuli to the affected body part elicits exaggerated nociceptive responses (► [primary hyperalgesia](#)), and even previously innocuous stimuli can elicit such versive responses (primary ► [allodynia](#)). In addition, healthy body parts near the affected areas may also show hyperexcitability (► [secondary hyperalgesia](#) and allodynia).

### Inflammation of Peripheral Tissues

One model of inflammatory pain in rats involves the injection of an antigenic substance, like complete Freund's adjuvant or carrageenan, into a hind paw or articular cavity. Another model consists of applying mustard oil to the skin of a hind leg; this excites C-fibers and thus mimics persistent peripheral damage.

Normally there is a tonic descending inhibition of spinal nociceptive transmission. When inflammation of peripheral tissues begins, an increased impulse flow reaches the spinal cord (Schaible and Grubb 1993). Here the (primary) neuronal pool that receives these impulses relays, in turn, an elevated number of impulses towards supraspinal, including brainstem, targets. At the same time, the primary neuronal pool becomes hyperexcitable. Primary hyperalgesia thus sets in. The normal tonic descending inhibition may hinder the development of primary hyperalgesia (Ren and Dubner 2002). Additionally, the hyperexcitable neuronal pool becomes more sensitive to descending noradrenergic and local opioidergic inhibition (Hylden et al. 1991, Stanfa and Dickenson 1994). Both factors tend to dampen the ensuing hyperalgesia. The increased flow of ascending nociceptive impulses induces time-dependent changes in the inhibitory and facilitatory influences which simultaneously descend from RVM. In primary hyperalgesia, descending inhibition predominates over facilitation, so that the resulting pain is not as intense as it could be (Ren and Dubner 2002, Schaible et al. 1991). This is due to an increase in enkephalin synthesis in RVM and PAG, as well as an increase in the expression of both NMDA and AMPA receptors in RVM, which results in an elevated opioidergic and

glutamatergic drive on descending inhibitory mechanisms (Hurley and Hammond 2001; Ren and Dubner 2002). Simultaneously, an increase in the activation of NMDA, AMPA, neurotensin and cholecystokinin (CCK) receptors in RVM, causes descending facilitation of secondary hyperalgesia (Urban and Gebhart 1999).

### Damage to Peripheral Nerves

The role of the descending pain-control system has also been studied in animal models of nerve damage. These include partial lesion of the sciatic nerve or ligation of spinal nerves L<sub>5</sub> and L<sub>6</sub>, which cause hyperalgesia and allodynia of the corresponding hind leg, and ligation of spinal nerves S<sub>1</sub>–S<sub>3</sub>, which causes allodynia of the tail. During the first few days after nerve damage, plasticity at both the damaged and neighboring nerve fibers, as well as at the spinal cord, trigger the development of primary hyperalgesia and allodynia. Potentially, these disturbances may subside after a few days, but descending influences from RVM maintain the neuropathic syndrome for several weeks (Burgess et al. 2002). Indeed, the primary neuronal pool at the spinal dorsal horn is under abnormal bombardment from peripheral fibers, and sends exaggerated ascending impulses that eventually induce changes in RVM. Among these changes is an activation of CCK receptors (Kovelowski et al. 2000). The so-called “on-cells” of RVM are then thought to convey facilitatory influences onto the spinal dorsal horn, and thus close a positive feedback circuit that goes from the primary neuronal pool to RVM and back to this pool. This circuit is broken, and hyperalgesia and allodynia thus disappear, if RVM is anesthetized with lidocaine, or its CCK receptors are blocked with an antagonist, or the on-cells are destroyed with a neurotoxin (Kovelowski et al. 2000; Porreca et al. 2001).

Together with descending facilitation of the primary neuronal pool, peripheral nerve damage triggers descending influences from PAG, which hinder nociceptive responses to stimulation of healthy areas around the neuropathic zone (Monhemius et al. 2001). Whether these PAG influences are channeled through RVM is still unknown.

### Conclusion

PAG and RVM are modified due to peripheral tissue damage. During inflammation, both inhibitory and facilitatory influences descend from RVM. However, inhibition predominates at the primary neuronal pool, thus attenuating primary hyperalgesia, while facilitation predominates at the secondary neuronal pool, thus exaggerating secondary hyperalgesia. During the neuropathic syndrome, descending facilitation is also accompanied by inhibition, but facilitation affects the primary neuronal pool and is essential for primary hyperalgesia and allodynia, whereas inhibition attenuates nociception at secondary neuronal pools.

## References

- Burgess SE, Gardell LR, Ossipov MH, Malan TP, Vanderah TW, Lai J, Porreca F (2002) Time-Dependent Descending Facilitation from the Rostral Ventromedial Medulla Maintains, but Does Not Initiate, Neuropathic Pain. *J Neurosci* 22:5129-5136
- Fields HL, Basbaum AI (1999) Central Nervous System Mechanisms of Pain Modulation. In: Wall PD, Melzack R (eds) *Textbook of Pain*. Churchill Livingstone, London, pp 309-329
- Hurley RW, Hammond DL (2001) Contribution of Endogenous Enkephalins to the Enhanced Analgesic Effects of Supraspinal  $\mu$ -Opioid Receptor Agonists after Inflammatory Injury. *J Neurosci* 21:2536-2545
- Hylden JLK, Thomas DA, Iadarola MJ, Nahin RL, Dubner R (1991) Spinal Opioid Analgesic Effects are Enhanced in a Model of Unilateral Inflammation/Hyperalgesia: Possible Involvement of Noradrenergic Mechanisms. *Eur J Pharmacol* 194:135-143
- Kovelowski CJ, Ossipov MH, Sun H, Lai J, Malan TP, Porreca F (2000) Supraspinal Cholecystokinin May Drive Tonic Descending Facilitation Mechanisms to Maintain Neuropathic Pain in the Rat. *Pain* 87:265-273
- Monhemius R, Green DL, Roberts MHT, Azami J (2001) Periaqueductal Grey Mediated Inhibition of Responses to Noxious Stimulation is Dynamically Activated in a Rat Model of Neuropathic Pain. *Neurosci Lett* 298:70-74
- Porreca F, Burgess SE, Gardell LR, Vanderah TW, Malan TP, Ossipov MH, Lappi DA, Lai J (2001) Inhibition of Neuropathic Pain by Selective Ablation of Brainstem Medullary Cells Expressing the  $\mu$ -Opioid Receptor. *J Neurosci* 21:5281-5288
- Ren K, Dubner R (2002) Descending Modulation in Persistent Pain: An Update. *Pain* 100:1-6
- Schaible H-G, Neugebauer V, Cervero F, Schmidt RF (1991) Changes in Tonic Descending Inhibition of Spinal Neurons with Articular Input During the Development of Acute Arthritis in the Cat. *J Neurophysiol* 66:1021-1032
- Schaible H-G, Grubb BD (1993) Afferent and Spinal Mechanisms of Joint Pain. *Pain* 55:5-54
- Stanfa LC, Dickenson AH (1994) Enhanced Alpha-2 Adrenergic Controls and Spinal Morphine Potency in Inflammation. *NeuroReport* 5:469-472
- Urban MO, Gebhart GF (1999) Supraspinal Contributions to Hyperalgesia. *Proc Nat Acad Sci USA* 96:7687-7692

## Descending Modulation of Pain

### Definition

Noradrenergic and serotonergic fibers descending from supraspinal loci may act to reduce nociceptive transmission at the level of the dorsal horn. This process is termed “inhibitory descending modulation”. Descending modulatory pathways may also act to enhance nociceptive transmission “facilitatory descending modulation”.

- ▶ [Descending Modulation and Persistent Pain](#)
- ▶ [Encoding of Noxious Information in the Spinal Cord](#)
- ▶ [Somatic Pain](#)

## Descending Modulation of Visceral Pain

ELIE D. AL-CHAER

Center for Pain Research (CPR), University of Arkansas for Medical Sciences, Little Rock, AR, USA  
ealchaer@uams.edu

## Synonyms

Descending inhibition; Descending Facilitation; Irritable Bowel Syndrome; IBS; Functional Abdominal Pain; Visceral Hyperalgesia; visceral hypersensitivity

## Definition

Spinal visceral nociceptive transmission is subject to descending modulatory influences from supraspinal structures (e.g. ► [periaqueductal gray](#) [PAG], nucleus raphe magnus [NRM], nuclei reticularis gigantocellularis [NGC], and the ventrobasal complex of the thalamus [VBC]). This descending modulation can be either inhibitory, facilitatory or both, depending on the context of the visceral stimulus or the intensity of the descending stimulation. The descending pathways originating in the brainstem and other cerebral structures play an important role in the modulation and integration of viscerosomatic messages in the dorsal horn. Serotonergic, noradrenergic and to a lesser extent dopaminergic networks comprise of major components of these descending mechanisms.

## Characteristics

Descending modulation of spinal visceral nociceptive processing is tonically active, and includes both inhibitory and facilitatory influences. Correlative behavioral and neuronal studies have demonstrated that descending modulation influences both behavior and neuronal activity at spinal cord levels in acute and persistent pain; this modulation includes descending facilitatory as well as inhibitory influences that may impact on pain of visceral origin (Dubner and Ren 1999). Electrical stimulation or chemical activation of a number of supraspinal centers can modulate the neuronal and behavioral responses to visceral stimuli. For example, responses to an intraperitoneal injection of hypertonic saline in rats are attenuated by electrical stimulation in the PAG (Giesler and Liebskind 1976). Chemical activation of cell bodies in the rostroventral medulla (RVM) attenuated responses to visceral stimulation (Coutinho et al. 1998, Urban et al. 1999). Electrical stimulation or glutamate microinjection into the PAG, NRM, or NGC inhibit spinal dorsal horn neuron responses (including spinoreticular and spinothalamic tract neurons) to visceral afferent fiber stimulation or noxious ► [colorectal distension](#) (CRD) (Ammons et al. 1984, Cervero et al. 1985, Ness and Gebhart 1987). The descending inhibitory effects from the RVM have been shown to be primarily mediated by pathways traveling in the dorsolateral spinal cord (Zhuo and Gebhart 2002).

Similarly, electrical stimulation of the ventrobasal complex of the thalamus (VBC) inhibits the responses of dorsal horn neurons to colorectal distension in normal rats, an effect attenuated in part by dorsal column (DC) input. However, thalamic descending inhibition proved to

be context-specific. For example, in chronically sensitized adult rats that received neonatal colon irritation, thalamic stimulation caused a facilitation of neuronal responses to colorectal distension in more than 60% of the neurons isolated. This facilitation was observed regardless of the intensity of electrical stimulation, and was facilitated by DC input. Inhibition in response to thalamic stimulation was seen in less than 40% of the neurons in chronically sensitized rats. This inhibition appeared to be controlled by DC input. This goes to show that descending pathways do not exclusively exert inhibitory actions in the dorsal horn. Indeed, individual transmitters may exert multiple actions in the dorsal horn as a function of the type of neuron targeted and the receptor activated (Park and Al-Chaer 2002, Saab et al. 2004). Nevertheless, studies have revealed evidence of tonic descending inhibition under normal circumstances, whose removal produced increases in spontaneous activity and/or responses of spinal neurons to visceral stimuli. For example, reversible cold block of the cervical spinal cord revealed that spinal viscerosomatic neurons are under tonic descending inhibitory influences from supraspinal structures (Akeyson et al. 1990, Cervero 1983, Tattersall et al. 1986).

On the other hand, a number of studies have shown that spinal visceral input is subject to facilitatory modulation, providing the basis of a mechanism that could enhance visceral perceptions in the absence of noxious visceral stimulation, which would explain in part the visceral hypersensitivity, often observed in cases of ► [functional bowel disorders](#) and irritable bowel syndrome. Tonic descending facilitatory influences have been documented. For example, 44% of viscerosomatic neurons, recorded from thoracic segments of the cat spinal cord, gave no responses to splanchnic nerve stimulation during cervical cold block (Tattersall et al. 1986). Electrical stimulation in the RVM produced intensity-dependent biphasic modulation (intensity-dependent inhibition, or facilitation) of the visceromotor response (VMR) to colorectal distension. Activation of glutamatergic receptors in the RVM also facilitated or inhibited the VMR to colorectal distension. The descending facilitatory effects were shown to be primarily mediated by pathways traveling in the ventral/ventrolateral spinal cord. Importantly, descending modulation, whether inhibitory or facilitatory, was shown to be linked to the stimulus; resting EMG activity was unaffected by either electrical stimulation or glutamate microinjection in the RVM (Zhuo and Gebhart 2002).

## References

1. Akeyson EW, Kneuper MM, Schramm LP (1990) Splanchnic Input to Thoracic Spinal Neurons and its Supraspinal Modulation in the Rat. *Brain Res* 536:30–40
2. Ammons WS, Blair RW, Foreman RD (1984) Raphe Magnus Inhibition of Primate T<sup>1</sup>-T<sup>2</sup> Spinothalamic Cells with Cardiopulmonary Visceral Input. *Pain* 20:247–260

3. Cervero F (1983) Supraspinal Connections of Neurons in the Thoracic Spinal Cord of the Cat: Ascending Projections and Effects of Descending Impulses. *Brain Res* 275:251–261
4. Cervero F, Lumb BM, Tattersall JEH (1985) Supraspinal Loops that Mediate Visceral Inputs to Thoracic Spinal Cord Neurons in the Cat: Involvement of Descending Pathways from Raphe and Reticular Formation. *Neurosci Lett* 56:189–194
5. Coutinho SV, Urban MO, Gebhart GF (1998) Role of Glutamate Receptors and Nitric Oxide in the Rostral Ventromedial Medulla in Visceral Hyperalgesia. *Pain* 78:59–69
6. Dubner R, Ren K (1999) Endogenous Mechanisms of Sensory Modulation. *Pain*: 45–53
7. Giesler GJ, Liebskind JC (1976) Inhibition of Visceral Pain by Electrical Stimulation in the Periaqueductal Gray Matter. *Pain* 2:43–48
8. Ness TJ, Gebhart GF (1987) Quantitative Comparison of Inhibition of Visceral and Cutaneous Spinal Nociceptive Transmission from the Midbrain and Medulla in the Rat. *J Neurophysiol* 58:850–865
9. Park YC, Al-Chaer ED (2002) Thalamic Stimulation Differentially Modifies Spinal Neuronal Responses to Colorectal Distension in Rats with Chronic Visceral Pain. *J Pain* 3 Suppl 1:31
10. Saab CY, Park YC, Al-Chaer ED (2004) Thalamic modulation of visceral nociceptive processing in adult rats with neonatal colon irritation. *Brain Res* 1008:186–192
11. Tattersall JEH, Cervero F, Lumb BM (1986) Effects of Reversible Spinalization on the Visceral input to Viscerosomatic Neurons in the Lower Thoracic Spinal Cord of the Cat. *J Neurophysiol* 56:785–796
12. Urban MO, Coutinho SV, Gebhart GF (1999) Biphasic Modulation of Visceral Nociception by Neurotensin in Rat Rostral Ventromedial Medulla. *J Pharmacol Exp Ther* 290:207–213
13. Zhuo M, Gebhart GF (2002) Facilitation and Attenuation of a Visceral Nociceptive Reflex from the Rostrovventral Medulla in the Rat. *Gastroenterology* 122:1007–1019

## Descending Noradrenergic Pathways

### Definition

Serotonergic and noradrenergic projections originate from pontine and medullary neurons, and descend into the spinal cord to modulate pain by inhibiting nociceptive transmission in the dorsal horn of the spinal cord. In some psychological disorders, these pathways may become dysfunctional and cause physical symptoms of pain that are unrelated to the mental state.

- ▶ Nitrous Oxide Antinociception and Opioid Receptors

## Descending Pain Control

- ▶ Descending Modulation of Nociceptive Processing
- ▶ Descending Modulation of Nociceptive Transmission during Persistent Damage to Peripheral Tissues

## Descending Pain Modulatory Pathways, Sex Differences

- ▶ Sex Differences in Descending Pain Modulatory Pathways

## Desensitization

### Definition

Non-operative therapy designed to treat pain is termed desensitization. This therapy produces a stream of new neural impulses that permits cortical remapping, and represents sensory re-education of the C-fibers and A-delta fibers. It is used in neuropathic pain conditions to help re-program the nerves in the affected area by touching the painful area. Simulation by an agonist that leads from unresponsiveness to further stimulation is also sometimes called desensitization.

- ▶ Complex Chronic Pain in Children, Interdisciplinary Treatment
- ▶ Nociceptor, Fatigue
- ▶ Opioid Receptor Trafficking in Pain States
- ▶ Painful Scars
- ▶ Psychology of Pain, Sensitisation, Habituation and Pain

## Desensitizing Toothpastes

### Definition

Desensitizing toothpastes apply medicaments to dentin that has become exposed and block fluid flow through the dentinal tubules and/or allow the diffuse of salts into the dental pulp that reduce the sensitivity of nociceptors.

- ▶ Dental Pain, Etiology, Pathogenesis and Management

## Desmin

### Definition

The intermediate filament system (mainly desmin) of skeletal muscle is believed to be responsible for the mechanical integration of the myofibrillar lattice in both the longitudinal and radial directions.

- ▶ Delayed Onset Muscle Soreness

## Detection Threshold

### Definition

The minimum amount of stimulus energy necessary to elicit a sensory response, defined as the lowest current amplitude perceived by the subject.

- ▶ Hyperaesthesia, Assessment
- ▶ Hyperpathia, Assessment
- ▶ Hypoesthesia, Assessment
- ▶ Pain in Humans, Electrical Stimulation (Skin, Muscle and Viscera)



## Developmental Level

### Definition

A period or phase in the life span. In children, foci include the development of cognition, language, affect, and motor skills.

- ▶ [Cancer Pain, Assessment in Children](#)

## Dexamethasone

### Definition

The long-acting parenteral or orally administered steroid dexamethasone prevents the increased expression of COX-2, which is stimulated by bacterial lipopolysaccharide, cytokines or growth factors.

- ▶ [Acute Pain in Children, Post-Operative](#)
- ▶ [Cyclooxygenases in Biology and Disease](#)

## Diabetes Mellitus

### Definition

The disease due to inadequate secretion of a pancreatic hormone (insulin) resulting in hyperglycemia (abnormally high glucose level in blood).

- ▶ [Toxic Neuropathies](#)

## Diabetes Mellitus Type I

### Definition

Diabetes brought on by an autoimmune attack on the insulin-producing beta cells of the pancreas. It is more common in the young, and onset of symptoms is usually abrupt. Patients are treated with a lifetime regimen of exogenous insulin.

- ▶ [Diabetic Neuropathies](#)

## Diabetes Mellitus Type II

### Definition

Diabetes in which cells develop difficulty uptaking insulin from the blood. Also known as adult-onset diabetes (it is more common in older individuals), type II is the most common type of diabetes in the Western world. Obesity is a major risk factor, and onset of symptoms is gradual.

- ▶ [Diabetic Neuropathies](#)

## Diabetic Amyotrophy

- ▶ [Diabetic Neuropathies](#)

## Diabetic Autonomic Polyneuropathy

- ▶ [Diabetic Neuropathies](#)

## Diabetic Cranial Mononeuropathy

- ▶ [Diabetic Neuropathies](#)

## Diabetic Mononeuritis

- ▶ [Diabetic Neuropathies](#)

## Diabetic Neuropathies

ANNE LOUISE OAKLANDER

Nerve Injury Unit, Departments of Anesthesiology, Neurology and Neuropathology, Massachusetts General Hospital, Harvard Medical School, Boston, MA, USA

aoaklander@partners.org

### Synonyms

Acute Painful Diabetic Neuropathy; burning feet syndrome; diabetic amyotrophy; diabetic autonomic polyneuropathy; diabetic cranial mononeuropathy; diabetic mononeuritis; diabetic sensorimotor polyneuropathy; diabetic sensory neuropathy; diabetic amyotrophy; diabetic symmetrical proximal neuropathy; DSPN; diabetic truncal mononeuropathy; hyperglycemic neuropathy; Insulin Neuropathy; mixed forms of diabetic neuropathy; proximal diabetic neuropathy; vasculitic neuropathy

### Definition

Focal or generalized damage to the peripheral nerves is common with ▶ [diabetes mellitus](#) type I or II. Various patterns of neural injury have been described. The mechanisms underlying them are poorly understood. Other metabolic derangements can also cause similar nerve damage, especially renal failure or hypothyroidism.

## Characteristics

### Epidemiology

Diabetes and related metabolic disturbances are the most common cause of peripheral neuropathies in Western countries. Demographic trends, including aging of the population and increasing obesity, suggest that incidence will increase. Diabetic neuropathies had been estimated to affect about one-third of diabetics (Dyck et al. 1991), but this figure is being revised upward as more sensitive tests for early diabetes and ► [glucose intolerance](#) are developed, and as almost half of patients with so-called idiopathic small-fiber neuropathy are found to have subtle abnormalities of glucose handling, which do not qualify as fully-fledged diabetes according to the current criteria (Singleton et al. 2001).

### Clinical Spectrum of Diabetic Nerve Damage

The mildest and most easily reversed types of diabetes-associated nerve damage are transient abnormalities due to either transient hyper- or hypoglycemia; these are associated with changes in ionic concentrations and fluid balances around axons that can temporarily disturb axonal conduction (Aley and Levine 2001). It has also been suggested that norepinephrine released into the bloodstream during glucose excursions has the ability to activate nociceptive axons (and cause pain) with abnormal properties from earlier diabetic damage.

Several types of longer-lasting but still reversible focal neuropathies, which affect one or a few discrete nerves, are common in diabetics. Such mononeuropathies can affect the ► [cranial nerves](#) (especially cranial nerve III, which usually causes double vision), or nerves or nerve roots that innervate the torso. Truncal diabetic radiculopathy typically presents as a band of pain along one side of the thorax or abdomen, in the territory of one or a few sensory segments. Damage to truncal nerve roots or intercostal nerves can cause bulging of the abdomen (due to muscle weakness) as well. This is rarely clinically significant but can provide a clue for diagnosis. Proximal diabetic amyotrophy, which usually causes pain and weakness of the thighs, is due to similar focal damage to the nerves innervating the thighs. These diabetic neuropathies are usually due to underlying focal ► [vasculitis](#), and resulting ischemia and infarction within individual nerves or roots. They present with the sudden onset of focal neurologic deficit (usually pain, weakness, and muscle atrophy), due to impaired function of the damaged nerve. These vasculitic mononeuropathies tend to improve if the damaged axons can regenerate (Lauria et al. 1998). If vasculitis is severe or present in multiple locations (mononeuritis multiplex), immunosuppression with corticosteroids and cyclophosphamide, or intravenous immunoglobulin may be indicated.

Nerves affected by diabetic peripheral neuropathy can be swollen and compromised, and therefore more vulner-

able to entrapment, whose effects can be additive to the underlying neuropathy. In such cases, surgical decompression (e.g., at the tarsal tunnel of the ankle) may be therapeutic (Aszmann et al. 2000). Electrophysiologic study has demonstrated central neural damage from diabetes as well (Comi 1997), which can contribute to pain and other neural abnormalities common in diabetes. Of course, diabetes is a major risk factor for stroke, usually because of accelerated atherosclerosis and vascular disease.

Generalized polyneuropathy affecting autonomic neurons is common and can cause difficulty with sexual function, gastric motility, or sweating. Dysfunction of autonomic innervation of the heart may contribute to excess cardiac disease in diabetics. Patients with diabetic autonomic nerve damage may no longer develop the symptoms of hypoglycemia (e.g., tachycardia, sweating), and thus experience clinically inapparent hypoglycemia that goes uncorrected until severe consequences develop. Similarly, loss of perception of anginal chest pain can lead to “silent” myocardial infarctions in diabetics.

### Diabetic Sensory Polyneuropathy (DSPN)

By far the most common form of diabetic neuropathy is a distal, symmetric, predominantly sensory, painful, small-fiber polyneuropathy (DSPN) (Dyck et al. 1991). DSPN patients usually complain of burning bilateral foot pain, which over time can spread upward along the legs, involving the arms and torso as it becomes more severe. DSPN is a major contributor to infection and amputation in diabetics, as well as to other major complications of diabetes, including sexual dysfunction, but it is the least understood of the common complications of diabetes.

### Pathophysiology

Several biochemical abnormalities have been described in diabetic nerves, although their relative clinical importance remains unknown. Increased activity of aldose reductase leads to accumulation of fructose and sorbitol, and depletion of NADPH (nicotinamide adenine dinucleotide phosphate). Loss of NADPH limits removal of toxic molecules, such as free radicals, that can damage neurons. Hyperglycemia produces pathologic glycation of a wide variety of molecules, and the products of this glycation reaction also cause free-radical damage. Increased activity of aldose reductase elevates activity of protein kinase C (PKC); this is associated with constriction of vasa nervori and possibly nerve ischemia. Immune abnormalities, such as autoantibodies or activation of T lymphocytes, have also been detected; these may play a role in the vasculitic diabetic mononeuropathies.

### Diagnosis

Diagnosis of early DSPN is easy when the patient complains of the typical “burning” foot pain. These

neuropathic pains are usually most severe at night, when there is nothing to distract attention away from them. Nocturnal exacerbation provides a valuable clue to diagnosis, because most pains from orthopedic or vascular causes typically worsen with activity and improve with rest. The major problem with diagnosis is that objective confirmation can be difficult to obtain on examination or through lab testing, since the axons most vulnerable to diabetic damage are the small-diameter, thinly myelinated (A-delta) or unmyelinated (C-fiber) axons that subserve pain and autonomic function. Damage to these types of neurons does not cause overt signs on exam (e.g., weakness, muscle atrophy, or loss of reflexes), and is not “captured” by electromyography and nerve conduction studies, the standard tests for diagnosing neuropathy. Damage to large myelinated axons, detectable as slowing and reduced amplitude of sensory nerve action potentials, does not often develop until the neuropathy is advanced and has spread to affect large-diameter axons as well. Lack of a marker for early DSPN may have contributed to negative results in clinical trials of potential treatments (Apfel et al. 1998). An early marker might also make presymptomatic diagnosis - as well as therapies that slow or prevent onset of clinical symptoms - possible.

### Neuropathology

Several methods have documented anatomical and functional loss of primary sensory axons in DSPN. Until recently, ► [sural nerve biopsy](#) was the “gold” standard, but it is invasive and cannot be repeated to monitor disease progress or the effects of therapy. It leaves about half of diabetics with persistent pain and sensory abnormalities. Examination and quantitation of nerve endings within ► [punch skin biopsies](#) is an easier, safer, and more sensitive diagnostic alternative; like sural nerve biopsy, it is only available at specialized centers (Kennedy et al. 1996). DSPN is a central-peripheral-distal axonopathy, with damage evident to the central as well as peripheral axons of primary afferent neurons.

### Pain Mechanisms

Various mechanisms contribute to pain in diabetic neuropathies. Early in vasculitic neuropathies, tissue hypoxia, acidosis, and abnormalities characteristic of acute inflammation are present. The *nervi nervorum* can be affected by all of the above, not to mention by intrafascicular edema, even well proximal to the distal end of the nerve. Early hyperexcitability of peripheral nerves can be followed by a more chronic picture of Wallerian degeneration, with atrophy and scarring within affected nerves. Many primary afferents will lose contact with their central post-synaptic targets, either from distal axonopathy or frank cell death, if damage is severe. Loss of enough primary afferents leads to biochemical and anatomical changes within the dorsal root ganglia, dorsal horn and higher centers. The net result

is that central pain-processing neurons fire, even in the absence of incoming pain signals, producing ongoing pain. Cross-connections between touch (low threshold) neurons and nociceptive neurons, at some point in the pathway, can render even the lightest touch painful (allodynia). Surviving neurons are left in an abnormal environment, because nearly all tissue contacted by axons (e.g., Schwann cells, muscle cells, keratinocytes) dramatically change their gene expression when axonal contact is lost. It is not clear how many of these changes are potentially reversible if diabetic control is maintained. Some patients experience periods of remission from pain, but the mechanisms are unknown.

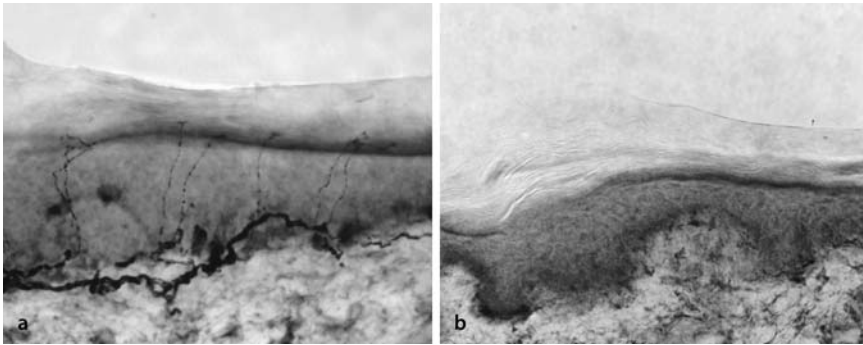
### Treatment Options

Two categories of treatment for DSPN exist. Of greatest potential importance are those that improve the underlying diabetes (disease-modifying treatments). Weight loss is probably the single most important and safest therapy for those with type II diabetes. The second is optimal control of hyperglycemia, which has been convincingly demonstrated to delay the onset and slow the progression of diabetic neuropathy (The Diabetes Control and Complications Trial Research Group 1993). A trial of nerve growth factor (NGF), with the goal of increasing axonal regeneration in DSPN, failed to show efficacy (Apfel et al. 1998). That trial has been criticized for methodological difficulties, and the efficacy of growth factors is far from disproven. Trials of dietary supplements (e.g., myo-inositol, alpha-lipoic acid, and aldose-reductase inhibitors) have been more helpful in animal models than in humans. Physical therapy to encourage motility and weight loss, as well as meticulous podiatric care to prevent and treat foot infections can go far in treating the underlying disease, as well as minimizing its complications. Decompressive neurosurgery is indicated only if entrapment contributes to clinically significant symptoms.

Symptomatic or palliative treatment is also commonly used for patients with moderate or severe symptoms, usually pain. For pain, randomized, controlled clinical trials have established efficacy and safety for several classes of medications, including the noradrenergically active tricyclic antidepressants (Max et al. 1987). Nortriptyline and desipramine have fewer side effects than amitriptyline. There are data supporting the use of anticonvulsants, especially gabapentin and diphenylhydantoin (Chadda and Mathur 1978), and several trials documenting safety and efficacy of opioid medications (Harati et al. 2000). There are preliminary data supporting use of topical local anesthetics applied to painful feet (Dworkin et al. 2003).

### Animal Models

Animal models of DSPN are used to study disease pathophysiology and to screen potential treatments. There are two major types: animals with genetic muta-



**Diabetic Neuropathies, Figure 1** PGP9.5-immunolabeled sensory nerve endings within punch skin biopsies. Representative labeled vertical skin-biopsy sections from subjects with and without diabetic neuropathy reveal distal loss of sensory nociceptive nerve endings. Both punches are from the standard biopsy site (10 cm above the lateral malleolus) used to diagnose peripheral neuropathy. (a) Skin biopsy from a normal subject is densely innervated, with a total of 320 epidermal neurites/mm<sup>2</sup> skin surface area; (b) biopsy from a patient with painful diabetic neuropathy shows near-total loss of innervation (2 epidermal neurites/mm<sup>2</sup> skin surface area). Immunohistochemistry and photography by Li Zheng.

tions that predispose them to diabetes, and those whose diabetes is experimentally induced. Induction of diabetes offers the advantage of not having to wait until diabetic complications develop as the animal ages. In rodents, a single systemic injection of streptozotocin (STZ), a pancreatic beta cell toxin, induces diabetes. Treated animals develop most symptoms characteristic of human DSPN, including ► [mechanical hyperalgesia](#) (Ahlgren and Levine 1993). These abnormalities develop within 1 to 2 weeks, are due to insulin deficiency and/or hyperglycemia (they resolve with insulin treatment) (Sima et al. 1988), and persist indefinitely. Neuropathologic evaluation has shown that diabetic rats develop similar structural lesions to diabetic humans (e. g., central peripheral distal axonopathy [CPDA] with degeneration of the central and peripheral axons of their primary sensory neurons). Early changes include axonal swelling and paranodal demyelination, followed by remyelination, axon degeneration and regeneration, and ultimately Wallerian degeneration of axons (Sima et al. 1988). On the other hand, STZ, a nitrosourea chemotherapeutic agent, also is directly neurotoxic. Other causes of metabolic neuropathy are considerably less common in Western cultures. They include neuropathy associated with chronic renal failure from any cause. Renal neuropathy typically presents differently from DSPN, as painless ► [ataxia](#), because it preferentially damages the large-diameter myelinated fibers that mediate touch, vibration, and joint position sense among others. Hypothyroidism can cause a nonselective axonal loss that can produce pain as well as sensory loss and ataxia. Testing kidney and thyroid function should be included in the evaluation of peripheral neuropathy. ► [Neuropathic Pain Model, Diabetic Neuropathy Model](#) ► [Toxic Neuropathies](#) ► [Ulceration, Prevention by Nerve Decompression](#)

## References

- Ahlgren SC, Levine JD (1993) Mechanical Hyperalgesia in Streptozotocin-Diabetic Rats. *Neuroscience* 52:1049–1055

- Aley KO, Levine JD (2001) Rapid Onset Pain Induced by Intravenous Streptozotocin in the Rat. *J Pain* 2:146–150
- Apfel SC, Kessler JA, Adornato BT, Litchy WJ, Sanders C, Rask CA (1998) Recombinant Human Nerve Growth Factor in the Treatment of Diabetic Polyneuropathy. *Neurology* 51:695–702
- Aszmann OC, Kress KM, Dellon AL (2000) Results of Decompression of Peripheral Nerves in Diabetics: A Prospective, Blinded Study. *Plast Reconstr Surg* 106:816–822
- Chadda VS, Mathur MS (1978) Double Blind Study of the Effects of Diphenylhydantoin Sodium on Diabetic Neuropathy. *J Assoc Physicians India* 26:403–406
- Comi G (1997) Evoked Potentials in Diabetes Mellitus. *Clin Neurosci* 4:374–379
- Dworkin RH, Hart-Gouleau S, Galer BS, Gammaitoni AR, Domingos J (2003) Effectiveness and Impact on Quality of Life of the Lidocaine Patch 5% in Painful Diabetic Neuropathy Patients With or Without Allodynia (abstract). Abstracts: Poster Session, APS 22nd Annual Meeting, American Pain Society, Chicago
- Dyck PJ, Kratz KM, Lehman KA, Karnes JL, Melton LJ, O'Brien PC, Litchy WJ, Windebank AJ, Smith BE, Low PA, Service FJ, Rizza RA, Zimmerman BR (1991) The Rochester Diabetic Neuropathy Study: Design, Criteria for Types of Neuropathy, Selection Bias, and Reproducibility of Neuropathic Tests. *Neurology* 41:799–807
- Harati Y, Gooch C, Swenson M, Edelman SV, Greene D, Raskin P, Donofrio P, Cornblath D, Olson WH, Kamin M (2000) Maintenance of the Long-Term Effectiveness of Tramadol in Treatment of the Pain of Diabetic Neuropathy. *J Diabetes Complications* 14:65–70
- Kennedy WR, Wendelschafer-Crabb G, Johnson T (1996) Quantitation of Epidermal Nerves in Diabetic Neuropathy. *Neurology* 47:1042–1048
- Lauria G, McArthur JC, Hauer PE, Griffin JW, Cornblath DR (1998) Neuropathological Alterations in Diabetic Truncal Neuropathy: Evaluation by Skin Biopsy. *J Neurol Neurosurg Psychiatry* 65:762–766
- Max MB, Culnane M, Schafer SC, Gracely RH, Walther DJ, Smoller B, Dubner R (1987) Amitriptyline Relieves Diabetic Neuropathy Pain in Patients with Normal or Depressed Mood. *Neurology* 37:589–596
- Sima AA, Zhang WX, Tze WJ, Tai J, Nathaniel V (1988) Diabetic Neuropathy in STZ-Induced Diabetic Rat and Effect of Allogeneic Islet Cell Transplantation. Morphometric analysis. *Diabetes* 37:1129–1136
- Singleton JR, Smith AG, Bromberg MB (2001) Painful Sensory Polyneuropathy Associated with Impaired Glucose Tolerance. *Muscle Nerve* 24:1225–1228
- The Diabetes Control and Complications Trial Research Group (1993) The Effect of Intensive Treatment of Diabetes on



the Development and Progression of Long-Term Complications in Insulin-Dependent Diabetes Mellitus. *N Engl J Med* 329:977–986

## Diabetic Neuropathy, Treatment

ANNE KJØRSVIK BERTELSEN<sup>1</sup>, JOHN W. GRIFFIN<sup>2</sup>

<sup>1</sup>Department of Neurology, Haukeland University Hospital, Bergen, Norway

<sup>2</sup>Department of Neurology and Departments of Neuroscience and Pathology, Johns Hopkins University School of Medicine, The Johns Hopkins Hospital, Baltimore, MD, USA

anne.kjorsvik@biomed.uib.no, jgriffi@jhmi.edu

### Synonyms

Symmetric diabetic neuropathy; diabetic polyneuropathy

### Definition

Focal or generalized damage to the peripheral nerves is common with diabetes mellitus type I or II.

### Characteristics

Most patients with diabetic neuropathy have the type designated diabetic sensory polyneuropathy (DSPN), and this section focuses on this form, emphasizing the aspects relevant to pain. The manifestations can include ► **neuropathic pain**, ► **hypalgesia** with loss of protective sensibility and a predilection for painless injuries, and autonomic dysfunction (Dyck and Dyck 1999). The autonomic manifestations can include cardiovascular (loss of heart period variability, loss of Valsalva response, orthostatic hypotension), genitourinary (impotence, retrograde ejaculation, incontinence), gastrointestinal (constipation, diarrhea, fecal incontinence), and sudomotor (loss of sweating) abnormalities. The hypalgesia is typically greatest in the feet, and can contribute to the development of skin ulcers, painless fractures and joint damage (Charcot feet), and ultimately amputations.

Neuropathic pain is prevalent in diabetics, reaching 16.9% of the diabetic population in a recent study, and is underreported to physicians (Daousi et al. 2004).

► **Spontaneous pain** can occur even in individuals with profound hypalgesia. The pain is usually greatest in the toes and feet. With progression it moves into the fingers and can involve a “shield” over the sternum and parasternal areas, representing the most distal regions of innervation of the intercostals nerves. Patients use many descriptors for their pain, including “burning” “squeezing” and “throbbing” The particular adjective that they use does not have clinical or prognostic correlates. Sudden stabbing lightning pains are frequent. The clinical manifestations conform to those described in ► **small fiber polyneuropathies**.

### Treatment of DSPN

The treatment can be divided into treatment of the underlying disease, treatment of neuropathic pain, protection from painless injuries, and currently topical unproved therapies.

### Treatment of the Underlying Disease

The unequivocal message of large-scale, prospective, controlled studies is that tight glycemic control improves the prognosis for neuropathy (DCCT Research Group 1988). A decade ago this was a controversial point, and it is of fundamental significance in planning diabetic care. This concept can now be extended to an important group of individuals with impaired glucose tolerance but without frank diabetes. Such individuals, identified by glucose tolerance tests (GTT), are at substantial risk to progress to diabetes within a few years (Tuomilehto et al. 2001). Prospective studies have shown that progression to diabetes can be deferred or prevented by weight loss and exercise. This issue is relevant to neuropathy, because it has recently been proved that a subgroup of individuals with impaired GTT develop painful neuropathies before frank diabetes (Singleton et al. 2001; Sumner et al. 2003), and because there is evidence of peripheral nerve damage in others who are asymptomatic (Smith et al. 2001).

### Treatment of Neuropathic Pain

Education regarding the physiologic basis and meaning of neuropathic pain is an essential first step; to the extent patients understand that the pain sensation does not reflect ongoing damage to the feet or the tissues, they are better able to objectify the pain. Taking advantage of their observations about factors that exacerbate or improve pain is useful. For example, if they have cold allodynia they may prefer to keep the feet warm. In contrast, many individuals are more comfortable with the feet cool, and prefer to sleep without covers over the feet. Similarly, if there is mechanical hyperalgesia the bed sheets are often painful at night; use of a foot cradle can eliminate that pain.

Drug treatments are adjuncts in management and are detailed below. The available agents include anticonvulsants (gabapentin, pregabalin and newer analogues), antidepressants including SNRI, tricyclic, and probably SSRI representatives (Sindrup and Jensen 2000; Sindrup et al. 2003), some non-opiate analgesics such as tramadol, and if needed, opiates. There are special considerations in choice of agents in diabetics. Due to the frequent association with atherosclerotic cardiovascular disease and autonomic insufficiency, tricyclics require special caution. Also, due to gastrointestinal motility disturbances, the opiates, and even tramadol, may cause severe constipation. Some data supports the use of  $\alpha$ -lipoic acid, an antioxidant (Ametov et al. 2003), and adverse reactions have not been recognized.

D

### Antiepileptic Drugs

Gabapentin has been demonstrated in two large clinical trials to result in significant pain relief in patients with painful DSPN (Backonja et al. 1998; Morello et al. 1999). Compared with amitriptyline, gabapentin has been shown to have equal efficacy; however, the side-effect profile of gabapentin has been shown to be more favorable, although dizziness and sedation are frequently reported (Dallocchio et al. 2000). The doses should therefore be titrated slowly to the maximum dose. It is recommended to start at 300 mg/d on day 1, increasing by 300 mg every day in three days to achieve a dose of 900 mg/d by day 3. Then further dose increases by 300 mg/day up to 1800 mg/d by day 14. Once this dose level is achieved, gabapentin can be titrated up to 3600 mg/d as required over the following weeks to achieve a maximal response with good tolerability or until intolerable side effects occur.

Pregabalin is a follow-up drug to gabapentin, which also binds to the  $\alpha_2\delta$  subunit of voltage-dependent calcium channels, but has a more linear bioavailability than gabapentin. Lower doses are therefore needed than for gabapentin, and the efficacy is more predictable. The therapeutic dose range for pregabalin is between 150–600 mg/d divided into two or three doses.

Oxcarbazepine may be effective in treating painful DSPN. Data from an open-label prospective study indicate that oxcarbazepine (mean effective dose 814 mg/d, range 150–1200 mg/d) may significantly improve pain scores in patients with painful diabetic peripheral neuropathy.

Lamotrigine, a phenyltriazine derivative, inhibits the release of glutamate, possibly by stabilizing the neural membrane through blocking activation of voltage-dependent sodium channels, and thus suppressing abnormal ectopic discharges. To avoid side effects such as skin-rash the doses should be titrated slowly to the therapeutic dose. It is recommended to start at 25 mg/d on day 1, increasing the dose by 25 mg every 14 days until a dose of 400–600 mg/d divided on two doses has been achieved.

### Antidepressant Drugs

Tricyclic antidepressants, like amitriptyline, doxepin and desipramine, are strong sodium channel modulators in addition to their well-known effect on reuptake of serotonin and noradrenaline. The sodium channel-blocking effect is presumed to be the pain-relieving mechanism of these drugs in cases of painful diabetic neuropathy. The cumulative efficacy reported from trials with subjects with diabetic neuropathy, suggests that about one third of patients will achieve a 50 percent reduction in neuropathic pain; however, the benefits are often outweighed by side effects, especially among the elderly.

Selective Serotonin-Reuptake Inhibitors (SSRIs), like paroxetine and citalopram, differ from tricyclic an-

tidepressants in that they selectively block serotonin reuptake. In clinical trials, SSRIs have shown to reduce the pain of diabetic neuropathy better than placebo, but not as effectively as tricyclic antidepressants.

### Topical Analgetics

Lidocaine is an amide-type local anesthetic that stabilizes neural membranes by modulating voltage-sensitive sodium channels. It is the most frequently used local anesthetic in the treatment of neuropathic pain, and has been shown to produce moderate reduction in pain in patients with diabetic neuropathy.

Capsaicin cream, (Zostrix) the active component in hot chili peppers, applied topically four to five times per day for 4 weeks is effective in treating painful diabetic peripheral neuropathy. However, initial burning of the skin upon application is an unpleasant side effect that leads to treatment discontinuation among more than 30% of patients. Capsaicin is thought to affect pain transmission by depleting the neural stores of substance P, a pain-modulating substance, in epidermal nerve fibers and temporary decrease in numbers of epidermal nerve fibers in treated regions. The capsaicin cream contains 0.025% to 0.075% capsaicin and should be applied to intact skin only. Patients should wash their hands thoroughly after applying capsaicin cream in order to prevent inadvertent contact with other areas.

### Opioid Analgesics and Opioid-Like Drugs

Although opioids are considered a last resort for chronic neuropathic pain control, limited data suggest efficacy and tolerability of oxycodone and other opioids for painful diabetic peripheral neuropathy. Tramadol, a centrally acting analgesic chemically unrelated to the opiates, has a low binding affinity at  $\mu$ -opioid receptors and weak inhibition of norepinephrine and serotonin reuptake. However, its precise mechanism is not known, since the analgesic effect is only partially antagonized by the opioid antagonist naloxone. Tramadol causes significantly less respiratory depression than morphine and, in contrast to morphine, does not stimulate the release of histamine. Tramadol does produce  $\mu$ -opioid type dependence like codeine or dextropropoxyphene; however, there appears to be little potential for tolerance development or abuse. Tramadol is thus a useful drug in the treatment of painful diabetic peripheral neuropathy, and in particular effective to treat the nociceptive component of axonal pain such as that caused by ischemia. Its use is however limited in elderly patients or those with impaired hepatic and renal function, and it should be used with caution by patients taking other psychoactive drugs. The dose of tramadol should be in the range of between 200–400 mg/d. As pain treatment in diabetic neuropathy is a long-term undertaking, beginning with monotherapy and evaluating progress with a daily visual analog scale log can simplify decisions.

### Protection from Painless Injuries

The problem of insensitive or anesthetic feet requires the individual to be constantly vigilant so that injuries to the feet can be prevented. It is particularly important to recognize early foot injuries and to treat all injuries promptly. Among the indications of failed foot care are ulcers in the skin and bony sequelae (Charcot joints) that result from unfelt injuries. In severe cases, amputation of digits, the foot, or even the lower leg may eventually be required. Repeated tiny injuries to the skin and bones of the feet, caused by loss of pain sensibility and loss of position sense, can be overcome by continual vigilance. Warning signs of danger are localized redness (erythema) or blisters on the feet, breaks in the skin, or hot points over the skin. The keystone is regular careful examination of the feet.

Shoes that fit well are essential. Callouses are a sign of longstanding excessive pressure on the skin and thus signal badly fitting shoes. Callouses are usually found on the balls of the feet, the sides of the feet, or the tops of the toes. A persistent or growing callous needs to be examined and treated by a medical professional.

Individuals with insensitive feet should not walk barefooted, as minor inadvertent injuries can cause major long-term problems. The feet should be bathed in lukewarm water, and the water temperature should be tested with a sensitive part of the body (the elbow or upper arm if the hands or wrists are insensitive). For some patients, heat feels good on the feet, but under no circumstances should a heating pad or hot water bottle be used, because of the potential for painless thermal injury. Insensitive fingers can be burned painlessly by smoking or during cooking. Gas ranges are preferable to electric ranges because it is apparent when they are “on”.

### Unproved Therapies

Patients can find a variety of devices that are advocated to provide relief in painful diabetic neuropathy, and the internet provides a marketplace for such devices. Transcutaneous nerve stimulators are widely used and it is reasonable to view their efficacy in terms of their effectiveness in other pain disorders. At present, no device specifically claimed to improve nerve function has been proved to be of value. Such claims have been made for a variety of bracelets, electrical devices, etc. Another unproved therapy is surgical release of putative nerve entrapments. Claims have been made that surgical release of multiple nerves in the legs and arms relieves pain and improves the neuropathic prognosis, including preventing ulcers, even in individuals in whom the only evidence of possible entrapment is a Tinel’s sign to percussion over possible entrapment sites (Aszmann et al. 2004; Lee and Dellon 2004). Diabetics are at increased risk for nerve entrapments. In individuals with physiologic and clinical evidence of entrapment, surgical correction should be considered.

### References

1. Ametov AS, Barinov A, Dyck PJ et al. (2003) The Sensory Symptoms of Diabetic Polyneuropathy are Improved with Alpha-Lipoic Acid: The SYDNEY Trial. *Diabetes Care* 26:770–776
2. Aszmann O, Tassler PL, Dellon AL (2004) Changing the Natural History of Diabetic Neuropathy: Incidence of Ulcer/Amputation in the Contralateral Limb of Patients with a Unilateral Nerve Decompression Procedure. *Ann Plast Surg* 53:517–522
3. Daousi C, MacFarlane IA, Woodward A et al. (2004) Chronic Painful Peripheral Neuropathy in an Urban Community: A Controlled Comparison of People With and Without Diabetes. *Diabet Med* 21:976–982
4. DCCT Research Group (1988) Factors in Development of Diabetic Neuropathy: Baseline Analysis of Neuropathy in Feasibility Phase of Diabetes Control and Complications Trial (DCCT). *Diabetes* 37:476–481
5. Dyck PJB, Dyck PJ (1999) Diabetic Polyneuropathy. In: Dyck PJ, Thomas PK (eds) *Diabetic Neuropathy*. WB Saunders Company, Philadelphia, pp 255–278
6. Lee CH, Dellon AL (2004) Prognostic Ability of Tinel Sign in Determining Outcome for Decompression Surgery in Diabetic and Nondiabetic Neuropathy. *Ann Plast Surg* 53:523–527
7. Sindrup SH, Bach FW, Madsen C et al. (2003) Venlafaxine versus Imipramine in Painful Polyneuropathy: A Randomized, Controlled Trial. *Neurology* 60:1284–1289
8. Sindrup SH, Jensen TS (2000) Pharmacologic Treatment of Pain in Polyneuropathy. *Neurology* 55:915–920
9. Singleton JR, Smith AG, Bromberg MB (2001) Painful Sensory Polyneuropathy Associated with Impaired Glucose Tolerance. *Muscle Nerve* 24:1225–1228
10. Smith AG, Ramachandran P, Tripp S et al. (2001) Epidermal Nerve Innervation in Impaired Glucose Tolerance and Diabetes-Associated Neuropathy. *Neurology* 57:1701–1704
11. Sumner CJ, Sheth S, Griffin JW et al. (2003) The Spectrum of Neuropathy in Diabetes and Impaired Glucose Tolerance. *Neurology* 60:108–111
12. Tuomilehto J, Lindstrom J, Eriksson JG et al. (2001) Prevention of Type 2 Diabetes Mellitus by Changes in Lifestyle among Subjects with Impaired Glucose Tolerance. *N Engl J Med* 344:1343–1350
13. Backonja M, Beydoun A, Edwards KR et al. (1998) Gabapentin for the Symptomatic Treatment of Painful Neuropathy in Patients with Diabetes Mellitus: A Randomized Controlled Trial. *JAMA* 280:1831–1836
14. Dallochio C, Buffa C, Mazzarello P et al. (2000) Gabapentin vs. Amitriptyline in Painful Diabetic Neuropathy: An Open-Label Pilot Study. *J Pain Symptom Manage* 20:280–285
15. Morello CM, Leckband SG, Stoner CP et al. (1999) Randomized Double-Blind Study Comparing the Efficacy of Gabapentin with Amitriptyline on Diabetic Peripheral Neuropathy Pain. *Arch Intern Med* 159:1931–1937

D

## Diabetic Polyneuropathy

### Definition

Diabetic polyneuropathy refers to pathological changes to nerve function due to diabetes mellitus. This usually manifests as loss of sensation and burning pain, s. also Diabetic Neuropathy.

- ▶ Diabetic Neuropathies
- ▶ Diabetic Neuropathy, Treatment
- ▶ Opioids in Geriatric Application

## Diagnosis

### Definition

The term – diagnosis, is derived from the Greek words:  $\delta\iota\alpha$  (dia) meaning between, and  $\gamma\nu\omicron\sigma\iota\varsigma$  (gnosis) meaning knowing. When used as a verb – to diagnose, it means to determine which of two or more possible causes of a complaint is actually the cause, e.g. “the doctor will diagnose the cause of your chest pain”. When used as an abstract noun, diagnosis means the act or process of determining the cause, e.g. “the patient was admitted to hospital for diagnosis of her chest pain”. When used as a common noun, diagnosis means what is found as a result of that process, and is a generic term for the name of the condition that is the cause of the complaint, e.g. “on the basis of the test results, the doctor provided a diagnosis of the patient’s chest pain”.

Classically, diagnosis requires establishing the pathology that is responsible for a patient’s symptoms, on the grounds that if the pathology is found, it can be rectified, and the patient’s symptoms thereby relieved. In Pain Medicine, this may not always be possible. Some sources of pain cannot be detected using currently available techniques of investigation.

In that event, physicians are nevertheless able to formulate an ► **assessment** of the patient and their problems. The assessment is not the same as a diagnosis, for a cause of the pain is not established. Nevertheless, the assessment may provide a sufficient basis for instituting treatment that may help the patient to reduce or eliminate their pain and associated problems.

► **Taxonomy**

## Diagnosis and Assessment of Clinical Characteristics of Central Pain

ELLEN JØRUM

The laboratory of clinical neurophysiology,  
Rikshospitalet University Hospital, Oslo, Norway  
ellen.jorum@rikshospitalet.no

### Synonyms

Central Pain, Diagnosis and Assessment of Clinical Characteristics

### Definition

► **Central pain** is defined as “pain initiated or caused by a primary lesion or dysfunction in the central nervous system” (Merskey and Bogduk 1994). Some common causes of central pain are spinal cord injury (SCI), vascular brain lesions, arteriovenous malformations, syringomyelia and multiple sclerosis (MS).

## Characteristics

### Clinical Characteristics

There is no major distinction between pain following a central or a peripheral nervous lesion. Chronic neuropathic pain in general may be ► **stimulus-independent** (spontaneous) or ► **stimulus-dependent** (evoked). The spontaneous pain may be ongoing and / or paroxysmal. The quality of the pain may be described in many terms, such as burning, pricking, stinging, aching, lancinating, throbbing, pressing (or a large variety of other adjectives) and many patients will experience two to four pain qualities. There is no single pain descriptor that characterizes the qualities of central pain. The onset of pain may be immediate or with a delay. Post-stroke pain was found to be delayed for at least 1 month in 37% of the patients (Andersen et al. 1995). Similar results have been reported by Leijon et al. (1989). Of a total of 591 patients with pain and or dysesthesia following SCI, the onset of pain was within the first year in 58% of the cases and pain was immediate from the moment of injury in 34% of the cases (Störmer et al. 1997). The location of pain will depend upon which parts of the central nervous system are injured, but some general distinctions between pain of different etiologies exist. One example is post-stroke pain, where 75% of the patients will suffer from a ► **hemipain**, situated contralateral to the lesion, while hemipain seldom occurs in MS (Boivie 2003). Ninety percent of MS patients will suffer from pain in the lower extremities and 36% in the upper extremities (Boivie 2003). Neuropathic pain following SCI may occur in segments above, at or below the level of injury and may be caused by factors other than the spinal cord lesion, such as compressive mononeuropathies and nerve root compression (Siddall et al. 1997; Siddall et al. 2000). There is no correlation between the size of the lesion and the risk of developing central pain (Boivie 2003). The location of the lesion, however, plays a crucial part in the development of pain and of special importance is whether the spinothalamic tract system is involved in the lesion.

### Clinical Diagnosis of Central Pain

The diagnosis of central pain is based on a thorough clinical and neurological examination of the patient. A thorough interview with the patient is mandatory, including detailed questions about spontaneous pain, both ongoing and paroxysmal as well as questions about stimulus-evoked pain. Pain drawings are recommended. But it is emphasized that a correct diagnosis cannot be made on evaluation of pain and sensory abnormalities alone. The investigation has to include examination of the motor system, reflexes, brainstem and cerebellar functions in order to be able to pinpoint the extent and level of the central lesion. In patients with central pain, there will be a large variation in the presence of other neurological symptoms. No major difficulty will be en-



countered in making a diagnosis of a spinal cord injury or a vascular brain lesion, but the complete extent of neurological deficits needs to be evaluated. Typically, central pain is characterized by sensory abnormalities, such as a possible combination of hypoesthesia and ► **allodynia** / ► **hyperalgesia** (or other combinations). Lesions involving the spinothalamic-thalamocortical projection system seem to be crucial for the development of central pain. The sensory abnormalities may be evaluated by simple means, such as cotton (for the evaluation of light touch), pins for pinprick and pain sensation and warm and cold water for the evaluation of the spinothalamic tract system. One should be aware, however, that in many cases, hypoesthesia to light touch may be masked by a concomitant allodynia to light touch and that a reduced sensitivity to painful pinprick may be masked by a hyperalgesia to pinprick. For the detection of sensory deficits in such cases, more sophisticated tools may be needed. The detailed sensory examination by ► **quantitative sensory testing** (QST) developed by Ulf Lindblom and colleagues has major advantages for the detailed examination of sensory deficits, but is not, in general, crucial for making a diagnosis of central pain.

#### **Quantitative Sensory Testing (QST)**

QST is used to measure the intensity of stimuli needed to produce specific sensory perceptions. Tests are developed to determine sensory thresholds for tactile, vibratory, pressure and temperature stimulation. All quantitative sensory tests are psychophysical tests requiring awake and alert patients who fully understand the instructions given and who are fully capable of cooperating. QST methods have been mainly used for research purposes for the classification of neuropathic pain, in studies of pathophysiological mechanisms and in pharmacological trials. For a purely clinical evaluation of the individual patient, the diagnosis of neuropathic pain may be made without using these time-consuming methods. The testing is restricted to a few laboratories and needs specially trained personnel. Through the use of QST, it has become evident that all patients with central post-stroke pain have lesions in the spinothalamic-cortical pathways, as seen by abnormal sensitivity to temperature and pain (Boivie et al. 1989). A high proportion of these patients (80%) did not feel any temperature between 0° and 50°C, indicating the severity of the sensory deficit. Many of these patients also had large deficits in the sensibility to touch and vibration, indicative of a disturbed function in the dorsal column-medial lemniscal pathway but, on the other hand, other patients had no sensory deficit related to these pathways. Similar results are obtained from studies of patients with MS, showing reduced sensibility to temperature and pain, but less prominent findings compared to patients with central post-stroke pain (Boivie 2003). In studies of central pain following spinal cord injury, similar results have been obtained. In a study of 13 pa-

tients with below-level pain following SCI by Beric et al. (1988), 10 patients had absence of sensibility to thermal stimulation measured by QST, while the sensation of vibration and light touch was present, but reduced. These results suggest a relative preservation of dorsal column function with an abolition of spinothalamic system function. Results of such studies show how QST can help in differentiating between sensibility changes due to dorsal column and spinothalamic tract functions. No other method than QST will accurately assess an eventual allodynia and hyperalgesia to thermal stimuli, but thermal allodynia has scarcely been reported in patients with central pain (Boivie et al. 1989), mainly because of a substantial loss of thermal sensibility in patients with central pain. Since evoked pain is an important feature in central pain, diagnostic tools should include tests of central hyperexcitability.

#### **Evaluation of Allodynia and Hyperalgesia**

Patients with central pain may, like all patients with neuropathic pain, complain of evoked pain, pain that is evoked by stimulation of painful skin area. There are two types of allodynia / hyperalgesia to tactile stimuli, one to light touch and one to punctate stimuli (the static type). Although both are caused by central sensitization mechanisms, they are mediated by different peripheral nerve fibers; allodynia to light touch is mediated by A  $\beta$  fibers, whereas the punctate type is mediated by A  $\delta$  fibers. Mapping of the area may be recommended for both types. Punctate hyperalgesia may be mapped by the use of von Frey hairs, while dynamic allodynia is usually mapped by lightly brushing the skin.

#### **Abnormal Temporal Summation**

Temporal summation of neural impulses in nociceptive nerve fibers is a physiologically important mechanism that can intensify the sensation of pain. Repetitive stimulation of a painful skin area in a patient suffering from neuropathic pain may produce an intense and long-lasting pain in a phenomenon referred to as ► **abnormal temporal summation** (or “wind-up-like pain”). The abnormal temporal summation seen in patients may be assessed roughly by repetitive skin stimulation with the frequency of 2–3 Hz with a von Frey hair for up to 20–30 s. If temporal summation is abnormal, the patient will report a sudden intense pain in the stimulated area, often occurring within a few seconds, with aftersensation and radiation. An abnormal increase in temporal summation may be regarded as a sign of central hyperexcitability and can be quantified by measuring latency, duration of aftersensation and area of radiation.

#### **Evidence of Central Hyperexcitability in Central Pain Following SCI**

In a study of 16 patients with traumatic SCI and below-level pain, somatosensory abnormalities in painful denervated skin areas below the level of the lesion as well as

in non-painful denervated skin areas at the level of the lesion were compared (Eide et al. 1996). In the painful denervated area, a highly significant reduction in sensitivity to heat and cold, indicating reduced function in the spinothalamic tract system and supporting the results of Beric et al. was found. An important observation was that there was no significant difference in sensory thresholds in the painful denervated skin areas compared with the nonpainful denervated skin areas. Thus, in these patients, deafferentation of spinothalamic pathways was not a sufficient condition for the development of central neuropathic pain. One of the main findings was the demonstration of evoked pain, both allodynia to brush and an abnormal temporal summation in the painful denervated area alone. These data show that sensory loss must be coupled with abnormal pain responsiveness to reach a diagnosis of central neuropathic pain (Eide et al. 1996). Similar findings have more recently been reported by others (Finnerup et al. 2003). The main finding of their study was a higher intensity of brush-evoked dysesthesia and pinprick hyperalgesia at the lesion level in SCI patients with central pain as opposed to SCI patients without below level pain, despite a similar degree of lost somatosensory function in the two groups. Brush-evoked pain or dysesthesia have also been reported to occur in patients with post-stroke pain (Boivie et al. 1989; Leijon et al. 1989; Andersen et al. 1995).

### Supplementary Investigations

Supplementary investigations such as CT (computer tomography), MRI (magnetic resonance imaging) and electrodiagnostic evaluations can be performed to visualize and functionally assess the central lesions. In clinical neurophysiology, measurement of ► **somatosensory evoked potentials** to electrical stimulation is routinely performed for investigating deficits in sensory pathways. It is important to be aware that electrical stimuli activate the dorsal column-lemniscal systems and that no information is obtained from the pain and temperature mediating spinothalamic tract system. Laser-evoked late potentials, on the other hand, may evaluate function in the spinothalamic tract system, but few results have so far been published on central pain (Garcia-Larrea et al. 2002).

### References

- Andersen G, Vestergaard K, Ingeman-Nielsen M et al. (1995) Incidence of central post-stroke pain. *Pain* 61:187–193
- Beric A, Dimitrijevic MR, Lindblom U (1988) Central dysesthesia syndrome in spinal cord injury patients. *Pain* 34:109–116
- Boivie J (1989) On central pain and central pain mechanisms. *Pain* 38:121–122
- Boivie J (2003) Central pain and the role of quantitative sensory testing (QST) in research and diagnosis. *Eur J Pain* 7:339–343
- Boivie J, Leijon G, Johansson I (1989) Central post-stroke pain—a study of the mechanisms through analyses of the sensory abnormalities. *Pain* 37:173–185
- Eide PK, Jørum E, Stenehjem AE (1996) Somatosensory findings in patients with spinal cord injury and central dysesthesia pain. *J Neurol Neurosurg Psychiatry* 60:411–415
- Finnerup NB, Johannesen IL, Fuglsang-Frederiksen A et al. (2003) Sensory function in spinal cord injury patients with and without central pain. *Brain* 126:57–70
- Garcia-Larrea L, Convers P, Magnin M et al. (2002) Laser-evoked potential abnormalities in central pain patients: the influence of spontaneous and provoked pain. *Brain* 125:2766–2781
- Leijon G, Boivie J, Johansson I (1989) Central post-stroke pain—neurological symptoms and pain characteristics. *Pain* 36:13–25
- Merskey H, Bogduk N (1994) Classification of chronic pain: descriptions of chronic pain syndromes and definitions of pain. IASP Press, Seattle
- Siddall PJ, Taylor DA, Cousins MJ (1997) Classification of pain following spinal cord injury. *Spinal Cord* 35:69–75
- Siddall PJ, Yezierski RP, Loeser JD (2000) Pain following spinal cord injury: clinical features, prevalence and taxonomy. *IASP Newsletter* 3:3–7
- Störmer S, Gerner HJ, Grüniger W et al. (1997) Chronic pain / dysesthesia in spinal cord injury patients: results of a multicentre study. *Spinal Cord* 35:446–455

## Diagnosis of Pain, Epidural Blocks

NIKOLAI BOGDUK

University of Newcastle, Department of Clinical Research, Royal Newcastle Hospital, Newcastle, NSW, Australia  
nbogduk@mail.newcastle.edu.au

### Synonyms

Epidural Diagnostic Blocks

### Definition

► **Epidural blocks** are a diagnostic test, in which a local anaesthetic (or another drug) is injected into the epidural space, in order to obtain information about a patient's pain.

### Characteristics

Diagnostic epidural blocks should not be confused with epidural injections for therapeutic purposes. Classically, epidural injections of local anaesthetic have been used to provide analgesia for childbirth and for certain operative procedures. Epidural injections of local anaesthetic, morphine, clonidine, corticosteroids, and other agents, have been used to provide relief of pain for a variety of conditions such as CRPS, cancer pain, neuropathic pain, radicular pain, and back pain that has failed to be relieved by surgery. In these instances, epidural injections have been used to provide sustained relief of pain, as a treatment.

When used for diagnostic purposes, epidural blocks are used to obtain information. Relief of pain may or may not occur, but relief of pain is not the objective; it is one of the possible results of the test.

Since they block multiple nerves, epidural blocks do not provide information about the location of a patient's pain. Instead, they provide information about the nature of the patient's pain.

## Diagnosis and General Pain Management

NIKOLAI BOGDUK

Department of Clinical Research, Royal Newcastle Hospital Newcastle, University of Newcastle, Newcastle, NSW, Australia  
michelle.gillam@newcastle.edu.au

Patients with pain look to physicians for treatment to stop that pain; but before treatment can be sensibly initiated, the physician needs to determine what is causing the pain. The process of finding that cause is called making a ► **diagnosis** and the name of the cause is also referred to as the diagnosis.

### Diagnosis

At their disposal, physicians have a variety of tools by which to pursue a diagnosis. These include taking a history (see ► **medical history**), performing a physical examination (see ► **musculoskeletal examination**). Depending on the nature of the complaint, the physician will use these tools to various extents. However, for the subsequent treatment to be effective the diagnosis must be correct and that requires that the tools used to make the diagnosis are both reliable and valid. Without these features the diagnosis that is made will be false.

► **Reliability** is the extent to which two observers, who use the same test on the same group of patients, agree on the results of the test. If the agreement is high, when the test is positive, it is highly likely that the patient truly has the abnormality that has been detected. However, if the agreement is low, neither observer, nor the patient, can be certain whether or not the patient has the abnormality.

► **Validity** is the measure of the extent to which a test actually detects the presence and absence of the condition that it is designed to detect. Whereas reliability measures the ability of observers to perform the test correctly, validity measures the intrinsic ability of the test to detect what it is supposed to detect, when it is performed correctly.

Various sub-types of validity can apply. The most elementary is concept ► **validity**, which is no more than a statement of the purported, theoretical basis for the test. A test is considered to have concept validity if, in principle, it sounds as if it should work. All tests in pain medicine have concept validity. They do sound as if they should work; but having only concept validity does not guarantee, in a scientific sense, that the test does indeed work. Unfortunately, too many tests that have been used in pain medicine are based solely on concept validity. They have not been shown to have any greater degree of validity or when subjected to scien-

tific scrutiny, they have been shown to lack any greater degree of validity.

The next level of validity is content validity. This requires that the test be defined with strict criteria that must be satisfied before the result of the test can be considered positive. Having content validity ensures that physicians use the test consistently, and do not differ from patient to patient in what they consider to constitute a positive result. In one sense, content validity serves to secure reliability in applying the test, but it also serves to ensure that the test is properly defined so as to identify specifically the particular condition that it is supposed to detect and not some other condition. How well a test actually discriminates between a particular condition and some other condition or conditions defines its construct validity. Just because the result of a test is positive does not necessarily mean that the condition sought for is present. Other conditions might also cause the result to be positive. Such results are false positive results. Similarly, test results may be negative, but the condition is nevertheless present. Such results are false negative. Construct validity is the measure of the extent to which a test is compromised by false positive and false negative results. The greater the incidence of false results, the less accurate, and less useful the test. The cardinal measures of the validity of a diagnostic test are its ► **sensitivity**, ► **specificity**, and likelihood ratios. The sensitivity is the extent to which the test correctly detects the presence of a condition. The specificity is the extent to which the test correctly detects the absence of the condition. The likelihood ratios indicate the extent to which a positive result is likely to be true positive and to which a negative result is likely to be true negative.

One of the means by which the reliability and validity of diagnosis in pain medicine is enhanced is by the use of taxonomies. A taxonomy is a catalogue that lists the conditions that can be a cause of pain and which stipulates for each condition the criteria that must be satisfied before the condition can be diagnosed. If the criteria are satisfied the condition can be legitimately be diagnosed. If the criteria are not satisfied, the condition cannot be diagnosed as the cause of pain, irrespective of the intuition or conviction of the physician that it is the cause. Taxonomies serve to prevent physicians arbitrarily and incorrectly making diagnoses that may be wrong.

The International Association for the Study of Pain (IASP) has produced a taxonomy that lists the possible causes of chronic pain (Merskey and Bogduk 1994). The IASP ► **taxonomy** catalogues these conditions in terms of the region of the body affected by the pain, the anatomical location of its source (if known), and its pathology (if known). A similar taxonomy has been developed for headache, by the International Headache

Society (IHS) (1988). The IHS ► [taxonomy](#) lists the criteria that must be satisfied before particular types of headache can be diagnosed. The American Psychiatric Association has produced the fourth edition of its taxonomy for psychiatric disorders, known as the Diagnostic and Statistical Manual of Mental Disorders (► [DSM-IV](#)) (American Psychiatric Association 1994). For certain conditions that may be associated with pain, the DSM-IV prescribes the criteria that must be satisfied before a patient can be considered to have a condition in which pain is due to or associated with a significant psychological disorder.

Despite the availability of taxonomies to assist diagnosis, it is often not possible to make a distinct, patho-anatomic or even psychological diagnosis of a patient's pain. In such cases, the physician can formulate an ► [assessment](#), instead of a diagnosis. The assessment typically describes the location and nature of the patient's pain, the associated psychological distress that the patient expresses and the disabilities that both of these features seem to produce. Such a formulation allows the physician to treat various components of the patient's problems when they do not have access to the root cause of the pain. Diagnosis and assessment differ only with respect to the end point that is achieved. The former defines the cause of the symptoms; the latter carefully defines the symptoms when the cause cannot be found. Both processes rely on the same tools.

The ► [pain history](#) is a catalogue of all the features of the pain that a patient can describe. The catalogue is produced by the patient responding to enquiries from the physician into possible features that may or may not be present. A comprehensive pain history is obtained by enquiry into a set of prescribed domains (see below). These domains are based on traditional wisdom expressed by experts experienced in assessing patients with pain. Not all domains of enquiry will necessarily be relevant or fruitful in every patient, but the set of domains covers all possibilities. Following the set ensures that the physician does not neglect or forget domains that may be relevant. The domains of enquiry for a comprehensive pain history are:

- Length of illness
- Aetiology
- Site
- Extent or Spread
- Intensity
- Quality
- Frequency
- Duration
- Time of Onset
- Mode of Onset
- Precipitating Factors
- Aggravating Factors

- Relieving Factors
- Associated Features

By taking a comprehensive history, a physician will often be able to establish the nature of the pain and at least its possible causes. Most forms of ► [headache](#) can be diagnosed from the history alone.

Physical examination complements the history. By examining the patient, the physician looks for abnormalities of structure or function that can be detected by inspection, palpation, movement or the application of simple tools at the bedside, such as a stethoscope or a patellar hammer and other neurological instruments. The examination can address particular body parts or body systems. A neurological examination (see ► [Diagnosis of Pain, Neurological Examination](#)) tests the integrity of the nervous system. A ► [musculoskeletal examination](#) tests the status and function of the muscles, bones and joints. Other parts of the body can be examined according to the complaint with which the patient presents. These might include an examination of the ear, nose and throat or the mouth, teeth and jaws or the chest, abdomen, pelvis or perineum.

However, whereas physical examination has been a traditional component of medical diagnosis, its reliability and validity is variable. Most reliable and valid is neurological examination. Any two observers will usually agree reasonably well on whether a patient has numbness or weakness; and the presence of such features accurately indicates particular causes. The same does not apply to musculoskeletal examination. Research studies have shown that observers have difficulties agreeing on the extent to which the patient has tenderness, stiffness, spasm or impaired movement. Furthermore, even if the observers can agree on the presence of such abnormalities, data are missing as to what these abnormalities actually imply about the possible cause of pain. The reliability and validity of other forms of examination are not known, in the context of pain.

Because of these limitations, physical examination has limited utility in allowing a patho-anatomic diagnosis to be made. Nevertheless, it does serve as a screening test to exclude obvious and major abnormalities; and it serves for descriptive purposes to define the nature and extent of the physical abnormalities that the patient exhibits. In conjunction with the history, the results of the physical examination may serve to indicate what investigations may or may not be required.

Having obtained a history and having performed a physical examination, a physician should be able to establish, in broad terms, the nature of the patient's pain. The major types of pain are ► [neuropathic pain](#), ► [central pain](#), ► [radicular pain](#), ► [neuralgia](#), ► [somatic pain](#) and ► [Visceral Nociception and Pain](#).



Somatic pain and visceral pain may be associated with ► **referred pain**. Because the latter can be mistaken for radicular pain, recognition of its features is important. Failure to distinguish the two conditions will lead to inappropriate investigations and possibly inappropriate treatment. Recognition of these broad categories of pain is not tantamount to having made a diagnosis. Investigations may be required to establish the cause or source of pain or to define more precisely its mechanisms.

The investigations used in the assessment of patients with pain include, but are not necessarily limited to, blood tests, electrophysiological tests and medical imaging. These tests, however, typically do not detect the pain but are designed to detect conditions that may be responsible for the pain. Their use is, therefore, indicated not by the presence of pain, but by features obtained by the history or examination that suggest the possibility of a particular cause.

Blood tests can be diagnostic for conditions such as acute intermittent porphyria and systemic infection. The erythrocyte sedimentation rate is an important and inexpensive screening test for conditions such as infection and cancer. A raised sedimentation rate calls for further investigation of a possible serious cause of pain. A normal sedimentation rate is essentially reassuring in so far as further pursuit of serious conditions is not indicated unless and until other clinical features suggestive of a possible serious illness are manifest. In patients with features of a visceral disorder, specific blood tests may be obtained, such as serum amylase for suspected pancreatitis and prostate specific antigen levels for suspected prostatic cancer. Serum calcium levels and alkaline phosphatase levels can be tested in patients with suspected osseous metastases or hyperparathyroidism. Catecholamine levels will be diagnostic of headache caused by pheochromocytoma. Serological tests can be used to confirm rheumatoid arthritis and related inflammatory disorders. Serological tests are appropriate in patients with spinal pain in whom myeloma is a possibility.

In some circles, ► **electromyography**, i.e. EMG and related electrophysiological tests such as ► **conduction velocities** are used in the assessment of patients with pain. Despite this practice however, the evidence challenges and even refutes their utility. Electrophysiological tests do not detect pain. They only show abnormalities in motor fibres and large diameter sensory fibres. Such abnormalities correlate poorly with pain. Systematic reviews and consensus statements have found no justification for electrophysiological tests for radicular pain that is otherwise clinically apparent (Anderson et al. 1996; Dvorak 1996, 1998). Only rarely might they be justified if the clinical features suggest peripheral neuropathy rather than radicular pain. Even for

carpal tunnel syndrome, the utility of electrophysiological testing has been questioned because of the very high false positive rate (Hadler 1997; Atroshi et al. 1999).

Similarly, ► **thermography** has been advocated as a test for pain due to radiculopathy and to assess sympathetic function in ► **Complex Regional Pain Syndromes, General Aspects**. For radiculopathy, however, thermography is essentially superfluous or redundant because the diagnosis can be made clinically and because other tests such as ► **MRI** establish the actual cause of the problem. Thermography may corroborate a diagnosis of complex regional pain syndrome but the operational criteria for this condition do not require thermography.

The mainstay of diagnosis in pain medicine is medical imaging. This may involve ► **plain radiography**, i.e. X-rays, ► **CT scanning**, ► **ultrasound**, ► **magnetic resonance imaging**, i.e. MRI, ► **bone scan** or ► **single photon emission tomography**, i.e. ► **SPECT**. Because of its limited sensitivity and specificity for disorders other than fractures, plain radiography is not suitable either as a diagnostic tool or a screening tool in patients with pain. It neither detects nor excludes serious disorders that are not otherwise manifest. Meanwhile, tumours and infections are demonstrated with far greater sensitivity and specificity by other tests, such as MRI. For conditions such as rheumatoid arthritis, plain radiography can demonstrate the state of a joint, but is not one of the diagnostic criteria for this condition. In patients with suspected osteoarthritis, features seen on plain radiography are barely more than coincidentally associated with pain. The indications for plain radiography are features possibly suggestive of fracture, *viz.* major trauma or minor trauma in elderly patients with osteoporosis, in patients on corticosteroids or with a risk factor for pathological fracture. It is also an appropriate screening test for patients suspected of having Paget's disease.

CT scanning is not an appropriate screening test for patients with pain. It is indicated only if clinical features, or other tests, implicate a serious disorder. In that context, CT is used to define better a lesion that has already been detected. Ultrasound can be used to demonstrate lesions in soft tissues. It is strongly diagnostic of visceral disorders that cause cystic lesions or abnormalities in hollow organs. For musculoskeletal disorders, its utility is questionable. Although it can show lesions such as tears in tendons, there is no evidence that these lesions are indeed the cause of the patient's pain.

Of all medical imaging tests, MRI has the highest sensitivity and highest specificity. It can detect lesions such as tumours, infections and osteonecrosis, early in their evolution, and can allow these lesions to be specifically identified. No other imaging test has these properties.

It defines soft tissue lesions as clearly as, or better than, ultrasound. However, specific lesions are uncommon in patients with pain. The utility of MRI is not so much to be diagnostic, but to detect or exclude occult or cryptic lesions that do not manifest distinctive clinical features. Bone scan does not demonstrate specific lesions. It shows only hyperaemia when this is a response to a lesion such as a stress, a fracture, an infection or a tumour. Although classically used to detect such lesions, bone scan is largely being replaced by MRI because of its greater specificity in diagnosing these disorders.

SPECT scanning combines the virtues of bone scanning and CT. Its utility in pain medicine has not been established. For classical disorders of the musculoskeletal system it does not reveal anything that is not otherwise evident on MRI. SPECT is used by some physicians to corroborate a diagnosis of complex regional pain syndrome, but it lacks sensitivity and specificity in this regard. Moreover, the diagnosis can be made clinically without recourse to tests such as SPECT.

More than any other branch of medicine, pain medicine is characterised by the use of ► **diagnostic blocks**. Injections of local anaesthetics or other agents can be used to determine either the mechanism of pain or its source. In patients with neuropathic pain, diagnostic blocks can be used to determine whether or not a particular nerve is involved in mediating the patient's symptoms. In patients with somatic pain, diagnostic blocks can be used to locate the structure from which the pain seems to arise. In patients with complex regional pain syndromes, diagnostic blocks can be used to determine if the pain is sympathetically maintained.

Diagnostic blocks can be performed by injecting small amounts of local anaesthetic onto peripheral nerves, in order to block conduction along that nerve. Relief of pain constitutes *prima facie* evidence that the nerve is responsible for mediating the pain, and that the source of pain lies somewhere in the territory supplied by the nerve. Diagnostic blocks can be performed as ► **intravenous infusions**. If a particular region of the body is infused with a local anaesthetic, relief of pain implies that the source of pain or its mechanism lies in the region infused. If a particular region is infused with a drug other than a local anaesthetic agent, relief of pain implies a mechanism for pain that involves a process that is blocked by the agent used. In that regard, sympathoplegic agents may be infused to determine if a patient's pain involves activity of the sympathetic nervous system.

Local anaesthetic agents may also be infused systemically. Systemic infusions are used to test if the patient has central pain. It is believed that systemic infusions suppress spontaneous activity in the central

nervous system that is responsible for the pain. Local anaesthetic agents and other drugs can be infused into the epidural or intrathecal space, as a diagnostic test.

► **Epidural Diagnostic Blocks** can be used when the actual source of pain is not evident. Relief of pain implies that the source lies somewhere in the periphery and that the pain is not central pain. Conversely, failure to relieve pain with an epidural block indicates that the source is not peripheral and strongly implicates some form of central cause.

For the diagnosis of spinal pain, diagnostic blocks have been refined to target particular and often small structures. They are performed under fluoroscopic control in order to deliver tiny amounts of local anaesthetic into small joints of the spine or onto small nerves that innervate these joints. These procedures include ► **cervical medial branch blocks** for the investigations of neck pain, ► **lumbar medial branch blocks** and ► **sacroiliac joint blocks** for the investigation of low back pain, ► **Spinal Nerve Block** for the investigation of lumbar radicular pain, ► **thoracic medial branch blocks and intra-articular blocks** for the investigation of thoracic spinal pain, and thoracic spinal nerve blocks for the investigation of thoracic radicular pain.

Analogous procedures do not involve the injection of local anaesthetic agents to relieve pain, but instead involve the injection of contrast medium to provoke the target structure with the objective of determining whether or not the patient's accustomed pain is reproduced or not. The singular examples of this form of test are ► **cervical discography** and ► **lumbar discography**. An important requirement for any invasive test, be it a diagnostic block or a provocation test, is that the test must be controlled. Without some form of control observation, a positive response to the test is not compelling. A patient may report relief of pain for reasons other than the action of the local anaesthetic injected. Such responses are known as ► **placebo responses**. Similarly, a patient may report provocation of their pain, not because the target structure is the source of their pain but because anything or everything in the target region hurts. Such false positive responses render the diagnosis incorrect. Performing control tests militates against false positive responses and incorrect diagnosis.

For diagnostic blocks, control tests can be performed using an inert agent or an active agent with a different duration of action. If an inert agent is used, the patient should report no relief of pain. If an alternative agent is used, the patient should report relief that lasts for the expected duration of action of the agent used. For provocation tests, structures other to the target one should also be tested. The target structure can be held to be symptomatic only if stimulating adjacent structures does not reproduce the pain.

## Treatment

Having made a diagnosis or having formulated an assessment of the patient's pain, a physician can implement treatment for it. This treatment may be highly specific, if the cause of pain is known and can be resolved or removed. The treatment may be target specific but not curative, if the pain from a particular structure can be stopped, but without resolving or removing its cause. Or the treatment may be palliative, in that the pain can be reduced, while the cause of pain takes its natural course. In addition, other dimensions of the patient's problem can be managed, without focusing or while focusing on their pain. Their distress can be managed using psychological interventions. Their disability can be managed using rehabilitation techniques.

For the relief of pain, physicians have at their disposal of a wide variety of tools, from which they can select ones that are appropriate for the patient's condition. These include ► **pharmacotherapy**, in which the physician may use ► **analgesics**, compound analgesics, ► **nonsteroidal anti-inflammatory drugs (NSAIDs)**, ► **opioids**, ► **tricyclic antidepressants** or ► **muscle relaxants** as systemic agents to relieve pain irrespective of its cause or source. They may use topical NSAIDs, topical local anaesthetics or topical capsaicin (see ► **Topical Drug Therapy**) to relieve pain in particular regions. Agents known as ► **nutraceuticals**, which are naturally occurring substances that can be used as drugs, are increasingly available. They are used to treat pain from joints. These include ► **glucosamine**, ► **chondroitin**, and ► **avocado-soya bean unsaponifiables**. There is emerging evidence that certain vitamins are effective for joint pain. There is evidence that ► **bisphosphonates** may relieve complex regional pain. For focal sources of pain, injection therapy may be indicated. Tender areas in muscles might be treated with local anaesthetic injections, ► **steroid injections**, ► **botulinum toxin**, or ► **prolotherapy**. Radicular pain may be treated with ► **epidural steroids**, or ► **lumbar transforaminal steroids** or ► **cervical transforaminal steroids**. Joint pain can be treated with ► **intra-articular steroids** or ► **hyaluronan**.

Regional pain problems might be treated with exercises, traction, manipulation, passive mobilization, massage, various physiotherapy modalities, such as ► **Shortwave Diathermy**, therapeutic ultrasound, or ► **interferential therapy** or with acupuncture or

► **transcutaneous electrical nerve stimulation**. Apart from formal psychological interventions, the patient may be treated holistically with assurance and activation, coupled with patient education.

Specific entities may be treated with conventional or traditional neurosurgical procedures that include destructive and augmentative therapies. Certain forms of pain can be relieved by techniques using ► **radiofrequency neurotomy**. These include: trigeminal neurotomy, ► **lumbar medial branch neurotomy**, ► **cervical medial branch neurotomy**, dorsal root ganglion lesioning and sacroiliac neurotomy.

Critical to the selection of any intervention from this armamentarium is whether or not the treatment works and if it has any attributable effect beyond that of placebo. For this reason, physicians should be aware of the data concerning the efficacy and effectiveness of any procedure that they select and its effect size, or ► **number needed to treat (NNT)**. Not all the treatments available to physicians work as well as their reputations pretend. Systematic reviews have brought into question many hallowed interventions. Increasingly, through publications and the Internet, consumers are becoming aware of these data, allowing them to demand access to treatments that have been shown to work and to question those treatments that do not.

## References

1. American Psychiatric Association (2000) DSM-IV-TR. Diagnostic and Statistical Manual of Mental Disorders, 4<sup>th</sup> edn. Text Revision, Washington DC
2. Andersson GBJ, Brown MD, Dvorak J et al. (1996) Consensus summary on the diagnosis and treatment of lumbar disc herniation. *Spine* 21:75–78
3. Dvorak J (1996) Neurophysiologic tests in diagnosis of nerve root compression caused by disc herniation. *Spine* 21:39–44
4. Dvorak J (1998) Epidemiology, physical examination and neurodiagnostics. *Spine* 23:2663–2673
5. Hadler NM (1997) Carpal tunnel syndrome diagnostic conundrum. *J Rheumatol* 24:417–418
6. Headache Classification Committee of the International Headache Society (1988) Classification and diagnostic criteria for headache disorders, cranial neuralgias and facial pain. *Cephalalgia* 8:1–96
7. Merskey H, Bogduk N (eds) (1994) Classification of Chronic Pain. Descriptions of Chronic Pain Syndromes and Definition of Pain Terms, 2nd edn. IASP Press, Seattle
8. Atroshi I, Gummesson C, Johnsson R, Ornstein E, Ranstam J, Rosen I (1999) Prevalence of carpal tunnel syndrome in a general population. *JAMA* 282:153–158

D

## Technique

A needle is inserted into the epidural space, usually at a mid-lumbar or low-lumbar level, using an interlaminar approach. Through the needle, a plastic tube is threaded into the epidural space, and the needle is withdrawn. The

tube is used to administer any of a selection of agents. A typical regimen requires the serial administration of normal saline, fentanyl, naloxone, and local anaesthetic. After each drug is administered the patient reports the intensity of their pain.

### Application

Epidural blocks can be used to determine the nature of a patient's pain, if this cannot be determined from the ► **medical history** or other tests. In particular, they can be used to distinguish nociceptive pain (i.e. ► **somatic pain**) from ► **neuropathic pain** or ► **central pain**. Epidural injection of a local anaesthetic should relieve nociceptive pain, but will have a variable effect on neuropathic pain, and no effect on central pain.

If a patient genuinely has nociceptive pain, they would obtain no relief on each occasion that normal saline is administered. Fentanyl should relieve their pain, but naloxone will subsequently reverse that effect. Finally, local anaesthetic will relieve their pain. Thus, if a patient exhibits this pattern of response, under controlled conditions, the interpretation is that they have a peripheral source for their pain.

If they do not obtain relief, some other explanation is required. It may be that they have neuropathic pain, or central pain. That diagnosis might be pursued using ► **intravenous infusions**.

If the patient has inconsistent or paradoxical responses, such as relief after normal saline, or relief after naloxone but not after fentanyl, the response suggests that psychological factors, rather than nociceptive processes, are the major determinants of the patient's complaint. In that event, treatment can be focused on behavioural factors.

### Utility

Diagnostic epidural blocks appear attractive in principle, as a means to not just distinguish between central and nociceptive pain, but also to distinguish patients in whom nociception or psychological factors are the principal determinants of their presentation. Evidence in this regard, however, is meagre. The application of epidural blocks has been described only in case series that illustrate their application.

The original series described several patients who had inconsistent or paradoxical responses (Cherry et al 1985). These patients responded to behavioural therapy. Other patients had a clearly nociceptive response, but a cause for their pain was not evident on first assessment. The response to the epidural block prompted further investigation. In one patient, a previously unrecognized neoplasm was detected. Other patients responded well to spinal cord stimulation.

The second series reported how 40 patients with back pain could be classified into those who had a nociceptive response; those who had neuropathic pain; and others who were non-responders (Sorensen et al 1996). The authors argued that establishing these distinctions serves to channel patients appropriately into pharmacological, behavioural, or surgical treatment regimens.

### References

1. Cherry DA, Gourlay GK, McLachlan M et al. (1985) Diagnostic Epidural Opioid Blockade and Chronic Pain: Preliminary Report. *Pain* 21: 143–152

2. Sorensen J, Kalman S, Tropp H et al. (1996) Can a Pharmacological Pain Analysis be Used in the Assessment of Chronic Low Back Pain? *Eur Spine J* 5: 236–242

## Diagnosis of Pain, Neurological Examination

NIKOLAI BOGDUK

University of Newcastle, Department of Clinical Research, Royal Newcastle Hospital, Newcastle, NSW, Australia  
nik.bogduk@newcastle.edu.au

### Definition

Neurological examination is a process in which the physician assesses the integrity of the nervous system by testing at the bedside, using hands and simple instruments, but not involving special devices.

### Characteristics

#### Principles

Neurological examination involves testing the function of either individual nerves, or of large parts or entire divisions of the nervous system, such as the spinal cord, or the sympathetic nervous system. Abnormality is deemed to be present if the normal function that is expected is absent or reduced.

Disorders of sensory fibres in peripheral nerves, or of sensory tracts in the spinal cord, are indicated by loss of sensation from skin, muscles, bones or joints. Disorders of motor nerves or of motor tracts are indicated by paralysis or weakness of movements. Disorders of the sympathetic nervous system are indicated by changes in temperature of the skin, discoloration, swelling, sweating, and by trophic changes in skin, muscles and joints. In certain neurological disorders, amplified or altered sensations can occur, when normal functions are disinhibited by injury to nearby or overlapping nerves. Hyperaesthesia is a sensation of exaggerated touch. Hyperalgesia is an increased sensation of pain. Allodynia is the perception of pain in response to a stimulus that would normally produce a sensation of touch or brush.

### Practice

Sensory function is tested by determining if the patient can feel selected stimuli, such as touch, brush, pin-prick, cold, or heat, when applied to selected areas of skin. Position sensation is tested by asking if the patient can detect movements passively applied to selected joints. Other sensory functions can be tested by eliciting reflexes from tendons, muscles, the skin, or from the cornea.

Motor function is tested by having the patient execute movements, with and without resistance, to determine how strongly they can activate the muscles responsible for that movement. Motor function can also be tested indirectly by eliciting reflexes to selected muscles.



Function of sympathetic nerves are tested indirectly, by examining for features of increased or decreased function in the form of temperature changes, discoloration, swelling in the skin, wasting of muscles, or stiffening of joints. For more direct testing of the sympathetic nervous system, laboratory tests are required, in which the responses of tissues are measured when sympathetic nerves are artificially stimulated or anaesthetised. Parasympathetic nerves are difficult to test directly, but disturbed function of parasympathetic nerves is inferred when features of that disturbance are evident. Typically, this occurs in the form of facial flushing or salivation in the case of cranial parasympathetic nerves, or bladder and ejaculatory dysfunction in the case of pelvic parasympathetic nerves.

#### Interpretation

By combining and correlating all the abnormalities detected in a neurological examination, a physician will usually be able to determine where in the nervous system an injury or disorder is located. When a peripheral nerve is affected, the abnormalities will all fall in the distribution of that nerve. When the disorder affects the spinal cord, the abnormalities will be distributed across greater or lesser regions of the body, according to which parts of the spinal cord are affected.

#### Reliability

Since it is a long-established, traditional part of medical practice, neurological examination at large has been assumed to be reliable. Consequently, it has not often been subject to formal study. When studied, however, it has typically been found to be reasonably reliable (Viikari-Juntura 1987; Waddell et al 1982; McCombe et al 1989; Nelson et al 1979).

#### Validity

Neurological examination serves well to establish the location of a neurological disorder. In that regard, it is considered to be valid. However, neurological examination does not usually establish the cause of the abnormality. It is not designed to do so. If an injury has occurred, that should be evident from the patient's history (see ► [medical history](#)). Otherwise, the actual cause typically requires special investigations, such as ► [electrodiagnostic testing](#) or medical imaging.

#### Relevance to Pain Medicine

Only a minority of patients with pain has a neurological disorder or a neurological cause for their pain. Consequently, neurological examination is not relevant for most patients with pain, other than perhaps to establish that there is no abnormal neurological function and, therefore, no neurological disorder.

Neurological examination is specifically indicated when patients report neurological symptoms in association with their pain. They may have a neurological disorder that is responsible for their pain, or they may have a

disorder that, on the one hand causes pain, and on the other hand causes the neurological features.

Some intrinsically painful neurological disorders lack any features detectable by neurological examination. Such disorders include ► [migraine](#) and ► [trigeminal neuralgia](#). Other intrinsically painful neurological disorders are consistently associated with signs of reduced or exaggerated function. These include ► [post-herpetic neuralgia](#), peripheral neuropathies, syringomyelia, and some spinal cord tumours.

Some painful disorders do not arise in the nervous system, but affect nearby nerves secondarily, usually by pressing on them. Such disorders include tumours, cysts, and infections of the vertebral column, and intervertebral disc herniations. In such cases, neurological examination does not establish the cause of pain, but does point to its location.

When peripheral nerves have been injured, injury is the obvious cause of abnormalities. In such cases, neurological examination is not required to establish the cause, but it serves to establish the nature and extent of altered functions.

Neurological examination is also used to determine the accuracy of diagnostic blocks that might be performed in the course of managing a painful disorder. When somatic nerves are blocked, finding numbness in the appropriate territory indicates that the block has been delivered correctly to the target nerve. Similarly, when sympathetic nerves are blocked, finding increased temperature or a Horner's syndrome, indicates that the target nerve has been successfully blocked.

#### References

1. McCombe PF, Fairbank JCT, Cockersole BC et al. (1989) Reproducibility of Physical Signs in Low-Back Pain. *Spine* 14:908–918
2. Nelson MA, Allen P, Clamp SE et al. (1979) Reliability and Reproducibility of Clinical Findings in Low-Back Pain. *Spine* 4:97–101
3. Viikari-Juntura E (1987) Interexaminer Reliability of Observations in Physical Examinations of the Neck. *Phys Ther* 67: 1526–1532
4. Waddell G, Main CJ, Morris EW et al. (1982) Normality and Reliability in the Clinical Assessment of Backache. *BMJ* 284:1519–1523

## Diagnostic and Statistical Manual of Mental Disorders

NIKOLAI BOGDUK

University of Newcastle, Department of Clinical Research, Royal Newcastle Hospital, Newcastle, NSW, Australia  
nbogduk@mail.newcastle.edu.au

#### Synonyms

DSM, DSM-IV, DSM-IVR; DSM-IV; DSM-IVR; Mental Disorders, Diagnostics and Statistics

## Definition

The DSM is a taxonomy and schedule designed to secure the accurate and reliable use of diagnostic terms for mental disorders.

Developed by the American Psychiatric Association, the manual has appeared in several editions, the latest being the fourth (DSM-IV) (American Psychiatric Association 1994), and a revised (DSM-IV-TR) (American Psychiatric Association 2000) edition.

## Characteristics

The DSM consists of two principal parts. A general section outlines how the assessment and description of patients with mental disorders should be conducted according to five axes. These are: Clinical Disorders, Personality Disorders, General Medical Conditions, Psychosocial and Environmental Problems, and Global Assessment of Functioning. The remainder of the manual systematically lists and numbers all psychiatric disorders; provides descriptions of each; and specifies criteria that must be satisfied before a particular diagnosis can be accorded. It is this latter section that potentially pertains to pain.

## Relevance to Pain

Pain can be a feature of certain psychiatric or behavioural disorders. The DSM indicates under which conditions a psychiatric diagnosis might be applied to a patient with pain. The Handbook of Differential Diagnosis (First et al. 2002), which accompanies the Manual, recommends the algorithm depicted in Fig. 1 for classifying patients with pain.

The algorithm primarily invites the decision that the pain is no more than a symptom of a medical condition, and requires no psychiatric diagnosis. For a psychiatric diagnosis to apply, the DSM prescribes explicit criteria that must be satisfied.

## Other Mental Disorder

The critical criterion for determining a mental disorder is that pain is not the focus of attention. By definition, such patients, who present with features of the mental disorder, may admit pain as a symptom, but it is neither their primary concern nor the cardinal cause of disability. Most patients with chronic pain would not qualify for this diagnosis, as pain is their primary complaint and primary concern.

## Conversion Disorder

Patients with pain are sometimes, if not commonly, regarded as having a conversion disorder. The essence of this diagnosis, however, is that the patient has a loss of motor or sensory function, such as paralysis, blindness, or numbness. The notes and diagnostic criteria for this rubric specifically preclude its use if pain is the sole symptom.

## Hypochondriasis

The diagnostic criteria for hypochondriasis stipulate that the patient has a preoccupation with fears of having a serious disease. Although patients with chronic pain may appear preoccupied with their pain, to the extent of seeking relief, this differs from having a preoccupation with a fear of having pain, or fear of a serious disorder.

## Somatisation Disorder

When an organic explanation cannot be found for a patient's pain, physicians are often attracted to attributing the pain to a psychological origin. Somatisation Disorder is one of the available rubrics that they might invoke. The diagnostic criteria for this condition, however, stipulate that the patient must have pain in at least four different sites, as well as two gastrointestinal symptoms, one sexual symptom, and one pseudoneurological symptom, the latter not limited to pain. Furthermore, the symptoms are not intentional. These criteria specify a complex disorder, that some patients with chronic pain may have; but by definition, the criteria do not apply to patients with pain in a single region, such as back pain, abdominal pain, or neck pain.

## Undifferentiated Somatoform Disorder

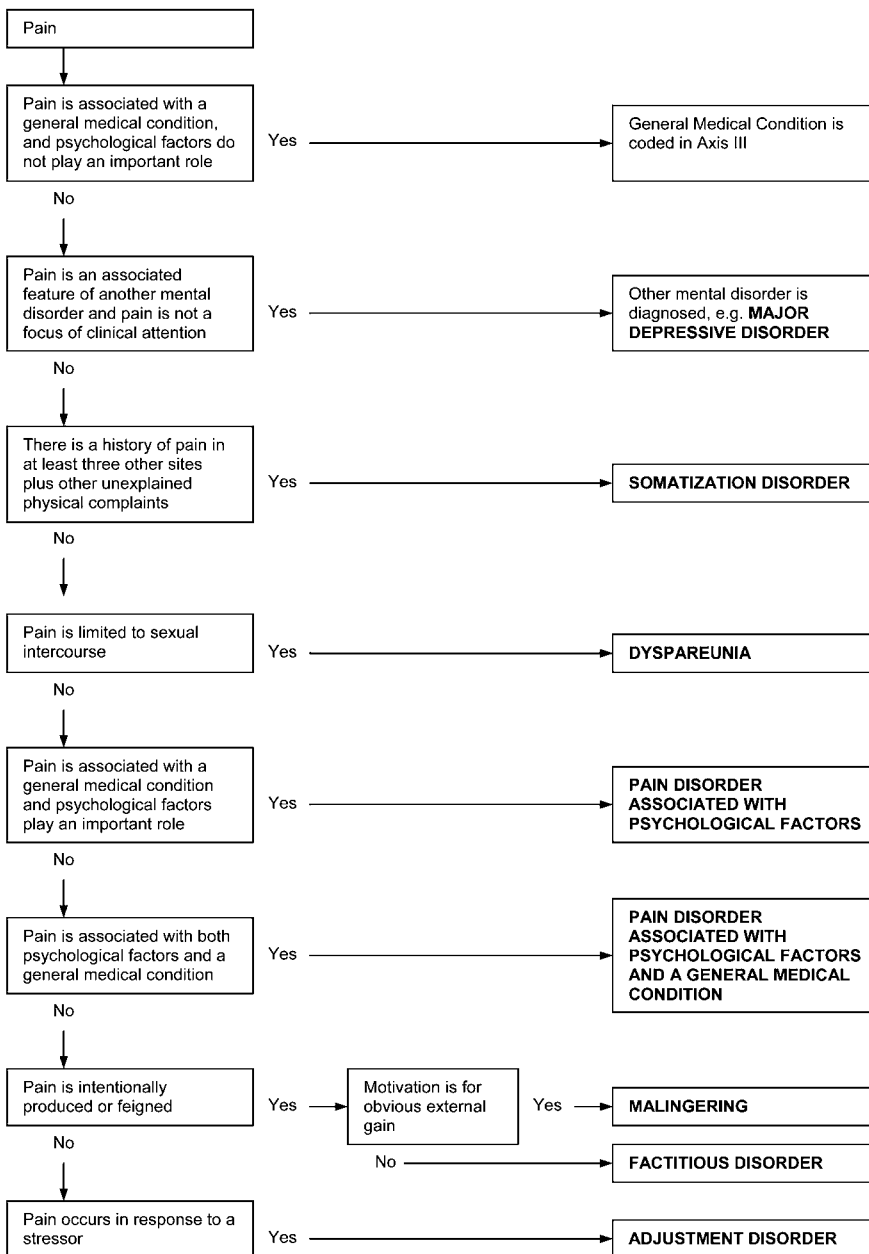
The diagnostic criteria for this disorder are more liberal than those for Somatisation Disorder, and some physicians may be attracted to attributing undiagnosed chronic pain to this disorder. The notes for this disorder, however, specify fatigue, loss of appetite, gastrointestinal, or urinary symptoms. Pain is conspicuously not mentioned, which suggests that this rubric was not designed to accommodate patients with pain for which there is no explanation.

## Factitious Disorder

This condition is characterized by the intentional production or feigning of physical or psychological signs or symptoms in order to assume a sick role, but where external incentives for the behaviour are absent. A further qualification is that individuals with factitious disorder present their history with dramatic flair, but are extremely vague and inconsistent when questioned in greater detail.

Pain may be the symptom produced, and distinction between a genuine and fabricated complaint may be difficult. Lack of external incentives distinguishes Factitious Disorder from Malingering; and a patient who is consistent and lacks dramatic flair when describing their symptoms is unlikely to qualify as having a factitious disorder.

For a physician to apply a diagnosis of Factitious Disorder they would need to be certain that the patient is intentionally complaining of a false symptom. This conviction should be based on objective evidence. It should not be a reflection of the physician's lack of knowledge about unusual or unfamiliar pain problems.



Diagnostic and Statistical Manual of Mental Disorders, Figure 1 Decision tree for the psychiatric diagnosis of pain.

**Malingering**

Malingering is not a formal psychiatric diagnosis, and the DSM does not provide diagnostic criteria for it. It states only that Malingering should be strongly suspected if any combination is noted of medicolegal context of presentation, marked discrepancy between the person’s claimed distress or disability and the objective findings, lack of cooperation during the diagnostic evaluation and in complying with the prescribed treatment regimen, and the presence of Antisocial Personality Disorder.

For many patients with chronic pain, some of these features must be carefully interpreted lest they be unjustly

incriminating. The criterion for medicolegal context pertains to overt, and deliberate compensation-seeking behaviour. It does not apply to injured patients covered by workers compensation who cannot avoid a medicolegal context. Some causes of pain may lack objective findings. In other instances, physical findings on musculoskeletal examination lack reliability and validity. Therefore, physicians will naturally fail to find a correlation between findings and symptoms. They should not misrepresent this natural feature of the disorder as malingering.

A systematic review found little scientific evidence to justify malingering as a diagnosis in patients with

chronic pain (Fishbain et al. 1999; Osterwels 1987). Expert opinion considers it to be a rare condition (Fishbain et al. 1999; Osterwels 1987).

### Adjustment Disorder

The essential feature for this diagnosis is a psychological response to an identifiable stressor that results in the development of clinically significant emotional or behavioural symptoms. Examples of stressors include termination of a relationship, business difficulties, living in a crime-ridden neighbourhood, and natural disasters. Although pain is listed as a symptom by the Handbook, it is conspicuously not mentioned by the Manual. Rather the Manual emphasizes behavioural symptoms such as anxiety and depression.

The use of this rubric may not be valid if the physician attributes pain to a stressor because superficially it is convenient to do so, instead of pursuing a diagnosis in a more rigorous manner.

### Pain Disorder

The DSM provides an entry that explicitly accommodates patients with chronic pain. It provides three subtypes:

- Pain Disorder Associated with Psychological Factors
- Pain Disorder Associated with Both Psychological Factors and a General Medical Condition
- Pain Disorder Associated with a General Medical Condition

For the first two subtypes, the critical criterion is that “psychological factors are judged to have an important role in the onset, severity, exacerbation, or maintenance of the pain”. What the DSM does not provide are guidelines by which this judgment is to be made. Therefore, the judgment becomes a matter of the physician’s opinion. For these rubrics to apply, psychological factors must overtly be responsible for the onset, severity, exacerbation, or maintenance of the pain. This is not the same as finding that patients have psychological features that are secondary to the persistence of pain. The third subtype is not specified as a mental disorder. Having pain, for which psychological factors are judged not to be important, is no more than a medical condition. Unless there is explicit evidence to the contrary, most patients with chronic pain should fall into this category. It is this category that would accommodate patients with psychological features that are caused by the pain, not vice-versa.

### Utility

The cardinal utility of the DSM is that it stipulates rigorous criteria that must be satisfied before a psychiatric diagnosis can be applied to a patient with pain. Unless those criteria are expressly satisfied, a psychiatric diagnosis cannot be justified.

The pivotal weakness of the DSM is that ‘judgment’ is required to determine whether or not psychological factors are associated with the disorder. This is a vexatious issue, and may be more a measure of the physician’s personal beliefs than a diagnosis of the patient.

### References

1. American Psychiatric Association (1994) DSM-IV. Diagnostic and Statistical Manual of Mental Disorders, 4<sup>th</sup> edn. Washington DC
2. American Psychiatric Association (2000) DSM-IV-TR. Diagnostic and Statistical Manual of Mental Disorders, 4<sup>th</sup> edn, Text Revision. Washington DC
3. First MB, Frances A, Pincus HA (2002) DSM-IV-TR Handbook of Differential Diagnosis. American Psychiatric Association, Washington DC
4. Fishbain DA, Cutler R, Rosomoff HL et al. (1999) Chronic Pain Disability Exaggeration/Malingering and Submaximal Effort Research. *Clin J Pain* 5:244–274
5. Osterwels R, Kleinman A, Mechanic D (1987) Institute of Medicine Committee on Pain, Disability, and Chronic Illness Behavior: Pain and Disability, Clinical Behavioral and Public Policy Perspectives. National Academy Press, Washington DC, p 171

## Diagnostic Block

### Definition

Relief of pain with local anesthetic injection.

- ▶ [Chronic Low Back Pain, Definitions and Diagnosis](#)
- ▶ [Pain Treatment, Spinal Nerve Blocks](#)
- ▶ [Peripheral Nerve Blocks](#)

## Diaphragmatic Breathing

### Definition

A type of relaxation training in which the individual is taught to monitor his or her respiration and to take deep breaths using the muscles of the diaphragm. This technique is associated with increased oxygen perfusion and reduction in muscle tension.

- ▶ [Coping and Pain](#)
- ▶ [Psychological Treatment in Acute Pain](#)
- ▶ [Relaxation in the Treatment of Pain](#)

## Diaries

### Definition

Diaries are self-report devices that involve the collection of information about variables over time capture (i.e. when it occurs, such as a rating of pain at a specific pre-designated interval, or whenever medication is taken), or gathering of information in relatively close proximity



to an event of interest, rather than relying on retrospective reporting of an extended time period such as weeks or months (e.g. pain over the past month).

► [Multiaxial Assessment of Pain](#)

## Diathermy

### Definition

Literally „heating through“. Originally the term was used to describe the deep heating effects of ultrasound, shortwaves and microwaves. This usage remains correct, but the word is now often broadened to include the putative non-thermal effects of these agents as well.

► [Therapeutic Heat, Microwaves and Cold](#)

## Diathesis

### Definition

Underlying constitutional factors, which are the biological and psychological make-up of the individual.

► [Pain as a Cause of Psychiatric Illness](#)

## Diathesis Stress

### Definition

Diathesis stress is an understanding of the relationship between a stressor and an individual's response.

► [Psychiatric Aspects of Pain and Dentistry](#)

## Diathesis-Stress Model of Chronic Pain

HERTA FLOR

Department of Clinical and Cognitive Neuroscience at the University of Heidelberg, Central Institute of Mental Health, Mannheim, Germany  
flor@zi-mannheim.de

### Synonyms

Biobehavioral Model; Multidimensional Model; Psychobiological Model; biopsychosocial model

### Definition

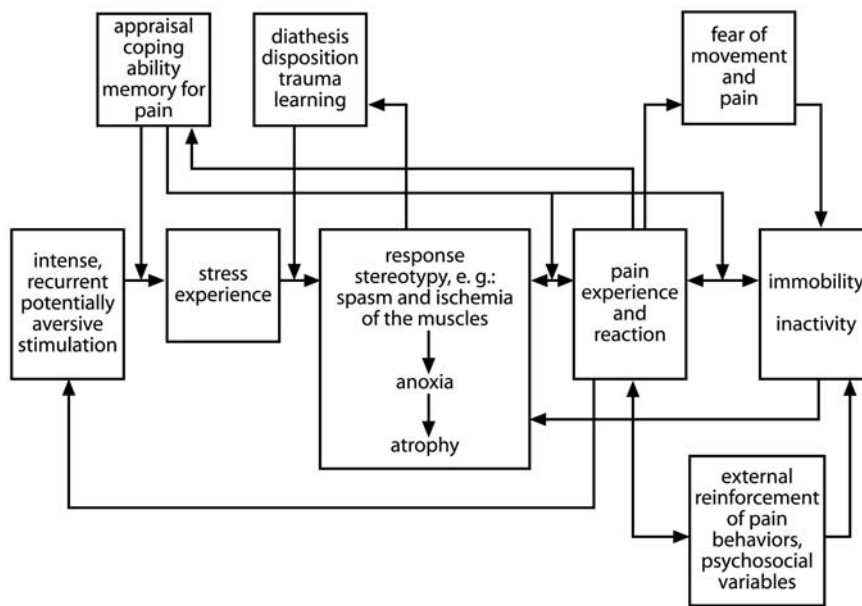
The diathesis-stress model views pain as a result of the interaction of predisposing and stress-related factors and assumes that social, psychological and physiological factors are equally important in the understanding of chronic pain states.

## Characteristics

Several authors (e.g. Feuerstein et al. 1987; Flor et al. 1990; Flor and Turk 2006; Traue 1989) have formulated biobehavioral conceptualizations of chronic pain states that incorporate a multifactorial dynamic view of chronic pain with a mutual interrelationship of physiological and psychological factors and the change in these interrelationships over time. The diathesis-stress model views pain as a response with physiological, behavioral and subjective components, that may or may not have an underlying organic-pathological basis in the sense of a structural change, but that will always have physiological antecedents and consequences. That is, behavior is also physiological and physiological processes have behavioral expressions. Thus, these three interrelated levels are incorporated in one model. The physiological level is comprised of ascending and descending neuronal connections, supraspinal and cortical mechanisms, as well as biochemical processes on all levels. The verbal-subjective modality consists of thoughts, feelings and images. The behavioral-motor level takes into consideration pain behaviors ranging from medication intake to grimacing, limping and use of the health care system. Interactions between the levels are continuous –learning occurs in physiological mechanisms and physiological mechanisms are modified by behavioral and subjective changes. Thus, pain behaviors may be motivated by physiological, cognitive and behavioral antecedents and consequences, all of which need to be considered in the analysis of pain. This view is consistent with the IASP definition that, to reiterate, views pain as an “unpleasant sensory and emotional experience associated with actual or potential tissue damage, or described in terms of such damage” (Merskey 1986, p 217) but in addition, emphasizes cognitive and learning parameters as integral to the experience of pain as a dynamic process.

Although everyone experiences acute pain, only a small percentage of people develop chronic pain syndromes. These preconditions include predisposing factors, precipitating stimuli, precipitating responses and maintaining factors (Fig. 1).

The existence of a physiological predisposition or diathesis involving a specific body system is the first component of the ► [diathesis stress](#) model. This predisposition consists of a reduced threshold for nociceptive activation that may be related to genetic variables, previous trauma, or social learning experiences and results in a physiological response stereotypy of the specific body system. The existence of persistent aversive external or internal stimuli (pain-related or other stressors) with negative meaning activate the sympathetic nervous system and muscular processes (e.g. various aversive emotional stimuli such as familial conflicts or pressures related to employment) as unconditioned and conditioned stimuli and motivate avoidance responses.



**Diathesis-Stress Model of Chronic Pain, Figure 1** A diathesis-stress model delineating the main factors contributing to the development and maintenance of chronic pain.

Aversive stimuli may be characterized by “excessive” intensity, duration, or frequency of an external or internal stimulus. “Inadequate” or “maladaptive” behavioral, cognitive or physiological repertoires of the individual to reduce the impact of these aversive environmental or internal stimuli are among the precipitating responses. Operant and respondent learning of behavioral, verbal-subjective and physiological pain responses may maintain the pain experiences.

An important role is played by the cognitive processing of external or internal stimuli related to the experience of stress and pain, for example, increased perception, preoccupation and over-interpretation of physical symptoms or inadequate perception of internal stimuli such as muscle tension levels. Moreover, the nature of the coping response – active avoidance, passive tolerance or depressive withdrawal – may determine the type of problem that develops as well as the course of the illness. Subsequent maladaptive physiological responding such as increased and persistent sympathetic arousal and increased and persistent muscular reactivity as well as sensitization of central structures including the cortex may induce or exacerbate pain episodes. Thus, learning processes in the form of respondent conditioning of fear of activity (including social, motor and cognitive activities), social learning and operant learning of pain behaviors – but also operant conditioning of pain-related covert and physiological responses as described above – make a contribution to the chronicity of pain.

It is important to note that these learning processes lead to both implicit and explicit memories for pain that subsequently guide the patient’s behavior and determine his or her pain perception. For example, it has been shown that chronic pain leads to the formation of ► [somatosensory pain memories](#) that are specific

for the site of pain and manifest themselves in an enlarged representation of the pain-affected body part in central structures. This type of implicit pain memory is outside the patient’s conscious awareness, but will lead to enhanced responsivity to stimuli that originate in the affected body region. It has also been shown that the explicit recall of a pain-related episode leads to the activation of a large cortical network subserving pain as shown by the enhanced dimensional complexity of the EEG in chronic pain patients. Thus learnt pain memories (i.e. psychological processes) directly influence the physiological processing of pain (cf. Flor 2000; Sandkühler 2000).

In short, a diathesis-stress model places greatest emphasis on the role of learning factors in the onset, exacerbation and maintenance of pain for those patients with persistent pain problems. It was suggested that a range of factors predispose individuals to develop chronic or recurrent acute pain, however, the predisposition is necessary but not sufficient. In addition to anticipation, avoidance and contingencies of reinforcement, cognitive factors, in particular expectations, are also of central importance in a diathesis-stress model of chronic pain. Conditioned reactions are viewed as self-activated on the basis of learned expectations as well as automatically evoked. The critical factor of this model, therefore, is not that events occur together in time, but that people learn to predict them and to summon appropriate reactions (Turk et al. 1983). It is the individual patient’s processing of information that results in anticipatory anxiety and avoidance behaviors.

The primary focus of a diathesis-stress model is thus on the patient, rather than symptoms and pathophysiology. In this model, we emphasize the patient’s explicit thoughts and feelings in addition to implicit condi-

tioning factors, as these will all influence behavior. From this perspective, assessment and treatment of the patient with persistent pain requires a broader strategy than those based on the previous dichotomous models described, that examines and addresses the entire range of psychosocial and behavioral factors, in addition to biomedical ones.

The diathesis-stress perspective on pain management focuses on providing the patient with techniques to gain a sense of control over the effects of pain on his or her life as well as actually modifying the affective, behavioral, cognitive and sensory facets of the experience (Turk and Flor 2006). Behavioral experiences help to show patients that they are capable of more than they assumed, increasing their sense of personal competence. ► **Cognitive** techniques help to place affective, behavioral, cognitive and sensory responses under the patient's control. Our assumption is that long-term maintenance of behavioral changes will occur only if the patient has learned to attribute success to his or her own efforts. There are suggestions that these treatments can result in changes of beliefs about pain, coping style and reported pain severity, as well as direct behavior changes. Further, treatment that results in increases in perceived control over pain and decreased catastrophizing are also associated with decreases in pain severity ratings and functional disability.

## References

1. Feuerstein M, Papciak AS, Hoon PE (1987) Biobehavioral mechanisms of chronic low back pain. *Clin Psychol Rev* 7:243–273
2. Flor H (2000) The functional organization of the brain in pain. *Prog Brain Res* 129:313–322
3. Flor H, Turk DC (in press) A biobehavioral perspective of chronic pain and its management. APA Press, Washington DC
4. Flor H, Birbaumer N, Turk DC (1990) The psychobiology of chronic pain. *Advances in Behaviour Res Ther* 12:47–84
5. Merskey H (1986) Classification of chronic pain: Descriptions of chronic pain syndromes and definitions of pain terms. *Pain* 1:225
6. Sandkühler J (2000) Learning and memory in pain pathways. *Pain* 88:113–118
7. Traue HC (1989) Gefühlsausdruck, Hemmungen und Muskelspannung unter sozialem Stress: Verhaltensmedizin myogener Kopfschmerzen [Emotional expression, inhibition, and muscle tension during social stress: Social-psychophysiological studies of myogenic headache]. Hogrefe, Göttingen
8. Turk DC, Flor H (2006) Cognitive-behavioral approach to pain management. In McMahon S, Koltzenburg M (eds) *Wall and Melzack's textbook of pain*, 5th edn. Elsevier, London, pp 241–258
9. Turk DC, Meichenbaum DH, Genes M (1983) *Pain and behavioral medicine: A cognitive-behavioral approach*. Guilford, New York

## Diazepam

### Definition

Diazepam is a classical benzodiazepine facilitating the effect of GABA at GABA<sub>A</sub> receptors. It causes sedation,

amnesia, anxiolysis and (central) muscle relaxation and acts as an anticonvulsant.

► **GABA and Glycine in Spinal Nociceptive Processing**

## Dictionary of Occupational Titles

**D**

### Synonyms

DOT

### Definition

The U.S. Department of Labor provides definitions of contents and demands (qualitative and quantitative) of occupations in order properly to match jobs and workers. These definitions are identified by electronic sources from the Occupational Information Network at (<http://www.oalj.dol.gov/publicgov/public/dot/refrne/how2find.htm>), or in Jist's Enhanced Dictionary of Occupational Titles S 2000. The dictionary is organized under the headings:

Nine-digit Occupational Code identifying: (a) a particular occupational group; (b) worker functions concerning data, people and things, and (c) differences between occupations.

Occupational title

Industry designation

The body of the occupational definition state

Worker actions, their purpose, machines, tools, equipment, or work aids used by the worker, material used, products made, subject matter dealt with, or services rendered, instructions followed or judgments made.

The definition trailer presents worker traits, i.e. selected occupational characteristics on a General Educational Development Scale, whereas Reasoning, Mathematical, and Language Development Scales and the Specific Vocational Preparation Scale determine the requirements of a specific occupation.

► **Vocational Counselling**

## Diencephalic Mast Cells

DANIEL MENÉTREY

CNRS, Université René Descartes, Biomédicale, Paris, France

menetrey@biomedicale.univ-paris5.fr

### Definition

► **Paracrine** immune cells as part of the neuroimmune axis making a contribution to developing, mature and degenerating nervous system.

## Characteristics

Mast cells are immune system elements, mostly found at host-environment interfaces such as skin, gastrointestinal and respiratory tracts. They are known to derive from the ► [bone marrow](#) and enter the tissues as immature or precursor cells which then mature under microenvironmental conditions (Metcalf 1997). Mast cells are routinely identified by their ► [proteoglycan](#) contents, mostly heparin and chondroitin sulfate. Two main types of cells have been recognized, connective and mucosal cells, which can be distinguished by their proteolytic enzyme contents, proteases I and II, respectively. Several lines of evidence indicate that the functions of mast cells are linked to their capacity to respond to a broad array of mediators (neuropeptides, chemokines,...) and their ability to synthesize and release potent bioactive and vasoactive molecules (histamine, heparin, cytokines, nerve growth factor, nitric oxide, serotonin, ... (Gordon 1990)). In addition to its anticoagulant properties, heparin is related to regulation of angiogenesis, suppression of delayed hypersensitivity and binding of proteins. Bioactive substances are stored in intracellular granules and released by extrusion. Mast cell activation may correspond to either intragranular changes accompanied with differential release of mediators or massive granule compound ► [exocytosis](#) (degranulation) as in ► [anaphylactic reactions](#). Mast cells have been demonstrated to be fundamental cellular elements in the development of allergic reactions and inflammation (Wasserman 1979).

Mast cells also exist within the brain of several species, including mammals and humans (Olsson 1968; Persinger 1977; Silver et al. 1996; Silverman et al. 2000). These include mast cells in ► [dura mater](#), ► [leptomeninges](#) and central nervous system (CNS), the last being exclusively located within the diencephalon. Evidence has been given that the diencephalic homing of mast cells can be triggered behaviorally and be influenced by physiological parameters (Theoharides 1990). The prevalent location of CNS mast cells within the dorsal thalamus, including nuclei with cortical projections, and their ability to react to physiological conditions raise the question of a potential role in sensory integrative processes. Diencephalic mast cell numbers vary with age, sex and physiological state, as well as with environmental and hormonal factors. In small mammals, they increase in situations such as hibernation, exposure to cold or magnetic fields, fostering, parturition, estrus phase, subordination stress and pharmacological insult. However, they decrease during social isolation or with daily handling. Diencephalic mast cells are more numerous in females than in males and show a left-sided predominance, especially in females. In doves, their number increases in aggressively behaving males and courted females as well as with steroid treatments. In all species, younger animals have more diencephalic mast

cells. Mast cells release histamine by degranulation and may account for up to 50% of this mediator in the adult rat brain (Sugimoto et al. 1995). Unlike dura mater cells, diencephalic mast cells store serotonin and heparin in different granules. Intravascular serotonergic cells having mast cell features but lacking heparin also exist (Men treay and Dubayle 2003).

Diencephalic mast cell functions still remain to be determined. It has been hypothesized that they could play a role in maintaining the normal physiology of vessel walls or local hemodynamics by regulating the opening of the blood-brain barrier (Zhuang et al. 1996; Esposito et al. 2001). A detoxifying action has also been envisaged since excessive numbers are often associated with infectious or degenerative processes. Their preferential functional relationships with ► [astrocytes](#) and their ability to provide delivery of neuromodulators to specific regions of the brain suggest neural-endocrine interactions at central level and the existence of a neuroimmune axis based on the cross-talk between mast cells, astrocytes and neurons (Purcell and Atterwill 1995).

## References

1. Esposito P, Gheorghie D, Kandere K et al. (2001) Acute stress increases permeability of the blood-brain-barrier through activation of brain mast cells. *Brain Res* 888:117–127
2. Gordon JR, Burd PR, Galli SJ (1990) Mast cells as a source of multifunctional cytokines. *Immunol Today* 11:458–464
3. Metcalf DD, Baram D, Mekori YA (1997) Mast cells. *Physiol Rev* 77:1033–1079
4. Men treay D, Dubayle D (2003) A one-step dual-labeling method for antigen detection in mast cells. *Histochem Cell Biol* 120:435–442
5. Olsson Y (1968) Mast cells in the nervous system. *Intern Rev Cytol* 24:27–70
6. Persinger MA (1977) Mast cells in the brain: possibilities for physiological psychology. *Physiol Psychol* 5:166–176
7. Purcell WM, Atterwill CK (1995) Mast cells in neuroimmune function: neurotoxicological and neuropharmacological perspectives. *Neurochem Res* 20:521–532
8. Silver R, Silverman A-J, Vitkovic L et al. (1996) Mast cells in the brain: evidence and functional significance. *TINS* 19:25–31
9. Silverman A-J, Sutherland AK, Wilhelm M et al. (2000) Mast cells migrate from blood to brain. *J Neurosci* 20:401–408
10. Sugimoto K, Maeyama K, Alam K et al. (1995) Brain histaminergic system in mast cell-deficient (Ws/Ws) rats: histamine content, histidine decarboxylase activity, and effects of (S) alpha-fluoromethylhistidine. *J Neurochem* 6:791–797
11. Theoharides TC (1990) Mast cells: the immune gate to the brain. *Life Sci* 4:607–617
12. Wasserman SI (1979) The mast cell and the inflammatory response. In: Pepys J, Edwards AM (eds), *The mast cell - Its role in health and disease*. Pitman Medical, Turnbridge Wells, pp 9–20
13. Zhuang X, Silverman A-J, Silver R (1996) Brain mast cell degranulation regulates blood-brain barrier. *J Neurobiol* 31:393–403

## Diencephalic Nociceptive Neurons in the Human

### ► Human Thalamic Nociceptive Neurons



## Dietary Variables in Neuropathic Pain

JASENKA BORZAN<sup>1</sup>, SRINIVASA N. RAJA<sup>1</sup>,  
YORAM SHIR<sup>2</sup>

<sup>1</sup>Department of Anesthesiology and Critical Care  
Medicine, Johns Hopkins University, Baltimore, MD,  
USA

<sup>2</sup>Pain Centre, Department of Anesthesia, McGill  
University Health Centre, Montreal General Hospital,  
Montreal, QC, Canada

jborzan1@jhmi.edu, sraja@jhmi.edu,  
yoram.shir@muhc.mcgill.ca

### Definition

Foods and beverages are composed of various substances that can be helpful or harmful to human health. However, data on a possible analgesic role of dietary constituents in acute and chronic pain states are still limited. Recent *in vitro* and *in vivo* animal studies have indicated that dietary amino acids, proteins and oils can be beneficial in neuropathic conditions. Most of the published human studies lack proper control groups, but the results corroborate the idea that specific dietary choices or supplements have the potential to alleviate chronic neuropathic pain. These beneficial effects probably depend on both genetic factors and the specific type of the neuropathic condition. Conversely, carbohydrate consumption among untreated diabetics or chronic alcohol abuse can lead to painful neuropathic conditions. A large number of dietary constituents have yet to be explored for their potential benefits in the treatment of neuropathic pain.

### Characteristics

Many peptides derived from foods have been identified to have opioid-like properties, and hence have been named ► **exorphins** (in contrast to endogenous opioid peptides-endorphins). As exorphins show opioid receptor agonist or antagonist properties, they are an indication that diet selection is of potential importance in neuropathic as well as other painful conditions (for review of bioactive proteins and peptides including exorphins, see Kitts and Weiler 2003).

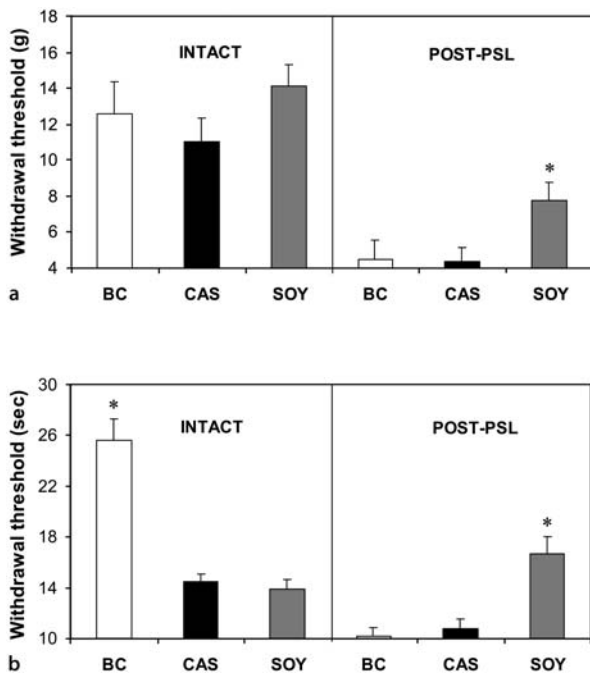
Chronic neuropathic pain conditions in humans have a variety of etiologies, making the association between dietary constituents and neuropathic pain very complex. The majority of the clinical data available to date on the effects of dietary components on neuropathic pain exist in diabetic patients and alcohol abusers with painful peripheral neuropathy. People with hyperglycemia, if untreated, often develop a painful neuropathic condition most commonly affecting the extremities (Duby et al. 2004). A diet high in carbohydrates can contribute to high intracellular glucose levels that can lead to pathological changes such as vasoconstriction and endothelial hyperplasia, increased ► **oxidative stress** and

activation of protein kinase C (PKC). These changes in turn promote ► **neuronal dysfunction** (e.g. decreased nerve blood flow resulting in neural hypoxia). Vegan diet combined with exercise has been reported to effectively reduce symptoms of painful diabetic neuropathy, supposedly by helping to regulate blood viscosity and filterability above and beyond glycemic control (McCarty 2002). Dietary supplements such as evening primrose oil, alpha-lipoic acid and capsaicin might also have some role in decreasing pain symptoms in painful diabetic neuropathy, without directly affecting blood glucose (Halat and Dennehy 2003).

Chronic alcohol abuse may result in a peripheral neuropathy in the lower extremities due to direct degenerative effects on both myelinated and unmyelinated nerve fibers, disruption of ► **axonal transport** and enhancement of ► **glutamate neurotoxicity** in neurons (Koike et al. 2001).

Only a small number of dietary constituents have been shown to possess analgesic properties in animal models of neuropathic pain. Diets enriched with the amino acids tryptophan (Abbott and Young 1991) and taurine (Belfer et al. 1998), and diets based on casein protein (Shir et al. 1997), have been shown to suppress ► **autotomy** (self mutilation) levels in a rat model of ► **deafferentation pain**, produced by total peripheral neurectomy. Tryptophan, a precursor of serotonin, could exert its analgesic effects by activating spinal and supraspinal serotonergic ► **antinociceptive** mechanisms. In a placebo controlled study, tryptophan supplements have been shown to reduce neuropathic pain in humans (as discussed in Abbott and Young 1991). Taurine, an inhibitory amino acid found abundantly in the CNS, is bioavailable primarily through ingestion of seafood and meat. Rats with a genetic tendency to develop high levels of autotomy (HA rats) expressed reduced levels of self mutilation following total hind limb denervation when consuming taurine enriched water, either pre- or post-nerve injury (Belfer et al. 1998). These authors argued that taurine might protect the inhibitory neurons in the central nervous system from the damaging ► **excitotoxic** barrage that accompanies nerve injury.

The most comprehensive evidence for the analgesic effect of diet in neuropathic pain models derives from the studies on the effect of soy protein on the development of chronic neuropathic pain behavior in rats undergoing partial sciatic nerve ligation injury (PSL model) (see ► **Neuropathic Pain Model, Partial Sciatic Nerve Ligation Model**). In these studies, tactile (Fig. 1a) and heat (Fig. 1b) ► **allodynia** and hyperalgesia were significantly attenuated in rats fed soy-rich diets, compared to rats fed soy deficient diets (Shir et al. 1998; 2001a). It was further established that the analgesic effects of soy was fairly short lasting, because discontinuation of a soy diet 15 h prior to nerve injury resulted in lack of analgesic effects (Shir et al. 2001b). In contrast to its prophylactic effect, palliative consumption of a soy



**Dietary Variables in Neuropathic Pain, Figure 1** The effect of bread and cucumber (BC), casein rich (CAS), or soy rich (SOY) diet on average mechanical (a) and heat (b) paw withdrawal thresholds before and 14 days after partial sciatic nerve ligation. Animals were fed one of the diets for 28 days (left panels: intact), or 14 days before and after the nerve injury (right panels: post-PSL). After PSL injury, rats fed soy rich diet displayed significantly less mechanical and heat allodynia than BC or CAS fed rats ( $p = 0.04$  and  $p = 0.001$  for mechanical, and  $p = 0.0002$  and  $p = 0.0006$  for thermal responses respectively). (Modified from Shir et al. 2001a).

diet following injury did not attenuate neuropathic pain behavior. Soy diet can affect the consequences of partial nerve ligation only within a few hours of the injury. Thus, it is reasonable to assume that the chronic pain resulting from PSL is triggered by pathological processes occurring relatively shortly after the injury (Shir et al. 2001b).

What is the active antinociceptive ingredient of soy? Phytoestrogens, abundantly found in soy products, were tested because they possess biological activities that could be relevant to pain (e.g. alteration of steroid hormone metabolism, inhibition of various protein-kinase enzymes, antioxidative properties) (Shir et al. 2002). In this study, rats were fed one of 5 diets containing different phytoestrogen levels for 2 weeks prior to and 2 weeks following PSL injury. At certain concentrations, phytoestrogens were associated with reduced neuropathic pain in rats. Average plasma concentrations of phytoestrogens (approximately 400–900 nmol/l) were associated with reduced levels of tactile allodynia and mechanical hyperalgesia, but not with reduced heat allodynia. Low and high plasma phytoestrogen levels, however, were not analgesic in these tests (Shir et al. 2002).

Since highly variable levels of neuropathic pain among rats undergoing nerve injury were also attributed to genetic factors, the interaction between genetic and dietary factors was studied in PSL-injured rats. Levels of heat hyperalgesia were highly variable across eight different rat strains fed seven different diets suggesting that genetic factors may influence the effects of diet on neuropathic pain (Shir and Seltzer 2001c).

Polyunsaturated fatty acids (PUFA), mainly the essential fatty acids linoleic acid (omega-6) and alpha-linolenic acid (omega-3), are another dietary group with biological activities that could be relevant to the suppression of chronic neuropathic pain (e.g. inhibition of voltage gated sodium and calcium channels; inhibition of several protein kinases) (Shapiro 2003). Perez et al. (2004) have tested the role of dietary fat and the fat/protein interactions in the development of tactile allodynia and heat hyperalgesia in PSL-injured rats. These experiments have shown that dietary fat is a significant independent predictor of levels of neuropathic pain in rats, and that this effect could be accentuated by dietary protein (Perez et al. 2004).

It is reasonable to assume that multiple dietary constituents have biologically significant consequences, some of which are directly related to neuropathic pain suppression. However, the identification of pro-analgesic nutrients has only recently started to emerge in preclinical and clinical research. Future investigations identifying new relevant dietary constituents and describing their underlying mechanisms in pain processing may provide novel therapeutic strategies in the treatment of neuropathic pain.

## References

- Abbott FV, Young SN (1991) The Effect of Tryptophan Supplementation on Autotomy Induced by Nerve Lesions in Rats. *Pharmacol Biochem Behav* 40:301–304
- Belfer I, Davidson E, Ratner A et al. (1998) Dietary Supplementation with the Inhibitory Amino Acid Taurine Suppresses Autotomy in HA rats. *Neuroreport* 9:3103–3107
- Duby JJ, Campbell RK, Setter SM et al. (2004) Diabetic Neuropathy: An Intensive Review. *Am J Health-Syst Pharm* 61:160–176
- Halat KM, Dennehy CE (2003) Botanicals and Dietary Supplements in Diabetic Peripheral Neuropathy. *J Am Board Fam Pract* 16:47–57
- Kitts DD, Weiler K (2003) Bioactive Proteins and Peptides from Food Sources. Applications of Bioprocesses Used in Isolation and Recovery. *Curr Pharm Des* 9:1309–1323
- Koike H, Mori K, Misu K et al. (2001) Painful Alcoholic Polyneuropathy with Predominant Small-Fiber Loss and Normal Thiamine Status. *Neurology* 56:1727–1732
- McCarty MF (2002) Favorable Impact of a Vegan Diet with Exercise on Hemorheology: Implications for Control of Diabetic Neuropathy. *Med Hypotheses* 58:476–486
- Pérez J, Ware MA, Chevalier S, Gougeon R, Bennett GJ, Shir Y (2004) Dietary fat and protein interact in suppressing neuropathic pain-related disorders following partial sciatic ligation injury in rats. *Pain* 111:297–305
- Shapiro H (2003) Could n-3 Polyunsaturated Fatty Acids Reduce Pathological Pain by Direct Actions on the Nervous System? *Prostaglandins Leukot Essent Fatty Acids* 68:219–224

10. Shir Y, Campbell JN, Raja SN et al. (2002) The Correlation between Dietary Soy Phytoestrogens and Neuropathic Pain Behavior in Rats after Partial Denervation. *Anesth Analg* 94:421–426
11. Shir Y, Ratner A, Raja SN et al. (1998) Neuropathic Pain following Partial Nerve Injury in Rats is Suppressed by Dietary Soy. *Neurosci Lett* 240:73–76
12. Shir Y, Ratner A, Seltzer Z (1997) Diet can Modify Autotomy Behavior in Rats following Peripheral Neurectomy. *Neurosci Lett* 236:71–74
13. Shir Y, Raja SN, Weissman CS et al. (2001b) Consumption of Soy Diet before Nerve Injury Preempts the Development of Neuropathic Pain in Rats. *Anesthesiology* 95:1238–1244
14. Shir Y, Seltzer Z (2001c) Heat Hyperalgesia following Partial Sciatic Nerve Ligation in Rats: Interacting Nature and Nurture. *NeuroReport* 12:809–813
15. Shir Y, Sheth R, Campbell JN et al. (2001a) Soy-Containing Diet Suppresses Chronic Neuropathic Sensory Disorders in Rats. *Anesth Analg* 92:1029–1034

## Differentiation

### Definition

The process cells undergo as they mature into normal cells. Differentiated cells have distinctive characteristics different from undifferentiated cells, perform specific functions and are less likely to divide than undifferentiated cells.

- ▶ Cell Therapy in the Treatment of Central Pain

## Difficulty to Disengage

### Definition

Difficulty in switching attention towards neutral information once a threat stimulus has been detected and is being processed.

- ▶ Hypervigilance and Attention to Pain

## Diffuse Noxious Inhibitory Controls

### Synonyms

DNIC

### Definition

The theoretical basis for understanding the inhibitory controls activated by noxious stimuli hypothesizes that noxious stimuli activate a surround inhibition that sharpens contrast between the stimulus zone and adjacent areas. This sharpened contrast would actually have a net enhancing effect on the perceived intensity of the painful stimuli and an analgesic effect outside the stimulated zone, i.e. inhibition within the spinal cord by noxious stimulation of one part of the body, inhibits nociception in another part of the body. This surround analgesia may explain counterirritation and acupuncture analgesia.

- ▶ Acupuncture Mechanisms
- ▶ Opiates During Development
- ▶ Pain Modulatory Systems, History of Discovery
- ▶ Tourniquet Test

## Diffusion

### Definition

The diffusion describes the effect of movement of particles from a region of higher concentration to a region of lower concentration.

- ▶ NSAIDs, Pharmacokinetics

## Diffusion Tensor Imaging

### Synonyms

DTI

### Definition

Allows the mapping of white matter tracts *in vivo*.

- ▶ Human Thalamic Response to Experimental Pain (Neuroimaging)

## Digital Nerve Blocks

### Definition

Local anesthetic blockade of the finger or toe.

- ▶ Acute Pain in Children, Post-Operative

## Digital Radiography

- ▶ Plain Radiography

## Dimension

### Definition

A dimension serves to define a point by its coordinates.

- ▶ Multidimensional Scaling and Cluster Analysis Application for Assessment of Pain
- ▶ Pain Measurement by Questionnaires, Psychophysical Procedures and Multivariate Analysis

## Dimethylsulfoxide

### Synonyms

DMSO

**Definition**

Dimethylsulfoxide is a substance that has been used for pain treatment. It selectively sensitizes A $\delta$  nociceptors and desensitizes C nociceptors.

- ▶ Opioid Modulation of Nociceptive Afferents In Vivo

**Diohyogastric Nerve Block**

- ▶ Dioinguinal and Diohyogastric Nerve Block

**Dioinguinal and Diohyogastric Nerve Block****Definition**

Blockade of sensory innervation to the groin and scrotal sac on the ipsilateral side by infiltration of the abdominal wall in the region of the superior anterior iliac spine, or fanshaped injection of 3-5 ml local anesthetic just beneath the internal oblique fascia.

- ▶ Acute Pain in Children, Post-Operative

**Direct Suggestion****Definition**

Direct suggestion in the context of hypnosis refers to a suggestion that directly indicates what experience or behavior will occur (e.g. “Your hand will feel progressively number and less painful” )

- ▶ Hypnotic Analgesia

**Disability****Definition**

According to the WHO International Classification of Impairments, Disabilities and Handicaps (ICIDH) it is defined as “any restriction or lack of ability to perform an activity in a manner or within the range considered normal for a human being”. All in all the term disability serves as an umbrella term for impairments, activity limitations and participation restrictions. It can therefore be seen as the negative term of functioning. The interaction of disability and health condition works in both directions, because the presence of disability may even modify the health condition.

- ▶ Disability and Impairment Definitions
- ▶ Disability, Upper Extremity
- ▶ Impairment, Pain-Related
- ▶ Oswestry Disability Index
- ▶ Pain as a Cause of Psychiatric Illness

**Disability and Health (ICF)**

- ▶ WHO System on Impairment and Disability

**Disability and Impairment Definitions**

GEROLD STUCKI, THOMAS EWERT

Department of Physical Medicine and Rehabilitation, Ludwig-Maximilians University, Munich, Germany  
gerold.stucki@med.uni-muenchen.de

**Synonyms**

Functioning; Functional Health; Handicap

**Definition**

▶ **Impairment** is a loss or abnormality in body structure or physiological function (including mental functions). Here, abnormality is used strictly to refer to a significant variation from established statistical norms (i.e. as a deviation from a population mean within measured standard norms), and should be used only in this sense.

▶ **Disability** is an umbrella term for impairments, ▶ **activity** limitations and ▶ **participation** restrictions. It denotes the negative aspects of the interaction between an individual (with a health condition) and that individual’s ▶ **contextual factors** (environmental and ▶ **personal factors**). Disability is characterized as the outcome or result of a complex relationship between an individual’s health condition and personal factors, and of the external factors that represent the circumstances in which the individual lives. The positive expression for disability is functioning.

**Characteristics**

The current framework of disability and impairment is the WHO International Classification of Functioning, Disability and Health (▶ **ICF**) (WHO 2001). Historically, there have been two major conceptual frameworks in the field of disability: the International Classification of Impairment, Disability and Handicap (ICIDH), which is the precursor to the ICF (WHO 1980), and the “functional limitation”, or Nagi, framework (Nagi 1964). In the ICIDH, the four concepts were disease, impairment, disability and handicap. In the Nagi framework, the four concepts are pathology, impairment, functional limitation, and disability. Different from the ICIDH, the Nagi framework was not accompanied by a classification. Building on the conceptual frameworks of the ICIDH and Nagi, the US Committee on a National Agenda for the Prevention of Disabilities developed a model emphasizing the interaction between the disabling process, quality of life and individual risk factors (Pope and Tarlov 1991).



The ICF, the current framework of disability, attempts to achieve a synthesis, thereby providing a coherent view of different perspectives of health from a biological, individual and social perspective. It emphasizes “building blocks” to form specific models, focusing on more detailed aspects. The ICF has addressed many of the criticisms of prior conceptual frameworks, and has been developed in a worldwide comprehensive consensus process over the few last years. For all these reasons, the ICF is likely to become the generally accepted conceptual framework and classification to describe a persons’ level of function and health.

It is important to recognize that the ICF is a common language (Stucki et al. 2002): The texts that can be created with it depend on the users, their creativity and their scientific orientation. The understanding of interactions between the components of the ICF is shown in Fig. 1.

Health condition refers to any kind of disorder or disease. It may include information about pathogenesis and/or etiology. There are (possible) interactions with all components of functioning: ► **Body functions and structures**, activity and participation.

Body functions are the physiological (and psychological) functions of body systems. ► **Body structures** are anatomical parts of the body. Problems in both constructs are impairments, which are defined as a significant deviation or loss (e.g. deformity) of structures (e.g. joints) and/or functions (e.g. reduced range of motion (ROM), muscle weakness, pain and fatigue). The levels of reference are body systems; accordingly, body structures are not considered as organs.

Activity is described as the execution of a task or action by an individual. It represents the individual’s perspective of functioning. Difficulties an individual may have in executing activities are activity limitations (e.g. limitations in mobility such as walking, climbing steps, grasping or carrying).

Participation is described as involvement in a life situation. It represents the societal perspective of functioning.

Problems an individual may experience in involvement in life situations are participation restrictions. Limitations and restrictions are assessed against a generally accepted population standard. It records discordance between the observed and the expected performance. The expected performance is the population norm, which represents the experience of people without the specific health condition (e.g. restrictions in community life, recreation and leisure, but maybe in walking too, if walking is an aspect of participation in terms of life situation). However, disability serves as an umbrella term for impairments, activity limitations and participation restrictions. So it can be seen as the negative term of functioning. The interaction of disability and health condition works in both directions, because the presence of disability may even modify the health condition.

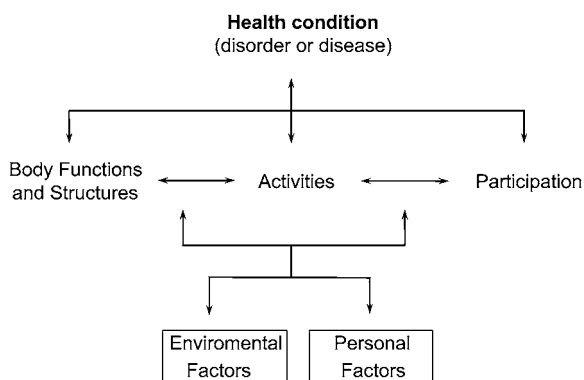
A person’s functioning and disability is conceived as a dynamic interaction between health conditions (diseases, disorders, injuries, traumas, etc.) and contextual factors. Likewise, there are (possible) interactions with all components of functioning and contextual factors.

Contextual factors are factors that together constitute the complete context of an individual’s life, and in particular, the backgrounds against which health states are classified in ICF. There are two components: ► **Environmental factors** and personal factors.

Environmental factors refer to all aspects of the external or extrinsic world that form the context of an individual’s life and, as such, have an impact on that person’s functioning. Environmental factors include the physical world and its features, the human-made physical world, other people in different relationships and roles, attitudes and values, social systems and services, and policies, rules and laws.

Personal factors are contextual factors that relate to the individual such as age, gender, social status, life experiences and so on. Risk factors could be described under both personal factors (e.g. lifestyle, genetic kit) and environmental factors (e.g. living and work conditions, architectural barriers) that are associated with conditions such as pain. Risk factors are not only associated with the onset, but interact with the disabling process at each stage. Bidirectional arrows in Figure 1 indicate the possibility of ‘feedback’. Risk factors also affect the progression of disability and may include, depending on the stage, treatment, rehabilitation, age of onset, financial resources, expectations and environmental barriers. Personal factors are included in the ICF model of functioning and health, but not classified.

The components of functioning and disability are distinct, but they are related. All kinds of loss in body-structures and functions, activities and participation are described with disability. Several health states can be mentioned, with (in particular) independent involvement of the components of functioning. For example, one may:



**Disability and Impairment Definitions, Figure 1** Interactions between the components of ICF.

**Disability and Impairment Definitions, Table 1** ICF Categories of the ICF Core Set for Chronic Widespread Pain

ICF Code	ICF Category Title
<i>categories of the component 'body functions'</i>	
b122	Global psychosocial functions
<b>b130</b>	<b>Energy and drive functions</b>
<b>b134</b>	<b>Sleep functions</b>
<b>b140</b>	<b>Attention functions</b>
<b>b147</b>	<b>Psychomotor functions</b>
<b>b152</b>	<b>Emotional functions</b>
<b>b1602</b>	<b>Content of thought</b>
b164	Higher-level cognitive functions
b180	Experience of self and time function
b260	Proprioceptive function
b265	Touch function
b270	Sensory function related to temperature and other stimuli
<b>b280</b>	<b>Sensation of pain</b>
<b>b455</b>	<b>Exercise tolerance functions</b>
b640	Sexual functions
b710	Mobility of joint functions
<b>b730</b>	<b>Muscle power functions</b>
b735	Muscle tone functions
b740	Muscle endurance functions
<b>b760</b>	<b>Control of voluntary movement functions</b>
b780	Sensations related to muscles and movement functions
<i>category of the component 'body structures'</i>	
s770	Additional musculoskeletal structures related to movement
<i>categories of the component 'activities and participation'</i>	
d160	Focusing attention
<b>d175</b>	<b>Solving problems</b>
d220	Undertaking multiple tasks
<b>d230</b>	<b>Carrying out daily routine</b>
<b>d240</b>	<b>Handling stress and other psychological demands</b>
d410	Changing basic body position
d415	Maintaining a body position
<b>d430</b>	<b>Lifting and carrying objects</b>
d450	Walking
d455	Moving around
d470	Using transportation
d475	Driving

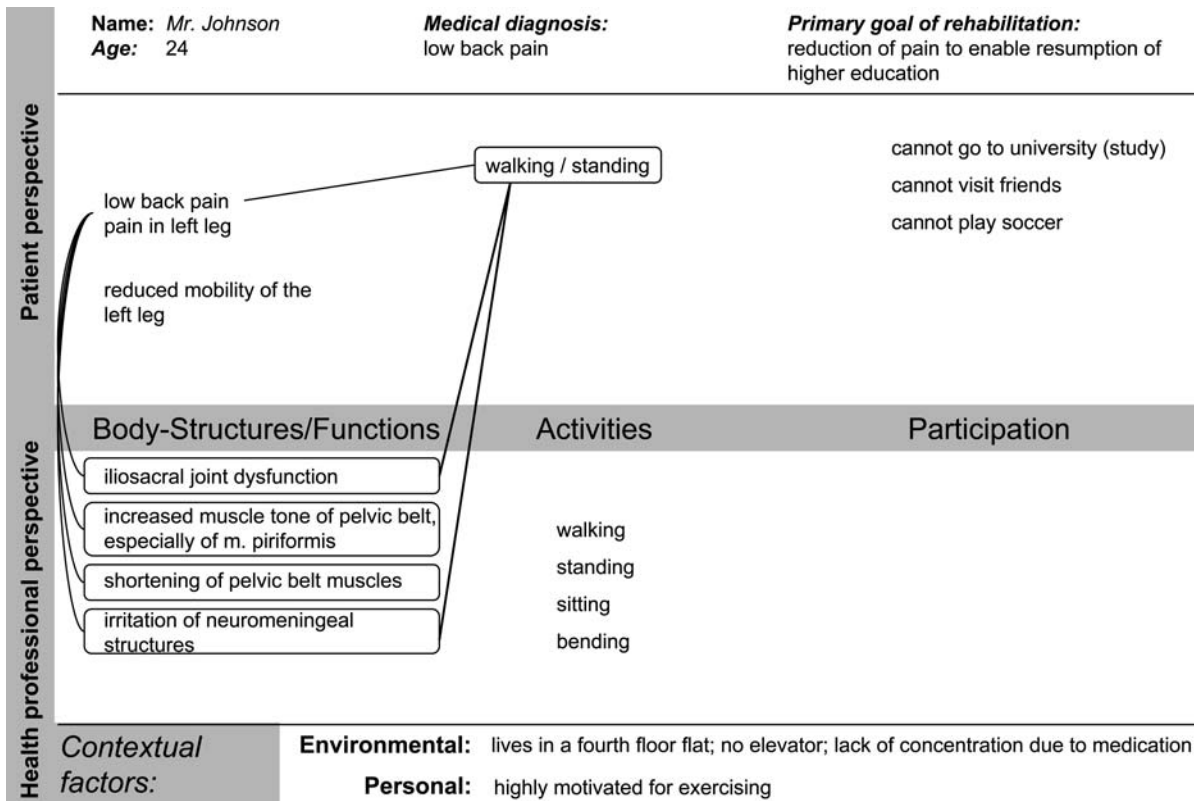
Disability and Impairment Definitions, Table 1 (continued)

ICF Code	ICF Category Title
d510	Washing oneself
d540	Dressing
d570	Looking after one's health
d620	Acquisition of goods and services
<b>d640</b>	<b>Doing housework</b>
d650	Caring for household objects
d660	Assisting others
d720	Complex interpersonal interactions
<b>d760</b>	<b>Family relationships</b>
<b>d770</b>	<b>Intimate relationships</b>
<b>d850</b>	<b>Remunerative employment</b>
d855	Non-remunerative employment
d910	Community life
<b>d920</b>	<b>Recreation and leisure</b>
<i>categories of the component 'environmental factors'</i>	
<b>e1101</b>	<b>Drugs</b>
<b>e310</b>	<b>Immediate family</b>
e325	Acquaintances, peers, colleagues, neighbors and community members
<b>e355</b>	<b>Health professionals</b>
<b>e410</b>	<b>Individual attitudes of immediate family members</b>
<b>e420</b>	<b>Individual attitudes of friends</b>
e425	Individual attitudes of acquaintances, peers, colleagues, neighbors and community members
e430	Individual attitudes of people in positions of authority
e450	Individual attitudes of health professionals
e455	Attitudes of Other Professionals
e460	Societal attitudes
e465	Social norms, practices and ideologies
<b>e570</b>	<b>Social security services, systems and policies</b>
e575	General social support services, systems and policies
e580	Health services, systems and policies
e590	Labor and employment services, systems and policies

Have limitations in activity without evident impairments (e.g. phantom pain or reduced performance in daily activities associated with many diseases)

Have participation restrictions without having impairments or activity limitations (e.g. an individual with migraine, not actually having any pain, but avoiding some situations like, for example, meeting friends in a pub)

The ICF is intended for use in multiple sectors that include, besides health, education, insurance, labor, health and disability policy, statistics, etc. In the clinical context, it is intended for use in needs assessment, matching interventions to specific health states, rehabilitation and outcome evaluation. However, the ICF needs to be tailored in order to suit these specific uses. Firstly, the



**Disability and Impairment Definitions, Figure 2** Illustration of how the ICF components can be used to structure patient problems (listed in the upper section “patient perspective”) as well as findings, and observations by the rehabilitation team (listed in the lower section “health professional perspective”). Lines between the selected target problems from the patient’s perspective (circled in the upper section), impaired body functions and structures as well as the given personal and environmental factors (circled in the lower section) denote their hypothesized relationship. Please note that the wording denotes patient’s words or special medical terms and not text from ICF categories.

joint use of the ICF and the International Classification of Diseases ICD–10 needs to be addressed when applying the ICF to medicine. WHO considers the ICF and the ICD–10 to be distinct but complementary classifications. According to this view, patient functioning and health are associated with, but are not merely a consequence of, a condition or disease. For practical purposes, lists of ICF categories called ICF Core Sets have been developed for a number of conditions with a high burden of disease, including chronic widespread pain and low back pain (Stucki et al. 2002). Table 1 shows the ICF Core Set for chronic widespread pain (Cieza et al. 2003). The brief ICF Core Set, marked in bold, includes the categories to be assessed in every clinical study and clinical encounter to allow for a meaningful description of a patients functioning and health. The comprehensive ICF Core Set includes the categories considered relevant for a comprehensive multidisciplinary assessment. A practical possibility of how to use the ICF is shown in Fig. 2.

Since the new ICF defines components of health and some health-related components of well-being (such as education and labor), it could also be used to obtain

information about quality of life. Quality of life refers to total well-being, encompassing both physical and psychosocial determinants. Quality of life is affected by each stage of the disabling process (e.g. in patients with scleroderma the quality of life may be decreased due to structure of the skin disease, pain, restricted grip function and consequently inability to shop). Within the disabling process, each stage affects an individual’s quality of life; it is not a finite endpoint, but an integral part of the disabling process.

The close relation of the ICF to quality of life applies accordingly to measures of quality of life, including measures of health related quality of life or generic measures, condition specific measures e.g. for low back pain, and dimension specific measures e.g. for pain and depression. The concepts contained in such measures can be linked to the ICF using defined linkage rules (Cieza et al. 2002). It seems that the concepts contained in these measures are generally represented in the ICF (Weigl et al. 2003; Cieza and Stucki 2003). It is important to recognize that different measures address different components of the ICF. Condition specific measures typically fo-



cus on body functions and activities, whilst generic measures tend to cover activities and participation including aspects of physical, mental and social health. Contextual factors are hardly covered by any of these instruments. Nonetheless, there is a need to address all components when assessing functioning and health in patients with chronic conditions (Ewert et al. 2004).

Finally, it is important to note, that the perspective of functioning, disability and health is different when viewed from a more medical versus functioning oriented perspective e.g. in rehabilitation. From the medical perspective, functioning and health are seen primarily as a consequence of a disease or condition. Accordingly, medical interventions are targeted towards the disease process. The measurement of functioning, disability and health is required to evaluate the patient-relevant outcomes of an intervention. Instead, from a functioning-oriented or rehabilitation perspective represented in the ICF, patients functioning and health are associated with, but not merely a consequence of, a condition or disease. Furthermore, functioning and health are not only seen in association with a condition, but also in association with personal and contextual factors. Therefore, the measurement of functioning, disability and health is not only relevant to evaluate intervention outcomes but for the diagnosis (assessment) and interventional management, as well. For the management of most patients with pain conditions, the latter perspective is more relevant.

## References

1. Cieza A, Brockow T, Ewert T et al. (2002) Linking Health-Status Measurements to the International Classification of Functioning, Disability and Health. *J Rehab Med* 34:205–210
2. Cieza A, Stucki G (2005) Content Comparison of Health Related Quality of Life (HRQOL) Instruments Based on the International Classification of Functioning, Disability and Health (ICF). *Qual Life Res* 14:1225–37
3. Cieza A, Stucki G, Weigl M et al. (2003) ICF Core Sets for chronic widespread pain. *J Rehab Med* 44 Suppl:63–68
4. Ewert T, Fuessl M, Cieza A et al. (2004) Identification of the Most Common Patient Problems in Patients with Chronic Conditions using the ICF Checklist. *J Rehab Med* 36:186–188
5. Nagi SZ (1964) A study in the Evaluation of Disability and Rehabilitation Potential: Concepts, Methods, and Procedures. *Am J Pub Health* 54:1568–1579
6. Pope AM, Tarlov AR (1991) *Disability in America: Toward a National Agenda for Prevention* National Academy Press, Washington
7. Stucki G, Ewert T, Cieza A (2002) Value and Application of the ICF in Rehabilitation Medicine. *Disabil Rehabil* 24:932–938
8. Stucki G, Ewert T, Cieza A et al. (2002) Application of the International Classification of Functioning, Disability and Health (ICF) in Clinical Practice. *Disabil Rehabil* 24:281–282
9. Weigl M, Cieza A, Harder M et al. (2003) Linking Osteoarthritis Specific Health Status Measures to the International Classification of Functioning, Disability and Health (ICF). *Osteoarthritis Cartilage* 11:1–5
10. WHO (2001) *International Classification of Functioning, Disability and Health: ICF*. WHO, Geneva
11. WHO (1980) *ICIDH. International Classification of Impairments, Disabilities and Handicaps*. WHO, Geneva

## Disability Assessment, Psychological / Psychiatric Evaluation

ROBERT J. GATCHEL

Department of Psychiatry, The University of Texas Southwestern Medical Center at Dallas, Dallas, TX, USA

robert.gatchel@utsouthwestern.edu

D

### Synonyms

Psychological Evaluation; Psychiatric Evaluation

### Characteristics

The fundamental goal of the disability evaluation procedure is usually to ascertain whether a patient can or cannot work. However, such a determination is quite difficult in evaluating painful conditions because of the misguided assumption that impairment can be precisely and objectively measured and is closely linked to “mechanical failure” of an organ or body part. Often however, chronic pain patients will report activity restrictions that cannot be fully understood in terms of a specific “mechanical failure.” There is often a low concordance between subjective reports of pain and objective data of impairment. Thus, this will introduce vagaries into the disability evaluation process. One disability evaluator may tend to ignore the patient’s subjective reports of pain and disability and rely more heavily on any objective evidence of mechanical dysfunction that is available. Another evaluator may rely more exclusively on the subjective appraisals and activity restrictions reported by the patient, regardless of whether they can be objectively quantified in terms of any measurable mechanical failure or dysfunction. Still another evaluator may attempt to develop a composite of both the subjective and objective measures. Unfortunately, there is currently no totally agreed upon disability evaluation system that can be used (Dembe 2000; Robinson 2001).

A “► **stepwise approach**” should be used in the psychological / psychiatric evaluation process (Gatchel 2000). This is because most clinicians are under various time constraints, as well as billing constraints imposed by third-party payers, when considering the best method of evaluating possible disability in their patients with pain. Therefore, a frequently asked question is, “If I were to choose the most time- and cost-efficient assessment method, which one should I select?” However, one must not make the assumption that there is a single instrument that can serve as the best assessment. For many patients, several methods and measures will be needed. Rather than asking which instrument and approach should be used, a better question is, “What sequence of testing should I consider to develop the best understanding of potential disability problems that might be encountered with this patient with reports

of pain?” Therefore, psychosocial evaluation should be viewed as a stepwise process, proceeding from global indices of emotional distress and disturbance to more detailed evaluations of specific diagnoses of psychopathology. Thus, for example, an initial evaluation of disability may involve the administration of specific assessment tools that have been developed for this purpose, such as the Million visual analog scale (Million et al. 1982) or the Roland and Morris disability questionnaire (Roland and Morris 1983). A comprehensive review of many of these instruments is provided by Gatchel (2001) and Turk and Melzack (2001). In addition to one of these instruments, an initial screening process that can be done efficiently to flag obvious psychosocial distress might consist of the administration of the SF-36 (Ware et al. 1993), the SCL-90 (Derogatis 1983, pp 115–132) and the Beck depression inventory (BDI; Beck et al. 1961). Any pronounced scale elevations on these instruments would alert clinical staff to the degree of emotional distress or dysfunction in a pain patient and would indicate the need for a more thorough evaluation. This may then lead to the administration of the MMPI-2 (Keller and Butcher 1991) or a structured interview to develop official American Psychiatric Association’s Diagnostic and Statistical Manual, 4<sup>th</sup> edition, DSM-IV-based diagnoses of an Axis I or Axis II disorder (First et al. 1995). The final step would be the administration of a psychosocial clinical interview, which is one of the most powerful assessment tools of the clinician. In addition to the traditional areas explored in a clinical history, there are other areas that would be explored that may pose potential barriers to recovery and could affect response to treatment. Some of these topics include history of head injury, convulsions or impairment of function, any stressful changes in lifestyle or marital status before or since the injury that precipitated the pain, any litigation pending for the patient’s current medical or pain problem and a work history, including explanation of job losses, changes and dissatisfaction. The interview allows the clinician to contrast the patient’s current psychosocial functioning with past functioning and to compare the testing data with the interview data. The clinician can then estimate the degree of disability reported by the patient and the potential for getting the patient to change behavior and possibly work toward rehabilitation.

Of course, the common denominator of all assessment methods is the qualities of ► **validity**, reliability (reproducibility) and predictive value. However, there often remain frequent misunderstandings over the appropriate use of assessments based upon the generalizability of the scientific reports of validity to the circumstances in which the health care professional is using the assessment method. Such ambiguities can be minimized by examining the match between the clinical context in which a test is evaluated and the patient to whom it is

applied in the clinical setting. Basically, it is answering the question of test validity by addressing the “valid for what purpose?” issue. Assessment methods may be valid for measuring specific biological states but have no validity in predicting, for example, disability or activities of daily living. Finally, it must be kept in mind that, when embracing a comprehensive biopsychosocial evaluation (see ► **biopsychosocial perspective**) model (Turk and Monarch 2002), it is important to consider each successive assessment measure in context with the other measures to be integrated. This will lead to the most comprehensive disability assessment of a patient that will then significantly contribute to the development of the most effective treatment regimen for dealing with the disability problem. A “step-wise approach” to assessment is recommended (Gatchel 2000), which proceeds from global indices of biopsychosocial concomitants of pain to more detailed evaluations of specific diagnoses.

## References

1. Beck AT, Ward CH, Mendelson MM et al. (1961) An inventory for measuring depression. *Archives of General Psychiatry* 4:561–571
2. Dembe AE (2000) Pain, function, impairment and disability: Implications for workers’ compensation and other disability insurance systems. In: Mayer TG, Gatchel J, Polatin PB (eds) *Occupational Musculoskeletal Disorders: Function, Outcomes and Evidence*. Lippincott Williams and Wilkins, Philadelphia
3. Derogatis L (1983) *The SCL90-R Manual-II: Administration, Scoring and Procedures*. Clinical Psychometric Research, Baltimore
4. First MB, Spitzer RL, Gibbon M et al. (1995) *Structured Clinical Interview for DSM-IV Axis I Disorders-Nonpatient Edition (SCID-I/NP, Version 2.0)*. New York State Psychiatric Institute, New York
5. Gatchel RJ (2000) How practitioners should evaluate personality to help manage patients with chronic pain. In: Gatchel RJ, Weisberg JN (eds) *Personality Characteristics of Patients with Pain*. American Psychological Association, Washington
6. Gatchel RJ (2001) *A Compendium of Outcome Instruments for Assessment and Research of Spinal Disorders*. North American Spine Society, LaGrange
7. Keller LS, Butcher JN (1991) *Assessment of Chronic Pain Patients with the MMPI-2*. University of Minnesota Press, Minneapolis
8. Million S, Hall W, Haavik NK et al. (1982) 1981 Volvo Award in Clinical Science: Assessment of the progress of the back-pain patient. *Spine* 7:204–212
9. Robinson RC (2001) Disability evaluation in painful conditions. In: Turk DC, Melzack R (eds) *Handbook of Pain Assessment*, 2nd edn. Guilford, New York
10. Roland M, Morris R (1983) A study of the natural history of back pain. Part I: Development of a reliable and sensitive measure of disability and low back pain. *Spine* 8:141–144
11. Turk DC, Melzack R (2001) *Handbook of Pain Assessment*, 2nd edn. Guilford, New York
12. Turk D, Monarch ES (2002) Biopsychosocial perspective on chronic pain. In: Turk DC, Gatchel RJ (eds) *Psychological Approaches to Pain Management: A Practitioner’s Handbook*, 2nd edn. Guilford, New York
13. Ware JE, Snow KK, Kosinski M et al. (1993) *SF-36 Health Survey: Manual and Interpretation Guide*. The Health Institute, New England Medical Center, Boston

## Disability Determination

- Disability Evaluation in the Social Security Administration

## Disability, Effect of Physician Communication

JAMES P. ROBINSON  
University of Washington Pain Center, University of Washington, Seattle, WA, USA  
jimrob@u.washington.edu

### Synonyms

Secondary Prevention; Disability Management

### Definition

Physicians engage in a wide range of behaviors to help injured workers return to work. The most obvious interventions are medical or surgical treatments that promote an injured worker's recovery from injury. Physicians also perform activities that facilitate return to work without directly altering the biology of an injury. These activities can collectively be called disability management activities. They include interacting with a worker's employer or workers' compensation claims manager (Pransky et al. 2004). They also include communication with a patient about the significance of his or her injury, and, in particular, its implications for the patient's ability to work.

### Characteristics

Extensive research demonstrates that the manner in which physicians communicate with patients affects encounters between them. Effective communication by physicians promotes more open disclosure by patients, increased patient satisfaction with their medical encounters, and increased patient adherence with medical regimens (Teutsch 2003). Much of the research in this area has addressed *how* physicians communicate with patients. In contrast, this essay is focused on the content of *what* physicians communicate to patients with work injuries. In particular, it will focus on communication that addresses common fears among patients who have sustained work-related low back injuries. The essay assumes that a physician is communicating with a worker who has localized back pain from a relatively minor work injury. That is, it assumes that the worker has not sustained major trauma such as a spinal fracture, does not have a lumbar radiculopathy, and does not have any "red flags" suggestive of non-mechanical sources of low back pain (LBP) such as neoplasm (Bigos et al. 1994). Abundant literature supports the conclusion that the outcomes of work injuries are affected by psychosocial factors as well as biomedical ones (Turner et al. 2000). The

relevant psychosocial factors are diverse. They include pre-injury problems such as substance abuse or major depression. However, there is also abundant evidence that workers' responses to low back injuries are affected by a variety of factors that become evident only after injury, and are more appropriately viewed as expected reactions to injury than as mental disorders. In particular, recent research indicates fear of pain and/or reinjury acts as a major impediment to return to normal activities for individuals who have sustained back injuries (Vlaeyen and Linton 2000).

Research suggests that various kinds of psychological interventions can lead to reductions in patients' fears regarding their pain conditions, and that clinical improvement following therapies is mediated by reductions in fear (Boersma et al. 2000; Burns et al. 2003; Woby et al. 2004). This literature supports the conclusion that low back pain patients benefit from interventions that reduce their fears, but it has only indirect relevance to the issue of whether communications by physicians allay patients' fears and/or increase their likelihood of returning to work. While expert opinion supports the conclusion that communication by MDs can influence patients' recoveries (Anema et al. 2002; Deyo 1988; Pransky et al. 2004), methodologic issues make it difficult to study the nuances of physician-patient communication empirically. Some research supports the proposition that communications by physicians can promote return to work following work injuries (Catchlove and Cohen 1982; Hall et al. 1994), but the findings of other studies have been negative or equivocal (Dasinger et al. 2001; Hazard et al. 1997).

In essence, it is not possible to derive any definite conclusions about how physicians should communicate with injured workers from research findings to date. However, informal experience and expert opinion suggest several common concerns among injured workers with back problems, and messages from physicians that might allay these concerns.

Concern #1 – "Low back injuries are disabling, and potentially catastrophic. I might end up in a wheelchair." Response: The physician can appropriately point out that LBP is an extremely common problem in modern societies, that it usually occurs in self-limited episodes, and that it only rarely causes protracted disability. Thus, although the severity of pain associated with acute LBP is often distressing, evidence about the natural history of LBP provides ground for optimism that the symptoms will subside (Cheadle et al. 1994).

Concern #2 – "I should reduce my activity to avoid pain in my back, because pain indicates that I am reinjuring myself."

Response: Patients with acute LBP often have enough pain, so that they have little choice but to reduce their activity levels for a short period of time. It is understandable that when people experience significant pain when they try to return to normal activities, they become concerned

that they are making their problem worse. However, research supports the conclusion that pain associated with moderate activity is unlikely to make a back problem worse. That is, the “hurt” that patients may feel during activity usually does not mean that they are harming their back, or delaying their recovery. Moreover, prolonged inactivity can create new problems, because patients become ► **deconditioned**. In general, research supports the strategy of early activation (Hagen et al. 2004), and indicates that even fairly vigorous exercise is more likely to facilitate recovery than to impede it (Rainville 2004). Concern #3 – “I need to let my back heal. I should not return to work or to normal activities until then.” It makes sense for patients with acute LBP to reduce their activity for a short period of time, but it is unrealistic and usually counterproductive for people to restrict their activities severely until all their symptoms are gone. Most people return to normal activity – and in particular, to work – before their pain has resolved completely (Von Korff M and Saunders 1996). Conversely, people who take the position that they must remain inactive until they are completely free of symptoms run the risk of adverse effects of deconditioning.

Concern #4 – “My pain implies that I have an injury that needs to be fixed. I expect doctors to find the specific cause of my pain (the ► **pain generator**), and to fix the problem. Only treatment by a skilled doctor will allow me to recover from my back injury – there is nothing that I can do about the problem.”

Response: This perspective rests on the assumptions that back pain is a result of a specific ► **structural lesion**, that physicians have the skill to identify and fix the lesion, and that it is essentially impossible for an individual to return to normal functioning until the lesion has been fixed. All of these assumptions are incorrect for most patients with non-radicular LBP. In addressing this belief system, it is important to note that physicians are often unable to identify a precise pain generator for patients with non-radicular LBP (White and Gordon 1982), and that it is often doubtful that a single pain generator even exists (Robinson et al. 2005). Perhaps because of the difficulty in determining the anatomic basis of LBP, definitive interventions to “fix” the back are often only modestly helpful. Conversely, the vast majority of people who hurt their backs rely on self-management, and recover with only minimal professional help. Thus, patients’ interests are best served by taking an active role in managing their problem, rather than by waiting for a professional to fix it.

Concern #5 – “My MRI scan shows a bulging disk. I am convinced that it is the cause of my pain, and that I won’t get better until someone fixes my disk.”

Response: This is a variant of the conceptual model outlined in #4 above. It embodies the enormous significance that LBP patients tend to place on imaging studies that demonstrate anatomic abnormalities (Rhodes et al. 1999). Many patients conclude that since they have

a bad disk, they can’t possibly recover unless the disk is fixed. Patients with this perspective need to realize that research demonstrates that MRI findings in non-radicular LBP tend to be non-specific – e.g. that abnormalities such as bulging disks are commonly found among individuals with no current back pain or history of back pain (Boos et. al. 2000).

### Barriers to Effective Communication

Physicians who attempt to allay the fears of their patients, to motivate them to take a vigorous role in rehabilitating their backs, and to encourage them to return to normal activities soon after injury, face an uphill battle for many reasons. One is that a rehabilitative approach (► **rehabilitation**) that makes heavy demands on the patient conflicts with prevalent myths in advanced societies about the magical power of medical/surgical treatment, and the sense that patients are entitled to rapid, effortless relief of suffering. Second, a physician who attempts to steer patients away from invasive therapies and promotes rapid return to work may be viewed as an agent of the employer or insurance company. Third, there are ongoing differences of opinion among spine physicians and surgeons about the benefits of alternatives to a rehabilitative approach that places a great deal of responsibility on patients. Claims about new ► **interventional therapies** create ambiguity in the medical community about how to approach patients with LBP. Moreover, regardless of their benefits as demonstrated in well controlled clinical trials, interventional therapies have the allure of promising patients a “fix” for their problem based on the magic of modern technology. In comparison to new interventional therapies, recommendations for self-management and return to activities in the absence of a total cure may be perceived by patients as outdated and unimaginative.

### Summary

Research to date suggests that physicians can influence the course of recovery following work-related back injuries by their communications with injured workers and with other interested parties (e.g. employers) (Pransky et al. 2004). This essay has focused on a specific area of physician communication – messages that address the belief systems and fears that patients frequently harbor regarding their back injuries. Expert opinion and a limited body of research support the conclusion that physicians can promote return to normal activity in injured workers with LBP by addressing these concerns.

### References

1. Anema JR, Van Der Giezen AM, Buijs PC et al. (2002) Ineffective Disability Management by Doctors is an Obstacle for Return-to-Work: A Cohort Study on Low Back Pain Patients Sicklisted for 3–4 Months. *Occup Environ Med* 59:729–733
2. Bigos S et al. (1994) Acute Low Back Problems in Adults (AHCPR publication #95-0642). U.S. Department of Health and Human Services, Public Health Service, Agency for Health Care Policy and Research, Rockville, MD



3. Boersma K, Linton S, Overmeer T et al. (2000) Lowering Fear-Avoidance and Enhancing Function through Exposure In Vivo. A Multiple Baseline Study Across Six Patients with Back Pain. *Pain* 108:8–16
4. Boos N, Semmer N, Elfering A et al. (2000) Natural History of Individuals with Asymptomatic Disc Abnormalities in Magnetic Resonance Imaging. *Spine* 25:1482–1492
5. Burns JW, Glenn B, Bruehl S et al. (2003) Cognitive Factors Influence Outcome Following Multidisciplinary Chronic Pain Treatment: A Replication and Extension of a Cross-Lagged Panel Analysis. *Behav Res Ther* 41:1163–1182
6. Catchlove R, Cohen K (1982) Effects of a Directive Return to Work Approach in the Treatment of Workman's Compensation Patients with Chronic Pain. *Pain* 14:181–191
7. Cheadle A, Franklin G, Wolfhagen C et al. (1994) Factors Influencing the Duration of Work-Related Disability: A Population-Based Study of Washington State Workers' Compensation. *Am J Public Health* 84:190–196
8. Dasinger LK, Krause N, Thompson PJ et al. (2001) Doctor Proactive Communication, Return-to-Work Recommendation, and Duration of Disability after a Workers' Compensation Low Back Injury. *J Occup Environ Med* 43:515–525
9. Deyo RA (1988) The Role of the Primary Care Physician in Reducing Work Absenteeism and Costs Due to Back Pain. *Occup Med* 3:17–30
10. Hagen KB, Hilde G, Jamtvedt G et al. (2004) Bed Rest for Acute Low-Back Pain and Sciatica (Cochrane Review). In: *The Cochrane Library*, Issue 3. John Wiley & Sons, Ltd, Chichester, UK
11. Hall H, McIntosh G, Melles T et al. (1994) Effect of Discharge Recommendations on Outcome. *Spine* 15:19:2033–2037
12. Hazard RG, Haugh LD, Reid S et al. (1997) Early Physician Notification of Patient Disability Risk and Clinical Guidelines after Low Back Injury: A Randomized, Controlled Trial. *Spine* 22:2951–2958
13. Pransky GS, Shaw WS, Franche R et al. (2004) Disability Prevention and Communication Among Workers, Physicians, Employers, and Insurers – Current Models and Opportunities for Improvement. *Disab Rehabil* 26:625–634
14. Rainville J (2004) Exercise as a Treatment for Chronic Low Back Pain. *Spine Journal* 4:106–115
15. Rhodes LA, McPhillips-Tangum CA, Markham C et al. (1999) The Power of the Visible: The Meaning of Diagnostic Tests in Chronic Back Pain. *Soc Sci Med*. 48(11):1189–1203
16. Robinson JP, Ricketts D, Hanscom DA (2005) Musculoskeletal Pain: 1975–2005. (in press)
17. Teutsch C (2003) Patient-Doctor Communication. *Med Clin North* 87:1115–1145
18. Turner JA, Franklin G, Turk DC (2000) Predictors of Chronic Disability in Injured Workers: A Systematic Literature Synthesis. *Am J Ind Med* 38:707–722
19. Vlaeyen JW, Linton SJ (2000) Review. Fear-Avoidance and its Consequences in Chronic Musculoskeletal Pain: A State of the Art. *Pain* 85:317–332
20. Von Korff M, Saunders K (1996) The Course of Back Pain in Primary Care. *Spine* 21:2833–2837
21. White AA, Gordon SL (1982) Symposium on Idiopathic Low Back Pain. Mosby, St. Louis
22. Woby SR, Watson PJ, Roach NK et al. (2004) Are Changes in Fear-Avoidance Beliefs, Catastrophizing, and Appraisals of Control, Predictive of Changes in Chronic Low Back Pain and Disability? *Eur J Pain* 8:201–210

## Disability Evaluation in the Social Security Administration

VICTORIA DORF

Social Security Administration, Baltimore, MD, USA  
victoria.dorf@ssa.gov

### Synonyms

Eligibility; Disability Determination; social security disability insurance; Supplemental Security Income

### Definition

Disability is the inability to engage in any **substantial gainful activity** by reason of any medically determinable physical or mental impairment that can be expected to result in death or that has lasted or can be expected to last for a continuous period of not less than 12 months.

### Characteristics

The Social Security Administration (SSA) has responsibility for the administration of the **Social Security Disability Insurance (SSDI)** program provided for under title II of the Social Security Act (the Act) and the **Supplemental Security Income (SSI) disability program** provided for under title XVI of the Act. The SSDI program provides disability benefits to disabled workers insured under the Act, children of insured workers who become disabled before age 22 and to disabled widows or widowers and certain surviving divorced spouses of insured workers. The SSI program is a means-tested program that provides monthly payments to needy disabled adults and disabled children (individuals under age 18). Both disability programs are national programs, with the same **definition of disability for adults** regardless of the city or State in which a person lives or where the disability determination is made. For adults, “disability” is defined as the inability to engage in any substantial gainful activity by reason of any medically determinable physical or mental impairment or combination of impairments that is expected to result in death or that has lasted or can be expected to last for a continuous period of not less than 12 months (1). Under SSI, “disability” for an individual under age 18 means a medically determinable physical or mental impairment or impairments that results in marked and severe functional limitations and that meets the **duration requirement** (2). For all individuals, a “medically determinable physical or mental impairment” is an impairment that results from anatomical, physiological, or psychological abnormalities which can be shown by medically acceptable clinical and laboratory diagnostic techniques. Likewise, the rules for considering **symptoms**, such as **pain**, in determining disability are essentially the same for both adults and children.

The SSA's policy for the evaluation of pain and other symptoms is set forth in regulations (3) and further clarified in agency instructions called Social Security Rulings (SSRs), SSR 96-3p (4), SSR 96-4p (5), and SSR 96-7p (6). A symptom, whether pain, fatigue, shortness of breath, nervousness, or any other symptom, is not a medically determinable impairment (5). Rather, SSA defines a symptom as a person's own perception or description of the impact of his or her physical or mental impairment(s)

D

(7). Neither are symptoms alone enough to establish the existence of a physical or mental impairment (7) or to establish disability. This is so regardless of how many symptoms the person alleges or how genuine the person's complaints may appear to be (5, 6). There must be an underlying impairment(s), shown by medically acceptable clinical and laboratory diagnostic techniques (8), which could reasonably be expected to produce the symptom(s) (3).

To evaluate a person's symptoms the SSA first determines if there is a medically determinable physical or mental impairment that could reasonably be expected to produce the pain or other symptom(s) that the person alleges (3, 6). Thus, for example, an impairment of the lumbar spine could reasonably be expected to produce low back pain or pain radiating into a lower extremity, but could not reasonably be expected to produce arm pain. The threshold for finding that there is a medical basis for the alleged symptom(s) is low and does not involve a determination as to the intensity, persistence, or functionally limiting effects of the symptom(s), only whether the impairment(s) could reasonably be expected to cause the kind of symptom(s) the person alleges (3). If there is no medically determinable physical or mental impairment, or if there is a medically determinable physical or mental impairment(s) but the impairment(s) could not reasonably be expected to produce the person's pain or other symptoms, the symptom(s) cannot be found to affect the person's ability to do ► [basic work activities](#) (6). Basic work activities are the abilities and aptitudes necessary to do most jobs. Examples of such activities include physical functions such as walking, standing, sitting, lifting, pushing, pulling, reaching, carrying or handling the capacities for seeing, hearing and speaking; and the mental abilities for understanding, carrying out and remembering simple instructions, use of judgment, responding appropriately to supervision, co-workers, and usual work situations; and dealing with changes in a routine work setting (9). If there is a medically determinable impairment that could reasonably be expected to produce the types of symptoms a person reports, the SSA goes on to consider the person's statements about the intensity, persistence, and functionally limiting effects of his or her impairment-related symptoms, unless a fully favorable determination can be made solely on the basis of the ► [objective medical evidence](#). If the person's statements about the intensity, persistence, or functionally limiting effects of symptoms are not substantiated by the objective medical evidence, the adjudicator must consider all of the evidence in the case record and make a finding as to the credibility of the person's statements.

This ► [credibility finding](#) is a determination as to the degree to which the person's statements about his or her symptoms can be believed and accepted as true. To make the credibility finding, consideration is given to the objective medical evidence, the person's own statements about his or her symptoms, statements and other infor-

mation provided by physicians and psychologists who have treated or examined the person, and others about the person's symptoms and how they affect the person, and any other relevant evidence in the case record. The person's pain or other symptoms will be found to diminish his or her capacity to do basic work activities to the extent that the alleged symptom-related functional limitations and restrictions can reasonably be accepted as consistent with the objective medical evidence and other evidence.

A credibility finding is straightforward if the person's statements are consistent with what would be expected on the basis of the objective medical evidence. But the SSA does not require objective medical evidence to establish a direct cause and effect relationship between the impairment and the alleged intensity, persistence, or functional effects of the symptom(s). Rather, the SSA recognizes that even people with the same impairment may experience symptoms differently (10), that some people who experience pain may also report other symptoms related to the pain (11), and that a person's statements about symptoms may not always be consistent with what can be expected solely on the basis of the objective medical evidence and may, in fact, indicate a greater severity of impairment than suggested by that evidence.

Because of this, the SSA's adjudicators do not disregard the person's statements about his or her symptoms and their functional effects solely because the statements are not fully corroborated by the objective medical evidence. Rather, if the information in the case record is insufficient to assess the credibility of the person's statements, the SSA's adjudicators must make every reasonable effort to obtain additional information that could shed light on the credibility of the statements.

In assessing the credibility of the person's statements about his or her symptoms, the objective medical evidence must always be considered. While the SSA does not require objective medical evidence to corroborate the person's statements about his or her symptoms, the clinical and ► [laboratory findings](#) cannot be ignored, whether those findings are positive or negative. However, adjudicators are aware that the objective medical evidence is only one of many medical and nonmedical factors that must be considered.

SSA needs evidence from acceptable medical sources to establish the existence of a medically determinable impairment (12). Once the existence of a medically determinable physical or mental impairment(s) is established, the SSA considers information from all medical sources – not just physicians or psychologists, but also other medical sources, such as physical therapists, nurse practitioners, audiologists and chiropractors – about the severity of the impairment(s) and how it affects the person's ability to work. Other sources, such as educational personnel and public and private social welfare agency personnel, can also provide information

about the person and how his or her impairment(s) affects function. And, evidence from relatives, friends, neighbors, co-workers, clergy, and others can provide valuable information about the person's functioning on a day-to-day basis - information about what the person does and how well he or she does these things now and how the person functions now compared to how the person functioned in the past.

The SSA also considers the person's longitudinal medical history. Repeated attempts to seek or try medical treatment tend to lend credibility to the person's statements, but the failure to pursue regular medical treatment does not necessarily mean the person's statements about the intensity, persistence, and functionally limiting effects of symptoms are not credible without first considering any explanations that he or she may provide and any other information in the case record that may explain infrequent or irregular medical visits or the failure to seek medical treatment.

The adjudicator does not have to totally accept or totally reject the person's statements. Rather, in any given case, the adjudicator may determine that the evidence supports a finding that all of the person's statements are believable, that only some of those statements are believable, or that none of the statements are believable. Or some of the statements may be believable, but only to a certain degree.

Once the adjudicator has arrived at a credibility finding, he or she must provide specific reasons for the finding, supported by the evidence in the case record. The reasons must be sufficiently specific to make clear the weight that was given to the person's statements and the reasons for that weight.

While the credibility finding is important in drawing conclusions as to the extent to which the person's symptoms affect his or her ability to perform basic work activities, it is not a determination as to whether the person is or is not disabled. Thus, a finding that all of the person's statements about the functionally limiting effects of pain or other symptoms are credible does not automatically mean that the person will be found disabled. Nor does a finding that only some or even none of the person's statements about pain or other symptoms are credible mean that the claim will be denied. Rather, the adjudicator must consider all of the evidence in the case record before a conclusion can be made about disability.

## References

- Sections 223(d)(1)(A) and (2)(A) [42 U.S.C. 423] and 1614(a)(3)(A) and (B) [42 U.S.C. 1382c] of the Social Security Act, as amended. Compilation of the Social Security Laws, U.S. Government Printing Office, Washington D.C. (2005); <http://www.socialsecurity.gov> under "Our Program Rules." Accessed February 2006
- Section 1614(a)(3)(C) [42 U.S.C. 1382c] of the Social Security Act, as amended. Compilation of the Social Security Laws, U.S. GPO, Washington D.C. (2005); <http://www.socialsecurity.gov> under "Our Program Rules." Accessed February 2006
- Title 20 of the Code of Federal Regulations (CFR), Parts 404.1529 and 416.929; Evaluation of Symptoms, Including Pain, 56 Federal Register (FR) 57941 and 56 FR 57944, effective November 14, 1991; [www.gpoaccess.gov/nara](http://www.gpoaccess.gov/nara) ("GPO Access"). Accessed February 2006
- SSR 96-3p, "Titles II and XVI: Considering Allegations of Pain and Other Symptoms in Determining Whether a Medically Determinable Impairment is Severe," 61 FR 34468 (July 2, 1996); <http://www.socialsecurity.gov>, under "Our Program Rules." Accessed February 2006
- SSR 96-4p "Titles II and XVI: Symptoms, Medically Determinable Physical and Mental Impairments, and Exertional and Nonexertional Limitations" 61 FR 34488 (July 2, 1996); <http://www.socialsecurity.gov>, under "Our Program Rules." Accessed February 2006
- SSR 96-7p, "Titles II and XVI: Evaluation of Symptoms in Disability Claims" 61 FR 34483 (July 2, 1996) <http://www.socialsecurity.gov>, under "Our Program Rules." Accessed February 2006
- 20 CFR 404.1528(a), 404.1529, 416.928(a) and 416.929; <http://www.socialsecurity.gov>, under "Our Program Rules." Accessed February 2006
- Sections 223(d)(3) [42 U.S.C. 423] and 1614(a)(3)(D) [42 U.S.C. 1382c] of the Social Security Act, as amended; <http://www.socialsecurity.gov>, under "Our Program Rules." Accessed February 2006
- 20 CFR 404.1521(b) and 416.921(b); <http://www.socialsecurity.gov>, under "Our Program Rules." Accessed February 2006
- 20 CFR 404.1545(e) and 416.945(e); <http://www.socialsecurity.gov>, under "Our Program Rules." Accessed February 2006
- Pain and Disability, Clinical, Behavioral and Public Policy Perspectives (1987) In: Osterweis M, Kleinman A, Mechanic D (eds) Institute of Medicine, p 116
- 20 CFR 404.1513(a) and 416.913(a); <http://www.socialsecurity.gov>, under "Our Program Rules." Accessed February 2006

D

## Disability, Fear of Movement

MAAIKE LEEUW<sup>1</sup>, JOHAN W. S. VLAEYEN<sup>2</sup>,  
GEERT CROMBEZ<sup>2</sup>

<sup>1</sup>Department of Medical, Clinical and Experimental Psychology, Maastricht University, Maastricht, The Netherlands

<sup>2</sup>Department of Experimental Clinical and Health Psychology, Ghent University, Ghent, Belgium  
m.leeuw@dmkep.unimaas.nl,  
j.vlaeyen@dep.unimaas.nl

## Synonyms

Kinesiophobia; Fear-avoidance; Pain-related fear; Fear of pain

## Definition

► **Fear of movement/(re)injury** is a specific form of pain-related fear, and refers to the fear that certain movements and physical activities will cause (re)injury. It is especially prominent in patients with (chronic) low back pain.

Kinesiophobia is defined as 'an excessive, irrational, and debilitating fear of physical movement and activity resulting from a feeling of vulnerability to painful injury or (re)injury' (Kori et al. 1990). It is associated with avoidance of fear-eliciting activities. Both fear of



movement/(re)injury and ► **avoidance behaviour** are postulated to significantly contribute to the development and maintenance of ► **chronic low back pain** (e.g. Kori et al. 1990; Vlaeyen et al. 1995; Vlaeyen and Linton 2000).

### Characteristics

The experience of pain can be characterized by psychophysiological (e.g. muscle activity), cognitive (e.g. anticipation), and behavioural (e.g. escape and avoidance) responses. The role of fear of movement/(re)injury in the transition from acute to chronic low back pain, and in the maintenance of chronic low back, has been well documented. In other pain syndromes, such as chronic fatigue syndrome, whiplash, headache, and fibromyalgia, the evidence on the importance of fear of movement/(re)injury in the process of chronicity is still preliminary. Fear of movement/(re)injury is strongly related to escape and avoidance behaviours. Some CLBP patients believe that performance of certain activities may promote pain and (re)injury. This belief leads to fear of movement/(re)injury and consequently to the avoidance of these activities, although there are no medical explanations for this behavioural pattern of avoidance. In most instances, these fear-avoidance beliefs take the form of erroneous 'if. . . .then' cognitions, for example, "If I lift this shopping bag, I will damage a nerve and end up paralysed".

Despite the fact that in acute pain the avoidance of daily activities may be adaptive in facilitating healing and recovery, in chronic pain avoidance behaviour is no longer necessary for recovery. The long-term maintenance and enhancement of avoidance behaviour can be established by the short-term effect of reduced suffering as proposed by Fordyce (1982), and by certain beliefs and expectations that confrontation with particular activities will promote pain and (re)injury (e.g. Asmundson et al. 1999; Kori et al. 1990; Philips 1987; Vlaeyen et al. 1995; Vlaeyen and Linton 2000).

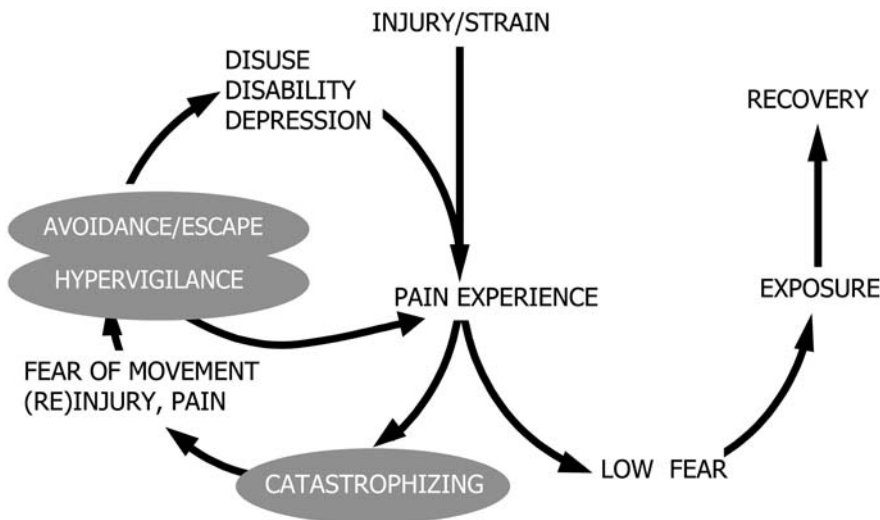
Several studies have shown that fear of movement/(re)injury is associated with poor physical performance on behavioural tasks (Crombez et al. 1999; Vlaeyen and Crombez 1999). The effect of pain-related fear on physical performance also seems to generalize to daily life situations. For example, fear-avoidance beliefs about work are strongly related to disability of daily living and work lost in the previous year, even more so than pain severity or other pain variables (Waddell et al. 1993). Moreover, self-reported fear of movement/(re)injury is a better predictor of self-reported disability than biomedical symptoms and pain severity (Crombez et al. 1999; Vlaeyen et al. 1995; Vlaeyen and Crombez 1999; Waddell et al. 1993; Vlaeyen et al. 2004). As fear of movement/(re)injury and avoidance behaviour are important determinants of disability, Waddell et al. (1993) concluded that 'fear of pain and what we do about it may be more disabling than pain itself'.

### A Cognitive Behavioural Model of Chronic Low Back Pain

Building upon the work of Lethem et al. (1983), the ► **cognitive-behavioural model** of fear of movement/(re)injury was developed to make sense of the development of chronic suffering in non-specific low back pain (Vlaeyen et al. 1995). According to the model, two opposing behavioural responses may occur in response to acute pain: 'confrontation' and 'avoidance'. A gradual confrontation and resumption of daily activities despite pain is considered an adaptive response that eventually leads to the reduction of fear, the encouragement of physical recovery and functional rehabilitation. In contrast, a catastrophic interpretation of pain is considered a maladaptive response, which initiates a vicious circle in which fear of movement/(re)injury, and the subsequent avoidance of activities, augment functional disability and the pain experience by means of hypervigilance, depression, and disuse (Fig. 1). This cognitive-behavioural model has several presumptions (Vlaeyen and Linton 2000):

1. ► **Pain catastrophizing**, an exaggerated negative orientation towards actual or anticipated pain experiences, is assumed to be a precursor of pain-related fear (Vlaeyen and Crombez 1999; Vlaeyen and Linton 2000). Studies have indeed found a strong association between fear of pain and catastrophizing in chronic pain patients, although most research is cross-correlational in nature. For example, chronic pain patients who catastrophized reported higher pain intensities, felt more disabled, and experienced more psychological distress (Vlaeyen et al. 2002). Laboratory and longitudinal studies allow investigation as to whether catastrophizing may actually precede pain-related fear. For example, pain-free individuals who catastrophized about pain became more fearful when threatened with an intense pain experience than did students who reported low catastrophizing (Crombez et al. 1998). Furthermore, pain catastrophizing appeared to be the most powerful predictor of back pain chronicity one year after the acute onset (Burton et al. 1995). Both studies indicate that catastrophizing is a precursor of fear of movement/(re)injury.
2. Fear is characterized by escape and avoidance behaviours, leading to an impaired ability to accomplish daily living tasks and subsequent functional disability. Several studies have shown that patients with chronic low back pain, who associate pain with damage, tend to avoid activities that they assume will promote pain (Asmundson et al. 1999; Kori et al. 1990; Philips 1987; Vlaeyen and Crombez 1999; Vlaeyen and Linton 2000). Avoidance behaviours can occur as early in the anticipation of pain rather than as a response to pain. Therefore, opportunities are excluded for correction of (erroneous) catastrophic cognitions and beliefs about the





**Disability, Fear of Movement, Figure 1** A cognitive behavioural model of pain-related fear. From: Vlaeyen, J.W.S. (2002). Fear in musculoskeletal pain. In J.O. Dostrovsky, D.B. Carr and M. Koltzenburg (eds), Proceedings of the 10<sup>th</sup> World Congress on Pain: 631–650, Seattle, IASP press. Reprinted with permission.

consequences of activities. By this means, avoidance is likely to expand and become more persistent.

- Excessive and long-lasting avoidance of physical activities may have detrimental physical and psychological consequences. A decrease of mobility, decreased muscle strength, and loss of fitness can occur, possibly resulting in a 'disuse syndrome'. Avoidance can also result in loss of self-esteem, deprivation of reinforcers, depression, and worrying. Both disuse and depression are known to decrease pain tolerance, and can thereby augment the pain experience (Crombez et al. 1999).
- In accordance with other forms of fear, pain-related fear interferes with cognitive functioning, such as attention (Eccleston and Crombez 1999; Vlaeyen and Linton 2000). Pain patients who report fear of movement/(re)injury may show hypervigilance to pain, which is the increased attention to pain, potential signals of pain and possible other somatosensory signals. Using attention-demanding tasks, studies demonstrated that chronic pain patients showed significant impairments in attentional performance. For instance, high-intensity pain appeared to be more disruptive than low-intensity pain. Furthermore, interruption by pain seemed to be mediated by threat. When threatened with intense pain, interruption of attention was strengthened for those who catastrophized and interpreted pain-related stimuli as threatening. In addition, patients with high somatic awareness suffered from inflated disruption of attention. This hypervigilance in fearful chronic pain patients appears at the expense of other tasks, such as everyday activities or pain coping strategies.
- Pain-related fear is associated with increased psychophysiological reactivity when the individual is confronted with situations that are evaluated as 'dangerous'. Results showed that contextual fear

caused by the experimental setting resulted in muscular reactivity, to which non-fearful patients readily habituated over time, while fearful patients did not (Vlaeyen et al. 1999).

There is substantial support for the cognitive-behavioural model in explaining the development of chronic non-specific low back pain. Additionally, there is increasing support for the idea that fear of movement/(re)injury can be initiated or stirred up by beliefs and attitudes of health care providers. Besides the fact that health care providers on average hold beliefs that are consistent with current evidence, many would still advise patients to avoid painful movements. Others still believe that pain-reduction is a necessary requirement for returning to work, or that sick-leave is an adequate treatment for back pain. The fear-avoidance beliefs of certain practitioners can, therefore, reinforce the beliefs and avoidance behaviours of patients (Linton et al. 2002).

#### Cognitive Behavioural Therapy with Exposure In Vivo

Evidence is accumulating that the advice to restrict activity or to rest in case of back pain is counterproductive, delays recovery, and may lead to chronic disability and complicated rehabilitation. Substantial evidence favours the recommendation to stay active and continue usual daily activities (e.g. Waddell 1998).

One of the clinical implications of the idea that chronic suffering and disability is caused by fear of movement and avoidance, is that treatment of CLBP patients should directly target these perpetuating and exacerbating factors. Therefore, in analogy with phobia and anxiety disorders, exposure *in vivo* has been proposed as a potentially effective treatment (Kori et al. 1990; Philips 1987; Vlaeyen et al. 2002A). Philips (1987) was the first to argue that graded exposure should be systematically ap-

plied, to realize disconfirmations between the erroneous expectations of harm, pain or other consequences and the actual pain of patients who are fearful of movement.

Exposure *in vivo* does not aim to reduce pain levels, but to restore the functional abilities despite pain. The treatment is embedded in a cognitive-behavioural treatment approach and is comprised of three stages (e.g. Vlaeyen et al. 2004). The treatment starts with a cognitive-behavioural assessment, consisting of an extensive interview regarding cognitive, behavioural, and psychophysiological aspects of the symptoms, and to estimate the magnitude of the influence of pain-related fear on the pain problem. An indication of the level of fear of movement can be obtained, for example, by the Tampa Scale for ► **Kinesiophobia** (For an overview of measures for fear of movement/(re)injury see e.g. Vlaeyen et al. 2002a; McCracken et al. 1996). Furthermore, insight is gained into avoidance behaviour and catastrophizing cognitions concerning the relationship between activities and pain and (re)injury. Besides defining feasible treatment goals, the cognitive-behavioural assessment is concluded with the establishment of a personal graded hierarchy of activities that the person is actually afraid of, starting with activities that produce only slight distress and concluding with activities that are beyond the present capabilities of the patient. Following this first stage of exposure *in vivo*, education is provided, aimed to motivate the patient to participate in previously avoided fear-provoking activities. During education, the pain problem is conceptualised as a common condition that can be self-managed, rather than a serious disease that needs careful protection. Additionally, a careful explanation of the cognitive-behavioural model is provided, in which the patients' idiosyncratic symptoms, cognitions, and behaviours are discussed. The third stage of the treatment proceeds with the implementation of behavioural experiments, during which the patient is systematically exposed to fear-provoking activities, leading to disconfirmation of harm beliefs and reduction of fear, thereby promoting recovery of activities and functional abilities (Vlaeyen et al. 2004).

#### **Effectiveness of Cognitive Behavioural Therapy with Exposure In Vivo**

At present, the effectiveness of graded exposure *in vivo* has only been investigated in single case experimental designs, in which exposure *in vivo* is compared to usual graded activity in reducing pain-related fear, catastrophizing and disability in CLBP patients reporting fear of movement/(re)injury (Vlaeyen et al. 2002B). Results show that remarkable improvements were observed on self-report measures of pain-related fear, catastrophizing, and disability, and in objective physical activity measurements whenever exposure *in vivo* was initiated. In addition, two Swedish single case studies (Boersma et al. 2004, Linton et al. 2002) also found evidence for

the effectiveness of exposure *in vivo*, which demonstrated generalization to other therapists and treatment settings, adding support for the external validity of the treatment. Taken together, although results on the effectiveness of cognitive behavioural treatments with exposure *in vivo* should be interpreted as preliminary, the results are quite promising.

#### **References**

1. Asmundson GJG, Norton PJ, Norton GR (1999) Beyond Pain: The Role of Fear and Avoidance in Chronicity. *Clin Psychol Rev* 19:97–119
2. Butron AK, Tillotson KM, Main CJ, Hollis S (1995) Psychosocial predictors of outcome in acute and subchronic low back trouble. *Spine* 20:722–728
3. Boersma K, Linton SJ, Overmeer T, Jansson M, Vlaeyen JWS, de Jong JR (2004) Lowering fear-avoidance and enhancing function through exposure *in vivo*: a multiple baseline study across six patients with back pain. *Pain* 108:8–16
4. Crombez G, Eccleston C, Baeyens F, Elen P (1998) When somatic information threatens, catastrophic thinking enhances attentional interference. *Pain* 75:187–198
5. Crombez G, Vlaeyen JWS, Heuts PHTG, Lysens R (1999) Pain-Related Fear is More Disabling than Pain Itself: Evidence on the Role of Pain-Related Fear in Chronic Back Pain Disability. *Pain* 80:329–339
6. Eccleston C, Crombez G (1999) Pain Demands Attention: A Cognitive-Affective Model of Interruptive Function of Pain. *Psychol Bull* 3:356–366
7. Fordyce WE, Shelton JL, Dundore DE (1982) The Modification of Avoidance Learning in Pain Behaviors. *J Behav Med* 5:405–414
8. Kori SH, Miller RP, Todd DD (1990) Kinisophobia: A New View of Chronic Pain Behavior. *Pain Manage Jan/Feb*: 35–43
9. Lethem J, Slade PD, Troup JD, Bentley G (1983) Outline of a Fear-Avoidance Model of Exaggerated Pain Perception: I. *Behav Res Ther* 21:401–408
10. Linton SJ, Overmeer T, Janson M, Vlaeyden JWS, de Jong JR (2002) Graded *in vivo* exposure treatment for fear-avoidant pain patients with functional disability: a case study. *Cognitive Behaviour Therapy* 31:49–58
11. Linton SJ, Vlaeyen JWS, Ostelo RW (2002) The Back Pain Beliefs of Health Care Providers: Are We Fear-Avoidant? *J Occup Rehab* 12:223–232
12. McCracken LM, Gross RT, Aikens J, Carrnike CLM jr (1996) The Assessment of Anxiety and Fear in Persons with Chronic Pain: A Comparison of Instruments. *Behav Res Ther* 34:927–933
13. Philips HC (1987) Avoidance Behaviour and it's Role in Sustaining Chronic Pain. *Behav Res Ther* 25:273–279
14. Vlaeyen JWS, Crombez G (1999) Fear of Movement/(Re)Injury, Avoidance and Pain Disability in Chronic Low Back Pain Patients. *Man Ther* 4:187–195
15. Vlaeyen JWS, de Jong JR, Sieben JM, Crombez G (2002A) Graded Exposure *In Vivo* for Pain-Related Fear. In: Turk DC, Gatchel RJ (eds) *Psychological Approaches to Pain Management: A Practitioner's Handbook*. The Guilford Press, New York, pp 210–233
16. Vlaeyen JWS, de Jong JR, Geilen M, Heuts PHTG, van Beukelen G (2002B) The Treatment of Fear of movement/ (re) injury in chronic lowback pain: further evidence on the effectiveness of exposure *in vivo*. *Clin J Pain* 18: 251–261
17. Vlaeyen JWS, de Jong JR, Leeuw M, Crombez G (2004) Fear Reduction in Chronic Pain: Graded Exposure *In Vivo* with Behavioral Experiments. In: Asmundson GJG, Vlaeyen JWS, Crombez G (eds) *Understanding and Treating Fear of Pain*. Oxford University Press
18. Vlaeyen JWS, Kole-Snijders, AMJ, Rotteveel AM, Ruesink R, Heuts PHTG (1995) The Role of Fear of Movement/(Re)injury in Pain Disability. *J Occup Rehab* 5:235–252

19. Vlaeyen JWS, Linton SJ (2000) Fear-Avoidance and its Consequences in Chronic Musculoskeletal Pain: A State of the Art. *Pain* 85:317–332
20. Vlaeyen JWS, Seelen HAM, Peters M, de Jong P, Aretz E, Beisiegel E, Weber W (1999). Fear of movement/ (re)injury and muscular reactivity in chronic low back pain patients: an experimental investigation. *Pain* 82:297–304
21. Waddell G (1998) *The Back Pain Revolution*. Churchill Livingstone, London
22. Waddell G, Newton M, Henderson I, Somerville D, Main CJ (1993) A Fear Avoidance Beliefs Questionnaire (FABQ) and the Role of Fear-Avoidance Beliefs in Chronic Low Back Pain and Disability. *Pain* 52:157–168

## Disability, Functional Capacity Evaluations

MICHELE C. BATTIÉ, DOUGLAS P. GROSS  
 Department of Physical Therapy, University of  
 Alberta, Edmonton, AB, Canada  
 michele.critesbattie@ualberta.ca,  
 doug.gross@ualberta.ca

### Synonyms

Functional capacity evaluation; Functional Abilities Evaluation; Functional Capacity Assessment; Functional Capacity Battery; Physical Capacity Evaluation; work capacity evaluation; work performance evaluation; Job Capacity Evaluation; Occupational Capacity Evaluation; work-related assessment; Vocational Assessment; work sample

### Definition

Functional capacity examinations or evaluations are standardized test batteries, aimed at determining an individual's ► **capacity** or tolerance for work or other activities (Abdel-Moty et al. 1993). They commonly rely on physiological, functional or performance-based measures, and are often used to assess readiness to return to work following injury.

### Characteristics

#### Context and Uses of Functional Capacity Evaluation

Two of the most sought after pieces of information from health care providers in cases of work-related injury claims resulting in work absence are whether or not the injured worker is ready to return to regular work duties and, if not, what physical restrictions are required. The answers to these questions have significant implications for injured workers and their families, employers, insurance carriers and society as a whole. Yet, few health care providers are confident in making such judgments. These determinations are further complicated when applied to ill defined musculoskeletal pain complaints, sometimes referred to as soft tissue injuries, which now constitute the majority of workers' compensation claims and costs in many jurisdictions.

► **Functional capacity evaluations** (FCE) are frequently relied on for assessing readiness for 'safe' return to work, particularly for workers' compensation and other insurance systems. The term "functional capacity evaluation" was coined by rehabilitation professionals, whose goals typically focus on assisting injured or ill individuals to optimize their ability to perform desired work and leisure activities, and assessing such capacities. The goal of functional capacity testing is to directly measure capacity for specific tasks, often in relation to the required physical demands of a particular activity. As mentioned, FCEs are frequently used to assess readiness to return to work following injury, they are also used to guide other clinical decisions (King et al. 1998; Lechner et al. 1991). They are sometimes used to establish baseline ► **performance** levels, to assist in planning functional restoration and work hardening programs and to measure program outcomes. In addition, FCEs are used to guide retraining programs and vocational planning following disabling injuries. Another suggested application, is in assessing the extent of disability, to assist in permanent impairment judgments and determination of wage-earning potential in litigation cases.

#### Types of Functional Capacity Evaluations

Some controversy exists over just what should be measured during functional capacity testing. In some cases, functional testing has been limited to specific body systems or tissue function, while others aim to measure ability for real-life physical tasks (Isernhagen 1992; Takala and Viikari-Juntura 2000). This has resulted in numerous testing methods reportedly measuring functional capacity, including tests of joint mobility, muscle strength, general physical fitness, self-report ratings of ability and entire batteries of such tests (Deyo 1988; Waddell et al. 1992). However, in the case of injuries leading to work disability, FCEs are commonly used to assist in case management and return to work decisions. Typically required work tasks are identified and then compared to performance on related functional tests. These tests often simulate to some degree work tasks of interest. Many FCEs incorporate the 20 physical work functions described in the U.S. Department of Labor's Selected Characteristics of Occupations as Defined in the Revised Dictionary of Occupational Titles (DOT) (Gibson and Strong 1997). These tests often include the evaluation of performance of materials handling, ambulation, and sustained postures and positioning. Due to the important decisions made based on FCE results and the major implications arising from such decisions, essential FCE measurement properties for appropriate, ethical use include adequate reliability, or test consistency, and validity. Validity refers to the extent to which a test measures what it is purported to measure, and includes various forms with the most important deemed construct, concurrent, and predic-

tive validity. In terms of functional capacity testing, little rigorous research has been performed evaluating these various basic measurement properties, as judged through recent comprehensive literature reviews (Gross 2004; Innes and Straker 1999; Innes and Straker 1999). No information has been published on FCE responsiveness, or the ability of such measures to detect important functional change over time or as a result of treatment. The few studies that have been published seem to indicate that FCEs are reliable measures of functional ability. However, their adequacy in meeting the primary objective for their use, accurately identifying safe ability to return to work, is questionable (Gross and Battié 2004). The relationship between demonstrated performance on FCE and future return to work appears weak, and lower in magnitude than the relationship between recovery outcomes and other personal and contextual factors. This appears to be the case especially in situations of pain-mediated disability such as low back pain (Gross et al. 2004; Matheson et al. 2002; Fishbain et al. 1999).

#### FCE in Persons with Pain-Mediated Disability Conditions

Considering the context in which FCEs are often performed, and the fact that many of the individuals undergoing testing have pain-mediated or non-specific disability conditions, questions have arisen as to whether functional capacity testing is measuring true physical capacity or other constructs. Performance during FCE or on any physical test can be influenced by multiple factors including, but not limited to, physiological limitations, pain intensity levels, motivation to perform, fear of movement or pain, and wellness on the day of the assessment. Several approaches have been used in an attempt to judge sincerity of effort during FCE, or whether performance during testing is being limited by physical capacity or by some other factor (Lechner et al. 1998). These approaches include observations of inconsistency between findings of musculoskeletal pathology and demonstrated functional performance, inconsistent performance on related functional tasks in an assessment, and other measures of inconsistencies, such as the coefficient of variation applied to maximal strength tests. However, the validity of the various tests of sincerity of effort has not been thoroughly evaluated. More importantly, the reason why individual subjects do not perform to maximum physical ability levels is typically unknown. Poor or submaximal performance on FCE appears to be related more to psychological factors, such as depression or high perceived disability, than to true physical limitations (Gibson and Strong 1998). In fact, given the important influence of psychological and environmental factors on performance during such testing, some authors have recommended that FCEs be viewed not merely as maximum physical ability tests, but as ► **behavioral assessments** that must be interpreted within each subject's unique personal and

environmental context (Gross and Battié 2005; Rudy 1996).

#### Summary

The use of FCE is becoming increasingly common in occupational rehabilitation, and functional or performance-based tests are being relied upon more frequently for making return to work and related decisions. However, the validity of FCE has not been adequately evaluated and, the evidence that does exist makes the usefulness of complex functional testing protocols appear limited in cases of pain-mediated disability. Given the important influence of psychological and other contextual factors on subject performance during FCE, these tests may be more accurately viewed as behavioral assessments rather than evaluations of maximum physical ability. Accordingly, FCE results must be interpreted within each subject's unique personal and environmental context, when return to work or related decisions are being made.

#### References

1. Abdel-Moty E, Fishbain DA, Khalil TM, Sadek S, Cutler R, Rosomoff RS, Rosomoff HL (1993) Functional Capacity and Residual Functional Capacity and their Utility in Measuring Work Capacity. *Clin J Pain* 9:168–173
2. Deyo RA (1988) Measuring the Functional Status of Patients with Low Back Pain. *Arch Phys Med Rehabil* 69:1044–1053
3. Fishbain DA, Cutler RB, Rosomoff H, Khalil T, Abdel-Moty E, Steele-Rosomoff R (1999) Validity of the Dictionary of Occupational Titles Residual Functional Capacity Battery. *Clin J Pain* 15:102–110
4. Gibson L, Strong J (1997) A Review of Functional Capacity Evaluation Practice. *Work* 9:3–11
5. Gibson L, Strong J (1998) Assessment of Psychosocial Factors in Functional Capacity Evaluation of Clients with Chronic Back Pain. *Br J Occ Ther* 61:399–404
6. Gross DP, Battié MC, Cassidy JD (2004) The prognostic value of functional capacity evaluation in patients with chronic low back pain: part 1: timely return to work. *Spine* 29:914–9
7. Gross DP, Battié MC (2004) The prognostic value of functional capacity evaluation in patients with chronic low back pain: part 2: sustained recovery. *Spine* 29:920–4
8. Gross DP (2004) Measurement properties of performance-based assessment of functional capacity. *J Occup Rehabil* 14:165–74
9. Gross DP, Battié MC (2005) Factors influencing results of functional capacity evaluations in workert's compensation claimants with low back pain. *Phys Ther* 85:315–22
10. Innes E, Straker L (1999) Reliability of Work-Related Assessments. *Work* 13:107–124
11. Innes E, Straker L (1999) Validity of Work-Related Assessments. *Work* 13:125–152
12. Isernhagen SJ (1992) Functional Capacity Evaluation: Rationale, Procedure, Utility of the Kinesiophysical Approach. *J Occup Rehab* 2:157–168
13. King PM, Tuckwell N, Barrett TE (1998) A Critical Review of Functional Capacity Evaluations. *Phys Ther* 78:852–866
14. Lechner D, Roth D, Straaton K (1991) Functional Capacity Evaluation in Work Disability. *Work* 1:37–47
15. Lechner DE, Bradbury SF, Bradley LA (1998) Detecting Sincerity of Effort: A Summary of Methods and Approaches. *Phys Ther* 78:867–888
16. Matheson LN, Isernhagen SJ, Hart DL (2002) Relationships Among Lifting Ability, Grip Force, and Return to Work. *Phys Ther* 82:249–256



17. Rudy TE, Dieber SJ, Boston JR (1996) Functional Capacity Assessment: Influence of Behavioural and Environmental Factors. *J Back Musculoskel Rehabil* 6:277–288
18. Takala EP, Viikari-Juntura E (2000) Do Functional Tests Predict Low Back Pain? *Spine* 25:2126–2132
19. Waddell G, Somerville D, Henderson I, Newton M (1992) Objective Clinical Evaluation of Physical Impairment in Chronic Low Back Pain. *Spine* 17:617–628

## Disability in Fibromyalgia Patients

ROBERT BENNETT  
Department of Medicine, Oregon Health and Science University, Portland, OR, USA  
bennetrob1@comcast.net

### Synonyms

Fibromyositis; fibromyalgia

### Definition

Fibromyalgia is a chronic pain syndrome defined in terms of widespread pain and tenderness as per the American College of Rheumatology 1990 Classification criteria (Wolfe et al. 1990).

### Characteristics

#### Prevalence of Disability in Fibromyalgia

Despite the superficial appearance of normality, many fibromyalgia (FM) patients have difficulty with remaining competitive in the work force (Liedberg and Henriksson 2002).

A survey of 1604 patients with FM, over a course of eight years in six U.S. academic medical centers, reported that 64% were able to work on all or most days, and over 70% were employed or homemakers. There was a considerable variation in disability rates from center to center, but overall 16% of patients were receiving Social Security disability benefits (lowest center-rate of 6.3% to highest center-rate of 35.7%), and 27% were receiving at least one form of disability payment (Wolfe et al. 1997). A similar degree of disability has been reported in Canada and Sweden (Henriksson and Liedberg 2000; White et al. 1999).

#### Causes of Disability

Disability is the result of an impairment. An impairment is defined as an anatomical, physiological or a psychological impediment. Impairment can relate to disorders of function at organ level (e.g. a left-sided hemiplegia – an anatomic problem, epilepsy – a physiologic problem, schizophrenia – a psychological problem). Disability is an integrated concept that views impairment in a multidimensional context that embraces: age, sex, educational level, psychological profile, past attainments, job satisfaction, motivation, re-training

prospects, social support systems, economic consequences and potential for being competitive in the workforce. The causes for functional impairment in FM include:

- Pain
- Fatigue
- Weakness
- Psychological distress
- Mood disorders
- Personality disorders
- Medications
- Cognitive impairment
- Ongoing litigation
- Poor social support
- Job dissatisfaction
- Lack of work autonomy
- Heavy physical work
- Associated disorders

Most FM patients report that chronic pain and fatigue adversely affect the quality of their life, and negatively impact on their ability to be competitively employed. Pain and fatigability adversely affect motor performance in people with FM, as every-day activities take longer. Two studies have reported that on self-assessment, FM patients have higher pain ratings and poorer functional status than patients with rheumatoid arthritis, osteoarthritis, systemic lupus erythematosus, and scleroderma. In general, they need more time to get going in the morning and usually require extra rest periods during the day (Henriksson and Liedberg 2000). Although many people with FM can tolerate work activity for short periods of time, the same tasks carried out for prolonged periods result in increased pain and fatigue. Furthermore, psychological stress, as is often found in time censored work, aggravate FM symptomatology. In particular, FM sufferers have difficulty with tasks involving repetitive activity or sustained muscle contraction. Cognitive dysfunction, particularly short-term memory and recall, is increasingly recognized as being a common problem in FM patients (Park et al. 2001) and has detrimental effects on most jobs, especially those that are intellectually demanding.

The fact that people diagnosed with FM usually look normal and can perform tasks effectively for short periods often generates pejorative attitudes in their immediate supervisors and co-workers, who suspect that FM is just an “excuse for not pulling their full weight”. The resulting workplace disharmony causes further stress and aggravation of fibromyalgia symptomatology.

#### Assessment of Disability

The problems that physicians encounter in assessing the chronic pain patient are largely related to 4 issues: (1) pain is a purely subjective perception which is usually interpreted in an emotional context; (2) chronic pain can-

not be fully understood in terms of the classical model of disease that equates pathogenesis with tissue damage or dysfunction; (3) many “non-sick” people have persistent pain but are not disabled; and (4) apparent impairment due to pain results from a complex interplay between past experiences, education, income level, work related self-esteem, motivation, psychological distress, fatigue, personal value systems, ethno-cultural background, and the availability of financial compensation.

In performing a disability evaluation, the physician should take a detailed medical, developmental, behavioral, and psychosocial history to assess a patient’s current and premorbid level of functioning, in an attempt to understand why the patient is now seeking disability. There are no validated instruments for assessing disability in people with FM. A useful practical resource for the assessment of FM related disability is the American Medical Association Guides to the Evaluation of Permanent Impairment (2001). The chapter (# 18) on chronic pain notes that: (1) pain evaluation does not lend itself to strict laboratory standards of accuracy; (2) the evaluation of chronic pain cannot be made on the basis of the degree of tissue damage – the classical medical model; (3) pain evaluation requires a thorough understanding of a multi-faceted biopsychosocial model of disease; and (4) the physicians judgment of impairment represents a blend of the art and science of medicine, and judgment must be characterized not so much by scientific accuracy as by procedural regularity. It acknowledges that physicians are often uncomfortable in evaluating chronic pain states, but notes that they regularly make decisions on the basis of probabilities backed up by experience and stated in terms of reasonable medical probability.

There are several studies that have correlated higher scores on the Fibromyalgia Impact Questionnaire (FIQ) with disability (White et al. 1999). There is one study that evaluated the work performance of FM and rheumatoid arthritis patients compared to healthy controls using a computerized workstation to physically stress shoulders, cervical/thoracic/lumbar spine, wrists and elbows in a simulated work environment. People with FM were equally as impaired as the rheumatoid patients and were only able to perform 62% of the healthy control workload.

The various factors that seemingly influence the development of disability in people with FM should also be considered:

### **Coping Strategies**

The lack of belief in one’s own ability to manage pain, cope and function despite persistent pain, is a significant predictor of the extent to which individuals with chronic pain become disabled and/or depressed. Therefore, therapy should target multiple goals, including: pain reduction, functional improvement and the enhancement of self-efficacy beliefs (Arnstein et al. 1999).

### **Self-Efficacy**

The belief that one is capable of doing an activity is related to the development from an impairment to disability. The coping strategies questionnaire has been used to determine factors associated with disability (Martin et al. 1996). Coping attempts (reinterpreting pain, ignoring pain sensations, diverting attention, coping self statements and increased activity level) were associated with lower levels of psychosocial disability but higher levels of physical and total disability. Catastrophizing was highly associated with disability.

### **Fibromyalgia Subgroups**

FM patients are a very heterogeneous population, and it is likely that different subgroups will display different levels of disability. The Multidimensional Pain Inventory (Kerns et al. 1985) has been used to classify FM subjects into three groups. It was found that nearly 90% of patients could be classified as dysfunctional, interpersonally distressed or adaptive copers. The dysfunctional and interpersonally distressed groups had higher levels of disability. Observed physical function (cervical spine mobility) was positively correlated with patient perceived disability in the adaptive copers group but not in the other two groups (Turk et al. 1996).

### **Work Conditions**

Work that is physically demanding, especially in adverse environmental conditions, is strongly associated with disability in people with FM. An inability or reluctance to modify work conditions and a lack of work autonomy are associated with disability (Teasell and Bombardier 2001).

### **Associated Conditions**

FM is often associated with other disorders (e.g. irritable bowel syndrome, multiple chemical sensitivity, irritable bladder, restless leg syndrome, depression, orthostatic hypotension) that often tend to act synergistically in causing disability.

### **Chronic Fatigue Syndrome**

A follow-up of 630 patients concluded: “there is substantial illness/related disability among those evaluated – those reporting the most pervasive disability met criteria for fibromyalgia either alone or in conjunction with chronic fatigue syndrome” (Assefi et al. 2003).

### **Rheumatic Disorders**

FM is commonly a complication of other rheumatic diseases, such as rheumatoid arthritis, systemic lupus erythematosus and Sjogren’s syndrome. In such instances, the impact of the central sensitization component of FM amplifies the associated rheumatic symptoms and increases disability (Naranjo et al. 2002).

## Depression

Mood disorders, especially depression, are a common accompaniment of chronic pain states. Depression by itself is, of course, a common cause of disability. When depression is accompanied by chronic pain, disability is magnified (Greenberg et al. 2003).

## Prevention of Disability

Gainful employment is a powerful force in fulfilling one's obligations to society, maintaining self-esteem and achieving financial security. Chronic pain invariably produces an existential crisis as it changes a person's perception of "self". This often results in varying degrees of anxiety, depression and anger with loss of self-esteem, reduced self-efficacy and functional decline. Enabling fibromyalgia patients to continue with productive employment must be based on two major strategies, namely (1) optimal management of FM symptomatology, and (2) a willingness to intercede in issues relating to job and workplace modifications (Liedberg and Henriksson 2002).

The optimal management of FM symptomatology needs to be based on a multimodal approach to management (Bennett 2002). At a minimum this involves attention to the following issues: patient education, pain, fatigue, sleep, psychological distress, deconditioning and attention to commonly associated disorders (e.g. irritable bowel syndrome).

A readiness on the part of physicians to act in an administrative role in making recommendations to employers is an essential component of minimizing disability in FM patients. In most cases, a careful workplace evaluation by an occupational therapist is an invaluable tool for making appropriate recommendations. Health care provider's unwillingness to act on a patient's behalf often results in a downhill spiral of increasing workplace stressors, depressive symptoms, and sense of victimization by people with FM. Thus, the prevention of disability in people with FM ultimately depends on both the expert management of their symptoms, and a willingness to act pro-actively on their behalf in securing appropriate workplace modifications.

If work efficiency and productivity progressively decline over several years of observation, in a patient who has been cooperative in management recommendations, then the physician should recommend the patient seek disability and be prepared to help administratively in this process.

## References

1. Arnstein P, Caudill M, Mandle CL et al. (1999) Self Efficacy as a Mediator of the Relationship between Pain Intensity, Disability and Depression in Chronic Pain Patients. *Pain* 80:483–491
2. Assefi NP, Coy TV, Uslan D et al. (2003) Financial, Occupational, and Personal Consequences of Disability in Patients with

Chronic Fatigue Syndrome and Fibromyalgia Compared to other Fatiguing Conditions. *J Rheumatol* 30:804–808

3. Bennett RM (2002) The Rational Management of Fibromyalgia Patients. *Rheum Dis Clin North Am* 28:181–199
4. Cocchiarella L, Andersson GBJ, American Medical Association (2001) *Guides to the Evaluation of Permanent Impairment*, 5<sup>th</sup> edn. AMA Press, Chicago, pp 565–591
5. Greenberg PE, Leong SA, Birnbaum HG et al. (2003) The Economic Burden of Depression with Painful Symptoms. *J Clin Psychiatry* 64:17–23
6. Henriksson C, Liedberg G (2000) Factors of Importance for Work Disability in Women with Fibromyalgia. *J Rheumatol* 27:1271–1276
7. Kerns RD, Turk DC, Rudy TE (1985) The West Haven-Yale Multidimensional Pain Inventory (WHYMPI). *Pain* 23:345–356
8. Liedberg GM, Henriksson CM (2002) Factors of Importance for Work Disability in Women with Fibromyalgia: An Interview Study. *Arth Rheum* 47:266–274
9. Martin MY, Bradley LA, Alexander RW (1996) Coping Strategies Predict Disability in Patients with Primary Fibromyalgia. *Pain* 68:45–53
10. Naranjo A, Ojeda S, Francisco F et al. (2002) Fibromyalgia in Patients with Rheumatoid Arthritis is Associated with Higher Scores of Disability. *Ann Rheum Dis* 61:660–661
11. Park DC, Glass JM, Minear M et al. (2001) Cognitive Function in Fibromyalgia Patients. *Arthritis Rheum* 44:2125–2133
12. Teasell RW, Bombardier C (2001) Employment-Related Factors in Chronic Pain and Chronic Pain Disability. *Clin J Pain* 17:39–45
13. Turk DC, Okifuji A, Sinclair JD et al. (1996) Pain, Disability, and Physical Functioning in Subgroups of Patients with Fibromyalgia. *J Rheumatol* 23:1255–1262
14. White KP, Speechley M, Harth M et al. (1999) Comparing Self-Reported Function and Work Disability in 100 Community Cases of Fibromyalgia Syndrome versus Controls in London, Ontario. The London Fibromyalgia Epidemiology Study. *Arthritis Rheum* 42:76–83
15. Wolfe F, Anderson J, Harkness D et al. (1997) Work and Disability Status of Persons with Fibromyalgia. *J Rheumatol* 24:1171–1178
16. Wolfe F, Smythe HA, Yunus MB et al. (1990) The American College of Rheumatology 1990 Criteria for the Classification of Fibromyalgia. Report of the Multicenter Criteria Committee. *Arthritis Rheum* 33:160–172

D

## Disability Insurance Benefits

### Definition

Monthly benefits provided for under the provisions of title II of the Social Security Act. Entitlement to disability insurance benefits (DIB) requires that an individual meet both medical and legal requirements defined by law and regulations.

- ▶ [Disability Evaluation in the Social Security Administration](#)

## Disability Management

- ▶ [Disability, Effect of Physician Communication](#)

## Disability Management in Managed Care System

BILL MCCARBERG

Pain Services, Kaiser Permanente and University of California School of Medicine, San Diego, CA, USA  
bill.h.mccarberg@kp.org

### Synonyms

Pre-paid care; capitated care; managed care

### Definitions

“► **Managed care**” does not have a precise definition. In a general way, it refers to settings where groups of health-care providers use a systematic approach to the delivery of healthcare. Managed care system may be mandated by governmental agencies, or be established spontaneously by groups of physicians or health insurance companies. Sometimes, the providers accept financial risk for the costs associated with medical care. However, ► **fee-for-service** medical treatment can also be provided according to a managed care plan. The key feature of managed care is that a set of guidelines is established to determine how certain medical conditions will be treated. Thus, a managed care system can be contrasted with a medical community in which several solo practitioners or small medical groups provide medical care based on informal, decentralized understandings about when specialty referrals will be made, when certain diagnostics will be performed, and so on.

### Characteristics

A major goal of managed care is to provide cost-effective treatment with the use of evidence-based guidelines. Rising medical costs in the 1980s and 1990s led to attempts by insurers to move from traditional fee-for-service to managed care plans. Workers' Compensation (WC) plans did not join this push to managed care (MC) and continued fee-for-service financing. As a result of this different strategy, from 1985 to 1992, annual medical expenditures for WC rose 45% faster than ► **group health** plans (Workers Comp Res Inst 1997). WC cash indemnity and medical benefits payments increased (Worker's compensation costs 1992), despite nationally declining prevalence rates of work disability (Prevalence of work disability-United States 1990) between 1980 and 1990.

In an attempt to control costs, many states made a concerted effort to embrace the tenets of cost-containment already proven effective in managed care group models (BNA's Workers' Compensation Report 1993). The use of managed care in workers' compensation has increased 150% since 1991. With 75% of employers who use managed WC plans finding them effective in controlling costs.

### Differences between Group Health and WC that are Relevant to Managed Care

Returning patients to health and function in a cost effective manner appears to be the goals of both group health and WC. However, there are fundamental differences that make use of group health managed care techniques problematic and difficult to implement in WC plans.

The state defines the level of coverage and medical services under WC, which are employer arranged under group health. There is salary replacement in WC, not in group health. Duration of coverage for a medical condition is generally longer for group health plans than for WC, because group health plans have an open ended commitment to a patient, whereas WC systems move toward claim closure when a person reaches maximal medical improvement. Employee productivity is all important. Since medical costs are just a part of expenses in WC, salary replacement costs must also be considered. Up to 60% of WC plan costs are non medical (Ducatman AM 1987), arguing for more aggressive, earlier intervention to return employees to the workplace. More medical resources are used to treat injuries under WC plans than under group health plans (Johnson WG et al. 1996), expenditures that may be appropriate given the added cost of lost work time.

The principles of managed care do not easily translate in WC. Managed care describes a broad concept of active management and control over the use of medical services. Active oversight and control of medical services reduces costs and eliminates unnecessary expenditures under this model. Gate keeping is a fundamental tool of managed care, controlling access to providers and services. Many of the fundamental precepts used to control cost in managed care may not apply to the workers' compensation system.

The primary care physician is the gatekeeper in the group health model. All access to care must come through this provider. The primary care provider is less well trained in specific areas than specialists, but more familiar with the patient and his or her family. Since the primary care provider can adequately treat 90% of medical conditions, this is the natural place for a gatekeeper. However, lack of familiarity with WC rules and procedures on the part of primary care providers can have deleterious consequences on disability and costs when these providers treat injured workers. Conversely, expedient and appropriate care by physicians familiar with the WC system has, in several studies, demonstrated reductions in disability and litigation, and improvement in patient satisfaction. Workers with chronic work-related conditions often require ongoing specialty care by musculoskeletal specialists, rendering the primary care provider less effective.

In group health, the parties involved are the patient and the primary care provider. In WC, besides these parties, the insurance carrier, the employer, and not infrequently



a lawyer are also involved. Therefore, due to a more complicated treatment environment in WC, the primary occupational provider (POP) may be a better choice as gatekeeper, and is being employed in many WC managed care plans (Greenberg EL et al. 1998).

Cost sharing is frequently used in group health managed care. Co-payment for appointments or medications alerts the patient to the cost of services, and provides an incentive for patients to use fewer resources. WC laws explicitly prohibit patient cost sharing. States require employers to pay all medical expenses.

The incentive structure in WC favors continued disability. With salary replacement, full coverage of medical expenses and exemption of WC salary from most income taxes, return to work can be a problem. Generosity of WC benefits and duration of illness have been linked in a number of studies (Loeser JD et al. 1995). Managed care techniques do not alter this inherent incentive bias to remain disabled.

Provider risk sharing is another strategy frequently used in group health managed care. The reward system provides an incentive to providers to decrease medical expenditures. Capitation is an example of risk sharing, where providers receive a flat fee (often monthly) for each health plan enrollee. This payment is independent of medical resource utilization, thereby favoring the provider who manages the patient more efficiently. Less resource utilization produces higher profits. ► **Case rate** arrangements are another risk sharing technique. Under case rate agreements, the provider receives a set payment for a given diagnosis. The provider is incentivized to use fewer resources. Restricting care due to profit concerns may be effective in group health models where benign neglect produces favorable results in many medical conditions. In WC, where early return to work is the goal, waiting and watching the patient recover may defeat this goal. Capitation is losing favor in group health plans, and is rarely used in WC. Case rate arrangements are also less common in WC, since early and aggressive intervention may cost more yet return the patient to work sooner.

#### **Opportunities for Effective use of Managed Care in WC**

Many strategies have been effectively utilized in managed care WC despite the differences listed above. Restricted provider networks allow for improved patient care, by steering patients to providers with expertise and competence in the management of occupational injury and illness. In so doing, managed care organizations can leverage their control over membership in provider networks to negotiate lower fees. Fewer providers allows for fewer billing sources, thereby decreasing administrative and management costs. A defined network of physicians also promotes standardized care based on treatment protocols, such as the ones that Aetna US Healthcare publishes in Coverage Policy Bulletins. With restricted provider networks, standardized care is possible

resulting in significantly reduced medical expenditures (Cheadle et al. 1999).

The disadvantage to restricting choice is decreased patient satisfaction. Whether in group health models or WC, restricting the patient's ability to choose a provider leads to unhappy patients. Evaluations of Florida, Oregon and Washington State WC managed care plans, which use restricted networks, found that injured workers were significantly less satisfied than similar workers in traditional WC plans. These results were independent of treatment outcomes (Dembe 1998).

Case management is another managed care strategy that can be used in both group health and WC. It is frequently utilized for diseases that require a lot of patient compliance, are labor intensive and costly if not managed aggressively. Examples in group health settings include HIV, diabetes and congestive heart failure. Examples in WC include work-related traumatic brain injuries and spinal cord injuries. Case managers are often nurses who work with physicians and other providers to maximize the coherence of a treatment plan. Case management is employed in WC due to the need for close follow-up, and the negative incentive for patients to return to work. Coordinating this care leads to better outcomes and reduced costs.

Something akin to case management can be used as a preventative strategy to reduce work related injuries. A physician/nurse team assigned to an employer with specific repeated work related injuries can risk manage, modify return to work policies and be the first contact for the employer/employee in injury and illness (Feldstein et al. 1998). This is an example of health maintenance through preventative services, long understood and practiced in managed care. More use of these strategies, through preventative safety engineering and ergonomic controls to abate workplace hazards and prevent injuries, are another managed care which needs to be used (Robinson 1998). Many of these techniques are difficult when individual providers offer care to the injured worker, but are ideal organizational fits for managed care and workers' compensation.

#### **When is a Medical Condition Work-Related**

Separating work-related injuries from general medical health is often artificial. A patient with a chronic low back condition may worsen with repetitive work stresses. What part of the condition is related to work, what part is the underlying chronic condition? Attempts to integrate group health and WC into one managed care delivery system are problematic. The advantage of keeping all services in one seamless system of care is obvious and enticing. Unfortunately, the culture, structure and financing of the WC system create barriers to such integration. In addition, healthcare providers, unfamiliar with management of work related injuries and the WC system, often have difficulty providing effective care. Several pilot programs were started

but never really developed fully due to these obstacles.

## References

1. Workers Comp Res Inst (1997) managed Care and Medical Cost Containment in Workers' Compensation: a National Inventory, 1997-1998. Rep WC-97-6, Workers Comp Res Inst, Cambridge, MA
2. Worker's compensation costs (1992) In: Medical Benefits. September:1-2. Panel Publishers Inc, New York, NY
3. Prevalence of work disability-United States (1990) MMWR 42:39
4. Managed care for workers' compensation up 150%, new survey finds (1993) BNA's Workers' Compensation Report. The Bureau of National Affairs Inc, Washington, DC, pp 181-182
5. Ducatman AM (1987) The inevitable growth of workers' compensation costs. In: Workers Compensation Best's Review. AM Best Company, Oldwick, NJ, pp 50-52,79-80
6. Johnson WG, Baldwin ML, Burton JF Jr (1996) Why is the treatment of work-related injuries so costly? New evidence from California. *Inquiry* 33:53-65
7. Greenberg EL, Leopold R (1998) Performance measurement in workers' compensation managed care organizations. *Occup Med* 13:755-72
8. Loeser JD, Henderlite SE, Conrad DA (1995) Incentive effects of workers' compensation benefits: a literature synthesis. *Med. Care Res Rev* 52:34-59
9. Cheadle A, Wickizer TM, Franklin G et al. (1999) Evaluation of the Washington state workers' compensation managed care pilot project II. *Med Care* 37:982-93
10. Dembe AE (1998) Evaluating the impact of managed health care in workers' compensation. *Occup Med* 13:787-98
11. Feldstein A, Breen V (1998) Prevention of work-related disability. *Am J Prev Med* 14(3S):33-30
12. Robinson JC (1998) The rising long term trend in occupational injury rates. *Am J Public Health* 78:276-281

## Disability Prevention

Gary M. Franklin<sup>1</sup>, Judith A. Turner,<sup>2</sup>  
Thomas M. Wickizer<sup>3</sup>,

Deborah Fulton-Kehoe<sup>4</sup>, Robert D. Mootz<sup>5</sup>

<sup>1</sup>Department of Environmental and Occupational Health Sciences

<sup>2</sup>Department of Psychiatry and Behavioral Sciences

<sup>3</sup>Department of Rehabilitation Medicine

<sup>4</sup>Department of Health Services

<sup>5</sup>Department of Environmental and Occupational Health Sciences

<sup>1-4</sup>University of Washington, Seattle, WA, USA

<sup>1,5</sup>Washington State Department of Labor and Industries, Olympia, WA, USA  
meddir@u.washington.edu

## Synonyms

Secondary Prevention

## Definition

Disability prevention is the prevention of long-term disability (LTD) that may develop following a work-related

**Disability Prevention, Table 1** Disability Prevention: Changing the paradigm

Primary prevention	Prevent workplace injuries and illnesses
Secondary prevention	Prevent disability among workers with work-related injuries and illnesses
Tertiary prevention	Manage disability to reduce residual deficit and dysfunction

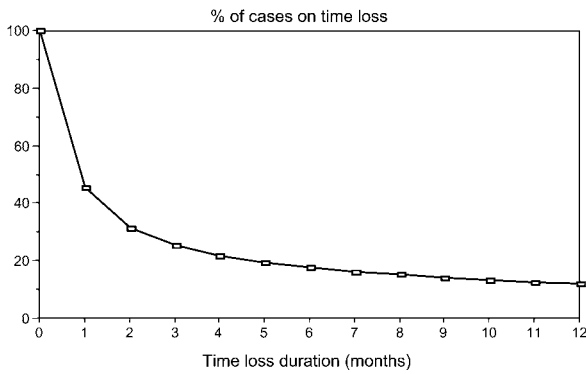
injury, when such disability would not normally be expected to result from the natural history of that injury. The term includes the integrated actions (healthcare, workplace, administrative) implemented to prevent long-term disability. Three types of prevention may be defined in the context of work-related injuries (see Table 1: 1) Primary prevention – prevention of the work-related injury (Frank et al. 1996a), 2) Secondary prevention – prevention of long-term disability after an injury has occurred (disability prevention) (Frank et al. 1996b); and 3) tertiary prevention – prevention of additional clinical consequences once long-term disability has become established.

Long-term disability (LTD) can be defined as having occurred, if the worker is still totally disabled from gainful employment (temporary total disability) for a continuous, or nearly continuous, period of 3–6 months following injury. LTD can be said to be established if the worker is still disabled at one year, because after that time, the chances of ever returning to full-time productive work at reasonable wages is likely less than 15%. Disability management, a common term in the insurance industry, appears to be applied to a variety of case management interventions aimed at both secondary and tertiary prevention. Thus, from the standpoint of the strategic use of resources, it is not an accurate term applied to the development of prevention strategies prior to 3–6 months of disability. The use of this generic term should be strongly discouraged in relation to disability prevention.

## Characteristics

### Introduction – Disability Prevention as a Critical Public Health Issue

The development of disability after non-catastrophic work-related injuries is a critical public health problem. The indirect cost to workers and employers, in terms of loss of productive work life, is enormous (Fulton-Kehoe et al. 2000). In terms of direct costs, approximately 5–10% of all injuries are LTD, but they account for approximately 80% of all claim costs (Hashemi et al. 1997). This translates to billions of dollars nationally per year. More hidden costs of long-term work disability are the devastating psychosocial consequences – depression, relationship difficulties, and social isolation are common. For these reasons, disability prevention is of the utmost importance in achieving the goals of fiscal stability of the workers'



**Disability Prevention, Figure 1** Disability prevention in the key health policy issue (adapted from Cheadle et al. (1994) *Am J Publ Health* 84:190–196).

compensation system, and of preventing workers from falling into the disability chasm.

**Is There a Natural History of Disabling Injury?**

Most workers who experience disabling injuries (at least 3–4 days of lost work time) return to work within 4–6 weeks (see Fig. 1) (Cheadle et al 1994). The slope of the disability curve changes abruptly, however, at 3 months. A worker who has 3 months of disability has a 50% chance of remaining disabled at one year. By one year of disability, the curve is nearly flat and the likelihood of returning to work at reasonable wages is probably less than 15%. Five percent of all work-loss injuries result in LTD, but only 10% of these could be considered medically severe (e.g. requiring hospitalization in the first 28 days) (Cheadle et al. 1994). Thus, the majority of LTD cases begin as routine injuries (e.g. back sprains), and most physicians who see these workers soon after their injuries are unaware of the potential for serious disability.

The reason for this partially lays in the fact that physician’ expectations of the natural history of most injuries are that they heal. How a common back sprain may actually worsen over time, so that a worker with a seemingly mild injury is completely unable to function three years later, defies current medical understanding.

A fallacy in this field relates to the concept of “healing periods,” which indicate the expected time for an injury to resolve. Data underlying healing periods are based upon injury-specific actuarial analyses, similar to the disability curve in Figure 1. These guidelines incorporate little clinical evidence but merely present average statistical profiles, which take no account of the many case-specific barriers to recovery or return to work that lead to substantial variation around the means. Failure to address these barriers in the treatment of injured workers is likely to promote – not prevent – long-term disability.

**Prediction of long-term Disability**

At this time, no method exists for accurately predicting which injured workers will develop long-term disability.

The best available data can only provide clues. Turner et al (Turner et al. 2000) and others (Cats-Baril and Frymoyer 1991) have conducted systematic reviews of the extensive literature, and only a few factors are strong and consistent predictors of chronic disability: older age, greater baseline pain, and greater baseline disability. Many other factors have been found in some studies to predict disability, but have not been replicated in multiple studies. Such factors include the presence of radiating leg pain in association with lumbar injuries, smaller company size, certain types of heavy work (e.g. construction), and not receiving an early offer of work accommodation (Turner et al. 2000).

Much of the early literature on this topic identified the principal culprit in LTD as the “accident process” itself (Behan and Hirschfeld 1963). Unfortunately, much of this literature placed blame on the worker seeking undeserved benefits. However, actual worker fraud in the workers’ compensation system has never been shown to account for more than a few percent of LTD cases. Most workers would never choose to live the life of a disabled, socially isolated person. However, injured workers may not recognize warning signs of disability becoming chronic, or actions taken that might result in increased disability.

**Which Predictors of Disability are Most Likely Modifiable?**

To achieve the goal of preventing chronic disability, it is logical to identify factors that are both predictive of chronic disability and modifiable. Table 2 outlines general categories of risk factors. In our view, organization and type of medical treatment, the opportunity to return to work early, and timeliness and accuracy of administrative decision making are modifiable areas. In the domain of medical care, for example, the availability of occupational health resources and timely communication with the employer and insurer are likely to be critical for early return to work (Loisel et al 1997). In the employment category, an early offer of accommodation (job modification) was found to predict less disability (Hogg-Johnson and Cole 2003). Finally, delays in claims administration decision-making can cause substantially worse outcomes for workers (Herbert et al 1999).

**Disability Prevention, Table 2** General categories of risk factors.

What are the key modifiable factors leading to disability?	*Medical
	*Work
	*Administrative
	Demographic
	Economic
	Psychosocial
	Legal

\* most modifiable

Attention to the more modifiable categories of predictors does not mean that other categories are less important, only that their potential for disability prevention may not be as robust. Psychosocial risk factors such as depression and other psychiatric disorders, fear of re-injury, unhappiness with one's job, and family issues that work against return to work may be associated with increased likelihood of chronic disability, but these individual issues are less easy to address in broadscale programmatic efforts. Although demographic factors, such as older age, are not modifiable, it is important to identify them in risk modeling, and may be an important consideration in selecting workers for early intervention programs designed to facilitate return to work.

Litigation or retention of attorneys to assist with claims, while much heralded as an important contributor to disability, is likely to be significantly overrated. Most workers retain attorneys either because they have received insufficient information regarding their right to benefits, or because there has been an administrative decision that the worker may see as adverse to his/her interests. However, most workers do not retain attorneys until late in the first year or in the second year following injury, well beyond a secondary prevention timeframe (Wickizer et al. 2004).

#### Timing and Type of Interventions Likely to Prevent Disability

To have a substantial impact on disability prevention, an intervention would need to occur prior to three months of disability, and ideally, prior to six weeks of disability. However, targeting every worker for special management at an early stage would be unnecessary and not cost-effective (Battie et al. 2002). A more cost-effective targeted approach is needed.

Reorganization of healthcare delivery, with an occupational medicine focus, holds considerable promise as a cost-effective means to prevent chronic disability (Wickizer et al. 2001). As workers' compensation laws in most states rely on the attending doctors' assessments of an injured workers' ability to return to work, the actions of these providers are critical to disability prevention. A related area, with substantial potential for secondary prevention, is the availability of expertise and resources to assist the return to work effort. Opportunity for workers to return to modified work is key. In one randomized trial, for example, an employer-based labor-management team that assisted healthcare providers, and/or promoted worksite interventions such as ergonomic changes, facilitated, disability prevention compared to routine medical care (Loisel et al. 1997). Finally, it seems plausible that improved timeliness and accuracy of claims administration decision-making would be critical, but not sufficient, to achieve disability prevention. For example, we conducted a field-based LTD prevention trial randomizing workers by employer to either an elite, resource-rich claims unit or to usual claims administration (Washington State Department of

Labor and Industries 1997). While all parties were more satisfied with claims management response times and service, significant disability prevention did not occur. Claims administration changes alone, in the absence of significant healthcare delivery and employer-based interventions, are not likely to substantially prevent LTD.

#### Conclusions

Systematic strategies aimed at work-related injury cases prior to three months of disability are needed to achieve disability prevention. This will require: 1) substantially better data from population-based prospective studies that identify the most significant and modifiable risk-factors for development of LTD, 2) reorganization of healthcare delivery with enhanced capacity to deliver timely, occupationally-focused care in the first six weeks after injury, 3) reassessment of the current incentives and resources available to employers and workers that are most likely to enhance early return to work, and 4) reorganization of claims management to focus on disability prevention as a strategy distinct from disability management, and with greater integration in assisting the delivery of appropriate healthcare services. Until more complete models of disability prediction are developed, and broad systems changes are implemented, clinicians should closely monitor elapsed time since injury. If a worker has gotten to four weeks of lost work time from a non-catastrophic injury, and return to work is not imminent, occupational health expertise should be sought to assist recovery and return to work.

#### References

1. Battie MC, Fulton-Kehoe D, Franklin G (2002) The Effects of a Medical Care Utilization Review Program on Back and Neck Injury Claims. *J Occup Environ Med* 44:365-371
2. Behan RC, Hirschfeld AH (1963) The Accident Process. II. Toward More Rational Treatment of Industrial Injuries. *JAMA* 186:300-306
3. Cats-Baril WL, Frymoyer JW (1991) Identifying Patients at Risk of Becoming Disabled Because of Low-Back Pain. The Vermont Rehabilitation Engineering Center predictive model. *Spine* 16:60-607
4. Cheadle A, Franklin G, Wolfhagen C et al. (1994) Factors Influencing the Duration of Work-Related Disability: A Population-Based Study of Washington State Workers' Compensation. *Am J Public Health* 84:190-196
5. Frank JW, Brooker AS, DeMaio SE et al. (1996) Disability Resulting from Occupational Low Back Pain. Part II: What do we Know About Secondary Prevention? A Review of the Scientific Evidence on Prevention before Disability Begins. *Spine* 21:2918-2929
6. Frank JW, Kerr MS, Brooker AS et al. (1996) Disability Resulting from Occupational Low Back Pain. Part I: What do we Know About Primary Prevention? A Review of the Scientific Evidence on Prevention before Disability Begins. *Spine* 21:2908-2917
7. Fulton-Kehoe D, Franklin G, Weaver M et al. (2000) Years of Productivity Lost Among Injured Workers in Washington State: Modeling Disability Burden in Workers' Compensation. *Am J Ind Med* 37:656-662
8. Hashemi L, Webster BS, Clancy EA et al. (1997) Length of Disability and Cost of Workers' Compensation Low Back Pain Claims. *J Occup Environ Med* 39:937-945



9. Herbert R, Janeway K, Schechter C (1999) Carpal Tunnel Syndrome and Workers' Compensation Among an Occupational Clinic Population in New York State. *Am J Ind Med* 35: 335–342
10. Hogg-Johnson S, Cole DC (2003) Early Prognostic Factors for Duration on Temporary Total Benefits in the First Year Among Workers with Compensation Occupational Soft Tissue Injuries. *Occup Environ Med* 60:244–253
11. Loisel P, Abenhaim L, Durand P et al. (1997) A Population-Based, Randomized Clinical Trial on Back Pain Management. *Spine* 22:2911–2918
12. Turner JA, Franklin G, Turk DC (2000) Predictors of Chronic Disability in Injured Workers: A Systematic Literature Synthesis. *Am J Ind Med* 38:707–722
13. Washington State Department of Labor and Industries (1997) Long-term Disability Prevention Pilots, Annual Report to the Legislature
14. Wickizer TM, Franklin G, Plaeger-Brockway R et al. (2001) Improving the Quality of Workers' Compensation Health Care Delivery: The Washington State Occupational Health Services Project. *Milbank Q* 79: 5–33
15. Wickizer TM, Franklin GM, Turner JA et al. (2004) Use of Attorneys in Appeal Filing in the Washington State Workers' Compensation Program: Does Patient Satisfaction Matter? *J Occup Environ Med* 46:331–339

## Disability Rating

- [Rating Impairment Due to Pain in a Workers' Compensation System](#)

## Disability, Upper Extremity

J. MARK MELHORN  
 Section of Orthopaedics, Department of Surgery,  
 University of Kansas School of Medicine, Wichita,  
 KS, USA  
 melhorn@ctdmap.com

### Synonyms

Disability; work related upper-extremity disorders; WRUEDs; Impairment, Functions Loss; musculoskeletal pains; MSPs; musculoskeletal disorders; MSDs/MSPs; cumulative trauma disorders; CTDs; repetitive strain injuries; RSIs

### Definition

► **Disability** arises out of an individual's inability to perform a task successfully because of an insufficiency in one or more areas of functional capability: physical function, mental function, agility, dexterity, coordination, strength, endurance, knowledge, skill, intellectual ability or experience. Disability is not necessarily related to any health ► **impairment** or medical condition, although a medical condition or impairment may cause or contribute to disability. Disability requires a conceptual definition and is context specific. Disability is the gap between what a person can do and what the person needs or wants to do in a specific environment,

may be temporary or permanent and is defined by the American Medical Association Guides to the Evaluation of Permanent Impairment (AMA Guides) (AMA 2000) as an alteration in an individual's capacity to meet personal, social or occupational demands or statutory or regulatory requirements, because of an impairment. Impairment is the loss of a physiological function or of an anatomical structure. Evaluation of impairment is addressed in the AMA Guides (AMA 2000) and is defined as a deviation from normal in a body part or organ system and its functioning. Impairment assessment is deemed a medical evaluation, while disability is determined in an operational setting, such as the workplace or in a structured, functional capacity evaluation where observations are made of the individual's capacity to carry out particular tasks or perform specified functions. Therefore, an impaired person is not necessarily disabled.

► **Pain** is an unpleasant perception associated with actual or potential cellular damage (Turk and Okifuji 2001). Pain is a concept, not a thing. People do not have pain; they experience the unpleasant effects of nociceptive stimulation or they suffer in ways that they associate with pain. Recognition of this point is basic to understanding pain and suffering. If pain consisted solely of a hard-wired stimulus response capability, there would be no role for learning or other cognitive processes. Conversely, if a hard-wired stimulus response capability were the defining characteristic of pain, neuroanatomical and pathophysiological parameters would suffice in dealing with pain, which, obviously, they do not (Melhorn 2002b). Persistent pain in the absence of continued tissue trauma is pathological and is influenced by learned behaviors.

Nociception is the response to an unpleasant (noxious) stimulus that produces pain in human subjects under normal circumstances (Turk and Okifuji 2001). Acute pain is elicited by the injury of body tissues and activation of nociceptive transducers at the site of local tissue damage. The local injury alters the response characteristics of the nociceptors and perhaps their central connections and the autonomic nervous system in the region. In general, the state of acute pain lasts for a relatively limited time and generally remits when the underlying pathology resolves. This type of pain is often a reason to seek care and occurs after trauma, surgery and some disease processes (Melhorn 2002b).

Chronic pain is elicited by an injury but may be perpetuated by factors that are both pathogenetically and physically remote from the originating cause. Chronic pain extends for a long period of time and represents low levels of underlying pathology not explained by the presence and / or extent of the pain. This type of pain frequently prompts patients to seek health care and is rarely treated effectively. Because the pain persists, it is likely that environmental and affective factors eventually interact with the tissue damage, contributing to the

persistence of pain and illness behaviors. Additionally, just as the brain is modified by experiences especially in early life, it may also alter the way noxious information is processed to augment or reduce its effect on subjective awareness (Melhorn 2002b).

Musculoskeletal pain (MSP) is any pain that may involve the muscles, nerves, tendons, ligaments, bones or joints. This pain can be real or anticipated. ► **Musculoskeletal disorders** (MSDs) is a term used to describe musculoskeletal pain that may include indeterminate or specific ICD-9 diagnoses. Other terms, such as ► **cumulative trauma disorders** (CTDs), repetitive stress injury (RSI) and repetitive motion injury (RMI) mean roughly the same thing as MSDs. However, RSI and RMI are arguably inaccurate, because these terms imply that repetition is the primary risk factor, which may or may not be the case. Again, MSDs are not a medical diagnosis but a descriptive term for musculoskeletal pain (Melhorn 2002a).

Work related or work compensable are terms used to describe or assign responsibility. Musculoskeletal disorders that are determined to be associated with the workplace may be considered work related or work compensable based on each state's legislative requirements (United States Bureau of Labor Statistics 1996). Work related musculoskeletal disorders (WRMSDs) require two elements, an individual and a job. Each element has unique risk factors. WRMSDs often become work compensable and fall under the workers' compensation system.

Workers' compensation is designed to be a no-fault and exclusive remedy system. Although described as a system, it isn't; each state, territory and federal employees have different and separate workers' compensation laws and regulations. The workers and their dependents are not required to prove fault for personal injuries, diseases or deaths arising out of and in the course of employment. The employer agrees to provide rapid payment to the injured worker for lost wages and medical care costs in exchange for limiting or eliminating the employer's potential liability for said occupational illness, injuries and death and, thereby, the possibility of large tort verdicts.

### Characteristics

► **Work related upper-extremity disorders** are an increasingly common cause of work related musculoskeletal pain and disability. Although most upper extremity disorders are acute and self-limited, a small percentage of workers develop chronic nonmalignant musculoskeletal pain which can progress to permanent disability and this group accounts for the majority of costs associated with WRUEDs. The progression from symptoms to disability and how the disability might be prevented requires an understanding of the multiple factors involved.

Depending upon one's definition of disability, between 35 and 46 million Americans can be labeled as disabled.

The definition of disability and the determination of who is disabled continue to challenge governments and adjudicating bodies and therefore expand and contract more along political and ideological lines than according to any clear physical determinations. If the cost of exclusion from the workplace, medical care, legal services and earning replacements are summed, the 1980 estimate was \$177 billion or approximately 6.5% of the gross domestic product (Demeter et al. 2001).

At any given time, up to 45% of currently employed workers could file work related injury or disability claims, but most do not, choosing instead to carry out their job responsibilities, accepting some discomfort as part of living (Biddle et al. 1998). This ability to tolerate discomfort is determined by the level of the biological stimulus (pain), existing psychosocial or biosocial issues and previous learned behaviors (Melhorn 2002b). Whenever one of these elements exceeds a personal toleration level, health care is sought.

Individual risk factors for the development of disability from the biological stimulus include age, gender and inherited health characteristics, from psychosocial and/or biosocial issues depression, current substance abuse, somatoform pain disorders, longer duration of symptoms, higher association of anxiety disorders, higher levels of stress in life events and lower levels of lifestyle organization (goal directedness, performance focus and efficiency, timeliness of task completion and organization of physical space). Risk factors from previously learned behavior include less time on the job, more surgeries, a higher frequency of acute antecedent trauma, indeterminate musculoskeletal diagnoses, self-reported higher pain levels, more anger with their employer, a greater psychological response or reactivity to pain, having an attorney and being involved in litigation with their employer (Himmelstein et al. 1995; Sikorski et al. 1989).

Workplace risk factors for the development of musculoskeletal pain include any part of the production process (the manufacturing of a product). The production process usually includes input (raw materials), the production (methods, materials, machines, environment, physical stressors – such as repetition, force, posture, vibration, cold temperatures, contact stress and static muscle loads, unaccustomed activities and combinations thereof) and the output (the finished product) (Melhorn 1998). As discussed before, the individual risk factors become contributors, moderators and buffers as to how the workplace may affect the individual for the development of MSDs.

Preventing disability and musculoskeletal pain is challenging. Physicians cannot prove or disprove the existence of pain clinically. With traumatic injuries occurring at a rate of 7.1 per 100 equivalent full-time employees in the private business sector at an estimated cost of over \$1.25 trillion, there is a need for better disability management.

Since the risk for developing musculoskeletal pain and the associated disability is 65 percent individual risk factors and 35 percent workplace, the solution will require intervention for both (Melhorn et al. 2001). Rest is often over-prescribed (Deyo et al. 1986). Healing is usually rapid and is often promoted by motion (Nachemson 1992). Rest, excessively or carelessly prescribed, may inhibit or interfere with healing while also encouraging deactivation. The problem is compounded if the task of determining whether healing has occurred and activity is now appropriate is assigned to the untrained patient, as by saying to the patient, "Let pain be your guide" to determine when to terminate rest and resume activity (Fordyce et al. 1986). Often, the result of this arrangement is that the patient, on moving, experiences some discomfort and interprets it to mean that healing has not occurred and that continued movement may impair healing. The patient then moves less, thereby increasing the adverse effects of disuse and making it more probable that future movement of the involved body part will be painful. Thus begins a vicious circle. Each painful movement is interpreted to reaffirm that healing has not occurred and encourages greater disuse and more pain. It also pairs movement with events in the environment that, through conditioning, become cues capable of eliciting more discomfort. In sum, the pain problem may persist and worsen despite adequate healing, because the consequences of use and movement were misinterpreted secondary to ambiguous clinician guidance. Behavior that avoids or postpones an anticipated aversive consequence, known as avoidance learning, has been studied in clinical pain (Fordyce et al. 1982). Therefore, physicians should discourage patients from prolonging disability beyond medical necessity. This will require a more aggressive approach to pain control; prevention of unnecessary surgery, directed efforts to improve patients' abilities to manage residual pain and distress and attention to employer-employee conflicts may be important in preventing the development of prolonged work disability in this population.

## References

1. AMA (2000) Philosophy, Purpose, and Appropriate Use of the Guides. In: Cocchiarella L, Andersson GBJ (eds) Guides to the Evaluation of Permanent Impairment. American Medical Press, Chicago, pp 1–16
2. Biddle J, Roberts K, Rosenman KD et al. (1998) What percentage of workers with work-related illnesses receive workers' compensation benefits? *J Occup Environ Med* 40:325–331
3. Demeter SL, Andersson GBJ, Smith GM (2001) Disability Evaluation. Mosby, St. Louis, MO
4. Deyo RA, Diehl AK, Rosenthal M (1986) How many days of bed rest for acute low back pain? A randomized clinical trial. *N Engl J Med* 315:1064–1070
5. Fordyce WE, Shelton JL, Dundore DE (1982) The modification of avoidance learning pain behaviors. *J Behav Med* 5:405–414
6. Fordyce WE, Brockway JA, Bergman JA et al. (1986) Acute back pain: a control-group comparison of behavioral vs traditional management methods. *J Behav Med* 9:127–140
7. Himmelstein JS, Feuerstein M, Stanek EJ et al. (1995) Work related upper extremity disorders and work disability: clinical and psychosocial presentation. *J Occup Environ Med* 37:1278–1286
8. Melhorn JM (1998) Management of Work Related Upper Extremity Musculoskeletal Disorders. Kansas Case Managers Annual Meeting. Wesley Rehabilitation Hospital, Wichita, pp 16–25
9. Melhorn JM (2002a) Cumulative Trauma Disorders (CTDs): The Science, Myths and Folklore. 16th Annual Scientific Session. American Academy of Disability Evaluating Physicians, Chicago
10. Melhorn JM (2002b) Understanding and Managing Chronic Non-malignant Pain for the Occupational Orthopaedists. In: Melhorn JM, Strain RE Jr (eds) Occupational Orthopaedics and Workers' Compensation: A Multidisciplinary Perspective. American Academy of Orthopaedic Surgeons, Rosemont
11. Melhorn JM, Wilkinson LK, O'Malley MD (2001) Successful management of musculoskeletal disorders. *J Hum Ecol Risk Assessment* 7:1801–1810
12. Nachemson AL (1992) Newest knowledge of low back pain. A critical look. *Clin Orthop* 8–20
13. Sikorski JM, Molan RR, Askin GN (1989) Orthopaedic basis for occupationally related arm and neck pain. *Aust N Z J Surg* 59:471–478
14. Turk DC, Okifuji A (2001) Pain terms and taxonomies of pain. *Bonica's Management of Pain*. Lippincott Williams & Wilkins, Philadelphia, pp 17–25
15. United States Bureau of Labor Statistics (1996) Survey of Occupational Injuries and Illnesses in 1994. United States Government Printing Office, Washington

## Disability-Litigation System

### Definition

A method of compensation that rewards injured workers for non-function or the inability to recover.

- ▶ Pain in the Workplace, Risk Factors for Chronicity, Job Demands

## Disc Displacement

### Definition

The cartilaginous disc, interposed between the mandibular condyle and the fossa of the temporomandibular joint, may get displaced. Most often an anterior disc displacement occurs, which may give rise to clicking noises during mandibular movement. If the disc is displaced permanently, a locking of the joint occurs that is habitually accompanied by a limitation of mandibular movement.

- ▶ Orofacial Pain, Taxonomy/Classification

## Discharge Frequency

### Definition

The number of times a neuron produces an action potential in a given unit of time.

- ▶ Encoding of Noxious Information in the Spinal Cord

## Discharge Pattern

### Definition

Particular form in which action potentials are fired in a given period of time.

► [Mechanoreceptors](#)

## Discogenic Back Pain

VIVEKANANDA GONUGUNTA<sup>1</sup>,  
EDWARD C. BENZEL<sup>1,2</sup>

<sup>1</sup>The Cleveland Clinic Foundation, Department of Neurosurgery, Cleveland, OH, USA

<sup>2</sup>The Cleveland Clinic Foundation, Cleveland Clinic Spine Institute, Cleveland, OH, USA  
benzele@ccf.org

### Synonyms

Black Disc Disease; Dark Disc Disease; Symptomatic Annular Tear

### Definition

Discogenic low back pain is defined as axial lumbar/lumbosacral pain originating from the intervertebral disc and disc space due to degenerative changes. In 39% of low back pain (LBP) patients, the pain is discogenic in nature (Schwarzer et al. 1995) and should be differentiated from LBP of other causes like spinal instability, facet arthropathy, tumor, infection, etc.

### Pathophysiology

The intervertebral disc is supplied with pain fibers from sympathetic chain via the sinuvertebral nerve that innervates the periphery (outer six layers) of the annulus fibrosus. Pain occurs when these nerve fibers are stimulated directly by annular tears or by noxious breakdown products of the nucleus pulposus extending into the tear. Following injury to the annulus, sprouting of fibers into the site of injury has also been observed and may be a factor in the formation of a symptomatic annular tear. A variety of inflammatory agents like TNF $\alpha$ , IL-8, IL-6, nitric oxide, phospholipase A2 and others are expressed by the nucleus pulposus. They may stimulate and sensitize the nerve endings, causing low back pain (Hurri et al. 2004). They may even sensitize the dorsal root ganglion and spinal nerve root, causing radiculopathy. However, not all patients with degenerated discs have symptoms and, vice versa.

### Characteristics

Pain is usually of gradual onset. It is characterized as a low back pain that may extend to the buttock, hip, groin or even a lower limb. A hallmark of a symptomatic annular tear is characterized by sitting intolerance and relief

with recumbency. Schwarzer et al. (1995) found no clinical features that could reliably distinguish patients with discogenic pain from those with other sources of low back pain. The leg pain that arises from a symptomatic annular tear may be mistaken for a true radiculopathy, but typically extends into the dorsal thigh and rarely extends below the knee. Physical examination reveals no neurological deficits. On close observation, there may be a tendency for frequent changes in position and a relative intolerance to sitting, especially forward flexion.

### Diagnosis

Plain spine radiographs are warranted to rule out vertebral instability, but otherwise are not helpful.

MRI (Fig. 1) is the single most sensitive and most specific investigation to exclude neoplasms, infections, soft tissue or neurologic lesions and disc herniations. HIZ, or a high intensity zone, on T2 weighted images is a unique finding of a discrete bright zone within the dorsal annulus fibrosus. It is felt to represent either disc material visualized within an annular tear, or edema fluid located within the dorsal annulus. This may represent the site of pain; however, it may also be asymptomatic. Endplate changes in the adjacent vertebral bodies (Modic changes, described by Modic



**Discogenic Back Pain, Figure 1** T2 weighted MRI of lumbar spine in a patient with chronic back pain showing a black disc at L5-S1, a sign of disc dehydration.





**Discogenic Back Pain, Figure 2** Post discography axial lumbar CT image demonstrating 'annular tear' in the form of contrast leak into the annulus.

et al. 1987), especially Modic Type 1 may be associated with discogenic pain.

Provocative discography involves injection of water-soluble contrast media into the involved disc, and a control disc under fluoroscopy to determine if patient's symptoms are reproduced, i.e. determining the level of concordance based on the development of the patient's typical referred pain. With the increased sensitivity of MRI, it is often difficult to identify the symptomatic disc and, hence, discography is advocated by many surgeons to resolve the issue. However, the reliability of the patient response is fundamental to discography, which impacts sensitivity and specificity of the test. False positive discography is likely to occur predominantly in patients with abnormal psychometric testing, multiple somatic complaints and previous back surgery. Post-discography CT scan (Fig. 2) can provide additional information regarding anatomic abnormalities.

Diagnostic anesthetic injections such as facet injections (intra-articular injections or medial branch blocks) and sacroiliac joint injections are also used to identify the source of pain. These strategies are based on the premise that the pain generator is a single discrete identity, that the anesthetic blockade affects only the intended pain generator, and that it has no overlap with other nerves or tissues.

Finally, CT scan and/or CT myelography are useful in patients who are unable to undergo MRI because of implanted metal or claustrophobia.

### Prevention

The degenerative process begins from the disc at the beginning of the second decade of life. It is felt that adequate physical exercise, minimization of harmful loads

and avoidance of smoking are the best ways of preventing painful disc disease.

### Treatment

Treatment begins with conservative therapy. This includes physical therapy, weight loss, NSAIDs and rarely opioids in patients who have failed conservative therapy or who are not candidates for invasive therapy.

Invasive therapies can be subclassified into surgical and non-surgical. Non-surgical measures include chemonucleolysis, ► **IDET** (intradiscal electrothermal therapy), ► **nucleoplasty**, ► **PIRFT**, laser discectomy etc. Various injection therapies like epidural injections, nerve blocks, facet injections etc. are other forms of treatment that are described elsewhere.

### Chemonucleolysis

Lyman W. Smith first performed this procedure in 1963 to decompress a contained disc herniation. This involved percutaneous injection of chymopapain into the nucleus pulposus causing chemical dissolution, i.e. breaking down the proteoglycans in the nucleus. It is rarely used today in the United States due to the reports of transverse myelitis, paraplegia and death from anaphylactic reactions.

### Annuloplasty (IDET – Intradiscal Electrothermal Therapy)

First described by Saal and Saal in 1997, this technique involves heating the posterior annulus with a thermal resistive coil (similar to capsuloraphy-radiofrequency treatment in arthroscopy that is designed to alter collagen fibers and to in turn stabilize the joint capsule) in an attempt to repair, denervate and stabilize an annular tear. The theory of annuloplasty is based on thermal energy causing collagen fiber reorganization and denervation of the annulus. However, the heat generated might be sufficient enough to cause neurolysis of nociceptive fibers to produce pain relief. Inclusion and exclusion criteria for IDET are well summarized by Davis et al. as follows (Davis et al. 2003):

#### Inclusion Criteria

- Unremitting, persistent low back pain of at least 6 months' continuous duration
- Lack of satisfactory improvement with a comprehensively applied non-operative care program including: back education, activity modification, a trial of manual physical therapy, etc.
- Normal neurological exam
- MRI that does not demonstrate a neural compressive lesion
- Positive concordant discography

#### Exclusion Criteria

- Inflammatory arthritis
- Non spinal conditions that could mimic lumbar pain

- Medical or metabolic disorder that would preclude appropriate follow-up and participation
- Previous surgery at the proposed level
- Overlying psychologic issues
- > 50% disc height loss, instability
- Extruded or sequestered disc

Saal and Saal (2002) reported success rates of approximately 70% in their first studies, whereas other studies found success rates varying from 23–60% depending heavily on patient selection. The best results were observed in patients with lesions confined to one quadrant of the posterior half of the disc, with 80% of disc height preserved and with a nearly intact annulus (Karasek et al. 2000). A large, randomized, double blinded, placebo controlled trial measuring outcomes post IDET demonstrated an apparent benefit at short term follow up of 6 months; however, longer follow-up has yet to be reported on these patients (Pauza et al. 2002). The procedure is safe with occasional complications of catheter breakage, superficial skin burns and very rarely cauda equina syndrome or bladder dysfunction, hence, reversal of conscious sedation during the heating process is required to evaluate neurological function.

#### **Nucleoplasty**

Approved by FDA in 2001 for treatment of contained herniated discs, this is a non-heat-driven process utilizing Coblation technology – a bipolar radiofrequency device to create a localized energy field that dissolves tissue without excessive heating. The advantages claimed with the technique are minimal collateral tissue damage and thermal penetration while allowing tissue removal. A slightly curved wand with a bipolar coil at the distal tip is placed into the center of nucleus and the coil creates a plasma field, which transforms the water content of the disc into hydrogen and oxygen. Usually, the disc volume can be reduced by 1 cc or 10%, which causes decompression of the disc. Pain reduction is due to a decrease in intradiscal pressure and hence used only for smaller disc protrusions and low-pressure sensitive discs. Singh et al. (2002) reported that 80% of patients (n = 67) obtained statistically significant improvement in pain scales preserved over 1 year. Nucleoplasty can be combined with heating treatments like IDET.

#### **PIRFT (Percutaneous Intradiscal Radiofrequency Thermocoagulation)**

A radiofrequency lesion is made in the nucleus pulposus, using the disc material as a vehicle for heat, causing thermal fibrosis which reduces nociceptive input from a painful intervertebral disc.

#### **Percutaneous Manual Nucleotomy**

This technique involves annular puncture and allowing the disc to extrude into the retroperitoneum and not into the spinal canal, using specialized forceps and curettes. This is not widely practiced or accepted due to high com-

plication rates and difficulty accessing the L5-S1 disc, especially in obese patients.

#### **APLD (Automated Percutaneous Lumbar Discectomy)**

First described by Onik et al. (1985), this procedure involves insertion of an 8-inch long probe through a 2.5 mm cannula positioned against the annulus fibrosus, and the probe is used both as a cutting instrument and for aspiration of disc material. Success rates ranged from 29–80% (Chatterjee et al. 1995, and Revel et al. 1993).

#### **Laser Discectomy**

Laser energy, using a variety of lasers like potassium-titanyl-phosphate (KTP), neodymium:yttrium-aluminum-garnet (Nd:YAG), holmium:YAG (Ho:YAG) is utilized to vaporize a part of the nucleus volume to debulk the space and decrease discal pressure causing regression of disc protrusion. The choice of laser depends on its ability to deliver energy through a fiberoptic system, tissue absorption/ablation properties, and the amount of thermal generation and spread (Chen et al. 2004).

#### **Surgical Treatment**

Open surgical treatment is reserved for carefully selected patients who failed the optimal medical and less invasive treatments listed above. Lumbar spinal fusion is the gold standard surgical procedure, which involves a discectomy (to eliminate the ‘pain generator’), and then performing fusion between the two vertebrae using bone graft (to stabilize the spine). Fusion is often supplemented with instrumentation to achieve a solid bony union. The spinal canal and nerve roots can also be decompressed during the procedure as necessary. Various types of spinal fusion, indications and complications of spinal fusion are discussed in another chapter of spinal fusion.

New technologies are also evolving as alternative to spinal fusion, which include nucleus pulposus replacement and total disc replacement by prosthetic devices similar to artificial joint replacements in orthopedic field.

#### **References**

1. Chatterjee S, Foy PM, Findlay GF (1995) Report of a Controlled Clinical Trial Comparing Automated Percutaneous Lumbar Discectomy and Microdiscectomy in the Treatment of Contained Lumbar Disc Herniation. *Spine* 20:734–738
2. Chen Y, Derby R, Lee S (2004) Percutaneous Disc Decompression in the Management of Chronic Low Back Pain. *Orthop Clin N Am* 35:17–23
3. Davis TT, Sra P, Fuller N et al. (2003) Lumbar Intervertebral Thermal Therapies. *Orthop Clin N Am* 34:255–262
4. Hurri H, Karppinen J (2004) Discogenic Pain. *Pain* 112:225–228
5. Karasek M, Bogduk N (2000) Twelve Month Follow-Up of a Controlled Trial of Intradiscal Thermal Annuloplasty for Back Pain Due to Internal Disc Disruption. *Spine* 25:2601–2007
6. Modic MT, Steinberg PM, Ross JS et al. (1987) Imaging of Degenerative Disk Disease. *Radiology* 163:227–231

7. Onik G, Helms CA, Ginsburg L et al. (1985) Percutaneous Lumbar Disketomy using a New Aspiration Probe. *Am J Roentgenol* 144:1137–1140
8. Pauza K, Howell S, Dreyfuss P et al. (2002) A Randomized, Double-Blind, Placebo-Controlled Trial Evaluating the Efficacy of Intradiscal Electrothermal Annuloplasty (IDET) for the Treatment of Chronic Discogenic Low Back Pain: 6 Month Outcomes. International Spinal Injection society. 10<sup>th</sup> Annual Meeting, Sept 7, 2002. Austin, Texas
9. Revel M, Payan C, Vallee C et al. (1993) Automated Percutaneous Lumbar Discectomy versus Chemonucleolysis in the Treatment of Sciatica. A Randomized Multicenter Trial. *Spine* 18:1–7
10. Saal JA, Saal JS (2002) Intradiscal Electrothermal Treatment for Chronic Discogenic Low Back Pain: A Prospective Outcome Study with Minimum 2 Year Follow-Up. *Spine* 27:966–973
11. Schwarzer AC, Aprill CN, Derby R et al. (1995) The Prevalence and Clinical Features of Internal Disc Disruption in Patients with Chronic Low Back Pain. *Spine* 20:1878–1883
12. Singh V, Piryani C, Liao K et al. (2002) Percutaneous Disc Decompression using Coblation (Nucleoplasty) in the Treatment of Chronic Discogenic Pain. *Pain Phys* 5:250–259

## Discogenic Pain

### Definition

Pain due to an abnormality of the vertebral disc.

- ▶ [Chronic Back Pain and Spinal Instability](#)
- ▶ [Chronic Low Back Pain, Definitions and Diagnosis](#)

## Discordant Illness Behaviour

- ▶ [Hypochondriasis, Somatoform Disorders and Abnormal Illness Behaviour](#)

## Discriminability

### Definition

Discriminability reflects the capacity for detection of the presence of a stimulus or differences between stimuli, usually those of intensity.

- ▶ [Pain in Humans, Psychophysical Law](#)
- ▶ [Pain Measurement by Questionnaires, Psychophysical Procedures and Multivariate Analysis](#)

## Discriminative Information

### Definition

Input distinguishable in time, place and intensity to which specific receptors in the skin are receptive. Refers to the processes that underlie localization and identification of the stimulus and its intensity, which can be differentiated by sensory afferent nerve fiber endings.

- ▶ [Postsynaptic Dorsal Column Projection, Functional Characteristics](#)

## Disease Modifying Antirheumatic Drugs

### Synonyms

DMARDs

### Definition

Disease modifying antirheumatic drugs (DMARDs) are used to treat chronic inflammatory diseases such as rheumatoid arthritis: they target immune cells in order to inhibit the cellular inflammatory response. Examples are methotrexate, lefunomide, and cyclosporine.

- ▶ [Neutrophils in Inflammatory Pain](#)
- ▶ [NSAIDs and their Indications](#)

## Disinhibition

### Definition

Excitation due to an inhibition of inhibitory processes.

- ▶ [Stimulation-Produced Analgesia](#)

## Disinhibition of Nociceptive Neurons

### Definition

A loss of inhibitory control of nociceptive neurons, which is normally exerted by GABAergic and glycinergic neurons in the spinal cord dorsal horn, is increasingly recognized as a major source of chronic pain. It can result from inhibition of glycine or GABA receptors, or reduced GABA or glycine release, apoptotic death of GABA and glycinergic neurons and from changes in the chloride gradient, which renders GABAergic and glycinergic input less inhibitory.

- ▶ [GABA and Glycine in Spinal Nociceptive Processing](#)

## Displacement

- ▶ [Social Dislocation and the Chronic Pain Patient](#)

## Disposition

- ▶ [Personality and Pain](#)

## Disruption

- ▶ [Social Dislocation and the Chronic Pain Patient](#)

## Dissection

### Definition

Separation of (usually arterial) vessel wall layers by an intramural hemorrhage.

- ▶ Headache due to Dissection

## Dissociation

### Definition

Separation or detachment from one's immediate environment; or the compartmentalization of various components of conscious experience. Hypnotic analgesia may be achieved, for example, by encouraging the subject to detach him or herself from the procedure room, or detach from the painful body part.

- ▶ Therapy of Pain, Hypnosis

## Dissociative Imagery

### Definition

Dissociative imagery is that form of imagery that is disconnected from the felt sense of the body.

- ▶ Hypnotic Analgesia

## Dissociative Sedation

### Definition

A trance-like cataleptic state induced by the dissociative agent ketamine and characterized by profound analgesia and amnesia, usually with the retention of protective airway reflexes, spontaneous respirations, and cardiopulmonary stability.

- ▶ Pain and Sedation of Children in the Emergency Setting

## Distal Axonopathy

### Definition

Peripheral nerve disorders beginning from degeneration of the most terminal parts of both central and peripheral processes of neurons, the major pathology of toxic neuropathies; also central-peripheral distal axonopathy and dying-back neuropathy.

- ▶ Toxic Neuropathies

## Distractibility

### Definition

Tendency to give attention to any stimulus regardless of its relevance.

- ▶ Hypervigilance and Attention to Pain

## Distracting Responses

### Definition

Distracting responses refer to cues from significant others intended to encourage alternative, presumably more adaptive, well behaviors (e.g. increased activity, use of distraction to cope with pain) on the part of the person experiencing pain.

- ▶ Spouse, Role in Chronic Pain

## Distraction

### Definition

The use of materials to provide alternative sensory stimulation for the infant during a painful procedure (e.g. music, mobiles).

- ▶ Acute Pain Management in Infants
- ▶ Psychological Treatment in Acute Pain

## Distraction Signs

- ▶ Lower Back Pain, Physical Examination

## Distribution

### Definition

The distribution characterizes the reversible transfer of a drug or a substance into regions within the body.

- ▶ NSAIDs, Pharmacokinetics

## Disuse Syndrome

### Definition

Decreased level of physical activities in daily life, in the long-term leading to physical deconditioning.

- ▶ Disability, Fear of Movement
- ▶ Muscle Pain, Fear-Avoidance Model



## Diurnal Variations of Pain in Humans

GASTON LABRECQUE

Faculty of Pharmacy, Université Laval, Quebec City,  
Montreal, QC, Canada

gaston.labrecque@videotron.ca

### Synonyms

24-hour variation; biological rhythms; Circadian Variations in Pain Level

### Definition

Diurnal changes in pain intensity usually mean that the bouts of pain occur during the daytime. However, pain intensity fluctuates throughout the day and night, and patients often report that peak pain occurs at specific hours of the day. In this case, we will talk about ► [biological rhythms](#) or ► [circadian variations](#) (about 24 h) in pain level.

### Characteristics

Pain is one of the most common symptoms for which patients seek advice and help from health professionals. This is a complex, subjective and unpleasant phenomenon influenced by factors such as anxiety, fatigue, suggestions or emotions and prior experience. Pain is rarely constant, and patients usually report bouts of pain throughout the 24 h period. Using the Visual Analog Scale (VAS), many studies have indicated that the intensity of pain varied specifically during the day or the night spans. Clinicians must rely on the patient's evaluation of pain intensity to decide which and how much drug must be prescribed, and when it must be taken by the patient. Information on biological rhythms of pain can be used to maximise the effect of analgesic drugs and/or to minimise their side effects. A recent literature review summarises the information regarding rhythms, pain and pain management (Labrecque and Vanier 2003).

### Rhythms in Endogenous Opioid Peptide Levels

In the last 25 years, data obtained from laboratory animals indicate the existence of 24 h variations in plasma and brain concentrations of  $\beta$ -endorphin or enkephalin: peak values were obtained late during the resting period or at the beginning of the activity period. Similar data were obtained in healthy volunteers and pregnant women: the highest  $\beta$ -endorphin plasma levels occurred between 6 and 8 am, while the lowest levels were found between 8 pm and midnight. It is also interesting to point out that a 2 fold rise in the plasma endogenous opioid peptide was found in the last semester of the pregnancy. This time-dependent variation was not found on the 4<sup>th</sup> day after delivery (2). Finally, a circannual variation of endorphin levels was reported 20 years ago in the CSF of patients with chronic pain syndrome of

psychogenic and organic aetiology: highest concentrations were found in January and February, whereas lowest concentrations occurred in July and August (see Labrecque and Vanier 1997; Labrecque and Vanier 2003 for references). Thus, time-dependent variations in pain level and/or in the requirements for analgesia should be expected in patients with pain.

D

### Circadian Rhythms in Human Pain

Patients often complain that pain intensity increases in the evening or at night. This phenomenon is usually explained by fatigue related to daily activity, or to the anxiety induced by the incoming sleeping period, or by the departure of the family visitors. Clinicians rarely consider that the pain level changes specifically during the day or night, but they forget that time-dependent changes have been documented in hospitalised and outpatients. In fact, these studies showed that the hour of highest and lowest pain level is specific for each painful stimulus. Table 1 shows that pain related to the onset of cardiovascular events is found very early in the morning, while the peak in the frequency of migraine and toothache is largest in the morning. On the other hand, the peak of biliary colic, intractable and low back pain was found in the evening. In cancer patients, most studies were carried out in patients receiving opioid analgesics, and they were mainly concerned with the pain relief produced by these drugs. For instance, Sittl et al. (1990) reported that cancer pain was largest by 6 pm. Other studies are obviously needed in cancer patients and it would be interesting to find whether the hour of pain varies with the causes and/or the severity of this disease.

The hour of arthritic pain deserves a special note, because the time of peak pain varies according to the cause of arthritis. In patients with rheumatoid arthritis (RA), the intensity of pain is highest at the beginning of the day, whereas it occurred late in the afternoon, at the end of the day in patients with osteoarthritis (OA) of the knee (Bellamy et al. 2002; Kowanko et al. 1981; Lévi et al. 1985). It must be pointed out that inter-individual differences in the hour of highest pain intensity were reported in OA patients. Studies by Lévi et al. (1985) and Bellamy et al. (2002) indicated that most OA patients reported peak pain between 4 pm and 11 pm, but they also reported that morning pain was highest in the morning in 5% of the OA patients, while about 10% of these patients did not find any rhythmic changes in the intensity of their arthritic pain. These disease-related and the inter-individual differences in the hour of arthritic pain should be taken into account when prescribing anti-arthritic medications.

### Biological Rhythm and the Effect of Medications

The circadian variation in arthritic pain can be used to maximise the effect of non-steroidal anti-inflammatory agents (NSAIDs). For instance, it was shown that RA patients must take an evening dose of flurbiprofen to

**Diurnal Variations of Pain in Humans, Table 1** Biological rhythms of pain in patients (see Labrecque and Vanier 1997, 2003 for references)

Causes of pain	No. Patients	Hours of peak	Hours of trough
Anginal pain	7788	6 am–noon	Midnight–6 am
Unstable angina	2586	8–10 am	2–4 am
Myocardial infraction	1229 703	5–9 am 5–10 am	
Biliary colic	50	11 pm–3 am	9 am–1 pm
Cancer pain	130	6 pm	4–10 am
Heavy burns	9	8 am–4 pm	Midnight–8 am
Intractable pain	41	10 pm	8 am
Migraine	15 117 114	10 am 8 am–noon 4–8 am	Midnight Midnight noon
Osteoarthritis of the knee	20 57 4	10 pm 2 pm–10 pm 7–11 pm	2–6 am 7 am
Rheumatoid arthritis	19	6–8 am	6 pm
Toothache	543	8 am	3 pm

control morning stiffness and pain (Kowanko et al. 1981). In OA patients, a multicenter study was carried out to answer the question often asked by patients: When should I take this once-daily NSAID? The optimal time of administration for each patient was related to the time of peak pain. The evening administration of indomethacin was most effective in patients with a predominantly nocturnal pain, while drug ingestion around noon was best for patients with peak pain occurring late in the afternoon or early in the evening. The analgesic effect of the NSAID was increased by 60% when the medication was taken at the time preferred by the patients (Lévi et al. 1985). Furthermore, double-blind crossover trials indicated that the frequency of side effects of sustained-release indomethacin (Lévi et al. 1985) and ketoprofen (Boissier et al. 1990) was significantly larger when these drugs were taken at 8 am than at 8 pm. Thus, appropriate selection of the time of ingestion of the well-established NSAIDs can increase their effectiveness, and it may reduce the side effects of the well-established agents. Unfortunately, there is no data for the newer NSAIDs, such as celecoxib and rofecoxib, but it is expected that biological rhythms can also be used to maximise their effectiveness.

Very few investigators have studied the temporal variation in the effects of morphine and other opioids in patients with acute pain. In acute surgical pain, the demands for morphine (Mo) or hydromorphone (Hm) administered with a patient-controlled analgesia (PCA) device were largest in the morning than in the evening. For instance, Graves et al. (Graves et al. 1983) reported that the demands for Mo by patients with gastric bypass

or abdominal surgery was 18% larger at 9 am than at 9 pm. Similar data was obtained in post-surgical cancer patients (Auvril-Novak et al. 1990), but morning and evening peaks in opioid demands were reported by others (Labrecque and Vanier 1997; Labrecque and Vanier 2003).

Only 2 groups of investigators looked at the temporal changes in the effect of opioids in patients with chronic pain. In patients with chronic cancer pain and in patients with metastasis, the doses of Mo or Hm was significantly larger late in the afternoon or early evening (Vanier et al. 1992; Wilder-Smith and Wilder-Smith 1992). On the other hand, the Mo doses required to reduce the pain level of patients with heavy burns were significantly larger between 8 am and 4 pm, because this is the time of the day for daily personal health by nurses and/or physiotherapy treatment (see Labrecque and Vanier 2003 for reference). Finally, Bruera et al. (1992) reviewed the distribution of the extra doses of opioids received by 61 patients admitted to a palliative care unit at 4 h intervals over 24 h period. The data indicated that 76% of the patients received their extra doses between 10 am and 10 pm than during the sleeping period; the number of extra doses during this period of day was 60% larger during the night. As pain can easily be altered by many factors such as anxiety, suggestions and emotion, it is interesting to determine whether biological rhythms can be found in the effect of placebo. To our knowledge, Pöllmann (1987) is the only investigator who evaluated this effect of placebo on pain relief. When healthy individuals ingested a sugar-coated placebo tablet in the morning, the pain threshold was increased by 25–30% between

9 am and 9 pm. When administered at night, the placebo did not produce any analgesic effect.

### Guidelines for using Rhythmic Changes in Clinical Situations Pertinent to Pain

The time-dependent changes in pain level and in the analgesic action of medications are relevant for the daily practice of health professionals. By selecting the most appropriate time for ingestion of analgesic agents, the clinicians can optimise and individualise drug treatment and also reduce the frequency of side effects of medications. To optimise and individualise the effect of analgesics, the clinicians should:

- Accept that pain intensity fluctuates during the 24 h period. Circadian variations are now well described in pain intensity.
- Determine when the pain level is highest and lowest during the 24 h period. Using a VAS, the practitioner can quickly determine when pain levels are highest and lowest. This approach also gives information on the inter-individual variations in the intensity of pain.
- Be aware that the action and pharmacokinetics of analgesics and most medications are not constant throughout the day or night. The time-dependent variations were found with most drugs, even when the slow release formulation was used.
- Administer analgesics to produce highest blood levels when pain is highest. In practice, drugs are administered at regular intervals such as 4 h after the last dose. This traditional approach does not take into account the time-dependent variations in pain intensity and the effect of analgesics; determinations of temporal changes in pain and in the effect of analgesics are the basis for the chronotherapeutic approach to pain management.
- Refrain from administering medications at time of highest toxicity or when the frequency of side effects is highest. Special attention must be given to the temporal changes in the pharmacokinetics of NSAIDs. The data indicate clearly that early morning doses should be avoided, because this is the time of day where the frequency of side effects is largest.

### Conclusions

Pain is a very complex phenomenon influenced by anxiety, fatigue, suggestions or emotion and prior experience. Human data now indicates that time of day is another factor that must be taken into account when prescribing pain medications. The data on biological rhythms suggest that inadequate pain management, which occurs frequently in clinical practice, may be reduced when time-dependent variations in pain and analgesic action are taken into account in daily practice.

### References

1. Auvril-Novak SE, Novak RD, Smolensky MH et al. (1990) Temporal Variation in the Self-Administration of Morphine Sulfate

via Patient-Controlled Analgesia in Post-Operative Gynecologic Cancer Patients. *Annu Rev Chronopharmacol* 7:253–256

2. Bellamy N, Sothorn RB, Campbell J et al. (2002) Rhythmic Variations in Pain, Stiffness, and Manual Dexterity in Hand of Osteoarthritis. *Ann Rheum Dis* 61:1075–1080
3. Boissier C, Decousus H, Perpoint B et al. (1990) Timing Optimizes Sustained Release Ketoprofen Treatment Osteoarthritis. *Annu Rev Chronopharmacol* 7:289–292
4. Bruera E, Macmilland K, Huehn N et al. (1992) Circadian Distribution of Extra Doses of Narcotic Analgesics in Patients with Cancer Pain: A Preliminary Report. *Pain* 49:311–314
5. Graves BA, Batenhorst RL, Bennett JG et al. (1983) Morphine Requirements using Patient-Controlled Analgesia: Influence of Diurnal Variation and Morbid Obesity. *Clin Pharm* 2:49–53
6. Kowanko IC, Pownall R, Knapp MS et al. (1981) Circadian Variations in the Signs and Symptoms of Rheumatoid Arthritis and in the Therapeutic Effectiveness of Flurbiprofen at Different Times of the Day. *Br J Clin Pharmacol* 11:477–484
7. Labrecque G, Vanier MC (1997) Biological Rhythms in Pain and in Analgesics. In: Redfern PH and Lemmer B (eds) *Physiology and Pharmacology of Biological Rhythms*. Springer, Berlin, pp 619–649
8. Labrecque G, Vanier MC (2003) Rhythms, Pain and Pain Management. In: Redfern PH (ed) *Biological Clocks: Pharmaceutical and Therapeutics Applications*. Pharmaceutical Press, London
9. Lévi F, LeLouarn C, Reinberg A (1985) Timing Optimized Sustained Indomethacin Treatment of Osteoarthritis. *Clin Pharmacol Ther* 37:77–84
10. Pöllmann L (1987) Circadian Variation of Potency of Placebo as Analgesic. *Funct Neurol* 22:99–103
11. Räisänen I (1988) Plasma Levels and Diurnal Variation of  $\beta$ -Endorphin,  $\beta$ -Lipotropin and Corticotropin during Pregnancy and Early Puerperium. *Eur J Obstet Gynecol Reprod Biol* 27:13–20
12. Sittl R, Kamp HD, Knoll R (1990) Zirkadiane Rhythmik des Schmerzempfindens bei Tumorpatienten. *Nervenheilkunde* 9:22–24
13. Vanier MC, Labrecque G, Lepage-Savary D (1992) Temporal Changes in the Hydromorphone Analgesia in Cancer Patients. 5<sup>th</sup> Int Conf Biological Rhythms and Medications, Amelia Island (FL), Abstract # XIII-8
14. Wilder-Smith CH, Wilder-Smith OH (1992) Diurnal Patterns of Pain in Cancer Patients during Treatment with Long-Acting Opioid Analgesics. Proc. 5<sup>th</sup> Conf Biological Rhythms and Medications, Amelia Island (FL), Abstract #XIII-7

D

## Divalproex Sodium

### Definition

Anticonvulsant medication.

- Migraine, Preventive Therapy

## Diver's Headache

- Primary Exertional Headache

## Dizziness

### Definition

A non-specific term that describes an altered orientation in space, reflecting a discrepancy between internal

sensation and external reality, creating sensory conflicts. The conflicts can be due to peripheral problems and occur between any of the vestibular, visual or somatosensory systems, or it may be caused by central problems involving not one particular modality, but rather the integration and weighting of the different modalities and their relation to memory. Words like light-headedness, faintness, giddiness, unsteadiness, imbalance, falling, waving and floating may be used to describe dizziness.

- ▶ [Coordination Exercises in the Treatment of Cervical Dizziness](#)

## DMARDs

- ▶ [Disease Modifying Antirheumatic Drugs](#)

## DMSO

- ▶ [Dimethylsulfoxide](#)

## DNA Recombination

### Definition

Biologically active deoxyribonucleic acid (DNA), which has been formed by the *in vitro* joining of segments of DNA from different sources.

- ▶ [Cell Therapy in the Treatment of Central Pain](#)

## DNIC

- ▶ [Diffuse Noxious Inhibitory Controls](#)

## Dobutamine

### Definition

Dobutamine is an intravenously administered inotropic sympathomimetic medication, which acts on beta receptors of cardiac muscle to increase contractility, and is used to stress the heart in „stress tests“ to detect myocardial ischemia.

- ▶ [Thalamus and Visceral Pain Processing \(Human Imaging\)](#)
- ▶ [Thalamus, Clinical Visceral Pain, Human Imaging](#)

## Doctor-Patient Communication

- ▶ [Chronic Gynaecological Pain, Doctor-Patient Interaction](#)

## DOMS

- ▶ [Delayed-Onset Muscle Soreness](#)

## DOP

- ▶ [Delta Opioid Receptor\(s\)](#)

## DOP Receptor

### Definition

The term  $\delta$ -opioid peptide receptor represents the G-protein coupled receptor protein that responds selectively to a group of largely experimental opioid drugs and endogenous opioid peptides. It is homologous with the MOP receptor and is expressed in areas of the nervous system that moderately mediate analgesia with a side-effect profile distinct from  $\mu$ -opioids. The DOP receptor protein is produced by a single gene. When activated, the DOP receptor predominantly transduces cellular actions via inhibitory G-proteins. The electrophysiological consequences of DOP receptor activation are usually inhibitory.

- ▶ [Delta Opioid Receptor \(s\)](#)
- ▶ [Opioid Electrophysiology in PAG](#)

## Dopamine

### Definition

Dopamine, abiogenicamine or catecholamine, is synthesized in the body (mainly by nervous tissue and adrenal glands) from the amino acid tyrosine. Dopamine is also a precursor to epinephrine (adrenaline) and norepinephrine (noradrenaline) in the biosynthetic pathways for these neurotransmitters. It plays an important role in the central nervous system and gastrointestinal regulation.

- ▶ [Cancer Pain Management, Gastrointestinal Dysfunction as Opioid Side Effects](#)
- ▶ [Descending Circuitry, Transmitters and Receptors](#)



## DOR-1

### Definition

DOR-1 refers to a clone that encodes a delta opioid receptor.

- ▶ Opioid Receptors

## Dorsal Column

### Definition

The dorsal column is an afferent pathway with primarily myelinated axonal fibers, predominantly from low threshold cutaneous or deep mechanoreceptors, and less commonly from visceral, thermal or nociceptive receptors, with the cellular soma in the dorsal root ganglion that projects through an uncrossed white matter tract, the posterior column spinal pathway, to the dorsal column nuclei. These nuclei give rise to the medial lemniscus that crosses and projects to the principle somatic sensory nucleus of the thalamus. Accordingly, the posterior column spinal pathway carries sensation of vibration, proprioception and some fine touch. Recent evidence also suggests a role in visceral pain sensation.

- ▶ Angina Pectoris, Neurophysiology and Psychophysics
- ▶ Pain Treatment, Spinal Cord Stimulation
- ▶ Postsynaptic Dorsal Column Projection, Functional Characteristics
- ▶ Visceral Nociception and Pain
- ▶ Visceral Pain and Nociception

## Dorsal Column Nuclei

### Definition

The dorsal column nuclei represent a collection of several somatosensory relay nuclei in the dorsal midline of the caudal medulla, which includes the nucleus cuneatus and nucleus gracilis. The nucleus cuneatus contains representation of the midthoracic to upper cervical levels (upper trunk/forelimb), whilst the nucleus gracilis contains representation of levels caudal to the midthoracic region (lower trunk/hindlimb).

- ▶ Opioids in the Spinal Cord and Modulation of Ascending Pathways (N. gracilis)
- ▶ Postsynaptic Dorsal Column Projection, Anatomical Organization
- ▶ Postsynaptic Dorsal Column Projection, Functional Characteristics
- ▶ Spinothalamic Projections in Rat

## Dorsal Column Stimulators

### Synonyms

DCS

### Definition

Are electrical stimulation from implanted electrodes placed over the dorsal columns of the spinal cord. It is thought to block or reduce nociceptive spinal transmission.

- ▶ Pain Treatment, Spinal Cord Stimulation
- ▶ Postherpetic Neuralgia, Pharmacological and Non-Pharmacological Treatment Options

## Dorsal Horn

### Definition

This structure is that part of the spinal cord gray matter in which the cell bodies of neurons primarily involved in the sensory part of the nervous system are housed. The dorsal horn is organized into laminae or layers, numbered I to VI in a dorsal to ventral direction. Although its architecture is extremely complex, with cells from deeper laminae sending dorsal dendrites to more superficial laminae, nociceptive interneuronal cell bodies involved in the processing of noxious inputs are principally located in Lamina II (otherwise termed the 'substantia gelatinosa'). Among other cell types located in the dorsal horn are those whose axons constitute the ascending tracts of white matter, projecting to the thalamus and other structures within the brain, and also involved in the transmission of noxious inputs. The deeper laminae contain cells that encode non-noxious stimuli. Of interest in studies involving infants is that these laminae undergo considerable reorganization during development in terms of afferent input. Studies in newborn rats have shown that low threshold A $\beta$  afferent fibers terminate more superficially in the newborn dorsal horn, which may allow them to activate cells that only have a high-threshold input in the adult.

- ▶ Amygdala, Pain Processing and Behavior in Animals
- ▶ Forebrain Modulation of the Periaqueductal Gray
- ▶ Infant Pain Mechanisms
- ▶ Opiates During Development
- ▶ Postsynaptic Dorsal Column Projection, Functional Characteristics
- ▶ Prostaglandins, Spinal Effects
- ▶ Somatic Pain
- ▶ Spinothalamic Projections from SM

## Dorsal Horn Neurons

### Definition

Neurons whose cell bodies lie in the dorsal horn of the spinal cord. These neurons receive input from peripheral tissues through primary afferent fibers, from higher centers in the central nervous system, and/or from interneurons located within the dorsal horn.

- ▶ [Cancer Pain Model, Bone Cancer Pain Model](#)
- ▶ [Postsynaptic Dorsal Column Neurons, Responses to Visceral Input](#)

## Dorsal Horn Opiate Systems

### Definition

Neurons in the dorsal horn that express opiate receptors, activation of which may produce analgesia.

- ▶ [Pain Treatment, Implantable Pumps for Drug Delivery](#)

## Dorsal Rhizotomy

### Definition

Dorsal rhizotomy is the transection of the dorsal roots of spinal nerves as they enter the spinal cord. The dorsal roots contain the central process of primary afferent fibers, including those of nociceptors, and thus prevent transmission of sensory information from the peripheral terminals of primary afferent fibers to the central nervous system.

- ▶ [Cancer Pain Management, Neurosurgical Interventions](#)
- ▶ [Dorsal Root Ganglionectomy and Dorsal Rhizotomy](#)
- ▶ [Muscle Pain Model, Inflammatory Agents-Induced](#)

## Dorsal Root Entry Zone

### Synonyms

DREZ

### Definition

Dorsal Root Entry Zone (DREZ) – according to the definition given by Sindou in 1972 – includes:

- 1) the ventro-lateral part of the central portion of the dorsal rootlets, where there is a lateral regrouping of fine fibers;
- 2) the medial part of the Lissauer's tract, where the small afferent enter and where they trifurcate to reach the dorsal horn, either directly or via pathways which ascend or descend several segments;

3) the dorsal-most layers of the dorsal horn, where the afferent fibers establish synaptic contacts with spino-reticulo-thalamic tract cells.

- ▶ [Brachial Plexus Avulsion and Dorsal Root Entry Zone](#)

## Dorsal Root Entry Zone Lesioning

### Synonyms

DREZ lesioning

### Definition

The dorsal root entry zone includes the central portion of the dorsal rootlets, the medial portion of Lissauer's Tract and Rexed Lamina One through Five in the dorsal horn. These are all areas where afferent nociceptive fibers enter and synapse in the spinal cord. Destroying this anatomical area interrupts the nociceptive pathway and can result in decreased pain. DREZ lesioning can be useful for well localized pain syndromes caused by cancer pain, brachial plexus avulsion injuries, spinal cord or thalamic injuries, peripheral nerve lesion, and post herpetic pain.

- ▶ [Cancer Pain Management, Overall Strategy](#)

## Dorsal Root Ganglion

### Synonyms

DRG; Dorsal Root Ganglia

### Definition

The collection (ganglion) of pseudo-unipolar sensory neuron cell bodies in the vicinity of the spinal cord, with a peripheral process to the target organs and a central process to the spinal cord to terminate in the dorsal horn or the dorsal column nuclei. These cell bodies comprise of the nucleus as well as the cellular machinery for protein synthesis. Following their synthesis, the proteins have to be axonally transported to both the central and peripheral nerve terminals. The axons within the dorsal root mainly convey somatosensory information. Dorsal root ganglia also contain local glia cells.

- ▶ [Central Pain, Diagnosis](#)
- ▶ [Cytokines, Effects on Nociceptors](#)
- ▶ [Dorsal Root Ganglion](#)
- ▶ [Dorsal Root Ganglionectomy and Dorsal Rhizotomy](#)
- ▶ [Inflammation, Role of Peripheral Glutamate Receptors](#)
- ▶ [Neuropathic Pain Model, Tail Nerve Transection Model](#)
- ▶ [Opioids and Inflammatory Pain](#)
- ▶ [Opioid Modulation of Nociceptive Afferents In Vivo](#)
- ▶ [Opioid Receptor Localization](#)
- ▶ [Prostaglandins, Spinal Effects](#)

- ▶ Spinal Cord Nociception, Neurotrophins
- ▶ Substance P Regulation in Inflammation
- ▶ Toxic Neuropathies
- ▶ Visceral Pain Model, Esophageal Pain

## Dorsal Root Ganglion Radiofrequency

WAY YIN, NIKOLAI BOGDUK  
 Department of Anesthesiology, University of  
 Washington, Seattle, WA, USA  
 wyin@nospinepain.com; nik.bogduk@newcastle.edu.au

### Synonyms

Partial dorsal root ganglion lesioning; partial dorsal rhizotomy; partial radiofrequency dorsal root ganglion lesion; RF-DRG

### Definition

Partial radiofrequency (RF) dorsal root ganglion (DRG) lesion (RF-DRG) is a procedure in which a radiofrequency electrode is placed in the vicinity of the dorsal root ganglion of a spinal nerve, and a radiofrequency current is passed through the electrode, for the purpose of creating a lesion in the nerve of sufficient magnitude sufficient to relieve pain, but without actually damaging the nerve (see ▶ [Radiofrequency Neurotomy, Electrophysiological Principles](#)).

### Characteristics

In principle, RF-DRG was born out of a need for a procedure that could treat spinal pain arising from a particular spinal segment that could not be treated by other methods, or which had not responded to other, more target-specific therapy. In practice, RF-DRG arose as a means of treating patients whose pain had not been relieved by medial branch neurotomy.

### Rationale

RF-DRG is not a procedure intended to destroy the dorsal root ganglion. Indeed, a critical objective of the procedure is to preserve function in the target nerve and its dermatome. One stated rationale of the procedure is “to expose the dorsal root ganglion to temperatures that prevail in the peripheral part of an RF lesion to preserve the large myelinated fibers and to deactivate the small unmyelinated fibers” (van Kleef).

Notwithstanding numerous theories, the mechanism by which RF-DRG is supposed to operate has not been demonstrated. A differential effect of heat lesions on myelinated and unmyelinated sensory fibers has been refuted (Zervas and Kuwayama 1972). In effect, the procedure advocated by some amounts to no more than placing an electrode sufficiently close to the target nerve in order to do something, but not so close as to actually damage the nerve. How close, or how far away, the

electrode should be placed has not been defined. Other investigators have advocated placing the electrode tip within the DRG (Stolker et al. 1994b), but the one anatomical study that has been conducted demonstrated that electrode placement is variable in relation to the target ganglion, and sometimes too far away for any lesion to have an effect on the nerve. Placement of the electrode tip within the DRG occurred in only 61% of levels studied (Stolker et al. 1994a).

Notwithstanding these limitations to the rationale and mechanism of the treatment, RF-DRG has assumed popularity in various regions across the world, to various extents. That popularity, however, is dissonant with the quality of the available literature on the procedure and its results.

### Efficacy

The popularity of RF-DRG has been sustained largely on the grounds of observational studies and word-of-mouth. Those studies claim some degree of effectiveness, and the procedure has gained a reputation of being something that works.

The first of the cervical studies (van Kleef et al. 1993) reported that 2/20 patients (10%) were pain-free at 3 months; 4/20 were so at 6 months, and 2/17 (11%) at 12 months. Eight patients had good relief at 3 months, but their numbers dropped to two at 6 months and two at 12 months. The authors did not conclude that their treatment was successful. They portrayed it as a “reversible procedure” that can be useful to provide a relatively pain-free period, which can be used to obtain the maximum benefit from conservative forms of treatment.

Despite the less than modest outcomes of this study, investigators from the same institution undertook a placebo-controlled trial (van Kleef et al. 1996). Success was defined as a reduction by 2 points or more on a 10-point visual analogue scale. A significantly greater proportion, (8/9) patients, had a successful outcome following active treatment than those (2/11) who underwent sham treatment. Follow-up, however, was limited to only eight weeks. At this time the actively treated patients had reduced their mean pain-scores from 6.4 to 3.3, whereas the sham-treated patients maintained the same scores (5.9, 6.0).

Although this study provided data to the effect that the initial effects of cervical RF-DRG were not due to placebo, they did not attest to a successful, lasting effect. Unlike its preceding study, the controlled study did not report on the number of patients completely relieved. Success was defined only as a 2-point decrease in pain scores. The duration of effect beyond 8 weeks was not measured. These data attest only to a modest and short-lived therapeutic effect. The data of the preceding observational study would predict that outcomes would attenuate substantially beyond 8 weeks.

The first of the lumbar studies (van Wijk et al. 2001) was a retrospective review of 361 patients, but results were available for only 279. At two months, 61 (17%) patients were pain-free. This number became 23 (6%) at a mean follow-up of 22.9 months, but the range of that period was 2–70 months. A further 103 (29%) patients reported incomplete but greater than 50% relief at two months. This number dropped to 73 (20%) at longer-term follow-up.

Lumbar RF-DRG was eventually subjected to a rigorous placebo-controlled trial (Geurts et al. 2003). In all patients, the DRG was anaesthetized, and a radiofrequency electrode was placed into position. The active treatment was RF-DRG at 67°C. The control treatment was no generation of current. At three months, 16% of the 44 patients treated with RF-DRG had greater than 50% reduction in pain. Meanwhile, 25% of the 36 patients who had sham treatment experienced the same outcome. These proportions are not significantly different statistically. This study, therefore, denied any attributable effect of the procedure. Patients whose DRG was anaesthetized, without a lesion being produced, had the same outcomes as actively treated patients.

The first of the thoracic studies (Stolker et al. 1994b) announced astounding results. At two months, 30/45 patients (67%) were pain-free, and a further 11 (24%) had greater than 50% reduction in pain. At long-term follow-up, ranging from 13 to 46 months, 20 patients were pain-free, and 15 had greater than 50% relief of pain.

The second thoracic study (van Kleef et al. 1995) did not reproduce these outcomes. At eight weeks, only 8 of 43 patients (18%) had complete relief of pain, and 9 (21%) had greater than 50% relief. At follow-up beyond 36 weeks, only 5 patients (12%) were pain-free and 8 (18%) had greater than 50% relief.

There is no obvious explanation for the discrepancy between these two studies. Patient selection may have been the source of difference. The first study had a large proportion (38%) of patients with post-surgical pain (thoracotomy, mastectomy, abdominal scar), in whom good outcomes were achieved. Such patients were absent from the second study. Conversely, the second study had a large proportion (47%) of patients with neuralgia. In the first study, patients with neuralgias had less than average outcomes. (The second study did not stratify its results according to diagnosis.) Another factor which may account for the discrepancies between the studies may have been technical. In the first study, the goal was to place the electrode within the DRG whereas in the second study, the goal of electrode placement was next to the DRG.

The outcomes of RF-DRG are not consistent across cervical, lumbar, and thoracic levels. The outcomes of cervical RF-DRG are less than modest, even in a controlled trial. For lumbar RF-DRG, a rigorous controlled trial has shown that sham therapy achieves at least equivalent outcomes to those of active therapy. Since it was conducted

by authors of the foregoing observational study, that trial surely refutes lumbar RF-DRG as a valid treatment; and by extrapolation casts doubt on the validity of RF-DRG in general.

Thoracic RF-DRG has not been subjected to a controlled trial, but it might be effective for certain types of thoracic pain, for which there is not an analogue at cervical and lumbar levels. The available data hint at the possibility that thoracic RF-DRG could be useful for post-surgical pain, although not for neuralgias, and placement of the electrode within the DRG itself may be an intensive as well as procedural prerequisite.

## References

1. Geurts JWM, van Wijk MAW, Wunne H et al. (2003) Radiofrequency Lesioning of Dorsal Root Ganglia for Chronic Lumbosacral Radicular Pain: A Randomized, Double-Blind, Controlled Trial. *Lancet* 361:21–26
2. Kleef M van, Barendse G, Sluiter M Response to Invited Commentary. Assessing a New Procedure: Thoracic Radiofrequency Dorsal Root Ganglion Lesions. *Clin J Pain* 12:76–78
3. Kleef M van, Barendse GAM, Dingemans WAAM et al. (1995) Effects of Producing a Radiofrequency Lesion Adjacent to the Dorsal Root Ganglion in Patients with Thoracic Segmental Pain. *Clin J Pain* 11:325–332
4. Kleef M van, Liem L, Lousberg R et al. (1996) Radiofrequency Lesion Adjacent to the Dorsal Root Ganglion for Cervicobrachial Pain. A Prospective Double-Blind Study. *Neurosurgery* 38:1127–1132
5. Kleef M van, Spaans F, Dingemans W et al. (1993) Effects and Side Effects of a Percutaneous Thermal Lesion of the Dorsal Root Ganglion in Patients with Cervical Pain Syndrome. *Pain* 52:49–53
6. Stolker RJ, Vervest AC, Groen GJ (1994b) The Treatment of Chronic Thoracic Segmental Pain by Radiofrequency Percutaneous Partial Rhizotomy. *J Neurosurg* 80:986–992
7. Stolker RJ, Vervest ACM, Ramos LMP et al. (1994a) Electrode Positioning in Thoracic Percutaneous Partial Rhizotomy: An Anatomical Study. *Pain* 57:241–251
8. Wijk RMAW van, Geurts J, Wynne HJ (2001) Long-Lasting Analgesic Effect of Radiofrequency Treatment of the Lumbosacral Dorsal Root Ganglion. *J Neurosurg (Spine)* 94:227–231
9. Zervas NT, Kuwayama A (1972) Pathological Characteristics of Experimental Thermal Lesions. Comparison of Induction Heating and Radiofrequency Electrocoagulation. *J Neurosurg* 37:418–422

## Dorsal Root Ganglionectomy and Dorsal Rhizotomy

MICHAEL J. DORSI, ALLAN J. BELZBERG  
Department of Neurosurgery, Johns Hopkins School of Medicine, Baltimore, MD, USA  
abelzber@jhmi.edu

## Synonyms

Sensory Ganglionectomy; Sensory Rhizotomy; dorsal rhizotomy and dorsal root ganglionectomy



## Definition

Dorsal root ganglionectomy and dorsal rhizotomy are neuroablative procedures, which interrupt peripheral sensory pathways. Dorsal root ganglionectomy is the surgical removal of the ► [dorsal root ganglion](#) of a spinal nerve. ► [Dorsal rhizotomy](#) is the transection of the dorsal root of a spinal nerve.

## Characteristics

### Anatomy

The primary sensory afferents project proximally (via the dorsal root) to form synapses in the dorsal horn of the spinal cord or the dorsal column nuclei, with pseudopolar cell bodies of these axons being located in the dorsal root ganglion. The traditional belief, established by the "Law of Bell and Magendie", is that for a given spinal nerve, sensory and motor functions are segregated in the dorsal and ventral roots respectively. However, it is now clear that afferent sensory fibers are also found in the ventral roots, with up to 29% of fibers in human ventral roots being small unmyelinated (presumably afferent) fibers (Coggeshall et al. 1975). Some of these fibers course from the periphery into the ventral root and loop back into the dorsal root before entering the dorsal horn (Coggeshall 1979). Others bypass the dorsal root and enter the spinal cord directly through the ventral root (Yamamoto et al. 1977). In addition, cell bodies of sensory afferents are sometimes located outside the DRG in the dorsal root, ventral root, or along the nerve in the periphery.

### Rationale

Neuroablative procedures, such as dorsal root ganglionectomy and dorsal rhizotomy, block the transmission afferent activity arising from ► [nociceptors](#), and so diminish pain evoked by experimental stimuli. Dorsal rhizotomy interrupts input to dorsal horn neurons from DRG cells that project centrally via the dorsal root. Removal of the dorsal root ganglion leads to ► [Wallerian degeneration](#) of afferent fibers in the periphery, dorsal root, and ventral root. Therefore, both procedures lead to deafferentation of the central nervous system.

It has been suggested that ganglionectomy is superior to dorsal rhizotomy, because it results in interruption of all afferent input at that spinal segment. One theoretical disadvantage of ganglionectomy is that the resulting Wallerian degeneration of peripheral afferents contributes to neuropathic pain in animal models (Li et al. 2000). Wallerian Degeneration in the periphery or target tissue denervation may alter the function of intact afferents adjacent to degenerating axons (Li et al. 2000). This effect may lead to sensitization of afferents or neurons at higher levels in the pain-signaling pathway.

## Indications

Neuroablation has been implemented in a diverse array of painful conditions including: radiculopathy, failed back surgery syndrome, post-herpetic neuralgia, malignancy, and multiple sclerosis. Dorsal rhizotomy at the level of C-2 has been performed for treatment of occipital neuralgia and cervicogenic headache. In general, neuroablative procedures are carried out in patients who have failed physical therapy, medical treatment, and other non-surgical therapies.

Neuroablative techniques are a plausible approach to pain treatment in cases in which there is a clearly identifiable pain generator. Determination of the spinal segmental level in which the pain occurs is complicated by preganglionic inter-segmental anastomoses, ventral root afferents, and denervation hypersensitivity. Diagnostic testing including electromyographic, imaging studies, and nerve blocks is implemented to identify the painful segment.

Nerve blocks have not proven to be a reliable predictor of outcome, and the validity of peripheral nerve blocks has been brought into question (North et al. 1996). A positive block occurs when there is good pain relief with a small volume of local anesthetic injected in the ► [neural foramen](#), and no pain relief achieved with placebo injection or injection at the nerve root above or below, performed in a blinded fashion.

Even when a single ► [dermatome](#) is identified as the pain generator, it is not clear how many roots may supply that distribution or how many segments should be denervated for pain relief. In primates, it is likely that at least three adjacent roots innervate each dermatome. It may be that one segment above and one below the target level should be included to achieve a clinical effect.

### Outcome

Response rates for dorsal rhizotomy and ganglionectomy vary between 19 and 69% for rhizotomy and between 0–100% for ganglionectomy. The lack of consistent results can be attributed to multiple uncontrollable variables.

The results of dorsal rhizotomy performed in 51 patients with chronic lumbar radiculopathy were published by Wetzel et al. (Wetzel et al. 1997). At 6 months after surgery, 55% were believed to have a good or excellent outcome, while at 2 to 4 years such outcomes were obtained in only 19% of patients. Similar deterioration of outcomes has been observed in several series, and has led many to favor ganglionectomy over rhizotomy. The most impressive results following ganglionectomy have been reported for treatment of thoracic and occipital pain, with some series reporting long-term success rates as high as 68% for thoracic pain (Young 1996) and 80% for occipital pain (Lozano et al. 1998). Results of ganglionectomy for ► [failed back surgery syndrome](#) (FBSS) are much less favorable. In one recent series, success was obtained in only 2 of 13 patients with FBSS

at two years after surgery and none at 5.5 years (North et al. 1991), although another series reported treatment success in four of six patients with FBSS at greater than 2 years (Wilkinson and Chan 2001).

In summary, both dorsal root ganglionectomy and dorsal rhizotomy are neuroablative procedures implemented for treatment of chronic pain. These procedures should be considered carefully in the light of available augmentative procedures, and should be limited to cases where the spinal segmental level of pain generation has been clearly defined.

## References

1. Coggeshall RE, Applebaum ML, Fazen M, Stubbs TB 3<sup>rd</sup>, Sykes MT (1975) Unmyelinated Axons in Human Ventral Roots, A Possible Explanation for the Failure of Dorsal Rhizotomy to Relieve Pain. *Brain* 98:157–166
2. Coggeshall RE (1979) Afferent Fibers in the Ventral Root. *Neurosurgery* 4:443–448
3. Li Y, Dorsi MJ, Meyer RA, Belzberg AJ (2000) Mechanical Hyperalgesia after an L5 Spinal Nerve Lesion in the Rat is not Dependent on Input from Injured Afferents. *Pain* 85(3):493–502
4. Lozano AM, Vanderlinden G, Bachoo R, Rothbart P (1998) Microsurgical C-2 Ganglionectomy for Chronic Intractable Occipital Pain. *J Neurosurg* 89:359–365
5. North RB, Kidd DH, Campbell JN, Long DM (1991) Dorsal Root Ganglionectomy for Failed Back Surgery Syndrome: A 5-Year Follow-Up Study. *J Neurosurg* 74:236–242
6. North RB, Kidd DH, Zahurak M, Piantadosi S (1996) Specificity of Diagnostic Nerve Blocks: A Prospective, Randomized Study of Sciatica due to Lumbosacral Spine Disease. *Pain* 65:77–85
7. Wetzel FT, Phillips M, Aprill CN, Bernard TN, LaRocca HS (1997) Extradural Sensory Rhizotomy in the Management of Chronic Lumbar Radiculopathy A Minimum 2-Year Follow-Up Study. *Spine* 22:2283–2292
8. Wilkinson HA, Chan AS (2001) Sensory Ganglionectomy: Theory, Technical Aspects, and Clinical Experience. *J Neurosurg* 95:61–66
9. Young RF (1996) Dorsal Rhizotomy and Dorsal Root Ganglionectomy. In: Youmans JR (ed) *Neurological Surgery*, 4th edn. WB Saunders, Philadelphia, pp 3442–3451
10. Yamamoto T, Takahashi K, Staomi H, Ise H (1977) Origins of Primary Afferent Fibers in the Ventral Spinal Roots in the Cat as Demonstrated by the Horseradish Peroxidase Method. *Brain Res* 126:350–354

## Dorsal Root Reflexes

### Definition

If primary afferent depolarization becomes suprathreshold, it can elicit action potentials in the central terminals of primary afferent nociceptors, which can then travel retrogradely to the periphery, release proinflammatory neuropeptides, and support neurogenic inflammation.

- ▶ [Arthritis Model, Kaolin-Carrageenan Induced Arthritis \(Knee\)](#)
- ▶ [GABA and Glycine in Spinal Nociceptive Processing](#)

## Dorsolateral Fasciculus

### Definition

Small longitudinal bundle of nerve fibers traveling in the peripheral portion of the dorsolateral quadrant of the spinal cord. A major portion of descending axons from rostral ventromedial medulla have been localized to the dorsolateral fasciculus. Targeted transection of the dorsolateral fasciculus has been routinely used to investigate the contribution of descending pathways in spinal pain transmission.

- ▶ [Descending Circuitry, Molecular Mechanisms of Activity-Dependent Plasticity](#)
- ▶ [Stimulation-Produced Analgesia](#)
- ▶ [Vagal Input and Descending Modulation](#)

## Dorsolateral Pons

### Definition

The dorsolateral pons is a region that contains several nuclei that project noradrenergic axons to the spinal cord. The particular nuclei that contain noradrenergic neurons include the locus coeruleus, subcoeruleus, Kölliker-Fuse and parabrachial nuclei.

- ▶ [Spinothalamic Tract Neurons, Descending Control by Brainstem Neurons](#)

## Dorsomedial Nucleus (DM)

### Definition

The largest of the medial nuclei of the thalamus. It makes extensive connections with most of the other thalamic nuclei.

- ▶ [Human Thalamic Response to Experimental Pain \(Neuroimaging\)](#)

## Dose Titration

### Definition

Dose titration refers to an approach for achieving a therapeutic response that involves the administration of a drug followed by an assessment of the response. This information is used to estimate the next dose. This dose, followed by a response approach, is continued until a satisfactory therapeutic response is achieved and the therapeutic dose is determined.

- ▶ [Opioid Rotation](#)

## Dosing Interval

### Definition

The dosing interval is the time interval between the administered doses of a drug.

- ▶ Opioid Rotation

## Dosing Regimen

### Definition

The dosing regimen is the dose and frequency of administration of a drug when that drug is used repeatedly.

- ▶ Opioid Rotation

## DOT

- ▶ Dictionary of Occupational Titles

## Double Depression

### Definition

Double Depression refers to a dual diagnosis of “Major Depression” and “Dysthymia”.

- ▶ Psychiatric Aspects of the Epidemiology of Pain

## Double-Blind

### Definition

The patient and treating physician are both unaware which treatment the patient is receiving.

- ▶ Antidepressants in Neuropathic Pain
- ▶ Central Pain, Pharmacological Treatments

## Down-Regulated

### Definition

A state whereby a physiologic feedback loop causes a substance to reduce the production or action of another substance.

- ▶ Cancer Pain Management, Orthopedic Surgery

## DREZ

- ▶ Dorsal Root Entry Zone

## DREZ Procedures

KENNETH M. LITTLE, ALLAN H. FRIEDMAN  
Division of Neurosurgery, Duke University Medical  
Center, Durham, NC, USA  
littl023@mc.duke.edu

### Synonyms

Microsurgical DREZotomy; DREZ lesion; Junctional DREZ Coagulation  
Nucleus Caudalis DREZ

### Definition

The dorsal root entry zone (DREZ) includes the central portion of the dorsal spinal rootlets, ▶ *Lissauer’s tract*, and layers I through V of the dorsal horn. At the cervicomedullary junction, the dorsal horn is contiguous with the nucleus caudalis, an analogous structure within the spinal trigeminal nucleus. Surgical DREZ lesions may be accomplished with radiofrequency-induced heating, mechanical incision, bipolar coagulation, laser coagulation, or ultrasonic destruction to treat a variety of ▶ *central pain syndromes*.

### Characteristics

#### Rationale

At the DREZ, fibers conveying nociceptive sensory information enter the spinal cord in the ventrolateral aspect of the dorsal root. These relatively small axons, with sparse or absent myelination, enter *Lissauer’s tract*, ascend and descend up to four segments, and terminate in laminae I through VI (principally I, II, and V) of the ipsilateral dorsal horn. Within the dorsal horn, sensory information, including pain, is modulated through neurochemical signaling and inhibitory anatomical connections. Central pain syndromes (pain mediated by the central nervous system), caused by spinal cord injury or peripheral deafferentation, may result from aberrations of this system. In animal models, epileptiform activity has been observed within the dorsal horn after root avulsion, possibly because of regenerative sprouting with abnormal neuronal reorganization. The rationale for DREZ procedures is to ablate or interrupt the central structures, and thus the abnormal physiological processes implicated in some pain syndromes.

#### Indications

Spinal and nucleus caudalis DREZ lesioning procedures can be an effective means of treating deafferentation pain syndromes, which are refractory to medical management or other operative interventions. The key to a successful outcome lies in careful patient selection.

#### Brachial Plexus Avulsion

Traumatic brachial plexus traction causing nerve root avulsions frequently result in a characteristic pain syn-

drome. The patient notes a constant burning or aching pain punctuated by paroxysms of crushing pain. Prior to proceeding with DREZ lesioning in these patients, root avulsion must be confirmed, as peripheral nerve injury pain does not respond to DREZ lesions. Care must be taken to identify and treat all of the painful segments, not just those identified as abnormal by radiographic studies or gross inspection.

### Spinal Cord Injury

There are different types of pain associated with trauma to the cervical, thoracic, and lumbosacral spinal cord. The pain that responds best to DREZ procedures is radicular or segmental, occurring in the partially deafferented levels adjacent to the level of injury. Diffuse pain occurring below the level of injury, especially constant burning pain in the sacral dermatomes, only occasionally responds to DREZ procedures.

### Conus Medullaris and Cauda Equina Injury

This type of pain often occurs following trauma to the T12 to L1 levels, injuring elements at both the conus medullaris and cauda equina. Patients that respond best to DREZ procedures in this region are those with incomplete neurologic deficits, those with pain that is “electrical” in character, and those with injury due to blunt trauma.

### Phantom Limb Pain

Patients suffering pain after limb amputation may experience stump pain, ► [phantom limb pain](#), or both. Typically, phantom limb pain responds significantly better to DREZ procedures than does stump pain.

### Cancer Pain

The type of cancer related pain that responds best to DREZ procedures is topographically limited to a few spinal segments (as with Pancoast syndrome). Patients with pain from thoracic or abdominal wall invasion or lumbosacral root involvement may also respond well. Lumbosacral pain must be limited, however, to avoid the increased risk of lower extremity hypotonia or sphincter dystonia associated with bilateral or more extensive DREZ lesions.

### Craniofacial Pain

The caudalis DREZ procedure may be indicated in patients with central craniofacial pain including anesthesia dolorosa, post-tic dysesthesias, atypical facial pain, postherpetic pain, pain related to neoplasms in the region of the gasserian ganglion, and facial pain caused by brainstem lesions such as infarction, tumors, and multiple sclerosis. The caudalis DREZ procedure, however, is controversial due to the relatively high risk of postoperative deficits and the transience of pain relief.

### Methods

Several DREZ lesioning methods have been described (Nashold and El-Naggar 1992; Iskandar and Nashold 1998; Sindou 2002). Laminectomies or, more elegantly, hemilaminectomies are performed over the spinal levels to be lesioned. In the case of ► [brachial plexus avulsion](#) injuries and spinal cord trauma, the pathologic segments are identified by a combination of gross inspection and impedance measurements. In cases in which there is no spinal cord pathology, the DREZ to be lesioned is identified by following nerve rootlets from their entry into the spine to their entry into the spinal cord, or by recording evoked potentials from the DREZ while stimulating the affected dermatomes. Lesions are made along the intermedialateral sulcus, extending approximately 2 mm into the DREZ. They may be made with radiofrequency-generated heat to 80 degrees Celsius at 1 mm intervals, mechanical incision, laser coagulation, bipolar coagulation, or ultrasonic destruction. It is important that the lesion extends into the DREZ above and below the affected dermatomes. For the caudalis DREZ procedure, a small suboccipital hemicraniectomy and bilateral C<sup>1</sup>-C<sup>2</sup> laminectomy is performed (Iskandar and Nashold 1998; Nashold and El-Naggar 1992). Classically, a specialized 3 mm electrode (with the proximal 1 mm being insulated to protect the overlying spinocerebellar tract) is used to make two rows of RF lesions at the cervicomedullary junction. The first row begins at the dorsal rootlets of C<sup>2</sup> extending rostrally to about 5 mm above the obex. The second row parallels the first, 1 mm dorsal to the DREZ. Recently, trigeminal evoked potentials, EMG, and SSEPs have been used during the caudalis DREZ procedure to target the symptomatic nucleus caudalis region specifically, and to identify and protect the adjacent corticospinal tract and dorsal column (Husain et al. 2002).

### Outcomes

In the larger series reported in the literature, adequate, long term pain relief has been reported in about 60 to 90% (Dreval et al. 1993; Thomas et al. 1994; Rath et al. 1997; Sindou et al. 2001). Variations in results can be attributed to differences between criteria for patient selection, outcome measures, times of follow-up, and techniques (Friedman et al. 1988; Nashold and El-Naggar 1992; Dreval et al. 1993; Thomas and Kitchen 1994; Sampson et al. 1995; Iskandar and Nashold 1998; Sindou 2002; Spiac et al. 2002).

### Complications

Following DREZ lesions for brachial plexus avulsion pain, 41% experienced objective sensory deficits and 41% objective motor deficits (Friedman et al. 1988). However, the majority of these deficits were mild, with only a single patient suffering a deficit sufficient to limit ambulation. In spinal cord and conus medullaris DREZ



procedures, permanent sensory and motor deficits occur in about 13% and 12%, respectively. Non-neurologic complications such as infection, CSF leak, and epidural hematoma occur in about 7%. The nucleus caudalis DREZ procedure is associated with more complications. Rates of postoperative ataxia have ranged from 39 to 54%, and diplopia or corneal anesthesia in about 20%. For this reason, the caudalis DREZ procedure is performed at a limited number of centers. In a recently reported series of nucleus caudalis DREZ procedures, aided by trigeminal evoked potentials, EMG, and SSEPs, fewer lesions were made resulting in no permanent neurological deficits and pain relief in 71% of patients at 12 months (Husain et al. 2002).

## References

1. Bullard DE, Nashold BS (1997) The Caudalis DREZ for Facial Pain. *Stereotactic & Functional Neurosurgery* 68:168–174
2. Dreval ON (1993) Ultrasonic DREZ-Operations for Treatment of Pain due to Brachial Plexus Avulsion. *Acta Neurochir* 122:76–81
3. Friedman AH, Nashold NS Jr (1986) DREZ Lesions for the Relief of Pain Related to Spinal Cord Injury. *J Neurosurg* 65:465–469
4. Friedman AH, Nashold BS, Bronec PR (1988) Dorsal Root Entry Zone Lesions for the Treatment of Brachial Plexus Avulsion Injuries: A Follow-Up Study. *J Neurosurg* 22:369–373
5. Gorecki JP, Nashold BS (1995) The Duke Experience with the Nucleus Caudalis DREZ Operation. *Acta Neurochir* S64:128–131
6. Gorecki JP, Nashold NS, Rubin L, Ovelmen-Levitt J (1995) The Duke Experience with Nucleus Caudalis DREZ Coagulation. *Stereotactic & Functional Neurosurgery* 65:111–116
7. Husain AM, Elliott SL, Gorecki JP (2002) Neurophysiological Monitoring for the Nucleus Caudalis Dorsal Root Entry Zone Operation. *Neurosurgery* 50:822–827
8. Iskandar BJ, Nashold BS (1998) Spinal and Trigeminal DREZ Lesions. In: *Gildenberg PL, Tasker RR (eds) Textbook of Stereotactic and Functional Neurosurgery*, McGraw-Hill, Health Professional Division, New York, pp 1573–1583
9. Nashold BS Jr, El-Naggar AO (1992) Dorsal Root Entry Zone (DREZ) Lesioning. In: *Rengachary SS, Wilkins RH (eds) Neurosurgical Operative Atlas, vol 2*. Williams & Wilkins, Baltimore, pp 9–24
10. Rath SA, Seitz K, Soliman N, Hahamba JF, Antoniadis G, Richter HP (1997) DREZ Coagulations for Deafferentation Pain Related to Spinal and Peripheral Nerve Lesions: Indication and Results of 79 Consecutive Procedures. *Stereotactic and Functional Neurosurgery* 68:161–167
11. Sampson JH, Cashman RE, Nashold BS, Friedman AH (1995) Dorsal Root Entry Zone Lesions for Intractable Pain after Trauma to the Conus Medullaris and Cauda Equina. *J Neurosurg* 82:28–34
12. Sindou MP (2002) Dorsal Root Entry Zone Lesions. In: *Burchiel (ed) Surgical Management of Pain*. Thieme Medical Publishers Inc, New York, pp 701–713
13. Sindou M, Mertens P, Wael M (2001) Microsurgical DREZotomy for Pain due to Spinal Cord and/or Cauda Equina Injuries: Long-Term Results in a Series of 44 Patients. *Pain* 92: 159–171
14. Spaic M, Markovic N, Tadic R (2002) Microsurgical DREZotomy for Pain of Spinal Cord and Cauda Equina Injury Origin: Clinical Characteristics of Pain and Implications for Surgery in a Series of 26 Patients. *Acta Neurochir* 144:453–462
15. Thomas DG, Kitchen ND (1994) Long-Term Follow-Up of Dorsal Root Entry Zone Lesions in Brachial Plexus Avulsion. *J Neurol Neurosurg & Psychiatry* 57:737–738

## DREZ Lesions

### Synonyms

DREZotomy

### Definition

DREZ lesions are destructive therapeutic lesions applied onto the dorsal root entry zone (DREZ). Therapeutic DREZ lesions include, according to the lesion-maker: 1) the microsurgical DREZotomy (Sindou 1972), 2) the Radio-Frequency-Thermocoagulation (Nashold 1974), 3) the Laser DREZ lesion (Levy, 1983), and 4) the Ultrasonic DREZ lesion (Kandel and Dreval 1987).

- ▶ Anesthesia Dolorosa Model, Autotomy
- ▶ Brachial Plexus Avulsion and Dorsal Root Entry Zone
- ▶ Dorsal Root Entry Zone
- ▶ Dorsal Root Entry Zone Lesioning
- ▶ DREZ Procedures

## DRG

- ▶ Dorsal Root Ganglion

## Drug Guidelines

- ▶ Analgesic Guidelines for Infants and Children

## Drugs Targeting Voltage-Gated Sodium and Calcium Channels

ANNE K. BERTELSEN<sup>1</sup>, MISHA-M. BACKONJA<sup>2</sup>  
<sup>1</sup>Department of Neurology, Haukeland University Hospital, Bergen, Norway  
<sup>2</sup>Department of Neurology, University of Wisconsin-Madison, Madison, WI, USA  
 anne.kjorsvik@biomed.uib.no,  
 backonja@neurology.wisc.edu

### Synonyms

Ion Channel Blockers; Membrane-Stabilizing Drugs; voltage-gated channels; anticonvulsants; Antiarrhythmics

### Definition

Drugs that attenuate inward sodium or calcium ion currents in nociceptive afferent neurons, thus exerting a membrane-stabilizing action on these neurones.

## Drugs and Procedures to Treat Neuropathic Pain

GEORGE L. WILCOX

Department of Neuroscience, Pharmacology and Dermatology, University of Minnesota Medical School, Minneapolis, MN, USA  
george@umn.edu

Treatment of neuropathic pain continues to be a great challenge. ► **Neuropathic pain** is defined by the International Association for the Study of Pain (IASP) as pain initiated or caused by a primary lesion or dysfunction of the nervous system. It is therefore important to bear in mind that neuropathic pain is not a disease itself, but a symptom of an underlying disease that has caused damage to the nervous system, either peripheral or central. The treatment of neuropathic pain is thus symptomatic rather than curative and the initial step for every patient with neuropathic pain must therefore always be to achieve an accurate diagnosis and an adequate treatment of the underlying disease.

Our improved knowledge of different neuropathic pain conditions can be attributed to a number of recent developments and this knowledge has in turn allowed improved management of many kinds of neuropathic pain. Clinical research has contributed improved recognition of neuropathic pain as an entity, standardization of likely syndrome etiologies and diagnostic procedures and dissemination of this knowledge and methodology; all of these advances contribute to make outcomes of treatment more predictable and comparable among sites. The efficacy of a number of new therapeutic agents belonging to the ► **Anticonvulsant (Agent)** class that act at voltage-gated sodium channels to discourage repetitive firing of axons (see ► **drugs targeting voltage-gated sodium and calcium channels**) and their broadening use over the past decade have implicated action potential initiation or propagation as key targets for continued therapeutic development. The contemporary development over the past 15 years by basic science researchers of several different animal models (see ► **Animal Models and Experimental Tests to Study Nociception and Pain**) involving peripheral nerve injury and emulating various peripheral, traumatic, metabolic and toxic insults to the nervous system has allowed the testing of hypotheses concerning the etiology and therapy of neuropathic pain (Lindenlaub and Sommer 2002). Translational research has endeavored to bridge these two areas of development and contributed more objective methods of assessment and diagnosis, for example ► **quantitative sensory testing (QST)** and skin nerve biopsy (Karanth et al. 1991; Kennedy et al. 1993; Hilliges et al. 1995; Hsieh et al.

1996; Kennedy et al. 1999) for quantitative analysis of epidermal nerve fiber loss. Most recently, the identification of a polymorphism in a voltage-gated sodium channel gene peculiar to peripheral nociceptors accompanying a neuropathic pain disorder called erythromelalgia is a most welcome reinforcement of the above inference from the efficacy of anticonvulsant therapy. Collectively, this body of knowledge applied to individual neuropathic entities and cases has contributed to more objective diagnoses of some disorders, but has yet to provide a panacea of adequate therapy applicable to a majority of neuropathic pain disorders. It is hoped that this collection of syndrome- and mechanism-directed essays on the treatment of neuropathic pain will provide a roadmap for the next decade of development of new neuropathic pain therapies.

Although the aforementioned animal models have improved our understanding of the taxonomy of and revealed some of the complex mechanisms probably underlying peripheral and central neuropathic pain, translation of these findings into improved therapies for neuropathic pain has been more difficult. It can be argued that many of the improvements in therapy introduced in the 1990s have instead resulted from clinical experience with new agents exploiting previously known mechanisms, for example extension of carbamazepine's use in trigeminal neuralgia to include newer anticonvulsants in numerous neuropathic disorders. In addition, systematic clinical investigations of patients with neuropathic pain, notably using QST and quantitation of ► **epidermal nerve** fibers in skin biopsies, have also contributed to our assessment and understanding of neuropathic pain. Exceptions include the alpha adrenergic agonist clonidine and the calcium channel blocker ziconotide: intrathecal clonidine analgesia was characterized preclinically in the 1980s before translation to human use in the 1990s; ziconotide, developed from a naturally occurring peptide toxin targeting N-type calcium channels, was studied preclinically in the early 1990s before its introduction to clinical use in 2004.

The pathophysiological phenotypes accompanying painful nervous system damage can include one or more of the following: 1) ► **Wallerian degeneration** and aberrations in peripheral nerves or dorsal root ganglia (► **CRPS, evidence based treatment**; ► **trigeminal neuralgia, diagnosis and treatment**) (Hsieh 2000), 2) aberrant immune signaling, both peripherally and centrally (► **proinflammatory cytokines**; ► **cytokines as targets in the treatment of neuropathic pain**), 3) aberrant neurotransmitter and neuropeptide signaling (► **peptides in neuropathic pain states**; ► **purine receptor targets in the treatment of neuropathic pain**), 4) aberrant metabolism in somatic or neural tissues as in

diabetes or lysosomal storage diseases (► [diabetic neuropathy, treatment](#); ► [postherpetic neuralgia, pharmacological and non-pharmacological treatment options](#)) and 5) pathological central connectivity brought about by CNS injury or peripheral pathology (► [phantom limb pain, treatment](#); ► [descending facilitation and inhibition in neuropathic pain](#); ► [Cancer Pain Management, Treatment of Neuropathic Components](#)); eleven of the essays in this section address various levels of this taxonomy. A variety of etiologies and mediators, both peripheral and central, account for these phenotypes and an equally large variety of medical therapies and surgical manipulations have been prescribed. There are three main approaches to attacking neuropathic pain in the clinic, medical management (five essays: ► [drugs targeting voltage-gated sodium and calcium channels](#); ► [Alpha\( \$\alpha\$ \) 2-Adrenergic Agonists in Pain Treatment](#); ► [antidepressants in neuropathic pain](#); ► [drugs with mixed action and combinations, emphasis on tramadol](#)), interventional therapies such as CNS stimulation, nerve blocks and surgical management (one essay: ► [central nervous system stimulation for pain](#)) and non-medical alternative or non-invasive approaches (four essays: ► [alternative medicine in neuropathic pain](#); ► [dietary variables in neuropathic pain](#); ► [fibromyalgia mechanisms and treatment](#); ► [evoked and movement-related neuropathic pain](#)), with progressively diminishing efficacy. This essay seeks to align the etiologies, pathophysiology and mediators of neuropathic pain with the therapeutic approaches used to manage it.

Sales of pain products, which generated an estimated \$40 billion USD in 2004, may double by the end of the decade. Pain accompanies many diseases and its significance is underappreciated by many medical specialties, which often focus attention on the disease itself to the exclusion of the intensity or treatment of the associated pain symptoms. Neuropathic pain is estimated to affect 26 million patients worldwide, including 10 million in the US, 3 million in Europe and 1.5 million in Japan; spending on these patients last year totaled \$2.5 billion globally and will probably double by the end of the decade ("CNS Drug Discoveries: Analgesia," June 2005, available at [www.researchandmarkets.com](http://www.researchandmarkets.com)). This anticipated increase is based on the likelihood that novel therapeutic agents will be developed that target subsets of neuropathic pain, accompanying, for example, post-herpetic neuralgia (PHN, shingles), diabetes (DN), HIV immune disorders and cancer chemotherapy. Neuropathic pain presents a substantial unmet clinical need due largely to inadequate pain management programs and global under-utilization of appropriate medications, such as antidepressants and opioids, particularly in Europe. Understanding the costs of neuropathic pain

treatment and the degree of under-utilization is made difficult by the prevalence of "off label" use of drugs such as antidepressants and anticonvulsants. More potentially pain-indicated medications are at or near introduction, including new antidepressants like duloxetine, anticonvulsants like pregabalin and lamotrigine, calcium channel antagonists like ziconotide, glutamate antagonists like memantine and cannabinoid agonists like the tetrabinex/nabidolex combination agent. The safety and efficacy of neuropathic pain therapy will probably be significantly different, hopefully improved, in 5 years.

### Disease Entities

Of the disease entities covered explicitly by essays, postherpetic neuralgia (PHN) (see ► [drugs targeting voltage-gated sodium and calcium channels](#)) and diabetic neuropathy (DN) (see ► [diabetic neuropathy, treatment](#)) are the two with the highest incidence, perhaps accounting for half of the overall incidence of neuropathic pain. These high incidence disorders also account for the vast majority of well designed and conclusive trials; therefore, the evidence basis for the majority of several other disease entities is an extension of what has been learned from these two entities. The multifactorial causes of cancer pain, including both somatic and neuropathic components, makes estimation of the incidence or contribution of neuropathic cancer pain difficult (see ► [cancer pain management, treatment of neuropathic components](#)). The combined incidence of complex regional pain syndrome (CRPS) (see ► [CRPS, evidence based treatment](#)) and fibromyalgia (FMS) (see ► [fibromyalgia, mechanisms and treatment](#)) is probably comparable to that of PHN or DN, alone. The other classifications trigeminal neuralgia (TN) (see ► [trigeminal neuralgia, diagnosis and treatment](#)), phantom pain (see ► [phantom limb pain, treatment](#)), and movement-related neuropathic pain (see ► [evoked and movement-related neuropathic pain](#)) collectively represent a relatively small fraction of neuropathic pain conditions. Comparison of the common treatment modalities effective across these various types of neuropathic pain yields a homogeneity that both derives from the evidence basis mentioned above and suggests a commonality in underlying mechanisms. This commonality of mechanisms is highlighted by the medical therapies, anticonvulsants, antidepressants and calcium channel blockers, described below.

### Medical vs. Non-Medical Therapies

Five essays address medical therapies used most frequently in management of neuropathic pain disorders or a target of some of these therapies, descending

modulatory systems. None of the therapies is curative, rather treating the symptoms of painful peripheral neuropathies. Antidepressants may be the most used medications, although their mechanisms of action are among the least well understood and the perhaps the least target-selective (see ► [antidepressants in neuropathic pain](#)). Anticonvulsants (► [drugs targeting voltage-gated sodium and calcium channels](#), and see voltage gated channels below) are perhaps becoming the most frequently used agents in neuropathic pain; most seem to target voltage-gated Na<sup>+</sup> channels but some of the newer agents in this class seem to target a subunit of voltage-gated Ca<sup>++</sup> channels. Medical treatments targeting multiple receptors, a prototype for which is tramadol (see ► [drugs with mixed action and combinations, emphasis on tramadol](#)), are less widely used, but nonetheless represent a significant fraction of medical treatments. By comparison, drugs targeting adrenergic receptors have a very low prevalence of use, largely because of the necessity of spinal targeting by implanted catheter (► [Alpha\(α\) 2-Adrenergic Agonist](#)). The spinal receptors for adrenergic agonists are also the target of descending inhibitory systems covered in ► [descending facilitation and inhibition in neuropathic pain](#); the descending terminals of these inhibitory systems may be targeted indirectly by antidepressants and tramadol (► [drugs with mixed action and combinations, emphasis on tramadol](#)). The essay ► [descending facilitation and inhibition in neuropathic pain](#) also addresses the potential for descending facilitatory influences to contribute to the neuroplastic changes thought to mediate formation of chronic neuropathic pain. These descending systems may be fruitful future targets for therapies.

Five essays address non-medical therapies. The essay ► [central nervous system stimulation for pain](#) discusses the indications and possible mechanisms for spinal cord (SCS), deep brain stimulation (DBS) and motor cortex stimulation; the first is useful in a broad range of disorders, such as CRPS, DN, PHN and spinal cord injury pain, but not back pain; DBS is indicated in central pain, ► [anesthesia dolorosa](#), post-cordotomy dysesthesias and possibly cluster headaches; the cortical stimulation site has shown utility in pain following deep brain or spinal ischemia and some forms of deafferentation pain. However, the mechanisms and utility of CNS stimulation for neuropathic pain remain obscure and controversial. The essay ► [phantom limb pain, treatment](#) explores the therapies useful (and not useful) in phantom pain: many treatments useful in other forms of neuropathic pain fail to exceed the efficacy of placebo in phantom pain; nonetheless, opioids, NMDA antagonists, gabapentin, TENS and sensory discrimination training appear to be effective. Prevention may be a promising future area

of development for controlling phantom pain, combining, for example, memantine and peripheral regional anesthesia. Four essays explore non-invasive, non-medical therapies including complementary and alternative medicine (► [alternative medicine in neuropathic pain](#)), dietary variables (► [dietary variables in neuropathic pain](#)), the utility of exercise particularly with respect to FMS (► [fibromyalgia, mechanisms and treatment](#)) and movement-related pain (► [evoked and movement-related neuropathic pain](#)). Although several studies document that many patients with neuropathic pain (20–50% in various countries) use alternative and complementary medicine, only electroacupuncture has been validated by randomized controlled trials. Some aspects of diet probably contribute to a patient's predisposition to developing neuropathic pain, but research into pro-analgesic nutrients is in its infancy. The causes and mechanisms underlying fibromyalgia (FMS) remain obscure, though suggestive evidence implicates glutamate, neuropeptides and nerve growth factor. Tricyclic antidepressants and tramadol have shown efficacy, but exercise remains the most effective therapy overall. This field of disorders, FMS and movement-related pain and therapeutic regimens, TENS, acupuncture and non-medical therapies, seems to constitute a fruitful area for development of future therapies.

### Voltage-Gated Channels

The dominance of diverse anticonvulsants as effective therapeutic agents in a broad range of neuropathic pain states (see ► [drugs targeting voltage-gated sodium and calcium channels](#)) together with the commonality of their molecular targets strongly links voltage-gated sodium and calcium channels to mediation of pain accompanying neuropathy. The involvement of calcium channels derives largely from presumptive targeting of the alpha-2 delta subunit of ► [voltage gated calcium channels](#) by gabapentin and newer pregabalin. Gabapentin's targets would presumably be the central terminals of primary afferent fibers where reduction in calcium-dependent release of excitatory transmitter could account for a pain-attenuating action. A very different recently introduced agent, ziconotide targets with extreme selectivity N-type voltage-gated calcium channels, which are thought to be directly linked to transmitter release in axon terminals. Ziconotide is approved for intrathecal application in neuropathic pain patients, but several side effects may limit the prevalence of its ultimate use (Wallace 2002).

The important sites of action of agents targeting voltage-gated sodium channels have been variously assigned to peripheral and central targets, but are generally invoked as sources of ► [ectopic discharges](#) in



hypersensitive zones of peripheral regenerating axon tips or in neuromas (Michaelis 2002). Axonal sensitization has been associated most often with injury-related or neurotrophin-imposed plasticity in expression of ► [voltage-gated sodium channels](#) (Black et al. 2002) and most recently with a genetic neuropathic pain-linked polymorphism in the Na<sub>v</sub>1.7 subtype that lowers the threshold for spike initiation (Dib-Hajj et al. 2005). This finding may prove to be seminal in seeking axonal mediators of sensory neuron sensitization accompanying neuropathic pain. Erythromelalgia manifests with paroxysmal episodes of burning pain in distal extremities initiated by warming; as such this disorder embodies many of the enigmatic characteristics of several neuropathic pain syndromes, including DN, Fabry disease and idiopathic burning hands and feet. Only rarely, has axonal sensitization after nerve injury been linked to inflammatory mediators released by mast cells, generally (Zuo et al. 2003), in proximal regenerating nerve tips (Zochodne et al. 1997) or distally in the dermis (Marchand et al. 2005). Release of excitatory substances (cytokines, histamine, serotonin, noradrenaline or ATP) has also been hypothesized proximally in DRG (Michaelis 2002) and distally in dermis (Marchand et al. 2005) as a promoter of ectopic activity. Site-specific study of cellular and molecular mediators of axonal or terminal sensitization would appear to be a fruitful area for future study.

### Neurotransmitters

Glutamate, the most prominent fast excitatory neurotransmitter between nociceptors and spinal neurons, activates ligand-gated channels that admit monovalent (mostly Na<sup>+</sup> and K<sup>+</sup> for all AMPA- and kainate-operated channels) and divalent (Ca<sup>++</sup> or Mg<sup>++</sup>, some AMPA / kainate receptors and all NMDA receptors) cations, depolarizing neural processes (Wilcox et al. 2005). Ca<sup>++</sup> entry mediated by these channels can activate such signaling systems as calcium-calmodulin kinase (CaM-kinase II), which can set in motion numerous intracellular cascades contributing to long-lasting changes in synaptic strength. Both types of receptors are thought to be involved in initiation and maintenance of neuropathic pain states. Normally, NMDA receptors are more directly involved in responses of dorsal horn neurons to intense noxious stimuli than are AMPA / kainate receptors, but increased surface expression of AMPA receptors by spinal neurons may accompany neuropathic pain. NMDA receptors in spinal cord are subject to positive modulation by PKC, which accompanies strong activation by among others SP acting at NK<sub>1</sub> receptors (see below) and can be blocked by dissociative anesthetics, including phencyclidine (PCP), MK-801, ketamine, memantine and the inactive opioid congener dextromethorphan. Only the latter

three agents have been investigated clinically for use in neuropathic pain; the other agents like AMPA antagonists are not likely to be of clinical use due to numerous side effects. AMPA receptor activation produces strong depolarization that is not dependent upon concurrent activity, making this process “non-contingent” On the other hand, the NMDA receptor is blocked by Mg<sup>++</sup> at resting potential, preventing ligand gating of the channel; depolarization of the plasma membrane removes this Mg<sup>++</sup> block allowing subsequent ligand gating. Removal of this Mg<sup>++</sup> block by prior depolarization makes NMDA-evoked depolarization “contingent” and may underlie the participation of this receptor in the “wind-up” phenomenon recruited by repetitive activation of C-fibers. NMDA receptors are critical participants in the induction of acute (e.g. formalin) and chronic (the chronic constriction injury neuropathic pain model, CCI) hyperalgesia.

The essay ► [peptides in neuropathic pain states](#) explores five of the peptide neurotransmitters, vasoactive intestinal polypeptide (VIP and similar PACAP), dynorphin (DYN), cholecystokinin (CCK) and neuropeptide Y (NPY), most directly contributing to enhanced excitatory neurotransmission following peripheral nerve injury. VIP and PACAP, contained in small diameter fibers, dramatically increase in DRG after peripheral nerve injury and participate strongly in induction and maintenance of hyperalgesic states induced by these injuries (Kashiba et al. 1992). DYN expression is also dramatically increased after nerve injury and somehow facilitates excitatory transmission, but this occurs in spinal cord neurons rather than in DRG. CCK is another central neuropeptide that is up-regulated in spinal cord and in pain-relevant brain structures after peripheral nerve injury; CCK probably plays an important role in maintaining neuropathic pain at both the spinal and supraspinal levels. Moderate levels of NPY normally occur in large diameter primary afferent fibers, but these levels are markedly up-regulated after peripheral nerve injury; this increased expression is an important component of hypersensitivity accompanying these injuries. These five peptides and their receptors represent likely targets for new drug development directed at neuropathic pain therapy.

Several other neuropeptides are altered after peripheral nerve injury and may participate in development or maintenance of hyperalgesic states. Galanin (GAL) levels in primary sensory neurons increase in DRG soon after nerve injury (Villar et al. 1991) or treatment with the chemotherapeutic agent vinblastine (Kashiba et al. 1992), apparently as a compensatory reaction *via* Gal<sub>1</sub> receptors countering hypersensitivity (Blakeman et al. 2003). However, GAL actions *via* its three receptor subtypes are complex, manifesting both inhibitory and excitatory effects depending on dose (Liu

et al. 2001). Calcitonin gene-related peptide (CGRP) is found normally in small diameter primary afferent fibers and its levels in DRG decrease after axotomy (Dumoulin et al. 1992) or partial sciatic nerve ligation (Ma et al. 2003). Conversely, spinal nerve ligation increases capsaicin-evoked CGRP release in spinal cord dorsal horn coincident with hyperalgesia (Gardell et al. 2003). Evidently, CGRP participates in maintenance of persistent hyperalgesia following peripheral nerve injury. Substance P (SP), like CGRP, is also found in small diameter primary afferent fibers and its levels similarly decrease in DRG after axotomy (Nietsch et al. 1987); as is the case with CGRP, SP signaling *via* spinal neurokinin-1 (NK<sub>1</sub>) receptors is increased after peripheral nerve injury and contributes to nerve injury-induced hyperalgesia (Cahill andCoderre 2002). Surprisingly, clinical trials of NK<sub>1</sub> antagonists in patients with painful diabetic neuropathy were negative (Goldstein et al. 2001). Somatostatin (SOM), another peptide contained in small diameter primary afferent fibers decreases in dorsal horn and increases in ventral horn after partial sciatic nerve injury (Swamydas et al. 2004); the mechanical hyperalgesia following this injury is also reversed by systemically administered SOM receptor antagonists (Pinter et al. 2002). One or more of these peptides may also be fruitful targets for therapeutic drug development.

### Inflammatory Mediators

Although immunocytes and cytokines are often invoked as factors contributing to neuropathic pain, the sites of their actions are rarely invoked. For example, a recent study of thalidomide in a rodent model of neuropathic pain opens with this sentence: "In almost every neuropathic pain state caused by peripheral nerve damage, whether due to trauma or disease, both structural damage and an inflammatory response exist." (Bennett 2000). The verity of this statement is accepted by most researchers in the field without question, but the design of this particular study, or indeed most such studies, rarely offer significant data or interpretation explicitly delineating the specific sites of the inflammatory response. Only within the past 8 years have cytokines and subsequently microglia been identified as necessary and sufficient spinal cord mediators of hyperalgesia in rodent models of neuropathic pain (see also ► [proinflammatory cytokines](#)). Presumably, intense activity on primary nociceptive afferent fibers is sufficient to activate spinal microglia, which in turn adopt an activated phenotype, up-regulate synthesis of proinflammatory cytokines and release excitatory neurotransmitters and neuromodulators. The substances released by spinal microglia are thought to include glutamate and nitric oxide, which contribute to the ongoing

excitatory cascade thought to establish the spinal and spinal-supraspinal substrates of chronic pain. Studies of peripheral neuroimmune action contemporary with the central microglial studies from Watkins's and Salter's groups have investigated the role of inflammatory cells at sites of experimental nerve injury. The chronic constriction injury developed by Bennett and Xie (1988) was found to rely on a local inflammatory reaction at the point of injury along the sciatic nerve. However, few recent studies have investigated inflammatory reactions taking place at the distal end of the afferent arm, that is in or near tissue hosting terminals of sensory nerves (e.g. epidermis) undergoing Wallerian degeneration. Do activated immunocytes near the terminal fields (e.g. subepidermal plexus) release ► [Allogene](#) capable of activating or sensitizing afferent axons?

### References

- Bennett GJ, (2000) A neuroimmune interaction in painful peripheral neuropathy. *Clin J Pain* 16:139–143
- Black JA, Cummins TR, Dib-Hajj SD et al. (2002) Sodium channels and the molecular basis for pain. In: Malmberg AB, Chaplan SR (eds) *Mechanisms and Mediators of Neuropathic Pain*. Birkhäuser Verlag, Basel-Boston-Berlin, pp 23–50
- Blakeman KH, Hao JX, Xu XJ et al. (2003) Hyperalgesia and increased neuropathic pain-like response in mice lacking galanin receptor 1 receptors. *Neuroscience* 117:221–227
- Cahill CM, Coderre TJ (2002) Attenuation of hyperalgesia in a rat model of neuropathic pain after intrathecal pre- or post-treatment with a neurokinin-1 antagonist. *Pain* 95:277–85
- Dib-Hajj SD, Rush AM, Cummins TR et al. (2005) Gain-of-function mutation in Nav1.7 in familial erythromelalgia induces bursting of sensory neurons. *Brain* 128:1847–1854
- Dumoulin FL, Raivich G, Haas CA et al. (1992) Calcitonin gene-related peptide and peripheral nerve regeneration. *Annals New York Acad Sci* 657:351–360
- Gardell LR, Vanderah TW, Gardell SE et al. (2003) Enhanced evoked excitatory transmitter release in experimental neuropathy requires descending facilitation. *J Neurosci* 23: 8370–8379
- Goldstein DJ, Wang O, Gitter BD et al. (2001) Dose-response study of the analgesic effect of lanepitant in patients with painful diabetic neuropathy. *Clin Neuropharmacol* 24:16–22
- Hilliges M, Wang L, Johansson O (1995) Ultrastructural evidence for nerve fibers within all vital layers of the human epidermis. *J Invest Dermatol* 104:134–137
- Hsieh ST, Choi S, Lin WM et al. (1996) Epidermal denervation and its effects on keratinocytes and Langerhans cells. *J Neurocytol* 25:513–524
- Hsieh ST, Chiang HY, Lin WM et al. (2000) Pathology of nerve terminal degeneration in the skin. *J Neuropathol Exp Neurol* 59:297–307
- Karanth SS, Springall DR, Kuhn DM et al. (1991) An immunocytochemical study of cutaneous innervation and the distribution of neuropeptides and protein gene product 9.5 in man and commonly employed laboratory animals. *Am J Anat* 191:369–383
- Kashiba H, Senba E, Kawai Y et al. (1992) Axonal blockade induces the expression of vasoactive intestinal polypeptide and galanin in rat dorsal root ganglion neurons. *Brain Res* 577:19–28
- Kennedy WR, Said G (1999) Sensory nerves in skin: answers about painful feet? *Neurology* 53:1614–1615
- Kennedy WR, Wendelschafer-Crabb G (1993) The innervation of human epidermis. *J Neurol Sci* 115:184–190

16. Lindenlaub T, Sommer C (2002) Epidermal innervation density after partial sciatic nerve lesion and pain-related behavior in the rat. *Acta Neuropathol* 104:137–143
17. Liu HX, Brumovsky P, Schmidt R et al. (2001) Receptor subtype-specific pronociceptive and analgesic actions of galanin in the spinal cord: selective actions via GalR1 and GalR2 receptors. *Proc Nat Acad Sci USA* 98:9960–9964
18. Ma W, Chabot JG, Powell KJ et al. (2003) Localization and modulation of calcitonin gene-related peptide-receptor component protein-immunoreactive cells in the rat central and peripheral nervous systems. *Neuroscience* 120:677–694
19. Marchand F, Perretti M, McMahon SB (2005) Role of the immune system in chronic pain. *Nature Reviews Neuroscience* 6:521–532
20. Michaelis M (2002) Electrophysiological characteristics of injured peripheral nerves. In: Malmberg AB, Chaplan SR (eds) *Mechanisms and Mediators of Neuropathic Pain*. Birkhäuser Verlag, Basel-Boston-Berlin, pp 23–50
21. Nielsch U, Bisby MA, Keen P (1987) Effect of cutting or crushing the rat sciatic nerve on synthesis of substance P by isolated L5 dorsal root ganglia. *Neuropeptides* 10:137–145
22. Pinter E, Helyes Z, Nemeth J et al. (2002) Pharmacological characterisation of the somatostatin analogue TT-232: effects on neurogenic and non-neurogenic inflammation and neuropathic hyperalgesia. *Naunyn-Schmiedeberg's Archives Pharmacology* 366:142–150
23. Swamydas M, Skoff AM, Adler JE (2004) Partial sciatic nerve transection causes redistribution of pain-related peptides and lowers withdrawal threshold. *Experimental Neurology* 188:444–451
24. Villar MJ, Wiesenfeld-Hallin Z, Xu XJ et al. (1991) Further studies on galanin-, substance P-, and CGRP-like immunoreactivities in primary sensory neurons and spinal cord: effects of dorsal rhizotomies and sciatic nerve lesions. *Exp Neurol* 112:29–39
25. Wallace M (2002) In: Malmberg AB, Chaplan SR (eds) *Mechanisms and Mediators of Neuropathic Pain*. Birkhäuser Verlag, Basel-Boston-Berlin
26. Wilcox GL, Stone LS, Ossipov MH et al. (2005) Pharmacology of pain transmission and modulation. I. Central mechanisms. In: Pappagallo M (ed) *The Neurologic Basis of Pain*. McGraw-Hill, New York, pp 31–52
27. Zochodne DW, Cheng C (2000) Neurotrophins and other growth factors in the regenerative milieu of proximal nerve stump tips. *J Anat* 196:279–283
28. Zochodne DW, Theriault M, Cheng C et al. (1997) Peptides and Neuromas. Peptides and neuromas: calcitonin gene-related peptide, substance P and mast cells in a mechanosensitive human sural neuroma. *Muscle Nerve* 7:875–880
29. Zuo Y, Perkins NM, Tracey DJ et al. (2003) Inflammation and hyperalgesia induced by nerve injury in the rat: a key role of mast cells. *Pain* 105:467–479

## Characteristics

Voltage-gated sodium channels (VGSCs) and voltage-gated calcium channels (VGCC) have a fundamental role in the excitability of all neurons. Agents that block these channels or encourage inactivation, often referred to as membrane-stabilizing agents, reduce nerve excitability by blocking the initiation of action potentials. The role of VGCCs in ► **neuropathic pain** is under intense investigation, but their role is far from clear. In contrast, VGSCs in sensory neurons are well studied and thought to play a crucial role in neuropathic pain caused by peripheral nerve injury. Alteration in VGSC expression or function has been shown to have profound effects on the firing pattern of primary afferent sensory neurons, as well as neurons in the central nervous system. After nerve injury, sodium channels may accumulate not only on the neuroma or sprouts of damaged peripheral nerve endings, but also along the rest of the axons and on uninjured neighboring axons (Cummins and Waxman 1997; England et al. 1996). This accumulation of sodium channels dramatically lowers the depolarization threshold of the nerves, and the nerves fire more readily in response to low-threshold stimulation (Matzner and Devor 1994). Increased firing of primary sensory neurons results in increased release of glutamate and substance P from central terminals of the primary afferent fibers, leading to subsequent activation of the NMDA receptors, and a state called ► **central sensitization** develops. Pathologically unstable membranes on primary afferent neurons are critical for induction of central sensitization and development of neuropathic pain after peripheral nerve injury. Patients

with this condition will typically experience stimulus-independent pain and/or stimulus-dependent pain as ► **hyperalgesia** and ► **allodynia**.

There are at least eight VGSCs present in the nervous system of mammals that differ in their expression patterns within the nervous system, their kinetics, and their recovery from inactivation. There are, for example, certain VGSCs that are only expressed in the dorsal root ganglia, secondary to down-regulation of certain sodium channel subtypes and the up-regulation of others (Cummins et al. 2000). Further, the sodium channels can be divided into tetrodotoxin-sensitive and tetrodotoxin-resistant channels, both of which play a physiological role in nociceptive impulse transmission (Brock et al. 1998). However, there is evidence to suggest that preferential expression and accumulation of tetrodotoxin-resistant sodium channels, especially Na<sub>v</sub>1.8 channels, may be relevant to the mechanisms of peripheral nerve injury-induced neuropathic pain (Lai et al. 2004).

A number of drugs modulate sodium channels in the peripheral nervous system, and are thought to provide relief from neuropathic pain by suppressing ► **ectopic discharges** originating in the injured ► **nociceptors**, or at the level of the associated dorsal root ganglia. The fact that the available agents lack selectivity for sodium channel subtypes means that multiple channel subtypes are affected, resulting in frequent adverse side effects. The therapeutic effects of these sodium channel-modulating drugs result from their ability to prolong the refractory period following action potentials, and to prevent the generation of spontaneous ectopic discharges at concen-

trations lower than those required to block or inhibit normal impulse generation and propagation.

### Individual Ion Channel Modulators in Treatment of Neuropathic Pain

A number of drugs have been used for treatment of neuropathic pain, and this use was primarily empirically derived (Dworkin et al. 2003a). The drugs used for treatment of neuropathic pain belong to a few classes and, because they modulate the activity of the nervous system to achieve this effect, they are sometimes referred to as neuromodulators. It should be noted that all of them provide only symptomatic pain relief and none of them reverses underlying pathology.

#### Anticonvulsant Agents

Gabapentin has been used since 1994 for the management of partial epilepsy, and is now one of the most widely used drugs in the management of neuropathic pain. Structurally, it is an analogue of gamma-aminobutyric acid, GABA, but pharmacologically gabapentin appears to have no direct effect on GABA uptake or metabolism. Its mechanisms of action appear to involve antagonism of non-NMDA receptors and binding to the  $\alpha_2\delta$  subunit of voltage-dependent calcium channels. The latter action could mediate reduced release of excitatory neurotransmitters. Although gabapentin is associated with few drug interactions and is well tolerated, the concentration range and value of therapeutic drug monitoring of this drug is unclear; therefore, the dosage should be adjusted based on efficacy and tolerability. Gabapentin seems to be most effective at or above doses of 1800 (up to 3600 mg/d) divided into three doses. Lower doses (<900 mg/d) have shown to have limited effect in the treatment of neuropathic pain (Backonja and Glanzman 2003). The dosage should be increased slowly, from the lowest recommended therapeutic daily dose and up to the maximum recommended daily dose, or until adequate pain relief is achieved and/or the patient complains about side effects.

Pregabalin, a follow-up drug to gabapentin, also binds to  $\alpha_2\delta$  subunit of voltage-dependent calcium channels, but has a more linear bioavailability than gabapentin. Lower doses are therefore needed for reducing pain and allodynia than gabapentin, and the efficacy is more predictable. The therapeutic dose range for pregabalin is between 150 and 600 mg/d divided in two or three doses (Dworkin et al. 2003b).

Carbamazepine binds preferentially to the inactivated state of voltage-gated sodium channels, thereby stabilizing axonal membranes. It is approved by the US Food and Drug Administration as the drug of first choice to relieve shock-like pain, such as that experienced with trigeminal neuralgia (TN). The pain relief in TN is so fast and effective with carbamazepine that it is sometimes used as a marker for determining whether a pa-

tient has TN or not. However, carbamazepine may not be as effective for atypical trigeminal neuralgia, and data with regard to other neuropathic pain disorders is negative or limited, or both. Dosages are adjusted for each person individually, but usually vary between 200 and 1200 mg/d. However, intolerance to the side effects and a need for laboratory monitoring limits its use, especially in the elderly. Phenytoin, next to carbamazepine, is another example of a drug that has negative clinical trial results. Theoretically, both of these drugs could be effective because of their specific effects on sodium channels, but their complex pharmacology limits their use.

Lamotrigine is a new sodium channel and presynaptic glutamate blocking drug that may possess beneficial properties for pain relief by suppressing abnormal ectopic discharge. It has recently been reported that lamotrigine, at doses of 400–600 mg/d, results in moderate pain relief with tolerable side effects in trials involving patients with diabetic and human immunodeficiency virus (HIV)-associated neuropathy (Simpson et al. 2000).

Topiramate, tiagabine and bupropion are other new generation anticonvulsants that display an ability to modulate sodium channels, but randomized trials for topiramate have been negative, and for the others are still lacking in indicating their utility in neuropathic pain management.

#### Local Anesthetics/Antiarrhythmics

Local anesthetic drugs should be considered as alternative therapies in the treatment of chronic neuropathic pain, because they reportedly provide effective relief in different neuropathic pain conditions such as painful diabetic neuropathy, postherpetic neuralgia, lumbar radiculopathies, complex regional pain syndrome (CRPS) type I and II and in traumatic peripheral nerve injuries. However, the usefulness of these agents is limited because of frequent association with numerous adverse effects, particularly CNS-related side effects, e.g. nausea and emesis, dizziness, ataxia and tinnitus, as well as cardiotoxicity, which severely limits its use, especially in the elderly.

Intravenous lidocaine (lignocaine) is the most frequently used local anesthetic in the treatment of neuropathic pain, and has been shown to produce a moderate reduction in pain in patients with diabetic neuropathy (Kastrup et al. 1987). It has been shown to be especially effective in pain states like trigeminal and post-herpetic neuralgia and painful diabetic neuropathy. However, intravenous administration poses a challenge for the long-term treatment because oral dosing is unavailable. Therefore, this treatment is administered periodically on a scheduled basis, or for excruciating episodes of neuropathic pain. In addition to its acute effect, it also produces pain relief for several days, an effect far outlasting drug elimination from the plasma. The mechanisms related to this phenomenon remain un-



clear. Intravenous lidocaine/lignocaine is advocated as a diagnostic aid for the presence of pain associated with nerve injury, and for its predictive value of potential analgesic efficacy of oral local anesthetic agents, such as mexiletine.

The orally administered “local anesthetics” include both tocainide and the type 1b antiarrhythmic agent mexiletine; both have been used with success either as monotherapies, or sequentially following an initial lignocaine infusion. However, there have been inconsistent results with the use of mexiletine. Patients with diabetic neuropathy obtained a beneficial effect from mexiletine (Oskarsson et al. 1997), and another demonstrated efficacy with regard to secondary outcomes, but not with regard to global pain relief (Stracke et al. 1992); a fourth trial in patients with HIV-associated neuropathy failed to demonstrate a benefit (Kemper et al. 1998).

A critical aspect of the analgesic action of local anesthetics is their ability, at low subanesthetic doses, to block the spontaneous and/or evoked repetitive, ectopic impulse activity in afferent fibers apparently mediated by both TTX-S and slowly inactivating TTX-R sodium channels. Lidocaine/lignocaine can suppress the generation of this abnormal impulse traffic and restore a more normal firing rhythm by acting either directly at the site of origin or at distant sites. Injured nerves that fire repetitively at high frequency are specifically sensitive to concentrations of these drugs that have minimal impact on normal, somatosensory (i.e. nociceptive) neuronal function, and this sensitivity of injured neurons is the basis for the efficacy of these drugs.

### Antidepressant Drugs

► **Tricyclic antidepressants** are the most well-studied and most used agents for relief of neuropathic pain. Interestingly, amitriptyline, doxepin and desipramine have been found to be strong sodium channel modulators (Pancrazio et al. 1998), in addition to their well-known effect on reuptake of serotonin and noradrenaline. This sodium channel-blocking effect is presumed to be the pain-relieving mechanism of these drugs in the case of neuropathic pain due to peripheral nerve injury, and they have efficacy on both spontaneous pain as well as for hyperalgesia. The accumulative efficacy reported from trials suggests that about one third of patients will achieve a 50% reduction in neuropathic pain; however, the benefits are often outweighed by side effects, especially among the elderly.

### References

1. Backonja M, Glanzman RL (2003) Gabapentin Dosing for Neuropathic Pain: Evidence from Randomized, Placebo-Controlled Clinical Trials. *Clin Ther* 25:81–104
2. Brock JA, McLachlan EM, Belmonte C (1998) Tetrodotoxin-Resistant Impulses in Single Nociceptor Nerve Terminals in Guinea-Pig Cornea. *J Physiol* 512:211–217
3. Cummins TR, Waxman SG (1997) Downregulation of Tetrodotoxin-Resistant Sodium Currents and Upregulation of a

Rapidly Repriming Tetrodotoxin-Sensitive Sodium Current in Small Spinal Sensory Neurons after Nerve Injury. *J Neurosci* 17:3503–3514

4. Cummins TR, Dib-Hajj SD, Black JA et al. (2000) Sodium Channels and the Molecular Pathophysiology of Pain. *Prog Brain Res* 129:3–19
5. Dworkin RH, Backonja M, Rowbotham MC et al. (2003a) Advances in Neuropathic Pain: Diagnosis, Mechanisms, and Treatment Recommendations. *Arch Neurol* 60:1524–1534
6. Dworkin RH, Corbin AE, Young JP Jr et al. (2003b) Pregabalin for the Treatment of Postherpetic Neuralgia: A Randomized, Placebo-Controlled Trial. *Neurology* 60:1274–1283
7. England JD, Happel LT, Kline DG et al. (1996) Sodium Channel Accumulation in Humans with Painful Neuromas. *Neurology* 47:272–276
8. Kastrup J, Petersen P, Dejgård A et al. (1987) Intravenous Lidocaine Infusion – A New Treatment of Chronic Painful Diabetic Neuropathy? *Pain* 28:69–75
9. Kemper CA, Kent G, Burton S et al. (1998) Mexiletine for HIV-Infected Patients with Painful Peripheral Neuropathy: A Double-Blind, Placebo-Controlled, Crossover Treatment Trial. *J Acquir Immune Defic Syndr Hum Retrovirol* 19:367–372
10. Lai Josephine, Porreca Frank, Hunter John C et al. (2004) Voltage-Gated Sodium Channels and Hyperalgesia. *Annu Rev Pharmacol Toxicol* 44:371–397
11. Matzner O, Devor M (1994) Hyperexcitability at Sites of Nerve Injury Depends on Voltage-Sensitive Na<sup>+</sup> Channels. *J Neurophysiol* 72:349–359
12. Oskarsson P, Lunggren JG, Lins PE (1997) Efficacy and Safety of Mexiletine in the Treatment of Painful Diabetic Neuropathy. *Diabetes Care* 20:1594–1597
13. Pancrazio JJ, Kamatchi GL, Roscoe AK et al. (1998) Inhibition of Neuronal Na<sup>+</sup> Channels by Antidepressant Drugs. *J Pharmacol Exp Ther* 284:208–214
14. Simpson DM, Olney R, McArthur JC et al. (2000) A Placebo-Controlled Trial of Lamotrigine for Painful HIV-Associated Peripheral Neuropathy. *Neurology* 54:2115–2119
15. Stracke H, Meyer UE, Schumacher HE et al. (1992) Mexiletine in the Treatment of Diabetic Peripheral Neuropathy. *Diabetes Care* 15:1550–1555

D

## Drugs with Mixed Action and Combinations, Emphasis on Tramadol

ROBERT B. RAFFA

Department of Pharmacology, Temple University  
School of Pharmacy, Philadelphia, PA, USA  
robert.raffa@temple.edu

### Synonyms

Mixed-Acting Analgesics; Multimodal Analgesics; Tramadol

### Definition

Analgesics for which a significant portion of their effect is attributed to the combined action of more than one mechanism. The different mechanisms can be contained within one drug or by combination of separate drugs.

### Characteristics

As the nature of neuropathic pain is diverse in its etiology, neuro(chemical/logical) pathology, and clinical manifestations, it is highly likely that multiple diverse

pain-signal transmitting pathways are involved. It seems reasonable, then, that a strategy to treat this type of pain might incorporate the simultaneous combined activation of diverse analgesic pathways. This section considers the treatment of neuropathic pain with analgesic drugs that have multiple mechanisms of analgesic action. The strategy of combining analgesics that have a single mechanism of action is also included.

#### Individual Agents (Classes)

In the recent comprehensive review by Dworkin and twenty other distinguished experts (Dworkin et al. 2003), five medications are listed as ‘first-line’ therapy: gabapentin, 5% lidocaine patch, opioids, tramadol hydrochloride, and ► **Tricyclics** (TCAs) (e.g. nortriptyline hydrochloride or desipramine hydrochloride). This list was selected on the basis of analgesic efficacy “consistently demonstrated in multiple randomized controlled trials”. Of this list of first-line therapies, gabapentin, lidocaine, and opioids, can be considered to be single-mechanism analgesics, non-selective TCAs and tramadol can be considered to be mixed-action analgesics.

#### Gabapentin

The role of gabapentin in the management of neuropathic pain has been reviewed recently by Rosner and Diwan (2003). The mechanism of analgesic action of gabapentin in treating neuropathic pain is not known. Gabapentin does not have affinity for opioid receptors ( $\mu$ ,  $\delta$ , or  $\kappa$ ) and, based on a surgically induced neuropathic pain model in the rat (Hwang and Yaksh 1997), gabapentin-induced antinociception does not involve GABA<sub>A</sub> or GABA<sub>B</sub> binding sites. It is the only antiepileptic drug that attenuates both cold and touch induced ► **hyperesthesias** (Hunter et al. 1997). The analgesic efficacy of gabapentin, and side effect profile, are summarized in Dworkin et al. (2003) and Rosner and Diwan (2003).

#### Lidocaine

Synthesized in 1943 by Löfgren, lidocaine is an ► **amide anesthetic** that blocks voltage-gated Na<sup>+</sup> channels. The uncharged form of lidocaine, a weak base, penetrates the membrane. After re-establishment of steady state, the charged (cationic) form binds to the receptor accessible from the internal side of the membrane. Low plasma blood levels during lidocaine patch (5%) (Rowbotham et al. 1996) application suggests a purely local effect.

#### Opioids

All of the opioids produce their analgesic effect through a well-known single mechanism: agonist action at 7-transmembrane G protein-coupled opioid receptors located in the spinal cord and higher CNS regions. Activation of opioid receptors on neurons has two well-established direct actions (Schumacher et al. 2004): (1) block of voltage-gated Ca<sup>2+</sup> channels on presynaptic

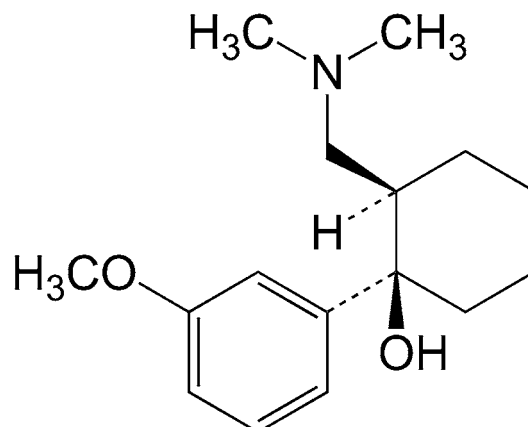
neurons (thereby reducing the release of neurotransmitters), and (2) enhancement of post-synaptic neuronal K<sup>+</sup> efflux (thereby hyperpolarizing the neuron and inhibiting excess neuronal firing).

#### Tricyclics

The tricyclics produce an analgesic effect that is demonstrably independent of their well-known antidepressant action. The efficacy of TCAs against neuropathic pain has been documented in controlled clinical trials (for summary, see Dworkin et al. 2003). TCAs have varying degrees of selectivity for inhibiting the neuronal reuptake of norepinephrine and/or 5-HT (5-hydroxytryptamine; serotonin). They are not always well tolerated, but a recent systematic review concluded that they are effective in relieving at least some types of neuropathic pain (McQuay et al. 1996).

#### Tramadol

Tramadol hydrochloride (tramadol) is the only analgesic of these first-line medications that has been demonstrated to have at least two distinct mechanisms that contribute to its analgesic action. Tramadol, (1*RS*,2*RS*)-2-[(dimethylamino)methyl]-1-(3-methoxyphenyl) cyclohexanol hydrochloride (Fig. 1), is a centrally acting synthetic analgesic. Based on animal and human studies, tramadol appears to produce its analgesic effect through two mechanisms (for summary, see Raffa and Friderichs 1996). One of the mechanisms appears to relate to a weak affinity for  $\mu$ -opioid receptors, estimated to be about 6,000-fold less than the affinity of morphine and about the same affinity as dextromethorphan. Its mono-*O*-desmethyl metabolite (designated M1) binds to  $\mu$ -opioid receptors with greater affinity than does the parent compound, and is presumably responsible for the opioid component. However, in most animal tests and in human clinical tests, the analgesic effect of tramadol is only partially blocked (<50%) by the



**Drugs with Mixed Action and Combinations, Emphasis on Tramadol, Figure 1** Tramadol hydrochloride (a racemic mixture of enantiomers).

opioid antagonist naloxone, suggesting a significant contribution of a non-opioid mechanism (Raffa and Friderichs 1996). The apparent non-opioid component of tramadol's analgesic mechanism appears to be related to its ability to inhibit the neuronal reuptake of norepinephrine and 5-HT. Tramadol does not have a significant peripheral or anti-inflammatory action and a mixed agonist-antagonist action has been ruled out. In addition to the individual contributions made by the opioid and non-opioid components of tramadol's mechanism of action, it appears that there is a synergistic interaction between these two mechanisms. The (+) ► **enantiomer of tramadol** binds to  $\mu$ -opioid receptors and inhibits neuronal reuptake of 5-HT more potently than does the (–) enantiomer, whereas the (–) enantiomer inhibits the neuronal reuptake of norepinephrine more potently than does the (+) enantiomer (Table 1). Each of the enantiomers individually produces centrally mediated (spinal) antinociception in mice; however, in several tests, the combination of the enantiomers was more potent than either enantiomer alone (i.e. the interaction was synergistic) (Raffa et al. 1993). Importantly, the enantiomers interact less than synergistically or even less than additively in several tests predictive of side-effect potential. Thus, the clinical profile of tramadol apparently results from the fortuitous combinations and interactions of its component parts. It is the proposed duality of mechanism of analgesic action that has been suggested to form the foundation for understanding tramadol's clinical attributes (e.g. Raffa and Friderichs 1996).

Tramadol is rapidly and almost completely absorbed after its oral administration, with an absolute bioavailability (100 mg dose) of about 75% that is not significantly affected by food. The plasma protein binding of tramadol is relatively low (about 20%). Tramadol's volume of distribution is about 2.7 L/kg. The analgesic effect of tramadol in humans begins within 1 h after its oral administration, and usually peaks in about 2–3 h. In humans, about 30% of tramadol is excreted unchanged in the urine, whereas animals metabolize tramadol much more extensively – only about 1–2% is excreted unchanged. The major metabolic pathways involve *N*- and *O*-demethylation and glucuronidation or sulfation in the liver. The M1 (*O*-desmethyl tramadol) pathway is

catalyzed by the CYP-2D6 isozyme of cytochrome P-450. Tramadol and its metabolites are excreted primarily via the kidney. The mean terminal plasma elimination half-life of tramadol is about 6.3 h, which increases slightly (about 1 h) upon multiple dosing.

The efficacy of tramadol for treating neuropathic pain has been reported from double-blind, placebo-controlled randomized clinical trials (for review see Dworkin et al. 2003). Pain was significantly reduced compared to placebo, and beneficial effects on ► **allodynia** and quality of life were reported.

### Combinations

Another approach to introducing a diversity of analgesic mechanisms into neuropathic pain therapy is the use of combinations of individual agents. Advantages and potential disadvantages of this strategy have been reviewed (e.g. Raffa 2001; Raffa et al. 2003). In relation to neuropathic pain, the major advantages could be facilitation of prescribing and enhanced compliance, broader coverage of diverse pain types, decreased side effects, and a possible synergistic analgesic interaction. The major potential disadvantage is higher cost, but many combination products are priced at about the combined expense of the single-entities. The most common combinations involve opioids or tramadol with non-steroidal anti-inflammatory drugs (NSAIDs) or with acetaminophen (paracetamol).

The mechanism of action of the NSAIDs was delineated in the early 1970's and is now generally accepted to be via inhibition of ► **cyclooxygenase (COX) isozymes**.

The mechanism of action by which acetaminophen, *N*-acetyl-*p*-aminophenol, produces its analgesic action is not well understood. It has been shown that acetaminophen-induced antinociception is related to its plasma concentration. It is also known that the analgesia induced by acetaminophen is not attributable solely, or even to any significant extent, to an anti-inflammatory action. There is a significant amount of evidence that points to the CNS as the major site of analgesic action of acetaminophen (see reviews by Walker 1995 and Björkman 1995).

In the case of the recently introduced combination of tramadol plus acetaminophen (Ultracet<sup>TM</sup>), in addition to the expected advantages of the simple additive effect of

D

**Drugs with Mixed Action and Combinations, Emphasis on Tramadol, Table 1** *In vitro* activity of tramadol, its enantiomers, and M1 metabolite (mono-*O*-desmethyl tramadol) at opioid  $\mu$ ,  $\delta$ , and  $\kappa$  receptors and at norepinephrine (NE) and serotonin (5-HT) neuronal reuptake sites. Values are  $K_i$  in  $\mu$ M. Modified from Raffa and Friderichs (1996).

	$\mu$	$\delta$	$\kappa$	NE	5-HT
Tramadol	2.1	57.6	42.7	0.78	0.99
(+) enantiomer	1.3	62.4	54.0	2.51	0.53
(–) enantiomer	24.8	213	53.5	0.43	2.35
M1 metabolite	0.0121	0.911	0.242	1.52	5.18

the combination, the combination produces a synergistic antinociceptive effect (Tallarida and Raffa 1996).

## References

1. Björkman R (1995) Central Antinociceptive Effects of Non-Steroidal Anti-Inflammatory Drugs and Paracetamol. *Acta Anaesthesiol Scand* 39:2–44
2. Dworkin RH, Backonja M, Rowbotham MC et al. (2003) Advances in Neuropathic Pain. *Neurol Rev* 60:1524–1534
3. Hunter JC, Gogas KR, Hedley LR et al. (1997) The Effect of Novel Anti-Epileptic Drugs in Rat Experimental Models of Acute and Chronic Pain. *Eur J Pharmacol* 324:153–160
4. Hwang JH, Yaksh TL (1997) Effect of Subarachnoid Gabapentin on Tactile-Evoked Allodynia in a Surgically Induced Neuropathic Pain Model in the Rat. *Reg Anesth* 22:249–256
5. McQuay HJ, Tramèr M, Nye BA et al. (1996) A Systematic Review of Antidepressants in Neuropathic Pain. *Pain* 68:217–227
6. Raffa RB (2001) Pharmacology of Oral Combination Analgesics: Rational Therapy for Pain. *J Clin Pharmacol Ther* 26:257–264
7. Raffa RB, Friderichs E (1996) The Basic Science Aspect of Tramadol Hydrochloride. *Pain Revs* 3:249–271
8. Raffa RB, Friderichs E, Reimann W et al. (1993) Complementary and Synergistic Antinociceptive Interaction between the Enantiomers of Tramadol. *J Pharmacol Exp Ther* 267:331–340
9. Raffa RB, Clark-Vetri R, Tallarida RJ et al. (2003) Combination Strategies for Pain Management. *Expert Opin Pharmacother* 4:1697–1708
10. Rosner H, Diwan S (2003) The Role of Gabapentin in the Management of Neuropathic Pain. In: Bountra C, Munglani R, Schmidt WK (eds) *Pain: Current Understanding, Emerging Therapies, and Novel Approaches to Drug Discovery*. Marcel Dekker, New York, pp781–794
11. Rowbotham MC, Davies PS, Verkempinck C et al. (1996) Lidocaine Patch: A Double-Blind Controlled Study of a New Treatment Method for Post-Herpetic Neuralgia. *Pain* 65:39–44
12. Schumacher MA, Basbaum AI, Way WL (2004) Opioid Analgesics & Antagonists. In: Katzung BG (ed) *Basic & Clinical Pharmacology*. McGraw-Hill, New York, pp 497–516
13. Tallarida RJ, Raffa RB (1996) Testing for Synergism Over a Range of Fixed Ratio Drug Combinations: Replacing the Isobologram. *Life Sci* 58:23–28
14. Walker JS (1995) NSAID: An Update on their Analgesic Effects. *Clin Exper Pharmacol Physiol* 22:855–860

## Dry Needling

CHANG-ZERN HONG

Department of Physical Medicine and Rehabilitation,  
University of California Irvine, Irvine, CA, USA  
czhong88@ms49.hinet.net

## Synonyms

Intramuscular Sensory Nerve Stimulation; twitch-obtained intramuscular stimulation

## Definition

► **Dry needling** is a procedure in which a small tipped needle is inserted multiple times into a myofascial trigger point region or acupuncture point in order to stimulate the sensory nerve endings and relieve muscle pain.

## Characteristics

Muscle pain can be caused by various conditions, including neurological lesions, muscular lesions, soft tissue lesions, skeletal lesions and systemic diseases. In the cases of neurological lesions or systemic diseases, the muscle pain is usually diffuse and without tender spots. More frequently, however, one or more tender spots can be identified in a muscle. These tender spots are usually myofascial trigger points. A ► **myofascial trigger point** (MTrP) is a hyperirritable spot that is well localized within a taut band of skeletal muscle fibers. Compression of an MTrP can cause pain (tenderness). An ► **active myofascial trigger point** is a spot with spontaneous pain or pain in response to movement, while a ► **latent myofascial trigger point** is a spot with pain or discomfort in response to compression only. Referred pain can also be elicited when the compression pressure is high enough. If the examiner compresses the MTrP with a fingertip, then follows with a snapping motion over the MTrP, in a direction perpendicular to the muscle fibers (this motion is known as snapping palpation), a brief contraction of the tense muscle fibers may occur. This is a polysynaptic spinal reflex known as a ► **local twitch response** (LTR).

Recent research studies on both human and animal subjects have determined that MTrPs are commonly found in the neuromuscular junction region (endplate zone). Latent MTrPs may be developed as early as 6 months after birth (Hong 2000; Hong 2002). A latent MTrP is probably caused by minor peripheral nerve injury due to repetitive minor trauma early in life (Gunn 1996; Hong 2000). A latent MTrP may become active (painful) after the soft tissue or the lesions involving various structures sustain an acute injury or endure chronic repetitive trauma or even after the patient suffers emotional stress (Hong 1996; Hong and Simons 1998).

It is possible that the formation of active MTrPs is actually a defense mechanism in the body. If muscle mobility is limited, further damage to the existing lesion – and further injury to the already injured soft tissue – may be prevented (Hong 1996). In some cases though, chronic active MTrPs may persist even after the etiological lesion is controlled. If the pain becomes so intolerable that it interferes with daily life, the MTrP may need to be inactivated. Conservative therapy, such as manual therapy combined with thermotherapy and electrotherapy can usually inactivate painful MTrPs. Other situations, however, might necessitate dry needling. Such cases include the following: 1) poor response to conservative therapy, 2) intolerable pain, 3) deep location of an MTrP, rendering it inaccessible by conservative manual therapy, 4) unavailable or inadequate time to accept the time-consuming conservative therapy, 5) persistent pain or discomfort after complete elimination of the underlying pathological lesions that activate MTrPs or 6) personal preference.



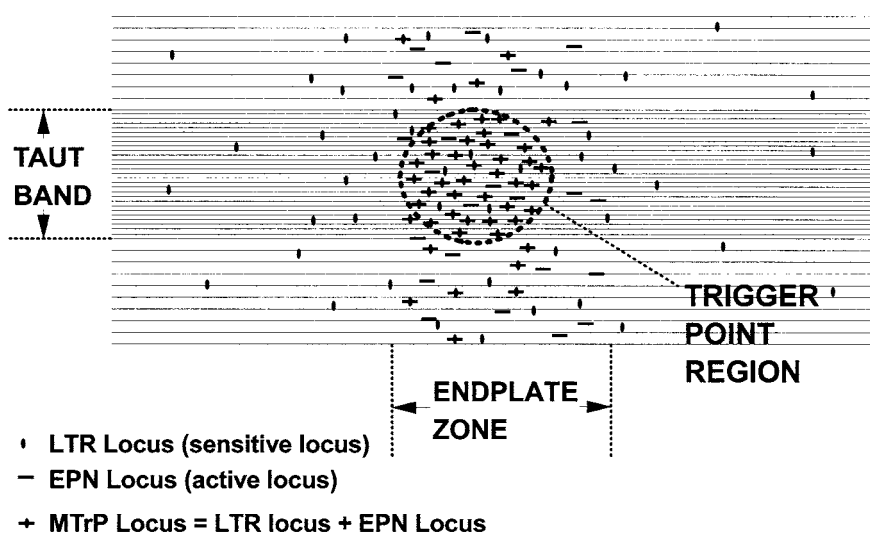
## Mechanisms

Although dry needling is one of the most effective methods for rapid inactivation of an active MTrP, the mechanism of pain relief is still unclear. Recently, clinical and basic science research studies of MTrPs have been summarized (Hong 1996, 2000, 2002; Hong and Simons 1998; Simons et al. 1999). The animal model developed by Hong and Torigoe in 1994 has facilitated understanding of the nature of MTrPs (Hong and Simons 1998; Hong and Torigoe 1994). Based on evidence from animal studies as well as clinical observations, a model of multiple small MTrP loci in an MTrP region has been proposed (Fig. 1) (Hong 1994a). According to this model, there are two components of an **MTrP locus**, the sensory component, known as the **sensitive locus** or local twitch response locus (LTR locus) and the motor component, known as the **active locus** or endplate noise locus (EPN locus).

A sensitive locus (LTR locus) is the site from which local and referred pain and LTR can be elicited by mechanical stimulation (Fig. 2). A weak stimulation to the sensitive locus can elicit pain and sometimes referred pain, but a strong stimulation (high pressure with a needle tip) is usually required to elicit an LTR. If the MTrP is extremely hyperirritable (painful), the patient may consistently experience referred pain in addition to the local pain and LTRs can be elicited easily with a light snapping palpation. Based on the studies by Mense and Simons (1999), the **referred muscle pain** (from muscle to muscle) elicited following noxious stimulation to the sensitive loci in an MTrP region seems to be a consequence of central sensitization in the spinal cord. The consistent pattern of referred pain from the MTrP of a specific muscle indicates that the interneuronal connections among different dorsal horn neurons follow a fixed pattern, similar to the “meridian connections”

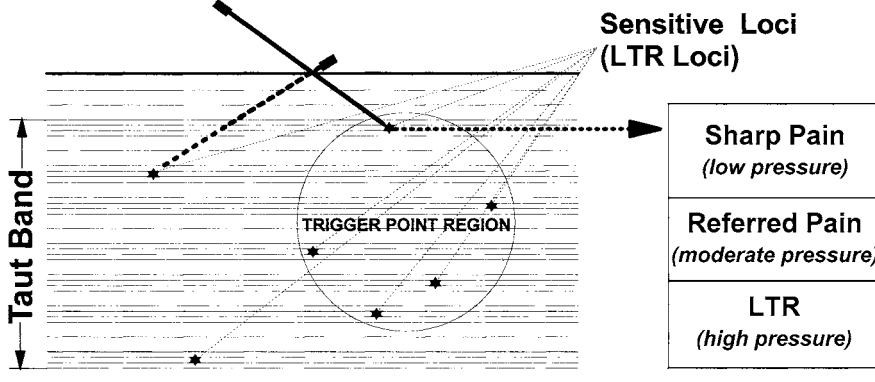
of acupuncture points (Hong 2000). In both human and rabbit subjects, the EMG activity of an LTR can be recorded specifically from the muscle fibers of the taut band in response to stimulation of the MTrP (Hong and Simons 1998; Hong and Torigoe 1994). The EMG activity of an LTR is diminished in a denervated human muscle or in a rabbit muscle following lidocaine block or transection of the innervating nerve. In the rabbit study, this activity disappeared temporarily after spinal cord transection during the spinal shock stage, but was almost completely recovered following the spinal shock period, indicating that the LTR is mediated through the spinal cord. The **MTrP circuit** (Hong 2002) cannot only transfer the nociceptive impulses to the brain, but may also control the referral pain patterns *via* connections to other MTrP circuits (Fig. 3). Furthermore, the occurrence of LTRs is mediated *via* the MTrP circuit. In a histological study of sensitive loci in rabbit skeletal muscle, a small nerve fiber was frequently found at the sensitive locus (Hong and Simons 1998), indicating that the sensitive loci in an MTrP region are sensitized nerve fibers (nociceptors).

An active locus (EPN locus) is the site from which spontaneous electrical activity, known as endplate noise (EPN), can be recorded. The active locus is in the immediate vicinity of a sensitive locus, with the MTrP locus comprising both active and sensitive loci. Simons has suggested that EPN is a consequence of excessive acetylcholine release, which may subsequently cause “taut band” formation (Fig. 4) (Simons et al. 1999). The contraction knots in an MTrP region appear to be directly responsible for the palpable nodule and the taut band of an MTrP (Simons et al. 1999). The resulting increase in energy consumption, combined with a reduction in the energy supply, may produce a local energy crisis evidenced by severe localized hypoxia (Fig. 4) (Hong and Simons 1998; Simons et al. 1999).

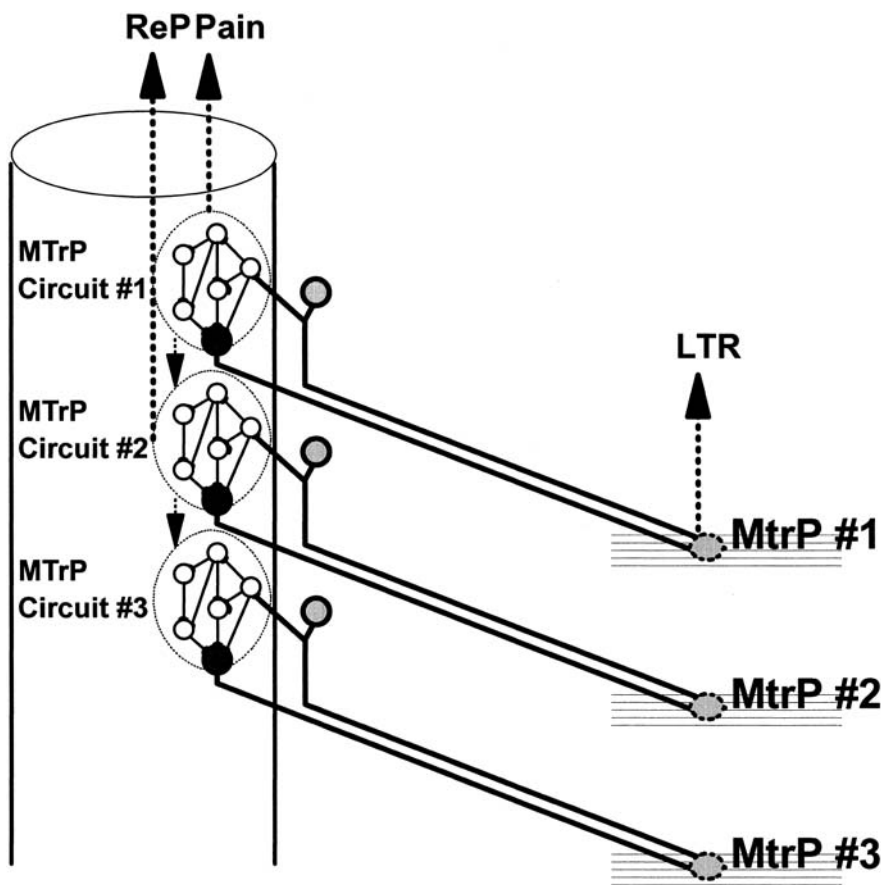


**Dry Needling, Figure 1** Multiple MTrP loci in an MTrP region.

**Multiple needle insertion during dry needling into an MTrP region**



Dry Needling, Figure 2 Characteristics of a sensitive (LTR) locus.

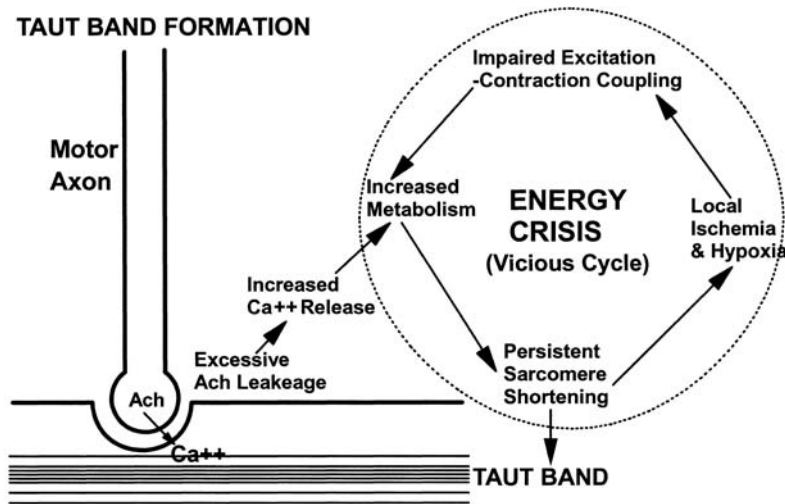


Dry Needling, Figure 3 MTrP circuits.

**Effectiveness**

The effectiveness of dry needling in relieving MTrP pain has been described in detail (Baldry 2000; Chu 1999; Gunn 1996; Hong 1994b; Hong 2000; Lewit 1979; Melzack 1981; Simons et al. 1999) but no randomized controlled trials are available. By using a special technique of “fast-in, fast-out” needle movement (to generate high pressure) into multiple loci in an MTrP region, immediate pain relief can be achieved

with local anesthetic injection or dry needling, but only if LTRs are elicited during needling (Hong 1994a, b). Since an MTrP can be inactivated without injection of any solution, the mechanical stimulation of the MTrP seems to be the most important factor for pain relief. It has been hypothesized that hyperstimulation analgesia “closes the gate” by disrupting reverberatory neural circuits (MTrP circuits) in the central nervous system and that this is the mechanism of pain relief for both dry



Dry Needling, Figure 4 Energy crisis in a taut band.

needling and acupuncture (Hong 2002; Melzack 1981). Many authors have documented the similarity between acupuncture and dry needling in treating MTrP (Baldry 2000; Gunn 1996; Hong 1994a; Hong 2000; Lewit 1979; Melzack 1981). The “Teh-Chi” effect, described by acupuncturists as an important sign for obtaining an optimal effect in acupuncture therapy, is similar to the sensation reported by patients when the needle tip approaches a sensitive locus in an MTrP region during MTrP injection. The patients being treated by dry needling or MTrP injection may also experience this sensation at the moment when an LTR is elicited. In fact, all MTrPs are acupuncture points, although many acupuncture points are not trigger points. Additionally, nociceptors are diffusely distributed in the subcutaneous tissues and may also connect to the MTrP circuit, although stimulation of subcutaneous nociceptors will not cause LTRs. This may explain the effectiveness of superficial dry needling (Baldry 2000).

#### Equipment

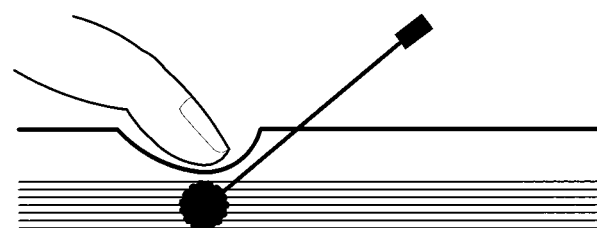
A hypodermal needle, an acupuncture needle or an electromyographic (EMG) needle (Chu 1999) can be used for this procedure. The disadvantage of a hypodermal needle is the sharp cutting edge of the needle tip, which may actually damage muscle fibers. An acupuncture needle is too flexible and is difficult to manipulate during the multiple muscle insertions. An EMG needle is therefore the best selection, since it can avoid the disadvantages of the other two. However, EMG needles (even disposable ones) are quite expensive.

#### Technique

A specific and very effective technique of dry needling has been recommended (Hong 1994b). This technique is similar to the procedure of MTrP injection. Gunn (1996) and Chu (1999) recommend a similar technique, but they fail to stress the importance of MTrP palpation during needling. Before dry needling, the exact spot (MTrP) that

causes discomfort or pain should be carefully identified (pain recognition). Most of the time, patients can simply point to the painful spot with their finger. In severe cases, however, the pain may be diffuse and vague. Illustrations in certain textbooks may thus be needed to help locate MTrPs (Simons et al. 1999; Travell and Simons 1992). During dry needling, it is important to identify the most painful region (MTrP site) by finger palpation with the hand not holding the needle (usually the non-dominant hand) (Fig. 5). Multiple rapid insertions of the needle into the MTrP site, without pulling the needle tip out from under the skin (i.e. the needle remains in the subcutaneous layer) are then performed. It is important to maintain an up-and-down motion of the needle, as a side-to-side motion can cut vessels or nerves. Moving the needle rapidly will also elicit LTRs more easily. LTRs should be elicited as often as possible by multiple needle insertions into the MTrP region.

Immediately after dry needling, the MTrP region should be compressed firmly for a few minutes to avoid bleeding, as this is the major cause of post-needling soreness. Post-needling pain usually occurs in fibromyalgia patients. If no excessive bleeding occurs after needling, application of thermotherapy after compression may help to reduce pain or soreness. A cold pack is usually unnecessary – and not recommended – unless the bleeding is massive. Cold temperatures can induce vasoconstriction, which may then lead to the impairment of local cir-



Dry Needling, Figure 5 Palpation of the MTrP during dry needling.

ulation and interfere with the resolution of any tissue damage caused by the needle.

Gunn uses an acupuncture needle (► [intramuscular stimulation](#)) (Gunn 1996), while Chu uses an EMG needle (► [twitch-obtaining intramuscular stimulation](#)) (Chu 1999) to perform dry needling. Both apply multiple insertions into the MTrP region. Baldry applies the needle into the subcutaneous, but not into muscle tissue (► [superficial dry needling](#)) (Baldry 2000). Sometimes, the needle is inserted into a trigger point in a region other than the subcutaneous tissue or muscle (such as a ligament, tendon, bursa, etc.).

► [Acupuncture](#)

## References

1. Baldry PE (2000) Superficial dry needling. In: Chaitow CL (ed) *Fibromyalgia syndrome: a practitioner's guide to treatment*. Churchill Livingstone, Edinburgh
2. Chu J (1999) Twitch-obtaining intramuscular stimulation: observation in the management of radiculopathic chronic low back pain. *J Musculoske Pain* 7:131–146
3. Gunn CC (1996) *Treatment of chronic pain. Intramuscular stimulation for myofascial pain of radiculopathic origin*. Churchill Livingstone, London
4. Hong C-Z (1994a) Consideration and Recommendation of Myofascial trigger point injection. *J Musculoske Pain* 2:29–59
5. Hong CZ (1994b) Lidocaine injection versus dry needling to myofascial trigger point: the importance of the local twitch response. *Amer J Phys Med Rehabil* 73:256–263
6. Hong C-Z (1996) Pathophysiology of Myofascial trigger point. *J Formos Med Assoc* 95:93–104
7. Hong C-Z (2000) Myofascial trigger points: pathophysiology and correlation with acupuncture points. *Acupunct Med* 18:41–47
8. Hong C-Z (2002) *New Trends in Myofascial Pain Syndrome*. Chinese Medical Journal 65:501–512
9. Hong C-Z, Simons DG (1998) Pathophysiologic and electrophysiologic mechanism of myofascial trigger points. *Arch Phys Med Rehabil* 79:863–872
10. Hong C-Z, Torigoe Y (1994) Electrophysiologic characteristics of localized twitch responses in responsive bands of rabbit skeletal muscle fibers. *J Musculoske Pain* 2:17–43
11. Lewit K (1979) The needle effect in relief of myofascial pain. *Pain* 6:83–90
12. Melzack R (1981) Myofascial trigger points: relation to acupuncture and mechanism of pain. *Arch Phys Med Rehabil* 62:114–117
13. Mense S, Simons DG (1999) *Muscle Pain: understanding its nature, diagnosis, and treatment*. Williams & Wilkins, Baltimore
14. Simons DG, Travell JG, Simons LS (1999) *Travell & Simons's Myofascial Pain and Dysfunction: The Trigger Point Manual, vol I, 2nd edn*. Williams & Wilkins, Baltimore
15. Travell JG, Simons G (1992) *Myofascial Pain and Dysfunction: The trigger point manual, vol II*. Williams & Wilkins, Baltimore

## DSM, DSM-IV, DSM-IVR

► [Diagnostic and Statistical Manual of Mental Disorders](#)

## DSPN

► [Diabetic Neuropathies](#)

## DTI

► [Diffusion Tensor Imaging](#)

## Dual Matrix (Agro Contin System)

### Definition

A dual matrix (Agro Contin System) that uses 2 different types of retarding polymers is utilized to achieve measured/controlled release of the active drug.

► [Postoperative Pain, Oxycodone](#)

## Ductus Arteriosus

### Definition

Ductus arteriosus is a blood vessel in a fetus that bypasses pulmonary circulation by connecting the pulmonary artery directly to the ascending aorta. It is open in the fetus but normally closes after birth.

► [NSAIDs, Adverse Effects](#)  
 ► [NSAIDs and their Indications](#)

## Dummy

► [Placebo](#)

## Dura Mater

### Definition

A tough, fibrous membrane that surrounds the brain and provides protection for the central nervous system.

► [Diencephalic Mast Cells](#)

## Dural Puncture

### Definition

A puncture of the dura mater is associated with a spinal nerve block and is a complication of epidural nerve block in about 1 in 100 patients. The puncture hole with an epidural needle of 16gauge is much larger than after a deliberate puncture with a spinal needle of 25 or smaller gauge. Headaches after dural puncture with an epidural needle often have to be treated by an epidural blood patch in order to block the hole made in the dura. The rent in the dura may, if not treated, take days or months to heal by normal processes.

► [Postpartum Pain](#)



## Dural Receptors

- ▶ Nociceptors in the Orofacial Region (Meningeal/Cerebrovascular)

## Duration of Ultrasound Treatment

### Definition

The duration is 1 – 15 min. Usually, the duration should be at least 3 min.

- ▶ Ultrasound Therapy of Pain from the Musculoskeletal System

## Duration Requirement

### Definition

The physical or mental impairment must be expected to result in death, or have lasted or can be expected to last for a continuous period of not less than 12 months.

- ▶ Disability Evaluation in the Social Security Administration

## Durogesic®

### Definition

Durogesic® is a transdermal patch system that continuously delivers fentanyl for 72 hours.

- ▶ Postoperative Pain, Fentanyl

## Dyesthesias

### Definition

An unpleasant abnormal sensation that may or may not be painful.

- ▶ Spinal Cord Injury Pain Model, Hemisection Model

## Dying-Back Neuropathy

### Definition

Peripheral nerve disorders beginning from degeneration of the most terminal parts of both central and peripheral processes of neurons, the major pathology of toxic neuropathies; also central-peripheral distal axonopathy and distal axonopathy.

- ▶ Toxic Neuropathies

## Dying Child

- ▶ Cancer Pain, Palliative Care in Children

## D

## Dynamic Allodynia

### Definition

Light brush evokes a sensation of pain.

- ▶ Allodynia (Clinical, Experimental)
- ▶ Hyperpathia, Assessment

## Dynamic Ensemble

### Definition

A conceptualization of pain mechanisms that suggests that the experience of pain is brought about by a variable network of interconnected regions, subject to dynamic influences of past history and reproductive status; compare with pain pathway.

- ▶ Gynecological Pain, Neural Mechanisms

## Dynamic Mechanical Allodynia

### Definition

Pain produced by moving a normally innocuous mechanical stimulus such as a soft artist's paint brush or cotton wisp across the skin.

- ▶ Allodynia (Clinical, Experimental)
- ▶ Hyperpathia, Assessment
- ▶ Quantitative Thermal Sensory Testing of Inflamed Skin

## Dynamic Mechanical Hyperalgesia

### Definition

Dynamic mechanical hyperalgesia refers to abnormal sensitivity, caused by activation of tactile receptors to a gentle stimulation such as light stroking with a cotton wisp or Q-tip. This is also referred to as allodynia.

- ▶ Allodynia (Clinical, Experimental)
- ▶ Restless Legs Syndrome

## Dynamic Pain

### Definition

Pain provoked by movement, such as deep breathing or coughing, getting out of bed, or walking (during the postoperative period).

- ▶ Postoperative Pain, Acute Pain Management, Principles
- ▶ Postoperative Pain, Acute Pain Team

## Dynorphins

### Definition

Peptides of several sizes, including dynorphin A and dynorphin B, which preferentially bind to KOP receptors. They are formed from prodynorphin and found through the central and peripheral nervous system, modulating pain sensation.

- ▶ Endogenous Opioid Peptides
- ▶ Nitrous Oxide Antinociception and Opioid Receptors
- ▶ Opiates During Development
- ▶ Peptides in Neuropathic Pain States

## Dysaesthesia (Dysesthesia)

### Definition

An unpleasant abnormal sensation, whether spontaneous or evoked.

- ▶ Anesthesia Dolorosa Model: Autotomy
- ▶ Central Nervous System Stimulation for Pain
- ▶ Cervical Transforaminal Injection of Steroids
- ▶ Dorsal Root Ganglionectomy and Dorsal Rhizotomy
- ▶ Hyperpathia
- ▶ Hyperpathia, Assessment
- ▶ Metabolic and Nutritional Neuropathies
- ▶ Postherpetic Neuralgia, Etiology, Pathogenesis and Management
- ▶ Postherpetic Neuralgia, Pharmacological and Non-Pharmacological Treatment Options
- ▶ Viral Neuropathies

## Dysautonomic

### Definition

Color changes, temperature changes or edema.

- ▶ CRPS-1 in Children

## Dyschezia

### Definition

Difficult or painful evacuation of feces from the rectum generally associated with endometriosis of the rectovaginal septum.

- ▶ Dyspareunia and Vaginismus

## Dysesthesia, Assessment

ELLEN JØRUM

The Laboratory of Clinical Neurophysiology,  
Rikshospitalet University, Oslo, Norway  
ellen.jorum@rikshospitalet.no

### Synonyms

There are no real synonyms to dysesthesia, but it may sometimes be difficult to decide whether one is dealing with dysesthesia or paresthesia. The important difference between the two terms implies, however, that dysesthesia is always unpleasant, whereas paresthesia is defined as an abnormal sensation which is not unpleasant (Classification of chronic pain 1994).

### Definition

An unpleasant abnormal sensation, whether spontaneous or evoked (Classification of chronic pain 1994).

### Characteristics

#### Assessment of Dysesthesia

##### Assessment of Spontaneously Occurring Dysesthesia

Dysesthesia is frequently present in ▶ **neuropathic pain** (Lindblom and Verrillo 1979; Eide et al. 1996; Nasreddine and Saver 1997), but may also occur in non-neuropathic pain states (Aikins et al. 2003) and in ▶ **epilepsy** (Duchowny 1993). The mechanisms underlying dysesthesia are largely unknown. Since this chapter is dealing only with the assessment of dysesthesia, further discussion of possible neurophysiological mechanisms will not be undertaken. The only possible way of assessing dysesthesia to ▶ **spontaneous pain**, is to obtain thorough verbal information from the patient, where they are asked to describe in detail the various sensations they may experience. It may be difficult for some patients to decide whether a sensation is unpleasant or not, and thereby sometimes difficult to decide whether one is dealing with dysesthesia or paresthesia. However, if patients are describing a purely painful sensation, dysesthesia will be the right term. The descriptors used by the patients may vary, probably even for the same experience, but since we are dealing with purely subjective sensations, a more objective evaluation is impossible. One may ask patients to describe the

quality of the ► **unpleasant sensation**, or use one of a large variety of scales, where patients may choose from a list of pain quality descriptors. One frequently employed scale is the McGill pain Questionnaire (MPQ), which is a well-validated and psychometrically reliable instrument consisting of 20 lists of pain descriptors (Melzack 1975). However, many other scales also exist. It may be worthwhile to assess not only the type of sensation, but also the intensity of a dysesthetic sensation, by, for example, using a visual analogue scale (VAS) from 0–10 cm or 0–100 mm, where 0 represents no pain and 10 or 100 the worst thinkable pain (or other intensity scales).

### Assessment of Evoked Dysesthesia

One may assess evoked dysesthesia to ► **tactile stimuli** or ► **thermal stimuli**. Special cases of dysesthesia include hyperalgesia and allodynia, making the distinctions between the different phenomena difficult. There is normally no painful sensation to light touch. However, light touch may evoke a painful sensation in a patient with neuropathic pain. In daily life, patients may experience evoked dysesthesia in many situations, such as being touched by fellow passengers in a crowded bus, bed linen in bed etc. In many reports, there are no distinctions made between allodynia to light touch or to brush and dysesthesia (Jørum et al. 2003). However, a dysesthetic sensation will always be an abnormal sensation, described by the patient as different from painful touch. There may be a large number of descriptors, which again may be assessed by asking the patient for a description or, by letting the patient choose from various descriptors in one of many possible pain-scales. The intensity of an evoked sensation may also be assessed by means of VAS (or another intensity-scale). Dysesthesia to thermal stimuli, especially to cold stimuli, is a common finding in neuropathic pain (Jørum et al. 2003) and in more generalized pain like fibromyalgia (Berglund et al. 2001). In most studies where cold dysesthesia has been described, the sensation of cold is studied by quantitative sensory testing (QST), where the thresholds for cold pain are assessed (Berglund et al. 2001; Jørum et al. 2003). In the study by Berglund and co-workers, the perceived quality of each thermal stimulus was assessed by means of a list of preselected verbal descriptors. Patients with fibromyalgia not only had lower threshold of cold pain and cold tolerance (allodynia and hyperalgesia), but they also used more pain-related descriptors than normal controls. A hyperfunction for heat pain and heat-pain tolerance was also found. Aberrant perceptions to cold stimulation were also reported (paradoxical heat, dysesthesia). In neuropathic pain, the sensation of cold is frequently reported as dysesthetic, as an unpleasant aberrant sensation, often a sensation of warmth (Jørum and Arendt-Nielsen 2002).

Dysesthesia is frequently reported in studies of neuropathic pain, but listed here are some examples of other conditions where the term may be encountered:

1. ► **Vulvar dysesthesia** is a not uncommon condition, frequently described in the literature and where spontaneous dysesthesia may occur. (Aikens et al. 2003; Reed et al. 2003) The dysesthesia is often characterized as a constant or intermittent burning sensation, but descriptors such as tender and sore have also been employed (Aikens et al. 2003)
2. Dysesthesia may occur in relation to epileptic seizures or as an adverse effect to vagal nerve stimulation (Akman et al. 2003)

In this report, the authors describe a patient who was treated for refractory complex partial epilepsy with vagal nerve stimulation, who reported complaints of intermittent and unpredictable “funny” feelings and tightness in his throat and stomach 4 months after the implantation of the vagal nerve stimulator. However, as the authors make clear, somatosensory symptoms, including various forms of dysesthesia, may occur in various forms of epilepsy, such as benign epilepsy of childhood with temporal spikes, where pharyngeal sensations of tingling, burning, constriction or unpleasant sensations (dysesthesia) are described (Duchowny 1993).

### References

1. Aikens J E, Reed B, Gorenflo D et al. (2003) Depressive Symptoms among Women with Vulvar Dysesthesia. *Am J of Obstetrics and Gynecology* 189:462–466
2. Akman C, Riviello JJ, Madsen JR et al. (2003) Pharyngeal Dysesthesia in Refractory Complex Partial Epilepsy: New Seizure or Adverse Effect of Vagal Nerve Stimulation? *Epilepsia* 44:855–858
3. Berglund B, Harju E-L, Kosek E et al. (2001) Quantitative and Qualitative Perceptual Analysis of Cold Dysesthesia and Hyperalgesia in Fibromyalgia. *Pain* 96:177–187
4. Duchowny M (1993) Identification of the Surgical Candidates and Timing of the Operation: Overview. In: Wyllie E (ed) *The Treatment of Epilepsy: Principles and Practice*. Lea & Febiger, Philadelphia, pp 999–1008
5. Eide PK, Jørum E, Stenehjeme A (1996) Somatosensory Findings in Spinal Cord Injury Patients with Central Dysesthesia. *J Neurol Neurosurg Psychiatry* 60:411–415
6. Jørum E, Arendt-Nielsen L (2003) Sensory testing and clinical neurophysiology. In: Breivik H, Campbell W, Eccleston C (eds) *Textbook of Clinical Pain Management*. Arnold, London, pp 27–38
7. Jørum E, Warncke T, Stubhaug A (2003) Cold Allodynia and Hyperalgesia in Neuropathic Pain: The Effect of N-methyl-D aspartate (NMDA) Receptor Antagonist Ketamine: A Double-Blind, Cross-Over Comparison with Alfentanil and Placebo. *Pain* 101:229–235
8. Lindblom U, Verrillo RT (1979) Sensory Functions in Chronic Neuralgia. *J Neurol Neurosurg Psychiatry* 42:422–435
9. Melzack R (1975) The McGill Pain Questionnaire: Major Properties and Scoring Methods. *Pain* 23:345–356
10. Nasreddine ZS, Saver JL (1997) Pain after Thalamic Stroke: Right Diencephalic Predominance and Clinical Features in 180 Patients. *Neurology* 48:1196–1199
11. Reed BD, Haefner HK, Cantor L (2003) Vulvar Dysesthesia (vulvodinia). A Follow-Up Study. *J Reprod Med* 48:409–416

## Dysesthetic Vulvodynia

### Synonyms

Essential vulvodynia

### Definition

Subset of vulvodynia characterized by generalized, spontaneous vulvar pain in the absence of physical findings.

► Vulvodynia

## Dysfunctional Pain and the International Classification of Function

BENGT H. SÖLUND

Rehabilitation and Research Centre for Torture Victims, South Danish University, Copenhagen, Denmark  
bsj@rct.dk

### Synonym

Sensory Impairment

### Definition

Pain conditions due to disturbances of function in the nervous system. In a wider sense, all ongoing (chronic) pain can be considered as a sensory impairment, i.e. a disturbance of normal sensory nociceptive function (WHO 2001).

### Characteristics

Often, there is not a traditional pathology in chronic pain conditions. For example, it was recently reported that 35% of nearly 2500 responders to a questionnaire in a southern rural / small town area in Sweden reported chronic musculo-skeletal pain (Bergman et al. 2001) whereas thorough clinical screening of smaller cohorts showed that only 0.5% fulfilled the criteria for rheumatoid arthritis (Simonsson et al. 1999) and 1.3% those for fibromyalgia (Lindell et al. 2000).

How should we classify such “non-specific” pain conditions? Several research groups have found that localized chronic musculoskeletal pain may be associated with sensory alterations in or close to the painful region, demonstrating a change of function in the sensory nervous system (Bendtsen et al. 1996; Graven-Nielsen et al. 2000; Kosek and Hansson 2002; Persson et al. 2003). It is not established at present whether such changes contribute to the pain but this may well be the case.

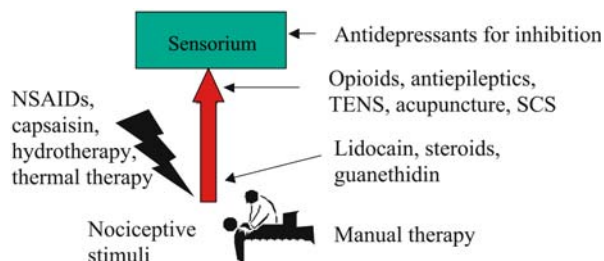
With the current official definition of neuropathic pain by the International Association for the Study of Pain (Merskey and Bogduk 1994), not only conditions due to primary lesions of the nervous system but also conditions due to dysfunction of the nervous system belong to

this group. However most pain management physicians would think of such pain conditions not as neuropathic in the sense secondary to structural nerve change but as disturbances in nervous system function. I have earlier suggested that pain conditions due to disturbances of function in the nervous system should be denoted dysfunctional pain (Sjölund 1994). These conditions do not really show “signs of organic disease” at all and may therefore be misinterpreted as “somatizing” but are analogous to e.g. epilepsy.

To be able to interpret such chronic pain conditions we should therefore include among the nociceptive, neuropathic and psychogenic pain categories a fourth main category, dysfunctional pain. The diagnosis of dysfunctional pain should be made whenever there are signs of central sensitization or central disinhibition, independent of type of afferent input. Likely examples of dysfunctional pain would be fibromyalgia (Graven-Nielsen et al. 2000), myofascial pain (Bendtsen et al. 1996) referred pain (Kosek and Hansson 2002) and centralization phenomena in neuropathic pain (Eide 2000; Flor et al. 2001). This proposal is in agreement with the new principle suggested for classification of pain syndromes, based on underlying pain mechanisms (Woolf et al. 1998).

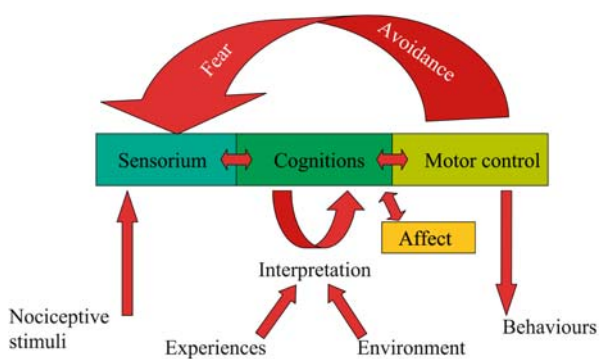
Can we then adequately assess and manage a person in chronic pain after labeling the category of pain / the mechanism of pain? Most clinicians trying to manage chronic pain patients work very hard to temporarily prevent the nociceptive stimuli from reaching the conscious sensory level (sensorium; Fig 1).

What about all those other factors important for that patient? How do we label the consequences of pain for that individual in a particular pain condition and in a particular setting? More specifically, is it possible with existing taxonomies to categorize the interpretation by the patient as well as the affective and behavioral consequences of that interpretation for a specific person in a certain context? As illustrated in Fig. 2, the awareness of painful stimuli immediately gives rise to an interpretative process where previous experience and environmental cues as well as affective aspects play

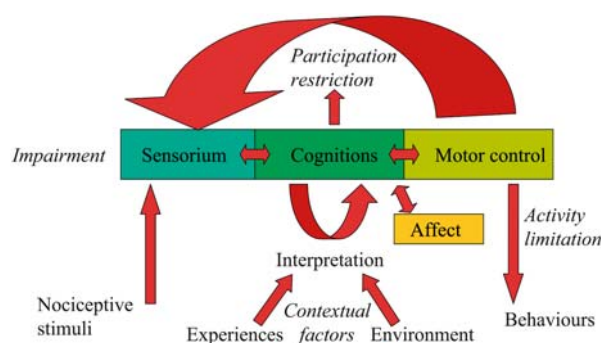


**Dysfunctional Pain and the International Classification of Function, Figure 1** Sites of action of traditional pain therapies. Abbreviations: NSAID, nonsteroidal anti-inflammatory drugs; TENS, transcutaneous electrical nerve stimulation; SCS, spinal cord stimulation. (Modified from Sjölund 2003).





**Dysfunctional Pain and the International Classification of Function, Figure 2** A comprehensive model of chronic pain. (Modified from Sjölund, 2003).



**Dysfunctional Pain and the International Classification of Function, Figure 3** Pain versus health. The ICF components (*italics*) integrated into the comprehensive model of chronic pain. (Modified from Sjölund 2003).

important roles. This interpretation thereby becomes heavily influenced by ► **personal factors**. These cognitive processes also form the basis for the resulting motor output, i.e. behaviours. In addition, the behaviours immediately influence the sensorium anew, since the occurrence and severity of pain is usually influenced by body movement, giving rise to phenomena like fear-avoidance. The present lack of a more generalized taxonomy for a person in chronic pain hampers the choice of treatment strategies, since the analysis may be limited to factors less relevant for the individual case. A more general and suitable system to describe pain and related influences on health is now available in the form of the international classification of function (► **ICF**) (WHO 2001) that is basically a component of a health system and describes functioning on the personal level. The new classification has two parts; one is denoted functioning and disability, where functioning is an umbrella term encompassing all body functions, activities and participation and disability serves as an umbrella term for impairments, ► **activity limitations** and ► **participation restriction**. The other part, ► **contextual factors**, forms the complete background of an individual. By body functions is meant the physiological functions of the body systems including psychological function. Impairments are problems in body function and structure such as significant deviation or loss. Activity is the execution of a task or action by an individual and activity limitations are difficulties an individual may have in executing activities. Participation is involvement in a life situation and participation restrictions are problems an individual may experience in involvement in such situations. In addition, the ICF contextual factors are environmental factors, that make up the physical, social and attitudinal environment in which people live and conduct their lives and personal factors that are internal influences and attributes, such as race, gender, lifestyle, education, path and current experiences. These components have multiple interactions.

To facilitate use of the ICF for the taxonomy and management of chronic pain I have proposed that longstanding pain in general (>3–6 months duration) should be classified as a significant deviation from normal function of the nociceptive transmission and thereby be seen as a severe sensory impairment (Sjölund 2003). This implementation enables us to use the ICF classifications to describe pain-related activity limitations and participation restrictions, both of which are cardinal features of the much used but officially denounced “chronic pain syndrome” (Sanders 1999) and of the much debated (somatoform) pain disorder (APA 1994). As can be seen in Fig. 3, impairments, activity limitations and participation restrictions act in an integrated fashion to explain the complex resulting picture in the sensory / interpretative / behavioral clinical presentation of longstanding pain. It may be much more meaningful (and true!) to describe a person in chronic pain with a combination of one or several of the four main pain categories mentioned previously and the ICF, rather than speculating if a particular organ system is affected by an uncertain pathology in a painful region and adding “pain behaviors” (Sanders 1999), “somatization / pain disorder” (APA 1994) or an empirical psychological characterization (Rudy et al. 1995).

For therapeutic strategies it is easier to define indications for pain management by deriving them from the ICF approach, assessing the pain category and its characteristics (the sensory impairment) as well as the activity limitations and participation restrictions in that individual in his / her context and to focus pain management on those persons who are distinctly limited or restricted by their pain. The planning and goal setting of pain management can be facilitated by directly asking, how can we reduce the sensory impairment? Can we remove the cause of chronic pain? Can we achieve temporary or permanent pain relief? How do we compensate for activity limitations and focus on specific participation restrictions in our rehabilitation efforts? How do we best consider environmental and personal factors? Such a structured and

individualized ICF-related assessment may allow pain management to be tested in a more meaningful scientific manner from now on.

## References

1. APA (1994) Diagnostic and Statistical Manual of Mental Disorders. American Psychiatric Association, Washington DC
2. Bendtsen L, Jensen R, Olesen J (1996) Qualitatively altered nociception in chronic myofascial pain. *Pain* 65:259–264
3. Bergman S, Herrstrom P, Hogstrom K et al. (2001) Chronic musculoskeletal pain, prevalence rates, and sociodemographic associations in a Swedish population study. *J Rheumatol* 28:1369–1377
4. Eide P (2000) Wind-up and the NMDA receptor complex from a clinical perspective. *Eur J Pain* 4:5–17
5. Flor H, Denke C, Schäfer M et al. (2001) Sensory discrimination training alters both cortical reorganization and phantom limb pain. *Lancet* 357:1763–1764
6. Graven-Nielsen T, Aspegren Kendall S et al. (2000) Ketamine reduces muscle pain, temporal summation, and referred pain in fibromyalgia patients. *Pain* 85:483–491
7. Kosek E, Hansson P (2002) The influence of experimental pain intensity in the local and referred pain area on somatosensory perception in the area of referred pain. *Eur J Pain* 6:413–425
8. Lindell L, Bergman S, Petersson IF et al. (2000) Prevalence of fibromyalgia and chronic widespread pain. *Scand J Prim Health Care* 18:149–153
9. Merskey H, Bogduk N (1994) Classification of chronic pain. Descriptions of chronic pain syndromes and definitions of pain terms. IASP Press, Seattle
10. Persson AL, Hansson GA, Kalliomiaki A et al. (2003) Increases in local pressure pain threshold after muscle exertion in women with chronic shoulder pain. *Arch Phys Med Rehabil* 84:1515–1522
11. Rudy T, Turk D, Kubinski JA et al. (1995) Differential treatment responses of TMD patients as a function of psychological characteristics. *Pain* 61:103–112
12. Sanders S (1999) Clinical practise guidelines for chronic non-malignant pain syndromes. *J Back Musculoskel Rehab* 5:115–120
13. Simonsson M, Bergman S, Jacobsson LT et al (1999) The prevalence of rheumatoid arthritis in Sweden. *Scand J Rheumatol* 28:340–343
14. Sjölund BH (1994) Chronic pain in society –a case for chronic pain as a dysfunctional state? *Qual Life Res* 3:5–9
15. Sjölund BH (2003) Current and future treatment strategies for chronic pain. In: Soroker N, Ring H (eds) *Advances in Physical and Rehabilitation Medicine*. Monduzzi Editore, Bologna, pp 307–313
16. WHO (2001) International Classification of Functioning, Disability and Health. World Health Organization, Geneva, pp 1–209
17. Woolf CJ, Bennett GJ, Doherty M et al (1998) Towards a mechanism-based classification of pain? *Pain* 77:227–229

## Dysfunctional Segmental Motion

- ▶ Chronic Back Pain and Spinal Instability

## Dysmenorrhea

### Definition

Painful cramping in the lower abdomen occurring before, and/or during menses, primarily as a result of endogenous (uterine) prostaglandin production.

Pain is often accompanied by other symptoms such as sweating, tachycardia, headaches, nausea, vomiting, diarrhea, and tremulousness. Cyclic symptoms can result in significant physical and emotional distress, as well as lifestyle disruption. Dysmenorrhea is a common gynecologic condition, affecting up to 50% of menstruating women. It is the leading cause of short-term, repeated absenteeism from school or work among teens and young adults. Diagnosis is based upon review of a daily pain diary indicating cyclicality of pain. Primary dysmenorrhea refers to pain with menses when there is no pelvic pathology, whereas secondary dysmenorrhea is painful menses with underlying pelvic pathology. Non-steroidal anti-inflammatory drugs (NSAIDs), with or without combined hormonal contraceptives, are the cornerstone of therapy and can be quite effective when used appropriately. Combined hormonal methods of birth control, including pills, the contraceptive patch and the vaginal ring, result in pain relief for more than 90% of women with primary dysmenorrhea. There is also some evidence for acupuncture or transcutaneous electrical nerve stimulation (TENS) in the management of dysmenorrhea. The management of secondary dysmenorrhea involves treatment of the underlying pathology. Surgical approaches for dysmenorrhea include laparoscopic uterine nerve ablation, presacral neurectomy, and hysterectomy

- ▶ [Dyspareunia and Vaginismus](#)
- ▶ [Gynecological Pain and Sexual Functioning](#)
- ▶ [Gynecological Pain, Neural Mechanisms](#)
- ▶ [Visceral Pain Models, Female Reproductive Organ Pain](#)

## Dysnosognosia

- ▶ [Hypochondriasis, Somatoform Disorders and Abnormal Illness Behaviour](#)

## Dyspareunia

### Definition

Recurrent or persistent genital pain associated with sexual intercourse.

- ▶ [Dyspareunia and Vaginismus](#)
- ▶ [Gynecological Pain and Sexual Functioning](#)
- ▶ [Gynecological Pain, Neural Mechanisms](#)
- ▶ [Myalgia](#)
- ▶ [Visceral Pain Models, Female Reproductive Organ Pain](#)

## Dyspareunia and Vaginismus

MARIE ANDREE LAHAIE, YITZCHAK M. BINIK  
McGill University, Montreal, QC, Canada  
binik@ego.psych.mcgill.ca

### Synonyms

Coital Pain; Sexual Pain Disorder; Urogenital Pain; Vaginismus and Dyspareunia; vulvar vestibulitis syndrome; vulvar dysesthesia; vulvodynia

### Definition

Dyspareunia is currently defined as “recurring genital pain associated with sexual activity” (APA 2000). Most classification systems and practitioners subcategorize dyspareunia as either of organic or psychological origin. This conceptualization is problematic for a variety of reasons:

- There are no validated criteria to differentiate organic from psychogenic dyspareunia
- It is likely that both psychological and biological factors coexist for many cases of dyspareunia
- The genital pain of dyspareunia can be experienced during non-sexual activities such as tampon insertion, gynecological examinations, urination and sports
- “Dyspareunic pain” may precede first sexual experiences and occur in adolescence during tampon insertion

The focus on the “association with sexual activity” has resulted in limited attention to the main symptom of dyspareunia, the pain. It is unusual that dyspareunia is defined by the primary activity with which it interferes, sexual intercourse, rather than by the location, characteristics, and mechanisms of the pain. Its current usage is inconsistent and vague, and is used by different health professionals to refer to a number of poorly defined urogenital pain syndromes (e.g. vulvar vestibulitis, ► [vulvodynia](#)) and to pain symptoms presumably linked to physical pathology. It has been proposed that dyspareunia be reconceptualized as a pain syndrome, rather than as a sexual dysfunction or a simple manifestation of underlying physical pathology (Binik et al. 1999).

### Characteristics

#### Epidemiology

The prevalence of dyspareunia in women varies depending on the definition used and the population sampled. A recent epidemiological study found that 21% of women under the age of 30 suffered from recurrent genital pain during sexual activity (Laumann et al. 1999). The most common form of superficial dyspareunia in premenopausal women is ► [vulvar vestibulitis syndrome](#) (VVS), with approximately 15% of premenopausal women suffering from VVS (Harlow et al. 2001). In a

pilot study investigating postpartum dyspareunia, 58% reported genital pain 3 months after delivery with 26% still experiencing dyspareunia 8–9 months after delivery (Barrett et al. 1999). In post-menopausal women, dyspareunia has been reported to affect between 6–30% of women (Versi et al. 2001). Despite the fact that dyspareunia appears to be highly prevalent across the lifespan, many women never seek treatment, and of those who do, many are never formally diagnosed (Harlow et al. 2001).

### Assessment

The primary step in evaluating patients with dyspareunia, is conducting a thorough multidisciplinary assessment of the pain and its resulting interference with quality of life. Assessment of the pain component should include specific information on its location, history, quality, intensity, exacerbating and ameliorating factors, temporal pattern, meaning and potential underlying pathology. Evaluation of the impact of the pain on the sexual response cycle (desire, arousal, orgasm, and sexual frequency), the couple relationship, and on personal well being may be crucial to treatment planning. A comprehensive gynecological examination is also crucial, but the timing of this examination should be carefully considered, since it can be very painful and sometimes a traumatic experience for both the woman and the physician. Depending on the history and interview, the examination might include the following:

- An inspection and cotton swab evaluation of the vulvar area
- Laboratory tests to investigate bacterial or viral infection
- Assessment for atrophic vaginitis
- Palpation and examination of the uterus, adnexa, urethra, bladder and surrounding structures
- Evaluation of the pelvic floor musculature
- ► [Colposcopy](#)
- ► [Laparoscopy](#)

In general, the clinician should attempt, during the manual examination, to replicate the quality of the pain reported by the patient. It is crucial to keep in mind that the presence of physical pathology may or may not be closely related to the experienced dyspareunia. Although there are a variety of “known syndromes” and physical and psychosocial pathologies associated with the diagnosis of dyspareunia (e.g. VVS, vulvodynia, vaginismus, ► [lichen sclerosus](#) etc.), the ability of clinicians to differentiate these reliably has not been carefully investigated.

### Physical Factors Associated with Dyspareunia

There is a wide range of underlying physical pathologies associated with dyspareunia. Deep dyspareunia, characterized by diffuse pain or localized tenderness,

is frequently associated with chronic pelvic pain and pelvic pathology. Some reported causes of deep dyspareunia are pelvic inflammatory disease, ▶ [endometriosis](#), ovarian pathology, fixed uterine retroversion, and inflammatory bowel disease. Superficial dyspareunia refers to pain localized at the entry of the vagina, which can be caused by vaginal infections, scar tissue in an episiotomy repair, vaginitis, ▶ [vulvo-vaginal atrophy](#), VVS, ▶ [interstitial cystitis](#) and urethral conditions. Women suffering from VVS have been found to have lower tactile and pain thresholds in the vulvar vestibule, deltoid, labium minus and forearm, and amplifications of brain activity in processing tactile and pain sensations in the genital region compared to healthy women, illustrating that they may suffer from a generalized sensory abnormality (Pukall et al. 2005). It is important to keep in mind that the degree of diagnosable physical pathology is only sometimes highly correlated with the intensity and experience of genital pain, as well as with the amount of interference with vaginal penetration activities (Binik et al. 1999).

#### Psychosocial Factors Associated with Dyspareunia

The psychosocial factors associated with dyspareunia vary depending on the age of onset, duration, course and subtype of dyspareunia. Not surprisingly, the psychosocial profile of a 25-year-old single women suffering from dyspareunia due to VVS, will be different from that of a 55-year-old married women who just started experiencing genital pain. Recent studies examining the psychosocial factors associated with dyspareunia found that women with recurrent genital pain show more psychological distress (e. g. increased interpersonal sensitivity, depression and phobic avoidance), sexual dysfunction, negative attitudes about sexuality, and relationship problems (Binik et al. 1999). In terms of sexual dysfunction, they have lower frequencies of intercourse, lower levels of sexual desire and arousal and greater difficulty achieving orgasms through oral stimulation and intercourse. Women suffering from VVS have been found to display ▶ [hypervigilance](#) for pain relevant information and a tendency to catastrophize about their VVS pain, which may result in an increased attention to pain and a diversion away from sexual stimuli (Payne et al. 2005). Other factors that have been found to be associated with VVS are: a history of depression and physical abuse (Harlow et al. 2003), early puberty and pain with first tampon use (Harlow et al. 2001), early and prolonged use of oral contraceptives (Bouchard et al. 2002), and increased state and trait anxiety (Payne et al. in press). Sexual abuse has been hypothesized to result in dyspareunia, however, current findings suggest that women suffering from dyspareunia without associated chronic pelvic pain do not significantly differ from healthy controls in this respect (Binik et al. 1999).

#### Treatment for Dyspareunia

Given that dyspareunia is often conceptualized as resulting from either a medical or psychosexual condition, most treatments to date have been unidisciplinary. A wide variety of psychological, medical, and surgical procedures have been used to treat dyspareunia but very few have been evaluated empirically. Even though the central complaint of women with dyspareunia is pain, the vast majority of present therapeutic strategies focus on presumed underlying physical pathologies or psychosexual distress. For example, estrogen replacement therapy is a common medical treatment for post-menopausal women suffering from dyspareunia. For dyspareunia resulting from VVS, common treatments include corticosteroids, anesthetic topical creams, antidepressant medications, ▶ [vestibulectomy](#), ▶ [Cognitive-Behavioral Therapy](#), and pelvic floor physical therapy including ▶ [biofeedback](#). As far as we are aware, there are no completed randomized controlled trials that have demonstrated the efficacy of any treatment for dyspareunia, except for a recent study which compared group cognitive-behavioral therapy, biofeedback and vestibulectomy in the treatment of dyspareunia due to VVS (Bergeron et al. 2001). Results showed that 60% of vestibulectomy patients were considered “treatment successes”, compared to 30% of the biofeedback and 40% of the group cognitive-behavioral therapy participants. Multidisciplinary interventions including sex therapy, physical therapy, and surgical interventions have been proposed as the most useful approach to treating dyspareunia (Bergeron et al. 2001).

#### Biopsychosocial Characteristics of Vaginismus

Vaginismus is currently defined as “recurrent or persistent involuntary muscle spasms of the outer third of the vagina which interferes with sexual intercourse” (APA 2000). Women who suffer from vaginismus can have diverse clinical presentations, with some experiencing problems specific to sexual intercourse, while others demonstrating disturbances in all activities involving vaginal penetration. There are no epidemiological studies investigating the prevalence of vaginismus in the general population, however, in clinical settings, the rates range from 12 to 17% (Binik et al. 1999). Numerous factors have been implicated in the etiology of vaginismus such as a history of sexual abuse, religious orthodoxy, negative sexual attitudes and dyspareunia: there is, however, little empirical evidence to support these factors. Reissing et al. (2003) found that more women with vaginismus reported a history of childhood sexual interference and less positive attitudes regarding sexuality compared to women with dyspareunia and controls, however, the differences were small and need to be replicated.

Although dyspareunia and vaginismus are considered mutually exclusive disorders, according to the DSM-IV-



TR (APA 2000), women suffering from dyspareunia and vaginismus have many common characteristics, such as difficulty with and pain during vaginal penetration activities. Moreover, health practitioners (i.e., gynecologists, physical therapists, psychologists) cannot reliably differentiate vaginismus from dyspareunia (Reissing et al. 2004). In fact, recent findings (Reissing et al. 2004) demonstrated that vaginal spasms, the principal diagnostic criteria for vaginismus, were neither exclusive nor specific to vaginismus.

### Treatment for Vaginismus

Currently, the most popular treatment for vaginismus is cognitive behavioral therapy. This treatment strategy focuses on erroneous cognitive beliefs, conditioned vaginal spasms, educational pelvic examination, Kegel's exercises, and vaginal desensitization through vaginal dilators. Although this treatment regimen is widely accepted as effective, there have been no randomized controlled treatment outcome studies to support its use and critical reviews do not support this view (Reissing et al. 1999). It has been proposed that pelvic floor physical therapy may be usefully integrated with the current treatment regimen (Binik et al. 1999).

### References

- American Psychiatric Association (2000) Diagnostic and Statistical Manual of Mental Disorders, 4<sup>th</sup> edn. American Psychiatric Association, Washington, DC
- Barrett G, Pendry E, Peacock J, Victor C, Thakar R, Manyonda I (1999) Women's Sexuality After Childbirth: A Pilot Study. *Arch Sex Behav* 28:179–191
- Bergeron S, Binik YM, Khalife S, Pagidas K, Glazer HI, Meana M, Amsel R (2001) A Randomized Comparison of Group Cognitive-Behavioral Therapy, Surface Electromyographic Biofeedback, and Vestibulectomy in the Treatment of Dyspareunia from Vulvar Vestibulitis. *Pain* 91:297–306
- Binik YM, Meana M, Berkley K, Khalife S (1999) The sexual pain disorders: is the pain sexual or is the sex painful? *Annu Rev Sex Res* 11:210–235
- Bouchard C, Brisson J, Fortier M, Morin C, Blanchette C (2002) Use of Oral Contraceptive Pills and Vulvar Vestibulitis: A Case-Control Study. *Am J Epidemiol* 156:254–261
- Harlow BL, Wise LA, Stewart EG (2001) Prevalence and Predictors of Chronic Lower Genital Tract Discomfort. *Am J Obstet Gynecol* 185:545–550
- Harlow BL, Stewart EG (2003) Childhood Victimization and the Risk of Vulvar Dysesthesia. *Ann Epidemiol* 13:565–566
- Laumann EO, Paik A, Rosen RC (1999) Sexual Dysfunction in the United States. Prevalence, Predictors and Outcomes. *JAMA* 281:537–545
- Payne KA, Binik YM, Amsel R, Khalife S (2005) When Sex Hurts, Anxiety and Fear Orient Attention Towards Pain. *Eur J Pain* 9:427–436
- Pukall CF, Strigo IA, Binik YM, Amsel R, Khalife S, Bushnell MC (2005) Neural Correlates of Painful Genital Touch in Women with Vulvar Vestibulitis Syndrome. *Pain* 115:118–27
- Reissing ED, Binik YM, Khalife S (1999) Does Vaginismus Exist? A Critical Review of the Literature. *J Nerv Ment Dis* 187:261–274
- Reissing ED, Binik YM, Khalife S, Cohen D, Amsel R (2003) Etiological Correlates of Vaginismus: Sexual and Physical Abuse, Sexual Knowledge Sexual Self-Schema and Relationship Adjustment. *Sex Marital Ther* 29:47–59
- Reissing ED, Binik YM, Khalife S, Cohen D, Amsel R (2004) Vaginal Spasm, Behaviour and Pain: An Empirical Investigation of the Reliability of the Diagnosis of Vaginismus. *Arch Sex Behav* 33:5–17
- Versi E, Harvey MA, Cardozo L, Brincat M, Studd JW (2001) Urogenital Prolapse and Atrophy at Menopause: A Prevalence Study. *Int Urogynecol J Pelvic Floor Dysfunct* 12:107–110

D

## Dyspareunia Model

- ▶ Visceral Pain Models, Female Reproductive Organ Pain

## Dyspepsia

### Definition

Recurrent or persistent pain or discomfort in the upper abdomen, also used to describe sensations of nausea, bloating and early satiety in relation to meals.

- ▶ Recurrent Abdominal Pain in Children

## Dysphagia

### Definition

Dysphagia is defined as difficulty in swallowing.

- ▶ Opioid Therapy in Cancer Pain Management, Route of Administration

## Dysraphism

### Definition

Any failure of closure of the primary neural tube. This general category would include the disorder myelomeningocele.

- ▶ Lower Back Pain, Physical Examination

## Dysthesia

### Definition

An inappropriate sensation associated with a stimulus or occurring in the absence of a stimulus.

- ▶ Satellite Cells and Inflammatory Pain

## Dysthymia

### Definition

Dysthymia is the term for chronic depression of a duration of two years or more.

- ▶ [Psychiatric Aspects of the Epidemiology of Pain](#)

## Dystonia

### Definition

Involuntary tonic contraction of a muscle or a muscle group due to a central nervous or inflammatory lesion. Most cases of dystonia are painful. The reasons for the pain are assumed to be low tissue pH and ischemia.

- ▶ [Sensitization of Muscular and Articular Nociceptors](#)

## EAE

- ▶ Experimental Allergic Encephalitis

## Early Mobilization

### Definition

Early mobilization is the early resumption of activities of daily living, usually within 24 hours after surgery.

- ▶ Postoperative Pain, Importance of Mobilisation

## ECD

- ▶ Equivalent Current Dipole

## Ectopia, Spontaneous

ROBERT H. LAMOTTE  
Department of Anesthesiology, Yale School of  
Medicine, New Haven, CT, USA  
robert.lamotte@yale.edu

### Synonym

Spontaneous Ectopia

### Definition

Ongoing nerve impulses produced by an atypical generator (“pacemaker”), often at an abnormal locus in the primary sensory neuron, for example at a site of injury. The ectopic discharges are spontaneous, i.e. endogenously generated by the neuron in the absence of an apparent external stimulus.

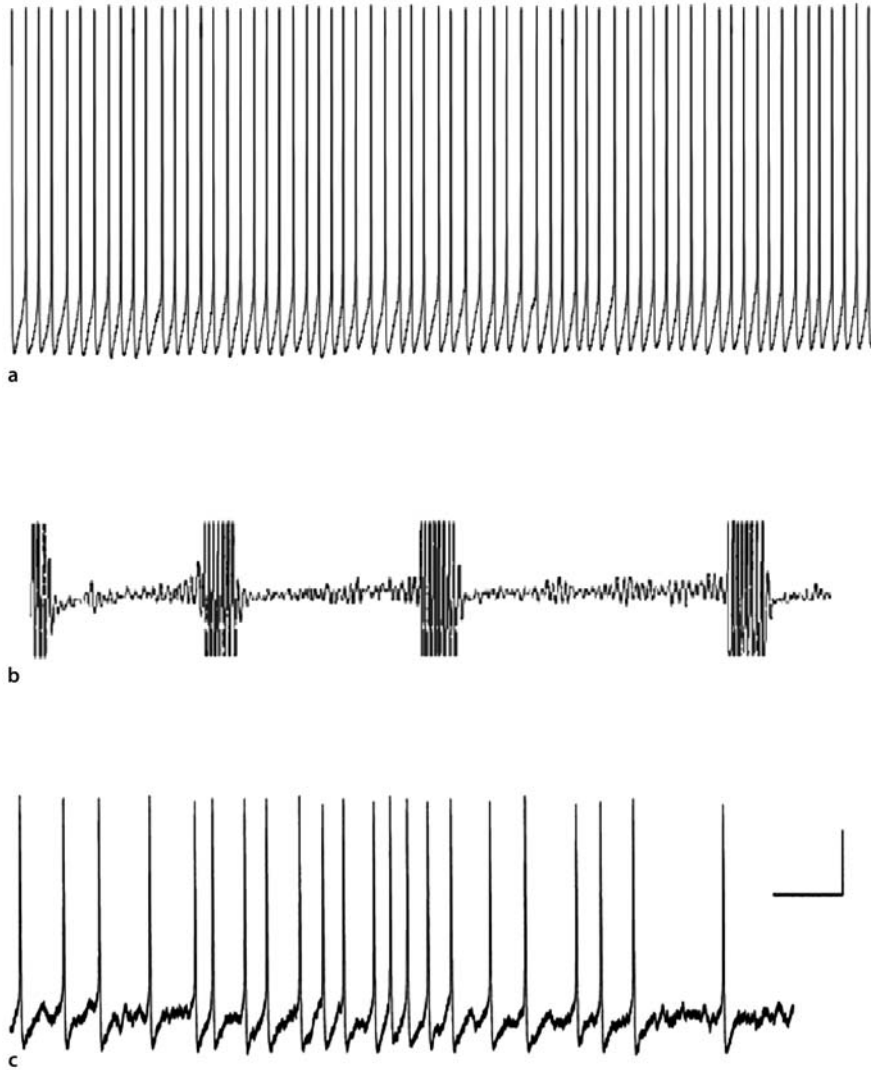
### Characteristics

The types of injuries that produce spontaneous ectopia (SE) (see ▶ [Ectopia, Spontaneous](#)) include axotomy, mechanical trauma such as nerve compression, demyelination and inflammation. However, after each kind of injury, only a subpopulation of neurons exhibits SE. The SE typically originates in a part of the neuron that is close to the site of injury, and/or within the ▶ [dorsal root ganglion](#) (DRG). In addition, SE sometimes also occurs in the neighboring uninjured neurons that presumably activated as a result of the injury (Wu et al. 2002; Ma et al. 2003). The SE in neurons with myelinated (A-fiber) axons typically has a regular pattern (with a more or less constant interval between nerve impulses, e.g. 35–65 ms) that, for some neurons, is continuous and, for others, periodically interrupted by periods of silence resulting in “bursts” (Fig. 1a, b). Other neurons with A-fibers, and most of those with unmyelinated (C-fiber) axons, exhibit an irregular pattern with longer intervals between impulses, e.g. 100–1000 ms or more) (Devor and Seltzer 1999) (Fig. 1c).

Although SE may appear to be endogenous to an electrophysiologically recorded hyperexcitable neuron, i.e. occurs in the absence of experimentally applied stimuli, it can in many instances be modulated (or in some cases produced in silent “injured” neurons) by externally applied mechanical, thermal or chemical stimuli. Such stimuli might normally be present *in vivo* in the form of body temperature, movement of limbs, local ischemia, anoxia and the presence of inflammatory mediators at the injury site. For example, there is a host of endogenous chemical factors that might modulate or induce SE in hyperexcitable neurons, including substances released from sympathetic neurons (e.g. norepinephrine), or from sensory neurons (neuropeptides), or inflammatory mediators normally present or released in injured or inflamed tissue (Devor and Seltzer 1999).

### SE in Axotomized Sensory Neurons

If the axon of an adult DRG neuron is transected (axotomized), for example by a cut, a severe compression, or as a result of disease, the end of the portion still connected to the cell body (soma) may begin to sprout within hours or days. After the transection of peripheral but not central (dorsal root) axons, some of these sprouts may regener-



**Ectopia, Spontaneous,**  
**Figure 1** Typical patterns of injury-induced ectopic discharge recorded intracellularly from the intact DRG. (a) Tonic discharge recorded from an L5- DRG with a myelinated axon, transected 5 days earlier by a spinal nerve ligation (from Ma et al. 2003, Fig. 7). (b) Bursting discharge in a non-axotomized L4 with a myelinated axon, 5 days after transection of the adjacent L5 spinal nerve. Each burst follows an increase in the amplitude of oscillation of the resting membrane potential (Liu et al. 2000, Fig. 1C, action potentials have been truncated). (c) Irregular discharge in a non-axotomized neuron with an unmyelinated axon and a cell body in a ganglion that had been compressed for 6 days by a rod inserted into the intervertebral foramen (from Zhang et al. 1999, Fig. 2E). Voltage scale: 10 mV for (a, b), 20 mV for (c). Time scale: 100 ms for (a), 200 ms for (b), and 500 ms for (c).

ate back to the target tissue and re-establish functional connections. Certain other regenerating sprouts may become trapped and entangled forming a structure called a “► **neuroma**”. A proportion of the injured neurons develop SE, which typically originates at the site of injury, but can also originate within the DRG.

After transection of the sciatic nerve, the incidence of SE is initially greater during the first two weeks for neurons with myelinated axons (A-neurons) than those with unmyelinated axons (C-neurons) (Devor and Seltzer 1999). Thereafter, the reverse is true, with SE being more common for C- rather than for A-neurons. For A-neurons, the incidence of SE is greater for nerve lesions closer to the somata (transection of the spinal- as opposed to the sciatic nerve). However, the reverse is true for C-neurons, where there is virtually no SE after transection of the spinal nerve (Liu et al. 2000). The reasons for these observations must await identification, both of the chemical factors that alter the excitability

of a neuron after axotomy, the cells that release the chemicals, and the events that lead to their release. Several weeks after a sciatic nerve injury, some pairs of injured nerve fibers develop an abnormal, but stable, electrical (“► **ephaptic**”) interaction between certain nerve fibers, for example, between the endings of two fibers terminating in a neuroma or within the site of a crush injury. Ephaptic communication can also develop within pairs of fibers that are in close apposition, with patches of demyelination presumably where the glial insulation is absent (Devor and Seltzer 1999). One possible functional consequence of ephaptic connections is that activity in nociceptive afferent nerve fibers are evoked by activity in low-threshold mechanoreceptive, sympathetic or motor nerve fibers.

Ephaptic connections do not form in the DRG. However, another type of cross-excitation can occur within the DRG between repetitively discharging neurons and their passive neighbors. This “cross excitatory dis-



charge" is mediated not electrically but by an unknown chemical mediator (Devor and Seltzer 1999).

### SE in Intact Sensory Neurons

SE can also develop in intact neurons after either an axotomy or, in the absence of axotomy, after a local demyelination, inflammation or compression of the nerve or the DRG. The SE can originate in the DRG, even in many instances when the site of injury or inflammation appears confined to the peripheral nerve.

After a transection of either a mixed (spinal) nerve or a ventral root (containing only motor nerve fibers) at L5, a low level of SE develops in intact sensory neurons with unmyelinated axons and cell bodies in the adjacent L4 ganglion (Wu et al. 2002). In addition, after a transection of the L5 spinal nerve, the various patterns of SE that develop in the axotomized L5 A-neurons are also found in intact A-neurons with cell bodies in the adjacent L4 DRG (Ma et al. 2003). Thus, the initiation of SE in the DRG may not be due to the absence of an axonally transported signal from the peripheral target, but rather to the retrograde delivery of a positive signal from the injury site to the DRG. Possible signals that might induce SE in the somata or distal axons of intact neurons include cytokines such as nerve growth factor (NGF), tumor necrosis factor- $\alpha$  (TNF $\alpha$ ), interleukin-1 $\alpha$  (IL-1 $\alpha$ ), IL-1 $\beta$ , and IL-6 released by reactive cells in the target tissue and/or, by Schwann cells surrounding nerve fibers undergoing Wallerian degeneration and by invading macrophages.

Certain neurodegenerative diseases such as multiple sclerosis or injuries produced by nerve entrapment may cause focal demyelination. A proportion of demyelinated axons do exhibit SE in the absence of axotomy or a loss of conduction (Kapoor et al. 1997).

Inflammatory processes per se can lead to SE in a subpopulation of peripheral sensory neurons. In an experimental model of immune mediated neuritis, topical application of Complete Freund's Adjuvant to a focal region of the sciatic nerve produced ipsilateral cutaneous ► **hyperalgesia** and SE described as irregular, of a slow rate (about 1 Hz), and confined to a subpopulation of unmyelinated and thinly myelinated nerve fibers innervating subcutaneous musculoskeletal tissue (Bove et al. 2003).

A ► **chronic constriction injury** (CCI) produced in the rat by a loose ligation of the sciatic nerve is accompanied by a partial axotomy, local inflammation and demyelination in the vicinity of the injury site and ipsilateral cutaneous hyperalgesia. SE in both C- and A-neurons originated at the injury site or within the DRG, and its rate increased by stimulation of sympathetic efferent neurons or by application of norepinephrine to the DRG or to the injury site. Most of the neurons with SE had transected axons, though a minority conducted through the injury site and thus could be considered as intact (Kajander and Bennett 1992).

A model of chronic compression of the DRG (CCD), which might occur with a laterally herniated disk or foraminal stenosis, was produced in the rat by the insertion a rod into the intervertebral foramen, one at L4 and another at L5. This produced cutaneous hyperalgesia in the ipsilateral hind paw and SE, originating in the DRG, in neurons with intact, conducting axons. The SE occurred in both neurons with unmyelinated and myelinated axons, and was exhibited even after the formerly compressed DRGs were removed from the animal and recorded *in vitro* from the intact ganglion (Zhang et al. 1999).

### Cellular Mechanisms of SE

There are similarities in the characteristics of somal hyperexcitability after seemingly different types of injury such as peripheral or spinal nerve axotomy, peripheral nerve constriction, or DRG compression without axotomy: these include SE that is regular, bursting or irregular (Fig. 1), lower than normal current thresholds (a lesser magnitude of current injected into the soma required to elicit an action potential), decreased accommodation (increased firing to an injection of steady, suprathreshold current), and subthreshold membrane potential oscillations (Devor and Seltzer 1999; Ma et al. 2003). These characteristics are exhibited by dissociated somata of the DRG neuron (after prior injury). The dissociated neurons can be labeled by a dye delivered peripherally prior to injury to determine whether the neuron innervated, for example, skin or muscle. For example, a subpopulation of A-neurons with medium size cell bodies, with narrow non-inflected action potentials and including some cutaneous but primarily muscle afferents, exhibited spontaneous subthreshold oscillations of their resting membrane potential or upon depolarization after peripheral or spinal nerve transection (Liu et al. 2002). A-neurons with similar oscillations and action potential properties were recorded intracellularly from the intact ganglion after spinal nerve transection (Liu et al. 2000) or after chronic compression of the ganglion (Zhang et al. 1999), and also from axons after experimentally induced demyelination (Kapoor et al. 1997). Blockers of sodium or potassium currents can respectively block or initiate an increase in the oscillations in these A-neurons (Kapoor et al. 1997; Liu et al. 2001). Of those DRG neurons exhibiting a bursting pattern of SE, the amplitude of ongoing membrane oscillation typically increased just prior to each burst, suggesting that the former triggered the latter (Fig. 1b).

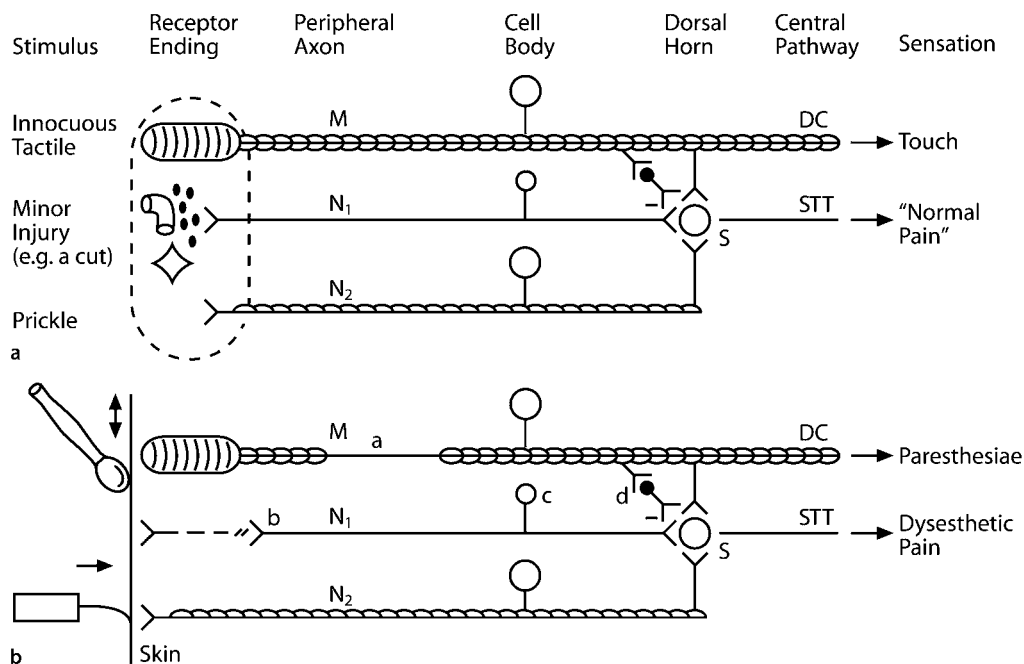
Patch-clamp recordings of isolated currents in dissociated DRG somata provide an insight into the effects of different injurious/inflammatory conditions in altering ion channel properties. Dissociated neurons from lumbar DRGs ipsilateral to a transection of the spinal or sciatic nerve express a variety of changes in sodium, potassium and calcium currents. These include an in-

crease and faster repriming of a kinetically fast ▶ TTX-sensitive sodium current (Nav 1.3) and decreases in other currents including a slow TTX-resistant current (Waxman et al. 1999), a high-voltage-activated calcium current (Baccei and Kocsis, 2000), and sustained and transient potassium currents (Everill and Kocsis 1999). TTX-R current in DRG somata also decreases after CCI (Dib-Hajj et al. 1999). The hyperpolarization cation current (I<sub>h</sub>) increases after CCD (Yao et al. 2003). A decrease in potassium current and increase in sodium and/or I<sub>h</sub> current could contribute to the decrease in current threshold and accommodation in excitable DRG neurons after nerve injury.

The responses of SE neurons to norepinephrine and inflammatory mediators such as serotonin, histamine, bradykinin and prostaglandin E<sub>2</sub> may be intrinsic properties of the cell bodies (somata) of neurons after a nerve injury such as CCI, because they are recorded *in vitro* from the intact ganglion and from cells that have been acutely dissociated (Petersen et al. 1996).

### Contribution of SE to Pain, Hyperalgesia and Allodynia

In addition to producing pain and paresthesiae, it is likely that SE in appropriate primary sensory nociceptive neurons could increase the sensitivity of second order neurons in the spinal dorsal horn (“central sensitization”). Central sensitization can occur in the absence of neuronal injury (Fig. 2a). For example, a local intradermal injection of capsaicin in the arm produces a wide area of hyperalgesia (enhanced pain to normally painful stimuli such as a pin prick), and allodynia (pain to normally non-painful stimuli, such as a touch) to mechanical stimulation of the skin surrounding the area exposed to the chemical. The basis for this is believed to be the lowered threshold responses and increased suprathreshold responses of spinal nociceptive neurons in the dorsal horn (LaMotte et al. 1991). Thus, it is possible that SE, resulting, for example, from nerve injury, may produce and maintain a state of chronic central sensitization (Fig. 2b) thereby contributing to a chronic state of hyperalgesia and allodynia.



**Ectopia, Spontaneous, Figure 2** Schematic of how pain might be evoked by normal activity in cutaneous dorsal root ganglion (DRG) neurons and by ectopic spontaneous activity after neuronal injury. (a) Normal activity in uninjured neurons. Pain and touch are normally elicited by respective activity in nociceptive- (N<sub>1</sub>, N<sub>2</sub>) and low-threshold mechanoreceptive (M) neurons. N terminates onto a spinothalamic tract (STT) neuron (S) whose cutaneous receptive field is shown on the left (large, dashed oval). M projects into the dorsal columns (DC) but sends a collateral axon to S. After a localized injury or inflammation of the skin (such as a minor cut to the skin resulting in release of inflammatory chemicals e.g. from blood vessels, mast cells), activity in N<sub>1</sub> releases a neurotransmitter that sensitizes S (“central sensitization”) such that its output in response to nociceptive mechanical stimuli (e.g. a pricking with a stiff hair that activates N<sub>2</sub>) is increased (contributing to hyperalgesia), and its response to innocuous touch (e.g. lightly stroking the skin that activates M) is enhanced, thereby contributing to touch-evoked allodynia both within and outside (larger dashed oval) the area of injury. (b) Spontaneous ectopic activity (SE) in injured neurons. SE can originate at the site of a local demyelination and/or inflammation (a), from the proximal ends of transected axons forming a neuroma (b), from the DRG of injured or inflamed neurons (c), or as a result of compression/inflammation of the ganglion itself. After axotomy, a loss of input to inhibitory neurons (d) might disinhibit activity in nociceptive STT neurons thereby causing pain of central origin. In this example, chronic ectopic discharges in N<sub>1</sub> could elicit, in addition to pain, central sensitization leading to chronic allodynia and hyperalgesia. SE in mechanoreceptive afferents mediating touch could elicit abnormal sensations (paresthesiae) and, in the presence of central sensitization, chronic pain

## References

1. Baccei ML, Kocsis JD (2000) Voltage-Gated Calcium Currents in Axotomized Adult Rat Cutaneous Afferent Neurons. *J Neurophysiol* 83:2227–2238
2. Bove GM, Ransil BJ, Lin HC et al. (2003) Inflammation Induces Ectopic Mechanical Sensitivity in Axons of Nociceptors Innervating Deep Tissues. *J Neurophysiol* 90:1949–55 2003
3. Devor M, Seltzer Z (1999) Pathophysiology of Damaged Nerves in Relation to Chronic Pain In: Wall PD, Melzack R (eds) *Textbook of Pain*, 4<sup>th</sup> edn. Churchill Livingstone London, pp 129–164
4. Dib-Hajj SD, Fjell J, Cummins RR et al. (1999) Plasticity of Sodium Channel Expression in DRG Neurons in the Chronic Constriction Injury Model of Neuropathic Pain. *Pain* 83:591–600
5. Everill B, Kocsis JD (1999) Reduction of Potassium Currents in Identified Cutaneous Afferent Dorsal Root Ganglion Neurons after Axotomy. *J Neurophysiol* 82:700–708
6. Kajander KC, Bennett GJ (1992) Onset of a Painful Peripheral Neuropathy in Rat: A Partial and Differential Deafferentation and Spontaneous Discharge in A Beta and A Delta Primary Afferent Neurons. *J Neurophysiol* 68:734–744
7. Kapoor R, Li YG, Smith KJ (1997) Slow Sodium-Dependent Potential Oscillations Contribute to Ectopic Firing in Mammalian Demyelinated Axons. *Brain* 120:647–652
8. LaMotte RH, Shain CN, Simone DA et al. (1991) Neurogenic Hyperalgesia: Psychophysical Studies of Underlying Mechanisms. *J Neurophysiol* 66:190–211
9. Liu CN, Michaelis M, Amir R et al. (2000) Spinal Nerve Injury Enhances Subthreshold Membrane Potential Oscillations in DRG Neurons: Relation to Neuropathic Pain. *J Neurophysiol* 84:205–215
10. Liu CN, Devor M, Waxman SG et al. (2002) Subthreshold Oscillations Induced by Spinal Nerve Injury in Dissociated Muscle and Cutaneous Afferents of Mouse DRG. *J Neurophysiol* 87:2009–2017
11. Ma C, Shu Y, Zheng Z et al. (2003) Similar Electrophysiological Changes in Axotomized and Neighboring Intact Dorsal Root Ganglion Neurons. *J Neurophysiol* 89:1588–1602
12. Petersen M, Zhang J, Zhang JM et al. (1996) Abnormal Spontaneous Activity and Responses to Norepinephrine in Dissociated Dorsal Root Ganglion Cells after Chronic Nerve Constriction. *Pain* 67:391–397
13. Waxman SG, Dib-Hajj S, Cummins TR et al. (1999) Sodium Channels and Pain. *Proc Natl Acad Sci USA* 96:7635–7639
14. Wu G, Ringkamp M, Murinson BB et al. (2002) Degeneration of Myelinated Efferent Fibers Induces Spontaneous Activity in Uninjured C-Fiber Afferents. *J Neurosci* 22:7746–7753
15. Yao H, Donnelly DF, Ma C et al. (2003) Upregulation of the Hyperpolarization Cation Current after Chronic Compression of the Dorsal Root Ganglion. *J Neurosci* 23:2069–2074

## Ectopic Activity (Ectopic Discharge)

### Definition

Ongoing nerve impulses (action potentials) produced by an atypical generator („pacemaker“) at an abnormal locus in the primary sensory neuron, for example, at a site of injury (e.g. at the axon proximal to the receptive ending or at the cell body membrane in the dorsal root ganglion). The ectopic discharges are spontaneous, i.e. endogenously generated by the neuron in the absence of an apparent external stimulus. These action potentials propagate in both directions from the somata, and are thought to contribute to central sensitization in the dorsal horn. Neuroma afferents usually display spontaneous

i.e. ectopic activity and mechanosensitivity (hence they are excitable). Ectopic excitability in nociceptive afferents is a putative mechanism for pain. Ectopic activity in non-nociceptive afferents may also be important if they acquire synaptic efficacy such that central pain signaling neurons are activated.

- ▶ [Drugs Targeting Voltage-Gated Sodium and Calcium Channels](#)
- ▶ [Ectopia, Spontaneous](#)
- ▶ [Neuroma Pain](#)
- ▶ [Neuropathic Pain, Joint and Muscle Origin](#)
- ▶ [Proinflammatory Cytokines](#)
- ▶ [Trigeminal Neuralgia, Diagnosis and Treatment](#)

E

## Ectopic Excitability

### Definition

Neuroma afferents display spontaneous activity and mechanosensitivity (hence they are excitable). This activity is ectopic in the sense that neural activity normally arises in the terminals of sensory fibers in the innervated structures. Ectopic excitability in nociceptive afferents is a putative mechanism for pain. Ectopic activity in non-nociceptive afferents may also be important if they acquire synaptic efficacy such that central pain signaling neurons are activated.

- ▶ [Ectopic, Spontaneous](#)
- ▶ [Neuroma Pain](#)

## Ectopic Mechanosensitivity

### Definition

Neuromas are mechanosensitive in the sense that mechanical stimuli applied to them evoke neural activity and sensation. The mechanosensitivity is ectopic, as pain is not evoked by mechanical stimulation along the course of healthy nerves.

- ▶ [Ectopic, Spontaneous](#)
- ▶ [Neuroma Pain](#)

## Ectopic Nerve Impulses

### Definition

Anomalous generation of impulses along nerve fibers. The type of symptom usually indicates the kind of fiber originating ectopic activity, which can be motor, sensory (with different submodalities) or autonomic.

- ▶ [Ectopia, Spontaneous](#)
- ▶ [Ectopic Activity \(Ectopic Discharge\)](#)
- ▶ [Painless Neuropathies](#)

## Edema

### Definition

The accumulation of excessive fluid in the intercellular spaces of subcutaneous tissue. This can be caused by an increased permeability of the microvascular endothelium, resulting in leakage of vascular components into tissue.

- ▶ [Inflammation, Modulation by Peripheral Cannabinoid Receptors](#)

## EDT

- ▶ [Electrodiagnostic Testing \(Studies\)](#)

## Education

- ▶ [Information and Psychoeducation in the Early Management of Persistent Pain](#)

## Education and Chronicity

- ▶ [Pain in the Workplace, Risk Factors for Chronicity, Demographics](#)

## EEG

- ▶ [Electroencephalogram/Electroencephalography](#)

## Effect Size

NIKOLAI BOGDUK  
Department of Clinical Research, Royal Newcastle Hospital, University of Newcastle, Newcastle, NSW, Australia  
nbogduk@mail.newcastle.edu.au

### Synonyms

Efficacy; effectiveness; Attributable Effect

### Definition

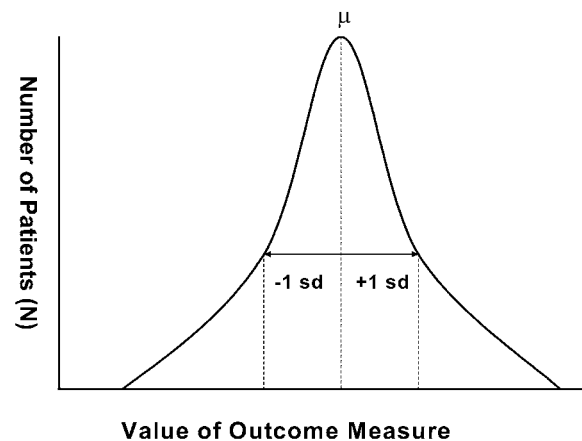
▶ **Effect size** is a measure of how effective a treatment is when applied to a group of patients. It can be used to measure by how much a group of patients improves after treatment, or by how much a particular treatment is better than another treatment to which it is compared.

### Characteristics

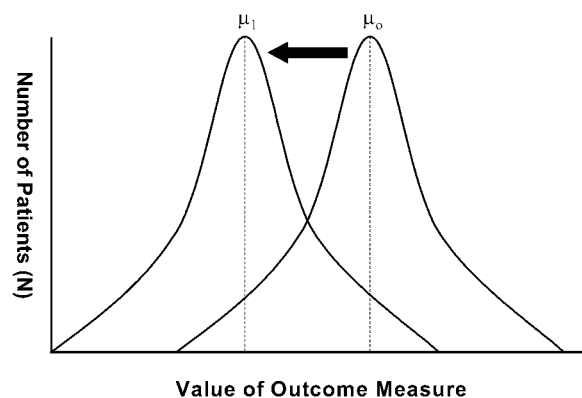
For any outcome variable, a group of patients will typically exhibit a normal distribution of values (Fig. 1). That distribution will have a mean value ( $\mu$ ) and a standard deviation (sd). About 68% of the patients will express a value between one standard deviation less than the mean value, and one standard deviation greater. The outcome measure may be pain scores or any other outcome of interest.

If that group of patients undergoes a treatment, their outcome variables will change, but will again assume a normal distribution (Fig. 2). The change in their scores will be reflected by the difference between the mean values before ( $\mu_0$ ) and after ( $\mu_1$ ) treatment.

Whether or not the change is a clinically meaningful one depends on the magnitude of the change with respect to the spread of values, before and after treatment. A given change in mean values may not be impressive if the patients exhibit a wide spread of values (Fig. 3a). Un-

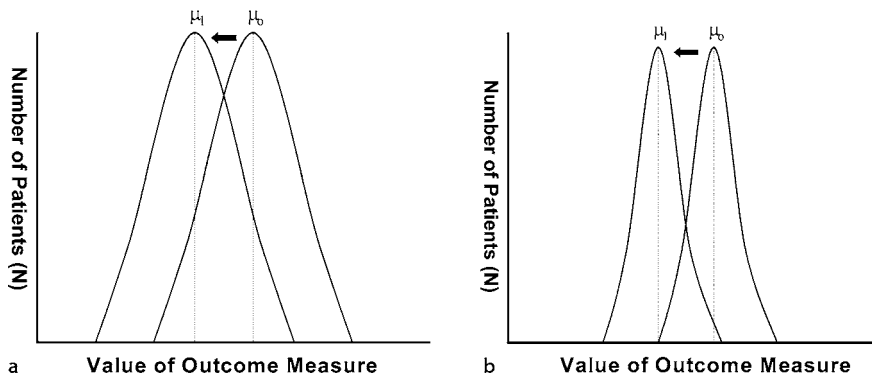


**Effect Size, Figure 1** In a sample of patients, the values of any outcome measure will assume a normal distribution. The mean value ( $\mu$ ) represents the average value. The spread of the values is reflected by the standard deviation (sd).



**Effect Size, Figure 2** Before treatment, a group of patients express values of an outcome measure are distributed in a normal fashion around a mean value ( $\mu_0$ ). After treatment, they express values distributed around a new mean value ( $\mu_1$ ).





**Effect Size, Figure 3** Graphic representations of the relative significance of a given change in mean values, before and after treatment, with respect to the spread of values exhibited by a group of patients. (a) The change in mean values is not greater than the spread of values in the group. Many patients after treatment have scores like those of many patients before treatment. (b) The same change in mean values is appreciably larger than the spread of values. The scores of most patients after treatment are outside the range of scores before treatment.

der those conditions, the change is not impressive, for it is encompassed by the extent to which patients normally differ in their values. After treatment, many patients still have scores that others had before treatment, which means that they have not improved categorically. The treatment does not render patients different from patients before treatment.

The same change, however, may be more impressive if it is appreciably greater than the normal spread of values (Fig. 3b). Under those conditions, most patients have scores after treatment, which are outside the range of scores before treatment. This attests to a definite categorical improvement. After treatment, most patients are distinctly better than patients before treatment.

The qualitative significance of a change can, therefore, be expressed as a ratio between the change in mean values and the distribution of values. Specifically, the **effect size** is the ratio between the difference in the mean value of a selected outcome measure, and the standard deviation of that value. Some authorities recommend that the distribution of values be expressed as the pooled standard deviation of the samples before and after treatment, but the simplest method is to use the standard deviation of the sample before treatment. Under that definition:

$$\text{Effect size} = \frac{\mu_1 - \mu_0}{sd}$$

This equation yields a single number that indicates how effective the intervention has been. That number can be translated into a verbal description that gauges the effect size (Table 1).

Effect sizes can be calculated to determine by how much a group of patients responds to a particular treatment. Separate effect sizes can be calculated for patients undergoing a particular treatment, and patients undergoing a comparison or control treatment. Those effect sizes can be compared, in order to determine the extent to which a treatment is better than control; or a relative effect size

**Effect Size, Table 1** Verbal translations of selected effect sizes

Effect Size	Descriptor
0.00	nil
0.20	small
0.50	medium
0.80	large

can be calculated by using the mean scores of the treatment group and the control group after treatment, and the standard deviation of the control group.

#### Utility

The attraction of effect size is that it provides, in a single number, a measure of how much a group of patients improves after treatment, or by how much a treatment achieves outcomes better than those of a control treatment. Different treatments can be compared according to the magnitude of their effect sizes.

A disadvantage of effect size is that it only describes the effect of treatment on a group of patients as a whole. It does not relate to individual patients. It does not indicate what chances a given patient has of benefiting, or by how much.

A further disadvantage stems from a statistical idiosyncrasy. Since the calculation of effect size requires mean values and standard deviations, the outcome variables must be normally distributed. If outcomes are not normally distributed, a mean value and, therefore, effect size, cannot be calculated.

- ▶ [Meta-Analysis](#)
- ▶ [Oswestry Disability Index](#)
- ▶ [Psychological Aspects of Pain in Women](#)
- ▶ [Psychology of Pain, Efficacy](#)

#### References

1. Cohen J (1977) *Statistical Power Analysis for the Behavioural Sciences*. Academic Press, New York, pp 20–23, 40

## Effective Analgesia

### Definition

Effective analgesia is the provision of adequate analgesia to enable the patient to perform „activities of daily living“.

- ▶ Postoperative Pain, Importance of Mobilisation

## Effectiveness

### Definition

The objective of any treatment is to relieve the problems that a patient suffers. For a patient with pain, the objective may be to relieve their pain, or it may be to relieve one or other of the other problems that they suffer, such as psychological distress or disabilities in everyday activities or work.

Effectiveness is a particular property of a treatment that indicates how well it achieves these objectives under average or typical conditions, e.g. when average practitioners perform the treatment on typical patients encountered in their practice. In this regard, effectiveness is distinguished from efficacy, which indicates how well the treatment works under ideal conditions.

Effectiveness is usually established by studies conducted after studies have determined the efficacy of a treatment. Efficacy studies pave the way for effectiveness studies by showing how well a treatment can work. Studies of effectiveness are undertaken to determine if the treatment works sufficiently well under average conditions to justify its wholesale application.

As a rule, the efficacy of a treatment will usually be greater than its effectiveness. In some instances, a treatment may well have efficacy, but it might lack effectiveness. Although it works under ideal conditions, the results of the treatment might be confounded by the other problems that patients in typical practice present; or average practitioners may not be as skilled in providing the treatment as experts are.

A treatment may not necessarily work for all domains of a patient's problems. It may work for one but not for others. The effectiveness of a treatment, therefore, should be qualified by the domain for which it works, e.g. efficacy for relief of pain, efficacy for depression, efficacy for return to work. Qualifying treatments in this manner avoids misinterpretation and misrepresentation, lest patients expect that because a treatment works for one symptom it will work for another.

The assessment of effectiveness is based on measuring the changes of outcome measures after treatment, and comparing them with changes after control treatments. Efficacy can be expressed statistically in terms of number needed to treat (NNT) or effect-size.

- ▶ Attributable Effect and Number Needed to Treat
- ▶ Effect Size
- ▶ Efficacy

## Effectiveness Measure

- ▶ Central Pain, Outcome Measures in Clinical Trials
- ▶ Effect Size

## Efficacy

### Definition

The objective of any treatment is to relieve the problems that a patient suffers. For a patient with pain, the objective may be to relieve their pain, or it may be to relieve one or other of the other problems that they suffer, such as psychological distress or disabilities in everyday activities or work.

Efficacy is a particular property of a treatment that indicates how well it achieves these objectives under optimal conditions, e.g. when experts perform the treatment on ideal patients, i.e. those with a clear-cut diagnosis of the problem to be treated, and no other problems that might interfere with the results of treatment. In this regard, efficacy is distinguished from ▶ **effectiveness**, which indicates how well the treatment works under less ideal conditions.

One purpose of determining the efficacy of a treatment is to set a benchmark, which indicates how well the treatment can work. Under less than ideal conditions, however, that benchmark might not be achieved. Therefore, although practitioners might aspire to achieve the same results as those encountered in efficacy studies, they should not necessarily expect to achieve those results. The patients that they treat may not be as ideal as those recruited to a study.

Another, more subtle purpose of an efficacy study is to identify treatments that do not work. If a treatment does not work in expert hands on ideal patients, it is highly unlikely to work under normal or average conditions. In essence, if a treatment has no efficacy, it is unlikely to have effectiveness.

A treatment may not necessarily work for all domains of a patient's problems. It may work for one but not for others. If a treatment has efficacy, it should be qualified by the domain for which it works, e.g. efficacy for relief of pain, efficacy for depression, efficacy for return to work. Qualifying treatments in this manner avoids misinterpretation and misrepresentation, lest patients expect that because a treatment works for one symptom it will work for another.

The assessment of efficacy is based on measuring the changes of outcome measures after treatment, and comparing them with changes after control treatments. Efficacy can be expressed statistically in terms of number needed to treat (NNT) or effect-size.

- ▶ Attributable Effect and Number Needed to Treat
- ▶ Effect Size
- ▶ Opioid Responsiveness in Cancer Pain Management

## Efficacy of Drugs

### Definition

It is possible to express the efficacy of a drug in terms of a fraction of the total receptor population (fractional receptor occupancy) that an agonist must occupy to yield a given effect. The number of receptors to be occupied is inversely proportional to the intrinsic activity. As the amount of the remaining un-occupied receptors depends on this property, the larger the receptor reserve, the greater the intrinsic efficacy. It has been suggested that the degree of tolerance is inversely related to the reserve of spare opioid receptors.

- ▶ Opioid Responsiveness in Cancer Pain Management

## Efficacy Study

### Definition

Efficacy studies determine the effects of specific treatments. In order to do this, studies are carried out where as many possible likely confounding factors are controlled by the careful selection of patients and standardized implementation of the treatment. Specific treatments are compared with highly controlled alternative treatments including those designed as a placebo, i.e. treatments in which the presumed active ingredients have been excluded. The randomized controlled trial is the de facto standard for efficacy studies. In contrast, effectiveness studies aim to determine whether the treatment may be generalized to the real world across a range of patient populations, therapists and delivery settings.

- ▶ Effect Size
- ▶ Psychology of Pain, Efficacy

## Effleurage

- ▶ Massage and Pain Relief Prospects

## Effort Headache

- ▶ Primary Exertional Headache

## Eicosanoids

### Definition

Eicosanoids refer to any product derived from arachidonic acid, an unsaturated fatty acid found in the plasma membrane of neurons. Eicosanoids are lipids that include prostaglandins, prostacyclins, thromboxanes, and leukotrienes. The eicosanoids can collectively mediate almost every aspect of the inflammatory response.

- ▶ Immunocytochemistry of Nociceptors
- ▶ Prostaglandins, Spinal Effects

E

## Electrical Stimulation Induced Analgesia

- ▶ Stimulation-Produced Analgesia
- ▶ TENS, Mechanisms of Action

## Electrical Stimulation Therapy

- ▶ Transcutaneous Electrical Nerve Stimulation (TENS) in Treatment of Muscle Pain

## Electrical Therapy

- ▶ Transcutaneous Electrical Nerve Stimulation

## Electro-Acupuncture (EA)

### Definition

Electrical stimulation through one or more pairs of acupuncture needles.

- ▶ Acupuncture Mechanisms

## Electroanalgesia

- ▶ Transcutaneous Electrical Nerve Stimulation Outcomes
- ▶ Transcutaneous Electrical Nerve Stimulation (TENS) in Treatment of Muscle Pain

## Electrodiagnosis and EMG

D. PAUL HARRIES  
Pain Treatment Center, Lexington, KY, USA  
pharries@yahoo.com

### Synonyms

Electromyography; nerve conduction studies

## Definition

Electrodiagnosis includes nerve conduction studies and electromyography (EMG). Nerve conduction studies are the measurement of electrical transmission within nerves as the result of an artificial, electrical or magnetic stimulus. EMG is the measurement of electrical activity within a muscle for diagnostic purposes. EMG is unfortunately incorrectly regarded by many as being synonymous with electrodiagnostic studies.

## Characteristics

### Nerve Conduction Studies

#### Physiology

When a peripheral nerve is stimulated electrically, action potentials will be evoked in all the axons within that nerve. By recording from the nerve, the combined response of those axons can be obtained. Generally, however, only the signals from the larger, faster, myelinated fibers are recorded. In clinical practice, impulses from slow fibers do not contribute significantly to the electrodiagnostic results.

Two types of nerve injury occur: axonal and demyelinating. These usually occur together to some degree, but one is usually predominant. The pattern of injury helps in diagnosis.

In demyelinating nerve injuries, the nerve remains intact, and continues to function; but the demyelination results in slowing of the conduction velocity. In a severe demyelinating nerve injury, conduction block appears. In conduction block, the impulses are slowed to such an extent that they cease to propagate, resulting in a drop in amplitude. A drop in amplitude of 50% is normally required to diagnose conduction block. It should be noted that conduction block is as a result of a focal lesion in the nerve membrane. Despite there being a drop in amplitude there is no axonal injury.

In axonal injury, the nerve is damaged, and the affected axons cease to function. The degree of nerve damage is proportional to the number of its axons that are affected. Those axons that still function will generally conduct at a normal velocity; but there will be fewer of them. So, the amplitude of activity recorded from the nerve will be reduced.

If a nerve is transected, the effects depend on the location of the injury with respect to the cell bodies of the nerve. If sensory nerves are transected distal to the dorsal root ganglion, axons distal to the site of injury will degenerate and exhibit no function and, therefore, no conduction. Proximal to the lesion, however, the axons will remain intact, and will conduct at normal velocity. If the lesion is in the dorsal root, the entire peripheral nerve remains connected to the dorsal root ganglion, and will exhibit normal function throughout. For motor nerves, the cell bodies lie in the spinal cord. When transected, the axons distal to the lesion will degenerate and cease to function, while their proximal ends will remain intact.

## Sensory

Sensory testing is performed by stimulating a nerve, and then recording a response in the nerve, either distal or proximal to the site of stimulation. A waveform known as the SNAP (Sensory Nerve Action Potential) is obtained. From the waveform the amplitude and peak latency are measured. The conduction velocity is defined as the distance between stimulator and recording electrode, divided by the time from stimulation to peak latency.

## Motor

Motor testing is performed by stimulating a nerve and recording from the muscles that it supplies. A Compound Muscle Action Potential (CMAP) is obtained. This waveform is very different to the SNAP, as it represents the response of a muscle, not a nerve. The impulse is effectively magnified at least 100 fold by the neuromuscular junction. The latency is measured to the onset of the impulse. Due to the transit time across the neuromuscular junction, velocity cannot simply be calculated from distance/time. Instead, two readings have to be taken, typically by stimulating the nerve at two locations at least 10 cm apart, and recording from the same location. The nerve conduction velocity is given by (distance between Proximal and Distal stimulation sites)/(time to onset latency from proximal stimulation–time to onset latency from distal stimulation)

## H-Reflex

When a muscle nerve is stimulated, impulses are propagated both distally and proximally from the site of stimulation. The orthodromic propagation occurs along motor axons, and elicits a response in the muscle, called the M wave. The antidromic propagation occurs in all muscle afferent fibers. These travel to the spinal cord where they synapse on anterior horn cells, which are activated. Their impulses then pass orthodromically into the nerve, and eventually reach the muscle, where they evoke a second response, called the H wave. This is the electrophysiological equivalent of the stretch reflex.

The H wave is best seen at low stimulation voltages prior to the production of the M wave. The reason for this is that amplification of the stimulus occurs at the spinal cord. H reflexes can only be consistently obtained from the gastrocnemius, upon stimulation of the tibial nerve; and to a lesser degree the flexor carpi radialis, upon stimulation of the median nerve.

## F-Wave

Upon stimulation of a muscle nerve, antidromic activity also occurs in the motor axons. When these impulses reach the anterior horn cell, some can be “reflected” in the axon. They eventually reach the muscle and evoke a third response, called the F wave. A relatively high stimulus is required to produce these waves. They can, however, be obtained from any nerve.



### Somatosensory Evoked Potentials (SSEP)

A peripheral nerve with sensory fibers is repeatedly stimulated. Small changes in voltage are detected as the impulse passes into the spinal cord and then onto the brain. SSEP is useful in determining where in the CNS a delay in conduction occurs. Traditionally, it has been used to help diagnose Multiple Sclerosis. Today it is often used during spinal surgery to warn a surgeon of compromise to neural structures.

### Current Perception Threshold (CPT)

In this test, a small electrical current is applied to an extremity. The patient indicates when they can first feel the current. CPT has been used in an attempt to pick up neuropathy, and also to determine which patients will be able to cooperate during sensory testing while performing Radiofrequency neurotomy. CPT has been used on an experimental basis in evaluating radiculopathy and in CRPS (Yamashita 2002).

### EMG

In order to study the activity of a muscle in detail, a fine needle is inserted into it, and the recorded waveforms are examined during three separate phases:

1. at rest;
2. with the patient still, but moving the needle to “provoke” the muscle;
3. during voluntary contraction of muscle.

The results are interpreted in the context of responses from other muscles in the same or different myotome, or peripheral nerve distribution.

The EMG provides information regarding the muscle itself, the neuromuscular junction and the motor axon. Classically, in axonal motor injury, fibrillations and positive sharp waves will be seen three weeks after injury, and will persist for many months. These both represent signs of muscle membrane instability. The muscle is easily provoked by the needle and responds by producing these waveforms. In chronic cases, fibrillations and positive sharp waves become less evident.

### Indications

The indications for nerve conduction studies and EMG in Pain Medicine are contentious. Pain is mediated by small diameter afferents, but these are not sampled by nerve conduction studies or EMG. Any relationship to pain is circumstantial or surrogate.

### Radiculopathy

The Taxonomy of Pain (Merskey and Bogduk 1994) defines a radiculopathy as: “objective loss of sensory and or motor function as a result of conduction block in axons of a spinal nerve or its roots”. This is synonymous with a demyelinating injury. The electromyographer defines radiculopathy as a lesion proximal to the dorsal root ganglion.

If the lesion is proximal to the dorsal root ganglion, the peripheral sensory nerve will have normal nerve conduction studies. If there is an axonal injury to the motor nerve, conduction studies may demonstrate reduced amplitude in motor nerves. If there is a pure demyelinating lesion of the motor root, then nerve conduction studies will be normal.

The H-reflex can in theory identify demyelinating sensory and motor root involvement. Unfortunately, the H-reflex is only of limited value in diagnosing S1 radiculopathy (American Academy of Electrodiagnostic Medicine 1998; Dumitru 1995).

EMG will detect a radiculopathy that has axonal motor involvement. EMG abnormalities, when present, are clearest 3–30 weeks after onset of the axonal injury. SSEP has been evaluated in radiculopathy and found not to be clinically useful (American Academy of Electrodiagnostic Medicine (1998).

It can be deduced from basic physiological principles that EMG and Nerve Conduction studies will not pick up pure sensory radiculopathies or pure demyelinating motor neuropathies. EMG can be invaluable in differentiating between radiculopathy and other causes of motor weakness. The AAEM mini monograph on radiculopathy claims that electrodiagnostic studies can pick up the vast majority of radiculopathies using EMG (American Academy of Electrodiagnostic Medicine (1998). Clearly this will not be the case in pure sensory radiculopathies.

The difficulty in determining validity of electrodiagnostic testing in radiculopathy stems from disagreement with regards to the definition of radiculopathy (Merskey and Bogduk 1994; American Academy of Electrodiagnostic Medicine 1998), and the absence of a criterion standard.

### Peripheral Neuropathy

EMG and nerve conduction studies, together with nerve biopsy, are the diagnostic tests of choice for peripheral neuropathies. Unfortunately, the information gained does not in any way help with the management of pain, except in very rare instances where the cause of the neuropathy can be effectively treated.

### Plexopathy

Differentiating radiculopathy from plexopathy can be done very elegantly using nerve conduction studies and EMG. Together with MRI it is the test of choice.

### Peripheral Nerve Injuries

In peripheral nerve injuries, nerve conduction studies and EMG can provide data that help determine prognosis, site of lesion, and need for surgical intervention.

### Complex Regional Pain Syndrome

Electrodiagnosis can help differentiate between type 1 and type 2 CRPS. CPT studies are asymmetric in CRPS, but do not correlate with pain (Yamashita 2002).

**Utility**

Electrodiagnostic studies are explicitly designed to study loss of function in sensory and motor nerves. However, they have no direct application for the investigation of pain. They might be used to obtain details in patients with a painful peripheral neuropathy or plexopathy, but such cases would be uncommon.

Although commonly used to investigate patients with spinal and ► **radicular pain**, nerve conduction studies and EMG have no proven utility in such patients (Bogduk and Govind 1999; Bogduk 1999). They may confirm certain features of radiculopathy, but radiculopathy and ► **radicular pain** are not synonymous.

**References**

1. American Academy of Electrodiagnostic Medicine (1998). AAEM Minimonomograph 32: The Electrodiagnostic Examination in Patients with Radiculopathies. *Muscle Nerve* 21:1612–1631
2. Bogduk N (1999) Medical Management of Acute Cervical Radicular Pain: An Evidence-Based Approach. Newcastle Bone and Joint Institute, Newcastle, pp 67–69
3. Bogduk N, Govind J (1999) Medical Management of Acute Lumbar Radicular Pain: An Evidence-Based Approach. Newcastle Bone and Joint Institute, Newcastle, pp 53–58
4. Dumitru D (1995) Electrodiagnostic Medicine. Hanley and Belfus, Philadelphia
5. Merskey H, Bogduk N (1994) Classification of Chronic Pain, 2<sup>nd</sup> edn. IASP Press, Seattle, p 16
6. Yamashita T (2002) A Quantitative Analysis of Sensory Function in Lumbar Radiculopathy using Current Perception Threshold Testing. *Spine* 27:1567–70

**Electrodiagnostic Testing (Studies)****Synonyms**

EDT

**Definition**

Electrodiagnostic studies are those that involve the use of electrical stimulation.

Traditional evaluation of the peripheral nervous system uses electrical stimuli to measure nerve conduction velocity (NCV) and muscle function (electromyography, EMG). This testing can be painful, but is objective, requiring no cognitive input from the person being tested for a response to the stimuli.

- **Carpal Tunnel Syndrome**
- **Causalgia, Assessment**

**Electroencephalogram/  
Electroencephalography****Synonym**

EEG

**Definition**

Synchronized extracellular currents in a few square centimeters of cortex generate electrical potentials measurable with electrodes on the scalp. The signal is low-pass filtered to 50 Hz.

- **Insular Cortex, Neurophysiology and Functional Imaging of Nociceptive Processing**
- **Thalamotomy for Human Pain Relief**

**Electrolytic Lesion****Definition**

Electrolytic lesion is a procedure that can produce death of neurons and nerve fibers in a nervous center by passing an electrical current through an electrode. The extent of the lesion depends on the intensity and duration of the injected current.

- **Lateral Thalamic Lesions, Pain Behavior in Animals**
- **Post-Stroke Pain Model, Thalamic Pain (Lesion)**
- **Thalamotomy**

**Electromyography****Definition**

This is a method of studying the electrical activity of a muscle by recording action potentials from the contracting muscle fibers, and is used to assess the level of muscular arousal. In newborn infants, the usual way of doing this is through surface electrodes applied to the overlying skin. However, in adults, for diagnostic purposes, it is useful to employ concentric needle electrodes that are inserted through the skin and into the muscle fibers themselves. The analogue signal from the electrical activity is either recorded on an oscilloscope, or more usually digitized and displayed via computer, where more complex waveform analysis can be conducted.

- **Electrodiagnosis and EMG**
- **Infant Pain Mechanisms**
- **Psychophysiological Assessment of Pain**

**Electron Microscopy****Definition**

Electron Microscope is a high-resolution imaging technique using electron beams.

- **Toxic Neuropathies**

## Electrophysiological Mapping

### Definition

Electrophysiological mapping is the recording of electrical responses in the brain in response to a stimulus that is applied to the body.

- ▶ [Thalamic Nuclei Involved in Pain, Cat and Rat](#)

## Electrophysiology

### Definition

Electrophysiology is the science and branch of physiology that pertains to the flow of ions in biological tissues and, in particular, to the electrical recording techniques that enable the measurement of this flow. It is useful for studying response properties of neurons.

- ▶ [Amygdala, Pain Processing and Behavior in Animals](#)
- ▶ [Cancer Pain Model, Bone Cancer Pain Model](#)

## Electrotherapy

### Definition

Electrotherapies are techniques, including TENS, CFS and acupuncture, used to stimulate nerve fibers or receptors to achieve analgesia or itch relief.

- ▶ [Cutaneous Field Stimulation](#)
- ▶ [Modalities](#)

## Eligibility

- ▶ [Disability Evaluation in the Social Security Administration](#)

## Elimination

### Definition

The elimination of a drug characterizes its irreversible loss from the body due to excretion or metabolism into another chemical molecule.

- ▶ [NSAIDs, Pharmacokinetics](#)

## Elimination Half-Life ( $t_{1/2}$ )

### Definition

The elimination half-life ( $t_{1/2}$ ) of a drug describes the time needed to reduce the drug concentration in blood, plasma or serum to one-half. The elimination half-life may be influenced by a variation in urinary excretion (pH), intersubject variation (e.g. polymorphic enzymes), age, drug-drug interactions and diseases (especially renal and liver diseases). Elimination means the annihilation of the administered drug, not its metabolites, from the body by biliary, urinary or other pathways of excretion (e.g. lung, skin, etc.) or rather biotransformation through metabolism.

- ▶ [NSAIDs, Pharmacokinetics](#)
- ▶ [Opioid Rotation](#)

E

## Elmiron®

### Definition

Pentosan Polysulfate Sodium; a commonly prescribed medication for IC. Structure similar to glycosaminoglycan layer of bladder mucosa.

- ▶ [Interstitial Cystitis and Chronic Pelvic Pain](#)

## Embolism

- ▶ [Postoperative Pain, Venous Thromboembolism](#)

## Emergence

### Definition

Emergence is the process by which a system of interacting elements spontaneously acquires a qualitatively new pattern and structure that is unpredictable from knowledge of the individual elements.

- ▶ [Consciousness and Pain](#)

## EMG-Assisted Relaxation

### Definition

EMG-assisted relaxation is a form of biofeedback that employs information about muscle tension levels in order to facilitate overall relaxation.

- ▶ [Biofeedback in the Treatment of Pain](#)

## Emotional Factors/Reactions

### Definition

Strong and roughly appropriate reaction to a significant event, tagged by an affective label, in the environment of the species. Emotional components arise from motivational and autonomic changes with a modulation by individual experience and a subjective perception. In the case of pain: defensive/aversive behavior with a myriad of autonomic changes and the avoidance learning (fear) of the noxious event.

- ▶ Hypothalamus and Nociceptive Pathways
- ▶ Multidimensional Scaling and Cluster Analysis Application for Assessment of Pain
- ▶ Pain in the Workplace, Risk Factors of Chronicity, Psychosocial Factors
- ▶ Parabrachial Hypothalamic and Amygdaloid Projections

## Empathic

### Definition

Making an effort to understand what the patient is thinking, feeling, and wanting. Being empathic often includes reflecting one's understanding of the patient back to the patient in the form of reflective listening.

- ▶ Chronic Pain, Patient-Therapist Interaction

## Employment Assessment

- ▶ Vocational Assessment in Chronic Pain

## ENaC/DEG

### Definition

ENaC/DEG is a family of ion channel proteins, several gated by low pH, for example the ASIC channel.

- ▶ Species Differences in Skin Nociception

## Enamel

### Definition

Enamel is the hardest biological tissue known and forms the crown of the tooth. It overlies the softer and more flexible dentin.

- ▶ Dental Pain, Etiology, Pathogenesis and Management

## Enantiomer of Tramadol

### Definition

Enantiomer of Tramadol refers to one of the two stereoisomers that comprise tramadol, a racemate.

- ▶ Drugs with Mixed Action and Combinations, Emphasis on Tramadol

## Encephalopathy

### Definition

Encephalopathy is a frequent symptom in cerebral vasculitis; manifestation of systemic vasculitides and the isolated angiitis of the central nervous system.

- ▶ Headache Due to Arteritis

## Encoding of Noxious Information in the Spinal Cord

ROBERT C. COGHILL

Department of Neurobiology and Anatomy, Wake Forest University School of Medicine, Winston-Salem, NC, USA

rcoghill@wfubmc.edu

### Synonyms

Nociceptive processing; Spinal Cord Nociception, Encoding of Noxious Stimuli

### Definition

The encoding of noxious information by the spinal cord is the process by which information from ▶ **Primary Afferents/Neurons** is assimilated, integrated, and prepared for transmission to central nervous system regions important in nociception and nociceptive reflex modulation. Information from ▶ **descending modulation** systems of the brain can strongly shape afferent information processing at the spinal level and contributes substantially to spinal nociceptive processing.

### Characteristics

The subjective sensory experience of pain is multidimensional and encompasses a conscious appreciation of the intensity, location, quality and temporal aspects of a stimulus that damages (or holds the potential to damage) the integrity of the body. Given that the experience of pain evoked by a noxious stimulus is largely built upon sensory information ascending from the spinal cord to the brain, information about the subjectively available sensory features of a noxious stimulus must necessarily be encoded and transmitted by neurons within the spinal cord.



The processing of nociceptive information within the spinal cord grey matter is accomplished by neurons with two broad classes of response properties, ► **wide dynamic range neurons** (WDR) and ► **nociceptive specific neurons** (NS). WDR neurons were the first class of nociceptive neurons to be identified (Wall and Cronly-Dillon 1960) and were named on the basis of their responsiveness to a wide range (i.e. noxious and innocuous) of stimulus intensities (Mendell 1966). NS neurons were identified several years later in 1970 (Christensen and Perl 1970). As their name implies, NS neurons respond exclusively to noxious stimulus intensities. Both classes of neurons are interspersed through laminae I, II, IV, V, VI, VII, and X of the spinal cord grey matter. However, NS neurons tend to predominate in the marginal layers of the dorsal horn, while WDR neurons predominate in the deeper lamina. Both classes of neurons project supraspinally to brain regions involved in pain and/or pain modulation. Since their discovery, debate has raged over the functional significance of both NS and WDR neurons.

Much of the current understanding of spinal nociceptive processing is significantly limited by the failure to explore and appreciate how populations of spinal neurons work together to encode pain. In particular, the contribution of WDR neurons to the encoding of noxious stimuli cannot be understood if the responses of single WDR neurons are considered in isolation. Single WDR neurons respond with equal vigor to both noxious and innocuous stimuli and are, therefore, incapable of encoding a distinction between a noxious and innocuous stimulus. However, these cells have complex ► **receptive field** properties that result in population responses being markedly different from the responses of single neurons within that population. WDR neurons have a small, central receptive field zone in which both noxious and innocuous stimuli evoke increases in discharge frequencies (see ► **discharge frequency**). This central receptive field zone is surrounded by a larger peripheral zone in which only noxious stimuli are sufficient to elicit increases in discharge frequency. Both receptive field zones have gradients of sensitivity, such that progressively greater discharge frequencies are evoked as the noxious stimulus is applied progressively closer to the central receptive field zone. If the stimulated region of the body surface is sufficiently large to encompass multiple, overlapping peripheral receptive field zones of WDR neurons, then a noxious stimulus would recruit far more WDR neurons than an innocuous stimulus of equal size. Thus, the total output of the WDR population would be far greater for the noxious stimulus. Functional imaging studies of the spinal cord have confirmed that noxious stimuli produce far greater rostro-caudal recruitment of neuronal activity than innocuous stimuli (Coghill et al. 1993a) and strongly suggest that the output of populations of WDR neurons is sufficient to support a subjective distinction

between noxious and innocuous stimuli. Importantly, both NS and WDR neurons are activated by noxious stimuli under most conditions and both probably work together to encode distinctions between noxious and innocuous stimuli.

To date, the neural mechanisms which encode the intensity of a noxious stimulus represent the best understood dimension of spinal nociceptive processing. Both NS and WDR neurons exhibit monotonic increases in discharge frequencies as the intensity of noxious stimulation increases, so both classes of neurons are capable of contributing to the subjective experience of pain intensity. However, WDR neurons are more sensitive to smaller changes in stimulus intensity in that they have steeper stimulus-response curves than NS neurons (Price et al. 1978). Furthermore, the stimulus-response functions obtained from WDR neurons closely parallel those obtained from human psychophysical studies (Price et al. 1978). Finally, WDR neurons encode sufficiently small distinctions in ► **noxious stimulus intensity** to support behavioral discriminative capacity (Maixner et al. 1986). Population recruitment also appears to be a critical dimension in the encoding of stimulus intensity. Progressive increases in noxious stimulus intensity recruit a progressively greater rostro-caudal distribution of neuronal activity (Coghill et al. 1991).

Mechanisms supporting the encoding of stimulus location by spinal cord neurons remain poorly understood (see ► **noxious stimulus location**). There is, however, a clear somatotopic organization, with caudal body regions being represented in the caudal spinal cord and rostral body regions being represented in the rostral spinal cord. There is also a medio-lateral organization, where distal structures are represented in the medial aspect of the dorsal horn and proximal structures are represented in the lateral aspect of the dorsal horn. Clearly, a significant degree of spatial processing and modulation occurs at the spinal level. In spinal cord transected animals, spinally mediated reflex withdrawal responses are appropriate for the body site stimulated. Furthermore, these responses can be modulated in a complex and elegant fashion when multiple body sites are stimulated simultaneously (Le Bars et al. 1979; Morgan 1999). Such interactions probably serve to generate the most appropriate withdrawal response to complex, multi-focal painful stimuli and underscore the fact that the spinal cord is equipped to both process and utilize spatial information. It remains unknown if this spinally processed spatial information can become subjectively available. Both NS and WDR neurons may participate in the encoding of spatial information. NS neurons appear to be ideally suited for the encoding of stimulus location based on their relatively small and well-localized receptive fields. The complex receptive fields of WDR neurons could also yield population responses with a high degree of spatial information, but

no existing data have confirmed such population-based encoding of stimulus location. However, population-based mechanisms may be significantly involved in the perceptual radiation of pain. Since recruitment of spatially remote neuronal populations occurs during intense noxious stimulation, such recruitment may contribute substantially to the experienced spatial distribution of a painful stimulus (Price et al. 1978; Coghill et al. 1991).

The encoding of ► **stimulus quality** (i.e. the subjective experience of burning, stinging, crushing, pinching etc.) has been minimally explored. A subclass of NS neuron, however, receives selective input from A- $\delta$  afferents that respond solely to noxious mechanical information. Such neurons would be well positioned to encode a distinction between noxious mechanical and noxious thermal information. WDR neurons receive input from a number of different classes of primary afferents and appear unlikely to make a clear contribution to the encoding of stimulus quality.

The experience of pain has multiple temporal aspects derived from interactions between differing populations of primary afferents and spinal cord neurons. In particular, when a noxious stimulus is applied to the distal portion of an extremity, the distinction between information carried by rapidly conducting (A $\delta$ ) nociceptors and slowly conducting (C) nociceptors becomes sufficiently amplified to become subjectively available. The sharp, well-localized pain sensation that is first perceived (► **first pain**) is thought to arise largely from information transmitted by A $\delta$  nociceptors, while the later, more diffuse burning sensation (► **second pain**) is thought to reflect information arising from C nociceptors. Both NS and WDR neurons have convergent input from A $\delta$  and C fibers and exhibit responses that would be consistent with their ability to support first and second pain. In the case of prolonged, repetitive noxious stimulation, C afferents undergo progressive decreases in their discharge frequencies. However, if inter-stimulus intervals are sufficiently brief, the discharge frequencies of spinal nociceptive neurons actually increase and perceived pain increases over time. This progressive ► **temporal summation** has been termed “► **wind-up**” (Mendell and Wall 1965). Neurons in both the deep and superficial laminae exhibit such temporal summation and could be sufficient to subserve temporal summation of pain and to overcome progressive diminution of C afferent input. In the case of maintained pain, NS and WDR neurons exhibit differing responses over the course of prolonged nociceptive stimuli. NS neurons exhibit prolonged responses to mechanical stimuli but exhibit significant adaptation to prolonged thermal stimuli. In contrast, WDR neurons exhibit prolonged responses to both heat and capsaicin pain. As such, either class of neuron appears sufficient to encode the duration of prolonged nociceptive stimuli of the appropriate modality (Coghill et al. 1993b).

The processing and encoding of nociceptive information by spinal cord neurons is both complex and elaborate. Clearly multiple spinal cord regions interact during the processing of noxious information. Neurons in the superficial dorsal horn can modulate the responses of neurons in deeper laminae (Suzuki et al. 2002). Spatially remote stimuli can modulate responses of ongoing stimuli (Le Bars et al. 1979; Morgan 1999). Significant gaps in our understanding of these processes represent substantial obstacles to the better understanding and treatment of pain. Although much work has been done at the level of the single neuron, much more work is needed to understand how populations of nociceptive neurons encode the magnitude, spatial and temporal features of noxious stimuli.

## References

1. Christensen BN, Perl ER (1970) Spinal neurons specifically excited by noxious or thermal stimuli: marginal zone of the dorsal horn. *J Neurophysiol* 33:292–307
2. Coghill RC, Price DD, Hayes RL et al. (1991) Spatial distribution of nociceptive processing in the rat spinal cord. *J Neurophysiol* 65:133–140
3. Coghill RC, Mayer DJ, Price DD (1993a) The roles of spatial recruitment and discharge frequency in spinal cord coding of pain: a combined electrophysiological and imaging investigation. *Pain* 53:295–309
4. Coghill RC, Mayer DJ, Price DD (1993b) Wide dynamic range but not nociceptive specific neurons encode multidimensional features of prolonged repetitive heat pain. *J Neurophysiol* 69:703–716
5. Le Bars D, Dickenson AH, Besson JM (1979) Diffuse noxious inhibitory controls (DNIC). I. Effects on dorsal horn convergent neurones in the rat. *Pain* 6:283–304
6. Maixner W, Dubner R, Bushnell MC et al. (1986) Wide-dynamic-range dorsal horn neurons participate in the encoding process by which monkeys perceive the intensity of noxious heat stimuli. *Brain Res* 374:385–388
7. Mendell LM (1966) Physiological properties of unmyelinated fiber projection to the spinal cord. *Exp Neurol* 16:316–332
8. Mendell LM, Wall PD (1965) Response of single dorsal cord cells to peripheral cutaneous unmyelinated fibres. *Nature* 206:97–99
9. Morgan MM (1999) Paradoxical inhibition of nociceptive neurons in the dorsal horn of the rat spinal cord during a nociceptive hindlimb reflex. *Neuroscience* 88:489–498
10. Price DD, Hayes RL, Ruda M et al. (1978) Spatial and temporal transformations of input to spinothalamic tract neurons and their relation to somatic sensations. *J Neurophysiol* 41:933–947
11. Suzuki R, Morcuende S, Webber M et al. (2002) Superficial NK<sup>1</sup>-expressing neurons control spinal excitability through activation of descending pathways. *Nat Neurosci* 5:1319–1326
12. Wall PD, Cronly-Dillon JR (1960) Pain, itch, and vibration. *Arch Neurol* 2:365–375

## Encoding of Noxious Stimuli

MARTIN SCHMELZ

Institute of Anaesthesiology, Operative Intensive Medicine and Pain Research, Faculty for Clinical Medicine Mannheim, University of Heidelberg, Mannheim, Germany  
martin.schmelz@anaes.ma.uni-heidelberg.de

## Definition

External and internal signals interacting with the body are transformed by sensory nerve terminals into electrical signals, such that the frequency of action potentials in their axons encodes the intensity, duration and rate of change of the stimulus. Classically, the spike initiation site, separating receptive nerve terminal and conductive axon, is the crucial point at which a stimulus interacting with a sensory nerve terminal is encoded to trains of action potentials, which are then propagated centrally.

## Characteristics

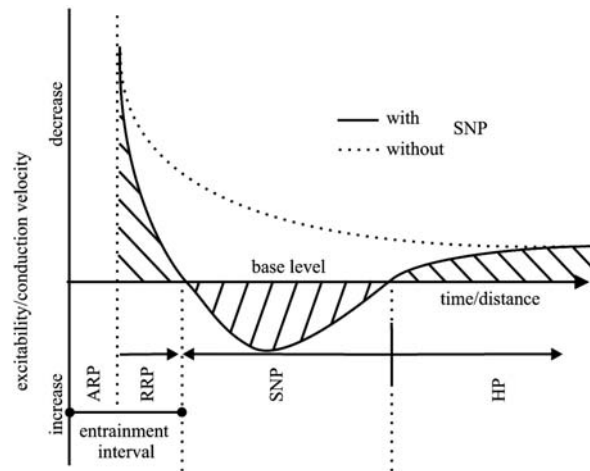
Electrophysiological investigation of nociceptive nerve endings is hampered by their small size. Results from extracellular recordings in nociceptive terminals in the guinea pig cornea, suggest that the generator potential and action potentials can be measured by superficially placed patch clamp pipettes (Brock et al. 1998; Carr et al. 2002; Carr et al. 2003). Spike generation in these terminals was not sensitive to tetrodotoxin (Brock et al. 1998), but blocked by lidocaine (Brock et al. 2001), implying the importance of **TTX** resistant sodium channels and a difference between nociceptors and cold receptors (Brock et al. 2001).

## Post-Excitatory Modulation of Excitability

The axon has mainly been regarded as passively propagating action potentials; however, along the axonal path action potential frequency can be extensively modulated. During the time period immediately following an action potential (AP), successive periods of post-excitatory conduction and excitability modulation are known (Weidner et al. 2000b). The absolute refractory period is directly followed by the relative refractory period, during which action potentials are conducted more slowly (Fig. 1). After the relative refractory period, a supernormal period (SNP) with increased conduction velocity and excitability may follow in some nerve fibers. Following the short lasting SNP, a long lasting period of conduction velocity slowing and reduced excitability is regularly observed (hypoexcitable period). Activation of the sodium potassium pump and calcium activated potassium channels probably underlies this long lasting hyperpolarization. In humans (Bostock et al. 2003; Serra et al. 1999; Weidner et al. 1999), and in animals (Gee et al. 1996; Raymond et al. 1990; Thalhhammer et al. 1994), this lasting hyperpolarization has been shown to correlate with the receptive properties of the nerve fibers.

## Axonal Modulation of Discharge Frequency

The activity induced conduction velocity slowing typically leads to a reduction of the conduction velocity of a subsequent action potential, i.e. the interval between two successive action potentials increases along the axonal propagation, and consequently the impulse frequency decreases with axonal length (Fig. 2). However, should



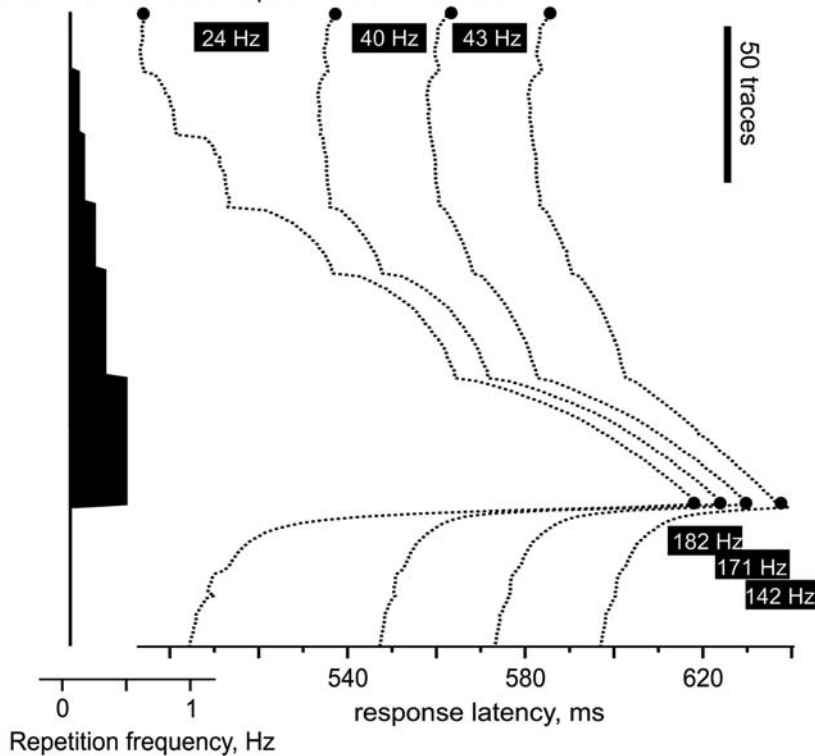
**Encoding of Noxious Stimuli, Figure 1** Post excitatory membrane potential changes following the action potential. ARP, absolute refractory period, during which no second AP can be induced (frog A-fiber 1,5–2 ms). RRP, relative refractory period that lasts from the end of APR to the intersection of threshold with the control level (frog A-fiber 1–2,5 ms, ARP+RRP human C-fiber > 5–10 ms). SNP, facultative super-normal period that extends from the end of RRP to the second intersection with the control level (frog A-fiber ~500 ms, human A $\beta$ -fiber 15–20 ms, human A $\alpha$ -fiber 4 s, human C-fiber ~500 ms). HP, the hypoexcitable period that lasts from the end of SNP to normalization of threshold (frog A-fiber and human C-fiber minutes) (modified from Weidner et al. 2000b).

the subsequent action potential fall into the supernormal period, it will be conducted faster than the preceding one, and i.e. the instantaneous frequency will increase with axonal length. The supernormal period in human C fibers increases with the magnitude of the activity dependent hyperpolarization. Therefore, the more action potentials an axon had conducted before, the more pronounced the activity dependent hyperpolarization and the supernormal period will be. Thus, instantaneous frequencies will gradually increase along the axon, eventually exceeding the original stimulation frequency in the peripheral innervation territory. Remarkably, with a high degree of hyperpolarization, the instantaneous frequencies can reach the maximum frequency of C axon (“entrainment frequency”), which is about 200 Hz. Thereby, a peripheral stimulation at a frequency of 50 Hz can provoke spike trains that will increase in instantaneous frequency along the axon, and may reach the spinal cord at a frequency that is 3–4  $\times$  higher than the original frequency generated in the periphery (Weidner et al. 2002). The most interesting part of this axonal modulation of the discharge frequency is given by the fact that modulation of instantaneous frequency is determined by the degree of hyperpolarization of the axon, which depends on the history of the stimulated fiber: the more active a unit has been in the time preceding a stimulus, the more prone it will be to accelerate the subsequent axon potentials. The discharge frequency reaching the spinal cord can, under these conditions, be increased by a factor of 3–4. This mechanism might, therefore,

Trains (50Hz) of electrical stimulation inside the receptive field

○ 50 Hz ○ 50 Hz ○ 50 Hz ○

Recorded trains of actions potentials at knee level:



**Encoding of Noxious Stimuli, Figure 2** Changes in instantaneous frequency with repetitive impulse firing. Repetitive trains of 4 pulses were applied to the innervation territory in the foot at 50 Hz, and responses of a C nociceptor were recorded by microneurography in the peroneal nerve at knee level. Responses of the nociceptor are depicted in one trace and subsequent stimulations are shown from top to bottom. Interspike intervals of the first response were longer as compared to the interstimulus interval, leading to instantaneous frequencies of 24–40 Hz (white letters in black box). When the repetition frequency of the trains was increased stepwise (left panel), instantaneous frequencies of the evoked response gradually increased, although the interstimulus interval was kept constant at 20 ms (50 Hz). With increasing repetition, frequency activity dependent hyperpolarization becomes more intense and supernormal conduction becomes more pronounced. Thus, gradually higher instantaneous frequencies of the evoked responses are observed far above the stimulation frequency in the periphery of 50 Hz. Maximum frequencies (entrainment) of more than 180 Hz were recorded in this example (modified from Weidner et al. 2000b).

compensate in part for fatigue or adaptation of the peripheral endings when confronted to sustained or repetitive stimulation. Moreover, it might contribute to windup phenomena seen with repetitive electrical stimulation, which is usually attributed to postsynaptic processing in the spinal cord.

The acceleration of a subsequent action potential is restricted to the supernormal period after an action potential, which lasts from about 15–300 ms in human C-fibers. While instantaneous frequencies can be increased in this time, actions potential arising later will be slowed down. Thus, this modulation will also act as some kind of contrast enhancement mechanism.

#### Modulation of Action Potential Shape

Repetitive discharge is known to prolong the duration of action potentials. As action potentials of longer duration provoke higher calcium influx, the synaptic strength will be increased (Geiger and Jonas 2000). The modula-

tory effects of axonal propagation including propagation failures, axo-axonal coupling and reflected propagation are extensively discussed in a recent review (Debanne 2004).

#### Unidirectional Block

Excitation of one peripheral ending in the axonal tree will generate action potentials that are conducted centrally, but that will also propagate antidromically at the branching points. Assuming that at each branching point the incoming action potential would be conducted in both directions, the entire axonal tree would be depolarized (see ► [axon reflex](#), ► [neurogenic inflammation](#)). Should two or more endings be active simultaneously, only the action potential that reaches the common branching point first is expected to reach the central nervous system, whereas the latter will collide with the retrogradely invading action potential. For a given stimulus that maximally activates sensory terminals



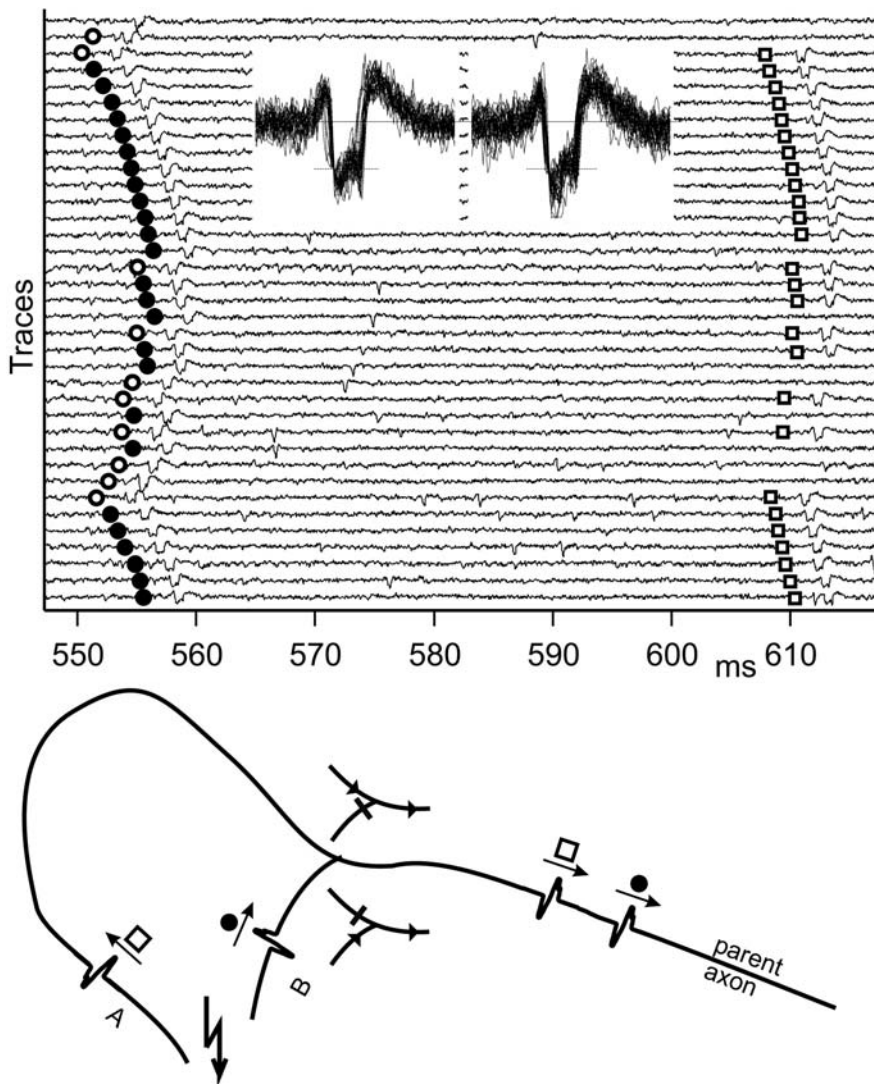
of a single nociceptor simultaneously, this mechanism would limit the maximum discharge frequency of the parent axon to the one of the fastest small branch. On the one hand, this provides a large safety margin, as only a minority of sensory endings is needed to produce the maximum discharge in the parent axon, but maximum discharge frequency in the parent axon would be limited by the maximum frequencies tolerated by the small branches. It is well known that the safety factor for propagation at branching points is low, especially when a thin axon enters an axon of larger diameter (Segev and Schneidman 1999).

Thus, it is not surprising that axonal propagation can be blocked at the branching points. If the action potential only propagates centrally, but does not invade the daughter branch antidromically (unidirectional block), action potentials generated in the non-invaded branches will not collide and can also reach the central nervous system (Fig. 3). It is interesting to note, that the unidirectional

block in the periphery will enhance discharge frequency in the parent axon, whereas unidirectional blocks of its central endings in the spinal cord will reduce the sensory input (Weidner et al. 2000a).

**References**

1. Bostock H, Campero M, Serra J et al. (2003) Velocity Recovery Cycles of C Fibres Innervating Human Skin. *J Physiol* 553:649–663
2. Brock JA, Mclachlan EM, Belmonte C (1998) Tetrodotoxin-Resistant Impulses in Single Nociceptor Nerve Terminals in Guinea-Pig Cornea. *J Physiol* 512:211–217
3. Brock JA, Pianova S, Belmonte C (2001) Differences between Nerve Terminal Impulses of Polymodal Nociceptors and Cold Sensory Receptors of the Guinea-Pig Cornea. *J Physiol* 533:493–501
4. Carr RW, Pianova S, Brock JA (2002) The Effects of Polarizing Current on Nerve Terminal Impulses Recorded from Polymodal and Cold Receptors in the Guinea-Pig Cornea. *J Gen Physiol* 120:395–405
5. Carr RW, Pianova S, Fernandez J et al. (2003) Effects of Heating and Cooling on Nerve Terminal Impulses Recorded from Cold-



**Encoding of Noxious Stimuli, Figure 3** Unidirectional block of a human CMIHi unit. (a) Responses of a human C-fiber to electrical stimulation in the receptive field in the dorsum of the foot are shown in successive traces from top to bottom. The fiber was recorded by microneurography at knee level. Although only one electrical stimulus was applied in each trace, in most of the traces the unit conducts two action potentials. Following each double response, conduction velocity slowing can be observed in both branches. In contrast, recovery follows the end of the double activation period. A single double pulse (open dot) intermittently leads to latency increase of the following single pulse immediately. In the inset, the action potentials of all first (left) and all second (right) responses during the unidirectional block depicted are superposed to show their identical AP shape. (b) The scheme of a branched axon is shown to illustrate the mechanism of the unidirectional block (modified from Weidner et al. 2003).

- Sensitive Receptors in the Guinea-Pig Cornea. *J Gen Physiol* 121:427–439
6. Debanne D (2004) Information Processing in the Axon. *Nat Rev Neurosci* 5:304–316
  7. Gee MD, Lynn B, Cotsell B (1996) Activity-Dependent Slowing of Conduction Velocity Provides a Method for Identifying Different Functional Classes of C-Fibre in the Rat Saphenous Nerve. *Neurosci* 73:667–675
  8. Geiger JRP, Jonas P (2000) Dynamic Control of Presynaptic  $Ca^{2+}$ -Inflow by Fast-Inactivating  $K^+$  Channels in Hippocampal Mossy Fiber Boutons. *Neuron* 28:927–939
  9. Raymond SA, Thalhammer JG, Popitz BF et al. (1990) Changes in Axonal Impulse Conduction Correlate with Sensory Modality in Primary Afferent Fibers in the Rat. *Brain Res* 526:318–321
  10. Segev I, Schneidman E (1999) Axons as Computing Devices: Basic Insights Gained from Models. *J Physiol Paris* 93:263–270
  11. Serra J, Campero M, Ochoa J et al. (1999) Activity-Dependent Slowing of Conduction Differentiates Functional Subtypes of C Fibres Innervating Human Skin. *J Physiol* 515:799–811
  12. Thalhammer JG, Raymond SA, Popitz Bergez FA et al. (1994) Modality-Dependent Modulation of Conduction by Impulse Activity in Functionally Characterized Single Cutaneous Afferents in the Rat. *Somatosens Mot Res* 11:243–257
  13. Weidner C, Schmelz M, Schmidt R et al. (2002) Neural Signal Processing: The Underestimated Contribution of Peripheral Human C-Fibers. *J Neurosci* 22:6704–6712
  14. Weidner C, Schmelz M, Schmidt R et al. (2000a) Unidirectional Conduction Block at Branching Points of Human Nociceptive C-Afferents: A Peripheral Mechanism for Pain Amplification. In: Devor M, Rowbotham M, Wiesenfeld-Hallin Z (eds) *Progress in Pain Research and Management*. IASP Press, Seattle, pp 233–240
  15. Weidner C, Schmelz M, Schmidt R et al. (1999) Functional Attributes Discriminating Mechano-Insensitive and Mechano-Responsive C Nociceptors in Human Skin. *J Neurosci* 19:10184–10190
  16. Weidner C, Schmidt R, Schmelz M et al. (2000b) Time Course of Post-Excitatory Effects Separates Afferent Human C Fibre Classes. *J Physiol* 527:185–191
  17. Weidner C, Schmidt R, Schmelz M et al. (2003) Action Potential Conduction in the Terminal Arborisation of Nociceptive C-Fibre Afferents. *J Physiol* 547:931–940

---

## End of Life Care

- ▶ [Cancer Pain, Palliative Care in Children](#)

---

## Endocannabinoids

### Definition

Endocannabinoids are the endogenous ligands for the known cannabinoid receptors, of which five have been detected so far: anandamide (CB1 receptor, located predominantly in the brain and spinal cord); homo- $\alpha$ -linolenylethanolamide; docosahexaenoylethanolamide; 2-arachidonoylglycerol and noladin ether. Both exogenous and endogenous cannabinoids have been demonstrated to have analgesic actions in models of inflammatory pain. They participate in the regulation of diverse body functions such as vasodilation, neuronal activity and immune functions.

- ▶ [Acute Pain Mechanisms](#)
- ▶ [Inflammation, Modulation by Peripheral Cannabinoid Receptors](#)
- ▶ [NSAIDs, Adverse Effects](#)

---

## Endogenous

### Definition

Endogenous means to originate internally.

- ▶ [Endogenous Analgesia System](#)
- ▶ [Stimulation-Produced Analgesia](#)

---

## Endogenous Analgesia System

### Definition

The descending antinociceptive pathways, which originate in the brain and terminate in the spinal cord (and in trigeminal sensory nuclei) and inhibit nociceptive processing, are collectively called the endogenous analgesia system. The inhibitory neurotransmitters released by this system include endogenous opioid compounds, as well as biogenic amines such as norepinephrine and serotonin.

- ▶ [Descending Modulation of Nociceptive Processing](#)
- ▶ [GABA Mechanisms and Descending Inhibitory Mechanisms](#)
- ▶ [Spinothalamic Tract Neurons, Descending Control by Brainstem Neurons](#)

---

## Endogenous Opiate/Opioid System

### Definition

Endogenous opiate system (also called opioid system) is a midbrain and spinal system of neurons containing morphine-like neurotransmitters that are released in response to pain and stress, leading to an analgesic effect.

- ▶ [Deep Brain Stimulation](#)

---

## Endogenous Opioid Peptides

### Definition

Endogenous opioid peptides are endogenous ligands for the three respective opioid receptors, which are synthesized by specific – mostly neuronal – cells. They are derived from three distinct genes coding the propeptides of the three opioid peptides  $\beta$  endorphin ( $\beta$ END), enkephalin (ENK) and dynorphin (DYN). Under normal conditions, they are not tonically released. However, upon specific endogenous (e.g. corticotropin releasing

hormone) or exogenous (e.g. postoperative pain) stimuli they can be released to counteract persistent pain.

- ▶ Nitrous Oxide Antinociception and Opioid Receptors
- ▶ Opioids and Inflammatory Pain
- ▶ Pain Treatment, Implantable Pumps for Drug Delivery
- ▶ Placebo Analgesia and Descending Opioid Modulation
- ▶ Trigeminal Brainstem Nuclear Complex, Immunohistochemistry and Neurochemistry

## Endogenous Opioid Receptors

### Definition

Opioid receptors are 7-transmembrane-spanning, G protein-coupled receptors that are the targets of exogenous opioid drugs and endogenous opioid peptides. They are found in the central nervous system and many peripheral tissues. The primary interest in opioid receptors has long been focused on their involvement in modulating pain response; however, it is obvious that they participate in a broad range of physiological processes ranging from cardiovascular and endocrine function to the immune system to behavior. There are four major subtypes of opioid receptors – mu ( $\mu$ ), delta ( $\delta$ ), kappa ( $\kappa$ ) and epsilon ( $\epsilon$ ) – each of which can mediate analgesia and is differentially sensitive to drugs and opioid peptides.

- ▶ Nitrous Oxide Antinociception and Opioid Receptors

## Endogenous Opioids/Opiates

### Definition

The term endogenous opioids represents any substances produced by the body (to date these are all peptides) that interact with MOP, DOP or KOP receptors. Three genes encoding a range of endogenous opioid peptides have been identified; pro-opiomelanocortin, proenkephalin and prodynorphin.

- ▶ Opioid Electrophysiology in PAG

## Endogenous Pain Control Pathway

### Definition

The transmission of pain impulses in the brain stem or spinal cord is modulated by a system that descends from the periaqueductal grey matter and locus coeruleus using serotonin and noradrenaline, respectively, as transmitter agents impinging on inhibitory interneurons, s. also endogenous analgesia system.

- ▶ Primary Stabbing Headache

## Endometriosis

### Definition

The presence and growth of endometrial glands and stroma, similar to the lining of the uterus (endometrium) but located outside the uterus, usually on the pelvic peritoneum, ovaries, or rectovaginal septum, and other pelvic viscera such as bowel and bladder, but rarely seen on more distant structures, such as diaphragm, lungs or brain. The pathogenesis of the disease, as well as the pain and infertility, are the subject of extensive research. The most widely accepted theory is that the disorder originates from retrograde menstruation, with passage and then implantation of endometrial tissue within the peritoneal cavity. It is uncertain whether in women with this hormonally mediated disease there is an underlying endometrial abnormality, unusual menstrual uterine contractile pattern, local peritoneal immunologic abnormalities, or other aberrant angiogenic and neuropathic factors. Associated symptoms can include dyspareunia, dyschezia, irregular uterine spotting, and infertility. Pelvic exam often reveals a fixed retroverted uterus, focal tenderness or nodularity of the uterosacral ligaments and ovarian masses, which on ultrasound usually has the characteristics of an endometrioma or “chocolate” cyst.

- ▶ Dyspareunia and Vaginismus
- ▶ Visceral Pain Models, Female Reproductive Organ Pain

## Endometriosis Externa

- ▶ Chronic Pelvic Pain, Endometriosis

## Endometriosis Model

- ▶ Visceral Pain Models, Female Reproductive Organ Pain

## Endomorphin 1 and Endomorphin 2

### Definition

Endomorphin 1 and endomorphin 2 are recently discovered opioid tetrapeptides with a high affinity and selectivity to  $\mu$  opioid receptors. Endomorphin 1 is more widely distributed throughout the brain, and endomorphin 2 is more prevalent in the spinal cord. Precursor proteins of endomorphin 1 and 2 are not yet known.

- ▶ Opiates During Development
- ▶ Opioids and Inflammatory Pain

## Endone®

- ▶ Postoperative Pain, Oxycodone

## Endorphins

### Definition

Endorphins are endogenous opioid-like substances that are produced in the body and have an affinity for opioid receptors, s. also Endomorphin.

- ▶ Alternative Medicine in Neuropathic Pain
- ▶ Endogenous Opioid Peptides
- ▶ Nitrous Oxide Antinociception and Opioid Receptors

## Endoscopic Sympathectomy

### Definition

Endoscopic sympathectomy is a minimally invasive technique for resecting components of the sympathetic chain.

- ▶ Complex Regional Pain Syndrome and the Sympathetic Nervous System

## Endothelins

### Definition

Endothelins are a family of three peptides that are released from endothelial cells and some tumor cells that can activate nociceptors, mount an inflammatory response, and stimulate angiogenesis and growth of tumor cells.

- ▶ Cancer Pain, Animal Models

## Endovanilloid

### Definition

Endovanilloids are endogenous metabolites that activate the capsaicin receptor by binding to the capsaicin binding site.

- ▶ Capsaicin Receptor
- ▶ Thalamus, Clinical Pain, Human Imaging

## Endplate Noise

### Synonym

EPN

### Definition

Complex noise-like potentials generated by a large increase (up to 1,000 times) in spontaneously released acetylcholine packets resulting in subsynaptic miniature endplate potentials. Many electromyographers have been taught that endplate noise represents normal function of the motor endplate.

- ▶ Myofascial Trigger Points

## Endurance Exercise

- ▶ Exercise

## Enforced Mobilisation

- ▶ Postoperative Pain, Importance of Mobilisation

## Enkephalin

### Definition

Enkephalin is one of two pentapeptides, comprised of five amino acids, which differ only at the last one (leu-enkephalin; met-enkephalin) that preferentially binds to DOP receptor. They are formed from proenkephalin and found in ratios of 6:1 Met:Leu. They are found throughout the central and enteric nervous systems and in the adrenal medulla.

- ▶ Endogenous Opioid Peptides
- ▶ Nitrous Oxide Antinociception and Opioid Receptors
- ▶ Opiates During Development
- ▶ Opioid Receptors

## Enteric Coating

### Definition

A coating applied to tablet granules in capsules. The enteric coating is insoluble in the acid contents of the stomach, but breaks down in the approximately neutral contents of the small intestine where the drug is released.

- ▶ NSAIDs and their Indications

## Enterohepatic Recirculation (Biliary Recycling)

### Definition

The enterohepatic recirculation (biliary recycling) describes the effect, where drugs are excreted via bile into



the small intestine, but can be reabsorbed from the distal intestinal lumen.

- ▶ NSAIDs, Pharmacokinetics

## Enthesis

### Definition

Enthesis is the periosteal attachment of a ligament or tendon.

- ▶ Myofascial Trigger Points

## Enthesopathy

### Definition

Enthesopathy is a disease process at musculotendinous or musculo-osseous junctions.

- ▶ Myofascial Trigger Points

## Entorhinal Cortex and Hippocampus, Functional Imaging

- ▶ Hippocampus and Entorhinal Complex, Functional Imaging

## Entrapment Neuropathies

### Definition

Entrapment neuropathies are abnormal peripheral nerve functions arising from compression by an anatomical structure.

- ▶ Spinal Cord Injury Pain

## Entrapment Neuropathies, Carpal Tunnel Syndrome

- ▶ Carpal Tunnel Syndrome

## Environmental Factors

### Definition

Environmental factors refer to all aspects of the external or extrinsic world that form the context of an individual's life and, as such, have an impact on that person's functioning.

- ▶ Disability and Impairment Definitions

## Ephaptic Coupling

### Definition

This term, based on the idea of an "electrical synapse", refers to the passage of an electrical current from one neuron to a closely apposed neighbor, in the absence of the apparatus, delay and pharmacology associated with a conventional chemical synapse. Current flow in ephaptically coupling cells may be due to the presence of gap junctions, or it may be due to a sufficient area of close membrane apposition without cytoplasmic continuity between the coupled cells. It is usually assumed to be an abnormal but stable, electrical interaction between two nerve fibers, for example, between the endings of two fibers terminating within a neuroma or a site of a crush injury whereby nerve impulses in one fiber triggers impulses in the other.

- ▶ Ectopia, Spontaneous
- ▶ Pain Paroxysms
- ▶ Tic and Cranial Neuralgias
- ▶ Trigeminal Neuralgia, Diagnosis and Treatment

## Epicondylitis

### Definition

Inflammation of the tendon attachments for muscles on the inside (medial) or outside (lateral) of the elbow joint.

- ▶ Ergonomics Essay

## Epicritic

### Definition

Relating to the perception of slight differences in the intensity of stimuli, especially touch, temperature, vibration and limb position in space. Cutaneous discriminative perception is typically attributed to the larger myelinated sensory nerve fibers. Epicritic pain refers to pains that convey precise information about location, duration, and intensity. For example, pricking pain from needle penetration is a form of epicritic pain.

- ▶ Postsynaptic Dorsal Column Projection, Functional Characteristics

## Epidemiology

### Definition

Although classically epidemiology has been understood to be the study of the characteristics of larger populations, such as in a census or transcultural studies, epidemiological methods are applied to a great

variety of scientific inquiries including the study of natural history of illnesses, the comparison of clinical or social policy interventions or natural events that affect health outcomes, studies of risk factors predicting new illnesses, factors affecting prognosis, and other applications.

- ▶ Low Back Pain, Epidemiology
- ▶ Prevalence of Chronic Pain Disorders in Children
- ▶ Psychiatric Aspects of the Epidemiology of Pain
- ▶ Psychological Aspects of Pain in Women

## Epidemiology of Chronic Pelvic Pain

STEPHEN KENNEDY<sup>1</sup>, KRINA ZONDERVAN<sup>2</sup>

<sup>1</sup>Nuffield Department of Obstetrics and Gynaecology, University of Oxford, John Radcliffe Hospital, Oxford, UK

<sup>2</sup>Wellcome Trust Centre for Human Genetics, Oxford, UK

stephen.kennedy@obs-gyn.ox.ac.uk

### Synonyms

Recurrent Pelvic Pain; Pelvic Pain Syndrome; Chronic Pelvic Pain, Epidemiology

### Definition

The most commonly used definition of chronic pelvic pain (CPP) for research purposes is: 'Recurrent or constant pain in the lower abdominal region that has lasted for at least six months'. Thus, women with dysmenorrhea (painful periods) or dyspareunia (pain on intercourse) only are excluded, as are those with pelvic pain related to pregnancy or malignancy. The definition solely considers the location and duration of the pain; no assumptions are made about its cause (Campbell and Collett 1994).

The International Association for the Study of Pain (1986) defines CPP without obvious pathology (CPP-WOP) as 'chronic or recurrent pelvic pain that cannot be sufficiently explained by an apparent physical cause'. The definition assumes a causal link between pelvic pathology and pain, which clinical experience and the published literature would suggest is not always the case. More recently, the American College of Obstetricians & Gynecologists (2004) has proposed a definition of CPP as 'non-cyclical pain of at least 6 months' duration that appears in locations such as the pelvis, anterior abdominal wall, lower back, or buttocks, and that is serious enough to cause disability or lead to medical care'.

Thus, there is little consensus regarding the definition of CPP. In fact, in a MEDLINE survey of the definitions used in papers published from 1966 to 2001 (Williams et al. 2004), there was no mention of the following: duration of pain (44%), restriction by pathology (74%), location of pain (93%) or restriction by comorbidity (95%).

### Characteristics

The lack of an unambiguous definition makes the study of the epidemiology of CPP difficult. Until recently, studies focused mainly on the frequency with which pelvic pathology was found at laparoscopy as an explanation for CPP, and on attempts to explain the symptoms when no such pathology was found.

Almost 10 years ago, the Oxford Group conducted a systematic review of the prevalence and incidence of CPP in the UK general population (Zondervan et al. 1998). It was clear that few attempts had been made to define an appropriate study population with an adequately powered sample size, which is essential if results are to be generalized to the wider population. The only study that investigated the epidemiology of CPP in any setting was a hospital-based survey of 559 pathology-free women who had undergone a laparoscopy for sterilization or investigation of infertility (Mahmood et al. 1991). The prevalence of CPP, defined as 'recurrent pelvic pain unrelated to menstruation or coitus', was 39%.

World-wide, the only truly community-based prevalence estimate at that time was 14.7% (95% confidence interval: 12.7–16.7%), based upon a telephone survey of 5,263 women, aged 18–50, randomly selected from the general US population (Mathias et al. 1996). CPP was defined as 'pelvic pain of at least six months' duration and with pain having occurred in the past three months'. In another US study, prevalence was assessed in 581 patients and their female companions aged 18–45 in waiting rooms of gynecology and family medicine practices (Jamieson and Steege 1996). Thirty-nine percent of women reported having some degree of pelvic pain, while 20% reported pelvic pain of more than 1 year's duration.

The lack of epidemiological data on CPP in the UK outside a hospital setting led the Oxford Group first to investigate its prevalence and incidence in primary care (Zondervan et al. 1999a). For this purpose, the MediPlus UK Primary Care Database (UKPCD) was used, which contains anonymised clinical and prescribing data from 1991 onwards on approximately 1,700,000 patients. The most common definition of CPP was used and cases were identified from a denominator of 278,509 women, on the basis of contacts for pelvic pain with the practices contributing information to the database between 1991 and 1995. The annual prevalence of CPP in women aged 15–73 was 38/1,000. This figure was comparable to those reported elsewhere for asthma (37/1,000) and back pain (41/1,000). The annual prevalence for women aged 18–50 was similar, at 37/1,000. CPP prevalence was found to vary with age, from 18/1,000 in 15–20 year olds to 28/1,000 in women older than 60.

Although the prevalence was high, the monthly incidence was only 1.6/1,000: one possible explanation for this combination would be long symptom duration. Therefore, CPP duration was estimated in a cohort

of 5,051 incident cases from MediPlus UKPCD, who were followed for 3–4 years from their first pelvic pain contact in primary care (Zondervan et al. 1999b). The median symptom duration was 15 months, with a third of women having persistent symptoms after 2 years. These results were probably influenced by the actual duration of symptoms, as well as by health care seeking behavior. A quarter of incident CPP cases received no diagnostic label during the 3–4 year follow-up, and only 40% were referred to a hospital specialist. The majority of women only received one diagnosis, the most common being irritable bowel syndrome (IBS) and cystitis in all age groups. In addition, pelvic inflammatory disease (PID) was common in women aged up to 40, and other gastrointestinal diagnoses in women above 50. The likelihood of receiving a diagnosis varied with age: women under 20 and older than 60 were less likely than others to receive a diagnosis. The referral rate varied similarly with age: women in the 31–40 age group were twice as likely to have been referred as the youngest or oldest women in the cohort.

As the true community prevalence could not be estimated from MediPlus UKPCD because it only provided information on women with CPP seeking health care, a postal questionnaire survey (<http://www.medicine.ox.ac.uk/ndog/cppr/frame.html>) was conducted among 4,000 women, randomly selected from 141,400 women aged 18–49 on the Oxfordshire Health Authority (OHA) register (Zondervan et al. 2001a). The most common definition of CPP was used. The response rate amongst those who received the questionnaire was 74%. The study group consisted of 2,016 women, after exclusion of those who had been pregnant in the last 12 months. CPP in the last three months was reported by 24.0% of the women (95% confidence interval: 22.1–25.8). This prevalence estimate was higher than the 14.7% reported by Mathias et al. (1996) in the USA. However, their study excluded women with ovulation-related pain; exclusion of those able to report ovulation-related pain would have reduced the Oxford estimate to a similar figure of 16.9%. The prevalence varied slightly with age: the lowest rate (20%) was found in the age groups 18–25 and 31–35, and the highest (28%) in 36–40 year olds. Non-Caucasian women had a much lower prevalence (10%) than Caucasian women (25%;  $p=0.003$ ); a risk ratio (RR) of 0.4 (95% confidence interval: 0.2–0.8). Adjustment for age and social class did not affect this result. Prevalence did not vary with social class, marital status, or employment status. A third of women with CPP reported that their pain had started more than 5 years ago.

Women with CPP who had consulted for their symptoms more than 12 months previously (27% of cases) appeared slightly less affected by their symptoms than recent consulters. However, a substantial number (43%) reported that the pain restricted their activities. The reasons why these women discontinued seeking medical advice despite ongoing symptoms were unclear. Some

women may have been controlling their pain after medical advice or treatment. It is also possible, however, that some may simply have been dissatisfied with their medical care.

Women with CPP who had never consulted for pelvic pain (41% of cases) were similar in terms of general health, pain severity, use of health care, and measures of pain-related functioning to women with dysmenorrhea alone. However, the reported effect of dysmenorrhea on women's lives when they had the pain was not negligible: three-quarters used medication for symptom relief and a third reported that the pain restricted their activities. Thus, non-consulting women with CPP appear to perceive their symptoms as no greater a burden than having painful periods. Another important observation in the study was that a third of women with CPP reported they were anxious about their pain, particularly its cause. This symptom-related anxiety was common in non-consulters as well as consulters.

### Symptom Complexity and Diagnoses

CPP is difficult to diagnose and treat, mainly due to the wide range of possible causes with overlapping symptomatology, e.g. endometriosis, chronic PID, adhesions, IBS, interstitial cystitis and the urethral syndrome. In gynecology clinics, high IBS prevalence rates (50–79%) have been reported in women referred for CPP (Prior et al. 1989). Similarly, high prevalence rates of dyspareunia (42%) and urinary symptoms (61%) have been reported in IBS patients (Whorwell et al. 1986). Community-based data on the overlap between CPP and other abdominal symptoms are, however, very limited. In the second part of the Oxfordshire Women's Health Study, the symptom overlap was investigated between CPP, IBS, genito-urinary symptoms, dysmenorrhea, and dyspareunia in the community, and associated investigations and diagnoses (Zondervan et al. 2001b). The diagnoses were based only on the woman's recall and were not validated using their medical records.

A substantial overlap was found between CPP, GU symptoms and IBS. Approximately half of the 483 women with CPP had at least one additional symptom; 39% had IBS and 24% had GU symptoms. Prevalence rates of dysmenorrhea and dyspareunia were much higher among women with CPP (81% and 41%, respectively) than among those without CPP (58% and 14%). These rates were high in all subgroups of CPP, irrespective of the presence of additional GU symptoms or IBS. The results demonstrated the complexity of the diagnostic problems presented by a CPP patient. Moreover, the study found that women with CPP and additional GU symptoms, and IBS in particular, were most affected in terms of pain severity and episode duration. This group also reported having received the widest range of diagnoses.

A recent study involving a large Australian twin cohort sampled from the community supported the multi-

faceted origin of CPP in terms of genetic background (Zondervan et al. 2005). It was found that, although CPP showed a moderate heritability of 41%, there was no independent genetic factor underlying CPP causation. Instead, CPP heritability could be completely attributed to genetic susceptibility for endometriosis, fibroids, dysmenorrhea and somatic anxiety (the latter a potential marker for increased nociception).

### Risk-Factors for CPP

Studying risk-factors for CPP provides a major challenge to the epidemiologist. Gradually emerging knowledge indicates that a host of somatic, psychological and socio-environmental factors may act and interact in its causation, together forming a multidimensional 'biopsychosocial' model of disease etiology. Women with CPP may suffer from various underlying somatic conditions, which may all have different or even conflicting risk-factors. Furthermore, psychological factors (e.g. traumatic events, depression, illness beliefs) and socio-environmental factors (e.g. the role of 'significant others') may play a role in pain etiology or maintenance. Risk of CPP may be influenced by a variety of these factors, some of which can be difficult to measure. Furthermore, different populations are likely to exhibit different frequencies of underlying somatic and psychosocial conditions, thus limiting comparability of results from one country to another.

The situation may be even more complex when CPP cases are identified from primary instead of secondary/tertiary care settings. Associations between CPP and risk-factors in these settings may be very different, because of differences in health care seeking behavior and referral patterns. For instance, if pelvic pain were common in young women, but if they were less inclined to seek medical advice than older women, they would be less likely to be identified as CPP cases and risk of CPP in this group would be seen as low. Differences in referral patterns from primary to secondary/tertiary care between certain demographic groups may result in an even further distorted picture of CPP risk. Therefore, risk-factor analysis of CPP is at present only of some value using cases identified at community level, and interpretation of the results remains complicated due to its multi-causality.

There are no population-based cohort or case-control studies investigating risk-factors for CPP. The information from cross-sectional studies is very limited. The community survey in the USA (Mathias et al. 1996), and the semi-community study of women and their companions in primary care clinics (Jamieson and Steege 1996), described the association between certain demographic factors and CPP. In a logistic regression model adjusted for age, ethnicity, education, and marital status, Mathias et al. (1996) found a slightly decreased risk of CPP in women older than 35 compared to younger women (OR: 0.7, 95% CI: 0.6–0.8).

Jamieson and Steege (1996) reported unadjusted results for the association between pelvic pain (defined as any current pain not associated with menstruation or intercourse) and age, with rates varying significantly from 49% in 26–30 year olds to 22% in 36–40 year olds. Mathias et al. (1996) found a reduced risk in women of African-American origin compared to Caucasian women (OR: 0.7, 95% CI: 0.5–0.95), whereas Jamieson and Steege (1996) found an increased risk (53% vs. 35%, respectively). Neither study found associations with educational status, income, or parity.

In the Oxfordshire Women's Health Study (unpublished data), significant differences in risk were found only with age, ethnicity, height, condom use, length of bleeding, and subfertility. Compared to women aged 18–25, ORs of other age categories varied from 0.72 (95% confidence interval: 0.44–1.18) for 46–49 year olds to 1.30 (95% confidence interval: 0.88–1.90) for 26–30 year olds. Non-Caucasian women had a much lower risk of CPP compared to Caucasian women (OR=0.35, 95% confidence interval: 0.16–0.78). However, although this result was consistent with the Mathias et al. (1996) findings, it was based on only 80 non-Caucasian women participating in the study, which reflects the small percentage of non-Caucasian women in the Oxfordshire population.

Surprisingly, tall woman ( $\geq 1.70$  meters) appeared to have an increased risk of CPP, even after adjustment for possible confounding factors such as social class or ethnicity (OR=1.37, 95% confidence interval 1.00–1.88). Another unexpected result was the association of condom use (but not the diaphragm) with increased risk of CPP, but this effect was limited only to use more than 12 months earlier (OR=1.55, 95% confidence interval 1.17–2.05). A tentative explanation for this elevated risk could be that condom users may not have used this method consistently, and that they were less likely to be long-term users of oral contraceptives.

Longer bleeding periods (7+ days) were associated with an increased risk of CPP (OR=1.34, 95% confidence interval 1.00–1.80). Subfertility was also found to be positively associated with CPP (OR=1.50, 95% confidence interval 1.08–2.07). Since both pelvic pain and infertility are common in women with endometriosis, this association was also not surprising.

### References

1. American College of Obstetricians & Gynecologists (2004) ACOG Practice Bulletin No. 51. Chronic Pelvic Pain. *Obstet Gynecol* 103:589–605
2. Campbell F, Collett BJ (1994) Chronic Pelvic Pain. *Br J Anaesth* 73:571–573
3. International Association for the Study of Pain (1986) Classification of Chronic Pain. Definitions of Chronic Pain Syndromes and Definition of Pain Terms. *Pain Suppl*:1–221
4. Jamieson DJ, Steege JF (1996) The Prevalence of Dysmenorrhea, Dyspareunia, Pelvic Pain, and Irritable Bowel Syndrome in Primary Care Practices. *Obstet Gynecol* 87:55–59



5. Mahmood TA, Templeton AA, Thomson L et al. (1991) Menstrual Symptoms in Women with Pelvic Endometriosis. *Br J Obstet Gynaecol* 98:558–563
6. Mathias SD, Kuppermann M, Liberman RF et al. (1996) Chronic Pelvic Pain: Prevalence, Health-Related Quality of Life, and Economic Correlates. *Obstet Gynecol* 87:321–327
7. Prior A, Wilson K, Whorwell PJ et al. (1989) Irritable Bowel Syndrome in the Gynecological Clinic. Survey of 798 New Referrals. *Dig Dis Sci* 34:1820–1824
8. Whorwell PJ, McCallum M, Creed FH et al. (1986) Non-Colonic Features of Irritable Bowel Syndrome. *Gut* 27:37–40
9. Williams RE, Hartmann KE, Steege JF (2004) Documenting the Current Definitions of Chronic Pelvic Pain: Implications for Research. *Obstet Gynecol* 103:686–691
10. Zondervan KT, Yudkin PL, Vessey MP et al. (1998) The Prevalence of Chronic Pelvic Pain in Women in the UK – A Systematic Review. *Br J Obstet Gynaecol* 105:93–99
11. Zondervan KT, Yudkin PL, Vessey MP et al. (1999a) Prevalence and Incidence in Primary Care of Chronic Pelvic Pain in Women: Evidence from a National General Practice Database. *Br J Obstet Gynaecol* 106:1149–1155
12. Zondervan KT, Yudkin PL, Vessey MP et al. (1999b) Patterns of Diagnosis and Referral in Women Consulting for Chronic Pelvic Pain in UK Primary Care. *Br J Obstet Gynaecol* 106:1156–1161
13. Zondervan KT, Yudkin PL, Vessey MP et al. (2001a) The Community Prevalence of Chronic Pelvic Pain in Women and Associated Illness Behaviour. *Br J Gen Pract* 51:541–547
14. Zondervan KT, Yudkin PL, Vessey MP et al. (2001b) Chronic Pelvic Pain in the Community: Symptomatology, Investigations and Diagnoses. *Am J Obstet Gynecol* 184:1149–1155
15. Zondervan KT, Cardon LR, Kennedy SH et al. (2005) Multivariate Genetic Analysis of Chronic Pelvic Pain and Associated Phenotypes. *Behav Genet* 35:177–188

## Epidemiology of Work Disability, Back Pain

ERNEST VOLINN

Pain Research Center, University of Utah, Salt Lake City, UT, USA  
epaulv@yahoo.com

### Definitions

“Low back pain disability” is composed of a combination of elusive entities, “low back pain” and “disability”. Definitions of each, nevertheless, will be attempted.

### Low Back Pain

The textbook definition of low back pain is “pain, muscle tension or stiffness localized below the costal margin and above the inferior gluteal folds, with or without leg pain (sciatica) (van Tulder et al. 2002).” As for its cause, Nachemson stated so cogently a generation ago (Nachemson 1979), “*Having been engaged in research in this field for nearly 25 years and having been clinically engaged in back problems for nearly the same period of time and as a member of and scientific adviser to several international back associations, I can only state that for the majority of our patients, the true cause of low back pain is unknown*”.

The pace of research on back pain has accelerated in the past generation. Even so, were it stated today, few would

dispute Nachemson’s position of a generation ago. Most back pain seen in primary care, about 70% of all cases, may be diagnosed as “idiopathic” (Deyo et al. 2001), meaning, more simply, that its origin is unknown.

To add a time dimension, “*chronic* back pain” is a term that is well entrenched in the literature, but, without modification, it may be misleading. The term obviously implies pain that has lasted a long time; according to the prevailing usage, it is pain that lasts 90 days or more. Why 90 days is viewed as the cut-off point with which to demarcate chronic back pain is not known. More importantly, most back pain patients seen in primary care continue to experience episodes of back pain far longer than 90 days after their “index visit” for the pain. Clearly, the large majority of these patients either did not interrupt their major activities (work, school, etc.) in the first place or resumed them well before the 90 day period that demarcates chronic pain. The labeling of such patients as “chronic back pain patients” may have untoward consequences. Instead, patients whose back pain recurs episodically for more than 90 days may be reassured that their experience conforms to the natural history of back pain. Pain that not only persists for 90 days or more but also leads to *disability* is more problematic.

### Disability

Disability is variously defined in the literature. One definition, however, stands out both because of the frequency with which it is used and its usefulness for gaining insight into how back pain may affect the patient outside the clinic. According to this definition, disability is a “form of inability or limitation in performing roles and tasks expected of an individual within a social environment” (Nagi 1979). Defined as such, disability directs attention outward from the body and toward the larger social environment inhabited by those with back pain. It is composed not only of patients’ reactions to the pain, but also tasks and roles expected of them. Among the common condition-specific measures of back pain disability are the Oswestry disability questionnaire (Fairbank et al. 1980) and Roland-Morris disability questionnaire (Roland and Morris 1983), both of which elicit responses on capability or incapability to perform everyday activities, such as walking, sleeping, and personal care.

A reason why back pain disability has remained such an elusive entity is that one of its key components has only recently assumed prominence in the literature. This is the loss of the work role, which may refer to a complete or partial loss of capability to perform the work role. Work loss is not included in common condition-specific measures of back pain disability. To a large extent, disability as determined by these measures varies independently from work loss (Waddell et al. 2002). Nevertheless, although exceptions are notable, many if not most studies on back pain and its treatment either omit measurement of work loss entirely or measure it only in passing. This constitutes a curious oversight, because the central-

ity of work in people's lives has long been recognized (Eisenberg and Lazarsfeld 1938) and the costs of work loss due to back pain have a demonstrable impact on the economies of westernized affluent countries (van Tulder et al. 2002).

To be sure, work loss is not an issue for those too young to enter the work force or already retired from it. Furthermore, a number of variables may intervene between the experience of back pain and the outcome of resuming the work role. Spousal income or a family income sufficient to permit work loss without economic hardship may lessen the incentive to resume work and, to a certain extent, so may worker's compensation payments for time off work. The work role may diminish in importance as retirement age approaches. Jobs that allow the resumption of the work role may be unavailable. A number of studies have shown that recurrent episodes of back pain and, correspondingly, recurrent absences from work may be the rule, not the exception. In short, the work role is multi-dimensional and, rather than a question or two on whether the patient has returned to work or not, it merits careful forethought and a separate questionnaire (Amick et al. 2000).

#### Synonyms for Back Pain

Other terms are sometimes used in place of "back pain", but they do little to clarify this entity and may obscure it further. "Back injuries" is a term commonly found in the literature. Unless a sudden, traumatic event, an identifiable accident, is substantiated and directly linked to the onset or aggravation of pain, back injury is a misattributed term. That criterion would exclude a large proportion of workers as well as others who seek health care for their back problem. "Back disorders" is another term commonly found in the literature, although its constituents may be left unstated. Apparently, this is a generic term that subsumes different types of back problems, such as self-reports of back pain, self-reports of work status, physicians' records of back examinations and tabulations of worker's compensation claims or other administrative data. Each of these back problems may have different predictors and the agglomeration of them into the single entity subsumed by back disorders may weaken or altogether undermine an analysis – e.g. predictors of self-reported back pain may differ from predictors of worker's compensation claims for back pain (Volinn et al. 2001). With no other term a notable improvement upon it, "back pain" will be used here.

#### Synonyms for Disability

An impairment, to refer to the World Health Organization definition, is a problem "in body function or structure such as a significant deviation or loss (World Health Organization 2001)." Impairment directs attention toward clinical evaluation of the patient's body and is to be contrasted with disability, which directs attention toward an assessment of the patient's capability to perform tasks

and roles outside the clinic. Back pain impairment, measured by such tests as flexion and straight leg lifting, does not necessarily determine back pain disability. Rather, just as work loss to a large extent varies independently from other aspects of disability besides work loss, so do these other aspects of disability to a large extent vary independently from impairment (Waddell et al. 2002).

#### Characteristics

A model of a funnel placed on its side may be used to illustrate the epidemiology of back pain disability (Fig. 1). In view of the documented importance of work to the individual and the high costs of its loss to society, loss of the work role indicates disability in the model. According to the model, all workers would enter the wide end of the funnel and most workers would proceed to its first stage, with a progressively smaller proportion of them reaching each successive stage.

The first stage after entering the model would be self-reported back pain unaccompanied by disability. In westernized, affluent countries, back pain is not, like death and taxes, inevitable, but it is commonplace. According to data compiled from different studies on low back pain in western European countries, the point prevalence ranges from 14% to 42% and the lifetime prevalence of ranges from 51% to 81% (Waddell et al. 2002).

Remarkably little is known about the epidemiology of back pain outside the westernized, affluent countries, where, of course, by far most of the world's population resides. According to fragmentary evidence, back pain prevalence may be higher in westernized affluent countries than in the rural areas of countries classified by the World Bank as low income (Volinn 1997). In urban areas of low-income countries, increasingly the sites of sweatshops and other forms of hard physical labor, the need for research on the epidemiology of back pain is critical.

The next stage of the funnel-shaped model is missed work attributed to back pain. That is a far less frequently occurring event than the experience of back pain itself. Of 65% of the construction workers in New York City



**Epidemiology of Work Disability, Back Pain, Figure 1** Self-reported back pain and frequency of events attributed to it.

who reported the symptom of low back pain during a 1 year period, only 12% reported they missed work because of it (Goldsheyder et al. 2002). Similarly, in a survey of the general population conducted in Sweden, 66% reported back or neck pain in the past year, but only about half of those who reported back or neck pain took sick leave or otherwise reported they missed work because of it (Linton et al. 1998).

Still less frequent than missing work due to back pain, and at a stage closer to the narrow end of the model, is administratively reported back pain. Several studies have shown that administrative reports compiled from worksites grossly under-estimate the prevalence of workers' back pain (Volinn et al. 2001). Accordingly, even though the U.S. Bureau of Labor Statistics has a mandate to collect data on work-related injuries and illnesses, back problems are routinely under-reported (Volinn et al. 2001). Worker's compensation claims for back pain constitute another type of administrative report. These too are relatively rare events in comparison with the proportion of workers who report back pain in a questionnaire or interview. The annual rate in the U.S. is less than 2 back pain claims per 100 workers eligible for worker's compensation (Murphy and Volinn 1999). That rate is to be contrasted with 9% of all workers in the U.S. who report they had back pain during a 1 year period that was both attributable to work and severe enough to last a week or more (Park et al. 1993). In other words, the rate of worker's compensation claims for back pain is less than one-fourth the rate with which workers report work-related back pain of some severity. The last stage of the model, at the narrow end to designate how infrequently workers reach it, is chronic disabling back pain, which is here represented by complete loss of the work role for 90 days or more. Worker's compensation data from the U.S. illustrate the disproportionate costs accrued by those who reach this stage (Volinn et al. 2001). Of the 2% of all workers who file a compensation claim each year (a high estimate), about 10% are off work for 90 days or more as indicated by time loss payments. In a given year, then, about 2% of all workers eligible for worker's compensation – or 2 out of 1,000 workers – file a back pain claim that persists into chronicity. This miniscule proportion, however, accounts for about 90% of all worker's compensation costs for back pain.

These costs are, furthermore, mainly "indirect costs" that cover work loss, as distinct from "direct costs" that cover medical care. Indirect costs include wage compensation payments and payments for early retirement. In European countries such as the UK, Sweden, and the Netherlands, about 90% of all back pain costs (direct + indirect) are indirect (van Tulder et al. 2002). Among worker's compensation claimants of back pain in the U.S., the proportion of indirect costs in relation to all back pain costs is less but is still greater than 50% (Murphy and Volinn 1999). What is commonly referred to as "the back pain problem" in large measure, then,

consists of work loss attributed in particular to chronic disabling back pain.

## References

1. Amick III BC, Lerner D, Rogers WH et al. (2000) A review of health-related work outcome measures and their uses, and recommended measures. *Spine* 25:3152–3160
2. Deyo RA, Weinstein JN (2001) Low back pain. *N Engl J Med* 344:363–370
3. Eisenberg P, Lazarsfeld PF (1938) The psychological effects of unemployment. *Psych Bull* 35:358–390
4. Fairbank JCT, Couper J, Davies JB et al. (1980) The Oswestry low back pain disability scale. *Physiotherapy* 66:271–273
5. Goldsheyder D, Nordin M, Schecter Weiner S et al. (2002) Musculoskeletal symptom survey among mason tenders. *Am J Ind Med* 42:348–96
6. Linton SJ, Hellsing AL, Halldén K (1998) A population-based study of spinal pain among 35–45-year-old individuals: Prevalence, sick leave, and health care use. *Spine* 23:1457–1463
7. Murphy PL, Volinn E (1999) Is occupational low back pain on the rise? *Spine* 24:691–697
8. Nachemson A (1979) A critical look at the treatment for low back pain. *Scand J Rehab Med* 11:143–147
9. Nagi SZ (1979) The concept and measurement of disability. In: Berkowitz ED (ed) *Disability Policies and Government Programs*. Praeger, New York, pp 1–15
10. Park CH, Wagener DK, Winn DM et al. (1993) *Health Conditions Among the Currently Employed: United States, 1988* (National Center for Health Statistics, Vital and Health Statistics, Series 10, No 186). US Government Printing Office, Washington, pp 7–22
11. Roland M, Morris R (1983) A study of the natural history of back pain. Part I. Development of a reliable and sensitive measure of disability in low-back pain. *Spine* 8:141–144
12. van Tulder MW, Koes BW, Bombardier C (2000) Low back pain. *Best Practice and Research Clinical Rheumatology* 16:761–75
13. Volinn E (1997) The epidemiology of low back pain in the rest of the world: A review of surveys in low and middle income countries. *Spine* 22:1747–1754
14. Volinn E, Spratt KF, Magnusson ML et al. (2001) The Boeing Prospective Study and Beyond. *Spine* 26:1613–1622
15. Waddell G, Aylward M, Sawney P (2002) *Back Pain, Incapacity for Work, and Social Security Benefits: An International Literature Review and Analysis*. London: Royal Society of Medicine Press, pp 1–17
16. World Health Organization (2001) *International Classification of Functioning, Disability, and Health*. Geneva: World Health Organization 10–13

E

## Epidural Nerves

### Definition

Epidural nerves are free nerve endings in the most-superficial layer of the skin (epidermis), also termed intraepidermal nerve fibers.

► [Toxic Neuropathies](#)

## Epidural

### Definition

Superficial to the dura, which covers the brain and spinal cord. The epidural space is a potential space in the spinal cord lying just outside the dura mater. Both

anesthesia and analgesia can be administered using an epidural catheter.

- ▶ Cancer Pain Management, Anesthesiologic Interventions
- ▶ Epidural Space
- ▶ Pain Treatment, Implantable Pumps for Drug Delivery
- ▶ Postherpetic Neuralgia, Etiology, Pathogenesis and Management
- ▶ Postoperative Pain, Appropriate Management

## Epidural Analgesia

### Definition

Even very intense pain during movement after surgery or during childbirth can be relieved effectively by administering small doses of local anesthetic, opioid, and adrenergic drugs to the epidural space outside the dural sack containing the spinal cord and spinal nerves, without making the patient numb or paralyzed (as under epidural anesthesia), s. also epidural space.

- ▶ Analgesia During Labor and Delivery
- ▶ Cancer Pain Management, Anesthesiologic Interventions, Neural Blockade
- ▶ Postoperative Pain, Acute Pain Management, Principles
- ▶ Postoperative Pain, Acute Pain Team

## Epidural Block

### Definition

Spinal blocks produced by injection of local anesthetic into the space between the dura and the spinal canal, usually in the lumbar spinal canal.

- ▶ McGill Pain Questionnaire
- ▶ Pain Treatment, Spinal Nerve Blocks

## Epidural Diagnostic Blocks

- ▶ Diagnosis of Pain, Epidural Blocks

## Epidural Drug Pumps

- ▶ Pain Treatment, Implantable Pumps for Drug Delivery

## Epidural Hematoma

- ▶ Headache Due to Intracranial Bleeding

## Epidural Infusions in Acute Pain

ANNE JAUMEEES

Royal North Shore Hospital, St Leonards, NSW, Australia

### Synonyms

Extradural Infusions; Perispinal Infusions; Peridural Infusions

### Definition

Epidural infusions are ▶ **infusions** of medications/drugs into the ▶ **epidural space**. They may be used in acute pain, chronic pain and cancer pain. They may be used in all age groups from neonates to the elderly.

They have a role in acute pain in the pre, intra and postoperative periods. They may be used in the management of pain during labour.

### Characteristics

#### History

The epidural space has been used since 1901 for provision of analgesia. It was originally accessed through the ▶ **sacral hiatus** (now called ▶ **caudal analgesia**). It became obvious that higher access would be needed for procedures in the thorax and abdomen; this was done *via* the thoracic and lumbar spine. The use of a continuous infusion *via* an epidural catheter was described in 1949, but it was not until the latter third of the 20<sup>th</sup> century that it was used with any frequency. Initially local anaesthetics were the only drugs used, but with the report of long lasting analgesia from intrathecal morphine in 1979 there was an increased use of epidural or intrathecal opioids (Miller 2004).

Many other drugs have been used. The most common include alpha agonists, ketamine and benzodiazepines. But various other drugs including neostigmine nonsteroidal anti-inflammatory drugs (NSAIDs) and droperidol have been trialled (Walker et al. 2002). Drugs are used either alone or in combination, reflecting clinical need and local practice.

#### Theoretical Basis

There are multiple receptors at spinal cord and brain levels that affect pain processing both in the ascending and descending pathways. These include among others, sodium channels (site of action for local anaesthetics), alpha-adrenergic receptors, opioid receptors and NMDA receptors. The delivery of drugs into the epidural space allows diffusion across the dura to act on these receptors on the spinal cord and nerve roots. The proximity of the drug to the effect site means a smaller amount of drug is given for a particular effect and this reduces the risk of side effects. It also allows regional



analgesia/anaesthesia with reduced systemic effects, e.g. sedation.

### Anatomy

The spinal cord is surrounded by three membranes called the meninges. The inner is the pia mater and is adherent to the spinal cord and the middle (the arachnoid) and the outer (the dura mater) lie close together and form the dural sac. The epidural space is a potential space that lies between the dura mater and the bone and ligaments of the spinal canal. It contains fat, connective tissue, blood vessels and nerve roots. Deeper than the arachnoid mater is the intrathecal or subarachnoid space, which contains cerebrospinal fluid and the spinal cord or cauda equina.

### When to Use Epidural Infusions

#### Preoperative

Epidurals may be used to obtain a good pain relief preoperatively, e.g. ischemic leg pain prior to amputation. Pre-emptive analgesia is the concept that by providing good analgesia prior to the painful stimulus (e.g. preoperatively) pain in the postoperative period is reduced. It is on this basis that epidurals have previously been promoted or proposed preoperatively. There have been good retrospective trials to support this, but prospective trials have been equivocal (Rodgers et al. 2000; Rigg et al. 2002). Therefore it is not usually current practice to place an epidural except in the immediate preoperative phase.

#### Intraoperative

Previous meta-analyses have demonstrate the benefit of epidurals over systemic analgesia on multiple levels including post-operative morbidity and mortality, reduced pulmonary complications, lower incidence of deep vein thrombosis (DVT) and myocardial infarctions and improved bowel recovery. However 2 large randomized controlled trials showed no major advantages with regards to outcomes except in aortic surgery or the reduction of pulmonary complications in high risk surgery (Rigg et al. 2002). Both meta-analyses and prospective trials show improved pain relief (Rigg et al. 2002; Block et al. 2003). Because of the conflicting evidence the role of epidurals in the peri-operative phase is being reviewed constantly and use reflects patient and procedure indications, anaesthetist preference and hospital set up (trained nursing staff etc).

#### Postoperative

Infusions may be continued into the postoperative phase. The duration depends on factors such as clinical indication and risk of infection.

#### Other Indications Include

- Obstetric- analgesia for labour
- Trauma, e.g. chest trauma with fractured ribs

## Epidural Drugs

### Local Anaesthetics

#### Action

Action is on nerve roots and spinal cord by crossing the dura.

#### Drugs

The most commonly used local anaesthetic (LA) is bupivacaine but various LAs may be used including ropivacaine and lignocaine. LAs are generally used in combination with an opioid that increases the efficacy of the pain relief.

#### Side Effects

These include motor and sensory block, hypotension due to sympathetic block, bradycardia with high block and urinary retention.

### Opioids

#### Action

Epidural administered opioids produce analgesia by blocking opioid receptors in the dorsal horn of the spinal cord and by systemic absorption. Lipid solubility influences the onset and duration of the effect and side effect profile. Very lipid soluble drugs (e.g. fentanyl) have a more rapid onset and offset with more specific segmental analgesic effects and therefore require a more precise positioning of the epidural catheter. Less soluble drugs such as morphine have slower onset and are cleared more slowly from the CSF and may therefore spread more rostrally and have a longer duration of action. Epidural opioids include morphine, hydromorphone, diamorphine (heroin), pethidine (meperidine), fentanyl and sufentanil.

#### Side Effects

These include sedation, respiratory depression (unusual), nausea and vomiting, pruritus and urinary retention. They also slow gastrointestinal motility but to a lesser extent than the equivalent systemic dose.

### Alpha Agonists

Clonidine is the most commonly used alpha agonist. It is analgesic alone or in combination with other analgesics for postoperative pain. It is more effective with fewer side effects in combination with other drugs. It is also useful in the treatment of complex regional pain syndrome (CRPS) as an epidural infusion.

#### Side Effects

Most common side effects include hypotension, bradycardia and sedation.

### Combinations

Combinations of analgesics are often additive in effect. The most commonly used combination is local anaesthetic ± opioid. However common combinations may include alpha agonists. Drugs such as neostigmine, midazolam and ketamine have been shown to have some analgesic effect both alone and in combination, but there

is a lack of large trials to fully evaluate analgesic efficacy and safety (Walker et al. 2002)

### Contraindications

#### Staff Factors

Unskilled/untrained staff – because of the risk of both more common but less severe side effects or less common but potentially devastating side effects and complications, it is important that epidural infusions are only used with staff trained in their use and in their monitoring.

#### Patient Factors

##### Absolute

- Patient refusal
- Local sepsis
- Coagulopathy

##### Relative/controversial

- Some neurological diseases, e.g. multiple sclerosis
- Generalised sepsis
- Hypovolemia
- Presence of dural puncture
- Concurrent anticoagulation (dependent on drug) (Macintyre and Ready 2001)

### Complications

#### 1. Post-dural Puncture Headache

This occurs when the dura is punctured and leakage of CSF occurs, resulting in a decrease in CSF pressure and tension on meninges and blood vessels. The risk is  $\sim < 1\%$  of epidurals.

##### Treatment

Treatment is simple analgesia, hydration and an epidural blood patch.

#### 2. Subarachnoid Injection (Subarachnoid Anaesthesia)

This may result in a total spinal anaesthetic with loss of consciousness  $\pm$  cardiovascular and respiratory changes which represents an anaesthetic emergency. The changes will resolve with time but require supportive care.

#### 3. Subdural Injection

This may result in a higher than expected block for the dose given. CVS and respiratory changes may also occur depending on the height of the block. Close monitoring and urgent management as appropriate are needed.

#### 4. Neurological Injury

Injury to either spinal cord or nerves may be either due to direct trauma or as a result of hypotension with secondary infarction.

The risk hard to estimate but the complication is rare.

#### 5. Epidural Haematoma

The risk is unknown but is likely to be  $< 1/150000$ .

### Diagnosis

It is important to have a high index of suspicion as signs and symptoms may be sudden in onset. Trained staff should regularly monitor for these. Symptoms include back pain or nerve root pain and evidence of neurological deficit due to nerve compression including muscle weakness, sensory, bladder or bowel dysfunction. MRI is the investigation of choice and should be arranged urgently.

### Treatment

Surgical decompression within 8–12 hours will allow the best chance of full recovery.

### 6. Epidural Abscess

This may result from direct contamination on insertion of the catheter or from the infusion of contaminated fluids. It may also occur spontaneously.

### Diagnosis

Symptoms and signs may be similar to those of epidural haematoma but with an onset that is later and slower. The most frequent presenting symptoms are of increasing and persistent back pain, back tenderness and signs of infection. The imaging of choice is MRI and blood investigations ( $\uparrow$ WCC, CRP), lumbar puncture may show evidence of infection.

### Treatment

Urgent neurosurgical assessment should be sought. Conservative treatment with antibiotics may be appropriate if there is no evidence of neurological compromise, however decompression within 8–12 hours of onset of neurological signs gives the best chance of recovery.

### 7. Intravascular Injection

#### Local Anaesthetic Toxicity

This can affect both the central nervous system (CNS) and the cardiovascular system (CVS). CNS toxicity occurs at lower doses than CVS toxicity and is initially excitatory due to the initial inhibition of inhibitory pathways. At higher doses, there is also inhibition of excitatory pathways and the general effect is one of CNS depression that may even result in death.

#### Anticoagulation and Epidurals

Anticoagulants are commonly used drugs in the community and in hospital. While it is generally contraindicated to use epidurals with a coagulation disorder, it is less clear when people are on anticoagulants and there must be a risk/benefit assessment for each patient.

#### Nonsteroidal Anti-Inflammatory Agents (NSAIDs)/ Aspirin

These have not been shown to increase the risk of epidural haematoma.

#### Oral Anticoagulants

The risk of epidural haematoma in these patients is unknown. If warfarin is started postoperatively, the best time to remove the catheters is unclear and it should be

done in conjunction with monitoring of coagulation status.

## Heparin

### *Unfractionated Heparin*

The epidural should be placed at least 1 hour before the dose. Catheters should be removed at least 6 hours post-dose and a further 1–2 hours before another dose is given.

### *Low Molecular Weight Heparin (LMWH)*

Concerns about the combination of LMWH and epidural or spinal anaesthesia causing epidural haematoma arose after a series of cases in the USA where patients received LMWH in a different dosing regimen from that used in many other parts of the world. Patients received twice-daily doses and had a total higher daily dose.

Currently the use of concurrent LMWH and epidurals varies depending on local prescribing practice (e.g. od or bd dosing). There is no clear evidence for any particular prescribing practice but a general guideline could be that insertion may not be within 24 hours of the last dose, with epidural catheter removal at least 12–18 hours following the last dose and subsequent doses not being given for 6 hours.

## References

- Block BM, Liu SS, Rowingson AJ et al. (2003) Efficacy of postoperative epidural analgesia: a meta-analysis. *JAMA* 290:2455–2463
- Breivik H (1999) Infectious complications of epidural anaesthesia and analgesia. *Curr Opin Anaesth* 12:573–577
- Macintyre PE, Ready LB (2001) *Acute pain management: A practical guide*, 2nd edn. WB Saunders
- Miller RD (2004) *Anesthesia*, 6th edn. Elsevier, Church Livingstone
- Rigg JR, Jamrozik K, Myles PS et al. (2002) Epidural anaesthesia and analgesia and outcome of major surgery: a randomised trial. *Lancet* 359:1276–1282
- Rodgers A, Walker N, Schug S et al. (2000) Reduction of post-operative mortality and morbidity with epidural or spinal anaesthesia: results from overview of randomized trials. *BMJ* 321:1493–497
- Vandermeulen E (1999) is anticoagulation and central neural blockade a safe combination? *Curr Opin Anaesth* 12:539–543
- Walker SM, Goudas L, Cousins MJ et al. (2002) Combination spinal analgesic chemotherapy: a systematic review. *Anesth Anal* 95:674–715

## Epidural Injection of Corticosteroids

- ▶ Epidural Steroid Injections

## Epidural Space

### Definition

The epidural space surrounds the dural mater sac, and is also called the extradural or peridural space. Anteriorly, it is bound by the posterior longitudinal ligament; posteriorly by the ligamenta flava and the periosteum of

the laminae; and laterally by the pedicles and the intervertebral foramina with their neural roots. Cranially, the epidural space is closed at the foramen magnum where the spinal dura attaches with the endosteal dura of the cranium. Caudally, the epidural space ends at the sacral hiatus that is closed by the sacrococcygeal ligament. The epidural space contains loose areolar connective tissue, fat, lymphatics, arteries, a plexus of veins, and the spinal nerve roots as they leave the dural sac and pass through the intervertebral foramina. The epidural space communicates freely with the paravertebral space through the intervertebral foramina.

- ▶ Acute Pain in Children, Post-Operative
- ▶ Epidural Infusions in Acute Pain

## Epidural Spinal Electrical Stimulation

- ▶ Pain Treatment, Spinal Cord Stimulation

## Epidural Steroid Injections

NIKOLAI BOGDUK

Department of Clinical Research, Royal Newcastle Hospital Newcastle, University of Newcastle, Newcastle, NSW, Australia  
nik.bogduk@newcastle.edu.au

### Synonyms

Epidural Injection of Corticosteroids; Lumbar Epidural Steroids; Caudal Epidural Steroids; Transforaminal Injection of Steroids

### Definition

Epidural injection of steroids is a treatment for radicular pain in which corticosteroid preparations are injected into the epidural space, using an interlaminar, caudal, or transforaminal route.

### Characteristics

Epidural injections of steroids are a common treatment that has been in use since 1952. The popularity of the treatment is supported by a large body of descriptive literature (Bogduk et al. 1993).

### Technique

Common to all techniques is placement of a needle into, or near, the epidural space at lumbar or sacral levels, so that material can be injected into that space. Access to the epidural space can be obtained through the ligamentum flavum, the sacral hiatus, or the intervertebral foramina. Respectively, these techniques are known as the lumbar or interlaminar route, the caudal route, and the transforaminal route (Bogduk et al. 1993).

Classically, lumbar and caudal injections have been performed blind, i.e. without radiological guidance, although increasingly commentators have called for fluoroscopic guidance to be adopted. Transforaminal injections have, since their inception, been performed under fluoroscopic guidance.

### Rationale

The rationale for epidural injection of steroids is that radicular pain is caused by inflammation of the lumbar or sacral nerve roots and that corticosteroids should suppress this inflammation and, thereby, provide relief of pain. In the past, this rationale had been presumptive. More recently, considerable evidence from animal experiments and clinical studies has established an inflammatory basis for lumbar radiculopathy (Bogduk and Govind 1999).

### Indications

Epidural steroids are a possible treatment for lumbar radicular pain. They are not indicated for low back pain. No literature supports their indiscriminate use for low back pain.

### Efficacy

The evidence concerning the efficacy of epidural steroids differs in quantity, strength, and conclusion, for each of the different techniques.

### Lumbar Injections

Early reviews were divided concerning the efficacy of lumbar epidural injections of steroids (Benzon 1986; Kepes and Duncalf 1985). An Australian government report found no evidence to either refute or endorse the practice (Bogduk et al. 1993). Later reviews concluded that there was no evidence of efficacy for lumbar epidural injections of steroids (Koes et al. 1995; Koes et al. 1999; Nelemans et al. 2001).

Since those reviews, two placebo-controlled studies have refuted the efficacy of lumbar epidural steroids. One found no differences in pain or disability, at three months after treatment with either epidural steroids or placebo (Carette et al. 1997). The other found no differences in outcome at 35 days (Valat et al. 2003). For lumbar epidural steroids, the ► **number needed to treat** (NNT) was 100.

### Caudal Injections

A meta-analysis found that the pooled data suggested that epidural steroids did have an attributable effect (Watts and Silagy 1995). For lumbar epidural steroids, that conclusion has now been refuted (Carette et al. 1997; Valat et al. 2003). For injections by the caudal route, the conclusion is still open. It essentially rests on the results of two studies, each of which alone lacked sufficient statistical power to provide a conclusion.

One study suggested that steroids were reasonably effective but that control injections of saline were

markedly ineffective (Breivik et al. 1976). The small sample size, however, failed to reach statistical significance. Similarly, the second study showed a trend in favour of steroids at 4 weeks although not at one year (Bush and Hillier 1991), but the differences in outcome were not statistically significant from control.

### Transforaminal Injections

Transforaminal injections of steroids are only modestly better than control treatment for the relief of pain (Vad et al. 2002). However, they are very effective at sparing patients from surgery (Riew et al. 2000; Weiner and Fraser 1997). An open study found that 47% of patients, previously listed for surgery, no longer required it at an average of three years after treatment with transforaminal injections (Weiner and Fraser 1997). This effect was corroborated in a controlled study, in which 29% of patients treated with steroids still required surgery, compared with 67% who were treated with transforaminal injections of bupivacaine alone (Riew et al. 2000).

### Discussion

The evidence from controlled trials and systematic reviews does not support the popular use of lumbar epidural injections of steroids. These injections have proven to be no more effective than placebo therapy. For caudal injections, the evidence only hints at these injections being effective.

With respect to relief of pain, transforaminal injections of steroids are barely better than the control treatments against which they have been compared. However, transforaminal injections do have a significant effect in saving patients from surgery for lumbar radicular pain.

Of all the techniques available for epidural injection of steroids, the transforaminal appears to be the most effective. The available literature on transforaminal injections, however, is limited to patients with chronic radicular pain, awaiting surgery. Their efficacy for acute radicular pain has not been reported.

### References

1. Benzon HT (1986) Epidural Steroid Injections for Low Back Pain and Lumbosacral Radiculopathy. *Pain* 24:277–905
2. Bogduk N, Christophidis N, Cherry D et al. (1993) Epidural use of Steroids in the Management of Back Pain and Sciatica of Spinal Origin. Report of the Working Party on Epidural use of Steroids in the Management of Back Pain. National Health and Medical Research Council, Canberra
3. Bogduk N, Govind J (1999) Medical Management of Acute Lumbar Radicular Pain: An Evidence-Based Approach. Newcastle Bone and Joint Institute, Newcastle
4. Breivik H, Hesla PE, Molnar I et al. (1976) Treatment of Chronic Low Back Pain and Sciatica. Comparison of Caudal Epidural Injections of Bupivacaine and Methylprednisolone with Bupivacaine followed by Saline. In: Bonica JJ, Albe-Fessard D (eds) *Advances in Pain Research and Therapy*, vol 1. Raven Press, New York, pp 927–932
5. Bush K, Hillier S (1991) A Controlled Study of Caudal Epidural Injections of Triamcinolone Plus Procaine for the Management of Intractable Sciatica. *Spine* 16:572–575



6. Carette S, LeClaire R, Marcoux S et al. (1997) Epidural Corticosteroid Injections for Sciatica due to Herniated Nucleus Pulposus. *N Eng J Med* 336:1634–1640
7. Kepes ER, Duncalf D (1985) Treatment of Backache with Spinal Injections of Local Anesthetics, Spinal and Systemic Steroids: A Review. *Pain* 22:33–47
8. Koes BW, Scholten RJPM, Mens JMA et al. (1995) Efficacy of Epidural Steroid Injections for Low-Back Pain and Sciatica: A Systematic Review of Randomized Clinical Trials. *Pain* 63:279–288
9. Koes BW, Scholten RJPM, Mens JMA et al. (1999) Epidural Steroid Injections for Low Back Pain and Sciatica: An Updated Systematic Review of Randomized Clinical Trials. *Pain Digest* 9241–9247
10. Nelemans PJ, Bie RA de, Vet HCW de et al. (2001) Injection Therapy for Subacute and Chronic Benign Low Back Pain. *Spine* 26:501–515
11. Riew KD, Yin Y, Gilula L et al. (2000) The Effect of Nerve-Root Injections on the Need for Operative Treatment of Lumbar Radicular Pain. A Prospective, Randomized, Controlled, Double-Blind Study. *J Bone Joint Surg* 82A:1589–1593
12. Vad VB, Bhat AL, Lutz GE et al. (2002) Transforaminal Epidural Steroid Injections in Lumbosacral Radiculopathy. *Spine* 27:11–16
13. Valat JP, Giraudeau B, Rozenberg S et al. (2003) Epidural Corticosteroid Injections for Sciatica: A Randomised, Double-Blind, Controlled Clinical Trial. *Ann Rheum Dis* 62:639–643
14. Watts RW, Silagy CA (1995) A Meta-Analysis on the Efficacy of Epidural Corticosteroids in the Treatment of Sciatica. *Anaesth Intensive Care* 23:564–569
15. Weiner BK, Fraser RD (1997) Foraminal Injection for Lateral Lumbar Disc Herniation. *J Bone Joint Surg* 79B:804–807

## Epidural Steroid Injections for Chronic Back Pain

DAVID M. SIBELL, BRETT R. STACEY  
Comprehensive Pain Center, Oregon Health and  
Science University, Portland, OR, USA  
sibell@dohsu.edu

### Synonyms

Caudal Injection; trans-foraminal epidural steroid injection; Interlaminar Epidural Steroid Injection; Translaminar Epidural Steroid Injection; Midline Epidural Steroid Injection; nerve block; sympathetic block; selective nerve root block; selective nerve root injection

### Definitions

#### Epidural Steroid Injections

The term “epidural steroid injection” (ESI) refers to the application of corticosteroids to the epidural space, an act that can be accomplished by many different approaches. There are many different techniques and variables involved in the clinical application of this treatment modality (Cluff et al. 2002).

The interlaminar or translaminar technique typically involves placing a specialized epidural needle in the epidural space via a posterior approach, in between

adjacent spinal lamina by traversing the ligamentum flavum. This technique deposits corticosteroid along with saline or local anesthetic in the posterior aspect of the epidural space, somewhat removed from the presumed targets of dorsal root ganglion, nerve roots, and dorsal horn of the spinal canal. This technique is essentially similar to the approach most commonly utilized for perioperative anesthesia and analgesia, and thus is familiar to many practitioners and therefore widely employed.

With the transforaminal (TFESI) approach, the epidural space is approached more laterally, via the neural foramen at the level of the selected spinal nerve and dorsal root ganglion. The transforaminal technique requires radiological guidance (typically fluoroscopy) to identify the needle endpoint and to verify correct spread of the injectate. This technique allows more precise delivery of the injectate to the selected target, but requires specialized equipment and expertise.

The caudal approach involves placing a needle into the epidural space via the sacrococcygeal ligament and caudal hiatus. As spinal stenosis and herniated discs are typically a distance from the caudal hiatus, either a relatively large volume is injected (10–30 ml) or a catheter is threaded in a cephalad direction to the targeted level. Utilizing either a fiberoptic scope or a stiff, steerable catheter under fluoroscopic guidance, lysis of adhesions or neuroplasty can be accomplished (Igarashi and Hirabayashi 2004).

### Characteristics

#### Epidural Steroid Injections

Epidural injections for relief of nerve root pain was first reported over a century ago, and the technique of ESI remains widely employed in the treatment of pain secondary to herniated intervertebral discs, foraminal stenosis, and spinal stenosis. Despite popularity of the technique, the prospective literature is sparse and controversies regarding patient selection, technique, medications to inject, and frequency of injection persist (Abram 1999).

Neural inflammation plays a major role in symptomatic spinal nerve root irritation, particularly when pro-inflammatory substances from the nucleus pulposus are present. This response involves not only the nerve root, but also the dorsal root ganglion (Kobayashi et al. 2004). Radicular pain is likely to result from the combination of inflammation, edema, and mechanical compression of nerve roots (Lipetz 2002).

Epidural steroids may decrease neurogenic inflammation, produce membrane stabilization, and decrease vascular permeability resulting in pain relief that evolves over a few days. Adding a local anesthetic to the injectate provides more immediate pain relief by a different mechanism, sodium channel blockade. Alternatively, the steroid may be delivered in a normal saline vehicle.

The primary indication for ESI is radicular extremity pain that has not responded to more conservative treatment. Primary back pain without leg symptoms is less likely to respond to ESI, but some advocate ESI for patients with symptomatic degenerative disc disease associated with back pain. ESIs are also used in the cervical spine, but the literature is even more limited and significant controversy exists regarding potential risks, particularly for the cervical transforaminal technique (Rathmell et al. 2004). The therapeutic goal is to decrease pain by decreasing neural inflammation, irritation, or sensitization.

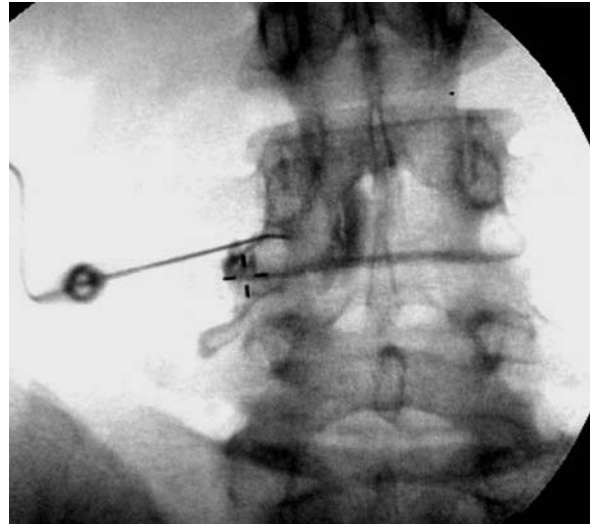
Traditionally, ESI has been performed without the benefit of imaging techniques to assist in confirming needle placement. Recent evidence suggests that using fluoroscopy or other imaging increases the likelihood of delivering medication to the targeted area of the spine and may confer increased safety (Fredman et al. 1999; Stretanski and Chopko 2005).

### Interlaminar Approach

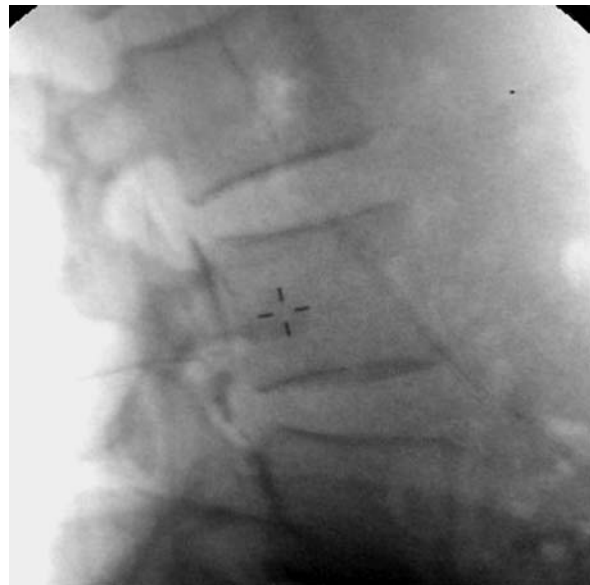
The loss of resistance (LOR) technique coupled with a specialized epidural needle is utilized to identify the posterior aspect of the epidural space, immediately anterior to the ligamentum flavum. Aspirating on the syringe after obtaining the LOR decreases, but does not eliminate, the risk of inadvertent intrathecal or intravascular injection. Radiographic guidance can be applied to identify the spinal level, confirm needle location, and then to confirm appropriate radio-opaque contrast spread at the targeted level. Commonly injected steroids include methylprednisolone (40–120 mg), betamethasone (3–9 mg), and triamcinolone (40–80 mg) diluted with either local anesthetic or normal saline to a total volume of 5–10 ml. The injection can be repeated every 1–3 weeks, depending on response, up to 3 times. Efficacy may be reduced in patients with prior spine surgery, concurrent smoking, nonradicular pain pattern, high pain intensity that does not vary, and unemployment because of pain.

### Transforaminal Approach

The more lateral TFESI targets a specific spinal segment, allowing the injectate to be more concentrated on the presumed source of pain. In the lumbar region, a small (22–25 G) needle is advanced under multi-planar fluoroscopic guidance to the superior aspect of the foramen. Radio-opaque contrast confirms spread into the epidural space and along the targeted nerve root. A selective nerve root block is very similar but with no intention of central epidural spread of the injectate. The precision of such a “selective” injection has been questioned (Furman and O’Brien 2000). Typically, steroid is mixed with a small volume of local anesthetic, giving a total volume of 2–3 ml of therapeutic injectate. In the lumbar spine, recent studies support this technique as safe, effective, and more effective than non-image guided midline ESI (Thomas et al. 2003) (Figs. 1, 2, 3).



**Epidural Steroid Injections for Chronic Back Pain, Figure 1** Left L4 Transforaminal ESI AP View.



**Epidural Steroid Injections for Chronic Back Pain, Figure 2** Left L4 Transforaminal ESI Lateral View.

### Other Approaches

The caudal approach utilizes the sacral hiatus as an entry to the epidural space. Techniques include high volume injections via a needle with the hope of cephalad spread to the symptomatic level, threading an epidural catheter up to the level of presumed pathology, or using a fiberoptic scope advanced through the caudal hiatus under direct vision and fluoroscopic control to the target area. These techniques are less well studied than the others.

### Efficacy

Without a strong basis in literature, many spinal injection experts consider the “best practice” of ESI to involve fluoroscopic guidance, strict inclusion crite-



**Epidual Steroid Injections for Chronic Back Pain, Figure 3** Left L4 Transforaminal ESI Oblique View.

ria (radicular pain or disc pathology), and injections directed at the level of presumed pathology. While the literature is full of retrospective, unblinded studies, large placebo-controlled, randomized studies with these “best practice” standards do not exist for ESI. Few studies control for other treatments and examine functional outcomes. Most commonly, the patient populations studied have been mixed, with inconsistent diagnoses, symptom duration, and localization of symptoms. These differences in study design, diagnostic criteria, injection techniques, drug combination, and duration of follow-up make comparison and meta-analysis difficult. In fact, meta-analysis has revealed conflicting conclusions.

Two blinded, prospective, placebo controlled studies with the interlaminar route, no fluoroscopic guidance, no local anesthetic, and no attempt to place the injection at the level of presumed level of pathology showed no significant long-term benefit (Carette et al. 1997; Valat et al. 2003). This technique without local anesthetic or image guidance appears to be less than ideal.

Recent prospective studies of the transforaminal approach (fluoroscopy, local anesthetic, steroid, aimed at presumed level of pathology) demonstrated improvement in pain and functional outcomes, possible decreased surgery rate, and superior results compared to the interlaminar route (Botwin et al. 2002; Riew et al. 2000; Vad et al. 2002).

In conclusion, ESI is a potentially valuable treatment option for patients with radicular leg pain, symptomatic intervertebral disc disease, and spinal stenosis. It appears that the best results are obtained with the use of imaging, directing the injection at the level of presumed pathology, and local anesthetic accompanying the steroid. Fu-

ture studies will help clarify unresolved issues of patient selection, medication selection, and specific technique.

## References

1. Abram SE (1999) Treatment of Lumbosacral Radiculopathy with Epidural Steroids. [See comment]. *Anesthesiology* 91:1937–1941
2. Botwin KP, Gruber RD, Bouchlas CG et al. (2002) Fluoroscopically Guided Lumbar Transformational Epidural Steroid Injections in Degenerative Lumbar Stenosis: An Outcome Study. *Am J Phys Med Rehabil* 81:898–905
3. Carette S, Leclaire R, Marcoux S et al. (1997) Epidural Corticosteroid Injections for Sciatica Due to Herniated Nucleus Pulposus. *N Engl J Med* 336:1634–1640
4. Cluff R, Mehio AK, Cohen SP et al. (2002) The Technical Aspects of Epidural Steroid Injections: A National Survey. *Anesth Analg* 95:403–408
5. Fredman B, Nun MB, Zohar E et al. (1999) Epidural Steroids for Treating “Failed Back Surgery Syndrome”: Is Fluoroscopy Really Necessary? *Anesth Analg* 88:367–372
6. Furman MB, O’Brien EM (2000) Is it Really Possible to do a Selective Nerve Root Block? *Pain* 85
7. Igarashi T, Hirabayashi Y, Seo N et al. (2004) Lysis of Adhesions and Epidural Injection of Steroid/Local Anaesthetic during Epiduroscopy Potentially Alleviate Low Back and Leg Pain in Elderly Patients with Lumbar Spinal Stenosis. *Br J Anaesth* 93:181–187
8. Kobayashi S, Yoshizawa H, Yamada S (2004) Pathology of Lumbar Nerve Root Compression. Part 2: Morphological and Immunohistochemical Changes of Dorsal Root Ganglion. *J Orthop Res* 22:180–188
9. Lipetz JS (2002) Pathophysiology of Inflammatory, Degenerative, and Compressive Radiculopathies. *Phys Med Rehabil Clin N Am* 13:439–449
10. Rathmell JP, Aprill C, Bogduk N (2004) Cervical Transforaminal Injection of Steroids. *Anesthesiology* 100:1595–1600
11. Riew KD, Yin Y, Gilula L, Bridwell KH, Lenke LG, Laurysen C, Goette K (2000) The Effect of Nerve-Root Injections on the Need for Operative Treatment of Lumbar Radicular Pain. A Prospective, Randomized, Controlled, Double-Blind Study. *J Bone Joint Surg Am* 82:1589–1593
12. Stretanski MF, Chopko B (2005) Unintentional Vascular Uptake in Fluoroscopically Guided, Contrast-Confirmed Spinal Injections: A 1-yr Clinical Experience and Discussion of Findings. *Am J Phys Med Rehabil* 84:30–35
13. Thomas E, Cyteval C, Abiad L et al. (2003) Efficacy of Transforaminal versus Interspinous Corticosteroid Injection in Discal Radiculargia – A Prospective, Randomised, Double-Blind Study. *Clin Rheumatol* 22:299–304
14. Vad VB, Bhat AL, Lutz GE et al. (2002) Transforaminal Epidural Steroid Injections in Lumbosacral Radiculopathy: A Prospective Randomized Study. *Spine* 27:11–16
15. Valat JP, Giraudeau B, Rozenberg S et al. (2003) Epidural Corticosteroid Injections for Sciatica: A Randomised, Double Blind, Controlled Clinical Trial. *Ann Rheum Dis* 62:639–643

## Epigastric

### Definition

Epigastric is pertaining to the region overlying the upper abdomen can be a site of pain associated with digestive system components such as the stomach and pancreas.

- ▶ [Animal Models and Experimental Tests to Study Nociception and Pain](#)
- ▶ [Visceral Pain Model, Pancreatic Pain](#)

## Epigastric Pain

- ▶ Visceral Pain Model, Pancreatic pain

## Epilepsy

### Definition

Epilepsy is the term given for syndromes of epileptic seizures, a disorder of the nervous system in which abnormal electrical activity in the brain causes seizures (sudden uncontrolled waves of electrical activity in the brain, causing involuntary movement or loss of consciousness).

- ▶ Central Pain, Outcome Measures in Clinical Trials
- ▶ Dysesthesia, Assessment

## Epileptiform Neuralgia

- ▶ Trigeminal, Glossopharyngeal, and Geniculate Neuralgias

## Episode Tension Type Headache

- ▶ Headache, Episodic Tension Type

## Episodic Pain

### Definition

Episodic pain is a synonymous term for breakthrough pain that is used in non-English speaking countries.

- ▶ Evoked and Movement-Related Neuropathic Pain

## Episodic Paroxysmal Hemicrania

### Definition

Attacks of paroxysmal hemicrania with remission periods of  $\geq 1$  month.

- ▶ Paroxysmal Hemicrania

## Episodic Tension-Type Headache (Frequent and Infrequent)

### Definition

This distinction was introduced with the 2<sup>nd</sup> Edition of the International Headache Classification Committee. Infrequent episodic tension-type headache (<12 days/year) can be described as a 'normal' headache almost everybody knows, with marginal influence on daily activities and no impact on quality of life.

- ▶ Headache, Episodic Tension Type

## EPN

- ▶ Active Locus
- ▶ Endplate Noise

## EPSC

- ▶ Excitatory Post-Synaptic Current

## Equianalgesic Dose

### Definition

Equianalgesic refers to the dose of one analgesic that produces the same analgesic response as another. The equianalgesic dose is estimated from a relative potency determination that compares graded doses of the two analgesics.

- ▶ Cancer Pain Management, Principles of Opioid Therapy, Drug Selection
- ▶ Opioid Rotation

## Equianalgesic Dose Ratios

### Definition

Equianalgesic dose ratios are estimates of the dose ratio of drug A and B that provide equivalent analgesia. If incomplete cross tolerance is observed between A and B, then the equianalgesic dose ratios of A/B will vary depending on the length of administration of A before B is substituted in opioid rotation.

- ▶ Opioid Rotation



## Equianalgesic Dose Table

### Definition

Equianalgesic dose table is a dosing table that describes the relative potencies for different opioids and routes of administration. All values correspond to intravenous morphine 10mg.

► [Opioid Rotation in Cancer Pain Management](#)

## Equivalent Current Dipole

### Synonyms

ECD

### Definition

A summation of currents of many neurons with the same positive-negative direction can be mimicked as one strong dipole. This is termed the equivalent current dipole (ECD).

► [Magnetoencephalography in Assessment of Pain in Humans](#)

## Ergonomic Approach

### Definition

A scientific approach aiming at reducing the physical load and psychological stress associated with work. In addition to a curative effect on potential tissue damage, a proper ergonomic approach has a preventive impact on complaints and will also improve performance, which in a working environment implies an increase in turnover and/or quality.

► [Ergonomic Counseling](#)

## Ergonomic Counseling

JOHN DE CLERCQ, GUY VANDERSTRAETEN  
Department of Rehabilitation Sciences and  
Physiotherapy, Ghent University Hospital, Ghent,  
Belgium  
guy.vanderstraeten@ugent.be

### Definition

An ergonomic approach to a ► [work-related musculoskeletal disorder](#) (WMSD) is directed at decreasing the impact of the ► [load](#), since the risk for the development of a WMSD is dependent on the relation between the imposed load and the physical resistance (► [load-bearing capacity](#)) of the tissue.

### Characteristics

Work-related musculoskeletal disorders have become a major problem in many industrialized countries and are among the most prevalent lost-time injuries in almost every industry (Bernard 1997). Consequently, the prevention of WMSDs is an important topic, not only for the welfare of the employees but also for the employer. However, workers adapt themselves relatively easily to difficult work situations and accept high levels of effort and/or discomfort as an inevitable 'part of the job' (Pope et al. 1984). The principles of prevention are therefore a part of the total treatment of the complaint rather than an effective prevention tool. Ergonomic counseling should be a part of the treatment, not only to promote the healing process but also to prevent recurrences.

### General Principles of Treatment

The aim of treatment is to restore compromised tissues to normal function. When a WMSD has been diagnosed, standard conservative treatment consists of medical treatment and physiotherapy, combined or not. The goal of traditional medical treatment with NSAIDs is to diminish the inflammation, which will alleviate the pain and break the vicious circle of pain, immobilization, dysfunction, inflammation and pain. The treatment with drugs can also be focused on blocking the pain stimulus resulting in pain relief. Traditional physiotherapy with mobilization, stretching, muscle strengthening and electrotherapy aims at normalizing the load-bearing capacity of the tissue.

The risk for the development of a WMSD is determined by the relation between the imposed load and the physical resistance (load-bearing capacity) of the tissue. When the imposed load exceeds the load-bearing capacity, the tissue will be damaged and a WMSD may develop. The prevention as well as the treatment of WMSDs is focused on these two factors, with the aim of normalizing the relationship between them.

### Impact on Force

The load itself is determined by multiple factors. The best-known biomechanical factor is the impact of force. While certain loads can be tolerated, all soft tissues, including muscle, tendon, ligament, fascia, synovia, cartilage, intervertebral disc and nerve, fail when subjected to sufficient force (Adams et al. 1995). Data from cadaveric studies provide ranges within which such failure occurs. However, even at force levels clearly below the failure level, scientific evidence shows that tissue response to deformation may produce inflammation and injury at microscopic levels and also muscle fatigue (► [tissue fatigue](#)). An important factor in the ergonomic approach is to diminish the force, to decrease the loads and to adapt them to the load-bearing capacity of the tissue. For instance, decreasing the weight of cement sacks (load) from 50 kg to 25 kg has a positive effect on the prevalence of WMSDs, especially on low back

pain. This also applies to other WMSDs. For instance, decreasing the required pinch force on a pair of tongs will diminish the occurrence of carpal tunnel syndrome. The lower the force, the lower is the risk of exceeding the tissue resistance and of developing a WMSD. Consequently, it is essential to have an idea of all activities and the extent to which the affected structure will be (over) used. An ergonomic assessment is necessary. The intensity of the exertion is not only related to the magnitude of the load but also to the resistance, the drag, the inertia, the accelerations and the reaction forces of the work objects.

### Impact on Posture

Biomechanical modeling of load-handling activities shows that ► **posture** also plays an important role in the structure of the load and its effect on the origin of WMSDs. Posture is defined as a position or attitude of the body or of a body part. Some positions require more effort than others or result in compression or stretching of tissue in or around the joints. Consideration of both the position and the length of time in the position are critical. In general the postural requirements for the upper extremity (minimal load) should include keeping the elbows close to the body, shoulder (abduction) angles below 20–30 degrees, forward arm flexion below 25–30 degrees combined with no pronation or supination. The neutral position of the forearm should be held with a minimal strength of pinch grip. Posture is always related to static force. The magnitude of this static force is in its turn determined by the posture itself.

This static force has an influence on the blood flow in the tissue and on ► **creep**. If a static force is imposed, the blood flow in the concerned tissue will decrease. Consequently, fewer metabolites will be washed away, possibly leading to complaints. In addition, this static force has an impact on the origin of the ‘creep’ phenomenon. Creep is the change that occurs in a ligament (collagen) when a constant force is imposed. As a consequence, disc herniations can theoretically be explained as being associated with work activities involving flexed and torted postures. This hypothesis, however, remains to be confirmed epidemiologically in occupational settings (Grandjean 1980). In a study by Boos et al. (1995) the presence of symptoms was related to nerve compromise and psychosocial aspects of work but not to exposure to physical stressors. The ergonomic (treatment) approach will be focused on the avoidance of critical postures. The need to adapt the working postures will have an influence on the workspace. For instance, the height of worktables must be adapted to the worker to avoid a burdened posture.

### Repetitiveness

A third important biomechanical factor is ► **repetitiveness of movement**. Inflammatory muscle responses have

been documented in humans subjected to repetitive loading. Repetitive loading also negatively affects ligaments and tendons (Armstrong 1994).

Health care providers tend to think of repetitiveness in terms of joint motions whereas ergonomists consider the task cycle or standard task completion. Consequently, repetition has been characterized in terms of the number of exertions per unit of time or frequency. An exertion is defined as the contraction of the muscle to produce force or movement. Other investigators have characterized repetition as the number of parts produced per unit of time or cycle time (Mish et al. 1991). The cycle time can easily be obtained from production records and interviews with the workers and supervisors. In general, ergonomists define a repetitive task as one with a task cycle shorter than 30 seconds. Consequently it becomes easy to identify the persons at risk. However, in some cases this approach will fail to prevent WMSDs. For instance, in keyboard work, the task cycle will be much longer than 30 seconds, but it is clear that the number of exertions is very high. Several studies have shown a clear relation between visual display work and the prevalence of WMSDs (Melhorn 1998). Thus it is important in the ► **ergonomic approach** to avoid repetitiveness, taking into account both definitions. WMSDs caused by repetitiveness can be prevented not only by lowering the frequency or increasing the cycle time, but also by implementing a different muscle activity. The implementation of a different muscle activity, in which no or very little activity of the strained muscles is required, will provide more recovery time for the strained muscles.

### Vibration

Another underestimated biomechanical stressor is cyclic loading, i.e. ► **vibration**. The effect of vibration of major mechanical significance concerns the duration of the fatigue life of tissues. Fatigue, which is defined as a loss of strength resulting from intermittent stressors over time, can lead to tissue failure. This can occur with relatively small stressors compared to those required for static stress failure (Hertzberg and Manson 1980). A tissue’s fatigue life (the number of loading cycles it can withstand) depends on the range of stress imposed. A ligament is a biological connective tissue and consists of collagen composed of polypeptide chains. A study of Fung (1981) showed that after cyclic loading the ultimate strength of the ligament was significantly less than that of its unstressed counterpart. The amount of softening in the ligament was related to the cyclic stress. Vibration of the tissue induces so-called ‘vibro-creep’, which has been defined as the acceleration of creep under vibrations (Kazarian 1972). Vibrocreep has been demonstrated in cadaveric specimens and it presumably also occurs in living subjects. The ergonomic approach has to determine which vibrations resonate with the body vibrations and must be minimized to avoid creep.

## Organization

In addition to biomechanical factors, organizational components may also give rise to WMSDs (Henrick et al. 1984). The most important ones are work pressure, work rhythm, breaks and time of exposure. Some less important factors that may also have an effect on the development of WMSDs are internal stress, monotony of work and environmental factors like temperature, light and noise. Some of these organizational components, e.g. the environmental factors, can 'easily' be influenced by ergonomic counseling. Although the direct influence of these environmental factors on the prevalence of WMSDs seems small, it is important to try to optimize these components as well.

The role of stress in the development and exacerbation of chronic conditions has been well documented (Feuerstein 1985; Holmes 1967; Liker et al. 1984). Lampe et al. (1998) studied chronic back pain patients whose pain had a clearly organic etiology, and patients with pain of unknown origin (idiopathic group). Significantly more members of the idiopathic group had experienced at least one highly stressful event preceding the most recent episode of pain exacerbation. The type of stress associated with 'overload' occurring when the level of demand exceeds one's coping capacity, has clearly a negative effect on the course of WMSDs (Niemcryk et al. 1987). Within the context of the work environment it is important to avoid all factors that contribute to overwhelming stress levels in the employees, regardless of how small the impact may seem at first sight.

The way in which a factor (stressor) is experienced as stressful by the employee (patient) can only be determined by the employee himself. It is thus extremely important to involve the employee (patient) in the ergonomic study, the so-called 'participated ergonomics'. The goal of such an ergonomic study is to determine all stressors that are stressful for the individual and to minimize or remove them at a later stage. For instance, the 8 h working day is an organizational component, which can be a psychological and muscular stressor. The introduction of a 'work rotation system', 4 h job A and 4 h job B, decreases muscular stress if the muscles that have been working in job A are different from those active during the execution of job B. These kinds of muscular pauses are called macro-pauses. They have a positive effect on the prevention of WMSDs because they reduce the total load on the tissue.

During a job task, the musculoskeletal tissue is not loaded continuously. Because of movement the muscles work alternately. When the agonist works, the antagonist is inactive. These types of pauses are called micro-pauses. They have been shown to have a positive effect on the prevention of WMSDs, especially in static muscle-work situations. The blood flow, lowered during the static effort, will normalize during the micro-pause. The ergonomic measurement has to be

focused on the increase in the amount and duration of the micro-pauses.

## Conclusion

The biomechanical and organizational factors discussed earlier all have an influence on the magnitude of the load. As explained a WMSD occurs when the load-bearing capacity of the tissue (tissue resistance) is exceeded. This capacity mainly depends on personal characteristics like age, gender, physical fitness, medical history etc. All the risk factors that have an influence on the load are inter-related. The ergonomic approach must therefore study the whole 'human work environment system'. Only then can all the risks be identified and evaluated. In a third step of the ergonomic approach, a risk qualification can be done, so that the most important risk factors can be modified to reduce their impact on the pain.

## References

1. Adams MA, Dolan P (1995) Recent advances in lumbar spinal mechanics and their clinical significance. *Clin Biomech* 10:3–19
2. Armstrong TJ (1994) Ergonomics and cumulative trauma disorders. In: Kasdan ML (ed) *Occupational injuries*. WB Saunders, Philadelphia, pp 553–567
3. Bernard BP (1997) A Critical Review of Epidemiologic Evidence for Work-Related Musculoskeletal Disorders of the Neck, Upper Extremity, and Low Back. US Department of Health and Human Services
4. Boos N, Reider V, Schade K et al. (1995) The diagnostic accuracy of magnetic resonance imaging, work perception and psychosocial factors in identifying symptomatic disc herniations. *Spine* 20:2613–2625
5. Feuerstein M, Sult S, Houle M (1985) Environmental stressors and chronic low back pain: life events, family and work environment. *Pain* 22:295–307
6. Fung YC (1981) *Mechanical properties of living tissues*. Springer, New York
7. Grandjean E (1980) *Fitting the task to the human: an ergonomic approach*. Taylor & Francis, London
8. Henrick HW, Brown O Jr (1984) Human factors in organization design and management. In: *Human factors*. New Holland, Amsterdam, pp 99–155
9. Hertzberg RW, Manson JA (1980) *Fatigue of engineering plastics*. Inc Academic Press, New York, p 64
10. Holmes TH, Rahe RH (1967) The social readjustment rating scale. *J Psychosom Res* 11:213–218
11. Kazarian LE (1972) Dynamic response characteristics of the human vertebral column. An experimental study on human autopsy specimens *Acta Orthop Scand Suppl* 146:1–186
12. Lampe A, Sollner W, Krismer M et al. (1998) The impact of stressful life events on exacerbation of chronic low back pain. *J Psychosom Res* 44:555–563
13. Liker JK, Joseph BS, Armstrong TJ (1984) From ergonomic theory to practice: organizational factors affecting the utilization of ergonomic knowledge. In: Henrick J, Brown A (eds) *Human factors in organizational design and management*. Wiley, New York, pp 1–256
14. Melhorn JM (1998) Cumulative trauma disorders and repetitive strain injuries: the future. *Clin Orthop* 351:107–106
15. Mish FC, Gilman EW (1991) *Webster's ninth new collegiated dictionary*. Merriam-Webster, Springfield, pp 87–88
16. Niemcryk S, Jenkins CD, Rose RM et al. (1987) The prospective impact of psychosocial variables on rates of illness and injury in professional employees. *J Occup Med* 29:645–652
17. Pope MH, Frymoyer JW, Andersson G (1984) *Occupational Low Back Pain*. Praeger, New York

## Ergonomics

- [Pain in the Workplace, Risk Factors for Chronicity, Job Demands](#)

## Ergonomics Essay

PEREGRIN O. SPIELHOLZ  
SHARP Program, Washington State Department of  
Labor and Industries, Olympia, WA, USA  
spip235@lni.wa.gov

### Synonyms

Human Factors Engineering; work place design

### Definition

Ergonomics has become a buzz word in product marketing for everything from chairs and automobiles to power tools. Many people first think of keyboarding and working at their desk when they hear the word. The roots of the word, ergo: “work” and –nomics: “the study of”, lead us toward the true roots of this discipline in manufacturing around the turn of the century. The field of Ergonomics incorporates much more than the design and evaluation of workstations.

Ergonomics, or Human Factors Engineering, is a field of study that incorporates the disciplines of biomechanics, industrial engineering, psychology and physiology to design jobs, products or tools to be compatible with human capabilities. Ergonomists are employed for tasks that include evaluation of injury risks to workers and job-redesign, usability testing and software or product design, accident investigation, sports and recreation, and engineering of complex display-control systems such as airplane cockpits. The field has its roots in work done by Frank and Lillian Gilbreth, and Frederick Taylor between the 1890s and 1920s. The studies of these scientists focused on determining the most efficient way to design and perform industrial work. They found that raising and tilting parts bins toward the worker makes it easier to retrieve parts, shoveling lighter loads more frequently can be more efficient and less strenuous, and that work is better distributed to include both hands. These findings are design principles used regularly today.

### Characteristics

#### History

The formal founding of the field of Ergonomics and Human Factors came directly out of World War II. Experimental psychologists were instrumental in the design of instruments for ranging weapons and the design of aircraft cockpit displays both during and after the war. The success of this work led to increased interest in human performance and capabilities, and the founding of the Human Factors (and Ergonomics) Society in 1957.

Ergonomics has received much attention in the United States, due to actions by government agencies using the word to describe regulations that require companies to evaluate the risk of work-related musculoskeletal disorders (WMSDs) and to reduce hazardous levels of physical risk factors. These regulations on both the federal and state level have become a lightning rod for both some business groups, symbolizing what they perceive to be far-reaching government regulation. Labor groups, on the other hand, have supported regulations to curb the large number of debilitating musculoskeletal injuries in the workforce.

Most large corporations in the United States have been addressing ergonomics as part of their safety and health programs without the threat of regulations. Companies and government agencies are doing these activities to protect workers, however, the economic consequences of WMSDs are a strong driving force. Over 700,000 workers a year are off the job due to a WMSD, which accounts for about one-third of all reported occupational injuries and illnesses. These injuries cost business and the US economy at least \$20 billion annually in lost productivity, health costs, and direct costs, not to mention the cost to society and the injured worker (AFL-CIO 1997).

Injuries occur on the job due to a variety of factors that may include physical work requirements, work organization, psychosocial issues, and individual differences (NRC 1999). These factors lead to the development of disorders of the soft tissues that include ► [tendinitis](#), ► [epicondylitis](#) (tennis or golfer’s elbow), ► [tenosynovitis](#), disc herniation or ► [sciatica](#), ► [carpal tunnel syndrome](#), rotator cuff tendinitis, and ► [Raynaud’s Vibration White Finger Syndrome](#).

The current body of research has shown that many of these disorders are likely to be a product of a combination of factors. Work-related factors have been shown by most epidemiology studies to be the strongest predictor of soft tissue musculoskeletal disorders (NIOSH 1997). However, the underlying health conditions of an individual must be evaluated by a physician in any case, as the development of a disorder can also be influenced by other conditions such as diabetes, obesity, thyroid conditions, or pregnancy to name a few.

Several reviews of the epidemiologic evidence for work-related musculoskeletal disorders and effect of company ergonomics programs were performed in the late 1990’s (GAO 1997; NIOSH 1997; NRC 1999). The conclusions of the National Academy of Sciences review (NRC 1999) were that: 1) there is strong biological plausibility to the relationship between the incidence of musculoskeletal disorders and exposure risk factors in high-exposure jobs; 2) there is a higher incidence of disorders in workers in high-exposure jobs versus low-exposure jobs; and 3) research clearly shows that the rate of musculoskeletal disorders can be reduced by specific interventions in high-exposure jobs. The Gen-



eral Accounting Office (GAO 1997), in an evaluation of five different companies, also found that ergonomics programs yielded positive results when designed for the needs of the individual workplace.

The most comprehensive review of the epidemiologic literature was done by the National Institute for Occupational Safety and Health (NIOSH 1997). Over 2,000 relevant studies were identified and over 600 studies were reviewed in detail. Four physical work factors were identified as being significant contributors to WMSDs of the neck/shoulder, elbow and hand/wrist: 1) Repetition, 2) Force, 3) Posture, and 4) Vibration. The following four risk factors showed evidence of causing back disorders: 1) Lifting and forceful movements, 2) Awkward postures, 3) Heavy physical work, and 4) Whole-body vibration.

### Representative Research on Ergonomic Factors

Carpal tunnel syndrome has received a large amount of attention in the press and scientific literature. Two epidemiologic studies of carpal tunnel syndrome were identified by NIOSH (1997), which separated force as an exposure variable and met all the review inclusion criteria regarding participation rate, health outcome definition, blinding, and exposure assessment (Chiang et al. 1993; Silverstein et al. 1987). Chiang et al. (1993) found a statistically significant increase in carpal tunnel syndrome (CTS) symptoms (OR 1.8, 95% CI 1.1–2.9) in jobs with an average hand force of 30 N. Silverstein et al. (1987) found an OR of 2.9 for jobs with an adjusted hand force of 58 N compared to a group with a hand force < 58 N. NIOSH (1997) also reviewed epidemiologic studies of the hand/wrist which addressed repetitiveness. Five studies met the inclusion criteria of 70% participation rate, health outcome defined by symptoms and physical examination, blinding to health or exposure status, and independent exposure assessment. Several studies (Osorio et al. 1994; Silverstein et al. 1987) have found increased odds ratios ranging from 1.9–5.5 for carpal tunnel syndrome symptoms in jobs classified as highly repetitive. While the definition is not widely agreed upon, Silverstein et al. (1987) defined high hand/wrist repetitiveness as a cycle time less than 30 s, or greater than 50% of the cycle time performing the same kind of fundamental motions. Results from Silverstein et al. (1987) showed that high repetition and high force may act in a multiplicative fashion, raising the OR to 15.5 in jobs with high force and repetition.

NIOSH (1997) in its review of epidemiologic evidence of risk factors for low-back musculoskeletal disorders found strong evidence for relationships with work-related lifting, forceful movements and whole-body vibration. The review also found evidence that awkward postures and heavy physical work were associated with low-back disorders. Punnett et al. (1991) conducted a case-control study examining back disorders and work-related exposures in auto assembly workers.

Mild or severe back flexion (OR 8.09, CI 1.4–44) and lifting (OR 2.16, CI 1.0–4.7) were associated with back disorders.

Marras et al. (1993, 1995) studied the relationship between back disorders and spinal loading during work-related lifting, taking dynamic variables such as velocity and acceleration into account. Spinal loading while lifting was associated with back injury reports (OR 10.7, CI 4.9–23.6) when accounting for lift frequency, velocity, sagittal angle, and load weight. Dynamic variables were generally shown to increase the predicted spinal loading over static models.

Dynamic motion and other physical risk factors have also been studied for their relationship with work-related musculoskeletal disorders. Velocity and acceleration (peak and mean) of wrist motions have been demonstrated as potential risk factors in their relation to musculoskeletal disorders (Marras and Schoenmarklin 1993). Other possible risk factors include: localized mechanical stress, short recovery times, low temperatures and segmental vibration (Hagberg et al. 1992; Hammarkjold et al. 1992; Sundelin and Hagberg 1989). Some research has also shown personal attributes such as age, gender, physical condition or carpal tunnel cross-sectional area may play a role in the development of disorders along with occupational factors (Nathan et al. 1992). However, NIOSH (1997) concluded that, while individual risk factors may influence the development of disorders, they do not act synergistically with physical risk factors.

### The Role of Psychosocial Factors

Physical demands of jobs are not the only factors that put workers at risk for musculoskeletal disorders. Psychosocial and work organization factors have also been shown to play a significant role in musculoskeletal disorder development, either as a confounder or direct contributor (NIOSH 1997; NRC 1999). Studies have found psychosocial issues such as job dissatisfaction within each worker and within the workplace as being a contributor to the development of work-related musculoskeletal disorders (Neimcryk et al. 1987). A study by Marras et al. (2000) found that physical loading may increase as a result of external psychological stress. Other studies also relate evidence that psychosocial stress may influence central nervous system function and promote disease development, retard the repair of damaged tissue, or alter an individual's perception of pain (Clauw and Williams 2002). These non-physical factors could play a significant role in WMSD development by aiding disorder development, hindering healing processes, or increasing physical exposure.

### Summary

The scientific evidence is very strong for a relationship between musculoskeletal disorder development and physical factors of posture, force, repetition, heavy

lifting, and vibration. However, other work-related and non-work factors may also play a role in the development of a disorder. The work done over the last several decades in this field has also demonstrated that a multitude of successful intervention strategies are available to reduce a person's chances of suffering a musculoskeletal condition. With further work in this area and continuing workplace changes we can hope to reduce the presence of these disorders for people in every environment.

## References

1. AFL-CIO (1997) Stop the Pain. AFL-CIO, Washington DC
2. Chiang H, Ko Y, Chen S et al. (1993) Prevalence of Shoulder and Upper-Limb Disorders Among Workers in the Fish-Processing Industry. *Scand J Work Environ Health* 19:126–131
3. Clauw DJ, Williams DA (2002) Relationship between Stress and Pain in Work-Related Upper Extremity Disorders: The Hidden Role of Chronic Multisymptom Illnesses. *Am J Indust Med* 41:370–382
4. General Accounting Office (GAO) (1997) Worker Protection: Private Sector Ergonomics Programs Yield Positive Results. United States General Accounting Office, Report to Congressional Requesters, publication #GAO/HEHS, pp 97–163
5. Hagberg M, Morgenstern H, Kelsh M (1992) Impact of Occupations and Job Tasks on the Prevalence of Carpal Tunnel Syndrome: A Review. *Scand J Work Environ Health* 12:277–279
6. Hammarskjold E, Harms-Ringdahl K, Ekholm J (1992) Reproducibility of Carpenters Work After Cold Exposure. *Int J Epidemiol* 9:195–204
7. Marras W, Schoenmarklin R (1993) Wrist Motions in Industry. *Ergonomics* 36:341–351
8. Marras W, Lavender S, Leurgans S et al. (1993) The Role of Dynamic Three-Dimensional Trunk Motion in Occupationally-Related Low Back Disorders: The Effects of Workplace Factors, Trunk Position, and Trunk Motion Characteristics on Risk of Injury. *Spine* 18:617–628
9. Marras W, Lavender S, Leurgans S et al. (1995) Biomechanical Risk Factors for Occupationally-Related Low Back Disorders. *Ergonomics* 38:377–410
10. Marras WS, Davis KG, Heaney CA et al. (2000) The Influence of Psychosocial Stress, Gender, and Personality on Mechanical Loading of the Lumbar Spine. *Spine* 25:3045–3054
11. National Academy of Sciences: National Research Council (NRC) (1999) Work-Related Musculoskeletal Disorders: A Review of the Evidence, Steering Committee for the Workshop on Work-Related Musculoskeletal Injuries. The Research Base, Committee on Human Factors. National Academy Press, Washington DC
12. National Institute for Occupational Safety and Health (NIOSH) (1997) Musculoskeletal Disorders and Workplace Factors: A Critical Review of Epidemiologic Evidence for Work-Related Musculoskeletal Disorders of the Neck, Upper Extremity, and Low Back. DHHS (NIOSH) Publication No. 97–141
13. Nathan PA, Keniston RC, Myers LD et al. (1992) Longitudinal Study of Median Nerve Sensory Conduction in Industry: Relationship to Age, Gender, Hand Dominance, Occupational Hand Use and Clinical Diagnosis. *J Hand Surg* 17A:850–857
14. Niemcryk SJ, Jenkins CD, Rose et al. (1987) The Prospective Impact of Psychosocial Variables on Rates of Illness and Injury in Professional Employees. *J Occup Med* 29:645–652
15. Osorio AM, Ames RG, Jones J et al. (1994) Carpal Tunnel Syndrome among Grocery Store Workers. *Am J Indust Med* 25:229–245
16. Punnett L, Fine LJ, Keyserling WM et al. (1991) Back Disorders and Nonneutral Trunk Postures of Automobile Assembly Workers. *Scand J Work Environ Health* 17:337–346
17. Silverstein BA, Fine LJ, Armstrong TJ (1987) Occupational Factors and Carpal Tunnel Syndrome. *Am J Indust Med* 11:343–358
18. Sundelin G, Hagberg M (1989) The Effects of Different Pause Types on Neck and Shoulder EMG Activity During VDU Work. *Ergonomics* 32:527–537

## ERK Regulation in Sensory Neurons during Inflammation

KOICHI OBATA, YI DAI, KOICHI NOGUCHI  
Department of Anatomy and Neuroscience, Hyogo  
College of Medicine, Hyogo, Japan  
noguchi@hyo-med.ac.jp

### Definition

Extracellular signal-regulated protein kinase (ERK) is involved in cell proliferation and differentiation and in neuronal plasticity, including long-term potentiation, learning and memory. The phosphorylation of ERK in primary afferent neurons occurs in response to acute noxious stimulation, such as with capsaicin or inflammatory mediators. Furthermore, the activation of ERK occurs after peripheral inflammation induced by complete Freund's adjuvant (CFA) and contributes to persistent inflammatory pain, *via* transcriptional regulation of key gene products. Thus, activation of ERK in sensory neurons during inflammation may participate in generating pain hypersensitivity through transcription-dependent and -independent means.

### Characteristics

► **Mitogen-activated protein kinases (MAPK)** are a family of serine/threonine protein kinases that transduce extracellular stimuli into intracellular posttranslational and transcriptional responses (Widmann et al. 1999). The MAPK family includes ► **extracellular signal-regulated protein kinase (ERK)**, ► **p38 MAPK**, **c-Jun N-terminal kinase/stress-activated protein kinase (JNK/SAPK)** and **ERK5**. ERK is activated by membrane depolarization and calcium influx, is activated by an upstream kinase, MAPK/ERK kinase (MEK) and is known to be one of the intracellular signaling pathways involved in neuronal plasticity, such as long-term potentiation, learning and memory. Physiological and pathological activity-dependent activation of ERK occurs in the CNS, especially in the hippocampus. Several studies have reported ERK phosphorylation in the nociceptive pathway; for example, acute noxious stimulation, such as that produced by formalin or capsaicin, induces ERK phosphorylation in spinal dorsal horn neurons (Ji et al. 1999; Karim et al. 2001). A MEK inhibitor, PD 98059, reduces acute pain behavior after subcutaneous formalin injection, suggesting a role for ERK in acute nociceptive processing by a nontranscriptional mechanism (Ji et al. 1999; Karim et al. 2001). On the other hand, the activation of ERK in dorsal horn neurons contributes to persistent inflammatory

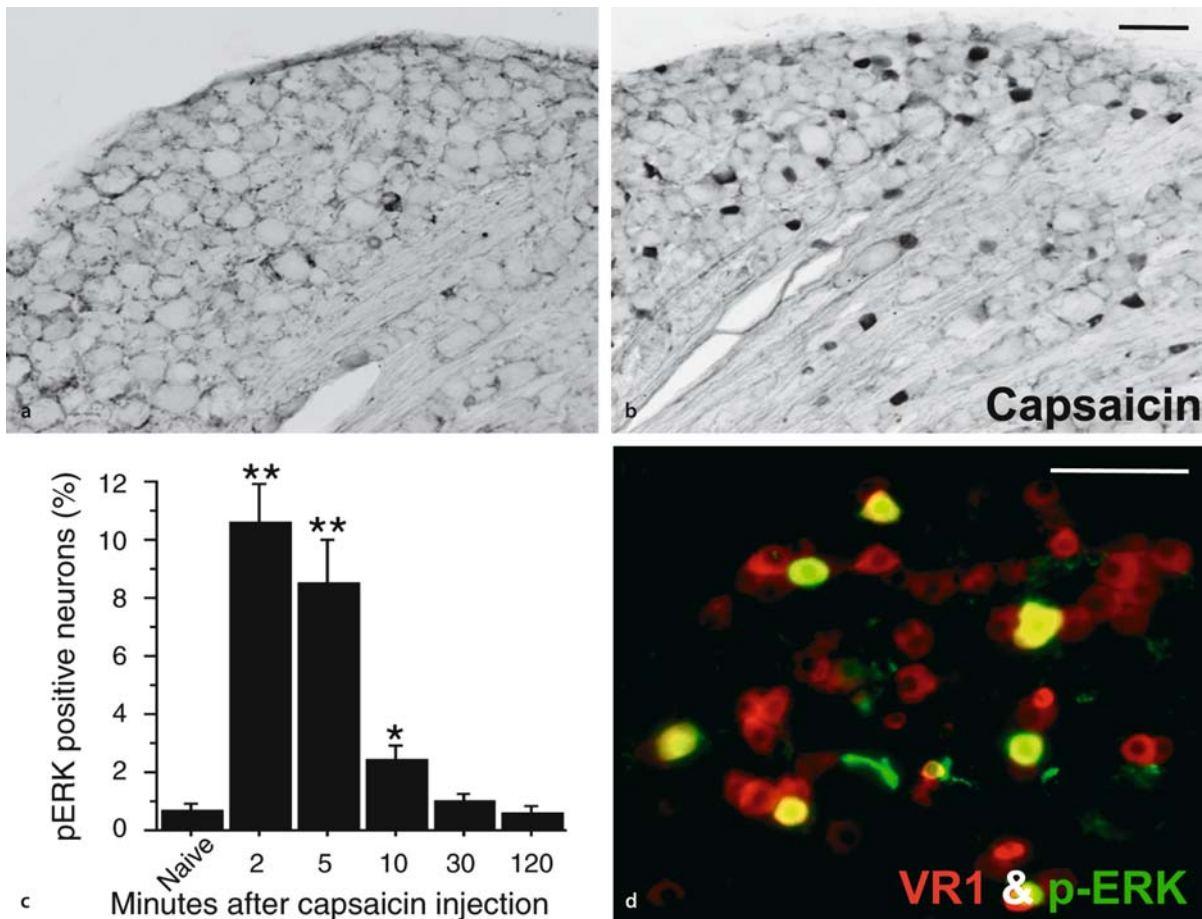
pain *via* transcriptional regulation of prodynorphin and neurokinin-1 (Ji et al. 2002a). Neuronal plasticity occurs in primary afferent neurons in the dorsal root ganglion (DRG), as well as in spinal dorsal horn neurons.

Inflammatory mediators, such as prostaglandin E<sub>2</sub>, serotonin, epinephrine and ► **nerve growth factor** (NGF), produce hyperalgesia through activation of ► **protein kinase A** (PKA) or ► **protein kinase C** (PKC) in primary afferent neurons. It has been shown that the ERK cascade acts in epinephrine-induced hyperalgesia; also, the Ras-MEK-ERK pathway is activated independently of PKA or PKC (Aley et al. 2001; Dina et al. 2003). ► **Bradykinin** (BK) injected into the peripheral tissue also increases phosphorylated-ERK (p-ERK) labeling in DRG neurons (Rashid et al. 2004). On the other hand, ERK pathway involvement in neurotrophin-dependent survival and differentiation of developing peripheral neurons has been characterized in detail. For example, the high-affinity receptor for NGF, ► **tyrosine kinase**

A (trkA), can signal through at least six different pathways, a major one of which is a MAPK pathway (i.e. the ERK pathway). In this pathway, activated receptors induce GTP loading and activation of the small G-protein Ras. In turn, Ras-GTP recruits a three-tiered enzyme cascade in which a MAPK kinase kinase (Raf) phosphorylates MEK, which phosphorylates and activates ERK. It has been reported that p-ERK is prominent in a few trkA-containing DRG neurons and in satellite glial cells, and is increased by NGF treatment (Averill et al. 2001; Delcroix et al. 2003). Furthermore, this p-ERK undergoes fast anterograde and retrograde axonal transport, indicated by accumulation at a sciatic nerve ligature and NGF reduces the level of retrograde p-ERK transport (Averill et al. 2001).

Phosphorylation of ERK in primary afferent neurons occurs in response to noxious stimulation of the peripheral tissue or electrical stimulation to the peripheral nerve, i.e. activity-dependent activation of ERK in DRG

E



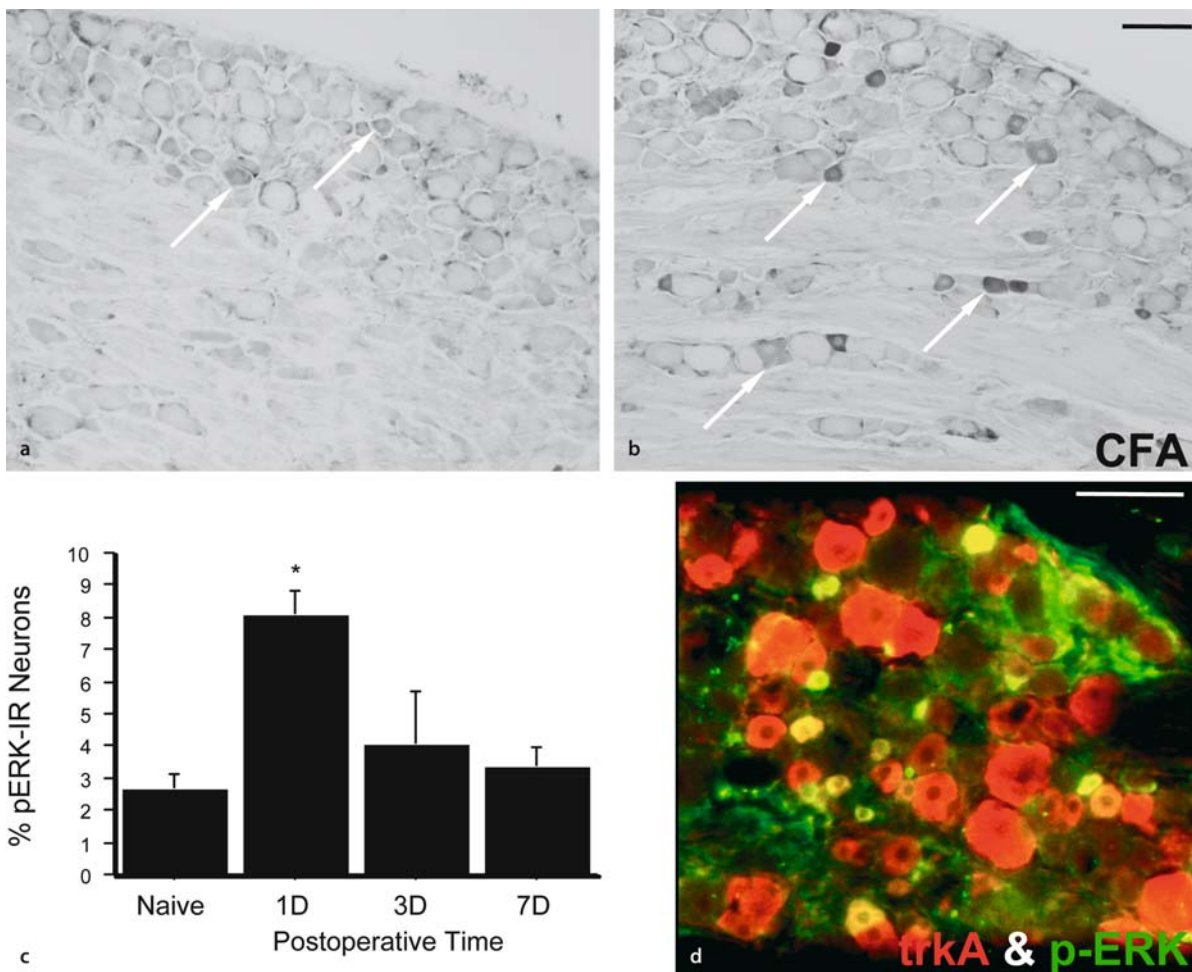
**ERK Regulation in Sensory Neurons during Inflammation, Figure 1** Stimulus-evoked ERK phosphorylation in rat DRG neurons. (a) L4 DRG section immunostained for p-ERK in the naive rat. (b) p-ERK labeling in many small L4 DRG neurons 2 min after intraplantar injection of capsaicin. (c) Time course of capsaicin-evoked p-ERK expression in L4/5 DRG neurons. \*  $p < 0.01$ ; \*\*  $p < 0.05$  compared with the naive control. (d) p-ERK-IR (green) and TRPV1-IR (red) in the ipsilateral L4 DRG after capsaicin injection are shown. Double labeling of neurons with p-ERK and TRPV1 was observed (yellow). Scale bars, 100  $\mu\text{m}$ . Modified from Dai et al. 2002.



neurons (Dai *et al.* 2002). For example, the electrical stimulation of A $\delta$ -fibers induces p-ERK, primarily in neurons with myelinated fibers, whereas c-fiber activation by capsaicin injection induced p-ERK in small neurons with unmyelinated fibers containing the transient receptor potential ion channel  $\blacktriangleright$  TRPV1, formerly known as the vanilloid receptor-1 (Fig. 1). In addition, noxious heat stimulation, as well as electrical stimulation, induces p-ERK in primary afferents in a stimulus intensity-dependent manner. On the other hand, capsaicin injection into the skin also increases p-ERK labeling significantly in peripheral fibers and terminals in the skin and a MEK inhibitor, U0126, dose-dependently attenuates thermal hyperalgesia after capsaicin injection. All of these results suggest that the activation of ERK pathways in primary afferents is

involved in peripheral sensitization in acute pain conditions. The phosphorylation of ERK in DRG neurons after noxious stimulation might be useful for examining the activation state of each neuron that contains various pain-related molecules (Dai *et al.* 2002). For example,  $\blacktriangleright$  P2X receptors in primary afferent neurons increase their activity with enhanced sensitivity of the intracellular ERK signaling pathway during inflammation and then contribute to the hypersensitivity to mechanical noxious stimulation in the inflammatory state (Dai *et al.* 2004).

The ERK in the nervous system produces not only short-term functional (non-transcriptional) changes by phosphorylating kinases, receptors and ion channels, but also long-term adaptive changes by activating transcriptional factors. For example, activated ERK



**ERK Regulation in Sensory Neurons during Inflammation, Figure 2** (a, b) Photomicrographs showing the p-ERK-IR in the contralateral (a) and ipsilateral (b) L4/5 DRG 1 day after peripheral inflammation. There was an increase in the number of p-ERK-IR neurons in the ipsilateral DRG (arrows). (c) Time course of the mean percentages of p-ERK-IR neurons relative to the total number of neurons in the L4/5 DRG. The mean percentages of p-ERK-IR neurons on the ipsilateral side significantly increased at 1 day after CFA injection compared to the naive control rats. \*  $p < 0.05$  compared with the naive control. (d) p-ERK-IR (green) and trkA-IR (red) in the ipsilateral L4/5 DRG after the CFA are shown. Double labeling of neurons with p-ERK and trkA was observed (yellow). Scale bars, 100  $\mu$ m. Modified from Obata *et al.* 2003.



translocates from the cytoplasm to the nucleus and activates Rsk2, which then phosphorylates the transcription factor cAMP response element-binding protein (CREB) on serine 133. The activated CREB then binds to the activating cAMP response element (CRE) sites on the promoter regions of the DNA and initiates the transcription of genes, such as *c-fos*, dynorphin and ► **brain-derived neurotrophic factor** (BDNF). The activation of ERK regulates gene expression of BDNF in primary afferent neurons after peripheral inflammation induced by CFA (Obata et al. 2003). Peripheral inflammation induces an increase in the phosphorylation of ERK, mainly in trkA-containing small-to-medium diameter DRG neurons (Fig. 2). Treatment with the MEK inhibitor, U0126, reverses the pain hypersensitivity and the increase in p-ERK and BDNF in DRG neurons. Furthermore, the intrathecal application of NGF induced an increase in the number of p-ERK- and BDNF-labeled cells, mainly small neurons. These findings suggest that the activation of ERK in the primary afferents occurs in DRG neurons after peripheral inflammation through alterations in the target-derived NGF and contributes to persistent inflammation *via* transcriptional regulation of BDNF expression (Obata et al. 2003).

It has been demonstrated that TRPV1 is regulated by NGF-induced activation of the ERK/MAPK pathway in DRG neurons *in vitro* (Bron et al. 2003), whereas Ji and colleagues showed that p38 MAPK activation in the DRG is required for NGF-induced increases in TRPV1 expression and contributes to the maintenance of inflammatory pain hypersensitivity (Ji et al. 2002b). Therefore, in addition to ERK, other MAPK pathways, such as the p38 or JNK/SAPK or ERK5 pathways, also may be activated by inflammation and play an important role in the generation of pain hypersensitivity (Obata and Noguchi 2004). Activation of MAPK clearly has a substantial role in the establishment and maintenance of nociceptive-induced plasticity in DRG neurons, not only by posttranslational modifications of target proteins, but also by increasing gene transcription. These attractive targets for study will give us new approaches for understanding the cellular/molecular mechanisms underlying pain hypersensitivity. Furthermore, inhibition of MAPK signaling in the primary afferents, as well as in the spinal cord, may provide a fruitful strategy for the development of novel analgesics.

## References

1. Aley KO, Martin A, McMahon T et al. (2001) Nociceptor sensitization by extracellular signal-regulated kinases. *J Neurosci* 21:6933–6939
2. Averill S, Delcroix JD, Michael GJ et al. (2001) Nerve growth factor modulates the activation status and fast axonal transport of erk 1/2 in adult nociceptive neurones. *Mol Cell Neurosci* 18:183–196
3. Bron R, Klesse LJ, Shah K et al. (2003) Activation of Ras is necessary and sufficient for upregulation of vanilloid receptor type 1 in sensory neurons by neurotrophic factors. *Mol Cell Neurosci* 22:118–132
4. Dai Y, Fukuoka T, Wang H et al. (2002) Phosphorylation of extracellular signal-regulated kinase in primary afferent neurons by noxious stimuli and its involvement in peripheral sensitization. *J Neurosci* 22:7737–7745
5. Dai Y, Iwata K, Fukuoka T et al. (2004) Contribution of sensitized P2X receptors in inflamed tissue to the mechanical hypersensitivity revealed by phosphorylated ERK in DRG neurons. *Pain*, in press
6. Delcroix JD, Valletta JS, Wu C et al. (2003) NGF signaling in sensory neurons: evidence that early endosomes carry NGF retrograde signals. *Neuron* 39:69–84
7. Dina OA, McCarter GC, de Coupade C et al. (2003) Role of the sensory neuron cytoskeleton in second messenger signaling for inflammatory pain. *Neuron* 39:613–624
8. Ji RR, Baba H, Brenner GJ et al. (1999) Nociceptive-specific activation of ERK in spinal neurons contributes to pain hypersensitivity. *Nat Neurosci* 2:1114–1119
9. Ji RR, Befort K, Brenner GJ et al. (2002a) ERK MAP kinase activation in superficial spinal cord neurons induces prodynorphin and NK-1 upregulation and contributes to persistent inflammatory pain hypersensitivity. *J Neurosci* 22:478–485
10. Ji RR, Samad TA, Jin SX et al. (2002b) p38 MAPK activation by NGF in primary sensory neurons after inflammation increases TRPV1 levels and maintains heat hyperalgesia. *Neuron* 36:57–68
11. Karim F, Wang CC, Gereau RW 4th (2001) Metabotropic glutamate receptor subtypes 1 and 5 are activators of extracellular signal-regulated kinase signaling required for inflammatory pain in mice. *J Neurosci* 21:3771–3779
12. Obata K, Yamanaka H, Dai Y et al. (2003) Differential activation of extracellular signal-regulated protein kinase in primary afferent neurons regulates brain-derived neurotrophic factor expression after peripheral inflammation and nerve injury. *J Neurosci* 23:4117–4126
13. Obata K, Noguchi K (2004) MAPK activation in nociceptive neurons and pain hypersensitivity. *Life Sciences*, in press
14. Rashid MH, Inoue M, Matsumoto M et al. (2004) Switching of bradykinin-mediated nociception following partial sciatic nerve injury in mice. *J Pharmacol Exp Ther* 308:1158–1164
15. Widmann C, Gibson S, Jarpe MB et al. (1999) Mitogen-activated protein kinase: conservation of a three-kinase module from yeast to human. *Physiol Rev* 79:143–180

## Error of Measurement

### Definition

As one aspect of the reliability of an outcome instrument, it is a measure of the precision of the instrument in detection of score change. It is calculated as a range of score units with 95% probability limits, taking into account the standard deviation of the score change and the test – retest reliability coefficient.

- **Oswestry Disability Index**

## Erythema

### Definition

Erythema is local redness or flushing of the skin due to dilatation of capillaries in the dermis.

- **UV-Erythema, a Model for Inducing Hyperalgesias**
- **UV-Induced Erythema**

## Erythema Nodosum

### Definition

Erythema nodosum is a frequent symptom in cerebral vasculitis

- ▶ Headache Due to Arteritis

## Erythema Nodosum Leprosum

- ▶ Type-2 Reaction (Leprosy)

## Erythropoietin

### Definition

Erythropoietin is a substance that is naturally produced by the kidneys, and that stimulates the bone marrow to make red blood cells. When erythropoietin is made in the laboratory, it is called epoetin alfa or epoetin beta.

- ▶ Cancer Pain Management, Chemotherapy

## ES Stimulation

### Definition

Intra-epidermal electrical stimulation using a very short needle. Only free-nerve endings are present there. A $\delta$  and C fibers are selectively stimulated.

- ▶ Magnetoencephalography in Assessment of Pain in Humans

## Escape Response

### Definition

Escape response is a response made to terminate a stimulus that is usually noxious.

- ▶ Visceral Pain Models, Female Reproductive Organ Pain

## ESES

- ▶ Epidural Spinal Electrical Stimulation

## Esophageal Pain, Non-Cardiac Chest Pain

- ▶ Visceral Pain Model, Esophageal Pain

## Essential Vulvodynia

- ▶ Dysesthetic Vulvodynia
- ▶ Vulvodynia

## Estrous Cycle

### Definition

Estrous cycle is a reproductive cycle in non-human animals, consisting of four stages of varying lengths, which are associated with changes in ovarian hormones and reproductive behaviors. The four stages include: proestrus, estrus, metestrus, and diestrus.

- ▶ Visceral Pain Models, Female Reproductive Organ Pain

## Etanercept

### Definition

A TNF-receptor fusion protein that serves as a TNF $\alpha$  inhibitor in human autoimmune disorders, mainly used in rheumatoid arthritis. It is beginning to be used for Crohn's disease and sciatica.

- ▶ Cytokines as Targets in the Treatment of Neuropathic Pain

## Ethics of Pain Control in Infants and Children

GARY A. WALCO

Hackensack University Medical Center; University of Medicine and Dentistry of New Jersey, New Jersey Medical School, Hackensack, NJ, USA  
gwalco@humed.com

### Definition

Data suggest that pain management for children is often very poor, even poorer than for their adult counterparts, which raises the question of whether such undertreatment of pain in the young is ethically justifiable (Walco et al. 1994). A fundamental principle of responsible medical care is not "do not hurt" but "do no harm." Harm occurs when the amount of hurt or suffering is greater than necessary to achieve the intended benefit. Since it is now clear that untreated pain has significant detrimental short- and long-term harmful psychological and physiological effects (Goldschneider and Anand 2003) and since caregivers are categorically committed to preventing harm to their patients, not using all available means to alleviate pain must be justified.

## Characteristics

### Revisionist Justification

Medical decision-making often relies on objective data. Pain is a subjective experience, however, and therefore direct quantitative assessment is difficult. This difficulty is compounded in young children in whom articulate verbal expressions of their pain and discomfort are either impossible or of questionable reliability, simply due to developmental factors. The fact that pain is so often undertreated in the young raises the possibility that available signs of pain, as well as children's reports of pain, are in some fashion "revised" in the context of observers' biases, so that evaluations of pain severity are minimized. In this view, there may be a "correct" or "reasonable" amount of pain that is associated with a given procedure or pathophysiological state, but this completely ignores the developmental factors related to pain systems (Andrews 2003), the individual differences in pain response that may be seen throughout the lifespan (Walco and Harkins 1999) and the complexity of factors that modulate the relationship between nociceptive stimulation and pain ratings in children and adolescents (Ilowitz et al. 1992). It is often assumed that adults are more reliable reporters of pain than are children and undue credence is put on parental or caregiver reports, rather than reports or expressions by children themselves. This assumption is not always valid however, as parents may project their own concerns onto the situation and they rely principally on behavioral cues to ascertain pain levels, which are not always consistent with children's internal states (Walco et al. 2005).

Incorrect notions about pain in children, especially neonates, are slowly reversing. For example, there was a prevailing view that neonates did not experience pain and if they did, the pain would not be remembered or it would have no lasting effect. Data are now clear that even premature infants, as young as 23 weeks gestation, experience pain. Furthermore, there is evidence to show that if untreated or undertreated, such pain experiences in the young may have significant lasting effects on the subsequent development of pain networks and may lead to hyperalgesic responses in the future, all in addition to the potentially detrimental hormonal and metabolic responses during the acute phases of the pain (Anand and Hickey 1987; Fitzgerald and de Lima 2001).

Finally, many questioned the reliability and value of pain assessment strategies in the young. There is now a plethora of literature on assessment strategies that may be used even in the smallest premature infants, through childhood and into adolescence. These instruments have been shown to be reliable, valid and clinically sensitive enough to detect changes in pain states, especially as a function of intervention (Stevens and Franck 2001). Thus, it is clear that even very young infants communicate their pain and it is the caregiver's job to utilize available strategies to make valid assessments.

Denial of relief from the pain that is proportionate to the expressed need for such relief must be judged an unjustified harm, unless such deprivation serves a substantially greater good.

### Comparative Justification

Once it has been ascertained that a child is in pain, one must weigh the benefits and risks of unrelieved pain against those of pain relief. In other words, while it always seems beneficial to alleviate pain, the "cost" of pain relief may be too high and thus imprudent to be invoked. In this arena, however, the reasons cited for withholding pain medications, for example, are often exaggerated or incorrect.

The modal intervention for moderate to severe pain in children involves the use of potent analgesic medications, such as opioids. These medications have problematic side effects and they have been associated with addiction. Thus, if one is concerned about respiratory depression (a known side effect of opioids), one may withhold these medications as it is presumed better to have a child in pain and breathing than it is to relieve pain and induce respiratory arrest. Similar arguments are made for addiction, as it would be better for a child to endure acute pain for a defined period if it spared opioid addiction in the future. However, data make it clear that with appropriate dosing and adequate monitoring, the likelihood of a clinically significant respiratory depression related to opioids in otherwise healthy children is quite low (Yaster et al. 2003). Likewise, the probability of a young child with no prior difficulties with substance abuse becoming addicted to opioid medication administered for pain is close to zero (Yaster et al. 2003). Based on these data, denying children adequate analgesia due to concerns about these extremely low probability events is way out of line with the usual level of risk physicians assume in prescribing treatment (Angell 1982).

### Pragmatic Justification

The pragmatic justification acknowledges that unrelieved pain is bad but asserts that such pain may be necessary to achieve a greater goal. Specifically, pain may be useful to monitor a clinical condition, especially if the diagnosis or extent of disease is not known or to assess the efficacy of some other treatment. Masking pain in these circumstances may be harmful to the patient and thus one must weigh the benefit of immediate pain relief against the benefit of long-term recovery.

In circumstances when residual or unrelieved pain is pragmatically justified, certain important questions must be considered. First, is the pain useful? Is it the means through which a goal may be attained? Second, is the pain necessary? If the same diagnostic or therapeutic goal may be met without the presence of pain, that should be considered as the choice alternative. Third, is the pain at the lowest possible level? If there

is therapeutic benefit to be derived from a child being in pain, one must be exquisitely economical with it, as the cost is the child's suffering.

### Final Considerations

There are now published guidelines that represent a consensus on the standard of care for pain assessment and management in children (American Academy of Pediatrics 2001; American Pain Society 2003), both of which emphasize the need for the regular assessment and appropriately aggressive treatment of acute pain in children. All health professionals should provide care that is consistent with the technological growth of the field and reflects current standards of practice. The assessment and treatment of pain in children are important parts of pediatric practice and failure to provide adequate control of pain amounts to substandard and unethical medical practice. Through ongoing educational efforts, it is hoped that more and more practitioners will provide care that meets stated standards and that those standards will change over time to reflect advances in the field.

### References

1. American Academy of Pediatrics Committee on Psychosocial Aspects of Child and Family Health, American Pain Society Task Force on Pain in Infants, Children, and Adolescents (2001) Policy statement: The assessment and management of acute pain in infants, children and adolescents (0793). *Pediatrics* 108:793–797
2. Anand KJ, Hickey PR (1987) Pain and its effects in the human neonate and fetus. *N Engl J Med* 317:1321–1329
3. Andrews KA (2003) The human developmental neurophysiology of pediatric pain. In: Schechter NL, Berde CB, Yaster M (eds) *Pain in Infants, Children, and Adolescents*, 2nd edn. Lippincott Williams & Wilkins, Philadelphia, pp 19–42
4. Angell M (1982) The quality of mercy. *N Engl J Med* 306:98–99
5. Fitzgerald MF, de Lima J (2001) Hyperalgesia and allodynia in infants. In: Finley GA, McGrath PM (eds) *Progress in Pain Research and Management*, vol 20. IASP Press, Seattle, pp 1–12
6. American Pain Society (2003) *Principle of Analgesic Use in the Treatment of Acute Pain and Cancer Pain*, 5th edn. American Pain Society, Glenview IL
7. Goldschneider KR, Anand KS (2003) Long-term consequences of pain in neonates. In: Schechter NL, Berde CB, Yaster M (eds) *Pain in Infants, Children, and Adolescents*, 2nd edn. Lippincott Williams & Wilkins, Philadelphia, pp 58–70
8. Ilowite NT, Walco GA, Pochaczewsky R (1992) Pain assessment in juvenile rheumatoid arthritis: relation between pain intensity and degree of joint inflammation. *Ann Rheum Dis* 51:343–346
9. Stevens BJ, Franck LS (2001) Assessment and management of pain in neonates. *Paediatric Drugs* 3:539–58
10. Walco GA, Harkins S (1999) Life-span developmental approaches to pain. In: Gatchel RJ, Turk DC (eds) *Psychosocial Factors in Pain: Critical Perspectives*. Guilford Publications, New York, pp 107–117
11. Walco GA, Cassidy RC, Schechter NL (1994) Pain, hurt, and harm: The ethical issue of pediatric pain control. *N Engl J Med* 331:541–544
12. Walco GA, Conte PM, Labay LE et al. (2005) Procedural distress in children with cancer: Self-report, behavioral observations, and physiological parameters. *Clin J Pain* 21:484–490
13. Yaster M, Kost-Byerly S, Maxwell LG (2003) Opioid agonists and antagonists. In: Schechter NL, Berde CB, Yaster M (eds) *Pain in Infants, Children, and Adolescents*, 2nd edn. Lippincott Williams & Wilkins, Philadelphia, pp 181–224

## Ethics of Pain, Culture and Ethnicity

DAVID B. MORRIS

University of Virginia, Charlottesville, VA, USA  
dbm6e@virginia.edu

### Definition

Ethnicity refers in everyday speech to groups having “common racial, cultural, religious or linguistic characteristics” (Oxford English Dictionary). Anthropologists debate its meaning, “instrumentalists” view ethnicity as fluid, dynamic and situational – a collective strategy for pursuing economic and political interests – while “primordialists” see ethnicity as a stable, ineffable, potentially coercive bond reinforced by culture. Culture is defined by primatologists as “social learning.” Human cultures are the constructed environments of material objects, ideas, institutions, social practices and interpersonal relationships in which we live. Ethics is the study of moral knowledge. It concerns principles of conduct – both personal and professional – as well as the wider field of individual and communal values.

### Characteristics

#### Ethnicity

Ethnicity is sometimes employed as a soft synonym for race, with an implication that ethnicity and race are both genetically determined. Some ethnic groups show physiological and morphological distinctness, such as variations in drug metabolism and in muscle enzyme levels after exercise. Such genetic variations, however, do not confirm a genetic basis for ethnicity or explain what ethnicity is. Patterns of gene frequencies resulting from marriage within a cultural group are “not so much the cause of ethnicity as the outcome” (Macbeth 2001). Most scientists view skin color, eye color, hair type and other outward signs associated with race as phenotypic variations insignificant at the level of the genotype. Human migration, intermarriage and genetic polymorphism mean that populations are rarely homogeneous. Africans, Caucasians and Asians (the most common racial designations) show wider genetic differences within groups than across groups. It is not race but racism that accounts for most documented differences in health status between minority and majority groups. Ethnicity is more dubious than race as a biological category. Government agencies in the US and UK increasingly prefer subjective criteria for establishing ethnicity. The term Hispanic offers insights into ethnic fluidity because Latin America has seen widespread intermarriage among European, Asian, African and native peoples. Health and census data show wide variation in racial self-identification across Hispanic groups. Like race, ethnicity is a powerful social fact, a source of intense political and personal identification as well as a source of inequalities in health care. In medicine, ethnic-



ity matters greatly when questions turn on the adequate treatment of minorities and on culturally-sensitive medical practices that respect the traditions and beliefs of minority groups. Such practice must recognize the limits of ethnic stereotypes; any social group includes members who resist its practices or reject its standards. In immigrant families, ethnicity is especially unstable across generations. Recognizing such difficulties, Crews and Bindon (1991) suggest that researchers state how they propose to use ethnicity, what their chosen categories imply biologically and sociologically, and why their particular analyses are needed.

Pain in its relations to ethnicity has been the subject of significant confusion in the design and interpretation of research studies (Morris 2001). Strong preliminary evidence suggests the existence of distinctive ethnic variations in pain (Bates et al. 1993; Greenwald 1991; Wolff 1985). Future studies, however, need to proceed with care in stipulating their assumptions. Ethnicity is shaped even by the methods of data collection that researchers employ to measure it. Senior and Bhopal (1994) argue that ethnicity implies one or more of three conditions: (1) a common language or religious tradition; (2) shared origins or social background; and (3) shared culture and traditions that are distinctive, maintained between generations and conducive to a sense of identity and group. This formula, while not trouble-free, avoids genetic or biological markers and suggests that ethnicity is inseparable from shared social experience or culture.

### Culture

Culture, as the constructed environment in which we live, plays no role in models of pain that emphasize the transmission of nociceptive impulses from the peripheral nervous system to the brain. The International Association for the Study of Pain, however, emphasizes that ► **nociception** is not pain. Pain, always psychological and always a subjective state, is inseparably linked to culture through the complex ► **neuromatrix** of thoughts, memories and emotions centered in the brain, which is, as neurosurgeon John Loeser writes, the organ responsible for all pain. A ► **biopsychosocial** model of pain implicitly recognizes the role of cultures. Cultures, in concert with the necessary biological processes, crucially shape and frame the human experience of pain.

Different historical cultures have framed the experience of pain within very different systems of thought (Morris 1991). The English word *pain* derives from the Latin word for punishment (*poena*), and Western societies until the nineteenth-century extended the ancient tradition that employed pain as a public method of legal penalty, whipping, branding and crushing. Nineteenth-century legal reforms replaced pain with incarceration, but they did not remove pain from the public realm. From Babylon to Homer, the ancient world had understood pain as a

punishment sent by the gods. From the mid nineteenth-century onwards, the modern world has understood pain as caused by a lesion. How people understand pain, as recent studies in ► **pain beliefs** demonstrate, correlates with pain intensity and with treatment outcomes.

The study of pain beliefs has focused in general on how individuals understand the cause, duration and outcome of their pain (Williams and Keefe 1991). ► **Catastrophizing** – the patient's mental-emotional conviction of a disastrous outcome – is both a barrier to successful treatment and a means of intensifying pain. Research shows that fear intensifies pain, but the fear in catastrophizing is more than a mere feeling. It is the product of beliefs that circulate within a culture long before they circulate within an individual brain. The pain associated with specific medical practices, such as the surgery without anesthesia until recently practiced on newborns, is no less the product of a culture or medical subculture. As for adolescents who cut their skin or who endure violent initiation rites, pain is a malleable experience that means different things in different contexts. Culture is the context through which pain connects nervous systems with the realm of social practices and individual meanings.

Children and patients with AIDS demonstrate how culture influences pain. Recently, pediatric pain units have made special efforts to overcome inherent limitations in language skills and in experience that typify children, as well as to address the distinctive fears and emotions that children feel. McGrath (1993) has emphasized the particular ways in which meaning and emotion enter into the child's experience of pain. The pain of patients with HIV / AIDS is complicated by social stigma associated with sexual deviance and illicit drug use. Heterosexual women, who make up an increasing percentage of AIDS patients, face the isolating cultural beliefs that AIDS is mainly a disease of homosexual males. The culturally charged categories of gender and race are associated with pain intensity among ambulatory AIDS patients in New York City (Breitbart et al. 1996). The role of multinational pharmaceutical companies in pricing drugs has a significant impact on the pain of AIDS patients in sub-Saharan Africa. Individual meanings, social practices and cultural assumptions shape, for better or for worse, the pain that patients experience.

### Ethics

Ethics is a cultural construction with ancient roots. By the 1970s, advances in medical technologies had so far outstripped traditional moral knowledge that a new sub-field emerged to address the gap, bioethics. Bioethics addresses moral issues that arise in medical practice and in particular it seeks to help doctors, hospitals and the modern corporate enterprise of medicine treat patients with respect and concern for individual rights. Such rights are widely understood to include the right to effective and appropriate treatment for pain.

The still dominant Western system of bioethics is known as principlism. Ethical decisions are considered under four main principles, autonomy, beneficence, justice and nonmalificence. Principlism, however, is under pressure to explain what standard underlies the selection of principles. Enlightenment assumptions about reason as a universal and absolute basis for moral judgments are no longer widely shared in a postcolonial, postmodern world that continually tests the limits of what is considered reasonable or ethical. Bioethical principles – especially when they are understood not as absolutes but as based in “common morality” and as “prima facie binding” (Beauchamp and Childress 1994) – always require interpretation and application by fallible human agents in specific cases where details are unique and outcomes uncertain. Pain specialists thus have no legitimate substitute for active, regular discussion of ethical issues. The 1970s brought very practical dilemmas. Pain research using animals was in effect unregulated and ran the risk of exceeding both what is humane science and what is tolerable to the nonscientific public. Public attitudes were changing. The year 1975 saw publication of philosopher Peter Singer’s groundbreaking *Animal Liberation: A New Ethic for Our Treatment of Animals*. In 1983 the International Association for the Study of Pain published its guidelines on experimental pain in conscious animals. The IASP report begins with the claim that research producing experimental pain in conscious animals is “essential” for new, clinically relevant knowledge about the mechanisms of pain. It also stipulates that researchers take measures to provide “reasonable assurance” that animals are exposed to “the minimal pain necessary for the purposes of the experiment.” Yet who defines what is reasonable or minimal? Are the purposes of an experiment ever other than human purposes? Human pain, with the far more complicated questions it evokes, did not receive official IASP research guidelines until 1995.

The usefulness of ethical guidelines is not in question. Guidelines, however, do not preempt the need for ongoing discussion, especially in the shift from a rights-based ethics to an ethics based on values (Morris 2003). A study of oncology nurses in the US concluded that the most frequently cited ethical dilemma involves the management of pain (Raines 2000). A pioneer of bioethics asserts that failure to relieve pain optimally is “tantamount to moral and legal malpractice” (Pellegrino 1998). Undermedication for pain, more pronounced in children than in adults, is not generally recognized as an ethical issue but treated as a technical problem of medical education, licensing and drug regulation. Its broader ethical implications are mostly un-addressed. Improved professional awareness of the ethical dilemmas surrounding pain is needed.

## References

1. Bates MS, Edwards WT, Anderson KO (1993) Ethnocultural influences on variation in chronic pain perception. *Pain* 52:101–112

2. Beauchamp TL, Childress JF (1994) *Principles of Biomedical Ethics*, 4th edn. Oxford University Press, New York
3. Breitbart W, Rosenfeld, BD, Passik SD et al. (1996) The undertreatment of pain in ambulatory AIDS patients. *Pain* 65:243–249
4. Crews DE, Bindon JR (1991) Ethnicity as a taxonomic tool in biomedical and biosocial research. *Ethnicity and Disease* 1:42–49
5. Greenwald HP (1991) Interethnic differences in pain perception. *Pain* 44:157–163
6. Macbeth H (2001) Ethnicity and race as epidemiological variables: centrality of purpose and context. In: Mabeth H, Shetty P (eds) *Health and ethnicity*. Taylor & Francis, London, pp 10–20
7. McGrath, PA (1993) Psychological aspects of pain perception. In: Schechter NL, Berde CB, Yaster M (eds) *Pain in infants, children, and adolescents*. Williams & Wilkins, Baltimore, pp 39–63
8. Morris DB (1991) *The Culture of Pain*. University of California Press, Berkeley
9. Morris DB (2001) Ethnicity and Pain. *Pain: Clinical Updates* 9:1–4
10. Morris DB (2003) Ethics Beyond Guidelines: Culture, Pain, and Conflict. In: Dostrovsky JO, Carr DB, Koltzenburg (eds) *Proceedings of the 10th World Congress on Pain*. IASP Press, Seattle, pp 37–48
11. Pellegrino ED (1998) Emerging ethical issues in palliative care. *JAMA* 279:1521–1522
12. Raines ML (2000) Ethical decision making in nurses: relationships among moral reasoning, coping style, and ethical stress. *JONA’s Healthc Law Ethics Regul* 2:29–41
13. Senior PA, Bhopal R (1994) Ethnicity as a variable in epidemiological research. *BMJ* 309:327–330
14. Williams DA, Keefe FJ (1991) Pain beliefs and the use of cognitive-behavioral coping strategies. *Pain* 46:185–190
15. Wolff BB (1985). Ethnocultural factors influencing pain and illness behavior. *Clin J Pain* 1:23–30

## Ethics of Pain, Human Dignity and the Ethical Management of Pain and Suffering

DARYL PULLMAN

Medical Ethics, Memorial University of Newfoundland,  
St. John’s, NL, Canada  
dpullman@mun.ca

### Definition

Dignity is a complex value concept that speaks to the worth human beings place upon themselves both individually and corporately. The evaluative content of the notion is determined to some degree by the context in which it is used. In some cases the term ‘dignity’ plays a largely formal role and is used to describe the intrinsic or inherent moral worth of every human being. Simply being a member of the human species affords one this dignity. One does nothing to earn it, and nothing can take it away (Kant 1785/1987). It is this sense of dignity that underwrites our general moral obligation to respect our fellow human beings and to treat them accordingly (Human Rights and Bioethics 1999). Our moral duty to respond to the pain and suffering of our fellow human beings is anchored in the intrinsic or basic dignity we all share as human beings.

There is another sense of dignity, however, that is more individualistic, social, and transient in nature. This dig-

nity is a socially constructed notion that is tied both to individual goals and social circumstances. Such personal dignity is related to an individual's sense of how he or she is perceived in the social world by both self and others. Personal dignity can be either enhanced or diminished depending upon a variety of contingent factors that may be largely outside the control of the person involved.

### Characteristics

Unmitigated pain and suffering are sometimes said to rob people of their dignity. When pain is not managed appropriately either through ignorance, indifference, or neglect, the goals and projects that together serve to define a person as an individual can be overwhelmed. Inasmuch as a person's dignity is to some extent dependent upon the ability to make and execute plans that provide meaning and purpose, poorly managed pain can undermine an individual's sense of dignity and self-worth. Our moral obligation to respond appropriately to the pain and suffering of other human beings is linked to our general moral obligation to recognize, honor, and otherwise preserve the basic dignity of our fellow human beings. Notice, however, that the dignity referred to in this paragraph is distinct from the dignity of the former paragraph. Here we are speaking of the basic dignity possessed by every human being. Pain and suffering cannot undermine this dignity because our intrinsic moral worth is immune to the vicissitudes of life. When we speak of the manner in which unmitigated pain might undermine the dignity of an individual then, it is personal dignity that is in view. The "death with dignity" movement in particular trades upon this more individualistic notion (Quill 1991; Pullman 1996).

A clearer understanding of the nature and extent of our moral obligation to respond appropriately to human pain and suffering requires a fuller explication of some of the terminology employed. In particular, the relationship between human pain and suffering must be explored (Pullman 2002).

Although the terms 'pain' and 'suffering' are often coupled in the literature on pain and symptom management, the terms are phenomenologically distinct. Pain does not necessarily involve suffering, and it is possible to suffer without being in pain. An individual afflicted with a congenital insensitivity to pain, for example, does not feel pain, but might nevertheless suffer from the effects of injuries sustained because of this insensitivity. Conversely, the pain of childbirth might be experienced as severe but rewarding.

Human beings are meaning conferring creatures. Our capacity for reflective self consciousness enables us to make sense of the world as we experience it. It is this capacity that enables us to distinguish between our selves and our bodies. Intense pain, however, can overwhelm this reflective capacity, such that it becomes impossible for the individual to distinguish between the self as person and the body in pain. Many have experienced this

phenomenon for a relatively brief duration when stubbing a toe or striking a thumb with a hammer. The more problematic occurrences, however, are those that involve acute or chronic pain occasioned by illness or disease that occurs over a sustained period of time. Intractable or poorly managed pain can inhibit the ability for reflective awareness, the capacity to make life plans, and to engage in other meaning conferring projects that contribute to a sense of dignity and self-worth.

Though phenomenologically distinct, pain and suffering are nevertheless closely related. Suffering is experienced by persons, not bodies (Cassell 1991). The manner in which a person suffers depends to some degree on their understanding of their pain. Hence it is possible to relieve a person's suffering in the presence of continuing pain by identifying the source of the pain, by changing its meaning, by demonstrating that the pain can be controlled, or by indicating that an end is in sight (Cassell 1982). The key observation here is that the primary link between pain and suffering is epistemic. That is, suffering occurs when the person in pain is unable to make sense of an experience that appears to undermine his or her integrity as a person. When the epistemic link is broken the individual's sense of personal dignity is compromised.

However, suffering is not confined only to those who experience pain. Inasmuch as suffering includes a significant epistemic component, others who share in or identify with the life project of the one in pain may suffer as well, as they strive corporately to make sense of their loved one's pain experience. "The loss that accompanies illness," writes Frank, "begins in the body, as pain does, then moves out until it affects the relationships connecting that body with others" (Frank 1991, p 36). We use terms like "sympathy" and "compassion" to describe the process of "suffering with" Clearly sympathy and compassion serve an important existential function as a means of psychological and social identification and support. However, they can also be viewed as part of an epistemic process by which we strive together to make sense of the pain endured by those whose lives we share. Ideally, "making sense" of such experiences involves an attempt to weave them into a meaningful narrative that can be shared, both by those who are actually in pain and by the sympathetic and compassionate ones who suffer with them. It is a process and a project that involves reference to our shared dignity.

The foregoing has several immediate implications for the ethical management of pain and suffering. First, health care providers who attend to the physical needs of patients in pain must be aware that their patient's suffering is not only physical and emotional, but to a large extent it is epistemic. While it is essential that the source of the pain is identified and that appropriate analgesics are provided if available, it is equally important to discuss the nature of the pain with the patient, to explain possible sequelae, and to attempt to help the patient

make some sense of the pain experience. Second, ethical management of pain and suffering extends beyond the person who experiences physical or psychical pain, to include those compassionate and sympathetic loved ones who share the illness narrative with the patient in pain. Inasmuch as we are social beings, our sense of personal dignity is tied up in the life stories of those we hold most dear. Hence, when our loved ones are in pain, we suffer. Thus, ethical pain management must extend to the community of care. Finally, the human resources necessary to provide this kind of ethical intervention are generally shared across a health care team rather than found in any single care-giver. Palliative care teams that include a full range of professionals that cover the gamut of needs from the physiological, to the psycho-social, to the spiritual are especially adept at providing this kind of intervention. Such teams could well serve as a model for other care providers who are striving for the highest ethical standards in the dignified management of human pain and suffering.

## References

1. Cassell E (1982) The Nature of Suffering and the Goals of Medicine. *N Engl J Med* 306 11:639–645
2. Cassell E (1991) *The Nature of Suffering*. Oxford, New York
3. Frank AW (1991) *At the Will of the Body: Reflections on Illness*. Houghlin, Mifflin, Boston
4. Human Rights and Bioethics (1999) C.H.R. res. 1999/63, U.N. Doc. E/CN.4/RES/1999/63
5. Kant I (1785/1987) *Fundamental Principles of the Metaphysics of Morals*. Abbott TK (trans.) Prometheus, Buffalo
6. Pullman D (1996) Dying with Dignity and the Death of Dignity. *Health Law J* 4:197–219
7. Pullman D (2002) Human Dignity and the Ethics and Aesthetics of Pain and Suffering. *Theor Med Bioeth* 23:75–94
8. Quill TE (1991) Death and Dignity. *N Engl J Med* 324:691–694

## Ethics of Pain in the Newborn Human

CARLO VALERIO BELLINI  
Neonatal Intensive Care Unit, University Hospital,  
Siena, Italy  
bellieni@iol.it

### Definition

Physiological, behavioral and hormonal responses indicate that neonates possess a functional ► **pain** system, which was recently widely recognized among the medical profession. Until 20 years ago, neonatal pain was largely underestimated. Opioids were rarely used even in surgery (De Lima et al. 1996) and many doctors maintained that neonates do not feel pain (Beyer et al. 1983). The neonatal brain was thought to be insufficiently developed to recognize noxious stimuli. Also the current definitions of pain do not really apply to the neonate. In 1991 the International Association for the Study of Pain (IASP) proposed the following definition of *pain*: “A sensory and emotional experience based on actual

or potential tissue damage or described in terms of such damage” (Merskey 1979). This definition implies introspection and expression by language not present in the neonate. The limits of this definition for the human neonate are now recognized (Anand and Craig 1996) and new definitions of pain and ► **suffering** have been proposed to encompass preverbal experience:

“Pain is an inherent quality of life itself, expressed by all viable living organisms and while influenced by life’s events, it does not require prior experience in the first instance.” (Anand and Craig 1996)

“Although pain and suffering are closely identified in the medical literature, they are phenomenologically distinct: pain, is a fundamentally “physical” phenomenon, the clash arising from an attack to our physical integrity, whereas suffering is something broader with pain as one of its sources and desire as its condition: we can define it the clash arising from an attack to our person’s integrity.” (Bellieni 2005).

### Characteristics

#### Principles in the Management of Neonatal Pain

In the last few years, analgesic drugs were used systemically and topically with success in neonatal care. In addition, non-pharmacological methods, such as non-nutritional sucking (Blass and Watt 1999) and the instillation of sucrose on the newborn’s tongue (Balon-Perin et al. 1991) were proposed to interfere with pain reactions in minor invasive procedures. Nevertheless, newborns are, in a certain sense, treated differently from other children or adults during potentially painful procedures; an older baby is reassured before, distracted during and soothed after blood sampling or injections. This rarely happens in dealing with neonates, are there physiological or psychological reasons for this? According to Als et al. (1997), preterm infants are neurobiologically social and the fact that they have needs and fears and feel pleasure should oblige us to reassure, distract and soothe them.

#### Studies on Sensory Saturation

In a recent study (Bellieni et al. 2001), we exploited newborns’ social behavior and sensoriality to stem pain. We studied premature babies during blood sampling using a technique of sensory stimulation and comforting. This technique was termed ► **sensory saturation** (SS) because competing sensory activation may result in saturation of central sensory pathways, which thus may prevent pain signals from reaching a response level. It consists in distracting and comforting babies by massaging them, speaking to them, establishing eye contact, offering a fragrance and instilling a sweet liquid to the tongue before and during heel-pricks.

The rationale of SS depends upon the fact that newborns have their own scent preferences (Thirion 1994), they see better than was previously thought and may have brief eye contact with their mothers (Robin 2000). Massage,



holding, sucking and sweetness have been shown to relax them. We recorded in the SS group a reduction in crying time and pain score with respect to a control group and with respect to groups in which only oral sugar, only sucking or a combination of the two were used. We repeated the experiment with term newborns and obtained similar results (Bellieni et al. 2002).

We attributed these results to the gate control theory of pain (Melzack and Wall 1965), but as this theory involves affective-motivational dimensions of pain experience, some further observation is necessary. We showed that giving sugar 2 minutes before heel lancing or mechanically putting a pacifier in the baby's mouth before taking a blood sample produces no sufficient analgesia; analgesia is more effective when newborns feel a nearby presence. This happens to some extent when sugar administration is accompanied by other little maneuvers, but it occurs to a greater extent during breastfeeding or with SS, because a more intense social relationship is established and babies do not feel alone and abandoned during the painful experience. These findings demonstrate that treating newborns with the respect due to an individual person, trying to comfort them during a stressful event is not only ethical, but also analgesic.

#### **Newborns not only Feel Pain: They also Suffer**

Newborns not only feel pain, they also experience suffering and anxiety (Als et al. 1997) and anxiety calls for the presence and involvement of a person of reference, not only analgesia. Infants, families and staff can be expected to grow in an environment where strengths are emphasized and vulnerability partnered. Unfortunately, in many cases this partnership is often reduced to fulfillment of a task (Cunningham et al. 1984). Caregivers should provide adequate relationship based care and help couples to become parents, to say "you" to the little preterm baby they see through the incubator window in the first hours of life (Bellieni 2003), recognizing its wishes, fears and suffering.

Schopenhauer defined suffering as the gap between what we demand or expect from life and what we actually get and his definition fits well with neonates. In fact we can affirm that newborns suffer, because they are persons who try to express their needs (Bellieni 2005), sometimes in a desperate way. We are right when we say that a newborn, though immature, is a person, because he/she has the features to be one, being alive, being an individual and belonging to the species capable of developing consciousness: mankind.

#### **Medical and Social Synergy to Prevent Pain**

We strongly promote the position that medical intervention should not be limited to drugs and technical procedures. What is required and needed is "presence" (Bellieni et al. 2003). Nurses and neonatologists should provide this presence and they should lead parents to become an active presence too, not being disappointed by

their babies' apparent fragility, immaturity and lack of reactivity, which make relief and suffering difficult to decode. Neonatal suffering can be expressed in many ways, as hinted consolation seeking, sometimes as a desperate need to sense the presence of the caregiver. Our task is to recognize this and to take care of it.

#### **References**

1. Als H, Gilkerson (1997) The role of relationship-based developmentally supportive newborn intensive care in strengthening outcome of preterm infants. *Semin Perinatol* 21:178–189
2. Anand KJS, Craig KD (1996) New perspectives on the definition of pain. *Pain* 67:3–6
3. Balon-Perin S, Kolanowski J, Berbinschi A et al. (1991) The effects of glucose ingestion and fasting on plasma immunoreactive beta-endorphin, adrenocorticotropic hormone and cortisol in obese subjects. *J Endocrinol Invest* 14:919–925
4. Bellieni CV (2003) Withholding and withdrawing neonatal therapy: an alternative glance. *Ethics Med* 19:99–102
5. Bellieni C (2005) Pain definitions revised: newborns not only feel pain, they also suffer. *Ethics Med* 21:5–9
6. Bellieni CV, Buonocore G, Nenci A et al. (2001) Sensorial saturation: an effective tool for heel-prick in preterm infants. *Biol Neonate* 80:15–18
7. Bellieni CV, Bagnoli F, Perrone S et al. (2002) Effect of multi-sensory stimulation on analgesia in term neonates: a randomized controlled trial. *Pediatr Res* 51:460–463
8. Bellieni CV, Bagnoli F, Buonocore G (2003) Alone no more: pain in premature children. *Ethics Med* 19:5–9
9. Beyer JE, De Good DE, Ashley LC et al. (1983) Patterns of postoperative analgesic use with adults and children following cardiac surgery. *Pain* 17:71–81
10. Blass EM, Watt LB (1999) Suckling and sucrose-induced analgesia in human newborns. *Pain* 83:611–23
11. Cunningham CC, Morgan PA, McGucken RB (1984) Down's syndrome: is dissatisfaction with disclosure of diagnosis inevitable? *Dev Med Child Neurol* 26:33–39
12. De Lima J, Lloyd-Thomas AR, Howard RF et al. (1996) Infant and neonatal pain: anaesthetists' perceptions and prescribing patterns. *BMJ* 313:787
13. Johnston CC, Stremmer R, Horton L et al. (1999) Effect of repeated doses of sucrose during heel stick procedure in preterm neonates. *Biol Neonate* 75:160–166
14. Melzack R, Wall PD (1965) Pain mechanisms: a new theory. *Science* 150:971–979
15. Merskey H (1979) Pain terms: a list with definitions and notes on usage. *Pain* 6:249–252
16. Robin M (2000) Premier regards, premiers échanges. In: Herbinet E, Busnel M-C (eds) *L'aube des sens*. Ed Stock, Paris, pp 55–66
17. Thirion M (1994) *Les compétences du nouveau-né*. Albin Michel SA, Ramsay, pp 121–126

E

## **Ethics of Pain-Related Disability Evaluations**

MARK D. SULLIVAN

Psychiatry and Behavioral Sciences, University of Washington, Seattle, WA, USA  
sullimar@u.washington.edu

#### **Synonyms**

Impairment rating; Malingering; Exaggerated pain

## Definition

The standards used for evaluating disability due to pain are primarily moral, rather than scientific, in nature. Criteria for legitimate entry to the sick role have evolved with society, with only modern industrial society placing heavy emphasis on tissue damage demonstrated on medical tests (Fabrega 1996). The highly variable relation between clinical pain and tissue damage poses a serious challenge to this strategy of illness behavior validation. The amount of objective tissue damage is a poor proxy for the amount of subjective pain. The strategy of validating pain complaints by matching them with something else is fundamentally flawed. Disability cannot be invalidated by matching public pain behavior with private pain experience. If this pain experience is truly private, it is not available to scientific investigation. Rather, pain behavior is judged as appropriate or exaggerated through complex assessments of the function of this behavior in its social context. It will remain necessary to triage suffering presented to health care providers into that which should be addressed in the medical setting and that which is better addressed elsewhere. However, current strategies of pain validation and triage are pseudo-scientific and distort the clinical care of those with pain.

## Characteristics

Malingering exists, though it is very rare in most clinical settings (Fishbain et al. 1999). The incentives for dissimulation in jails, emergency rooms and disability ratings may make it more common in these settings. Much more commonly, in clinical settings such as primary care or pain clinics, one hears about patients “exaggerating” their pain or reporting pain “out of proportion” with their physical findings. My purpose in this paper is to explore what we mean by these claims of exaggeration, taking malingering as a special case of exaggeration. I specifically want to inquire into the standards we use for exaggeration. I will claim that these are primarily moral, rather than scientific standards. I will argue that there is no scientific procedure by which we can determine whether private pain and public pain behavior are “equal”, because private pain is not accessible to scientific observation. Rather, we determine whether someone is being a good sport and playing by the rules of the game established by the group.

Assessments of illness behavior and disability ratings are part of the very general problem of accommodating the weak, the ill, the old and the young in any social group. It is one of the core ethical challenges of civilization. Though care of the sick is a universal feature of human societies, it is often morally ambiguous (Wolff and Langley 1977). This ambiguity cannot be resolved by sorting the ill into accurate and inaccurate reporters of pain. The quest to identify and extinguish all “secondary gain” is futile.

## Validating Pain Behavior

### Matching Pain Behavior and Pain Experience at a Personal Level

Consider our own ability to match our pain behavior with our pain experience. We certainly know if we are being insincere about the magnitude of our pain. The intention to lie about pain is apparent on introspection, but how could we be sure we were being sincere? How could we verify that our sensation was equivalent to our expression of pain? How could we verify that we were being “completely transparent” about the nature and extent of our pain? We do not simply rely upon accurate self-observation; checking and negotiating with others is necessary. Sincerity may not be the gold standard for “true” pain behavior that we think it is. What constitutes “too much” pain behavior when experiencing pain is judged by social, not scientific, standards. Knowledge of pain severity, like knowledge of one’s personal location, requires a context, not just a private experience. This context provides us with a metric to measure our experience and our behavior (Wittgenstein 1953).

### Interpreting the Pain Behavior of Another Person

A similar point can be made concerning our knowledge of others’ pain. I do not validate pain behavior by confirming its equality with the private pain experience of the person I am evaluating. By definition, I have no access to the other person’s private experience. I validate pain behavior if it has a comprehensible place within a wider social context. We think that our personal experience with pain must allow us to judge whether others are exaggerating or simply lying about their pain, for these judgments are made in clinical settings everyday. Yet, is it the concept of ‘pain’, rather than personal experience of the sensation of pain, which provides a framework within which the appropriateness of pain behavior can be judged. Judgments about exaggerating or faking pain, whether these are about others or about oneself, are not made on the basis of a simple encounter with a sensation. These judgments must be made on the basis of established criteria for appropriate behaviour. One cannot establish meaningful criteria entirely by oneself (Wittgenstein 1953).

### Interpreting Pain Behavior on the Basis of Physical Performance

The bulk of recent scientific literature about exaggeration and malingering among patients with chronic pain uses measures of physical function rather than measures of pain itself (Lechner et al. 1998). While this might appear to be a different issue, it is liable to the same critique. Such physical testing relies on the notion of honest or “maximal” effort. Various devices and strategies (e.g. isometric or isokinetic testing) have been devised to detect “sub-maximal” effort. Most have shown poor ability to detect malingerers in experimental settings (Lechner et al. 1998), but this is actually beside the point. The prob-

lem lies in defining what constitutes honest, sincere or maximal effort. Maximal voluntary effort is determined, not just by the individual and his pain- as is implied by this type of physical capacity testing. Maximal effort is also defined by the social context, including the standards and incentives it provides. It is not possible for even the individual being tested to determine what a maximal effort is without reference to this context. Does maximal effort occur in the presence of verbal encouragement, a \$1,000 reward, or a loaded gun pointed at the head?

### Interpreting Pain Behavior by Comparison to Tissue Damage

Another variant of the matching of pain with pain behavior is matching pain with tissue damage. The validation of pain complaint through correlation with tissue damage remains common in clinical and medico-legal settings (Rondinelli and Katz 2000), but is inconsistent with modern pain research. The relationship between the amount of tissue damage and the amount of pain experienced is highly variable. Physiological mechanisms whereby the organism increases (e.g. central sensitization) or decreases (e.g. pain modulation with endogenous opioids) the pain experienced from a given amount of tissue damage have been identified (Fields 2000). The inference that a patient's pain is "psychogenic" because a peripheral lesion "adequate" to explain the pain cannot be identified, is not justified by current science.

### Interpreting Pain Behavior by Comparing Experimental Pain to Clinical Pain

An enormous amount of research has been done on experimentally induced pain in normal people. Some researchers have asked subjects with ongoing, clinically significant pain to compare their experience of this pain to their experience of experimentally induced pain (Koelbaek et al. 1999). Research on comparisons between clinically significant and experimental pain is new enough, that its relevance to the broad issue of interpreting pain cannot yet be discerned. However, it is doubtful that such research will resolve the dilemmas associated with interpreting clinical pain. The social context and the behavioral incentives differ markedly between experimental and clinical pain, making it very difficult to infer the former from the latter.

### Summary

New standards of disability evaluation are necessary if we are to fairly evaluate the patient claiming disability due to pain. The ethical component of these standards should be acknowledged and publicly debated.

### References

1. Fabrega H (1996) *The Evolution of Sickness and Healing*. University of California Press, Berkeley, p 62
2. Fields HL (2000) Pain Modulation: Expectation, Opioid Analgesia and Virtual Pain. *Prog Brain Res* 122:245–253
3. Fishbain DA, Cutler R, Rosomoff HL et al. (1999) Chronic Pain Disability Exaggeration/Malingering and Submaximal Effort Research. *Clin J Pain* 15:244–274

4. Koelbaek M, Graven-Nielsen T, Olesen AS et al. (1999) Generalised Muscular Hyperalgesia in Chronic Whiplash Syndrome. *Pain* 83:229–234
5. Lechner DE, Bradbury SF, Bradley LA (1998) Detecting Sincerity of Effort: A Summary of Methods and Approaches. *Phys Ther* 78:867–888
6. Rondinelli RD, Katz RT (2000) *Impairment Rating and Disability Evaluation*. WB Saunders, Philadelphia
7. Wittgenstein L (1953) *Philosophical Investigations*. Translated by G.E.M. Anscombe. Blackwell, Oxford, p 253
8. Wolff BB, Langley S (1977) Cultural Factors and the Response to Pain. In: Landy D (ed) *Culture and Disease and Healing*. McMillan, New York, NY, pp 313–319

E

## Ethnic Group

### Definition

A self-identified cultural group that resides within another society and has beliefs, values and rules that permit appropriate interactive behavior among its members.

► [Cancer Pain, Assessment of Cultural Issues](#)

## Ethnicity

### Definition

An individual's self-identification with a group, or pertaining to a group of people recognized as a class on the basis of certain distinctive characteristics such as religion, language ancestry, culture or national origin.

► [Cancer Pain, Assessment of Cultural Issues](#)

## Etomidate

### Definition

Etomidate is an intravenous anesthetic acting at least partly via GABA<sub>A</sub> receptors.

► [GABA and Glycine in Spinal Nociceptive Processing](#)

## Evaluation of Pain-Related Thought, Psychological Aspects of Pain

► [Psychology of Pain, Assessment of Cognitive Variables](#)

## Evaluation of Permanent Impairment

► [Rating Impairment Due to Pain in a Workers' Compensation System](#)

## Evaluation of Pain in Humans

LARS ARENDT-NIELSEN

Laboratory for Experimental Pain Research, Center for Sensory-Motor Interaction, Aalborg University, Aalborg, Denmark  
lan@hst.aau.dk

It has always been the dream of pain researchers and clinicians to have an objective measure of pain. This is not possible and will most likely never be possible. Pain is a multidimensional unpleasant sensory and emotional experience and cannot as such be represented or described by a single parameter or number. However, different possibilities exist for quantitatively assessing various aspects of the complex sensory experience of pain and the implications of the pain on daily activities and social interactions. By measuring different aspects of the pain experience and by combination of the various measures, more can be learned about which dimensions are possible, which mechanisms / pathways are impaired and which are functioning normally.

The ultimate goal of pain assessment procedures is to obtain a better understanding of mechanisms involved in pain transduction, transmission and perception under normal and pathophysiological conditions. Such quantitative and differentiated information on pain provides fundamental knowledge, is of diagnostic value, may help in targeting treatment and can be used to evaluate the progression of diseases quantitatively and for evaluation of treatment efficacies / outcome. A major advantage of quantitative assessment is that the various pain measures can be followed over time and provide the researcher or clinician with quantitative data.

Modern pain diagnosis and management should be mechanism based – meaning that (1) the mechanisms involved and (2) the targeted pharmacological intervention should both be assessed and evaluated quantitatively. It may never be possible to develop and utilize a mechanism based approach to its full extent, but it may provide the framework for future developments and form the basis for basic scientists and clinicians to design studies in the future. The most fundamental tools for working along these lines are quantitative methods for differentiated assessment of pain, which include standardised methods to activate specific pain pathways/mechanisms. A given measure or set of measures can be adequate for some situations / patient groups, but may be difficult to administer in other settings or patient groups and hence the choice of method may not always be the most optimal and comprehensive. Since pain is a problem in most clinical areas, the possibilities obviously differ from area to area – assessment of can-

cer pain differs from assessment of naturopathic pain, which again differs from post-operative monitoring of pain or basic experimental human volunteer studies in the laboratory.

Assessment of pain and evaluation of treatment effect can be divided into three main categories (Fig. 1):

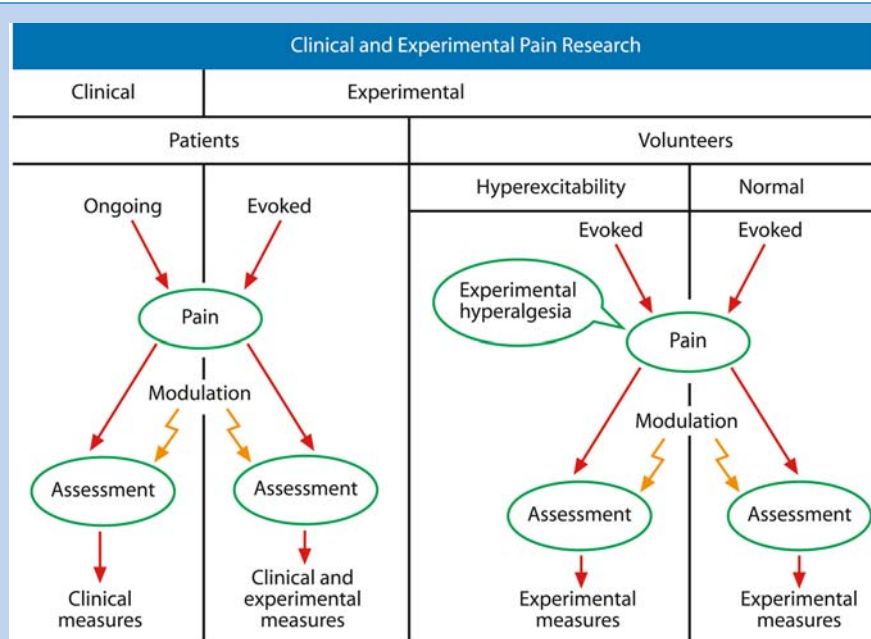
- Assessment of ongoing clinical pain
- Assessment of experimentally evoked pain for diagnosis and monitoring of patients
- Assessment of experimentally evoked pain for basic studies in healthy volunteers under normal conditions and conditions with experimentally induced hyperalgesia

Assessment of pain intensity, quality, location or quality of life in pain patients may be useful in many situations, but may not provide detailed information about the actual pathways or pathophysiological mechanisms involved. An extended and more advanced approach is to impose some additional and standardised painful stimuli on the patient and evaluate the response (Fig. 1). This quantitative and experimental approach is termed ► **quantitative sensory testing (QST)** or human experimental pain research. It is obvious that patients suffering from pain most often have a variety of pathophysiological mechanisms involved – theoretically, for example three, termed “A”, “B” and/or “C” (Fig. 2). To obtain more quantitative information, additional short lasting standardised experimental painful stimuli can be applied to the patients. Assuming that different stimulus paradigms activate different mechanisms / pathways, it is then possible to tease out which of these respond abnormally to activation. In theory, the activation of mechanism / pathway of say “A” may respond abnormally – the target for pharmacological intervention has then been clarified. This information would be beneficial if the interaction between available drugs and the various mechanisms is known. The drug specifically inhibiting the abnormal functioning of mechanism “A” could then be selected leaving the rest of the pain / sensory system unaffected.

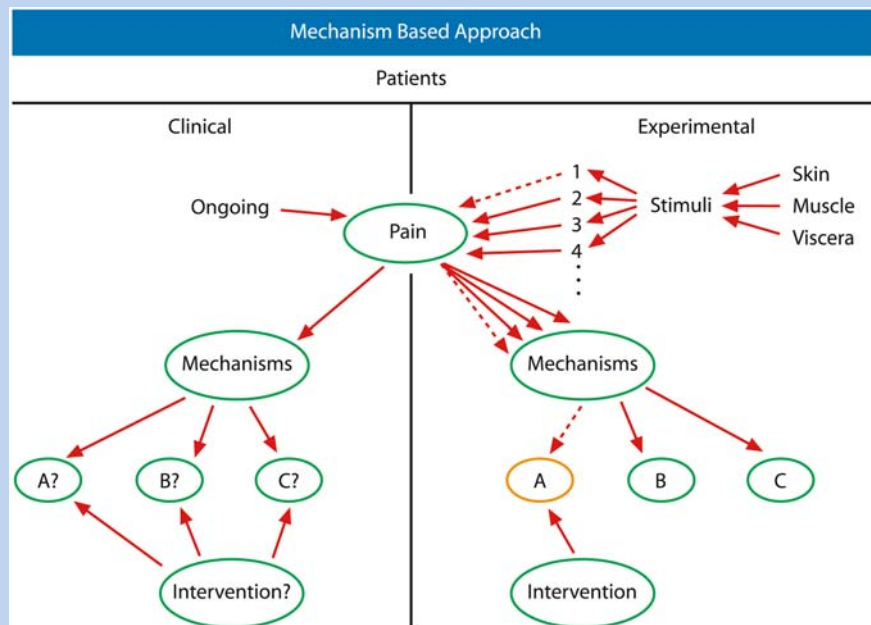
The implications of such a simplified scenario are obviously that better knowledge will be needed concerning the profile of action of current and new drugs. This knowledge can partly be acquired in basic human experimental pain studies on healthy volunteers where the modulation of responses to given stimulus configuration / modalities is evaluated before and after drug administration (Figs. 1, 2). As a normal and pathophysiological pain systems under many conditions respond differently to drug interventions, it is also important to have human experimental models available that can simulate pathophysiological conditions. In healthy volunteers, the experimental stimuli can be applied under normal conditions or in volunteers where the tis-



E



**Evaluation of Pain in Humans, Figure 1** An illustration of how pain can be assessed in clinical and experimental settings. In the clinical situation the various measures of the ongoing pain can be e.g. pain intensity, pain quality, location and quality of life. Various experimental stimuli can also be applied to the patients and can, together with the clinical measures, also assess their responses to such experimental stimuli in order to determine the degree of e.g. hyperalgesia, allodynia, hyperpathia, after-sensations and wind-up-like pain. In healthy volunteers, responses to experimental stimuli can be evaluated under normal conditions and conditions with experimentally induced hyperalgesia (hyperexcitability). The experimental measures can be e.g. pain thresholds, stimulus-response function, temporal summation and evoked potentials.



**Evaluation of Pain in Humans, Figure 2** A theoretical presentation of how various pain mechanisms can be assessed using experimental pain stimuli applied to skin, muscle, and viscera. The left side of the panel illustrates the clinical condition with ongoing pain where it is not possible to tease out which mechanism is involved, A, B or C. Therefore, a determination of which mechanism the intervention should target is not possible. The right panel illustrates the situation where a variety of different stimuli (1-4) can be applied to a specific tissue (e.g. muscle) of the patient. If a given stimulus (1) is assumed to activate a given mechanism (A), which is found abnormal, it is now possible for example to evaluate the effect of a given intervention on this specific mechanism as compared to normal conditions. Activating mechanism B and C could show normal reactions.

sue has been sensitised (experimental hyperalgesia, see later, Fig. 1). Experimental investigations of such mechanisms may increase the knowledge associated with diseases such as, for example, neuropathic pain.

### Assessment of Ongoing Clinical Pain and Treatment Effects

Assessment of pain in a systematic and consistent manner is an important instrument for promoting identification of unrelieved pain at the individual patient care level. This requires some collaboration from the patient and special considerations / precautions should be taken when pain is assessed e.g. in neonates, children, the elderly or cognitively impaired persons (see ► [Pain Assessment in Children](#), [Pain Assessment in Neonates](#), [Pain Assessment in the Elderly](#)). Pain assessment scales and methods used for neonates, children and in the elderly have received special attention. Factors known to aggravate or relieve pain may initially be recorded and qualitative information about the interaction with daily living, including work and recreational activities, ► [diurnal variation](#), ► [sleep disturbances](#), mobility, appetite, sexual functioning and mood should be gathered. These data are normally not quantitative, but may still be recorded in databases for later analysis. The psychosocial assessment should emphasize the effect of pain on patients and their families, as well as patients' preferences among pain management methods. Technological developments have provided small hand-held devices (data logger), which can be used as ► [pain diaries](#).

Some of the quantitative methods used to assess ongoing clinical pain may also be used to assess experimentally induced pain, whereas others are exclusively for clinical purposes. An assessment of pain intensity should include an evaluation of not only the present pain intensity, but also pain at its least and worst and when aggravated by various internal or external factors (activity, weather, stress, hormonal level, etc.).

The clinical pain assessment techniques can roughly be divided into five categories of which only 1–3 are dealt with here:

- quality of life
- Sensory component
  - ► [Sensory-discriminative aspect](#) (intensity)
  - Quality
  - Location
  - Temporal profile
- Psychophysiological methods
- Affective components
- Cognitive component

### Quality of Life

The pain inventory SF-36 (see ► [SF-36 Health Status Questionnaire](#)) is a measure of various quality of life dimensions and the scores are given within eight individual items related to physical functioning, physical problems, bodily pain, general health perspectives, vitality, social function, emotional problems and mental health. Specific self-report questionnaires have been developed in e.g. physical therapy (Oswestry disability questionnaire, Roland and Morris questionnaire) and cancer pain research (functional living index cancer scale, 36 item European organization for research and treatment of cancer quality of life questionnaire for cancer).

The ► [West Haven Yale multidimensional pain inventory](#) consists of 12 scales designed to measure the impact of pain on a patient's activities of daily living and is a comprehensive instrument developed to evaluate psychosocial and cognitive-behavioural factors related to pain. The symptom checklist 90-revised (SCL-90-R) is used for measuring the psychological symptomatology associated with chronic pain.

### Sensory Components

#### Sensory-Discriminative Aspect (Intensity)

The intensity and / or unpleasantness of ongoing or evoked pain can in principle be assessed by:

- Visual analogue scale (VAS)
- Numerical rating scale (NRS)
- Verbal rating scale (VRS)

The use of two separate psychophysical scales (mainly visual analogue scales or verbal rating / descriptor scales) for the assessment of pain intensity and pain unpleasantness has become a kind of a standard. The two dimensions have been proven to be sufficiently independent to justify separate assessments.

The visual analogue scale (VAS) can be a horizontal or a vertical line of e.g. 10 cm length anchored at the beginning like "no pain" and at the end like "worst pain imaginable". The subject is required to express the pain intensity by indicating a line length subjectively proportional to the perception. The pain intensity can also be rated on an electronic device where the scores are logged by a computer for later analysis or as part of a pain diary. The scales can also be defined as thermometers or have different shapes to compensate for the possible nonlinearity – an increased rating from 1 to 2 many not in relative magnitude correspond to an increase from 7 to 8. Generally, it is not recommended to apply words or numbers along the line as this may lead to uneven distribution (clustering) along the line. The cognitive demands in using a VAS may be too high for some patients (e.g. cognitively impaired, elderly).

The direct scaling methods are said to produce scales with interval or even ratio qualities. Such metric qualities are, however, not unalterable features because they are dependent on the rating behaviour of the given population under investigation.

The numerical rating scales (NRS) use verbal anchors such as “no pain” and “worst pain imaginable” at the starting and end points of the scale to define the scale range. Only numbers represent the categories themselves. It is tempting to assume that the numbers guarantee the equidistance between categories, which is not normally the case. Numerical scales are like verbal scale easy to explained and understood.

A verbal rating scale (VRS) is normally divided into several categories, which are labelled for example with “no pain”, “slight pain”, “moderate pain” and “strong pain.” A subject is asked to express the pain perception by use of these categories. The scores are quantified afterwards in case of e.g. a 4-point numerical rating scale by assigning a number from 1 to 4 according to the category chosen. The advantage of this approach is that it is easily understood by the subject and does not require a skilled investigator. However, the assumed equidistance between categories has not been proven for many of these scales. Therefore, ordinal scale properties ought to be taken for granted instead of interval scale properties. These limitations can be avoided by calibrating the psychometric distance between categories in advance.

Different pain assessment tools have been developed for different disciplines, for example the most frequently used multi-item measure of pain intensity in cancer pain research is the pain intensity scale of the brief pain inventory (BPI) combining 4 NRS (current pain, worst, least and averaged) into a single pain intensity score. Variants of the methods of direct scaling are magnitude estimation and cross-modality matching. Magnitude estimation requires the subjects to assign numbers proportionally to the intensity of pain perception. At the beginning the numbers can either be chosen completely arbitrarily by the subjects or the investigator can introduce certain values. Thus, the subject is instructed to assign a 10 to the first stimulus or a 50 to a “barely painful stimulus”. Furthermore, certain stimulus intensities can be used as references, which are assigned certain scale values. Such preset scale values are called a modulus and are thought to homogenise the use of a scale. The metric properties of such scales can be outstanding as long as a trained and skilled subject is the rater. However, the high cognitive demands associated with such scales prevent the use in populations with low education and cognitive disabilities. Cross-modality matching requires the subject to express the intensity of pain perception in a second sensory modality. A well-known example is the handgrip

method, in which a pressure sensitive grip is to be compressed proportionally to the pain intensity.

The scales can be combined in various ways e.g. numbers and descriptors. The scales (VAS, NRS and VRS) can also be used to assess pain relief. There is no evidence that one is better than another. However, practical considerations might suggest that VRS of pain relief (e.g. no relief, slight relief, moderate relief, lots of relief and complete relief) may help the chances that the patient will not confuse the relief rating with pain intensity ratings because NRS and VAS pain intensity measures can look very similar to NRS and VAS measures of pain relief.

### Quality

A multidimensional approach to assess pain qualities is the ► [McGill pain questionnaire](#) (MPQ) where a total of 78 pain descriptors are classified into 20 categories of pain to assess four major dimensions, sensory, affective, evaluative and “miscellaneous” pain as well as the total severity score. The questionnaire has been translated into many languages and validated independently. A short form MPQ (SF-MPQ) consists of a subset of 15 descriptors drawn from the sensory and affective categories. Whereas many clinical pain conditions have been quantified by means of the MPQ, it has infrequently been used to assess experimental pain. A further approach consists of the determination of the dimensionality of pain itself without using an *a priori* set of dimensions. The method of multidimensional scaling allows statistically finding the dimensionality of a given pain by using similarity estimates for series of perceptions of this pain under systemically varied conditions (e.g. different intensities, different durations, different areas, etc.). The number of distinct dimensions of pain is by this, not a prerequisite, but a result. The resulting dimensions are, however, not necessarily straightforward in their physiological or psychological meaning. In case of neurological disorders ► [paresthesia](#) may occur and here sensory qualities like numbness, tingling, burning and prickling should be assessed.

### Location

For painful muscular and visceral pain conditions, the referred pain patterns are of clinical importance and represent many years of empirical descriptions. Only more recently basic studies have tried to understand the underlying mechanisms of referred pain – and there is a general consensus that it represents a central phenomenon and that central sensitization may enlarge the referred pain areas. Referred pain can still be projected to an area completely anaesthetised or deafferented – indicating the role of the central nervous system.

The areas of pain (► [pain drawings](#)) or abnormal sensory perception can be assessed by a pain drawing or a pain site checklist. A pain drawing consists of an outline drawing of the human body, and patients are asked to indicate on the drawing specific sites of pain, other sensations or abnormal sensitivity to various standardised stimuli (e.g. mechanical and thermal). The areas can be quantified and used for later quantitative comparisons.

### Temporal Profile

The temporal aspects of pain, such as its variability, frequency and duration as well as its pattern across time (minutes, hours, days and months) can be assessed. Attempts have been made to use VRS to quantify how frequently the pain occurs over the day (ranging from “not at all” to “all day”). An important temporal aspect in relation to e.g. neurogenic pain is whether stimulus independent pain may be continuous or ► [paroxysmal](#) or whether the stimulus-evoked pain may show e.g. facilitated ► [wind-up](#) like pain with long after-sensation. Another aspect is the temporal response to a standardised experimental stimulus, e.g. a brief 51° stimulus. Such a stimulus will cause a well-localized, sharp, pricking first pain sensation (predominantly A $\delta$ -fibre mediated response) followed by a less well localized, diffuse, burning second pain sensation (predominantly C-fibre mediated response). This perceptual and temporal pattern may be markedly changed in patients suffering from e.g. neuropathic pain. Under normal conditions, it may be that pain evoked by even a cutaneous stimulus extends beyond the boundaries of the actual stimulus location (radiation). This radiation is more prominent in many types of clinical pain (e.g. assessment of ► [neuralgia](#) and ► [causalgia](#)).

### Psychophysiological Methods

Psychophysiological measures can be muscular or autonomic indicators. Muscle tension as assessed by use of surface electrodes over the muscles of interest (surface EMG) can be measured. The surface EMG methods aim at assessing the increased tension of certain muscles regionally related to the myalgic complaints, in rest or under physical or psychological stress, the slowing of muscle relaxation after use or the static or dynamic asymmetries in certain muscles groups responsible for posture and balance. Tension of many muscles can be scanned or that of a few muscles can be analysed quantitatively in detail. Simple linear relationships between muscle tension and subjective pain have been little observed. Attempts have also been made to measure firing from single motor units in relation to painful musculoskeletal disorders and stressful demanding work operations.

The regional blood flow through body areas affected by painful conditions and the blood stream in certain vessels can be assessed by use of e.g. photo-plethysmography, laser Doppler flowmetry, reflectance spectroscopy, thermography and thermistors. Blood pressure, heart rate and skin conductance level are non-specific correlates of nociception and may reflect physiological arousal. They are not capable of differentiating painful states precisely because the stimulus-response relationships are very variable and loosely determined.

### Experimentally Induced Pain

Standardised activation / stimulation of the nociceptive and non-nociceptive pathways is important for quantitative sensory testing in basic experiments or for diagnostic purposes. From a mechanism based point of view, experimental tools are important for acquiring differentiated information about the different mechanisms / pathways involved / affected (Fig. 2).

The perception of pain cannot, however, be validly examined by experimental tools due to the fact that the pain stimulus used in the experiments is an artificial one. Moreover, the experimental measurements of pain have, as a rule, been developed on healthy individuals. Indeed, the experimental pain stimulus is usually short, harmless, predictable, easily tolerated and hardly emotionally stressful and therefore exhibits marked differences from clinical pain. Despite these objections, various clinical pain conditions have been increasingly analysed using experimental techniques.

The main advantages of an experimental approach are:

- Stimulus intensity, duration and modality are controlled and can be repeated over time
- Differentiated responses to activation of different structures (skin, muscle, viscera) can be assessed (multitissue sensory testing approach)
- Differentiated responses to different stimulus modalities can be assessed (multimodal sensory testing approach)
- The physiological and psychophysical responses can be assessed quantitatively and compared over time
- Pain sensitivity can be compared quantitatively between various normal / affected regions

The requirements for an ideal stimulator are:

1. Can be applied to all body parts without causing damage
2. Activates selective receptor populations
3. Can induce temporal and spatial summation
4. Has a causal relationship between stimulus intensity and pain intensity



5. Elicits different and discriminatory pain intensities and qualities
6. Delivers reproducible stimuli
7. Is easy to apply and control in laboratory and clinical settings

Unfortunately the ideal stimulator does not exist and hence the most adequate for a particular study should be selected, according to pros and cons. The probes or electrodes used for delivering the stimuli will be developed particularly for skin, muscle or visceral stimulation and, as such, not generally versatile.

Stimuli can have phasic (short lasting, milliseconds to a few seconds) or tonic properties (long lasting, many seconds to minutes). The various pain induction techniques are summarised in the list below and, as can be seen, most methods have been developed for cutaneous applications. Most of the phasic stimuli can be applied (1) as a single stimulus or as a series of repeated stimuli (to evoke temporal summation) and (2) as a stimulus activating a small or large / multiple area(s) for the study of spatial summation.

As pain is a multi-dimensional perception, the reaction to a single standardised experimental stimulus of a given modality can obviously only represent a very limited fraction of the entire pain experience. Therefore, it is mandatory to combine different stimulation and assessment approaches to gain advanced differentiated information about the nociceptive system under normal and pathophysiological conditions.

#### Pain Induction Modalities and Methods

##### Electrical

- Trans-cutaneous
- Intra-cutaneous
- Tooth-pulp
  - Intra-muscular
  - Trans-mucosal (oral, viscera)

##### Thermal

- Heat
  - Radiant (laser, light, infrared) (skin)
  - Contact thermode (skin)
  - Circulating hot water (skin, muscle, viscera)
- Cold
  - Cold pressor test (skin)
  - Contact thermode (skin)
  - Evaporation of gas (skin)
  - Menthol (skin)
  - Circulating cold water (muscle, viscera)

##### Mechanical

- Brushing / stroking (skin, in case of allodynia)
  - Pin prick (skin)
- Pinch (skin)
- Impact stimuli (skin)
  - Pressure (skin, muscle)
  - Tourniquet / (skin, muscle)
  - ► Ischemia (skin, muscle)
  - Distension (viscera)

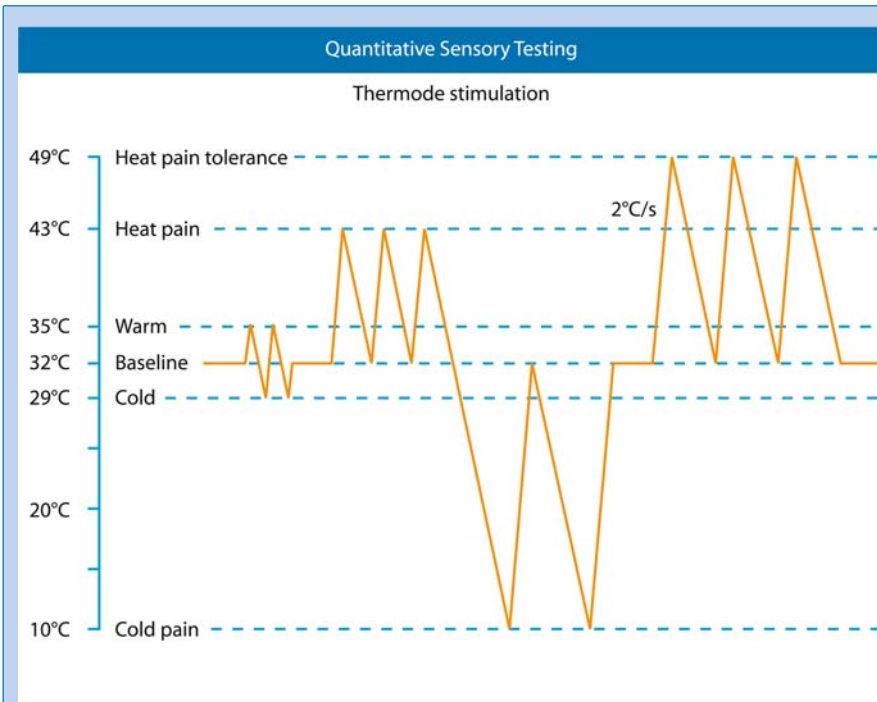
##### Chemical

- ► Capsaicin (skin, muscle, viscera)
- Mustard oil (skin)
- Melittin (skin)
- Hypertonic saline (skin, muscles)
- Bradykinin, serotonin, substance P and other algogenic substances (muscle)
- CO<sub>2</sub> (nasal mucosa)
  - Glutamate (muscle)
- Nerve Growth Factor (muscle)
- Post-exercise soreness (muscle)
- Glycerol (viscera)
- Hydrochloride acid (viscera)

##### Stimulus Modalities

Selectivity is a major problem for experimental pain stimuli. Most studies have used electrical stimulation, but this technique is non-selective and bypasses the receptors by depolarising the afferent nerve fibre. Many attempts have been made to refine electrodes to activate the pain fibres selectively, but so far without success. The most selective heat stimulator is probably a ► laser that can emit concentrated light or heat radiation. Many types have been applied to the skin (argon (488–515 nm), copper vapour lasers (510–577 nm), semi-conductor lasers (e.g. 980 nm), Nd-YAG (1064 nm), thulium-YAG (1800 nm) and CO<sub>2</sub> (10600 nm)). The advantage is that the laser light can be applied without touching the skin and hence does not contaminate the stimulation by mechanosensitive input. The stimuli can be short (e.g. 50 ms) and be used for both psychophysical and electrophysiological (evoked potentials, reflexes) evaluations.

The Peltier contact thermode, which can either warm or cool depending on the direction of the current (Fig. 3), is easy to use and is often used in the clinic. For more tonic cold stimulation, the so-called cold pressor test (immerse the hand into ice water) has been used.



**Evaluation of Pain in Humans, Figure 3** When a Peltier element for thermal stimulation is used, it is possible to heat and cool with fixed temperature rise (e.g. 2/s) and fall times and determine the various psychophysical thresholds (cold pain, cold detection, warm, heat pain and heat pain tolerance). Normally, a given threshold is measured several times due to variability and the average is calculated.

During this test the person continuously scores the pain intensity / unpleasantness. Depending on the duration, for which the person can endure the pain, they are classified as pain tolerant or pain sensitive.

Depending on the conditions, ► **mechanical stimuli** can activate all fibres – ranging from A $\beta$ -fibres (brushing / stroking used to assess ► **allodynia**, tactile (► **von Frey hair**) to assess ► **hyper-, hypo- or dysaesthesia (dysesthesia)**), via activation of both A $\beta$ - and A $\delta$ -fibres (pin prick, often used to assess hyper- or hypo-algesia) to full activation of A $\beta$ -, A $\delta$ - and C-fibres (pressure or pinch). For visceral stimulation, different distension techniques have been used, where the most advanced methods also include the assessment of the cross sectional area, which can be used to calculate the actual strain, applied to the wall of a hollow organ.

Chemical stimuli are of nature tonic and difficult to repeat over time as some of them induce peripheral and central sensitisation (e.g. capsaicin). Stimulation of muscle tissue has in particular utilised chemical stimulation, as e.g. intramuscular hypertonic saline is useful to generate local and referred pain phenomena in healthy volunteers or in patients. An adequate chemical method to elicit pain from the nasal mucosa is by an air stream with high CO<sub>2</sub> concentration.

### Temporal and Spatial Summation

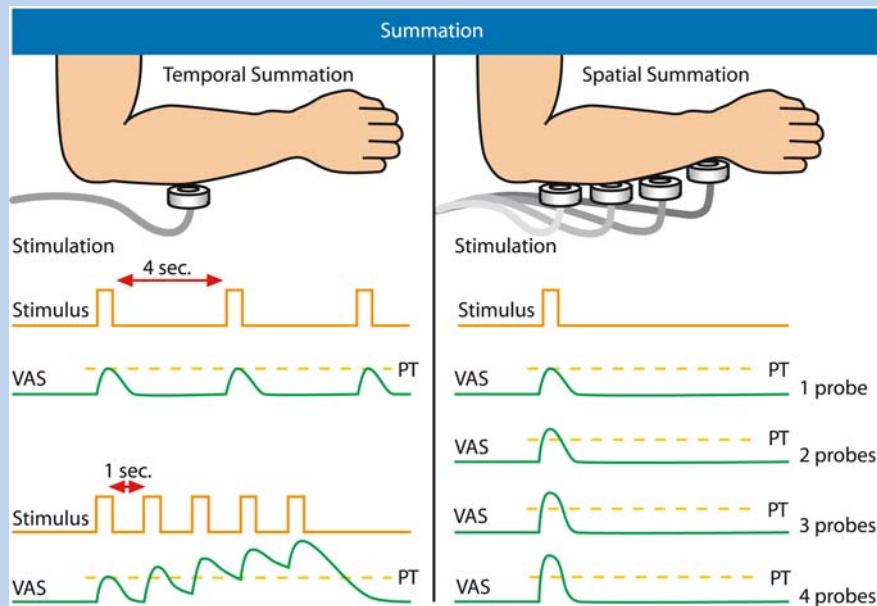
The phenomenon that a single painful or even sub-pain threshold stimulus by repetition causes exaggerated

perceptions of pain in man is called temporal summation (Fig. 4).

Temporal summation can be induced from the skin, muscles and viscera by repeated thermal, electrical, mechanical or chemical stimuli. Temporal summation can be measured by either psychophysical (pain summation threshold) or electrophysiological responses (facilitation of the ► **nociceptive withdrawal reflex**). Temporal summation is stimulus intensity and frequency dependent – and can for high stimulus intensities be elicited down to 0.3 Hz. Summation up to 20 Hz is reported. Temporal summation is a very potent mechanism, which is difficult to block pharmacologically and is assumed to be most probably an important mechanism in neuropathic pain. Spatial summation is the phenomenon which occurs when a given stimulus intensity is applied to an area and when the same stimulus is applied to a larger area, the pain is perceived as stronger. Spatial summation has predominantly been studied with thermal stimuli (Fig. 4).

### Assessment of Experimentally Induced pain: Basic and Clinical Applications

As there are various experimental ways of pain induction, there are also various experimental methods for assessing pain and its physiological correlates. In addition to the methods available to assess clinical ongoing pain, a number of psychophysical, electrophysiological and imaging procedures have been specifically



**Evaluation of Pain in Humans, Figure 4** Left panel. If consecutive painful stimuli are applied with an interval of 4 s, the individual stimuli are theoretically perceived to be of equal intensity (e.g. just exceeding the pain threshold (PT)). If the interval between consecutive stimuli is reduced to e.g. 1 s, the pain intensity increases during the series, although the stimulus intensity is the same - this is temporal summation. Right panel. A given stimulus is applied to one probe, and the perceived intensity is just exceeding the pain threshold (PT). If the same stimulus is now applied simultaneously to more probes, the pain intensity increases as the number of probes is increased - this is spatial summation.

developed to assess experimentally induced pain (see list below).

#### Assessment of Experimentally Induced Pain

##### Psychophysics

- VAS / VRS / NRS
  - Intensity / Unpleasantness
  - Stimulus-response function
- Cross-modality matching
- Pain detection and tolerance thresholds
- McGill Pain Questionnaire (MPQ)
- Signal detection theory (SDT)

##### Electrophysiological

- Microneurography
- Excitatory or inhibitory reflexes
- ► Evoked potentials
- ► Electroencephalogram/Electroencephalography
- ► Magnetoencephalogram

##### Psychophysiological

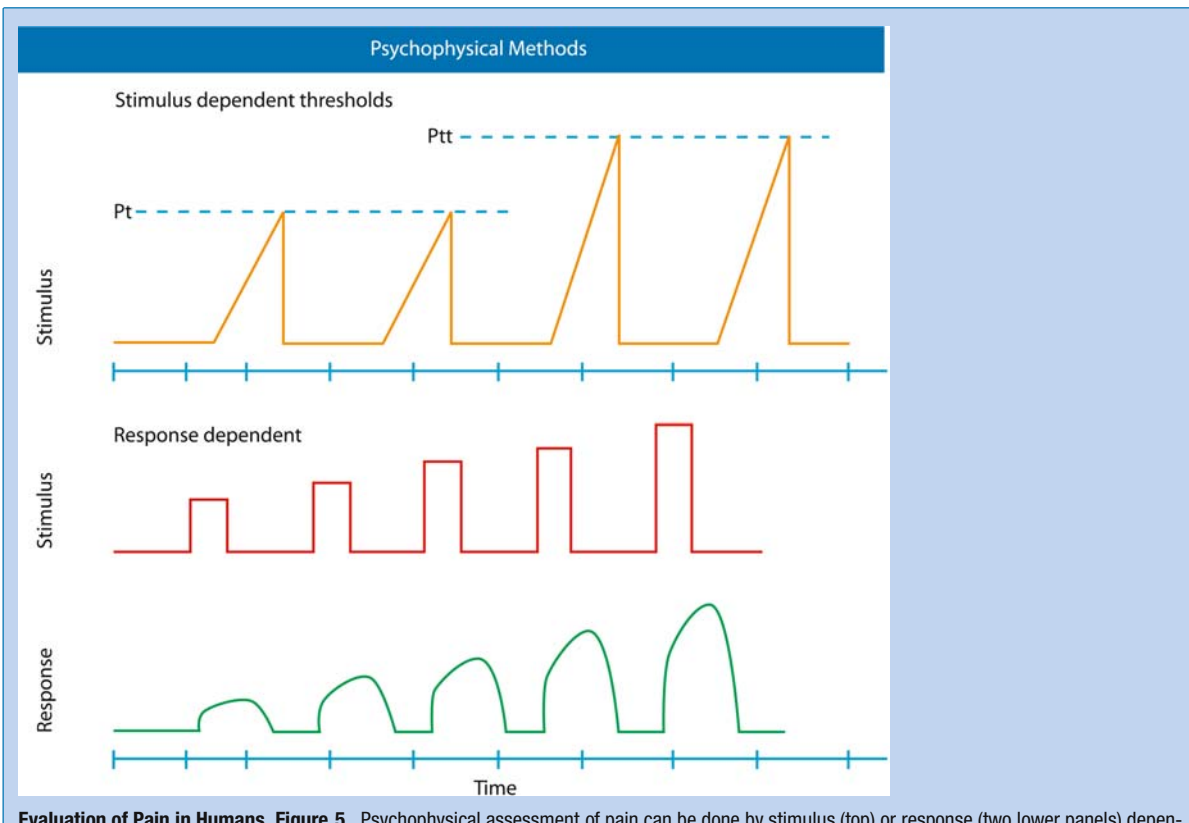
- Cutaneous temperature (thermography)
  - Cutaneous blood flow (laser Doppler flowmetry)
- Blood pressure
- Heart rate

- Respiration
    - Pupillary responses
  - Galvanic skin resistance
- ##### Imaging techniques
- PET
  - FMRI
  - SPECT

##### Psychophysical Methods

The psychophysical methods are developed on basis of the ► [psychophysical laws](#) and can be divided into response and stimulus dependent methods (Fig. 5). The response dependent methods rely on how the person evaluates the stimulus intensity or unpleasantness on a given scale (VAS / VRS / NRS) or as a cross-modality match (Fig. 5).

The stimulus dependent methods are based on adjustment of the stimulus intensity until a pre-defined response, typically a threshold, is reached. The stimulus intensity required to reach the threshold is in physical units and therefore the use of scales is avoided (Fig. 5). ► [Stimulus-response functions](#) are more informative than a threshold determination as super-threshold response characteristics can be derived from the data. All quantitative sensory tests are psychophysical tests, which require conscious and alert patients, who fully



**Evaluation of Pain in Humans, Figure 5** Psychophysical assessment of pain can be done by stimulus (top) or response (two lower panels) dependent methods. Using a stimulus dependent method the stimulus intensity is gradually increased until a given threshold (e.g. pain detection or pain tolerance) is reached. For response dependent methods fixed stimulus intensities (middle panel) are delivered and the volunteers/patients rate the perceived pain intensities (lower panel) on a given scale (e.g. VAS). Based on those responses e.g. stimulus-response curves can be constructed.

understand the instructions given. Stimulus-response functions are valuable to assess ► [hyperpathia](#) to various stimulus modalities.

The determination of pain thresholds (► [pain detection and pain tolerance thresholds](#)) has most often been used in experimental pain research. Thresholds are of great value because they are reliably, easily and simply assessed. There are several ways of assessing these thresholds: the ► [method of constant stimuli](#), the ► [method of adjustment](#), the ► [method of limits](#), method of levels, ► [forced choice procedure](#), staircase method, etc. They all look for the least amount of physical energy necessary to elicit pain in the case of pain threshold or for the most amount of physical energy still tolerable for an individual in the case of pain tolerance threshold. Thresholds only demonstrate where the pain range starts (► [pain threshold](#)), and where it ends (► [pain detection and pain tolerance thresholds](#)). There is no information about pain perception between these range delimiters as obtained using stimulus-response functions.

The multidimensional scaling using e.g. MPQ is not often used in experimental studies, as a standardised stimulus is less multidimensional than ongoing clinical pain. ► [Sensory decision / detection theory](#) (SDT)

yields two measures of perceptual performance 1) the accuracy with which a person judges whether e.g. a strong painful or a weak painful event occurs and 2) the subject's response bias which quantifies a general tendency to report one of the events as occurring more frequently than the other. These parameters can be presented and interpreted using the ► [receiver operating characteristics](#) (ROC) curves.

The SDT paradigms ask for long series of pain stimuli under constant conditions, which constitutes a prerequisite that is difficult to meet. The study of patients does not often allow for sessions of long duration. Sensitisation, adaptation or habituation prevent constant conditions in long series of stimuli. Such limitations have led to a decline in the use of SDT in experimental pain research.

Before new scales or new configurations are applied in the laboratory or clinic, they need to be validated and the reliability evaluated. Although it seems simple to rate a given pain on a scale, there are many endogenous and exogenous confounding factors – training, instruction / introduction, sex of investigator *versus* sex of patient / volunteer, experimental environment (e.g. is the spouse present or not), educational level of patient / volunteers, if the scores are done by experimenter / clini-



cian / nurse or self-reported, etc. Other situational and individual factors known to influence pain are for example diurnal variations (time of day), menstrual cycle, gender, race and ethnicity.

### Electrophysiological Methods

The electrophysiological assessment methods have mainly been applied in basic studies as they are complicated to use in the clinic. Microneurography is the direct recording of the activity of nerve fibres following peripheral stimulation and has been used to characterise firing. This method may identify activation patterns of nociceptive of A $\delta$ - and C-fibres and of different classes of nociceptors.

The nociceptive withdrawal reflex is a spinal reflex of the lower limb that is elicited by painful somatic stimulus. The reflex can be used for assessment in two ways, either as a reflex threshold or as an amplitude to a fixed supra-threshold stimulus intensity. The reflex can be used to assess the response to both a single stimulus and a repeated stimulus (temporal summation). Under some conditions the reflex threshold and the pain detection threshold coincide. The generation of a withdrawal reflex is initiated by the nociceptive input, but an extensive processing takes place within the spinal cord. The neural connection from the primary sensory neurons to the motor neurones is a polysynaptic pathway and other afferent input, descending activity and the excitability of the neurones in this pathway modulate the generation of the spinal nociceptive reflex. The reflex threshold shows substantial inter- and intra-individual variation and hence the method has exclusively been used in experimental studies. Under some conditions, a nociceptive stimulus may also cause an inhibitory reflex (e.g. silent period, extero-suppression period) of a contracting muscle (e.g. the jaw muscle). The inhibitory reflexes are not nociceptive specific.

The evoked potentials to painful stimulation and in particular the late event related vertex potential have been widely used in pain research, due to the relation between amplitude and pain intensity. The vertex potential is modulated by many cognitive factors such as attention, habituation, vigilance and inter-stimulus interval and may, therefore, exhibit large inter- and intra-individual variation.

In more recent years it has been possible, on the basis of multi-channel (e.g. 64–128 channels) electroencephalographic or magnetoencephalographic recordings, to calculate the scalp [▶ topography](#) of the evoked potentials elicited by painful stimuli. This has also provided the possibility of estimating the various electrical brain sources (dipoles) responsible for a given topographic pattern. Since the estimation procedures for [▶ Source Analysis](#) are becoming more and more advanced, it may be a reliable technique in the future.

The vertex potential can be elicited by any abrupt change in a sensory modality – including pain perception. The vertex potential elicited by an unspecific stimulus such as electrical stimulation may not correlate with the pain intensity, whereas a specific nociceptive stimulus (A $\delta$ -fibre activation) from a laser may generate potentials that are a result of traffic along the nociceptive pathways. As such the laser-evoked potential has gained some clinical impact. Both the electro- and magneto-encephalographic responses have been used. Quantifying the C-fibre mediated laser evoked potential (latency >1000 ms) has also been attempted. However, due to strongly varying latencies, the results have rarely been reliable.

Since the brain potentials to painful stimuli mirror only the cortical electro- or [▶ magnetoencephalographic](#) activity elicited by very brief painful stimuli, attempts have been made to use the spontaneous EEG for assessing the cerebral activity accompanying experimental pain over long periods of time. Some of the spectral components of the EEG have shown a causal relationship to the presence of pain and to the intensity of pain. Furthermore, some of these spectral changes occur over specific cortical areas with relation to the somatic structure stimulated. Studies on EEG and ongoing clinical pain have not yet revealed better understanding of the cortical structures involved in the processing of pain.

To disclose aspects of cortical processing of nociceptive information, a change in the regional blood flow can be detected and represented by various brain imaging techniques. [▶ Positron emission tomography](#) (PET) and single photon emission tomography (SPECT) require the injection of water or glucose labelled by a radioisotope into the blood stream to the brain. The radioisotopes with a short half-life accumulate for a brief period of time in the active areas of brain and can there be localised by scanners sensitive to the transient increase in radioactivity. The temporal resolution and spatial resolution are not as good as with functional magnetic resonance imaging (fMRI, see below), but PET and SPECT allow in addition the assessment of the concentrations of ligands and receptors with relevance for pain transmission in the brain.

fMRI is based on the different magnetic properties of the tissues in the brain, which can be made obvious in very strong magnetic fields. Red blood cells loaded with oxygen (oxygenated haemoglobin) present with different magnetic properties from unloaded ones (desoxygenated haemoglobin). Active areas in the brain have higher levels of oxygenated haemoglobin. This blood oxygenation level dependent signal allows the detection of active areas with good spatial and temporal resolution by magnetic field scanners. The brain imaging techniques have disclosed some of the many

structures involved in pain processing including e.g. somatosensory cortices I and II, the thalamus, the anterior part of the gyrus cinguli, the cerebellum and the basal ganglia.

### Induction and Assessment of Hyperexcitability

Peripheral and / or central hyperexcitability (hyperalgesia, allodynia) can be induced experimentally. This approach can be used to study neuroplastic changes important for various pain syndromes (e.g. neuropathic pain).

Experimental hyperexcitability has mainly been studied following sensitisation of the skin, but a few models exist for the induction of muscular and visceral sensitisation.

The manifestations of cutaneous hyperexcitability are flare reaction (neurogenic inflammation) and primary and secondary hyperalgesia. The flare reaction can be assessed by laser Doppler flowmetry, reflectance spectroscopy and thermography and by visual inspection (mark the area). Primary hyperalgesia occurs in the skin underlying the actual site of stimulation (e.g. topical application) and is mainly a result of peripheral sensitisation of the nociceptors. Normally, thermal stimuli are used to quantify primary hyperalgesia. A pain threshold can drop from approx. 44°C to 33°C and responses to supra-threshold stimulation increase.

Secondary hyperalgesia can be separated into an area of brush-evoked hyperalgesia (dynamic hyperalgesia, allodynia) and a slightly larger area of pinprick (punctate) hyperalgesia (static hyperalgesia). The secondary hyperalgesia is predominantly a central phenomenon reflecting neuroplastic changes in spinal cord neurons and ongoing pain seems essential to maintain the secondary manifestations. Allodynia is normally assessed by stroking the skin with a cotton swab in a standardised way and the area where the sensation changes from touch to pain is marked. Punctate hyperalgesia is normally determined by a nylon filament (e.g. von Frey hair, bending force of e.g. 70 g). The stimuli are applied along e.g. 6 vectors towards the centre of the injury in steps of a few millimetres. The points where the pinprick sensation changes into stronger pain are marked for every vector and the area estimated. Electrical stimulation can also be used whereas the existence of secondary thermal hyperalgesia is still controversial.

Cutaneous hyperalgesia can be induced by chemical, thermal and mechanical stimuli. Intradermal injection (e.g. 100 µg of capsaicin in a 20 µl volume) or topical (e.g. 1% capsaicin, 1.5 g cream applied to 4 cm<sup>2</sup> for 40 min) application of capsaicin is the most commonly used model. Intradermal capsaicin elicits a severe stinging / burning pain lasting for approximately a minute leaving well characterised areas of primary and secondary hyperalgesia, which last up to 24 h. Topi-

cal application is better tolerated, but the manifestation and duration of hyperalgesia are less as compared to i.d. application. Cutaneous hyperexcitability can also be induced by noxious cold (e.g. -28°C for 10 s), heat (e.g. 47°C for 7 min) or strong, prolonged or repeated mechanical pressure stimuli (e.g. 8 N repeated pinching for 2 min).

Few possibilities exist to induce experimental hyperexcitability from deep tissue. Muscle sensitisation can be transiently induced by intramuscular injection of capsaicin or algogenic substances e.g. bradykinin, serotonin, substance P and nerve growth factor. Visceral sensitisation can be elicited by capsaicin, glycol or acid. The manifestations of deep pain hyperexcitability are increased in response to pressure / distension (most likely peripheral sensitisation) and enlarged referred pain areas to standardised muscle / visceral experimental stimuli. The enlargement of the referred area is a central effect and is also found in patients with chronic musculoskeletal or visceral pain.

### References

1. Angst MS, Brose WG, Dyck JB (1999) The relationship between the visual analog pain intensity and pain relief scale changes during analgesic drug studies in chronic pain patients. *Anesthesiology* 91:34–41
2. Arendt-Nielsen L (1994) Characteristics, detection and modulation of Laser-evoked vertex Potentials. *Acta Anaesth Scand* 38:1–44
3. Arendt-Nielsen L (1997) Induction and assessment of experimental pain from human skin, muscle and viscera. In: Jensen TS, Turner JA, Wiesenfeld-Hallin Z (eds) *Proceedings of the 8th World Congress on Pain*. IASP Press, Seattle, pp 393–425
4. Arendt-Nielsen L, Bjerring P (1988) Sensory and pain threshold characteristics to laser stimuli. *J Neurol Neurosurg Psychiatr* 51:35–42
5. Arendt-Nielsen L, Svensson P (1997) Referred muscle pain: basic and clinical findings. *Clin J Pain* 17:11–19
6. Arendt-Nielsen L, Brennum J, Sindrup S et al. (1994) Electrophysiological and psychophysical quantification of central temporal summation of the human nociceptive system. *Eur J Appl Physiol* 68:266–273
7. Backonja MM, Galer BS (1998) Pain assessment and evaluation of patients who have neuropathic pain. *Neurol Clin* 16:775–790
8. Boivie J, Hansson P, Lindblom U (1994) Touch, Temperature, and Pain in Health and Disease: Mechanisms and Assessment. *Progress in Pain Research and Management*, vol 3, IASP Press, Seattle, pp 548
9. Bromm B (1984) *Pain measurement in man*. Elsevier, Amsterdam
10. Bromm B, Desmedt J (1995) Pain and the Brain: From nociception to cognition. *Advances in Pain Research and Therapy*, vol 22. Raven Press, New York
11. Chang PF, Arendt-Nielsen L, Graven-Nielsen T et al. (2003) Psychophysical and EEG responses to repeated experimental muscle pain in humans: Pain intensity encodes EEG activity. *Brain Res Bull* 15:533–543
12. Chapman CR, Loeser JD (1989) *Issues in Pain Measurement*. *Advances in pain research and therapy*, vol 12. Raven Press, New York
13. Chapman CR, Casey KL, Dubner R et al. (1985) Pain measurement: An Overview. *Pain* 22:1–31

14. Collins SL, Moore RA, McQuay HJ (1997) The visual analogue pain intensity scale: what is moderate pain in millimetres? *Pain* 95:97
15. Edwards CL, Fillingim RB, Keefe F (2001) Race, ethnicity and pain. *Pain* 94:133–137
16. Finley GA, McGrath PJ (1998) Measurement of Pain in Infants and Children. *Progress in Pain Research and Management*, vol 10. IASP Press, Seattle, pp 224
17. Gebhart GF (1995) Visceral pain, *Progress in Pain Research and Management*, vol 5. IASP Press, Seattle
18. Gibson SJ, Helme RD (2001) Age-related differences in pain perception and report. *Clin Geriatr Med* 17:433–56
19. Gracely RH (1994) Studies of pain in normal man. In: Wall PD, Melzack R (eds) *Textbook of Pain*. Churchill Livingstone, London, pp 315–336
20. Gracely RH, Lota L, Walter DJ et al. (1988) A multiple random staircase method of psychophysical pain assessment. *Pain* 32:55–63
21. Graven-Nielsen T, Arendt-Nielsen L, Svensson P et al. (1997) Quantification of local and referred muscle pain in humans after sequential i.m. injections of hypertonic saline. *Pain* 69:111–117
22. Handwerker HO, Kobal G (1993) Psychophysiology of experimentally induced pain. *Physiol Rev* 73:639–671
23. Kems RD, Turk DC, Rudy TE (1985) The West Haven-Yale Multidimensional Pain Inventory (WHYMPI). *Pain* 23:345–356
24. Lautenbacher S, Rollman GB (1993) Sex differences in responsiveness to painful and non-painful stimuli are dependent upon the stimulation method. *Pain* 53:255–264
25. Lindblom U (1994) Analysis of abnormal touch, pain, and temperature sensation in patients. In: Boivie J, Hansson P, Lindblom U (eds) *Touch, temperature, and pain in Health and Disease: Mechanisms and Assessments*. *Progress in Pain Research and Management*, vol 3. IASP Press, Seattle, pp 63–84
26. Melzack R (1975) The McGill Pain Questionnaire: major properties and scoring methods. *Pain* 1:277–299
27. Melzack R, Katz J (1994) Pain measurement in persons in pain. In: Wall PD, Melzack R (eds) *Textbook of Pain*. Churchill Livingstone, London, pp 337–356
28. Ness TJ, Gebhart GF (1990) Visceral pain: a review of experimental studies. *Pain* 41:167–234
29. Opsommer E, Weiss T, Miltner WH et al. (2001) Scalp topography of ultralate (C-fibres) evoked potentials following thulium YAG laser stimuli to tiny skin surface areas in humans. *Clin Neurophysiol* 112:1868–1874
30. Petersen-Felix S, Arendt-Nielsen L, Bak P et al. (1996) The effects of isoflurane on repeated nociceptive stimuli (central temporal summation). *Pain* 64:277–281
31. Price DD (1999) Psychological mechanisms of pain and analgesia. *Progress in Pain Research and Management*, vol 15. IASP Press, Seattle
32. Riley JL III, Robinson ME, Wise EA et al. (1998) Sex differences in the perception of noxious experimental stimuli: a meta-analysis. *Pain* 74:181–187
33. Riley JL III, Robinson ME, Wise EA et al. (1999) A meta-analytic review of pain perception across the menstrual cycle. *Pain* 8:225–235
34. Rollman GB (1977) Signal detection theory measurement of pain: a review and critique. *Pain* 3:187–211
35. Rollman GB, Lautenbacher S (2001) Sex differences in musculoskeletal pain. *Clin J Pain* 17:20–24
36. Turk DC, Melzack R (1992) *Handbook of pain assessment*. Guilford Press, New York
37. Vecchiet L, AlbeFessard D, Lindblom U et al. (1993) *New Trends in Referred Pain and Hyperalgesia*. Elsevier, Amsterdam
38. Willis W (1992) *Hyperalgesia and Allodynia*. Raven Press, New York
39. Woolf CJ, Bennett GJ, Doherty M et al. (1998) Towards a mechanism-based classification of pain? *Pain* 77:3:227–229
40. Yarnitsky D, Sprecher E, Zaslansky R et al. (1995) Heat pain thresholds: normative data and repeatability. *Pain* 60:329–332

E

## Evaluation of Vocational Capacity

### Definition

A time-limited investigation where only a formal norm-referenced psychometric test battery is used. The results delineate the impaired client's personality, general aptitude (e.g. general intelligence, literary skills), readiness for work, or occupational interests. This test procedure is used when the client: (a) needs vocational guidance, e.g. when unemployed, or (b) to reveal over- or under-employment. However, the results do not determine vocational capacity, work ability and tolerance, or job retention.

► Vocational Counselling

fields (the so-called late-near field potentials are generated in the cortex cerebri).

► Nociception in Nose and Oral Mucosa

## Evidence-Based Treatments

### Definition

Treatment effect evidenced by randomized, double-blind, controlled clinical trials.

► Antidepressants in Neuropathic Pain

## Event-Related Potential

### Definition

Event-related potential is a cortical response to stimulation consisting of changes in electrical and magnetic

## Evoked Activity

### Definition

Activity of neurons elicited by stimulation of its receptive field.

► Molecular Contributions to the Mechanism of Central Pain

## Evoked and Movement-Related Neuropathic Pain

LOIS J. KEHL

Department of Anesthesiology, University of Minnesota, Minneapolis, MN, USA  
lois@mail.ahc.umn.edu

### Synonyms

Incident pain; breakthrough pain; episodic pain; pain flares

### Definition

Evoked and movement related neuropathic pains are intermittent episodes of pain that occur in response to nerve injury, persist after the acute injury and are elicited by external stimuli or movement. The term ► **breakthrough pain** is often used to refer to evoked and ► **movement related pain**. Breakthrough pain has been defined as “Intermittent exacerbations of pain that can occur spontaneously or in relation to specific activity; pain that increases above the level of pain addressed by the ongoing analgesic; includes incident pain and end-of-dose failure” (American Pain Society 2002). Note that different definitions of breakthrough pain may be used in different countries, with some defining breakthrough pain as occurring only after background pain is controlled (Zeppetella et al. 2001). Breakthrough pain occurring as the result of normal voluntary or involuntary movement is referred to as ► **incident pain**. Unfortunately, much of the literature does not differentiate between incident pain and breakthrough pain. To address this problem a Breakthrough Pain Questionnaire has been developed (Portenoy and Frager 1999). This instrument is not yet validated.

### Characteristics

Our understanding of mechanisms contributing to neuropathic pain has grown tremendously since the development of appropriate animal models. This increased knowledge is reflected in advances made in clinical management of this pain condition since the conception of these models. Unfortunately, one important aspect of neuropathic pain that is still poorly understood and evades effective management is pain associated with movement. Movement-evoked pain is a significant clinical problem because of its high incidence, the distress it causes affected individuals and its resistance to currently available treatments. Lack of adequate pain control with movement can interfere with normal function and rehabilitation efforts following trauma, surgery or malignant disease. Much of the literature supports a multifactorial etiology for movement related pain in clinical conditions that include a neuropathic pain component, such as cancer pain

and ► **low back pain**. This discussion will highlight these two prevalent clinical problems because they are perhaps the best characterized with respect to mechanisms that mediate evoked and movement related neuropathic pain.

### Pathobiology Associated with Movement-Evoked Neuropathic Pain Disorders

#### Neuropathic Pain Associated with Bone Cancer

Clinical and preclinical research studies indicate that cancer pain shares clinical and neuropathological characteristics with neuropathic pain. These similarities are best characterized in studies using animal models of bone cancer pain. More complete descriptions of this work are included elsewhere in this volume. This essay will focus on what is known about incident pain during the phase of cancer induced bone pain that most closely resembles neuropathic pain.

Von Frey fiber testing is commonly used in studies of neuropathic pain. This method directly assesses cutaneous sensitivity to innocuous and noxious tactile stimuli. The effect of nerve damage on movement related hyperalgesia can only be inferred indirectly from these results. A few investigators have directly evaluated the effect of sensory nerve injury on movement related hyperalgesia using observation of ambulatory behaviors, performance on the rotarod and measurement of forelimb grip force. The movement made during grip force measurement is thought to activate musculoskeletal nociceptors *via* the innocuous pressure placed on muscle, joint and deep tissue afferents during movement (Kehl et al. 2000). These dependent measures model incident pain by approximating clinical situations in which bone cancer pain is aggravated by movement and weight bearing.

Characteristics consistent with neuropathic pain begin to manifest between 9 and 16 days following implantation of ► **osteolytic fibrosarcoma** cells into bone in one murine model of bone cancer pain (Cain et al. 2001). These include spontaneous activity in C-fibers near the tumor and a significant reduction in epidermal nerve fibers (Cain et al. 2001). In this model, the level of movement related hyperalgesia, measured using grip force, more than doubled from 7–10 days following implantation of tumor cells (Wacnik et al. 2003). At this time point, systemically administered morphine attenuated tumor-induced movement related hyperalgesia in a dose dependent manner. Morphine was 3.5 times less potent ( $ED_{50} = 23.9$  mg/kg (11.4–50.1)) for tumor-induced hyperalgesia than for carrageenan induced hyperalgesia ( $ED_{50} = 6.9$  mg/kg (4.8–9.7)) measured concomitantly in the same study (Wacnik et al. 2003). Furthermore, morphine was less efficacious 10 days post-implantation than at 7 days post-implantation and when administered to carrageenan injected mice. These results were mirrored in a parallel study evaluating the



capacity of the non-selective ▶ **cannabinoid** agonist WIN55,212-2 (i.p.) to reverse movement evoked hyperalgesia in the same two animal models (i.e. tumor and carrageenan). WIN55,212-2 was less efficacious and approximately 4 times less potent in reversing movement-evoked hyperalgesia following tumor implantation ( $ED_{50} = 23.3$  mg/kg (13.6–40.0)) compared to i.m. carrageenan ( $ED_{50} = 5.6$  mg/kg (3.4–9.6)) (Kehl et al. 2003). These findings parallel what is observed clinically with respect to the reduced potency and efficacy of opioids in managing movement related cancer pain.

A second group of investigators reported changes consistent with neuropathic pain in a model of bone cancer pain involving implantation of mammary gland carcinoma cells (Donovan-Rodriguez et al. 2004). By the 11<sup>th</sup> day post-implantation, lamina I wide dynamic range neurons exhibited significant increases in electrically evoked C-fiber and post-discharge responses. Between days 15 and 17, A $\beta$  fiber evoked responses also increased significantly. These spinal cord changes are similar to those seen in neuropathic pain models. The electrophysiological changes coincided with behavioral findings consistent with incident pain, including significant reductions in weight bearing ipsilateral to the tumor, general activity and latency to fall on the rotarod test (Donovan-Rodriguez et al. 2004).

Although some characteristic elements of neuropathic pain exist in bone cancer pain models, some differences exist. For example, dorsal horn hyperexcitability (Urch et al. 2003) and spinal immunohistochemical profiles (Honore et al. 2000) seen in these models don't closely resemble changes typically seen in animal models of neuropathic pain. These findings suggest that cancer pain may be a unique pain state that shares some characteristics of neuropathic pain. Urch and colleagues propose that differences in the degree of C fiber denervation between neuropathic and bone cancer pain models may help to explain these differences (Urch et al. 2003).

### Neuropathic Pain Associated with Intervertebral Disc Herniation

For many years, mechanical compression of spinal nerve roots has been considered the primary cause for low back pain (LBP) and its associated neurological symptoms. Compression of spinal nerve roots or dorsal root ganglia (DRG), such as that which may occur secondary to intervertebral disc (IVD) herniation or swelling, produces spontaneous activity in the peripheral sensory nerve fibers of laboratory animals. This mechanical compression is thought to be responsible for the associated edema, ischemia and demyelination that occur in DRG and nerve roots in these situations. Findings such as these provide support for the view that mechanical compression leads to the pain and neurological symptoms associated with LBP.

In addition to dorsal nerve root and DRG compression, the density of pain sensing nerve fibers increases in degenerated joint structures. For example, Freemont and colleagues reported that deep nerve growth into the inner third of lumbar IVDs (normally only the outer third of the IVD is innervated) was present in 57% of patients with chronic LBP compared to 25% of discs harvested post-mortem from subjects without a history of back pain (Freemont et al. 1997). Diseased IVD nerve fibers associated with blood vessels were immunopositive for substance P (SP) and growth-associated protein (GAP-43) (Freemont et al. 1997), a protein expressed in areas of axonal sprouting following nerve injury and remodeling of the nervous system. Nociceptive nerve ingrowth into painful IVDs was correlated with local production of NGF by blood vessels growing into IVDs from adjacent vertebral bodies (Freemont et al. 1997). *TrkA* receptors were expressed in the nerve terminals and the cytoplasm of chondrocytes in painful IVDs but not in controls (Freemont et al. 2002).

In addition, evidence also exists for immune system involvement in the development of LBP. Various cell types in herniated IVDs produce pro-nociceptive compounds such as cyclooxygenase-2, prostaglandin E<sub>2</sub>, pro-inflammatory cytokines, leukotrienes, nitric oxide and matrix metalloproteinases. Indeed, it has been shown that application of ▶ **nucleus pulposus** or some of its constituents (i.e. tumor necrosis factor- $\alpha$ , interleukin-1 $\beta$ ) to the epidural space produces increases in spinal nerve root excitability and sodium channel density as well as mechanical allodynia in the ipsilateral hind limb.

### Clinical Presentation

#### Breakthrough Pain Associated with Cancer

At present, the phenomenon of movement-evoked pain is best characterized in studies of cancer pain. In this context breakthrough pain is thought to occur secondarily to tumor progression, cancer treatments such as chemotherapy or radiation or factors unrelated to the cancer.

Estimates for the prevalence of breakthrough pain in patients with malignancy range from 46–93% (Portenoy and Hagen 1990). Banning and colleagues (Banning et al. 1991) reported that of 184 cancer pain patients, 93% had movement-evoked pain and 78% had pain at rest. 1 to 2 weeks after analgesic regimens were begun, 63% of patients still had movement-evoked pain. A study of hospice patients with cancer reported breakthrough pain in 89% of subjects; 10% were considered to be neuropathic in origin (Zeppetella et al. 2000). The number of daily breakthrough pain episodes of all types ranged from 1–14; 38% of all breakthrough pain episodes were reported to be severe or excruciating. ▶ **Rescue analgesic** agents were not prescribed to more than 40% of patients on long acting opioids, even though these pa-

tients reported frequent episodes of breakthrough pain. These findings provide evidence that breakthrough pain is a substantial problem for most cancer pain patients and that it remains a major problem for half of those who are undergoing an established analgesic regimen. Typically, neuropathic breakthrough pains associated with malignancy are for the most part brief (91% have  $\leq 30$  minutes duration) when compared to breakthrough pain of somatic or visceral origin (69% and 62% respectively have  $\leq 30$  minutes duration) (Zeppetella et al. 2000). The implications of this pattern for successful treatment are addressed in the next section.

### Neuropathic Breakthrough Pain Associated with Non-Malignant Pathology

Although many studies have investigated the clinical and pathobiological characteristics of neuropathic pain, the breakthrough and incident pain component of this type of pain is much less well studied in patients with non-malignant pain. However, some information has been reported. In one such study, breakthrough pain was characterized in a group of hospice patients with terminal non-malignant disease (Zeppetella et al. 2001). Sixty-three percent of patients evaluated reported breakthrough pain. Of these, 25% were classified as neuropathic, 46% as somatic, 14% as visceral and 15% were of mixed etiology. Note that a larger percentage of non-malignant pain patients were classified with neuropathic breakthrough pain (i.e. 25% vs. 10% respectively). These subjects (non-malignant pain patients) also reported a larger percentage of severe or excruciating breakthrough pain (60% vs. 38% respectively) compared to the previous study of malignant pain. Both groups reported a similar number (1–13/day) and duration of daily breakthrough pain episodes (75% were  $\leq 30$  minutes duration).

### Treatment

Breakthrough pain is typically managed using oral or parenteral supplemental rescue medications that are administered in addition to regularly scheduled analgesics. As indicated in the previous section, breakthrough pains of neuropathic origin are typically brief but occur frequently. Consequently, effective management requires that rescue analgesics should be quickly absorbed and have a rapid onset of action. Because opioids (i.e. morphine, hydromorphone, oxycodone) used conventionally in the past for breakthrough pain are not very lipophilic, their slower absorption reduces their effectiveness for managing breakthrough pain. As a result, short acting oral immediate release or transmucosal opioids on an as needed basis are becoming more widely used. Intranasal morphine formulations are also under evaluation.

The management of neuropathic breakthrough pain associated with cancer presents a somewhat difficult situation in that this type of pain does not respond well to opi-

oids. Furthermore, in most patients neuropathic breakthrough pains last 30 minutes or less but short acting oral morphine preparations may require up to an hour for onset and then last for 4 hours. Consequently, adjuvant analgesics used to treat non-malignant neuropathic pain, such as anticonvulsants and antidepressants, may more effectively manage this component of breakthrough cancer pain (Zeppetella et al. 2000).

### References

1. American Pain Society (2002) Guideline for the Management of Pain in Osteoarthritis, Rheumatoid Arthritis and Juvenile Chronic Arthritis.
2. Banning A, Sjogren P, Henriksen H (1991) Treatment outcome in a multidisciplinary cancer pain clinic. *Pain* 47:129–134; 127–128
3. Cain DM, Wacnik PW, Turner M et al. (2001) Functional interactions between tumor and peripheral nerve: changes in excitability and morphology of primary afferent fibers in a murine model of cancer pain. *J Neurosci* 21:9367–9376
4. Donovan-Rodriguez T, Dickenson AH, Urch CE (2004) Superficial dorsal horn neuronal responses and the emergence of behavioural hyperalgesia in a rat model of cancer-induced bone pain. *Neurosci Lett* 360:29–32
5. Freemont AJ, Peacock TE, Goupille P et al. (1997) Nerve ingrowth into diseased intervertebral disc in chronic back pain. *Lancet* 350:178–181
6. Freemont AJ, Watkins A, Le Maitre C et al. (2002) Nerve growth factor expression and innervation of the painful intervertebral disc. *J Pathol* 197:286–292
7. Honore P, Rogers SD, Schwei MJ et al. (2000) Murine models of inflammatory, neuropathic and cancer pain each generates a unique set of neurochemical changes in the spinal cord and sensory neurons. *Neuroscience* 98:585–598
8. Kehl LJ, Trempe TM, Hargreaves KM (2000) A new animal model for assessing mechanisms and management of muscle hyperalgesia. *Pain* 85:333–343
9. Kehl LJ, Hamamoto DT, Wacnik PW et al. (2003) A cannabinoid agonist differentially attenuates deep tissue hyperalgesia in animal models of cancer and inflammatory muscle pain. *Pain* 103:175–186
10. Portenoy RK, Frager G (1999) Pain management: pharmacological approaches. *Cancer Treat Res* 100:1–29
11. Portenoy RK, Hagen NA (1990) Breakthrough pain: definition, prevalence and characteristics. *Pain* 41:273–281
12. Urch CE, Donovan-Rodriguez T, Dickenson AH (2003) Alterations in dorsal horn neurones in a rat model of cancer-induced bone pain. *Pain* 106:347–356
13. Wacnik PW, Kehl LJ, Trempe TM et al. (2003) Tumor implantation in mouse humerus evokes movement-related hyperalgesia exceeding that evoked by intramuscular carrageenan. *Pain* 101:175–186
14. Zeppetella G, O'Doherty CA, Collins S (2000) Prevalence and characteristics of breakthrough pain in cancer patients admitted to a hospice. *J Pain Symptom Manage* 20:87–92
15. Zeppetella G, O'Doherty CA, Collins S (2001) Prevalence and characteristics of breakthrough pain in patients with non-malignant terminal disease admitted to a hospice. *Palliat Med* 15:243–246

## Evoked Pain

### Definition

Evoked pain is pain due to stimulation.

► [Dysesthesia, Assessment](#)

## Evoked Pain and Morphine

- ▶ Opioids, Effects of Systemic Morphine on Evoked Pain

## Evoked Potentials

### Definition

Brain activity elicited by a sensory stimulation and extracted from the brain electroencephalographic background activity by averaging multiple responses during a window time-locked to the stimulus.

- ▶ Migraine Without Aura

## Evolution of Pediatric Pain Treatment

NEIL SCHECHTER

Department of Pediatrics, University of Connecticut School of Medicine and Pain Relief Program, Connecticut Children's Medical Center, Hartford, CT, USA

nschecht@stfranciscare.org

### Synonyms

Unrecognized Pain in Children; Undertreated Pain in Children; Pediatric Pain Treatment, Evolution

### Definition

Pain treatment in children has changed dramatically over the past 30 years. Pain management has evolved from being essentially non-existent to being considered an essential aspect of humane medical care of children.

### Characteristics

Prior to 1970, the few references in the literature to pain in children were anecdotal and reflected two prevailing biases 1) that children's pain as a symptom is not worthy of independent treatment because once the underlying illness is addressed, pain will dissipate naturally and 2) that children probably do not experience pain as intensely as adults because their nervous systems are immature and therefore they are even less worthy of treatment. Such attitudes are reflected in the work of Swafford and Allen who justify the negligible use of opioids postoperatively in their intensive care unit by stating, "pediatric patients seldom need medication for relief of pain. They tolerate discomfort well" (Swafford 1968). Beginning in the 1970s and continuing on through the mid 1980s, a series of papers emerged which specifically examined pain treatment in children. Eland's seminal study in 1974 (Eland 1974) revealed that only half of the postoperative children on her unit received any analgesia during their hospital stay and that adults

were 25 × more likely to receive analgesia than children. An outpouring of papers subsequently replicated and expanded on her findings. In general, this research identified the under treatment of pain in essentially all domains of pediatric care (postoperative, procedure related, newborn, acute illness) and revealed significant differences in the way that children and adults with similar problems were addressed (Miser 1987; Purcell-Jones 1988; Schechter 1986). Children's postoperative pain was rarely treated, and if treated, the pain control drugs and doses used were often inadequate. Sedation to lessen distress during painful procedures was rarely used even in children with cancer who required repeated noxious procedures such as bone marrow aspirations. When sedation was considered, the agents used often were inappropriate (such as benzodiazepines or chloral hydrate, neither of which are analgesic). Pain in newborns likewise was essentially ignored even in neonatal intensive care units where children would be subjected to almost continuous discomfort secondary to repeated procedures (chest tubes, blood sampling) as well as mechanical ventilation.

### Changing Clinical Practice

Anand and colleagues (Anand 1987) in the mid 80s, documented that premature infants undergoing ductal ligation surgery with minimal or no anesthesia (standard practice at that time) exhibited profound surgical stress responses and, in fact, experienced a much higher morbidity and mortality rate than infants who received anesthesia. This finding prompted a series of editorials in major medical journals demanding a change in surgical practice (Berry 1987; Fletcher 1987), leading to a perceptible change in the attitude and practice of clinicians in the early 90s. New research on how to treat pain in infants and children began to seep into textbooks and post-graduate education sessions. Recent studies suggest that, although far from perfect, we have come a very long way (Broome 1996; Tesler 1994). Post-operative pain management is much improved with the advent of better assessment techniques and the development of new tools such as patient controlled analgesia and regional anesthetic techniques. Sedation is now standard for painful procedures and although not uniform, it has been well studied and more reasonable choices are available to clinicians. Pain management in the newborn and premature has improved dramatically with sedation for ventilation, postoperative analgesia and local anesthetic usage being the standard of care.

### Historical Reasons for Undertreatment

It seems logical to ask how it could have occurred that children's pain was so uniformly ignored given the strong parental instinct to protect children from suffering coupled with the fact that pediatric providers tend to be caring compassionate individuals. Several factors coalesced to dampen interest in this area and limit the

research needed to generate new knowledge. Without the ability to counter the prevailing mythology with knowledge, misinformation persisted which further undermined the sense of urgency to address pain and allowed the *status quo* to persist. It is helpful to examine some of the historical reasons for under-treatment so that we can gain additional insight into overcoming those barriers that continue to prevent adequate pain management in children.

### **The Multifactorial Nature of Pain**

Children's pain is a complex phenomenon with neurological, psychological, social and developmental contributions. Because pain is so ubiquitous, associated with almost every disease process and its nature is so complex, no one discipline in the past has had "ownership" of the symptom of pain. Pain was perceived as a fellow traveler with disease and the elimination of disease was the focus, not the elimination of pain. As a result, investigation of pain as a symptom was limited and narrow in scope. It was not until the development of pediatric multidisciplinary pain services in the 1990s, which were capable of addressing the wide-ranging factors that both amplified and muffled it, that the symptom of pain could be adequately addressed.

### **Difficulty with Pain Assessment in Infants and Children**

As discussed in other essays on pain assessment, adequate assessment is the cornerstone of pain treatment and the individual's self report of his or her discomfort is the foundation of assessment (Finley 1998). However, clinicians often assumed that children could not rate their pain in a valid manner so that they failed to document children's pain or verify that a treatment had lessened their pain. Over the past 15 years, new pain measures have been developed for infants, toddlers, children and adolescents, as well as for neurologically handicapped individuals. This allows not only for dramatically improved clinical care but also serves as a critical component in the further understanding of pain and its treatment.

### **Societal Attitudes about Children's Pain**

Several socio-cultural attitudes impact on the vigor with which pain in children is treated. In eras where disease or circumstance has devalued individual life, concerns about quality-of-life issues like pain management are less likely to be emphasized (McGrath 1987). Until recently, the high incidence of child mortality limited the importance placed on child comfort. There was little interest in pain control when survival was at stake. This has changed dramatically in developed countries in the 20<sup>th</sup> century. Similarly with the enormous improvement in neonatal and pediatric cancer survival over the past 20 years, quality of life concerns are now perceived as legitimate areas for research investigation.

Broader societal attitudes towards pain also affect the expression and response to pain (Bernstein 2003). In some cultures, the ability to endure pain is both valued and promoted as character building while in others, pain expression is reinforced. It is clear that if pain is perceived as growth promoting, there will be little enthusiasm for vigorously treating it. These societal attitudes influence the intellectual and financial investment that a society is willing to make in pain relief.

### **Disciplinary Biases about Children's Pain**

In addition to cultural and societal values, there are distinct differences in the way that varying disciplines within medicine understand and treat pain. There are multiple cultures within the medical and health care community, each of which may have unique attitudes regarding pain and its implications. It is quite clear in surveys of physician attitudes towards pain in children, that there is now increasing uniformity in the belief that children are capable of experiencing pain at birth and that pain should be aggressively treated regardless of its origin. Such values represent a major shift from attitudes held merely 20 years ago.

### **Lack of Interest by the Pharmaceutical Industry**

In the past, there was essentially no research by the pharmaceutical industry aimed at developing drugs that reduce pain in children. Almost no analgesic drugs had formally approved pediatric indications. There are many reasons for this lack of interest. Although mild to moderate pain is a common occurrence in children, severe pain necessitating pharmacological intervention is far less frequent in children than in adults. Thus, the potential market for these agents was quite limited. As a result, there were few financial incentives to entice the pharmaceutical industry to invest in research on pediatric pain. Ethical constraints on pediatric pain research coupled with the complexities of pain assessment further reduced whatever enthusiasm still persisted. As a result, even now, most drugs used to treat pain in children have not been fully researched and their dose and indications are often extrapolated from adult literature. This is most unfortunate because not only do children have different pharmacokinetics from adults, they often have different types of pain problems. In some countries, various legislative initiatives are underway to remedy this situation by providing additional incentives for the pharmaceutical industry to study children in addition to adults when developing new drugs.

### **Lack of Recognition of Long Term Effects of Persistent Pain**

Although it has long been perceived that pain treatment is necessary for humanitarian reasons, it has only recently been recognized that there are important physiological and psychological consequences that may stem from inadequately treating pain (see ► [Long-Term Effects of](#)



**Pain in Infants**). The biological alteration of the nervous system due to repeated or persistent pain may sometimes be ameliorated through the use of adequate anesthesia and analgesia, thus advancing the case for aggressive pain control.

Research has also suggested that there are significant psychological ramifications of inadequately treated pain. Children who have had bone marrow aspirations with inadequate analgesia report more pain on subsequent bone marrow aspirations even when adequate analgesia is used, than do children who have had appropriate analgesia (Weisman 1998). The recognition that there may be long term consequences to inadequately treated pain has clearly impacted practice. Most neonatal units now aggressively treat pain. The American Academy of Pediatrics has recently changed its policy on circumcisions based on this data and now endorses analgesia / anesthesia for them. Sedation is now viewed as essential during painful procedures such as bone marrow aspirations.

### Lack of Systemic Institutional Approach

Because pain is a symptom that is associated with almost every medical or surgical condition, most physicians perceive they have developed some expertise in pain management. In the past, their focus however, was typically on alleviation of the underlying condition producing the pain and they brought far less sophistication to the treatment of the symptom itself. In addition, most of the research on pain management is not published in journals typically perused by practicing clinicians but in pain-oriented journals. Unfortunately, as a result, many clinicians have not been aware of the broad advances that have occurred in pain management and these advances are not brought to the bedside.

The emergence of multidisciplinary pediatric pain services has significantly improved this situation (Berde 2003). Pain services not only provide care for the small subset of children who are referred to them but they create an institutional environment in which pain is more likely to be considered and addressed in all patients. Institutions with pain services are more likely to offer educational programs in pain management and to insist on better documentation of pain ratings. Pain services often develop treatment protocols that will create a far more uniform approach to pain control in the institution and make it less subject to the variations of knowledge of each clinician.

### Summary

Pain management in children has been a long ignored dimension of the medical care of children. Until the middle of the 1980s, there was essentially no research and concomitantly no information on the management of pain in children. Children received minimal analgesia post-operatively and were subjected to medical diagnostic and treatment procedures without sedation

using only physical restraint. Pain control was rarely considered in the care of fragile newborns, who were frequently subjected to noxious treatments.

Pain management for children has improved dramatically in the past 20 years. Multidisciplinary pediatric pain services, the gradual development of uniform approaches to pain control for all children and an increased awareness of the problem of under-treatment of children have created a cultural shift in clinical care. The development of better pain assessment techniques has allowed for improved recognition and monitoring. Advances in understanding the developmental biology of pain transmission have emphasized the importance of the adequate treatment of pain to prevent long-term negative consequences, as well as providing additional clinical insights. Research has documented the importance of psychological and physical as well as pharmacological strategies for pain relief. We now recognize that treating pain in children is not only humane but also medically prudent and, for the overwhelming majority of problems, we have the tools available to accomplish this important task.

### References

1. Anand KJS, Sippell WG, Aynsley-Green A (1987) Randomized trial of fentanyl anesthesia in preterm babies undergoing surgery: effects on stress response. *Lancet* 1:243–248
2. Berde CB, Solodiuk J (2003) Multidisciplinary programs for the management of acute and chronic pain. In: Schechter NL, Berde CB, Yaster M (eds) *Pain in Infants, Children, and Adolescents*, 2nd edn. Lippincott Williams and Wilkins, Philadelphia, pp 471–489
3. Bernstein B, Pachter L (2003) Cultural consideration in children's pain. In: Schechter NL, Berde CB, Yaster M (eds) *Pain in Infants, Children, and Adolescents*, 2nd edn. Lippincott Williams and Wilkins, Philadelphia, pp 142–157
4. Berry FA, Gregory GA (1987) Do premature infants require anesthesia for surgery? *Anesthesiology* 67:291–293
5. Broome ME, Richtsmeier A, Maikler V et al. (1996) Pediatric pain practices: a national survey of health professionals. *J Pain Symptom Manage* 11:312–320
6. Eland JM (1974) Children's communication of pain (thesis). University of Iowa, Iowa City
7. Fletcher AB (1987) Pain in the neonate. *New Engl J Med* 317:1347–1348
8. Finley GA, McGrath PJ (1998) Measurement of Pain in Infants and Children. *Progress in Pain Research and Measurement*. IASP Press, Seattle
9. McGrath PJ, Unruh A (1987) *Pain in Infants and Children*. Elsevier, Amsterdam
10. Miser AW, Dothage JA, Wesley RA et al. (1987) The prevalence of pain in pediatric and young adult cancer population. *Pain* 29:73–83
11. Purcell-Jones G, Dorman F, Sumner E. (1988) Paediatric anaesthetists perception of neonatal pain and infant pain. *Pain* 33:181–187
12. Schechter NL, Allen DA, Hanson K (1986) Status of pediatric pain control: a comparison of hospital analgesic use in adults and children. *Pediatrics* 77:11–15
13. Swafford L, Allen D (1968) Relief in pediatric patients. *Medical Clinics of North America*. 52:131–136
14. Tesler MD, Wilkie DJ, Holzemer WE et al. (1994) Postoperative analgesics for children and adolescents: prescription and administration. *J Pain Symptom Manage* 9:85–94

15. Weisman SJ, Bernstein B, Schechter NL (1998) The consequences of inadequate analgesia during painful procedures in children. *Archives Pediatrics Adolescent Med* 152:147–149

## Excitatory Amino Acids

### Definition

Amino acid neurotransmitters that depolarize neurons and mediate excitatory synaptic transmission. Potential candidates include glutamate, aspartate, cysteate and homocysteate. Excitatory amino acids are used as transmitters for synapses in ascending and descending pain pathways.

- ▶ [Descending Circuitry, Molecular Mechanisms of Activity-Dependent Plasticity](#)
- ▶ [Fibromyalgia, Mechanisms and Treatment](#)

## Excitatory Post-Synaptic Current

### Synonyms

EPSC

### Definition

Generates the excitatory postsynaptic potential, EPSP.

- ▶ [Corticothalamic and Thalamocortical Interactions](#)

## Excitotoxic

### Definition

Excitotoxic effects are those that initially excite and then destroy cells and tissues. For example, glutamate is an excitatory amino acid that in excessively high concentrations can cause neuronal death by its stimulatory effects.

- ▶ [Dietary Variables in Neuropathic Pain](#)
- ▶ [Glutamate Homeostasis and Opioid Tolerance](#)

## Excitotoxic Lesion

### Definition

An excitotoxic lesion is produced by infusing a chemical that overexcites the local neurons. This results in the preferential destruction of cells but not axons of passage.

- ▶ [Lateral Thalamic Lesions, Pain Behavior in Animals](#)

## Excitotoxic Model

- ▶ [Spinal Cord Injury, Excitotoxic Model](#)

## Excruciating Pain

### Definition

Excruciating pain refers to extremely severe, atrocious, pain.

- ▶ [Sunct Syndrome](#)

## Exercise

SUSAN MERCER

School of Biomedical Sciences, The University of Queensland, Brisbane, QLD, Australia  
susan.mercer@stonebow.otago.ac.nz

### Synonyms

Physical Therapy; Aerobic Exercise; strengthening exercise; Endurance Exercise; Flexion Exercise; Extension Exercises; stabilizing exercise

### Definition

Exercise is an activity undertaken by an individual that is characterized by the deliberate use of muscles either to produce movement or to maximize muscle activity by resisting the movement that the muscles would produce. There are no explicit synonyms for exercise, but various adjectives may be used to define a particular form of exercise, according to the purpose of the exercise or the type of movement that it produces. Examples include aerobic exercise, strengthening exercise, endurance exercise, flexion exercise, extension exercises and stabilizing exercise. Some other exercises are named after the individual who invented them.

### Characteristics

#### Mechanism

The use of exercise in pain management is advocated for a variety of reasons. It is used to strengthen target muscles, increase joint mobility, improve motor control, stretch tight tissues, improve endurance, improve function and improve general fitness. Notwithstanding the intrinsic merits of these objectives, in most cases the association between the biological rationale of exercise and the relief of pain is only conjectural.

The classical role of exercise has been to strengthen the target muscle. That this can be achieved is not in doubt, but doubts arise when exercise is prescribed to treat pain, for in that event there is no known relationship between improvements in muscle strength and the mechanisms of pain or its relief. On the other hand, exercises might be used simply to encourage or increase mobility and function, despite pain. In that event, exercises are used to treat the effects of pain, not the pain itself.

A more sophisticated application of exercise requires training patients to co-ordinate their muscles differently, for example to remember to co-contract their transversus abdominis and multifidus, in order to enhance the stability of the lumbar spine (Richardson et al. 2000). With respect to rationale, the cardinal limitation to this model of intervention is that its physiological basis has not been elaborated. The supposed instability has not been defined. Nor has it been shown how the instability relates to the production of pain and how it should be identified clinically. The model hinges on the perplexing demonstration that in certain patients with chronic low back pain the onset of activation of transversus abdominis is delayed during the performance of, for example, upper limb tasks (Hodges and Richardson 1996). This delay has loosely been taken to imply impaired stability of the lumbar spine through lack of action of the transversus abdominis on the thoracolumbar fascia (Hodges and Richardson 1996). What the model ignores is that even at maximum contraction, the transversus abdominis contributes barely more than 5 Nm to the moments acting on the lumbar spine (Macintosh et al. 1987), which is no more than 2% of the moment required during lifting. The model, therefore, rests on the significance of a delayed onset of a less than trivial influence on the lumbar spine. In essence, this is a model with an ambiguous physiological basis. Nevertheless it has attracted adherents and has been tested clinically.

#### Applications

In pain medicine, exercises have not been used prominently in a therapeutic sense for conditions such as cancer pain, neuropathic pain, headache or postoperative pain. They have principally been used in the treatment of musculoskeletal pain and of complex regional pain syndromes.

#### Efficacy

Systematic reviews have provided data on the efficacy of exercises for several common, regional pain conditions. They provide mixed conclusions.

#### Acute Low Back Pain

A Cochrane review found that exercise therapy is not more effective than inactive treatments or other active treatments for acute low back pain (van Tulder et al. 2000). It also found that flexion and extension exercises are not effective.

#### Chronic Back Pain

Exercise therapy is more effective than usual care by a general practitioner and better than back school, but the evidence is conflicting on whether or not exercise is more effective than an inactive, sham treatment (Bogduk 2004). Strengthening exercises are not more effective than other types of exercises (Bogduk 2004). Specific stabilising exercises have been shown to be more effective than usual care for patients with spondylosis

or spondylolisthesis (O'Sullivan et al. 1997). They improve pain and function by a factor of 50% and the effects are enduring. It is not evident from this study, however, whether the therapeutic benefit is due to a biomechanically specific stabilising effect on the lumbar spine or the intensity of intervention and attention during the 10-week treatment programme is the operant factor.

#### Acute Neck Pain

Simple exercises designed to encourage and maintain mobility of the neck appear to be the single most effective intervention (Australian Acute Musculoskeletal Pain Guidelines Group 2003). Of all interventions that have been tested, exercises have produced the most enduring outcomes. Compared to manual therapy, exercise therapy is no less effective in the short term, but achieves a significantly greater proportion of patients free of pain two years after treatment.

#### Chronic Neck Pain

Exercise is the only conservative therapy that has been shown to provide any benefit. Depending on the study, and depending on the type of exercises, reductions in pain range between 25% and 75% (Bogduk and McGuirk 2006). Strengthening exercises are no more effective than endurance exercises, but intensive exercises are more effective than light exercises, although not necessarily more effective than ordinary activity (Bogduk and McGuirk 2006). Special stabilising exercises are not more effective than home exercises and are barely more effective than heat treatment (Bogduk and McGuirk 2006).

#### Shoulder Pain

The evidence is limited and confounded by difficulties concerning accurate diagnosis of various conditions. For so-called rotator cuff disease, exercise seems to be of benefit in both the short and longer-term (Green et al. 2002). For other entities, evidence is lacking. For chronic impingement syndrome, exercises are superior to placebo therapy and are as effective as arthroscopic surgery, both in the short-term (Brox et al. 1993) and at follow-up 2.5 years later (Brox et al. 1999). However, about one in four patients treated by exercise ultimately turn to surgery (Brox et al. 1999).

#### Anterior Knee Pain

Alone, or in combination with other interventions, exercises are the only intervention for anterior knee pain for which there is evidence of efficacy (Crossley et al. 2001). Eccentric quadriceps exercises are more effective, particularly in relation to functional outcomes, than standard quadriceps strengthening exercises.

#### Complex Regional Pain Syndrome

In conjunction with other interventions, such as analgesics and therapeutic blocks, exercises are recommended and used to mobilize the affected part in com-

plex regional pain syndrome (Harden 2000; Stanton-Hicks et al. 1998). This prescription serves to prevent or reduce atrophy and contractures and thereby preserve the affected tissues. However, the benefit achieved has not been demonstrated in controlled studies and any efficacy of exercises in relieving the pain of complex regional pain syndrome has not been established.

#### Side Effects

A particular virtue of exercises is that they are conspicuously free of any deleterious side effects.

► [Training by Quotas](#)

#### References

1. Australian Acute Musculoskeletal Pain Guidelines Group (2003) Evidence-Based Management of Acute Musculoskeletal Pain. Australian Academic Press, Brisbane Online. Available at <http://www.nhmrc.gov.au>
2. Bogduk N (2004) Management of chronic low back pain. *Med J Aust* 180:79–83
3. Bogduk N, McGuirk B (2006) Medical Management of Acute and Chronic Neck Pain. An Evidence-Based Approach. Elsevier, Amsterdam (in press)
4. Brox I, Staff PH, Ljunggren AE et al. (1993) Arthroscopic surgery compared with supervised exercises in patients with rotator cuff disease (stage II impingement syndrome). *BMJ* 307:899–903
5. Brox JI, Gjengedal E, Uppheim G et al. (1999) Arthroscopic surgery versus supervised exercises in patients with rotator cuff disease (stage II impingement syndrome). *J Shoulder Elbow Surg* 8:102–111
6. Crossley K, Bennell K, Green S et al. (2001) A systematic review of physical interventions for patellofemoral pain syndrome. *Clin J Sport Med* 11:103–110
7. Green S, Buchbinder R, Glazier R et al. (2002) Interventions for shoulder pain In: *The Cochrane Library*; Issue 2. Update Software, Oxford
8. Harden RN (2000) A clinical approach to complex regional pain syndrome. *Clin J Pain* 16:26–32
9. Hodges PW, Richardson C (1996) Inefficient muscular stabilization of the lumbar spine associated with low back pain. A motor control evaluation of transversus abdominis. *Spine* 21:2650–2650
10. Macintosh JE, Bogduk N, Gracovetsky S (1987) The biomechanics of the thoracolumbar fascia. *Clin Biomech* 2:78–83
11. O'Sullivan PB, Twomey, LT, Allison GT (1997) Evaluation of specific stabilizing exercise in the treatment of chronic low back pain with radiologic diagnosis of spondylolysis or spondylolisthesis. *Spine* 22:2959–2967
12. Richardson CA, Jull GA, Hides JA (2000) A new clinical model of the muscle dysfunction linked to the disturbance of spinal stability: implications for treatment of low back pain. In: Twomey LT, Taylor JR (eds) *Physical Therapy of the Low Back*, 3rd edn. Churchill Livingstone, New York, pp 249–267
13. Stanton-Hicks M, Baron R, Boas R et al. (1998) Complex regional pain syndromes: guidelines for therapy. *Clin J Pain* 14:155–166
14. van Tulder MM, Malmivaara A, Esmail R et al (2000) Exercise therapy for low back pain (Cochrane Review). In: *The Cochrane Library*, Issue 2. Update Software, Oxford

## Exercise-Induced Muscle Soreness

► [Delayed Onset Muscle Soreness](#)

## Exertional Activity

#### Definition

One of the primary strength activities (sitting, standing, walking, lifting, carrying, pushing, and pulling) defining a level of work. The Social Security definition is the same as that used by the Department of Labor to classify occupations by strength levels. Any job requirement that is not exertional (as defined above by the primary strength activities) is considered nonexertional.

► [Disability Evaluation in the Social Security Administration](#)

## Exertional Capability

#### Definition

Exertional capability is the ability to perform any of the primary strength activities, i.e. sitting, standing, walking, lifting, carrying, pushing, and pulling.

► [Disability Evaluation in the Social Security Administration](#)

## Exertional Limitations and Restrictions

#### Definition

Limitations or restrictions that affect the capability to perform an exertional (primary strength) activity – sitting, standing, walking, lifting, carrying, pushing, and pulling.

► [Disability Evaluation in the Social Security Administration](#)

## Existential Distress

#### Definition

Concerns regarding survival.

► [Cancer Pain Management, Interface Between Cancer Pain Management and Palliative Care](#)

## Exocytosis

#### Synonym

Extrusion

#### Definition

Exocytosis is the process of exporting material in vesicles that is used to release substances, such as hormones or neurotransmitters, from a cell.

► [Diencephalic Mast Cells](#)



## Exogenous Muscle Pain

THOMAS GRAVEN-NIELSEN  
Laboratory for Experimental Pain Research, Center  
for Sensory-Motor Interaction, Aalborg University,  
Aalborg, Denmark  
tgn@hst.aau.dk

### Synonyms

Experimental Muscle Pain

### Definition

Exogenous muscle pain is muscle pain provoked by external interventions, e.g. electrical stimulation of muscle afferents, injection of analgesic substances, or strong mechanical pressure. In contrast, endogenous muscle pain is caused by natural stimuli, for example by ischemia or by exercise.

### Characteristics

Sensory manifestations of muscle pain are seen as a diffuse aching pain in the muscle, pain referred to distant somatic structures and modifications in the superficial and deep sensitivity in the painful areas (Graven-Nielsen et al. 2001). These manifestations are different from cutaneous pain, which is normally superficial and localized around the injury, with a burning and sharp quality. Kellgren (1938) was one of the pioneers to study experimentally the diffuse characteristics of exogenous muscle pain, and the actual locations of ► **referred pain** to selective activation of specific muscle groups. The sensation of exogenous muscle pain is the result of activation of ► **group III** (A $\delta$ -fiber) and ► **group IV** (C-fiber) polymodal ► **muscle nociceptors** (Mense 1993). The nociceptors can be sensitized by release of neuropeptides from the nerve endings. This may eventually lead to ► **hyperalgesia** and ► **central sensitization** of dorsal horn neurons manifested as prolonged neuronal discharges, increased responses to defined noxious stimuli, response to non-noxious stimuli, and expansion of the ► **receptive field** (Mense 1993).

### Electrical

Intramuscular electrical stimulation (Fig. 1) is used to assess the sensitivity of muscles (Vecchiet et al. 1988), and to study basic aspects of muscle and referred pain (Arendt-Nielsen et al. 1997). Intramuscular electrical stimulation is a tissue specific (although receptor unspecific) and reliable model to study sensory manifestations of exogenous muscle pain, such as referred pain (Laursen et al. 1999) and ► **temporal summation** of muscle pain (Arendt-Nielsen et al. 1997), but is confounded by concurrent activated muscle twitches. Electrical stimulation offers a unique possibility to compare both muscle and cutaneous tissues with the same stimulus modality. Intraneural microstimulation

of muscle nociceptive afferents causes a muscle pain sensation (area and intensity), which is dependent on the stimulation time (temporal summation) and the number of stimulated afferents (► **spatial summation**).

### Mechanical

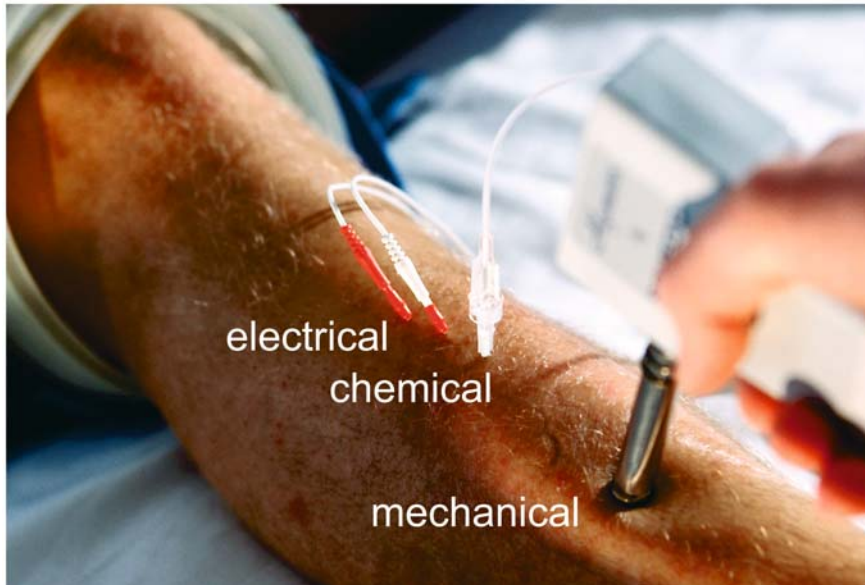
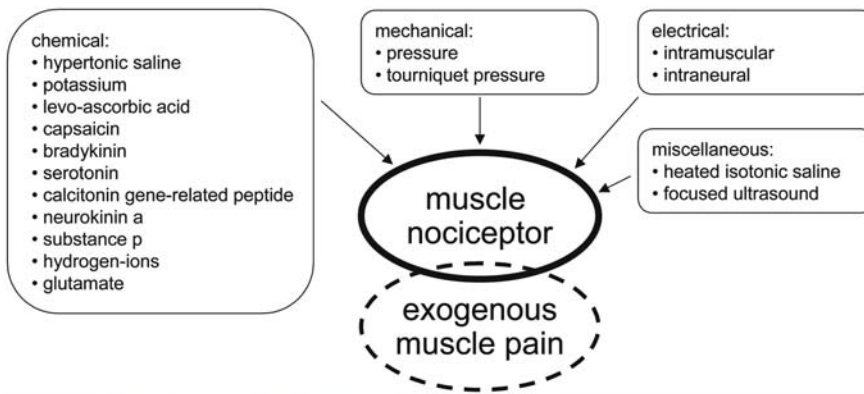
Mechanical painful stimulation (Fig. 1) can be achieved with pressure algometers. The most widely used technique is manual pressure algometry (Fischer 1998). It is important to recognize that pressure stimulates both the skin and muscle. Methodological concerns like short-term and long-term reproducibility, influence of pressure rates, muscle contraction levels and examiner expectancy have all been carefully addressed.

An alternative to pressure algometry, with the inherent variability related to manual application, is computer-controlled pressure algometry, where the rate and peak pressure can be predefined and automatically controlled. This method allows estimation of the stimulus-response function between pressure and pain intensities. Pressure algometry assesses a relatively small volume of tissue. However, a larger volume can be assessed using the computer-controlled cuff-algometry technique. In short, the pain intensity related to inflation of a tourniquet applied around an extremity is used to establish stimulus-response curves. After intramuscular injections of lidocaine, the stimulus-response curve between the tourniquet pressure and pain intensity was shifted right, indicating the ability to assess the sensitivity of muscles (Polianskis et al. 2002).

### Chemical

Intramuscular injections of analgesic substances have been used to induce exogenous muscle pain (Fig. 1) (for specific references see Graven-Nielsen et al. 2001). The experimental method that has been used extensively is an I.M. injection of hypertonic saline, as the quality of the exogenous muscle pain is comparable to acute clinical muscle pain with localized and referred pain. The work of Kellgren and Lewis in the late thirties (1938) initiated the method of saline-induced muscle pain, and the safety of the technique is illustrated by there being no reports of side effects after more than 1,000 I.M. infusions. A major advantage of the hypertonic saline model is that a detailed description of sensory and motor effects can be obtained, as the pain lasts for minutes. Furthermore, the model is reliable for studying referred pain from musculoskeletal structures, due to the longer lasting pain. A systematic evaluation of the relation between infusion parameters (infusion concentration, volume, rate, and tissue) and pain intensity, quality, and local and referred pain patterns has been described.

The sensitization of muscle nociceptors is the best-established peripheral mechanism for the subjective tenderness and pain during movement of a damaged muscle. The sensitized nociceptors not only have a lowered mechanical excitation threshold, but also exhibit



**Exogenous Muscle Pain, Figure 1** Stimulus modalities for exogenous muscle pain (top). Induction of exogenous muscle pain in the tibialis anterior muscle by electrical and mechanical stimulation and infusion of an algescic substance (bottom).

larger responses to noxious stimuli. If the muscle lesion is extensive, high amounts of endogenous algescic agents will be released, which could lead to direct excitation of nociceptors, resulting in spontaneous pain. In humans this has been seen as decreased pressure pain thresholds after intramuscular injections of ► **capsaicin** (Witting et al. 2000). Intra-arterial injections of serotonin, bradykinin, and prostaglandin have been found to be effective in sensitizing animal nociceptors (Mense 1993). In humans, a decrease in the pressure pain threshold after combined intramuscular injections of serotonin and bradykinin was found (Babenko et al. 1999). Moreover, intramuscular co-injection of serotonin and a serotonin receptor antagonist, granisetron, reduced the spontaneous pain evoked by injection of serotonin, and prevented allodynia/hyperalgesia to mechanical pressure stimuli (Ernberg et al. 2000). Thus, peripheral serotonergic receptors could be involved in the regulation of musculoskeletal pain disorders. Glutamate receptors (ionotropic and metabotropic) are other receptor types that are potentially involved in muscle hyperalgesia. Intramuscular injections of

glutamate produce pain and muscle hyperalgesia to pressure stimuli in humans (Svensson et al. 2003). The glutamate-induced muscle pain is attenuated by an N-methyl-D-aspartate (NMDA) receptor antagonist (ketamine) when co-injected with glutamate in humans, or decrease the afferent activity recorded in animals (Cairns et al. 2003). This indicates that activation of peripheral NMDA receptors may contribute to exogenous muscle pain. Interestingly, injections of glutamate in women induced significantly more muscle pain than similar injections in men (Cairns et al. 2001). This might be explained by greater glutamate-evoked afferent fiber activity in female rats, compared to male rats (Cairns et al. 2001). The gender difference is particularly important in relation to the high dominance of women with musculoskeletal pain syndromes.

#### Miscellaneous

From animal studies, afferent recordings have shown that a subgroup of muscle nociceptors responds to thermal stimulation (Mense 1993). It was also found that injections of heated isotonic saline induced muscle

pain in contrast to isotonic saline at room temperature (Graven-Nielsen et al. 2002). It may be the thermal-induced muscle pain that is involved in conditions of widespread muscle pain observed in fever conditions. Focused ultrasound has been used to induce muscle, joint and skin pain (Wright et al. 2002). The transducer for ultrasound stimulation is located externally, but as a result of focusing the beam, the energy can be applied maximally to the deeper tissues, thereby selectively activating nociceptors in deep structures. By appropriate adjustment, it is possible to focus the main ultrasound energy to muscles and other subcutaneous structures. Repeated focused ultrasound stimulation of muscle induced pain, which was progressively increasing to a larger extent than skin stimulation; indicates that temporal summation of muscle pain is more pronounced than skin pain (Wright et al. 2002).

## References

1. Arendt-Nielsen L, Graven-Nielsen T, Svensson P, Jensen TS (1997) Temporal Summation in Muscles and Referred Pain Areas: An Experimental Human Study. *Muscle Nerve* 20:1311–1313
2. Babenko V, Graven-Nielsen T, Svensson P, Drewes AM, Jensen TS, Arendt-Nielsen L (1999) Experimental Human Muscle Pain and Muscular Hyperalgesia Induced by Combinations of Serotonin and Bradykinin. *Pain* 82:1–8
3. Cairns B E, Hu JW, Arendt-Nielsen L, Sessle BJ, Svensson P (2001) Sex-Related Differences in Human Pain and Rat Afferent Discharge Evoked by Injection of Glutamate into the Masseter Muscle. *J Neurophysiol* 86:782–791
4. Cairns B E, Svensson P, Wang K, Hupfeld S, Graven-Nielsen T, Sessle BJ, Berde CB, and Arendt-Nielsen L (2003) Activation of Peripheral NMDA Receptors Contributes to Human Pain and Rat Afferent Discharges Evoked by Injection of Glutamate into the Masseter Muscle. *J Neurophysiol* 2003:2098–2105
5. Ernberg M, Lundeberg T, Kopp S (2000) Effect of Propranolol and Granisetron on Experimentally Induced Pain and Allodynia/Hyperalgesia by Intramuscular Injection of Serotonin into the Human Masseter Muscle. *Pain* 84:339–346
6. Fischer AA (1998) *Muscle Pain Syndromes and Fibromyalgia. Pressure Algometry for Quantification of Diagnosis and Treatment Outcome.* Haworth Medical Press, New York
7. Graven-Nielsen T, Arendt-Nielsen L, Mense S (2002) Thermosensitivity of Muscle: High-Intensity Thermal Stimulation of Muscle Tissue Induces Muscle Pain in Humans. *J Physiol* 540:647–656
8. Graven-Nielsen T, Segerdahl M, Svensson P, Arendt-Nielsen L (2001) Methods for Induction and Assessment of Pain in Humans with Clinical and Pharmacological Examples. In: Kruger L (ed) *Methods in Pain Research.* CRC Press, Boca Raton, pp 264–304
9. Kellgren JH (1938) Observations on Referred Pain Arising from Muscle. *Clin Sci* 3:175–190
10. Laursen RJ, Graven-Nielsen T, Jensen TS, Arendt-Nielsen L (1999) The Effect of Compression and Regional Anaesthetic Block on Referred Pain Intensity in Humans. *Pain* 80:257–263
11. Mense S (1993) Nociception from Skeletal Muscle in Relation to Clinical Muscle Pain. *Pain* 54:241–289
12. Polianskis R, Graven-Nielsen T, Arendt-Nielsen L (2002) Pressure-Pain Function in Desensitized and Hypersensitized Muscle and Skin Assessed by Cuff Algometry. *J Pain* 3:28–37
13. Svensson P, Cairns B E, Wang K, Hu JW, Graven-Nielsen T, Arendt-Nielsen L, Sessle BJ (2003) Glutamate-Evoked Pain and Mechanical Allodynia in the Human Masseter Muscle. *Pain* 101:221–227
14. Vecchiet L, Galletti R, Giamberardino MA, Dragani L, Marini F (1988) Modifications of Cutaneous, Subcutaneous and Muscular Sensory and Pain Thresholds after the Induction of an Experimental Algogenic Focus in the Skeletal Muscle. *Clin J Pain* 4:55–59
15. Witting N, Svensson P, Gottrup H, Arendt-Nielsen L, Jensen TS (2000) Intramuscular and Intradermal Injection of Capsaicin: A Comparison of Local and Referred Pain. *Pain* 84:407–412
16. Wright A, Graven-Nielsen T, Davies I, Arendt-Nielsen L (2002) Temporal Summation of Pain from Skin, Muscle and Joint Following Nociceptive Ultrasonic Stimulation in Humans. *Exp Brain Res* 144:475–482

E

## Exon

### Definition

An exon comprises of the protein coding region in the DNA sequence of a gene. Hence it reflects that part of a gene, whose sequence is present in the mature mRNA.

► [NSAIDs, Pharmacogenetics](#)

## Exorphins

### Definition

Exorphins are peptides that can activate opioid receptors. They are derived from food such as wheat or milk by digestion.

► [Dietary Variables in Neuropathic Pain](#)

## Expectancies

### Definition

Expectancies are the perceived probability of occurrence of a particular outcome.

► [Psychology of Pain, Assessment of Cognitive Variables](#)

## Expectation

### Definition

Expectation is the anticipation of an event. According to expectation theories, expecting an outcome affects the outcome itself.

► [Placebo Analgesia and Descending Opioid Modulation](#)

## Experimental Allergic Encephalitis

### Synonyms

EAE

**Definition**

Experimental allergic encephalitis (EAE) is an autoimmune disease that is initiated by immunizing experimental animals with myelin proteins. EAE is used as a model for CNS demyelinating diseases such as multiple sclerosis.

- ▶ [Demyelination](#)

**Experimental Diabetic Neuropathy**

- ▶ [Neuropathic Pain Model, Diabetic Neuropathy Model](#)

**Experimental Endpoint****Definition**

Experimental endpoint is a biological effect used as an index of the effect of a chemical or other manipulation on an organism.

- ▶ [Amygdala, Pain Processing and Behavior in Animals](#)

**Experimental Jaw Muscle Pain****Definition**

Numerous techniques are available to evoke a deep, diffuse pain in jaw muscles of healthy volunteers, for example, by injection of algogenic substances such as hypertonic saline, excitatory amino acids, capsaicin, prostaglandins and serotonin. Electrical and mechanical stimuli can also be used.

- ▶ [Orofacial Pain, Movement Disorders](#)

**Experimental Muscle Pain**

- ▶ [Exogenous Muscle Pain](#)

**Experimental Pain****Definition**

Stimuli that artificially replicates a painful condition in humans.

- ▶ [Human Thalamic Response to Experimental Pain \(Neuroimaging\)](#)

**Experimental Pain in Children**

JENNIE C. I. TSAO, LONNIE K. ZELTZER  
Pediatric Pain Program, Department of Pediatrics,  
David Geffen School of Medicine at UCLA, Los  
Angeles, CA, USA  
lzeltzer@mednet.ucla.edu.

**Synonyms**

Laboratory Pain; cold pressor task

**Definition**

Experimental pain involves the use of standardized tasks conducted within a controlled environment to test specific hypotheses regarding pain responsivity in children that would be difficult to test outside the laboratory. These tasks are designed to induce safely mild to moderate pain sensations in a reliable fashion across research participants. The nature of the pain stimulation (e.g. cold, pressure) and the types of pain tasks vary and have typically been based on procedures developed and refined in adults. Although some have questioned the utility of experimental pain studies in children, it has become increasingly recognized that such studies can assist researchers in understanding the nature of the pain response and individual differences in these responses while posing minimal harm to children. Experimental pain methods have often been used to investigate questions concerning clinical pain, to teach ▶ [pain coping skills](#) and to evaluate the effectiveness of ▶ [psychosocial treatments for pain](#) – applications that have recently gained increased popularity in studies with children. The reproducibility of experimental pain procedures allows the investigation of intervention effects across time without confounding variables (e.g. variations in intensity and / or duration) inherent to clinical pain episodes and painful “real world” medical procedures.

**Characteristics**

The most commonly used experimental pain tasks in children are described below.

**Cold Pressor Task**

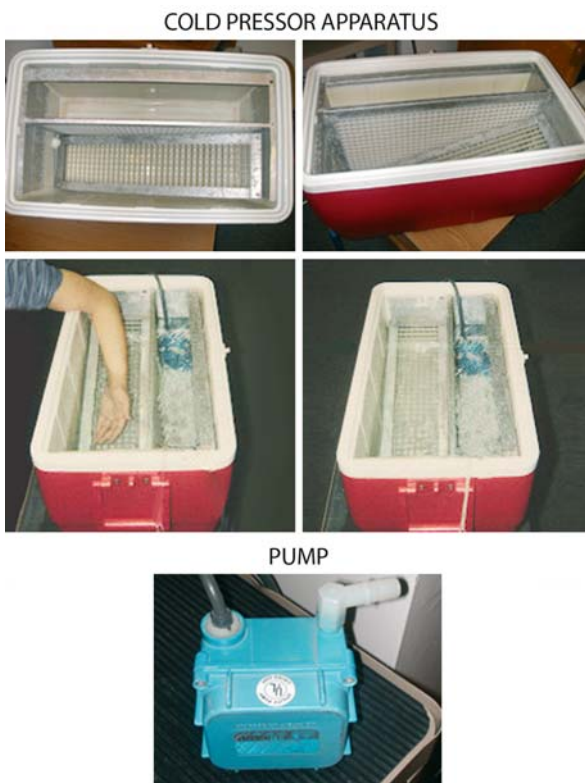
The cold pressor task (CPT) involves placing a hand or forearm in cold water, a stimulus that produces a slowly mounting pain of mild to moderate intensity and is terminated by voluntary withdrawal of the limb. Use of the CPT with children was first reported in 1937 and it has been used since then in at least 24 published studies involving over 1700 children without reported adverse effects (for review, see von Baeyer et al. 2005). Notably, the CPT has been used with healthy children, as well as in children with a variety of clinical conditions including ▶ [juvenile rheumatoid arthritis \(JRA\)](#), ▶ [recurrent abdominal pain](#) and recurrent headache. Thus, it is the



most widely used experimental pain task in studies of children.

Because the CPT is a painful stimulus lasting up to 3 or 4 min (i.e. the typical ceiling at which participants are instructed to withdraw from the apparatus if they have not already done so voluntarily), it is likely to be most comparable with acute somatic clinical pains lasting from a few minutes to several hours (e.g. post-operative pain), rather than visceral or chronic pain (von Baeyer et al. 2005).

The majority of cold pressor studies have used a custom-made apparatus to maintain constant water temperature and to achieve a flow of water over the hand. Various types of tanks (e.g. insulated picnic chest) (Fig. 1) have been adapted with two compartments separated by a plastic or metal filter – one compartment holds ice and water, while the other, the immersion tank, holds water alone so that the child's hand never comes into direct contact with ice. A pump causes water to flow between the two compartments, a process that helps to keep the water near the target temperature and prevents the development of a microenvironment of warm water around the child's hand. To guide the child's placement of the hand and to control depth of immersion, an armrest is usually included. The armrest is typically made of plastic rather than metal (to reduce the effects of heat conductivity through contact with the armrest)



**Experimental Pain in Children, Figure 1** Example of a cold pressor task (CPT) apparatus.

and has holes in it to permit circulation of water on the lower side of the immersed hand. Although varied cold temperatures are used, von Baeyer and colleagues (2005) recommend a continuously circulating water bath at a temperature of  $10 \pm 1^\circ\text{C}$  for children.

### Assessment of Pain Response

The CPT provides a context in which a variety of pediatric pain outcome measures may be considered, including pain threshold, pain tolerance, pain intensity ratings and distress ratings as well as stress hormonal and autonomic / cardiovascular responses. Some studies have also used observational measures of facial, verbal and bodily expression of pain during the procedure.

The CPT provides a useful measure of pain tolerance. This is typically defined as the duration of immersion (in seconds) from the time the hand is placed in the water to the time it is voluntarily withdrawn. Alternatively, cold-pressor tolerance may be defined as the duration of immersion time following pain threshold (i.e. the point at which the sensation is considered by the child to be painful). However, younger children may be less reliable in reporting pain threshold (Miller et al. 1994), perhaps because they focus on the procedure and forget to indicate when they first feel pain. Hence, the former definition of tolerance is recommended for use with children when conducting the CPT.

Self-report ratings of pain can be obtained concurrently with the immersion by verbal numerical rating scales (0–10) or using mechanical [visual analog scales](#) (VAS) or faces scales employing the non-immersed hand. Self-report pain scales should be explained to the child prior to the CPT in order to minimize distractions during the CPT. However, any rating procedure may entail reactive effects of measurement, that is changes produced by the measurement procedure itself (von Baeyer 1994). These reactive effects may operate to decrease tolerance by drawing the participant's attention to pain (Fanurik et al. 1993; LeBaron et al. 1989; Zeltzer et al. 1989) or to increase tolerance because of the inherent distraction of interacting with the experimenter (Mikail et al. 1986). Retrospective ratings immediately upon limb withdrawal from the water can be obtained using any self-report method (Champion et al. 1998).

### Practical Considerations

Although there have been no documented adverse physical or psychological effects arising from use of the CPT in children, it is possible that a rare participant may react to the pain with a stress response, for example increased heart rate and, in extreme instances, fainting associated with a [vasovagal response](#). As noted by von Baeyer et al. (2005), this risk can be eliminated by (a) excluding children with a history of: cardiovascular disease, fainting or seizures, frostbite or [Raynaud's syndrome](#) and (b) giving the children fruit juice to drink beforehand

to ensure that they are hydrated before the experiment. This procedure can reduce the risk of vasovagal stress responses in children who have not had anything to eat or drink all day at the time of the experiment. Children should also be given time to habituate to the laboratory setting before starting the CPT. That time can be occupied with completing pretest measures.

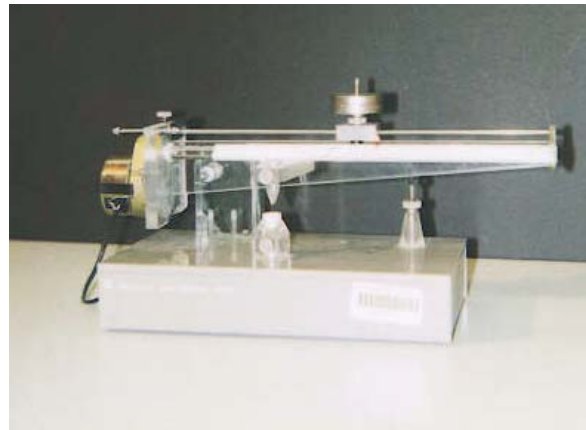
### Pressure Pain

A few studies have examined laboratory pressure pain responsivity in children. The Forgione-Barber focal pressure stimulator, in which a dull Lucite edge applies continuous pressure to the finger, is the most commonly used device (Forgione and Barber 1971). The pressure sensations gradually build to a dull aching pain (Forgione and Barber 1971); the rate at which the sensations become painful may be varied by applying different weights to the apparatus, thus changing the intensity of the pressure. The stimulator is considered to be reliable and relatively unmodified by extraneous physiological events (e.g. vasomotor activity) (Forgione and Barber 1971). Pressure pain reactivity to sphygmomanometer (blood pressure cuff) inflation has also been examined in children (Walco et al. 1990). These pressure pain tasks have been administered to healthy children (Tsao et al. 2004) as well as to children with chronic illnesses including ► [sickle cell disease](#) (Gil et al. 1997; Walco et al. 1990), JRA and asthma (Walco et al. 1990), without documented adverse effects. These studies have included children as young as 5 years of age (Walco et al. 1990).

### Assessment of Pain Response

In the study by Walco and colleagues (1990), pressure applied by the Forgione-Barber stimulator was increased by approximately  $250 \text{ g cm}^{-2} -1$  at 2 s intervals, although the initial amount of force applied was not specified. For the sphygmomanometer, the cuff was inflated rapidly to 40 mmHg and then increased in increments of 10 mmHg s<sup>-1</sup>. For both tasks, children were instructed to state when the sensations were first perceived as pain, thus providing a measure of pain threshold. Pain tolerance was not examined in this study. Results indicated that threshold assessments for both tasks were reliable across trials. Interestingly, children with sickle cell disease and JRA had significantly lower pain thresholds than healthy controls.

Gil and colleagues (1997) assessed pressure pain responses to four stimulus intensities (force = 2.83–8.76) by asking 41 children (ages 8–17 years) with sickle cell disease to rate each of 32 trials using a 10-point scale of verbal descriptors (1 = not noticeable to 10 = worst possible pain). Children were asked for pain ratings at 15 s or when the child did not want to tolerate the trial any longer and withdrew from the apparatus. Tolerance times were not reported. Notably, children who reported



**Experimental Pain in Children, Figure 2** Modified Forgione-Barber pressure stimulator.

using active cognitive and behavioral coping strategies reported less pain in response to the pressure task.

Tsao and colleagues (2004) using a modified Forgione-Barber device (Fig. 2) exposed 118 healthy children (ages 8–18 years) to four trials of pressure pain at two weight levels (322.5 g and 465 g). The trials were conducted with an uninformed ceiling of 3 minutes. Tolerance, defined as time in seconds elapsed from the onset of the pain stimulus to participants' withdrawal from the stimulus ( $M = 41.6 \text{ s}$ ,  $SD = 45.4$ ), as well as pain intensity, rated on a 10-point VAS, were assessed for each trial. Results indicated that ratings of ► [anticipatory anxiety](#) in relation to the upcoming pressure trials significantly predicted pressure pain intensity. Pressure tolerance however was unrelated to anticipatory anxiety.

### Thermal Heat Pain and Vibration Pain

Quantitative sensory testing (QST), a noninvasive computer-based method, has been used to assess thermal sensations and vibration sensation. Although its use in children has been limited, QST has been used extensively in adults to screen for ► [peripheral neuropathies](#) with loss of sensation and increased cutaneous sensitivity and to monitor disease progression and responsiveness to therapy. In children, Hilz and colleagues have reported normative ranges for thermal and vibration perception using a commercially available apparatus (Somedic, Stockholm, Sweden) (Hilz et al. 1998a, b). Using a different device (Medoc Ltd. Advanced Medical Systems, Ramat Yishai, Israel), Meier and colleagues (2001) reported normative data on thermal and vibration detection thresholds in 101 healthy children aged 6–17 years. The findings from these two groups of investigators support the use of QST in documenting and monitoring the clinical course of sensory abnormalities in children with neurological disorders or neuropathic pain.



**Experimental Pain in Children, Figure 3** Device for assessment of thermal heat pain reactivity.

These studies however, examined threshold to detect sensations and did not assess pain tolerance or intensity. In their study of healthy children, Tsao et al. (2004), using a commercially available device (Ugo Basile Biological Research Apparatus #7360 Unit, Comerio, Italy) (Fig. 3), administered four trials of infrared radiant heat 2" proximal to the wrist and 3" distal to the elbow on both volar forearms, with an uninformed ceiling of 20 s. Thermal pain tolerance was electronically measured with an accuracy of 0.1 s ( $M = 9.4$  s,  $SD = 5.0$ ). Anticipatory anxiety ratings in relation to the thermal heat trials significantly predicted tolerance and pain intensity. In addition, children's self-reported anxiety symptoms were significantly associated with thermal heat intensity ratings.

In summary, relative to clinical pain contexts, experimental pain tasks have the advantage of being free from the influence of potentially confounding factors such as nausea and fatigue related to illness and painful medical procedures. Experimental pain methods allow greater control over details of the stimulus location, duration and intensity than is possible with clinical pain thereby facilitating the testing of specific hypotheses regarding individual difference variables and potential moderators of pain reactivity such as age, sex and ethnicity.

## References

1. Champion GD, Goodenough B, von Baeyer CL et al. (1998) Measurement of pain by self-report. In Finley GA, McGrath PJ (eds) *Measurement of pain in infants and children*. IASP Press, Seattle, pp 123–160
2. Fanurik D, Zeltzer LK, Roberts MC et al. (1993) The relationship between children's coping styles and psychological interventions for cold pressor pain. *Pain* 52:255–257
3. Forgione AG, Barber TX (1971) A strain gauge pain stimulator. *Psychophysiology* 8:102–106
4. Gil KM, Edens JL, Wilson JJ et al. (1997) Coping strategies and laboratory pain in children with sickle cell disease. *Ann Behav Med* 19:22–29
5. Hilz MJ, Axelrod FB, Hermann K et al. (1998a) Normative values of vibratory perception in 530 children, juveniles and adults aged 3–79 years. *J Neurol Sci* 159:219–225
6. Hilz MJ, Stemper B, Schweibold G et al. (1998b) Quantitative thermal perception testing in 225 children and juveniles. *J Clin Neurophysiol* 15:529–534
7. LeBaron S, Zeltzer LK, Fanurik D (1989) An investigation of cold pressor pain in children part I. *Pain* 37:161–171
8. Meier PM, Berde CB, DiCanzio J et al. (2001) Quantitative assessment of cutaneous thermal and vibration sensation and thermal pain detection thresholds in healthy children and adolescents. *Muscle Nerve* 24:1339–1345
9. Mikail SF, Vandeursen J, von Baeyer CL (1986) Rating pain or rating serenity: Effects on cold-pressor pain tolerance. *Can J Beh Sci* 18:126–132
10. Miller A, Barr RG, Young SN (1994) The cold pressor test in children: Methodological aspects and the analgesic effect of intraoral sucrose. *Pain* 56:175–183
11. Tsao JC I, Myers CD, Craske MG et al. (2004) Role of anticipatory anxiety and anxiety sensitivity in children's and adolescents' laboratory pain responses. *J Pediatr Psychol* 29:379–388
12. von Baeyer CL (1994) Reactive effects of measurement of pain. *Clin J Pain* 10:18–21
13. von Baeyer CL, Piira T, Chambers CT et al. (2005) Guidelines for the cold pressor task as an experimental pain stimulus for use with children. *J Pain* 6:218–27
14. Walco GA, Dampier CD, Hartstein G et al. (1990) The relationship between recurrent clinical pain and pain threshold in children. In Tyler DC, Krane EJ (eds), *Advances in pain research therapy*. Raven Press, Ltd., New York, pp 333–340
15. Zeltzer LK, Fanurik D, LeBaron S (1989) The cold pressor pain paradigm in children: Feasibility of an intervention model part II. *Pain* 37:305–313

E

## Expert Patient

### Definition

Patients with trigeminal neuralgia need to gather information about the condition in order to be able to make informed decisions about their management and improve their pain control.

► [Trigeminal Neuralgia, Etiology, Pathogenesis and Management](#)

## Explanatory Model

### Definition

The Explanatory Model refers to the explanations held by individuals regarding the nature of their plight. These may evolve from individuals' direct experiences, what they have observed or learned from the media, and what they have been told by others including family and health care providers.

► [Psychological Assessment of Pain](#)

## Exposure In Vivo

### Definition

Cognitive-behavioral treatment during which chronic pain patients are gradually exposed to fear-eliciting

stimuli in order to disconfirm erroneous cognitions and to extinguish fear, thereby restoring activities and decreasing disability levels. Exposure *in vivo* treatment has proven to be effective in anxiety disorders and in chronic low back pain patients with fear of movement/(re)injury.

- ▶ Disability, Fear of Movement
- ▶ Fear and Pain
- ▶ Fear Reduction through Exposure in Vivo
- ▶ Muscle Pain, Fear-Avoidance Model

## Exposure Techniques for Reducing Activity Avoidance

- ▶ Behavioral Therapies to Reduce Disability

## Exposure Treatment

- ▶ Fear Reduction through Exposure in Vivo

## Extension Exercises

- ▶ Exercise

## Extensive First Pass Metabolism

### Definition

Morphine, a weak base ( $pK_a - 8.0$ ), undergoes extensive first pass metabolism, and its oral bioavailability is 25-30%.

- ▶ Postoperative Pain, Morphine

## Exteroception

### Definition

The term exteroception is antonymous to the term interoceptions, and defines the sense for outside stimuli such as vision, hearing, taste, smell, and touch.

- ▶ Functional Imaging of Cutaneous Pain

## Exteroceptive

### Definition

Exteroceptive, receiving stimuli from the skin or intraoral mucosa.

- ▶ Trigeminal Brainstem Nuclear Complex, Anatomy

## Exteroceptive Suppression

- ▶ Jaw-Muscle Silent Periods (Exteroceptive Suppression)

## Exteroreceptive

Exteroreceptive refers to sensory detection and processing of objects in the external environment.

- ▶ Spinothalamic Tract Neurons, in Deep Dorsal Horn

## Extinction

### Definition

Extinction is a process by which a conditioned emotional reaction is eliminated, when the conditioned stimuli are no longer paired with the stimuli that had previously elicited the occurrence of that behavior.

- ▶ Fear Reduction through Exposure in Vivo

## Extracellular Signal-Regulated Protein Kinase

### Synonyms

ERK

### Definition

ERK is activated by an upstream kinase, MAPK kinase (MEK), which produces not only short-term functional changes in the nervous system by post-translational modifications of target proteins, but also long-term adaptive changes by increasing gene transcription. The activation of ERK in dorsal horn neurons by noxious stimulation or after peripheral inflammation is known to contribute to pain hypersensitivity.

- ▶ ERK Regulation in Sensory Neurons during Inflammation
- ▶ Spinal Cord Nociception, Neurotrophins

## Extradural Infusions

- ▶ Epidural Infusions in Acute Pain
- ▶ Postoperative Pain, Epidural Infusions

## Extralemniscal Myelotomy

- ▶ Midline Myelotomy



---

## Extrasegmental Analgesia

### Definition

Extrasegmental Analgesia is the analgesic effect outside the stimulated segment.

- ▶ Transcutaneous Electrical Nerve Stimulation Outcomes

---

## Extrasegmental Anti-Nociceptive Mechanisms

### Synonyms

Supraspinal anti-nociceptive mechanisms

### Definition

Neural circuitry that originates above the spinal cord, and when active prevents the onward transmission of

noxious information en route to higher centers in the brain.

- ▶ Transcutaneous Electrical Nerve Stimulation (TENS) in Treatment of Muscle Pain

---

## Extrusion

- ▶ Exocytosis

**E**

---

## Eye Nociceptors

- ▶ Ocular Nociceptors

---

## Eye Pain Receptors

- ▶ Ocular Nociceptors



---

## F2 Intercross

### Definition

The second-generation descendants of a cross of two contrasting populations (e.g. inbred strains). The offspring of the cross (i.e. F<sub>1</sub> hybrids) are sib-mated to produce F<sub>2</sub> hybrids, in which homologous recombination has „shuffled“ the genomes of the progenitors in a unique manner. F<sub>2</sub> hybrids from inbred strain progenitors are useful for quantitative trait locus (QTL) mapping.

- ▶ Heritability of Inflammatory Nociception
- ▶ Quantitative Trait Locus Mapping

---

## Faces Pain Scale

### Definition

Visual pain scale of seven faces now tested in older adults as well as children.

- ▶ Cancer Pain, Assessment in the Cognitively Impaired

---

## Facet Denervation

- ▶ Facet Joint Procedures for Chronic Back Pain

---

## Facet Joint

### Definition

Facet is a flat, plate-like surface that acts as part of a joint; as seen in the vertebrae of the spine and in the subtalar joint of the ankle. Each vertebra has two superior and two inferior facets. Facet joints are small stabilizing synovial joints located between and behind adjacent vertebrae.

- ▶ Chronic Back Pain and Spinal Instability
- ▶ Chronic Low Back Pain, Definitions and Diagnosis
- ▶ Facet Joint Pain
- ▶ Pain Treatment, Spinal Nerve Blocks

---

## Facet Joint Injection

- ▶ Facet Joint Procedures for Chronic Back Pain

---

## Facet Joint Pain

ALFRED T. OGDEN, CHRISTOPHER J. WINFREE  
Department of Neurological Surgery, Neurological  
Institute Columbia University, New York, NY, USA  
cjw12@columbia.edu

### Synonyms

Facet Syndrome; Zygapophysial Joint Pain, Sciatica; zygapophysis

### Definition

Although the intervertebral joint has long been known to be a common generator of low back pain and leg pain, the ▶ [facet joint](#) has been proposed as another potential focus of degenerative pathology that can reproduce similar symptoms. Structurally analogous to joints in the extremities, the facet joint has the capacity to degenerate over time, and cause pain through the same mechanisms that are at play in osteoarthritis of the hip or the knee. This pain can be “felt” by the patient in the area of the facet, producing low back pain, or it can potentially be referred to other parts of the body through the activation of adjacent pain fibers within the dorsal root ganglion. Although a “facet syndrome” including a component of ▶ [sciatica](#) was initially proposed, stimulation of the nerve supply to facet joints in live subjects has shown reproducible patterns of pain that are limited to the low back, flank, abdomen, and buttock. Many studies have claimed a benefit from treatment of low back pain through interventions aimed at disrupting the nervous afferents supplying the facet joint, but the handful of randomized clinical trials of these interventions have generally failed to demonstrate any benefit beyond placebo (Carette et al. 1991; Leclaire et al. 2001; Lilius et al. 1989; Slipman et al. 2003). These studies have been criticized, however, and their generally negative results may stem from poor patient selection and improper selection of therapeutic target.

## Characteristics

### Anatomical Considerations

Ghormley is credited with coining the phrase the “facet syndrome” in 1933 (Ghormley 1933). In his seminal article, he noted that facet joints were the only “true” joints in the spinal column, meaning that they contain a complete joint capsule with a clear synovial membrane and hyaline cartilage at the articular surface. Such true joints are termed zygapophysial joints and exist in all the typical weight-bearing places affected by osteoarthritis such as the hip, the knee, and the ankle. He conjectured and offered ▶ **histopathological** evidence that these joints degenerate over time like their counterparts in the extremities. He theorized that this process could produce a syndrome of low back pain, scoliosis, and sciatica, perhaps induced by rotatory strain of the lumbosacral region.

Detailed anatomical studies of the nerve supply of facet joints have provided the blueprint for testing and treating the “facet syndrome.” Each joint is innervated by spinal nerves from the adjacent and superior vertebral level on the ipsilateral side (Bogduk and Long 1979; Maldjian et al. 1998; Mooney and Robertson 1976). Arising from the dorsal root ganglion, the medial branch of the posterior ▶ **ramus** passes through a notch at the base of the transverse process. Twigs are given off to the facet joint at the same level before the nerve descends inferiorly, giving off muscular and cutaneous branches, as well as a branch to the superior aspect of the facet joint one vertebral level below. Bogduk and Long published the most detailed anatomical study of these relationships, and proposed calling the branches comprising this dual nerve supply the proximal and distal zygapophysial nerves (Bogduk and Long 1979). These same authors recognized variability at L5-S1 mandated by the absence of transverse processes at this level, and noted the medial branch of the posterior ramus of L5 passes through a groove between the sacral ala and the root of the superior articular process of the sacrum. The key points from this anatomical study were that ▶ **denervation** of a facet joint would require a lesion of the medial branch of the posterior ramus at the same vertebral level and the level above, and that a denervation procedure directed at the facet joint proper might result in an incomplete lesion.

### Provocative Studies

The first report of nervous stimulation of facet joints that induced back and leg pain was by Hirsch et al. in 1963 (Hirsch 1963). The first systematic analysis of referred lumbar facet joint pain was written by Mooney and Robertson in 1975 (Mooney and Robertson 1976). These authors studied five normal subjects and fifteen patients with low back pain, and reported a non-specific pattern of pain referral to the flank, buttock, and the leg upon injection of 5% hypertonic saline into the facet joint. An important discrepancy was noted between normal and low back pain patients in that the latter

complained of more frequent and more widespread patterns of pain referral. The only reports of induced pain in a sciatic distribution came from the low back pain cohort. These authors also related their results with fluoroscopically-guided anesthetic injections, and offered a detailed description of the procedure, which served as a model for future studies. Due to difficulty in locating the precise vertebral level of the pain generator, injections at three lumbar levels were advocated and injections were directed into the facet joint proper. The facet joint, as the target of treatment, has been used by many clinicians and in many studies ever since, but this approach has come under criticism by some, who maintain that a more efficacious target of anesthetization or ▶ **neurotomy** is the medial branch of the posterior ramus (Bogduk and Long 1979).

The technique of Mooney and Robertson was applied by McCall et al. (1979) to six healthy individuals who received fluoroscopically-guided injections of 6% hypertonic saline into lumbar facet joints of L1-2 and L4-5. They noted several important findings. L1-2 injections reproduced pain to the adjacent lower back, flank and groin. L4-5 injections produced pain in the adjacent lower back, buttock, groin, and lateral thigh. There was significant overlap in the distribution of the patterns of referred pain, even though the facet joints selected were three levels apart, and there was no patient that complained of pain below the mid-thigh.

Provocative studies have shown fairly clearly that stimulation of the sensory nerves around facet joints can induce pain, and that this stimulation can reproducibly generate pain that is referred to other parts of the body. It is still unclear to what extent this induced pain has a relationship to the clinical entity of low back pain in the general population. The paucity of provocative evidence for the induction of referred leg upon stimulation of facet joints in control populations, casts some doubt on the sciatic component of the alleged “facet syndrome.” The lack of dermatomal specificity for referred pain from facet joint stimulation may reflect the dual level innervation, and contribute to the difficulty in localization of the potential pain-generating level.

### Randomized Clinical Trials

There have been multiple studies of treatments for facet joint pain including both anesthetic and steroid injections and ▶ **radiofrequency** nerve ▶ **ablations**. These studies vary greatly in their selection criteria and reported results. For example, reported efficacy of facet joint steroid injection ranges from 10–63% (Carette et al. 1991). The vast majority of these studies are ▶ **retrospective** case series. These divergent results are likely to stem from variable selection criteria, variable technique and target selection, variable follow-up and variable criteria for a successful treatment. As such they are very difficult to interpret. One review of these studies found “sparse evidence” to support the use of



interventional techniques in the treatment of facet joint pain, and called for more randomized clinical trials (Slipman et al. 2003).

Four peer-reviewed randomized clinical trials for the treatment of low back pain through facet joint procedures have been published, and the conclusion from three out of four of these studies was that no treatment has demonstrated any benefit beyond placebo (Carette et al. 1991; Leclaire et al. 2001; Lilius et al. 1989; van Kleef et al. 1999). There are criticisms of each study, however, which could have significantly affected results, and these criticisms are discussed below.

In 1989, Lilius et al. (1989) randomized 109 patients with low back pain to receive injections of cortisone, local anesthetic, or saline into two facet joints. Patients were examined at one hour, two weeks, and six weeks, and also filled out a questionnaire regarding work performance and pain level at three months. 70% of patients experienced initial pain relief and 36% of patients reported continued benefit at three months. These results were irrespective of the contents of the injection. The major flaw in this study was that there were no selection criteria beyond low back pain to ensure that the facet joints were the pain generators in these patients. Another criticism was that the facet joint was used as the therapeutic target and not the medial branch of the posterior ramus.

In 1991, Carette et al. (1991) randomized 97 patients who reported >50% immediate relief from low back pain following local anesthetic injection into facet joints, both at L4-5 and at L5-S1, to receive either steroid injections or saline injections. They followed the technique described by Mooney and Robertson, that is fluoroscopic guidance using contrast to localize the facet joint and injection into the facet joint proper. Patients were assessed immediately following the procedure and at one, three and six month follow-up intervals. They found that 11 patients in the steroid group and 5 patients in the saline group had prolonged relief from the injections. The difference was not statistically significant. A post hoc analysis of the subgroup of patients who claimed >90% relief from the initial anesthetic injections yielded similar results. As mentioned previously, the target selection according to the technique of Mooney and Robertson has been criticized. It is also notable that their results approached significant levels ( $p = 0.19$ ), begging the question of whether their study was simply underpowered.

In 1999, van Kleef et al. (1999) randomized 31 patients selected for >50% relief from facet nerve block to receive radiofrequency nerve ablation or sham treatment. These authors targeted the medial branch of the posterior ramus according to the description of Bogduk and Long. Patients were assessed immediately after the procedure and at one, three, six and twelve month intervals. Although initial analysis of their patient population showed no statistically significant benefit of radiofrequency ablation

over placebo, a post hoc analysis of the patients that reported the most relief from screening anesthetic injections demonstrated a benefit from the procedure. The authors concluded that this subpopulation of patients were the true sufferers of facet joint pain and that these patients, when properly selected, would benefit from radiofrequency neurotomy.

In 2001, Leclaire et al. (2001) randomized 70 patients selected for "significant" relief of low back pain after two level anesthetic injections. The target selected was the facet joint itself. Patients were assessed at four weeks and at twelve weeks using two measures of functional ability and one pain scale. Although one of the functional assessments showed a small but statistically significant improvement in the treatment group at 4 weeks, there were no statistically significant differences in the other functional assessment or the pain assessment at four weeks, or in any of the outcome measures at twelve weeks. The authors concluded that beyond a mild transient reduction in functional disability, radiofrequency facet joint neurotomy had no proven benefit in the treatment of low back pain. No post-hoc analysis of the patients who were most relieved by the selecting anesthetic injections was done. This study was criticized for its vague selection criteria and for its use of the facet joint as a target (Dreyfuss et al. 2002).

While the existence of a "facet syndrome" that includes sciatica seems unlikely, a syndrome of low back pain caused by degenerative changes in the facet joints seems plausible. Provocative studies of sensory nerves to facet joints, as well as the close anatomical association between the nervous supply to the facet joint and the dorsal root ganglion, provide evidence of a pattern of referred pain to areas as distant as the buttocks and inguinal region. The prevalence of this entity within the vast population of patients with low back pain remains unknown. Randomized clinical trials have failed to demonstrate convincing data to justify facet joint steroid injections or radiofrequency neurotomy within the populations of patients studied, but these results could easily be the result of improper patient selection. In the absence of a reliable radiographic diagnostic tool, more stringent screening criteria are required before these procedures should be dismissed. The cut-off of >50% pain relief after a single session of anesthetic injections used by the studies reviewed may be too liberal and/or too unreliable. One interesting study probed this issue. Starting with 176 patients with low back pain, 47 were selected that reported a "definite" or "complete" response after facet block with a short acting anesthetic. When this cohort was brought back for a confirmatory block two weeks later, only 15% reported >50% response (Schwarzer et al. 1994). Facet joint degeneration may thus be a relatively rare cause of low back pain. Perhaps, anesthetic injections are simply not a reliable screening tool. Another explanation for the negative results from clinical trials may lie in target selection. It has yet to be determined whether the facet

capsule or the medial branch of the posterior ramus is preferred. Only randomized trials of steroid injections or ablation procedures that use more stringent selection criteria and compare results using different therapeutic targets will answer these questions.

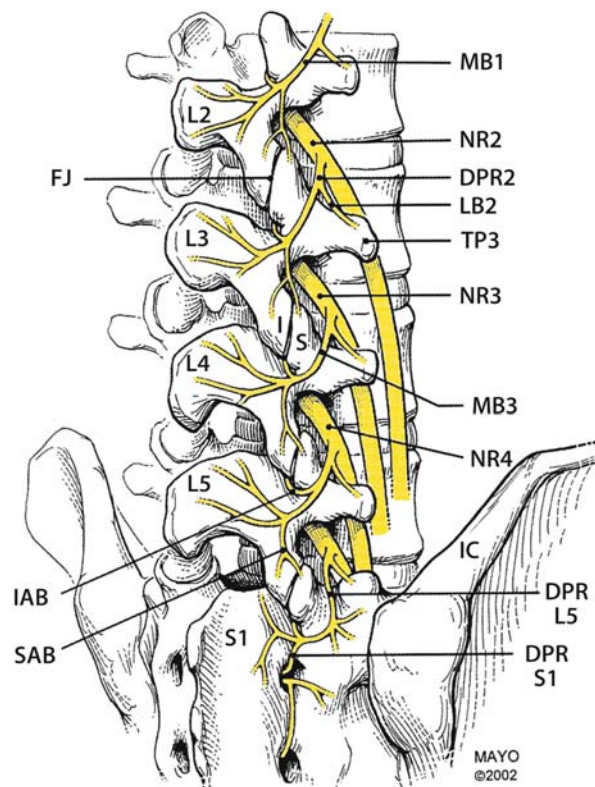
## References

1. Bogduk N, Long DM (1979) The Anatomy of the So-Called "Articular Nerves" and their Relationship to Facet Denervation in the Treatment of Low-Back Pain. *J Neurosurg* 51:172-177
2. Carette S, Marcoux S, Truchon R et al. (1991) A Controlled Trial of Corticosteroid Injections into Facet Joints for Chronic Low Back Pain. *N Engl J Med* 325:1002-1007
3. Dreyfuss P, Baker R, Leclaire R et al. (2002) Radiofrequency Facet Joint Denervation in the Treatment of Low Back Pain: A Placebo-Controlled Clinical Trial to Assess Efficacy. *Spine* 27:556-557
4. Ghormley RK (1933) Low Back Pain: With Special Reference to the Articular Facets. *JAMA* 101:1773-1777
5. Hirsch D, Ingelmark B, Miller M (1963) The Anatomical Basis for Low Back Pain. *Acta Orthop Scand* 33:1
6. Kleef M van, Barendse GA, Kessels A et al. (1999) Randomized Trial of Radiofrequency Lumbar Facet Denervation for Chronic Low Back Pain. *Spine* 24:1937-1942
7. Leclaire R, Fortin L, Lambert R et al. (2001) Radiofrequency Facet Joint Denervation in the Treatment of Low Back Pain: A Placebo-Controlled Clinical Trial to Assess Efficacy. *Spine* 26:1411-1417
8. Lilius G, Laasonen EM, Myllynen P et al. (1989) Lumbar Facet Joint Syndrome. A Randomised Clinical Trial. *J Bone Joint Surg Br* 71:681-684
9. Maldjian C, Mesgarzadeh M, Tehranzadeh J (1998) Diagnostic and Therapeutic Features of Facet and Sacroiliac Joint Injection. Anatomy, Pathophysiology, and Technique. *Radiol Clin North Am* 36:497-508
10. McCall IW, Park WM, O'Brien JP (1979) Induced Pain Referral from Posterior Lumbar Elements in Normal Subjects. *Spine* 4:441-446
11. Mooney V, Robertson J (1976) The Facet Syndrome. *Clin Orthop*:149-156
12. Schwarzer AC, Aprill CN, Derby R et al. (1994) Clinical Features of Patients with Pain Stemming from the Lumbar Zygapophysial Joints. Is the Lumbar Facet Syndrome a Clinical Entity? *Spine* 19:1132-1137
13. Slipman CW, Bhat AL, Gilchrist RV et al. (2003) A Critical Review of the Evidence for the use of Zygapophysial Injections and Radiofrequency Denervation in the Treatment of Low Back Pain. *Spine J* 3:310-316

## Characteristics

Zygapophyseal (Facet) Joints are synovial diarthroses, and are present from C1 to S1, inclusive. These joints allow for articular motion in the posterior spinal column, and are innervated by medial branch of the primary posterior ramus of the segmental spinal nerves. Each articular process receives innervation from a spinal nerve, so each joint, comprised of two articular processes, is innervated by two medial branches (Fig. 1).

The medial branch is primarily sensory to the joint and surrounding structures, and is innervated richly with nociceptive fibers. Numerous pain-mediating neurotransmitters (e.g. bradykinin, substance P, and neuropeptide Y) are also found in these neurons (Morinaga et al. 1996).



**Facet Joint Procedures for Chronic Back Pain, Figure 1** Illustration of right posterior view of lumbosacral spine showing key right posterior neural structures. L2 through S1 spinous processes labeled. Right: MB1=medial branch of L1 dorsal primary ramus; NR2=L2 nerve root; DPR2=L2 dorsal primary ramus; LB2=lateral branch of L2 dorsal primary ramus; TP3=L3 transverse process; NR3=L3 nerve root; MB=medial branch of L3 dorsal primary ramus that extends around the base of the right superior articular process (S) of L4 and innervates portions of the right L3-4 and L4-5 facet joint capsules; NR4=L4 nerve root; IC=iliac crest; DPRL5=L5 dorsal primary ramus; DPRS1=S1 dorsal primary ramus; I=inferior articular process L3; S=superior articular process of L4. Left: FJ=L2-3 facet (zygapophysial) joint, which is innervated by branches of L1 and L2 medial branch nerves; IAB=inferior articular branches from medial branch of L4 dorsal primary ramus; SAB=superior articular branches from medial branch of L4 dorsal primary ramus (from Czervionke LF, Fenton DS (2003) *Facet Joint Injection and Medial Branch Block*. In: Czervionke LF, Fenton DS (eds) *Image-Guided Spine Intervention*. WB Saunders, Philadelphia with permission).

## Facet Joint Procedures for Chronic Back Pain

DAVID M. SIBELL  
Comprehensive Pain Center, Oregon Health and Science University, Portland, OR, USA  
sibell@dohsu.edu

## Synonyms

Facet Joint Injection; Zygapophyseal Joint Injection; zygapophysial joint injection; Medial Branch Block; Median Branch Block; Facet Rhizolysis; Facet Denervation; radiofrequency ablation

These nerves are also motor to the multifidus muscles, and multifidus EMG studies have been used to validate the results of radiofrequency medial branch denervation (Dreyfuss et al. 2000).

Initially, the approach to treating facet arthropathy-related pain was limited to surgical excision and/or stabilization. It is difficult to assess the results of the surgical approaches to facet arthropathy, as patients do not uniformly have diagnostic procedures first, and the surgical treatment is almost always a part of another surgical procedure (e.g. fusion, laminectomy, etc.).

Joint injections with local anesthetic and steroid are still popular in many practices, but these injections have not been demonstrated to be reliably diagnostic (due to potential epidural spread of injectate) or of any prolonged therapeutic value (Dreyfuss and Dreyer 2003). Numerous prospective, double blinded, randomized controlled trials have shown these injections to be no better than placebo in the treatment of chronic back and neck pain (Barnsley et al. 1994; Carette et al. 1991).

Fluoroscopically guided diagnostic medial branch blocks anesthetize the facet joint selectively, and are used to provide prognostic information for radiofrequency medial branch denervation. They are not intended for prolonged analgesia. Generally, a two-block paradigm is used: one injection of short-acting local anesthetic and one of long-acting anesthetic (Lord 1995). When performed correctly, these blocks have high specificity for anesthetizing the facet joint (Dreyfuss et al. 1997) (Fig. 2).

There has been debate regarding the exact interpretation of these blocks, fueled by the problems inherent in attempting to make an objective diagnosis in a subjective disorder (i.e. pain). Much of this debate has focused on the test characteristics of the procedure, and uses terms

such as “placebo response,” and “false positive” (Barnsley et al. 1993). Unfortunately, these terms are misleading in this sense. A subject may have an unanticipated response to an injection, but if an active treatment is used, by definition, that response is not a placebo response. Moreover, it is inappropriate to use the term “false positive” in this situation, as there is no gold standard test with which to compare the results.

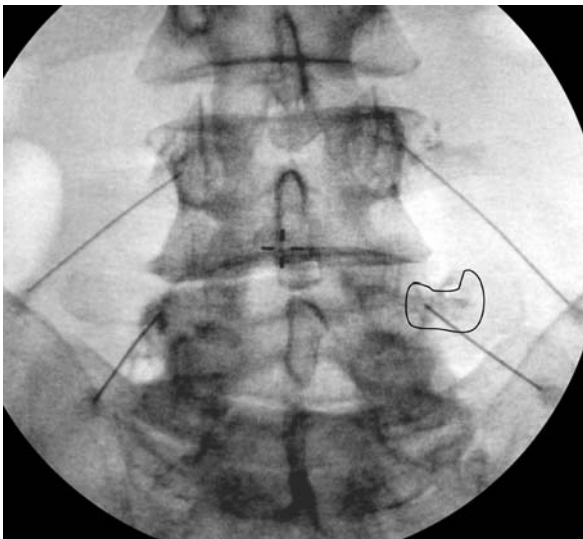
These studies do not take into account the analgesic effect that simultaneously anesthetizing the multifidus muscle has, which may account for the prolonged duration of some subjects’ responses. Therefore, since this field deals with subjective responses, most operators use a somewhat more liberal interpretation of the results of diagnostic medial branch blocks, and allow for prolonged concordant responses (i.e. both responses more prolonged than would be expected solely due to the local anesthetic, but of duration proportional to the anticipated duration).

Once the diagnosis of painful facet arthropathy is made, radiofrequency facet denervation is the minimally invasive treatment of choice. This technique has been used over the last three decades, and has advantages in the treatment of facet arthropathy over other neurolytic techniques, such as chemodenervation or cryotherapy. As the technology and techniques have improved, prospective studies have demonstrated efficacy in select groups, although there has been some lack of uniformity amongst these results (Dreyfuss et al. 2002; Niemisto et al. 2003; Slipman et al. 2003; van Kleef et al. 2001).

The technique involved in radiofrequency facet denervation is similar to that of medial branch blocks, inasmuch as the instrument is placed in proximity to the medial branches innervating a joint, as opposed to entering the joint itself (Lau et al. 2004). However, instead of using plain needles, special cannulae are used. These are coated with Teflon, in order to insulate most of the needle. This focuses the release of radiofrequency energy on the active tip, which leads to a focused, reproducible lesion. When positioned appropriately, this lesion includes the medial branch, while limiting collateral damage to surrounding structures. As a result of this precision, the risk of adverse events is exceedingly low (Kornick et al. 2004). The safety profile is one of the features that make this procedure an attractive alternative in the treatment of this common disorder.

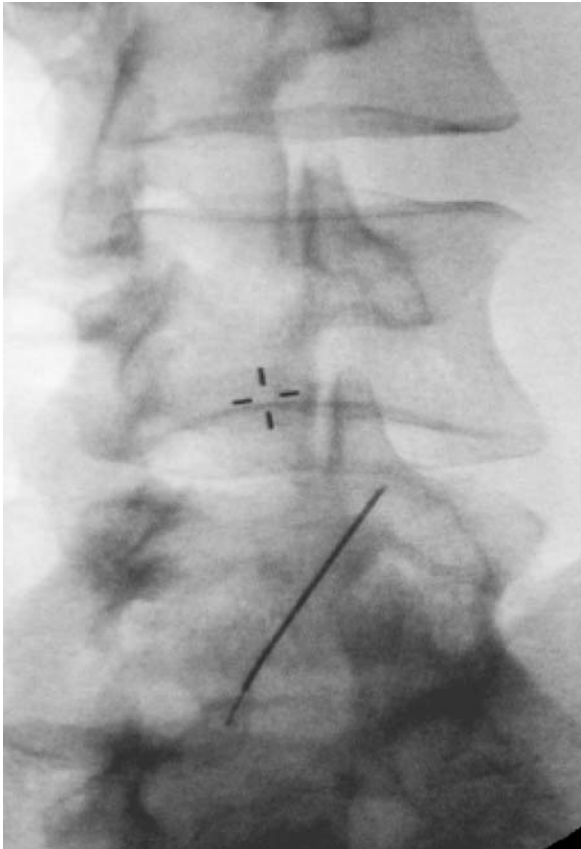
The desired outcome in this procedure is the focal denervation of the joints in which the patient’s back pain was relieved upon performance of diagnostic medial branch blocks. This does not treat the underlying arthropathy, but reduces the painful limitation to mobility that it causes. The nature of radiofrequency denervation does allow for regrowth of the medial branch nerve. Therefore, the procedure may require repetitive treatments over time. Although exact recurrence rates for lumbar denervation are not known, the improvement after cervical medial branch denervation, which may be

F



**Facet Joint Procedures for Chronic Back Pain, Figure 2** Lumbar medial branch block AP view.





**Facet Joint Procedures for Chronic Back Pain, Figure 3** Lumbar medial branch block lateral oblique view.

used as a guide, is over 1 year (McDonald et al. 1999). Since the denervation procedure does not address comorbidities, such as myofascial pain, post-denervation physical therapy may be used to extend the benefits of the procedure, to include relief of myofascial pain and associated loss of range of motion.

Future directions of study in this field will include improved understanding of the prognosis of this procedure, related to, for example, patient demographics and physical examination. Furthermore, patients will benefit maximally when practitioners develop enhanced understanding of the intersection of radiofrequency facet denervation and rehabilitation therapies.

## References

1. Barnsley L, Lord S, Wallis B et al. (1993) False-Positive Rates of Cervical Zygapophysial Joint Blocks. *Clin J Pain* 9:124–130
2. Barnsley L, Lord SM, Wallis BJ et al. (1994) Lack of Effect of Intraarticular Corticosteroids for Chronic Pain in the Cervical Zygapophysial Joints. *N Engl J Med* 330:1047–1050
3. Carette S, Marcoux S, Truchon R et al. (1991) A Controlled Trial of Corticosteroid Injections into Facet Joints for Chronic Low Back Pain. *N Engl J Med* 325:1002–1007
4. Dreyfuss P, Schwarzer AC, Lau P et al. (1997) Specificity of Lumbar Medial Branch and L5 Dorsal Ramus Blocks. A Computed Tomography Study. *Spine* 22:895–902

5. Dreyfuss P, Halbrook B, Pauza K et al. (2000) Efficacy and Validity of Radiofrequency Neurotomy for Chronic Lumbar Zygapophysial Joint Pain. *Spine* 25:1270–1277
6. Dreyfuss P, Baker R, Leclaire R et al. (2002) Radiofrequency Facet Joint Denervation in the Treatment of Low Back Pain: A Placebo-Controlled Clinical Trial to Assess Efficacy. *Spine* 27:556–557
7. Dreyfuss P, Dreyer SJ (2003) Lumbar Zygapophysial (Facet) Joint Injections. *Spine J* 3:50–59
8. Kleef M van, Weber WE, Kessels A et al. (2000) Re: Efficacy and Validity of Radiofrequency Neurotomy for Chronic Lumbar Zygapophysial Joint Pain. *Spine* 25:1270–1277
9. Kleef M van, Weber WE, Kessels A et al. (2001) Re: Efficacy and Validity of Radiofrequency Neurotomy for Chronic Lumbar Zygapophysial Joint Pain. *Spine* 26:163–164
10. Kornick C, Kramarich SS, Lamer TJ et al. (2004) Complications of Lumbar Facet Radiofrequency Denervation. *Spine* 29:1352–1354
11. Lau P, Mercer S, Govind J et al. (2004) The Surgical Anatomy of Lumbar Medial Branch Neurotomy (Facet Denervation). *Pain Medicine* 5:289–298
12. Lord SM, Barnsley L, Bogduk N (1995) The Utility of Comparative Local Anesthetic Blocks versus Placebo-Controlled Blocks for the Diagnosis of Cervical Zygapophysial Joint Pain. *Clin J Pain* 11:208–213
13. McDonald GJ, Lord SM, Bogduk N (1999) Long-Term Follow-Up of Patients Treated with Cervical Radiofrequency Neurotomy for Chronic Neck Pain. *Neurosurgery* 45:61–68
14. Morinaga T, Takahashi K, Yamagata M et al. (1996) Sensory Innervation to the Anterior Portion of Lumbar Intervertebral Disc. *Spine* 21:1848–1851
15. Niemisto L, Kalso E, Malmivaara A et al. (2003) Radiofrequency denervation for Neck and Back Pain: A Systematic Review within the Framework of the Cochrane Collaboration Back Review Group. *Spine* 28:1877–1888
16. Slipman CW, Bhat AL, Gilchrist RV et al. (2003) A Critical Review of the Evidence for the Use of Zygapophysial Injections and Radiofrequency Denervation in the Treatment of Low Back Pain. *Spine J* 3:310–316

## Facet Rhizolysis

- ▶ Facet Joint Procedures for Chronic Back Pain

## Facet Syndrome

- ▶ Facet Joint Pain

## Facial Ganglion Neuralgia

- ▶ Genuiculate Neuralgia

## Facial Pain

### Definition

Facial pain identified by its location, usually excluding tic doloureux.

- ▶ Pain Treatment, Motor Cortex Stimulation



## Facial Pain Associated with Disorders of the Cranium

- ▶ Headache from Cranial Bone

## Facilitative Tucking

### Definition

A caregiver uses their hands to swaddle an infant by placing a hand on the infant's head and feet while providing flexion and containment.

- ▶ Acute Pain Management in Infants

## Factor Analysis

- ▶ Multidimensional Scaling and Cluster Analysis Application for Assessment of Pain

## Factor Loading

### Definition

Factor analysis is a statistical procedure that groups together variables that share common variance. Variables that 'load' on the same factor are presumed to reflect a similar underlying process.

- ▶ Psychology of Pain, Self-Efficacy

## Factors Associated with Low Back Pain

- ▶ Low Back Pain, Epidemiology

## Failed Back

### Definition

Clinical syndrome characterized by back or lower extremity pain or both following surgery for decompression of neural elements in the lower back.

- ▶ Pain Treatment, Spinal Cord Stimulation

## Failed Back Surgery Syndrome

### Definition

Failed back surgery syndrome is axial or radicular pain persisting after surgical approaches to relieve the pain. Also known as Failed Back Syndrome.

- ▶ Central Nervous System Stimulation for Pain
- ▶ Dorsal Root Ganglionectomy and Dorsal Rhizotomy

## False Affirmative Rate

### Definition

False affirmative rate is the probability of response „A“ when event B has occurred.

- ▶ Statistical Decision Theory Application in Pain Assessment

## Familial Adenomatous Polyposis

### Synonyms

FAP

### Definition

An inherited disease which is characterized by the formation of numerous polyps on the inside walls of the colon and rectum. The FAP disease is associated with a 100% risk for developing colorectal cancer.

- ▶ NSAIDs and Cancer

## Familial Dysautonomia Type II

- ▶ Congenital Insensitivity to Pain with Anhidrosis

## Familial Factors

- ▶ Impact of Familial Factors on Children's Chronic Pain

## Familial Hemiplegic Migraine

### Definition

Familial hemiplegic migraine is an inherited form of migraine with aura in which patients experience weakness and other neurological disturbances as their aura.

- ▶ Migraine, Pathophysiology

## Familial Polyposis Coli

### Definition

People with this syndrome have massive numbers of colonic polyps and almost invariably develop cancer of the colon.

- ▶ NSAIDs and their Indications

## Family Centered Care

### Definition

Care directed at improving the health and well-being of the family and its members by assessing the family health needs and identifying potential obstacles.

- ▶ Chronic Pain In Children, Physical Medicine And Rehabilitation

## Family Environment

- ▶ Impact of Familial Factors on Children's Chronic Pain

## Family Stressors

- ▶ Fear and Pain
- ▶ Stress and Pain

## Family Systems Theories

### Definition

A psychological theory of human behavior that views the family as an emotional unit and uses systems thinking to describe the complex interactions within the unit.

- ▶ Impact of Familial Factors on Children's Chronic Pain
- ▶ Spouse, Role in Chronic Pain

## FAP

- ▶ Familial Adenomatous Polyposis

## Fascia Iliaca Compartment Block

### Definition

Injection via needle or catheter of local anesthetic deep to the fasciae lata and iliaca medial to the anterior superior iliac spine and inferior to the inguinal ligament.

- ▶ Acute Pain in Children, Post-Operative

## Fasciculus Cuneatus

### Definition

The lateral bundle of nerves in the dorsal column referred to as the cuneate fasciculus, which terminates in the cuneate nucleus just off the dorsal midline in the caudal medulla.

- ▶ Postsynaptic Dorsal Column Projection, Anatomical Organization

## Fasciculus Gracilis

### Definition

The medial bundle nerves in the dorsal column referred to as the fasciculus gracilis, which terminates in the gracile nucleus in the dorsal midline of the caudal medulla.

- ▶ Postsynaptic Dorsal Column Projection, Anatomical Organization

## Fast Track Surgery

- ▶ Postoperative Pain, Importance of Mobilisation

## Fatigue

### Definition

Fatigue is a decrement of response seen with repeated stimulation, and is a prominent attribute of nociceptors and other primary afferents.

- ▶ Pain in Humans, Electrical Stimulation (Skin, Muscle and Viscera)
- ▶ Polymodal Nociceptors, Heat Transduction

## FCA

- ▶ Freund's Complete Adjuvant

## FCA-Induced Arthritis

### Definition

An experimental model of unilateral hindpaw inflammation. It is induced by injection of suspension of killed mycobacteria into the hindpaw. During the first 4-6 days, the inflammation remained confined to the inoculated paw

and lead to typical signs of local inflammation (dolor, rubor, edema, hyperalgesia). This is the best examined animal model for peripheral analgesic effects of opioids.

► [Opioids and Inflammatory Pain](#)

## FCE

► [Functional Capacity Evaluation](#)

## Fear

### Definition

Fear is the emotional expression of the fight-flight response, which is the immediate readiness or activation of the body to respond to an event that is perceived as dangerous or threatening. Fear is therefore a present-oriented state that is designed to protect the individual from the perceived immediate threat.

► [Fear and Pain](#)

## Fear and Pain

MAAIKE LEEUW<sup>1</sup>, JOHAN W. S. VLAEYEN<sup>1, 2</sup>

<sup>1</sup>Department of Medical, Clinical and Experimental Psychology Maastricht University, Maastricht, Netherlands

<sup>2</sup>Pain Management and Research Center, University Hospital Maastricht, Maastricht, Netherlands  
m.leeuw@dmkep.unimaas.nl,  
j.vlaeyen@dep.unimaas.nl

### Synonyms

Pain-related fear; Pain-Related Anxiety; fear of movement/(re)injury; kinesiophobia

### Definition

► **Fear of pain** is a general term used to describe several forms of fear with respect to pain. Depending on the anticipated source of threat, the content of fear of pain varies considerably. For example, fear of pain can be directed towards the occurrence or continuation of pain, towards physical activity, or towards the induction of (re)injury or physical harm. A more specific fear of pain concerns ► [fear of movement/\(re\)injury](#), which is the specific fear that physical activity will cause (re)injury. Synonymously, ► [kinesiophobia](#) is defined as ‘an excessive, irrational, and debilitating fear of physical move-

ment and activity resulting from a feeling of vulnerability to painful injury or re-injury’ (Kori et al. 1990).

### Characteristics

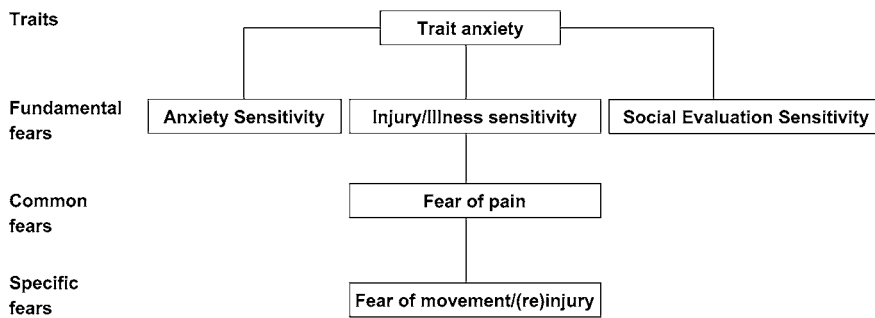
In recent years, chronic pain has no longer been conceptualized as purely a medical problem, but rather as a complex bio-psychosocial phenomenon in which the relationship among impairments, pain, and disability is weak. In chronic pain patients, anxiety disorders frequently co-occur, indicating that patients with persistent musculoskeletal pain fear a variety of situations that are not essentially related to pain (Asmundson et al. 1999; Asmundson et al 2004). Besides the finding that chronic pain patients seem to suffer more frequently from anxiety symptoms, fear and anxiety are often an integral part of the chronic pain problem. The experience of pain can be characterized by psychophysiological (e.g. muscle reactivity), cognitive (e.g. worry), and behavioural (e.g. escape and avoidance) responses, showing similarities with responses regarding fear and anxiety (Vlaeyen and Linton 2000).

There are multiple pathways by which pain-related fear mediates disability, namely through escape and avoidance behaviours, through interference with cognitive functioning, through reduced opportunities to correct the erroneous underlying cognitions guiding the avoidance behaviours, and through detrimental effects of long-lasting avoidance on various physiological systems (Crombez et al. 1999). Empirical findings support the notion that fear of pain is a significant contributor to the chronification and maintenance of chronic pain syndromes (Asmundson et al. 1999; Crombez et al. 1999; Vlaeyen and Linton 2000).

### Fear and Anxiety

In the literature describing fear of pain, the concepts of fear and anxiety are often used interchangeably. Despite the fact that these concepts are substantially related, some differences can be distinguished (Asmundson et al. 2004).

► **Fear** is the emotional expression of the fight-flight response, which is the immediate readiness of the body to respond to an event that is perceived as dangerous or threatening. Fear is therefore a present-oriented state that is designed to protect the individual from the perceived immediate threat. ► **Anxiety**, however, is a cognitive-affective state that is rather future-oriented. It tends to occur in to the anticipation of a dangerous or threatening event, and is therefore more indefinite and uncertain in nature. Instead of initiating the fight-flight response as in case of fear, the state of anxiety seems to facilitate and stimulate the fight-flight response only in case the threatening event occurs. Both in fear and anxiety, cognitive, physiological and behavioural dimensions of responses can be distinguished. Physiologically, fear and anxiety responses are characterised by the activation of the sympathetic nervous system,



**Fear and Pain,**  
**Figure 1** Hierarchical  
structure of fear of pain.

designed to increase the likelihood of survival by promoting escape from or protection against the perceived threat. In anxiety, these physiological responses are less present than in fear. The cognitive element, relatively more present in anxiety, is more narrowed in anxiety and directed in such a way that a source of threat, when present, will be detected. Fear, on the other hand, comprises thoughts of danger, threat, or death, through which the attention towards the threat is advanced while irrelevant distracters are ignored and the initiation of action is stimulated. On a behavioural level, anxiety guides motivation to engage in preventative and avoidance behaviours, while fear motivates to engage in defensive behaviours. Despite the definition of pain-related fear, both fear and anxiety are distinct processes that contribute significantly to chronic pain (Asmundson et al. 2004).

### Hierarchy of Fear

Besides the important distinction between fear and anxiety in chronic pain, understanding about the hierarchical nature of fear and anxiety is also an important consideration. The hierarchical structure of anxiety is displayed in Fig. 1.

### Fundamental Fears

According to the expectancy theory (Reiss 1987), most fears can be derived from one of three more ► **fundamental fears** or sensitivities: (1) fear of anxiety symptoms (anxiety sensitivity) (2) fear of negative evaluation (social evaluation sensitivity), and (3) fear of illness/injury (injury/illness sensitivity). ► **Anxiety Sensitivity** refers to the fear of anxiety symptoms arising from the belief that anxiety has harmful somatic, psychological and social consequences. Social evaluation sensitivity reflects anxiety and distress that is associated with expectations that others will have negative evaluations about oneself, and with avoidance of evaluative situations. Finally, injury/illness sensitivity refers to fear concerning injury, illness or death. These fundamental fears are quite distinct from each other and comprise stimuli that are considered to be essentially aversive to most people (Asmundson et al. 2000; Taylor 1993; Vlaeyen 2003).

### Common Fears: Fear of Pain

► **Common fears** (such as spider phobia, agoraphobia, fear of pain) arise as the result of an interaction between the fundamental fears and learning experiences, and can thus be logically derived from these three fundamental fears. In contrast to fundamental fears, they do not refer to a wide variety of stimuli and are not essentially considered to be aversive to most people. Due to fear of anxiety, causing one to fear the symptoms that are associated with anxiety, a common fear about a particular situation easily arises when in the concerning situation anxiety symptoms are expected or likely to be experienced. In essence, anxiety sensitivity can be considered as a vulnerability factor that exacerbates the development and maintenance of common fears, the same holding for injury sensitivity and social evaluation sensitivity (Asmundson et al. 2000; Taylor 1993).

In chronic low back pain, fear of pain is a common fear that can be derived from the fundamental fear of anxiety symptoms (anxiety sensitivity). When someone who is highly anxiety sensitive expects to encounter anxiety symptoms during the experience of pain, fear of pain will likely develop (Asmundson 2000). However, Keogh and Asmundson (2004) argue that it is more reasonable to assume that fear of pain is related to injury/illness sensitivity, which is also supported by Vancleef et al. (2005). Fear of pain is still a relatively general construct. Fear of pain can be directed at pain sensations, as well as activities and situations that are associated with pain. In chronic low back pain patients, one of the more specific forms of fear of pain is fear of movement/(re)injury, which is the specific fear that physical activity will cause (re)injury (Kori et al. 1991).

### Specific Fears: Fear of Movement/(Re)Injury

A number of CLBP patients believe that performance of certain activities may induce or promote pain and (re)injury. Beliefs concerning harmful consequences of activities lead to fear of movement/(re)injury and consequently to the avoidance of these activities, although medical indications for this behavioural pattern of avoidance are lacking. Despite the fact that in acute pain the avoidance of daily activities may be adaptive in facilitating healing and recovery, avoidance behaviour



is no longer necessary for recovery in chronic pain (Kori et al. 1991; Vlaeyen and Linton 2000).

### Cognitive Behavioural Models

A ► **cognitive behavioural model of chronic low back pain** has been proposed, which emphasizes the crucial importance of the role of fear of movement/(re)injury and avoidance behaviour in chronic low back pain patients (Vlaeyen 2003; Vlaeyen and Linton 2000). According to the model, two opposing behavioural responses may occur in response to acute pain: ‘confrontation’ and ‘avoidance’. A gradual confrontation and resumption of daily activities despite pain is considered as an adaptive response that eventually leads to the reduction of fear, the encouragement of physical recovery and functional rehabilitation. In contrast, a catastrophic interpretation of pain is considered to be a maladaptive response, which initiates a vicious circle in which fear of movement/(re)injury and the subsequent avoidance of activities augment functional disability and the pain experience by means of hypervigilance, depression, and disuse. Substantial support for this cognitive behavioural model and the role of the specific fear of movement/(re)injury has been found (summarized in a review of Vlaeyen and Linton 2000).

In addition to this cognitive behavioural model, Asmundson et al. (2004) propose to update the model by integrating the concept of anxiety in addition to fear, referring to this as the ► **fear-anxiety-avoidance model** (Fig. 2).

This model states that ► **catastrophizing** about pain produces fear of pain, designed to protect the individual from the perceived immediate threat. This fear of pain in turn might promote pain-related anxiety. Pain-producing stimuli result through pain-related fear in escape and protecting behaviours aimed at reducing pain-intensity. These behaviours in turn strengthen erroneous beliefs about pain, increase catastrophizing, and further enhance pain-related fear. The addition of an anxiety-related pathway to the pathway of pain-related

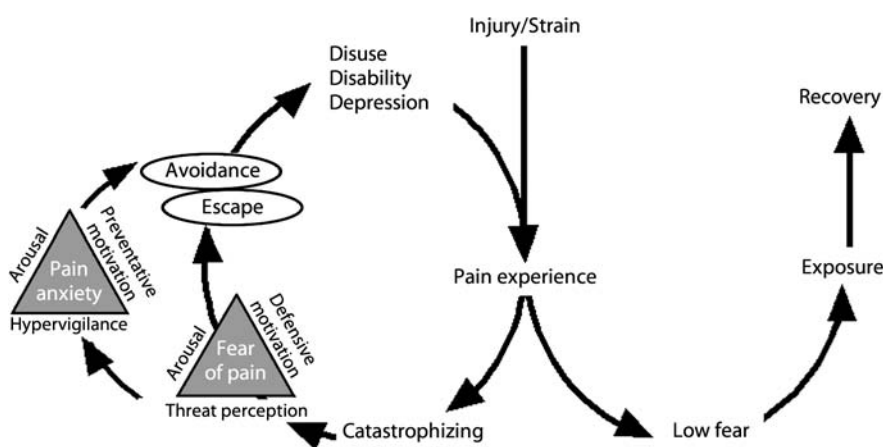
fear provides a more accurate explanation for the fact that chronic pain interferes with one’s daily life. In the anticipation, rather than in the presence of pain and/or injury, anxiety is evoked, leading to an increased attention (► **hypervigilance**) for evidence of potential pain or injury. This hypervigilance and psychological responses may interact with memories, and may promote misinterpretations of harmless stimuli as impending danger of pain or injury. Behaviourally, anxiety results in avoidance and preventative behaviours, increasing disability and disuse (Asmundson et al. 2004).

### Other Objects of Fear in Pain

Morley and Eccleston (2004) propose the existence of a range of ‘feared objects’ in chronic pain, because of the overwhelming threat value of pain and three associated capacities to: (1) interrupt, (2) interfere, and (3) impact on one’s identity. Many potential fears arise because of the ability of pain to threaten the whole range of a person’s existence. Interruption is established because the immediate pain experience interrupts behaviour and influences the person’s cognitive functioning (e.g. thoughts about possible harm). Interference is visible in the diminished accomplishment of daily functional activities. Finally, when repeated interference occurs to a degree that it concerns major goals, a threat to the identity is instigated. As chronic pain interferes with current tasks, plans, and goals, the person’s perspective of oneself is changed, both with respect to the future and the past. Fear and anxiety are likely to occur when goals and the identity of a person are threatened.

### Assessment of Fear of Pain

Several measurements of fear of pain are available (for an overview see McNeil and Vowles, 2004). Anxiety sensitivity can be measured by the 16-item Anxiety Sensitivity Index (ASI) (Peterson and Reiss 1987), measuring the degree to which people are concerned about the possible negative consequences of anxiety symptoms. Injury/illness sensitivity can be measured



**Fear and Pain, Figure 2** Fear-anxiety-avoidance model of chronic pain. Adapted from the cognitive behavioural model of Vlaeyen and Linton (2000) and the fear-anxiety-avoidance model of Asmundson et al (2004).

with the corresponding subscale of the sensitivity index (Taylor 1993). Fear of pain can be measured by, for example, the Pain Anxiety Symptoms Scale (PASS) (McCracken et al. 1993), designed to assess pain-specific fearful appraisals, cognitive symptoms of anxiety, physiological symptoms of anxiety, and escape and avoidance behaviour. Fear of movement/(re)injury can best be measured with the 17-item Tampa Scale for Kinesiophobia (TSK; Kori et al. 1990).

### Treatment Implications

Due to the inextricable binding between fear and (chronic) pain, treatment of chronic pain should aim to focus on these perpetuating factors. A relatively new treatment in chronic pain concerns ► [exposure in vivo](#), during which patients are systematically exposed to fear-provoking activities, which leads to disconfirmation of pain beliefs and reduction of fear, thereby promoting recovery of activities and functional abilities (Vlaeyen 2004). Fear and anxiety focused treatments seem to provide promising results in chronic low back pain patients (Vlaeyen et al 2004).

### References

1. Asmundson GJG, Norton PJ, Norton GR (1999) Beyond Pain: The Role of Fear and Avoidance in Chronicity. *Clin Psychol Rev* 19:97–119
2. Asmundson GJ, Wright KD, Hadjistavropoulos HD (2000) Anxiety Sensitivity and Disabling Chronic Health Conditions: State of the Arts and Future Directions. *Scand J Behav Ther* 29:100–117
3. Asmundson GJ, Norton PJ, Vlaeyen JWS (2004) Fear-Avoidance Models of Chronic Pain: An Overview. In: Asmundson GJG, Vlaeyen JWS, Crombez G (eds) *Understanding and Treating Fear of Pain*. Oxford University Press, Oxford
4. Crombez G, Vlaeyen JWS, Heuts PHTG et al. (1999) Pain-Related Fear is More Disabling than Pain Itself: Evidence on the Role of Pain-Related Fear in Chronic Back Pain Disability. *Pain* 80:329–339
5. Keogh E, Asmundson GJG (2004) Negative affectivity, catastrophizing, and anxiety sensitivity. In: Asmundson GJG, Vlaeyen JWS, Crombez G (eds) *Understanding and Treating Fear of Pain*. Oxford University Press, Oxford
6. Kori SH, Miller RP, Todd DD (1990) Kinesiophobia: A New View of Chronic Pain Behavior. *Pain Manage*: 35–43
7. McCracken LM, Zayfert C, Gross RT (1993) The Pain Anxiety Symptoms Scale (PASS): A Multidimensional Measure of Pain-Specific Anxiety Symptoms. *Behavior Therapist* 16:183–184
8. McNeil DW, Vowles KE (2004) Assessment of Fear and Anxiety Associated with Pain: Conceptualisation, Methods, and Measures. In: Asmundson GJG, Vlaeyen JWS, Crombez G (eds) *Understanding and Treating Fear of Pain*. Oxford University Press, Oxford
9. Morley S, Eccleston C (2004) The Object of Fear in Pain. In: Asmundson GJG, Vlaeyen JWS, Crombez G (eds) *Understanding and Treating Fear of Pain*. Oxford University Press, Oxford
10. Peterson RA, Reiss S (1987) *Anxiety Sensitivity Index Manual*. International Diagnostic Systems, Palos Heights
11. Reiss S, McNally RJ (1985) The Expectancy Model of Fear. In: Reiss S and Bootzin RR (eds) *Theoretical Issues in Behavior Therapy*. Academic Press, New York
12. Taylor S (1993) The Structure of Fundamental Fears. *J Behav Ther Exp Psychiatry* 24:289–299
13. Van Cleef LMG, Peters ML, Roelofs J, Asmundson GJG (2005) Do fundamental fears differentially contribute to pain-related fear and pain catastrophizing? An evaluation of the sensitivity index. *Eur J Pain*: Sep 29, Epub ahead of print
14. Vlaeyen JWS (2003) Fear in Musculoskeletal Pain. In: Dostrovsky O, Carr DB, Koltzenburg M (eds) *Proceedings of the 10<sup>th</sup> World Congress on Pain, Progress in Pain Research and Management*, vol 24. IASP Press, Seattle, pp 631–650
15. Vlaeyen JWS, Linton SJ (2000) Fear-Avoidance and its Consequences in Chronic Musculoskeletal Pain: A State of the Art. *Pain* 85:317–332
16. Vlaeyen JWS, Jong JR de, Sieben JM et al. (2002) Graded Exposure *In Vivo* for Pain-Related Fear. In: Turk DC, Gatchel RJ (eds) *Psychological Approaches to Pain Management: A Practitioner's Handbook*. The Guilford Press, New York, pp 210–233

## Fear-Anxiety-Avoidance Model

### Definition

The Fear-Anxiety-Avoidance Model states that catastrophic misinterpretations in response to acute pain can lead to fear of pain and subsequently to pain-related anxiety. Fear urges the escape from the pain stimulus, while anxiety in anticipation of pain or threat urges avoidance of those situations. As a result of this, a self-perpetuating cycle develops in which subsequent avoidance of activities augment functional disability and the pain experience by means of hypervigilance, depression and decreased physical fitness, thereby further advancing chronicity.

► [Fear and Pain](#)

## Fear Avoidance

### Definition

Fear avoidance is the avoidance of activities in order to prevent injury, reinjury, or exacerbation of any injury or pain. In this way, pain related fear can lead to disability, catastrophizing beliefs, hypervigilance to bodily signals and avoidance behavior.

- [Disability, Fear of Movement](#)
- [Pain in the Workplace, Risk Factors for Chronicity, Psychosocial Factors](#)
- [Psychiatric Aspects of Pain and Dentistry](#)

## Fear Avoidance Beliefs

### Definition

Fear avoidance beliefs are cognitions often found in elderly individuals with pain, which support avoidance behavior and make participation in physical activity programs more difficult. Patients believe that physical activity initiated their pain and that physical activity is bound to aggravate the pain in the long run.

► [Psychological Treatment of Pain in Older Populations](#)

## Fear-Avoidance Model

### Definition

The basic tenet of the fear-avoidance model is that catastrophic misinterpretations in response to acute pain lead to pain-related fear, which subsequently urges the escape from the painful stimuli, and to selectively attend to bodily sensations. As a result a self-perpetuating cycle develops in which subsequent avoidance of activities augment functional disability, depression and decreased physical fitness.

- ▶ Fear Reduction through Exposure In Vivo
- ▶ Muscle Pain, Fear-Avoidance Model

## Fear Hierarchy

### Definition

The sequential ordering of feared stimuli or behaviors in terms of an intensity gradient (i.e. from lowest fears to most intense fears).

- ▶ Behavioral Therapies to Reduce Disability

## Fear of Movement/(Re)Injury

### Definition

Fear related to movement and physical activity, inextricably associated with the fear that physical activity will cause pain and (re)injury. Fear of movement is most prominent in patients with chronic pain syndromes.

- ▶ Disability, Fear of Movement
- ▶ Fear and Pain

## Fear of Pain

### Definition

Pain-related fear is a general term to describe several forms of fear with respect to pain. Depending on the anticipated source of threat, the content of fear of pain varies considerably. Fear of pain can be directed towards the occurrence or continuation of pain, towards physical activity, or towards the induction of (re)injury or physical harm.

- ▶ Disability, Fear of Movement
- ▶ Fear and Pain
- ▶ Muscle Pain, Fear-Avoidance Model

## Fear Reduction through Exposure In Vivo

JEROEN R. DE JONG<sup>1</sup>, JOHAN W. S. VLAEYEN<sup>2</sup>

<sup>1</sup>Department of Rehabilitation and Department of Medical Psychology, University Hospital Maastricht and Department of Medical, Clinical and Experimental Psychology, Maastricht University, Maastricht, Netherlands

<sup>2</sup>Department of Medical Psychology and Pain Management and Research Center, University Hospital Maastricht and Department of Medical, Clinical and Experimental Psychology Maastricht University, Maastricht University, Maastricht, Netherlands  
jdjo@smmps.azm.nl, j.dejong@irv.nl, j.vlaeyen@dep.unimaas.nl

F

### Synonyms

Exposure in vivo; graded exposure; Exposure Treatment; Graded Exposure in Vivo with Behavioral Experiments; extinction

### Definition

Exposure *in vivo*, originally based on ▶ extinction of ▶ Pavlovian conditioning (Bouton 1988), is currently viewed as a cognitive process during which fear is activated and catastrophic expectations are being challenged and disconfirmed, resulting in reduction of the threat value of the originally fearful stimuli. During graded exposure, special attention goes to the establishment of an individual hierarchy of the ▶ pain-related fear stimuli. Exposure in vivo includes activities that are selected based on the fear hierarchy and the idiosyncratic aspects of the fear stimuli.

### Characteristics

In order to produce disconfirmations between expectations of pain and harm, the actual pain, and the other consequences of the activity or movement, Philips (1987) was one of the first to argue for repeated, graded, and controlled exposures to such situations. Experimental support for this idea is provided by the match-mismatch model of pain (Rachman and Arntz 1991), which states that people initially tend to overpredict how much pain they will experience, but after some exposures these predictions tend to be corrected to match with the actual experience. Crombez et al. (2002) and Goubert et al. (2002) found a similar pattern in a sample of chronic low back pain patients, who were requested to perform certain physical activities. As predicted, the chronic low back pain patients initially overpredicted pain, but after repetition of the activity, the overprediction was readily corrected. Overpredictions of pain and the negative consequences of pain are more pronounced in individuals reporting increased fear of pain. A number of studies examined the effectiveness of a graded ▶ exposure in vivo treatment in reducing pain-related fear, ▶ pain

catastrophizing, and ► **pain disability** in chronic pain patients who were referred for outpatient behavioral rehabilitation (Vlaeyen et al. 2001; Vlaeyen et al. 2002a; Vlaeyen et al. 2002b; de Jong et al. 2005a; de Jong et al. 2005b). These showed improvements in pain-related fear, pain catastrophizing and pain disability whenever the graded exposure was initiated. Measured with ambulatory activity monitors, the improvements also generalized to increases in physical activity in the home situation (Vlaeyen et al. 2002a). Besides behavioral and cognitive changes, one study in patients with ► **Complex Regional Pain Syndrome (CRPS)** even found observed positive changes in edema, skin color, excessive sweating, and motor function disturbances (de Jong et al. 2005a). Although the preliminary evidence reported here is limited in that it only a small number of patients were included, it seems that graded exposure to painful activities, movements and/or situations that were previously avoided, may indeed be a successful treatment approach for pain patients reporting substantial pain-related fear.

### Graded Exposure In Vivo

We suggest that the intervention generally be designed in three steps: cognitive-behavioral assessment, education, and exposure *in vivo* with ► **behavioral experiments**.

### Cognitive-Behavioral Assessment

#### Specific Questionnaires:

A basic question that may be asked is “what is the nature of the perceived threat?” The answer is not as simple as it seems. Patients may not view their problem as involving fear at all, and may simply see inability in performing certain activities due to pain. In addition, the specific nature of pain-related fear varies considerably, making an idiosyncratic approach almost indispensable. Patients may not fear pain itself, but the impending (re)injury it signals: pain is seen as a warning signal for a seriously threatening situation. The list below outlines pain-related fear questionnaires, including sample items:

#### Pain and Impairment Relationship Scale

(PAIRS: Riley et al. 1988)

*“I have to be careful not to do anything that might make my pain worse”*

*“All of my problems would be solved if my pain would go away”*

#### Tampa Scale for Kinesiophobia

(TSK: Miller et al. 1991)

#### Harm:

*“My body is telling me I have something dangerously wrong”*

#### Avoidance of activity:

*“Pain lets me know to stop exercising so that I don’t injure myself”*.

#### Pain Anxiety Symptoms Scale

(PASS: McCracken et al. 1992)

#### Cognitive anxiety:

*“I can’t think straight when in pain”*.

#### Escape/avoidance:

*“I will stop any activity as soon as I sense pain coming on”*.

#### Fear:

*“When I feel pain I am afraid that something terrible will happen”*.

#### Physiological anxiety:

*“I begin trembling when engaged in an activity that increases pain”*.

#### Fear-Avoidance Beliefs Questionnaire

(FABQ: Waddell et al. 1993)

#### Fear-avoidance beliefs about work:

*“My work might harm my back”*.

#### Fear-avoidance beliefs about physical activity:

*“My pain was caused by physical activity”*.

### Interview

The semi structured interview is an additional tool to better estimate the role of pain-related fear in the pain problem. It includes information about the antecedents (situational and/or internal), catastrophic (mis)interpretations, and consequences of the pain-related fear. Information is gathered about the assumptions patients make of the association between activity, pain, and (re)injury. Factors that often seem to be associated with the development of fear are the characteristics of pain onset, and the ambiguity surrounding the presence or absence of positive findings on medico-diagnostics. Reports about misconceptions and misinterpretations of information can later be used during the educational part of the intervention. Finally, the interview should also clarify whether other problems such as major depression, marital conflicts, or disability claims warrant specific attention before or after treatment.

### Graded Hierarchies

What is the patient actually afraid of? In addition to checklists of daily activities, the presentation of visual materials, such as pictures of stressing activities and movements reflecting the full range of situations avoided by the patient, can be quite helpful in the development of graded hierarchies. They start with activities or situations that provoke only mild discomfort and end with those that are beyond the patient’s present abilities. The Photograph Series of Daily Activities uses photographs representing various physical daily activities to be placed along a fear thermometer.

### Education

One of the major goals of the educational section is to increase the willingness of patients to finally engage in activities they avoided for a long time. The aim is to correct the misinterpretations and misconceptions that occurred early on during the development of the pain-related fear. The educational section is



more than just reassuring that there are no specific physical abnormalities. Unambiguously educating the patient in a way that the patient views his or her pain as a common condition that can be self-managed, rather than a serious disease or condition that needs careful protection, is a useful first step. It can be explained to patients that they may have probably overestimated the value of diagnostic tests, and that in symptom free people similar abnormalities can also be found.

### Graded Exposure In Vivo with Behavioral Experiments

#### Graded Exposure In Vivo

As firsthand evidence of actually experiencing oneself behaving differently is far more convincing than rational argument, the most essential step consists of graded exposure to the situations the fearful patient has identified as 'dangerous' or 'threatening'. The patient is encouraged to engage in these fearful activities as much as possible, until disconfirmation has occurred and anxiety levels have decreased. If the rating has decreased significantly, the therapist may consider moving on to the next item of the hierarchy. Each activity or movement is first modeled by the therapist. His presence, initially acting as a safety signal to promote more exposures, is gradually withdrawn to facilitate independence, and to create contexts that mimic those of the home situation (Vlaeyen et al. 2002c).

#### Behavioral Experiments

The graded exposure to fear-eliciting activities can be carried out in the form of a behavioral experiment in which a collaborative empiricism is the bottom line. The essence of a behavioral experiment is that the patient performs an activity to challenge the validity of his catastrophic assumptions and misinterpretations. These assumptions take the form of "If . . . then . . ." statements and are empirically tested in such a behavioral experiment.

#### Generalization and Maintenance of Change

Exposure to physical activities is not likely to result in a fundamental change in the belief of the pain patient that certain movements are harmful or painful (Goubert et al. 2002). More likely, the patient will learn that the movements involved in the exposure treatment are less harmful or painful than anticipated. In other words, during successful exposure, exceptions to the rule are learned, rather than there being a fundamental change of that rule. Generalization and maintenance can be enhanced by the following measures. First, exposure to the full spectrum of contexts and natural settings in which fear has been experienced is required. Second, during the exposure, it is best that stimuli be varied as much as possible. Third, expanded-spaced, rather than a massed exposure, is preferred (Vlaeyen et al. 2002c).

## References

1. Bouton ME (1988) Context and Ambiguity in the Extinction of Emotional Learning: Implications for Exposure Therapy. *Behav Res Ther* 26:137–149
2. Crombez G, Eccleston C, Vlaeyen J W, Vansteenwegen D, Lysens R, Eelen P (2002) Exposure to Physical Movements in Low Back Pain Patients: Restricted Effects of Generalization. *Health Psychol* 21:573–578
3. de Jong JR, Vlaeyen JWS, Onghena P, Cuypers C, den Hollander M, Ruygrok J (2005a) Reduction of pain-related fear in complex regional pain syndrome type I: the application of graded exposure in vivo. *Pain* 116:264–275
4. de Jong JR, Vlaeyen JW, Onghena P, Goossens ME, Geilen M, Mulder M (2005b) Fear of Movement/(Re) Injury in Chronic Low Back Pain: Education or Exposure *In Vivo* as Mediator to Fear Reduction? *Clin J Pain* 21:9–17
5. Goubert L, Francken G, Crombez G, Vansteenwegen D, Lysens R (2002) Exposure to Physical Movement in Chronic Back Pain Patients: No Evidence for Generalization Across Different Movements. *Behav Res Ther* 40:415–429
6. Philips HC (1987) Avoidance Behaviour and its Role in Sustaining Chronic Pain. *Behav Res Ther* 25:273–279
7. Rachman S, Arntz A R (1991) The Overprediction and Underprediction of Pain. *Clin Psychol Rev* 11:339–355
8. Vlaeyen JW, de Jong JR, Geilen M, Heuts PH, van Breukelen G (2002a) The Treatment of Fear of Movement/(Re) Injury in Chronic Low Back Pain: Further Evidence on the Effectiveness of Exposure *In Vivo*. *Clin J Pain* 18:251–61
9. Vlaeyen JW, de Jong JR, Onghena P, Kerckhoffs-Hanssen M, Kole-Snijders AM (2002b) Can Pain-Related Fear be Reduced? The Application of Cognitive-Behavioral Exposure *In Vivo*. *Pain Res Manag* 7:144–153
10. Vlaeyen JW, de Jong JR, Sieben JM, Crombez G (2002c) Graded Exposure *In Vivo* for Pain-Related Fear In: Turk DC, Gatchel RJ (eds) *Psychological Approaches to Pain Management A Practitioner's Handbook*. Guilford Press, New York, pp 210–233

F

## Feasible

### Definition

The simple, economic and easy application of a measure.

- ▶ Pain Assessment in Neonates

## Feedback Control of Pain

### Definition

Ascending pain signal activates a central mechanism (e.g. an inhibitory brainstem-spinal pathway) that suppresses successive pain signals.

- ▶ Descending Modulation and Persistent Pain

## Fee-for-Service

### Definition

Patients or insurance pay for medical care as it is needed and according to the service provided.

- ▶ Disability Management in Managed Care System

## Female Reproductive Organ Pain Model

- ▶ Visceral Pain Models, Female Reproductive Organ Pain

## Femoral Nerve Block

### Definition

Local anesthetic blockade of the femoral nerve that provides sensory innervation to the upper leg. It provides prompt analgesia and muscle relaxation in children with femoral shaft fractures.

- ▶ Acute Pain in Children, Post-Operative

## Fentanyl

### Definition

Fentanyl is a synthetic opioid that is a phenylpiperidine derivative and structurally related to meperidine.

- ▶ Postoperative Pain, Fentanyl

## Fibroblast

### Definition

Fibroblast is a connective tissue cell.

- ▶ Wallerian Degeneration

## Fibroblast-Like Satellite Cells

- ▶ Satellite Cells and Inflammatory Pain

## Fibrocartilage

### Definition

Fibrocartilage is cartilage that is largely composed of fibers like those in ordinary connective tissue.

- ▶ Sacroiliac Joint Pain

## Fibromyalgia

DAVID VIVIAN<sup>1</sup>, NIKOLAI BOGDUK<sup>2</sup>

<sup>1</sup>Metro Spinal Clinic, Caulfield, VIC, Australia

<sup>2</sup>Department of Clinical Research, Royal Newcastle Hospital Newcastle University of Newcastle, Newcastle, NSW, Australia

dvivian@metrospinal.com.au,

nik.bogduk@newcastle.edu.au

### Synonyms

Fibrositis; Muscular Rheumatism; psychogenic rheumatism; chronic widespread pain

### Definition

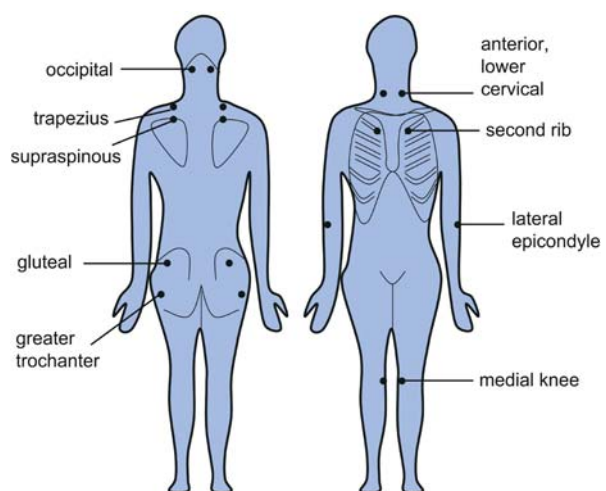
Fibromyalgia is a condition characterized by chronic widespread pain and tenderness at several specific points across the body.

### Characteristics

The American College of Rheumatology declared that the diagnostic criteria of fibromyalgia were widespread pain in combination with tenderness at 11 or more of 18 specific tender points (Wolfe et al. 1990). To be considered widespread, the pain had to encompass both the left and right sides of the body, and regions both above and below the waist. In addition, spinal pain had to be present. The diagnostic tender points are located in the neck, around the shoulder girdle, in the hip girdle, and at the elbow and knee (Fig. 1).

### Pathophysiology

The pathophysiology of fibromyalgia is unknown and remains in dispute. Patients with fibromyalgia exhibit increased pain sensitivity to pressure, heat, cold, and electrical stimulation, but these features are not unique to fibromyalgia (Gracely et al. 2003).



**Fibromyalgia, Figure 1** The location of the diagnostic tender points for fibromyalgia.

Other markers of the disorder have been explored, but the results have not been consistent or reproducible. Nor are the abnormalities, when evident, expressed by all patients with fibromyalgia. Nor are they unique to these patients.

Some patients exhibit a sleep anomaly known as ▶ **Alpha(α)-Delta(δ) Sleep**, but 60% of patients do not. The same anomaly occurs in other conditions, and in 15% of healthy individuals (Carette 1995). Histological abnormalities have been reported in the muscles of patients with fibromyalgia, but no differences have been found in adequately controlled studies (Carette 1995). Nor have disturbances in muscle metabolism been verified (Carette 1995). Patients with fibromyalgia exhibit deficiencies in ▶ **serotonin**, increased levels of ▶ **substance P** in their cerebrospinal fluid, and abnormalities of the ▶ **hypothalamic pituitary axis** (Carette 1995); but these differences have not been shown to be unique to fibromyalgia.

One model that has been proposed is that fibromyalgia is due to an impairment of the diffuse noxious inhibitory control system (DNIC) (Gracely et al. 2003). The implication is that patients perceive spontaneous pain because of a lack of tonic inhibition of the central nociceptive pathways. The circumstantial evidence is that of conditioning, that painful stimuli produce analgesia in normal subjects, but fail to do so in patients with fibromyalgia (Gracely et al. 2003).

Although this may be so, commentators have questioned whether the syndrome is due to altered central nociception or to hypervigilance; and if there is altered nociception, does it arise because of somatic factors or psychogenic influences (Cohen and Quintner 1998).

### Nosology

Commentators have disputed the legitimacy of fibromyalgia as a diagnostic entity. They argue that because tenderness is not a unique feature it cannot be used to define a unique condition (Cohen and Quintner 1993; Cohen and Quintner 1998; Croft et al. 1994). Furthermore, fibromyalgia shares the same features as many conditions associated with widespread pain, as well as several rheumatological diseases (Gran 2003). Consequently, it may be an artificial diagnosis or a pseudonym for chronic widespread pain (of unknown origin).

While disputing the taxonomic validity of fibromyalgia, some commentators are conciliatory. They recognize that offering patients a simple, although artificial, diagnostic label may be more palatable than a diagnosis of widespread pain (Carette 1995).

### Treatment

A variety of treatments have been applied to patients with fibromyalgia. The reputation of most is based on anecdote and hearsay. A review of nonpharmacological interventions found the literature to be of poor quality,

and found no strong evidence for any single intervention (Sim and Adams 2002). It found preliminary support, of moderate strength, for aerobic exercise.

A synopsis statement summarised several pragmatic reviews of treatment published in the same journal (Claw and Crofford 2003). It recommended tricyclic antidepressants for control of pain, as well as aerobic exercises and cognitive behavioural therapy.

- ▶ **Chronic Low Back Pain, Definitions and Diagnosis**
- ▶ **Fibromyalgia, Mechanisms and Treatment**
- ▶ **Human Thalamic Response to Experimental Pain (Neuroimaging)**
- ▶ **Muscle Pain, Fibromyalgia Syndrome (Primary, Secondary)**
- ▶ **Myalgia**
- ▶ **Nocifensive Behaviors (Muscle and Joint)**
- ▶ **Opioids and Muscle Pain**
- ▶ **Physical Exercise**
- ▶ **Psychological Aspects of Pain in Women**

### References

1. Carette S (1995) Fibromyalgia 20 Years Later. What Have we Accomplished? *J Rheumatol* 22:590–594
2. Claw DJ, Crofford LJ (2003) Chronic Widespread Pain and Fibromyalgia: What We Know, and What We Need to Know. *Best Pract Res Clin Rheumatol* 17:685–701
3. Cohen ML, Quintner JL (1993) Fibromyalgia Syndrome, a Problem of Tautology. *Lancet* 342:906–909
4. Cohen ML, Quintner JL (1998) Fibromyalgia Syndrome and Disability: A Failed Construct Fails Those in Pain. *Med J Aust* 402–404
5. Croft P, Schollum J, Silman A (1994) Population Study of Tender Point Counts and Pain as Evidence of Fibromyalgia. *BMJ* 309:696–699
6. Gracely RH, Grant MAB, Giesecke T (2003) Evoked Pain Measures in Fibromyalgia. *Best Pract Res Clin Rheumatol* 17:593–609
7. Gran JT (2003) The Epidemiology of Chronic Generalized Musculoskeletal Pain. *Best Pract Res Clin Rheumatol* 17:547–561
8. Sim J, Adams N (2002) Systematic Review of Randomized Controlled Trials of Nonpharmacological Interventions for Fibromyalgia. *Clin J Pain* 2002 18:324–336
9. Wolfe F, Smythe HA, Yunus MB et al. (1990) The American College of Rheumatology 1990 Criteria for the Classification of Fibromyalgia. *Arth Rheum* 33:160–172

## Fibromyalgia, Mechanisms and Treatment

ALICE A. LARSON, KATALIN J. KOVÁCS  
Department of Veterinary and Biomedical Sciences,  
University of Minnesota, St. Paul, MN, USA  
larso011@umn.edu

### Definition

Historically, fibromyalgia syndrome (FMS) was referred to as fibrositis. This term was coined by Sir Edward Gowers, at the turn of the century, to describe the inflammation he proposed to be responsible for the stiffness and pain experienced by a group of non-arthritic

patients. Later, as extensive histological examination of muscle biopsies indicated no classically defined tissue damage of patients, other terms, including fibralgia, have since been suggested to avoid the implication of inflammation associated with the suffix “itis”. Fibromyalgia syndrome was the name adopted in 1990 by the American College of Rheumatology (Wolfe et al. 1990). The consensus document on fibromyalgia at the MYOPAIN conference held in Copenhagen, Denmark in 1992 provides a description of the syndrome, the diagnostic criteria and its prevalence, but fails to offer effective treatment or prevention, a situation that largely persists to this day.

The definition of FMS is based on a set of specific symptoms. Many chronic pain conditions and FMS display overlapping symptoms. Those conditions must be diagnosed separately and eliminated as an important first step in the diagnostic protocol. The diagnostic criteria include widespread pain in all four quadrants of the body for a minimum of three months, and are based on tenderness to digital palpation at 11 of the 18 anatomically defined tender points. Tender points are exquisitely sensitive to pressure (mechanical pain). Reductions in electrical and thermal pain thresholds have also been established in patients with FMS, suggesting a multimodal change in pain sensitivity. In a multicenter study, by testing specific tender points for their ► **mechanosensitivity** to pain, thirty-five researchers examined 558 patients, of which 265 were age- and sex-matched positive controls with other symptoms that overlapped to varying degrees with FMS. Using the criteria specified in that report, patients were diagnosed with 88% accuracy.

## Characteristics

### Prevalence

In North America, approximately 2% of the population, or greater than 3.7 million people, are estimated to suffer from FMS. The majority of these patients, approximately three out of four, are female. While it is the second most common syndrome presented in rheumatology clinics, the treatment is typically unsatisfactory, resulting in disability and handicap. Studies in several countries and ethnicities suggest a poor prognosis over several years of treatment.

### Co-Morbidity

Chronic widespread pain is the primary complaint bringing most patients with FMS into the clinic. In addition to pain, non-restorative sleep, fatigue, anxiety and depression, interstitial cystitis, and irritable bowel syndrome are symptoms frequently diagnosed in patients with FMS. A higher incidence of cold intolerance, restless leg syndrome, cognitive dysfunction, rhinitis and multiple chemical sensitivities are also common in FMS patients than in healthy normal controls, adding to the

perplexing mosaic of the disease. The etiology of FMS is unknown, and the relationship between pain and the other symptoms of FMS is unclear. Acute pain usually results in increased activation of the pituitary-adrenal and sympathomedullary pathways as well as growth hormone production. Patients with FMS, in contrast, present with hypofunction of the ► **HPA axis**, thyroidal and gonadal axis, diminished growth hormone production (Bennett 1998), and abnormally low sympathetic output (Clauw and Chrousos 1997). Consistent with a close link between FMS and abnormal autonomic activity, exposure to stressful situations, including noise, lights and weather, exacerbate symptoms of FMS. Patients with FMS generally have an impaired ability to activate the hypothalamic-pituitary portion of the HPA axis as well as the sympathoadrenal system, leading to reduced adrenocorticotrophic hormone (ACTH) and epinephrine responses (Adler et al. 1999). These events may lead to an inappropriate response to daily stressful situations.

### Unique Characteristics of Tender Points

Tender points are generally distributed in areas whose primary afferent nerves project to spinal lumbar levels 3–5 and cervical levels 2–7 spinal cord segments. It may be of importance that these areas surround the thoracic 1 through to the lumbar 3 spinal cord segments that are involved with regulation of the sympathetic nervous system, whose function is significantly altered in patients with FMS (Clauw and Chrousos 1997). It is also noteworthy that tender points reside in areas that receive a relatively low density of afferent innervation (trunk and proximal limbs) compared to areas typically considered ‘sensitive’ by virtue of their dense innervation, e.g. the fingers, mouth, feet and genitals. The sensitivity of these tender points does not, therefore, originate from a simple hyperactivity of all mechanically sensitive tissues, but rather from an unknown, symmetrically distributed change in afferent input. Based on this and other psychophysical evidence of windup, the etiology of this syndrome is widely believed to be within the CNS.

### Excitatory Amino Acids

► **Excitatory amino acids**, such as glutamate and aspartate, are widely believed to transmit pain signals, including those in patients with FMS (Larson et al. 2000). While the concentrations of most amino acids in the cerebrospinal fluid do not differ between subjects with FMS compared to healthy normal controls, a high degree of correspondence was found between specific amino acids and the degree of pain reported at the 18 tender points (tender point index, TPI). Excitatory amino acid activity is known to trigger synthesis of ► **nitric oxide (NO)**, a gaseous signaling compound that has been proposed to be critical for the development and expression of chronic pain. Enhanced synthesis of NO



results from a variety of depolarizing events, including excitatory amino acid and substance P activity, both of which lead to influx of calcium and activation of the enzyme NO synthase. NMDA activity is also associated with the production of nerve growth factor (NGF), a compound that regulates the synthesis of peptides in primary afferent C-fibers such as substance P.

### Substance P

The first documentation of a biochemical characteristic consistent with chronic pain in patients with FMS was the increased concentration of substance P in the cerebrospinal fluid of patients with FMS (Russell et al. 1994; Vaeroy et al. 1988; Welin et al. 1995), similar to that in many other pain states. Substance P is a neuroactive peptide released from small-diameter, unmyelinated primary afferent fibers called ► **nociceptors**, in response to mechanical pain. Substance P is upregulated in chronic, inflammatory pain conditions by increased concentration of NGF. As its role in the mediation of acute pain appears to be minimal, enhanced substance P content in the cerebrospinal fluid of patients with FMS likely reflects a chronic rather than transient state.

### Nerve Growth Factor (NGF)

Synthesis of NGF, a ► **neurotrophin**, in inflamed tissue is responsible for the upregulation of SP synthesis during chronic pain and the development of mechanical hyperalgesia and allodynia. Intravenous administration of NGF in humans causes muscle pain in a dose-dependent manner, primarily in bulbar and truncal musculature, and affects women more than men (Petty et al. 1994). While there is no gross inflammation at tender points to account for a peripheral source of NGF, delivery of NGF to the spinal area of mice or rats is sufficient to cause hyperalgesia. Based on the hyperalgesic effect of this pool of NGF, the concentration of NGF in the cerebrospinal fluid of patients with FMS was measured (Giovengo et al. 1999) and found to be enhanced only in patients with primary FMS. The concentration of NGF centrally is normally low or immeasurable in healthy individuals, leaving the source of this neurotrophin in patients with FMS a mystery. It is, therefore, possible that an elevated concentration of NGF found in patients with FMS is responsible for the hyperalgesia and allodynia associated with this syndrome, while secondary FMS results from conditions producing areas of pain sensitivity that overlap extensively with the 18 tender points.

### FMS and Thalamic Activity

Positron emission tomography (PET) and functional magnetic resonance imaging (fMRI) studies in humans indicate that the thalamus as well as the anterior insula and S2 area is important in the perception of pain. Activation of the thalamus by pain normally initiates descending inhibitory activity that controls pain. Stim-

ulation of the somatosensory thalamus has even been successfully used to treat extreme conditions of chronic pain in humans. Descending activity originating from the thalamus is sufficiently important that thalamotomy in rats results in both thermal as well as mechanical hyperalgesia. Although pain normally stimulates the thalamus in healthy individuals, a different pattern of activation occurs in patients with chronic pain. Regional blood flow in response to painful stimulation also differs in patients with FMS compared to that in normal control individuals (Risberg et al. 1995). These studies suggest that either the ascending spinothalamic nociceptive pathways are not fully functional, or the thalamus responds abnormally to input from spinothalamic neurons. As other parts of the CNS respond appropriately in patients with FMS, ascending activity appears sufficient. Rather, thalamic neurons are likely to fail to initiate sufficient descending inhibitory activity controlling nociceptive processing at the spinal cord level, a concept supported by altered nociceptive responses in patients with FMS.

### Treatment

Low doses of tricyclic antidepressants, such as amitriptyline, have been found to be temporarily effective, similar to their efficacy in other chronic pain conditions (O'Malley et al. 2000). The efficacy of this, and related drugs, is likely to be due to their action on nociceptive pathways and is not related to its antidepressant activity. As tolerance to this analgesic activity develops, low doses (10 mg or less) are recommended at the outset, gradually increasing by 10 mg as needed until an optimal dose of 70–80 mg is reached. Cyclobenzaprine, a relative of amitriptyline with muscle relaxant properties, and tramadol have also been found to be effective. Future treatments may be aimed at enhancing growth hormone and attenuating the excessive wind-up of pain pathways in patients with fibromyalgia (Staud et al. 2001).

Exercise remains the most effective treatment for FMS and should be initiated immediately after analgesic treatment has commenced (Sims and Adams 2002). Patients need to understand that exercise is the key to recovery, even if the extent of the exercise is merely doubling their distance walked within the house from one day to the next. The intensity of exercise should be escalated very gradually or it will prove too stressful and temporarily exacerbate their symptoms. Drug treatment to temporarily alleviate their pain, including ► **amitriptyline**, ► **NSAIDs** and even narcotic analgesics (reviewed by Rao and Bennett 2003), should be geared to facilitating this new level of activity (review by Clauw and Crofford 2003). Heat therapy, in the form of a long, hot bath immediately prior to bedtime, has been anecdotally reported to be effective for episodic bouts of intense pain. In contrast, cold exacerbates their condition and should be avoided.

- ▶ Chronic Low Back Pain, Definitions and Diagnosis
- ▶ Disability in Fibromyalgia Patients
- ▶ Fibromyalgia, Mechanisms and Treatment
- ▶ Human Thalamic Response to Experimental Pain (Neuroimaging)
- ▶ Muscle Pain, Fibromyalgia Syndrome (Primary, Secondary)
- ▶ Myalgia
- ▶ Nocifensive Behaviors (Muscle and Joint)
- ▶ Opioids and Muscle Pain
- ▶ Physical Exercise
- ▶ Psychological Aspects of Pain in Women

## References

1. Adler GK, Kinsley BT, Hurwitz S et al. (1999) Reduced Hypothalamic-Pituitary and Sympathoadrenal Responses to Hypoglycemia in Women with Fibromyalgia Syndrome. *Am J Med* 106:534–543
2. Bennett RM (1998) Disordered Growth Hormone Secretion in Fibromyalgia: A Review of Recent Findings and a Hypothesized Etiology. *Z Rheumatol* 57:72–76
3. Clauw DJ, Chrousos GP (1997) Chronic Pain and Fatigue Syndromes: Overlapping Clinical and Neuroendocrine Features and Potential Pathogenic Mechanisms. *Neuroimmunomodulation* 4:143–153
4. Clauw DJ, Crofford LJ (2003) Chronic Widespread Pain and Fibromyalgia: What we know, and what we need to know. *Best Pract Res Clin Rheumatol* 17:685–701
5. Giovengo SL, Russell IJ, Larson AA (1999) Increased Concentrations of Nerve Growth Factor in Cerebrospinal Fluid of Patients with Fibromyalgia. *J Rheumatol* 26:1564–1569
6. Larson AA, Giovengo SL, Russell IJ et al. (2000) Changes in the Concentrations of Amino Acids in the Cerebrospinal Fluid that Correlate with Pain in Patients with Fibromyalgia: Implications for Nitric Oxide Pathways. *Pain* 87:201–211
7. O'Malley PG, Balden E, Tomkins G et al. (2000) Treatment of Fibromyalgia with Antidepressants. *J Gen Intern Med* 15:659–666
8. Petty BG, Cornblath DR, Adornato BT et al. (1994) The Effect of Systemically Administered Recombinant Human Nerve Growth Factor in Healthy Human Subjects. *Ann Neurol* 36:244–246
9. Rao SG, Bennett RM (2003) Pharmacological Therapies in Fibromyalgia. *Best Pract Res Clin Rheumatol* 17:611–627
10. Risberg JG, Rosenhall U, Orndahl G et al. (1995) Cerebral Dysfunction in Fibromyalgia: Evidence from Regional Cerebral Blood Flow Measurements, Otoneurological Tests and Cerebrospinal Fluid Analysis. *Acta Psychiatr Scand* 91:86–94
11. Russell IJ, Orr MD, Littman B et al. (1994) Elevated Cerebrospinal Fluid Levels of Substance P in Patients with the Fibromyalgia Syndrome. *Arthritis Rheum* 37:1593–1601
12. Sim J, Adams N (2002) Systematic Review of Randomized Controlled Trials of Nonpharmacological Interventions for Fibromyalgia. *Clin J Pain* 18:324–336
13. Staud R, Robinson ME, Vierck CJ et al. (2003) Diffuse Noxious Inhibitory Controls (DNIC) Attenuate Temporal Summation of Second Pain in Normal Males but not in Normal Females or Fibromyalgia Patients. *Pain* 101:167–174
14. Vaeroy H, Helle R, Forre O et al. (1988) Elevated CSF Levels of Substance P and High Incidence of Raynaud's Phenomenon in Patients with Fibromyalgia: New Features for Diagnosis. *Pain* 32:21–26
15. Wolfe F, Smythe HA, Yunus MB et al. (1990) The American College of Rheumatology 1990 Criteria for the Classification of Fibromyalgia. Report of the Multicenter Criteria Committee. *Arthritis Rheum* 33:160–172
16. Welin M, Bragee B, Nyberg F et al. (1995) Elevated Substance P Levels are Contrasted by a Decrease in Met-Enkephalin-arg-phe Levels in CSF from Fibromyalgia Patients. *J Musculoskel Pain* 3:4

## Fibromyalgia Syndrome

- ▶ Fibromyalgia
- ▶ Fibromyalgia, Mechanisms and Treatment
- ▶ Muscle Pain, Fibromyalgia Syndrome (Primary, Secondary)

## Fibromyositis

- ▶ Disability in Fibromyalgia Patients

## Fibrositis

- ▶ Fibromyalgia
- ▶ Muscle Pain, Fibromyalgia Syndrome (Primary, Secondary)
- ▶ Myalgia

## Fibrositis Syndrome

- ▶ Muscle Pain, Fibromyalgia Syndrome (Primary, Secondary)
- ▶ Myalgia

## Field Block

### Definition

Local anesthetic injected through intact skin adjacent to the surgical site to create a subcutaneous wall encompassing the injury.

- ▶ Acute Pain in Children, Post-Operative

## Fifth Lobe

- ▶ Insular Cortex, Neurophysiology and Functional Imaging of Nociceptive Processing

## Firing of Suburothelial Afferent Nerves

### Definition

Firing of suburothelial afferent nerves and the threshold for bladder activation, may be modified by both inhibitory (e.g., NO) and stimulatory (e.g., ATP, tachykinins, prostanoids) mediators. These mechanisms can be involved in the generation of detrusor overactivity causing urgency, frequency and incontinence, but also bladder pain.

► Opioids and Bladder Pain/Function

## First and Second Pain Assessment (First Pain, Pricking Pain, Pin-Prick Pain, Second Pain, Burning Pain)

DONALD D. PRICE

Oral Surgery and Neuroscience, McKnight Brain Institute University of Florida, Gainesville, FL, USA  
dprice@dental.ufl.edu

### Synonyms

Pricking Pain; First Pain Assessment; Pin-Prick Pain; Second Pain Assessment; burning pain

### Definition

Prior to the development of methods for physiological and anatomical characterization of axons within peripheral nerves, Henry Head concluded that the skin was served by epicritic and protopathic afferent systems in which each gave rise to its own particular qualities of sensations (Head 1920). Epicritic pain, for example, was said to be accurately localized, to not outlast the stimulus, and to provide precise qualitative information about the nature of the stimulus. Thus, epicritic pain could be elicited by mild pricking of the skin with a needle, a form of pain known to almost everyone as pricking pain. In contrast, protopathic pain was described as less well localized, slow in onset, often outlasting the stimulus, and summing with repeated stimulus application. Protopathic pain was considered more difficult to endure and contained special feelings of unpleasantness or “feeling tone”. The concept of ‘protopathic’ has been applied to burning pain, aching pain, throbbing pain, and dull pain. Head based these ideas largely on observations made of his own experiences of pain, after nerve division and during nerve regeneration.

With the advent of modern electrophysiological and neuroanatomical techniques, it became clear that pain depended on two types of peripheral nerve axons. The first is that of thinly myelinated A-delta axons, whose conduction velocities range between 3 and 30 meters/second, and the second is that of unmyelinated

C axons, whose conduction velocities range between 0.5 and 2.0 meters/second. Based on their differences in conduction velocity and reminiscent of the functional dichotomy proposed by Head, Zotterman proposed that A-delta and C afferent axons could account for first and second pain, which often occurs in response to a brief intense stimulus to the hand or foot (Zotterman 1933). Landau and Bishop explicitly related first pain to epicritic pain and second pain to protopathic pain (Landau and Bishop 1953). Interestingly, they based their conclusions as a result of an approach similar to that of Head. They carefully observed and recorded their own pain experiences in response to ‘experimental’ pain stimuli, before and after selective conduction block of A-delta or C axons of peripheral nerves. They used local injections of dilute solutions of procaine to selectively block C axons within small nerve branches in order to study pain from impulses in A-delta axons. They selectively blocked all myelinated axons in peripheral nerves of their lower arms by means of a 250 mm Hg pressure cuff in order to assess the types of pains evoked by impulses in C axons. They applied various types of painful stimuli to skin, fascia, and periosteal surfaces, including bee stings, turpentine injections, intramuscular KCL injections, and application of deep and sharp pressure with mechanical probes. When they blocked C axons with procaine, well localized brief duration stinging sharp pains, such as those elicited by pin pricks (i.e. pricking pain or first pain), were preserved, but prolonged, deep, and diffuse burning pains evoked by inflammatory stimuli, such as the second pain from a bee sting, could no longer be elicited. When they blocked all myelinated (A) axons by means of the blood pressure cuff, the latter types of pain could be elicited and were more intense than before blockade of myelinated axons.

These general observations have since been corroborated in conventional studies, wherein investigators studied responses of volunteer participants (Price 1972, Collins et al. 1960, Price 1999). An important aspect of the study by Collins et al. was that compound action potentials were monitored (Collins et al. 1960). They placed stimulating and recording electrodes under the sural nerve of cancer patients undergoing anterolateral chordotomy for relief of pain. They found that stimulation of A-delta axons produced sharp pricking pain sensations that were accurately localized. When A-delta axons were blocked by cold, stimulation of C axons at a rate of 3/sec resulted in summing unbearable diffuse burning pain that was not as well localized.

The association of first and second pain with impulses in A-delta and C axons, and the relationship of these two types of pain to epicritic and protopathic pain, have pivotal roles in the history of pain research. However, like all functional dichotomies, it is important not to over-generalize their explanatory role, for example, to prematurely label different central pain-related pathways as

“epicritic” or “protopathic”. Even Head warned against this type of error, when he concluded that epicritic and protopathic systems recombined once they entered the dorsal horn (Head 1920). Thus, although zones of relatively pure epicritic or protopathic sensibility could be found after dorsal root or peripheral nerve lesions, he noted that such zones were never observed after lesions of the spinal cord or brain. More than 40 years before electrophysiological studies were carried out on dorsal horn nociceptive neurons, Head anticipated the synaptic convergence of two functional types of primary nociceptive afferents (known since as A-delta and C) onto neurons of the dorsal horn.

One must also take note of the fact that A-delta and C nociceptive afferents are rarely activated in isolation. Most acute pains are likely to reflect a combination of input from A-delta and C nociceptive afferents and, in most cases, from non-nociceptive afferents as well. Indeed, the composition of input from different types of nociceptive and non-nociceptive afferents undoubtedly contributes a lot to the diverse qualities of both painful and non-painful somatic sensation (Price 1999). However, many long duration pains, especially those that are diffuse, spatially spreading, and especially unpleasant in their “feeling tone” may depend to a greater extent on tonic input from C nociceptive afferents than from input from A-delta nociceptive afferents. The initial pains from abrupt injuries (e.g., stepping on a tack) are likely to depend heavily on A-delta nociceptive afferents.

## Characteristics

### Temporal Characteristics of First and Second Pain and their Relationships to Neural Mechanisms

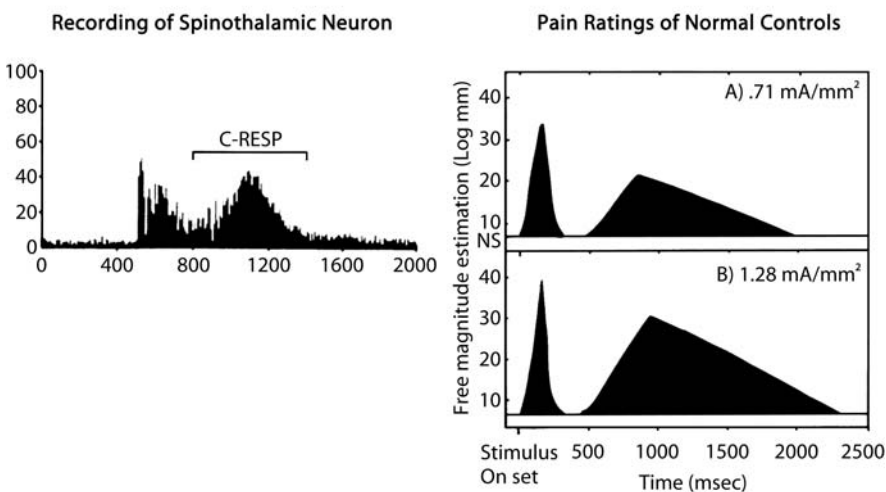
First and second pains are often easily distinguished when a sudden tissue damaging, or potentially tissue-

damaging stimulus occurs on a distal part of the body, such as the hand or foot (Fig. 1).

The 0.5 to 1.5 second delay between the two pains occurs as a result of the fact that nerve impulses in C axons travel much slower (0.5 to 1.5 meters/sec) than those in thinly myelinated A axons (6–30 meters/sec). Lewis and Pochin independently mapped the body regions wherein they experienced both first and second pains (Lewis and Pochin 1938). The body maps of both Lewis and Pochin were nearly identical. The maps showed that first and second pain could be perceived near the elbow but not the lower trunk, even though both sites were about the same distance from the brain. The reason for this difference is that C fibers that supply the trunk have a short conduction distance to the spinal cord, whereas C fibers that supply the skin near the elbow, have a long conduction distance. Once both “trunk” and “elbow” C fibers reach the spinal cord, they synapse on nerve cells that have fast-conducting axons. As a result of differences in peripheral conduction distance and time, first and second pain can be discriminated at the elbow but not the trunk.

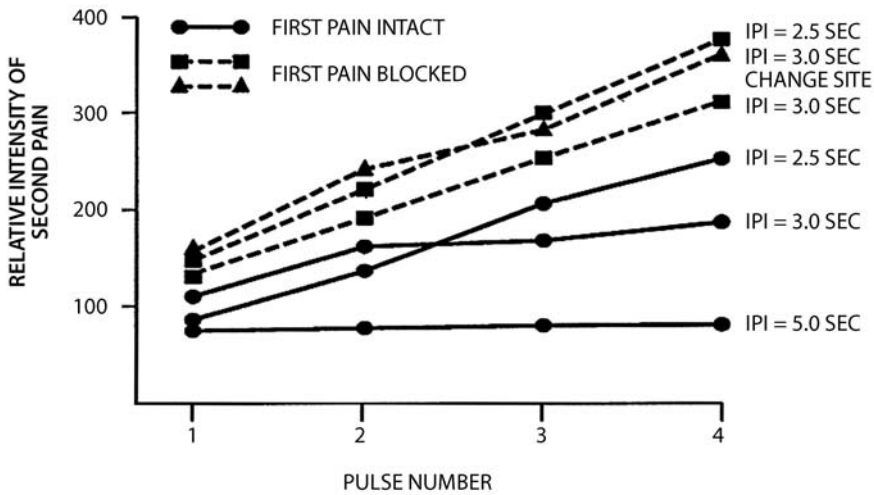
Later, studies using psychophysical methods replicated and extended the ones just described (Price 1972; Price 1999). These methods relied on delivering brief and well-controlled experimental stimuli to the distal part of an extremity, such as the hand or foot. These regions were chosen because they allowed for discrimination of first and second pain related to impulse conduction in A-delta and C axons respectively. Reaction time measurements were used to confirm that subjects could indeed distinguish the two pains. Both trained and untrained subjects reported qualities of first pain as “pricking” “stinging” or “sharp” (i.e. pin-prick pain), without provocation or suggestion that such qualities existed. Subjects were trained to judge the perceived

## First and Second Pain Intensity

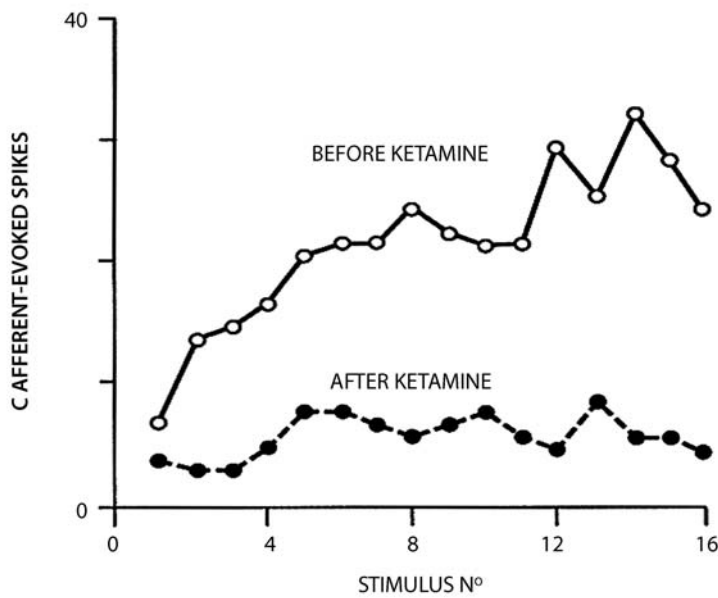


**First and Second Pain Assessment (First Pain, Pricking Pain, Pin-Prick Pain, Second Pain, Burning Pain), Figure 1** (Left) Double response of spinothalamic tract dorsal horn neuron to synchronous stimulation of A-delta and C axons by means of electrical shocks to a cutaneous nerve. The delay between the two post-synaptic impulse responses is related to the faster and slower conduction velocities of A and C axons respectively. (Right) Subjects' mean ratings of intensities of first and second pains. Note similarity of profiles of neuron responses to pain ratings. Modified from (6).





F



**First and Second Pain Assessment (First Pain, Pricking Pain, Pin-Prick Pain, Second Pain, Burning Pain), Figure 2** Subjects' mean ratings of second pain in response to series of 9 mA electric shocks. Note temporal summation of second pain at inter-stimulus intervals of 3 seconds but not 5 seconds and the fact that first pain remains at the same intensity throughout series of shocks. From (9).

magnitudes of first and second pain by squeezing a handgrip dynamometer in some experiments (Price et al. 1977), or using a mechanical visual analogue scale in others (Price et al. 1994). Mean psychophysical ratings of intensities of first pain during trains of computer-driven heat pulses (2.5 sec duration, peak temperature 52°C) decreased progressively (Price 1999; Price et al.1977; Price et al.1994), and stayed the same in the case of 5–9 mA electric shocks (Price 1972; Price et al. 1994). Unlike first pain, second pain progressively increased in mean intensity and duration throughout a series of shocks or heat pulses, when the inter-stimulus interval was less than three seconds but not when it was five seconds (Price 1972; Price 1999; Price et al. 1977; Price et al. 1994) (Fig. 2). Moreover, second pain became stronger, more diffuse, and more unpleasant with repeated heat pulses or repeated electrical shocks.

When the same types of heat pulses or electrical shocks described above are applied to the skin of monkeys, spinothalamic tract neurons within the spinal cord dorsal horn respond with a double response (i.e. two sets of impulse discharges) (Price 1999), as shown in Figure 1. The earlier of the two is related to synaptic input from A-nociceptors and the delayed response is related to synaptic input from C nociceptors (Price 1999, Price et al.1977). Similar to first pain, the first response decreases or remains the same during heat pulses or shocks respectively, whereas the second delayed response to heat pulses or shocks increases progressively both in magnitude and duration. Similar to second pain, temporal summation of the delayed neural response was observed when the inter-stimulus interval was 3 seconds or less but not five seconds (Price 1999). For neurons, this temporal summation has been termed “windup”

(Price 1999). Moreover, this summation must occur within the spinal cord dorsal horn, because similar experiments conducted on peripheral A and C nociceptors show that their responses do not increase with stimulus repetition (Price et al. 1977; Price et al. 1994). Thus, temporal summation of second pain depends on mechanisms of the central nervous system (i.e. dorsal horn neurons) not changes in peripheral receptors. These psychophysical-neural parallels have been confirmed not only in the case of single neurons of the spinal cord dorsal horn, but also in the case of neural imaging at the level of the somatosensory region of the cerebral cortex (Tommerdahl et al. 1996). Using a brain imaging method of intrinsic optical density measurements (OIS), Tommerdahl and colleagues (Tommerdahl et al. 1996) imaged neural activity within the primary somatosensory cortex of anesthetized squirrel monkeys as their hands were repetitively tapped with a heated thermode. These taps reliably evoke first and second pain in human subjects. Their method of neural imaging has a high degree of both spatial and temporal resolution, measuring local cortical neural activity within 50–100 microns, and sampling neural activity that has occurred within a third of a second. Heat taps produced localized activity in two regions of the primary somatosensory cortex, termed 3a and 1. When a train of heat taps was presented at a rate of once per 3 seconds, each tap evoked delayed neural activity within these regions. The neural response to each tap grew progressively more intense and larger in area with each successive tap. This temporal summation of this neural response paralleled human psychophysical experiences of second pain in several distinct ways. Both types of responses summate at the same rate of stimulus repetition, and have a similar growth in intensity during a series of heat taps. The perceived skin area in which second pain is perceived, and the area of cortical neural activity, both increase with repeated heat taps.

Windup and temporal summation of second pain are related to synaptic interactions between C-nociceptive afferents and dorsal horn neurons. These interactions involve long duration excitatory processes related to the release of neurotransmitters such as glutamate/aspartate and neuromodulators such as substance P. These agents respectively activate NMDA (N-methyl-D-aspartate) receptors and neurokinin 1 receptors, leading to prolonged depolarizations (Thompson and Woolf 1990, for review). Thus, NMDA receptor antagonists block both temporal summation of second pain and the 'windup' responses of dorsal horn neurons to repeated C fiber input (Price 1999). Windup is related to hyperalgesic states that can be produced experimentally as well as those occurring in pathophysiological pain, such as post-herpetic neuralgia (Arendt-Nielsen 1997; Dubner 1991). Indeed, slow temporal summation has long been considered a central neural mechanism that has a role in pathophysiological pain (Noordenbos 1959).

## References

1. Arendt-Nielsen L (1997) Induction and Assessment of Experimental Pain from Human Skin, Muscle, and Viscera. In: Jensen TS, Turner JA, Wiesenfeld-Hallin Z (eds) Proceedings of the 8th World Congress on Pain. IASP Press, Seattle, pp 393–403
2. Collins WF, Nulsen FE, Randt CT (1960) Relation of Peripheral Nerve Fiber Size and Sensation in Man. *Archives of Neurology (Chicago)* 3:381–385
3. Dubner R (1991) Neuronal Plasticity and Pain Following Peripheral Tissue Inflammation or Nerve Injury. In: Bond M, Charlton E, Woolf CJ (eds), Proceedings of Vth World Congress on Pain. Pain Research and Clinical Management, vol 5. Elsevier, Amsterdam, pp 263–276
4. Head H (1920) *Studies in Neurology*. Oxford University Press, London
5. Landau W, Bishop GH (1953) Pain from Dermal, Periosteal, and Fascial Endings and from Inflammation. *Archives of Neurology and Psychiatry* 69: 490–504
6. Lewis T, Pochin EE (1938) The Double Response of the Human Skin to a Single Stimulus. *Clin Sci* 3: 67–76
7. Noordenbos W (1959) Pain. Elsevier, Amsterdam
8. Price DD (1972) Characteristics of Second Pain and Flexion Reflexes Indicative of Prolonged Central Summation. *Exp Neurol* 37:371–387
9. Price DD (1999) Psychological Mechanisms of Pain and Analgesia. IASP Press, Seattle, p 250
10. Price DD, Hu JW, Dubner R, Gracely R (1977). Peripheral Suppression of First Pain and Central Summation of Second Pain Evoked by Noxious Heat Pulses. *Pain* 3:57–68
11. Price DD, Frenk H, Mao J, Mayer DJ (1994) The NMDA Receptor Antagonist Dextromethorphan Selectively Reduces Temporal Summation of Second Pain. *Pain* 59:165–174
12. Thompson SWN, Woolf CJ (1990) Primary Afferent-Evoked Prolonged Potentials in the Spinal Cord and their Central Summation: Role of the NMDA Receptor. In: Bond MR, Carlton J, Woolf CJ (eds) Proceedings of the VIth World Congress on Pain. Elsevier, Amsterdam, pp 291–298
13. Tommerdahl M, Delemos KA, Vierck CJ, Favorov OV, Whitsel BL (1996) Anterior Parietal Cortical Response to Tactile and Skin Heating Stimulation. *J Neurophysiol* 75(6):2662–2670
14. Zotterman Y (1933) Studies in the Peripheral Nervous Mechanisms of Pain. *Acta Medica Scand* 80:185–242

## First Pain

### Definition

First pain is a rapid onset, sharp, pricking noxious sensation that is associated with the activation of A $\delta$  nociceptors. When a noxious stimulus is sufficient to activate both A $\delta$  and C nociceptors, first pain is perceived before second pain due to differences in nerve conduction velocity.

- ▶ [Encoding of Noxious Information in the Spinal Cord](#)
- ▶ [First and Second Pain Assessment \(First Pain, Pricking Pain, Pin-Prick Pain, Second Pain, Burning Pain\)](#)
- ▶ [Opioids, Effects of Systemic Morphine on Evoked Pain](#)

## First Pain Assessment

- ▶ [First and Second Pain Assessment \(First Pain, Pricking Pain, Pin-Prick Pain, Second Pain, Burning Pain\)](#)

## First-Pass Metabolism

### Definition

The first-pass metabolism describes the transformation of the active drug after absorption prior to reaching the systemic circulation, i.e. pre-systemic elimination of the drug. It mainly occurs after oral or deep rectal administration and can be avoided by intravenous, intramuscular, sublingual, buccal or topical administration.

- ▶ NSAIDs, Pharmacokinetics

## Fit of Pain

- ▶ Pain Paroxysms

## Fitness Training

- ▶ Physical Exercise

## Flare

- ▶ Nociceptor, Axonal Branching

## Flare, Flare Response

### Definition

Flare is a vascular reaction in the skin triggered by vasoactive neuropeptides released at the peripheral endings of activated nociceptors (neurogenic inflammation response). Flare is mediated by a peripheral axon reflex following activation of a subpopulation of C nociceptors by a noxious stimulus. Activation of one branch of a nociceptor results in antidromic spread of the action potential to the terminals of adjacent branches, resulting in an area of flare often much larger than the actual injured area. The flare is characterized by an even central area of reddening that leads to irregular borders with isolated dots of vasodilation spreading out from the border.

- ▶ Nociceptor, Axonal Branching
- ▶ Polymodal Nociceptors, Heat Transduction
- ▶ Quantitative Thermal Sensory Testing of Inflamed Skin

## Flexion Exercise

- ▶ Exercise

## Flexion Withdrawal Reflex

### Definition

This reflex is a protective reflex usually elicited in the lower limb, and was originally described by Charles Sherrington as 'the withdrawal of a limb from an offending stimulus'. As originally characterized, it involved the activation of flexor muscles via a group of afferent nerve fibers called 'flexor reflex afferents', and corresponding inhibition of extensor muscles. However, more recent research has revealed that the flexion withdrawal reflex has a more complex modular organization, its activation being contingent upon the area of skin being stimulated. Nevertheless, in the adult, the nociceptive (i.e. produced by noxious stimuli) flexion withdrawal reflex has proved invaluable as a model of pain processing, and shows a clear correlation with pain perception in terms of threshold, peak intensity, and sensitivity to analgesics. However, in the newborn infant, the flexion withdrawal reflex can also be evoked with low intensity mechanical stimuli to the foot, such as calibrated monofilaments (also called von Frey hairs), and has a much lower threshold than the nociceptive flexion withdrawal reflex in the adult.

- ▶ Infant Pain Mechanisms

## Flinching

### Definition

At its most vigorous, flinching of the paw and/or hindquarters is paw shaking, and when less vigorous, is rapid paw lifting. It is observed as drawing of the paw under the body and rapidly vibrating it, and this causes a shudder or rippling motion across the back and is easy to observe even when the paw is not visible. Each episode is recorded as a single flinch.

- ▶ Formalin Test

## Flip-Flop Isoform of AMPA Receptors

### Definition

AMPA receptors have four subunits named GluR1-4 (or GluRA-D), respectively. Each subunit of the AMPA receptor exists in two isoforms, so called "flip" and "flop" due to alternative splicing of a 115-base pair region encoding 38 amino acid residues immediately preceding the predicted fourth membrane domain. The flip and flop isoforms of AMPA receptors may be differentially involved in pain transmission and response to injury.

- ▶ Descending Circuitry, Molecular Mechanisms of Activity-Dependent Plasticity

## Flunarizin

### Definition

Helpful for prophylaxis of migraine in rheumatologic patients.

- ▶ Headache Due to Arteritis

## Fluorocitrate

### Definition

Fluorocitrate blocks the activation of glial cells, without directly affecting neurons, and functions to inhibit the activity of aconitase, an enzyme in the Krebs cycle of glia, but not neurons. Peri-spinal administration of fluorocitrate blocks exaggerated pain.

- ▶ Cord Glial Activation

## Flurbiprofen

### Definition

Flurbiprofen is a non-steroid anti-inflammatory drug (NSAID), which inhibits the formation of prostaglandins by cyclooxygenase. It is selective for COX-1; thus inhibits COX-1 at lower concentrations than COX-2.

- ▶ Cyclooxygenases in Biology and Disease

## fMRI

- ▶ Functional Magnetic Resonance Imaging

## fMRI Imaging and PET in Parietal Cortex

- ▶ PET and fMRI Imaging in Parietal Cortex (SI, SII, Inferior Parietal Cortex BA40)

## FMS

- ▶ Muscle Pain, Fibromyalgia Syndrome (Primary, Secondary)

## Focal Pain

### Definition

Focal pain is that which is experienced at one site, superficial to the underlying nociceptive lesion.

- ▶ Cancer Pain, Goals of a Comprehensive Assessment

## Focused Analgesia

### Definition

Focused analgesia is based on increased and directed attention to that part of the body for which suggestions of analgesia have been given. For example, suggestions for numbness in the hand may produce the experience of numbness as well as reduced pain sensation.

- ▶ Hypnotic Analgesia

## Follicular Phase

### Definition

The follicular phase is the time during which a single dominant ovarian follicle develops. The follicle should be mature at midcycle for ovulation. The average length of this phase is about 10–14 days. Variability in the length of this phase is responsible for variations in total cycle length.

- ▶ Premenstrual Syndrome

## Forced Choice Procedure

### Definition

Forced choice procedure is a statistical decision theory method in which a sensory decision is made after two or more stimulus presentations.

- ▶ Statistical Decision Theory Application in Pain Assessment

## Forearm Ischemia Procedure

- ▶ Tourniquet Test

## Forearm Occlusion Pain

- ▶ Tourniquet Test

## Forebrain

### Definition

Forebrain is the part of the brain including the cerebral cortex, limbic system and hypothalamus.

- ▶ Forebrain Modulation of the Periaqueductal Gray



## Forebrain Modulation of the Periaqueductal Gray

MATTHEW ENNIS<sup>1</sup>, YI-HONG ZHANG<sup>1</sup>,  
ANNE Z. MURPHY<sup>2</sup>

<sup>1</sup>Department of Anatomy and Neurobiology,  
University of Tennessee Health Science Center,  
Memphis, TN, USA

<sup>2</sup>Department of Biology, Center for Behavioral  
Neuroscience Georgia State University, Atlanta, GA,  
USA

mennis@utmem.edu, yzhang32@utmem.edu,  
amurphy@gsu.edu

### Definition

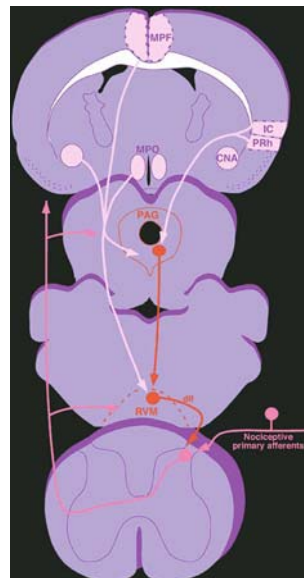
The ► **brainstem** circuits mediating descending modulation of ► **nociception** and opiate receptor-dependent analgesia involve at least 2 critical components, the mid-brain ► **periaqueductal gray** (PAG) and the ► **rostral ventromedial medulla** (RVM). The PAG projects heavily and directly to the RVM, which in turn projects to the ► **dorsal horn** of the spinal cord (SC). The descending PAG-RVM-SC circuit has dominated research in the pain field for at least 3 decades. It is well known that emotional, motivational and cognitive factors modulate the sensation of pain. How these factors, classically associated with higher order cortical and subcortical ► **forebrain** regions, modulate nociception is not known. Numerous anatomical studies demonstrate that PAG afferents arise predominantly in the forebrain. Notably, the PAG receives significant innervation from a number of cortical and subcortical sites involved in nociception. These forebrain projections terminate with a high degree of topographical specificity, forming sets of longitudinal input columns extending focally throughout the rostrocaudal extent of the PAG. Many forebrain input columns innervate and activate equally well-organized longitudinal columns of PAG output neurons projecting to the ventral medulla. More strikingly, several of these same forebrain structures send parallel projections to the other major brainstem node in the descending pain regulatory system, the RVM. These sites include the medial preoptic area (MPO), central nucleus of the amygdala (CNA) and certain medial prefrontal cortical fields. In this article, evidence for forebrain modulation of the PAG-RVM-SC circuit is reviewed.

### Characteristics

#### Bi-Directional Modulation of Nociception by the PAG-RVM-spinal Cord Circuit

The seminal study of Reynolds (1969) demonstrated that electrical stimulation of the PAG produced analgesia. This report was followed by a wealth of research that firmly established the PAG as a major node in the descending pain inhibitory network (Fields et al.

1991; Behbehani 1995). In addition to ► **stimulation-produced analgesia**, the PAG is also a crucial neural substrate for ► **opioid analgesia**. Administration of ► **morphine** or mu ► **opioid** receptor agonists into the PAG produces potent analgesia that is blocked by central or systemic administration of the opioid receptor antagonist naloxone (Jensen and Yaksh 1986). Later studies of PAG-mediated analgesia showed that stimulation of the PAG activates neurons in the RVM and that RVM, but not PAG, neurons project to the spinal cord (*via* the dorsolateral funiculus) to inhibit dorsal horn neurons involved in pain transmission (see Fig. 1) (Fields et al. 1991; Behbehani 1995). Collectively, we define the RVM as the region encompassing the nucleus raphe magnus (NRM), the nucleus gigantocellularis pars alpha and the rostral portion of the nucleus paragigantocellularis medially adjacent to the facial nucleus. The nucleus gigantocellularis proper, which exerts ► **Descending Facilitation**, is dorsolaterally adjacent to the RVM. The RVM is critical for PAG evoked analgesia; lesions of the RVM or transection of the dorsolateral funiculus block analgesia elicited by activation of, or microinjection of opiates into, the PAG (Fields et al. 1991; Behbehani 1995).



**Forebrain Modulation of the Periaqueductal Gray, Figure 1** Schematic diagram showing the main components of the brainstem descending pain modulatory circuit and forebrain sites that regulate this circuit. Nociceptive input to the spinal cord terminates primarily in the dorsal horn and then ascends; this information is routed, among other areas, to the medullary region including the RVM and to the PAG as well as to the thalamus (not shown). The descending PAG-RVM circuit modulates spinal cord dorsal horn neuronal responses to nociceptive afferent input. The PAG receives dense projections from the forebrain including the medial prefrontal cortex (MPF, including orbital, medial precentral, anterior cingulate and infralimbic cortices), the lateral cortex (including insular [IC] and perirhinal [PRh] cortices), the central nucleus of the amygdala (CNA) and the hypothalamus (including the medial preoptic area [MPO]). Some of these areas also give rise to a parallel projection to the RVM. Dif, dorsolateral funiculus.

Growing evidence suggests that the PAG and RVM, as well as other central sites, give rise to descending facilitatory influences on dorsal horn neuronal responses to nociceptive stimuli (Zhuo and Gebhart 1997). Therefore, the influence of these structures on nociception can be bidirectional. Thus, in some circumstances, activation of certain subpopulations of PAG or RVM neurons may produce analgesia (i.e. ► [descending inhibition](#)) or hyperalgesia (descending facilitation). Whether inhibition or facilitation of nociception is produced by PAG or RVM stimulation may depend on the strength of stimulation and specific location of the stimulation site (Zhuo and Gebhart 1997). Recent studies demonstrate that the balance of descending inhibition and facilitation is dynamically regulated by persistent pain as occurs during inflammation (Terayama et al. 2000).

#### Descending Inputs to the PAG from the Forebrain

In the 1980s and 1990s, tract-tracing studies from a number of laboratories (e.g. Beitz 1982; Shipley et al. 1991) revealed an important feature of the PAG; afferent inputs to the PAG arise from a staggering number of cortical and subcortical forebrain sites. Over this same period, there has been a growing recognition that the PAG itself is far more complex than initially suspected and is clearly involved in many more functions than nociception. For example, stimulation of different columnar organized regions of the PAG produces a number of distinctly different behavioral and physiological responses including vocalization, autonomic changes, sexual/reproductive behaviors and fear and rage reactions (for review see Shipley et al. 1991; Bandler and Shipley 1994; Behbehani 1995; Ennis et al. 1997; Shipley et al. 1996). Not surprisingly, many of the forebrain sites that project to the PAG are also known to regulate similar functions. Based on these findings, the authors and others have adopted a more integrative conceptual framework guided by the working hypothesis that the PAG is a structure that plays a central role in the production of certain stereotypical behaviors (e.g., reproduction, defense reactions, vocalization) essential to the animal's survival. These behaviors require rapid, profound autonomic adjustments and simultaneously, significant alterations in pain thresholds. From this perspective, it is reasonable to consider that more highly elaborated forebrain structures interact with the PAG to coordinate antinociceptive, behavioral and autonomic responses in concert with the dominant role of the forebrain in cognitive and emotional processing. Descending PAG output neurons also exhibit columnar organization, such that different output columns terminate with medial to lateral specificity in the ventral medulla in sites involved in nociception, autonomic responses, sexual/reproductive behaviors and vocalization (Rizvi et al. 1996; Ennis et al. 1997; Shipley et al. 1996). Taken together, these findings suggest that forebrain sites may trigger or modulate specific nociceptive

and autonomic adjustments *via* activation of discrete columns of PAG output neurons. The present review focuses on forebrain inputs as they relate to nociception and regulation of the PAG-RVM-SC network.

#### Forebrain Inputs to PAG: Columnar Organization

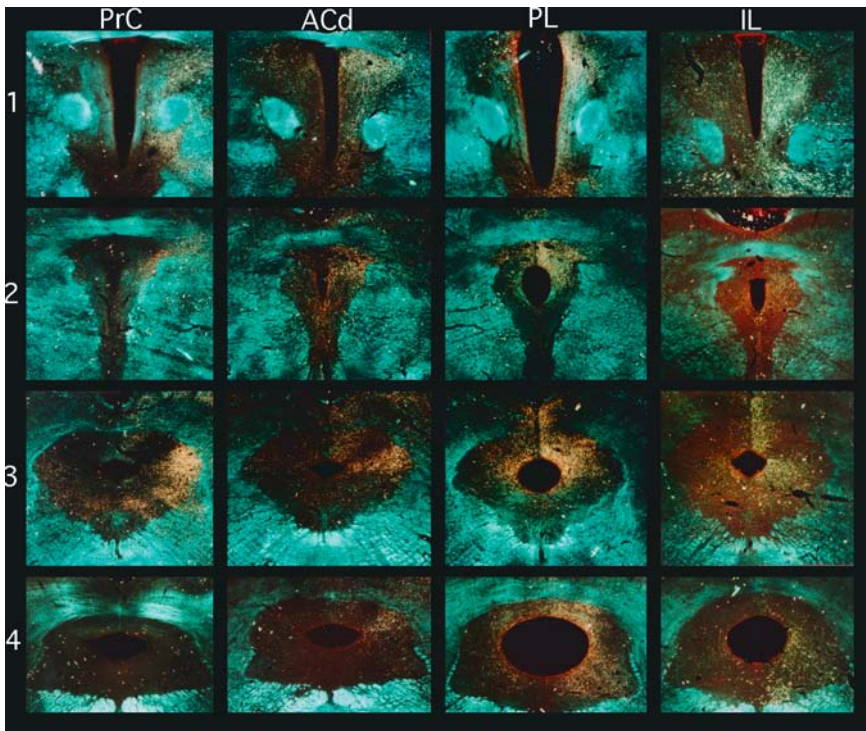
Tract-tracing studies over the last 15 years have revealed that forebrain inputs to the PAG are much heavier than previously suspected and terminate with a remarkable degree of topographic specificity. Consideration of the impressive list of forebrain inputs to the PAG is beyond the scope of this chapter. Instead, forebrain inputs arising from the prefrontal cerebral cortex, amygdala and hypothalamic preoptic area that have been studied in detail (Figs. 1, 2) will be discussed.

#### Prefrontal Cortex

The PAG receives dense inputs from large groups of neurons in the orbital, medial prefrontal and lateral (insular and perirhinal) cortices (Bietz 1982; Shipley et al. 1991; Floyd et al. 2000). In total, inputs to the PAG arise from at least 8 distinct cytoarchitectonic fields in the medial prefrontal and lateral cortices (Shipley et al. 1991). Retrograde tracing demonstrated that projections to the PAG from the cerebral cortex arise from all fields of the medial prefrontal cortex (infralimbic, prelimbic, anterior cingulate, and precentral medialis). Equally extensive projections arise from the lateral suprarhinal (insular cortex) and perirhinal cortical areas. Anterograde tracing showed that the pattern of terminal labeling from each medial or lateral cortical field is highly organized and selectively targets discrete, columnar subregions of the PAG along its entire rostrocaudal axis. Inputs from different cortical fields terminate as different, largely complementary, longitudinal columns (Fig. 2). Imaging studies in humans have shown that anterior cingulate and insular orbital cortices are consistently activated by the sensory-perceptual and affective (i.e. emotional or unpleasant) aspects of pain (Price 2000; Rolls et al. 2003). Analgesia, including opiate receptor dependent analgesia, can be elicited from the anterior cingulate and insular cortices (see Shipley et al. 1991; Burkey et al. 1996), and both areas are activated in humans following opioid or placebo treatment (Petrovic et al. 2002).

#### Medial Preoptic Area

The MPO-PAG projection is very dense and exhibits columnar organization. This projection arises from neurons in several cytoarchitectonically distinct subdivisions of the MPO, including the sexually dimorphic medial preoptic nucleus. Injections of anterograde tracers into the MPO label dense, highly organized and topographically specific projections to the PAG. A hallmark of this projection, like other forebrain inputs studied to date, is that it forms longitudinally organized input columns that selectively target dis-



**Forebrain Modulation of the Periaqueductal Gray, Figure 2** Micrographs comparing the complementary innervation patterns from medial prefrontal cortical fields at four rostrocaudal levels of PAG (1 rostral to 4 caudal). Left to right columns show labeling at each of the 4 rostrocaudal levels from the medial precentral cortex (PrC), anterior cingulate cortex pars dorsalis (ACd), prelimbic cortex (PL) and infralimbic cortex (IL). Each cortical field terminates in a longitudinal manner, forming rostrocaudally-organized columns that target discrete subdivisions throughout much of the PAG. Note that the input patterns are largely complementary and exhibit rostral to caudal, radial (i.e. central to peripheral) and columnar specificity. For example the input from PL heavily targets the central, circumaqueductal portions of the PAG, while inputs from the PrC avoid this region. There is some overlap among these cortical inputs. For example, both the PL and the IL terminate in the dorsomedial region, especially at mid- to caudal-levels of the PAG.

F

crete subregions of the PAG (i.e. the dorsomedial and lateral/ventrolateral PAG) along its rostrocaudal axis. Activation of the MPO also activates longitudinally organized columns of PAG neurons, including those that project to the ventral medulla (Rizvi et al. 1996). The MPO is sexually dimorphic and plays a key role in neuroendocrine and steroidal regulation and maternal/reproductive behaviors. Nociceptive thresholds shift across the estrus cycle, with steroid hormone administration and during reproductive activities (see ► [sex differences in descending pain modulatory pathways](#)). Both the MPO and the PAG contain high levels of estrogen and androgen receptors (see ► [sex differences in descending pain modulatory pathways](#)). In this regard, it is interesting to note that there are sex differences in pain thresholds as well as sex differences in how inflammatory pain activates the PAG-RVM circuit (see Murphy, 2004). The MPO therefore, may provide a key link mediating hormonal influences on nociceptive thresholds and may also regulate descending nociception during maternal/reproductive behaviors (Murphy et al. 1999). Consistent with this hypothesis, stimulation of the MPO activates PAG neurons that project to the RVM (Rizvi et al. 1996), inhibits dorsal horn spinal cord neuronal responses to nociceptive stimuli and also elicits analgesia (see Shipley et al. 1991; Zhang and Ennis 2005).

#### Central Nucleus of the Amygdala

Projections to the PAG arise predominantly from the medial division, but also from the lateral division of the

CNA. Like the MPO, the CNA projects in a columnar manner to the PAG (Shipley et al. 1991). Additionally, a substantial population of PAG neurons project to the CNA. The CNA projection terminates as rostrocaudally oriented input columns that focally target different PAG subdivisions (Fig. 1). The dorsomedial and lateral/ventrolateral subdivisions are especially heavily targeted (Shipley et al. 1991). The CNA is a key component of circuits involved in defense reactions, as well as the mediation of both conditioned and innate fear related responses. In this regard, it is noteworthy that conditioned and unconditioned fear and aversive responses are accompanied by antinociception (Helmstetter and Tershner 1994). Stimulation of the CNA produces analgesia (Shipley et al. 1991; Oliveira and Prado 2001) and the CNA is involved in analgesia elicited by systemically administered opiates (Manning and Mayer 1995). It is reasonable to speculate, therefore, that CNA projections to the PAG may mediate antinociceptive responses that accompany fear and aversive responses. In agreement with this hypothesis, lesions of the PAG and RVM attenuate analgesia associated with aversive conditioned responses (Helmstetter and Tershner 1994) and PAG lesions block CNA stimulation produced analgesia (Oliveira and Prado 2001).

#### Direct Forebrain Modulation of RVM?

In addition to the PAG, several forebrain regions also send a dense, parallel projection that directly targets the RVM. For example, the MPO, which densely inner-



vates the PAG, also projects heavily to the RVM (Fig. 1) (Murphy et al. 1999). Retrograde tracer injections in the RVM produced intense retrograde labeling in both the median preoptic nucleus and the MPO. Anterograde tracer injections into the MPO produce robust terminal labeling in the PAG as described above and simultaneously, dense labeling throughout the RVM (Murphy et al. 1999). These results suggest that at least some forebrain sites projecting to the PAG have a parallel, direct projection to the RVM. In addition to the MPO, other sites reported to project to the PAG and RVM include additional hypothalamic nuclei (Murphy et al. 1999), the CNA, the anterior cingulate cortex and the insular cortex.

The role of parallel projections from many of these forebrain sites to the PAG/RVM in the modulation of nociception is unknown. An important question is if these parallel projections to the PAG and RVM arise from the same or different forebrain neurons? If, for example, neurons in individual forebrain sites such as the MPO collateralized to both the PAG and the RVM, this would suggest that there is coordinate regulation of the PAG-RVM-spinal cord system by forebrain structures that are known to influence nociception. On the other hand, if projections to the PAG and RVM arise from different populations of neurons, this would suggest that there are independent channels for modulation of discrete components of the PAG-RVM-SC circuit. This would allow, for example, differential activation of pathways to the PAG and the RVM depending upon behavioral state, sensory processing, cognition and emotional responses. Another question is the manner in which activation of these forebrain-PAG-RVM-SC and forebrain-RVM-SC pathways modulate nociception. Do these parallel pathways represent a hardwired redundancy as in other sensory systems or alternatively might these pathways exert different functional roles? Recent electrophysiological studies may provide insights into this issue (Jiang and Behbehani 2001). These studies show that activation of the MPO modulates the activity of neurons in the RVM. Many RVM units continue to be modulated by MPO activation after synaptic block of the PAG; however, with the PAG functionally intact, MPO stimulation causes more long lasting modulation of the firing rates of RVM cells. These results suggest that the MPO-PAG-RVM circuit may amplify both the magnitude and duration of the direct MPO-evoked modulation of RVM neurons. Based on this, it is reasonable to hypothesize that direct forebrain-RVM projections may induce weak and/or brief duration modulation of nociception, while activation of the forebrain-PAG-RVM circuit may amplify both the magnitude and duration of such modulation.

### Summary

The PAG and the RVM are major nodes for bi-directional modulation of nociception and spinal cord neuronal re-

sponses to noxious sensory input. The PAG-RVM circuit is demonstrably central to analgesia elicited by activation of endogenous opioidergic systems as well as that resulting from systemically administered opioids. Nociceptive regulation is but one aspect of this circuit as the PAG is clearly a highly organized structure that integrates defensive, fear/anxiety and hormonal/reproductive behaviors in discrete columns that extend longitudinally through the structure. These columns receive dense and topographically specific input from cortical and subcortical forebrain areas centrally involved in these same functions. Some forebrain areas also project in parallel to the RVM and the functional significance of such dual projections is not known. In humans, whose behavior is dominated by the massive and highly elaborated forebrain, the projections to the PAG and RVM are likely to regulate nociception in concert with forebrain mediated cognitive and emotional processing of pain and its perceived impact.

### References

1. Bandler R, Shipley MT (1994) Columnar organization in the midbrain periaqueductal gray: modules for emotional expression? *Trends Neurosci* 17:379–389
2. Behbehani MM (1995) Functional characteristics of the midbrain periaqueductal gray. *Prog Neurobiol* 46:575–605
3. Beitz AJ (1982) The organization of afferent projections to the periaqueductal gray of the rat. *Neurosci* 7:133–159
4. Burkey AR, Carstens E, Wenniger JJ et al. (1996) An opioidergic cortical antinociception triggering site in the agranular insular cortex of the rat contributes to morphine antinociception. *J Neurosci* 16:6612–6623
5. Ennis M, Xu S-J, Rizvi TA (1997) Discrete subregions of the rat midbrain periaqueductal gray project to nucleus ambiguus and the periambigual region. *Neurosci* 80: 829–845
6. Fields HL, Heinricher MM, Mason P (1991) Neurotransmitters in nociceptive medullary circuits. *Ann Rev Neurosci* 14: 219–245
7. Floyd NS, Price JL, Ferry AT et al. (2000) Orbitomedial prefrontal cortical projections to distinct longitudinal columns of the periaqueductal gray in the rat. *J Comp Neurol* 422:556–578
8. Helmstetter FJ, Tershner SA (1994) Lesions of the periaqueductal gray and rostral ventromedial medulla disrupt antinociceptive but not cardiovascular aversive conditional responses. *J Neurosci* 14: 3099–7108
9. Jensen TS, Yaksh TL (1986) III. Comparison of the antinociceptive action of mu and delta opioid receptor ligands in the periaqueductal gray matter, medial and paramedial ventral medulla in the rat as studied by microinjection technique. *Brain Res* 372:301–312
10. Jiang M, Behbehani MM (2001) Physiological characteristics of the projection pathway from the medial preoptic to the nucleus raphe magnus of the rat and its modulation by the periaqueductal gray. *Pain* 94:139–147
11. Manning BH, Mayer DJ (1995) The central nucleus of the amygdala contributes to the production of morphine antinociception in the rat tail flick test. *J Neurosci* 15:8199–8213
12. Murphy AZ, Rizvi TA, Ennis M et al. (1999) The organization of preoptic-medullary circuits in the male rat: evidence for interconnectivity of neural structures involved in reproductive behavior, antinociception and cardiovascular regulation. *Neuroscience* 91:1103–1116
13. Oliveira MA, Prado WA (2001) Role of the PAG in the antinociception evoked from the medial or central amygdala in rats. *Brain Res Bull* 54:55–63



14. Petrovic P, Kalso E, Petersson KM et al. (2002) Placebo and opioid analgesia—imaging a shared neuronal network. *Science* 295:1737–1740
15. Price DD (2000) Psychological and neural mechanisms of the affective dimension of pain. *Science* 288:1769–1772
16. Reynolds DV (1969) Surgery in the rat during electrical analgesia induced by focal brain stimulation. *Science* 164:444–445
17. Rizvi TA, Ennis M, Murphy AZ et al. (1996) Medial preoptic afferents to periaqueductal gray medullo-output neurons: a combined Fos and tract tracing study. *J Neurosci* 16:333–344
18. Rolls ET, O'Doherty J, Kringelbach ML et al. (2003) Representations of pleasant and painful touch in the human orbitofrontal and cingulate cortices. *Cerebral Cortex* 13:308–317
19. Shipley MT, Ennis M, Rizvi TA et al. (1991) Topographical specificity of forebrain inputs to the midbrain periaqueductal gray: evidence for discrete longitudinally organized input columns. In: Depaulis A, Bandler R (eds) *The Midbrain Periaqueductal Gray Matter*. Plenum Press, New York, pp 417–448
20. Shipley MT, Murphy AZ, Rizvi TA et al. (1996) Olfaction and brainstem circuits of reproductive behavior in the rat. *Progress in Brain Research*. Holstege G, Bandler R, Saper CB (eds) *The emotional motor system*, vol 107. Elsevier, Amsterdam, New York, pp 355–377
21. Terayama R, Guan Y, Dubner R et al. (2000) Activity-induced plasticity in brain stem pain modulatory circuitry after inflammation. *Neuroreport* 26:1915–1919
22. Zhang Y-H, Ennis M (2005) Activation of the rat medial preoptic area elicits analgesia: role of the periaqueductal gray. *Soc Neurosci Abstr*
23. Zhuo M, Gebhart GF (1997) Biphasic modulation of spinal nociceptive transmission from the medullary raphe nuclei in the rat. *J Neurophysiol* 78:746–758

## Formalin Test

TERENCE J. CODERRE<sup>1</sup>, FRANCES V. ABBOTT<sup>2</sup>, JANA SAWYNOK<sup>3</sup>

<sup>1</sup>Department of Anesthesia Neurology, Neurosurgery and Psychology McGill University, Montreal, QC, Canada

<sup>2</sup>Department of Psychiatry and Psychology, McGill University, Montreal, QC, Canada

<sup>3</sup>Department of Pharmacology, Dalhousie University, Halifax, NF, Canada  
terence.coderre@mcgill.ca

### Synonyms

Nociception induced by injection of dilute formaldehyde

### Definition

The formalin test refers to the quantification of ► **spontaneous nociceptive behaviors**, which occur in response to subcutaneous (s.c.) or intradermal injection of a dilute solution of formaldehyde in 0.9 % saline, typically into the dorsal or plantar hindpaw of rodents.

### Characteristics

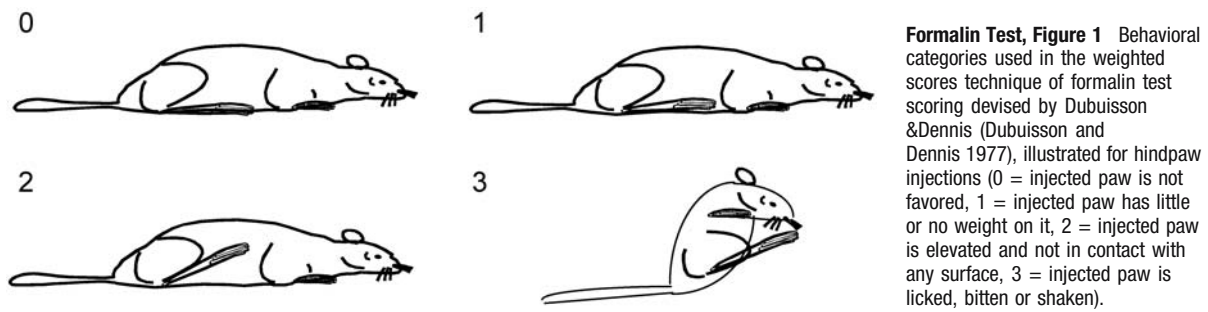
The formalin test was originally described by Dubuisson and Dennis (Dubuisson and Dennis 1977) using 50 µl of 5 % formalin injected s.c. into the dorsal surface of one forepaw in rats and cats. “5 % Formalin” consisted of

1 ml of saturated formaldehyde (37 %) in water + 19 ml 0.9 % saline (i.e. 1.85 % formaldehyde). It is now more common to inject between 0.2 % and 5 % formalin into the dorsal or plantar hindpaw, using 20–50 µl in rats or 10–25 µl in mice. Another common site is the lateral aspect of the muzzle, or the temporomandibular joint, in rats, as a model of orofacial pain (Clavelou et al. 1995). The hindpaw has replaced the forepaw as a preferred site, because rats and mice frequently lick the forepaw in normal grooming. The formalin test has also been used in other species, including guinea pigs, rabbits, primates, crocodiles, domestic fowl and octodon degus (Tjølsen et al. 1992).

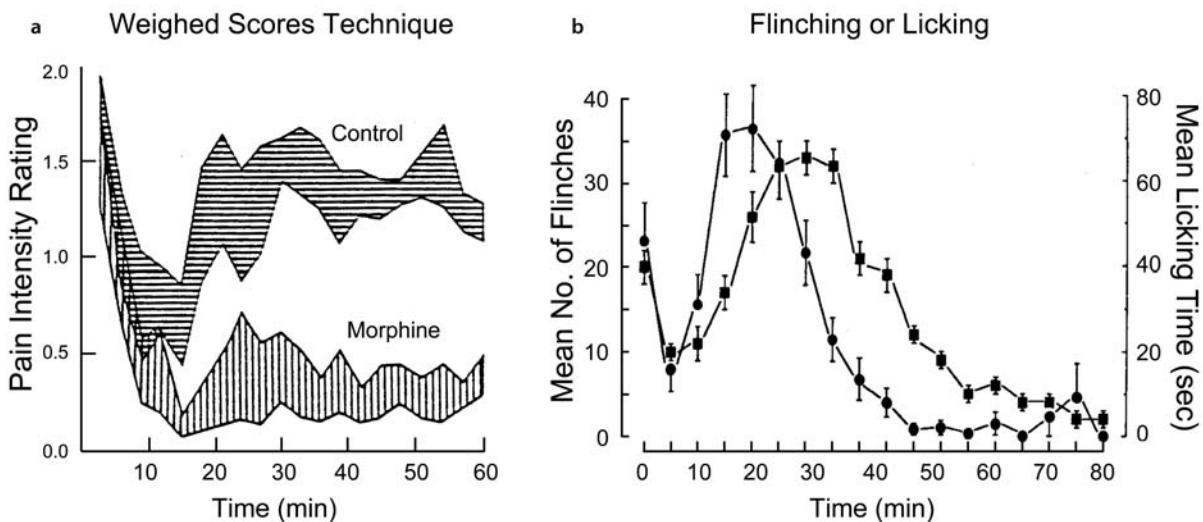
Nociceptive behaviors increase with formalin concentration in rats and mice, but reach a plateau between 2 to 5 % formalin regardless of the scoring method used (see below) (Tjølsen et al. 1992; Coderre et al. 1993; Abbott et al. 1995, Sawynok and Liu 2004). With further increases in concentration, the magnitude and duration of the behavioral response is not increased; rather the animal's behavior becomes more disorganized, and the nociceptive scores may actually fall. Formalin concentrations of 1 % or less are useful for detecting the actions of weak analgesic agents, avoiding ceiling effects (Abbott et al. 1995; Sawynok and Liu 2003).

Factors which influence the magnitude of the response include the site of injection (plantar injections produce greater responses), age of the animal (pain is higher in infant rats), the strain, the degree to which the animal is habituated to handling, and the testing environment (unfamiliar environments produce stress analgesia), level of morbidity (e.g. time since surgery), temperature of the animal colony and the testing environment (heat increases peripheral blood flow and the inflammatory response). Other environmental factors, such as sounds, odors, light, atmospheric pressure or even activity of humans in the test room can also influence the expression of nociceptive behaviors. Formalin concentrations should be decided on the basis of the scientific objectives of the study, with adjustments for the response of animals under the conditions prevailing at the laboratory (Tjølsen et al. 1992; Sawynok and Liu 2003). For ethical reasons, the lowest possible concentration of formalin consistent with scientific objectives should be used.

Dubuisson and Dennis (Dubuisson and Dennis 1977) quantified formalin nociception using a ► **weighted scores technique** (WST), which involves assigning weights to each behavioral category measured (paw favoring, paw elevation, licking, biting or shaking of the paw) (Fig. 1 and Fig. 2a). The ordinality and validity of the category weights in the WST have been well established in rats (Coderre et al. 1993; Abbott et al. 1995). Others have used single behavioral scoring methods, including recording of the time spent licking/biting the injected paw (Hunnskaar et al. 1985) or counting the number of flinches (Wheeler-Aceto 1991) (Fig. 2b), or have used automated scoring techniques (Jourdan et



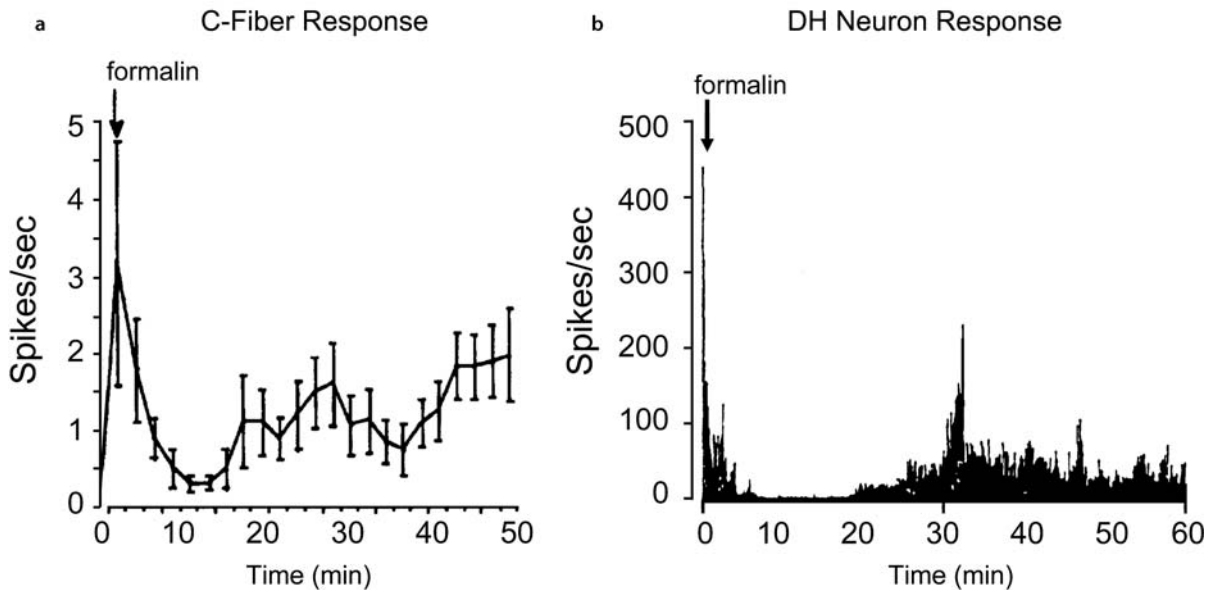
**Formalin Test, Figure 1** Behavioral categories used in the weighted scores technique of formalin test scoring devised by Dubuisson & Dennis (Dubuisson and Dennis 1977), illustrated for hindpaw injections (0 = injected paw is not favored, 1 = injected paw has little or no weight on it, 2 = injected paw is elevated and not in contact with any surface, 3 = injected paw is licked, bitten or shaken).



**Formalin Test, Figure 2** Time course of nociceptive responses after injection of 5% formalin in rats. (a) Pain intensity ratings using the weighted scores technique. (b) Number of flinches (closed squares) and time spent licking (closed circles). Note that all three measures illustrate the biphasic nature of nociceptive responses. Modified with permission from A) Dubuisson & Dennis (Dubuisson and Dennis 1977) and B) Wheeler-Aceto & Cowan (Wheeler-Aceto and Cowan 1991).

al. 2001). Parametric analysis suggests that the WST is superior to any single nociceptive measure; however, it is clear that assessment of paw favoring adds little to the equation, and may be omitted from the analysis (Abbott et al. 1995). Paw licking/biting scores are commonly used in the mouse formalin test, since these behaviors predominate in mice and are easily quantified. It has been argued that **flinching** is more robust, and less influenced by treatments affecting other behaviors (e.g. motor function), while licking/biting is regarded as being more variable and subject to motor influences, stereotypy and perhaps taste aversion following earlier licking episodes (Wheeler-Aceto 1991). Flinching and licking/biting may reflect distinct neuronal mechanisms, as they can be differentially modulated by certain drugs and procedures (e.g. amitriptyline and naloxone decrease licking/biting behaviors, while simultaneously increasing flinching behaviors (Sawynok and Liu 2003). Concerning validation, the formalin concentration-response relationship, and the analgesic effects of opioids, has been examined for most scoring methods. However, few studies have determined whether nociceptive scores are suppressed by agents known not

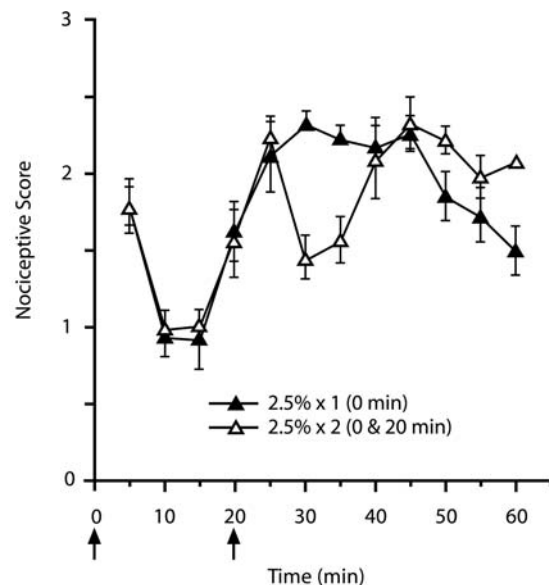
to be analgesic in humans. The latter is particularly important, because sedation and other toxic effects can appear as analgesia. When different behaviors compete (e.g. a rat cannot favor its paw at the same time as licking it), then the interpretation of the change depends on whether one behavior represents more pain than another. This is problematic for some scoring methods, because a decrease in a behavior considered to represent more pain may occur because of drug side effects (Abbott et al. 1995). On the other hand, the selection of scoring method may also depend on other factors, such as the drug administration method. For example, in some cases the presence of a chronic intrathecal (I.T.) cannula can eliminate the expression of licking/biting behaviors, yet leave flinching unaltered. This may be the reason why studies using rats and chronic I.T. cannulas (PE-10 tubing) generally do not report licking/biting behaviors as an outcome, yet when drugs are given spinally by acute lumbar puncture, such behaviors are often reported (Sawynok and Reid 2003). An important characteristic of the formalin test is that there are two distinct phases of nociceptive behavior, described as the early and late, or first and second phases.



**Formalin Test, Figure 3** Time course of (a) mean C-fiber responses in sural nerve and (b) an individual dorsal horn (DH) convergent neuron response to hindpaw formalin injections of 5% formalin in rats. Note the biphasic nature of neuronal responses in both C-fibers and DH neurons. Modified with permission from (a) Puig & Sorkin (Puig and Sorkin 1995) and (b) Dickenson & Sullivan (Dickenson and Sullivan 1987).

The early phase lasts 5–10 min; this is followed by a quiescent interval of 5–10 min, and then a subsequent late phase of activity is observed up to 60–90 min. The biphasic response to formalin is prominent in rats and mice, regardless of the nociceptive scoring method (i.e. WST, flinches, licking/biting, or automated) (Fig. 2), but is less obvious in other species (Tjølsen et al. 1992). The biphasic nature of the formalin response is also observed for heart rate and blood pressure (Taylor et al. 1995), as well as the neuronal activity of A $\delta$ - and C-fiber sensory afferent neurons (Puig and Sorkin 1995) or deep dorsal horn neurons of the spinal cord (Dickenson et al. 1987) (Fig. 3). The two phases of nociceptive activity likely reflect an initial direct activation of nociceptive sensory afferents by formalin, followed by afferent activation produced by inflammatory mediators released following tissue injury (Dubuisson and Dennis 1977, Tjølsen et al. 1992). The late phase may also involve **central sensitization** (Coderre 2001). A quiescent interval in C-fiber and dorsal horn neuron activation (Puig and Sorkin 1995, Dickenson and Sullivan 1987), tends to support the notion that distinct mechanisms underlie the two phases of behavioral and electrophysiological activation. However, the “interphase” also reflects **active inhibition** initiated by processes activated in phase 1. For example, a second formalin injection, administered 20 min. after the initial injection, produces inhibition of behavioral responses and electrophysiological activity, with a time frame that corresponds to the first interphase interval (Fig. 4) (Henry et al. 1999).

Electrophysiological and pharmacological studies suggest that the early phase formalin response depends on both the direct activation of nociceptors, and



**Formalin Test, Figure 4** Effects of one or two injections (20 min. inter-injection interval) of 2.5% formalin into the plantar surface of one hindpaw on nociceptive scores in the formalin test. Filled triangles show the typical biphasic nociceptive response to a single injection. Open triangles show the effects of two injections of formalin. Note the second inhibitory interphase after the second formalin injection in the group that had two injections. Modified with permission from Henry et al. (Henry et al. 1999).

**neurogenic inflammation** generated by the release of bradykinin, 5-hydroxytryptamine, histamine and adenosine triphosphate (Tjølsen et al. 1992; Sawynok and Liu 2003). Formalin might also disrupt the perineurium, and this could enhance the access of tissue mediators to the sensory nerve. The late phase formalin

response depends in part on neurogenic inflammation induced by the above mediators, as well as inflammatory responses associated with the release of cytokines and breakdown of arachidonic acid (Tjølsen et al. 1992; Sawynok and Liu 2003). There is also evidence to suggest that substance P- and glutamate-mediated central sensitization, initiated during the early phase, contributes to nociception in the late phase of the formalin test. This evidence arose from observations that the spinal administration of local anesthetics, opiates, and substance P or glutamate (N-methyl-D-aspartate) receptors antagonists inhibits late responses when given prior to, but not after, the early phase (Dickenson and Sullivan 1987; Coderre 2001). These findings have prompted the extensive use of the formalin test as an animal model for examining the potential of treatments for producing ► [pre-emptive analgesia](#). The mechanisms underlying the active inhibition during the interphase are not completely understood, but probably depend on both spinal and supraspinal influences, since the interphase is still present in spinalized animals, but is eliminated by brain transection at the mesencephalic-diencephalic junction. A role for GABA<sub>A</sub> receptors is suggested, since the interphase is reduced both by spinal administration of GABA<sub>A</sub> receptor antagonists and by systemic administration of low doses of barbiturates (Sawynok and Liu 2003).

While release of inflammatory mediators contributes to formalin-induced nociception, inflammation alone is not sufficient to produce the spontaneous nociceptive behavior induced by formalin. Thus, other inflammatory agents (yeast, carrageenan, complete Freund's adjuvant) produce profound edema, but essentially no spontaneous pain behaviors, and they do not generate high frequency firing of sensory afferents. This implies that activation of nociceptive afferents is a complex process that is to some extent dissociable from inflammatory processes (Sawynok and Liu 2003). Importantly, the inflammatory response to formalin, and the reliance of nociceptive response on inflammation, depends significantly on the concentration and volumes of formalin administered. Assuming that injection volumes are similar, low concentrations of formalin (1–2.5 % formalin or less) produce very little ► [plasma extravasation](#) and oedema, while higher concentrations (5 %) produce significant levels of inflammation, lasting for as long as 1 week after injection. In addition, studies using adult pretreatment with capsaicin (to desensitize C-fibers), and anti-inflammatory drugs (to target ► [non-neurogenic inflammation](#)), suggest that low concentrations of formalin produce effects that depend on neurogenic inflammation, while higher concentrations depend on non-neurogenic inflammation (Sawynok and Liu 2003, Coderre 2001). With higher concentrations of formalin, it is also more difficult to demonstrate a role for central sensitization in the late phase. Thus, nociceptive behaviors produced by

1–2.5 % formalin, but not those produced by 3.75–5 % formalin, are sensitive to pre-emptive effects of spinal administration of local anesthetics (Coderre 2001). The evidence indicating the differing roles of neurogenic and non-neurogenic inflammation with low and high formalin concentrations have been recognized in rats, but not mice. However, it should be noted that the relatively high volumes of formalin injections typically used in mice produce significant inflammation even at low formalin concentrations (reflecting different injection to tissue volume ratios), and might not allow for such a clear distinction.

Formalin injections also activate processes that lead to long-term changes in the central nervous system. Formalin injections lead to the spinal activation of various intracellular signaling molecules, such as cyclic-adenosine monophosphate (cAMP), protein kinase C, nitric oxide, cyclic-guanosine monophosphate (cGMP), mitogen-activated protein kinase (MAPK), cAMP-response element binding protein (CREB), as well as proto-oncogenes and their protein products, including *c-fos*, *c-jun*, Krox-24, Fos, Jun B and Jun D. Formalin injections also produce delayed activation of microglia in spinal cord dorsal horn. These changes may underlie long-term changes in mechanical and thermal sensitivity that occur in sites adjacent to or remote from the injection site, which last from days to weeks after the injection (Sawynok and Liu 2003; Coderre 2001).

- [Cingulate Cortex, Nociceptive Processing, Behavioral Studies in Animals](#)
- [Heritability of Inflammatory Nociception](#)
- [Nociceptive Processing in the Hippocampus and Entorhinal Cortex, Neurophysiology and Pharmacology](#)

## References

1. Abbott FV, Franklin KBJ, Westbrook RF (1995) The Formalin Test: Scoring Properties of the First and Second Phases of the Pain Response in Rats. *Pain* 60:91–102
2. Clavelou P, Dallel R, Orliaguet T, Woda A, Raboisson P (1995) The Orofacial Formalin Test in Rats: Effects of Different Formalin Concentrations. *Pain* 62:295–301
3. Coderre TJ (2001) Noxious Stimulus-Induced Plasticity in Spinal Cord Dorsal Horn: Evidence and Insights on Mechanisms Obtained using the Formalin Test. In: Patterson MM, Grau JW (eds) *Spinal Cord Plasticity: Alterations in Reflex Function*. Kluwer Academic Publishers, Boston, pp 163–183
4. Coderre TJ, Fundytus ME, McKenna JE, Dalal S, Melzack R (1993) The Formalin Test: A Validation of the Weighted-Scored Method of Behavioral Pain Rating. *Pain* 54:43–50
5. Dickenson AH, Sullivan AF (1987) Subcutaneous Formalin-Induced Activity of Dorsal Horn Neurons in the Rat: Differential Response to an Intrathecal Opioid Administered Pre or Post Formalin. *Pain* 30:349–360
6. Dubuisson D, Dennis SG (1977) The Formalin Test: A Quantitative Study of the Analgesic Effects of Morphine, Meperidine, and Brain Stem Stimulation in Rats and Cats. *Pain* 4:161–174
7. Henry JL, Yashpal K, Pitcher GM, Coderre TJ (1999) Physiological Evidence that the “Interphase” in the Formalin Test is Due to Active Inhibition. *Pain* 82:57–63
8. Hunskaar S, Fasmer OB, Hole K (1985) Formalin Test in Mice, A Useful Technique for Evaluating Mild Analgesics. *J Neurosci Methods* 14:69–76



9. Jourdan D, Ardid D, Eschaliere A (2001) Automated Behavioural Analysis in Animal Pain Studies. *Pharmacol Res* 43:103–110
10. Puig S, Sorkin LS (1995) Formalin-Evoked Activity in Identified Primary Afferent Fibres: Systemic Lidocaine Suppresses Phase-2 Activity. *Pain* 64:345–355
11. Sawynok J, Liu XJ (2003) The Formalin Test: Characteristics and Usefulness of the Model. *Rev Analg* 7:145–163
12. Sawynok J, Reid AR (2003) Chronic Intrathecal Cannulas Inhibit Some and Potentiate Other Behaviors Elicited by Formalin Injection. *Pain* 103:7–9
13. Tjølsen A, Berge OG, Hunskaar S, Rosland JH, Hole K (1992) The Formalin Test: an Evaluation of the Method. *Pain* 51:5–17
14. Wheeler-Aceto H, Cowan A (1991) Standardization of the Rat Paw Formalin Test for the Evaluation of Analgesics. *Psychopharmacology* 104:35–44
15. Taylor BK, Peterson MA, Basbaum AI (1995) Persistent Cardiovascular and Behavioral Nociceptive Responses to Subcutaneous Formalin require Peripheral Nerve Input. *J Neurosci* 15:7575–7584

## Forty Hz Oscillations

### Definition

40 Hz Activity is oscillatory activity described in the brain when the organism is actively engaged in a task.

- ▶ [Corticothalamic and Thalamocortical Interactions](#)

## Fos Expression

### Definition

The expression of Fos protein, the gene product of the c-Fos gene. Fos expression in a particular set of central nervous system neurons is often taken to indicate activity of that set of neurons in response to a noxious stimulus.

- ▶ [Visceral Pain Model, Lower Gastrointestinal Tract Pain](#)

## Fos Protein

### Definition

Fos is the protein that is expressed by the c-Fos gene in nociceptive neurons after noxious stimulation. Fos protein is found in the nucleus, where it serves as a transcription factor (third messenger).

- ▶ [Spinal Cord Injury Pain Model, Contusion Injury Model](#)
- ▶ [Spinal Dorsal Horn Pathways, Dorsal Column \(Visceral\)](#)
- ▶ [Spinothalamic Tract Neurons, Role of Nitric Oxide](#)
- ▶ [c-fos](#)

## Fothergill's Disease

- ▶ [Trigeminal, Glossopharyngeal, and Geniculate Neuralgias](#)

## Fractalkine

### Definition

Fractalkine is a cell-surface protein expressed by neurons in the spinal cord. When sufficiently activated, spinal neurons release fractalkine, which then binds to receptors expressed on microglia, thereby inducing the release of the proinflammatory cytokine interleukin (IL)–1. Peri-spinal administration of fractalkine, as well as IL–1, induces exaggerated pain responses. Importantly, inhibiting fractalkine activity blocks neuropathic pain, implying that endogenous fractalkine generates enhanced pain responses.

- ▶ [Cord Glial Activation](#)

F

## Fractional Receptor Occupancy

### Synonyms

FRO

### Definition

The threshold percentage of receptors required to be occupied by ligands to produce some effect. A direct relationship exists between nociceptive stimulus intensity and FRO, such that higher doses of opioid (resulting in higher FRO) are required to decrease the perception of pain of higher intensity. If certain genotypes are more sensitive to pain, such that they perceive it as of higher intensity, a reduced sensitivity to opioid analgesia would follow.

- ▶ [Opioid Analgesia, Strain Differences](#)

## Free from Bias

### Definition

A personal attitude that may influence the evaluation of patients' pain conditions or the interpretation of study results. Pain measures should be bias-free in that children should use them in the same manner regardless of differences in how they wish to please adults.

- ▶ [Pain Assessment in Children](#)

## Free Magnitude Estimation

### Definition

Free magnitude estimation is the numerical rating of sensation magnitude without upper or lower boundaries.

- ▶ [Opioids, Effects of Systemic Morphine on Evoked Pain](#)

## Free Nerve Endings

### ► Non-Corpuscular Sensory Endings

## Freeze Lesion

### Definition

A brief punctual freeze lesion of human skin that cause moderate burning or itching sensations together with a reddening and a short lived edema, after 24 hours hyperalgesia to punctuate stimuli, hyperalgesia to blunt pressure and impact stimuli, and increased heat sensitivity. Brush-evoked hyperalgesia does not develop after freezing.

### ► Freezing Model of Cutaneous Hyperalgesia

## Freezing Model of Cutaneous Hyperalgesia

SUSANNE K. SAUER

Department of Physiology and Pathophysiology,  
University of Erlangen, Erlangen, Germany  
sauer@physiology1.uni-erlangen.de

### Synonyms

Cutaneous Freeze Trauma; Cutaneous Hyperalgesia; Cold-Induced Hyperalgesia; Inflammatory Hyperalgesia by Skin Freezing

### Definition

A brief ► [freeze lesion](#) of human skin is a viable model to induce a slowly developing and sustained pattern of ► [hyperalgesia](#). During freezing, moderate burning or itching sensations together with a reddening and a short-lived edema of the lesioned skin site can be observed. No spontaneous pain or hyperalgesia arise during the first hours after freezing the skin. About 24 hours after induction, a typical pattern of hyperalgesia develops, hyperalgesia to punctuate stimuli, hyperalgesia to blunt pressure and impact stimuli and increased heat sensitivity. Brush-evoked hyperalgesia (► [allodynia](#)) does not usually develop after freezing.

### Characteristics

Injury of the skin is often followed by augmented pain sensations following mechanical, thermal or chemical stimuli. Since the mechanism of the induction and maintenance of the different types of hyperalgesia are of considerable interest, scientists have searched for adequate experimental models, e.g. standardized lesions of the skin. Freeze injury of the skin was first described by Lewis and Love in 1926 (Lewis and Love 1926),

maybe stirred by reports from expeditions to the North Pole in this decade, describing freeze injuries of fingers and feet.

### Experimental Procedures

Experimental inflammation by freezing the skin has been induced on the upper leg, the forearm or the back of the hand. For this purpose a cylindrical copper bar with a standardized diameter and weight (e.g. 15 mm and 290 g, respectively) was cooled to  $-28^{\circ}\text{C}$  (Kilo et al. 1994). This bar was briefly placed on the skin, with its long axis perpendicular to the surface and a contact pressure provided by its weight. To improve thermal contact to the skin, saline soaked filter paper was placed on the skin beneath the copper bar. The degree of developing inflammation is determined by the temperature of the copper bar and the thawing time of the lesioned skin site. The duration of freezing assessed by the latency of thawing was normally 20–40 s. Sensory testing for different forms of hyperalgesia followed 22–24 h after freezing the skin.

### Early Skin Reactions and Activation of Primary Afferents

Volunteer subjects describe freezing of the skin as moderately painful, with sensations of electric prickling or slight itching. Intense burning sensations are reported rarely. At the lesioned skin site, a sharply delineated region of local reddening develops, due to both cold-induced vasodilatation and local edema, which subside within 1–2 h (Lewis and Love 1926; Kilo et al. 1994). Freezing itself obviously provokes relatively little activity in superficial ► [nociceptors](#) because they are rapidly inactivated by the decrease in skin temperature. Before inactivation by freezing A $\delta$  and C nociceptors respond to noxious temperatures down to about  $-10^{\circ}\text{C}$  with graded responses. Units are recruited progressively with decreasing temperature and are thus suited to contribute to the sensation of cold pain (Simone and Kajander 1996; Simone and Kajander 1997; Campero et al. 1996). The obviously brief activation of nociceptors is reflected in a very spatially limited region of ► [neurogenic inflammation](#) around the frozen skin, since no flare or wheal reaction can be observed. The destruction of the cells in the upper skin layers evokes a complex inflammatory process, responsible for the altered pain sensation developing within the first day after freezing the skin.

### Activation and Sensitization of Nociceptive Spinal cord Neurons

Nociceptive spinal dorsal horn neurons respond to freeze injury of the skin. Both ► [wide dynamic range](#) (WDR) and ► [nociceptive specific neurons](#) (NS) are stimulated when the skin temperature in their innervation territories is lowered to  $-15^{\circ}\text{C}$  (Khasabov et al. 2001). WDR and NS neurons respond with a high frequency discharge at the onset of freezing and subsequent ongoing activity.

Moreover a cross-sensitization of heat and cold activation thresholds is observed on freezing. Although little is known about the specific subtypes of peripheral afferents that excite the WDR and NS neurons, it is known that both types of dorsal horn neurons contribute to cold and heat hyperalgesia produced by freeze injury. In a rat model, freezing the skin of the hind paw also leads to increased c-fos expression (see ► [c-Fos Immediate-Early Gene Expression](#)) in the spinal cord (Abbadie et al. 1994; Doyle and Hunt 1999).

### Heat Hyperalgesia

Heat hyperalgesia, for instance that following ► [capsaicin](#) application, is restricted to the primary hyperalgesic zone and the underlying mechanism responsible for this is a peripheral sensitization of polymodal, mechano-heat sensitive, mostly unmyelinated nociceptors (Treede et al. 2004; Ali et al. 1996). Similarly heat hyperalgesia is observed at the injured skin site after freezing (1° zone) and to a minor extent also in the 2° zone. The peripheral sensitization of heat sensitive ion channels such as TRPV1 – which is expressed in these nerve fibers - by locally released inflammatory mediators, is responsible for the increased heat sensitivity after freeze lesion (Patapoutian et al. 2003). The sensitization to heat stimuli of spinal nociceptive neurons after freeze injury has also been demonstrated in the rat and thus these also contribute to the development of heat hyperalgesia (Khasabov et al. 2001).

### Mechanical Hyperalgesia

After freezing the skin a characteristic pattern of mechanical hyperalgesia develops to punctuate stimulation (pin-prick hyperalgesia), to pressure stimulation and to impact stimulation of the treated skin area. Increased sensitivity to non-noxious mechanical stimulation (brush-evoked, allodynia) has not been observed. The alterations of sensitivity to different types of mechanical stimuli at the site of the freeze injury (primary zone or 1°) and the area surrounding the site of injury (secondary zone or 2°) are described as follows:

#### Pinprick Hyperalgesia

Pinprick hyperalgesia tested by punctuate stimulation of the skin develops in the primary and secondary zone after freezing the skin in a manner very similar to the pattern of pin-prick hyperalgesia observed after capsaicin application (Kilo et al. 1994). This form of hyperalgesia is generally accepted to be mainly a consequence of central nervous plasticity rather than sensitization of primary afferent nociceptors (Torebjork et al 1996). Which fiber types contribute to the central sensitization resulting in the pinprick hyperalgesia in the freeze model is not clear. Apparently no ongoing activity of nociceptors is required to maintain a once initiated augmentation of synaptic processes in the spinal cord. In another model of experimental hyperalgesia, it has been shown

that mainly capsaicin-insensitive A $\delta$  nociceptors are responsible for the 2° hyperalgesia to pinprick (Magerl et al. 2001).

#### Brush-evoked Hyperalgesia

Brush-evoked hyperalgesia or allodynia, normally occurring in the 1° and 2° zone, is not consistently found in the 2° zone and only rarely found in the 1° zone of the freeze model (Kilo et al. 1994). Mechanical allodynia is mediated by an enhanced central processing of sensory input from myelinated, mechano-sensitive A-fibers (A $\beta$  fibers) that normally transmit non-painful, tactile sensations (Torebjork et al. 1992; Treede et al. 2004). Allodynia after capsaicin application may be found in the 1° and 2° hyperalgesic zones and results from central plasticity induced and sustained by persistent C-nociceptor activity from the primary zone. After freezing, no psychophysiological correlate of A $\beta$  fiber-mediated pain has been encountered, suggesting that a limited ongoing activity of nociceptors fails to induce the switching of A $\beta$ -input into the pain pathway.

#### Hyperalgesia to Tonic Pressure

In contrast to pinprick and brush-evoked hyperalgesia, that to tonic pressure is restricted to the primary zone. It seems to be a consequence of the sensitization of nociceptors, in particular the mechano-insensitive C-fibers (Schmidt et al. 2000). Recruitment of this fiber class leads to increased spatial summation at central synapses and thus to primary mechanical hyperalgesia.

#### Hyperalgesia to Impact Stimuli

C and A $\delta$  fiber nociceptors are able to encode impacts of different strengths and after sensitization these fibers mediate hyperalgesia to impact stimuli (Koltzenburg and Handwerker 1994). The freezing lesion, in contrast to capsaicin application, induced this special type of hyperalgesia in the primary zone (Kilo et al. 1994). This may be due to long-lasting and severe inflammatory tissue damage, which induces the sensitization of mechano- and/or polymodal nociceptors.

#### The Freeze Model as a Tool for Studying Analgesic Drugs

It has been proven, that the carefully controlled types of hyperalgesia induced in healthy human volunteers provide a sensitive tool for studying anti-inflammatory analgesic drugs. Therapeutic doses of ibuprofen significantly diminished the impact pain in the freeze model, whereas they were ineffective against the allodynia due to capsaicin application (Kilo et al. 1994).

#### References

1. Abbadie C, Honore P, Besson JM (1994) Intense cold noxious stimulation of the rat hindpaw induces c-fos expression in lumbar spinal cord neurons. *Neuroscience* 59:457–468
2. Ali Z, Meyer RA, Campbell JN (1996) Secondary hyperalgesia to mechanical but not heat stimuli following a capsaicin injection in hairy skin. *Pain* 68:401–411

3. Campero M, Serra J, Ochoa JL (1996) C-polymodal nociceptors activated by noxious low temperature in human skin. *J Physiol* 497:565–572
4. Doyle CA, Hunt SP (1999) A role for spinal lamina I neurokinin-1-positive neurons in cold thermoreception in the rat. *Neuroscience* 91:723–732
5. Khasabov SG, Cain DM, Thong D et al. (2001) Enhanced responses of spinal dorsal horn neurons to heat and cold stimuli following mild freeze injury to the skin. *J Neurophysiol* 86:986–996
6. Kilo S, Schmeltz M, Koltzenburg M et al. (1994) Different patterns of hyperalgesia induced by experimental inflammation in human skin. *Brain* 117:385–396
7. Koltzenburg M, Handwerker HO (1994) Differential ability of human cutaneous nociceptors to signal mechanical pain and to produce vasodilatation. *J Neurosci* 14:1756–1765
8. Lewis T, Love WS (1926) Vascular reactions of the skin to injury. Part III. Some effects of freezing, of cooling and of warming. *Heart* 13:27–60
9. Magerl W, Fuchs PN, Meyer RA et al. (2001) Roles of capsaicin-insensitive nociceptors in cutaneous pain and secondary hyperalgesia. *Brain* 124:754–1764
10. Patapoutian A, Peier AM, Story GM et al. (2003) ThermoTRP channels and beyond: mechanisms of temperature sensation. *Nat Rev Neurosci* 4:529–539
11. Schmidt R, Schmeltz M, Torebjork HE et al. (2000) Mechanosensitive nociceptors encode pain evoked by tonic pressure to human skin. *Neuroscience* 98:793–800
12. Simone DA, Kajander KC (1996) Excitation of rat cutaneous nociceptors by noxious cold. *Neurosci Lett* 213:53–56
13. Simone DA, Kajander KC (1997) Responses of cutaneous A-fiber nociceptors to noxious cold. *J Neurophysiol* 77:2049–2060
14. Torebjork HE, Lundberg LE, LaMotte RH (1992) Central changes in processing of mechanoreceptive input in capsaicin-induced secondary hyperalgesia in humans. *J Physiol* 448:765–780
15. Torebjork HE, Schmeltz M, Handwerker HO (1996) Functional properties of human cutaneous nociceptors and their role in pain and hyperalgesia. In: Belmonte C, Cervero F (eds) *Neurobiology of Nociceptors*. Oxford, Oxford, pp 349–369
16. Treede RD, Handwerker HO, Baumgärtner U et al. (2004) Hyperalgesia and Allodynia: Taxonomy, Assessment, and Mechanisms. In: Brune K HH (ed) *Hyperalgesia: Molecular Mechanisms and Clinical Implications*. IASP Press, Seattle

## French Energetic Acupuncture

- ▶ Acupuncture

## Frequency-Dependent Nociceptive Facilitation

- ▶ Wind-Up of Spinal Cord Neurons

## Frequency of Low Back Pain

- ▶ Low Back Pain, Epidemiology

## Frequency of Ultrasound Treatment

### Definition

The most commonly used frequencies are in the range of 0.8 to 1.1 MHz, although frequencies around 3.0 MHz are also fairly common.

- ▶ [Ultrasound Therapy of Pain from the Musculoskeletal System](#)

## Freund's Complete Adjuvant

### Synonym

FCA

### Definition

Freund's Complete Adjuvant (FCA) is a suspension of heat killed mycobacterium in neutral oil, usually paraffin or mineral oil. Suspension is often achieved by ultrasonication.

- ▶ [Arthritis Model, Adjuvant-induced Arthritis](#)

## FRO

- ▶ [Fractional Receptor Occupancy](#)

## Frontal-Posterior Neck Electromyographic Sensor Placement

### Definition

Frontal-posterior neck electromyographic sensor placement is an approach designed to assess muscle activity across a broad region, ranging from the back of the neck to the front of the head.

- ▶ [Psychophysiological Assessment of Pain](#)

## Frustration

- ▶ [Anger and Pain](#)

## Fulcrum

### Definition

The fulcrum is a pivot about which a lever turns.

- ▶ [Sacroiliac Joint Pain](#)



## Full and Partial Opioid Receptor Agonists

### Definition

Full opioid receptor agonists (e.g. morphine, codeine, methadone) do not have a ceiling to their analgesic efficacy, and will not reverse or antagonize the effects of other opioids given simultaneously. In comparison to full opioid receptor agonists, a partial agonist (e.g. Buprenorphine) has a lower intrinsic efficacy at the opioid receptor.

- ▶ Opioids and Inflammatory Pain

## Functional

### Definition

Functional is a term used before a symptom or disease to describe a process where a symptom or disease cannot be explained by any lesion, change in structure or derangement of an organ.

- ▶ Recurrent Abdominal Pain in Children

## Functional Abdominal Pain

- ▶ Descending Modulation of Visceral Pain
- ▶ Visceral Pain Model, Irritable Bowel Syndrome Model

## Functional Abilities Evaluation

- ▶ Disability, Functional Capacity Evaluations

## Functional Aspects of Visceral Pain

- ▶ Psychiatric Aspects of Visceral Pain

## Functional Bowel Disorder

### Definition

Functional bowel disorder is a disorder or disease where the primary abnormality is an altered physiological function (the way the body works) rather than an identifiable structural or biochemical cause. A functional disorder does not show any evidence of an organic or physical disease. It is a disorder that generally cannot be diagnosed in a traditional way, as an inflammatory, infectious, or structural abnormality that can be seen by commonly used examination, x-ray, or laboratory test.

- ▶ Descending Modulation of Visceral Pain

- ▶ Visceral Pain Model, Irritable Bowel Syndrome Model

## Functional Brain Imaging

### Definition

Functional brain imaging is a non-invasive neuroimaging techniques that detect changes in brain metabolism or neuronal activity in response to sensory or motor tasks, giving information regarding the function of specific brain regions, s. also Functional Imaging, s. also fMRI.

- ▶ Thalamus and Visceral Pain Processing (Human Imaging)

## Functional Capacity

### Definition

For Social Security purposes, functional capacity represents the measure of a person's ability to perform particular work-related physical and mental activities.

- ▶ Disability Evaluation in the Social Security Administration

## Functional Capacity Assessment

- ▶ Disability, Functional Capacity Evaluations

## Functional Capacity Battery

- ▶ Disability, Functional Capacity Evaluations

## Functional Capacity Evaluation

### Synonym

FCE

### Definition

Functional capacity evaluation systematically measures the worker's ability to carry out work tasks safely. It includes trait-oriented systems of norm-referenced assessment, e.g. the Baltimore Therapeutic Equipment (BTE) (▶ <http://www.bteco.com/>). The results demonstrate the client's physical functional capacity, e.g. lifting capacity, fine motor dexterity, work tolerance, and preparedness for returning to work.. FCE has been criticized for the lack of correspondence between the client's functional capacity and a job's real requirements: it does not demonstrate the client's opportunities of returning to,

and retaining, a job. Synonyms: physical capacity evaluation; work capacity evaluation.

- ▶ [Disability, Functional Capacity Evaluations](#)
- ▶ [Vocational Counselling](#)

## Functional Changes in Sensory Neurons Following Spinal Cord Injury in Central Pain

JING-XIA HAO, XIAO-JUN XU  
Department of Neurotechnology, Section of  
Clinical Neurophysiology, Karolinska University  
Hospital-Huddinge, Stockholm, Sweden  
xiaojun.xu@labmed.ki.se

### Synonyms

Central Pain, Functional Changes in Sensory Neurons Following Spinal Cord Injury

### Definition

Chronic pain is a common consequence of spinal cord injury (SCI), often mixed with nociceptive, visceral and neuropathic components. Neuropathic SCI pain is a form of central pain that represents a major challenge for those responsible for clinical pain management (Siddall et al. 2002). Several models of SCI have been developed in recent years that allow the direct examination of neuronal mechanisms mediating SCI induced central pain (Vierck et al. 2000).

▶ [Central pain](#) refers to neuropathic pain associated with a lesion of the central nervous system. ▶ [Spinal cord injury pain](#) (SCI pain) is a particular form of central pain seen in patients with spinal cord injury or diseases of the spinal cord, e.g. syringomyelia, tumors. The dorsal horn of the spinal cord is the first relay point for somatosensory perception. Neurons in the dorsal horn process sensory input and transmit this information to higher brain centers, while initiating motor and autonomic reflexes. Sensory neurons in the dorsal horn can be classified into three types with respect to responses to mechanical stimulation: ▶ [low threshold \(LT\) neurons](#) that respond maximally to innocuous stimuli, ▶ [wide dynamic range \(WDR\) neurons](#) that give graded responses to innocuous and noxious stimulation and ▶ [high threshold \(HT\) neurons](#) that respond exclusively to noxious stimulation.

### Characteristics

In recent years, several studies have been published characterizing the response patterns of dorsal horn neurons in rats with spinal cord injury and behaviors suggesting the presence of SCI pain. The models of injury employed include photochemically induced ischemic SCI (Hao et al. 1992; Hao et al. 2004), excitotoxicity associated with intraspinal injection of quisqualic acid (Yeziarski

and Park 1993), contusion (Drew et al. 2001; Hoheisel et al. 2003; Hains et al. 2003a), transection (Scheifer et al. 2002) and hemisection (Hains et al. 2003b). Below are described four functional characteristics of dorsal horn neurons that have been described as changing following spinal cord injury.

### Receptive Fields

The proportion of dorsal horn neurons without a demonstrable mechanical receptive field (RF) is increased after spinal cord injury (Hoheisel et al. 2003; Hao et al. 2004). These neurons tend to have high frequency ongoing activity and are clustered around the rostral end of the injured spinal segment. This suggests that the normal afferent input (either direct or indirect) to some of these neurons has been interrupted by injury, resulting in a lack of RF. The original RFs of these neurons are likely to be on skin areas rendered anesthetic by the injury. Abnormal spontaneous discharges of these neurons, especially those projecting to higher centers, may give rise to dysesthesia or pain referred to the anesthetic skin areas caudal to the lesion. This type of pain is referred to as below level pain and is a major component of the pain syndrome in patients with SCI (Siddall et al. 2002). There are also behavioral indications of below level pain in rat models in the form of autotomy and excessive scratching/grooming leading to skin damage (Vierck et al. 2000).

### Spontaneous Activity

In our analysis of activity of dorsal horn neurons after SCI we have described animals with segmental allodynia and these rats have a larger proportion of neurons with high rates of spontaneous activity (SA) (Hao et al. 2004). These neurons were located near the edge of the lesion site. This is similar to the results of Hoheisel et al. (2003) who found that neurons close to a spinal contusion injury exhibited increased levels of ongoing activity. Yeziarski and Park (1993) and Drew et al. (2001) have also reported a higher level of such activity in neurons in spinally injured rats. In our sample, the level of spontaneous activity of HT neurons and neurons without receptive fields was significantly higher than that of LT or WDR neurons. Interspike interval analysis indicated that the discharges were irregular and burst-like in the majority of SA neurons. Since HT neurons receive input from nociceptors and are involved in pain signaling (Chung et al. 1986), the high rate of SA in HT neurons may give rise to spontaneous pain sensations in skin areas with sensory loss. Hoheisel et al. (2003) have also noted several forms of pathophysiological background activity that were not seen in normal animals, including bursting-like activity.

### Changes in the Functional Type of Neurons Recorded

In normal rats, the proportion of different neuronal types recorded depends on several factors, including

classification criteria used, type of preparations, anesthesia, etc. In our study, we used an intact rat preparation with urethane anesthesia and we recorded from neurons with response characteristics resembling those of LT, WDR and HT neurons (Chung et al. 1986). The relative proportion of these neuronal types in a sample of normal rats was similar to that reported in most previous studies in the field. By contrast, considerably more WDR neurons were encountered in spinally injured rats 2–3 segments above the injury (Hao et al. 2004). Since neurons in normal and injured rats were recorded from different animals, it is impossible to know the original phenotype of these WDR neurons. We have speculated that the increased proportion of WDR neurons reflects either the appearance of novel innocuous input to HT neurons or increased responses of LT neurons to noxious input. Both possibilities imply that there is an increased excitability in sensory pathways in the spinal cord underlying behavioral allodynia. A decrease in inhibitory influences may also contribute to these functional changes. Drew et al. (2001) have also compared the response properties of neurons in normal, spinally injured non-allodynic and allodynic rats. Interestingly, they observed that the proportion of LT neurons was increased and they became more common than WDR neurons rostrally, but not caudally, to the lesion site. The difference between our results and those of Drew et al. (2001) may be due to differences in classification criteria, since they did not have HT neurons in their sample.

#### Responses to Peripheral Stimulation

Mechanical ► **allodynia** is a common symptom in patients with SCI pain (Siddall et al. 2002) and similar behavior is consistently observed in rat models of SCI pain (Xu et al. 1992; Vierck et al. 2000). In support of the behavioral observations, electrophysiological recording of dorsal horn activity in these animals has revealed increased neuronal responsiveness to mechanical stimulation. This included increased responses of WDR neurons to brush, pinch and graded von Frey hair stimulation, decreased von Frey threshold, increased response of HT neurons and increases in afterdischarges (Hao et al. 1992; Yezierski and Park 1993; Drew et al. 2001; Hains et al. 2003; Hoheisel et al. 2003). These changes are likely to underlie the mechanical allodynia observed following spinal injury. Similarly, we have also found that the responses of dorsal horn neurons to cold stimulation increased after SCI, corresponding to cold allodynia in these rats. A higher percentage of WDR and LT neurons, which normally react poorly to cold, react to cold stimulation in allodynic rats (Hao et al. 2004).

#### Conclusions

Abnormal electrophysiological properties of dorsal horn neurons can be documented in rats with chronic

pain related behaviors after SCI. Based on the similarities between the neuronal and behavioral responses, it is likely that neuronal changes in the dorsal horn around the level of injury are responsible for the behavioral manifestation of pain-like responses. Some of the abnormalities are most probably the result of deafferentation in the zone immediately rostral to the spinal lesion. The reduction of spinal GABAergic inhibition has also been shown to be involved in the mechanical hypersensitivity of dorsal horn neurons after SCI (Hao et al. 1992). Moreover, SCI induces complex neurochemical changes in areas rostral to the lesion, which may also contribute to the neuronal abnormalities. It is important to note that some of neuronal changes observed in spinally injured rats, noticeably spontaneous hyperactivity in the dorsal horn, have also been seen in patients with SCI pain and lesions of the dorsal root entry zone; targeting areas of spontaneous activity have been shown to alleviate pain (Loeser and Ward 1967; Edgar et al. 1993; Falci et al. 2002).

#### References

1. Chung J-M, Surmeier DJ, Lee KH et al. (1986) Classification of primate spinothalamic and somatosensory thalamic neurons based on cluster analysis. *J Neurophysiol* 56:308–327
2. Drew GM, Siddall PJ, Duggan AW (2001) Responses of spinal neurons to cutaneous and dorsal root stimuli in rats with mechanical allodynia after contusive spinal cord injury. *Brain Res* 893:59–69
3. Edgar RE, Best LG, Quail PA et al. (1993) Computer-assisted DREZ microcoagulation: posttraumatic spinal deafferentation pain. *J Spinal Disord* 6:48–56
4. Falci S, Best L, Bayles R et al. (2002) Dorsal root entry zone microcoagulation for spinal cord injury-related central pain: operative intramedullary electrophysiological guidance and clinical outcome. *J Neurosurg* 97:193–200
5. Hains BC, Klein JP, Saab CY et al. (2003a) Upregulation of sodium channel  $Na_v1.3$  and functional involvement in neuronal hyperexcitability associated with central neuropathic pain after spinal cord injury. *J Neurosci* 23:8881–8892
6. Hains BC, Willis WD, Hulsebosch CE (2003b) Serotonin receptors 5-HT<sub>1A</sub> and 5-HT<sub>3</sub> reduces hyperexcitability of dorsal horn neurons after spinal cord hemisection injury in rat. *Exp Brain Res* 149:174–186
7. Hao J-X, Xu X-J, Yu Y-X et al. (1992) Baclofen reverses the hypersensitivity of dorsal horn wide dynamic range neurons to low threshold mechanical stimuli after transient spinal cord ischemia: implication for a tonic GABAergic inhibitory control upon myelinated fiber input. *J Neurophysiol* 68:392–396
8. Hao J-X, Kupers R, Xu X-J (2004) Response characteristics of spinal cord dorsal horn neurons in chronic allodynic rats after spinal cord injury. *J Neurophysiol* 92:1391–1399
9. Hoheisel U, Scheifer C, Trudrung P et al. (2003) Pathophysiological activity in rat dorsal horn neurons in segments rostral to a chronic spinal cord injury. *Brain Res* 974:134–145
10. Loeser JD, Ward AA Jr (1967) Some effects of deafferentation on neurons of the cat spinal cord. *Arch Neurol* 17:629–636
11. Scheifer C, Hoheisel U, Trudrung P et al. (2002) Rats with chronic spinal cord transection as a possible model for the at-level pain of paraplegic patients. *Neurosci Lett* 323:117–120
12. Siddall PJ, Yezierski RP, Loeser JD (2002) Taxonomy and epidemiology of spinal cord injury pain. In: Yezierski RP, Burchiel KJ (eds) *Spinal Cord Injury Pain: Assessment, Mechanisms, Management*. IASP Press, Seattle, pp 9–24
13. Vierck CJ Jr, Siddall P, Yezierski RP (2000) Pain following spinal cord injury: animal models and mechanistic studies. *Pain* 89:1–5

14. Xu X-J, Hao J-X, Aldskogius H et al. (1992) Chronic pain-related syndrome in rats after ischemic spinal cord lesion: a possible animal model for pain in patients with spinal cord injury. *Pain* 48:279–290
15. Yeziarski RP, Park S-H (1993) The mechanosensitivity of spinal sensory neurons following intraspinal injections of quisqualic acid in the rat. *Neurosci Lett* 157:115–119

## Functional Changes in Thalamus

- ▶ [Thalamic Plasticity and Chronic Pain](#)

## Functional Gastrointestinal Disorders

### Definition

Functional gastrointestinal disorders are a collection of symptom based gastrointestinal conditions for which no biomedical abnormality can be found to explain symptoms. Similar to other functional conditions such as fibromyalgia.

- ▶ [Thalamus and Visceral Pain Processing \(Human Imaging\)](#)

## Functional Health

- ▶ [Disability and Impairment Definitions](#)

## Functional Imaging

### Definition

Functional imaging is a general term used to describe methodologies that allow function to be located either spatially or temporally within the brain (and other organs). The methods allow detection of molecular signals that indicate the presence of biochemical activity and changes, such as cell activity or death. They are generally non-invasive and used for human studies. The term neuroimaging is often used when applied specifically to brain studies. Methods include: Functional Magnetic Resonance Imaging (fMRI), Positron Emission Tomography (PET), Magneto-Encephalography (MEG) and Electro-Encephalography (EEG).

- ▶ [Hippocampus and Entorhinal Complex, Functional Imaging](#)
- ▶ [Insular Cortex, Neurophysiology and Functional Imaging of Nociceptive Processing](#)
- ▶ [Psychiatric Aspects of Visceral Pain](#)

## Functional Imaging of Cutaneous Pain

JÜRGEN LORENZ

Hamburg University of Applied Sciences, Hamburg, Germany

Juergen.Lorenz@rzbd.haw-hamburg.de

### Synonyms

Cutaneous pain, functional imaging

### Definition

Methodologies that monitor the spatial distribution of cerebral metabolic, hemodynamic, electrical or magnetic reactions by which areas of the brain are identified that are active during the processing and perception of experimentally-induced or clinical pain originating in the human skin.

### Characteristics

Functional imaging techniques applied for the study of cutaneous pain are ▶ [positron emission tomography \(PET\)](#), ▶ [functional magnetic resonance imaging \(fMRI\)](#), multi-lead electroencephalography (EEG) and ▶ [magnetoencephalography \(MEG\)](#). PET measures cerebral blood flow, glucose metabolism or neurotransmitter kinetics. A very small amount of labeled compound (called the radiotracer) is intravenously injected into the patient or volunteer. During its uptake and decay in the brain, the radionuclide emits a positron, which, after traveling a short distance, “annihilates” with an electron from the surrounding environment. This event results in the emission of two gamma rays of 511 keV in opposite directions, the coincidence of which is detected by a ring of photo-multipliers inside the scanner. In case of the most common use of  $O^{15}$ -water injection, counting and spatial reconstruction of these occurrences within the brain anatomy allow visualization of the regional cerebral blood flow response (rCBF) as an indicator of neuronal activity. Usually scans during painful stimulation are statistically compared with scans during the resting state or non-painful stimulation (blocked design) and plotted as 3-dimensional color-coded t- or Z-score maps. fMRI images blood oxygenation, a technique called BOLD (blood oxygen level-dependent) which exploits the phenomenon that oxygenated and deoxygenated hemoglobin possess different magnetic properties. Both the rCBF using  $O^{15}$ -water PET and the BOLD technique rely on neuro-vascular coupling mechanisms that are not yet fully understood, but which overcompensate local oxygen consumption, thus causing a flow of oxygenated blood into neuronally active brain areas in excess of that utilized.

EEG and MEG are non-invasive neurophysiological techniques that measure the respective electrical poten-

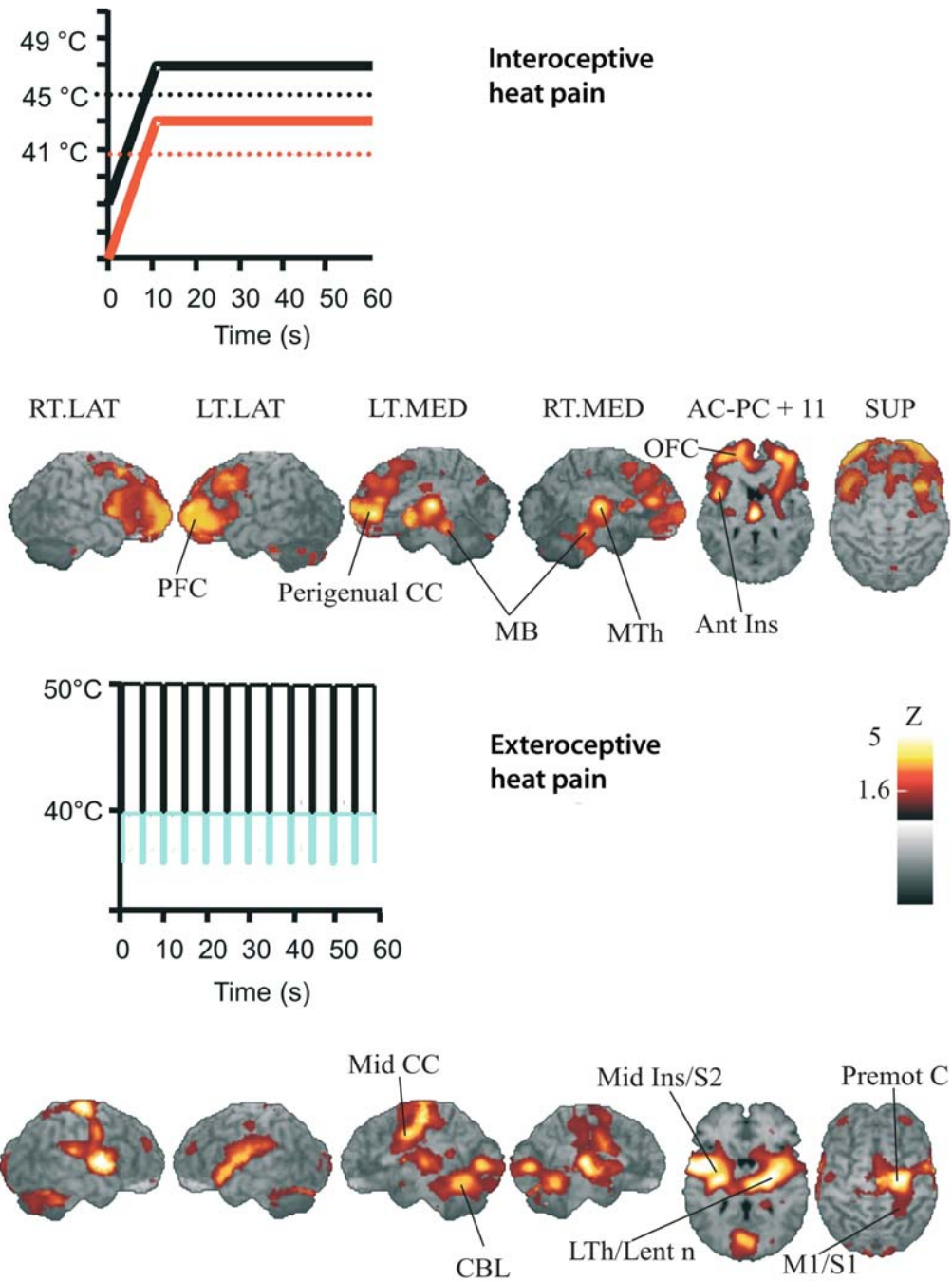


tials and magnetic fields generated by neuronal activity of the brain and propagated to the surface of the skull where they are picked up with EEG-electrodes or, in the case of its magnetic counterpart, received by SQUID (supra conducting quantum interference device) sensors located outside the skull. Compared with PET and fMRI, EEG and MEG are direct indicators of neuronal activity and yield a higher temporal resolution of the investigated brain function. The spatial distributions of EEG potentials and MEG fields at characteristic time points following noxious stimulation (▶ **noxious stimulus**) are analyzed using an inverse mathematical modeling approach called equivalent current dipole (ECD) reconstruction. An ECD evoked by painful stimuli hence represents a source model of pain-relevant activity within the brain. The spatial acuity of MEG is higher than that of EEG because the latter measures the extracellular volume currents that are distorted by the differentially conducting tissues such as grey and white matter, cerebrospinal fluid, durae and bone. In contrast, MEG measures the magnetic field perpendicular to the intracellular currents undistorted by the surrounding tissue. Given the different geometry of electrical potentials and magnetic fields, MEG is predominantly sensitive to dipoles oriented tangentially to the head convexity, whereas EEG depends primarily on radial, but also on tangential dipoles. Functional imaging using PET, fMRI, EEG and MEG has substantially increased the knowledge about the cerebral representation of pain (Casey 1999) and its modulation by psychological phenomena (Porro 2003).

A bone of contention in the research field dealing with the cerebral representation of pain is the involvement of primary and secondary somatosensory cortex. When using contact heat to activate ▶ **nociceptors**, multiple areas of the brain such as the thalamus, the primary (SI) and secondary (SII) somatosensory cortices, posterior and anterior parts of the insula, and mid-caudal parts of the anterior cingulate cortex (ACC) respond to this input in a correlated manner with perceived intensity (Coghill et al. 1999). However, the touch of the probe or attentional effects inherent in block designs could explain SI and SII cortex activity being unrelated to pain. Yet, if single infrared laser stimuli, that lack a concomitant tactile component are applied over a range of randomly presented intensities in event-related designs by MEG (Timmermann et al. 2001) or fMRI (Bornhoevd et al. 2002), SI activity shows a steady increase with intensity whereas the SII and insula respond robustly to painful, but not or only slightly to non-painful intensities. These stimulus-response functions fit with the behavior of distinct wide dynamic range (WDR) and nociceptive-specific (NS) neurons of the dorsal horn, thalamus and SI cortex (Price et al. 2003). These features and the importance of a relay of afferent activity in lateral thalamic nuclei substantiate the key role of SI and SII cortex as part of a lateral pain system subserving the

sensory-discriminative function of pain (Melzack and Casey 1968; Price 2000). Under conditions of specific psychological interventions such as hypnosis (Rainville et al. 1997), pain anticipation (Ploghaus et al. 1999), or ▶ **placebo** cognitions (Petrovic et al. 2002) frontal brain regions such as ACC and the anterior insula appear to subservise more specifically the affective-motivational and cognitive component of pain (Melzack and Casey 1968; Price 2000). They represent the major targets of the medial pain system given a major afferent input to these brain areas from medial thalamic nuclei. Other areas such as ▶ **basal ganglia**, ▶ **cerebellum** and various structures within the ▶ **prefrontal cortex** yielded activation by experimental pain in several studies, their role in pain processing, however, remained elusive and is mainly deduced from their importance in other cognitive, motor or behavioral functions.

The concept of a nociceptive pathway that closely parallels or is partly convergent with that of touch at distinct sites of spinal cord, thalamus and parietal lobe, as key element for the sensory-discriminative or exteroceptive function of pain has recently been challenged by Craig (2003). An important component of his hypothesis is the assumption that pain is a purely interoceptive perception like hunger, thirst or itch, originating in specific spinothalamic tract (STT) neurons of the superficial dorsal horn (lamina I). As 'labeled lines', these STT neurons impinge upon specific thalamic nuclei, such as the posterior part of the ventro-medial nucleus (VMpo) and the ventral caudal part of the mediodorsal nucleus (MDvc), which relay afferent input to dorsal posterior insula and caudal ACC respectively. These two pathways are regarded as important elements of a hierarchical system subserving ▶ **homeostasis**, linking the sense of the physiological condition of the body (▶ **interoception**) with subjective feelings and emotion. Although the interoceptive function of pain is often neglected, negation of an exteroceptive function of pain is neither intuitive nor supported by functional imaging data (see above). Word descriptors such as those compiled in the McGill Pain Questionnaire e.g. cutting, pinching, stinging, squeezing or crushing and many more express how a stimulus from outside the body causes pain and are often used by pain patients to describe their pain, although there is no exteroceptive stimulus. In contrast, there is clearly less richness of exteroceptive sensory descriptors for hunger or thirst, even though the latter are much more every day sensations or feelings than pain. Lenz et al. (2004) electrically stimulated thalamic termination areas of STT neurons in conscious patients undergoing stereotactic procedures for the treatment of movement disorders and chronic pain. Patients used mainly exteroceptive words, rarely internal or emotional phenomena to describe their subjective responses to the stimuli. Furthermore, two groups of responses were observed following stimuli applied to distinct thalamic locations, a binary response



**Functional Imaging of Cutaneous Pain, Figure 1.** Stimulus paradigms to differentially manipulate body-related (interoceptive) and stimulus-related (exteroceptive) pain processes with positron emission tomography (PET). The top section shows the temporal profile of two slowly ramped heat stimuli reaching different plateaus equated for subjective pain intensity. One stimulus is applied on the normal skin of the left volar forearm to approximately 47°C (solid black), which is 2°C above the average heat pain threshold (dotted black) and felt as a clear, but tolerable pain sensation. Another stimulus is applied to approximately 43°C on the same skin, when it had been sensitized by a topical solution of capsaicin (solid red). This treatment caused a drop in the heat pain threshold by approximately 4°C (dotted red), rendering the heat stimulus as painful as the 4°C more intense stimulus applied on normal skin. The subtraction of PET scans between the two conditions (capsaicin-treated minus normal skin) is shown at the bottom of section A. Surface rendered images and median sagittal cuts from both sides, a horizontal slice 11 mm above the AC-PC line and a superior view are displayed. The images demonstrate activity of the midbrain, medial thalamus, anterior insula, perigenual cingulate and prefrontal cortex representing the change in the physiological status of the skin (sensitized vs. normal). The bottom section shows the temporal profile of two heat stimuli that were set to a constant temperature of either 50 or 40°C in different blocks and repeatedly applied to different spots of the normal skin, each contact lasting 5 sec. Images comparing these two stimuli illustrate activity in the lateral thalamus, lenticular nucleus, mid-posterior insula/SII, mid-anterior cingulate, cerebellum and premotor cortex, the latter extending into the M1/S1 region.

signaling pain, but no non-painful sensation, and an analog response covering graded intensities across non-painful and painful sensations. This result is consistent with exteroceptive pathways that convey alarm according to an all-or-nothing stimulus-response relationship, and others that indicate how strong and where the stimulus is.

Sound support for the hypothesis that cutaneous pain inherits both exteroceptive and interoceptive functions is provided by a PET imaging study conducted by Lorenz et al. (2002). These authors addressed the question of whether nociceptive activity resulting from two equally painful contact heat stimuli applied to normal skin or the same skin sensitized by a topical solution of capsaicin would yield different functional imaging results. They tested, whether the effect of skin sensitization would be similar to that of pain intensity observed by the same group in an earlier study when painful heat was compared with non-painful warmth (Casey et al. 2001). Thus, whereas the critical aim of the Lorenz et al. experiment was to match subjective intensities of a slowly-ramped and continuously applied contact heat stimulus across normal and sensitized skin conditions to minimize a confound with perceived intensity and test the importance of the physiological status of the tissue (interoception), the Casey et al. study tested the importance of different applied and perceived intensities of repeated rapidly-ramped contact heat stimuli without changing the tissue status (► [exteroception](#)). Their results illustrated in Fig. 1 show that interoceptive and exteroceptive manipulations of burning pain engage clearly different forebrain structures. Key structures responding to manipulating the exteroceptive stimulus condition are the lateral thalamus, lenticular nucleus/putamen, mid-posterior insula/SII, SI/MI, caudal ACC, premotor cortex and cerebellum. In contrast, key structures responding to manipulating the interoceptive stimulus condition are the medial thalamus, ventral caudate/nucleus accumbens, anterior insula, dorsolateral prefrontal and orbitofrontal cortices and the perigenual ACC. Notably, although the perceived intensities were equated between the two skin conditions in the Lorenz et al. study, pain on sensitized skin (heat allodynia) yielded greater negative affect according to ratings subjects made using both a visual analog scale of 'unpleasantness' and a short form of the McGill pain questionnaire at the end of each scan. This result is consistent with the close relationship of interoception with emotion giving rise to intrinsically stronger affective pain experiences during pathological tissue states. Furthermore, the involvement of cerebral motor systems differs between exteroceptive and interoceptive pain. Whereas exteroceptive pain recruits brain structures such as the putamen, motor and premotor cortex and cerebellum, suited to govern an immediate and spatially guided defense or withdrawal due to their somatotopic organization (Bingel et al. 2004a; Bingel

et al. 2004b), interoceptive pain engages the ventral caudate and nucleus accumbens, which are part of a limbic basal ganglia loop relevant for motivational drive of behavior rather than motor execution. Overall, these results substantiate suggestions that different projection systems originating in the dorsal horn of the spinal cord mediate normal pain and pain during ► [neurogenic inflammation](#) (Hunt and Mantyh 2001). In differentiating different pain types by their origins from either outside or inside the body, the brain may engage different behavioral adaptations according to the meaning of the pain in relation to the physiological status of the body.

F

## References

1. Bingel U, Lorenz J, Glauche V, Knab R, Gläscher J, Weiller C, Büchel C (2004a) Somatotopic organization of human somatosensory cortices for pain: a single trial fMRI study. *Neuroimage* 23:224–232
2. Bingel U, Gläscher J, Weiller C, Büchel C (2004b) Somatotopic representation of nociceptive information in the putamen: an event related fMRI study. *Cereb Cortex* 14:1340–1345
3. Bornhoevd K, Quante M, Glauche V et al. (2002) Painful stimuli evoke different stimulus-response functions in the amygdala, prefrontal, insula, and somatosensory cortex: a single trial fMRI study. *Brain* 123:601–619
4. Casey KL (1999) Forebrain mechanisms of nociception and pain: Analysis through imaging. *Proc Nat Acad Sci USA* 96:7668–7674
5. Casey KL, Morrow TJ, Lorenz J et al. (2001) Temporal and spatial dynamics of human cerebral activation pattern during heat pain: analysis of positron emission tomography. *J Neurophysiol* 85:951–959
6. Coghill RC, Sang CN, Maisog JM et al. (1999) Pain intensity processing in the human brain: a bilateral, distributed mechanisms. *J Neurophysiol* 82:1934–1943
7. Craig AD (2003) A new view of pain as a homeostatic emotion. *Trends Neurosci* 6:303–307
8. Hunt SP, Mantyh PW (2001) The molecular dynamics of pain control. *Nat Neurosci* 2:83–91
9. Lenz FA, Ohara S, Gracely RH et al. (2004) Pain encoding in the human forebrain: binary and analog exteroceptive channels. *J Neurosci* 24:6540–6544
10. Lorenz J, Cross DJ, Minoshima S et al. (2002) A unique representation of heat allodynia in the human brain. *Neuron* 35:383–393
11. Melzack R, Casey KL (1968) Sensory, motivational, and central control determinants of pain. In: Kenshalo DR (ed) *The skin senses*. Thomas, Springfield Illinois, pp 423–443
12. Ploghaus A, Tracey I, Gati JS, Clare S, Menon RS, Matthews PM et al. (1999) Dissociating pain from its anticipation in the human brain. *Science* 284:1979–1981
13. Petrovic P, Kalso E, Petersson KM et al. (2002) Placebo and opioid analgesia – imaging a shared neuronal network. *Science* 295:1737–1740
14. Porro CA (2003) Functional imaging and pain: behavior, perception, and modulation. *Neuroscientist* 9:354–69
15. Price DD (2000) Psychological and neural mechanisms of the affective dimension of pain. *Science* 288:1769–1772
16. Price DD, Greenspan JD, Dubner R (2003) Neurons involved in the exteroceptive function of pain. *Pain* 106:215–219
17. Rainville P, Duncan GH, Price DD et al. (1997) Pain affect encoded in human anterior cingulate but not somatosensory cortex. *Science* 277:968–971
18. Timmermann L, Ploner M, Haucke K et al. (2001) Differential coding of pain in the human primary and secondary somatosensory cortex. *J Neurophysiol* 86:1499–1503

## Functional Imaging of Descending Modulation

- ▶ Descending Circuits in the Forebrain, Imaging

## Functional Loss

### Definition

Functional Loss is a decrease or loss of physiological function.

- ▶ Disability, Upper Extremity

## Functional Magnetic Resonance Imaging

### Synonyms

fMRI

### Definition

Functional Magnetic Resonance Imaging (or fMRI) is the use of MRI to learn which regions of the brain are active in a specific cognitive task or in a pain experiment. It is one of the most recently developed forms of brain imaging, and measures hemodynamic signals related to neural activity in the brain or spinal cord of humans or other animals. As nerve cells “fire” impulses, they metabolize oxygen from the surrounding blood. Approximately 6 seconds after a burst of neural activity, a hemodynamic response occurs and that region of the brain is infused with oxygen-rich blood. As oxygenated hemoglobin is diamagnetic, while deoxygenated blood is paramagnetic, MRI is able to detect a small difference (a signal of the order of 3%) between the two. This is called a blood-oxygen level dependent, or “BOLD” signal. The precise nature of the relationship between neural activity and the BOLD signal is a subject of current research.

- ▶ Amygdala, Functional Imaging
- ▶ Cingulate Cortex, Functional Imaging
- ▶ Descending Circuits in the Forebrain, Imaging
- ▶ Human Thalamic Response to Experimental Pain (Neuroimaging)

- ▶ Nociceptive Processing in the Cingulate Cortex, Behavioral Studies in Humans
- ▶ Nociceptive Processing in the Nucleus Accumbens, Neurophysiology and Behavioral Studies
- ▶ Pain Processing in the Cingulate Cortex, Behavioral Studies in Humans
- ▶ PET and fMRI Imaging in Parietal Cortex (SI, SII, Inferior Parietal Cortex BA40)
- ▶ Thalamus and Visceral Pain Processing (Human Imaging)
- ▶ Thalamus, Clinical Pain, Human Imaging
- ▶ Thalamus, Clinical Visceral Pain, Human Imaging

## Functional Restoration

### Definition

Functional Restoration is a pain management approach geared specifically for chronic low back pain patients. This approach places a strong emphasis on function, and combines a quantitatively-directed exercise progression with disability management and psychosocial interventions such as individual and group therapy.

- ▶ Psychological Treatment of Chronic Pain, Prediction of Outcome

## Fundamental Fears

### Definition

According to the expectancy theory of Reiss (1985), three fundamental fears or sensitivities exist: (1) fear of anxiety symptoms (anxiety sensitivity), (2) fear of negative evaluation (social evaluation sensitivity), and (3) fear of illness/injury (injury/illness sensitivity).

- ▶ Fear and Pain

## Funiculus

### Definition

Longitudinal subdivisions of the spinal white matter that are named according to their location within the spinal cord.

- ▶ Spinothalamic Projections in Rat



## G Protein

### Definition

G Proteins are coupling proteins that lead to second-messenger production. They are called G proteins because they bind to guanine-nucleotide proteins. They are located on the cytoplasmic side of the membrane and are activated by the intracellular domain of the receptor protein. The G-protein consists of three functional subunits ( $G_{\alpha,\beta,\gamma}$ ). Several different types of G proteins exist including inhibitory ( $G_i$ ) and stimulatory ( $G_s$ ) proteins. Activation of  $G_i$  proteins inhibit, and activation of  $G_s$  proteins stimulate the production of the second messenger adenylate cyclase (cAMP), release of  $Ca^{2+}$ , activation of enzymes, and changes in gene expression.

- ▶ Opioids and Inflammatory Pain
- ▶ Sensitization of Muscular and Articular Nociceptors
- ▶ Spinothalamic Tract Neurons, Peptidergic Input

## G Protein Coupling

### Definition

The  $G_{\alpha}$  subunit in its resting state is bound to guanine-diphosphate (GDP). After a G protein coupled receptor is activated by its ligand, guanine triphosphate (GTP) is exchanged for guanine diphosphate (GDP), the  $G_{SS/\gamma}$  subunit dissociate from the  $G_{\alpha}$  subunit, and the G protein dissociates from the OR. Both subunits ( $G_{\alpha}$  and  $G_{\beta\gamma}$ ) can activate down-stream effector systems such as adenylate cyclase (cAMP), ion channels, and other second-messenger cascades.

- ▶ Opioids and Inflammatory Pain

## G Protein-Coupled Receptor

### Synonyms

GPCR

### Definition

GPCR span the cell membrane seven times, with the amino terminus located extra-cellularly and the carboxy terminus inside the cell. These receptors are coupled to G proteins, which are composed of three units (alpha, beta and gamma), and are located inside the surface of the cell membrane.

- ▶ Cytokines, Effects on Nociceptors
- ▶ Opioid Receptor Localization

## GABA and Glycine in Spinal Nociceptive Processing

HANNS ULRICH ZEILHOFER

Institute for Pharmacology and Toxicology, University of Zürich, Zürich, Switzerland  
zeilhofer@pharma.unizh.ch

### Synonyms

Inhibitory Synaptic Transmission

### Definitions

The spinal cord dorsal horn represents the first site of synaptic integration in nociceptive processing. Here and elsewhere in the spinal cord and brainstem fast inhibitory neurotransmission is mediated by the amino acids ▶  $\gamma$ -amino butyric acid (GABA) and glycine. Both transmitters open ligand gated anion channels designated ▶  $GABA_A$  receptors and inhibitory (▶ strychnine-sensitive) glycine receptors, respectively. Their activation impairs transmission of nociceptive signals through the spinal cord to higher brain areas. GABAergic neurons and GABA receptors are found throughout the central nervous system, while glycinergic terminals and strychnine-sensitive glycine receptors are largely restricted to in the spinal cord, brainstem and cerebellum.

### Characteristics

#### Cellular Function

Upon activation,  $GABA_A$  and strychnine-sensitive glycine receptors permit the permeation of chloride (and to a lesser extent of bicarbonate) ions through the

plasma membrane. This increase in anion conductance inhibits neuronal activity through two major mechanisms. First, in most neurons chloride flux is inwardly directed at the physiological resting potential and hyperpolarizes neurons. Second, activation of dendritic GABA<sub>A</sub> and glycine receptors causes a “shunting” conductance and thereby impairs the dendritic propagation of excitatory postsynaptic currents along the dendrite.

### Molecular Structure and Pharmacology

GABA<sub>A</sub> receptors and strychnine-sensitive glycine receptors are pentameric protein complexes and belong to the same family as nicotinic acetylcholine and serotonin 5-HT<sub>3</sub> receptors. A total of 19 mammalian GABA<sub>A</sub> receptor subunits are known ( $\alpha 1 - \alpha 6$ ,  $\beta 1 - \beta 3$ ,  $\gamma 1 - \gamma 3$ ,  $\delta$ ,  $\epsilon$ ,  $\nu$ ,  $\pi$ ,  $\rho 1 - \rho 3$ ), each of which is encoded by a separate gene. The most prevalent form of the GABA<sub>A</sub> receptor in the CNS is probably  $\alpha 1 - \beta 2 - \gamma 2$ . GABA<sub>A</sub> receptors containing  $\alpha 1$ ,  $\alpha 2$ ,  $\alpha 3$  or  $\alpha 5$  subunits are benzodiazepine sensitive and potentiated by classical benzodiazepines including ► **diazepam**, while  $\alpha 4$  and  $\alpha 6$  are benzodiazepine-insensitive (for details see Rudolph et al. 2001). The  $\beta$  subunits bind barbiturates and intravenous anesthetics including ► **propofol** and ► **etomidate**, which also facilitate the activation of GABA<sub>A</sub> receptors. ► **Bicuculline**-insensitive ionotropic GABA receptors have been termed GABA<sub>C</sub> receptors. They contain  $\rho$  subunits, which can in most cases form functional homomeric receptor channels.

### GABA<sub>B</sub> Receptors

In addition to ionotropic GABA<sub>A</sub> receptors, GABA binds to G-protein coupled GABA<sub>B</sub> receptors, which are heterodimeric receptors with 7 transmembrane domains. They couple to pertussis toxin-sensitive (inhibitory) G-proteins, activate G-protein coupled K<sup>+</sup> channels, inhibit Ca<sup>2+</sup> channels and reduce the formation of c-AMP.

### Glycine Receptors

Glycine receptors (GlyRs) show much less diversity than GABA<sub>A</sub> receptors. Four  $\alpha$  subunits,  $\alpha 1$  through  $\alpha 4$ , are known and one  $\beta$  subunit, each encoded by a separate gene. The  $\alpha$  subunits bind glycine and are capable of forming functional homomeric or heteromeric ion channels, while the  $\beta$  subunit confers postsynaptic clustering through an interaction with the intracellular protein gephyrin. Heteropentameric channels composed of GlyR $\alpha 1$  and GlyR $\beta$  subunits constitute the most prevalent adult strychnine-sensitive glycine receptor isoform (for details see Legendre 2001).

Glycine serves a dual role in spinal neurotransmission. It not only binds to inhibitory glycine receptors but also to a strychnine-insensitive binding site at excitatory glutamate receptors of the N-methyl D-aspartate (► **NMDA**) subtype. These receptors are primarily gated by glutamate, but require glycine as an obligatory

coagonist. Increasing evidence meanwhile indicates that glycine binding to NMDA receptors is not saturated under resting conditions; opening the possibility that NMDA receptor activity is modulated by changes in extracellular glycine. A recent study suggests that ► **spillover** of glycine synaptically released from inhibitory interneurons contributes to the facilitation of NMDA receptor activation in the spinal cord dorsal horn to facilitate nociception (Ahmadi et al. 2003).

### Synthesis, Storage and Re-uptake of GABA and Glycine

GABA is synthesized through two isoforms of ► **glutamic acid decarboxylase** (GAD-65 and GAD-67). In the ventral horn, GAD-67 is predominant, while both forms coexist in the dorsal horn. Unlike GABA, glycine is a proteogenic amino acid and therefore ubiquitously present. In glycinergic neurons it accumulates, probably through specific uptake from the extracellular space. Following synaptic release, glycine and GABA are removed from the synaptic cleft and taken up by specific membrane associated transporters, which belong to the family of Na<sup>+</sup>-Cl<sup>-</sup>-dependent neurotransmitter transporters. Two forms of ► **glycine transporters** (► **GlyT-1** and ► **GlyT-2**) exist. GlyT-2 is primarily expressed in glycinergic neurons and hence restricted mainly to the spinal cord, brainstem and cerebellum. GlyT1 is mainly found on astrocytes and expressed more widely in the CNS. GlyT1 is believed to mediate fast removal of glycine from the synaptic cleft, whereas GlyT2 mediates the recycling of glycine in glycinergic neurons. A role for both transporters in spinal nociceptive processing has been proposed, but is not yet firmly established. Five types of ► **GABA transporters** (GAT1, GAT2, GAT3, BGT1, TAUT) have been identified. Their contribution to spinal nociceptive processing is also unclear. The transport of GABA and glycine into the presynaptic storage vesicles is mediated by the ► **vesicular inhibitory amino acid transporter** (VIAAT).

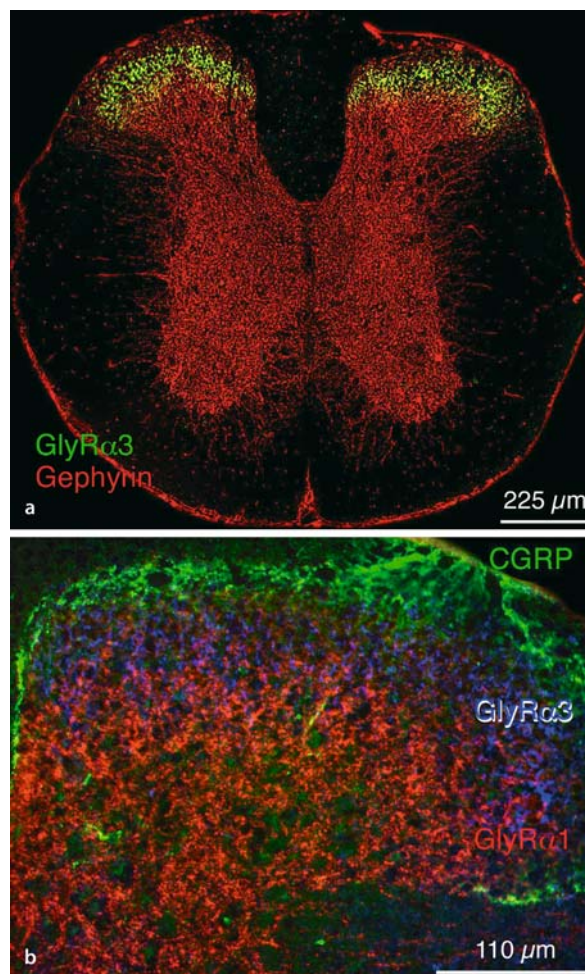
### GABA and Glycine in the Dorsal Horn

Blockade of spinal GABA<sub>A</sub> (with e.g. ► **bicuculline**) and GABA<sub>B</sub> receptors (with e.g. phaclofen) produces tactile allodynia and thermal hyperalgesia, while iontophoretic application of GABA diminishes the size of cutaneous receptive fields of dorsal horn projection neurons. At the spinal cord level, benzodiazepines inhibit the propagation of nociceptive input through the spinal cord. Although antinociceptive effects of benzodiazepines have been reported in animal models, particularly after intrathecal injection, their systemic use does not induce apparent analgesia in humans. This may be due to a potentiation of GABA receptors in supraspinal CNS areas, where GABA inhibits descending antinociceptive neurons and hence increases pain. The subunit composition of GABA<sub>A</sub> receptors exhibits characteristic differences through the different

laminae of the spinal cord. In laminae I and II  $\alpha 2$  and  $\alpha 3$  are abundant, while  $\alpha 1$  and  $\alpha 5$  are almost absent. Deeper dorsal horn laminae show less specific subunit expression (Bohlhalter et al. 1996). The contribution of the different GABA<sub>A</sub> receptor subunits to the spinal control of nociception has not yet been systematically evaluated.

Compared with GABA, the contribution of endogenous glycine to nociception is more difficult to assess because of its prominent role in the control of motor function. However, spinal application of strychnine in rats, experiments with glycine receptor-mutant mice (*spastic* mice) and accidental poisoning of humans with strychnine indicate an important role of glycine in the spinal control of nociception. Within the dorsal horn, glycinergic dendrites and somata are postsynaptic to myelinated primary afferent terminals suggesting that glycine may be primarily involved in the processing of input from low threshold mechanoreceptors. However, glycinergic neurons have also been reported to be postsynaptic to substance P containing terminals indicating that they also receive input from C fiber nociceptors. Like GABA<sub>A</sub> receptors, glycine receptors exhibit a characteristic pattern of expression in the spinal cord dorsal horn. While the GlyR $\alpha 1$  and GlyR  $\beta$  subunits are rather homogeneously distributed throughout the different laminae, GlyR $\alpha 3$  shows a distinct expression in the superficial dorsal horn, where thinly myelinated and unmyelinated primary afferents terminate (Fig. 1). Glycinergic neurotransmission in this CNS area is inhibited by nanomolar concentrations of PGE<sub>2</sub> through protein kinase A-dependent phosphorylation (Ahmadi et al. 2002). Mice deficient in the GlyR $\alpha 3$  subunit not only lack PGE<sub>2</sub>-mediated inhibition of glycine receptors, but also show a dramatic reduction in central inflammatory pain sensitization, identifying PGE<sub>2</sub>-mediated inhibition of glycinergic neurotransmission as the dominant mechanism of inflammatory hyperalgesia (Harvey et al. 2004). The prevention of this process probably constitutes the major analgesic mechanism of action of cyclooxygenases inhibitors (Fig. 2).

These and other recently reported findings indicate that a ► **disinhibition of spinal nociceptive neurons** through a decrease in inhibitory dorsal horn neurotransmission plays a key role in the development of chronic pathological pain states, including chronic ► **neuropathic pain**. Peripheral nerve injury causes a transsynaptic decrease in the expression of a potassium chloride transporter (KCC2), which reduces the chloride gradient of lamina I dorsal horn neurons and in turn reduces the inhibitory effect of GABAergic and glycinergic input (Coull et al. 2003). Furthermore, it has recently been proposed that neuropathic pain is associated with ► **apoptotic degeneration** of inhibitory mainly GABAergic interneurons in the spinal cord (Moore et al. 2002), but the data is still controversial (Polgar et al. 2003).

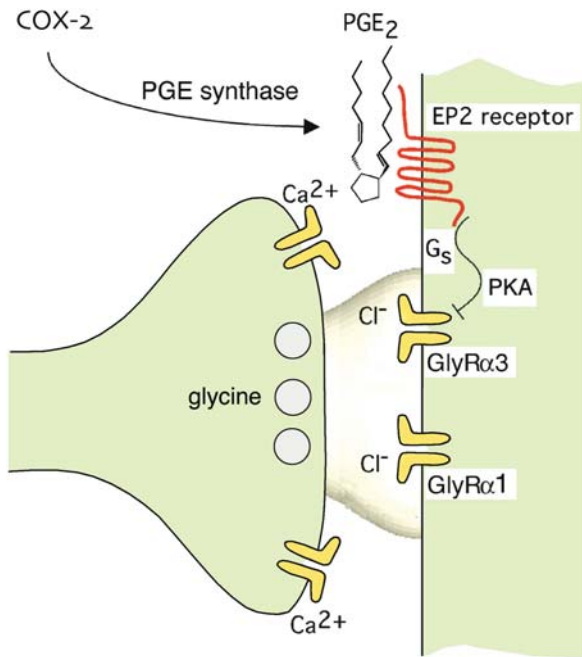


**GABA and Glycine in Spinal Nociceptive Processing, Figure 1** The  $\alpha 3$  subunit of strychnine-sensitive glycine receptors (GlyR $\alpha 3$ ) exhibits a distinct expression pattern in the spinal cord dorsal horn. (a) GlyR $\alpha 3$  staining (green) is almost exclusively found in the superficial laminae of the spinal cord dorsal horn, where nociceptive afferents terminate, while gephyrin, a postsynaptic protein which anchors glycine and GABA receptors in the postsynaptic membrane, is ubiquitously distributed throughout the gray matter of the spinal cord. (b) Co-staining of GlyR $\alpha 3$  (blue) with calcitonin gene related peptide (CGRP, green), a marker of peptidergic primary afferent nerve fibers, and GlyR $\alpha 1$  (red), the most abundant adult glycine receptor subunit. (Modified from Harvey et al. GlyR $\alpha 3$ : an essential target for spinal PGE<sub>2</sub>-mediated inflammatory pain sensitization. *Science* 304:884-887, 2004).

#### GABA<sub>A</sub> Receptors on Primary Afferent Neurons

Primary sensory neurons achieve an unusually high intracellular chloride concentration due to the expression of a ► **Na<sup>+</sup>K<sup>+</sup>Cl<sup>-</sup> cotransporter** (slc12a2), which accumulates Cl<sup>-</sup> inside cells, and the lack of K<sup>+</sup>Cl<sup>-</sup> cotransporters, which extrude Cl<sup>-</sup> from cells, (Kanaka et al. 2001). This peculiar expression pattern causes GABAergic input to depolarize central terminals of these neurons and causes GABA<sub>A</sub> receptor-mediated primary afferent depolarization (PDA). This depolarization can lead to voltage-dependent inactivation of ion channels in the terminal and thereby reduce trans-





**GABA and Glycine in Spinal Nociceptive Processing, Figure 2** Schematic diagram illustrating the pathway leading to PGE<sub>2</sub>-mediated reduction of inhibitory glycinergic neurotransmission in the superficial layers of the spinal cord dorsal horn. PGE<sub>2</sub> binds to postsynaptic EP2 receptors, which activate adenyl cyclase and finally trigger protein kinase A-dependent phosphorylation and inhibition of GlyRα3.

mitter release (► [presynaptic inhibition](#)). Under certain conditions, primary afferent depolarization may become supra-threshold and then evoke retrograde action potentials giving rise to so-called ► [dorsal root reflexes](#).

#### Therapeutic Interventions Targeting Spinal GABA and Glycine Receptors

Although the role of glycine and GABA in spinal nociceptive processing is increasingly recognized, only very few analgesic drugs target these transmitter systems so far. Systemic and intrathecal ► [baclofen](#), an agonist at GABA<sub>B</sub> receptors, has been successfully used in pain patients suffering from multiple sclerosis or after spinal cord injury. Antagonists at the glycine-binding site of NMDA receptors are currently being developed for the treatment of chronic pain states. Blockade of the glycine-binding site of NMDA receptors has proven antinociceptive in several animal models of pain including chronic neuropathic pain.

#### References

- Ahmadi S, Lippross S, Neuhuber WL et al. (2002) PGE<sub>2</sub> selectively blocks inhibitory glycinergic neurotransmission on rat superficial dorsal horn neurons. *Nat Neurosci* 5:34–40
- Ahmadi S, Muth-Selbach U, Lauterbach A et al. (2003) Facilitation of spinal NMDA receptor-currents by synaptically released glycine. *Science* 300:2094–2097
- Bohlhalter S, Weinmann O, Möhler H et al. (1996) Laminar compartmentalization of GABA<sub>A</sub>-receptor subtypes in the spinal cord: an immunohistochemical study. *J Neurosci* 16:283–297

- Coull JA, Boudreau D, Bachand K et al. (2003) Trans-synaptic shift in anion gradient in spinal lamina I neurons as a mechanism of neuropathic pain. *Nature* 424:938–942
- Harvey RJ, Depner UB, Wässle H et al. (2004) GlyR α3: An essential target for spinal inflammatory pain sensitization. *Science* 304:884–887
- Kanaka C, Ohno K, Okabe A et al. (2001) The differential expression patterns of messenger RNAs encoding K-Cl cotransporters (KCC1,2) and Na-K-2Cl cotransporter (NKCC1) in the rat nervous system. *Neuroscience* 104:933–946
- Legendre P (2001) The glycinergic inhibitory synapse. *Cell Mol Life Sci* 58:760–793
- Moore KA, Kohno T, Karchewski LA et al. (2002) Partial peripheral nerve injury promotes a selective loss of GABAergic inhibition in the superficial dorsal horn of the spinal cord. *J Neurosci* 22:6724–6731
- Polgar E, Hughes DI, Riddell JS et al. (2003) Selective loss of spinal GABAergic or glycinergic neurons is not necessary for development of thermal hyperalgesia in the chronic constriction injury model of neuropathic pain. *Pain* 104:229–239
- Rudolph U, Crestani F, Möhler H (2001) GABA<sub>A</sub> receptor subtypes: dissecting their pharmacological functions. *Trends Pharmacol Sci.* 22:188–194

## GABA Mechanisms and Descending Inhibitory Mechanisms

WILLIAM D. WILLIS

Department of Neuroscience and Cell Biology,  
University of Texas Medical Branch, Galveston, TX,  
USA

wdwillis@utmb.edu

#### Synonyms

Centrifugal Control of Nociceptive Processing; Supraspinal Regulation; endogenous analgesia system; GABAergic Inhibition; Descending Inhibitory Mechanisms and GABA Mechanisms

#### Definition

Pathways that originate in the brain can inhibit nociceptive neurons in the dorsal horn, including spinothalamic tract (STT) cells. Several different inhibitory neurotransmitters are used by the endogenous analgesia system. One of these is gamma-aminobutyric acid (GABA). GABA can be released either directly by the axons of brainstem neurons that descend to the spinal cord or indirectly by the excitation of GABAergic inhibitory interneurons in the spinal cord through release of excitatory transmitters from descending axons. There are several mechanisms for GABAergic inhibitory actions. These include pre- and post-synaptic inhibition following actions of GABA on GABA<sub>A</sub> or GABA<sub>B</sub> receptors.

#### Characteristics

► [Gamma\(γ\)-Aminobutyric Acid](#) (GABA) is a major inhibitory neurotransmitter in the spinal cord, especially in the dorsal horn (Willis and Coggeshall 2004). Its synthetic enzyme is ► [glutamic acid decarboxylase](#)

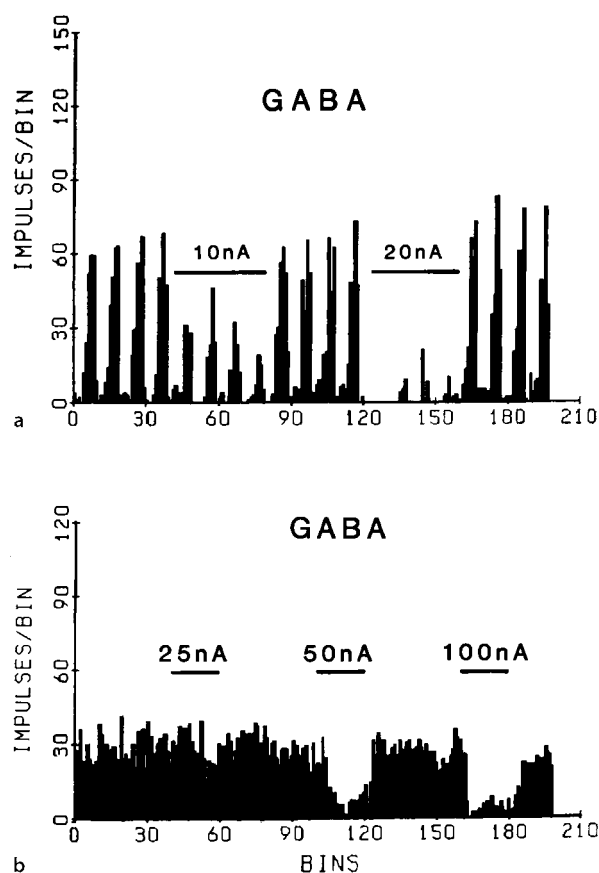


(GAD). There are several forms of GAD. The sources of GABAergic terminals in the spinal cord include GABAergic spinal interneurons (see ► [GABAergic Cells \(Inhibitory Interneurons\)](#)) (Carlton and Hayes 1990) and axons that descend from the rostral ventral medulla (Millhorn et al. 1987; Reichling and Basbaum 1990). GABA-containing synapses have been demonstrated on primate spinothalamic tract cells in an electron microscopic study (Carlton et al. 1992). GABA is also contained in presynaptic contacts with primary afferent terminals (Willis and Coggeshall 2004).

There are at least 3 types of GABA receptors (see ► [GABA<sub>A</sub> Receptors and GABA<sub>B</sub> Receptors](#)), GABA<sub>A</sub>, GABA<sub>B</sub> and GABA<sub>C</sub> receptors. Emphasis here will be on the first two of these. GABA<sub>A</sub> receptors are ionotropic receptors and cause the opening of chloride channels (Willis and Coggeshall 2004). This can result in either a hyperpolarization or a depolarization, depending on where Cl<sup>-</sup> is concentrated. The concentration of Cl<sup>-</sup> depends on the type of ► [Cl<sup>-</sup> Transporter](#) that is present in the neuronal membranes (Willis and Coggeshall 2004; Willis 1999). In the case of presynaptic endings, GABA<sub>A</sub> receptor activation results in primary afferent depolarization and ► [presynaptic inhibition](#) (Willis 1999). In the case of postsynaptic neurons, GABA<sub>A</sub> receptors cause hyperpolarization and ► [postsynaptic inhibition](#) (Willis and Coggeshall 2004).

GABA<sub>B</sub> receptors are metabotropic G-protein coupled receptors (see ► [Metabotropic Glutamate Receptors](#)) (Willis and Coggeshall 2004). They are found both pre- and post-synaptically. Their activation can also cause pre- or post-synaptic inhibition. However, presynaptic inhibition in this case is not accompanied by primary afferent depolarization. Instead, it is due to a reduction in the Ca<sup>++</sup> current that is necessary for release of transmitter from presynaptic terminals. Postsynaptic inhibition that is mediated by GABA<sub>B</sub> receptors results from an increased conductance for K<sup>+</sup> ions.

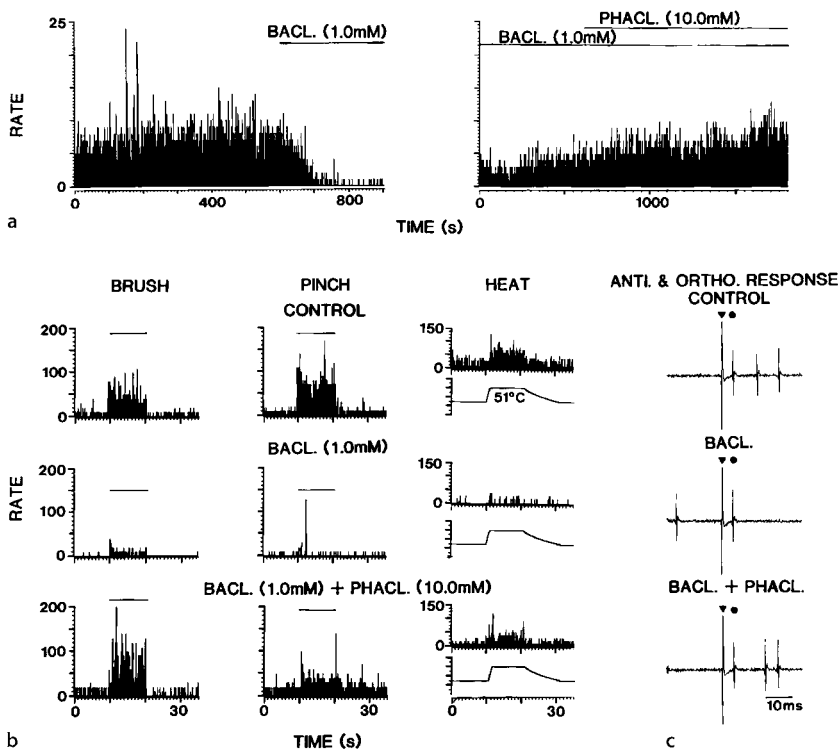
Experiments in which drugs were released by ► [microiontophoresis](#) near primate STT cells have shown that the excitation of these neurons by the pulsed release of glutamate or by noxious compression of the skin can be reduced by GABA (Fig. 1) (Willcockson et al. 1984). The iontophoretic release of the GABA<sub>A</sub> receptor agonist, muscimol, also inhibited the activity of all of the STT cells tested (Lin et al. 1996a). However, the GABA<sub>B</sub> receptor agonist, baclofen, produced inhibition in only 17% of STT cells examined. On the other hand, microdialysis administration of baclofen into the dorsal horn resulted in a strong inhibition of STT cells (Fig. 2). This was counteracted by co-administration of the GABA<sub>B</sub> receptor antagonist, phaclofen. ► [Microdialysis](#) administration of the GABA<sub>A</sub> antagonist, bicuculline or the GABA<sub>B</sub> receptor antagonist, phaclofen enhanced the responses of STT cells (Lin et al. 1996a). This evidence suggests that GABA<sub>B</sub> receptors are likely to be more im-



**GABA Mechanisms and Descending Inhibitory Mechanisms, Figure 1** Inhibition of the activity of a primate spinothalamic tract (STT) neuron by iontophoretic release of GABA. (a) shows the responses of an STT cell to pulsed release of glutamate. The iontophoretic currents lasted for 5 s and were repeated at 10 s intervals. At the times indicated by the horizontal bars, GABA was also released, using the indicated currents. (b) shows the inhibitory effects of GABA release on the responses of the same STT neuron to continuous noxious pinch of the skin in the receptive field. The iontophoretic currents are indicated. (From (Willcockson et al. 1984).)

portant for presynaptic inhibition than for postsynaptic inhibition.

Stimulation in the midbrain ► [periaqueductal gray](#) (PAG) can produce a strong inhibition of the responses of nociceptive dorsal horn neurons, including STT cells (Hayes et al. 1979). This inhibition is at least partly due to the effects of the release of GABA in the spinal cord (Lin et al. 1996a; Peng et al. 1996). Evidence for this was obtained by administration of antagonists of GABA receptors into the spinal cord by microdialysis. The antagonists reduced the amount of inhibition produced by PAG stimulation. GABA<sub>A</sub> receptors are activated by PAG stimulation, since PAG inhibition is partially blocked by the GABA<sub>A</sub> antagonist, bicuculline (Fig. 3). GABA<sub>B</sub> receptors are less involved in PAG inhibition of STT cells, since administration of the GABA<sub>B</sub> antagonist, phaclofen reduced the inhibition produced by PAG stimulation in only 22% of the



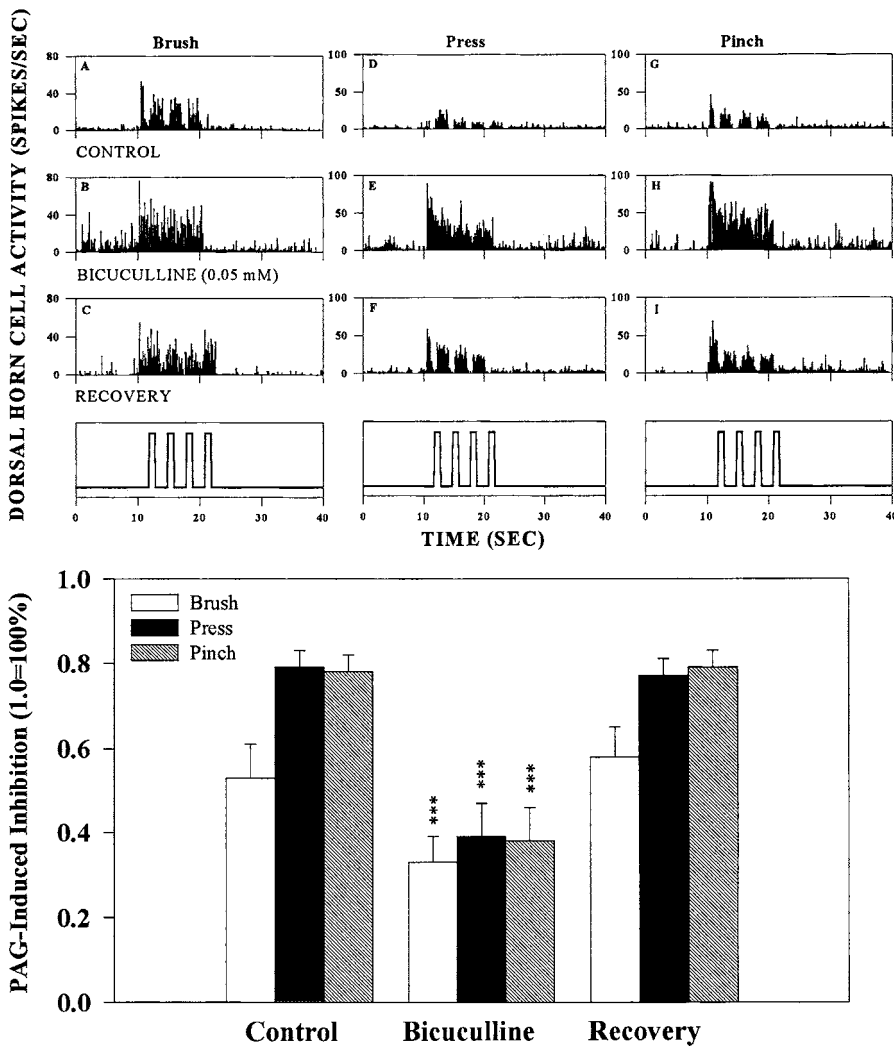
**GABA Mechanisms and Descending Inhibitory Mechanisms, Figure 2** Inhibition of the activity of a primate STT cell by spinal cord microdialysis administration of baclofen and the antagonistic effect of phaclofen. (a) left histogram, shows the background discharge of an STT cell. During the time indicated by the horizontal bar, baclofen was infused into the spinal cord by microdialysis. (a) right histogram, shows the antagonistic action of phaclofen when this agent was co-administered with baclofen. (b) shows the inhibitory effects of baclofen on the responses of the neuron to brush and pinch stimuli and to noxious heat. The stimuli were applied at the times indicated by the horizontal bars or by the temperature monitor. The upper row of histograms shows the control responses, the middle row the inhibited responses during baclofen administration and the lower row the responses when phaclofen was co-administered with baclofen. In (c), baclofen is shown to block orthodromic but not antidromic responses of the STT cell. The effect was reversed by phaclofen. (From Lin et al. 1996a).

STT cells tested. Thus, GABA, as well as opioids and monoamines, such as serotonin and norepinephrine is one of the inhibitory neurotransmitters utilized by the ► [endogenous analgesia system](#) (Willis and Coggeshall 2004).

The inhibitory action of GABA has been shown to have an important antinociceptive action (see ► [Antinocception](#)) in the spinal cord that is mediated by GABA<sub>A</sub> receptors (Aanonsen and Wilcox 1989). Release of GABA has been offered as an explanation for the antinociceptive effects of spinal cord stimulation (Linderoth et al. 1994). In contrast, antagonism of GABA<sub>A</sub> receptors in rats produces a profound state of ► [mechanical allodynia](#) (Sivilotti et al. 1994). Consistent with this is the observation that the inhibition of primate STT cells produced by iontophoretic application of GABA or muscimol is greatly reduced during the ► [central sensitization](#) that follows intradermal injection of capsaicin (Lin et al. 1996b). Central sensitization is likely to be due to both an increase in the responsiveness of excitatory amino acid receptors and to a decrease in the responsiveness of inhibitory amino acid receptors (Willis and Coggeshall 2004).

## References

1. Aanonsen LM, Wilcox GL (1989) Muscimol,  $\gamma$ -aminobutyric acid<sub>A</sub> receptors and excitatory amino acids in the mouse spinal cord. *JPET* 248:1034–1038
2. Carlton SM, Hayes ES (1990) Light microscopic and ultrastructural analysis of GABA-immunoreactive profiles in the monkey spinal cord. *J Comp Neurol* 300:162–182
3. Carlton SM, Westlund KN, Zhang D et al. (1992) GABA-immunoreactive terminals synapse on primate spinothalamic tract cells. *J Comp Neurol* 322:528–537
4. Hayes RL, Price DD, Ruda MA et al. (1979) Suppression of nociceptive responses in the primate by electrical stimulation of the brain or morphine administration: behavioral and electrophysiological comparisons. *Brain Res* 167:417–421
5. Lin Q, Peng YB, Willis WD (1996a) Role of GABA receptor subtypes in inhibition of primate spinothalamic tract neurons: difference between spinal and periaqueductal gray inhibition. *J Neurophysiol* 75:109–123
6. Lin Q, Peng YB, Willis WD (1996b) Inhibition of primate spinothalamic tract neurons by spinal glycine and GABA is reduced during central sensitization. *J Neurophysiol* 76:1005–1014
7. Linderoth B, Stiller CO, Gunasekera L et al. (1994) Gamma-aminobutyric acid is released in the dorsal horn by electrical spinal cord stimulation: an in vivo microdialysis study in the rat. *Neurosurgery* 34:484–488
8. Millhorn DE, Hökfelt T, Seroogy K et al. (1987) Immunohistochemical evidence for colocalization of  $\gamma$ -aminobutyric acid and serotonin in neurons of the ventral medulla oblongata projecting to the spinal cord. *Brain Res* 410:179–185
9. Peng YB, Lin Q, Willis WD (1996) Effects of GABA and glycine receptor antagonists on the activity and PAG-induced inhibition of rat dorsal horn neurons. *Brain Res* 736:189–201
10. Reichling DB, Basbaum AI (1990) Contribution of brainstem GABAergic circuitry to descending antinociceptive control. I. GABA-immunoreactive projection neurons in the periaqueductal gray and nucleus raphe magnus. *J Comp Neurol* 302:370–377
11. Sivilotti L, Woolf CJ (1994) The contribution of GABA<sub>A</sub> and glycine receptors to central sensitization: disinhibition and touch-evoked allodynia in the spinal cord. *J Neurophysiol* 782:169–179



**GABA Mechanisms and Descending Inhibitory Mechanisms, Figure 3** Reduction in the PAG inhibition of nociceptive dorsal horn neurons in the rat spinal cord following microdialysis administration of the GABA<sub>A</sub> receptor antagonist, bicuculline. The upper row of histograms in (a) show repeated periods of inhibition of the responses of a dorsal horn neuron to brush, press and pinch stimuli due to four periods of stimulation in the periaqueductal gray (PAG). The stimulus monitor pulses in the lowest row of records indicate the timing of PAG stimulation. The second row of histograms shows that the PAG inhibition was blocked during the microdialysis administration of bicuculline into the spinal cord. The third row of histograms shows recovery from the bicuculline. (b) shows the grouped results for 19 dorsal horn neurons. Bicuculline infusion resulted in a significant reduction in the PAG inhibition. (From Peng et al. 1996).

- Willcockson WS, Chung JM, Hori Y et al. (1984) Effects of iontophoretically released amino acids and amines on primate spinothalamic tract cells. *J Neurosci* 4:732–740
- Willis WD (1999) Dorsal root potentials and dorsal root reflexes: a double-edged sword. *Exp Brain Res* 124:395–421
- Willis WD, Coggeshall RE (2004) *Sensory Mechanisms of the Spinal Cord*, 3rd edn. Kluwer Academic/Plenum Publishers, New York

An Ionotropic (bicuculline-sensitive)  $\gamma$ -amino butyric acid (GABA) receptor. GABA<sub>A</sub> receptors are ionotropic (gating primarily Cl<sup>-</sup> and K<sup>+</sup> currents) and typically mediate fast inhibitory processes.

► [GABA and Glycine in Spinal Nociceptive Processing](#)

## GABA Transporter

### Definition

Plasma membrane transporters, which transport GABA into neurons and glial cells.

► [GABA and Glycine in Spinal Nociceptive Processing](#)

## GABA<sub>A</sub> Receptors

### Definition

## GABA<sub>B</sub> Receptors

### Definition

GABA<sub>B</sub> is a type of receptor for the inhibitory amino acid  $\gamma$ -amino butyric acid. GABA<sub>B</sub> receptors are metabotropic and typically mediate slower inhibitory processes.

► [GABA Mechanisms and Descending Inhibitory Mechanisms](#)

► [Nociceptive Neurotransmission in the Thalamus](#)

► [Thalamic Plasticity and Chronic Pain](#)

## GABAergic

### Definition

Synaptic transmission at which the  $\gamma$ -amino acid GABA ( $\gamma$ -aminobutyric acid) is used as an inhibitory neurotransmitter.

- ▶ Opioid Receptors at Postsynaptic Sites

## GABAergic Cells (Inhibitory Interneurons)

### Definition

GABAergic cells are neurons that use gamma-aminobutyric acid (GABA), an inhibitory neurotransmitter, as their neurotransmitter. GABAergic inhibitory interneurons are local circuit inhibitory neurons that use GABA as their neurotransmitter.

- ▶ GABA Mechanisms and Descending Inhibitory Mechanisms
- ▶ Nociceptive Neurotransmission in the Thalamus
- ▶ Thalamic Nuclei Involved in Pain, Cat and Rat
- ▶ Thalamocortical Loops and Information Processing

## GABAergic Inhibition

- ▶ GABA Mechanisms and Descending Inhibitory Mechanisms

## Gabapentin

### Definition

Gabapentin is an antiepileptic drug that is also effective in neuropathic pain conditions as, for example, postherpetic neuralgia and diabetic neuropathy. It is very likely that gabapentin may reduce phantom pain.

- ▶ Migraine, Preventive Therapy
- ▶ Postoperative Pain, Gabapentin
- ▶ Postoperative Pain, Postamputation Pain, Treatment and Prevention

## GAD

- ▶ Glutamic Acid Decarboxylase

## Gainful Work Activity

### Definition

Gainful work activity is that which is done for pay or profit. Work activity is gainful if it is the kind of work usually done for pay or profit whether or not a profit is realized.

- ▶ Disability Evaluation in the Social Security Administration

## Galactorrhea

### Definition

Galactorrhea is the normal production and flow of milk after pregnancy. This condition is considered abnormal in the absence of recent pregnancy.

- ▶ Cancer Pain Management, Opioid Side Effects, Endocrine Changes and Sexual Dysfunction

## Galanin

### Definition

Galanin is a 29-amino acid peptide (30 in humans), which was purified from porcine intestine. It is widely distributed in the nervous system and has inhibitory effects on its target cells. Galanin-containing dorsal root ganglion neurons seem to play a role in pain processing, particularly following nerve injury. Roles in the central control of feeding, body weight and affect are also discussed.

- ▶ Neuropeptide Release in the Skin

## Gamma Knife

### Definition

A gamma knife is a highly specific and focused, non-invasive, gamma radiation device used as a surgical unit.

- ▶ Cancer Pain Management, Anesthesiologic Interventions

## Gamma( $\gamma$ )-Aminobutyric Acid

### Synonym

GABA



## Definition

GABA is a biologically active amino acid found in plants as well as in the brain and other animal tissues. One of the principle inhibitory amino acid neurotransmitters in the central nervous system. GABA acts as an agonist at two receptors, the GABA<sub>A</sub> receptor, which is a chloride channel, and the GABA<sub>B</sub> receptor, which is a G-protein linked receptor. Primary afferent depolarization in the central nervous system is thought to be mediated by the release of GABA at axo-axonic synapses. Activation of GABA<sub>A</sub> receptors by synaptically released GABA depolarizes the central terminals of afferent fibers, increasing their excitability. It is found primarily in inhibitory interneurons throughout the neuraxis.

- ▶ [GABA Mechanisms and Descending Inhibitory Mechanisms](#)
- ▶ [GABA and Glycine in Spinal Nociceptive Processing](#)
- ▶ [Molecular Contributions to the Mechanism of Central Pain](#)
- ▶ [Nociceptors in the Orofacial Region \(Temporomandibular Joint and Masseter Muscle\)](#)
- ▶ [Somatic Pain](#)
- ▶ [Spinal Cord Nociception, Neurotrophins](#)
- ▶ [Stimulation-Produced Analgesia](#)
- ▶ [Thalamic Neurotransmitters and Neuromodulators](#)
- ▶ [Thalamic Plasticity and Chronic Pain](#)

## Ganglionopathies

JOHN W. GRIFFIN

Department of Neurology Johns Hopkins University School of Medicine, Departments of Neuroscience and Pathology Johns Hopkins Hospital, Baltimore, MA, USA  
jgriffi@jhmi.edu

### Synonyms

Sensory Neuronopathy; Sensory Ganglionitis; Idiopathic Ataxic Neuropathy

### Definition

A group of disorders of the peripheral nervous system characterized by loss of primary sensory neurons in the dorsal root ganglia, with or without concomitant loss of autonomic neurons from the peripheral ganglia.

### Characteristics

The primary sensory neurons lie in the dorsal root ganglia and cranial nerve ganglia. In a group of disorders of the peripheral nervous system (PNS) they degenerate and are lost, along with their peripheral and central axons. There are several etiologies that can produce such sensory ganglionopathies, includ-

ing inflammatory, toxic, and infectious causes. Most types of sensory ganglionopathies affect large sensory neurons and so produce loss of proprioception, joint position sensibility, and kinesthesia (Denny-Brown 1948; Griffin et al. 1990; Kuntzer et al. 2004; Windebank et al. 1990). When the legs are affected there is sensory ataxia, characterized by ataxia associated with the inability to stand with their eyes closed (Romberg's sign). When the arms are affected there is typically drift of the outstretched arms with the eyes closed, associated with "piano-playing" involuntary movements in the fingers (pseudoathetosis). Pseudoathetosis is easiest to see with the arms outstretched, but in severe cases it can be recognized in the hands at rest. A useful test is to ask the patient to find the thumb of one hand with the index finger of the other without visual guidance. In normal individuals this is a prompt, secure movement. In patients with loss of kinesthesia, the moving hand must search for the thumb. In the most severe cases, so much touch sensibility is lost, that the patient may not recognize when contact is made.

These features reflect loss of sensation from relatively proximal levels of the arms and legs. Most nerve diseases produce length-dependent loss of function, so that sensation is lost in the toes and feet first, and only with advanced disease would gait ataxia, drift of the arms, and pseudoathetosis develop. Thus a characteristic feature of the ganglionopathies is the loss of large-fiber sensory functions, which is not length-dependent in fashion, so that short as well as long nerves are affected.

Spontaneous sensations (tingling paresthesias or burning pain) may be present in affected regions. Reflecting the nonlength-dependent pathology, the affected regions frequently include the face and the trunk (Denny-Brown 1948; Griffin et al. 1990; Windebank et al. 1990), regions rarely affected in length-dependent axonal degenerations. A characteristic electrodiagnostic finding is loss of sensory nerve action potential (SNAP) amplitudes in a nonlength-dependent fashion – the SNAP amplitudes from the ulnar, median, or radial nerves may be reduced at times when the responses from the sural nerves in the legs are still elicitable, or all SNAP responses may be lost at the same time (Lauria et al. 2003). In length-dependent axonal degenerations the sural SNAP amplitude is reduced or lost well before the SNAP amplitudes in the arms. There are two other indications that the neuronal loss in ganglionopathies is nonlength-dependent. First, magnetic resonance imaging (MRI) of the spinal cord shows evidence of fiber loss in the dorsal column at all levels of the spinal cord, reflecting loss of the central processes of large primary afferent neurons (Lauria et al. 2000). In length-dependent axonal degenerations, loss of fibers in the dorsal columns occurs first in the rostral gracile tract. Second, skin biopsies immunostained for nerve fibers show loss of nerve fibers from proximal sites such as the thigh, back, and chest, as well as distal sites (Lauria

et al. 2001). In length-dependent axonal degeneration fibers are lost first from the distal leg.

### Immune-Mediated Ganglionopathies

Three disorders are included under the designation sensory ganglionitis: carcinomatous sensory neuropathy, ataxic neuropathy associated with Sjogren's syndrome, and idiopathic sensory neuronopathy. All share the pathologic features of lymphocytic infiltration of dorsal root ganglia and destruction of sensory neurons. As indicated in Table I, there are clinical differences that allow suspicion of the correct diagnosis in the clinic.

#### Carcinomatous Sensory Neuropathy

This disorder was the first recognized sensory ganglionopathy (Denny-Brown 1948), and its diagnosis has special urgency because it may be the presenting manifestation of an underlying malignancy. Sensory ganglionopathy can be associated with underlying lung, breast, ovary, or other carcinomas. The pathology is an intense lymphocytic infiltration of the dorsal root ganglia, often with autoaggressive T cells invading the sensory nerve cells (Denny-Brown 1948). The initial symptom is often neuropathic pain that involves the hands, trunk, and/or face as well as the feet. The sensory loss is global, as reflected in nerve biopsies that show loss of small myelinated and unmyelinated fibers as well as large myelinated fibers. Some individuals have evidence of CNS involvement such as dementia, cerebellar dysfunction, or myelopathy. The spinal fluid often has a mild lymphocytic pleocytosis and elevated protein. A key diagnostic test is a search for antineuronal antibodies associated with sensory ganglionopathies. These antibodies include anti-Hu antibodies, also called ANNA-1 antibodies, directed against a 37 kD nuclear antigen. Other antibodies include anti-ampiphysin antibodies, ANNA-2, and ANNA-3. Patients who present with subacute sensory ganglionopathy require meticulous examination for underlying carcinoma, especially when one of these antibodies is detected.

The course is usually inexorable, although occasionally the disease stabilizes. Early discovery of the neoplasm can be life-saving, and occasionally results in stabilization of the ganglionopathy. Immunosuppressive therapies have had disappointing results. Control of the neuropathic pain is often difficult and may require opiates.

#### Ataxic Ganglionopathy with Features of Sjogren's Syndrome

Sjogren's syndrome is an autoimmune rheumatologic disorder that includes dry eyes, dry mouth, and serologic abnormalities that often include anti-nuclear antibodies. The dry mouth and dry eyes reflect lymphocytic infiltration of the salivary and lacrimal glands, respectively. Testing for tear production (Shirmer test) and lip biopsy (minor salivary gland biopsy), and looking for lymphocytic inflammation are adjuncts to the diagnosis. Several types of neuropathy can be associated with Sjogren's syndrome (Griffin et al. 1990; Mellgren et al. 1989). In typical Sjogren's syndrome, it has been shown that ataxic neuropathy is rare, whereas multiple mononeuropathies and axonal sensorimotor neuropathies are frequently encountered. In the ganglionopathy, the ocular and other features of Sjogren's syndrome are often minor, and the neuropathy is usually the presenting manifestation (Griffin et al. 1990). The ataxic neuropathy patients thus form a distinct subgroup of the Sjogren's patients.

Ataxic neuropathy associated with features of Sjogren's syndrome is a syndrome that can be recognized by clinical and laboratory testing. The laboratory features useful in recognizing this syndrome are positive Schirmer and rose bengal tests for dry eyes and keratitis respectively, inflammation of the minor salivary glands on lip biopsy, and a markedly abnormal antinuclear antibody titer, with or without the Ro or La reactivity often associated with Sjogren's syndrome.

The neurologic examination is similar to the other ganglionopathies, with sensory ataxia and loss of kines-

**Ganglionopathies, Table 1** Sensory Ganglionitis Syndromes

Feature	Sicca syndrome	Idiopathic	Carcinomatous
Female predilection	Marked	Modest	Absent
Course	Variable, acute to chronic	Variable, acute to chronic	Subacute
Progression	Variable, may stabilize or improve	Variable, may stabilize or improve	Progressive
Fiber predilection	Large fiber, kinesthetic loss	Large fiber, kinesthetic loss	More global
Associated central nervous system involvement	Usually none	None	Cerebellar involvement
Serologic studies	ANA <sup>+</sup> , elevated IgG	Normal	Anti-Hu in many
Antineuronal nuclear antibody	-	-	+
Cerebrospinal fluid	Normal	Normal	Some cells, protein
Nerve biopsy	Inflammation, large fiber loss	Large fiber loss	More global fiber loss

thesia in the arms (Griffin et al. 1990). Autonomic dysfunction, reflected in orthostatic hypotension and loss of heart period variability, is common. A characteristic abnormality is the development of Adie's pupils, unilaterally or bilaterally (Griffin et al. 1990). Adie's pupils are mid-position pupils with a slow reaction to changes in illumination, prompt reconstriction to accommodation, and vermicular movements under a slit lamp. Bilateral Adie's pupils are sufficiently rare in other disorders that they suggest the possibility of Sjogren's ganglionopathy.

The histologic appearance is remarkable for a variable degree of neuronal loss and marked lymphocytic infiltration of the ganglia and dorsal roots (Griffin et al. 1990). In cutaneous sensory nerves, large myelinated fibers are lost. Small myelinated and unmyelinated fiber densities are relatively preserved. Several nerve biopsy specimens have had small perivascular inflammatory cuffs around epineurial vessels.

In general, attempts at immunotherapy have proved disappointing. In most patients, oral and intravenous corticosteroids, cyclophosphamide, and azathioprine have had no obvious effect on the course of the disorder, although a slowing of the progression cannot be excluded. Most patients received their initial therapy at a time when SNAPs were markedly reduced or absent, making the likelihood of recovery low. Rare patients with relatively preserved SNAPs stabilize or improve after treatment with intravenous methylprednisolone and oral azathioprine.

### Idiopathic Sensory Neuronopathy

This category, one of the most frequent causes of sensory ganglionopathy, includes patients with acute, subacute, and chronic disease courses (Windebank et al. 1990). In the acute form, devastating sensory loss develops over a few days. The spinal fluid protein value may be normal or elevated. Results of other laboratory tests are normal and useful principally in excluding Sjogren's syndrome and occult cancer. Pathologic studies have been rare, but the results have been similar to the findings in Sjogren's syndrome with sensory ganglionitis.

The prognosis is highly variable, but in time the majority of patients with this disorder are able to return to their previous career (Windebank et al. 1990). The role of therapy is uncertain; most patients have received corticosteroids at some point, and such therapy may minimize progression (Windebank et al. 1990). More important are reassurance, gait training and safety instruction, as described below.

### The Fisher Syndrome

The Fisher syndrome is a variant of the Guillain Barre syndrome that is characterized by ataxia, loss of reflexes, and inability to move the eyes (ophthalmoparesis) associated with pupils that do not react to light or looking at near objects. Like the other forms of the Guillain Barre

syndrome, the Fisher syndrome is an acute monophasic autoimmune disorder that can follow infections. Like the other forms, it is likely that the immune response to antigens on infectious agents result in an immune attack on similar moieties within peripheral nerve molecular mimicry. In the Fisher syndrome, serologic studies have found the presence of antibodies against the ganglioside GQ1b (Chiba et al. 1993; Willison et al. 1993), and experimental studies have shown that exposure to strains of *Campylobacter jejuni*, that bear related epitopes with their lipopolysaccharides, can produce pathogenic anti-GQ1b antibodies (Plomp et al. 1999). In the inflammatory demyelinating form of Guillain Barre syndrome treatment with plasmapheresis—the removal of the immunoglobulin fraction of plasma by exchange for albumin—or the infusion of large amounts of human immunoglobulin, a procedure that ameliorates many immune disorders, speeds recovery. Although no data applies specifically to the Fisher syndrome, it is reasonable to infer that these treatments would be efficacious in this disorder as well.

Whether the ataxic represents a ganglionopathy is unresolved. Immunization of rabbits with GD1b produces an inflammatory ganglionopathy and ataxia (Kusunoki et al. 1999). However, the reversibility of the ataxia in the Fisher syndrome suggests that the ganglion cells need not be destroyed.

### Toxic Causes

Several pharmacologic agents can produce ataxic neuropathies. Whether these are truly sensory ganglionopathies is questionable. Some agents, such as pyridoxine, can produce loss of large DRG neurons experimentally, but the reversibility of the effects of intoxication by large doses of pyridoxine in man, suggests that it at least begins as a length-dependent axonal degeneration. Regeneration can occur when the agent is discontinued. Several can produce neuropathic pain, and experimental models of taxane-induced painful neuropathies have been developed.

### References

1. Chiba A, Kusunoki S, Obata H, Machinami R, Kanazawa I (1993) Serum Anti-GQ1b Antibody is Associated with Ophthalmoplegia in Miller Fisher Syndrome and Guillain-Barre Syndrome: Clinical and Immunohistochemical Studies. *Neurology* 43:1911–1917
2. Denny-Brown D (1948) Primary Sensory Neuropathy with Muscular Changes Associated with Carcinoma. *J Neurol Neurosurg Psychiatry* 11:73–87
3. Griffin JW, Cornblath DR, Alexander E, Campbell J, Low PA, Bird S, Feldman EL (1990) Ataxic Sensory Neuropathy and Dorsal Root Ganglionitis Associated with Sjogren's Syndrome. *Ann Neurol* 27:304–315
4. Kuntzer T, Antoine JC, Steck AJ (2004) Clinical Features and Pathophysiological Basis of Sensory Neuronopathies (Ganglionopathies). *Muscle Nerve* 30:255–268
5. Kusunoki S, Hitoshi S, Kaida K, Arita M, Kanazawa I (1999) Monospecific Anti-GD1b IgG is Required to Induce Rabbit Ataxic Neuropathy. *Ann Neurol* 45:400–403

6. Lauria G, Pareyson D, Grisoli M, Sghirlanzoni A (2000) Clinical and Magnetic Resonance Imaging Findings in Chronic Sensory Ganglionopathies. *Ann Neurol* 47:104–109
7. Lauria G, Pareyson D, Sghirlanzoni A (2003) Neurophysiological Diagnosis of Acquired Sensory Ganglionopathies. *Eur Neurol* 50:146–152
8. Lauria G, Sghirlanzoni A, Lombardi R, Pareyson D (2001) Epidermal Nerve Fiber Density in Sensory Ganglionopathies: Clinical and Neurophysiologic Correlations. *Muscle Nerve* 24:1034–1039
9. Mellgren SI, Conn DL, Stevens JC, Dyck PJ (1989) Peripheral Neuropathy in Sjogren Syndrome. *Neurology* 39:390–394
10. Plomp JJ, Molenaar PC, O'Hanlon GM, Jacobs BC, Veitch J, Daha MR, vanDoorn PA, van der Meche FGA, Vincent A, Morgan BP, Willison HJ (1999) Miller Fisher Anti-GQ1b Antibodies:  $\alpha$ -Latrotoxin-Like Effects on Motor End Plates. *Ann Neurol* 45:189–199
11. Willison HJ, Veitch J, Patterson G, Kennedy PGE (1993) Miller Fisher Syndrome is Associated with Serum Antibodies to GQ1b Ganglioside. *J Neurol Neurosurg Psychiatry* 56:204–206
12. Windebank AJ, Blexrud MD, Dyck PJ, Daube JR, Karnes JL (1990) The Syndrome of Acute Sensory Neuropathy: Clinical Features and Electrophysiologic and Pathologic Changes. *Neurology* 40:584–591

## Gap Junctions

### Definition

Gap junctions are intercellular channels established between cells through which small molecules can pass. Within the spinal cord, the majority of gap junctions are found between astrocytes. Gap junctions allow for fast communication between cells over long distances. Due to this, gap junction communication may be salient to extra-territorial/ mirror-image pain.

- ▶ [Cord Glial Activation](#)

## Gastroesophageal Reflux Disease

- ▶ [GERD](#)
- ▶ [Visceral Pain Model, Esophageal Pain](#)

## Gastrointestinal Tract, Nocifensive Behaviors

- ▶ [Nocifensive Behaviors, Gastrointestinal Tract](#)

## GAT 1, GAT 2, GAT 3

### Definition

Plasma membrane GABA transporter, isoforms 1-3.

- ▶ [GABA and Glycine in Spinal Nociceptive Processing](#)

## Gate Control Theory

### Definition

The Gate Control Theory was devised by Melzack and Wall in 1965. It proposed an explanation (later falsified) on how innocuous stimulation inhibits pain via a presynaptic inhibitory mechanism. It was claimed that innocuous stimulation, such as produced by rubbing your skin, activates large sensory nerve fibers and inhibits nociceptive neurons in the spinal cord. If small fiber nociceptive primary afferents are simultaneously being activated by a noxious stimulus such as a bee sting, less pain is felt because the “pain gate“ is closed.

- ▶ [Central Nervous System Stimulation for Pain](#)
- ▶ [Pain Treatment, Spinal Cord Stimulation](#)

## Gazelius Model

- ▶ [Retrograde Cellular Changes after Nerve Injury](#)

## GBS

- ▶ [Guillain Barré Syndrome](#)

## GDNF

- ▶ [Glial Cell Line-Derived Neurotrophic Factor](#)

## GDNF-Dependent Neurons

- ▶ [IB4-Positive Neurons, Role in Inflammatory Pain](#)

## Gender

### Definition

Gender is the psychosocial identity in males and females such as masculinity and femininity. It is both the person's representation as male or female, and how that person is responded to by social institutions on the basis of the individual's gender presentation. Gender refers to the social, political and psychological aspects of what it means to live as male or female in a given society.

- ▶ [Gender and Pain](#)
- ▶ [Psychological Aspects of Pain in Women](#)



## Gender and Pain

ANITA M. UNRUH

Health and Human Performance and Occupational Therapy, Dalhousie University, Halifax, NS, Canada  
aunruh@dal.ca

### Definition

Gender and sex are often used interchangeably as if they were synonyms but they have different meanings. Sex refers to the anatomical, hormonal, and physiological differences associated with being male or female. Gender refers to the social, cultural, political and sometimes religious contexts in which humans are socialized to assume male and female roles. When differences between men and women occur it is tempting to ask whether these differences are because of sex or because of gender, but these factors are highly interactive. A biopsychosocial framework incorporating the interactive nature of sex and gender is necessary to examine men's and women's pain experience.

### Characteristics

Sex difference (see ► [Sex Differences in Descending Pain Modulatory Pathways](#)) in the prevalence of pain experience has been identified in many epidemiological studies (see LeReshe 2000). Women report more migraines, tension headaches, abdominal pain, facial/oral pain, pelvic pain and musculoskeletal pains (especially pain in the neck and shoulders). Women report more severe and more frequent pain and pain that is of longer duration. They are more likely to report pain due to multiple sclerosis, cancer, reflex sympathetic dystrophy, irritable bowel syndrome, and carpal tunnel syndrome. Other pains, such as pain due to sickle cell disease and post herpetic neuralgia, are more common in men. Women have a greater physiological predisposition for pain due to differences in the actions of sex differences that affect neuroactive agents, opiate and non-opiate systems, nerve growth factor and the sympathetic system (Berkley 1997; Holdcroft and Berkley 2006). The prevalence of migraines illustrates the contribution of biology to sex differences and also the complex influence of hormones on women's pain experience. Prior to puberty, the prevalence of migraine is similar for boys and girls and in some studies higher for boys. Following puberty, prevalence sharply increases for females, remaining elevated throughout life even following menopause, though rates decrease in the later life period. Nevertheless, some women experience migraines only during pregnancy while other women have reduced risk of migraine while pregnant. Hormonal effects can occur across the menstrual cycle. They can alter nociceptive responses in central and peripheral mechanisms, and can result in increased and sometimes

decreased pain sensitivity. The menstrual cycle also influences women's sensitivity to experimental and clinical pains, with greater sensitivity often reported about the ovulation and the peri-menstrual period.

The contribution of biology is also evident in sex and species differences in response to analgesia (see Craft 2003; Fillingim and Ness 2000). In non-human species (mice and rats), greater opioid analgesia is found in males, but in the limited human literature, greater opioid analgesia is reported for women. Greater analgesia to cholinergic agents has been shown in women, as well as greater analgesic response to ibuprofen in men. These differences have only been examined in acute pain. Whether sex influences analgesic response to chronic administration of analgesics is currently unknown.

Studies of sex differences in the non-human literature also demonstrate the complexity of sex differences in observed pain behaviors and potential pain mechanisms. Sex differences can be identified in basal nociception and morphine antinociception in rodents, but they appear to be dependent on the genetic background of the rat or mouse being studied (Mogil 2000). The likelihood of observing sex differences in opioid analgesics in rats seems to increase as opioid efficacy (maximal analgesia) decreases. That is, sex differences may be related to the effectiveness of the opioid. While the sex of the animal is important, the type of animal, its genetic background, and the analgesic testing procedures also influence response to analgesics.

In addition to analgesic response, opioids may have other effects that may also be related to sex. In nonhumans, sex differences are found in respiration, blood pressure, body temperature, urination, nausea and vomiting, food intake, and locomotor activity in response to opioids. These effects have not yet been examined by sex in the human population.

People have different expectations about males and females in the way that they might typically respond to pain (Myers et al. 2001); these expectations are linked to cultural values about gender-related roles (Nayak et al. 2000). Women are often thought to be more emotional in response to pain and men to be more stoical. The socialization of pain through gender-related expectations can be seen through studies about pain in childhood (Unruh and Campbell 1999). Fathers expect that their sons will tolerate pain better than their daughters. Children learn to express pain to mothers rather than to fathers. Girls show more affective and behavioral distress in response to pain, even though their pain ratings are often similar to boys. Men are expected to be more stoical when they experience pain, and may be treated more seriously when they do complain of pain. Attractiveness of patients, particularly women, also matters. A more attractive person is perceived to have less pain and to be able to cope with pain better than someone who is not attractive (Hadjistavropoulos et al. 1996).

There are a number of studies showing that males and females are not treated in the same way for pain, with women receiving more psychological explanations for their pain, less pain medication and more sedatives (see Hoffmann and Tarzian 2001; Unruh 1996). Such differential treatment on the basis of gender may occur even in childhood. Women are also less likely to be referred to a pain clinic, and when they are referred for rehabilitation services, they are less likely to receive services that facilitate employment. Such studies demonstrate that the effect of gender in pain management is more often to the detriment of women, but two earlier studies found that women received more powerful analgesics for pain due to cancer than did men, and while men made more requests for pain medication, women received medication. Taken together, these studies demonstrate that social judgments and expectations about how men and women ought to behave when they are in pain can influence the nature of the pain assessment and management they receive, but the impact can be variable.

Social expectations pose certain risks for women and men. Women are more inclined to discuss their emotional response to pain and may receive more psychological explanations (as causal and contributory explanations) for their pain. They may be offered more psychological interventions and fewer medical, physical and pharmacological treatments. Men are more likely not to comment on emotional aspects of their pain, and hence receive fewer psychological interventions and more invasive medical, physical and pharmacological interventions. Assessment and management is biased by social expectations about gender and pain in either case, and may result in inadequate pain relief and disability reduction.

There is little evidence that women and men worry differently about pain, but women may attend to pain sooner and they do appear to have some important coping differences (Robinson et al. 2000). Women worry about pain and its interference on activities more readily. They develop a greater repertoire of coping strategies per pain event, and they use more social support and more health care to manage pain. The use of social support is consistent with women's tendency to use more social support for other, non-pain related health concerns.

The possible effect of sex and gender on pain response can be observed in the experimental pain literature. Women and men are often similar in their pain responses, but when they differ, men report higher pain thresholds, higher pain tolerance and lower pain intensity ratings. There is limited experimental pain research in pediatric pain, but it does suggest that these differences may begin in the school-age years. Interestingly, if the initial noxious stimulus is more severe, for example if the temperature of the cold water is lowered, then sex differences may be eliminated. The influence of gender can be seen in the way that participants respond to experimenter gender and to manipulation of social

variables in experimental research. When male and female experimenters wear clothing that accentuates their masculinity or femininity, they alter the responses of male subjects but not females. Similarly, changing social expectations in the study design tends to alter significantly the pain responses of male subjects, with some variation among the female subjects but to a lesser and usually non-significant extent.

While researchers have tended to emphasize sex and gender differences in pain experience in basic science research, experimental research, and in clinical pain research, there is considerable within group variation. Virtually nothing is known about these within group differences and why they might occur. There are likely to be important factors that contribute to within group differences that need to be better understood, particularly with respect to pain management both from a biological and a psychosocial perspective.

There is some debate about whether boys and girls, men and women should be treated differently when they are seen for pain. There is very little evidence to indicate that one gender is better than the other in coping with chronic pain, but there is suggestive evidence that they tend to cope with pain differently. Girls and women tend to talk about emotional aspects of pain, and may find the social support and information seeking inherent in this discussion to be helpful. It is possible that the greater risk to catastrophize in response to pain for women would be reduced by an emphasis on cognitive-behavioral interventions, in addition to other pain management strategies for girls and women. It is possible that the same argument is pertinent to catastrophizing in males. However, discussions about psychological aspects of pain with boys and men may require gender specific strategies to reduce the social expectation of stoicism. Nevertheless, it is possible that the social expectation of stoicism in males has some benefit in reducing their risk of pain-related disability. The existing research about sex differences in response to analgesics suggests that perhaps males and females should be managed differently, but the research is too preliminary to come to this conclusion (Miaskowski et al. 2000). Further research is needed to explore biological and psychological mechanisms of sex differences in pain response to analgesics and the circumstances in which they may or may not occur. In addition, within group differences of pain response to analgesics must be better understood.

The previous ten years have seen considerable advancement in sex and gender in pain research. In another five to ten years, the mechanisms of these differences and their impact on pain assessment and management will be better understood.

## References

1. Berkley KJ (1997) Sex Differences in Pain. *Behav Brain Sci* 20:371–380

2. Craft RM (2003a) Sex Difference in Opioid Analgesia: "From Mouse to Man". *Clin J Pain* 19:175–186
3. Craft RM (2003b) Sex Differences in Drug- and Non-Drug-Induced Analgesia. *Life Sci* 72:2675–2688
4. Fillingim RB, Maixner W (1995) Gender Differences in the Responses to Noxious Stimuli. *Pain Forum* 4:209–221
5. Fillingim RB, Ness TJ (2000) Sex-Related Hormonal Influences on Pain and Analgesic Responses. *Neurosci Biobehav Rev* 24:485–501
6. Hadjistavropoulos T, McMurty B, Craig KD (1996) Beautiful Faces in Pain: Biases and Accuracy in the Perception of Pain. *Psychol Health* 11:411–420
7. Hoffman DE, Tarzian AJ (2001) The Girl Who Cried Pain: A Bias Against Women in the Treatment of Pain. *J Law Med Ethics* 29:13–27
8. Holdcroft A, Berkley KJ (2006) Sex and Gender Differences in Pain and its Relief. In: McMahon SB, Koltzenburg M (eds) *Wall & Melzack's Textbook of Pain*, 5<sup>th</sup> ed, Elsevier Churchill Livingstone, Edinburgh, pp 11181–1197
9. LeReshe L (2000) Epidemiologic Perspectives. In: Fillingim RB (ed) *Sex, Gender, and Pain*. IASP Press, Seattle, pp 233–249
10. Miaskowski C, Gear RW, Levine JD (2000) Sex-Related Differences in Analgesic Responses. In: Fillingim RB (ed.) *Sex, Gender, and Pain*. IASP Press, Seattle, p 209–230
11. Mogil JS (2000) Interactions between Sex and Genotype in the Mediation and Modulation of Nociception in Rodents. In: Fillingim RB (ed) *Sex, Gender, and Pain*. IASP Press, Seattle, pp 25–40
12. Myers CD, Papas RK, Emily EA, Waxenberg LB, Fillingim RB, Robinson ME, Riley JL (2001) Gender Role Expectations of Pain: Relationship to Sex Differences in Pain. *J Pain* 2:251–257
13. Nayak S, Shifflett SC, Eshun S, Levine FM (2000) Culture and Gender Effects in Pain Beliefs and the Perception of Pain Tolerance. *Cross-Cultural Research* 34:135–151
14. Robinson ME, Riley JL, Myers CD (2000) Psychosocial Contributions to Sex-Related Differences in Pain Responses. In: Fillingim RB (ed) *Sex, Gender, and Pain*. IASP Press, Seattle, pp 41–68
15. Unruh AM (1996) Gender Variations in Clinical Pain Experience. *Pain* 65:123–167
16. Unruh AM, Campbell MA (1999) Gender Variation in Children's Pain Experiences. In: McGrath PJ, Finley GA (eds) *Chronic and Recurrent Pain in Children and Adolescents*. *Prog Pain Res Manage* 13:199–241
17. Wizemann TM, Pardue ML (2001) Exploring the Biological Contributions to Human Health. Does Sex Matter? National Academy Press, Washington

## Gender Differences in Opioid Analgesia

- ▶ Sex Differences in Opioid Analgesia

## Gender Role Expectation of Pain Scale

### Synonym

GREP Scale

### Definition

The Gender Role Expectation of Pain Scale measures sex-related stereotypic attributions of pain sensitivity, endurance, and willingness to report pain.

- ▶ Psychological Aspects of Pain in Women

## Gender Role Theories in Pain

### Definition

Gender role theories in pain suggest that women and men are socialized to respond differently to pain. Masculinity is stereotypically associated with stoicism, and femininity is stereotypically associated with increased sensitivity.

- ▶ Psychological Aspects of Pain in Women

G

## Gene

### Definition

A gene contains hereditary information encoded in the form of DNA and is located at a specific position on a chromosome in a cell's nucleus. Genes individually determine many aspects of physiological functions by controlling the production of proteins.

- ▶ NSAIDs, Pharmacogenetics

## Gene Array

### Definition

Nucleic acid arrays work by hybridization of labeled RNA or DNA in solution to DNA molecules attached at specific locations on a surface. The hybridization of a sample to an array is, in effect, a highly parallel search by each molecule for a matching partner on an 'affinity matrix', with the eventual pairings of molecules on the surface determined by the rules of molecular recognition.

- ▶ Retrograde Cellular Changes after Nerve Injury

## Gene Therapy and Opioids

- ▶ Opioids and Gene Therapy

## Gene Transcription

### Definition

Gene transcription is the process of constructing a messenger RNA molecule using a DNA molecule as a template, with resulting transfer of genetic information to the messenger RNA.

- ▶ NSAIDs, Pharmacogenetics

## General Adaptation Syndrome

- ▶ Postoperative Pain, Pathophysiological Changes in Neuro-Endocrine Function in Response to Acute Pain

## General Anesthesia

### Definition

General Anesthesia is a drug-induced loss of consciousness during which patients are not arousable, and often have impaired cardiorespiratory function needing support.

- ▶ Pain and Sedation of Children in the Emergency Setting

## Generator Currents

### Definition

Membrane currents originated at the membrane of sensory receptor endings when transduction channels are open or closed by the stimulus. These currents spread passively from the stimulated membrane patch to neighbor sites (electrotonic propagation) according to the spatial and temporal cable properties of the axon.

- ▶ Nociceptor Generator Potential

## Generic Carbamazepine

- ▶ Tegretol

## Genetic Correlation

### Definition

Genetic Correlation is a mediation by similar sets of genes, suggestive of overlapping physiological mediation. Genetic correlation of two traits can be inferred by a significant correlation of inbred strain means on each trait.

- ▶ Heritability of Inflammatory Nociception

## Genetic Factors Contributing to Opioid Analgesia

- ▶ Opioid Analgesia, Strain Differences

## Genetic Linkage

### Definition

- ▶ Heritability of Inflammatory Nociception
- ▶ Quantitative Trait Locus Mapping

## Geniculate Neuralgia

### Synonyms

Facial ganglion neuralgia

### Definition

Pain paroxysms felt in the depth of the ear, lasting for seconds or minutes, or intermittent occurrence associated with injury or dysfunction of the seventh cranial nerve (facial nerve) via the nervus intermedius (of Wrisberg) are known as facial (geniculate) ganglion neuralgia.

- ▶ Neuralgias
- ▶ Neuralgia, Assessment
- ▶ Tic and Cranial Neuralgias
- ▶ Trigeminal, Glossopharyngeal, and Geniculate

## Genital Mucosa, Nociception

- ▶ Nociception in Mucosa of Sexual Organs

## Genome

### Definition

A genome is the total set of genes carried by an individual or a cell. The genome determines, in part, the final morphology or body or form of the individual human or cell.

- ▶ Cell Therapy in the Treatment of Central Pain

## Genotype

### Definition

The genotype describes the genetic makeup of an individual organism, determined by the full complement of genes that organism possesses.

- ▶ NSAIDs, Pharmacogenetics

## Genotypic Influences on Opioid Analgesia

- ▶ Opioid Analgesia, Strain Differences



## GERD

### Synonym

Gastroesophageal reflux disease

### Definition

Frequent reflux of gastric acid into the esophagus during transient lower esophageal relaxation. Acid reflux produces heartburn and in chronic cases it produces erosive esophagitis.

- ▶ Visceral Pain Model, Esophageal Pain

## Geriatric Medicine

### Definition

Geriatric medicine is a discipline dedicated to the study, assessment and treatment of diseases related to older populations.

- ▶ Psychological Treatment of Pain in Older Populations

## GFR $\alpha$ 1 or GFR $\alpha$ 2

### Definition

The GFR $\alpha$ 1 or GFR $\alpha$ 2 receptors are the ligand-binding domains for Glial cell line-derived neurotrophic factor (GDNF). They are each glycosylphosphatidylinositol (GPI)-anchored surface co-receptors that couple to c-RET, a tyrosine kinase, which forms the signal transducing subunit. GFR $\alpha$ 1 is the preferred receptor for GDNF, whereas GFR $\alpha$ 2 is the preferred receptor for neurturin (a related member of the GDNF family). However, both GDNF and neurturin can bind and activate GFR $\alpha$ 1 or GFR $\alpha$ 2. Within the DRG, GFR $\alpha$ 1, GFR $\alpha$ 2 and RET receptor expression overlap extensively with Isolectin B4 binding.

- ▶ Immunocytochemistry of Nociceptors

## Giant Cell Arteritis (Arthritis)

### Definition

Giant cell arteritis is an autoimmune disease with vasculitis, with preference for extracranial branches of the arteria carotis, including the temporal and arteries to the retina and the optical nerve. The symptoms include muscle pain as in polymyalgia.

- ▶ Muscle Pain in Systemic Inflammation (Polymyalgia Rheumatica, Giant Cell Arteritis, Rheumatoid Arthritis)

## Gigantocellular Reticular Nucleus

### Definition

Gigantocellular reticular nucleus is the medial zone of the rostral medullary reticular formation containing large cell bodies.

- ▶ Spinothalamocortical Projections to Ventromedial and Parafascicular Nuclei

## GIRK Channel

### Definition

A group (Kir 3.1 – 3.4) of inwardly rectifying (so-named because they have a higher conductance for potassium entering than leaving the cell) potassium channels that are activated by G-protein  $\beta\gamma$ -subunits. When activated they hyperpolarize membranes to reduce excitability.

- ▶ Opioid Electrophysiology in PAG

## Glabrous

### Definition

Glabrous means smooth, non hairy, for example

- ▶ glabrous skin.
- ▶ Substance P Regulation in Inflammation

## Glabrous Skin

### Definition

The glabrous skin is the completely hairless skin areas, including the palmer surface of the hand and the plantar surface of the foot.

- ▶ Pain in Humans, Thresholds

## Glans Clitoris

### Definition

Glans is the very sensitive and visible part of the clitoris, made up entirely of erectile tissue, soft to the touch even when aroused and engorged with blood land, usually averaging 4–5 mm in diameter.

- ▶ Clitoral Pain

## Glia

### Definition

Glia are cells that surround and support neurons in the central nervous system; glial and neural cells together compose the tissue of the central nervous system. There are three types of CNS glial cells, they are astrocytes (part of the blood brain barrier), oligodendrocytes (myelin producing cell of the CNS), and microglia (CNS macrophages).

- ▶ [Cytokine Modulation of Opioid Action](#)

## Glial Activation

### Definition

Glia (microglia, astrocytes) exit their basal states and become activated in response to inflammation, damage, infection, and various neuron-to-glia signals (fractalkine, various neurotransmitters, etc). The basal state of astrocytes is active, but not activated. That is, astrocytes regulate the extracellular ion and chemical environment, amongst other duties. The basal state of microglia is quiescent surveillance. Upon activation, both types of glia can release a variety of neuroexcitatory substances (activation markers) such as proinflammatory cytokines, nitric oxide, prostaglandins, etc. Glial activation is associated with exaggerated pain states.

- ▶ [Cord Glial Activation](#)
- ▶ [Proinflammatory Cytokines](#)

## Glial Cell Line-Derived Neurotrophic Factor

### Synonym

GDNF

### Definition

Glial cell line-derived neurotrophic factor (GDNF) was the first described member of a novel family of trophic factors that also includes neurturin, persephin, and artemin. In addition to effects in the CNS, GDNF, neurturin, and artemin promote the *in vitro* survival of many peripheral neurons, including enteric, sympathetic, and sensory neurons. Members of the GDNF family exert their effects via a multicomponent receptor complex consisting of RET, a tyrosine kinase receptor acting as a signal transducing domain, in combination with a member of the GFR $\alpha$  family of GPI-linked receptors (GFR $\alpha$ <sup>1</sup>-GFR $\alpha$ <sup>4</sup>) acting as ligand binding domains. Either GFR $\alpha$ <sup>1</sup> or GFR $\alpha$ <sup>2</sup> in conjunction with RET can mediate GDNF signaling, although GDNF is thought

to bind preferentially to GFR $\alpha$ <sup>1</sup>. GFR $\alpha$ <sup>1</sup> and GFR $\alpha$ <sup>2</sup> overlap extensively with the IB4 positive population of sensory neurons.

- ▶ [IB4-Positive Neurons, Role in Inflammatory Pain](#)
- ▶ [Immunocytochemistry of Nociceptors](#)

## Glial Proliferation

### Definition

Following a peripheral nerve injury, the satellite glia around large diameter sensory neurones within dorsal root ganglia that project into the damaged nerve start to proliferate. They form an onion-like structure of many layers around these somata. If the neurone is able to regenerate, the extent of proliferation is readily reduced so that the usual glial investment is recovered.

## Glomerulations

### Definition

Glomerulations are punctuate hemorrhages often seen in the bladder of IC patients; often noted upon hydrodistention of bladder.

- ▶ [Interstitial Cystitis and Chronic Pelvic Pain](#)

## Glossopharyngeal Neuralgia

### Definition

Glossopharyngeal neuralgia is a chronic neuropathic pain state associated with injury or dysfunction of the eleventh cranial nerve (glossopharyngeal nerve) or its ganglion and felt in the distribution of this nerve. It is described as sharp, jabbing, electric, or shock like pain located deep in the throat on one side.

- ▶ [Neuralgia, Assessment](#)
- ▶ [Tic and Cranial Neuralgias](#)
- ▶ [Trigeminal, Glossopharyngeal, and Geniculate Neuralgias](#)

## Glove Anesthesia

### Definition

Glove anesthesia is a common clinical technique in which analgesia/anesthesia is induced in a hand by hypnotic suggestion. A variety of approaches is used, including imagining a protective glove being placed on the hand. Once good anesthesia is achieved and validated, this may be transferred in imagination to the painful area.

- ▶ [Therapy of Pain, Hypnosis](#)

## Glucocorticosteroid

### Definition

Glucocorticosteroids are a class of drugs related to the endogenous hormone cortisol from the adrenal glands. They have potent anti-inflammatory effects and relieve acute pain effectively.

- ▶ [Postoperative Pain, Acute Pain Management, Principles](#)

## Glucosamine

- ▶ [Nutraceuticals](#)

## Glucose Intolerance

### Definition

Glucose intolerance is a difficulty in removing glucose from the extracellular fluids for intracellular use or storage; can be an early sign of impending diabetes.

- ▶ [Diabetic Neuropathies](#)

## Glucuronide Metabolites of Morphine

### Definition

The main metabolites of morphine are morphine-3-glucuronide, and morphine-6-glucuronide. The former is thought to be anti-analgesic and has low affinity for opioid receptors. It can cause central excitation in animals, and is thought to contribute to the central excitatory phenomena seen in morphine toxicity in humans. The latter has high affinity for the mu receptor and may cause analgesia, sedation, respiratory depression and nausea at high levels. Both are renally excreted.

- ▶ [Postoperative Pain, Transition from Parenteral to Oral](#)

## Glutamate

### Definition

L-glutamate is the principle excitatory amino acid neurotransmitter in the central nervous system. Glutamate activates excitatory amino acid receptors, which are non-selective cation channels that permit the movement of sodium, potassium, and in some cases calcium ions, across the neuronal membrane. These excitatory

amino acid receptors are named the NMDA, kainate, and AMPA receptors, respectively, after their selective agonists. L-glutamate plays an important role in learning and memory. Under certain circumstances, it can be an excitotoxin causing neuronal cell death in a variety of neurodegenerative disorders.

- ▶ [Descending Circuitry, Transmitters and Receptors](#)
- ▶ [Glutamate Homeostasis and Opioid Tolerance](#)
- ▶ [Glutamate Neurotoxicity](#)
- ▶ [Nociceptors in the Orofacial Region \(Temporo-mandibular Joint and Masseter Muscle\)](#)
- ▶ [Opioid Modulation of Nociceptive Afferents In Vivo](#)
- ▶ [Somatic Pain](#)
- ▶ [Spinothalamic Tract Neurons, Glutamatergic Input](#)

G

## Glutamate Homeostasis

### Definition

A balanced glutamate system for maintaining glutamate-mediated physiological functions.

- ▶ [Glutamate Homeostasis and Opioid Tolerance](#)

## Glutamate Homeostasis and Opioid Tolerance

JIANREN MAO

Pain Research Group, MGH Pain Center, and Department of Anesthesia and Critical Care, Massachusetts General Hospital Harvard Medical School, Boston, MA, USA

[jmao@partners.org](mailto:jmao@partners.org)

### Synonyms

Glutamate homeostasis; Glutamate Regulation; glutamate transporter; Morphine Tolerance; Opioid Tolerance and Glutamate Homeostasis

### Definition

Regulation of endogenous ligands of ▶ [glutamate receptors](#) such as glutamate, through a highly efficient ▶ [glutamate transporter](#) system, may play a significant role in ▶ [Opioid Tolerance](#), a pharmacological phenomenon related to chronic opioid administration. Regulation of glutamate transporters is also implicated in the mechanisms of opioid-induced neuronal apoptosis and increased pain sensitivity associated with the development of opioid tolerance. Modulation of GT activity and expression with pharmacological agents has been shown to regulate the development of morphine tolerance, suggesting a new strategy for improving

opioid analgesic efficacy in pain management through regulating regional ► [glutamate homeostasis](#).

## Characteristics

### Glutamate Transporters and Glutamate Regulation

► **Glutamate** is a major excitatory amino acid neurotransmitter in the central nervous system (CNS), which participates in the maintenance of important physiological functions such as synaptic plasticity and cognitive awareness. Maintaining a low extracellular glutamate concentration is key to preventing glutamate over-excitation and neurotoxicity that could occur under many pathological conditions. Regulating extracellular glutamate is primarily carried out by an efficient, high-capacity glutamate transporter (GT) system within the CNS, because clearance of extracellular glutamate via glutamate metabolism or diffusion is virtually negligible. To date, at least five cell membrane GT proteins have been identified and cloned (Robinson and Dowd 1997; Danbolt 2001). In general, GTs are labeled by a common name 'excitatory amino acid transporter' (e.g. EAAT1 to EAAT5). Among these cell membrane GTs, EAAT1 (GLAST), EAAT2 (GLT-1), and EAAT3 (EAAC1) are particularly relevant to the regulation of glutamate uptake in broad CNS regions. EAAT4 is likely to be associated with Purkinje cells in the cerebellum, and the exact location of EAAT5 (a likely retinal GT) in the mammalian system remains unclear. In addition, there have been increasing reports of vesicular GTs, but their role and regulations remain to be determined.

### Cellular Distribution of GTs

Among the five membrane GTs, EAAC1 is generally considered as a neuronal GT, whereas GLAST and GLT-1 are primarily astroglial GTs, although both GLAST and GLT-1 have also been demonstrated in neuronal cells during the developmental but not adult stage (Robinson and Dowd 1997; Danbolt 2001). GTs are primarily located in the CNS with a sporadic extra-CNS presence in the heart, kidney, and gastrointestinal system. There is evidence for the existence of GTs in glutamatergic nerve endings (Robinson and Dowd 1997; Danbolt 2001), indicating the capability by GTs of tightly regulating glutamate uptake at glutamatergic synapses besides glial cells. Subcellularly, GTs are located in plasma membranes, mitochondria, and synaptic vesicles, with the vast majority of GTs being associated with plasma membranes of both neuronal and glial cells (Robinson and Dowd 1997; Danbolt 2001). GTs participate in regulating the uptake of L-glutamate as well as L- or D-aspartate in a Na<sup>+</sup>- and K<sup>+</sup>-dependent manner.

The exact stoichiometry of glutamate uptake by GTs in relation to Na<sup>+</sup> and K<sup>+</sup> ions remains unclear. In general, GTs transport glutamate from the low-concentration ex-

tracellular compartment to the high-concentration intracellular compartment, at the cost of both Na<sup>+</sup> and K<sup>+</sup> ion gradients. Under certain circumstances such as global CNS ischemia, reversed uptake (from intracellular to extracellular compartment) could take place secondary to a weakened driving force from decreased transmembrane electrochemical gradients (Robinson and Dowd 1997; Danbolt 2001).

### Role of GTs in Broad Neurological Disorders

Glutamate plays a dual role both as a major excitatory neurotransmitter essential for physiological functions and as a neurotoxic mediator contributory to pathological processes. Given the critical role of GTs in maintaining the homeostasis of extracellular glutamate, an imbalance in such a crucial regulatory system could become a fundamental cause of many neurological disorders. Of significance is that, although inhibition of GT activity may not significantly prolong a single stimulus-induced excitatory postsynaptic glutamate current, it does so if the stimulus is repetitive and excessive (Overstreet et al. 1999), a condition that can be encountered under many pathological circumstances including peripheral nerve injury. Reduced GT function leads to accumulation of extracellular glutamate, causing excessive activation of glutamate receptors and initiating processes of glutamate-mediated neuronal over-excitation and ► [excitotoxicity](#). To date, a large number of studies have shown the detrimental effects of reduced GT function on the pathogenesis of a variety of neurological disorders including brain ischemia, epilepsy, spinal cord injury, amyotrophic lateral sclerosis, AIDS neuropathy, and Alzheimer's disease.

### Role of GTs in Nociceptive Processing

GTs have been shown to be involved in the spinal nociceptive processing in response to the hindpaw formalin injection or exogenous NMDA or prostaglandins (Minami et al. 2001; Niederberger et al. 2003). A series of recent experiments have demonstrated that both expression and uptake activity of spinal GTs changed following peripheral nerve injury and contributed to neuropathic pain behaviors in rats (Sung et al. 2003). Intrathecal administration of the tyrosine kinase receptor inhibitor K252a and the mitogen-activated protein kinase inhibitor PD98059 reduced and nearly abolished the increase in GT expression, respectively. Moreover, peripheral nerve injury significantly reduced spinal GT uptake activity, which was prevented by riluzole (a positive GT activity regulator). Riluzole also effectively attenuated and gradually reversed neuropathic pain behaviors. These results indicate that spinal GTs may play a critical role in both induction and maintenance of neuropathic pain following nerve injury via regulating regional glutamate homeostasis. The involvement



of GTs in the mechanism of ► **neuropathic pain** is of particular interest, because compelling evidence has indicated that neuropathic pain and opioid tolerance may have much in common in terms of their neural mechanisms (Mao et al. 1995a).

#### Role of GTs in Opioid Tolerance

In animal models of ► **morphine** tolerance, subcutaneous injection of a proposed GT activator MS-135 diminished the development of morphine tolerance (Nakagawa et al. 2001). More recently, chronic morphine administered through either intrathecal boluses or continuous infusion, has been shown to induce a dose-dependent down-regulation of GTs (EAAC1 and GLAST) in the rat's superficial spinal cord dorsal horn (Mao et al. 2002b). This GT down-regulation was mediated through opioid receptors because naloxone blocked such GT changes. Morphine-induced GT down-regulation reduced the ability to maintain *in vivo* glutamate homeostasis at the spinal level, since the hyperalgesic response to exogenous glutamate was enhanced, including an increased magnitude and a prolonged time course, in morphine-treated rats with reduced spinal GTs. Moreover, the down-regulation of spinal GTs exhibited a temporal correlation with the development of morphine tolerance. Consistently, the GT inhibitor PDC potentiated, whereas the positive GT regulator riluzole reduced, the development of morphine tolerance. The effects from regulating spinal GT activity by PDC were at least in part mediated through activation of the N-methyl-D-aspartate receptor (NMDAR), since the non-competitive NMDAR antagonist MK-801 blocked morphine tolerance that was potentiated by PDC. These results indicate that spinal GTs may contribute to the neural mechanisms of morphine tolerance by means of regulating regional glutamate homeostasis.

#### Role of GTs in Opioid Dependence

Recent evidence has suggested that GTs may also play a role in opioid dependence. Firstly, changes in the GLT-1 mRNA level occurred following naloxone-precipitated morphine withdrawal (Oazwa et al. 2001). Secondly, during the withdrawal period from a sustained morphine treatment, glutamate uptake activity at hippocampal synapses was substantially increased, accompanied by an increase in the expression of GLT-1 (Xu et al. 2003). These results indicate that there may be a compensatory change in GT activity and expression, a response that is likely to serve as a buffer system to minimize the impact of a glutamate surge accompanying opioid withdrawal.

#### Role of GTs in Opioid-Induced Apoptosis and Pain Sensitivity

Both preclinical and clinical studies have indicated that the development of morphine tolerance is associated with an increased pain sensitivity, which may con-

tribute to the manifestation of opioid tolerance (Mao et al. 1995a; Mao et al. 1995b; Ossipov et al. 1995; Celerier et al. 2001). In addition, neurotoxic events in the form of neuronal ► **apoptosis** have been demonstrated in association with the development of morphine tolerance (Mao et al. 2002a). These apoptotic cells were predominantly located in the superficial spinal cord dorsal horn, and most apoptotic cells also expressed GAD, a key enzyme for the synthesis of the inhibitory neurotransmitter GABA. In addition, increased nociceptive sensitivity to heat stimulation was observed in these same rats, and modulation of GT activity regulated the occurrence of both opioid-induced neuronal apoptosis and increased pain sensitivity (Mao et al. 2002a). These results are consistent with a role of the spinal glutamatergic system in both opioid tolerance and neuropathic pain, and provide new insights into interactions between the cellular mechanisms underlying both opioid tolerance and pain hypersensitivity.

#### Possible Mechanisms of GT Actions

The cellular mechanisms of GT regulation and actions in response to chronic opioid administration remain to be investigated. There are at least two possible regulatory mechanisms of GT actions. The GT expression could be regulated by extracellular glutamate, as suggested by the observations that down-regulation of GLT-1 and GLAST occurs in the rat's brain regions following an impaired cortical glutamatergic connection, and conversely, that an increase in extracellular glutamate up-regulates GLT-1 in astroglial cultures. Another possibility is that opioids could regulate GTs via opioid receptor-mediated intracellular changes such as cAMP, because cAMP has been shown to regulate the expression of GLT-1 and GLAST in cell cultures. These mechanisms are under current investigation, and each may play a role in opioid-induced GT regulation.

#### Clinical Implications

A functional role for GTs in the development of opioid tolerance suggests a new strategy for preventing opioid tolerance, opioid-induced neuronal apoptosis and pain sensitivity, by regulating regional glutamate homeostasis using a GT regulator such as riluzole. Extensive investigation is under way to further explore such possibilities. Further, studies on GT regulation and opioid tolerance may provide new insights into the neural mechanisms of ► **substance abuse**, which may be particularly relevant to the mechanisms of heroin addiction, since heroin metabolites (6-monoacetylmorphine or morphine) interact with opioid receptors.

#### Acknowledgement

This work was supported in part by PHS grants DA08835 and NS42661.

## References

1. Celerier E, Laulin JP, Corcuff JB, Le Moal M, Simonnet G (2001) Progressive Enhancement of Delayed Hyperalgesia Induced by Repeated Heroin Administration: A Sensitization Process. *J Neurosci* 21:4074–4080
2. Danbolt NC (2001) Glutamate Uptake. *Prog Neurol* 65:1–105
3. Mao J, Price DD, Mayer DJ (1995a) Mechanisms of Hyperalgesia and Opioid Tolerance: A Current View of their Possible Interactions. *Pain* 62:259–274
4. Mao J, Price DD, Mayer DJ (1995b) Experimental Mononeuropathy Reduces the Antinociceptive Effects of Morphine: Implications for Common Intracellular Mechanisms Involved in Morphine Tolerance and Neuropathic Pain. *Pain* 61:353–364.
5. Mao J, Sung B, Ji RR, Lim G (2002a) Neuronal Apoptosis Associated with Morphine Tolerance: Evidence for an Opioid-Induced Neurotoxic Mechanism. *J Neurosci* 22:7650–7661
6. Mao J, Sung B, Ji RR, Lim G (2002b) Chronic Morphine Induces Downregulation of Spinal Glutamate Transporters: Implications in Morphine Tolerance and Abnormal Pain Sensitivity. *J Neurosci* 22:8312–8323
7. Minami T, Matsumura S, Okuda-Ashitaka E, Shimamoto K, Sakimura K, Mishina M, Mori H, Ito S (2001) Characterization of the Glutamatergic System for Induction and Maintenance of Allodynia. *Brain Res* 895:178–185
8. Nakagawa T, Ozawa T, Shige K, Yamamoto R, Minami M, Satoh M (2001) Inhibition of Morphine Tolerance and Dependence by MS-153, a Glutamate Transporter Activator. *Eur J Pharmacol* 419:39–45
9. Niederberger E, Schmidt A, Rothstein JD, Geisslinger G, Tegeder I (2003) Modulation of Spinal Nociceptive Processing through the Glutamate Transporter GLT-1. *Neuroscience* 116:81–87
10. Oazwa T, Nakagawa T, Shige K, Minami M, Satoh M (2001) Changes in the Expression of Glial Glutamate Transporters in the Rat Brain Accompanied with Morphine Dependence and Naloxone-Precipitated Withdrawal. *Brain Research* 905:254–258
11. Ossipov MH, Lopez Y, Nichols ML, Bian D, Porreca F (1995) The Loss of Antinociceptive Efficacy of Spinal Morphine in Rats with Nerve Ligation Injury is Prevented by Reducing Spinal Afferent Drive. *Neurosci Lett* 199:87–90
12. Overstreet LS, Kinney GA, Liu YB, Billups D, Slate NT (1999) Glutamate Transporters Contribute to the Time Course of Synaptic Transmission in Cerebellar Granule Cells. *J Neurosci* 19:9663–9673
13. Robinson MB, Dowd LA (1997) Heterogeneity and Functional Properties of Subtypes of Sodium-Dependent Glutamate Transporters in the Mammalian Central Nervous System. *Adv Pharmacol* 37:69–115
14. Sung B, Lim G, Mao J (2003) Altered Expression and Uptake Activity of Spinal Glutamate Transporters following Peripheral Nerve Injury Contributes to the Pathogenesis of Neuropathic Pain in Rats. *J Neurosci* 23:2899–2910
15. Xu NJ, Bao L, Fan HP, Bao GB, Pu L, Lu YL, Wu CF, Zhang X, Pei G (2003) Morphine Withdrawal Increases Glutamate Uptake and Surface Expression of Glutamate Transporter GLT-1 at Hippocampal Synapses. *J Neurosci* 23:4775–4784

## Glutamate Neurotoxicity

### Definition

Glutamate neurotoxicity is neuronal death caused by excessive activation of glutamate receptors. Repeated activation of glutamate receptors results in increased intracellular calcium ion levels, which initiate a cascade of events producing free radicals and causing cell death.

- ▶ [Dietary Variables in Neuropathic Pain](#)

## Glutamate Receptors

### Definition

Glutamate receptors are membrane receptors for the excitatory amino acid transmitter L-glutamate. These receptors may also be acted upon by other endogenous substances, e.g. L-aspartate, L-homocysteate, and N-acetyl-aspartyl-glutamate. They consist of ionotropic and metabotropic subclasses. The ionotropic glutamate receptors are further divided into NMDA, AMPA and kainate subtypes. The metabotropic glutamate receptors have eight subtypes that can be divided into three groups. Glutamatergic synapses may have a combination of different subtypes of glutamate receptors that interact with each other and facilitate synaptic responses. For example, postsynaptic metabotropic glutamate receptors may enhance ionotropic NMDA receptor phosphorylation and contribute to spinal dorsal horn hyperexcitability. All receptor subtypes are highly expressed in the spinal cord dorsal horn and at nociceptive synapses.

- ▶ [Descending Circuitry, Molecular Mechanisms of Activity-Dependent Plasticity](#)
- ▶ [Descending Circuitry, Transmitters and Receptors](#)
- ▶ [Glutamate Homeostasis and Opioid Tolerance](#)
- ▶ [Metabotropic Glutamate Receptors in the Thalamus](#)
- ▶ [NMDA Receptors in Spinal Nociceptive Processing](#)
- ▶ [Nociceptive Neurotransmission in the Thalamus](#)

## Glutamate Regulation

- ▶ [Glutamate Homeostasis and Opioid Tolerance](#)

## Glutamate Transporter

### Definition

A high capacity system responsible for glutamate uptake from either extracellular space or cytoplasm.

- ▶ [Glutamate Homeostasis and Opioid Tolerance](#)

## Glutamatergic

### Definition

Synaptic transmission at which the amino acid glutamate is used as an excitatory neurotransmitter.

- ▶ [Opioid Receptors at Postsynaptic Sites](#)

## Glutamic Acid Decarboxylase

### Synonym

GAD

### Definition

An enzyme mediating the synthesis of GABA from glutamic acid. Two isoforms exist (GAD-65 and GAD-67).

- ▶ [GABA and Glycine in Spinal Nociceptive Processing](#)
- ▶ [GABA Mechanisms and Descending Inhibitory Mechanisms](#)
- ▶ [Thalamic Neurotransmitters and Neuromodulators](#)

## Gluteus Medius

### Definition

Gluteus medius is the middle of three gluteal muscles.

- ▶ [Sacroiliac Joint Pain](#)

## Glycerol Rhizotomy

### Definition

Glycerol rhizotomy is the treatment of TN by a mild injury produced instillation of glycerol into the space around the sensory (Gasserian) ganglion containing the cell bodies of the sensory fibers in the trigeminal nerve.

- ▶ [Trigeminal, Glossopharyngeal, and Geniculate Neuralgias](#)

## Glycine Transporter

### Definition

A plasma membrane protein that transports glycine into neurons and/or astrocytes, together with  $3\text{Na}^+$  and  $1\text{Cl}^-$  ion (GlyT2), or together with  $2\text{Na}^+$  and  $1\text{Cl}^-$  ion (GlyT-1).

- ▶ [GABA and Glycine in Spinal Nociceptive Processing](#)

## Glycolysis

### Definition

Glycolysis is a ubiquitous metabolic pathway in cells that allows for the production of energy by the breakdown of sugars. This complex pathway involves nine different enzymes and can function in the presence or absence of oxygen.

- ▶ [Arthritis Model, Osteoarthritis](#)

## Glycosaminoglycan

### Definition

Glycosaminoglycan is a type of long, unbranched polysaccharide molecule. They are major structural components of cartilage and are also found in the cornea of the eye.

- ▶ [Perireceptor Elements](#)

## Glycyrrhizic Acid

### Definition

Glycyrrhizic acid inhibits  $1^{\beta}$ -beta-hydroxysteroid dehydrogenase, as does carbenoxolone, without disrupting gap junctions. Due to the specific activity of glycyrrhizic acid, it can be used in carbenoxolone experiments to assess non-specific effects of carbenoxolone (i.e. effects other than gap junction decoupling). In studies completed to date, glycyrrhizic acid does not affect basal pain responses, territorial pain, or mirror-image pain.

- ▶ [Cord Glial Activation](#)

## GlyT-1

### Definition

Glyt-1 is a plasma membrane glycine transporter isoform found on astrocytes and neurons. It mediates fast reuptake of glycine after synaptic release, and is encoded by gene Slc6a9.

- ▶ [GABA and Glycine in Spinal Nociceptive Processing](#)

## GlyT-2

### Definition

Glyt-2 is a plasma membrane glycine transporter isoform found in glycinergic neurons. It mediates accumulation of glycine in glycinergic neurons and recycles synaptically released glycine. It is encoded by gene Slc6a5.

- ▶ [GABA and Glycine in Spinal Nociceptive Processing](#)

## Goals for Pain Treatment in the Elderly

### Definition

Complete pain relief is not a realistic goal for pain treatment in the elderly. Apart from a better control of the pain, the treatment aims primarily at the maintenance or

restitution of functional independence as a precondition of social participation.

- ▶ Psychological Treatment of Pain in Older Populations

## gp120

### Definition

gp120 is a glycoprotein found on the outer surface of the human immunodeficiency virus (HIV-1). Immunocompetent cells including glial cells recognize gp120. Perispinal administration of gp120 induces exaggerated pain responses.

- ▶ Cord Glial Activation

## GPCR

- ▶ G Protein-Coupled Receptor

## GPI (Guinea Pig Ileum) and MVD (Mouse Vas Deferens)

### Definition

Classical “in vitro” test to evaluate the potency of mu-opioid agonists (GPI) and delta-opioid agonists (MVD). The opioid agonists concentration-dependently inhibit the electrically stimulated twitch in smooth muscle preparations of guinea pig ileum (rich in mu-opioid receptors) and of mouse vas deferens (rich in delta receptors).

- ▶ Opioid Peptides from the Amphibian Skin

## Gracile Nucleus

### Definition

Discriminative sensory information from cutaneous regions in the lower half of the body is relayed to the thalamus through the gracile nucleus in the dorsal midline of the caudal medulla.

- ▶ Cuneate Nucleus
- ▶ Postsynaptic Dorsal Column Projection, Anatomical Organization

## Graded Activity Approaches to Chronic Pain

- ▶ Behavioral Therapies to Reduce Disability

## Graded Exposure in Vivo with Behavioral Experiments

- ▶ Fear Reduction through Exposure In Vivo

## Gradiometer

- ▶ Magnetoencephalography in Assessment of Pain in Humans

## Granulocyte Colony Stimulating Factor

### Definition

Granulocyte colony stimulating factor is a naturally-occurring protein that stimulates the production of certain white blood cell precursors.

- ▶ Cancer Pain Management, Orthopedic Surgery

## Granulocytopenia

### Definition

Granulocytopenia is a deficiency in the number of granulocytes, a type of white blood cell, predisposed to infection.

- ▶ Cancer Pain Management, chemotherapy

## Granulomas

### Definition

Granulomas of the nose and the paranasal sinuses, in the limited stage of WG, causes headache, compression of cranial nerves, diabetes insipidus or exophthalmus. For granulomatous arteritis of the nervous system (GANS).

- ▶ Angiitis of the CNS
- ▶ Headache Due to Arteritis

## Gravity-Assisted Traction

- ▶ Lumbar Traction

## Gray Matter Density

- ▶ Thalamus, Clinical Pain, Human Imaging



## GREP Scale

- ▶ Gender Role Expectation of Pain Scale

## Grip Force

### Definition

Grip force is the force produced by grasping that can be measured using a strain gauge.

- ▶ Cancer Pain Model, Bone Cancer Pain Model
- ▶ Muscle Pain Model, Inflammatory Agents-Induced

## Group Health

### Definition

Group health is care provided by a network of providers, including physicians and physician extenders, with the goal of a coordinated practice, primarily in one or more group practice facilities, often sharing common overhead expenses.

- ▶ Disability Management in Managed Care System

## Group III/Group IV Afferent Fibers

### Definition

Small-diameter myelinated (Group III) or unmyelinated (Group IV) muscle afferent nerve fibers. Group IV corresponds to cutaneous C-fibers and group III to A $\delta$ -fibers. Conduction velocities for cat muscle afferent fibers are below 2.5 m/s for group IV and 2.5 to 30 m/s for group III fibers, s. also Afferent Nerve Fibers.

- ▶ Exogenous Muscle Pain
- ▶ Sensitization of Muscular and Articular Nociceptors

## Group Stimulus Space

### Definition

Group stimulus space is a configuration of points (stimulus objects) along dimensions in continuous space or as clusters in discrete space.

- ▶ Multidimensional Scaling and Cluster Analysis Application for Assessment of Pain
- ▶ Pain Measurement by Questionnaires, Psychophysical Procedures and Multivariate Analysis

## Group-Oriented Practice

- ▶ Physical Medicine and Rehabilitation, Team-Oriented Approach

## Growth Factor

### Definition

Growth factor is a substance that affects the growth of a cell or an organism.

- ▶ Animal Models of Inflammatory Bowel Disease

## Growth Hormone

### Definition

Growth hormone is released by the anterior pituitary gland. It is regulated by many endogenous substances, e.g. the serotonin 5-HT<sub>1</sub> receptors, which increase its secretion.

- ▶ Placebo Analgesia and Descending Opioid Modulation

## Guarding

- ▶ Nocifensive Behaviors, Muscle and Joint

## Guided Imagery/Guided Mental Imagery

### Definition

Guided imagery is a relaxation technique that is often combined with diaphragmatic breathing and progressive muscle relaxation. It involves the use of mental imagery to produce calming cognitive and physical effects. It is most effective in individuals who report good visualization skills.

- ▶ Coping and Pain
- ▶ Psychological Treatment in Acute Pain
- ▶ Relaxation in the Treatment of Pain

## Guillain-Barré Syndrome

JOHN W. SCADDING

The National Hospital for Neurology and Neurosurgery,  
London, UK  
jwscadding@hotmail.com

### Synonyms

GBS; Acute Inflammatory Demyelinating Polyneuropathy

## Definition

Guillain-Barré syndrome (GBS) is an Acute Inflammatory Demyelinating Polyradiculoneuropathy (AIDP). Guillain et al. described the essential diagnostic features in 1916. The pathology is multifocal demyelination, affecting spinal nerve roots and peripheral nerves. Axonal immune-mediated attack can produce a clinically exactly similar illness. This affects motor and sensory roots, Acute Motor Sensory Axonal ▶ **Neuropathy** (AMSAN), and there is a pure motor form, Acute Motor Axonal Neuropathy (AMAN).

Other variants include the Miller Fisher syndrome (ophthalmoplegia, ataxia and areflexia, with mild or absent limb weakness). The Miller Fisher syndrome accounts for about 5 % of GBS. In the rare Acute Pandysautonomia, there is rapid onset of combined sympathetic and parasympathetic failure, usually with areflexia, but without weakness or sensory loss.

## Characteristics

### Incidence

The mean annual incidence is in the region of 1.8 per 100,000 of the population, and is higher with increasing age.

### Diagnostic Criteria

The diagnostic criteria are summarised in Table 1.

### Clinical Features

#### Antecedent Illness

There is a history of a preceding illness or other event in about two thirds of patients with GBS, the commonest being either a respiratory or gastrointestinal infection. The organisms most often identified are *Campylobacter jejuni* (approximately 26 % of patients, particularly those with the axonal form of GBS), and *Mycoplasma pneumoniae* (10 %). Other infective agents include cytomegalovirus, HIV, Epstein-Barr virus, varicella zoster virus and hepatitis A and B. In a small proportion, there is a history of preceding immunisation or surgery.

*Campylobacter jejuni* shows a particularly strong association with the axonal form of GBS; in Northern China

evidence of infection with this microorganism is found in 76 % of patients with AMAN, and in 42 % of patients with AIDP.

GBS has been reported in immunocompromised patients, either due to underlying disease, such as Hodgkin's lymphoma, or to therapeutic immunosuppression.

#### Pain

Although paralysis (often severe and generalised) is the dominant problem in GBS, pain is an early, and often the first symptom, being troublesome in up to 85 % of patients at presentation. Sites include the interscapular and lumbar regions, buttocks, thighs and calves. Pain quality is typically deep aching, and sometimes burning. Associated tingling ▶ **paraesthesiae**, usually in a distal neuropathic distribution are common, and some patients complain of an unpleasant tightness in the legs. Similar painful symptoms and paraesthesiae occur in the arms and around the shoulder girdle, but are less frequent and usually milder than the lumbar and lower limb symptoms. Pain may be asymmetric, and occasionally focal. Pain mimicking ▶ **sciatica** is recognised, and because pain in GBS may precede the development of weakness by several days, spinal imaging may occasionally be needed to exclude alternative, particularly compressive, pathology.

Pain of myalgic type is less common, and is not always easy to distinguish clinically from pain of neuropathic type.

Pain in GBS tends to subside over the first 2–3 weeks of the illness, but in a small proportion may persist for longer.

#### Paralysis

Weakness of the limbs and trunk follows pain within hours or days, and progresses over a variable period. Oropharyngeal and respiratory weakness is common; ventilation is required in up to 23 % of patients. Severe weakness can develop within 12–24 hours, but the average time from onset of weakness to its maximum severity is between 7 and 14 days. By definition, weakness progressing for longer than 4 weeks is not

**Guillain-Barré Syndrome, Table 1** Diagnostic Criteria for Guillain-Barré Syndrome

Required clinical features	Clinical features supportive of diagnosis	Laboratory features supportive of diagnosis
Progressive weakness of arms and legs	Progression over days, up to 4 weeks	Raised CSF protein concentration
Areflexia	Mild sensory loss	<10 white cells/ $\mu$ l CSF
	Symmetry of deficit	Slowing of nerve conduction and/or conduction block
	Cranial nerve involvement, particularly bifacial palsies	Electrodiagnostic features of axonopathy in AMSAN/AMAN
	Autonomic dysfunction	

(adapted from Asbury and Cornblath, 1990)

longer AIDP; sub-acute inflammatory demyelinating polyradiculoneuropathy refers to patients in whom weakness progresses for up to 10 weeks, and progression after this time becomes chronic inflammatory demyelinating polyradiculoneuropathy (CIDP). CIDP may take the form of a chronic progressive or a chronic relapsing illness.

Weakness in AIDP may be predominantly distal, or global, involving limbs and trunk. It is usually more severe in the legs than the arms. Cranial nerve involvement is common, particularly bifacial palsies.

#### Autonomic Disturbances

Autonomic disturbances develop in up to 65 % of patients with GBS (excluding Acute Pandysautonomia). There may be either reduced or increased autonomic activity. Signs of decreased sympathetic activity include orthostatic hypotension and anhidrosis; reduced parasympathetic activity leads to urinary retention, intestinal ileus and iridoplegia. Increased sympathetic activity may cause hypertension, sinus tachycardia or cardiac arrhythmias. Excessive parasympathetic vagal activity can lead to sinus bradycardia, heart block and even asystole. Electrocardiographic abnormalities are common in GBS, often asymptomatic. These autonomic disturbances are more common in patients with severe weakness and particularly those with respiratory paralysis.

#### Other Features

Raised intracranial pressure, with ► [papilloedema](#) is a rare complication in GBS. It is related to a very high cerebrospinal fluid (CSF) protein concentration.

#### Physical Examination

Examination reveals reduced muscle tone, weakness, reduced or absent tendon reflexes, and glove and stocking distribution sensory loss that is usually mild. Straight leg raising may exacerbate lumbar and leg pain, reflecting the prominent spinal root pathology. Autonomic disturbances, as described above, may be present.

It is mandatory to measure the vital capacity at presentation, and to monitor this frequently during the period of progressive weakness.

#### Investigation

In the early stages, peripheral nerve conduction may be normal, as the pathology is often predominantly in the spinal roots. It may be several days after the onset of weakness before peripheral electrophysiological abnormalities are found. Prolonged F wave latencies or absent F waves are early signs; later, there is motor conduction slowing, and conduction block, which manifest by greater than 30 % reduction in the compound motor action potentials (CMAP). A CMAP amplitude of less than 20 % of the lower limit of normal is associated with a poor outcome in GBS.

Cerebrospinal fluid (CSF) characteristically shows a raised total protein content, with a normal cell count or a mild pleocytosis (<10 cells/ $\mu$ l). It is often several days before the CSF protein level rises.

Serum anti-ganglioside antibodies are found in raised titres, and there is a strong association of anti-GQ 1b ganglioside antibodies with Miller Fisher syndrome. Electrocardiograms should be monitored, particularly in patients with rapidly progressive weakness.

#### Differential Diagnosis

The diagnosis of GBS is often straightforward, but presentation with a long prodrome of pain without weakness, asymmetric or focal onset weakness, weakness confined to the legs, or prominent autonomic features early in the course of the illness can lead to diagnostic difficulties. Table 2 lists the wide differential diagnosis.

#### Pathogenesis of GBS

GBS is an organ-specific autoimmune disorder mediated by autoreactive T cells and humoral antibodies. The nature of the antigens remains uncertain. A preceding infection, immunisation or other insult may provoke a reaction in which an immune response is mounted against antigens shared with the host's peripheral nerves.

G

**Guillain-Barré Syndrome, Table 2** Differential Diagnosis of Guillain-Barré Syndrome

Brain stem and Spinal Cord Disorders	Radiculopathies	Peripheral Neuropathies	Neuromuscular Junction	Myopathies
Basilar artery thrombosis	Cytomegalovirus	Diphtheria	Myasthenia gravis	Rhabdomyolysis
Brain stem encephalitis	Lyme borreliosis	Porphyria Toxins: organophosphates, thallium, arsenic, lead, shellfish poisons	Botulinum toxin	Polymyositis
Poliomyelitis		Tick paralysis		Hypokalaemic paralysis
Rabies		Critical illness		
Transverse myelitis		polyneuropathy		
		Vasculitic polyneuropathy		

### Pathogenesis of Pain in GBS

Demyelination and axonal degeneration are likely to lead to ectopic impulse generation, causing ► **neuropathic pain** and paraesthesiae. Pain may also result from root swelling and entrapment. A third component may be a nociceptive type of pain (► **nociceptive pain**), arising from acute inflammatory changes in the nerve roots, signalled by the *nervi nervorum* (nerve trunk pain).

### Treatment of GBS

High dose intravenous human immunoglobulin (IVIG), and plasma exchange have been found to be equally effective in GBS. Due to ease of administration, IVIG is the treatment of choice. Corticosteroids are ineffective. General supportive measures, and in particular, elective ventilation, together with these disease specific treatments, have reduced mortality from around 30 % to 5 %. Patients with falling vital capacity or cardiovascular instability should be monitored in a high dependency care setting, where full resuscitation facilities are available. Respiratory and cardiac function and blood pressure require close monitoring. Tracheal suctioning may provoke episodes of arrhythmia or hypotension. Nasogastric feeding is needed in patients with oropharyngeal weakness; early assessment and frequent monitoring of swallowing is essential.

### Pain Relief

Simple analgesia or weak opiates are sufficient in many patients. For more severe neuropathic pain, ► **tricyclic antidepressants** may be indicated, but tricyclics should not be given to patients with disturbances of autonomic function. Gabapentin is an alternative, although in clinical trials it has not been shown to relieve neuropathic pain specifically in GBS. Occasional patients with severe pain may benefit from morphine or other strong opiates, though these may further impair reduced respiratory function, and should be used with extreme caution in non-ventilated patients with moderate to severe weakness.

### Course and Prognosis

Following the progressive phase of the illness, there is a period of 2–4 weeks on average, during which the deficit remains static. Recovery then begins. Up to 5 % of patients die during the acute stage. 82 % recover completely within 2 years. There is a recurrence rate of about 3 %. Factors associated with a poorer outcome include CMAPs less than 20 % of the lower limit of normal, age greater than 60 years, the need for ventilation, and rapid progression of weakness (maximum at less than 7 days).

### References

1. Asbury AK, Cornblath DR (1990) Assessment of Current Diagnostic Criteria for Guillain-Barré Syndrome. *Ann Neurol* 27 Suppl:S21–S24

2. Griffin JW, Li CY, Ho TW et al. (1996) Pathology of the Motor-Sensory Axonal Guillain-Barré Syndrome. *Ann Neurol* 39:17–28
3. Hafer-Macko CE, Sheikh KA, Li CY et al. (1996) Immune Attack on the Schwann Cell Surface in Acute Inflammatory Demyelinating Neuropathy. *Ann Neurol* 39:625–635
4. Hartung HP, Pollard JD, Harvey GK, Toyka KV (1995) Immunopathogenesis and Treatment of Guillain-Barré Syndrome-Part 1. *Muscle Nerve* 18:137–153
5. Ho TW, Mishu B, Li CY et al. (1995) Guillain-Barré Syndrome in Northern China: Relationship to *Campylobacter* Jejuni Infection and Anti-Glycolipid Antibodies. *Brain* 118:597–605
6. The French Cooperative Group on Plasma Exchange in Guillain-Barré syndrome (1997) Appropriate Number of Plasma Exchanges in Guillain-Barré Syndrome. *Ann Neurol* 41:298–306
7. The Italian Guillain-Barré study group (1996) The Prognosis and Main Prognostic Indicators of Guillain-Barré Syndrome: A Multicenter Prospective Study of 297 Patients. *Brain* 119:2053–2061
8. Moulin DE, Hagen N, Feasby TE et al. (1997) Pain in Guillain-Barré Syndrome. *Neurology* 48:328–331
9. Plasma Exchange/Sandoglobulin Guillain-Barré Syndrome Trial Group (1997) Randomized Trial of Plasma Exchange, Intravenous Immunoglobulin, and Combined Treatments in Guillain-Barré Syndrome. *Lancet* 349:225–230
10. Zochodne DW (1994) Autonomic Involvement in Guillain-Barré Syndrome: A Review. *Muscle Nerve* 17:1145–1155

## Gynecological Cancer

### ► Gynecological Pain and Sexual Functioning

## Gynecological Pain and Sexual Functioning

PH. TH. M. WEIJENBORG, M. M. TER KUILE  
Department of Gynecology, Leiden University Medical Center, Leiden, Netherlands  
p.t.m.weijenberg@lumc.nl

### Synonyms

Acute Pelvic Pain; dysmenorrhea; chronic pelvic pain; Sexual Dysfunctions  
Vulvodynia; Chronic Vulvar Pain; vulvar vestibulitis syndrome; dyspareunia  
Gynecological Cancer

### Characteristics

#### Gynecological Pain

Pain is often a normal aspect of biological functioning for women, as it relates to her reproductive cycle and is therefore mostly located in the pelvis.

Taking the duration of pain as point of view, gynaecological pain can be divided into acute, intermittent, predominantly cyclic, and chronic pain. The pain might be located in the pelvis and/or the vulvo-vaginal part of the body. Radiation to, for instance, upper abdomen, groin, back or legs is possible. Save ovarian cancer stage III and IV, pelvic pain is an uncommon complaint for gynecological cancer patients.



**Gynecological Pain and Sexual Functioning, Table 1** Sexual problems, definition

302.71 Hypoactive Sexual Desire Disorder	Persistently or recurrently deficient (or absent) sexual fantasies and desire for sexual activity. The judgment of deficiency or absence is made by the clinician, taking into account factors that affect sexual functioning, such as age and the context of the person's life.
302.72 Female Sexual Arousal Disorder	Persistent or recurrent inability to attain, or to maintain until completion of the sexual activity, an adequate lubrication-swelling response of sexual excitement.
302.73 Female Orgasmic Disorder	Persistent or recurrent delay in, or absence of, orgasm following a normal sexual excitement phase. Women exhibit wide variability in the type or intensity of stimulation that triggers orgasm. The diagnosis of Female Orgasmic Disorder should be based on the clinician's judgment that the woman's orgasmic capacity is less than would be reasonable for her age, sexual experience, and the adequacy of sexual stimulation she receives.
302.76 Dyspareunia	Recurrent or persistent genital pain associated with sexual intercourse in either a male or a female.
302.79 Sexual Aversion Disorder	Persistent or recurrent extreme aversion to, and avoidance of, all (or almost all) genital sexual contact with a sexual partner.
306.51 Vaginismus	Recurrent or persistent involuntary spasm of the musculature of the outer third of the vagina that interferes with sexual intercourse.

G

According to the APA Diagnostic Classification DSM-IV-TR

### Sexual Functioning

The definitions of the most common sexual problems, presented in medical practice, are given in table 1 (APA 2000). All disturbances can occur as a primary, secondary, situational or general condition. Each has to cause marked distress or interpersonal difficulty.

To assess the impact of gynaecological pain on sexual functioning, the issue of sexual functioning and pain must be brought up by the health care professional as a prerequisite (Berman et al. 2003). The diagnosis can be made after taking the sexual history of the patient, preferably together with her partner (see table 2), followed by a gynaecological examination, if indicated. A history of sexual abuse has to be addressed explicitly before doing the exam. Traumatic memories may be aroused by the intimacy of a gynaecological examination. For instance, the lithotomy position during the pelvic examination or the insertion of instruments, such as a speculum or fingers, into a woman's vagina, may be regarded and experienced as an abusive situation (Chalmers 1998).

The consequences of the different gynecological pains on sexual functioning is dependent on diverse factors like duration and location of the pain, the quality of sexual functioning of the woman before the pain started, relational as well as psychosocial factors.

**Gynecological Pain and Sexual Functioning, Table 2** To assess the impact of the gynecological pain on sexual functioning

1	pain and the consequences of pain on sexuality of woman and her partner
2	sexual functioning in the past, including sexual, physical and emotional abuse
3	relational factors
4	psychosocial functioning

### Acute Pain, Impact on Sexuality

There are a variety of gynecological diseases causing acute *abdominal* pain. Symptoms of these diseases and the accompanying pain subside after adequate treatment, therefore sexuality and sexual functioning of the woman and her partner will only be impaired during the period of pain, but not thereafter.

Acute vulvar pain, especially during intercourse (also called ► *dyspareunia*), might go hand in hand with a vaginal infection, like for instance candidiasis, trichomoniasis or herpes. On some occasions, after adequate diagnosis and treatment, the pain complaint doesn't vanish, although the original infection has subsided.

### Intermittent Pain, Impact on Sexuality

The ► *vulvar vestibulitis syndrome (VVS)* is a subset of ► *vulvodynia*, as defined by the International Society for the Study of Vulvar Diseases (ISSVD), and characterised by the complaint of ► *superficial dyspareunia* or entry dyspareunia for at least six months, with physical findings of localised vulvar erythema and exquisite tenderness of the vestibule on touch with a cottonwool stick (Friedrich 1987). VVS is thought to be the most common form of premenopausal dyspareunia. It is not quite clear how many women are affected by this condition during their lifetimes. Nearly 15% of all women in a gynecological practice can be diagnosed as VVS (Goetsch 1991).

As a consequence of dyspareunia, the woman might mention a hypertonicity of the pelvic floor muscles (Glazer et al. 1995; Bergeron et al. 2002) and a lowered genital arousal during sexual contact, resulting in a loss of sexual desire. Reissing (Reissing et al. 2003) found that women with VVS reported less desire, less pleasure, less arousal and less self-stimulation than a no-pain control group. No difference in marital adjustment was

found between the two groups. Different treatments are reported in literature, ranging from inert ointments, corticosteroid cremes, pelvic floor muscle exercises, cognitive behavioral therapy to surgical interventions as lasertreatment and vestibulectomy (Bergeron et al. 1997). Recently, the first randomized controlled trial on the treatment of VVS was published (Bergeron et al. 2001). The study compared group cognitive-behavioral therapy, surface electromyographic biofeedback, and vestibulectomy in the treatment of dyspareunia resulting from vulvar vestibulitis. All three groups significantly improved on measures of psychological adjustment and sexual function from pretreatment to 6-month follow-up. A two-year follow-up of the initial study participants revealed that in terms of self-reported pain during intercourse, the vestibulectomy group was equal to the cognitive behavioural therapy group (Bergeron et al. 2002).

Deep dyspareunia is defined as pain in the abdomen during intercourse, especially at the time of deep penetration. The complaint is mostly dependent on the position of the male and female during sexual intercourse. Gynecological causes have to be excluded as, for instance, chronic pelvic inflammatory disease, fixed retroverted uterus, enlarged uterus by myomata, endometriosis deposits in the cul-de-sac and/or the recto-vaginal space, or an ovarian cyst and pelvic mass, irritable bowel syndrome or other gastro intestinal diseases (see ► [Chronic pelvic pain](#))

Dysmenorrhoea can be defined as recurrent cyclic pain, starting some days before or just at the menstrual period and lasting for some days (see ► [Chronic pelvic pain](#) and [dysmenorrhoea](#)).

#### **Chronic Gynecological Pain, Impact on Sexuality**

► [Chronic pelvic pain](#) (CPP) is described as pain suffered by women in the lower abdominal area for at least six months, not exclusively associated with the menstrual cycle (dysmenorrhea) and/or sexual intercourse (deep dyspareunia).

Chronic pelvic pain is a long lasting and often disabling condition (Howard et al. 2000) (see ► [chronic pelvic pain](#)).

Problems with sexual functioning resulting from chronic pelvic pain have to be addressed and assessed by the health care professional. Logically, as a result of the pain itself, extreme tiredness or depressive mood, the woman may mention all kinds of sexual problems ranging from decreased pleasure and frequency of intercourse, deficient lubrication during sexual contact, superficial or deep dyspareunia and/or problems in reaching orgasm to a total aversion towards sexual intimacy.

Reports in literature about the coincidental prevalence of sexual problems with chronic pelvic pain are scarce. Krina Zondervan (Zondervan et al. 2001) found in an a-selected sample of 2016 women from the general population of Great Britain (18–49 years), that 24% of

the total sample reported chronic pelvic pain during the previous three months. Among these women who were sexually active, 41% said they experienced dyspareunia occasionally, versus 14% of women without chronic pelvic pain. A quarter of all women with dyspareunia had intercourse less frequently because of pain. The severity of dyspareunia appeared greatest among women with CPP, who also reported complaints of IBS and genitourinary symptoms such as frequency, urgency or stinging on passing urine. This last group refrained from intercourse more often than women with chronic pelvic pain only. Mathias (Mathias et al. 1996) investigated the prevalence of chronic pelvic pain and its relation to quality of life in a telephone survey of 5263 women aged 18–50 years, randomly selected from the general American population. Fifteen percent of these women reported chronic pelvic pain. Eighty-two percent of the women with chronic pelvic pain reported dyspareunia. Collett and colleagues (Collett et al. 1998) carried out the only comparative study on this issue. They found that women with chronic pelvic pain reported significantly more sexual problems than women with another type of pain-problem or painfree women. The reported sexual problems were dyspareunia, loss of interest in sex, post-coital pain and vaginismus. Women with CPP were less satisfied with their current sexual relationship than the two control groups. However, the majority of women in each of the three groups rated their general relationship as good or very good.

Chronic vulvar pain, also called ► [vulvodinia](#), is defined according to the ISSVD as a “chronic vulvar discomfort especially characterized by the patient’s complaint of burning, stinging, irritation or rawness”. Frequently, women avoid intercourse, as they are anxious that the vulvar pain might deteriorate. However, studies on this issue are really very scarce (see chapter ► [Vulvodinia](#) and ► [Dyspareunia](#)).

#### **Gynecological Cancer and Sexuality**

Since some gynecological cancers are curable due to advances in detection and treatment, not only the physical, but also the psychosocial and sexual consequences of genital cancer are important determinants of quality of life. Five longitudinal studies on sexual rehabilitation during the first year of post treatment for early stage gynecological cancer using comparison groups, can be found (Weijmar Schultz and Van de Wiel 2003). A great diversity of sexual problems and marked differences in rated distress are reported, depending on physical factors such as treatment modalities (surgery, irradiation and/or chemotherapy) and organ(s) involved (uterus, cervix, ovary or vulva), as well as psychological and social factors.

#### **References**

1. Bergeron S, Binik YM, Khalifé S, Pagidas K (1997) Vulvar Vestibulitis Syndrome: A Critical Review. *Clin J Pain* 13:27–42

2. Bergeron S, Binik YM, Khalifé S, Pagidas K, Glazer HI, Meana M, Amsel R (2001) A Randomized Comparison of Group Cognitive-Behavioral Therapy, Surface Electromyographic Biofeedback, and Vestibulectomy in the Treatment of Dyspareunia Resulting from Vulvar Vestibulitis. *Pain* 91:297–306
3. Bergeron S, Binik YM, Khalifé S (2002) In Favor of an Integrated Pain-Relief Treatment Approach for Vulvar Vestibulitis Syndrome. *J Psychosom Obstet Gynecol* 23:7–9
4. Bergeron S, Brown C, Lord M, Oala M, Binik YM, Khalifé S (2002) Physical Therapy for Vulvar Vestibulitis Syndrome: A Retrospective Study. *J Sex Mar Ther* 28:183–192
5. Berman L, Berman J, Feder S, Pollets D, Chhabra S, Miles M, Powell JA (2003) Seeking Help for Sexual Function Complaints: What Gynecologists Need to Know About the Female Patient's Experience. *Fer Ster* 79:572–576
6. Chalmers B (1998) Psychosomatic Obstetrics and Gynecology in the Next Millennium: Some Thoughts and Observations. *J Psychosom Obstet Gynecol* 19:62–69
7. Collett BJ, Cordle CJ, Stewart CR, Jagger C (1998) A Comparative Study of Women with Chronic Pelvic Pain, Chronic Non-pelvic Pain and those with no History of Pain Attending General Practitioners. *Br J Obstet Gynaecol* 105:87–92
8. Diagnostic and Statistical Manual of Mental Disorders. Fourth Edition- Text Revision (2000) American Psychiatric Association
9. Friedrich EG (1987) Vulvar Vestibulitis Syndrome. *J Reprod Med* 32:110–114
10. Glazer HI, Rodke G, Swencionis C, Hertz R, Young, AW (1995) The Treatment of Vulvar Vestibulitis Syndrome by Electromyographic Biofeedback of Pelvic Floor Musculature. *J Reprod Med* 40: 283–290
11. Goetsch MF (1991) Vulvar Vestibulitis: Prevalence and Historic Features in a General Gynaecologic Practice Population. *Am J Obstet Gynecol* 161:1609–1617
12. Howard FM, Perry CP, Carter JE, El-Minawi AM (2000) *Pelvic Pain: Diagnosis & Management*. Lippincott Williams & Wilkins, Philadelphia
13. Mathias SD, Kuppermann M, Liberman RF, Lipschutz RC, Steege JF (1996) Chronic Pelvic Pain: Prevalence, Health-Related Quality of Life, and Economic Correlates. *Obstet Gynecol* 87:321–327
14. Reissing ED, Binik YM, Khalife S, Cohen D, Amsel R (2003) Etiological Correlates of Vaginismus: Sexual and Physical Abuse, Sexual Knowledge, Sexual Self-Schema, and Relationship Adjustment. *J Sex Marital Ther* 29:47–59
15. Weijmar Schultz WCM, Van de Wiel HBM (2003) Sexuality, Intimacy and Gynaecological Cancer. *J Sex Marital Ther* 29(s): 121–128
16. Zondervan KT, Yudkin PL, Vessey MP, Jenkinson CP, Dawes MG, Barlow D, Kennedy SH (2001) The Community Prevalence of Chronic Pelvic Pain in Women and Associated Illness Behaviour. *Br J Gen Pract* 51:541–547

## Gynecological Pain Model

- ▶ [Visceral Pain Models, Female Reproductive Organ Pain](#)

## Gynecological Pain, Neural Mechanisms

KAREN J. BERKLEY, NATALIA DMITRIEVA  
 Program in Neuroscience, Florida State University,  
 Tallahassee, FL, USA  
 kberkley@darwin.psy.fsu.edu,  
 dmitrieva@darwin.psy.fsu.edu

## Synonyms

Dysmenorrhea; dyspareunia; vulvar vestibulitis; Mittelschmerz; pelvic inflammatory disease; Labor Pain; chronic pelvic pain; Mastitis; Cross-System Viscero-Visceral Interactions; dynamic ensemble

## Definition

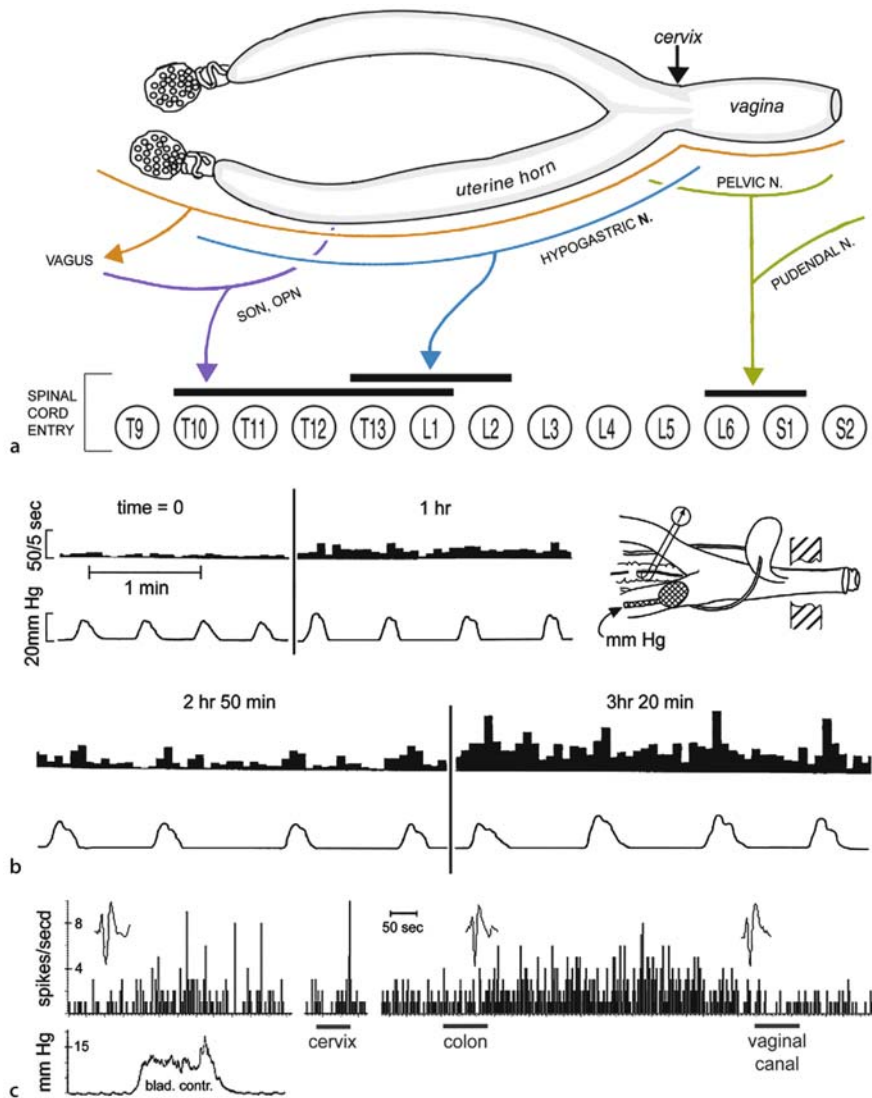
Gynecological pain is defined as pain associated with the female reproductive organs. It is usually considered in the context of pelvic pain as a subcategory of visceral pain, although pains associated with the breast are also sometimes included.

## Characteristics

Although gynecological pain is usually associated with specific disease conditions such as endometriosis, parametritis, salpingo-oophoritis, uterine leiomyoma, and ovarian cysts, the severity of the disease and the pain often do not correlate well. In fact, gynecological pain also occurs without obvious pathophysiology. Such pains can be chronic (e.g. primary dysmenorrhea, vulvodynia, chronic pelvic pain), and their severity can vary with reproductive status; i.e., puberty, ovarian cycle, birth control hormones, pregnancy, puerperium, parity, reproductive senescence, and hormone replacement (Wessellmann and Burnett 1999). Pain associated with pathophysiology of internal reproductive organs is usually poorly localized internally, and is often also “felt” in somatic structures (muscles, skin) of the affected organ's bodily segments, a phenomenon called “▶ referred pain” (Giamberardino 2003). Sometimes the skin and muscles in the referral region are also tender, a phenomenon called “▶ referred hyperalgesia.” Referred hyperalgesia in muscles can remain for many months after the initial pathology has resolved (Giamberardino 2003). Furthermore, distressing chronic gynecological pains are surprisingly frequently found to co-occur with other painful disorders such as irritable bowel syndrome, interstitial cystitis, and even migraine (Berkley 2001).

Much of our present and still meager understanding of mechanisms of gynecological pain comes from work on rodents. The studies have shown that female reproductive organs are supplied by afferent and efferent fibers in a roughly rostro-caudal topographic fashion (Fig. 1a) (Papka and Traurig 1993; Berkley et al. 1993; Temple et al. 1999). A similar topographic pattern is likely to exist for women (Wessellmann and Burnett 1999; Papka and Traurig 1993). The afferent fibers in these nerves convey modality- and organ-specific information to the spinal cord and brain about events occurring in relatively small and localized areas (Berkley et al. 1993).

Response sensitivity of the peripheral afferent fibers can be altered by reproductive status (puberty, ovarian cycle, pregnancy, lactation, reproductive senescence, hormone replacement) as well as by pathophysiology (Fig. 1b)

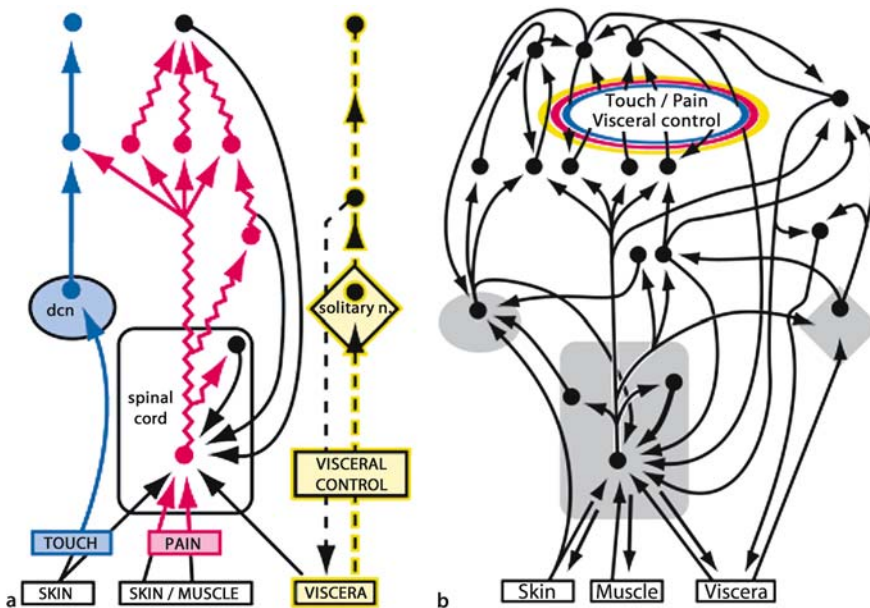


**Gynecological Pain, Neural Mechanisms, Figure 1** Innervation of female reproductive organs and their input to spinal cord and medulla. (a) Diagram of innervation of rat reproductive tract and spinal entry segments (adapted from Berkley et al. 1993; Temple et al. 1999). Note topographic organization of the input; i.e., vagina/cervix via pelvic nerve to L6/S1 segments; cervix/uterus via hypogastric nerve to T13-L1 segments; ovary via superior ovarian and ovarian plexus nerves to T10-L1 segments. Although the fibers enter the spinal cord via dorsal root ganglia in these segments, the terminations of the afferents in the spinal cord extend to many segments rostrally and caudally from their entry. Note also, that the entire tract is innervated by the vagus nerve (Komisaruk 2003). (b) Responses of fibers in the hypogastric nerve (histograms in the top line) to contractions of the uterus as the contractions pass over the balloon in the uterine horn. The diagram in the inset shows the location of the balloon inside the horn (hatched area) and the recording electrode on the hypogastric nerve (double hooked lines). Note how the responses increase with time in association with increasing inflammation of the uterus. The receptive field for these neurons to mechanical stimulation of the uterus was directly over the balloon. This field enlarged during the recording session to include a bigger portion of the uterine horn, but the neuron remained unresponsive to stimulation of any other pelvic organ (data from experiments reported in Berkley et al. 1993). (c) Responses of a single neuron in the gracile nucleus of the medulla to stimulation of different pelvic organs. The neuron's spike is shown three times at different times during the recording period. Note that this neuron responded during a bladder contraction, was inhibited by pressure on the cervix, had a delayed response to innocuous distention of the colon with a long-lasting afterdischarge, and was inhibited by noxious distention of the vaginal canal. (Data from work by Peng et al., unpublished, based on Bradshaw and Berkley 2000).

(Berkley et al. 1993). Notably, however, the responses remain organ-specific. For example, although injury to the uterus can increase sensitivity of hypogastric nerve fibers in response to stimulation to a small part of the uterus, and the receptive field may increase slightly, the sensory afferent fibers will still respond only to stimulation of the uterus, and fail to respond to stimulation

of other nearby organs such as the vagina, bladder or colon (Fig. 1b) (Berkley et al. 1993). Thus, although such changes in response sensitivity are likely to contribute to changes in nociceptive/pain sensitivity of the innervated regions, they fail to explain the many and common gynecological pains mentioned above that do not correlate with peripheral pathophysiology, nor can they ex-





**Gynecological Pain, Neural Mechanisms, Figure 2** Conceptualizations of how the transmission of stimulus information from bodily receptors in skin, muscle, and internal organs (including the reproductive organs) to and through various central nervous system regions might give rise to perceptions of pain and touch and modulate visceral function. (a) represents the current traditional “pathway” view in which different pathways are invested with different perceptual functions. (b) represents a “dynamic distributed ensemble” view that takes into account connective features such as cross-system visceroviscero-somatic convergence of input into the dorsal column nuclei (dcn), solitary nucleus, and spinal cord, widespread divergence and convergence in the brain and spinal cord, and dynamic processes such as central sensitization and hormonal modulation of CNS activity. (Diagrams modified from Berkley 2001).

plain referred pain, referred hyperalgesia, and the co-occurrence of cross-system pains.

What is important, therefore, is how the central nervous system processes the information it receives to create pain. The most common conceptualization of this process involves a “pathway” mechanism in which there are parallel and separate tracks through the CNS, whose activation gives rise to different bodily perceptions such as touch or pain (Fig. 2a). Regarding the ► **pain pathway**, the experience of pain is created when a noxious or pathophysiological stimulus in an organ (e.g. a reproductive organ) activates peripheral afferent fibers, which convey their information to the spinal cord, from where the information is relayed through a series of central neural structures to reach cerebral cortex. To account for variations in reported pain experiences despite similar peripheral noxious stimuli, an additional rheostat-like, pain-modulatory control mechanism exists, in which neurons in various parts of the brain influence, via descending fibers, the information arriving in the spinal cord.

One problem with this view is that it requires a peripheral ► **noxious stimulus** for pain to occur, and thereby fails to explain pain without injury as well as referred pain/hyperalgesia, and co-occurrence of cross-system pains. These problems have led to the development of another concept (Fig. 2b), referred to as a ► **dynamic ensemble**,” rather than a “pathway” view. This newer concept derives from four recently discovered features

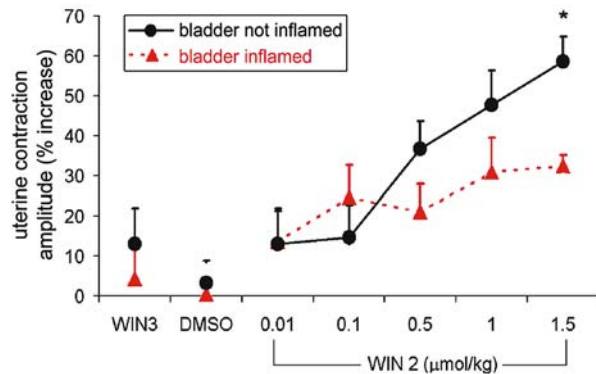
about how the CNS processes information arriving from reproductive and other visceral structures.

The first feature is a connective situation called “► **cross-system viscerovisceral convergence**” (Berkley 2001; Dmitrieva and Berkley 2002). It involves the fact that organ-specific information provided by sensory afferents is conveyed to neurons in many segments in the spinal cord, as well as to the dorsal column and solitary nuclei in the brainstem, converging there with information arriving not only from skin and muscles in the same segments, but also from other organs such as the colon and bladder (Fig. 1c). The second feature, widespread divergence and convergence, also connective, refers to the fact that information from neurons in each of the three recipient regions is then conveyed to the other regions, as well as to a large number of other sites in the brain which themselves interconnect (Berkley 2001). The third feature is a dynamic process called “► **central sensitization**” (Melzack et al. 2001). It involves the fact that if the afferent fibers have been made hyperactive by noxious events in the periphery, then the input can sensitize the recipient CNS neurons, which often remain sensitized long after the noxious peripheral event (injury, disease) has resolved, producing, in effect, “► **injury memories**” (Nathan 1985). The fourth feature, also dynamic, hormonal modulation, refers to the fact that the responses of recipient CNS neurons, regardless of whether or not they have been sensitized, are strongly subject to modulation

by circulating hormones (Bradshaw et al. 2000). The dynamic ensemble view (Fig. 2b), supported by these four connective and dynamic features, clearly places the decision for the perception of pain within networks of CNS neurons, thereby allowing pain to depend as much or more on the manipulation of information by CNS neurons as it does on peripheral nociceptive events. The connective features of this view also illustrate that the CNS provides a substrate by which events occurring in one organ can influence the events occurring in another organ, while the dynamic features provide a means by which these cross-system influences can be modified by injury, pathophysiology or reproductive status. In so doing, this view helps explain the poor correlation between pathophysiology of reproductive organs and pain, referred pain, referred hyperalgesia, and cross-system co-occurrence of painful conditions. It also helps explain the dynamics of these pains.

Perhaps even more interesting is that the dynamic ensemble view also provides a different way of assessing pain and its neural mechanisms, with important clinical implications. Here are three examples:

1. In rats it has been found that vaginal nociception varies only moderately with estrous stage (rats tolerate more pressure in the vaginal canal when fertile than they do in other stages; Bradshaw et al. 1999). However, when the rats have been subjected to surgery to produce endometriosis, the estrous changes are exaggerated and modified (rats develop vaginal hyperalgesia when in their fertile period (Cason et al. 2003). A similar situation exists for women. Thus, the menstrual cyclicity of muscle and skin pain thresholds in women with dysmenorrhea is exaggerated when compared with women without dysmenorrhea (Giamberardino et al. 1997)
2. Using a rat model of surgically-induced endometriosis, it has been found that this condition exacerbates pain behaviors and referred muscle hyperalgesia arising from a ureteral stone, but the surgical control procedure (partial unilateral hysterectomy) actually reduces those pain behaviors and the referred hyperalgesia, producing in effect a condition that has been named "silent stones" (Giamberardino et al. 2002). Similarly, in women who pass multiple ureteral stones, colic pain episodes and referred hyperalgesia are more frequent in those who suffer from endometriosis or severe dysmenorrhea than in women without those problems (Giamberardino et al. 2001)
3. In rats, it has been found that the actions of a drug on uterine contractility are reduced when the bladder of the rat has been inflamed, and this effect is strongly influenced by estrous stage (Dmitrieva and Berkley 2002) (Fig. 3). Such cross-system pharmacological effects have not yet been studied in women.



**Gynecological Pain, Neural Mechanisms, Figure 3** Increases in uterine contraction amplitude produced by a cannabinoid receptor agonist (WIN 22, 212-2) are reduced by inflammation of the bladder with turpentine. Data from Dmitrieva and Berkley 2001.

In summary, conceptualizations of neural mechanisms of gynecological pain are now changing to take into account new data on cross-system visceroviscerosomatic interactions, the widespread divergence and convergence of information flow throughout the CNS, central sensitization (injury memories), and hormonal modulation. In so doing, such conceptualizations, i.e. "dynamic ensembles", help explain puzzling features of gynecological pain that are common to pain associated with other internal organs, such as poor correlation of pathophysiology and pain severity, referred pain and referred hyperalgesia, and co-occurrence of painful conditions associated with different systems. In addition, dynamic ensembles are also helping to improve our understanding of how central dynamic processing of information gives rise to the many variations of gynecological pain experience throughout a woman's life.

## References

1. Berkley KJ (2001) Multiple Mechanisms of Pelvic Pain: Lessons from Basic Research. In: MacLean A, Stones RW, Thornton S (eds) Pain in Obstetrics and Gynaecology. RCOG Press, London, pp 26–38
2. Berkley KJ, Robbins A, Sato Y (1993) Functional Differences between Afferent Fibers in the Hypogastric and Pelvic Nerves Innervating Female Reproductive Organs in the Rat. *J Neurophysiol* 69:533–544
3. Bradshaw HB, Berkley KJ (2000) Estrous Variations in Responses of Neurons in the Rat Gracile Nucleus to Stimulation of Hindquarter Skin and Pelvic Viscera. *J Neurosci* 20:7722–7727
4. Bradshaw HB, Temple JL, Wood E et al. (1999) Estrous Variations in Behavioral Responses to Vaginal and Uterine Distention in the rat. *Pain* 82:187–197
5. Cason A., Samuelsen C, Berkley KJ (2003) Estrous Changes in Vaginal Nociception in a Rat Model of Endometriosis. *Horm Behav* 44:123–131
6. Dmitrieva N, Berkley KJ (2002) Contrasting Effects of WIN 55212-2 on Motility of the Rat Bladder and Uterus. *J Neurosci* 22:7147–7153
7. Giamberardino MA, Berkley KJ, Affaitati G et al. (2002) Influence of Endometriosis on Pain Behaviors and Muscle Hyperalgesia Induced by Ureteral Calculus in Female Rats. *Pain* 95:247–257

8. Giamberardino MA, Berkley KJ, Iezzi S et al. (1997) Pain Threshold Variations in Somatic Wall Tissues as a Function of Menstrual Cycle, Segmental Site and Tissue Depth in Non-Dysmenorrheic Women, Dysmenorrheic Women and Men. *Pain* 71:187–197
9. Giamberardino MA, De Laurentis S, Affaitati G et al. (2001) Modulation of Pain and Hyperalgesia from the Urinary Tract by Algogenic Conditions of the Reproductive Organs in Women. *Neurosci Lett* 304:61–64
10. Giamberardino MA (2003) Referred Muscle Pain/Hyperalgesia and Central Sensitisation. *J Rehabil Med* 41Suppl:85–88
11. Komisaruk BR, Sansone G (2003) Neural Pathways Mediating Vaginal Function: The Vagus Nerves and Spinal Cord Oxytocin. *Scand J Psychol* 44:241–250
12. Melzack R,Coderre TJ, Katz J et al. (2001) Central Neuroplasticity and Pathological Pain. *Ann NY Acad Sci* 933:157–174
13. Nathan PW (1985) Pain and Nociception in the Clinical Context. *Philos Trans R Soc Lond B Biol Sci* 308:219–226
14. Papka RE, Traurig HH (1993) Autonomic Efferent and Visceral Sensory Innervation of the Female Reproductive System: Special Reference to Neurochemical Markers in Nerves and Ganglionic Connections. In: Maggi CA (ed) *Nervous Control of the Urogenital System*. Harwood Academic Publishers, Chur, Switzerland, pp 423–466
15. Temple J, Bradshaw HB, Wood E et al. (1999) Effects of Hypogastric Neurectomy on Escape Responses to Uterine Distention in the Rat. *Pain Suppl* 6:S13–20
16. Wesselmann U, Burnett AL (1999) Genitourinary Pain. In: Wall PD, Melzack R (eds) *Textbook of Pain*, 4<sup>th</sup> edn. Churchill Livingstone, Edinburgh, pp 689–709





## Habituation

### Definition

Habituation is the reverse process of sensitization, consisting of a waning response to repeated stimulation that can be rapid or gradual. It involves a reduction in excitability, and means that neurons cease to fire when stimulated. However, if the interval between stimuli is altered randomly, and the strength of the stimulus is increased, this process can be reversed.

- ▶ [Infant Pain Mechanisms](#)
- ▶ [Migraine Without Aura](#)
- ▶ [Psychology of Pain, Sensitisation, Habituation and Pain](#)

## Hamstring Muscle Strain

### Definition

Hamstring muscle strain produces pain in the biceps femoris muscles in the back of the thigh. Stretching the muscle can produce pain, as is found with a straight leg raising maneuver.

- ▶ [Sciatica](#)

## Handicap

- ▶ [Disability and Impairment Definitions](#)

## Hansen's Disease

AKI J. HIETAHARJU<sup>1</sup>, MAIJA HAANPÄÄ;<sup>2</sup>

<sup>1</sup>Department of Neurology and Rehabilitation, Pain Clinic, Tampere University Hospital, Tampere, Finland

<sup>2</sup>Department of Anaesthesiology and Department of Neurosurgery, Pain Clinic, Helsinki University Hospital, Helsinki, Finland

aki.hietaharju@pshp.fi

### Synonym

Leprosy

### Definition

Hansen's disease is a chronic granulomatous infection of the skin and peripheral nerves caused by ▶ [Mycobacterium leprae](#). It is associated with marked disabilities which result from the impairment of both sensory and motor nerve function.

### Characteristics

Hansen's disease used to be widely distributed all over the world, but now the major part of the global burden of the disease is represented by resource-poor countries, in tropical and warm temperate regions. In 1985, there were an estimated 12 million people with ▶ [leprosy](#) worldwide, resulting in a prevalence of 12 per 10,000 (Britton and Lockwood 2004). At the beginning of 2003, the number of Hansen's disease patients receiving antimicrobial therapy was around 534,000, as reported by 110 countries. About 621,000 new cases were detected during 2002. The six top endemic countries at the start of 2003 were India, Brazil, Madagascar, Mozambique, Nepal, and Tanzania (WHO).

*Mycobacterium leprae* is an acid-fast gram-positive bacillus, which is supposed to be transmitted mainly by aerosol spread of nasal secretions and uptake through nasal or respiratory mucosa (Noordeen 1994). The infection is not spread by touching, because the bacterium cannot penetrate intact skin. *Mycobacterium leprae* has a peculiar ▶ [tropism](#) for macrophages and ▶ [Schwann cells](#). After having invaded the Schwann cell, the leprosy bacilli replicate slowly over years. These bacilli show preference for growth in cooler regions of the body causing damage to superficial nerves. Peripheral nerves are affected in fibro-osseous tunnels near the surface of the skin e.g. posterior tibial nerve near the medial malleolus (Britton and Lockwood 2004).

The dynamic nature of the immune response to *Mycobacterium leprae* often leads to spontaneous fluctuations in the clinical state, which are called ▶ [leprosy reaction's](#). They are divided into two types. ▶ [Leprosy type 1 reaction](#) or reversal reaction is caused by spontaneous increases in T-cell reactivity to mycobacterial antigens (Britton 1998). In type 1 reactions, especially borderline patients may present with reactions to nerve pain, sudden palsies, and many new skin lesions. ▶ [Leprosy type 2 reaction](#) or erythema nodosum

leprosum, is a systemic inflammatory response to the deposition of extravascular immune complexes. It occurs only in borderline-lepromatous and lepromatous leprosy (Lockwood 1996).

Diagnosis of leprosy is clinical and based on patients having at least one of three cardinal signs, which are: (1) hypopigmented or reddish patches with definite loss of sensation, (2) thickened peripheral nerves, and (3) acid-fast bacilli on skin smears of biopsy material (WHO 1998). Leprosy is divided into five subtypes based on histologic and immunologic features: tuberculoid (▶ **tuberculoid leprosy**), borderline tuberculoid (▶ **borderline leprosy**), midborderline, borderline lepromatous and ▶ **lepromatous leprosy** (Ridley and Jopling 1966). These subtypes have been consolidated into two groups, paucibacillary and multibacillary, for assignment to treatment regimens. According to WHO guidelines, the former is treated with ▶ **dapsone** 100 mg daily and rifampicin 600 mg monthly for 6 months. In multibacillary leprosy, duration of the treatment is a minimum 2 years, and ▶ **clofazimine** 50 mg daily and 300 mg monthly is added to paucibacillary regimen (Britton and Lockwood 2004).

The most devastating clinical consequence of the intracutaneous nerve damage is the total sensory loss of the extremities (Brand and Fritschi 1985). Pain and temperature sensation are most strikingly decreased in early cases, and later tactile and pressure sense are also lost. Anaesthesia of the extremities predisposes the patient to chronic ulcers and severe secondary deformities, and therefore leprosy remains a significant cause of neurologic disability worldwide.

Since Hansen's disease causes severe sensory loss, it is assumed that pain is uncommon in leprosy. However, peripheral nerve pain, dysesthesias and paraesthesias may complicate leprosy, both during and after treatment. Data on consumption of analgesics by patients with neuropathic pain gives some indication of the extent of the problem. In a Malaysian study of 235 leprosy patients, neuritic pain was the main reason for consumption of analgesic preparations. In 46 patients (19.5%), an overall total intake had been more than 2 kg of analgesics. The duration of intake ranged from 2 to more than 20 years (Segasothy et al. 1986).

Acute pain in one or several nerves may be the presenting feature in Hansen's disease. Pain is a familiar symptom of reactions and neuritis, due to entrapment of the oedematous inflamed nerve in sites of predilection (Nations et al. 1998). Neuritis of cutaneous nerves may also be painful (Theuvenet et al. 1993). Peripheral nerve abscesses, which are often associated with severe acute pain, occur in all types of leprosy and a variety of nerve trunks and cutaneous nerves (Kumar et al. 1997). Leprosy related acute pain can usually be relieved by steroids or other therapeutic measures, such as anti-inflammatory drugs and immobilisation or surgical intervention.

Chronic neuropathic pain in Hansen's disease has received scant attention. Hietaharju et al. (2000) reported on moderate or severe chronic neuropathic pain in 16 patients with treated multibacillary leprosy. In 10 patients, the pain had a glove and stocking-like distribution, and in 2 patients it followed the course of a specific nerve. The quality of pain was burning in 9, biting in 3, pricking in 3, cutting in 2, and electric-shock-like in 2 patients. The occurrence of pain was continuous in 50% of the patients. In an evaluation of 303 patients from a Brazilian referral centre, 174 (57%) patients complained of neuropathic pain (Stump et al. 2002). In 84 patients (48%), pain manifested as bursts. Pain affected one or more peripheral nerve territories; ulnar nerve in 101 (58%) patients and tibial nerve course in 48 (28%). There was a polyneuropathic distribution as glove-like in 47 patients (27%), and sock-like in another 47 patients. At the time of evaluation, pain was present in 47 (27%) patients.

There is little data on the occurrence of sensory disturbances such as dysesthesias, paresthesias or allodynia in patients with leprosy. In a study by Hietaharju et al. (2000), 4 patients complained of a tingling sensation, which was considered as unpleasant and painful, i.e. they had dysesthesia. Dysesthesia followed glove and stocking-distribution in 2 patients, the course of femoral cutaneous nerve in 1 patient, and was located in both legs below mid-thigh in 1 patient. Allodynia, pain due to a stimulus that does not normally provoke pain, was noticed in 2 patients. In both of these patients, enlargement and tenderness of the nerves (cutaneous femoral, common peroneal and posterior tibial) without abscess formation was discovered in clinical examination.

The most typical sensory abnormalities in leprosy patients are severely impaired perception of tactile stimuli and mechanical and thermal pain, indicating damage of A $\beta$ , A $\delta$  and C fibres at the painful site (Hietaharju et al. 2000). The cases with sensory loss associated with pain suggest peripheral deafferentation, i.e. pain due to loss of sensory input into the central nervous system, as occurs with different types of lesions of peripheral nerves. However, in a considerable proportion of the patients with pain the sensory function may be quite well preserved, suggesting other pathophysiological mechanisms. Early involvement of small fibres due to mycobacterial invasion can cause dysfunction and damage leading to paresthesia and pain. Other possible explanations include the impact of previous episodes of reactions, neuritis and inflammation, which may leave the nerve fibrosed, and at risk of entrapment (Negesse 1996). Some patients may have a chronic ongoing neuritis manifesting clinically with pain (Haanpää et al. 2004). Inflammation along nerve trunks has been shown to produce ectopic activity in nerves, and therefore past or present inflammatory conditions represent a source for central sensitisation, which may manifest as chronic neuropathic pain. A delayed ▶ **vasculitic**

neuropathy, probably precipitated by persisting mycobacterial antigen, is a rare complication of leprosy (Bowen et al. 2000). Vasculitic neuropathies, such as HIV and rheumatoid disease related neuropathies are known to be painful.

## References

1. Bowen JRC, McDougall AC, Morris JH, Lucas SB, Donaghy M (2000) Vasculitic neuropathy in a patient with inactive treated lepromatous leprosy. *J Neurol Neurosurg Psychiatry* 68:496-500
2. Brand PW, Fritschi EP (1985) Rehabilitation in leprosy. In: Hastings RC (ed) *Leprosy*, 1st edn. Churchill-Livingstone, Edinburgh, pp 287-319
3. Britton WJ (1998) The management of leprosy reversal reactions. *Lepr Rev* 69:225-234
4. Britton WJ, Lockwood DN (2004) Leprosy. *Lancet* 363:1209-1219
5. Haanpää M, Lockwood DN, Hietaharju A (2004) Neuropathic pain in leprosy. *Lepr Rev* 75:7-18
6. Hietaharju A, Croft R, Alam R, Birch P., Mong A., Haanpää M. (2000). The existence of chronic neuropathic pain in treated leprosy. *Lancet* 356:1080-1081
7. Kumar P, Saxena R, Mohan L, Thacker AK, Mukhija RD (1997) Peripheral nerve abscess in leprosy: report of twenty cases. *Indian J Lepr* 69:143-147
8. Lockwood DN (1996) The management of erythema nodosum leprosum: current and future options. *Lepr Rev* 67:253-259
9. Nations SP, Katz JS, Lyde CB, Barohn RJ (1998) Leprous neuropathy: an American perspective. *Semin Neurol* 18:113-124
10. Negesse Y (1996) Comment: 'silently arising clinical neuropathy' and extended indication of steroid therapy in leprosy neuropathy. *Lepr Rev* 67:230-231
11. Noordeen SK (1994) The epidemiology of leprosy. In: Hastings RC (ed) *Leprosy*, 2nd edn. Churchill-Livingstone, Edinburgh, pp 29-48
12. Ridley DS, Jopling WH (1966). Classification of leprosy according to immunity: a five-group system. *Int J Lepr* 54:255-273
13. Segasothy M, Muhaya HM, Musa A, Rajagopalan K, Lim KJ, Fatimah Y, Kamal A, Ahmad K.S. (1986) Analgesic use by leprosy patients. *Int J Lepr Other Mycobact Dis* 54:399-402
14. Stump P, Baccarelli R, Marciano L, Lauris J, Ura S, Teixeira M, Virmond M (2002) Prevalence and characteristics of neuropathic pain and consequences of the sensory loss in 303 patients with leprosy. In: Abstracts of the 10<sup>th</sup> world congress on pain, August 17-22, 2002, San Diego, California, USA. IASP Press, Seattle, p 93
15. Theuvenet WJ, Finlay K, Roche P, Soares D, Kauer JMG (1993) Neuritis of the lateral femoral cutaneous nerve in leprosy. *Int J Lepr* 61:592-596
16. WHO (1998) Expert Committee on Leprosy, 7th Report, pp 1-43
17. WHO. <http://www.who.int/lepr/> (accessed Jun 24, 2004)

## Hargreaves Test

- ▶ Thermal Nociception Test

## Head Pain

- ▶ Headache

## Headache

NIKOLAI BOGDUK

Department of Clinical Research Royal Newcastle Hospital, University of Newcastle, Newcastle, NSW, Australia  
nbogduk@mail.newcastle.edu.au

## Synonyms

Head Pain; Cephalalgia

## Definition

Headache is pain perceived in the head. Specifically, in order to constitute headache, the pain must be perceived in the occipital, temporal, parietal, or frontal regions of the head, or in some combination of these regions. Pain from these regions may extend to encompass the orbital region, and some forms of headache may particularly affect the orbit. Pain localized to the eye, however, is not generally regarded as headache, and is better described as eye pain. Similar, pain in the face does not conventionally constitute headache; it is regarded separately as facial pain.

## Characteristics

There are many varieties of headache, with many possible causes (Headache Classification Subcommittee of the International Headache Society 2004, Olesen et al. 2000). For the most common types of headache, the actual causes are not known. Although several theories are available, they relate rather to the mechanism of pain-production, and do not explain the fundamental reason why the headache occurs. That remains unknown.

Headaches are distinguished and defined largely on the basis of their clinical features. These can be described systematically under the categories of enquiry recommended for taking a ▶ **history** of a pain problem (see ▶ **medical history**):

- Length of Illness
- Site
- Radiation
- Quality
- Intensity
- Frequency
- Duration
- Time of Onset
- Mode of Onset
- Precipitating Features
- Aggravating Features
- Relieving Features
- Associated Features

## Length of Illness

This domain pertains to whether or not this is the first episode of headache that the patient has suffered.

H

Headache for the first time is the cardinal clue for a small set of serious headaches, such as those caused by aneurysm, subarachnoid haemorrhage, meningitis, or sudden, severe hypertension.

### Site

The site in which pain is felt is of no diagnostic significance, other than to establish that the complaint is one of headache. However, whether the pain is unilateral or bilateral does bear on the diagnosis of some forms of headache. For example, tension-type headache typically affects the entire head, whereas most other forms of headache are typically, although not always, unilateral. Pain of a neuralgic quality (see below), in the distribution of the nerve affected, is diagnostic of trigeminal neuralgia, glossopharyngeal or vagal neuralgia, and C2 neuralgia.

### Radiation

Noting the areas *to which* pain radiates does not help in diagnosis. Different forms of headache may have the same pattern of radiation. However, it can be helpful to recognize sites *from which* pain appears to be referred. Although the pain may be perceived in the forehead, if it appears to have spread from the occiput or neck, a possible cervical source should be considered.

### Intensity

All forms of headache can be mild, moderate, or severe in intensity. So, intensity alone does not serve to discriminate different types of headache. However, certain types of headache are characterized by severe headache of sudden onset, sometimes described as “thunderclap” headache. Possible causes include subarachnoid haemorrhage, meningitis, and pheochromocytoma.

### Quality

Most headaches will be dull, aching, or throbbing in quality. These features do not help in making a diagnosis. On the other hand, a lancinating quality of pain establishes that the pain is neuralgic, and is one of the defining features of trigeminal neuralgia, glossopharyngeal or vagal neuralgia, and of C2 neuralgia. Stabbing pain, or jabs of pain, is characteristic of cluster headache, although other features more strongly define this condition.

### Frequency

Of all pain problems, headache is the one condition in which frequency is a cardinal diagnostic feature. Short, repeated jabs of pain, recurring in bouts over several minutes are what characterize cluster headache. Periods of pain lasting half a day, or up to three or four days, interspersed with periods free of pain, is what characterizes migraine. Other types of headache occur in paroxysmal bouts, i.e. sustained periods of repeated jabs of intense pain that then switch off. These include chronic paroxysmal hemicrania (CPH), and SUNCT (sudden, unilateral,

neuralgiform headache with conjunctival injection and tearing).

### Duration

Duration of pain is often inextricably linked to frequency. In cluster headache, and its congeners, the frequency of jabs of pain is high, but the duration of each jab is short, i.e. seconds. In migraine, the headache is established and remains constant, such that its duration is measured in hours or days, but then a pain-free interval appears.

### Time of Onset

This is probably an obsolete category of enquiry for diagnostic purposes. Its heritage is that early morning headache was once regarded as pathognomonic of hypertension headache, but this has been disproved. Nevertheless, sometimes the time of onset can provide clues to the cause of headache. For example, headache caused by exposure to chemicals or allergens may occur at only particular times of the day, particular days of the week, or particular seasons of the year. Synchrony with menstrual cycle strongly suggests menstrual migraine.

### Mode of Onset

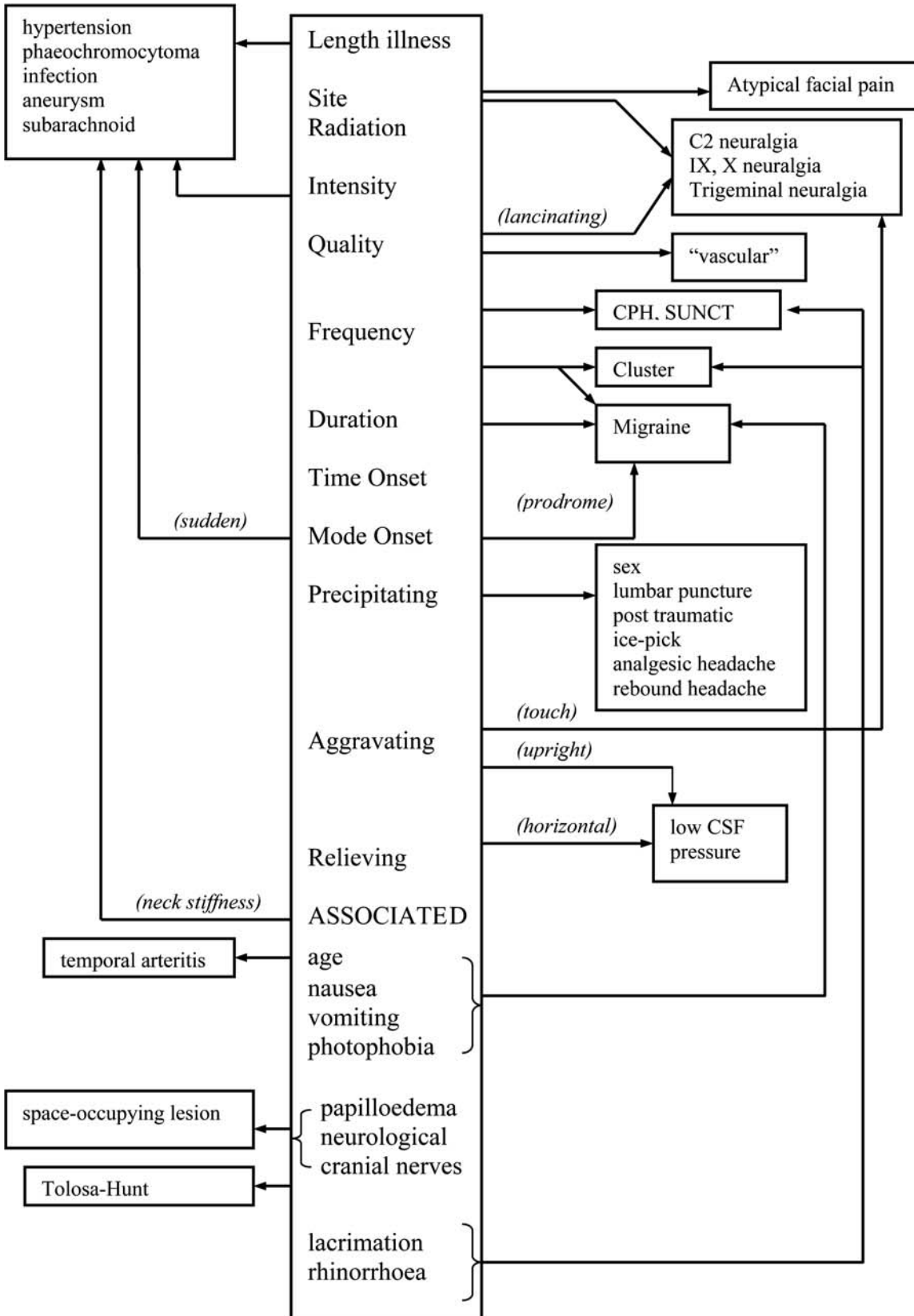
Severe headaches of sudden onset suggest subarachnoid haemorrhage, meningitis, or hypertension as the causes. Otherwise, most headaches come on gradually or in an unremarkable fashion. However, some forms of migraine can have a prodrome. A prodrome of neurological symptoms is virtually diagnostic of classical migraine (now known as migraine with prodrome (Headache Classification Subcommittee of the International Headache Society 2004)). Some patients with migraine will suffer cravings for certain types of foods, before the onset of headache. This fits with serotonin mechanisms that on the one hand are involved with pain, and on the other hand are involved with satiety.

### Precipitating Factors

Some forms of recurrent headache can be precipitated, inadvertently or consciously, by certain actions. In some patients, the pain of trigeminal neuralgia can be precipitated by touching trigger spots on the face, or in the mouth. Headache precipitated by sexual activity is referred to as “sex headache”, and appears to be related to a rapid rise in blood pressure. A rare, but distinctive entity, is colloid cyst of the third ventricle, in which headache can be precipitated by extension of the head, which causes the cyst to occlude the cerebral aqueduct and precipitate a sudden rise in cerebrospinal fluid pressure. “Ice-pick headache” is the term accorded to headache precipitated by exposure to cold foods or liquids.

For headaches of recent onset, not experienced before, an antecedent event may indicate the possible or likely cause. A classical example is post-lumbar puncture headache. A vexatious issue is trauma. Patients may





H

Headache, Figure 1 The differential diagnosis of headache by clinical history and examination.

report an injury that apparently caused the headache. However, a direct link between trauma and headache may be difficult to prove, and is sometimes contentious. Nevertheless, a history of trauma may be the only defining feature of some forms of headache; on which grounds the entity of “post-traumatic headache” is recognized.

Some headaches can be caused by exposure to drugs such as alcohol. Some headaches, paradoxically, can be caused by excessive consumption of analgesics. Withdrawal of analgesics can cause rebound headache.

#### Aggravating Factors

Few features that aggravate headache help in establishing a diagnosis, for many different forms of headache may be aggravated by activities such as turning the head, or exertion. However, certain features that appear to aggravate the pain are better classified as associated features (see below).

#### Relieving Factors

Many patients with headache resort to lying down. So, lying down per se is not a discriminating feature. However, when lying down promptly relieves the headache, and when resumption of the upright posture restores it, the leading diagnosis is low-pressure cerebrospinal fluid, which can be idiopathic or secondary to lumbar puncture.

#### Associated Features

It is in the domain of associated features that most headaches can be distinguished. Photophobia, nausea and vomiting are the cardinal diagnostic features of migraine. Lacrimation, rhinorrhoea, and conjunctival injection are reflex parasympathetic effects that occur with a family of headaches. Classically, they are the associated features of cluster headache, but they also occur in paroxysmal hemicrania and SUNCT syndrome. Papilloedema and focal neurological signs are the classic features of space occupying lesion of the cranium. Other important features are neck stiffness and Kernig’s sign, which are virtually diagnostic of spread of infection or haemorrhage into the cervical subarachnoid space. Neurological signs affecting the III, IV, and VI cranial nerves are diagnostic of Tolosa–Hunt syndrome, i.e. granuloma of the cavernous sinus.

Age is an important feature. New headache in an elderly patient may be the only warning feature of temporal arteritis.

The diagnosis of acute herpes zoster can be made immediately once the eruption of vesicles occurs, but the pain may precede the eruption by up to three days.

#### Diagnosis

Figure 1 illustrates how taking a systematic history can allow many types of headache to be diagnosed on the basis of certain clinical features, singly or in combination. Migraine is diagnosed on the basis of periodic pain as-

sociated with photophobia, nausea, or vomiting. Cluster headache is defined by paroxysmal pain associated with lacrimation, rhinorrhoea, and conjunctival injection. Its relatives—CPH and SUNCT, only differ essentially with respect to the periodicity and duration of the headache. Intracranial lesions are diagnosed on the basis of associated neurological signs.

Certain entities, however, cannot be recognized clinically, because they do not have any distinctive features. Those entities are: benign intracranial hypertension, sphenoid sinusitis, cervicogenic headache, and tension type headache.

The first three of these entities require investigations. Benign intracranial hypertension requires a CT scan. Sphenoid sinusitis is perhaps the most “impalpable” headache. It exhibits nothing but pain, felt somewhere deep in the centre of the head. The diagnosis is established eventually by medical imaging. The diagnosis of cervicogenic headache requires the establishment of a cervical source of pain, by medical imaging or by diagnostic blocks of cervical structures or nerves.

Tension type headache is notable because there are no positive diagnostic criteria for this entity. It is a diagnosis by exclusion of other possible causes.

Other ill-defined entities include so-called “vascular headache”, whose cardinal feature is throbbing pain, but which does not exhibit any of the diagnostic features of migraine.

#### ► Chronic Daily Headache in Children

#### References

1. Headache Classification Subcommittee of the International Headache Society (2004) The International Classification of Headache Disorders, 2nd edn. *Cephalalgia* 24 Suppl 1:1–160
2. Olesen J, Tfelt-Hansen P, Welch KM (2000) *The Headaches*, 2nd edn. Lippincott Williams & Wilkins, Philadelphia

## Headache, Acute Post-Traumatic

MIGUEL JA LÁINEZ-ANDRÉS<sup>1</sup>,  
ANA M PASCUAL-LOZANO<sup>2</sup>

<sup>1</sup>Department of Neurology, University of Valencia, Valencia, Spain

<sup>2</sup>Clinical Hospital, University of Valencia, Valencia, Spain

jlainez@meditex.es

#### Synonyms

Post-Traumatic Headache; PTHA

#### Definition

Post-traumatic headache (PTHA) is usually one of several symptoms of the “post-traumatic syndrome” and therefore may be accompanied by somatic, psychological or cognitive disturbances (Solomon 2001). A variety of pain patterns may develop after head injury and may

closely resemble primary headache disorders. Common headache pathways have been described for primary and post-traumatic headaches but the pathogenesis of PTHA is still not well known (Martelli 1999).

### Characteristics

Tension-type is the most common variety of PTHA (more than 80% of the patients suffered a tension-type headache after head or neck trauma), followed by cervicogenic headache. Exacerbations of migraine and cluster-like headaches also occur. Post-traumatic migraine (PTMA) represents approximately 8–10% of PTHA. This is usually a migraine without aura, often found in children, adolescents and young adults with familial history of migraine. Migraine with visual aura has been described in only a few patients (Hachinski 2000).

Mild, moderate and severe head injuries can be associated with a PTHA. Clinical quantification of traumatic brain injury patients should be based on the Glasgow Coma Scale score (GCS), duration of loss of consciousness (LOC) and presence of posttraumatic amnesia (PTA). In addition, a short practicable neuropsychological test may be useful in detecting minor memory and attentional deficits. Paradoxically, mild head injury is often accompanied by headache and additional symptoms, more frequently than moderate or severe head traumas.

To differentiate between a primary and a post-traumatic headache can be difficult in some cases. Patients who develop a new form of headache in close temporal relation to head or neck trauma should be coded as having a secondary headache. Patients in whom this type of headache was pre-existing but significantly worsened in close temporal relation to trauma, without evidence of a causal relationship between the primary headache and the other disorder, receive only the primary headache diagnosis. However, if there is both a very close temporal relation to the trauma and other good evidence that the particular kind of trauma has aggravated the primary headache, that is if trauma in scientific studies of good quality has been shown to aggravate the primary headache disorder, the patient receives the primary and the secondary headache diagnoses. In many cases of secondary headache, the diagnosis is definite only when the headache resolves or greatly improves within a specified time after effective treatment or spontaneous remission of the causative disorder. In such cases, this temporal relation is an essential part of the evidence of causation.

It is easy to establish the relationship between a headache and head or neck trauma when the headache develops immediately or in the first days after trauma has occurred. On the other hand, it is very difficult when a headache develops weeks or even months after trauma, especially when the majority of these headaches have the pattern of tension-type headache and the prevalence of this type of headache in the population is very high.

Such late onset post-traumatic headaches have been described in anecdotal reports but not in case-control studies. In accordance with new IHS Classification, that will soon be published, acute PTHA develops within 7 days after head trauma or regaining consciousness following head trauma and resolves within 3 months.

### New Diagnostic Criteria for Acute Post-traumatic Headache: Acute Posttraumatic Headache with Moderate or Severe Head Injury Diagnostic Criteria

- a) Headache, no typical characteristics known, fulfilling criteria C and D
- b) Head trauma with at least one of the following:
  1. Loss of consciousness for >30 minutes
  2. Glasgow Coma Scale (GCS) <13
  3. Post-traumatic amnesia for >48 h
  4. Imaging demonstration of a traumatic brain lesion (cerebral hematoma, intracerebral and/or sub-arachnoid haemorrhage, brain contusion and/or skull fracture)
- c) Headache develops within 7 days after head trauma and after regaining consciousness following head trauma
- d) One or other of the following:
  1. Headache resolves within 3 months after head trauma
  2. Headache persists but 3 months have not yet passed since head trauma

### Acute Posttraumatic Headache with Mild Head Injury Diagnostic Criteria

- a) Headache, no typical characteristics known, fulfilling criteria C and D
- b) Head trauma with all the following:
  1. Either no loss of consciousness, or loss of consciousness of <30 minutes duration
  2. Glasgow Coma Scale (GCS) >13
  3. Symptoms and/or signs diagnostic of concussion
- c) Headache develops within 7 days after head trauma
- d) One or other of the following:
  1. Headache resolves within 3 months after head trauma
  2. Headache persists but 3 months have not yet passed since head trauma.

Before new diagnosis criteria, acute-PTHA might begin less than 14 days after head or neck trauma and continue for up to 8 weeks post-injury (Headache Classification Committee of IHS 1988). Headache that develops longer than 14 days after head injury has been termed “delayed-PTHA or late-acquired headache”. If such

headaches persist beyond the first 3 months post-injury, they are subsequently referred to as chronic-PTHA

**New Diagnostic Criteria for Chronic Post-traumatic Headache: Chronic Posttraumatic Headache with Moderate or Severe Head Injury Diagnostic Criteria**

- a) Headache, no typical characteristics known, fulfilling criteria C and D
- b) Head trauma with at least one of the following:
  1. Loss of consciousness >30 minutes
  2. Glasgow Coma Scale (GCS) <13
  3. Post-traumatic amnesia >48 hours
  4. Imaging demonstration of a traumatic brain lesion (cerebral hematoma, intracerebral and/or sub-arachnoid haemorrhage, brain contusion and/or skull fracture)
- c) Headache develops within 7 days after head trauma or after regaining consciousness following head trauma
- d) Headache persists for >3 months after head trauma

**Chronic Posttraumatic Headache with Mild Head Injury Diagnostic Criteria**

- a) Headache, no typical characteristics known, fulfilling criteria C and D
- b) Head trauma with all the following:
  1. Either no loss of consciousness, or loss of consciousness of <30 minutes duration
  2. Glasgow Coma Scale (GCS) >13
  3. Symptoms and/or signs diagnostic of concussion
- c) Headache develops within 7 days after head trauma
- d) Headache persist for >3 months after head trauma

After mild head trauma, laboratory and ► **neuroimaging** investigations are not habitually needed. When the GCS score is less than 13 in the emergency room after head or neck trauma, LOC is longer than 30 min, there is PTA, neurological deficits or personality disturbances, neuroimaging studies (computer tomography scan, CT, or magnetic resonance imaging, MRI) are indicated. MRI (using at least T1 weighted, T2 weighted, proton density and gradient-echo sequence images) is much more sensitive than CT in detecting and classifying brain lesions. Within 1 week of a head injury, MRI can identify cortical contusions and lesions in the deep white matter of the cerebral hemispheres underdiagnosed by CT. MRI thus provides a sounder basis for diagnosis and treatment in patients suffering from late sequelae of cranial injuries (Voller 2001).

Complementary studies (neuroimaging, EEG, evoked potentials, CSF examination, vestibular function tests) should also be considered for patients with ongoing posttraumatic headaches. The relationship between

severity of the injury and severity of the post-traumatic syndrome has not been conclusively established. Moreover, there are some controversial data. Most studies suggest that PTHA is less frequent when the head injury is more severe. Differential diagnosis may include a symptomatic headache, secondary to structural lesions and simulation. There is no evidence that an abnormality in the complementary explorations changes the ► **prognosis** or contributes to treatment. Special complementary studies should be considered on a case-by-case basis or for research purposes.

After several months, some patients developed a daily headache. In the majority of patients with episodic headaches after head injury, this condition is self-limited, but a minority of individuals may develop persistent headaches. Neurological factors have been implicated in the initial phase, psychological and legal factors (litigation and expectations for compensation) in the maintenance of them. Premorbid personality can contribute to development of chronic symptoms, affecting adjustment to injury and treatment outcome. Surprisingly, the risk of developing chronic disturbances seems to be greater for mild-moderate head injury.

Age, gender, certain mechanical factors, a low intellectual, educational and socio-economic level, previous history of headache or alcohol abuse and long duration of unconsciousness or neurological deficits after the head or neck injury, are recognized ► **risk factors** for a poor outcome. Women have higher risk of PTHA and increasing age is associated with a less rapid and less complete recovery. Mechanical impact factors, such as an abnormal position of the head (rotation or inclined) increase the risk of PTHA. Other predictor factors are presence of skull fracture, reduced value of Glasgow Scale, elevated serum protein S-100B and dizziness, headache and nausea in the emergency room (De Krujik 2002).

The role of litigation in the persistence of headache is still discussed. The relationship between legal settlements and the temporal profile of chronic-PTHA is not clearly established, but it is important to carefully assess patients who may be malingering and/or seeking enhanced compensation. In general, medico-legal issues should be solved as soon as possible.

**Pathophysiology of PTHA**

Pathophysiology of post-traumatic headaches is still not well understood but biological, psychological and social factors are included. In the pathogenesis, common headache pathways with primary headaches have been proposed.

During typical migraine, cerebral cortical and brain stem changes occur. The activation of the brainstem monoaminergic nuclei has been demonstrated with functional imaging studies (Bahra 2001). Disturbed neuronal calcium influx and / or hemostatic alterations



have also been involved. However, these events have not been included for PTMA yet.

In recent years, several pieces of research have implicated similar neurochemical changes in both typical migraine and experimental traumatic brain injury, excessive release of excitatory amino acids, alterations in serotonin, abnormalities in catecholamines and endogenous opioids, decline in magnesium levels, abnormalities in nitric oxide formation and alterations in neuropeptides (Packard 1997). Whether these changes are determining, contributing or precipitating factors for headache in each patient is still unknown. In addition, in patients with late-PTMA a sensitization phenomenon is possible. In some patients without previous migraine and history of a recent mild head injury, trigeminal neuron sensitization could be a central cause in relation to focal lesions. Central and peripheral sensitizations have been proposed before by other authors (Malick 2000; Packard 2002).

Further researches are still necessary to clarify the relationship between chronic symptoms after mild head trauma and neuroimaging abnormalities. These abnormalities could provide a pathological basis for long-term neurological disability in patients with post-concussive syndrome. New techniques of MRI (especially diffusion tensor imaging and magnetization transfer ratio) are useful for the detection of small parenchymal brain lesions, diffuse axonal injury secondary to disruption of axonal membranes or delayed cerebral atrophy (Hofman 2002). In normal appearing white matter, magnetic resonance spectroscopy studies detect metabolic brain changes (an early reduction in N-acetyl aspartate and an increase in choline compounds), which correlate with head injury severity (Garnett 2000). Positron-emission tomography (PET), single-photon emission computed tomography (SPECT) and xenon 133 CT may provide evidence of brain perfusion abnormalities after mild head trauma and in the presence of chronic posttraumatic symptoms (Aumile 2002).

### Management Strategies

Trauma-induced headaches are usually heterogeneous in nature, including both tension-type and intermittent migraine attacks. Over time, PTHA may take on a pattern of daily occurrence, although if aggressive treatment is initiated early, PTHA is less likely to become a permanent problem. Adequate treatment typically requires both “central” and “peripheral” measures. Delayed recovery from PTHA may be a result of inadequately aggressive or ineffective treatment, overuse of analgesic medications resulting in analgesia rebound phenomena or comorbid psychiatric disorders (post-traumatic stress disorder, insomnia, substance abuse, depression or anxiety) (Lane 2002).

In general, treatment strategies are based upon studies of non-traumatic headache types. Acute-PTHA may be treated with analgesics, anti-inflammatory agents and physiotherapy. PTMA may be also treated with

ergotamine or triptans. Chronic-PTHA needs prophylactic medication, chronic-PTMA specific antimigraine medications. Previously amitriptyline or propranolol used alone or in combination and verapamil have been demonstrated to improve all symptoms of post-concussive syndrome, especially the migraine. Recently, Packard has published very good results with divalproex sodium as a preventive option in the treatment of PTMA (Packard 2000). Additional physical therapy, psychotherapy (bio-feedback) and appropriate educational support can be supplied, especially in patients with risk factors for poor prognosis. Explanation of the headache’s nature can also improve the patient’s evolution. In some cases, when a post-traumatic lesion is identified as a peripheral triggering factor for headache, specific treatment of the triggering lesion can resolve the pain. PTMA poorly treated will affect family life, recreation and employment. There is no good evidence that litigation and economical expectation is associated with prolongation of headaches, however litigation should be solved as soon as is possible.

### Conclusions

Trauma induced headache and headache attributed to whiplash should be treated early or associated complications will appear (daily occurrence of headache, overuse of analgesic medications and comorbid psychiatric disorders). Preventive and symptomatic treatments may be prescribed according to the clinical pattern of the headache (tension-type, migraine, cluster or cervicogenic headaches) as a primary headache. Physiotherapy, psychotherapy and resolution of litigation can be contributing factors to recovery.

### References

1. Aumile EM, Sandel ME, Alavi A et al. (2002) Dynamic imaging in mild traumatic brain injury support for the theory of medial temporal vulnerability. *Arch Phys Med Rehabil* 83:1506–1513
2. Bahra A, Matharu MS, Buchel C et al. (2001) Brainstem activation specific to migraine headache. *Lancet* 357:1016–1017
3. De Kruijk JR, Leffers P, Menheere PP et al. (2002) Prediction of posttraumatic complaints after mild traumatic brain injury: early symptoms and biochemical markers. *J Neurol Neurosurg Psychiatry* 73:727–732
4. Garnett MR, Blamire AM, Rajagopalau B et al. (2000) Evidence for cellular damage in normal-appearing white matter correlates with injury severity in patients following traumatic brain injury: a magnetic resonance spectroscopy study. *Brain* 123:1043–1049
5. Hachinski W (2000) Posttraumatic headache. *Arch Neurol* 57:1780
6. Headache Classification Committee of the International Headache Society (1988) Classification and diagnostic criteria for headache disorders, cranial neuralgias and facial pain. *Cephalalgia* 8:1–96
7. Hofman PA, Verhey FR, Wilmink JT et al. (2002) Brain lesions in patients visiting a memory clinic with postconcussional sequelae after mild to moderate brain injury. *J Neuropsychiatry Clin Neurosci* 14:176–178
8. Lane J, Arciniegas DB (2002) Post-traumatic Headache. *Curr Treat Options Neurol* 4:89–104
9. Malick A, Burstein R (2000) Peripheral and central sensitization during migraine. *Funct Neurol* 15:28–35

10. Martelli MF, Grayson RL, Zasler ND (1999) Post-traumatic headache: neuropsychological and psychological effects and treatment implications. *J Head Trauma Rehabil* 14:49–69
11. Packard RC, Haw CP (1997) Pathogenesis of PTH and migraine: a common headache pathway? *Headache* 37:142–152
12. Packard RC (2000) Treatment of chronic daily posttraumatic headache with divalproex sodium. *Headache* 40:736–739
13. Packard RC (2002) The relationship of neck injury and posttraumatic headache. *Curr Pain Headache Rep* 6:30131–30137
14. Solomon S (2001) Post-traumatic headache. *Med Clin North Am* 85:987–996
15. Voller B, Auff E, Schnider P et al. (2001) To do or not to do MRI in mild traumatic brain injury? *Brain Inj* 15:107–115

## Headache Associated with Disorders of the Cranium

- ▶ Headache from Cranial Bone

## Headache Associated with Psychotic Disorder

- ▶ Headache Due to Somatoform Disorder

## Headache Associated with Somatisation Disorder

- ▶ Headache Due to Somatoform Disorder

## Headache Attributed to a Substance or its Withdrawal

STEPHEN D. SILBERSTEIN  
 Jefferson Medical College, Thomas Jefferson University and Jefferson Headache Center, Thomas Jefferson University Hospital, Philadelphia, PA, USA  
 stephen.silberstein@jefferson.edu

### Synonyms

Medication-Induced Headaches; headaches associated with substances or their withdrawal

### Definition

The International Headache Society (IHS) previously grouped medication-induced headaches under the rubric “headaches associated with substances or their withdrawal (Headache Classification Committee of the International Headache Society 1988).” The new IHS classification (Headache Classification Committee 2003) now calls these “headaches attributed to a substance or its withdrawal (Monteiro and Dahlof 2000).”

Food, chemical and drug ingestion or exposure can be both a cause of and a trigger for headache (Silberstein 1998). Their association is often based on reports of adverse drug reactions and anecdotal data and does not prove causality. When a new headache occurs for the first time in close temporal relation to substance exposure, it is coded as a secondary headache attributed to the substance. When a pre-existing primary headache is made worse by substance exposure, there are two possibilities. The patient can either be given only the diagnosis of the pre-existing primary headache or be given both this diagnosis and the diagnosis of headache attributed to the substance (Headache Classification Committee 2003).

### Headache Attributed to Acute Substance Use or Exposure (Headache Classification Committee 2003)

#### Diagnostic Criteria

1. Headache fulfilling criteria 3 and 4.
2. Acute use of or other acute exposure to a substance.
3. Headache develops within 12 h of use or exposure.
4. Headache resolves within 72 h after single use or exposure.

#### Characteristics

Alcohol, food and food additives and chemical and drug ingestion and withdrawal have all been reported to provoke or activate migraine in susceptible individuals. Since headache is a complaint often attributed to placebo, substance-related headache may arise as a result of expectation. The association between a headache and an exposure may be coincidental (occurring just on the basis of chance) or due to a concomitant illness or a direct or indirect effect of the drug and may depend on the condition being treated. Headache can be a symptom of a systemic disease and drugs given to treat such a condition will be associated with headache. Some disorders may predispose to substance-related headache. Alone, neither the drug nor the condition would produce headache. A ▶ [NSAIDs](#), [Survey](#) may produce headache by inducing aseptic meningitis in susceptible individuals. The possible relationships between drugs and headache are outlined below (Silberstein 1998).

#### Drug and Substance Related Headache

- A Coincidental
- B Reverse causality
- C Interaction headache
- D Causal

Acute: Primary effect; Secondary Effect

#### Acute Drug-induced Headache

Whether or not a drug triggers a headache often depends on the presence or absence of an underlying headache disorder. Headaches are usually similar to the pre-existing headache. The drugs most commonly associated

with acute headache can be divided into several classes (Monteiro and Dahlof 2000).

#### Vasodilator's

Headache is a frequent side effect of antihypertensive drugs. It has been reported with the beta-blockers, ► **calcium channel blockers** (especially nifedipine), ACE inhibitors and methyldopa. Nicotinic acid, dipyrindamole and hydralazine have also been associated with headache. The headache mechanism is uncertain (Thomson Healthcare 2003).

#### Nitric Oxide Donor-induced Headache

Headache is well known as a side effect of therapeutic use of nitroglycerin (GTN) and other ► **nitric oxide (NO)** donors. They may cause headache by activating the trigeminal vascular pathway. There is an immediate NO donor-induced headache (GTN headache), which develops within 10 min after absorption of NO donor and resolves within 1 h after release of NO has ended. There is also a delayed NO donor-induced headache, which develops after NO is cleared from the blood and resolves within 72 h after single exposure (Ashina et al. 2000).

#### Phosphodiesterase Inhibitor-induced Headache

Phosphodiesterases (PDEs) are a large family of enzymes that break down cyclic ► **nucleotides** (cGMP and cAMP). PDE-5 inhibitors include sildenafil and dipyrindamole. The headache, unlike GTN-induced headache, is monophasic. In normal volunteers it has the characteristics of tension-type headache, but in migraine sufferers it has the characteristics of migraine without aura (Headache Classification Committee 2003).

#### Histamine-induced Headache

Histamine causes an immediate headache in non-headache sufferers and an immediate as well as a delayed headache in migraine sufferers. The mechanism is primarily mediated *via* the H<sub>1</sub> receptor because it is almost completely blocked by mepyramine. The immediate histamine-induced headache develops within 10 min and resolves within 1 h after absorption of histamine has ceased. The delayed histamine-induced headache develops after histamine is cleared from the blood and resolves within 72 h (Krabbe and Olesen 1980).

#### Nonsteroidal Anti-Inflammatory Drugs

The nonsteroidal anti-inflammatory drugs, especially indomethacin, have been associated with headache. Mechanisms include aseptic meningitis (especially with ibuprofen) and reverse causality.

#### Serotonin Agonists

M-chlorophenylpiperazine, a metabolite of the antidepressant trazodone, can trigger headache by activating the serotonin (5-hydroxytryptamine [HT]) 2B and 2C receptors (Brewerton et al. 1988). This may be the mecha-

nism of headache induction during early treatment with selective serotonin reuptake inhibitors.

#### Foods and Natural Products (Headache Induced by Food Components and Additives)

Chocolate, alcohol, citrus fruits, cheese and dairy products are the foods that patients most commonly believe trigger their migraine, but the evidence is not persuasive.

#### Amino Acids

Monosodium glutamate (MSG) (Schamburg et al. 1969) and aspartame, the active ingredient of "NutraSweet," may cause headache in susceptible individuals (Schiffmann et al. 1987). Phenyl ethylamine, tyramine and aspartame have been incriminated, but their headache-inducing potential is not sufficiently validated.

#### Monosodium Glutamate-induced Headache (Chinese Restaurant Syndrome)

MSG can induce headache and the Chinese restaurant syndrome in susceptible individuals. The headache is typically dull or burning and non-pulsating, but may be pulsating in migraine sufferers. It is commonly associated with other symptoms, including pressure in the chest, pressure and / or tightness in the face, burning sensations in the chest, neck or shoulders, flushing of the face, dizziness and abdominal discomfort (Schamburg et al. 1969).

#### Aspartame

Aspartame a sugar substitute is an o-methyl ester of the dipeptide L- $\alpha$ -aspartyl-L-phenylalanine that blocks the increase in brain tryptophan, 5-HT and 5-hydroxyindolacetic acid normally seen after carbohydrate consumption (Schiffmann et al. 1987). It produced headache in two controlled studies but not a third (Silberstein 1998).

#### Tyramine

Tyramine is a biogenic amine that is present in mature cheeses. It is probably not a migraine trigger (Silberstein 1998).

#### Phenyl Ethylamine

Chocolate contains large amounts of  $\beta$ -phenyl ethylamine, a vasoactive amine that is, in part, metabolized by monoamine oxidase. The evidence to support it as a trigger is weak (Silberstein 1998).

#### Ethanol

Alone or in combination with ► **congener s** (wine), ethanol can induce headache in susceptible individuals. The attacks often occur within hours after ingestion. In the United Kingdom, red wine is more likely to trigger migraine than white, while in France and Italy white wine is more likely to produce headache than red. Headaches are more likely to develop in response to white wine if red coloring matter has been added.

Migraineurs who believed that red wine (but not alcohol) provoked their headaches were challenged either with red wine or with a vodka mixture of equivalent alcoholic content. The red wine provoked migraine in 9 / 11 subjects, the vodka in 0 / 11. Neither provoked headache in other migraine subjects or controls (Littlewood et al. 1988). It is not known which component of red wine triggers headache and the study may not have been blinded to oenophiles.

The susceptibility to hangover headache has not been determined. Migraineurs can suffer a migraine the next day after only modest alcoholic intake, while non-migraineurs usually need a high intake of alcoholic beverages to develop hangover headache. A few subjects develop headache due to a direct effect of alcohol or alcoholic beverages (cocktail headache). This is much rarer than delayed alcohol-induced headache (hangover headache).

#### Lactose Intolerance

Lactose intolerance is a common genetic disorder, occurring in over two-thirds of African-Americans, native Americans and Ashkenazi Jews and in 10% of individuals of Scandinavian ancestry. The most common symptoms are abdominal cramps and flatulence. How lactose intolerance triggers migraine is uncertain (Silberstein 1998).

#### Chocolate

Chocolate is the food most frequently believed to trigger headache, but the evidence supporting this belief is inconsistent (Scharff and Marcus 1999). Chocolate is probably not a migraine trigger, despite the fact that many migraineurs believe that it triggers their headache. It is the most commonly craved food in the United States. Women are more likely than men to have migraine and they crave chocolate more than men. Sweet craving is a premonitory symptom of migraine and menses are often associated with an increase in carbohydrate and chocolate craving.

#### Chemotherapeutic Drugs

► **Intrathecal** methotrexate and diaziquone can produce aseptic meningitis and headache. Methylchlorophen, interferon B and interleukin 2 are all associated with headache (Boogerd 1995).

#### Immunomodulating Drugs

Cyclosporine, FK-506, thalidomide and antithymocyte globulin have been associated with headache (Shah and Lisak 1995).

#### Antimicrobial and Antimalarial Drugs

Amphotericin, griseofulvin, tetracycline and sulfonamides have been associated with headache. Chloroquine and ethionamide are also associated with headache.

#### Other Substances

##### Carbon monoxide-induced Headache (Warehouse Workers' Headache)

Typically this is a mild headache without associated symptoms with carboxyhemoglobin levels of 10–20%, a moderate pulsating headache and irritability with levels of 20–30% and a severe headache with nausea, vomiting and blurred vision with levels of 30–40%. When carboxyhemoglobin levels are higher than 40%, headache is not usually a complaint because of changes in consciousness.

##### Cocaine-induced Headache

Headache is common, develops immediately or within 1 h after use and is not associated with other symptoms unless there is concomitant stroke or TIA (Dhopesht et al. 1991).

##### Cannabis-induced Headache

Cannabis use is reported to cause headache associated with dryness of the mouth, paresthesias, feelings of warmth and suffusion of the conjunctivae (elMallakh 1987).

#### References

- Ashina M, Bendtsen L, Jensen R et al. (2000) Nitric oxide-induced headache in patients with chronic tension-type headache. *Brain* 123:1830–1837
- Bix KJ, Pearson DJ, Bentley SJ (1984) A psychiatric study of patients with supposed food allergy. *Br J Psychiatry* 145:121–126
- Boogerd W (1995) Neurological complications of chemotherapy. In: DeWolff FA (ed) *Handbook of clinical neurology*. Elsevier, Amsterdam New York, pp 527
- Brewerton TD, Murphy DL, Mueller EA et al. (1988) Induction of migraine like headaches by the serotonin agonist m-chlorophenylpiperazine. *Clin Pharmacol Ther* 43:605–609
- Dhopesht V, Maany I, Herring C (1991) The relationship of cocaine to headache in polysubstance abusers. *Headache* 31:17–19
- elMallakh RS (1987) Marijuana and migraine. *Headache* 27:442–443
- Headache Classification Committee of the International Headache Society (1988) Classification and diagnostic criteria for headache disorders, cranial neuralgia, and facial pain. *Cephalalgia* 8:1–96
- Headache Classification Committee (2003) *The International Classification of Headache Disorders II*. Cephalalgia (in press)
- Krabbe AA Olesen J (1980) Headache provocation by continuous intravenous infusion of histamine, clinical results and receptor mechanisms. *Pain* 8:253–259
- Littlewood JT, Glover V, Davies PT et al. (1988) Red wine as a cause of migraine. *Lancet* 559
- Monteiro JM Dahlof CG (2000) Single use of substances. In: Olesen J, Tfelt-Hansen P, Welch KM (eds) *The Headaches*. Lippincott Williams & Wilkins, Philadelphia, pp 861–869
- Rose FC (1997) Food and headache. *Headache Quarterly* 8:319–329
- Schamburg HH, Byck R, Gerstl R et al. (1969) Monosodium L-glutamate: its pharmacology and role in the Chinese restaurant syndrome. *Science* 163:826–828
- Scharff L, Marcus DA (1999) The association between chocolate and migraine: A review. *Headache Quarterly* 10:199–205
- Schiffmann SS, Buckley CE, Sampson HA et al. (1987) Aspartame and susceptibility to headache. *N Engl J Med* 317:1181–1185



16. Shah AK Lisak R (1995) Neurological complications of immunomodulating therapy. In: DeWolff FA (ed) Handbook of clinical neurology. Elsevier, Amsterdam New York, pp 547
17. Silberstein SD (1998) Drug-induced headache. *Neurol Clin N Amer* 16:107–123
18. Thomson Healthcare (2003) Physicians' Desk Reference. Thomson PDR, Montvale
19. VanDenEeden SK, Koepsell TD, Longstreth WT et al. (1994) Aspartame ingestion and headaches: a randomized crossover trial. *Neurology* 44:1787–1793

## Headache Due to Arteritis

PETER BERLIT

Department of Neurology, Alfried Krupp Hospital, Essen, Germany  
peter.berlit@krupp-krankenhaus.de

### Synonyms

Vasculitis; Angiitis of the CNS

### Definition

Headache is the most common complaint in ► **temporal arteritis**. The major symptoms of central nervous system arteritis are multifocal neurological symptoms following ► **stroke**, in combination with headache and some degree of ► **encephalopathy**, with and without ► **seizures**. CNS-vasculitis may be part of a systemic autoimmune disease or the only manifestation of angiitis (isolated ► **angiitis of the central nervous system** – IAN).

### Characteristics

#### Temporal Arteritis

Temporal arteritis (► **cranial arteritis**, giant cell arteritis) is an autoimmune disease of elderly people, affecting women more frequently than men (3:1). Mean age at the beginning of the disorder is 65 years or more; the disease rarely appears before the age of 50. The incidence is 18/100,000; there is a frequent association with HLA-DR4. The diagnosis is confirmed by the histological examination of a ► **biopsy** specimen from the temporal artery, demonstrating the arteritis with necrosis of the media and a granulomatous inflammatory exudate containing lymphocytes, leukocytes and giant cells. Headache is the most common complaint in temporal arteritis, associated with a markedly elevated sedimentation rate. The patient develops an increasingly intense head pain, usually unilateral, sometimes bilateral. It has a non-pulsating often sharp and stabbing character, sometimes with a temporal pronunciation. But the localization of the headache may be frontal, occipital or even nuchal (Pradalier and Le Quellec 2000). The pain increases during the night hours and persists throughout the day. Due to ischemia of the masseter muscles during mastication, ► **jaw claudication** may appear

**Headache Due to Arteritis, Table 1** Frequency of signs and symptoms with temporal arteritis (adapted from Caselli and Hunder 1996)

Symptom	all (%)	initial symptom (%)
headache	72	33
polymyalgia rheumatica	58	25
malaise, weight loss	56	20
jaw claudication	40	4
fever	35	11
cough	17	8
neuropathies (mono-, or multiplex)	14	0
disorders of swallowing	11	2
amaurosis fugax	10	2
permanent loss of vision	8	3
claudication of limbs (legs)	8	0
stroke	7	0
neuro-otologic disorders	7	0
flimmer-scotoma	5	0
pain of the tongue	4	0
depression	3	0.6
diplopia	2	0
myelopathy	0.6	0

H

(Berlit 1997). The superficial temporal artery may be thickened and tender without pulsation –“cord-sign“.

#### Diagnostic criteria of temporal arteritis

- age 50 years or more
- newly developed headache
- tenderness of the superficial temporal artery
- elevated sedimentation rate, at least 50 mm / h
- giant cell arteritis in a biopsy specimen from the temporal artery

Besides the headache, there may be severe pain, aching and symmetrical stiffness in proximal muscles of the limbs (polymyalgia rheumatica) in as many as 50% of patients. Many patients present the symptoms of a cryptogenic neoplasm, anorexia, loss of weight, anemia, malaise and low-grade fever.

Sudden blindness results from involvement of the posterior ciliary arteries, and blindness of one eye may be followed by the other. Other complications include the affection of intracranial or spinal vessels, necrosis of the scalp or tongue and generalization of the arteritis affecting the coronary arteries, the aorta or the intestines.

The treatment of choice at the earliest suspicion of cranial arteritis is ► **prednisone** 60–80 mg / day. If ischemic complications are present, a steroid pulse-

therapy for 3 days with at least 500 mg prednisone i.v. is recommended. Patients respond quickly and often very impressively to steroids. The start of this therapy should not be delayed for the biopsy. Depending on the clinical symptoms and the sedimentation rate, steroids are gradually reduced. In the majority of patients, steroid treatment is necessary for at least 20 months; therefore a biopsy is mandatory in all cases. During the long-term course, the CRP is more helpful in the prediction of relapses than the sedimentation rate (Berlit 1997). If necessary, ► **azathioprine** or ► **methotrexate** may be used as steroid sparing agents.

### Systemic Lupus Erythematosus (SLE)

► **Systemic lupus erythematosus (SLE)** is the most frequent systemic autoimmune disease, incidence 7 / 100,000 (Ruiz-Irastorza et al. 2001); the prevalence in Europe and the USA is 10 to 60 / 100,000 per year, women : men = 10 : 1. The most common age of manifestation is 15–30 years. Both migraine type headaches (see ► **migraine**) are frequent. SLE is characterized by a disturbed regulation of T- and B-cell immunity with antinuclear antibodies and autoreactivity against other autoantigens in the progressive relapsing course of the disease. The multilocal manifestations are caused by a thrombotic vasopathy or antibodies interacting with cell membrane functions; a true vasculitis is rare. Antinuclear antibodies are present in 95%, ds-DNA-antibodies in 80%. ► **Photosensitivity** of the skin with a ► **butterfly erythema** of the face are typical symptoms of SLE. Arthritis and serositis with pulmonary and cardiac manifestations are frequent. Neurological symptoms are present in about 50% of the patients, encephalopathy (60%), seizures (60%) and stroke (40%). In SLE, strokes are frequently caused by a secondary ► **antiphospholipid syndrome** (25% of all SLE patients). This diagnosis is made with the detection of lupus anticoagulant and IgG-anticardiolipin antibodies. Stroke may also be caused by cardiogenic embolism with Libman-Sacks endocarditis or by thrombotic thrombocytopenic purpura. Some autoantibodies (ab) are associated with certain clinical manifestations, ribosomal P – psychosis, Jo 1 – polymyositis, antineuronal – epilepsy, encephalopathy. A classification of the neuropsychiatric SLE-manifestations including headache has been given by the ACR Ad Hoc Committee on Neuropsychiatric Lupus in 1999. In case-control studies, there was no difference between SLE patients and the general population regarding the prevalence and incidence of migraine or tension type headache (Fernandez-Nebro et al. 1999; Sfikakis et al. 1998). In SLE patients with tension type headache, there was an association with personality changes, emotional conflicts and depression (Omdal 2001). Most of these patients have higher disease activity scores (Amit et al. 1999). There was no association between anticardiolipin antibodies and migraine in a prospective study

(Vazquez-Cruz et al. 1990). If a SLE patient develops a new headache, a neurological examination including ► **MRI** and lumbar puncture is mandatory. The association with a ► **pseudotumor cerebri** should be excluded. Treatment of idiopathic headache syndromes in SLE is the same as in the general population. A headache as the sole neurological symptom of SLE should not alter the immunosuppressive strategy in the individual patient.

### Sjögren's Syndrome

► **Sjögren's syndrome** is clinically characterized by keratoconjunctivitis sicca and symptomatic xerostomia (the sicca-syndrome) and associated with the detection of anti-Ro (SSA–97%) and anti-La (SSB–78%) autoantibodies. In addition to multifocal CNS symptoms with encephalopathy, depression or headache, a polyneuropathy and myopathy occur frequently. Whenever possible the diagnosis should be verified with a salivary gland biopsy. The incidence of migraine is higher in patients with a sicca syndrome or Raynaud phenomenon (Pal et al. 1989). ► **Flunarizin** may be helpful for prophylaxis in rheumatologic patients with migraine (Mazagri and Shuaib 1992).

### Wegener's Granulomatosis (WG)

► **Wegener's granulomatosis (WG)** is a rare autoimmune disease (1 per 100,000) associated with antineutrophil cytoplasmic antibodies (c-ANCA); men are affected twice as often as women. In the limited stage of the disease, necrotizing granulomas of the nose and the paranasal sinuses may lead to compression of neighborhood structures with cranial nerve lesions, diabetes insipidus or exophthalmus. With generalization, the systemic necrotizing vasculitis involving small arteries and veins leads to affections of the lung and kidney.

In the limited stage of WG, headaches are frequent and often caused by sinusitis, non-septic meningitis or local granulomas (Lim et al. 2002). MRI may show enhancement of the basal meninges especially of the tentorium (Specks et al. 2000); the development of an occlusive or communicating hydrocephalus is possible (Scarow et al. 1998) and must be excluded.

Prednisone and ► **cyclophosphamide** are the treatment of choice in generalized WG. In the limited stage of the disease, the combination of 2 × 800 mg sulfamethoxazole and 2 × 160 mg trimethoprim (► **Cotrimoxazol**) may be sufficient. Headaches are treated symptomatically with paracetamol or non-steroidal antiphlogistics.

### Behçet's Disease

► **Behçet's disease** presents with the trias of iridocyclitis and oral and genital ulcers. The underlying systemic vasculitis of especially the veins may lead to an ► **erythema nodosum**, a thrombophlebitis, polyarthritis or ulcerative colitis. Behçet's syndrome is rare in the USA and Germany (incidence 1 / 500,000), but

frequent in Turkey (300 / 100,000); men are affected twice as often as women, usually between the ages of 20 and 40. There is an association with HLA-B5. Neurological manifestations occur in approximately 30%, either as ► **meningoencephalitis** of the brain stem and cerebellum or as a ► **sinus thrombosis**, which presents often as pseudotumor cerebri (Akman-Demir et al. 1999). Headaches are the most common complaint in ► **neuro-Behçet** (87%). The holocephal stabbing severe pain does not usually respond to conventional analgetics, but resolves with steroid treatment. MRI and lumbar puncture are diagnostic. Steroids and immunosuppressants like azathioprine are the treatment of choice. In sinus thrombosis, anticoagulants must be given in addition.

#### Isolated Angiitis of the Central Nervous System – IAN (Granulomatous Arteritis of the Nervous System – GANS)

Isolated angiitis of the central nervous system – IAN (granulomatous arteritis of the nervous system – GANS) is an idiopathic medium and small vessel vasculitis affecting exclusively CNS vessels of the brain or spinal cord. About 350 cases have been documented worldwide (Schmidley 2000). The major symptoms of IAN are multifocal neurological symptoms following stroke, in combination with headache and some degree of encephalopathy, with or without seizures, cranial nerve palsies or ► **myelopathy**.

The encephalopathy occurs in 40–80%, subacute or chronic headaches in 40–60%, focal symptoms in 40–70% and seizures are present in 30%. An acute beginning of IAN has been described in only 11%; most patients develop the symptoms slowly and progressively. Systemic signs of inflammation (fever, ESR, CRP) are rare (10–20%). On the other hand, there are usually signs of inflammation in the CSF (pleocytosis, elevation of protein, oligoclonal banding). The specificities of cerebral ► **angiography** or MRI are below 30%. For definitive diagnosis of IAN, a combined leptomeningeal and parenchymal biopsy is necessary, especially in order to exclude infections or tumors (lymphoma!). Before the treatment of choice with prednisone and cyclophosphamide is established, a systemic inflammation or infection must be excluded and leptomeningeal and parenchymal biopsies must demonstrate the vascular inflammation (Moore 1989). Without histological verification of the diagnosis, blind treatment is dangerous and possibly harmful for the patient and must be strictly avoided. With immunosuppressive therapy the headaches resolve completely within a few weeks.

#### References

1. ACR Ad Hoc Committee on Neuropsychiatric Lupus Nomenclature (1999) The American College of Rheumatology nomenclature and case definitions for neuropsychiatric lupus. *Arthritis Rheum* 42:599–608

2. Akman-Demir G, Serdaroglu P, Tasci B (1999) Clinical patterns of neurological involvement in Behçet's disease: evaluation of 200 patients. The Neuro-Behçet Study Group. *Brain* 122:2171–2182
3. Amit M, Molad Y, Levy O et al. (1999) Headache in systemic lupus erythematosus and its relation to other disease manifestations. *Clin Exp Rheumatol* 17:467–470
4. Berlit P (1997) Giant Cell Arteritis. In: Lechtenberg R, Schutta HS (eds) *Practice Guidelines for Neurologic Therapy*. Marcel Dekker, New York
5. Caselli RJ, Hunder GG (1996) Neurologic complications of giant cell (temporal) arteritis. *Sem Neurol* 14:349–353
6. Fernandez-Nebro A, Palacios-Munoz R, Gordillo J et al. (1999) Chronic or recurrent headache in patients with systemic lupus erythematosus: a case control study. *Lupus* 8: 151–156
7. Lim IG, Spira PJ, McNeil HP (2002) Headache as the initial presentation of Wegener's granulomatosis. *Ann Rheum Dis* 61:571–572
8. Mazagri R, Shuaib A (1992) Flunarizine is effective in prophylaxis of headache associated with scleroderma. *Headache* 32: 298–299
9. Moore PM (1989) Diagnosis and management of isolated angiitis of the central nervous system. *Neurology* 39:167–173
10. Omdal R, Waterloo K, Koldingsnes W et al. (2001) Somatic and psychological features of headache in systemic lupus erythematosus. *J Rheumatol* 28:772–779
11. Pal B, Gibson C, Passmore J et al. (1989) A study of headaches and migraine in Sjogren's syndrome and other rheumatic disorders. *Ann Rheum Dis* 48:312–316
12. Pradalier A, Le Quellec A (2000) Headache due to temporal arteritis. *Pathol Biol* 48:700–706
13. Ruiz-Irastorza G, Khamashta MA, Castellino G et al. (2001) Systemic lupus erythematosus. *Lancet* 357:1027–1032
14. Scarrow AM, Segal R, Medsger TA Jr et al. (1998) Communicating hydrocephalus secondary to diffuse meningeal spread of Wegener's granulomatosis: case report and literature review. *Neurosurgery* 43:1470–1473
15. Schmidley JW (2000) *Central nervous system angiitis*. Butterworth-Heinemann, Boston
16. Sfikakis PP, Mitsikostas DD, Manoussakis MN et al. (1998) Headache in systemic lupus erythematosus: a controlled study. *Br J Rheumatol* 37:300–303
17. Specks U, Moder KG, McDonald TJ (2000) Meningeal involvement in Wegener granulomatosis. *Mayo Clin Proc* 75:856–859
18. Vazquez-Cruz J, Traboulsi H, Rodriguez-De la Serna A et al. (1990) A prospective study of chronic or recurrent headache in systemic lupus erythematosus. *Headache* 30:232–235

H

## Headache Due to Brain Metastases

### Definition

Intracranial metastases are found in about 25% of all patients who have died of cancer. Some of these tumors are silent, but the majority cause the syndrome consisting of headache, nausea and vomiting, mental change, confusion, seizures and neurological deficit. Some tumors frequently produce brain secondaries (e.g. cancers of the lung and breast as well as melanoma), some only seldomly (e.g. cancer of ovary). Primary tumors, although relatively rare, can produce the same syndrome. Headache may arise from an expanding mass within the skull and distension of meninges. The treatment of choice is skull irradiation accompanied

by the use of dexamethasone. The headache may get worse after morphine.

► [Cancer Pain](#)

## Headache Due to Dissection

MATHIAS STURZENEGGER

Department of Neurology, University of Bern, Bern, Switzerland

matthias.sturzenegger@insel.ch

### Synonyms

There are no direct synonyms for headaches resulting from dissections of cervico-cranial arteries. The location of these headaches is variable and mainly dependent on the dissected vessel segment and thus may cause differential diagnostic confusions.

### Differential Diagnostic Aspects

The following three pathophysiologically poorly defined and most probably heterogeneous clinical syndromes with a diagnostic eponym may well be caused by dissection.

Sturzenegger 1995).

Carotidynia is a poorly defined syndrome with unilateral anterolateral cervical pain and tenderness. It is good advice to rule out underlying carotid dissection first, since most reports of this entity date from decades ago and the patients' carotid arteries have not been properly studied (no ultrasound, MRI, MRA or angiographic evaluation) (Biousse and Boussier 1994).

Tolosa-Hunt Syndrome (Painful Ophthalmoplegia); variable combination of periorbital pain, ipsilateral oculomotor nerve palsies, oculosympathetic palsy and trigeminal sensory loss) localize the pathological process to the region of the cavernous sinus. The causes may be traumatic, neoplastic, vascular or inflammatory. Within the inflammatory category, there is a specific subset of patients with a steroid responsive relapsing and remitting course – Tolosa-Hunt syndrome in the strict sense. The comprehensive patient evaluation is essential in establishing the correct diagnosis (Kline and Hoyt 2001).

Furthermore, the severe intensity and frequently orbital pain location of headache due to ICAD may at a first glance mimic cluster headache, but there are usually no recurrent short lasting attacks and no clustered bouts.

### Definition

As already indicated by the title, the headaches are defined by their underlying pathology, i.e. dissection of the arteries. Since we are talking about headache, it is evident that we talk about dissections of cervico-cranial arteries; it is exceptional that dissection of the subclavian artery or aorta produce headache.

### Pathogenesis

We have however to keep in mind that pain is usually a symptom of arterial dissections any where in the body, e.g. also of the aorta, renal or coronary arteries. The question rises why dissections are painful. Other pathologies of arterial walls may also be painful such as arteritis (e.g. giant cell arteritis) whereas atherosclerosis is usually painless.

We know that the walls of extracranial and also basal intracranial arteries are densely supplied with nociceptive, mainly trigeminal nerve fibers (Norregaard and Moskowitz 1985). These fibers are sensitive to inflammatory stimuli such as in vasculitis or to distension of the vessel wall that may take place during balloon dilatation or as a consequence of intramural hemorrhage such as in dissection. In atherosclerosis, although usually considered as an inflammatory process too, the inflammatory activity is probably simply too low to cause nociceptor discharge. It is controversial whether the irritation of the perivascular sympathetic nerve plexus, existing around the carotid as well as the vertebral arteries is another explanation or a contributing etiological factor of dissection-associated pain (De Marinis et al. 1991). In my personal experience, pain may be equally intense in dissections with definite vessel diameter extension as in those dissections without enlargement but merely vessel stenosis or occlusion. Furthermore, also from merely personal experience, pain is not more frequent in patients with Horner's syndrome compared to those without.

Dissection associated pain is usually reported with internal carotid (ICA) or vertebral artery (VA) dissections. We do not have data regarding dissection of extracranial carotid arteries and their branches or subclavian arteries and their branches, nor whether such pathologies exist and how frequently nor whether they may cause any pain. We know, that dissections may take place without causing pain. It seems to be rare, but we usually detect dissections because of their consequences such as pain or cerebral ischemia. That means that asymptomatic dissections may simply go undetected and painless dissections with other complications, such as lower cranial nerve palsy or cerebral ischemia may go unrecognized, since adequate diagnostic methods to detect dissections are not performed. In patients with "painful Horner's syndrome", many physicians have learned to think of ipsilateral internal carotid artery dissection (ICAD), but in what percentage of painless Horner's syndrome is ICAD the cause or is ICAD searched for?

The larger the affected vessel (carotid *versus* vertebral arteries) the more easily dissections are detected, i.e. can be imaged. Yet, without applying fat saturated T1 MRI sequences and, furthermore, that specific method to the appropriate vessel segment (e.g. the high cervical retro-mandibular ICA segment) painful ICAD without causing vessel stenosis may not be detected even when per-



forming Doppler, Duplex MRA and conventional MRI. In the VA, it is well known that for various reasons MRI, as well as Doppler / Duplex examination are much less sensitive to dissections as compared to angiography, an invasive procedure not completely without risks.

To summarize: pain may herald dissections early on, absence of pain does not exclude dissections, the frequency of painless and asymptomatic dissections is not known but they certainly exist.

### Clinical Relevance

The most important aspect of headaches caused by dissections is the fact that they usually herald the onset of dissection and allow early recognition of the underlying pathology. Paying adequate attention to these warning symptoms enables the aversion of the often life-threatening sequelae of cerebral ischemia. 50–80% of patients with a dissection of the cervicocerebral arteries suffer a subsequent stroke; dissections are responsible for 20–30% of all strokes in young (<45 years) persons; warning headaches preceding stroke have been noted in 47–74% of patients with ICAD and in 33–85% of patients with VAD (Fisher 1982; Silbert et al. 1995; Sturzenegger 1994; Sturzenegger 1995).

### Characteristics

Headaches caused by dissections have some typical although eventually unspecific features, which are not necessarily present in all cases. Independent of the affected vessel, these are high pain intensity, pain quality not experienced before, continuous more frequent than fluctuating pain over days, constant localization, sharp quality and tenderness of the painful head, face or neck area. Headache onset may be acute or even “thunderclap”-like suggesting subarachnoid hemorrhage, which indeed may be a complication of dissections of intracranial, especially vertebral artery, segments.

Additional characteristics are dependent on the vessel segment affected by the dissection. In the literature there are usually two broad categories, the traumatic and the spontaneous (non traumatic) dissections. This distinction is somewhat arbitrary since in many ▶ [spontaneous dissections](#) one will find some kind of so-called “trivial” trauma such as neck thrusting, a fall or certain sports or other violent physical activities with questionable significance.

From the literature one gets the impression that traumatic dissections are more frequently painless; yet this may simple be an assessment bias since in traumatic dissections there are additional injuries readily explaining pain or the health state of the patients is too serious to worry about pain or to make pain assessment possible. In the spontaneous dissection subgroup, the literature reports four major categories, extracranial carotid dissections, intracranial carotid dissections and their branches, extracranial vertebral artery dissections and intracranial vertebral artery dissections and their

branches. It may however well be that these categories are human constructions, just for educational reasons, without reflecting the reality of e.g. dissections affecting several segments of one artery or even several arteries. The vessel segments affected by dissections obviously show regional or probably ethnic variations with e.g. dissections of intracranial vertebral artery segments and their branches predominantly reported from Japan.

### Spontaneous Internal Carotid Artery Dissection

The most typical clinical syndrome and the most frequent dissection is that of the extracranial segment of the internal carotid artery. Usually the most distal (high cervical, retromandibular) carotid segment just before entering the petrous canal is affected.

### Spontaneous Dissection of Extracranial Internal Carotid Artery

Headache is reported in 55–95% of ICAD and was the first symptom in 47–68% (Bioussé et al. 1994; Fisher 1982; Schievink 2001; Silbert et al. 1995; Sturzenegger 1995). Headache, facial or orbital pain may be the sole symptom of dissection, probably more frequently than reported so far (5%) and poses a diagnostic challenge. Local neurological manifestations (Horner’s sign (35–48%), lower cranial nerve palsies (~10%) or pulsatile tinnitus (up to 30%)) are found in 30–48% of cases (Sturzenegger 1995; Sturzenegger and Huber 1993). Up to one third may complain of unilateral scalp tenderness and hair hypersensitivity. Ischemic cerebral events occur in 86% (stroke in 60% and TIA in 20%) and retinal events in 20% (Bioussé et al. 1994; Schievink 2001; Sturzenegger 1995). Headache location is unilateral (79–90%), ipsilateral to the side of dissection (almost all), in the forehead (~70%), temple (~75%), eye or peri-orbital (~60%; ~10% isolated) or ear (~20%; ~10% isolated). The headache quality is steady (~75%), pulsating (25–40%), of severe intensity in 85%, thunderclap-like (14%, mimicking SAB), severe periorbital (10%, mimicking cluster headache), unique and never experienced before (65%). Headache duration is less than 1 week in 90% (range, hours to years). Anterolateral neck pain is reported by 26–60%, usually located in the upper neck behind the angle of the jaw.

Since migraine is a frequent disease, and reported in up to 40% of patients with carotid dissection and even considered a risk factor for dissection (D’Anglejean Chatillon et al. 1989), it is important not to confound migraine headaches with dissection headaches. The patient can usually distinguish these two headache types; dissection headache is a pain he never experienced before, is a continuous and not episodic pain, is not associated with general vegetative symptoms (nausea, vomiting, photophobia) and is usually constant not throbbing. Before assum-

ing a so-called “migrainous infarct”, one should exclude underlying carotid dissection as the cause of the pain and (embolic) brain ischemia. Thus, if a patient with a history of migraine, reports any change in the headache pattern (e.g. unique quality, long-lasting) or clinical characteristic, which he has not experienced before, ICAD should be considered and the appropriate investigation (ultrasound, MRI, MRA) performed soon.

The distinction from cluster headache is usually possible taking into account the duration (repetitive short attacks for cluster) and the autonomic symptoms (hyperhidrosis in cluster, anhidrosis in ICAD).

#### Spontaneous Dissection of the Intracranial Internal Carotid Artery

Intracranial carotid artery dissection affecting the supraclinoid portion of the ICA and/or the middle and anterior cerebral arteries is very rare, especially when compared with dissections of the extracranial ICA. Whether it represents a unique entity, different from the more common extracranial variant, is unclear. Diagnosis is more difficult and usually needs angiography or high quality MRA. According to the literature, it preferentially affects very young patients (between 15 and 25 years) without any vascular risk factors. The clinical presentation comprises severe unilateral retroorbital and temporal headache followed by contralateral hemiparesis usually immediately after headache onset (Chaves et al. 2002).

#### Spontaneous Vertebral Artery Dissection

Dissections of the VA most frequently affect the mobile and easily distorted V3 segment. The distal extension is frequently difficult to assess and distinction between extracranial and intracranial dissection more difficult in the vertebrobasilar territory than in the carotid.

Yet it could probably be of relevance, since anticoagulation of intracranial dissections, more frequently producing aneurysms, bears a significant risk of subarachnoid hemorrhage, which may accompany intracranial VAD even without anticoagulant treatment.

Headache is reported in 69–85% and was the first symptom in 33–75% (Silbert et al. 1995; Sturzenegger 1994). Headache location is ipsilateral to the side of dissection (almost always), usually in the occiput (~ 80%). Pain always started suddenly, was of sharp quality and severe intensity, different from any previously experienced headache. Headache was steady in about 60% and pulsating in about 40%. The time course of pain was monophasic with gradual remission of a persistent headache lasting 1 to 3 weeks.

Posterior neck pain is reported by 46–80% and may be the only symptom (no associated headache). A delay between onset of head and neck pain heralding onset of dissection and neurological dysfunction is frequent (33–85%) and may be of variable duration (hours to

3 weeks). Report of this distinct type of headache should raise suspicion of an underlying dissection of a vertebral artery. Its early diagnosis and immediate anticoagulation if confined to the extracranial segments may help prevent vertebro-basilar ischemic deficits, which are frequently severe. Presenting clinical features of VAD are extremely variable and include locked-in syndrome, Wallenberg syndrome, which represents the most frequently encountered type of neurological dysfunction, cerebellar syndrome, vestibular syndrome, transient amnesia, tinnitus and hemianopia. Vertebral artery dissection may also occur silently, even without headache and is detected by chance. This seems to happen predominantly in the case of multiple dissections of cervical arteries.

Vertebral artery dissection may be caused by neck manipulation (Williams and Biller 2003). If neck pain is the sole indication for such a treatment, especially in young people who never experienced such a pain before, one should be aware that VAD may be the cause and manipulation might be fatal.

#### References

1. Biouesse V, D'Anglejan-Chatillon J, Massiou H et al. (1994) Head pain in non-traumatic carotid artery dissection: a series of 65 patients. *Cephalalgia* 14:33–36
2. Biouesse V, Bousser M-G (1994) The myth of carotidynia. *Neurology* 44:993–995
3. Chaves C, Estol C, Esnaola MM et al. (2002) Spontaneous intracranial internal carotid artery dissection. Report of 10 patients. *Arch Neurol* 59:977–981
4. D'Anglejean Chatillon J, Ribeiro V, Mas JL et al. (1989) Migraine – a risk factor for dissection of cervical arteries. *Headache* 29:560–561
5. De Marinis M, Zaccaria A, Faraglia V et al. (1991) Post-endarterectomy headache and the role of the oculosympathetic system. *J Neurol Neurosurg Psychiatry* 54:314–317
6. Fisher CM (1982) The headache and pain of spontaneous carotid dissection. *Headache* 22:60–65
7. Kline LB, Hoyt WF (2001) The Tolosa-Hunt syndrome. *J Neurol Neurosurg Psychiatry* 71:577–582
8. Norregaard TV, Moskowitz MA (1985) Substance P and the sensory innervation of intracranial and extracranial feline cephalic arteries. *Brain* 108:517–533
9. Schievink WI (2001) Spontaneous dissection of the carotid and vertebral arteries. *N Engl J Med* 344:899–906
10. Selky AK, Pascuzzi R (1995) Raeder's paratrigeminal syndrome due to spontaneous dissection of the cervical and petrous internal carotid artery. *Headache* 35:432–434
11. Silbert PL, Mokri B, Schievink WI (1995) Headache and neck pain in spontaneous internal carotid and vertebral artery dissections. *Neurology* 45:1517–1522
12. Sturzenegger M (1994) Headache and neck pain: The warning symptoms of vertebral artery dissection. *Headache* 34:187–193
13. Sturzenegger M (1995) Spontaneous internal carotid artery dissection: Early diagnosis and management in 44 patients. *J Neurology* 242:231–238
14. Sturzenegger M, Huber P (1993) Cranial nerve palsies in spontaneous carotid artery dissection. *J Neurol Neurosurg Psychiatry* 56:1191–1199
15. Williams LS, Biller J (2003) Vertebrobasilar dissection and cervical spine manipulation. A complex pain in the neck. *Neurology* 60:1408–1409

## Headache Due to Hypertension

JOHN EDMEDS

Sunnybrook and Woman's College Health Sciences  
Centre, University of Toronto, Toronto, ON, Canada  
john.edmeads@sw.ca

### Synonyms

Hypertensive Headaches; hypertensive encephalopathy; Reversible Posterior Leucoencephalopathy Syndrome

### Definition

Headaches and hypertension have in common the characteristics that both are prevalent, both are caused by multiple factors and both can have acute and chronic phases. The relationships between them are thus multiple and complex.

1. They most often exist coincidentally, with no causal relation between high blood pressure and headache. It is a common lay misconception that chronic hypertension frequently causes headaches. Epidemiological studies show that the prevalence of headache is no higher in patients with mild or moderate hypertension than it is in age-matched normotensive populations (Badran et al. 1970) and, conversely, hypertension is no more common in headache populations than in those without headaches (Waters 1971). When patients with mild to moderate hypertension (diastolic below 120) have headaches, they are likely to be the same migraine and tension-type headaches that bedevil their normotensive brethren. However, severe hypertension (diastolic above 120) may cause headaches by a number of mechanisms.
2. Chronic severe hypertension may cause characteristic recurrent early morning headaches (see section on "Characteristics" for clinical details). It is believed that in chronic severe hypertension the ability of the cerebral circulation to autoregulate itself – that is, to vasoconstrict in order to prevent an increased cerebral blood volume, increased brain capillary hydrostatic pressure and cerebral edema – is impaired and that this, in combination with the effects of the head low position during sleep and perhaps with the vasodilating effects of CO<sub>2</sub> retention during sleep, causes increased intracranial pressure and headache.
3. As a rare complication of chronic hypertension, acute ▶ [hypertensive encephalopathy](#) may occur (see section on "Characteristics" for clinical details). In this condition there is segmental failure of protective constriction by some of the brain arterioles with the formation of pockets of paralytic vasodilatation. There is transudation of fluid and perhaps extravasation of blood in these regions, with the

production of a pathological picture of multiple foci of cerebral edema with or without hemorrhages and of a clinical picture of increased intracranial pressure with headache, papilledema, obtundation, seizures and / or multifocal deficits. When this vasogenic edema occurs mostly in the distribution of the posterior (vertebrobasilar) circulation, an MRI (magnetic resonance imaging) picture of reversible posterior ▶ [leucoencephalopathy](#) may result (see section on "Characteristics" for clinical details).

4. Abrupt marked rises in blood pressure (acute ▶ [paroxysmal hypertension](#)) may cause severe paroxysmal headaches, with or without other neurological symptoms (see section on "Characteristics" for clinical details). Here again there is failure of autoregulation with its protective vasoconstriction and headache results from sudden vasodilatation of the intracranial vessels, with or without an element of vasogenic cerebral edema and increased intracranial pressure. Such paroxysms of severe hypertension may occur in response to ingestion of exogenous pressor substances such as amphetamines or cocaine or to the taking of tyramine-containing foods or sympathomimetic medications with monoamine oxidase inhibitors. Endogenous pressor amine secretion, as in sexual intercourse or with pheochromocytoma, may produce ▶ [paroxysmal hypertensive headaches](#). Failure of neurogenic regulation of blood pressure, as in paraplegia or in the Landry-Guillain-Barré syndrome, may lead to acute hypertensive headaches, as may the hypertension of pre-eclampsia and eclampsia.
5. On a more banal note, medications prescribed for the control of hypertension may themselves produce headaches, usually through the mechanism of cranial vasodilatation. These include some calcium channel blockers, enalapril, hydralazine, methyldopa and some beta-blockers (Edmeads 2000)

### Characteristics

The morning headache of severe hypertension either awakens the patient early in the morning or is present on spontaneous awakening. It is dull, often vaguely throbbing and is maximal in the posterior part of the head, though on occasion it may be mostly bifrontal. Its characteristic feature is that as the patient gets up and about, the headache begins to abate and within a few hours it is gone – until the next morning. The patient may also complain of feeling "dull" or "muzzy" for the first few hours of the morning and this too clears as the day wears on. The diastolic blood pressure is usually above 120. Often the patient is overweight or is known to snore – factors that predispose to nocturnal CO<sub>2</sub> retention. Otherwise, there are no characteristic findings on examination. The treatment of this headache is that for the high blood pressure.

Acute hypertensive encephalopathy is a rare but dreaded complication of chronic severe hypertension of any etiology. While the diastolic blood pressure (BP) is typically greater (often much greater) than 120, acute hypertensive encephalopathy has been reported with lower blood pressures, such as 150 / 100, particularly in children (whose BP may normally be 90 / 50) and especially in children whose BP has been rapidly elevated by substances which also impair autoregulation, such as cancer chemotherapies or immunosuppressants (Pavlakis et al. 1999).

The patient acutely develops severe generalized headache, sometimes more marked bi-occipitally. Nausea is frequent; vomiting may occur. Visual symptoms are sometimes prominent, perhaps because the parieto-occipital white matter may be particularly edematous (see below) or because of papilledema; this visual impairment may range from non-specific blurring, through transient deficits to blindness. Papilledema, though often present, is no longer considered a prerequisite for the diagnosis. Some degree of confusion or mental obtundation is nearly always present. The foregoing symptoms are consistent with the cerebral edema and increased intracranial pressure that are the basis of this syndrome. Also, there may be focal neurological features such as seizures or hemiparesis.

Stroke (cerebral infarction or hemorrhage) is the major differential diagnosis of acute hypertensive encephalopathy and distinguishing between the two can be difficult. Computerized tomographic (CT) scanning shows multifocal or diffuse cerebral edema, sometimes with scattered small hemorrhages or microinfarcts. Magnetic resonance (MR) imaging may show the appearance of a "reversible posterior leucoencephalopathy" (Hinchey et al. 1996), characterized by increased signal on T<sub>2</sub>-weighted and FLAIR sequences found mostly in the posterior parts of the cerebrum, especially the parieto-occipital white matter. The frontal white matter, cerebellum and brainstem may also be involved; there are rare cases of these changes being confined to the brainstem (Gondim and Cruz-Flores 2001). Diffusion-weighted imaging (DWI) can be normal or may demonstrate increased diffusion characteristic of vasogenic edema. This MRI picture is believed to be due to failure of autoregulation, particularly in the posterior (vertebrobasilar) circulation, which has been shown to have a relative paucity of sympathetic vasomotor innervation. Typically these MRI changes reverse when the hypertension is treated and any offending drugs eliminated.

While reduction of blood pressure is the mainstay of treatment for acute hypertensive encephalopathy, it is crucial to avoid precipitous lowering of BP (Weinberger 2003). With autoregulation severely impaired, overly rapid or excessive reduction of perfusion pressure can produce cerebral ischemia and infarction. If systolic blood pressure is greater than 200 mm Hg on

presentation, it must not be reduced below 160; if it is less than 200 on presentation, it must not be reduced below 140. In severe hypertensive encephalopathy (obtundation, seizures, visual impairment or major focal deficits), this reduction should be effected over a period of about 15 min. The most controllable regimen is a slow intravenous infusion of sodium nitroprusside with constant BP monitoring, preferably through an arterial line. Alternative regimens include repeated intravenous boluses of labetalol, enalapril or diltiazem; all require continuous BP monitoring for safe use. In patients with lesser degrees of acute hypertensive encephalopathy (awake, with no seizures, visual disturbances or major neurological deficits), more slowly acting (30–45 min) medications can be given by mouth, with intermittent cuff pressures rather than continuous intra-arterial line monitoring. These oral medications include calcium channel blockers, ACE inhibitors and angiotensin receptor blockers.

Acute paroxysmal severe hypertension can produce acute paroxysmal severe headache. The causes of such sudden marked rises are noted above (see section on "Definition"). These headaches are diffuse, severe, often pounding and worse with movement and may be associated with nausea and vomiting. They resemble a very severe migraine headache but, unlike migraine, they do not usually present as multiple recurrent episodes – and, of course, they are accompanied by severe hypertension. The International Headache Society (IHS) has provided diagnostic criteria for some of these acute hypertensive headaches (Headache Classification Committee of the International Headache Society 2004). For a diagnosis of headache caused by an acute pressor response to an exogenous substance, the requirements are evidence of an appropriate toxin or medication, that the headache be accompanied by an acute rise in BP and that the headache clear within 24 h of normalization of BP. For a diagnosis of headache caused by a pheochromocytoma, the IHS requires that the headache be accompanied by an abrupt rise in BP and by at least one adrenergic symptom such as sweating, palpitations, pallor or anxiety, that there be demonstration of the pheochromocytoma by biochemical or imaging procedures and / or at surgery and that the headache clears within one hour of normalization of BP. For a headache to be attributed to pre-eclampsia or eclampsia, the IHS requires that the headache occur during pregnancy (or the puerperium) that there be clinical features of pre-eclampsia or eclampsia (hypertension at least 140/90, and proteinuria), that appropriate investigation rules out other causes of hypertensive headaches such as medications etc and that the headache clears within 7 days of normalization of BP.

The treatment of these acute paroxysmal hypertensive headaches is that of the underlying causes – removal of exogenous toxins and medications and treatment of exogenous conditions such as pheochromocytoma and pre-eclampsia / eclampsia. Where the cause cannot



be identified, treatment is difficult, because the hypertension that causes the headaches is paroxysmal and this makes chronic treatment with hypotensive agents problematic.

## References

1. Badran RH, Weir RJ, McGuinness JB (1970) Hypertension and headache. *Scott Med J* 15:48–51
2. Edmeads J (2000) Headache in the elderly. In: Olesen J, Tfelt-Hansen P, Welch KMA (eds) *The Headaches*, 2nd edn. Lippincott Williams & Wilkins, Philadelphia, pp 947–951
3. Gondim F, Cruz-Flores (2001) Two cases of brainstem variant of hypertensive encephalopathy with distinct outcomes. *Neurology* 56:430–431
4. Headache Classification Subcommittee of the International Headache Society (2004) *The International Classification of Headache Disorders*, 2<sup>nd</sup> edn. *Cephalalgia* 24 (Suppl 1):1–160
5. Hinchey J, Chaves C, Appignani B et al. (1996). A reversible posterior leucoencephalopathy syndrome. *N Engl J Med* 334: 494–500
6. Pavlakis SG, Frank Y, Chusid R (1999) Hypertensive encephalopathy, reversible occipitoparietal encephalopathy, or reversible posterior leucoencephalopathy : three names for an old syndrome. *J Child Neurol* 14:277–281
7. Waters WE (1971). Headache and blood pressure in the community. *Br Med J* 1:142–143
8. Weinberger MH (2003). Hypertensive encephalopathy. In: Noseworthy J (ed) *Neurological Therapeutics: Principles and Practice*. Martin Dunitz, London, pp 592–595

## Headache Due to Intracranial Bleeding

SEYMOUR SOLOMON

Montefiore Medical Center, Albert Einstein College of Medicine, New York, Bronx, NY, USA  
ssolomon@montefiore.org

### Synonyms

Intracerebral Hematoma: Apoplexy; Blood Clot in Brain; Hemorrhagic Stroke  
Subdural Hematoma  
Epidural Hematoma: Acute Traumatic Epidural Hematoma

### Definition

#### Intracerebral Hematoma

Bleeding within the brain due to rupture of a blood vessel.

#### Subdural Hematoma

Hemorrhage between the brain and the dura matter, the covering of the brain, usually due to trauma.

#### Epidural Hematoma

Bleeding between the outer layer of the dura, the covering of the brain and the skull, due to trauma that fractures the skull and tears the artery within the bone.

## Characteristics

### Intracerebral Hematoma

Primary intracerebral hemorrhages are the third most common cause of stroke, after cerebral arterial thrombosis and embolism. (Hemorrhage may also be secondary to trauma, tumor or hemorrhagic diseases.) Cerebral infarcts may become hemorrhagic particularly those caused by embolism. In recent years, hemorrhagic transformation of a cerebral infarct may be a complication of early thrombolysis therapy (Fiorelli et al. 1999). A spontaneous brain hemorrhage is usually the result of long standing hypertension and associated degenerative changes in cerebral arteries (Fang et al. 2001). In recent decades, with widespread understanding of the need to control blood pressure, the incidence of intracerebral hemorrhage has decreased. In the vast majority of cases the hemorrhage/stroke occurs while the person is up and about rather than during sleep (Caplan 1993). The neurological symptoms and signs are dependent on the location and size of the hemorrhage. About 50% of hemorrhages are deep in the brain. Seepage or rupture of blood into the ventricular system is common with resultant bloody cerebrospinal fluid. Less common sites of hemorrhage are the cerebral lobes and the cerebellar hemisphere. If the hematoma is in the cerebral lobes, the focal signs will be appropriate to the function of the cerebral site. Typically there is the sudden onset of headache and vomiting. If the cerebral hemorrhage is large and deep, there is depression of consciousness, hemiplegia, coma and death.

If the hemorrhage is in the cerebellum, the initial symptoms of headache may be subacute or sudden. Inability to stand and walk may be the only signs and the diagnosis may be missed if the patient is examined only in bed or stretcher (Ropper and Brown 2005). As the hematoma grows, brain stem compression results in depressed consciousness, paralysis of gaze, other brain stem signs and finally pinpoint pupils, decerebrate posture, coma and death. Computerized tomography will allow almost immediate visualization of the blood. Prompt surgical evacuation of the cerebellar hematoma is often life saving but the value of surgery for cerebral hemorrhages is more problematic. Surgery is almost always futile once the patient has become comatose (Rabinstein et al. 2002).

High plasma levels of proinflammatory biochemicals within 24 h of the hemorrhage are predictive of a poor outcome (Castillo et al. 2002). The prognosis for large and deep hemorrhages is grave (Arboix et al. 2002). About one-third of patients will die during the first few days to 1 month. In those who survive there may be a surprising degree of recovery since, contrary to cerebral infarction, the hemorrhage stretches brain tissue rather than destroys it. Nevertheless only one third of patients regain independent functional status after 3 months (Weimar et al. 2003).

Headache is not invariable in patients with intracerebral hematoma. The frequency ranges from one-third to two thirds of patients (Mitsias and Jensen 2006). The frequency of headache is highest in cerebellar and occipital hemorrhages and when the hematoma is large. The pain is presumably due to the stretching and stimulation of pain sensitive structures by the mass effect of the hematoma and the irritation of blood (if subarachnoid bleeding is associated). The site of the headache often overlies the cerebral hematoma; occipital headache often is associated with cerebellar or occipital hematoma.

### Subdural Hematoma

The course of neurological events may be acute or chronic, more or less corresponding to the degree of trauma. The location of the hematoma is usually over one or both cerebral hemispheres but rarely it may form in the posterior fossa.

In people who develop an acute subdural hematoma, the symptoms may be similar to those of acute epidural hematoma and the two conditions often occur together. Headache or loss of consciousness may be immediate, due to cerebral concussion following the blow to the head. Recovery from concussion is often associated with a lucid interval, but soon the effects of the mass of blood compressing the brain become evident with increasing headache and decreasing consciousness. Computerized tomography is used to visualize the hemorrhage. Prompt surgical evacuation of the hematoma is essential (Koc et al. 1997).

Chronic subdural hematoma is less clearly associated with head trauma (Iantosca and Simon 2000). The slowly developing blood clot is over one or sometimes both cerebral hemispheres. The trauma may be trivial or may have been forgotten. This is particularly true in the elderly when the brain shrinks and the veins bridging the skull and brain traverse a longer distance. For this reason the veins are more easily sheared by slight trauma. The symptoms develop slowly over weeks or months. Headache is most common along with depression of mentation, drowsiness, inattentiveness and confusion; focal signs are usually minor or absent. The initial symptoms are often subtle and may be mistaken for depression, Alzheimer's disease, drug intoxication or brain tumor. Symptoms often fluctuate in severity, sometimes suggesting transient ischemic events. The hematoma eventually becomes encysted by a fibrous membrane (LaBadie and Glover 1976). As blood contents dissipate, computerized tomography may no longer reveal the striking density of blood, rather the diagnosis is made by the space occupying effect of the mass. Contrast material used during the study will show the surrounding fibrous membrane. The hematoma may spontaneously reabsorb. But if it continues to grow surgical drainage is necessary. Subdural hematoma causes headache in about two thirds of patients and is related more to the location in the head

and irritation of the meninges than to the volume of the hematomas (Melo et al. 1996). Because the hematoma is due to venous bleeding the symptoms as well as the course may range from acute to chronic. The time between injury and headache may range from hours to months. The headache is almost always ipsilateral to the hematoma but the qualities of the headache are not specific.

### Epidural Hematoma

Because of arterial bleeding the course of epidural hemorrhage is acute (Castillo et al. 2002). Typically the blow to the head causes loss of consciousness due to cerebral concussion. Recovery of consciousness after a few minutes is followed by a lucid interval of minutes or hours. The epidural hematoma, rapidly expanding against the brain, causes headache, vomiting, drowsiness, coma, and (if not treated) death. Compression of the brain may cause hemiparesis and eventual compression of the brain stem causes generalized spasticity of the limbs and a dilated pupil on the side of the hematoma. Fracture of the skull is seen on standard roentgenograms and computerized tomograms reveal a lens-shaped clot. Usually the middle meningeal artery is sheared within the fractured temporal bone. Surgical drainage of the hematoma is the only life saving treatment.

If loss of consciousness is not immediate, head pain will be associated with trauma. Headache first on the side of the trauma, progresses in intensity as the clinical course progresses. The qualities of the headache are not specific.

### References

1. Ropper AH, Brown RH (2005) Cerebrovascular diseases. In: Adams and Victor's Principles of Neurology, 8<sup>th</sup> edn. McGraw-Hill, New York, pp 821–924
2. Arboix A, Comes E, Garcia-Eroles I et al. (2002) Site of bleeding and early outcome in primary intracerebral hemorrhage. *Acta Neurol Scand* 105:282–288
3. Caplan LR (1993) *Stroke: A Clinical Approach*, 2nd edn. Butterworth-Heinemann, Boston, pp 425–467
4. Castillo J, Davalos A, Alvarez-Sabin J et al. (2002) Molecular signatures of brain injury after intracerebral hemorrhage. *Neurology* 58:624–629
5. Fang XH, Longstreth WT Jr, Li SC et al. (2001) Longitudinal study of blood pressure and stroke in over 37,000 people in China. *Cerebrovasc Dis* 11:225–229
6. Fiorelli M, Bastianello S, von Kummer R et al. (1999) Hemorrhagic transformation within 36 hours of a cerebral infarct: relationships with early clinical deterioration and 3-month outcome in the European Cooperative Acute Stroke Study I (ECASSI) cohort. *Stroke* 11:2280–2284
7. Iantosca MR, Simon RII (2000) Chronic subdural hematoma in adult and elderly patients. *Neurosurg Clin N Am* 11:447–454
8. Mitsias P, Jensen TJ (2006) Headache associated with ischemic stroke and intracranial hematoma In: Olesen J, Goadsby PJ, Ramadam NM, Tfelt-Hansen P, Welch KMA (eds) *The Headaches* 3<sup>rd</sup> edn., Lippincott William and Wilkins, Philadelphia, pp 885–892
9. Koc RK, Akdemir II, Oktem IS et al. (1997) Acute subdural hematoma: outcome and outcome prediction. *Neurosurg Rev* 20:239–244

10. LaBadie EI, Glover D (1976) Physiopathogenesis of subdural hematomas. *J Neurosurg* 45:382–393
11. Melo TP, Pinto AN, Ferro JM (1996) Headache in intracerebral hematomas. *Neurology* 47:494–500
12. Rabinstein AA, Atkinson JL, Wijdicks EFM (2002) Emergency craniotomy in patients worsening due to expanded cerebral hematoma. To what purpose? *Neurology* 58:1367–1372
13. Weimar C, Weber C, Wagner M et al. (2003) Management patterns and health care use after intracerebral hemorrhage. A cost of illness study from a societal perspective in Germany. *Cerebrovasc Dis* 15:29–36

## Headache Due to Low Cerebrospinal Fluid Pressure

ANDREAS R. GANTENBEIN, PETER S. SÁNDOR  
Headache & Pain Unit, University Hospital Zurich,  
Zurich, Switzerland  
peter.sandor@usz.ch

### Synonyms

Spontaneous Intracranial Hypotension; Symptomatic Intracranial Hypotension; Post-Lumbar Puncture Headache; Low Intracranial Pressure Headache; Spontaneous Aliquorhea; Ventricular Collapse; Hypotension of Spinal Fluid

### Definition

There are 3 types of headache attributed to low ► **cerebrospinal fluid** (CSF) pressure in the new classification of the International Headache Society (IHS, Headache Classification Committee of the International Headache Society 2004): Post-dural puncture headache (7.2.1), CSF fistula headache (7.2.2), and headache related to spontaneous low CSF pressure (7.3.3). They have in common an ► **orthostatic component**, as the headache usually begins within 15 min of standing or sitting up. The headache mainly improves in the recumbent position; however, this is a diagnostic criterion only for post- ► **lumbar puncture** in the IHS classification. The headache is associated with at least one of the following symptoms: neck stiffness, tinnitus, hypacusis, photophobia, or nausea. The aetiology is different for the 3 types. See Table 1 for compared classification criteria (Headache Classification Committee of the International Headache Society 2004).

### Characteristics

In 1938, Schaltenbrand, a German neurologist, wrote about two conditions regarding cerebrospinal fluid:

- a) ‘Liquorrhea’ involving headache and ► **papilloedema**, which later became known as pseudotumor cerebri, and
- b) ‘Spontaneous aliquorhea’, presenting with orthostatic headaches and features of intracranial hypotension. He explained the syndrome of low CSF

pressure by three possible pathological mechanisms: decreased production, increased absorption or leakage, e.g. after a lumbar puncture (Schaltenbrand 1938).

The brain is ‘swimming’ in the CSF. The average weight of 1500 g is reduced to 50 g by the intracranial pressure. The remaining weight is held by the meningeal blood vessels, the outgoing cranial nerves, and microstructures. If the CSF pressure decreases, there is traction on the supporting structures of the brain. Recent MRI studies have even shown the “descending” brain (Pannullo et al. 1993). It is thought that traction on the cranial nerves (V, IX, X), on the three upper cervical nerves, and on bridging veins which are pain-sensitive structures, causes the headache and its associated features. However, there are contradictory reports to this so called ‘sagging theory’ (Levine and Rapalino 2001). As long as magnetic imaging cannot be performed in the erect position, it will probably be difficult to bring an end to that discussion.

Magnetic imaging of the head and spine has revolutionized the knowledge and the detection of this disorder (Fishman and Dillon 1993; Mokri 2001; Sable and Ramadan 1991). It was not until the 1990s that investigators demonstrated that the production of about 500 ml per day is relatively constant, and therefore is rarely a cause for the problems. The CSF volume is estimated to be between 150–210 ml, this means the total volume is renewed 2–3 times per day. CSF volume is smaller in women, younger, and obese persons. Most of the CSF is absorbed via the arachnoid villi into the venous sinuses and cerebral veins, and only a very small part is absorbed through simple diffusion. On this background, the most obvious and common reason for low intracranial pressure is CSF leakage. The spontaneous leaks are mostly located on the thoracic or cervical level (Sencakova et al. 2001).

Post-lumbar puncture headache happens in up to one-third of patients with lumbar puncture (Adams et al. 2002). Patients with preceding headaches, and young women with low BMI, may be at higher risk of developing headaches. Patients with postural headaches should be imaged before lumbar puncture, and if there are MRI signs of ► **pachymeningeal enhancement**, a lumbar puncture should not be performed.

### Symptoms

Low CSF pressure usually causes orthostatic headaches, which develop in the upright position and improve when lying down (recumbency). The onset of the headache is usually sudden or gradual. The character of the pain is often described as severe and throbbing or dull, and it can be diffuse or focal, with a frontal or occipital localisation. The headache typically has orthostatic features in the beginning (e.g. onset within 30 min after standing up), however, these features may blur with

**Headache Due to Low Cerebrospinal Fluid Pressure, Table 1** Compared diagnostic criteria of the International Headache Classification 2<sup>nd</sup> Edition regarding headache attributed to low CSF pressure

Post-dural puncture headache	CSF fistula headache	Spontaneous low CSF
Headache within 15 min of sitting or standing		
Resolving within 15 min after lying		
<b>Associated symptoms (1 of the following):</b>		
Neck stiffness Tinnitus Hypacusis Photophobia Nausea		
<b>Etiology</b>		
Dural puncture	CSF leakage: MRI evidence (pachymengial enhancement) Conventional or CT myelography, cisternography OP <60 mm CSF in sitting position	
<b>Onset</b>		
Within 5 days after lumbar puncture	Close relation to CSF leakage	No lumbar puncture or leakage
<b>Resolving</b>		
Spontaneously within 1 week or Within 48 h after treatment	Within 1 week of sealing leak	Within 72 h after blood patch

chronicity and result in a chronic daily headache which is worse when the patient is in an upright position and improves when lying down. Other exaggerating factors include movements of the head, sneezing, coughing, straining, and jugular venous compression. In general pain killers do not sufficiently improve the headache. Recumbency is often the only measure which can relieve the pain; usually within 10–15 min. Associated features can be manifold: anorexia, nausea, vomiting, vertigo, dizziness, neck stiffness, blurred vision, and even photophobia are commonly described. Tinnitus, bilateral hyp(er)acusis, unsteadiness, staggering gait, diplopia, transient visual obscuration, hiccups, and dysgeusia have been reported.

### Examination

The neurological examination is typically normal. However, mild neck stiffness is frequently noted.

The CSF opening pressure is typically below 70 mm, however, it can be low normally. Fluid is typically clear and colourless, occasionally ► **xanthochromic**. The CSF protein level is usually normal, but may be high, mostly still below 100 mg/dl. Cell counts give variable results: erythrocytes and leukocytes may be normal or elevated. Cytologic and microbiologic tests are always negative, and glucose rate CSF/plasma is always between 0 and 1.

The standard diagnostic investigation for low CSF pressure and CSF leaks is MR imaging with Gadolinium. The most common abnormality is diffuse pachymeningeal enhancement (Mokri 2004). According to the Monro-Kellie doctrine (brain volume + CSF + intracranial

blood = constant) the CSF loss is compensated by venous hyperaemia. Whereas the leptomeninges have blood brain barriers, the pachymeninges (dura mater) do not and therefore accumulate the contrast medium. The enhancement is typically linear, thick and uninterrupted, and diffuse, including supra- and infratentorial meninges. Furthermore, there is commonly sinking or sagging of the brain, which can sometimes mimic Chiari I malformation, subdural fluid collections (they may be unilateral), and decrease in size of ventricles. Less common abnormalities include pituitary enlargement, engorged venous sinuses, and elongation of the brain stem. MRI of the spine can show spinal pachymeningeal enhancement, engorgement of venous plexus, and extraarachnoidal fluid, but only rarely reveal the site of the leak. The most accurate technique to find the exact site of CSF leaks is CT myelography. It is to be mentioned that different leaks and diverticles of different sizes can be found in the same patient. An exact identification of the site of the leak, however, is only necessary when surgical intervention is needed.

A CT scan of the head is usually unremarkable and therefore not very useful. Older diagnostic techniques include radioisotope cisternography with Indium-111, myelography without CT, and meningeal biopsy.

### Differential-Diagnosis

Most patients present with a new onset daily headache following a lumbar puncture or another dural trauma, or, if developing spontaneously present as new daily persistent headache, which would act as a working diagnosis, unless low CSF pressure headache is diagnostically clas-



sified using imaging techniques (► MRI, CT myelography).

The orthostatic component is a salient feature. It is therefore hard to understand that in a recent study (Schievink 2003) spontaneous intracranial hypotension (SIH) was misdiagnosed in 94% of the reviewed cases, with a mean diagnostic delay of 13 months (median 5 weeks, range 4 days to 13 years). Sometimes associated features, such as nausea or photophobia, can mimic migraine. Especially when there is a personal or family history of headaches, the picture can be diluted. Furthermore, the orthostatic feature becomes less prominent with time. Obviously, the diagnosis of low CSF pressure headache is easier when the patient is seen at the beginning of the problem, and when there is a close temporal relationship to a lumbar puncture or another trauma affecting the spine. The differential diagnosis to the other orthostatic headache due to raised intracranial pressure should be fairly easy. Interestingly, almost all patients with low CSF pressure develop headaches, but only 30–80% of the patients with increased intracranial pressure do so (Mokri 2001).

Whereas both, low and high pressure headaches can be aggravated by coughing or straining, intracranial hypertension typically develops when lying down, especially in the morning, and is mostly present with transient visual loss or papilloedema in the neurological examination.

#### Management & Treatment

Fortunately, many low pressure headaches dissolve spontaneously within days. Treatments vary for the three different types of low CSF pressure headache. Conservative strategies include bed rest, fluid intake and an abdominal binder. Caffeine (250–500 mg i.v.), theophylline and to a lesser part steroids can be effective. When conservative treatments give no sufficient pain relieve within 24 h, an epidural ► **blood patch** (10–15 ml of autologous blood into the epidural space) would be indicated. Blood patches seem to have not only an immediate effect, through simple volume replacement, but also a delayed sealing of the leak. Post-lumbar puncture headaches are often relieved after the first (rarely the second) blood patch, while patients with spontaneous CSF leaks may need up to 4 or more. Instead of a second or third blood patch an epidural saline infusion could be attempted, using a catheter placed at the L2-3 level and a flow rate of 20ml/h for 72 h. If a leak is clearly located with imaging techniques and the headache is treatment refractory a surgical closure may be considered.

#### References

1. Adams MG, Romanowski CA, Wrench IJ (2002) Spontaneous Intracranial Hypotension – Lessons to be Learned for the Investigation of Post Dural Puncture Headache. *Int J Obstet Anesth* 11:65–67

2. Fishman RA, Dillon WP (1993) Dural Enhancement and Cerebral Displacement Secondary to Intracranial Hypotension. *Neurology* 43:609–611
3. Headache Classification Committee of the International Headache Society (2004) The International Classification of Headache Disorders, 2<sup>nd</sup> edn. *Cephalalgia* 24:9–160
4. Levine DN, Rapalino O (2001) The Pathophysiology of Lumbar Puncture Headache. *J Neurol Sci* 192:1–8
5. Mokri B (2001) Low Cerebrospinal Fluid Pressure Headache. In: Silberstein SD, Lipton RB, Dalessio DJ (eds) *Wolff's Headache and Other Pain*, 7<sup>th</sup> edn. Oxford University Press, New York, pp 417–433
6. Mokri B (2004) Spontaneous Low Cerebrospinal Pressure/Volume Headaches. *Curr Neurol Neurosci Rep* 4:117–124
7. Pannullo SC, Reich JB, Krol G et al. (1993) MRI Changes in Intracranial Hypotension. *Neurology* 43:919–926
8. Sable SG, Ramadan NM (1991) Meningeal Enhancement and Low CSF Pressure Headache. An MRI study. *Cephalalgia* 11:275–276
9. Schaltenbrand G (1938) Neuere Anschauungen zur Pathophysiologie der Liquorzirkulation. *Zentralbl Neurochir* 3:290–300
10. Schievink WI (2003) Misdiagnosis of Spontaneous Intracranial Hypotension. *Arch Neurol* 60:1713–1718
11. Sencakova D, Mokri B, McClelland RL (2001) The Efficacy of Epidural Blood Patch in Spontaneous CSF Leaks. *Neurology* 57:1921–1923

H

## Headache Due to Sinus-Venous Thrombosis

VOLKER LIMMROTH, HANS-CHRISTOPH DIENER  
Department of Neurology, University of Essen, Essen,  
Germany  
volker.limmroth@uni-essen.de,  
h.diener@uni-essen.de

#### Definition

Cerebral venous sinus thrombosis (CVST) is a rare but challenging condition and is therefore often unrecognised. Its clinical presentation may vary significantly from case to case. Headache, however, is often the very first and leading symptom. The headache is mostly described as dull holocephalic pain, of increasing intensity and can easily be mistaken for tension type headache, migraine headache or other disorders such as pseudotumor cerebri. Along with headache, additional symptoms typical to increasing intracranial pressure such as papilloedema, nausea, vomiting and cognitive decline may be present. Further symptoms are focal deficit and seizures. The headache does not typically respond to classical anti-headache drugs, which should be taken as an important sign that further evaluation is necessary. Classical patients with CVST are young females with risk factors such as oral contraceptive pill, nicotine abuse, being overweight or during pregnancy, but all age groups can be affected and CVST can evolve secondary to an adjacent infectious process; dehydration, hypercoagulable state, inflammatory disorders, malignancies or head traumas. The diagnosis can be easily confirmed by MRI with venography or modern spiral-CAT-scan.

The treatment of choice is intravenous heparin followed by oral anticoagulation for 3–6 months. The prognosis is good if treatment is initiated early but can be fatal when the condition is overlooked. Despite its low incidence, CSVT is, therefore, one of the most important differential diagnosis clinicians must bear in mind when evaluating patients with headache.

### Characteristics

#### Pathophysiology

Venous blood drains through small cerebral veins into larger veins that empty into dural sinuses and eventually into the internal jugular veins. Pre-existing anastomoses between cortical veins allow the development of collateral circulation in the event of an occlusion. The main cerebral venous sinuses affected by CVST are the superior sagittal sinus (72%) and the lateral sinuses (70%). In about one-third of cases more than one sinus is affected, in a further 30–40% both sinuses and cerebral or cerebellar veins are involved (Ameri and Bousser 1992; Bousser and Barnett 1992; Villringer et al. 1994). In contrast to arterial thrombus, a venous thrombus evolves slowly, due good collateralisation of the venous vessels, which probably explains the usually gradual onset of symptoms, frequently over weeks and months. Sudden onset, however, may occur and may then cause predominating focal deficits rather than headache. Haemorrhagic infarction occurs in approximately 10–50% of cases, principally affecting the cortex and adjacent white matter (Bousser et al. 1985; de Bruijn et al. 1996; Buonanno et al. 1982; Provenzale et al. 1998). This is thought to be primarily due to elevated venous and capillary pressure caused by the persistence of thrombosis.

#### Predisposing Factors

An overview of predisposing factors is given below. In most of the cases one or more of these factors can be identified. In general, a distinction can be made between infective and non-infective causes or, as suggested by Bousser and Barnett, between local and systemic causes (Bousser and Barnett 1992). Within recent decades, infective causes have declined and are now responsible for less than 10% of cases and are mostly caused by staphylococcal infection of the face. Amongst the non-infective causes, systemic conditions such as connective tissue diseases, other granulomatous or inflammatory disorders and malignancies are the most common. Other risk factors in otherwise healthy subjects are overweight, hormonal therapy, smoking and underlying – mostly unknown – clotting disorders. In many cases several of these factors can be found.

#### Local causes

- penetrating head injury
- intracranial infection
- regional infection
- stroke and haemorrhage

- space occupying lesions
- neurosurgery

#### Systemic causes

- severe dehydration
- hormonal and endocrine causes
- cardiac disease
- red blood cell disorders
- thrombocythaemia
- coagulation disorders (acquired or hereditary)
- infusions *via* central venous catheter
- surgery with immobilisation
- malignancies
- inflammatory bowel disease
- connective tissue diseases
- Behcet's disease
- sarcoidosis
- nephrotic syndrome
- drugs (L-asparaginase, epsilonaminocaproic acid, ecstasy)
- sepsis and systemic infection

#### Clinical Presentation

Depending on the sinus involved and the extent of the venous thrombus, CVST presents with a wide spectrum of symptoms and signs. Headache is the leading symptom and present in 70–90% of cases. Other important symptoms are focal deficits such as hemiparesis and hemisensory disturbance, seizures, impairment of level of consciousness and papilloedema (Ameri and Bousser 1992; Bousser et al. 1985). The onset may also vary a great deal from acute, subacute or insidious, but most patients develop symptoms over days or weeks.

In a series of 110 cases, Ameri and Bousser (1992) found several typical clinical constellations; up to 75% of cases are characterised by a focal neurological deficit and headache, 30%–50% may present with seizures often followed by a Todd's paresis and 18–38% of cases present with a syndrome resembling benign intracranial hypertension with headache, papilloedema and visual disturbances. As indicated above, symptoms also depend on the location of the thrombus. The (isolated) thrombosis of the superior sagittal sinus (which occurs in less than 5% of the cases) presents with bilateral or alternating deficits, particularly in the lower limbs and/or seizures, the (isolated) thrombosis of the cavernous sinus (3% of the cases) with chemosis, proptosis and painful ophthalmoplegia. Patients with lateral sinus thrombosis may present with a pseudotumor cerebri-like syndrome. Recently, Farb et al. (2003), using a technique called auto-triggered elliptic-centric-ordered 3-dimensional gadolinium-enhanced MR venography, found that 27 of 29 patients with idiopathic intracranial hypertension suffered from a bilateral sinovenous stenosis which was only seen in 4 of 59 control subjects. Severe cases with the involvement of the superior

sagittal sinus, the cavernous sinus and the lateral sinus, however, may present with a rapidly progressive condition including headache, nausea, pyramidal signs and deepening coma.

CVST appears to be slightly more frequent in women with a suggested female-to-male ratio of 1.29:1. Interestingly, while 61% of women with CVST were aged 20–35 years, a uniform age distribution has been suggested for men with CVST. The most likely explanation for this specific age distribution in women is the use of oral contraceptives and fact that CVST is frequently observed during pregnancies.

### Diagnosis

Patients with a suspected CVST must undergo specific cranial imaging immediately. Magnetic resonance imaging (MRI) combined with magnetic resonance venography (MRV) have largely replaced invasive cerebral angiography and conventional computed tomography (CT). Modern subsecond spiral CT and multi-detector-row-CT-scanners (MDCT), however, are now able to obtain whole-brain CT venograms in less than a minute. Unlike the conventional CT scanner, MDCT scanners have sufficient speed for high resolution images of the entire brain and all dural sinuses during the peak venous enhancement (Casey et al. 1996; Wetzel et al. 1999). The technique can therefore – if available – be used as a first line diagnostic tool since the procedure is cheaper and faster than MRI/MRV. Moreover, using a CT scanner of the latest generation, a recent study has been shown that CT venography may be superior to MRV in visualising sinuses or smaller cerebral veins or cortical veins with low flow. However, it goes without saying that MRI/MRV are the imaging techniques of choice for pregnant women. Some doubtful cases may still require cerebral angiography. One of the common problems is the absence or hypoplasia of the anterior portion of the superior sagittal sinus, a normal variant that can simulate thrombosis on MRV (Provenzale et al. 1998; Wang 1996). Also, contrast enhancement along the edge of the thrombus can be mistaken for normal contrast material accumulating within a patient's sinus. Aside from confirming the diagnosis by cranial imaging, it is mandatory to search for the underlying causes including the search for local infection, head injury, malignancies, connective tissue diseases with inflammatory markers, autoantibodies and markers of coagulation disorders such as Factor V Leiden mutation if resistance to activated protein C is abnormal, activities of proteins C and S, antithrombin III, plasminogen, fibrinogen and anticardiolipin antibodies (de Bruijn et al. 1998; Deschiens et al. 1996; Kellett et al. 1998) All these investigations should probably be performed twice, i.e. before starting anticoagulation, and 6 months later after finishing since the acute status of the disease may influence the expression of these parameters.

### Treatment

Only a few therapeutic trials have evaluated potential therapeutic agents in CVST. Antithrombotic treatment modalities include heparin, thrombolysis and oral anticoagulants. Einhäupl et al. (1991) in a randomised and placebo-controlled trial, demonstrated the benefits of heparin in a series of 20 patients. There was a significant difference in favour of intravenous heparin with respect to neurological recovery and mortality compared to placebo. Interestingly, in an additional retrospective analysis on 102 patients with CVST the same authors suggested heparin to be beneficial, even in those patients who had an intracranial haemorrhage prior to treatment initiation. A few years later, de Bruijn et al. (1999) compared low-molecular-weight heparin followed by warfarin, or placebo. A significant difference between the groups could not be detected in this study (de Bruijn and Stam 1999).

Several groups (Frey et al. 1999; Horowitz et al. 1995; Kim and Suh 1997; Smith et al. 1994) addressed the question of whether additional benefit could be achieved by thrombolysis via selective catheterisation of the occluded sinus. Although all studies included a small number of patients ( $n =$  between 7 and 12 patients per study), all studies suggested that the majority of patients undergoing catheterisation and thrombolysis with urokinase recovered well, and only a few patients suffered from an additional cerebral haemorrhage. Since there is no direct comparative trial between heparin and thrombolysis, the question if this approach provides an additional benefit and an acceptable benefit-to-risk ratio when compared to i.v. heparin is not answered. The disadvantage of catheterisation in patients with CVST is the significant logistic effort and expertise necessary to have this intervention always available.

There is a general agreement that oral anticoagulants should follow as treatment of the acute phase for 3–6 months. In patients with known prothrombotic conditions anticoagulation may be a life-long requirement. No agreement has been reached regarding the question whether patients who present with seizures should undergo anti-epileptic treatment after the acute phase. This decision remains to be made from case to case and under the consideration of the individual circumstances. Taken together, intravenous heparin is the first-line treatment in a dosage sufficient to increase the aPTT to 2–3 times of the control value. Several authors suggest a start with a heparin bolus of 5000 U and to continue according to the aPTT elevation, which mostly requires dosages between 1000 and 1600 U/h for adults. Heparin is the first-line treatment, even in the presence of haemorrhagic infarction (Boussier 1999). In case of clinical deterioration despite adequate heparinisation, selective local thrombolysis should be considered, in spite of the increased haemorrhagic risk.

### Prognosis

Mortality in untreated cases of venous thrombosis has been reported to range from 13.8–48% (Preter et al. 1996). A recent Portuguese study suggested a morbidity of around 8% despite adequate treatment in a group of 91 prospectively analyzed consecutively admitted patients with a mean 1 year follow-up interval (Ferro et al. 2004). Interestingly, 82% of the patients recovered completely, but 59% developed thrombotic events during the follow-up, 10% had seizures and 11% complained of severe headaches. Recently Buccino et al. (2003) found a good overall outcome in a series of 34 patients with CSVT. Still, 10 patients (30%) suffered from episodic headaches, 3 patients (8.8%) from seizures, 4 patients (11.7%) from pyramidal signs and 2 (5.9%) from visual deficits and 6 patients (17.6%) from working memory deficit and depression. All these studies clearly emphasize that CSVT is a treatable condition in the majority of cases and that early diagnosis and immediate initiation of heparin treatment are the key components for a good overall outcome.

### References

- Ameri A, Bousser MG (1992) Cerebral venous thrombosis. *Neurol Clin* 10:87–111
- Bousser MG (1999) Cerebral venous thrombosis: nothing, heparin, or local thrombolysis? *Stroke* 30:481–483
- Bousser MG, Barnett HJM (1992) Cerebral venous thrombosis. *Stroke: pathophysiology, diagnosis and management*, 2nd edn. Churchill-Livingstone, New York, pp 517–537
- Bousser MG, Chiras J, Bories J et al. (1985) Cerebral venous thrombosis –a review of 38 cases. *Stroke* 16:199–213
- Buonanno FS, Moody DM, Ball TLM (1982) CT scan findings in cerebral sinus venous occlusion. *Neurology* 12:288–292
- Buccino G, Scoditti U, Patteri I et al. (2003) Neurological and cognitive long-term outcome in patients with cerebral venous sinus thrombosis. *Acta Neurol Scand* 107:330–335
- Casey SO, Alberico RA, Patel M et al. (1996) Cerebral CT venography. *Radiology* 198:163–170
- de Bruijn SF, Stam J for the CVST Study Group (1999) Randomised, placebo-controlled trial of anticoagulant treatment with low-molecular-weight heparin for cerebral sinus thrombosis. *Stroke* 30:484–488
- de Bruijn SF, Stam J, Kapelle LJ (1996) Thunderclap headache as first symptom of cerebral venous sinus thrombosis. CVST Study Group. *Lancet* 348:1623–1625
- de Bruijn SF, Stam J, Koopman MM et al. (1998) Case-control study of risk of cerebral sinus thrombosis in oral contraceptive users who are cautious of hereditary prothrombotic conditions. *BMJ* 316:589–592
- Deschiens MA, Conard J, Horellou MH et al. (1996) Coagulation studies, Factor V Leiden and anticardiolipin antibodies in 40 cases of cerebral venous thrombosis. *Stroke* 27:1724–1730
- Einhäupl KM, Villringer A, Meister W et al. (1991) Heparin treatment in sinus venous thrombosis. *Lancet* 338:597–600
- Farb RI, Scott JN, Willinsky RA et al (2003) Intracranial venous system: gadolinium-enhanced three-dimensional MR venography with auto-triggered elliptic centric-ordered sequence –initial experience. *Radiology* 226:203–209
- Ferro JM, Canhao P, Stam J et al.; ISCVT Investigators (2004) Prognosis of cerebral vein and dural sinus thrombosis: results of the International Study on Cerebral Vein and Dural Sinus Thrombosis (ISCVT). *Stroke* 35:664–670
- Frey JL, Muro GJ, McDougall CG et al. (1999) Cerebral venous thrombosis: combined intrathrombus rtPA and intravenous heparin. *Stroke* 30:489–494
- Horowitz M, Purdy P, Unwin H et al. (1995) Treatment of dural sinus thrombosis using selective catheterisation and urokinase. *Ann Neurol* 38:58–67
- Kellett MW, Martin PJ, Enevoldson TP et al. (1998) Cerebral venous sinus thrombosis connected with 20210, a mutation of the prothambin gene. *J Neurol Neurosurg Psychiatry* 65:611–612
- Kim SY, Suh JH (1997) Direct endovascular thrombolytic therapy for dural sinus thrombosis: infusion of alteplase. *Am J Neuro-radiol* 18:639–664
- Preter M, Tzourio C, Ameri A et al. (1996) Long-term prognosis in cerebral venous thrombosis: follow-up of 77 patients. *Stroke* 27:243–246
- Provenzale JM, Joseph GJ, Barboriak DP (1998) Dural sinus thrombosis: findings on CT and MRI imaging and diagnostic pitfalls. *AJR* 170:777–783
- Smith TP, Higashida RT, Barnwell SL et al. (1994) Treatment of dural sinus thrombosis by urokinase infusion. *Am J Neuroradiol* 15:801–807
- Villringer A, Mehraen S, Einhäupl KM (1994) Pathophysiological aspects of cerebral sinus venous thrombosis. *J Neuroradiol* 21:72–80
- Wang AM (1997) MRA of venous sinus thrombosis. *Clin Neurosci* 4:158–164
- Wetzel SG, Kirsch E, Stock KW et al. (1999) Cerebral veins: comparative study of CT venography with intraarterial digital subtraction angiography. *AJNR Am J Neuroradiol* 20:249–255

## Headache Due to Somatoform Disorder

RETO M. AGOSTI

Headache Center Hirslanden, Zurich, Switzerland

reto.agosti@kopfwww.ch

### Synonyms

Headache Associated with Somatisation Disorder;  
Headache Associated with Psychotic Disorder

### Definition

Headaches of no typical characterisation (such as migraine or cluster headaches) with close temporal association with undifferentiated somatoform disorder (as defined by DSM IV).

### Characteristics

This type of headache does not have any characteristic symptoms that are unique to these types of headaches. Any other headache type, primary (such as migraine, cluster headaches, etc) or secondary, must be excluded. By definition, there must be a close temporal relationship with the multiple symptoms of an undifferentiated somatoform disorder as defined by DSM-IV: a) A physical complaint, plus headache, that, after appropriate investigation, cannot be fully explained by a known general medical condition, or by the direct effects of a substance or medication or, when there is a related medical condition, that complaint or impairment is in excess of what would be expected from the history, examination and/or laboratory findings; and b) The physical com-



plaint and headaches cause distress or impairment and last at least 6 months. The headache occurs exclusively during the course of the other physical complaint, and resolves after the undifferentiated somatoform disorder remits. A similar condition with clearly more stringent criteria regarding the somatoform symptoms and complaints are headaches associated with somatisation disorder, for which DSM-IV requires a minimum of eight somatoform symptoms or complaints and age of onset under 30. Both types of headaches (associated with somatoform and somatisation disorder) only entered the IHS classification of headaches in 2004, and are highly debated regarding their existence as proper diagnoses, with the persistent lack of a biological marker for primary headaches as one of the major obstacles. The diagnosis is fully based on phenomenology, and the treatment symptomatic towards treating the headaches or the underlying psychiatric disorder. A causal relationship in any direction is under debate. Association of headaches with other psychiatric disturbances such as depression, phobias etc. are classified separately. Headaches associated with somatisation disorder are rare, but headaches associated with somatoform disorder are more frequent.

### References

1. American Psychiatric Association (1994) Diagnostic and Statistical Manual of Mental Disorders, 4<sup>th</sup> edn. (DSM IV) American Psychiatric Association, Washington, DC
2. Puca F, Genco S, Prudenzano MP (1999) Psychiatric Comorbidity and Psychosocial Stress in Patients with Tension-Type Headache from Headache Centers in Italy. The Italian Collaborative Group for the Study of Psychopathological Factors in Primary Headaches. *Cephalalgia* 19:159–164
3. Yutzy S (2003) Somatoform Disorders In: Tasman A, Kay J, Lieberman JA (eds) *Psychiatry*, 2<sup>nd</sup> edn. John Wiley and Sons, Chichester, pp 1419–1420

## Headache, Episodic Tension Type

ANDREAS R. GANTENBEIN, PETER S. SÁNDOR  
Headache & Pain Unit, University Hospital Zurich,  
Zurich, Switzerland  
andy.gantenbein@gmx.ch, peter.sandor@usz.ch

### Synonyms

Episode Tension Type Headache; Idiopathic Headache; Muscle Contraction Headache; Ordinary Headache; Psychogenic Headache; Psychomyogenic Headache; Tension Headache

### Definition

The new classification of the International Headache Society (IHS) distinguishes an infrequent (less than 1 day per month) and a frequent form (at least 1 day but less than 15 days per month) of episodic tension type headache. Duration varies from minutes to days. The pain is typically bilateral, of mild to moderate intensity,

and has a ► **pressing/tightening** character. There is no worsening with routine physical activity. There is no nausea, but ► **photophobia** or ► **phonophobia** may be present. Both infrequent and frequent types can be subdivided according to the presence or absence of pericranial ► **tenderness** (jaw, scalp and neck muscles). See Table 1 for the classification criteria (Headache Classification Subcommittee of the International Headache Society 2003).

### Characteristics

With a lifetime prevalence of 30–78% in general population, tension type headache is the most common primary headache and has a high socio-economic impact. The male to female ratio is 1:1.5. The prevalence in childhood ranges from 0.5–12% (Anttila et al. 2002; Rasmussen et al. 1991; Rasmussen 2001; Schwartz et al. 1998). Tension headache was first defined by the IHS classification committee in 1988. This type of headache previously had a psychological label and was thought to be caused exclusively by mental conflicts, stress, tension, or emotional overload. There was exciting little interest from research and pharmaceutical companies. However, more recently a number of studies have investigated neurobiological mechanisms. Peripheral pain mechanisms, such as myofascial tenderness, hyperalgesia and muscle hardness have been implicated in the episodic type, and dysfunction of central sensitisation in the chronic type. Overall tension-type headache appears to be a central disinhibitory phenomenon, probably with involved neurotransmitter changes, defective nociceptive control, increased sensitivity to both myofascial and vascular input, and associated personality traits (Jensen and Olesen 2000). Whether tension type headache and migraine are separate entities, as suggested by epidemiological data, or rather represent a continuum with shared pathophysiology remains controversial (Rasmussen 1996; Ulrich et al. 1996).

### Symptoms

The headache can be described in simple terms as pain in the head without associated symptoms. Unlike migraine there is no sensory hypersensitivity, e.g. to sound, light, or movements. Unlike cluster headache autonomic features (tearing, redness of the eye and blocked nose) are not present. Due to the usually mild and short lasting character, patients with less frequent tension headache often view their symptoms as a nuisance and rarely seek the advice of a specialist. Accordingly, these patients often treat their headache with standard over-the-counter pain killers (often containing caffeine) or with non-pharmacological treatments, such as hot or cold packs, or massage. If the headache is more frequent it may well become distressing and interfere with daily life. This may be associated with regular intake of non-specific analgesics, and can lead to further problems, including chronification of the headache.

**Headache, Episodic Tension Type, Table 1** Compared diagnostic criteria frequent episodic tension-type headache and migraine without Aura from the International Headache Classification 2<sup>nd</sup> edn

Diagnosis:	Frequent episodic tension type headache	Migraine without Aura
Number of episodes:	At least 10	At least 5
Number of days with such headache:	≥ 1 day and < 15 days per month (for at least 3 months)	< 15 days/month (untreated or unsuccessfully treated)
Duration of the headache:	30 min to 7 days	4–72 h
Pain characteristics:	At least two of the following:	At least two of the following:
	Pressing/tightening (non-pulsating) quality	Pulsating quality
	Mild or moderate intensity	Moderate or severe pain intensity
	Bilateral location	Unilateral location
	No aggravation by walking stairs or similar routine physical activity	Aggravation by or causing avoidance of routine physical activity
Accompanying Symptoms:	Both of the following:	At least one of the following:
	No nausea or vomiting (anorexia may occur).	Nausea and/or vomiting
	Photophobia or phonophobia or none	Photophobia and phonophobia

Episodic tension type headache has a high intra- and inter-individual variability with respect to frequency and intensity. Additionally, the duration of each attack may range from 30 minutes to 7 days. It usually has a diffuse pressing character, often described by patients as a ‘tight band around the head’. The pain is dull, persistent and often diurnal. The headache is bilateral in 80–90% of cases. Most commonly intensity is mild to moderate and may interfere with (though not usually prevent) performance of daily activities. Characteristically it is not aggravated by routine physical activity. Nausea and vomiting are absent. Patients may complain of mild intolerance to loud sound or bright light, though true photophobia or phonophobia is rare and strongly suggest migraine (certainly when both present). There is no blurred vision and no focal neurological disturbance. Patients may complain of a feeling of giddiness or light-headedness, sometimes as a consequence of hyperventilation in association with anxiety. Many patients report difficulties in concentrating and lack of interest in work and hobbies. With age, tension-type headache can increase in frequency and duration, and there tends to be more variability of localization and rarely nausea may develop (Wober-Bingol et al. 1996).

### Examination

Tension type headache patients require thorough neurological examination, including inspection and palpation of ► **pericranial muscles**. Pericranial tenderness is easily recorded by small rotating movements and a firm pressure with two fingers on the frontal, temporal, masseter, pterygoid, sternocleidomastoid, splenius and trapezius muscles. A local tenderness score from 0–3 on each muscle can be summated to a total tenderness score for each

individual. The use of a palpometer (pressure sensitive device) can improve validity and reproducibility. Palpation is also a useful guide for treatment strategy, and adds value and credibility to the explanations given to the patient.

### Differential-Diagnosis

An accurate diagnosis is essential, and migraine, as well as secondary headache, should be excluded. Tension-type headache is sometimes difficult to distinguish from migraine in patients who have both tension headache and migraine with or without aura. It is important to educate patients in the differentiation between these headaches, as the right treatment for the right headache can be administered and medication overuse headache can be avoided. A diagnostic headache diary can be helpful to identify different patterns, since patients often describe only the characteristics of recent or the most severe attacks. In favour of tension type headache is a highly variable temporal profile and pain improvement with exercise. Unsuccessful treatment with ergotamins or triptans for acute attacks, or with beta-blockers or Flunarizin for prevention, also suggest a diagnosis of tension type headache. (Kaniecki 2002) See Table 1 for the comparison of classification criteria for migraine without aura and tension-type headache.

If headache is new (particularly over the age of 50), has a sudden onset, changes significantly in established pattern or characteristics, or does not fit a classical scheme, then secondary causes need to be excluded. Head trauma, vascular disorder, nonvascular intracranial disorder, substance abuse, noncephalic infection, metabolic disorder, and cranial structure defects can sometimes imitate tension type headache. If the neu-

**Headache, Episodic Tension Type, Table 2** Acute treatment options in episodic tension-type headache

List of effective acute drugs			
Paracetamol/ Acetaminophen	1000 mg		
Aspirin	1000 mg	Steiner et al. Cephalalgia 2003	
Ibuprofen	400 mg	Packman et al. Headache 2000	
Ketoprofen	25 mg	Steiner et al. Cephalalgia 1998	
Naproxen	750 mg	Autret et al. Cephalalgia 1997	
Diclofenac	12.5–25 mg	Kubitsek et al. EurJPain 2002	
Metamizol	1000 mg	Martinez et al.	Cephalalgia 2001
Medications for children			
Ibuprofen	10 mg/KG		
Paracetamol	15 mg/KG		

H

rological examination is normal and the headache has no worrisome characteristics, there is no need for further investigations such as neuroimaging or lumbar puncture, and the patient can be reassured.

A number of precipitating factors have been described, including oromandibular dysfunction, non-psychological motor stress, local myofascial release of irritants, sleep deprivation, and coexisting migraine (Spierings et al. 2001). More controversial is the role of psychological factors, although the triggering of attacks by psychological stress is recognised. Up to one third of tension type headache patients show associated symptoms of depression or anxiety, though surveys of personality profiles have not demonstrated significant abnormalities (Holroyd 2002; Merikangas et al. 1994; Mitsikostas and Thomas 1999).

### Management and Treatment

As yet there is no specific treatment for tension-type headache. Episodic and mild headaches are often successfully treated with non-specific analgesics, without the involvement of specialists. Drugs with evidence based benefit for acute treatment include aspirin, paracetamol and NSAIDs (Table 2). Compound analgesics should be used with caution, as repeated self-medication can yield to dependency, rebound headache and chronic headache suggests an additional medication-overuse headache (IHS classification). The following rules apply for the acute treatment of ► [episodic tension-type headache](#) :

1. The analgesics should be taken at relatively high dose!
2. The intake should be as early as possible! \*
3. Drugs should not be taken on more than 2 days a week!\*

4. The use of compound analgesics (codeine, caffeine, etc.) should be avoided, or at least limited and carefully monitored!

\*cave: balance!

As a preventative treatment for frequent tension-type headaches a typical first choice is a tricyclic antidepressant, such as Amitriptyline. High dose Magnesium may be effective. Combination with a non-pharmacological treatment, such as cognitive behavioural therapy, progressive muscle relaxation, or psychological counselling may be useful. In addition, advice may be also needed about the mechanisms of hyperventilation. Management must include elimination of exacerbating factors, such as dental pathology, sinus disease, depressive disorders, un-physiological working conditions, and disturbed sleep patterns. Physiotherapy, physical treatment (hot and cold packs), ultra-sound, electrical stimulation, posture improvement, relaxation and exercise programs are helpful in certain cases. Some patients report beneficial effects of muscle relaxants, tiger balm, and peppermint oil. (Stillman 2002)

### References

1. Anttila P, Metsahonkala L, Aromaa M et al. (2002) Determinants of Tension-Type Headache in Children. *Cephalalgia* 22:401–408
2. Headache Classification Subcommittee of the International Headache Society (2003) International Classification of Headache Disorders, 2<sup>nd</sup> edn. *Cephalalgia*
3. Holroyd KA (2002) Behavioral and Psychologic Aspects of the Pathophysiology and Management of Tension-Type Headache. *Curr Pain Headache Rep* 6:401–407
4. Jensen R, Olesen J (2000) Tension-Type Headache: An Update on Mechanisms and Treatment. *Curr Opin Neurol* 13:285–289
5. Kaniecki RG (2002) Migraine and Tension-Type Headache: An Assessment of Challenges in Diagnosis. *Neurology* 58:15–20
6. Merikangas KR, Stevens DE, Angst J (1994) Psychopathology and Headache Syndromes in the Community. *Headache* 34:17–22
7. Mitsikostas DD, Thomas AM (1999) Comorbidity of Headache and Depressive Disorders. *Cephalalgia* 19:211–217

8. Rasmussen BK (1996) Migraine and Tension-Type Headache are Separate Disorders. *Cephalalgia* 16:217–220; discussion 223
9. Rasmussen BK (2001) Epidemiology of Headache. *Cephalalgia* 21:774–777
10. Rasmussen BK, Jensen R, Schroll M et al. (1991) Epidemiology of Headache in a General Population – A Prevalence Study. *J Clin Epidemiol* 44:1147–1157
11. Schwartz BS, Stewart WF, Simon D et al. (1998) Epidemiology of Tension-Type Headache. *Jama* 279:381–383
12. Spierings EL, Ranke AH, Honkoop PC (2001) Precipitating and Aggravating Factors of Migraine versus Tension-Type Headache. *Headache* 41:554–558
13. Stillman MJ (2002) Pharmacotherapy of Tension-Type Headaches. *Curr Pain Headache Rep* 6:408–413
14. Ulrich V, Russell MB, Jensen R et al. (1996) A Comparison of Tension-Type Headache in Migraineurs and in Non-Migraineurs: A Population-Based Study. *Pain* 67:501–506
15. Wober-Bingol C, Wober C, Karwautz A et al. (1996) Tension-Type Headache in Different Age Groups at Two Headache Centers. *Pain* 67:53–58

## Headache from Cranial Bone

HARTMUT GÖBEL

Kiel Pain Center, Kiel, Germany

hg@schmerzlinik.de

### Synonyms

Headache Associated with Disorders of the Cranium;  
Facial Pain Associated with Disorders of the Cranium

### Definition

Pain in the head or face caused by a lesion within the cranial bone.

### Characteristics

Most disorders of the skull (e.g. congenital abnormalities, fractures, tumours, metastases) are not usually accompanied by headache. Exceptions of importance are osteomyelitis, multiple myeloma and Paget's disease. Headache may also be caused by lesions of the mastoid, and by petrositis. No epidemiological data are available on headaches due to lesions of the cranial bone.

The bone of the skull has limited sensitivity to pain because only a few nerve fibers enter it from the overlying periosteum. The periosteum is more pain sensitive, and skull lesions therefore produce headache, chiefly by involving it. The lesions of the skull most likely to do this are those that are rapidly expansile, aggressively osteoclastic, or have an inflammatory component.

Most skull lesions are asymptomatic and are discovered as incidental findings on roentgenograms or other imaging procedures done to investigate unrelated complaints, including fibrous dysplasia, osteomas, epidermoid cysts, metastatic cancers, hemangiomas, eosinophilic granulomas, and Paget's disease of the skull. Some of these lesions, notably hemangiomas and eosinophilic granulomas and the rare aneurysmal bone cysts, may present with a tender swelling on the calvarium but not with spontaneous headache.

Relatively few skull lesions produce headache. Multiple myeloma often presents with bone pain anywhere in the body, and skull deposits are sometimes a source of such pain. The multiplicity of the deposits, and the proclivity of the myeloma cells to produce osteoclast activating factor, are likely to account for the production of head pain by this particular bone tumor. Osteomyelitis produces spontaneous head pain because of its rapid evolution and its inflammatory component. Although most cases of Paget's disease of the skull are asymptomatic, remodeling of bone, by producing basilar invagination, may cause headache either through traction on the upper cervical nerve roots, or by the production of cerebrospinal fluid pathway distortion with hydrocephalus. Skull lesions as a cause of headache are infrequent, but usually require neurosurgical treatment. If necessary, surgical excision can serve to confirm the diagnosis and retard the progression of neurological dysfunction and head pain. Apart from specific medication, non-opioid and opioid analgesics may be used for pain relief.

### References

1. Bhatoo HS (1998) Deshpande GU. Primary Cranial Ewing's Sarcoma. *Br J Neurosurg* 12:165–169
2. Göbel H (1997) Die Kopfschmerzen. Ursachen, Mechanismen, Diagnostik und Therapie in der Praxis. Springer Verlag, Berlin Heidelberg New York, pp 1–901
3. Göbel H, Edmeads JG (2000) Disorders of the Skull and Cervical Spine. In: Olesen J, Tfelt-Hansen P, Welch KMA (eds) *The Headaches*, 2<sup>nd</sup> edn. Lippincott Williams & Wilkins, Philadelphia, pp 891–898
4. Hayashi T, Kuroshima Y, Yoshida K et al. (2000) Primary Osteosarcoma of the Sphenoid Bone with Extensive Periosteal Extension – Case Report. *Neurol Med Chir (Tokyo)* 40:419–22
5. International Classification of Headache Disorders 2<sup>nd</sup> edn (2004) *Cephalalgia* 24:9–160
6. Scherer A, Engelbrecht V, Nawatny J (2001) MRI of the Cerebellopontine Angle in Patients with Cleidocranial Dysostosis. *Rofo Fortschr Geb Rontgenstr Neuen Bildgeb Verfahr* 173:315–318
7. Voorhies RM, Sundaresan N (1985) Tumors of the Skull. In: Wilkins RH, Rengachary SS, (eds) *Neurosurgery*. McGraw-Hill, New York, pp 984–1001

## Headache in Aseptic Meningitis

K. RAVISHANKAR

The Headache and Migraine Clinic, Jaslok Hospital and Research Centre, Lilavati Hospital and Research Centre, Mumbai, India

dr\_k\_ravishankar@vsnl.com

### Synonyms

Viral Meningitis; Serous Meningitis; Abacterial Meningitis; Aseptic Meningitis

### Definition

► **Aseptic Meningitis** is the term applied to an acute clinical syndrome that comprises headache, fever, signs of



meningeal inflammation and a predominantly lymphocytic pleocytosis with normal glucose and normal to elevated proteins in the cerebro-spinal fluid (CSF).

Historically, the word 'aseptic' was introduced to denote the nonbacterial aetiology of this syndrome, and included forms of infective meningitis (viral and fungal) that were negative on routine bacteriologic stains and culture. With the introduction of polymerase chain reaction (PCR) based investigations and improved diagnostic techniques, the yield has improved, and the list of conditions that can present with a clinical picture like aseptic meningitis has expanded considerably. Although often used interchangeably, this term is therefore no longer synonymous with ► **Viral Meningitis**.

## Characteristics

### Introduction

Both infective and noninfective conditions may present with a picture that fits the definition of aseptic meningitis. Infective causes (Table 1) are mostly viral in origin and less commonly of fungal, parasitic, nonpyogenic bacterial, rickettsial or mycoplasmal origin; non-infective causes (Table 2) include tumours of the central nervous system, carcinomas, leukaemias, sarcoidosis, systemic lupus erythematosus (SLE), rheumatoid arthritis, certain drugs, vaccines, immunoglobulins, intrathecal agents and rarely some disorders of unproven aetiology like Behcets syndrome, Vogt-Koyanagi-Harada syndrome.

Aseptic meningitis is common and seen more often in children and young adults, especially during the summer months. Except in the neonatal period, the mortality and morbidity rates are low (Norris et al. 1999; Cherry 1998). Most patients with aseptic meningitis due to viral causes have a benign course and spontaneously improve, while others may run a complicated course unless specifically

**Headache in Aseptic Meningitis, Table 1** Viral Conditions that may present with aseptic meningitis

Infectious Etiologies	Non-Infectious Causes
	<b>Drugs:-</b>
Enteroviruses, Polio, coxsackievirus, echovirus	NSAIDs
HSV types 1 and 2	Trimethoprim
Varicella-zoster virus	Azathioprine
Adenovirus	Intravenous immunoglobulin
Epstein-Barr virus	Isoniazid
LCMV	Intrathecal
HIV	Methotrexate
Influenza A and B	Vaccines
	Allopurinol

**Headache in Aseptic Meningitis, Table 2** Non-Viral Conditions that may present with aseptic meningitis

Infectious Etiologies	Non-Infectious Causes
<b>Bacteria:-</b>	<b>Other Diseases:-</b>
M.tuberculosis	Sarcoidosis
Borrelia burgdorferi	Leptomeningeal carcinoma
Treponema pallidum	SLE
Brucella	CNS vasculitis
Mycopl.pneumoniae	Behcet disease
<b>Fungi:-</b>	Vogt-Koyanagi-Harada syndrome
Crypto. Neoformans	Migraine
Histo. capsulatum	
Coccidiodes immitis	
Blasto. Dermatitides	
<b>Parasites:-</b>	
Toxoplasma gondii	
Taenia solium	

H

treated. World-wide prevalence varies depending on geographic factors, seasonal influence, epidemiologic patterns of diseases and vaccination policies.

### Clinical Features

Aseptic meningitis is characterized by abrupt onset of headache, fever and neck stiffness. Additional clinical symptomatology may vary depending on the underlying cause. Focal signs and seizures are rarely seen in aseptic meningitis, but mumps, certain arboviruses, and lymphocytic choriomeningitis virus may cause a meningoencephalitis (Rice 2001).

The headache of aseptic meningitis has no typical characteristics. It is severe, most often bilateral and may be associated with fever and vomiting. Lamonte et al. (1995), in their retrospective review of 41 patients with aseptic meningitis, noted that headache was present in all, started or worsened abruptly in 24; in 39 the headache was severe and in 6 it was the worst headache. There was no consistent pattern of location or type of pain. In all cases the headache was different from the usual headache. Systemic prodromal symptoms preceded the onset of headache in 19 patients. Nausea, vomiting, cognitive changes, back pain, blurred vision, phonophobia, photophobia and tinnitus were the associated symptoms seen in their series (Marian et al. 1995).

Migraine headache may mimic aseptic meningitis, but if a patient presents acutely with fever and headache that is bilateral, throbbing not relieved with analgesics and different from their earlier headaches, then aseptic meningitis needs ruling out. Rarely migraine itself can cause

aseptic meningitis. Bartleson et al. (1981) reported a series of patients with complicated migraine and CSF pleocytosis preceded by a viral-like illness (Gomez-Aranda et al. 1997). Other causes of similar headache that may confuse include subarachnoid haemorrhage and other acute headaches.

The cell count in aseptic meningitis is usually less than 1000 per cu. mm, and there may be an early predominance of polymorphonuclear leucocytes. Repeated lumbar puncture in 8-12 hours frequently shows a change from neutrophil to lymphocyte predominance. CSF glucose levels are normal and CSF proteins may be normal or elevated. CSF culture for viruses and PCR studies help in further confirming the diagnosis.

### Differential Diagnosis

Viruses are the most common causative agents, but even when all viral diagnostic facilities are available, the causal agent may be difficult to identify in a good proportion of cases. Viral pathogens may enter the CNS through the haematogenous or neural route. Neural penetration is limited to herpes viruses (HSV-1, HSV-2 and varicella zoster virus) and some enteroviruses. Exposure to mosquito or tick vectors is a risk factor for transmission (Adams and Victor 2001). Over 80% of aseptic meningitis are caused by enteroviruses (coxsackie A or B, enterovirus 68 to 71, echovirus and poliovirus), followed by the mumps virus, HSV-2, HIV, and less commonly HSV-1, varicella zoster virus (VZV), Epstein-Barr virus and cytomegalovirus (CMV). Rarely arbovirus, lymphocytic choriomeningitis virus (LCMV) and adenovirus may be responsible for similar symptoms. Influenzal and parainfluenzal illnesses can also cause aseptic meningitis. The incidence of polio and mumps in the vaccination era has decreased significantly in developed countries. In younger people, measles virus may cause aseptic meningitis that is associated with a rash (Waisman et al. 1999).

Human Immunodeficiency Virus (HIV) infection may present with aseptic meningitis, particularly at the time of seroconversion (Levy et al. 1990). Patients may present with CSF pleocytosis, elevated protein level and high intracranial pressure. Besides the usual meningeal signs, patients with HIV infection may have neurological deficits and may need imaging. Adenovirus may be a major cause of meningitis in patients with HIV infections. Varicella zoster virus can affect the immunocompromised.

Arbovirus accounts for approximately 5% of cases of aseptic meningitis in North America, and the incidence varies depending on the life cycle of arthropod vectors, animal reservoirs and their contact with humans. Some of the important viruses include Eastern and Western equine encephalitis viruses, St Louis Encephalitis virus, West Nile virus, Japanese B virus and Colorado tick fever. LCMV affects those at risk who come in contact with rodents or their excreta (Nelsen et al. 1993).

The immediate concern in practice should not be aimed at establishing a particular virus as the cause of the illness, but more importantly to exclude the few conditions with aseptic meningitis like picture, but having another underlying non-viral cause warranting specific management. In every patient with aseptic meningitis one has to look beyond viruses as the causative factor.

Non-viral causes have a more complicated course but can be managed with specific treatment. Tuberculous, fungal, syphilitic, spirochaetal, rickettsial, parasitic and other mycoplasmal infections can cause aseptic meningitis, which should be suspected in the appropriate clinical setting. In the early stages, tuberculous meningitis may appear like aseptic meningitis and can be difficult to diagnose. The glucose levels are reduced only in the later stages and the organism is difficult to find. CSF features of aseptic meningitis, but without fever, may be seen with acute syphilitic meningitis. Cryptococcal infections, other fungal infections, and some rare conditions like *Mycoplasma pneumoniae*, Brucellosis and Q fever can also present like aseptic meningitis. Brucellosis is common in specific geographic locations.

Conjunctival suffusion with transient erythema, severe leg and back pain, pulmonary infiltrates and aseptic meningitis should suggest leptospiral infection. Infection is acquired by contact with soil or water contaminated by the urine of rats, dogs, or cattle. Lyme borreliosis is a common spirochaetal cause of aseptic meningitis and meningoencephalitis. The spirochaete is tick borne, common in north eastern United States from May to July (Eppes et al. 1999).

Leukaemias in children and lymphomas in adults are common sources of meningeal reactions with aseptic meningitis like CSF picture. In these disorders, and in meningeal carcinomatosis, neoplastic cells are found throughout the leptomeninges with additional root involvement. Features of the aseptic meningitis syndrome can also be caused by brain abscess, parameningeal infections and partially treated bacterial meningitis, when it may be mistakenly diagnosed as viral aseptic meningitis. A careful history of previous antibiotic administration must therefore be obtained in all patients with meningitis.

Sarcoidosis, Behcets syndrome, vasculitis and granulomatous angiitis can present with aseptic meningitis syndrome by infiltrating the leptomeninges. These conditions, however, rarely present with a clinical picture of meningitis alone, more often they are seen with other neurological accompaniments (Gullapalli and Phillips 2002; Nelsen et al. 1993). Some chronic diseases like systemic lupus erythematosus, serum sickness and Vogt-Koyanagi-Harada syndrome, may present with aseptic meningitis (Adams and Victor 2001).

Drug induced aseptic meningitis (DIAM), either by: 1) direct irritation of the meninges with intrathecal administration, or by 2) immunological hypersensitivity to the drug, has been reported as an uncommon

adverse reaction with numerous agents (Chaudhry and Cunha 1991). The major categories of causative agents are non-steroidal anti-inflammatory drugs (NSAIDs), antimicrobials, intravenous immunoglobulins, isoniazid, allopurinol and vaccines for measles, mumps and rubella. In addition to headache, there may be signs of a hypersensitivity reaction. Trimethoprim-sulphamethoxazole, azathioprine and intrathecal injections can result in the clinical findings of aseptic meningitis. The association between SLE and ibuprofen as a cause of DIAM is important to recognise. A high index of suspicion is necessary to make the diagnosis. Treatment is to withhold the drug. There are no long-term sequelae of DIAM.

Besides the typical CSF picture, it is essential to isolate the virus in CSF, stool, saliva and throat swabs using PCR and other serologic tests (Jeffery et al. 1997). It is important to enquire about a past history of infectious disease, immunisations, contact with animals, insect bites, recent respiratory or gastro-intestinal infection and recent travel. The season during which the illness occurs and the geographical location are helpful pointers.

Recurrent aseptic meningitis is also known as Mollaret's meningitis and can be a diagnostic dilemma. There is spontaneous remission and no causative agent has been consistently found. It is difficult to identify the virus in the CSF. These patients need detailed investigations with repeat lumbar punctures, cytology or CSF bacterial cultures, PCR, HIV testing and MRI with contrast if necessary. Recurrence in a few cases is caused by HSV-1 and HSV-2 infections (Cohen et al. 1994).

### Conclusion

Most patients with aseptic meningitis need only supportive care. It may be prudent to start antibiotics until cultures are shown to be negative, or a second examination of CSF shows a more typical picture. Most patients recover completely and rapidly when the aetiology is viral, unless there is an associated encephalitic component. Precautions should be taken when specific viruses are identified. Effective antiviral therapy is available against HSV-1, varicella and CMV. For HSV-2, acyclovir is the drug of choice. Other causes need appropriate management. Rarely, patients may have persistent headache, mild mental impairment, incoordination or weakness that lasts for months. Although aseptic meningitis is an acute illness, most patients eventually improve.

### References

- Adams RD, Victor M (2001) Viral Infections in the Nervous System. In: Adams RD, Victor M (eds) Principles of Neurology, 7<sup>th</sup> edn. McGraw-Hill, New York
- Bartleson JD, Swanson JW, Whisnant JP (1981) A Migrainous Syndrome with Cerebrospinal Fluid Pleocytosis. *Neurology* 1:1257-1262
- Chaudhry HJ, Cunha BA (1991) Drug-Induced Aseptic Meningitis: Diagnosis Leads to Quick Resolution. *Postgrad Med* 90:65-70
- Cherry JD (1998) Aseptic Meningitis and Viral Meningitis. In: Feigin RD, Cherry JD (eds) Textbook of Pediatric Infectious Diseases, vol 2, 4<sup>th</sup> edn. Saunders, Philadelphia, pp 450-457
- Cohen BA, Rowley AH, Long CM (1994) Herpes Simplex Type 2 in a Patient with Mollaret's Meningitis: Demonstration by Polymerase Chain Reaction. *Ann Neurol* 35:112-116
- Eppes SC, Nelson DK, Lewis LL, Klein JD (1999) Characterization of Lyme Meningitis and Comparison with Viral Meningitis in Children. *Pediatrics* May 103:957-960
- Gomez-Aranda F, Canadillas F, Marti-Masso JF et al. (1997) Pseudomigraine with Temporary Neurological Symptoms and Lymphocytic Pleocytosis. A Report of 50 Cases. *Brain* 120:1105-1113
- Gullapalli D, Phillips LH (2002) Neurologic Manifestations of Sarcoidosis. *Neurol Clin* 20:59-83
- Jeffery KJ, Read SJ, Petro TE et al. (1997) Diagnosis of Viral Infections of the Central Nervous System: Clinical Interpretation of PCR Results. *Lancet* 349:313-317
- Levy RM, Bredesen DE, Rosenblum ML (1990) Neurologic Complications of HIV Infection. *Am Fam Physician* 41:517-536
- Lamonte M, Silberstein SD, Marcellis JF (1995) Headache Associated with Aseptic Meningitis. *Headache* 35:520-526
- Nelsen S, Sealy DP, Schneider EF (1993) The Aseptic Meningitis Syndrome. *Am Fam Physician* 48:809-815
- Norris CM, Danis PG, Gardner TD (1999) Aseptic Meningitis in the Newborn and Young Infant. *Am Fam Physician* 59:2761-2770
- Rice P (2001) Viral Meningitis and Encephalitis. *Medicine* 29:54-57
- Waisman Y, Lotem Y, Hemmo M et al. (1999) Management of Children with Aseptic Meningitis in the Emergency Department. *Pediatr Emerg Care* 15:314-317

H

## Health Informatics

- ▶ Information and Psychoeducation in the Early Management of Persistent Pain

## Heart Pain

- ▶ Visceral Pain Model, Angina Pain

## Heat Hyperalgesia

### Definition

Heat hyperalgesia is increased pain produced by a normally painful heat stimulus.

- ▶ Neuropathic Pain Model, Partial Sciatic Nerve Ligation Model
- ▶ Sympathetically maintained Pain and Inflammation, Human Experimentation

## Heat Lesion

- ▶ Radiofrequency Neurotomy, Electrophysiological Principles

## Heat Sensor

- ▶ Capsaicin Receptor

## Heightened Attention

- ▶ Hypervigilance and Attention to Pain

## Heightened Vigilance

- ▶ Hypervigilance and Attention to Pain

## Helical CT

- ▶ CT Scanning

## Helicobacter Pylori

### Definition

Helicobacter Pylori are bacteria that cause inflammation and ulcers in the stomach.

- ▶ NSAIDs, Adverse Effects

## Heliotherapy

### Definition

Heliotherapy is the exposure to sun rays and ultraviolet rays.

- ▶ Spa Treatment

## Helplessness

### Definition

Helplessness is a belief in one's inability to adequately manage or cope with a stressful situation and to exert any control over one's circumstances, symptoms, and life.

- ▶ Catastrophizing
- ▶ Cognitive-Behavioral Perspective of Pain

## Hemianesthesia

### Definition

Hemianesthesia is the sensory loss in the left or right side of the body.

- ▶ Central Nervous System Stimulation for Pain

## Hemibody Radiation

### Definition

Hemibody radiation is an external beam of radiation administered to half of the body, i.e. above or below the diaphragm, for systemic metastatic disease.

- ▶ Adjuvant Analgesics in Management of Cancer-Rated Bone Pain

## Hemicrania Continua

LAWRENCE C. NEWMAN

Albert Einstein College of Medicine, New York, NY, USA

lnewman@chpnet.org

### Definition

An under-recognized, primary headache disorder that is characterized by a constant, one-sided headache with fluctuating intensity. In general, the headache is present as a persistent background discomfort of mild to moderate intensity, but exacerbations of more severe pain, superimposed upon the baseline pain, occurs periodically. During these painful flare-ups, patients experience one or more symptoms on the side of the headache. These symptoms include, drooping of the eyelid, reddening or tearing of the eye, constriction of the pupil, and stuffiness or dripping of the nostril. Recognition of the disorder is important, because the headache responds dramatically to treatment with the anti-inflammatory medication indomethacin.

### Characteristics

Hemicrania continua (HC) is an under-recognized primary headache disorder. Initially, HC was believed to be a very rare disorder, however, in headache subspecialty practices, HC is a common cause of refractory, ▶ unilateral, chronic daily headache. (Peres et al. 2001) Sjaastad and Spierings initially described the disorder in two patients with continuous headaches from onset (Sjaastad and Spierings 1984). Since that initial description, approximately 150 cases have been described in the literature.

Hemicrania continua demonstrates a marked female preponderance, with a female to male ratio of approximately 2:1. The condition most often begins during adulthood. The age of onset ranges from 5-67 years (mean 28 years) (Peres et al. 2001; Matharu et al. 2003). Most sufferers describe strictly unilateral pain, without side-shift. Rarely, bilateral pain (Pasquier et al. 1987; Iordanidis and Sjaastad 1989; Trucco et al. 1992), or pain that alternated sides, has been described (Newman et al. 1992; Newman et al. 2004). The maximal pain



is experienced in the eye, temple and cheek regions. On occasion, the pain may radiate into the ► [ipsilateral](#) occiput, neck and retro-orbital areas.

The pain is usually described as a steady ache or throbbing pain. Superimposed upon the continuous baseline low-level discomfort, the majority of patients report exacerbations of more intense pain lasting from 20 minutes to several days. Although significantly more intense than the usual background discomfort, the painful exacerbations never reach the level experienced by ► [cluster headache](#) sufferers. These exacerbations may occur at any time of the day or night, and frequently awaken the patient from sleep. Migraine-like associated symptoms such as nausea, vomiting, ► [photophobia](#) and ► [phonophobia](#) often accompany these exacerbations. Rarely, painful exacerbations may be preceded by a migrainous visual aura (Peres et al. 2002). ► [Autonomic features](#) of cluster headache, including ipsilateral ► [ptosis](#), ► [conjunctival injection](#), ► [lacrimation](#) and nasal congestion, often accompany exacerbations of pain. When present, however, these associated features are usually much less pronounced than those seen in cluster headaches. Painful exacerbations are also associated with a sensation of ocular discomfort, often likened to a foreign body in the eye (typically reported as sand or hair). Concurrent ► [primary stabbing headaches](#) (“jabs and jolts”) are reported by many patients, occasionally occurring only in association with the painful exacerbations. During exacerbations of pain, patients assume the pacing activity usually seen with cluster headaches. The International Headache Society (IHS) diagnostic criteria for HC are as follows:

#### Diagnostic Criteria

- a) Headache for > 3 months fulfilling criteria B–D
- b) All of the following characteristics:
  1. unilateral pain without side-shift
  2. daily and continuous, without pain-free periods
  3. moderate intensity, but with exacerbations of severe pain
- c) At least one of the following autonomic features occurs during exacerbations and ipsilateral to the side of pain:
  4. conjunctival injection and/or ► [lacrimation](#)
  5. nasal congestion and/or ► [rhinorrhea](#)
  6. ptosis and/or miosis
- d) Complete response to therapeutic doses of indomethacin
- e) Not attributed to another disorder

Three temporal profiles of HC have been reported (Newman et al. 1994, Goadsby and Lipton 1997). A chronic form in which headaches persist unabated for years, an episodic form in which distinct headache phases are separated by periods of pain-free remissions, and an initially episodic form that over time evolves

into the chronic, unremitting form. HC is chronic from onset in 53%, chronic evolved from episodic in 35%, and episodic in 12% of sufferers (Matharu et al. 2003). There are also individual case reports of atypical presentations; one patient initially experienced the chronic form that over time became episodic (Pareja 1995), another patient with the episodic form experienced headaches with a clear seasonal pattern (Peres et al. 2001).

Organic mimics of HC have been reported to occur in association with brain tumors involving the bones of the skull and skull base (Matharu et al. 2003). HC has been reported to occur in a patient diagnosed with HIV, although a causal relationship was not definitively established (Brilla et al. 1998). Rarely, the diagnosis of HC is masked by a concurrent medication rebound headache. In these instances, discontinuation of the overused analgesic is not associated with headache cessation, and the diagnosis of HC is made by exclusion (Matharu et al. 2003). In rare instances, HC followed head trauma (Lay and Newman 1999).

Hemicrania continua is often misdiagnosed. Although it is not a true cluster headache variant, HC may be mistaken for cluster if the physician focuses on the painful flare-ups with associated autonomic features. A careful history should reveal the presence of the continuous, low-level baseline discomfort in addition to the more disabling exacerbations. Additionally, the autonomic features of HC, when present, tend to be much less pronounced than those of cluster. Similarly, the associated nausea, vomiting, photophobia and phonophobia that accompany exacerbations of pain may be misdiagnosed as chronic migraine headaches. HC is distinguished from migraine by the presence of the persistent dull background discomfort.

Like all primary headache disorders, HC is diagnosed based on the patients' history, medical and neurological examinations. As it is a relatively uncommon headache disorder, and because there have been serious disorders that mimic HC, all patients with features of HC should undergo an MRI scan of the brain prior to initiating therapy.

The treatment of HC is with the medication ► [indomethacin](#). In fact, the diagnosis of HC is predicated on response to treatment with indomethacin. The initial dosage is 25 mg, three times daily. If clinical response is not seen within 1–2 weeks, the dosage should be increased to 50–75 mg, three times daily. Complete response to treatment with indomethacin is prompt, usually within 1–2 days of reaching the effective dose. The typical maintenance dose ranges from 25–100 mg, daily. Skipping or delaying the dose often results in headache recurrence. An intramuscular injection of indomethacin, 50–100 mg (the “indotest”) has been proposed as a diagnostic procedure for HC (Antonaci et al. 1998). Total resolution of the pain of HC was

reported to occur within 2 hours of the injection. Injectable indomethacin is not available in the United States.

Patients suffering with the episodic form should be instructed to continue the medication for 1–2 weeks longer than their typical headache phase and then gradually taper the dose. For those patients with the chronic form, medication tapering should be attempted every 6 months. Patients requiring long-term indomethacin therapy should be given medications such as antacids, misoprostol, histamine H<sub>2</sub> blockers or proton pump inhibitors to mitigate the gastrointestinal side effects of this agent.

In patients who do not respond to treatment with adequate doses of indomethacin, another diagnosis should be considered. Other agents, which may have partial success in the treatment of HC, include naproxen and paracetamol, paracetamol in combination with caffeine, ibuprofen, piroxicam, and reficoxib (Matharu et al. 2003). Six patients who met the clinical criteria for HC, yet failed to respond to treatment with indomethacin, have been reported (Matharu et al. 2003). Nonetheless, the IHS clinical criteria for HC specify that indomethacin responsiveness is necessary for the diagnosis.

## References

1. Antonaci F, Pareja JA, Caminero AB et al. (1998) Chronic Paroxysmal Hemicrania and Hemicrania Continua: Parenteral Indomethacin: The “Indotest”. *Headache* 38:122–128
2. Brilla R, Evers S, Soros P et al. (1998) Hemicrania Continua in an HIV-Infected Outpatient. *Cephalalgia* 18:287–288
3. Headache Classification Subcommittee of the International Headache Society. The International Classification of Headache Disorders, 2<sup>nd</sup> edn (2004) *Cephalalgia* 24:1–150
4. Iordanidis T, Sjaastad O (1989) Hemicrania Continua: A Case Report. *Cephalalgia* 9:301–303
5. Lay C, Newman LC (1999) Posttraumatic Hemicrania Continua. *Headache* 39:275–279
6. Matharu MS, Boes CJ, Goadsby PJ (2003) Management of Trigeminal Autonomic Cephalgias and Hemicrania Continua. *Drugs* 63:1–42
7. Newman LC, Lipton RB, Russell M et al. (1992) Hemicrania Continua: Attacks May Alternate Sides. *Headache* 32:237–238
8. Newman LC, Lipton RB, Solomon S (1994) Hemicrania Continua: Ten New Cases and a Review of the Literature. *Neurology* 44:2111–2114
9. Newman LC, Spears RC, Lay CL (2004) Hemicrania Continua: A Third Case in which Attacks Alternate Sides. *Headache* 44:821–823
10. Pareja JA (1995) Hemicrania Continua: Remitting Stage Evolved from the Chronic Form. *Headache* 35:161–162
11. Pasquier F, Leys D, Petit H (1987) Hemicrania Continua: The First Bilateral Case. *Cephalalgia* 7:169–170
12. Peres MFP, Silberstein SD, Nahmias S et al. (2001) Hemicrania Continua is Not That Rare. *Neurology* 57:948–951
13. Peres MFP, Siow HC, Rozen TD (2002) Hemicrania Continua with Aura. *Cephalalgia* 22:246–248
14. Sjaastad S, Spierings EL (1984) Hemicrania Continua: Another Headache Absolutely Responsive to Indomethacin. *Cephalalgia* 4:65–70
15. Trucco M, Antonaci F, Sandrini G (1992) Hemicrania Continua: A Case Responsive to Piroxicam-beta-cyclodextrin. *Headache* 32:39–40

## Hemicrania Continua Headache

### Definition

Hemicrania continua is a continuous (always present) but fluctuating unilateral headache, moderate to severe in intensity, and accompanied by one of the following during pain exacerbations: conjunctival injection, lacrimation, nasal congestion, rhinorrhea, ptosis, or eyelid edema. It is uniquely responsive to indomethacin.

- ▶ [Chronic Daily Headache in Children](#)
- ▶ [New Daily Persistent Headache](#)
- ▶ [Paroxysmal Hemicrania](#)

## Hemicrania Simplex

- ▶ [Migraine Without Aura](#)

## Hemipain

### Definition

Hemipain is pain that is situated in one half of the body.

- ▶ [Diagnosis and Assessment of Clinical Characteristics of Central Pain](#)

## Hemisection Model

- ▶ [Spinal Cord Injury Pain Model, Hemisection Model](#)

## Hemisphere

### Definition

The hemisphere is either half of the cerebrum or brain; the human brain has a left and a right hemisphere.

- ▶ [PET and fMRI Imaging in Parietal Cortex \(SI, SII, Inferior Parietal Cortex BA40\)](#)

## Hemorrhagic Stroke

- ▶ [Headache Due to Intracranial Bleeding](#)

## Hereditary Motor and Sensory Neuropathy

### Definition

Hereditary motor and sensory neuropathy is an alternative name for Charcot-Marie-Tooth Disease.

- ▶ [Hereditary Neuropathies](#)

## Hereditary Neuropathies

WILLIAM N. KELLEY, STEVEN S. SCHERER  
Department of Neurology, The University of  
Pennsylvania Medical School, Philadelphia, PA, USA  
sscherer@mail.med.upenn.edu

### Synonyms

Charcot-Marie-Tooth disease (CMT); Hereditary Motor and Sensory Neuropathy (HMSN); Dejerine-Sottas neuropathy (DSN); Congenital Hypomyelinating Neuropathy; Hereditary Neuropathy with Liability to Pressure Palsies

### Definition

Hereditary neuropathies are inherited diseases that injure peripheral nerves.

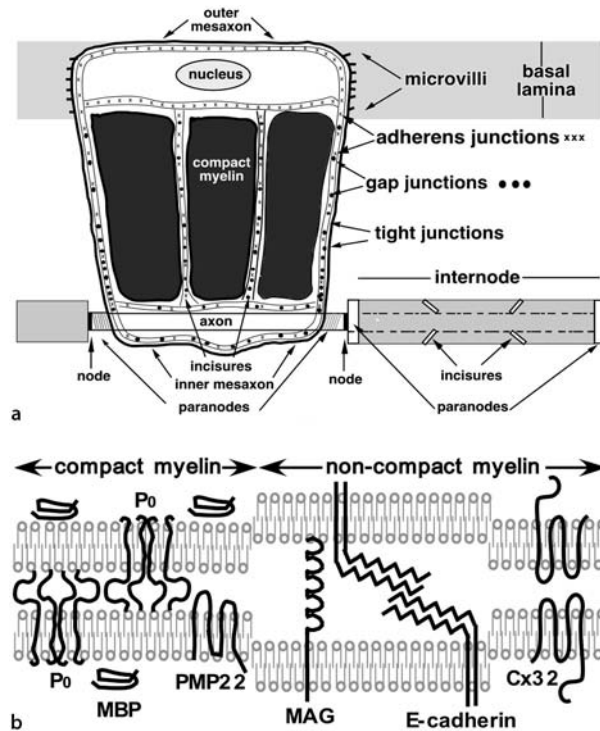
### Characteristics

#### Classification of Hereditary Neuropathies

Inherited neuropathies can be separated according to whether they are syndromic (i. e., one of a number of affected tissues), and whether they are “axonal” or “demyelinating” (whether the primary abnormality appears to affect axons/neurons or myelinating ► [Schwann cells](#)). Non-syndromic inherited neuropathies (Tab. 1) are usually called ► [CMT](#) or ► [HMSN](#). Different kinds are recognized clinically, aided by electrophysiological testing of peripheral nerves (Dyck et al. 1993; Lupski and Garcia 2001; Kleopa and Scherer 2002). If the forearm motor nerve conduction velocities (NCVs) are greater or less than 38 m/s, then the ► [neuropathy](#) is traditionally considered to be “axonal” (CMT2/HMSN II) or “demyelinating” (CMT1/HMSN I), respectively. Some non-syndromic inherited neuropathies have been given different names because their phenotypes differ; these may be milder (e.g. HNPP) or more severe (DSN CHN). Mutations in different genes can cause a similar phenotype, and different mutations in the same gene can cause different phenotypes (Lupski and Garcia 2001; Suter and Scherer 2003; Wrabetz et al. 2004). For most of these mutations, the evidence favors the idea that the more severe phenotypes are caused by a gain of function and that (heterozygous) loss of function alleles cause milder phenotypes.

#### The Biology of Myelinated Axons and Neuropathies

The structure and function of myelinating Schwann cells is the basis for understanding how mutations cause inherited demyelinating neuropathies. The ► [myelin sheath](#) itself can be divided into two domains, compact and non-compact myelin, each of which contains a non-overlapping set of proteins (Fig. 1). Compact myelin forms the bulk of the myelin sheath. It is largely composed of lipids, mainly cholesterol and sphingolipids,



**Hereditary Neuropathies, Figure 1** The architecture of the myelinated axon in the PNS. In (a) one myelinating Schwann cell has been “unrolled” to reveal the regions forming compact myelin, as well as paranodes and incisures, regions of non-compact myelin. In (b) note that P<sub>0</sub>, PMP22, and MBP and are found in compact myelin, whereas Cx32, MAG and E-cadherin are localized in non-compact myelin. Modified from (Kleopa and Scherer 2002), with permission of Elsevier Science.

including galactocerebroside and sulfatide, and three proteins – MPZ/P<sub>0</sub>, PMP22, and myelin basic protein (MBP). Found in the paranodes and incisures, non-compact myelin contains tight junctions, gap junctions, and adherens junctions. In most cell types, these junctions join adjacent cells, whereas in Schwann cells, they are found between adjacent layers of non-compact myelin (Scherer et al. 2004). Gap junctions formed by Cx32 may form a radial pathway, directly across the layers of the myelin sheath; this would be advantageous as it provides a much shorter pathway (up to 1000-fold) than a circumferential route.

Genetic evidence supports the long-standing doctrine that neuropathies are length-dependent, because the longest axons are the most vulnerable to defects in axonal transport (Suter and Scherer 2003). Neurofilaments and microtubules comprise the axonal cytoskeleton. Neurofilaments are composed of three subunits, termed heavy, medium, and light. Dominant mutations in the gene encoding the light subunit (*NEFL*) cause an axonal neuropathy (CMT2E, Tab. 1). Most proteins are synthesized in the cell body and transported down the axon. Microtubule-activated ATPases, known as kinesins, which are molecular motors that use microtubules as tracks, mediate axonal transport.

**Hereditary Neuropathies, Table 1** Non-syndromic inherited neuropathies with a genetically identified cause. The neuropathies are classified by MIM (<http://www.ncbi.nlm.nih.gov/Omim/>); the references for the individual mutations are compiled in the CMT mutation database (<http://molgen-www.uia.ac.be/CMTMutations/DataSource/MutByGene.cfm>). Bolded diseases have pronounced effects on pain.

Disease (MIM)	Mutated gene/linkage	Clinical features
Autosomal or X-linked dominant demyelinating neuropathies		
HNPP (162500)	Usually deletion of one <i>PMP22</i> allele	Episodic mononeuropathies at typical sites of compression; also mild demyelinating neuropathy
CMT1A (118220)	Usually duplication of one <i>PMP22</i> allele	Onset 1 <sup>st</sup> –2 <sup>nd</sup> decade; weakness, atrophy, sensory loss; beginning in the feet and progressing proximally
CMT1B (118200)	<i>MPZ</i>	Similar to CMT1A; severity varies according to mutation (from “mild” to “severe” CTM1)
CMT1C (601098)	<i>LITAF/SIMPLE</i>	Similar to CMT1A; motor NCVs about 20 m/s
CMT1D (607687)	<i>EGR2</i>	Similar to CMT1A; severity varies according to mutation (from “mild” to “severe” CTM1)
CMT1X (302800)	<i>GJB1</i>	Similar to CMT1A, but distal atrophy more pronounced; men are more affected than are women
Autosomal dominant axonal neuropathies		
CMT2A (118210) CMT2A2 (609260)	<i>KIF1Bβ</i> <i>MFN2</i>	Onset of neuropathy by 10y; progresses to distal weakness and atrophy in legs; mild sensory disturbance
<b>CMT2B (600882)</b>	<i>RAB7</i>	Onset 2 <sup>nd</sup> –3 <sup>rd</sup> decade; severe sensory loss with distal ulcerations; also length-dependent weakness
CMT2C (606071)	<i>12q23-24</i>	Prominent vocal cord and diaphragmatic weakness
CMT2D (601472)	<i>GARS</i>	Arm more than leg weakness; onset of weakness 2 <sup>nd</sup> –3 <sup>rd</sup> decade; sensory axons involved
<b>CMT2E (162280)</b>	<i>NEFL</i>	Variable onset and severity; ranging from DSS-like to CMT2 phenotype; pain sensation may be diminished
<b>CMT2-P<sub>0</sub> (118200)</b>	<i>MPZ</i>	Late onset (30y or older); but progressive neuropathy; pain; hearing loss; abnormally reactive pupils
Severe demyelinating neuropathies (autosomal dominant or recessive; “CMT3 or HMSN III”)		
DSS (Dejerine-Sottas Syndrome) (145900)	Dominant ( <i>PMP22</i> ; <i>MPZ</i> ; <i>GJB1</i> ; <i>EGR2</i> ; <i>NEFL</i> ) and recessive ( <i>MTMR2</i> ; <i>PRX</i> ) mutations	Delayed motor development before 3y; severe weakness and atrophy; severe sensory loss particularly of modalities subserved by large myelinated axons; motor NCVs less than 10 m/s; dysmyelination on nerve biopsies
CHN (Congenital Hypomyelinating Neuropathy; 605253)	Dominant ( <i>EGR2</i> ; <i>PMP22</i> ; <i>MPZ</i> ) & recessive ( <i>EGR2</i> ) mutations	Clinical picture often similar to that of Dejerine-Sottas syndrome; but hypotonic at birth
Autosomal recessive demyelinating neuropathies (“CMT4”)		
CMT4A (214400)	<i>GDAP1</i>	Early childhood onset; progressing to wheelchair-dependency; mixed demyelinating and axonal features
CMT4B1 (601382)	<i>MTMR2</i>	Early childhood onset; may progress to wheelchair-dependency; focally-folded myelin sheaths
CMT4B2 (604563)	<i>MTMR13</i>	Childhood onset; progression to assistive devices for walking; focally-folded myelin sheaths; glaucoma
CMT4C (601596)	<i>KIAA1985</i>	Infantile to childhood onset; progressing to wheelchair-dependency; severe to moderate NCV slowing
CMT4D (601455)	<i>NDRG1</i>	Childhood onset; progression to severe disability by 50y; hearing loss and dysmorphic features
CMT4F (605260)	<i>PRX</i>	Childhood onset; usually progression to severe disability; prominent sensory loss
CMT4 (605253)	<i>EGR2</i>	Infantile onset; progressing to wheelchair-dependency



Hereditary Neuropathies, Table 1 (continued)

Disease (MIM)	Mutated gene/linkage	Clinical features
Autosomal recessive axonal neuropathies ("AR-CMT2" or "CMT 2B")		
AR-CMT2A(605588)	<i>LMNA</i> mutations	Onset of neuropathy in 2 <sup>nd</sup> decade; progresses to severe weakness and atrophy in distal muscles
Hereditary Motor Neuropathies (HMN or "distal SMA")		
SMARD1 (604320)	Recessive <i>IGHMBP2</i> mutations	Distal infantile spinal muscular atrophy with diaphragm paralysis
HMN 5 (600794)	Dominant <i>GARS</i> mutations	Arm more than leg weakness; onset of weakness 2 <sup>nd</sup> –3 <sup>rd</sup> decade; no sensory involvement
Hereditary Sensory (and Autonomic) Neuropathies/Neuronopathies (HSN or HSAN)		
<b>HSN-1 (162400)</b>	Dominant <i>SPTLC1</i> mutations	Onset 2 <sup>nd</sup> –3 <sup>rd</sup> decade (often with phase of lacerating pain); severe sensory loss (including nociception) with distal ulcerations; also length-dependent weakness
<b>HSN-2 (201300)</b>	Recessive <i>HSN2</i> mutations	Childhood onset of progressive numbness in hands and feet, exacerbated by cold; reduced pain sensation; no overt autonomic dysfunction
<b>HSN-3 (Riley-Day syndrome; 223900)</b>	Recessive <i>IKBKAP</i> mutations	Congenital onset; dysautonomic crises; decreased pain sensation; absent fungiform papilla; overflow tears
<b>HSN-4 (CIPA; 256800)</b>	Recessive <i>NTRKA</i>	Dysautonomia and loss of pain sensation caused by congenital absence of sensory and sympathetic neurons
<b>HSN-5 (608654)</b>	Recessive <i>NGFB</i> mutations	Childhood onset; unheeded pain leads to development of Charcot joints; decreased sensation to multiple modalities
<b>HSN with cough and gastroesophageal reflux (608088)</b>	3p22-p24	Adult onset cough and sensory neuropathy; with sensory loss; painless injuries; and/or lacerating pains

H

A mutation in the gene encoding kinesin KIF1B $\beta$  causes CMT2A1 a dominantly inherited axonal neuropathy. Mutations in the genes encoding gigaxonin and the p150 subunit of dynactin also disrupt axonal transport and cause neuropathy/neuronopathy. Defective axonal transport has been implicated in a host of other inherited neurological diseases, including the inherited spastic paraplegias, which appear to be length-dependent CNS axonopathies.

### CMT and Pain

The best examples of a dominantly inherited neuropathy that is associated with pain are *MPZ* mutations, which cause a CMT2-like phenotype (CMT2-P<sub>0</sub>), particularly the Thr124Met mutation. Several families have been found to have an adult-onset neuropathy with painful lacerations and hearing loss. Nerve biopsies from clinically affected patients show axonal loss, clusters of regenerated axons, and some thinly myelinated axons. In spite of a late onset, many patients progress relatively rapidly to the point of using a wheelchair. Neuropathic pain is not a prominent symptom in most patients with *MPZ* mutations (CMT1B).

Neuropathic pain can be a prominent feature in some CMT2 (e.g. CMT2-P<sub>0</sub>) patients (Gemignani et al. 2004), but the genetic cause(s) of these cases is not yet known. CMT2B patients have the opposite problem –

they do not feel pain, and insensitivity to pain commonly leads to distal ulcerations in the feet, even toe amputations. CMT2B is caused by dominant mutations in *RAB7*, which encodes a member of the Rab family of Ras-related GTPases that are essential for proper intracellular membrane trafficking. *RAB7* is widely expressed, including in motor and sensory neurons. A similar, ulceromutilating neuropathy has been reported in an Austrian family, which did not link to the CMT2B locus, indicating further genetic heterogeneity in this phenotype.

### Hereditary Sensory (and Autonomic) Neuropathies (HSN or HSAN)

They were initially classified together for their shared characteristics - the loss of sensory (especially of small fibers) and ► **autonomic** fibers, resulting in severe sensory loss to the point that the hands and feet became mutilated from unheeded trauma. They proved to be genetically heterogeneous (Tab. 1). HSN-1 is an autosomal dominant trait and manifests in adolescence with small fiber sensory loss, burning pain (distal>proximal and legs>arms), pedal deformity, acromutilation, and distal weakness. It is caused by mutations in the gene encoding serine palmitoyl transferase, long-chain base subunit 1 (*SPTLC1*). The mutations that cause HSN-1 reside in a conserved region, and the corresponding mu-

tations in the yeast enzyme act as dominants because the enzyme is part of a heterodimer.

HSN-2, HSN-3 and HSN-4 are autosomal recessive. HSN-2 begins in early childhood with similar phenotype to HSN-1. HSN-3, also known as the Riley-Day syndrome or familial dysautonomia with congenital indifference to pain, is usually caused by a mutation that leads to missplicing of *IKBKAP* (inhibitor of  $\kappa$  light polypeptide gene enhancer in B cells, kinase complex-associated protein) (Axelrod 2004). Some characteristics manifest at birth, indicating that certain populations of autonomic and sensory neurons/axons either fail to develop or are already affected, but axonal/neuronal loss progresses even after birth. Although initial deficits such as dysautonomic crises appear to stem from the loss of small fibers, large myelinated fibers are progressively affected. Loss of sensation renders patients prone to self-injury. At least two syndromic neuropathies, cold-induced sweating and Stüve-Wiedemann/Schwartz-Jampel type 2 syndrome have features in common with HSN-3 (Tab. 2). HSN-4 is a syndromic disease, characterized by congenital insensitivity to pain with anhidrosis (hence the alternative name, CIPA syndrome), with the associated features of small fiber sensory loss, autonomic failure, mental retardation, and acromutilation. CIPA syndrome is caused by mutations in *NTRKA*, which encodes a receptor tyrosine kinase for nerve growth factor (Indo 2001).

#### Syndromic Inherited Neuropathies and Pain

Demyelinating neuropathies are part of several recessive neurological syndromes, but are typically overshadowed by other manifestations (Tab. 2). Neuropathic pain is uncommon except in metachromatic leukodystrophy. An axonal neuropathy is a part of many syndromes, and most appear to be neuron-autonomous. Discussed below are some of the inherited syndromic axonal neuropathies that have pronounced effects on pain.

Familial amyloid polyneuropathy (FAP) 1 and 2 is caused by dominant mutations in the transthyretin (*TTR*) gene – almost all are caused by a single nucleotide change that results in an amino acid substitution (Benson 2000). In the United States, the majority of mutations are found in families of European ancestry, and, in many cases, the mutations have been traced to the country of origin. Adults develop dysesthesias in the lower extremities, with or without small fiber findings such as decreased temperature sensation, and/or autonomic dysfunction-constipation and diarrhea or impotence. The progressive loss of large myelinated (sensory and motor) fibers leads to progressive sensory loss and motor impairment. Amyloidosis results from the transformation of a protein into  $\beta$ -structured fibrils that are deposited in various organs, causing dysfunction by their presence and magnitude. FAP 3, caused by mutations in *Apolipoprotein A1*, also causes neuropathy and neuropathic pain.

Recurrent episodes of painful brachial plexus lesions are the hallmark of hereditary neuralgic amyotrophy – a dominantly inherited disorder (Windebank 1993). Individual episodes are similar to those in idiopathic neuralgic amyotrophy; both kinds are heralded by severe pain, followed by weakness within days, and recovery over weeks to months. Episodes may be triggered by immunization and childbirth, and perivascular inflammation and Wallerian degeneration are characteristic lesions (Klein et al. 2002). Subtle dismorphic features in affected patients with the inherited form indicate that this is a syndromic disorder. Neuralgic amyotrophy is caused by mutation in *SEPT9*, but another locus is possible.

Porphyrias are caused by mutations in the genes involved in heme biosynthesis. Dominant mutations in porphobilinogen deaminase, coproporphyrinogen 3 oxidase, protoporphyrinogen oxidase, ferrochelatase may produce different syndromes (photosensitivity, psychosis, and/or liver disease), but all can cause acute attacks of abdominal pain followed by neuropathy (Windebank and Bonkovsky 1993). High levels of porphyrins are found during attacks, and may be toxic to motor axons/neurons, but why those innervating certain muscle groups are mainly affected remains to be determined. The somatic neuropathy itself is usually not painful, but it is conceivable that the abdominal pain is related to damaged visceral afferent axons. Hereditary tyrosinemia type 1 causes crises that resemble the porphyrias, including elevated urinary  $\delta$ -aminolevulinic acid, except for limb pain that may be neuropathic.

Fabry disease is caused by deficiency of an X-linked lysosomal hydrolase,  $\alpha$ -galactosidase, leading to accumulation of glycosphingolipids in many cell types, including sensory neurons. The loss of sensory axons and sensory neurons is presumed to cause neuropathic pain, which is the most common and the earliest symptom (MacDermot et al. 2001). Patients had a mean pain score of five (1–10 scale) in spite of pharmacological therapy. In addition to constant pain, patients can have severe attacks of pain, often triggered by heat, fever, alcohol, or exercise.

#### Concluding Thoughts

Inherited neuropathies are common, and their genetic causes are rapidly being determined. A lack of pain in certain inherited neuropathies can be related to the loss of the relevant sensory axons/neurons, particularly for HSN-1, HSN-3, and HSN-4/CIPA syndrome. Discovering the molecular causes of even rarer kinds of inherited insensitivity to pain should lead to a better understanding of the neurobiology of pain. Why pain is a characteristic of some neuropathies and not others is far less clear. It seems that neuropathies that mainly affect small myelinated and unmyelinated (nociceptive and other kinds of sensory) axons are more likely to cause pain than those that chiefly affect large myelinated (mo-

**Hereditary Neuropathies, Table 2** Selected syndromic inherited neuropathies For references; see the following websites: <http://www.ncbi.nlm.nih.gov/Omim/>; <http://molgen-www.uia.ac.be/CMTMutations/DataSource/MutByGene.cfm>; and <http://www.neuro.wustl.edu/neuromuscular/>. Bolded diseases have pronounced effects on pain. For abbreviations; see text

Disease (MIM)	Mutated gene/linkage	Clinical features
Dominantly inherited; syndromic demyelinating neuropathies		
Wardeenburg type IV (602229)	<i>SOX10</i>	CNS and PNS demyelination; Hirschsprung disease
Recessively inherited; syndromic demyelinating neuropathies		
<b>Metachromatic leuko-dystrophy (250100)</b>	<i>Arylsulfatase A</i>	Demyelinating neuropathy; optic atrophy; mental retardation; hypotonia; phase of neuropathic pain
Globoid cell leuko-dystrophy (245200)	<i>Galactosylceramide β-galactosidase</i>	Demyelinating neuropathy; spasticity; optic atrophy; mental retardation
Dominantly inherited; syndromic axonal neuropathies		
<b>Hereditary Neuralgic Amyotrophy (162100)</b>	<i>SEPT9</i>	Episodes of painful neuropathies of the brachial plexus; hypotelorism; small palpebral fissures; small mouth
<b>FAP 1 and 2 (176300)</b>	<i>TTR</i> (Transthyretin)	Painful axonal neuropathy with prominent involvement of small axons; other organs involved; FAP 2 also has carpal tunnel syndrome
<b>FAP 3/"Iowa" type (107680)</b>	<i>Apolipoprotein A-1</i>	Painful axonal neuropathy; renal and hepatic disease
FAP 4/"Finnish" type (105120)	<i>Gelsolin</i> (137350)	Corneal lattice dystrophy; cranial neuropathies; peripheral neuropathy not typically painful
Acute intermittent porphyria (176000)	<i>Porphobilinogen deaminase</i>	Acute neuropathy follows crises of abdominal pain; psychosis; depression; dementia; seizures
Coproporphyrinemia (121300)	<i>Coproporphyrinogen 3 oxidase</i>	Skin photosensitivity; psychosis; crises of acute neuropathy (and abdominal pain) are rare
Variegate porphyria(176200)	<i>Protoporphyrinogen oxidase</i>	South Africa: founder effect; symptoms similar to those in acute intermittent porphyria
Erythropoietic proto-porphyrinemia (17000)	<i>Ferrochelatase</i>	Dermatitis; photosensitivity; liver disease; acute neuropathy rare
<b>Fabry disease (301500)</b>	<i>α-galactosidase</i>	X-linked; painful neuropathy even painful crises; cardiomyopathy; renal failure; angiokeratoma
Recessively inherited; syndromic axonal neuropathies		
Giant axonal neuropathy (256850)	<i>Gigaxonin</i>	Mental retardation; spasticity; kinky/curly hair
Hereditary tyrosinemia type 1 (276700)	<i>Fumarylacetoacetase</i>	Hepatic and renal disease; cardiomyopathy; crises of acute neuropathy and abdominal pain similar to those in porphyrias (but in infancy/childhood)
<b>Tangier Disease (205400)</b>	<i>ABCA1</i> (60046)	Atherosclerosis and/or peripheral neuropathy; syringomyelia-like loss of pain sensation can result in painless ulcerations and acromutilation
<b>Congenital sensory and autonomic neuropathy and neurotrophic keratitis (256810)</b>	unknown	Affects Navajo infants/children; encephalopathy; myelopathy; neuropathy resulting in painless ulcerations and acromutilation; fatal liver disease
<b>Cold-induced sweating (272430)</b>	<i>CRLF1</i>	Poor sucking in infancy; cold-induced sweating; diminished pain caused by cold/hot/mechanical stimuli
<b>Stüve-Wiedemann/ Schwartz-Jampel type 2 syndrome</b>	<i>LIFR</i>	Osteodysplasia with similar findings to HSN-3/familial dysautonomia: lack of corneal reflex, lack of fungiform papillae, tongue ulceration; also cold-induced sweating

H

tor and non-nociceptive sensory) axons. This reasoning does not account for why it is that neuropathic pain is more common in CMT2 than in CMT1 (Gemignani et al. 2004), and so prominent CMT2-P<sub>0</sub> (see above). Further, it remains to be explained why pain was much

more commonly reported in a patient survey (Carter et al. 1998) than described in typical reports. Part of this discrepancy may owe to the failure to discriminate between neuropathic pain from other causes (Carter et al. 1998) as discussed by Gemignani et al. (2004).

## References

1. Axelrod FB (2004) Familial Dysautonomia. *Muscle Nerve* 29:352–363
2. Benson MD (2000) Amyloidosis. In: Scriver CR, Beaudet AL, Sly WS, Valle D, Childs B, Kinzler KW, Vogelstein B (eds) *The Metabolic and Molecular Bases of Inherited Disease*, vol IV. McGraw Hill, New York, pp 5345–5378
3. Carter GT, Jensen MP, Galer BS, Kraft GH, Crabtree LD, Beardsley RM, Abresch RT, Bird TD (1998) Neuropathic Pain in Charcot-Marie-Tooth Disease. *Arch Phys Med Rehabil* 79:1560–1564
4. Dyck PJ, Chance P, Lebo R, Carney JA (1993) Hereditary Motor and Sensory Neuropathies. In: Dyck PJ, Thomas PK, Griffin JW, Low PA, Poduslo JF (eds) *Peripheral Neuropathy*. WB Saunders, Philadelphia, pp 1094–1136
5. Gemignani F, Melli G, Alfieri S, Inglese C, Marbini A (2004) Sensory Manifestations in Charcot-Marie-Tooth Disease. *J Periph Nerv Syst* 9:7–14
6. Indo Y (2001) Molecular Basis of Congenital Insensitivity to Pain with Anhidrosis (CIPA): Mutations and Polymorphisms in TRKA (NTRK1) Gene Encoding the Receptor Tyrosine Kinase for Nerve Growth Factor. *Hum Mutat* 18:462–471
7. Klein CJ, Dyck PJB, Friedenber SM, Burns TM, Windebank AJ, Dyck PJ (2002) Inflammation and Neuropathic Attacks in Hereditary Brachial Plexus Neuropathy. *J Neurol Neurosurg Psychiatr* 73:45–50
8. Kleopa KA, Scherer SS (2002) Inherited Neuropathies. *Neuro Clin N Am* 20:679–709
9. Lupski JR, Garcia CA (2001) Charcot-Marie-Tooth Peripheral Neuropathies and Related Disorders. In: Scriver CR, Beaudet AL, Sly WS, Valle D, Childs B, Kinzler KW (eds) *The Metabolic Molecular Basis of Inherited Disease*. McGraw-Hill, New York, pp 5759–5788
10. MacDermot KD, Holmes a, Miners AH (2001) Anderson-Fabry Disease: Clinical Manifestations and Impact of Disease in a Cohort of 98 Hemizygous Males. *J Med Genet* 38:750–560
11. Scherer SS, Arroyo EJ, Peles E (2004) Functional Organization of the Nodes of Ranvier. In: Lazzarini RL (ed) *Myelin Biology and Disorders*, vol 1. Elsevier, pp 89–116
12. Suter U, Scherer SS (2003) Disease Mechanisms in Inherited Neuropathies. *Nat Neurosci Rev* 4:714–726
13. Windebank T (1993) Inherited Recurrent Focal Neuropathies. In: Dyck PJ, Thomas PK, Griffin JW, Low PA, Poduslo JF (eds) *Peripheral Neuropathy*. W.B. Saunders, Philadelphia, pp 1137–1148
14. Windebank T, Bonkovsky HL (1993) Porphyric Neuropathy. In: Dyck PJ, Thomas PK, Griffin JW, Low PA, Poduslo JF (eds) *Peripheral Neuropathy*. WB Saunders, Philadelphia, pp 1161–1168
15. Wrabetz L, Feltri ML, Kleopa KA, Scherer SS (2004) Inherited Neuropathies - Clinical, Genetic, and Biological Features. In: Lazzarini RL (ed) *Myelin Biology and Disorders*, vol 2. Elsevier, pp 905–951

## Hereditary Neuropathy with Liability to Pressure Palsies

- Hereditary Neuropathies

## Hereditary Sensory and Autonomic Neuropathy Type IV, HSAN IV, HSAN 4

- Congenital Insensitivity to Pain with Anhidrosis

## Hereditary Sensory Neuropathy

### Definition

Hereditary Sensory Neuropathy is an inherited neuropathy that mainly affects sensory axons and/or sensory neurons.

- Hereditary Neuropathies

## Heritability of Inflammatory Nociception

JEFFREY S. MOGIL

Department of Psychology and Centre for Research on Pain, McGill University, Montreal, QC, Canada  
jeffrey.mogil@mcgill.ca

### Synonyms

Inflammatory Nociception, Heritability; Inflammatory Nociception, Genotypic Influences; Inflammatory Nociception, Genetic Factors

### Definition

Humans and laboratory animals display widely variable responses to inflammatory stimuli. Even when the amount of inflammation is held constant, robust individual differences in the pain accompanying that inflammation are observed. Some proportion of this variability can be attributed to inherited genetic factors, and progress is being made in identifying the relevant genes using ► [inbred strains](#) of mice. Genes contributing to variability in inflammatory nociception are probably distinct from genes contributing to variability in the development of inflammation itself.

### Characteristics

Susceptibility to developing inflammatory pathologies like rheumatoid arthritis is considerably ► [heritable](#), with one recent meta-analysis of ► [twin studies](#) suggesting that inherited genetic factors account for approximately 60% of the variation in disease liability (MacGregor et al. 2000). A number of animal models of autoimmune and/or inflammatory disorders have been developed, and scores of “modifier” genetic loci (i.e. non-major histocompatibility complex genes) influencing disease susceptibility or severity have been detected using ► [quantitative trait locus \(QTL\) mapping](#) (Griffiths et al. 1999). These loci show considerable overlap with the results of human genome-wide scans for ► [genetic linkage](#) in pedigrees of autoimmune/inflammatory disease sufferers (Becker et al. 1998). In a few cases, the precise genes and DNA variants responsible for the modified susceptibility or severity have been unambiguously identified, including ► [single nucleotide polymorphisms \(SNPs\)](#) in the human *SLC22A4* gene encoding an organic cation



transporter (Tokuhiro et al. 2003) and the rat *Ncf1* gene encoding a cytosolic factor in the NADPH oxidase complex (Olofsson et al. 2003).

However, the heritability of inflammatory *pain* remains poorly understood; none of the genes described above are necessarily relevant to variable pain responses given a particular degree of inflammation. A large number of ► **transgenic knockout mice** have been developed that display altered sensitivity to inflammatory nociception (see Mogil and Grisel 1998), thus providing evidence for the crucial roles of the targeted genes in the processing of inflammatory pain. Knockout mice represent a poor model to study inherited variability though, because their genetic “lesion” is far more dramatic than the subtle changes in function and expression that more generally characterize genetic variation in a population. The contrasting responses of different inbred strains of rats and mice have clearly demonstrated that assays of inflammatory nociception featuring standardized stimuli are robustly heritable. For example, recuperative licking behavior on the “tonic” or “late” phase of the ► **formalin test** – thought by many to reflect ongoing inflammatory nociception – ranges by up to 10-fold among 14 strains tested (Mogil et al. 1998) (Fig. 1). We have extensively characterized the extreme-responding strains, A/J and C57BL/6, and observed differences in formalin potency and efficacy and alterations in the timing of licking behavior in the tonic phase. However, these strains do not differ in edema produced by formalin injection, whether assessed *via* hind-paw thickness, *via* hind-paw weight, or histologically.

To provide evidence that the behavioral strain difference in licking time truly reflects a difference related to pain processing rather than non-specific factors (e.g., emotionality, locomotor activity, propensity to lick injured tissue), we conducted a study evaluating the ► **genetic correlation** between formalin-induced licking and ► **c-fos immediate-early gene expression** in the spinal cord dorsal horn. We found an extremely high correlation ( $r=0.94$ ) between tonic-phase licking and Fos-protein immunoreactivity in the deep (laminae V/VI) but not superficial (laminae I/II) dorsal horn among eight mouse strains (Bon et al. 2002). This high correlation suggests that the strain-dependent behavioral differences are reflected in the processing of the noxious stimulus in appropriate pain-relevant ascending pathways.

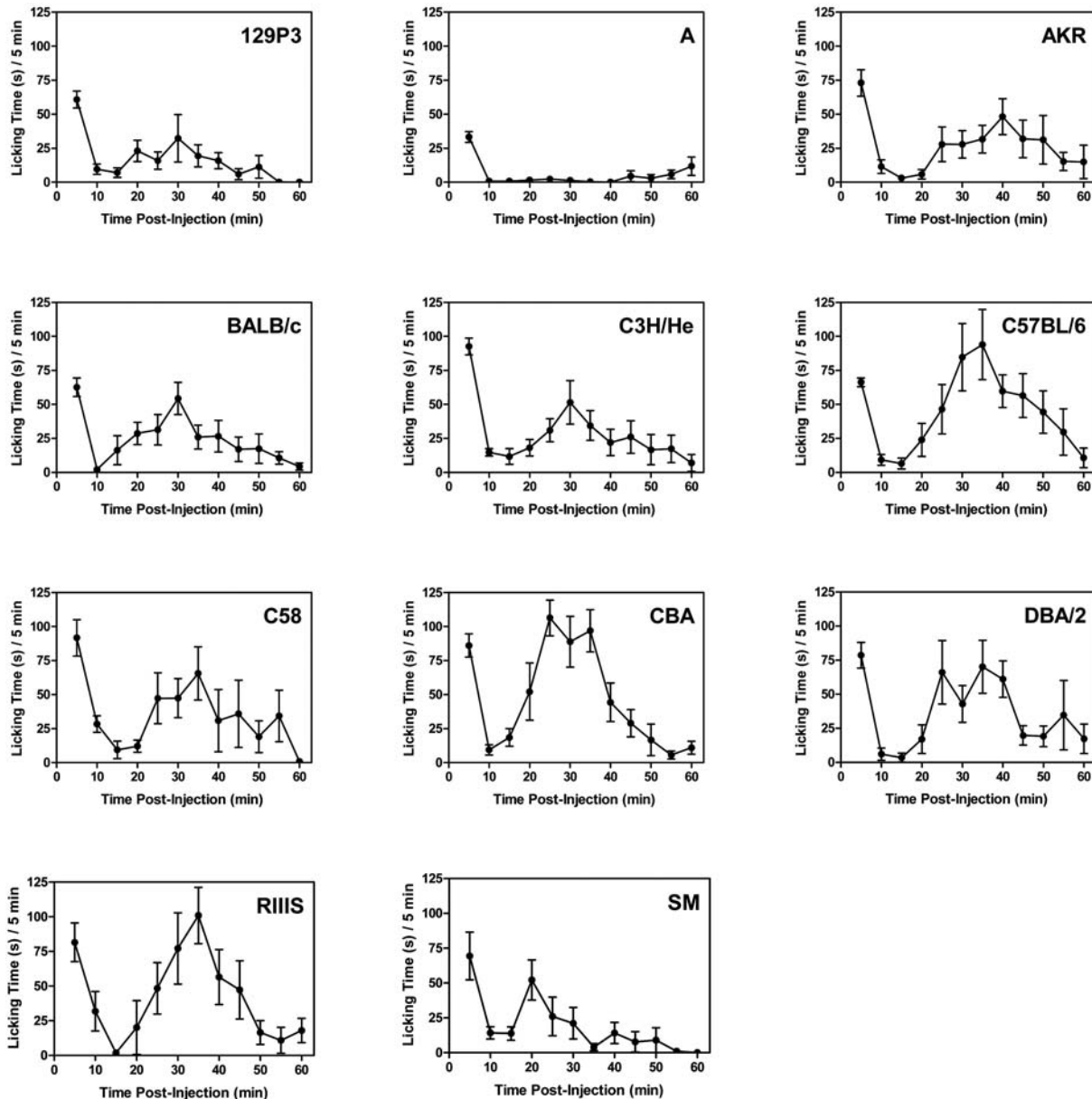
As a first step to identifying the genes responsible for the robust differences between A/J and C57BL/6J mice on the formalin test, we performed a QTL mapping study in an ► **F2 intercross** of these strains (Wilson et al. 2002). Two statistically significant QTLs were identified; one of these (called *Nociq2*), on distal mouse chromosome 10, was associated with the tonic phase and accounted for 15% of the overall trait variance. In this F<sub>2</sub> population, the ≈25% of mice inheriting two copies of the A/J ► **allele** at a gene very near the end of chromosome 10 displayed 200 seconds *less* licking in the tonic phase

than mice with one or two C57BL/6J alleles. We have now provided confirmatory evidence for the existence of this formalin test-relevant gene using more advanced mapping populations (e.g. recombinant inbred strains, recombinant congenic strains) (Darvasi 1998), and have pinpointed its exact location to less than 3 cM (i.e. <3 million nucleotides; unpublished data), a genomic region containing only 14 known genes.

When genes associated with variable inflammatory pain sensitivity are identified, what will their relevance be to other pain states? Using genetic correlation analysis applied to over 22 different nociceptive assays in 12 mouse strains, we have determined that at least five fundamental ‘types’ of nociception exist. The defining feature of these pain types is noxious stimulus modality; that is, sensitivity to thermal stimuli is inherited similarly, but sensitivity to noxious chemical stimuli depends on a different set of genes (Lariviere et al. 2002). Generally speaking, the same mouse strains that are sensitive on the formalin test are also sensitive to injection of acetic acid, capsaicin or bee venom; such strains might not, however, be sensitive in the hot-plate test. It is interesting that the presence or absence of inflammation does *not* appear to be the defining feature, but rather the use of a noxious chemical substance producing spontaneously emitted pain behaviors. Some inflammatory mediators produce very little behavioral evidence of spontaneous pain (e.g. carrageenan), instead yielding long-lasting thermal and mechanical hypersensitivity. In these cases, what appears to be inherited in mice is not sensitivity to the mediator itself, but rather sensitivity to the evoking stimulus. That is, mouse strains sensitive to the development of thermal hypersensitivity after carrageenan injection are not the same strains that are sensitive to the development of mechanical hypersensitivity (Lariviere et al. 2002), implying the existence of modality-selective genes. Another finding from this analysis is that the same set of genes appear to be relevant to hypersensitivity states, whether they were induced by inflammation or nerve damage, possibly suggesting an important inflammatory component in the development of neuropathic pain.

The predictions described above will require the identification of many more pain variability-related genes for their evaluation. It is interesting, however, that none of the existing murine QTLs for thermal nociception (see Mogil 2004) are located on distal chromosome 10. Furthermore, an unpublished study (H.S. Hain and J.K. Belknap, personal communication) using the chemical/inflammatory acetic acid writhing test has also detected a statistically significant QTL on distal chromosome 10.

Once genes associated with variable sensitivity to inflammatory nociception are identified, the demonstration of the relevance of those genes and their common variants to humans might be important in a number



**Heritability of Inflammatory Nociception, Figure 1** Strain-dependent responses to formalin injection in 11 inbred mouse strains. Naïve adult male mice were habituated to Plexiglas observation cylinders for at least 30 min. Then, 25  $\mu$ l of 5% formalin was injected subcutaneously into the plantar surface of the right hind paw using a 50  $\mu$ l microsyringe with a 30-gauge needle. Mice were then returned to the cylinders, and behavioral observations were begun immediately. The total time spent licking/biting the right hind paw over the next 60 min was measured with a stopwatch. Symbols represent mean  $\pm$  S.E.M. time spent licking the affected hind paw in each 5-min period. These data were published in Mogil et al. (1998) in a different form.

of ways. For example, it is well appreciated that the amount of pain experienced by sufferers of osteoarthritis can not be easily predicted by the extent of their joint degeneration (e.g. Link et al. 2003). **► Genotyping** of arthritis sufferers and others at relevant genes might allow better prediction and management of inflammatory pain. Finally, it should be noted that responses to analgesics used in the management of inflammatory pain are also highly variable (e.g. Walker et al. 1994) and that the **► pharmacogenetics** of analgesia is also being studied (Wilson et al. 2003).

## References

1. Becker KG, Simon RM, Bailey-Wilson JE et al. (1998) Clustering of non-major histocompatibility complex susceptibility candidate loci in human autoimmune diseases. *Proc Natl Acad Sci USA* 95:9979–9984
2. Bon K, Wilson SG, Mogil JS et al. (2002) Genetic evidence for the correlation of deep dorsal horn Fos protein immunoreactivity with tonic formalin pain behavior. *J Pain* 3:181–189
3. Darvasi A (1998) Experimental strategies for the genetic dissection of complex traits in animal models. *Nature Genet* 18:19–24
4. Griffiths MM, Encinas JA, Remmers EF et al. (1999) Mapping autoimmunity genes. *Curr Opin Immunol* 11:689–700

5. Lariviere WR, Wilson SG, Laughlin TM et al. (2002) Heritability of nociception. III. Genetic relationships among commonly used assays of nociception and hypersensitivity. *Pain* 97:75–86
6. Link TM, Steinbach LS, Ghosh S et al. (2003) MR imaging findings in different stages of disease and correlation with clinical findings. *Radiology* 226:373–381
7. MacGregor AJ, Snieder H, Rigby AS et al. (2000) Characterizing the quantitative genetic contribution to rheumatoid arthritis using data from twins. *Arthritis Rheum* 43:30–37
8. Mogil JS (2004) Complex trait genetics of pain in the laboratory mouse. In: Mogil JS (ed) *The Genetics of Pain, Progress in Pain Research and Management*, vol 28. IASP Press, Seattle, pp 123–149
9. Mogil JS, Grisel JE (1998) Transgenic studies of pain. *Pain* 77:107–128
10. Mogil JS, Lichtensteiger CA, Wilson SG (1998) The effect of genotype on sensitivity to inflammatory nociception: characterization of resistant (A/J) and sensitive (C57BL/6) inbred mouse strains. *Pain* 76:115–125
11. Olofsson P, Holmberg J, Tordsson J et al. (2003) Positional identification of *Ncf1* as a gene that regulates arthritis severity in rats. *Nature Genet* 33:25–32
12. Tokuhira S, Yamada R, Chang X et al. (2003) An intronic SNP in a RUNX1 binding site of *SLC22A4*, encoding an organic cation transporter, is associated with rheumatoid arthritis. *Nature Genet* 35:341–348
13. Walker JS, Nguyen TV, Day RO (1994) Clinical response to non-steroidal anti-inflammatory drugs in urate-crystal induced inflammation: a simultaneous study of intersubject and intrasubject variability. *Br J Clin Pharmacol* 38:341–347
14. Wilson SG, Chesler EJ, Hain HS et al. (2002) Identification of quantitative trait loci for chemical/inflammatory nociception in mice. *Pain* 96:385–391
15. Wilson SG, Bryant CD, Lariviere WR et al. (2003) The heritability of antinociception II: pharmacogenetic mediation of three over-the-counter analgesics in mice. *J Pharmacol Exp Ther* 305:755–764

## Heritable

### Definition

A heritable trait is one which is passed on through generations (i.e., „runs in families“), such that offspring tend to resemble their parents. The strong implication is that inherited genetic factors are responsible, although non-genomic transmission has been demonstrated. Heritability is best established in humans using *twin studies*, in which the similarity of pairs of monozygotic and dizygotic twins is compared. In animals, heritability is best established by successful selective breeding for the trait.

- ▶ [Heritability of Inflammatory Nociception](#)
- ▶ [Opioid Analgesia, Strain Differences](#)
- ▶ [Twin Studies](#)

## Herpes Simplex Virus Vectors

### Definition

Herpes simplex virus (HSV) is a human pathogen that causes the common cold sore and infections of the conjunctiva, and is a double-stranded DNA virus with a capsid and surrounding tegument and envelope. The

152 kB genome can potentially accommodate up to approximately 44 kB of foreign DNA. The propagation of replication-incompetent HSV vectors in cultured cells is accomplished using cell lines that complement essential gene products that have been removed from the vector genome. HSV vector genomes do not integrate, but remain as episomes in the nucleus of transduced cells. HSV vectors, like the parental virus, efficiently target to sensory neurons from the skin and can establish a life-long latent state in those neurons.

- ▶ [Opioids and Gene Therapy](#)

## Herpes Virus

### Definition

Herpes virus can infect nerve roots, including nerve roots of the sciatic nerve. In the case of shingles (Herpes zoster), a rash is usually present along the course of the infected nerve root.

- ▶ [Sciatica](#)

## Herpes Zoster

### Definition

Herpes zoster is an infection of the nervous system caused by the varicella zoster virus (VZV), the same virus that causes chickenpox. VZV can remain dormant in the sensory ganglia for decades after an infection. Herpes zoster results when the dormant virus in these nerves is reactivated, often as a result of decline in cellular immunity to VZV with aging or immunosuppression.

- ▶ [Cancer Pain, Assessment in the Cognitively Impaired](#)
- ▶ [Postherpetic Neuralgia](#)
- ▶ [Postherpetic Neuralgia, Pharmacological and Non-Pharmacological Treatment Options](#)

## Herpes Zoster Pain

- ▶ [Postherpetic Neuralgia, Etiology, Pathogenesis and Management](#)

## Heteromeric Channels

### Definition

Heteromeric channels are protein complexes that form pores in the cell membrane. Typically, channels are made up of several subunits, which may be identical, result-

ing in homomeric channels, or different, resulting in heteromeric channels.

- ▶ [Purine Receptor Targets in the Treatment of Neuro-pathic Pain](#)

## Heterotopic Ossification

### Definition

Heterotopic Ossification is the appearance of bony tissue elements in what are normally soft tissue structures.

- ▶ [Spinal Cord Injury Pain](#)

## Heterozygosity

### Definition

Heterozygosity is a state in which the maternal and paternal allele of a gene are not the same. In this common situation, the expression of that gene will depend on dominance of the alleles. In inbred strains, all heterozygosity is lost, and every gene is fixed in a homozygous state.

- ▶ [Alleles](#)
- ▶ [Inbred Strains](#)
- ▶ [Opioid Analgesia, Strain Differences](#)

## Heterozygous Carriers

### Definition

Heterozygous carriers refer to the state of possessing two different alleles of a particular gene, one inherited from each parent.

- ▶ [NSAIDs, Pharmacogenetics](#)

## Hidden Triggers

### Definition

Hidden Triggers are internal precipitating mechanisms.

- ▶ [Sunct Syndrome](#)

## High Dependency or Intensive Care Units

### Definition

High dependency or intensive care units are specialized wards where one or two highly trained nurses take care of each patient

- ▶ [Postoperative Pain, Acute Pain Team](#)

## High Thoracic Epidural Anesthesia

### Definition

High thoracic epidural anesthesia leads to a reversible cardiac sympathectomy blocking the segments T<sup>1</sup>-T<sup>5</sup>. The epidural catheters are inserted at levels C7 -T1 or at level T<sup>1</sup>-T2 by the median approach and with hanging drop technique.

- ▶ [Postoperative Pain, Thoracic and Cardiac Surgery](#)

## High Threshold Mechanoreceptor

- ▶ [Mechanoreceptors](#)
- ▶ [Nociceptors in the Orofacial Region \(Skin/Mucosa\)](#)

## High-Threshold Mechanosensitive Muscle Receptors

### Definition

In experiments employing recordings from single muscle receptors with unmyelinated or thin myelinated afferent fibers, many units exhibit a high mechanical threshold when tested with local pressure stimuli (e.g. using a forceps with broadened tips on the exposed muscle). These receptors do not respond to passively stretching the muscle or aerobic active contractions, but require pressure stimulation of tissue-threatening and subjectively painful intensity for activation. The receptors are also typically responsive to stimulation with algescic substances. The general interpretation is that these receptors are nociceptors and induce muscle pain when activated.

- ▶ [Muscle Pain Model, Ischemia-Induced and Hypertonic Saline-Induced](#)

## High Threshold Neurons

### Synonym

HT neurons

### Definition

HT neurons respond fairly selectively to noxious mechanical stimuli. They may have a minimal response to innocuous mechanical stimuli, but they are essentially tuned for strong stimuli. They may also respond to noxious thermal and chemical stimuli. Sometimes HT cells are referred to as nociceptive-specific neurons.

- ▶ [Functional Changes in Sensory Neurons Following Spinal Cord Injury in Central Pain](#)
- ▶ [Nick Model of Cutaneous Pain and Hyperalgesia](#)
- ▶ [Spinothalamic Input, Cells of Origin \(Monkey\)](#)
- ▶ [Thalamus, Nociceptive Cells in VPI, Cat and Rat](#)



## High-Threshold VDCCs

- ▶ Calcium Channels in the Spinal Processing of Nociceptive Input

## High Velocity Thrust Manipulation

- ▶ Spinal Manipulation, Characteristics

## High-Voltage Calcium Channels

- ▶ Calcium Channels in the Spinal Processing of Nociceptive Input

## Hindlimb Flexor Reflex

- ▶ Opioids and Reflexes

## Hippocampal Formation or Hippocampal Region

### Definition

The hippocampus (dentate gyrus and pyramidal cell fields CA1-3) and the subiculum are together referred to as the hippocampal formation, s. Hippocampus for details. Perhaps the most extensively studied structure in the brain, the hippocampal region has most often been implicated in memory processing.

- ▶ Hippocampus
- ▶ Hippocampus and Entorhinal Complex, Functional Imaging

## Hippocampus

### Definition

Brain structure comprising the dentate gyrus and the pyramidal cell fields of the hippocampus. There are three different pyramidal cell fields: CA1, CA2 and CA3. These subregions differ in their cellular organization and connectivity. The hippocampus is primarily organized as a unidirectional circuit. Information from the entorhinal cortex converges on the dentate gyrus, which in turn projects to field CA3, which sends projections to field CA1. The circuit is completed as CA1 projects to the subiculum, the major output region of the hippocampus. Strictly speaking, the subiculum does not form part of the hippocampus, but together the two structures make up the hippocampal formation.

- ▶ Hippocampus and Entorhinal Complex, Functional Imaging

## Hippocampus and Entorhinal Complex, Functional Imaging

SIRI LEKNES<sup>1, 2</sup>, IRENE TRACEY<sup>1, 2</sup>

<sup>1</sup>Pain Imaging Neuroscience (PaIN) Group, Department of Physiology, Anatomy and Genetics, Oxford University, Oxford, UK

<sup>2</sup>Centre for Functional Magnetic Resonance Imaging of the Brain, Oxford University, Oxford, UK  
irene.tracey@anat.ox.ac.uk

H

### Synonyms

Entorhinal Cortex and Hippocampus, Functional Imaging; Parahippocampal Region, Neuroimaging

### Definition

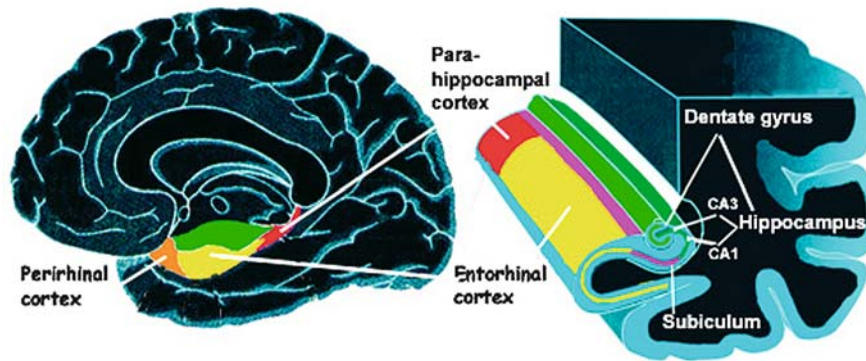
The ▶ **hippocampus** is comprised of the dentate gyrus and the CA1, CA2 and CA3 pyramidal cell fields. The ▶ **hippocampal formation** consists of the hippocampus and the subiculum. The adjacent entorhinal, perirhinal, and parahippocampal cortices comprise the ▶ **parahippocampal region** (Fig. 1). These limbic subregions differ in their cellular organization and connectivity, but are commonly implicated in memory and emotion processing.

The hippocampus lies at the end of a cortical processing hierarchy, and the entorhinal cortex is the major source of its cortical projections. Much of the cortical input to the entorhinal cortex originates in the adjacent perirhinal and parahippocampal cortices, which in turn receive widespread projections from sensory and association areas in the frontal, temporal and parietal lobes (Squire et al. 2004).

▶ **Functional imaging** is a general term used to describe methodologies that allow function to be located either spatially or temporally within the brain (and other organs). The methods are generally non-invasive and used for human studies; the term neuroimaging is often used when applied specifically to brain studies. Methods include functional magnetic resonance imaging (fMRI), positron emission tomography (PET), magneto-encephalography (MEG) and electroencephalography (EEG). Unless otherwise stated, the studies discussed in this article are fMRI or PET studies of the brain.

### Characteristics

Melzack and Casey (1968) proposed that the hippocampus and associated cortices participate in mediating the aversive drives and affective characteristics of pain perception. A wide range of animal studies support the notion that pain processing is a primary function of the hip-



**Hippocampus and Entorhinal Complex, Functional Imaging, Figure 1** (left) Medial view of the human brain outlining the perirhinal cortex (orange); parahippocampal cortex (red); and entorhinal cortex (yellow). (right) Section of the temporal lobe showing the components of the hippocampal/entorhinal complex in some detail: the dentate gyrus (pale green); the CA1 and CA3 hippocampal fields (green) that make up the hippocampus proper; the subiculum (pink); the perirhinal cortex (orange); parahippocampal cortex (red); and entorhinal cortex (yellow).

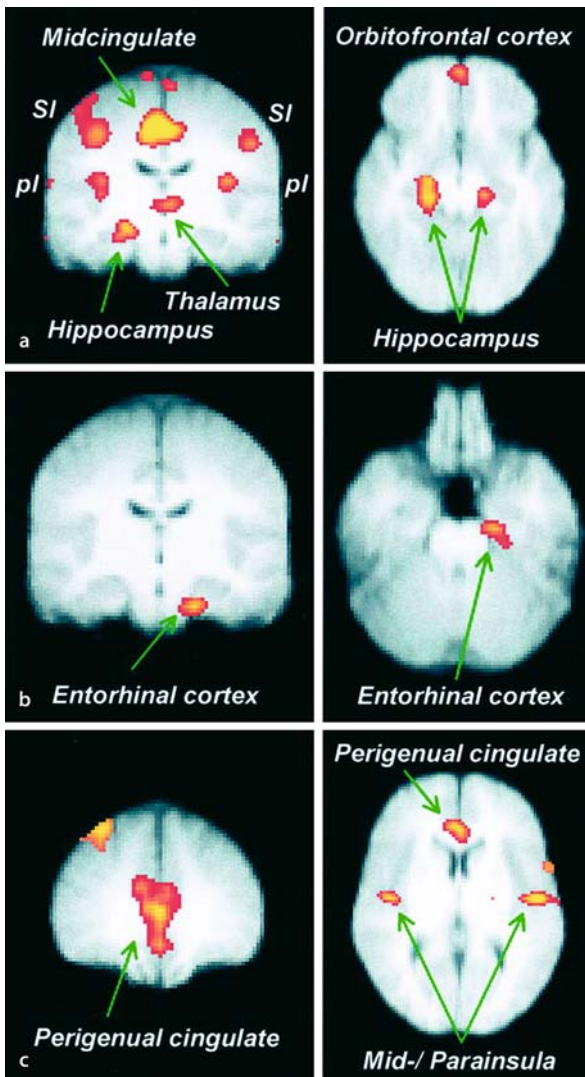
pocampal complex. Importantly, Dutar and colleagues (1985) demonstrated that septo-hippocampal neurons in rats respond directly to noxious peripheral stimulation. Similarly, functional imaging studies of pain perception have repeatedly reported a direct implication of areas within the hippocampus in the processing of nociceptive stimuli. Since nociceptive information is typically novel and of high priority, a direct role for the hippocampus in nociceptive processing is consistent with comparator theories of hippocampal function (e.g. McNaughton and Gray 2000). Comparator theory maintains that the hippocampus is involved in novelty detection and that its function is to compare actual and expected stimuli (i.e. stimuli registered in memory).

In an early PET study, Derbyshire and colleagues (1997) found hippocampal activation in response to mildly and moderately painful heat stimuli, when contrasted with warm, non-painful stimulation. Using very specific nociceptive stimuli (laser stimulation of A- $\delta$  fibers only) to subjects' left and right hands, Bingel and colleagues (2002) found bilateral activation of the amygdala and hippocampal complex. The receptive fields of hippocampal neurons are predominantly large and bilateral (Dutar et al. 1985). As other pain-related activation was lateralized, the authors suggested that the hippocampal activity reflected direct nociceptive projections to the hippocampus, perhaps revealing novelty detection (Bingel et al. 2002). Further, Ploghaus and colleagues (2001) found that pain modulation by drying stimulus temperature caused activation of a region of the hippocampus proper, consistent with a role of the hippocampus in pain intensity encoding (Fig. 2a).

Nevertheless, the large majority of human functional imaging studies of pain do not report activation of regions within the hippocampus / entorhinal complex. There are several possible explanations for this discrepancy. The first concerns the signal to noise ratio. As the complex is a relatively small structure, the spatial resolution of conventional whole-brain imaging paradigms

means that partial volume effects might occur and decrease signal to noise in this region. One caveat specific to functional imaging of this region is the implication of the hippocampus in the **resting state network** (Greicius and Menon 2004). PET and FMRI studies have suggested that the resting brain has a default mode of internal processing in which the hippocampus is a central component. In the neuroimaging of pain perception, nociceptive processing is commonly compared with baseline (rest) conditions. The hippocampus' involvement in resting state / baseline processing may mask out the activation of this region in such task-baseline comparisons if increased baseline activity reduces subsequent stimulation evoked responses and therefore could yield a false negative result. Another factor that may mask out activation of regions within the medial temporal lobe is the registration of individual brains onto a standard template for group comparison. Traditional techniques that optimize whole-brain alignment (e.g. aligning to the atlas of Talairach & Tournoux) do not adequately account for variations in location and shape of medial temporal lobe structures (see Squire et al. 2004 for review).

Regions within the hippocampus / parahippocampal complex have been more consistently activated in studies where pain perception has been modulated by expectation and / or anxiety. It is clear that memory (which influences expectation) modulates pain perception. While certain expectation is associated with fear, uncertain expectation is associated with anxiety. For instance, a rat experiences fear when it must enter a space where a cat is present. Anxiety, on the other hand, corresponds to the state a rat is in when it must enter a space where a cat may or may not be present. While fear facilitates rapid reactions (fight or flight) and causes distraction and analgesia from the pain, anxiety is characterized by risk assessment behavior or behavioral inhibition (the rat hesitates to enter the space where a cat might be). This behavior is associated with



**Hippocampus and Entorhinal Complex, Functional Imaging, Figure 2** (a) Temperature-related activation increases in perceived pain: Bilateral S1, dorsal margin of posterior insula, thalamus, midcingulate and right hippocampus. (b) Anxiety-related activation increases in perceived pain associated with significant activation in left entorhinal cortex. (c) Activity in the perigenual cingulate and the mid- / para insula was significantly correlated with entorhinal FMRI signal during pain modulation by anxiety. Reproduced with permission from Ploghaus et al. 2001.

increased somatic and environmental attention, which can lead to anxiety-driven hyperalgesia (McNaughton and Gray 2000).

Using fMRI to investigate the effects of expectation on pain perception, Ploghaus and colleagues (2000) found that areas in the hippocampal complex were activated during mismatches between expected and actual pain. Consistent with comparator theory, the same ► [hippocampal regions](#) were implicated in three different types of mismatch: when no pain was expected (novelty); when the nociceptive stimulus differed from expectation; and when the painful stimulus was unexpectedly omitted. In a subsequent study, Ploghaus

and colleagues (2001) manipulated the certainty of expectation about impending nociceptive stimulation, to investigate its modulation on pain perception. This study examined the neural mechanism by which anxiety (uncertain expectation) causes increased pain perception (hyperalgesia), and contrasted it with the process by which a heightened nociceptive stimulation causes increased pain perception. The Gray-McNaughton theory proposes that the hippocampal formation responds to aversive events such as pain whenever they form part of a behavioral conflict, e.g. a conflict caused by uncertain expectation of pain. This conflict induces anxiety. Output from the comparator has two effects that underpin anxiety and behavioral inhibition. First, it tends to suppress both of the currently conflicting responses. Second, it increases the valence of the affectively negative associations of each of the conflicting goals (McNaughton and Gray 2000).

As predicted from theory, Ploghaus and colleagues reported activation of the entorhinal cortex during anxiety-driven hyperalgesia, but not during increased pain perception caused by augmented nociceptive input (Fig. 2b; Ploghaus et al. 2001). Studies of other (not anxiety-related) types of hyperalgesia typically report no significant activation of the hippocampus / parahippocampal region (e.g. Zambreanu et al. 2005). One exception is a recent fMRI study of drug modulation during pain (Borras et al. 2004). Naloxone, a predominantly  $\mu$  opioid antagonist, was administered to naïve subjects in low doses. During rest (baseline) conditions where no stimulation was applied, regions in the hippocampal / entorhinal complex were activated more in the drug condition than during placebo. According to the Gray-McNaughton theory, the entorhinal cortex primes responses that are adaptive to an aversive input, such as the motor response necessary for escape from a threatening environment. Enhanced activation in this region after naloxone infusion indicates a change in basal activity, potentially lowering the threshold for activation of adaptive responses.

In line with this argument, differences between naloxone and placebo conditions during nociceptive processing were found in several areas within the hippocampus / parahippocampal region. When pain ratings were matched across conditions, an area within the posterior parahippocampal gyrus was significantly more activated in the naloxone condition. Activation of the hippocampus proper to nociceptive stimulation in the drug condition compared to the placebo condition was found only when subjects rated the pain intensity higher in the naloxone condition (nociceptive stimuli were of equal intensity across conditions). This result adds further support for the role of the hippocampus proper in pain intensity encoding. In their study of anxiety-driven hyperalgesia, Ploghaus and colleagues (2001) found that the entorhinal cortex activation was predictive of activity in the perigenual cingulate and



**Hippocampus and Entorhinal Complex, Functional Imaging, Table 1** Summary of functional imaging studies outlined here, listing stimulus type, neuroimaging technique and activations/deactivations in hippocampal/parahippocampal regions

Authors	Stimulus type		Hippocampus proper	Parahippocampal region
Derbyshire et al. 1997	Laser (heat nociception or warm)	PET	Nociceptive encoding	-
Ploghaus et al. 2000	Thermal (heat nociception or warm)	FMRI	Expectation related	Expectation related
Ploghaus et al. 2001	Thermal (heat nociception)	FMRI	Nociceptive encoding	Expectation related
Bingel et al. 2002	A- $\delta$ -specific laser	FMRI	Nociceptive encoding	-
Wilder-Smith et al. 2004	Rectal balloon distension and thermal (cold nociception)	FMRI	Patients more than controls	Patients more than controls
Borras et al. 2004	Thermal (heat nociception)	FMRI	Nociceptive encoding	May be related to shift in threshold for adaptive response
Greicius and Menon 2004	Visual (resting state examined)	FMRI	Resting state network	Resting state network
Napadow et al. 2005	Acupuncture in pain-free controls	FMRI	Deactivation	-

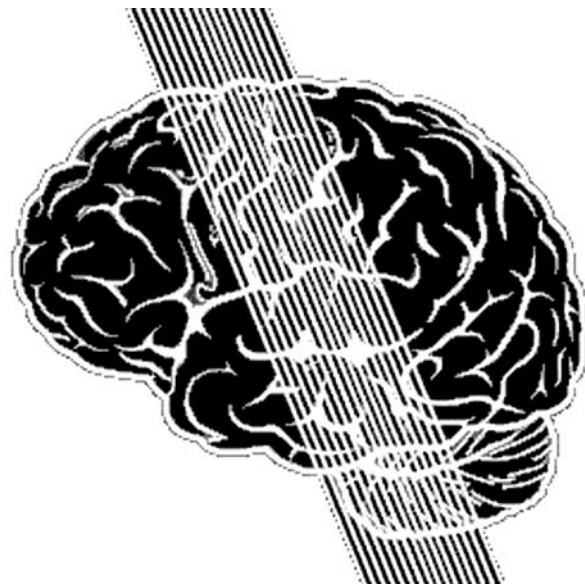
mid-insula (Fig. 2c). Corresponding regions of the cingulate and insular cortices were also implicated in naloxone-induced increases in pain perception (Borras et al. 2004). The authors concluded that the regions where activation by noxious heat was modulated by naloxone were the sites of action of endogenous opioid pathways involved in regulating the central nervous system response to aversive stimuli.

Some support for the involvement of the hippocampus / parahippocampal region in opioid regulation of the brain's response to nociceptive input comes from functional imaging studies of acupuncture. Several studies investigating brain responses to acupuncture in healthy, pain-free volunteers have reported ► **deactivation** of regions within the hippocampus / entorhinal complex (e.g. Napadow et al. 2005). A recent study examining the effects of acupuncture in chronic pain patients does not report involvement of the hippocampus or parahippocampal areas (Pariante et al. 2005), but this study did not include a contrast for deactivation of specific brain regions.

There can be little doubt that the role of the hippocampus / entorhinal complex in nociceptive processing and the generation of pain perception demands further investigation in both healthy volunteers and in clinical pain patients. So far, the functional imaging studies of pain reporting hippocampus / entorhinal complex activation have been whole-brain studies examining the effects of nociceptive stimulation on all regions of the brain. This contrasts with the neuroimaging literature on the role of the hippocampal complex in memory, where researchers have been able to focus solely on this narrow region of cortex, improving spatial resolution and avoiding registration caveats e.g. by employing partial-coverage imaging techniques (Fig. 3) (see also Squire et al. 2004). To disentangle the roles of the subregions within the hippocampus / entorhinal complex in nociceptive processing and pain perception, high-

resolution studies of this region during pain, employing similar measures, are needed. Care must also be taken to optimize study design in order to avoid the masking out of nociceptive-related hippocampal activations by processing of the resting state network.

The role of hippocampus / entorhinal complex in clinical pain is still largely unknown. A study of patients suffering from irritable bowel syndrome (IBS) has recently shown involvement of hippocampus in pain processing in patients compared to healthy controls (Wilder-Smith et al. 2004). Given the known involvement of anxiety



**Hippocampus and Entorhinal Complex, Functional Imaging, Figure 3** Visualization of slice positioning in a high-resolution, partial-coverage study of hippocampus / entorhinal complex function. By only covering a section of the brain, resolution can be improved significantly, and it may be possible to begin disentangling the function of small subregions within the hippocampus/parahippocampal complex for nociceptive processing and pain perception.



in irritable bowel syndrome, this result lends further support to the postulated involvement of the hippocampus / entorhinal complex in anxiety-driven increases of pain perception. Further, the hippocampus may form part of a system of central involvement that drives the visceral hypersensitivity of these patients. More studies of anxiety and hippocampus / entorhinal complex function in clinical pain should shed light on the importance of centrally generated pain and hyperalgesia. In conclusion, converging evidence from human neuroimaging and animal studies points to a direct role for the hippocampus in the processing of nociceptive information such as pain intensity encoding. Areas within the hippocampus / entorhinal complex are involved in the comparison between actual and expected nociceptive stimuli, and play a role in anxiety-driven hyperalgesia. The increases in pain perception caused by uncertain expectation may be due to a modulation of the opiate system, as hinted at by a study investigating the effects of the  $\mu$  opioid antagonist naloxone (Borras et al. 2004).

### References

1. Bingel U, Quante M, Knab R et al. (2002) Subcortical structures involved in pain processing: evidence from single-trial fMRI. *Pain* 99:313–321
2. Borras MC, Becerra L, Ploghaus A et al. (2004) fMRI measurement of CNS responses to naloxone infusion and subsequent mild noxious thermal stimuli in healthy volunteers. *J Neurophysiol* 91:2723–2733
3. Derbyshire SWG, Jones AKP, Gyulai F et al. (1997) Pain processing during three levels of noxious stimulation produces differential patterns of central activity. *Pain* 73:431–445
4. Dutar P, Lamour Y, Jobert A (1985) Activation of identified septo-hippocampal neurons by noxious peripheral stimulation. *Brain Res* 328:15–21
5. Greicius MD, Menon V (2004) Default-mode activity during a passive sensory task: uncoupled from deactivation but impacting activation. *J Cogn Neurosci* 16:1484–1492
6. McNaughton N, Gray JA (2000) Anxiolytic action on the behavioural inhibition system implies multiple types of arousal contribute to anxiety. *J Affect Disord* 61:161–176
7. Melzack R, Casey KL (1968) Sensory, motivational, and central control determinants of pain. In: Kenshalo DR (ed) *The skin senses*. Thomas, Springfield, IL, pp 423–439
8. Napadow V, Makris N, Liu J et al. (2005) Effects of electroacupuncture versus manual acupuncture on the human brain as measured by fMRI. *Hum Brain Mapp* 24:193–205
9. Pariente J, White P, Frackowiak RSJ et al. (2005) Expectancy and belief modulate the neuronal substrates of pain treated by acupuncture. *NeuroImage* 25 1161–1167
10. Ploghaus A, Narain C, Beckmann CF et al. (2001) Exacerbation of pain by anxiety is associated with activity in a hippocampal network. *J Neurosci* 21:9896–9903
11. Ploghaus A, Tracey I, Clare S et al. (2000) Learning about pain: The neural substrate of the prediction error for aversive events. *PNAS* 97:9281–9286
12. Squire LR, Stark CEL, Clark RE (2004) The Medial Temporal Lobe. *Ann Rev Neurosci* 27:279–306
13. Wilder-Smith CH, Schindler D, Lovblad K et al. (2004) Brain functional magnetic resonance imaging of rectal pain and activation of endogenous inhibitory mechanisms in irritable bowel syndrome patient subgroups and healthy controls. *Gut* 53:1595–1601
14. Zambreanu L, Wise RG, Brooks JCW et al. (2005) A role for the brainstem in central sensitisation in humans. Evidence from functional magnetic resonance imaging. *Pain* 114:397–407

## Histamine

### Definition

Histamine is a naturally occurring compound that is endogenous in mammalian tissue. It is synthesized by the decarboxylation of the amino acid histidine. It is a hydrophilic vasoactive amine and is involved in many central nervous system functions, such as arousal, the physiologic response to anxiety and stress, water retention and the suppression of eating. It has been suggested that the neuronal histamine system functions as a danger response mechanism. In skin it is intensely pruritic and painful in higher concentrations.

- ▶ [Cancer Pain Management, Gastrointestinal Dysfunction as Opioid Side Effects](#)
- ▶ [Nociceptor, Categorization](#)

H

## Histopathological

### Definition

The method of microscopical examination to derive the diagnosis from typical changes in the normal structure of tissues.

- ▶ [Facet Joint Pain](#)

## History of Analgesics

KAY BRUNE, BURKHARD HINZ  
Department of Experimental and Clinical Pharmacology and Toxicology, Friedrich Alexander University Erlangen-Nürnberg, Erlangen, Germany  
brune@pharmakologie.uni-erlangen.de  
hinz@pharmakologie.uni-erlangen.de

### Synonym

Analgesics, History

### Definition

Attempts to relieve pain are probably as old as mankind. Dioscorides, a Greek physician, prescribed extracts of willow bark against joint pain, whilst Hildegard von Bingen and the Reverend Stone, in his famous letter to the Royal Society of Medicine in London, suggested the same therapy (Brune 1997; Rainsford 1984). Local inflammation often goes along with “general inflammation” manifested by fever and malaise. The reasons for this were recently uncovered: the release of pyrogenic cytokines such as TNF $\alpha$  and IL-1. Fever along with malaise was treated on the basis of the Hippocratic concept by purgation, sweating and blood-letting (Brune 1984). Such practices were continued until the 19<sup>th</sup> century (Williams 1975) – probably without success.

It was only recently that the inhibition of the cytokine effect has become feasible (Smolen et al. 2000).

### Characteristics

A scientific approach to pain therapy became possible in the 19<sup>th</sup> century, with substances isolated from plants including the willow tree (salicylic acid esters), and then the description of the complete synthesis by Kolbe (Marburg), (Brune 1997; Rainsford 1984). To provide sufficient amounts, the first “scale up” of a synthetic process was invented and the first drug factory built (Salicylic Acid Works founded by von Heyden, 1874; 6). Salicylic acid was found to be active against fever (Buss, Switzerland) and rheumatoid arthritis (Stricker, Berlin; Mac Lagan, Dundee) (Brune 1997; Rainsford 1984; Sneader 1985).

Earlier (1806), a pharmacist in Einbeck, Sertürner, had isolated morphine, the main analgesic ingredient of the opium resin. He checked extracts from opium for sedative activity in his pack of dogs and ended up with a pure substance (morphine) (Sertürner 1806; Sneader 1985). With morphine, for the first time, a pure (crystalline) drug was available. Death due to overdose or lack of effect could now be avoided by exact dosing (Bender 1966).

### New Chemicals

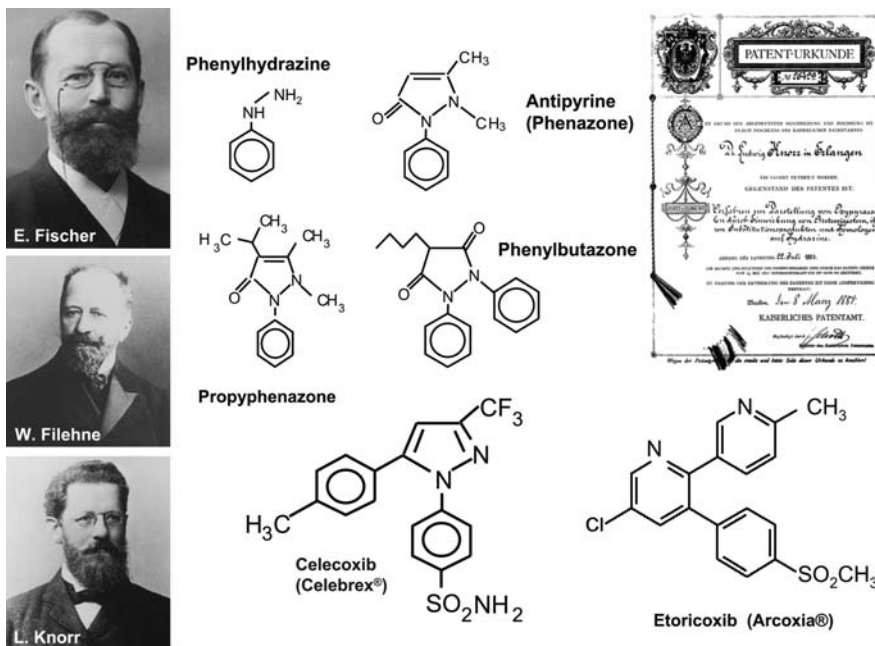
The next step was taken by chemists who tried to compensate for an impaired supply of opium, china bark (quinine) and others by chemical synthesis. It was made possible by E. Fischer’s discovery of phenylhydrazine, which allowed the synthesis of nitrogen-containing ring systems. His scholar, L. Knorr, tried to synthesize quinine, but produced phenazone (Fig. 1) (Brune 1997),

which proved to be active against fever. The patent for this compound (Antipyrene<sup>®</sup>) was bought by a dye factory in Hoechst. This was the start of the pharmaceutical company Hoechst (Brune 1997). Another chemist (F. Hoffmann) esterified salicylic acid with acetate and (re-)discovered Aspirin. This synthesis was done in another dye factory, namely Bayer (Rinsema 1999). The new science of chemistry helped to transform the dye-industry by providing both synthetic dyes and new synthetic drugs.

Pain therapy was aided by another accidental discovery. In Strasbourg, two physicians, Cahn and Hepp, attempted to eradicate intestinal worms. The worms survived, but the fever resolved (Cahn and Hepp 1886). An analysis revealed that the pharmacy had provided acetanilide rather than naphthalene. This led to the discovery of acetanilide, which was marketed by another dye factory (Kalle) under the name Antifebrin<sup>®</sup> (Brune 1997; Sneader 1986). Bayer further investigated acetanilide and found that a by-product of aniline dye production, namely “acetophenetidine”, was equally effective. It was marketed as Phenacetin<sup>®</sup> (Sneader 1986). These discoveries constituted, as Tainter phrased it (Tainter 1948), “[. . .] the beginning of the famous German drug industry and ushered in Germany’s forty-year dominance of the synthetic drug and chemical field.” Thus, by the end of the 19<sup>th</sup> century, 4 prototype substances were available for the treatment of pain: Morphine, salicylic acid, phenazone and phenacetin.

### Chemical Modifications of Analgesics

Salicylic acid, phenazone and phenacetin were widely used, and physicians soon recognized the disadvantages of these drugs. They were of low potency, and had to



**History of Analgesics,**  
**Figure 1** Synthesis of Phenazone,  
 the first synthetic drug ever, in  
 Erlangen 1882.



Adolf Kolbe



Felix Hoffmann



Heinrich Dreser



1899 Implementation of Acetylsalicylic Acid (Aspirin®)

History of Analgesics,  
Figure 2 Synthesis of acetylsalicylic acid in 1897.

H

be taken in gram quantities (spoon-wise). Sodium salicylate had an unpleasant taste. Taking several grams of phenacetin led to methaemoglobinaemia, while phenazone often caused allergic reactions. Consequently, the expanding drug industry set their chemists into action to produce improved derivatives.

F. Hoffman, a young chemist at the Bayer Company, attempted to improve the taste of salicylic acid to please his father who suffered from rheumatoid arthritis (Brune 1997; Sneader 1986). On a suggestion of v. Eichengrün (Bayer), Hoffmann produced acetylsalicylic acid, which his father preferred (Brune 1997; Sneader 1986). Acetylsalicylic acid proved difficult to handle due to its instability. Bayer, therefore, took a patent on the water-free production process invented by Hoffmann and secured the name Aspirin® (derived from acetyl and the plant *spirea ulmaria*). H. Dreser, the first pharmacologist at Bayer, tried to demonstrate the reduced toxicity of aspirin as compared to salicylic acid. He employed a goldfish model, believing that the “mucosa” of their fins comprised an analogue of human intestinal mucosa. Dipping the fins of goldfish into solutions of either salicylic acid or aspirin, he observed that higher concentrations of aspirin were necessary to “cloudy” the fins (Fig. 2). He concluded that this was proof of better gastrointestinal tolerability (Dreser 1899). Later, Heinrich Dreser himself recognised that he didn’t measure a “gastrotoxic effect”, but rather “acidity”, and salicylic acid is more acidic than aspirin (Dreser 1907).

To further improve the tolerability of phenacetin, Bayer investigated a metabolite of phenacetin, acetaminophen

(paracetamol). It appeared that (their) acetaminophen (due to impurities?) also caused methaemoglobinaemia. In contrast, Sterling (UK) found acetaminophen free of methaemoglobinaemia and marketed it as Panadol® (Sneader 1985).

At Hoechst, the structure of phenazone was modified. The resulting compounds amidopyrin, melubrin and dipyron proved to be somewhat more active (Brune 1997). Roche substituted an amino group of phenazone with isopropyl. The resulting propyphenazone is still in use. It is relatively free of toxicity, i.e. it lacks kidney, GI- and bone marrow toxicity (Kaufman et al. 1991). Finally, several companies combined two active principles, e.g. by producing salts of aspirin with amidopyrine or esters between acetaminophen and salicylic acid (Benorylate®). Moreover, the three basic ingredients were mixed and supplemented, e.g. with caffeine (APC-powder); with vitamins, minerals and other partly obscure ingredients. This diversity of “drugs” pleased the consumer, but was without major medical benefit – it may rather have led to abuse and kidney toxicity (Dubach et al. 1983).

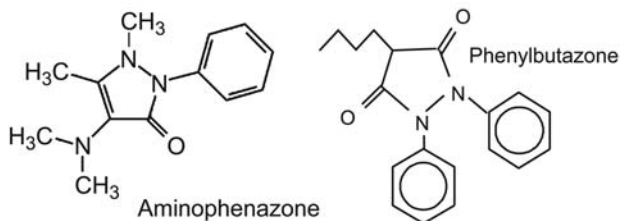
#### New Compounds: Pharmacology Comes into Play

In 1949, an unexpected observation once again paved the way for new analgesics. Hoping to reduce toxicity and increase effectiveness of aminophenazone, Geigy (Basel) produced an injection containing the salt of the basic aminophenazone with an acidic derivative – later named phenylbutazone (Fig. 3). This salt was found to be very active, particularly in rheumatoid pain (Brune





Gerhard Wilhelmi



Erythema of the depilated back of a guinea pig

History of Analgesics, Figure 3 Synthesis of Phenylbutazone in 1949.

1997; Sneader 1985). Burns and Brodie related this effect to phenylbutazone, which was present for much longer periods of time than aminophenazone (Domejz 1960). The conclusion was that the “salt forming” partner of aminophenazone was the dominant active ingredient. To further investigate this clinical observation, G. Wilhelmi (Geigy) developed novel models of inflammation (Wilhelmi 1949). Phenylbutazone turned out to be particularly active in reducing the UV erythema elicited in the skin of guinea pigs (Fig. 3) (Wilhelmi 1949). It was one of the first pharmacological models of inflammation, with which several phenylbutazone analogues were found.

In the USA, C. Winter, at Merck (MSD) and later at Parke Davis, developed his models of inflammatory pain. He introduced the cotton string granuloma and the carrageenin-induced rat paw model (Shen 1984). These assays turned out to be especially useful for measuring anti-inflammatory activity (Winter et al. 1962) (Fig. 4). A similar model was employed by Randall and Selitto for detecting analgesic activity (Randall and Selitto 1957). Using these models led to the discovery of several chemical classes of analgesics. Merck identified indols (including indomethacin and sulindac, T.Y. Shen) (Shen 1984), Boots found propionic acid derivatives (ibuprofen and flurbiprofen, S. Adams; (Adams 1992), Parke Davis developed fenamates (e.g. mefenamic acid) (Shen 1984), Geigy was successful with new aryl-acetic acids, e.g. diclofenac (Shen 1984) and Rhone Poulenc with Bayer introduced ketoprofen (Shen 1984), and finally, Lombardino at Pfizer rediscovered the ketoenolic acids (phenylbutazone). The advantage of these compounds is that all pharmacokinetic parameters can be tailored by minor changes in

the molecular structure (Lombardino 1974). Pfizer's piroxicam (Otterness et al. 1982) was soon followed by tenoxicam (Roche) and meloxicam (Boehringer). All of these differ in their potency and in pharmacokinetic parameters including their metabolism and drug interactions, although their mode of action is basically the same. Most were identified using animal models before the mode of action of “aspirin-like” drugs – as these substances were formerly named – was determined. It was 70 years after the synthesis of aspirin when John



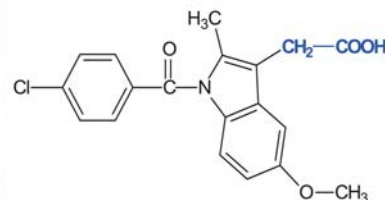
Charles Winter



Carrageenan-induced rat paw edema



Dr. T.Y. Shen



Indomethacin

History of Analgesics, Figure 4 Carrageenin-induced rat paw model.



Vane's group could demonstrate that these compounds were inhibitors of prostaglandin synthesis (Vane 1971). This discovery, however, did not answer the question of why many of the old compounds (found by serendipity – such as phenazone, propyphenazone, phenacetin, paracetamol) were non-acidic chemicals that barely inhibited cyclooxygenases, whilst all the compounds developed in animal models of inflammation and pain were acidic and potent inhibitors (Brune 1974)? All pharmacological models inflict an acute inflammation elicited by local prostaglandin production. Consequently, drugs that work by blocking cyclooxygenases in the inflamed tissue excel in these models. Acidic compounds (comprising pKa values of around 4, ~99% protein binding and amphiphilic structures) reach long lasting high concentrations in inflamed tissue, but also relatively high concentrations in liver, kidney and the stomach wall (Brune and Lanz 1985). This skewed distribution causes complete inhibition of prostaglandin synthesis in these locations resulting in superior anti-inflammatory activity, but also liver, kidney and stomach toxicity (Brune and Lanz 1985). This distributional selectivity may have reduced some of the side-effects including CNS toxicity and increased the anti-inflammatory effects. Non-acidic compounds such as phenazone or paracetamol distribute homogeneously throughout the body. Their inhibition of prostaglandin production in inflamed tissue is small. Consequently, they are used to curb mild pain, but not inflammation. The discovery of the existence of two cyclooxygenases, COX-1 and COX-2 (Flower 2003), has changed the landscape again. It provided a new dimension of selectivity, not limited to differences of tissue distribution, but based on enzyme selectivity.

#### Analgesics in the Age of Molecular Pharmacology

The discovery of prostaglandins and the inhibition of prostaglandin production by aspirin-like drugs caused the investigation of the effects of anti-inflammatory steroids on prostaglandin production. Many researchers observed that steroids can reduce prostaglandin production along with anti-inflammatory activity, but do not block it completely (e.g. Brune and Wagner 1979). Only P. Needleman came up with a molecular explanation that proposed 2 different enzymes, one being regulated by steroids (Fu et al. 1990; Masferrer et al. 1990). They were soon characterized (Kujubu et al. 1991). For the first time in the history of pharmacology, 2 molecular drug targets, cyclooxygenase-1 and cyclooxygenase-2 (the expression in the inflamed tissue is blocked by steroids), were identified before the biological role of the enzymes was fully known.

It was soon clear that it might be advantageous to have drugs that block only cyclooxygenase-2, because this enzyme appeared not to be involved in the production of GI-protective prostaglandins. Diclofenac and meloxicam were found to exert some, but not sufficient

selectivity to warrant GI-tolerance (Tegeader et al. 1999). This situation changed with the discovery of the highly selective sulfonamides, celecoxib and valdecoxib, and methylsulfones, rofecoxib and etoricoxib. These compounds are relatives of old compounds like phenazone (Fig. 1). They extend the paracetamol/phenazone group of non-acidic compounds which are devoid of gastrointestinal toxicity (Brune and Lanz 1985). However, these new analgesics are not free of other side effects. Inhibition of cyclooxygenase-2 affects kidney function, blood pressure and maybe more (for review, see e.g. Brune and Hinz 2004a; Hinz and Brune 2002). Another type of COX-2 selective inhibitor is Lumiracoxib. It is a relative of diclofenac and, like diclofenac, is sequestered into inflamed tissue. It combines COX-2 selectivity with selective tissue distribution (Feret 2003). The clinical success of this compound will tell us if this approach offers advantages.

#### Conclusion

After 120 years of development of pure analgesics, we have made some progress. Serendipity, as well as targeted research, has provided clinicians with many useful drugs that differ in many pharmacological and clinical aspects. Knowing a little of the history of their discovery and development may provide a perspective to better understand their effects and side-effects. A humble acknowledgment of the role of serendipity may change our attitude towards research and marketing claims. But then serendipity is not all, as E. Kästner, a German poet, phrased it:

Irrtümer sind ganz gut, Jedoch nur hier und da.  
Nicht jeder, der nach Indien fährt, entdeckt AMERIKA.  
Errors are fine, but only sometime(s).  
Not everyone heading for India discovers AMERICA.

#### Acknowledgements

The helpful discussion with many scientists, in particular I. Otterness, A. Sallmann, T.Y. Shen (†) and G. Wilhelm is gratefully acknowledged.

#### References

1. Adams SS (1992) The Propionic Acids: A Personal Perspective. *J Clin Pharmacol* 32:317–323
2. Bender GA (1966) Great Moments in Pharmacy. Davis & Company, Parke
3. Brune K (1974) How Aspirin Might Work: A Pharmacokinetic Approach. *Agents Actions* 4:230–232
4. Brune K (1984) The Concept of Inflammatory Mediators. In: Parnham MJ, Bruinvels J (eds) Discoveries in Pharmacology. Haemodynamics, Hormones and Inflammation, vol 2. Elsevier, Amsterdam, pp 487–498
5. Brune K (1997) The Early History of Non-Opioid Analgesics. *Acute Pain* 1:33–40
6. Brune K, Hinz B (2004a) Selective Cyclooxygenase-2 Inhibitors: Similarities and Differences. *Scand J Rheumatol* 33:1–6
7. Brune K, Hinz B (2004b) The Discovery and Development of Antiinflammatory Drugs. *Arthritis Rheum* 50:2391–2399

8. Brune K, Lanz R (1985) Pharmacokinetics of Non-Steroidal Anti-Inflammatory Drugs. In: Bonta IL, Bray MA, Parnham MJ (eds) Handbook of Inflammation, vol 5. Elsevier, Amsterdam, pp 413–449
9. Brune K, Wagner K (1979) The Effect of Protein/Nucleic Acid Synthesis Inhibitors on the Inhibition of Prostaglandin Release from Macrophages by Dexamethasone. In: Brune K, Baggiolini M (eds) Arachidonic Acid Metabolism in Inflammation and Thrombosis. Agents Actions (Suppl 4), Basel, Boston. Birkhäuser, Stuttgart pp 73–77
10. Cahn A, Hepp P (1886) Das Antifebrin, ein Neues Fiebermittel. Centralbl Klin Med 7:561–564
11. Domejoz R (1960) The Pharmacology of Phenylbutazone Analogues. Ann NY Acad Sci 1960:263
12. Dreser H (1899) Pharmacologisches über Aspirin (Acetylsalicylsäure). Pflügers Arch Ges Phys 76:306–318
13. Dreser H (1907) Ueber Modifizierte Salizylsäuren. Medizinische Klinik 14:390–393
14. Dubach UC, Rosner B, Pfister E (1983) Epidemiologic Study of Analgesics Containing Phenacetin – Renal Morbidity and Mortality (1968–1979). N Engl J Med 308:357–362
15. Feret B (2003) Lumiracoxib: A Cox-2 Inhibitor for the Treatment of Arthritis and Acute Pain. Formulary 38:529–537
16. Flower RJ (2003) The Development of Cox-2 Inhibitors. Nat Rev 2:179–191
17. Fu JY, Masferrer JL, Seibert K et al. (1990) The Induction and Suppression of Prostaglandin H<sub>2</sub> Synthase (Cyclooxygenase) in Human Monocytes. J Biol Chem 265:16737–16740
18. Hinz B, Brune K (2002) Cyclooxygenase-2 – 10 Years Later. J Pharmacol Exp Ther 300:367–375
19. Kaufman DW, Kelly JP, Levy M et al. (1991) The Drug Etiology of Agranulocytosis and Aplastic Anemia. Oxford University Press, New York
20. Kujubu DA, Fletcher BS, Varnum BC et al. (1991) TIS10, A Phorbol Ester Tumor Promoter-Inducible mRNA from Swiss 3T3 Cells, Encodes a Novel Prostaglandin Synthase/Cyclooxygenase Homologue. J Biol Chem 266:12866–12872
21. Lombardino JG (1974) Enolic Acids with Anti-Inflammatory Activity. In: Scherrer RA, Whitehouse MW (eds) Medical Chemistry: A Series of Monographs. Academic Press, New York, pp 129–157
22. Masferrer JL, Zweifel BS, Seibert K et al. (1990) Selective Regulation of Cellular Cyclooxygenase by Dexamethasone and Endotoxin in Mice. J Clin Invest 86:1375–1379
23. Otterness IG, Larson DL, Lombardino JG (1982) An Analysis of Piroxicam in Rodent Models of Arthritis. Agents Actions 12:308–312
24. Rainsford KD (1984) Aspirin and the Salicylates. Butterworth & Co, London
25. Randall LO, Selitto JJ (1957) A Method for Measurement of Analgesic Activity on Inflamed Tissue. Arch Int Pharmacodyn 111:409–419
26. Rinsema TJ (1999) One Hundred Years of Aspirin. Medical History 43:502–507
27. Shen TY (1984) The Proliferation of Non-Steroidal Anti-Inflammatory Drugs (NSAIDs). In: Parnham MJ, Bruinvels J (eds) Discoveries in Pharmacology. Haemodynamics, Hormones and Inflammation, vol 2. Elsevier, Amsterdam, pp 523–553
28. Sertürmer FW (1806) Darstellung der Reinen Mohnsäure (Opiumsäure) Nebst einer Chem. Untersuchung des Opiums. Tromsdorf J Pharm 14:47–93
29. Smolen JS, Breedveld FC, Burmester GR et al. (2000) Consensus Statement on the Initiation and Continuation of Tumour Necrosis Factor Blocking Therapies in Rheumatoid Arthritis. Ann Rheum Dis 59:504–505
30. Sneader W (1985) Drug Discovery: The Devolution of Modern Medicines. J Wiley & Sons, Chichester
31. Tainter ML (1948) Pain. Am NY Acad Sci 51:3–11
32. Tegeder I, Lotsch J, Krebs S et al. (1999) Comparison of Inhibitory Effects of Meloxicam and Diclofenac on Human Thromboxane Biosynthesis after Single Doses and at Steady State. Pharmacol Ther 65:533–544
33. Vane JR (1971) Inhibition of Prostaglandin Synthesis as a Mechanism of Action of Aspirin-Like Drugs. Nature New Biol 231:232–235
34. Wilhelmi G (1949) Guinea-Pig Ultraviolet Erythema Test. Schweiz Med Wochenschr 79:577–580
35. Williams G (1975) The Age of Agony. The Art of Healing 1700–1800. Constable, London
36. Winter CA, Risley EA, Nuss GW (1962) Carrageenin-Induced Edema in Hindpaw of the Rat as an Assay for Anti-Inflammatory Drugs. Proc Soc Exp Biol 111:544–547

---

## Hit Rate or Sensitivity

### Definition

Hit rate or sensitivity is the probability of response „A“ when event A has occurred.

- ▶ [Statistical Decision Theory Application in Pain Assessment](#)

---

## HIV and Pain

- ▶ [Cancer Pain and Pain in HIV / AIDS](#)
- ▶ [Pain in Human Immunodeficiency Virus Infection and Acquired Immune Deficiency Syndrome](#)

---

## HMSN

### Definition

The acronym for Hereditary Motor and Sensory Neuropathy.

- ▶ [Hereditary Neuropathies](#)

---

## HNPP

- ▶ [Hereditary Neuropathy with Liability to Pressure Palsies](#)

---

## Hoffman-Tinel Sign

- ▶ [Tinel Sign](#)

---

## Holistic Medicine

- ▶ [Alternative Medicine in Neuropathic Pain](#)

## Homeopathy

### Definition

Homeopathy is a system of medicine developed by Samuel Hahnemann in the 19<sup>th</sup> century based on a concept of vital energy inherent in all matter, which increases in potency with repeated dilution; and on the idea that substances can be used to treat conditions that mimic their toxicity

- ▶ [Alternative Medicine in Neuropathic Pain](#)

## Homeostasis

### Definition

Homeostasis is a basic biological function associated with the maintenance of an internal environment that guarantees survival through adjusting important biological parameters (water, salt, glucose, temperature, acidity etc.).

- ▶ [Clinical Migraine with Aura](#)
- ▶ [Functional Imaging of Cutaneous Pain](#)

## Homeostatic Adaptations

### Definition

Physiological responses or behavioral actions which maintain or restore normal levels of biological function (e.g., maintain or restore normal body temperature).

- ▶ [Opioids, Effects of Systemic Morphine on Evoked Pain](#)

## Homework

### Definition

Activities that a patient is asked to complete or practice, usually outside of the hospital or clinic is referred to as homework.

- ▶ [Multidisciplinary Pain Centers, Rehabilitation](#)

## Homologous Gene

### Definition

An homologues gene has a similar, though often far from identical, sequence to another gene.

- ▶ [Species Differences in Skin Nociception](#)

## Homomeric Channels

### Definition

Channels are protein complexes, which form pores in the cell membrane. Typically, channels are made up of several subunits, which may be identical, resulting in homomeric channels, or different, resulting in heteromeric channels.

- ▶ [Purine Receptor Targets in the Treatment of Neuropathic Pain](#)

## Homozygous Carriers

### Definition

Homozygous carriers refer to the state of possessing two identical alleles of a particular gene, one inherited from each parent.

- ▶ [NSAIDs, Pharmacogenetics](#)

## Horsley-Clarck Apparatus or Stereotaxic Frame

### Definition

Horsley-Clarck Apparatus or Stereotaxic Frame is a solid metallic frame made of two horizontal graduated bars fixed perpendicularly to a metal plate, holding a device for the fixation of the head of the animal through its upper jaw and orbits. The horizontal bars hold at mid-distance a device to fix two bars introduced into the ears (external auditory meatus).

- ▶ [Post-Stroke Pain Model, Thalamic Pain \(Lesion\)](#)

## Hospice Care

### Definition

Hospice care is a form of palliative or supportive care offered when the disease is at an advanced stage. The term hospice can refer to the philosophy of care, but is also used to describe the institution or site of care.

- ▶ [Cancer Pain Management, Interface Between Cancer Pain Management and Palliative Care](#)

## Hostility

### Definition

Hostility refers to “A set of negative attitudes, beliefs and appraisals concerning other”. Can be inwardly di-

rected towards oneself (“intrapunitiveness”) or directed towards others (“extrapunitiveness”), Smith TW (1992).

- ▶ [Chronic Gynecological Pain, Doctor-Patient Interaction](#)
- ▶ [Anger and Pain](#)

#### Reference

Smith TW (1992) Hostility and Health: Current Status of a Psychosomatic Hypothesis. *Health Psychology* 11: 215-225.

## Hot Plate Test (Assay)

#### Definition

Placement of the rat (or mouse) on a heated metal pad (temperature  $\geq 50^{\circ}\text{C}$ ), with the time for paw licking or jumping corresponding to the latency of the test. This method is used to assess the threshold for thermonociception.

- ▶ [Thalamotomy, Pain Behavior in Animals](#)

## Hot Tooth Syndrome

#### Definition

A tooth is sometimes described as ‘hot’ when it is very painful and difficult to anesthetize even with regional block anesthesia. The tooth is usually spontaneously painful, tender to touch and difficult to treat.

- ▶ [Dental Pain, Etiology, Pathogenesis and Management](#)

## Household Income and Chronicity

- ▶ [Pain in the Workplace, Risk Factors for Chronicity, Demographics](#)

## HPA Axis

#### Definition

The hypothalamus-pituitary-adrenal axis forms the basic response triad regulating endogenous glucocorticoid concentrations in the circulation.

- ▶ [Fibromyalgia, Mechanisms and Treatment](#)

## HT Neurons

- ▶ [High Threshold Neurons](#)

## Human Factors Engineering

- ▶ [Ergonomics Essay](#)

## Human Infant Pain Neurophysiology

- ▶ [Infant Pain Mechanisms](#)

## Human Models of Inflammatory Pain

LOUISE HARDING

Hospitals NHS Foundation Trust, University College London, London, UK

[louise.harding@uclh.org](mailto:louise.harding@uclh.org)

#### Synonym

Inflammatory Pain, Human Models

#### Definition

Research tools used to investigate the mechanisms and pharmacology of inflammatory pain and neuronal sensitisation.

#### Characteristics

Inflammation is a response of the body tissues to injury or irritation. Its most prominent features are pain, swelling, redness and heat. Through activation and sensitisation of nociceptors, inflammatory mediators also cause peripheral and central sensitisation of the somatosensory system, altering the way we perceive mechanical and thermal stimuli in and around inflamed skin. Studying these changes can provide information on the underlying mechanisms and, when combined with drug studies, on the pharmacology of inflammation and neuronal sensitisation. A number of experimental models have been developed for this purpose. In each model, inflammation is evoked by a different insult or injury and different models have specific characteristics. Table 1 compares the key features of the most common models which are summarised below.

#### The Capsaicin Model

- ▶ [Capsaicin](#) is the chemical component of chilli peppers that gives them their ‘hot’ quality. It directly activates ▶ [TRPV1](#), a heat sensitive cationic ion channel expressed on cutaneous nociceptors, resulting in pain and inflammation. Capsaicin can either be applied topically, typically at 1 %, or injected intradermally (doses of 25–250  $\mu\text{g}$ ). Intradermal injection is associated with a quick hit of intense pain lasting 1–2 minutes, compared to the mild-moderate pain of topical application that develops slowly over 10–30 minutes. Both methods pro-



**Human Models of Inflammatory Pain, Table 1** Comparison of somatosensory changes produced by different human models of inflammatory pain

	Capsaicin	Burn	Heat/Capsaicin	Mustard oil	Electrical	UVB	Freeze
1 <sup>o</sup> heat pain <sup>1</sup>	yes	yes	yes	yes	yes	yes	yes
2 <sup>o</sup> punctate <sup>2</sup>	yes	yes	yes	yes	yes	yes	yes
2 <sup>o</sup> dynamic <sup>3</sup>	yes	yes	yes	yes	yes	no	no
dynamic duration <sup>4</sup>	< 1hr	< 1 hr	4 hrs	< 1 hr	> 2 hrs	-	-
2 <sup>o</sup> punctate onset <sup>5</sup>	< 1 hr	< 1 hr	< 1 hr	< 1 hr	< 1 hr	> 4 hrs	> 4 hrs

<sup>1</sup>decreased heat pain threshold in the inflamed site, <sup>2</sup>area of secondary punctate hyperalgesia, <sup>3</sup>area of secondary dynamic mechanical allodynia, <sup>4</sup>duration of dynamic mechanical allodynia, <sup>5</sup>time to onset of secondary punctate hyperalgesia. See text on individual models for data references

duce neurogenic inflammation and similar changes in somatosensory function (LaMotte et al. 1991). At the primary zone, i.e. the area of inflammation, heat pain thresholds are reduced in the capsaicin model due to sensitisation of TRPV1. Very high concentrations of capsaicin desensitise the heat responsive ion channel. This is sometimes evident following intradermal delivery, and is characterised by an increase in heat pain thresholds in a 1–3 mm area around the injection site. Surrounding the primary zone, two discrete areas of ► [secondary hyperalgesia](#) develop; an area of dynamic ► [mechanical allodynia](#) and an area of ► [punctate hyperalgesia](#). These two areas differ in development time, size, pharmacological sensitivity and duration. The area of dynamic mechanical allodynia is maintained by ongoing afferent input from excited nociceptors and fades within an hour of capsaicin delivery as its concentration in the skin fades. In contrast, the area of punctate hyperalgesia, once established, appears independent of afferent input and may remain for 24 hours.

#### The Burn Model

In this model, heat is used to produce a first degree burn on the skin. CO<sub>2</sub> lasers and electronically coupled thermodes are typically used to induce the burn, by heating the skin to approximately 47°C for 7 minutes (Pedersen et al. 1998). The burn stimulus is moderately painful during its application; however, the pain quickly subsides once the heat stimulus is stopped. The injury produces a flare response similar to the capsaicin model. Evoked somatosensory changes in the primary zone are heat pain sensitisation (reduced heat pain threshold), together with a mild hypoesthesia (loss of sensation) to warming and cooling. A secondary area of punctate hyperalgesia develops around the primary zone and ► [dynamic mechanical allodynia](#) can also develop, but this depends on experimental conditions. Thermode size, location of skin stimulated, temperature and duration of burn stimulus shape the intensity of the burn. If the burn is very mild, insufficient afferent drive is sustained to maintain dynamic mechanical allodynia once the burn stimulus is removed.

#### The Heat/Capsaicin Model

This model, as it suggests, uses both heat and capsaicin to produce inflammatory pain and hyperalgesia. A heat stimulus of 45°C is applied to the skin for 5 min. followed by a 30 min. application of low dose (0.075 %) topical capsaicin (Petersen and Rowbotham 1999). This produces areas of primary and secondary hyperalgesia comparable to the capsaicin model. Like the capsaicin model, the area of dynamic mechanical allodynia starts to fade after approximately 20 minutes, but in this model the area can be rekindled by re-stimulating the treated site with a heat stimulus of 40°C for 5 minutes. This rekindling can be repeated every 20 minutes for up to four hours, providing a much longer opportunity to study the mechanisms of dynamic mechanical allodynia than the capsaicin and heat models alone.

#### The Mustard Oil Model

The irritant mustard oil, allyl isothiocyanate, produces characteristics of inflammation and somatosensory changes comparable to the capsaicin model, i.e. sensitisation to heat in the primary zone and secondary areas of dynamic mechanical allodynia and punctate hyperalgesia (Koltzenburg et al. 1992). Applied topically for 5 minutes, either at 100 % or diluted for a lesser effect, mustard oil produces moderate to severe pain and neurogenic inflammation. It's mechanism of action is essentially unknown. Allyl isothiocyanate has recently been shown to be an agonist of the ► [TRPA1](#) receptor (previously known as ANKTM1) expressed in nociceptors (Jord et al. 2004), and this receptor may be key to its inflammatory effects. Prolonged application of mustard oil however causes blistering, which suggests the inflammation process in this model may also involve tissue damage pathways.

#### The Electrical Stimulation Model

As discussed, in experimental models of pain, dynamic mechanical allodynia is maintained by ongoing afferent input from excited c nociceptors. The electrical stimulation model uses continuous electrical activation of ► [C-fibres](#) to evoke and maintain a stable area of dynamic allodynia throughout the experimental period. Current is

injected at a frequency of 5 Hz and adjusted until the subject reports a pain intensity of 5/10 on a numerical pain intensity rating scale (mean current: 67 mA) (Koppert et al. 2001). This method produces an inflammatory pain response with stable dynamic allodynia for study periods of up to 2 hours. Other characteristics of this model are the reduced heat pain thresholds in the primary zone, and secondary area of punctate hyperalgesia common to most established models of inflammation.

#### The UVB/Sunburn Model

This model has two essential differences to those discussed so far. Firstly, there is a prolonged delay period of 6–12 hours between the inflammatory stimulus and the development of erythema and hyperalgesia. Secondly, the stimulus event used to create inflammation is not in itself painful (Bickel et al. 1998). This model is particularly interesting, therefore, as the mechanisms of inflammation and hyperalgesia may differ somewhat to those evoked by direct activation of nociceptors. In this model, inflammation is produced by irradiating the skin with ultraviolet light in the UVB wavelength range (290–320 nm), typically over an area of approximately 5 cm diameter. There is considerable intersubject variability in the dose of radiation required to produce inflammation, consequently, subjects are assessed prior to the experimental period to establish the minimum dose of UVB required. For studies of ► **primary and secondary hyperalgesia**, three times the minimum dose required to produce ► **erythema** is used for experimentation. The UV model produces primary hyperalgesia to heat and secondary hyperalgesia to punctate mechanical stimuli, but not dynamic mechanical allodynia. Both primary and secondary events have a delayed onset, and are typically studied 20 hours after irradiation. This model is therefore relatively demanding, compared to other models, as subjects are required on 3 consecutive days. An advantage of this model however, is that the sensory changes are stable for 10 hours, giving a long window for detailed study.

#### The Freeze Lesion Model

Delayed onset hyperalgesia is also a characteristic of the freeze lesion model. Freeze lesions can be created using a 1.5 cm diameter copper rod cooled to  $-28^{\circ}\text{C}$  and held perpendicularly against the skin for 10 seconds (Kilo et al. 1994). This produces mild to moderate sharp pricking pain, vasodilation of the stimulated and surrounding area and a local oedema. Pain, oedema and flushing outside the contact area subside within 2 hours; however, a discrete erythema at the contact area remains for a number of days. No primary or secondary hyperalgesia can be detected in the first hours following the injury, but both are developed by the subsequent day. This model does not produce dynamic mechanical allodynia, and the area of punctate hyperalgesia produced by the freeze lesion

model is typically much smaller than that produced by other models.

In addition to the models described above, inflammatory pain and hyperalgesia have been reported following administration of a number of other inflammatory stimuli. This is not an exhaustive list, but for reference includes Melatin from bee venom (Sumikura et al. 2003), acidic phosphate buffered solution (Steen and Reeh 1993) complete Freund's adjuvant (Gould 2000) and bradykinin (Manning et al. 1991).

#### References

1. Bickel A, Dorfs S, Schmelz M et al. (1998) Effects of Antihyperalgesics on Experimentally Induced Hyperalgesia in Man. *Pain* 76:317–325
2. Gould HJ (2000) Complete Freund's Adjuvant-Induced Hyperalgesia: A Human Perception. *Pain* 85:301–303
3. Jordt SV, Bautista DM, Chuang HH et al. (2004) Mustard Oils and Cannabinoids Excite Sensory Nerve Fibres through the TRP Channel ANKTM1. *Nature* 427:260–265
4. Kilo S, Schmelz M, Koltzenburg M et al. (1994) Different Patterns of Hyperalgesia Induced by Experimental Inflammation in Human Skin. *Brain* 117:385–396
5. Koppert W, Derm SK, Sittl R et al. (2001) A New Model of Electrically Evoked Pain and Hyperalgesia in Human Skin. *Anaesthesiology* 95:395–402
6. Koltzenburg M, Lundberg LER, Torebjork HE (1992) Dynamic and Static Components of Mechanical Hyperalgesia in Human Hairy Skin. *Pain* 51:207–219
7. LaMotte RH, Shain CN, Simone DA et al. (1991) Tsai EFP. Neurogenic Hyperalgesia: Psychophysical Studies of Underlying Mechanisms. *J Neurophysiol* 66:190–211
8. Manning DC, Raja SN, Meyer RA, Campbell JN (1991) Pain and Hyperalgesia after Intradermal Injection of Bradykinin in Humans. *Clin Pharmacol Ther* 50:721–729
9. Pedersen JL, Kehlet H (1998) Hyperalgesia in a Human Model of Acute Inflammatory Pain: A Methodological Study. *Pain* 74:139–151
10. Petersen KL, Rowbotham MC (1999) A New Human Experimental Pain Model: The Heat/Capsaicin Sensitization Model. *Neuroreport* 10:1511–1516
11. Steen KH, Reeh PW (1993) Sustained Graded Pain and Hyperalgesia from Harmless Experimental Tissue Acidosis in Human Skin. *Neurosci Lett* 154:113–116
12. Sumikura H, Andersen OK, Drewes AM et al. (2003) A Comparison of Hyperalgesia and Neurogenic Inflammation Induced by Melittin and Capsaicin in Humans. *Neurosci Lett* 337:147–150

## Human Thalamic Nociceptive Neurons

KAREN D. DAVIS, JONATHAN O. DOSTROVSKY  
University of Toronto and the Toronto Western  
Research Institute, University Health Network,  
Toronto, ON, Canada  
kdavis@uhnres.utoronto.ca, j.dostrovsky@utoronto.ca

#### Synonyms

Thalamic Nociceptive Neurons; Diencephalic Nociceptive Neurons in the Human; Wide dynamic range (WDR) neurons and nociceptive specific (NS) neurons in human thalamus

## Definition

Central nervous system neurons whose cell bodies are located within the human thalamus (diencephalon) and that have a preferential or exclusive response to ► **noxious stimuli**.

The human thalamus, which is very similar to the monkey thalamus, includes several regions where neurons responding specifically or preferentially to nociceptive stimuli are found. However, in view of the very limited opportunities available to search for such neurons in the human and perform extensive testing on them, our knowledge concerning their properties and locations is extremely limited.

## Characteristics

It is possible to directly study human thalamic nociceptive neurons during the electrophysiological mapping used by some neurosurgical teams as part of functional neurosurgical procedures for treating chronic pain, Parkinson's disease or other movement disorders (Lenz et al. 1988; Tasker and Kiss 1995). During these mapping procedures, microelectrodes are inserted into the thalamus to record the electrophysiological properties of individual thalamic neurons.

The unique opportunity afforded by functional stereotactic surgery to record and stimulate in the thalamus of awake patients, has provided some interesting findings and validation of subhuman primate studies related to thalamic function in pain. Unfortunately, the inherent limitations of these studies (time constraints, ethical considerations and lack of histological confirmation) limit the interpretation of the findings. The studies have attempted to address the following questions:

1. Where can one record nociceptive and thermoreceptive neurons?
2. What are the properties of nociceptive and thermoreceptive neurons?
3. What are the perceptual consequences of microstimulation in the regions containing nociceptive and thermoreceptive neurons?
4. Where can one evoke painful and temperature sensations by stimulating in the thalamus and what are the qualities of the sensations?
5. Are there any alterations in neuronal firing characteristics, receptive fields or stimulation-evoked sensations in chronic pain patients?

This section briefly summarizes the findings pertaining to these questions.

### Nociceptive Neurons in Lateral Thalamus

The existence of nociceptive neurons in ► **Vc** (ventrocaudal nucleus often termed VP or ventroposterior nucleus) and adjacent regions has been reported by Lenz and colleagues (for review see Lenz and Dougherty 1997). The vast majority of Vc neurons are classified as non-nociceptive tactile neurons, since they respond

to light touch of a distinct area of skin (i.e. the neuron's receptive field). However, there have been a few reports of some nociceptive neurons in Vc. Approximately 5–10% of Vc neurons have been classified as nociceptive, based on their responses to noxious thermal stimuli (Lenz et al. 1993a; Lenz et al. 1994). A larger proportion of Vc neurons, up to 25%, were found to respond selectively or preferentially to noxious mechanical stimuli (Lee et al. 1999; Lenz et al. 1994). These neurons were primarily located in the posterior-inferior portion of Vc. Interestingly, in the adjoining posterior-inferior area, which includes ► **VMpo** (Blomqvist et al. 2000), they identified NS neurons that responded to noxious heat, and none of the neurons in this area responded to innocuous tactile stimuli (Lenz et al. 1993a). The true proportion of thalamic nociceptive neurons may be underestimated in these studies for a variety of technical, physiological and ethical reasons. First, there are very few opportunities to test for nociceptive responses in awake human subjects, and the small body of data that has been obtained derives from patients with either movement disorders or a chronic pain condition. Second, extensive testing for nociceptive responses (both in terms of the number of neurons tested and the skin area tested) is limited due to the painful nature of the stimulus. Third, it is not clear whether there is any selection bias in the ability of microelectrodes to record from nociceptive versus tactile neurons (e.g. based on cell size, spontaneous activity, etc.).

### Medial Thalamus

Much less is known regarding the role of the medial thalamus compared to the lateral thalamus in human pain, largely due to the fact that there are few opportunities to record and stimulate in this region during functional stereotactic surgery. There are some discrepancies in the incidence of medial thalamic nociceptive responses across the few published studies. One group (Ishijima et al. 1975) reported a similar proportion of mechanical- and thermally-responsive nociceptive neurons in the CM-Pf region, as compared to the findings of Lenz and colleagues in lateral thalamus. However, another group found only 2 of 318 medial thalamic neurons that responded to noxious stimuli (Jeanmonod et al. 1993). It is, however, difficult to evaluate these findings as few details were provided by the authors, and more recent studies have failed to replicate the findings (see Lenz and Dougherty 1997 for references).

### Stimulation-Induced Pain

One of the unique aspects of electrophysiological studies in human patients is the ability to question the patient about sensations evoked by electrical stimulation within the brain. Electrical stimulation within Vc and adjacent regions of the thalamus usually evokes innocuous parasthesia. However, several early studies documented that stimulation in the area posterior-inferior to

Vc elicited reports of painful sensations in some patients (Halliday and Logue 1972; Hassler and Riechert 1959; Tasker 1984). Recent studies have examined the effects of stimulation in much greater detail (Davis et al. 1996; Dostrovsky et al. 2000; Lenz et al. 1993b), and these show that pain and innocuous thermal sensations can be evoked from a region at the posterior-inferior border of Vc and extending several millimeters posterior, inferior and medial. Microstimulation applied at the Vc sites of confirmed nociceptive neuronal responses rarely evokes pain, but rather produces a non-painful tingling sensation (Lee et al. 1999; Lenz et al. 1993a, b, 1994). A greater incidence of stimulation-evoked pain in Vc and the ventroposterior region has been reported in patients with a history of visceral pain, phantom pain or post-stroke pain (Davis et al. 1995; Davis et al. 1996; Davis et al. 1998; Lenz et al. 1995)

The incidence of evoked pain/thermal sensations is much higher in the posterior-inferior area than within Vc proper. Unlike the paresthetic (tingling and 'electric shock') sensations evoked in Vc, the pain/thermal sensations are usually reported as quite natural. They are always perceived on the contralateral side of the body, and the projected fields can be quite small. The painful sensations are frequently described as burning pain. In a few cases, sensations of pain referred to deep and visceral sites have been elicited (Lenz et al. 1994; Davis et al. 1995). Lenz and colleagues have reported that microstimulation within Vc (at sites where WDR neurons responding to noxious mechanical stimuli were found) rarely results in pain, whereas at the sites in the region posterior-inferior to Vc where microstimulation evoked pain there was a high likelihood of finding nociceptive neurons (Lenz and Dougherty 1997). Histological confirmation of these stimulation and recording sites has of course not been obtained in such patients, but it seems likely that the physiologically localized region posterior-inferior to Vc corresponds anatomically to VMpo.

A few studies have reported that stimulation in the posterior aspect of medial thalamus can evoke pain (Jeanmonod et al. 1993; Sano 1979), but in most cases large tipped electrodes and high intensities were used for stimulation, so current spread is an issue. More recent studies have failed to replicate these findings.

#### Innocuous Cool Neurons and Sensations

Cells responding to innocuous thermal stimuli are also of great interest and highly relevant, due to the well-known association of the pain and temperature pathways. Cooling-specific neurons are only found in lamina I of the spinal and trigeminal dorsal horns, and have been shown to project to VMpo in the monkey (Dostrovsky and Craig 1996). In animal studies, cooling neurons in the thalamus have only been reported in VMpo (monkey) and medial VPM (cat). Cooling-specific neurons in human thalamus were located in

the region medial and posterior-inferior to Vc that likely corresponds to the human VMpo (Davis et al. 1999). Of particular interest was the finding that stimulation at such sites evoked cooling sensations that were graded with stimulus intensity, and that were referred to the same cutaneous region as the receptive fields of the cooling-specific neurons recorded at the site. Stimulation in this posterior-inferior region can also elicit pain (see above) and, as shown by Lenz and colleagues (1993a; 1993b), this region also contains nociceptive-specific neurons.

#### References

- Blomqvist A, Zhang ET, Craig AD (2000) Cytoarchitectonic and immunohistochemical characterization of a specific pain and temperature relay, the posterior portion of the ventral medial nucleus, in the human thalamus. *Brain* 123:601–619
- Davis KD, Kiss ZHT, Luo L et al. (1998) Phantom Sensations Generated by Thalamic Microstimulation. *Nature* 391:385–387
- Davis KD, Tasker RR, Kiss ZHT et al. (1995) Visceral Pain Evoked by Thalamic Microstimulation in Humans. *Neuroreport* 6:369–374
- Davis KD, Kiss ZHT et al. (1996) Thalamic Stimulation-Evoked Sensations in Chronic Pain Patients and in Non-Pain (Movement Disorder) Patients. *J Neurophysiol* 75:1026–1037
- Davis KD, Lozano RM et al. (1999) Thalamic relay site for cold perception in humans. *J Neurophysiol* 81:1970–1973
- Dostrovsky JO, Manduch M et al. (2000) Thalamic stimulation-evoked pain and temperature sites in pain and non-pain patients. In: Devor M, Rowbotham M, Wiesenfeld-Hallin Z (eds) *Proceedings of the 9<sup>th</sup> World Congress on Pain*. IASP Press, Seattle 7:419–425
- Dostrovsky JO, Craig AD (1996) Cooling-specific spinothalamic neurons in the monkey. *J Neurophysiol* 76:3656–3665
- Halliday AM, Logue V (1972) Painful sensations evoked by electrical stimulation in the thalamus. In: Somjen GG (ed) *Neurophysiology Studied Man*. Excerpta Medica, Amsterdam, pp 221–230
- Hassler R, Riechert T (1959) Clinical and anatomical findings in stereotactic pain operations on the thalamus. *Arch Psychiatr Nervenkr Z, Gesamte Neurol Psychiatr* 200:93–122
- Ishijima B, Yoshimasu N, Fukushima T et al. (1975) Nociceptive Neurons in the Human Thalamus. *Confinia Neurol* 37:99–106
- Jeanmonod D, Magnin M, Morel A (1993) Thalamus and Neurogenic Pain: Physiological, Anatomical and Clinical Data. *Neuroreport* 4:475–478
- Lee J, Dougherty PM, Antezana D et al. (1999) Responses of Neurons in the Region of Human Thalamic Principal Somatosensory Nucleus to Mechanical and Thermal Stimuli Graded into the Painful Range. *J Comp Neurol* 410:541–555
- Lenz FA, Dougherty PM (1997) Pain Processing in the Human Thalamus. In: Steriade M, Jones EG, McCormick DA (eds) *Thalamus, Vol II, Experimental and Clinical Aspects*. Elsevier, Amsterdam, pp 617–652
- Lenz FA, Dostrovsky JO, Kwan HC et al. (1988) Methods for Microstimulation and Recording of Single Neurons and Evoked Potentials in the Human Central Nervous System. *J Neurosurg* 68:630–634
- Lenz FA, Gracely RH, Romanoski AJ et al. (1995) Stimulation in the Human Somatosensory Thalamus can Reproduce Both the Affective and Sensory Dimensions of Previously Experienced Pain. *Nat Med* 1:910–913
- Lenz FA, Gracely RH, Rowland LH et al. (1994) A Population of Cells in the Human Thalamic Principal Sensory Nucleus Respond to Painful Mechanical Stimuli. *Neurosci Lett* 180:46–50
- Lenz FA, Seike M, Lin YC et al. (1993a) Neurons in the Area of Human Thalamic Nucleus Ventralis Caudalis Respond to Painful Heat Stimuli. *Brain Res* 623:235–240



18. Lenz FA, Seike M, Richardson RT et al. (1993b) Thermal and Pain Sensations Evoked by Microstimulation in the Area of Human Ventrocaudal Nucleus. *J. Neurophysiol* 70:200–212
19. Tasker RR (1984) Stereotaxic surgery. In: Wall PD, Melzack R (eds) *Textbook of Pain*, Churchill Livingstone, pp 639–655
20. Tasker RR, Kiss ZHT (1995) The Role of the Thalamus in Functional Neurosurgery. *Neurosurg Clin N Am* 6:73–104

## Human Thalamic Response to Experimental Pain (Neuroimaging)

ALEXANDRE F. M. DASILVA,  
NOUCHINE HADJIKHANI  
Martinos Center for Biomedical Imaging,  
Massachusetts General Hospital, Harvard Medical  
School, Charlestown, MA, USA  
alexandr@nmr.mgh.harvard.edu,  
nouchine@nmr.mgh.harvard.edu

### Synonyms

Thalamic Response to Experimental Pain in Humans

### Definition

The thalamus is the major relay structure in the forebrain for noxious and non-noxious sensory inputs. In the case of ► **noxious stimuli**, the thalamus distributes the incoming information to other specific cortical areas for proper processing of their discriminative, cognitive and affective components. Recent neuroimaging techniques can effectively detect transient thalamic neuronal activation following the application of experimental stimuli that artificially replicate painful conditions in humans.

### Characteristics

Thalamic neuronal activation is frequently observed in functional neuroimaging studies following ► **experimental pain**. Through the use of neuroimaging techniques, the role of the thalamus has been gradually dissected in the nociceptive CNS network. Under those studies, experimental pain resultant of different noxious stimuli has revealed a pattern of thalamic activation that depends on the type of stimuli (e.g. thermal), area of application, and conditions inherent to the subject or patient, such as attention, or the presence of a chronic pain disorder.

### Techniques

Of the neuroimaging technologies available, ► **functional magnetic resonance imaging** (fMRI) and ► **positron emission tomography** (PET) have greatly expanded our knowledge of human thalamic response to pain. Both indirectly measure the neuronal activity based on changes in the metabolism during a particular transient task (e.g. experimental pain) compared to a baseline state (e.g. no-pain state). The specific contrast for fMRI is the blood oxygenation level-dependant (BOLD) contrast, which does not require any tracer agent but relies

on blood volume and blood flow, whereas radioactive labeled tracers are used to measure changes in cerebral blood flow and metabolism in PET.

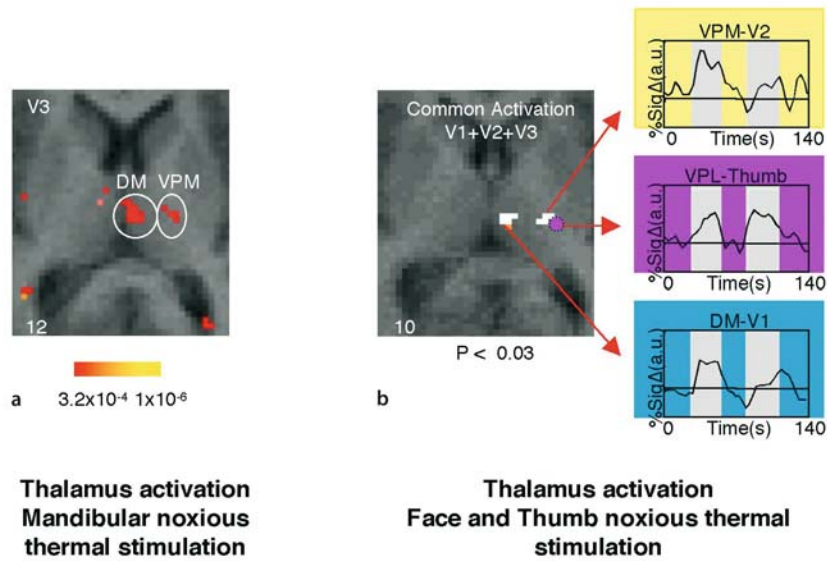
### Thalamic Nuclear Function

There are 14 major thalamic nuclei identified, but this number diverges depending on the histological technique applied. Some of them, or subdivisions, have specific roles in the thalamic nuclear configuration for pain processing. Activations of the ventroposterior nuclei of the ventrobasal complex (lateral), and other more medial nuclei of the thalamus, have been consistently described in neuroimaging studies. These studies confirm previous animal experiments that noxious and innocuous discriminative input from cranial and the body parts are respectively processed by the ventroposterior medial nucleus (VPM) and the ► **ventroposterior lateral nucleus** (VPL), and afterward projected to the somatosensory cortex. The lateral nuclear activation has a clear somatotopic configuration for different kinds of sensory input, while the medial thalamus, such as the ► **dorsomedial nucleus (DM)**, has particular thermoreceptive functions. Noxious thermal stimulation to the facial skin of each trigeminal division in healthy human volunteers activates the contralateral VPM, while the same noxious stimulation applied to the palmar surface of the thumb activates the VPL (DaSilva et al. 2002). In both cases, during trigeminal and thumb noxious thermal stimulation, the contralateral DM nucleus of the thalamus shows activation (Fig. 1).

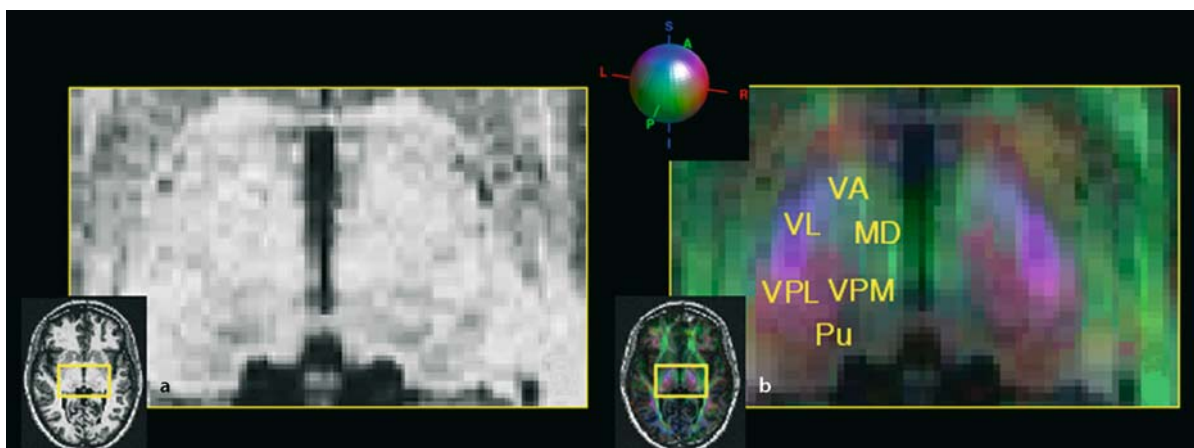
A specific thalamic nuclear pathway is involved in interoceptive mechanism of homeostasis: the basal part of the ventromedial nucleus (VMb) and the ► **posterior part of the ventromedial nucleus** (VMpo) play an important role in thermal nociceptive inflow through main direct projections to the insular cortex (Craig 2002). With the future improvement of the spatial resolution (2 mm for PET and <1 mm for fMRI) and signal noise rate in the neuroimaging studies, as well as the superposition of structural ► **diffusion tensor imaging** (DTI) maps to delineate nuclear architecture under the activations (Fig. 2), we will be able to precisely define the pattern of thalamic activation following painful stimulus in human (DaSilva et al. 2003; Wiegell et al. 2003).

### Experimental Noxious Stimuli

Most of the noxious stimuli used in neuroimaging studies are thermal in nature, applying temperatures higher than 45°C for heat pain, and usually lower than 6°C for cold pain, enough to activate nociceptive fibers (C and A-delta). The noxious thermal stimuli are delivered by non-magnetic contact probes, water immersion, and laser (heat) to a particular part of the body in an alternating fashion with a non-noxious state (e.g. neutral 32°C x noxious 46°C). Similar noxious sensations have also been produced by interlaced application of non-noxious



**Human Thalamic Response to Experimental Pain (Neuroimaging), Figure 1** Activation in Thalamus. (a) Activation in the thalamus contralateral to a noxious thermal stimulus to the V3 (mandibular trigeminal branch) region of the face. (b) Activation in the thalamus following contralateral stimulation to the face and hand. The white areas show regions of common activation following noxious thermal stimulation to the V1 (ophtalmic), V2 (maxillary) and V3 (mandibular) distributions of the face, in regions defined as the dorsomedial (DM) and ventroposteromedial (VPM) nuclei. Activation of the thumb is mapped onto the same anatomical section (purple circle) and corresponds to the ventroposterolateral (VPL) nucleus. The regions are defined anatomically using the Talairach Atlas. Time courses of activation for each area are shown in inserts. Percent signal change is shown in arbitrary units (a.u.); numbers in bottom corners indicate the Talairach coordinate in the rostro-caudal (z) axis. (Da Silva et al. 2002).xxx



**Human Thalamic Response to Experimental Pain (Neuroimaging), Figure 2** Color-coded DTI map superimposed on high-resolution anatomical image. Comparison of an axial (a) MPRAGE structural image and the corresponding (b) color-coded DTI map. The ROI is taken from the yellow box shown in the whole slice image at bottom-left. On the MPRAGE, the thalamus appears homogeneous, whereas the DTI map shows significant substructure. The thalamic nuclei have been labeled according to their anatomical position and fiber orientation. The color-coding depicts the local fiber orientation (i.e. the principal eigenvector of the diffusion tensor) with red indicating mediolateral, green anteroposterior, and blue superoinferior. The color-coding is also indicated by the red-green-blue sphere shown at top-center. Abbreviations: VA, ventral anterior; VL, ventrolateral; MD, mediodorsal; VPL, ventral posterior lateral; VPM, ventral posterior medial; Pu, pulvinar. (Da Silva et al. 2003).

warm and cold temperatures, which is known as the thermal-grill illusion of pain. Other noxious stimuli that have been used in pain studies are mechanical (e.g. tonic pressure), electrical (e.g. intramuscular electrical stimulation) and chemical (e.g. subcutaneous injection of ► [capsaicin](#) or ascorbic acid). Neuroimaging studies applying experimental stimuli produce thalamic activation. Noxious and innocuous

thermal stimuli (cold and heat) activate the medial and lateral thalamic nuclei, with predominant contralateral activation, while innocuous mechanical stimuli mostly activate the lateral thalamus. Noxious mechanical stimuli (tonic pressure) elicit inconsistent contralateral thalamic activation (Creac'h et al. 2000), as tonic pain (long duration) elicits less thalamic activation than phasic pain (short duration). In addition, the amount

of thalamic activation observed depends on the size of the somatotopic representation of the body part being stimulated (the face has, for example, a much bigger cortical representation than the foot).

If the experimental noxious stimulus is applied to the same region but in different tissues, the thalamic activation pattern can also be distinct, as in the case of experimental skin and muscular pain (Svensson et al. 1997). Although noxious intramuscular electrical stimulation and cutaneous pain, elicited by CO<sub>2</sub> laser in the left brachioradialis area produce equal positive correlation between increases in regional cerebral flow (rCBF) in thalamus and anterior insula, only the cutaneous noxious stimulation shows a negative relationship in rCBF changes between thalamus and contralateral primary sensorimotor cortex, indicating a possible inhibitory mechanism between both structures.

Chemical experimental pain using capsaicin has been used in neuroimaging studies in two different ways: to induce acute and/or allodynic pain. Capsaicin is a hot pepper-derived substance that induces consistent ongoing pain, with a response including midline thalamic nuclei such as the DM nucleus (Iadarola et al. 1998). The cutaneous area treated with capsaicin, injected or topically applied, also develops secondary **▶ allodynia**. Allodynia is a reversible state of painful sensitivity to non-noxious stimuli, such as brush and warm stimuli that replicates a clinical phenomenon common in **▶ neuropathic pain**, burn lesions and **▶ migraine** patients. Capsaicin-allodynia to non-noxious heat activates the medial thalamus simultaneously with the frontal cortex, orbital and dorsolateral prefrontal (DLPFC), suggesting a greater affective and cognitive response, which correlates with the higher unpleasantness rating compared to normal heat pain rating (Lorenz et al. 2003).

Conditions inherent to the subjects also affect the thalamic response to experimental pain. There is an indication that gender differences in pain perception influence thalamus function. For the same thermal noxious pain, females show a higher rating for pain intensity than males, translated into higher activation in the contralateral thalamus, as well as in the prefrontal cortex and anterior insula (Paulson et al. 1998). Male subjects demonstrate higher  $\mu$ -opioid system activation than female subjects in the anterior thalamus, ventral basal ganglia and amygdala during sustained deep muscular pain (Zubieta et al. 2002). Pain perception is also altered by attention, hypnosis or pharmacologic effect through a modulation of the pain system involving mainly the thalamus and cingulate cortex. Distraction tasks presented to subjects during thermal pain correlate with decreased perception of pain, and consequently lower medial thalamic activation (Bantick et al. 2002). In a hypnotic state, the patient's reduced pain perception correlates with high functional modulation between the midcingulate cortex, the thalamus and the midbrain (Faymonville et al. 2003). Under

the influence of fentanyl, a  $\mu$ -opioid receptor agonist, there is a strong attenuation of responses to noxious cold stimulation in the contralateral thalamus and primary somatosensory cortex (Casey et al. 2000).

Acute and chronic pain can alter the pattern of thalamic and cortical activation. Patients suffering acute post-dental extraction show increased response to heat pain applied to the ipsilateral hand in the somatosensory pathway, including thalamus and S1 (Derbyshire et al. 1999). This increased level of rCBF does not occur when the same noxious stimulus is applied to the hand contralateral to the dental extraction. This fact can be explained by the ongoing post-surgical inflammatory process, and its repercussions in the CNS awareness, amplifying any further sensory input from the ipsilateral areas, surrounding or distant (for safeguard) from the injury. Chronic pain disorders have shown a central distinct neuroplastic mechanism in response to the persistent pain input overflow. Instead of thalamic increase activation to painful stimulation, there is attenuation of the response and even a decrease of the rCBF in the thalamus. This is the case for **▶ fibromyalgia** and neuropathic patients, where chronic thalamic activation following their persistent evoked and ongoing clinical pain, attenuates or decreases its response after time (Gracely et al. 2002; Hsieh et al. 1995; Kwiatek et al. 2000). Patients suffering from **▶ cluster headache**, a primary headache disorder, also show similar results, with significantly lower rCBF changes during the headache-free period compared to control subjects in the contralateral thalamus and S1 after ipsilateral tonic cold pain stimulation (Di Piero et al. 1997).

### Conclusion

Although it is clear that neuroimaging research can contribute to the understanding of the thalamic neuronal activation regarding experimental and clinical pain, its nuclear specificity is yet to be completely defined. Technical improvement of imaging tools will provide better anatomical and functional nuclear maps of the thalamus, and consequently, of its correlation with each intrinsic aspect of a noxious event.

### References

1. Bantick SJ, Wise RG, Ploghaus A et al. (2002) Imaging How Attention Modulates Pain in Humans using Functional MRI. *Brain* 125:310–319
2. Casey KL, Svensson P, Morrow TJ et al. (2000) Selective Opiate Modulation of Nociceptive Processing in the Human Brain. *J Neurophysiol* 84:525–533
3. Craig AD (2002) How do you feel? Interoception: The Sense of the Physiological Condition of the Body. *Nat Rev Neurosci* 3:655–666
4. Creac'h C, Henry P, Caille JM et al. (2000) Functional MR Imaging Analysis of Pain-Related Brain Activation after Acute Mechanical Stimulation. *AJNR Am J Neuroradiol* 21:1402–1406
5. DaSilva AF, Becerra L, Makris N et al. (2002) Somatotopic Activation in the Human Trigeminal Pain Pathway. *J Neurosci* 22:8183–8192

6. DaSilva AF, Tuch DS, Wiegell MR et al. (2003) Diffusion Tensor Imaging – A Primer on Diffusion Tensor Imaging of Anatomical Substructure. *Neurosurg Focus* 15:1–4
7. Derbyshire SW, Jones AK, Collins M et al. (1999) Cerebral Responses to Pain in Patients Suffering Acute Post-Dental Extraction Pain Measured by Positron Emission Tomography (PET). *Eur J Pain* 3:103–113
8. Di Piero V, Fiacco F, Tombari D et al. (1997) Tonic Pain: A SPET Study in Normal Subjects and Cluster Headache Patients. *Pain* 70:185–191
9. Faymonville ME, Roediger L, Del Fiore G et al. (2003) Increased Cerebral Functional Connectivity Underlying the Antinociceptive Effects of Hypnosis. *Brain Res Cogn Brain Res* 17:255–262
10. Gracely RH, Petzke F, Wolf JM et al. (2002) Functional Magnetic Resonance Imaging Evidence of Augmented Pain Processing in Fibromyalgia. *Arthritis Rheum* 46:1333–1343
11. Hsieh JC, Belfrage M, Stone-Elander S et al. (1995) Central Representation of Chronic Ongoing Neuropathic Pain Studied by Positron Emission Tomography. *Pain* 63:225–236
12. Iadarola MJ, Berman KF, Zeffiro TA et al. (1998) Neural Activation during Acute Capsaicin-Evoked Pain and Allodynia Assessed with PET. *Brain* 121:931–947
13. Kwiatek R, Barnden L, Tedman R et al. (2000) Regional Cerebral Blood Flow in Fibromyalgia: Single-Photon-Emission Computed Tomography Evidence of Reduction in the Pontine Tegmentum and Thalami. *Arthritis Rheum* 43:2823–2833
14. Lorenz J, Minoshima S, Casey KL (2003) Keeping Pain Out of Mind: The Role of the Dorsolateral Prefrontal Cortex in Pain Modulation. *Brain* 126:1079–1091
15. Paulson PE, Minoshima S, Morrow TJ et al. (1998) Gender Differences in Pain Perception and Patterns of Cerebral Activation during Noxious Heat Stimulation in Humans. *Pain* 76:223–229
16. Svensson P, Minoshima S, Beydoun A et al. (1997) Cerebral Processing of Acute Skin and Muscle Pain in Humans. *J Neurophysiol* 78:450–460
17. Wiegell MR, Tuch DS, Larsson HB et al. (2003) Automatic Segmentation of Thalamic Nuclei from Diffusion Tensor Magnetic Resonance Imaging. *Neuroimage* 19:391–401
18. Zubieta JK, Smith YR, Bueller JA et al. (2002) mu-Opioid Receptor-Mediated Antinociceptive Responses Differ in Men and Women. *J Neurosci* 22:5100–5107

## Hunner's Ulcer

### Definition

Hunner's ulcer is a focal inflammatory lesion of the bladder wall in chronic interstitial cystitis; its surface may crack and bleed with bladder distension.

- ▶ [Interstitial Cystitis and Chronic Pelvic Pain](#)

## HVTM

- ▶ [High Velocity Thrust Manipulation](#)

## Hyaline Cartilage

### Definition

Hyaline cartilage is translucent cartilage that is common in joints and the respiratory passages.

- ▶ [Sacroiliac Joint Pain](#)

## Hyaluronan

BRIAN MCGUIRK

Occupational (Musculoskeletal) Medicine, Hunter Area Health Service, Newcastle, NSW, Australia  
mgillam@mail.newcastle.edu.au

### Synonyms

Hyaluronic acid; Viscosupplementation

### Definition

Hyaluronic acid is a naturally occurring glycosaminoglycan, consisting of a repeating dimer of glucuronic acid and N-acetyl-glucosamine (Weissman and Meyer 1954). The proprietary form is known as hyaluronan. This agent is administered by intra-articular injection, as a treatment for osteoarthritis.

### Characteristics

Hyaluronic acid is a widely distributed polysaccharide, which plays an important role in all mammalian connective tissues, due to its peculiar physico-chemical and biological properties. By nature of its propensity to form highly hydrated and viscous matrices, hyaluronic acid imparts stiffness, resilience and lubrication to various tissues. The unique biophysical properties of hyaluronic acid are manifested in its mechanical function in the synovial fluid, the vitreous humour of the eye, and the ability of connective tissues to resist compressive forces (Laurent 1998).

In normal human synovial fluid, hyaluronic acid has a high molecular weight and acts in a visco-elastic manner. Due to its hyaluronic acid content, joint fluid acts as a viscous lubricant during slow movement of the joint, as in walking, and as an elastic shock absorber during rapid movement, as in running.

In osteoarthritis, both the concentration and molecular weight of hyaluronic acid in the synovial fluid are reduced (Marshall 1998; George 1998), which impacts on its biophysical properties. It was this finding that gave rise to the concept of *viscosupplementation*, in which injection of exogenous hyaluronic acid into the joint space is presumed to augment the functions of endogenous hyaluronic acid.

### Mechanism

The mechanism by which intra-articular hyaluronic acid works in patients with osteoarthritis remains unknown. Although restoration of the elasto-viscous properties of synovial fluid seems to be the most logical explanation, other mechanisms must exist. The actual period that the injected hyaluronic acid product stays within the joint space is in the order of hours to days, but the time of clinical efficacy is often in the order of months (Cohen 1998; Balazs and Denlinger 1993). Possible explanations include stimulation of endogenous production of



hyaluronic acid; inhibition of inflammatory mediators such as cytokines and prostaglandins; stimulation of cartilage matrix synthesis as well as inhibition of cartilage degradation; and a direct protective action on nociceptive nerve endings.

#### Technique

Hyaluronan is injected into the joint to be treated using a strict, no-touch, aseptic technique. If an effusion is present, aspiration of the joint is recommended before the injection, in order to prevent dilution of the injectate. Excessive weight-bearing physical activity should be avoided for 1–2 days.

#### Applications

The US Food & Drug Administration has approved the use of hyaluronan for patients with osteoarthritis of the knee, whose joint pain has not responded to non-medicinal measures and analgesic drugs. The guidelines for osteoarthritis from the American College of Rheumatology (American College of Rheumatology Subcommittee on Osteoarthritis Guidelines 2000) state that it may be “especially advantageous in patients in whom non-selective ► NSAIDs and Cox-2 specific inhibitors are contra-indicated, or in whom they have been associated either with a lack of efficacy or with adverse events”. Intra-articular hyaluronic acid is generally used after non-pharmacologic treatments, analgesics and a trial of several NSAIDs.

#### Efficacy

Since the 1970s many studies have been carried out to evaluate the efficacy of hyaluronan. Despite a number of randomised, controlled trials having been carried out, the results and their interpretation, remain conflicting. Whereas the earliest studies suggested benefits, more recent double-blind placebo-controlled trials did not show any benefit over placebo. In other studies, hyaluronan has been suggested to have an overall benefit over placebo.

An extensive review on intra-articular administration of hyaluronan, published by Brandt et al. (2000), concludes that “although several clinical trials indicate that intra-articular injection of [hyaluronan] results in relief of joint pain in patients with knee [osteoarthritis], and that this effect may last for months, similar results are seen with placebo, and it is not clear that the difference between [hyaluronan] and placebo, even if statistically significant, is clinically significant.”

In response, Miller, in correspondence to the Journal of American Academy of Orthopaedic Surgeons (Miller 2001), argued that the decrease in the total number of knee replacements performed in the USA has occurred as a direct result of the use of viscosupplementation, citing a number of studies that formed the basis of the presentation to the FDA for its approval of hyaluronan as a treatment for osteoarthritis.

#### Side Effects

Transient localised pain and/or effusion is the most commonly reported side effect, albeit occurring in a low (0–3) percentage of patients, based on the majority of clinical trials conducted to date (Puttick et al. 1995). These resolve spontaneously within a short period. Several cases of pseudogout have been confirmed (Luzar and Altawil 1998). Long-term side-effects have not been identified.

#### References

1. American College of Rheumatology Subcommittee on Osteoarthritis Guidelines (2000) Recommendations for the Medical Management of Osteoarthritis of the Hip and Knee. *Arthritis Rheum* 43:1905–1915
2. Balazs E, Denlinger J (1993) Viscosupplementation: A New Concept in the Treatment of Osteoarthritis. *J Rheumatol* 20 (Suppl):3–9
3. Brandt K, Smith G, Simon L (2000) Intraarticular Injection of Hyaluronan as Treatment for Knee Osteoarthritis: What is the Evidence? *Arthritis Rheum* 43:1192–1203
4. Cohen M, (1998) Hyaluronic Acid Treatment (Viscosupplementation) for OA of the Knee. *Bull Rheum Dis* 47:4–7
5. George E (1998) Intra-Articular Hyaluronan Treatment for Osteoarthritis. *Ann Rheum Dis* 57:637–640
6. Laurent TC (ed) (1998) The Chemistry, Biology and Medical Applications of Hyaluronan and its Derivatives. Wenner-Gren International Series, vol 72, Portland Press, London
7. Luzar M, Altawil B (1998) Pseudogout following Intraarticular Injection of Sodium Hyaluronate *Arthritis Rheum* 41:939–940
8. Marshall KW (1998) Viscosupplementation for Osteoarthritis: Current Status, Unresolved Issues and Future Directions. *J Rheumatol* 25:2056–2058
9. Miller E (2001) Correspondence. Viscosupplementation: Therapeutic Mechanisms and Clinical Potential in Osteoarthritis of the Knee. *J Am Acad Orthop Surg* 9:146–147
10. Puttick M, Wade J, Chalmers A, Connell D, Rangno K (1995) Local Reactions after Intra-Articular Hylan for Osteoarthritis of the Knee. *J Rheumatol* 22:1311–1314
11. Weissman B, Meyer K (1954) The Structure of Hyalbiuronic Acid and of Hyaluronic Acid from Umbilical Cord. *J Am Chem Soc* 76:1753–1757

H

## Hyaluronic Acid (HA)

#### Definition

Investigational drug for the treatment of IC; appears to temporarily replace defective mucosa.

- Hyaluronan
- Interstitial Cystitis and Chronic Pelvic Pain

## Hydrodistention

#### Definition

Hydrodistention is the filling of bladder under anesthesia, to assess for mucosal tears, glomerulations, and bladder capacity; part of diagnostic workup as well as therapy for IC.

- Interstitial Cystitis and Chronic Pelvic Pain

## Hydroperoxides

### Definition

Hydroperoxides such as PGG<sub>2</sub> are required to initiate the conversion of arachidonic acid into prostaglandins.

► [Cyclooxygenases in Biology and Disease](#)

## Hydrotherapy

### Definition

Hydrotherapy is the external application of water, e.g. the immersion of the body in thermal water.

► [Chronic Pain in Children, Physical Medicine and Rehabilitation](#)

► [Spa Treatment](#)

## Hydroxy-7.8-Dihydrocodeinone

► [Oxycodone](#)

## Hypalgesia

► [Hypoalgesia](#)

► [Hypoalgesia, Assessment](#)

## Hypalgia

► [Hypoalgesia, Assessment](#)

## Hyperaesthesia

► [Hyperalgesia](#)

## Hyperaesthesia, Assessment

KRISTINA B. SVENDSEN<sup>1</sup>, TROELS S. JENSEN<sup>2</sup>, F. W. BACH<sup>2</sup>

<sup>1</sup>Danish Pain Research Center, Aarhus University Hospital, Aarhus, Denmark

<sup>2</sup>Danish Pain Research Center and Department of Neurology, Aarhus University Hospital, Aarhus, Denmark

kristina@akhphd.au.dk, tsj@akhphd.au.dk

### Definition

Hyperaesthesia is increased sensitivity to stimulation, excluding the special senses (Merskey and Bogduk

1994). ► [Allodynia](#) and ► [hyperalgesia](#) are included in the definition.

### Characteristics

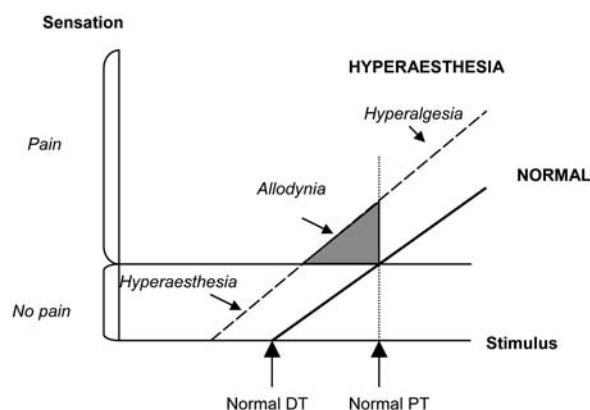
Hyperaesthesia refers to both the finding of a lowered threshold to a non-noxious or a noxious stimulus, and to an increased response to suprathreshold stimuli (Merskey and Bogduk 1994). It can best be described as a leftward shift of the stimulus-response curve, which relates the response to the stimulus intensity (Fig. 1). Hyperaesthesia has to be distinguished from hyperpathia, which is a classical feature of neuropathic pain and easily demonstrated in skin territories innervated by damaged nerve fibres (Jensen et al. 2001), (Jensen and Baron 2003).

Hyperaesthesia may occur after traumatic or inflammatory injury to the skin (Treede et al. 1992) or in the undamaged skin in neuropathic pain conditions (Boivie 1999, Woolf and Mannion 1999). Hyperaesthesia may also be found in the skin area of referred muscle (Svensson et al. 1998) and visceral pain (Hardy 1950, Stawowy et al. 2002). In tissue injury, increased sensibility to stimuli may be found in both the injured area (normally called primary hyperalgesia) and in surrounding non-injured skin area (secondary hyperalgesia) (Treede and Magerl 2000).

### Induction and Assessment

Hyperaesthesia may be induced by different stimulus modalities including mechanical, thermal, and chemical stimuli (Treede et al. 1992, Jensen et al. 2001, Woolf and Mannion 1999).

Hyperaesthesia can be assessed by determining ► [detection thresholds](#) for a given stimulus. In the case of noxious stimuli, pain detection and pain tolerance thresholds can be used. Assessment of hyperalgesia includes stimulus-response curves, where noxious stimuli of different intensities (e.g. thermal stimuli or



**Hyperaesthesia, Assessment, Figure 1** Hyperaesthesia refers to both lowered thresholds and to increased response to suprathreshold stimuli. Decreased pain threshold is called allodynia. Increased response to normally painful stimuli is called allodynia. DT, detection threshold. PT, pain threshold.

pressure) are applied in a random order and the pain sensation/intensity is assessed for each stimulus. Hyperaesthesia is present when the detection and/or ► **pain threshold** for a given stimulus is decreased (Fig. 1), or the response to suprathreshold stimuli is increased. In the case where pain is induced by a normally non-painful stimulus, the term allodynia is used. Increased response to normally painful stimuli, e.g. evaluated by the stimulus-response curve, is termed hyperalgesia.

### Clinical Examination/Studies

Bedside sensory screening may be useful in the evaluation of the anatomical distribution and the qualitative characterisation of sensory abnormalities of the skin (Hansson and Lindblom 1992). Bedside examination includes mechanical stimuli (cotton wool, paintbrush, pressure with fingertip, pinprick), thermal stimuli (thermal rollers kept at 20° and 40°C, acetone drop) and vibration sense (tuning fork) (Table 1).

Sensory examination is normally done in the area with maximal pain and compared with the contralateral site of the body (Andersen et al. 1995, Jensen et al. 2001) or the adjacent body area not involved in disease. Hyperaesthesia is present in the case of increased sensation/pain to a non-painful (hyperaesthesia/allodynia) or a painful stimulus (hyperalgesia).

Quantitative assessment of hyperaesthesia is performed using quantitative sensory testing (QST). QST includes mechanical (► **Von Frey hair**, pressure algometry) and thermal stimuli (Thermotest) (Table 1). The results of QST from the affected site of the body are normally compared with results from an unaffected contralateral body site. However, when the contralateral site is also affected by disease, values from healthy subjects/general population may be used (Kemler et al. 2000). For standard-

ized regions such as feet, hands and face several laboratories have established normative data for thermal and mechanical stimuli. Hyperaesthesia is present in the case of lowered detection and/or pain thresholds. Pain Detection and Pain Tolerance Thresholds (see ► **Pain Detection and Pain Tolerance Thresholds**) indicates hyperalgesia.

The qualitative aspect of pain can be assessed by various questionnaires such as McGill Pain Questionnaire (Melzack 1975), verbal rating scales, visual analogue scales, numerical rating scales etc. (Turk and Melzack 1992).

### Patient Example

A 54 year old man with peripheral neuropathic pain following a trauma located to the right antebraechium. The sensory function of the right hand was assessed by QST, and the results were compared with the healthy contralateral site. The patient had signs of hyperaesthesia with decreased tactile detection threshold, allodynia with decreased tactile pain threshold; decreased pressure pain threshold, decreased heat and cold pain thresholds and hyperalgesia with decreased pressure tolerance threshold (see Fig. 2). In addition he had cold allodynia evoked by acetone drop.

### Experimental Studies

#### Human

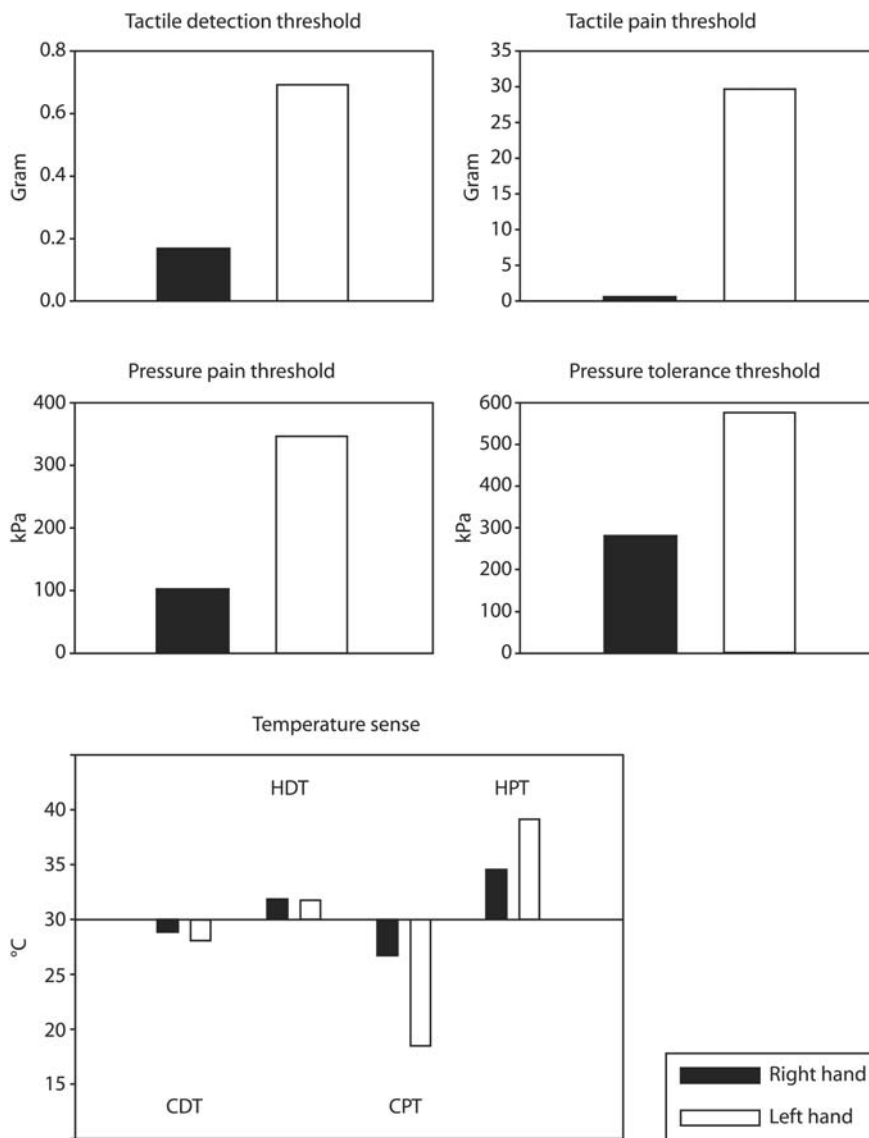
Hyperaesthesia is found in various human pain models: Burn injury of the skin (a model of cutaneous injury) is followed by heat and mechanical allodynia in both injured and the adjacent non-injured surrounding skin (Pedersen and Kehlet 1998).

Capsaicin application of the skin produces allodynia with decreased heat pain threshold at the site of injection, and pain induced by a light normally non-painful

H

Hyperaesthesia, Assessment, Table 1 Sensory testing

	Stimulus	Method	Sensation
Bedside examination	Mechanical stimuli -Dynamic Touch -Static Touch -Punctate stimuli	Stroking the skin with a paintbrush / cotton swab Gentle pressure with fingertip Pinprick	Increased sensation/pain = hyperaesthesia
	Thermal stimuli -Cold -Warm	Metallic thermal roller kept at 20°C Acetone / menthol Metallic thermal roller kept at 40°C	
Quantitative sensory testing	Mechanical stimuli -Tactile detection threshold -Tactile pain threshold -Pressure pain threshold -Pressure pain tolerance threshold	Von Frey Hair Pressure Alogometry	Decreased threshold = hyperaesthesia
	Thermal stimuli -Cold detection threshold -Warm detection threshold -Cold pain threshold -Heat pain threshold -Heat tolerance threshold	Thermotest	



**Hyperaesthesia, Assessment, Figure 2** Quantitative sensory testing in a patient with nerve lesion of the right antebrachium. CDT, cold detection threshold; HDT, heat detection threshold; CPT, cold pain threshold; HPT, heat pain threshold.

mechanical stimulus in an area surrounding the injection site (Treede et al. 1992). Burn injury has also been combined with capsaicin in a heat-capsaicin sensitisation model (Petersen et al. 2001).

Intramuscular injections of hypertonic saline, capsaicin, glutamate and other excitatory or algogenic substances have been used as a model of localised and referred muscular pain (Graven-Nielsen and Arendt-Nielsen 2003). In these muscle pain models decreased pressure pain thresholds have been found. Hypertonic saline may induce mechanical hyperaesthesia located to the overlying or adjacent skin (Svensson et al. 1998).

#### Animal

Strictly speaking, hyperaesthesia including allodynia and hyperalgesia with increased sensitivity to specific sensory stimulation cannot be determined in experimental animal models. Nevertheless, it is generally

accepted that increased motor responses to mechanical (Von Frey hair), thermal (cold bath, hot plate, acetone, focal heat) and chemical (capsaicin) stimuli in animal models of nerve injury, inflammation or diabetes reflects a hypersensitivity of the animal to the pertinent stimulus (Scholz and Woolf 2002).

#### References

- Andersen G, Vestergaard K, Ingeman-Nielsen M, Jensen TS (1995) Incidence of Central Post-Stroke Pain. *Pain* 61:187–193
- Boivie J (1999). Central Pain. In: Wall PD, Melzack R (eds) *Textbook of Pain*. Churchill Livingstone, New York, pp 879–914
- Graven-Nielsen T, Arendt-Nielsen L (2003) Induction and Assessment of Muscle Pain, Referred Pain, and Muscular Hyperalgesia. *Curr Pain Headache Rep* 7:443–451
- Hansson P, Lindblom U (1992) Hyperalgesia Assessed with Quantitative Sensory Testing in Patients with Neurogenic Pain. In: Willis WD (ed) *Hyperalgesia and Allodynia*. Raven Press, New York, pp 335–343



5. Hardy JD, Wolff HG, Goodell H (1950) Experimental Evidence on the Nature of Cutaneous Hyperalgesia. *J Clin Invest* 29:115–140
6. Jensen TS, Baron R (2003) Translation of Symptoms and Signs into Mechanisms in Neuropathic Pain. *Pain* 102:–18
7. Jensen TS, Gottrup H, Sindrup SH, Bach FW (2001) The Clinical Picture of Neuropathic Pain. *Eur J Pharmacol* 429:1–11
8. Kemler MA, Schouten HJ, Gracely RH (2000) Diagnosing Sensory Abnormalities with either Normal Values or Values from Contralateral Skin: Comparison of Two Approaches in Complex Regional Pain Syndrome I. *Anesthesiology* 93:718–727
9. Melzack R (1975) The McGill Pain Questionnaire: Major Properties and Scoring Methods. *Pain* 1:277–299.
10. Merskey H, Bogduk N (1994) Classification of Chronic Pain: Descriptions of Chronic Pain Syndromes and Definitions of Pain Terms, Prepared by the International Association for the Study of Pain, Task Force of Taxonomy. IASP Press, Seattle
11. Pedersen JL, Kehlet H (1998) Secondary Hyperalgesia to Heat Stimuli after Burn Injury in Man. *Pain* 76:377–384
12. Petersen KL, Jones B, Segredo V, Dahl JB, Rowbotham MC (2001) Effect of Remifentanyl on Pain and Secondary Hyperalgesia Associated with the Heat-Capsaicin Sensitization Model in Healthy Volunteers. *Anesthesiology* 94:15–20
13. Scholz J, Woolf CJ (2002) Can we Conquer Pain? *Nat Neurosci* 5 suppl: 1062–1067
14. Stawowy M, Rossel P, Bluhme C, Funch-Jensen P, Arendt-Nielsen L, Drewes AM (2002) Somatosensory Changes in the Referred Pain Area following Acute Inflammation of the Appendix. *Eur J Gastroenterol Hepatol* 14:1079–1084
15. Svensson P, Graven-Nielsen T, Arendt-Nielsen L (1998) Mechanical Hyperesthesia of Human Facial Skin Induced by Tonic Painful Stimulation of Jaw Muscles. *Pain* 74:93–100
16. Treede RD, Magerl W (2000) Multiple Mechanisms of Secondary Hyperalgesia. *Prog Brain Res* 129:331–41
17. Treede RD, Meyer RA, Raja SN, Campbell JN (1992) Peripheral and Central Mechanisms of Cutaneous Hyperalgesia. *Prog Neurobiol* 38:397–421
18. Turk DC, Melzack R (1992) Handbook of Pain Assessment. The Guilford Press, New York
19. Woolf CJ, Mannion RJ (1999) Neuropathic Pain: Aetiology, Symptoms, Mechanisms, and Management. *Lancet* 353:1959–1964

## Hyperalgesia

ROLF-DETLEF TREEDE

Institute of Physiology and Pathophysiology, Johannes Gutenberg University, Mainz, Germany  
treede@uni-mainz.de

### Synonyms

Primary hyperalgesia; secondary hyperalgesia; algesia; hyperesthesia

### Definition

Increased pain sensitivity. Antonym: ► **hypoalgesia** (decreased pain sensitivity). Increased pain sensitivity at a site of tissue damage is called primary hyperalgesia. Increased pain sensitivity in normal skin surrounding a site of tissue damage is called secondary hyperalgesia. Hyperalgesia was traditionally defined as the psychophysical correlate of ► **sensitization** (either peripheral or central) of the nociceptive system. As such, it is characterized by a decreased pain threshold and

increased pain to suprathreshold stimuli. The current definition by the International Association for the Study of Pain (IASP) refers only to the latter phenomenon (“increased pain to a stimulus that is normally painful”). A decreased pain threshold would operationally fulfill the IASP definition of ► **allodynia** (“pain induced by stimuli that are not normally painful”). This narrow definition has proved to be counterproductive for two reasons: 1) all known mechanisms of sensitization lead to changes in both threshold and suprathreshold response, 2) the extended use of the term allodynia has distracted from its initial clinical meaning and has hampered the transfer of knowledge from animal research to the clinic. Therefore, this essay uses the traditional definition of hyperalgesia as the psychophysical correlate of sensitization, which will probably be adopted by IASP in the near future.

### Characteristics

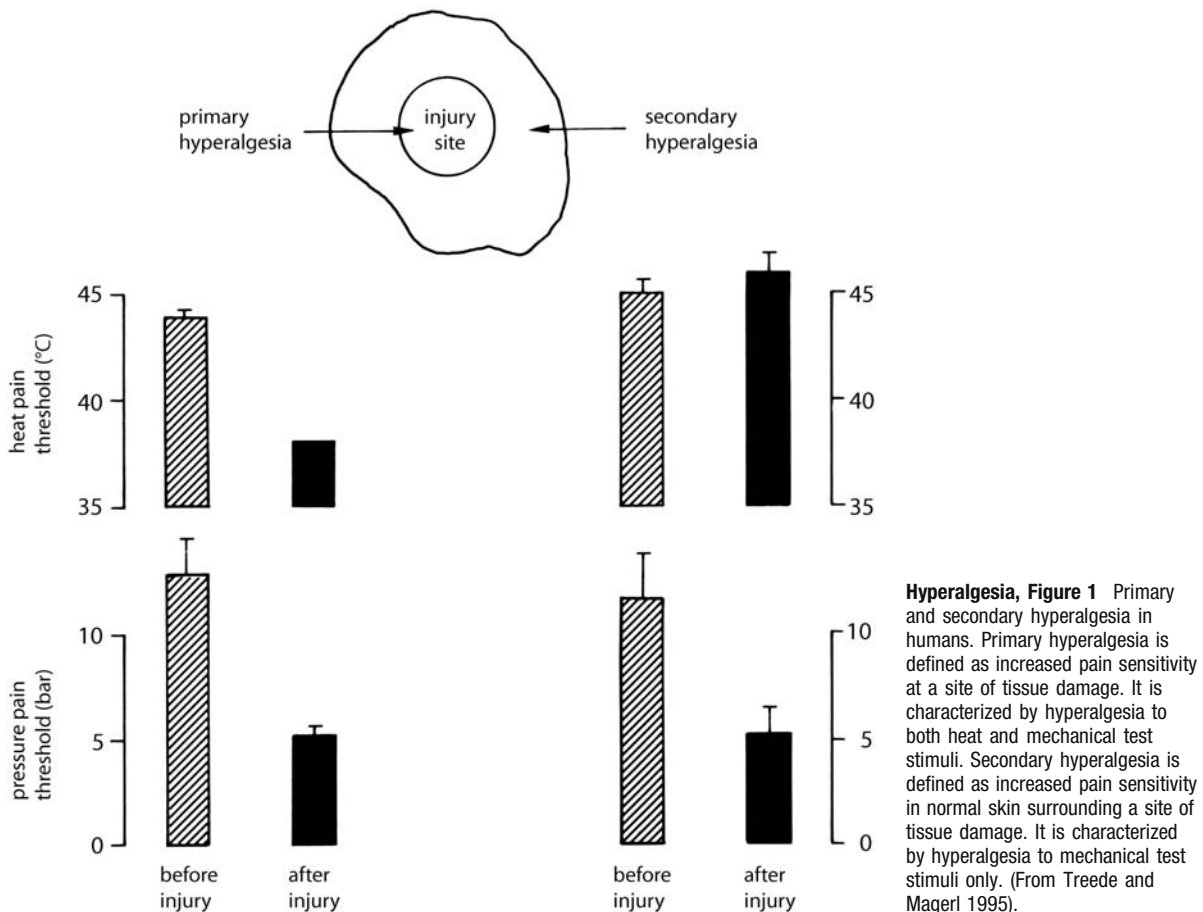
Increased pain sensitivity (hyperalgesia) can be differentiated according to the test stimulus that is perceived as more painful, mechanical hyperalgesia, heat hyperalgesia, cold hyperalgesia, and chemical hyperalgesia (Table 1). Mechanical hyperalgesia can be further differentiated according to the size of the object contacting the skin (punctate or blunt) and the temporal dynamics of its application (static or dynamic). The underlying mechanisms are sensitization either in the periphery or in the central nervous system or both. Hyperalgesia at a site of tissue damage is called primary hyperalgesia; hyperalgesia surrounding this site is called secondary hyperalgesia. The sensory characteristics of primary and secondary hyperalgesia differ considerably (Fig. 1). Whereas primary hyperalgesia encompasses increased sensitivity to both mechanical and heat stimuli, secondary hyperalgesia is relatively specific for mechanical stimuli (Treede et al. 1992).

Primary hyperalgesia to heat stimuli is fully accounted for by ► **peripheral sensitization** of the terminals of primary nociceptive afferents (Raja et al. 1999). Peripheral sensitization shifts the stimulus-response function for heat stimuli to the left. This leftward shift is associated with a decreased threshold, increased responses to suprathreshold stimuli, and spontaneous activity (Fig. 2). Primary nociceptive afferents express the heat-sensitive ion channel TRPV1 (Caterina and Julius 2001). This channel can be sensitized by inflammatory mediators and the ensuing drop in heat threshold turns normal body temperature into a suprathreshold stimulus (Liang et al. 2001). Thus, primary hyperalgesia to heat can also explain ongoing pain of inflammatory origin. Secondary hyperalgesia to mechanical stimuli is not associated with any change in peripheral coding (Baumann et al. 1991), but can be explained by enhanced synaptic responses of second order neurons in the spinal cord to their normal afferent input (► **central sensitization**). These neurons also exhibit a drop in threshold and

**Hyperalgesia, Table 1** Types of hyperalgesia and their likely mechanisms

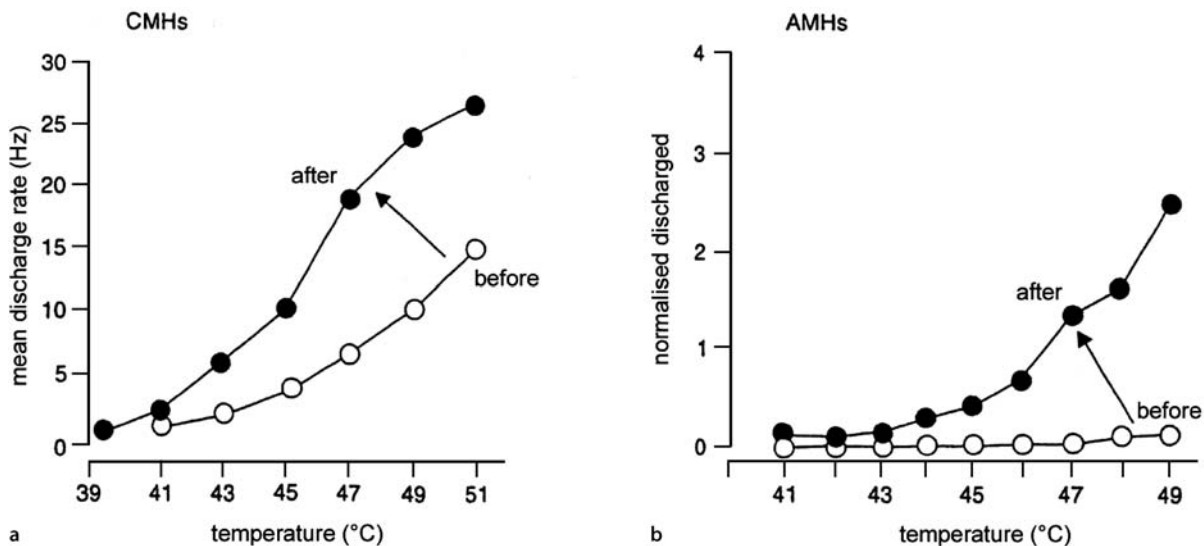
Test stimulus	Occurrence	Afferents	Sensitization
heat	primary zone	type I & II AMH, CMH	peripheral
blunt pressure	primary zone	MIA, (type I AMH?)	peripheral
impact	primary zone	MIA, (type I AMH?)	peripheral
punctate	neuropathic secondary zone primary zone	type I AMH type I AMH type I AMH, MIA	central central peripheral/central?
stroking	neuropathic secondary zone primary zone	A $\beta$ -LTM A $\beta$ -LTM A $\beta$ -LTM	central central central
cold	neuropathic pain secondary zone?	? ?	central? central?
chemical	inflammation	type II AMH, CMH, MIA ?	peripheral ?

Abbreviations: A $\beta$ -LTM A $\beta$ -fiber low-threshold mechanoreceptor ("touch receptor"), probably rapidly adapting subtype (Meissner corpuscle); type I AMH A-fiber nociceptor with slow high-threshold heat response (no TRPV1), probably equivalent to A-fiber high-threshold mechanoreceptor; type II AMH A-fiber nociceptor with rapid low-threshold heat response (TRPV1); CMH C-fiber mechano-heat nociceptor (TRPV1); MIA mechanically insensitive (silent) nociceptive afferent (From Treede et al. 2004).



an increase in suprathreshold responses (Simone et al. 1991). In addition, expansion of the **receptive field** is a prominent feature of central sensitization. The molecular mechanisms of central sensitization resemble those

of long-term potentiation of synaptic efficacy (LTP). LTP has been demonstrated for neurons in isolated spinal cord slices, in intact animals and on a perceptual level in human subjects (Klein 2004; Sandkühler 2000;



**Hyperalgesia, Figure 2** Peripheral sensitization of nociceptive afferents by a burn injury in monkey. The stimulus response function relating the discharge rate of nociceptive C- (a) and A-fiber nociceptors (b) is shifted to the left following injury to the receptive field. This shift is characterized by a drop in threshold, increased responses to suprathreshold stimuli, and by spontaneous activity. Spontaneous discharges occur when the heat threshold is below body temperature. Peripheral sensitization is restricted to the injured part of the receptive field. (From Treede et al. 1992).

Treede and Magerl 1995). As a cellular correlate of learning and memory, LTP in the nociceptive system is a phylogenetically old mechanism, present even in invertebrates (Woolf and Walters 1991).

Although not characterized in as much detail, descending supraspinal mechanisms may contribute to both primary and secondary hyperalgesia, *via* reduced descending inhibition or *via* enhanced descending facilitation (Millan 2002; Porreca et al. 2002). Moreover, central sensitization may also occur at the thalamic or cortical level.

The mechanisms of cold hyperalgesia, which is a frequent finding in some ► **neuropathic pain** states, are still enigmatic (Wasner et al. 2004). Peripheral sensitization of nociceptive afferents cannot be ruled out, because the peripheral encoding of noxious cold stimuli has not been investigated sufficiently (Raja et al. 1999). Some evidence supports the concept of central disinhibition by selective loss of a sensory channel specific for non-noxious cold that exerts a tonic inhibition on nociceptive channels (Craig and Bushnell 1994). Central sensitization, similar to mechanical hyperalgesia, is another possibility.

### Clinical Implications

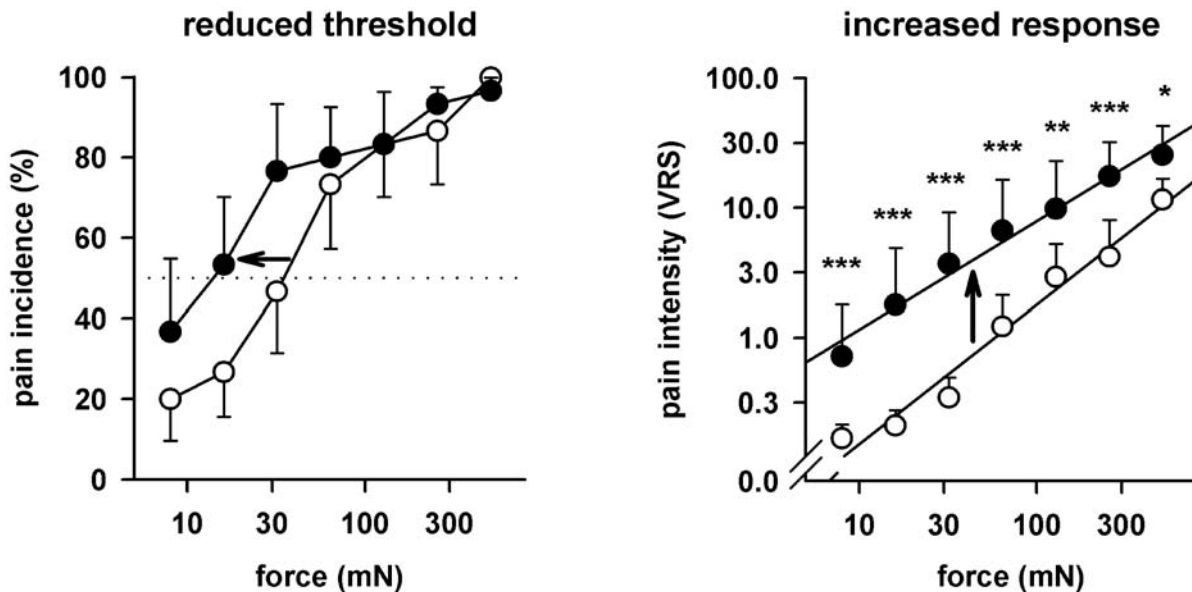
Primary and secondary hyperalgesia occur transiently after each injury, and are hence part of the normal clinical picture of postoperative pain. Chronic inflammatory hyperalgesia resembles primary hyperalgesia. Hyperalgesia in neuropathic pain and referred hyperalgesia in visceral pain resemble secondary hyperalgesia (Treede et al. 1992). Cancer pain and musculo-skeletal pain states including low-back pain may also be accompanied by hyperalgesia. Parallel to the definition of sensi-

tization, hyperalgesia is characterized by a decrease in pain threshold, increased pain to suprathreshold stimuli and spontaneous pain.

### Hyperalgesia Versus Allodynia

The current IASP taxonomy has restricted the term “hyperalgesia” to increases in pain to suprathreshold stimuli (Merskey and Bogduk 1994). But are threshold changes and suprathreshold changes two independent phenomena needing two separate terms? This question can be addressed in a clinical example, the increased pain sensitivity to punctate mechanical stimuli in patients suffering from neuropathic pain (Baumgärtner et al. 2002). Figure 3 illustrates that hyperalgesia to calibrated pinpricks in these patients is characterized by both an increase in pain to suprathreshold stimuli and a decrease in pain threshold. According to the IASP taxonomy the threshold decrease would be labeled ‘allodynia’, whereas the increase in pain to suprathreshold stimuli would be labeled ‘hyperalgesia’ (Fig. 3). Consistent use of the IASP taxonomy is obviously awkward in this case, because these observations reflect two aspects of the same phenomenon and the same data, i.e. a dramatic leftward shift of the psychometric function and upward shift of the stimulus response function of pain to the same set of test stimuli. The traditional usage of the term ‘hyperalgesia’ as an umbrella term for all phenomena of increased pain sensitivity describes hyperalgesia to punctate mechanical stimuli more adequately (Treede et al. 2004).

- **Allodynia and Allokneseis**
- **Allodynia (Clinical, Experimental)**
- **Amygdala, Pain Processing and Behavior in Animals**
- **Cancer Pain**



**Hyperalgesia, Figure 3** Hyperalgesia to punctate mechanical stimuli in neuropathic pain. Averaged data from a group of six patients with neuropathic pain were plotted in two different ways: as incidence (left) and as intensity (right) of pain sensation in neuropathic pain skin areas (filled circles) compared to normal skin (open circles). Stimuli were graded punctate probes (diameter 0.2 mm) of seven intensities (8–512 mN). Left panel: reduced threshold (intersection with dotted line at 50%) implies pain due to a stimulus, which does not normally evoke pain ("allodynia?"). Right panel: Increased pain response to a stimulus, which is normally painful ("hyperalgesia?"). Note that both graphs are different aspects (pain incidence and pain intensity) plotted from the same data set. Arrows: leftward shift of pain incidence and upward shift of pain intensity. VRS = verbal rating scale. Mean  $\pm$  SEM across subjects. Post hoc least significant differences tests: \*\*  $p < 0.01$ ; \*\*\*  $p < 0.001$ . (From Treede et al. 2004).

- ▶ Cancer Pain, Animal Models
- ▶ Capsaicin Receptor
- ▶ CRPS, Evidence-Based Treatment
- ▶ Cytokine Modulation of Opioid Action
- ▶ Deafferentation Pain
- ▶ Diagnosis and Assessment of Clinical Characteristics of Central Pain
- ▶ Drugs Targeting Voltage-Gated Sodium and Calcium Channels
- ▶ Forebrain Modulation of the Periaqueductal Gray
- ▶ Freezing Model of Cutaneous Hyperalgesia
- ▶ Hyperaesthesia
- ▶ Hyperpathia
- ▶ Hyperpathia, Assessment
- ▶ Hypoesthesia, Assessment
- ▶ Inflammation, Modulation by Peripheral Cannabinoid Receptors
- ▶ Lateral Thalamic Lesions, Pain Behavior in Animals
- ▶ Metabotropic Glutamate Receptors in Spinal Nociceptive Processing
- ▶ Muscle Pain Model, Inflammatory Agents-Induced
- ▶ Nerve Growth Factor Overexpressing Mice as Models of Inflammatory Pain
- ▶ Neuropathic Pain Model, Tail Nerve Transection Model
- ▶ Nociceptive Circuitry in the Spinal Cord
- ▶ Nociceptive Processing in the Amygdala, Neurophysiology and Neuropharmacology
- ▶ NSAIDs, Mode of Action
- ▶ Opioid Receptor Trafficking in Pain States

- ▶ Pain Modulatory Systems, History of Discovery
- ▶ Percutaneous Cordotomy
- ▶ Polymodal Nociceptors, Heat Transduction
- ▶ Postherpetic Neuralgia, Etiology, Pathogenesis and Management
- ▶ Postherpetic Neuralgia, Pharmacological and Non-Pharmacological Treatment Options
- ▶ Post-Stroke Pain Model, Thalamic Pain (Lesion)
- ▶ Psychiatric Aspects of Visceral Pain
- ▶ Satellite Cells and Inflammatory Pain
- ▶ Spinal Cord Injury Pain Model, Contusion Injury Model
- ▶ Spinothalamic Tract Neurons, Central Sensitization
- ▶ Sympathetically Maintained Pain in CRPS II, Human Experimentation
- ▶ TENS, Mechanisms of Action
- ▶ Thalamotomy, Pain Behavior in Animals
- ▶ Thalamus, Clinical Pain, Human Imaging
- ▶ Thalamus, Dynamics of Nociception
- ▶ Transition from Acute to Chronic Pain
- ▶ Vagal Input and Descending Modulation
- ▶ Visceral Nociception and Pain
- ▶ Visceral Pain and Nociception

#### References

1. Baumann TK, Simone DA, Shain CN et al. (1991) Neurogenic hyperalgesia: the search for the primary cutaneous afferent fibers that contribute to capsaicin-induced pain and hyperalgesia. *J Neurophysiol* 66:212–227
2. Baumgärtner U, Magerl W, Klein T et al. (2002) Neurogenic hyperalgesia versus painful hypoalgesia: two distinct mechanisms of neuropathic pain. *Pain* 96:141–151



3. Caterina MJ, Julius D (2001) The vanilloid receptor: a molecular gateway to the pain pathway. *Annu Rev Neurosci* 24:487–517
4. Craig AD, Bushnell MC (1994) The thermal grill illusion: Unmasking the burn of cold pain. *Science* 265:252–255
5. Klein T, Magerl W, Hopf HC et al. (2004) Perceptual correlates of nociceptive long-term potentiation and long-term depression in humans. *J Neurosci* 24:964–971
6. Liang YF, Haake B, Reeh PT (2001) Sustained sensitization and recruitment of rat cutaneous nociceptors by bradykinin and a novel theory of its excitatory action. *J Physiol* 532:229–239
7. Merskey H, Bogduk N (1994) *Classification of Chronic Pain*. IASP Press, Seattle, p 240
8. Millan MJ (2002) Descending control of pain. *Prog Neurobiol* 66:355–474
9. Porreca F, Ossipov MH, Gebhart GF (2002) Chronic pain and medullary descending facilitation. *TINS* 25:319–325
10. Raja SN, Meyer RA, Ringkamp M et al. (1999) Peripheral neural mechanisms of nociception. In: Wall PD, Melzack R (eds) *Textbook of Pain*, 4th edn. Churchill Livingstone, Edinburgh, pp 11–57
11. Sandkühler J (2000) Learning and memory in pain pathways. *Pain* 88:113–118
12. Simone DA, Sorkin LS, Oh U et al. (1991) Neurogenic hyperalgesia: Central neural correlates in responses of spinothalamic tract neurons. *J Neurophysiol* 66:228–246
13. Treede RD, Magerl W (1995) Modern concepts of pain and hyperalgesia: beyond the polymodal C-nociceptor. *News Physiol Sci* 10:216–228
14. Treede R-D, Meyer RA, Raja SN et al. (1992) Peripheral and central mechanisms of cutaneous hyperalgesia. *Prog Neurobiol* 38:397–421
15. Treede R-D, Handwerker HO, Baumgärtner U et al. (2004) Hyperalgesia and allodynia: taxonomy, assessment, and mechanisms. In: Brune K, Handwerker HO (eds) *Hyperalgesia: Molecular Mechanisms and Clinical Implications*. IASP Press, Seattle, pp 1–15
16. Wasner G, Schattscheider J, Binder A, Baron R (2004) Topical menthol - a human model for cold pain by activation and sensitization of C nociceptors. *Brain* 127:1159–1171
17. Woolf CJ, Walters ET (1991) Common patterns of plasticity contributing to nociceptive sensitization in mammals and Aplysia. *TINS* 14:74–78

## Hyperalgesia, Primary and Secondary

### Definition

Primary Hyperalgesia is increased pain sensitivity at a site of tissue damage. Secondary hyperalgesia is increased pain sensitivity in normal skin surrounding a site of tissue damage. It is characterized by hyperalgesia to mechanical test stimuli.

- ▶ Allodynia (Clinical, Experimental)
- ▶ Hyperalgesia

## Hyperemia

### Definition

Increased blood flow or an excess of blood in a body parties known as hyperemia.

- ▶ Clinical Migraine with Aura

## Hyperesthesia

- ▶ Hyperalgesia

## Hyperexcitability

### Definition

Large diameter sensory neurones with myelinated A-fiber axons that lie in dorsal root ganglia that project into a damaged peripheral nerve are often more easily discharged than the same type of neurone in ganglia from uninjured animals. The neurones fire from a greatly reduced current threshold. In some cases, a small depolarization produced by the local action of, e.g. a humoral substance, or by modifications in the extracellular environment (e.g. ischemia) may be enough to discharge these cells.

- ▶ Sympathetic and Sensory Neurons after Nerve Lesions, Structural Basis for Interactions

## Hyperglycemic Neuropathy

- ▶ Diabetic Neuropathies

## Hyperhidrosis

### Definition

Hyperhidrosis means increased sweating.

- ▶ CRPS, Evidence-Based Treatment

## Hyperknesis

### Definition

Hyperknesis is the abnormal pruriceptive state in which a normally pruritic stimulus (such as a fine diameter hair which can elicit a prickle sensation followed by an itch) elicits a greater than normal duration and/or magnitude of itch.

- ▶ Allodynia and Alloknesis

## Hyperpathia

JOHN W. SCADDING

The National Hospital for Neurology and Neurosurgery,  
London, UK

jwscadding@hotmail.com

### Definition

The IASP, in its Classification of Chronic Pain (1994), defines hyperpathia thus:

“Hyperpathia is a painful syndrome characterized by an abnormally painful reaction to a stimulus, as well as an increased threshold.”

The following note is added:

“It may occur with ► [allodynia](#), ► [hyperesthesia](#), ► [hyperalgesia](#), or ► [dysesthesia](#). Faulty identification and localization of the stimulus, delay, radiating sensation and after-sensation may be present, and the pain is often explosive in character.”

### Characteristics

#### Introduction

Use of the term hyperpathia varies in the current scientific literature, and many avoid it. For example, in the fourth edition of *The Textbook of Pain* (1999), hyperpathia is mentioned by name in only 4 of 68 chapters, and possible explanations for the symptom complex are discussed in depth in only one of these. Likewise, several recent influential studies and reviews, tackling the difficult and elusive problem of linking individual symptoms and signs to underlying pathophysiological mechanisms, avoid use of the word hyperpathia altogether, or make only passing reference to it (Woolf et al. 1998; Woolf and Mannion 1999; Otto et al. 2003; Jensen and Baron 2003).

The reason is that hyperpathia describes a complex sensory experience occurring in the context of ► [neuropathic pain](#). This complex can be broken down into component parts, each of which may be experienced by patients independent from the other constituent properties of hyperpathia; however, there is a tendency for the whole complex to occur in many patients suffering from neuropathic pain.

#### Historical Aspects

A brief historical examination reveals the variable usage of the term hyperpathia. Foerster (1927) suggested a lengthy and all-inclusive definition and description of hyperpathia, which most would agree comprehensively encapsulates the properties of stimulus-evoked painful sensations in patients suffering from neuropathic pain. He proposed the term hyperpathia be used when the following symptoms could be elicited from a regenerating area:

“a relative elevation of threshold, when the duration of the stimulus or summation of stimuli become important,

a latent period, an intensive explosive outbreak of pain of abnormal unpleasant character accompanied by strong withdrawal movements, vasomotor and vegetative reactions, lack of or insufficient relationship between the strength of the stimulus and the strength of the sensation, a long after-reaction of the pain when the stimulus has ceased, irradiation, faulty localisation, and the inability to identify the nature of the stimulus which causes the pain.”

Livingston (1943) equated hyperpathia with hyperalgesia:

“Any injury that directly or indirectly involves the sensory nerves may lead to the development of an abnormal sensitiveness of the skin. All sensory experiences derived from the skin may be altered in this condition, so that it is frequently called a “hyperesthesia” or a “hyperpathia”. However, since the principal alteration in sensibility is an intensification of pain sensation it is more commonly referred to as a “hyperalgesia.” In this state the tissues are unduly sensitive and they tend to react to the most innocuous stimuli with explosive sensations of pain accompanied by withdrawal reflexes.”

Finally, Noordenbos (1959) suggests:

“Hyperpathia is present when the response to noxious or non-noxious stimuli presents the following features: delay, overshooting and after-reaction.”

#### Definition or Description

This brief historical survey serves to emphasise two important points. The first, is the general point that a definition should include those characteristics that are the minimum necessary to categorise a condition, item or state as separate and identifiably distinct; in relation to the definition of diseases and clinical syndromes/states, a definition must have clinical relevance and usefulness. The second point, with reference specifically to the definition of hyperpathia, is that the definition is based on a collection of symptoms and signs. As is evident throughout this Encyclopaedic Reference, the last few decades have witnessed enormous progress in the basic neuroscience of pain. However, it is still not yet possible to define conditions and terms such as neuropathic pain, hyperalgesia, hyperesthesia, allodynia and hyperpathia on the basis of pathophysiological mechanisms, though there are, of course, numerous candidate mechanisms. It seems likely that each of the symptoms and signs of painful states may be produced by more than one underlying pathophysiology.

For the moment, however, we are stuck with frustratingly imprecise clinical syndromal definitions.

#### Symptoms and Signs Comprising Hyperpathia

It is notable that the current IASP definition of hyperpathia, quoted above, includes little detail, and it is left to the accompanying note to elaborate the symptoms. Most would agree that there are four main clinical features to hyperpathia:

1. An increased threshold to stimulation.
2. An abnormal delay in perception of a stimulus.
3. Summation, by which is meant increasingly painful sensation to a repetitive stimulus of steady intensity. Summation may take the form of an explosive, unbearable increase in pain, and it leads to brisk withdrawal from the provoking stimulus.
4. After-sensation. This is a perception by the sufferer that the stimulus evoking the pain continues after the stimulus has in fact ceased. Painful after-sensations may persist for seconds, minutes, or even hours, following brief periods of stimulation lasting only a few seconds.

### Conditions in Which Hyperpathia Occurs

It is clear from numerous published accounts that hyperpathia may accompany (or, perhaps more accurately, be a part of) neuropathic pain, due to lesions at any level in the peripheral or central nervous system sensory pathways. This includes painful cutaneous scars, peripheral sensory or mixed peripheral neuropathies, brachial or lumbar plexopathies, spinal sensory radiculopathies, myelopathies, and brain stem, thalamic, sub-cortical and, very occasionally, cortical lesions. In other words, all of the many causes of neuropathic pain may be associated with hyperpathia, and multiple aetiologies are involved (Scadding 2003).

Noordenbos (1959) described in detail six patients with peripheral and central lesions, all of whom had severe hyperpathia, specifically to illustrate the occurrence of hyperpathia. Other classical accounts are to be found in Weir Mitchell et al. (1864), Riddoch (1938) and Livingston (1943).

### Is Hyperpathia a Clinically Relevant and Useful Term?

Hyperpathia is very common and troublesome to patients, despite the impression one might get from perusal of the recent basic and clinical scientific literature on pain, which, as discussed above, tends to consider the component properties of hyperpathia rather than addressing hyperpathia as a whole. It is certainly highly relevant to patients. For example, a patient suffering from post-herpetic neuralgia (PHN) in a mid-thoracic dermatome, with an accompanying hyperpathic response to normally innocuous stimulation, may find the gentle rubbing of clothes on the affected area of skin quite intolerable. Indeed, for patients with PHN, it is often hyperpathia, much more than ongoing pain, which is the major component of their suffering and immobilization. Hyperpathia at other sites has the same devastating effect on the lives of numerous patients.

Although tremendous advances have been made in the measurement of pain, and particularly in the various attributes of neuropathic pain, hyperpathia is difficult to quantify, and so has tended to be underestimated in published studies (routine quantitative sensory testing does not accurately assess this).

**Hyperpathia, Table 1** Possible Pathophysiological Substrates for Hyperpathia

Symptom	Mechanism
1. Increased threshold lesion	Reduced input due to sensory lesion
2. Delay in perception	Reduced large fibre input
3. Summation	Crossed after-discharge in lesion Ephaptic transmission in lesion? Central sensitization
4. After-sensation	Crossed after-discharge DRG ectopic firing Central disinhibition

DRG, dorsal root ganglion

Woolf and Mannion (1999), Devor and Seltzer (1999), Jensen and Baron (2003)

H

### Pathophysiology

Table 1 lists some possible pathophysiological substrates for the development of hyperpathia.

- ▶ Cancer Pain
- ▶ Causalgia, Assessment
- ▶ Deafferentation Pain
- ▶ Peripheral Neuropathic Pain
- ▶ Hypoesthesia, Assessment

### References

1. Devor M, Seltzer Z (1999) Pathophysiology of Damaged Nerves in Relation to Chronic Pain. In: Wall PD, Melzack R (eds) *Textbook of Pain*, 4th edn. Churchill Livingstone, Edinburgh, ch 5, pp 129–164
2. Foerster O (1927) *Die Leitungsbahnen des des Schmerzgefhls*. Urban & Schwarzenberg, Wien
3. International Association for the Study of Pain (IASP) (1994) *Classification of Chronic Pain*. Merskey H, Bogduk N (eds) *Classification of Chronic Pain: Description of Chronic Pain Syndromes and Definitions of Pain terms*, 2nd edn. IASP Press, Seattle
4. Jensen TS, Baron R (2003) Translation of Symptoms and Signs into Mechanisms in Neuropathic Pain. *Pain* 102:1–8
5. Livingston WK (1943) *Pain Mechanisms. A Physiologic Interpretation of Causalgia and its Related States*. MacMillan, New York
6. Noordenbos W (1959) *Pain. Problems Pertaining to the Transmission of Nerve Impulses Which Give Rise to Pain*. Elsevier, Amsterdam
7. Otto M, Bak S, Bach FW, Jensen TS, Sindrup SH (2003) Pain Phenomena and Possible Mechanisms in Patients with Painful Neuropathy. *Pain* 101:187–192
8. Riddoch G (1938) Central Pain. *Lancet* 1: 1150–1156 and 1205–1209
9. Scadding JW (2003) Neuropathic Pain. *Adv Clin Neurosci Rehab* 3:2–5
10. *Textbook of Pain* (1999) Wall PD, Melzack R (eds) 4th edition. Churchill Livingstone, Edinburgh
11. Weir Mitchell S, Morehouse GR, Keen WW (1864) *Gunshot Wounds and Other Injuries of Nerves*. Lippincott, Philadelphia
12. Woolf CJ, Bennett GJ, Doherty M, Dubner R, Kidd B, Koltzenburg M, Lipton R, Loeser JD, Payne R, Torebjork E (1998) Towards a Mechanism-Based Classification of Pain? *Pain* 77:227–229
13. Woolf CJ, Mannion RJ (1999) Neurogenic Pain: Aetiology, Symptoms, Mechanisms, and Management. *Lancet* 353:1959–1964

## Hyperpathia, Assessment

ASTRID J. TERKELSEN, TROELS S. JENSEN  
Danish Pain Research Center and Department of  
Neurology, Aarhus University Hospital, Aarhus,  
Denmark  
astrid@akhphd.au.dk, tsj@akhphd.au.dk

### Definition

Hyperpathia is a painful syndrome characterized by an abnormally painful reaction to a stimulus, especially a repetitive stimulus, as well as an increased threshold for sensory detection (Merskey and Bogduk 1994).

### Characteristics

Hyperpathia includes increased ► **detection threshold**, steeper stimulus-response function than normal and often a time lag between stimulus and sensation, abnormal summation, after-sensations, pain radiating phenomena, faulty identification and faulty localization of the stimulus (Noordenbos 1979; Lindblom 1979; Merskey and Bogduk 1994; Bennett 1994).

### Induction and assessment

Thermal-, mechanical-, and chemical- hyperpathia may exist singly or in any combination. Therefore, multiple different noxious and innocuous stimulus modalities have to be used to document or to exclude hyperpathia (Lindblom 1994) (Table 1).

Hyperpathia is assessed by performing stimulus-response curves, repetitive suprathreshold stimulation, and by asking the patient to report after-sensations, pain radiation, and coexistent phenomena.

Hyperpathia is present at increased detection threshold, decreased ► **pain threshold**, and ► **allodynia** (Fig. 1A and B, and Fig. 2B). At increased detection threshold without allodynia (Fig. 1, example 1C and 1D, and Fig. 2A), hyperpathia is present at steeper stimulus-response curve than normal (Fig. 3) or at exaggerated response (increased intensity and duration of pain) following single or repetitive suprathreshold stimulation (Table 1 and Fig. 1E).

In unilateral involvement, the contralateral mirror image area is used as control. In bilateral involvement, data should preferably be compared with normal values from sex- and age-matched controls.

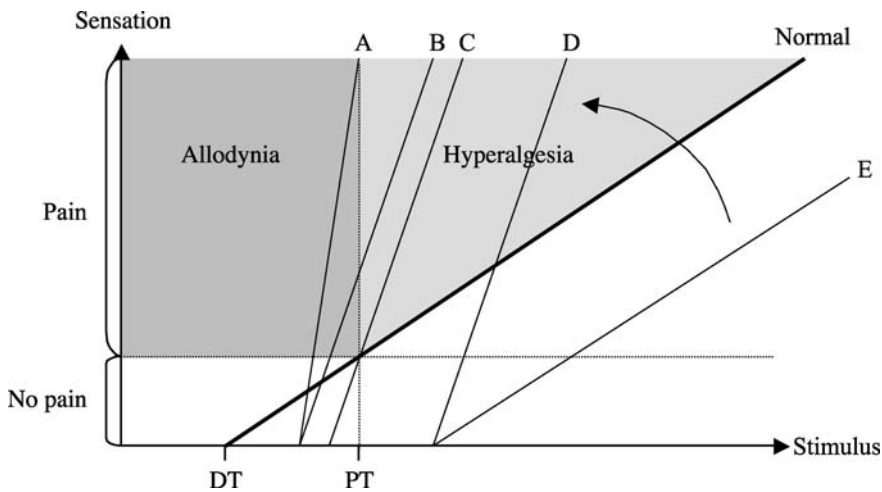
### Stimulus-Response

An increased sensory detection threshold (Fig. 1 and Fig. 2) characterizes hyperpathia. There can be poor localization of the stimulus and faulty identification where the patient feels pain, but not the specific modality of the stimulus (Fig. 2B) or the patient's misnaming of the stimulus modality (Fig. 3). The pain is often felt by a remarkable delay characterized by a time lag between the stimulus and the report of any sensory perception. The time lag can extend from two to three seconds to more than ten seconds.

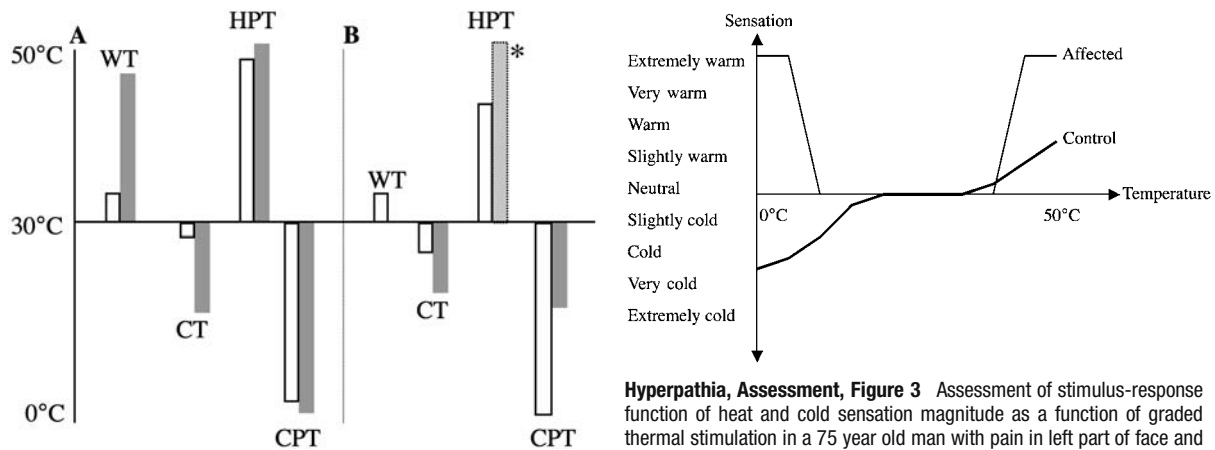
**Hyperpathia, Assessment, Table 1** Assessment of hyperpathia with Quantitative Sensory Testing (QST)

Stimuli to evoke hyperpathia	Assessment of detection threshold (DT) and pain threshold (PT)	Stimulus response function following graded innocuous and / or noxious stimuli	Repetitive suprathreshold stimulation
Thermal stimuli:			
Screening with metallic cold and heat thermorollers			
Quantitative thermal Sensory Testing with Peltier device: -Heat: -Cold:	DT, PTDT, PT	Ass. of thermal allodynia / hyperalgesia++	Repetitive heat or cold pulses++
Mechanical stimuli:			
Light touch: -Wisp of cotton: -Camel-hair brush:	-	-	Brushing with a velocity > 0.3 Hz++
Punctuate stimuli: Screening with safety pin -Von Frey hair:	DT, PT	Ass. of ► <b>punctuate allodynia</b> / hyperalgesia +	Multiple > 0.3 Hz pinprick stimuli +
Static stimuli: -Pressure: -Skin fold:	PTPT	Ass. of ► <b>static allodynia</b> / hyperalgesia++	++
Electrical stimulation:	DT, PT	+	+
Vibrametry:	DT, (PT)	+	+
Chemical stimuli:			
Topical capsaicin:	Time before detection (DT) and pain (PT)	Pain increase as a function of time	-





**Hyperpathia, Assessment, Figure 1** Schematic description of different stimulus-response curves occurring at hyperpathia. Normal response (Normal) with normal detection threshold (DT) and normal pain threshold (PT). (A) Hyperpathia with increased DT, decreased PT, allodynia, and steeper stimulus-response curve as compared to normal. (B) Hyperpathia with increased DT, decreased PT, allodynia, hyperalgesia, and steeper stimulus-response curve as compared to normal. (C) Hyperpathia with increased DT, normal PT, hyperalgesia, and steeper stimulus-response curve. (D) Hyperpathia with increased DT, increased PT, hyperalgesia, and steeper stimulus-response curve. (E) At repetitive stimulation, pain threshold decreases and the slope of the stimulus-response curve increases thereby unmasking hyperpathia.



**Hyperpathia, Assessment, Figure 2** Assessment of stimulus-response function of heat and cold sensation magnitude as a function of graded thermal stimulation in a 75 year old man with pain in left part of face and right leg and arm following brain stem infarct. Stimulus-response curve at right affected forearm (Affected) shows hyperpathia with steeper stimulus-response curve than at control side (Control) and faulty identification of stimulus modality with cold stimulation misnamed as heat stimulation. Control stimulus-response curve is assessed at contralateral mirror image area. Modified from Vestergaard and co-workers .

**Hyperpathia, Assessment, Figure 3** Assessment of stimulus-response function of heat and cold sensation magnitude as a function of graded thermal stimulation in a 75 year old man with pain in left part of face and right leg and arm following brain stem infarct. Stimulus-response curve at right affected forearm (Affected) shows hyperpathia with steeper stimulus-response curve than at control side (Control) and faulty identification of stimulus modality with cold stimulation misnamed as heat stimulation. Control stimulus-response curve is assessed at contralateral mirror image area. Modified from Vestergaard and co-workers .

There is a steeper stimulus-response function than normal (Fig. 1 and Fig. 3) (Hansson and Lindblom 1992) with an intense, exaggerated, and explosive pain response to suprathreshold stimuli. Stimulus and response modality may be the same (► [hyperalgesia](#)) and/or different (allodynia) (Fig. 1) (Merskey and Bogduk 1994).

### Temporal Summation

Hyperpathia is most likely elicited by increasing stimulus duration or by repetitive stimulation (Nordenbos

1959). Temporal summation refers to an abnormally increasing painful sensation to repetitive stimulation, although the actual stimulus remains constant and is the clinical equivalent to ► [wind-up](#) (Mendell and Wall 1965; Price et al. 1992). At repetitive stimulation above sensory detection threshold, hyperpathic subjects can report a gradual change from a faint sensation to a mildly unpleasant sensation and then a sudden exaggerated response with unbearable pain (Lourie and King 1966). During this repetitive stimulation, pain threshold decreases and the slope of the stimulus-response curve increases (Fig. 1E). This exaggerated response can be provoked by both noxious and innocuous stimuli (Table 1).

### After-Sensations

After-sensations refer to abnormal persistence of pain seconds to minutes after termination of stimulation (Gottrup et al. 2003).

### Pain Radiation

There may be a radiating sensation out from the point of stimulation to the cutaneous area around the stimulus or to wide adjacent areas (Bennett 1994).

### Coexistent Phenomena

Hyperpathia is often accompanied by a general alerting response with strong withdrawal movements, vasomotor and vegetative reactions. It may occur with allodynia, ► [hyperesthesia](#), hyperalgesia, or ► [dysesthesia](#) (Merskey and Bogduk 1994).

### Clinical Examination/Studies

Pain history evaluates symptoms evoked by stimulation of the affected extremity like after-sensations, pain radiating phenomena, and allodynia induced by movement, non-painful cold or heat, wind touching the extremity, contact with clothing or bedlinen etc.

A bedside screening for hyperpathia is performed with heated and cold thermorollers kept at 20°C and 40°C, respectively, a wisp of cotton, and pinprick (Von Frey hair or safety pin), moving from the normal towards the painful area (Jensen et al. 2001). This screening may detect areas with possible increased sensory detection and exaggerated pain responses.

Usually the site of maximal pain reported by the patient is chosen as the test area. In this area, Quantitative Sensory Testing is performed (Fruhstorfer et al. 1976; Hansson and Lindblom 1992; Backonja and Galer 1998) to estimate detection- and pain thresholds (Table 1 and Fig. 2). At increased detection threshold, stimulus-response curves (Fig. 3) and repetitive stimulation with suprathreshold stimuli (Table 1) are performed in the test area. During examination, patient's behavioral responses are observed, such as facial expression or withdrawal from stimulus.

### Experimental Studies

Hyperpathia is a clinical phenomenon and cannot be induced in human or animal experimental conditions.

- [Allodynia \(Clinical, Experimental\)](#)
- [Amygdala, Pain Processing and Behavior in Animals](#)
- [Cordotomy Effects on Humans and Animal Models](#)
- [Nerve Growth Factor Overexpressing Mice as Models of Inflammatory Pain](#)
- [Opioids, Effects of Systemic Morphine on Evoked Pain](#)

### References

1. Backonja MM, Galer BS (1998) Pain Assessment and Evaluation of Patients who have Neuropathic Pain. *Neurol Clin* 16:775–790
2. Bennett G (1994) Neuropathic pain. In: Wall PD, Melzack R (eds) *Textbook of Pain*. Elsevier, Amsterdam, pp 201–224

3. Fruhstorfer H, Lindblom U, Schmidt WG (1976) Method for Quantitative Estimation of Thermal Thresholds in Patients. *J Neurol Neurosurg Psychiatry* 39:1071–1075
4. Gottrup H, Kristensen AD, Bach FW, Jensen TS (2003) After-sensations in Experimental and Clinical Hypersensitivity. *Pain* 103:57–64
5. Hansson P, Lindblom U (1992) Hyperalgesia Assessed with Quantitative Sensory Testing in Patients with Neurogenic Pain. In: Willis WD (ed) *Hyperalgesia and Allodynia*. Raven Press, New York, pp 335–343
6. Jensen TS, Gottrup H, Sindrup SH, Bach FW (2001) The Clinical Picture of Neuropathic Pain. *Eur J Pharmacol* 19:1–11
7. Lindblom U (1979) Sensory Abnormalities in Neuralgia. In: Bonica J (ed) *Advances in Pain Research and Therapy*. Raven Press, New York, pp 111–120
8. Lindblom U (1994) Analysis of Abnormal Touch, Pain, and Temperature Sensation in Patients. In: Boivie J, Hansson P, Lindblom U (eds) *Touch, Temperature, and Pain in Health and Disease: Mechanisms and Assessments, Progress in Pain Research and Management*. IASP Press, Seattle, pp 63–84
9. Lourie H, King RB (1966) Sensory and Neurohistological Correlates of Cutaneous Hyperpathia. *Arch Neurol* 14:313–320
10. Mendell LM, Wall PD (1965) Responses of Single Dorsal Cord Cells to Peripheral Cutaneous Unmyelinated Fibres. *Nature* 206:97–99
11. Merskey H, Bogduk N (1994) *Classification of Chronic Pain: Descriptions of Chronic Pain Syndromes and Definitions of Pain Terms*. IASP Press, Seattle
12. Noordenbos W (1979) Sensory Findings in Painful Traumatic Nerve Lesions. In: Bonica J (ed) *Advances in Pain Research and Therapy*. Raven Press, New York, pp 91–101
13. Price DD, Long S, Huitt C (1992) Sensory Testing of Pathophysiological Mechanisms of Pain in Patients with Reflex Sympathetic Dystrophy. *Pain* 49:163–173
14. Vestergaard K, Nielsen J, Andersen G, Ingeman-Nielsen M, Arendt-Nielsen L, Jensen TS (1995) Sensory Abnormalities in Consecutive, Unselected Patients with Central Post-Stroke Pain. *Pain* 61:177–186

## Hyperpolarization

### Definition

Hyperpolarization is an increase in inside negativity of the transmembrane resting potential of an excitable cell, such as a neuron that can make a neuron less excitable and, if of sufficient magnitude, can prevent the occurrence of action potentials.

- [Chronic Pain](#)
- [Descending Circuitry, Opioids](#)
- [Drugs with Mixed Action and Combinations, Emphasis on Tramadol](#)
- [Thalamic Bursting Activity](#)

## Hyperresponsiveness

### Definition

Increased responsivity and improper frequency control of classes of sensory neurons in the central nervous system originated by anomalous inputs.

- [Deafferentation Pain](#)

## Hypersensitivity

### Definition

Hypersensitivity is an increased sensation of stimuli or increased scores of symptoms in response to standard stimuli.

- ▶ Chronic Pelvic Pain, Musculoskeletal Syndromes
- ▶ Deafferentation Pain
- ▶ Psychology of Pain, Sensitisation, Habituation and Pain
- ▶ Recurrent Abdominal Pain in Children
- ▶ Sensitization of Visceral Nociceptors

## Hypersensitivity Maintained Pain

### Synonyms

Central sensitization

### Definition

A phenomenon developing in the central nervous system after peripheral injury by which mechanoreceptors acquire the ability to evoke pain. Clinically, it is characterized by secondary hyperalgesia, i.e. an increased painfulness of stimuli applied to a region outside the area of injury.

- ▶ Alpha( $\alpha$ ) 2-Adrenergic Agonists in Pain Treatment

## Hyperstimulation Analgesia

### Definition

Hyperstimulation Analgesia is a short but very painful stimulation that reduces (short-term) pain.

- ▶ Acupuncture Mechanisms

## Hypertensive Encephalopathy

### Definition

Hypertensive encephalopathy is a change in the brain caused by failure of auto regulation of the cerebral circulation in the presence of severe hypertension, characterized pathologically by vasogenic cerebral edema and, sometimes, microhemorrhages and microinfarcts, and characterized clinically by headache, obtundation, seizures, visual changes, and/or focal deficits.

- ▶ Headache Due to Hypertension

## Hypertensive Headaches

- ▶ Headache Due to Hypertension

## Hypertonic Saline

### Definition

Hypertonic saline is a solution of greater than 155 mM sodium chloride. Sodium chloride solutions of 1.0 M can be injected into muscle tissue and produce pain, presumably due to their osmotic strength.

- ▶ Nociceptors in the Orofacial Region (Temporo-mandibular Joint and Masseter Muscle)

## Hypervigilance

### Definition

Hypervigilance is the excessive predisposition to attend to a certain class of events, or the excessive readiness to select and respond to a certain kind of stimulus from the external or internal environment. In the context of fear of movement, hypervigilance concerns the increased attention to pain, potential signals of pain and other possible somatosensory signals. General hypervigilance is the tendency of highly anxious individuals to pay attention to other irrelevant (neutral) stimuli.

- ▶ Disability, Fear of Movement
- ▶ Dyspareunia and Vaginismus
- ▶ Fear and Pain
- ▶ Hypervigilance and Attention to Pain
- ▶ Muscle Pain, Fear-Avoidance Model

## Hypervigilance and Attention to Pain

GEERT CROMBEZ<sup>1</sup>, STEFAAN VAN DAMME<sup>1</sup>, CHRISTOPHER ECCLESTON<sup>2</sup>

<sup>1</sup>Department of Experimental Clinical and Health Psychology, Ghent University, Ghent, Belgium

<sup>2</sup>Pain Management Unit, University of Bath, Bath, UK  
geert.crombez@ugent.be,  
stefaan.vandamme@ugent.be, c.eccleston@bath.ac.uk

### Synonyms

Heightened Vigilance; Overalertness; Heightened Attention

### Definition

▶ **Hypervigilance** to pain or somatic sensations is the excessive tendency to attend to pain/somatic sensations, or the excessive readiness to select pain-related information over other information from the environment. In the context of pain, hypervigilance is assumed to be initiated and maintained by its immediate threat value. ▶ **Pain-related fear** and ▶ **Catastrophic Thinking** have often been found to be strong predictors of hypervigilance to pain.

## Characteristics

Chapman (1978) was one of the first to apply the construct of (hyper)vigilance to somatic sensations and pain. He referred to hypervigilance as a perceptual habit of scanning of the body for somatic sensations. Hypervigilance was thought to be an emergent property of the threat value of pain. People who appraise bodily sensations as dangerous were thought to be more likely to develop a habit of scanning the body for threatening sensations. His view is similar to the view expressed by Watson and Pennebaker (1989), who explored diverse explanations for the robust relationship between ► **negative affectivity** (NA) and somatic complaints. Indeed, an impressive number of studies has revealed that NA is strongly associated with symptom reporting and a heightened self-report of all types of physical sensations and symptoms, even in the absence of medical markers of disease. Watson and Pennebaker argued that this relationship is best explained by a hypervigilance to somatic information in persons with high levels of NA: “First, [individuals with] high NA may be more likely to notice and attend to normal body sensations and minor aches and pains. Second, because their scanning is fraught with anxiety and uncertainty, [individuals with] high NAs may interpret normal symptoms as painful or pathological” (Watson and Pennebaker 1989, p 247).

Hypervigilance has become a key theoretical and clinical construct in explaining high symptom reporting, especially in situations of medically unexplained or ambiguous sensations (Barsky and Klerman 1983; Rollman and Lautenbacher 1993). We should, however, be careful in equating high symptom reporting with hypervigilance. Hypervigilance is only one possible explanation for high symptom reporting, and other explanations using central nervous processes are often not taken into account. It is also presumptuous to conclude that a low ► **pain threshold** and a low ► **pain tolerance** are sensitive and specific indicators of hypervigilance. Hypervigilance may only be invoked as an explanatory construct when attentional processes are involved. Hypervigilance may be assessed by using self-report, psychophysiological and behavioural measures (Van Damme et al. 2004b).

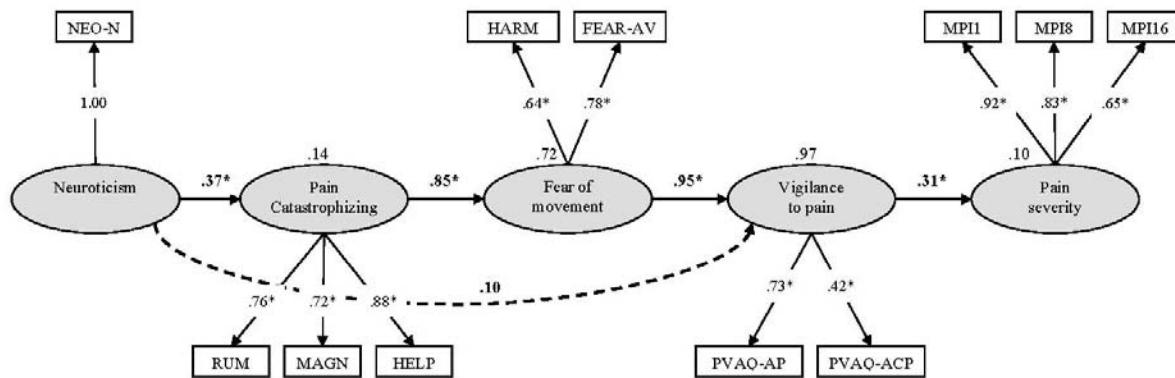
In understanding hypervigilance, it is important to consider “normal” attention to pain. Eccleston and Crombez (1999) were among the first to systematically investigate the “normal” attentional processes to pain. In their cognitive-affective model of the interruptive function of pain, they argued that pain imposes an overriding priority for attentional engagement by activating a primitive defensive system that urges escape from somatic threat. Whether pain will demand attention, is the result of both pain-related characteristics (i.e. intensity, novelty, catastrophizing about pain, pain-related fear) and characteristics of other demands in

the environment (monotonous environment, attention absorption in other activities). In their model, it is difficult to draw a sharp delineation between vigilance and hypervigilance. Hypervigilance to pain does not seem to result from an abnormal characteristic of the individual, such as negative affectivity. Available evidence suggests that hypervigilance to pain emerges as the working of normal attentional mechanisms in abnormal situations. Such situations are: (1) the chronic presence of high-intensity pain, (2) monotonous environments, or environments that lack external stimulation, and (3) most importantly, the high threat value of pain. Indeed, Goubert et al. (2004) found that the key mediating variable in explaining hypervigilance to pain was not an abnormally high level of negative affectivity, but the immediate threat value of pain, measured by pain-related fear and catastrophic thinking about pain (Fig. 1). Negative affectivity was best conceived as a vulnerability factor: It lowers the threshold at which pain is perceived as threatening, and at which catastrophic thoughts about pain emerge.

The idea that one is hypervigilant for threatening information is well-known in the clinical literature on fear and anxiety (Eysenck 1992; Pincus and Morley 2001). In contrast with the view of Chapman (1978), hypervigilance to threat is not restricted to one particular attentional mechanism, i.e. scanning. It is therefore reasonable to assume that hypervigilance to pain and somatic sensations may also become manifest in a variety of ways. The following example may clarify these different components: Imagine a person, afraid of back pain and (re)injury during movements, who has to resume a backstraining job after a period of pain-related work absence. The thought of going back to work will be sufficient to make him fearful. This thought may make him distracted by several irrelevant stimuli in the environment (► **distractibility**). From the moment he starts with some backstraining activities at work, he may begin to scan his body for pain or for other potential signals of bodily harm (► **scanning**). This may result in the rapid detection of any bodily sensation in his back. Attention will be drawn automatically to any change in back sensations (► **attentional bias**), and once it is detected, the person may experience difficulties disengaging attention from these somatic sensations and to re-engage attention towards his work (difficulty disengaging attention).

There are a number of promising paradigms that allow these various components of hypervigilance to pain to be disentangled (Van Damme et al. 2002; Spence et al. 2002). Studies have begun to investigate the critical role of these components in hypervigilance to pain. Results suggest that the rapid detection of pain or signals of pain is not critically dependent upon the presence of pain (attentional bias). The introduction of any somatosensory stimulus – painful or non-painful – introduces a rapid shift of attention towards that stimulus.





**Hypervigilance and Attention to Pain, Figure 1** Psychology of Pain, hypervigilance and attention to pain.

H

Of more importance seems to be the effect of threat upon the difficulty disengaging from pain. Once pain or signals for pain have been detected, there is a difficulty disengaging from that threatening information. The difficulty is even more pronounced for those who catastrophize about pain (Van Damme et al. 2004a). Our understanding of hypervigilance has a number of implications. First, hypervigilance may be one mechanism by which pain-related fear may fuel avoidance. Patients with ► **kinesiophobia** are also hypervigilant for pain and possible signals of impending pain. Their attention dwells more on somatic sensations and will easily promote ► **avoidance behaviour** (Vlaeyen and Linton 2000). Second, hypervigilance to pain and somatic sensations will result in the more frequent reporting of symptoms. Third, as research shows that a high threat value of pain results in difficulty disengaging from pain and pain signals, cognitive interference will occur. Fourth, as hypervigilance seems to be mediated by the threat value of pain, distraction is probably not an effective treatment technique in patients with a high level of catastrophic thinking about pain. This was confirmed in the study by Hadjistavropoulos et al. (2000), who found that distraction was not effective in chronic pain patients with a high level of health anxiety.

## References

1. Barsky AJ, Klerman GL (1983) Overview: Hypochondriasis, Bodily Complaints, and Somatic Styles. *Am J Psychiatry* 140:273–283
2. Chapman CR (1978) Pain: The Perception of Noxious Events. In: Sternbach RA (ed) *The Psychology of Pain*. Raven Press, New York, pp169–202
3. Eccleston C, Crombez G (1999) Pain Demands Attention: A Cognitive-Affective Model of Interruptive Function of Pain. *Psychol Bull* 3:356–366
4. Eysenck MW (1992) *Anxiety: The Cognitive Perspective*. Hillsdale, Lawrence Erlbaum Associates, p 195
5. Hadjistavropoulos HD, Hadjistavropoulos T, Quine A (2000) Health Anxiety Moderates the Effects of Distraction versus Attention to Pain. *Behav Res Ther* 38:425–438
6. Goubert L, Crombez G, Van Damme S (2004) The Role of Neuroticism, Pain Catastrophizing and Pain-Related Fear in

Vigilance to Pain: A Structural Equations Approach. *Pain* 107:234–241

7. Pincus T, Morley S (2001) Cognitive Processing processing bias in chronic pain: A review and integration. *Psychol Bull* 127:599–617
8. Rollman GB, Lautenbacher S (1993) Hypervigilance Effects in Fibromyalgia: Pain Experience and Pain Perception. In: Voeroy H, Merskey H (eds) *Progress in Fibromyalgia and Myofascial Pain*. Elsevier Science Publishers BV, New York, pp 149–159
9. Spence C, Bentley DE, Phillips N, McGlone FP, Jones AKP (2002) Selective Attention to Pain: A Psychophysical Investigation. *Exp Brain Res* 145:395–402
10. Van Damme S, Crombez G, Eccleston C (2002) Retarded Disengagement from Pain Cues: The Effects of Pain Catastrophizing and Pain Expectancy. *Pain* 100:111–118
11. Van Damme S, Crombez G, Eccleston C (2004a). Impaired Disengagement from Pain: The Role of Catastrophic Thinking About Pain. *Pain* 107:70–76
12. Van Damme S, Crombez G, Eccleston C, Roelofs J (2004b) The Role of Hypervigilance in the Experience of Pain. In: Asmundson JG, Vlaeyen J, Crombez G (eds) *Understanding and Treating Fear of Pain*. Oxford University Press, pp 71–99
13. Vlaeyen JWS, Linton SJ (2000) Fear-Avoidance and its Consequences in Chronic Musculoskeletal Pain: A State of the Art. *Pain* 85:317–332
14. Watson D, Pennebaker JW (1989) Health Complaints, Stress, and Distress: Exploring the Central Role of Negative Affectivity. *Psychol Rev* 96:234–254

## Hypesthesia

### Definition

Hypesthesia is a decreased sensation to stimuli.

- [Hypoesthesia, Assessment](#)
- [Viral Neuropathies](#)

## Hypnic Alarm Clock Headache Syndrome

- [Hypnic Headache](#)

## Hypnic Headache

JAMES W. LANCE

Institute of Neurological Sciences, Prince of Wales Hospital and University of New South Wales, Sydney, NSW, Australia  
jimlance@bigpond.com

### Synonym

Hypnic Alarm Clock Headache Syndrome

### Definition

Headache awakening the subject from sleep, not occurring during waking hours, usually lasting less than 180 min and not associated with autonomic features.

### Characteristics

The headache is unilateral in about 40% of patients but is bilateral in the remainder. It usually develops after the age of 50 years, recurs more than fifteen times a month and is not severe but persists for more than 15 min after waking. It may be accompanied by nausea, photophobia or phonophobia, but not all three of these migrainous features. The bilateral site, mild intensity and the lack of autonomic features distinguish it from cluster headache. It usually responds to the administration of caffeine or lithium taken on retiring to bed.

### Clinical Reports and Pathophysiology

Raskin (1988) first drew attention to this uncommon syndrome. He reported six patients, five of whom were male, all aged 60 years or more who were waking up consistently with generalised headaches that persisted for 30–60 min. Two volunteered that they were always woken from a dream by these headaches. Three patients reported accompanying nausea. The headaches were not alleviated by amitriptyline or propranolol but responded to lithium 300 mg or propranolol 600 mg at night. Raskin attributed the condition to a disorder of the brain's "► biological clock" in the hypothalamus, pointing out that cluster headache, cyclical migraine and manic-depression disorder were also tied to bodily rhythms and responded to lithium.

Ten of the nineteen patients described by Dodick et al. (1998) were awakened by headache at a consistent time, usually between 1.00 am and 3.00 am, giving rise to the term "alarm clock" headache. Three patients had infrequent but identical headaches during daytime naps. One described the headaches as developing during vivid dreams. Three patients mentioned infrequent nausea. It is not clear why one patient who had a severe unilateral headache with ipsilateral lacrimation and rhinorrhea was included in this series and not classified as cluster headache. An additional link with dreaming

was provided by one of the three patients described by Morales-Asin et al. (1998).

In attempts to clarify this question, ► polysomnography has been carried out successfully in recording the onset of hypnic headache in six patients. Dodick (2000) found that an episode started during ► rapid eye movement (REM) sleep at a time of severe oxygen desaturation. Evers et al. (2003) reported two patients with onset during REM sleep, one of whom had periodic limb movements throughout the night. Oxygen desaturation did not exceed 85% at any time. Pinessi et al. (2003) recorded four hypnic headaches in two patients, all emerging from the REM phase of sleep without any oxygen desaturation. These authors pointed out that a patient reported by Arjona et al (2000) as being aroused by hypnic headache in stage 3 slow wave sleep, was being treated with venlafaxine, which may have altered her sleep pattern.

Cells that switch REM sleep cells off are found in the locus coeruleus and dorsal raphe nucleus and discharge regularly during waking hours, ceasing during REM sleep. Their action depends on noradrenergic and serotonergic transmission respectively. Since pathways from these areas form part of the body's endogenous pain control system their switching off could account for the onset of pain with REM sleep. (Dodick et al. 2003; Pinessi et al. 2003) The sleep-wake cycle is controlled by the suprachiasmatic nucleus of the hypothalamus and reduced ► melatonin secretion is thought to play a part in the initiation of hypnic headache.

Martins and Gouveia (2001) reported the case of a patient in remission for 10 months after lithium therapy who flew from Portugal to Brazil over three time zones. Her hypnic headaches recurred each night for 10 days while away but ceased on her return.

### Summary

Evers and Goadsby (2003) have reviewed the seventy-one cases of hypnic headache reported in the literature to date. There were twenty-four men and forty-one women ranging in age from 26 to 83 years. The headache was bilateral in 61% and unilateral in 39%. It varied in frequency from one each week to six per night. It usually started 2–4 h after falling asleep, was moderate in intensity and persisted for 15 min to 3 h.

Nausea was reported by 19.4%. Mild photophobia, phonophobia or both were experienced by 6.8%. Some autonomic features such as lacrimation were recorded in six patients, two of whom developed ptosis. No relevant abnormality was found on CT, MRI, EEG or carotid Doppler ultrasound studies.

Evers and Goadsby (2003) summarised the response to treatment in reported cases. Good results were achieved by lithium in 26 / 35 patients; caffeine in 6 / 16, indomethacin in 7 / 18, flunarizine in 4 / 5, melatonin in 3 / 7 and prednisone in the only two patients in whom it had been tried (Relja et al. 2002).

## References

1. Arjona JA, Jimenez-Jimenez FJ, Vela-Bueno A et al. (2000) Hypnic headache associated with stage 3 slow wave sleep. *Headache* 40:753–754
2. Dodick DW (2000) Polysomnography in hypnic headache syndrome. *Headache* 40:748–752
3. Dodick DW, Mosek AC, Campbell JK (1998) The hypnic (“alarm clock”) headache syndrome. *Cephalalgia* 18:152–156
4. Dodick DW, Gross EJ, Parish JM (2003) Clinical, anatomical and physiologic relationship between sleep and headache. *Headache* 43:282–292
5. Evers S, Goadsby PJ (2003) Hypnic headache. Clinical features, pathophysiology and treatment. *Neurology* 60:905–909
6. Evers S, Rahmann A, Schwaag S et al. (2003) Hypnic headache –The first German cases including polysomnography. *Cephalalgia* 23:20–23
7. Martins IP, Gouveia RG (2001) Hypnic headache and travel across time zones: a case report. *Cephalalgia* 21:928–931
8. Morales-Asin F, Mauri JA, Iiguez C et al. (1998) The hypnic headache syndrome: report of three new cases. *Cephalalgia* 18:157–158
9. Pinessi L, Rainero I, Cicolin A et al. (2003) Hypnic headache syndrome: association of the attacks with REM sleep. *Cephalalgia* 23:150–154
10. Raskin NH (1998) The Hypnic headache Syndrome. *Headache* 28:534–536
11. Relja G, Zarzon M, Locetelli L et al. (2002) Hypnic headache: rapid and long-lasting response to prednisone in two new cases. *Cephalalgia* 22:157–159

## Hypnosis

### Definition

A process of focusing attention that typically produces deep relaxation and openness to verbal suggestions; it can be performed on oneself or by others by using a combination of relaxation and intensive guided imagery techniques. The resulting altered state of consciousness is known as a trance. Hypnosis is widely used in both adults and children, and is broadly effective in the management of chronic and acute pain, especially cancer pain.

- ▶ [Complex Chronic Pain in Children, Interdisciplinary Treatment](#)
- ▶ [Coping and Pain](#)
- ▶ [Hypnotic Analgesia](#)
- ▶ [Psychological Treatment in Acute Pain](#)
- ▶ [Relaxation in the Treatment of Pain](#)

## Hypnotherapy

- ▶ [Therapy of Pain, Hypnosis](#)

## Hypnotic Analgesia

DONALD D. PRICE<sup>1</sup>, PIERRE RAINVILLE<sup>2</sup>

<sup>1</sup>Oral Surgery and Neuroscience, McKnight Brain Institute, University of Florida, Gainesville, FL, USA

<sup>2</sup>Department of Stomatology, University of Montreal, Montreal, QC, Canada  
dprice@dental.ufl.edu, pierre.rainville@umontreal.ca

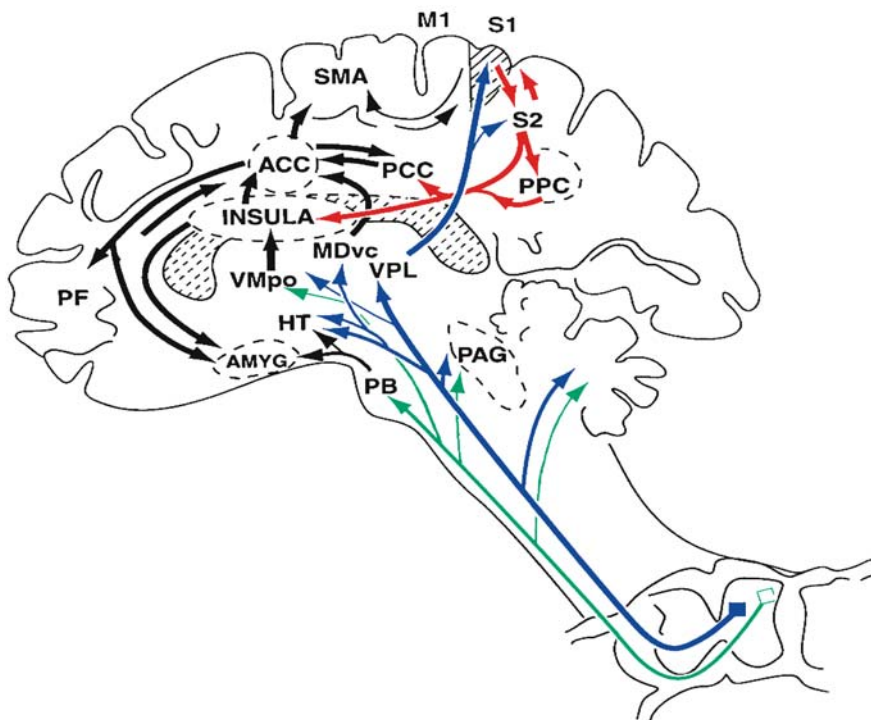
### Definition

Psychological factors and interventions can sometimes powerfully modulate pain, and there is an emerging neurobiology of pain-modulatory mechanisms. Central neural mechanisms associated with such phenomena as placebo/nocebo, hypnotic suggestion (see ▶ [Post-Hypnotic Suggestion](#)), attention, distraction and even ongoing emotions are now thought to modulate pain by decreasing or increasing neural activity within many of the brain structures shown in Figure 1 (Rainville 2002). This modulation includes endogenous pain-inhibitory and pain-facilitation pathways that descend to spinal dorsal horn, the origin of ascending spinal pathways for pain as well as modulation, which takes place within cortico-limbic circuits once nociceptive information has reached cortical levels (De Pascalis 2001; Fields and Price; Hofbauer 2001; Porro et al. 2002; Rainville 2002). Hypnotically induced reduction in pain is based on changes in pain induced by suggestions and facilitated by an alteration of consciousness (Hilgard and Hilgard 1983; Price and Barrell 1990; Rainville and Price 2003). This alteration is accompanied by changes in brain activity involved in the regulation of consciousness (Rainville and Price 2003). Hypnotic changes in pain experience can consist of selective changes in the ▶ [affective dimension \(component\) of pain](#), or reductions in both sensory and affective dimensions depending on the nature of the suggestions. Changes in affective and sensory components of pain are associated with corresponding changes in anterior cingulate cortical activity and somatosensory cortical activity respectively (Rainville and Price 2003; Rainville 2002). Different hypnotic analgesic approaches are clinically useful.

### Characteristics

#### What are the Types of Hypnotic Suggestions for Analgesia

The suggestions for alteration of the experience of pain in studies of hypnotic analgesia, relate closely to the dimensions of pain and to the psychological stages of pain processing. Thus, there are suggestions that specifically target the affective-motivational dimension of pain, as distinguished from the ▶ [sensory-discriminative dimension](#) (Rainville et al. 1999). These would include suggestions for reinterpreting sensations as neutral or pleasant rather than unpleasant, as well as suggestions for reducing or eliminating the implications of threat or harm from the sensations. Then there are suggestions designed for specifically altering the quality and/or intensity of painful sensations so that they become less intense or absent altogether. There are three very different types of hypnotic suggestions for altering pain sensation in-



**Hypnotic Analgesia,**  
**Figure 1** Schematic of ascending pathways, subcortical structures, and cerebral cortical structures involved in processing pain. PAG, periaqueductal grey; PB, parabrachial nucleus of the dorsolateral pons; VMpo, ventromedial part of the posterior nuclear complex; MDvc, ventrocaudal part of the medial dorsal nucleus; VPL, ventroposterior lateral nucleus; ACC, anterior cingulate cortex; PCC, posterior cingulate cortex; HT, hypothalamus; S-1 and S-2, first and second somatosensory cortical areas; PPC, posterior parietal complex; SMA, supplementary motor area; AMYG, amygdala; PF, prefrontal cortex (Figure from Price, Science (2001)).

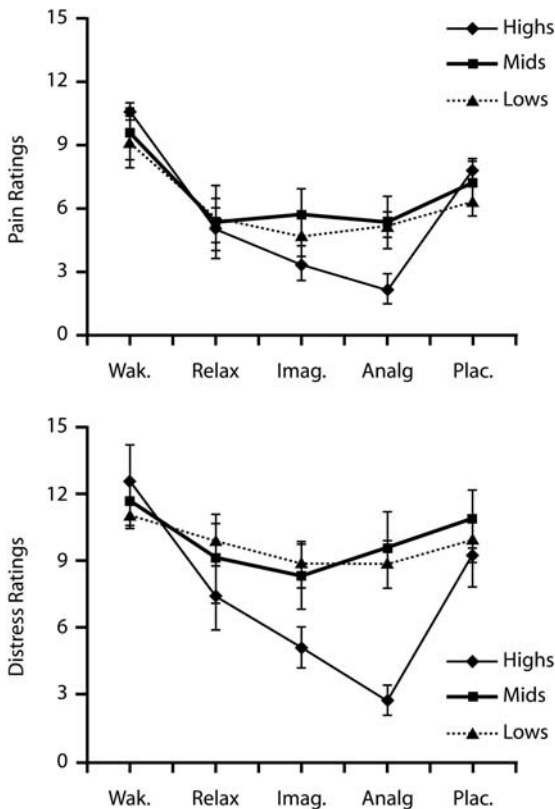
tensity (De Pascalis et al. 1999; De Pascalis 2001). One type provides ► **dissociative imagery** by suggesting experiences that are disconnected from the felt sense of the body. An example would be a suggestion to imagine oneself “floating out of the body and up in the air” combined with the implicit or explicit suggestion that the pain belongs to the body and not to the one who experiences being somewhere else. Common to suggestions for dissociation, is the intention of having subjects not feel parts of their bodies that would otherwise be painful, and/or experience themselves in another location and context altogether. Another type is ► **focused analgesia**, which is intended to replace sensations of pain with others, such as numbness or warmth or with the complete absence of sensation. In complete contrast to dissociative analgesia, focused analgesia requires increased attention to the body area wherein pain is present, combined with a replaced sensation in that body area. For example, focused analgesia might include suggestions to focus on sensations in the hand, and to experience all sensations of the hand *as if* it were in a large glove. A third type of suggestion involves the reinterpretation of the meaning of the sensory experience. In this case, the significance of the experience for the integrity of the body is reduced or completely abolished, so that pain sensations are no longer associated with feelings of threat. Just as studies are needed to assess the role of hypnotic depth and individual components of hypnosis on pain, so there also need to be studies of differential effects of various types of suggestion on sensory and affective dimensions of pain experience. For example, what are the effects on

pain of suggestions exclusively designed to reinterpret the meanings of the sensations so that they are less threatening or unpleasant?

#### Which Types of Hypnotic Suggestions are Most Effective in Producing Analgesia

Very few hypnotic analgesia studies have directly compared effects from the different types of hypnotic suggestions described above. However, De Pascalis et al. conducted studies that compared analgesic effects produced by experimental conditions of Deep Relaxation, Dissociated Imagery, Focused Analgesia, and Placebo in comparison to a Waking Control condition (De Pascalis et al. 1999; De Pascalis 2001). They compared these conditions across groups of high, medium, and low hypnotizable participants, and utilized several dependent pain-related measures. These included pain and distress ratings, pain threshold determinations, somatosensory event-related potentials (SERP), heart rate, and skin conductance responses (SCR). The experimental stimuli consisted of non-painful and painful levels of electrical pulses delivered to the right wrist. Of the four experimental conditions, Deep Relaxation, Dissociated Imagery, and Focused Analgesia produced statistically significant reductions on all pain-related measures among all three groups of participants (i.e. low, mid-, high). However, these analgesic effects interacted with ► **hypnotizability**, as shown in Figure 2. During Focused Analgesia, highly hypnotizable participants had larger reductions in pain ratings in comparison to low and medium hypnotizable participants. Further-





**Hypnotic Analgesia, Figure 2** Pain sensory and distress ratings in response to noxious electrical stimulation delivered to the wrist in normal subjects with high (Highs), moderate (Mids), or low (Lows) hypnotic susceptibility. Both pain sensory and distress ratings decrease significantly in response to hypnotic suggestions for relaxation (Relax), dissociative imagery (Imag.), and focused analgesia (Analg.), compared to the baseline wakefulness (Wak.) and placebo (Plac.) conditions. Larger pain reductions are observed in more susceptible subjects (Highs) and during focused analgesia. Also, note that there is no significant placebo analgesia observed for all three groups. (De Pascalis et al. 2001).

more, highly susceptible subjects had more pronounced reductions in distress ratings during Focused Analgesia and Dissociated Imagery, in comparison to the other two groups. Focused Analgesia produced the largest reductions in all dependent measures within highly hypnotizable participants. No significant placebo effects were obtained for any of the three groups. The combination of these results indicates several interesting features of hypnotic analgesia. First, hypnotic analgesia cannot simply be understood as a placebo effect and is more than just relaxation. Second, very different types of suggestions for analgesia are effective and are facilitated by hypnotizability. Third, hypnotic analgesia can affect physiological reflexive responses associated with pain (Hilgard and Hilgard 1983; Rainville 2002). Each of the types of hypnotic suggestion discussed so far can be given directly or indirectly. A ► **direct suggestion** for analgesia would be “You will notice that the pain is less intense. . . .” whereas an ► **indirect suggestion** would be “I wonder if you will notice whether the

sensation you once experienced as painful will be experienced as just warmth or pressure or perhaps even numbness. . . .” The latter is permissive, ambiguous, and refers to alternative experiences without the implication of a direct instruction. Resistance to hypnotic suggestions may be less in the case of permissive-indirect as compared to restrictive-direct suggestions, because one is not directly told what to experience. Furthermore, restrictive-direct suggestions may be perceived as unnecessarily authoritarian. One might expect that a larger proportion of people could benefit from a hypnotic approach that uses indirect suggestions and there is some, albeit limited, evidence that this is so (Price and Barber 1987; Price and Barrell 1990).



**What are the Factors that Determine the Efficacy of Hypnotic Analgesia**

The efficacy of hypnotic analgesia and its relationship to hypnotic susceptibility has been shown to depend on several factors (Price and Barber 1987). These include the pain dimension that is measured, baseline pain intensity, the maintained presence of the hypnotist or hypnotic suggestions, and finally hypnotic ability. Some of these factors are shown in Table 1. When suggestions were given for both reinterpreting the meaning of experimentally induced heat sensations and for experiencing them as less intense, pain sensation intensity was reduced by an average of about 50 percent, and pain unpleasantness was reduced by 87 percent in a group of sixteen subjects. Thus, pain affect was more powerfully attenuated in comparison to pain sensation. Although hypnotic suggestions exerted a more powerful reduction of pain affect than pain sensation, it was also quite apparent that both dimensions were reduced, as has been amply demonstrated in several experimental laboratories (Barber and Mayer 1977; De Pascalis et al. 1999; De Pascalis 2001; Rainville et al. 1999; Rainville 2002). Reduction in pain sensation was statistically associated with hypnotic susceptibility, albeit at modest levels (Tab. 1). Therefore, the component of the hypnotic intervention that relied on hypnotic ability and a hypnotic state was the one most influential on pain sensation intensity. Interestingly, the association became stronger with increasing levels of pain intensity (Tab. 1). It makes sense that the reduction

**Hypnotic Analgesia, Table 1** Hypnotic Susceptibility and Analgesia

Stimulus Temperature	Sensory Analgesia Spearman Correlation	Affective Analgesia Correlation Coefficient
44.5° C	+0.04	-0.23
47.5° C	+0.21	-0.11
49.5° C	+0.43*	-0.08
51.5° C	+0.56*	+0.10

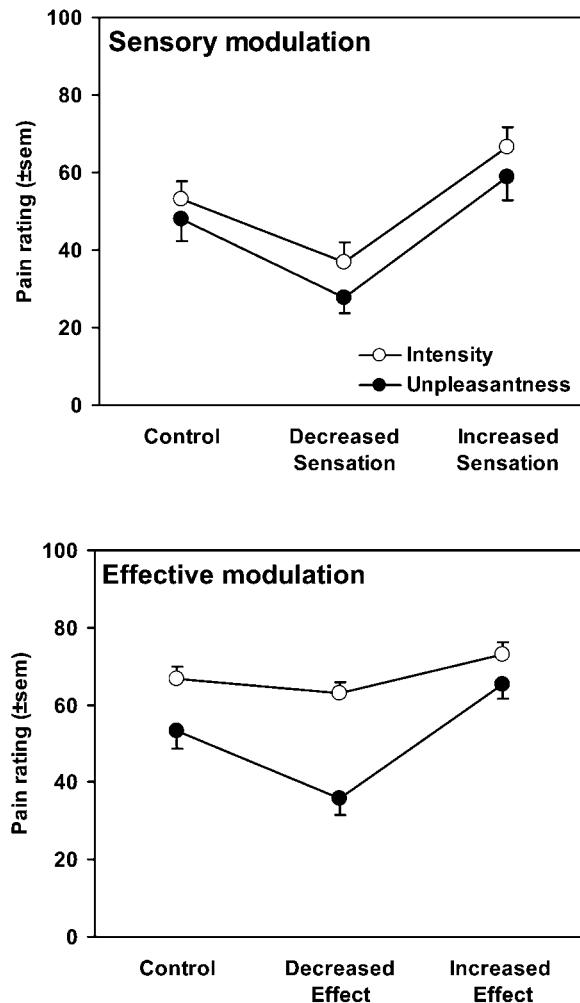
\*P<0.05

in stronger pains requires more hypnotic ability than the reduction in weaker pains. A final factor was maintained contact between the hypnotist and the subject. Statistically significant analgesia developed in one group of subjects that had maintained contact with the hypnotist during the pain testing session, and did not develop in the group that did not have maintained contact. Thus, multiple factors are involved in analgesia that results from a hypnotic intervention. These may include those that are unrelated to hypnotic susceptibility and perhaps even to a hypnotic state. Such potential multiple factors are closely related to different proposed mechanisms of hypnotic analgesia.

Rainville et al. further clarified the relationship between different types of hypnotic suggestions for analgesia, and the dimensions of pain that are modulated by these suggestions (Rainville et al. 1999). This study conducted two types of experiments, one in which hypnotic suggestions were selectively targeted toward increasing or decreasing the sensory intensity of pain, and the other in which hypnotic suggestions were targeted toward decreasing or increasing the affective dimension of pain. In both types of experiments, normal subjects who were trained in hypnosis, rated pain intensity and pain unpleasantness produced by a tonic heat pain test (1-min immersion of the hand in 45.0–47.5° C water). The results of the two experiments are illustrated in Figure 3.

In the first experiment, suggestions to modulate pain sensation intensity resulted in significant changes in both pain sensation intensity ratings and pain unpleasantness ratings, that is, both dimensions were modulated in parallel. This was so, despite the fact that no suggestions were given about pain affect. In the second experiment, pain unpleasantness was significantly increased and decreased after suggestions were given for these changes, and these changes occurred without corresponding changes in pain sensation intensity. Hypnotic susceptibility (Stanford Hypnotic Susceptibility Scale Form A) was specifically associated with pain sensation intensity modulation in the first experiment (directed toward pain sensation; Spearman- $r = 0.69$ ), and with pain unpleasantness modulation in the second experiment (directed toward pain affect; Spearman- $r = 0.43$ ).

Thus, hypnotic changes in pain experience can consist of selective changes in the affective dimension of pain or reductions in both sensory and affective dimensions, depending on the nature of the suggestions. Selective changes in only affective components of pain are associated with corresponding changes in anterior cingulate cortical activity, and changes in sensory components are accompanied by corresponding changes in somatosensory cortical activity (Hofbauer 2001; Rainville 2002). Reinterpretation of meanings of pain, dissociation, and focused analgesia reflect different psychological mechanisms of hypnotic analgesia. These multiple mecha-



**Hypnotic Analgesia, Figure 3** Self-reports of the pain experienced during the immersion of the hand in hot water following hypnotic suggestions directed at the sensory and affective dimension of pain. Suggestions directed at the sensory aspect of pain (Sensory modulation) produce parallel changes in self-reports of pain sensation intensity and unpleasantness. In contrast, suggestions for the reinterpretation of pain with decreased and increased sense of threat and discomfort (Affective modulation) produce specific changes in pain unpleasantness that largely exceed the changes in pain sensation intensity. (Rainville et al. 1999)

nisms are likely to be associated with intracortical and descending brain-to-spinal cord mechanisms, to varying extents. Although there is some evidence that hypnotic analgesia has demonstrable clinical efficacy, there is a strong need for improvements in methodologies of clinical studies. In particular, there is a need to compare the efficacy of different hypnotic approaches and provide rigorous standardized outcome measures.

It is useful to consider how results of experiments by De Pascalis et al. (De Pascalis et al. 1999; De Pascalis 2001) and Rainville et al. (Rainville et al. 1999; Rainville 2002), described above, help identify the necessary and sufficient psychological factors for hypnotic analgesia. Hypnotic analgesia cannot work only by means of dis-

traction, because suggestions for Focused Analgesia are among the most effective, particularly among highly hypnotizable participants. Focused Analgesia requires greater not lesser attention to the body area wherein analgesia develops. Hypnotically induced changes in pain affect can occur directly through suggestions that alter the meaning of the experience of the stimulus, or indirectly through suggestions that target the pain sensation. Hypnotic changes in the latter can also occur through suggestions for dissociation or through suggestions for changes in the way the sensory qualities are experienced (e. g. numbness versus burning). Hypnotic analgesia cannot only work by means of a placebo effect, because subjects are likely to experience placebo and hypnotic suggestions differently. Moreover, there is now good evidence that ► [placebo analgesia](#), but not hypnotic analgesia, requires an endogenous opioid pain-inhibitory mechanism. Placebo analgesia is naloxone reversible in studies of experimental pain, whereas several studies have shown that hypnotic analgesia is not naloxone reversible (Barber and Mayer 1977; Goldstein and Hilgard 1975). Finally, placebo analgesia, unlike hypnotic analgesia, is not significantly associated with hypnotic susceptibility (Hilgard and Hilgard 1983).

### Conclusions

The combination of anatomical, psychological, and neurophysiological approaches to understanding the brain mechanisms underlying sensory and affective dimensions of pain and its modulation by psychological interventions, such as hypnotic suggestions, has led to a vastly improved ability to answer questions that only 10 years ago were relatively impenetrable. In particular, studies that combine brain imaging with psychophysical methods and sophisticated experimental designs, have led to the possibility of understanding complex mechanisms by which sensory and affective dimensions of pain are interrelated, and how these dimensions can be modulated by cognitive factors. The brain networks for these mechanisms are extensive and involve both serial and parallel circuitry, which is itself under dynamic control from several brain regions.

### References

1. Barber J, Mayer D (1977) Evaluation of the Efficacy and Neural Mechanism of a Hypnotic Analgesia Procedure in Experimental and Clinical Dental Pain. *Pain* 4:41–48
2. De Pascalis V, Magurano MR, Bellusci A (1999) Pain Perception, Somatosensory Event-Related Potentials and Skin Conductance Responses to Painful Stimuli in High, Mid, and Low Hypnotizable Subjects: Effects of Differential Pain Reduction Strategies. *Pain* 83:499–508
3. De Pascalis V, Magurano MR, Bellusci A et al. (2001) Somatosensory Event-Related Potential and Autonomic Activity to Varying Pain Reduction Cognitive Strategies in Hypnosis. *Clin Neurophysiol* 112:1475–1485
4. Fields HL, Price D (1997): Toward a neurobiology of placebo analgesia. In: Harrington A (ed): *The Placebo Effect*. Harvard University Press, Cambridge, Massachusetts, pp 93–115
5. Goldstein A, Hilgard ER (1975) Lack of Influence of the Morphine Antagonist Naloxone on Hypnotic Analgesia. *Proc Natl Acad Sci USA* 72:2041–2043
6. Hilgard ER, Hilgard JR (1983) *Hypnosis in the Relief of Pain*. William Kaufmann, Los Altos, CA, pp 294
7. Hofbauer RK, Rainville P, Duncan GH et al. (2001) Cortical Representation of the Sensory Dimension of Pain. *J Neurophysiol* 86:402–411
8. Porro CA, Balrardi P, Pagnoni G et al. (2002) Does Anticipation of Pain Affect Cortical Nociceptive Systems? *J Neurosci* 22:3206–3214
9. Price DD, Barber J (1987) An Analysis of Factors that Contribute to the Efficacy of Hypnotic Analgesia. *J Abnorm Psychol* 96: 46–51
10. Price DD, Barrell JJ (1990) The Structure of the Hypnotic State: A Self-Directed Experiential Study. In: Barrell JJ (ed) *The Experiential Method: Exploring the Human Experience*. Copely Publishing Group, Massachusetts, pp 85–97
11. Rainville P, Price DD (2003). Hypnosis Phenomenology and the Neurobiology of Consciousness. *Int J Clin Exp Hypn* 51:105–129
12. Rainville P, Carrier B, Hofbauer RK et al. (1999) Dissociation of Sensory and Affective Dimensions of Pain using Hypnotic Modulation. *Pain* 82:159–171
13. Rainville P (2002) Brain Mechanisms of Pain Affect and Pain Modulation. *Curr Opin Neurobiol* 12:195–204

## Hypnotic Relaxation

- [Relaxation in the Treatment of Pain](#)

## Hypnotism

- [Therapy of Pain, Hypnosis](#)

## Hypnotizability

### Definition

Hypnotic susceptibility, hypnotic capacity or hypnotic responding delineates a variable that determines the extent to which an individual is able to respond to hypnotic suggestion. Research has shown that hypnotizability can be measured with good reliability and is a remarkably stable trait in adults. It correlates with dissociative experiences and with measures of absorption. Highly hypnotizable individuals tend to have a high imaginative capacity.

- [Hypnotic Analgesia](#)
- [Therapy of Pain, Hypnosis](#)

## Hypoesthesia

### Definition

Hypoesthesia is a decreased sensitivity to stimulation, excluding special senses.

- ▶ Hyperaesthesia
- ▶ Hypoaesthesia
- ▶ Hypoesthesia, Assessment

## Hypoalgesia, Assessment

MISHA-MIROSLAV BACKONJA  
 Department of Neurology; University of Wisconsin-  
 Madison, Madison, WI, USA  
 backonja@neurology.wisc.edu

### Synonyms

Hypalgia; Assessment of Hypoalgesia

### Definition

IASP Taxonomy (Merskey and Bogduk 1994) defines hypoalgesia as “decreased perception of noxious stimuli.” Hypoalgesia could be in response to a wide variety of mechanical stimuli such as pinch, strong pressure or punctuate and to thermal noxious stimuli of heat and cold, basically any physical force of sufficient intensity to disrupt or threaten the integrity or homeostasis of any tissue.

In other terms, hypoalgesia is diminished experience of pain in response to a normally painful stimulus. Hypoesthesia covers the case of diminished sensitivity to stimulation that is normally not painful.

Hypoalgesia is also defined as raised threshold to painful stimuli.

### Characteristics

Hypoalgesia is a ▶ **negative sensory phenomenon** seen exclusively in patients with neurological disease or injury, including patients with ▶ **neuropathic pain** (Backonja and Galer 1998; Lindblom and Ochoa 1986; Backonja 2003). Hypoalgesia indicates a decrease or loss of function that comes as a result of neurological disease or injury affecting thermonociceptive pathways, anywhere from primary afferents to cerebral cortical structures. Distinction of hypoalgesia from hypoesthesia is based primarily on the type and intensity of the stimulus applied to the thermonociceptive sensory system.

### Methods of Assessment and the Interpretation

Assessment of the sensory nervous system function is most commonly done at the bedside where testing is primarily qualitative in nature, while quantitative assessment, increasingly using computerized electronic equipment, is done in a quantitative sensory laboratory (Backonja and Galer 1998; Greenspan 2001). Either should be able to detect hypoalgesia, but the way these methods arrive to the conclusion about presence and severity of hypoalgesia is distinct, and that is also reflected in the

definition. Qualitative bedside exam relies on patient report. Quantitative sensory testing arrives at its conclusion about hypoalgesia on the basis of the raised thresholds to painful stimuli.

Qualitative assessment is based on the subject’s ability to compare and report quality of sensation from standard methods of stimulation, from the ▶ **symptom** affected areas, when it is compared to normal unaffected areas. Qualitative method is very convenient for bedside evaluations. Frequently utilized bedside methods include standard neurological examination tools such as safety pin, monofilament, and various metal objects that could be conveniently warmed or cooled in the clinical setting. A degree of quantification is possible, and requires that the subject reports whether a decrease of pain from painful stimulation is mild, moderate, severe or completely absent, when compared to a normal unaffected area. Since a qualitative method requires psychophysical interaction, this method can be used only in humans who can linguistically communicate with the examiner, and as such it cannot be used in animal models of pain studies.

Quantitative assessment of sensory deficits requires a more sophisticated approach and frequently utilizes electronically controlled devices, although a number of psychophysical methods, especially mechanical stimuli, are used and all of them place much longer time demands on patients. Traditionally this method is known as quantitative sensory testing (QST). The primary outcome of QST is determination of thresholds for specific modalities which are then compared to the established norms (Greenspan 2001; Goetz et al. 2005). Increase in threshold to painful stimuli is then interpreted as hypoalgesia. QST methods could be used not only in human studies but also in animal models.

One of the main goals of neurological evaluation is to determine the site and level of ▶ **neuraxis** where pathological processes that produce symptoms, including pain, originate (Dyck and O’Brien 2003). In addition to establishing the nature of ▶ **neurological deficit**, such as hypoalgesia to a specific modality, it is important to establish a special pattern of these abnormalities, since the pattern serves as the basis for the determination whether the lesion that is causing symptoms, including pain, involve specific peripheral nerve structures, such as peripheral nerves, plexus or the nerve root, versus central nervous system structures such as spinal cord, brainstem, subcortical or cortical structures and pathways of the brain.

### Caveats and Unresolved Issues

Difficulty of assessing hypoalgesia arises from the inherent difficulty of assessing negative sensory phenomenon. For example, conceptually it is easier to illustrate ▶ **positive sensory phenomenon** to subjects, such as pain with instruction that 0 = none, and 10 = worst imaginable. In contrast, it is much harder conceptually to illustrate and request a rating of spontaneous



loss of sensation because it is not possible to feel what one is not able to feel, in spite of the instruction that the patient is to imagine scaling between one end being a normal sensation and the other absence of sensation.

Another phenomenon that can result from painful stimulation and the one that is on the opposite end of the spectrum of sensory experience is ► **hyperalgesia**. The difficulty of assessing sensory abnormalities which are characterized by hypoalgesia to one sensory modality and hyperalgesia to another sensory modality in the same area frequently seen in patients with neuropathic pain leads to confusion not only for patients but also for inexperienced clinicians. Depending on the way stimulation is conducted even when hypoalgesia is present, the outcome can be either hyperalgesia or hyperpathia. For example, in the case of partial hypoalgesia and when the stimulus is “strong enough” the outcome could be hyperalgesia, and in the case that stimulus is not “strong enough” with temporal and spatial summation that could result in increased pain, which would become hyperpathia. Consequently, from the pain mechanisms prospective, the relationship between hypoalgesia and hyperalgesia still far from clear. In summary, hypoalgesia is a ► **clinical sign** of neurological injury or disease, which in some patients can lead to neuropathic pain. Methods for determining the presence of hypoalgesia are qualitative, such as in bedside exam or quantitative, such as QST. Mechanisms of hypoalgesia for specific modalities, and in particular its relationship to hyperalgesia and hyperpathia, are poorly understood.

- **Allodynia (Clinical, Experimental)**
- **Amygdala, Pain Processing and Behavior in Animals**
- **Cordotomy Effects on Humans and Animal Models**
- **Nerve Growth Factor Overexpressing Mice as Models of Inflammatory Pain**
- **Opioids, Effects of Systemic Morphine on Evoked Pain**

## References

1. Merskey H, Bogduk N (1994) Classification of Chronic Pain, vol 2. IASP Press, Seattle
2. Backonja MM, Galer BS (1998) Pain Assessment and Evaluation of Patients who have Neuropathic Pain. *Neurol Clin* 16:775–790
3. Lindblom U, Ochoa J (1986) Somatosensory Function and Dysfunction. In: Asbury AK, McKhann GM, McDonald WI (eds) Diseases of the Nervous System. Clinical Neurobiology. W.B. Saunders Company, Philadelphia, pp 283–298
4. Backonja M (2003) Defining Neuropathic Pain. *Anesthesia Analgesia* 97:785–790
5. Greenspan JD (2001) Quantitative Assessment of Neuropathic Pain. *Curr Pain Headache Rep* 5:107–113
6. Dyck PJ, O'Brien PC (2003) Quantitative Sensory Testing: Report of the Therapeutics and Technology Assessment Subcommittee of the American Academy of Neurology. *Neurology* 61:1628–1630
7. Getz KK, Cook T, Backonja MM (2005) Pain Ratings at the Thresholds are Necessary for Interpretation of Quantitative Sensory Testing. *Muscle Nerve* 32:179–184

## Hypochondriaca

### Definition

Hypochondriaca refers to a persistent conviction that one is or is likely to become ill, when a patient complains of symptoms that have no organic basis. These symptoms persist despite reassurance and medical evidence to the contrary

- **Psychiatric Aspects of Visceral Pain**

## Hypochondriasis

### Definition

Hypochondriasis is a minimum six month preoccupation with fears of having a serious disease, based on misinterpretation of bodily symptoms (e.g. a sore throat is thought to be throat cancer), which persists in spite of medical evidence that the serious disease is not present.

- **Somatization and Pain Disorders in Children**

## Hypochondriasis, Somatoform Disorders and Abnormal Illness Behaviour

ISSY PILOWSKY

Emeritus Professor of Psychiatry, University of Adelaide, Adelaide, SA, Australia  
 issyp@med.usyd.edu.au

### Synonyms

Abnormal Illness Behaviour of the Unconsciously Motivated, Somatically Focussed Type; Discordant Illness Behaviour; Dysnosognosia; somatoform disorders

### Definition

In the Fourth edition of the Diagnostic and Statistical Manual of the American Psychiatric Association (1994), Hypochondriasis is defined according to the following criteria:

- Because of misinterpreting bodily symptoms, the patient becomes preoccupied with ideas or fears of having a serious illness.
- Appropriate medical investigation and reassurance do not relieve these ideas.
- These ideas are not delusional (as in Delusional Disorder) and are not restricted to concern about appearance (as in Body Dysmorphic Disorder).
- They cause distress that is clinically important or impair work, social or personal functioning.
- They have lasted 6 months or longer.

- These ideas are better explained by Generalized Anxiety Disorder, Major Depressive Episode, Obsessive-Compulsive Disorder, Panic Disorder, Separation Anxiety or a different Somatoform Disorder.

Specify when with poor insight: During most of this episode, the patient does not realize that the preoccupation is excessive or unreasonable.

It is of interest to compare this development with the earlier criteria for the diagnosis of hypochondriasis as listed in DSM-III-R (the revised edition of DSM-III).

They are as follows:

- a) Preoccupation with the fear of having, or the belief that one has, a serious disease, based on the person's interpretation of physical signs or sensations as evidence of physical illness.
- b) Appropriate physical evaluation does not support the diagnosis of any physical disorder that can account for the physical signs or the person's unwarranted interpretation of them, and the symptoms in 'A' are not just those of panic attacks.
- c) The fear of having or belief that one has a disease persists despite medical reassurance.
- d) Duration of the disturbance is at least six months.
- e) The belief in A is not of delusional intensity, as in Delusional Disorder, Somatic Type (i.e. the person can acknowledge the possibility that the fear or the belief of having a serious illness is unfounded). [Comment: In which case the psychopathological phenomenon could be labelled an 'abnormal preoccupation' or an 'overvalued idea' .].

### Characteristics

Hypochondriasis is regarded as one of the Somatoform Disorders in both the DSM IV, and the tenth edition of the WHO Classification of Mental and Behavioural Disorders: (ICD-10): Clinical descriptions and diagnostic guidelines.

The Somatoform disorders are defined in DSM IV as essentially the presence of physical symptoms for which there are no demonstrable organic findings or known physiological mechanisms'.

In both DSM-IV and ICD-10, a significant departure is made from the principle of classifying on the basis of phenomenological description only. Thus, in DSM-IV we find the inclusion of the statement that 'the symptoms are linked to psychological factors or conflicts'.

Illness, the Sick role, illness behaviour and abnormal illness behaviour. (Pilowsky 1969, 1978, 1997).

Illness is defined as any state of an organism which fulfils the requirements of a relevant reference group for admission to a sick role.

### The Sick Role

As delineated by the sociologist Talcott Parsons (1964, 1978), the sick role is a partially and conditionally

granted social role. The individual seeking this role is required to fulfil three obligations. These are: a) accept that the role is "undesirable"; one which should be relinquished as soon as possible; b) co-operate with others so as to achieve "health", and c) utilize the services of those regarded by society as competent to diagnose and treat the condition. (In technologically advanced societies, this person is usually a formally registered doctor who is granted the authority to sign 'sickness certificates')

If these obligations are met, the following privileges are granted: a) the person is regarded as not "responsible" for the condition (i.e. he cannot produce or terminate it by an act of will, and is not to be considered a malingerer); b) the person is regarded as someone requiring care, and c) is entitled to exemption from age appropriate normal obligations.

All of these definitions demonstrate how central the role of the doctor is (in Technologically advanced societies) when it comes to the allocation of healthcare resources. It also draws attention to the pressures on the Doctor-Patient relationship from without, and their inevitable interaction with interpersonal and intrapersonal forces.

### Abnormal Illness Behaviour (AIB)

This is defined as: An inappropriate or maladaptive mode of experiencing, evaluating or acting in relation to one's own state of health, despite the fact that a doctor (or other recognized social agent) has offered accurate and reasonably lucid information concerning the person's health status and the appropriate course of management (if any), based on a thorough examination of all parameters of functioning (i.e. physical psychological and social) taking into account the individual's age, educational and socio-cultural background.

A detailed analysis of this definition is to be found in Pilowsky (1997).

### Clinical Characteristics

Pain is a common feature of hypochondriacal disorders. Since the patient tends to reject the presence of psychological problems, such individuals are not encountered in psychiatric settings but rather in medical, surgical and, in the case of conversion disorders, in neurological clinics.

Another relevant somatoform disorder is 'conversion disorder', also known as 'Hysterical neurosis, conversion type' The difference between hypochondriasis and conversion, is that the latter is defined as manifesting 'a loss or alteration of physical functioning that suggests a physical disorder in the absence of physical signs on examination to support the presence of a physical disorder'. However 'psychological factors are judged to be aetiologically related, because of a temporal relationship between a psychosocial stressor that is apparently related to a psychological conflict or need, and initiation or exacerbation of the symptom.'

A feature often described in association with a conversion disorder is 'la belle indifference', which refers not simply to an absence of concern, but rather to a sort of positive serenity, clearly inappropriate to the apparent seriousness of the physical disability.

The condition named 'somatoform pain disorder' is described in virtually the same terms as conversion disorder, except for the statement that it is primarily characterised by: 'Pain which causes significant distress or impairment in functioning, which cannot be fully explained by a physician. It must be judged to be related to psychological factors and cannot be better explained by another disorder'.

Thus, the major difference between pain as a feature of hypochondriasis, and pain as a conversion symptom, is that in the former case there is concern and preoccupation as to what the pain may mean, in terms of specific illnesses such as cancer or heart disease; while in the latter the patient denies concern over any specific condition, but is rather troubled by the experience of pain as a cause of disability and suffering.

### Management

The key to management is the establishment of an alliance with the patient. This issue is of particular salience, when the clinician is a psychologist or psychiatrist, has been discussed at length in Pilowsky (1997), because patients often consider a referral to such a person to mean that the referring doctor believes 'it is all in my mind'. By which is meant that they are being accused of malingering. Achieving an alliance is not possible unless the acceptance of the reality of the symptoms is clearly conveyed to the patient by the attention paid to the alleviation of discomfort, and prevention of further disability by appropriate supportive psychotherapeutic, physiotherapeutic and psychopharmacological (e.g. antidepressants in low doses), and if necessary by psychological methods such as cognitive-behavioural therapy. In theory, this should be easiest at the initial presentation to the first doctor who sees the patient, especially as this is usually a non-psychiatrist, and most often a family doctor who should, ideally, be well acquainted with the patient and his circumstances, as well as, hopefully, his family.

How this doctor might manage the situation has been described and researched by Goldberg et al. (1989). They have developed a methodology whereby the doctor can help the patient to reattribute the physical symptoms to psychological causes. Once this has been achieved, it is reasonable to proceed with a problem-solving approach to any of the difficulties the patient is invariably experiencing in his life (Rost and Smith 1990; Wilkinson and Mynors-Wallis 1994; Scicchitano 20000). When a multi-modal approach is necessary, this is generally best provided by a multidisciplinary pain clinic, when it is available.

Some Pain Clinics have in-patient facilities with well trained experienced staff that are able to provide programmes for patients manifesting severe invalidism and perhaps dependence on drugs such as opiates.

### References

1. American Psychiatric Association (1994) Diagnostic and Statistical Manual of Mental Disorders, 3rd edn Revised. American Psychiatric Association, Washington, DC
2. Goldberg DP, Gask L, O'Dowd T (1989) The Treatment of Somatization-Teaching Techniques of Reattribution. *J Psychosom Res* 33:689-696
3. Parsons T (1964) Social Structure and Personality. Collier-Macmillan, London
4. Parsons T (1978) Action Theory and the Human Condition. Free Press, New York
5. Pilowsky I (1969) Abnormal Illness Behaviour. *Br J Med Psychol* 42:347-351
6. Pilowsky I (1978) A General Classification of Abnormal Illness Behaviours. *Br J Med Psychol* 51:131-137
7. Pilowsky I (1997) Abnormal Illness Behaviour. Wiley, Chichester
8. Rost KM, Smith GR Jr (1990) Improving the Effectiveness of Routine Care for Somatization. *J Psychosom Res* 43:463-465
9. Scicchitano JP (2000) Identification and Management of Somatization in the Primary Care Setting in Terms of Illness Behaviour and Risk of Psychiatric Illness. PhD Thesis, University of Adelaide
10. Wilkinson P, Mynors-Wallis L (1990) Problem-Solving Therapy in the Treatment of Unexplained Physical Symptoms in Primary Care. *J Psychosom Res* 38:591-598
11. World Health Organisation (1992) Classification of Mental and Behavioural Disorders: Clinical descriptions and Diagnostic Guidelines. World Health Organization, Geneva

H

## Hypoesthesia, Assessment

MISHA-MIROSLAV BACKONJA  
Department of Neurology, University of Wisconsin-Madison, Madison, WI, USA  
backonja@neurology.wisc.edu

### Synonyms

Hypesthesia; hypoaesthesia

### Definition

Hypoesthesia refers to decreased perception of innocuous stimuli, a condition where the body is much less sensitive than normal to stimulation that by its nature and intensity does not produce pain. Special senses are excluded (Merskey and Bogduk 1994). Hypoesthesia refers to diminished perception of a large range of mechanical stimuli such as touch, brush, pressure and vibration and thermally innocuous stimuli of warm and cold. Stimulation and locus are specified. Hypoesthesia is also defined as a raised threshold to nonpainful stimuli and this definition is used as a criterion for hypoesthesia during quantitative sensory testing (QST). There are two phenomena that are the opposite of hypoesthesia, hyperesthesia and allodynia. Hyperesthesia is increased

but not painful sensation from innocuous stimulation and allodynia is pain from innocuous stimulation. If stimulation is of nature or intensity to produce tissue damage and the subject perceives it as harmless, then the phenomenon is defined as hypoalgesia.

### Characteristics

Hypoesthesia is a ► **negative sensory phenomenon** seen primarily in patients with neurological disease or injury, including patients with ► **neuropathic pain** (Lindblom and Ochoa 1986; Backonja and Galer 1998; Backonja 2003). Hypoesthesia indicates decrease or loss of function that arises as a result of neurological disease or injury affecting somatic sensory and thermal pathways, anywhere from primary afferents to cerebral cortical structures. Hypoesthesia is demonstrated by means of sensory examination during which standard methods of mechanical and thermal stimulus are applied with the goal of activating specific classes of receptors. The specificity of somatic sensory pathways in conducting particular somatic sensations is significantly altered by disease and injury of the ► **somatosensory nervous system** and hypoesthesia is probably the most sensitive and reliable indication of such injury. In contrast, positive sensory phenomena, such as allodynia and ► **hyperalgesia**, are relatively frequent components of neuropathic pain; the complexity of underlying mechanisms makes them much more difficult to interpret. Understanding the relationship between injury of the somatosensory neural structures and its manifestations, such as hypoesthesia is relevant to pain mechanisms, because methods of testing and interpretations are based on the specificity of sensory modalities. Distinction of hypoesthesia from hypoalgesia is based primarily on the type and intensity of the stimulus applied to the thermosensitive sensory system.

### Methods of Assessment and Interpretation

Assessment of sensory nervous system function is most commonly done at the bedside and under these circumstances the testing is primarily qualitative in nature. Quantitative assessment increasingly utilizes computerized electronic equipment in the environment of a quantitative sensory laboratory (Backonja and Galer 1998; Greenspan 2001). Either approach should be able to detect hypoesthesia, but the ways in which these methods arrive at conclusions about the presence and severity of hypoesthesia are distinctly different and this distinction is also reflected in the definitions stated earlier. Qualitative bedside examination of the presence of hypoesthesia is based primarily on patient report that a stimulus is perceived as decreased. Quantitative sensory testing arrives at conclusions about hypoesthesia on the basis of raised thresholds to painful stimuli. Qualitative somatosensory assessment is based on the subject's ability to compare and report quality of sensa-

tion resulting from standard methods of stimulation of affected areas compared to normal unaffected areas. The qualitative method is very convenient for bedside evaluations. Frequently utilized bedside methods include standard neurological examination tools such as cotton tips, monofilaments, tuning forks for testing of vibration and various metal objects that can conveniently be warmed or cooled in the clinical setting. A degree of quantification is possible and requires that the subject report whether the decrease in perceived sensation from applied stimuli is mild, moderate, severe or completely absent when compared to a normal unaffected area. Since the qualitative method requires psychophysical interaction, this method can only be used in humans who can communicate linguistically with the examiner and hence cannot be used in infants or aphasic subjects or in animal models in somatosensory and pain research.

Quantitative assessment of sensory deficits requires a more sophisticated approach and frequently utilizes electronically controlled devices, though a number of psychophysical methods especially mechanical stimuli are used. Traditionally this method is known as quantitative sensory testing (QST). All of the quantitative methods require much longer times for completion. The primary outcome of QST is determination of thresholds for specific modalities, which are then compared, to the established norms (Greenspan 2001). Increases in the threshold to innocuous stimuli are interpreted as hypoesthesia. The QST method can be used not only in human studies but also in animal models.

A crucial step in the interpretation of QST is to obtain a pain rating at the threshold. In spite of the fact that the pain threshold is increased, the presence or absence of positive sensory phenomena, one of them being ► **hyperpathia** (increased threshold but even innocuous stimuli are perceived as painful) and consequently presence of a painful neuropathic disorder (Getz Kelly 2004). The advantage of testing with innocuous stimuli and detecting hypoesthesia, especially for cold detection, is that it is one of the most sensitive methods of detecting somatic sensory deficits, which characterize neurological disorders, including neuropathic pain disorders (Dyck 2000).

One of the main goals of neurological evaluation is to determine the site and level of ► **neuraxis** where pathological processes that produce symptoms, including pain, originate (Dyck and O'Brien 2003). In addition to establishing the nature of the ► **neurological deficit**, such as hypoesthesia, to a specific modality, it is important to establish the special pattern of these abnormalities, since the pattern serves as the basis for the determination as to whether the lesion that is causing symptoms including pain, involves specific peripheral nerve structures, such as peripheral nerves, plexuses or nerve roots, or central nervous system structures such as spinal cord, brainstem, subcortical or cortical structures and pathways of the brain.



### Caveats and Unresolved Issues

The difficulty of assessing hypoesthesia arises from the inherent difficulty of assessing a negative sensory phenomenon. For example, it is easier conceptually to illustrate to the subjects a ► **positive sensory phenomenon**, such as pain, with instructions that 0=none and 10=worst imaginable. In contrast, it is much harder conceptually to illustrate and request a rating of spontaneous loss of sensation, because it is not possible to feel what one is not able to feel, in spite of the instruction that the patient is to imagine scaling between normal sensation and absence of sensation.

Other phenomena that can result from innocuous stimulation and are on the opposite end of the spectrum of sensory experience are hyperesthesia, allodynia or even hyperpathia. Confusion for the examiner as well as for the patient is caused by the difficulty of assessment that comes from the fact that pain disorders, most frequently neuropathic pain, are characterized by allodynia or hyperalgesia to one sensory testing modality but are also found to have evidence of hypoesthesia to another testing modality in the same area. Depending on the way stimulation is conducted, even when hypoesthesia is present, the outcome can be hyperpathia in case of repeated stimulation. For example, in the case of partial hypoesthesia when the stimulus is in the way to lead to temporal and spatial summation could result in increased threshold but what is perceived is painful, which is then interpreted as hyperpathia. Consequently, from the pain mechanisms perspective, the relationship of hypoesthesia and hyperpathia still far from clear.

In summary, hypoesthesia is a sensitive clinical sign of neurological injury or disease, which in some patients can lead to neuropathic pain. Methods for determining the presence of hypoesthesia are qualitative, as in bedside examination or quantitative, as with QST. Mechanisms of hypoesthesia for specific modalities and its relationship to hyperpathia are still not well understood.

### References

1. Backonja M (2003) Defining neuropathic pain. *Anesth Analg* 97:785–790
2. Backonja MM, Galer BS (1998) Pain assessment and evaluation of patients who have neuropathic pain. *Neurol Clin North Am* 16:775–790
3. Dyck PJ, O'Brien PC (2003) Quantitative sensory testing: Report of the Therapeutics and Technology Assessment Subcommittee of the American Academy of Neurology. *Neurology* 61:1628–1630
4. Greenspan JD (2001) Quantitative assessment of neuropathic pain. *Curr Pain Headache Reports* 5:107–113
5. Lindblom U, Ochoa J (1986) Somatosensory function and dysfunction. In: Asbury AK, McKhann GM, McDonald WI (eds) *Diseases of the Nervous System -Clinical Neurobiology*. W.B. Saunders Company, Philadelphia, pp 283–298
6. Merskey H, Bogduk N (1994) *Classification of Chronic Pain*, vol 2. IASP Press, Seattle

## Hypogastric Neurectomy

### Definition

Hypogastric Neurectomy is a surgical resection of the hypogastric nerves.

- [Visceral Pain Models, Female Reproductive Organ Pain](#)

## Hyponatremia

### Definition

Hyponatremia represents less than normal levels of sodium ions, or salt, in the blood, which may result in cognitive impairment.

- [Trigeminal Neuralgia, Diagnosis and Treatment](#)

## Hypophysectomy

### Definition

Excision of the pituitary gland is known as hypophysectomy.

- [Cancer Pain Management, Neurosurgical Interventions](#)

## Hypotension of Spinal Fluid

- [Headache Due to Low Cerebrospinal Fluid Pressure](#)

## Hypothalamic Pituitary Axis

### Definition

These organs combine with the gonads to play a critical role in the development and regulation of a number of the body's systems, such as the reproductive and immune systems.

- [Fibromyalgia](#)

## Hypothalamus

### Definition

The hypothalamus is a very prominent group of neurons located below the thalamus at the base of the brain forming the ventral-most part of the diencephalon. It is divided into three lateral levels (medial, intermediate and lateral) and five caudo-rostral levels (mammillary, posterior, intermediate, anterior, and preoptic). Its role

includes the neuroendocrine regulations (arcuate, paraventricular and supraoptic nuclei), autonomic regulations (cardio-respiratory, thermoregulation, metabolic, digestive) and processing of motivational behaviors like sexual, feeding, drinking, waking/sleep state, aggressiveness and illness feeling. It is also involved in modulating nociception.

- ▶ [Descending Circuitry, Transmitters and Receptors](#)
- ▶ [Parabrachial Hypothalamic and Amygdaloid Projections](#)

## Hypothalamus and Nociceptive Pathways

JEAN-FRANÇOIS BERNARD

Faculté de Médecine Pitié-Salpêtrière, Institut National de la Santé et de la Recherche Médicale, INSERM U-677, Paris, France  
jfbarnar@ext.jussieu.fr

### Definition

The hypothalamus is a complex structure that occupies the ventral half of the diencephalon below the thalamus on either side of the third ventricle. It lies just above the ▶ [pituitary gland](#) responsible for neuroendocrine secretions.

The hypothalamus includes about 40 nuclei of very different shapes and sizes. For simplification, it is generally divided into three medio-lateral zones, periventricular, medial and lateral and four caudo-rostral regions, mammillary, tuberal, anterior and preoptic. Combination of zones and regions permitted the recognition of twelve hypothalamic areas (Simerly 1995).

Neurosecretory neurons are mainly located within the periventricular zone with a particularly high density in the paraventricular nucleus. In addition, another important group of neurosecretory neurons is located in the supraoptic nucleus, a well-individualized nucleus located in the lateral region, on the lateral border of the optic chiasm. The neurosecretory system is subdivided into two parts, 1) magnocellular neurosecretory neurons (oxytocin and vasopressin), which directly innervate the posterior pituitary gland and 2) parvocellular neurosecretory neurons (corticotropin, gonadotropin, growth hormone, thyrotropin releasing hormones, somatostatin, angiotensin II and dopamine), which innervate the median eminence, the hypothalamic hormones being transported to the anterior pituitary gland *via* the hypophysial portal system (Swanson 1987).

The medial and lateral zones of the hypothalamus are chiefly devoted to the control of ▶ [autonomic functions](#) (cardiovascular, respiratory, blood fluid balance, energy metabolism, thermoregulatory and digestive) and major basic instinctive behaviors (feeding, drinking, reproductive, flight, defensive and aggressive) including the wakefulness-sleep cycles (Swanson 1987).

### Characteristics

The hypothalamus is a fascinating region of the brain, which is much more than a control center for neuroendocrine secretion. Indeed, the hypothalamus is the upper center for autonomic functions and basic behaviors that assure the survival of both the individual and the species. It is easy to understand the role of the hypothalamus when it guarantees an adequate level of homeostasis for autonomic functions needed for survival. It is not so obvious to appreciate the importance of the myriad basic behaviors it generates. Thus, it is basically responsible for most of the motivations that govern our life, such as for example, hunger, the pleasures of eating and satiety, sexual desire, aggressiveness, fear, drowsiness, alertness and numerous other fundamental motivations of life.

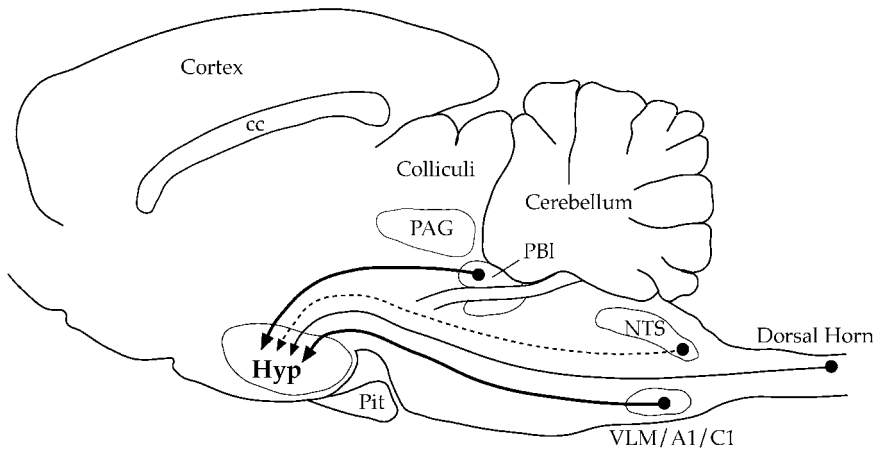
Considering these functions, it seems that the hypothalamus should play an important role in the autonomic and ▶ [motivational components](#) of pain. All the same, the precise role of hypothalamus in different components of pain remains unclear. The only clearly accepted function of the hypothalamus in pain is the neuroendocrine corticotropin response.

In humans, imagery studies indicate that the acute traumatic pain comes with a noticeable activation of the hypothalamus (Hsieh et al. 1996). However, these studies provide neither information about the activation of different hypothalamic nuclei nor data about the role of hypothalamus in pain. In fact until now, most evidence for an involvement of the hypothalamus in nociceptive processing comes from anatomical and c-fos data. Cross-checking these data with the known functions of hypothalamic nuclei, it becomes possible to make hypotheses about the involvement of the hypothalamus in pain.

### Nociceptive Afferent Inputs to the Hypothalamus

The hypothalamus has three well-documented sources of nociceptive inputs, the spinal and trigeminal dorsal horn, the parabrachial area and the ventrolateral medulla (Fig. 1).

- Spinal and trigeminal inputs – a number of spinal and trigeminal neurons are labeled after a large injection of retrograde axonal tracer within the hypothalamus. Labeled neurons are located in superficial and, above all, in deep laminae of the dorsal horn i.e. in regions known to be involved in nociceptive processing. Electrophysiological studies indicate that most spino / trigemino-hypothalamic neurons respond to a variety of noxious stimuli (Burstein 1996). These data, which seem to indicate a major nociceptive input to the hypothalamus, are challenged by anterograde axonal tracing studies that show much lower spinal and trigeminal projection upon the hypothalamus (Gauriau and Bernard 2004). Comparative examination of all the studies seems to point



**Hypothalamus and Nociceptive Pathways, Figure 1** Schematic representation, in sagittal sections, of the three main hypothalamic nociceptive inputs: the PBI, the VLM/A1/C1 region and the trigeminal and spinal dorsal horn (mainly the deep laminae). Thick line: extensive nociceptive projection; thin line: medium density nociceptive projection; dotted line: hypothetical nociceptive projection. Abbreviations: A1, A1 noradrenaline cells; C1, C1 adrenaline cells; cc, corpus callosum; Hyp, hypothalamus; NTS, nucleus tractus solitarius; PAG, periaqueductal gray matter; PBI, lateral division of the parabrachial nucleus; Pit, pituitary gland; VLM, ventrolateral medulla.

H

to at least a moderate but indisputable nociceptive projection, mainly to the lateral (Fig. 2) but also to the posterior and the paraventricular hypothalamic nuclei.

- Parabrachial inputs (see parabrachial hypothalamic and amygdaloid projections)—the lateral parabrachial area receives a heavy nociceptive input from spinal and trigeminal lamina I nociceptive neurons. The lateral parabrachial area projects heavily to the hypothalamic ventromedial nucleus and extensively to the retrochiasmatic, the median and the ventrolateral preoptic hypothalamus. Although less extensive, a notable projection reaches the dorsomedial, the periventricular, the paraventricular and the lateral nuclei (Fig. 2). Electrophysiological studies indicate that this strong afferent input to the hypothalamus from the parabrachial nucleus is primarily nociceptive (Bernard et al. 1996; Bester et al. 1997).
- Caudal ventrolateral medulla inputs—this reticular region includes the A1 / C1 catecholaminergic neurons and receives nociceptive inputs from both the superficial and the deep laminae of the dorsal horn. The caudal ventrolateral medulla projects extensively to the paraventricular nucleus and, to a lesser extent, to the periventricular, the supraoptic and the median preoptic hypothalamic nuclei (Fig. 2). Here again it was shown that this afferent input contains nociceptive neurons (Burstein 1996; Pan et al. 1999).

The nucleus of the solitary tract was also proposed as a nociceptive input for the hypothalamus. However, this nucleus is primarily a center for autonomic / visceral and gustatory information. The role and the importance of solitary tract neurons in conveying nociceptive messages from the spinal cord to the hypothalamus need to be confirmed.

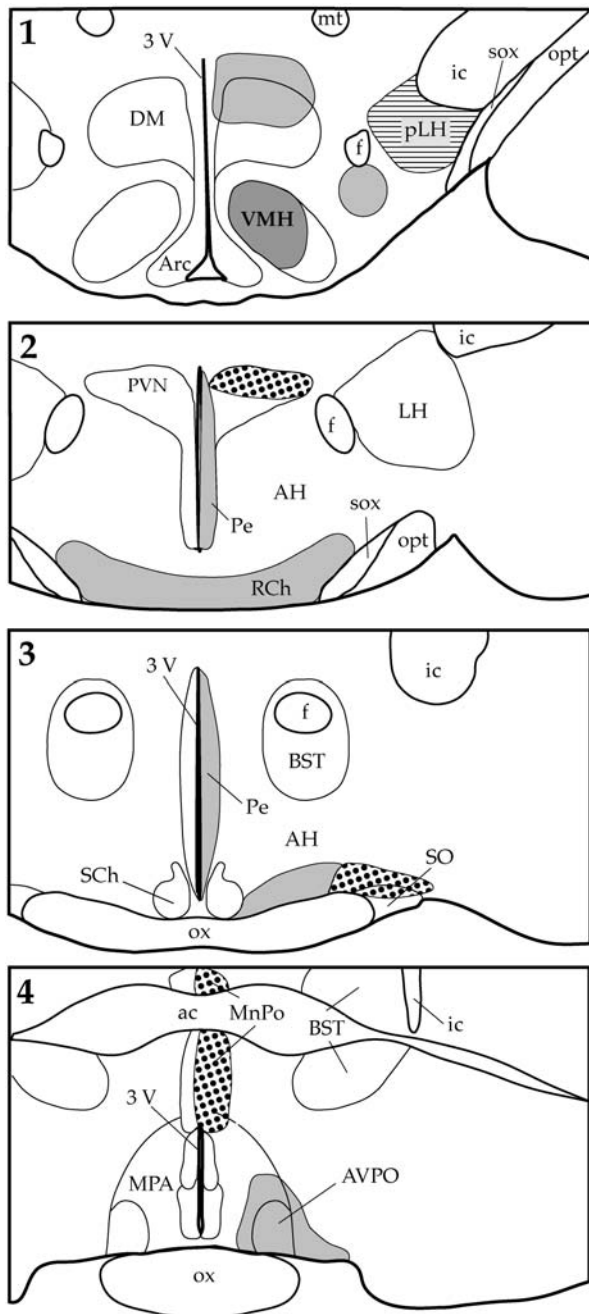
To summarize, anatomical data indicate several hypothalamic subregions that appear to be more specifically involved in nociceptive processing:

1. The neuroendocrine group (the paraventricular nucleus and to a lesser extent the periventricular and supraoptic nuclei) that receives nociceptive messages from all the nociceptive sources described above.
2. The ventromedial nucleus, the perifornical and the retrochiasmatic areas that receive a very prominent nociceptive input from the parabrachial area.
3. The median and ventrolateral preoptic area, the dorsomedial, the lateral and the posterior hypothalamic region, which receive lower but yet substantial nociceptive inputs.

Corroborating the anatomical data closely, it was shown that various painful stimuli evoke c-fos expression in regions receiving nociceptive afferent projections. The strongest c-fos expression was observed in neuroendocrine neurons of the hypothalamus located in the paraventricular, the supraoptic and the periventricular / arcuate nuclei. A substantial c-fos expression is evoked in the posterior, the ventromedial and the dorsomedial nuclei and the retrochiasmatic, the lateral and the anterior regions of the hypothalamus (Rodella et al. 1998; Snowball et al. 2000).

#### Role of Hypothalamus in Visceromotor Responses to Painful Stimuli

The anatomical data indicate that both parabrachial and A1 / C1 projections to the paraventricular nucleus innervate more densely neurons containing corticotropin releasing hormone as well as ► **magnocellular neurons** (that contain vasopressin and oxytocin). Painful stimuli evoke specifically c-fos expression in neurons containing corticotropin releasing hormone, vasopressin



**Hypothalamus and Nociceptive Pathways, Figure 2** Summary diagram illustrating, in coronal sections, the location of nociceptive projections within the hypothalamus (1–4, caudal to rostral). The parabrachial “nociceptive” area projects primarily upon the VMH (dark gray) and extensively upon the DM and the perifornical area (1), the RCh and the Pe (2), the rostral Pe and the ventral AH (3) and the AVPO (4) hypothalamic nuclei (gray). Both the parabrachial nucleus and the A1/C1 group within the ventrolateral medulla project to the PVN (2), the SO (3) and the MnPO (4) (black points). Both the parabrachial area and the spinal and trigeminal dorsal horn project to the pLH (1) (horizontal hatching). Abbreviations: 3V, third ventricle; A1/C1 A1, noradrenaline cells, C1, adrenaline cells; ac, anterior commissure; AH, anterior hypothalamic area; Arc, arcuate nucleus; AVPO, anteroventral preoptic nucleus; BST, bed nucleus of stria terminals; DM, dorsal medial nucleus; f, fornix; ic, internal capsule; LH, lateral hypothalamus; MnPO, median preoptic nucleus; MPA, medial preoptic area; SCh, supra-chiasmatic nucleus; SO, supraoptic nucleus; sox, supraoptic decussation; VMH, ventromedial hypothalamic nucleus

and oxytocin at the levels of paraventricular, arcuate and supraoptic nuclei. This neuroendocrine response is specific for these neurohormones; it does not include gonadotropin, growth hormone, and thyrotropin releasing hormones (Pan et al. 1996).

The neuroendocrine component of pain is indisputably under hypothalamic control with well-identified pain pathways to drive it. The role of these neurohormones in pain is not completely understood. It is likely that an increase in the corticotropin hormone axis is important to cope with the dangerous or traumatic situation

that comes with pain (mobilization of metabolism and mental energy). Nonetheless, in the case of chronic pain, the stimulation of the corticotropin axis might become deleterious (anxiety, depression, decrease of immunity, neuronal loss). Vasopressin may accompany corticotropin secretion to increase or maintain blood pressure. The role and amount of oxytocin secretion in cases of acute pain remain yet poorly understood.

Importantly, psychological stress (immobilization, anxiety, and fear) acts on the corticotropin axis of the hypothalamus *via* limbic projections (bed nucleus of the



stria terminalis, prefrontal cortex) different from those described for nociceptive stimuli (physical stress). Numerous paraventricular neurons (chiefly in a dorsal position) are not neuroendocrine cells but provide descending projections to the brainstem and the spinal cord. Although the paraventricular nucleus provides the more extensive set of descending projections, other hypothalamic nuclei also receiving nociceptive messages send similar descending projections, namely the periventricular, the retrochiasmatic area, the dorsomedial, the dorsal, the perifornical and the lateral hypothalamic areas. These hypothalamic neurons project to the periaqueductal gray matter, the parabrachial area, the solitary tract, the motor vagus, the ambiguous nuclei and the ventrolateral medulla in the brainstem. In the spinal cord, they project chiefly to the sympathetic preganglionic column (Saper 1995). These hypothalamic neurons are adequately placed to drive both the sympathetic and the ► **parasympathetic components** of pain. They might, in connection with brainstem neurons, increase or decrease blood pressure and cardiac frequency and modify circulatory territory, according to the nature of the painful stimuli.

#### Role of Hypothalamus in Behavioral Response to Painful Stimuli

Several hypothalamic nuclei, which receive an extensive nociceptive input, play an important role in motivational components of pain.

The first group, including the ventromedial and the dorsomedial nuclei, the perifornical and the retrochiasmatic areas, is markedly involved in defensive-aggressive behavior. This group of nuclei projects extensively to the periaqueductal gray matter, each nucleus targeting a specific quadrant. The periaqueductal gray matter appears to be a major hypothalamic descending output to mediate aggressive-defensive behavior. Each nucleus of this hypothalamic group receives an extensive nociceptive input from the lateral parabrachial area, the ventromedial hypothalamic nucleus receiving the heaviest input. The ventromedial nucleus has been involved in aggressive-defensive behavior. Stimulation applied in this nucleus induces vocalization, attack, escape, piloerection, mydriasis and micturition that resemble the pseudo-affective reactions induced by noxious stimuli (Bester et al. 1997; Swanson 1987). Recently, the dorsomedial portion of the ventromedial nucleus has been shown to be responsible for the vocalization induced by painful electrical shock applied to the tail (Borszcz 2002). The ventromedial nucleus has also been involved in feeding behavior (it has long been considered as the "satiety center") and regulation of energy metabolism (Swanson 1987). Recently, the ventromedial hypothalamic nucleus has thus been proposed to be responsible for the anorexia induced by migraine (Malick et al. 2001). Pain should act on appetite *via* a parabrachio-ventromedial CCKergic link. Leptin receptors, which

are abundant in this hypothalamic nucleus, might also participate in the loss of appetite. Finally, stimulation applied within the ventromedial nuclei produces an analgesia, which is also probably mediated *via* the periaqueductal output. Thus, it appears that the medial zone of the tuberal (posterior) and the anterior hypothalamus is responsible for the defensive-aggressive and feeding motivational component of pain.

The second group, including the median and the anteroventral preoptic hypothalamic nuclei, is involved in osmotic / blood fluids balance regulation and sleep promoting / thermoregulation functions. These nuclei also receive a substantial nociceptive input from the lateral parabrachial area. The influence of nociceptive input upon the neurons of this hypothalamic region is less clear. It might alter drinking behavior, vasopressin secretion, falling asleep and the thermoregulation set point according to the nature of the nociceptive aggression (Saper et al. 2001; Swanson 1987).

The posterior portion of the lateral hypothalamus receives a diffuse but substantial nociceptive input directly from the deep laminae of the dorsal horn and indirectly *via* the internal lateral parabrachial nucleus. The role of the lateral hypothalamus in nociceptive processing remains obscure because this hypothalamic region was involved in a myriad functions, such as feeding behavior (it has long been considered to be a "feeding center"), drinking behavior and cardiovascular and visceral regulation, as well as in wakefulness and anti-nociceptive and rewarding mechanisms. However, the recent discovery that ► **narcolepsy** can be induced by lack of orexin / hypocretin (a peptide located in the neurons of lateral hypothalamus), indicates that the lateral hypothalamus is probably markedly involved in the wakefulness mechanism (Saper 2001). One role of nociceptive inputs upon neurons of the posterior lateral hypothalamus could be to trigger awakening.

#### Conclusion

Bringing together anatomical and functional data, the hypothalamus appears as a key center for most visceromotor (neuroendocrine, autonomic response) and motivational (aggressive-defensive reactions, ingestive behaviors, wakefulness, antinociception) components of pain. It yet remains to check experimentally the actual role of hypothalamic subregions and / or neuromodulators in the genesis of different components of pain. Anatomical data also indicate that hypothalamic functions are probably strongly modulated by the upper limbic structures (notably the extended amygdala and the cingulate / prefrontal cortex), which are also involved in the emotional appreciation of pain.

#### References

1. Bernard JF, Bester H, Besson JM (1996) Involvement of the spino-parabrachio-amygdaloid and -hypothalamic pathways in the autonomic and affective emotional aspects of pain. *Prog Brain Res* 107:243–255

2. Bester H, Besson JM, Bernard JF (1997) Organization of efferent projections from the parabrachial area to the hypothalamus: a Phaseolus vulgaris-leucoagglutinin study in the rat. *J Comp Neurol* 383:245–281
3. Borszcz GS (2002) The ventromedial hypothalamus contributes to generation of the affective dimension of pain in rats. Program N°. 653.5 2002 Abstract Viewer / Itinerary Planner. Society for Neuroscience, Washington, DC, Online
4. Burstein R (1996) Somatosensory and visceral input to the hypothalamus and limbic system. *Prog Brain Res* 107:257–267
5. Gauriau C, Bernard JF (2004) A comparative reappraisal of projections from the superficial laminae of the dorsal horn in the rat: the forebrain. *J Comp Neurol* 468:24–56
6. Hsieh JC, Stahle-Backdahl M, Hagermark O et al. (1996) Traumatic nociceptive pain activates the hypothalamus and the periaqueductal gray: a positron emission tomography study. *Pain* 64:303–314
7. Mallick A, Jakubowski M, Elmquist JK et al. (2001) A neurochemical blueprint for pain-induced loss of appetite. *Proc Natl Acad Sci USA*. 98: 9930–9935. Erratum in: *Proc Natl Acad Sci USA* 98:14186
8. Pan B, Castro-Lopes JM, Coimbra A (1996) Activation of anterior lobe corticotrophs by electroacupuncture or noxious stimulation in the anaesthetized rat, as shown by colocalization of Fos protein with ACTH and beta-endorphin and increased hormone release. *Brain Res Bull* 40:175–182
9. Pan B, Castro-Lopes JM, Coimbra A (1999) Central afferent pathways conveying nociceptive input to the hypothalamic paraventricular nucleus as revealed by a combination of retrograde labeling and c-fos activation. *J Comp Neurol* 413:129–145
10. Rodella L, Rezzani R, Gioia M et al. (1998) Expression of Fos immunoreactivity in the rat supraspinal regions following noxious visceral stimulation. *Brain Res Bull* 47:357–366
11. Saper CB (1995) Central autonomic system. In: Paxinos G (ed) *The rat nervous system*, 2nd edn. Academic Press, San Diego, pp 107–135
12. Saper C, Chou TC, Scammell TE (2001) The sleep switch: hypothalamic control of sleep and wakefulness. *Trends Neurosci* 24:726–731
13. Simerly RB (1995) Anatomical substrates of hypothalamic integration. In: Paxinos G (ed) *The rat nervous system*, 2nd edn. Academic Press, San Diego, pp 353–376
14. Snowball RK, Semenenko FM, Lumb BM (2000) Visceral inputs to neurons in the anterior hypothalamus including those that project to the periaqueductal gray: a functional anatomical and electrophysiological study. *Neuroscience* 99:351–361
15. Swanson LW (1987) The hypothalamus. In: Hökfelt T, Swanson LW (eds) *Handbook of chemical neuroanatomy*, vol 5. Integrated systems of the CNS, part I. Elsevier, Amsterdam, Oxford, pp 1–124

## Hypothalamus-Anterior Pituitary-Gonadal Axis

### Definition

The hypothalamus controls endocrine function by direct release of neuropeptides, or indirectly through the secretion of regulatory hormones to the anterior pituitary. These regulatory substances are secreted by the hypothalamus into the local portal plexus within the median eminence, which then drains into the blood vessels of the anterior pituitary. There are a wide number of substances released by the hypothalamus that either inhibit or stimulate the release of anterior pituitary hormones, including factors that affect the release of growth hormone, thyrotropin, and others. Related to sexual and reproductive function, the hypothalamus secretes prolactin-releasing factor (PRF), which stimulates the release of prolactin. Dopamine, also secreted by the hypothalamus, inhibits prolactin's release. Additionally, the hypothalamus secretes gonadotropin-releasing hormone (GnRH) to the pituitary gland, which triggers the secretion of luteinizing hormone (LH) from the pituitary gland. Luteinizing hormone then stimulates the Leydig cells of the testes to produce testosterone or the ovaries to produce progesterone.

► [Cancer Pain Management, Opioid Side Effects, Endocrine Changes and Sexual Dysfunction](#)

## Hypoxia

### Definition

Hypoxia is a pathological condition in which the whole organism (*generalized hypoxia*) or only a region of the organism (*tissue hypoxia*) is deprived of adequate oxygen supply.

► [NSAIDs and Cancer](#)

---

## IAIABC System

► Impairment Rating, Ambiguity, IAIABC System

---

## Iatrogenic Causes of Neuropathy

PAOLO MARCHETTINI  
Pain Medicine Center, Scientific Institute San Raffaele,  
Milan, Italy  
marchettini.paolo@hsr.it

### Synonyms

Post Surgical Nerve Injury; Chronic Postoperative Pain;  
Chronic Post-Surgical Neuralgia

### Definition

Iatros in Greek means physician, the term iatrogenic defines a pathological complication of medical care. ► **Iatrogenic neuropathy** is a nerve injury caused by surgical or pharmacological treatment or by its consequence.

It is estimated that iatrogenic neuropathy is a major cause of chronic pain, although the condition is still unrecognized and poorly managed. The encompassing term “► **chronic post-surgical pain syndrome**” which is commonly used to cluster all these not so rare outcomes of surgery, is unhelpful as it offers little insight into the pathophysiology operating in each case. For the sake of clarity, the use of the widespread terms “failed” and “syndrome” are not useful when defining post-surgical pain conditions, as they do not determine the etiology of the pain. A proper attempt to diagnose the cause of chronic post-surgical pain permits appropriate steering of the clinical management.

### Characteristics

Pain and other abnormal sensory symptoms replicate the typical description of sensory aberration in mono- or poly-neuropathy (Hansson et al. 2001). Iatrogenic neuropathy however, has more psychological complications, because the recognition of nerve injury is often missed or belated. The onset of neuropathic pain can be delayed for days, weeks or, rarely, months. Doctor

and patient may erroneously attribute early onset neuropathic pain to the expected “normal” post-operative pain. The operation was technically successful and there were no infections or other obvious complications. Delayed recognition may also be the consequence of immobilization by postoperative cast, bed rest, reduced activity or sedation due to anesthetic or analgesic medication. The nerve injury may selectively affect a sensory branch, hampering objective evidence of the lesion. The intensity of the pain is often unrelated to the severity of the nerve damage; indeed partial nerve injury may predispose to neuropathic pain to a greater extent than total injury. When the diagnosis is made, at times many years later, patients are frustrated by delayed treatment and by inadequate and unspecific clinical management (Horowitz 1984). The typical clinical picture of chronic pain, sensory disorder, insomnia and depression is complicated by frustration and disbelief toward physicians and other medical care providers, judged in general to be responsible for the prolonged and unnecessary suffering.

### Symptoms

When a patient describes tingling (spontaneous discharges in large myelinated fibers), pins and needles (small myelinated fibers), cramps and burning (unmyelinated fibers) in the region of the surgical procedure, iatrogenic nerve injury is high on the list of differential diagnoses. The diagnosis is made based on such typical neuropathic symptoms and on the identification of sensory disorder in the anatomical territory of the injured nerve(s). It is also fundamental to search for a Tinel sign to identify the site of the injury. A condition that may hamper the diagnosis is a partial injury in continuity. Painful iatrogenic neuropathy often originates from injury confined to a sensory nerve, without evidence of muscle wasting and weakness. At times the nerve injury is rather selective, affecting small fascicular rami and may be hard to detect clinically and electrophysiologically. Command of peripheral nerve sub anatomy helps early recognition. As all neuropathic pains, iatrogenic neuralgia also can be spontaneous and evoked by stimuli to the skin or perhaps just movement. At times even minor stimuli, normally not painful, can evoke a burning and unpleasant tingling sensation or thermal sensations (dysesthesia - allodynia). Stimulus evoked pain is so

distressing that patients report sensory dysfunction beyond the anatomical distribution of hypoesthesia, in territories that are wider than those supplied by the injured nerve. However, sensory dysfunction is usually confined within a territory that surrounds the cutaneous distribution of the affected plexus, root or peripheral nerve. Occasionally, the nerve injury is the consequence of progressive entrapment in the surgical scar. Such entrapment, unlike anatomical entrapment syndromes, is rarely focal, usually being more homogeneously distributed along the scar. In the early phase, ectopic neural activity may exist in the absence of nerve conduction block and neurophysiological signs may remain within normal values for a long time. The clinical equivalence is that the positive symptoms of pain, paresthesia and dysesthesia may appear without striking negative phenomena (hypo-anesthesia).

### Diagnosis

In clinical practice recognizing a cutaneous nerve injury by the patient's description of tingling pins and needles and burning is relatively simple. Diagnosing an injury of nerves supplying deep structure is more demanding. In such cases the pain quality replicates the quality of a deep tissue injury, making the differential diagnosis between neuropathy and connective tissue disease not always so self-evident. Deep neuropathic pain is commonly more widespread and more difficult to localize, it is often referred at a distance from the injury site and might spread along an entire radicular territory. At times entrapment can be related to or aggravated by movement or positioning. If a nerve injury is suspected, a thorough clinical examination including sensory hyperphenomena (identification and documentation of allodynia and hyperalgesia) as well as sensory loss and motor function is required. Nerve conduction studies and quantitative sensory testing may be helpful in supporting the clinical diagnosis. When a comparison with a contralateral nerve is possible, the sensitivity of such a test is improved. The clinical assessment should also take into account that any injury to the sensory component of a motor nerve may result in pain. The motor system should be examined properly through electromyography and motor nerve conduction studies. This comprehensive sensorimotor examination allows objective identification of the neurological dysfunction. Careful evaluation means that precise follow-up can be ensured, providing a yardstick helpful in reassuring the patient that the nerve damage is not worsening and is possibly improving. Such evaluation also provides specific evidence in the event of medico-legal assessment. Assessment of the social and psychological aspects of the disease is also necessary, so that the full picture can be documented.

### Epidemiology

Solid data are still much wanted. Cox et al. (1974) found a 27% incidence of neuropathic symptoms in the best-

case scenario after saphenectomy. The majority of the injuries were symptomless. Only 12% of the patients, less than half of those with a clinically identifiable injury, reported subjective sensory abnormalities and only 5% of all operated patients reported pain. The most frequently injured nerves during medical interventions are 1)

brachial plexus; 2) palmar cutaneous branch of the median nerve; 3) infrapatellar cutaneous branch of the saphenous nerve, 4) ilioinguinal, iliohypogastric, genitofemoral and femoral nerves, 5) accessory and greater auricular nerves, 6) long thoracic nerve and 7) alveolar nerve. Our observation reiterates the homogeneous lists of Horowitz (1984), Dawson and Krarup (1989) and Sunderland (1991).

The surgical interventions most commonly associated with nerve injury are peripheral anesthetic nerve block, odontoiatric treatment, ENT surgery, cardiovascular surgery, orthopedic surgery and general surgery.

### Odontoiatric Treatment

In endodontic surgery, nerve damage may result from direct intrusion of instruments or implants into the mandibular canal or from introducing neurotoxic substances such as paraformaldehyde close to the inferior alveolar nerve.

### ENT Surgery

Nasal sinus surgery may damage the maxillary branch of the trigeminal nerve, resulting in persistent pain in the region of the eye (Neuhaus 1990).

### Cardiovascular Surgery

Varicose vein striping, particularly of the saphenous vein, may result in nerve injury. After thoracotomy, a sensory disorder, in particular mechanical allodynia indicating a neuropathic component for the pain, has been found in 80 consecutive patients complaining of chronic pain after coronary artery by pass grafting (Eisenberg et al. 2001).

### Orthopedic Surgery

Shoulder arthroscopy, as with all arthroscopic techniques, is becoming a more frequent cause of iatrogenesis, although reports vary widely (from 10% to one case out of 439 (Stanish and Peterson 1995).

Carpal tunnel release is a common surgical intervention that can be complicated by a lesion of the median and, more rarely, of the ulnar nerve. The reported incidence of iatrogenic nerve injury varies from five out of eighty three cases to 0.8% in a series of 3035 hands reported in a review of fourteen papers. Almost 10% of patients complaining of complications following endoscopic carpal tunnel release have neuropathic pain (Kelly et al. 1994). Breast surgery is associated with chronic pain sequels in over 20% of patients (Foley 1990). Harvesting of bone for grafting has been reported amongst the causes of injury to the lateral femoral-cutaneous nerve (Hudson



et al. 1979). Incision around the knee joint has been associated with lesions of the infrapatellar branch of the saphenous nerve. In 1983, Swanson and co-workers reported a 63.2% incidence of prepatellar neuropathy in eighty-seven patients immediately after open meniscectomy, while Sherman and co-workers noted only a 0.6% incidence of reported symptoms following 2,640 arthroscopic procedures on the knee (Swanson 1983, Sherman et al. 1986). In 1995, Mochida and Kikuchi reported a 22.2% incidence of sensory disturbances in sixty-eight consecutive patients operated on between 1990 and 1991 (Mochida and Kikuchi 1995). Limb amputation is also frequently followed by chronic pain (the highest frequency reported is as high as 80% of the amputees).

### General Surgery

Lymph node biopsy in the neck is sometimes associated with injury to the accessory nerve and cutaneous nerves in the neck (Murphy 1983). Ilioinguinal nerve lesion is an important complication following inguinal hernioplasty (Heise and Starling 1998). Anterior hernioplasty, which requires the dissection of spermatic cord and sensory nerves, is a more common cause of this injury. Laparoscopic repair of the hernia is increasing simultaneously with the injuries to neural structures coursing through the groin. The femoral branches of the genitofemoral nerve and the lateral cutaneous nerve of the thigh, not visible during laparoscopic inguinal hernia repair, are more vulnerable. Abdominal rectopexy has been associated with femoral nerve injury in six patients out of a series of twenty-four patients, twenty-one of whom were operated on for rectal prolapse and three for recto-rectal intussusception (Infantino et al. 1994).

### Therapy

Treatment of painful iatrogenic neuropathy requires all means used in the management of any other neuropathic pain (Senegor 1991, Sindrup and Jensen 1999). In this medically provoked condition, it is even more fundamental to care for the psychological co-morbidities. These should be prevented by early recognition of the neuropathic symptoms and the identification of the injured nerve. Early recognition, besides improving pain management, avoiding psychological overlay and possibly preventing chronification, favors the reestablishment of a trustful patient doctor relationship.

### References

- Cox SJ, Wellwood JM, Martin A (1974) Saphenous nerve injury caused by stripping of the long saphenous vein. *Br Med J* 1:415-417
- Dawson DM, Krarup C (1989) Perioperative nerve lesions. *Arch Neurol* 46:1355-1360
- Eisenberg E, Pultorak Y, Pud D et al. (2001). Prevalence and characteristics of post coronary artery bypass graft surgery pain (PCP). *Pain* 92:11-17
- Foley KM (1990) Brachial plexopathy in patients with breast cancer. In: Harris JR, Hellman S, Henderson IC et al. (eds) *Breast Diseases*, 2nd edn. Lippincott JB, Philadelphia, pp 722-729
- Hansson PT, Lacerenza M, Marchettini P (2001) Aspects of clinical and experimental neuropathic pain: the clinical perspective. In: Hansson PT, Fields HL et al. (eds) *Neuropathic Pain: Pathophysiology and Treatment*. Progress in Pain Research and Management. IASP Press, Seattle, pp 1-18
- Heise CP, Starling JR (1998) Mesh inguinodynia: a new clinical syndrome after inguinal herniorrhaphy? *J Am Coll Surg* 87:514-518
- Horowitz SH (1984) Iatrogenic causalgia. Classification, clinical findings, and legal ramifications. *Arch Neurol* 41:821-824
- Hudson AR, Hunter GA, Waddell JP (1979) Iatrogenic femoral nerve injuries. *Can J Surg* 22:62-66
- Infantino A, Fardin P, Pirone E et al. (1994) Femoral nerve damage after abdominal rectopexy. *Int J Colorectal Dis* 9:32-4
- Kelly CP, Pulisetti D, Jamieson AM (1994) Early experience with endoscopic carpal tunnel release. *J Hand Surg (Br)* 19:18-21
- Mochida H, Kikuchi S (1995) Injury to infrapatellar branch of saphenous nerve in arthroscopic knee surgery. *Clin Orthop Relat Res* 320:88-94
- Murphy TM (1983) Complications of diagnostic and therapeutic nerve blocks. In: Orkin FK, Cooperman LH (eds) *Complications in anaesthesiology*. Lippincott, Philadelphia
- Neuhaus RW (1990) Orbital complications secondary to endoscopic sinus surgery. *Ophthalmology* 97:1512-1518
- Senegor M (1991) Iatrogenic saphenous neuralgia: successful therapy with neuroma resection. *Neurosurgery* 28:295-298
- Sherman OH, Fox JM, Snyder SJ et al. (1986) Arthroscopy-"no-problem surgery" An analysis of complications in two thousand six hundred and forty cases. *JBJS* 68:256-265
- Sindrup SH, Jensen TS (1999) Efficacy of pharmacological treatments of neuropathic pain: an update and effect related to mechanism of drug action. *Pain* 83:389-400
- Stanish WD, Peterson DC (1995) Shoulder arthroscopy and nerve injury: pitfalls and prevention. *Arthroscopy* 11:458-466
- Sunderland S (1991) Miscellaneous causes of nerve injury. In: Sunderland S (ed) *Nerve injuries and their repair. A critical appraisal*. Churchill- Livingstone, Edinburgh, pp 197-199
- Swanson AJ (1983) The incidence of prepatellar neuropathy following medial meniscectomy. *Clin Orthop Relat Res* 181:151-153

## Iatrogenic Effect/Response

### Definition

Iatrogenic effects/responses are outcomes inadvertently induced by a physician or surgeon or by medical treatment or diagnostic procedures.

- ▶ Acute Pain Management in Infants
- ▶ Cancer Pain, Assessment in Children
- ▶ Iatrogenic Causes of Neuropathy

## Iatrogenic Neuropathy

### Definition

Iatrogenic neuropathy is a nerve injury caused by surgical or pharmacological treatment, or by its consequence.

- ▶ Iatrogenic Causes of Neuropathy

## IB4-Binding Neurons

### ► IB4-Positive Neurons, Role in Inflammatory Pain

## IB4-Positive Neurons, Role in Inflammatory Pain

CHERYL L. STUCKY

Department of Cell Biology, Neurobiology and Anatomy, Medical College of Wisconsin, Milwaukee, WI, USA

cstucky@mcw.edu

### Synonyms

IB4-Binding Neurons; GDNF-Dependent Neurons; IB4-Positive Nociceptors

### Definition

An IB4-positive neuron is a sensory neuron whose cell body lies in the dorsal root or trigeminal ganglia and whose membrane expresses surface carbohydrates ( $\alpha$ -D galactose groups of glycol conjugates) that bind the plant lectin isolectin B4 (IB4) from *Griffonia simplicifolia* I. IB4-positive neurons have small size cell bodies and primarily give rise to unmyelinated fibers, many of which are nociceptive.

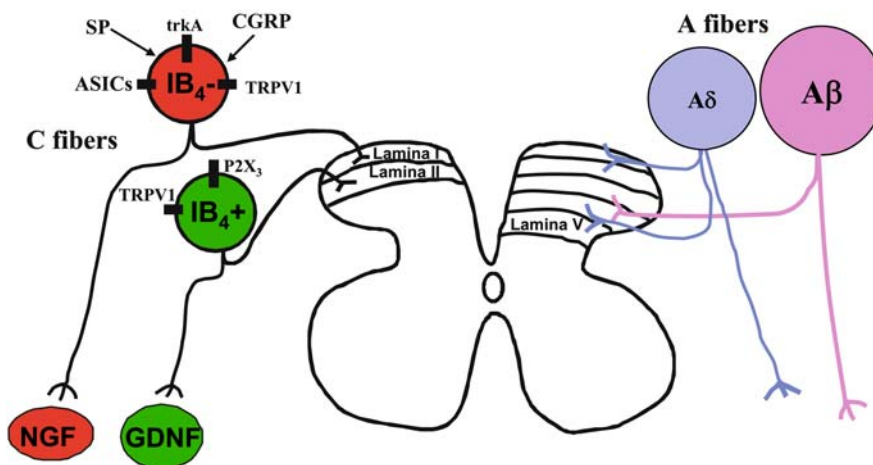
### Characteristics

IB4-positive neurons comprise one of two broad classes of small diameter, C-fiber sensory neurons. The other class (IB4 negative) typically expresses neuropeptides such as substance P and calcitonin gene related peptide (CGRP) and expresses ► *trkA* receptors for ► *nerve growth factor* (NGF). IB4-positive neurons express receptors for ► *glial cell line-derived neurotrophic factor*

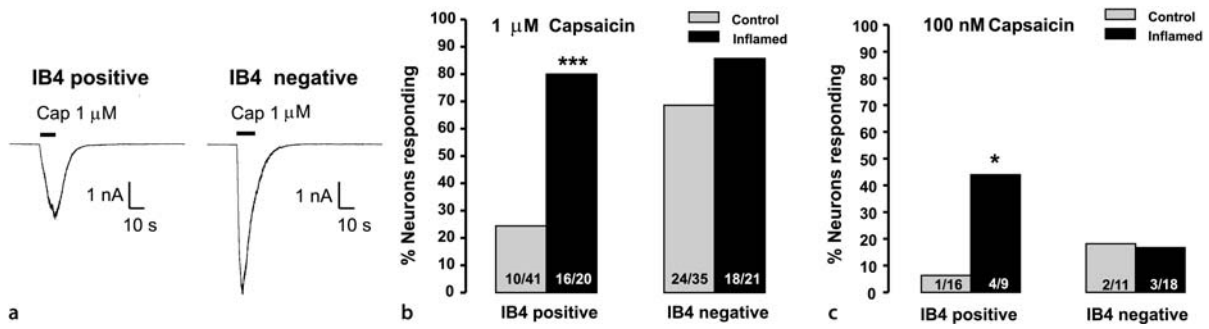
(GDNF) and depend on GDNF for survival after birth (Bennett et al. 1998). IB4 positive neurons selectively express the ► *P2X3 Receptor* for ATP. IB4-positive neurons are relatively poor in expression of neuropeptides or *trkA* receptors (Silverman and Kruger 1990; Averill et al. 1995; Molliver et al. 1995), but some studies show overlap between IB4 binding and neuropeptide or *trkA* expression (Wang et al. 1994; Kashiba et al. 2001). The central terminals of IB4-positive neurons terminate predominantly in the inner ► *lamina II* of the superficial dorsal horn of the spinal cord (Gerke and Plenderleith 2004), whereas IB4-negative neurons terminate mainly in lamina I and outer lamina II (Fig. 1).

The neurochemical differences between IB4 positive and negative neurons suggest that the two classes of small diameter neurons may have different functional properties in conveying nociceptive information. Compared to IB4 negative neurons, IB4 positive neurons isolated from uninjured mice or rats have longer duration action potentials and higher densities of ► *tetrodotoxin (TTX) resistant sodium channel* currents (Stucky and Lewin 1999), higher densities of N-type  $Ca^{2+}$  channel currents (Wu and Pan 2004) and higher densities of voltage gated  $K^+$  (*Kv*) channel currents (Vydyanathan et al. 2005). Furthermore, IB4 positive neurons from uninjured mice are significantly *less* responsive to noxious chemical stimuli, including capsaicin and protons, than IB4 negative neurons (Dirajlal et al. 2003).

Several authors have hypothesized that IB4 negative, but not IB4 positive, neurons contribute to inflammatory pain (Mantyh and Hunt 1998; Snider and McMahon 1998). To address this hypothesis, a recent study investigated whether peripheral inflammation *in vivo* alters the response properties of isolated IB4 positive or IB4 negative neurons to the noxious stimulus capsaicin, which activates the transient receptor potential vanilloid 1 (TRPV1) receptor (► *TRPV1 receptor*) (Breese et al. 2005). TRPV1 function was investigated because



**IB4-Positive Neurons, Role in Inflammatory Pain, Figure 1** Schematic of cross-section of the lumbar spinal cord and innervation by the general subclasses of primary afferent neurons.



**IB4-Positive Neurons, Role in Inflammatory Pain, Figure 2** Inflammation sensitizes IB4 positive neurons to capsaicin. (a) Examples of whole cell voltage clamp recordings from an IB4 positive and an IB4 negative small diameter neuron ( $\leq 26 \mu\text{m}$ ) that responded to  $1 \mu\text{M}$  capsaicin. (b) Percentage of IB4 positive and IB4 negative neurons from the L4/L5 DRG of control or CFA-injected mice that responded to a 10 s exposure to  $1 \mu\text{M}$  capsaicin. Capsaicin-evoked currents in all cells tested were  $> 40 \text{ pA}$ .\*\*\* indicates that significantly more IB4 positive neurons from inflamed mice responded to capsaicin compared to the control IB4 positive group ( $P < 0.0001$ ; Fisher's Exact test). (c) Percentage of IB4 positive and IB4 negative small diameter neurons isolated from the L4/L5 DRG from control or CFA-injected mice that responded to 100 nM capsaicin.\* indicates that significantly more IB4 positive neurons from inflamed mice responded to capsaicin compared to control IB4 positive neurons ( $P < 0.05$ ; Fisher's Exact test). The percentage of IB4 negative neurons that responded to 100 nM capsaicin was unaltered by inflammation. (Modified from Breese et al. 2005).

TRPV1 is a key heat transducer on nociceptors and mediates the heat hyperalgesia that accompanies peripheral inflammation (Caterina et al. 2000; Davis et al. 2000). Peripheral inflammation was induced by injection of ► **complete Freund's adjuvant** (CFA) in the hind paw of mice. Two days later, the lumbar 4–5 ganglia, which contain the cell bodies of neurons that project to the hind paw were isolated and dissociated and whole cell patch clamp recordings were performed on small diameter neurons. Fig. 2 shows that the proportion of IB4 positive neurons that respond to capsaicin with an inward current is markedly increased (3-fold) after inflammation, whereas IB4 negative neurons are unaltered. The increase in capsaicin responsiveness in IB4 positive neurons is due to increased TRPV1 function because IB4 positive neurons from ► **TRPV1-Null Mice** with CFA inflammation are unresponsive to capsaicin. Similarly, inflammation increases the proportion of IB4 positive

neurons, but not IB4 negative neurons, that respond to protons (pH 5.0) in a TRPV1-dependent manner (not shown). In parallel, CFA-induced inflammation increases by 3-fold the percentage of IB4-positive neurons that express TRPV1-immunoreactivity, but has no effect on IB4 negative neurons (Fig. 3 and Table 1). Since the IB4 positive small diameter neurons are selectively increased in TRPV1 function and expression during peripheral inflammation, they may play an important role in inflammatory pain. Natural stimuli for TRPV1 during inflammation may be noxious heat or endogenous TRPV1 ligands including protons, *N*-arachidonoyl-dopamine, anandamide or eicosanoids such as leukotriene B4, 12-(*S*)-HPETE or 15-(*S*)-HPETE molecules. An increase in the number of IB4 positive neurons that respond to TRPV1 stimuli including heat or endogenous TRPV1 inflammatory ligands could increase, by ► **spatial summation**, the amount of nociceptive information transmitted to the dorsal horn of the spinal cord and ultimately contribute to inflammatory pain and hyperalgesia. The IB4-positive neurons' capacity to become sensitized highlights them as a putative target for novel therapies for inflammatory pain.

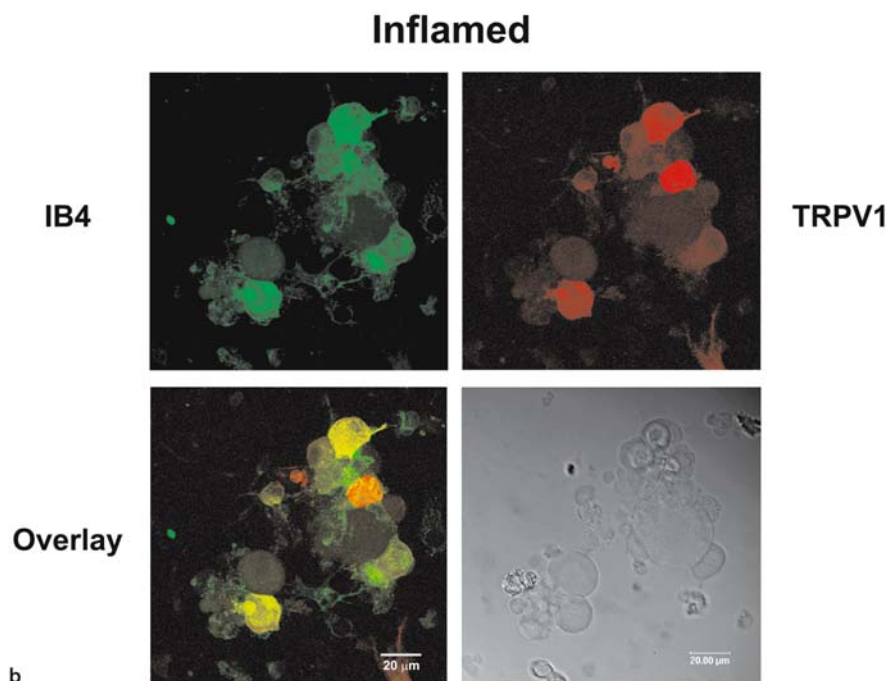
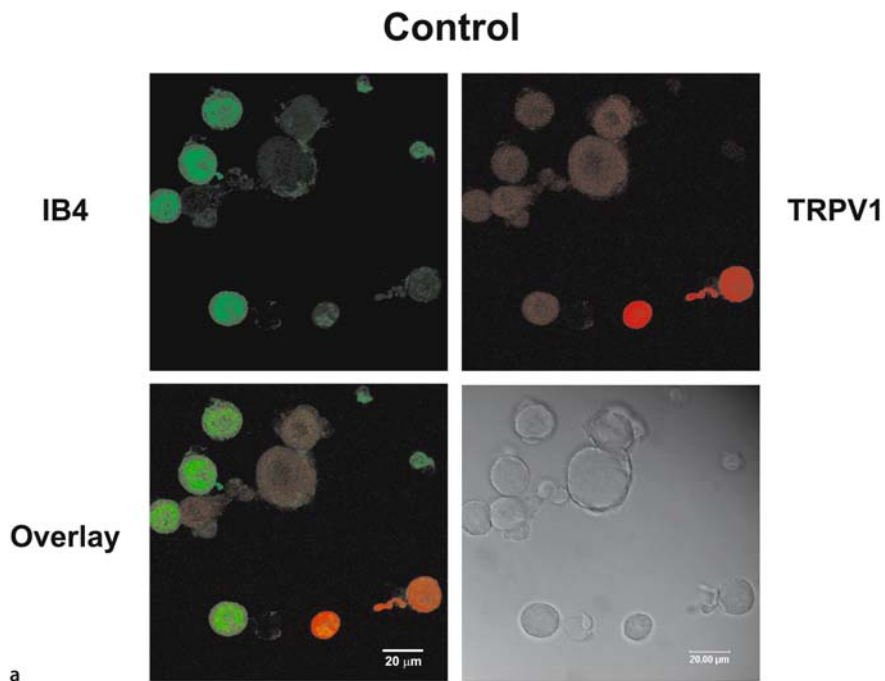
**IB4-Positive Neurons, Role in Inflammatory Pain, Table 1** TRPV1-immunoreactivity in IB4 positive and IB4 negative small diameter neurons from control and CFA-injected mice

TRPV1-ir (%)	Control (%)	Inflamed (%)
% total neurons	10.7 ± 4.0	25.0 ± 3.0 *
% of IB4 positive neurons	4.5 ± 2.1	15.5 ± 3.6 †
% of IB4 negative neurons	20.9 ± 12.2	34.7 ± 8.6

m) L4/L5 DRG neurons co-stained for IB4 and TRPV1. \* indicates that the percentage of neurons that are TRPV1-immunoreactive (TRPV1-ir) was increased in CFA-injected mice compared to control mice ( $P < 0.05$ ; two-tailed unpaired *t*-test). † indicates that the percentage of IB4 positive neurons that are TRPV1-ir was increased in CFA-injected mice compared to control mice ( $P < 0.05$ ; two-tailed unpaired *t*-test). The percentage of TRPV1-ir IB4 negative neurons was not significantly altered in CFA-injected mice compared to control mice ( $P > 0.3$ ; two-tailed unpaired *t*-test).  $n = 5$  control mice (1201 total neurons analyzed for TRPV1 and IB4 staining);  $n = 12$  CFA-injected mice (1232 total neurons analyzed for TRPV1 and IB4 staining) (Breese et al. 2005).

**References**

1. Averill S, McMahon SB, Clary DO et al. (1995) Immunocytochemical localization of trkA receptors in chemically identified subgroups of adult rat sensory neurons. *Eur J Neurosci* 7:1484–1494
2. Bennett DL, Michael GJ, Ramachandran N et al. (1998) A distinct subgroup of small DRG cells express GDNF receptor components and GDNF is protective for these neurons after nerve injury. *J Neurosci* 18:3059–3072
3. Breese NM, George AC, Pauer LE et al. (2005) Peripheral inflammation selectively increases TRPV1 function in IB4-positive sensory neurons from adult mouse. *Pain* 115:37–49
4. Caterina MJ, Leffler A, Malmberg AB et al. (2000) Impaired nociception and pain sensation in mice lacking the capsaicin receptor. *Science* 288:306–313



**IB4-Positive Neurons, Role in Inflammatory Pain, Figure 3** Inflammation increases TRPV1-immunoreactivity in IB4-positive neurons. Confocal images of acutely isolated DRG neurons from control (a) and CFA-injected (b) wild-type mice that were co-stained with IB4 and a TRPV1 antibody. Lumbar 4/5 DRG neurons were isolated from control, non-injected mice or mice 22 days after CFA injection and fixed 6-9 h later for staining. Merged confocal images show that few IB4-positive neurons from control mice are TRPV1-immunoreactive, but after CFA-induced peripheral inflammation, more IB4-positive neurons are immunoreactive for TRPV1. Although neurons from control and inflamed mice were fixed at the same time after isolation, neurons from CFA-injected mice typically exhibited more processes, less round somata and more clustering than controls.

- Davis JB, Gray J, Gunthrope MJ et al. (2000) Vanilloid receptor-1 is essential for inflammatory thermal hyperalgesia. *Nature* 405:183-187
- Dirajlal S, Pauers LE, Stucky CL (2003) Differential response properties of IB(4)-positive and -negative unmyelinated sensory neurons to protons and capsaicin. *J Neurophysiol* 69:1071-1081
- Gerke MB, Plenderleith MB (2004) Ultrastructural analysis of the central terminals of primary sensory neurones labeled by transganglionic transport of *Bandeiraea simplicifolia* I-isolectin B4. *Neuroscience* 127:165-175
- Kashiba H, Uchida Y, Senba E (2001) Difference in binding by isolectin B4 to trkA and c-ret mRNA-expressing neurons in rat sensory ganglia. *Brain Res Mol Brain Res* 95:18-26
- Mantyh PW, Hunt SP (1998) Hot peppers and pain. *Neuron* 21:644-645
- Molliver DC, Radeke MJ, Feinstein SC et al. (1995) Presence or absence of TrkA protein distinguishes subsets of small sensory



neurons with unique cytochemical characteristics and dorsal horn projections. *J Comp Neurol* 361:404–416

11. Silverman JD, Kruger L (1990) Selective neuronal glycoconjugate expression in sensory and autonomic ganglia: relation of lectin reactivity to peptide and enzyme markers. *J Neurosci* 23:789–801
12. Snider WD, McMahon SB (1998) Tackling pain at the source: new ideas about nociceptors. *Neuron* 20:629–632
13. Stucky CL, Lewin GR (1999) Isolectin B(4)-positive and -negative nociceptors are functionally distinct. *J Neurosci* 19:6497–6505
14. Vydyanathan A, Wu ZZ, Chen SR et al. (2005) A-type voltage-gated K<sup>+</sup> currents influence firing properties of isolectin B4-positive but not isolectin B4-negative primary sensory neurons. *J Neurophysiol* 93:3401–3409
15. Wang H, Rivero-Melian C, Robertson G et al. (1994) Transganglionic transport and binding of the isolectin B4 from *Griffonia simplicifolia* I in rat primary sensory neurons. *Neuroscience* 62:539–551
16. Wu ZZ, Pan HL (2004) High voltage-activated Ca<sup>2+</sup> channel currents in isolectin B(4)-positive and -negative small dorsal root ganglion neurons of rats. *Neurosci Lett* 368:96–101

## IB4-Positive Nociceptors

- ▶ IB4-Positive Neurons, Role in Inflammatory Pain

## IBS

- ▶ Descending Modulation of Visceral Pain
- ▶ Irritable Bowel Syndrome
- ▶ Visceral Pain Model, Irritable Bowel Syndrome Model

## IC<sub>50</sub> Value

### Definition

IC<sub>50</sub> Value is the concentration where 50% of the inhibitory effect of a drug is reached.

- ▶ NSAIDs, COX-Independent Actions

## Ice-Pick Pain

### Definition

This describes a sharp jabbing pain in contrast to a persisting ache.

- ▶ Primary Stabbing Headache

## Ice-Water Bucket Test

### Definition

A test involving immersing an extremity into a bucket filled with ice and water, usually resulting in a temperature of 4 degrees Celsius. The test can be used as a test of pain sensitivity (e.g. by measuring how long the extremity is left immersed before pain becomes intolerable) or as a defined conditioning stimulus for testing the body's inhibitory responses to pain or nociceptive input. If the latter is intended, the extremity is left in the bucket for a defined length of time (or until a defined temperature is reached), with quantitative sensory testing (or other formal sensory testing) being performed before and after the test to quantitate the inhibitory response.

- ▶ Quantitative Sensory Testing

## ICF

### Definition

International Classification of Functioning, Disability and Health. It was developed by the World Health Organization. The ICF has addressed many of the criticisms of prior conceptual frameworks, and has been developed in a worldwide comprehensive consensus process over the few last years.

- ▶ Disability and Impairment Definitions

## ICSI

### Synonym

O'Leary-Sant Interstitial Cystitis Symptom Index

### Definition

ICSI stands for O'Leary-Sant Interstitial Cystitis Symptom Index, which is utilized for quantifying the degree of symptoms associated with interstitial cystitis.

- ▶ Interstitial Cystitis and Chronic Pelvic Pain

## IDET

### Synonym

Intra Discal Electrothermal Therapy

### Definition

IDET stands for Intra Discal Electrothermal Therapy – this technique is also called annuloplasty, and

involves treatment of posterior annulus with heat from a thermal resistive coil in an attempt to repair, denervate and stabilize an annular tear.

- ▶ Discogenic Back Pain
- ▶ Intradiscal Electrothermal Therapy
- ▶ Spinal Fusion for Chronic Back Pain

## Idiopathic

### Definition

If a condition or disease is of unknown cause, it is described as idiopathic.

- ▶ Diabetic Neuropathies

## Idiopathic Ataxic Neuropathy

- ▶ Ganglionopathies

## Idiopathic Cramps

### Definition

This type of cramp is the main symptom of a disease about which little is known, the cause of the cramp being obscure or speculative. Idiopathic cramps can be either sporadic or inherited, and are usually not associated with any cognitive, pyramidal, cerebellar, or sensory abnormalities.

- ▶ Muscular Cramps

## Idiopathic Headache

- ▶ Headache, Episodic Tension Type

## Idiopathic Myalgia

- ▶ Myalgia

## Idiopathic Orofacial Pain

- ▶ Atypical Facial Pain, Etiology, Pathogenesis and Management

## Idiopathic Stabbing Headache

- ▶ Primary Stabbing Headache

## Idiopathic Vulvar Pain

- ▶ Vulvodynia

## IEGs

- ▶ Immediate Early Genes

## iGluRs

- ▶ Ionotropic Glutamate Receptors

## Ignition Hypothesis

### Definition

Hypothesis, proposed by Rappaport and Devor (1994), which attempts to explain paroxysmal pain in trigeminal neuralgia in terms of sustained afterdischarge and cross excitation, amplified by positive feedback among neighboring neurons in the trigeminal root and/or ganglion.

- ▶ Pain Paroxysms
- ▶ Tic and Cranial Neuralgias

## IL-1beta

### Definition

IL-1beta is a cytokine with many properties similar to TNF. At higher endocrine concentrations, it is associated with fever and formation of acute-phase plasma proteins in the liver.

- ▶ Cytokines as Targets in the Treatment of Neuropathic Pain

## IL-4

### Definition

Interleukin-4 is an anti-inflammatory cytokine that has also been shown to have analgesic properties.

- ▶ Cytokines as Targets in the Treatment of Neuropathic Pain

## IL-6

### Definition

IL-6 is a cytokine with mostly proinflammatory and algogenic actions. It is a member of the IL-6 cytokine family that includes leukemia inhibitory factor (LIF) and ciliary neurotrophic factor (CNTF).

- ▶ Cytokines as Targets in the Treatment of Neuropathic Pain

## IL-10

### Definition

Interleukin-10 is an anti-inflammatory cytokine that has also been shown to have analgesic properties.

- ▶ Cytokines as Targets in the Treatment of Neuropathic Pain

## Ilium

### Definition

The Ilium is the upper portion of the hipbone.

- ▶ Sacroiliac Joint Pain

## Illness Behaviour

- ▶ Interpersonal Pain Behaviour

## Illusory Cramp

### Definition

Illusory cramp is a phenomenon in which the sensation of cramping is experienced, but little or no contraction of the muscle occurs.

- ▶ Muscular Cramps

## Imagery

### Definition

Representations in the mind of visual, auditory, tactile, olfactory, gustatory or kinesthetic experiences. The subjective reality of these experiences may vary between and within individuals. Guided, directed or elicited imagery can be a potent means of changing subjective experiences of pain.

- ▶ Therapy of Pain, Hypnosis

## IME

- ▶ Independent Medical Examinations

## Imitation Learning

- ▶ Modeling, Social Learning in Pain

## Immediate Early Genes

### Synonym

IEGs

### Definition

Immediate early genes (IEGs) are genes that are rapidly induced in the absence of de novo protein synthesis. The best characterized immediate early genes are c-jun and c-fos; both genes encode transcription factors that bind to specific regulatory sequences and activate expression of responsive genes. c-jun has a leucine zipper motif, which forms a heterodimer with a variety of proteins including c-fos. The jun-fos protein complex, also known as the activator complex (AP)-1, binds to a number of cellular promoters through a common element (5'-TGACTCA-3'). IEGs are distinct from "late response" genes, which can only be activated later following the synthesis of early response gene products. IEGs have therefore been called the "gateway to the genomic response".

- ▶ Amygdala, Pain Processing and Behavior in Animals
- ▶ NGF, Regulation during Inflammation

## Immortalization

### Definition

Immortalization is to confer the property of continuous division by the addition or upregulation of a gene, that when expressed in the cell, stimulates the cell to continuously divide until removed or downregulated.

- ▶ Cell Therapy in the Treatment of Central Pain

## Immune Cell Recruitment

### Definition

Inflammation induces immune cell migration from the circulation in multiple steps, including rolling, adhesion, and transmigration of immune cells through the vessel wall.

- ▶ Opioids and Inflammatory Pain

## Immune Cells

### Definition

B- and T-lymphocytes, macrophages and monocytes are immune cells patrolling through the body. They can migrate to areas with inflammation (chemotaxis).

▶ [Opioid Modulation of Nociceptive Afferents in vivo](#)

## Immunocompetent Cells

### Definition

Immunocompetent cells are able to respond to bacterial and viral stimuli. These cells respond by releasing classical immune mediators including proinflammatory cytokines. Within the CNS, these cells include astrocytes and microglia. Activation of these cells with immunogenic substances induces exaggerated pain.

▶ [Cord Glial Activation](#)

## Immunocytochemistry

### Definition

Immunocytochemistry is a method for demonstrating the localization of compounds in tissues, based on the use of antibodies.

▶ [Immunocytochemistry of Nociceptors](#)

▶ [Opioid Receptors at Postsynaptic Sites](#)

## Immunocytochemistry of Nociceptors

CHERYL L. STUCKY

Department of Cell Biology, Neurobiology and Anatomy, Medical College of Wisconsin, Milwaukee, WI, USA

dstucky@mcw.edu

### Synonyms

Immunohistochemistry; Immunoreactivity; Immunostaining; Neurochemistry; Neurochemical Markers; Nociceptors, Immunocytochemistry

### Definition

The study of molecules or proteins (antigens) found in the cytoplasm or membrane of nociceptors by using immunologic staining methods, such as the use of fluorescent antibodies or enzymes (e.g. horseradish peroxidase). The immunocytochemistry procedure is usually performed on sections of tissue that has been fixed by a cross-linking fixative like paraformaldehyde or glutaraldehyde. Typical tissues include the dorsal

root or trigeminal ganglion, peripheral nerve or target tissue such as skin. Most of these immunocytochemical markers label not only the cell bodies but also the axons and terminals of the sensory neurons.

### Characteristics

Nociceptive sensory neurons express a large variety of molecules that are involved in neuronal communication and many of these molecules are present in high enough concentrations to be detected by immunocytochemical methods. For example, nociceptors contain neurotransmitters and neuropeptides which, when released from central terminals act on spinal cord neurons or when released from peripheral terminals act on other cells in the skin or target tissues. Furthermore, nociceptors express ion channels and receptors in their plasma membrane that allow them to respond to external stimuli (heat, cold, mechanical force) or internal stimuli such as molecules released by other cell types. The goal of this essay is to highlight examples of the major immunocytochemical markers that are most frequently used to characterize subpopulations of nociceptors within the ▶ [dorsal root ganglion](#) (DRG) or trigeminal ganglion. However, because DRG and trigeminal neurons are exceptionally heterogeneous with respect to their expression of peptides, enzymes and receptors, there are many molecules and subpopulations of neurons that are not described here.

### Peptidergic Population: CGRP and Substance P

The most extensively characterized neuropeptides in nociceptive sensory neurons are ▶ [calcitonin gene related peptide](#) (CGRP) and ▶ [substance P](#). The CGRP- and substance P-expressing population of small diameter neurons is frequently called the “peptidergic” population of small diameter neurons because both of these neuropeptides are found in many small diameter neurons that stain darkly with basic aniline dyes and are called “small dark cells.” Small dark cells can be distinguished from large light cells, which stain clear or lightly, because they contain many neurofilaments that do not stain with the basic dyes.

### Calcitonin Gene-related Peptide

CGRP is expressed by more sensory neurons than other peptides and estimates range from 20–80% of DRG or trigeminal ganglion neurons expressing CGRP. The wide range among studies is due to differences between species, the location along the cervical to sacral neuraxis, the target tissue innervated and whether or not colchicine, which blocks microtubule transport of neuropeptides, was used. Most studies agree that 35–50% of all rat lumbar DRG neurons express CGRP. Within the spinal cord, CGRP is localized exclusively in primary afferent neurons. Most CGRP-expressing sensory neurons are small or medium size in diameter (many are nociceptors), but a few are large diameter.



This is consistent with the finding that the afferent fibers of CGRP-positive neurons are primarily unmyelinated C fibers and thinly myelinated A $\delta$  fibers and a few are large myelinated A $\beta$  fibers (McCarthy and Lawson 1990).

### Substance P

Substance P (SP) is expressed in approximately 20% of DRG neurons and most of these are small diameter neurons, although a few are medium diameter. Consistent with this, individually identified SP-expressing DRG neurons have either C fiber or A $\delta$  fiber axons and exhibit nociceptive response properties (Lawson et al. 1997). Substance P is highly colocalized with CGRP in that nearly all SP-expressing DRG neurons also contain CGRP, although only half of the CGRP-expressing neurons also contain SP.

### Other Characteristics

The peptidergic population of small dark neurons overlaps extensively with expression of ► [trkA](#), the high affinity receptor for the neurotrophin ► [nerve growth factor](#) (NGF) and depends on NGF for survival during development (Averill et al. 1995). Because good antibodies are available for the ► [trkA receptor](#), immunocytochemistry for trkA is frequently used as an alternative marker for the peptidergic population of small dark neurons. The central terminals of the peptidergic/trkA neurons are concentrated in lamina I and II outer of the superficial dorsal horn as well as in lamina V and X of the spinal cord.

CGRP-positive and SP-positive neurons innervate all types of peripheral target tissue, including skin, muscle, joint, bone and visceral organs. It is important to note that the expression pattern and levels of CGRP and SP in DRG neurons change with injury. Both CGRP and SP increase following persistent peripheral inflammation and conversely, they decrease following peripheral nerve lesion (Donnerer et al. 1992; Villar et al. 1991). This caveat must be carefully considered when using these markers to label and follow subpopulations of neurons in models of injury.

Other neuropeptides found in (typically smaller) subpopulations of mammalian DRG neurons that can be localized *via* antibody staining include somatostatin, vasoactive intestinal peptide, galanin, vasopressin, bombesin, dynorphin, enkephalin, neuropeptide Y, cholecystokinin and endothelin-1. Their distribution and characteristics will not be discussed in detail here.

### Non-Peptidergic or “Peptide Poor” Population: Isolectin B4 and FRAP

The population of small dark C fiber neurons that is poor in expression of the neuropeptides CGRP or SP is typically characterized by labeling with the plant lectin, isolectin B4 (IB4). Isolectin B4 binds to surface carbohydrates, specifically the ► [Alpha\( \$\alpha\$ \)-D Galactose](#)

groups of glycol conjugates (Silverman and Kruger 1990). The IB4 binding technique is most frequently used today because it is very adaptable, easy to perform, and IB4 conjugated directly to fluorescein (IB4-FITC) or other fluorescent markers can be used to label live neurons within minutes after performing physiological experiments (Stucky and Lewin 1999). However, the “peptide poor” population can also be labeled by immunoreactivity to the antibody LA4, which recognizes the  $\alpha$ -galactose oligosaccharides (Dodd and Jessell 1985) or by the presence of the fluoride resistant acid phosphatase (FRAP) enzyme, an extra-lysosomal acid phosphatase that is resistant to fluoride ions (Silverman and Kruger 1988). The function of the  $\alpha$ -D galactose groups is not clear, but they have been hypothesized to play a role in the cell-cell interactions during the development of connections of primary afferent neurons to the dorsal horn of the spinal cord (Dodd and Jessell 1985). The function of FRAP is not known.

### Other Characteristics

The IB4 positive/FRAP positive population of small diameter neurons also expresses receptors for ► [glial cell-line derived neurotrophic factor](#) (GDNF) and depends on GDNF for survival during postnatal development (Molliver et al. 1997; Bennett et al. 1998). Receptors for GDNF include the ligand binding domain ► [GFR \$\alpha\$ 1](#) or [GFR \$\alpha\$ 2](#) and the signal transducing, tyrosine kinase domain, RET. IB4 positive neurons primarily terminate in ► [lamina IIinner](#) of the superficial dorsal horn of the spinal cord, a region also known as the substantia gelatinosa.

Although a number of investigations have reported a clear separation between the peptidergic/trkA and the non-peptidergic/IB4 binding populations, other reports indicate that CGRP/SP/trkA and IB4/FRAP staining overlap extensively (Wang et al. 1994; Kashiba et al. 2001). The diverse findings may be due to differences in methods used or sensitivity of detection of the labels. It is likely that there is at least a subpopulation of neurons that expresses neuropeptides and binds IB4.

Importantly, IB4 binding decreases substantially following nerve injury (Bennett et al. 1998) and therefore caution must be exercised when using this marker to label subpopulations of neurons in animal models of injury.

### Neurofilament Markers: Antibodies RT97 and N52

The antibody clones RT97 and N52 both recognize the high molecular weight (200 kD) ► [neurofilament protein NF200](#), which is found in sensory neurons that have myelinated axons. Both RT97 and N52 antibody labeling have been used to identify the large light population of DRG neurons. One difference between the two antibodies is that RT97 recognizes only the phosphorylated form of the 200 kD neurofilament protein whereas N52 recognizes both the phosphorylated and

non-phosphorylated forms of the protein. Thus, there may be some differences in the populations of neurons labeled by these two markers. An advantage of RT97 is that a cell-by-cell correlation between RT97 staining and conduction velocities has been made for rat and all A fiber (A $\delta$  and A $\beta$ ) DRG neurons were found to be RT97-positive whereas all C fiber neurons were RT97-negative (Lawson and Waddell 1991). No such correlation between N52 and conduction velocity has yet been made.

There is almost no overlap between RT97 and IB4 staining or between N52 and IB4 staining, indicating that RT97/N52 and IB4 label distinct subpopulations of large light and small dark neurons, respectively. There is, however, significant overlap between RT97 and CGRP as approximately 30% of RT97-positive neurons contain CGRP and these are medium/large size neurons (McCarthy and Lawson 1990).

#### Ion Channels: TRPV1 and P2X3

Subpopulations of nociceptors can also be identified by antibodies that recognize specialized transduction molecules on the plasma membrane. Examples of these include receptors for noxious heat (TRPV1 receptor) and for ATP (P2X<sub>3</sub> receptor).

#### Transient Receptor Potential Vanilloid 1 (TRPV1) Receptor

The TRPV1 receptor/ion channel is the receptor for capsaicin, the potent algogen found in "hot" chili peppers (Caterina et al. 1997). Formerly known as VR1, TRPV1 is a member of the [▶ transient receptor potential family of ion channels](#) and when activated, allows calcium and sodium to flow into the neuron, resulting in depolarization. Besides capsaicin, TRPV1 also responds to moderately noxious heat (> 43°C), acid (~pH 5.0) and a number of other endogenous ligands that may be present during inflammation or injury, including *N*-arachidonoyl-dopamine, anandamide or [▶ eicosanoids](#) such as leukotriene B<sub>4</sub>, 12-(S)-HPETE or 15-(S)-HPETE molecules. Good antibodies to TRPV1 exist and TRPV1 immunoreactivity is found on many small diameter and some medium diameter sensory neurons (Caterina et al. 1997). Because capsaicin responsiveness is often used as a functional marker for nociceptors, TRPV1-immunoreactivity is frequently used as a neurochemical marker for nociceptors. Many TRPV1-immunoreactive neurons contain the neuropeptides CGRP or SP, whereas others bind IB4 (Tominaga et al. 1998). As is the case with neuropeptide immunoreactivity and IB4 binding, TRPV1 expression is also not stable after injury. The mRNA and protein for TRPV1 decreases in directly injured DRGs after [▶ axotomy](#) or [▶ Spinal Nerve Ligation Model](#). Conversely, TRPV1 increases in adjacent DRGs after spinal nerve ligation and is reported to increase following peripheral inflammation (Hudson et al. 2001).

#### P2X<sub>3</sub> Receptor for ATP

Extracellular adenosine triphosphate (ATP) has been implicated in nociceptive signaling in normal and pathological pain conditions and ATP directly excites nociceptors. P2X<sub>3</sub> receptors are multimeric ion channels gated by ATP. They exist on native DRG neurons as either P2X<sub>3</sub> homomers or as a heteromeric combination with the P2X<sub>2</sub> receptor (P2X<sub>2/3</sub>). Good antibodies against the P2X<sub>3</sub> receptor are available and studies document that P2X<sub>3</sub> receptors are selectively expressed on small diameter DRG neurons. Under uninjured conditions, P2X<sub>3</sub> receptors are almost exclusively localized to the IB4-binding population and only a few P2X<sub>3</sub>-positive neurons contain neuropeptides (Bradbury et al., 1998). Consistent with the pattern for IB4 binding neurons, the central terminals of P2X<sub>3</sub>-expressing neurons project primarily to the lamina II<sub>inner</sub> of the superficial dorsal horn. The expression of P2X<sub>3</sub> receptors decreases following nerve injury and this decrease can be reversed by *in vivo* administration of GDNF (Bradbury et al. 1998).

#### References

1. Averill S, McMahon SB, Clary DO et al. (1995) Immunocytochemical localization of trkA receptors in chemically identified subgroups of adult rat sensory neurons. *Eur J Neurosci* 7:1484–1494
2. Bennett DL, Michael GJ, Ramachandran N et al. (1998) A distinct subgroup of small DRG cells express GDNF receptor components and GDNF is protective for these neurons after nerve injury. *J Neurosci* 18:3059–3072
3. Bradbury EJ, Burnstock G, McMahon SB (1998) The expression of P2X<sub>3</sub> purinoreceptors in sensory neurons: effects of axotomy and glial-derived neurotrophic factor. *Mol Cell Neurosci* 12:256–268
4. Caterina MJ, Schumacher MA, Tominaga M, Rosen TA, Levine JD, Julius D (1997) The capsaicin receptor: a heat-activated ion channel in the pain pathway. *Nature* 389:816–824
5. Dodd J, Jessell TM (1985) Lactoseries carbohydrates specify subsets of dorsal root ganglion neurons projecting to the superficial dorsal horn of rat spinal cord. *J Neurosci* 5:3278–3294
6. Donnerer J, Schuligoi R, Stein C (1992) Increased content and transport of substance P and calcitonin gene-related peptide in sensory nerves innervating inflamed tissue: evidence for a regulatory function of nerve growth factor *in vivo*. *Neuroscience* 49:693–698
7. Hudson LJ, Bevan S, Wotherspoon G et al. (2001) VR1 protein expression increases in undamaged DRG neurons after partial nerve injury. *Eur J Neurosci* 13:2105–2114
8. Kashiba H, Uchida Y, Senba E (2001) Difference in binding by isolectin B<sub>4</sub> to trkA and c-ret mRNA-expressing neurons in rat sensory ganglia. *Brain Res Mol Brain Res* 95:18–26
9. Lawson SN, Waddell PJ (1991) Soma neurofilament immunoreactivity is related to cell size and fibre conduction velocity in rat primary sensory neurons. *J Physiol* 435:41–63
10. Lawson SN, Crepps BA, Perl ER (1997) Relationship of substance P to afferent characteristics of dorsal root ganglion neurons in guinea-pig. *J Physiol* 505:177–191
11. McCarthy PW, Lawson SN (1990) Cell type and conduction velocity of rat primary sensory neurons with calcitonin gene-related peptide-like immunoreactivity. *J Neurosci* 10:623–632
12. Molliver DC, Wright DE, Leitner MJ et al. (1997) IB4-binding DRG neurons switch from NGF to GDNF dependence in early postnatal life. *Neuron* 19:849–861

13. Silverman JD, Kruger L (1988) Lectin and neuropeptide labeling of separate populations of dorsal root ganglion neurons and associated "nociceptor" thin axons in rat testis and cornea whole-mount preparations. *Somatosens Res* 5:259–267
14. Silverman JD, Kruger L (1990) Selective neuronal glycoconjugate expression in sensory and autonomic ganglia: relation of lectin reactivity to peptide and enzyme markers. *J Neurocytol* 19:789–801
15. Stucky CL, Lewin GR (1999) Isolectin B(4)-positive and -negative nociceptors are functionally distinct. *J Neurosci* 19:6497–6505
16. Tominaga M, Caterina MJ, Malmberg AB et al. (1998) The cloned capsaicin receptor integrates multiple pain-producing stimuli. *Neuron* 21:531–543
17. Villar MJ, Wiesenfeld-Hallin Z, Xu XJ et al. (1991) Further studies on galanin-, substance P- and CGRP-like immunoreactivities in primary sensory neurons and spinal cord: effects of dorsal rhizotomies and sciatic nerve lesions. *Exp Neurol* 112:29–39
18. Wang H, Rivero-Melian C, Robertson G et al. (1994) Transganglionic transport and binding of the isolectin B4 from *Griffonia simplicifolia* I in rat primary sensory neurons. *Neuroscience* 62:539–551

## Immunocytokines

- ▶ Cytokines, Effects on Nociceptors
- ▶ Cytokines, Regulation in Inflammation

## Immunodeficient

### Definition

An innate, acquired, or induced inability to develop a normal immune response.

- ▶ Animal Models of Inflammatory Bowel Disease

## Immunoglobulin Therapy

### Definition

Intravenous administration of immunoglobulin has been clinically shown to have anti-inflammatory immunomodulatory effects in GBS and CIDP. Doses required are higher than those required for immunodeficiency states.

- ▶ Inflammatory Neuritis

## Immunohistochemistry

### Definition

Immunohistochemistry is a staining method using the principle of antigen-antibody interactions to demonstrate a defined protein in tissue sections.

- ▶ Immunocytochemistry of Nociceptors
- ▶ Toxic Neuropathies

## Immuno-Inflammatory Muscle Pain

- ▶ Muscle Pain in Systemic Inflammation (Polymyalgia Rheumatica, Giant Cell Arteritis, Rheumatoid Arthritis)

## Immunoisolation

### Definition

When supplying donor grafted tissue or cells, immunoisolation allows the separation of that tissue from the host, for example in an inert device that cannot be detected by the host immune system. Such a procedure is more likely to lead to long-term survival of donor tissue or cells.

- ▶ Cell Therapy in the Treatment of Central Pain

## Immunoreactivity

- ▶ Immunocytochemistry of Nociceptors

## Immunostaining

- ▶ Immunocytochemistry of Nociceptors

## Immunosuppression

### Definition

Inhibiting the activation and function of immune cells either by disease, or by drugs.

- ▶ Proinflammatory Cytokines
- ▶ Vascular Neuropathies

## Impact of Familial Factors on Children's Chronic Pain

LINDSAY S. UMAN<sup>1</sup>, CHRISTINE T. CHAMBERS<sup>2</sup>  
<sup>1</sup>Department of Psychology, Dalhousie University, Halifax, NS, Canada

<sup>2</sup>Departments of Pediatrics and Psychology, Dalhousie University and IWK Health Centre, Halifax, NS, Canada

luman@dal.ca, christine.chambers@dal.ca

### Synonyms

Psychosocial factors; Familial Factors; Parental Response; Family Environment

## Definition

Of the many psychosocial variables known to affect chronic pain in children, the family has emerged as one of the more prominent. Families are involved in all aspects of their children's pain, including assessment and management. It is now generally accepted that parents play an important role in influencing how their children learn to respond to pain. Having a child with chronic pain can also place a significant emotional and financial burden on families. This review will provide a brief description of the major research areas examining the impact of familial factors on children's chronic pain. Several more comprehensive reviews of family factors and pain are also available elsewhere (e.g. Chambers 2003; Palermo 2000).

## Characteristics

It has long been observed that ► **chronic pain** tends to run in families, whereby children who report pain are likely to have parents who report pain and *vice versa*. The majority of the studies examining aggregation of pain in families have been retrospective; however, a large-scale prospective study found considerable support for the association between pain and pain-related disability among children and their parents (Goodman et al. 1997). Although genetic predisposition and shared environment may account in part for the tendency for pain to run in families, psychological processes, particularly ► **social learning theory** and ► **operant conditioning**, have emerged as important in understanding how children acquire information about how to respond to pain. These theories indicate that children can learn how to cope with pain from their parents through various pathways. For example, children may learn through direct parental instruction or reprimands (i.e. being told to respond or not respond in a certain way to pain) as well as through observational or vicarious learning (i.e. by watching how the parent responds to his / her own pain) (Craig 1986). Parents may also indirectly teach their children about how to express pain by how they react to their children's expressions of pain (e.g. by providing special time or exemptions when the child has pain). These childhood learning experiences may, in turn, provide the foundation for the development of pain-related behaviours and coping styles later in life. Fortunately, there is evidence that parental behaviour and responses to pain can be modified successfully in order to produce improvements in pain and coping in children.

In addition to what can be explained by various learning theories, there is some evidence for the role of general parenting style and other familial characteristics in childhood pain. Although certain parenting styles such as over-protectiveness, discouragement of adaptive strategies, and encouragement of maladaptive strategies have been associated with poorer functioning in

children with chronic pain, the evidence regarding the importance of these characteristics has been inconsistent at best (Chambers 2003). A recent study found that parent-child interactions during an exercise task were not related to children's general pain coping strategies nor their level of pain-related disability (Reid et al. 2005). However, parents' discouragement of coping in response to their children's negative statements about pain made it more difficult for the children to maintain task activity.

## Parental Responses to Chronic Pain

The ways in which parents choose to respond to their children's pain complaints can have significant consequences for how children learn to express them (Walker and Zeman 1992). Principles of both positive and negative reinforcement can influence pain expression in children. ► **Positive reinforcement** may include providing tangible treats such as presents or favourite foods, as well as non-tangible rewards such as special privileges, sympathy and increased attention for pain behaviours. ► **Negative reinforcement** may include allowing the child to stay home from school, as well as exemption from chores and other unpleasant or anxiety-provoking activities (e.g. music lessons, sport practices). Both positive and negative reinforcement may inadvertently reward pain behaviours and encourage their display, while simultaneously discouraging adaptive coping in the face of pain.

This combination of reinforcement can lead to problematic consequences, as children may learn to adopt a ► **sick role**. Children may be motivated to adopt the sick role because it provides an acceptable excuse for exemption from responsibilities as well as less than desirable performance or behaviour (Walker and Zeman 1992). There is evidence that parents are more likely to excuse the misbehaviour of children with physical illnesses when there is a medical explanation or known organic aetiology for the pain compared to children with medically unexplained pain (Walker et al. 1995). The Illness Behavior Encouragement Scale (IBES) was developed by Walker and Zeman (1992) in order to assess and quantify parental responses to child illness and pain behaviours. The IBES is a 12-item scale with questions related to how parents respond when their child is ill or experiencing pain (e.g. "How often do you let your child stay home from school when he / she has pain?"). The questions are designed to provide information about the extent to which parents reinforce or provide encouragement for sick role behaviours. Research using the IBES has shown that mothers tend to encourage the sick role more than fathers, and that girls perceive their parents as more encouraging of illness behaviour than do boys. The IBES is a useful tool for elucidating and targeting maladaptive parental behaviours (for research and in clinical practice) that



could be altered in order to promote better child health and pain management.

### Family Involvement in Interventions for Chronic Pain

Psychological interventions for chronic pain are typically cognitive-behavioural (► [cognitive-behavioural therapy](#)) in nature and frequently involve training parents to encourage positive coping behaviours and take attention away from maladaptive behaviours in their children. Interventions that involve parents have been shown to be more effective than those targeting the child alone and are also more likely to result in maintained gains over time. For example, in a study examining the role of parent-mediated management of childhood migraines, it was found that the children undergoing ► [biofeedback](#) treatment whose parents also received pain management guidelines displayed significantly greater reductions in headache frequency and were more likely to be headache-free than children whose parents did not receive these guidelines (Allen and Shriver 1998). Parents were taught how their own behaviour can influence the pain behaviour of their children, and they were also trained to encourage adaptive coping while discouraging maladaptive pain behaviours.

Several studies have also examined the role of short-term cognitive-behavioural family interventions for paediatric recurrent abdominal pain (Sanders et al. 1989; Sanders et al. 1994). A recent study by Robins and colleagues (2005), in which parents were taught to be active partners in their children's pain management intervention (e.g. by involving the parent as a "coach" and restricting the extent to which secondary gains from sick behaviours were provided), found that children whose families had been involved in their treatment reported significantly less abdominal pain and had fewer school absences as compared to children who received standard medical care.

The research to date suggests that involving the family in the management of chronic pain in children is advantageous. Most of the interventions involving parents have been based on behavioural principles. Future research is needed to examine the value of ► [family systems](#) oriented approaches in pain management in children.

### Impact of Pain on the Family

While it is generally understood that families can significantly impact their children's pain, only recently has the reciprocal impact of pain on the family been acknowledged. Parenting a child with chronic pain typically involves extensive financial and emotional costs to the family, in the form of multiple medical appointments, missed time from work or school and increased stress. In a study examining the effect of chronic pain on the quality of life in adolescents and their families, it was found that more intense and frequent chronic pain in adolescents was associated with decreased self-reports

of quality of life related to psychological functioning as well as physical and functional status (Hunfeld et al. 2001). Many children with chronic pain do not have an identified organic disease or underlying biological explanation for the pain, which can be an additional source of frustration for families who desire a definitive diagnosis with a time-limited treatment plan (Hunfeld et al. 2002). Treatment of a child with chronic pain is typically an ongoing long-term process, involving a multi-disciplinary team of health-care professionals. Given the numerous family resources (e.g. parental attention) devoted to caring for a child with chronic pain, it is possible that non-ill family members (e.g. siblings) may inadvertently feel neglected and resentful. Thus, caring for a child with chronic pain is a process that affects all members of the family in some capacity. Additional research is needed to further delineate the complex ways that pain can influence the health and well-being of children and their families.

### Conclusion

It should be clear that familial factors are important to consider when evaluating a child with chronic pain. These family influences are multi-faceted and dynamic and can interact with various other biological, psychological and social factors over time. Children learn how to cope with and express their pain from their parents. Parental responses to child pain including positive and negative reinforcement, may foster and encourage sick role behaviours. Involving parents in interventions for chronic pain in children appears beneficial, and the financial and emotional burden related to caring for a child with chronic pain should also be considered.

### References

1. Allen JD, Shriver MD (1998) Role of parent-mediated pain behavior management strategies in biofeedback treatment of childhood migraines. *Behav Ther* 29:477–490
2. Chambers CT (2003) The role of family factors in pediatric pain. In: McGrath PJ, Finley GA (eds) *Pediatric Pain: Biological and Social Context*, Progress in Pain Research and Management, vol 26. IASP Press, Seattle, pp 99–130
3. Craig KD (1986) Social modeling influences: Pain in context. In: Sternbach RA (ed) *The Psychology of Pain*, 2nd edn. Raven Press, New York, pp 67–95
4. Goodman, JE, McGrath PJ, Forward SP (1997) Aggregation of pain complaints and pain-related disability and handicap in a community sample of families. In: Jensen TS, Turner JA, Wiesenfeld-Hallin Z (eds) *Proceedings of the 8th World Congress on Pain*, Progress in Pain Research and Management, vol 8. IASP Press, Seattle, pp 673–682
5. Hunfeld JAM, Perquin CW, Duivenvoorden HJ et al. (2001) Chronic pain and its impact on quality of life in adolescents and their families. *J Pediatr Psychol* 26:145–153
6. Hunfeld JAM, Perquin CW, Hazebroek-Kampschreur AAJM et al. (2002) Physically unexplained chronic pain and its impact on children and their families: The mother's perception. *Psychol Psychother* 75:251–260
7. Palermo T (2000) Impact of recurrent and chronic pain on child and family daily functioning: A critical review of the literature. *Dev Behav Pediatr* 21:58–69

8. Reid GJ, McGrath PJ, Lang BA (2005) Parent-child interactions among children with juvenile fibromyalgia, arthritis, and healthy controls. *Pain* 113:201–210
9. Robins PM, Smith SM, Glutting JJ et al. (2005) A randomized controlled trial of a cognitive-behavioral family intervention for pediatric recurrent abdominal pain. *J Pediatr Psychol* 30:397–408
10. Sanders MR, Rebgetz M, Morrison M et al. (1989) Cognitive-behavioral treatment of recurrent nonspecific abdominal pain in children: An analysis of generalization, maintenance, and side effects. *J Consult Clin Psychol* 57:294–300
11. Sanders MR, Shepherd RW, Cleghorn G et al. (1994) The treatment of recurrent abdominal pain in children: A controlled comparison of cognitive-behavioral family intervention and standard pediatric care. *J Consult Clin Psychol* 62:306–314
12. Walker LS, Zeman JL (1992) Parental response to child illness behaviour. *J Pediatr Psychol* 20:329–345
13. Walker LS, Garber J, Van Slyke DA (1995) Do parents excuse the misbehavior of children with physical or emotional symptoms? An investigation of the pediatric sick role. *J Pediatr Psychol* 20:329–345

---

## Impact on Activities of Daily Living

- ▶ Rating Impairment Due to Pain in a Workers' Compensation System

---

## Impairment

### Definition

Impairment is a loss, loss of use, or derangement of any body part, organ system, or organ function as a direct consequence of illness.

- ▶ Disability and Impairment Definitions
- ▶ Disability, Upper Extremity
- ▶ Pain as a Cause of Psychiatric Illness
- ▶ Physical Medicine and Rehabilitation, Team-Oriented Approach

---

## Impairment Due to Pain

- ▶ Rating Impairment Due to Pain in a Workers' Compensation System

---

## Impairment Evaluation

### Definition

Evaluations performed by a physician to determine the presence and/or severity of a claimant's impairment. The evaluations are often commissioned by insurance companies or disability agencies.

- ▶ Impairment, Pain-Related

---

## Impairment, Functions Loss

- ▶ Disability, Upper Extremity

---

## Impairment, Pain-Related

JAMES P. ROBINSON

University of Washington Pain Center, University of Washington, Seattle, WA, USA

jimrob@u.washington.edu

### Synonyms

Organ or Body Part Dysfunction; activity limitation; disability; Pain-Related Impairment

### Definition

“Impairment” does not have a unique definition. The American Medical Association (AMA) defines it as: “A loss, loss of use, or derangement of any body part, organ system, or organ function” (p. 2) (Cocchiarella and Andersson 2001). The World Health Organization gives the following definition: “Impairments are problems in body function or structure as a significant deviation or loss” (p. 226) (World Health Organization (2001). The United States Social Security Administration defines impairments as “anatomical, physiological, or psychological abnormalities that can be shown by medically acceptable clinical and laboratory diagnostic techniques” (p. 3) (US Government Printing Office 1994). The present essay focuses on impairment as conceptualized by the AMA in Guides to the evaluation of permanent impairment, 5<sup>th</sup> edition (Cocchiarella and Andersson 2001).

### Characteristics

Although the above definitions of impairment differ somewhat, they all emphasize that impairments are biomedical abnormalities that can be analyzed at the level of organs or body parts. In fact, a critical distinction between impairment and disability is that they address limitations at different levels of analysis – impairment refers to a limitation in the function or structure of an organ or body part, whereas disability refers to a limitation in the behavior of a person. This distinction is reflected in the syntax used to describe impairments and disabilities. For example, one would say “Ms. Smith's right leg is weak because of her polio” to describe her impairment, and “Ms. Smith is unable to walk up stairs” to describe her consequent disability.

Since impairment refers to the function or structure of organs or body parts rather than to the behavior of people, observers often assume that physicians can perform impairment evaluations objectively and relatively independently of the persons to whom the organs/body

parts belong. For example, a physician could assess renal impairment on the basis of creatinine clearance or cardiac impairment on the basis of ejection fraction. Thus, ► **impairment evaluations** are thought to bypass the complications that arise when examiners try to understand claimants at the “whole person” level, or to perform analyses that rely on claimants’ self-reports and voluntary behavior.

### The Significance of Impairment Evaluations

Agencies that administer disability programs need a method to determine whether people who seek benefits are actually disabled – i.e. whether they have medical conditions that significantly limit their ability to carry out certain activities. Among individuals who allege disability, ones who are truly disabled need to be distinguished from ones who cannot perform activities because of non-medical circumstances (e.g. inability to find work due to an economic depression), and from ones who will not perform activities, even though they are capable of doing so. Physicians are often enlisted to make the above distinctions by objectively evaluating medical factors that may underlie a claimant’s allegations of incapacitation. For at least the past 45 years, the AMA has persuasively argued that physicians can evaluate these medical factors by performing impairment evaluations. In fact, most physicians and disability adjudicators think of impairment evaluations as being synonymous with evaluations of medical factors that contribute to disability.

In practice, agencies that administer work disability programs often combine impairment data with non-medical data (e.g. educational background and prior work history) to determine whether an individual is actually disabled from work. The logic of this approach can be summarized as follows:

1. Work disability results from a combination of medical and non-medical factors.
2. Impairment evaluations measure the medical component of disability – i.e. the severity of medical factors that contribute to work disability, therefore,
3. Work disability awards should be based on impairment evaluations supplemented by non-medical data.

### The Problem of Subjective Factors

However elegant the above syllogism appears to be, it leaves out an important category of information – the self-reports that disability applicants provide about their experiences as they try to engage in activities (Robinson et al. 2004). These reports provide a first-person perspective that, in principle, might be very important to the assessment of an applicant’s disability.

In particular, applicants can provide subjective data regarding a variety of aversive experiences – such as anxiety, pain, fatigue, or subjective weakness – that make it difficult for them to engage in normal activities. Pain is

the most common of the aversive experiences reported by applicants for work disability benefits.

The potential importance of subjective experiences is highlighted by Osterweis et al. in an Institute of Medicine monograph on the role of pain in disability awards by the Social Security Administration:

The notion that all impairments should be verifiable by objective evidence is administratively necessary for an entitlement program. Yet this notion is fundamentally at odds with a realistic understanding of how disease and injury operate to incapacitate people. Except for a very few conditions, such as the loss of a limb, blindness, deafness, paralysis, or coma, most diseases and injuries do not prevent people from working by mechanical failure. Rather, people are incapacitated by a variety of unbearable sensations when they try to work (p. 28) (Osterweis et al. 1987).

Pain and other unbearable sensations cannot be incorporated into impairment evaluations, as conceptualized in the AMA system, for two reasons. First, since pain is inherently subjective, the methods used to assess it violate the tenet that impairment evaluations should be based on objective indices of the function of organs or body parts. Secondly, pain and its effects need to be analyzed at the level of the whole person, rather than at the level of a specific organ or body part. People with chronic pain typically attribute their pain and activity limitations to dysfunction of an organ or body part. However, these subjective reports are difficult to assess precisely because examination of the involved organ or body part often does not identify abnormalities that make the pain reports inevitable. It often appears to an observer that the affected organ or body part is capable of functioning, but that the claimant does not use it normally because of pain. The observer must consider the person as a whole in order to make sense of the situation. Thus, the assessment of incapacitation secondary to pain violates the tenet that impairment evaluations should assess the functioning of organs or body parts, rather than the functioning of an individual as a whole.

### Attempts to Solve the Conundrum

At one level, the question of whether pain-related activity limitations can be construed as impairments is a simple one of semantics. In principle, it can be resolved in at least two ways. One is to expand the definition of “impairment”, so that the concept includes limitations secondary to pain. A second strategy is to retain the interpretation of impairment as a problem at the level of organs or body parts, but to stipulate that in the medical assessment of a disability applicant, a physician should evaluate both impairment and subjective factors – such as pain – that contribute to the applicant’s activity limitations.

Regardless of the semantic issue of whether or not pain is construed as a type of impairment, disability systems face a dilemma regarding the weight they place on pain

and other subjective factors (such as fatigue or perceived weakness) during disability determinations. If a system equates impairment with the medical component of disability, it will ignore the subjective factors that often play a dominant role in preventing people from working. Such a system would be objective, but might also be somewhat irrelevant, since it would systematically exclude important factors that bear on the ability of an individual to work. Conversely, a system that gives undue weight to the subjective reports of claimants may inappropriately reward ► **symptom magnifiers** and ► **malingers**. The challenge is to develop a disability assessment system that strikes a reasonable balance between the weight given to ► **objective factors** (such as amputations) and ► **subjective factors** (especially pain). No disability system has been able to resolve this challenge in a completely satisfactory way.

### References

1. Cocchiarella L, Andersson GBJ (2001) *Guides to the Evaluation of Permanent Impairment*, 5<sup>th</sup> edn. AMA Press, Chicago, Illinois
2. Osterweis M, Kleinman A, Mechanic D (1987) *Pain and Disability*. National Academy Press, Washington, DC
3. Robinson JP, Turk DC, Loeser JD (2004) Pain, Impairment, and Disability in the AMA Guides. *J Law Med Ethics* 32:315–326
4. US Government Printing Office (1994) *Disability Evaluation under Social Security* (SSA Publication No. 64-039). Washington, DC
5. World Health Organization (2001) *International Classification of Functioning, Disability and Health*. World Health Organization, Geneva

## Impairment Rating

- [Impairment Rating, Ambiguity](#)
- [Impairment Rating, Ambiguity, IAIABC System](#)
- [Rating Impairment Due to Pain in a Workers' Compensation System](#)

## Impairment Rating, Ambiguity

ALAN L. COLLEDGE, GREGORY KROH  
Utah Labor Commission, International Association  
of Industrial Accident Boards and Commissions, Salt  
Lake City, UT, USA  
farmboyac@msn.com

### Synonyms

Workers' compensation; Permanent Partial Impairment; Permanent Partial Disability; Ambiguity

### Definitions

Permanent partial impairment – a permanent loss of or abnormality of psychological, physiological, or anatomical structure or function permanent.

Permanent partial disability – a permanently reduced ability to engage in substantial gainful employment by reason of any physical or mental impairment.

### Characteristics

Permanent injury compensation is a large and growing component of workers' compensation system cost. In the US, it represents about two thirds of all indemnity benefits (Berkowitz and Burton 1987). Moreover, the frequency and cost of permanent injury is increasing as a share of all workers' compensation claims. Citing data from the National Council on Compensation Insurance, David Durbin states, "During the six-year period from 1988 to 1994, average PPD [permanent partial disability] costs increased 25%, an increase of approximately 4% per year, while the frequency increased almost 29% or 4.4% annually. These increasing average costs and frequencies have resulted in an increase in the permanent partial cost per worker of approximately 52% (over 7% annually) over the same six year period" (Durbin and Kish 1998).

Numerous wage-loss studies document that in virtually every state, and every classification of claimants, compensation awards are smaller than the actual or predicted wage losses that workers incur after an injury. Moreover, the correlation between impairment ratings and actual economic losses following injury are poor. For example, the statistical work by Durbin and Kish tries to measure the consistency of initial physician impairment ratings, disability ratings awarded, and final compensation given to injured workers across various US jurisdictions. They concluded that:

The results show that impairment ratings are only one of a variety of factors that systematically influence the size of a final disability award. Specifically, even for cases with benefits awarded for non-economic loss, in addition to the treating physician's determination of physical impairment, the determination of the degree of permanent disability appears to take into account factors such as age, sex, pre-injury wage, weekly temporary total benefits, and whether an attorney is involved in the case. Moreover, even after these other factors are considered, a less than one-to-one relationship exists between impairment and final disability ratings, which might be expected.

Similar results were found by Park and Butler (2000). They found that degrees of permanent impairment assigned by physicians, even under Minnesota's relatively well administered guidelines, were not statistically related to the reduction in pre-injury wages after the injury. Even after adjusting permanent injury awards for age, occupation, and other economic factors, they found that the impairment ratings had a very poor statistical relation to the actual wage loss. This finding is consistent with mainstream belief by medical and non-medical researchers in workers' compensation.



Several factors account for this lack of correlation between permanent disability compensation and wage loss. First, most jurisdictions do not consciously or deliberately set out to provide benefit levels that match the future loss of earnings. The statutes and rules that establish permanent injury compensation do not equate impairment with disability, nor do they explicitly state what the PPD award is intended to compensate. Rather, benefit levels are set in a political arena. The employer's cost of workers' compensation, and how that affects the competitive position of one jurisdiction relative to its competitors, is a far more common metric in the political debate than statistical measures of wage loss from permanent injuries.

Second, differences across workers cause the permanent disability formulae to be relatively more generous to some injured workers and relatively prone to under compensate others. Especially in pure impairment states, the rules for scheduled injury benefits impose uniform awards for each degree of physical loss, e.g. a 5% loss of the wrist is the same for a concert violinist and cement finisher. These uniform awards do not address the fact that relatively minor impairments often cause severe job limitations for construction workers, but minimal or no job limitations for office workers. In addition, younger workers tend to be under compensated for permanent injury relative to workers nearing retirement.

The focus of this paper is on the third reason for lack of predictability of impairment ratings: the physical measurements of bodily loss are not reliably and consistently measured by doctors. Doctors do not set benefit levels for specific injuries, but the measurement of physical loss they provide translates directly into dollar benefits. This lack of consistency among rating physicians is widely observed (for a review see Colledge 1994).

Much anecdotal evidence and a few formal studies suggest that a major problem with the system revolves around the consistency and defensibility of permanent impairment ratings made by physicians. Complaints in this area are routinely reported in the trade press. From the anecdotal evidence, the problem seems to exist in many jurisdictions.

Inconsistencies have been demonstrated when similar injury cases have been presented to multiple practitioners, and when the same practitioner has evaluated similar cases through time.

For example, in a 1999 study by the State of Texas, a significant number of the cases with multiple impairment ratings for the same injury showed disparities of 5% or greater: Specifically, the study found that 24% of injured workers with multiple impairment ratings had no difference between the first and last ratings, 29% had a difference of 5–10 percentage points, and 14% had a difference of 10 percentage points or more. One of the authors has documented similar inconsistencies in the State of

Utah prior to that state's recodification of impairment rating guides (Colledge 2001).

Multiple factors contribute to these inconsistencies. A major source of the problem is that state laws and regulations related to impairment and disability evaluation are often poorly crafted and are inconsistent in awarding payment, how benefit levels are set, and the formulas and procedures for guiding physician impairment ratings. Victor and Boden (1991) contend that the clarity of law on evaluating permanent injury helps control disputes. Even if laws and regulations are consistent within states, there are often inconsistencies in methods and expectations across states. This is problematic for doctors who have multi-state practices or attempt to deal with these issues from a national perspective. Another challenge for doctors is that state laws, regulations, and administrative law judges are sometimes out of step with the best available medical evidence.

Finally, injuries differ greatly in the ease with which they can be rated. A wide variety of common injuries are amenable to reasonably concrete and precise formulae, which convert measured losses to percentages of loss of use of a limb or the whole body. This type of injury is often classified as a scheduled injury. The rating of many scheduled injuries is not particularly difficult or ambiguous for a reasonably trained practitioner. For example, amputations or total loss of use of extremities are not a major source of error or inconsistency. They are objective and relatively easy to measure.

Problems can arise, though, in the evaluation of partial loss to an extremity. At what point does nerve, tendon, joint, or muscle damage render an arm or hand functionally useless? The rules on rating such partial disabilities are variable from jurisdiction to jurisdiction. A much greater problem arises in rating injuries to the spine, which are governed by much more general and subjective guidelines.

Psychological or mental injury and all the related behavioral and motivational consequences are another intractable problem. Psychological injury is real, but it is very difficult to differentiate from pre-existing psychological illness not related to the workplace and it is difficult to rate or measure. For these reasons psychological injury is a lightning rod where it is being compensated by workers' compensation. New South Wales is one recent example: "...the rights of the people of NSW have been gravely compromised by the Government's subsequent decision to use the very flawed and unfair Psychiatric Impairment Rating Scale (PIRS) to measure such impairments, and by excluding psychologists from assessment of psychological and psychiatric impairment. Apparently the Government is attempting to save on compensation payouts at the expense of psychologically impaired workers. This is a dangerous election ploy. (Lynette Shumack, NSW Executive, The Australian Psychological Society, April 5, 2002)

Rating pain is the greatest problem of all. Some jurisdictions take the position that pain is not compensable in workers' compensation. Others hold that the pain must be directly linked to the loss of use of body part, e.g. acute pain limiting the range of motion on a limb. Policy makers in such jurisdictions apparently hold the belief that workers' compensation is a no fault system that tries to get away from the problems of measuring pain and suffering that are so difficult to assign values to in civil tort cases. Other jurisdictions make some allowance for pain, if only in an indirect or implicit way. For example, some jurisdictions assign minimum impairment ratings for surgery even if the outcome was rated as 100% successful in restoring function. This might implicitly be regarded as a reward to the injured worker for the uncertainty and trauma of the surgical procedure.

In the ideal situation, a skilled practitioner using a well-defined set of criteria might be able to fairly rate the intangibles of an injury, most importantly pain. However, there is ample evidence to suggest that pain is difficult to evaluate and subject to a host of psycho-social overlays that have nothing to do with the injury itself.

Inconsistencies develop not only over the severity of impairment associated with an injury, but also over causation of the impairment. Disagreements regarding causation are particularly likely to occur when workers sustain covert injuries (such as repetitive strain injuries of the upper extremity) rather than overt ones (such as an upper extremity fracture), when an injury is superimposed on a chronic musculoskeletal condition, workers present with symptoms that do not have a clear cause or etiology, e.g. sick building syndrome or stress claims.

The consequences of the Inconsistencies described above are substantial. They tend to lead to "deuling doctors" (that is, differences of opinion between the treating physician and an expert hired by the payer of the claim), delays, and high cost litigation. In general, disputes over medical evidence are very expensive. The personnel and the support system needed for hearings tend to be among the most expensive parts of a workers' compensation agency budget. State agencies are continually experimenting with techniques to reduce case backlogs and speed decisions. Delays and other inefficiencies stimulate legislative inquiries, and as constituent frustration levels rise, lawmakers are inclined to "reform" the system. Some states go through a cycle of reform-dissatisfaction-reform

For these reasons it is vital that permanent injury benefits be managed better in most states. The keys to success:

- Fixed conditions under which permanent injury benefits can be awarded.
- A clear trigger for when permanent injury can be evaluated.
- Well defined responsibilities for the physician who is to make the legally required medical determinations.

- Uniform procedures for the measurement and evaluation of the parameters of permanent impairment to the body.
- An objective way to express the basis for the impairment rating.

Whenever any one of these is lacking, doubt and mistrust by workers or their employers enters into the benefit award. Also, opportunists find ways to exploit the ambiguity to maximize gains by "gaming" the system. Gaming the system or adversarial disputes are signs of system failure in workers' compensation.

The State of Wisconsin presents an example of a very smoothly functioning impairment system for scheduled injuries. Wisconsin Administrative Rule 80.20 specifies quite clearly how impairments from scheduled injuries translate into percentages of body part loss. Loss of motion of fingers is a good example: the physician need only measure the loss of flexion and extension at each joint of the injured finger(s) to produce a precise measure of impairment under Wisconsin law. Even more serious/complex injuries to the knee have explicit standards. Finger and knee impairment ratings by treating physicians are almost never challenged by claims adjusters and virtually never litigated.

The role of physician or administrative judgment has been circumscribed by many jurisdictions. They have reacted to ambiguity in various ways: 1) eliminating the compensability of a class of injuries, 2) constraining the range of judgment about certain injuries, or 3) assigning a narrow range of estimates. These understandable responses to uncertainty have the undesirable consequence of introducing inequity. Some workers are simply not compensated as much as they should be relative to other workers with more tangible and specific injuries. This is a political, not medical, issue. Clearly, simple and direct rules work. They mete out compensation with efficiency and speed. Of course, some would object that "cookie cutter" justice is unfair. Yet, the very basis of workers' compensation is accepting administrative simplicity in benefit delivery for the individualistic tort based approach to equitable benefit determination.

In a companion essay (Impairment – Ambiguity, Part 2 – the IAIABC System), the work of the International Association of Industrial Accident Boards and Commissions (IAIABC) to improve the process of rating injuries is described.

## References

1. Berkowitz, Monroe, Burton J (1987) Permanent Disability Benefits in Workers' Compensation. W.E. Upjohn Institute for Employment Research, Kalamazoo, Mich
2. Colledge A (1994) Impairment Ratings. Occupational Health and Safety, July 1994
3. Colledge A, Sewell J, Hollbrook B (2001) Impairment Ratings in Utah, Reduction of Variability and Litigation within Workers' Compensation. Disability Medicine, ABIME 1

4. Durbin D, Kish J (1998) Factors Affecting Permanent Partial Disability Ratings in Workers' Compensation. *J Risk Insur Mt. Vernon*; Mar 1998
5. Park Y-S, Butler R (2000) Permanent Partial Disability Awards and Wage Loss. *J Risk Insur* 67:331–350
6. Shumack L (2002) NSW Executive. *The Australian Psychological Society*, April 5
7. Victor R, Boden L (1991) Model States Show Lawsuits Can Be Prevented. National Underwriter, Chicago

## Impairment Rating, Ambiguity, IAIABC System

ALAN L. COLLEDGE, GREGORY KROH  
Utah Labor Commission, International Association  
of Industrial Accident Boards and Commissions, Salt  
Lake City, UT, USA  
farmboyac@msn.com

### Synonyms

Workers' compensation; Permanent Partial Impairment; Permanent Partial Disability; Ambiguity; IAIABC system

### Definitions

Permanent partial impairment is defined as a permanent loss of or abnormality of psychological, physiological, or anatomical structure or function permanent.

Permanent partial disability is defined as a permanently reduced ability to engage in substantial gainful employment by reason of any physical or mental impairment.

### Characteristics

In the past, many jurisdictions, especially in North America, have deferred to the American Medical Association (AMA) Guides for rating occupational injuries. These guides have gone through years of evolution and are now in their 5<sup>th</sup> edition. The evolution has not mitigated disputes over the clarity and consistency of the guides. Spieler et al. (2000) best catalogued the shortcomings of the AMA Guides in the *Journal of the American Medical Association*. A survey done by the International Association of Industrial Accident Boards and Commissions (IAIABC) of workers' compensation agencies showed a high degree of dissatisfaction with the AMA 5<sup>th</sup> Edition.

Unfortunately, because of the lack of sensitivity and specificity of the Guides for evaluating impairment in injured workers, some jurisdictions have set out their own standards. As an example, the background section to the 1996 Florida Uniform Impairment Rating Schedule states:

In the past, much confusion has resulted from inadequate understanding by physicians and others of the scope of medical responsibility in the evaluation of permanent

disability, and the difference between "permanent disability" and "permanent impairment." It is vitally important for every physician to be aware of his or her proper role in the evaluation of permanent disability under any private or public program for the disabled. It is equally important that physicians have the necessary authoritative material to assist them in competently fulfilling their particular responsibility – the evaluation of permanent impairment (Section 440.13, Florida Statutes).

Wisconsin, Florida and at least seven other jurisdictions in the US have developed their own guides for impairment rating. To date, there has been little sharing of information among the states on "best practices."

During the Fall of 2001, the International Association of Industrial Accident Boards and Commissions (IAIABC) began to study the feasibility of a way to assist physicians in rating permanent occupational injuries. A special committee of 16 doctors and other medical experts was formed to develop a supplemental guide to the AMA Guides. Its focus was on occupational impairment rating and injury types that are most difficult to rate.

These supplemental guides contain:

- An introduction to practitioners on the nature of occupational impairment rating.
- Definitions of key terms and concepts, such as maximum medical improvement.
- Discussion of general issues, especially the measurement of pain.
- Guides to rating surgical and non-surgical injuries of the back.
- Guides for rating the upper and lower extremities.
- Standardized reporting worksheets.

An introduction to impairment rating is critical because many physicians who do ratings are unsure of their role, or have misunderstandings about the rating procedure in a given jurisdiction. This is particularly true of those who only do ratings on an occasional or infrequent basis, or who are confronted with a rating scheme from a jurisdiction outside their normal practice.

### Methodology

The Impairment Rating Committee embraced some guiding principles in their development of the supplemental guides:

- They should be based on the best available empirical evidence on the reliability of tests, measurements, and correlations of measurements to biomechanical limits on the normal use and functioning of the body.
- They should be practical in their administration by physicians.
- They should be clearly explainable to practitioners.

These principles are challenging to implement. They involve tradeoffs. For example, sophisticated mea-

tures that might be arguably more precise might be impractical and costly for a non-specialist physician. Also, the goals of objectivity and practicality often fly in the face of individual equity. The participants in the preparation of the draft IAIABC guides have elected to err on the side of simple consistent rules based on objective medical evidence.

Pain is a particularly controversial issue. It is a real consequence of injury and surely affects post injury reintegration into work and non-work activities of daily living. Having said this, the committee could not find many reliable and practical tools for rating most injuries for residual pain. Some psychological tools may be able to consistently differentiate between simulated pain and “really experienced” pain. Further, such tools may be able to gauge the approximate degree of experienced pain. However, the tools available to the drafters appeared to fall short of being easily learned and applied by treating physicians who do not specialize in occupational injury.

### Results

To date, provisional Supplemental Guides have been produced. They provide specific guidance on issues not fully or clearly addressed in the AMA Guides.

Part 1 of the Supplemental Guides provides general background on the workers’ compensation system and the role of the physician in awarding benefits for permanent work injuries. Much of this educational material is common knowledge for jurisdictional administrators, workers’ compensation managers, and claims adjusters. Yet, it is surprising how few physicians who do not practice occupational medicine understand these fundamental concepts. The physician-rater must have an appreciation of their role in the benefit process for the system to work in accordance with the law.

This first part also reviews some of the generic concepts of impairment rating, such as maximum medical improvement and apportionment of injury. The highly controversial subject of pain is also addressed.

Part 2 of the Supplemental Guides addresses issues and problems associated with injuries to the back.

Part 3 is for rating upper and lower extremities to the draft guides.

The review process of the exposure draft of the Supplemental Guides continues. The current status of the Supplemental Guides can be viewed at [http://www.iaibc.org/Impairment/Impairment\\_index.htm](http://www.iaibc.org/Impairment/Impairment_index.htm)

### Impairment Ratings for Pain

The IAIABC system stresses the importance of simplicity, consistency and objective medical evidence in the assessment of impairment. Impairment ratings based on these principles are possible for many common injury types, but objective, consistent methods have not yet been developed for subjective conditions such as pain and psychological injury. Therefore, the IAIABC supplemental guides do not offer a comprehensive

method for rating these conditions, although they do provide methods for rating selected conditions such as phantom pain from amputation. Of course this does not mean that subjective injury is not real. Evaluating and compensating it pose great practical problems – in particular increases in disputes, challenges, and litigation, which many jurisdictions want to avoid. In effect, the Supplemental Guides subordinate the quest for better individual equity on claims to overall system savings. Thus, purely subjective conditions, if they are to be compensated, should be addressed by explicit norms and rules outside the purview of medical examiners and raters.

### Uses to Date

To date, the best practical application of the Supplemental Guides is in the State of Utah. In many respects the guides resemble administrative rules adopted by that state for the rating of permanent injuries.

The use of the Utah guides has had a dramatic reduction on litigation over impairment disputes. Less than one percent of claims with permanent disability are litigated since the revised impairment guides were adopted in 1997. This produced a dramatic cost savings to the Utah Labor Commission, since the direct cost to the agency is estimated to be \$5,200 per case litigated. The chief administrator of the Utah Commission reports that the 1997 guides have been well received by attorneys, insurers, and worker representatives.

The IAIABC supplemental guides will not displace the need for the AMA guides. Rather, they provide support, clarification, and extension of the AMA guides. Individual states may wish to adopt portions of the IAIABC guides for specific issues or classes of claims.

### Conclusions

Ambiguity and uncertainty over rating permanent injury produce higher administrative costs for workers’ compensation systems, because: (1) Multiple examinations caused by disputed ratings are expensive, and (2) litigation over large discrepancies in ratings causes delay in benefits and further administrative cost.

One cure for the above problems of compensating for permanent injury is to establish clear and simple rules for awarding benefits. The downside to simplicity is a loss of individual equity and fairness among injured workers, i.e. some are relatively better off, and some are disadvantaged by rules that do not take into consideration how their physical loss has affected their earnings potential. This paper has argued for rating systems that stress objective medical evidence and consistent guidelines. These emphases are possible for many common injury types, but objective, consistent methods have not yet been developed for subjective conditions such as pain and psychological injury. Therefore, the IAIABC supplemental guides do not offer a comprehensive method for rating these conditions, although it does



provide methods for rating selected conditions such as phantom pain from amputation. Of course this does not mean that subjective injury is not real. Evaluating and compensating it creates great practical problems – in particular increases in disputes, challenges, and litigation, which many jurisdictions want to avoid. In effect, the Supplemental Guides subordinate the quest for better individual equity on claims to overall system savings. Thus, purely subjective conditions, if they are to be compensated, should be addressed by explicit norms and rules outside the purview of medical examiners and raters.

We re-emphasize that impairment rating does not predict disability or loss of earning capacity. Further, we take no position on whether a jurisdiction should use pure impairment ratings, adjustments for age/occupation, wage loss, or some hybrid system taking all of these factors into consideration. The purposes of this essay are to note that many impairment ratings using AMA guides are inconsistent and indefensible, and to describe steps taken by the IAIABC to develop supplemental guides.

### References

1. Cocchiarella L (2001) Guides to the Evaluation of Permanent Impairment, 5<sup>th</sup> edn. American Medical Association, Chicago, IL.
2. Spieler E, Barth PS, Burton JF Jr (2000) Recommendations to Guide Revision of the Guides to the Evaluation of Permanent Impairment. *J Am Med Ass* 283:519–523

## Impartial Medical Evaluation

- ▶ Independent Medical Examinations

## In Vitro

### Definition

Latin for “in glass” In cells or tissues obtained from animals and maintained outside the living organism by artificial means. Opposite to *in vivo*.

- ▶ Descending Circuitry, Opioids
- ▶ In Vitro CCK Release
- ▶ NSAIDs, COX-Independent Actions

## In Vitro CCK Release

### Definition

Tissue slices of certain CNS regions are placed in a perfusion chamber, and the concentration of CCK-like immunoreactivity (CCK-LI) is monitored in the perfusion

medium surrounding the tissue. The effect of pharmacological agents can be studied by administration to the perfusion medium. Both basal and potassium/veratridine induced release can be studied.

The release of CCK-LI can be related to the total concentration in the tissue slices.

- ▶ Opioid-Induced Release of CCK

## In Vivo

### Definition

Within a living organism.

- ▶ Animal Models of Inflammatory Bowel Disease
- ▶ Descending Circuitry, Opioids
- ▶ In Vivo CCK Release by Microdialysis

## In Vivo CCK Release by Microdialysis

### Definition

*In vivo* microdialysis in distinct regions of the CNS can be used to monitor changes in the extracellular concentration of neuropeptides, for example, CCK in response to administration of opioids. The major advantage of this technique is that experiments can be performed on awake or anaesthetized animals with intact neuronal connections, and that drugs can be administered in a way that mimics the clinical situations as close as possible.

However, it has to be kept in mind that the microdialysis technique can only monitor the extracellular level, which is affected not only by release, but also by enzymatic degradation and diffusion of the released transmitter.

The concentration of CCK in the microdialysate is typically determined by radioimmunoassay. The dominating molecular form detected is sulphated CCK-8, but other minor components may also contribute to the CCK-like immunoreactivity (CCK-LI) measured. Thus, microdialysis studies do not investigate CCK release per se, but the overflow of CCK-like immunoreactivity (CCK-LI) to the extracellular fluid.

The low extracellular concentration and the relatively large molecular size of neuropeptides limits the usefulness of this technique for measurement of release of this class of substances. For these reasons highly sensitive detection methods have to be used in combination with relatively large microdialysis probes (250  $\mu$ m diameter; 1-2 mm length) and extended sampling periods (15-30 min). Furthermore, in order to prevent enzymatic peptide degradation in the extracellular space, peptidase inhibitors have to be added to the perfusion medium.

- ▶ Opioid-Induced Release of CCK

## Inactive Agent

- ▶ Placebo

## Inappropriate Symptoms and Signs

- ▶ Non-Organic Symptoms and Signs

## Inbred Strains

### Definition

The result of repeated brother x sister matings over at least 20 generations. This breeding scheme eliminates heterozygosity, rendering each individual genetically identical (isogenic) to all others of the strain, barring rare *de novo* mutations. A large number of inbred mouse strains have been developed, all ancestors of European and East Asian „fancy mice“ originally bred at the turn of the 20<sup>th</sup> century. Due to their isogenicity, within-strain variation must be due to environmental factors, whereas between-strain variation is likely to be due to genetic factors.

- ▶ Heritability of Inflammatory Nociception
- ▶ Heterozygosity
- ▶ Opioid Analgesia, Strain Differences

## INCB

- ▶ International Narcotics Control Board

## Incentive

- ▶ Motivational Aspects of Pain

## Incidence

### Definition

Incidence is the number of new events occurring in a defined population during a specified time period.

- ▶ Low Back Pain, Epidemiology
- ▶ Migraine Epidemiology
- ▶ Prevalence of Chronic Pain Disorders in Children

## Incidence of Low Back Pain

- ▶ Low Back Pain, Epidemiology

## Incident Pain

### Definition

Incident pain is a subtype of breakthrough pain that occurs as the result of normal voluntary or involuntary movement but does not typically occur at rest. Incident pain often occurs predictably in response to identified triggers. Consequently, it may be possible to provide prophylactic pain control for these episodes.

- ▶ Breakthrough Pain
- ▶ Cancer Pain, Animal Models
- ▶ Cancer Pain, Goals of a Comprehensive Assessment
- ▶ Evoked and Movement-related Neuropathic Pain
- ▶ Rest and Movement Pain

## Incision Model for Postoperative Pain

- ▶ Nick Model of Cutaneous Pain and Hyperalgesia

## Inclusion Body Myositis

### Definition

Slowly progressive, immunogenic myositis especially in the elderly which involves proximal and distal muscles from the beginning. It is often asymmetric. Muscle wasting is nearly always pronounced in selected muscles. Muscle pain is absent. The diagnosis can be confirmed by muscle biopsy including electronmicroscopy.

- ▶ Myositis

## Incomplete Cross Tolerance

### Definition

Refers to a special type of cross tolerance between two drugs. Cross tolerance occurs when repeated dosing with drug A results not only in a decrease in the response to drug A but also to another, usually related, drug B. Therefore, the potency of a test dose of B is decreased by the repeated administration of A. If the loss of potency of B is estimated to be less than the loss of potency to A, it is assumed that the cross tolerance between A and B is incomplete. In analgesic therapy, incomplete cross tolerance complicates the estimation of the opioid rotation dose when switching from A to B.

- ▶ Opioid Rotation

## Incomplete Spinal Cord Injury

### Definition

Spinal cord injury where there is some preservation of distal function. This has in the past led to some confusion. The American Spinal Injury Association (ASIA) Classification defines a complete injury as “ASIA A is defined as a person with no motor or sensory function preserved in the sacral segments S4–S5” There are four categories of incomplete injuries. Please refer to <http://www.asia-spinalinjury.org> for more details

- ▶ Spinal Cord Injury Pain

## Inconsistent Symptoms and Signs

- ▶ Non-Organic Symptoms and Signs

## Indemnity Costs

### Definition

Indemnity costs are expenditures paid to an injured worker to cover the harm, loss, or damage associated with a work-related injury.

- ▶ Pain in the Workplace, Risk Factors for Chronicity, Workplace Factors

## Independent Medical Evaluation

- ▶ Independent Medical Examinations

## Independent Medical Examinations

CHRISTOPHER R. BRIGHAM  
Brigham and Associates, Inc., Portland, ME, USA  
[cbrigham@brighamassociates.com](mailto:cbrigham@brighamassociates.com)

### Synonyms

IME; Independent Medical Evaluation; Impartial Medical Evaluation; Agreed Medical Examination; Binding Medical Examination; Neutral Medical Examination

### Definition

Independent medical evaluations (IMEs) are examinations performed by a physician, or another healthcare provider, who is not involved in the person's care, to answer medical and case questions associated with a workers' compensation, personal injury or disability claim (Brigham and Engelberg 1994).

### Characteristics

Independent medical evaluations (IMEs) are performed to provide information for case management, and for evidence in hearings and other legal proceedings (Brigham et al. 1996). IMEs are a component of all workers' compensation statutes, although the specifics vary by state (Tompkins 1992). They are also widely used in automobile casualty, personal injury and disability cases. IMEs are also an integral component of case management and are used universally by insurers, attorneys (defense and plaintiff), and others involved in these cases. They are performed at several stages during the cycle of injury/illness, treatment, rehabilitation and return to work (Demeter et al. 1996). These evaluations are often performed to clarify physical, behavioral, psychological, psychosocial, vocational, and legal issues. (Aronoff 1991; Turk et al. 1988).

Assessments may be requested because of a lack of medical information or conflict on specific matters, such as the cause of a problem, the severity of the problem, the prognosis (the outlook for the future), the impairment (the loss of, loss of use, or derangement resulting from an injury), the functional abilities of the examinee, appropriateness of care, and recommendations. Due to the nature of these cases, most IMEs are done for pain-associated complaints.

These evaluations vary in complexity, dependent upon the specifics of the case and the issues involved. The process may require hours of physician time, dependent both on the case and the effectiveness of the physician. Most evaluations are based on a single visit with the examining physician. Occasionally an evaluation may involve multiple physicians.

The examinee is not necessarily a willing participant, and may present with more dysfunctional behavior than is usually encountered in a typical treatment setting. The assessments, therefore, are more challenging and require greater patience. Depending on the complexity of the case and the tools used in the process, a comprehensive IME may require up to several hours of physician time, with approximately two hours of that time spent with the examinee. The use of other staff, structured assessment protocols, and software will reduce the time needed to conduct a thorough evaluation.

The performance of these assessments requires specific skills in addition to clinical acumen. The physician must not only have a strong clinical background, but also have an appreciation of the biomedical, emotional, and vocational aspects of injury and illness. Credentials should be solid; this is not an arena for an inexperienced physician or someone who is unable to support conclusions if challenged. The specialty of the physician performing the evaluation is often dependent on the type of problem the examinee is experiencing, and/or the specialty of the treating physician. Specialties commonly involved in performing these evaluations are physical medicine

and rehabilitation, orthopedic surgery, occupational medicine, neurology, neurosurgery, pain management, psychiatry, and psychology.

The examiner doing an independent medical evaluation needs to keep in mind the three elements of an IME: independent, medical, and examination. Evaluations are to be independent, impartial, and without bias toward the client. All physicians have biases based upon their experiences and perspective. The evaluator should strive not to allow these biases to distort the evaluation of a case. IMEs are medical evaluations. They involve the essential elements of a medical assessment including history, examination, and review of applicable diagnostic studies.

Independent medical evaluations are not done for the purpose of medical treatment. The sole purpose of an IME is to provide information to the client who requested the evaluation. There is no treating physician/patient relationship. The information presented by the individual being examined (i.e. the examinee) is presented in the report and may be conveyed to the client, as the examinee has waived the traditional physician/patient confidentiality relationship. The person being evaluated is known as the "examinee" and the person requesting the evaluation is known as the "client".

The product of an independent medical evaluation is the examiner's report to the client. The client requesting the IME relies upon the report and what is contained in it. The report should be considered a legal document, and therefore should be a thorough, clear, easy-to-read report and address the issues requested by the client. The report reflects the quality of the evaluation.

#### Issues Addressed in IMEs

Issues associated with an IME often differ from clinical consultations in role and focus. The most common issues are diagnosis, causation, prognosis, maximal medical improvement, permanent impairment, functional ability (work capacity), appropriateness of care, and recommendations. Typically, the client requesting the examination will pose specific questions.

Pain, pathology, impairment, residual functional capacity, and disability are separate concepts. Pain, especially chronic pain, may not be associated with significant physical pathology (Loesser 1991). Pathology may be present without symptoms or dysfunction. Impairment is a measurable decrement in some physiologic function, whereas disability considers not only the physical or mental impairment but also the social, psychological, or vocational factors associated with a person's ability to work (Brena and Spektar 1993). Functional limitations are manifestations of impairment (Vasudevan 1992). Chronic pain, the most common problem seen in the performance of IMEs, may not be a symptom of an underlying acute somatic injury, but a multidimensional biopsychosocial phenomenon. A multi-axial assessment of biomedical,

psychosocial, and behavioral-functional issues is necessary (Turk 1991, Turk et al. 1988, Turk and Melzack 1992).

Diagnoses, i.e. clinical impressions, include the primary illness or injury and other significant conditions. They are commonly presented as a problem list of clinical diagnoses in relative order of significance. The significance of medical problems is discussed, such as the relationship between the extents of symptoms (subjective complaints) and signs (objective findings). Causation is a critical issue in work-related and liability cases. A work-related problem is defined as one that "arose out of and during the course of employment." (Larson 1982). The physician must establish causation to a reasonable degree of medical probability, which implies that it is more probable than not (i.e. there is more than a 50% probability) that a certain condition is secondary to an injury. Possibility implies less than 50% likelihood. A medical condition may be the result of one or multiple factors. Apportionment refers to the extent to which a condition is related to each of the multiple factors. An aggravation implies a long-standing effect due to an event, resulting in a worsening, hastening, or deterioration of the condition. An exacerbation is a temporary increase in symptoms from the condition. Thus, an aggravation has an ongoing substantial impact on the physical condition, whereas an exacerbation results in a flare of symptoms, without a significant change in the underlying pathology.

The client may request that the physician identify the prognosis for a problem, that is, the extent and predicted time of recovery.

Maximal medical improvement is a phrase used to indicate when further recovery and restoration of function can no longer be anticipated to a reasonable degree of medical probability.

The client may request an impairment evaluation as part of the assessment. These are usually performed using the American Medical Association's Guides to the Evaluation of Permanent Impairment (American Medical Association 2000). The Guides distinguish between an impairment evaluation and a disability evaluation. According to the Guides, impairment is "the loss of, the loss of use of, or a derangement of any body part, system or function" and disability is "the limiting loss of the capacity to meet personal, social or occupational demands, or to meet statutory or regulatory requirements." Impairment is considered permanent when it has reached maximum medical improvement (MMI), meaning it is well-stabilized and unlikely to change substantially in the next year with or without medical treatment.

Subjective complaints such as fatigue or pain, when not accompanied by demonstrable organ dysfunction, clinical signs or other independent, measurable abnormalities, are generally not ratable with the AMA Guides. However, a significant change with the 5<sup>th</sup> Edition is that pain may be ratable if there is an under-



lying organic cause, providing up to 3% whole person permanent impairment in certain circumstances.

Functional ability, specifically work capacity, is a primary issue in many IMEs. Judgments of work capability are formed by the examinee's report, clinical condition, and measurements of functional performance. Disability durations that provide the length of disability typically associated with a diagnosis or disorder may also provide very valuable insight into how much and how long a problem may have an impact on functional ability. (Reed 2001).

Clients may request a review of the appropriateness of care or recommendations. This review can include issues of unnecessary and/or omitted diagnostic evaluation, and inappropriate, excessive, and/or omitted treatment.

### IME Process

The IME process consists of three phases: pre-evaluation, evaluation, and post-evaluation. The use of structured questionnaires, inventories, and software with report templates facilitates this procedure.

A request for an IME specifies issues to be addressed and background, demographic, clinical, and claims information. The examinee may be asked to complete a questionnaire and inventories, either as forms or computer-based, before the evaluation. Pain and functional inventories are particularly helpful in identifying behavioral and psychological components related to an illness or injury.

At the beginning of the visit, the physician explains the nature of the evaluation, that an independent evaluation will be conducted, and no treatment will be provided. There is no patient-physician relationship, and a report will be sent to the requesting client. The history usually commences with a detailed review of the injury or illness, including the reported mechanism, symptoms at the time, and events immediately thereafter. The history also includes relevant preexisting conditions and prior injuries. The chronology of events from the time of injury through to the present is determined. The current status is explored in detail, with attention directed to the examinee's primary concern. The person's perceived functional status is documented to clarify both capacity and behavioral issues. The examinee's perceptions are useful in understanding the personal experience with the medical problem. The history includes a thorough occupational history, particularly if the individual is disabled, and psychosocial history. The history concludes with a traditional past medical history, which notes medical and surgical procedures, medications and allergies, review of systems, and family history.

The physical examination includes a behavioral assessment and detailed examination of the involved area(s). Regional examinations should ensure reliability and ideally reproducibility of positive, negative, and

non-physiologic findings (Waddell et al. 1992; Harris and Brigham 1990). The assessment should also look for non-physiologic findings of symptom magnification.

Psychological and behavioral factors must be considered in a disability assessment (Osterweis et al. 1987). A number of self-report, interview, and behavioral inventories have been developed to assess pain and disability (Tait 1993). Numerous self-report instruments have been developed, using both comprehensive and brief formats. It is useful to include these in an IME to assess behavioral, personality, psychological and psychosocial issues. Radiographic films brought by the examinee (or supplied by the client) are reviewed at the visit. The findings are compared with those of the reviewing radiologist.

Most clients prefer that the examiner does not discuss their findings directly with the examinee, nor send the examinee a copy of the report. Reports should be organized and detailed, and present the information obtained during the evaluation. The available medical records, the patient's behavior and quality as a historian, individuals accompanying the examinee, and the context of the assessment should be described. The history, physical examination findings, results of pain inventories, and interpretation of radiographic studies should follow. Each of the issues and questions asked by the client should be answered in the discussion.

### References

1. American Medical Association (2000) Guides to the Evaluation of Permanent Impairment, 5<sup>th</sup> edn. American Medical Association, Chicago
2. Aronoff GM (1991) Chronic Pain and the Disability Epidemic. *Clin J Pain* 7:330
3. Brena SF, Spektar S (1993) Systematic Assessment of Impairment and Residual Functional Capacity in Pain-Impaired Patients. *J Back Musculoskel Rehabil* 3:6
4. Brigham CR, Engelberg AL (1994) The Disability/Impairment Evaluation. In: McCunney RJ (ed) *A Practical Approach to Occupational and Environmental Medicine*, 2<sup>nd</sup> edn. Little, Brown, Boston, MA, p 85
5. Brigham CR, Mangraviti JJ, Babitsky S (1996) The Independent Medical Evaluation Report: A Step-by-Step Guide with Models. SEAK, Inc, Falmouth, MA
6. Demeter SL, Andersson GBJ, Smith GM et al. (1996) Disability Evaluation. Mosby, St. Louis, MO
7. Harris JS, Brigham CR (1990) Low Back Pain: Impact, Causes, Work Relatedness, Diagnosis and Therapy. *OEM Rep* 4:84
8. Larson, A (1982) *The Law of Workmen's Compensation*, New York: Matthew Bender
9. Loesser JD (1991) What is Chronic Pain? *Theor Med* 12: 213
10. Osterweis M, Kleinman A, Mechanic D (1987) Institute of Medicine Committee on Pain, Disability and Chronic Illness Behavior (eds) *Pain and Disability: Clinical, Behavioral, and Public Policy Perspectives*. National Academy Press, Washington, DC
11. Reed P (2001) *The Medical Disability Advisor*. Reed Group, Ltd, Boulder, CO
12. Tait RC (1993) Psychological Factors in the Assessment of Disability Among Patients with Chronic Pain. *J Back Musculoskel Rehabil* 3:20

13. Tompkins N (1992) Independent Medical Examination: The How, When, and Why of this Useful Process. OSHA Compliance Advisor 215:7–12
14. Turk DC (1991) Evaluation of Pain and Disability. J Disability 2:24
15. Turk DC, Melzack R (1992) Handbook of Pain Assessment. Guilford Press, New York
16. Turk, DC, Rudy TE, Steig RL (1988) The Disability Determination Dilemma: Toward a Multi-Axial Solution. Pain 3:217
17. Vasudevan SV (1992) Impairment, Disability, and Functional Capacity Assessment. In: Turk DC, Melzack R (eds) Handbook of Pain, Assessment. Guilford Press, New York
18. Waddell G et al. (1992) Objective Clinical Evaluation of Physical Impairment in Chronic Low Back Pain. Spine 17:617

## Indirect Suggestion

### Definition

Indirect suggestion, in the context of hypnosis, refers to a suggestion that is vague and/or permissive and offers several alternatives for experience and behavior (e.g. "I wonder if the sensations in your hand will feel unexpectedly different than before, perhaps more like numbness or tingling or perhaps nothing at all, with nothing to bother or disturb you.")

- ▶ Hypnotic Analgesia

## Individual Differences

### Definition

Individuals differ markedly from one another in the pain they experience in response to virtually identical tissue trauma. Although this stems in part from genetic factors that influence nociceptive transduction and/or transmission, most inter-individual variance reflects each individual's unique construction of the pain experience.

- ▶ Consciousness and Pain
- ▶ Personality and Pain

## Indomethacin

### Definition

A non-steroidal, anti-inflammatory (NSAID) medication. These agents are usually used in the treatment of arthritis, but are potent pain relievers and can be used in the treatment of many painful conditions. Several headache disorders are termed "indomethacin-responsive" in that indomethacin, but none of the other NSAID's, treat the pain and associated symptoms. Indomethacin-responsive headache disorders include hemicrania continua, the paroxysmal hemicranias, and primary stabbing headaches.

- ▶ Hemicrania Continua

## Induration

### Definition

Induration is an increase of fibrous elements in tissue commonly associated with inflammation.

- ▶ Autologous Thrombocyte Injection as a Model of Cutaneous Pain

## Inert Agent

- ▶ Placebo

## Infant Composite Pain Measures

- ▶ Pain Assessment in Neonates

## Infant Pain

- ▶ Long-Term Effects of Pain in Infants

## Infant Pain Instruments

- ▶ Pain Assessment in Neonates

## Infant Pain Mechanisms

KATHARINE ANDREWS CAMPBELL  
Department of Anatomy and Developmental Biology,  
University College London, London, UK  
k.campbell@ich.ucl.ac.uk

### Synonyms

Pain Mechanisms Investigation in Human Infants; Human Infant Pain Neurophysiology

### Definition

Infant pain mechanisms comprise the functional and structural processes involved in the handling of noxious stimuli within the developing nervous system in children under 1 year. An understanding of these processes is vital for appropriate pain assessment and management in this age group. Nevertheless, much remains to be discovered in this area. Although there have been elegant studies on developing animals, which have elucidated some of the elements underlying pain mechanisms at the level of the spinal cord, very little is known of how signals from noxious stimuli are processed at higher levels of the nervous system up to and including the cerebral cortex in either animals or humans when they

are very young. Neurophysiological studies on human newborns and infants are technically difficult to perform and ethically it is totally unacceptable to give children painful stimuli of any kind except through clinical necessity, such as a heel lance for required blood sampling (Andrews 2003). Therefore, inference has to be drawn by recording responses that are modulated by the presence of ongoing pain, but that can be elicited using non-noxious stimuli, such as the ► [flexion withdrawal reflex](#) and the ► [abdominal skin reflex](#).

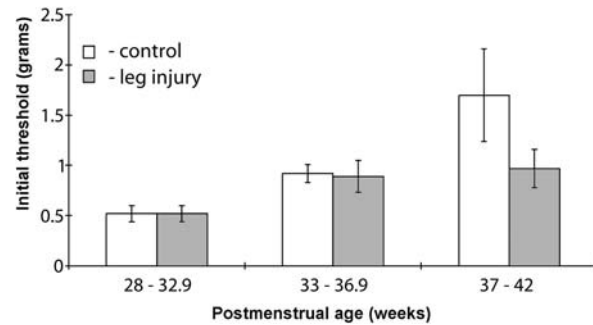
### Characteristics

The study of reflexes has proved valuable in observing the development of pain mechanisms, because it is possible to obtain objective, quantitative measurements of threshold (Andrews and Fitzgerald 1994; Andrews and Fitzgerald 1999) and other reflex parameters through ► [electromyography](#) (Andrews and Fitzgerald 1999). Studies in normal human infants have demonstrated exaggerated reflex responses and lower thresholds (Andrews and Fitzgerald 1994; 1999; Fitzgerald et al. 1989), indicative of increased excitability in the developing nervous system. One reason for this may be that, at the level of the spinal cord, the connections necessary for the presence of these reflexes are fully functional, but lacking input from descending inhibitory fibres (Fitzgerald and Koltzenberg 1986). Despite these features, there is still a differential lowering of threshold in the presence of tissue injury (Andrews and Fitzgerald 1999; Fitzgerald et al. 1989). Threshold changes also reflect changes in skin sensitivity due to the application of local anaesthetic cream to the skin (Jain and Rutter 2000).

Furthermore, the advantage of using reflexes such as the flexion withdrawal reflex and the abdominal skin reflex is that they are relatively unaffected by factors such as hunger or stress and can be elicited equally well during regular sleep or quiet wakefulness (Andrews and Fitzgerald 1994). Both reflexes have been used successfully in the newborn intensive care environment and postoperatively to yield information on human ► [somatosensory](#) development, with and without the presence of tissue injury consequent to intensive care or abdominal surgery.

### The Flexion Withdrawal Reflex

The threshold of this reflex in the newborn is much lower than in the adult, but rises with increasing postmenstrual age (PMA) (Andrews and Fitzgerald 1994; Andrews and Fitzgerald 1999; Fitzgerald et al. 1989), reflecting changes in patterns of connections within the ► [dorsal horn](#) of the spinal cord during development (Fitzgerald and Jennings 1999). Reflex thresholds are significantly lowered in the presence of tissue injury to the leg or foot of the type received during newborn intensive care and do not show the normal increase with PMA under these circumstances, even if that injury is



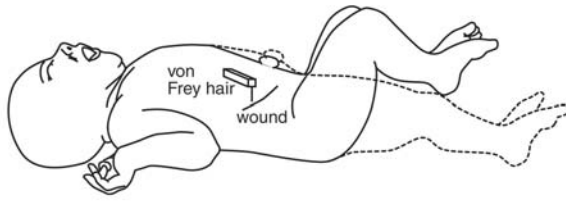
**Infant Pain Mechanisms, Figure 1** Mean initial threshold for the mechanically evoked flexion reflex rises with postconceptional age in the control group ( $P = 0.027$ , one way ANOVA,  $n = 3, 24$ , and  $9$  for 3 age bands respectively), but less markedly in the leg injury group ( $P = 0.022$ , one way ANOVA,  $n = 6, 7$ , and  $6$  for 3 age bands respectively). Error bars denote standard error of the mean. (From Andrews and Fitzgerald 1999, with permission).

on the contralateral leg (Fig. 1) (Andrews and Fitzgerald 1999; Fitzgerald et al. 1989). Therefore it seems possible to use withdrawal reflex threshold changes to monitor the effects of trauma on the developing somatosensory system.

Another feature of the flexion withdrawal reflex in preterm newborns below 30–35 weeks PMA (full-term = 40 weeks PMA) is the ► [sensitisation](#) that occurs with repeated non-noxious stimulation. This has been measured both by an increase in the amplitude and number of responses with decreasing PMA, and by a significant drop in threshold of 10–20% following repeated stimulation (Andrews and Fitzgerald 1999). Above approximately 35 weeks PM age, ► [habituation](#) to repeated non-noxious stimulation occurs, characterised by a decrease in the number of responses and no drop in threshold on repeated stimulation (Andrews and Fitzgerald 1994). The point of interest here is that, in the preterm newborn, non-noxious stimulation produces sensitisation, whereas in term infants, older children and adults, this phenomenon is only produced by noxious stimulation. Studies of newborn rat dorsal horn cells have shown that they sensitise to repeated non-noxious skin stimulation exciting ► [A afferent fibres](#) and this may be the phenomenon underlying the sensitisation to non-noxious stimuli in preterm newborn infants.

### The Abdominal Skin Reflex

The use of reflexes to elucidate mechanisms of pain processing in newborns and infants has been extended to the study of abdominal sensitivity in infants following surgery, using the abdominal skin reflex (ASR) (Andrews and Fitzgerald 2002; Andrews et al. 2002). Post-surgical pain in children continues to be an issue because it remains under-treated, despite improvements in pain treatment over the last 15 years (Cummings et al. 1996). In common with the flexion withdrawal reflex, although more reliably evoked by noxious stimulation of the abdomen, the ASR can also be elicited by non-



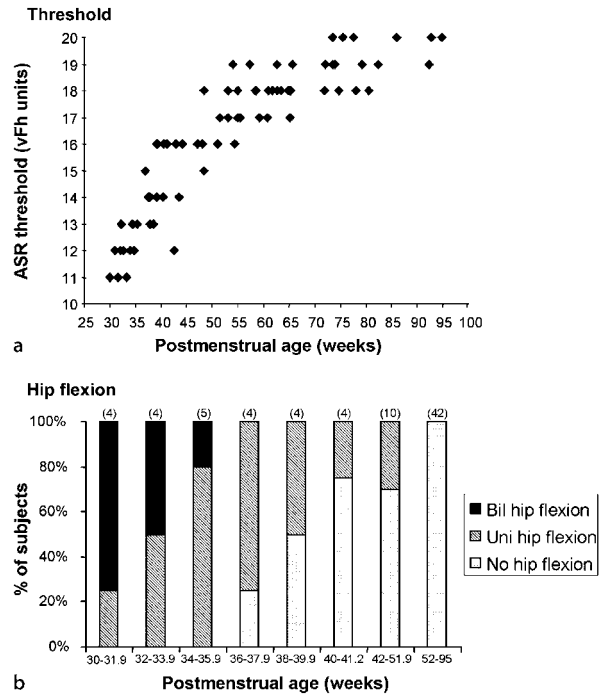
**Infant Pain Mechanisms, Figure 2** Diagrammatic representation of the abdominal skin reflex in an infant. The reflex is elicited by touching the surface of the abdomen either side of the midline with a calibrated von Frey hair. The dotted lines indicate the position of the abdomen and legs in the resting state, whereas the solid lines show what happens when the threshold for the reflex is reached. (From Andrews and Fitzgerald 2002, with permission).

noxious stimuli such as touch, thresholds being very low in newborns and infants (Andrews and Fitzgerald 2002; Andrews et al. 2002). Also, in common with other reflexes at this age, reflex spread to the flexor muscles of the thigh has been observed, whereby a contraction of the abdominal muscles is accompanied by either bilateral or unilateral hip flexion (Fig. 2).

Nevertheless, ASR thresholds are clearly developmentally regulated (Andrews et al. 2002), there being a rise in threshold with increasing PMA (Fig. 3a), similar to that seen in the flexion withdrawal reflex of the leg. In addition, a decrease in ASR spread with increasing PMA has been shown, bilateral hip flexion being replaced by unilateral hip flexion and subsequently no hip flexion during the progression from newborn period to infancy (Fig. 3b). These developmental changes in ASR properties are likely to reflect alterations in spinal cord connectivity during this period (Fitzgerald and Jennings 1999). Studies in the newborn rat have shown that low threshold  $\blacktriangleright$  *A $\beta$*  afferent fibres encoding non-noxious stimuli terminate more superficially in the newborn dorsal horn, which may allow them to activate cells that only have a high-threshold (*A $\delta$*  and C fibre) input in the adult (Fitzgerald and Jennings 1999).

Following surgery in infants under 1 year, a large drop in threshold of up to 78% was observed in both operation groups studied, hernia repair and  $\blacktriangleright$  *pyeloplasty* (Fig. 4; Andrews and Fitzgerald 2002), which was maximal 1–3 h after surgery, indicating that infants are clearly more sensitive in the wound area, and reflecting the sensitivity of damaged skin. Perhaps surprisingly, sensitivity in the wound area in the surgical infants in this study occurred even in the presence of intra- and post-operative analgesia. A significant increase in threshold 6–8 h after hernia repair was seen only if analgesia had been given within the last 2 h, and in pyeloplasty infants who were receiving ongoing intravenous analgesia with morphine (Andrews and Fitzgerald 2002).

A significant drop in ASR threshold was seen at the same level on the contralateral side of the abdomen 1–3 h after surgery, and also 6–8 h after surgery in hernia repair infants to whom no recent analgesia had been given

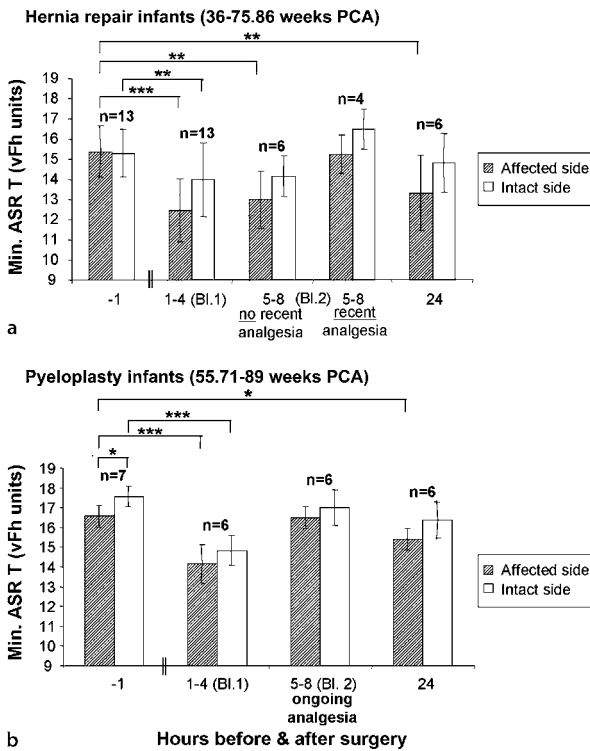


**Infant Pain Mechanisms, Figure 3** Abdominal skin reflex threshold rises (a) and incidence of hip flexion decreases (b) with increasing postconceptional age in healthy control newborns and infants under 1 year. (a) ASR thresholds in response to punctate von Frey hair stimulation measured in von Frey hair number units (vFh units), in healthy newborns of 30–41.2 weeks PCA ( $n = 25$ ) and control infants of 42–95 weeks PCA ( $n = 52$ ). There is a significant rise in ASR threshold with increasing age in healthy newborns and control infants ( $P = 0.00$ ,  $d.f. = 1$ ,  $G = 125.868$ ,  $n = 73$ , ordinal logistic regression). There are some overlapping data points in this figure, which is why the full number of threshold values appears not to be visible. (b) Percentage incidence of either bilateral (solid bars), unilateral (hatched bars), or no (speckled bars) hip flexion, accompanying the ASR, in healthy newborns grouped into 2 week age bands from 30–41.2 weeks PCA ( $n = 25$ ), and control infants from 42–95 weeks PCA, firstly divided into a 10 week age band of 42–51.9 weeks ( $n = 10$ ) in which there was some hip flexion. The infants from 52–95 weeks PCA ( $n = 42$ ) were grouped together because no hip flexion occurred in these infants. Numbers of infants in each age band are shown in parentheses over each column. There is a significant decrease in bilateral hip flexion, and then in unilateral hip flexion and a significant increase in no hip flexion, with age ( $P = 0.00$ ,  $d.f. = 1$ ,  $G = 80.798$ ,  $n = 73$ , ordinal logistic regression). (From Andrews et al. 2002, with permission).

(Fig. 4). This is further evidence of changes in sensory processing at the spinal cord level, as the threshold drop was remote from the site of injury, and indicates that the tenderness surrounding the wound had spread from the incision site. This degree of sensitivity is not seen in adult studies. The contralateral effects seen in infants are again likely to be due to increased excitability in the infant spinal cord, which would increase the extent of central sensitisation.

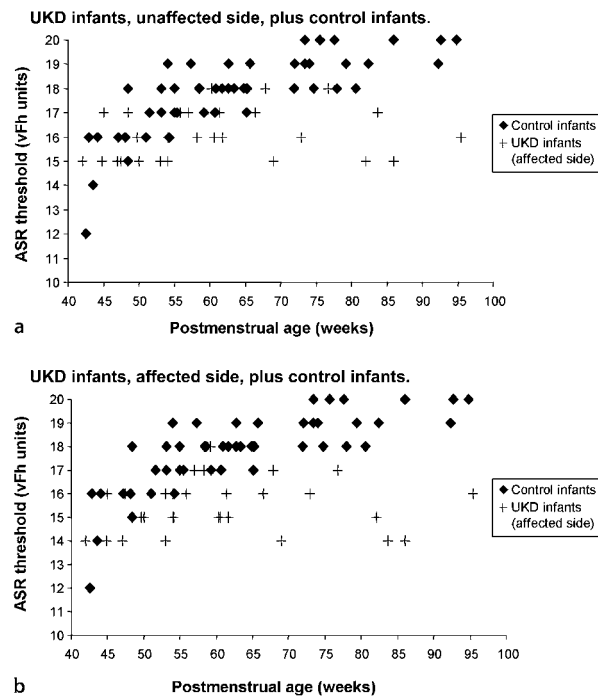
Evidence of more long-lasting post-surgical wound sensitivity in infants in the ASR study is reflected in lower than preoperative thresholds on the surgical side of the abdomen 24 h after surgery and after discontinuation of analgesia. This rebound sensitisation may be due to sig-





**Infant Pain Mechanisms, Figure 4** Significant difference between surgical groups in patterns of ASR threshold prior to surgery, and significant drop in abdominal skin reflex threshold following surgery. Mean ASR thresholds in von Frey hairs units (vFh units) from the affected side (hatched bars), and the contralateral intact side (open bars), of the abdomen, in infants undergoing unilateral hernia repair (a), and unilateral pyeloplasty (b). Error bars denote standard deviation. Bl.1 = Block 1 (1–4 h after surgery), Bl.2 = Block 2 (5– 8 h after surgery). Hernia repair infants (a) were divided into 2 groups at Block 2; those who had not received analgesia ('no recent analgesia'), and those who had received analgesia ('recent analgesia') within this period. Comparisons between sides in both groups prior to surgery were made using Wilcoxon signed rank tests. Post hoc comparisons of pre- and post-surgical ASR thresholds were made using the Bonferroni method, following three-factor repeated measures ANOVAs. Stars denote levels of significance as follows:  $\leq 0.05$  \*,  $\leq 0.01$  \*\*,  $\leq 0.001$  \*\*\*. Horizontal brackets indicating which pair is being compared denote the significant pairwise comparisons. Numbers of infants for each group at each time point are shown in parentheses above the means and error bars. (From Andrews and Fitzgerald 2002, with permission).

nals from neurons receiving simultaneous signals from both the skin and abdominal organs, particularly in the pyeloplasty group (Giamberardino 2000). Another interesting finding yielded by our study on the ASR (Andrews et al. 2002) was that infants with one-sided kidney disease due to obstruction of the ureter did not display an increase in threshold with increasing PMA, thresholds remaining low throughout the first year of life, unlike healthy control infants (Fig. 5). This increased abdominal sensitivity was more marked on the affected side of the abdomen, but was also present on the unaffected side. Therefore, in addition to being a measure of wound sensitivity, ASR threshold may also indicate the existence of more chronic, disease-related pain. These findings parallel those seen following kid-



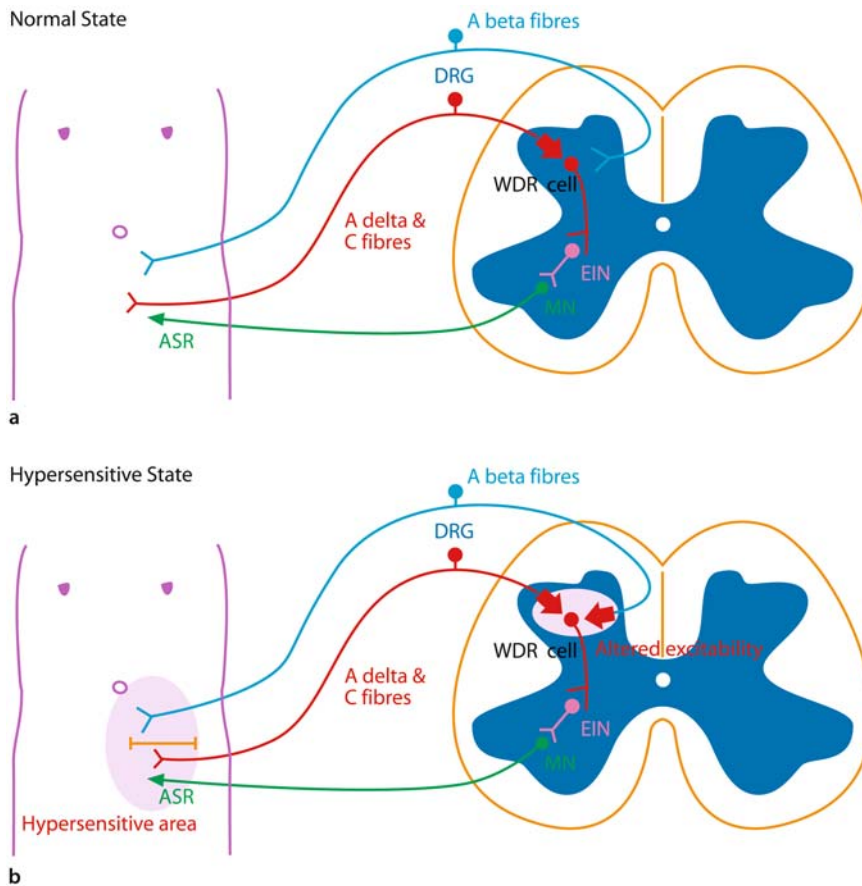
**Infant Pain Mechanisms, Figure 5** ASR threshold does not rise with increasing postconceptional age in infants with unilateral kidney disease, either on unaffected (a) or affected (b) sides of the abdomen. ASR thresholds in response to punctate von Frey hair stimulation measured in von Frey hair number units (vFh units) in infants with unilateral kidney disease (UKD) of 42–95.4 weeks PCA (small crosses). There is no rise in threshold with increasing PCA in these infants, either on the unaffected side (a), ( $P = 0.284$ ,  $d.f. = 1$ ,  $G = 1.146$ ,  $n = 30$ , ordinal logistic regression), or on the affected side (b), ( $P = 0.624$ ,  $d.f. = 1$ ,  $G = 0.240$ ,  $n = 30$ , ordinal logistic regression). ASR threshold data from control infants (diamonds) across the same age range are included in each figure for comparison. Even when these data from control infants are compared with those from the unaffected side in infants with unilateral kidney disease, the difference between slopes is significant ( $P = 0.00$ ,  $d.f. = 3$ ,  $G = 81.472$ ,  $n = 78$ , ordinal logistic regression). There are some overlapping data points in this figure, which is why the full number of threshold values appears not to be visible. (From Andrews et al. 2002, with permission).

ney / ureteral stones in adult man (Giamberardino 2000), in whom the severity of pain is dependent upon the number of episodes of kidney stones and appears to arise from central sensitisation of spinal cord sensory neurons following repeated painful episodes (Giamberardino 2000).

The changes in ASR threshold following surgery seen in these studies and with kidney disease were accompanied by alterations in reflex spread, as denoted by the degree of hip flexion. Again, central sensitisation of spinal cord neurons in these infants would increase the size of dorsal horn neuron and reflex **receptive fields** (Dubner 1992), leading to reflex spread to adjacent muscle groups.

**Secondary Hypersensitivity Around a Wound in Newborns and Infants**

The phenomenon of increased sensitivity to touch in the area around a skin wound or skin irritation, but not di-



**Infant Pain Mechanisms, Figure 6** Diagrammatic representation of possible changes in neuronal circuitry underlying mechanisms of secondary hypersensitivity, as they relate to ASR threshold changes in infants following surgery. In the normal state (a), wide dynamic range (WDR) interneurons in the dorsal horn of the spinal cord receive input predominantly from A $\delta$  and C fibres, via small diameter primary sensory neurons in the dorsal root ganglion (DRG), and a lesser input from A $\beta$  fibres. Following a stimulus, information to these cells is conveyed, via excitatory interneurons (EIN) to motor neurons (MN), thus producing an ASR. However, in a hypersensitive state such as may occur following an abdominal surgical wound (b), peripheral sensitisation and greatly increased C fibre input to the dorsal horn lead to an increase in spinal cord excitability, termed central sensitisation. The balance of inputs to WDR cells is altered in favour of A $\beta$  fibres, causing increased abdominal sensitivity and consequent lowering of the ASR threshold. (From: Andrews 2003, with permission).

rectly over the wound itself (secondary hypersensitivity) has hardly been investigated in newborns and infants, although studies in adults have demonstrated that increases in spinal cord excitability caused by prolonged input from C fibres are responsible for the maintenance of the area of hypersensitivity (Fig. 6). What is known is that repeated heel lancing in newborns receiving intensive care has been shown to produce an area of reddening and inflammation that extends beyond the immediate puncture sites (Fitzgerald et al. 1989). Furthermore, lowering of flexion withdrawal reflex thresholds on the limb contralateral to substantial leg injury received during intensive care, has been demonstrated in infants of 38–42 weeks PMA (Andrews and Fitzgerald 1999) and a drop in ASR threshold on the opposite side of the abdomen to a surgical wound has been shown in infants under 1 year (Andrews and Fitzgerald 2002). Both of these phenomena provide evidence of central changes in nervous system excitability, since they occur remote from the site of injury.

Therefore, we studied this phenomenon in newborns and infants (Andrews and Fitzgerald 2000), as a means of gaining hitherto unobtainable information on sensory processing in these age groups. As before, changes in ASR thresholds were used to map an area of secondary hypersensitivity around an abdominal surgical wound.

This area of secondary hypersensitivity was reflected in significantly lowered ASR thresholds post surgery, both above the wound and at the same level, to a distance of 4 cm from the wound, although thresholds were lowest closest to the incision. These changes were present from 1 h after surgery, but were attenuated by postoperative analgesia, particularly 6–8 h after surgery with ongoing intravenous morphine. However, they were not abolished by it. A control group of infants not having surgery did not display significant threshold changes within the same area over time. These features may be due to incision-induced changes in the receptive field sizes of individual dorsal horn neurons (Dubner 1992), which would contribute to post-surgical central sensitisation.

#### Investigation of Sensory Processing at Higher Levels in the Central Nervous System in Infants

Although the study of reflexes has provided useful insights into developmental aspects of sensory processing in preverbal children, mostly at spinal cord level, very little is known about the development of functional connections in the brain, up to and including the cerebral cortex (Taylor 2003). ► **Somatosensory evoked potentials (SEPs)**, and ► **near-infrared spectroscopy (NIRS)** represent means by which the functional development of sen-

sory connectivity in the brain could be examined. They are most suitable for infants as they are non-invasive and can be repeated without risk.

Indeed, NIRS has been used already in a preliminary investigation of the maturation of the response within the cerebral cortex to noxious stimulation caused by heel lance (Slater et al. 2005). The responses were studied using double channel NIR spectrophotometry and demonstrated that infants over a wide range of PMA from 29 to 42 weeks show a large response, localised to the somatosensory areas of the cerebral cortex, resulting from noxious stimulation.

Somatosensory evoked potentials (SEPs) can be reliably elicited from 27 weeks PMA and the appearance of the SEP waveform does not alter from that time until 40 weeks PMA (Pike et al. 1997). SEPs have been used to investigate the integrity of somatosensory pathways during the newborn period and in infancy, and as prognostic indicators of neurological impairment in high-risk infants (Pierrat et al. 1993). However, they have not yet been used to investigate the development of sensory processing in infants and young children, and it would be very interesting to observe the development of sensory connections within the brain in these age groups using this method.

### Conclusions

It is evident that the study of neurophysiological phenomena can provide direct and quantitative information concerning processing of sensory information in the developing nervous system. It is also true that there are structural and functional features of this immature system that have a profound influence on pain processing in the newborn and infant. Furthermore, laboratory and clinical investigation of both mechanisms and behaviour have provided information about pain processing at the spinal cord level, but the challenge is to unravel the mystery of how much of a noxious stimulus reaches and is processed in the brain of the newborn and infant, and how this can be investigated. In the mean time, the information that we already have is sufficient to tell us that the management of pain in infancy requires not only the limitation of procedures as far as possible, but also careful and creative management of analgesia.

### References

- Andrews KA (2003) The human developmental neurophysiology of pain. In: Schechter NL, Berde CB, Yaster M (eds) *Pain in Infants, Children, and Adolescents*, 2nd edn. Lippincott Williams & Wilkins, Philadelphia
- Andrews KA, Fitzgerald M (1994) The cutaneous withdrawal reflex in human neonates: sensitization, receptive fields, and the effects of contralateral stimulation. *Pain* 56:95–101
- Andrews KA, Fitzgerald M (1999) The cutaneous flexion reflex in human neonates: a quantitative study of threshold and stimulus / response characteristics, following single and repeated stimuli. *Dev Med Child Neurol* 41:696–703
- Andrews KA, Fitzgerald M (2000) Mapping of the area of secondary hypersensitivity around a surgical wound in human infants using the abdominal skin reflex threshold. *Eur J Neurosci* 12 (Suppl. 11):71
- Andrews KA, Fitzgerald M (2002) Wound sensitivity as a measure of analgesic effects following surgery in human neonates and infants. *Pain* 99:185–195
- Andrews KA, Desai D, Dhillon HK et al. (2002) Abdominal sensitivity in the first year of life: comparison of infants with and without unilateral hydronephrosis. *Pain* 100:35–46
- Cummings EA, Reid GJ, Finley GA et al. (1996) Prevalence and source of pain in pediatric inpatients. *Pain* 68:25–31
- Dubner R (1992) Hyperalgesia and expanded receptive fields, editorial comment. *Pain* 48:3–4
- Fitzgerald M, Koltzenburg M (1986) The functional development of descending inhibitory pathways in the dorsolateral funiculus of the newborn rat spinal cord. *Dev Brain Res* 24:261–270
- Fitzgerald M, Millard C, MacIntosh N (1989) Cutaneous hypersensitivity following peripheral tissue damage in newborn infants and its reversal with topical anaesthesia. *Pain* 39:31–36
- Fitzgerald M, Jennings E (1999) The postnatal development of spinal sensory processing. *Proc Natl Acad Sci USA* 96:7719–7722
- Giamberardino MA (2000) Visceral hyperalgesia. In: Devor M, Rowbotham MC, Wiesenfeld-Hallin Z (eds) *Proceedings of the 9th World Congress on Pain*. IASP Press, Seattle, pp 523–550
- Jain A, Rutter N (2000) Local anaesthetic effect of topical amethocaine gel in neonates: randomised controlled trial. *Arch Dis Child Fetal Neonatal Ed* 82:42–45
- Pierrat V, Eken P, Duquennoy C et al. (1993). Prognostic value of early somatosensory evoked potentials in neonates with cystic leukomalacia. *Dev Med Child Neurol* 35:683–690
- Pike AA, Marlow N, Dawson C (1997) Posterior tibial somatosensory evoked potentials in very preterm infants. *Early Human Dev* 47:71–84
- Slater R, Gallella S, Boyd SG et al. (2005) Noxious stimulation causes functional activation of the somatosensory cortex in newborn infants. *Early Human Dev*
- Taylor M J (2003) Where and when in the developing brain: neurophysiology of cognition in infants and children. *Int J Psychophysiol* 51:1–3

## Infant Pain Reduction/Therapy/Treatment

### ► Acute Pain Management in Infants

## Inflammation

### Definition

Inflammation is a complex response to areas affected by injury or disease, which is meant to protect tissues, but is often a major source of damage. It involves the recruitment and activation of various cells (leukocytes and macrophages) and extracellular proteins, and is induced and maintained by numerous mediators like cytokines, histamine, plasma proteases, arachidonic acid metabolites (prostaglandins, leukotrienes), growth factors and ions (potassium, protons). The main signs of inflammation are dolor, rubor, calor and tumor. Dolor, or pain, occurs due to activation of nociceptors that become sensitized with a lower threshold for activation. Rubor, or redness, is due to local vasodilatation with increased blood flow in the affected area. Calor, or heat,

is due to a combination of increased local blood flow and an increase in cellular metabolic activity. Tumor or swelling occurs due to an increase in capillary permeability with plasma extravasation and localized edema. This may be exacerbated by restricted function in the affected area.

- ▶ Acid-Sensing Ion Channels
- ▶ COX-2 Inhibitors
- ▶ Lower Back Pain, Physical Examination
- ▶ Opioids in the Periphery and Analgesia
- ▶ Pain Modulatory Systems, History of Discovery
- ▶ Postoperative Pain, COX-2 Inhibitors

## Inflammation, Modulation by Peripheral Cannabinoid Receptors

ISOBEL LEVER

Neural Plasticity Unit, Institute of Child Health,  
University College London, London, UK  
i.lever@ich.ucl.ac.uk

### Definition

Cannabinoids are chemical compounds derived from the *cannabis sativa* plant and their synthetic analog. Pain responses resulting from inflammation can be reduced by cannabinoids, applied locally to peripheral tissues at systemically inactive doses. This analgesic mechanism involves the activation of peripheral cannabinoid receptors outside the CNS, making it distinct from the analgesic action of cannabinoids operating at receptors in the spinal cord and brain.

### Characteristics

Two G-protein coupled receptors that respond to cannabinoids (CBs) have been identified so far and named CB<sub>1</sub> and CB<sub>2</sub>. There is also evidence for additional cannabinoid receptor sub-types, which have yet to be characterised (Howlett et al. 2002). CB<sub>1</sub> receptors are found primarily in CNS neurones, and the majority of CB<sub>2</sub> receptors are expressed peripherally by cells with inflammatory and immune response functions. Both CB receptor sub-types have been detected in peripheral tissues from rat, mouse and human (Howlett et al. 2002), with evidence for CB<sub>1</sub> expression in peripheral neurones and glia, as well as on immune cells (although expression levels are lower than for CB<sub>2</sub> receptors) (Howlett et al. 2002, Walter and Stella 2004). Richardson et al. (1998) first demonstrated modulation of inflammatory pain states by the activation of peripheral cannabinoid receptors in an animal model of inflammatory pain. Injection of the inflammatory agent carrageenan into rat hind paw skin was used to induce a localised inflammatory response (measured by paw oedema due to ▶ [plasma extravasation](#) caused by increased microvasculature permeability) and

▶ [hyperalgesia](#) (measured by increased behavioural responses to noxious stimuli). After inflammatory injury, both the effects of paw oedema and thermal hyperalgesia were attenuated by a local injection of a small dose of the cannabinoid anandamide (AEA) to the paw skin, but not when the same dose of AEA was applied systemically. Co-administration of a selective antagonist to the CB<sub>1</sub> receptor (SR141716), to the paw skin, reversed the effect of AEA on thermal hypersensitivity. It also attenuated the cannabinoid-mediated reduction of plasma extravasation (stimulated by a ▶ [capsaicin](#)-induced ▶ [neurogenic inflammation](#)), thus demonstrating both an anti-hyperalgesic as well as an anti-inflammatory action of cannabinoids operating via peripheral CB<sub>1</sub> type cannabinoid receptors.

Local application of other cannabinoids: WIN55, 212-2, HU-210, methanandamide as well as AEA, in the formalin model of the rat hind paw skin inflammation, confirmed a reduction in pain behaviour via the activation of peripheral CB<sub>1</sub> receptors (Calignano et al. 1998). The ▶ [endocannabinoid](#) ligand AEA was similarly effective in this model and could be detected in paw tissue, along with a related endogenous compound Palmitoylethanolamide (PEA), which does not bind to any known cannabinoid receptor but the actions of which are reversed by the CB<sub>2</sub> receptor antagonist SR144528 (Howlett et al. 2002). Interestingly, when both of these compounds were injected into the paw together they produced a synergistic reduction of pain behaviour (Calignano et al. 1998). However, the anti-hyperalgesic effects of PEA were attenuated by local blockade of CB<sub>2</sub> but not CB<sub>1</sub> receptors in paw skin tissue. The contribution of CB<sub>2</sub> receptor signalling to the peripheral action of cannabinoids indicated by this study has since been confirmed, by using newly developed ligands that are selective for the CB<sub>2</sub> cannabinoid receptor sub-type (Malan et al. 2003). Application of the selective CB<sub>2</sub> receptor agonist AM1241 to inflamed rat paw skin tissue can reduce both mechanical and thermal hyperalgesic responses, an action which can also be locally reversed by CB<sub>2</sub> receptor antagonists (Quartilho et al. 2003, Hohmann et al. 2004). Other CB<sub>2</sub> receptor agonists have also been shown to be effective against paw tissue oedema when they were administered systemically (Clayton et al. 2002; Malan et al. 2003). Thus, cannabinoids have a dual anti-inflammatory and anti-hyperalgesic action mediated by both CB<sub>1</sub> and CB<sub>2</sub> peripheral cannabinoid receptor sub-types.

### The Anti-Hyperalgesic Action of Peripheral CB Receptors

Behavioural studies report that cannabinoid receptors can be exogenously activated in inflamed hind paw skin, to produce a reduction in pain responses to noxious stimuli. Also, AEA and PEA (compounds that endogenously activate cannabinoid receptor signalling pathways) can be detected in this tissue (Calignano et al. 1998). It is therefore possible that these com-



pounds interact with cannabinoid receptors on the peripheral endings of cutaneous ► **nociceptive sensory neurones**, in order to directly modulate the transmission of nociceptive signals to the CNS. As evidence of this mechanism, the local application of CB<sub>1</sub> and CB<sub>2</sub> receptor agonists to carrageenan-inflamed skin can reduce the responses of spinal cord cells receiving noxious mechanical inputs from this area (Kelly et al. 2003; Sokal et al. 2003). CB<sub>1</sub> receptors can also inhibit ► **neurosecretion** of the vasodilatory peptide CGRP from peripheral terminals of capsaicin-sensitive neurones in isolated paw skin (Richardson et al. 1998). This also suggests that cannabinoids might have a direct modulatory action on the signalling functions of nociceptive sensory neurones. In support of this mechanism, CB<sub>1</sub> mRNA and protein has been detected in the cell bodies of hind limb sensory nerves contained within dorsal root ganglia (DRG) (Bridges et al. 2003). However, the distribution of these receptors among the small, peptide-containing soma that are typical of nociceptive nerve fibres, was found to be limited in favour of intermediate to large-sized cells, which predominately have non-nociceptive sensory functions. It should be noted, however, that there is currently a discrepancy between the CB<sub>1</sub> receptor distribution reported in DRG tissue versus cultured DRG neurones (Bridges et al. 2003). CB<sub>2</sub> receptors have not been found on adult DRG neurones, although, as with CB<sub>1</sub>, the presence of these receptors in functionally significant but as yet undetectable amounts *in vivo*, cannot be entirely ruled out. Functional CB<sub>1</sub> receptors have been demonstrated on cultured sensory neurones, where they are reported to signal via inhibitory G<sub>i/o</sub> proteins, to inhibit N-type voltage-activated calcium currents. Crucially, the activity of these receptors has not been demonstrated on small-sized CGRP-containing sensory neurones *in vitro* (Khasabova et al. 2004).

#### The Anti-Inflammatory Action of Peripheral CB Receptors

An alternative mechanism to explain the anti-hyperalgesic action of cannabinoids is linked to anti-inflammatory effects of these compounds in peripheral tissues. CB agonists may indirectly inhibit transmission in nociceptive afferents by reducing the release of by-products of inflammatory and excitotoxic processes, which serve to sensitise peripheral nociceptive fibres to mechanical and thermal stimuli. Cannabinoid receptors are present on cells that are functionally involved in immune responses to tissue injury, including B and T cells, natural killer cells, neutrophils, macrophages and mast cells (Howlett et al. 2002; Samson et al. 2003; Walter and Stella 2004). Furthermore, mitogen activation of some immune cells, such as human lymphocytes, has been shown to stimulate an up-regulation of cannabinoid receptors and also trigger the production of endocannabinoids (Howlett et al. 2002; Walter and Stella 2004). Taken together, this evidence suggests

that cannabinoids are endogenous immuno-modulators. Suppression of the pro-inflammatory functions of glial and immune cells (Walter and Stella 2004) is believed to mediate the inhibitory effects of cannabinoids on oedema and plasma extravasation. However, much of the evidence for cell-specific regulatory actions of cannabinoids has been derived from studies with isolated cell lines.

Cannabinoids are reported to reduce the production and release of pro-inflammatory signalling molecules, including tumour necrosis factor, nitric oxide and interleukin, and to enhance the release of anti-inflammatory cytokines like the IL-1 receptor antagonist, IL-4 and IL-10 (Molina-Holgado et al. 2003; Howlett et al. 2002; Walter and Stella 2004). Nerve growth factor (NGF) is an important mediator of inflammatory responses due to its ability to recruit and activate mast cells, and also to directly sensitise the receptors involved in transducing noxious stimuli on sensory neurones. Intradermal injections of NGF are used to artificially produce inflammation and hyperalgesia, and AEA and PEA compounds can be used to alleviate both effects, operating via CB<sub>1</sub> and CB<sub>2</sub> receptors, respectively (Farquhar-Smith et al. 2003). The action of NGF in tissues is amplified by mast cell function, as these cells produce and release NGF locally, as well as being activated by it. They also synthesise and release other inflammatory mediators that increase local vascular permeability and others, like serotonin, which can sensitise nociceptors. The ability of CB<sub>1</sub> and CB<sub>2</sub> receptor signalling to reduce inflammatory responses has been linked to their regulation of mast cell function (Samson et al. 2003). CB<sub>1</sub> receptor activation on mast cell lines is linked to the suppression of serotonin secretory responses, whereas co-expressed CB<sub>2</sub> receptors regulate the activation of signalling pathways that regulate gene expression. Mast cells have also been reported to produce endocannabinoids and PEA, suggesting the existence of an autocrine regulatory signalling pathway involving cannabinoids in these cells (Samson et al. 2003). Cannabinoids are also reported to suppress immune cell proliferation and chemotactic processes, which contribute to the establishment of inflammatory sites in tissues (Howlett et al. 2002; Walter and Stella 2004). Specifically, PEA has been shown to reduce neutrophil accumulation in hind paw skin inflamed by NGF injections (Farquhar-Smith et al. 2003). This is speculated to involve peripheral CB<sub>2</sub> receptor signalling pathways, which act to reduce the production and/or release of mast cell-derived neutrophil chemotactic factors, such as Leukotriene B<sub>4</sub> or even NGF itself. PEA and endocannabinoids like AEA are likely by-products of the inflammatory and excitotoxic processes occurring after tissue injury, providing endogenous signalling molecules to activate CB<sub>1</sub> and CB<sub>2</sub> receptor pathways. There is evidence that CB receptors are endogenously activated in inflamed skin tissue, as

administration of CB<sub>2</sub> receptor antagonists alone to non-inflamed paw tissue increased the mechanical hypersensitivity and tissue oedema caused by a subsequent carrageenan inflammation (Clayton et al. 2002). Also, the injection of both CB<sub>1</sub> and CB<sub>2</sub> receptor antagonists to hind paws before inflammation by formalin, led to an enhancement of pain responses. This result similarly indicates that cannabinoid receptors are tonically activated in peripheral tissue (Calignano et al. 1998). In summary, cannabinoids can act at CB<sub>1</sub> and CB<sub>2</sub> receptors in peripheral tissue to modulate immune and nociceptor functions: They suppress the pro-inflammatory actions of immune and glial cells leading to the reduction of tissue inflammation, and reduce the hypersensitivity of sensory nerves responding to mechanical and thermal pain stimuli. These are two ways in which the action of cannabinoids at local receptors in peripheral tissue could be effective in altering pain responses to inflammatory injury. This peripheral action is of potential therapeutic importance because it presents a way of delivering the analgesic benefit of cannabinoid compounds, whilst circumventing their centrally mediated psychoactive side effects.

## References

- Bridges D, Rice ASC, Egertova M, Elphick MR, Winter J, Michael GJ (2003) Localisation of Cannabinoid Receptor 1 in Rat Dorsal Root Ganglion Using *In Situ* Hybridisation and Immunohistochemistry. *Neurosci* 119:803–812
- Calignano A, La Rana G, Giuffrida A, Peiomelli D (1998) Control of Pain Initiation by Endogenous Cannabinoids. *Nature* 394:277–280
- Clayton N, Marshall FH, Bountra C, O'Shaughnessy CT (2002) CB1 and CB2 Cannabinoid Receptors are Implicated in Inflammatory Pain. *Pain* 96:253–260
- Farquhar-Smith WP, Rice ASC (2003) A Novel Neuroimmune Mechanism in Cannabinoid-Mediated Attenuation of Nerve Growth Factor-Induced Hyperalgesia. *Anesthesiology* 99:1391–1401
- Hohmann AG, Farthing JN, Zvonok AM, Makriyannis A (2004) Selective Activation of Cannabinoid CB2 Receptors Suppresses Hyperalgesia Evoked by Intradermal Capsaicin. *J Pharmacol Exp Ther* 308:446–453
- Howlett AC, Barth F, Bonner TI, Cabral G, Casellas P, Devane WA, Felder CC, Herkenham M, Mackie K, Martin BR, Mechoulam R, Pertwee RG (2002) International Union of Pharmacology. XXVII. Classification of Cannabinoid Receptors. *Pharmacol Rev* 54:161–202
- Kelly S, Jhaveri DM, Sagar DR, Kendall DA, Chapman V (2003) Activation of Peripheral Cannabinoid CB1 Receptors Inhibits Mechanically Evoked Responses of Spinal Neurons in Non-Inflamed Rats and Rats with Hind Paw Inflammation. *Eur J Neurosci* 18:2239–2243
- Khasabova IA, Harding-Rose C, Simone DA, Seybold VS (2004) Differential Effects of CB1 and Opioid Agonists on Two Populations of Adult Rat Dorsal Root Ganglion Neurons. *J Neurosci* 24:1744–1753
- Malan TP, Ibrahim MM, Lai J, Vanderah TW, Makriyannis A, Porreca F (2003) CB2 cannabinoid Receptor Agonists: Pain Relief Without Psychoactive Effects? *Curr Opin Pharmacol* 3:62–67
- Molina-Holgado F, Pinteaux E, Moore JD, Molina-Holgado E, Guaza C, Gibson RM, Rothwell NJ (2003) Endogenous Interleukin-1 Receptor Antagonist Mediates Anti-Inflammatory and Neuroprotective Actions of Cannabinoids in Neurons and Glia. *J Neurosci* 23:6470–6474
- Quartilho A, Mata HP, Ibrahim MM, Vanderah TW, Porreca F, Makriyannis A, Malan TP (2003) Inhibition of Inflammatory Hyperalgesia by Activation of Peripheral CB2 Cannabinoid Receptors. *Anesthesiol* 99:955–960
- Richardson JD, Kilo S, Hargreaves KM (1998) Cannabinoids Reduce Hyperalgesia and Inflammation via Interaction with Peripheral CB1 Receptors. *Pain* 75: 111–119
- Walter L, Stella N (2004) Cannabinoids and neuroinflammation. *Brit J Pharmacol* 141:775–785
- Samson MT, Small-Howard A, Shimoda LMN, Koblan-Huberson M, Stokes AJ, Turner H (2003) Differential Roles of CB1 and CB2 Cannabinoid Receptors in Mast Cells. *J Immunol* 170:4953–4962
- Sokal DM, Elmes SJR, Kendall DA, Chapman V (2003) Intraplantar Injection of Anandamide Inhibits Mechanically-Evoked Responses of Spinal Neurons via Activation of CB2 Receptors in Anaesthetised Rats. *Neuropharmacol* 45:404–411

## Inflammation, Neuropeptide Release

### ► Neuropeptide Release in Inflammation

## Inflammation, Role of Peripheral Glutamate Receptors

SUSAN M. CARLTON

University of Texas Medical Branch, Galveston, TX, USA

smcarlto@utmb.edu

### Synonyms

Peripheral Glutamate Receptors, Role in Inflammation

### Definition

Inflammation and its accompanying pain is a complicated process. Recently it has been reported that peripheral glutamate and peripheral glutamate receptors contribute to inflammatory pain and these data are summarized here.

### Characteristics

There are several lines of evidence that glutamate receptors in the skin contribute to inflammatory pain. The data are derived from anatomical, behavioral and physiological experiments.

Anatomical studies in the ► dorsal root ganglia (DRG) indicate that ► ionotropic glutamate receptors (iGluR) are expressed by significant populations of sensory neurons. N-methyl-D-aspartate receptor 1 (NMDAR1) receptors are localized in virtually all DRG cells, however, only subpopulations of DRG neurons express kainate and  $\alpha$ -amino-3-hydroxy-5-methyl-4-isoxazole propionic acid (AMPA) receptors (Sato et al. 1993). Immunohistochemistry at the electron microscopic level demonstrates that  $48 \pm 18\%$  of unmyelinated axons in the rat digital nerve are positively labeled for the NMDAR1 subunit, while  $27 \pm 3\%$  and  $23 \pm$

8% are labeled for subunits of the kainate and AMPA receptor (Coggeshall and Carlton 1998). Forty-eight hours after intraplantar injection of complete Freund's adjuvant (CFA), there is a significant increase in the number of digital axons expressing the iGluRs (Carlton and Coggeshall 1999). The percentage of NMDAR1-labeled fibers increases from 48% to 61%, for kainate the increase is from 27% to 47% and for AMPA it is from 23% to 43%. These results suggest that there is an increased potential for activation of glutamate receptors in the inflamed state. ► **Metabotropic glutamate receptors** (mGluRs) have also been localized in primary sensory neurons (Bhave et al. 2001; Carlton et al. 2001). At this time it is unknown whether their expression changes during inflammation.

In behavioral studies, activation of these peripheral receptors following intraplantar injection of glutamate (Carlton et al. 1995) or injection of more selective iGluR or mGluR agonists in normal skin results in increased mechanical sensitivity as well as thermal sensitivity (Zhou et al. 1996; Carlton et al. 1998; Bhave 2001; Zhou et al. 2001). Intraplantar injection of 1 mM NMDA in normal animals produces a change in mechanical sensitivity equivalent to that seen 48 h post-CFA injection. Furthermore, concentrations of NMDA that have no effect in normal animals produce a significant reduction in mechanical thresholds in the inflamed hind paw (Du et al. 2003). This data suggests that subthreshold concentrations of glutamate may result in activation of glutamate receptors in the inflamed hind paw. Locally applied iGluR or Group I mGluR antagonists and Group II mGluR agonists can reduce nociceptive behaviors in several models of inflammation including those due to formalin, carrageenan, CFA and mustard oil (Carlton 2001; Neugebauer and Carlton 2002).

Recording from identified nociceptors using an *in vitro* skin-nerve preparation demonstrates that normal nociceptors are excited and sensitized by application of glutamate (Du et al. 2001) or NMDA (Du et al. 2003). Both A $\delta$  and C nociceptors show a significant increase in activity compared to background when their receptive fields are exposed to 300  $\mu$ M glutamate. Surprisingly, 1 mM glutamate results in lesser activity, however, it is possible that a desensitization of receptors occurs at this higher concentration. Furthermore, a 2 min exposure to 300  $\mu$ M glutamate will increase unit responses to heat. This heat sensitization can occur whether the unit is excited by glutamate or not (Du et al. 1001). In 48 h CFA-inflamed skin, there is a slight shift to the left in the dose-response curve for NMDA-induced activation of nociceptors compared to normal skin, indicating that the amount of NMDA required to induce nociceptor activation is reduced 10-fold in inflamed skin. Furthermore, the percentage of NMDA-activated nociceptors and NMDA-induced discharge rates in these nociceptors is significantly increased in inflamed compared to normal skin and this activity can be blocked by co-

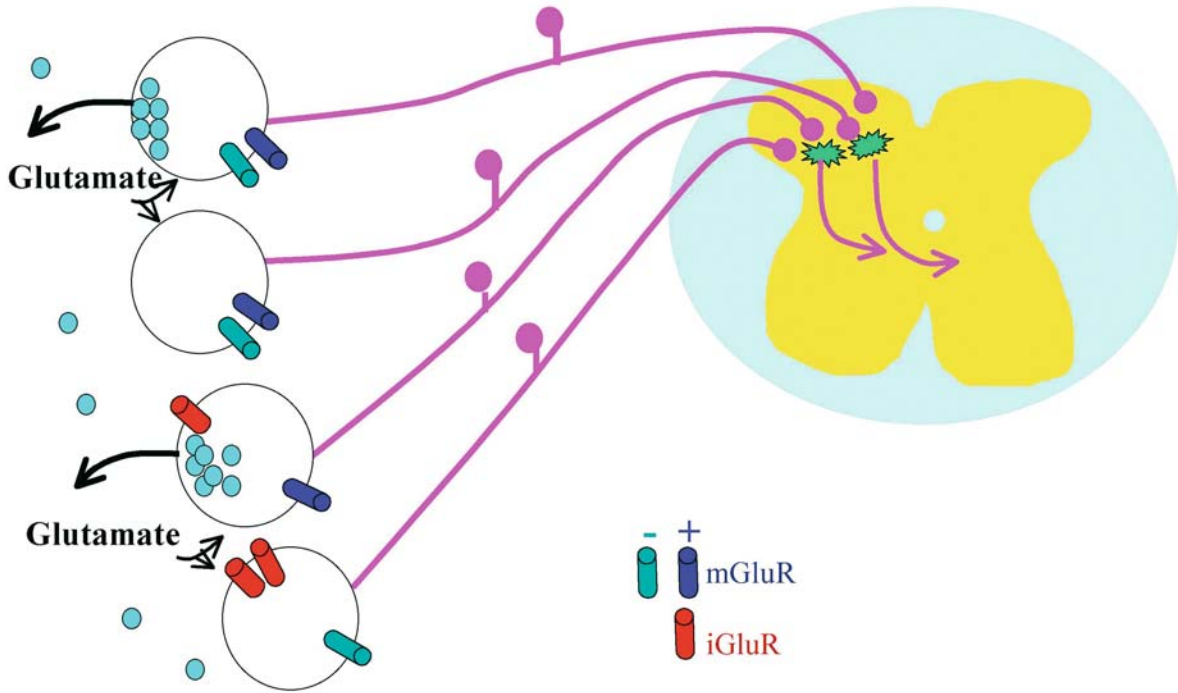
application of the NMDA antagonist MK-801 (Du et al. 2003). Thus, it is clear that responses of nociceptors to glutamate stimulation change in the inflamed state.

A major source of ligand for activation of these peripheral receptors in normal and inflamed skin is the primary afferent terminals themselves since over 90% of DRG cells contain glutamate at concentrations considered to be higher than that representing metabolic stores. Stimulation of primary afferent fibers in the non-noxious or noxious range results in release of glutamate from peripheral primary afferent terminals (deGroot et al. 2000). The endogenous glutamate could then initiate or enhance the activity of nociceptors in the microenvironment through paracrine or autocrine stimulation (Fig. 1). There are several lines of evidence that glutamate content increases in inflamed tissue in both animal and human studies. Nerves innervating inflamed knee joints show an increase in glutamate immunoreactivity suggesting enhanced glutamate content (Westlund et al. 1992). There is increased glutamate content in inflamed hind paws as measured by microdialysis (Omote et al. 1998). The macrophages and serum that infiltrate inflamed regions will also contribute to the glutamate content (Piani et al. 1991; McAdoo et al. 1997). In human studies glutamate content increases in the synovial fluid of arthritic patients (McNearney et al. 2000). There is a ready source of ligand for glutamate receptors in inflamed regions (Fig. 2).

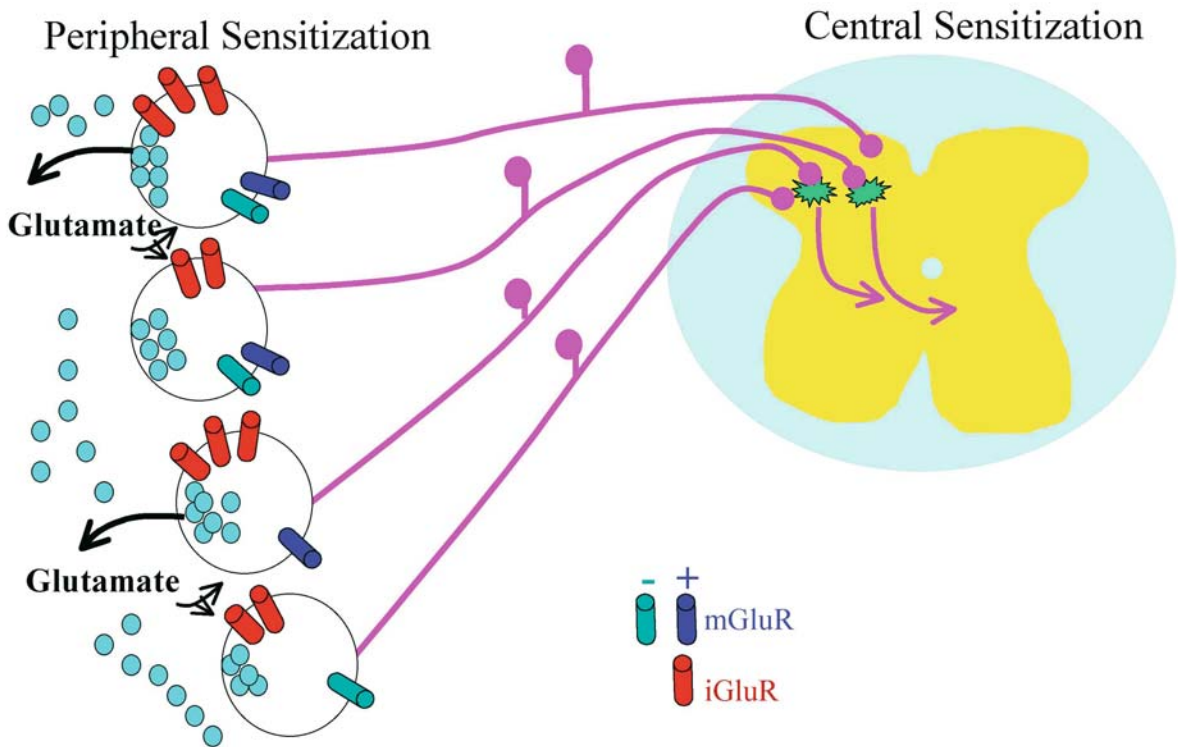
That glutamate receptors and ligand contribute to nociception and that both receptors and ligand increase during inflammation have clinical relevance. It has been demonstrated that iGluRs are present on unmyelinated axons in human skin (Kinkelin et al. 2000). Also, local treatment of the skin with ketamine, an NMDAR antagonist reduces hyperalgesia associated with experimental burn injuries (Warncke et al. 1997). Formulation of glutamate receptor antagonists that do not cross the blood brain barrier could be useful in reducing peripheral nociceptor activity while avoiding central side effects. Glutamate antagonists could be used in the periphery in combination with drugs that target the central nervous system to reduce both peripheral and central sensitization. These glutamate receptor antagonists would offer a non-opiate method for control of inflammatory pain.

## References

1. Bhave G, Karim F, Carlton SM et al. (2001) Peripheral group I metabotropic glutamate receptors modulate nociception in mice. *Nat Neurosci* 4:417–423
2. Carlton SM (2001) Peripheral excitatory amino acids. *Curr Opin Pharm* 1:52–56
3. Carlton SM, Hargett GL, Coggeshall RE (1995) Localization and activation of glutamate receptors in unmyelinated axons of rat glabrous skin. *Neurosci Lett* 197:25–28
4. Carlton SM, Zhou S, Coggeshall RE (1998) Evidence for the interaction of glutamate and NK1 receptors in the periphery. *Brain Res* 790:160–169
5. Carlton SM, Coggeshall RE (1999) Inflammation-induced changes in peripheral glutamate receptor populations. *Brain Res* 820:63–70



**Inflammation, Role of Peripheral Glutamate Receptors, Figure 1** Glutamate-evoked activity in normal nociceptors. This schematic drawing depicts nociceptors terminating in the skin. In the normal state, many of the terminals contain glutamate in vesicles that are released upon stimulation. Through autocrine and/or paracrine routes, glutamate receptors (iGluRs, mGluRs) on nociceptors can be activated, modulating nociceptive transmission to the spinal cord.



**Inflammation, Role of Peripheral Glutamate Receptors, Figure 2** Glutamate-enhanced nociception in inflammation. In the inflamed state, there is an increase in glutamate content in terminals innervating the inflamed region, an increase in the number of glutamate receptor (GluR)-containing axons and thus an increased probability of GluR activation. In the inflamed region, other elements may contribute to an increase in glutamate content in the vicinity including mast cells and serum from leaky blood vessels. All of these factors will lead to enhanced nociceptive transmission.



6. Carlton SM, Hargett GL, Coggeshall RE (2001) Localization of metabotropic glutamate receptors 2/3 on primary afferent axons in the rat. *Neuroscience* 105:957–969
7. Coggeshall RE, Carlton SM (1998) Ultrastructural analysis of NMDA, AMPA and kainate receptors on unmyelinated and myelinated axons in the periphery. *J Comp Neurol* 391:78–86
8. deGroot JF, Zhou S, Carlton SM (2000) Peripheral glutamate release in the hindpaw following low and high intensity sciatic stimulation. *NeuroReport* 11:497–502
9. Du J, Koltzenburg M, Carlton SM (2001) Glutamate-induced excitation and sensitization of nociceptors in rat glabrous skin. *Pain* 89:187–198
10. Du J, Zhou S, Coggeshall RE et al. (2003) N-methyl-D-aspartate-induced excitation and sensitization of normal and inflamed nociceptors. *Neuroscience* 118:547–562
11. Kinkelin I, Brocker E.-B, Koltzenburg M et al. (2000) Localization of ionotropic glutamate receptors in peripheral axons of human skin. *Neurosci Lett* 283:149–152
12. McAdoo DJ, Hughes M, Xu G.-Y et al. (1997) Microdialysis studies of the role of chemical agents in secondary damage upon spinal cord injury. *J Neurotrauma* 14:507–515
13. McNearney, T, Speegle, D, Lawand NB et al. (2000) Excitatory amino acid profiles of synovial fluid from patients with arthritis. *J Rheumatol* 27:739–745
14. Neugebauer E, Carlton SM (2002) Peripheral metabotropic glutamate receptors as drug targets for pain relief. *Expert Opin Ther Targets* 6:349–361
15. Omote, K, Kawamata T, Kawamata M et al. (1998) Formalin-induced release of excitatory amino acids in the skin of the rat hindpaw. *Brain Res* 787:161–164
16. Piani D, Frei K, Do KQ et al. (1991) Murine brain macrophages induce NMDA receptor mediated neurotoxicity *in vitro* by secreting glutamate. *Neurosci Lett* 133:159–162
17. Sato K, Kiyama H, Park HT et al. (1993) AMPA, KA and NMDA receptors are expressed in the rat DRG neurones. *NeuroReport* 4:1263–1265
18. Warncke T, Jorum E, Stubhaug A (1997) Local treatment with the N-methyl-D-aspartate receptor antagonist ketamine, inhibits development of secondary hyperalgesia in man by a peripheral action. *Neurosci Lett* 227:1–4
19. Westlund KN, Sun YC, Sluka KA et al. (1992) Neural changes in acute arthritis in monkeys. II. Increased glutamate immunoreactivity in the medial articular nerve. *Brain Res Rev* 17:15–27
20. Zhou S, Komak S, Du J et al. (2001) Metabotropic glutamate 1 $\alpha$  receptors on peripheral primary afferent fibers: their role in nociception. *Brain Res* 913:18–26
21. Zhou Z, Bonasera L, Carlton SM (1996) Peripheral administration of NMDA, AMPA or KA results in pain behaviors in rats. *NeuroReport* 7:1–6

## Inflammatory

### Definition

Pertaining to the local response to an injury (usually including redness, warmth and pain).

- ▶ [Pain Modulatory Systems, History of Discovery](#)

## Inflammatory Bowel Disease, in Animal Models

- ▶ [Animal Models of Inflammatory Bowel Disease](#)

## Inflammatory Hyperalgesia by Skin Freezing

- ▶ [Freezing Model of Cutaneous Hyperalgesia](#)

## Inflammatory Mediators

### Definition

Inflammatory mediators comprise of a variety of endogenous substances including bradykinin, serotonin, histamine, prostaglandins, leukotrienes, amines, purines, cytokines and chemokines that are released in inflammation. They act on primary afferent nociceptors to cause pain by either inducing activity in nociceptors (activation/ excitation), or increasing nociceptor responses evoked by other stimuli (sensitization). In addition, inflammatory mediators cause the local release of other mediators from leucocytes and phagocytotic cells and attract leucocytes to the site of inflammation. Inflammatory mediators are involved in the process of removal of injured tissue and repair of the injured site. The role of inflammatory pain in this protective process is to prevent further trauma to the already injured tissue.

- ▶ [Neuropeptide Release in Inflammation](#)
- ▶ [Perireceptor Elements](#)
- ▶ [Quantitative Thermal Sensory Testing of Inflamed Skin](#)

## Inflammatory Myopathies

- ▶ [Myositis](#)

## Inflammatory Neuritis

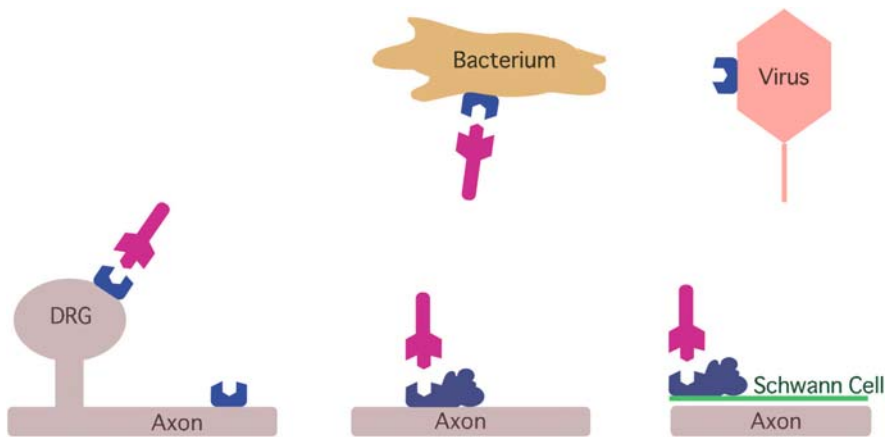
LINDA S. SORKIN  
Anesthesia Research Laboratories, University of California, San Diego, CA, USA  
lsorkin@ucsd.edu

### Synonyms

Nerve Inflammation; Neuritis; Inflammatory Neuropathy

### Definition

Inflammation of a nerve or nerves. Note: Not to be used unless inflammation is thought to be present (Linblom et al. 1986), however this should include presence of neuroimmune reactions.



**Inflammatory Neuritis, Figure 1** This schematic illustrates the principle of molecular mimicry. If bacteria/ viruses and Schwann cells/axons contain similar surface epitopes, antibodies generated as part of a normal immune response can cross-react with the neural elements and trigger a local immune cascade around the nerve. The epitope can be part of a more complex antigen as long as it is exposed. Exogenously administered antibody can trigger similar immune responses.

### Characteristics

Inflammation of sensory nerves leading to pain is a common clinical occurrence. The etiology can range from responses to a local infection to neuroimmune reactions. In the latter case, antibodies generated in response to bacteria or viruses attack an axon or cell body of a sensory nerve or elements of local Schwann cells (usually myelin) because these structures share the epitope to which the antibody was originally directed. The autoimmune reaction resulting from this shared identity is termed molecular mimicry (Fig. 1). Alternatively, exogenous antibodies administered as part of a therapeutic regime can elicit similar responses resulting in an iatrogenic neuritis. In all cases, local immune reactions alter the microenvironments of the affected nerves. Under some conditions, the response seems to involve ► **complement** activation, in others activation of T and/or B cells is implicated. Frank infiltration of T cells, macrophages and neutrophils can occur, but perhaps due to the non-linearity of the inflammation, are not always seen in biopsy or autopsy specimens. Generation of prostaglandins, pro-inflammatory ► **cytokines**, oxygen free radicals and nitric oxide may all play a role in the immune cascade and help to break down the blood-nerve barrier. Antibody attack and/or the presence of pro-inflammatory agents within the local milieu can alter the activity of and/or destroy nerve fibers depending on the duration and severity of the response. When this includes A-delta and C nociceptive fibers, the disease is often characterized by painful dysesthesias during at least part of its course. Observed pathology can range from edema and axonal irritation, through localized demyelination with a resultant conduction slowing to irreversible axonal loss. Pain is frequently a prominent symptom of several stages of neuritis, but is not necessarily present throughout the full course of the disease.

### Animal Models

Current animal models of neuritis with documented pain behavior involve placement of pro-inflammatory sub-

stances on or around the mid sciatic nerve (Eliav et al. 1999; Sorkin and Doom 2000; Gazda et al. 2001). These tend to model the less severe end of the nerve damage continuum with the most prominent change in pathology being a reversible edema of the affected nerve. Resident peri-sciatic immune cells may increase local release of interleukins, tumor necrosis factor (► **TNF**) and oxygen free radicals in the absence of prominent changes in the number of infiltrating immune cells (Gazda et al. 2001). However, application of complete Freund's adjuvant (CFA) to the nerve results in increases in both CD4 and CD8 staining T-lymphocytes (Eliav et al. 1999). Increases in endogenous pro-inflammatory substances in these models are local and are not observed in plasma. Epineural application of pro-inflammatory agents uniformly results in a profound mechanical ► **allodynia** in the ipsilateral hind paw of the affected nerve. Increasing the severity of the insult (dose of the inflammatory agent) serves to make the allodynic portions of the skin bilateral (mirror image pain). The pain behavior is reversed by spinal administration of glial inhibitors, p38 MAP kinase antagonists, antagonists to pro-inflammatory cytokines, N-methyl D-aspartate receptor antagonists and  $\kappa$ -opioids, but not by morphine (Eliav et al. 1999; Milligan et al. 2003).

Interestingly, epineural TNF or CFA elicits bursting activity in unmyelinated C nociceptive fibers and to a lesser extent in the finely myelinated A-delta fibers (Sorkin et al. 1997), (Eliav et al. 2001). The TNF-induced axonal firing is enhanced in conditions of inflammation and/or nerve damage. Systemic or intrathecal administration of exogenous antibody to a ganglioside found in peripheral nerve (GD<sub>2</sub> ganglioside) also produces mechanical allodynia in the absence of detectable thermal hyperalgesia. Like TNF administration, GD<sub>2</sub> ganglioside results in bursting activity in peripheral C fibers at a higher frequency than in A-delta afferent fibers within the sural nerve (Xiao et al. 1997). Low dose intravenous lidocaine (1–2  $\mu$ g/ml plasma levels) temporarily turns off the ectopic activity, indicating that sodium channel stabilizing agents may be an effective treatment for the symp-

tomatology, but not the origins, of the neuritis-associated pain.

While animal models for multiple sclerosis (experimental autoimmune encephalomyelitis) are used and might model more severe inflammatory neuritis, these models are not routinely examined for pain behavior.

### Clinical Syndromes

Neuritis resulting from probable autoimmune pathogenesis has several common characteristics. There is a known or presumed antibody response against an epitope found within the peripheral nerve. The most common epitopes involved in molecular mimicry resulting in neuritis are the gangliosides and myelin-associated proteins (MAG) found in cell surface membranes. Neural membranes are enriched with sialic acid containing sphingolipids, including gangliosides. Detectable plasma levels of antibodies to several disialosyl gangliosides are associated with sensory ataxic neuropathy, Miller-Fisher syndrome and many variants of ► [Guillain-Barré syndrome](#) (GBS) (Quarles and Weiss 1999). In the first month of the disease, 70%–90% of GBS patients complain of severe pain (Moulin et al. 1997). Acute GBS has been reported secondary to *Campylobacter jejuni*, Epstein-Barr virus and cytomegalovirus. More rarely it has occurred following therapeutic administration of ganglioside mixtures (Illa et al. 1995). Interestingly, systemic administration of GD<sub>2</sub> ganglioside as an immunotherapy results in a whole body allodynia; nerve biopsy in adult patients (who have more severe symptoms than pediatric patients) indicated demyelination and mononuclear infiltrates in both the endoneurial and perivascular spaces (Saleh et al. 1992). Thus, exogenous antibodies to nerve gangliosides can initiate a prominent neuritis. High plasma levels of IgM antibodies to MAG are also associated with neuropathic syndromes with a strong sensory deficit. Various circulating antibodies against neural tissue, including GD<sub>1a</sub> and GD<sub>1b</sub> gangliosides, have been found in patients with ► [chronic inflammatory demyelinating polyneuropathy](#) (CIPD). However, much evidence points to T cell and macrophage initiated involvement (van der Meche and van Doorn 1995). Pain is less frequently reported overall in CIPD (about 20%), however, when the population is restricted to patients with sensory variants, it approaches that of GBS. Infiltration of inflammatory cells into the endoneurium is less common in CIPD than in GBS. If perivascular infiltrates occur, they are found primarily in the epineurium. Disease pathology including demyelination and decreases in nerve conduction velocity can be reproduced in experimental animals by injection of plasma from patients (Dalakas 1995).

In both GBS and CIPD timely removal of antibodies using plasma exchange or suppression of their synthesis by ► [immunoglobulin therapy](#) remains the most effective treatment. An early study of diabetic patients with

polyneuropathy that meets the electrophysiological criteria for CIPD suggests that immunoglobulin therapy may elicit clinical improvement in this population indicating similar etiologies for both diseases (Sharma et al. 2002).

### References

1. Dalakas M C (1995) Basic aspects of neuroimmunology as they relate to immunotherapeutic targets: present and future prospects. *Ann Neurol* 37 Suppl 1:S2–13
2. Eliav E, Herzberg U, Caudle RM (1999) Neuropathic pain from an experimental neuritis of the rat sciatic nerve. *Pain* 83:169–182
3. Eliav E, Benoliel R, Tal M (2001) Inflammation with no axonal damage of the rat saphenous nerve trunk induces ectopic discharge and mechanosensitivity in myelinated axons. *Neurosci Lett* 311:49–52
4. Gazda L S, Milligan ED, Hansen MK et al. (2001) Sciatic inflammatory neuritis (SIN): behavioral allodynia is paralleled by peri-sciatic proinflammatory cytokine and superoxide production. *J Peripher Nerv Syst* 6:111–129
5. Illa I, Ortiz N, Gallard E et al. (1995) Acute axonal Guillain-Barré syndrome with IgG antibodies against motor axons following parenteral gangliosides. *Annals of Neurology* 38:218–224
6. Linblom U, Mersky H, Mumford JM et al. (1986) Pain terms: a current list with definitions and usage. *Pain Suppl.* 3:S215–S221
7. Milligan E D, Twining C, Chacur M et al. (2003) Spinal glia and proinflammatory cytokines mediate mirror-image neuropathic pain in rats. *J Neurosci* 23:1026–1040
8. Moulin D E, Hagen N, Feasby TE et al. (1997) Pain in Guillain-Barré syndrome. *Neurology* 48:328–331
9. Quarles R H, Weiss MD (1999) Autoantibodies associated with peripheral neuropathy. *Muscle Nerve* 22:800–822
10. Saleh MN, Khazaeli MB, Wheeler RH et al (1992) Phase I trial of the chimeric anti-GD2 monoclonal antibody ch14.18 in patients with malignant melanoma. *Human Antibodies and Hybridomas* 3:19–24
11. Sharma KR, Cross J, Ayyar DR et al (2002) Diabetic demyelinating polyneuropathy responsive to intravenous immunoglobulin therapy. *Arch Neurol* 59:751–757
12. Sorkin L S, Doom C (2000) Epineurial application of TNF elicits an acute mechanical hyperalgesia in the awake rat. *J Peripheral Nervous Sys* 5: 96–100
13. Sorkin L S, Xiao WH, Wagner R et al (1997) Tumour necrosis factor-alpha induces ectopic activity in nociceptive primary afferent fibres. *Neuroscience* 81:255–262
14. van der Meche FGP, van Doorn A (1995) Guillain-Barre syndrome and chronic inflammatory demyelinating polyneuropathy: immune mechanisms and update on current therapies. *Ann Neurol* 37 Suppl 1:S14–31
15. Xiao W H, Yu AL, Sorkin LS (1997) Electrophysiological characteristics of primary afferent fibers after systemic administration of anti-GD2 ganglioside antibody. *Pain* 69:145–151

## Inflammatory Neuropathy

### ► Inflammatory Neuritis

## Inflammatory Nociception, Genetic Factors

### ► Heritability of Inflammatory Nociception

## Inflammatory Nociception, Heritability

### ► Heritability of Inflammatory Nociception

## Inflammatory Nociceptor Sensitisation, Prostaglandins and Leukotrienes

BLAIR D. GRUBB

Department of Cell Physiology and Pharmacology,  
University of Leicester, Leicester, UK  
bdg1@leicester.ac.uk

### Synonyms

Prostaglandins in Inflammatory Nociceptor Sensitisation; Leukotrienes in Inflammatory Nociceptor Sensitisation

### Definition

The term prostaglandins (PG) describes a group of oxygenated polyunsaturated fatty acids containing a cyclopentane ring and two alkyl side chains that are derived from arachidonic acid by the action of cyclooxygenase (cox) enzymes. The alphanumeric nomenclature (e.g. E<sub>2</sub>, I<sub>2</sub>, D<sub>2</sub>, F<sub>2</sub> α) describes the nature and position of side groups and double bonds on the cyclopentane ring and of double bonds on the alkyl side groups. The leukotrienes (e.g. LTB<sub>4</sub>, LTC<sub>4</sub>, LTD<sub>4</sub>) are a related group of conjugated trienes synthesised from arachidonic acid by the enzyme 5-lipoxygenase (Benedetto et al. 1987).

### Characteristics

The link between PG synthesis and nociceptors' sensitisation was established over 30 years ago when it was discovered that non-steroidal anti-inflammatory drugs (NSAIDs) produced analgesia by inhibiting PG synthesis (Vane 1971; Ferreira, 1972). PGs elicit nociceptor sensitisation by lowering mechanical and thermal activation thresholds in nociceptive nerve endings thus reducing the stimulus intensity required to elicit action potential firing in the afferent axon.

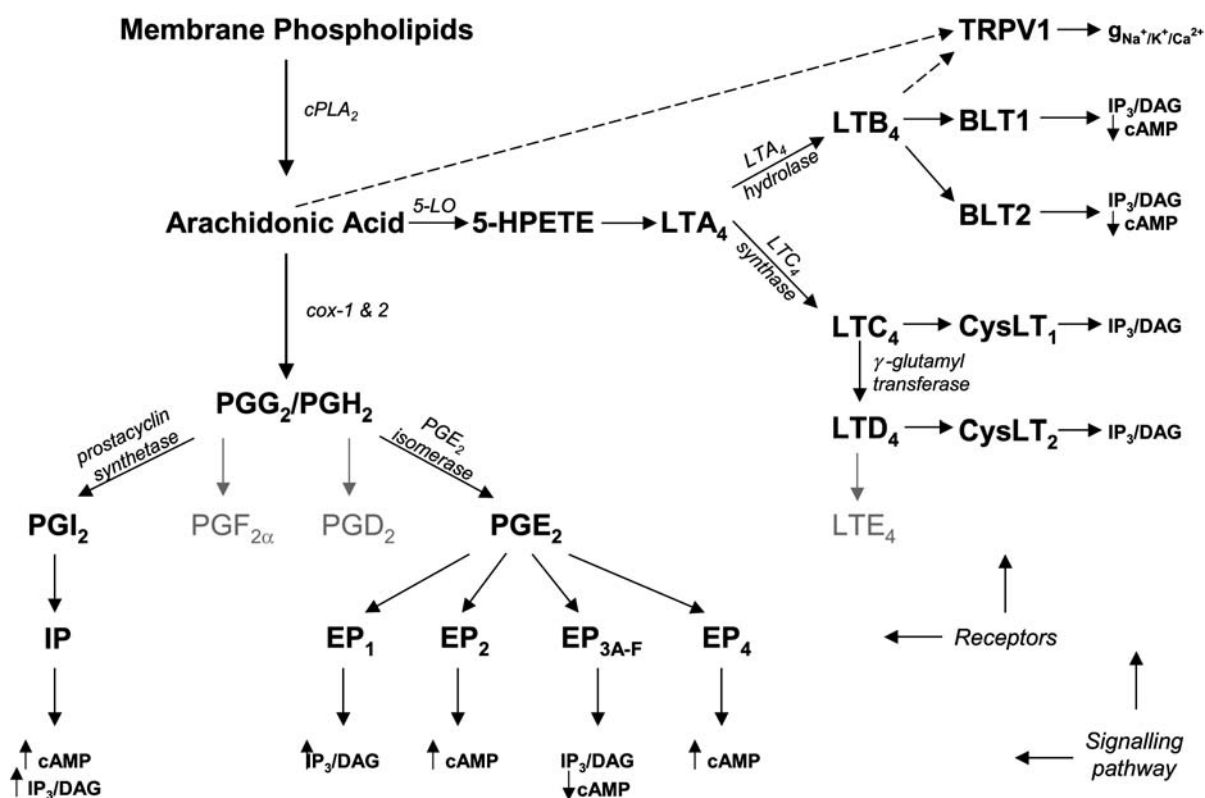
PGs are synthesised by cyclooxygenase (cox) enzymes from their natural precursor arachidonic acid (Fig. 1). Three cox isoforms have been cloned in mammalian species, cox-1, -2 and -3. Cox-1 is a constitutively expressed isoform present in most tissues and is responsible for PG synthesis associated with normal physiological processes. Cox-2 is constitutively expressed in some tissues, e.g. brain, spinal cord and kidney, but in most tissues expression levels are low unless the tissues are damaged. Cox-2 gene expression is up-regulated in somatic and neural tissues 3–12 hours after tissue damage as part of the normal immune re-

sponse. Since PGs are lipids and cannot be stored inside cells, tissue damage results in an increase in extracellular levels of PGs, which can contribute to the sensitisation of nociceptors. Cox-3 was identified only recently and is a splice variant of cox-1 that is present in dog and appears to be the molecular target for acetaminophen (paracetamol) in this species. In humans, however, cox-3 protein is probably not expressed due to a frame-shift mutation that results in an incomplete gene product.

Although several different PG species exist, only PGE<sub>2</sub> and PGI<sub>2</sub> (prostacyclin) produce pronounced nociceptors' sensitisation to mechanical and thermal stimuli (Schaible and Grubb 1993; Bley et al. 1998). It should be noted, however, that PGs can also directly excite some nociceptive nerve terminals suggesting that they might have more than one mode of action (Birrell et al. 1991; Shepelmann et al. 1992; Schmeltz et al. 2003). There are many examples of PG sensitisation of nociceptors skin, muscle and joint *in vivo*. The sensitisation of joint afferents has been studied extensively in studies where these compounds or their analogues have been applied by close arterial injections. PGE<sub>2</sub> primarily elicits sensitising responses to mechanical stimuli whilst PGI<sub>2</sub> and analogues produce both sensitisation and excitation. Interestingly, PGs do not act independently to produce nociceptor sensitisation but act in concert with other inflammatory mediators. A good example of this is PGE<sub>2</sub>-mediated enhancement of bradykinin responses in articular nociceptors. Bradykinin alone is a potent algogen and electrophysiological recordings from naïve primary afferents show that it directly activates a proportion of nociceptors and also enhances responses to mechanical stimuli. In the presence of PGs however, these actions are significantly enhanced (Schaible and Schmidt 1988; Birrell et al. 1993). Interestingly, bradykinin-induced sensitisation of nociceptors to some stimuli can be attenuated by NSAIDs suggesting that a component of the bradykinin effect itself involves synthesis of PGs (Pethö et al. 2001)

PGs elicit nociceptor sensitisation by binding to G-protein coupled PG receptors on nerve terminals and inducing changes in membrane excitability. PG receptors are named after the PG species that is the endogenous ligand (EP, IP, DP and FP). There are four EP receptor subtypes, EP<sub>1-4</sub>, and two of these, EP<sub>1</sub> and EP<sub>3</sub>, can express varying numbers of splice variants in different species. The EP<sub>3</sub> receptor is most prolific in this respect having up to 9 splice variants dependent on species. By contrast there are only single IP, DP and FP receptor subtypes. This diversity of receptors and receptor subtypes mean that a number of signalling cascades are activated by PGs depending on the receptor subtype that is expressed in each tissue. In sensory neurones, mRNA for all EP receptors and for IP receptors has been identified (Oida H 1995; Donaldson et al. 2001) (Fig. 1). However, a lack of suitable antibodies





**Inflammatory Nociceptor Sensitisation, Prostaglandins and Leukotrienes, Figure 1** A cartoon showing the possible membrane targets for prostaglandins and leukotrienes in nociceptors' peripheral terminals. Prostaglandins seem to mediate their effects through GPCRs located on the cell membrane whilst leukotrienes can elicit either direct or indirect effects. Solid lines indicate pathways for which there is solid evidence whilst dotted lines show possible pathways.

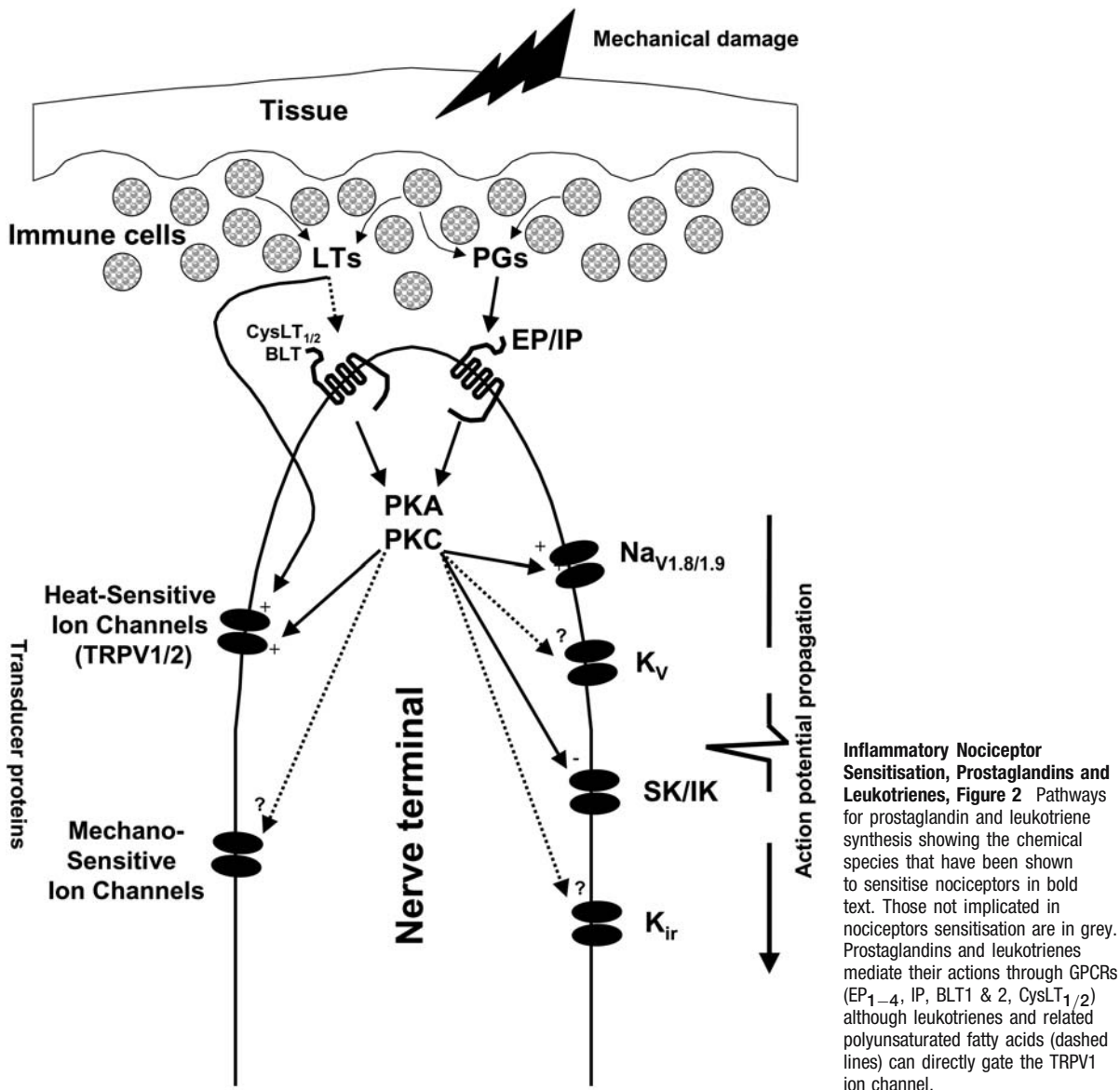
has precluded an objective assessment of PG receptor distribution in sensory ganglia and there is little known about the co-expression of individual prostaglandin receptors/subtypes with phenotypic markers of different class of primary afferent neurones, e.g. peptidergic nociceptors (CGRP expressing), non-peptidergic (labelled by isolectin B4) and non-nociceptive fibres (labelled by microfilament protein antibody, RT-97).

EP<sub>1</sub> receptors couple primarily to the G<sub>q/11</sub> family of G-proteins and their activation results in an activation of protein kinase C (PKC) and elevated levels of inositol 1,4,5 trisphosphate (IP<sub>3</sub>) and diacylglycerol. This results in an increase in intracellular calcium and activation of protein kinase C, which may underlie the regulation of ion channel conductances or mechanical or thermal transducer proteins. EP<sub>2</sub> and EP<sub>4</sub> receptors couple to the G<sub>s</sub> family of g-proteins and ligand binding results in activation of adenylyl cyclase and an increase in intracellular concentrations of cAMP and protein kinase A (PKA). Like PKC, PKA can phosphorylate and regulate a number of different ion channels to change membrane excitability. The G-protein coupling of EP<sub>3</sub> receptors is less well understood since there is a multitude of similar but subtly different splice variants in different species. It is clear, however, that depending on the splice variant

concerned, G<sub>q/11</sub>, G<sub>i/o</sub> (or even G<sub>s</sub>) proteins could be activated following ligand binding to EP<sub>3</sub> receptors. IP receptor coupling is primarily G<sub>s</sub> linked, although some studies have suggested that there is a G<sub>q/11</sub>-mediated activation of phosphoinositide turnover (Bley et al. 1998) (Fig. 1).

Primary afferent nociceptors are phenotypically distinct, expressing a number of ion channels that can be modulated by PGs. PGE<sub>2</sub> can regulate the mechanical and thermal transduction processes by modulating capsaicin/heat-sensitive TRPV1 currents and mechanosensitive currents in sensory neurones through PKA-dependent pathways (Lopshire and Nicol 1998; Cho et al. 2002). In addition to transducer channels, PGE<sub>2</sub> can modulate the activity of a number of channels that regulate action potential threshold and firing frequency (Fig. 2). In dorsal root ganglion neurones, for example, the activation kinetics (firing threshold) of the tetrodotoxin-resistant sodium current is altered by PGE<sub>2</sub> (England et al. 1996) through cAMP/PKA-dependent phosphorylation of Na<sub>v</sub>1.8 (Fitzgerald et al. 1999) and PKC-dependent mechanisms (Gold et al. 1998).

Potassium channels that control action potential repolarisation are also targets for PGs. PGE<sub>2</sub> and PGI<sub>2</sub> inhibit



delayed rectifier potassium currents to increase cell excitability and action potential firing (Nicol et al. 1997; Jiang et al. 2003). In addition, calcium-activated potassium channels present in nociceptors are modulated by PGE<sub>2</sub> resulting in a decrease in spike frequency adaptation and an increase in action potential firing frequency (Weinreich and Wonderlin 1987).

In comparison to PGs, the role of leukotrienes and their receptors in nociceptors sensitisation has been neglected. There is good evidence showing that leukotrienes are present in inflammatory exudates but a limited number of studies where leukotrienes have been implicated in nociceptor sensitisation (Martin et al. 1987; Madison et al. 1990). Furthermore, it is not yet known whether leukotriene receptors are present on nociceptors terminals nor if they mediate the sensitising actions of

leukotrienes (Figs. 1 and 2). Indeed there is much better evidence that leukotrienes can influence nociceptor sensitisation through direct interactions with ion channel proteins. This has been demonstrated for LTB<sub>4</sub>, which is structurally related to capsaicin and activates TRPV1, the heat sensitive ion channel, by binding to the cytoplasmic domain of this protein (Hwang et al. 2000). Furthermore a number of other ion channels are known to be modulated by leukotrienes in different tissues, although it is not yet known whether this occurs in nociceptors.

## References

1. Benedetto C, McDonald-Gibson RG, Nigam S et al. (1987) Prostaglandins and related substances: a practical approach. IRL Press Ltd, Oxford, Washington

2. Birrell GJ, McQueen DS, Iggo A et al. (1991) PGI<sub>2</sub>-induced sensitisation of articular mechanonociceptors. *Neurosci Lett* 124:5–8
3. Birrell GJ, McQueen DS, Iggo A et al. (1993) Prostanoid-induced potentiation of the excitatory and sensitising effects of bradykinin on articular mechanonociceptors in the rat ankle joint. *Neuroscience* 54:537–544
4. Bley KR, Hunter JC, Eglen RM et al. (1998) The role of IP prostanoid receptors in inflammatory pain. *Trends Pharmacol Sci* 19:141–147
5. Cho H, Shin J, Shin CY et al (2002) Mechanosensitive ion channels in cultured sensory neurons of rats. *J Neurosci* 22:1238–1247
6. Donaldson LF, Humphrey PS, Oldfield S et al. (2001) Expression and regulation of prostaglandin E receptor subtype mRNAs in rat sensory ganglia and spinal cord in response to peripheral inflammation. *Prostaglandins Other Lipid Mediat* 63:109–122
7. England S, Bevan S, Docherty RJ (1996) PGE<sub>2</sub> modulates the tetrodotoxin-resistant sodium current in neonatal rat dorsal root ganglion neurones via the cyclic AMP-protein kinase A cascade. *J Physiol* 495:429–440
8. Ferreira SH (1972) Prostaglandins, aspirin-like drugs and analgesia. *Nat New Biol* 240:200–203
9. Fitzgerald EM (1999) cAMP-dependent phosphorylation of the tetrodotoxin-resistant voltage-dependent sodium channel SNS. *J Physiol* 516:433–466
10. Gold MS, Levine JD, Correa AM (1998) Modulation of TTX-R I<sub>Na</sub> by PKC and PKA and their role in PGE<sub>2</sub>-induced sensitisation of rat sensory neurones *in vitro*. *J Neurosci* 18:10345–10355
11. Hwang SW, Cho H, Kwak J et al. (2000) Direct activation of capsaicin receptors by products of lipoxygenases: Endogenous capsaicin-like substances. *PNAS* 97:6155–6160
12. Jiang X, Zhang YH, Clark JD et al. (2003) Prostaglandin E<sub>2</sub> inhibits the potassium current in sensory neurones from hyperalgesic Kv1.1 knockout mice. *Neuroscience* 119:65–72
13. Lopshire JC, Nicol GD (1998) The cAMP transduction cascade mediates the prostaglandin E<sub>2</sub> enhancement of the capsaicin-elicited current in rat sensory neurons: whole cell and single channel studies. *J Neurosci* 18:6081–6092
14. Madison S, Whitsel EA, Suarez-Roca H et al. (1990) Sensitising effects of leukotriene B<sub>4</sub> on intradental primary afferents. *Pain* 49:99–104
15. Martin HA, Basbaum AI, Kwiat GC et al. (1987) Leukotriene and prostaglandin sensitisation of cutaneous high threshold C- and A-delta mechanonociceptors in the hairy skin of the rat hindlimbs. *Neuroscience* 22:651–659
16. Nicol GD, Vasko MR, Evans AR (1997) Prostaglandins suppress an outward potassium current in embryonic rat sensory neurones *J Physiol* 77:167–176
17. Oida H, Namba T, Sugimoto Y et al (1995) *In situ* hybridization studies of prostacyclin receptor mRNA expression in various mouse organs *Br J Pharmacol* 116:2828–2837
18. Pethö G, Derow A, Reeh PW (2001) Bradykinin-induced nociceptor sensitisation to heat is mediated by cyclooxygenase products in isolated rat skin. *Eur J Neurosci* 14:210–218
19. Schaible H-G, Grubb (1993) Afferent and spinal mechanisms of joint pain. *Pain* 55:5–54.
20. Schaible H-G, Schmidt RF (1988) Excitation and sensitisation of fine articular afferents from cat's knee joint by prostaglandin E<sub>2</sub>. *J Physiol* 403:91–104
21. Schepelmann K, Meßlinger K, Schaible H-G et al. (1992) Inflammatory mediators and nociception in the joint: Excitation and sensitization of slowly conducting afferent fibres of the cat's knee by prostaglandin I<sub>2</sub>. *Neuroscience* 50:237–247
22. Schmelz M, Schmidt R, Weidner C et al. (2003) Chemical response pattern of different classes of c-nociceptors to pruritogens and algogens. *J Neurophysiol* 89:2441–2448
23. Vane JR (1971) Inhibition of prostaglandin synthesis as a mechanism of action for aspirin-like drugs. *Nat New Biol* 231:232–235
24. Weinreich D and Wonderlin WF (1987) Inhibition of calcium-dependent spike after-hyperpolarisation increases excitability of rabbit visceral sensory neurones. *J Physiol* 294:415–427

## Inflammatory Pain

### Definition

Inflammatory pain is that which is associated with chronic inflammation (e.g. present in arthritis, back pain or temporomandibular joint disorders).

► NSAIDs, Mode of Action

## Inflammatory Pain and NGF

DAVID BENNETT

Department of Neurology, King's College Hospital, London, UK

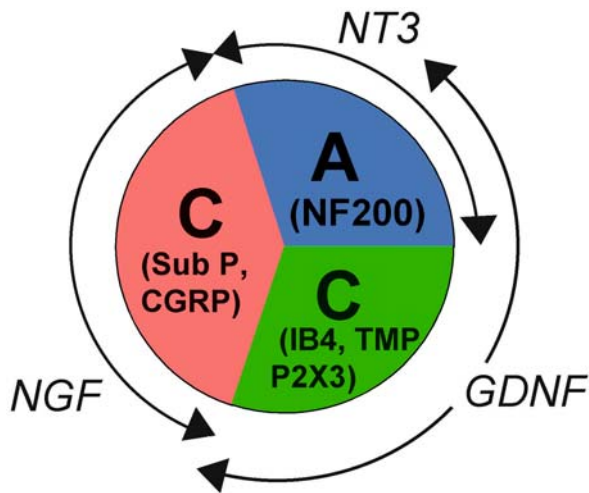
dlhbennett@talk21.com

### Definition

Inflammation is the body's reaction to injury in which part of the body becomes hot, red, swollen and painful. At the cellular level initially neutrophils and subsequently macrophages infiltrate the affected area. Many chemical mediators are involved in this process one of which is nerve growth factor (NGF). NGF is a secreted protein of molecular mass of 13 kD which exists as a homodimer. It is a member of the neurotrophin family, which also includes brain derived neurotrophic factor (BDNF), neurotrophin-3 (NT3) and neurotrophin-4/5 (NT4/5). NGF binds to both a high affinity tyrosine kinase receptor trkA and a low affinity receptor p75.

### Characteristics

NGF is the archetypal 'target derived neurotrophic factor' and was initially characterised for its neurodevelopmental effects. During the period of naturally occurring cell death, the survival of post-ganglionic sympathetic neurons and small diameter nociceptive sensory neurons is critically dependent on limiting amounts of NGF produced in their target fields. This role of NGF is shown in people who have a mutation in the trkA NGF receptor resulting in congenital insensitivity to pain and anhidrosis in which nociceptive neurons and sympathetic neurons fail to develop (Indo 2002). During development, virtually all small diameter nociceptive neurons express trkA and are NGF dependent; however this receptor is down-regulated during the postnatal period (Bennett et al. 1996). In the adult trkA expression is restricted to those small diameter DRG cells which express the neuropeptides substance P (SP) and calcitonin gene related peptide (CGRP) (Fig. 1). There is a second group of small diameter DRG cells which do not express neuropeptides but possess cell surface glycoconjugates that bind the lectin isolectin B<sub>4</sub> (IB<sub>4</sub>). These cells do not possess trkA receptors but express receptors for and are sensitive to another trophic factor glial cell line-derived neurotrophic factor.



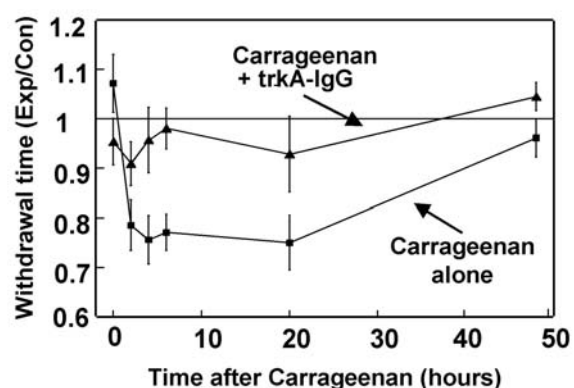
**Inflammatory Pain and NGF, Figure 1** Pie chart relating trophic factor sensitivity to the different neurochemically defined classes of DRG cells. Large diameter DRG cells (A-fibres) have myelinated axons and express the neurofilament NF200. These cells are responsive principally to the trophic factors NT-3 and GDNF. Small diameter DRG cells (C-fibres) have unmyelinated axons and can be broadly divided into two groups. The first group express the neuropeptides SP and CGRP and are NGF sensitive. The second group are non-peptidergic and bind the lectin IB4, these cells are GDNF sensitive.

NGF expression is required for the maintenance of a healthy neuronal phenotype in adult peptidergic DRG cells. NGF deprivation *in vivo* results in reduced thermal and chemical sensitivity in these neurons which is accompanied by a withdrawal of their terminals from their target fields (McMahon et al. 1995).

There is now strong evidence that NGF is an important mediator of inflammatory pain hypersensitivity: NGF levels increase following inflammation, NGF has been shown to sensitise nociceptive systems and most importantly blocking NGF bioactivity reduces inflammatory pain. The expression of NGF increases rapidly following an inflammatory stimulus and such increased levels have been shown in animals after inflammation induced by skin wounding, skin blistering, ultraviolet light, complete Freund's adjuvant, carrageenan and in a model of cystitis. Increased NGF levels have also been demonstrated in the bladder of patients with cystitis and in the synovial fluid of patients with arthritis. Studies in cell culture indicate that many growth factors and cytokines can increase NGF mRNA levels and NGF secretion these include: interleukin-1 (IL-1), IL-4, IL-5, tumour necrosis factor  $\alpha$  (TNF $\alpha$ ), transforming growth factor  $\beta$  (TGF  $\beta$ ), platelet-derived growth factor (PDGF), acid and basic fibroblast growth factors (FGF-1, FGF-2) and epidermal growth factor (EGF). Both IL1 and TNF $\alpha$  have been shown to be important in increasing NGF levels *in vivo* (Safieh-Garabedian et al. 1995; Woolf et al. 1997). Some agents have been shown to consistently reduce NGF mRNA levels and secretion; these include glucocorticoids and the interferons.

The administration of small doses of NGF to adult animals and man can produce pain and hyperalgesia. In rodents a thermal hyperalgesia develops within 30 minutes of systemic NGF administration and both a thermal and a mechanical hyperalgesia is present after a couple of hours (Lewin et al. 1993). Subcutaneous NGF produces a thermal and mechanical hyperalgesia at the injection site (Andreev et al. 1995). In humans intravenous injections of very low doses of NGF produce widespread myalgia and hyperalgesia at the injection site. Injection site hyperalgesia was a prominent side effect in trials of the use of NGF in the treatment of diabetic neuropathy (Apfel et al. 2000).

The critical test of the hypothesis that NGF has a role in mediating inflammatory pain was to show that blocking NGF bioactivity could reduce the hyperalgesia induced by inflammation and this has now been demonstrated by multiple groups using different model systems. We have used a fusion protein of the ligand binding domain of the trkA receptor and Fc region of human IgG (McMahon et al. 1995). This binds to and therefore blocks the activity of endogenous NGF. Application of trkA-IgG either locally or systemically could significantly reduce the thermal hyperalgesia resulting from intra-plantar administration of carrageenan in the rodent (Fig. 2). This molecule also prevents the development of thermal hyperalgesia following skin incision and detrusor hyperexcitability in a rodent model of cystitis. Similar findings have been shown using function blocking antibodies to NGF in inflammation evoked by complete Freund's adjuvant (Woolf et al. 1994; Safieh-Garabedian et al. 1995). Blocking NGF reduces thermal hyperalgesia and in some studies mechanical hyperalgesia, without altering many of the other aspects of the inflammatory process such as the degree of oedema. There is now in-



**Inflammatory Pain and NGF, Figure 2** An NGF sequestering molecule trkA-IgG was used to investigate the role of NGF in inflammation. Thermal hyperalgesia develops in rats within hours following intraplantar injection of carrageenan. Animals which are inflamed and concurrently treated with trkA-IgG fail to develop most of the thermal hyperalgesia. Adapted from McMahon et al. 1995.



creasing understanding of how NGF contributes to inflammatory pain.

NGF administration causes a sensitisation of nociceptors to both thermal and chemical stimuli. These effects are probably mediated by a combination of acute changes in second messenger pathways within the nociceptor terminal itself as well as more chronic changes in gene expression within nociceptive neurons. The mechanisms by which NGF produces nociceptor sensitisation are the subject of a separate chapter, NGF sensitization of nociceptors. The analgesic actions of NGF are not only limited to peripheral actions but in addition it has secondary effects on the spinal processing of nociceptive information. Firstly, the activation and sensitization of primary afferent nociceptors may lead to sufficient afferent activity to trigger central changes. Peripheral NGF administration to some visceral structures results in somatotopically appropriate induction of *c-fos* in the dorsal horn. Secondly NGF can modulate the expression of a number of neuropeptides and neuromodulators expressed within nociceptive neurons. NGF administration has been shown to increase the expression of SP and CGRP within nociceptive neurons both *in vitro* and *in vivo*. Following NGF treatment the release of SP within the dorsal horn is increased. The release of sensory neuropeptides is a well-known trigger for the induction of central sensitisation. Several hours after systemic NGF treatment, C-fibre stimulation produces greater than normal amounts of central sensitisation seen as wind-up of ventral root reflexes (Thompson et al. 1995). A-fibres also develop the novel ability to produce wind-up during inflammation and this may be secondary to novel SP expression within A-fibres (Thompson et al. 1995; Neumann et al. 1996). NGF can also modulate the central processing of nociceptive information through a novel mechanism-by increasing the expression and release of a second neurotrophic factor BDNF. BDNF is normally expressed within the NGF sensitive population of small diameter DRG cells and is anterogradely transported to their terminals within the superficial laminae of the dorsal horn where it is present within dense core vesicles (Michael et al. 1997). NGF and inflammation increase the expression of BDNF within these cells. The elevated expression of BDNF is accompanied by increased release of this factor following C-fibre stimulation. Exogenous BDNF results in facilitation of the flexor reflex (Kerr et al. 1999). This facilitation is mediated through activation of ERK MAP kinase in dorsal horn neurons, phosphorylation of the NMDA receptor subunit 1 and facilitation of NMDA receptor mediated responses (Lever et al. 2003). A trkB-IgG fusion protein has been used to sequester endogenous BDNF released within the dorsal horn and has demonstrated that BDNF has a role in the generation of hyperalgesia produced by inflammation or NGF administration (Kerr et al. 1999; Mannion et al. 1999).

In summary inflammation leads to a rapid induction of NGF expression and this can lead to a sensitisation of pain signalling systems via both peripheral and central mechanisms. There is now strong evidence that blocking NGF bioactivity reduces inflammatory hyperalgesia. NGF therefore provides a novel analgesic target and indeed clinical trials of the use of function blocking molecules in the treatment of inflammatory pain are under way.

## References

1. Andreev NY, Dimitrieva N, Koltzenburg M et al. (1995) Peripheral administration of nerve growth factor in the adult rat produces a thermal hyperalgesia that requires the presence of sympathetic post-ganglionic neurones. *Pain* 63:109–115
2. Apfel SC, Schwartz S, Adornato BT et al. (2000) Efficacy and safety of recombinant human nerve growth factor in patients with diabetic polyneuropathy: A randomized controlled trial. *rhNGF Clinical Investigator Group. JAMA* 284:2215–2221
3. Bennett DL, Averill S, Clary DO et al. (1996) Postnatal changes in the expression of the trkA high-affinity NGF receptor in primary sensory neurons. *Eur J Neurosci* 8:2204–2208
4. Indo Y (2002) Genetics of congenital insensitivity to pain with anhidrosis (CIPA) or hereditary sensory and autonomic neuropathy type IV. Clinical, biological and molecular aspects of mutations in TRKA(NTRK1) gene encoding the receptor tyrosine kinase for nerve growth factor. *Clin Auton Res* 12 Suppl 1:120–132
5. Kerr BJ, Bradbury EJ, Bennett DL et al. (1999) Brain-derived neurotrophic factor modulates nociceptive sensory inputs and NMDA-evoked responses in the rat spinal cord. *J Neurosci* 19:5138–5148
6. Lever IJ, Pezet S, McMahon SB et al. (2003) The signaling components of sensory fiber transmission involved in the activation of ERK MAP kinase in the mouse dorsal horn. *Mol Cell Neurosci* 24:259–270
7. Lewin GR, Ritter AM, Mendell LM (1993) Nerve growth factor-induced hyperalgesia in the neonatal and adult rat. *J Neurosci* 13:2136–2148
8. Mannion RJ, Costigan M, Decosterd I et al. (1999) Neurotrophins: peripherally and centrally acting modulators of tactile stimulus-induced inflammatory pain hypersensitivity. *Proc Natl Acad Sci USA* 96:9385–9390
9. McMahon SB, Bennett DL, Priestley JV et al. (1995) The biological effects of endogenous nerve growth factor on adult sensory neurons revealed by a trkA-IgG fusion molecule. *Nat Med* 1:774–780
10. Michael GJ, Averill S, Nitkunan A et al. (1997) Nerve growth factor treatment increases brain-derived neurotrophic factor selectively in TrkA-expressing dorsal root ganglion cells and in their central terminations within the spinal cord. *J Neurosci* 17:8476–8490
11. Neumann S, Doubell TP, Leslie T et al. (1996) Inflammatory pain hypersensitivity mediated by phenotypic switch in myelinated primary sensory neurons. *Nature* 384:360–364
12. Safieh-Garabedian B, Poole S, Allchorne A et al. (1995) Contribution of interleukin-1 beta to the inflammation-induced increase in nerve growth factor levels and inflammatory hyperalgesia. *Br J Pharmacol* 115:1265–1275
13. Thompson SW, Dray A, McCarron KE et al. (1995) Nerve growth factor induces mechanical allodynia associated with novel A fibre-evoked spinal reflex activity and enhanced neurokinin-1 receptor activation in the rat. *Pain* 62:219–231
14. Woolf CJ, Safieh-Garabedian B, Ma QP et al. (1994) Nerve growth factor contributes to the generation of inflammatory sensory hypersensitivity. *Neuroscience* 62:327–331
15. Woolf CJ, Allchorne A, Safieh-Garabedian B et al. (1997) Cytokines, nerve growth factor and inflammatory hyperalgesia: the contribution of tumour necrosis factor alpha. *Br J Pharmacol* 121:417–424

## Inflammatory Pain and Opioids

- ▶ Opioids and Inflammatory Pain

## Inflammatory Pain, Human Models

- ▶ Human Models of Inflammatory Pain

## Inflammatory Pain Models

### Definition

The inflammatory process can be classified in three distinct phases: an acute and subacute phase, characterized by local vasodilatation, increased capillary permeability and infiltration of phagocytotic cells, and a chronic proliferative phase, in which tissue degeneration and fibrosis occur. According to these phases, *in vivo* animal models of inflammation/inflammatory pain have been developed. Models for testing acute and subacute inflammation are, for example, UV-induced erythema in guinea-pigs, and oxazolone- or croton-oil-induced ear edema in mice. A well-established model of chronic inflammation is adjuvant-induced arthritis in rats produced by intradermally inoculating a suspension of *Mycobacterium butyricum* into both hindpaws. To study visceral inflammation, experimental colitis is caused by rectal instillation of trinitrobenzene sulfonic acid. Local inflammation to measure inflammatory pain in animals is induced by intraarticular or intraplantar injection of carrageenan or formalin.

- ▶ [Neuropeptide Release in Inflammation](#)

## Inflammatory Syndrome

- ▶ [Lower Back Pain, Physical Examination](#)

## Infliximab

### Definition

Monoclonal antibodies to TNF $\alpha$  that serve as a TNF $\alpha$  inhibitor in human autoimmune disorders.

- ▶ [Cytokines as Targets in the Treatment of Neuropathic Pain](#)

## Inflow Artefacts

### Definition

Susceptibility artifacts. In MRI, susceptibility artifacts are caused, for example, by medical devices in or near the magnetic field or by implants of the patient. These materials with magnetic susceptibility distort the linear magnetic field gradients, which results in bright areas (misregistered signals) and dark areas (no signal) nearby the magnetic material.

- ▶ [Amygdala, Functional Imaging](#)

## Information and Psychoeducation in the Early Management of Persistent Pain

STEVEN J. LINTON

Department of Occupational and Environmental Medicine, Department of Behavioral, Social and Legal Sciences, Örebro University Hospital, Örebro, Sweden  
 steven.linton@orebroll.se

### Synonyms

Education; Back Schools; Pain Schools; Patient Information; Health Informatics; Psychoeducation

### Definition

Educational and informational approaches are concerned with providing patients with knowledge about their painful illness that will help them to cope better with the problem. Psychoeducation refers to approaches that in particular utilize psychological knowledge and advice, often provided in a “study group” format. In part, the aim is to provide basic knowledge about pain and how it operates, in order to increase knowledge and decrease distress and uncertainty about the pain problem. Moreover, informational activities almost always strive to change the patient’s behavior to enhance coping.

### Characteristics

Modern approaches to back and neck pain stress self-management. In order to achieve this, patients need to understand their problem and how they can manage it and consequently change their behavior in accordance. For example, a patient may need to understand that the pain itself is not harmful and that activity will enhance recovery. Further, the patient may be asked to engage in exercises, to take pain relievers on a specific time basis in order to remain active and to practice relaxation.

A lack of information or knowledge may therefore have grave consequences in the treatment of musculoskeletal pain for three reasons. First, lack of a correct explanation of the illness, its cause, course and treatment may well lead to uncertainty and an increase in anxiety

and psychological distress. In other words, patients may worry and suffer needlessly. Second, when not properly informed, patients may not feel engaged in the process. Decisions about assessment and treatment may be perceived as over the head of the patient, thus pre-empting active participation. Third, self-care by the patient may be limited if the patient does not understand its importance. For example, patients may be unclear as to what they should do to enhance recovery. Moreover, if instead the patient feels she is being “taken care of”, this may reduce motivation to engage in self-care activities. This is particularly salient because many of the self-care activities such as exercise involve considerable time and effort. Thus, there is good reason to believe that educational interventions may serve an important purpose.

Since communication problems in medicine are common, several attempts have been made to provide patients with clear information. In the rehabilitation clinic, patient information is sometimes used as a basic building block in multidimensional treatments for chronic pain that include many components. It is difficult to ascertain the extent of the effect of such information in relation to the effects of the other components. However, including such information is probably not particularly effective because the information is often limited in scope and provided to patients with difficult problems. At best, the information may be necessary but not sufficient to produce significant improvements (Burton and Waddell 2002).

Another approach has been to provide general health information. Some health authorities for example, have provided booklets designed to help patients self-manage minor illnesses such as colds, flu and cuts. However, controlled scientific tests of their effectiveness have been quite disappointing, as these booklets have little or no effect in reducing the number of clinical consultations e.g. (Heaney et al. 2001).

### Written Materials

To be effective, written information needs to be read, understood, believed relevant and acted upon. A review of these premises however, shows that it is far from the usual case (Ley 1997). Indeed, written information as the only intervention appears to have small effect in changing behaviors. However, it might be incorporated into practices to enhance communication.

In the musculoskeletal pain area, several attempts have been made to provide patients with concrete educational materials in the form of pamphlets, books, videos or Internet services. These materials reflect different approaches primarily to back pain. Historically, written material was based on an ergonomic approach to back pain, where patients were provided with information about the structure of the spine and how injuries may occur. The message was focused on avoiding movements that are not ergonomic. In addition, these booklets

usually advised patients to contact their doctor if any of a host of pain situations occurred. Not surprisingly this type of information has not proved to be effective in lowering distress, absenteeism or consultation (Burton and Waddell 2002).

There is now rather extensive theoretical and scientific knowledge on which to base potent patient information. As a result, the current trend is to combine the growing evidence about the role of psychosocial factors and the emergence of guidelines. It has become evident that psychosocial factors may create barriers for recovery and return to work. This idea is based on recent knowledge that psychological factors are strongly associated with the transition from acute to chronic pain (Linton 2000). At the same time, several authorities have developed guidelines for the treatment of back pain that are derived from the scientific literature. Although the guidelines vary (Koes et al. 2001), there are a number of key recommendations included in most. These include prescribing activity rather than rest and providing reassurance to reduce anxiety and fear. Written materials have been developed to provide patients with the key messages. Consequently, these pamphlets often provide clear messages aimed at reducing fear, avoidance of activities and distress, e.g. (Symonds et al. 1995).

A review of the studies employing written materials indicates that under certain conditions they can be effective (Burton and Waddell 2002). While written information remains a rather weak intervention, a coordinated effort where the information is employed to enhance the messages and advice provided by clinicians, may be of value. Carefully selected and presented information presented in an uncompromising style that is in line with current management guidelines can have a positive effect on the beliefs patients have, as well as on clinical outcomes.

### Schools

A number of educational efforts have been initiated in the form of a “school” or study group; these include back schools, neck schools and pain management schools. They assume that an important reason why people develop problems is a lack of knowledge. Back schools, for example, may include a wide range of topics, but typically focus on body mechanics and ergonomics. Other topics normally included are exercise, lifting and stress. A trained professional such as a physical therapist almost always provides these educational efforts in groups. However, there is great variation in the content, number and length of sessions.

Unfortunately, the school concept has demonstrated limited effects. In a review of the effects as an early, preventive intervention, it was concluded that neck and back schools were not effective (Linton and van Tulder 2001). While other reviews find some effects on knowledge and correct back posture, there is considerable agreement that back schools, at best, have only slight effects on variables such as health care utilization or absenteeism and

virtually no effects on clinical variables such as pain intensity (Maier-Riehle and Harter 2001).

### Psychoeducation: CBT Groups as an Early Intervention

These learning experiences focus on psychological aspects of pain, such as developing effective coping strategies, altering dysfunctional attitudes or alleviating fears about the problem. These interventions are almost always provided in groups and are a method of providing a psychologically oriented therapy in an effective and inexpensive way. A key concept is promoting self-help. A psychoeducational group program, based on cognitive behavioral therapy, was developed for patients with arthritis and then modified to be applicable for musculoskeletal pain problems (Lorig et al. 1993). In one study, chronic pain patients were randomly assigned to either the psychoeducation program or to a waiting list control (LeFort et al. 1998). The course offered six 2 h sessions designed to maximize group problem solving and self-management skills. Results indicated that the educational intervention group made significant improvements in pain, vitality, functioning, satisfaction and self-efficacy in comparison to the control group.

More recently, programs have also been adapted for early intervention aimed at preventing the development of chronic back or neck pain (Linton 2002). Although neck and back pain are very common, only a relatively small number of patients develop persistent problems restricting work capacity and requiring health care. However, these small numbers consume the majority of the resources. Consequently, identification and providing early, preventive interventions could be an effective strategy to reduce the problem. Psychological factors have been found to be an important link in the transition from acute to persistent back pain, and therefore psychologically oriented interventions seem to be needed to address the problem properly (Linton 2000). This is a particularly relevant idea because early interventions focus on changing the participant's behavior and lifestyle.

The effects of providing an early, cognitive behavioral group intervention were tested in a randomized study of 255 primary care back pain patients (Von Korff et al. 1998). The cognitive behavioral intervention consisted of four sessions focusing on problem solving skills, activity management and educational videos. Relative to the control group, those receiving the cognitive behavioral group intervention significantly reduced their worry and disability and increased their self-help skills. Similar results have been reported in other studies (Moore et al. 2000; Saunders et al. 1999).

A cognitive behavioral intervention was specifically developed for primary care patients found to be at risk on psychosocial variables. In this program patients meet six times in groups of about 8 people for 2 h once a week. The course is led by a professional and is based on helping participants to change their beliefs and be-

haviors. Several steps are taken to enhance engagement, such as prompting discussion, homework and "hands on" skills training. Each session contains a review of homework, a short presentation of educational material, problem solving, coping skills acquirement and individualized homework assignments. The end product for participants is a personalized coping program that they design themselves. The utility of this approach has been tested in four separate randomized controlled trials (Linton and Andersson 2000; Linton et al. 2001; Linton et al. 2006). All of these studies have demonstrated that this intervention has a clear preventive effect on future sick absenteeism and function. Thus, there is support for the contention that a psychoeducational intervention designed to match the psychological needs of the participants may help prevent the development of persistent musculoskeletal pain.

### References

- Burton AK, Waddell G (2002) Educational and informational approaches. In: Linton SJ (ed), *New avenues for the prevention of chronic musculoskeletal pain and disability*. Elsevier, Amsterdam, pp 245–258
- Heaney D, Wyke S, Wilson P et al. (2001) Assessment of impact of information booklets on use of healthcare services: Randomized controlled trial. *BMJ* 322:1218
- Koes BW, van Tulder MW, Ostelo R et al. (2001) Clinical guidelines for the management of low back pain in primary care. *Spine* 26:2504–2514
- LeFort SM, Gray-Donald K, Rowat KM et al. (1998) Randomized controlled trial of a community-based psychoeducation program for the self-management of chronic pain. *Pain* 74:297–306
- Ley P (1997) Written communication. In: Baum A, Newman S, Weinman J et al. (eds) *Cambridge handbook of psychology, health, and medicine*. Cambridge University Press, Cambridge, pp 331–334
- Linton SJ (2000) A review of psychological risk factors in back and neck pain. *Spine* 25:1148–1156
- Linton SJ (ed) (2002) *New avenues for the prevention of chronic musculoskeletal pain and disability*, vol 1. Elsevier Science, Amsterdam
- Linton SJ, Andersson T (2000) Can chronic disability be prevented? A randomized trial of a cognitive-behavior intervention and two forms of information for patients with spinal pain. *Spine* 25:2825–2831
- Linton SJ, Ryberg M (2001) A cognitive-behavioral group intervention as prevention for persistent neck and back pain in a non-patient population: A randomized controlled trial. *Pain* 90:83–90
- Linton SJ, van Tulder MW (2001) Preventive interventions for back and neck pain: What is the evidence? *Spine* 26:778–787
- Linton SJ, Boersma K, Jansson M et al. (2006) The effects of cognitive-behavioral and physical therapy preventive interventions on pain related sick leave: A randomized controlled trial. *Clin J Pain* (in press)
- Lorig K, Mazonson PD, Holman HR (1993) Evidence suggesting that health education for self-management in patients with chronic arthritis has sustained health benefits while reducing health care costs. *Arthritis Rheum* 36:439–446
- Maier-Riehle B, Harter M (2001) The effects of back schools: A meta-analysis. *Int J Rehab Med* 24:199–206
- Marhold C, Linton SJ, Melin L (2001) Cognitive behavioral return-to-work program: effects on pain patients with a history of long-term versus short-term sick leave. *Pain* 91:155–163
- Moore J, Von Korff M, Cherkin D et al. (2000) A randomized trial of a cognitive-behavioral program for enhancing back pain self care in a primary care setting. *Pain* 88:145–153



16. Saunders KW, Von Korff M, Pruitt SD et al. (1999) Prediction of physician visits and prescription medicine use for back pain. *Pain* 83:369–377
17. Symonds TL, Burton AK, Tillotson KM et al. (1995) Absence resulting from low back trouble can be reduced by psychosocial intervention at the work place. *Spine* 20:2738–2745
18. Von Korff M, Moore JE, Lorig K et al. (1998) A randomized trial of a lay-led self-management group intervention for back pain patients in primary care. *Spine* 23:2608–2615

## Infraclavicular Block

### Definition

A technique employed to block innervation by the brachial plexus. It is achieved by injection of local anesthetic inferior to and near the midpoint of the clavicle.

- ▶ Acute Pain in Children, Post-Operative

## Infusion

### Definition

The therapeutic infusion of fluid.

- ▶ Epidural Infusions in Acute Pain

## Inherited Factors Implicated in the Mechanisms of Migraine

- ▶ Migraine, Genetics

## Inherited Variability of Drug Response

- ▶ NSAIDs, Pharmacogenetics

## Inhibitory Synaptic Transmission

- ▶ GABA and Glycine in Spinal Nociceptive Processing

## Injection Acupuncture

- ▶ Acupuncture

## Injections of Corticosteroids

- ▶ Steroid Injections

## Injections of Steroids

- ▶ Steroid Injections

## Injury Discharge

### Definition

When axons are cut across acutely, or neurons are punctured, they tend to produce a brief burst of impulses, usually lasting no more than a few seconds. This „injury discharge“ is due to the intense depolarization caused by breaching the cell membrane.

- ▶ Neuropathic Pain Models, CRPS-I Neuropathy Model
- ▶ Peripheral Neuropathic Pain

## Injury Memory

### Definition

A process by which sensitized peripheral afferent fibers can produce a long-lasting sensitization of CNS neurons whose duration outlasts the peripheral sensitizing stimulus, in effect producing a memory of the injury by the brain.

- ▶ Gynecological Pain, Neural Mechanisms

## Innervation of the Urinary Bladder

### Definition

The bladder receives efferent sympathetic (hypogastric nerve), parasympathetic (pelvic nerve), and somatic-motor (pudendal nerve) innervation. Afferent (sensory) information is conveyed via the hypogastric, the pelvic and the pudendal nerves.

- ▶ Opioids and Bladder Pain/Function

## Innocuous Input/Stimulus

### Definition

An innocuous stimulus is one that is not painful or damaging to normal tissues. Non-painful stimuli mediated by large myelinated afferent fibers for transmission to the central nervous system.

- ▶ Arthritis Model, Kaolin-Carrageenan Induced Arthritis (Knee)
- ▶ Nociceptive Processing in the Amygdala, Neurophysiology and Neuropharmacology

- ▶ Postoperative Pain, Pre-Emptive or Preventive Analgesia
- ▶ Postsynaptic Dorsal Column Projection, Functional Characteristics

## Instability

### Definition

Instability is the inability to limit excessive or abnormal spinal displacement.

- ▶ Chronic Back Pain and Spinal Instability

## Installation Block

### Definition

Block achieved by pouring local anesthetic into the wound where it bathes injured tissue edges. It is removed 20-60 seconds later prior to wound closure.

- ▶ Acute Pain in Children, Post-Operative

## Instrumental Conditioning

### Definition

Instrumental conditioning is a term used to describe how the probability of occurrence of a specific behavior (e.g. limping) is influenced by the nature of its association with a particular outcome (e.g. reinforcement vs. punishment).

- ▶ Behavioral Therapies to Reduce Disability

## Insula

- ▶ Insular Cortex, Neurophysiology and Functional Imaging of Nociceptive Processing

## Insula/Insular Cortex

### Synonyms

Insular area; insular cortex

### Definition

A part of the cerebral cortex which became infolded during embryonic development as a result of the deepening of the lateral cerebral fissures (of Sylvius). It can only be seen by separating the lips of the fissure, or by cutting away the operculum which overhangs it. The insular cortex (or insula) is a cortical association area of whose function little is known.

- ▶ Amygdala, Pain Processing and Behavior in Animals
- ▶ Magnetoencephalography in Assessment of Pain in Humans
- ▶ Nociceptive Processing in the Secondary Somatosensory Cortex
- ▶ Secondary Somatosensory Cortex (S2) and Insula, Effect on Pain Related Behavior in Animals and Humans

## Insular Cortex, Neurophysiology and Functional Imaging of Nociceptive Processing

TUAN DIEP TRAN<sup>1, 2, 3</sup>, KENNETH L. CASEY<sup>1, 2</sup>

<sup>1</sup>Department of Neurology, University of Michigan, Ann Arbor, MI, USA

<sup>2</sup>Neurology Research Laboratory, VA Medical Center, Ann Arbor, MI, USA

<sup>3</sup>Department of Pediatrics, University of Medicine and Pharmacy of Ho Chi Minh City, Ho Chi Minh City, Vietnam

kencasey@umich.edu

### Synonyms

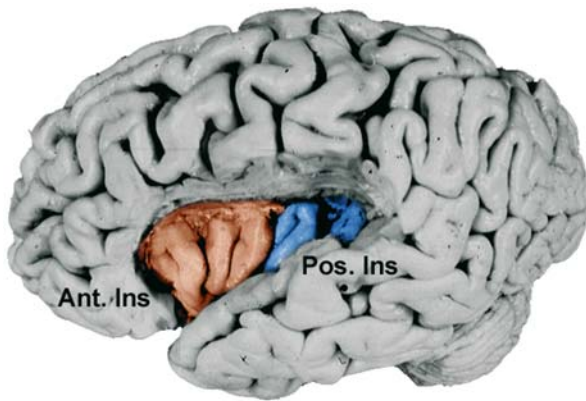
Insula; insular cortex; insular area; insular lobe; Island of Reil; Central Lobe; Fifth Lobe

### Definition

Insula in Latin means island. Despite its name, the insular cortex is not an island; it is an oval region of the cerebral cortex overlying the external capsule, lateral to the lenticular nucleus, buried in the ▶ [sylvian fissure](#) (lateral fissure) beneath the operculum, which forms the lips of the lateral fissure (Fig. 1, see also Fig. 1 in ▶ [Secondary Somatosensory Cortex \(S2\) and Insula, Effect on Pain Related Behavior in Animals and Humans](#)). The insula is buried simply because of the relatively greater growth of the rest of the hemisphere around it; therefore it is not visible on the surface and can only be seen when the lips – frontoparietal and temporal ▶ [operculum](#) – are pulled apart or removed. The insular cortex has connections to widespread thalamic, limbic and cortical regions related to all sensory modalities, autonomic and limbic functions (Augustine 1996).

### Characteristics

Anatomically, the insular cortex is mainly divided into three cytoarchitectural fields. In rostrocaudal order



**Insular Cortex, Neurophysiology and Functional Imaging of Nociceptive Processing, Figure 1** The insula is not visible on the surface and can only be seen when the lips, frontoparietal and temporal operculum, are pulled apart or removed. Ant. Ins, anterior insula (orange); Pos. Ins, posterior insula (blue).

they are: a rostroventral agranular field (Ia), a transitional dysgranular field (Id) and a posterior granular field (Ig). The anterior insula (AI) – Ia and Id – is predominantly connected with cortical areas related to limbic, olfactory, gustatory and viscer-autonomic functions, whereas posterior insula (PI) – Ig and part of Id – is predominantly connected with cortical areas related to somatosensory, auditory and visual functions (Augustine 1996).

The evidence for a pain representation in the insular cortex is provided by the anatomical connectivity and electrophysiological properties of this area in monkeys (for review see Willis 1995). The ► **spinothalamic tract** (STT), which carries ► **nociceptive** information, terminates in thalamic nuclei that project to the insular cortex. In particular, the ventroposterior inferior nucleus (VPI), the supragenulate-limitans nucleus (SG-Li) and the posterior complex (Po) project to the PI and the posterior portion of the ventral medial nucleus (VMpo) projects to the AI cortex. In accord with these inputs, ► **single-unit recordings** reveal nociceptive responses in neurons of the PI and AI. These neurons have large ► **receptive fields**, either contralateral or bilateral.

In human lesion studies, brain lesions involving the posterior portion of the insula have led to an impairment of tactile and pain perception and changes in pain sensitivity (Greenspan et al. 1999). Large lesions that include the anterior portion of the insula apparently reduce pain affect and appropriate reactions to painful stimuli, the so-called asymbolia for pain (Berthier et al. 1988; Greenspan et al. 1999).

► **Electroencephalography** (EEG), ► **nociceptive selective stimulation** and scalp or subdural ► **laser evoked potential** (LEP) recordings reveal activity bilaterally in the SII-insular cortices (Lenz et al. 2000; Valeriani et al. 2000). ► **Magnetoencephalography** (MEG) with ► **laser evoked magnetic field** (LEF) recordings and

selective activation of ► **A $\delta$  fibers** (Kakigi et al. 1996) and ► **C Fiber** (Tran et al. 2002) show activity in SII bilaterally but not in the insula. This is because MEG can only detect tangential but not radial dipoles, which are believed to be generated in the insula. Since the SII and the insula are anatomically adjacent, there has long been a debate in dipole source modeling studies about whether the activity in the parasyllian area originates from two generators – SII and insula – or from only one generator in the insula. A meta-analysis of neuroimaging studies (PET, fMRI, scalp and intracerebral LEP source analyses) shows that the spatial resolution of these techniques is not sufficient to segregate SII and insular activities (Peyron et al. 2002). However, using depth intracerebral electrodes in epileptic patients, a recent study has demonstrated a dual representation of pain in both SII and insular cortices (Frot and Mauguiere 2003). The high temporal resolution of LEP and LEF also reveals that the contralateral SII and insular cortices are activated earlier than the ipsilateral side by an average of 14–18 ms (Frot and Mauguiere 2003; Tran et al. 2002). Moreover, insular activity is delayed ~50 ms following SII activation (Frot and Mauguiere 2003). The delay may reflect either sequential activation from contralateral to ipsilateral through transcallosal transmission and from SII to insular cortices *via* intracortical connections, or the direct activation of bilateral SII and insula through distinct thalamocortical projection fibers with different conduction times.

Human ► **functional imaging** studies reveal that pain related activation is located in the anterior part of the insular cortex either contralateral or bilateral to the stimulation side (Casey et al. 1996; Coghill et al. 1994). The activity in AI is modulated by pain affect (Rainville et al. 1997), pain anticipation (Porro et al. 2002), pain attention (Brooks et al. 2002), pain illusion (Craig et al. 1996), pain anxiety (Ploghaus et al. 2001) and pain suggestion (Hofbauer et al. 2001). Neuroimaging studies also show another peak of pain related activation in the contralateral posterior part of the insular cortex (Brooks et al. 2002; Casey et al. 2001; Craig et al. 2000). This activity in PI is correlated with thermal intensity and duration (Brooks et al. 2002; Casey et al. 2001; Craig et al. 2000). Moreover, stimulation studies show that electrical stimulation of the anterior part of the insula in conscious humans produces visceral sensory experiences and visceral motor responses, but not reports of pain, whereas stimulation of the posterior part of insula elicits somesthetic sensation including pain sensation in body areas contralateral to the stimulation site (Ostrowsky et al. 2002). The imaging findings, neuronal projections, anatomical connections and lesion and stimulation studies provide convergent evidence that insular activation is related to the affective-motivational and internal state of the body. However, PI activity may be more closely related to direct somatosensory processing. Averaged event related activities (LEP, LEF) evoked by laser stimulation, which

has less – if any – affective and emotional effect, often reveal pain related dipole sources primarily in the parasyllian cortex, including the SII and the posterior part of the insula (Kakigi et al. 1996; Lenz et al. 2000; Tran et al. 2002; Valeriani et al. 2000). Neuroimaging studies, which reflect metabolic demands over several seconds, may however show both AI and PI activity in the course of repetitive noxious stimulation (Casey et al. 2001). The insular cortex is in a special position to act as an interface between intrapersonal and extrapersonal information processes and between the lateral and medial pain systems as represented by the lateral and medial targets of the spinothalamic tract. The insula processes intrapersonal information and involves the affective-motivational components of pain in the medial system and somatosensory information related to the sensory discriminative aspect of pain in the lateral system. The circuitry of the insular cortex in primates including humans – with connections to widespread thalamic, limbic, and cortical regions – suggests a wide variety of functions related to all sensory modalities and to autonomic, neuroendocrine and behavioral responses. The insular cortex may be an essential part of the neural substrate that integrates all external sensory sources and internal physiological conditions. Physiologically, the insula may be involved in autonomic reactions to a noxious stimulus, in sensory discriminative and affective-motivational components of pain and in pain related memory and learning. More studies are needed to explore the physiological functions of the AI and PI, the interaction of these two areas, and the temporal dynamics of the interaction. In addition, the anatomically adjacent SII and insular cortices require further investigations on their distinct roles in pain perception. The complementary use of neurophysiological techniques (LEP and LEF) with excellent temporal resolution in the order of milliseconds and functional imaging (PET and fMRI) with better spatial resolution is promising. The multimodal approach would certainly improve our understanding of normal pain perception and create a basis for studying pathological pain states and pain treatment.

### Acknowledgements

This work was supported by NIAMS AR46045 and the Dept. of Veteran's Affairs (KLC); NINDS / WHO Fellowship (TDT).

### References

- Augustine JR (1996) Circuitry and functional aspects of the insular lobe in primates including humans. *Brain Res Brain Res Rev* 22:229–244
- Berthier M, Starkstein S, Leiguarda R (1988) Asymbolia for pain: a sensory-limbic disconnection syndrome. *Ann Neurol* 24:41–49
- Brooks JC, Nurmiikko TJ, Bimson WE et al (2002) fMRI of thermal pain: effects of stimulus laterality and attention. *Neuroimage* 15:293–301
- Casey KL, Minoshima S, Morrow TJ et al. (1996) Comparison of human cerebral activation pattern during cutaneous warmth, heat pain, and deep cold pain. *J Neurophysiol* 76:571–581
- Casey KL, Morrow TJ, Lorenz J et al. (2001) Temporal and spatial dynamics of human forebrain activity during heat pain: analysis by positron emission tomography. *J Neurophysiol* 85:951–959
- Coghill RC, Talbot JD, Evans AC et al. (1994) Distributed processing of pain and vibration by the human brain. *J Neurosci* 14:4095–40108
- Craig AD, Reiman EM, Evans A et al. (1996) Functional imaging of an illusion of pain. *Nature* 384:258–260
- Craig AD, Chen K, Bandy D et al. (2001) Thermosensory activation of insular cortex. *Nat Neurosci* 3:184–190
- Frot M, Mauguiere F (2003) Dual representation of pain in the operculo-insular cortex in humans. *Brain* 126:438–450
- Greenspan JD, Lee RR, Lenz FA (1999) Pain sensitivity alterations as a function of lesion location in the parasyllian cortex. *Pain* 81:273–282
- Hofbauer RK, Rainville P, Duncan GH et al (2001) Cortical representation of the sensory dimension of pain. *J Neurophysiol* 86:402–411
- Kakigi R, Koyama S, Hoshiyama M et al (1996) Pain-related brain responses following CO<sub>2</sub> laser stimulation: magnetoencephalographic studies. *Electroencephalogr Clin Neurophysiol* 47:111–120
- Lenz FA, Krauss G, Treede RD et al (2000) Different generators in human temporal-parasyllian cortex account for subdural laser-evoked potentials, auditory-evoked potentials, and event-related potentials. *Neurosci Lett* 279:153–156
- Ostrowsky K, Magnin M, Rylvlin P et al (2002) Representation of pain and somatic sensation in the human insula: a study of responses to direct electrical cortical stimulation. *Cereb Cortex* 12:376–385
- Peyron R, Frot M, Schneider F et al (2002) Role of operculo-insular cortices in human pain processing: converging evidence from PET, fMRI, dipole modeling, and intracerebral recordings of evoked potentials. *Neuroimage* 17:1336–1346
- Ploghaus A, Narain C, Beckmann CF et al (2001) Exacerbation of pain by anxiety is associated with activity in a hippocampal network. *J Neurosci* 21:9896–9903
- Porro CA, Baraldi P, Pagnoni G et al (2002) Does anticipation of pain affect cortical nociceptive systems? *J Neurosci* 22:3206–3214
- Rainville P, Duncan GH, Price DD et al (1997) Pain affect encoded in human anterior cingulate but not somatosensory cortex. *Science* 277:968–971
- Tran TD, Inui K, Hoshiyama M et al (2002) Cerebral activation by the signals ascending through unmyelinated C-fibers in humans: a magnetoencephalographic study. *Neuroscience* 113:375–386
- Valeriani M, Restuccia D, Barba C et al (2000) Sources of cortical responses to painful CO<sub>2</sub> laser skin stimulation of the hand and foot in the human brain. *Clin Neurophysiol* 111:1103–1112
- Willis WDJr (1995) From nociception to cortical activity. In: Bromm B, Desmedt JE (eds) *Pain and the brain*. Raven Press, New York, pp 1–19

## Insulin Neuropathy

### ► Diabetic Neuropathies

## Insurance Incentives

### ► Disability Incentives



## Intensity of Pain

### Definition

Intensity of pain is scored on a verbal points scale. 0 no pain; 1 mild pain, does not interfere with activities; 2 moderate pain, inhibits, but does not prohibit activities; 3 severe pain, prohibits activities. It may alternatively, be measured in a visual analogue scale (VAS).

- ▶ [Sunct Syndrome](#)

## Intensity of Ultrasound

### Definition

The intensity is power per unit area.

- ▶ [Ultrasound Therapy of Pain from the Musculoskeletal System](#)

## Intentionality

### Definition

A complex adaptive system has intentionality when it exhibits directedness toward some future state or goal. Intent comprises of the endogenous initiation, construction and direction of perception, action and goal-directed behavior.

- ▶ [Consciousness and Pain](#)

## Intercostal Space

### Definition

A potential space at the inferior margin of each rib through which the intercostal nerve, vein, and artery travel for each rib. The intercostal nerve provides sensory and motor function to the superficial chest and abdominal wall.

- ▶ [Postoperative Pain, Regional Blocks](#)

## Interdisciplinary

### Definition

Interdisciplinary refers to a team or collaborative process where members of different disciplines assess and treat patients jointly.

- ▶ [Complex Chronic Pain in Children, Interdisciplinary Treatment](#)
- ▶ [Physical Medicine and Rehabilitation, Team-Oriented Approach](#)

## Interdisciplinary Pain Management Programs

- ▶ [Interdisciplinary Pain Rehabilitation](#)

## Interdisciplinary Pain Rehabilitation

CHRIS J. MAIN

University of Manchester, Manchester, UK  
cmain@fs1.ho.man.ac.uk

### Synonyms

Interdisciplinary Pain Management Programs; Cognitive-Behavioral Programs

### Definition

Interdisciplinary pain management (IPM) does not offer cures for pain but comprises an integrated biopsychosocial approach to pain management from a team of health care professionals with the aim of maximizing the patient's own ability to manage their pain and pain associated dysfunction. A range of cognitive and behavioural strategies focused on re-activation and minimisation of unnecessary physical and psychosocial dysfunction are used. Perhaps most important of all as a defining characteristic of IPM is the promulgation of self-help and personal responsibility. This is evident particularly in the emphasis on active rather than passive approaches to treatment.

### Characteristics

The University of Washington in Seattle pioneered multidimensional treatment, research, education and interdisciplinary working in the field of pain. From the perspective of interdisciplinary pain management, its 5<sup>th</sup> mission statement was critically important: "To enhance interaction and communication among all pain investigators at the University of Washington and to encourage cross-fertilization of ideas on pain research and therapy" (Bonica 1990). The "Seattle model" became not only an example of a practical implementation of a biopsychosocial model of pain, but also an illustration of the mutual inter-dependence of clinical practice, teaching, training and research.

More specifically, in the early days, the Seattle group promoted a view of illness that incorporated both physical and behavioural aspects. Although most pain management programs now would define themselves as cognitive behavioural in their orientation, the power and incisiveness of the behavioural component (Fordyce 1976) in the original Seattle model was critical to the development of modern inter-disciplinary pain management. During the last 30 years, variants of the Seattle model have appeared all over the world.

Modern pain management programs (PMPs) contain a number of discrete elements blended into a package of care. Each of these elements has its own pedigree as an approach to treatment and each element has its origins in a particular perspective on the nature of pain. Typically these will include rationalisation of medication use, development of individually tailored re-activation programs, training in problem solving techniques and enhancement of adaptive pain coping strategies including goal setting and pacing, with the objective of maximising positive adaptation. Programs differ in the extent to which they have a specific work focus.

An appropriate educational component is a major ingredient of all PMPs, but it seems that education, although necessary, is not sufficient for established pain programs. It seems that unless increased understanding leads to significant behavioural change, it is of little value.

Specific therapeutic objectives usually include decreasing stiffness and immobility, recovery of fitness, development of strength and the reversal of the “disuse syndrome”, treatment of distress (including depression) and the modification of pain behaviour. They differ from the “sports medicine approach”, typified in functional restoration programs (Mayer and Gatchell 1988), in that they usually place less emphasis specifically on strength and mobility and have traditionally focused on clinical rather than on occupational outcomes.

It is not possible to overstress the importance of the behavioural perspective as an alternative to the disease / pathology model in offering a new and alternative understanding of pain. It has led to the focus on pain management as an alternative to cure, which is not available for many pain conditions. More recently incorporation of the cognitive perspective (Turk and Okifuji 2003; Turk et al. 1983) has produced a psychologically oriented approach which, with a focus on re-activation and self-management, is frequently described as a cognitive behavioural program and has become the treatment of choice for the dysfunctional chronic pain patient, with clear scientific evidence of its efficacy (Morley et al. 1999) over more narrowly focused traditional approaches.

#### Desirable Characteristics of PMPs

The British and Irish chapter of the International Association for the Study of Pain, therefore, inspired by the IASP report (IASP 1990) and by Sanders (1994) recently produced a set of “desirable characteristics” for PMPs (Pain Society 1997). The key features are:

- Behavioural rather than a disease perspective
- Focus on pain management rather than cure
- Blend of ingredients
- Interdisciplinary skill-mix
- Incorporation of group therapy

- Emphasis on active rather than passive approaches to treatment
- Promulgation of self-help and patient responsibility

#### The Context of Pain Management

There is a gradient of complexity in pain management, ranging from specific types of individualized intervention such as medication adjustment, spinal manipulation or provision of educational material to “packages of care” involving not only multifaceted treatment but also intervention by a range of professionals using a team approach. Multidisciplinary treatment undoubtedly offers a much wider range of potential therapeutic options that can be offered by a single-handed practitioner, but there are also inherent dangers of iatrogenic confusion or distress if the patient is given inconsistent information or offered a package of care that is poorly integrated or even contradictory. Integrated care has become known as interdisciplinary pain management. The potential limitations of a multidisciplinary approach (in contrast to an interdisciplinary approach) are:

- Poor communication leading to a lack of awareness of problem areas. (For example, the physiotherapist may be unaware that a patient has an alcohol problem).
- Fragmentation of the approach to treatment and assessment in which the patient’s problems are tackled sequentially rather than in an integrated fashion. The patient then comes to view the different professionals as having over-prescribed roles, making it difficult to tackle inter-dependent problems.
- There may be unnecessary duplication of certain parts of the assessment procedure. This is not only inefficient but can be irritating to patients.
- Different management strategies may be employed in dealing with the same problem.
- Patients and their relatives may receive conflicting information from different disciplines leading to confusion on their part about which approach should be adopted.
- In certain cases manipulative patients can “play off” one team member against other members.
- Restricted communication within the multidisciplinary team may lead to a sense of isolation and lack of support among individual team members

#### General Advantages of the Interdisciplinary Approach

In interdisciplinary pain management, a special effort is made to offer a consistent and coherent approach to both assessment and management. The structuring and delivery of IPM is dealt with in detail elsewhere (Main and Spanswick 2000), but for present purposes a number of strategies merit consideration. In the interdisciplinary team, according to Melvin (1980) “...individuals not only require the skills of their own disciplines, but also have the added responsibility of the group effort

on behalf of the activity or client involved. ...The group activity of an interdisciplinary team is synergistic, producing more than each individually and separately could accomplish” (p 379).

Two differing patterns of co-operation within the interdisciplinary team have been described (Finset et al. 1995). In the co-ordinated interdisciplinary team, mutual goals are set and the individuals from each discipline attempt to work on these goals in their individual sessions. In the integrated interdisciplinary team, mutual goals are worked on in joint treatment sessions with members of different disciplines participating in the sessions. The treatment could not be carried out by individual members of the team alone.

The key features of an interdisciplinary team are as follows:

- The team members share common assessment and treatment goals.
- The main task of all members of the team is to deliver treatments that are dependent on the patient’s needs, not on the constraints of the individual disciplines involved.
- Unlike multidisciplinary teams, interdisciplinary teams are not necessarily led by a member of the medical profession. They are most likely to be led by an experienced clinician who has knowledge not only of working with patients with chronic pain but also a knowledge of working in a team.
- There are core areas of speciality unique to each discipline, but these are secondary to the goals of the team as a whole.
- Team members will have explicit knowledge of the skills of other disciplines involved in the team.
- Effective communication occurs between all team members
- All team members have equal status within the team
- Decisions are arrived at after considering input from all team members

Recommendations for the development, establishment and maintenance of the interdisciplinary team include:

- The philosophy of the team should be made articulate in an agreed policy document and made explicit to all members. This should be re-appraised at regular intervals and modified if necessary.
- There must be a system for staff induction and training, with a focus particularly on processes within groups, the development of core team skills required and education regarding the work of other disciplines.
- Communication is vital to the effective running of the team and a considerable amount of time should be spent on this area, both formally and informally, including regular team meetings. However, team meetings are expensive, therefore it is of importance that they are conducted efficiently and effectively.

- Meetings should have a clear agenda, with effective firm leadership to ensure focus, concluding with action points within a spirit of group cohesiveness.
- Rules of confidentiality concerning both staff and patients must be made explicit.

#### Team Maintenance

When different disciplines set up and work as an interdisciplinary team, this can give rise to problems in managerial, organisational and inter-personal areas. Strategies to assist integration of external hospital managers might include involving management during the early stages of planning and development of the team, discussion with management of the policy document and associated specific working practices required and developing specific and relevant outcome measures.

Ensure effective and efficient time management not only in patient assessment and treatment delivery, but also in decision-making and audit. Clinic structuring and minimisation of inappropriate referrals and failure to attend appointments lessen the dangers of fragmentation of the team and formation of “splinter groups” within the team. Ensure that good communication occurs between all team members by controlling the size of the team and encouraging cohesiveness by using team-building techniques. Any communication or interpersonal problems between team members need to be dealt with as early as possible. There should be time set aside specifically for team development and team building; this is particularly important in the early stages of forming an interdisciplinary team. Pay particular attention to the integration of new members to the team. A ‘probationary period’ may be extremely useful. Ensure the availability of support systems to help team members cope with the emotional pressures that can occur when working with such a demanding group of patients.

#### Conclusion

The interdisciplinary clinic would seem to have a number of specific advantages over uni-professional or multi-disciplinary clinics. The principal advantages include:

1. Greater range of professional expertise, permitting a wider range of treatment options
2. Decreased likelihood of inappropriate interventions as a consequence of failure to recognise (or take adequately into account) important obstacles to recovery
3. Minimising the likelihood of producing further iatrogenic distress and confusion
4. Coherent and integrated treatment approach, with clear identification of goals and responsibilities

It could, I think, reasonably be argued that the framework, with its range of options and integration of perspectives, offers the potential for optimal clinical care. Clinicians who have genuinely embraced the

inter-disciplinary perspective seem to find it a professionally stimulating and satisfying approach to clinical management.

There are however potential difficulties with the approach. Some of the more frequent difficulties include patient and staff scheduling, negotiating adequate time for initial assessment and failure amongst the staff to arrive at an agreed clinical formulation and treatment plan. Indeed over the last decade, there have been increasing difficulties in obtaining and securing funding for such clinics, particularly those run on an in-patient basis. Nonetheless, as a way of managing patients, the inter-disciplinary approach as developed in the early pain management programs has offered a powerful new way of managing patients and the philosophy and practice have had a powerful influence on the design and establishment of modern pain management, not only in tertiary health care, but also in secondary prevention and in occupational settings.

### References

1. Bonica JJ (1990) Multidisciplinary / interdisciplinary pain programs. In: Bonica JJ (ed) The management of pain, 2nd edn. Lea & Febiger, Philadelphia, pp 197–208
2. Finset A, Krogstad JM, Hansen H et al. (1995) Team development and memory training in traumatic brain injury rehabilitation: two birds with one stone. *Brain Inj* 9:495–507
3. Fordyce WE (1976) Behavioral methods for chronic pain and illness. C.V. Mosby, St. Louis
4. IASP (1990) Desirable characteristics for pain treatment facilities (Report of Task Force on Guidelines for Desirable Characteristics for Pain treatment Facilities). IASP, Seattle
5. Loeser JD (1990) Interdisciplinary, multimodal management of chronic pain In: Bonica JJ (ed) The management of pain, 2nd edn. Lea & Febiger, Philadelphia, pp 2107–2120
6. Main CJ, Spanswick CC (2000) Pain management: an interdisciplinary approach. Churchill-Livingstone, Edinburgh
7. Mayer TG, Gatchel R (1988) Functional Restoration for spinal disorders. The sports medicine approach. Lea & Febiger, Philadelphia
8. Melvin JL (1980) Interdisciplinary and Multidisciplinary Activities and the ACRM. *Arch Phys Med Rehab* 61:379–380
9. Morley S, Eccleston C, Williams A (1999) A Systematic review and meta-analysis of randomised controlled trials of cognitive behaviour therapy and behaviour therapy for chronic pain in adults, excluding headache. *Pain* 80:1–13
10. Pain Society (1997) Desirable characteristics for pain management programmes: Report of a Working Party of the Pain Society of Great Britain and Ireland (The British and Irish Chapter of the International Association for the Study of Pain). The Pain Society, London
11. Sanders SH (1994) An image problem for pain centers: relevant factors and possible solutions. *APS Bull* Jan / Feb:17–18
12. Turk DC, Okifuli A (2003) In: Melzack R, Wall PD (eds) Handbook of pain management: a clinical companion to Wall and Melzack's textbook of pain. Churchill-Livingstone, Edinburgh, pp 533–541
13. Turk DC, Meichenbaum DH, Genest M (1983) Pain and behavioural medicine. A cognitive-behavioural perspective. The Guilford Press, New York & London

## Interlaminar Epidural Steroid Injection

- Epidural Steroid Injections for Chronic Back Pain

## Interleukin(s) (IL)

### Definition

A group of molecules within the cytokine family involved in signaling between cells participating in immune and inflammatory events; distinct interleukins are defined by different numbers and letters (e.g. IL-1 $\alpha$ , IL-1 $\beta$  and IL-6).

- Cytokines as Targets in the Treatment of Neuropathic Pain
- Wallerian Degeneration

## Intermittent Claudication

### Definition

Intermittent claudication is a condition that is characterized by pain and lameness during muscular exercise or – in the leg – during walking. The most frequent cause is narrowing of arteries in the lower leg and foot by arteriosclerosis.

- Muscle Pain Model, Ischemia-Induced and Hypertonic Saline-Induced

## Internal Capsule

### Definition

White matter pathway carrying fibers afferent to the cortex from the thalamus and efferent from the cortex to nuclei of the brain and to the spinal cord.

- Deep Brain Stimulation

## Internal Disc Disruption

### Definition

Ruptured vertebral disc at the center of the nucleus pulposus.

- Chronic Low Back Pain, Definitions and Diagnosis

## Internal Neurolysis

### Definition

Scarring related to a peripheral nerve can be external, causing adherence of the entire nerve to an adjacent structure, such as the roof of the carpal tunnel for the median nerve. When sufficient chronic compression or direct trauma create scarring between the fascicles of the peripheral nerve, there is internal scarring. The



microsurgical release of this interfascicular scarring is termed an „internal neurolysis“.

- ▶ [Carpal Tunnel Syndrome](#)

## Internal Validity

### Definition

The treatment and comparison groups are selected and compared in such a manner that the observed differences between them on the dependent variables under study, may only be attributed to the hypothesized intervention under investigation.

- ▶ [Lumbar Traction](#)

## Internalization

### Definition

Endocytosis; movement of proteins from the plasma membrane of a cell to intracellular compartments.

- ▶ [Opioid Receptor Trafficking in Pain States](#)

## Internalization of Receptors

### Definition

Endocytosis of surface membrane receptors after they bind a ligand. The receptors may later be recycled and reinserted into the membrane. When internalization occurs, it can be assumed that the ligand has been released in response to a stimulus. For example, when neurokinin-1 receptors are internalized, it is presumed that substance P (or a related neurokinin) has been released from nearby presynaptic terminals. Observation of this phenomenon is an indirect way of demonstrating the release of certain neurotransmitters.

- ▶ [Visceral Pain Model, Lower Gastrointestinal Tract Pain](#)

## International Narcotics Control Board

### Synonyms

INCB

### Definition

An element of the United Nations drug control program. It is charged with prevention of illegal growth, manu-

facture, and distribution of narcotic and other controlled medications for non-medical or non-scientific use. Its activities are set forth by the Single Convention on Narcotic Drugs and the Convention on Psychotropic substances. It has recommended that governments facilitate the availability for the treatment of chronic pain including cancer pain. It collaborates closely with the World Health Organization.

- ▶ [Cancer Pain Management, Undertreatment and Clinician-Related Barriers](#)

## Interneuron

### Definition

An interneuron is a neuron that communicates only to other neurons; they are often inhibitory.

- ▶ [Nociceptive Circuitry in the Spinal Cord](#)
- ▶ [Somatic Pain](#)
- ▶ [Thalamocortical Loops and Information Processing](#)
- ▶ [Visceral Nociception and Pain](#)

## Interoception

### Definition

The term interoception is often used to define perceptual experiences that are not determined by “outside” stimuli. It refers to the sense of the physiological condition of the body and links sensations such as thirst, hunger, cold and warmth and pain with emotional experience (feelings) and motivation, as it drives the individual towards adaptive behavior in order to establish homeostasis (e.g. by drinking, eating and protection against environmental challenges).

- ▶ [Angina Pectoris, Neurophysiology and Psychophysics](#)
- ▶ [Functional Imaging of Cutaneous Pain](#)
- ▶ [Spinothalamic Tract Neurons, in Deep Dorsal Horn](#)
- ▶ [Thalamus, Visceral Representation](#)
- ▶ [Trigeminal Brainstem Nuclear Complex, Anatomy](#)

## Interpersonal Pain Behaviour

PAUL J. WATSON

University Department of Anaesthesia, University of Leicester, Leicester, UK

pjw25@le.ac.uk

### Synonyms

Pain behaviour; non-organic signs; Illness Behaviour

### Definition

Pain behaviour has been defined by Loeser and Fordyce (1983) as "all outputs that a reasonable observer would characterise as suggesting pain". These include posture, facial expression, verbalization, lying down, taking medicines, seeking medical assistance and receiving compensation.

### Characteristics

Pain behaviours can be subdivided by how they are assessed, self report behaviours include pain reporting and self-reported responses to pain; externally validated behaviours, include consultation rates, work absence and receipt of wage compensation; and overt pain behaviours that are observable such as changes in posture, mobilisation and vocalisation associated with pain.

Pain behaviour is the product of both respondent and operant conditioning. Movement, for example bending in the case of a person with back pain, which causes pain, may lead to the modification of movement or avoidance of that activity, at least until the symptoms resolve (respondent conditioning). In this case, the restriction of movement or guarding is in response to the expectation of pain on movement, rather than in direct response to the pain itself (classical conditioning).

If the person with back pain is observed restricting their movement, or if they also moan or groan when moving, this might action sympathetic attention from others. If this attention is valued, a pattern might develop where the behaviour is expressed in order to elicit sympathetic attention (operant conditioning). The adoption of pain behaviours may also allow the patient to avoid an aversive experience, such as a stressful workplace. If the pattern of behaviour is regularly reinforced, through regular favourable attention and avoidance of difficult situations, it may become very difficult to extinguish.

The demonstration of pain behaviour is a form of social communication and it is normal to express such behaviours when in pain. The behavioural expression of pain is a function of social learning and as such is highly influenced by life experiences, culture and the social environment. Behavioural theorists, such as Fordyce (1976), suggested that pain behaviour, as well as being a communication of pain, may serve a purpose as an adaptive response to acute pain to provide a period of reduced activity in response to pain to allow repair. However, such behaviours become inappropriate and maladaptive if they persist. In this regard, behavioural theorists maintain that persistent, and persistently reinforced, pain behaviours result in high levels of physical and psychological disability (Keefe and Lefebvre 1994; Keefe and Smith 2002). Romano et al. (1995) demonstrated a relationship between spouse solicitousness and pain behaviour. In a group of patients who reported high levels of pain, patients

who had solicitous spouses had higher levels of pain behaviour and higher levels of disability than patients with non-solicitous spouses. In an earlier experiment, Romano et al. (1992) found that spouse behaviours not only followed patient demonstrations of pain behaviours but they also preceded patient behaviours, for example, as the patient started a task which normally produced pain behaviour. The authors contended that this demonstrated the behaviours had been rehearsed and reinforced over time.

Hadjistavropoulos and Craig (2002) have argued that pain behaviours can operate at a subtle, automatic level. Although they recognise that overt behaviours can be exaggerated, they contend that such conscious exaggeration can be, in part, identified. They further argue that observed pain behaviours, if assessed appropriately, can give a better representation of pain than self-report. In their interpretation, self-report always involves higher mental processes, requires attention to the task and focuses attention towards the pain, which might compromise coping and thus influence the report, whereas the automaticity of facial expression and body movement is less compromised. They argue for a combination of measures encompassing self-report and behavioural observation.

### Assessment of Pain Behaviours

Pain behaviour can be reliably assessed by patient self-report, through observation or third party validation. Simple self-report diaries have been used extensively in research and clinical practice. Patients are required to report medication usage, pain report and "uptime" – the length of time spent out of a reclining position (Follick et al. 1984; Keefe and Lefebvre 1994). Structured format questionnaires have been developed asking the patient to identify the types of pain behaviour they engage in and the frequency. Some questionnaires also assess the responses of the patient's spouse or significant other to their pain behaviour (Kerns et al. 1985).

Assessments of overt pain behaviours require the patient to be observed over a period of time. Such measures can be used in the inpatient setting or outpatient setting using standardised structured assessments (Richards et al. 1982; Vlaeyen et al. 1987), behaviour is recorded by trained personnel on standard assessment sheets. The advantage of these is that they allow observation over a long period of time. The disadvantage is that the patient may avoid all pain provoking activities during the period of assessment. The sample of behaviour must include observation of the patient performing activities which would elicit pain behaviours, for example sitting, walking and performing everyday tasks.

Keefe and Block (1982) defined a list of observed pain behaviours in subjects with chronic pain that has been successfully used in a number of other painful conditions. Subjects are required to perform a num-

ber of tasks; sitting, walking, getting into and out of a chair and onto and up from a bed. Standardised video taping procedures are used and the occurrence of key behaviours of limping, facial grimacing, stopping and resting, touching or holding the affected area, guarding and bracing the affected part and verbalisation, such as reporting pain and sighing or groaning, are recorded. Such a system demonstrated high inter-rater reliability, test/re-test reliability and good internal consistency. Behaviours have also been observed to reduce after pain management or pain relieving interventions.

In response to criticism that the videotape procedure was not sufficiently exacting to allow expression of pain behaviours, Keefe and Dunsmore (1992) and Koho et al. (2001) developed a video-based assessment during functional task performance using a similar list of behaviours, and demonstrated a similar level of reliability.

A very subtle approach to assessment is offered by Craig et al. (1992); the Facial Coding System relies on change in facial expression. It has been well validated in groups from new born to adults, and has evidence to suggest that it can separate genuine from faked expressions of pain (Craig et al. 1991). Hadjistavropoulos and Craig (2002) argue that it is a better reflection of automaticity in pain expression, and less influenced by volitional control than other assessments of overt behaviour.

Videotaping and rating assessments is time consuming and requires training. A number of assessments of pain behaviour in real time have been developed for use during clinical examination. Waddell and colleagues developed a list of self-reported symptoms and responses to examination that were unlikely to be associated with underlying pathology in groups of low back pain patients (Waddell et al. 1980; Waddell et al. 1984). The assessment can be performed relatively quickly by a single clinician, but it has not been used to formally assess pain behaviour or responses to treatment, the focus has mainly been in identifying people who are unlikely to respond well to treatments. A more recent and comprehensive assessment has been developed by Prkachin et al. (2002). This requires an independent observer to be present at a standardised back pain assessment to record pain behaviours. The advantages of such "real time" assessments is they give the clinician instant feedback of the results.

### Purpose of Assessing Pain Behaviours

Reducing pain behaviour is a focus of behavioural pain management programmes, and is often a declared aim of multidisciplinary cognitive behavioural pain management programmes (Turk and Flor 1987; Watson 2003). Significant reductions in pain behaviour scores following interventions have been reported.

### Misinterpretation of Pain Behaviours

Pain behaviour is the consequence of an individual's experience of an internal state, which is then encoded into an expressive behaviour that then allows the observer to make a judgement about that experience. In this, it is a normal communication of suffering from one individual to another. However, pain behaviour is sometimes interpreted as "exaggerated" illness presentation. It is important to bear in mind that even some gross pain behaviours are rarely a conscious attempt to mislead, and alone are not evidence of malingering (Main and Waddell 1998). Clinicians are trained to "match" the observed pain behaviours to the report of pain and the extent and severity of the pathology, but interpreting behaviour purely in such terms might lead to misinterpretation on the part of the clinician. Such responses cannot be taken out of the context of the patient's expectations of the assessment, his/her previous experience of assessment and their psychological distress at the time of the assessment. A desire to access treatment may result in the patient trying to convince the clinician of the veracity of their condition through their overt behaviour, obvious scepticism by the clinician may enhance this. The observer should also be aware of his or her own bias in interpreting pain behaviour. For example, clinicians have been shown to underestimate pain reported by men but give higher estimates of pain intensity in women. The physical attractiveness of the patient also influences the clinician, with less attractive patients being rated as having more pain (Hadjistavropoulos et al. 1996).

### Special Groups

The traditional reliance on pen and paper self-report requires higher cognitive function and adequate language skills and vocabulary. Some people suffering pain are unable to express themselves adequately due to cognitive impairment, impaired consciousness, speech deficits or because they and the observer do not share a common language. Self-report measures are also inappropriate for neonates and infants. It is not the purpose of this essay to discuss these groups in detail but it is when working with such groups that pain behaviour assessments are particularly useful. Although a number of assessments have been developed for specific groups, much more work is required to develop instruments for use in those with severe physical disabilities and in elderly patients with profound cognitive impairment.

Pain is a multidimensional phenomenon, although many have suggested that is an intensely private experience and can only be assessed through the report of the person suffering it. In truth, pain is rarely entirely private, people also communicate through characteristic behaviours which can be reliably measured. Observing

pain behaviours can offer additional information to give a multidimensional perspective on the personal pain experience.

## References

1. Craig KD, Hyde SA, Patrick CJ (1991) Genuine, Suppressed and Faked Facial Behavior during Exacerbation of Chronic Low Back Pain. *Pain* 46:161–172
2. Craig KD, Prkachin KM, Grunau RVE (1992) The Facial Expression of Pain. In Turk DC and Melzack R (eds) *Handbook of Pain Assessment*. Guildford, New York, pp 255–274
3. Follick MJ, Ahern DK, Laser-Wolston (1984) Evaluation of Daily Activity Diary for Chronic Pain Patients. *Pain* 19:373–382
4. Fordyce WE (1976) *Behavioural Methods for Chronic Pain and Illness*. Mosby, St. Louis
5. Hadjistavropoulos T, Craig KD (2002) A Theoretical Framework for Understanding Self-Report and Observational Measures of Pain: A Communications Model. *Behav Res Ther* 40:551–570
6. Hadjistavropoulos T, McMurtry B, Craig KD (1996) Beautiful Faces in Pain: Biases and Accuracy in the Perception of Pain. *Psychol Health* 11:411–420
7. Keefe FJ, Block AR (1982) Development of an Observational Method for Assessing Pain Behaviour in Chronic Low Back Pain Patients. *Behav Ther* 13: 363–375
8. Keefe FJ, Dunsmore J (1992) Pain Behaviour Concepts and Controversies. *Am Pain Soc J* 2:92–100
9. Keefe FJ, Lefebvre (1994) Pain Behaviour Concept. Controversies, Current Status and Future Directions. In: Gebhart G, Hammond DL, Jensen TS (eds) *Proceedings of the VIIth World Congress on Pain*. Elsevier, New York
10. Keefe FJ, Smith S (2002) The Assessment of Pain Behaviour: Implications for Applied Psychology and Future Research Directions. *Appl Psychophysio Biofeedback*. 27:117–127
11. Kerns RD, Turk DC, Rudy TE (1985) The West Haven-Yale Multidimensional Pain Inventory (WHYMPI) *Pain* 23:345–356
12. Koho P, Aho S, Watson P et al. (2001) Assessment of Chronic Pain Behaviour: Reliability of the Method and its Relationship with Perceived Disability, Physical Impairment and Function. *J Rehabil Med* 33:128–132
13. Loeser JD, Fordyce WE (1983) Chronic pain. In: Carr JE, Dennerik HA (eds) *Behavioural Science in the Practice of Medicine*. Elsevier, Amsterdam
14. Main CJ, Waddell G (1998) Behavioral Responses to Examination. A Reappraisal of the Interpretation of “Non-Organic Signs” *Spine* 23:2367–2371
15. Prkachin KM, Hughes E, Schultz I et al. (2002). Real-Time Assessment of Pain Behavior during Clinical Assessment of Low Back Pain Patients. *Pain* 95:23–30
16. Richards AH, Nepomuceno C, Riles M, Suer Z (1982) Assessing Pain Behaviors: The UAB Pain Behavior Scale. *Pain* 12:393–398
17. Romano JM, Turner JA, Jensen MP et al. (1992) Sequential Analysis of Chronic Pain Behaviors and Spouse Responses. *J Consult Clin Psychol* 60:777–782
18. Romano JM, Turner JA, Jensen MP et al. (1995) Chronic Pain Patient-Spouse Interactions Predict Pain Disability. *Pain* 15:300–306
19. Turk DC, Flor H (1987) Pain greater than Pain Behaviours: The Utility and Limitations of the Pain Behaviour Construct. *Pain* 31:277–295
20. Vlaeyen JWS, Van Eek HV, Groenman NH et al. (1987) Dimensions and Components of Observed Chronic Pain Behaviour. *Pain* 31:65–75
21. Waddell G, McCulloch JA, Kummel E et al. (1980) Non-Organic Signs in Low Back Pain. *Spine* 5:117–125
22. Waddell G, Main CJ, Morris EW et al. (1984) Chronic Low Back Pain, Psychological Distress and Illness Behavior. *Spine* 9:209–213
23. Watson PJ (2003) Interdisciplinary Pain Management in Fibromyalgia. In: Chaitow L (ed) *Fibromyalgia: A Practitioners Guide to Treatment*. 2<sup>nd</sup> Edition. Harcourt Brace, Edinburgh

## Interprofessional Approach

### Definition

Healthcare professionals co-working in an integrated process.

- ▶ [Physical Medicine and Rehabilitation, Team-Oriented Approach](#)

## Interscalene

### Definition

Pertaining to the potential fascial space between the anterior and middle scalene muscles in the neck through which the brachial plexus traverses.

- ▶ [Postoperative Pain, Regional Blocks](#)

## Interscalene Block

### Definition

Injection via a needle or catheter of local anesthetic at the interscalene groove to block sensory and/or motor innervation of the brachial plexus.

- ▶ [Acute Pain in Children, Post-Operative](#)

## Interspike Interval

### Synonyms

ISI

### Definition

Interspike interval is the time interval (usually measured in milliseconds) between action potentials discharged by a neuron.

- ▶ [Central Pain, Human Studies of Physiology](#)
- ▶ [Chronic Pain](#)
- ▶ [Thalamic Bursting Activity](#)

## Interstitial Cystitis and Chronic Pelvic Pain

ELLIOT M. PAUL, EVAN R. EISENBERG,  
ROBERT M. MOLDWIN  
Department of Urology, Long Island Jewish Medical  
Center, New York, NY, USA  
elielpaul@yahoo.com

### Synonyms

Interstitial Cystitis; Pelvic Pain Syndrome of Bladder Origin; Chronic Pelvic Pain, Interstitial Cystitis



**Definition**

Interstitial Cystitis (IC) is a chronic pelvic pain syndrome largely defined by its symptoms, which include urinary urgency, frequency, and pelvic pain—all in the absence of well-defined pathologies such as urinary tract infection or bladder cancer. The “classic” form of interstitial cystitis is that marked by gross erythematous changes of the bladder wall, representing panmural inflammation, fibrosis and granulation tissue. These so called “Hunner’s” patches or ulcers, originally described by Guy Hunner, are identified in only 5–10% of IC patients (Hunner 1915). The remaining “non-classic” IC patients have a normal cystoscopic appearance. The prevalence of IC is 10–55 cases/100,000 population in the United States, and affects women 10 times as frequently as men. Recent literature has highlighted the similarities between this condition and non-bacterial prostatitis and prostatodynia (reclassified as category III A and B chronic pelvic pain syndrome, respectively). The quality of life for patients with IC is typically poor, with 50% reporting the inability to work fulltime and 60% complaining of dyspareunia (Ratner et al 1994). There is no known cure for IC, and no single therapy has been shown to alleviate the symptoms in all afflicted patients.

**Characteristics**

Interstitial cystitis is a chronic pelvic pain syndrome presenting at any age, but most commonly in the 3<sup>rd</sup> through to 5<sup>th</sup> decades of life. The syndrome is characterized by irritative voiding symptoms and pelvic discomfort, in the absence of a urinary tract infection or any other definable pelvic pathology that might give rise to such symptoms. Pain associated with bladder filling is common. In fact, urinary frequency, both during the day and at nighttime, is usually a product of the patient’s desire to maintain the lowest pain level possible.

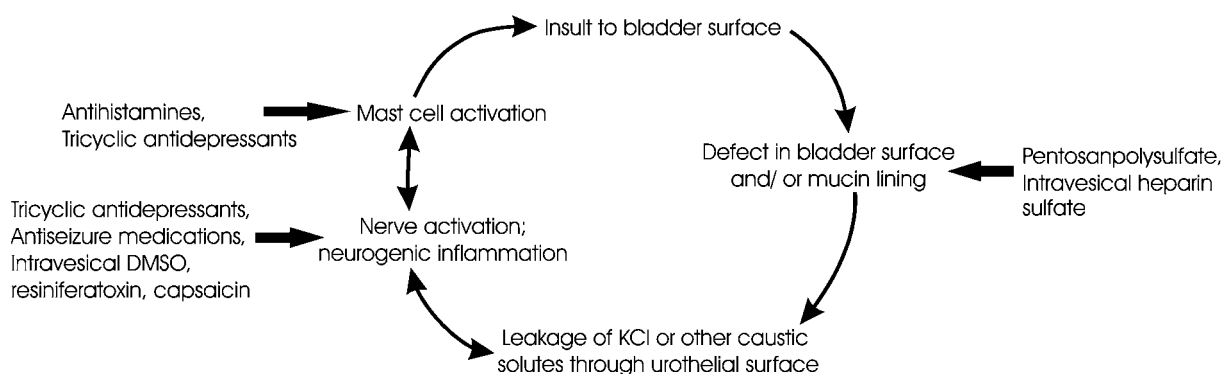
A wide spectrum of symptom severity is common amongst IC patients. For example, many patients

with mild symptoms may complain of pelvic pressure worsening with bladder filling and void 2–3 times per evening. Severe patients may be incapacitated by pelvic pain and void every 5–10 minutes throughout the day and night. Urinary hesitancy is a frequent complaint. The National IC Database Study noted this symptom in 78% of patients (Kirkemo et al 1997). A retrospective review of 100 consecutive IC patients in our facility revealed a decrease in the force of the urinary stream (75%), urinary hesitancy (73%), the need to strain with urination (70%), and dyspareunia (45%).

Misdiagnosis of patients with either bacterial cystitis or bladder motor overactivity is common. Hence, many patients have been treated empirically with antibiotics and/or anticholinergic agents without success. Likewise, the symptoms of interstitial cystitis may vary with the menstrual cycle, often leading to a misdiagnosis of endometriosis. Unlike endometriosis, menstrual amelioration of symptoms is common in the IC patient. One study found that 38% of chronic pelvic pain patients presenting for laparoscopic evaluation (presumably to diagnose endometriosis) were ultimately diagnosed with interstitial cystitis (Clemons et al 2002).

**Pathophysiology**

Many theories to explain the pathogenesis of IC have been proposed, yet its true etiology remains elusive. Some suggest the presence of an unknown infectious etiology (Duncan and Schaeffer 1997), while others postulate that the urothelial surface and its protective bladder surface mucin are dysfunctional, thus allowing noxious solutes in the urine to gain access to underlying tissue (Parsons et al 1991). Alternative hypotheses include a neurogenic component (Pang et al 1995), excessive mast cell activation (Theoharides et al 2001), an autoimmune process (Anderson et al 1989), or a combination of some or all of these factors, as depicted in Figure 1.



**Interstitial Cystitis and Chronic Pelvic Pain, Figure 1** Schematic of several pathologies seen in interstitial cystitis and theoretical interaction between them. Note therapies available that address the various described pathologies.

**Interstitial Cystitis and Chronic Pelvic Pain, Table 1**

Differential Diagnosis
Bladder Calculi
Cystitis (infectious, radiation-induced, iatrogenic)
Neurological
Prostatitis
Sexually Transmitted Disease
Urethrocele, Cystocele
Urethral Diverticulum
Pelvic Floor Dysfunction
Gynecological Disorders (i. e. Endometriosis, PID)
Bladder Cancer/Carcinoma in situ

### Diagnosis

Unfortunately, the diagnosis of IC remains one of exclusion (Table 1).

The National Institute of Diabetes, Digestive and Kidney Diseases established a set of diagnostic criteria for IC (Table 2), however, many physicians consider these criteria to be too restrictive and useful only for research purposes. In fact, it has been stated that as many as 60% of IC patients would be missed if these criteria were employed (Hanno et al 1999).

In clinical practice, the diagnosis is generally made by history, physical exam, urine analysis and culture, urine cytology, and cystoscopy, with or without bladder ► **hydrodistention**, under general anesthesia. Standard office cystoscopy demonstrates a normal bladder surface in 90–95% of patients. 5–10% of patients will have gross inflammatory changes of the bladder wall, termed Hunner's patches. Hydrodistention, filling the bladder to a relatively high pressure (80–100 cm H<sub>2</sub>O) under anesthesia, has been employed to aid in the diagnosis of interstitial cystitis. Frequent findings with hydrodistention include the development of ► **glomerulations** (punctuate hemorrhages found in all regions of the bladder surface), mucosal tears, and a decreased bladder capacity. Other tests often employed during the evaluation of IC include ► **potassium sensitivity testing** (intravesical infusion of a potassium solution which often elicits pain in these patients), and urodynamics. Radiographic imaging may be used to exclude other pelvic pathology.

Various questionnaires have been created in order to assist in the diagnosis and as a measure of treatment responsiveness for patients with interstitial cystitis. The Pelvic Pain, Urgency, and Frequency (► **PUF**) Patient Symptom Scale and the O'Leary-Sant Interstitial Cystitis Symptom Index (► **ICSI**) are the most commonly used questionnaires for these purposes.

### Treatment

The absence of a standardized treatment protocol for IC continues to frustrate patients as well as physicians. Regimens include dietary changes, oral agents, intravesical therapies, and surgical intervention. In most instances, a combination of therapies may be used in any given patient, many of which have an impact on pathologies identified in IC patients.

**Dietary changes:** Although no formal clinical trials have been carried out, many interstitial cystitis patients appear to have symptom exacerbation with the intake of various foods and beverages including: citrus fruits, carbonated beverages, alcoholic beverages, spicy foods, foods with high potassium content, caffeinated items, and artificial sweeteners (Table 3).

Not every IC patient is sensitive to each of these products, and patients are therefore encouraged to start with a bland diet and slowly add potentially irritating items. As a response to urinary frequency, many IC patients will decrease their fluid consumption, ultimately resulting in concentrated urine and as a consequence more bladder-based pain. An increase in fluid intake may therefore be helpful. Smoking may also worsen symptoms and should similarly be discouraged.

### Behavioral Therapies

Bladder training, to gradually increase intervals between voids, may aid a minority of patients with IC, mostly those with more benign symptomatology. Similar behavioral therapy, using relaxation and distraction techniques, in order to assist the bladder training process, may be useful in some instances. Pelvic floor relaxation exercises and gentle stretching may be similarly beneficial in a small subset of patients with IC.

Other options include bladder retraining protocols (teaching patients to progressively increase intervals between voids, after their pain is controlled) and the use of support services, such as the Interstitial Cystitis Association (website: [www.ichelp.org](http://www.ichelp.org); telephone support: 1-800-help-ICA).

**Oral Therapies:** Pentosan Polysulfate Sodium (PPS) (► **Elmiron**) is often used as first-line therapy for the treatment of IC, and remains the only FDA approved oral medication for the treatment for IC. PPS is a synthetic glycosaminoglycan, very similar in molecular structure to the constituents of bladder surface mucin. One theory of IC pathogenesis is a defect in this layer that allows noxious urine solutes access to underlying tissue, thus beginning a cascade of nerve sensitization and/or inflammation. PPS's presumed mechanism of action is that it "augments" this layer and thus provides a slow improvement in symptoms. In one study, 38% of those treated with Pentosan Polysulfate Sodium experienced >50% improvement in pain compared to 18% in a placebo group (Parsons et al 1993). It is a well-tolerated

**Interstitial Cystitis and Chronic Pelvic Pain, Table 2** NIDDK Criteria for the Diagnosis of I.C.

Required Findings	Automatic Exclusions
Hunner's Ulcers or diffuse glomerulations after hydrodistention and Pain associated with the bladder or urinary urgency	Less than 18 years of age
	Duration of symptoms less than 9 months
	Urinary frequency of less than 8 times per day
	Absence of nocturia
	Presence of bladder tumors
	Radiation cystitis
	Tuberculous cystitis
	Bacterial cystitis or prostatitis
	Vaginitis
	Cyclophosphamide cystitis
	Urethral diverticulum
	Uterine, cervical, vaginal, or urethral cancer
	Active herpes
	Bladder or lower ureteral calculi
	Symptoms relieved by antibiotics, urinary antiseptics, analgesics, anticholinergics, antispasmodics
	Involuntary bladder contractions
	Bladder capacity less than 350 cc while awake

**Interstitial Cystitis and Chronic Pelvic Pain, Table 3** Foods that may Worsen Symptoms of Interstitial Cystitis

Aged cheeses	Cranberries	Nuts (except cashews, pine nuts)	Vinegar
Sour cream	Grapes	Alcoholic beverages	Citric acid
Yogurt	Nectarines	Carbonated beverages	Benzol alcohol
Chocolate	Peaches	Coffee	Monosodium glutamate (MSG)
Fava beans	Pineapples	Tea	Artificial sweeteners
Lima beans	Plums	Fruit juices	Saccharine
Pickles	Pomegranates	Mayonnaise	Preservatives
Sauerkraut	Rhubarb	Ketchup	Artificial ingredients
Onions	Strawberries	Mustard	Artificial colors
Tofu	Rye bread	Salsa	Tobacco
Soy beans	Sourdough bread	Spicy foods	Caffeine
Tomatoes	Smoked meats	Soy sauce	Diet pills
Apples	Smoked fish	Miso	Junk foods
Apricots	Anchovies	Salad dressing	Recreational drugs
Avocados	Caviar		Cold medications
Bananas	Chicken livers		Allergy medications
Cantaloupes	Salad dressing		
Citrus fruits			

agent with few side effects. Standard dosing is 100 mg, three times daily.

Various analgesic agents have been prescribed for patients with IC. NSAIDs may have some theoretical benefit in reducing the associated inflammation, however, there is the potential to paradoxically worsen the symptoms of IC due to the release of histamines. Short-term narcotic therapy is frequently used for symptom

flares, and chronic narcotic therapy may be indicated in selected patients.

The inhibition of histamine release from mast cells can be accomplished with the use of antihistamines, such as hydroxyzine or tricyclic antidepressants (TCAs), such as amitriptyline. Amitriptyline and other TCAs have many other effects that are useful in the treatment of IC. Apart from their analgesic activity, their anticholinergic

effect may be helpful in patients with concomitant bladder over activity (~15%). Many patients with IC may have poor urinary flow rates secondary to pelvic floor spasm. TCAs should be avoided or low doses used in IC patients, for fear of reducing flow further or promoting acute urinary retention. These agents may cause fatigue and are therefore taken in the evening to promote better sleep and decrease nocturia. Pain, nocturia, and urinary frequency are the symptoms most typically reduced by these agents.

Lastly, the use of antispasmodics and antiseizures medications have been described to aid in the relief of the debilitating symptoms associated with IC.

### Intravesical Therapies

50% Dimethyl sulfoxide (DMSO) (Rimso-50<sup>®</sup>) is the only FDA-approved intravesical therapeutic agent for interstitial cystitis. Its precise method of action is unknown, however, it possesses anti-inflammatory, analgesic, and muscle-relaxing properties and appears to increase bladder capacity in many patients. DMSO may provide symptomatic relief in the majority of patients, however, repeated treatments are often necessary. Furthermore, the first several treatments may cause symptoms to flare.

Heparin sulfate (10,000 units in 10 ml sterile water) has also been used as an intravesical agent for the treatment of IC. Heparin sulfate is a normal component of the bladder's protective mucus layer. Like PPS, heparin's theoretical mechanism of action is an augmentation of the bladder's normal protective coating, thus preventing noxious bladder solutes from stimulating the bladder surface. One study reported clinical improvement in 56% of patients treated with intravesical heparin 3 times per week for 3 months, and continued remission for nearly all patients treated for six to twelve months (Parsons et al 1994). Others demonstrated the enhanced effects of a combination of DMSO and heparin compared with either agent alone (Perez-Marrero et al 1993). Relapse rates were reduced and duration of remissions were extended with this protocol. At our institution, we use a cocktail comprised of 20,000 units of heparin sulfate, 40 mg triamcinolone, and 30 ml of 1:1 0.5% bupivacaine and 2% viscous lidocaine, which has resulted in a >50% decrease in pain (visual analogue scores) in 71% of IC patients, often for many weeks.

Outside of the United States, ► **hyaluronic acid (HA)** and ► **resiniferatoxin (RTX)** are being investigated for their potential to improve the symptoms associated with IC. RTX appears to desensitize bladder nerve fibers, while HA, like heparin sulfate, theoretically augments bladder surface mucin. These agents may ultimately prove to have clinically significant benefits, and may add to our intravesical armamentarium against the symptoms of IC.

### Surgery

As a last resort, surgery has been employed in a desperate attempt at providing relief for those with the most debilitating symptoms. ► **Hunner's ulcer** fulguration, transurethral excision of ulcers, subtotal cystectomy with bladder augmentation, and even total cystectomy are all options. Fulgurations and excisions of well-defined lesions, although not major surgeries can result in clinical remissions, however, long-term symptom relief is rarely achieved. Subtotal cystectomy with bladder augmentation (using a portion of detubularized bowel) is best performed in patients with severely diminished bladder capacities and unrelenting symptoms. Although the benefit of this procedure is that the urethra and bladder trigone are left intact, morbidity includes the potential for postoperative urinary retention (and the subsequent need to perform life-long intermittent catheterization) and persistence of pain. Total cystectomy may also be considered in patients refractory to other conservative modalities.

### Conclusion

The diagnosis of interstitial cystitis remains one largely based upon presenting symptoms consistent with an irritative/painful bladder-based syndrome. Primary evaluation is dedicated to eliminating well-defined pathologies that might account for similar complaints. Further confirmatory testing, such as bladder hydrodistention under anesthesia or intravesical potassium chloride challenge, may be helpful at defining the bladder as the source of symptoms. Treatment options run the gambit from dietary changes to oral medications to cystectomy. Although no cure is at hand, a combination of conservative modalities may afford significant symptom relief to the majority of IC patients.

► **Dyspareunia and Vaginismus**

► **Opioids and Bladder Pain/Function**

### References

1. Anderson JB, Parivar F, Lee G, Wallington TB, MacIver AG, Bradbrook RA, et al (1989) The Enigma of Interstitial Cystitis: An Autoimmune Disease? *Br J Urol* 63:58–63
2. Clemons JL, Arya LA, Myers DL (2002) Diagnosing Interstitial Cystitis in Women with Chronic Pelvic Pain. *Obstet Gynecol* 100:337–341
3. Duncan JL, Schaeffer AJ (1997) Do Infectious Agents Cause Interstitial Cystitis? *Urology* 49(Suppl 5A):48–51
4. Hanno PM, Landis JR, Matthews-Cook Y, Kusek J, Nyberg L R (1999) The Diagnosis of Interstitial Cystitis Revisited: Lessons Learned from the National Institutes of Health Interstitial Cystitis Database Study. *J Urol* 161:553–557
5. Hunner G L (1915) A Rare Type of Bladder Ulcer in Women: Report of Cases. *Boston Med Surg J* 172:660–665
6. Kirkemo A, Peabody M, Diokono AC, Afanasyev A, Nyberg LM, Landis JR, et al (1997) Associations Among Urodynamic Findings and Symptoms in Women Enrolled in the Interstitial Cystitis Database (ICDB) Study. *Urology* 49(Suppl 5A):76–80
7. Parsons CL, Lilly JD, Stein P (1991) Epithelial Dysfunction in Nonbacterial Cystitis (Interstitial Cystitis). *J Urol* 145: 732–735
8. Pang X, Marchand J, Sant GR, Kream RM, Theoharides TC (1995) Increased Number of Substance P Positive Fibers in Interstitial Cystitis. *Br J Urol* 75:744–750



9. Ratner V, Slade D, Greene G (1994) Interstitial Cystitis. A Patient's Perspective. *Urol Clin NA* 21: 1–5
10. Theoharides T, Duraisamy K, Sant G (2001) Mast Cell Involvement in Interstitial Cystitis: A Review of Human and Experimental Evidence. *Urology* 57(Suppl 6A):47–55
11. Parsons CL, Benson G, Childs S, Hanno P, Sant GR, Webster G (1993) A Quantitatively Controlled Method to Study Prospectively Interstitial Cystitis and Demonstrate the Efficacy of Pentosanpolysulfate. *J Urol* 150:845–848
12. Parsons CL, Housley T, Schmidt JD, Lebow D (1994) Treatment of Interstitial Cystitis with Intravesical Heparin. *Br J Urol* 73:504–507
13. Perez-Marrero R, Emerson LE, Maharajh DO, Juma S (1993) Prolongation of Response to DMSO by Heparin Maintenance. *Urol* 41(1 Suppl):64–66

## Interventional Therapies

### Definition

In relation to low back pain, these typically encompass spinal surgery and a variety of injection therapies such as epidural steroid injections.

- ▶ [Disability, Effect of Physician Communication](#)

## Intervertebral Disc

### Definition

The portion between each vertebral body, composed of the annulus fibrosus and the nucleus pulposus.

- ▶ [Chronic Low Back Pain, Definitions and Diagnosis](#)

## Intervertebral Foramen, Cervical

### Definition

The cervical intervertebral foramen lies between adjacent cervical vertebrae and serves as the bony conduit through which the spinal nerve root exits the bony spinal canal. Its roof and floor are formed by the pedicles of consecutive vertebrae. Its posterolateral wall is formed largely by the superior articular process of the lower vertebra, and in part by the inferior articular process of the upper vertebra and the capsule of the zygoapophysial joint. The lower end of the upper vertebral body, the uncinat process of the lower vertebra, and the posterolateral corner of the intervertebral disc form the anteromedial wall.

- ▶ [Cervical Transforaminal Injection of Steroids](#)

## Intra-Articular Blocks and Thoracic Medial Branch Blocks

- ▶ [Thoracic Medial Branch Blocks and Intra-Articular Blocks](#)

## Intra-Articular Injections of Steroids

NIKOLAI BOGDUK

Department of Clinical Research, Royal Newcastle Hospital Newcastle, University of Newcastle, Newcastle, NSW, Australia  
 nik.bogduk@newcastle.edu.au

### Synonyms

Intra-Articular Steroid Injections; intra-articular corticosteroids; Intra-Articular Steroid Injections

### Definition

Intra-articular injections of corticosteroids are a treatment for pain, ostensibly stemming from a synovial joint, in which a corticosteroid preparation is injected into the cavity of the painful joint. The injections may be blind or fluoroscopically guided.

### Characteristics

Intra-articular injections of steroids were originally used as a treatment for overtly inflammatory joint diseases, such as rheumatoid arthritis. Their use for rheumatoid arthritis is not questioned. For that condition, intra-articular injections of steroids are held to be a useful adjunct to other therapy. They are not portrayed as a singular or curative treatment. They are used to suppress joint inflammation rapidly, while drug therapy is used to modify the disease process, long-term.

The success of intra-articular injections of steroids for rheumatoid arthritis inspired their use for other painful conditions of joints, notably and most commonly osteoarthritis. In practice, any painful joint can be treated, and most joints of the body have attracted this form of treatment. The treatment has become very popular, and is used not just by rheumatologists but also by orthopaedic surgeons, anaesthetists, physiatrists, and pain specialists. The literature on its efficacy, however, is sobering.

### Rationale

The implicit rationale for the injection of steroids is that they relieve pain by suppressing inflammation. However, whereas this rationale is applicable to overtly inflammatory joint diseases, it is harder to sustain for osteoarthritis or undiagnosed joint pain. The evidence is weak or lacking that these latter conditions involve significant inflammation, if at all.

Rarely recognized in the literature is the fact that corticosteroids have a long-term local anaesthetic effect (Johansson et al. 1990). This effect, rather than any anti-inflammatory action, may be the basis for the observed relief of pain following intra-articular injection.

### Technique

The technique for intra-articular injection differs according to the joint targeted. Common to all techniques

is the need to place a needle in the cavity of the target joint. Large joints, such as the knee are readily accessed, using palpation as a guide. The smaller the joint, and the deeper in the body that it lies, the more difficult it is to enter the joint accurately with a needle. Smaller and deeper joints can be accessed under fluoroscopic guidance.

Any of a number of corticosteroid preparations can be used. Those most commonly used contain betamethasone, dexamethasone, triamcinolone, or methylprednisolone. Often these corticosteroids are provided in a depot preparation which allows for sustained, slow release of the active agent.

### Application

Although any joint can be targeted, the literature describes the use of intra-articular steroids for the larger joints of the body, and some small ones. Most of the literature is anecdotal in nature, but there have been some controlled trials and systematic reviews.

### Shoulder Joints

A systematic review (Buchbinder et al. 2003) assessed the literature on steroid injections for two common conditions of the shoulder. For rotator cuff disease, it found that subacromial steroid injection had a small benefit over placebo in some trials, but no benefit over NSAIDs was demonstrated. For adhesive capsulitis, two trials suggested a possible early benefit of intra-articular steroid injection over placebo; and one trial suggested short-term benefit of intra-articular corticosteroid injection over physiotherapy in the short-term. Subsequent studies have shown that subacromial injections of steroids are no more effective than placebo for post-traumatic impingement of the shoulder (McInerney et al. 2003), and injection therapy is no more effective than physiotherapy for stiff shoulder (Hay et al. 2003). For adhesive capsulitis, fluoroscopically guided injections followed by exercises are more effective than injections alone or physiotherapy alone (Carette et al. 2003). For frozen shoulder, distension of the glenohumeral joint with steroids is more effective than sham treatment for three weeks, but thereafter the differences attenuate (Buchbinder et al. 2004).

### Acromioclavicular Joint

Few studies have addressed treatment of pain stemming from the acromioclavicular joint. The one controlled study found intra-articular steroids to be no more effective than placebo (Jacob and Sallay 1997).

### Knee Joint

Reviews have concluded that intra-articular steroids for osteoarthritis of the knee are more effective than placebo, but they only have a short-term effect (3 weeks) (Arroll and Goodyear-Smith 2004; Creamer 1999; Raynaud et al. 2003; Towheed and Hochberg 1997). Steroid injections

confer no long-term benefit for osteoarthritis of the knee (Creamer 1999).

### Hip Joint

Although the hip joint has been less studied than the knee, the efficacy of intra-articular steroids seems to be the same. Injection of steroids is more effective than injection of local anaesthetic alone, but only for about 3 weeks (Kullenberg et al 2004).

### Thumb

The carpometacarpal joint of the thumb is another site affected by painful osteoarthritis, and which attracts treatment with intra-articular injection of steroids. A controlled trial, however, found no **Attributable Effect** for this treatment (Meenagh et al 2004).

### Neck Pain

Injections of steroids into the cervical zygapophysial joints have been used to treat chronic neck pain. A controlled study, however, found that injection of steroids was no more effective than injection of local anaesthetic alone, and that the beneficial effects of both agents rapidly disappeared in about 2 weeks (Barnsley et al. 1994).

### Back Pain

Injection of steroids into the lumbar zygapophysial joints has been a popular treatment for low back pain. A review of the observational studies and the controlled studies available, found that injection of steroids is no more effective than sham therapy (Bogduk 2005).

### Interpretation

The popularity of intra-articular injections of steroids for joint pain is not matched by the literature concerning their efficacy. For all joints that have been studied, the pattern is the same. Either the injections are not more effective than placebo or sham therapy, or any pain-relieving effects last for only a matter of a few weeks.

### References

1. Arroll B, Goodyear-Smith F (2004) Corticosteroid Injections for Osteoarthritis of the Knee: Meta-Analysis. *BMJ* 328:869
2. Barnsley L, Lord SM, Wallis BJ et al. (1994) Lack of Effect of Intraarticular Corticosteroids for Chronic Pain in the Cervical Zygapophyseal Joints. *N Engl J Med* 330:1047–1050
3. Bogduk N (2005) A Narrative Review of Intra-Articular Corticosteroid Injections for Low Back Pain. *Pain Medicine* 6:297–298
4. Buchbinder R, Green S, Youd JM (2003) Corticosteroid Injections for Shoulder Pain. *Cochrane Database Syst Rev* CD004016
5. Buchbinder R, Green S, Forbes A et al. (2004) Arthrographic Joint Distension with Saline and Steroid Improves Function and Reduces Pain in Patients with Painful Stiff Shoulder: Results of a Randomised, Double Blind, Placebo Controlled Trial. *Ann Rheum Dis* 63:302–309
6. Carette S, Moffet H, Tardif J et al. (2003) Intraarticular Corticosteroids, Supervised Physiotherapy, or a Combination of the Two in the Treatment of Adhesive Capsulitis of the Shoulder: A Placebo-Controlled Trial. *Arthritis Rheum* 48:829–838

7. Creamer P (1999) Intra-Articular Corticosteroid Treatment in Osteoarthritis. *Curr Opin Rheumatol* 11:417–421
8. Hay EM, Thomas E, Paterson SM et al. (2003) A Pragmatic Randomised Controlled Trial of Local Corticosteroid Injection and Physiotherapy for the Treatment of New Episodes of Unilateral Shoulder Pain in Primary Care. *Ann Rheum Dis* 62:394–399
9. Jacob AK, Sallay PI (1997) Therapeutic Efficacy of Corticosteroid Injections in the Acromioclavicular Joint. *Miomed Sci Instrum* 34:380–385
10. Johansson A, Hao J, Sjolund B (1990) Local Corticosteroid Application Blocks Transmission in Normal Nociceptive C-Fibres. *Acta Anaesthesiol Scand* 34:335–338
11. Kullenberg B, Runesson R, Tuvhag R et al. (2004) Intraarticular Corticosteroid Injection: Pain Relief in Osteoarthritis of the Hip? *J Rheumatol* 31:2265–2268
12. McInerney JJ, Dias J, Durham S et al. (2003) Randomised Controlled Trial of Single, Subacromial Injection of Methylprednisolone in Patients with Persistent, Post-Traumatic Impingement of the Shoulder. *Emerg Med J* 20:218–221
13. Meenagh GK, Patton J, Kynes C et al. (2004) A Randomised Controlled Trial of Intra-Articular Corticosteroid Injection of the Carpometacarpal Joint of the Thumb in Osteoarthritis. *Ann Rheum Dis* 63:1260–1263
14. Raynauld JP, Buckland-Wright C, Ward R et al. (2003) Safety and Efficacy of Long-Term Intraarticular Steroid Injections in Osteoarthritis of the Knee: A Randomized, Double-Blind, Placebo-Controlled Trial. *Arthritis Rheum* 48:370–377
15. Towheed TE, Hochberg MC (1997) A Systematic Review of Randomized Controlled Trials of Pharmacological Therapy in Osteoarthritis of the Knee, with an Emphasis on Trial Methodology. *Semin Arthritis Rheum* 26:755–770

## Intra-Articular Morphine

### Definition

Local application of morphine in patients undergoing arthroscopic knee surgery, which induces significant postoperative pain reduction lasting up to 24 hours.

- ▶ Opioids and Inflammatory Pain

## Intra-Articular Sacroiliac Joint Block

- ▶ Sacroiliac Joint Blocks

## Intra-Articular Steroid Injections

- ▶ Intra-Articular Injections of Steroids

## Intra Discal Electrothermal Therapy

- ▶ IDET

## Intracellular Labeling

### Definition

Intracellular labeling is a technique that stains a single neuron by injecting a neural tracer intracellularly through a glass microelectrode containing the tracer.

- ▶ Trigeminal Brainstem Nuclear Complex, Anatomy

## Intracerebral Hematoma Apoplexy

- ▶ Headache Due to Intracranial Bleeding

## Intracerebroventricular Drug Pumps

- ▶ Pain Treatment, Implantable Pumps for Drug Delivery

## Intracerebroventricular, Intracerebral and Intrathecal

### Definition

Drugs are frequently administered directly into the brain of experimental animals because such drugs may not penetrate the blood-brain barrier, or systemic administration of such drugs is prohibited by cost. Intracerebroventricular (i.c.v.) injections are made into the cerebral ventricle of the brain. Intracerebral (i.c.) injections are made into brain tissue and generally require stereotaxic implantation of microinjection guide sleeves in order to deliver the drug to a specific locus in the brain. Intrathecal (i.t.) injections are made into the cerebrospinal fluid that bathes the spinal cord.

- ▶ Nitrous Oxide Antinociception and Opioid Receptors
- ▶ Proinflammatory Cytokines

## Intracranial

### Definition

Structures located within the skull.

- ▶ Pain Treatment, Intracranial Ablative Procedures

## Intracranial Ablative Procedures

- ▶ Pain Treatment, Intracranial Ablative Procedures

## Intracranial Nociceptors

- ▶ Nociceptors in the Orofacial Region (Meningeal/Cerebrovascular)

## Intractable

### Definition

Persistence of an abnormal or harmful function despite usual treatment. For instance, intractable pain that persists after the etiology is treated and defies usual pain treatments.

- ▶ Pain Treatment, Intracranial Ablative Procedures

## Intracutaneous Injection Pain

- ▶ Autologous Thrombocyte Injection as a Model of Cutaneous Pain

## Intradental Nociceptors

- ▶ Nociceptors in the Dental Pulp

## Intradermal

### Definition

Intradermal relates to areas between the layers of the dermis (skin).

- ▶ PET and fMRI Imaging in Parietal Cortex (SI, SII, Inferior Parietal Cortex BA40)

## Intradiscal Electrothermal Anuloplasty

- ▶ Intradiscal Electrothermal Therapy

## Intradiscal Electrothermal Therapy

KEVIN PAUZA, NIKOLAI BOGDUK  
Tyler Spine and Joint Hospital, Tyler, TX, USA  
kevinpauza@tyler.net, nik.bogduk@newcastle.edu.au

### Synonyms

IDET; intradiscal eletrothermal anuloplasty

### Definition

Intradiscal Electrothermal Therapy (IDET) is a treatment devised to relieve the pain of internal disc disruption. It involves threading into the painful disc a flexible, wire electrode, which is used to heat the tissues of the posterior anulus fibrosus in an effort to relieve the pain.

### Characteristics

IDET was born of the desire and need for a procedure for the treatment of discogenic low back pain, other than major surgical procedures such as fusion and disc replacement. Since its introduction into clinical practice, it has met with variable acceptance and considerable criticism. Much of the resistance, however, has been financial and social in nature, with insurers concerned about the costs of a new and potentially popular procedure, and some critics expressing concerns that much of the literature on the efficacy of the procedure is being published by its inventors.

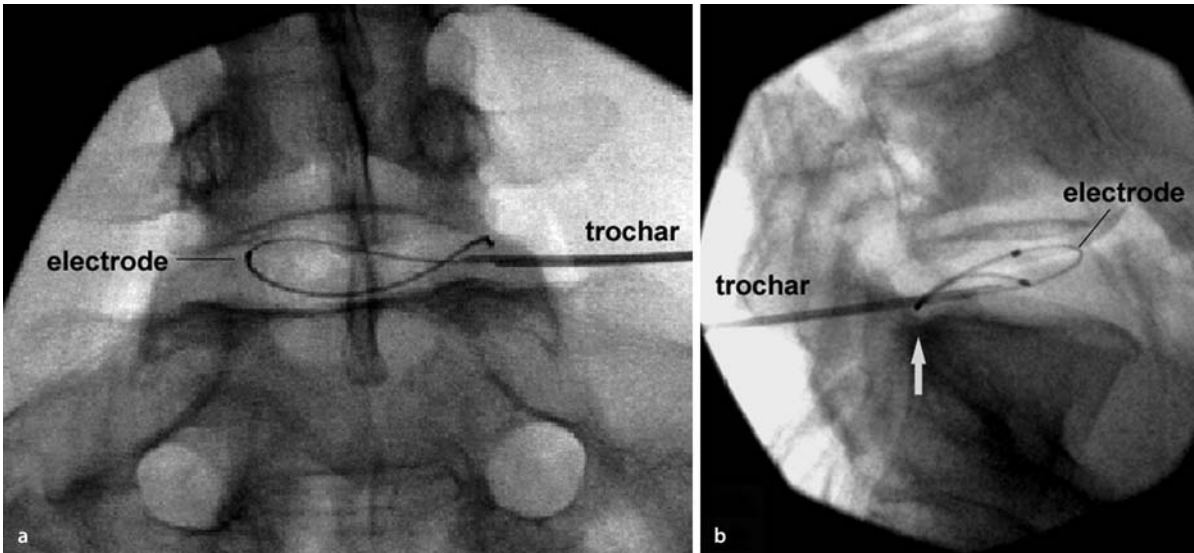
### Indications

The procedure is expressly indicated for low back pain caused by internal disc disruption. Practitioners, however, differ in how rigorously they make this diagnosis. Some rely only on the results of lumbar discography. Others insist on more rigorous criteria (Karasek and Bogduk 2001) that include demonstration of a radial fissure on post-discography CT (See: CT scan.). Nevertheless, discography is common to both approaches and is essential for the diagnosis of discogenic pain.

Eligibility criteria for IDET (Karasek and Bogduk 2001):

- Chronic, intrusive low back pain for greater than 3 months
- Failure to achieve adequate improvement with comprehensive nonoperative treatment
- No red flag condition
- No medical contraindications
- No neurologic deficit
- Normal straight-leg raise
- Nondiagnostic MRI scan
- No evidence for segmental instability, spondylolisthesis at target level
- No irreversible psychological barriers to recovery
- Motivated patient with realistic expectations of outcome
- No greater than 25% loss of disc height
- Criteria for IDD satisfied, viz.
  - Disc stimulation is positive at low pressures (< 50 psi)
  - Disc stimulation reproduces pain of intensity > 6/10
  - Disc stimulation reproduces concordant pain





**Intradiscal Electrothermal Therapy, Figure 1** Radiographs of an IDET procedure on an L5-S1 disc. (a) Postero-anterior view. The electrode has been threaded through a trochar, into and around the disc. (b) Lateral view. The electrode has passed through the outer, posterior annulus (arrow). Adapted from the Practice Guidelines for Spinal Diagnostic and Treatment Procedures of the International Spinal Intervention Society (Bogduk 2003).

- CT discography reveals a Grade 3 or greater annular tear
- Control disc stimulation is negative at one and preferably two, adjacent levels

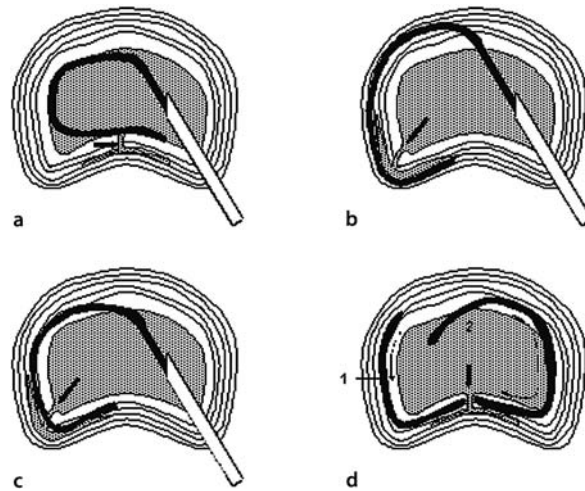
**Rationale**

The professed rationale of IDET varies between proponents. None has been tested, and none has been validated. Amongst the conjectures is that heating the posterior anulus: stiffens the collagen of the disc (Saal and Saal 2000a); denatures chemical exudates in radial and circumferential fissures; seals fissures; and destroys nociceptive nerve endings (Karasek and Bogduk 2001).

**Technique**

Practitioners differ in the manner in which they execute IDET. Indeed, the procedure has undergone various modifications since its original description. Common to all variants is the introduction of a flexible electrode into the disc. A trochar is passed into the disc along a posterolateral trajectory, such that its tip reaches the inner boundary of the anulus fibrosus. Through the trochar, a wire electrode is threaded and then navigated within the disc to assume a circumferential disposition, parallel to the lamina of the anulus. The objective is to place the 50 length of the active tip of the electrode across the radial fissure in the disc (Fig. 1).

The original description of the procedure required that the electrode be placed across the junction of the outer nucleus pulposus and the inner anulus fibrosus (Saal and Saal 2000a) (Fig. 2a). Subsequent variations have included: placing the electrode as far peripherally as possible in the outer anulus; attempting multiple placements



**Intradiscal Electrothermal Therapy, Figure 2** Variants of intradiscal electrothermal therapy. (a) The original description, in which the electrode is placed across the base of the radial fissure (arrowed) in the plane of the junction of the outer nucleus and inner anulus. (b) A variant in which the electrode is placed in the outermost annulus, parallel and external to the circumferential extension of the radial fissure (arrowed). (c) A variant in which the electrode is placed around the inner annulus, through the radial fissure (arrowed), but internal to its circumferential extension. (d) A variant in which the radial and circumferential fissures are attacked with two electrodes (1 and 2), introduced from opposite sides of the disc. Adapted from the Practice Guidelines for Spinal Diagnostic and Treatment Procedures of the International Spinal Intervention Society (Bogduk 2003).

but at different heights within the anulus; and approaching the target fissure from both sides, and at different heights (Figs. 2b, 2c, 2d).

**Efficacy**

In observational studies, practitioners of IDET have reported outcomes of various magnitudes for different du-

**Intradiscal Electrothermal Therapy, Table 1** Outcomes of IDET based on observational studies: a: Visual analog pain scale (0–100). b: Physical Functioning on the SF36 (0–100). c: Change in visual analog pain scale (0–100). d: Roland-Morris Disability Questionnaire (0–30). e: Bodily Pain on the SF36. f: Oswestry Disability Inventory (0–100). g. Reported as 8–24 months

Study	N	Outcome Measures	Baseline	6 M	12 M	24 M
Saal and Saal (2000b, 2002)	58	VAS <sup>a</sup> Mean	66		35	34
		Sd	19		23	20
		SF36:PF <sup>b</sup> Mean	40		60	72
		Sd	25		22	23
Lutz and Lutz (2003)	33	VAS <sup>a</sup> Mean	75		39 <sup>g</sup>	
		Sd	24		30	
		RMDQ <sup>d</sup> Mean	14		7 <sup>g</sup>	
		Sd	5.9		7.2	
Lee et al. (2003)	62	VAS <sup>a</sup> Mean	79			47
		Sd	13			30
		RMDQ <sup>d</sup> Mean	15			8.8
		Sd	5.3			7.5
Cohen et al. (2003)	79	> 50% relief		0.48		
		VAS <sup>a</sup> mean	59	21		
		Sd	18	13		
		> 90% relief		0.10		
Gerszten et al. (2002)	27	SF36: BP <sup>e</sup>	27		38	
		SF36: PF <sup>b</sup>	32		47	
		ODI <sup>f</sup>	34		30	

rations of follow-up (Table 1). Most of these studies have reported clinically significant reductions in pain. Some have reported sustained relief for up to two years and beyond.

Others, however, have reported less than impressive outcomes. One retrospective audit found that 50% of patients were dissatisfied with their outcome one year after treatment; and only 39% had less pain (Davis et al. 2004). The other reported that 55% of patients still required treatment after IDET; but 39% resumed or remained at work (Webster et al. 2004).

Another study found that it was unable to achieve good outcomes in the same proportion of patients as reported in the more favourable outcome studies (Freedman et al. 2003). Nevertheless, it found some patients who had satisfying relief. The authors concluded that, although IDET was not a substitute for fusion, it nevertheless

could be entertained as an option prior to undertaking fusion as a treatment.

Two controlled trials have produced favourable results (Table 2). In one (Bogduk and Karasek 2002), IDET was compared with the efficacy of a rehabilitation program. A significantly greater proportion of patients treated with IDET achieved relief of pain, which endured for up to two years. In particular, 20% achieved complete relief of pain, and 57% achieved greater than 50% relief of pain. In the other study (Pauza et al. 2004), IDET was found to achieve a significantly greater reduction in pain than did sham treatment.

Another controlled study failed to find any difference in outcome between patients treated with IDET or sham therapy (Freeman et al. 2003). In that study, however, no patients benefited from either therapy. No placebo effect was encountered in either group.

**Intradiscal Electrothermal Therapy, Table 2** The outcomes of IDET based on controlled studies. a: Visual analog scale for pain (0–100). b: Interquartile range. c: Change in visual analog score for pain (0–100). d: Change in Oswestry Disability Inventory (0–100)

Study	N	Outcome Measures	Baseline	3 M	6 M	12 M	24 M		
Bogduk and Karasek (2002)	control	VAS <sup>a</sup> Median	80	80		75	75		
		IQR <sup>b</sup>	50–80	70–80		50–80	40–80		
	IDET	VAS <sup>a</sup> median	80	35	30	30	30		
		IQR <sup>b</sup>	70–90	10–50	10–60	10–70	10–70		
		p value	0.70	0.00		0.01	0.03		
	control	50% relief					0.22		
		IDET	50% relief				0.57		
		p value					0.04		
	control	100% relief					0.00		
		IDET	100% relief				0.20		
		p value					0.047		
	Pauza et al. (2004)	sham	ΔVAS <sup>c</sup> median		11				
			IQR <sup>b</sup>		26				
			IDET	ΔVAS <sup>c</sup> median		24			
			IQR <sup>b</sup>		24				
		p value		0.045					
sham		Δ ODI <sup>d</sup> median		4					
		IQR <sup>b</sup>		11					
		IDET	Δ ODI <sup>d</sup> median		11				
		IQR <sup>b</sup>		11					
		p value		0.05					
control		50% relief		7					
		75% relief		0					
		100% relief		1					
IDET		50% relief		5					
		75% relief		5					
	100% relief		3						
	p value		0.03						

**Discussion**

Both in observational studies and in the controlled trials, differences in outcome can potentially be attributed to a variety of factors: differences in patient selection; differences in diagnostic criteria; the particular technique

that was used; and the rigour with which the technique was executed. None of these possible confounders has been formally tested. The one piece of evidence in this regard, is that the best results reported to date have been in patients to whom the most rigorous diagnostic and se-

lection criteria were applied, and in whom the electrode was assiduously placed in the outer annulus. Implicitly, less stringent variants of the procedure are not as effective.

A conciliatory resolution of the current controversy concerning IDET is that, in its present form, IDET is only the forerunner of what might prove to be a better procedure. The electrode currently in use produces only a small lesion around its perimeter. That lesion may not be large enough for many of the intradiscal lesions suffered by patients. In effect, the IDET lesion undertreats these patients. This would explain the substantial failure rate of the procedure (50%) even in the best hands. Improvements in the technology, such as producing a larger lesion, may provide for better outcomes of the procedure in a greater proportion of patients.

## References

- Bogduk N (2003) Practice Guidelines for Spinal Diagnostic and Treatment Procedures. Intradiscal electrothermal therapy. International Spinal Intervention Society, San Francisco
- Bogduk N, Karasek M (2002) Two-Year Follow-Up of a Controlled Trial of Intradiscal Electrothermal Annuloplasty for Chronic Low Back Pain Resulting from Internal Disc Disruption. *Spine J* 2:343–350
- Cohen SP, Larkin T, Abdi S et al. (2003) Risk Factors for Failure and Complications of Intradiscal Electrothermal Therapy: A Pilot Study. *Spine* 28:1142–1147
- Davis TT, Delamarter RB, Sra P et al. (2004) The IDET Procedure for Chronic Discogenic Low Back Pain. *Spine* 29:752–756
- Freedman BA, Cohen SP, Kuklo TR et al. (2003) Intradiscal Electrothermal Therapy (IDET) for Chronic Low Back Pain in Active-Duty Soldiers: 2-Year Follow-Up. *Spine J* 3:502–509
- Freeman BJC, Fraser RD, Cain CMJ et al. (2003) A Randomized Double-Blind Controlled Efficacy Study: Intradiscal Electrothermal Therapy (IDET) versus Placebo. Presented at the 30<sup>th</sup> Annual Meeting of the International Society for the Study of the Lumbar Spine, Vancouver, May 13–15
- Gerszten PC, Welch WC, McGrath PM et al. (2002) A Prospective Outcomes Study of Patients Undergoing Intradiscal Electrotherapy (IDET) for Chronic Low Back Pain. *Pain Physician* 5:360–364
- Karasek M, Bogduk N (2001) Intradiscal Electrothermal Annuloplasty: Percutaneous Treatment of Chronic Discogenic Low Back Pain. *Techniques in Regional Anesthesia and Pain Management* 5:130–135
- Lee MS, Cooper G, Lutz GE et al. (2003) Intradiscal Electrothermal Therapy (IDET) for Treatment of Chronic Lumbar Discogenic Pain: A Minimum 2-Year Clinical Outcome Study. *Pain Physician* 6:443–448
- Lutz C, Lutz GE, Cooke PM (2003) Treatment of Chronic Lumbar Diskogenic Pain with Intradiscal Electrothermal Therapy: A Prospective Outcome Study. *Arch Phys Med Rehabil* 84:23–28
- Pauza KJ, Howell S, Dreyfuss P et al. (2004) A Randomised, Placebo-Controlled Trial of Intradiscal Electrothermal Therapy for the Treatment of Discogenic Low Back Pain. *Spine J* 4:27–35
- Saal JS, Saal JA (2000a) Management of Chronic Discogenic Low Back Pain with a Thermal Intradiscal Catheter. A Preliminary Report. *Spine* 25:382–388
- Saal JA, Saal JS (2000b) Intradiscal Electrothermal Treatment for Chronic Discogenic Low Back Pain. A Prospective Outcome Study with Minimum 1-Year Follow-Up. *Spine* 25:2622–2627
- Saal JA, Saal JS (2002) Intradiscal Electrothermal Treatment for Chronic Discogenic Low Back Pain. Prospective Outcome Study with a Minimum 2-Year Follow-Up. *Spine* 27:966–974
- Webster BS, Verma S, Pransky GS (2004) Outcomes of Workers' Compensation Claimants with Low Back Pain Undergoing Intradiscal Electrothermal Therapy. *Spine* 29:435–441

## Intralaminar Thalamic Nuclei

### Definition

A group of small nuclei including the centromedian, paracentral, parafascicular, and lateral and medial central nuclei, within the internal medullary lamina of the thalamus. The intralaminar thalamic nuclei are involved in pain processing as well as other behavioral and cognitive functions.

- ▶ Spinothalamic Terminations, Core and Matrix
- ▶ Thalamic Nuclei Involved in Pain, Human and Monkey
- ▶ Trigeminothalamic Tract Projections

## Intramuscular Sensory Nerve Stimulation

- ▶ Dry Needling

## Intramuscular Stimulation

This is a technique of dry needling developed by Gunn. He uses an acupuncture needle to perform dry needling.

- ▶ Dry Needling

## Intraoperative Awareness

### Definition

Awareness is a rare complication of general anesthesia with an approximate incidence of one case in every 500 anesthetics given. Predisposing factors include small doses of the principal anesthetic, increased anesthetic requirement of some patients, or machine malfunction or misuse resulting in an inadequate delivery of anesthetic. The risk is greatest when muscle relaxants are used. Its most-feared consequence is post-traumatic stress disorder. Management of a case of awareness should be precise, detailed, and documented, but compassionate. Measures to prevent awareness include avoidance of „overly“light anesthesia, gaining more knowledge about anesthetic requirements of patients, and development of methods to detect consciousness during anesthesia.

- ▶ Postoperative Pain, Preoperative Education



## Intraperitoneal

### Definition

Within the peritoneal cavity, the area that contains the abdominal organs

- ▶ [Animal Models of Inflammatory Bowel Disease](#)

## Intrathecal

### Definition

Administration of an agent directly into the cerebrospinal fluid (CSF) beneath the arachnoid membrane.

- ▶ [Descending Circuitry, Opioids](#)
- ▶ [Headache Attributed to a Substance or its Withdrawal](#)
- ▶ [Opioids and Reflexes](#)
- ▶ [Opioids, Effects of Systemic Morphine on Evoked Pain](#)
- ▶ [Opioid Receptor Trafficking in Pain States](#)
- ▶ [Postoperative Pain, Appropriate Management](#)

## Intrathecal Drug Pumps

- ▶ [Pain Treatment, Implantable Pumps for Drug Delivery](#)

## Intrathecal Injection

### Synonyms

Spinal injection

### Definition

Injection of drugs into the subarachnoid space, which contains cerebro-spinal fluid. Placement of a catheter or needle into the subarachnoid space enables administration of drugs into the cerebrospinal fluid that bathes the spinal cord. This approach typically limits distribution of drugs to the spinal cord.

- ▶ [Alpha\( \$\alpha\$ \) 2-Adrenergic Agonists in Pain Treatment](#)
- ▶ [Cancer Pain Management, Anesthesiologic Interventions](#)
- ▶ [Descending Circuitry, Opioids](#)
- ▶ [Intrathecal Space](#)
- ▶ [Pain Treatment, Implantable Pumps for Drug Delivery](#)
- ▶ [Postoperative Pain, Appropriate Management](#)

## Intrathecal Space

### Definition

Deep to the arachnoid membrane and between the arachnoid mater and the pia mater lies the intrathecal or subarachnoid space. It contains cerebrospinal fluid, the spinal nerve roots, a trabecular network between the two membranes, blood vessels that supply the spinal cord, and the lateral extensions of the pia mater, the dentate ligaments.

- ▶ [Postoperative Pain, Intrathecal Drug Administration](#)

## Intravenous Infusions, Regional and Systemic

JOHN ROBINSON

Pain Management Centre, Burwood Hospital,  
Christchurch, New Zealand

jon.r@xtra.co.nz

### Synonyms

IV block; Regional Infusion; IV infusion; intravenous regional block; intravenous regional analgesia

### Definition

Intravenous (IV) infusions are a means of delivering a drug in order to determine if it relieves pain. The drug is administered through a needle or cannula inserted into a vein. The drug can be allowed to enter the circulation of the body, in which case the infusion becomes a systemic one. If a pressure cuff is applied to the limb proximal to the site of injection, the drug can be restricted to the circulation and tissue distal to the cuff, in which case the infusion becomes a regional one.

### Characteristics

#### Principles

The objective of regional infusions is to relieve pain, either temporarily as a diagnostic test, or for prolonged periods as a therapeutic intervention. Different drugs may be used, either to block nociceptive neurons in the periphery, or pain pathways in the central nervous system; or to block efferent sympathetic nervous activity that may be sensitising nociceptive neurons.

### Regional Infusions

#### Sympathetic Blocks

Intravenous regional sympathetic blocks (IRSBs) are designed to block efferent sympathetic activity. The drugs used are ones that either prevent the release of noradrenaline (norepinephrine) from the peripheral terminals of sympathetic nerves, or block the receptors to noradrenaline in peripheral tissues.

For preventing the release of noradrenaline, the most commonly used agent is guanethidine (Jadad et al. 1995; Ramamurthy et al. 1995). For blocking receptors phentolamine is used (Raja et al. 1991). Older drugs, whose use has been supplanted by these agents, include bretylium and reserpine.

Regional sympathetic blocks are typically used in the assessment and treatment of complex regional pain syndromes. As a diagnostic test, they are used to determine if the patient's pain or other symptoms are maintained by activity in efferent sympathetic nerves. The test is considered positive if administering the sympathetic blocking agent relieves the patient's pain. In that event, the pain is considered to be sympathetically maintained pain. Some practitioners use a positive response as an indication for sympathectomy to treat sympathetically maintained pain.

If pain is relieved for a prolonged and useful period, regional sympathetic blocks may be used as a treatment. In some patients, repeating the blocks progressively increases the duration of relief that ensues.

### Local Anaesthetic Blocks

Intravenous local anaesthetic blocks involve the injection of a local anaesthetic agent, typically lignocaine (lidocaine). They are used to anaesthetize a larger area than might be possible with nerve blocks, or to anaesthetize a region in which the source of pain is unknown and, therefore, not amenable to a specific nerve block. A typical dose is 30–40 ml of 0.5% lignocaine, injected over 2–3 minutes (Buckley 2001).

Intravenous local anaesthetic blocks are most commonly used in the management of complex regional pain syndrome. These blocks may provide prolonged periods of relief in their own right, but are usually used to provide analgesia so that other measures, such as physical therapy, can be instituted in patients who otherwise cannot bear to have the affected limb touched.

### Systemic Infusions

#### Local Anaesthetic

Systemic infusions of a local anaesthetic agent can be used as a diagnostic test and as a treatment for ► **central pain**. It is believed that the agent circulates to the central nervous system where it decreases abnormal activity, either in central pain pathways or in the brain, to produce relief of pain without anaesthesia. The agent can be delivered either as a bolus by slow injection from a syringe, or as a slow infusion from a drip.

A positive response to a diagnostic infusion is taken as evidence that the patient has central pain. Treatment can be instituted either by prescribing oral local anaesthetic agents or a slow infusion (Buckley 2001).

#### Phentolamine

Unlike other sympathetic blocking agents, phentolamine does not have significant side-effects when

administered systemically. Therefore, phentolamine does not need to be restricted to a regional infusion. It can be administered systemically in order to test for sympathetically maintained pain, in the manner in which regional sympathetic blocks are used.

### Bisphosphonates

A recent innovation for the treatment of complex regional pain syndromes is the intravenous administration of ► **bisphosphonates**. These agents are believed to relieve pain by acting on descending pain modulatory pathways. Examples include alendronate (Adami et al. 1997), clodronate (Varenna et al. 2000), and pamidronate (Robinson 2002; Kingery 1997).

### Other Agents

Other agents that have been used for systemic infusions, usually for the treatment of complex regional pain syndromes, include calcitonin (Kingery 1997), bretylium, clonidine, ketorolac, ketanserin, lysine acetylsalicylate, naftidrofuryl, methylprednisolone, labetalol, reserpine, hydralazine, thymoxamine (Shipton 1999) droperidol, and atropine (Galer et al. 2001).

### Indications

The most common indications are complex regional pain syndromes or neuropathic pain for regional infusions, and central pain for systemic infusions. Intravenous methylprednisolone has been used successfully to treat acute cervical radicular pain after whiplash (Pettersson and Toolanen 1998).

### Validity

When used as a diagnostic test, intravenous infusions have questionable validity. Although assumed to be valid, formal studies have rarely established their validity. Rather, placebo-controlled studies have shown that intravenous guanethidine and intravenous phentolamine have effects indistinguishable from those of normal saline, when administered under double-blind conditions (Robinson 2002; Kingery 1997). Consequently, in a given patient, responses to intravenous infusions cannot be considered to be positive unless accompanied by a negative response to placebo-controlled infusions.

### Utility

When used as a treatment, intravenous infusions have been assumed to be effective. However, few agents have been submitted to placebo-controlled studies, and even fewer have been shown to be more effective than placebo. The only agents proven to be effective are bretylium, ketanserin, and bisphosphonates (Robinson 2002, Kingery 1997). The evidence on phentolamine is conflicting, but the data favour that phentolamine does not produce analgesia greater than placebo, or provides short-term relief in only a small subset of patients (Kingery 1997).

## References

1. Adami S, Fossaluzza V, Gatti D, Fracassi E, Braga V (1997) Bisphosphonate Therapy for Reflex Sympathetic Dystrophy Syndrome. *Ann Rheum Dis* 56:201–204
2. Buckley FP (2001) Regional Anesthesia with Local Anesthetics. In: Loeser JD (ed) *Bonica's Management of Pain*. Lippincott, Williams & Wilkins, Philadelphia, pp 1893–1952
3. Galer BS, Schwartz L, Allen RJ (2001) Complex Regional Pain Syndromes – Type I: Reflex Sympathetic Dystrophy, and Type II: Causalgia. In Loeser JD (ed) *Bonica's Management of Pain*. Lippincott, Williams & Wilkins, Philadelphia, pp 388–411
4. Jadad AR, Carrol D, Glynn CJ, McQuay HJ (1995) Intravenous Regional Sympathetic Blockade in Reflex Sympathetic Dystrophy: A Systemic Review and Randomized Crossover Double Blind Study. *J Pain Sympt Manage* 10:13–20
5. Kingery W (1997) A Critical Review of Controlled Trials for Peripheral Neuropathic Pain and Complex Regional Pain Syndromes. *Pain* 73:123–139
6. Pettersson K, Toolanen G (1998) High-dose Methylprednisolone Prevents Extensive Sick Leave after Whiplash Injury. A Prospective, Randomized, Double-Blind Study. *Spine* 23:984–989
7. Raja AN, Treed RD, Davis KD, Campbell JN (1991) Systemic Alpha Adrenergic Blockade with Phentolamine: A Diagnostic Test for Sympathetically Maintained Pain. *Anaesthesiology* 74:691–698
8. Ramamurthy S, Hoffman J (1995) Intravenous Regional Guanethidine in the Treatment of RSD/Causalgia: A Randomised Double Blind Study Group. *Anaesth Analg* 81:718–23
9. Robinson J (2002) The Treatment of Complex Regional Pain Syndrome Type I. *Australasian Musculoskeletal Medicine* 7:101–105
10. Shipton EA (1999) Complex Regional Pain Syndromes. In: *Pain Acute and Chronic*. Arnold, London, pp 210–231
11. Varena M, Zucchi F, Ghiringhelli D, Binelli L, Bevilacqua M, Bettica P, Sinigaglia L (2000) Intravenous Clodrinat in the Treatment of Reflex Sympathetic Dystrophy Syndrome. *J Rheumatol* 27:1477–1483

## Intravenous Regional Analgesia/Block

### Definition

Intravenous regional anesthesia is performed by occluding the circulation in a limb with a tourniquet, and then injecting local anesthetic into a distal vein. Intravenous regional blocks (IVRB) using a range of agents have been utilized for the management of CRPS. Guanethidine depletes noradrenaline in the post-ganglionic adrenergic terminal, but its use in IVRBs has not been supported in controlled trials.

- ▶ Intravenous Infusions, Regional and Systemic
- ▶ Postoperative Pain, Acute Presentation of Complex Regional Pain Syndrome

## Intravenous Tramadol

### Definition

Intravenous tramadol (2mg/kg) provides similar antinociceptive effects to that of meperidine. Tramadol generally has no significant effects on gastrointestinal function. Tramadol has been shown to cause idiopathic

seizures in clinical follow-ups, with an incidence of <10%. Tramadol is rapidly absorbed, with an oral bioavailability of 70% after a single dose administration and  $\approx$  90% after multiple doses (due to saturated first-pass hepatic metabolism).

- ▶ Post-Operative Pain, Tramadol

## Intraventricular

### Definition

Within the cerebrospinal fluid filled ventricles of the brain.

- ▶ Pain Treatment, Implantable Pumps for Drug Delivery

## Intraventricular Drug Pumps

- ▶ Pain Treatment, Implantable Pumps for Drug Delivery

## Intravesical

### Definition

Within the bladder.

- ▶ Nocifensive Behaviors of the Urinary Bladder

## Invasive

### Definition

Procedures involving the introduction of instruments or other objects into the body or body cavities.

- ▶ Acute Pain in Children, Procedural

## Inverse Agonist

### Definition

Compound that stabilizes the inactive conformation of a receptor and inhibits the constitutive activity of the receptor.

- ▶ Metabotropic Glutamate Receptors in Spinal Nociceptive Processing

## Inverse Problems

### Definition

Problems in which the inputs or sources are estimated from the outputs or responses. This is in contrast to “direct” problems, in which outputs or responses are determined using a knowledge of the inputs or sources. (However, inverse problems are often ill-posed problems.)

- ▶ [Magnetoencephalography in Assessment of Pain in Humans](#)

## Ion Channel

### Definition

An ion channel is a specialized membrane protein that acts as a pore, and allows rapid diffusion of ions into and out of the cell through an aqueous pore within the molecule. It is usually selective for one ion (e.g. sodium, potassium, calcium) or a group of ions (e.g. all cations), and usually has some sort of gating mechanism (by voltage, binding a chemical, or sensory stimuli) that can switch the channel between open and closed states.

- ▶ [Mechanonociceptors](#)
- ▶ [Nociceptors, Action Potentials and Post-Firing Excitability Changes](#)
- ▶ [Nociceptors in the Orofacial Region \(Skin/Mucosa\)](#)
- ▶ [Painful Channelopathies](#)
- ▶ [Species Differences in Skin Nociception](#)
- ▶ [Trafficking and Localization of Ion Channels](#)

## Ion Channel Blockers

- ▶ [Drugs Targeting Voltage-Gated Sodium and Calcium Channels](#)

## Ion Channel Trafficking

- ▶ [Trafficking and Localization of Ion Channels](#)

## Ionotropic Glutamate Receptors

### Synonyms

iGluRs

### Definition

Family of ligand-gated ion channels that include N-methyl-D-aspartate (NMDA) receptors and non-NMDA (AMPA and Kainate) receptors. They act quickly to depolarize the neuron and mediate fast synaptic events.

- ▶ [Inflammation, Role of Peripheral Glutamate Receptors](#)
- ▶ [Metabotropic Glutamate Receptors in Spinal Nociceptive Processing](#)
- ▶ [Metabotropic Glutamate Receptors in the Thalamus](#)
- ▶ [Nociceptive Neurotransmission in the Thalamus](#)
- ▶ [Nociceptive Processing in the Amygdala, Neurophysiology and Neuropharmacology](#)

## Ionotropic Receptor

### Definition

Ionotropic receptor is a protein complex that forms an ion-permeable pore within the plasma membrane. Generally, two subunits of the complex have binding sites for a neurotransmitter. Binding of a neurotransmitter results in the opening of the ion channel. In the case of ionotropic receptors for glutamate, the ion channel is permeable to cations such as  $\text{Na}^+$  and  $\text{Ca}^{2+}$ , resulting in depolarization of neurons. In the case of ionotropic receptors for GABA, the ion channel is permeable to  $\text{Cl}^-$ , generally resulting in hyperpolarization of the neuron.

- ▶ [GABA Mechanisms and Descending Inhibitory Mechanisms](#)
- ▶ [NMDA Receptors in Spinal Nociceptive Processing](#)
- ▶ [Spinothalamic Tract Neurons, Peptidergic Input](#)

## Ipsilateral

### Definition

Situated or appearing on or affecting the same side of the body.

- ▶ [Hemicrania Continua](#)
- ▶ [Opioid Receptor Trafficking in Pain States](#)
- ▶ [Spinothalamocortical Projections from SM](#)

## Irritable Bowel Syndrome

### Synonyms

IBS



## Definition

Irritable bowel syndrome (IBS) is the most commonly reported functional gastrointestinal disorder effecting the large bowel and rectum. It is a syndrome characterized by abdominal pain or discomfort and altered defecation (such as diarrhea or constipation, other common symptoms are bloating, passing mucus in the stools, or a sense that the bowels were not completely emptied) without abnormalities on conventional medical tests. It is one of the most commonly seen conditions by gastroenterologists in clinical practice. IBS is not an inflammatory bowel disease, and should be diagnosed using the consensus 'Rome' clinical criteria. These are:

1. Three months of continuous or recurring symptoms of abdominal pain or irritation that may be relieved with a bowel movement, may be coupled with a change in frequency, or may be related to a change in the consistency of stools;
2. Two or more of the following are present at least 25 percent of the time: a change in stool frequency, noticeable difference in stool form, passage of mucus, bloating or altered stool passage including sensations of incomplete evacuation, straining, or urgency.
  - ▶ Amygdala, Functional Imaging
  - ▶ Amygdala, Pain Processing and Behavior in Animals
  - ▶ Chronic Gynaecological Pain, Doctor-Patient Interaction
  - ▶ Descending Modulation of Visceral Pain
  - ▶ Postsynaptic Dorsal Column Neurons, Responses to Visceral Input
  - ▶ Psychological Aspects of Pain in Women
  - ▶ Thalamus
  - ▶ Thalamus and Visceral Pain Processing (Human Imaging)
  - ▶ Thalamus, Clinical Visceral Pain, Human Imaging
  - ▶ Visceral Pain Model, Irritable Bowel Syndrome Model

## Irritable Bowel Syndrome Model

- ▶ Visceral Pain Model, Irritable Bowel Syndrome Model

## Irritant

### Definition

An irritant is a chemical used in prolotherapy solutions which acts by damaging cells directly or rendering them antigenic. They include phenol, guaiacol and tannic acid.

- ▶ Prolotherapy

## Ischemia

### Definition

Insufficient or suppressed blood supply to an organ caused by blockage of a blood vessel (blood clot, atherosclerosis plaque, contractions, artery spasms). It prevents the tissue from receiving nutrients and oxygen and leads to accumulation of metabolic wastes like carbon dioxide and metabolic acids, and thus induces local acidosis.

- ▶ Acid-Sensing Ion Channels
- ▶ TRPV1, Regulation by Protons

## Ischemia Model

- ▶ Spinal Cord Injury Pain Model, Ischemia Model

## Ischemic Heart Disease

### Definition

Is a condition in which blood flow (and thus oxygen and nutrients) is reduced in areas of the heart where the diameters of the coronary arteries are significantly narrowed.

- ▶ Visceral Pain Model, Angina Pain

## Ischemic Neuropathies

- ▶ Vascular Neuropathies

## Ischemic Pain/Test

### Definition

Experimental ischemic pain from skeletal muscles can be easily produced by exercising a limb or an arm during a temporary block of the arterial blood supply.

- ▶ Tourniquet Test

## ISH

- ▶ Idiopathic Stabbing Headache

## ISI

- ▶ Interspike Interval

## Island of Reil

- ▶ Insular Cortex, Neurophysiology and Functional Imaging of Nociceptive Processing

## Isolectin B4

### Definition

The isolectin B4 of the plant lectin *Griffonia simplicifolia* recognizes a sugar moiety found selectively on the surface of small myelinated and unmyelinated nerve fibers, and is a useful marker for nociceptive neurons.

- ▶ Nociceptor, Categorization
- ▶ Trigeminal Brainstem Nuclear Complex, Immunohistochemistry and Neurochemistry

## Itch/Itch Fibers

MARTIN SCHMELZ

Institute for Anesthesiology and Operative Intensive Medicine, Fakultät für Clinical Medicine Mannheim, University Heidelberg, Mannheim, Germany  
martin.schmelz@anaes.ma.uni-heidelberg.de

### Synonyms

Pruritus

### Definition

Itch (Latin: *pruritus*) obviously serves nociceptive functions, but it is clearly distinct from pain sensation. It is restricted to the skin and some adjoining mucosae. Whereas painful stimuli inflicted on the skin provoke withdrawal reflexes, itching stimuli provoke the very characteristic scratching reflex. This reflex pattern indicates that the neuronal apparatus for itch has developed as a nocifensive system for removal of irritating objects and agents affecting the skin. One might also describe scratching as a reflex pattern that is used in situations in which the noxious stimulus has already invaded the skin. In this situation withdrawal would be useless; instead localizing the injured site by scratching and a close inspection appears to be more adequate.

### Characteristics

C-fibers, responding to histamine application in parallel to the itch ratings of subjects have been discovered among the group of mechano-insensitive C-afferents (Schmelz et al. 1997) suggesting that there is a specific pathway for itch (Fig. 1). In contrast, the most common type of C-fibers, mechano-heat nociceptors (CMH or polymodal nociceptors) are either insensitive to histamine or only weakly activated by it (Schmelz et al. 2003b). This fiber type cannot account for the

prolonged itch induced by the intradermal application of histamine.

The histamine-sensitive or ‘itch’ fibers or pruriceptors are characterized by a particular low conduction velocity, large innervation territories, mechanical unresponsiveness and high transcutaneous electrical thresholds (Schmelz et al. 2003b). In line with the large innervation territories of these fibers, two-point discrimination for histamine-induced itch is poor (15 cm in the upper arm).

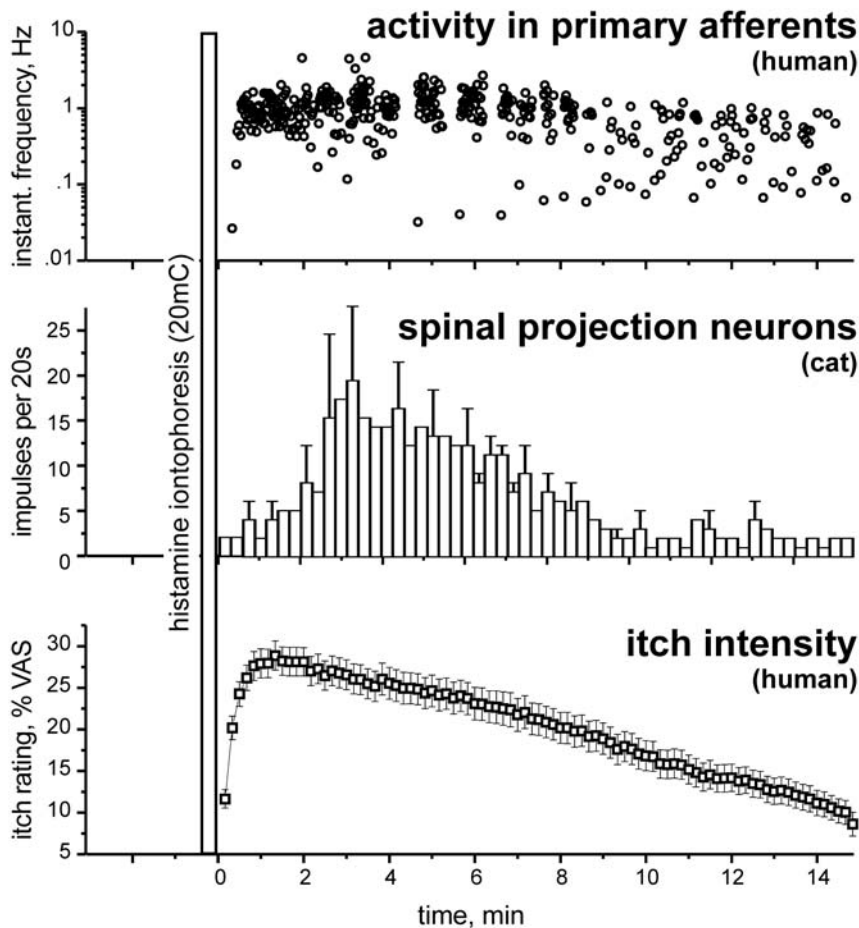
The relative prevalence of the different C-fiber types has been estimated from recordings in the superficial peroneal nerve. About 80% are polymodal nociceptors, which respond to mechanical, heat and chemical stimuli. The remaining 20% do not respond to mechanical stimulation. These fibers are mainly “mechano-insensitive nociceptors” (Schmidt et al. 1995), which are activated by chemical stimuli (Schmelz et al. 2000), and can be sensitized to mechanical stimulation in the presence of inflammation (Schmelz et al. 2000; Schmidt et al. 1995). Among the mechano-insensitive afferent C-fibers, there is a subset of units that have a strong and sustained response to histamine. They comprise about 20% of the mechano-heat-insensitive class of C-fibers, i.e. about 5% of all C-fibers in the superficial peroneal nerve.

### Specific Spinal Pruriceptive Neurons

The concept of dedicated pruriceptive neurons has now been complemented and extended by recordings from the cat spinal cord. A specific class of dorsal horn neurons projecting to the thalamus has been demonstrated, which respond strongly to histamine administered to the skin by iontophoresis (Andrew and Craig 2001). The time course of these responses was similar to that of itch in humans and matched the responses of the peripheral C-itch fibers (Fig. 1). These units were also unresponsive to mechanical stimulation and differed from the histamine insensitive nociceptive units in lamina I of the spinal cord. In addition, their axons had a lower conduction velocity and anatomically distinct projections to the thalamus. Thus, the combination of dedicated peripheral and central neurons with a unique response pattern to pruritogenic mediators and anatomically distinct projections to the thalamus, provide the basis for a specific neuronal pathway for itch.

### Peripheral Sensitization

Increased intradermal nerve fiber density has been found in patients with chronic pruritus. In addition, increased epidermal levels of neurotrophin 4 (NT4) have been found in patients with atopic dermatitis and massively increased serum levels of NGF and SP have been found to correlate with the severity of the disease in such patients (Toyoda et al. 2002). Increased fiber density and higher local NGF concentrations were also found in patients with contact dermatitis. It is known



**Itch/Itch Fibers, Figure 1** In the upper panel instantaneous discharge frequency of a mechano- and heat insensitive C-fiber (CMiHi) in the superficial peroneal nerve following histamine iontophoresis (20 mC; marked as open box in the diagram) is shown. In the central panel activation of a spinal projection neuron following histamine iontophoresis is depicted. The lower panel shows average itch magnitude ratings of a group of 21 healthy volunteers after an identical histamine stimulus. Ratings at 10 s intervals on a visual analogue scale with the end points “no itch” - “unbearable itch” Bars: standard error of means (modified from Schmelz et al. 1997 and Andrew et al. 2001).

that NGF and NT4 can sensitize nociceptors. These similarities between localized painful and pruritic lesions might suggest that similar mechanisms of nociceptor sprouting and sensitization exist on a peripheral level.

### Central Sensitization

There is a remarkable similarity between the phenomena associated with central sensitization to pain and itch. Activity in chemo-nociceptors leads not only to acute pain but, in addition, can sensitize second order neurons in the dorsal horn, thereby leading to increased sensitivity to pain (hyperalgesia).

In itch processing, similar phenomena have been described; touch or brush-evoked pruritus around an itching site has been termed ‘itchy skin’ (Bickford 1938). Like allodynia, it requires ongoing activity in primary afferents and is most probably elicited by low threshold mechanoreceptors ( $A\text{-}\beta$  fibers). Also more intense prick-induced itch sensations in the surroundings, ‘hyperknesis’, have been reported following histamine iontophoresis in healthy volunteers (Atanassoff et al. 1999).

The exact mechanisms and roles of central sensitization for itch in clinical conditions have still to be explored, whereas a major role for central sensitization in patients with chronic pain is generally accepted. It should be noted that there is also emerging evidence for corresponding phenomena in patients with chronic pain and chronic itch. In patients with neuropathic pain, it has recently been reported that histamine iontophoresis resulted in burning pain instead of pure itch, which would be induced by this procedure in healthy volunteers (Birklein et al. 1997; Baron et al. 2001). This phenomenon is of special interest as it demonstrates spinal hypersensitivity to C-fiber input. Conversely, normally painful electrical, chemical, mechanical and thermal stimulation is perceived as itching when applied in or close to lesional skin of atopic dermatitis patients (Ikoma et al. 2003).

Long lasting activation of pruriceptors by histamine has been shown experimentally to induce central sensitization for itch in healthy volunteers (Ikoma et al. 2003); following the application of histamine *via* dermal microdialysis fibers, low pH stimulation of the skin close to the histamine site was perceived as itch instead of pain. On-

going activity of pruriceptors, which might underlie the development of central sensitization for itch, has already been confirmed microneurographically in a patient with chronic pruritus (Schmelz et al. 2003a).

While there is obviously an antagonistic interaction between pain and itch under normal conditions, the patterns of spinal sensitization phenomena are surprisingly similar. It remains to be established whether this similarity will also include the underlying mechanism, which would also imply similar therapeutic approaches, such as gabapentin or clonidine, for the treatment of neuropathic itch.

## References

- Andrew D, Craig AD (2001) Spinothalamic lamina 1 neurons selectively sensitive to histamine: a central neural pathway for itch. *Nat Neurosci* 4:72–77
- Atanassoff PG, Brull SJ, Zhang J et al. (1999) Enhancement of experimental pruritus and mechanically evoked dysesthesiae with local anesthesia. *Somatosens Mot Res* 16:291–298
- Baron R, Schwarz K, Kleinert A et al. (2001) Histamine-induced itch converts into pain in neuropathic hyperalgesia. *Neuroreport* 12:3475–3478
- Bickford RGL (1938) Experiments relating to itch sensation, its peripheral mechanism and central pathways. *Clin Sci* 3:377–386
- Birklein F, Claus D, Riedl B et al. (1997) Effects of cutaneous histamine application in patients with sympathetic reflex dystrophy. *Muscle Nerve* 20:1389–1395
- Ikoma A, Rukwied R, Stander S et al. (2003) Neuronal sensitization for histamine-induced itch in lesional skin of patients with atopic dermatitis. *Arch Dermatol* 139:1455–1458
- Schmelz M, Schmidt R, Bickel A et al. (1997) Specific C-receptors for itch in human skin. *J Neurosci* 17:8003–8008
- Schmelz M, Schmidt R, Handwerker HO et al. (2000) Encoding of burning pain from capsaicin-treated human skin in two categories of unmyelinated nerve fibres. *Brain* 123:560–571
- Schmelz M, Hilliges M, Schmidt R et al. (2003a) Active “itch fibers” in chronic pruritus. *Neurology* 61:564–566
- Schmelz M, Schmidt R, Weidner C et al. (2003b) Chemical response pattern of different classes of C-nociceptors to pruritogens and algogens. *J Neurophysiol* 89:2441–2448
- Schmidt R, Schmelz M, Forster C et al. (1995) Novel classes of responsive and unresponsive C nociceptors in human skin. *J Neurosci* 15:333–341
- Toyoda M, Nakamura M, Makino T et al. (2002) Nerve growth factor and substance P are useful plasma markers of disease activity in atopic dermatitis. *Br J Dermatol* 147:71–79

## ITCH MAN

### Definition

A scale to quantify the severity of itching on a 10 point scale. It was developed and copyrighted by P. Blakeney and J. Marvin, Shriners Hospitals for Children, Galveston, Texas

► [Pain Control in Children with Burns](#)

## Itchy Skin

### Definition

The cutaneous areas of abnormally enhanced itch that are characterized by a greater than normal sensation of itch in response to a normally itchy stimulus (*hyperknesis*), and/or a sensation of itch evoked by stimuli that normally do not elicit itch (*alloknesis*). These states are sometimes accompanied by mild hyperalgesia in which a normally painful stimulus can evoke a greater than normal magnitude and duration of pain.

► [Allodynia and Alloknesis](#)

## IUPHAR

### Definition

The IUPHAR recommend that the opioid receptors should be called MOP ( $\mu$  or mu receptor), DOP ( $\delta$  or delta receptor), KOP (kappa receptor) or NOP (orphan receptor).

► [Postoperative Pain, Opioids](#)



## Jab-Like and Jolt-Like Headache

### Definition

Jab-Like and Jolt-Like Headache refers to a benign stabbing headache.

- ▶ Primary Exertional Headache

## Jabs and Jolts Syndrome

- ▶ Primary Stabbing Headache

## Japanese Meridian Therapy

- ▶ Acupuncture

## Jaw Claudication

### Definition

Pain during mastication due to ischemia of the masseter muscles in temporal arteritis.

- ▶ Headache Due to Arteritis

## Jaw-Muscle Silent Periods (Exteroceptive Suppression)

GIORGIO CRUCCU

Department of Neurological Sciences, La Sapienza University, Rome, Italy  
Cruccu@uniroma1.it

### Synonyms

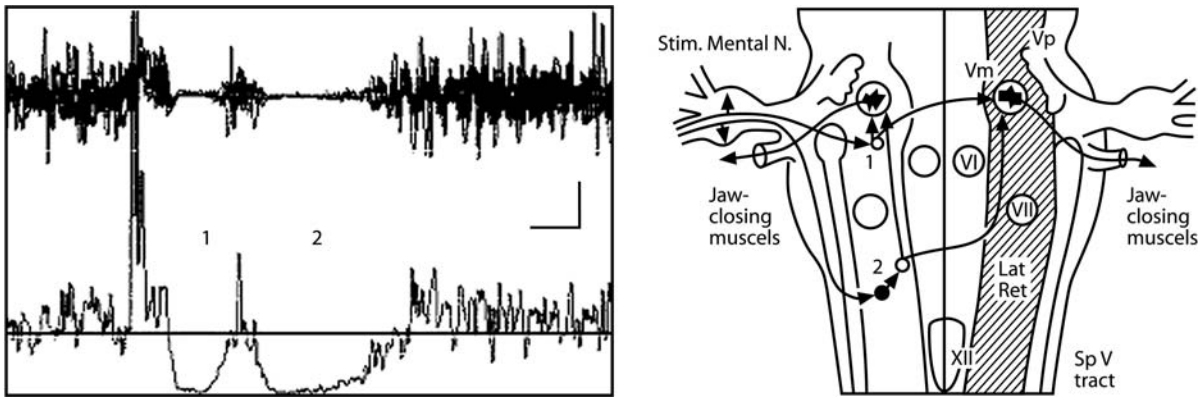
Masseter inhibitory reflex; Masseter Silent Periods; Exteroceptive Suppression

### Definition

The jaw-muscle silent periods are trigemino-trigeminal inhibitory reflexes elicited by electrical, mechanical, or radiant heat stimuli delivered to the oral region (in the territory of the maxillary and mandibular trigeminal divisions); on electromyographic recordings from contracted jaw-closers, this reflex inhibition appears as an early and a late phase of suppression, also called ES1 and ES2 exteroceptive suppressions or SP1 and SP2 silent periods.

### Characteristics

Whereas in the reflex control of jaw movement in lower mammals, the jaw-opening and jaw-closing muscles act in equilibrium, in humans the jaw-openers (digastric and suprahyoid muscles) play a marginal role. The jaw-closers (masseter, temporalis and pterygoid muscles) serve both functions, for reflex jaw closing under normal circumstances (excitation) and for reflex jaw opening when they undergo inhibition. The jaw-closers are excited by way of the A $\alpha$  muscle spindle input and strongly inhibited by way of A $\beta$  capsulated mechanoreceptors and A $\delta$  free nerve endings. The powerful inhibition exerted by cutaneous and intraoral mechanoreceptors probably compensates for the unusual organization of the jaw-closing motoneurons, which undergo inhibitory control neither by reciprocal nor by recurrent inhibition. Electrical or mechanical stimuli delivered to the oral region evoke a reflex inhibition of the jaw-closing muscles, the ▶ **masseter inhibitory reflex** (Fig. 1). On EMG recordings from contracted jaw-closers, this reflex inhibition appears as an early and a late phase of suppression, also called ▶ **ES1 and ES2 exteroceptive suppressions** (Godaux and Desmedt 1975), or ▶ **SP1 and SP2 silent periods** (Cruccu and Deuschl 2000). Probably because electrical stimuli yield a mixed – nociceptive and non-nociceptive – input, whether the first or the second or both components are ▶ **nociceptive reflexes** remains controversial (Miles and Turker 1987). Innocuous mechanical stimuli will elicit both components, however, and indirect evidence supports the view that the afferents belong to the intermediately myelinated A $\beta$  group. Afferent impulses reach the pons *via* the sensory mandibular or maxillary root of the trigeminal nerve. The first inhibitory



**Jaw-Muscle Silent Periods (Exteroceptive Suppression), Figure 1** Masseter inhibitory reflex and brainstem circuits. Left: first (1) and second (2) inhibitory periods. Recording from the right masseter muscle. Stimulation of the right mental nerve. Upper traces: 8 trials are superimposed. Lower trace: rectified and averaged signal. The horizontal line indicates 80% of the background EMG level. Calibration 20 ms / 200  $\mu$ V. Right: schematic drawing of the reflex circuits. Afferents for the first inhibitory period connect with an inhibitory interneuron (1) located close to the ipsilateral trigeminal motor nucleus. The afferents for the second inhibitory period descend along the spinal trigeminal tract and connect with a multisynaptic chain of excitatory interneurons. The last interneuron is inhibitory (2) and projects bilaterally onto the jaw-closing motoneurons. Vm, trigeminal motor nucleus; Vp, trigeminal principal sensory nucleus; Sp V tract, spinal trigeminal tract; VI, abducens nucleus; VII, facial nucleus; XII, hypoglossal nucleus; Lat Ret, lateral reticular formation. (From Cruccu and Deuschl 2000).

period (10–13 ms latency) is probably mediated by one inhibitory interneuron, located close to the ipsilateral **trigeminal motor nucleus**. This interneuron projects onto jaw-closing motoneurons bilaterally. The whole circuit lies in the mid-pons. The afferents for the second inhibitory period (40–50 ms latency) descend in the **spinal trigeminal complex** and connect to a polysynaptic chain of excitatory interneurons, probably located in the **medullary lateral reticular formation**. The last interneuron of the chain is inhibitory and gives rise to ipsilateral and contralateral collaterals that ascend medially to the right and left spinal trigeminal complexes, to reach the trigeminal motoneurons (Cruccu et al. 2005; Ongerboer de Visser et al. 1990).

As shown by experiments with noxious, high-intensity laser stimuli directed to the perioral region, selective activation of A $\delta$  afferents elicits a single, late (70 ms latency) silent period in jaw-closing muscles (Ellrich et al. 1997; Romaniello et al. 2002). This nociceptive reflex (**laser silent period, LSP**) is supposedly mediated by the spinal trigeminal nucleus, pars caudalis.

#### Technical Requirements and Normal Values

The masseter inhibitory reflex is usually evoked by transcutaneous electrical stimulation of the mentalis territory (to test the mandibular division) or of the infraorbital territory (to test the maxillary division), by placing the cathode on the skin overlying the mental or the infraorbital foramen and the anode 2 cm laterally. A stimulus lasting 0.1 ms delivered at an intensity of about 3  $\times$  the sensory threshold allows best visualization of the first and second inhibitory periods without causing excessive discomfort. The patient clenches the teeth at maximum strength, receives the stimulus and is then allowed

a few seconds' rest. At least 8 trials, but preferably 16, are repeated and superimposed. Quantitative studies of the excitability of the brainstem inhibitory interneurons require measurement of the size of responses (e.g. area of suppression); the level of background EMG activity must be kept constant and the signal is full-wave rectified and averaged (Fig. 1).

The onset latency should correspond to the beginning of the EMG suppression. This is usually taken at the intersection between the inhibitory shift and a line corresponding to 80% of the mean background EMG activity. The size of the response can be evaluated by measuring the area of suppression or the duration, taking the end-latency at the point when EMG returns to 80%. The onset latency is the most reliable measure for clinical applications (Table 1 shows normal values). The latency of the first inhibitory period (though not the second) has a rel-

**Jaw-Muscle Silent Periods (Exteroceptive Suppression), Table 1** Masseter Inhibitory Reflex in 100 normal subjects aged 15–80 years

Latency (ms)	First inhibitory period (SP1 or ES1)	Second inhibitory period (SP2 or ES2)
Median	12	45
Mean	11.8	45.1
SD	0.8	5.2
Range	10–13.6	38–60
20-year old subjects*	11.1	42
70-year old subjects*	12.3	48

\*standard curve calculations for age-latency (from Cruccu and Deuschl 2000)

atively narrow range of variability, thus allowing comparisons between subjects. The intraindividual latency difference between sides is small (range 0–1.2 ms, mean  $0.3 \text{ ms} \pm [\text{SD}] 0.37 \text{ ms}$  in 100 normal subjects). A latency difference between sides larger than 1.2 ms is abnormal. The second inhibitory period is considered abnormal if it is absent unilaterally or the latency difference between sides exceeds 8 ms. The second inhibitory period may be absent bilaterally in elderly patients or in patients with malocclusion (Cruccu et al. 1997).

### Clinical Applications

Brainstem inhibitory reflexes cannot be tested by clinical procedures alone. In some patients, clinical examination discloses no signs of trigeminal impairment, yet testing the masseter inhibitory reflex reveals trigeminal or brainstem dysfunction. As in ► [blink reflex](#) studies, the pattern of abnormality (afferent, mixed or efferent) provides information on the site of the lesion (Cruccu et al. 2005; Ongerboer de Visser et al. 1990). Nevertheless, except in rare conditions such as a purely motor trigeminal neuropathy and hemimasticatory spasm, the “efferent” type of abnormality (abnormal responses confined to the muscle on one side, regardless of the side of stimulation) is extremely uncommon.

The two inhibitory periods of the masseter inhibitory reflex have distinct EMG features and clinical applications. The first inhibitory period appears to be insensitive to peripheral conditioning and suprasegmental modulation, its latency varies little and it is probably mediated by a small number of afferents. For these reasons it is the best available response for assessing function of the maxillary and mandibular afferents in focal and in generalized diseases. In patients with symptomatic ► [trigeminal neuralgia](#) or focal lesions within the pons, it has a diagnostic sensitivity similar to that of the R1 blink reflex (Cruccu and Deuschl 2000; Cruccu et al. 2005). The second inhibitory period is far less sensitive than the first to lesions along the reflex arc. Being mediated by a multisynaptic chain of interneurons of the lateral reticular formation however, it is modulated by suprasegmental influences. Like the R2 blink reflex, the second inhibitory period shows a strongly enhanced recovery cycle in patients with extrapyramidal disorders and an increased habituation in hemiplegia (Cruccu and Deuschl 2000). The second inhibitory period (recorded from the temporalis muscle and called ES2) is a focus of research in several centers for patients with headache. Although the findings are still controversial, some data suggest that this response might help in differentiating tension-type headache from vasomotor headaches (Schoenen et al. 1987).

Unlike the electrically elicited masseter inhibitory reflex (Cruccu et al. 1997), the laser silent period, a purely nociceptive reflex, has been demonstrated to undergo modulation by experimental pain and found to be absent in

patients with ► [temporo-mandibular pain](#) (Romaniello et al. 2002, 2003).

### References

1. Cruccu G, Deuschl G (2000) The clinical use of brainstem reflexes and hand-muscle reflexes. *Clin Neurophysiol* 111:371–387
2. Cruccu G, Frisardi G, Pauletti G et al. (1997) Excitability of the central masticatory pathways in patients with painful temporomandibular disorders. *Pain* 73:447–454
3. Cruccu G, Iannetti GD, Marx JJ et al. (2005) Brainstem reflex circuits revisited. *Brain* 128:386–394
4. Ellrich J, Hopf HC, Treede RD (1997) Nociceptive masseter inhibitory reflexes evoked by laser radiant heat and electrical stimuli. *Brain Res* 764:214–220
5. Godaux E, Desmedt JE (1975) Exteroceptive suppression and motor control of the masseter and temporalis muscles in normal man. *Brain Res* 85: 447–458
6. Miles TS, Turker KS (1987) Reflex responses of motor units in human masseter muscle to electrical stimulation of the lip. *Exp Brain Res* 65: 331–336
7. Ongerboer de Visser BW, Cruccu G, Manfredi M et al. (1990) Effects of brainstem lesions on the masseter inhibitory reflex. Functional mechanisms of reflex pathways. *Brain* 113:781–792
8. Romaniello A, Arendt-Nielsen L, Cruccu G et al. (2002) Modulation of trigeminal laser evoked potentials and laser silent periods by homotopical experimental pain. *Pain* 98:217–228
9. Romaniello A, Cruccu G, Frisardi G et al. (2003) Assessment of nociceptive trigeminal pathways by laser-evoked potentials and laser silent periods in patients with painful temporomandibular disorders. *Pain* 103:31–39
10. Schoenen J, Jamart B, Gerard P et al. (1987) Exteroceptive suppression of temporalis muscle activity in chronic headache. *Neurology* 37:1834–1836

J

## Job Analysis

### Definition

Job analysis includes description of work tasks; methods, techniques or processes involved and the work devices used, results; worker (skills, knowledge, adaptations needed). Job analysis may expose environmental and organizational factors needed to accomplish the work tasks. The Revised Handbook of Analyzing Jobs (RHAJ) explores the procedures and techniques used to analyze jobs and to record the analyses. Such analyses underlie, and are congruent with, the occupational definitions of the Dictionary of Occupational Titles (DOT. A job analysis according to R/HAJ) addresses the worker’s relationship to data, people, and things (i.e. Worker Functions), the methodologies and techniques employed (i.e. Work Fields), the machines, tools, equipment, and work aids used (MTEWA), the material, procedures, subject matter, or services (MPSMS), and what worker attributes contribute to successful job performance (Worker Characteristics).

► [Vocational Counselling](#)

## Job Capacity Evaluation

► [Disability, Functional Capacity Evaluations](#)

## Job Demands

### Definition

Job demands are the mental and physical requirements necessary to fulfill requirements associated with specific jobs.

- ▶ [Pain in the Workplace, Risk Factors for Chronicity, Workplace Factors](#)

## Job Requirements

### Definition

Job requirements are the demands an occupation or job tasks place on a worker for expected quality and quantity standard. The Dictionary of Occupational Titles (DOT) defines more than 20 000 occupations in the Labor Market in standards of Worker Functions; Work Fields, MPSMS, and Worker Characteristics.

- ▶ [Vocational Counselling](#)

## Job Satisfaction

### Definition

A measure of how happy or pleased someone is with different aspects of the work environment or the occupation as a whole.

- ▶ [Pain in the Workplace, Risk factors for Chronicity, Job Demands](#)

## Job Site Evaluation

- ▶ [Situational Assessment](#)

## Joint Deformities

### Definition

Joint deformities are changes from the typical size or shape of a particular joint.

- ▶ [Chronic Pain in Children, Physical Medicine and Rehabilitation](#)

## Joint Nociceptors

- ▶ [Articular Nociceptors](#)

## JRA

- ▶ [Juvenile Rheumatoid Arthritis](#)

## Junctional DREZ Coagulation

- ▶ [DREZ Procedures](#)

## Just-Noticeable-Difference

### Definition

On a stimulus continuum  $a$ , what is the smallest increment?  $(a)$  such that  $a+(a)$  just noticeably exceeds  $a$ ? This minimum increment of stimulus intensity is usually called the 'just-noticeable-difference' (JND or 'difference threshold' or 'difference limen').

- ▶ [Pain Evaluation, Psychophysical Methods](#)

## Juvenile Rheumatoid Arthritis

### Synonyms

JRA

### Definition

Is a condition characterized by joint inflammation and stiffness for more than 6 weeks in children 16 years or younger. The inflammation causes redness, swelling, warmth, and soreness in the joints. Any joint can be affected and inflammation may limit the mobility of affected joints. JRA is a disease of the immune system. In JRA, the immune system attacks the body's own healthy cells, which causes inflammation in the lining and connective tissues of the joints.

- ▶ [Experimental Pain in Children](#)

## Juxtaglomerular Apparatus

### Definition

The functional entity in the kidney that consists of juxtaglomerular cells (epithelioid cells in the media of the afferent arterioles) and the macula densa (tubular epithelium at the region of afferent arteriole and efferent arteriole to the glomerulus), and is involved in the regulation of salt and water excretion and renal blood flow.

- ▶ [NSAIDs, Adverse Effects](#)



## K/C Arthritis

- ▶ Arthritis Model, Kaolin-Carrageenan Induced Arthritis (Knee)

## K<sup>+</sup> Channel

### Definition

K<sup>+</sup> channel is a voltage-dependent permeation pathway for potassium ions.

- ▶ Ion Channel
- ▶ Ionotropic Receptor
- ▶ Trafficking and Localization of Ion Channels

## Kainate-Induced Lesion

### Definition

Neuronal death due to injection of the excitotoxin Kainate.

- ▶ Lateral Thalamic Lesions, Pain Behavior in Animals

## Kainate Receptor

### Definition

A type of ionotropic glutamate receptor that is activated by the agonist kainate. However, it should be noted that kainate will also activate other glutamate receptors, and thus should not be regarded as a specific agonist. Kainate receptors comprise of several subunits (GluR5, GluR6, GluR7, KA1, KA2) that form a heteromeric receptor-ion-channel complex.

- ▶ Nociceptive Neurotransmission in the Thalamus

## Kaolin

### Definition

Hydrated aluminium silicate.

- ▶ Amygdala, Pain Processing and Behavior in Animals
- ▶ Arthritis Model, Kaolin-Carrageenan Induced Arthritis (Knee)

## Kaolin-Carrageenan Induced Arthritis

### Definition

Animal model of inflammatory pain arising from the knee joint, mimicking osteoarthritis in humans.

- ▶ Arthritis Model, Kaolin-Carrageenan Induced Arthritis (Knee)
- ▶ Nociceptive Processing in the Amygdala, Neurophysiology and Neuropharmacology

## Kapanoll

### Definition

Kapanol is a formulation of morphine prepared as polymer coated sustained release pellets contained in a capsule.

- ▶ Post-Operative Pain, Morphine

## Kappa(κ) Opiate/Opioid Receptors

### Synonyms

KOP

### Definition

One of three major opiate receptors that have been cloned (delta and mu receptors are the other two). The predominant kappa receptor is kappa<sub>1</sub>, which has dynorphin A as the endogenous ligand. Several other kappa receptor classes have been defined. Also known as OP2 receptors, they are found in cerebral cortex,

amygdala, hippocampus, thalamus, hypothalamus, mesencephalon, pons, medulla and spinal cord. They are associated with analgesia, sedation, dysphoria and miosis.

- ▶ Opiates During Development
- ▶ Opioids, Kappa Receptors and Visceral Pain
- ▶ Opioid Receptors
- ▶ Pain Modulatory Systems, History of Discovery
- ▶ Postoperative Pain, Transition from Parenteral to Oral

---

## Keratinocytes

### Definition

Keratinocytes are cells in skin that secrete keratin as well as neurotrophins. Basal keratinocytes release NGF, whereas suprabasal keratinocytes release NT-3.

- ▶ Nerve Growth Factor, Sensitizing Action on Nociceptors

---

## Ketalar

- ▶ Postoperative Pain, Ketamine

---

## Ketamine

- ▶ Postoperative Pain, Ketamine

---

## Kidney Stone Pain

- ▶ Visceral Pain Model, Kidney Stone Pain

---

## Kinesiophobia

### Definition

Kinesiophobia is an excessive, irrational, and debilitating fear of physical movement and activity resulting from a feeling of vulnerability to painful injury or (re)injury.

- ▶ Disability, Fear of Movement
- ▶ Fear and Pain
- ▶ Hypervigilance and Attention to Pain
- ▶ Muscle Pain, Fear-Avoidance Model

---

## Kinesthesia

### Definition

Conscious information about body position and movement.

- ▶ Postsynaptic Dorsal Column Neurons, Responses to Visceral Input

---

## Knee Joint Nociceptors

- ▶ Nociceptor Generator Potential

---

## Knockout Mice

### Definition

Mice in which a portion of a specified gene is disrupted or removed, eliminating the corresponding protein.

- ▶ Opioid Receptors

---

## KOP Receptor

### Definition

The term  $\kappa$ -opioid peptide receptor represents the G-protein coupled receptor that responds selectively to a group of largely experimental opioid drugs. It is expressed in areas of the nervous system that moderately mediate analgesia, with a side-effect profile distinct from  $\mu$ -opioids. The KOP receptor protein is produced by a single gene. When activated, the KOP receptor predominantly transduces cellular actions via inhibitory G-proteins. The electrophysiological consequences of KOP receptor activation are usually inhibitory.

- ▶ Kappa( $\kappa$ ) Opiate/Opioid Receptors
- ▶ Opioid Electrophysiology in PAG

---

## KOR-1

### Definition

KOR-1 is a clone encoding a kappa<sub>1</sub> opioid receptor.

- ▶ Opioid Receptors

---

## Kyphotic

### Definition

Characteristic of or suffering from kyphosis, an abnormality of the vertebral column.

- ▶ Lower Back Pain, Physical Examination

## La Belle Indifference

### Definition

Individuals with a health condition or pain problem who seem to appear unconcerned about the nature or implications of their condition. For children with certain complex pain conditions, either children or their parents may exhibit „la belle indifference“. In some cases, children may be unable to walk during the physical examination but parents are totally unaffected.

- ▶ [Chronic Daily Headache in Children](#)

## Labor Pain

- ▶ [Gynecological Pain, Neural Mechanisms](#)
- ▶ [Obstetric Pain](#)

## Labor Pain Model

- ▶ [Visceral Pain Models, Female Reproductive Organ Pain](#)

## Laboratory Findings

### Definition

Anatomical, physiological, or psychological phenomena that can be shown by the use of medically acceptable laboratory diagnostic techniques. Some of these diagnostic techniques include chemical tests, electrophysiological studies (electrocardiogram, electroencephalogram, etc.), medically acceptable imaging tests (X-rays, CAT scans, etc.), and psychological tests.

- ▶ [Disability Evaluation in the Social Security Administration](#)

## Laboratory Pain

- ▶ [Experimental Pain in Children](#)

## Lacrimation

### Definition

Lacrimation is the tearing of an eye. During acute bouts of cluster headache and during exacerbations of hemiplegia continua, the eye on the side of the pain often tears.

- ▶ [Hemicrania Continua](#)

## Laminae I and V Neurones

### Definition

Lamina I and V Neurones are neurones located in the superficial dorsal horn and deeper layers, respectively. Also known as the marginal layer of Waldeyer, Lamina I is the most superficial lamina of the dorsal horn in Rexed's classification. It is a very thin layer of small neurons that often send long distance ascending projections to the brain. Numerous are nociceptive (often nociceptive specific), with a smaller number being thermoreceptive or sensitive to itch inducing stimuli.

- ▶ [Nociceptor, Categorization](#)
- ▶ [Opioids in the Spinal Cord and Central Sensitization](#)
- ▶ [Parabrachial Hypothalamic and Amygdaloid Projections](#)
- ▶ [Spinomesencephalic Tract](#)
- ▶ [Spinothalamocortical Projections from SM](#)
- ▶ [Thalamic Nuclei Involved in Pain, Cat and Rat](#)

## Laminae II<sub>outer</sub> and Lamina II<sub>inner</sub>

### Definition

The spinal cord in cross section has been divided into areas based on morphological characteristics (Rexed 1952). Laminae I and II comprise of the most superficial aspect of the dorsal horn of the gray matter, and are known to receive the central terminal projections of many unmyelinated (C-fiber) and thinly-myelinated (A $\delta$ -fiber) nociceptors. Lamina II is also known as the "substantia gelatinosa." The inner aspect of Lamina II receives the projections of many IB4-positive

unmyelinated neurons. The outer aspect of Lamina II and Lamina I receive the terminals of many peptidergic unmyelinated neurons.

- ▶ IB4-Positive Neurons, Role in Inflammatory Pain
- ▶ Immunocytochemistry of Nociceptors
- ▶ Morphology, Intraspinal Organization of Visceral Afferents
- ▶ Nociceptor, Categorization

#### References

1. Rexed B (1952) The Cytoarchitectonic Organization of the Spinal Cord in the Rat. *J. Comp. Neurol.* 96: 415-466

## Lamina Propria

#### Definition

A thin vascular layer of connective tissue beneath the epithelium of an organ.

- ▶ Animal Models of Inflammatory Bowel Disease

## Laminae I/II Inputs to the Thalamus

- ▶ Spinothalamic Terminations, Core and Matrix

## Laminae IV-IV, X

#### Definition

The basal parts of the dorsal horn and the area around the central canal of the spinal cord, respectively. These areas correspond with the nucleus proprius and central gray of the spinal cord.

- ▶ Morphology, Intraspinal Organization of Visceral Afferents

## Laminectomy

#### Definition

Laminectomy is the excision of the posterior arch of a vertebra.

- ▶ Chronic Back Pain and Spinal Instability

## Lancinating Pain

- ▶ Pain Paroxysms

## Langerhans Cells

#### Definition

Langerhans cells are dendritic cells in the epidermis. They have phagocytic properties and are responsible for antigen presentation in a variety of CD4-dependent immune responses. They are involved in the early stages of contact dermatitis, skin graft rejection or HIV-1 infection.

- ▶ Neuropeptide Release in the Skin

## Laparoscopic Pain Mapping

- ▶ Chronic Pelvic Pain, Laparoscopic Pain Mapping

## Laparoscopy

#### Definition

Laparoscopy is a diagnostic tool designed to visualize the peritoneal cavity and the structures within by means of a laparoscope, which is a miniature telescope.

- ▶ Dyspareunia and Vaginismus

## Laparoscopy (for Pain) under Local Anesthesia

- ▶ Chronic Pelvic Pain, Laparoscopic Pain Mapping

## Large Fibers

#### Definition

Large fibers is a collective term for large myelinated nerves, including motor nerves and the proprioceptive type of sensory nerves, also large-diameter nerves.

- ▶ Toxic Neuropathies

## Large Fiber Neuropathy

#### Definition

Peripheral nerve disorders mainly affecting large myelinated nerves (large fibers).

- ▶ Toxic Neuropathies
- ▶ Ulceration, Prevention by Nerve Decompression



## Laser

BENGT H. SJÖLUND  
 Rehabilitation and Research Centre for Torture  
 Victims, South Danish University, Copenhagen,  
 Denmark  
 bsj@rct.dk

### Synonyms

Low-Level Laser Therapy; LLLT

### Definition

Low-level laser therapy (LLLT) utilizes a pure light source of varying wavelength, intensity and temporal characteristics to attempt to treat various types of pain. It does not generate heat or sensations, but may cause superficial photochemical reactions.

### Characteristics

The use of laser (light) therapy originates in biophysical observations that fibroblast growth may be stimulated by ordinary light or laser light exposure. There is no proven link to pain modulating mechanisms.

LLLT for pain was originally advocated by single authorities and by manufacturers of laser equipment, having little but case reports to substantiate their claims. Randomized controlled studies on patients with chronic low back pain have not found that low-energy laser stimulation plus exercise provides a significant advantage over exercise alone (Klein and Eek 1990). Similarly, Gur et al. (2003) in 75 patients with chronic low back pain exposed to a gallium arsenide laser + exercise, laser alone or exercise alone, found significant improvements in all groups, but were not able to single out laser therapy as superior.

One possible cause of a treatment effect by low-power laser exposure in muscle pain conditions could be an increase in local microcirculation. In one study, the immediate effects on masseter muscle blood flow of low-power laser exposure in patients with chronic orofacial pain of muscular origin were examined in comparison to healthy individuals (Tullberg et al. 2003). Intramuscular laser Doppler flowmetry was performed unilaterally in the tenderest point (patients) or in a standardized point (healthy subjects) of the masseter muscle on twelve patients with myofascial pain of orofacial muscles and 12 age and gender matched healthy individuals. The muscle was first exposed to a gallium aluminum arsenide laser or placebo laser for 2 min in a randomized and double blind manner. After another 8 min the muscle was treated with the other laser for 2 min and the LDF recording continued for 8 min. Finally, the patients again assessed the pain intensity. The pain intensity was not affected by laser exposure and the blood flow did not change significantly in the patients, but increased

after active laser exposure and decreased after placebo exposure in the healthy individuals. Thus, the study did not support an effect of low-power laser exposure on masseter muscle microcirculation in patients with chronic orofacial pain.

There is conflicting evidence on the benefit of LLLT in the treatment of osteoarthritis, as shown in a recent Cochrane review (Brosseau et al. 2004). Seven controlled clinical trials, with 184 patients randomized to laser and 161 to an inactive laser probe were identified. The pooled results indicated no effect of 1 month of LLLT on pain or overall patient rated assessment of disease activity. However, three trials showed very positive effects on pain relief and three trials found no effect. The reviewers concluded that there is a need for further large-scale studies of laser therapy for osteoarthritis. Lower dosage of LLLT was found to be as effective as higher dosage for reducing pain and improving the range of knee motion.

In another Cochrane review, the same reviewers (Brosseau et al. 1998) found LLLT to provide short-term pain relief for patients with rheumatoid arthritis in five trials with 204 patients, both reducing pain and morning stiffness. However, there were no differences in overall disability, local swelling or range of motion and no data exists for long-term effects beyond the treatment period of 4 to 10 weeks. There were no significant differences between subgroups based on LLLT dosage, wavelength, site of application or treatment length. For RA, relative to a control group using the opposite hand, there was no difference between the control and treated hands, but all hands improved in terms of pain relief and disease activity. Despite some positive findings, this meta-analysis lacked data on how LLLT effectiveness is affected by four important factors, wavelength, treatment duration, dosage and site of application.

Not uncommonly, a low-energy laser is applied in the form of laser acupuncture. In a recent controlled study on chronic tension type headache (Ebnesahidi et al. 2005), the effects of laser acupuncture were examined in fifty patients, randomly allocated to low-energy laser acupuncture or placebo laser acupuncture (zero level) in selected acupuncture points for less than a minute in ten sessions, given three per week. Remarkably, there were significant differences between groups ( $P < 0.001$ ) in changes from baseline in months one, two and three, in median score for headache intensity, in median duration of attacks and in median number of days with headache per month.

Similarly, in a prospective, double blind, randomized, controlled trial in patients with chronic myofascial pain syndrome in the neck to evaluate the effects of infrared low-level 904 nm gallium arsenide (Ga-As) laser therapy *versus* placebo laser on pain, disability, mood and quality of life, statistically significant improvements were detected in all outcome measures compared with base-

line ( $P < 0.01$ ) in the active laser group, while in the placebo laser group, significant improvements were detected only in pain score at rest 1 week later. The score for self-assessed improvement of pain was significantly different between the active and placebo laser groups (63 vs. 19%) (Gur et al. 2004).

Painful symptoms of diabetic sensorimotor polyneuropathy (DSP) on the other hand were not relieved by LLLT in a randomized sham therapy controlled clinical trial in 50 patients with painful DSP diagnosed with the Toronto clinical neuropathy score (Zinman et al. 2004). All patients received sham therapy over a 2-week baseline period and were then randomized to receive biweekly sessions of either sham or LLLT for 4 weeks. Both groups noted a decrease in weekly mean pain scores during sham treatment. After the 4-week intervention, the LLLT group had an additional reduction in weekly mean pain scores of  $-1.0 \pm 0.4$  compared with  $-0.0 \pm 0.4$  for the sham group, a difference that did not reach significance.

In summary, the present data do not allow the conclusion that LLLT can be recommended for the treatment of chronic pain other than possibly that from RA. It is interesting to speculate that a reason for this short lasting effect may be a transient influence on superficial inflammatory processes.

## References

1. Brosseau L, Welch V, Wells G et al. (1998) Low level laser therapy (Classes I, II and III) for treating rheumatoid arthritis. The Cochrane Database of Systematic Reviews 1998, Issue 4. Art. No. CD002049. DOI: 10.1002/14651858.CD002049
2. Brosseau L, Welch V, Wells G et al. (2004) Low level laser therapy (Classes I, II and III) for treating osteoarthritis. The Cochrane Database of Systematic Reviews 2004, Issue 3. Art. No. CD002046. DOI: 10.1002/14651858.CD002046.pub2
3. Ebneshahidi NS, Heshmatipour M, Moghaddami A et al. (2005) The effects of laser acupuncture on chronic tension headache – a randomised controlled trial. *Acupunct Med* 23:13–18
4. Gur A, Karakoc M, Cevik R et al. (2003) Efficacy of low power laser therapy and exercise on pain and functions in chronic low back pain. *Lasers Surg Med* 32:233–238
5. Gur A, Sarac AJ, Cevik R et al. (2004) Efficacy of 904 nm gallium arsenide low level laser therapy in the management of chronic myofascial pain in the neck: a double-blind and randomize-controlled trial. *Lasers Surg Med* 35:229–235
6. Klein RG, Eek BC (1990) Low-energy laser treatment and exercise for chronic low back pain: double-blind controlled trial. *Arch Phys Med Rehabil* 71:34–37
7. Tullberg M, Alstergren PJ, Ernberg MM (2003) Effects of low-power laser exposure on masseter muscle pain and microcirculation. *Pain* 105:89–96
8. Zinman LH, Ngo M, Ng ET et al. (2004) Low-intensity laser therapy for painful symptoms of diabetic sensorimotor polyneuropathy: a controlled trial. *Diabetes Care* 27:921–924

## Laser Acupuncture

- Acupuncture

## Laser-Doppler Flowmetry

### Definition

The Laser-Doppler technique measures blood flow in the very small blood vessels of the microvasculature. Depending on the Doppler principle, low power light from a laser is scattered by moving red blood cells and, as a consequence, is frequency broadened. The frequency broadened light, together with laser light scattered from static tissue, is photodetected, and the resulting photocurrent processed to provide a blood flow measurement.

- Autologous Thrombocyte Injection as a Model of Cutaneous Pain

## Laser Evoked Field

### Synonyms

LEF

### Definition

An event-related magnetic field, elicited by, and time-locked to a laser stimulus.

- Insular Cortex, Neurophysiology and Functional Imaging of Nociceptive Processing

## Laser-Evoked Potential

### Synonyms

LEP

### Definition

An event-related potential, elicited by, and time-locked to a laser stimulus.

## Laser Heat Stimulator

### Definition

A laser (acronym for Light Amplification by Stimulated Emission of Radiation) is a very unique light source. In comparison to classical incandescent light heat stimulators which emit their radiative energy in all spatial directions and in a large spectrum of wavelengths, the laser energy is confined to a narrow beam of nearly parallel monochromatic electromagnetic waves. This results in a high power density (radiation per unit area). The combination of these characteristics make the laser a light source with a spectral energy density (radiation per unit wavelength) several orders of magnitude higher than any

known light source. This is an essential characteristic if fast and high transfer of radiation energy is needed.

- ▶ Pain in Humans, Thermal Stimulation (Skin, Muscle, Viscera), Laser, Peltier, Cold (Cold Pressure), Radiant, Contact

## Laser Silent Period

### Synonyms

LSP

### Definition

Reflex inhibition of the contracted masseter muscle elicited by noxious, high-intensity laser stimuli in the trigeminal territory.

- ▶ Jaw-Muscle Silent Periods (Exteroceptive Suppression)

## Laser Speckle Imaging

### Definition

A blood flow technique that allows simultaneous measurement of vessel diameter both on the surface of the brain and within meningeal vessels.

- ▶ Clinical Migraine with Aura

## Latent Myofascial Trigger Point

### Definition

A latent myofascial trigger point is a sensitive spot with pain or discomfort in response to compression only, but is not causing a clinical pain complaint. Every person develops latent MTrPs as early as six months after birth. A latent MTrP is probably caused by minor peripheral nerve injury due to repetitive minor trauma early in life. A latent MTrP may become active (painful) after an acute injury or chronic repetitive minor trauma to the soft tissue or other structures, or even after an emotional stress.

- ▶ Dry Needling
- ▶ Myofascial Trigger Points
- ▶ Trigger Point

## Lateral and Dorsal Funiculi

### Definition

White mater adjacent to the dorsal horn dorsally and laterally, excluding Lissauer's tract.

- ▶ Morphology, Intraspinal Organization of Visceral Afferents

## Lateral and Medial Thalamic Nociceptive System

- ▶ Thalamic Nuclei Involved in Pain, Cat and Rat

## Lateral Cervical Nucleus

### Synonyms

LCN

### Definition

The lateral cervical nucleus is a collection of neurons adjacent to the spinal cord dorsal horn in the uppermost cervical segments. It receives input by way of the spinocervical tract, which originates from neurons in laminae III and IV on the ipsilateral side. The neurons of the lateral cervical nucleus project their axons into the contralateral medial lemniscus, and the axons synapse in the ventral posterior lateral thalamic nucleus. Some of the neurons in the spino-cervicothalamic pathway are nociceptive.

- ▶ Spinothalamic Input, Cells of Origin (Monkey)
- ▶ Spinothalamic Projections in Rat

L

## Lateral Division (of the Spinal Dorsal Root)

### Definition

The spinal dorsal roots of mammals separate into two major divisions as they join the spinal cord; the lateral division contains almost exclusively unmyelinated and thinly myelinated fibers.

- ▶ Nociceptor, Categorization

## Lateral Geniculate Nucleus

### Definition

The main visual information transmitting nucleus in the thalamus.

- ▶ Thalamocortical Loops and Information Processing

## Lateral Pain System

### Definition

The lateral pain system is a neural circuit consisting of laterally projecting spinothalamic and trigeminothalamic pathways that terminate in lateral thalamic nuclei (i.e. VPL, VPM), which in turn project to primary

and secondary somatosensory cortices that process the sensory-discriminative dimension of the pain.

- ▶ [Spinothalamic Projections to Ventromedial and Parafascicular Nuclei](#)
- ▶ [Thalamo-Amygdala Interactions and Pain](#)

---

## Lateral Spinal Nucleus

### Synonyms

LSN

### Definition

A spinal nucleus located caudally to the lateral cervical nucleus throughout the spinal cord.

- ▶ [Spinothalamic Projections in Rat](#)

---

## Lateral Sulcus

- ▶ [Sylvian Fissure](#)

---

## Lateral Thalamic Lesions, Pain Behavior in Animals

PERRY N. FUCHS, YUAN BO PENG  
Department of Psychology, University of Texas at  
Arlington, Arlington, TX, USA  
fuchs@uta.edu

### Synonyms

Thalamus Lesion; thalamotomy, pain behaviors in animals

### Definition

Thalamotomy is a term that refers to damage which results in cellular loss to specific or numerous thalamic nuclei. Stereotaxic thalamotomy, using electrolytic and excitotoxic approaches, has been performed in animals as a method to ameliorate nociceptive conditions, or to simulate the human condition of central pain secondary to intracranial lesions.

### Characteristics

Although chronic pain following thalamic lesion was first described 100 years ago (Dejerine and Egger 1903), it still remains a substantial clinical problem. The qualitative and quantitative experience of pain following thalamic lesion is variable, but is most often described as elevated sensitivity to touch, temperature, or pain in the affected body region that is also associated with

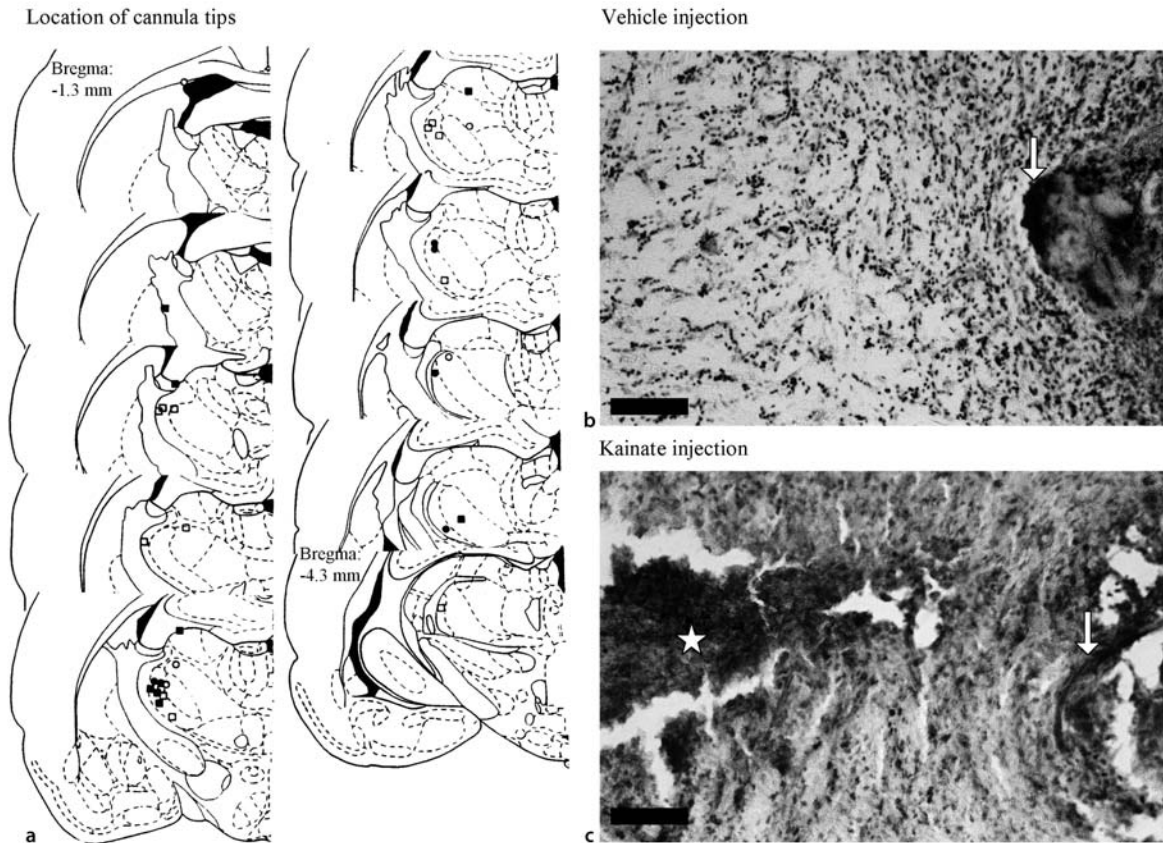
burning or lacerating sensation (Fuchs et al. 2001). Central pain secondary to intracranial lesions is quite often associated with thalamic damage, but disturbances of the parietal lobe, basal ganglia, and spinothalamic tract distant from the cerebral hemispheres also cause central pain. In general, lesions anywhere along the spinothalamic/thalamocortical system can result in central pain. In particular, lesions involving the VPL in humans, due to trauma or infarct, or stereotactic electrolysis (Pagni 1976) often result in central pain syndrome.

There are a number of reasons why attention should be directed towards exploring the relationship between thalamotomy and pain behavior in animals. First, although significant advances have been made in identifying the underlying neural substrates that cause central pain when damaged, the physiological mechanisms associated with the peculiar symptoms of this syndrome remain poorly understood. Second, the large number of treatment options for central pain syndrome reflects the fact that there is no single pharmacological or surgical procedure that relieves pain in most cases (Fuchs et al. 2001). Third, the development of central pain syndrome following thalamotomy questions the traditional concept of the thalamus as a relay station for the transmission of sensory input.

Surprisingly, only a few studies have explored the relationship between the ▶ [ventral-posterior lateral nucleus \(VPL\)](#) and pain behavior in rats. In one study, responses to mechanical, thermal and acute inflammatory stimuli were tested following rather extensive ▶ [electrolytic lesions](#) of the thalamus (including medial, lateral and subtotal) (Saadé et al. 1999). In general, electrolytic thalamotomy produces a long-lasting enhancement of reactivity to normally noxious mechanical and thermal stimuli (▶ [hyperalgesia](#)). A more recent report measured the responses to mechanical and thermal stimuli before and up to 48 h after a selective ▶ [excitotoxic lesion](#) of the VPL induced by kainite microinjection (LaBuda et al. 2000) (Fig. 1). Similar to the outcome of the study performed by Saadé et al. (1999), ▶ [kainate-induced lesion](#) of the VPL results in a leftward shift in the force/response function, as revealed by a significant increase in response to normally innocuous mechanical and thermal stimuli. The mean frequency of responses at 24 h after the kainite injection more than doubled the baseline responses, and at 48 h, the responses were greater than three times the baseline response frequency (Fig. 2). The animal model described here mimics many of the peculiar symptoms of ▶ [central pain syndrome](#), including delayed onset of pain and hyperalgesia to mechanical and thermal stimuli.

In addition to the possibility that the excitotoxic VPL lesion model can be used to study the underlying basic mechanisms associated with central pain syndrome, a number of additional general issues have arisen from





**Lateral Thalamic Lesions, Pain Behavior in Animals, Figure 1** (a) Schematic representation of cannula tip locations for the Surgery (■), Vehicle injection (□), Kainate Miss (○) and Kainate Hit (·) groups based on plates from Paxinos and Watson (1986). (b) Photomicrograph of a subject that received vehicle injection within the region of the VPL. The arrow indicates the boundary of the cannula tip (dorsal aspect is right). (c) Photomicrograph of a subject that received kainate injection within the region of the VPL. The arrow indicates the boundary of the cannula tip and the star indicates the area of pronounced glial proliferation (dorsal aspect is right). All subjects included in the Kainate Hit group had cannula tip locations on target with the VPL and pronounced glial proliferation. Scale bar = 250  $\mu$ M

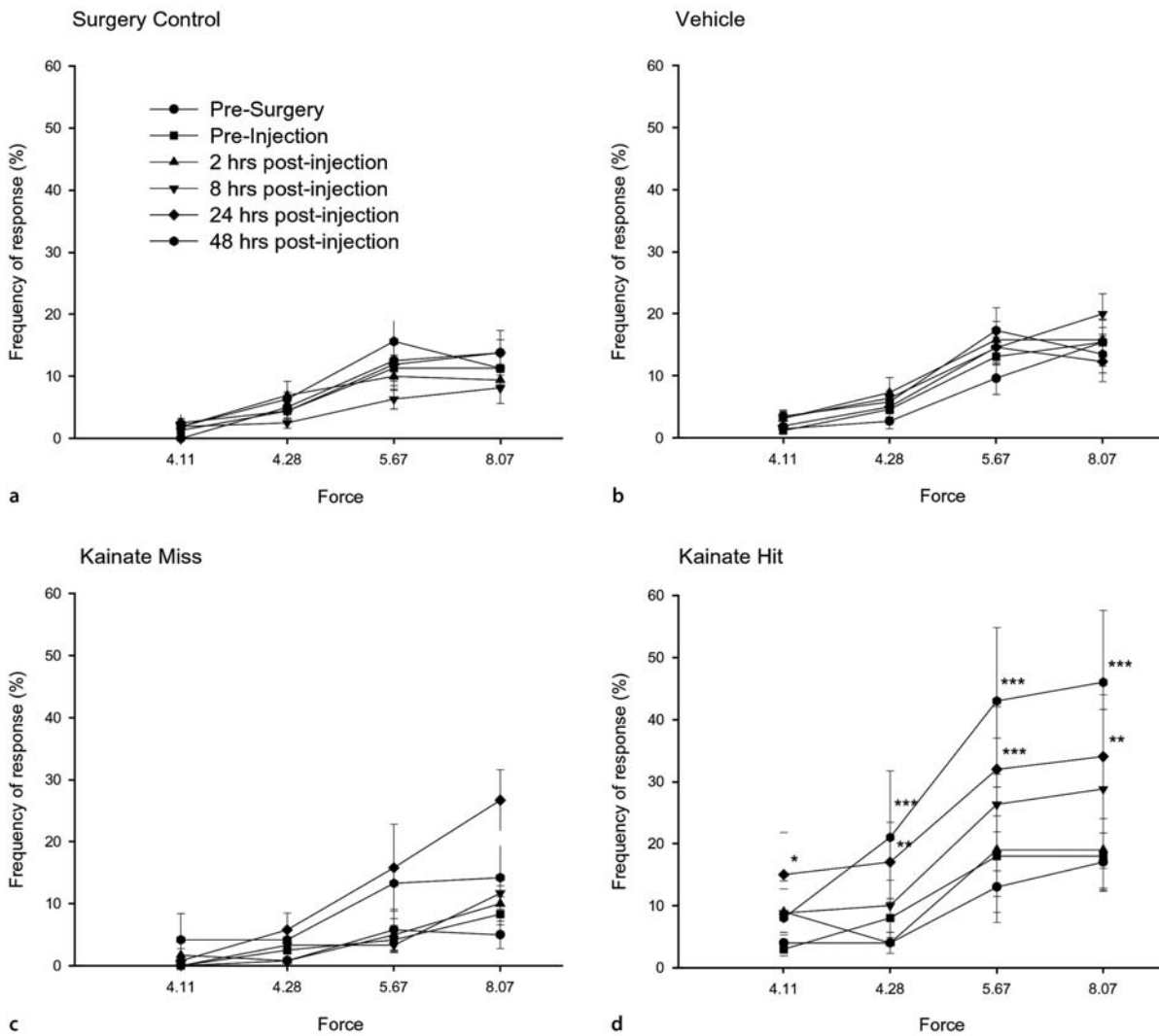
the thalamotomy findings. First, the lateral thalamus is traditionally considered as a relay station, transmitting sensory input to the primary somatosensory cortex. Consequently, the initial expectation would be that a lesion of the VPL would result in contralateral loss of processing of somatosensory input, possibly reflected as a decrease in nociceptive threshold (► [analgesia](#)). However, the observation of pain behavior following thalamotomy in rats is an outcome that is opposite to the expectations provided by the traditional concept of the thalamus. This outcome highlights the complex nature of the somatosensory pathways responsible for transmitting nociceptive signals. Second, the experimental results following thalamotomy in rats have not addressed specific hypotheses that have been proposed for ► [central pain syndrome](#). It remains to be determined if thalamotomy pain behavior in animals is based on: 1) irritable focus created at the site of injury, 2) sympathetic dysfunction, 3) hypothalamic dysfunction, 4) deafferentated central sensory nuclei, 5) hyperactivity

of deafferentated nonspecific reticulothalamic pathways, and 6) deafferentation of cortical nociceptive pathways.

Thalamic stimulation has been used to relieve clinical pain syndromes (Duncan et al. 1998; Marchand et al. 2003; Mazars et al. 1975). Paradoxically, thalamic stimulation has also been reported to induce pain (Lenz et al. 1995), an effect that is most likely due to the location of the stimulating electrode. Moderate increases in the function of the VPL, such as that produced by electrical stimulation or by microinjection of physiological concentrations of excitatory neurotransmitters or reuptake inhibitors, may be a suitable means of treatment for ► [central pain syndrome](#).

## References

1. Dejerine J, Egger M (1903) Le Syndrome Douloureaux Thalamique. *Rev Neurol* 14:521–532
2. Duncan G, Kupers R, Marchand S et al. (1998) Stimulation of Human Thalamus for Pain Relief. *J Neurophysiol* 80:3326–3330



**Lateral Thalamic Lesions, Pain Behavior in Animals, Figure 2** The symbol and line plots summarizes the effects of surgery alone (a), vehicle injection (b), injection of kainate confined to nuclei outside of the VPL (c) and injection of kainate localized to the VPL (d) on the mean percent of paw withdrawal response ( $\pm$  SEM) to punctate stimulation of the hindpaw. The responses to four intensities of punctate stimuli are shown at several time points including pre-surgery, pre-injection, 2, 8, 24 and 48 h post-injection. \* =  $p < 0.05$ , \*\* =  $p < 0.01$ , \*\*\* =  $p < 0.001$  compared to pre-surgery baseline

- Fuchs PN, Lee JI, Lenz FA (2001) Central Pain Secondary to Intracranial Lesions. In: Burchiel KJ (ed) Pain Surgery. Thieme, New York
- LaBuda CJ, Cutler TD, Dougherty PM et al. (2000) Mechanical and Thermal Hypersensitivity Develops following Kainate Lesion of the Ventral Posterior Lateral Thalamus in Rats. *Neurosci Lett* 290:79–83
- Lenz FA, Gracely RH, Romanoski AJ et al. (1995) Stimulation in the Human Somatosensory Thalamus can Reproduce Both the Affective and Sensory Dimensions of Previously Experienced pain. *Nature Med* 1:910–913
- Marchand S, Kupers RC, Bushnell MC et al. (2003) Analgesic and Placebo Effects of Thalamic Stimulation. *Pain* 105:481–488
- Mazars GJ (1975) Intermittent Stimulation of Nucleus Ventralis Posterolateralis for Intractable Pain. *Surg Neurol* 4:93–95
- Pagni CA (1976) Central Pain and Painful Anesthesia. *Prog Neurol Surg* 8:132–257
- Paxinos G, Watson C (1986) The Rat Brain in Stereotaxic Coordinates. Academic Press, New York
- Saadé NE, Kafrouni AI, Saab CY et al. (1999) Chronic Thalamotomy Increases Pain-Related Behavior in Rats. *Pain* 83:401–409

## Lateral Thalamic Nuclei

### Definition

The lateral thalamic nuclei includes VPL, VPM and other secondary nuclei. Activation of these neurons by the spinothalamic tract is important for sensory discrimination.

- ▶ [Lateral Thalamic Lesions, Pain Behavior in Animals](#)
- ▶ [Parafascicular Nucleus, Pain Modulation](#)
- ▶ [Spinothalamic Tract Neurons, Visceral Input](#)

## Lateral Thalamic Pain-Related Cells in Humans

ANDRES FERNANDEZ, SHINJI OHARA,  
NIRIT WEISS, STAN ANDERSON, FRED A. LENZ  
Departments of Neurosurgery, Johns Hopkins  
University, Baltimore, MD, USA  
Flenz1@jhmi.edu

### Synonyms

Pain System; ventral posterior nucleus of thalamus; posterior nucleus; Thermoreception; mechanoreception

### Definition

Neurons located in the human ► **thalamus** that respond selectively or differentially to painful stimuli.

### Characteristics

Studies of patients at autopsy after lesions of the ► **STT** show that the human STT ascends to the thalamus medial to the medial geniculate (Mehler 1966) before terminating in the magnocellular medial geniculate, limitans and Vc portae nuclei, posterior to Vc (Mehler 1966). More anteriorly, the STT makes its most dense termination as irregular clusters in Vc (Mehler 1966). The STT terminations are concentrated in posterior inferior Vc and in dorsal Vc parvocellularis (Mehler 1966). Similarly, in monkeys, STT terminals occur as dense clusters in VPL (Boivie 1979; Apkarian and Hodge 1989). A more uniform, less dense termination is found in ventral posterior inferior - VPI (Apkarian and Hodge 1989), in the posterior nuclear group including posterior nucleus (Boivie 1979), pulvinar oralis, limitans, magnocellular medial geniculate, suprageniculate nuclei (Apkarian and Hodge 1989) and in the posterior division of the ventral medial nucleus (Blomqvist et al. 2000). Anatomic studies in patients following cordotomy demonstrate that nuclei where the STT terminates in humans are similar to those in monkeys (Mehler 1966). Finally, an area posterior, inferior and medial to monkey ventral posterior (► **VP**), corresponding to human Vc, is a proposed pain-related nucleus (ventral medial pars posterior - VMpo) (Blomqvist et al. 2000). Thus there is ample evidence of inputs from the STT to the region of Vc that could explain the occurrence of cellular responses to noxious and thermal stimuli.

Our physiological studies have demonstrated that cells in and posterior inferior to the human principal somatic sensory nucleus (ventral caudal - Vc) respond to painful mechanical stimuli (Lenz et al. 1994), painful heat stimuli (Lenz et al. 1993) and innocuous cool stimuli (Lenz and Dougherty 1998). The degree of convergence of thermal and mechanical modalities graded into the painful range has not previously been studied. Cells responding to both types of stimuli may explain both

the sensation of pain, i.e. hyperalgesia and allodynia, evoked by normally nonpainful stimuli (Fruhstorfer and Lindblom 1984) and the alleviation of pain by thermal stimuli. The responses of human thalamic cells to painful and nonpainful thermal and mechanical stimuli in patients undergoing thalamic procedures for the treatment of movement disorders were examined.

The largest study of human cells responding to both thermal and mechanical stimuli graded into the painful range explored these neuronal responses in the region of Vc of 24 patients undergoing surgery for treatment of movement disorders (Lee et al. 1999). Preoperative somatic sensory testing was carried out with a series of thermal and somatic stimuli into the painful range on all patients. Intraoperative testing was carried out on 57 cells in the region where cells responded to innocuous cutaneous somatic sensory stimuli. Thermal stimuli consisted of contact cold or heat from 6 to 51 °C. The somatic series included stimulation with a camel hair brush and large, medium and small arterial clips. Preoperative somatic sensory testing established that both the mechanical and thermal series of stimuli spanned intensities extending into the painful range.

Of 57 cells tested, 15 had a graded response to mechanical stimuli extending into the painful range and thus were classified in the ► **wide dynamic range** (WDR) category. The mean stimulus-response function of cells in the WDR class, normalized to baseline, showed a four-fold mean increase in firing rate above baseline across the mechanical series of stimuli. Seven of these cells also responded to heat stimuli extending into the painful range (WDR-H) and 2 responded to cold stimuli (WDR-C). Twenty-five cells were in a class (multiple receptive - MR) that showed a response to both brush and compressive stimuli, although the responses were not graded into the painful range. Three of these cells (MR-H) had a response to heat stimuli and 5 cells responded to cold stimuli (MR-C). Nine cells responded to brushing without a response to the compressive stimuli (low threshold - LT). Although we have no direct anatomic evidence to confirm electrode location, the present results are consistent with monkey studies and suggest that cells differentially responsive to mechanical stimuli are located in Vc, Vcpc, Vcpor and anterior Po.

Brief stimuli spanning the range of the VAS (0-10) were used with preoperative training and intraoperative testing in the present study. This is unlike studies of awake monkeys where intense noxious stimuli were not used (Bushnell et al. 1993; Bushnell and Duncan 1987). The intense stimuli used in the present study may explain the large proportion of WDR cells in the region of Vc in this study. Another human study did not demonstrate WDR cells in the region of Vc (Tasker et al. 1997). The lack of such cells may be due to the stimuli used, although details of the methods have not been published for that study.

Microstimulation studies suggest that there is partitioning of thermal/pain sensations at different locations in the region of Vc. Stimulation sites where thermal/pain sensations are evoked are located near the posterior border of the core and within the posterior inferior region (Lenz et al. 1993). Microstimulation in the postero-inferior region evokes thermal sensations or pain often referred to large RFs and subcutaneous structures. Other reports identify sites where pain but not thermal sensations are evoked posterior and inferior to the core (Dostrovsky et al. 1991).

The largest study of micro-stimulation-evoked sensations in Vc reports explorations during stereotactic procedures for the treatment of tremor in 124 thalamic and 116 patients. Core was defined as the area above the most inferior cell with a response to nonpainful cutaneous stimulation and anterior to the most posterior cell of this type. Warm sensations were evoked more frequently in the posterior region than in the core. The proportion of sites where microstimulation evoked cool and pain sensations did not differ between the core and the posterior region. In the posterior region, however, warm sensations were evoked more frequently in the lateral plane (10.8%) than in the medial planes (3.9%). No mediolateral difference was found for sites where pain and cool sensations were evoked. The presence of sites where stimulation evoked taste or where RFs and PFs were located on the pharynx were used as landmarks of a plane located as medial as VMpo. Microstimulation in this plane evoked cool, warm, and pain sensations. The results suggest that thermal and pain sensations are processed in the region of Vc as far medial as VMpo. Therefore, thermal and pain sensations seem to be mediated by neural elements in a region probably including the core of Vc, VMpo and other nuclei posterior and inferior to Vc.

Nociceptive neurons (see ► [Human Thalamic Nociceptive Neurons](#)) have been identified in the human medial thalamus. Ishijima et al found that one quarter (20/80) of the cells they recorded from the central medial/parafascicularis complex of man responded to noxious pinprick (Ishijima et al. 1975). None of these cells responded to non-noxious cutaneous stimuli. One group of cells responded to painful stimuli with long latency and showed prolonged after-discharges while others had a time course similar to the stimulus. Another study (Tsubokawa and Moriyasu 1975) also found a relatively large number of nociceptive neurons which they localized to the central medial nucleus. Neither of these reports has been confirmed by more recent studies of patients with neuropathic pain (Rinaldi et al. 1991). Instead cells with very high rates of spontaneous bursting discharge activity were reported in the more recent studies.

Studies of nociceptive responsive cells in humans are consistent with the results reported in awake and anesthetized monkeys. In a study of responses of cells in

VPM of awake monkeys to graded mechanical stimuli (Bushnell and Duncan 1987), 10% of cells (9/89) are classified as WDR. These cells were clustered in ventral VPM. Another study reports 22 thermal responsive cells from a population of hundreds recorded in alert, trained, *Cynomologous* monkeys (Bushnell et al. 1993). Eighteen percent (4/22) of these cells responded to noxious heat only. No such cells were found in the present analysis, perhaps because of the search stimuli used. Among cells with a WDR mechanical response pattern, those that also responded to heat stimuli graded into the noxious range comprised 27% of cells (6/22) in that series.

Cells in VP, VPI and Po of anesthetized monkeys can respond to innocuous stimuli (Apkarian and Shi 1994). In a recent study forty cells responded to noxious mechanical stimuli; of these 23 cells also responded to noxious heat and 9 responded to noxious cold. These cells were located in VPI and Po more commonly than in VP. Studies in awake squirrel monkeys have found that 8% (3/36) to 12% (9/76) of cells in VP responded to noxious mechanical stimuli (Casey and Morrow, 1983). These cells were widely distributed throughout VP. In another study, a smaller number of WDR and HT cells were found throughout VP in anesthetized rhesus monkeys (73 cells/thousands of cells) (Chandler et al. 1992). Overall, monkey studies suggest that cells responsive to innocuous and noxious inputs are located in VP, VPI and Po. Cells responding to cold stimuli have tentatively been located in the region proposed to correspond to human VMpo (Davis et al. 1999). Although we have no direct anatomic evidence, the present results are consistent with monkey studies and suggest that cells responsive to painful mechanical stimuli are located in Vc, Vcpc, Vcpor and Po.

Blockade of the activity of these cells by thalamic injection of local anesthetic significantly interferes with the monkey's ability to discriminate temperature in both the innocuous and noxious range (Duncan et al. 1993). These studies establish that cells in the region of the monkey principal somatic sensory nucleus are involved in pathways signaling cutaneous thermal sensations into the noxious range. Therefore, the region of Vc is a pain-signaling pathway, as demonstrated by the presence of afferent connections from the STT, of cells responding to noxious stimuli, of sites where stimulation evokes pain and of sites where lesions relieve pain (Duncan et al. 1993). This is strong evidence for a role of Vc and adjacent nuclei in the human pain system.

## References

1. Apkarian AV, Hodge CJ (1989) Primate spinothalamic pathways: III. Thalamic terminations of the dorsolateral and ventral spinothalamic pathways. *J Comp Neurol* 288:493–511
2. Apkarian AV, Shi T (1994) Squirrel monkey lateral thalamus. I. Somatic nociresponsive neurons and their relation to spinothalamic terminals. *J Neurosci* 14:6779–6795



3. Blomqvist A, Zhang ET, Craig AD (2000) Cytoarchitectonic and immunohistochemical characterization of a specific pain and temperature relay, the posterior portion of the ventral medial nucleus, in the human thalamus. *Brain* 123:601–619
4. Boivie J (1979) An anatomic reinvestigation of the termination of the spinothalamic tract in the monkey. *J Comp Neurol* 186:343–369
5. Bushnell MC, Duncan GH (1987) Mechanical response properties of ventroposterior medial thalamic neurons in the alert monkey. *Exp Brain Res* 67:603–614
6. Bushnell MC, Duncan GH, Tremblay N (1993) Thalamic VPM nucleus in the behaving monkey. I. Multimodal and discriminative properties of thermosensitive neurons. *J Neurophysiol* 69:739–752
7. Casey KL, Morrow TJ (1983) Ventral posterior thalamic neurons differentially responsive to noxious stimulation of the awake monkey. *Science* 221:675–677
8. Chandler MJ, Hobbs SF, Fu Q-G et al. (1992) Responses of neurons in ventroposterolateral nucleus of primate thalamus to urinary bladder distension. *Brain Res* 571:26–34
9. Davis KD, Lozano AM, Manduch M et al (1999) Thalamic relay site for cold perception in humans. *J Neurophysiol* 81:1970–1973
10. Dostrovsky JO, Wells FEB, Tasker RR (1991) Pain evoked by stimulation in human thalamus. In: Sjoggenaga Y (ed) International symposium on processing nociceptive information. Elsevier, Amsterdam, pp 115–120
11. Duncan GH, Bushnell MC, Oliveras JL et al. (1993) Thalamic VPM nucleus in the behaving monkey. III. Effects of reversible inactivation by lidocaine on thermal and mechanical discrimination. *J Neurophysiol*. 70:2086–2096
12. Fruhstorfer H, Lindblom U (1984) Sensibility abnormalities in neuralgic patients studied by thermal and tactile pulse stimulation. In: von Euler C (ed) Somatosensory mechanisms. MacMillan, London, pp 353–361
13. Ishijima B, Yoshimasu N, Fukushima T et al. (1975) Nociceptive neurons in the human thalamus. *Confin Neurol* 37:99–106
14. Lee J-I, Antezanna D, Dougherty PM et al. (1999) Responses of neurons in the region of the thalamic somatosensory nucleus to mechanical and thermal stimuli graded into the painful range. *J Comp Neurol* 410:541–555
15. Lenz FA, Dougherty PM (1998) Cells in the human principal thalamic sensory nucleus (Ventralis Caudalis -Vc) respond to innocuous mechanical and cool stimuli. *J Neurophysiol* 79:2227–2230
16. Lenz FA, Gracely RH, Rowland LH et al. (1994) A population of cells in the human thalamic principal sensory nucleus respond to painful mechanical stimuli. *Neurosci Lett* 180:46–50
17. Lenz FA, Seike M, Richardson RT et al. (1993) Thermal and pain sensations evoked by microstimulation in the area of human ventrocaudal nucleus. *J Neurophysiol* 70:200–212
18. Mehler WR (1966) The Posterior Thalamic Region in Man. *Confin Neurol* 27:18–29
19. Rinaldi PC, Young RF, Albe-Fessard DG et al. (1991) Spontaneous neuronal hyperactivity in the medial and intralaminar thalamic nuclei in patients with deafferentation pain. *J Neurosurg* 74:415–421
20. Tasker RR, Davis KD, Hutchinson WD et al. (1997) Subcortical and thalamic mapping in functional neurosurgery. In: Gildenberg PL, Tasker RR (eds) Stereotactic and Functional Neurosurgery. McGraw-Hill, New York, pp 883–923
21. Tsubokawa T, Moriyasu N (1975) Follow-up results of centre median thalamotomy for relief of intractable pain. A method of evaluating the effectiveness during operation. *Confin Neurol* 37:280–284

## Laughing Gas

- ▶ Nitrous Oxide Antinociception and Opioid Receptors

## Law of Bell and Magendie

### Definition

The ventral root contains motor fibers and the dorsal root contains sensory fibers.

- ▶ Dorsal Root Ganglionectomy and Dorsal Rhizotomy

## LCN

- ▶ Lateral Cervical Nucleus

## Learned Helplessness

### Definition

Experimental paradigm where animals learn to stop attempting to escape inescapable shock.

- ▶ Pain Modulatory Systems, History of Discovery

L

## LEF

- ▶ Laser Evoked Field

## Lemington 5 Element Acupuncture

- ▶ Acupuncture

## Lemnicus Trigeminalis

- ▶ Trigeminothalamic Tract Projections

## Lemniscal Fibers

### Definition

A band or bundle of ascending fibers from the secondary sensory nuclei to the ventral posterior part of the opposite thalamus. Lemniscal fibers conveying sensory discriminative component of pain information.

- ▶ Trigeminothalamic Tract Projections

## LEP

- ▶ Laser-Evoked Potential

## Lepromatous Leprosy

### Definition

Lepromatous leprosy is the most malignant and infectious type of leprosy. It is characterized by widespread dissemination of leprosy bacilli in the tissues due to poor immune response to infection. Clinical features include widespread, symmetrical and innumerable macules, which may progress to form nodules and infiltrations. The manifestations of nerve damage appear slowly.

- ▶ Hansen's Disease

## Leprosy

### Definition

Also called Hansen's disease. It is a slowly progressive, chronic infectious disease caused by *Mycobacterium leprae*. It is characterized by granulomatous or neurotrophic lesions in the skin, nerves and viscera.

- ▶ Hansen's Disease

## Leprosy Reaction

### Definition

An acute or subacute hypersensitivity state occurring during the course of anti-leprosy treatment or in untreated leprosy. They are divided into two types: type 1 reaction and type 2 reaction.

- ▶ Hansen's Disease

## Leptomeninges

### Definition

A collective name for the arachnoid and pia mater membranes, the two innermost layers of the meninges, and between which the cerebrospinal fluid circulates.

- ▶ Diencephalic Mast Cells

## Leptomeningitis

### Definition

Inflammation of the leptomeninges (pia mater and arachnoid).

- ▶ Viral Neuropathies

## Lesion

### Definition

Selective controlled destruction of a structure within the brain.

- ▶ Pain Treatment, Intracranial Ablative Procedures

## Leucoencephalopathy

### Definition

Reversible posterior leucoencephalopathy is an MRI appearance seen in hypertensive encephalopathy, and consists of T2-weighted and FLAIR changes in the cerebral and brainstem white matter, most prominent in the distribution of the vertebrobasilar circulation.

- ▶ Headache Due to Hypertension

## Leukocytes

### Definition

White blood cells that are important in the induction of the immune response and host defense.

- ▶ Cytokines, Effects on Nociceptors

## Leukotrienes

### Definition

Leukotrienes are hormone-like, lipid-soluble regulatory molecules constructed from arachidonic acid by lipoxygenases. They participate in the regulation of diverse body functions such as bronchial constriction and allergic reactions.

- ▶ NSAIDs, Adverse Effects

## Leukotrienes in Inflammatory Nociceptor Sensitisation

- ▶ Inflammatory Nociceptor Sensitisation, Prostaglandins and Leukotrienes

## Levator Ani Syndrome

### Definition

A myofascial pain syndrome with painful, more or less permanent, spasms of the puborectal and levator ani muscles.

- ▶ Pudendal Neuralgia in Women

## Level of the Measurement Scale

### Definition

**Nominal scale:** An arrangement of values of a categorical variable that has no meaningful order (such as hair color or occupation).

**Ordinal scale:** An order that can be imposed on the values of a variable in a subject, where the order ranges from the highest value (such as “very interested”) to the lowest value (such as “not at all interested”).

**Interval scale:** An interval scale allows for the classification and labeling of elements or objects into categories based on defined features that are numerically ranked or otherwise ordered with respect to one another. In addition, equal differences between numbers reflect equal magnitude differences between the corresponding categories. Thus, this scale has nominal and ordinal properties and in addition it incorporates a zero, but this zero value is not absolute (lacks true meaning). The lack of an absolute zero means that this scale cannot be used to calculate the ratio of two values (cannot say – one level is twice as „painful“ as another level). A common example of an interval scale is the (continuous) scale of a thermometer.

**Ratio scale:** The ordering of numeric values when zero is meaningful (such as money or weight). Ratio scales incorporate the properties of the 3 other scales; and because they make use of a meaningful 0, their values can be interpreted to mean a true difference between numbers, and the numbers reflect true ratios of magnitude.

- ▶ Pain Assessment in Neonates
- ▶ Pain Measurement by Questionnaires, Psychophysical Procedures and Multivariate Analysis

## LFP

- ▶ Local Field Potential

## Liberation

### Definition

The liberation of a drug describes its release from the pharmaceutical product.

- ▶ NSAIDs, Pharmacokinetics

## Libido

### Definition

Libido, the desire for sexual intimacy, may be altered by emotional, metabolic, and physiologic phenomenon, as well as by many medications.

- ▶ Cancer Pain Management, Opioid Side Effects, Endocrine Changes and Sexual Dysfunction

## Lichen Sclerosis

### Definition

Lichen sclerosis is a painful skin condition generally affecting the vulva (or penis) and anus. It is characterized by thinning and white patches of skin, itching and/or burning, painful sexual intercourse, and sores or lesions resulting from scratching. If left untreated, it can result in fusing of the skin, atrophy, and narrowing of the vagina.

- ▶ Clitoral Pain
- ▶ Dyspareunia and Vaginismus

## Lidocaine

- ▶ Postoperative Pain, Lignocaine

L

## Lifetime Prevalence

### Definition

Lifetime prevalence is the total number of persons known to have had the disease or attribute for at least part of their life

- ▶ Prevalence of Chronic Pain Disorders in Children

## Ligands

### Definition

Chemicals that have an affinity for a receptor.

- ▶ Alternative Medicine in Neuropathic Pain

## Lightning Pain

- ▶ Pain Paroxysms

## Lignocaine

- ▶ Post-Operative Pain, Lignocaine

## Likert Scale

### Definition

A Likert scale presents a set of attitude statements and asks respondents to express agreement or disagreement on a numerical scale. Each degree of agreement is given a numerical value. Thus, a total numerical value can be calculated from all the responses.

- ▶ Pain Inventories

## Limb Amputation

### Definition

Limb amputation (removal of a limb) may be caused by surgery or trauma. In Western countries, limb amputation is most often performed because of medical disease. Many amputees experience phenomena as phantom pain, phantom sensation and stump pain.

- ▶ Postoperative Pain, Postamputation Pain, Treatment and Prevention

## Limbic Forebrain Matrix

- ▶ Thalamo-Amygdala Interactions and Pain

## Limbic Forebrain/System

### Definition

The Limbic Forebrain/System is a set of structures deep in the brain, including the amygdala, hypothalamus and the parahippocampal and cingulate gyri, which are commonly grouped together as the limbic system. At the cortical level, it also includes the insular cortex and the cingulate cortex. These areas are phylogenetically older than the surrounding neocortex. The amygdala and the hippocampus form the central axis of the limbic system. The limbic structures are involved in the processing of emotion and motivation and are critical for normal human functioning.

- ▶ Amygdala, Functional Imaging
- ▶ Arthritis Model, Kaolin-Carrageenan Induced Arthritis (Knee)
- ▶ Cingulate Cortex, Functional Imaging
- ▶ Hippocampus and Entorhinal Complex, Functional Imaging
- ▶ Nociceptive Processing in the Cingulate Cortex, Behavioral Studies in Humans
- ▶ Pain Treatment, Intracranial Ablative Procedures
- ▶ Thalamo-Amygdala Interactions and Pain

## Linkage Disequilibrium

### Definition

Linkage disequilibrium is the condition in which the number of closely linked loci on a chromosome (haplotype frequencies) in a population, deviate from the values they would have if the genes at each locus were combined at random.

- ▶ NSAIDs, Pharmacogenetics

## Lipophilic

### Definition

Chemically lipophilic or hydrophobic species are electrically neutral and nonpolar, and thus prefer other neutral and nonpolar solvents or molecular environments such as lipids.

- ▶ Rest and Movement Pain

## Lissauer's Tract

### Definition

Lissauer's tract is a pathway formed from the proximal end of small unmyelinated and poorly myelinated fibers in peripheral nerves, which enter at the lateral aspect of the dorsal horn and ascend and descend up to four segments, and terminate in Rexed's laminae I through to VI (principally I, II, and V) of the ipsilateral dorsal horn.

- ▶ Acute Pain Mechanisms
- ▶ DREZ Procedures
- ▶ Somatic Pain

## List of Diagnoses and their Definitions

- ▶ Taxonomy

## LLLT

- ▶ Laser

## Load

### Definition

The total load imposed on a structure, consisting of the whole of stressors seeking to disrupt the initial integrity of the structure. Load is determined by various factors such as strength, repetitiveness, etc.

- ▶ Ergonomic Counseling



## Load-Bearing Capacity

### Definition

The capacity of the structure to resist the destructive, negative impact of loading. Structures with a high load-bearing capacity can resist more load before damage occurs than structures with a low load-bearing capacity.

► Ergonomic Counseling

## Local Anaesthetics

MARK JOHNSON, NIKOLAI BOGDUK  
Musculoskeletal Physician, Hibiscus Coast Highway,  
Orewa, New Zealand  
markjohn@ihug.co.nz, nik.bogduk@newcastle.edu.au

### Synonyms

“Local”

### Definition

Local anaesthetics are drugs with the unique property of being able to block conduction along peripheral nerves.

### Characteristics

Local anaesthetics are perhaps the most powerful and most valuable drug used in Pain Medicine. They are the only ones known to be able to stop pain completely. Their effect, however, is not lasting. They exert only a temporary effect, measured in hours. Their application, therefore, is limited to diagnostic tests.

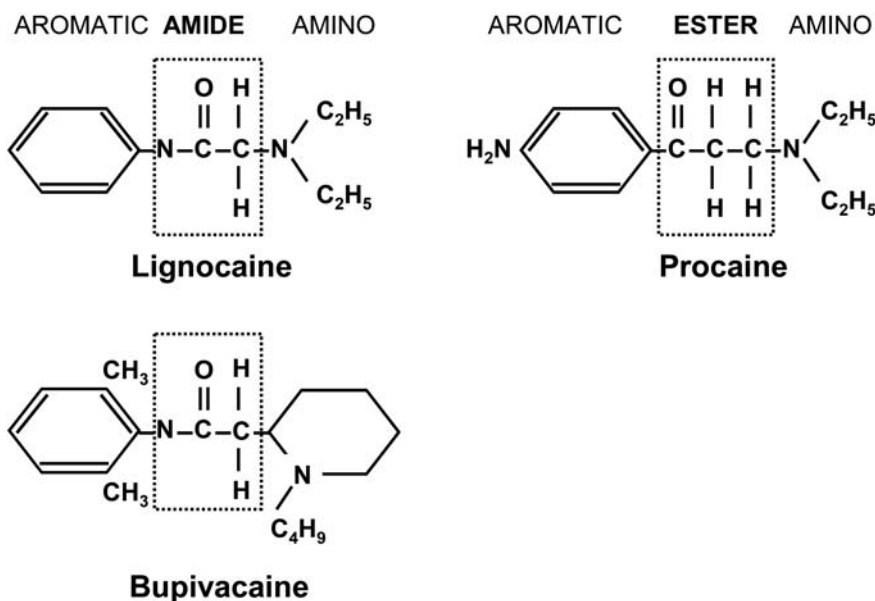
### Chemistry

Local anaesthetics are drugs formed by aromatic and amino residues linked by either an amide or an ester (Fig. 1). The agents most commonly used in Pain Medicine are lignocaine and bupivacaine from amongst the amides, and procaine from the esters. The differences in chemistry underlie the differences in duration of action and metabolism of these drugs.

### Mechanisms

Local anaesthetics act on sodium channels in nerve membranes to prevent or impede sodium flux, but their binding and duration of action depends on whether the channels are resting, open, closed, or inactivated (Butterworth and Strichartz 1990; Strichartz 1988). In turn, these states of the channels depend on whether the membrane is being depolarised and the frequency of depolarisation. In nerves that are actively conducting, local anaesthetics have a greater affinity for the channel than they have in resting nerves.

This difference in affinity underlies certain quantitative properties of local anaesthetics that pertain to the interpretation of diagnostic blocks. The duration of action of local anaesthetics has been determined by observation in subjects who were not experiencing ongoing or chronic pain. What was tested was cutaneous anaesthesia in patients undergoing minor operative procedures or during childbirth. Accurate figures are difficult to ascertain because some investigators added adrenaline to the local anaesthetic, whereas others did not. Nevertheless, representative figures for lignocaine would be mean duration of 2–4 h, with a standard deviation of 1–3 h (Moore et al. 1970a; Moore et al. 1970b; Rubin and Lawson 1968; Watt et al. 1968). A duration of up to 7 h is not unusual, and periods longer than 10 h have been reported (Watt



**Local Anaesthetics, Figure 1** The structural formulae of three common local anaesthetics, illustrating how aromatic and amino residues are linked by either an amide or an ester.

et al. 1968). For bupivacaine, a mean duration of 4–8 h with a standard deviation of 2–3 h would be representative (Moore et al. 1970a; Moore et al. 1970b; Rubin and Lawson 1968; Watt et al. 1968). Periods of anaesthesia up to 12 h are not unusual.

These figures should be understood to apply to individuals about to experience pain. They may not, and do not necessarily, apply to patients with persistent or chronic pain. Indeed, patients with neuropathic pain often exhibit extraordinarily prolonged responses to lignocaine (Arner et al. 1990), probably because the agent is able to bind strongly and persistently to open and changing sodium channels. What the “normal” duration of action of local anaesthetics is in patients with chronic pain has not been determined.

### Pharmacology

As local anaesthetics are weak bases, they have an affinity to hydrogen ions, but are subject to dissociation. The affinity and dissociation are described by the Henderson-Hasselbach equation. Different components of that equation govern the various pharmacological properties of local anaesthetics (Fig. 2). The difference between the ambient pH and the equilibrium constant ( $K_a$ ) determines the fraction of the local anaesthetic available in the base form. That form is the active form. Being more lipid soluble, it is the base form that penetrates cell membranes to get to the active site. The lipid solubility of the base form determines the potency of the agent. Its protein binding determines its duration of action.

Meanwhile, the acid form of the local anaesthetic is its soluble form. Local anaesthetic agents are prepared and stored in their soluble form. In order to permit storage in the soluble form, local anaesthetic agents are stored at a low pH (e.g. 4.0). For most agents the  $pK_a$  is about 7.9. In a pH environment of 4.0, the difference between pH

and  $pK_a$  is  $4.0-7.9 = -3.9$ . In which case, the fraction of the agent in the non-soluble form is  $10^{-3.9}$ , i.e. 1 in 10,000. That means that virtually all of the agent is in the soluble form.

When the agent is injected into tissues of pH 7.4, the difference between pH and  $pK_a$  is  $7.4-7.9 = -0.5$ . Under those conditions, the fraction of the active, insoluble form is  $10^{-0.5}$ , i.e. 31% is in the active form.

### Metabolism

The amides and esters differ in how they are metabolized. Both are rapidly distributed through the blood stream, and pass to tissues of high vascularity (Fig. 3). The amides are metabolized by the liver, after which they are excreted by the kidneys. The esters are metabolized in the blood by plasma cholinesterase. The products are excreted by the kidneys.

Once absorbed into the bloodstream, all local anaesthetic agents reach the heart and the brain. At these sites they can exert their toxic effects.

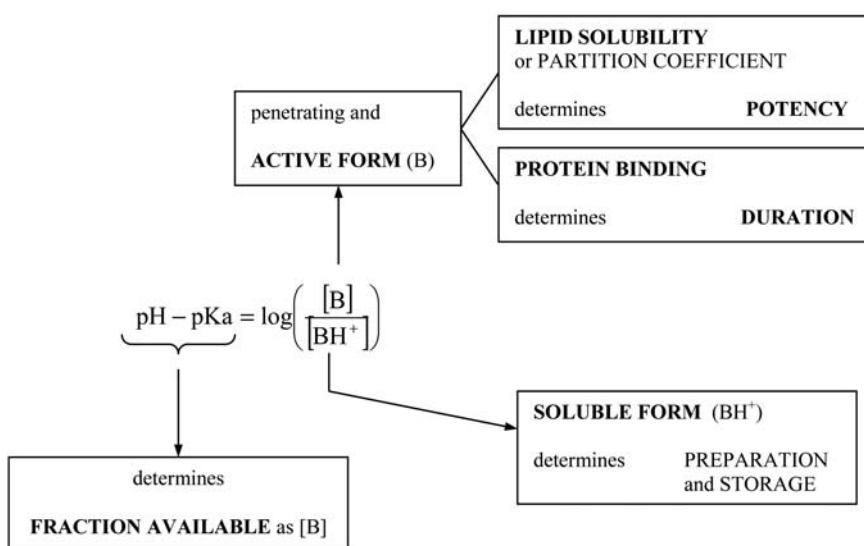
### Toxicity

At toxic concentrations, local anaesthetics can suppress electrical activity in the heart. In the central nervous system they suppress inhibitory neurons, which results in excitation of disinhibited systems. This is manifest clinically as fitting.

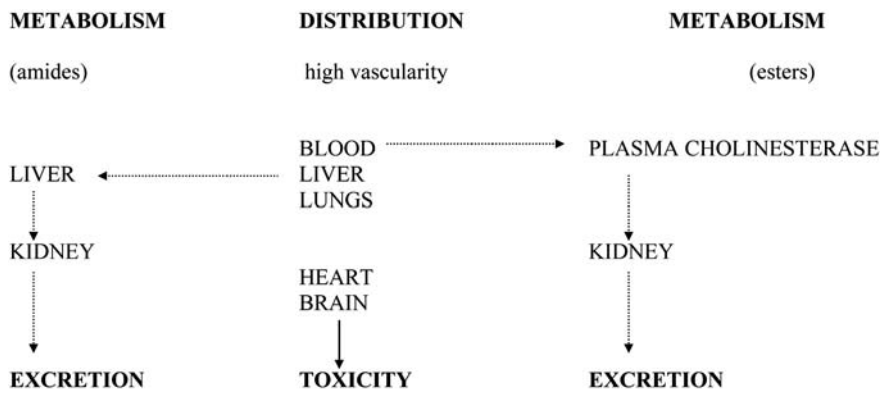
The toxic doses required to produce these effects, however, are considerably higher than the amounts used for most clinical purposes in Pain Medicine. For bupivacaine, the total body dose that is typically toxic is about 150 mg; for lignocaine the dose is 200 mg (Rosenberg et al. 2004).

### Applications

In Pain Medicine, local anaesthetics are used in three main ways. Most commonly they are used to perform di-



**Local Anaesthetics, Figure 2** The relationship between the equilibrium equation of local anaesthetics and their pharmacological properties.



**Local Anaesthetics, Figure 3** A flow chart showing the main steps of the metabolism of local anaesthetic agents.

agnostic blocks of peripheral nerves or of spinal nerves (See: Peripheral Nerve Blocks). These blocks are used to identify either the source of pain or the nerves that are mediating the pain (Bogduk 2002). Local anaesthetic agents can also be administered intravenously, for the diagnosis or treatment of neuropathic pain or central pain. Occasionally they are administered orally for the treatment of neuropathic pain.

### References

- Arner S, Lindblom U, Meyerson BA et al. (1990) Prolonged Relief of Neuralgia after Regional Anaesthetic Blocks. A Call for Further Experimental and Systematic Clinical Studies. *Pain* 43:287–297
- Bogduk N (2002) Diagnostic Nerve Blocks in Chronic Pain. *Best Pract Res Clin Anaesthesiol* 16:565–578
- Butterworth JF, Strichartz GR (1990) Molecular Mechanisms of Local Anesthesia: A Review. *Anesthesiology* 72:711–734
- Moore DC, Bridenbaugh LD, Bridenbaugh PO et al. (1970a) Bupivacaine for Peripheral Nerve Block: A Comparison with Mepivacaine, Lidocaine, and Tetracaine. *Anesthesiology* 32:460–463
- Moore DC, Bridenbaugh LD, Bridenbaugh PO et al. (1970b) Bupivacaine: A Review of 2,077 Cases. *JAMA* 214:713–718
- Rosenberg PH, Veering BT, Urmev WF (2004) Maximum Recommended Doses of Local Anesthetics: A Multifactorial Concept. *Reg Anesth Pain Med* 29:564–575
- Rubin AP, Lawson DIF (1968) A Controlled Trial of Bupivacaine: A Comparison with Lignocaine. *Anaesthesia* 23:327–331
- Strichartz GR (1988) Neural Physiology and Local Anesthetic Action. In: Cousins MJ, Bridenbaugh PO (eds) *Neural Blockade in Clinical Anesthesia and Management of Pain*, 2<sup>nd</sup> edn. JB Lippincott, Philadelphia, pp 25–45
- Watt MJ, Ross DM, Atkinson RS (1968) A Double Blind Trial of Bupivacaine and Lignocaine. *Anaesthesia* 23:331–337

## Local Anesthetic Agents/Drugs

### Definition

Local anesthetic agents are drugs that prevent excitable tissues from being excited, and are usually administered in the region of spinal structures or peripheral nerves. These drugs are used to allow procedures to be carried out painlessly, but are also used as an aid to determine

the diagnosis, prognosis or treatment of painful conditions. Local anesthetics are commonly used as part of spinal or epidural anesthesia.

- ▶ [Analgesia During Labor and Delivery](#)
- ▶ [Cancer Pain Management, Anesthesiologic Interventions, Neural Blockade](#)
- ▶ [Local Anaesthetics](#)
- ▶ [Pain Treatment, Spinal Nerve Blocks](#)
- ▶ [Postoperative Pain, Local Anaesthetics](#)

L

## Local Anesthetic Motor Blockade

### Definition

Skeletal muscles paralyzed by local anesthetic interruption of nerve impulses to muscle cells.

- ▶ [Postoperative Pain, Acute Pain Team](#)

## Local Anesthetics/Antiarrhythmics

### Definition

Local anesthetics/antiarrhythmics are sodium-channel modulators that depress the action potential and enhance repolarization of primary afferent neurones.

- ▶ [Drugs Targeting Voltage-Gated Sodium and Calcium Channels](#)

## Local-Circuit Cells

### Definition

Neurons in the brain are divided into two major groups, projection neurons and interneurons, local neurons, or local-circuit neurons.

- ▶ [Trigeminal Brainstem Nuclear Complex, Anatomy](#)

## Local Circuit Interneuron

### Definition

Neuron with axonal arborization located in the area occupied by its own dendritic tree.

- ▶ [Spinothalamic Tract Neurons, Morphology](#)

## Local Field Potential

### Synonyms

LFP

### Definition

Synchronized extracellular currents of a few hundred cells generate a LFP that reflects the average input to individual neurons. The LFP can be recorded with a microelectrode with impedance up to 0.5 MΩ. The signal is analyzed for frequencies up to 100 Hz.

- ▶ [Thalamotomy for Human Pain Relief](#)

## Local Twitch Response

### Synonyms

LTR

### Definition

A transient, poorly synchronized, prolonged twitch-like contraction of the group of taut band fibers that is associated with a myofascial trigger point, MTrP. The response is a polysynaptic spinal reflex with its afferent limb commonly arising from mechanical stimulation of sensitized nociceptors in the trigger point, and the efferent limb begins as an activation of alpha motor neurons that supply the involved nerve terminals of taut band fibers in the same or sometimes in functionally related muscles. It can be easily elicited when the needle tip encounters a sensitive locus in the MTrP region during high-pressure stimulation.

- ▶ [Dry Needling](#)
- ▶ [Myofascial Trigger Points](#)

## Local-Twitch-Response Locus

- ▶ [Sensitive Locus](#)

## Localized Muscle Pain

- ▶ [Myofascial Pain](#)

## Locus Coeruleus

### Definition

A noradrenergic nucleus that is located in the pons-mesencephalic junction, and is involved in the regulation of vigilance and descending feedback control of pain. Many neurons in this region contain the neurotransmitter norepinephrine.

- ▶ [Descending Modulation and Persistent Pain](#)
- ▶ [Vagal Input and Descending Modulation](#)

## Locus of Control

### Definition

Beliefs about whether certain outcomes in life are a result of ones' efforts (internal) or a result of luck, fate, or the actions of others (external).

- ▶ [Psychological Treatment of Headache](#)

## Longitudinal Myelotomy

- ▶ [Midline Myelotomy](#)

## Longitudinal Study

### Synonyms

Cohort study

### Definition

A cohort study is an epidemiological method identifying a study population by age, or by using other means or traits of grouping individuals for the purpose of research (Timmreck, 2002).

- ▶ [Pain in the Workplace, Risk factors for Chronicity, Job Demands](#)
- ▶ [Prevalence of Chronic Pain Disorders in Children](#)

## Long-Lasting Acute Pain

- ▶ [Postoperative Pain, Acute-Recurrent Pain](#)

## Long-Term Depression in the Spinal Cord

- ▶ [Long-Term Potentiation and Long-Term Depression in the Spinal Cord](#)



## Long-Term Effects of Pain in Infants

RUTH ECKSTEIN GRUNAU

Centre for Community Child Health Research, Child and Family Research Institute and the University of British Columbia, Vancouver, BC, Canada  
rgrunau@cw.bc.ca

### Synonyms

Infant Pain; long-term effects

### Definition

Humans and non-human mammals are born with the ability to display reflex responses to injury or noxious stimulation. Exposure to pain is generally rare in the neonatal period. However, with the advent of neonatal intensive care units (NICU), infants born very prematurely or with serious medical complications are exposed to repeated invasive procedures. Survival of the tiniest infants, who are born at extremely low gestational age (i.e.  $\leq 28$  weeks) and are thereby physiologically very immature, has increased significantly in recent years. Medical intensive care of these infants involves prolonged exposure to procedures that result in ► **stress** and ► **pain** at a time of very rapid brain development.

### Characteristics

Tissue injury induces numerous behavioral, physiological and endocrine changes in neonates, which are consistent with pain responses in older children and adults under similar circumstances. Long-term functional and structural changes in ► **nociception** can occur, related to pain in the neonatal period (Fitzgerald 2005). Moreover, there is a growing body of evidence suggesting that cumulative neonatal pain and stress may contribute to long-term alterations of pain systems, and perhaps to multiple aspects of behavior and development in the most vulnerable infants (Anand 2000; Grunau 2002). A model for conceptualizing long-term effects of pain in human neonates has been proposed recently (Grunau 2002).

### Neurobiology of Infant Pain

Pain perception is functional by mid-gestation in human infants (Fitzgerald 2005). Due to advances in knowledge of the developmental neurobiology of pain, it is now clear that the immature nervous system responds differently to tissue damage and pain. In experimental animal studies with rats, pain induced in the neonatal period (comparable timing in rats to human premature birth) can induce changes to pain systems, which are not seen when the pain is applied at later ages. This “critical window” suggests that the long-term effects of pain are potentially greatest in premature infants. In premature human infants and immature rat pups, reflex responses to touch show greater sensitivity com-

pared to those of older infants and children (Fitzgerald and Beggs 2001). With repeated stimulation, even at innocuous levels, the thresholds for touch and pain responses drop even further, indicating that these immature infants become even more sensitive. It is noteworthy that the phenomenon of sensitization is greatest at 28–33 weeks postconceptional age and is gone by 42 weeks. Sensory neurons in the spinal cord and brainstem become hyperexcitable following inflammation, which is referred to as ► **central sensitization**. Activation of these central cells by repetitive pain results in hypersensitivity to low-level input of non-skin breaking handling. For example, due to greater tactile (touch) sensitivity in very immature mammals, frequent pain alters touch ► **thresholds** so that even non-invasive handling such as diaper changes elicits pain-like responses in extremely premature infants. In this way, repetitive pain may lay the groundwork for chronic pain and discomfort in the NICU.

### Neonatal Prolonged Pain and Re-programming of Stress Systems

The process of maintaining physiological stability involves numerous behavioral, autonomic and hormonal adjustments. The very immature developing organism is not yet capable of fine-tuning these multiple dimensions in a balanced fashion; thus premature neonates born at extremely low gestational age are potentially more sensitive to external stress than infants born at term (i.e.  $\geq 37$  weeks). Of all the environmental input, the stress induced by invasive skin breaking procedures over a prolonged period is thought to be primary. Cortisol is the main stress hormone in humans. While infants are still in the NICU, higher cumulative stress related to procedural pain since birth is associated with lower capacity to mount a stress response both behaviorally and hormonally (Grunau et al. 2005). Of greater concern, however, are findings that basal cortisol is higher in extremely preterm infants much later in infancy, at 8 months “corrected age” (CA, age corrected for prematurity) (Grunau et al. 2004a). Furthermore, in another study also at 8 months, infants born at extremely low birth weight (ELBW  $\leq 800$  g) displayed higher resting heart rates. Together these findings suggest a possible long-term “resetting” of basal physiological regulation following prolonged cumulative stress and pain exposure associated with extreme prematurity.

In experimental animal studies, neonatal stress (e.g. due to maternal separation) can permanently reprogram stress responses in the hypothalamic-pituitary-adrenal (H-P-A) systems. In contrast, in studies of long-term effects of pain applied in the neonatal period, no changes were found to H-P-A responses subsequently in adult rats (Anand et al. 1999; Walker et al. 2003). Walker et al. showed that in rats, the frequency of maternal licking and grooming increased in those pups exposed

to pain; this maternal care behavior appeared to prevent the reprogramming of the H-P-A axis. There is some evidence that specific mother-infant interaction in humans that may moderate effects of neonatal pain can be identified. However, a great deal remains to be learned.

#### **Animal Studies of Long-Term Effects of Neonatal Pain Exposure**

Most of the evidence for long-term effects of neonatal pain on the developing nervous system is from experimental research on rats. Although we cannot extrapolate directly to human infants, these studies are useful because with humans there are multiple factors that cannot be controlled experimentally. Rats are most often studied because the central nervous system of rat pups at birth is very immature, providing an approximation to the central nervous system of a 24 week gestation, extremely premature human infant. Very early exposure to pain in immature organisms has effects that are not observed when pain exposure occurs at later ages. Long-term changes to pain systems have been found using repeated pin pricks or high doses of long-lasting inflammatory agents. However, it is very important to note that with shorter-acting inflammatory agents only short-term reversible changes were found, not long-term changes. Pain induces long-term effects only when applied in the neonatal period, not in more mature animals and the direction (hypersensitivity or reduced sensitivity) and extent of effects varies depending on the type of pain stimulus and whether pain is short lasting or is ongoing (Ren et al. 2004).

#### **Pain and Stress in the NICU Environment**

The medical care of “high risk” preterm infants in the NICU involves exposure to frequent invasive procedures. From birth to discharge from the NICU, infants undergo an average of about 50 procedures, which reflects approximately 2–8 procedures per day. However, some of the tiniest, sickest infants can have 200 procedures or more from admission through discharge, the majority of which are heel lances for blood tests. While infants are in the NICU, their tactile and pain responses are altered depending on the context, including their immediate and cumulative pain experience, gestational age at birth and postnatal age. Increased reactivity is typical in infants who are handled immediately before a procedure or who have had more skin breaking procedures the day before, consistent with sensitization. Conversely, however, cumulatively over time, those infants who had more total exposure to prior pain since birth show decreased behavioral and stress hormone reactivity to invasive procedures later while they are still exposed to ongoing stress in the NICU. This is consistent with animal studies of more prolonged pain. Behavioral responses to pain may be dampened over time in both human infants and animal pups that have had more intense early pain exposure.

#### **Pain Responsivity Later in Infancy and Childhood**

##### **Preterm Infants**

Few studies have directly compared pain reactivity of extremely premature infants with that of healthy infants born full-term. Contrary to expectation, ELBW infants showed little difference in reactivity to pain at 4 months CA compared to full-term infants, except for a subset who had spent the longest time in the NICU. Then surprisingly, pain responses were more divergent in the ELBW children at 8 months corrected age. The pattern was complex, in that the ELBW infants initially showed very brief behavioral hyper-reactivity to a finger lance, followed by significantly faster behavioral and autonomic recovery (see Grunau 2003). Later at 18 months CA, parents rated their ELBW toddler’s pain sensitivity to everyday bumps and scrapes significantly lower than parents of heavier preterm and full-term infants (see Grunau 2002). Overall, the findings suggest dampened pain reactivity in the long run for young children born extremely preterm, when they are very young; however, this may predominantly reflect faster recovery.

While somatization (pain of no known cause) was reported to be higher in ELBW children at age 4–5 years, there were no longer any differences at age 9 years (see Grunau 2002), or 17 years (Grunau et al. 2004b). In a study of health status, ELBW teenagers reported more functional limitations, including pain, than full-term teens (Saigal et al. 1996). Furthermore, in late adolescence internalizing behaviors related to anxiety and depression are more prevalent in ELBW than full-term teens. However, there are multiple possible reasons in addition to early pain exposure for such differences. There is wide variation in long-term outcomes of extreme prematurity for children exposed to comparable amounts of pain in the neonatal period.

##### **Full-term Infants**

Tissue damage without anesthetic during circumcision in newborn boys can lead to sensitization apparent months later during immunization (Taddio et al. 1997). However, following surgery in toddlers with appropriate pain management, no differences were found in later pain responses (Peters et al. 2003).

##### **Developmental Outcomes in Preterm Infants**

Learning, academic and behavior problems are prevalent in children born extremely prematurely, persisting to late adolescence (Grunau et al. 2004b; Hack et al. 2002). For the tiniest, most fragile infants, the period of pain exposure is prolonged, during the last trimester of “fetal” life, which is a time of very rapid and complex brain development. It is known that immature neurons are more sensitive to toxic influences, and brain volumes are smaller in preterm compared to full-term children (Bhutta and Anand 2002). At this time there is no direct evidence for a causal connection between neonatal pain and later developmental and behavioral difficulties

in preterm infants. However, there are concerns that chronic neonatal pain may contribute to alterations in the developing brain.

### Sex Differences

In animal studies, sex differences in vulnerability to early stress and effects on long-term pain reactivity have been reported. However, sex has rarely been examined in human infant studies of long-term effects of pain, therefore no conclusions can be drawn at this point.

### Maternal-Infant Factors

Multiple interacting intrinsic and extrinsic factors potentially ameliorate or exacerbate effects of neonatal experience on developmental trajectories. Later in childhood and as adults, pain perception and / or expression is affected by multiple interacting factors including social modeling, family variables, child temperament, culture and sex. However, this work has been conducted almost entirely on older children born at term.

Maternal verbalizations that promoted coping in full-term human infants at age 6 months, but not general maternal sensitivity, were associated with altered infant behavior during immunization. Moreover, in former extremely preterm infants, child and family factors predicted ► [somatization](#) at age 4½ years, and positive maternal responsivity was associated with normalized pain response in infancy (see Grunau 2002). Furthermore, in animal studies, it is very important to note that increased maternal behaviors appear to prevent negative effects of early pain on stress hormone response (Walker et al. 2003). Together these studies suggest that in mammals, alterations to pain systems may be modulated, at least to some extent, by ongoing caregiving.

### Memory for Pain

There are different types of memory, other than declarative recall for events, which is generally accepted as only accessible after age 2 years. However, conditioned learning begins very early in life, which implies memory at some level. In addition, physiological changes after repeated pain experiences implies “biological memory.” Thus, although infants cannot recall early experience, their central nervous system may retain a type of memory that is manifested later in altered responses to pain in new situations (Taddio et al. 1997; Grunau 2003).

### Summary

In human preterm infants, pain reactivity is altered while infants are in the NICU. There is also evidence that reactivity and recovery to pain is different in extremely preterm infants for many months after hospital discharge; however evidence is limited to a small number of studies. In preterm infants, the findings of enhanced pain response in the neonatal period in the presence of ongoing stress and pain but reduced sensitivity in the longer run, are consistent with recent animal studies.

Adaptation of an organism to the environment occurs through multiple processes during the prenatal and neonatal periods, infancy and childhood. The mammalian brain is characterized by its plasticity, namely the ability to adjust to changes in the internal or external environment, which especially applies to the developing nervous system. The extent to which human infants can compensate over time for the adverse early experiences of prolonged pain exposure in the NICU is unknown. The most long-lasting changes may be to generalized stress systems rather than specifically to pain. The extent to which sensitive and responsive parenting may modulate such effects is unknown.

### References

1. Anand KJS (2000) Effects of perinatal pain and stress. *Progress in Brain Research* 122:117–129
2. Anand KJS, Coskun V, Thirivikraman KV et al. (1999) Long-term behavioral effects of repetitive pain in neonatal rat pups. *Physiol Behav* 66:627–637
3. Bhutta AT, Anand KJS (2002) Vulnerability of the developing brain: Neuronal mechanisms. *Clin Perinatol* 29:357–372
4. Fitzgerald M (2005) The development of nociceptive circuits. *Nature Reviews Neuroscience* 6:507–520
5. Grunau RE (2002) Early pain in preterm infants. A model of long-term effects. *Clin Perinatol* 29:373–394
6. Grunau RE (2003) Self-regulation and behavior in preterm children: effects of early pain. In: McGrath P, Finley GA (eds) *Pediatric Pain: Biological and Social Context*. IASP Press, Seattle, pp 23–51
7. Grunau RE, Weinberg J, Whitfield MF (2004a) Neonatal procedural pain and preterm infant cortisol response to novelty at 8 months. *Pediatrics* 114:77–84
8. Grunau RE, Whitfield MF, Fay TB (2004b) Psychosocial and academic characteristics of extremely low birth weight (<800 g) adolescents who are free of major impairment compared with full-term control subjects. *Pediatrics* 114:725–732
9. Grunau RE, Holsti L, Haley DW et al. (2005) Neonatal procedural pain exposure predicts lower cortisol and behavioral reactivity in preterm infants in the NICU. *Pain* 113:293–300
10. Hack M, Flannery DJ, Schluchter M et al. (2002) Outcomes in young adulthood for very-low-birth-weight infants. *N Engl J Med* 346:149–157
11. Peters JW, Koot HM, de Boer JB et al. (2003) Major surgery within the first 3 months of life and subsequent biobehavioral responses to immunization at later age: a case comparison study. *Pediatrics* 111:129–35
12. Ren K, Anseloni V, Zou S-P et al (2004) Characterization of basal and re-inflammation-associated long-term alteration in pain responsivity following short-lasting neonatal local inflammatory insult. *Pain* 110:588–596
13. Saigal S, Feeny D, Rosenbaum P et al. (1996) Self-perceived health status and health-related quality of life of extremely low-birth-weight infants at adolescence. *JAMA* 276:453–459
14. Taddio A, Katz J, Ilersich AL et al. (1997) Effect of neonatal circumcision on pain response during subsequent routine vaccination. *Lancet* 349:599–603
15. Walker CD, Kudreikis K, Sherrard A et al. (2003) Repeated neonatal pain influences maternal behavior, but not stress responsiveness in rat offspring. *Dev Brain Res* 140:253–261

## Long-Term Potentiation

### Synonyms

LTP



## Definition

This is a long-lasting increase in synaptic efficacy resulting from repetitive activation of the synapse. This process was first described in hippocampus, whereby high-frequency stimulation of afferent pathways leads to a potentiated post-synaptic response that can last for hours to days. It is a form of activity-dependent plasticity. LTP may increase the efficiency of pain transmission for weeks to months or longer.

- ▶ [Alternative Medicine in Neuropathic Pain](#)
- ▶ [Opioids in the Spinal Cord and Central Sensitization](#)
- ▶ [Spinothalamic Tract Neurons, Role of Nitric Oxide](#)

## Long-Term Potentiation and Long-Term Depression in the Spinal Cord

JÜRGEN SANDKÜHLER

Department of Neurophysiology, Center for Brain Research, Medical University of Vienna, Vienna, Austria

juergen.sandkuehler@meduniwien.ac.at

### Synonyms

Long-Term Potentiation in the Spinal Cord; Long-Term Depression in the Spinal Cord

### Definition

Hyperalgesia may result from an acute noxious event such as trauma, inflammation or nerve injury and may persist long after the primary cause for pain has disappeared. Altered processing of sensory information in the central nervous system may contribute to these forms of hyperalgesia. The long-term potentiation of synaptic strength in nociceptive pathways is a cellular model of pain amplification.

Long-term potentiation (LTP) and long-term depression (LTD) of synaptic strength are long-lasting changes in synaptic efficiency irrespective of the type and the location of chemical synapse. Activity dependent forms outlast conditioning pre- and/or post-synaptic stimulation by at least 30 min. Shorter lasting forms of synaptic plasticity are short-term potentiation or depression, post-tetanic potentiation and paired-pulse facilitation or depression. LTP and LTD may be induced and maintained by pre- and/or by post-synaptic mechanisms such as changes in transmitter release or receptor sensitivity or density. LTP and LTD are divided into at least two phases; the early phase up to 6 h is caused solely by posttranslational changes. In contrast, maintenance of the late stage (more than 6 h after conditioning) requires *de novo* protein synthesis. The signal transduction pathways involved depend upon the induction protocol, type of synapse, types of pre- and post-synaptic neurons, direction of synaptic plasticity and developmental stage. While synaptic plas-

ticity cannot be studied by recording action potential firing or polysynaptic or behavioural responses, evaluation of these parameters is indispensable to show that synaptic plasticity is relevant to information processing downstream in the transmission path.

### Characteristics

#### Synaptic Models for Learning and Memory in Pain Pathways

LTP and LTD were first described for synapses in the hippocampus and are now considered the major cellular models for learning and memory. The final proof is, however, still lacking, mainly since the neuronal elements and their activity patterns involved in cognitive or motor learning are largely unknown (Barnes 1995). Fortunately, in the nociceptive system our knowledge is considerably more advanced: The primary afferent nerve fibres as well as their activity patterns that lead to pain are known. Recently, 2<sup>nd</sup> order neurons in superficial spinal dorsal horn were identified that mediate hyperalgesia and allodynia. In particular, neurons in lamina I that express the NK1 receptor for substance P are essential for full expression of hyperalgesia in various animal model of inflammation and neuropathy (Nichols et al. 1999). These neurons are all nociceptive specific, most project to the parabrachial area and/or periaqueductal grey and receive input from primary afferent, peptidergic C-fibres.

Conditioning stimulation of primary afferent C-fibres leads to LTP at C-fibre synapses with these lamina I projection neurons, but not other lamina I neurons (Ikeda et al. 2003). Several independent and convergent lines of evidence suggest that synaptic LTP in superficial spinal dorsal horn is a cellular mechanism of afferent induced hyperalgesia (reviewed in (Sandkühler 2000a; Willis 2002; Moore et al. 2000), see also additional original work cited in the text):

#### a) Protocols that Induce LTP also Cause Hyperalgesia in Animals and Humans

1. Continuous electrical stimulation of C-fibres at low frequencies (1–5 Hz for 2 or 3 min) or high frequency burst-like stimulation (three to five 100 Hz bursts of 1 sec duration) induce LTP in various spinal cord-dorsal root slice preparations under different recording conditions (Ikeda et al. 2000; Ikeda et al. 2003; Randic et al. 1993) and in intact animal models (Liu and Sandkühler 1997) (Fig. 1). LTP at the first nociceptive synapse apparently affects downstream events in nociceptive pathways. Action potential firing in deep dorsal horn, wide dynamic range neurons (Svendsen et al. 1999) and pain rating in human volunteers (Klein et al. 2004) are also potentiated by similar conditioning stimuli (Fig. 1).
2. Natural patterns of afferent barrage during noxious stimuli (subcutaneous injections of capsaicin



or formalin) in intact (i.e. not spinalised) animals also induce LTP in spinal cord and hyperalgesia in behaving animals.

b) Time Courses for LTP and Hyperalgesia are similar

3. LTP and hyperalgesia are induced within minutes after conditioning stimulation, excluding any time consuming processes such as sprouting of nerve fibres. LTP and hyperalgesia may outlast the conditioning stimulation by hours.
4. LTP and hyperalgesia may spontaneously reverse within hours or days or may persist for longer periods depending upon induction protocols and the context of conditioning.

c) Shared Pharmacology and Signal Transduction Pathways for LTP and Hyperalgesia

5. Co-activation of NMDA-, group I mGlu- and NK<sup>1</sup>-receptors is required.
6. Activation of voltage-gated calcium channels is required.
7. Ca<sup>2+</sup>-dependent signal transduction pathways are involved.
8. Activation of protein kinase C, calcium-calmodulin-dependent protein kinase II and nitric oxide synthase (in some cases) is necessary.

d) LTP and Hyperalgesia Can Be Prevented by the Same Means

9. Activity in descending inhibitory pathways raises the threshold for induction of both LTP and hyperalgesia.
10. Opioids can pre-empt induction of LTP (Benrath et al. 2004) and hyperalgesia (Katz et al. 2003).

Not all details of signal transduction pathways that have been explored in one model have also been investigated in the other. All presently known cellular key elements are, however, shared by spinal LTP and afferent induced, centrally expressed hyperalgesia. This strongly suggests that LTP at synapses of primary afferent C-fibres is a cellular mechanism of hyperalgesia. However, until now LTP has only been found at synapses of primary afferent C-fibres, but not at synapses of A $\beta$ - or A $\delta$ -fibres. Thus, neither A $\delta$ -fibre mediated hyperalgesia, nor A $\beta$ -fibre induced allodynia can presently be explained by synaptic LTP in superficial spinal dorsal horn.

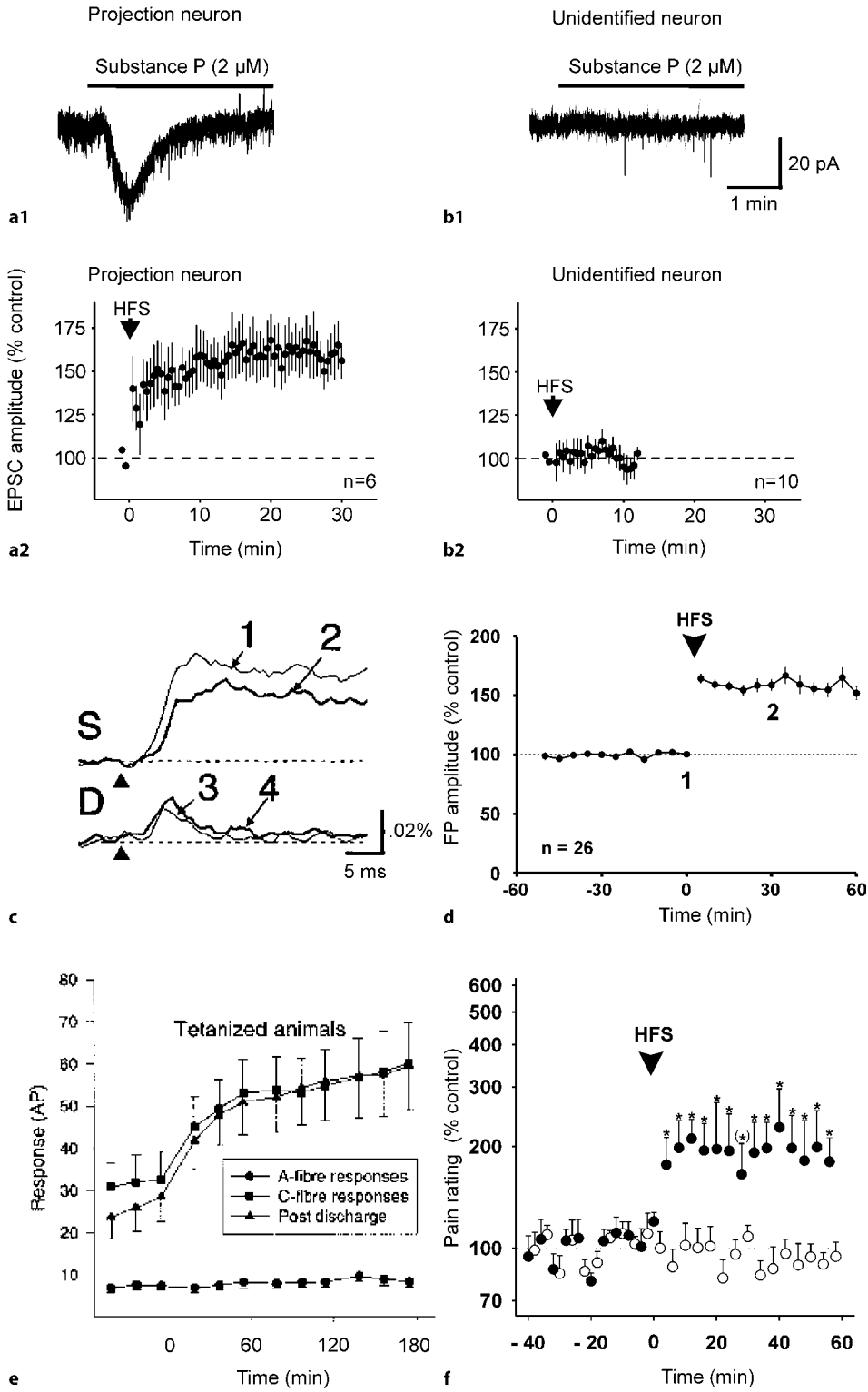
### Synaptic Long-Term Depression in Pain Pathways

Conditioning stimulation of primary afferent A $\delta$ -fibres but not A $\beta$ -fibres at low frequencies (1 Hz for 15 min) induces a homosynaptic LTD at A $\delta$ -fibres synapses *in vitro* (Sandkühler et al. 1997; Chen and Sandkühler 2000; Randic et al. 1993) and a heterosynaptic LTD at synapses of C-fibres in intact animals (Liu et al. 1998).

Similar stimulation parameters lead to long-term depression of primary afferent induced EPSCs in deep dorsal horn neurons (Garraway and Hochman 2001), of the jaw-opening reflex in mice (Ellrich 2004) and of human nociceptive skin senses (Nilsson et al. 2003; Klein et al. 2004). High intensity, low frequency forms of transcutaneous electrical nerve stimulation (TENS) can alleviate clinical pain in some human pain patients. (Electro-) Acupuncture, which leads to the “d Q” sensation, probably also induces a low frequency afferent barrage in A $\delta$ -fibres. When effective, pain relief outlasts the duration of these forms of TENS and acupuncture for hours or days. This is compatible with synaptic LTD in pain pathways if counterirritation is applied closely to the painful area. In contrast, TENS given at high frequencies, but at low (A $\beta$ -fibre) intensity, does not lead to long-lasting analgesia and cannot be explained by synaptic LTD in pain pathways. This low intensity-high frequency form of TENS most probably involves excitation of spinal inhibitory interneurons as described in the “gate-control” theory (reviewed in Sandkühler 2000b). In conclusion convergent evidence suggest that long-term potentiation at or near the first central synapse in pain pathways is relevant to some forms of hyperalgesia (synaptic long-term potentiation) and can also be used therapeutically to treat and perhaps prevent chronic pain states (synaptic long-term depression).

### References

1. Barnes CA (1995) Involvement of LTP in memory: are we “searching under the street light”? *Neuron* 15:751–754
2. Benrath J, Brechtel C, Martin E et al. (2004) Low doses of fentanyl block central sensitization in the rat spinal cord *in vivo*. *Anesthesiology* 100:1545–1551
3. Chen J, Sandkühler J (2000) Induction of homosynaptic long-term depression at spinal synapses of sensory A $\delta$ -fibres requires activation of metabotropic glutamate receptors. *Neuroscience* 98:141–148
4. Ellrich J (2004) Electric low-frequency stimulation of the tongue induces long-term depression of the jaw-opening reflex in anesthetized mice. *J Neurophysiol* 1:1–2
5. Garraway SM, Hochman S (2001) Serotonin increases the incidence of primary afferent-evoked long-term depression in rat deep dorsal horn neurons. *J Neurophysiol* 85:1864–1872
6. Ikeda H, Asai T, Murase K (2000) Robust changes of afferent-induced excitation in the rat spinal dorsal horn after conditioning high-frequency stimulation. *J Neurophysiol* 83:2412–2420
7. Ikeda H, Heinke B, Ruscheweyh R et al. (2003) Synaptic plasticity in spinal lamina I projection neurons that mediate hyperalgesia. *Science* 299:1237–1240
8. Katz J, Cohen L, Schmid R et al. (2003) Postoperative morphine use and hyperalgesia are reduced by preoperative but not intraoperative epidural analgesia: implications for preemptive analgesia and the prevention of central sensitization. *Anesthesiology* 98:1449–1460
9. Klein T, Magerl W, Hopf HC et al. (2004) Perceptual correlates of nociceptive long-term potentiation and long-term depression in humans. *J Neurosci* 24:964–971
10. Liu X, Sandkühler J (1997) Characterization of long-term potentiation of C-fiber-evoked potentials in spinal dorsal horn of adult rat: essential role of NK1 and NK2 receptors. *J Neurophysiol* 78:1973–1982
11. Liu XG, Morton CR, Azkue JJ et al. (1998) Long-term depression of C-fibre-evoked spinal field potentials by stimulation of



◀ **Long-Term Potentiation and Long-Term Depression in the Spinal Cord, Figure 1**, Long-term potentiation (LTP) of synaptic strength in nociceptive pathways can be demonstrated under a wide range of experimental conditions *in vitro* (a-c) and *in vivo* (d-f) including human subjects (f). (a) In a rat spinal cord-dorsal root slice preparation, conditioning stimulation of dorsal root at C-fibre strength induces LTP at synapses of primary afferent C-fibres with lamina I projection neurons that express NK1 receptors for substance P. A1 illustrates an inward current elicited by bath application of substance P in the presence of tetrodotoxin. A2 shows the mean time course of peaks of monosynaptically, C-fibre-evoked postsynaptic currents before and after conditioning stimulation at time zero. (b) The same conditioning stimulation failed to induce LTP in unidentified neurons of lamina I that did not respond to substance P. Modified from Ikeda et al. 2003. (c) LTP can also be demonstrated by optical recording of C-fibre-evoked responses in superficial spinal dorsal horn in a spinal cord slice preparation. Superimposed time courses of optical responses immediately before (thin lines) and 75 min after (bold lines) high-frequency stimulation at two different locations in the dorsal horn, lamina II "S" and deeper dorsal horn "D". These responses are spatial averages recorded in all pixels present in the area ( $\approx 60$  pixels). Modified from Ikeda et al. 2000. (d) C-fibre-evoked field potentials recorded in superficial spinal dorsal horn of intact, deeply anaesthetized rats are potentiated throughout the recording period of up to 17 h by conditioning high-frequency stimulation of sciatic nerve at C-fibre strength (modified from Benrath et al. 2004). (e) C-fibre but not A-fibre-evoked firing responses of deep dorsal horn neurons and post discharge in spinalized rats are potentiated by a tetanic sciatic nerve stimulation at time zero (mean  $\pm$  S.E.M.  $n = 8$ ), modified from Svendsen et al. 1999. (f) Heterotopic effects of conditioning high frequency electrical stimulation of peptidergic cutaneous nerve fibres on pin prick-evoked pain. Conditioning HFS induced a significant enhancement of pin prick-evoked pain adjacent to the conditioning electrode (▲) but not adjacent to the control electrode (○). This secondary hyperalgesia occurred after conditioning stimulus intensities of  $10\times$  the detection threshold. Mean  $\pm$  S.E.M. values across eight subjects are shown. Modified from Klein et al. 2004.

primary afferent A delta-fibres in the adult rat. Eur J Neurosci 10:3069–3075

12. Moore KA, Baba H, Woolf CJ (2000) Synaptic transmission and plasticity in the superficial dorsal horn. In: Sandkühler J, Bromm B, Gebhart GF (eds) Nervous system plasticity and chronic pain. Elsevier, Amsterdam, Lausanne, New York, pp 63–81
13. Nichols ML, Allen BJ, Rogers SD et al. (1999) Transmission of chronic nociception by spinal neurons expressing the substance P receptor. Science 286:1558–1561
14. Nilsson HJ, Psouni E, Schouenborg J (2003) Long term depression of human nociceptive skin senses induced by thin fibre stimulation. Eur J Pain 7:225–233
15. Randic M, Jiang MC, Cerne R (1993) Long-term potentiation and long-term depression of primary afferent neurotransmission in the rat spinal cord. J Neurosci 13:5228–5241
16. Sandkühler J (2000a) Learning and memory in pain pathways. Pain 88:113–118
17. Sandkühler J (2000b) Long-lasting analgesia following TENS and acupuncture: Spinal mechanisms beyond gate control. In: Devor M, Rowbotham MC, Wiesenfeld-Hallin Z (eds) Proceedings of the 9th World Congress on Pain, Progress in Pain Research and Management, vol 16. IASP Press, Seattle, pp 359–369
18. Sandkühler J, Chen JG, Cheng G et al. (1997) Low-frequency stimulation of afferent Adelta-fibers induces long-term depression at primary afferent synapses with substantia gelatinosa neurons in the rat. J Neurosci 17:6483–6491
19. Svendsen F, Tjolsen A, Gjerstad J et al. (1999) Long term potentiation of single WDR neurons in spinalized rats. Brain Res 816:487–492
20. Willis WD (2002) Long-term potentiation in spinothalamic neurons. Brain Res Rev 40:202–214

## Long-Term Potentiation in the Spinal Cord

- ▶ Long-Term Potentiation and Long-Term Depression in the Spinal Cord

## Loss of Consciousness Associated with Fentanyl

### Definition

Loss of consciousness associated with fentanyl occurs at mean serum concentrations of 34 ng/ml.

- ▶ Postoperative Pain, Fentanyl

## Loss of Olfactory Function

### Definition

Also called dysosmia; anosmia describes the total loss of the sense of smell, and hyposmia describes a partial loss of olfactory function.

- ▶ Nociception in Nose and Oral Mucosa

## Low Back Pain

### Definition

Low back pain affects almost everyone at some point in their lives. It can be acute or chronic in nature and is a primary cause of functional disability in the working population. Multiple causes exist for low back pain including degeneration of the lumbar spine and associated intervertebral discs; intervertebral disc herniation; strain of associated muscles, ligaments, and tendons; and referral from other organs and tissues.

- ▶ Chronic Low Back Pain, Definitions and Diagnosis
- ▶ Evoked and Movement-Related Neuropathic Pain
- ▶ Low Back Pain, Epidemiology
- ▶ Low Back Pain Patients, Imaging

## Low Back Pain, Epidemiology

J. MOCCO, RICARDO J. KOMOTAR,  
CHRISTOPHER J. WINFREE  
Department of Neurological Surgery, Neurological  
Institute, Columbia University, New York, NY, USA  
cjw12@columbia.edu

### Synonyms

Pervasiveness of low back pain; Prevalence of low back pain; Incidence of Low Back Pain; Frequency of Low Back Pain; Factors Associated with Low Back Pain

## Definition

The word ► **epidemiology** comes from the Greek words *epi*, “on or upon”, *demōs*, “the common people”, and *logos*, “study.” Taken from these roots one can extrapolate epidemiology to be the study of that which is upon the people. According to the American College of Epidemiology, epidemiology is “the study of the distribution and determinants of disease risk in human populations.” Therefore, the epidemiology of ► **low back pain** is the study of the distribution and determinants of low back pain.

## Characteristics

Disability from back pain is more common than any other cause of activity limitation in adults of less than 45 years, and second only to arthritis in people aged 45–65 years (Frank et al. 1996). Additionally, not only is low back pain (LBP) one of the most common causes of missed workdays but it is becoming a bigger problem every year. In fact, over the past 50 years, the number of workdays missed secondary to LBP has increased more than ten-fold (Clinical Standards Advisory Group 1994). A recent review found that 2% of the US work force is compensated for back injuries each year (Andersson 1999). Therefore, efforts to better understand the epidemiology of low back pain are critical.

► **Prevalence** is the number of people in a defined population who have a specific disease or condition at a particular time (Jekel and Katz 1996). Unfortunately, because of the recurrent nature and variable definitions of LBP that are used from study to study, traditional epidemiological concepts are difficult to apply to the experience of low back pain. A recent comprehensive methodological review of the body of literature concerning the prevalence of LBP found that the 1-year prevalence ranged from 3.9–63% with a mean of 32%, and the prevalence at a single point in time ranged from 4.4–33% (Loney and Stratford 1999). If only the highest quality studies were used then the range narrowed to 13.7–28.7% (Loney and Stratford 1999).

► **Incidence** is the occurrence of new cases of disease in a candidate population over a specific time period (Aschengrau 2005). True incidence is essentially impossible to determine for LBP, since onset is often difficult to determine and recurrent episodes confound investigators ability to identify true “new cases.” The incidence of LBP has been estimated to vary between 4 and 15% annually in most industrialized countries (Leighton and Reilly 1995; Office of National Statistics 1996).

After attempting to understand the general distribution of LBP, the next step is to better establish the determinants of LBP. Said another way, what factors are associated with the occurrence of LBP? There have been many studies undertaken to attempt to tease out the relevant factors associated with LBP in both patients’ workplace

and personal environments. Unfortunately, much of this literature is poorly designed and/or contains conflicting results.

Personal risk factors associated with LBP include obesity, smoking, severe scoliosis, and depression (Devereaux 2003a; Devereaux 2003b). An individual’s general physical fitness has not been shown to reduce the occurrence of acute LBP, but it has been shown to lower the incidence of chronic LBP and reduce the time needed to recover from episodes of acute LBP (Devereaux 2004). Despite some debate, the greater weight of evidence supports no association between gender and LBP (Devereaux 2004).

In the workplace, a number of characteristics have been identified as risk factors for the occurrence of LBP or a worse disease course. These can be divided into physical and psychosocial characteristics. Accepted physical risk factors include heavy physical labor, long static work postures, and excessive vibration (Devereaux 2003a; Devereaux 2003b). Psychosocial aspects of the workplace that affect LBP were reviewed by Hoogendoorn et al. in a systematic review of the literature, in which there was strong evidence for low workplace social support and low job satisfaction being associated with back pain (Hoogendoorn et al. 2000). In contrast, other commonly held risk factors, such as a high work pace, job autonomy, and long periods of attentiveness, were not strongly associated with LBP, despite some weak supporting literature. Finally, a study by Leino et al. found that monotonous work with few possibilities to learn new skills was associated with LBP in blue-collar workers (Leino and Hanninen 1995).

A final risk factor for LBP recurrence and conversion from acute to chronic status is the presence of litigation and/or workman’s compensation claims. Litigation deserves special consideration as multiple studies have been performed in order to elucidate the association between LBP and litigation and/or workman’s compensation claims, and the majority of these have found a positive association (Blake and Garrett 1997; Rainville et al. 1997; Valat et al. 1997). These include a well-designed ► **prospective observational cohort study** of 192 individuals, determining that patients with compensation involvement appear to have worse depression and disability before and after rehabilitation interventions (Rainville et al. 1997).

In conclusion, the study of the epidemiology of low back pain has determined that roughly a third of the adult population will suffer low back pain over the course of a year. Many of these individuals will be obese, smoke, suffer from depression, or be employed in careers that expose them to physical labor, long static work postures, excessive vibration, low workplace social support, or low job satisfaction. Of those who suffer low back pain, those with either litigation or workers’ compensation involvement are more likely to have a chronic course with worse outcomes and more workdays missed.



## References

1. Andersson GB (1999) Epidemiological Features of Chronic Low-Back Pain. *Lancet* 354:581–585
2. Aschengrau S (2005) *Essentials of Epidemiology in Public Health*. Jones and Bartlett, Sudbury
3. Blake C, Garrett M (1997) Impact of Litigation on Quality of Life Outcomes in Patients with Chronic Low Back Pain. *Ir J Med Sci* 166:124–126
4. Clinical Standards Advisory Group (1994) *Epidemiology Review: The Epidemiology and Cost of Back Pain*. London, UK
5. Devereaux MW (2003a) Approach to Neck and Low Back Disorders. *ERW Saunders Manual of Neurologic Practice*. Elsevier, Philadelphia, pp 745–751
6. Devereaux MW (2003b) Neck and Low Back Pain. *Med Clin North Am* 87:643–662
7. Devereaux MW (2004) Low Back Pain. *Prim Care* 31:33–51
8. Frank K, Brooker et al. (1996) Disability Resulting from Occupational LBP: I: What do we know About Primary Prevention? A Review of the Scientific Evidence on the Prevention before Disability Begins. *Spine* 21:2908–2917
9. Hoogendoorn WE, Poppel MN van, Bongers PM et al. (2000) Systematic Review of Psychosocial Factors at Work and Private Life as Risk Factors for Back Pain. *Spine* 25:2114–2125
10. Jekel E, Katz (1996) *Epidemiology, Biostatistics, and Preventative Medicine*. WB Saunders Co, Toronto, Canada, pp 20–22
11. Leighton DJ, Reilly T (1995) Epidemiological Aspects of Back Pain: The Incidence and Prevalence of Back Pain in Nurses Compared to the General Population. *Occup Med* 45:263–267
12. Leino PI, Hanninen V (1995) Psychosocial Factors at Work in Relation to Back and Limb Disorders. *Scand J Work Environ Health* 21:134–142
13. Loney PL, Stratford PW (1999) The Prevalence of Low Back Pain in Adults: A Methodological Review of the Literature. *Phys Ther* 79:384–396
14. Office of National Statistics (1996) *Omnibus Survey. Social Survey Division*. Department of Health, London, UK
15. Rainville J, Sobel JB, Hartigan C et al. (1997) The Effect of Compensation Involvement on the Reporting of Pain and Disability by Patients Referred for Rehabilitation of Chronic Low Back Pain. *Spine* 22:2016–2024
16. Valat J P, Goupille P, Vedere V (1997) Low Back Pain: Risk Factors for Chronicity. *Rev Rhum Engl Ed* 64:189–194

## Low Back Pain Patients, Imaging

PRAMIT PHAL, DANIEL RIRIE, GARY NESBIT  
Department of Radiology, Oregon Health and Science  
University, Portland, OR, USA  
nesbitg@ohsu.edu

### Synonyms

Lumbar Pain; diagnostic studies

### Definition

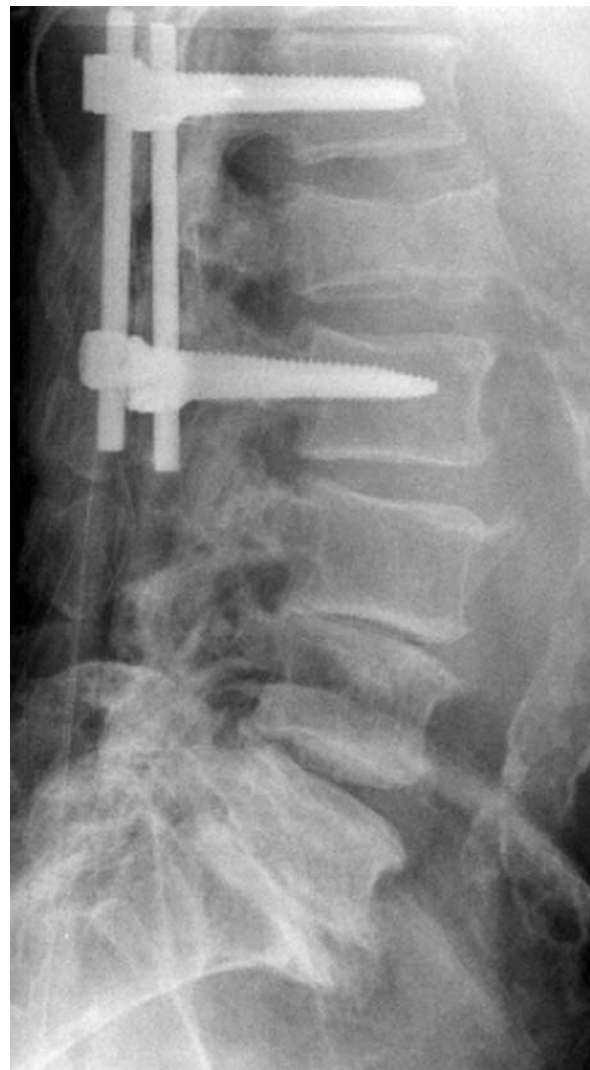
Diagnostic evaluation of pain localized to the lower back, often associated with radiation in a radicular distribution.

### Characteristics

The differential diagnosis for low back pain is broad, including mechanical, compressive, neoplastic, infectious, and referred visceral disease as causes. Only after thorough history and physical examination should one

consider the use of imaging studies. For most adult patients under age 50 who do not exhibit signs or symptoms of systemic illness, conservative therapy without imaging is considered appropriate.

The choices available for imaging of back pain are also quite broad and often complimentary. They include: plain radiographs, cross sectional imaging such as computed tomography (CT) (see ► [Single Photon Emission Computed Tomography](#)) and ► [magnetic resonance imaging \(MRI\)](#), myelography, discography, and radionuclide bone scan. The selection of which modality is best suited for a given patient is based on what are the major considerations, such as bone or soft tissue, and what degree of detail is needed.



**Low Back Pain Patients, Imaging, Figure 1** Lateral radiograph of the lumbar spine demonstrates a burst fracture of L1 with posterior spinal fusion with bilateral paraspinous rods and pedicle screws in T12 and L2. Severe degenerative disc changes are seen in the lower lumbar spine L3 through S1 with loss of disc height, subchondral sclerosis and osteophyte formation.

### Plain Films

Plain radiographs are generally the first test performed, perhaps related to their ease of accessibility and low cost. A full lumbar spine series includes an antero-posterior (AP) and lateral projection, along with a spot lateral of the lumbosacral junction and bilateral oblique views. AP and lateral views allow assessment of overall alignment, disc and vertebral body heights and a gross assessment of bony density. Oblique views allow assessment of the pars interarticularis and facet joints, but are often dispensed with due to concerns of excessively irradiating gonadal tissue, particularly in females of reproductive age. If there are concerns of instability or ligamentous injury, lateral views in flexion and extension can be performed.

Plain radiographs have a limited role in the assessment of back pain. As many of the cases of back pain are due to mechanical causes, plain films suffer due to the inability to visualize soft tissue. Hence, disc protrusions and nerve root compression cannot be directly visualized. Only the secondary effects of disc degeneration on the adjacent vertebral body, namely subchondral sclerosis and cysts, osteophytosis, disc space narrowing and vacuum phenomenon, are observed. In spinal canal stenosis, only bony narrowing of the spinal canal can be seen. Plain films generally lack sensitivity in diagnosing metastatic disease, as 50% of the bony trabeculae must be destroyed before these lesions are visible (Sartoris et al. 1986).

The current role of plain films in assessment of lower back pain includes that of a screening test in trauma and limited dynamic assessment, by performing flexion and extension views. They are a useful screening test combined with lab tests for symptoms suggesting systemic illness, and can demonstrate specific findings to complement the more sensitive but less specific studies such as MRI and radionuclide bone scan. Plain films have limited usefulness in radiculopathy, only showing bony narrowing of neural exit foramina. They do, however, remain useful in the post-operative patient, particularly in the presence of metallic hardware.

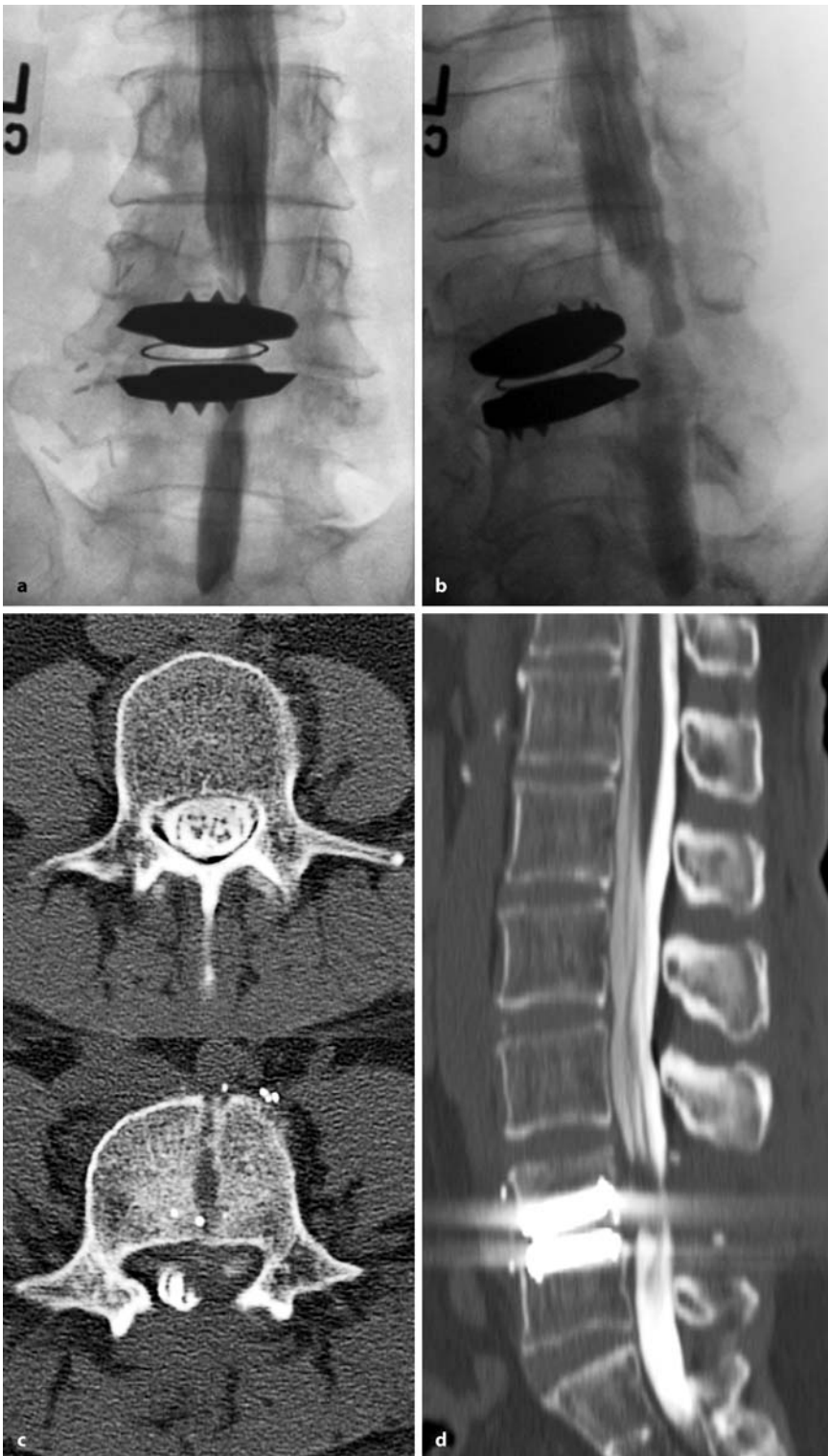
### Cross-Sectional Imaging

With the advent of cross-sectional imaging, computed tomography (CT) and magnetic resonance imaging (MRI) have rapidly become mainstays in the imaging of chronic low back pain. CT utilizes x-rays and a series of detectors to measure density in an axial or helical cross-sectional envelope, whereas MRI utilizes magnetic fields and radiowaves to evaluate water concentrations and interactions within tissue. Multiplanar capabilities using either technique provide the ability to interrogate the spine in sagittal, coronal, and even 3-dimensional methods. This, combined with improved contrast resolution over plain radiography, make both techniques superior in evaluating the spinal canal, neural foramina, and paraspinal soft tissues. CT or MRI is usually reserved for those patients



**Low Back Pain Patients, Imaging, Figure 2** A sagittal T2 weighted MRI image of the lumbar spine. A bulge of the L4/5 disc encroaches on the central spinal canal. The relative decreased signal in the L4/5 and L5/S1 intervertebral discs is due to decreased water content, a finding of disc degeneration.

with lower back pain who are considering surgery, or in whom neoplastic disease is strongly suspected (Jarvik and Deyo 2002). Additional indications include those with progressive neurologic deficit, suspected cauda equina syndrome, or those who have failed to improve after 6–8 weeks of conservative management (Hicks et al. 2002). The indiscriminate use of MRI and CT may result in unnecessary intervention, which is, in part, due to the extremely high sensitivity of MRI. There is a relatively high prevalence of



**Low Back Pain Patients, Imaging, Figure 3** A frontal (a), and oblique (b) projection of the lumbar spine is shown following the intrathecal injection of contrast for a myelogram. The nerve roots of the cauda equina are well visualized. Surgical changes of posterior laminectomy and intervertebral disc prosthesis at L4-L5 is present. Extrinsic compression of the contrast-filled thecal sac is noted above the L4-L5 disc level. A CT scan of the same patient at L3 (c, upper) shows contrast outlining the normal nerve roots in the canal and L4 (c, lower) there is a midline fracture, bilateral laminectomy and the compression of the thecal sac. A sagittal reconstruction of the CT scan (d) delineates the disc prosthesis, thecal sac and soft-tissue compression of the cauda equina.

disk bulges, protrusions, and facet arthropathy in the asymptomatic population, and the presence of these pathologies in patients with back pain may, in many cases, be coincidental (Gaensler 1999). These findings underscore the need for judicious use of diagnostic

imaging when evaluating any patient with low back pain.

Pediatric patients, in contrast, rarely have degenerative disease. These patients usually have more serious underlying disease that should be assessed differ-



ently and often involves advanced imaging (Osborne 1994).

Determining whether to use CT or MRI in a given patient is usually by physician preference, however, there are situations when one modality is favored over another. Patients with certain implanted devices or claustrophobia may prohibit the use of MRI, although metallic artifacts from spinal surgical implants are often worse on CT than MRI. CT provides greater bone detail than MRI and is excellent for evaluating neural foraminal and central canal stenosis (Gaensler 1999). The sensitivity and specificity of disk herniation is slightly higher with MRI than CT, but the two modalities are essentially equally effective in evaluating the degree of spinal stenosis (Jarvik and Deyo 2002). MRI has demonstrated superiority in evaluating for neoplasm, with sensitivity and specificity ranging from 0.83–0.93 and 0.9–0.97, respectively (Jarvik and Deyo 2002). Infection is also best evaluated by MRI with sensitivity of 0.96 and specificity of 0.92 (Jarvik and Deyo 2002). In patients who have had prior surgery, MRI is the preferred modality. These patients should always be imaged with gadolinium contrast material to help distinguish scar tissue from recurrent disc herniation (Helms 1999). MRI has also been shown to be particularly useful as a screening tool in evaluating patients with symptomatic discs by identifying tears of the annulus fibrosus with high sensitivity; the relative low specificity, however, cannot replace the need for discography (Yoshida et al. 2002).

### Myelography

When intrathecal contrast material is administered for myelography, the contents of the spinal canal and neural foramina are more clearly visualized. When combined with CT, the additional anatomic information can provide a crucial supplement in the evaluation of nerve root impingement in the lateral recess as a cause for radiculopathy, because MRI tends to underestimate the degree of stenosis in this location (Bartynski and Lin 2003). Although myelography is invasive, and its use has decreased with the advent of MRI, it still remains an important technique when other modalities remain equivocal.

### Nuclear Medicine

A radionuclide bone scan involves intravenous injection of a radionuclide taken up by bone, most commonly bound to a compound containing phosphate. Imaging is performed with a gamma camera and the use of cross sectional techniques such as SPECT (single photon emission computed tomography) can increase sensitivity and anatomic localization. Early imaging in the blood flow and blood pool phases, detect areas of hyperemia. Delayed images demonstrate bony uptake. This imaging modality is most useful in conditions where there is increased bony turnover: osteoblastic metastases, infection, fractures, in particular in the

diagnosis of stress fractures, and differentiating acute from chronic vertebral body compression fractures (Avrahami et al. 1989). While radionuclide bone scan has excellent sensitivity for detection of these conditions, it suffers from a lack of specificity, and involves exposure to ionizing radiation.

### Discography

Discography is a semi-invasive procedure that involves placement of a needle into the central nucleus pulposus of the disc and injection of iodinated contrast material directly into the nucleus.

Information gained from this procedure includes a morphological assessment of the disc. The procedure is most often done under fluoroscopy during which spot images are taken. CT of the lumbar spine is often performed after the procedure, including sagittal and coronal reformatted images. Degenerative change can range from fissures and clefts in the nucleus pulposus, annular tears with contrast extending to the disc periphery and disc rupture with leakage of injected contrast (Anderson 2004; Sachs et al. 1987).

The patient's pain response during the procedure is also assessed. During the procedure the patient is asked to grade the severity pain (usually out of 5) and also the similarity of the pain to their usual symptoms.

Discography is very sensitive for detection of annular tears of the intervertebral disc, a common cause of back pain not confidently detected on MRI. Disparity between MRI and clinical presentation is a major indication for discography. Discography should only be performed on surgical candidates who have failed a period of conservative therapy of around 6 months. Other indications for discography include determining the symptomatic level in multilevel degenerative disease, preoperative planning and evaluation of the postoperative patient.

Due to the semi-invasive nature of the procedure, potential risks of discography include infection, bleeding, neural damage, accentuation of pain and post procedural headache if the dura is traversed. The other main disadvantage of discography is its high false positive rate, which is likely to be around 10% (Saal 2002).

### References

1. Anderson MW (2004) Lumbar Discography: An Update. *Semin Roentgenol* 39:52–67
2. Avrahami E, Tadmor R, Dally O et al. (1989) Early MR Demonstration of Spinal Metastases in Patients with Normal Radiographs and CT and Radionuclide Bone Scans. *J Comput Assist Tomogr* 13:598–602
3. Bartynski WS, Lin L (2003) Lumbar Root Compression in the Lateral Recess: MR Imaging, Conventional Myelography, and CT Myelography Comparison with Surgical Confirmation. *Am J Neuroradiol* 24:348–360
4. Gaensler E (1999) Nondegenerative Diseases of the Spine. In: Brant W (ed) *Fundamentals of Diagnostic Radiology*. Williams and Wilkins, Baltimore, pp 233–280



5. Helms C (1999) Lumbar Spine Disc Disease and Stenosis. In: Brant W (ed) *Fundamentals of Diagnostic Radiology*. Williams and Wilkins, Baltimore, pp 281–288
6. Hicks GS, Duddleston DN, Russell LD et al. (2002) Low Back Pain. *Am J Med Sci* 324:207–211
7. Jarvik JG, Deyo RA (2002) Diagnostic Evaluation of Low Back Pain with Emphasis on Imaging. *Ann Intern Med* 137:586–597
8. Osborne A (1994) *Nonneoplastic Disorders of the Spine and Spinal Cord*. Neuro radiology. Mosby, St. Louis, pp 820–875
9. Saal JS (2002) General Principles of Diagnostic Testing as Related to Painful Lumbar Spine Disorders: A Critical Appraisal of Current Diagnostic Techniques. *Spine* 27:2538–2546
10. Sachs BL, Vanharanta H, Spivey MA et al. (1987) Dallas Discogram Description. A New Classification of CT/Discography in Low-Back Disorders. *Spine* 12:287–294
11. Sartoris DJ, Clopton P, Nemcek A et al. (1986) Vertebral-Body Collapse in Focal and Diffuse Disease: Patterns of Pathologic Processes. *Radiology* 160:479–483
12. Yoshida H, Fujiwara A, Tamai K et al. (2002) Diagnosis of Symptomatic Disc by Magnetic Resonance Imaging: T2-Weighted and Gadolinium-DTPA-Enhanced T<sup>1</sup>-Weighted Magnetic Resonance Imaging. *J Spinal Disord Tech* 15:193–198

## Low First Pass Metabolism

### Definition

Oral oxycodone undergoes low first pass metabolism and is among those opioids possessing a short elimination half-life.

- ▶ [Postoperative Pain, Oxycodone](#)

## Low Frequency Oscillations

### Definition

Oscillatory activity described in the brain when the organism is not attentive or drowsy.

- ▶ [Corticothalamic and Thalamocortical Interactions](#)

## Low Intracranial Pressure Headache

- ▶ [Headache Due to Low Cerebrospinal Fluid Pressure](#)

## Low Threshold Calcium Spike

### Synonyms

LTS

### Definition

A membrane depolarization resulting from an inflow of Ca<sup>++</sup> ions through T-type channels. The LTS occurs when the membrane potential is sufficiently hyperpolarized to cause de-inactivation of the T-channels.

- ▶ [Burst Activity in Thalamus and Pain](#)

## Low Threshold Calcium Spike Burst

### Synonyms

LTS burst

### Definition

Bursting discharges produced by thalamic and reticular cells, when their membranes are hyperpolarized by either disfacilitation or overinhibition. They are due to the deinactivation of calcium T-channels causing the appearance of a large calcium spike, itself inducing a burst of sodium action potentials.

- ▶ [Burst Activity in Thalamus and Pain](#)
- ▶ [Thalamotomy for Human Pain Relief](#)

## Low Threshold Neuron

### Synonyms

LT neurons

### Definition

LT neurons are best activated by innocuous mechanical stimuli.

- ▶ [Functional Changes in Sensory Neurons Following Spinal Cord Injury in Central Pain](#)
- ▶ [Postoperative Pain, COX-2 Inhibitors](#)
- ▶ [Spinothalamic Input, Cells of Origin \(Monkey\)](#)

## Lower Back Pain, Acute

T. SHAH, STEPHAN A. SCHUG  
Royal Perth Hospital and University of Western  
Australia, Crawley, WA, Australia  
schug@cyllene.uwa.edu.au

### Synonyms

Acute Lumbago; Acute Sciatica; Acute Backache; Bad Back

### Definition

Acute lower back pain refers to spinal pain of sudden onset originating from lumbar, sacral or lumbosacral areas. It may also be referred pain from other areas such as the sacro-iliac joints ([www.emia.com.au/Medical-Providers/EvidenceBasedMedicine/overview.html](http://www.emia.com.au/Medical-Providers/EvidenceBasedMedicine/overview.html)).

Although often used to mean lower back pain, sciatica specifically refers to pressure on the sciatic nerve causing pain passing down the posterior medial aspect of the leg.

## Characteristics

Lower back pain is extremely common, with 60–80 % of adults experiencing it at some time. It is the most common reason cited for absence from work, and its management, therefore, has strong socioeconomic implications. Ninety percent of acute lower back pain, however, will resolve within 6 weeks ([www.emia.com.au/MedicalProviders/EvidenceBasedMedicine/overview.html](http://www.emia.com.au/MedicalProviders/EvidenceBasedMedicine/overview.html), <http://www.acc.co.nz/acc-publications/pdfs/ip/acc1038-col.pdf>, <http://www.health.gov.au/nhmrc/publications/synopses/cp94syn.htm>). The underlying diagnosis is often unknown. There is level I evidence that common findings in patients with lower back pain (e.g. osteoarthritis, spondylosis or spinal canal stenosis) may also be present in asymptomatic patients, and do not necessarily represent the cause of the pain (<http://www.health.gov.au/nhmrc/publications/synopses/cp94syn.htm>).

Due to its frequent occurrence, it is essential to identify early those rare causes of lower back pain that may have an underlying serious pathology or be non-biomechanical in origin. These should prompt early referral to appropriate treatment that might be urgent. A thorough history and simple examination largely identify these so-called 'red flags'. Red flags include neurological signs and symptoms, a history of significant trauma, weight loss and other signs of systemic illness and severe unrelenting pain, especially in those at risk of pathological fractures. Conditions identified in such cases include cauda equina syndrome, fractures (traumatic or pathological), tumours and infection. In patients with no red flags imaging is largely unnecessary. 'Yellow flags' are also discussed with respect to acute lower back pain. These are behavioural and psychosocial factors that make progression to chronic back pain more likely, and that make rehabilitation from acute back pain difficult, and, or undesirable. Problems such as depression, poor job satisfaction and a belief that physical activity can cause further damage fall under this heading. Early identification and intervention can alter this course and ultimately reduce chronic disability ([www.emia.com.au/MedicalProviders/EvidenceBasedMedicine/overview.html](http://www.emia.com.au/MedicalProviders/EvidenceBasedMedicine/overview.html)).

Management of simple mechanical lower back pain has altered significantly in the last few decades. There is now very good evidence that previous recommendations of prolonged bed rest are detrimental, and that staying active and an early return to work are beneficial ([www.emia.com.au/MedicalProviders/EvidenceBasedMedicine/overview.html](http://www.emia.com.au/MedicalProviders/EvidenceBasedMedicine/overview.html), <http://www.acc.co.nz/acc-publications/pdfs/ip/acc1038-col.pdf>, <http://www.health.gov.au/nhmrc/publications/synopses/cp94syn.htm>). Manipulative techniques in the first 4–6 weeks have been shown to improve outcome (<http://www.acc.co.nz/acc-publications/pdfs/ip/acc1038-col.pdf>, Meade et al 1995), as do simple analgesia (e.g. paracetamol)

and heat wraps (<http://www.health.gov.au/nhmrc/publications/synopses/cp94syn.htm>). The evidence for the use of a non steroidal anti-inflammatory drug is conflicting and side effects (in particular gastric mucosal ulceration) are common with long term use (<http://www.health.gov.au/nhmrc/publications/synopses/cp94syn.htm>). Manipulation under anaesthesia and the use of muscle relaxants (e.g. diazepam) have been shown to be harmful (<http://www.acc.co.nz/acc-publications/pdfs/ip/acc1038-col.pdf>). Use of oral opioid analgesia may be necessary to relieve pain in acute stages. If used, a short acting regular drug is preferable for as brief a period as possible. The ongoing need for use should prompt a reassessment of the patient (<http://www.health.gov.au/nhmrc/publications/synopses/cp94syn.htm>).

Patients should have a time frame for their progress and be educated about what to expect. They should be aware that they play an active role in their rehabilitation and should take this on as their responsibility. Those not responding to treatment at 4–12 weeks should be reassessed and considered for specialist referral. They might constitute a group of patients with increased risk of chronification and subsequent complex biopsychosocial consequences.

## References

1. Evidence-Based Management of Acute Musculoskeletal Pain-Australian Acute Musculoskeletal Pain Guideline Group. <http://www.health.gov.au/nhmrc/publications/synopses/cp94syn.htm>
2. Meade TW, Dyer S, Browne W et al. (1995) Randomised Comparison of Chiropractic and Hospital Outpatient Management for Low Back Pain: Results from Extended Follow-Up. *BMJ* 311:349–351
3. Overview of Clinical Guidelines for the Management of Acute Lower Back Pain. [www.emia.com.au/MedicalProviders/EvidenceBasedMedicine/overview.html](http://www.emia.com.au/MedicalProviders/EvidenceBasedMedicine/overview.html)
4. The New Zealand Acute Lower Back Pain Guide. <http://www.acc.co.nz/acc-publications/pdfs/ip/acc1038-col.pdf>

## Lower Back Pain, Physical Examination

PATRICK B. SENATUS, CHRISTOPHER J. WINFREE  
Department of Neurological Surgery, Neurological  
Institute, Columbia University, New York, NY, USA  
[cjw12@columbia.edu](mailto:cjw12@columbia.edu)

## Synonyms

Distraction Signs; Inflammatory Syndrome; Lumbago; Lumbosacral; Mechanical Syndrome; Myofascial syndrome; Neural Compressive Syndrome; Neurogenic Claudication; Neuropathic Syndrome; Paravertebral Muscle; Provocative Maneuver; Psychosocioeconomic Syndrome; Radiculopathy; Sacroiliac joint; Schrober's Test; Sciatic Notch; Spondylolisthesis; Straight-Leg-Raising Sign

## Definition

Component of the clinical evaluation focusing on the region between L1 above and S1 below and the paravertebral erector spinae muscles laterally (Merskey 1994), relying on inspection palpation, and physical maneuvers to elicit signs and reproduce symptoms in the diagnosis of low back pathology.

## Characteristics

### Goals

The physical examination of the lower back is an essential part of the evaluation of disorders stemming from this region, particularly lumbago and sciatica. The diagnosis of back pain is complex and must distinguish among disparate entities such as ► **myofascial** syndrome, in which pain is derived from ligamentous and muscular soft tissue; mechanical syndrome, in which instability and abnormal motion across joints and ligaments causes pain; neural compressive syndrome, in which pain derives from pressure on individual nerve roots or the cauda equina; ► **inflammatory** syndrome, in which pain is derived from inflammatory diseases such as osteomyelitis, diskitis, or ankylosing spondylitis; osteogenic syndrome, in which pain is derived from bone itself such as with compression fractures and bony metastasis; neuropathic syndrome, in which pain is of neural origin arising from permanent injury to peripheral nerves, nerve roots, or spinal cord; and finally ► **psychosocioeconomic** syndrome, in which a major contributor to pain is personality dysfunction, depression, or secondary gain. Therefore, when presented with a patient for evaluation the clinician must keep in mind the broad differential diagnosis from which to select the etiology of the patient's ailment (Kirkaldy-Willis 1983).

After a focused detailed history of present illness is obtained, a directed physical examination is undertaken. It should proceed in a fashion as to test, rule out, and distinguish among items on the differential diagnosis. Moreover, it should be used in conjunction with the history to guide and justify further examination including static and dynamic imaging, serological studies, and invasive provocative tests such as discography.

### Inspection

The examination begins with a general inspection to determine the patient's overall state of comfort, pain, posture, and gait. The inability to achieve a stable comfortable position while standing or seated may speak to the intensity and nature of the cause of the disease. A persistent flexed posture may be reflective of neural compressive syndrome, as that would tend to alleviate pressure on neural elements that would be exacerbated by hyperextension. Asymmetric gait, or favoring of one extremity, may point to lateralizing ► **radiculopathy**. Neurogenic claudication, manifesting as bilateral diffuse leg

pain on standing or walking, is indicative of spinal stenosis.

From a lateral vantage point, the transition from the thoracic ► **kyphotic** curve to the lumbar lordotic curve must be assessed. Deviation from the expected degrees of curvature may be indicative of pathology. Loss of lumbar lordosis may be a sign of lumbar spondylopathy as the lumbar spine attempts to straighten itself to minimize neural compression and deleterious force vectors. Exaggerated lumbar lordosis may indicate ► **spondylolisthesis**. From a posterior vantage point, any lateral or scoliotic curve should be noted. The spinous processes for T1 down should lie along a straight line that should extrapolate through the gluteal cleft. Disparities with respect to shoulder level, the level of the iliac crests, and symmetry of gluteal folds may result from scoliosis or other vertebral abnormalities. Asymmetry of ► **paraspinal** musculature may indicate spasm or underlying scoliosis.

Tufts of hair, ► **melanotic** or vitiliginous patches, lipomas, skin dimples, or draining sinuses should raise the suspicion for occult spinal ► **dysraphism** that may require further investigation.

Inspection under dynamic conditions can yield important diagnostic data. As a patient rotates the shoulder with respect to the hips, bends forward, backward, and laterally, the range of motion, smoothness, symmetry, and changes in the lumbar curvature should be noted. Decreased mobility may point to ankylosing spondylitis, osteoarthritis, or paravertebral muscle spasm as causes of pain.

Schrober's test, in which the change in distance between two points (one 10 cm above S1 and one 5 cm below S1) during maximal forward bending, can be used to quantify restricted mobility. An increased distance of less than 5 cm is abnormal and may point to ankylosing spondylitis (Karnath 2003).

Exacerbation of symptoms on forward bending may point to myofascial syndrome as an etiology. ► **Amelioration** of symptoms on forward bending and exacerbation on hyperextension suggest spinal stenosis. Asymmetric exacerbation on lateral bending or rotation may point to paracentral or laterally herniated disk.

### Palpation

Palpating the lower back in standing, sitting, and prone positions can be informative. Feeling the spines and spinous interspaces can help discern relationships between adjacent vertebrae. Unusual prominence of a spinous process may be a sign of spondylolisthesis or retrolisthesis of one body with respect to the other. Unusual prominence of an interspace may signal disruption or incompetence of posterior spinal elements. If palpation or gentle percussion of the spine causes pain, this raises the specter of fracture, malignancy, diskitis, or osteomyelitis, which may require further work up. Tenderness of the paravertebral muscle, spinous pro-

cess, intervertebral joint and sacroiliac notch, may be indicative of intervertebral disc herniation.

#### Provocative Maneuvers

Provocative maneuvers are helpful in determining the etiology of low back pain. The ipsilateral and crossed straight leg raising (iSLR and cSLR) tests should be performed in patients in whom radiculopathy is suspected. With the patient lying supine, a positive iSLR sign is obtained if elevation of the ipsilateral lower extremity to between 30 and 60 degrees reproduces sciatica. With the patient in the same position, a positive cSLR sign is obtained if elevation of the contralateral lower extremity reproduces sciatica in the ipsilateral lower extremity. Ipsilateral SLR sign has high sensitivity but low specificity whereas the crossed SLR has both high sensitivity and specificity. These tests can be performed in the seated position to elicit distraction signs used to rule out overlay.

#### Psychosocioeconomic Syndrome

As depression, personality dysfunction, somatization, and secondary gain can affect the experience of disease and how it is expressed, the clinician should be cognizant of inconsistencies and non-physiologic findings that suggest supratentorial overlay or psychosocioeconomic syndrome. Overreaction during physical examination, inappropriate tenderness that is too generalized or too superficial, pain on simulated but not actual rotation of the spine or on simulated axial loading, regional impairment of strength or sensation that fails to conform to radicular or dermatomal distributions, and positive distraction signs, such as inconsistent performance during distracting maneuvers, can help the clinician identify psychosocioeconomic syndrome (Waddell et al. 1980).

#### References

1. Bates B (1995) The Musculoskeletal System. In: Bates B (ed) A Guide to Physical Examination and History Taking, 6<sup>th</sup> edn. JB Lippincott Company, Philadelphia, pp 477–478
2. Karnath B (2003) Clinical Signs of Low Back Pain. Hospital Physician 39:39–44
3. Kirkaldy-Willis WH (1983) The Pathology and Pathogenesis of Low Back Pain. In Kirkaldy-Willis WH (ed), Managing Low Back Pain. Churchill Livingstone, Philadelphia, pp 23–44
4. Merskey H, Bogduk N (1994) Classification of Chronic Pain: Descriptions of Chronic Pain Syndromes and Definitions of Pain Terms. 2<sup>nd</sup> edn. IASP Press, Seattle, pp 11–36
5. Sybert G, Arpin-Sybert E (2004) Evaluation and Management of the Failed Back Syndrome. In: Winn HR (ed) Youmans Neurological Surgery, 5<sup>th</sup> edn. Saunders, Philadelphia, pp 4327–4345
6. Waddell G, McCulloch JA, Kummel E et al. (1980) Nonorganic Physical Signs in Low-Back Pain. Spine 5:117–125

## Lower Gastrointestinal Tract Pain Models

- ▶ Visceral Pain Model, Lower Gastrointestinal Tract Pain

## Low-Level Laser Therapy

- ▶ Laser

## Low-Threshold Calcium Channels

- ▶ Calcium Channels in the Spinal Processing of Nociceptive Input

## Low-Threshold VDCCs

- ▶ Calcium Channels in the Spinal Processing of Nociceptive Input

## Low-Voltage Calcium Channels

- ▶ Calcium Channels in the Spinal Processing of Nociceptive Input

## LSN

- ▶ Lateral Spinal Nucleus

## LSP

- ▶ Laser Silent Period

## LT Neurons

- ▶ Low Threshold Neuron

## LTP

- ▶ Long-Term Potentiation

## LTR

- ▶ Local Twitch Response

## LTR Locus

- ▶ Sensitive Locus



## LTS

- ▶ Low Threshold Calcium Spike

## LTS Burst

- ▶ Low Threshold Calcium Spike Burst

## Lumbago

### Definition

Pain in the back occasionally radiating into the buttocks.

- ▶ Chronic Back Pain and Spinal Instability
- ▶ Lower Back Pain, Physical Examination
- ▶ Radiculopathies

## Lumbar Disc Stimulation

- ▶ Lumbar Discography

## Lumbar Discogram

- ▶ Lumbar Discography

## Lumbar Discography

DAVID DIAMANT  
Neurological and Spinal Surgery, Lincoln, NE, USA  
ddiamant@neb.rr.com

### Synonyms

Lumbar Discogram; provocation discography; provocative discography; Lumbar Disc Stimulation

### Definition

Lumbar discography is a diagnostic procedure designed to test if a patient's pain arises from a lumbar intervertebral disc. It involves injecting contrast medium into the disc in an effort to reproduce the patient's pain.

## Characteristics

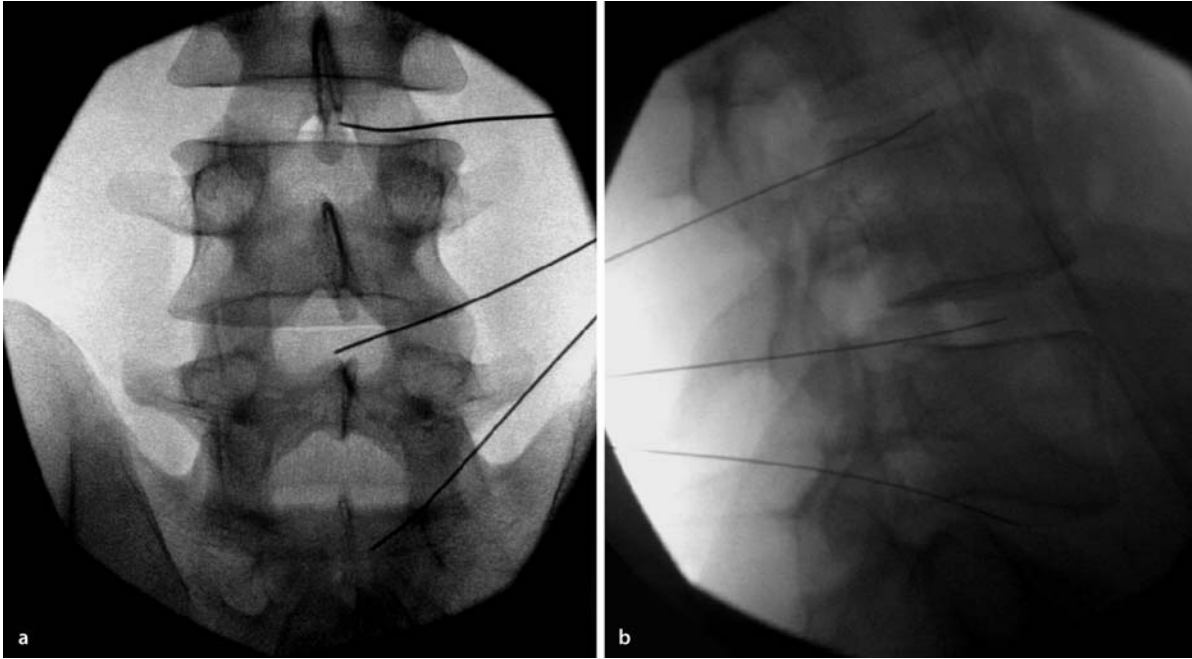
### Principles

Since they are innervated, the lumbar intervertebral disc can be a source of low back pain (Bogduk 1983). However, there are no conventional means, such as ▶ [musculoskeletal examination](#) or medical imaging, whereby it can be determined if a particular disc is painful or not. For this reason, lumbar discography was adopted and used as the only available means to test if a disc was painful.

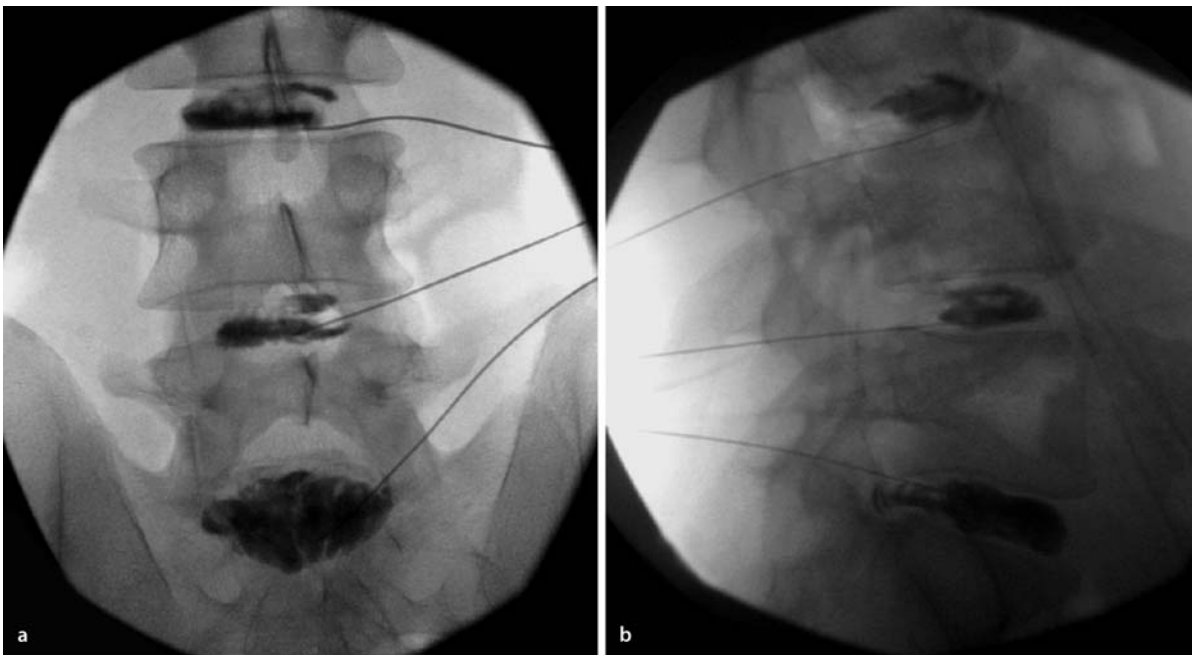
The test is analogous to palpation for tenderness, but because lumbar discs are inaccessible to palpation, needles must be used. The needle is used to stress the disc by injecting contrast medium into its nucleus. Contrast medium will outline the internal structure of the disc. This process is described as discography. It verifies that the disc has been correctly injected, but is not the critical component of the test. Critical, is whether or not stressing the disc reproduces the patient's accustomed pain. This phase is called disc stimulation.

### Technique

With the patient prone on the x-ray table, and their lumbar area prepped in sterile fashion, a needle is inserted into the target disc via a posterolateral approach through the skin and muscles of the back. Once the needle has been correctly placed (Fig. 1), a pressure transducer is connected to the needle, and contrast dye, mixed with antibiotic, is injected into the nucleus pulposus in a relatively rate controlled fashion (Fig. 2). The flow of contrast medium, the pressure within the disc during injection, and the patient's response to injection are all simultaneously monitored. The nucleus pulposus of a typical lumbar disc may contain between 1.5–2.5 cc of such solution (Aprill 1991). Spread of contrast medium from the nucleus pulposus into the annulus fibrosus may be associated with the onset of pain. It is the pain response, in accordance with a visualized anular spread of dye, which is of critical importance when interpreting the study. When diagnosing the lumbar disc as the pain generator, injection of the disc must provoke reproduction of the patient's typical pattern of pain (concordant pain). Stimulation of an asymptomatic disc will typically not cause such pain, or it will cause pain in an atypical (non-concordant) pattern. Pain patterns may be isolated to the lumbar area, or they may encompass areas that are topographically separated from the site of pathology, such as the buttock and/or lower limb. The manner in which contrast medium spreads within the disc is salient for interpretation of the study. Although visualization of such spread can be attained fluoroscopically, it is best appreciated by computerized tomography (CT) scan. In order to accept a disc as the pain generator, not only must concordant pain have been elicited during disc stimulation, but an internal tear extending at least to the outer one third of the



**Lumbar Discography, Figure 1** Radiographs of needles placed for L3, L4, and L5 discography. (a) AP view. (b) Lateral view. Reproduced courtesy of the International Spinal Intervention Society (2004).



**Lumbar Discography, Figure 2** Radiographs of an L3, L4, and L5 discogram, after injection of contrast medium. (a) AP view. (b) Lateral view. Reproduced courtesy of the International Spinal Intervention Society (2004).

posterior or posterolateral disc must be evident on the CT scan. These features correlate significantly with the reproduction of pain (Moneta et al. 1994). Some 70% of fissured discs are painful, and some 70% of painful discs exhibit radial fissures (Vanharanta et al. 1987). If fissures are evident, the diagnosis becomes one of internal disc disruption (Merskey and Bogduk 1994;

Bogduk and McGuirk 2002). However, further data is necessary from this procedure in order to accept a particular disc as a pain generator.

Although reproduction of concordant pain is a necessary step in the diagnosis of discogenic pain, discographic study of an adjacent disc or discs is not ideally associated with concordant pain reproduction. According to

the standards of the International Spinal Intervention Society (2004), the diagnosis of lumbar discogenic pain is most robust if stimulation of a single disc reproduces concordant pain, while stimulation of two adjacent discs does not. Furthermore, the intensity of concordant pain must be of moderate or severe magnitude in order to consider that disc a significant pain generator. In diagnosing lumbar discogenic pain, observation of the pressure within the disc, at the development of moderate to severe concordant pain, is of importance. A certain amount of pressure (known as opening pressure) is necessary to induce flow of contrast dye into the nucleus pulposus. Once this is ascertained, then the pressure at which concordant pain is reproduced is determined and recorded. If concordant pain occurs at relatively low pressure, e.g. 15 pounds per square inch (psi) or less above the opening pressure, then the response is considered positive. If concordant pain occurs at a pressure of 15–50 psi above opening pressure, then the pain response is indeterminate, possibly being positive. If concordant pain occurs at greater than 50 psi over opening pressure, then such a concordant pain response cannot be considered positive, since there is no way to reliably differentiate whether pain occurred from significant mechanical stimulation, which may cause pain in a normal disc (Carragee et al. 2000), or from pain as a result of internal disc disruption. Therefore, according to standard (International Spinal Intervention Society 2004), the intervertebral disc is deemed to be the generator of an individual's pain if the following criteria are met:

1. Stimulation of the target disc reproduces the patient's accustomed pain.
2. Stimulation of adjacent discs does not reproduce their pain.
3. Pain is produced at a pressure of injection of not greater than 50 psi, and preferably at a pressure less than 15 psi.
4. The evoked pain has an intensity estimated by the patient as greater than 6, on a 10-point numerical pain rating scale.

### Validity

In order for lumbar provocation discography to be valid, it must be demonstrated that the four criteria previously listed are adhered to. If these criteria are satisfied, the diagnosis becomes one of discogenic pain. False-positive results can occur due to technical errors, neurophysiological phenomena and/or psychological factors. Some investigators have warned that discography can be false-positive, on the grounds that discs can be painful when stimulated in asymptomatic volunteers (Carragee et al. 2000). However, the false-positive rate can be kept to less than 10% if the diagnostic criteria are strictly observed (International Spinal Intervention Society 2004).

Stimulation of the anulus fibrosus, either by injecting into it or by moving the needle within it, can be painful. Accepting a concordant pain response secondary to such an event would be inappropriate in the context of this procedure, as injection must be within the nucleus pulposus while the needle is not otherwise being manipulated. Acceptance of concordant pain that is of mild intensity does not necessarily implicate that disc as one's pain generator, as one of the principal diagnostic tenets for symptomatic internal disc disruption is moderate to severe concordant pain reproduction. Acceptance of concordant pain reproduction at manometric pressures greater than 50 psi above opening pressure would be inappropriate, as high intradiscal pressures have been noted to evoke pain in asymptomatic individuals (Carragee et al. 2000). Acceptance of concordant pain without significant anular disruption would violate the principles of this test, as only the outer one-third of the anulus fibrosus is definitively known to be innervated. Lastly, in those with somatisation disorder, it has been noted that lumbar provocation discography may result in false-positive responses (Carragee et al. 2000).

### Applications

The cardinal purpose of provocation discography is to establish if a patient's back pain is due to discogenic pain (internal disc disruption). The diagnostic utility is to provide a diagnosis, and thus help the clinician in planning treatment of such pain. Treatment options include palliative care or surgical management, such as interbody fusion, disc replacement, or ► [intradiscal electrothermal therapy](#). It has been shown that provocation discography in the lumbar spine can assist in predicting outcomes of surgical and non-surgical management of symptomatic internal disc disruption (Derby et al. 1999).

### References

1. Aprill CN (1991) Diagnostic Disc Injection. In: Frymoyer JW (ed) *The Spine: Principle and Practice*. Raven Press, New York, pp 45–84
2. Bogduk N (1983) The Innervation of the Lumbar Spine. *Spine* 8:286–293
3. Bogduk N, McGuirk B (2002) Causes and Sources of Chronic Low Back Pain. In: Bogduk N, McGuirk B (eds) *Medical Management of Acute and Chronic Low Back Pain. An Evidence-Based Approach*. Elsevier, Amsterdam, pp 113–125
4. Carragee EJ, Truong T, Rossi M, Hagle C (2000) The Rates of False-Positive Lumbar Discography in Select Patients without Low Back Symptoms. *Spine* 25:1373–1381
5. Derby R, Howard MW, Grant JM, Lettice JJ, Van Peteghem PK, Ryan DP (1999) The Ability of Pressure-Controlled Discography to Predict Surgical and Non-Surgical Outcomes. *Spine* 24:364–372
6. International Spinal Intervention Society (2004). *Lumbar Disc Stimulation*. In: Bogduk N (ed) *Practice Guidelines for Spinal Diagnostic and Treatment Procedures*. International Spinal Intervention Society, San Francisco
7. Merskey H, Bogduk N (eds) (1994) *Classification of Chronic Pain. Descriptions of Chronic Pain Syndromes and Definitions of Pain Terms*, 2nd edn. IASP Press, Seattle, p 179
8. Moneta GB, Videman T, Kaivanto K, Aprill C, Spivey M, Vanharanta H, Sachs BL, Guyer RD, Hochschuler SH, Raschbaum

- RF, Mooney V (1994). Reported Pain during Lumbar Discography as a Function of Anular Ruptures and Disc Degeneration. A Re-Analysis of 833 Discograms. *Spine* 17:1968–1974
9. Vanharanta H, Sachs BL, Spivey MA, Guyer RD, Hochschuler SH, Rashbaum RF, Johnson RG, Ohnmeiss D, Mooney V (1987) The Relationship of Pain Provocation to Lumbar Disc Deterioration as Seen by CT/Discography. *Spine* 12:295–298

## Lumbar Epidural Steroids

- ▶ Epidural Steroid Injections

## Lumbar Facet Denervation

- ▶ Lumbar Medial Branch Neurotomy

## Lumbar Facet Rhizolysis

- ▶ Lumbar Medial Branch Neurotomy

## Lumbar Lordosis

### Definition

The lumbar lordosis is the anterior concavity in the curvature of the lumbar spine as viewed from the side.

- ▶ Lumbar Traction

## Lumbar Medial Branch Blocks

PAUL VERRILLS  
Metropolitan Spinal Clinic, Prahran, VIC, Australia  
verrills@bigpond.net.au

### Definition

Lumbar medial branch blocks are a diagnostic procedure used to determine if a patient's pain arises from a lumbar zygapophysial joint. They involve anaesthetising the nerves that innervate the joint or joints suspected of being the source of pain.

### Characteristics

The lumbar zygapophysial joints are a common source of chronic low back pain. In younger aged, injured workers with chronic low back pain the prevalence of lumbar zygapophysial joint pain is about 15% (Schwarzer et al. 1994). In older, non-injured patients, the prevalence may be as high as 40% (Schwarzer et al. 1995). This pain, however, cannot be diagnosed by ▶ [medical history](#), ▶ [musculoskeletal examination](#), or medical imaging. Diagnostic blocks are the only means by which to establish the ▶ [diagnosis](#).

### Validity

Although lumbar zygapophysial joint pain can be diagnosed by intra-articular blocks, that type of block has not been validated. Nor have they been shown to have therapeutic utility. In contrast, ▶ [lumbar medial branch blocks](#) have been validated.

Of the structures innervated by the medial branches of the lumbar dorsal rami, the zygapophysial joints are the only ones known to be possible sources of chronic pain. There is no evidence to support the competing proposition, that chronic pain can arise from the specific segments of the muscles innervated by individual medial branches (Bogduk et al. 1982).

Lumbar medial branch blocks are target specific, provided that precise target points are accurately accessed with needles introduced under fluoroscopic control (Dreyfuss et al. 1997). That is, structures other than the targeted nerves are not anaesthetised by lumbar medial branch blocks.

In 89% of cases, normal volunteers are protected from experimentally induced lumbar zygapophysial joint pain if the appropriate medial branches are anaesthetised (Kaplan et al. 1998). The 11% false-negative rate may be due local vascular puncture and repositioning of the needle (Kaplan et al. 1998).

Lumbar medial branch blocks are preferable to performing intra-articular injections, as they are easier to perform, safer and more expedient. They are also more easily subjected to pharmacological controls.

Medial branch blocks do have therapeutic utility, for they lead to the target-specific treatment of ▶ [radiofrequency neurotomy](#), which has independently been validated as appropriate treatment for lumbar zygapophysial joint pain.

### Control Blocks

Control blocks are essential to minimise false-positive responses. To this end, comparative local anaesthetic blocks are used with a short-acting and a long-acting agent (Barnsley et al. 1993, Lord et al. 1995, International Spine Intervention Society 2004). In clinical practice, these would be lidocaine 2% and bupivacaine 0.5%.

A concordant response would be that the patient reports complete relief of pain for a shorter duration when the short-acting agent is used, and a longer duration of relief when the long-acting agent is used (see ▶ [Peripheral Nerve Blocks](#)). These criteria provide for a highly specific diagnosis of zygapophysial joint pain, but may lack sensitivity. Due to the paradoxically prolonged durations of action of lignocaine, some patients with genuine zygapophysial joint pain may be excluded if these criteria are applied.

More generous criteria would require complete relief of pain on each of the two occasions that the nerves are blocked, irrespective of the duration of relief obtained. These criteria will result in a higher sensitivity but a



lesser specificity, i.e. more patients will be diagnosed as having zygapophysial joint pain, but this will include false-positive cases. Since the treatment of lumbar zygapophysial joint pain is considered safe and otherwise relatively innocuous, false-positive responses are tolerable. Patients are not put at risk, for lack of a correct diagnosis, but may fail to benefit from the treatment. Although placebo-controlled blocks would secure the most valid results, they require three blocks (Lord et al. 1995, International Spine Intervention Society 2004), and are not readily implemented in conventional practice. Meanwhile, comparative local anaesthetic blocks have been shown to be cost-effective (Bogduk and Holmes 2000).

#### Patient Selection

Medial branch blocks are not indicated for acute pain. They are appropriate only for patients with persisting low back pain, for whom a diagnosis is required. A fundamental prerequisite is that serious possible causes of back pain, such as infection, tumours, vascular disease and metabolic disease, have been excluded by careful and thorough ► [medical history](#), ► [musculoskeletal examination](#), ► [neurological examination](#), laboratory tests, and medical imaging if necessary. The working diagnosis should be that of lumbar spinal pain of unknown origin.

#### Contraindications

Absolute contra-indications include bacterial infection, either systemic or localised, in the region that blocks are to be performed, bleeding diatheses or possible pregnancy. Relative contra-indications include allergy to contrast media or local anaesthetics.

#### Technique

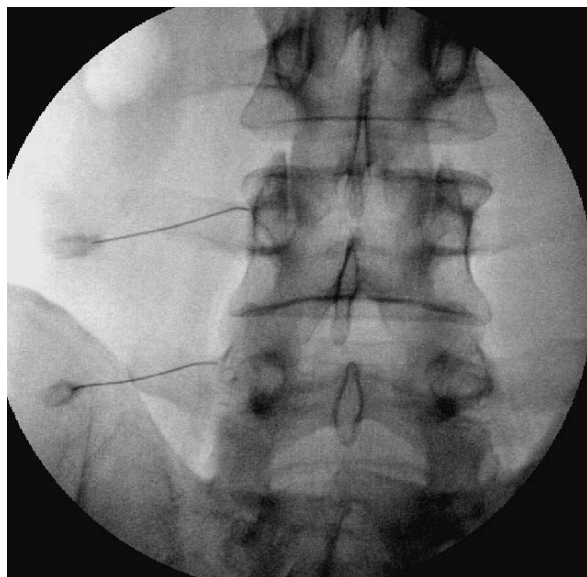
The patient lies prone, and the target points are identified under a C-arm fluoroscope. The target points for the L1 to L4 medial branches are best approached from an oblique view. They lie where the target nerve crosses the junction of the superior articular process and the transverse process, midway between the superior border of the transverse process and the location of the mamillo-accessory notch (Fig. 1).

Correct placement of the needle is confirmed by obtaining a posterior anterior view. A small dose of contrast medium is injected to ensure that there is no venous uptake. Following this, 0.3 ml of local anaesthetic is injected onto the target nerve.

At the L5 level, it is the dorsal ramus proper that is blocked. The target point lies opposite the middle of the base of the superior articular process, and hence, slightly below the silhouette of the top of the ala of the sacrum. An injection point higher or lower than this has an increased risk of foraminal or epidural spread. (Dreyfuss et al. 1997).

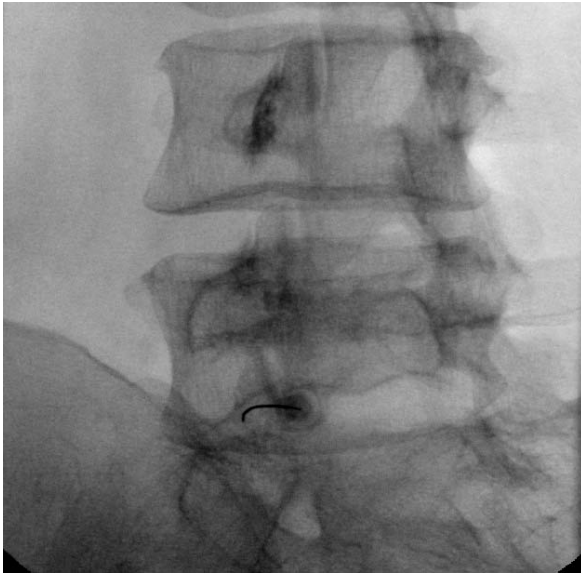


**Lumbar Medial Branch Blocks, Figure 1** An oblique view of the lumbar spine, showing needles in correct position on the roots of the L4 and L5 transverse processes, to block the L3 and L4 medial branches. Reproduced, courtesy of the International Spinal Intervention Society (2004).



**Lumbar Medial Branch Blocks, Figure 2** A postero-anterior view of the lumbar spine, showing needles in correct position on the roots of the L4 and L5 transverse process, to block the L3 and L4 medial branches. Reproduced, courtesy of the International Spinal Intervention Society (2004).

Each zygapophysial joint is innervated from above and below by the medial branch of dorsal rami. Therefore, two nerves need to be blocked for any one joint. For example, an L4 medial branch and L5 dorsal ramus block, anaesthetises the L5/S1 zygapophysial joint; an L3 and L4 medial branch block, anaesthetises the L4/5 zygapophysial joint.



**Lumbar Medial Branch Blocks, Figure 3** An oblique view of the lumbar spine, showing a needle in correct position on the ala of the sacrum, to block the L5 dorsal ramus. Reproduced, courtesy of the International Spinal Intervention Society (2004).

### Evaluation

The optimal means of reducing error and securing reliable diagnostic information is real time assessment. The response to the diagnostic block is evaluated immediately after the block, and for some time afterwards, at the clinic at which the block was performed, and by an independent observer using validated and objective instruments or tools.

Visual analogue scores are recorded before the block, immediately afterwards, at 30 minutes and then hourly. The patient is instructed to monitor the extent and duration of any relief that ensues. Further, if relief occurs, the patient should carefully attempt movements and activities that are usually restricted by pain, to assess their response during the anaesthetic phase.

If the block is negative, then zygapophysial joint pain can effectively be ruled out at the level tested. It is, therefore, common to perform an initial screening block at the L3, L4 and L5 levels, either unilaterally or bilaterally, depending on clinical pain patterns. If such a screening block is negative, one procedure serves to rule out zygapophysial joint pain at the segmental levels most commonly affected.

If the screening block is positive, then further blocks can be undertaken to identify the particular segment or segments responsible. These blocks can target the L5–S1 joint, in the first instance, and subsequently L4–5, if necessary. If the patient has a concordant response for controlled local anaesthetic medial branch blocks, then the putative diagnosis of zygapophysial joint pain is confirmed and the patient can be considered for

► [radiofrequency neurotomy](#) treatment (International Spine Intervention Society 2004).

### References

1. Barnsley L, Lord S, Bogduk N (1993) Comparative Local Anaesthetic Blocks in the Diagnosis of Cervical Zygapophysial Joints Pain. *Pain* 55:99–106.
2. Bogduk N, Holmes S (2000) Controlled Zygapophysial Joint Blocks: The Travesty of Cost-Effectiveness. *Pain Med* 1:25–34
3. Bogduk N, Wilson AS, Tynan W (1982) The Human Lumbar Dorsal Rami. *J Anat* 134:383–397
4. Dreyfuss P, Schwarzer AC, Lau P, Bogduk N (1997) Specificity of Lumbar Medial Branch and L5 Dorsal Ramus Blocks: A Computed Tomographic Study. *Spine* 22:895–902
5. International Spine Intervention Society (2004). Lumbar Medial Branch Blocks. In: Bogduk N (ed). *Practice Guidelines for Spinal Diagnostic and Treatment Procedures*. International Spinal Intervention Society, San Francisco (in press)
6. Kaplan M, Dreyfuss P, Halbrook B, Bogduk N (1998) The Ability of Lumbar Medial Branch Blocks to Anesthetize the Zygapophysial Joint. *Spine* 23:1847–1852
7. Lord SM, Barnsley L, Bogduk N (1995) The Utility of Comparative Local Anaesthetic Blocks versus Placebo-Controlled Blocks for the Diagnosis of Cervical Zygapophysial Joint Pain. *Clin J Pain* 11:208–213
8. Schwarzer AC, Aprill CN, Derby R, Fortin J, Kine G, Bogduk N (1994) Clinical Features of Patients with Pain Stemming from the Lumbar Zygapophysial Joints. Is the Lumbar Facet Syndrome a Clinical Entity? *Spine* 19:1132–1137
9. Schwarzer AC, Wang S, Bogduk N, McNaught PJ, Laurent R (1995) Prevalence and Clinical Features of Lumbar Zygapophysial Joint Pain: A Study in an Australian Population with Chronic Low Back Pain. *Ann Rheum Dis* 54:100–106

## Lumbar Medial Branch Neurotomy

PAUL DREYFUSS

Department of Rehabilitation Medicine, University of Washington, Seattle, WA, USA  
pauldspine@aol.com

### Synonyms

Lumbar Facet Denervation; Lumbar Facet Rhizolysis; Lumbar Radiofrequency Neurotomy

### Definition

Lumbar medial branch neurotomy is a treatment for low back pain stemming from one or more of the zygapophysial joints of the lumbar spine. It involves coagulating the nerves that innervate the painful joint, or joints, with an electrode inserted through the skin. A generator delivers a high-frequency electrical current to the tip of the electrode, which causes the tissues immediately around the tip of the electrode to be heated and, thereby, denatured. Back pain is relieved because nerves incorporated into the heat lesion are made to be unable to conduct nociceptive information from the painful joint or joints (see ► [Radiofrequency Neurotomy, Electrophysiological Principles](#)).

## Characteristics

### Indications

Lumbar medial branch neurotomy is not a treatment for any form of back pain. It is explicitly and solely designed to relieve pain from the zygapophysial joints. Therefore, the singular indication for the procedure is complete, or near complete, relief of pain following controlled, ► **diagnostic blocks** of the nerves innervating the painful joint or joints, i.e. ► **lumbar medial branch blocks**. These blocks must be controlled, because the false-positive rate of uncontrolled blocks is such that responses to single blocks will be false in up to 60% of patients, and those patients will not benefit from the denervation procedure (Schwarzer et al. 1994a; Bogduk and Holmes 2000).

### Setting

The procedure is conducted in a procedure room equipped with a fluoroscope and the necessary apparatus to generate the heat lesion. The procedure is performed under local anesthesia, and no premedication or sedation is required. The patient should be substantially alert in order to report any problems that might occur which threatens their safety. Sedation would be indicated only if the patient is particularly anxious and cannot be relaxed by explanation and assurance; but in that event, the patient must nevertheless always remain conscious.

Typically, the patient will lie face down on a radiolucent table. The physician will cleanse the skin of the back. An x-ray will be taken, using the fluoroscope, in order to identify the target points at which the nerves will be coagulated.

### Technique

Exactly what happens in the procedure depends on the type of electrode used. If a blunt electrode is used, the physician will first place a needle onto the target nerve as for a medial branch block. This is used to anaesthetize the nerve and the surrounding tissues, so as to render painless the heating phase of the procedure. That needle is left in place in order to guide the insertion of the electrode. If a hollow electrode is used, this first step can be circumvented, for the electrode can be used to anaesthetize the nerve prior to producing the heat lesion.

In order to maximize the effect on the nerve and to optimize the relief of pain, the electrodes should be inserted so as to lie parallel to the nerve. This requires inserting the electrode upwards and slightly medially through the skin and back muscles, until it reaches the target position. This lies on the root of the superior articular process (Fig. 1). Once the electrode has been correctly placed, the heating current is gradually increased by about 1°C per second. Raising the temperature slowly provides time for both the patient and the physician

to react if any untoward sensations arise. This could occur if the electrode has dislodged, or the target site was not adequately anaesthetized. The physician can respond before any injury occurs to the patient. Once a temperature of 80° – 85°C has been achieved, it is maintained for about 90 seconds to ensure adequate coagulation of the nerve.

Depending on the patient's anatomy, the physician may readjust the electrode to accommodate variations in the possible location of the target nerve, and will produce another lesion in that new location.

The procedure is repeated for all nerves that were anaesthetized, in order to produce relief of pain during the prior conduct of diagnostic lumbar medial branch blocks.

### Variants

The optimal technique requires that the electrode be placed parallel to the target nerves (Dreyfuss et al. 2000). Under this condition, a maximal length of the nerve is coagulated, which produces a lasting effect on the pain. Some operators, however, use variants in which the electrode is not placed parallel to the nerve, but at some angle to it. This behavior can be traced to older versions of the procedure (Shealy 1975; Shealy 1976; Ogsbury et al. 1977; Mehta and Sluijter 1979; Sluijter and Mehta 1981; Gallagher et al. 1994), which were used before the nature of radiofrequency lesions was fully appreciated (Bogduk et al. 1987). These techniques are suboptimal, for they can fail to coagulate the target nerve, or coagulate only a small section of it. In which case, the nerve regenerates rapidly and pain recurs.

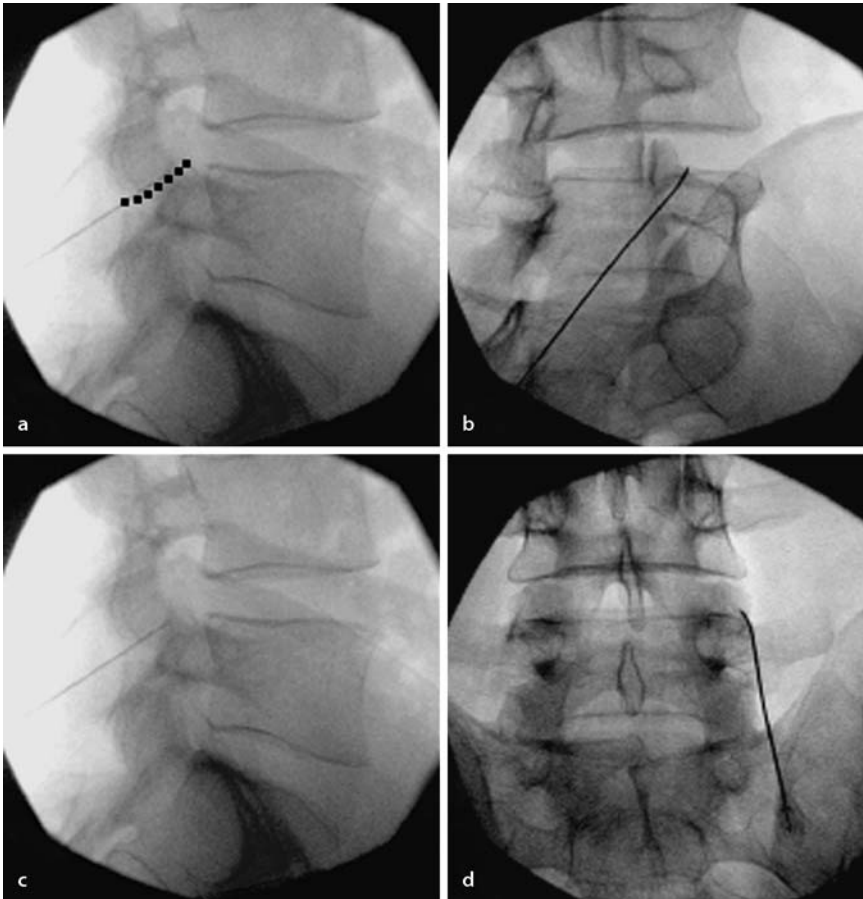
### Efficacy

A controlled trial has shown that the effects of lumbar medial branch neurotomy cannot be attributed to a ► **placebo** response (van Kleef et al. 1999). When correctly performed, the ► **efficacy** of lumbar medial branch neurotomy is genuine.

Provided that patients are correctly selected using controlled lumbar medial branch blocks, good outcome can be expected from lumbar medial branch neurotomy. Relief of pain is not permanent. In time, the coagulated nerves regenerate and may again transmit nociceptive information from the painful joint or joints. The time that it takes for this regeneration to occur depends on how accurately and how thoroughly the nerves were coagulated. If suboptimal techniques are used, little of the target nerve may be coagulated, and it recovers rapidly. If a substantial length of nerve is coagulated, relief of pain may last up to and beyond 12 months. Pain may return gradually; it may not return to its former intensity. In some patients the pain never returns.

If the optimal technique is used, 60% of patients can expect at least 80% relief of their pain, and some 80% of patients can expect at least 60% relief of their pain at 12 months after treatment (Dreyfuss et al. 2000).





**Lumbar Medial Branch Neurotomy, Figure 1** Radiographs showing an electrode in position to coagulate an L4 medial branch. (a) Lateral view showing the course of the nerve depicted by a dotted line. (b) Oblique view. (c) Lateral view. (d) Antero-posterior view.

If pain recurs, and becomes sufficiently intense again as to warrant treatment, lumbar medial branch neurotomy can be repeated in order to reinstate relief. Patients have been successfully treated two, three, and more times, to reinstate and maintain prolonged relief of their pain (Schofferman, in press).

#### Complications

Provided that the correct technique is used, no complications are associated with this procedure. Such complications that are known to be associated with lumbar medial branch neurotomy, incurred in medicolegal proceedings but not published in the literature, have been due to misplacement of the electrode and the use of general anesthesia, which prevented the patient from reporting the onset of complications.

Whereas it may be believed by some that denervating a joint will create a neuropathic joint (Charcot's arthropathy), there is no evidence that this occurs, and no grounds for believing that it would occur. Charcot's arthropathy occurs in limbs that have been completely denervated, in which potentially unstable joints are not protected by muscle activity. In contrast, the zygapophysial joints are intrinsically stable; they are stabilized further by the intervertebral disc, and most of the muscles that act on the affected segment remain functional.

#### Utility

Lumbar medial branch neurotomy is the singular means by which pain from lumbar zygapophysial joints can be eliminated. No other forms of treatment have been shown to be as effective for the treatment of proven lumbar zygapophysial joint pain. Given that the prevalence of lumbar zygapophysial joint pain is about 15% in some populations (Schwarzer et al. 1994b), and as high as 40% in others (Manchikanti et al. 1999; Schwarzer et al. 1995), this procedure has a possible application in a substantial proportion of patients with chronic low back pain.

#### References

1. Bogduk N, Holmes S (2000) Controlled Zygapophysial Joint Blocks: The Travesty of Cost-Effectiveness. *Pain Med* 1:25–34
2. Bogduk N, Macintosh J, Marsland A (1987) Technical Limitations to the Efficacy of Radiofrequency Neurotomy for Spinal Pain. *Neurosurgery* 20:529–535.
3. Dreyfuss P, Halbrook B, Pauza K, Joshi A, McLarty J, Bogduk N (2000) Efficacy and Validity of Radiofrequency Neurotomy for Chronic Lumbar Zygapophysial Joint Pain. *Spine* 25:1270–1277
4. Gallagher J, Petriccione di Valdo PL, Wedley JR, Hamann W, Ryan P, Chikanza I, Kirkham B, Price R, Watson MS, Grahame R, Wood S (1994) Radiofrequency Facet Joint Denervation in the Treatment of Low Back Pain: A Prospective Controlled Double-Blind Study to Assess its Efficacy. *The Pain Clinic* 7:193–198



5. Manchikanti L, Pampati V, Fellows B, Bakhit CE (1999) Prevalence of Lumbar Facet Joint Pain in Chronic Low Back Pain. *Pain Physician* 2:59–64.
6. Mehta M, Sluiter ME (1979) The Treatment of Chronic Back Pain. *Anaesthesia* 34:768–775
7. Ogsbury JS, Simon RH, Lehman RAW (1977) Facet Denervation in the Treatment of Low Back Syndrome. *Pain* 3:257–263
8. Schofferman J Spine (in press)
9. Schwarzer AC, Aprill CN, Derby R, Fortin J, Kine G, Bogduk N (1994a) The False-Positive Rate of Uncontrolled Diagnostic Blocks of the Lumbar Zygapophysial Joints. *Pain* 58:195–200
10. Schwarzer AC, Aprill CN, Derby R, Fortin J, Kine G, Bogduk N (1994b) Clinical Features of Patients with Pain Stemming from the Lumbar Zygapophysial Joints. Is the Lumbar Facet Syndrome a Clinical Entity? *Spine* 19:1132–1137
11. Schwarzer AC, Wang S, Bogduk N, McNaught PJ, Laurent R (1995) Prevalence and Clinical Features of Lumbar Zygapophysial Joint Pain: A Study in an Australian Population with Chronic Low Back Pain. *Ann Rheum Dis* 54:100–106
12. Shealy CN (1975) Percutaneous Radiofrequency Denervation of Spinal Facets. *J Neurosurg* 43:448–451
13. Shealy CN (1976) Facet Denervation in the Management of Back Sciatic Pain. *Clin Orthop* 115:157–164
14. Sluiter M E, Mehta M (1981) Treatment of Chronic Back and Neck Pain by Percutaneous Thermal Lesions. In: Lipton S, Miles J (eds) *Persistent Pain. Modern Methods of Treatment*, vol 3. Academic Press, London, pp 141–179
15. van Kleef M, Barendse GAM, Kessels A, Voets HM, Weber WEJ, de Lange S (1999) Randomized Trial of Radiofrequency Lumbar Facet Denervation for Chronic Low Back Pain. *Spine* 24:1937–1942

## Lumbar Pain

- ▶ [Low Back Pain Patients, Imaging](#)

## Lumbar Plexus

### Definition

A network of nerves originating from the spinal nerves of the 2nd through 4th lumbar nerves. This network provides motor and sensory function to a large portion of the proximal leg, such as knee.

- ▶ [Postoperative Pain, Regional Blocks](#)

## Lumbar Puncture

### Definition

An invasive diagnostic test, in which a needle is inserted into the spinal column at the level between the 3<sup>rd</sup> and the 5<sup>th</sup> lumbar vertebra, to examine cerebrospinal fluid, and measure intracranial pressure.

- ▶ [Headache due to Low Cerebrospinal Fluid Pressure](#)

## Lumbar Radiofrequency Neurotomy

- ▶ [Lumbar Medial Branch Neurotomy](#)

## Lumbar Traction

JUDY CLARKE<sup>1</sup>, ANDREA D. FURLAN<sup>1, 2</sup>, MAURITS VAN TULDER<sup>3</sup>

<sup>1</sup>Institute for Work & Health, Toronto, ON, Canada

<sup>2</sup>Institute for Work & Health, University of Toronto, Toronto, ON, Canada

<sup>3</sup>Institute for Research in Extramural Medicine, Free University Amsterdam, Amsterdam, The Netherlands  
jclarke@iwh.on.ca, mw.vantulder@vumc.nl

### Definition

Traction is one of a wide variety of treatments used for low back pain (LBP). Lumbar traction is applied to stretch the lumbar segment of the spine, generally by putting harnesses around the lower rib cage and around the iliac crest. Traction can be applied through different techniques. The forces can be applied using a motorized pulley (mechanical traction) or by forces exerted by the therapist (manual traction). There are also variations depending on how the forces are applied; the patient may control the forces by grasping pulling bars (auto-traction), traction may be performed with the patient fixed perpendicularly in a deep pool and grasping a bar under the arms (underwater traction) or traction may be given in the bed rest position with forces exerted by a pulley and weights (gravitational traction). Duration and level of force exerted can be varied and force can be applied in a continuous or intermittent mode. Only in mechanical and gravitational traction can the force be standardized.

### Characteristics

It has been suggested that the mechanism by which traction works involves spinal elongation, which through decreasing lordosis and increasing intervertebral space, inhibits nociceptive impulses, improves mobility, decreases mechanical stress, reduces muscle spasm or spinal nerve root compression, releases ▶ [luxation](#) of a disc or capsule from the ▶ [zygo-apophysial joint](#) and releases adhesions around the zygo-apophysial joint and the ▶ [annulus fibrosus](#) (van der Heijden et al. 1995). Proponents of traction claim that LBP patients with radiating symptoms are the ones most likely to benefit from traction (Krause et al. 2000). Some also advise lumbar traction for muscle spasm using appropriately applied traction of adequate force (Geiringer et al. 1993). There is discussion about what constitutes adequate technique and forces for lumbar traction. It has been suggested (Beurskens et al. 1995) that forces below 25% of the body weight are ▶ [placebo](#) treatment, whereas others (Krause et al. 2000) argue that even low force traction can be expected to produce positive results.

### Systematic Review of Lumbar Traction as a Treatment for LBP

A ► [systematic review](#) of ► [randomized controlled trials](#) (RCTs) involving traction was performed in order to determine whether this modality is effective for LBP with or without radiating symptoms. The review was an update of a previous review (van der Heijden et al. 1995) and was conducted under the framework of the Cochrane Collaboration Back Review Group. Detailed information on the methods of the review and the specific RCTs is available in the Cochrane Library (Clarke et al. 2006). The RCTs that were selected involved adults treated for ► [non-specific low back pain](#) (acute, sub-acute or chronic), with or without symptoms radiating below the knee (including radicular pain). Trials could involve any type of traction. The primary outcome measures were pain, global well-being, functional status and return to work. Reported side effects were also considered.

The methodological quality of the RCTs was independently assessed by two reviewers, using Cochrane Collaboration guidelines (van Tulder et al. 2003). Because the studies did not provide sufficient data to enable statistical pooling, we performed a qualitative analysis, summarizing the results of the studies in terms of the strength of the scientific evidence. “Strong evidence” indicates consistent findings among multiple high quality RCTs. “Moderate evidence” means consistent findings among multiple low quality RCTs and / or one high quality RCT. “Limited evidence” means only one low quality RCT. “Conflicting evidence” means inconsistent findings among multiple RCTs. “No evidence” means no RCTs. High quality studies were defined as RCTs that fulfilled 5 or more of the 11 ► [internal validity](#) criteria.

The systematic review included 24 RCTs, 17 of these involved patients with radiating symptoms and in the remaining eight there was a mix of patients with and without such symptoms. Seven studies included solely or primarily patients with chronic LBP (more than 12 weeks); in one study patients were all in the sub-acute range (4–12 weeks); in 12 studies the duration of LBP was a mix of acute, sub-acute and chronic; in five studies duration was not specified. In general, the methodological quality of the RCTs was low. Only five studies were classified as “high quality” studies.

For patients with radiating symptoms, the evidence indicated that continuous or intermittent lumbar traction is not better than placebo, ► [Sham](#), no treatment or other treatments (e.g. spinal manipulation, exercise, corset or infra-red lamp). For mixed groups of patients (with and without radiating pain), the conclusions were the same as stated above; however the strength of the evidence was stronger due to more high quality RCTs in this group. In the trials classifying their control groups as “sham traction” the force applied varied from 1.8–9.1 kg or from 10–20% of body weight. No significant differences were demonstrated in any of these trials.

Although it has been argued that some subgroups of patients may benefit from traction, such as patients with acute radicular pain with concomitant neurological deficit (Krause et al. 2000), the preponderance of evidence on the efficacy of traction comes from studies with methodological problems and potential ► [bias](#), which do not distinguish between subgroups of patients (for example, with differing pain duration and radicular symptoms).

### Conclusion of the Systematic Review

Two recent high-quality studies have strengthened the findings that traction is not indicated in the treatment of LBP. Based on the RCTs currently available in the literature, there is moderate to strong evidence that traction is not an effective treatment for LBP patients, and some suggestion that patients receiving continuous traction are more likely to experience adverse effects, such as increased pain and subsequent surgery.

Regarding side effects, in our systematic review we found one study that mentioned there were no adverse effects, six studies reported some adverse effects (increased pain and more subsequent surgeries) and the remaining studies made no mention of this issue. However, most trials had small sample sizes that were not adequate to evaluate side effects. The few available case reports published in the literature suggest that there is some danger for nerve impingement in heavy traction (i.e. with forces exceeding 50% of body weight). Other potential risks include respiratory constraints due to the traction harness or increased blood pressure during inverted positional traction.

### ► Lumbar Traction

### References

1. Beurskens AJHM, van der Heijden GJMG, de Vet HCW et al. (1995) The Efficacy of Traction for Lumbar Back Pain: Design of a Randomized Clinical Trial. *J Manipulative Physiol Ther* 18:141–147
2. Beurskens AJHM, de Vet HCW, Köke AJA et al. (1997) Efficacy of Traction for Nonspecific Low Back Pain: 12-Week and 6-Month Results of a Randomized Clinical Trial. *Spine* 22:2756–2762
3. Clarke JA, van Tulder MW, Blomberg SEI et al. (2006) Systematic Cochrane review of traction for low back pain with or without radiating symptoms. Cochrane Collaboration Back Group, Toronto, Ontario (submitted)
4. Geiringer SR, Kincaid CB, Rechten JR. (1993) Traction, Manipulation, and Massage. In: DeLisa JA (ed) *Rehabilitation Medicine: Principles and Practice*, 2nd edn. JB Lippincott Company, Philadelphia, pp 440–462
5. Krause M, Refshauge KM, Dessen M et al. (2000) Lumbar spine traction: evaluation of effects and recommended application for treatment. *Man Ther* 5:72–81
6. van der Heijden GJMG, Beurskens AJHM, Koes BW et al. (1995) The efficacy of traction for back and neck pain: a systematic, blinded review of randomized clinical trial methods. *Phys Ther* 75:93–104
7. van Tulder M, Furlan A, Bombardier C et al. and the Editorial Board of the Cochrane Collaboration Back Review Group (2003) Updated method guidelines for systematic reviews in the Cochrane Collaboration Back Review Group. *Spine* 28:1290–1299

## Lumbar Transforaminal Injection of Steroids

JAMES M. BOROWCZYK

Department of Orthopaedics and Musculoskeletal Medicine, Christchurch Public Hospital, Christchurch Clinical School of Medicine and Health Sciences, Christchurch, New Zealand  
jmbor@clear.net.nz

### Synonym

Transforaminal Steroids

### Definition

Lumbar transforaminal injection (TFI) of corticosteroids, is a procedure whereby an aliquot of a given corticosteroid preparation is delivered into the immediate vicinity of a lumbar spinal nerve and its respective roots, by way of the corresponding intervertebral foramen. The procedure is designed as a treatment for lumbar radicular pain.

### Characteristics

#### Background

The first description of the 'epidural' injection of corticosteroid was via the transforaminal route (Robecchi and Capra 1952). This became the standard route of administration in the 1950's and 1960's, but was superseded by the caudal and interlaminar routes in the United States and in Britain in the 1960's, and later in Europe and Scandinavia. These latter routes became the standard for common practice.

In the late 1900's, the beginning of a reversion to the transforaminal route was prompted by a number of factors. These include, among others; reviews suggesting that caudal and interlaminar routes were not as effective as had previously been claimed; an increasing use of transforaminal nerve root injection for radicular pain diagnosis; and subsequently, reports of successful outcomes for transforaminal injection in both observational studies, and later in controlled trials (Vad et al. 2002).

#### Rationale

There is circumstantial evidence that inflammatory processes may play a major role in the production of at least some of the clinical symptoms experienced when a lumbar nerve root is compromised by an intervertebral disc herniation (McCarron et al. 1987; Olmarker et al. 1995; Kang et al. 1995). Corticosteroid delivery to this site of putative inflammation then becomes a logical intervention. This offers a theoretical advantage, in that it targets the site of such inflammation, and may reduce the supposed inflammatory process, presumably through inhibition of phospholipase-A and cellular inflammatory mechanisms (see ► [Radicular Pain](#)). A competing interpretation is that the steroid preparation may exert a long-

lasting local anaesthetic effect (Johansson et al. 1990) on the nerve root, and the dura that surrounds it.

### Efficacy

Observational studies have demonstrated statistical benefits from lumbar TFI. With respect to the conservative and non-surgical management of radicular pain, several authors have reported a benefit from transforaminal epidural injection (Weiner and Fraser 1997; Lutz et al. 1998). Prospective, randomised, controlled, double-blinded studies have also suggested a surgery-sparing effect for lumbar TFI, particularly for the corticosteroid component of the injectate (Riew et al. 2000).

### Indications

Lumbar TFI is advocated for patients with lumbar radicular pain:

- who require pain relief, and
- who have not responded to other non-surgical (conservative) interventions, or
- for whom other non-surgical interventions are deemed inappropriate, and
- whose pain may have an inflammatory basis

### Patient Selection

According to the guidelines set out by the International Spinal Injection Society (2004), selected patients should have symptoms consistent with lumbar or sacral radicular pain that may be amenable to lumbar TFI. Specific signs and symptoms compatible with this include:

- Numbness or paraesthesiae in a dermatomal distribution
- Weakness in a myotomal distribution
- Inhibition of straight-leg raising to 30° or less

Additional confirmatory investigations should ideally include:

- Medical imaging demonstrating a cause of the radicular pain consistent with the clinical findings.
- Medical imaging as above that would theoretically be amenable to lumbar TFI.

Imaging findings which do not constitute intervention with LTFI would include:

- Tumour
- Angioma
- Cysts (with the possible exception of zygapophyseal synovial cysts)
- Arachnoiditis

### Absolute Contraindications

- The (fully informed) patient is unable or unwilling to consent to the procedure
- The use of contrast media is contra-indicated
- There is evidence of an untreated localized infection in the procedural field

- The patient has a bleeding diathesis
- The patient is unable to co-operate during the procedure
- Adequate imaging of the target is difficult or impossible

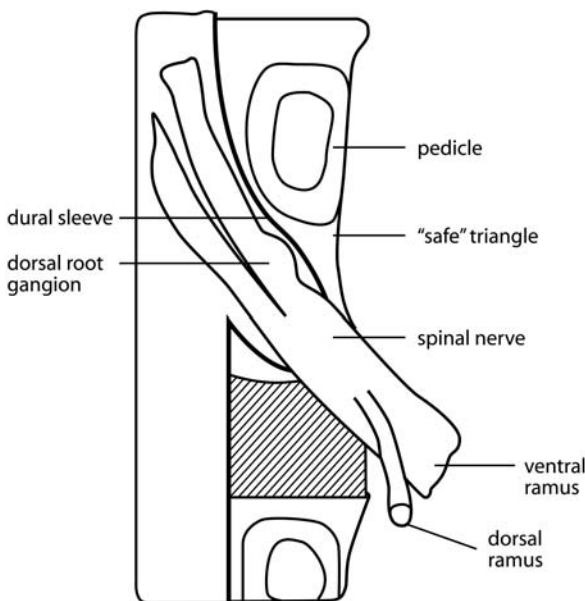
#### Relative Contra-Indications

- Allergy to any of the administrable drugs
- Concurrent use of anticoagulants, or relative anticoagulants
- Anatomical or surgical derangements within the procedural field
- Systemic infection
- Significant co-existing disease
- Immunosuppression
- Pregnancy

#### Technique

Full details of the technique are provided elsewhere (International Spinal Intervention Society 2004). In essence, the procedure requires placing the injectate as close as possible to the target nerve.

This is first facilitated by visualising the appropriate intervertebral foramen under image intensification. Appropriate adjustments of the imaging apparatus are necessary to maximise the ease of approach to the injection site (International Spinal Intervention Society 2004). The point of needle placement should be in the so-called 'safe triangle' (Bogduk et al. 1995a; Bogduk et al. 1995b) (Fig. 1).



**Lumbar Transforaminal Injection of Steroids, Figure 1** A sketch of a lumbar intervertebral foramen, showing the "safe triangle" in relation to the spinal nerve. Reproduced, courtesy of the International Spinal Intervention Society (Riew et al. 2000).



**Lumbar Transforaminal Injection of Steroids, Figure 2** An anteroposterior radiograph of the lumbar spine showing a transforaminal injection at L4-5. Contrast medium outlines the course of the L4 spinal nerve and its roots. Reproduced, courtesy of the International Spinal Intervention Society (Riew et al. 2000).

Upon successfully accessing the target point, needle placement is confirmed by visualisation of the needle tip position against the posterior aspect of the vertebral body, in a lateral radiographic view. Proximity to the nerve is then confirmed in the AP projection by the injection of contrast medium so as to obtain a 'radiculogram', and to confirm that there is no intravascular loss of the contrast medium in 'real-time' imaging (Fig. 2). Having satisfied these criteria, the transforaminal corticosteroid injection may be placed.

#### Complications

Lumbar TFIs are subject to all the possible complications of trans-dermal injection procedures. These include infection, local bleeding, the puncture of adjacent structures, allergy to the various components of the injectate, and adverse vaso-vagal reactions of the injection recipient. With respect to the local anatomy, specific complications include epidural abscess, epidural haematoma, and puncture of the dural sac. Careful and aseptic technique will minimise these risks. Allergic reactions and induced haematomata remain a risk, even with careful patient screening and practised technique. Of the few studies reporting adverse reactions to the procedure, one cited non-positional headache in 4.8% of patients, increased back pain in 4.8%, increased leg pain in 1.6%, and facial flushing (thought to be due to the effect of the corticosteroid component of the injectate) in a further 1.6% (Botwin et al. 2000). Another report cited three patients who suffered paraplegia following the procedure, thought to be due to the inadvertent intravascular injection of colloid corticosteroid into a radicular artery supplying the distal end of the spinal cord (Houten and



Errico 2002). Careful attention to the flow of contrast medium should detect inadvertent placement, or intravascular positioning of the needle, and should avoid such complications.

### Utility

The injection of corticosteroid preparations next to the lumbar nerve root, using the transforaminal approach, has been shown to be a useful modality in the treatment of lumbar ► **radicular pain**. The technique is relatively non-invasive, and carries few inherent dangers to the patients. Whilst not universally effective, it may confer significant benefits to the patient in terms of relief of pain and return to normal function. Studies indicate that in an appropriately targeted population, the technique is more effective than, the previously more commonly used, caudal and interlaminar epidural injections. Lumbar TFI deserves consideration in all cases of lumbar radicular pain where conservative measures have failed, and surgery is the only alternative.

### References

- Bogduk N, Aprill C, Derby R (1995a) Selective Nerve Root Blocks. In: Wilson DJ (ed) *Interventional Radiology of the Musculoskeletal System*. London, Edward Arnold, ch 10, pp121–132
- Bogduk N, Aprill C, Derby R (1995b) Epidural Steroids. In: White AD (ed) *Spine Care, vol 1: Diagnosis and Conservative Treatment*. St Louis, Mosby, ch 22, pp 322–343
- Botwin KP, Gruber RD, Bouchlas CG, Torres-Ramos FM, Freeman TL, Slaten WK (2000) Complications of Fluoroscopically Guided Transforaminal Lumbar Epidural Injections. *Arch Phys Med Rehabil* 81:1045–1050
- Houten JK, Errico TJ (2002) Paraplegia after Lumbosacral Nerve Root Block: Report of Three Cases. *Spine J* 2:70–75
- International Spinal Intervention Society (2004) *Lumbar Transforaminal Injection of Corticosteroids*. In: Bogduk N (ed) *Practice Guidelines for Spinal Diagnostic and Treatment Procedures*. International Spinal Intervention Society, San Francisco
- Johansson A, Hao J, Sjolund B (1990) Local Corticosteroid Application Blocks Transmission in Normal Nociceptive C-Fibres. *Acta Anaesthesiol Scand* 34:335–338
- Kang JD, G.H., McIntyre L et al. (1995) Herniated Lumbar Intervertebral Discs make Neutral Metalloproteinases, Nitric Oxide, and Interleukin-6. *Orthop Trans* 19:53
- Lutz GE, Vad VB, Wisneski RJ (1998) Fluoroscopic Transforaminal Lumbar Epidural Steroids: An Outcome Study. *Arch Phys Med Rehabil* 79:1362–1366
- McCarron RF, WM, Hudkins PG, Laros GS (1987) The Inflammatory Effect of Nucleus Pulposus: A Possible Element in the Pathogenesis of Low Back Pain. *Spine* 12:760–764
- Olmarker K, Blomquist J, Stromberg J, Nanmark U, Thomsen P, Rydevik B (1995) Inflammotogenic Properties of Nucleus Pulposus. *Spine* 20:665–669
- Riew KD, Yin Y, Gilula L, Bridwell KH, Lenke LG, Lauryssen C, Goette K (2000) The Effect of Nerve-Root Injections on the Need for Operative Treatment of Lumbar Radicular Pain. A Prospective, Randomized, Controlled, Double-Blind Study. *J Bone Joint Surg* 82A:1589–1593
- Robecchi A, Capra R (1952) L'idrocortisone (composto F). Prime Esperienze Cliniche in Campo Reumatologico. *Minerva Med* 98:1259–1263
- Vad VB, Bhat AL, Lutz GE, Cammisa F (2002) Transforaminal Epidural Steroid Injections in Lumbosacral Radiculopathy. *Spine* 27:11–16
- Weiner BK, Fraser R (1997) Foraminal Injection for Lateral Lumbar Disc Herniation. *J Bone Joint Surg* 79B:804–807

## Lumbosacral Radiculitis

- Lower Back Pain, Physical Examination
- Sciatica

## Luteal Phase

### Definition

The luteal phase is the time from ovulation to the onset of menses, with an average length of 14 days.

- Premenstrual Syndrome

## Luxation

### Definition

Dislocation.

- Lumbar Traction

## LVCCs

- Calcium Channels in the Spinal Processing of Nociceptive Input

## Lymphokines

- Cytokines as Targets in the Treatment of Neuropathic Pain

## Lysis of Adhesions

### Definition

An invasive procedure performed in the epidural space with a catheter. Solutions are injected to expand scar tissue in hopes of relieving pressure on nerve roots inside the spine.

- Sciatica



## M1

- ▶ Primary Motor Cortex

## MAC

- ▶ Minimal Alveolar Concentration

## Magnetic Resonance Imaging

PETER LAU

Department of Clinical Research, Royal Newcastle Hospital, University of Newcastle, Newcastle, NSW, Australia  
peterclau@hotmail.com

### Synonyms

MRI; Nuclear Magnetic Resonance; NMR

### Definition

Magnetic resonance imaging (MRI) is a means of obtaining images of the internal structure of the body based on the detection of radio-frequency waves emitted from the body under special conditions when it has been placed in a magnetic field.

### Characteristics

#### Principles

Approximately 63% of the atoms in the human body are hydrogen atoms, largely in the forms of fat or water. These hydrogen atoms consist of an electron cloud and a nucleus containing a single proton. The proton behaves as a tiny magnet with a north and south pole. The proton has a property called spin, which acts as a small magnetic field. When placed in an external magnetic field, the magnetic fields of the protons are forced to align with the external field. However, the alignment is not perfect. There are protons lining up with and against the external magnetic field. The distribution is uneven as it takes less energy for a proton to line up with than against the external magnetic field. Slightly more protons therefore line up with than against the

external magnetic field, resulting in a net magnetization of the human body. This net magnetization is measured to make the MR images.

However, the net magnetization cannot be measured while it is lined up with the magnetic field of the MR system. By tilting the net magnetization away from its alignment with the magnetic field of the MR system, the protons of the body generate the signals that are used to make the MR images.

The net magnetization of the protons behaves like a spinning top on a table; it wobbles around before finally falling over. This phenomenon is called PRECESSION. Precession is simply the wobbling motion of the net magnetization of a group of the body's protons around the main magnetic field of the MR system.

The speed at which magnetization precesses is described by the Larmor equation

$$f = K \times B$$

where

f = Precessional or Larmor frequency (in MHz)

K = the gyromagnetic ratio = 42.6 MHz per Tesla (for hydrogen nuclei)

B = Magnetic field (in Tesla)

The net magnetization is tilted by an RF pulse called the excitation pulse. The RF energy tilts the net magnetization from the longitudinal plane to the transverse plane. After the RF pulse is turned off, the natural tendency of the net magnetization of the protons is to realign with the external magnetic field from the transverse plane back to the longitudinal plane. During this process, which is called RELAXATION, energy that was absorbed by the excitation pulse is released back into the surrounding molecular environment in the form of radio waves, which are measured as RF signals.

The amount of energy released by the relaxation process of a decaying proton is small. Therefore, its emission is faint. However, if a radiofrequency excitation pulse is again transmitted into the body, it effectively bounces the proton's net magnetization back into the transverse plane, from which its precession once again decays. As it does so, it again emits the same amount of energy at the same rate as before. By repeating this process, the behavior of the proton can be studied repeatedly. Each faint signal is repeated and a cumulative consistent signal that is no longer faint can be harvested. This repetitive

process is the basis of Pulse Sequences such as spin echo and fast spin echo sequences.

In different molecules and in different tissues, the precessions of protons decay at different rates. Consequently, at different times after the commencement of decay, different tissues emit radio waves of different intensities. By sampling emissions at various selected times, a picture can be generated of different tissues according to the energy that they are emitting at that time. By exploiting the properties of frequency (how fast the net magnetization of the protons is precessing) and phase (the direction in which the net magnetization of the protons is pointing), the sampling of each RF excitation pulse forms the basis of encoding anatomically where within a slice of the body specific echo information originated. Furthermore, by exploiting variations in the gradient strengths of the external magnetic field in the X, Y and Z axes, the net magnetization of the precessional frequency of the protons can be varied. This variation will allow sampling in different slice locations and thickness in all three planes (The MR CrossTrainer Study modules, Medical Imaging Consultants, Inc).

By recording the emissions across various diameters of the body, a computer can be used to synthesize a virtual anatomical image of the internal structure of the body,

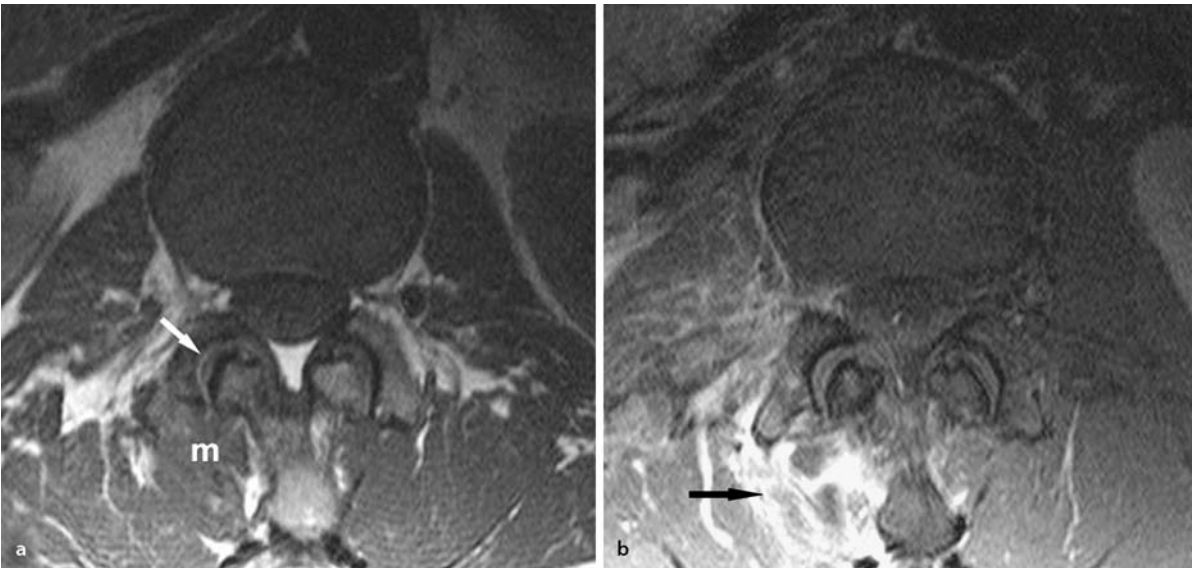
based on the inferred source of the emissions. These images can be printed as views at any depth across any plane, but sagittal, axial and coronal or oblique views are typically used. By varying the sampling times and other variables such as the timing of radiofrequency pulses, the images obtained can focus on different types of tissues. The terms T1 and T2 refer to different time constants that apply to the net magnetization decay behavior of protons. Images based on these constants are referred to as T1-weighted and T2-weighted, respectively.

In general, T1-weighted signals generate images of solid structures, such as muscles and bones and are used to assess the anatomical details of body structures. T2-weighted signals generate images of more fluid tissues and are used for tissue differentiation, particularly in pathological states. Fat and water have similar signal intensities under normal conditions, but a particular pulse sequence, known as fat saturation, can be used to suppress signals from fat, so that fatty tissue signals can be differentiated from water signals. This becomes relevant when signals from inflammatory exudates need to be differentiated from normal fatty tissue signals. In clinical practice, external magnets of low, mid and high field strengths can be used, ranging in strength from 0.3 to 1.5 Tesla. Super-high field strength magnets are



**Magnetic Resonance Imaging, Figure 1** A sagittal MRI scan showing a metastasis in a thoracic vertebral body, crossing the intervertebral disc into the next vertebral body. (a) T1-weighted image. (b) T1-weighted image with gadolinium enhancement. The gadolinium shows the increased vascular activity of the tumour as a white signal.





**Magnetic Resonance Imaging, Figure 2** Axial MRI scans of a septic arthritis of a right L1-2 zygapophysial joint. (a) The joint on the right exhibits a slightly bright signal in its cavity (arrow) compared with the opposite side. In addition, the architecture of the multifidus (m) is distorted compared with the other side. (b) Administered intravenously, gadolinium enhances the oedema in the multifidus behind the infected joint, rendering it bright white (arrow).

reserved for research purposes, but recently, 3 Tesla units have become commercially available. The drive to higher field strength magnets is driven by higher signal to noise ratios and greater speed of imaging. As field strength increases however, safety issues increase. These include not only the need for greater magnetic shielding but also possible adverse biological effects, although to date, there have been no significant reported clinical side-effects. Body heating and possible superficial burns have been reported, but these have been attributed to faulty equipment such as surface coils and unsuspected internal metallic objects, rather than to the magnetic field itself (Shellock 2000).

### Applications

Of all medical imaging tests, MRI has the highest sensitivity and highest specificity. It can detect lesions, such as tumours, infections and osteonecrosis, early in their evolution (Figs. 1, 2). Moreover, it allows these lesions to be specifically identified. No other imaging test has these properties. MRI defines soft tissue lesions as clearly as, or better than, ultrasound. For these reasons MRI has assumed a paramount position in imaging for general medical conditions. Its relevance in pain medicine, however, is more limited.

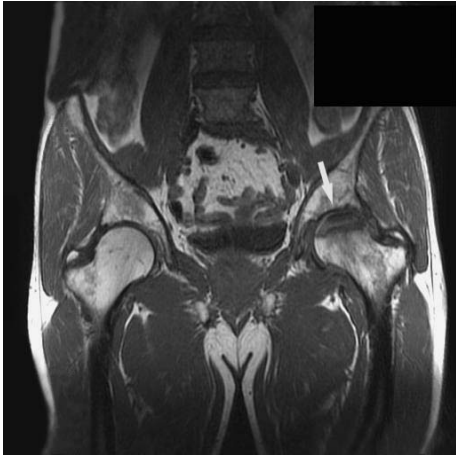
The cardinal application of MRI in pain medicine is as a screening test to detect occult or cryptic lesions that do not manifest distinctive clinical features. Such lesions, however, are unusual and rare. Consequently, when MRI is used as a screening test, the default expectation is that it will not reveal lesions. Under those conditions, MRI is used to clear patients of serious disorders such as tumours, infection or osteonecrosis.

In neurology, headache is a common clinical problem. Some 10–15% of MR studies are undertaken for headache but fewer than 1% of these investigations reveal significant pathology. Apart from tumours and infections, subarachnoid haemorrhage due to a leaking aneurysm in the circle of Willis can be demonstrated by MRI and by MR-angiography. This has the advantage of being non-invasive and avoids the complications of a more invasive procedure such as four-vessel cerebral angiography. MRI can be used to diagnose headaches due to changes in pressure of cerebrospinal fluid (CSF), benign intracranial hypertension, idiopathic low CSF pressure and post-traumatic CSF leakage.

In musculoskeletal medicine, MRI is the best way to detect osteonecrosis (Fig. 3). For this condition, MRI is both sensitive and specific and is able to detect changes earlier than plain radiography or CT or even bone scan. MRI is also able to measure the size of the osteonecrotic bone fragment.

Because of its better resolution of nerves and its ability to provide coronal and sagittal images as well as axial images, MRI is the preferred means of investigating radiculopathy (Fig. 4). The dorsal root ganglion, the spinal nerve roots and nerve-root sleeves can be clearly differentiated from the adjacent dura and the CSF in the spinal canal, making assessment of nerve root compression more reliable than is possible by CT.

Its ability to demonstrate the internal structure of intervertebral disks accords MRI a unique role in the investigation of chronic back pain. Some 30% of patients with low back pain exhibit a high intensity zone in one of their disks (April and Bogduk 1992). This zone is a bright spot located in the posterior anulus fibrosus (Fig. 5). The



**Magnetic Resonance Imaging, Figure 3** A coronal MRI scan of the pelvis and hips, showing avascular necrosis of the head of the left femur. The necrosis appears as a darkened area (arrow).

zone corresponds to a collection of fluid in a circumferential fissure crossing the posterior anulus and correlates strongly with that disk being the source of pain. When present, this sign has positive likelihood ratio of about 6 for incriminating the affected disc as the source of pain (Bogduk and McGuirk 2002).

For other lesions and abnormalities affecting the spine, the utility of MRI is far more questionable. Lesions such as disc bulges, disc herniations and degenerative disc disease occur very commonly in patients with no pain and increasingly with age (Jensen et al. 1994). Consequently, they are not diagnostic signs of back pain.

MR neurography can be used to enhance the appearance of nerves, such as the brachial plexus and lumbar plexus and large peripheral nerves such as the sciatic nerve, radial and ulnar nerves. However, unless there is gross lesion, such as tumour infiltration or neuroma, MR neurography has no proven role in detecting causes of pain arising in nerves.

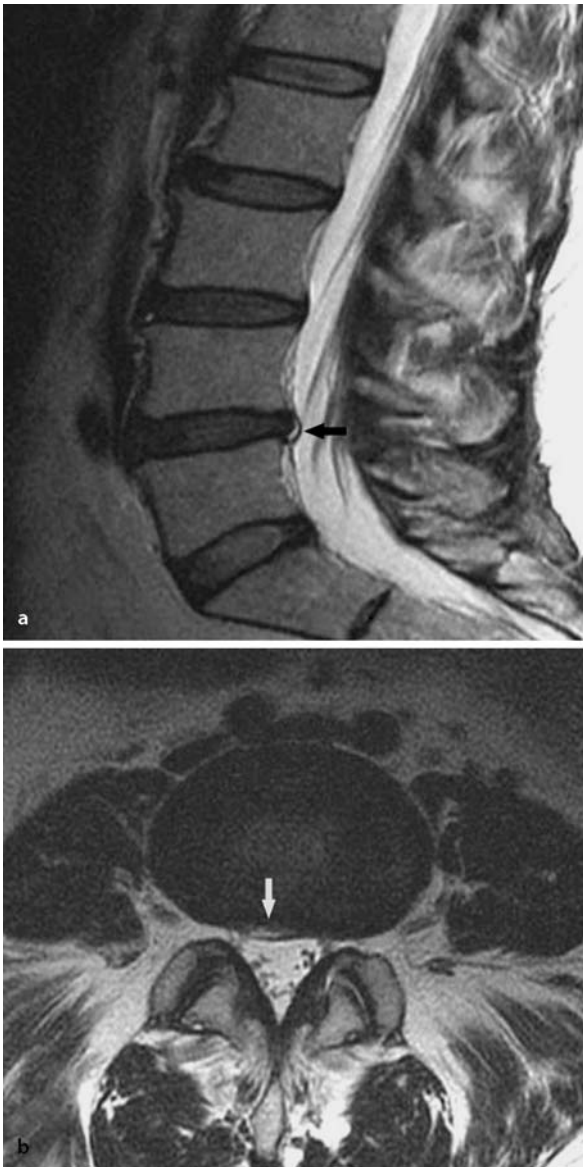
The ability of MRI to resolve connective tissues makes it the premier means of assessing joints and periarticular structures. In some instances, MRI has an established and valid role. In others, the validity of various MR findings has not been established. In patients with chronic knee pain, MRI can detect meniscal tears, anterior cruciate or posterior cruciate ligament tears and is replacing direct arthroscopy as the preferred, primary diagnostic test. For the assessment of acute knee injury, a short MRI examination following radiography has been shown to save costs and improve quality of life after injury, in terms of time absent from work, additional investigations and time required to recover (Nikken et al. 2003). Although MRI can demonstrate the structure of the shoulder in great detail, tears of the rotator cuff and other lesions occur in totally asymptomatic subjects and increasingly with age. Therefore, demonstrating these lesions by MRI is not diagnostic of the cause of shoul-



**Magnetic Resonance Imaging, Figure 4** MRI scans of a herniation of an L5-S1 intervertebral disc. (a) Sagittal scan. The disc herniation (arrow) protrudes beyond the posterior margin of the L5 vertebral body. (b) Axial scan. The herniation (arrow) protrudes posteriorly to the right, towards the zygapophysial joint.

der pain. Pains in the elbow, wrist, ankle or foot are common problems encountered by sportspeople, either after acute injury or as a result of chronic repeated stress. In such individuals, MRI is being used increasingly to detect bone bruises and chronic enthesopathy or to rule out these conditions so that the athlete may resume activities.

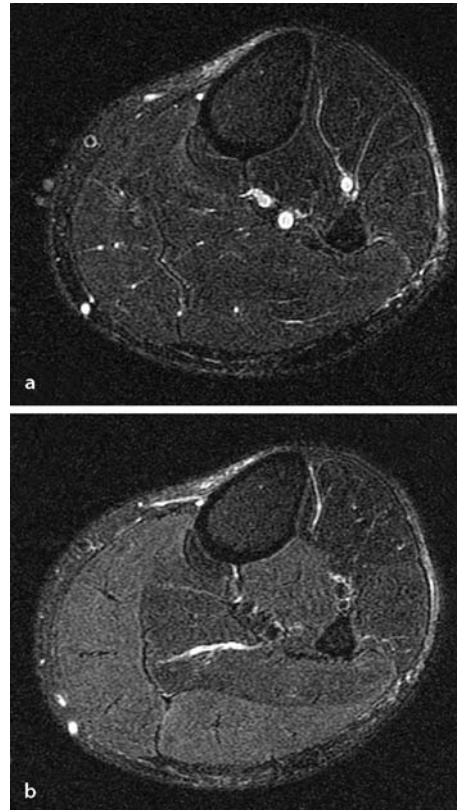
Muscles pain and muscle imaging, however, remain an enigma. Signal changes, due to tissue disruption and



**Magnetic Resonance Imaging, Figure 5** MRI scans of a high-intensity zone (HIZ) in an L4-5 intervertebral disc. (a) Sagittal scan. In T2-weighted images, the HIZ appears as a bright signal in the posterior annulus fibrosus (arrow). (b) Axial scan. The HIZ corresponds to a circumferential tear (arrow), which appears as a bright crescentic signal in the posterior annulus.

oedema, can be seen in patients with muscle strains or tears or with overuse and compartment syndromes (Fig. 6). However, no role for MRI has been established for more common entities such as myofascial pain and fibromyalgia. No features have been identified that allow these conditions to be diagnosed or studied by MRI.

There is work in progress on MR elastography (MRE), which may throw some imaging light on the elastic biomechanical property of muscles in health and disease. MRE is a non-invasive, phase-contrast MRI technique used to spatially map and measure displace-



**Magnetic Resonance Imaging, Figure 6** Axial MRI scans of the calf showing the effects of strenuous exercise. (a) Before exercise. (b) After exercise. The gastrocnemius muscles exhibit a faint increase in signal intensity, making them appear slightly whiter than the soleus and anterior tibial muscles and whiter than they were before exercise.

ment patterns in the muscle fibres in response to an external harmonic shear wave. Amplitude changes are detectable at the level of microns or less.

- ▶ [Amygdala, Pain Processing and Behavior in Animals](#)
- ▶ [fMRI](#)
- ▶ [Headache Due to Arteritis](#)
- ▶ [Motor Cortex \(M1\)](#)
- ▶ [Secondary Somatosensory Cortex \(S2\) and Insula, Effect on Pain Related Behavior in Animals and Humans](#)

## References

1. April C, Bogduk N (1992) High intensity zone: a diagnostic sign of painful lumbar disc on magnetic resonance imaging. *Br J Radiol* 65:361–369
2. Bogduk N, McGuirk (2002) *Medical Management of Acute and Chronic Low Back Pain. An Evidence Based Approach*. Elsevier, Amsterdam, p 136
3. Jensen MC, Brant-Zawadzki MN, Modic MT et al. (1994) Magnetic resonance imaging of the lumbar spine in people without back pain. *N Eng J Med* 331:69–73
4. Nikken J, Edwin O, Hunink M (2003) A short low-field MRI examination in all patients with recent peripheral joint injury: is it worth the costs? 89<sup>th</sup> Annual Meeting of the Radiological Society of North America. Chicago, Illinois, November 2003
5. Shellock FG (2000) Radiofrequency energy-induced heating during MR procedures: a review. *J Magn Res Imag* 12:30–36



## Magnetoencephalography

### Synonyms

MEG

### Definition

Synchronized extracellular currents in a few square centimeters of cortex generate magnetic fields measurable with sensors on the surface of the scalp. The biggest advantage of MEG, as compared with electroencephalography (EEG), is its high spatial resolution due to less of an effect of cerebrospinal fluid, skull and skin, since magnetic fields are not affected by electric current conductivity.

- ▶ [Insular Cortex, Neurophysiology and Functional Imaging of Nociceptive Processing](#)
- ▶ [Magnetoencephalography in Assessment of Pain in Humans](#)
- ▶ [Thalamotomy for Human Pain Relief](#)

## Magnetoencephalography in Assessment of Pain in Humans

RYUSUKE KAKIGI, KOJI INUI,  
MINORU HOSHIYAMA, SHOKO WATANABE,  
DAISUKE NAKA, KENSAKU MIKI,  
HIROSHI YAMASAKI, DIEP TUAN TRAN,  
YUNHAI QIU, XIAOHONG WANG  
Department of Integrative Physiology, National  
Institute for Physiological Sciences, Okazaki, Japan  
kakigi@nips.ac.jp

### Synonyms

Topography; Source Analysis; magnetoencephalogram; Superconducting Quantum Interference Device; Gradiometer; Biomagnetometer; Magnetometer

### Definition

Cortical neurons are excited by the signals conducted through thalamo-cortical fibers from the thalamus. After signals are received, electric currents are conducted through apical dendrites of pyramidal cells of the cerebral cortex. The electric currents generate magnetic fields. The electric currents are recorded as electroencephalography (EEG) and magnetic fields are recorded as ▶ [magnetoencephalography](#) (MEG). There are two kinds of postsynaptic potentials (PSP), excitatory ones (EPSP) and inhibitory ones (IPSP). EPSP are considered to be the main generators for both EEG and MEG. There are two kinds of cellular currents, intra-cellular and extra-cellular. MEG mainly records intra-cellular currents. EEG records both, but mainly extra-cellular currents.

To record clear MEG, at least 20000 or 30000 neurons must be activated simultaneously, which causes the same directed intra-cellular currents. A summation of the currents of many neurons with the same positive-negative direction can be mimicked as one strong dipole. Since it is easy and simple to imagine it present in the cortex, we hypothesized it by naming the ▶ [equivalent current dipole](#) (ECD).

### Characteristics

At first, the advantages of MEG compared with EEG will be introduced. When electric currents generated in the cortex are recorded using scalp electrodes, there are effects of cerebrospinal fluid, skull and skin, whose electric conductivities vary markedly. In contrast, since magnetic fields are not affected by current conductivity, the recorded MEG is theoretically unchanged. Therefore, the spatial resolution of MEG is higher than that of EEG. The advantages and disadvantages of MEG compared with positron emission tomography (PET) and functional magnetic resonance imaging (fMRI) are listed below.

#### Advantages of MEG

1. Completely non-invasive.
2. Measures neuronal activity rather than blood flow changes or metabolic changes.
3. ▶ [Temporal resolution](#) is much larger, in the order of ms.
4. Stimulus evoked or event related responses can easily be measured in detail.
5. Frequency response (brain rhythm) analysis can be done, which means physiological changes can be analyzed spatiotemporally.
6. Results in an individual subject can be analyzed in detail, so that averaging results in a number of subjects is not necessary. In other words, one can analyze inter-individual differences.

#### Disadvantages of MEG

1. Spatial resolution is lower than for PET and fMRI, particularly when the ▶ [signal-to-noise ratio](#) is low.
2. An inverse problem solution program is necessary. In other words, measuring results are indirectly or artificially induced.
3. The quality of algorithms (solution programs) is not good enough at present when multiple areas are activated simultaneously. Therefore, it is sometimes difficult to use MEG to analyze long-latency components mainly relating to emotional and / or cognitive functions. However, this is an endless game, since users always want new and improved software.
4. It is difficult to detect magnetic fields generated in deep areas. Therefore, the smaller the distance between activated regions and detecting coils the better.



5. It is impossible to record activities generated in white matter and pathways, since EPSPs are not generated there.
6. It is difficult or impossible to record activities in some regions such as the thalamus showing a so-called physiological closed field.
7. Activated location measured by MEG must be overlaid on CT or MRI, but the location can change, though the change must be very small.

Considering the advantages and disadvantages of MEG outlined above, the temporal characteristics of primary components just after the period when signals ascending through ► **A $\delta$  fibers** and ► **C Fiber** reach the cortex are the best indication for MEG and later activities relating to cognition are mainly analyzed by PET and fMRI.

### Methods

Various methods are used to record pain-related SEP and SEF (see review by Kakigi et al. 2000a,b; 2003a; 2005). The first study was reported by Hari et al. based on dental pulp stimulation (Hari et al. 1983). Then, CO<sub>2</sub> gas was applied to the nasal mucosa, a painful impact stimulation (Arendt-Nielsen et al. 1999), and epidermal electrical stimulation was applied (see review by Kakigi et al. 2000a,b; 2003a; 2005). Each method has its own advantages and disadvantages, but the ideal pain stimulation is pain-specific, controllable, safe and repeatable. At present, there are two main methods for recording pain-related SEP (SEF); (1) SEP (SEF) following high-intensity painful electrical stimulation (see review by Kakigi et al. 2000a,b) and (2) SEP (SEF) following painful CO<sub>2</sub> ► **laser beam** stimulation (see reviews by Bromm and Lorentz 1998; Kakigi et al. 2000a,b; 2003a; 2005). Since the latter method, which is usually called pain-related SEP (SEF), or laser evoked potential (LEP) or magnetic field (LEF), has several advantages as described below, it is more popular.

1. Other methods causing pain or heat sensation such as needle stimulation of the skin activate not only nociceptive receptors but also mechanoreceptors. Therefore, for example, the SEP waveform recorded following needle stimulation is very similar to that following electrical stimulation. In contrast, since a CO<sub>2</sub> laser beam is light, it does not activate mechanoreceptors of the skin, i.e. it is a purely noxious stimulation.
2. For analyzing temporal information in the order of msec, the time difference (lag) between the stimulus timing and the beginning of the sweep of the computer should be very stable and short, less than 1 ms. Figure 1 shows the procedure using our MEG device. A laser beam is applied to the subject's hand through optical fibers.

One interesting method reported recently is electrical stimulation of a very short needle, whose tip is located



**Magnetoencephalography in Assessment of Pain in Humans, Figure 1** The procedure using our MEG device (VectorView 306-channels, Elekta Neuromag Oy, Helsinki). The laser stimulator is set outside the shielded room because of its large magnetic artifacts and the laser beam is applied to the subject's hand through optical fibers. The laser beam can be applied any part of the body except the eyes, so both the experimenter and the subject must wear special glasses or swimming goggles.

in the epidermis where only free nerve endings are present, named ► **ES stimulation** (Inui et al. 2003a,b). The biggest advantages of this method are: (1) Only A $\delta$  and C fibers are stimulated. (2) When the needle is inserted, subjects feel no uncomfortable painful feeling and show no bleeding. (3) Since a small intensity with a short duration is enough for recording A $\delta$  fiber-related MEG, subjects feel only a tolerable jingling pain. (4) No special device is necessary except for a hand-made short needle, which is easily made.

One of the biggest recent topics in this field is the MEG response to the signals ascending through unmyelinated C fibers (see review by Kakigi et al. 2003a; 2005). Several methods have been reported to selectively stimulate C fibers, but they were difficult to record and the responses obtained were not consistently recorded. Our method was based on that reported by Brussels's group (Bragard et al. 1996). Since the number of polymodal receptors of C fibers relating to second pain is larger than

that of A $\delta$  fibers, and since the temperature threshold of the former is slightly lower than that of the latter, C fiber receptors can be selectively activated by using a low-intensity CO<sub>2</sub> laser beam on tiny areas of skin. We made a new device for recording C fiber-related MEG responses.

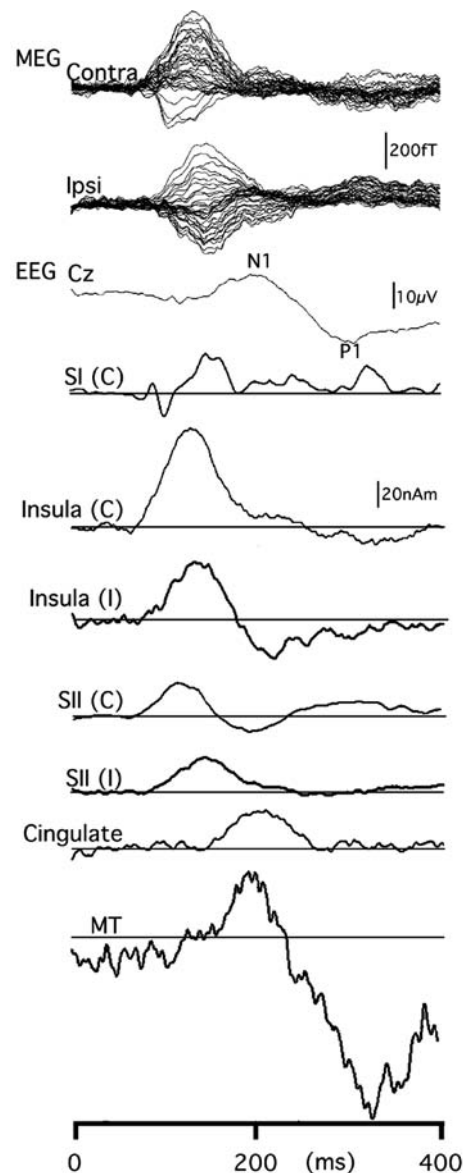
### Results

Results using ES stimulation are shown as a representative case, since it is the newest method in this field and the results were fundamentally similar to those obtained using a CO<sub>2</sub> laser (Inui et al. 2003) (Figs. 2, 3).

First, the primary somatosensory cortex (SI) in the hemisphere contralateral to the stimulation was activated, whose peak latency was approximately 100 ms. It is very small in amplitude and the generator is considered to be area 1 in SI. This long latency is, of course, due to the slow conduction velocity of A $\delta$  fibers (10–20 m/s). Then, ► [secondary somatosensory cortex \(SII\)](#) and insula in the bilateral hemispheres were activated simultaneously as the primary major component, even after stimulation applied to other sites, i.e. bilateral function. Their peak latencies were approximately 150 ms, but ipsilateral responses were significantly longer than contralateral ones, probably through the corpus callosum. SI component in the contralateral hemisphere was also recorded by laser stimulation (Kanda et al. 2000; Ploner et al. 1999). Then, cingulate cortex and mid-temporal regions around the amygdala in the bilateral hemispheres were activated; peak latencies of the first negative and second positive components were approximately 200 and 300 ms, respectively. We believe that MEG is the most appropriate method for a detailed spatio-temporal analysis of these early activities within 300–400 ms after stimulation, which PET and fMRI cannot do.

### Factors that Affect the Waveforms of Pain

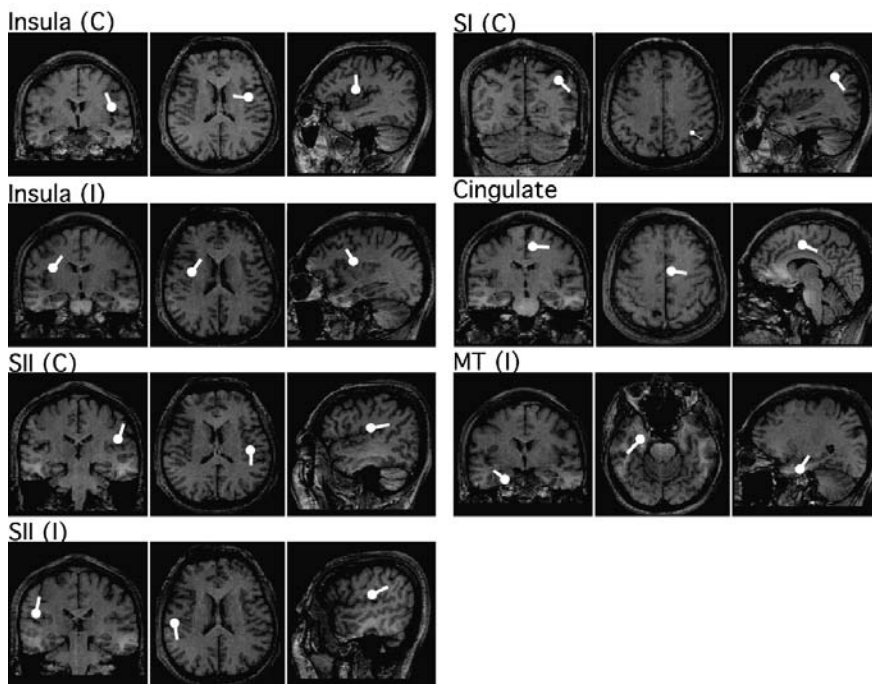
One frequently sustains an injury while playing sport, but does not notice it until after the game. This clearly indicates that psychological conditions affect pain perception. These interesting findings were also confirmed by MEG (see reviews by Kakigi et al. 2000a,b; 2003b; Kakigi 2005; Kakigi and Watanabe 1996). When subjects paid close attention to a mental activity such as a calculation or memorization (distraction task), MEG responses, particularly the later components generated in limbic systems, were much reduced in amplitude or disappeared and a mental pain rating (► [visual analogue scale](#), VAS) showed a positive correlation with the MEG changes. In contrast, early responses in SI and SII were reduced but still present. Therefore, early components seem important for primary functions such as the localization of stimulus points, but later components are very related to cognitive functions of pain perception. This pattern was more remarkable after C fiber than A $\delta$  stim-



**Magnetoencephalography in Assessment of Pain in Humans, Figure 2** MEG waveforms measured using the ES method (intra-epidermal electrical needle stimulation) for primary pain perception in humans by activating A $\delta$  fiber stimulation. C and I: Hemispheres contralateral and ipsilateral to the stimulation, respectively. SI and SII: Primary and secondary somatosensory cortices, respectively. MT Mid-temporal region around amygdala. (Applied from Inui et al. 2003).

ulation. Therefore, second pain may be more related to cognitive functions than the first pain.

During sleep, we usually do not notice pain, unless it is very strong, so what happens in the brain while receiving painful sensations during sleep (see review by Kakigi et al. 2003b)? Most of the MEG responses, particularly later components, were much reduced in amplitude or disappeared. This finding is very similar to the changes in the distraction task, but more remarkable. Interestingly, MEG responses during sleep



**Magnetoencephalography in Assessment of Pain in Humans, Figure 3** Activated regions using the ES method (intra-epidermal electrical needle stimulation) for primary pain perception in humans by activating A $\delta$  fiber stimulation. The calculated equivalent current dipole (ECD) of each region was overlaid on the MRI of this subject. See also legend of Fig. 2. (Applied from Inui et al. 2003).

M

to other modalities, such as touch, auditory or visual stimuli were enhanced, probably due to an inhibition of the inhibitory system while awake. Therefore, pain perception seems very different from other kinds of sensations.

MEG and EEG changes and VAS were also significantly reduced in amplitude by other kinds of sensations such as touch, vibration, cooling and movements (see review by Kakigi et al. 2000a; Kakigi et al. 2000b; Kakigi et al. 2003a; Kakigi et al. 2005; Kakigi and Watanabe 1996). The effects of pain relief by tactile stimulation applied to painful areas simultaneously is utilized in transcutaneous electric nerve stimulation (TENS). I think “movement” is most effective for pain relief, since we automatically move painful regions to reduce pain. For example, if we touch a very hot object with our hand, we involuntary shake that hand strongly. We are now trying to clarify the underlying mechanisms by MEG.

#### Clinical Application

Unfortunately, the clinical application of MEG for pain relief is not very popular at present. Most interesting studies were reported from Germany on MEG responses following tactile stimulation in patients with ► **phantom limb pain** after amputation (Flor et al. 1995). They confirmed a plasticity of the somatosensory cortex using MEG. These interesting and important issues are described in detail in another chapter. The following 3 review articles are recommended on the basic physiological and clinical background of pain including MEG (Bromm and Lorentz 1998; Treede et al. 1999, 2000).

#### References

1. Arendt-Nielsen L, Yamasaki H, Nielsen J et al. (1999) Magnetoencephalographic responses to painful impact stimulation. *Brain Res* 839:203–208
2. Bragard D, Chen ACN, Plaghki L (1996) Direct isolation of ultra-late (C-fibre) evoked brain potentials by CO<sub>2</sub> laser stimulation of tiny cutaneous surface areas in man. *Neurosci Lett* 209:81–84
3. Bromm B, Lorentz J (1998) Neurophysiological evaluation of pain. *Electroencephalogr Clin Neurophysiol* 107:227–253
4. Flor H, Elbert T, Knecht S et al. (1995) Phantom-limb pain as a perceptual correlate of cortical reorganization following arm amputation. *Nature* 375:482–484
5. Hari R, Kaukoranta E, Reinikainen K et al. (1983) Neuromagnetic localization of cortical activity evoked by painful dental stimulation in man. *Neurosci Lett* 42:77–82
6. Inui K, Tran TD, Qiu Y et al. (2003a) A comparative magnetoencephalographic study of cortical activations evoked by noxious and innocuous somatosensory stimulations. *Neuroscience* 120:235–248
7. Inui K, Wang X, Qiu Y et al. (2003b) Pain processing within the primary somatosensory cortex in humans. *Eur j Neurosci* 18:2858–2866
8. Kakigi R, Watanabe S (1996) Pain relief by various kinds of interference stimulation applied to the peripheral skin in humans: pain-related brain potentials following CO<sub>2</sub> laser stimulation. *J Peripher Nerv Syst* 1:189–198
9. Kakigi R, Watanabe S, Yamasaki H (2000a) The pain-related somatosensory evoked potentials. *J Clin Neurophysiol* 17:295–308
10. Kakigi R, Hoshiyama M, Shimojo M et al. (2000b) The somatosensory evoked magnetic fields. *Prog Neurobiol* 61:495–523
11. Kakigi R, Tran TD, Qiu Y et al. (2003a) Cerebral responses following stimulation of unmyelinated C-fibers in humans: Electro- and magneto-encephalographic study. *Neurosci Res* 45:255–275
12. Kakigi R, Naka D, Okusa T et al. (2003b) Sensory perception during sleep in humans: A magnetoencephalographic study. *Sleep Med* 4:493–507
13. Kakigi R, Inui K, Tamura V (2005) Electrophysiological studies on human pain perception. *Clin Neurophysiol* 116:743–763



14. Kanda M, Nagamine T, Ikeda A et al. (2000) Primary somatosensory cortex is actively involved in pain processing in human. *Brain Res* 853:282–289
15. Ploner M, Schmitz F, Freund HJ et al. (1999) Parallel activation of primary and secondary somatosensory cortices in human pain processing. *J Neurophysiol* 81:3100–104
16. Treede RD, Kenshalo DR, Gracely RG et al. (1999) The cortical representation of pain. *Pain* 79:105–111
17. Treede RD, Apkarian AV, Bromm B et al. (2000) Cortical representation of pain: functional characterization of nociceptive areas near the lateral sulcus. *Pain* 87:113–119

---

## Magnetometer

- ▶ [Magnetoencephalography in Assessment of Pain in Humans](#)

---

## Magnification

### Definition

The tendency to exaggerate the threat value associated with a particular symptom, situation or outcome.

- ▶ [Catastrophizing](#)

---

## Magnocellular Neurons

### Definition

Magnocellular neurons are neurons with soma of a large size located in the paraventricular and supraoptic hypothalamic nuclei. These neurons synthesize vasopressin and oxytocin and transport them via their axons to the posterior neurohypophysis.

- ▶ [Hypothalamus and Nociceptive Pathways](#)

---

## Maintenance

### Definition

A readiness to change stage, in which a person has made a behavior change and has maintained that change for long enough that relapse is unlikely.

- ▶ [Motivational Aspects of Pain](#)
- ▶ [Operant Perspective of Pain](#)

---

## Maitland Mobilisation

- ▶ [Passive Spinal Mobilisation](#)

---

## Major Depressive Disorder

### Synonyms

MDD

### Definition

Major Depressive Disorder (MDD), as defined by the Diagnostic and Statistical Manual of Mental Disorders 4<sup>th</sup> ed. (DSM-IV)(American Psychiatric Association, 1994), is the presence of a collection of symptoms that must include depressed mood or loss of interest or pleasure in most activities lasting at least 2 weeks. Additional symptoms include fatigue, feelings of excessive or inappropriate worthlessness or guilt nearly every day, significant weight loss or gain, insomnia or hypersomnia, diminished concentration or ability to make decisions, frequent thoughts of death, suicidal ideation or suicide attempt. In order to meet criteria for MDD, symptoms must cause distress or impairment in functioning.

- ▶ [Depression and Pain](#)

---

## Maladaptive Coping

- ▶ [Catastrophizing](#)

---

## Maladaptive Thoughts

### Definition

Cognitions that interfere with successful coping and adaptation to noxious stimuli or aversive events, or contribute to inappropriate behavior.

- ▶ [Multiaxial Assessment of Pain](#)

---

## Malalignment Syndromes

### Definition

Malalignment syndromes are abnormal body alignments (for example, an abnormally pronated rear foot) thought to predispose overuse syndromes.

- ▶ [Stretching](#)

---

## Malignant Bone Pain

- ▶ [Adjuvant Analgesics in Management of Cancer-Related Bone Pain](#)



## Malignant Bowel Obstruction

### Definition

A mechanical obstruction of the gastrointestinal tract secondary to a malignant tumor that occurs in 5% to 43% of all terminally ill patients. The obstruction may be partial or complete and at one site or multiple sites, however, the small bowel is more commonly involved than the large bowel. It is associated with colorectal, pancreatic, endometrial, gastric, mesothelial, breast, and prostatic cancers, but may develop with any cancer predisposed to metastases to the gastrointestinal tract. Malignant bowel obstruction may occur secondary to extrinsic compression of the bowel lumen, intraluminal occlusion, intramural occlusion, intestinal motility disorders, and miscellaneous causes such as fecal impaction.

- ▶ [Cancer Pain Management, Adjuvant Analgesics in Management of Pain Due To Bowel Obstruction](#)

## Malignant Pain

### Definition

Pain associated with cancer.

- ▶ [Cancer Pain](#)
- ▶ [Pain Treatment, Implantable Pumps for Drug Delivery](#)

## Malingerer

### Definition

A malingerer is an individual who consciously and deliberately feigns incapacitation. Malingering is a form of fraud.

- ▶ [Impairment, Pain-Related](#)

## Malingering

### Definition

A conscious decision to deliberately fake or lie about having pain in order to fool someone.

- ▶ [Credibility, Assessment](#)
- ▶ [Pain in the Workplace, Risk factors for Chronicity, Job Demands](#)

## Malingering, Primary and Secondary Gain

DAVID A. FISHBAIN

University of Miami School of Medicine and The Rosomoff Pain Center at South Shore Hospital, Miami Beach, FL, USA  
dfishbain@miami.edu

### Synonyms

Sick role; reinforcers

### Definitions

Primary gain (Fishbain 1994; Fishbain et al. 1995): A decrease in anxiety (gain) from an unconscious defensive operation, which then causes a physical or conversion symptom, e.g. an arm is voluntarily paralyzed because it was used to hurt somebody, thereby allaying guilt and anxiety.

Secondary gain (Fishbain 1994; Fishbain et al. 1995): The gain achieved from the physical or conversion symptom, which enables the patient to avoid a particularly noxious activity or which enables the patient to get support from the environment (gain) not otherwise forthcoming.

Malingering (Fishbain et al. 1999; Fishbain et al. 2002): It is the intentional production of false or grossly exaggerated physical or psychological symptoms motivated by external incentives (secondary gain), such as avoiding military duty or work or criminal prosecution and obtaining financial compensation or drugs.

### Characteristics

#### Primary and Secondary Gain

Sigmund Freud was the first to define primary and secondary gain and apply these concepts to illness behavior, which was not medically explained. Since then, the concept of secondary gain has infiltrated the nomenclature of every medical specialty, usually being applied in case of medically unexplained symptoms, and/or illness affirming states. The following is a list of previously described secondary gains: gratification of dependency or revengeful strivings; fulfillment of needs for sympathy, concern, solicitousness, or attachment; maintenance of family status, love or domination; desire for financial rewards and to prove entitlement for disability; avoidance of hazardous work conditions; permission to withdraw from an unsatisfactory life or socioemotional role; need for the ▶ [sick role](#); acquisition of drugs; manipulation of spouse; and contraception. It is not clear whether secondary gains are the same as reinforcers. Operationally, some are equivalent; the gain may be the reinforcer. Secondary gains, however, are the more unconscious motivation for the observed behaviors.

- ▶ [Secondary losses](#) has been described as follows: economic; inability to now relate to others through work;

loss of family life, social support, and recreational activities; loss of community approval and resultant social stigma of being disabled; guilt over disability; negative sanctions from family and those in the helping roles (e.g. doctors; and loss of a clearly defined role). In general, the secondary losses far outweigh the secondary gains. Yet, patients act in spite of this economy. This problem with the economy of secondary gains and losses is a direct challenge to the integrity of the secondary gain concept and its importance to some of the Illness Affirming States.

Scientifically, there are also major problems with the secondary gain concept. It is poorly defined and rests on psychoanalytic concepts, which are difficult to prove or disprove. Fishbain et al. (1995) recently reviewed the scientific evidence for this concept. They found that results of studies relating to this issue were in conflict, and many had methodological flaws relating to how the presence of secondary gain was established. However, the presence of a secondary gain agenda did change patient behaviors.

The secondary gain concept is also clinically abused. The presence of financial incentives, such as disability payments if associated with treatment failure, results in the accusation of secondary gain, which in turn is utilized as a rationalization for the treatment failure. Clinicians in this paradigm usually focus on the secondary gains and ignore the secondary losses. In addition, clinicians ignore two facts. The alleged presence of a secondary gain does not necessarily mean that the gain has had an etiological or reinforcing effect on the illness, and there is a significant amount of evidence that indicates that physician practices are influenced by secondary gain agendas (Fishbain et al. 1995).

### Malingering

Malingering can be divided into the following types (Fishbain et al. 1999): Pure malingering is the feigning of disease or disability when it does not exist. Positive malingering (simulation) is the feigning of symptoms that do not exist. Partial malingering is the conscious exaggeration of symptoms that do exist. False imputation is the ascribing of actual symptoms to a cause consciously recognized to have no relationship to the symptoms. Dissimulation, also a form of malingering, is the concealment or minimization of symptoms for secondary gain reasons. Two other types of malingering may also occur: genuine symptoms formerly present may cease to exist but may be fraudulently alleged to continue, or genuine symptoms may be fraudulently attributed to a cause other than the actual one.

There are no reliability studies on malingering, as these can only be generated if someone admits to being a malingerer. This is rarely the case. As such, three unique approaches for the study of malingering/disease simulation have evolved. In the first approach, a patient suspected of malingering is assigned a task that impacts on

this alleged impairment or symptoms. This task is such that the patient is forced to make a choice (e.g. the patient complaining of sensory loss will be asked to close his or her eyes and guess which hand was being touched for a large number of trials). This is called a forced choice technique. In this case the patient has a 50% chance of being correct if he has a sensory impairment. However, hysterical and malingering patients usually will perform at significantly below chance levels, indicating that they may be deliberately providing false answers.

The second approach involves a volunteer group performing a task such as completing a psychological test battery pretending to fake an illness (e.g. fake insanity). The resultant volunteer "faking scores" can be used in two ways. First, the "the faking scores" can be compared with normal scores for differences and for the development of a "faking" profile. Second, the "faking scores" can be compared with authentic patient scores for differences and perhaps for the selection of similar faking profiles.

The third approach involves actual patients. In this case, a patient or groups of patients are asked to complete a task (e.g. a psychological battery) in such a way as to simulate an illness.

These faking patient scores may then be compared with scores from a new group of patients for identification of similar or different profiles. Fishbain et al. (1999) recently reviewed these different approaches in reference to pain. Their findings/conclusions were as follows. Malingering and dissimulation do occur within the chronic pain patient setting. Malingering may be present in 1.25% to 10.4% of chronic pain patients. However, because of poor study quality, these prevalence percentages are not reliable. The study evidence also indicated that facial expression testing, questionnaire, sensory testing, or clinical examination were not reliable ways of identifying malingering. There was no acceptable scientific information on symptom magnification syndrome. Hand-grip testing using the Jamar Dynamometer and other types of isometric strength testing did not reliably discriminate between a submaximal/malingering effort and a maximal/best effort. However, isokinetic strength testing appeared to have potential for discriminating between maximal and submaximal effort, and between best and malingered efforts. Repetitive testing with the coefficient of variation was not a reliable method for discriminating a real/best effort from a malingered effort. It was concluded that as yet there is no reliable method for detecting malingering within chronic pain patients, although isokinetic testing shows promise.

A final issue relating to malingering is that of ► **Waddell Signs**. These are 8 physical signs frequently found in chronic pain patients. Historically, there has been disagreement on what these signs indicate. However, in a recent evidence-based structured review, Fishbain et al. (2003) concluded the following about Waddell signs:

- They do not discriminate organic from nonorganic problems
- May represent an organic phenomenon
- Are associated with poorer treatment outcome
- Are associated with greater pain levels
- Are not associated with secondary gain; and as a group
- Studies demonstrate methodological problems

In a further evidence-based review, specifically addressing the issue of whether Waddell signs indicate malingering, Fishbain et al. (2004) concluded the following: there is little or no evidence that Waddell signs are associated with malingering.

### References

1. Fishbain DA (1994) The Secondary Gain Concept: Definition Problems and Its Abuse in Medical Practice. *Am Pain Soc J* 3:264–273
2. Fishbain DA, Rosomoff HL, Cutler RB, Rosomoff RS (1995) Secondary Gain Concept: A Review of the Scientific Evidence. *Clin J Pain* 11:6–21
3. Fishbain DA, Cutler R, Rosomoff HL, Rosomoff RS (1999) Chronic Pain Disability Exaggeration/Malingering and Submaximal Effort Research. *Clin J Pain* 15:244–274
4. Fishbain DA, Cutler R, Rosomoff HL, Rosomoff RS (2002) Does the Conscious Exaggeration Scale Detect Deception within Patients with Chronic Pain Alleged to have Secondary Gain? *Pain Medicine* 3:39–46
5. Fishbain DA, Cole B, Cutler RB, Lewis J, Rosomoff HL, Rosomoff RS (2003) A Structured Evidence-Based Review on the Meaning of Nonorganic Physical Signs: Waddell signs. *Pain Medicine* 4:141–181
6. Fishbain DA, Goldberg M, Rosomoff RS, Rosomoff H (1991) Chronic Pain Patients and the Nonorganic Physical Sign of Non-Dermatomal Sensory Abnormalities (NDSA). *Psychosomatics* 32:294–303
7. Fishbain DA, Cutler RB, Lewis J, Cole B, Rosomoff RS, Rosomoff HL (2003) Is the Location of Nondermatomal Sensory Abnormalities (NDSAs) Related to Pain Location? *Pain Med* 4:238–243
8. Fishbain DA, Cutler RB, Lewis J, Cole B, Rosomoff RS, Rosomoff HL (2004) Do Waddell Signs Indicate Malingering? An Evidence-Based Structured Review. *Clin J Pain* 20:399–408

## Malnutrition

- ▶ Metabolic and Nutritional Neuropathies

## Managed Care

### Definition

A board term used to describe various health care payment systems that attempt to contain costs by controlling the type and level of services provided.

- ▶ Disability Management in Managed Care System

## Management of Postoperative Pain

- ▶ Postoperative Pain, Appropriate Management

## Mandibular Dysfunction

- ▶ Orofacial Pain, Movement Disorders

## Manipulation Without Impulse

- ▶ Passive Spinal Mobilisation

## Manipulation Without Thrust, Oscillatory Mobilisation

- ▶ Passive Spinal Mobilisation

M

## Manual or Continuous Traction

- ▶ Lumbar Traction

## Manual Therapy

### Definition

Manipulation of body tissues to restore movement.

- ▶ Chronic Pain in Children, Physical Medicine and Rehabilitation

## MAO

- ▶ Monamine Oxidase Inhibitors

## MAPK

- ▶ Mitogen-Activated Protein Kinase

## Marital Status and Chronicity

- ▶ Pain in the Workplace, Risk Factors for Chronicity, Demographics

## Marstock Method

### Definition

The Marstock method is a threshold determination protocol for the thermal senses. This is a reaction time-dependent protocol that was originally developed by Drs. Heinrich Fruhstorfer and W. Schmidt of Marburg, and Dr. Ulf Lindblom of Stockholm, hence the name.

► [Threshold Determination Protocols](#)

## Massage and Pain Relief Prospects

MICHAEL QUITTAN

Department of Physical Medicine and Rehabilitation,  
Kaiser-Franz-Joseph Hospital, Vienna, Austria  
michael.quittan@wienkav.at

### Synonyms

Effleurage; Petrissage; friction; Tapotement; vibration

### Definition

The English word 'massage' is derived from the Arabic word "mass'h" which means to press gently. At its most basic, massage is a simple way of easing pain, while at the same time aiding relaxation, promoting a feeling of well being and a sense of receiving good care. Scientifically, massage may be defined as group of systematic and scientific manipulations of body tissues best performed with the hands, for the purpose of affecting the nervous and muscular system and the general circulation.

Although massage techniques may vary considerably between therapists, classical massage consists of a number of basic techniques that have remained essentially unchanged for centuries. Per Henrik Ling is considered the founder of modern massage and subsequently these techniques are referred to as Swedish massage. Five elemental techniques are used in classical massage named effleurage, petrissage, friction, tapotement and vibration. Specific purposes are attributed to each technique.

### Effleurage

Effleurage (or stroking) is a deep stroking performed in the direction of venous or lymph flows. It is used to accustom the subject to the following massage procedures.

### Petrissage

Petrissage (or kneading) is a deeper technique than effleurage and consists of repeated rolling, grasping and lifting. The technique is directed towards muscles and connective tissue.

### Friction

Friction (or rubbing) should be done in a slow elliptical or circular movement with the fingertips or the thenar eminence. It is a deep penetrating technique to relieve trigger points. There may be pain from the application of deep friction massage so this technique is optional. It should not be confused with deep transverse frictions.

### Tapotement

Tapotement (or hacking) is a series of blows that may also be described as slapping, tapping, clapping, hacking or cupping, depending on the positioning of the hands.

### Vibration

Vibration (or shaking) consists of small tremulous movements with the hands and fingers and in some cases with a electromechanical device. The vibration is performed rhythmically in an attempt to enhance relaxation or stimulation.

Before initiating massage, the patient's individual preferences and responsiveness to touch and massage should be assessed. Cultural and social feelings towards massage should be considered, as well as the patient's ability to communicate concerns or express unwillingness to receive massage therapy. Deep transverse friction massage is a technique popularised by Dr. James Cyriax for pain and inflammation relief in musculoskeletal conditions (Cyriax 1975). It is a technique that attempts to reduce abnormal fibrous adhesions and makes scar tissue more mobile in sub-acute and chronic inflammatory conditions by realigning the normal soft tissue fibres. The technique has been advocated to enhance normal healing conditions by breaking cross bridges and preventing abnormal scarring. Its mechanical action causes hyperaemia, which results in increased blood flow to the area. Beside these classic techniques there are numerous other procedures claiming specific effects. Reflexologists propose that there are reflex points on the feet corresponding to organs and structures of the body and that pain may be reduced by gentle manipulation or pressing certain parts of the foot. Pressure applied to the feet has been shown to result in an anaesthetizing effect on other parts of the body (Ernst and Koeder 1997).

### Characteristics

#### Analgesic Mechanisms

Classical massage is thought to improve physiological and clinical outcomes by offering the symptomatic relief of pain through different mechanisms. Massaging a particular area stimulates large diameter nerve fibres, thus mechanisms described by the gate-control theory. Additionally, a moderate elevation of serum beta-endorphin levels lasting 1 h after cessation of massage has been demonstrated (Goats 1994). Motoneuron activity may be attenuated during application of massage thus beneficially influencing the "pain-spasm-pain" cycle. It is noteworthy that massage both affects the motoneuron



pool of the massaged muscles and lasts solely during application of massage (Dishman and Bulbulian 2001). It has recently been shown that intramuscular temperature in superficial layers of the m.vastus lateralis is increased after application of massage, mainly due to mechanical manipulation of the skin (Drust et al. 2003). Blood flow is increased, predominantly by dilatation of superficial blood vessels. Vigorous massage techniques enhance these effects by additional histamine release, which may then last as long as 1 h (Goats 1994). Finally, massage promotes physical and mental relaxation contributing to pain relief.

### Indications and Outcomes

Despite definitions described above, there have been many variations, with differences in masseur expertise and time of application. This lack of standardisation renders comparison of studies difficult. Nevertheless, massage has been increasingly investigated in the pain management area, for its potential to be a functional, nonpharmacological intervention for reducing chronic pain.

### Back Pain

Massage therapy is among the most popular therapeutic strategies used by back pain patients. A survey of an urban rehabilitation medicine outpatient office in New York, addressing the use of alternative therapy and its perceived effectiveness indicated that 29% of the subjects had used one or more alternative medical therapies in the past 12 months and the most common therapy cited was massage (Wainapel et al. 1998). This evidence is confirmed by European data indicating that up to 87% of back pain patients received massage as one form of treatment (Wiesinger et al. 1997).

Until recently, massage was included in RCTs only as a control treatment for various physical treatments. These massage control treatments were poorly described and often involved superficial massage techniques, brief treatment sessions of 10–15 min or few sessions (<5) (for reviews see Ernst 1999; Furlan et al. 2002). Recent published trials therefore address the effectiveness of massage therapy for back pain. Preyde randomly assigned 104 patients with low back pain (lasting 1 week to 8 months) to comprehensive massage therapy including stretching exercises, soft tissue manipulation alone, remedial exercise with posture education and sham laser therapy. Over a 1 month period, all patients received 6 therapies. At 1 month follow-up 63% of subjects in the comprehensive massage therapy group reported no pain as compared with 27% of the soft tissue manipulation group, 14% of the remedial exercise group and 0% of the sham laser therapy group. Clinical significance was evident for the comprehensive massage therapy group and the soft tissue manipulation group on the measure of function (Preyde 2000).

Another RCT compared massage therapy with progressive muscle relaxation (Hernandez-Reif et al. 2001). Twenty-four adults with low back pain of nociceptive origin with a duration of at least 6 months were randomly assigned to a massage therapy or a progressive muscle relaxation group. Sessions were 30 min long twice a week for 5 weeks. By the end of the study, the massage therapy group, as compared to the relaxation group, reported experiencing less pain, depression and anxiety and improved sleep. They also showed improved trunk and pain flexion performance. Furthermore, their serotonin and dopamine levels were higher. The authors conclude that massage therapy is effective in reducing pain, stress hormones and symptoms associated with chronic low back pain. Finally, Cherkin et al. randomly assigned 262 patients with low back pain to receive therapeutic massage compared to acupuncture or self-educational material. After the 10 week treatment period massage was found to be superior both to acupuncture (function) and self education (function and symptoms). At 1 year follow-up massage remained superior to acupuncture regarding function and symptoms (Cherkin et al. 2001).

### Cancer-related Pain

At present, evidence exists from multiple time series with or without the intervention that massage is beneficial in pain relief in cancer patients (Pan et al. 2000). In their review, Pan and co-workers identified two studies evaluating massage as single treatment for pain in palliative care patients and 1 study in combination with aromatherapy. In an unblinded randomised controlled trial, 28 patients (mean age 61.5 years) with cancer were assigned to either Swedish massage therapy or a visitor for 10 min. Men experienced immediate pain relief (VAS from 4.2–2.9,  $P < 0.01$ ), but this effect subsided by 1 h after the massage. There was no significant benefit in women (Weinrich and Weinrich 1990). In a case series, 9 male cancer patients (mean age 56.6 years) who received two consecutive 30 min evening massages reported significant reductions in pain as compared to baseline, lasting for 2 days. There was also a reduction in anxiety and enhanced feelings of relaxation (Ferrell-Torry and Glick 1993). In a case series involving 103 patients with cancer, a combination of massage and aromatherapy promoted pain relief in 33% of patients who completed the study (47%) (Wilkinson 1995).

### Massage and Critical Care

A recent review identified as many as 19 research articles evaluating the effect of back massage on pain, relaxation and sleep in patients in various forms of critical care settings (Richards et al. 2000). The authors conclude that the most consistent effect of massage is a significantly decreased anxiety or perception of tension. Massage is therefore advocated as an effective treatment for promoting relaxation as indicated by significant changes in

the expected direction in one or more physiological indicators. Additionally, massage was found to be effective in reducing pain. Further investigations of the beneficial effects of massage therapy comprise the incidence of chronic tension headache (Quinn et al. 2002) and post exercise muscle pain (Weber et al. 1994).

### Contraindications and Safety Considerations

Massage is recognised as a safe therapeutic modality, with little risk or adverse effects. However there are contraindications such as applying massage over an area with acute inflammation, skin infection, non-consolidated fracture, burn, deep vein thrombosis or over sites of active cancer tumour (Vickers and Zollman 1999). Caution should be used in patients with advanced osteoporosis regarding applying only a little pressure on the tissue and the underlying bones.

### References

- Cherkin DC, Eisenberg D, Sherman KJ et al. (2001) Randomized trial comparing traditional Chinese medical acupuncture, therapeutic massage, and self-care education for chronic low back pain. *Arch Intern Med* 161:1081–1088
- Cyriax J (1975) *Textbook of Orthopaedic Medicine*, vol 2, 9th edn. Williams and Wilkins, Baltimore
- Dishman JD, Bulbulian R (2001) Comparison of effects of spinal manipulation and massage on motoneuron excitability. *Electromyogr Clin Neurophysiol* 41:97–106
- Drust B, Atkinson G, Gregson W et al. (2003) The effects of massage on intra muscular temperature in the vastus lateralis in humans. *Int J Sports Med* 24:395–399
- Ernst E (1999) Massage therapy for low back pain: a systematic review. *J Pain Symptom Manage* 17:65–69
- Ernst E, Koeder K (1997) An overview of reflexology. *Eur J Genl Pract* 97:52–57
- Ferrell-Torry AT, Glick OJ (1993) The use of therapeutic massage as a nursing intervention to modify anxiety and the perception of cancer pain. *Cancer Nurs* 16:93–101
- Furlan AD, Brosseau L, Imamura M et al. (2002) Massage for low-back pain: a systematic review within the framework of the Cochrane Collaboration Back Review Group. *Spine* 27:1896–1910
- Goats, G. C. (1994) Massage—the scientific basis of an ancient art: part 2. Physiological and therapeutic effects. *Br J Sports Med* 28:153–156
- Hernandez-Reif M, Field T, Krasnegor J et al. (2001) Lower back pain is reduced and range of motion increased after massage therapy. *Int J Neurosci* 106:131–145
- Pan CX, Morrison RS, Ness J et al. (2000) Complementary and alternative medicine in the management of pain, dyspnea, and nausea and vomiting near the end of life. A systematic review. *J Pain Symptom Manage* 20:374–387
- Preyde M (2000) Effectiveness of massage therapy for sub-acute low-back pain: a randomized controlled trial. *CMAJ* 162:1815–1820
- Quinn C, Chandler C, Moraska A (2002) Massage therapy and frequency of chronic tension headaches. *Am J Public Health* 92:1657–1661
- Richards KC, Gibson R, Overton-McCoy AL (2000) Effects of massage in acute and critical care. *AACN Clin Issues* 11:77–96
- Vickers A, Zollman C (1999) ABC of complementary medicine. The manipulative therapies: osteopathy and chiropractic. *BMJ* 319:1176–1179
- Wainapel SF, Thomas AD, Kahan BS (1998) Use of alternative therapies by rehabilitation outpatients. *Arch Phys Med Rehabil* 79:1003–1005
- Weber MD, Servedio FJ, Woodall WR (1994) The effects of three modalities on delayed onset muscle soreness. *J Orthop Sports Phys Ther* 20:236–242
- Weinrich SP, Weinrich MC (1990) The effect of massage on pain in cancer patients. *Appl Nurs Res* 3:140–145
- Wiesinger GF, Quittan M, Ebenbichler G et al. (1997) Benefit and costs of passive modalities in back pain outpatients: A descriptive study. *Eur J Phys Med Rehabil* 7 / 6:186
- Wilkinson S (1995) Aromatherapy and massage in palliative care. *Int J Palliat Nurs* 1:21–30

## Massage, Basic Considerations

SUSAN MERCER

School of Biomedical Sciences, University of Queensland, Brisbane, QLD, Australia

susan.mercer@stonebow.otago.ac.nz

### Synonyms

Soft tissue manipulation; Classical Massage; Swedish massage; friction massage

### Definition

Massage is the application of force, typically by the hands, to the skin, fascia and muscles of the body. Various techniques, e.g. stroking and gliding (effleurage), kneading (petrissage), tapping, clapping, percussion (tapotement), and deep friction that uses different rates and rhythm, direction, pressure and duration of movements are utilized in an effort to enhance circulation and remove waste products from the soft tissues of the body.

### Characteristics

#### Mechanism

Massage therapy is believed to relieve pain by increasing local circulation, stimulating large diameter nerve fibers, stimulating the release of endorphins, decreasing muscle tone, normalizing the general mobility of muscles, tendons, ligaments, and fascia, reducing swelling and relaxing the mind (Ernst 2003; Furlan et al. 2002; Nicholson and Clendaniel 1989).

#### Applications

Massage is used for its psychological and physiological effects. Slow to evenly applied strokes of light to medium pressure are used in the direction of muscle fibers if general relaxation is desired. To stretch scarring in skin and subcutaneous tissue, moderate to heavy pressure in all directions is applied at a moderate, even rhythm. If the desired effect is to loosen or stretch connective tissue, a slightly less heavy pressure is applied more slowly. However, if adhesions in ligaments, tendons and muscle are to be broken, a heavy pressure perpendicular to the direction of fibers applied at a moderate, even speed is advocated. Here the therapist's fingers and the patient's skin move as one. To reduce swelling moderate to deep

pressure is applied slowly and evenly in the direction of venous return. Tapping is used in desensitizing operative sites e.g. following amputation.

### Efficacy

Massage is widely used in the general community for the treatment of painful conditions. It can be provided by professional, remedial massage therapists. Physiotherapists and osteopaths may incorporate it into their treatment regimens. Lay persons, such as spouses, may provide it.

Despite the popularity of massage, the literature provides little evidence of efficacy. Reviews have established that massage has little or no effect in relieving pain (Ernst 2004), headaches (Jensen et al. 1990), post exercise muscle pain (Ernst 1998); Weber et al. 1994), or acute, subacute or chronic low back pain (Ernst 1999; Furlan et al. 2002; Godfrey et al. 1984; Hoehler et al. 1981; Preyde 2000).

### Side Effects

Incidences of adverse effects are unknown, but are probably low. Reports include fracture of osteoporotic bone, haematoma, peripheral nerve damage, and hearing loss typically associated with the use of too much force (Ernst 2003a; Ernst 2003b).

### References

- Cherkin DC, Eisenberg D, Sherman KJ et al. (2001) Randomized Trial Comparing Traditional Chinese Medical Acupuncture, Therapeutic Massage, and Self-Care Education for Chronic Low Back Pain. *Arch Int Med* 161:1081–1088
- Ernst E (1998) Does Post-Exercise Massage Treatment Reduce Delayed Onset Muscle Soreness? A Systematic Review. *Br J Sports Med* 32:212–214
- Ernst E (1999) Massage Therapy for Low Back Pain. A Systematic Review. *J Pain Symptom Manage* 17:65–69
- Ernst E (2003a) Massage Treatment for Back Pain. Evidence for Symptomatic Relief is Encouraging but not Compelling. *BMJ* 326:562–563
- Ernst E (2003b) The Safety of Massage Therapy. *Rheumatology* 42:DOI:10.1093
- Ernst E (2004) Manual Therapies for Pain Control: chiropractic and massage. *Clin J Pain* 20:8–12
- Furlan AD, Brosseau L, Imamura M et al. (2002) Massage for Low-Back Pain: A Systematic Review within the Framework of the Cochrane Collaboration Back Review group. *Spine* 27:1896–1910
- Jensen OK, Nielsen FF, Vosmar L (1990) An Open Study Comparing Manual Therapy with the Use of Cold Packs in the Treatment of Post-Traumatic Headache. *Cephalalgia* 10:241–250
- Godfrey CM, Morgan PP, Schatzker J (1984) A Randomized Trial of Manipulation for Low-Back Pain in a Medical Setting. *Spine* 9:301–304
- Hsieh CY, Adams AH, Tobis J et al. (2002) Effectiveness of Four Conservative Treatments for Subacute Low Back Pain: A Randomized Clinical Trial. *Spine* 27:1142–1148
- Hoehler FK, Tobis JS, Buerger AA (1981) Spinal Manipulation for Low Back Pain. *JAMA* 245:1835–1838
- Nicholson GG, Clendaniel RA (1989) Manual Techniques. In: Scully RM, Barnes MR (eds) *Physical Therapy*. JB Lippincott, Philadelphia
- Preyde M (2000) Effectiveness of Massage Therapy for Subacute Low-Back Pain: A Randomized Controlled Trial. *Can Med Assoc J* 162:1815–1820
- Weber MD, Servedio FJ, Woodall WR (1994) The Effects of Three Modalities on Delayed Muscle Soreness. *J Orthop Sports Phys Ther* 20:236–242

## Masseter Inhibitory Reflex

### Definition

Reflex inhibition of the jaw-closing muscles (masseter, temporalis, or pterygoid) that appears as a double phase of electric silence during voluntary contraction, and is elicited by electrical or mechanical stimuli in the intra- or perioral region.

- ▶ [Jaw-Muscle Silent Periods \(Exteroceptive Suppression\)](#)

## Masseter Muscle

### Definition

The jaw-closer muscle. This muscle elevates the mandible for mouth closing and during chewing.

- ▶ [Nociceptors in the Orofacial Region \(Temporo-mandibular Joint and Masseter Muscle\)](#)

M

## Masseter Silent Periods

- ▶ [Jaw-Muscle Silent Periods \(Exteroceptive Suppression\)](#)

## Mast Cells

### Definition

Mast cells are immune competent cells recruited to regions of injury including the skin. They are resident in most tissues and release proinflammatory mediators including NGF when activated.

- ▶ [Nerve Growth Factor, Sensitizing Action on Nociceptors](#)

## Mastery Experience

### Definition

Experiences that result in the elevation of an individual's assessment of his or her abilities in a specific skill domain.

- ▶ [Psychology of Pain, Self-Efficacy](#)

## Mastitis

### ► Gynecological Pain, Neural Mechanisms

## Matrix Metalloproteinases

### Synonyms

MMP

### Definition

Matrix Metalloproteinases (MMP) are a zinc- and calcium-dependent family of proteins that are collectively responsible for the degradation of the extracellular matrix tissues. MMP are involved in wound healing, angiogenesis, and tumor cell metastasis. An imbalance between the active enzymes and their natural inhibitors leads to the accelerated destruction of connective tissue, which is associated with the pathology of diseases such as arthritis, cancer, multiple sclerosis and cardiovascular diseases.

### ► Neutrophils in Inflammatory Pain

## McGill Pain Questionnaire

RONALD MELZACK, JOEL KATZ  
Department of Psychology, McGill University,  
Montreal, QC, Canada  
rmelzack@ego.psych.mcgill.ca

### Synonyms

Subjective pain measurement; Pain evaluation; MPQ; SF-MPQ

### Definition

The ► [McGill Pain Questionnaire](#) (MPQ) consists of 78 words, obtained from pain-patient interviews and the clinical literature, which describe distinctly different aspects of the experience of pain. The words are categorized into three major classes:

1. Words that describe the sensory qualities of the experience in terms of temporal, spatial, pressure, thermal, and other properties
2. Words that describe ► [affective](#) qualities in terms of tension, fear, and autonomic properties that are part of the pain experience
3. Evaluative words that describe the subjective overall intensity of the total pain experience.

Each class comprises several subclasses, which contain a group of words that are considered by most subjects to be qualitatively similar.

In addition to the list of pain descriptors, the questionnaire contains descriptors of the overall present pain intensity (PPI). The PPI is recorded as a number from 1 to 5, in which each number is associated with the following words: 1, mild; 2, discomforting; 3, distressing; 4, horrible; 5, excruciating. The mean scale values of these words, which were chosen from the evaluative category, are approximately equally far apart, so that they represent equal scale intervals and thereby provide “anchors” for the specification of the overall pain intensity.

### Characteristics

The descriptor lists of the MPQ are read by (or to) a patient, with the explicit instruction that he or she choose only those words that describe his or her feelings and sensations currently, or during a specific period (such as “during the past week.” Four major indices are obtained:

1. The pain rating index (PRI) based on the rank values of the words. In this scoring system, the word in each subclass implying the least pain is given a value of 1, the next word is given a value of 2, and so on. The rank values of the words chosen by a patient are summed to obtain a score separately for the sensory (subclasses 1–10), affective (subclasses 11–15), evaluative (subclass 16), and miscellaneous (subclasses 17–20) words, in addition to providing a total score (subclasses 1–20)
2. The PRI-corrected scores, using empirically determined scale values to enhance discriminability
3. The number of words chosen (NWC) in the word sets
4. The PPI, the number-descriptor combination chosen as the indicator of the current overall pain intensity.

Since its introduction in 1975, the MPQ has been translated into more than 25 languages. As pain is a private, personal experience, it is impossible for us to know precisely what someone else’s pain feels like. However, the MPQ provides us with an insight into the qualities that are experienced. Recent studies indicate that each kind of pain is characterized by a distinctive constellation of words. There is a remarkable consistency in the choice of words used by patients suffering the same or similar pain syndromes, and there is strong evidence that the MPQ is a valid, reliable tool for ► [pain measurement](#). The short-form McGill Pain Questionnaire (SF-MPQ) (Fig. 1) was developed for use in research settings when the time to obtain information from patients is limited, and when more information is desired than that provided by intensity measures such as the VAS or PPI. The SF-MPQ consists of 15 representative words from

► **McGill Pain Questionnaire, Figure 1**, The short-form McGill Pain Questionnaire. Descriptors 1–11 represent the sensory dimension of pain experience and 12–15 represent the affective dimension. Each descriptor is ranked on an intensity scale of 0 = none, 1 = mild, 2 = moderate, 3 = severe. The Present Pain Intensity (PPI) of the standard long-form McGill Pain Questionnaire and the visual analogue scale are also included to provide overall pain intensity scores.



**SHORT-FORM MCGILL PAIN QUESTIONNAIRE**  
**RONALD MELZACK**

PATIENT'S NAME: \_\_\_\_\_

DATE: \_\_\_\_\_

	<u>NONE</u>	<u>MILD</u>	<u>MODERATE</u>	<u>SEVERE</u>
THROBBING	0) _____	1) _____	2) _____	3) _____
SHOOTING	0) _____	1) _____	2) _____	3) _____
STABBING	0) _____	1) _____	2) _____	3) _____
SHARP	0) _____	1) _____	2) _____	3) _____
CRAMPING	0) _____	1) _____	2) _____	3) _____
GNAWING	0) _____	1) _____	2) _____	3) _____
HOT-BURNING	0) _____	1) _____	2) _____	3) _____
ACHING	0) _____	1) _____	2) _____	3) _____
HEAVY	0) _____	1) _____	2) _____	3) _____
TENDER	0) _____	1) _____	2) _____	3) _____
SPLITTING	0) _____	1) _____	2) _____	3) _____
TIRING-EXHAUSTING	0) _____	1) _____	2) _____	3) _____
SICKENING	0) _____	1) _____	2) _____	3) _____
FEARFUL	0) _____	1) _____	2) _____	3) _____
PUNISHING-CRUEL	0) _____	1) _____	2) _____	3) _____

**M**



- 0 NO PAIN \_\_\_\_\_
- 1 MILD \_\_\_\_\_
- 2 DISCOMFORTING \_\_\_\_\_
- 3 DISTRESSING \_\_\_\_\_
- 4 HORRIBLE \_\_\_\_\_
- 5 EXCRUCIATING \_\_\_\_\_

the sensory (n = 11) and affective (n = 4) categories of the standard, long-form (LF) MPQ. The PPI and a VAS are included to provide indices of overall pain intensity. The 15 descriptors making up the SF-MPQ were selected based on their frequency of endorsement by patients with a variety of acute, intermittent, and chronic pains. Each descriptor is ranked by the patient on an intensity scale of 0 = none, 1 = mild, 2 = moderate, 3 = severe. The SF-MPQ correlates very highly with the major PRI indices (sensory, affective, and total) of the LF-MPQ, and is sensitive to traditional clinical therapies-analgesic drugs, ► [epidural blocks](#), and ► [transcutaneous electrical nerve stimulation](#). The SF-MPQ is now available in over 30 languages. A procedural model for testing the factorial validity of the SF-MPQ, which can be applied to translated versions, is provided by Wright et al. (2001).

- [Amygdala, Pain Processing and Behavior in Animals](#)
- [fMRI](#)
- [Headache Due to Arteritis](#)
- [Motor Cortex \(M1\)](#)
- [Secondary Somatosensory Cortex \(S2\) and Insula, Effect on Pain Related Behavior in Animals and Humans](#)

### References

1. Melzack R, Torgerson WS (1971) On the Language of Pain. *Anesthesiology* 34:50–59
2. Melzack R (1975) The McGill Pain Questionnaire: Major Properties and Scoring Methods. *Pain* 1:277–299
3. Melzack R (1987) The Short-Form McGill Pain Questionnaire. *Pain* 30:191–197
4. Melzack R, Katz J (2001) The McGill Pain Questionnaire: Appraisal and Current Status In: Turk DC and Melzack R (eds) *Handbook of Pain Assessment*, 2nd edn. Guilford Press, New York
5. Wright KD, Asmundson GJ, McCreary DR (2001) Factorial validity of the short-form McGill pain questionnaire (SF-MPQ). *Eur J Pain* 5:279–284

## MCID

- [Minimal Clinical Important Difference](#)

## Mcl-1

### Definition

Human myeloid cell differentiation protein, which is involved in programming of differentiation and concomitant maintenance of viability but not of proliferation. Isoform 1 inhibits apoptosis.

- [NSAIDs and Cancer](#)

## MDD

- [Major Depressive Disorder](#)

## MDdc

- [Densocellular Subnucleus of the Mediodorsal Nucleus](#)

## Measuring Tools

- [Outcome Measures](#)

## Mechanical Allodynia

### Definition

Mechanical allodynia is the abnormal sensation of pain from usually non-painful mechanical stimulation and is elicited by, for example, lightly touching.

- [Cancer Pain](#)
- [GABA Mechanisms and Descending Inhibitory Mechanisms](#)
- [Neuropathic Pain Model, Chronic Constriction Injury](#)
- [Neuropathic Pain Model, Partial Sciatic Nerve Ligation Model](#)
- [Neuropathic Pain Model, Tail Nerve Transection Model](#)
- [Spinal Cord Injury Pain Model, Contusion Injury Model](#)

## Mechanical Allodynia Test

- [Allodynia Test, Mechanical and Cold Allodynia](#)

## Mechanical Effects of Ultrasound

### Definition

The mechanical effect on the target tissue results in an increased local metabolism, circulation, extensibility of connective tissue, tissue regeneration and bone growth.

- [Ultrasound Therapy of Pain from the Musculoskeletal System](#)

## Mechanical Hyperalgesia

### Definition

An exaggerated response to a painful mechanical stimulus (e.g. a pin-prick producing severe or prolonged pain). A sign that pain pathways are functioning abnormally and may be damaged.

- [Diabetic Neuropathies](#)
- [Freezing Model of Cutaneous Hyperalgesia](#)
- [Restless Legs Syndrome](#)

## Mechanical Low Back Pain

- ▶ Chronic Back Pain and Spinal Instability

## Mechanical Nociceptors

- ▶ Mechanonociceptors

## Mechanical Stimuli

### Definition

Input produced by physical forces, such as touch, stretch, pressure, and vibration.

- ▶ Postsynaptic Dorsal Column Projection, Functional Characteristics

## Mechanical Syndrome

- ▶ Lower Back Pain, Physical Examination

## Mechanically-Evoked Itch

### Definition

Sensation of itch produced by innocuous mechanical stimulation of the skin.

- ▶ Spinothalamic Tract Neurons, Central Sensitization

## Mechanism-Based Approaches to Pain and Nociception

### Definition

A therapeutic approach to the treatment of pain and pain syndromes that is based upon treatment of the underlying mechanisms, as opposed to an empirical approach based on symptoms. The prerequisite to this approach is: 1) knowledge of the mechanisms underlying the pain process or disorder in question; and 2) knowledge of the mechanisms of action of the therapeutic intervention proposed.

- ▶ Quantitative Sensory Testing

## Mechanoheat Nociceptor

- ▶ Nociceptors in the Orofacial Region (Skin/Mucosa)
- ▶ Polymodal Nociceptors, Heat Transduction

## Mechano-Insensitive C-Fibres, Biophysics

CHRISTIAN WEIDNER

Department of Physiology and Experimental Pathophysiology, University Erlangen, Erlangen, Germany  
weidner@physiologie1.uni-erlangen.de

### Synonyms

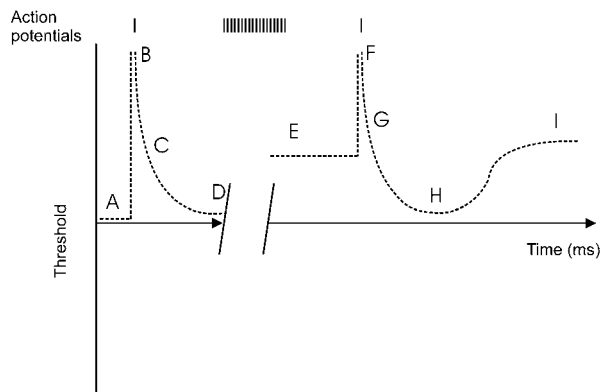
Action Potential Conduction of C-Fibres; Post-Excitatory Effects of C-Fibres

### Definitions

Biophysical properties of nerve fibres comprise passive properties of the membrane and nerve (resistance, capacitance and derived measures like ▶ **time constant**) and active properties of membrane channels. For unmyelinated (C-) fibres i.e. nerve fibres with a functionally accessible receptive field *in vivo* and *in vitro*, these properties can only be derived from indirect measures e.g. with the teased fibre technique in animals or ▶ **microneurography** in humans.

### Characteristics

Directly after an action potential, several phases of after-effects can be distinguished (see Fig. 1). An action potential is immediately followed by the absolute refractory period, which is determined by inactivity of most voltage gated Na<sup>+</sup> channels and a repolarising current through open voltage gated K<sup>+</sup> channels.



**Mechano-Insensitive C-Fibres, Biophysics, Figure 1** Summary of after-effects. Threshold (inversely correlated to conduction velocity) of this exemplified nociceptive nerve fibre starts at an unconditioned level A, increases to an infinite level during the absolute refractory period B followed by a subnormal level during the relative refractory period C. Several seconds after the excitation there is still a remaining subnormality D which cumulates after a series of action potentials to a level E. Starting at level E an action potential of the accommodated nerve fibre again increases threshold during absolute (F) and relative refractory period (G). Thereafter a supernormal period H intermittently renders the nerve more excitable than before the respective action potential (level E) but never more than initially (level A). This relative supernormality is typical for human C-fibres whereas other species can also develop absolute supernormality (exceeding level A). Again a late subnormality I follows this activation.

Thereafter, during the relative refractory period action potentials can be induced at higher than normal stimulus strength and at lower than normal conduction velocity. The refractory periods together last at least 10 ms in all human C-fibre afferents without a difference between receptive classes. In other species they are shorter. After the refractory periods, a supernormal period might briefly turn a nerve fibre hyperexcitable and make action potentials travelling faster than initially. This supernormal period is not constantly observed but varies between species, fibre classes and state of ► [accommodation](#) of nerve fibres. While an absolute supernormal period could be observed in different species, in human C-fibres the observed supernormality has always been relative. “Relative” means, that cumulating long-term after-effects must have established an accommodation that slows down all action potentials of the ongoing stimulus train. If a conditioning stimulus is interposed at an inter-stimulus interval adequate to induce supernormality in the conditioned action potential, this supernormality can speed up the conditioned action potential as compared to the conduction velocity it would have had without the conditioning stimulus (relative supernormality). The initial conduction velocity prior to accommodation cannot be exceeded. The supernormal period is directly followed by the subnormal periods. On a cellular basis several subtypes of ► [afterhyperpolarisation](#) with different time constants have been suggested as a basis for the late subnormal period. For peripheral nerves, these types are intermingled and a separation using a pharmacological access has not been reported. However, the cumulating long lasting subnormality can most probably be equated with the slow AHP observed in central neurons.

#### Differences Between Human C-Fibre Classes

Biophysical and receptive properties of human afferent C-fibres are strongly correlated and separate two distinct fibre classes, the mechano-responsive (usually also heat responsive) fibres known as CMH fibres or ► [polymodal nociceptors](#) and the mechano-insensitive fibres, with two subclasses, heat responsive (CMi) and heat-insensitive (CMiHi).

Unlike other species, mechano-insensitive fibres of humans do not even respond to the strongest mechanical stimuli but can gain mechanical responsiveness as a result of primary sensitization (“waking up” of a ► [Sleeping Nociceptor](#)). Mechano-insensitive fibres have larger ► [receptive fields](#) (Schmidt et al. 2002) and higher heat thresholds than CMH fibres (Weidner et al. 1999), sensitise to tonic pressure (Schmelz et al. 1997), respond longer to ► [capsaicin](#) injection (Schmelz et al. 2000b) and are responsible for ► [neurogenic inflammation](#) (Schmelz et al. 2000a). These properties make mechano-insensitive human afferent C-fibres prominent candidates for an outstanding role in the

development of chronic and pathological forms of pain. Besides these receptive differences the two fibre classes also differ with regard to their biophysical properties, in particular to the long-term effects described in the next paragraph.

#### Long-Term After-Effects

After-effects with time constants in the range of seconds are studied with repetitive pulse protocols. These effects are well known from animal experiments and good evidence is available that the threshold increase and conduction velocity decrease are equivalent measures (Raymond and Lettvin 1978). For experimental ease of assessment, all human studies use conduction velocity decrease as the measure. After the onset of a repetitive stimulation at a certain frequency or the increase to a higher frequency, the conduction latency increases until reaching a plateau. A frequency decrease leads to a velocity increase again. The time constants are in the range of 10–60 s. The amount of activity dependent conduction velocity slowing, but not the time constant clearly separates mechano-insensitive “sleeping” from mechano-responsive afferents (Serra et al. 1999; Weidner et al. 1999). Taking into account the difference in the unconditioned conduction velocities of mechano-insensitive (~0.8 m/s) and mechano-responsive (~1.0 m/s) afferents, the amount of conduction velocity slowing separates the two classes without overlap. A dissociation of these closely linked conductive and receptive properties in patients with pathological pain has been interpreted as “sleeping” nociceptors that “woke up”, i.e. have been sensitised in the course of the disease and gained receptive properties like mechano-responsiveness while their conduction velocity slowing remained typical for “sleeping” nociceptors (Orstavik et al. 2003).

Different mechanisms that could influence or account for the accommodation of nerve fibres have been suggested. The Na/K ATPase activity should lead to hyperpolarisation of a nerve fibre and should be activated by Na ions that are brought into the cell by its activity. Hyperpolarisation in turn will slow down action potential propagation by increasing the difference of resting membrane potential and the activation threshold of voltage gated sodium channels. Therefore electrotonic depolarisation of the membrane in front of a fully depolarised (Na channels open) part of the axon will exceed the Na channel threshold over a shorter distance. The effect of ouabain, a blocker of the Na/K pump, on activity dependent threshold increase makes its contribution likely but not necessarily the only factor (Raymond and Lettvin 1978). Changes of K conductance can also modulate the resting membrane potential and have an influence on conduction velocity and activation threshold. An ► [apamin](#) insensitive Ca dependant K current is responsible for the slow after-hyperpolarisation (AHP) in central neurons (Wilson and Goldberg 2006). Further-



more the AHP itself can activate the inward rectifying Ih current carried by hyperpolarisation activated cyclic nucleotide gated channels (HCN) that have also been found in peripheral nerves (Takigawa et al. 1998). The Ih current counteracts the AHP and therefore limits the activity dependent conduction velocity slowing. Finally, geometrical reasons could also partly account for the observed differences in accommodation between mechano-responsive and mechano-insensitive C-fibres. The large receptive field of “sleeping” nociceptors is an indication of an extensively branched terminal arborisation with long and thin terminals. In thin fibres with an increased surface to volume quotient (it is indirectly proportional to the radius), all surface bound channels/pumps at a given density (parts per surface-area) will have a higher effect on intracellular concentration (parts per volume).

### Short-Term After-Effects

Short-term after-effects with time constants in the range of milliseconds cannot be assessed with the above-mentioned method. The delay between conditioning and conditioned action potential must be in the same range. Therefore, a protocol with a stable ongoing frequency and interposed conditioning action potentials at varying inter-stimulus intervals can be used to assess short term after-effects (Weidner et al. 2000; Weidner et al. 2002; Bostock et al. 2003). Extracellular accumulation of potassium was made responsible for the supernormal period and could explain relative and absolute supernormality. In human C-fibres, however, another mechanism seems to account for the relative supernormality. After an action potential, voltage gated potassium channels repolarise the axon to the resting membrane potential. If accommodation has made the axon hyperpolarised, these potassium channels will only repolarise the fibre to the normal resting membrane potential but not to the hyperpolarised level prior to excitation. After closure of the repolarising potassium channels, the remaining repolarisation back to the accommodated hyperpolarised level is carried out by the “leakage” current, i.e. the current with all gated channels closed. It resembles the time constant to charge or discharge the membrane capacitor. No difference in the supernormal period and the underlying time constant of the axon could be observed for mechano-responsive or mechano-insensitive fibres with the provision that the same amount of accommodation is present. As described above, a higher stimulus frequency is needed for mechano-responsive fibres to yield the same accommodation as mechano-insensitive fibres.

### Functional Implications

The most obvious implication of the long-term after-effects is the use dependent desensitisation of nerve fibres. If the threshold to induce an action potential as

tested by external electrical stimulation is increased, all receptor potentials will meet the same increased excitation threshold. Paradoxically the maximum frequency that can be reached by a high frequency burst of an accommodated nerve fibre exceeds that in an unused fibre. This is because an unused fibre will only have subnormal after-effects delaying an action potential quickly following another. For an accommodated nerve fibre, the supernormal period can speed up a succeeding action potential. For a train of four action potentials at 50 Hz in the receptive field, this can lead to an “intra-burst” frequency of 160 Hz at the knee level. This is an effective contrast enhancement mechanism.

### References

1. Bostock H, Campero M, Serra J et al. (2003) Velocity recovery cycles of C fibres innervating human skin. *J Physiol (Lond)* 553:649–663
2. Orstavik K, Weidner C, Schmidt R et al. (2003) Pathological C-fibres in patients with a chronic painful condition. *Brain* 126:567–578
3. Raymond SA, Lettvin JY (1978) Aftereffects of activity in peripheral axons as a clue to nervous coding. In: Waxman SG (ed) *Physiology and pathobiology of axons*. Raven Press, New York, pp 203–225
4. Schmelz M, Schmidt R, Bickel A et al. (1997) Differential sensitivity of mechanosensitive and -insensitive C-fibers in human skin to tonic pressure and capsaicin. *Society of Neuroscience Abstract* 23:1004
5. Schmelz M, Michael K, Weidner C et al. (2000a) Which nerve fibers mediate the axon reflex flare in human skin? *Neuroreport* 11:645–648
6. Schmelz M, Schmidt R, Handwerker HO et al. (2000b) Encoding of burning pain from capsaicin-treated human skin in two categories of unmyelinated nerve fibres. *Brain* 123:560–571
7. Schmidt R, Schmelz M, Weidner C et al. (2002) Innervation territories of mechano-insensitive C nociceptors in human skin. *J Neurophysiol* 88:1859–1866
8. Serra J, Campero M, Ochoa J et al. (1999) Activity-dependent slowing of conduction differentiates functional subtypes of C fibres innervating human skin. *J Physiol (Lond)* 515:799–81
9. Takigawa T, Alzheimer C, Quasthoff S et al. (1998) A special blocker reveals the presence and function of the hyperpolarization-activated cation current IH in peripheral mammalian nerve fibres. *Neuroscience* 82:631–634
10. Weidner C, Schmelz M, Schmidt R et al. (1999) Functional Attributes Discriminating Mechano-Insensitive and Mechano-Responsive C Nociceptors in Human Skin. *J Neurosci* 19:10184–10190
11. Weidner C, Schmidt R, Schmelz M et al. (2000) Time course of post-excitatory effects separates afferent human C fibre classes. *J Physiol (Lond)* 527:185–191
12. Weidner C, Schmelz M, Schmidt R et al. (2002) Neural signal processing: the underestimated contribution of peripheral human C-fibers. *J Neurosci* 22:6704–6712
13. Wilson CJ, Goldberg JA (2006) Origin of the slow afterhyperpolarization and slow rhythmic bursting in striatal cholinergic interneurons. *J Neurophysiol* 95:196–204

M

## Mechano-Insensitive Nociceptor

### ► Silent Nociceptor

## Mechanonociceptors

ELVIRA DE LA PEÑA GARCÍA  
 Instituto de Neurociencias, Universidad Miguel  
 Hernández-CSIC, Alicante, Spain  
 elvirap@umh.es

### Synonyms

Mechanical nociceptors; high-threshold mechanoreceptors; C-mechanoreceptor; A Delta( $\delta$ )-mechanoreceptor

### Definition

Subpopulation of sensory afferents activated only by strong mechanical stimulation, most effectively by sharp objects.

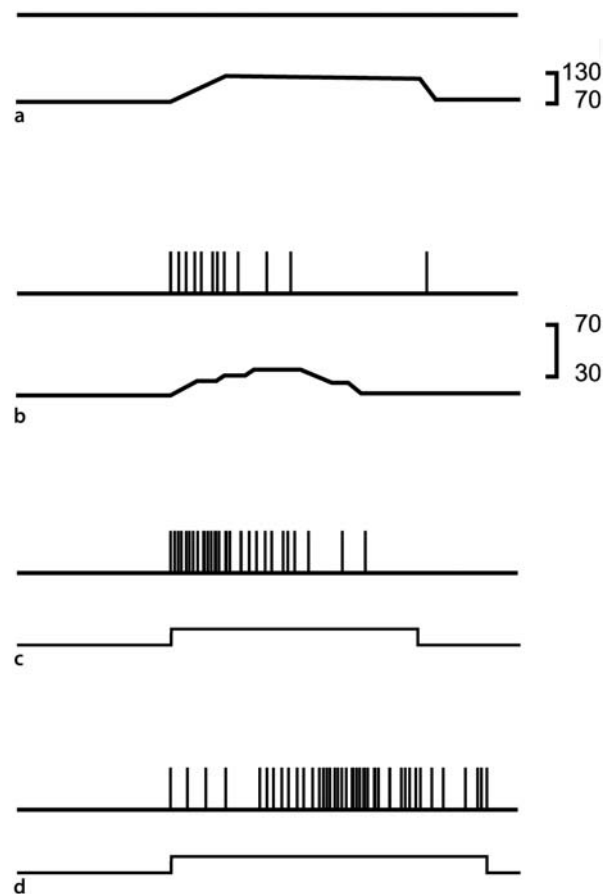
### Characteristics

Mechanonociception has been observed in organisms of various evolutionary levels: paramecium, worm, insects and mammals. In mammals, mechano- **▶ nociceptors** are peripheral endings of primary sensory neurons that are activated only when harmful mechanical stimuli are applied to their **▶ receptive field**, that is located in the skin, superficial mucosa and cornea (Belmonte et al. 1991; Burgess and Perl 1967), in deep tissues, such as joints and muscles (Mense 1977; Schaible and Schmidt 1983) and in the viscera (Cerveró 1994). The force necessary to evoke a nerve impulse discharge in mechanonociceptors is several orders of magnitude higher than the force required for the activation of low-threshold mechanoreceptors, which are the sensory **▶ receptors** detecting innocuous mechanical stimuli.

Mechanonociceptor neurons have peripheral axons of variable diameter and degree of **▶ myelination** belonging either to the thin myelinated, A $\delta$  (conduction velocity: 2–20 m/s) or to the unmyelinated, C (conduction velocity <2 m/s) fiber type that end as naked nerve endings. Their somas are located in the dorsal root and cephalic sensory ganglia, and are in general of small diameter. Mechanonociceptors were first described by Burgess and Perl in 1967 in recordings of single **▶ Primary Afferents/Neurons** fibres innervating the hind limb of the cat. These authors reported the presence of fibres conducting between 6 and 37 m/s, which were classified as mechanonociceptors because they were activated only by damaging mechanical stimulation of the skin. Burgess and Perl observed that such fibres responded maximally to cutting or pinching the skin with serrated forceps, while noxious heat (50°), noxious cold (20°), acid applied to the receptive fields and **▶ bradykinin** injected into skin did not excite this class of sensory afferents. Typically, their receptive fields were 2–5 cm long by 1–2.5 cm wide, and consisted of responsive spots (under 1 mm diameter) separated by unresponsive areas. An example of the **▶ discharge pattern** evoked

by noxious mechanical forces in this type of nociceptor is shown in Fig. 1.

The classification of a peripheral sensory afferent as a mechanonociceptor, polymodal nociceptor, cold nociceptors or 'silent' (mechano-insensitive) nociceptor (see nociceptor, categorization), has been established experimentally by applying stimuli of different modality such as mechanical (pressure), thermal (heat or cold), and chemical (acid, inflammatory mediators) stimuli to the receptive field of the fiber. Often, the initial classification of a sensory afferent as nociceptive was defined by its response only to mechanical force of near injurious or injurious intensity. In most cases, strong heating was subsequently used to determine the **▶ polymodality** of the nociceptive fiber. Nevertheless, in the skin, C- and A-delta fibres responsive to high intensity mechanical stimuli but also to strong heating, named respectively CMHs, and AMHs, have often been



**Mechanonociceptors, Figure 1** Responses of a nociceptive fibre to mechanical stimuli. Fibre conduction velocity, 29 m/s. Upper traces in (a), (b), (c) and (d) show the output of a pulse circuit triggered by unitary action potentials. (a) Pressure is used to stimulate the receptive field. (b) Pinching with a needle used as stimuli. (c) Fold of skin in the centre of the receptive field squeezed with serrated forceps used as stimuli. (d) Clip used to pinch the centre of the receptive field used as stimuli. Calibrations on right in g. (Modified from Burgess and Perl 1967).

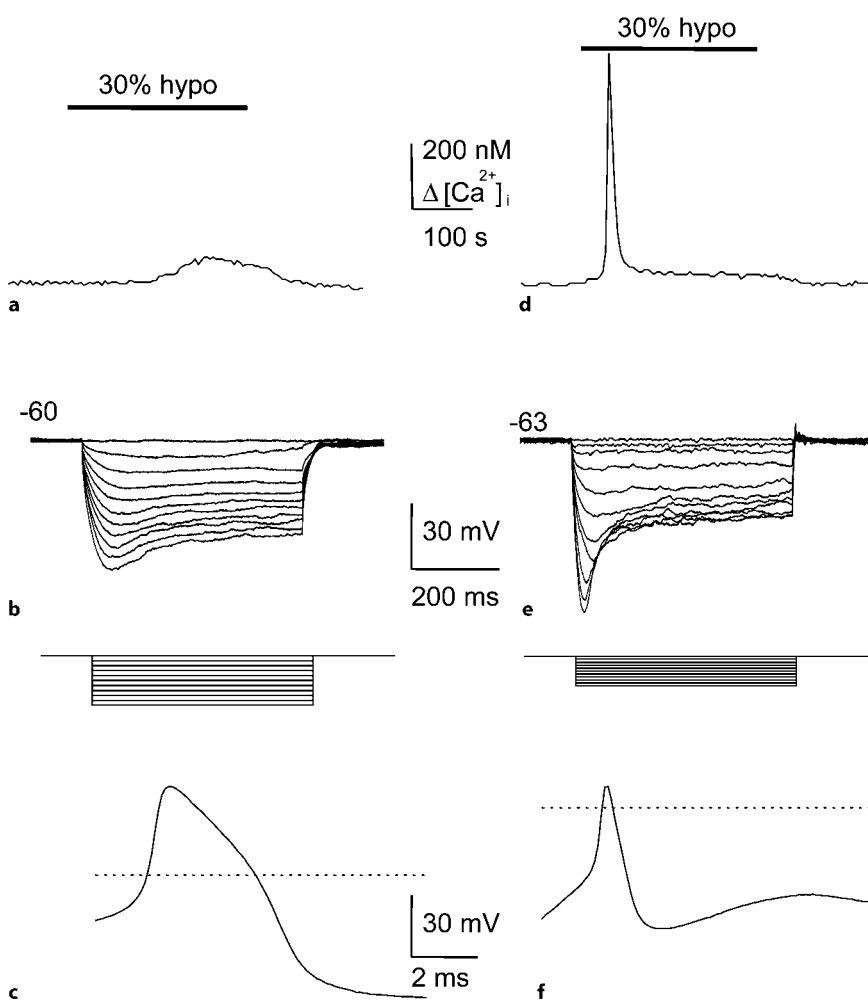
referred to as mechanonociceptors. This is incorrect, and only those units with high mechanical thresholds, absence of heat response and no initial sensitivity to chemical stimuli (although these have been seldomly tested systematically), can be considered pure mechanical nociceptors, sometimes also called “high threshold mechanoreceptors”. The designation as polymodal nociceptor is preferred for CMHs, AMHs and other sensory afferent types that, in addition to their sensitivity to high intensity mechanical forces, also respond to other stimulus modalities (Lynn 1994).

Pure mechanonociceptors have a wide range of sensitivities to mechanical stimuli varying from near noxious to overtly noxious intensities. In this population, A fibres generally respond to equivalent stimuli at higher rates of firing than C fibres (Garell et al. 1996). No background discharges are usually present in mechanonociceptors, which develop partial inactivation after repetitive stimulation of their receptive field. The **adaptation** of mechanonociceptors to a sustained stimulus was intermediate, when compared with that of typical phasic or tonic mechanoreceptors (Perl 1967).

With the advent of microneurography in humans (Hallin and Torebjörk 1970), mechanonociceptors have also been identified in the skin of the leg and foot of human subjects (Schmidt et al. 1997). Their receptive fields are not single sensitive spots as classical psychophysical studies had suggested, but cover a relatively large innervation territory.

The cellular and molecular mechanisms by which mechanonociceptors are sensitive only to mechanical stimuli of noxious or near noxious intensity, in contrast with the responsiveness to very light mechanical forces that characterizes low threshold mechanoreceptors, are still unknown.

Mechanotransduction is finally accomplished by opening or closing **ion channels** present in the cellular membrane. Many different types of mechanosensitive (MS) channels have been characterized in a wide variety of cell types (García-Añoveros and Corey 1997; Kellenberger and Schild 2002). Also, a variety of extracellular and intracellular proteins have been implicated in the transmission/amplification/modulation of mechanical force to the MS channels present in the cellular



**Mechanonociceptors, Figure 2** Electrophysiological properties and  $[Ca^{2+}]_i$  responses to hypotonic solution. (a) Time course of the increase in  $[Ca^{2+}]_i$  in response to a 5-min application of a 30% hypotonic solution of a possible mechanonociceptor neuron. (b) Membrane voltage responses of the same neuron to hyperpolarizing current steps of 15 pA. (c) Action potential evoked in the same neuron by depolarizing current pulse at threshold. (d) Time course of the increase in  $[Ca^{2+}]_i$  in response to a 5-min application of a 30% hypotonic solution of a possible mechanosensitive neuron. (e) Membrane voltage responses of the same neuron to hyperpolarizing current steps of 10 pA. (f) Action potential evoked in the same neuron by depolarizing current pulse at threshold. (Modified from Viana et al. 2001)

membrane during the transduction process. CaV3.2, a T-type calcium channel, seems to be required for normal function of D-hair mechanosensory neurons, but it has not yet been directly related with mechanonociception (Dubreuil et al. 2004; Shin et al. 2003). TREK-1, TREK-2 and TRAAK of the 2P domain mechanogated K<sup>+</sup> channels exhibit mechanosensitivity, but there is no experimental proof of their relationship with mechanonociception (Patel et al. 2001). The role played by ASICs, the mammalian homologues of MEC-4 and MEC-10 that mediate mechanotransduction in *Caenorhabditis elegans*, appears to be minor in mechanical sensitivity in mammals (Drew et al. 2004). TRPV4, an [▶ osmosensitive](#) channel in mammalian cells, has also been implicated in mechanotransduction (Alessandri-Haber et al. 2003). P2X3 receptors are present in small primary sensory neurons and respond to strong mechanical stimuli when expressed in oocytes of *Xenopus*. Thus, their implication in the mechanical sensitivity of nociceptor neurons has also been suggested (Cook et al. 1997; Nakamura and Strittmatter 1996).

However, the nature of the MS channels and of the extra- and intracellular matrix proteins involved in the different types of mechanotransduction in mammalian sensory neurons is still unsolved. Whether differences in mechanical threshold between low- and high threshold mechanosensory neurons are due to the expression of different MS channels, to differences in channel density, or to the presence of different associated proteins has been ignored. Cho et al (2002) identified two types of mechanosensitive (MS) channels in isolated membrane patches of cultured neurons of the dorsal root ganglion, with different pressure thresholds as well as distinct biophysical properties, that they named Low-threshold Mechanosensitive (LT-MS) and High-threshold Mechanosensitive channels (HT-MS). The reversal potential of these MS channels was near zero, as occurs with non-selective cationic channels, and they were blocked by the MS channels blocking agent Gd<sup>3+</sup>. HT-MS channels were present only in small sensory neurons (10–17.5 μm), and were activated only by high pressures and sensitized by PGE2, suggesting their implication in nociceptive transduction.

Neurons with low and high sensitivity to mechanical stimuli appear to have distinct electrophysiological properties. Viana et al. (2001), in cultured trigeminal neurons of the mouse, mechanically stimulated with hypoosmotic solutions, described a small fraction of neurons (12%) that exhibited narrow action potentials and marked time dependent inward rectification, which responded to hypoosmotic solution with fast and prominent elevations of intracellular calcium (Fig. 2), and were classified as low threshold mechanosensitive neurons. In contrast, they identified another group of neurons (19%) showing large and wide action potentials, with an inflexion in the falling phase and no rectification, which

produced smaller and slower elevations of intracellular calcium in response to hypoosmotic stimuli and were classified as mechano nociceptor neurons.

In spite of the progress made in the last years, the molecular and cellular basis of mechanotransduction in mammalian mechano and polymodal nociceptors, and the molecular basis of their differences with low-threshold mechanoreceptors, require further research.

- ▶ [Nociceptors in the Orofacial Region \(Skin/Mucosa\)](#)
- ▶ [Sensitization of Visceral Nociceptors](#)

## References

1. Alessandri-Haber N, Yeh JJ, Boyd AE (2003) Hypotonicity Induces TRPV4-Mediated Nociception in Rat. *Neuron* 39:497–511
2. Belmonte C, Gallar J, Pozo MA et al. (1991) Excitation by Irritant Chemical Substances of Sensory Afferent Units in the Cat's Cornea. *J Physiol* 437:709–725
3. Burgess PR, Perl R (1967) Myelinated Afferent Fibres Responding Specifically to Noxious Stimulation of the Skin. *J Physiol* 190:541–562
4. Cerveró F (1994) Sensory Innervation of the Viscera: Peripheral Basis of Visceral Pain. *Physiol Rev* 74:95–138
5. Cho H, Shin J, Shin CY et al. (2002) Mechanosensitive Ion Channels in Cultured Sensory Neurons of Neonatal Rats. *J Neurosci* 22:1238–1247
6. Cook SP, Vulchanova L, Hargreaves KM et al. (1997) Distinct ATP Receptors on Pain-Sensing and Stretch-Sensing Neurons. *Nature* 387:505–508
7. Dubreuil AS, Boukhaddaoui H, Desmadryl G et al. (2004) Role of T-Type Calcium Current in Identified D-Hair Mechanoreceptor Neurons Studied *In Vitro*. *J Neurosci* 24:8480–8484
8. Drew LJ, Rohrer DK, Price MP et al. (2004) Acid-Sensing Ion Channels ASIC2 and ASIC3 Do Not Contribute to Mechanically Activated Currents in Mammalian Sensory Neurons. *J Physiol* 556:691–710
9. García-Añoveros J, Corey DP (1997) The Molecules of Mechanosensation. *Annu Rev Neurosci* 20:567–594
10. Garell PC, Mcgillis SL, Greenspan JD (1996) Mechanical Response Properties of Nociceptors Innervating Feline Hairy Skin. *J Neurophysiol* 75:1177–1189
11. Hallin RG, Torebjork HE (1970) C-Fibre Components in Electrically Evoked Compound Potentials Recorded from Human Median Nerve Fascicles *In Situ*. A Preliminary Report. *Acta Soc Med Ups* 75:77–80
12. Kellenberger S, Schild L (2002) Epithelial Sodium Channel/Degenerin Family of Ion Channels: A Variety of Functions for a Shared Structure *Physiol Rev* 82:735–767
13. Lynn B (1994) The Fibre Composition of Cutaneous Nerves and the Classification and Response Properties of Cutaneous Afferents, with Particular Reference to Nociception. *Pain Reviews* 1:172–183
14. Mense S (1977) Muscular Nociceptors. *J Physiol* 73:233–240
15. Nakamura F, Strittmatter SM (1996) P2Y1 Purinergic Receptors in Sensory Neurons: Contribution to Touch-Induced Impulse Generation. *PNAS* 93:10465–10470
16. Patel AJ, Lazdunski M, Honoré E (2001) Lipid and Mechanogated 2P Domain K<sup>+</sup> Channels. *Curr Opin Cell Biol* 13:422–427
17. Perl ER (1968) Myelinated Afferent Fibres Innervating the Primate Skin and their Response to Noxious Stimuli. *J Physiol* 197:593–615
18. Schaible HG, Schmidt RF (1983) Activation of Groups III and IV Sensory Units in Medial Articular Nerve by Local Mechanical Stimulation of Knee Joint. *J Neurophysiol* 49:35–44
19. Schmidt R, Schmeltz M, Ringkamp M et al. (1997) Innervation Territories of Mechanically Activated C Nociceptor Units in Human Skin. *J Neurophysiol* 78:2641–2648
20. Shin JB, Martinez-Salgado C, Heppenstall PA et al (2003) A T-Type Calcium Channel Required for Normal Function of a Mammalian Mechanoreceptor. *Nat Neurosci* 6:724–730



21. Viana F, Pena E de la, Pecson B et al. (2001) Swelling-Activated Calcium Signalling in Cultured Mouse Primary Sensory Neurons. *Eur J Neurosci* 13:722–734

## Mechanoreceptive/Mechanosensitive Visceral Receptors

### Definition

Receptive endings in viscera that respond to mechanical stimuli. The receptors are not designated as nociceptors, because many mechanoreceptive/mechanosensitive visceral receptors respond to low intensity mechanical stimulation in the physiological range. Some mechanoreceptive/mechanosensitive visceral receptors, however, have response thresholds above the physiological range, and thus likely function as nociceptors. In viscera (and in muscle), both low threshold and high threshold mechanoreceptive/mechanosensitive visceral receptors encode stimulus intensity into the noxious range.

- ▶ Sensitization of Visceral Nociceptors

## Mechanoreceptor Afferents

### Definition

Peripheral afferent fibers that respond to mechanical stimulation. They may begin in “specialized” endings to the skin (sensory receptors e.g. Pacinian corpuscles) or as free nerve endings.

- ▶ Hyperaesthesia
- ▶ Hypoaesthesia
- ▶ Nick Model of Cutaneous Pain and Hyperalgesia

## Mechanosensitive

### Definition

Mechanosensitive is the characteristic of nociceptors that are responsive to stimuli such as touch, stretch, vibration and pressure.

- ▶ Postsynaptic Dorsal Column Projection, Functional Characteristics

## Mechanosensitive Sympathetic Afferent Fibers

### Definition

Afferent fibers that transmit information about mechanical changes that occur in the heart.

- ▶ Visceral Pain Model, Angina Pain

## Mechanosensitivity

### Definition

Mechanosensitivity is the ability to perceive a tactile input.

- ▶ Fibromyalgia, Mechanisms and Treatment

## MED

### Synonyms

Minimum Erythema Dose

### Definition

MED is the abbreviation for Minimum Erythema Dose. Ascending doses of UV irradiation determine the individual MED, and enables the quantification of inter-individually UV-evoked skin reactions. The lowest dose of UV radiation, just sufficient to induce a visible erythema that can be distinguished from normal and untreated skin, is defined as one-fold MED. Increasing doses of irradiation are expressed as multiples of the MED. The MED is an accepted measure to assess the skin sensitivity of humans; it does not define the irradiance power or the duration of the UV irradiation.

- ▶ UV-Erythema, a Model for Inducing Hyperalgesias

M

## Medial Branch Block

- ▶ Facet Joint Procedures for Chronic Back Pain

## Medial Lemniscus (ML)

### Definition

The medial lemniscus is the fiber bundle that originates from the dorsal column nuclei and projects to the thalamus.

- ▶ Spinothalamic Projections in Rat
- ▶ Thalamocortical Loops and Information Processing

## Medial Pain System

### Definition

The medial pain system is the neural circuit consisting of medially projecting spinothalamic pathways that terminate in medial thalamic nuclei, which in turn project to limbic and cortical structures (anterior cingulate cortex, insula, prefrontal cortex, amygdala) that underlie the processing of the affective-motivational dimension of pain.

- ▶ Spinothalamocortical Projections to Ventromedial and Parafascicular Nuclei
- ▶ Thalamo-Amygdala Interactions and Pain

## Medial Part of the Posterior Complex

### Synonyms

POm

### Definition

The medial part of the posterior complex receives terminations from the spinothalamic tract and probably projects to the insula. The exact functional role remains unclear.

- ▶ Thalamus, Nociceptive Cells in VPI, Cat and Rat

## Medial Thalamotomies

### Definition

Medial thalamotomies are stereotactic operations that have been performed since the beginning of the nineteen fifties against chronic pain. They have been used against both chronic nociceptive and neurogenic pain syndromes, and several different targets within the medial tier of the thalamus have been explored, for example, the centre médian-parafascicular complex, central lateral nucleus, posterior complex and medial pulvinar. The results of these operations have been characterized by pain relief without production of somatosensory deficits and without risk for postoperative pain increase.

- ▶ Thalamotomy for Human Pain Relief

## Medial Thalamus

### Definition

The intralaminar and midline nuclei of the thalamus. This region of the thalamus most likely contributes to the affective components as well as to attention and arousal associated with pain.

- ▶ Spinothalamic Tract Neurons, Visceral Input
- ▶ Thalamo-Amygdala Interactions and Pain

## Median Branch Block

- ▶ Facet Joint Procedures for Chronic Back Pain

## Median Nerve Compression at the Wrist

- ▶ Carpal Tunnel Syndrome

## Mediate

### Definition

The mechanism or process through which one variable exerts its influence on a second variable.

- ▶ Psychology of Pain, Self-Efficacy

## Medical Decision-Making Model

### Definition

Medical decision-making model refers to the application of statistical decision theory to judgments concerning diagnostic decisions and treatment outcomes.

- ▶ Statistical Decision Theory Application in Pain Assessment

## Medical History

WADE KING

Department of Clinical Research, Royal Newcastle Hospital, University of Newcastle, Newcastle, NSW, Australia

wmbaking@tpg.com.au

### Definition

Medical history is the account given by a patient of their symptoms, relevant matters, and their general health. History-taking forms the basis of clinical [assessment](#), and also helps establish the doctor-patient relationship that is essential for medical care.

### Characteristics

One imperative in eliciting a history is for the physician to be alert to so-called “red flags”, i.e. clinical features known to correlate with serious pathology such as infection or neoplasm. In the interest of securing the patient’s safety, such possibilities must be explored at the initial assessment and at every subsequent contact.

Taking a history needs to be thorough, lest important issues pertaining to the patient’s problems be overlooked. A comprehensive history would entail exploring each of the following domains:

- Identification
- Presenting symptoms
- History of the index condition
- Concurrent conditions
- Concurrent medical treatment
- General medical history
- Systems review
- Psychological history
- Social history

### Identification

The physician should ask the patient's name, address, age, lateral dominance and occupation. Age is a risk factor for some conditions. Lateral dominance and occupation relate to how the affected part has been used in the past and activities the patient may undertake in the future.

### Presenting Symptoms

All current symptoms should be listed and ranked in order of significance to the patient. The one for which the patient is seeking treatment should be identified as the "index condition".

### History of the Index Condition

The physician should elicit the history of the index condition systematically, using simple questions to guide the patient so they describe all relevant features. A suitable approach to a pain history is to follow the checklist below:

- Site
- Distribution
- Quality
- Duration
- Periodicity
- Intensity
- Aggravating Factors
- Relieving Factors
- Effects on Activities of Daily Living
- Associated Symptoms
- Onset
- Previous Similar Symptoms
- Previous Treatment
- Current Treatment

### Site

The site of pain is the anatomical region or area in which the patient perceives their pain. That may or may not be the site of origin of the pain. The patient may be describing an area into which pain is ► *referred*. In recording the site of pain, the physician should take care to ensure that any terms used by the patient are not incorrect, and are correctly understood by the physician and others who might become engaged in the patient's management. For example, what a patient calls 'back pain' may not accurately be "lumbar spinal pain", which should be distinguished from loin pain or buttock pain (Merskey and Bogduk 1994). "Leg pain" should be distinguished from pain in the thigh or pain in the (entire) lower limb.

### Distribution

The distribution of pain, and to where it spreads, can provide clues to its origin. Patterns called "pain maps" have been determined experimentally for pain from particular segments of the cervical spine (Dwyer et al. 1990; Aprill et al. 1990; Dreyfuss et al. 1994; Fukui

et al. 1996), thoracic spine (Dreyfuss et al. 1994) and lumbar spine (Mooney and Robertson 1976; Fukui et al. 1997), from sacroiliac joints (Fortin et al. 1994) and from peripheral joints such as the sternoclavicular joint (Hassett and Barnsley 2001). In other instances, such as abdominal pain, the distribution of pain may be used to explore sources amongst structures with the same segmental innervation as the area of distribution.

### Quality

Dull, aching pain is typical of ► *somatic pain*, and if it radiates from the spine to a limb it suggests ► *somatic referred pain* of spinal origin. Sharp pain shooting from the spine into a limb is likely to be ► *radicular*. Burning pain is often, if not typically, ► *neuropathic*.

### Duration

Establishing if the pain is acute, subacute, or chronic (see ► *Acute Pain, Subacute Pain and Chronic Pain*), is important for it predicates treatment. Interventions that work for acute pain may not be appropriate for chronic pain, and vice-versa.

### Periodicity

Constant pain may be associated with continuing pathology. Intermittent pain, especially pain on movement, may be associated with injury of parts that become painful under load. Some forms of neurogenic pain, particularly the ► *neuralgias*, may be intrinsically periodic, i.e. occurring in bursts. Some forms of ► *headache* have characteristic periodicities.

### Intensity

The intensity of pain should be measured on a visual analogue scale or other instrument. If pain is not measured initially it cannot later be said to have been relieved (Huskisson 1974). Severe pain, of sudden onset, may indicate a serious cause that requires rapid diagnosis and immediate management.

### Aggravating Factors

Aggravating factors include stresses that load impaired tissues. Identifying aggravating factors may assist in formulating management, which includes not only specific interventions but also guiding the patient as to what they should not do, and what they might do in better ways despite the pain. Pain that is not aggravated by moving or palpating the region in which pain is perceived suggests the possibility of a remote origin, which should be pursued.

### Relieving Factors

Relieving factors usually reduce stresses on the affected part; e.g. avoiding certain movements. Pain that is not relieved by rest raises concern about a possible serious cause that needs to be investigated.

### Effects on Activities of Daily Living

The effects of pain on activities of daily living (ADLs) provide an index of ways in which the pain disables or handicaps the patient. These should be addressed in the plan of management, lest the patient become unnecessarily disabled for fear of aggravating their pain.

### Associated Symptoms

Associated symptoms are important clues to serious causes of pain. Sooner or later, serious causes will produce features other than pain. These features serve to identify the cause. In the absence of associated symptoms, a serious cause of pain is highly unlikely. For different conditions, different associated symptoms apply, and should be asked about, lest a serious condition be missed. Infection can be associated with fever and malaise; tumours with weight loss, malaise, or neurological symptoms; vascular disorders with transient ischaemic attacks.

### Onset

The onset means the first appearance of the pain and the circumstances in which it started. Those circumstances may provide clues to the cause of the pain. Sometimes this may be an injury. Sometimes it might be an antecedent infection. These features can provide clues as to the possible cause of pain and its aetiology.

### Previous Similar Symptoms

Previous related symptoms suggest a chronic or recurrent condition. In that event, persistent risk factors for recurrence should be explored and managed.

### Previous Treatment

All measures used to treat the condition, their outcomes and any unwanted effects should be noted. Interventions to which there have been favourable responses may be harnessed for further management. Treatment failures may provide clues to the nature of the cause of pain; failures also suggest treatments to avoid.

### Current Treatment for the Index Condition

All current treatment should be recorded, including self-applied measures like local heat and all substances whether prescribed or otherwise, with the patient's appraisal of each. Knowing the current treatment serves to warn about possible deleterious interactions with treatment about to be prescribed.

### Intercurrent Conditions

Any intercurrent problems should be noted, and consideration given to any "red flags".

### Other Current Medical Treatment

All forms of treatment in use for other conditions should be considered for any effect they may have on the index condition or its treatment.

### Past Medical History

Past history can provide clues to possible serious causes of current pain. A past history of cancer warns of possible recurrence or metastases. Recent skin penetration, current infections, or immunological compromise warn of possible infection. Prolonged use of corticosteroids is a risk factor for peptic ulceration and osteoporosis resulting in stress factors. Renal disease, use of corticosteroids, immunosuppression, and diabetes mellitus are risk factors for osteonecrosis.

### Systems Review

Asking specifically about past or present symptoms from each bodily system may yield clues to possible serious causes that may not have been evident otherwise.

### Psychological History

The physician should consider how the patient reacts to the condition mentally, and should identify any psychosocial risk factors, i.e. psychological and social issues correlated statistically with the likelihood of chronic disability. Sensitive exploration of a patient's psyche can enhance the doctor-patient relationship, enable development of empathy, and help the physician care for them in the manner advocated by Cochrane (Cochrane 1977).

Aspects to be addressed include affect, in particular if anxious or depressed; understanding of the condition; any associated fears; relevant cognitions and beliefs; and coping strategies. The physician must decide if these factors are likely to influence the course of the condition (Lethem et al. 1983), and whether special psychological management is needed.

### Social History

The social history helps the physician understand the patient in their social environment. It should include their family, other close relationships, home, employment, sources of income, education, occupational qualifications and leisure interests. These factors may bear on what strategies may or may not be employed in the management plan. Some may constitute risk factors for impeded recovery. In which case, they need to be addressed.

### References

1. Aprill C, Dwyer A, Bogduk N (1990) Cervical Zygapophyseal Joint Pain Patterns: II – A Clinical Evaluation. *Spine* 15:458–461
2. Cochrane AL (1977) *Effectiveness and Efficiency. Random Reflections on Health Services.* Cambridge University Press, Cambridge, p 95
3. Dreyfuss P, Michaelsen M, Fletcher D (1994) Atlanto-Occipital and Lateral Atlanto-Axial Joint Pain Patterns. *Spine* 19:1125–1131
4. Dreyfuss P, Tibiletti C, Dreyer SJ (1994) Thoracic Zygapophyseal Joint Pain Patterns. *Spine* 19:807–811
5. Dwyer A, Aprill C, Bogduk N (1990) Cervical Zygapophyseal Joint Pain Patterns: I – A Study in Normal Volunteers. *Spine* 15:453–457



6. Fortin JD, Dwyer AP, West S, Pier J (1994) Sacroiliac Joint: Pain Referral Maps upon Applying a New Injection/Arthrography Technique; Part 1: Asymptomatic Volunteers. *Spine* 19:1475–1482
7. Fukui S, Ohseto K, Shiotani M, Ohno K, Karasawa H, Naganuma Y, Yuda Y (1996) Referred Pain Distribution of the Cervical Zygapophyseal Joints and Cervical Dorsal Rami. *Pain* 68:79–83
8. Fukui S, Ohseto K, Shiotani M, Ohno K, Karasawa H, Naganuma Y (1997) Distribution of Referred Pain from the Lumbar Zygapophyseal Joints and Dorsal Rami. *Clin J Pain* 13:303–307
9. Hassett G, Barnsley L (2001) Pain Referral from the Sternoclavicular Joint: A Study in Normal Volunteers. *Rheumatology* 40:859–862
10. Huskisson EC (1974) Measurement of Pain. *Lancet* 2:1127–1131
11. Lethem J, Slade PD, Troup JDG, Bentley G (1983) Outline of a Fear Avoidance Model of Exaggerated Pain Perception – I. *Behav Res Ther* 21:401–408
12. Merskey H, Bogduk N (1994) Classification of Chronic Pain. Descriptions of Chronic Pain Syndromes and Definitions of Pain Terms, 2nd edn. Seattle, IASP Press, pp 3, 11–12
13. Mooney V, Robertson J (1976) The Facet Syndrome. *Clin Orthop* 115:149–156

## Medical Hydrology

- ▶ Spa Treatment

## Medical Misadventures

- ▶ Postoperative Pain, Adverse Events (Associated with Acute Pain Management)

## Medical Mishaps

- ▶ Postoperative Pain, Adverse Events (Associated with Acute Pain Management)

## Medical Outcomes Study 36-Item Short-Form Health Survey (SF-36)

### Definition

The Medical Outcomes Study 36-Item Short-Form Health Survey (SF-36) is a 36 item general measure of perceived health status that is usually self-administered.

- ▶ Pain Inventories

## Medical Signs

### Definition

Anatomical, physiological, or psychological abnormalities that can be observed, apart from a person's

statements (symptoms). Signs must be shown by medically acceptable clinical diagnostic techniques. Psychiatric signs are medically demonstrable phenomena that indicate specific psychological abnormalities, e.g. abnormalities of behavior, mood, thought, memory, orientation, development, or perception. They must also be shown by observable facts that can be medically described and evaluated.

- ▶ [Disability Evaluation in the Social Security Administration](#)

## Medically Incongruent Symptoms and Signs

- ▶ Non-Organic Symptoms and Signs

## Medication-Induced Headaches

- ▶ Headache Attributed to a Substance or its Withdrawal

**M**

## Mediodorsal Nucleus (MD)

### Definition

The main medial nucleus of the thalamus, limited by the intralaminar nuclei.

- ▶ Spinothalamic Terminations, Core and Matrix
- ▶ Thalamus, Visceral Representation

## Mediolongitudinal Myelotomy

- ▶ Midline Myelotomy

## Meditation

### Definition

Meditation is a means of narrowing the focus of one's attention to a simple activity (e.g. awareness of the breath) or word (e.g. a mantra), thereby quieting and calming the mind.

- ▶ [Relaxation in the Treatment of Pain](#)

## Medullary Dorsal Horn

### Definition

The medullary dorsal horn is a caudal portion of the sub-nucleus caudalis of the spinal trigeminal nucleus, which has laminated cytoarchitecture analogous to the dorsal horn of the spinal cord. The medullary dorsal horn plays a major role in the processing of nociceptive information from the head, face and mouth regions.

- ▶ DREZ Procedures
- ▶ Trigeminothalamic Tract Projections

## Medullary Lateral Reticular Formation

### Definition

Lying dorso-medially to the spinal trigeminal nucleus, it contains the interneurons that mediate the long-latency trigeminal reflexes.

- ▶ Jaw-Muscle Silent Periods (Exteroceptive Suppression)

## MEG

- ▶ Magnetoencephalography
- ▶ Pain in Humans, EEG Documentation

## Meissner Receptor

### Definition

Encapsulated cutaneous mechanosensory receptors specialized for the detection of fine touch and pressure. Meissner receptors transmit information about the velocity of the stimulus. They belong to the moderately rapid adapting detectors.

- ▶ Perireceptor Elements

## Melanotic

### Definition

Melanotic refers to a high level of blackish pigmentation that produces a very dark or black color.

- ▶ Lower Back Pain, Physical Examination

## Melatonin

### Definition

Melatonin is a substance secreted by the pineal gland associated with circadian rhythms such as the sleep-wake cycle.

- ▶ Hypnic Headache

## Membrane Capacitance

### Definition

The ability of a cell membrane to store ionic charge.

- ▶ Demyelination

## Membrane Potential

### Definition

The electric potential difference across the membrane of living cells at rest, due to a differential distribution of ions (particularly Na<sup>+</sup>, K<sup>+</sup> and Cr) consecutive to the variable permeability of the membrane and the active transport of ions.

- ▶ Nociceptor Generator Potential

## Membrane Resistance

### Definition

A measurement of how easily ions cross the cell membrane.

- ▶ Demyelination

## Membrane Stabilising Agents

- ▶ Postoperative Pain, Membrane Stabilising Agents

## Membrane Stabilizers

### Definition

Pharmacological agents that reduce the electrical excitability of neurons. Typical membrane stabilizing drugs are local anesthetics and other Na<sup>+</sup> channel blockers.

- ▶ Pain Paroxysms
- ▶ Tic and Cranial Neuralgias

## Membrane-Stabilizing Drugs

- ▶ Drugs Targeting Voltage-Gated Sodium and Calcium Channels

## Memory Decision Theory

### Definition

Memory decision theory refers to the application of signal detection theory to judgments concerning whether a descriptor is “old”, that is, previously used to describe a symptom, or „new“, that is, not previously used.

- ▶ Statistical Decision Theory Application in Pain Assessment

## Meningeal Afferents

- ▶ Nociceptors in the Orofacial Region (Meningeal/Cerebrovascular)

## Meningeal Carcinomatous

### Definition

This is wide spread infiltration of the meninges with cancer. Symptoms and signs may reflect involvement of multiple sites in the central nervous system and may include altered mental status, headache and pain. Carcinomatous meningitis occurs in two to three percent of patients with adenocarcinoma of the lung and small cell lung cancer. The median survival of patients with carcinomatous meningitis is two to four months.

- ▶ Cancer Pain Management, Overall Strategy

## Meningeal Layer

### Definition

The protective membranes that encase the central nervous system.

- ▶ Motor Cortex (M1)
- ▶ Secondary Somatosensory Cortex (S2) and Insula, Effect on Pain Related Behavior in Animals and Humans

## Meningeal Nociceptors

- ▶ Nociceptors in the Orofacial Region (Meningeal/Cerebrovascular)

## Meningoencephalitis

### Definition

Of the brain stem and cerebellum: neurologic manifestation of Behçet’s disease.

- ▶ Headache Due to Arteritis

## Meniscus

### Definition

Flattened cartilaginous plate found in certain joints, including the knee. The meniscus serves to maintain the apposition of the opposed surfaces in their various motions, to ease the gliding movement of the joint, and to decrease the effects of pressure and sudden impact on the joint.

- ▶ Arthritis Model, Osteoarthritis

## Mensendieck System

### Definition

A pedagogically designed system of functional exercises based on an analysis of human anatomy, physiology, and biomechanics, developed by MD Bess M. Mensendieck, in the early 1900s. The aims are to better the individual’s functional capacity in daily life by increasing understanding of anatomically and physiologically correct movements, and improving the ability to interpret body signals.

- ▶ Body Awareness Therapies

## Menstrual Suppression

### Definition

The use of hormonal or anti-hormonal medication such as combined hormonal contraception, high dose progestins, androgens or GnRH agonists for prolonged periods of time in order to obviate or minimize menstrual flow and pain.

- ▶ Dyspareunia and Vaginismus

## Mental Disorders, Diagnostics and Statistics

- ▶ Diagnostic and Statistical Manual of Mental Disorders

## Mental Pain

- ▶ Pain, Psychiatry and Ethics

## Menthol

### Definition

Menthol is a natural substance (2-isopropyl-5-methyl-cyclohexanol) obtained from plant leaves of the genus *Mentha*, widely used in products such as common cold medications, toothpastes, confectionery and cosmetics. l-menthol evokes a sensation of coolness by stimulation of oral, nasal and skin cold thermoreceptors. Menthol can also act as an irritant involving capsaicin-sensitive pathways. A cold and menthol receptor, named TRPM8, was cloned from peripheral sensory neurons.

- ▶ Nociceptors, Cold Thermotransduction

## Meralgia Paresthetica

### Definition

Meralgia Paresthetica is a painful mononeuropathy of the lateral femoral cutaneous nerve due to focal entrapment in the inguinal ligament. It results in pain in the lateral thigh.

- ▶ Neuralgia, Assessment
- ▶ Sciatica

## Merkel Receptor

### Definition

Encapsulated cutaneous mechanosensory receptors specialized for the detection of fine touch and pressure. Merkel receptors transmit information about the intensity of the stimulus. They belong to the slowly adapting detectors.

- ▶ Perireceptor Elements

## Mesencephalic Nucleus

### Definition

Mesencephalic nucleus, containing the cell bodies of primary afferents innervating the jaw muscle spindles or periodontal ligaments.

- ▶ Trigeminal Brainstem Nuclear Complex, Anatomy

## Mesencephalic Tractotomy

- ▶ Pain Treatment, Intracranial Ablative Procedures

## Mesencephalon

### Definition

The narrow short part of the brain stem above the pons and below the thalamus. An operation to interrupt a pathway at the level of the mesencephalon is called a mesencephalotomy.

- ▶ Pain Treatment, Intracranial Ablative Procedures

## Mesencephalotomy

- ▶ Pain Treatment, Intracranial Ablative Procedures

## Mesmerism

- ▶ Therapy of Pain, Hypnosis

## Meta-Analysis

### Definition

Meta-analysis is a statistical technique for combining the findings from independent studies. It is a systematic review that uses quantitative methods to summarize the results. It is most often used to assess the clinical effectiveness of healthcare interventions. Meta-analysis is an effective means of correcting both for bias and lack of power in individual randomized controlled studies. It provides a precise estimate of treatment effect, providing due weight to the size of the studies included. The validity of meta-analysis depends on the quality of the systematic review. A meta-analysis may also allow the investigator to explore whether features associated with studies influence the magnitude of the effects observed, e.g. do studies using skilled therapists obtain better effect than those using relatively unskilled ones?

- ▶ Operant Treatment of Chronic Pain
- ▶ Postoperative Pain, Preoperative Education
- ▶ Psychology of Pain, Efficacy
- ▶ Transition from Acute to Chronic Pain



## Metabolic and Nutritional Neuropathies

ALEX BARLING, JOHN B. WINER  
 Department of Neurology, Birmingham Muscle and Nerve Centre, Queen Elizabeth Hospital, Birmingham, UK  
 corisanderoad@aol.com, j.b.winer@bham.ac.uk

### Synonyms

Vitamin Neuropathy; Beri Beri Disease; Malnutrition; Alcoholism; Cuban Neuropathy Fabry's Disease; Para-proteinemic Neuropathies; Nutritional Neuropathies; Metabolic Neuropathies

### Definition

Neuropathy encompasses conditions occurring with systemic organ failure as well as inherited or acquired metabolic defects. Nutritional neuropathies are those related to malnutrition and resulting vitamin deficiency. Neuropathy related to alcoholism is also discussed in this section as a toxic metabolic cause that has been suggested for the axonal injury, it is also frequently related to malnutrition. Axonal neuropathies usually result in damage to the nerve cell body and lead to a dying back of the longest axons.

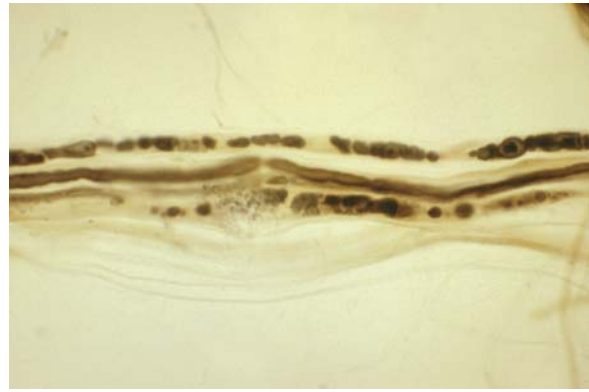
### Characteristics

#### Alcohol

Alcohol remains the second most common cause of neuropathy after diabetes mellitus and affects a third of alcoholics (Neundorfer 2001). It is unclear whether alcohol is toxic itself or simply associated with malnutrition that results in neuropathy. A recent study by Koike suggested a direct causal role (Koike 2003).

The neuropathy typically manifests as burning feet with distal, symmetrical loss of pain sensation and ► **allodynia** in the lower limbs. As the neuropathy progresses distal weakness occurs, initially in the legs and then the arms. These features can be accompanied by ataxia from joint position loss or cerebellar degeneration, Wernick-Korsakoff encephalopathy and stigmata of chronic liver disease. Impotence and postural hypotension from autonomic nerve involvement are often under diagnosed (Monforte 1995).

There are no diagnostic investigations, but the clinical signs in conjunction with a history of alcohol consumption, typically greater than 3 litres of beer or 300 ml of spirits per day for three years, are suggestive (Behse 1977). A red cell macrocytosis, elevated transaminase and gamma glutamyltransferase are also pointers. Analysis of cerebral spinal fluid should be normal, although the protein may be minimally elevated. The nerve conduction studies, (NCS), mirror the clinical findings and show distal, predominantly lower limb, symmetrically, reduced sensory nerves action



**Metabolic and Nutritional Neuropathies, Figure 1** Teased fibre preparation of a peripheral nerve showing axonal degeneration as seen in alcoholic neuropathy.

potentials. Histology demonstrates axonal loss in fibres of all sizes in the absence of inflammation (Fig. 1). Treatment of alcoholic neuropathy requires abstinence and multivitamins including thiamine. Sensory symptoms may initially worsen on treatment.

### Nutritional Neuropathies

Nutritional neuropathies occur predominantly in developing countries where crop failure and malnutrition are common. The last major outbreak was in Cuba in 1992 (Roman 1994). In developed countries nutritional neuropathies are rare but still occur in the context of alcoholism, malignancy, chronic infection and pregnancy. They are important to recognise, as prompt treatment can halt the progression and sometimes improve the neuropathy.

#### Thiamine Deficiency, B<sub>1</sub>

Thiamine deficiency causes the syndrome of Beri Beri, which encompasses peripheral neuropathy (dry Beri Beri) and congestive cardiac failure (wet Beri Beri). Initially recognised early in the 19<sup>th</sup> century, it was associated with a diet of processed rice or during sea voyages. Thiamine deficiency should be suspected in any malnourished patient. The symptoms and signs are similar to alcoholic neuropathy with burning ► **dysaesthesia** in the legs. The condition progresses over weeks and months, with the sensory symptoms spreading proximally followed by weakness. Less commonly, the cranial nerves can be affected e.g. laryngeal weakness, facial weakness and tongue deviation.

Laboratory studies of thiamine levels are unreliable. Numerous studies have looked at pyruvate which accumulates in thiamine deficiency, however the sensitivity is poor. Assay of erythrocyte transketolase levels, a vitamin B<sub>1</sub> dependant enzyme, is more helpful if measured prior to any supplementation as it reflects B<sub>1</sub> stores. NCS are similar to that of alcoholic neuropathy with predominantly distal, symmetrical axonal loss. The pathology shows distal axonal degeneration.

**Metabolic and Nutritional Neuropathies, Table 1** Features of Metabolic and Nutritional Neuropathy

Cause	Symptoms	Pain	Examination	Specific Investigations	Pathology
Alcohol	burning feet	+++	distal, symmetrical, loss of pain and hyperaesthesia to light touch	raised red cell mean cell volume raised transaminase raised gamma glutamyltransferase	sensory axonal
thiamine deficiency	burning Feet	+++	distal, symmetrical, loss of pain and hyperaesthesia to light touch	raised erythrocyte transketolase	axonal
pyridoxine deficiency	Distal numbness and tingling		distal, symmetrical sensory loss		sensory axonal
cobalamine deficiency	Distal tingling and numbness +/- ataxia & weakness		distal loss of vibration followed by joint position sense Absent ankle reflexes	low B <sub>12</sub> , raised homocysteine and methionine variable increase in haemoglobin & mean cell volume	axonal
vitamin E deficiency	ataxia and weakness		distal areflexia and loss of vibration +/- ataxia	vitamin E level (in presence of normal lipid levels)	axonal
uraemia	Distal paraesthesia	+	distal sensory loss	raised urea	axonal
hepatic dysfunction	variable		variable	deranged liver function tests +/- vitamin E deficiency	demyelinating or axonal
thyroid disease	Distal paraesthesia	++	distal sensory loss	TSH and T4	sensory axonal
Porphyria	Distal paraesthesia & proximal weakness	+	distal paraesthesia & proximal weakness +/- Respiratory muscle weakness	urinary porphobilinogens	axonal
Amyloid	Distal paraesthesia		distal, symmetrical loss of pain and temperature +/- autonomic dysfunction	Congo red staining of nerve biopsy	Axonal
Refsums Disease	Distal paraesthesia	+	distal, symmetrical loss of vibration and proprioception Mild distal weakness	raised plasma phytanic acid and pipercolic acid	demyelinating
Fabrys Disease	burning hands & feet	+++	progressive or episodic sensory loss	α-galactosidase levels in fibroblasts	axonal

The treatment of polyneuropathy is with oral thiamine, 300 mg per day. In the presence of heart failure or Wernicke's encephalopathy, thiamine should be administered parenterally (see ► [Wernicke-Korsakoff Syndrome](#)). Supplementation with multivitamins is recommended as the neuropathy is often not the result of a single vitamin deficiency state.

#### Pyridoxine Deficiency, B<sub>6</sub>

Pyridoxine deficiency is rare and usually secondary to treatment with isoniazid or hydralazine. These drugs inhibit the phosphorylation of pyridoxine to the active coenzyme pyridoxal phosphate. Distal, symmetrical numbness with tingling is the common presentation. Discontinuing the offending drug usually reverses the symptoms. A daily oral dose of 50–100 mg of pyridoxime is generally advised. Doses above 180 mg per

day are toxic to nerves, leading to a pyridoxime induced neuropathy.

#### Cobalamine Deficiency, B<sub>12</sub>

The most common cause of B<sub>12</sub> deficiency is malabsorption secondary to pernicious anaemia. In this condition, antibodies to intrinsic factor prevent absorption of B<sub>12</sub> specifically. A deficiency state is also well documented in patients post gastrectomy or resection of the terminal ileum. Less frequent causes of deficiency include tropical sprue, severe steatorrhoea, drugs such as colchicine which reduce absorption and rarely a strict vegan diet. Occasionally general anaesthesia with nitrous oxide can precipitate a deficit; this is because nitrous oxide can interfere with the B<sub>12</sub> dependant conversion of homocysteine to methionine. B<sub>12</sub> is stored in the liver and many years of deficiency are needed to deplete the stores.

B<sub>12</sub> deficiency usually begins insidiously and progresses over weeks and months. Practically it is very difficult to separate the symptoms or neuropathy from the myelopathy of sub-acute combined degeneration of the spinal cord as they usually coexist. In the early stages ► [paraesthesia](#) and numbness are the most common symptoms. Lower limb weakness and ataxia then ensues. Other symptoms include impotence, memory loss and mental slowing.

Examination typically reveals loss of vibration sensation in the early stages followed by loss of joint position sense and then light touch. The ankle reflexes are reduced or absent. The myelopathy leads to pyramidal motor dysfunction, hyperreflexia at the knee and a positive Babinski sign.

Serum B<sub>12</sub> levels can be measured but the methods of assay varies, and all are prone to inaccuracy, as B<sub>12</sub> is predominantly protein bound. This means that a normal B<sub>12</sub> concentration does not exclude a deficiency state. Also, falsely elevated levels are seen in myeloproliferative and hepatic disorders and falsely low levels are seen in pregnancy. B<sub>12</sub> deficiency is also associated with a macrocytic anaemia. There is debate about whether significant neurological dysfunction from B<sub>12</sub> deficiency can occur in the presence of a normal haemoglobin level. Significant reduction of the B<sub>12</sub> concentration will cause an elevation in B<sub>12</sub> dependant metabolites, homocysteine and methionine. Measuring the levels of these metabolites can be useful in cases of borderline deficiency, to help establish those with neurology resulting from their deficiency. Ninety percent of patients with significant neurological disease have elevated levels (Yuen 2001). NCS show reduced sural nerve action potentials resulting from presumed axonopathy. The pathological studies in this area are limited and inconclusive (Windebank 1993).

Vitamin B<sub>12</sub> deficiency is treated with intramuscular injections. Partial neurological improvement is usually seen predominantly in the first six months, but recovery can continue for up to a year or more.

### Vitamin E Deficiency

Vitamin E is a fat soluble vitamin and absorption is dependent on bile salts and pancreatic esterases in the small bowel. Causes of the deficiency include cystic fibrosis, bile salt deficiency from congenital cholestasis and small bowel resection, a rare inherited defect of chylomicrons and lipoprotein synthesis known as abetalipoproteinaemia, and defects in alpha-tocopherol transfer protein genes which are inherited in an autosomal recessive manner.

There are significant reserves of vitamin E in the adipose tissue; this means that deficiency states in adults take many years or decades to become clinically significant. Deficiency of vitamin E leads to spinocerebellar dysfunction with variable peripheral nerve involvement; affected patients usually complain of an unsteady gait

and weakness. Examination reveals distal areflexia, prominent loss of vibration and joint position sense with minimal weakness. Other sensory modalities such as light touch are seldom affected. Ataxia can be a feature of both joint position loss and cerebellar involvement. The clinical picture can be confounded by proximal muscle weakness and a positive Babinski sign.

Vitamin E assays are accurate in the presence of normal lipid levels as vitamin E is primarily located in lipoprotein, however, hyperlipidaemic patients with normal vitamin E assays, may still have a deficiency. In general, levels need to be undetectable to be able to attribute neurological disease to vitamin E deficiency. NCS demonstrate a reduction in sensory nerve action potentials with preservation of conduction velocity. Motor nerves are usually unaffected. ► [Somatosensory evoked potentials](#) and visually evoked potentials (► [visual evoked potentials](#)) are often delayed due to spinal or central nerve involvement. Electromyography can show mild denervation. CSF examination is normal.

The role of vitamin E as an antioxidant and free radical scavenger are well documented, but the mechanism by which vitamin E deficiency affects the nervous system is not established.

Treatment of vitamin E deficiency involves large doses of oral vitamin E, 1–4 g/day (Sokol 1990). Every case should be carefully monitored and the dose individually tailored. In cases of severe damage to the nervous system, regression is unlikely and treatment would aim to halt the progress of the disease. If conditions such as abetalipoproteinaemia are diagnosed early enough, the condition may be prevented by supplementing vitamin E.

### Metabolic

Chronic uraemia causes a progressive sensory motor, axonal neuropathy which can be painful (Wolfe 2002). The frequency has decreased over the last ten years due to improved management with dialysis and renal transplant (Said 1987; Lagueny 2002), although the exact mechanism underlying this neuropathy is unknown.

Toxins can effect both the peripheral nerve and liver, but some neuropathies do occur as a consequence of hepatic dysfunction alone: Chronic hepatic failure can lead to an asymptomatic demyelinating neuropathy, and neuropathy is detectable in 93% of patients pre liver transplant (McDougall 2003); An acute demyelinating polyneuropathy similar to Guillian Barré can accompany viral hepatitis. A sensory neuropathy is associated with Primary Biliary Cirrhosis, while childhood cholestatic liver disease can cause a sensory neuropathy secondary to vitamin E deficiency.

A mild chronic sensory motor neuropathy can be seen in both hyperthyroidism and hypothyroidism.

Acute intermittent porphyria can cause an axonal neuropathy which is preceded by the first attack of abdom-

**Metabolic and Nutritional Neuropathies, Table 2** Paraproteinemic Neuropathies

Condition	Systemic Symptoms	Neuropathy	Pain	Examination	Specific Investigations	Pathology
MGUS	Nil	Distal numbness, paraesthesia and pain with ataxia. Can resemble chronic inflammatory demyelinating polyneuropathy, CIDP	+++	Predominantly sensory loss Weakness occurs late	IgG or IgM-K paraprotein <3g/dl Bone marrow biopsy < 5% plasma cells	Predominantly demyelinating
Multiple Myeloma	Fatigue, bone pain	Distal weakness and dysaesthesia		Distal, symmetrical, weakness and numbness	IgM or IgG-K paraprotein >3g/dl. Low haemoglobin Raised calcium Renal impairment Skeletal survey	Predominantly axonal
Waldenstrom's macroglobulin-aemia	Fatigue, weight loss, bleeding and hyper-viscosity	Numbness in the feet followed by foot drop	+	Distal, symmetrical paraesthesia and numbness followed by distal weakness initially in the lower limbs	IgM-K paraprotein Full blood count	Demyelinating
Amyloidosis (usually systemic)	Autonomic symptoms, e.g. postural hypotension, diarrhoea and impotence Weight loss cardiac and renal dysfunction can occur	Numb feet initially progressing to lancinating pain and loss of temperature sensation.	+++	Symmetrical, distal, predominantly sensory disturbance.	IgG or IgA- $\lambda$ paraprotein Biopsy of sural nerve, rectum or bone marrow with congo red staining	Axonal
POEMS Syndrome (osteosclerotic myeloma)	Polyneuropathy Organomegaly Endocrinopathy M protein Skin changes +/- plasmacytoma	Progressive distal sensory disturbance and weakness	+/-	Symmetrical, distal, allodynia, numbness, loss of joint position sensation and weakness.	IgG or IgA- $\lambda$ paraprotein Skeletal survey	Demyelinating
Castleman's Disease	Lymphadenopathy +/- POEMS syndrome	Variable: can resemble motor neurone disease or CIDP	+/-	Variable	IgM or IgG paraprotein Lymph node biopsy looking for angiofollicular hyperplasia	Axonal
Cryoglobulin-aemia	Raynaud's phenomenon Evidence of lymphoproliferative disorders, collagen vascular or chronic inflammatory disease	Pain in the early stages Generalized or multi-focal weakness Paraesthesia can be precipitated by the cold	+++	Symmetric or asymmetric sensorimotor disturbance	IgM or IgG paraprotein, but can be polyclonal Precipitation of cryoglobulins from serum.	Axonal

inal pain. Motor involvement is typically proximal and can affect the respiratory muscles; sensory involvement is mild, distal and symmetrical. The neuropathy can also affect the autonomic system leading to tachycardia, labile blood pressure, urinary retention and diarrhoea. Amyloid neuropathy occurs in twenty percent of patients with light chain disease. This axonal neuropathy is predominantly sensory, distal and symmetrical. Pain and temperature loss occurs initially, but distal weakness can develop in the later stages. Involvement of the autonomic nerves leads to orthostatic hypotension, impotence, bladder dysfunction, hypohydrosis and meiotic pupils. A multifocal neuropathy also oc-

curs and frequently presents as carpal tunnel syndrome.

Refsums disease is an autosomal recessive condition caused by a defect in phytanoyl-CoA-hydroxylase that causes ataxia, retinal damage and deafness. The associated demyelinating neuropathy causes a slow, progressive, distal, symmetrical loss of vibration and proprioception. Weakness also occurs and progresses proximally. Painful paraesthesia can be a feature.

Fabry's disease, caused by  $\alpha$  Galactosidase deficiency, is a X linked condition that affects the peripheral nervous system, the central nervous system, the heart and the kidneys. The associated neuropathy is particularly



painful. Patients describe burning in the hands and feet which can be episodic or chronic and progressive. Neurophysiology demonstrates an axonal neuropathy which affects the small fibres initially.

### Paraproteinaemic Neuropathies

Paraproteins are associated with ten percent of peripheral neuropathies, and they can be detected by immunoelectrophoresis or immunofixation of blood or urine. The identified proteins are usually the product of a single clone of plasma cells and are therefore termed monoclonal, M proteins.

Paraproteinaemic neuropathies can precede or be associated with a number of systemic disorders.

Monoclonal gammopathy of undetermined significance, MGUS, is the most common (Kelly 1981). In this condition the paraprotein level is less than 3 g/dl in the serum, the paraprotein usually possesses a kappa light chain component. IgG is the most common paraprotein found in patients with MGUS and no neuropathy, but when MGUS accompanies a neuropathy the IgM isotype is more frequent. MGUS is distinguished from Myeloma by the lower level of paraprotein and the absence of systemic features. The condition typically affects men over the age of fifty and presents with distal numbness and paraesthesia. Fifty percent of patients develop lancinating pains, dysaesthesia or aching discomfort in the limbs; light touch, joint position sense and vibration sensation are also affected (Ropper 1998). In advanced cases distal weakness can occur. Investigations usually reveal a demyelinating but occasional axonal neuropathy. Cerebral spinal fluid protein is typically elevated.

The treatment of MGUS is not established but intravenous immunoglobulin, plasma exchange, steroids and immunosuppression have all been used with variable success. A number of recent small studies have reported beneficial effects treating MGUS with rituximab, this is a humanized monoclonal antibody directed against CD20 antigens. (Pestronk 2003; Renaud 2003) These studies have not been as promising as originally anticipated, large randomised control trials are awaited to further assess the efficacy of rituximab. In addition to managing the neuropathy, it is important to monitor the paraprotein level in patients with MGUS, as 30% will develop a malignant plasma-cell disorder within 25 years (Veneri 2004). The risk of progression of MGUS to malignancy is, on average, 1.5% per year (Kyle 2003).

Other paraproteinaemic disorders associated with a neuropathy are listed in Table 2. These conditions are important to recognise, as treatment can lead to remission of the condition and improvement in the neuropathy. Therefore, immunoelectrophoresis and immunofixation should be an essential part of the investigations of any unexplained neuropathy.

### References

- Behse F, Buchthal F (1977) Alcoholic Neuropathy: Clinical, Electrophysiological and Biopsy Findings. *Ann Neurol* 2:95
- Kelly JJ, Kyle RA, O'Brien PC et al. (1981) Prevalence of Monoclonal Protein in Peripheral Neuropathy. *Neurology* 31:1480-1483
- Koike H, Iijima M, Sugiura M et al. (2003) Alcoholic Neuropathy is Clinicopathologically Distinct from Thiamine-Deficiency Neuropathy. *Ann Neurol* 54:19-29
- Kyle RA, Therneau TM, Rajkumar SV et al. (2003) Long-Term Follow-up of IgM Monoclonal Gammopathy of Undetermined Significance. *Semin Oncology* 30:169-171
- Laguensy A (2000) Metabolic and Nutritional Neuropathies. *Rev Prat* 50:731-5
- McDougall AJ, Davies L, McCaughan GW (2003) Autonomic and Peripheral Neuropathy in End Stage Liver Disease and following Liver Transplant. *Muscle Nerve* 28:595-600
- Monforte R, Estruch R, Valls-Sole J et al. (1995) Autonomic and Peripheral Neuropathies in Patients with Chronic Alcoholism. *Arch Neurol* 52:45-51
- Neundorfer B (2001) Alcohol Polyneuropathy. *Fortschr Neurol Psychiatr* 69:341-5
- Pestronk A, Florence J, Miller T et al. (2003) Treatment of IgM Associated Polyneuropathies using Rituximab. *J Neurol Neurosurg Psychiatry* 74:485-489
- Renaud S, Gregor M, Fuhr P et al. (2003) Rituximab in the Treatment of Anti-MAG Associated Polyneuropathy. *Muscle Nerve* 27:611-615
- Roman GC (1994) An Epidemic in Cuba of Optic Neuropathy, Sensorineural Deafness, Peripheral Sensory Neuropathy and Dorsolateral Myeloneuropathy. *J Neurol Sci* 127:11-28
- Ropper AH, Gorson KC (1998) Neuropathies Associated with Paraproteinemia. *N Engl J Med* 338:1601-1607
- Said G (1987) Acquired Metabolic Neuropathies (2): Kidney Failure, Hypothyroid and Hypoglycaemia. *Rev Neurol* 143:785-90
- Sokol RJ (1990) Vitamin E and Neurologic Deficits. *Adv Pediatr* 37:119-148
- Veneri D, Aquel H, Franchini M et al. (2004) Malignant Evolution of Monoclonal Gammopathy of Undetermined Significance: Analysis of 633 Consecutive Cases with Long-Term Follow-Up. *Haematologica* 89:876-878
- Windebank A (1993) Polyneuropathy due to Nutritional Deficiency and Alcoholism. In: *Peripheral Neuropathy* 3<sup>rd</sup> edn. W B Saunders Company, Philadelphia, pp 1310-1321
- Wolfe GI, Barohn RJ (2002) Painful Peripheral Neuropathy. *Curr Treat Options Neurol* 4:177-188
- Yuen T (2001) Nutritional and Alcoholic Neuropathies. In: *Peripheral Neuropathy: A Practical Approach to Diagnosis and Management*. Lippincott Williams and Wilkins, Philadelphia, pp 223-232

M

## Metabolic Neuropathies

### ► Metabolic and Nutritional Neuropathies

## Metabolism

### Definition

The metabolism of a drug describes its biotransformation into other substances due to chemical conversion.

### ► NSAIDs, Pharmacokinetics

## Metabotropic Glutamate Receptors

### Synonyms

mGlu Receptors; mGluRs

### Definition

Family of G-protein-coupled glutamate receptors (mGluRs) that are coupled to intracellular second messenger (G-Protein) systems. There are eight known mGlu receptor subtypes (mGlu1 - mGlu8), and some of these are known to form homo-dimers. The eight receptors can be placed into three groups (Groups I, II, III) on the basis of sequence homology and pharmacology. They trigger long-lasting intracellular processes and mediate slow synaptic components, s. also Glutamate Receptor.

- ▶ Inflammation, Role of Peripheral Glutamate Receptors
- ▶ Metabotropic Glutamate Receptors in the Thalamus
- ▶ Molecular Contributions to the Mechanism of Central Pain
- ▶ Nociceptive Neurotransmission in the Thalamus
- ▶ Nociceptive Processing in the Amygdala, Neurophysiology and Neuropharmacology

## Metabotropic Glutamate Receptors in Spinal Nociceptive Processing

VOLKER NEUGEBAUER

Department of Neuroscience & Cell Biology,  
University of Texas Medical Branch, Galveston, TX,  
USA

voneugeb@utmb.edu

### Synonyms

Spinal Cord Nociception, Glutamate Receptor (Metabotropic)

### Definition

G-protein-coupled receptors that are activated by glutamate and are linked to a variety of signal transduction pathways to regulate neuronal excitability and synaptic transmission in normal nervous system functions as well as in neurological and psychiatric disorders. They also modulate nociceptive processing at different levels of the pain neuraxis, including the spinal dorsal horn.

### Characteristics

Metabotropic glutamate receptors (mGluRs) (see ▶ [metabotropic receptor](#)) belong to family 3 of G-protein-coupled receptors, which can trigger long-lasting intracellular processes and "metabolic" changes and mediate synaptic plasticity. They are characterized by a seven transmembrane domain topology and a large

N-terminal extracellular domain, which contains important residues for ligand binding and forms two lobes that close like a Venus' flytrap upon ligand binding (Bockaert and Pin 1999). The second intracellular loop determines G-protein specificity and the intracellular C-terminal interacts directly with intracellular proteins such as Homer proteins (Bhave et al. 2003; Bockaert and Pin 1999; De Blasi et al. 2001). Eight mGluR subtypes have been cloned to date and are classified into groups I (mGluRs 1 and 5), II (mGluRs 2 and 3) and III (mGluRs 4, 6, 7 and 8) based on their sequence homology, signal transduction mechanisms and pharmacological profile (De Blasi et al. 2001; Gasparini et al. 2002; Neugebauer 2001; Schoepp et al. 1999; Varney and Gereau 2002) (see Table 1). Several splice variants have been identified which may differ with regard to their pharmacology and G-protein coupling.

### Signal Transduction

Group I mGluRs couple through  $G_{q/11}$  proteins to the activation of phospholipase C (PLC), resulting in phosphoinositide (PI) hydrolysis, release of calcium from intracellular stores and protein kinase C (PKC) activation (Anwyl 1999; Gasparini et al. 2002; Neugebauer 2001; Schoepp et al. 1999). Tyrosine kinase activation is another signaling pathway of group I mGluRs. The PKC- and tyrosine kinase-dependent pathways are two major signal transduction mechanisms that can activate the mitogen-activated protein kinases (MAPKs) such as the extracellular signal-regulated kinase 1/2 (ERK1/2) (Karim et al. 2001). Group II and group III mGluRs are negatively coupled to adenylyl cyclase (AC) through  $G_i/G_o$  proteins, thereby inhibiting cyclic AMP (cAMP) formation and cAMP-dependent protein kinase (PKA) activation (Anwyl 1999; Gasparini et al. 2002; Neugebauer 2001; Schoepp et al. 1999).

### Modulation of Voltage- and Ligand-Gated Ion Channels

In general, the predominant effect of group I mGluR activation is enhanced neuronal excitability and synaptic transmission, whereas activation of groups II and III typically produces inhibitory effects. Exceptions exist however, and different subtypes within one group (e.g. mGluR1 and mGluR5) may exert opposing effects. mGluRs can regulate neuronal excitability through direct or indirect effects on a variety of voltage sensitive ion channels, including high voltage-activated  $Ca^{2+}$  channels,  $K^+$  channels and nonselective cationic channels (Anwyl 1999; Neugebauer 2001; Schoepp et al. 1999). The modulation of ligand-gated ion channels by mGluRs includes the group I mGluR-mediated enhancement of ionotropic glutamate receptor (see ▶ [ionotropic receptor](#)) function, which probably involves receptor phosphorylation (Anwyl 1999; Neugebauer 2001). Group I mGluRs also potentiate the function of the capsaicin/vanilloid receptor (VR1) (Neugebauer 2001). Convincing evidence suggests that mGluRs interact

**Metabotropic Glutamate Receptors in Spinal Nociceptive Processing, Table 1** Classification and pharmacology of mGluRs

Group	Group I	Group II	Group III
<b>Subtype</b>	mGluR1, 5	mGluR2, 3	mGluR4, 6, 7, 8
<b>Agonist</b>	S-DHPG (1,5) CHPG (5)	LY354740 LY379268 2 <i>R,4R</i> -APDC	LAP4 LSOP
<b>Antagonist</b>	CPCCOEt (1) LY367385 (1) BAY36-7620 (1) MPEP (5) SIB-1757 (5) SIB-1893 (5)	EGLU LY341495	UBP1112 MSOP MAP4
<b>Effector</b>	G <sub>q</sub> -protein (G <sub>s</sub> -protein) PLC ↑ ERK ↑ (PLD ↑) (AC ↑) tyrosine kinase ↑	G <sub>i/o</sub> -protein AC ↓	G <sub>i/o</sub> -protein AC ↓

with the opioid system and play a role in the development of opioid tolerance and dependence (Fundytus 2001). mGluRs can also modulate the release of transmitters by acting as autoreceptors (glutamate) or heteroreceptors (GABA, substance P, serotonin, dopamine and acetylcholine) (Cartmell and Schoepp 2000).

#### Pharmacology and Modulation of mGluRs

Several potent and mGluR subgroup/subtype selective compounds have been developed in recent years (see Table 1). Presently available agonists are subgroup-selective; the only subtype-selective agonist is CHPG (for mGluR5). LY367385 is a competitive mGluR1 subtype-selective antagonist. Other subtype-selective group I antagonists that distinguish between mGluR1 (CPCCOEt, BAY36-7620) and mGluR5 (MPEP, SIB-1757, SIB-1893) are ► **non-competitive antagonist** s or ► **inverse agonist** s. ► **Competitive antagonists** that are selective for group II and group III mGluRs are available (Gasparini et al. 2002; Schoepp et al. 1999; Varney and Gereau 2002).

The intracellular C-terminal of group I mGluRs is also the target of interacting proteins, such as the Homer proteins, which can regulate subcellular receptor localization, G-protein coupling and constitutive (basal) activity of mGluR1 and mGluR5 (Gasparini et al. 2002). Receptor phosphorylation is another important mechanism for modulating mGluR function, including PKC-mediated desensitization of group I mGluRs and uncoupling of groups II and III mGluRs from G proteins by PKC and PKA (Karim et al. 2001; Neugebauer 2001; Varney and Gereau 2002).

#### Spinal Nociception

The important role of group I mGluRs in spinal nociceptive processing, ► **central sensitization** and spinally mediated pain behavior is now well established. The functions of groups II and III mGluRs are less well known

(Fundytus 2001; Neugebauer 2001; Neugebauer 2002; Varney and Gereau 2002). The current focus of research is on the role of individual mGluR subtypes and signal transduction pathways.

#### Group I mGluRs

Both mGluR1 and mGluR5 are functionally expressed in the spinal dorsal horn. Anatomical and recent electrophysiological data further suggest that mGluR1 and mGluR5 are localized pre- as well as post-synaptically (Neugebauer 2002; Neugebauer 2001; Park et al. 2004; Varney and Gereau 2002).

#### Agonists

Activation of spinal group I mGluRs generally produces pro-nociceptive effects in behavioral and electrophysiological assays, although mixed excitatory and inhibitory effects have been reported (Fundytus 2001; Neugebauer 2001; Varney and Gereau 2002). Intrathecal administration of group I agonists such as S-DHPG evokes spontaneous nociceptive behavior, thermal ► **hyperalgesia** (cold and heat), mechanical hyperalgesia, mechanical ► **allodynia** and enhanced formalin-induced nociception in the second phase (Fundytus 2001; Neugebauer 2001; Varney and Gereau 2002). These effects are mediated through mGluR1 as well as mGluR5 since they were blocked with antagonists or antibodies for mGluR1 or mGluR5, where tested (Fundytus 2001; Neugebauer 2001; Varney and Gereau 2002).

In electrophysiological studies in anesthetized animals *in vivo*, intraspinally administered group I mGluR agonists, including S-DHPG, had excitatory effects on spinal dorsal horn neurons and increased their responses to ► **Innocuous Input/Stimulus** and, less consistently, to ► **noxious** mechanical stimulation of cutaneous or deep tissue (Neugebauer et al. 1999; Neugebauer 2001). In addition, dual excitatory-inhibitory effects of group I

mGluR activation have been observed *in vivo* as well as in spinal cord slices *in vitro* (Chen et al. 2000, Gerber et al. 2000; Neugebauer 2001). The facilitatory effects of group I agonists can be blocked with antagonists selective for mGluR1 (CPCCOEt) or mGluR5 (MPEP) whereas the inhibitory effects are mimicked by an mGluR5 agonist (CHPG), suggesting that mGluR1 and mGluR5 are involved in excitation whereas inhibition is mediated through mGluR5 (Neugebauer 2001; Neugebauer 2002; Park et al. 2004).

The functional differences between mGluR1 and mGluR5 may be due to differences in their pre- and postsynaptic distribution, localization on excitatory and inhibitory synapses, regulation of excitatory and inhibitory transmission and different cellular effects, including signal transduction mechanisms and effectors.

### Inhibition

The endogenous activation of spinal group I mGluRs, particularly mGluR1, in prolonged nociception and persistent pain states is well documented in behavioral and electrophysiological studies using antagonists, antibodies and antisense oligonucleotides in models of inflammatory (second phase of formalin test; intradermal capsaicin; intraplantar carrageenan; kaolin/carrageenan knee joint arthritis; complete Freund's adjuvant-induced inflammation) and neuropathic pain (Fundytus 2001; Karim et al. 2001; Neugebauer et al. 1999; Neugebauer 2001; Neugebauer 2002; Varney and Gereau 2002; Zhang et al. 2002). The role of group I mGluRs in brief nociception and acute phases of pain remains unclear. Some studies suggested that the block of spinal group I mGluRs reduced noxious heat responses and the first phase of the formalin test whereas several other studies were unable to detect such effects (Fundytus 2001; Neugebauer 2001; Varney and Gereau 2002).

Electrophysiological studies of spinal dorsal horn neurons, including spinothalamic tract cells, in anesthetized animals *in vivo* further emphasize the important role of spinal group I, particularly mGluR1, in nociceptive transmission and pain-related central sensitization in the capsaicin model of central sensitization and mustard oil-induced spinal hyperexcitability and in the kaolin/carrageenan-induced knee joint arthritic pain model (Fundytus 2001; Neugebauer 2001; Neugebauer et al. 1999; Varney and Gereau 2002). The involvement and intrinsic activation of mGluR5 during brief and prolonged nociceptive processing in spinal neurons remains to be investigated.

### Groups II and III mGluRs

The roles of group II and group III mGluRs in spinal nociceptive processing are less clear. Both group II mGluR2/3 and group III mGluR4 and 7, but not mGluR6 and 8, are present in the spinal cord. Group III mGluRs

are localized predominantly on presynaptic terminals in the dorsal and ventral horns whereas group II mGluRs have been detected on presynaptic terminals in the superficial dorsal horn as well as on postsynaptic elements in deeper laminae (Neugebauer 2001; Varney and Gereau 2002).

Behavioral studies showed antinociceptive effects of group II or group III mGluR activation (Neugebauer 2002; Neugebauer 2001; Varney and Gereau 2002). Intrathecal administration of a nonselective group II mGluR agonists increased withdrawal thresholds to noxious mechanical cutaneous stimuli in the absence of tissue damage or inflammation, and this effect was blocked by a group II antagonist (EGLU). Intrathecal administration of a group III agonist (LAP4) produced antinociceptive effects both early and late in the second phase of the formalin test. Effects of group II activation are less well documented, but preliminary data suggest that selective group II agonists (LY354740, LY379268) can inhibit nociceptive behavior in the formalin test and carrageenan-induced thermal hyperalgesia.

Electrophysiological studies in anesthetized animals *in vivo* measured inhibitory effects of group II and group III agonists on spinal nociceptive processing (Neugebauer 2001; Varney and Gereau 2002). Activation of spinal group II mGluRs inhibited electrically evoked C-fiber responses of nociceptive dorsal horn neurons in carrageenan-induced hind paw inflammation, whereas mixed effects (inhibition and facilitation) were observed in control rats. Similarly, intraspinal administration of a selective group II agonist (LY379268) inhibited central sensitization of primate spinothalamic tract cells in the capsaicin pain model, but had no effect on normal transmission in non-sensitized neurons (Neugebauer et al. 2000). A group III agonist (LAP4) inhibited the responses of spinothalamic tract cells to brief noxious and innocuous mechanical cutaneous stimuli as well as capsaicin-induced central sensitization (Neugebauer et al. 2000). These data suggest a dramatic change in the functional role of group II, rather than group III, mGluRs in central sensitization associated with prolonged pain.

### References

1. Anwyl R (1999) Metabotropic glutamate receptors: electrophysiological properties and role in plasticity. *Brain Res Brain Res Rev* 29:83–120
2. Bhawe G, Nadin BM, Brasier et al. (2003) Membrane topology of a metabotropic glutamate receptor. *J Biol Chem* 278:30294–30301
3. Bockaert J, Pin JP (1999) Molecular tinkering of G protein-coupled receptors: an evolutionary success. *EMBO J* 18:1723–1729
4. Cartmell J, Schoepp DD (2000) Regulation of neurotransmitter release by metabotropic glutamate receptors. *J Neurochem* 75:889–907
5. Chen J, Heinke B, Sandkuhler J (2000) Activation of group I metabotropic glutamate receptors induces long-term depression



- at sensory synapses in superficial spinal dorsal horn. *Neuropharmacology* 39:2231–2243
6. De Blasi A, Conn PJ, Pin, J et al. (2001) Molecular determinants of metabotropic glutamate receptor signaling. *Trends Pharmacol Sci* 22:114–120
  7. Fundytus ME (2001) Glutamate receptors and nociception. Implications for the drug treatment of pain. *CNS Drugs* 15:29–58
  8. Gasparini F, Kuhn R, Pin JP (2002) Allosteric modulators of group I metabotropic glutamate receptors: novel subtype-selective ligands and therapeutic perspectives. *Curr Opin Pharmacol* 2:43–49
  9. Gerber G, Youn DH, Hsu CH et al. (2000) Spinal dorsal horn synaptic plasticity: involvement of group I metabotropic glutamate receptors. *Prog Brain Res* 129:115–134
  10. Karim F, Wang CC, Gereau RW (2001) Metabotropic glutamate receptor subtypes 1 and 5 are activators of extracellular signal-regulated kinase signaling required for inflammatory pain in mice. *J Neurosci* 21:3771–3779
  11. Neugebauer V (2001) Metabotropic glutamate receptors: novel targets for pain relief. *Expert Rev Neurotherapeutics* 1:207–224
  12. Neugebauer V (2002) Metabotropic glutamate receptors - important modulators of nociception and pain behavior. *Pain* 98:1–8
  13. Neugebauer V, Chen PS, Willis WD (1999) Role of metabotropic glutamate receptor subtype mGluR1 in brief nociception and central sensitization of primate STT cells. *J Neurophysiol* 82:272–282
  14. Neugebauer V, Chen P-S, Willis WD (2000) Groups II and III metabotropic glutamate receptors differentially modulate brief and prolonged nociception in primate STT cells. *J Neurophysiol* 84:2998–3009
  15. Park YK, Galik J, Ryu PD et al. (2004) Activation of presynaptic group I metabotropic glutamate receptors enhances glutamate release in the rat spinal cord substantia gelatinosa. *Neurosci Lett* 361:220–224
  16. Schoepp DD, Jane DE, Monn JA (1999) Pharmacological agents acting at subtypes of metabotropic glutamate receptors. *Neuropharmacology* 38:1431–1476
  17. Varney MA, Gereau RW (2002) Metabotropic glutamate receptor involvement in models of acute and persistent pain: prospects for the development of novel analgesics. *Current Drug Targets* 1:215–225
  18. Zhang L, Lu Y, Chen Y et al. (2002) Group I Metabotropic glutamate receptor antagonists block secondary thermal hyperalgesia in rats with knee joint inflammation. *J Pharmacol Exp Ther* 300:149–156

## Metabotropic Glutamate Receptors in the Thalamus

THOMAS E. SALT  
Institute of Ophthalmology, University College  
London, London, UK  
t.salt@ucl.ac.uk

### Synonyms

Metabotropic glutamate receptor; mGlu receptor; mGluR; G-Protein-coupled glutamate receptor; Thalamus, Metabotropic Glutamate Receptors

### Definition

Metabotropic glutamate (mGlu) receptors are ► [glutamate receptors](#) that are coupled to intracellular second messenger (G-protein) systems.

### Characteristics

Eight metabotropic glutamate receptor subtypes (mGlu1–mGlu8) have been characterised to date. They can be placed into three Groups (I, II, III) on the basis of their sequence homology, their pharmacological characteristics and the types of intracellular transduction cascade to which they may couple in *in vitro* expression systems (Conn and Pin 1997). In such expression systems, Group I (mGlu1, mGlu5) receptors typically couple to postsynaptic inositol phosphate metabolism, while Group II (mGlu2, mGlu3) and Group III (mGlu4, mGlu6–8) receptors may couple to an inhibitory cyclic-AMP cascade. All of these receptors can be activated by L-glutamate with a variety of affinities. This amino acid is assumed to be the endogenous ligand, but the receptors may also be activated by other endogenous ligands (e.g. sulphur-containing amino acids such as L-homocysteic acid or dipeptides such as N-acetyl-aspartyl-glutamate or NAAG). A variety of synthetic agonists and antagonists have been developed, some of which show selectivity for mGlu receptor groups or even subtypes (Table 1).

The Group I receptors have been thought to predominantly mediate postsynaptic actions, whereas the Group II receptors and Group III receptors have been found to have presynaptic actions, regulating transmitter release. It is however becoming evident that the situation is more complex than this and that receptors of all three groups can have pre-, post- or extra-synaptic actions (Conn and Pin 1997). The complexity introduced by the variety of glutamate receptor types is compounded by their non-uniform distribution within the brain and within the neuropil, synapses and extra-synaptic areas. Within the thalamus, the distribution of a considerable number of the various mGlu receptors has been described in some detail (Martin et al. 1992; Petralia et al. 1996; Godwin et al. 1996; Liu et al. 1998; Mineff and Valtchanoff 1999; Neto et al. 2000; Tamaru et al. 2001).

### Group I Receptors

There is expression of the mRNA for the group I mGlu receptors (mGlu1 and mGlu5) in the thalamus (Martin et al. 1992; Abe et al. 1992), with both mGlu1 and mGlu5 receptor-like immunoreactivities being found on the distal dendrites of ► [thalamocortical neurons](#) opposed to the corticothalamic axon terminals (Martin et al. 1992; Godwin et al. 1996; Liu et al. 1998) and also on the dendrites of local circuit interneurons pre-synaptic to thalamocortical neurons (Godwin et al. 1996). A particular focus has been the function of mGlu1 receptors, as these have been localised postsynaptically predominantly beneath terminals of cortico-thalamic fibres (Martin et al. 1992; Godwin et al. 1996). Activation of mGlu receptors in thalamic relay neurones causes a slow depolarising response associated with an increase in membrane resis-

M

**Metabotropic Glutamate Receptors in the Thalamus, Table 1** Metabotropic Glutamate Receptor Subtypes

Group	Receptor	Transduction Mechanism	Agonists	Antagonists
subtype-selective	group-selective	subtype-selective	group-selective	
I	mGlu1	IP3 /Ca <sup>++</sup> cascade	DHPG	LY367385, CPCOOEt
	mGlu5		CHPG	MPEP
II	mGlu2	Inhibitory cAMP	LY354740, CCG-1, APDC	LY341495
	mGlu3	cascade		
III	mGlu4	Inhibitory cAMP	L-AP4,	MAP4,
	mGlu6	cascade	L-SOP	CPPG
	mGlu7			
	mGlu8		DCPG	

**Abbreviations**

APDC, 2R,4R-4-aminopyrrolidine-2,4-decarboxylate; CCG-1, (2S,1'S,2'S)-2-(2-carboxycyclopropyl)glycine; CHPG, 2-chloro-5-hydroxyphenylglycine; CP-COOEt, 7-(hydroxyimino)cyclopropa[b]chromen-1a-carboxylate; 4CPG, (S)-4-carboxyphenylglycine; CPPG, *alpha*-cyclopropyl-4-phosphonophenylglycine; DCPG, (S)-3,4-dicarboxyphenylglycine; DHPG, 3,5-dihydroxyphenylglycine; L-AP4, L-2-amino-4-phosphonobutyric acid; L-SOP, L-serine-0-phosphate; LY341495, 2S-2-amino-2-(1S,2S-2-carboxycyclopropyl-1-yl)-3-(xanth-9-yl)propanoic acid; LY354740, (+)-2-aminobicyclo [3.1.0]hexane-2,6-dicarboxylate; LY367385, (+)-2-methyl-4-carboxyphenylglycine; MAP4, (S)-2-amino-2-methyl-4-phosphonobutanoic acid; MPEP, 2-methyl-6-(phenylethynyl)-pyridine; NAAG, N-Acetyl-aspartyl-glutamate

tance, as seen in many other parts of the brain, probably due a reduction in a potassium conductance. This has been shown to be mediated specifically *via* mGlu1 receptors, which can be synaptically activated by stimulation of cortico-thalamic afferents (Turner and Salt 2000; Hughes et al. 2002). A specific synaptic role for mGlu5 receptors in the thalamus remains to be demonstrated, although these receptors do appear to be activated under physiological conditions (Salt and Binns 2000).

**Group II Receptors**

High levels of mRNA and protein for Group II receptors have been found in the ► **thalamic reticular nucleus** (TRN), and much of this may be attributable to mGlu3 receptors, some of which may be localised in glial cells as well as neuronal bodies and dendrites (Petralia et al. 1996; Neto et al. 2000; Tamaru et al. 2001). Intriguingly, it has been shown that activation of these receptors can lead to an inhibition of TRN neurone activity (Cox and Sherman 1999). Ultrastructural information from rodent ventrobasal thalamus (VB) suggests that Group II receptors are localised in glial processes, some of which appear to be surrounding GABAergic terminals (Liu et al. 1998; Mineff and Valtschanoff 1999). More recently mGlu3 receptors have been found to be concentrated on GABAergic axons in VB arising from TRN (Tamaru et al. 2001). Thus Group II receptors may modulate GABAergic transmission within VB, a notion supported by the finding that activation of Group II receptors within VB results in a reduction of TRN-originating inhibition onto relay cells (Turner and Salt 2003).

**Group III Receptors**

Of the Group III receptors, only mGlu7-like immunoreactivity has been demonstrated in the thalamus (Kinoshita et al. 1998). However, the mRNAs for mGlu4, mGlu7 and mGlu8 receptors are expressed throughout the thalamus-TRN-cortex network (Ohishi et al. 1995; Saugstad et al. 1997; Neto et al. 2000). This suggests that these receptors may be involved in the control of transmission at cortico-thalamic and TRN-thalamic synapses. Consistent with this are electrophysiological data, which suggest that Group III (probably mGlu7) receptors mediate a presynaptic reduction of the corticothalamic excitatory postsynaptic potential (Turner and Salt 1999) and a presynaptic reduction of the TRN-mediated inhibition of VB neurone responses to sensory stimuli *in vivo* and *in vitro* (Turner and Salt 2003).

**Functional Considerations**

There is little evidence to suggest that mGlu receptors are directly involved in ascending sensory transmission to the thalamic relay nuclei; rather it seems that such fast transmission is mediated *via* ► **ionotropic glutamate receptors** of the ► **NMDA** and ► **AMPA** variety (Salt and Eaton 1996). The characteristics of mGlu receptors are more suited to slow synaptic transmission or modulation (Conn and Pin 1997) and the roles in thalamic function that have been determined fit into this category. The cortico-thalamic projection has been the subject of many studies. It has been speculated that the influence of the cortical input may operate *via* ► **NMDA receptors** or mGlu receptors (Sherman and Guillery 2000), largely because transmission *via* these receptor types

would allow non-linear amplification of excitatory inputs mediated *via*, for example, ► [AMPA receptors](#). This is a particularly attractive hypothesis in the case of mGlu1 receptors, as these are restricted to corticothalamic synapses and because NMDA-receptor mediated responses have been shown to be modulated by activation of Group I (i.e. mGlu1 / mGlu5) receptors in several brain areas. In the VB, activation of mGlu1 receptors potentiates responses mediated *via* either AMPA or NMDA receptors *in vivo* (Salt and Binns 2000). It is probable that this is due to the direct effects of mGlu1 activation on neuronal membrane potential and resistance rather than a specific interaction at the receptor level, or that the potentiation that is seen is a combination of these factors (Salt and Binns 2000). Thus, although the isolated cortico-thalamic synaptic potential which can be attributed to mGlu1 receptors *in vitro* appears to be rather small, it would be able to exert a large influence on ionotropic receptor mediated responses, if the sensory stimulus was appropriate to recruit activity in the cortico-thalamic output. Conditions where this might come into play are, for example, during the processing of nociceptive information in the thalamus (Salt and Binns 2000).

The GABAergic inhibitory output from the TRN onto relay cells is a major contributor to the overall response profile of the relay cells, and thus the control of this inhibition by mGlu receptors is potentially of great functional significance. The location of Group II receptors and the effects of their activation in this circuit suggest they play a pivotal role in these mechanisms. All of these receptors are in locations removed from sites of synaptically released glutamate. Thus this raises the possibility that these receptors are activated by glutamate which spills out of the conventional synaptic area, possibly under conditions of intense synaptic activity. This concept of “synaptic spillover” has been postulated on the basis of *in vitro* experiments from a number of non-thalamic brain areas (Kullmann 2000). This raises the possibility that the Group II (and possibly Group III) receptors may be activated by glutamate via a synaptic spillover mechanism. This glutamate could be released from terminals of sensory or cortical afferents or from astrocytes. This might occur under conditions of intense synaptic activation, perhaps during nociceptive processing or seizure activity. An intriguing further possibility is that mGlu3 receptors could be activated by the endogenous mGlu3 agonist NAAG, which is co-localised with GABA in TRN neurones and within the neuropil within VB (Henderson and Salt 1988). This raises the possibility that NAAG may be released from GABAergic TRN terminals so as to down-regulate GABA release, thus reducing IPSP amplitude. Thus it may be that NAAG has a function as a co-transmitter to regulate GABAergic transmission from TRN to VB, possibly coming into play at higher stimulus frequencies.

## References

1. Abe T, Sugihara H, Nawa H et al. (1992) Molecular characterization of a novel metabotropic glutamate receptor mGluR5 coupled to inositol phosphate/Ca<sup>2+</sup> signal transduction. *J Biol Chem* 267:13361–13368
2. Conn PJ, Pin JP (1997) Pharmacology and functions of metabotropic glutamate receptors. *Annu Rev Pharmacol Toxicol* 37:207–237
3. Cox CL, Sherman SM (1999) Glutamate Inhibits Thalamic Reticular Neurons. *J Neurosci* 19:6694–6699
4. Godwin DW, Van Horn SC, Erisir A et al. (1996) Ultrastructural localization suggests that retinal and cortical inputs access different metabotropic glutamate receptors in the lateral geniculate nucleus. *J Neurosci* 16:8181–8192
5. Henderson Z and Salt TE (1988) The effects of N-acetyl-aspartylglutamate and distribution of N-acetyl-aspartylglutamate-like immunoreactivity in the rat somatosensory thalamus. *Neurosci* 25:899–906
6. Hughes SW, Cope DW, Blethyn KL, Crunelli V (2002) Cellular Mechanisms of the Slow (< 1 Hz) Oscillation in Thalamocortical Neurons in Vitro. *Neuron* 33:947–958
7. Kinoshita A, Shigemoto R, Ohishi H et al. (1998) Immunohistochemical localization of metabotropic glutamate receptors, mGluR7a and mGluR7b, in the central nervous system of the adult rat and mouse: a light and electron microscopic study. *J Comp Neurol* 393:332–352
8. Kullmann DM (2000) Spillover and Synaptic Cross Talk Mediated by Glutamate and GABA in the Mammalian Brain. *Prog Brain Res* 125:339–351
9. Liu XB, Munoz A, Jones EG (1998) Changes in subcellular localization of metabotropic glutamate receptor subtypes during postnatal development of mouse thalamus. *J Comp Neurol* 395:450–465
10. Martin LJ, Blackstone CD, Haganir RL et al. (1992) Cellular localization of a metabotropic glutamate receptor in rat brain. *Neuron* 9:259–270
11. Mineff E, and Valtchanoff J (1999) Metabotropic Glutamate Receptors 2 and 3 Expressed by Astrocytes in Rat Ventrobasal Thalamus. *Neurosci Lett* 270:95–98
12. Neto FL, Schadrack J, Berthele A et al. (2000) Differential distribution of metabotropic glutamate receptor subtype mRNAs in the thalamus of the rat. *Brain Res* 854:93–105
13. Ohishi H, Akazawa C, Shigemoto R et al. (1995) Distributions of the mRNAs for L-2-amino-4-phosphonobutyrate-sensitive metabotropic glutamate receptors, mGluR4 and mGluR7, in the rat brain. *J Comp Neurol* 360:555–570
14. Petralia RS, Wang YX, Niedzielski AS, Wenthold RJ (1996) The metabotropic glutamate receptors, mGluR2 and mGluR3, show unique postsynaptic, presynaptic and glial localizations. *Neurosci* 71:949–976
15. Salt TE, Binns KE (2000) Contributions of mGlu1 and mGlu5 receptors to interactions with N-methyl-D-aspartate receptor-mediated responses and nociceptive sensory responses of rat thalamic neurones. *Neurosci* 100:375–380
16. Salt TE, Eaton SA (1996) Functions of ionotropic and metabotropic glutamate receptors in sensory transmission in the mammalian thalamus. *Prog Neurobiol* 48:55–72
17. Saugstad JA, Kinzie JM, Shinohara MM et al. (1997) Cloning and Expression of Rat Metabotropic Glutamate Receptor 8 Reveals a Distinct Pharmacological Profile. *Mol Pharmacol* 51:119–125
18. Sherman SM, Guillery RW (2000) *Exploring the Thalamus*. Academic Press, New York
19. Tamaru Y, Nomura S, Mizuno N, Shigemoto R (2001) Distribution of Metabotropic Glutamate Receptor mGluR3 in the Mouse CNS: Differential Location Relative to Pre- and Postsynaptic Sites. *Neurosci* 106:481–503
20. Turner JP, Salt TE (1999) Group III metabotropic glutamate receptors control corticothalamic synaptic transmission in the rat thalamus *in vitro*. *J Physiol* 519:481–491
21. Turner JP, Salt TE (2000) Synaptic activation of the Group I metabotropic glutamate receptor mGlu1 on the thalamocortical

neurones of the rat dorsal lateral geniculate nucleus *in vitro*. *Neurosci* 100:493–505

22. Turner JP, Salt TE (2003) Group II and III metabotropic glutamate receptors and the control of the TRN input to rat thalamocortical neurones *in vitro*. *Neurosci* 122:459–469

## Metabotropic Receptor

### Definition

A Metabotropic Receptor is a G-protein-coupled receptor. The term reflects the fact that transmitter binding results in the production of intracellular metabolites. Metabotropic receptors that couple to G-proteins are a complex of three proteins. Transmitter binding to the receptor results in a conformation change in the receptor, thereby activating the G-protein. One subunit of the G-protein may modulate ion channels, other subunits may increase or decrease the activity of enzymes that produce intracellular messengers that modulate the activity of kinases. Small molecule neurotransmitters such as glutamate, acetylcholine, and serotonin activate metabotropic receptors as well as ionotropic receptors; mammalian peptides generally activate only metabotropic receptors.

- ▶ [Amygdala, Pain Processing and Behavior in Animals](#)
- ▶ [GABA Mechanisms and Descending Inhibitory Mechanisms](#)
- ▶ [Metabotropic Glutamate Receptors in Spinal Nociceptive Processing](#)
- ▶ [Spinothalamic Tract Neurons, Peptidergic Input](#)

## Metalloproteases

### Definition

Metalloproteases are peptide hydrolases using a metal in the catalytic mechanism, and are implicated in many inflammatory processes.

- ▶ [Vascular Neuropathies](#)

## Metastasis

### Definition

Metastasis means the spread of cancer cells from the tissue of origin to distant organs. Cancer cells can break out of the primary tumor, penetrate into lymphatic and blood vessels, circulate through the bloodstream, and form a new focus (metastasis) within normal tissues elsewhere in the organism.

- ▶ [NSAIDs and Cancer](#)

## Methadone

- ▶ [Postoperative Pain, Methadone](#)

## Method of Adjustments

### Definition

A psychophysical procedure used in a discrimination (or detection) experiment and in which the subjects adjust the value of the stimulus (e.g. by turning a dial) and sets it to apparent equality with a standard or reference stimulus. Repeated applications of the procedure yields an empirical distribution of stimulus intensities that is used to estimate the just-noticeable-difference (or threshold).

- ▶ [Pain Evaluation, Psychophysical Methods](#)

## Method of Constant Stimuli

A psychophysical procedure used in a discrimination (or detection) experiment, which consists of repeatedly presenting the same set of stimuli (between 5 and 9 different intensities each presented a large number of times) in a random order throughout the experiment. The proportion (p) of “yes” responses is recorded and graphed as a psychometric function of stimulus intensity. Critical values (e.g. p=0.5) of the psychometric function are then estimated from the data.

- ▶ [Pain Evaluation, Psychophysical Methods](#)

## Method of Limits

### Definition

A psychophysical procedure used in a discrimination (or detection) experiment, which consists in varying on each successive trial the intensity of the stimulus, in small ascending or descending steps. At each step the subject reports whether the stimulus appears smaller or larger than the reference stimulus (or is perceived or not). The values of the stimulus at which the subject’s response shifts from one category to another is recorded and the threshold is estimated by averaging these values.

- ▶ [Pain Evaluation, Psychophysical Methods](#)

## Methotrexate

### Definition

Methotrexate is a steroid sparing agent in cranial arteritis.

- ▶ [Headache Due to Arteritis](#)



## Methyl-2-(2,6-Xylyloxy)-Ethylamine-Hydrochloride

- ▶ Postoperative Pain, Mexiletine

## Methylprednisolone

### Definition

Steroid drug.

- ▶ Whiplash

## Methysergide

Serotonin antagonist.

- ▶ Migraine, Preventive Therapy

## Metopropol

### Definition

Beta-blocker.

- ▶ Migraine, Preventive Therapy

## Mexiletine/Mexitil

- ▶ Postoperative Pain, Mexiletine

## mGlu Receptors/mGluRs

- ▶ Metabotropic Glutamate Receptors
- ▶ Metabotropic Glutamate Receptors in the Thalamus

## MH, HTM, PMN

### Definition

Nociceptors are often designated as mechanoheat (MH), high threshold mechanoreceptive (HTM), or polymodal (PM). These designations refer to their capacity to respond to mechanical, thermal or chemical stimuli. The designation HTM implies that the nociceptor responds only to mechanical stimuli. The designation MH, implies that the nociceptor responds to both mechanical and heat stimuli. The designation PMN, implies that the nociceptor responds to mechanical thermal and at least one kind of chemical stimulus (e.g. bradykinin).

- ▶ Nociceptors in the Orofacial Region (Skin/Mucosa)

## Micro-Arousal

### Definition

An increase in EEG and heart rate frequency with a possible rise in muscle tone. It should last more than 3 sec. but less than 10 seconds. The subject is unaware of such physiological activity.

- ▶ Orofacial Pain, Sleep Disturbance

## Microdialysis

### Definition

Microdialysis is a technique that allows the administration of drugs or sampling of substances in the extracellular fluid by means of a small dialysis fiber of the type used for renal dialysis. The semi-permeable dialysis membrane has pores of a certain size, and molecules smaller than these pores diffuse across the dialysis membrane due to concentration gradients, either into the extracellular space or into the dialysate. The dialysis fluid is continually pumped through the fiber. Microdialysis allows minimal invasive insights into tissue metabolism. Drugs can be dissolved in the dialysate for tissue administration, or samples of the dialysate can be taken for analysis of extracellular fluid concentrations of substances.

- ▶ Amygdala, Pain Processing and Behavior in Animals
- ▶ GABA Mechanisms and Descending Inhibitory Mechanisms
- ▶ Spinal Dorsal Horn Pathways, Dorsal Column (Visceral)
- ▶ Spinothalamic Tract Neurons, Role of Nitric Oxide
- ▶ Sympathetically maintained Pain and Inflammation, Human Experimentation

M

## Microglia

### Definition

Microglia are considered to be the resident immune cells of the CNS. These cells release classical immune proteins, respond to immunogenic stimuli, and express cell surface receptors characteristic of peripheral phagocytic cells. Blocking microglial activation inhibits the onset of exaggerated pain.

- ▶ Cord Glial Activation

## Microglia Activation

- ▶ Cord Glial Activation

## Microinjection

### Definition

Microinjection is a common technique in behavioral neuroscience in which micro- or nanoliter amounts of a liquid is directly infused into a specific brain region.

- ▶ [Cingulate Cortex, Nociceptive Processing, Behavioral Studies in Animals](#)

## Microiontophoresis

### Definition

Microiontophoresis is a technique for releasing active agents near a neuron from which recordings are made. A multibarreled array of micropipettes is generally used. The central barrel records the activity of a neuron, whereas the other barrels are filled with solutions that contain agonist or antagonist drugs or other substances. The dissolved agents are usually charged, and so they can be released from the micropipette by passing a current of the appropriate sign through the micropipette. A current of the opposite sign is generally used to restrain the agent when its release is not desired.

- ▶ [GABA Mechanisms and Descending Inhibitory Mechanisms](#)

## Microneurography and Intraneural Microstimulation

### Definition

Microneurography is a sophisticated neurophysiological technique for recording electrical activity from an intact peripheral nerve using a sharp tungsten microelectrode inserted into the nerve percutaneously. It allows *in vivo* action potential recording (single or multifiber-recordings) from sympathetic efferent and nociceptive afferent neurons in awake human subjects.

- ▶ [Mechano-Insensitive C-Fibres, Biophysics](#)
- ▶ [Nociceptors, Action Potentials and Post-Firing Excitability Changes](#)
- ▶ [Painless Neuropathies](#)
- ▶ [Polymodal Nociceptors, Heat Transduction](#)
- ▶ [Sympathetically maintained Pain and Inflammation, Human Experimentation](#)

## Microneuroma

### Definition

A neuroma is the proximal cut end of a peripheral nerve branch or nerve fascicle. Severed axons form swollen

terminal endbulbs, and there is usually aborted sprouting. If these regenerative sprouts are not able to elongate they often form a tangled mass at the nerve end. If only a part of the cross-section of the nerve is cut, the cut axons form a neuroma-in-continuity adjacent to their intact neighbors. Transection of small groups of axons scattered throughout a nerve trunk, or of tiny nerve fascicles or tributary yields microneuromas.

- ▶ [Neuroma Pain](#)
- ▶ [Peripheral Neuropathic Pain](#)

## Microstimulation

### Definition

Low current stimulation ( $\mu\text{A}$ ) through a small diameter electrode, either intraoperatively or during experiments.

- ▶ [Central Pain, Human Studies of Physiology](#)

## Microsurgical DREZotomy

- ▶ [Brachial Plexus Avulsion and Dorsal Root Entry Zone](#)
- ▶ [DREZ Procedures](#)

## Microswitch

### Definition

A microswitch is a very small switch that acts by the movement of a small lever and is sensitive to minute motions.

- ▶ [Assessment of Pain Behaviors](#)

## Microvascular Decompression

### Synonyms

MVD

### Definition

Neurosurgical procedures to relieve cranial nerve compression by intracranial arteries or veins as described under 'vascular compression syndromes'. The main indication is for pain relief in cranial nerve neuralgias.

- ▶ [Pain Paroxysms](#)
- ▶ [Tic and Cranial Neuralgias](#)
- ▶ [Trigeminal, Glossopharyngeal, and Geniculate Neuralgias](#)

## Microwaves

- ▶ [Therapeutic Heat, Microwaves and Cold](#)

## Midazolam

### Definition

Midazolam is a benzodiazepine drug with an imidazole structure, commonly used as an anxiolytic, amnesic, and sedative/hypnotic. Spinal administration has recently been advocated in the management of complex pain syndromes.

- ▶ [Postoperative Pain, Appropriate Management](#)

## Midline Commissural Myelotomy

### Definition

Dividing the spinal cord longitudinally in the midline to ablate nerve fibers at the point where they cross the spinal cord.

- ▶ [Cancer Pain Management, Neurosurgical Interventions](#)

## Midline Epidural Steroid Injection

- ▶ [Epidural Steroid Injections for Chronic Back Pain](#)

## Midline Myelotomy

H. J. W. NAUTA  
University of Texas Medical Branch, Galveston, TX,  
USA  
hjnauta@utmb.edu

### Synonyms

Longitudinal Myelotomy; mediolongitudinal myelotomy; dorsal longitudinal myelotomy. Related terms include commissural myelotomy; Punctate Midline Myelotomy; extralemniscal myelotomy; Bischof Myelotomy; Pourpre Myelotomy; myelotomy

### Definition

Midline myelotomy refers to surgical procedures that involve an incision in the dorsal midline of the spinal cord. More recently, the term has come to include derived procedures that continue to include an intervention through the dorsal midline of the spinal cord.

## Characteristics

### Background

The spinal cord is commonly characterized by both its segmental organization, and the long tracts that link the segments to each other and to the brain. Surgical interventions on the spinal cord similarly can be characterized by their effects on segmental components, long tracts, or both. The distinction is important. If the goal is to interrupt a long ascending tract, then a single lesion should suffice. If the goal is an intervention at the segmental level, then typically several spinal levels must be accessed, and an incision made in the spinal cord over several segments.

### Myelotomy – Origin from Procedures Directed at Segmental Structures, not Long Tracts

The original myelotomy procedures were directed at the segments of the spinal cord for treatment of pain or spasticity. The long spinal cord incision distinguished myelotomy from “cordotomy”, where a single rostrocaudal level lesion is made, which interrupts longitudinal pathways. The distinction between myelotomy and cordotomy has blurred over time. It is now fairly safe to say that while the anterolateral cordotomy procedure continues to be understood as interrupting ascending tracts related to the conduction of pain, only the Bischoff myelotomy (Bischof 1951; Bischof 1967), still occasionally used to treat painful spasticity, continues to be understood as a procedure directed at the segmental level, and therefore requiring a long incision into the spinal cord. The original myelotomy procedures used to treat pain have mutated into much more concise procedures, and are now understood to be effective through their interruption of ascending pain tracts near the midline of the dorsal columns (Nauta et al. 2002). Due to their history, however, these procedures continue to be described as myelotomies, although they no longer require a long incision into the spinal cord.

### Impetus to Develop Myelotomy and Original Concepts of Benefit

Anterolateral cordotomy for interruption of the long tract system related to pain has evolved into an elegant fluoroscopic-guided percutaneous procedure at the C1-C2 level, which is effective for all levels below the lesion. The principal disadvantage of the anterolateral cordotomy was the unavoidable concomitant interruption of descending pathways in the anterolateral quadrant related to respiration and bladder control. The potential for the loss of automatic respiration (Ondine’s curse) and development of incontinence required special strategies, if bilateral anterolateral cordotomy was contemplated for the all too common bilateral, midline or visceral pain. These problems with bilateral cordotomy led to the proposal in 1926, by the neuropathologist Greenfield, that a longitudinal midline incision of the spinal cord could interrupt the crossing

fibers of the spinothalamic pathway bilaterally, near their segmental level of origin and before these fibers assemble into a long ascending tract. The longitudinal midline myelotomy required definition of segmental levels of pain origin, and a large enough exposure to incise the cord deeply over enough levels to bracket the levels of pain origin.

#### **Clinical Observation at Odds with the Original Concept**

The long midline myelotomy for pain was first performed by Armour in 1926 (Armour 1927), and while there were several early advocates, the procedure as originally conceived required a big operation which limited its wider acceptance. However, it became clear that the procedure was effective, even when a short myelotomy was performed at a level well above the segmental origin of the treated pain, and that pain relief extended to levels caudal to the zone of decreased pin sensation. Hirshberg et al. (1996) and Hitchcock (1974) originally attempting to treat neck and upper extremity pain, made lesions of only limited rostro-caudal extent near the midline at C1, and observed relief of pain with analgesia extending into the legs. Such observations suggested that the midline myelotomy procedure was interrupting an ascending pain conducting system, perhaps a multisynaptic pathway separate from the spinothalamic tract, as proposed by Hitchcock (Hitchcock 1969; Hitchcock 1974) and others (Davis et al. 1929; Noordenbos 1959). Surprisingly, the midline myelotomy procedure remained effective even if a short midline incision was made above and not deep enough to reach either the commissural fiber systems or the central grey matter (Hirshberg et al. 1996).

#### **Laboratory Evidence of a Dorsal Column Pain Pathway**

The literature concerning myelotomy for pain shows an interesting progression, with late recognition that there is a pain pathway ascending near the midline of the dorsal columns (Hirshberg et al. 1996; Nauta et al. 2002). The old concept is that there are two pathways carrying somatic sensation to the brain: the spinothalamic system described as conducting crude or "protopathic" sensations such as pain and temperature, the dorsal column pathway conducting the "epicritic" sensations, such as vibration and proprioception. Recent evidence demonstrates that the dorsal columns do contain a post-synaptic pain pathway (Rustioni et al. 1979; Uddenberg 1968; Willis and Coggeshall 1991), but its role in somatic pain conduction was considered minor. Berkley and Hubscher (1995) gave evidence that neurons in the dorsal column nuclei can respond to innocuous and noxious stimulation of both pelvic viscera and skin. Finally, Al Chaer and others (1996b) demonstrated that the post synaptic dorsal column pain pathway predominated in the conduction of visceral pain. Microdialysis fiber infusion of neurotransmitters or antagonists (morphine or CNQX) into the spinal

cord suggested the presence of a synapse in the pathway (Al Chaer et al. 1996a; Al Chaer et al. 1996b). Retrograde tracer studies, depositing a marker in the nucleus gracilis (Christensen et al. 1996), revealed the likely cell bodies of origin of the pathway to reside at the medial base of the dorsal horn just above the central canal, an area known from earlier experiments to receive primary visceral fiber input. Injection of anterograde tracers into the same cell territory (Wang et al. 1999) resulted in fiber labeling ascending near the dorsal column midline, to end in the medial part of the nucleus gracilis. Further studies by this group defined a somatotopic organization within the postsynaptic dorsal column pathway, wherein the fibers originating in the lumbosacral cord ascend near the midline of the dorsal columns, while fibers originating in the thoracic cord terminate in the lateral part of nucleus gracilis and adjacent medial parts of nucleus cuneatus (Wang et al. 1999; Willis et al. 1999).

#### **Subsequent Clinical Observations**

Once the basis for the benefit from midline myelotomy was better understood, Nauta et al. (1997, 2000) made very small transverse (rather than sagittal longitudinal) midline incisions in the dorsal columns, well above the segmental level of pain origin, to treat medically intractable pelvic pain. The incisions, later crush, across the midline of the dorsal columns extended only 1mm to either side of the exact midline, and only to a depth of 5 mm. The effective lesion was so small that it was dubbed "punctate myelotomy" since the original lesions were made with what amounted to a puncture across the spinal cord midline with a 16 gauge hypodermic needle. Pain relief from these tiny lesions confirmed that an ascending pathway in the dorsal column was being interrupted. The lesions were effective without reaching the commissures or the central grey, demonstrating that these latter structures were not essential to the benefit. Surprisingly, postoperative neurological examination in these patients by an independent neurologist failed to reveal any new deficit, emphasizing an important distinction between the consequences of small midline lesions of the dorsal columns and tabes dorsalis, in which a pathologic process effects the dorsal root ganglia in a widespread manner and results not only in visible changes in the dorsal columns, but less visible changes in other sensory pathways as well. While Nauta et al. (1997, 2000) treated only pelvic origin visceral pain, more recent reports (Kim and Kwon 2000) suggest that more rostral visceral origin pain related to gastric cancer can also be treated effectively by punctate midline myelotomy at an upper thoracic level. Since it is now understood that the benefit depends on the interruption of an ascending pathway, there are good theoretical reasons to believe that it would be worthwhile to revive the percutaneous procedure described by Hitchcock (1970, 1974) and



Schvarcz (1984), only modified to emphasize the medial dorsal columns rather than the subjacent central grey. Clearly the term “extralemniscal myelotomy” used by Schvarcz (Kanpolat 2002) would no longer apply to such an operation, because the dorsal columns are well known to contribute to signaling within the medial lemniscus.

The Bischof myelotomy and its variants can be used to treat severe, medically intractable, often painful, lower limb spasticity, usually in quadri- or paraplegic or paretic patients (Livshits et al. 2002; Putty and Shapiro 1991). The goal of the procedure is to interrupt the segmental reflex arcs underlying spasticity that pass between the dorsal horn and the motor neurons in the ventral horn. The goal is also to preserve as much residual function as possible and, above all, the anterior horn cells and their continuity with the muscles so that atrophy is minimized, and padding over bony prominences maintained to protect against the development of pressure sores. The latter can be a significant problem following ventral root section or neurectomy. The myelotomy method also offers an advantage over simple dorsal rhizotomy where recurrence of spasticity is more common. Since the availability of intrathecal Baclofen infusion pumps (Penn and Kroin 1987), the procedure is performed less frequently, but still remains a reasonable option for cases where severe problems with the pump are experienced or anticipated.

Since the Bischof myelotomy is directed at the segmental level, there is no alternative to an exposure of the spinal cord by laminectomy (typically, vertebral levels T10-L1) to gain access to those levels determined preoperatively to give rise to the worst spasticity (typically T12-S1). The required spinal cord incision is made in the longitudinal plane, perpendicular to the midsagittal plane. This plane passes through the central canal and dentate ligament of either side, thus filleting the spinal cord into a dorsal and ventral half. The incision along this plane was originally described from the lateral aspect of the cord (Bischof 1951) on either side, and was typically performed with an angled triangular ophthalmology knife inserted just posterior to the dentate ligament and directed towards the central canal. Great care is required to minimize injury to the spinal cord vasculature. Pourpre (Pourpre 1960), who proposed a Myelotomy en croix, in which the cord is entirely bisected into a right and left half. (Bischof 1967), modified his original lateral approach making an upside down “T” incision instead, beginning with a long myelotomy in the midsagittal plane to a depth reaching the center of the cord but sparing the anterior white commissure. An angled triangular ophthalmology knife is then passed laterally along the depth of the midline incision aimed at the pia just above the dentate ligament of either side, thereby separating the dorsal horn from the ventral horn of each side. The lateral limbs of this myelotomy are intended to pass through the grey matter, but not far into

the lateral funiculus containing whatever corticospinal fibers may still be functional.

► [Postsynaptic Dorsal Column Neurons, Responses to Visceral Input](#)

► [Spinal Dorsal Horn Pathways, Dorsal Column \(Visceral\)](#)

## References

1. Al Chaer ED, Lawand NB, Westlund KN et al. (1996a) Pelvic Visceral Input into the Nucleus Gracilis is Largely Mediated by the Postsynaptic Dorsal Column Pathway. *J Neurophysiol* 76:2675–2690
2. Al Chaer ED, Lawand NB, Westlund KN et al. (1996b) Visceral Nociceptive Input into the Ventral Posterolateral Nucleus of the Thalamus: A New Function for the Dorsal Column Pathway. *J Neurophysiol* 76:2661–2674
3. Armour D (1927) Surgery of the Spinal Cord. *Lancet* 2:691
4. Berkley KJ, Hubscher CH (1995) Are There Separate Central Nervous System Pathways for Touch and Pain? *Nat Med* 1:766–773
5. Bischof W (1951) Die Longitudinale Myelotomie. *Zentralbl Neurochir* 11:79–88
6. Bischof W (1967) Zur Dorsalen Longitudinalen Myelotomie. *Zentralbl Neurochir* 28:123–126
7. Christensen MD, Willis WD, Westlund KN (1996) Anatomical Evidence for Cells of Origin of a Postsynaptic Dorsal Column Visceral Pathway: Sacral Spinal Cord Cells Innervating the Medial Nucleus Gracilis. *Society for Neuroscience Abstract* 22:109
8. Davis L, Hart JT, Crain RC (1929) The Pathway for Visceral Afferent Impulses within the Spinal Cord. II. Experimental Dilatation of the Biliary Ducts. *Surg Gynecol Obstet* 48:647–651
9. Hirshberg RM, Al Chaer ED, Lawand NB et al. (1996) Is There a Pathway in the Posterior Funiculus that Signals Visceral Pain? *Pain* 67:291–305
10. Hitchcock E (1969) Stereotaxic Spinal Surgery. A Preliminary Report. *J Neurosurg* 31:386–392
11. Hitchcock E (1970) Stereotaxic Cervical Myelotomy. *J Neurol Neurosurg Psychiatry* 33:224230
12. Hitchcock E (1974) Stereotaxic Myelotomy. *Proc R Soc Med* 67:771–772
13. Kanpolat Y (2002) Percutaneous Stereotaxic Pain Procedures: Percutaneous Cordotomy, Extralemniscal Myelotomy, Trigeminal Tractotomy-Nucleotomy. In: Burchiel KJ (ed) *Surgical Management of Pain*. Thieme, New York, pp 745–762
14. Kim YS, Kwon SJ (2000) High Thoracic Midline Dorsal Column Myelotomy for Severe Visceral Pain due to Advanced Stomach Cancer. *Neurosurg* 46:85–90
15. Livshits A, Rappaport ZH, Livshits V et al. (2002) Surgical Treatment of Painful Spasticity after Spinal Cord Injury. *Spinal Cord* 40:161–166
16. Nauta HJ, Hewitt E, Westlund KN et al. (1997) Surgical Interruption of a Midline Dorsal Column Visceral Pain Pathway. Case Report and Review of the Literature. *J Neurosurg* 86:538–542
17. Nauta HJ, Soukup VM, Fabian RH et al. (2000) Punctate Midline Myelotomy for the Relief of Visceral Cancer Pain. *J Neurosurg* 92:125–130
18. Nauta HJW, Westlund KN, Willis WD (2002) Midline Myelotomy. In: Burchiel KJ (ed) *Surgical Management of Pain*. Thieme, New York, pp 714–731
19. Noordenbos W (1959) *Pain: Problems Pertaining to the Transmission of Nerve Impulses Which Give Rise to Pain*. Elsevier, Amsterdam
20. Penn RD, Kroin JS (1987) Long-Term Intrathecal Baclofen Infusion for Treatment of Spasticity. *J Neurosurg* 66:181–185
21. Pourpre MH (1960) *Traitement Neuro-Chirurgical des Contractures chez les Paraplegiques Posttraumatiques*. Neurochirurgie 6:229–236
22. Putty TK, Shapiro SA (1991) Efficacy of Dorsal Longitudinal Myelotomy in Treating Spinal Spasticity: A Review of 20 Cases. *J Neurosurg* 75:397–401

23. Rustioni A, Hayes NL, O'Neill S (1979) Dorsal Column Nuclei and Ascending Spinal Afferents in Macaques. *Brain* 102:95–125
24. Schwarcz JR (1984) Stereotactic High Cervical Extralemniscal Myelotomy for Pelvic Cancer Pain. *Acta Neurochir* 33:431–435
25. Uddenberg N (1968) Functional Organization of Long, Second-Order Afferents in the Dorsal Funiculus. *Exp Brain Res* 4:377–382
26. Wang CC, Willis WD, Westlund KN (1999) Ascending Projections from the Area around the Spinal Cord Central Canal: A Phaseolus Vulgaris Leucoagglutinin Study in Rats. *J Comp Neurol* 415:341–367
27. Willis WD, Coggeshall RE (1991) Sensory Mechanisms of the Spinal Cord. Plenum Press, New York
28. Willis WD, Al Chaer ED, Quast MJ et al. (1999) A Visceral Pain Pathway in the Dorsal Column of the Spinal Cord. *Proc Natl Acad Sci USA* 96:7675–7679

## Migraine

### Definition

Migraine is a common, episodic neurovascular headache disorder characterized by unilateral pulsating moderate to severe headache, typically lasting 4 to 72 hours, of throbbing quality and with associated symptoms of light and sound sensitivity, nausea and vomiting, phono- and/or photophobia. The headache may be preceded by visual disturbances (aura).

- ▶ [Calcitonin Gene-Related Peptide and Migraine Headaches](#)
- ▶ [Human Thalamic Response to Experimental Pain \(Neuroimaging\)](#)
- ▶ [Migraine, Preventive Therapy](#)
- ▶ [New Daily Persistent Headache](#)

## Migraine Accompanee

- ▶ [Clinical Migraine with Aura](#)

## Migraine Aphasic

- ▶ [Clinical Migraine with Aura](#)

## Migraine, Childhood Syndromes

ERIC M. PEARLMAN  
 Pediatric Education, Mercer University School of  
 Medicine, Savannah, GA, USA  
[pearlmane@aol.com](mailto:pearlmane@aol.com)

### Synonyms

Childhood Migraine; Pediatric Migraine; Periodic Disorders of Childhood that are Precursors to Migraine; Migraine Variants of Childhood

### Definitions

There are many paroxysmal disorders of childhood that have been associated with migraine. The link to migraine is very strong for some of these childhood syndromes, and more tenuous for others. The International Headache Society (The International Classification of Headache Disorders 2004) considers the following to be linked to migraine:

- Abdominal migraine
- Cyclic vomiting syndrome
- Benign paroxysmal vertigo
- Alternating hemiplegia of childhood
- Familial hemiplegic migraine

Benign paroxysmal torticollis is probably associated with migraine, based on genetic links. ▶ [Ophthalmoplegic migraine](#), originally considered to be linked to migraine, is probably not actually a migraine variant. Other disorders probably represent unusual auras of migraine rather than separate entities. These include acute ▶ [confusional migraine](#), ▶ [basilar-type migraine](#) and ▶ [Alice in Wonderland syndrome](#).

### Characteristics

Migraine with or without aura may differ slightly between children and adults. The diagnostic criteria proposed by the International Classification of Headache (IHS) Disorders II for children less than 15 years requires headaches of 1 to 48 hours in duration instead of the 4 to 72 hours in individuals greater than 15 years of age. The remainder of the criteria are similar to the adult diagnostic criteria, including at least five attacks with either photophobia and phonophobia, nausea or vomiting and two symptoms out of unilateral pain, throbbing or pulsatile pain, moderate or severe pain intensity or exacerbation by routine activity (Tab. 1).

There are features of headache in children that are not specifically recognized by the IHS classification, but are commonly noted in adolescents and children (Table 2). The quality of the pain may be described as constant or squeezing instead of throbbing. Children also are more likely to report bilateral, bifrontal or a nondescript location rather than unilateral pain. Adults who have migraine with aura have onset and resolution of their aura before the onset of head pain. When aura occurs in children, it may also overlap with the actual headache in onset. Aura should resolve before the headache phase ends. The onset of the head pain may be quite dramatic in children, with maximal pain achieved within 15 minutes. Pain also may resolve fairly quickly, i.e. in 2–4 hours, and may require just a short period of sleep to achieve resolution.

### Abdominal Migraine

Abdominal migraine is an idiopathic disorder characterized by discreet episodes of abdominal pain, is poorly localized, is moderate to severe in intensity

**Migraine, Childhood Syndromes, Table 1** Classification of adolescent and pediatric migraine with and without aura (The International Classification of Headache Disorders 2004)

Pediatric Migraine without Aura	Pediatric Migraine with Aura
A. At least 5 distinct attacks	E. Fulfills criteria for migraine without aura
B. Headache attack lasting 1–48 hours	F. At least 3 of the following:
C. Headache has at least 2 of the following:	1. One or more fully reversible aura symptoms indicating focal cortical and/or brainstem dysfunction
1. Bilateral location (frontal/temporal) or unilateral location	2. At least one aura developing gradually over more than 4 minutes or two or more symptoms occurring in succession
2. Pulsating quality	3. No aura lasting more than 60 minutes
3. Moderate to severe intensity	4. Headache follows in less than 60 minutes
4. Aggravation by routine physical activity	
D. During headache, at least one of the following:	
1. Nausea and/or vomiting	
2. Photophobia and/or phonophobia	

**Migraine, Childhood Syndromes, Table 2** Differentiating features in childhood vs. adult migraine

Duration	1 hour to 48 hours	4 hours to 72 hours
Quality	May or not be described as throbbing	Throbbing/pulsatile
Location	Unilateral, bilateral, whole head	Unilateral; bilateral less likely
Aura	May overlap with head pain	Resolves prior to head pain
Resolution	Resolves with rest or brief sleep	Resolves with longer sleep
Associated Features	Nausea/vomiting, photophobia or phonophobia – may be less prominent	Nausea/vomiting, photophobia, phonophobia – necessary for diagnosis

M

and lasts from 1 to 72 hours. These episodes are often associated with anorexia, nausea, vomiting and pallor. Sometimes headache, photophobia and phonophobia accompany migraine episodes. Eight percent of school children between 5–15 years reported recurrent abdominal pain and 4.1% reported episodes that fulfilled the criteria for the diagnosis of abdominal migraine. Abdominal migraine affects both boys and girls equally with a peak age of onset at 10 years. Affected children are otherwise normal between attacks. Often, children undergo extensive gastrointestinal evaluations before the diagnosis of abdominal migraine is considered. Individual attacks will ultimately resolve spontaneously and the syndrome can last from months to years before abating. In these children, there is a strong family history of migraine and individuals who suffer from abdominal migraine are more likely to develop migraine as adults than the general population.

### Cyclic Vomiting Syndrome

Cyclic vomiting syndrome consists of stereotypical attacks of intense nausea and vomiting lasting from 1 hour to 5 days. Vomiting can be quite dramatic, occurring at least 4 times in 1 hour. It can lead to significant dehydration and children often require intravenous rehydration. Associated features include lethargy, pallor, headache, photophobia, phonophobia, vertigo, diarrhea, excess salivation and fever. It is equally distributed between males and females and has a mean age of onset of

5.2 years (Li and Balint 2000). The duration of attacks is usually 2–3 years and is associated with significant morbidity. Children with cyclic vomiting syndrome miss on average 20 days of school each year, and more than 50% will require hospitalization for rehydration. Almost half of the children with a diagnosis of cyclical vomiting will go on to develop migraine later in life.

Both cyclic vomiting syndrome and abdominal migraine have a periodicity to attacks, so that many families can predict when the next attack might occur. Attacks can be triggered by many of the same triggers as migraine, for example, infection, certain foods, menstruation, sleep changes, physical exertion and psychological stress.

### Benign Paroxysmal Vertigo

Benign paroxysmal vertigo is another paroxysmal disorder linked to migraine. It is characterized by attacks of vertigo, dizziness or unsteadiness lasting minutes to hours. These attacks occur in toddlers or preschoolers and are associated with nystagmus, irritability, pallor, nausea and vomiting. Children will describe an unreal sense of movement. Younger children will often refuse to walk, sit down or cling to a parent until the episode subsides. Attacks are usually brief and do not require any treatment. The key in distinguishing these attacks from seizures or metabolic disturbances is the sparing of consciousness. Attacks often resolve with sleep and can occur in clusters. As with the other paroxysmal disorders, individuals often go on to develop migraine.

### Alternating Hemiplegia of Childhood

Alternating hemiplegia of childhood is another rare, perplexing paroxysmal disorder of childhood with a recently identified genetic link to migraine. This syndrome consists of repeated, frequent attacks of hemiparesis, monoparesis or diparesis usually beginning before 18 months of age. Episodes can last from hours to days and may include dystonia or athetosis along with the weakness, which can be on either side of the body or shift from side to side during an attack. There also can be bulbar dysfunction leading to swallowing and respiratory difficulties, which may result in respiratory failure. All these features disappear during sleep. Attacks may increase in frequency, plateau and eventually decrease in frequency, often resolving after 5–7 years. The syndrome may occur in the setting of mild developmental delays and can rarely be associated with developmental regression. The exact etiology is unknown but inborn errors of metabolism, mitochondrial dysfunction and channelopathy have all been suggested. Recently, a genetic link with familial hemiplegic migraine has been identified. In a family with alternating hemiplegia of childhood; affected individuals had a mutation in the ATP1A2 gene, which is an **▶ ATP-dependent Na/K pump** (Bassi et al. 2004). Interestingly, mutations in this gene are also associated with familial hemiplegic migraine.

### Familial Hemiplegic Migraine

Familial hemiplegic migraine is a rare autosomal dominant disorder characterized by an aura that has more stroke-like qualities than typical aura. The aura consists of motor weakness, usually unilateral, along with other neurological changes. These include positive visual changes (e.g. scintillating lights, colors or lines) or vision loss, sensory changes (e.g. pins and needles sensation or numbness) or speech difficulties. The aura develops gradually, lasts between 5 minutes and 24 hours and may or may not be associated with headache fulfilling the criteria for migraine. Identification of a first or second degree relative with similar attacks completes the diagnostic criteria. While there is no diagnostic testing for familial hemiplegic migraine, specific causative gene mutations have been identified. A missense mutation in **▶ P/Q type calcium channel gene** (CACNA1A) on chromosome 19p13 is responsible for the disorder in about 50% of the families (Kors et al. 2003). Mutations in this gene are also responsible for acetazolamide responsive episodic ataxia and benign paroxysmal torticollis (Ducros et al. 2001). Other families with familial hemiplegic migraine have been identified with mutations in the ATP1A2 gene, which is an ATP-dependent Na/K pump found on chromosome 1q31. This suggests that there may be multiple mechanisms for the neuronal instability that leads to these unusual auras.

### Benign Paroxysmal Torticollis

Benign paroxysmal torticollis is an uncommon disorder occurring in infants. This syndrome consists of recurrent attacks of head tilt, truncal ataxia and occasionally vomiting. The attacks last from several hours to days. Attacks may be associated with some irritability but no alteration in consciousness. The differential diagnosis for this condition includes congenital torticollis, disorders of the cranio-cervical junction, intracranial abnormalities, especially in the posterior fossa and metabolic disorders. A completely normal interictal examination and repeated pattern of attacks is reassuring, but further diagnostic evaluations are certainly appropriate. A strong family history of migraine and tendency to develop migraine later in life suggested a link between benign paroxysmal torticollis and migraine. Recently, a genetic link has been suggested. Giffin and colleagues have found mutations in the CACNA1A gene in 4 cases of benign paroxysmal torticollis. Mutations in this P/Q-type calcium channel gene have been linked to familial hemiplegic migraine, a rare migraine phenotype (Giffin et al. 2002).

### References

1. Abu-Arafeh I, Russell G (1995) Prevalence and clinical features of abdominal migraine compared with those of migraine headache. *Archives of Disease in Childhood* 72:413–417
2. Bassi MT, Bresolin N, Tonelli A et al. (2004) A novel mutation in the ATP1A2 gene causes alternating hemiplegia of childhood. *J Med Genet* 41:621–628
3. Ducros A, Denier C, Joutel A et al. (2001) The clinical spectrum of familial hemiplegic migraine associated with mutations in a neuronal calcium channel. *N Engl J Med* 345:17–24
4. Giffin NJ, Benton S, Goadsby PJ (2002) Benign paroxysmal torticollis of infancy: four new cases and linkage to CACNA1A mutation. *Dev Med Child Neurol* 44:490–493
5. Kors EE, Haan J, Giffin NJ et al. (2003) Expanding the phenotypic spectrum of the CACNA1A gene T666M mutation: a description of 5 families with hemiplegic migraine. *Arch Neurol* 60:684–688
6. Li BU, Balint JP (2000) Cyclic vomiting syndrome: evolution in our understanding of a brain-gut disorder. *Adv Pediatr* 47:117–60
7. Ophoff RA, Terwindt GM, Vergouwe MN et al. (1997) Familial hemiplegic migraine: involvement of a calcium neuronal channel. *Neurologia* 12:31–37
8. Proceedings of the 2nd International Scientific Symposium on Cyclic Vomiting Syndrome (1999) *Dig Dis Sci* 44:1S–119S
9. The International Classification of Headache Disorders: 2nd edn (2004) *Cephalalgia* 24:9–160
10. Thomsen L, Eriksen M, Roemer S et al. (2002) A population-based study of familial hemiplegic migraine suggests revised diagnostic criteria. *Brain* 125:1379–1391

## Migraine Epidemiology

RICHARD B. LIPTON<sup>1</sup>, MARCELO E. BIGAL<sup>2</sup>  
<sup>1</sup>Departments of Neurology, Epidemiology and Population Health, Albert Einstein College of Medicine and Montefiore Headache Unit, Bronx, NY, USA  
<sup>2</sup>Department of Neurology, Albert Einstein College of Medicine, The New England Center for Headache,



Stamford, CT, and Montefiore Headache Unit, Bronx, NY, NY, USA  
rlipton@aecom.yu.edu

## Definition

Migraine is a prevalent under-diagnosed and under-treated medical disorder, associated with a severe impact on the quality of life of the sufferers and their families as well as an enormous economic impact on society. This essay reviews the epidemiology and burden of migraine in population studies. Epidemiological studies often focus on the ► **incidence** and ► **prevalence** of disease in defined populations.

## Characteristics

### The Incidence of Migraine

The incidence of migraine has been investigated in a limited number of studies (Fig. 1). Stewart et al found that in females, the incidence of migraine with aura peaked between ages 12 and 13 (14.1 / 1000 person-years); migraine without aura peaked between ages 14 and 17 (18.9 / 1000 person-years). In males, the incidence of migraine with aura peaked several years earlier, around 5 years of age at 6.6 / 1000 person-years; the peak for migraine without aura was 10 / 1000 person-years between 10 and 11 years. New onset of migraine was uncommon in men in their twenties. This study suggests that migraine begins earlier in males than in females and that migraine with aura begins earlier than migraine without aura (Stewart et al. 1993).

Three other studies assessed the incidence of migraine. A study performed in a random sample of young adults (21–30 years), found that the incidence of migraine was 5.0 per 1,000 person-years in males and 22.0 in females (Breslau et al. 1994), supporting the findings

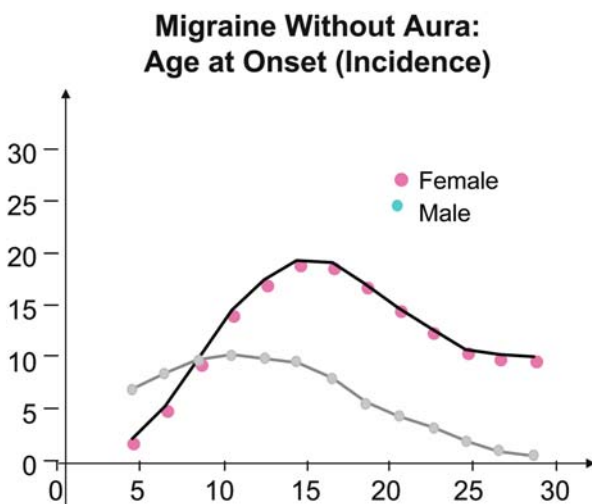
reported above (Stang et al. 1992). A second study using a linked medical records system showed a lower incidence (probably because many people with migraine do not consult doctors or receive a medical diagnosis) (Breslau et al. 1994). In this study, the average annual incidence rate per 1,000 person-years was 3.4 (4.8 in women and 1.9 in men). In women, incidence rates were low at the extremes of age and higher among those aged between 10 and 49 years, with a striking peak at the age of 20 to 29 years. In this study, incidence also peaked later than in other studies, probably because medical diagnosis may occur long after the age of onset. Finally, in the Danish population, the annual incidence of migraine in those aged 25 to 64 years old was 8 / 1,000, being 15 / 1,000 in males and 3 / 1,000 in females (Lyngberg et al. 2003).

### The Prevalence of Migraine

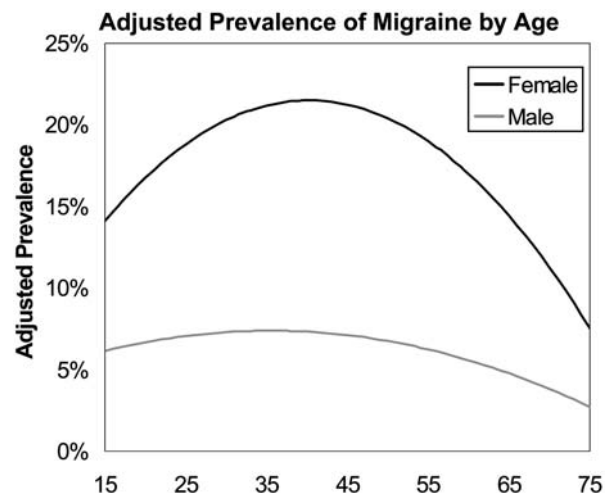
The published estimates of migraine prevalence have varied broadly, probably because of differences in the methodology. The studies presented herein primarily used the IHS definition.

### Prevalence by Age

Before puberty, as suggested by the incidence data, migraine prevalence is higher in boys than in girls; as adolescence approaches, incidence and prevalence increase more rapidly. As a consequence, at all post-pubertal ages, migraine is more common in girls than in boys. The prevalence increases throughout childhood and early adult life until approximately age 40, after which it declines (Fig. 2) (Scher et al. 1999). Overall, prevalence is highest from 25–55, the peak years of economic productivity. The gap between peak inci-



**Migraine Epidemiology, Figure 1** Incidence of migraine, by age and sex (from Stewart et al. 1993).



**Migraine Epidemiology, Figure 2** Adjusted prevalence of migraine by age from a meta-analysis of studies using IHS criteria. (from Scher et al. 2001).

**Migraine Epidemiology, Table 1** Prevalence of headache and migraine by age in selected community and school based-studies

Author(Y) Country	Type of Population	Sample Size	Age Range (Years)	Time Frame	Migraine Definition	Headache Prevalence			Migraine Prevalence		
						Males	Females	Overall	Males	Females	Overall
Ayatollahi (2002) Iran	School teenage girls	1,868	11–18	?	IHS					6.1%	
Al Jumah M (2002) Saudi Arabia	School Children	1,400	6–18	?	IHS				6.4%	7.7%	7.1%
Abu-Arafah (1994)		1,754	5–15	1 year	IHS <sup>1</sup>						10.6
Bille (1962) Sweden	School Children	8,993	7–15	Lifetime	Vahlquist <sup>1</sup>	58.0	59.3	-	3.3	4.4	-
Linnet (1989) USA	Community	10,132	12–29	1 year	2 of NV/U/VA	90	95	-	5.3	14	-
Mortimer (1992) UK	General Practice	1,083	3–11	1 year	IHS <sup>1</sup>	40.6*	36.9*	38.8*	4.1	2.9	3.7
Raielli (1995) Italy	School Children	1,445	11–14	1 year	IHS <sup>1</sup>	19.9	28.0	23.9	2.7	3.3	3.0
Sillanpaa (1976) Finland	School Children	4,825	3 7	? ?	Vahlquist <sup>1</sup>		4.3		3.2	3.2	3.2
Sillanpaa (1983) Finland	School Children	3,784	13	1 year	Vahlquist <sup>1</sup>	79.8	84.2	-	8.1	15.1	-

\* age adjusted

N, nausea; U, unilateral, V, vomiting; VA, visual aura

dence in adolescence and peak prevalence in middle life indicates that migraine is a condition of long duration. Despite suggestions to the contrary, the prevalence of migraine is probably not increasing. According to the Centers for Disease Control, self-diagnosed migraine prevalence in the U.S. increased 60%, from 25.8 / 1000 to 41 / 1000 persons, between 1981 and 1989 (MMWR 1991). Because this study relies on self-reported migraine, an increase in diagnosis or disease awareness could be mistaken for an increase in prevalence. Numerous population studies in the U.S. show that prevalence is stable, while consultation and diagnosis have increased (Lipton et al. 2001). It may be that these increases in medical consultation and diagnosis have caused an apparent rather than a real increase in migraine prevalence.

### Prevalence in Children and Adolescents

The prevalence of headache in children, as investigated in a number of school and population-based studies shows that by age 3, headache occurs in 3–8% of children. At age 5, 19.5% have headache and by age 7, 37 to 51.5% have headaches. In 7 to 15 year-olds, headache prevalence ranges from 57–82%. The prevalence increases from ages 3–11 in both boys and girls, with higher headache prevalence in 3–5 year

old boys than in 3–5 year old girls. Thus, the overall prevalence of headache increases from preschool age children to mid-adolescence, when examined using various cross-sectional studies (Bille 1989).

Recent studies report the prevalence of pediatric migraine in the Asian Middle East. The first one, performed in the southern Iran, evaluated a random sample of 1868 teenaged girls (aged 11 to 18 years). The overall prevalence rate for migraine was 6.1% (95% CI, 5.0 to 7.2). The second study evaluated 1,400 randomly selected Saudi children in grades 1 through 9. Overall, the headache prevalence was 49.8%. The prevalence of migraine was 7.1%. There was a sharp increase in the prevalence rate (from around 2% to around 9%) at aged 10 to 11, in both boys and girls. Age adjusted prevalence for migraine between aged 6 and 15 was 6.2% (for references on the original studies the reader is referred to Bigal et al. 2004).

Another recent study evaluated the evolution of juvenile migraine without aura in adolescents over 5 years. Sixty-four subjects out of 80 previously selected were re-evaluated. Thirty two (50%) had migraine without aura. After 5 years, migraine without aura persisted in 56.2%, converted to migrainous disorder or non-classifiable headache respectively in 9.4% and 3.1% of cases, changed to episodic tension-type headache in 12.5% and remitted in 18.8%.

### Prevalence by Gender in Adults

Estimates of migraine prevalence range from 3.3 to 21.9% for women and 0.7% to 16.1% for men. In the United States, the American Migraine Study II found that the prevalence of migraine was about 18% in women and 6% in men (Lipton et al. 2001). Table 1 summarizes several prevalence studies conducted in the last 12 years. The prevalence of migraine in different geographic locations, overall and by gender is presented. The female to male gender ratio is about 3 to 1 in most places where it has been studied.

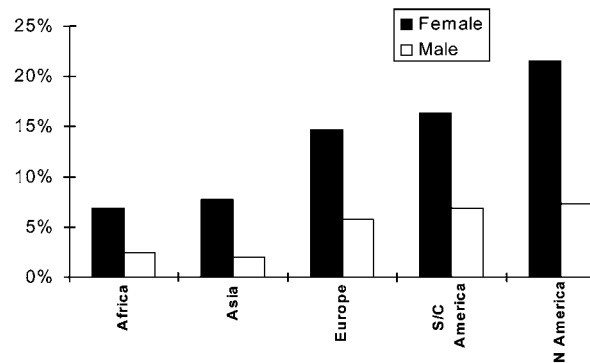
### Prevalence of Migraine by Socioeconomic Status

The relationship between migraine prevalence and socioeconomic status is uncertain. In physician- and clinic-based studies, migraine appears to be associated with high intelligence and social class. In his studies of children, Bille did not find an association between migraine prevalence and intelligence (Bille 1989). Similarly, in adults, epidemiological studies do not support a relationship between occupation and migraine prevalence (Lipton et al. 2001). In both the American Migraine Studies I and II, migraine prevalence was inversely related to household income (i.e. migraine prevalence fell as household income increased) (Lipton et al. 2001). This inverse relationship between migraine and socioeconomic status was confirmed in another U.S. study based on members of a managed care organization and in the National Health Interview Study. In Europe, results are contradictory. While one large study failed to demonstrate an association between migraine and socioeconomic status (Launer et al. 1999), a second recent study in England showed this relationship (Steiner et al. 2003).

The higher prevalence in the lower socioeconomic groups may be a consequence of a circumstance associated with low income and migraine, such as poor diet, poor medical care or stress. It may also reflect social selection, that is migraineurs may have lower incomes because migraine interferes with educational and occupational function, causing a loss of income or the ability to rise from a low-income group. The relationship of migraine and socioeconomic status, especially in children and adolescents, requires further study.

### Prevalence of Migraine by Geographical Distribution

Migraine prevalence also varies by race and geography. In the U.S., it is highest in Caucasians, intermediate in African Americans and lowest in Asian Americans (Scher et al. 1999). Similarly, a meta-analysis of prevalence studies suggests that migraine is most common in North and South America, similar in Europe, but lower in Africa and often lowest in studies from Asia (Fig. 3) (Scher et al. 1999). The data suggest that race related differences in genetic risk may contribute.



**Migraine Epidemiology, Figure 3** Adjusted prevalence of migraine by geographical area and gender in a meta-analysis of studies using IHS criteria (from Scher et al. 2001).

### The Burden of Migraine

#### The Impact of Migraine on the Individual

The burden of migraine is significant both to the individual sufferer and to the society. In the American Migraine Study II, 92% of women and 89% of men with severe migraine had some headache related disability (Lipton et al. 2001). About half were severely disabled or needed bed rest. In addition to the attack related disability, many migraineurs live in fear, knowing that at any time an attack could disrupt their ability to work, care for their families or meet social obligations. Abundant evidence indicates that migraine reduces health related quality of life.

The World Health Organization (WHO) has recently released a report on the burden of diseases (The World Health Report 2001). The WHO report defines the “burden” of a disease to include the economic and emotional difficulties that a family experiences as a result of migraine, as well as the lost opportunities – the adjustments and compromises that prevent other family members from achieving their full potential in work, social relationships and leisure. The global burden of disease (GBD) is an analysis of the onset of disorders and the disability caused by them. Using the GBD methodology, migraine is estimated to account for 2.0% years of life lost due to a disability in women of all ages. In both sexes of all ages, migraine is responsible for 1.4% of total years of life lost due to a disability and ranks within the top 20 most disabled studied disorders (Table 2).

#### The Impact of Migraine on the Family

The impact of migraine extends to household partners and other family members. In a recent study, one half of the participants believed that, because of their migraine, they were more likely to argue with their partners (50%) and children (52%), while majorities (52–73%) reported other adverse consequences for their relationships with their partner and children and at work. A third (36%) believed they would be better partners but for their headaches. Participating

**Migraine Epidemiology, Table 2** Gender-Specific Prevalence Estimates of Migraine from 25 Population-Based Studies Using IHS Diagnostic Criteria

Author (Year of Publication)	Country	Source	Method	Sample Size	Time Frame	Age Range	Migraine Prevalence (%)			Comments
							Female	Male	Total	
Abu-Arefeh (1994)	Scotland	School	Clin Interview	1,754	1 Year	5–15	11.5	9.7	10.6	Prevalence is higher in boys prior to age 12 (1.14:1). After age 12, more common in girls (2.0:1).
al Rajeh (1997)	Saudi Arabia	Community	Face to face/ Clin Interview	22,630		All	6.8	3.2	5.0	
Alders (1996)	Malaysia	Community	Face to face	595	1 Year	5+	11.3	6.7	9.0	
Arregui (1991)	Peru	Community	Clin Interview	2,257		All	12.2	4.5	8.4	
Bank et al (2000)	Hungary	Community	Questionnaire	813	1 Year	15–80			9.6	
Barea (1996)	Brazil	School	Clin Interview	538	1 Year	10–18	10.3	9.6	9.9	2-48 hour duration allowed
Breslau (1991)	US	Community	Face to face/ Telephone	1,007	1 Year	21–30	12.9	3.4	9.2	
Cruz (1995)	Ecuador	Community	Clin Interview	2,723	Lifetime	All	7.9	5.6	6.9	Community endemic for cysticercosis
Cull (1992)	UK	Community	Face to face	16,002		16+	11.0	4.3	7.8	Without aura only
Dahlof et al (2003)	Sweden	Community	Telephone interview	1,668	1 Year	18–74	16.7	9.5	13.2	
Deleu et al (2002)	Saudi Arabia	Community	Face to face	1158	1 Year	10+	5.6	4.5		
Göbel (1994)	Germany	Community	Mail SAQ	4,061	Lifetime	18+	15.0	7.0	11.0	
Hagen et al (2000)	Norway	Community	Clin Interview	51,833	1 Year	20+	16.0	8.0	12.0	
Haimanot (1995)[	Ethiopia	Community	Face to face/ Clin Interview	15,000	1 Year	20+	4.2	1.7	3.0	
Henry, P (1992)	France	Community	Face to face	4,204	1 Year	15+	11.9	4.0	8.1	
Henry et al (2002)	France	Community	Face to face	10,585	1 Year	15+	11.2	4.0	7.9	
Jabbar, A (1997)	Saudi Arabia	Community	Face to face	5,891	Lifetime	15+			8.0	
Jaillard (1997)[	Peru	Community	Clin Interview	3,246	1 Year	15+	7.8	2.3	5.3	
Kececi et al (2002)	Turkey	Community	Face to face'	1320	1 Year	All	17.1	7.9		
Lamp et al (2003)	Sweden	Community	Face to face	997	1 Year	15+	13.8	6.1	10.2	
Lenore et al (1999)	Nether- lands	Community	Questionnaire and telephone	6,491	Lifetime 1 Year	18-65	33 25	13.3 7.5		
Lipton et al (2001)	United States	Community	Telephone	29 727	1 Year	12+	18.2	6.5		
Lipton et al (2002)	United States	Community	Telephone	11,863	1 Year	18–65	17.2	6		



Migraine Epidemiology, Table 2 (continued)

Author (Year of Publication)	Country	Source	Method	Sample Size	Time Frame	Age Range	Migraine Prevalence (%)			Comments
							Female	Male	Total	
Merikangas (1993)	Switzer- land	Community	Clin Interview	379	1 Year	28–29	32.6	16.1	24.5	Weighted prevalence
Michel (1995)	France	Community	Mail SAQ	9,411	3 Month	18+	18.0	8.0	13.0	
Miranda et al (2003)	Puerto Rico	Community	Telephone	1610	1 Year	All	6	16.7	13.5	
O'Brien (1994)	Canada	Community	Telephone	2,922	1 Year	18+	21.9	7.4	15.2	
Raieli (1994)	Italy	School	Clin Interview	1,445	1 Year	11–14	3.3	2.7	3.0	
Rasmussen (1992)	Denmark	Community	Clin Interview	740	1 Year	25–64	15.0	6.0	10.0	
Russell (1995)	Denmark	Community	Clin Interview	3,471	Lifetime	40	23.7	11.7	17.7	
Sakai (1996)	Japan	Community	Mail SAQ	4,029	1 Year	15+	12.9	3.6	8.4	Female:Male prevalence ratio=3.6. Regional differences
Steiner et al (2003)	England	Community	CATI	4,007	1 Year	18–65	14.3	7.6	18.3	
Stewart (1992)	US	Community	Mail SAQ	20,468	1 Year	12–80	17.6	5.7	12.0	
Stewart (1996)	US	Community	Telephone	12,328	1 Year	18–65	19.0	8.2	14.7	Racial differences
Takehima et al (2004)	Japan	Community	Questionnaires and telephone	5758	1 year	18+	9.1	2.3	6	Study done in the rural area of western Japan
van Rooijen (1995)	Nether- lands	Community	Face-to-face	10,480	1–Year	12+	12.0	5.0	9.0	
Wang (1997)	China	Community	Clin Interview	1,533	1 Year	65+	4.7	0.7	3.0	
Wong (1995)	Hong Kong	Community	Telephone	7,356	1 Year	15+	1.5	0.6	1.0	
Zivadinov et al (2001)	Croatia	Community	Telephone and face to face	5173	Lifetime 1 Year	15–65	22.9 18	14.8 12.3	19	

M

partners partly confirmed these findings; 29% felt that arguments were more common because of headaches and 20–60% reported other negative effects on relationships at home. Compared with subjects who did not have migraine, regarding their work performance, a statistically significantly higher proportion of migraine partners were unsatisfied with work demands placed on them, with their level of responsibilities and duties and with their ability to perform (Lipton et al. 2003). Results from this study show that the impact of migraine extends to household partners and other family members (impact beyond the individual).

### The Societal Impact of Migraine

Migraine has an enormous impact on society. Studies have evaluated the indirect costs of migraine as well as

the direct costs (Lipton et al. 2001). Indirect costs include the aggregate effects of migraine on productivity at work (paid employment), for household work and in other roles. The largest components of indirect costs are the productivity losses caused by absenteeism and reduced productivity while at work. Hu et al estimated that productivity losses due to migraine cost American employers 13 billion dollars per year (Hu et al. 1999). In an UK study, 5.7 working days were lost per year for every working person or student with migraine, although the most disabled 10% accounted for 85% of the total, projecting a lost 25 million days from work or school each year (Steiner et al. 2003).

Migraine's impact on healthcare utilization is marked as well. Studies show that 4% of all visits to physicians' offices are for headache (Bigal et al. 2004). Migraine also

**Migraine Epidemiology, Table 3** Global burden of migraine. Leading causes of years of life lost due to a disability according to the global burden of disease initiative (modified from Lipton et al. 2003)

Females All Ages		% Total	Both Sexes All Ages		% Total
1	Unipolar depressive disorders	1	Unipolar depressive disorders	11.9	
2	Iron-deficiency anemia	2	Hearing loss, adult onset	4.6	
3	Hearing loss, adult onset	3	Iron-deficiency anemia	4.5	
4	Osteoarthritis	4	Chronic obstructive pulmonary disease	3.3	
5	Chronic obstructive pulmonary disease	5	Alcohol use disorders	3.1	
6	Schizophrenia	6	Osteoarthritis	3.0	
7	Bipolar affective disorder	7	Schizophrenia	2.8	
8	Falls	8	Falls	2.8	
9	Alzheimer's and other dementias	9	Bipolar affective disorder	2.5	
10	Obstructed labor	10	Asthma	2.1	
11	Cataracts	11	Congenital abnormalities	2.1	
12	Migraine	12	Perinatal conditions	2.0	
13	Congenital abnormalities	13	Alzheimer's and other dementias	2.0	
14	Asthma	14	Cataracts	1.9	
15	Perinatal conditions	15	Road traffic accidents	1.8	
16	Chlamydia	16	Protein-energy malnutrition	1.7	
17	Cerebrovascular disease	17	Cerebrovascular disease	1.7	
18	Protein-energy malnutrition	18	HIV/AIDS	1.5	
19	Abortion	19	Migraine	1.4	
20	Panic disorder	20	Diabetes mellitus	1.4	

results in major utilization of emergency rooms and urgent care centers (Bigal et al. 2004). Vast amounts of prescription and over the counter medications are taken for headache disorders. OTC sales of pain medication (for all conditions) were estimated to be 3.2 billion dollars in 1999 (U.S.) and headache accounts for about one third of OTC analgesic use (Bigal et al. 2004).

## References

1. Bigal ME, Lipton RB, Stewart WF (2004) The epidemiology and impact of migraine. *Curr Neurol Neurosci Rep* 4:98–104
2. Bille B (1989) Migraine in children: prevalence, clinical features, and a 30-year follow-up. In: Ferrari MD, Lataste X (eds) *Migraine and other headaches*. Parthenon, New Jersey
3. Breslau N, Davis GC, Schultz LR et al. (1994) Joint 1994 Wolff Award Presentation. Migraine and major depression: a longitudinal study. *Headache* 34:387–393
4. Hu XH, Markson LE, Lipton RB et al. (1999) Burden of migraine in the United States: disability and economic costs. *Arch Intern Med* 159: 813–818
5. Launer LJ, Terwindt GM, Ferrari MD (1999) The prevalence and characteristics of migraine in a population-based cohort: the GEM Study. *Neurology* 53:537–542
6. Lipton RB, Stewart WF, Diamond S et al. (2001) Prevalence and Burden of migraine in the United States: data from the American Migraine Study II. *Headache* 41:646–657
7. Lipton RB, Bigal ME, Kolodner K et al. (2003) The family impact of migraine: population-based studies in the USA and UK. *Cephalalgia* 23:429–440
8. Lyngberg A, Jensen R, Rasmussen BK et al. (2003) Incidence of migraine in a Danish population-based follow-up study. (abstract). *Cephalalgia* 23:596
9. MMWR (1991) Prevalence of chronic migraine headaches – United States, 1980–89. *MMWR* 40:331–338
10. Ozge A, Bugdayci R, Sasmaz T et al. (2002) The sensitivity and specificity of the case definition criteria in diagnosis of headache: a school-based epidemiological study of 5562 children in Mersin. *Cephalalgia* 22:791–798
11. Scher AI, Stewart WF, Lipton RB (1999) Migraine and headache: a meta-analytic approach. In: Crombie IK (ed), *Epidemiology of Pain*. IASP Press, Seattle, Washington, pp 159–170
12. Stang PE, Yanagihara T, Swanson JW et al. (1992) Incidence of migraine headaches: A population-based study in Olmstead County, Minnesota. *Neurology* 42:1657–1662
13. Stang PE, Sternfeld B, Sidney S (1996). Migraine headache in a pre-paid health plan: ascertainment, demographics, physiological and behavioral factors. *Headache* 36:69–76
14. Steiner T, Scher A, Stewart W et al. (2003) The prevalence and disability burden of adult migraine in England and their relationships to age, gender and ethnicity. *Cephalalgia* 23:519–527
15. Stewart WF, Linet MS, Celentano DD et al. (1993) Age and sex-specific incidence rates of migraine with and without visual aura. *Am J Epidemiol* 34:1111–1120

16. The World Health Report 2001: Mental health, new understanding, new hope. Available at [www.who.int/en/](http://www.who.int/en/)

## Migraine, Genetics

ANNE DUCROS

Headache Emergency Department and Institut National de la Santé et de la Recherche Médicale (INSERM), Faculté de Médecine Lariboisière, Lariboisière Hospital, Paris, France  
anne.ducros@lrb.ap-hop-paris.fr

### Synonyms

Inherited Factors Implicated in the Mechanisms of Migraine

### Definition

Migraine is a primary headache disorder. It is a complex disease in which environmental factors interact with genetic factors. The major goal of genetic studies is the identification of susceptibility genes that may give clues to the mechanisms underlying migraine, and may help to identify new therapeutic targets.

### Characteristics

Migraine is a primary headache disorder responsible for recurrent attacks of disabling pain lasting a few hours to a few days. This condition is characterized by the repetition of such attacks in the absence of any disorder causing secondary headaches. The International Headache Society (IHS) classification distinguishes different varieties of migraine attacks, the most frequent being migraine without aura (MO) and migraine with typical aura (MA). In MO attacks, the headache is the most prominent and disabling symptom. In MA attacks, the headache phase is preceded or accompanied by transient neurological signs including visual, sensory and language troubles. Some patients have only MO, others have only MA, and some have both types of attacks. In addition, hemiplegic migraine is a rare variety of MA characterized by the presence of a motor deficit during the aura, in addition to one or more of the typical aura symptoms. In familial hemiplegic migraine (FHM), the index case has at least one first- or second-degree relative who also has migraine with aura including motor weakness. In sporadic hemiplegic migraine, there is no such familial history. Migraine is a highly frequent condition affecting about 15% of the western population. Familial aggregation has long been known, and was even classically used as a diagnosis criterion. Genetic epidemiological surveys have demonstrated that this familial aggregation was not observed purely by chance, but was due to the existence of genetic factors.

Twin studies have shown that the 'pairwise' concordance rates were significantly higher among monozygous than dizygous twin pairs for MO (Gervil 1999)

and for MA (Ulrich 1999), demonstrating the existence of genetic factors in migraine that interact with environmental factors to produce the phenotype. Family studies provided further evidence in favor of the existence of genetic factors in MO and MA, those factors being more important in MA than in MO (Russell and Olesen 1995). In addition, segregation analysis showed that both MO and MA have a non-mendelian polygenic mode of inheritance (Russell 1995). The possible number of genetic susceptibility loci is still unknown. FHM is the only variety of migraine in which a monogenic mendelian mode of inheritance has been clearly established. Two clinical forms of FHM have been described: pure FHM (80% of the families), and FHM with permanent cerebellar symptoms in which some affected subjects have nystagmus and/or ataxia. In addition to usual attacks, patients may have severe attacks with confusion, coma, fever and prolonged hemiplegia. Genetic tools are more powerful to identify the genes responsible for monogenic conditions than genes responsible for polygenic conditions. Thus, the only known migraine genes have been identified in FHM. FHM is genetically heterogeneous, with at least three responsible genes of which two have been identified. The first gene, CACNA1A, located on chromosome 19p13, was identified in 1996 (Ophoff 1996). CACNA1A encodes the pore-forming  $\alpha 1A$ -subunit of voltage-gated neuronal  $Ca_v2.1$  (P/Q type)  $Ca^{2+}$  channels. CACNA1A is implicated in about 50% of unselected FHM families and in the vast majority of families with permanent cerebellar symptoms. The second gene, ATP1A2, located on chromosome 1q21-q23, was identified in 2003 (De Fusco 2003). ATP1A2 is implicated in about 20–30% of unselected FHM families, and encodes the catalytic  $\alpha 2$ -subunit of a transmembrane  $Na^+/K^+$  ATPase. Both known FHM genes encode proteins regulating ion translocation, FHM is thus a channelopathy.

$Ca_v2.1$  channels are found exclusively in neurons including central and peripheral neurons at the neuromuscular junction. They play a major role in neurotransmitter release (mainly glutamate) and in the control of neuronal excitability. CACNA1A is a large gene containing 47 exons. Thus far, a total of 17 CACNA1A mutations have been identified in 41 FHM1 families (33 affected by FHM and cerebellar symptoms and 8 by pure FHM), and in 4 sporadic cases affected by HM and cerebellar symptoms. Five of these mutations are recurrent, i.e. they have been detected in two or more unrelated families. The most frequent mutation T666M has been detected in 19 families and 2 sporadic cases. All mutations are missense mutations, changing only one of the 2550 amino-acids of the predicted protein. They are located in important functional domains of the subunit, near the ionic pore or within the voltage sensor. Mutations causing FHM1 with cerebellar symptoms are distinct from those causing pure FHM1, and all recurrent mutations are causing FHM1 with cerebellar

symptoms. Mutations have been detected in sporadic cases, including a de novo mutation, demonstrating that sporadic HM is due to CACNA1A mutations in at least a part of the cases.

Different kinds of CACNA1A mutations have been identified in two other autosomal dominant neurological disorders. Episodic ataxia type 2 is a paroxysmal neurological condition producing recurrent attacks of major cerebellar ataxia, which is due to CACNA1A mutations (Ophoff 1996). Spinocerebellar ataxia type 6 (SCA6) is a progressive cerebellar disease characterized by an adult onset ataxia, which is due to small expansions of the CAG repeat contained within exon 47 of CACNA1A. Electrophysiological studies of CACNA1A mutations causing FHM1 have shown that all mutations analyzed so far modify the density and the gating properties of  $Ca_v2.1$  currents (Pietrobon and Striessnig 2003). Mutated single  $Ca_v2.1$  channels display lower activation thresholds and increased opening probabilities. FHM1 mutations are thus gain-of-function mutations. On the contrary, EA2 mutations have been shown to be loss-of-function mutations, the mutated allele generating no current when expressed in heterologous cells.

Knockout mice that do not have the CACNA1A gene are born with a severe ataxia and die within a few days. Mice carrying different spontaneous mutations within CACNA1A display distinct phenotypes called tottering, leaner, or rocker, characterized by various paroxysmal manifestations (absence epilepsy, motor attacks) always associated with a permanent cerebellar ataxia of variable severity. Leaner mice have lower levels of voltage-dependant glutamate release measurable by cerebral microdialysis. They also have an elevated threshold for initiating cortical spreading depression (CSD) and a slower velocity of CSD propagation. Knockin mice carrying the human pure FHM1 mutation R192Q display multiple gain-of-function phenotypes: increased  $Ca_v2.1$  current density in cerebellar neurons, enhanced neurotransmission at the neuromuscular junction, and, in the intact animal, a reduced threshold and increased velocity of cortical spreading depression (van den Maagdenberg 2004). This mouse is the first animal model for FHM. These various abnormalities strongly suggest that FHM1 mutations in the  $Ca_v2.1$  channel modify the cortical excitability and increase the susceptibility to CSD, which is the mechanism underlying the aura.

ATP1A2 encodes the catalytic  $\alpha$ -2 subunit of a transmembrane  $Na^+/K^+$  ATPase. This protein hydrolyses ATP to extrude  $Na^+$  ions and pump  $K^+$  ions into the cell. This active pumping maintains the  $Na^+$  transmembrane gradient that is essential for the transport of amino-acids, neurotransmitters (including glutamate) and  $Ca^{2+}$ . In neonates, the  $\alpha$ -2 subunit is mainly expressed in neurons. In adults, it is mainly expressed in astrocytes. ATP1A2 contains 23 exons. So far, 14 mutations have been identified in 14 families and one sporadic case.

These mutations are missense mutations responsible for the substitution of one of the 1020 amino-acids of the protein. Only one mutation (R763H) was found in two unrelated families. In the family with the R689Q mutation, FHM cosegregates with benign familial infantile convulsions. In another family with the T378N mutation, the phenotypic spectrum includes features characteristic of FHM and of alternating hemiplegia. Electrophysiological studies initially suggested that ATP1A2 mutations are loss of function mutations leading to haploinsufficiency. Further studies suggest that the mutations are gain of function mutations leading to an abnormal function of the pump.

FHM is characterized by an important clinical variability. The age of onset, the frequency and duration of attacks, the aura features and the headache characteristics may vary from one patient to another, even among affected members from a given family who are carrying the same mutation in the same gene. This variability suggests complex interactions between the consequences of the FHM causing mutation and environmental factors or modifying genetic factors. However, several studies have shown that the various genotypes play a role in producing this clinical variability. FHM1, due to CACNA1A mutations, is characterized by a higher penetrance of FHM and of permanent cerebellar symptoms, the vast majority of families with permanent cerebellar symptoms being linked to CACNA1A (Ducros 2001). FHM2, due to ATP1A2 mutations, is characterized by a lower penetrance of FHM. Cerebellar symptoms are rarely part of the clinical spectrum of FHM2 (2 families published). In addition, striking correlations between genotype and phenotype have been shown in patients with CACNA1A mutations, including the fact that the most frequent FHM1 causing mutation, T666M, had the highest penetrance of hemiplegic migraine, severe attacks with coma and nystagmus (Ducros 2001). The existence of different CACNA1A mutations partly accounts for the clinical variability.

The implication of CACNA1A in the more frequent varieties of migraine has been analyzed by the mean of linkage and association studies with contradictory results, 3 studies concluding in favor and 5 against. None of the positive studies provided a direct analysis of the CACNA1A gene in order to detect pathogenic mutations. CACNA1A is thus probably not a susceptibility gene for the more common varieties of migraine. Moreover, a subsequent study showed that the 19p13 region does indeed contain a susceptibility locus for MA that is distinct from CACNA1A. The same group showed an association between migraine and five polymorphisms within the insulin receptor (INSR) gene located in 19p13.3/2 (McCarthy 2001). These five polymorphisms had no effect on INSR transcription, translation, and protein expression, and INSR-mediated functions. The nature of the implication of the INSR gene in migraine remains to be understood.



With regards to the FHM2 gene, a linkage analysis conducted in a single family suggested the presence of a possible migraine susceptibility locus in 1q31, distinct from the ATP1A2 locus in 1q21-q23. An ATP1A2 mutation (R548H) was found in a small family in which the two affected subjects had migraine with basilar, non-hemiplegic, aura. This mutation was not found in 100 healthy controls, or in 77 migrainous controls. Actual data do not permit a conclusion regarding the implication of ATP1A2 in MO/MA.

Three linkage analyses, each conducted in a large panel of MA families, have permitted the mapping of three susceptibility loci for MA: the first on 4q24 (in 50 Finnish families) (Wessman 2002), the second on 11q24 (in 43 Canadian families) (Cader 2003), and the last on 15q11-q13 (in 10 Italian families) (Russo 2004). An important linkage analysis in a group of 289 Icelandic patients with MO identified a susceptibility locus on 4q21 (Bjornsson 2003). This genetic interval overlapped the genetic region identified in the Finnish families on 4q24, suggesting an implication of this chromosome 4q region both in MO and MA. Finally, several linkage analyses, each conducted in a single family, suggested the existence of other migraine susceptibility loci on 1q21-q23, 6p12.2-p21.1, 14q21.2-q22.3 and Xq24-q28 (Estevez and Gardner 2004). None of the results have been replicated.

Finally, numerous association studies have been performed in migraine. A wide range of candidate polymorphisms have been tested in migraine. Association studies compare the frequency of alleles of a polymorphic genetic marker between cases and controls. In the absence of methodological shortcomings, a significant difference means that the polymorphism is located within the susceptibility gene or is in linkage disequilibrium with the susceptibility gene. Association studies do not provide any demonstration of the implication of the tested gene, or of an abnormal function of the tested gene in the pathophysiology of the studied disease. Positive associations have been found between migraine and polymorphisms within the dopamine receptor D2 (DRD2) gene, the human serotonin transporter gene, the catechol-o-methyltransferase gene, the endothelin type A gene, the dopamine beta-hydroxylase (DBH) gene, and the 5,10-methylenetetrahydrofolate reductase (MTHFR). These various candidate polymorphisms have been chosen based on the hypothesis that the genes containing them encode proteins that are suspected to be involved in migraine. However, additional studies are needed to determine if the alleles associated with migraine have any biological effect.

## References

1. Bjornsson A, Gudmundsson G, Gudfinnsson E et al. (2003) Localization of a Gene for Migraine without Aura to Chromosome 4q21. *Am J Hum Genet* 73:986–993

2. Cader ZM, Noble-Topham S, Dyment DA et al. (2003) Significant Linkage to Migraine with Aura on Chromosome 11q24. *Hum Mol Genet* 12:2511–2517
3. De Fusco M, Marconi R, Silvestri L et al. (2003) Haploinsufficiency of ATP1A2 Encoding the Na<sup>+</sup>/K<sup>+</sup> Pump Alpha2 Subunit Associated with Familial Hemiplegic Migraine Type 2. *Nat Genet* 33:192–196
4. Ducros A, Denier C, Joutel A et al. (2001) The Clinical Spectrum of Familial Hemiplegic Migraine Associated with Mutations in a Neuronal Calcium Channel. *N Engl J Med* 345:17–24
5. Estevez M, Gardner KL (2004) Update on the Genetics of Migraine. *Hum Genet* 114:225–235
6. Gervil M, Ulrich V, Kaprio J, Olesen J, Russell MB (1999) The Relative Role of Genetic and Environmental Factors in Migraine without Aura. *Neurology* 53:995–999
7. Maagdenberg AM van den, Pietrobon D, Pizzorusso T et al. (2004) A Cacna1a Knockin Migraine Mouse Model with Increased Susceptibility to Cortical Spreading Depression. *Neuron* 41:701–710
8. McCarthy LC, Hosford DA, Riley JH et al. (2001) Single-Nucleotide Polymorphism Alleles in the Insulin Receptor Gene are Associated with Typical Migraine. *Genomics* 78:135–149
9. Ophoff RA, Terwindt GM, Vergouwe MN et al. (1996) Familial Hemiplegic Migraine and Episodic Ataxia Type-2 are Caused by Mutations in the Ca<sup>2+</sup> Channel Gene CACNL1A4. *Cell* 87:543–552
10. Pietrobon D, Striessnig J (2003) Neurobiology of Migraine. *Nat Rev Neurosci* 4:386–398
11. Russell MB, Iselius L, Olesen J (1995) Inheritance of Migraine Investigated by Complex Segregation Analysis. *Hum Genet* 96:726–730
12. Russell MB, Olesen J (1995) Increased Familial Risk and Evidence of Genetic Factor in Migraine. *Bmj* 311:541–544
13. Russo L, Mariotti P, Sangiorgi E et al. (2004) A New Susceptibility Locus for Migraine with Aura in the 15q11-q13 Genomic Region Containing Three GABA-A Receptor Genes. *Am J Hum Genet* 76:2
14. Ulrich V, Gervil M, Kyvik KO et al. (1999) Evidence of a Genetic Factor in Migraine with Aura: A Population-Based Danish Twin Study. *Ann Neurol* 45:242–246
15. Wessman M, Kallela M, Kaunisto MA et al. (2002) A Susceptibility Locus for Migraine with Aura, on Chromosome 4q24. *Am J Hum Genet* 70:652–662

M

## Migraine Hemiparesthetic

- Clinical Migraine with Aura

## Migraine Hemiplegic

- Clinical Migraine with Aura

## Migraine Ophthalmic

- Clinical Migraine with Aura

## Migraine Optical

- Clinical Migraine with Aura

## Migraine, Pathophysiology

PETER J. GOADSBY

Institute of Neurology, The National Hospital for Neurology and Neurosurgery, London, UK  
peterg@ion.ucl.ac.uk

### Introduction

An understanding of the pathophysiology of migraine should be based upon the anatomy and physiology of the pain producing structures of the cranium integrated with knowledge of central nervous system modulation of these pathways. Headache in general, and in particular migraine (Goadsby et al. 2002) and cluster headache (Goadsby 2002b), is better understood now than has been the case for the last four millennia (Lance and Goadsby 2005). This chapter will set out the current understanding of migraine.

### Migraine — Explaining the Clinical Features

Migraine is in essence a familial episodic disorder whose key marker is headache with certain associated features (Table 1). It is these features that give clues to its migraine pathophysiology and will ultimately provide insights leading to new treatments.

The essential elements to be considered are:

- Genetics of migraine;
- Physiological basis for the ► [aura](#)
- Anatomy of head pain, particularly that of the ► [trigeminovascular system](#)
- Physiology and pharmacology of activation of the peripheral branches of ophthalmic branch of the trigeminal nerve;
- Physiology and pharmacology of the trigeminal nucleus, in particular its caudal most part, the ► [trigemincervical complex](#)
- ► [Brainstem](#) and diencephalic modulatory systems that influence trigeminal pain transmission and other sensory modality processing.

Migraine involves a form of sensory processing disturbance with wide ramifications within the central nervous system, while pain pathways will be used as an

**Migraine, Pathophysiology, Table 1** International Headache Society defined features of migraine (Headache Classification Committee of The International Headache Society 2004) Repeated episodic headache (4–72 h) with the following features:

Any two of	Any one of
unilateral throbbing worsened by movement moderate or severe	nausea / vomiting photophobia and phonophobia

example, it is useful to remember that migraine is not simply a pain problem.

### Genetics of Migraine

One of the most important aspects of the pathophysiology of migraine is the inherited nature of the disorder. It is clear from clinical practice that many patients have first degree relatives who also suffer from migraine (Lance and Goadsby 2005; Silberstein et al. 2002). Transmission of migraine from parents to children has been reported as early as the seventeenth century (Willis 1682) and numerous published studies have reported a positive family history (Russell 1997).

### Genetic Epidemiology

Studies of twin pairs are the classical method to investigate the relative importance of genetic and environmental factors. A Danish study included 1,013 monozygotic and 1,667 dizygotic twin pairs of the same gender, obtained from a population based twin register (Ulrich et al. 1999). The pairwise concordance rate was significantly higher among monozygotic than dizygotic twin pairs ( $P < 0.05$ ). Several studies have attempted to analyze the possible mode of inheritance in migraine families and conflicting results have been obtained (Lalouel and Morton 1981; Mochi et al. 1993; Russell et al. 1995). Both twin studies and population based epidemiological surveys strongly suggest that migraine without aura is a multifactorial disorder, caused by a combination of genetic and environmental factors.

### Familial Hemiplegic Migraine (FHM)

In approximately 50% of the reported families, FHM has been assigned to chromosome 19p13 (Joutel et al. 1994; Ophoff et al. 1994). Few clinical differences have been found between chromosome 19 linked and unlinked FHM families. Indeed, the clinical phenotype does not associate particularly with the known mutations (Ducros et al. 2001). The most striking exception is cerebellar ataxia, which occurs in approximately 50% of the chromosome 19 linked, but in none of the unlinked families (Haan et al. 1994; Joutel et al. 1993, 1994; Ophoff et al. 1994; Teh et al. 1995). Another less striking difference includes the fact that patients from chromosome 19 linked families are more likely to have attacks that can be triggered by minor head trauma or are that associated with coma (Terwindt et al. 1996). The biological basis for the linkage to chromosome 19 is mutations (Ophoff et al. 1996) involving the  $Ca_v2.1$  (P / Q) type ► [voltage gated calcium channel](#) (Ertel et al. 2000) *CACNA1A* gene. Now known as FHM-I, this mutation is responsible for about 50% of identified families. Mutations in the *ATPIA2* gene (De Fusco et

al. 2003; Marconi et al. 2003) have been identified to be responsible for about 20% of FHM families. Interestingly, the phenotype of some FHM-II families involves epilepsy (Jurkat-Rott et al. 2004; Vanmolkot et al. 2003), while it has also been suggested that alternating hemiplegia of childhood can be due to *ATPIA2* mutations (Swoboda et al. 2004). The latter cases are most unconvincing for migraine.

Taken together, the known mutations suggest that migraine, or at least the neurological manifestations currently called the aura, are caused by a ► **channelopathy** (Goadsby and Ferrari 2001). Linking the channel disturbance for the first time to the aura process has demonstrated that human mutations expressed in a knock-in mouse produce a reduced threshold for ► **cortical spreading depression** (van den Maagdenberg et al. 2004), which has some profound implications for understanding that process (Goadsby 2004).

### Migraine Aura

Migraine aura is defined as a focal neurological disturbance manifest as visual, sensory or motor symptoms (Headache Classification Committee of The International Headache Society 2004). It is seen in about 30% of patients (Rasmussen and Olesen 1992) and it is clearly neurally driven (Cutrer et al. 1998; Olesen et al. 1990). The case for the aura being the human equivalent of the cortical spreading depression (CSD) of Leao (1944a, 1944b) has been well made (Lauritzen 1994). In humans, visual aura has been described as affecting the visual field, suggesting the visual cortex and it starts at the centre of the visual field and propagates to the periphery at a speed of 3 mm / min (Lashley 1941). This is very similar to spreading depression described in rabbits (Leao 1944b). Blood flow studies in patients have also shown that a focal hyperemia tends to precede the spreading oligemia (Olesen et al. 1981) and again this is similar to what would be expected with spreading depression. After this passage of oligemia, the cerebrovascular response to hypercapnia in patients is blunted, while autoregulation remains intact (Harer and Kummer 1991; Lauritzen et al. 1983; Sakai and Meyer 1979). Again this pattern is repeated with experimental spreading depression (Kaube and Goadsby 1994; Kaube et al. 1999; Lambert et al. 1999). Human observations have rendered the arguments reasonably sound that human aura has cortical spreading depression as its equivalent in animals (Hadjikhani et al. 2001). An area of controversy surrounds whether aura in fact triggers the rest of the attack and is indeed painful (Moskowitz et al. 2004). Based on the available experimental and clinical data this author is not at all convinced that aura is painful (Goadsby 2001), but this does not diminish its interest, or the importance of understanding it. Indeed therapeutic develop-

ments may shed even further light on these relationships.

Tonabersat is a CSD inhibitor that has entered clinical trials in migraine. Tonabersat (SB-220453) inhibits CSD, CSD induced nitric oxide (NO) release and cerebral vasodilation (Read et al. 1999; Smith et al. 2000). Tonabersat does not constrict isolated human blood vessels (MaassenVanDenBrink et al. 2000), but does inhibit trigeminally induced craniovascular effects (Parsons et al. 2001). Remarkably, topiramate, a proven preventive agent in migraine (Brandes et al. 2004; Diener et al. 2004; Silberstein et al. 2004), also inhibits CSD in cat and rat (Akerman and Goadsby 2004). Tonabersat is inactive in the human NO model of migraine (Tvedskov et al. 2004a) as is propranolol (Tvedskov et al. 2004c), although valproate showed some activity in that model (Tvedskov et al. 2004b). Topiramate inhibits trigeminal neurons activated by nociceptive intracranial afferents (Storer and Goadsby 2004), but not by a mechanism local to the trigeminocervical complex (Storer and Goadsby 2005) and thus CSD inhibition may be a model system to contribute to the development of preventive medicines.

### Headache Anatomy

#### The Trigeminal Innervation of Pain-Producing Intracranial Structures

Surrounding the large cerebral vessels, pial vessels, large venous sinuses and dura mater is a plexus of largely unmyelinated fibers that arise from the ophthalmic division of the trigeminal ganglion (Liu-Chen et al. 1984) and in the posterior fossa from the upper cervical dorsal roots (Arbab et al. 1986). Trigeminal fibers innervating cerebral vessels arise from neurons in the trigeminal ganglion that contain substance P and ► **calcitonin gene related peptide** (CGRP) (Udman et al. 1985), both of which can be released when the trigeminal ganglion is stimulated either in humans or the cat (Goadsby et al. 1988). Stimulation of the cranial vessels, such as the superior sagittal sinus (SSS), is certainly painful in humans (Feindel et al. 1960; Wolff 1948). Human dural nerves that innervate the cranial vessels largely consist of small diameter myelinated and unmyelinated fibers (Penfield and McNaughton 1940) that almost certainly subserve a nociceptive function.

### Headache Physiology — Peripheral Connections

#### Plasma Protein Extravasation

Moskowitz (1990) has provided a series of experiments to suggest that the pain of migraine may be a form of sterile neurogenic inflammation. Although this seems clinically implausible, the model system has been helpful in understanding some aspects of trigeminovascular

physiology. Neurogenic plasma extravasation can be seen during electrical stimulation of the trigeminal ganglion in the rat (Markowitz et al. 1987). Plasma extravasation can be blocked by ergot alkaloids, indomethacin, acetylsalicylic acid and the serotonin-5HT<sub>1B/1D</sub> receptor agonist, sumatriptan (Moskowitz and Cutrer 1993). The pharmacology of abortive anti-migraine drugs has been reviewed in detail (Cutrer et al. 1997). In addition there are structural changes in the dura mater that are observed after trigeminal ganglion stimulation. These include mast cell degranulation and changes in post-capillary venules including platelet aggregation (Dimitriadou et al. 1991, 1992). While it is generally accepted that such changes and particularly the initiation of a sterile inflammatory response would cause pain (Burstein et al. 1998; Strassman et al. 1996), it is not clear whether this is sufficient of itself or requires other stimulators or promoters. Preclinical studies suggest that cortical spreading depression may be a sufficient stimulus to activate trigeminal neurons (Bolay et al. 2002), although this has been a controversial area (Ebersberger et al. 2001; Goadsby 2001; Ingvar et al. 1997; Ingvar et al. 1998; Moskowitz et al. 1993).

Although plasma extravasation in the retina, which is blocked by sumatriptan can be seen after trigeminal ganglion stimulation in experimental animals, no changes are seen with retinal angiography during acute attacks of migraine or cluster headache (May et al. 1998b). Clearly, blockade of neurogenic plasma protein extravasation is not completely predictive of anti-migraine efficacy in humans, as evidenced by the failure in clinical trials of substance P, neurokinin-1 antagonists (Connor et al. 1998; Diener and The RPR100893 Study Group 2003; Goldstein et al. 1997; Norman et al. 1998), specific PGE blockers, CP122,288 (Roon et al. 1997) and 4991w93 (Earl et al. 1999), an endothelin antagonist (May et al. 1996) and a neurosteroid (Data et al. 1998).

### Sensitization and Migraine

While it is highly doubtful that there is a significant sterile inflammatory response in the dura mater during migraine, it is clear that some form of sensitization takes place during migraine, since allodynia is common. About two-thirds of patients complain of pain from non-noxious stimuli, allodynia (Burstein et al. 2000a, b; Selby and Lance 1960). A particularly interesting aspect is the demonstration of allodynia in the upper limbs ipsilateral and contralateral to the pain. This finding is consistent with at least third order neuronal sensitization, such as sensitization of thalamic neurons and firmly places the pathophysiology within the central nervous system. Sensitization in migraine may be peripheral, with local release of inflammatory

markers, which would certainly activate trigeminal nociceptors (Strassman et al. 1996). More likely in migraine is a form of central sensitization, which may be classical central sensitization (Burstein et al. 1998) or a form of disinhibitory sensitization with dysfunction of descending modulatory pathways (Knight et al. 2002).

### Neuropeptide Studies

Electrical stimulation of the trigeminal ganglion in both humans and the cat leads to increases in extracerebral blood flow and local release of both CGRP and SP (Edvinsson and Goadsby 1998). In the cat, trigeminal ganglion stimulation also increases cerebral blood flow by a pathway traversing the greater superficial petrosal branch of the facial nerve, again releasing a powerful vasodilator peptide, vasoactive intestinal polypeptide (VIP) (May and Goadsby 1999). Interestingly, the VIPergic innervation of the cerebral vessels is predominantly anterior rather than posterior (Matsuyama et al. 1983) and this may contribute to this regions vulnerability to spreading depression, explaining why the aura is so very often seen to commence posteriorly. Stimulation of the more specifically vascular pain producing superior sagittal sinus increases cerebral blood flow and jugular vein CGRP levels. Human evidence that CGRP is elevated in the headache phase of migraine (Gallai et al. 1995; Goadsby et al. 1990), cluster headache (Fanciullacci et al. 1995; Goadsby and Edvinsson 1994) and chronic paroxysmal hemicrania (Goadsby and Edvinsson 1996) supports the view that the trigeminovascular system may be activated in a protective role in these conditions. It is of interest in this regard that compounds which have not shown activity in human migraine, notably the conformationally restricted analogue of sumatriptan, CP122,288 (Knight et al. 1999), and the conformationally restricted analogue of zolmitriptan, 4991w93 (Knight et al. 2001), were both ineffective inhibitors of CGRP release after superior sagittal sinus stimulation in the cat. The recent development of non-peptide, highly specific CGRP antagonists (Doods et al. 2000) and the announcement of proof of concept for a CGRP antagonist in acute migraine (Olesen et al. 2004), firmly establishes this as a novel and important new emerging principle for acute migraine.

## Headache Physiology — Central Connections

### The Trigemincervical Complex

Fos immunohistochemistry is a method for looking at activated cells by plotting the expression of Fos protein. After meningeal irritation with blood, Fos expression is noted in the trigeminal nucleus caudalis (Nozaki et al. 1992), while after stimulation of the superior sagittal sinus, Fos-like immunoreactivity is seen in the trigeminal nucleus caudalis and in the dorsal horn at the C<sub>1</sub>



and C<sub>2</sub> levels in the cat (Kaube et al. 1993c) and monkey (Goadsby and Hoskin 1997; Hoskin et al. 1999). These latter findings are in accord with similar data using 2-deoxyglucose measurements with superior sagittal sinus stimulation (Goadsby and Zagami 1991). Similarly, stimulation of a branch of C<sub>2</sub>, the greater occipital nerve, increases metabolic activity in the same regions, i.e. trigeminal nucleus caudalis and C<sub>1/2</sub> dorsal horn (Goadsby et al. 1997). In experimental animals, one can record directly from trigeminal neurons with both supratentorial trigeminal input and input from the greater occipital nerve, a branch of the C<sub>2</sub> dorsal root (Bartsch and Goadsby 2002). Stimulation of the greater occipital nerve for 5 min results in substantial increases in responses to supratentorial dural stimulation, which can last for over an hour (Bartsch and Goadsby 2002). Conversely, stimulation of the middle meningeal artery dura mater with the C-fiber irritant mustard oil sensitizes responses to occipital muscle stimulation (Bartsch and Goadsby 2003). Taken together these data suggest convergence of cervical and ophthalmic inputs at the level of the second order neuron. Moreover, stimulation of a lateralized structure, the middle meningeal artery, produces Fos expression bilaterally in both cat and monkey brain (Hoskin et al. 1999), a finding that is consistent with the fact that up to one third of patients complain of bilateral pain. This group of neurons from the superficial laminae of trigeminal nucleus caudalis and C<sub>1/2</sub> dorsal horns should be regarded functionally as the trigeminocervical complex.

These data demonstrate that trigeminovascular nociceptive information comes by way of the most caudal cells. This concept provides an anatomical explanation for the referral of pain to the back of the head in migraine. Moreover, experimental pharmacological evidence suggests that abortive anti-migraine drugs, such as ergots (Hoskin et al. 1996), acetylsalicylic acid (Kaube et al. 1993b), sumatriptan after blood-brain barrier disruption (Kaube et al. 1993a), eletriptan (Goadsby and Hoskin 1999; Lambert et al. 2002), naratriptan (Cumberbatch et al. 1998; Goadsby and Knight 1997), rizatriptan (Cumberbatch et al. 1997) and zolmitriptan (Goadsby and Hoskin 1996) can have actions at these second order neurons that reduce cell activity and suggest a further possible site for therapeutic intervention in migraine. This action can be dissected out to involve each of the 5-HT<sub>1B</sub>, 5-HT<sub>1D</sub> and 5-HT<sub>1F</sub> receptor subtypes (Goadsby and Classey 2003). Interestingly, ► **triptans** also influence the CGRP promoter (Durham et al. 1997) and regulate CGRP secretion from neurons in culture (Durham and Russo 1999). Furthermore, the demonstration that some part of this action is post-synaptic with either 5-HT<sub>1B</sub> or 5-HT<sub>1D</sub> receptors located non-presynaptically (Goadsby et al.

2001; Maneesi et al. 2004) offers a prospect of highly anatomically localized treatment options.

### Higher Order Processing

Following transmission in the caudal brain stem and high cervical spinal cord information is relayed rostrally.

### Thalamus

Processing of vascular nociceptive signals in the thalamus occurs in the ventroposteromedial (VPM) thalamus, medial nucleus of the posterior complex and in the intralaminar thalamus (Zagami and Goadsby 1991). Zagami and Lambert (1991) have shown by application of capsaicin to the superior sagittal sinus that trigeminal projections with a high degree of nociceptive input are processed in neurons particularly in the ventroposteromedial thalamus and in its ventral periphery. These neurons in the VPM can be modulated by activation of GABA<sub>A</sub> inhibitory receptors (Shields et al. 2003) and, perhaps of more direct clinical relevance, by propranolol through a β<sub>1</sub>-adrenoceptor mechanism (Shields and Goadsby 2005). Remarkably, triptans can also inhibit VPM neurons locally through 5-HT<sub>1B/1D</sub> mechanisms, as demonstrated by microiontophoretic application (Shields and Goadsby 2004), suggesting a hitherto unconsidered locus of action for triptans in acute migraine. Human imaging studies have confirmed activation of the thalamus contralateral to pain in acute migraine (Afridi et al. 2005a; Bahra et al. 2001), cluster headache (May et al. 1998a) and SUNCT (short-lasting unilateral neuralgiform headache with conjunctival injection and tearing) (May et al. 1999).

### Activation of Modulatory Regions

Stimulation of nociceptive afferents by stimulation of the superior sagittal sinus in the cat activates neurons in the ventrolateral periaqueductal grey matter (PAG) (Hoskin et al. 2001). PAG activation in turn feeds back to the trigeminocervical complex with an inhibitory influence (Knight and Goadsby 2001). PAG is clearly included in the area of activation seen in PET studies in migraineurs (Weiller et al. 1995). This typical negative feedback system will be further considered below as a possible mechanism for the symptomatic manifestations of migraine.

Another potential modulatory region activated by stimulation of nociceptive trigeminovascular input is the posterior hypothalamic grey (Benjamin et al. 2004). This area is crucially involved in several primary headaches, notably cluster headache (Goadsby 2002b), short-lasting unilateral neuralgiform headache attacks with conjunctival injection and tearing (SUNCT) (May et al. 1999) and hemicrania continua (Matharu et al. 2004b). Moreover, the clinical features of the premonitory phase (Giffin et al. 2003)

and other features of the disorder (Bes et al. 1982; Peroutka 1997) suggest dopamine neuron involvement. Orexinergic neurons in the posterior hypothalamus can be both pro- and anti-nociceptive (Bartsch et al. 2004), offering a further possible region whose dysfunction might involve the perception of head pain.

### Central Modulation of Trigeminal Pain

#### Brain Imaging in Humans

Functional brain imaging with positron emission tomography (PET) in studies during migraine without aura has demonstrated activation of the dorsal midbrain including the periaqueductal grey (PAG) and in the dorsal pons near the locus coeruleus (Weiller et al. 1995). Dorsolateral pontine activation is seen with PET in spontaneous episodic (Afridi et al. 2005a) and chronic migraine (Matharu et al. 2004a) and with nitroglycerin triggered attacks (Afridi et al. 2005b; Bahra et al. 2001). These areas are active immediately after successful treatment of the headache but are not active interictally. The activation corresponds with the brain region that Raskin et al. (1987) initially reported and Veloso confirmed (Veloso et al. 1998) to cause migraine-like headache when stimulated in patients with electrodes implanted for pain control. Similarly, Welch and colleagues (2001) have noted excess iron in the PAG of patients with episodic and chronic migraine and chronic migraine can develop after a bleed into a cavernoma in the region of the PAG (Goadsby 2002a) or with a lesion of the pons (Afridi and Goadsby 2003). What could dysfunction of these brain areas lead to?

#### Animal Experimental Studies of Sensory Modulation

It has been shown in the experimental animal that stimulation of the nucleus locus coeruleus, the main

central noradrenergic nucleus, reduces cerebral blood flow in a frequency dependent manner (Goadsby et al. 1982) through an  $\alpha_2$ -adrenoceptor linked mechanism (Goadsby et al. 1985). This reduction is maximal in the occipital cortex (Goadsby and Duckworth 1989). While a 25% overall reduction in cerebral blood flow is seen, extracerebral vasodilatation occurs in parallel (Goadsby et al. 1982). In addition the main serotonin containing nucleus in the brain stem, the midbrain dorsal raphe nucleus can increase cerebral blood flow when activated (Goadsby et al. 1991). Furthermore, stimulation of PAG will inhibit sagittal sinus evoked trigeminal neuronal activity in the cat (Knight and Goadsby 2001), while blockade of P/Q-type voltage-gated  $Ca^{2+}$  channels in the PAG facilitates trigemino-vascular nociceptive processing (Knight et al. 2002) with the local GABAergic system in the PAG still intact (Knight et al. 2003).

#### Electrophysiology of Migraine in Humans

Studies of evoked potentials and event related potentials provide some link between animal studies and human functional imaging (Kaube and Giffin 2002). Authors have shown changes in neurophysiological measures of brain activation but there is much discussion as to how to interpret such changes (Schoenen et al. 2003). Perhaps the most reliable theme is that the migrainous brain does not habituate to signals in a normal way (Afra et al. 2000; Proietti-Cecchini et al. 1997; Schoenen et al. 1995; Wang and Schoenen 1998). Similarly, contingent negative variation (CNV), an event related potential, is abnormal in migraineurs compared to controls (Schoenen and Timsit-Berthier 1993). Changes in CNV predict attacks (Kropp and Gerber 1998) and preventive therapies alter and normalize such changes (Maertens de Noordhout et al.

**Migraine, Pathophysiology, Table 2** Neuroanatomical processing of vascular head pain

	Structure	Comments
Target innervation: Cranial vessels Dura mater	Ophthalmic branch of trigeminal nerve	
1 <sup>st</sup>	Trigeminal ganglion	Middle cranial fossa
2 <sup>nd</sup>	Trigeminal nucleus (quintothalamic tract)	Trigeminal n. caudalis and C <sub>1</sub> /C <sub>2</sub> dorsal horns
3 <sup>rd</sup>	Thalamus	Ventrobasal complex Medial n. of posterior group Intralaminar complex
Modulatory	Midbrain Hypothalamus	Periaqueductal grey matter Posterior and lateral nuclei
Final	Cortex	insulae frontal cortex anterior cingulate cortex basal ganglia

1985). Attempts to correlate clinical phenotypes with electrophysiological changes (Gantenbein et al. 2004), may enhance further studies in this area.

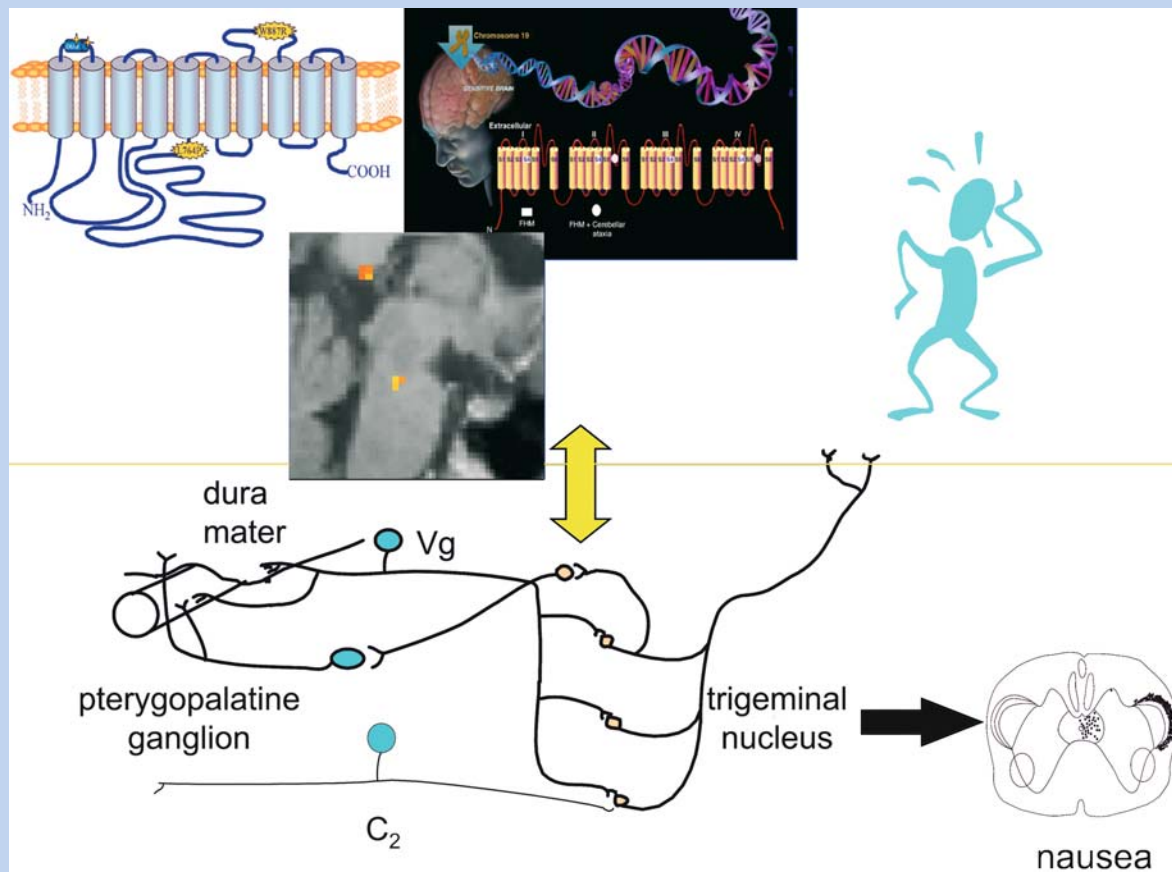
### What Is Migraine?

Migraine is an inherited, episodic disorder involving sensory sensitivity. Patients complain of pain in the head that is throbbing, but there is no reliable relationship between vessel diameter and the pain (Kruuse et al. 2003; Olesen et al. 1990) or its treatment (Limmroth et al. 1996). They complain of discomfort from normal lights and the unpleasantness of routine sounds. Some mention otherwise pleasant odors are unpleasant. Normal movement of the head causes pain and many mention a sense of unsteadiness as if they have just stepped off a boat, having been nowhere near the water!

The anatomical connections of, for example, the pain pathways are clear, the ophthalmic division of the trigeminal nerve subserves sensation within the cranium and explains why the top of the head is headache and the maxillary division is facial pain. The convergence of cervical and trigeminal afferents explains

why neck stiffness or pain is so common in primary headache. The genetics of channelopathies is opening up a plausible way to think about the episodic nature of migraine. However, where is the lesion, what is actually the pathology?

If one considers what patients say, then perhaps they tell us the answer to this question. Migraine aura cannot be the trigger, there is no evidence at all after 4,000 years that it occurs in more than 30% of migraine patients, it can be experienced without pain at all and is seen in the other primary headaches. There is not a photon of extra light that migraine patients receive over others, so for that symptom and phonophobia and osmophobia, the basis of the problem must be abnormal central processing of a normal signal. Perhaps electrophysiological changes in the brain have been mislabeled as hyperexcitability whereas dyshabituation might be a simpler explanation. If migraine was basically an attentional problem with changes in cortical synchronization (Niebur et al. 2002) or hypersynchronization (Angelini et al. 2004), all its manifestations could be accounted for in a single over-arching pathophysiology-



**Migraine, Pathophysiology, Figure 1** Illustration of some of the elements of migraine biology. Patients inherit a dysfunction in brain control systems for pain and other afferent stimuli, which can be triggered and are in turn capable of activating the trigeminovascular system as the initiating event in a positive feedback of neurally driven vasodilatation. Pain from cervical inputs that terminate in the trigeminocervical complex accounts for the non-trigeminal distribution of pain in many patients. Migraine has thus a pain system for its expression and brain centers and modulatory systems that define the associated symptoms and periodicity of the clinical syndrome. Brain stem changes after Bahra and colleague (2001).

ical hypothesis of a disturbance of sub-cortical sensory modulation systems (Goadsby 2003). While it seems likely that the trigeminovascular system and its cranial autonomic reflex connections, the trigeminal-autonomic reflex (May and Goadsby 1999) act as a feed-forward system to facilitate the acute attack, the fundamental problem in migraine is in the brain. Unraveling its basis will deliver great benefits to patients and considerable understanding of some very fundamental neurobiological processes.

### Acknowledgements

The work of the author has been supported by the Wellcome Trust.

### References

- Afra J, Sandor P, Schoenen J (2000) Habituation of visual and intensity dependence of cortical auditory evoked potentials tend to normalise just before and during migraine attacks. *Cephalalgia* 20:347
- Afridi S, Goadsby PJ (2003) New onset migraine with a brainstem cavernous angioma. *J Neurol Neurosurg Psychiatry* 74:680–682
- Afridi S, Giffin NJ, Kaube H et al. (2005a) A PET study in spontaneous migraine. *Arch Neurol* 2005 (in press)
- Afridi S, Matharu MS, Lee L et al. (2005b) A PET study exploring the laterality of brainstem activation in migraine using glyceryl trinitrate. *Brain* 128:932–939
- Akerman S, Goadsby PJ (2004) Topiramate inhibits cortical spreading depression in rat and cat: a possible contribution to its preventive effect in migraine. *Cephalalgia* 24:783–784
- Angelini L, Tommaso M de, Guido M et al. (2004) Steady-state visual evoked potentials and phase synchronization in migraine patients. *Phys Rev Lett* 93:038103-1–038103-4
- Arbab MA-R, Wiklund L, Svendgaard NA (1986) Origin and distribution of cerebral vascular innervation from superior cervical, trigeminal and spinal ganglia investigated with retrograde and anterograde WGA-HRP tracing in the rat. *Neuroscience* 19:695–708
- Bahra A, Matharu MS, Buchel C et al. (2001) Brainstem activation specific to migraine headache. *Lancet* 357:1016–1017
- Bartsch T, Goadsby PJ (2002) Stimulation of the greater occipital nerve induces increased central excitability of dural afferent input. *Brain* 125:1496–1509
- Bartsch T, Goadsby PJ (2003) Increased responses in trigeminocervical nociceptive neurones to cervical input after stimulation of the dura mater. *Brain* 126:1801–1813
- Bartsch T, Levy MJ, Knight YE et al. (2004) Differential modulation of nociceptive dural input to [hypocretin] Orexin A and B receptor activation in the posterior hypothalamic area. *Pain* 109:367–378
- Benjamin L, Levy MJ, Lasalandra MP et al. (2004) Hypothalamic activation after stimulation of the superior sagittal sinus in the cat: a Fos study. *Neurobiol Dis* 16:500–505
- Bes A, Geraud A, Guell A et al. (1982) Dopaminergic hypersensitivity in migraine: a diagnostic test? *La Nouvelle Presse Medicale* 11:1475–1478
- Bolay H, Reuter U, Dunn AK et al. (2002) Intrinsic brain activity triggers trigeminal meningeal afferents in a migraine model. *Nat Med* 8:136–142
- Brandes JL, Saper JR, Diamond M et al. (2004) Topiramate for migraine prevention: a randomized controlled trial. *JAMA* 291:965–973
- Burstein R, Yamamura H, Malick A et al. (1998) Chemical stimulation of the intracranial dura induces enhanced responses to facial stimulation in brain stem trigeminal neurons. *J Neurophysiol* 79:964–982
- Burstein R, Cutrer MF, Yarnitsky D (2000a) The development of cutaneous allodynia during a migraine attack. *Brain* 123:1703–1709
- Burstein R, Yarnitsky D, Goor-Aryeh I et al. (2000b) An association between migraine and cutaneous allodynia. *Ann Neurol* 47:614–624
- Connor HE, Bertin L, Gillies S et al. (1998) The GR205171 Clinical Study Group. Clinical evaluation of a novel, potent, CNS penetrating NK<sub>1</sub> receptor antagonist in the acute treatment of migraine. *Cephalalgia* 18:392
- Cumberbatch MJ, Hill RG, Hargreaves RJ (1997) Rizatriptan has central antinociceptive effects against durally evoked responses. *European J Pharmacol* 328:37–40
- Cumberbatch MJ, Hill RG, Hargreaves RJ (1998) Differential effects of the 5HT<sub>1B/1D</sub> receptor agonist naratriptan on trigeminal versus spinal nociceptive responses. *Cephalalgia* 18:659–664
- Cutrer FM, Limmroth V, Waerber C et al. (1997) New targets for antimigraine drug development. In: Goadsby PJ, Silberstein SD (eds) *Headache*. Butterworth-Heinemann, Philadelphia, pp 59–72
- Cutrer FM, Sorensen AG, Weisskoff RM et al. (1998) Perfusion-weighted imaging defects during spontaneous migrainous aura. *Ann Neurol* 43:25–31
- Data J, Britch K, Westergaard N et al. (1998) A double-blind study of ganaxolone in the acute treatment of migraine headaches with or without an aura in premenopausal females. *Headache* 38:380
- De Fusco M, Marconi R, Silvestri L et al. (2003) Haploinsufficiency of ATP1A2 encoding the Na<sup>+</sup> / K<sup>+</sup> pump  $\alpha$ 2 subunit associated with familial hemiplegic migraine type 2. *Nat Genet* 33:192–196
- Diener HC, Tfelt-Hansen P, Dahlof C et al. (2004) Topiramate in migraine prophylaxis —results from a placebo-controlled trial with propranolol as an active control. *J Neurol* 251:943–950
- Diener H-C, The RPR100893 Study Group (2003) RPR100893, a substance-P antagonist, is not effective in the treatment of migraine attacks. *Cephalalgia* 23:183–185
- Dimitriadou V, Buzzi MG, Moskowitz MA et al. (1991) Trigeminal sensory fiber stimulation induces morphological changes reflecting secretion in rat dura mater mast cells. *Neuroscience* 44:97–112
- Dimitriadou V, Buzzi MG, Theoharides TC et al. (1992) Ultrastructural evidence for neurogenically mediated changes in blood vessels of the rat dura mater and tongue following antidromic trigeminal stimulation. *Neuroscience* 48:187–203
- Doods H, Hallermayer G, Wu D et al. (2000) Pharmacological profile of BIBN4096BS, the first selective small molecule CGRP antagonist. *Br J Pharmacol* 129:420–423
- Ducros A, Denier C, Joutel A et al. (2001) The clinical spectrum of familial hemiplegic migraine associated with mutations in a neuronal calcium channel. *N Engl J Med* 345:17–24
- Durham PL, Russo AF (1999) Regulation of calcitonin gene-related peptide secretion by a serotonergic antimigraine drug. *J Neurosci* 19:3423–3429
- Durham PL, Sharma RV, Russo AF (1997) Repression of the calcitonin gene-related peptide promoter by 5-HT<sub>1</sub> receptor activation. *J Neurosci* 17:9545–9553
- Earl NL, McDonald SA, Lowy MT, 4991W93 Investigator Group (1999) Efficacy and tolerability of the neurogenic inflammation inhibitor, 4991W93, in the acute treatment of migraine. *Cephalalgia* 19:357
- Ebersberger A, Schaible H-G, Averbeck B et al. (2001) Is there a correlation between spreading depression, neurogenic inflammation, and nociception that might cause migraine headache? *Ann Neurol* 41:7–13
- Edvinsson L, Goadsby PJ (1998) Neuropeptides in headache. *Eur J Neurol* 5:329–341
- Ertel EA, Campbell KP, Harpold MM et al. (2000) Nomenclature of voltage-gated calcium channels. *Neuron* 25:533–535



38. Fanciullacci M, Alessandri M, Figini M et al. (1995) Increase in plasma calcitonin gene-related peptide from extracerebral circulation during nitroglycerin-induced cluster headache attack. *Pain* 60:119–123
39. Feindel W, Penfield W, McNaughton F (1960) The tentorial nerves and localization of intracranial pain in man. *Neurol* 10:555–563
40. Gallai V, Sarchielli P, Floridi A et al. (1995) Vasoactive peptides levels in the plasma of young migraine patients with and without aura assessed both interictally and ictally. *Cephalalgia* 15:384–390
41. Gantenbein A, Goadsby PJ, Kaube H (2004) Introduction of a clinical scoring system for migraine research applied to electrophysiological studies. *Cephalalgia* 24:1095–1096
42. Giffin NJ, Ruggiero L, Lipton RB et al. (2003) Premonitory symptoms in migraine: an electronic diary study. *Neurology* 60:935–940
43. Goadsby PJ (2001) Migraine, aura and cortical spreading depression: why are we still talking about it? *Ann Neurol* 49:4–6
44. Goadsby PJ (2002a) Neurovascular headache and a midbrain vascular malformation—evidence for a role of the brainstem in chronic migraine. *Cephalalgia* 22:107–111
45. Goadsby PJ (2002b) Pathophysiology of cluster headache: a trigeminal autonomic cephalgia. *Lancet Neurol* 1:37–43
46. Goadsby PJ (2003) Migraine pathophysiology: the brainstem governs the cortex. *Cephalalgia* 23:565–566
47. Goadsby PJ (2004) Migraine aura: a knock-in mouse with a knock-out message. *Neuron* 41:679–680
48. Goadsby PJ, Classey JD (2003) Evidence for 5-HT<sub>1B</sub>, 5-HT<sub>1D</sub> and 5-HT<sub>1F</sub> receptor inhibitory effects on trigeminal neurons with craniovascular input. *Neuroscience* 122:491–498
49. Goadsby PJ, Duckworth JW (1989) Low frequency stimulation of the locus coeruleus reduces regional cerebral blood flow in the spinalized cat. *Brain Res* 476:71–77
50. Goadsby PJ, Edvinsson L (1994) Human *in vivo* evidence for trigeminovascular activation in cluster headache. *Brain* 117:427–434
51. Goadsby PJ, Edvinsson L (1996) Neuropeptide changes in a case of chronic paroxysmal hemicrania—evidence for trigeminoparasympathetic activation. *Cephalalgia* 16:448–450
52. Goadsby PJ, Ferrari MD (2001) Migraine: a multifactorial, episodic neurovascular channelopathy? In: Rose MR, Griggs RC (eds) *Channelopathies of the Nervous System*. Butterworth Heinemann, Oxford, pp 274–292
53. Goadsby PJ, Hoskin KL (1996) Inhibition of trigeminal neurons by intravenous administration of the serotonin (5HT)<sub>1B</sub> / <sub>1D</sub> receptor agonist zolmitriptan (311C90): are brain stem sites a therapeutic target in migraine? *Pain* 67:355–359
54. Goadsby PJ, Hoskin KL (1997) The distribution of trigeminovascular afferents in the nonhuman primate brain *Macaca nemestrina*: a c-fos immunocytochemical study. *J Anatomy* 190:367–375
55. Goadsby PJ, Hoskin KL (1999) Differential effects of low dose CP122,288 and eletriptan on fos expression due to stimulation of the superior sagittal sinus in cat. *Pain* 82:15–22
56. Goadsby PJ, Knight YE (1997) Inhibition of trigeminal neurons after intravenous administration of naratriptan through an action at the serotonin (5HT)<sub>1B</sub> / <sub>1D</sub> receptors. *Br J Pharmacol* 122:918–922
57. Goadsby PJ, Zagami AS (1991) Stimulation of the superior sagittal sinus increases metabolic activity and blood flow in certain regions of the brainstem and upper cervical spinal cord of the cat. *Brain* 114:1001–1011
58. Goadsby PJ, Lambert GA, Lance JW (1982) Differential effects on the internal and external carotid circulation of the monkey evoked by locus coeruleus stimulation. *Brain Res* 249:247–254
59. Goadsby PJ, Lambert GA, Lance JW (1985) The mechanism of cerebrovascular vasoconstriction in response to locus coeruleus stimulation. *Brain Res* 326:213–217
60. Goadsby PJ, Edvinsson L, Ekman R (1988) Release of vasoactive peptides in the extracerebral circulation of man and the cat during activation of the trigeminovascular system. *Ann Neurol* 23:193–196
61. Goadsby PJ, Edvinsson L, Ekman R (1990) Vasoactive peptide release in the extracerebral circulation of humans during migraine headache. *Ann Neurol* 28:183–187
62. Goadsby PJ, Zagami AS, Lambert GA (1991) Neural processing of craniovascular pain: a synthesis of the central structures involved in migraine. *Headache* 31:365–371
63. Goadsby PJ, Hoskin KL, Knight YE (1997) Stimulation of the greater occipital nerve increases metabolic activity in the trigeminal nucleus caudalis and cervical dorsal horn of the cat. *Pain* 73:23–28
64. Goadsby PJ, Akerman S, Storer RJ (2001) Evidence for postjunctional serotonin (5-HT<sub>1</sub>) receptors in the trigeminocervical complex. *Ann Neurol* 50:804–807
65. Goadsby PJ, Lipton RB, Ferrari MD (2002) Migraine—current understanding and treatment. *N Engl J Med* 346:257–270
66. Goldstein DJ, Wang O, Saper JR et al. (1997) Ineffectiveness of neurokinin-1 antagonist in acute migraine: a crossover study. *Cephalalgia* 17:785–790
67. Haan J, Terwindt GM, Bos PL et al. (1994) Familial hemiplegic migraine in The Netherlands. *Clinical Neurol Neurosurgery* 96:244–249
68. Hadjikhani N, Sanchez del Rio M, Wu O et al. (2001) Mechanisms of migraine aura revealed by functional MRI in human visual cortex. *Proc Natl Acad Sci USA* 98:4687–4692
69. Harer C, Kummer R (1991) Cerebrovascular CO<sub>2</sub> reactivity in migraine: assessment by transcranial Doppler ultrasound. *J Neurol* 238:23–26
70. Headache Classification Committee of The International Headache Society (2004) *The International Classification of Headache Disorders*, 2nd edn. *Cephalalgia* 24:1–160
71. Hoskin KL, Kaube H, Goadsby PJ (1996) Central activation of the trigeminovascular pathway in the cat is inhibited by dihydroergotamine. A c-Fos and electrophysiology study. *Brain* 119:249–256
72. Hoskin KL, Zagami A, Goadsby PJ (1999) Stimulation of the middle meningeal artery leads to Fos expression in the trigeminocervical nucleus: a comparative study of monkey and cat. *J Anatomy* 194:579–588
73. Hoskin KL, Bulmer DCE, Lasalandra M et al. (2001) Fos expression in the midbrain periaqueductal grey after trigeminovascular stimulation. *J Anatomy* 197:29–35
74. Ingvarsdson BK, Laursen H, Olsen UB et al. (1997) Possible mechanism of c-fos expression in trigeminal nucleus caudalis following spreading depression. *Pain* 72:407–415
75. Ingvarsdson BK, Laursen H, Olsen UB et al. (1998) Comment on Ingvarsdson et al. (1997) *Pain* 72:407–415; Reply to Moskowitz et al. (1998) *Pain* 76:266–267
76. Joutel A, Bousser MG, Biouesse V A et al. (1993) A gene for familial hemiplegic migraine maps to chromosome 19. *Nat Genet* 5:40–45
77. Joutel A, Ducros A, Vahedi K et al. (1994) Genetic heterogeneity of familial hemiplegic migraine. *American J Hum Gen* 55:1166–1172
78. Jurkat-Rott K, Freilinger T, Dreier JP et al. (2004) Variability of familial hemiplegic migraine with novel A1A2 Na<sup>+</sup> / K<sup>+</sup>-ATPase variants. *Neurology* 62:1857–1861
79. Kaube H, Giffin NJ (2002) The electrophysiology of migraine. *Curr Opin Neurol* 15:303–309
80. Kaube H, Goadsby PJ (1994) Anti-migraine compounds fail to modulate the propagation of cortical spreading depression in the cat. *Eur Neurol* 34:30–35
81. Kaube H, Hoskin KL, Goadsby PJ (1993a) Inhibition by sumatriptan of central trigeminal neurones only after blood-brain barrier disruption. *Br J Pharmacol* 109:788–792
82. Kaube H, Hoskin KL, Goadsby PJ (1993b) Intravenous acetylsalicylic acid inhibits central trigeminal neurons in the dorsal

- horn of the upper cervical spinal cord in the cat. *Headache* 33:541–550
83. Kaube H, Keay KA, Hoskin KL et al. (1993c) Expression of *c-Fos*-like immunoreactivity in the caudal medulla and upper cervical cord following stimulation of the superior sagittal sinus in the cat. *Brain Res* 629:95–102
  84. Kaube H, Knight YE, Storer RJ et al. (1999) Vasodilator agents and supracollicular transection fail to inhibit cortical spreading depression in the cat. *Cephalalgia* 19:592–597
  85. Knight YE, Goadsby PJ (2001) The periaqueductal gray matter modulates trigeminovascular input: a role in migraine? *Neuroscience* 106:793–800
  86. Knight YE, Edvinsson L, Goadsby PJ (1999) Blockade of CGRP release after superior sagittal sinus stimulation in cat: a comparison of avitriptan and CP122,288. *Neuropeptides* 33:41–46
  87. Knight YE, Edvinsson L, Goadsby PJ (2001) 4991W93 inhibits release of calcitonin gene-related peptide in the cat but only at doses with 5HT<sub>1B</sub> / 1D receptor agonist activity. *Neuropharmacology* 40:520–525
  88. Knight YE, Bartsch T, Kaube H et al. (2002) P/Q-type calcium channel blockade in the PAG facilitates trigeminal nociception: a functional genetic link for migraine? *J Neurosci* 22:1–6
  89. Knight YE, Bartsch T, Goadsby PJ (2003) Trigeminal antinociception induced by bicuculline in the periaqueductal grey (PAG) is not affected by PAG P/Q-type calcium channel blockade in rat. *Neurosci Lett* 336:113–116
  90. Kropp P, Gerber WD (1998) Prediction of migraine attacks using a slow cortical potential, the contingent negative variation. *Neurosci Lett* 257:73–76
  91. Kruuse C, Thomsen LL, Birk S et al. (2003) Migraine can be induced by sildenafil without changes in middle cerebral artery diameter. *Brain* 126:241–247
  92. Lalouel JM, Morton NE (1981) Complex segregation analysis with pointers. *Human Heredity* 31:312–321
  93. Lambert GA, Michalick J, Storer RJ et al. (1999) Effect of cortical spreading depression on activity of trigeminovascular sensory neurons. *Cephalalgia* 19:631–638
  94. Lambert GA, Boers PM, Hoskin KL et al. (2002) Suppression by eletriptan of the activation of trigeminovascular sensory neurons by glyceryl trinitrate. *Brain Res* 953:181–188
  95. Lance JW, Goadsby PJ (2005) *Mechanism and Management of Headache*. Elsevier, New York
  96. Lashley KS (1941) Patterns of cerebral integration indicated by the scotomas of migraine. *Arch Neurol Psychiatry* 46:331–339
  97. Lauritzen M (1994) Pathophysiology of the migraine aura. The spreading depression theory. *Brain* 117:199–210
  98. Lauritzen M, Skyhoj-Olsen T, Lassen NA et al. (1983) The changes of regional cerebral blood flow during the course of classical migraine attacks. *Ann Neurol* 13:633–641
  99. Leao AAP (1944a) Pial circulation and spreading activity in the cerebral cortex. *J Neurophysiol* 7:391–396
  100. Leao AAP (1944b) Spreading depression of activity in cerebral cortex. *J Neurophysiology* 7:359–390
  101. Limmroth V, May A, Auerbach P et al. (1996) Changes in cerebral blood flow velocity after treatment with sumatriptan or placebo and implications for the pathophysiology of migraine. *J Neurol Sci* 138:60–65
  102. Liu-Chen L-Y, Gillespie SA, Norregaard TV et al. (1984) Colocalization of retrogradely transported wheat germ agglutinin and the putative neurotransmitter substance P within trigeminal ganglion cells projecting to cat middle cerebral. *J Comp Neurol* 225:187–192
  103. MaassenVanDenBrink A, van den Broek RW, de Vries R et al. (2000) The potential anti-migraine compound SB-220453 does not contract human isolated blood vessels or myocardium; a comparison with sumatriptan. *Cephalalgia* 20:538–545
  104. Maertens de Noordhout A, Timsit-Berthier M, Schoenen J (1985) Contingent negative variation (CNV) in migraineurs before and during prophylactic treatment with beta-blockers. *Cephalalgia* 5:34–35
  105. Maneesi S, Akerman S, Lasalandra MP et al. (2004) Electron microscopic demonstration of pre- and postsynaptic 5-HT<sub>1D</sub> and 5-HT<sub>1F</sub> receptor immunoreactivity (IR) in the rat trigeminocervical complex (TCC) new therapeutic possibilities for the triptans. *Cephalalgia* 24:148
  106. Marconi R, De Fusco M, Aridon P et al. (2003) Familial hemiplegic migraine type 2 is linked to 0.9Mb region on chromosome 1q23. *Ann Neurol* 53:376–381
  107. Markowitz S, Saito K, Moskowitz MA (1987) Neurogenically mediated leakage of plasma proteins occurs from blood vessels in dura mater but not brain. *J Neurosci* 7:4129–4136
  108. Matharu MS, Bartsch T, Ward N et al. (2004a) Central neuromodulation in chronic migraine patients with suboccipital stimulators: a PET study. *Brain* 127:220–230
  109. Matharu MS, Cohen AS, McGonigle DJ et al. (2004b) Posterior hypothalamic and brainstem activation in hemicrania continua. *Headache* 44:462–463
  110. Matsuyama T, Shiosaka S, Matsumoto M et al. (1983) Overall distribution of vasoactive intestinal polypeptide-containing nerves on the wall of the cerebral arteries: an immunohistochemical study using whole-mounts. *Neuroscience* 10: 89–96
  111. May A, Goadsby PJ (1999) The trigeminovascular system in humans: pathophysiological implications for primary headache syndromes of the neural influences on the cerebral circulation. *J Cerebral Blood Flow Metabolism* 19:115–127
  112. May A, Gijsman HJ, Wallnoefer A et al. (1996) Endothelin antagonist bosentan blocks neurogenic inflammation, but is not effective in aborting migraine attacks. *Pain* 67:375–378
  113. May A, Bahra A, Buchel C et al. (1998a) Hypothalamic activation in cluster headache attacks. *Lancet* 352:275–278
  114. May A, Shephard S, Wessing A et al. (1998b) Retinal plasma extravasation can be evoked by trigeminal stimulation in rat but does not occur during migraine attacks. *Brain* 121:1231–1237
  115. May A, Bahra A, Buchel C et al. (1999) Functional MRI in spontaneous attacks of SUNCT: short-lasting neuralgiform headache with conjunctival injection and tearing. *Ann Neurol* 46:791–793
  116. Mochi M, Sangiorgi S, Cortelli P et al. (1993) Testing models for genetic determination in migraine. *Cephalalgia* 13:389–394
  117. Moskowitz MA (1990) Basic mechanisms in vascular headache. *Neurologic Clinics* 8:801–815
  118. Moskowitz MA, Cutrer FM (1993) Sumatriptan: a receptor-targeted treatment for migraine. *Ann Rev Med* 44:145–154
  119. Moskowitz MA, Nozaki K, Kraig RP (1993) Neocortical spreading depression provokes the expression of C-fos protein-like immunoreactivity within the trigeminal nucleus caudalis via trigeminovascular mechanisms. *J Neurosci* 13:1167–1177
  120. Moskowitz MA, Bolay H, Dalkara T (2004) Deciphering migraine mechanisms: Clues from familial hemiplegic migraine genotypes. *Ann Neurol* 55:276–280
  121. Niebur E, Hsiao SS, Johnson KO (2002) Synchrony: a neural mechanism for attentional selection? *Curr Opin Neurobiol* 12:190–194
  122. Norman B, Panebianco D, Block GA (1998) A placebo-controlled, in-clinic study to explore the preliminary safety and efficacy of intravenous L-758,298 (a prodrug of the NK1 receptor antagonist L-754,030) in the acute treatment of migraine. *Cephalalgia* 18:407
  123. Nozaki K, Boccalini P, Moskowitz MA (1992) Expression of c-fos-like immunoreactivity in brainstem after meningeal irritation by blood in the subarachnoid space. *Neuroscience* 49:669–680
  124. Olesen J, Larsen B, Lauritzen M (1981) Focal hyperemia followed by spreading oligemia and impaired activation of rCBF in classic migraine. *Ann Neurol* 9:344–352
  125. Olesen J, Friberg L, Skyhoj-Olsen T et al. (1990) Timing and topography of cerebral blood flow, aura, and headache during migraine attacks. *Ann Neurol* 28:791–798

126. Olesen J, Diener H-C, Husstedt I-W et al. (2004) Calcitonin gene-related peptide (CGRP) receptor antagonist BIBN4096BS is effective in the treatment of migraine attacks. *N Engl J Med* 350:1104–1110
127. Ophoff RA, Eijk Rv, Sandkuijl LA et al. (1994) Genetic heterogeneity of familial hemiplegic migraine. *Genomics* 22:21–26
128. Ophoff RA, Terwindt GM, Vergouwe MN et al. (1996) Familial hemiplegic migraine and episodic ataxia type-2 are caused by mutations in the Ca<sup>2+</sup> channel gene CACNL1A4. *Cell* 87:543–552
129. Parsons AA, Bingham S, Raval P et al. (2001) Tonabersat (SB-220453) a novel benzopyran with anticonvulsant properties attenuates trigeminal nerve-induced neurovascular reflexes. *Br J Pharmacol* 132:1549–1557
130. Penfield W, McNaughton FL (1940) Dural headache and the innervation of the dura mater. *Arch Neurol Psychiatry* 44:43–75
131. Peroutka SJ (1997) Dopamine and migraine. *Neurology* 49:650–656
132. Proietti-Cecchini A, Afra J, Schoenen J (1997) Intensity dependence of the cortical auditory evoked potentials as a surrogate marker of central nervous system serotonin transmission in man: demonstration of a central effect for the 5HT1B / 1D agonist zolmitriptan (311C90, Zomig). *Cephalalgia* 17:849–854
133. Raskin NH, Hosobuchi Y, Lamb S (1987) Headache may arise from perturbation of brain. *Headache* 27:416–420
134. Rasmussen BK, Olesen J (1992) Migraine with aura and migraine without aura: an epidemiological study. *Cephalalgia* 12:221–228
135. Read SJ, Smith MI, Hunter AJ et al. (1999) SB-220453, a potential novel antimigraine compound, inhibits nitric oxide release following induction of cortical spreading depression in the anaesthetized cat. *Cephalalgia* 20:92–99
136. Roon K, Diener HC, Ellis P et al. (1997) CP-122,288 blocks neurogenic inflammation, but is not effective in aborting migraine attacks: results of two controlled clinical studies. *Cephalalgia* 17:245
137. Russell MB (1997) Genetic epidemiology of migraine and cluster headache. *Cephalalgia* 17:683–701
138. Russell MB, Iselius L, Olesen J (1995) Investigation of the inheritance of migraine by complex segregation analysis. *Hum Genet* 96:726–730
139. Sakai F, Meyer JS (1979) Abnormal cerebrovascular reactivity in patients with migraine and cluster headache. *Headache* 19:257–266
140. Schoenen J, Timsit-Berthier M (1993) Contingent negative variation: methods and potential interest in headache. *Cephalalgia* 13:28–32
141. Schoenen J, Wang W, Albert A et al. (1995) Potentiation instead of habituation characterizes visual evoked potentials in migraine patients between attacks. *Eur J Neurol* 2:115–122
142. Schoenen J, Ambrosini A, Sandor PS et al. (2003) Evoked potentials and transcranial magnetic stimulation in migraine: published data and viewpoint on their pathophysiologic significance. *Clin Neurophysiol* 114:955–972
143. Selby G, Lance JW (1960) Observations on 500 cases of migraine and allied vascular headache. *J Neurol Neurosurg Psychiatry* 23:23–32
144. Shields KG, Goadsby PJ (2004) Naratriptan modulates trigemino-vascular nociceptive transmission in the ventroposteromedial (VPM) thalamic nucleus of the rat. *Cephalalgia* 24:1098
145. Shields KG, Goadsby PJ (2005) Propranolol modulates trigemino-vascular responses in thalamic ventroposteromedial nucleus: a role in migraine? *Brain* 128:86–97
146. Shields KG, Kaube H, Goadsby PJ (2003) GABA receptors modulate trigemino-vascular nociceptive transmission in the ventroposteromedial (VPM) thalamic nucleus of the rat. *Cephalalgia* 23:728
147. Silberstein SD, Lipton RB, Goadsby PJ (2002) Headache in Clinical Practice. Martin Dunitz, London
148. Silberstein SD, Neto W, Schmitt J et al. (2004) Topiramate in migraine prevention: results of a large controlled trial. *Arch Neurol* 61:490–495
149. Smith MI, Read SJ, Chan WN et al. (2000) Repetitive cortical spreading depression in a gyrencephalic feline brain: inhibition by the novel benzoylamino-benzopyran SB-220453. *Cephalalgia* 20:546–53
150. Storer RJ, Goadsby PJ (2004) Topiramate inhibits trigemino-vascular neurons in the cat. *Cephalalgia* 24:1049–1056
151. Storer RJ, Goadsby PJ (2005) Topiramate has a locus of action outside of the trigeminocervical complex. *Neurol* (in press)
152. Strassman AM, Raymond SA, Burstein R (1996) Sensitization of meningeal sensory neurons and the origin of headaches. *Nature* 384:560–563
153. Swoboda KJ, Kanavakis E, Xaidara A et al. (2004) Alternating hemiplegia of childhood or familial hemiplegic migraine? A novel ATP1A2 mutation. *Ann Neurol* 55:884–887
154. Teh BT, Silburn P, Lindblad K et al. (1995) Familial cerebellar periodic ataxia without myokymia maps to a 19-cM region on 19p13. *Am J Hum Genet* 56:1443–1449
155. Terwindt GM, Ophoff RA, Haan J et al. (1996) The Dutch Migraine Genetics Research Group. Familial hemiplegic migraine: a clinical comparison of families linked and unlinked to chromosome 19. *Cephalalgia* 16:153–155
156. Tvedskov JF, Iversen HK, Olesen J (2004a) A double-blind study of SB-220453 (Tonerbasat) in the glyceryltrinitrate (GTN) model of migraine. *Cephalalgia* 24:875–882
157. Tvedskov JF, Thomsen LL, Iversen HK et al. (2004b) The prophylactic effect of valproate on glyceryltrinitrate induced migraine. *Cephalalgia* 24:576–585
158. Tvedskov JF, Thomsen LL, Iversen HK et al. (2004c) The effect of propranolol on glyceryltrinitrate-induced headache and arterial response. *Cephalalgia* 24:1076–1087
159. Uddman R, Edvinsson L, Ekman R et al. (1985) Innervation of the feline cerebral vasculature by nerve fibers containing calcitonin gene-related peptide: trigeminal origin and co-existence with substance P. *Neurosci Lett* 62:131–136
160. Ulrich V, Gervil M, Kyvik KO et al. (1999) Evidence of a genetic factor in migraine with aura: a population based Danish twin study. *Ann Neurol* 45:242–246
161. van den Maagdenberg AMJM, Pietrobon D, Pizzorusso T et al. (2004) A Ca<sub>v</sub>1a knock-in migraine mouse model with increased susceptibility to cortical spreading depression. *Neuron* 41:701–710
162. Vanmolkot KRJ, Kors EE, Hottenga JJ et al. (2003) Novel mutations in the Na<sup>+</sup>.K<sup>+</sup>-ATPase pump gene ATP1A2 associated with Familial Hemiplegic Migraine and Benign Familial Infantile Convulsions. *Ann Neurol* 54:360–366
163. Veloso F, Kumar K, Toth C (1998) Headache secondary to deep brain implantation. *Headache* 38:507–515
164. Wang W, Schoenen J (1998) Interictal potentiation of passive “oddball” auditory event-related potentials in migraine. *Cephalalgia* 18:261–265
165. Weiller C, May A, Limmroth V et al. (1995) Brain stem activation in spontaneous human migraine attacks. *Nat Med* 1:658–660
166. Welch KM, Nagesh V, Aurora S et al. (2001) Periaqueductal grey matter dysfunction in migraine: cause or the burden of illness? *Headache* 41:629–637
167. Willis T (1682) *Opera Omnia. Amstelædami: Henricum Wetstenium*
168. Wolff HG (1948) *Headache and Other Head Pain*. Oxford University Press, New York
169. Zagami AS, Goadsby PJ (1991) Stimulation of the superior sagittal sinus increases metabolic activity in cat thalamus. In: Rose FC (ed) *New Advances in Headache Research*: 2. Smith-Gordon, London, pp 169–171
170. Zagami AS, Lambert GA (1991) Craniovascular application of capsaicin activates nociceptive thalamic neurons in the cat. *Neurosci Lett* 121:187–190



## Migraine, Preventive Therapy

STEPHEN D. SILBERSTEIN

Jefferson Medical College, Thomas Jefferson University and Jefferson Headache Center, Thomas Jefferson University Hospital, Philadelphia, PA, USA  
stephen.silberstein@jefferson.edu

### Definition

► **Migraine** is a primary episodic headache disorder characterized by various combinations of neurologic, gastrointestinal, and autonomic changes. Diagnosis is based on the headache's characteristics and associated symptoms (Silberstein et al. 2001). The International Headache Society's diagnostic criteria for headache disorders were recently revised, and provide criteria for a total of seven subtypes of migraine (Headache Classification Committee 2004). This review relied on the Technical Reports of the Agency for Healthcare Policy and Research (Goslin et al. 1994; Gray et al. 1999) and the US Headache Consortium Guidelines (Ramadan et al. 1999).

### Characteristics

#### Treatment

Migraine treatment begins with making a diagnosis (Silberstein et al. 2001), explaining it to the patient, and developing a treatment plan that considers coincidental or comorbid conditions. Headache calendars record headache duration, severity, and treatment response. ► **Comorbidity** indicates an association between two disorders that is more than coincidental. Conditions that occur in migraineurs with a higher prevalence than would be expected include stroke, epilepsy, Raynaud's syndrome, and affective disorders, which include depression, mania, anxiety, and panic disorder. Possible associations include essential tremor, mitral valve prolapse, and irritable bowel syndrome (Silberstein 2004). ► **Pharmacotherapy** may be acute (abortive) or preventive (prophylactic), and patients may require both approaches. Acute treatment attempts to reverse or stop the progression of a headache once it has started. It is appropriate for most attacks and should be limited to 2–3 days a week. ► **Preventive therapy** is designed to reduce attack frequency and severity.

### Preventive Treatment

Preventive medications reduce attack frequency, duration, or severity (Silberstein and Goadsby 2004; Silberstein et al. 2001). According to the US Headache Consortium Guidelines (Ramadan et al. 1999), indications for preventive treatment include:

- Migraine that significantly interferes with the patient's daily routine despite acute treatment;
- Failure of, contraindication to, or troublesome adverse events (AEs) from acute medications;

- Acute medication overuse;
- Very frequent headaches (>2/week) (risk of medication overuse);
- Patient preference;
- Special circumstances, such as hemiplegic migraine or attacks with a risk of permanent neurologic injury.

Preventive medication groups include beta-adrenergic blockers, ► **antidepressants**, ► **calcium channel antagonists**, ► **serotonin antagonists**, ► **Anticonvulsant (Agent)**, and ► **NSAIDs, Survey** (NSAIDs). Choice is based on efficacy, AEs, and coexistent and comorbid conditions (Table 5). The medication is started at a low dose and increased slowly until therapeutic effects develop or the ceiling dose is reached. A full therapeutic trial may take 2–6 months. Acute headache medications should not be overused. If headaches are well controlled, medication can be tapered and discontinued. Dose reduction may provide a better risk-to-benefit ratio. Women of childbearing potential should be on adequate contraception.

Behavioral and psychological interventions used for prevention include ► **relaxation training**, thermal ► **biofeedback** combined with relaxation training, electromyography biofeedback, and cognitive-behavioral therapy (Silberstein 2004). These interventions are effective as monotherapy, but are more effective when used in conjunction with pharmacologic management.

### Medication

► **Beta(β) Blockers** ► **Propranolol**, ► **nadolol**, ► **atenolol**, ► **metopropol**, and ► **timolol** are effective preventive drugs (Gray et al. 1999). Their relative efficacy has not been established; choice is based on beta-selectivity, convenience, AEs, and patients' reactions (Silberstein et al. 2001). Beta-blockers can produce behavioral AEs, such as drowsiness, fatigue, lethargy, sleep disorders, nightmares, depression, memory disturbance, and hallucinations; they should be avoided when patients are depressed. Decreased exercise tolerance limits their use by athletes. Less common AEs include impotence, orthostatic hypotension, and bradycardia. Beta-blockers are useful for patients with angina or hypertension. They are relatively contraindicated for patients with congestive heart failure, asthma, Raynaud's disease, and insulin-dependent diabetes.

### Antidepressants

► **Amitriptyline** (a tricyclic antidepressant) is the only antidepressant with fairly consistent support for efficacy (Gray et al. 1999). AEs include increased appetite, weight gain, dry mouth, and sedation; cardiac toxicity and orthostatic hypotension occasionally occur (Saper et al. 1994). There has been one positive trial for fluoxetine. Sexual dysfunction is a common AE. Antidepressants are especially useful for patients with comorbid depression and anxiety disorders.



### Calcium-Channel Blockers

The Agency for Healthcare Policy and Research analyzed 45 controlled trials (Gray et al. 1999). Flunarizine was effective, nimodipine had mixed results, and nifedipine was difficult to interpret. ► **Verapamil** was more effective than placebo in two of three trials, but both positive trials had high dropout rates, rendering the findings uncertain (Silberstein et al. 2001). Its most common AE is constipation. Flunarizine is the most effective drug of this class, but it is not available everywhere. AEs include Parkinsonism, depression, and weight gain.

### Anticonvulsant Medications

Divalproex sodium (500–1000 mg) and sodium valproate are effective, as is the extended release formulation (Gray et al. 1999). The most frequent AEs were nausea (42%), alopecia (31%), tremor (28%), asthenia (25%), dyspepsia (25%), somnolence (25%), and weight gain (19%) (Silberstein and Collins 1999). Hepatotoxicity and pancreatitis are the most serious AEs, but irreversible hepatic dysfunction is extremely rare in adults. Baseline liver function studies should be obtained, but follow-up studies are probably not needed in adults on monotherapy. Divalproex carries a high risk of congenital abnormality.

► **Gabapentin** (1800–2400 mg) showed efficacy in a placebo-controlled, double-blind trial only when a modified intent to treat analysis was used. Migraine attack frequency was reduced by 50% in about one-third of patients (Mathew et al. 2001). The most common AEs were dizziness or giddiness and drowsiness.

► **Topiramate**, a D-fructose derivative, has been associated with weight loss, not weight gain. In two large, double-blind, placebo-controlled, multicenter trials, topiramate, both 100 and 200 mg, was effective in reducing migraine attack frequency by 50% in half of the patients (Brandes et al. 2004; Silberstein et al. 2004). Dropouts due to AEs were common in the topiramate groups, but did not affect statistical significance.

Divalproex and topiramate are useful in patients with epilepsy, anxiety disorder, or manic-depressive illness. They can be used in patients with depression, Raynaud's disease, asthma, and diabetes, circumventing the contraindications to beta-blockers.

### Serotonin Antagonists

► **Methysergide** is effective (Gray et al. 1999; Silberstein 1998). AEs include transient muscle aching, claudication, abdominal distress, nausea, weight gain, and hallucinations. The major complication is rare (1/2500) retroperitoneal, pulmonary, or endocardial fibrosis (Silberstein 1998). To prevent this, a 4-week medication-free interval is recommended after 6 months of continuous treatment (Silberstein 1998; Silberstein et al. 2001). Pizotifen, a benzocycloheptathiophene derivative, is effective (Ramadan et al. 1999). AEs include drowsiness,

increased appetite, and weight gain. It is not available in the US.

### Natural Products

Feverfew (*Tanacetum parthenium*) is a medicinal herb whose effectiveness has not been totally established. Riboflavin (400 mg) was effective in one placebo-controlled, double-blind trial, with over half the patients responding. *Petasites hybridus* root (butterbur) is a perennial shrub. A standardized extract (75 mg bid) was effective in a double-blind, placebo-controlled study. The most common AE was belching (Silberstein 2004).

### Newer Treatments

Botulinum toxin type A (Botox<sup>R</sup> 0, 25, or 75 U) showed promising results in one placebo-controlled, double-blind trial. It was injected into glabellar, frontalis, and temporalis muscles. The 25 U treatment group was significantly better than the placebo group in reducing mean frequency of moderate to severe migraines during days 31–60, incidence of 50% reduction in all migraine at days 61–90, and reduction in all migraine at days 61–90 (Silberstein et al. 2000).

### Setting Treatment Priorities (Table 1)

The preventive medications with the best documented efficacy are the beta-blockers, amitriptyline, divalproex, and topiramate. Choice is made based on a drug's proven efficacy, the physician's informed belief about medications not yet evaluated in controlled trials, the drug's AEs, the patient's preferences and headache profile, and the presence or absence of coexisting disorders (Silberstein et al. 2001). Coexistent diseases have important implications for treatment. In some instances, two or more conditions may be treated with a single drug. If individuals have more than one disease, certain categories of treatment may be relatively contraindicated.

### Summary

Migraine is an extremely common neurobiologic headache disorder that is due to increased CNS excitability. It ranks among the world's most disabling medical illnesses. Diagnosis is based on the headache's characteristics and associated symptoms. The economic and societal impact of migraine is substantial. It impacts on sufferers' quality of life and impairs work, social activities, and family life. Increased headache frequency is an indication for preventive treatment. Preventive treatment decreases migraine frequency and improves quality of life. More treatments are being developed, which provides hope to the many sufferers who are still uncontrolled.

### References

1. Brandes JL, Saper JR, Diamond M et al. (2004) Topiramate for Migraine Prevention: A Randomized Controlled Trial. *JAMA* 291:965–973

**Migraine, Preventive Therapy, Table 1** Choices of Preventive Treatment in Migraine: Influence of Comorbid Conditions

Drug	Relative Contraindication	Relative Indication
Beta-blockers	Asthma, depression, CHF, Raynaud's disease, diabetes	HTN, angina
Antiserotonin Pizotifen	Obesity	
Methysergide	Angina, PVD	Orthostatic hypotension
Calcium channel blockers		
Verapamil Flunarizine	Constipation, hypotension Parkinson's	Migraine with aura, HTN, angina, asthma Hypertension, FHM
Antidepressants		
TCA's SSRIs MAOIs	Mania, urinary retention, heart block Mania Unreliable patient	Other pain disorders, depression, anxiety disorders, insomnia Depression, OCD Refractory depression
Anticonvulsants		
Divalproex/Valproate Gabapentin Topiramate	Liver disease, bleeding disorders Liver disease, bleeding disorders kidney stones	Mania, epilepsy, anxiety disorders Mania, epilepsy, anxiety disorders Mania, epilepsy, anxiety disorders
NSAIDs		
Naproxen	Ulcer disease, gastritis	Arthritis, other pain disorders

CHF, Congestive heart failure; OCD, Obsessive compulsive disorder; HTN, Hypertension; PVD, Peripheral vascular disease; MAOIs, Monoamine oxidase inhibitors; SSRI, Serotonin specific reuptake inhibitor; NSAIDs, Nonsteroidal anti-inflammatory drugs; TCA, Tricyclic antidepressants

- Goslin R, Gray RN, McCrory DC (1999) Behavioral and Physical Treatments for Migraine Headache. Prepared for the Agency for Health Care Policy and Research, Contract No. 290-94-2025. Available from the National Technical Information Service, Accession No. 127946, 1999
- Gray RN, Goslin RE, McCrory DC (1999) Drug Treatments for the Prevention of Migraine Headache. Prepared for the Agency for Health Care Policy and Research, Contract No. 290-94-2025. Available from the National Technical Information Service, Accession No. 127953, 1999
- Headache Classification Committee (2004) The International Classification of Headache Disorders, 2<sup>nd</sup> edn. Cephalalgia 24:1-160
- Mathew NT, Rapoport A, Saper J et al. (2001) Efficacy of Gabapentin in Migraine Prophylaxis. Headache 41:119-128
- Ramadan NM, Silberstein SD, Freitag FG (1999) Evidence-Based Guidelines of the Pharmacological Management for Prevention of Migraine for the Primary Care Provider. Neurology
- Saper JR, Silberstein SD, Lake AE (1994) Double-Blind Trial of Fluoxetine: Chronic Daily Headache and Migraine. Headache 34:497-502
- Silberstein SD (1998) Methysergide. Cephalalgia 18:421-435
- Silberstein SD (2004) Migraine. Lancet 363:391
- Silberstein SD, Collins SD (1999) Safety of Divalproex Sodium in Migraine Prophylaxis: An Open-Label, Long-Term Study (for the Long-Term Safety of Depakote in Headache Prophylaxis Study Group). Headache 39:633-643
- Silberstein SD, Mathew N, Saper J (2000) Botulinum Toxin Type A as a Migraine Preventive Treatment. Headache 40:445-450
- Silberstein SD, Saper JR, Freitag F (2001) Migraine: Diagnosis and Treatment. In: Silberstein SD, Lipton RB, Dalessio DJ (eds) Wolff's Headache and Other Head Pain, 7<sup>th</sup> edn. Oxford University Press, New York, pp 121-237
- Silberstein SD, Goadsby PJ (2002) Migraine: Preventive Treatment. Cephalalgia 22:491-512
- Silberstein SD, Neto W, Schmitt J et al. (2004) Topiramate in the Prevention of Migraine Headache: A Randomized, Double-Blind, Placebo-Controlled, Multiple-Dose Study. For the MIGR-001 Study Group. Arch Neurol 61:490-495

## Migraine Type Headache

### Definition

Manifestation of SLE, Sjögren's syndrome or systemic vasculitides.

- Headache Due to Arteritis

## Migraine Variants of Childhood

- Migraine, Childhood Syndromes

## Migraine With Aura

- Clinical Migraine with Aura

## Migraine With Pleocytosis, Pseudomigraine With Lymphocytic Pleocytosis

► Transient Headache and CSF Lymphocytosis

## Migraine Without Aura

ARNAUD FUMAL, JEAN SCHOENEN  
Departments of Neurology and Neuroanatomy,  
University of Liège, CHR Citadelle, Liege, Belgium  
jschoenen@ulg.ac.be

### Synonyms

Common Migraine; Clinical Migraine without Aura;  
Hemicrania Simplex

### Definition

Migraine without aura (MO) is a recurrent headache manifesting in attacks lasting between 4 and 72 h. Typical features of this headache are unilateral location, pulsating quality, moderate or severe intensity, aggravation by routine physical activity and association with nausea and / or photophobia and phonophobia (see Diagnostic criteria according to the International Classification of Headache Disorders, 2<sup>nd</sup> edition or ICHD-II 2004).

### Diagnostic Criteria of Migraine without Aura

1. At least 5 attacks fulfilling criteria 2–4
2. Headache attacks lasting 4–72 h (untreated or unsuccessfully treated)
3. At least 2 of the following pain characteristics:
  - a) Unilateral location
  - b) Pulsating quality
  - c) Moderate or severe intensity
  - d) Aggravation by or causing avoidance of routine physical activity (e.g. walking or climbing stairs)
4. During headache at least one of the following:
  - a) Nausea and / or vomiting
  - b) Photophobia and phonophobia
5. Not attributed to another disorder

### Characteristics

#### Epidemiology

The most recent population-based studies in adults, all using the diagnostic criteria of the IHS (International Headache Society), have reached very similar prevalence rates. Several European and American studies have reported somewhat congruent prevalence figures for migraine in adults (Steiner et al. 2003). The overall

1 year period prevalence of migraine with or without aura in adults is about 15% (7.6% among men and 19.1% among women). The overall 1 year prevalence of migraine with aura is about 5.8% (male 2.6%, female 7.7%). Studies in general populations agree that it is most common for migraineurs to have about one attack a month. In clinic samples the frequency is higher, since high frequency may be a compelling reason for referral. A large number of headache sufferers with features of migraine fail to meet criteria for strict migraine but do meet criteria for probable migraine (attacks and / or headache missing one of the features 1–4 needed to fulfill all criteria for migraine without aura, see above). The 1 year prevalence for probable migraine was 14.6% (15.9% in women, 12.6% in men) in a recent study (Patel et al. 2004).

### Phenotype

The heterogeneity of the clinical phenotype of migraine is underestimated. Despite a common diagnostic denominator, some clinical features such as type of aura symptoms, pain intensity, presence of prodromes, coexistence of migraine with and without aura or associated symptoms such as vertigo, may characterize subgroups of patients bearing different underlying pathophysiological and genetic mechanisms. Pain intensity can help to distinguish migraine without aura from tension-type headache (TTH); indeed among subjects in the general population classified as TTH sufferers, clinical features suggestive of migraine, i.e. aggravation by routine physical exercise, pulsating quality, anorexia, photophobia, unilateral headache and nausea may occur in non-negligible proportions. Trigger factors are manifold and may vary between patients and during the disease course. The most common ones are stress, the perimenstrual period and alcohol. Overuse of acute anti-migraine drugs, in particular of combination analgesics and ergotamine is another underestimated aggravating factor. There is a complex interrelation between migraine and depression, which are highly comorbid. It is not determined, however, whether the increased prevalence of depression in patients with frequent migraines is primary or secondary. Episodic vertigo without other signs of ► [basilar migraine](#) might belong to the migraine phenotype.

### Genotype

The common migraine phenotypes appear to be complex genetic disorders, where additive genetic effects (susceptibility genes) and environmental factors are interrelated (Stewart et al. 1997). Some studies suggest different liability loci for migraine headache (Estevez et al. 2004). Migraine is characterized by recurrent attacks. Genetic load can be seen as determining on the one hand a critical threshold for migraine attacks. On the other hand, genetic abnormalities may induce incidental subclinical dysfunctions, such as, for instance, a reduced neuromus-

cular junction safety factor (Ambrosini et al. 2001) or subtle cerebellar hypermetria (Sandor et al. 2001). Various gene polymorphisms were found to be more prevalent in migraineurs than in controls (Estevez et al. 2004). Their precise role remains to be determined; some of them may not be specific to migraine, but they could increase susceptibility to the disorder and induce endophenotypic vulnerability markers (see below).

### Pathophysiology

The present consensus is that both neuronal and vascular components are relevant in migraine and most probably interrelated (Goadsby et al. 2002). The neuronal structures involved are the cerebral cortex, the brainstem (periaqueductal gray matter, aminergic nuclei) and the peripheral as well as the central components of the ► **trigeminovascular system**. The sequence of activation and the relative roles of these structures are still controversial.

### Possible Role of the Brainstem

During attacks of migraine without aura, an area of increased blood flow has been identified contralaterally in the dorso-lateral part of the brainstem in a positron emission tomography (PET) study (Weiller et al. 1995). This led to the hypothesis of a “migraine generator” in the region of the dorsal raphe nucleus, locus coeruleus and periaqueductal gray which would suggest that migraine is a central pain disorder and explain recurrence after acute antimigraine drug treatment. Considering the well-known projections of second order trigeminal nociceptors on the periaqueductal gray and the fact that activations were found in a similar location after other spontaneous and experimental pains, it cannot be excluded that the brain stem activations found in migraineurs reflect secondary modulation of pain.

► **Cutaneous allodynia** has been described during the attack, ipsilateral and contralateral to the hemicrania as well as in the forearm, indicating central ► **sensitization** at the level of 2<sup>nd</sup> and thereafter of 3<sup>rd</sup> order nociceptors (Burstein et al. 2000). This may justify the clinical rule that early treatment of the attack is more effective (Burstein et al. 2004).

### Possible Role of the Cortex

During the headache-free interval, an abnormal functioning of the migrainous brain can be demonstrated by neurophysiological and metabolic studies. Neurophysiological methods show that cortical information processing in migraineurs is characterized by a deficient ► **habituation** during repetition of the stimulation (see Schoenen et al. 2003 for a review). This has been demonstrated for event-related and visual ► **evoked potentials** (VEPs). Moreover, intensity dependence of auditory evoked cortical potentials is increased in migraine patients compared to normal controls. The cortical abnormality is likely to be genetically deter-

mined. Although not confirmed in every study, it may represent an endophenotypic vulnerability marker (see above). It could be due to low activity in raphe-cortical serotonergic pathways, which would reduce preactivation levels of sensory cortices, allowing a wider range for suprathreshold cortical activation and thus enhancing intensity dependence and reducing habituation. During the attack, when brain stem activation has been found (see above), electrophysiological methods demonstrate a “normalization” of event-related and evoked potentials.

► **Transcranial magnetic stimulation** (TMS) studies to assess excitability of motor and visual cortices have yielded conflicting results, but taken together they suggest normal or increased rather than decreased excitation thresholds between attacks (Schoenen et al. 2003). High frequency repetitive TMS (rTMS), which activates the underlying cortex, is able to normalize interictal VEPs in migraineurs, whereas low frequency rTMS, which has an inhibitory effect, induces in healthy volunteers a VEP potentiation similar to the one found in migraine (Bohotin et al. 2002). These rTMS results favor the hypothesis put forward to explain the habituation deficit found interictally in evoked potentials, i.e. that the preactivation level of sensory cortices is reduced in migraineurs.

Metabolic studies using nuclear magnetic resonance spectroscopy (MRS) have shown a low mitochondrial phosphorylation potential (Welch et al. 1989) in brain and muscles of migraineurs. Nevertheless, none of the known mutations of mitochondrial DNA has been found up to now in the common forms of migraine. It has been hypothesized that the conjunction of a decreased mitochondrial energy reserve and a deficit in habituation of cortical information processing, known to protect against over-stimulation and lactate accumulation, might lead to activation of the trigeminovascular system (Schoenen 1994). It is still to be determined whether the mitochondrial abnormality is an independent pathophysiological component or rather a consequence of other functional deficits.

### Role of the Trigeminovascular System

The trigeminovascular system is the major pain signaling structure of the visceral organ brain, but there is still no definite proof that an activation of its peripheral components is necessary to produce a migraine attack. Such activation is indeed suggested by the increase of CGRP (► **calcitonin gene related peptide**) in external jugular vein blood during the attack and by the effectiveness of most acute anti-migraine medications including ► **triptans** in the experimental neurogenic inflammation model in the rat. It is not known what activates the trigeminovascular nociceptive pathway in migraine. But a link between the migraine aura (probably due to a cortical ► **spreading depression**) and the headache



is suggested by the experimental finding that cortical spreading depression is able to activate trigeminovascular afferents and to evoke a series of cortical, meningeal and brainstem events consistent with the development of headache (Bolay et al. 2002).

### Role of Nitric Oxide

Nitric oxide (NO) donors such as glyceryl trinitrate (GTN) are able to induce attacks in patients suffering from migraine with or without aura. The underlying mechanisms are not well established but there is clinical and experimental evidence that NO may favor central sensitization of trigeminal nociceptors.

### Treatment of Migraine

#### Acute Treatment

During the last decade, the advent of highly effective 5-HT<sub>1B/1D</sub> agonists, the triptans, has been a major breakthrough in the attack treatment. Triptans are able to act as vasoconstrictors *via* vascular 5-HT<sub>1B</sub> receptors and to inhibit neurotransmitter release at the peripheral as well as at the central terminal of trigeminal nociceptors *via* 5-HT<sub>1D/1B</sub> receptors. The site of action relevant for their efficacy in migraine is still a matter of controversy; possibly their high efficacy rate is due to their capacity to act at all three sites contrary to other anti-migraine drugs. Sumatriptan, the first triptan, was followed by several second-generation triptans (zolmi-, nara-, riza-, ele-, almo-, frova-triptan), which were thought to correct some of the shortcomings of sumatriptan.

A large meta-analysis of a number of randomized controlled trials performed with triptans (Ferrari et al. 2001) confirms that the subcutaneous auto-injectable form of sumatriptan (6 mg) has the best efficacy, whatever outcome measure is considered. Differences between oral triptans do exist for some outcome measures, but in practice each patient has to find the triptan that gives him the best satisfaction.

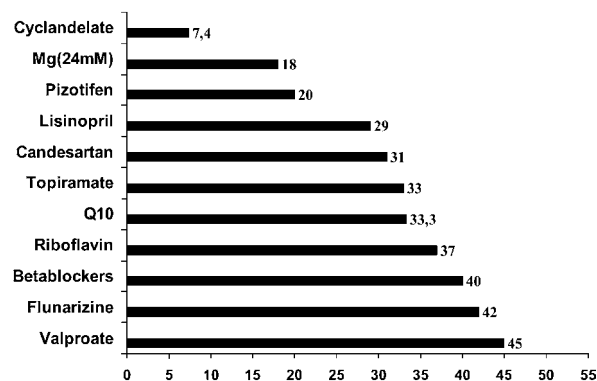
At present the major reason for not considering triptans as first choice treatments for migraine attacks is their high cost and, in some patients, their cardiovascular side effects. However, stratifying care by prescribing a triptan to the most disabled patients has been proven cost-effective. In severely disabled migraineurs, the efficacy rate of injectable sumatriptan for pain-free at 2 h is twice that of ergot derivatives or NSAIDs taken at high oral doses and of iv acetylsalicylic acid lysinate. The ► **therapeutic gain** tends to be clearly lower for simple analgesics or NSAIDs such as acetaminophen 1000 mg po, effervescent aspirin 1000 mg or ibuprofen 600 mg than for the oral triptans, when severe attacks are considered. Combining analgesics or NSAIDs to an antiemetic and / or to caffeine or administering them as suppositories increases their efficacy. As expected, the triptans have not solved the patients' problems. There

is room for more efficient and safer oral acute migraine treatments, among which CGRP receptor antagonists are at present most promising (Olesen et al. 2004).

### Prophylactic Therapy in Migraine

Prophylactic anti-migraine treatment has to be individually tailored to each patient taking into account the migraine subtype, the ensuing disability, the patient's history and demands and the associated disorders. A major drawback of most classical prophylactics (beta-blockers devoid of intrinsic sympathomimetic activity, valproic acid, Ca<sup>2+</sup> antagonists, antiserotoninergics, tricyclics.), which have all on average a 50% efficacy score, is the occurrence of side effects.

In recent years some new prophylactics with fewer side effects have been studied. High dose magnesium or cyclandelate are well-tolerated, but poorly effective in comparison to the classical prophylactics (Fig. 1). A novel preventive treatment for migraine is high dose (400 mg / d) riboflavin which has an excellent efficacy / side effect ratio and probably acts by improving the mitochondrial phosphorylation potential (see above). Co-enzyme Q10 (100 mg t.i.d.), another actor in the mitochondrial respiratory chain, is also effective in migraine prophylaxis (see Sandor et al. 2005, also for review of therapeutic gain of different drugs used in migraine prophylaxis). Lisinopril (10 mg bid), an inhibitor of angiotensin converting enzyme and, even more so, candesartan (16 mg bid) an angiotensin II inhibitor well known for the treatment of hypertension, were found useful in migraine. Recent preliminary but encouraging results with novel antiepileptic compounds like gabapentin need to be confirmed in large randomized controlled trials, whereas topiramate was found to be effective in several placebo-controlled trials. Non-pharmacological and herbal treatments are increasingly subject to controlled studies and some, like butterbur, are found to be clearly more effective than placebo.



**Migraine Without Aura, Figure 1** Therapeutic gain in migraine preventive treatment (% of "responders", with a reduction of minimum 50% of attacks).

## References

1. Ambrosini A, Maertens de Noordhout A, Schoenen J (2001) Neuromuscular transmission in migraine: a single fiber EMG study in clinical subgroups. *Neurology* 56:1038–1043
2. Bohotin V, Fumal A, Vandenheede M et al. (2002) Effects of repetitive transcranial magnetic stimulation on visual evoked potentials in migraine. *Brain* 125:912–922
3. Bolay H, Reuter U, Dunn AK et al. (2002) Intrinsic brain activity triggers trigeminal meningeal afferents in a migraine model. *Nat Med* 8:136–142
4. Burstein R, Cutrer MF, Yamitsky (2000) The development of cutaneous allodynia during a migraine attack clinical evidence for the sequential recruitment of spinal and supraspinal nociceptive neurons in migraine. *Brain* 123:1703–1709
5. Burstein R, Jakubowski M, Collins B (2004) Defeating migraine pain with triptans: A race against the development of cutaneous allodynia. *Ann Neurol* 19–26
6. Estevez M, Gardner K (2004) Update on the genetics of migraine. *Hum Genet* 114:225–235
7. Ferrarri MD, Roon KI, Lipton RB et al. (2001) Oral triptans (serotonin 5-HT<sub>1B/1D</sub> agonists) in acute migraine treatment: a meta-analysis of 53 trials. *Lancet* 358:1668–1675
8. Goadsby PJ, Lipton RB, Ferrarri MD (2002) Migraine-current understanding and treatment. *N Engl J Med* 24:257–270
9. Olesen J, Diener HC, Husstedt IW et al. (2004) BIBN 4096 BS Clinical Proof of Concept Study Group. Calcitonin gene-related peptide receptor antagonist BIBN 4096 BS for the acute treatment of migraine. *N Engl J Med* 350:1104–1110
10. Patel NV, Bigal ME, Kolodner KB et al. (2004) Prevalence and impact of migraine and probable migraine in a health plan. *Neurology* 63:1432–1438
11. Sándor PS, Mascia A, Seidel L et al. (2001) Subclinical cerebellar impairment in the common types of migraine: A 3-dimensional analysis of reaching movements. *Ann Neurol* 49:668–672
12. Sandor PS, Di Clemente L, Coppola G et al. (2005) Effectiveness of Coenzyme Q10 in migraine prophylaxis: A randomized controlled trial. *Neurology* 64:713–715
13. Schoenen J (1994) Pathogenesis of migraine: the biobehavioural and hypoxia theories reconciled. *Acta Neurol Belg* 94:79–86
14. Schoenen J, Ambrosini A, Sandor PS et al. (2003) Evoked potentials and transcranial magnetic stimulation in migraine: published data and viewpoint on their pathophysiologic significance. *Clin Neurophysiol* 114:955–972
15. Steiner TJ, Scher AI, Stewart WF et al. (2003) The prevalence and disability burden of adult migraine in England and their relationships to age, gender and ethnicity. *Cephalalgia* 23:519–527
16. Stewart WF, Staffa J, Lipton RB et al. (1997) Familial risk of migraine: a population-based study. *Ann Neurol* 41:166–172
17. The International Classification of Headache Disorders, 2nd edn (ICHD-II) (2004) *Cephalalgia* 24:1–160
18. Weiller C, May A, Limmroth V et al. (1995) Brain stem activation in spontaneous human migraine attacks. *Nat Med* 1:658–660
19. Welch KM, Levine SR, D'Andrea G et al. (1989) Preliminary observations on brain energy metabolism in migraine studied by *in vivo* <sup>31</sup>P-phosphorus NMR spectroscopy. *Neurology* 39:538–541

## Minimal Alveolar Concentration

### Synonyms

MAC

### Definition

Alveolar concentration of a volatile anesthetic at 1 atm pressure, which abolishes motor response to a painful surgical stimulus in 50% of patients.

► [Alpha\(α\) 2-Adrenergic Agonists in Pain Treatment](#)

## Minimal Clinical Important Difference

### Synonyms

MCID

### Definition

The smallest difference in score in the domain of interest which patients perceive as beneficial.

► [Oswestry Disability Index](#)

## Minimal Sedation

### Synonyms

Anxiolysis

### Definition

A drug-induced state in which the patient responds normally to verbal commands. Ventilatory and cardiovascular functions are unaffected, although cognitive function and coordination may be impaired.

► [Pain and Sedation of Children in the Emergency Setting](#)

## Minimum Effective Analgesic Serum Concentrations of Fentanyl

### Definition

Minimum effective analgesic serum concentrations of fentanyl range from 0.3 – 1.5 ng/ml.

► [Postoperative Pain, Fentanyl](#)

## Minimum Erythema Dose

► [MED](#)

## Minocycline

### Definition

Minocycline is used to pharmacologically block microglial activation without directly affecting neurons or astrocytes. As a result, minocycline blocks the production of microglial-derived proinflammatory cytokines. In neuropathic pain, administration of minocycline disrupts exaggerated pain by inhibiting proinflammatory cytokines. Importantly, minocycline has revealed that microglia may be more important in the initiation, rather than the maintenance, of exaggerated pain states.

► [Cord Glial Activation](#)

## Miss Rate

### Definition

Miss rate is the probability of response „B“ when event A has occurred.

- ▶ Statistical Decision Theory Application in Pain Assessment

## Mitogen-Activated Protein Kinase

### Synonyms

MAPK

### Definition

MAPK mediate intracellular signal transduction in response to a variety of stimuli, including several hormones and growth factors. Among them, extracellular signal-regulated protein kinase (ERK) is involved in cellular growth and differentiation, whereas p38 MAPK and *c-Jun* N-terminal kinase (JNK) function as mediators of cellular stresses such as inflammation and apoptosis.

- ▶ ERK Regulation in Sensory Neurons during Inflammation

## Mittelschmerz

- ▶ Gynecological Pain, Neural Mechanisms

## Mixed-Acting Analgesics

- ▶ Drugs with Mixed Action and Combinations, Emphasis on Tramadol

## Mixed Forms of Diabetic Neuropathy

- ▶ Diabetic Neuropathies

## MMP

- ▶ Matrix Metalloproteinases

## Mnemonic Function

### Definition

The hippocampus plays a role in learning and memory, especially declarative learning and memory that involves, at least partly, forming associations between different stimuli.

- ▶ Nociceptive Processing in the Hippocampus and Entorhinal Cortex, Neurophysiology and Pharmacology

## Mobilisation/Mobilization

### Definition

Mobilization is the restoration of motion in a joint.

- ▶ Chronic Pain in Children, Physical Medicine and Rehabilitation
- ▶ Passive Spinal Mobilisation

## Mobilisation Following Surgery

- ▶ Postoperative Pain, Importance of Mobilisation

## Mobilisation With Impulse

- ▶ Spinal Manipulation, Characteristics

## Mobilisation With Thrust

- ▶ Spinal Manipulation, Characteristics

## Modalities

ALISON THOMAS  
Lismore, NSW, Australia  
alison.thomas@crsrehab.gov.au

### Synonyms

Electrotherapy; shortwave diathermy; therapeutic ultrasound; interferential therapy; pulsed electromagnetic therapy

## Definition

The term ► **modalities** is used, in practice, as a generic term to encompass a variety of treatments that share the characteristic of requiring an electrical device to deliver some form of energy to the tissues of the body. That energy may be an electrical current, intended to stimulate or inhibit nerve conduction, or electromagnetic or acoustic energy, intended to heat tissues by inducing agitation of molecules within the tissue.

## Characteristics

### Shortwave Diathermy

#### Mechanism

Application of a high frequency (27.12 MHz) electromagnetic current induces rapid movement of charged ions in the target tissue. The current can be successfully delivered to heat deep tissues (Mercer and Bogduk 2004). Heating tissues results in the physiological reactions of increased blood flow, stimulation of peripheral nerves and increased localized metabolic rate (Baxter and Barlos 2002). *In vitro* studies have identified effects on fibroblast and chondrocyte proliferation in human tissue (Hill et al. 2002).

#### Applications

Common purported therapeutic effects are: acceleration of the resolution of chronic inflammation, acceleration of healing, relief of pain, reduction of muscle spasm and increase in extensibility of fibrous tissue. Common applications for which shortwave diathermy is used are acute and chronic osteoarthritis, polyarthritis, rheumatoid arthritis, acute and chronic low back pain, acute and chronic soft tissue injuries including haematomas and sinusitis.

#### Efficacy

Experimental evidence has shown that the increase in heat in deep tissues by a shortwave diathermy does raise the pain threshold in that region, but only for a period of 30 minutes (Mercer and Bogduk 2004). It has also been shown that the increase in heat is much less than that generated by moderate or gentle exercise (Mercer and Bogduk 2004), and that the effect on healing rate of wounds is equivocal. Clinical trials have generally been of relatively poor quality.

In essence, there is little experimental or high quality clinical data at this time to support the purported therapeutic effects of shortwave diathermy. Temporary change in pain threshold due to heating of tissues may be effected more safely and expeditiously through gentle exercise.

#### Side Effects

Shortwave diathermy has the potential to cause burns (particularly in an area surrounding a metal implant or vascular insufficiency), interfere with cardiac pacemak-

ers and stimulate further changes in carcinoma or infection. It should not be used over a pregnant uterus (Baxter and Barlos 2002).

#### Indications

Based on current experimental evidence and efficacy data, there are no indications for the therapeutic use of shortwave diathermy.

### Therapeutic Ultrasound

#### Mechanism

High frequency sound waves (0.75 to 1.0 MHz) are generated by vibration of a piezo-electric crystal in the sound head of the machine. These are delivered to tissues by application of the sound head to the skin via a coupling medium (a gel or water). The ultrasound head is moved rhythmically over the area to be treated. There is reasonable evidence that ultrasound heats deep tissues and produces a range of non-thermal effects such as cavitation, acoustic streaming and standing waves (Mercer and Bogduk 2004).

#### Applications

Ultrasound therapy is commonly used to treat acute and chronic musculoskeletal symptoms, including joint inflammation or restriction, pain and related disability (Gam and Johannsen 1995; van der Windt et al. 1999). It is proposed that the underlying mechanisms include increased blood flow, increased extensibility of collagenous tissues, decreased pain and decreased muscle spasm (Mercer and Bogduk 2004). Ultrasound therapy is also used for the promotion of wound healing and tissue-repair processes in both acute (soft tissue injury) and chronic (ulcerative) conditions (Watson 2000).

#### Efficacy

There is evidence, from *in vitro* and cutaneous lesion studies, that ultrasound has proinflammatory effects on damaged tissue. This may justify the use of ultrasound therapy for superficial wound healing and ulcers (Mercer and Bogduk 2004).

Early evidence that ultrasound therapy increases blood flow, increases extensibility of collagen tissue, increases muscle strength and improves the strength and quality of repair of injured tendons has not been confirmed with subsequent studies (Mercer and Bogduk 2004). Experimental evidence of the physiological effect of ultrasound on peripheral nerve conduction (Baxter and Barlos 2002) has yet to be demonstrated to have an analgesic effect.

The results of three, recent, systematic reviews on the efficacy of ultrasound therapy for musculoskeletal disorders concluded that there was little or no evidence for the clinical effectiveness of ultrasound therapy (Gam and Johannsen 1995; van der Windt et al. 1999; Robertson and Baker 2001).



### Side Effects

Ultrasound has the potential to produce unstable cavitation and standing wave formation within the tissues. Unstable cavitation occurs when the gas bubble collapses and reforms. Standing waves are created when the sound waves are reflected from a dense surface, and interfere with incoming waves to produce a high concentration of energy in the tissue. Both may result in tissue damage (Baxter and Barlos 2002).

Ultrasound therapy should not be applied over areas of acute infection, artificial implants, fractures, air filled cavities, rapidly dividing tissues, bony prominences, eyes, testicles and areas of impaired circulation or sensation (Baxter and Barlos 2002).

### Indications

Ultrasound may have a role in the healing of superficial tissues. There is no evidence to support the role of ultrasound in the healing of deep tissues. To date, there is no conclusive evidence that ultrasound is efficacious in the treatment of pain associated with musculoskeletal injuries.

### Interferential Therapy

#### Mechanism

Interferential therapy is produced by two different, medium-frequency currents delivered to the tissues in such a way as to produce a low frequency current in the target tissue. It is generally applied using two pairs of electrodes, either plate (carbon-rubber) or circular suction electrodes. The suction electrodes provide a "massage-like" effect in addition to the current. The rationale for this application has been that the medium frequency currents overcome the high skin impedance encountered by low frequency currents. Low frequency currents can then be delivered to tissues at a greater depth.

#### Applications

Common purported therapeutic effects include pain relief, stimulation of muscle fibres to produce contraction, increase in blood flow and promotion of tissue healing (Baxter and Barlos 2002). Interferential therapy has been widely used for the treatment of pain and swelling in soft tissues injuries, and to enhance the healing of bone fractures. It is also one of the most commonly used modalities for the management of back pain (Baxter and Barlos 2002).

#### Efficacy

To date, there has been little experimental data to substantiate the alleged physiological effects of interferential therapy (Watson 2000).

The pivotal rationale in the use of interferential therapy is that it is the effects of the low frequency current, generated by different swing patterns of the medium frequency

currents, which are therapeutic. It has been shown that the amplitude-modulated frequency was immaterial to the effects of interferential current on sensory or motor nerves (Palmer et al. 1999), and pain-relieving effects are not affected by different swing patterns (Johnson and Tabasam 2003a). This would indicate that the medium frequency component is the main parameter in stimulation. It appears that interferential offers no advantage over transcutaneous nerve stimulation for pain relief (Johnson and Tabasam 2003b).

### Side Effects

It is not recommended that interferential be used over areas of compromised skin sensation, over the carotid sinus, pregnant uterus, cardiac pacemakers, eyes or gonads, or for the treatment of undiagnosed pain.

Chemical burns may occur if an excessively high intensity of current is delivered.

When suction cap electrodes are used to deliver the current, injury or bruising may result if the pressure is too high.

### Indications

On current available evidence, it appears that interferential therapy is no more efficacious in the treatment of pain than transcutaneous electrical nerve stimulation.

### References

1. Baxter GD, Barlos P (2002) Electrophysical Agents in Pain Management. In: Strong, Unruh, Wright, Baxter (eds) *Pain: A Textbook for Therapists*. Harcourt Publishers, Edinburgh, pp 207–226
2. Gam AN, Johannsen F (1995) Ultrasound Therapy in Musculoskeletal Disorders: A Meta-Analysis. *Pain* 63:85–91
3. Hill J, Lewis M, Mills P, Kieley C (2002) Pulsed Short-Wave Diathermy Effects on Human Fibroblast Proliferation. *Arch Phys Med Rehabil* 83:832–836.
4. Johnson MI, Tabasam G (2003a) A Single-Blind Investigation into the Hypoalgesic Effects of Different Swing Patterns of Interferential Currents on Cold-Induced Pain in Healthy Volunteers. *Arch Phys Med Rehabil* 84:350–357
5. Johnson MI, Tabasam G (2003b) An Investigation into the Analgesic Effects of Interferential Currents and Transcutaneous Electrical Nerve Stimulation on Experimentally Induced Ischemic Pain in Otherwise Pain-Free Volunteers. *Physical Therapy* 83:208–223
6. Mercer S, Bogduk N (2004). Selection and Application of Treatment. In: Efshaug RK, Gass E (eds) *Musculoskeletal Physiotherapy*. Clinical Science and Practice, 2<sup>nd</sup> edn. Butterworth Heinman (in press)
7. Palmer ST, Martin DJ, Steedman WM, Ravey J (1999) Alteration of Interferential Current and Transcutaneous Nerve Stimulation Frequency: Effects on Nerve Excitation. *Arch Phys Med Rehabil* 80:1065–1071
8. Robertson VJ, Baker KG (2001) A Review of Therapeutic Ultrasound: Effectiveness Studies. *Physical Therapy* 81:1339–1358
9. van der Windt DAWM, van der Heijden GJMG, van den Berg SGM, ter Riet G, de Winter AF, Bouter LM (1999) Ultrasound Therapy for Musculoskeletal Disorders: A Systematic Review. *Pain* 81:257–271
10. Watson T (2000) The Role of Electrotherapy in Contemporary Physiotherapy Practice. *Manual Therapy* 5:132–141

## Model of Neuropathic Pain

### Definition

There are several models of neuropathic pain. Neuropathic pain is induced by injury to a nerve and results in both mechanical and heat hyperalgesia. One model involves tying loose ligatures around the sciatic nerve. Another model involves tying tight ligations around the spinal nerves, L5 and/or L6.

► TENS, Mechanisms of Action

## Model of Spontaneous Neuropathic Pain

► Anesthesia Dolorosa Model, Autotomy

## Modeling, Social Learning in Pain

CHRISTIANE HERMANN

Department of Neuropsychology and Clinical Psychology, Central Institute of Mental Health, Mannheim, Germany  
chermann@zi-mannheim.de

### Synonyms

Observational Learning; modeling; Imitation Learning; Vicarious Learning

### Definition

Social learning or learning by observation of others' reaction to pain, has been implicated as an important mechanism by which pain responses and complex pain behavior patterns are acquired (for a recent review see Craig and Riddell 2003). By observing their parents and other significant persons, children acquire attitudes about health and health care, learn to perceive and interpret physical symptoms and how to respond to illness and injury (Baranowski and Nader 1985). From this perspective, a member in the immediate family environment who suffers from chronic pain may act as a pain model. Exposure to such a pain model at an early age will shape the child's future pain behavior and pain experience. Social learning of maladaptive pain responses and pain behavior is then presumed to act as a predisposing factor in the development of chronic pain.

### Characteristics

Learning by observing others, or modeling, enables the observer to acquire new patterns of behaviors and rules for regulating behavior, without having to rely on one's own actions or trial and error experiences

(Bandura 1986). Much of human behavior is presumed to be learned by modeling. This includes cognitive and motor skills, knowledge, attitudes and beliefs, values and judgmental standards and emotional responses. For example, phobic fears can be acquired by ► vicarious instigation of emotional arousal when observing a model's fear response to an object. Social learning can serve to direct attention to stimuli that otherwise would be ignored. A child may increasingly become aware of bodily symptoms and interpret them as threatening by repeated observations of a parent focusing and being preoccupied about somatic symptoms. Modeling can also exert an inhibiting or facilitating influence on previously learned behavior, since it entails learning about the functional value of behaviors. For example, by observing the mother receiving much attention and care from her spouse when she is verbally and nonverbally expressing her pain, a child may as an adult be more likely to show high levels of pain behavior. It is a core characteristic of modeling that it is to be inferred primarily by its outcome, rather than being directly observable. Also, few learning trials are necessary for social learning to occur. The effects of modeling are not necessarily tangible in close temporal relationship to the learning phase. Whether or not behaviors previously acquired by modeling are performed depends on situational and motivational cues. Thus, modeling constitutes one facet of the social context in which pain occurs.

Two main strategies have been followed to demonstrate the contribution of social learning in shaping pain responses, and as a risk factor for the development of chronic pain. Correlational studies have focused on the co-occurrence of pain problems within families or, under naturalistic conditions have examined the modulating impact of a positive family history of pain on responses to acute pain and injury. Experimental manipulations of modeling behavior have been used to delineate its direct influence on the observer's reaction to painful stimuli.

### Correlational Studies

Since the late 1970s, several reports have noted that pain problems tend to run in families. Studies have looked at the incidence of pain models within the families of adult and child pain patients, but also at the incidence of pain and illness in the offspring of pain patients. For example, adult chronic pain patients as compared to pain-free chronic patients indicated a greater number of family members also suffering from pain (e.g. Violon and Giurgea 1984). Similarly, parents of children with recurrent abdominal pain were more likely to report pain and somatization than parents of healthy children. Familial aggregation of pain problems and the implied role of modeling have also received support in non-clinical samples. Among students, correlations between the reported frequency of current pain episodes and the num-

ber of familial pain models have been observed in several studies (e.g. Edwards et al. 1985). In children of chronic pain patients, a higher frequency of illness (but not injuries), more days of school absence, more behavioral problems and greater somatic distress have been noted (e.g. Rickard 1988). The specific influence of a parental pain model on the frequency of pain in children has not been addressed systematically. In one study, children of parents with chronic pain indicated a higher frequency of abdominal pain episodes than children of parents without pain (Jamison and Walker 1992). Rather little is known about whether a positive family history of pain determines an individual's response to naturally occurring or injury-related pain. Schrader et al. (1996) questioned a cohort of individuals for the occurrence of neck and other pain 1–3 years after they had experienced a rear-end collision. A positive family history of pain emerged as an important risk factor for the evolution of pain problems subsequent to the injury.

While being consistent with the proposed influence of modeling, mere observation of the co-occurrence of pain problems in families says little about the involved learning processes. From a social learning perspective, one would expect at least some relationship between the model's and the observer's pain behavior, coping behavior and reaction to the pain. Consistent with this assumption, students coming from families with a history of multiple pain problems did not only report more pain sites, but also indicated that their pains interfered more with their daily activities (Lester et al. 1994). Similarly, in a group of mothers with chronic pain, significant correlations were observed between the frequency of pain episodes in the child and the mother's perceived pain intensity, subjective pain-related interference in every-day life and the level of emotional distress (Jamison and Walker 1992). Altogether, these results are well in accordance with previous findings on the impact of parental modeling of illness behavior during childhood on later illness behavior. Growing up with a familial pain model may increase the risk of later experiencing pain problems by learning maladaptive pain and illness behaviors and exacerbating responses to pain. However, the social transmission of specific (maladaptive) pain behaviors, including coping responses, is yet to be clarified. Investigating the role of modeling is complicated by the fact that familial pain models may exert their influence in a sex-dependent manner. Early on, pain models were found to have a greater impact on females than on males (e.g. Edwards et al. 1985). More recently, a higher incidence of familial pain models in a female than a male student population has been noted (Koutantji et al. 1998). Moreover, in females a positive family history of pain was associated with more frequent pain and an enhanced sensitivity to experimental pain stimuli (Fillingim et al. 2000). One explanation has been that females may be more aware of pain in others. Yet, it may also reflect sex-specific

effects of modeling. It is well established that social learning depends on the model's attributes, and the perceived similarity between observer and model. For example, sex-role information is conveyed by observational learning in a sex-selective manner (Bandura 1986). Since more women are affected by chronic pain, girls may be more likely than boys to grow up with a relevant pain model. The possible sex-dependent impact of social learning on pain behavior, and its interaction with sex-related genetically determined differences in pain susceptibility, certainly needs to be further explored.

### Experimental Studies

The pioneering experimental work by Kenneth Craig has been most important in accruing empirical support for the hypothesis that social learning can account for individual differences in pain responding (for a review see Craig 1986). Starting in the late 1960s, Craig has conducted a series of experimental studies using variations of the following experimental paradigm. Students were exposed to a series of increasingly painful shocks starting with a noticeable, but not painful stimulus. After each shock, the subject rated pain intensity and then observed a confederate rating the same stimulus as either less (i.e. tolerant model) or more (i.e. intolerant model) painful. This procedure continued for the whole series of shocks. Across studies, subjects exposed to a tolerant model as compared to those exposed to an intolerant model had a higher pain threshold, were less autonomically aroused and indicated less subjective stress. Moreover, ► [signal detection analyses](#) revealed that subjects showed greater discrimination between painful and non-painful stimuli when they had observed an intolerant model. As Turkat and Guise (1983) noted, the model's behavior served both as an antecedent and a consequence of the subject's pain response in these studies, and therefore may have shaped the subject's response. When this was controlled for, prior exposure to a pain-tolerant or intolerant model again yielded a change of the subjects' ► [pain tolerance](#) in the expected direction (Turkat and Guise 1983). Recently, first experimental evidence for the influence of maternal modeling on children's pain responses during a ► [cold pressor test](#) was provided (Goodman and McGrath 2003). Mothers had been instructed to exaggerate their pain display during a cold pressor task, while their children were watching. These children later had a significantly lower ► [pain threshold](#) as compared to the control children. Minimized maternal pain behavior did not increase the children's pain threshold. Maternal modeling also had no impact on the children's subjective pain intensity ratings during the task.

Overall, experimental studies have consistently demonstrated that modeling can modulate the observer's detection of a stimulus as painful. Whether social learning can also alter the perceived intensity and aversive-

ness of a painful stimulus, is less clear. It should be noted that in all experimental studies, the observers could rely either on verbal responses or other overt behavioral responses to infer that the model was detecting pain. Under natural conditions, however, the level of pain experienced by a model is less easily decoded by the observer. Whether vicariously induced emotional arousal in the observer, when observing a person in pain, may shape the intensity and quality of the observer's later pain response, has not been studied systematically. Experimental studies further suggest that individual differences in pain sensitivity may impose constraints on the direction and magnitude of the change of the pain response that can be induced by modeling influences. Moreover, the impact of a tolerant versus an intolerant model may not be symmetrical (e.g. Goodman and McGrath 2003). In one study (Prkachin and Craig 1986), female students were first selected based on whether they had a high or low pain threshold, and were then tested alone or in the presence of another participant with either a high or low pain threshold. Results showed that only women with high pain thresholds lowered their pain threshold when exposed to a low-threshold model. Modeling had no effect on the pain threshold in subjects with a low pain threshold.

Taken together, there is converging evidence from both correlational and experimental studies that social learning is important in shaping an individual's pain response and pain behavior, even though the exact mechanisms by which this occurs are not fully understood. Data suggest that the effects of social modeling may be modulated by the observer's (and possibly the model's) sex and interindividual differences in pain sensitivity.

- ▶ Motivational Aspects of Pain
- ▶ Psychology of Pain and Psychological Treatment

## References

1. Bandura A (1986) Social Foundations of Thought and Action: A Social Cognitive Theory. Prentice Hall, Englewood Cliffs, NJ
2. Baranowski T, Nader PR (1985) Family Health Behavior. In: Turk DC, Kerns RD (eds) Health, Illness, and Families: A Life-Span Perspective. Wiley, New York, pp 51–80
3. Craig KD (1986) Social Modeling Influences on Pain. In: Sternbach RA (ed) Chronic Pain: Psychological Factors in Rehabilitation. Williams and Wilkins, Baltimore, pp 73–109
4. Craig KD, Pillai Riddell RR (2003) Social Influences, Culture, and Ethnicity. In: McGrath PJ, Finley GA (eds) Pediatric Pain: Biological and Social Context. IASP Press, Seattle, pp 159–182
5. Edwards PW, Zeichner A, Kuczmierczyk AR et al. (1985) Familial Pain Models: Relationship between Family History of Pain and Current Pain Experience. *Pain* 21:379–384
6. Fillingim RB, Edwards RR, Powell T (2000) Sex-Dependent Effects of Reported Familial Pain History on Recent Pain Complaints and Experimental Pain Responses. *Pain* 86:87–94
7. Goodman JE, McGrath PJ (2003) Mothers' Modeling Influences Children's Pain During a Cold Pressor Task. *Pain* 104:559–565
8. Jamison RN, Walker LS (1992) Illness Behavior in Children of Chronic Pain Patients. *Int J Psychiatr Med* 22:329–342
9. Koutantji M, Pearce SA, Oakley DA (1998) The Relationship between Gender and Family History of Pain with Current Pain Experience and Awareness of Pain in Others. *Pain* 77:25–31
10. Lester N, Lefebvre BA, Keefe FJ (1994) Pain in Young Adults: I. Relationship to Gender and Family Pain History. *Clin J Pain* 10:282–289
11. Prkachin KM, Craig KD (1986) Social Transmission of Natural Variations in Pain Behaviour. *Behav Res Ther* 24:581–585
12. Rickard K (1988) The Occurrence of Maladaptive Health-Related Behaviors and Teacher-Rated Conduct Problems in Children of Chronic Low Back Pain Patients. *J Behav Med* 11:107–116
13. Schrader H, Obelieniene D, Bovim G et al. (1996) Natural Evolution of Late Whiplash Syndrome Outside the Medicolegal Context. *Lancet* 347:1207–1211
14. Turkat ID, Guise BJ (1983) The Effects of Vicarious Experience and Stimulus Intensity on Pain Termination and Work Avoidance. *Behav Res Ther* 21:241–245
15. Violon A, Giurgea D (1984) Familial Models for Chronic Pain. *Pain* 18:199–203

## Moderate Sedation

### Definition

A drug-induced state of depressed consciousness during which the patient responds purposefully to verbal or light tactile stimulation, while maintaining protective airway reflexes and airway patency. Cardiovascular function is usually maintained.

- ▶ Pain and Sedation of Children in the Emergency Setting

## Modifications of Treatment for the Elderly

### Definition

The treatment protocol has to take functional, sensory and cognitive restrictions of elderly individuals into account, e.g. by facilitating comprehension and providing more time for a session.

- ▶ Psychological Treatment of Pain in Older Populations

## Modifying Factors

### Definition

Pain related factors that may affect the assessment of pain in the newborn include gestational age (number of days since conception), post natal age (number of days of life since birth), behavioral state (sleep/wake state), severity of illness, and gender. Pain expression in infants may also be affected by developmental ability, consolability, chronic pain, environmental stimulation and repeated exposure to pain and stress events, medication, caregiving including direct parent involvement

- ▶ Pain Assessment in Neonates



## Molecular Contributions to the Mechanism of Central Pain

BRYAN C. HAINS

The Center for Neuroscience and Regeneration Research, Department of Neurology, Yale University School of Medicine, West Haven, CT, USA  
bryan.hains@yale.edu

### Synonyms

Central Pain Mechanisms, Molecular Contributions

### Definition

Changes in ion channels, neurotransmitters, receptors, signaling pathways and gene expression represent important consequences of disease or ischemic and traumatic injury of the central nervous system that ultimately impact the functional state of neurons at different levels of the neuraxis, leading to the development of central pain.

The molecular organization of the structural and functional components of a neuron endow it with certain electrophysiological properties. After injury to the central nervous system, molecular reconfiguration of ion channels, neurotransmitters and receptors takes place in nociceptive neurons, leading to dysfunctional firing properties and the development and maintenance of central pain syndromes.

### Characteristics

The spinal cord dorsal horn contains the primary synapse through which afferent somatosensory information related to touch, pressure, brush, temperature and noxious stimuli is received from the periphery. Dorsal horn sensory neurons receive this information primarily from the skin, perform a degree of processing and transmit signals through distinct tracts within the spinal cord to supraspinal structures where pain is perceived. Within peripheral nerves and spinal cord, pain is thought to exist simply as a signal and is subject to a degree of modulation by circuitry that it passes through.

Experimental spinal cord injury (SCI) induces electrophysiological changes in dorsal horn sensory neurons that contribute to pain-like behaviors in animals (Hains et al. 2003b). These include shifts in proportions of cells responding to evoked noxious stimulation, increases and irregularity in spontaneous **▶ Background Activity / Firing**, increased **▶ evoked activity** to (formerly) innocuous and noxious stimuli and increases in **▶ afterdischarge** activity following stimulation. Since the nature of the applied stimuli does not change, other mechanisms must account for the alterations in stimulus processing that lead to central pain. Central changes in expression of molecules such as ion channels, neurotransmitters and their receptors, contribute to altered

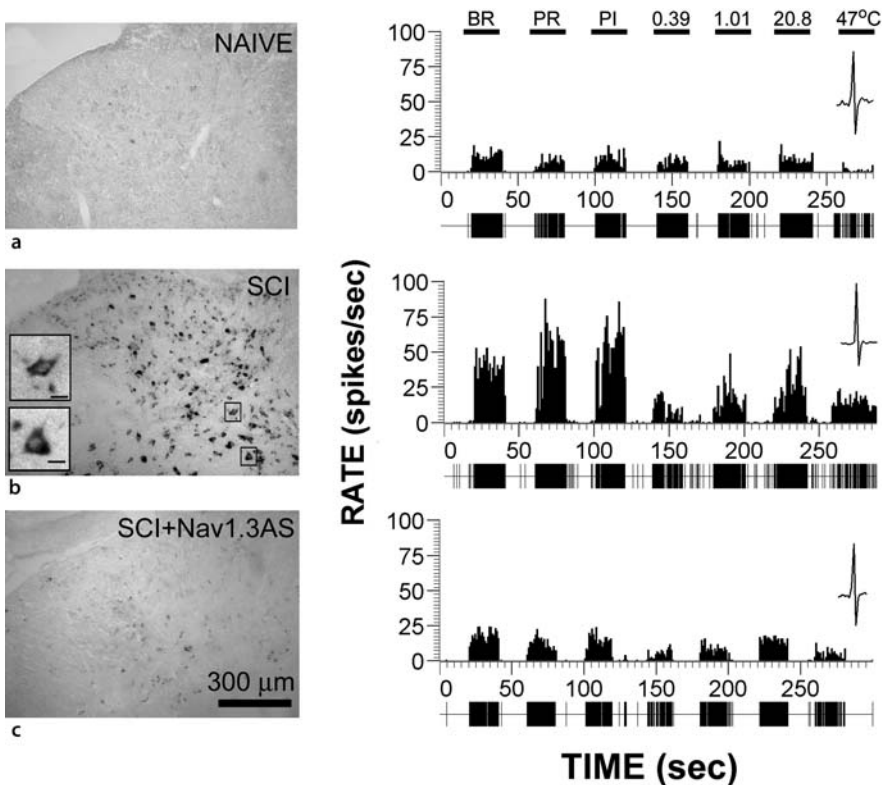
sensory processing by changing the electrophysiological excitability and therefore output of sensory neurons. Specific molecular changes shown to contribute to the development of central pain in animal models and specifically to the development of pain following spinal cord injury (SCI) are described below.

### Ion Channels

At the most fundamental level, **▶ action potential** generation and propagation by sensory neurons relies on multiple isoforms of **▶ voltage gated sodium channels** (termed Na<sub>v</sub>). The selective expression of ensembles of sodium channels tunes the biophysical properties of each neuron. Within the normal nervous system, properties fundamental to neuronal function such as activation threshold, inactivation and **▶ refractory period**, rates of **▶ repriming** and the ability to generate and conduct high frequency trains of action potentials all depend on the type(s) of sodium channels expressed within a given neuron (Waxman 2000). Similarly, dysregulation of channel expression can abnormally reconfigure neuronal function in disease states. Ten genes encode molecularly distinct voltage gated sodium channels, at least seven of which are expressed in the rat nervous system. In the adult spinal cord dorsal horn, Na<sub>v</sub>1.1, Na<sub>v</sub>1.2 and Na<sub>v</sub>1.6 are strongly detectable, whereas Na<sub>v</sub>1.3 expression decreases with development and is down-regulated in adults. In the adult spinal cord, Na<sub>v</sub>1.3 is expressed at very low levels (Fig. 1a) (Felts et al. 1997). Following SCI, expression of Na<sub>v</sub>1.3 is up-regulated in the dorsal horn (Fig. 1b) and colocalizes with NK<sup>1</sup>-R, a marker of nociceptive neurons. Na<sub>v</sub>1.3 plays a role in maintaining hyperresponsiveness to peripheral stimulation as well as pain-related behaviors, as evidenced through selective knockdown of Na<sub>v</sub>1.3 expression *via* antisense oligodeoxynucleotide administration (Fig. 1c) (Hains et al. 2003a). The Na<sub>v</sub>1.3 sodium channel produces a rapidly repriming tetrodotoxin sensitive sodium current that permits neuronal firing at higher than normal frequencies (Cummins et al. 2001). Since stimulus intensity is encoded in the dorsal horn by the rate of firing, this change in how neurons process incoming sensory information serves to amplify incoming signals, so that perceived pain thresholds are lowered.

### Neurotransmitters and Receptors

Neurotransmitter molecules and their receptors produce signals that cause depolarization of dorsal horn sensory neurons. After SCI, neurotransmitter levels are altered in a way that is facilitative to central pain. **▶ Serotonin** (5-HT) is an important molecule that participates in the functional modulation of dorsal horn nociceptive neurons. Released by terminals of fibers descending from cell bodies located within the midline **▶ raphe nuclei** of the brain stem, 5-HT can act directly on ion channels or trigger intracellular cascades that cause neuronal depo-



### Molecular Contributions to the Mechanism of Central Pain,

**Figure 1**  $Na_v1.3$  mRNA is expressed at low levels in naïve animals, (a) but is upregulated in lumbar dorsal horn neurons after spinal cord injury (SCI). (b) Treatment with antisense oligodeoxynucleotides against  $Na_v1.3$  reduces  $Na_v1.3$  transcripts after SCI. (c) Corresponding unit recordings show evoked activity to peripheral stimulation (BR = brush, PR = press, PI = pinch, increasing strength von Frey filament stimulation and noxious thermal heating ( $47^\circ C$ )), after SCI (b) compared to controls (a). After  $Na_v1.3$  antisense delivery, evoked activity of dorsal horn neurons resembles that found in naïve levels (c).

larization and/or regulate intrinsic excitability. SCI results in a loss of the supply of 5-HT within the spinal cord through interruption of descending sources (Hains et al. 2001). After SCI, replacement of interrupted 5-HT reduces abnormal activity of dorsal horn neurons, as well as pain-related behaviors.

Following SCI, 5-HT receptors also undergo changes in expression levels, a change thought to play a role in the development of central pain. The major class of 5-HT receptor found in the dorsal horn is the 5-HT<sub>1</sub> family (Zemlan and Schwab 1991). Of this subset of receptors, 5-HT<sub>1A</sub> represents a high percentage of all high affinity 5-HT binding sites, with highest receptor densities in laminae I and II. 5-HT<sub>1A</sub> couples an intracellular G-protein cascade and is up-regulated after SCI (Giroux et al. 1999). Also highly represented in the spinal cord, the 5-HT<sub>3</sub> receptor, which gates a non-selective monovalent cation channel, has been found in the substantia gelatinosa at all levels of the spinal cord (Hamon et al. 1989). Following SCI, direct activation of both the 5-HT<sub>1A</sub> and 5-HT<sub>3</sub> (Hains et al. 2002) receptors reduces neuronal hyper-responsiveness and/or pain-related behaviors caudal to the injury site. 5-HT<sub>3</sub> receptors are thought to be facilitatory to pain after SCI at levels rostral to the injury site (Oatway et al. 2004). The 5-HT transporter protein, which regulates the activity level of 5-HT, undergoes up-regulated expression following SCI (Hains et al. 2001).

Reductions in spinal levels of the inhibitory neurotransmitter gamma-aminobutyric acid (► GABA) also

support central pain after SCI by decreasing the inhibitory influences within spinal circuitry (Drew et al. 2004). Synthesized locally, GABA is the major inhibitory neurotransmitter and acts *via* ligand gated ion channels (GABA<sub>A</sub> receptors) and G-protein coupled (GABA<sub>B</sub>) receptors. After SCI, reduced GABAergic inhibition results in abnormally exaggerated evoked and spontaneous neuronal firing through the impairment of GABA production or release and/or loss of GABA-releasing cells.

Another mechanism for maintained hyperexcitability of dorsal horn neurons leading to central pain involves changes in the expression of metabotropic glutamate receptors (► mGluRs). mGluRs are G-protein coupled receptors that have been subdivided into three groups, based on sequence similarity, pharmacology and intracellular signaling mechanisms. Group I is made up of mGluR1 and 5, Group II is made up of mGluR2 and 3 and Group III is made up of mGluR4, 6, 7, and 8. mGluR1 is found primarily in deeper laminae of the dorsal horn and mGluR5 is found at highest levels in lamina II. mGluR2/3 is also expressed in high levels within lamina II. The differential distribution of mGluRs within laminae associated with sensory processing implicates them in central pain after SCI. In the spinal cord, mGluRs directly modulate neuronal excitability; for example group I mGluRs decrease thresholds of activation, inhibit afterhyperpolarization and induce transient membrane depolarizations. Following SCI, mGluR1 expression increases at the level of

injury and mGluR2/3 expression levels are chronically decreased in and around the lesion site. There is also a chronic increase in mGluR1 in all laminae measured and a decrease in mGluR2/3 in laminae Iii, III, IV and V (Mills et al. 2001). SCI produces an increase in mGluR1 expression on spinothalamic tract neurons in both the cervical enlargement and the spinal segment just rostral to the injury site (Mills et al. 2002). Treatment with agonists to group II and III mGluRs affects pain responses following SCI.

Genetic changes that may play a role in pain pathogenesis after SCI have been brought to light by microarray analysis. SCI can lead to altered expression of genes whose transcripts help to determine membrane excitability, including increases in mRNAs for ionotropic glutamate receptors and sodium and calcium channels and decreases in mRNAs for GABA receptors and potassium channels (Nesic et al. 2002).

In summary, molecular events involved in the processing of afferent signals in spinal neurons significantly change following SCI. These changes endow affected neurons with maladaptive functional properties, and provide the substrate to both generate and amplify incorrect signals that ultimately contribute to central pain after SCI. Although the majority of studies related to molecular changes following central injury have focused on changes occurring at the level of the spinal cord (following spinal injury), similar changes are likely to be found at supraspinal levels.

**References**

1. Cummins TR, Aglieco F, Renganathan M et al. (2001) Nav1.3 sodium channels: rapid repriming and slow closed-state inactivation display quantitative differences after expression in a mammalian cell line and in spinal sensory neurons. *J Neurosci* 21:5952–5961
2. Drew GM, Siddall PJ, Duggan AW (2004) Mechanical allodynia following contusion injury of the rat spinal cord is associated with loss of GABAergic inhibition in the dorsal horn. *Pain* 109:379–388
3. Felts PA, Yokoyama S, Dib-Hajj S et al. (1997) Sodium channel alpha-subunit mRNAs I, II, III, NaG, Na6 and hNE (PN1): different expression patterns in developing rat nervous system. *Brain Res Mol Brain Res* 45:71–82
4. Giroux N, Rossignol S, Reader TA (1999) Autoradiographic study of alpha1- and alpha2-noradrenergic and serotonin1A receptors in the spinal cord of normal and chronically transected cats. *J Comp Neurol* 406:402–414
5. Hains BC, Fullwood SD, Eaton MJ et al. (2001) Subdural engraftment of serotonergic neurons following spinal hemisection restores spinal serotonin, downregulates serotonin transporter, and increases BDNF tissue content in rat. *Brain Res* 913:35–46
6. Hains BC, Willis WD, Hulsebosch CE (2002) Serotonin receptors 5-HT1A and 5-HT3 reduce hyperexcitability of dorsal horn neurons after chronic spinal cord hemisection injury in rat. *Exp Brain Res* 149:174–186
7. Hains BC, Johnson KM, Eaton MJ et al. (2003a) Serotonergic neural precursor cell grafts attenuate bilateral hyperexcitability of dorsal horn neurons after spinal hemisection in rat. *Neuroscience* 116:1097–1110
8. Hains BC, Klein JP, Saab CY et al. (2003b) Upregulation of sodium channel Nav1.3 and functional involvement in neuronal hyperexcitability associated with central neuropathic pain after spinal cord injury. *J Neurosci* 23:8881–8892

9. Hamon M, Gallissot MC, Menard F et al. (1989) 5-HT3 receptor binding sites are on capsaicin-sensitive fibres in the rat spinal cord. *Eur J Pharmacol* 164:315–22
10. Mills CD, Hulsebosch CE (2002) Increased expression of metabotropic glutamate receptor subtype 1 on spinothalamic tract neurons following spinal cord injury in the rat. *Neurosci Lett* 319:59–62
11. Mills CD, Fullwood SD, Hulsebosch CE (2001) Changes in metabotropic glutamate receptor expression following spinal cord injury. *Exp Neurol* 70:244–247
12. Nesic O, Svrakic NM, Xu GY et al. (2002) DNA microarray analysis of the contused spinal cord: effect of NMDA receptor inhibition. *J Neurosci Res* 68:406–423
13. Oatway MA, Chen Y, Weaver LC (2004) The 5-HT3 receptor facilitates at-level mechanical allodynia following spinal cord injury. *Pain* 110:259–268
14. Waxman SG (2000) The neuron as a dynamic electrogenic machine: modulation of sodium-channel expression as a basis for functional plasticity in neurons. *Philos Trans R Soc Lond B Biol Sci* 355:199–213
15. Zemlan FP, Schwab EF (1991) Characterization of a novel serotonin receptor subtype (5-HT1S) in rat CNS: interaction with a GTP binding protein. *J Neurochem* 57:2092–2099

**Monamine Oxidase Inhibitors**

M

- ▶ Antidepressant Analgesics in Pain Management

**Monoamines**

**Definition**

Classification of neurochemicals based on their chemical structure (usually used to refer to serotonin, norepinephrine and dopamine).

- ▶ Stimulation-Produced Analgesia

**Monocyte/Macrophage**

**Definition**

Monocytes are circulating immune/inflammatory cells that originate in bone marrow and differentiate into macrophages after migrating through blood vessel walls into tissues.

- ▶ Wallerian Degeneration

**Monosynaptic**

**Definition**

Pertaining to a single synapse.

- ▶ Amygdala, Pain Processing and Behavior in Animals

## Mood

### Definition

DSM4 APA: Includes mood disorders associated with depression: depressive disorders, bipolar disorders, mood disorders due to a general medical condition and substance-induced mood disorder, as well as anxiety: especially post traumatic stress disorder, acute stress disorder, generalized anxiety disorder, anxiety disorder due to a general medical condition, substance-induced anxiety disorder and anxiety disorder not otherwise specified. Other mood states may include anger, frustration, fear and disappointment.

- ▶ Pain Assessment in the Elderly

## MOP Receptor

### Definition

The term  $\mu$ -opioid ( $\mu$  from morphine) peptide receptor represents the G-protein coupled receptor that responds selectively to the majority of clinically useful opioid drugs. It is expressed in areas of the nervous system that mediate therapeutic and adverse effects of most opioid drugs. The MOP receptor protein is produced by a single gene. Several mRNA splice variants are known to exist and produce receptor proteins that display different properties when expressed in cells. When activated, the MOP receptor predominantly transduces actions via inhibitory G-proteins. The electrophysiological consequences of MOP receptor activation are usually inhibitory.

- ▶ Mu( $\mu$ )-Opioid Receptor
- ▶ Opioid Electrophysiology in PAG

## MOR-1

### Definition

A clone encoding a mu opioid receptor.

- ▶ Opioid Receptors

## Moral Hazard

### Definition

When the presence of insurance changes a disability claimant's or health care providers behavior.

- ▶ Disability Incentives

## Morbus Sudeck

- ▶ Complex Regional Pain Syndromes, General Aspects
- ▶ Sympathetically Maintained Pain in CRPS I, Human Experimentation

## Morning Stiffness

### Definition

In arthritis, morning stiffness of joints and muscles may last for several hours.

- ▶ Muscle Pain in Systemic Inflammation (Polymyalgia Rheumatica, Giant Cell Arteritis, Rheumatoid Arthritis)

## Morphine

### Definition

Morphine is a strong (potent) naturally-occurring opiate (a phenantere derivative) produced from extracts of the poppy plant. Morphine undergoes extensive hepatic biotransformation by phase II reactions to morphine-3-glucuronide (70%) and morphine-6-glucuronide (5–10%) and the remainder undergoes sulphation.

- ▶ Forebrain Modulation of the Periaqueductal Gray
- ▶ Postoperative Pain, Morphine

## Morphine and Muscle Pain

- ▶ Opioids and Muscle Pain

## Morphine Sulphate

- ▶ Postoperative Pain, Morphine

## Morphine Tolerance

- ▶ Glutamate Homeostasis and Opioid Tolerance



## Morphology, Intraspinal Organization of Visceral Afferents

YASUO SUGIURA

Nagoya University School of Medicine, Graduate School of Medicine, Department of Functional Anatomy & Neuroscience, Nagoya, Japan  
ysugiura@med.nagoya-u.ac.jp

### Synonyms

Synaptic Organization of Afferent Fibers from Viscera in the Spinal Cord

### Definition

► Visceral afferent A $\delta$ - and ► C Fiber convey sensory information from the viscera via vagal and spinal nerves. Intraspinal organization of visceral afferents is composed of the large number of sympathetic afferents which mediate pain, and a small number of the vagal afferents. The afferent terminals make synapses with dendrite of the projecting or internuncial neurons or axons of inhibitory neurons in the spinal cord.

### Characteristics

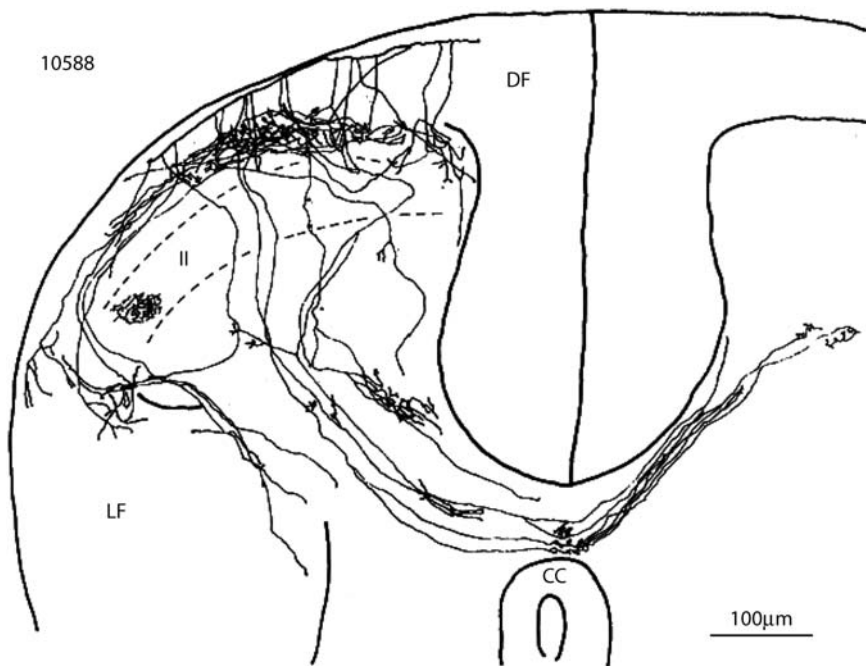
#### Terminal Distribution in the Spinal Cord

Visceral afferent fibers terminate in the superficial (I, II) spinal laminae (see ► Spinal cord laminae) and deeper ► (IV–V, X) spinal laminae (de Groat et al. 1978). A single visceral afferent C-fiber can project to the dorsal, superficial spinal cord and also in laminae V and X of the contralateral spinal cord (Sugiura et al. 1989). Visceral afferent C-fibers have collateral branches

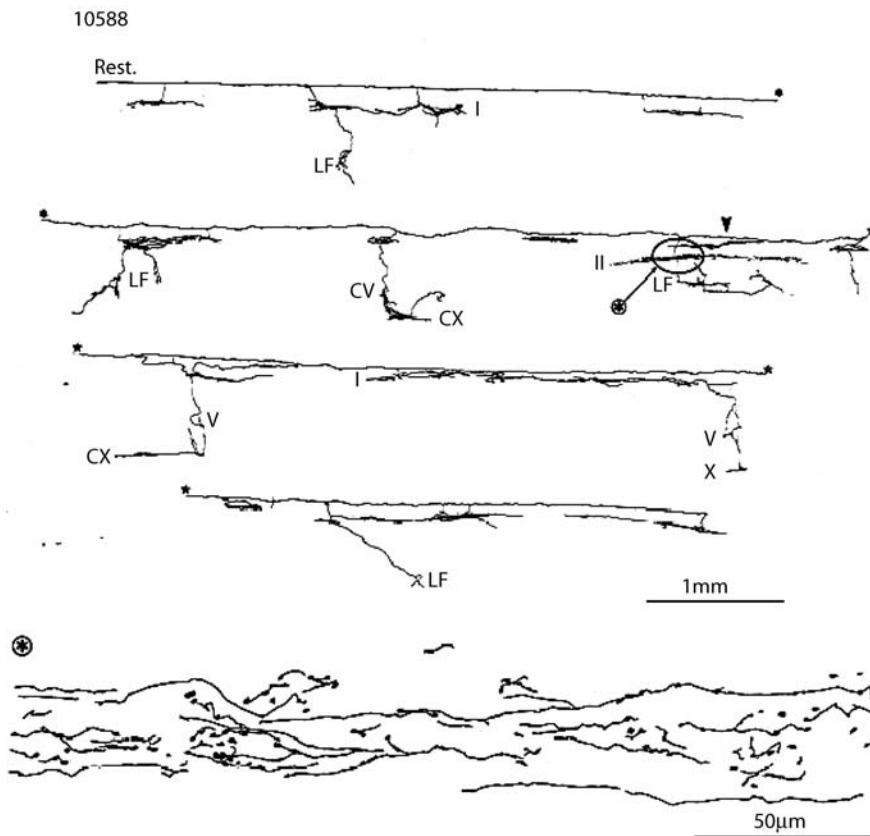
with terminal swellings in the adjacent white mater of ► lateral and dorsal funiculi, in addition to terminal branches in the spinal dorsal horn, revealing a distinctly different pattern of termination from somatic afferent C-fiber terminals (Fig. 1). Along the longitudinal axis of the spinal cord, visceral afferent C-fibers terminate with about 20 collateral branches, which are given off at 3–400 $\mu$ m spans in several ► spinal segments from rostral and caudal branches. The rostral branch of the C-fiber shown in Figure 2 runs in the surface of the dorsal funiculus, which may project to the dorsal column nucleus (Nucleus gracilis), part of a new tract for visceral pain (Fig. 2) (Al-Chaer et al. 1998). Each collateral branch ramified in a relative narrow sheet consisting of only one or two daughter branches, which did not form a concentrated nest-like termination commonly seen with somatic C-fibers. The collateral branches have 250–300 terminal swellings, forming an array arranged in the orientation of the neuropil of the spinal laminae (Sugiura et al. 1993). The number of terminal swellings is summarized in Table 1. About 5000 to 6000 enlargements (boutons) were identified in visceral afferent C-fibers. Over 60% of visceral terminal swellings are found in the superficial dorsal horn, lamina I and adjacent area, which seems to be the main region of termination. About 10% of terminal swellings are found in deeper dorsal horn (laminae IV and V). A few visceral fiber boutons are in other laminae.

### Synaptic Organization

Light microscopic examination gives us some information about the terminal swellings (boutons). The



**Morphology, Intraspinal Organization of Visceral Afferents, Figure 1** A transverse reconstruction of the central projection of a visceral afferent C-fiber. One of the collaterals could be traced to synaptic enlargements in lamina II. Broken lines indicate borders of Laminae I, II, and III; LF, Lateral funiculus; DF, dorsal funiculus; CC, central canal. (Sugiura et al. 1989)



**Morphology, Intraspinal Organization of Visceral Afferents, Figure 2** Sagittal view of reconstructions of the arborization of visceral afferent C-fibers. On entering the spinal cord (arrow head), the axon bifurcated into rostral and caudal main branches. The main branches ran on the dorsal surface of the dorsal funiculus or in Lissauer's tract, as far rostrally as the 10th thoracic segment (top left) and as far caudally as the 2nd lumbar segment (bottom right). Many collaterals left these parent branches to terminate in laminae I(I) and II(II). Some collaterals also terminated in the lateral funiculus (LF) and the ipsilateral or contralateral laminae V(V, CV) and X(X, CX). The asterisk in a circle (bottom) shows the terminal profiles in lamina II, which is indicated by the circle in the upper view.

**Morphology, Intraspinal Organization of Visceral Afferents, Table 1** Number of Terminal Swellings

Case Number	Visceral Fibers*		Somatic Fibers	
	10588	30488	70887	72987
Number of swellings	6099(100)	5370(100)	1482	1450
Number of terminal areas	22	18	1	2
Mean number of areas	277	298	-	725
Dorsal funiculus	359(5.9)	1089(20.3)		
Lamina I	3735(61.2)	2466(45.9)		
Lamina II	240(3.9)	151(2.8)		
Lamina IV and V	391(6.4)	553(10.3)		
Lateral funiculus	276(4.5)	21(0.4)		
Lamina X	171(2.8)	153(2.8)		
Contralateral X	121(2.0)	61(1.1)		
Contralateral VI and V	108(1.8)	142(2.6)		
Total	5401(88.6)	4636(86.3)		

\*Number and (percentage).

terminal swellings of visceral afferent C-fibers ranged 1.6 to 1.7 $\mu\text{m}$  in diameter and are 4.3 to 5.7 $\mu\text{m}^2$  in area each, which is smaller than those of somatic afferents. If presented graphically, the distribution of visceral

terminal swellings occupy a smaller fraction (one third to one half) of somatic terminal swellings.

In electron microscopy, primary afferent terminals in the spinal cord generally show a central synaptic profile

**Morphology, Intraspinal Organization of Visceral Afferents, Table 2** Incidence of Central Terminals of Primary C Afferents

	Fraction	Percentage
Somatic fiber:		
High-threshold mechanoreceptor	24/32	75.0
Polymodal nociceptor	13/16	81.03
Mechanical cold nociceptor	53/63	84.1
Warming receptor	12/38	31.5
Visceral fiber:		
Superficial layer	3/29	10.3
Deeper layer	10/38	26.3

composed of axons and some dendritic spines. In somatic nociceptors, over 75% of terminals show central synaptic profiles, but visceral afferent terminals show a ► **simple synapse** and less than 30% of terminals show central synaptic profiles (Table 2) (reviewed in Sugiura and Tonosaki 1995).

A great number of visceral afferent cell bodies in dorsal root ganglia contain neuropeptides, especially substance P, calcitonin-gene related peptide, somatostatin and vasoactive intestinal peptide, and some are IB-4 positive.

#### Functional Exploration from Morphological Organization

Visceral afferent C-fibers terminate in spinal lamina I and V, similar to terminals thinly myelinated fibers from somatic nociceptors, which are different

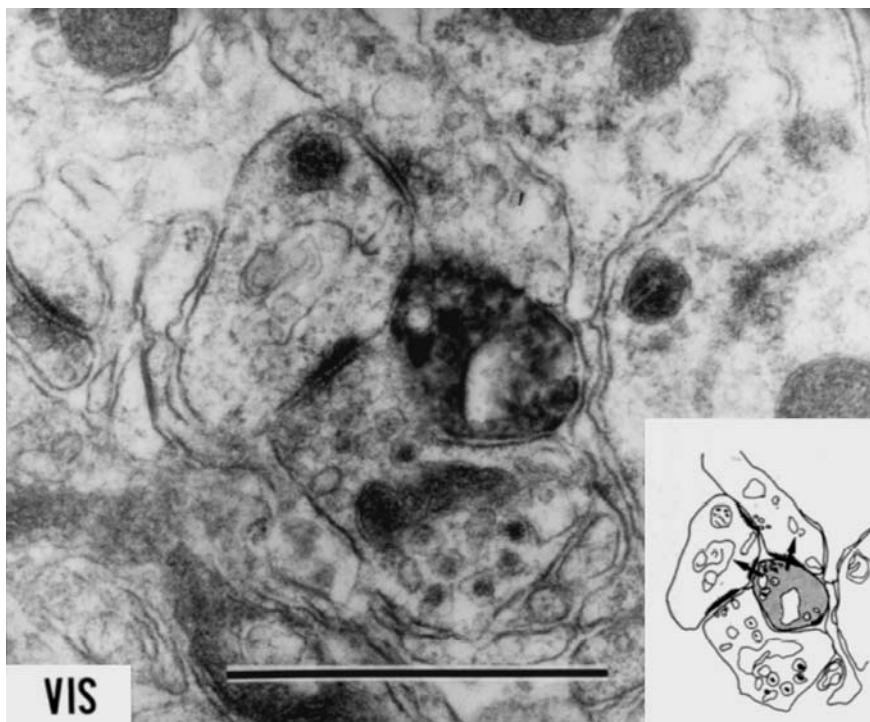
from C-fiber terminals of the somatic organ (skin and muscle) (Ling et al. 2003). The laminar arrangement of visceral afferent C-fiber terminals suggests that ► **somato-visceral convergence** on neurons in laminae I and V arise from somatic myelinated and visceral unmyelinated fibers. This system may be committed to referred pain, whereas some somatic unmyelinated afferents may only subservise the transmission of nociceptive information to secondary neurons in the dorsal horn.

Visceral afferent fibers terminate in ► **single or straight form of terminal branches**. Compared with the concentrated focus of somatic terminations, visceral C afferents appear in thin sheets of termination having one or two terminal branches with several enlargements at each terminal focus. These terminal features may reveal the morphological background for the poor localization and possibly vagueness of referred pain (Cervero 1994).

The size of terminal boutons on visceral afferent C fibers is smaller than the boutons found on many kinds of myelinated fiber terminals (Brown et al. 1981) and those of somatic afferent C-fibers (Sugiura et al. 1995). This difference in size may have relevance to the receptor or to the nature of the synaptic transmission in the dorsal horn. The size of terminal swellings of visceral afferent fibers seems to reflect the morphological variety of synaptic ultrastructural profiles (Ribeiro da Silva and Coimbra 1982, Alvarez et al. 1993).

Somatic C-fiber nociceptors make central terminal profiles, which have various shapes according to the adequate noxious stimulus: high threshold nociceptor, cold nociceptor or polymodal nociceptor. These ultrastruc-

M



**Morphology, Intraspinal Organization of Visceral Afferents, Figure 3** An ultrastructural profile of a visceral afferent C-fiber. A visceral afferent terminal has simple synaptic contacts with post synaptic elements. To easily identify the synaptic relation, a schematic illustration is drawn (right bottom). Bar; 1  $\mu\text{m}$  (modified from Sugiura et al. 1992, Sugiura & Tonosaki 1995).

tural profiles may reveal the possibility of pain modulation at the synaptic site of central terminals (Wall 1989). Contrary to the somatic nociceptors, most visceral afferent C-fiber terminals show simple synaptic profiles. This means that these terminals transmit peripheral inputs to secondary neurons or elements, without modulating the information at the synaptic site. In this interpretation, somatic central terminals may be essential to transmit pain from peripheral somatic tissues to the central nervous system, but visceral pain may be transmitted by other mechanisms or mediated by small numbers of central terminals. If we presume that these central terminals mainly mediate visceral pain, visceral pain would be a ► [vague, strange feeling](#) and not definitive for nociception.

### References

1. Al-Chaer ED, Feng Y, Willis WD (1998) A Role for the Dorsal Column in Nociceptive Visceral Input into the Thalamus of Primates. *J Neurophysiol* 70:3143–3150
2. Alvarez FJ, Kavookjian AM, Light AR (1993) Ultrastructural Morphology, Synaptic Relationships, and CGRP Immunoreactivity of Physiologically Identified C-Fiber Terminals in the Monkey Spinal Cord. *J Comp Neurol* 329:472–490
3. Brown AG (1981) Organization in the Spinal Cord: The Anatomy and Physiology of Identified Neurons. Springer-Verlag, New York, pp 1–138
4. Cervero F (1994) Sensory Innervation of the Viscera: Peripheral Basis of Visceral Pain. *Physiol Rev* 74:495–138
5. de Groat WC, Nadelhaft I, Morgan C, Schauble T (1978) Horseradish Peroxidase Tracing of Visceral Afferent and Primary Afferent Pathways in the Cat's Sacral Spinal Cord using Benzidine Processing. *Neurosci Lett* 10:103–108
6. Ling L-J, Honda T, Shimada Y, Ozaki N, Shiraishi Y, Sugiura Y (2003) Central Projection of Unmyelinated (C) Primary Afferent Fibers from Gastrocnemius Muscle in the Guinea Pig. *J Comp Neurol* 461:140–150
7. Ribeiro da Silva A, Coimbra A (1982) Two Types of Synaptic Glomeruli and their Distribution in Laminae I–III of the Rat Spinal Cord. *J Comp Neurol* 209:176–186
8. Sugiura Y, Terui N, Hosoya Y (1989) Difference in Distribution of Central Terminals between Visceral and Somatic Unmyelinated (C) Primary Afferent Fibers. *J Neurophysiol* 62:834–840
9. Sugiura Y, Terui N, Hosoya Y, Tonosaki Y, Nishiyama K, Honda T (1993) Quantitative Analysis of Central Terminals Projections of Visceral and Somatic Unmyelinated (C) Primary Afferent Fibers in the Guinea Pig. *J Comp Neurol* 332:315–325
10. Sugiura Y, Tonosaki Y, Nishiyama K, Honda T, Oda S (1992) Organization of the central projections of unmyelinated primary afferent fibers. In: Inoki R, Shigenaga Y, Tohyama M (eds) *Processing and Inhibition of nociceptive information*. Excerpta Medica, Amsterdam, pp 9–13
11. Sugiura Y, Tonosaki Y (1995) Spinal Organization of Unmyelinated Visceral Afferent Fibers in Comparison with Somatic Afferent Fibers. In: Gebhart GF (ed) *Visceral pain, Progress in Pain research and Management*, vol 5. IASP Press, Seattle, pp 41–59
12. Wall PD (1989) Introduction. In: Wall PD, Merzack R (eds) *Text of Pain*, 2nd edn. Churchill Livingstone, Edinburgh, pp 1–18

## Morris Water Maze

### Definition

Morris water maze is a behavioral test used to measure spatial and working memory.

► [Cingulate Cortex, Nociceptive Processing, Behavioral Studies in Animals](#)

## Morton's Neuroma

### Definition

Morton described a painful condition of the fourth toe of the foot, which, over time, has been interpreted as being due to a neuroma of the interdigital nerve to the 3<sup>rd</sup>/4<sup>th</sup> webspace of the foot. Tradition has called this a neuroma, and the traditional treatment has been to resect this nerve, which creates a true neuroma. Light and electron microscopy has demonstrated that the excised nerve has chronic compression and not neuroma formation. Today, the approach includes a neurolysis, rather than an excision, of this nerve.

► [Painful Scars](#)

## Motif

### Definition

The motif is the region of a protein that is responsible for binding or functional action, which is homologous to other proteins of like function.

► [Trafficking and Localization of Ion Channels](#)

## Motivation

### Definition

Motivation is that which contributes or leads to the initiation, direction, persistence, intensity, or termination of behavior.

► [Motivational Aspects of Pain](#)

► [Psychology of Pain and Psychological Treatment](#)

## Motivational-Affective

### Definition

Response to nociceptive stimuli involving the emotional (limbic) and visceral components, including response by homeostatic systems responsible for regulation of blood pressure, respiration rate, and responses involving the hypothalamic-pituitary-adrenal axis.

► [Spinomesencephalic Tract](#)

► [Spinothalamic Tract Neurons, Descending Control by Brainstem Neurons](#)



## Motivational-Affective Aspects/Components of Pain

### Definition

The pain experience includes motivational and affective aspects/components, such as negative emotions and arousal.

- ▶ Parafascicular Nucleus, Pain Modulation
- ▶ Spinothalamic Input, Cells of Origin (Monkey)
- ▶ Thalamic Nuclei Involved in Pain, Cat and Rat
- ▶ Motivational Aspects of Pain

## Motivational Aspects of Pain

MARK P. JENSEN

Department of Rehabilitation Medicine, University of Washington, Seattle, WA, USA  
mjensen@u.washington.edu

### Synonyms

Incentive; drive

### Definition

▶ **Motivation** refers to the initiation, direction, persistence, intensity, and termination of behavior (Landy and Backer 1987). According to most theories of motivation, the primary factors that lead to behavior change can be classified as falling into two categories: (1) the perceived importance of behavior change and (2) the belief that behavior change is possible (i.e. ▶ **self-efficacy** Bandura 1986).

### Characteristics

As the management of chronic pain depends more on what patients do than on what is done to them, patient motivation for pain self-management represents an essential, yet under-studied aspect of clinical care (Jensen et al. 2003). The more that clinicians understand motivation and the factors that contribute to motivation for pain self-management, the better they will be at helping patients learn, practice, and use adaptive pain self-management coping strategies.

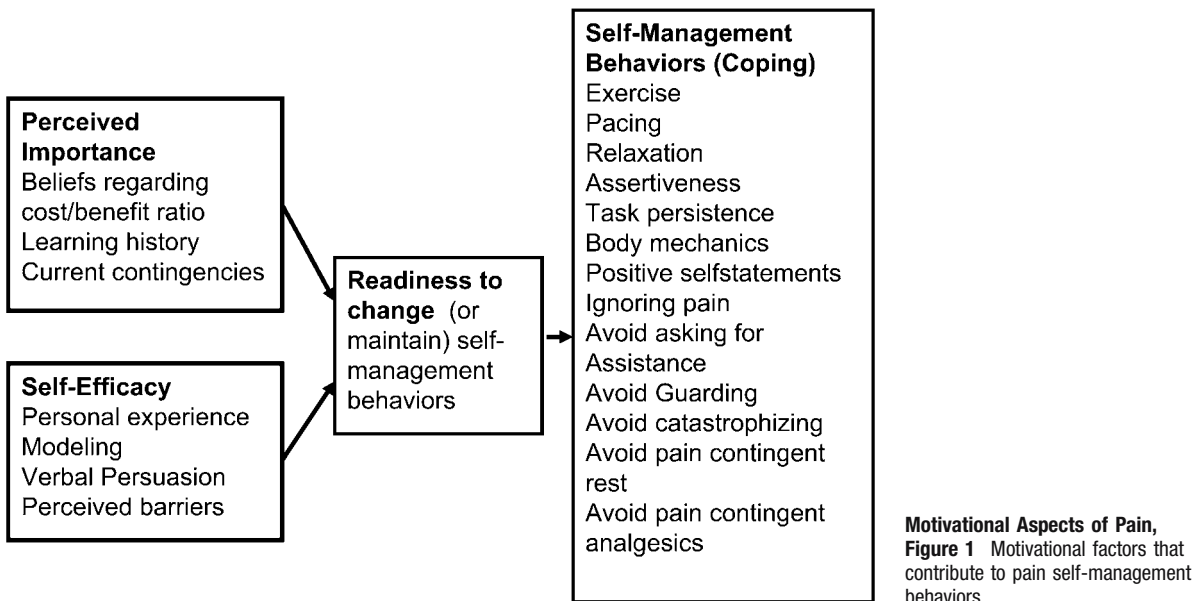
### Theories of Health Behavior and Health Behavior Change

A number of theories and models have been developed that address the motivational issues that impact on health behavior and health behavior change: the operant model, Cognitive-Behavioral Theory, expectancy-value models, the Transtheoretical Model, and client-centered approaches. The operant learning theory of chronic pain emphasizes the role that environmental ▶ **contingencies** have on pain behavior (Fordyce 1976). According to this model, patients continue to use maladaptive pain

management strategies (such as pain-contingent rest and guarding) because such strategies are followed by reinforcement. Motivation for change therefore results when the contingencies are changed; for example, by encouraging and praising adaptive coping efforts and ignoring maladaptive ones. Cognitive-Behavioral Theory views behavior as a complex interaction of cognitive structures, processes and their consequences. Cognitive-Behavioral Therapy for chronic pain uses various strategies for helping patients change maladaptive cognitions that contribute to both pain and suffering, and also integrates a number of other techniques for modifying, teaching, and encouraging adaptive coping skills (▶ **positive reinforcement**, ▶ **biofeedback**, self-control techniques) (Bradley 1996). Expectancy-value models of motivation and health behavior change posit that motivation for behavior and behavior change is determined by patient beliefs (expectancies) and values (incentives) (Bandura 1986; Janz and Becker 1984; Rogers 1983). According to these models, motivation for behavior change increases as people believe that the benefits of change outweigh the costs, and as they increase their beliefs that change is possible. The Transtheoretical Model of behavior change (Prochaska and DiClemente 1984) emphasizes the fact that people vary in their readiness (or motivation) to make change, and classify readiness into five distinct stages: ▶ **precontemplation**, ▶ **contemplation**, ▶ **preparation**, ▶ **action**, and ▶ **maintenance**. This model argues that different therapeutic responses may be used to help patients move from one stage of readiness to the next, until the patient is able to maintain the change for good. Although there has been debate concerning whether readiness to change is best thought of as a stage or continuous dimension, few researchers question the importance of the readiness construct, especially when determining the approach best taken with a particular patient (see Jensen et al. 2003). Finally, client-centered approaches to patient motivation, such as Motivational Interviewing and the Patient-Centered Counseling Model, have identified specific therapeutic responses that increase patient motivation for adaptive behavior change, including such responses as developing a collaborative (rather than confrontive) relationship, eliciting and reinforcing patient self-statements consistent with adaptive change, and increasing patient awareness of the risks of maladaptive responses, while at the same time encouraging patient beliefs that adaptive change is possible (Miller and Rollnick 2002; Ockene et al. 1988).

### Clinical Implications of the Motivation Models for Enhancing Patient Self-Management

Clinicians may use the motivational models of health behavior change as guides when helping motivate patients with chronic pain make adaptive changes. For example, based on the transtheoretical model, clinicians would



be wise to assess a patient's readiness to participate in whatever specific pain treatment(s) is/are being recommended (e.g. by stating "I think that this intervention is worth trying," and then asking, "What do you think?"). This is particularly important if the treatment involves active patient participation to be effective (such as keeping to a specific medication regimen, relaxation or self-hypnosis training, and active physical or occupational therapy, etc.). If the patient expresses a clear disinterest in the planned treatment approach (i.e. is in the "pre-contemplation stage" concerning this approach), then minimal participation can be expected, leading to few benefits. In this case, specific motivational interventions should be considered to help increase patient readiness to engage in treatment. However, motivational interventions can be useful at all readiness levels, to maximize patient commitment to active participation throughout treatment.

A variety of clinician behaviors and responses will increase patient motivation for engagement in active pain management. Most of these can be classified as interventions that impact either the importance the patient places on participating in treatment, and/or the beliefs that participation is possible (see Fig. 1).

To increase the importance for engaging in regular exercise, for example, clinicians could start with providing patients with information concerning the long-term (negative) effects of inactivity and the benefits of regular exercise. However, information alone is unlikely to produce a change motivation for exercise, or any other adaptive coping behavior, unless patients incorporate this information into their belief system. Merely lecturing patients can, in fact, have a paradoxical effect of pushing patients into the position of defending their current maladaptive (e.g. inactivity, rest) coping responses, caus-

ing them to argue against and therefore resist making adaptive changes (Miller and Rollnick 2002). A more effective strategy is to first provide information, and then encourage the patient to discuss and think through the implications of this information for his or her own pain problem; that is, to elicit from the patient his or her own thoughts concerning the information provided, and especially to pay attention to and reinforce patient statements indicating incorporation of the information. Patients are much more likely to believe what they themselves say than what is told to them (Miller and Rollnick 2002).

The importance that patients place on any particular pain coping response can also be changed by altering the contingencies surrounding that response (Fordyce 1976). Clinicians can, and should, praise and reinforce approximations towards adaptive coping, and seek to ignore coping responses associated with greater dysfunction. Patients' attention on their efforts towards adaptive coping can be emphasized by asking questions about these efforts, and helping the patient come up with solutions to problems associated with the use of new adaptive coping strategies. Such discussion can help focus patients' attention on adaptive coping efforts. Patients, and the people who are close to the patient, can also be taught operant principals, and be encouraged to integrate regular reinforcement for adaptive coping (e.g. exercise contingent rest, praise for regular exercise) (Fordyce 1976).

Self-efficacy for adaptive coping can also be increased in a number of ways. One of these is to simply encourage patients to engage (slowly at first) in new adaptive coping efforts. As the patient sees himself/herself engage in adaptive coping, he/she learns that such coping is possible. Such direct experience is perhaps the most powerful

strategy for increasing self-efficacy (Bandura 1986). Self-efficacy can also be increased by observing others engage in the behavior (► [modeling](#)), such as occurs when pain treatment is provided in a group setting. Eliciting from patients their past successes at changing behavior (Miller and Rollnick 2002), and directly addressing perceived barriers, can also increase self-efficacy for adaptive pain self-management.

By understanding that patient motivation is a state that can vary as a function of clinician responses, and by engaging in responses that increase the importance that patients place on adaptive coping and patient beliefs that adaptive coping is possible, clinicians can help patients increase their motivation for engagement in treatment and adherence to treatment recommendations. To the extent that the treatment is effective, motivational interventions can therefore lead to improved outcomes for many patients.

## References

1. Bandura A (1986) *Social Foundations of Thought and Action: A Social Cognitive Theory*. Prentice Hall, Englewood Cliffs, NJ
2. Bradley L (1996) *Cognitive-Behavioral Therapy for Chronic Pain*. In: Gatchel R, Turk D (eds) *Psychological Approaches to Pain Management: A Practitioner's Handbook*. Guilford Press, New York, pp 131–147
3. Fordyce W (1976). *Behavioral Methods for Chronic Pain and Illness*. Mosby, Saint Louis, MO
4. Janz N, Becker M (1984) The Health Belief Model: A Decade Later. *Health Educ Q* 11:1–47
5. Jensen MP, Nielson WR, Kerns RD (2003). Toward the Development of a Motivational Model of Pain Self-Management. *J Pain* 4: 477–492
6. Landy F, Becker W (1987) Motivation Theory Reconsidered. *Research in Organizational Behavior* 9:1–38
7. Miller W, Rollnick S (2002) *Motivational Interviewing: Preparing People to Change*, 2<sup>nd</sup> edn. Guilford Press, New York
8. Ockene J, Quirk M, Goldberg R, Kristeller J, Donnelly G, Kalan K, Gould B, Greene H, Harrison-Atlas R, Pease J, Pickens S, Williams J (1988) A Residents' Training Program for the Development of Smoking Intervention Skills. *Arch Intern Med* 148: 1039–1045
9. Prochaska J, DiClemente C (1984) The Transtheoretical Approach: Crossing Traditional Boundaries of Therapy. Dow Jones Irwin, Homewood, IL
10. Rogers R (1983) Cognitive and Physiological Processes in Fear-Based Attitude Change: A Revised Theory of Protection Motivation. In: In Cacioppo J, Petty R (eds) *Social Psychophysiology: A Sourcebook*. Guilford Press, New York, pp153–176

## Motivational Components

### Definition

Motivational components are a group of basic behaviors induced by a homeostatic survival necessity. Awakening, falling asleep, aggressive/defensive reaction, vocalization, flight, freezing, and hypotonic immobility.

► [Hypothalamus and Nociceptive Pathways](#)

## Motivational Reactions

### Definition

Motivational reactions are basic behaviors induced by a homeostatic necessity. Awakening, aggression, flight, freezing or hypotonic immobility in response to a noxious event.

► [Parabrachial Hypothalamic and Amygdaloid Projections](#)

## Motor Cortex

### Definition

Primate pre-central cortex receiving inputs from cerebellar receiving zones of thalamus and projecting to the spinal cord, striatum and pontine nuclei. Histologically identified by the presence of large pyramidal cells in deep layers of cortex.

► [Pain Treatment, Motor Cortex Stimulation](#)

M

## Motor Cortex, Effect on Pain-Related Behavior

LUC JASMIN, PETER T. OHARA

Department of Anatomy, University of California San Francisco, San Francisco, CA, USA  
ucpain@itsa.ucsf.edu, pto@itsa.ucsf.edu

### Definition

Electrical stimulation of the ► [primary motor cortex \(M1\)](#) is routinely used to relieve intractable pain in humans. Stimulating electrodes are placed over the primary motor cortex and used to deliver an electrical current, which activates the underlying neurons. For reasons that are not yet well understood, this leads to a reduction in certain types of chronic pain without affecting thoughts, mood, motor function or other sensation of any kind including acute pain perception. The electrodes can be left in place and can be effective for years.

### Characteristics

Electrical stimulation of the motor cortex in humans results in the relief of chronic, intractable pain that is not responsive to other therapies. Stimulating the motor cortex for this purpose seems counterintuitive, as one would assume that the primary somatosensory cortex (SI) is a more logical target for interventions aimed at relieving pain. However, large lesions of the primary somatosensory cortex in humans rarely disrupt pain sensation and direct electrical stimulation of the cortex in hundreds

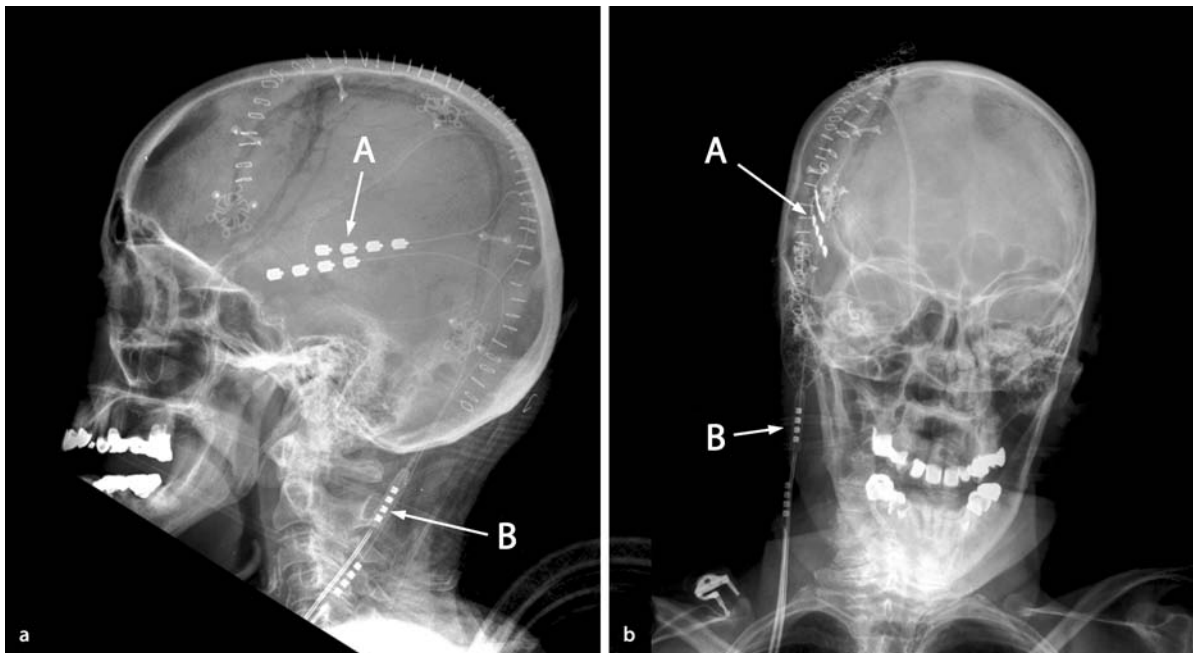
of cases of conscious surgery rarely produced pain sensations. Furthermore, from modern functional imaging studies, we know that the sensory, not the motor cortex, is often activated by nociceptive stimuli (Bushnell et al. 1999).

If activation of the cerebral cortex is necessary for the perception of pain, changing the cortical activity should alter its experience. Proof of this emerged in the early 1990s, largely through the pioneering work of Tsubokawa and colleagues (Hirayama et al. 1990; Tsubokawa et al. 1991, 1993) who reported that stimulating the motor cortex is often successful in relieving central pain (i.e. pain due to lesion of the CNS). The effectiveness of motor cortex stimulation might seem puzzling, particularly if one adopts a textbook view of the nervous system and sees the motor and sensory systems as separate entities. However, it has long been known that stimulation of the motor gyrus can produce sensory responses and anatomical studies have shown connections between somatosensory and motor cortices providing support for interaction between the motor and sensory systems.

In a series of articles beginning in 1990, Tsubokawa and colleagues (Hirayama et al. 1990; Tsubokawa et al. 1991; Tsubokawa et al. 1993) described stimulating the motor cortex in humans as a means to relieve chronic central pain that was not responsive to other treatment and 70% of the patients in these studies reported pain relief. The procedure has since gained wide acceptance and, inasmuch as any invasive surgical procedure can be called routine, this form of treatment for chronic

central or, occasionally, neuropathic pain has become a standard procedure. In most cases, the motor cortex on the side ► **contralateral** to the area of the body that hurts is stimulated. Ipsilateral stimulation is usually reserved for patients in whom the contralateral motor cortex is damaged, most often following an ischemic event.

Motor cortex stimulating electrodes are implanted using standard surgical techniques. The precise details vary according to the particular preferences of the surgeon but there is little evidence that any difference here affects the efficacy of the procedure as long as the localization of the electrodes is adequate. The surgery is carried out under general or local anesthesia and the cranium is opened exposing the dura mater (the thick opaque ► **meningeal layer** covering the brain). The bony opening consists of one or more small burr holes or a small cranial flap. The dura mater can be left intact or opened to allow direct visualization of the cerebral cortex. The cortical area to be stimulated is then localized. With the existing technology one cannot stimulate the entire motor cortex, which means that for patients with pain that extends to an entire hemibody, the neurosurgeon and patient have to first agree on where the pain is maximal and if relieving that painful area leaving the others untouched would be worthwhile. For instance, in many patients the most bothersome pain is present in the face and hand. Because those two areas are immediately adjacent in the motor cortex it is possible to concomitantly stimulate them and bring adequate relief. Once the appropriate location of the electrode array is determined (see below), it is fixed to the outer surface



**Motor Cortex, Effect on Pain-Related Behavior, Figure 1** Post-operative lateral (a) and frontal (b) cranial X-rays of a patient with two stimulating electrodes (A) located over the primary motor cortex. The leads from the electrodes are tunneled subcutaneously *via* the neck to the extension wires (B), which connect it to the internal current generator (not seen).



of the dura matter (most neurosurgeons prefer there to be no direct contact between the electrode and the cortex because of risk of scar formation). The electrode array usually consists of 4 or 10 individual electrodes. The electrode wires are tunneled subcutaneously to the anterior chest where they can be connected to a small current generator (similar to a pacemaker) and the entire system is internalized under the skin.

Although the actual implantation of the electrodes is a relatively straightforward procedure, identifying the motor cortex is not so easily achieved. Even if the motor cortex can be recognized on strictly anatomical grounds by its location anterior to the central ► (Rolandic) sulcus such identification is not straightforward. As the dura mater is not always opened and even when it is there is only a very limited exposure of the cortex, it is often difficult to identify landmarks that would ensure proper location. Modern imaging techniques such as ► CT scans or preferably ► MRI can give high quality images in which it is possible to identify the central sulcus and pre-central gyrus with good precision before any surgery is initiated. In addition to correctly locating the motor cortex, one has to also determine the ► somatotopical location. Functional MRI allows one to selectively locate the somatotopically relevant areas of the motor cortex by having the subject perform small movements of the hand or foot while in the magnet. The use of the images obtained pre-operatively combined with an intraoperative computer-assisted 3D navigation and guidance system (► neuronavigation) and direct electrical stimulation or recording of the cortex allows the surgeon to locate the appropriate parts of the motor cortex in most cases. Additional methods to localize the somatotopically relevant areas are to record the cortical potentials evoked in response to stimulating a peripheral nerve or to stimulate the motor cortex and locate the region of the body where muscle twitches or movements occur using standard electromyography. These latter techniques suffer some technical issues that reduce their reliability.

As soon as the electrodes are implanted, it is usually preferable to test the electrodes for placement and function. Although the anesthesia often precludes testing for pain relief, it is good confirmation of proper operation of the electrodes if some muscle twitch of the targeted area is obtained on low frequency stimulation (< 5 cycle / s). Once in place and functioning correctly, the stimulation parameters required for pain relief are below those that produce any muscle activation or seizures. A wide range of stimulation parameters that have been reported as effective (Brown and Barbaro 2003; Canavero and Bonicalzi 2001, 2002) as might be imagined from the large number of variables involved in each placement. The stimulation parameters that have been used and reported to provide relief range from 0.5–1.5 V with frequencies from 5–130 Hz and pulse widths from 60–460  $\mu$ s. The times used for stimulation

also vary widely from continuously on to 10 min a day. The most usual is several hours at a time spread evenly throughout the day or activated by the patient as required. As with other treatments for central or neuropathic pain, it is some times the case that short-term treatment with the cortical stimulators results in long lasting and occasionally permanent pain relief.

The reported success rate of this procedure runs the gamut, with some patients reporting no relief while others experiencing complete (i.e. 100%) analgesia. Fifty to 80% pain relief seems to be the more usual result (Brown and Barbaro 2003; Canavero and Bonicalzi 2001). In terms of numbers of patients helped, Canavero and Bonicalzi (Canavero and Bonicalzi 2001) conclude that approximately 50% of patients with central pain had satisfactory long-term results. The number finding relief from neuropathic pain (i.e. peripheral nerve injury pain) is too limited to draw conclusions. It should be noted that these numbers are from reported studies and might not be completely representative of what happens on a daily basis (there is no registry of all implanted patients).

Motor cortex stimulation is clearly most applicable in central or neuropathic pain (recently it is also emerging as a treatment for abnormal movement disorders). However, the facts that the technique involves surgical intervention and cannot be considered without risk and that success is not ensured argues that other, less invasive therapy might be considered first. It would be useful if there were some way to predict the success of the procedure. Although there have been attempts to find predictive factors there are not yet any reliable markers. Barbiturate sensitivity and opioid insensitivity have been suggested as possible predictors of response (Tsubokawa et al. 1993; Yamamoto et al. 1997) as has ► transcranial magnetic stimulation (Migita et al. 1995). None of these indicators has been found to be infallible and exceptions to these predictors have been reported.

The mechanism by which cortical stimulation leads to pain reduction is not clearly understood. In their original description, Tsubokawa and colleagues (Tsubokawa et al. 1991) considered that motor cortex stimulation reduced somatosensory cortex and / or thalamic activity through inhibition evoked by non-nociceptive neuron activity. Although this might be a reasonable general explanation, there is little detail on how or through exactly what pathways the inhibition might occur. Cortical stimulation might operate at the cortical level through some form of inhibition or gating of somatosensory cortex or other cortical areas known to be associated with pain (Ohara et al. 2005). Alternatively cortical stimulation could activate subcortical sites directly or indirectly and disrupt nociceptive signals. Currently there is no consensus on this question, although one can find individual studies and evidence in the literature to support almost any particular hypothesis. Although we often speak of the motor and sensory systems as

though they were separate entities, in actuality we know they are intimately linked functionally and anatomically. It has been thought for some time (Teuber 1966) that activity in the motor cortex directly influences the somatosensory cortex and evidence has been steadily accumulating to support the idea that activity in the motor cortex alters somatosensory cortex activation by direct connections (Nelson 1996). Thus it is reasonable to postulate that stimulation of the motor cortex gates or damps down activity in the somatosensory cortex. It must be re-iterated that there is still a question over how much role the primary sensory cortex plays in nociceptive processing, so even if motor cortex stimulation does affect SI directly, it is not clear what, if any, the effect on pain would be.

There is considerable anatomical and electrophysiological evidence from animal studies that the motor cortex projects to and influences the responses of both the dorsal column nuclei and the spinal cord dorsal horn (Giuffrida et al. 1985; Zhang et al. 1991) both of which are parts of the pathways transmitting sensory information to the thalamus. These, and other subcortical sites such as the periaqueductal gray matter and raphe nuclei, are known to be involved in pain modulation circuits (Millan 2002) and are obvious sites where the motor cortex could exert sensory effects. Here it should be emphasized that we are concerned specifically with stimulation of the motor cortex. There is substantial experimental evidence that lesion or stimulation of a number of cortical regions such as the cingulate, medial prefrontal and insular cortices in animals (a majority of this work has been done on rats) can change the behavioral responses to noxious stimuli as well as the activity of spinal nociceptive neurons. In this case, most evidence suggests that descending projections to the regions including the hypothalamus, amygdala and brainstem mediate the sensory changes. There is very little data on stimulation specifically of motor cortex in animals and so there is little basic biological data to support or refute suggestions as to how motor cortex stimulation might work in the clinical setting. A full explanation of why motor cortex stimulation works in terms of neural pathways, neurotransmitters and physiological and biochemical changes will depend on development of an animal model and analysis with modern neurobiological experimental methods.

## References

1. Brown JA, Barbaro NM (2003) Motor cortex stimulation for central and neuropathic pain: current status. *Pain* 104:431–435
2. Bushnell MC, Duncan GH, Hofbauer RK et al. (1999) Pain perception: is there a role for primary somatosensory cortex? *Proc Natl Acad Sci USA* 96:7705–7709
3. Canavero S, Bonicalzi V (2001) Motor cortex stimulation. *J Neurosurg* 94:688–689
4. Canavero S, Bonicalzi V (2002) Therapeutic extradural cortical stimulation for central and neuropathic pain: a review. *Clin J Pain* 18:48–55
5. Giuffrida R, Sanderson P, Sapienza S (1985) Effect of microstimulation of movement-evoking cortical foci on the activity of neurons on the dorsal column nuclei. *Somatosens Res* 2:237–247
6. Hirayama T, Tsubokawa T, Katayama Y et al. (1990) Chronic changes in activity of thalamic relay neurons following spinothalamic tractotomy in cat. Effects of motor cortex stimulation. *Pain Suppl* 5:273
7. Migita K, Uozumi T, Arita K et al. (1995) Transcranial magnetic coil stimulation of motor cortex in patients with central pain. *Neurosurgery* 36:1037–1040
8. Millan MJ (2002) Descending control of pain. *Prog Neurobiol* 66:355–474
9. Nelson RJ (1996) Interactions between motor commands and somatic perception in sensorimotor cortex. *Curr Opin Neurobiol* 6:801–810
10. Ohara PT, Vit JP, Jasmin L (2005) Cortical modulation of pain. *Cell Mol Life Sci* 62:44–52
11. Teuber H-L (1966) Alterations of perception after brain injury. In: Eccles JC (ed) *Brain and Conscious Experience*. Springer-Verlag, New York, pp 182–216
12. Tsubokawa T, Katayama Y, Yamamoto T et al. (1991) Chronic motor cortex stimulation for the treatment of central pain. *Acta Neurochir Suppl (Wien)* 52:137–139
13. Tsubokawa T, Katayama Y, Yamamoto T et al. (1993) Chronic motor cortex stimulation in patients with thalamic pain. *J Neurosurg* 78:393–401
14. Yamamoto T, Katayama Y, Hirayama T et al. (1997) Pharmacological classification of central post-stroke pain: comparison with the results of chronic motor cortex stimulation therapy. *Pain* 72:5–12
15. Zhang DX, Owens CM, Willis WD (1991) Short-latency excitatory postsynaptic potentials are evoked in primate spinothalamic tract neurons by corticospinal tract volleys. *Pain* 45:197–201

## Movement Cycles

### Definition

Units of behavior counted to program reinforcement. A movement cycle is said to have occurred when the person is in a position to repeat it. Moving the left foot forward is not a movement cycle. Moving the left and then the right puts the person in a position to repeat; hence, left/right step is a movement cycle. Movement cycles can often be combined into more easily managed units. For example, left step/right step is a movement cycle. A 50-meter lap contains many steps. Those can usually be combined into one lap and „lap“ becomes the unit of behavior.

► [Training by Quotas](#)

## Movement-Related Pain

### Definition

Movement-related pain is pain that occurs with movement. This term refers to both breakthrough pain, in which background pain exists in addition to pain during activity, and incident pain, in which background pain is absent or controlled.

► [Evoked and Movement-Related Neuropathic Pain](#)

## MPQ

- ▶ McGill Pain Questionnaire

## MPS

- ▶ Myofascial Pain Syndrome

## MRI

- ▶ Magnetic Resonance Imaging

## MRS

### Synonyms

Hydrogen Magnetic Resonance Spectroscopy

### Definition

<sup>1</sup>H-MRS (Hydrogen Magnetic Resonance Spectroscopy) is an NMR based technique for assessing function in the brain. MRS takes advantage of the fact that protons (H) possess slightly different resonant properties depending upon the compound. For a given volume of brain (typically > 1 cubic cm), the distribution of these H resonances can be displayed as a spectrum. The area under the peak for each resonance provides a quantitative measure of the relative abundance of that compound.

- ▶ Thalamus, Clinical Pain, Human Imaging

## MS Contin<sup>®</sup>

### Definition

MS Contin<sup>®</sup> is a controlled (slow) release tablet formulation of morphine that produces a peak morphine concentration 4-5 hours post dose, and therapeutic concentrations persist for about 12 hours.

- ▶ Postoperative Pain, Morphine

## MS Contin<sup>®</sup> Controlled (Slow) Release Morphine Sulphate

- ▶ Postoperative Pain, Morphine

## MSDs/MSPs

- ▶ Disability, Upper Extremity

## MTrP

- ▶ Myofascial Trigger Point

## MTrP Circuit

### Definition

An MTrP circuit comprises of the inter-neuronal connections in the spinal cord. The circuit cannot only transfer the nociceptive impulses to the brain, but may also control referred pain patterns via connections to other MTrP circuits. The occurrence of LTRs is also mediated via the MTrP circuit.

- ▶ Dry Needling

## MTrP Locus

### Definition

There are multiple MTrP loci in an MTrP region. An MTrP locus contains two components: the sensitive locus, also known as the local-twitch-response locus (LTR locus), and the active locus, also known as the endplate-noisy locus (EPN locus).

- ▶ Dry Needling

## Mu( $\mu$ )- and Kappa( $\kappa$ )-Opioids

### Definition

Opioids that selectively bind on mu- and kappa- receptors.

- ▶ Endogenous Opioid Receptors
- ▶ MOP Receptor
- ▶ Nitrous Oxide Antinociception and Opioid Receptors
- ▶ Psychological Aspects of Pain in Women

## Mucosa

### Definition

The smooth inner lining of the large intestine that secretes mucus to lubricate the waste materials.

- ▶ Animal Models of Inflammatory Bowel Disease

## Mucosa of Sexual Organs, Nociception

### ► Nociception in Mucosa of Sexual Organs

## Mucositis

### Definition

Mucous membrane toxicity often occurs shortly after administration of chemotherapy or radiotherapy. Inflammation, ulceration, and infection can then occur on the oral and other mucus membranes.

### ► Cancer Pain Management, Overall Strategy

## Mud Therapy

### Definition

Mud therapy involves the application of heated mud packs to parts of the body.

### ► Spa Treatment

## Multiaxial Assessment of Pain

DENNIS C. TURK  
Department of Anesthesiology, University of  
Washington, Seattle, WA, USA  
turkdc@u.washington.edu

### Synonyms

Comprehensive Assessment; Multidisciplinary Assessment

### Definition

Multiaxial assessment refers to a comprehensive assessment of chronic pain sufferers that addresses biomedical, psychosocial, and behavioral domains, as each of these contribute to the chronic pain and disability (Turk and Rudy 1987).

### Characteristics

The ► **biopsychosocial model** of pain proposes that dynamic and reciprocal interactions among biological, psychological, and sociocultural variables shape the pain experience (Turk 1996; Turk et al. 2004). According to this model, the pain experience usually begins when peripheral nociceptive barrage produces physiological changes, although there may be central mechanisms involved in the initiation of pain, and the experience is thoroughly modulated by the unique genetic endowment, learning history, beliefs, affective state, and behavior.

Reports of pain severity and impact will vary depending on a range of contributions, and are not solely the result of physical pathology or perturbations within the nervous system. The biopsychosocial perspective forces an evaluator not only to consider the nature, cause, and characteristics of the noxious stimulation, but the presence of the sensations reflected against a history that preceded symptom onset.

The biopsychosocial model incorporates cognitive-behavioral (CB) concepts (see ► **Cognitive-Behavioral Perspective**) in understanding chronic pain. For example, proponents of this model propose that both the person and the environment reciprocally determine behavior. People not only respond to their environment but elicit environmental responses by their behavior. The person who becomes aware of a physical event and decides the symptom requires attention from a health care provider, initiates a set of circumstances different from the individual with the same symptom who chooses to self-manage symptoms. Another assumption of the CB perspective is that people are active agents and capable of change. The passive role many patients have in traditional physician-patient relationships often reinforces their beliefs that they have minimal ability to impact their own recovery.

To understand and appropriately treat a patient whose primary symptom is pain should begin with a comprehensive history and physical examination. Patients are usually asked to describe the characteristics (for example, stabbing, burning), location, and severity of their pain. Physical examination procedures and sophisticated laboratory and imaging techniques are readily available for use in detecting organic pathology. Physical and laboratory abnormalities, however, correlate poorly with patients' pain reports, and it is often not possible to make any precise pathological diagnosis or even to identify an adequate anatomical origin for the pain. Thus, an adequate pain assessment also requires clinical interviews and utilization of assessment tools to assist in the evaluation of the myriad ► **Psychosocial Factors** and behavioral factors that influence the subjective report.

As there is no pain thermometer that can provide an objective quantification of the amount or severity of pain experienced by a patient, it can only be assessed indirectly based on a patient's overt communication, both verbal and behavioral. However, even a patient's communications make pain assessment difficult, as pain is a complex, subjective phenomenon, comprised of a range of factors, and is uniquely experienced by each individual. Wide variability in pain severity, quality, and impact may be noted in reports of patients attempting to describe what appear to be objectively identical phenomena. Patient's descriptions of pain are also colored by cultural and sociological influences.

A patient's beliefs about the cause of symptoms, their trajectory, and beneficial treatments will have impor-



tant influences on emotional adjustment and adherence to therapeutic interventions. Clinical attention should focus on the patient's specific thoughts, behaviors, emotions, and physiological responses that precede, accompany, and follow pain episodes or exacerbations, including environmental and temporal conditions, and consequences associated with the patient's responses (cognitive, emotional, and behavioral, including frequency and specificity/generality across situations) in these situations. It is valuable to note any patterns of ► **maladaptive thoughts**, as they may contribute to a sense of hopelessness, dysphoria, and unwillingness to engage in activity. Topics that can be covered in an assessment interview might include: asking what the patient thinks is wrong with him/her, what the patient thinks about the pain (e.g. cause, impact), what worries the patient has (e.g. exacerbation of symptoms, impairment), problems the patient has experienced due to pain (e.g. marital, financial, occupational), how the patient lets others know when pain is present, what effect the patient believes the pain is having on others, in what situations the patient experiences increased pain, what others think about their pain, how others respond to their pain, medications they are taking, strategies they have used to alleviate pain, what treatments they have endured for pain management, and prior and current stressful life events.

Turk and Meichenbaum (1994) have suggested that three central questions should guide assessment of people who report pain: (1) What is the extent of the patient's disease or injury (physical impairment)? (2) What is the magnitude of the illness? That is, to what extent is the patient suffering, disabled, and unable to enjoy usual activities? and (3) Does the individual's behavior seem appropriate to the disease or injury, or is there any evidence of amplification of symptoms for any of a variety of psychological or social reasons or purposes? These three general questions can be conceptualized and address three general domains or axes – biomedical, psychosocial, and behavioral.

A thorough clinical assessment should also involve gathering a detailed history from the patient, including past medical history, drug/alcohol use, history of mental illness, and a list of current medications. It is important for the clinician treating chronic pain patients to understand the use of pain medications, in addition to the side-effects associated with them, so as to avoid misinterpreting symptoms and potential misdiagnosis. Patients may also make use of alcohol and illicit drugs to palliate their symptoms. Patients with histories of substance abuse may be at particular risk of becoming dependent on and abusing pain medications. Reviewing the chart and conducting a detailed history of previous and current prescription and substance use may help ascertain whether this area warrants further inquiry.

In addition to interviews, a number of assessment instruments designed to evaluate patients' attitudes, beliefs,

and expectancies about themselves, their symptoms, and the health care system have been developed. Standardized assessment instruments have advantages over semi-structured and unstructured interviews. They are easy to administer, can suggest issues to be addressed in more depth during an interview, require less time, and most importantly, they can be submitted to analyses that permit determination of their ► **reliability** and ► **validity**. The poor reliability and questionable validity of physical examination measures has led to the recent development of self-report functional status measures that seek to quantify symptoms, function, and behavior directly, rather than inferring them. Another advantage of self-report instruments is that they enable the assessment of a wide range of behaviors that are relevant to the patient, some of which may be private (sexual relations) or unobservable (thoughts, emotional arousal). Even traditional psychological measures have been used to identify psychosocial characteristics of the pain experience. These measures, however, must be used with caution, as they were usually not developed for or standardized on samples of medical patients. As a result, it is always best to corroborate information gathered from the instruments with other sources, such as interviews with the patient and significant others, and chart review.

In addition to self-report instruments, more valid information may be obtained by asking about current levels of pain or pain over the past week, and by having patients maintain regular ► **diaries** of pain intensity with ratings recorded several times each day for several days or weeks. Through such diaries, patients can also record activities and the amount of time or the number of times they perform specific behaviors such as reclining, sitting, standing, walking, and so forth.

A third use of patient diaries is to record medication use over a specified interval. Diaries not only provide information about the frequency and quantity of medication, but may also permit identification of the antecedent and consequent events of medication use. For example, a patient might note that he took medication after an argument with his wife, and that when she saw him taking the medication she expressed sympathy. Antecedent events might include stress, boredom, or activity. Examination of antecedents is useful in identifying patterns of medication use that may be associated with factors other than pain per se. Similarly, patterns of response to the use of analgesic may be identified. Does the patient receive attention and sympathy whenever he or she is observed by significant others taking medication? That is, do significant others provide positive reinforcement for the taking of analgesic medication, and thereby unwittingly increase medication use?

The multiaxial approach to assessment is designed to assess and integrate physical, psychosocial, and behavior contributors to pain and disability. There are a large number of measures and procedures that can be used to evaluate each axis. The multiaxial approach to assessment

does not specify any particular methods for assessment. The evaluator will determine the appropriate methods based on his or her experience with chronic pain sufferers, and specific questions that may be of particular importance for a given patient.

Components of the multi-axial assessment can be summarized as follows:

#### Biomedical

- Medical History
- Co-morbid medical conditions
- Pain (intensity, quality, duration, location, exacerbating and alleviating factors)
- Physical Examination
- Laboratory Diagnostic Tests
- Imaging Procedures
- Response to previous treatment (both positive and adverse)

#### Psychosocial

- General history (family composition, education)
- Living status (e.g. married, divorced, romantic relationship)
- Quality of relationships with significant others
- Socioeconomic status
- Work history
- Substance abuse history and current use of drugs and alcohol to control pain as well as recreational.
- Impact of pain on physical, emotional, and social functioning
- Beliefs, attitudes, expectations, and fears about pain, treatment, their plight, and the future
- Prior and current psychiatric status, degree of emotional distress (fear, depression, anger), treatment of patient and family
- Use of coping methods (e.g. problem solving, distraction)
- Satisfaction with previous and current treatment(s)

#### Behavioral

- Use of behavioral methods of coping with pain (e.g. medication, alcohol, exercise, withdrawal)
- Observation of ► [pain behaviors](#) (overt communications of pain distress and suffering)
- Response to pain behaviors by significant others
- Physical, social, and recreational activities
- Vocational status
- Adherence to treatment recommendations (e.g. medication, exercise)

#### References

1. Turk DC, Rudy TE (1987) Toward a Comprehensive Assessment of Chronic Pain Patients. *Behav Res Ther* 25:237–249
2. Turk DC (1996) Biopsychosocial Perspective on Chronic Pain. In: Gatchel RJ, Turk DC (eds) *Psychological Approaches to Chronic Pain Management: Clinical Handbook*. Guilford Press, New York, pp 3–33

3. Turk DC, Meichenbaum D (1994) *A Cognitive-Behavioural Approach to Pain Management*. Wall PD, Melzack R (eds) *Textbook of Pain*, 2<sup>nd</sup> edn. Churchill Livingstone, London, pp 1337–1338
4. Turk DC, Monarch ES, Williams AD (2004) Assessment of Chronic Pain Sufferers. In: Hadjistavropoulos T, Craig KD (eds) *Pain: Psychological Perspectives*. Lawrence Erlbaum, Mahwah NJ, pp 209–243

---

## Multichannel CT

- [CT Scanning](#)

---

## Multidimensional

### Definition

A pain assessment tool that includes measurement of two or more indicators of newborn pain (behavioral, physiological or biochemical). Multidimensional approaches to pain assessment incorporate the use of pain assessment tools that include measurement of two or more indicators of newborn pain, and concurrent consideration of a variety of contextual and modifying factors.

- [Pain Assessment in Neonates](#)

---

## Multidimensional Model

- [Diathesis-Stress Model of Chronic Pain](#)

---

## Multidimensional Scaling and Cluster Analysis Application for Assessment of Pain

W. CRAWFORD CLARK  
College of Physicians and Surgeons, Columbia  
University, New York, NY, USA  
clarkcr@pi.cpmc.columbia.edu

### Synonyms

Multidimensional scaling; Factor Analysis; Pain Questionnaire; Cluster Analysis; pain; emotion

### Definition

Multivariate scaling (MVS), a subset of multivariate statistics, includes a large group of mathematical techniques and data collection procedures. Of particular interest here are multidimensional scaling (MDS), cluster analysis and preference mapping (PREFMAP). These models yield a geometric representation that makes it easier for an investigator to uncover the “hidden structure” of complex data bases. These techniques

use similarity judgments or other measures of association to generate proximities among a set of ► **stimulus objects** as input. An object is a thing, or event; a stimulus is the perceived object. Stimulus objects may be words, physical stimuli or concepts. Just as a map yields far more information (distance, direction) than does a list of cities, so MVS procedures yield more information than do scores on rating scales or questionnaires. These procedures yield the ► **group stimulus space**, a configuration of points (stimulus objects) along dimensions in continuous space, or as clusters in discrete space. A ► **dimension** is a characteristic that serves to define a point by its coordinates. Another advantage of these models is that they also quantify individual differences by providing ► **subject weights** in the source or weight space, which quantify the saliency or relative importance that each individual attaches to each cluster or dimension. The subject weight scores can be correlated with other test scores or used to distinguish subpopulations in the sample. Information about individual differences promises to be useful in determining treatment strategies for individual patients. An important aspect of MVS procedures is that the subject is typically asked to make similarity judgments between pairs of a set of stimulus objects. Thus, the MVS procedures are more objective than commonly used procedures that assign scales determined by the investigator, because the participant, not the investigator, determines the dimensions or clusters.

## Characteristics

### Introduction to Multivariate Scaling

#### Multidimensional Scaling

Introductions to INDSCAL and other spatial distance models are provided by Carroll and Arabie (1998), Kruskal and Wish (1978), Schiffman (1981), Weinberg and Carroll (1992), and Lattin et al. (2003). Introductions and reviews of applications to pain and emotion are available (Clark 2003).

Of paramount importance to the investigation of sensory pain and emotional suffering is that the stimulus objects may be calibrated physical stimuli (e.g. heat, cold, electrical) or they may be verbal descriptors (e.g. moderate pain, stabbing, anxiety), or both. A variety of data collection procedures and mathematical models are used to obtain and analyze measures of proximity – a number that represents the amount of similarity or difference between a pair of stimulus objects. One of the key ideas in MVS is that these subjective proximity measures, which represent psychological distance, can be used to scale physical distance. MVS models construct a configuration of points as on a map, so that the distances in the group stimulus space systematically model the judged proximities. To obtain direct proximity data, pairs of stimuli are judged with respect to their degrees of similarity or dissimilarity. In general, prox-

imity measures may be obtained from other measures of association such as correlations, joint probabilities, or phi-coefficients. As the number of pairwise comparisons rapidly increases with the number of stimulus objects, less direct procedures, such as pile-sort where the subject partitions the stimulus objects into groups based on similarity, are used.

#### Interpreting Dimensions

Dimensions are interpreted by examining the stimulus objects at each pole (the remaining central stimulus objects will usually be found at the poles of other dimensions). The stimulus objects at the poles of each dimension should share a common meaning, and the two poles will generally be opposite in nature. The use of PREFMAP in interpreting the meaning of a dimension is described later. Interpretation of the spatial features is somewhat subjective, since, because the sampling distributions are unknown, there are no inferential statistical tests available for determining the number of dimensions. However, Weinberg and Carroll (1992) describe a number of approaches to approximating the true space.

#### Two-Way, Three-Way and Higher-Way Models

MVS clustering and multidimensional models are classified as two-way, three-way or higher-way (Carroll and Chaturvedi 1995). In these models, the data are organized into a half-matrix, in which rows and columns correspond to stimulus objects and the cells contain some measure of similarity. As two-way models (e.g. KYST) are computed from a single group matrix in which the cells are means averaged over subjects, they yield only the group stimulus space. Three-way, or individual differences scaling, models (e.g. INDSCAL) treat matrices that correspond to individual subjects, or, if desired, to subgroups. Three-way models assume that different individuals perceive stimuli in terms of a common set of dimensions or clusters, but that these features differ in their saliency or importance to different individuals. In addition to the group stimulus space, the three-way models provide a source space that yields individual subject weights on each dimension or cluster. Subject weights measure the importance of each dimension to an individual. They can be used to distinguish among subgroups in the sample population, and may be correlated with psychological and physiological measures. In medicine, where knowledge about the individual patient is essential, the three-way model is essential.

#### Cluster Analysis

Cluster models represent the structure of a set of stimulus objects as subsets of clusters, where each cluster corresponds to a meaningful group of stimulus objects. Depending upon the model used, the clusters may be non-overlapping or overlapping. Two major types of clus-

ter models are the hierarchical and the additive models (Latin et al. 2003).

### **Relationship between Clustering and Spatial Distance Models**

Cluster and MDS (spatial distance) models are similar in many ways: the same pairwise similarity judgment data can be analyzed by either procedure and both are distance models. However, important differences exist. Cluster analysis groups stimulus objects that are most similar, while spatial distance models emphasize ways in which items are different. Cluster analysis is superior to multidimensional scaling when the stimulus objects are discrete and not readily placed on a continuum or when the number of descriptors is large.

### **Property or Preference Mapping (PREFMAP)**

Property or preference mapping (PREFMAP) models (Carroll and Chaturvedi 1995) provide an objective aid to the interpretation of dimensions. Features, that is, the dimensions of the clusters in the group stimulus space, are usually interpreted by inspection. However, if the features are ambiguous, or if specific hypotheses are being tested, it is useful to have additional information that is objectively based on subjects' judgments. The PREFMAP model provides independent information that aids interpretation of the group stimulus.

### **Relation of MVS to Factor Analysis**

Factor analysis, another multivariate procedure, has proven useful for the study of responses to questionnaires by various pain patient populations. However, because the investigator determines the response scales, factor analysis cannot reveal in an unbiased manner the number and types of dimensions that underlie patients' sensory, emotional and other experiences. Schiffman et al. (1981) point out other advantages of the multivariate scaling approach over that of factor analysis. It is easier to interpret the distances between points than angles between vectors, and MVS provides more easily interpretable solutions with fewer and much more homogeneous dimensions.

### **Pain Studies with MVS Procedures**

MVS studies of responses to calibrated sensory stimuli offer a way to discover the dimensions of physical pain and their relationship to pain descriptors. In the first application of INDSCAL to the study of pain, Clark et al. (1986) analyzed judgments made to various intensities of noxious and non-noxious heat stimuli and obtained a two-dimensional solution. In a subsequent study, INDSCAL analysis of pairwise similarity ratings made to electrical stimuli of five intensities (milliwatts) and three frequencies (hertz) yielded a two-dimensional solution with the stimuli ordered with respect to intensity along a Sensory Magnitude dimension and with respect to fre-

quency along a Frequency dimension (Janal et al. 1993). The interpretation of the dimensions in the group stimulus space was supported by PREFMAP analysis of subjects' ratings of each of the stimuli with respect to bipolar property scales (e.g. Faint Pain – Severe Pain). As expected, the Pain Magnitude dimension was related to property scales in the Sensory, Emotional and Arousal domains, while the Frequency dimension was identified only with the Fast-Slow property scale.

### **Studies with Descriptors of Pain and Emotion**

The number and composition of the dimensions underlying the sensory, emotional, motivational, and other aspects of pain remain controversial in spite of considerable speculation and some research. These various views concerning the number of dimensions and their composition are based entirely on subjective impressions. Clearly "armchair taxonomy" cannot settle arguments over the number and nature of pain dimensions. Clark et al. (2001) used INDSCAL to study this question. INDSCAL analysis of responses to 16 descriptors of sensations, negative and positive emotions and motivation yielded four dimensions (D) in the group stimulus space. Dimensions are defined by the descriptors at the poles. D-1, Intense to Moderate Experiences, contained two attributes: Strong Pain Sensations (Severe Pain to Slight Sensation) and Strong Emotions (Upsetting to Comforting). D-2, Moderate to Weak Experiences, exhibited two attributes: (i) moderate pain sensations (Faint Pain to No Sensation) and (ii) moderate emotions (Uncomfortable to Comforting). D-3, Motivational State, possessed two attributes: (i) pain (Severe Pain to Faint Pain) and (ii) arousal level (Startling to Indifferent). D-4, Sensory Qualities, exhibited two attributes: (i) pain (Severe Pain to Faint Pain) and (ii) somatosensory qualities (Hammering to Tingling). The interpretation of the dimensions was supported by PREFMAP and by correlations between subject weights and psychological tests. The results clearly demonstrated that pain and other dimensions are not orthogonal to one another, for in each of the four dimensions the sensory pain attribute is inseparable from both the strong and weak emotional attributes, the motivational attribute and the somatosensory qualities attribute. It may be concluded that sensory pain does not exist as an independent dimension separate from other dimensions of pain. The practical implication of this finding is that a score on a unidimensional pain intensity rating scale cannot be a pure measure of the patient's pain experience. That a patient cannot separate these components of pain has been strongly supported by the finding that ratings of pain intense by patients experiencing postoperative pain on a unidimensional numerical pain rating scale are strongly influenced by the patients' emotional state, specifically depression, anxiety, anger and fear (Clark et al. 2002).



### Quantifying the Relation between Physical Stimuli and Verbal Descriptors

What is the relationship between sensory experiences induced by physical stimuli and the descriptors of these experiences? In the first study of its kind, we used INDSCAL to study pairwise similarity responses for a set of stimulus objects containing both electrical stimuli of various intensities, and sensory and emotional descriptors used to describe these sensory experiences (Janal 1995). The subjects made pairwise similarity judgments to all possible pairings of 16 stimulus objects: 8 electrocutaneous stimuli ranging in intensity from innocuous (3 mW) to noxious (235 mW), and 8 somatosensory and affective descriptors of these sensations which ranged from Slight Sensation, Tingling and Comforting to Severe Pain, Hammering and Upsetting. INDSCAL analysis revealed a 1-dimensional solution with a close relationship between the perceived intensities of the physical stimulus coordinates and the words describing them. While preparing this paper, it occurred to this author that a quantitative relation between the verbal and the physical stimulus weights could be obtained, by plotting the INDSCAL stimulus coordinates of both the verbal and the physical stimulus objects (ordinate) against a scale of intensities in milliwatts (abscissa). A plot of the perceived stimulus coordinates (ordinate) against an objective scale (abscissa) yielded two exponential functions that contain more information than found with magnitude estimation procedures.

### Clinical Pain: Identifying Individual Differences in the Saliency of Pain Dimensions

The results of the following study suggest how multidimensional scaling could be used to determine treatment strategies. Clark et al. (1989) used INDSCAL to compare the group stimulus and subject weight spaces of inpatients suffering cancer-related pain with those of healthy volunteers. The question was "Do patients and volunteers differ in whether the emotional or the sensory dimension is more salient?" The participants made pairwise similarity judgments between all possible pairings of a set of nine descriptors of sensory pain, emotional pain and somatosensory qualities. The group stimulus spaces of patients and controls revealed similar 3-dimensional solutions: Sensory Pain Magnitude, Emotional Quality, and Somatosensory Quality. However, the subject weight space, which yields coordinates for each individual on each dimension, demonstrated that the saliency of the various dimensions varied widely among subjects. For some individuals the Pain Magnitude dimension was most important in determining their similarity judgments (high values on the abscissa, low on ordinate); for others the Emotional Quality dimension was most salient, while for yet others the two dimensions were equally important. The coordinates for each subject in the subject weight or source space revealed wide individual differences, but significantly

more patients than controls found the Pain Magnitude dimension to be the most salient. The wide individual differences found suggest that the location of a patient in the subject weight space might prove useful in tailoring treatment. For example, a patient who finds the Pain Magnitude dimension to be most salient might profit from a higher analgesic dose, while a patient who weights on the Emotional Quality dimension might experience relief following the addition of a psychoactive medication and, perhaps, a reduction in the analgesic. In brief, the patient's coordinates in the subject weight space can help determine treatment.

### Other MDS Applications to Problems of Pain

A number of imaginative applications of various MVS procedures to problems in pain have been pursued: measurement of neural response patterns to noxious stimulation using cluster analysis; pain during activities of daily living; in post-operative myalgia patients by PREFMAP; facial expression of clinical pain and emotion; cross cultural comparison of dental pain and emotional attitudes in Chinese and Western patients and dentists by cluster analysis and cross-cultural comparisons of cancer pain in various European and Asian groups using MDS. Details appear in a review by Clark (2003).

### Questionnaire Construction by Cluster Analysis

Another application of MVS is the construction of questionnaires. Clark et al. (1995) used a hierarchical clustering model to analyze pile-sort similarity judgments made by seven experienced pain researchers to 270 descriptors of sensory pain, negative and positive emotions, motivation, illness and health. Analysis by the average-linkage-between-groups clustering model produced a dendrogram with 50 subclusters subsumed within 18 primary clusters. No evidence was found to support the homogeneous status claimed for descriptors in the major Evaluative Class of the MPQ. A large number of the descriptors that were assigned to each of the 22 subgroups of the MPQ were found to be dispersed over a number of different clusters in the dendrogram. In a subsequent study, described by Yang et al. (2000), healthy male and female African-American, Euro-American and Puerto Rican subjects sorted 189 descriptors into similar piles (pile-sort technique), and then sequentially merged their piles on the basis of similarity (merge technique) until only two piles remained. The addition of the merge technique greatly improved the hierarchical structure of the dendrogram. Dendrograms for each of the six groups revealed striking gender and ethnocultural differences in the language of pain. Men and women and ethnocultural groups disagreed on the cluster location, and hence the meaning, of 30 descriptors; 58 other descriptors were found to be very similar (redundant). The remaining 101 descriptors and clusters determined the structure of the Multidimensional Affect and Pain Survey (MAPS). Thus, unlike the MPQ,

the MAPS questionnaire is based on the structure of the empirically derived dendrogram that emerged from subjects' views of their sensory-emotional pain spaces.

### Validation of MAPS

Factor analysis has demonstrated the validity of MAPS, and hence, the advantage of the cluster analytic approach to test construction (Clark et al. 2003). If MAPS is a valid questionnaire for the quantification of emotion and pain, then factor analysis of cancer patients' ratings should produce factors that correspond uniquely to the clusters and superclusters of the MAPS dendrogram. Almost all of the clusters in the MAPS Somatosensory Pain Supercluster loaded on three sensory-pain related factors. Most of the clusters in the Emotional Pain Supercluster loaded on emotional factors, and the Well-being Supercluster loaded on the good health factor. This correspondence between clusters and factors stands in sharp contrast with factor analytic studies of the MPQ, where subclasses of its sensory, affective and even evaluative classes often load on a single factor. The meanings of such mixed factors are very difficult to interpret. The cause of this factor heterogeneity and the discrepant results obtained by various investigators is probably due to the a priori procedure used by investigators of the MPQ to classify descriptors into its major classes and subclasses.

### Conclusions

It is obvious that the MVS models, multidimensional scaling, cluster analysis and PREFMAP, offer original approaches to many theoretical and practical questions in a variety of fields. They identify the underlying structure of the dimensions of the experience and response to pain and emotion, drug induced states, patterns of neural response and facial expressions. These methods can be used to construct new questionnaires and to discover the latent structure of existing questionnaires. In addition, MDS of similarity responses to descriptors and to physical stimuli can be used to quantify the intensity of descriptors at a ratio scale level of measurement. Considering the widespread use of MDS, cluster analysis and PREFMAP in psychology and the social sciences (where it has been used to study visual, auditory and taste perception, language, consumer preferences, kinship patterns, the provenance of ancient pottery, etc.), it is astonishing that these methods have not been applied more extensively to complex medical problems.

### Acknowledgements

This essay and much of the research here was supported by the Nathaniel Wharton Fund for Research and Education in Brain, Body and Behavior, NIDR 20248 and NICDR 12725. The author wishes to thank Dr. J.D. Carroll, Board of Governor's Professor, Rutgers University, for his many helpful comments, but the author is responsible for any errors that may remain.

### References

1. Carroll JD, Arabie P (1998) Multidimensional Scaling. In: Birnbaum MH (ed) Handbook of Perception and Cognition. Vol 3: Measurements, Judgment and Decision. Academic Press, San Diego, pp 179–250
2. Carroll JD, Chaturvedi A (1995) A General Approach to Clustering and Multidimensional Scaling of Two-Way, Three-Way, or Higher-Way Data. In: Luce RD, D'Zmura M, Hoffman DD (eds) Geometric Representation of Perceptual Phenomena. Erlbaum, Mahwah, pp 295–318
3. Clark WC (2003): Pain, Emotion, and Drug-Induced Subjective States. In: Adelman G, Smith B (eds) Encyclopedia of Neurosciences, 3<sup>rd</sup> edn. Elsevier, Amsterdam (CD-ROM)
4. Clark WC, Carroll JD, Yang JC et al. (1986): Multidimensional Scaling Reveals Two Dimensions of Thermal Pain. *J Exp Psychol (Hum Percept)* 12:103–107
5. Clark WC, Ferrer-Brechner T, Janal MN et al. (1989) The Dimensions of Pain: A Multidimensional Scaling Comparison of Cancer Patients and Healthy Volunteers. *Pain* 37:23–32
6. Clark WC, Janal MN, Hoben EK et al. (2001) How Separate are the Sensory, Emotional, and Motivational Dimensions of Pain? A Multidimensional Scaling Analysis. *Somatosens Mot Res* 18:31–39
7. Clark WC, Kuhl JP, Keohan ML et al. (2003) Factor Analysis Validates the Cluster Structures of the Dendrogram Underlying the Multidimensional Affect and Pain Survey (MAPS) and Challenges the A Priori Classification of the Descriptors in the McGill Pain Questionnaire (MPQ). *Pain* 106:357–363
8. Clark WC, Yang JC, Tsui SL et al. (2002) Unidimensional Pain Rating Scales: A Multidimensional Affect and Pain Survey (MAPS) Analysis of What They Really Measure. *Pain* 98:241–247
9. Janal MN (1995) Concerning the Homology of Painful Experiences and Pain Descriptors: a Multidimensional Scaling Analysis. *Pain* 64:373–378
10. Janal MN, Clark WC, Carroll JD (1993) Multidimensional Scaling of Painful Electrocutaneous Stimulation: INDSCAL Dimensions, Signal Detection Theory Indices, and the McGill Pain Questionnaire. *Somatosens Motor Res* 10:31–39
11. Kruskal JB, Wish M (1978) Multidimensional Scaling. Sage, Beverly Hills
12. Lattin JM, Carroll JD, Green PE (2003) Analyzing Multivariate Data. Duxbury Press, Belmont
13. Schiffman SS, Reynolds ML, Young FW (1981) Introduction to Multidimensional Scaling. Academic Press, New York
14. Weinberg SL, Carroll JD (1992) Multidimensional Scaling: An Overview with Applications in Educational Research. *Adv Soc Sci Methodology* 2:99–135
15. Yang JC, Clark WC, Tsui SL et al. (2000): Preoperative Multidimensional Affect and Pain Survey (MAPS) Scores Predict Post-Colectomy Analgesia Requirement. *Clin J Pain* 16:314–320

## Multidisciplinary

### Definition

Medical disciplines working with the same patient.

- ▶ [Physical Medicine and Rehabilitation, Team-Oriented Approach](#)

## Multidisciplinary Assessment

- ▶ [Multiaxial Assessment of Pain](#)

## Multidisciplinary Pain Centers, Rehabilitation

DENNIS C. TURK

Department of Anesthesiology, University of Washington, Seattle, WA, USA  
turkdc@u.washington.edu

### Synonyms

Multidisciplinary pain clinics, Interdisciplinary pain rehabilitation programs, Functional restoration program, Pain clinics

### Definition

An organization of health care professionals and basic and applied scientists that includes research, teaching, and patient care related to acute and chronic pain. It includes a wide array of health care professionals including physicians, psychologists, nurses, physical therapists, occupational therapist, and other specialty healthcare providers. Multiple therapeutic modalities are available. These centers provide evaluation and treatment and are usually affiliated with major health science institutions. Multidisciplinary pain clinics are similar to multidisciplinary pain centers (MPC), with the exception being that they do not include basic scientists and may not be involved in conducting research.

### Characteristics

Although there is no single format for multidisciplinary pain management or the operations of an MPC, almost every treatment facility of this type has a generic concept and plan.

#### Concepts of Treatment at Multidisciplinary Pain Clinics

- Reconceptualization of the patient's pain and associated problems from uncontrollable to manageable
- Overt or covert efforts are made to foster optimism and combat demoralization
- Flexibility is the norm with attempts to individualize some aspects of treatment to patient needs and unique physical and psychological characteristics
- Emphasize active patient participation and responsibility
- Provide educational and training in the use of specific skills such as exercise, relaxation, and problem solving
- Encourage patient feelings of success, self-control, and self-efficacy
- Encourages patients to attribute success to their own efforts

These treatment programs also share general features.

#### General Features of Multidisciplinary Pain Treatment Teams

- Share a common conceptualization of chronic pain patients

- Synthesize the diverse sets of information based on their own evaluations, as well as those of outside consultants, into a differential diagnosis and treatment plan customized to meet the specific need of each patients
- Work together to formulate and implement a comprehensive rehabilitation plan based on available data
- Share a common philosophy of disability management
- Act as a functional unit whose members are willing to learn from each other and modify, when appropriate, their own opinions based on the combined observations and expertise of the entire group

In MPCs, patients are usually treated in groups. Patients work on at least 4 issues simultaneously: physical, pharmacological, psychological, and vocational. Programs usually emphasize helping patients to gain knowledge about pain and how the body functions, physical conditioning, medication management, acquisition of coping and vocational skills. Individual and group counseling address patient's needs. In contrast to traditional Western health care, the emphasis is upon what the patient accomplishes, not on what they say. The providers serve as teachers, coaches, and sources of information and support (Loeser and Turk 2001).

Multidisciplinary pain management requires the collaborative efforts of many healthcare providers, including, but not limited to, physicians, nurses, psychologists, physical therapists, occupational therapists, and vocational counselors. The healthcare providers act as a team, with extensive interaction amongst the team members.

The following list itemizes the goals of multidisciplinary pain management. Every patient will have a different mixture of functional limitations, pain behaviors, affective disturbance, physical disability, and vocational dysfunction. Successful treatment will address each of these general areas.

#### Goals of Multidisciplinary Pain Management

- Identify and treat unresolved medical issues
- Symptomatic improvement
- Eliminate inappropriate medications, institute desirable medications
- Improve aerobic conditioning, endurance, strength and flexibility (restoration of physical functioning)
- Eliminate excessive guarding behaviors that interfere with normal activities
- Improve coping skills and psychological well-being
- Alleviate depression
- Foster independence
- Assess patient resources and identify vocational and recreational opportunities
- Educate the patient about pain, anatomy, physiology and psychology, discriminating hurt from harm

- Educate the patient about prudent health care consumption
- Assist the patient to establish realistic goals and to maintain treatment gains
- Restoration of social and occupational functioning - social reintegration, return to productive employment
- Reduction in use of healthcare system

The original MPCs were inpatient-based. It is now apparent that outpatient programs can be equally successful if they have adequate intensity and duration (for a review see Turk et al. 1993). There are no controlled studies to determine the optimal duration of treatment and hours per day; nor does the literature reveal which aspects of the various components are most important for a treatment program. It is clear, however, that the effects of an MPC are greater than the sum of its parts. Common features of all programs include physical therapy, medication management, education about how the body functions, psychological treatments (e.g. learning coping skills, problem solving, communication skills training), assessment, and therapies aimed at improving function and the likelihood of return to work. Programs usually have a standard daily and weekly format that providers can tailor to individual patient needs. The overall length of a program depends, in part, upon unique patient requirements. Typical programs operate 8 hours per day, 5 days per week and last 3 to 4 weeks, although some programs meet less frequently and are of longer duration.

#### Roles of the Physician

The physician is responsible for the initial history and physical examination; review of outside records and determination of the need for any further diagnostic tests. Detailed assessment of the patient's medication history is also a key physician contribution. The implementation of medication management, including drug tapering by means of a ► **pain cocktail** technique (described below), is also a physician role. Another important task for the physician is to review with the patient the medical issues and the findings of diagnostic tests and imaging studies. The physician also plays an essential role in the education of the patient, and in legitimating all of the other components of the treatment program.

#### Roles of the Psychologist

The psychologist typically conducts the initial psychological evaluation, monitors and implements the cognitive and behavioral treatment strategies, teaches the patient coping skills, and educates patients about the relationship between thoughts, feelings, behavior, and physiology. The psychologist usually leads both individual and group educational and counseling sessions for the patients. In addition, the psychologist plays a critical role in helping other members of the treat-

ment team to employ sound behavioral principles in designing patient treatment activities (Turk and Gatchel 2002).

#### Roles of the Nurse

The nurse is a key part of the treatment program, playing a major role in patient education regarding such topics as medication, diet, sleep hygiene, and sexual activity. Another nursing function is assisting patients in the practice of newly learned skills, assessing medication responses, and acting as the focal point of the communication that keep such a program operational. The roles of nurses vary with their skills and their interaction with other providers. Since the nurses tend to be with the patients throughout their entire treatment course, they play a central role in maintaining continuity during the treatment program.

#### Roles of Physical and Occupational Therapists

Physical and occupational therapists provide assessment and active physical therapies for patients to improve their strength, endurance and flexibility. They do not provide passive modalities of treatment. They assist the patient in developing proper body mechanics and strategies for coping with the physical demands of a job and everyday life, and function mainly as teachers and coaches.

The occupational therapists review the patient's work history, disabilities, and factors that may play a role in determining who goes back to work and who does not. They help in the establishment of work hardening and training activities. Some programs heavily emphasize ergonomic issues and utilize high technology in physical therapies; however, the need for this type of treatment is unclear.

#### Role of the Vocational Counselor

The vocational counselor plays a critical role in the treatment of an individual for whom return to work is a treatment goal. Initial assessment occurs as part of the screening process, but in-depth evaluation of interests, education, aptitude, physical capacities, learning capabilities, work experience, transferable skills and vocational goals occurs upon entry into the treatment program. The goals are to identify vocational opportunities and barriers to effective return to work. In addition to occupational counseling, counselors provide job seeking skills training, placement counseling, work hardening, information about educational options and liaison services. Information obtained by the vocational counselor is critical for other team members to establish realistic goals for the patient. In some organizations, rehabilitation nurses provide this service.

#### Treatment Principles

The goals of multidisciplinary pain management are normally specific, definable, operationalizable, and realistic in nature (see list 'Goals of Multidisciplinary Pain



**Multidisciplinary Pain Centers, Rehabilitation, Table 1** Issues Addressed by Psychologists

Impact of pain on life, significant others	Resourcefulness vs. helplessness
Communication	Problem Solving
Reinforcement and pain behaviors	Relationship between thoughts, feelings, behavior, and physiology
Goal setting, homework, adherence	Coping Skills (relaxation, distraction, positive thoughts)
Self-reinforcement	Fear of activity
Stress and Pain and Homework	Generalization, maintenance, flare-ups, Relapse

**Multidisciplinary Pain Centers, Rehabilitation, Table 2** General Educational Topics Covered

Body mechanics, modification of movement patterns	Role of medication
Posture	Sleep hygiene
Energy conservation	Diet
Performance of activities of daily living	Sexuality
Hurt vs. harm	Anatomy & Physiology
Leisure activities	Gate Control Theory
Vocational activities	Home practice
Active vs. passive exercises and modalities	Progressive exercises
Adherence to recommendations	Management of flare-ups

M

Management'). As they have evolved, MPC treatments have become performance based, goal-directed, and outcome driven. Integration of medical evidence related to patient's pain and physical impairment with information concerning what patients are doing or failing to do because of their pain, how these behaviors influence patient's physical capacity, how others respond to the patient, the influence of psychosocial factors that contribute directly and indirectly to patient's physical and emotional status, and the potential for rehabilitation (i.e. disability) are essential. The treatment team must build an alliance with patients to instill a willingness to accept the need for self-management.

Physical therapy employs behavioral medicine principles (Turk et al. 2000) and, as noted, engages few, if any, passive modalities. The emphasis is upon improving strength, endurance and flexibility through the patient's physical activities. The therapists provide instruction, guidance, safety and encouragement. Accomplishments, rather than pain behaviors, receive rewards. Patients maintain graphs of their daily activity and track progress. As patients progress, they enroll in more complex activities that simulate the workplace requirement.

Medications are given on a time contingent basis, so as to uncouple the reinforcement of pain behaviors by medications. In general, patients in an MPC program do not derive adequate pain relief from analgesic medications, and this is why they are usually tapered by means of the pain cocktail technique. This technique is simply

a method of converting all opioids to an equivalent dose of methadone, delivered with a masking vehicle. The dose is then tapered over the period of treatment, always with the full knowledge of the patient. Most medications are discontinued; the common exceptions are antidepressants, which often help chronic pain patients. MPCs discourage long-term use of other medications, both because of their potential side effects and because their use undermines the philosophical concept that the patient must learn to control his or her pain, and not depend upon healthcare providers or their prescriptions. Psychological strategies generally target altering behavior rather than changing the patient's personality. Patients learn coping skills because this is frequently a deficiency that has led to the patient's many difficulties (see following list). Couples therapy is sometimes appropriate. Issues that patients bring up receive attention in either the group format or in individual therapy, as needed. As depression is so often a component of the chronic pain problem, it warrants both psychological as well as pharmacological interventions. Psychologists provide relaxation and consolidation sessions that allow the patients to work on newly acquired skills, and explore educational topics and new psychological skills (see Table 1).

#### Coping Skills Taught

- Relaxation
- Distraction (attention diversion) methods

- Cognitive restructuring – identification and challenging maladaptive thoughts and feelings
- Problem solving
- Anger management
- Desensitization
- Rehearsal and home practice
- Communication skills including assertiveness
- Goal setting
- Pleasant activity planning
- Self-monitoring and Self-reinforcement

An important aspect of MPCs is education. This is an activity that is shared by physicians, psychologists and nurses. Topics cover a wide array of the problems facing those who suffer from chronic pain. Topic selection and content is to some degree a function of the needs of each group of patients, but content always includes a core set of issues (see Table 2).

An important issue is the maintaining of gains that have occurred during the treatment program. Surrounded by a team of supportive healthcare providers and other patients, most patient see some gains by the end of treatment. However, many are unable to maintain their gains when they return to their normal family and occupational activities. Each patient must learn strategies for maintaining his or her gains in a less supportive environment. Most programs have established brief follow-up interactions to try to assist patients to keep up their physical and psychological skills and to prevent relapses.

### Outcomes

A substantial body of literature supports the assertion that multidisciplinary pain treatment is effective in reducing pain, the use of opioid medication, the use of health care services; it increases activity, returns people to work, and aids in the closing of disability claims (e.g. Cutler et al. 1994, Guzman et al. 2001). Moreover, treatment at MPCs targets patients with the most recalcitrant problems, yet the benefits appear to exceed those for conventional treatments including surgery and, in contrast to surgery, there are no known iatrogenic complications of treatment at MPCs (Turk 2002). Not only do MPCs appear to be clinically effective, they also appear to be cost-effective, with the potential to provide substantial savings in healthcare and disability payments (Turk 2002).

### Conclusions

The team approach to complex chronic pain patients, as found in a multidisciplinary pain treatment facility, has evolved with an underlying set of principles. These include the recognition that Cartesian mind-body dualism is a curse upon effective healthcare. Second, a biopsychosocial model is required to capture all of the relevant factors. Third, the treatment must address the pain itself, and not just be a search for hidden causes and specific remedies for these causes. Fourth, the treatment must

address the restoration of well-being and not just aim at the alleviation of symptoms. Finally, the illness is not just chronic pain but is also the failure to work, often ascribed erroneously to the pain instead of the patient or the patient's circumstances.

### References

1. Cutler RB, Fishbain DA, Rosomoff HL et al. (1994) Does Non-surgical Pain Center Treatment of Chronic Pain Return Patients to Work? A Review and Meta-Analysis of the Literature. *Spine* 19:643–652
2. Guzman J, Esmail R, Karjalinen K et al. (2001) Multidisciplinary Rehabilitation for Chronic Low Back Pain: Systematic Review. *BMJ* 322:1511–1516
3. Loeser JD, Turk DC (2001) Multidisciplinary Pain Management. In: Loeser JD, Butler SD, Chapman CR, Turk DC (eds) *Bonica's Management of Pain*, 3<sup>rd</sup> edn. Lippincott Williams and Wilkins, Philadelphia PA, pp 2069–2079
4. Turk DC (2002) Clinical Effectiveness and Cost Effectiveness of Treatments for Chronic Pain Patients. *Clin J Pain* 18:355–365
5. Turk DC, Gatchel RJ (2002) *Psychological Treatment of Chronic Pain: Clinical Handbook*, 2<sup>nd</sup> edn. Guilford Press, New York
6. Turk DC, Okifuji A, Sherman J (2000) Behavioral Aspects of Low Back Pain. In: Taylor JR, Twomey L (eds) *Physical Therapy of the Low Back*, 3<sup>rd</sup> edn. Australia, pp 351–383
7. Turk DC, Rudy T, Sorkin B (1993) Neglected Topics in Chronic Pain Treatment Outcome Studies: Determination of Success. *Pain* 53:3–16

---

## Multidisciplinary Pain Treatment for the Elderly

### Definition

The elderly are underrepresented in multidisciplinary programs, despite the fact that multimodal treatment is a key to successful practice in geriatric medicine.

- ▶ [Psychological Treatment of Pain in Older Populations](#)

---

## Multidisciplinary Treatment Program

### Definition

Physicians, nurses, physical therapists, and psychologists in one pain-management center. Treatment staff meet weekly to review patient progress in the program, which emphasizes pain reduction and functional outcomes.

- ▶ [Complex Chronic Pain in Children, Interdisciplinary Treatment](#)
- ▶ [Multimodal Rehabilitation Treatment and Psychiatric Aspects of Multimodal Treatment for Pain](#)
- ▶ [Psychological Treatment of Chronic Pain, Prediction of Outcome](#)

## Multimodal

### Definition

Refers to treatment approaches that use more than one type of therapy (e.g. a combination of drug, psychological and or physical therapies).

- ▶ [Complex Chronic Pain in Children, Interdisciplinary Treatment](#)

## Multimodal Analgesia

### Synonyms

Balanced analgesia

### Definition

Multimodal analgesia (also known as balanced analgesia) occurs from a combination of analgesics (multimodal mixture). The rationale is that each drug exerts its analgesic effect via a different mechanism. Thus, a low-dose combination might offer the best therapeutic effect, while minimizing the risk of the unwanted adverse effects seen with high doses of each of these drugs.

- ▶ [Epidural Infusions in Acute Pain](#)
- ▶ [Multimodal Analgesia in Postoperative Pain](#)
- ▶ [Postoperative Pain, Importance of Mobilisation](#)
- ▶ [Postoperative Pain, Transition from Parenteral to Oral Drugs](#)

## Multimodal Analgesia in Postoperative Pain

EDWARD A. SHIPTON  
Christchurch School of Medicine and Health Sciences,  
Department of Anaesthesia, University of Otago,  
Christchurch, Otago, New Zealand  
shiptonea@xtra.co.nz

### Synonyms

Balanced analgesia

### Definition

▶ **Multimodal analgesia** is the technique of combining multiple modalities of pain relief to provide more effective analgesia and a lower incidence of adverse effects. Different analgesics act on different receptors, enzymes and ionic channels, creating an additive or synergistic response. There is a concomitant reduction in adverse effects, owing to the lower dose of the individual drugs and differences between drugs in adverse effect profiles (Shang and Gan 2003).

### Characteristics

Single analgesics, for example opioids or non-steroidal anti-inflammatory drugs (NSAIDs), are not able to provide effective pain relief without side effects such as nausea, vomiting, sedation, or bleeding (Jin and Chung 2001). The use of multi-drug therapy such as in ▶ **neuraxial blocks**, is a common and effective example of the multimodal approach, and may help to prevent rapid tolerance to individual medications. Studies of multimodal approaches for postoperative pain control have shown improvements in postoperative pain scores and similar reductions in analgesic requirements (Shang and Gan 2003).

Pharmacological pain relief can be markedly improved by attention to choice of drugs, positive drug interaction, administration route, timing and dosing (Breivik 2002). This may be carried out using the '▶ **Acute Pain Service**' with anaesthetist-supervised pain nurses.

Commonly, acetaminophen (paracetamol) and NSAIDs are in routine use as components of multimodal analgesia, in combination with opioids or local anaesthetic techniques to modulate this (Power and Barratt 1999). Alpha 2 antagonists (e.g. clonidine) and ▶ **N-Methyl-D-Aspartate antagonists** (e.g. ketamine to reduce wound secondary mechanical hyperalgesia) can be added either intravenously (in patient controlled analgesia) or epidurally (single shot, constant infusion or by patient controlled epidural analgesia) (Potgatzki et al. 2003). The use of spinal neostigmine and adenosine is currently being investigated (Shipton 1999).

Improved pain control includes the optimal use of acetaminophen (paracetamol) by mouth, rectally or intravenously (as the prodrug proparacetamol). Evidence is now sufficient to recommend that an NSAID be added to acetaminophen for short-term postoperative pain relief, unless there are any known contraindications to NSAIDs (Breivik 2002). These include allergy, gastro-intestinal ulcer disease, potential bleeding problems (due to its irreversible effects on platelet function), renal functional impairment, asthma, hypovolaemia, hyperkalaemia, severe liver disease, circulatory failure, pre-eclampsia or certain drugs (ACE inhibitors, diuretics, beta blockers, cyclosporine, methotrexate) (Breivik 2002).

The new ▶ **COX-2 inhibitor** ▶ **NSAIDs** have relative gastric and platelet sparing effects, and can be given orally (e.g. rofecoxib, celecoxib, etoricoxib, valdecoxib) and intravenously (e.g. paracoxib) as a component of multimodal analgesia (Shang and Gan 2003).

Where acetaminophen and NSAIDs result in inadequate pain relief, opioids can be given either orally, rectally, intramuscularly or intravenously (nurse administered or by patient controlled analgesia). Opioid adverse effects such as nausea, vomiting, pruritus and urinary retention are reduced by multimodal analgesia.

Local anaesthetic infiltration (in tissue, joints, peritoneal cavity) as part of a multimodal regimen offers a simple, safe and inexpensive alternative to epidural pain control (Schumann et al. 2003). Intra-articularly, local anaesthetics are often combined with opioids (morphine) (Menigaux 2001). Catheters can be used to provide constant infusions of local anaesthetics around peripheral nerves and plexuses (with or without a multimodal mixture).

► **Regional anaesthesia** attenuates the endocrine-metabolic effects (the rise in cortisol, catecholamines, glucagon, hyperglycaemia, insulin resistance and negative nitrogen balance) on stress-induced organ dysfunction, and extends analgesia into the postoperative period (Kehlet and Wilmore 2002). The inhibitory effects on catabolic responses are most pronounced when regional anaesthesia is provided for up to 24–48 hours, preferably as a continuous epidural analgesic technique. After major thoracic or abdominal surgery, patients at risk of postoperative respiratory and cardiac complications are offered optimal analgesia, with thoracic or thoracolumbar epidural infusion of low doses of local anaesthetic (e.g. levobupivacaine, ropivacaine), a lipophilic opioid (e.g. fentanyl, sufentanil) and epinephrine (adrenaline) (Breivik 2002).

Accelerated multimodal postoperative recovery programmes are being developed as a multidisciplinary effort, with the integration of postoperative pain management into a postoperative rehabilitation programme (Kehlet 1999). Multimodal intervention may reduce stress induced organ dysfunction and accompanying morbidity (Kehlet and Wilmore 2002).

An integrated approach to perioperative care (comprising minimally invasive surgical access, optimal pain relief provided by epidural analgesia, early oral nutrition, avoidance of nasogastric tubes, and aggressive active mobilization) decreases time to discharge, readmission rate, and postoperative morbidity with increased patient satisfaction and safety after discharge (Carli et al. 2002). After colonic surgery, as compared to intravenous opioids, epidural analgesia in a multimodal analgesic regimen results in significantly less deterioration in postoperative functional status (lower pain and fatigue scores, earlier mobilization and return of gastro-intestinal function), and health related quality of life at six-week follow-up (Wu and Rajah 2002).

The use of perioperative multimodal techniques may provide long-term benefits to patients.

## References

- Breivik H (2002) Postoperative Pain: Toward Optimal Pharmacological and Epidural Analgesia. In: Giamberardino MA (ed) Pain 2002 – An Updated Review. IASP Press, Seattle, pp 337–349
- Carli F, Mayo N, Klubien K et al. (2002) Epidural Analgesia Enhances Functional Exercise Capacity and Health-Related Quality of Life after Colonic Surgery: Results of a Randomized Trial. *Anesthesiology* 97:540–549
- Jin F, Chung F (2001) Multimodal Analgesia for Postoperative Pain Control. *J Clin Anesth* 13:524–539
- Kehlet H (1999) Acute Pain Control and Accelerated Postoperative Surgical Recovery. *Surg Clin North Am* 79:431–443
- Kehlet H, Wilmore DW (2002) Multimodal Strategies to Improve Surgical Outcome. *Am J Surg* 183:630–641
- Menigaux C, Guignard B, Fletcher D et al. (2001) Intraoperative Small-Dose Ketamine Enhances Analgesia after Knee Arthroscopy. *Anesth Analg* 93:606–612
- Pogatzki EM, Niemeier JS, Sorkin LS et al. (2003) Spinal Glutamate Receptor Antagonists Differentiate Primary and Secondary Mechanical Hyperalgesia Caused by Incision. *Pain* 105:970–1007
- Power I, Barratt S (1999) Analgesic Agents for the Postoperative Period. Nonopioids. *Surg Clin North Am* 79:275–295
- Schumann R, Shikora W, Weis JM et al. (2003) A Comparison of Multimodal Perioperative Analgesia to Epidural Pain Management after Gastric Bypass Surgery. *Anesth Analg* 96:469–474
- Shang AB, Gan TJ (2003) Optimising Postoperative Pain Management in the Ambulatory Patient. *Drugs* 63:855–867
- Shipton EA (1999) The Future. In: Shipton EA (ed) Pain – Acute and Chronic. Arnold, London, pp 326–365
- Wu CL, Raja SN (2002) Optimising Postoperative Analgesia. *Anesthesiology* 97:533–534

## Multimodal Analgesics

- **Drugs with Mixed Action and Combinations, Emphasis on Tramadol**

## Multimodal Rehabilitation Treatment and Psychiatric Aspects of Multimodal Treatment for Pain

DAVID A. FISHBAIN

Department of Psychiatry and Department of Neurological Surgery and Anesthesiology, University of Miami, School of Medicine and H. Rosomoff Pain Center at South Shore Hospital, Miami, FL, USA  
dfishbain@miami.edu

### Synonyms

Multidisciplinary treatment; Psychiatric Aspects of Multimodal Treatment for Pain; Multimodal Treatment

### Definition

- Multimodal treatment is defined as applying several treatments simultaneously / concurrently or sequentially (one after another) in order to improve pain and facilitate rehabilitation.
- Multidisciplinary treatment is defined as treatment involving more than one treatment discipline and as different disciplines usually utilize different treatments, multidisciplinary treatment is by definition multimodal.



## Characteristics

### Pain Treatment Facilities

Pain treatment facilities developed for a number of reasons. First, people in general put a very high value on living a pain-free life. Second, numerous epidemiological studies determined that a large percentage (2–40%) of the general population suffered from chronic intractable benign pain. And third, the experience of treating continuous severe pain in battle injured World War II soldiers determined that a coordinated team was required to manage the different types of pain (Rosomoff and Steele-Rosomoff 1991).

Multidisciplinary pain clinics or centers evolved from these concepts in the early 1970s. It was observed that a significant percentage of low back pain and neck pain patients did not improve with traditional medical treatment but remained disabled (Rosomoff and Steele-Rosomoff 1991). These patients demonstrated a host of behavioral and psychosocial problems in association with their chronic pain. These problems required the intervention of disciplines besides those of neurosurgery, orthopedic surgery and anesthesiology (Rosomoff and Steele-Rosomoff 1991). In addition, these patients required a concurrent highly integrated multidisciplinary treatment approach that would address all the patient's problems simultaneously, i.e. multimodal treatment (Rosomoff and Steele-Rosomoff 1991).

There were approximately 1500–2000 pain treatment facilities in the US (Rosomoff and Steele-Rosomoff 1991). They differed in their staff composition, size, philosophy and most importantly, treatment approach. Because of this problem, the International Association for the Study of Pain (IASP) developed definitions for four types of pain treatment facilities (see below) (Loeser 1991).

### IASP Classification of Pain Facilities (Adapted from Loeser 1991)

#### Modality-oriented Clinic

- Provides specific type of treatment, e.g. nerve blocks, transcutaneous nerve stimulation, acupuncture, biofeedback.
- May have one or more health care disciplines.
- Does not provide an integrated, comprehensive approach.

#### Pain Clinic

- Focuses on the diagnosis and management of patients with chronic pain or may specialize in specific diagnoses or pain related to a specific region of the body.
- Does not provide comprehensive assessment or treatment, an institution offering appropriate consultative and therapeutic services would qualify but never an isolated solo practitioner.

#### Multi-Disciplinary Pain Clinic

- Specializes in the multi-disciplinary diagnosis and management of patients with chronic pain or may specialize in specific diagnoses or pain related to a specific region of the body.
- Staffed by physicians of different specialties and other health care providers.
- Differs from a multi-disciplinary pain center only because it does not include research and teaching.

#### Multi-Disciplinary Pain Center

- Organization of health care professionals and basic scientists that includes research, teaching and patient care in acute and chronic pain.
- Typically a component of a medical school or a teaching hospital.
- Clinical programs supervised by an appropriately trained and licensed director.
- Staffed by a minimum of physician, psychologist, occupational therapist, physical therapist and registered nurse.
- Services provided integrated and based on interdisciplinary assessment and management.
- Offers both inpatient and outpatient program.

Inspection of the list above indicates that there is a clear distinction between modality-oriented clinics, pain clinics and multidisciplinary facilities. Differences between multidisciplinary pain clinics and multidisciplinary pain centers (MPC) include research and teaching in the MPCs. These definitions also indicate that the MPCs may be more likely to have inpatient and outpatient treatment and to have larger and more diversified multi-disciplinary staffs, including more than one physician specialty. As a consequence, MPCs are likely to offer a wider range of treatments than multidisciplinary pain clinics and thus involve more multimodal treatment. Most of the pain facility treatment outcome studies involve MPCs.

#### MPC Treatment Outcome Studies

Because MPC developed in the 1970s and because they had to demonstrate treatment efficacy, there are now close to three hundred treatment outcome studies in the literature (Fishbain et al. 1993). As such, this literature has been subjected to a number of meta-analyses (Table 1). It is interesting to note that these meta-analyses (four) were consistent in indicating that MPC treatment or multimodal treatment is effective. This meta-analysis literature has recently been reviewed for meta-analytic procedure quality and found to be of acceptable quality (Fishbain et al. 2000). It is also important to note that this literature now indicates that multidisciplinary (multimodal) treatment is superior to single treatment such as medical therapy or physical therapy (Flor et al. 1992).

**Multimodal Rehabilitation Treatment and Psychiatric Aspects of Multimodal Treatment for Pain, Table 1** MPC Chronic Pain Treatment Meta-Analyses

Author/Year	Treatment type and clinical condition	Outcome measure	Author clinical interpretation of meta-analysis data
Malone and Strube (1988)	Pain facility, chronic pain	Activity level. Frequency pain. Index pain. Intensity pain. Medication use. Mood.	Treatment effective, good effect sizes.
Curtis (1992)	Multi-disciplinary pain facility, chronic low-back pain.	Physical fitness. Subjective distress. Daily activity increase. Medication decrease.	Multi-disciplinary treatment programs effective.
Flor et al. (1992)	Multi-disciplinary pain facilities, chronic low-back pain.	Activity level. Pain behavior. Medication use. Return to work.	Multi-disciplinary pain clinics effective at returning chronic back pain patients to work.
Cutler et al. (1994)	Multi-disciplinary pain facility, chronic low-back pain.	Return to work.	Multi-disciplinary pain facilities return chronic low-back pain patients to work.

### Which Treatments or Combination Makes MPC Treatment Effective?

For an exhaustive list of treatment by medical specialty available at MPCs, please refer to Fishbain DA et al. (1997). It is to be noted that some of these treatments, e.g. physical therapy, have been studied in a placebo fashion, resulting in a significant number of studies in the literature. There are meta-analysis results available for some of these (Fishbain et al. 2000). Of the non-pharmacological treatments having meta-analyses, physical therapy, cognitive and behavior therapy and educational therapy appear to be effective. Of the psychopharmacological treatments, antidepressants, topical NSAIDs, capsaicin and anticonvulsants are effective (Fishbain et al. 1997; Fishbain et al. 2000). Yet, in reality MPCs may or may not provide these treatments or may provide a greater range of treatments (Fishbain et al. 1997). Pain facilities generally use multiple treatments simultaneously which are integrated into a treatment package (Fishbain et al. 1997). Thus, it is impossible to say whether the positive MA results for MPCs related to the fact that the specific treatments shown to be effective were provided or that other hitherto untested treatments were utilized. This question awaits further research.

Another issue in relation to which treatments make MPC treatment effective is what outcome variables are examined (Fishbain et al. 1993). As an example, a specific treatment such as capsaicin may decrease pain, but if used alone, it may not be enough to return the patient to work. In other words, for the attainment of some outcome variables, such as return to work, a combination of specific treatments may be required. The evidence indicates that treatments under one category, such as behavior, may have equal efficacy. For example, operant conditioning has been found to be as effective as cognitive-behavior treatment (Turner and

Clancy 1988) and outpatient group cognitive therapy, relaxation training and cognitive therapy have all been demonstrated to be equally efficacious (Turner and Jensen 1993).

In addition, different treatments within one category appear not to be additive. When a cognitive component was added to operant pain treatment there was no decrease in patient medical utilization costs or improvement in patient quality of life scores (Goossens et al. 1998). However, treatments from different groups may have an additive effect. The combined package of cognitive-behavioral group pain treatment with physical therapy has been found to be superior to physical therapy alone (Nicholas et al. 1992). This speaks to the apparent advantage of multimodal treatment.

At this time, it is unclear what combination of MPC treatments delivered in a treatment package is effective. It is therefore unclear what combination of treatments is necessary for an effective package. It is also possible that the effectiveness of MPCs rests in their ability to deliver this treatment package and an ability to integrate treatments into a package (Rosomoff and Steele-Rosomoff 1991). This last issue may influence an overall effectiveness that has not been explored in the literature.

### Psychiatric Multimodal Treatment within MPCs

Early in the course of development of MPCs it became clear that the vast majority of chronic pain patients suffered from associated psychiatric comorbidity (Fishbain 1999). In addition, it has recently become clear that drugs commonly utilized by psychiatrists, e.g. antidepressants, anticonvulsants, have strong analgesic properties (Fishbain et al. 2000). Finally, it has become recognized that many chronic pain patients have neuropathic pain for which psychopharmacological treatment is becoming increasingly available (Fishbain et al. 2000). This confluence of factors and the

fact that psychiatrists by the nature of their specialty have expertise in psychopharmacological treatment and detoxification (Fishbain 2002) has increased the potential impact of this medical specialty on pain treatment outcome.

The list below presents the functions of the psychiatrist within MPCs and the potential treatments that he / she can initiate in a multimodal fashion. With reference to treatments, it is to be noted that these now reflect the major issue of directing psychopharmacological treatment both at pain relief and at the same time psychiatric comorbidity. Thus, the psychiatrist working at an MPC should be very familiar with the literature addressing the psychopharmacological treatment of pain in order to be able to choose an agent for pain, which will also have impact on the psychiatric comorbidity. This concept is very different from 10–15 years ago, when psychiatrists treated psychiatric comorbidity exclusively. In addition, it is to be noted that as there is now a subspecialty psychiatry board in pain management, some psychiatrists are developing expertise in the procedure treatments of chronic pain.

### Psychiatric Functions and Multimodal Treatments

#### Potential Functions

1. Diagnosis of psychiatric comorbidity per DSM-system.
2. Determination presence of psychological difficulties, problems, etc., e.g. suicidal ideation, homicidal ideation, marital / system conflicts, etc.
3. Determination presence of somatic comorbidities, e.g. sleep problems, headaches, dizziness, etc.
4. Develop a psychopharmacological and non-psychopharmacological treatment plan for #1–#3 above.
5. Administer behavioral rating scale testing if necessary.
6. According to the history, physical examination and required laboratory workup determine whether the pain is nociceptive, neuropathic or both.
7. Participate in multidisciplinary case staffing in order to develop a multidisciplinary treatment plan that would encompass the psychiatric treatment plan.
8. Act as consultant to other multidisciplinary staff.
9. Educate members of multidisciplinary staff on psychiatric aspects of chronic pain.
10. Perform clinical research on all aspects of pain.
11. Act as director of the multidisciplinary team.

#### Multimodal Treatments

1. Psychopharmacological treatment directed at nociceptive pain.
2. Psychopharmacological treatment directed at neuropathic pain.
3. Psychopharmacological treatment directed at psychiatric comorbidity.
4. Detoxify patient if necessary.

5. Provide supportive counseling.
6. Lead behavior rehabilitation groups.
7. Provide program patient education for his / her area of expertise.
8. Participate in the behavior modification (reinforcement) aspects of the multidisciplinary program.
9. If within his / her area of expertise, perform procedures such as trigger point injections, acupuncture, blocks, epidurals, etc.

#### References

1. Cutler RB, Fishbain DA, Rosomoff HL et al. (1994) Does non-surgical pain center treatment of chronic pain return patients to work? A review and meta-analysis of the literature. *Spine* 19:643–652
2. Curtis JE (1992) The efficacy of multidisciplinary treatment programs for chronic low back pain: a meta-analysis. *Dissertation Abstracts International* 53:4948
3. Fishbain DA (1999) Approaches to treatment decisions for psychiatric comorbidity in the management of the chronic pain patient. *Med Clin North Am* 83:737–759
4. Fishbain DA (2002) Opiate, hypnotic, alcohol, and nicotine detoxification protocols. In: Tollison CD, Satterthwaite JR, Tollison JW (eds) *Practical Pain Management*, Lippincott Williams and Wilkins, Philadelphia, pp 314–329
5. Fishbain DA, Rosomoff HL, Goldberg M et al. (1993) The prediction of return to the workplace after multidisciplinary pain center treatment. *Clin J Pain* 9:3–15
6. Fishbain DA et al. (1997) Pain facilities: a review of their effectiveness and referral selection criteria. *Current Review Pain* 1:107–115
7. Fishbain D, Cutler RB, Rosomoff HL et al. (2000) What is the quality of the implemented meta-analytic procedures in chronic pain treatment meta-analyses? *Clin J Pain* 16:73–85
8. Flor H, Fydrich T, Turk DC (1992) Efficacy of multidisciplinary pain treatment centers: a meta-analytic review. *Pain* 49:221–230
9. Goossens ME, Rutten-Van Molken MP, Kole-Snijders AM et al. (1998) Health economic assessment of behavioural rehabilitation in chronic low back pain: a randomised clinical trial. *Health Econ* 7:39–51
10. Loeser JD (1991) Desirable characteristics for pain treatment facilities: reports of the IASP taskforce. In: Bond MR, Charlton JE, Woolf CJ (eds) *Proceedings of the VI th World congress on Pain*. Elsevier, Amsterdam, pp 411–415
11. Malone MD, Strub MJ (1988) Meta-analysis of non-medical treatments for chronic pain. *Pain* 34:231–244
12. Nicholas MK, Wilson PH, Goyen J (1992) Comparison of cognitive-behavioral group treatment and an alternative nonpsychological treatment for chronic low back pain. *Pain* 48:339–347
13. Rosomoff HL, Steele-Rosomoff R (1991) Comprehensive multidisciplinary pain center approach to the treatment of low back pain. *Neurosurgical Clinics of North America* 2:877–890
14. Turner JA, Clancy S (1988) Comparison of operant behavioral and cognitive-behavioral group treatment for chronic low back pain. *Clin Psychol* 56:261–266
15. Turner JA, Jensen MP (1993) Efficacy of cognitive therapy for chronic low back pain. *Pain* 52:169–177

M

## Multimodal Treatment

- [Multimodal Rehabilitation Treatment and Psychiatric Aspects of Multimodal Treatment for Pain](#)

## Multiple Sclerosis (MS)

### Definition

An idiopathic immune system disease of the central nervous system in which gradual destruction of myelin occurs in patches throughout the brain or spinal cord (or both), interfering with the nerve pathways and causing muscular weakness, loss of coordination and speech and visual disturbances. Sometimes manifests as radiating pain in a similar distribution as the sciatic nerve.

- ▶ Central Pain, Outcome Measures in Clinical Trials
- ▶ Sciatica
- ▶ Trigeminal, Glossopharyngeal, and Genuate Neuralgias

## Multipolar Cells

### Definition

Neuron type whose cell body (soma) issues an axon and several primary dendrites forming the dendritic tree.

- ▶ Trigeminal Brainstem Nuclear Complex, Anatomy

## Multiprofessional

### Definition

Healthcare professionals working with the same patient

- ▶ Physical Medicine and Rehabilitation, Team-Oriented Approach

## Multireceptive Neuron (MR)

### Definition

A neuron that is activated by a variety of innocuous and noxious mechanical and thermal stimuli applied to its receptive field, which is typically widespread and comprises of cutaneous and deep tissue.

- ▶ Arthritis Model, Kaolin-Carrageenan Induced Arthritis (Knee)
- ▶ Chronic Pain
- ▶ Thalamic Bursting Activity
- ▶ Thalamus, Nociceptive Cells in VPI, Cat and Rat

## Multisensory Perceptions

### Definition

Perceptions of external objects based on more than one form of sensory input (e.g. sight and smell).

- ▶ Amygdala, Pain Processing and Behavior in Animals

## Munchausen's by Proxy

### Definition

A severe type of factitious disorder where the parent consciously causes the child to assume the sick role to satisfy the parent's psychological need.

- ▶ Somatization and Pain Disorders in Children

## Mu( $\mu$ )-Opioid Receptor

### Synonyms

MOP

### Definition

Opioid receptors that preferentially bind endomorphins and morphine-like drugs. It was originally named for the effects of morphine. Also known as OP3 receptors, they are the main sites of action for most opioid drugs. They share the same distribution as kappa receptors with the exception of the hypothalamus. Agonists are associated with analgesia, respiratory depression, euphoria bradycardia, miosis, reduced gut motility and nausea and vomiting.

- ▶ Opiates During Development
- ▶ Opioid Receptors
- ▶ Opioid Rotation in Cancer Pain Management
- ▶ Postoperative Pain, Appropriate Management
- ▶ Postoperative Pain, Transition from Parenteral to Oral

## Muscle and Joint Pain

- ▶ Spinal Dorsal Horn Pathways, Muscle and Joint

## Muscle Contraction Headache

- ▶ Headache, Episodic Tension Type

## Muscle Cramp

### Definition

Involuntary sudden painful muscle contraction. During the cramp, the muscle is visibly and palpably taut and painful, often with abnormal posture of the affected joint, condition which can be relieved by stretching or massage.

- ▶ Muscular Cramps



## Muscle Discrimination

### Definition

This refers to a person's ability to accurately sense the current level of tension within the muscles being monitored.

► [Psychophysiological Assessment of Pain](#)

## Muscle Hyperactivity

► [Orofacial Pain, Movement Disorders](#)

## Muscle Nociceptor

### Definition

A free nerve ending with high thresholds to mainly mechanical and chemical stimuli (nociceptive); also high-intensity thermal stimuli may excite muscle nociceptors. Their afferents are small-diameter myelinated (Group III) or unmyelinated (Group IV) muscle nerve fibers. Group IV corresponds to cutaneous C-fibers and group III to A $\delta$ -fibers. Conduction velocities for cat muscle afferent fibers are below 2.5 m/s for group IV and 2.5 to 30 m/s for group III fibers.

► [Exogenous Muscle Pain](#)

## Muscle Nociceptors, Neurochemistry

SIEGFRIED MENSE

Institute for Anatomy and Cell Biology III, University Heidelberg, Heidelberg, Germany  
mense@urz.uni-heidelberg.de

### Definitions

A nociceptor is a receptive ending that specializes in informing the central nervous system (CNS) about the presence of a tissue threatening stimulus. A nociceptor has an elevated stimulation threshold just below the noxious level. (The receptor already has to respond to stimuli below the level that causes tissue damage, because it is supposed to fulfill the function of an alarm system and prevent tissue damage). In addition to an elevated stimulation threshold, a nociceptor has to be able to encode the intensity of a stimulus within the noxious range, i.e. it must not saturate when a stimulus reaches noxious levels.

A receptor molecule is a protein located within the axonal membrane of a receptive ending. It binds sensitizing and stimulating substances in a highly specific manner and is either coupled to an ion channel (which opens after the binding has occurred) or a ► [G protein](#), which starts

an intracellular cascade of events that – among other effects – leads to the activation of enzymes such as kinases.

### Characteristics

#### Morphology

A nociceptor is an unencapsulated (“free”) nerve ending that is connected to the CNS by thin myelinated (group III) or unmyelinated (group IV) nerve fibers. These fibers have a slow conduction velocity, with ► [group III fibers](#) conducting between 2.5 and approximately 20 m/s and ► [group IV fibers](#) between 0.5 and 1 m/s. Histologically, the nerve ending is not free in the strict sense but is surrounded by a single layer of ► [Schwann cells](#). The Schwann cells leave small patches of the axonal membrane uncovered, the so-called exposed axon areas. These areas are assumed to be the sites of action for the chemical stimuli that are present in a pathologically altered muscle.

#### Neuropeptide Content

There is no ► [neuropeptide](#) that can be regarded as specific for sensory fibers from muscle or for muscle nociceptors. Nerve endings in skeletal muscle of the rat have been reported to contain ► [substance P](#) (SP), calcitonin-gene related peptide (► [CGRP](#)), ► [somatostatin](#) (SOM), ► [vasoactive intestinal polypeptide](#) (VIP) as well as the neurotrophin ► [nerve growth factor](#) (NGF), and thus presents a neuropeptide pattern similar to that of cutaneous nerves. Of these neuropeptides, SP is of particular interest because, in experiments on fibers from the skin, SP has been shown to be predominantly present in nociceptive fibers (Lawson et al. 1997). The peptides are released during excitation of the ending and influence the chemical milieu of the tissue around the receptor. SP has a strong dilating and permeability increasing action on small blood vessels. By these effects, SP causes an increase in local microcirculation and edema formation at the site of the lesion. In addition to that, SP has a sensitizing action on nociceptors.

#### Receptor Molecules in the Membrane of a Nociceptive Ending

Data concerning the presence of receptor molecules in muscle nociceptors have not been reported. Based on responsiveness of these endings to intramuscular and intraarterial injections of ► [Algesic Agent / Algesic Chemical](#), and existing parallels with cutaneous nociceptors, the following types of receptor molecule are likely to be present (Caterina and David 1999; Mense and Meyer 1985; McCleskey and Gold 1999):

1. Receptors for inflammatory substances. Among these are receptors for ► [bradykinin](#) (BK; B1 and B2 receptors), 5-hydroxytryptamine (5-HT, ► [serotonin](#); e.g. 5-HT<sub>3</sub> receptor), and prostaglandins (e.g. PGE<sub>2</sub>; EP<sub>2</sub> receptor). In intact tissue, BK is known to influence the ending via the B<sub>2</sub> receptor; in inflamed tissue, the B<sub>1</sub> receptor is synthesized in

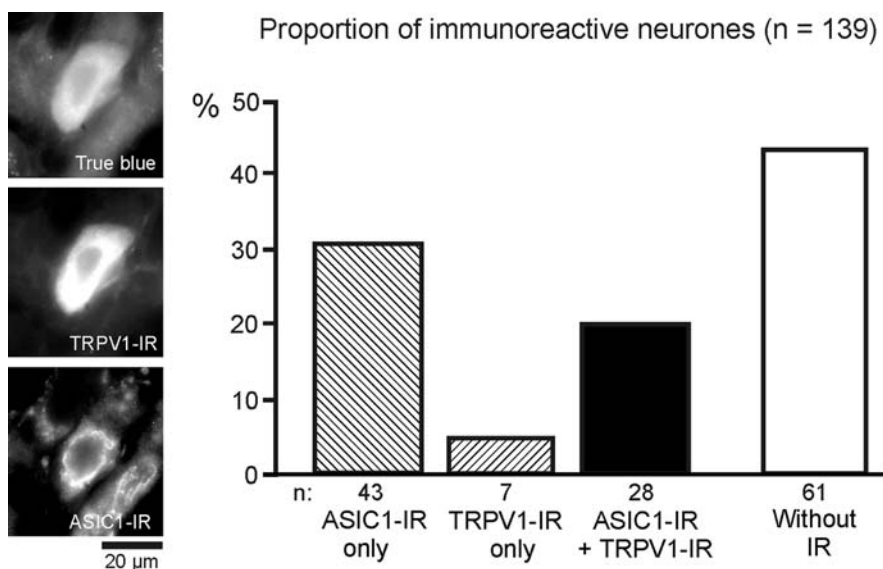
the soma of the nociceptive neuron, transported to the receptive ending and inserted into its membrane. This is an example of a neuroplastic change in the nociceptive ending. In contrast to the 5-HT<sub>3</sub> receptor that controls an ion channel, the BKN receptors activate a G protein.

2. Receptors for protons. Besides immunoreactivity (IR) for acid-sensing ion channels (e.g. ASIC1), IR for the transient receptor potential vanilloid receptor (▶ **TRPV1**) (Caterina and David 1999) is present in somata of the dorsal root ganglion that supply receptive endings in skeletal muscle (U. Hoheisel and S. Mense, unpublished; Fig. 1). The receptor is sensitized by and responds to an increase in H<sup>+</sup>-concentration and to heat. The sensitivity of this receptor to protons is important under conditions in which the pH of the tissue is lowered (e.g. exhaustive muscle work, ischemia, inflammation, tonic contraction). A specific stimulant for this receptor molecule is capsaicin, the active ingredient of chili peppers. In inflamed tissue, TRPV1 receptors have been reported to be more frequent than under normal conditions (Carlton and Coggeshall 2001).
3. Purinergic receptors. These receptor molecules bind adenosine triphosphate (ATP) and the products of ATP degradation. The P2X<sub>3</sub> receptor (Burnstock 2000; Cook and McCleskey 2002) has been demonstrated to be present in cutaneous nociceptors; it has also been shown to exist in ▶ **DRG** cells supplying the gastrocnemius-soleus mus-

cle of the rat (U. Hoheisel and S. Mense, unpublished).

4. Receptors for growth factors. In our group, nerve growth factor (NGF; ▶ **TrkA receptor**) proved to excite muscle nociceptors in concentrations that caused cutaneous pain in humans. ▶ **Brain-derived neurotrophic factor** (BDNF; TrkB receptor) had no excitatory effect on muscle nociceptors but desensitized the endings to mechanical stimuli (i.e. after i.m. injection of BDNF the response magnitude of the ending to noxious pressure stimuli was reduced).
5. Receptors for excitatory amino acids. Reports in the literature indicate that nociceptors in the deep tissues around the temporomandibular joint are activated by glutamate (Cairns et al. 1998). This means that glutamate receptors must be present in nociceptors of deep somatic tissues.
6. Opioid receptors. These receptors were found on A $\delta$ - and C fibers in cutaneous nerves (Stein et al. 1990). They are upregulated during tissue inflammation.

Other algescic agents may activate muscle nociceptors without binding to specific receptor molecules. An example of this are potassium ions which might depolarize and excite nociceptors following muscle trauma if the relatively high intracellular concentration of K<sup>+</sup> is released from muscle cells. High concentrations of Na<sup>+</sup> may likewise have an unspecific mechanism of action. A marked increase in extracellular Na<sup>+</sup> does not occur under (patho)physiologic conditions, but is induced in



**Muscle Nociceptors, Neurochemistry, Figure 1** Neurons in the rat spinal ganglion L5 exhibiting immunoreactivity (IR) for the acid-sensing ion channel 1 (ASIC 1) and the vanilloid receptor 1 (TRPV1), respectively. All evaluated neurons were retrogradely labelled from the gastrocnemius-soleus (GS) muscle with the fluorescent dye True blue. (a) the same neuron labelled with three different stains: Aa, retrograde labelling with True blue from the GS muscle; Ab, fluorescent staining with antibodies to TRPV1; Ac, fluorescent staining with antibodies to ASIC 1. (b) proportion of neurons with IR for ASIC 1 and/or TRPV1. The filled bar shows neurons exhibiting IR for both ASIC 1 and TRPV1 (ASIC 1-IR + TRPV1-IR). Without IR, neurons exhibiting neither ASIC 1-IR nor TRPV1-IR (J. Reinöhl, U. Hoheisel and S. Mense, unpublished).

clinical studies on muscle pain mechanisms when hypertonic saline injections or infusions are injected i.m. (Graven-Nielsen et al. 1997). In these studies, the high  $\text{Na}^+$  concentration – and not the hypertonicity of the solution – appears to be the effective stimulus (see essay ► [muscle pain model, ischemia-induced and hypertonic saline-induced](#)).

### Response Properties

#### Mechanical Stimulation

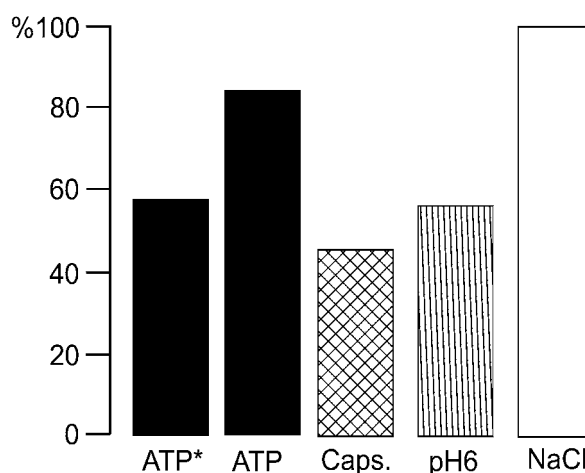
Upon mechanical stimulation (e.g. by pressure stimuli), a muscle nociceptor has a high stimulation threshold and requires noxious (tissue-threatening, subjectively painful) intensities of stimulation for excitation. In intact muscle, a nociceptor does not respond to everyday stimuli such as physiologic movements or muscle stretch (Mense 1997). Recordings of the activity of single muscle afferent fibers in cats and rats have shown that nociceptors as described in the above definition are present in skeletal muscle (Mense and Meyer 1985). Microneurographic recordings in humans also demonstrated the existence of muscle nociceptors (Marchettini et al. 1996). It is important to note that not all unencapsulated nerve endings in skeletal muscle have nociceptive properties. Many of them can be excited by weak innocuous pressure stimuli and probably mediate subjective pressure sensations.

#### Chemical Stimulation

BK, 5-HT, and prostaglandin E2 have long been known to excite muscle nociceptors in concentrations that are likely to be present in an inflamed or ischemic muscle (Kumazawa and Mizumura 1977; Mense and Meyer 1985). 5-HT and PGE2 are ubiquitously present in the body and are released under pathologic conditions. BK is cleaved by enzymatic action from kallidin, a plasma protein. Tissue ischemia is a potent stimulus for inducing this cleavage.

In experiments by the author's group, acidic solutions were effective stimulants for muscle receptors with group IV afferent fibers in the rat. Approximately 60% of the tested receptors were excited by intramuscular injections of an acidic phosphate buffer (pH 6; Fig. 2). Such a lowering in pH is known to occur in inflamed or ischemic tissue. The proton-sensitive nociceptors may be of particular importance for the induction of chronic muscle pain. There is evidence indicating that repeated intramuscular administration of acidic solutions results in long-lasting hyperalgesia (Sluka et al. 2001).

In patients, the pain during ► [bruxism](#), chronic ► [dys-tonia](#), and some cases of ► [tension-type headache](#) may be mediated by the TRPV1 receptor or other acid-sensing ion channels, because these conditions are likely to be associated with low tissue pH and ischemia. Due to the ischemia, BK acting on B2 or B1 receptors could also contribute to this pain. In microneurographic recordings from muscle nerves in humans, muscle no-



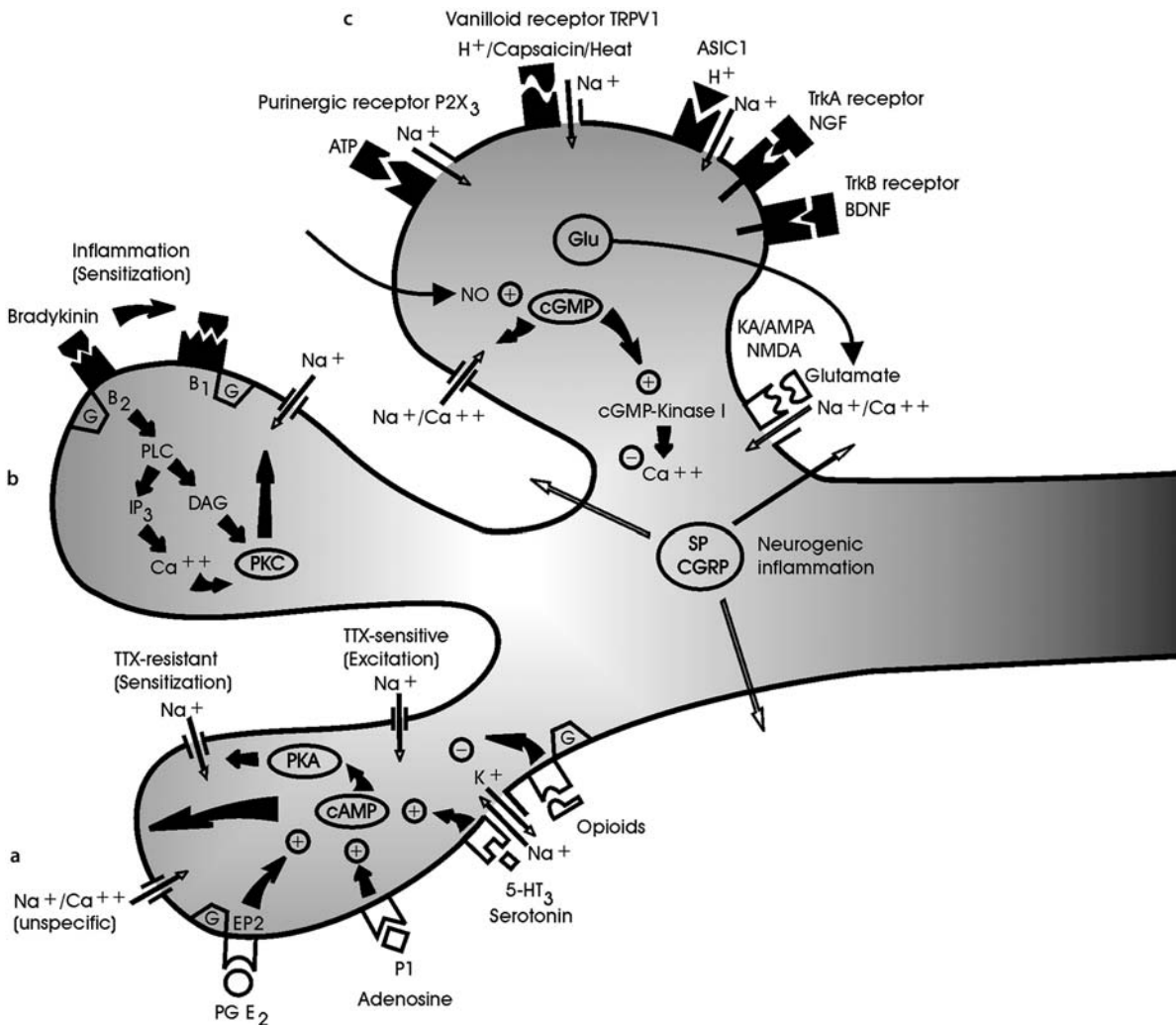
**Muscle Nociceptors, Neurochemistry, Figure 2** Proportion of rat muscle nociceptors responding to adenosine triphosphate (ATP), capsaicin (Caps.), acidic phosphate solution (pH 6), and hypertonic saline (NaCl, 5%). The data were obtained in electrophysiological experiments in which the impulses of single group IV afferent fibers from rat muscle were recorded. The stimulating solutions (injection volume 25  $\mu\text{l}$ ) were injected intramuscularly into the mechanosensitive receptive field of the ending. ATP\*, ATP dissolved in tyrode. The solution had a pH of 5.5. ATP, ATP dissolved in tyrode with the pH adjusted to neutral (7.4). NaCl 5% was the most effective stimulus and activated all of the units tested, the other agents excited at least 40% of the nociceptors (J. Reinöhl, U. Hoheisel and S. Mense, unpublished).

M

ciceptors with moderate to high mechanical thresholds were found that could be activated by intramuscular injections of capsaicin (Marchettini et al. 1996). The capsaicin injections were associated with strong muscle pain. As capsaicin is assumed to be a specific stimulant for the TRPV1 receptor, these data show that TRPV1 is present in human muscle nociceptors.

Nociceptors of the gastrocnemius muscle in the rat have been shown to respond to ATP in concentrations that are present in muscle cells (Reinöhl et al. 2003). This means that every time a muscle cell is damaged, it releases ATP in amounts that can excite muscle nociceptors. Human muscle nociceptors also appear to be equipped with purinergic receptors, since ATP causes pain when injected i.m. (Mörk et al. 2003). In patients, ATP may not only be involved in the pain of muscle trauma, but also in cases of sympathetically maintained pain. The underlying mechanism is that postganglionic sympathetic fibers release ATP as a co-transmitter of norepinephrine.

Among the growth factors studied so far, NGF is of particular interest because data obtained in the author's group indicate that NGF excites nociceptive free nerve endings exclusively, i.e. the low-threshold mechanosensitive (presumably non-nociceptive) endings were not affected. NGF is the only substance known so far that has such an exclusive action on nociceptive free nerve endings. An overview of most of the known receptor molecules in the membrane of a nociceptive ending is given in Fig. 3.



**Muscle Nociceptors, Neurochemistry, Figure 3** Receptor molecules in the membrane of a nociceptor. The scheme shows three branches of a free nerve ending. Not all of the receptor molecules included in the figure have been proven to exist in muscle nociceptors, some (e.g. the opioid receptor) are known from studies on nociceptors in the skin. The following processes are of practical importance. Branch (a), sensitization. Sensitization is caused by the binding of sensitizing substances (e.g. prostaglandin E<sub>2</sub> (PGE<sub>2</sub>) or serotonin (5-HT)) to receptor molecules, which induce intracellular cascades of events that—among other effects— increase the sensitivity of the Na<sup>+</sup> channels by phosphorylation (addition of anorganic phosphate to the channel protein) through activated protein kinase A (PKA). Branch (b), neuroplastic changes of the bradykinin (BKN) receptor. In intact tissue, BKN excites nociceptors by binding to the B<sub>2</sub> receptor, in inflamed tissue, it does so by binding to the B<sub>1</sub> receptor. Branch (c), other more recently detected receptors. Purinergic receptors (e.g. P2X<sub>3</sub>) bind adenosine triphosphate (ATP) and its degradation products, and vanilloid receptors (e.g. TRPV1-1) are sensitive to protons (H<sup>+</sup>), capsaicin, and heat. ASICs are acid-sensing ion channels (e.g. ASIC 1) that can be opened by low pH. TrkA is the high-affinity receptor for nerve growth factor (NGF), TrkB for brain derived neurotrophic factor (BDNF). alpha-amino-3-hydroxy-5-methyl-4-isoxazole propionic acid, receptor for glutamate; cAMP, cyclic adenosine monophosphate; cGMP, cyclic guanosin monophosphate; CGRP, calcitonin gene-related peptide; G, Glu, glutamate; G protein; KA, kainic acid; NMDA, N-methyl-D-aspartate, receptor for glutamate; NO, nitric oxide; PKC, protein kinase C; (PLC, IP<sub>3</sub>, and DAG are steps of the intracellular cascade that leads to the activation of PKC); SP, substance P; TTX, tetrodotoxin.

### Interactions between Stimulants at the Receptive Nerve Ending

Interactions between algogenic agents have been mainly studied for BK on the one hand, and PGE<sub>2</sub> or 5-HT on the other. PGE<sub>2</sub> and 5-HT enhance the excitatory action of BK on slowly conducting muscle afferents (Mense 1981). The pain elicited in volunteers by i.m. injection of a combination of BK and 5-HT is likewise stronger than that caused by either stimulant alone (Babenko et al. 1999; Mörk et al. 2003). These interac-

tions are of clinical significance, because the substances are released together in damaged or pathologically altered tissue.

The concentration of PGE<sub>2</sub> and 5-HT required for potentiating the action of BK is lower than that for exciting the nociceptors. Therefore, in the course of a tissue inflammation, the receptive endings will first be sensitized and then excited. Clinical observations point in the same direction; in the course of a pathologic alteration, the patient experiences tenderness first (because of nociceptor



► **sensitization**) and then spontaneous pain (because of nociceptor excitation).

### Polymodal Response Behavior

Most of the muscle nociceptors studied in single fiber recordings responded to noxious local pressure and injections of BKN (and some even additionally to thermal stimuli), but receptors were also found that were activated by one type of noxious stimulation only (mechanical or chemical). This finding indicates that different types of nociceptors are present in skeletal muscle, similar to the skin where mechano-, mechano-heat, and polymodal nociceptors are known to exist (Millan 1999).

### References

1. Babenko V, Graven-Nielsen T, Svensson P et al. (1999) Experimental Human Muscle Pain and Muscular Hyperalgesia Induced by Combinations of Serotonin and Bradykinin. *Pain* 82:1–8
2. Burnstock G (2000) P2X Receptors in Sensory Neurones. *Br J Anaesth* 84:476–488
3. Cairns BE, Sessle BJ, Hu JW (1998) Evidence that Excitatory Amino Acid Receptors within the Temporomandibular Joint Region are involved in the Reflex Activation of the Jaw Muscles. *J Neurosci* 18:8056–8064
4. Carlton SM, Coggeshall RE (2001) Peripheral Capsaicin Receptors Increase in the Inflamed Rat Hindpaw: A Possible Mechanism for Peripheral Sensitization. *Neurosci Lett* 310:53–56
5. Caterina MJ, David J (1999) Sense and Specificity: A Molecular Identity for Nociceptors. *Curr Opin Neurobiol* 9:525–530
6. Cook SP, McCleskey EW (2002) Cell Damage Excites Nociceptors through Release of Cytosolic ATP. *Pain* 95:41–47
7. Graven-Nielsen T, Arendt-Nielsen L, Svensson P et al. (1997) Experimental Muscle Pain: A Quantitative Study of Local and Referred Pain in Humans following Injection of Hypertonic Saline. *J Musculoskel Pain* 5:49–69
8. Kumazawa T, Mizumura K (1977) Thin-Fiber Receptors Responding to Mechanical, Chemical, and Thermal Stimulation in the Skeletal Muscle of the Dog. *J Physiol* 273:179–194
9. Lawson SN, Crepps BA, Perl ER (1997) Relationship of Substance P to Afferent Characteristics of Dorsal Root Ganglion Neurons in Guinea-Pig. *J Physiol* 505:177–191
10. Marchettini P, Simone DA, Caputi G, Ochoa JL (1996) Pain from Excitation of Identified Muscle Nociceptors in Humans. *Brain Res* 40:109–116
11. McCleskey EW, Gold MS (1999) Ion Channels of Nociception. *Ann Rev Physiol* 61:835–856
12. Mense S (1981) Sensitization of Group IV Muscle Receptors to Bradykinin by 5-Hydroxytryptamine and Prostaglandin E<sub>2</sub>. *Brain Res* 225:95–105
13. Mense S (1997) Pathophysiologic Basis of Muscle Pain Syndromes. *Phys Med Rehab Clin N Am* 8:23–53
14. Mense S, Meyer H (1985) Different Types of Slowly Conducting Afferent Units in Cat Skeletal Muscle and Tendon. *J Physiol* 363:403–417
15. Millan MJ (1999) The Induction of Pain: An Integrative Review. *Prog Neurobiol* 57:1–164
16. Mörk H, Ashina M, Bendtsen L et al. (2003) Experimental Muscle Pain and Tenderness following Infusion of Endogenous Substances in Humans. *Eur J Pain* 7:145–153
17. Reinöhl J, Hoheisel U, Unger T et al. (2003) Adenosine Triphosphate as a Stimulant for Nociceptive and Non-Nociceptive Muscle Group IV Receptors in the Rat. *Neurosci Lett* 338:2528
18. Sluka KA, Kalra A, Moore SA (2001) Unilateral Intramuscular Injections of Acidic Saline Produce a Bilateral Long-Lasting Hyperalgesia. *Muscle Nerve* 24:37–46
19. Stein C, Hassan AHS, Przewlocki R et al. (1990) Opioids from Immunocytes Interact with Receptors on Sensory Nerves

to Inhibit Nociception in Inflammation *Proc Natl Acad Sci USA* 87:5935–5939

## Muscle Pain

### Definition

Pain originating from muscle and usually experienced as dull, deep, diffuse and aching.

- **Myalgia**
- **Spinothalamic Tract Neurons, Visceral Input**

## Muscle Pain, Fear-Avoidance Model

GEERT CROMBEZ<sup>1</sup>, JOHAN W.S. VLAEYEN<sup>2</sup>, LIESBET GOUBERT<sup>1</sup>

<sup>1</sup>Ghent University, Department of Experimental Clinical and Health Psychology, Ghent, Belgium

<sup>2</sup>Maastricht University, Department of Medical, Clinical and Experimental Psychology, Maastricht, The Netherlands

geert.crombez@ugent.be, j.vlaeyen@dep.unimaas.nl, liesbet.goubert@ugent.be

M

### Synonyms

Kinesiophobia; pain-related fear; fear of pain; fear-avoidance model

### Definition

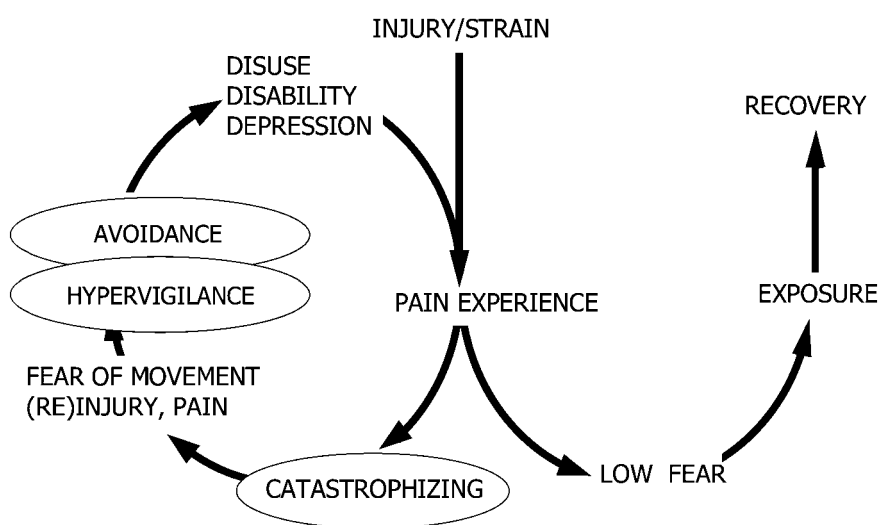
Fear-avoidance models explain how and why patients experiencing acute pain may become chronic sufferers and become trapped into a vicious circle of more pain and disability. Common in these models is their focus upon the role of ► **pain-related fear** (fear of pain, fear of movement / (re)injury) and dynamic learning processes (avoidance learning).

### Characteristics

Pain is more than an unpleasant perceptual and emotional experience. It elicits innate responses and action tendencies that prepare and facilitate escape from pain (Eccleston and Crombez 1999). Pain is an experience that drives learning. The relevance of learning in chronic pain has been recognised early on in the field of pain (Fordyce 1976) and continues to play a role in more recent biopsychosocial accounts of chronic pain (Asmundson et al. 2004; Vlaeyen and Linton 2000). Fordyce (1976) was the first to apply the principles of ► **operant conditioning** to the problems of chronic pain patients. The central idea was that “pain behaviour” (e.g. verbal complaints, medication use, bed rest, avoidance of home and work responsibilities) should be conceived of as behaviours that are learned and maintained by their positive consequences (empathy from solicitous spouses, access to pain medications,

financial compensation, avoidance of pain-worsening activities or escape from distressing events). In the context of fear-avoidance models, the principles of ► **classical conditioning** and operant conditioning are of paramount importance. Much behaviour is learned because it permits the person to avoid or postpone an aversive experience. What exactly is avoided may vary considerably between persons. An obvious example of ► **avoidance behaviour** is that patients learn to avoid pain. Some patients do not avoid activities because of anticipated pain, but because they fear that these activities may lead to (re)injury (Kori et al. 1990). It may also be true that pain behaviours are maintained by the avoidance of aversive experiences that are not at all related to pain. A popular example is that pain behaviour and, in particular sick leave, may be reinforced and maintained by the avoidance of aversive and unsatisfying work conditions. Whenever these extra benefits outweigh the costs of pain behaviour, one talks about secondary gain. Although clinical practice suggests that secondary gain does occur, its incidence is probably overestimated. It is often overlooked that the presence of pain also creates distress and frustration at work. Patients, whose pain interferes with their valued professional activities, may not resume work because they avoid these distressing and frustrating experiences. Building upon the model of Lethem et al. (1983), the ► **cognitive-behavioural model** of fear of movement / (re)injury was developed to explain the development of chronic suffering in non-specific low back pain. Vlaeyen and Linton (2000) postulated two extreme responses to pain, namely confrontation and avoidance. As depicted in Figure 1, a gradual confrontation and resumption of daily activities despite pain is considered as an adaptive response that eventually leads to the reduction of fear, the encouragement of physical recovery and functional rehabilitation. In contrast, a catastrophic interpretation of pain is considered as a

maladaptive response that initiates a vicious circle in which fear of movement / (re)injury and the subsequent avoidance of activities augment functional disability and the pain experience by means of hypervigilance, depression, and disuse (Vlaeyen and Linton 2000). The latter response is also known as ► **kinesiophobia**. Several empirical studies have provided support for these central ideas. First, ► **pain catastrophizing**, an exaggerated negative orientation towards actual or anticipated pain experiences, has been found to be strongly related to pain-related fear (e.g. Goubert et al. 2006b; Vlaeyen and Linton 2000). Second, fear of movement / (re)injury has been found to be characterized by escape and avoidance behaviours and to lower the ability to accomplish daily living tasks. Patients who are afraid of pain or of (re)injuring themselves during physical activities tend to avoid physical activities or are reluctant to perform vigorously during standard physical tests (Crombez et al. 1999, see video extract). Because avoidance behaviours occur in anticipation of pain rather than as a response to pain, opportunities are limited to correct (erroneous) beliefs about their pain. As a consequence, pain-related fear and avoidance may become resistant and persistent (e.g. Crombez et al. 1999; Vlaeyen and Crombez 1999). Prospective studies have further substantiated the important and unique role of pain-related fear and avoidance as predictors of chronic pain problems (Klenerman et al. 1995; Linton et al. 2000). Third, excessive avoidance of physical activities may have detrimental physical and psychological consequences. A decrease in mobility, decreased muscle strength, and loss of fitness can occur, possibly resulting in a ► **'disuse syndrome'** (Verbunt et al. 2003). Avoidance can also result in loss of self-esteem, deprivation of reinforcers, depression and worrying. Fourth, pain-related fear has been found to be related to a ► **hypervigilance** for pain (Goubert et al. 2004b) and a difficulty in switching attention away



**Muscle Pain, Fear-Avoidance Model, Figure 1** Confrontation to pain.

from pain (Eccleston and Crombez 1999). This pattern of hypervigilance in fearful chronic pain patients may further diminish the ability to perform everyday activities and hamper the recruitment of pain coping strategies (Eccleston and Crombez 1999; McCracken and Gross 1993).

Fear-avoidance models are dynamic in that both pain-related fear and avoidance are not static or stable characteristics of the individual (Goubert et al. 2006b), but are the result of complex interactions that are typical for a biopsychosocial perspective. Catastrophic thinking about pain and pain-related fear do not emerge within a social and cultural vacuum. In Western cultures many – even pain-free – persons hold a biomedical view of back pain. As a consequence, many believe that back pain is caused by an injury, that a wrong movement can lead to serious problems if one has back pain, that X-ray and imaging tests can always identify the cause of back pain and that bed rest is an important part of treatment (Goubert et al. 2004a). Health-care providers may further reinforce these beliefs, inadvertently, fuelling pain-related fear and avoidance. Indeed, Linton et al. (2002) have found that many health care providers still advise patients to avoid painful movements and believe that pain-reduction is a necessary requirement for return to work or that sick-leave is an adequate treatment for back pain.

One of the clinical implications of the fear-avoidance models is that treatment should directly target pain-related fear and avoidance. Therefore, in analogy with phobia and anxiety disorders, ► **exposure in vivo** has been proposed as a potentially effective treatment of pain-related fear (Vlaeyen et al. 2002). During exposure, patients are gradually exposed to physical activities that are feared or believed to be harmful, in order to correct erroneous cognitions and to extinguish fear and avoidance. At present, the effectiveness of exposure *in vivo* has only been investigated in single case experimental designs. Results show remarkable improvements on self-report measures of pain-related fear, catastrophizing and disability (Vlaeyen et al. 2002).

## References

1. Asmundson GJG, Vlaeyen JWS, Crombez G (2004) Understanding and treating fear of pain. Oxford University Press, Oxford, p 367
2. Crombez G, Vlaeyen JWS, Heuts PHTG et al. (1999) Pain-related fear is more disabling than pain itself: evidence on the role of pain-related fear in chronic back pain disability. *Pain* 80:329–339
3. Eccleston C, Crombez G (1999) Pain demands attention: a cognitive-affective model of interruptive function of pain. *Psychol Bull* 3:356–366
4. Fordyce WE (1976). Behavioral methods for chronic pain and illness. The C.V. Mosby Company, Saint Louis
5. Goubert L, Crombez G, De Bourdeaudhuij I (2004a) Low back pain, disability and back pain myths in a community sample: prevalence and interrelationships. *European J Pain* 8:385–394
6. Goubert L, Crombez G, Van Damme S (2004b) The role of neuroticism, pain catastrophizing and pain-related fear in vigilance to pain: a structural equations approach. *Pain* 107:234–241
7. Klenerman L, Slade PD, Stanley M et al. (1995) The prediction of chronicity in patients with an acute attack of low back pain in a general practice setting. *Spine* 20:478–484
8. Kori SH, Miller RP, Todd DD (1990) Kinesiophobia: a new view of chronic pain behavior. *Pain Manage Jan / Feb*:35–43
9. Lethem J, Slade PD, Troup JD et al. (1983) Outline of a fear-avoidance model of exaggerated pain perception: I. *Behav Res Ther* 21:401–408
10. Linton SJ, Buer N, Vlaeyen JWS et al. (2000). Are fear-avoidance beliefs related to the inception of an episode of back pain? A prospective study. *Psychol Health* 14:1051–1059
11. Linton SJ, Vlaeyen JWS, Ostelo RW (2002). The back pain beliefs of health care providers: are we fear-avoidant? *J Occup Rehabil* 12:223–232
12. McCracken LM, Gross RT (1993) Does anxiety affect coping with chronic pain? *Clin J Pain* 9:253–259
13. Vlaeyen JWS, Crombez G (1999) Fear of movement / (re)injury, avoidance and pain disability in chronic low back pain patients. *Man Ther* 4:187–195
14. Vlaeyen JWS, Linton SJ (2000) Fear-avoidance and its consequences in chronic musculoskeletal pain: a state of the art. *Pain* 85:317–332
15. Vlaeyen JWS, de Jong JR, Sieben JM et al. (2002) Graded exposure *in vivo* for pain-related fear. In: Turk DC, Gatchel RJ (eds) *Psychological approaches to pain management: a practitioner's handbook*. The Guilford Press, New York, pp 210–233
16. Verbunt JA, Seelen HA, Vlaeyen JWS et al. (2003) Disuse and deconditioning in chronic low back pain: concepts and hypotheses on contributing mechanisms. *Eur J Pain* 7:9–21

M

## Muscle Pain, Fibromyalgia Syndrome (Primary, Secondary)

I. JON RUSSELL

Division of Clinical Immunology and Rheumatology,  
Department of Medicine, The University of Texas  
Health Science Center, San Antonio, TX, USA  
russell@uthscsa.edu

### Synonyms

Fibromyalgia Syndrome; Fibrositis Syndrome; FMS; chronic widespread allodynia

### Definition

The ► **Fibromyalgia Syndrome** (FMS) is a common, female gender-predominant, idiopathic clinical syndrome characterized by widespread musculoskeletal pain, and reproducible tenderness to deep palpation pressure at anatomically defined soft tissue structures, collectively called ► **tender points** (TePs) (Wolfe et al. 1990). The classification of soft tissue pain (STP) disorders, including the FMS, is shown below (Russell 1993).

### Characteristics

Taxonomically, FMS is classified among over 100 other clinical conditions that cause pain in soft tissue structures (including nerve, muscle, ligament, tendon, and/or bursae) of the musculoskeletal system. The term ► **“soft tissue pain”** (STP) has been proposed (Russell 1993)

as the generic heading for this long list of clinical disorders. As such, the term STP replaces the antiquated term “non-articular rheumatism”. The proposed classification of STP as listed below is based on the typical body distributions of the included conditions, rather than upon their pathogenesis. For example:

Localized STP is exemplified by ► [tendinitis](#) and ► [bursitis](#); Regionalized STP is exemplified by ► [complex regional pain syndrome](#) and ► [myofascial pain syndrome](#) with ► [trigger points](#) (TrPs); and Generalized STP is exemplified by FMS with tender points (TePs) and by chronic fatigue syndrome, when that condition presents with musculoskeletal pain. As a member of the generalized STP category, FMS is now viewed as the human model for chronic, widespread, ► [allodynia](#) (see ► [Allodynia \(Clinical, Experimental\)](#)).

#### Localized

- Bursitis [subacromial, olecranon, trochanteric, prepatellar, anserine]
- Tenosynovitis [biceps, supraspinatus, infrapatellar, Achilles]
- Enthesopathies [lateral epicondylitis, medial epicondylitis]
- Entrapment syndrome [carpal tunnel, tarsal tunnel, cubital tunnel]

#### Regionalized

- Myofascial pain syndrome [trapezius, piriformis, iliopsoas]

**Muscle Pain, Fibromyalgia Syndrome (Primary, Secondary), Table 1** American College of Rheumatology (ACR) Criteria for Classification (Wolfe et al. 1990) History – Chronic, widespread (four quadrants) soft tissue pain for three months **Examination** – Pain (1+ or greater severity) induced by 4 kg of palpation pressure at 11 of 18 anatomically defined tender points \*

Number	Official ACR Bilateral Tender Point Sites
1, 2	Occiput: suboccipital muscle insertions
3, 4	Low cervical: anterior aspects of C5-7 inter-transverse spaces
5, 6	Trapezius: midpoint of upper border
7, 8	Supraspinatus: origins, above the scapula spine, near medial border
9,10	2nd rib: upper lateral surface of second costochondral jn
11,12	Lateral epicondyle: two cm distal to the epicondyles
13,14	Gluteal: upper outer buttock, anterior fold of muscle
15,16	Greater trochanter: posterior to trochanteric prominence
17,18	Knees: medial fat pad, just proximal to medial condyle

Sensitivity and specificity are > 80 %  
Anatomically Defined Tender Points in Fibromyalgia Syndrome (FMS). Note that named sites are bilateral, even number refers to right side

- Myofascial pain dysfunction syndrome [MPDS, replaces TMD]
- Referred pain [angina or subphrenic abscess to shoulder, hip to thigh]
- Complex regional pain syndrome [CRPS]
- Type 1 – non-nerve injury [replaces reflex sympathetic dystrophy]
- Type 2 – nerve injury [replaces causalgia]

#### Generalized

- Fibromyalgia syndrome
- Chronic fatigue syndrome
- Hypermobility syndrome

The term ‘primary FMS’, has come into common usage to identify a condition meeting the American College of Rheumatology (ACR) classification criteria based upon widespread pain and TeP tenderness (Wolfe et al. 1990), but lacking evidence for any associated painful condition.

It is apparent, however, that patients can exhibit the same ACR classification criteria (Wolfe et al. 1990) in association with other painful conditions (see Table 2). That seems to be the case in about 30 % of patients with rheumatoid arthritis, 40 % of patients with systemic lupus erythematosus and 50 % with Sjögren’s syndrome. The FMS has been recognized in association with tuberculosis, syphilis, and Lyme disease. There also seems to be a high prevalence of FMS among women having body pain in association with silicone breast implants. For want of better terminology, the FMS in such settings has been collectively referred to as ‘secondary FMS’.

The ACR classification criteria study (Wolfe et al. 1990) failed to disclose any clinical features in the secondary FMS patients that would clearly distinguish them from primary FMS, so it was recommended that the term secondary FMS be abandoned. Despite that, essentially all of the current and past FMS clinical trials, sponsored by industry or by government agencies, have specified enrollment of only primary FMS patients. They accomplish that distinction by excluding all subjects with a concomitant rheumatic disease or organ related abnormalities.

In each of the secondary FMS situations, it has been unclear what pathogenic role the ‘other’ condition might have had in the development of the FMS. The current belief is that the comorbid inflammatory conditions have not developed from the FMS, nor has the FMS necessarily resulted from them, so the implication of causality in the term secondary FMS is likely to be a misnomer. Despite that, the terminology serves a need, and has become entrenched, so it will probably endure, at least for the short term.

Biochemical studies help to support this distinction of a single syndrome developing in two or more different settings. Most people with FMS (both primary and sec-



**Muscle Pain, Fibromyalgia Syndrome (Primary, Secondary), Table 2** Illnesses Concomitant with Secondary Fibromyalgia Syndrome. With Tests Profile to Characterize the Diagnosis (Russell 1993)\*

Illness	Tests
<b>Rheumatic disease</b>	
a. Systemic lupus erythematosus	ANA + ESR or CRP <sup>‡</sup>
b. Rheumatoid arthritis	RF + ESR or CRP
c. Polymyositis	Creatine phosphokinase
d. Sjögren's syndrome	Labial salivary gland biopsy
<b>Infection/inflammation</b>	
a. Tuberculosis	PPD, ESR, Chest X-ray
b. Chronic syphilis	VDRL, FTA, CSF
c. Subacute bacterial endocarditis	Culture, ESR
d. Lyme disease	Serology
e. Parvovirus	Serology, Change
e. Acquired immunodeficiency syndrome	Serology
f. Breast implant	Serology
g. Inflammatory bowel syndromes	Colonoscopy
<b>Endocrine disorders</b>	
a. Hypothyroidism	Thyroxine, TSH
b. Hypopituitary	Prolactin
<b>Obstructive myelopathy</b>	
a. Whiplash C1,2 or subaxial subluxation	CT or MRI of CSpine
b. Chiari malformation	MRI foramen magnum
c. Syringomyelia	MRI of brainstem/Cspine
d. Spinal stenosis	MRI of Cspine

\*Adapted with consent

Abbreviations:

ANA=antinuclear antibody; ESR=Westergren erythrocyte sedimentation rate; CRP=C-reactive protein; RF=rheumatoid factor; PPD=purified protein derivative delayed cutaneous test for exposure to tuberculosis bacilli; VDRL=serologic screening test for syphilis; FTA=fluorescent treponemal antibody test for syphilis; CSF=cerebrospinal fluid tests; TSH=thyroid stimulating hormone; C1,2=cervical spine level 1 and level 2 atlantoaxial; CT=computerized tomography; CSpine=cervical spine; MRI=magnetic resonance tomography

ondary) have elevated spinal fluid (CSF) substance P as an amplifier of afferent pain signals. The distinction seems to be, that only primary FMS patients exhibit elevated concentrations of nerve growth factor as a substance P inducing agent (Giovengo et al. 1999). In secondary FMS, associated with an inflammatory condition, the nerve growth factor levels were found to be normal. The inflammation itself may be responsible for initiating the high CSF substance P levels in

those conditions. This concept is important because it provides evidence that there may be a final common pathway (related to the elevated CSF substance P) by which primary FMS and secondary FMS could exhibit the same clinical syndrome (i.e. FMS).

### Epidemiology

The FMS exhibits a world-wide distribution. It is viewed as being common, because it affects 2–5 % of the general population. It is female predominant, with 8 of 10 affected individuals being female. It increases in prevalence with age, such that about 10 % of women in the 50–60 years of age decade are affected. About one third of FMS patients are so severely affected by their symptoms that they are unable to maintain their usual occupational activities (Wolfe et al. 1997c). The average annual direct cost of this condition in the United States was estimated to be about \$2,250 (Wolfe et al. 1997a). The natural history of FMS is to develop a pattern of severity over a relatively short period of time, and then remain relatively unchanged over a period of many years (Wolfe et al. 1997b). It does not usually become another medical condition like a rheumatic disease.

### Comorbidities

In addition to the defining widespread musculoskeletal pain and TePs, people with FMS typically exhibit a constellation of painful symptoms or syndromes that can include insomnia, which occurs in about 70 % (Smythe and Moldofsky 1977), nocturnal myoclonus, cognitive dysfunction, headache, depression in about 40 % (Ahles et al. 1991), anxiety, autonomic neuropathy (Martinez-Lavin 2003), nocturnal bruxism, myofascial pain dysfunction syndrome (the so-called TMJ syndrome), myofascial pain syndrome (particularly involving the piriformis muscles), hypermobility syndrome in about 30 % (Acasuso-Diaz and Collantes-Estevéz 1998), biceps tendinitis, pes anserine bursitis, irritable bowel syndrome in about 40 % (Aaron and Buchwald 2001), and irritable bladder syndrome (interstitial cystitis) in about 10 % (Clauw et al. 1997). Despite overlapping features and prevalence, FMS can be distinguished from rheumatic diseases, the complex regional pain syndromes, the chronic fatigue syndrome, and the myofascial pain syndrome affecting a variety of muscles, on the basis of its clinical presentation, its consistent epidemiologic pattern, and its predictable prognosis.

### Heterogeneity

How should this heterogeneity of associated manifestations be viewed? Should clinicians caring for FMS patients be lumpers or splitters? It is worthy, in this regard, to consider the established situation with systemic lupus erythematosus (SLE). The ACR supports the concept that 11 diagnostic criteria are important to the clinical diagnosis of SLE, but only four of these cri-

teria are required to diagnose SLE in a given individual (Tan et al. 1982). Lupus subgroups are characterized by their patterns of major organ involvement, critical to the prognosis and management of the disorder (Hughes 1978). For example, in various combinations, about 50 % of SLE patients have renal involvement, 50 % exhibit lung involvement, cardiac involvement is seen in about 40 %, neuropsychiatric manifestations are present in about 60 %, autoimmune hemolysis occurs in about 5 %, and about 30 % have concomitant FMS. The findings from prior psychological studies of FMS, in which two or three distinct clusters (subgroups?) of FMS patients had been identified, were reviewed by Walen and colleagues (Walen et al. 2002). They then conducted extensive evaluations on 600 FMS patients who were members of a health maintenance organization. Cluster analysis on the data from those subjects confirmed the previously described unique clusters of FMS patients that differed from each other with respect to mood disturbance, pain, physical function, and social support. While these subgroup differences were statistically definable, all three subgroups were still much worse than healthy normal controls in the general population. Electrophysiological assessment methods, such as combinations of quantitative electroencephalography (qEEG) and electromyography (sEMG) have also helped to identify distinct FMS subgroups (Donaldson et al. 2002). Forty patients with FMS, off their usual FMS medications for five half lives, were stratified into three subgroups on the basis of their Symptom Checklist-90-Revised (SCL-90-R) Global Severity Index (GSI) scores (Derogatis 1994). The subgroups were then examined by qEEG activity patterns with the subjects resting, eyes closed. By-subgroup differences in the quantity of the typical qEEG wave forms were found. Across the GSI-defined subgroups, from least to most distressed, alpha brainwave activity (7.5–13 Hertz) progressively decreased, while theta activity (3.5–7.5 Hertz) progressively increased. Beta activity (13–22 Hertz) was highest in the middle group; while delta activity (0.5–3.5 Hertz) was consistently low across all three subgroups. The addition of sEMG data in this study demonstrated widely dispersed skeletal muscle co-contraction in response to a distant volitional stimulus, but the magnitude of this abnormality did not differ among the three GSI-defined subgroups.

### Muscle

The FMS is probably is a central neurological disorder rather than a disorder of skeletal muscle, but there was a time in the history of the disorder when skeletal muscle was the focus of investigation into the pathogenesis of FMS. Indeed, the clinical complaint most consistently reported by FMS patients is deep, aching, body pain. Whether spontaneously, or as learned from their health care providers, FMS patients have tended to interpret these symptoms as muscle pains, muscle

fatigue, and muscle stiffness. That may have been what prompted early FMS researchers to seek some specific pathology in affected muscles. Controlled histological examination of FMS muscle tissue sections by light microscopy and electron microscopy have disclosed minor mitochondrial abnormalities, atrophy of type 2 muscle fibers, ragged red fibers, or moth-eaten fibers (Yunus et al. 1989; Lindman et al. 1995), and lower than normal capillary density, but the histological evidence did not support FMS specificity. In addition, lower levels of ATP and phosphoryl creatine were found in the trapezius and the tibialis anterior muscles of FMS patients compared with HNC (Bengtsson et al. 1986). Clearly, skeletal muscle that is at risk could serve as a peripheral pain generator in FMS patients who fail to maintain physical fitness of the very muscle groups needed for usual function, and for critical situations of physiological stress that cause the falling injuries observed to be common among people with FMS.

### Biochemistry

Biochemical analysis of fluid samples from patients with FMS has also identified apparent subgroups. For example, 84 % of FMS patients had elevated cerebrospinal fluid levels of substance P (Russell et al. 1994). As noted earlier, patients with “primary” FMS had elevated levels of nerve growth factor not seen in normal controls, or in FMS patients with concomitant rheumatic diseases (“secondary” FMS), or in rheumatic disease patients who do not have FMS (Giovengo et al. 1999). Similarly, blood samples from a subgroup of about 50 % of FMS patients exhibit an antibody to an environmental polymer (Wilson et al. 1999), so the antipolymer antibody assay is being proposed as a way to distinguish these two unique subgroups. A genetic predisposition appears to be a factor in a subgroup of FMS (Iyengar et al. 2003). The current hope is that the findings from objective tests, which are now in active development, can be leveraged to identify pathogenic mechanisms.

### Medications

Finally, attempts at diagnostic treatment regimens have disclosed differences in the responses of FMS patients to ketamine, suggesting that the N-methyl-D-aspartic receptor (which ketamine inhibits) in the spinal cord is important to the perceived pain in FMS (Graven-Nielsen et al. 2000). Patient volunteers in one key study (Sorensen et al. 1997) were treated (randomized serial crossover) with brief intravenous infusions of ketamine, morphine sulfate, lidocaine, or saline placebo. Of the 18 FMS patients studied, two patients were placebo responders (responded with improvement to all three agents and the placebo) and three were nonresponders (no improvement with any of the administered agents). The majority (N = 13) responded to one or more of the active medications but not to placebo. Four

patients responded to a single drug (morphine-one, ketamine-three), six responded to two drugs (lidocaine and morphine-four, lidocaine and ketamine-two), and three responded to all three active drugs. Since all of the patients were clinically diagnosed as having FMS, this study implies substantial heterogeneity in the response of FMS patients to treatment. It may further help to explain why some patients fail to respond to a clinician's favorite regimen.

From the preceding discussion, it seems likely that the composite of FMS subjects, identified by the 1990 ACR criteria for the classification of FMS (Wolfe et al. 1990), are heterogeneous in several important respects. Walen and colleagues (Walen et al. 2002) concluded their assessment by saying that: "People with FMS may fall into distinct subgroups; . . . (but) the utility of dividing participants into these (sub) groups in planning interventions remains unclear." On the other hand, they also suggest that "the most helpful direction for future research would involve comparing the effects of interventions designed especially for each cluster to a 'nontailored' intervention." Finally, It always comes back to the hopeful prediction that the better we understand the mechanisms of chronic FMS pain, the more likely we are to find specific and effective therapies.

### Pathogenesis

The pathogenesis of FMS is becoming increasingly evident from studies of physiology, pharmacology, neurochemistry, and brain imaging. Available evidence supports the hypothesis that the underlying dysfunction in FMS is within the central nervous system. It is no longer considered to be merely a psychological disorder, a diagnosis to be made by exclusion, or a condition devoid of objective laboratory findings. Patients with FMS exhibit objective abnormalities in ► **nociception** and in neuroendocrine functions, which undoubtedly contribute substantially to their generalized symptoms. Some of the biological participants in this process include: unmyelinated dorsal horn neurons (like A-delta and C-fibers), excitatory amino acids, neuropeptides, zinc, biogenic amines, nitric oxide, wide-dynamic range spinal neurons, the limbic system of the midbrain, and several regions of the cerebral cortex. A lowered pain threshold (ie. allodynia) characterizes the examination findings in FMS. Allodynia can be caused in animal systems by strategic manipulation of nociceptive neurochemicals. Studies of the nociceptive neurochemicals in FMS spinal fluid find them abnormal in concentration and/or correlated with the symptoms. Those observations change the way FMS is viewed, and identify it as a remarkably interesting human syndrome of chronic central neurochemical pain amplification.

### Management

Dealing with FMS has been a complicated process for twentieth century medicine, leading to widely conflict-

ing opinions about it. The reasons for the resultant role modeling are buried deep in the fabric of belief system anchoring. Effective contemporary management of FMS requires each of the following (Russell 1996): The unequivocal recognition that pain is always subjective, a willingness to accept FMS as a medical syndrome, the effort to integrate a logical but increasingly complex pathogenesis, and empathetic individualization of increasingly evidence-based therapy. The components of a practical regimen include: accurate diagnosis of the FMS and associated conditions, education about FMS, physical modalities such as exercise, medications for the presenting symptoms, and follow-up assessment to monitor therapeutic progress.

### References

1. Aaron LA, Buchwald D (2001) A Review of the Evidence for Overlap among Unexplained Clinical Conditions. *Ann Intern Med* 134:868–881
2. Acasuso-Diaz M, Collantes-Estevez E (1998) Joint Hypermobility in Patients with Fibromyalgia Syndrome. *Arthritis Care Res* 11:39–42
3. Ahles TA, Khan SA, Yunus MB et al. (1991) Psychiatric Status of Patients with Primary Fibromyalgia, Patients with Rheumatoid Arthritis, and Subjects without Pain: A Blind Comparison of DSM-III Diagnoses. *Am J Psychiat* 148:1721–1726
4. Bengtsson A, Henriksson KG, Larsson J (1986) Reduced High Energy Phosphate Levels in the Painful Muscles of Patients with Primary Fibromyalgia. *Arthritis Rheum* 29:817–821
5. Clauw DJ, Schmidt M, Radulovic D et al. (1997) The Relationship Between Fibromyalgia and Interstitial Cystitis. *J Psychiatr Res* 31:125–131
6. Derogatis L (1994) SCL-90-R: Administration, Scoring, and Procedures Manual. Clinical Psychometric Research
7. Donaldson M, Donaldson CC, Mueller HH et al. (2002) QEEG Patterns, Psychological Status, and Pain Reports of Fibromyalgia Sufferers. *Am J Pain Management* (Submitted)
8. Giovengo SL, Russell IJ, Larson AA (1999) Increased Concentrations of Nerve Growth Factor in Cerebrospinal Fluid of Patients with Fibromyalgia. *J Rheumatol* 26:1564–1569
9. Graven-Nielsen T, Aspegren KS, Henriksson KG et al. (2000) Ketamine Reduces Muscle Pain, Temporal Summation, and Referred Pain in Fibromyalgia Patients. *Pain* 85:483–491
10. Hughes GRV (1978) Systemic Lupus Erythematosus. In: Scott JT (ed) *Copeman's Textbook of the Rheumatic Diseases*. T & A Constable Ltd, Edinburgh, pp 901–922
11. Iyengar SK, Arnold LM, Khan MA et al. (2003) Genetic Linkage of Fibromyalgia Syndrome to the Serotonin Receptor 2A Region on Chromosome 13 and the HLA Region on Chromosome 6. In Preparation
12. Lindman R, Hagberg M, Bengtsson A et al. (1995) Capillary Structure and Mitochondrial Volume Density in the Trapezius Muscle of Chronic Trapezius Myalgia, Fibromyalgia and Healthy Subjects. *J Musculoske Pain* 3:5–22
13. Martinez-Lavin M (2003) Use of the Leeds Assessment of Neuropathic Symptoms and Signs Questionnaire in Patients with Fibromyalgia. *Seminars in Arthritis & Rheumatism* 32:407–411
14. Russell IJ (1993) A New Journal. *J Musculoske Pain* 1:1–7
15. Russell IJ (1996) Fibromyalgia Syndrome: Approaches to Management. *Bull Rheum Dis* 45(3):1–4
16. Russell IJ, Orr MD, Littman B et al. (1994) Elevated Cerebrospinal Levels of Substance P Patients Fibromyalgia Syndrome. *Arthritis Rheum* 37:1593–1601
17. Smythe HA, Moldofsky H (1977) Two Contributions to Understanding of the "Fibrositis" Syndrome. *Bull Rheum Dis* 28:928–931
18. Sorensen J, Bengtsson A, Ahlner J et al. (1997) Fibromyalgia – Are there Different Mechanisms in the Processing of Pain?



- A Double-Blind Crossover Comparison of Analgesic Drugs. *J Rheumatol* 24:1615–1621
19. Tan EM, Cohen AS, Fries JF et al. (1982) The 1992 Revised Criteria for the Classification of Systemic Lupus Erythematosus. *Arthritis Rheum* 25:1271–1277
  20. Walen HR, Cronan TA, Serber ER et al. (2002) Subgroups of Fibromyalgia Patients: Evidence for Heterogeneity and an Examination of Differential Effects Following a Community-Based Intervention. *J Musculoske Pain* 10:9–32
  21. Wilson RB, Gluck OS, Tesser JR et al. (1999) Antipolymer Antibody Reactivity in a Subset of Patients with Fibromyalgia Correlates with Severity. *J Rheumatol* 26:402–407
  22. Wolfe F, Anderson J, Harkness D et al. (1997a) A Prospective, Longitudinal, Multicenter Study of Service Utilization and Costs in Fibromyalgia. *Arthritis Rheum* 40:1560–1570
  23. Wolfe F, Anderson J, Harkness D et al. (1997b) Health Status and Disease Severity in Fibromyalgia: Results of a Six Center Longitudinal Study. *Arthritis Rheum* 40:1571–1579
  24. Wolfe F, Anderson J, Harkness D et al. (1997c) Work and Disability Status of Persons with Fibromyalgia. *J Rheumatol* 24:1171–1178
  25. Wolfe F, Smythe HA, Yunus MB et al. (1990) The American College of Rheumatology 1990 Criteria for the Classification of Fibromyalgia. *Arthritis Rheum* 33:160–172
  26. Yunus MB, Kalyan-Raman UP, Masi AT et al. (1989) Electron Microscopic Studies of Muscle Biopsy in Primary Fibromyalgia Syndrome: A Controlled and Blinded Study. *J Rheumatol* 16:97–101

## Muscle Pain in Systemic Inflammation (Polymyalgia Rheumatica, Giant Cell Arteritis, Rheumatoid Arthritis)

HENNING BLIDDAL  
The Parker Institute, Frederiksberg Hospital,  
Copenhagen, Denmark  
hb@fh.hosp.dk

### Synonyms

Arthritogenic Pain; Immuno-Inflammatory Muscle Pain; polymyalgia rheumatica; giant cell arthritis; rheumatoid arthritis

### Definition

With the exception of some cases of ► **myositis**, the inflammatory conditions of joints and muscles have muscle pain as a very prominent symptom. The pain may be caused by changes in the muscles *per se*, including possible referred pain, or be secondary to the inflammatory changes in the joints. Inflammation in both tendon sheaths and tendon insertions may contribute to the condition, which may be quite complex with regard to pain analysis. Due to its frequent involvement, ► **giant cell arteritis** is often called ► **temporal arteritis**.

### Characteristics

The inflammatory process involves an increased production of ► **cytokines** e.g. the important pro-inflammatory cytokines TNF- $\alpha$  and IL-1. These cytokines are involved in the pathogenesis of pain (Gotoh et al. 2002) and pain in

these conditions is accompanied by tiredness and anemia due to systemic actions of the cytokines as in rheumatoid cachexia (Walsmith and Roubenoff 2002).

In the elderly, it may be very difficult to distinguish between ► **rheumatoid arthritis (RA)** and ► **polymyalgia rheumatica / giant cell arteritis (PMR / GCA)** with a possible overlap between the diseases (Lange et al. 2000; Salvarani and Hunder 1999).

PMR / GCA is associated with pain and muscle soreness in the shoulder and head regions. The two diseases have similar symptoms from the muscles but may be distinguished by the finding of vasculitis in a biopsy of the temporal artery in the latter. PMR occurs in the elderly population with an incidence rate of about 0.5 per 10,000 population aged more than 50, while GCA is considerably less frequent, although the incidence may vary over the world.

The muscle pain in PMR / GCA may resemble other conditions in the area and there are no pathognomonic features of the head and ► **neck pain** with the possible exception of jaw claudication present in about half of the cases (Hall et al. 1983). The diagnosis must be suspected in any person above 50 years of age with unexplained changes in pain patterns in the proximal parts of the upper extremity and to some extent the lower extremity as well. In more than 2 / 3 of the patients, the pain involves the shoulder region as well as headache. The muscles of the shoulder girdle are sore and exhibit exercise intolerance and fatigue. There is often pain at night and decreased range-of-motion of the joints in the affected area. The finding of an elevated erythrocyte sedimentation rate substantiates the diagnosis. The signs of systemic inflammatory action, e.g. light fever, malaise and weight loss may dominate pain as a secondary phenomenon.



**Muscle Pain in Systemic Inflammation (Polymyalgia Rheumatica, Giant Cell Arteritis, Rheumatoid Arthritis), Figure 1** Arteritis temporalis. The artery is abnormally swollen and sore on palpation due to immuno-inflammatory changes in the arterial wall. This may eventually lead to obstruction of the lumen and as the process may involve other arteries in the area, including the arteria to the optic nerve, a feared complication is blindness.



### Rheumatoid Arthritis (RA)

RA has a prevalence of about 1%, with maximum incidence among the 30–50 year olds and a female / male ratio of 2.5–3. The etiology is unknown, with autoimmune mechanisms involved in the pathogenesis. The disease is most often chronic with fluctuations of disease activity leading to a gradual loss of function. Cardinal symptoms are ► **morning stiffness** of joints, swollen and tender finger joints, symmetrical distribution of arthritis and, depending on severity, joint erosions. The symptoms and signs may differ with the age group. All patients suffer from inflammatory pain in synovial tissues including joints, tendon sheaths and bursae. In the elderly the muscle pain may be very prominent, while all patients have various degrees of muscle fatigue. Some of the medications used for treatment of RA may induce myopathy (Le Quintrec and Le Quintrec 1991). The weakness and the associated activity induced pain in the muscles may not be a primary feature as indicated by the lack of correlation with the muscle strength (Schiottz-Christensen et al. 2001). A specific muscle weakness induced by treatment with ► **steroids** is well described; it is probable, but not fully established, that this may be accompanied by pain (Danneskiold-Samsoe and Grimby 1986). It is possible for patients with RA to train in spite of their joint disease (Bearne et al. 2002; Lyngberg et al. 1994) and exercises to increase muscle strength should be encouraged to maintain general functional abilities.

RA, in 20% of cases, coexists with ► **Sjögren's syndrome**, which, apart from the ► **sicca-syndrome**, is characterized by general muscle pain and fatigue. Myositis may occur in Sjögren's as well and is unrelated to the pain, which is of unknown origin (Lindvall et al. 2002). Finally, RA may – as do other immune-inflammatory diseases - induce a secondary fibromyalgia and the pain quality in the two diseases may be indistinguishable (Burckhardt et al. 1992). In the elderly, an overlap-syndrome exists, with muscle pain in the shoulder region as a common sign between PMR / GCA and RA. In younger women, a similar diagnostic problem arises in the lighter cases of RA, which may resemble fibromyalgia for long periods before a certain diagnosis can be given.

There are aspects of the pain in inflammatory rheumatic diseases, which makes the arthritogenic pain differ from other chronic pain condition.

1. The rheumatic patient is typically well diagnosed with a clear explanation of the pain. Most often the pain correlates with either obvious clinical changes in the joints, e.g. swelling, readily understandable blood tests, e.g. erythrocyte sedimentation rate, ESR or imaging of the inflammatory changes in synovial tissue, e.g. by ultrasound-Doppler or MRI (Terslev et al. 2003). The patients will often have frequent contacts with a specialist, who can reassure them about the nature of the pain. In consequence, unlike other



**Muscle Pain in Systemic Inflammation (Polymyalgia Rheumatica, Giant Cell Arteritis, Rheumatoid Arthritis), Figure 2** Muscle wasting in rheumatoid arthritis. The inflammation of the joints and the arthritogenic pain affect the whole movement segment with pain-induced muscle wasting. The process is irreversible in cases of joint destruction as in this case where subluxations and ulnar deviation is evident in both wrist joint and fingers.

chronic pain conditions, there is less uncertainty associated with the origin or extent of the rheumatic pain.

2. The rheumatic patient has unique possibilities of pain relief by anti-inflammatory agents. The most pronounced effect is the well-documented, almost immediate effect of glucocorticoids in polymyalgia rheumatica (PMR / GCA), which may even be used to substantiate the diagnosis.

By such procedures the pain may be explained and even documented to both patients and social contacts, which may save the patients from a deterioration due to an uncertainty of diagnosis, which is otherwise a definite psychological problem in muscle pain of the shoulders (Dyrehag et al. 1998). Nevertheless, the patients with inflammatory diseases may benefit from general therapeutic measures against their pain, including non-medicinal pain management (Evers et al. 2003; Keefe et al. 2001).

Combined muscle and joint pain in a patients involves a number of considerations in internal medicine and in unsettled diagnosis it must be suggested that both clinical examination and blood tests including calcium and thyroid hormones are performed (Table 1).

### References

1. Bearne LM, Scott DL, Hurley MV (2002) Exercise can reverse quadriceps sensorimotor dysfunction that is associated with rheumatoid arthritis without exacerbating disease activity. *Rheumatology* 41:157–166
2. Burckhardt CS, Clark SR, Bennett RM (1992) A comparison of pain perceptions in women with fibromyalgia and rheumatoid arthritis: relationship to depression and pain extent. *Arthritis Care Res* 5:216–222
3. Danneskiold-Samsoe B, Grimby G (1986) The relationship between the leg muscle strength and physical capacity in patients

**Muscle Pain in Systemic Inflammation (Polymyalgia Rheumatica, Giant Cell Arteritis, Rheumatoid Arthritis), Table 1** Medical diseases, which may give rise to both joint and muscle pain

Suspected disease	Pain region	Examination
Heart disease	Neck/shoulder/arm	Stethoscopy, EKG
Disease close to diaphragm (e.g. pneumonia, gall-bladder problems)	Neck/shoulder/arm	Stethoscopy, palpation of the abdomen
Thyroid diseases	Diffuse pain in muscles and joints	Palpation of the thyroid—other signs of thyroid disease incl. eye changes
Calcium metabolism	Diffuse pain in muscles and joints	In severe cases, cramps and involuntary muscle contractions

with rheumatoid arthritis, with reference to the influence of corticosteroids. *Clin Rheumatol* 5:468–474

- Dyrehag LE, Widerstrom-Noga EG, Carlsson SG et al. (1998) Relations between self-rated musculoskeletal symptoms and signs and psychological distress in chronic neck and shoulder pain. *Scand J Rehabil Med* 30:235–242
- Evers AW, Kraaijaat FW, Geenen R et al. (2003) Stress-vulnerability factors as long-term predictors of disease activity in early rheumatoid arthritis. *J Psychosom Res* 55:293–302
- Gotoh M, Hamada K, Yamakawa H et al. (2002) Interleukin-1<sup>α</sup>-induced glenohumeral synovitis and shoulder pain in rotator cuff diseases. *J Orthop Res* 20:1365–1371
- Hall S, Persellin S, Lie JT et al. (1983) The therapeutic impact of temporal artery biopsy. *Lancet* 2:1217–1220
- Keefe FJ, Affleck G, Lefebvre J et al. (2001) Living with rheumatoid arthritis: The role of daily spirituality and daily religious and spiritual coping. *J Pain* 2:101–110
- Lange U, Piegsa M, Teichmann J et al. (2000) Ultrasonography of the glenohumeral joints—a helpful instrument in differentiation in elderly onset rheumatoid arthritis and polymyalgia rheumatica. *Rheumatol Int* 19:185–189
- Le Quintrec JS, Le Quintrec JL (1991) Drug-induced myopathies. *Baillieres Clin Rheumatol* 5:21–38
- Lindvall B, Bengtsson A, Ernerudh J et al. (2002) Subclinical myositis is common in primary Sjogren's syndrome and is not related to muscle pain. *J Rheumatol* 29:717–725
- Lyngberg KK, Ramsing BU, Nawrocki A et al. (1994) Safe and effective isokinetic knee extension training in rheumatoid arthritis. *Arthritis Rheum* 37:623–628
- Salvarani C, Hunder GG (1999) Musculoskeletal manifestations in a population-based cohort of patients with giant cell arteritis. *Arthritis Rheum* 42:1259–1266
- Schiottz-Christensen B, Lyngberg K, Keiding N et al. (2001) Use of isokinetic muscle strength as a measure of severity of rheumatoid arthritis: a comparison of this assessment method for RA with other assessment methods for the disease. *Clin Rheumatol* 20:423–427
- Terslev L, Torp-Pedersen S, Savnik A et al. (2003) Doppler ultrasound and magnetic resonance imaging of synovial inflammation of the hand in rheumatoid arthritis: a comparative study. *Arthritis Rheum* 48:2434–2441
- Walsmith J, Roubenoff R (2002) Cachexia in rheumatoid arthritis. *Int J Cardiol* 85:89–99

## Muscle Pain Model, Inflammatory Agents-Induced

DARRYL T. HAMAMOTO, DONALD A. SIMONE  
University of Minnesota, Minneapolis, MN, USA  
simon003@umn.edu

### Synonyms

Animal Models of Inflammatory Myalgia; Animal Models of Inflammatory Muscle Pain; Nocifensive Behaviors Evoked by Myositis

### Definition

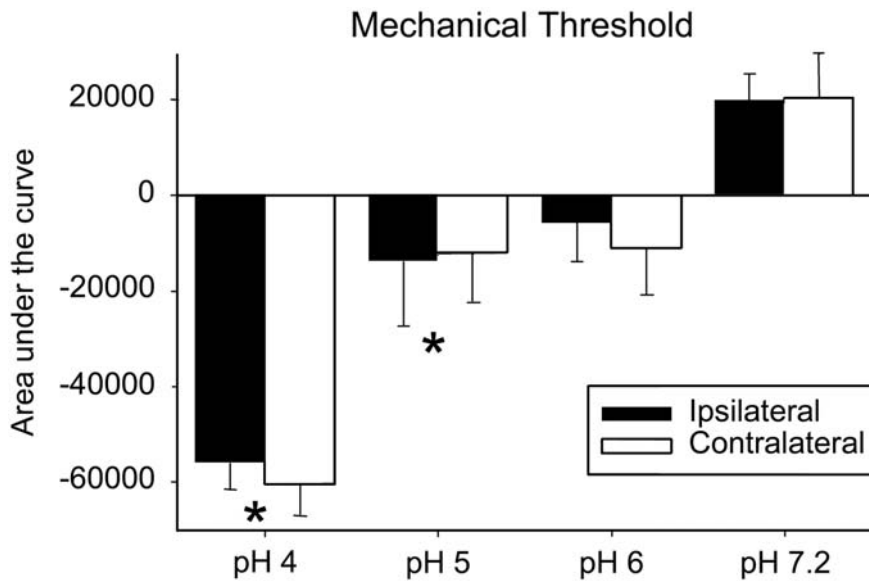
Animal models have been recently developed that may allow further elucidation of the underlying mechanisms of pain associated with inflammation of muscle (i.e. ► **myositis**). A better understanding of these mechanisms may lead to the development of novel approaches to treating inflammatory ► **myalgia** (i.e. muscle pain). These animal models also provide methods by which the efficacy and potency of novel pharmaceutical agents can be examined.

Animal models of inflammatory muscle pain consist of two parts: a method of inducing inflammation in muscle, and a method of evaluating changes in ► **nocifensive behaviors**. Methods of inducing inflammation in muscle include intramuscular injection of substances, such as carrageenan (Kehl et al. 2000), or components of the inflammatory milieu, such as protons (i.e. acidity) (Sluka et al. 2001). Changes in nocifensive behaviors examined by these models are usually described as ► **hyperalgesia**, because they increase the response to stimuli that are normally considered nociceptive. One method of evaluating changes in nocifensive behaviors involves measuring the amount of force that an animal can produce with the inflamed muscle (e.g. ► **grip force**). Another method examines changes in withdrawal responses to controlled mechanical (► **von Frey monofilaments**) stimuli applied to areas of skin, often the hind paw, that are remote from the inflamed muscle.

### Characteristics

#### Protons

Inflammation can result in decreased tissue pH (i.e. acidosis), which activates cutaneous ► **nociceptors** (Steen et al. 1992) and increases withdrawal responses to mechanical stimuli in rats (Hamamoto et al. 2001). In humans, constant infusion of acidic buffer into skin or muscle produces flow-dependent pain that has been shown to correlate with decreased tissue pH, at least



**Muscle Pain Model, Inflammatory Agents-Induced, Figure 1** Decreased mechanical threshold following two injections of acidic saline into the gastrocnemius muscle of one hind limb of a rat. The injections were spaced 2 or 5 days apart. Decrease in the threshold force is expressed as area under the curve for the 6 weeks after the second injection. A significant decrease in mechanical withdrawal threshold occurred bilaterally for rats injected with pH 4 or pH 5 saline, but not for those injected with pH 6 or 7.2. Data are expressed as mean  $\pm$  SEM, N=8 rats/group, \*P < 0.05. Figure modified from Sluka et al. 2001.

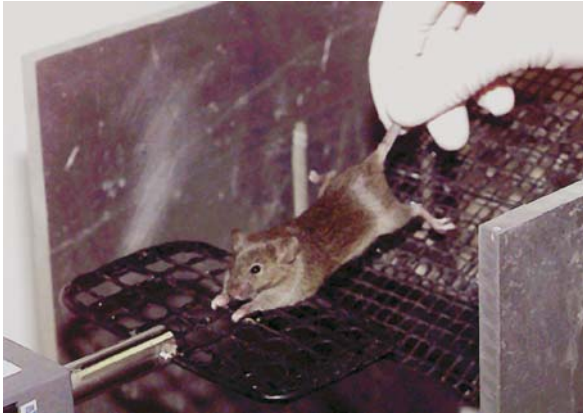
in the skin (Steen et al. 1995; Isseberner et al. 1996). Thus, decreased tissue pH may contribute to pain associated with muscle inflammation. Two injections of acidic saline (pH 4.0 – 6.0) administered 2 days apart into the gastrocnemius muscle of one hind limb of a rat, produced cutaneous mechanical hyperalgesia that persisted for up to 4 weeks (Fig. 1) (Sluka et al. 2001). In this model, mechanical hyperalgesia was examined by applying von Frey monofilaments to the plantar surface of the hind paw, a site remote from the site where the acidic saline was injected. The contralateral hind paw also exhibited mechanical hyperalgesia. After mechanical hyperalgesia had developed, neither pharmacological (i.e. intramuscular injection of lidocaine into the site of acidic saline injection) nor physical (i.e. [dorsal rhizotomy](#)) interruption of input from primary afferent innervating the gastrocnemius muscle abolished the contralateral mechanical hyperalgesia. These results suggest that [central sensitization](#) following nociceptive input from muscle may underlie the [secondary hyperalgesia](#) in this model. Interestingly, injection of acidic saline produced histologic evidence of only mild injury and inflammation of the muscle fibers in some rats, which was attributed to the needle penetration and not to the acidic solution. Thus, this model appears to isolate the effects of one component of inflammation, which is tissue acidity. Of interest is the long lasting (i.e. 4 weeks) hyperalgesia produced by two injections of acidic saline. Also, the mechanical hyperalgesia was exhibited in a different tissue (i.e. skin) and at a site remote from the acidified muscle tissue. This pattern of referral from deep structures to remote cutaneous sites has been shown in humans (Marchettini et al. 1990). Thus, this model of acid-induced muscle pain may help to determine the mechanisms by which patients with chronic generalized musculoskeletal pain,

such as fibromyalgia, experience areas of tenderness called tender points (Sluka et al. 2001). This model has subsequently been used to examine the role of excitatory amino acid receptors in the development and maintenance of mechanical hyperalgesia induced by intramuscular injection of acidic saline (Skyba et al. 2002).

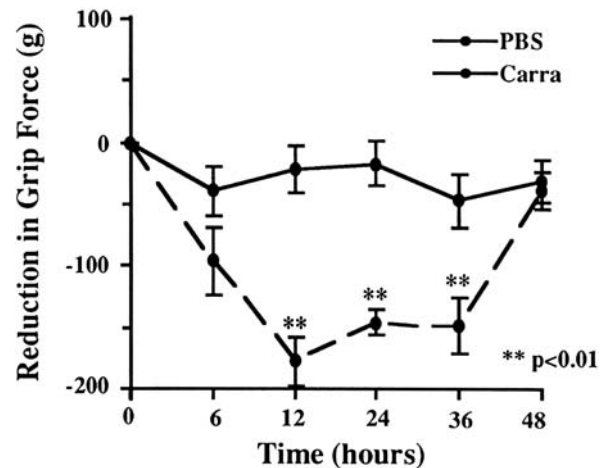
#### Carrageenan

Injection of carrageenan into muscle evokes a localized myositis, as demonstrated by accumulation of leukocytes around the site of injection (Diehl et al. 1988). In electrophysiological studies, injection of carrageenan into muscle sensitizes nociceptors, both increasing their spontaneous activity and lowering their threshold to activation by mechanical stimuli (Berberich et al. 1988; Diehl et al. 1988). Thus, when inflamed muscle is contracted, nociceptors in the muscle would be activated by lower than normal magnitudes of mechanical stimuli. The animal might then react to this nociceptive input by decreasing contraction of the muscle, in order to decrease mechanical activation of muscle nociceptors. This reduction in effort would reduce the force produced by the muscle. Thus, Kehl and colleagues have developed a model of inflammatory muscle pain that involves bilateral injections of carrageenan into the triceps muscles, and examines the grip force produced by the inflamed muscle in rats and mice (Kehl et al. 2000; Wacnik et al. 2003). This appears to be a clinically relevant model, because patients with muscle pain exhibit reduced grip force (Norsdenskiold and Grimby 1993). In this model, grip force is measured using a strain gauge attached to a wire mesh upon which the rodent is allowed to grab with its fore paws (Fig. 2). The rodent is held by the tail and gently pulled until it releases the wire mesh and the maximum force produced by the rodent is





**Muscle Pain Model, Inflammatory Agents-Induced, Figure 2** Measurement of grip force in mice. Mice are positioned and allowed to grasp a wire mesh with their fore paws. Mice are held by the tail and gently moved in a rostral-caudal direction. The wire mesh is attached to a strain gauge and the peak grip force produced by the mouse is determined.



**Muscle Pain Model, Inflammatory Agents-Induced, Figure 3** Time-response curve for the reduction in fore limb grip force in rats following injection of carrageenan (4 mg) or an equal volume (75  $\mu$ l) of PBS into the triceps muscles both fore limbs. Intramuscular carrageenan (Carra) produced a significant treatment- and time-dependent reduction in grip force. Data are expressed as mean  $\pm$  SEM, N=15 rats/group, \*\*P<0.01. Figure modified from Kehl et al. 2000.

recorded. Grip force is subject to factors, such as hyperalgesia, that influence the behavioral performance of the rodent. Kehl and colleagues have shown that intramuscular injection of carrageenan into the triceps muscle in rodents produces a dose- and time-dependent reduction in grip force (Fig. 3). This reduction in grip force was specific to the inflamed triceps muscles, because the force produced by the hind limbs was not affected. Furthermore, injection of carrageenan into one triceps muscle did not affect the grip force in the contralateral fore limb. Additional support for the clinical relevance of this model of inflammatory muscle pain is the fact that carrageenan-induced reduction in grip force is attenuated by the opioid levorphanol, the nonsteroidal anti-inflammatory drug indomethacin and the steroid dexamethasone. These drugs represent three classes of analgesic agents used clinically to treat muscle pain. Additionally, experimental analgesic agents such as the non-competitive NMDA antagonist MK801 and the cannabinoid agonist WIN 55,212-2 have been shown to have attenuated inflammatory muscle hyperalgesia using this model.

The carrageenan-induced model of muscle pain has several advantages over the model of acidic saline induced hyperalgesia. First, the carrageenan-induced model of muscle pain is a model of pain produced by inflammation in muscle, whereas injection of individual or multiple inflammatory mediators may not be. Second, the carrageenan model is a model of **primary hyperalgesia**, because it examines the function of the inflamed muscle. In contrast, models in which the site of hyperalgesia is remote from the site of inflammation or injury are models of secondary hyperalgesia. Third, the grip force assay avoids the potential of misinterpreting drug-induced motor dysfunction or sedation with **antihyperalgesia**. Many behavioral assays, such

as paw withdrawal from mechanical or thermal stimuli, are based on the assumption that an animal that withdraws less or withdraws at a higher threshold is exhibiting antihyperalgesia. However, drug-induced motor dysfunction and sedation may produce the same behavioral response. That is, it may take a more intense mechanical or thermal stimulus to elicit a withdrawal response. In contrast, if a drug produces motor dysfunction or sedates an animal then it will produce less grip force, which will not be misinterpreted as antihyperalgesia. Thus, the carrageenan model appears to be useful for further elucidation of the mechanisms associated with inflammatory muscle pain. Furthermore, the grip force assay provides a method by which the analgesic efficacy and potency of novel pharmaceutical agents can be examined in models of inflammatory muscle pain.

## References

- Berberich P, Hoheisel U, Mense S (1988) Effects of a Carrageenan-Induced Myositis on the Discharge Properties of Group III and IV Muscle Receptors in the Cat. *J Neurophysiol* 59:1395-1409
- Diehl B, Hoheisel U, Mense S (1988) Histological and Neurophysiological Changes Induced by Carrageenan in Skeletal Muscle of Cat and Rat. *Agents Actions* 25:210-213
- Hamamoto DT, Ortiz-Gonzalez XR, Honda JM, Kajander KC (2001) Intraplantar Injection of Hyaluronic Acid at Low pH into the Rat Hindpaw Produces Tissue Acidosis and Enhances Withdrawal Responses to Mechanical Stimuli. *Pain* 74:225-234
- Issberner U, Reeh PW, Steen KH (1996) Pain due to Tissue Acidosis: A Mechanism for Inflammatory and Ischemic Myalgia? *Neurosci Lett* 208:191-194
- Kehl LJ, Trempe TM, Hargreaves KM (2000) A New Animal Model for Assessing Mechanisms and Management of Muscle Hyperalgesia. *Pain* 85: 333-343



6. Marchettini P, Cline M, Ochoa J (1990) Innervation Territories for Touch and Pain Afferents of Single Fascicles of the Human Ulnar Nerve. *Brain* 113:1491–1500
7. Nordskiöld UM, Grimby, G (1993) Grip Force in Patients with Rheumatoid Arthritis and Fibromyalgia and in Healthy Subjects: A Study with the Grippit Instrument. *Scand J Rheumatol* 22:14–19
8. Skyba DA, King EW, Sluka KA (2002) Effects of NMDA and Non-NMDA Ionotropic Glutamate Receptor Antagonists on the Development and Maintenance of Hyperalgesia Induced by Repeated Intramuscular Injection of Acidic Saline. *Pain* 98:69–78
9. Sluka KA, Kalra A, Moore SA (2001) Unilateral Intramuscular Injections of Acidic Saline Produce a Bilateral, Long-Lasting Hyperalgesia. *Muscle Nerve* 24:37–46
10. Steen KH, Reeh PW, Anton F, Handwerker HO (1992) Protons Selectively Induce Lasting Excitation and Sensitization to Mechanical Stimulation of Nociceptors in Rat Skin, *In Vitro*. *J Neurosci* 12:86–95
11. Steen KH, Issberner U, Reeh PW (1995) Pain due to Experimental Acidosis in Human Skin: Evidence for Non-Adapting Nociceptor Excitation. *Neurosci Lett* 199:29–32
12. Wacnik PW, Kehl LJ, Trempe TM, Ramnaraine ML, Beitz AJ, Wilcox GL (2003) Tumor Implantation in Mouse Humerus Evokes Movement-Related Hyperalgesia Exceeding that Evoked by Intramuscular Carrageenan. *Pain* 101:175–186

## Muscle Pain Model, Ischemia-Induced and Hypertonic Saline-Induced

SIEGFRIED MENSE

Institute of Anatomy and Cell Biology III, University Heidelberg, Heidelberg, Germany  
mense@urz.uni-heidelberg.de

### Synonyms

Ischemia-induced muscle pain: Ischemic muscle pain

### Definitions

**Ischemia-induced muscle pain:** muscle pain during and following muscle exercise under ischemic conditions. In clinical studies, ischemic conditions were induced by occlusion of blood vessels of an entire limb (e.g. by a tourniquet, or by administration of adrenalin to study pain mechanisms in the tooth pulp). In animal experiments, the blood flow was interrupted by occlusion of arteries using a ligature or clamp, by a tourniquet around the tail or by circulatory arrest.

**Hypertonic saline-induced pain:** muscle pain induced by intramuscular or intraarterial (into the muscle artery) injection of hypertonic saline (NaCl) at a concentration of 5–10% (5.6–11.1 times hypertonic).

### Characteristics

#### Ischemia-Induced Pain

Data from clinical studies and animal experiments indicate that ischemia alone (without muscle contractions) is not an effective stimulus for muscle nociceptors. In clinical studies where a tourniquet was used to induce ischemia in a limb, the pain that occurred after approximately half an hour appeared to be mostly due to the

pressure exerted on the nerve by the tourniquet, and not by the ischemia.

### Clinical Findings and Results from Studies on Human Subjects

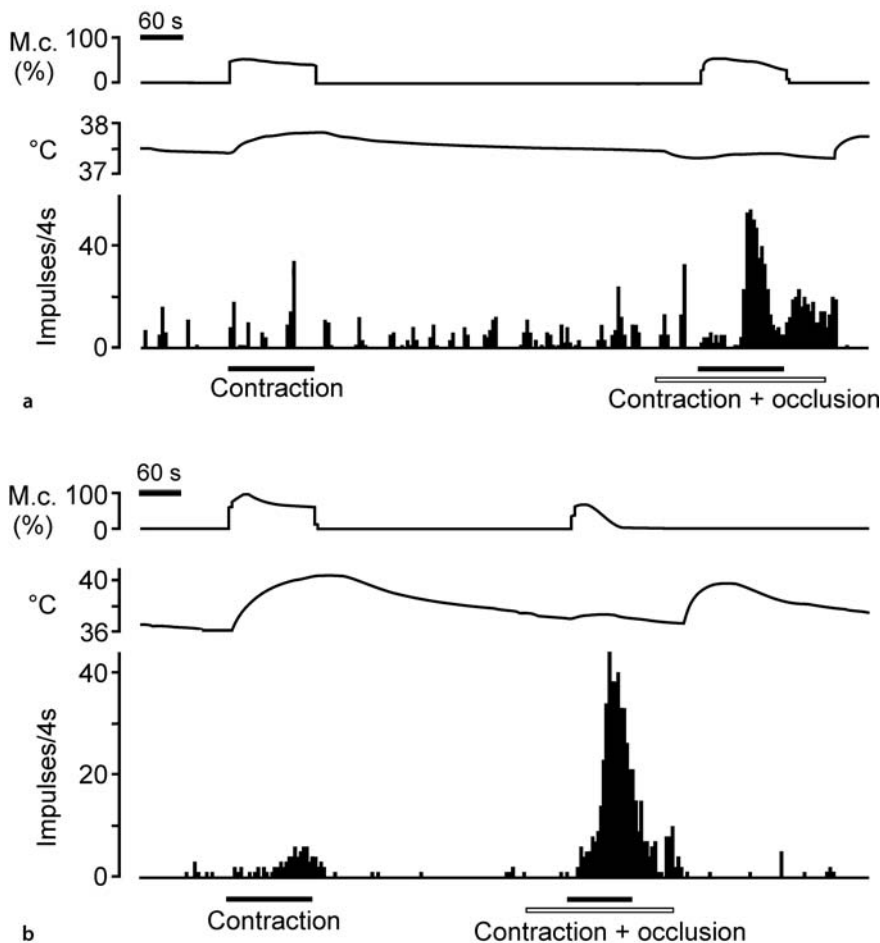
One of the clinically important types of ischemic muscle pain is the pain of ► **intermittent claudication**. It occurs during walking in patients with sclerotic narrowing of the arteries of the lower leg and foot. In earlier clinical studies, a multitude of factors were discussed as being the cause of the pain, e.g. chemical metabolites, accumulation of potassium ions (K<sup>+</sup>), and reduced pH due to release of lactic acid. Lactic acid was soon ruled out, because patients with McArdle's disease – who are unable to produce lactic acid due to a gene defect – often present with pain of intermittent claudication or angina pectoris. Another candidate substance was the nonapeptide bradykinin (BKN) that is cleaved by kallikrein – a proteinase – from plasma proteins. The importance of BKN for the pain of intermittent claudication was supported by the finding that administration of a proteinase inhibitor in claudication patients extended the distance the patients were able to walk without pain (Digiesi et al. 1975). Electron microscopic investigations of bioptic material of claudication patients showed that the muscle exhibited signs of inflammation with infiltration by inflammatory cells and muscle fiber necrosis. The latter finding adds adenosine triphosphate (ATP) to the list of candidate substances, because muscle cells contain high concentrations of ATP, which are released into the interstitial space when a muscle fiber is damaged (see below).

### Data from Animal Experiments

The results obtained from animal studies indicate that the following agents or factors may be involved in ischemic pain:

1. Potassium ions. The potassium concentration is increased in muscles of experimental animals following contractions with and without occlusion of the blood supply.
2. Proton concentration (pH). The interstitial pH is lowered to approximately 6.5 during prolonged ischemia plus exercise.
3. Kinins such as BKN and kallidin. The kinin-forming activity of muscle tissue is increased after prolonged ischemia.
4. Degeneration and necrosis of muscle fibers. If necrosis is present in a chronically ischemic muscle, the ATP concentrations released from the muscle cells are sufficient to activate muscle nociceptors (Reinöhl et al. 2003).

Electrophysiological recordings from single muscle afferent fibers have shown that in skeletal muscle of cat and rat, receptive endings are present that respond specifically to ischemic contractions, in that they are not excited



**Muscle Pain Model, Ischemia-Induced and Hypertonic Saline-Induced, Figure 1** Impulse activity of single cat muscle receptors with unmyelinated afferent fibers showing exclusive or predominant activation during ischemic contractions. In both panels, the upper trace indicates the force of the contraction of the gastrocnemius-soleus muscle in percent of maximal contraction (M.c.) induced by electrical stimulation of the muscle nerve, the middle trace shows the temperature inside the muscle, and the lower trace is a histogram of the fiber's activity (bin width 4s). Periods of contractions are marked by filled bars underneath the abscissa; occlusion of the muscle artery is marked by open bars. In (a), the force of contraction was adjusted to approximately 50% M.c., and in (b) to 100%. Under the latter condition, the muscle could not maintain the contraction force during occlusion of the muscle artery. Note that in both panels the discharge frequency drops markedly at the end of the contraction period. This indicates that in addition to chemical factors a mechanical component is involved in the activation of the receptors during ischemic contractions. From Mense and Stahnke 1983.

by short-lasting ischemia alone but require ischemia plus contractions for activation (Bessou and Laporte 1958; Mense and Stahnke 1983; Fig 1). This behavior was interpreted as indicating that the units were nociceptors and may mediate the pain of intermittent claudication, but other authors emphasized a possible function in the adjustment of respiration and circulation to the requirements during muscle work (Kaufman et al. 1984).

#### What Factors Cause the Pain of Intermittent Claudication?

The available data suggest that it is not a single factor that is responsible for ischemic muscle pain but that several stimuli act in combination. Recent findings regarding receptor molecules that are present in the membrane of nociceptors suggest that the following agents could be involved in the induction of ischemic pain:

1. BKN acting on the B2 ► **bradykinin receptors** (unless the nociceptor is sensitized, then BKN stimulates the ending by binding to the B1 receptor).
2. the low pH in an ischemic muscle is likely to sensitize the vanilloid receptor subtype VR 1 (now called ► **TRPV1**), and to activate other acid sensing ion channels (ASICs) (Immke and McCleskey 2003;

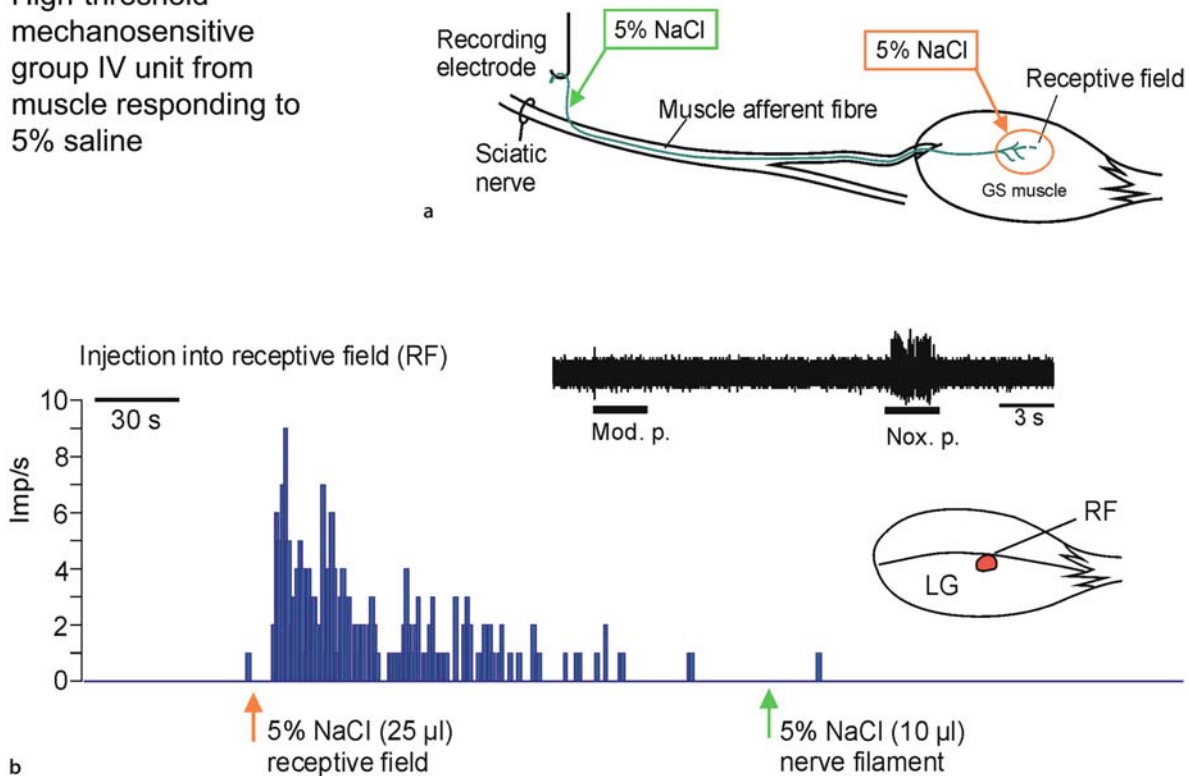
for a review on ASICs as channels mediating the pain of angina pectoris, see Sutherland et al. 2000).

► **Capsaicin** is assumed to be a specific ligand for the VR 1 receptor. The fact that intramuscular injection of capsaicin causes strong pain in humans by exciting group IV units (Marchettini et al. 1996) indicates that VR 1 receptors are present in human skeletal muscle.

3. as muscle fibers of claudication patients exhibit necrosis, another likely factor for the activation of muscle nociceptors is ATP, which binds to ► **purinergic receptors** (e.g. the P2X3 receptor) (Burnstock 2000) and activates muscle group IV nociceptors in concentrations that are present in muscle fibers (Reinöhl et al. 2003).

In conclusion, a possible mechanism of activation of muscle nociceptors, in a muscle that contracts under acute ischemic conditions, is that first, BKN or low pH sensitize the ► **high-threshold mechanosensitive muscle receptors** (putative nociceptors) (Mense and Meyer 1985), and subsequently, in the sensitized state, nociceptors are activated by the mechanical force of the contractions. Such a mechanism is suggested by the time

### High-threshold mechanosensitive group IV unit from muscle responding to 5% saline



M

**Muscle Pain Model, Ischemia-Induced and Hypertonic Saline-Induced, Figure 2** Effects of hypertonic saline on a single high-threshold mechanosensitive (presumably nociceptive) group IV afferent fiber from rat gastrocnemius-soleus (GS) muscle. (a) Experimental set-up. The impulse activity of a single unmyelinated afferent fiber was recorded from a thin nerve filament dissected from the sciatic nerve. (b) Response of the unit to 5% NaCl injected into that region of the muscle where the receptive ending was located with mechanical stimuli (receptive field, RF). The same NaCl solution that had evoked the strong response when injected i.m. was later put on the nerve filament to show that the axonal membrane was not the site of action of the hypertonic saline. Inset: original recording showing the high mechanical threshold of the receptive ending. Mod.p., moderate, innocuous pressure; Nox.p., noxious, painful pressure.

course of activation of the single group IV unit shown in Figure 1a: the unit was not activated by ischemia or contractions alone, but gave a strong response during ischemic contractions. Moreover, the activity dropped markedly when the contractions were discontinued but the ischemia maintained. The unit in Figure 1b was weakly activated at the end of the contraction period without ischemia (in this case the force of contraction was higher: close to 100% maximal voluntary contraction), but likewise showed a much stronger excitation when the contractions were repeated with the muscle artery occluded.

The release of ATP from damaged muscle fibers appears to occur more under chronic ischemic conditions, but ATP might also be involved in cases of acute ischemic pain, because ATP is a product of any ▶ [anaerobic glycolysis](#) (Sutherland et al. 2000).

### Hypertonic Saline-Induced Muscle Pain

**Studies in human subjects** . There are few conditions in which muscle pain is induced by hypertonicity of the tissue in patients. Abscess formation is one of them (Schade 1924), but most cases of myositis

do not exhibit abscesses. In clinical studies, hypertonic saline has been extensively used to induce pain in human subjects. One of the pioneers in this field was Kellgren, who induced pain in muscles and ligaments of volunteers by injecting 0.1 to 0.3 ml of 6% NaCl (Kellgren 1938). Presently, several groups inject or infuse hypertonic NaCl (5–10%) into muscles in healthy subjects and patients to study the mechanisms of muscle pain in humans. With this method, muscle pain of moderate to strong intensity (values around 7 on a VAS with a range from 1 to 10) can be induced. The injected volume is of importance, because the innervation density of muscle with nociceptors is low. Therefore, small injection volumes are likely to yield variable or ill-reproducible pain responses. The results obtained with intramuscular injections of hypertonic saline, suggest that the receptor population mediating ischemia-induced muscle pain is distinct from that mediating hypertonic saline-induced pain (Graven-Nielsen et al. 2003). In human subjects, hypertonic saline appears to excite predominantly group IV muscle afferent units (as opposed to group III units).

**Data from animal experiments**. Many authors who recorded the activity of single muscle nociceptors used injections of hypertonic saline for receptor activation. Interestingly, 5% NaCl proved to be the only chemical stimulus that excited all of the nociceptors tested, in a recent study (Hoheisel and Mense, unpublished) (Fig. 2) in which the stimulants were injected into the mechanosensitive receptive field of rat group IV receptors. The other agents excited only a fraction of the receptors.

### Mechanisms of Nociceptor Activation by Hypertonic Saline

The mechanisms by which muscle nociceptors are excited by hypertonic saline are obscure. Several possibilities exist (for an overview see Kress and Reeh 1996):

1. activation by increased tonicity in the interstitial space. The receptive ending might shrink in the hypertonic environment, and stretch-sensitive Na<sup>+</sup>-channels could be opened. However, nothing is known about the water permeability of nociceptive endings, and the high mechanical stimulation threshold of muscle nociceptors speaks against this mechanism.
2. activation by ionic changes. The high Na<sup>+</sup> concentration in the interstitial fluid should have only little influence on the membrane potential of the nociceptive ending, because the Na<sup>+</sup> conductance of an axon is normally low. However, there is evidence indicating that the Na<sup>+</sup> conductance of receptive endings is higher, and therefore the high extracellular Na<sup>+</sup> concentration could cause an effective depolarization with ensuing excitation of the ending. Thus, the high Na<sup>+</sup> concentration could be the decisive factor for hypertonic saline-induced muscle pain. The high Cl<sup>-</sup> concentration appears not to be a stimulus, because in peripheral nerve fibers Cl<sup>-</sup> channels are rare. An additional unknown factor is that – if shrinking of the ending occurs – the intraaxonal concentrations of all ions increase to an unknown extent.
3. indirect activation of the nociceptor by other algescic agents released from muscle tissue or the nociceptive ending itself. The injection of hypertonic saline has been reported to release glutamate from muscle tissue (Tegeeder et al. 2002). Glutamate excites muscle nociceptors and causes muscle pain in humans (Svensson et al. 2003). Hypertonic solutions have also been shown to release substance P from airway sensory cells *in vitro* (Garland et al. 1995).

### References

1. Bessou P, Laporte Y (1958) Activation des Fibres Afférentes Amyéliniques d'Origine Musculaire. *Compt Rend Soc Biol (Paris)* 152:1587–1590
2. Burnstock G (2000) P2X Receptors in Sensory Neurones *Br J Anaesth* 84:476–488
3. Digiesi V, Bartoli V, Dorigo B (1975) Effect of a Proteinase Inhibitor on Intermittent Claudication or on Pain at Rest in Patients with Peripheral Arterial Disease. *Pain* 1:385–389
4. Garland A, Jordan JE, Necheles J, Alger LE, Scully MM, Miller RJ, Ray DW, White SR, Solway J (1995) Hypertonicity, but not Hyperthermia, Elicits Substance P Release from Rat C-Fiber Neurons in Primary Culture. *J Clin Invest* 95:2359–2366
5. Graven-Nielsen T, Jansson Y, Segerdahl M, Kristensen JD, Mense S, Arendt-Nielsen L, Sollevi A (2003) Experimental Pain by Ischaemic Contractions Compared with Pain by Intramuscular Infusions of Adenosine and Hypertonic Saline. *Eur J Pain* 7:93–102
6. Immke DC, McCleskey EW (2003) Protons Open Acid-Sensing Ion Channels by Catalyzing Relief of Ca<sup>2+</sup> Blockade. *Neuron* 37:75–84
7. Kaufman MP, Rybicki KJ, Waldrop TG, Ordway GA (1984) Effect of Ischemia on Responses of Group III and IV Afferents to Contraction. *J Appl Physiol* 57:644–650
8. Kellgren JH (1938) Observations on Referred Pain Arising from Muscle. *Clin Sci* 3:175–190
9. Kress M, Reeh P (1996). Chemical Excitation and Sensitization in Nociceptors. In: Belmonte C, Cervero F (eds) *Neurobiology of Nociceptors*. Oxford University Press, Oxford, pp 259–297
10. Marchettini P, Simone DA, Caputi G, Ochoa JL (1996) Pain from Excitation of Identified Muscle Nociceptors in Humans. *Brain Res* 40:109–116
11. Mense S, Stahnke M (1983) Responses in Muscle Afferent Fibres of Slow Conduction Velocity to Contractions and Ischaemia in the Cat. *J Physiol* 342:383–397
12. Mense S Meyer H (1985) Different Types of Slowly Conducting Afferent Units in Cat Skeletal Muscle and Tendon. *J Physiol* 363:403–417
13. Reinöhl J, Hoheisel U, Unger T, Mense S (2003) Adenosine Triphosphate as a Stimulant for Nociceptive and Non-Nociceptive Muscle Group IV Receptors in the Rat. *Neurosci Lett* 338:25–28
14. Schade H (1924) Die Molekularpathologie in ihrem Verhältnis zur Zellulärpathologie und zum klinischen Krankheitsbild am Beispiel der Entzündung. *Münch Med Wochschr* 71:1–4
15. Sutherland SP, Cook SP, McCleskey EW (2000) Chemical Mediators of Pain due to Tissue Damage and Ischemia. *Prog Brain Res* 129:21–38
16. Svensson P, Cairns BE, Wang K, Hu JW, Graven-Nielsen T, Arendt-Nielsen L, Sessle BJ (2003) Glutamate-Evoked Pain and Mechanical Allodynia in the Human Masseter Muscle. *Pain* 101:221–227
17. Tegeeder L, Zimmermann J, Meller ST, Geisslinger G (2002) Release of Algesic Substances in Human Experimental Muscle Pain. *Inflamm Res* 51:393–402

## Muscle Pain, Referred Pain

MARIA ADELE GIAMBERARDINO

Department of Medicine and Science of Aging, G. D'Annunzio University of Chieti, Chieti Scalo, Italy  
mag@unich.it

### Synonyms

Musculoskeletal Transferred Pain; referred muscle pain

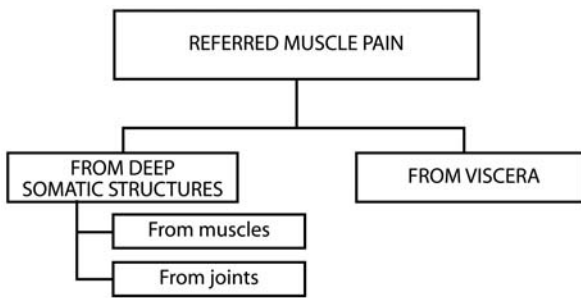
### Definition

Pain perceived at muscle level due to a primary algogenic process located at a distance, either in a visceral organ or in a deep somatic structure.

### Characteristics

Referred muscle pain can result from an algogenic process in internal organs or in deep somatic structures,





**Muscle Pain, Referred Pain, Figure 1** Classification of referred muscle pain.

e.g., another muscle or a joint (referred muscle pain from viscera or from deep somatic structures) (Fig. 1). In both cases, it may or may not be accompanied by secondary hyperalgesia, i.e. increased local sensitivity to pain / decreased pain threshold (referred muscle pain with or without hyperalgesia) (Vecchiet et al. 1999). When present, hyperalgesia is proportional in extent to the degree of activity of the primary algogenic focus and is often accompanied by local trophic changes, i.e. decreased thickness / sectional area of the muscle (Galletti et al. 1990; Giamberardino 2000; Simons and Mense 2003; Vecchiet et al. 1991). Both central (neuronal sensitization) and peripheral (reflex arc activation) mechanisms are likely to be involved in the pathophysiology of referred phenomena at muscle level (Arendt-Nielsen and Svensson 2001; Cervero and Laird 2004; Mense 1994; Procacci et al. 1986).

#### Referred Muscle Pain from Viscera

Pain referral occurs constantly in visceral nociception (Cervero and Laird 2004). After the transitory phase of “true visceral pain” (midline, vague and poorly defined), the sensation is “transferred” to somatic areas neuromerically connected to the specific viscus (Procacci et al. 1986). Secondary hyperalgesia most often arises at this level, especially if pain episodes are recurrent and / or prolonged; this may involve all three body wall tissues – skin, subcutis and muscle – but is most frequently confined to muscle, often accompanied by sustained contraction (referred muscle pain from viscera without and with hyperalgesia) (Vecchiet et al. 1989). Trophic changes may also occur in the same sites, i.e. increased thickness of subcutis but mostly decreased thickness of muscle (Procacci et al. 1986; Vecchiet et al. 1989). In patients with algogenic conditions from a number of internal organs, muscle hyperalgesia in referred zones has been detected clinically (hypersensitivity to digital compression) and quantified instrumentally (decrease in pain thresholds to different stimuli); in a minor percentage of visceral pain patients, muscle trophic changes have also been measured, using ultrasounds (Giamberardino et al. 1997; Giamberardino et al. 2005; Vecchiet et al. 1989).

Hyperalgesia is accentuated by the repetition of the visceral episodes; although decreasing as they stop, it usually remains significant after cessation of the spontaneous pain and sometimes even after removal of the primary visceral focus. Trophic changes are even more persistent than the hyperalgesia, often remaining unaltered for a long time after extinction of the visceral trigger (Giamberardino et al. 2005).

#### Clinical Examples

In myocardial infarction, pain is referred to the thoracic region, anteriorly or posteriorly, often extending to the left arm. Hyperalgesia almost always affects the pectoralis major and muscles of the interscapular region and forearm. Trapezius and deltoid muscles are less frequently involved. Dystrophic muscle changes may also occur at the same level. In a low percentage of cases, pain is also referred to the skin, within dermatomes C8-T1 on the ulnar side of the arm and forearm and hyperalgesia is found at the same level (Giamberardino 2000; Procacci et al. 1986). In urinary colics from calculosis, referred pain is perceived in the lumbar region of the affected side, with radiation towards the ipsilateral flank and anteriorly towards the groin. Hyperalgesia and trophic changes characteristically affect muscles of the lumbar and flank area (quadratus lumborum, oblique muscles) (Vecchiet et al. 1989). In biliary calculosis, pain is referred to the upper right quadrant of the abdomen with radiation towards the back. Hyperalgesia and reduced trophism of the rectus abdominis at the cystic point (junction of 10th rib with outer margin of the same muscle) are typical findings (Giamberardino et al. 2005). In dysmenorrhea, pain is referred to the lower abdomen, perineum and sacral region, with radiation towards the groin and upper part of the thighs. Hyperalgesia and trophic changes can be detected in the lowest part of the rectus abdominis and muscles of the pelvic region (Giamberardino et al. 1997).

Referred muscle pain and hyperalgesia are typically enhanced in the case of “viscero-visceral hyperalgesia”, when concurrent algogenic conditions affect two viscera which share part of their central sensory projection (Giamberardino 2000). Women suffering from both dysmenorrhea and irritable bowel syndrome (IBS) (common projection for uterus and colon, T10-L1), for instance, frequently report more menstrual pain, intestinal pain and abdominal / pelvic muscle hyperalgesia (in areas of referral from uterus and intestine) than women with dysmenorrhea or IBS only (unpublished observation). Patients with dysmenorrhea / endometriosis plus urinary calculosis (common projection for uterus and upper urinary tract, T10-L1) present with more menstrual pain, urinary colic pain and abdomino-pelvic / lumbar muscle hyperalgesia (in areas of referred pain from uterus and urinary tract) than patients with one condition only (Giamberardino

et al. 2001). The phenomenon of “viscero-visceral hyperalgesia” has therapeutic implications. In fact, effective treatment of one condition may significantly improve typical symptoms from the other, e.g. decrease in urinary pain and referred lumbar hyperalgesia after hormonal treatment of dysmenorrhea or decrease in menstrual pain and referred abdomino-pelvic hyperalgesia after urinary stone elimination following lithotripsy (Giamberardino 2000; Giamberardino et al. 2001).

### Pathophysiology

“Referred muscle pain from viscera without hyperalgesia” is explained on the basis of the convergence of visceral and somatic afferent fibers upon the same central neurons (convergence-projection theory) (Cervero and Laird 2004; Procacci et al. 1986). Messages from the viscus are “interpreted” by higher brain centers as coming from muscles due to mnemonic traces of previous experiences of somatic pain, more numerous than those of visceral pain in life. “Referred muscle pain from viscera with hyperalgesia” is contributed to by central mechanisms, i.e. a process of sensitization in the central nervous system (CNS), triggered by the massive afferent visceral barrage involving hyperactivity and hyperexcitability of viscerosomatic convergent neurons, as shown by the results of electrophysiological studies on animal models of referred muscle hyperalgesia from viscera (Cervero and Laird 2004; Giamberardino 2000). This process would facilitate the central effect of the normal input coming from the muscle (convergence-facilitation theory). NMDA receptors have been suggested to play an important role in the generation of these central hyperexcitability changes (Cervero and Laird 2004).

In addition to central changes, the afferent visceral barrage probably activates a number of viscerosomatic reflex arcs, whose afferent branch is represented by sensory fibers from the internal organ and whose efferent branch is represented by sympathetic efferences to the skin / subcutis and somatic efferences to the muscle of the referred area (Procacci et al. 1986). Activation of this arc would produce sustained contraction in the skeletal muscle, this, in turn, being responsible for sensitization of nociceptors locally. Studies in a rat model of referred muscle hyperalgesia from artificial ureteric calculosis provide experimental support for this mechanism. Positivity was found for a number of ultrastructural indices of contraction in the hyperalgesic muscle ipsilateral to the affected ureter at lumbar level but not in the contralateral, non-hyperalgesic muscle and the extent of these indices was proportional to the degree of visceral pain behavior and referred hyperalgesia recorded in the animals. In the same model, c-Fos activation was found in the spinal cord not only in sensory neurons but also motoneurons, significantly more on the affected side (refs. in Giamberardino et al. 2005).

Mechanisms underlying enhancement of referred phenomena in “viscero-visceral hyperalgesia” are still hypothetical, but probably involve sensitization of viscerosomatic convergent neurons. Along with the well-documented viscerosomatic convergence onto the same sensory neurons, extensive viscerovisceral convergence has also been found in the CNS, for instance between the colon / rectum, bladder, vagina and uterine cervix (refs. in Vecchiet et al. 1999). The increased afferent barrage from one visceral organ would thus enhance the afferent signal from the second organ projecting to the same neuron and also from the referred area. This hypothesis needs to be verified in electrophysiological studies on animal models of the condition, such as the model of endometriosis plus ureteral calculosis in the female rat in which an enhancement is observed of both spontaneous pain behavior and referred lumbar muscle hyperalgesia (Giamberardino 2000).

### Referred Muscle Pain from Deep Somatic Structures

#### Clinical Examples

Myofascial pain syndromes (MPSs) are classical examples of “referred muscle pain from muscles”. An MPS is characterized by regional muscle pain and dysfunction due to the presence, in muscles or their fascia, of active trigger points (TrPs). A trigger point is a site of tissue hyperirritability included in a taut, palpable band of muscle fibers. When stimulated, it gives rise to pain not only locally, but also at a distance, in an area called “target” because it is often remote from its location (Simons and Mense 2003). The target zone (area of referred pain) is typical and characteristic for each muscle and is the site not only of spontaneous pain, but also of sensory changes. These consist of hyperalgesia, which is a function of the degree of hyperirritability of the trigger point, i.e. the more irritable the TrP, the greater the degree of hyperalgesia in the target and the greater the extension of the tissues involved. Latent trigger points (pre-clinical phase of MPSs) only give rise to muscle hyperalgesia in the target, while active TrPs give rise to hyperalgesia, which extends from the muscle to the overlying subcutaneous / cutaneous tissues also. The dependence of these changes on the presence of the TrPs is testified by their regression after the TrP is extinguished through local infiltration (Vecchiet et al. 1991).

A typical example of “referred muscle pain from joints” is represented by the painful symptomatology in patients with osteoarthritis of the knee (Vecchiet et al. 1999). Pain from this condition is deep, fairly well localized and of varying intensity, sometimes making walking difficult. It spreads upward to the lower part of the thigh and downward as far as the middle of the calf. It begins when walking, increases as walking continues and decreases at rest. The skin appears pale and hypothermic to touch in an area covering the anterior surface of the knee. The underlying subcutis is tender and thickened at pincer palpation; the skeletal muscles connected to the joint are

tender and tense. Pain thresholds to electrical stimulation of all three tissues of the parietal wall (but mostly the muscle) in the painful area are decreased (hyperalgesia). The sectional area of periarticular muscles (mostly the vastus medialis), measured *via* ultrasounds, is reduced. The sensory changes in the referred area are reversible when the intraarticular focus is extinguished, testifying their referred nature (Galletti et al. 1990).

Patients with osteoarthritis of the knee have also been shown to present increased pain intensity and larger referred and radiating pain areas after infusion of hypertonic saline into the leg muscles (tibialis anterior) as compared to controls, a finding suggesting the setting up of central sensitization by painful osteoarthritis (Bajaj et al. 2001).

### Pathophysiology

As deducible from the two clinical examples provided (MPS and osteoarthritis), referred muscle pain from somatic structures is almost exclusively of the type “referred with hyperalgesia” Similar to what has been described for visceral nociception, referred pain from somatic structures has been attributed mainly to phenomena of central hyperexcitability triggered by the primary algogenic focus (Arendt-Nielsen and Svensson 2001). Animal studies have indeed provided good evidence that dorsal horn neurons become hyperexcitable in response to noxious stimulation of deep tissues (and that NMDA receptors and neurokinin receptors are most probably involved in this mechanism) (Hoheisel et al. 1993; Mense 1994). To account for the phenomenon of referral, however, central hyperexcitability should involve neurons receiving convergent input from the site of injury and the referred zone, whereas it is known that in dorsal horn neurons there is little convergence from deep tissues (Mense 1994). Thus, referred pain from somatic structures is not easily explained by the “convergence-facilitation” theory in its original form. A modified theory has therefore been suggested, especially for referred pain from one muscle to another, based on animal studies. Recordings from dorsal horn neurons reveal that noxious stimuli to a specific receptive field in a muscle generate within minutes new muscle receptive fields at a distance from the original one (Hoheisel et al. 1993). On this basis, the explanation proposed is that convergent connections from deep tissues to dorsal horn neurons are not present from the beginning, but are opened by nociceptive input from skeletal muscle. Referral to myotomes outside the lesion is due to spread of central sensitization to adjacent spinal segments (Mense 1994). Central mechanisms alone, however, are not adequate to account for all referred phenomena, especially the trophic changes. Thus, like the hypothesis for visceral nociception, it has been suggested that the afferent barrage from the deep focus (in muscle or joint) triggers the activation of reflex arcs towards the periphery (area of referral)

*via* both somatic (towards the muscle) and sympathetic (towards subcutis and skin) efferent fibers, responsible for the local referred changes (Vecchiet et al. 1999).

### Diagnosing Referred Muscle Pain

Detection and interpretation of simple referred pain (without hyperalgesia) are relatively easy, as the absence of tenderness at the site of the symptom immediately points out a site of origin of the algogenic impulses at a distance. Correct diagnosis of referred muscle pain with hyperalgesia is, however, much more difficult and represents a major clinical problem, since this form is far more frequent than that of simple referred pain. The problem concerns differentiation from primary muscle pain, i.e. that arising in relation to an algogenic pathology primarily affecting the tissue. Only careful study of the clinical history, accurate physical examination and complete sensory evaluation of the painful areas can help towards diagnostic orientation, an indispensable step in the institution of a therapeutic strategy that is not merely symptomatic (Vecchiet et al. 1999).

### References

1. Arendt-Nielsen L, Svensson P (2001) Referred Muscle Pain: Basic and Clinical Findings. *Clin J Pain* 17:11–19
2. Bajaj P, Bajaj P, Graven-Nielsen T et al. (2001) Osteoarthritis and its association with muscle hyperalgesia: an experimental controlled study. *Pain* 93:107–114
3. Cervero F, Laird JM (2004) Understanding the signaling and transmission of visceral nociceptive events. *J Neurobiol* 61:45–54
4. Galletti R, Obletter M, Giamberardino MA et al. (1990) Pain from osteoarthritis of the knee. *Adv Pain Res Ther* 13:183–191
5. Giamberardino MA (2000) Visceral Hyperalgesia. In: Devor M, Rowbotham MC, Wiesenfeld-Hallin Z (eds) *Progress in Pain Research and Management*, vol 16. IASP Press, Seattle, pp 523–550
6. Giamberardino MA, Berkley KJ, Iezzi S et al. (1997) Pain threshold variations in somatic wall tissues as a function of menstrual cycle, segmental site and tissue depth in non-dysmenorrheic women, dysmenorrheic women and men. *Pain* 71:187–197
7. Giamberardino MA, De Laurentis S, Affaitati G et al. (2001) Modulation of pain and hyperalgesia from the urinary tract by algogenic conditions of the reproductive organs in women. *Neurosci Lett* 304: 61–64
8. Giamberardino MA, Affaitati G, Lerza R et al. (2005) Relationship between pain symptoms and referred sensory and trophic changes in patients with gallbladder pathology. *Pain* 114:239–249
9. Hoheisel U, Mense S, Simons DG et al. (1993) Appearance of new receptive fields in rat dorsal horn neurons following noxious stimulation of skeletal muscle: a model for referral of muscle pain? *Neurosci Lett* 153:9–12
10. Mense S (1994) Referral of muscle pain. *APS J* 3:1–9
11. Procacci P, Zoppi M, Maresca M (1986) Clinical approach to visceral sensation. In: Cervero F, Morrison JFB (eds) *Visceral Sensation, Progress in Brain Research*. Elsevier, Amsterdam, pp 21–28
12. Simons DG, Mense S (2003) Diagnosis and therapy of myofascial trigger points. *Schmerz* 17:419–424
13. Vecchiet L, Giamberardino MA, Dragani L et al. (1989) Pain from renal / ureteral calculosis: evaluation of sensory thresholds in the lumbar area. *Pain* 36:289–295
14. Vecchiet L, Giamberardino MA, Saggini R (1991) Myofascial pain syndromes: clinical and pathophysiological aspects. *Clin J Pain* 7:16–22

15. Vecchiet L, Vecchiet J, Giamberardino MA (1999) Referred Muscle Pain: Clinical and Pathophysiologic Aspects. *Curr Rev Pain* 3:489–498

## Muscle Relaxants

MARK JOHNSON, NIKOLAI BOGDUK  
Musculoskeletal Physician, Hibiscus Coast Highway,  
Orewa, New Zealand  
markjohn@ihug.co.nz, nik.bogduk@newcastle.edu.au

### Definition

Muscle relaxants are drugs ostensibly designed to relieve pain by reducing painful muscle spasm.

### Characteristics

Muscle relaxants have been largely used in the treatment of spinal pain, for it is believed that spasm of the spinal muscles occurs in response to pain, but is itself painful. Most of the literature describes their use for low back pain, but they have also been used and tested for neck pain.

### Rationale

The rationale for the use of muscle relaxants is that if they can relieve the spasm, they serve as analgesics by relieving at least part of the pain caused by the muscle spasm. This rationale, however, is not vindicated by the evidence.

There is no evidence that spasm of the back muscles is painful or contributes to the patient's pain. There is no evidence that so-called muscle spasm can be reliably diagnosed. There is no correlation between clinical muscle spasm and any biological parameter such as EMG. Indeed, eminent authorities have decried the wisdom of belief in muscle spasm (Johnson 1989) or lamented its lack of validity (Andersson et al. 1989).

### Efficacy

The most recent, systematic review (Van Tulder et al. 2003) concluded that there was strong evidence that muscle relaxants are more effective than placebo for short-term relief of acute low back pain. Inspection of the review revealed that studies included in the tables were not included in the narrative, where the conclusions were drawn. Inspection of the original studies suggests that this conclusion may have been overly generous (Bogduk 2004).

The data are conflicting for orphenadrine (Bogduk 2004). One study found that only nine out of 20 patients treated with orphenadrine had reduced pain at 48 h after treatment, compared to four out of 20 patients treated with placebo. No other, or better, measure of outcome was reported. In contrast, another study found no superiority over placebo.

A low quality study found diazepam to be more effective than placebo at day 5, but a high quality study found it to be no more effective than placebo (Bogduk 2004). Dantrolene was considered more effective than placebo on the grounds that it reduced pain during maximum voluntary movement to a greater extent, but not at other times (Bogduk 2004).

Carisoprodol was considered effective because it reduced pain to a greater extent than placebo at four days (Bogduk 2004). Methocarbamol was as effective as chlormezanone, but chlormezanone was as effective as an NSAID (Bogduk 2004).

Conflicting data concerning tizanidine have been reported by the same investigators in two separate studies. One found no differences in outcome at three and at seven days between patients treated with tizanidine and those treated with placebo (Bogduk 2004). The other study compared tizanidine plus ibuprofen with tizanidine plus placebo (Bogduk 2004). It found no differences in pain scores between the two groups at three days and at seven days. The success attributed to tizanidine was based on a larger proportion of patients having no pain or only mild pain at night, at three days but not at seven days; and a larger proportion of patients having no pain or only mild pain at rest, both at three days and at seven days. The respective proportions in the latter instance were 90% vs. 72% at three days, and 93% vs. 77% at seven days. Two other studies found no differences from placebo (Bogduk 2004).

Baclofen is significantly more effective than placebo in reducing pain, but the magnitude of the difference is about 10% in absolute terms, and 20% in relative terms, but applies only to assessment at ten days after treatment (Bogduk 2004).

Cyclobenzaprine is more effective than placebo in so far as it achieved a reduction in pain, nine days after treatment, of 5.5 points on a 10-point scale, compared with 4 points for placebo (Bogduk 2004). However, cyclobenzaprine is not more effective than NSAIDs (Bogduk 2004). For relieving pain and improving daily activities, it was slightly more effective than placebo at day 7 but not at day 14 (Bogduk 2004). A meta-analysis of studies that compared cyclobenzaprine with placebo (Browning et al. 2003) found that cyclobenzaprine substantially improved local pain and global symptoms when used for four days, but the effect declined considerably after the first week, and was associated with a 25% increase in side-effects such as drowsiness, dry mouth and dizziness compared to placebo. That meta-analysis, however, included studies that were rejected by a systematic review on the grounds that they did not explicitly address low back pain (Van Tulder et al. 2003).

These data indicate that for orphenadrine, diazepam, and tizanidine, the evidence is conflicting as to whether the drugs are more effective than placebo, with the balance favouring no superiority over placebo. Methocarbamol



has not been shown to be more effective than placebo. Carisoprodol is more effective than placebo but only at four days. Baclofen and cyclobenzprine are each only slightly more effective than placebo but only for a few days, but not thereafter. Meanwhile, the evidence is strong that muscle relaxants have consistently been associated with a greater incidence of central nervous system side-effects (Van Tulder et al. 2003). This factor, balanced against their limited attributable effect, gives cause to question the propriety of their use for acute low back pain, especially when other interventions are no less effective, or even more effective, with far less risk of troublesome side-effects.

For the treatment of chronic low back pain, the data on muscle relaxants are limited to only a few studies of a few agents. Agents used for acute low back pain have not been studied for chronic low back pain. Those that have been studied, show limited or no superiority of placebo (Bogduk 2004).

Two studies each showed that tetrazepam was significantly more effective than placebo in reducing pain at seven days, but not subsequently (Bogduk 2004). Flupirtin was perceived by physicians as achieving better overall improvement than placebo at seven days, but improvements in pain or muscle spasm were not significantly better (Bogduk 2004). In terms of global impression of efficacy, tolperisone was not significantly better than placebo (Bogduk 2004).

For the treatment of neck pain, diazepam and phenobarbital have been tested, and found to have no greater effect than placebo for the treatment of acute neck pain (Basmajian 1983).

## References

1. Andersson G, Bogduk N, Deluca C et al. (1989) Muscle: Clinical Perspectives. In: Frymoyer JW, Gordon SL (eds) *New Perspectives On Low Back Pain*. American Academy Of Orthopaedic Surgeons, Park Ridge, Illinois, pp 293–334
2. Basmajian JV (1983) Reflex Cervical Muscle Spasm: Treatment by Diazepam, Phenobarbital or Placebo. *Arch Phys Med Rehabil* 64:121–124
3. Bogduk N (2004) Pharmacological Alternatives for the Alleviation of Back Pain. *Expert Opin Pharmacother* 5:2091–2098
4. Browning R, Jackson JL, O'Malley PG (2001) Cyclobenzaprine and Back Pain: A Meta-Analysis. *Arch Int Med* 161:1613–1620
5. Johnson EW (1989) The Myth of Skeletal Muscle Spasm (editorial). *Am J Phys Med* 68:1
6. Van Tulder MW, Touray T, Furlan AD et al. (2003) Muscle Relaxants for Nonspecific Low Back Pain: A Systematic Review within the Framework of the Cochrane Collaboration. *Spine* 28:1978–1992

## Muscle Scanning

### Definition

A form of psychophysiological assessment that involves making multiple bilateral recordings of muscle tension levels from varied locations.

- ▶ [Biofeedback in the Treatment of Pain](#)
- ▶ [Psychophysiological Assessment of Pain](#)

## Muscle Spasm

- ▶ [Chronic Back Pain and Spinal Instability](#)
- ▶ [Muscle Cramps](#)

## Muscle Tension

### Definition

Muscle tension refers to the level of tension in a muscle that is usually measured by electromyography and is related to the amount of contraction in muscle fibers.

- ▶ [Muscle Cramps](#)
- ▶ [Respondent Conditioning of Chronic Pain](#)

## Muscular Cramps

MARIANO SERRAO

Department of Neurology and Otorinolaringoiatry,  
University of Rome La Sapienza, Rome, Italy  
victor.m@mclink.it

M

### Synonym

Muscle cramps

### Definition

▶ [Muscle cramps](#) are “spasmodic, painful, involuntary, contractions of the skeletal muscle” (Layzer and Rowland 1971). They represent one of the most common medical complaints. Cramps sometimes occur spontaneously at rest, especially when the muscle is slack (i.e. relaxed and shortened). More often, cramps are triggered by a brief contraction or during exercise of a susceptible muscle (Layzer and Rowland 1971). They can occur in any muscle of the body, though the foot and calf muscles are more frequently involved (Jansen et al. 1991). During the cramp, the muscle is visibly and palpably taut and painful, often with abnormal posture of the affected joint, a condition which can be relieved by stretching or massage (Rowland 1985).

### Characteristics

The mechanism of muscle cramps is still speculative, because both their expression and their association with numerous diseases vary. Thus, their pathophysiology awaits clarification. A clear etiological distinction should be made between cramps generically named “▶ [contractures](#)”, present in metabolic myopathies (e.g. McArdle’s disease) and cramps associated with most other pathologies, usually named “▶ [ordinary](#)

cramps". The former type of cramp is characterized by an absence of activity ("electrical silence") on EMG recordings, suggesting a muscular origin (Layzer 1994); in most cramps, however, the EMG shows brief periodic bursts of high-frequency, high-voltage action potentials (Norris et al. 1957), suggesting a neural origin.

The origin of the pain associated with muscle cramps is not known and there are no consistent studies that have investigated this aspect. The pain present during the muscle cramp seems to be strikingly associated to the muscular contraction, which probably produces a mechanical stimulation of the group III or IV intramuscular fibers (Layzer 1985). Other factors such as an ischemia produced during the muscle contraction, an increase in muscular metabolites or a direct lesion of the muscular fibers have been hypothesized as well.

Muscle cramps have been classified according to their anatomic site of origin, cause or clinical features (Layzer and Rowland 1971; McGee 1990; Rowland 1985). Recently we have proposed a new classification (Parisi et al. 2003) based primarily on their site of pathogenesis and on Layzer's definition of muscle cramp (see below). In accordance with such a definition, the muscle contraction of the cramp must be painful, which therefore excludes involuntary muscle contractions of various origins which are not painful, such as myotonia, stiffness, dystonia and various movement disorders, e.g. myoclonias, chorea, tremors, tics. Furthermore, the muscle contraction must be sudden and sustained for a period of time ranging from a few second to a few minutes. Any pathological conditions such as antalgic contractures, which develop after a muscle injury and last for several days or weeks, should be excluded from this classification because they, unlike cramps, are neither sudden nor transient. In addition, muscular, articular or nervous disorders that induce strong, localized pain but are not associated with a real muscle contraction (e.g. neuralgia, contusion, myalgia) should be distinguished from cramps.

### Classification of Muscle Cramps

#### Paraphysiological Cramps

- Occasional cramps
- Cramps during sporting activity
- Cramps during pregnancy

#### Idiopathic Cramps

- Familial
  - Autosomal dominant cramping disease
  - Familial nocturnal cramps
  - Continuous muscle fibers activity syndrome
- Sporadic
  - Continuous muscle fiber activity syndrome (Isaac's syndrome, Stiffman syndrome, cramp-

fasciculation syndrome, myokymia-cramp syndrome)

- Syndrome of progressive muscle ► spasm, alopecia, and diarrhea (Sathoyoshi's syndrome)
- Idiopathic nocturnal cramps
- Idiopathic generalized myokymia
- Myokymia-hyperhidrosis syndrome
- Others (familial insulin resistance with acanthocytosis nigricans and acral hypertrophy, muscle cramps in cancer patients)

#### Symptomatic Cramps

- Central and Peripheral Nervous System Diseases
  - Motor neuron disease
  - Occupational dystonias
  - Parkinson's disease
  - Tetanus
  - Multiple sclerosis
  - Radiculopathies
  - Plexopathies
  - Peripheral neuropathies (inherited, endocrine-metabolic, infectious, toxic, inflammatory, demyelinating)
  - Others rare (neurolathyrism, familial paroxysmal dystonic choreoathetosis)
- Muscular Diseases
  - Metabolic myopathy (deficiency of myophosphorylase, phosphofructokinase, phosphoglyceromutase, phosphoglycerokinase, lactate dehydrogenase (LDH), adenylate deaminase, G6PDH, phosphorylase b-kinase)
  - Mitochondrial myopathy (carnitine deficiency, CPT1 e 2 deficiency)
  - Endocrine myopathy (Hoffman's syndrome etc)
  - Dystrophinopathies (Duchenne, Becker, others)
  - Myotonia (Thomsen, Becker, rippling syndrome)
  - Inflammatory myopathies (myositis, myopathy with tubular aggregates, rheumatic polymyalgia)
  - Others rare (Lambert-Brody's diseases, Swartz-Jampel syndrome, eosinophilia-myalgia syndrome, type two muscle fiber myopathy)

#### Cardiovascular Diseases

- Venous diseases
- Arterial diseases
- Heart diseases
- Hypertension

#### Endocrine-metabolic Disease

- Hypo-hyperthyroidism

- Hypo-hyperparathyroidism
  - Cirrhosis
  - Isolated deficiency of ACTH accompanied by generalized painful muscle cramp
  - Bartter's syndrome
  - Gitelman's syndrome
  - Conn's disease
  - Addison's disease
  - Uremia and dialysis
- Hydro-electrolyte Disorders
    - Dehydration with or without electrolytes imbalance (diarrhea, vomiting etc)
    - Hypo-hyponatremia
    - Hypo-hypercalcemia
    - Hypo-hyperkalemia
    - Hypomagnesemia
    - Heat cramps
  - Toxic and Pharmacological Causes
    - Drugs
    - Pesticides
    - Black widow bite
    - Toxic oil syndrome
    - Malignant hyperthermia

#### Psychiatric Disorders

By contrast, all the true “sudden, involuntary and painful muscular contractions” are included in the definition of muscle cramps. Thus, many diseases in which the cramp is not well recognized or in which the cramp is not the principal symptom, such as multiple sclerosis, Parkinson's disease and myotonia with painful spasms, have been recognized as causes of muscle cramps.

► **Paraphysiological cramps** are characterized by the occurrence of cramps in healthy subjects during particular conditions such as pregnancy or exercising. We have named occasional cramps (Parisi et al. 2003) those cramps that occasionally occur in healthy subjects in the absence of exercising or pregnancy. In this case, a strong muscular contraction or a sustained abnormal posture may lead to muscle cramps.

► **Idiopathic cramp** is the main symptom of a disease about which little is known, the cause of the cramp being obscure or speculative. Idiopathic cramps can be either sporadic or inherited and are not usually associated with any cognitive, pyramidal, cerebellar or sensory abnormalities. In the case of the familial forms, several authors have described an ► **autosomal dominant cramping disease** (Jacobsen et al. 1986; Lazaro et al. 1981; Ricker and Moxley 1990; Van den Bergh et al. 1980). Among the idiopathic forms, continuous muscle fiber activity syndrome and other rare diseases show frequent muscle cramps (Arimura et al. 1997; Solimena et al. 1988).

► **Symptomatic cramps** include cramps due to several types of diseases. Both central and peripheral nervous

**Muscular Cramps, Table 1** Drugs inducing muscle cramps

Hypocholesterolemics	Clofibrate Fenofibrate Bezafibrate
Antiblastics	Vincristine
Antihypertensive	Diuretics Beta-blockers Angiotensin-converting enzyme inhibitors, calcium channel blockers
Hormones	Medroxyprogesterone acetate Testosterone Estrogens and progesterone
Beta agonist	Terbutaline Salbutamol Pindolol
Others	Penicillamine Insulin

system pathologies as well as numerous muscular diseases are associated with muscle cramps (Parisi et al. 2003). Moreover, muscular cramps are frequent in patients affected by vascular diseases, endocrinopathies, electrolyte imbalance and psychiatric disorders. Furthermore, toxic and pharmacological causes (Table 1) can induce muscle cramps (Parisi et al. 2003).

M

#### References

1. Arimura K, Watanabe O, Kitajima I et al. (1997) Antibodies to potassium channels of PC12 in serum of Isaacs' syndrome: Western blot and immunohistochemical studies. *Muscle Nerve* 20:299–305
2. Jacobsen JH, Rosenberg RS, Huttenlocher PR et al. (1986) Familial nocturnal cramping. *Sleep* 9:54–60
3. Jansen PHP, Joosten EM, Van Dijk J et al. (1991) The incidence of muscle cramps. *J Neurol Neurosurg Psychiatr* 54:1124–1125
4. Layzer RB, Rowland LP (1971) Cramps. *N Engl J Med* 285:31–40
5. Layzer RB (1985) Diagnosis of neuromuscular disorders. In: Layzer RB (ed) *Neuromuscular manifestation of systemic disease*. Davis, Philadelphia, pp 19–22
6. Layzer RB (1994) Muscle pains, cramps and fatigue. In: Engel AG, Franzini Armstrong C (eds) *Myology*. McGraw-Hill, New York, pp 3462–3497
7. Lazaro RP, Rollinson RD, Fenichel GM (1981) Familial cramps and muscle pain. *Arch Neurol* 38:22–24
8. McGee SR (1990) Muscle cramps. *Arch Intern Med* 150:511–518
9. Norris FH, Gasteiger EL, Chatfield PO (1957) An electromyographic study of induced and spontaneous muscle cramps. *Electroencephalogr Clin Neurophysiol* 9:139–147
10. Parisi L, Amabile G, Valente G et al. (2003) Muscular cramps: a new proposal of classification. *Acta Neurol Scand* 107:176–186
11. Ricker K, Moxley RT (1990) Autosomal dominant cramping disease. *Arch Neurol* 47:810–812
12. Rowland LP (1985) Cramps, spasms and muscle stiffness. *Rev Neurol* 141:261–273
13. Solimena M, Folli F, Denis-Donini S et al. (1988) Autoantibodies to glutamic acid decarboxylase in a patient with stiff-man syndrome, epilepsy, and type I diabetes mellitus. *N Engl J Med* 318:1012–1020
14. Van den Bergh P, Bulcke JA, Dom R (1980) Familial muscle cramps with autosomal dominant transmission. *Eur Neurol* 19:207–212

15. Whiteley AM (1982) Cramps, stiffness and restless legs. *Practitioner* 226:1085–1087

## Muscular Nociceptors, Sensitization

- ▶ Sensitization of Muscular and Articular Nociceptors

## Muscular Rheumatism

- ▶ Fibromyalgia
- ▶ Myalgia

## Musculoskeletal Disorders

### Definition

Musculoskeletal disorders is a descriptive term used to label pain associated with repetitive activities.

- ▶ Disability, Upper Extremity

## Musculoskeletal Examination

WADE KING

Department of Clinical Research, Royal Newcastle Hospital, University of Newcastle, Newcastle, NSW, Australia  
wmbaking@tpg.com.au

### Definition

Musculoskeletal examination means the physical examination of the musculoskeletal system. By tradition, examination complements the history in clinical assessment. Its main purpose is to elicit objective information about the index condition. It can also foster rapport and enhance the doctor-patient relationship.

### Characteristics

The three elements of physical examination are described in an aphorism by Apley (Apley and Solomon 1993) as “look, feel, move” or:

- inspection
- palpation
- movement testing

### Inspection

Observations made by visual inspection of the patient are general and specific. General observations include dynamic posture (gait and other gross movements), static posture (standing and sitting) and bodily deformity. Specific observations of the affected region include skin discoloration, scars, swelling and other local abnormalities of form or shape.

### Palpation

Tenderness is the main finding on palpation. It may be focal or diffuse. Other palpatory signs include alterations of skin sensitivity and apparent alteration of bony landmarks or soft tissue conformation.

*Movement Testing.* Movements are assessed by testing active, passive and accessory ranges, and challenging restraints.

*Ranges of Movement.* Active ranges are assessed by the patient assuming a neutral position and then moving the body part in question in each direction as far as they can. For the spine the standard movements are extension, flexion, sidebending to left and right, and rotation to left and right. For peripheral joints they are extension, flexion, abduction, adduction, external rotation and internal rotation. Conventions have been set (Greene and Heckman 1994, Russe et al. 1976) for these tests. Ranges are estimated visually or measured with a goniometer (an instrument like a protractor with arms) or inclinometer (a device with gravitational reference and a dial showing degrees). The examiner records any limitation of range and any association with pain.

Passive movements are tested through the same ranges with the patient relaxed and the examiner supplying the effort instead of the patient.

Accessory movements are movements that cannot typically be executed in isolation by a patient, but which can be elicited by an examiner. They can be translations or rotations, and their ranges are usually small. They are tested by fixing one body part and moving the other as required. The accessory movements of a joint all contribute to “joint play”.

*Challenging Restraints.* Restraints to movement include bones, joint capsules, ligaments, tendons and muscles. They are tested actively by the patient moving a body segment as far as possible. They are tested passively by the examiner moving a joint through its ranges and accessory movements. During testing, the examiner makes a judgment as to what may be limiting the movement. This may be the onset of pain, an obstruction by bone or soft tissue, tethering by tight ligaments or fascia, or tension in antagonist muscles.

Movements may be limited or impeded before terminal restraints are engaged, if structures adjacent to the moving one produce pain or interfere with movement. A “painful arc” is part of a range through which movement is associated with pain (Kessell and Watson 1977). The “impingement sign” relates to the shoulder. The sign is considered positive if, during flexion of the shoulder, movement is limited by pain as the humeral head and acromion move closer and impinge on tissues between them, but the pain and limitation is abolished after subacromial injection of lignocaine (Neer 1972). The “apprehension sign” occurs when the patient exhibits apprehension as the examiner starts to test restraints to a particular movement. It is said to signify instability, in particu-



lar of a glenohumeral joint (Blazina and Satzman 1969) or a patella (Hughston 1972).

Many other tests of restraints have been developed for spinal segments and peripheral joints. They are described in articles and textbooks dealing with disorders of various regions of the musculoskeletal system.

### Application

Musculoskeletal examination is often overlooked. A study of patients in a teaching hospital (Ahern et al. 1991) showed 55% had musculoskeletal symptoms and 18% significant musculoskeletal disorders, yet musculoskeletal examination was performed on only 15%, compared to examination of the respiratory system on 100%, and cardiovascular examination on 99%.

Although musculoskeletal examination is often not done, many clinicians perform a ► **neurological examination** to assess musculoskeletal problems, probably because of confusion about mechanisms of pain. Low back pain and neck pain in particular are widely considered due to impingement on spinal nerves, even though such beliefs are at variance with the evidence base. There is no good reason for neurological examination of a patient with musculoskeletal pain unless they also have neurological symptoms. If so, the neurological condition should be addressed first, and the pain dealt with when the neurological issues have been clarified.

### Clinical Utility

The diagnostic utility of physical tests depends on data from well-designed studies, of which there have been many in recent years. In general, despite the traditional use of musculoskeletal examination, formal studies have shown that few tests have ► **reliability** and ► **validity** (Australian Acute Musculoskeletal Pain Guidelines Group 2003). Space permits only a few examples to be outlined here.

### Evidence of Reliability

*Inspection.* The reliability of inspection of any musculoskeletal region is unknown as there are no relevant data.

*Palpation.* Studies have shown high reliability (kappa 0.80–1.0) of tenderness elicited at non-specific sites around a painful shoulder or lower back, but the validity of such non-specific tenderness is unknown (Australian Acute Musculoskeletal Pain Guidelines Group 2003). Much lower reliability (kappa 0.11–0.38) has been shown for finding focal tenderness in the lumbar region (Australian Acute Musculoskeletal Pain Guidelines Group 2003), and its significance is also uncertain. There are no data on the reliability of focal tenderness in other regions (Australian Acute Musculoskeletal Pain Guidelines Group 2003).

*Movement Testing—Ranges of Movement.* Visual estimations of ranges of shoulder movement seem of varying reliability (Australian Acute Musculoskeletal

Pain Guidelines Group 2003). Goniometry confers no advantage (Australian Acute Musculoskeletal Pain Guidelines Group 2003). Inclination seems better if done by trained practitioners but is not uniformly reliable (Australian Acute Musculoskeletal Pain Guidelines Group 2003).

*Movement Testing—Challenging Restraints.* For various joints and regions of the body, some tests have reasonable reliability, but for others reliability is poor or lacking (Australian Acute Musculoskeletal Pain Guidelines Group 2003). This means clinicians can be trained to perform physical tests in similar ways and sometimes achieve consistent results, but it does not mean that the findings have diagnostic significance. That depends on validity of data.

### Evidence of Validity

*Inspection.* There are no data on the validity of inspection of any part of the musculoskeletal system (Australian Acute Musculoskeletal Pain Guidelines Group 2003).

*Palpation.* There are no data showing the validity of tenderness in any musculoskeletal region (Australian Acute Musculoskeletal Pain Guidelines Group 2003).

*Movement Testing—Ranges of Movement.* There are no data on the validity of ranges of movement of any part of the musculoskeletal system, so the utility of these tests is unknown too (Australian Acute Musculoskeletal Pain Guidelines Group 2003).

*Movement Testing—Challenging Restraints.* Evidence on the validity of challenging restraints is also exemplified by data relating to the shoulder, on which there have been many studies.

One study (Çali et al. 2000) of physical examination of the shoulder found “the highly sensitive tests seem to have low specificity values and the highly specific ones to have low sensitivity”. This is reflected in the low positive likelihood ratios of all individual tests. Other investigators (MacDonald et al. 2000; Naredo et al. 2002) have reported similarly, even for combinations of tests.

### References

- Ahern MJ, Soden M, Schulz D, Clark M (1991) The Musculoskeletal Examination: A Neglected Skill. *Aust NZ J Med* 21:303–306
- Apley AG, Solomon L (eds.) (1993) *Apley's System of Orthopaedics and Fractures*. 7th edn. Butterworth-Heinemann, Oxford, pp 8–12, 261–263
- Australian Acute Musculoskeletal Pain Guidelines Group (2003) *Evidence-Based Management of Acute Musculoskeletal Pain*. Australian Academic Press, Brisbane, [Online. available at ► <http://www.nhmrc.gov.au> ]
- Blazina ME, Satzman JS (1969) Recurrent Anterior Subluxation of the Shoulder in Athletics: A Distinct Entity. *J Bone Joint Surg* 51A:1037–1038
- Çali M, Akgün K, Birtane M, Karacan I, Çali H, Tüzün F (2000) Diagnostic Values of Clinical Diagnostic Tests in Subacromial Impingement Syndrome. *Ann Rheum Dis* 59:44–47
- Greene WB, Heckman JD (1994) The Clinical Measurement of Joint Motion. *American Academy of Orthopaedic Surgeons*, Rosemont

7. Hughston JC (1972) Subluxation of the Patella in Athletes. In: Symposium on Sports Medicine. CV Mosby, St. Louis, p 162
8. Kessell L, Watson M (1977) The Painful Arc Syndrome: Clinical Classification as a Guide to Management. *J Bone Joint Surg* 59B:166
9. MacDonald PB, Clark P, Sutherland K (2000) An Analysis of the Diagnostic Accuracy of the Hawkins and Neer Subacromial Impingement Signs. *J Shoulder Elbow Surg* 9:299–301
10. Naredo E, Aguado P, De Miguel E, Uson J, Mayordomo L, Gijón-Baños J, Martín-Mola E (2002) Painful Shoulder: Comparison of Physical Examination and Ultrasonographic Findings. *Ann Rheum Dis* 61:132–136
11. Neer CS (1972) Anterior Acromioplasty for the Chronic Impingement Syndrome of the Shoulder. *J Bone Joint Surg* 54A:41
12. Russe O, Gerhardt JJ, King PS (1976) *An Atlas of Examination, Standard Measurements and Diagnosis in Orthopaedics and Traumatology*, 2nd edn. Hans Huber, Bern

## Musculoskeletal Transferred Pain

- ▶ Muscle Pain, Referred Pain

## Musculoskeletal Type of Pain

### Definition

This refers to types of pain that involve the musculature.

- ▶ Respondent Conditioning of Chronic Pain

## MVD

- ▶ Microvascular Decompression

## Myalgia

ROBERT D. GERWIN  
Department of Neurology, Johns Hopkins University,  
Bethesda, MD, USA  
gerwin@painpoints.com

### Synonyms

Fibromyalgia; myofascial pain syndrome; muscle pain; Myofibrositis; Myogelosis; fibrositis; Muscular Rheumatism; idiopathic myalgia; fibrositis syndrome

### Definition

Myalgia is muscle pain or pain of muscular origin, without regard to cause. ▶ **Fibromyalgia** (FMS) is a syndrome in which there is chronic, widespread muscle tenderness related to central hypersensitization. ▶ **Myofascial pain syndrome** (MPS) is a condition in which there are discrete taut bands of hardened muscle that contain zones of exquisite muscle tenderness and which generate pain referred to another, usually distal, site.

## Characteristics

### Introduction

Myalgia can be a primary chronic pain state in which there are no laboratory abnormalities. Pain can be disabling and is often associated with debilitating fatigue as in FMS. Myalgia can be co-morbid with other conditions as in secondary FMS. Myalgia is considered chronic when it has been present for at least 3 months. The most common myalgic syndromes are FMS and MPS. These two conditions both give rise to muscle tenderness, but otherwise, they form two distinct entities. FMS is a syndrome of central sensitization and augmentation that results in widespread musculoskeletal tenderness and pain. MPS is the result of local muscle metabolic stress that is thought to produce an energy crisis. MPS is associated with discrete, linear band-like hardness or tautness within one or more muscles, leading to the release of nociceptive substances such as substance P, potassium and histamine that activate peripheral nociceptive receptors and dorsal horn nociceptive neurons. The region of a taut band is exquisitely tender and can refer pain to another, usually distal, region. Non-restorative sleep in addition to chronic myalgia is characteristic of FMS. Exercise intolerance can be seen with either FMS or MPS. However, muscle pain associated with exercise intolerance and fatigue can be due to an entirely different problem, such as a mutation in the cytochrome *b* gene of mtDNA (Hanna et al. 1999), Lyme disease or hypothyroidism. Consideration of the differential diagnosis in myalgia is essential.

### Fibromyalgia: Characteristics

FMS is a chronic, widespread myalgia that involves 3 or 4 quadrants of the body, the American College of Rheumatology criteria (ACR) (Wolfe et al. 1990). Using the ACR criteria, 3.5% of women and 0.5% of men in the United States are estimated to have FMS. The ACR criteria, intended to provide a uniform definition of fibromyalgia for research studies, require that 1) symptoms have been present for at least 3 months and 2) that 11 of 18 specified sites be tender. The clinical diagnosis of FMS in clinical practice was never intended to be as strict. The ACR criteria do not distinguish FMS from chronic, widespread MPS or any other chronic condition where there is widespread muscle tenderness. MPS is the most common condition that must be considered in the differential diagnosis (Gerwin). Consequently, the physical examination performed for the evaluation of myalgia must include palpation for the taut bands of MPS trigger points as well as for the tender points of FMS. A comprehensive medical evaluation is necessary in order to identify conditions in which diffuse muscle pain occurs secondarily. The diagnosis of FMS is based on the history and physical examination. Laboratory tests and imaging procedures are not useful for making a positive diagnosis, but

## Musculoskeletal Pain

LARS ARENDT-NIELSEN

Laboratory for Experimental Pain Research, Center for Sensory-Motor Interaction, Aalborg University, Aalborg, Denmark  
lan@hst.aau.dk

The leading causes of disability in people in their working years are musculoskeletal conditions, which are almost exclusively associated with pain. Moreover, the efficacy of treatment of many musculoskeletal pain conditions by currently available pharmacological and non-pharmacological interventions is often less than optimal. Musculoskeletal diseases are one of the most expensive areas for the health system and hence have a substantial socio-economic impact, which leads to suffering for many patients. Musculoskeletal pain is more frequent in the elderly than in the young population with a predominance among females for many of the disorders e.g. joint pain, neck pain, shoulder pain, low back pain, temporomandibular disorders, ► **fibromyalgia**, whiplash and tension type headache. Although musculoskeletal pain is an important factor in many disorders such as injuries, degenerative diseases and cancer, the peripheral and central mechanisms underlying muscle pain are poorly understood. Musculoskeletal disorders can be classified as articular (e.g. ► **rheumatoid arthritis**, osteoarthritis) or non-articular (e.g. low back pain, ► **myofascial pain syndrome**, fibromyalgia) (Mense and Simons 2001).

### Basis for Musculoskeletal Pain

In animal studies two major types of A $\delta$ - (type III) and C-fibre (type IV) muscle nociceptors (free nerve endings) have been found, chemo-nociceptors and mechano-nociceptors (Mense 1993). The stimuli for nociceptors are mechanical (e.g. strong pressure, etc.) or chemical (e.g. bradykinin, serotonin, potassium, hypertonic saline and capsaicin) and some of the latter are excited only with particular stimulus configurations like long-lasting contractions during ischaemia. Many of these receptors are notably polymodal, i.e. they respond to stimuli of different modalities (mechanical, thermal, chemical, etc.) or they can be sensitised by one stimulus (e.g. chemical) in order to respond to another stimulus (e.g. mechanical).

Free nerve endings are widely distributed throughout most of the articular structures. The majority remains silent during normal conditions, but become active when the articular tissue is subjected to damaging mechanical deformations and to certain chemical substances. These chemosensitive units are activated by certain ions and inflammatory mediators, such as sero-

tonin, histamine, bradykinin and prostaglandins. Thus they are most probably nociceptors.

Little is known about the peripheral transduction and encoding apparatus for muscle-, ligament-, periosteum- and joint-nociceptive afferents and only very few human microneurographic studies have been published. It seems more difficult to obtain stable recordings from muscle / joint nociceptive afferents than cutaneous nociceptors. The nociceptors can be sensitised by release of neuropeptides from the nerve endings. This may also lead to peripheral sensitisation of the nociceptors and central hyperexcitability of dorsal horn neurones resulting in prolonged neuronal discharges, increased responses to defined noxious stimuli, response to non-noxious stimuli and expansion of the receptive field. A variety of inputs following intense and / or prolonged noxious stimuli and consequent activation of group III and IV fibres increase spinal excitability. Three different pathophysiological processes in the spinal cord can account for the above alterations.

### Structural Re-organisation

The synaptic connections between afferent fibres and central (spinal) neurons can be changed structurally and physiologically (or pathophysiologically) in response to a variety of influences (nerve damage, ► **inflammation**, etc.).

### Decreased Inhibition

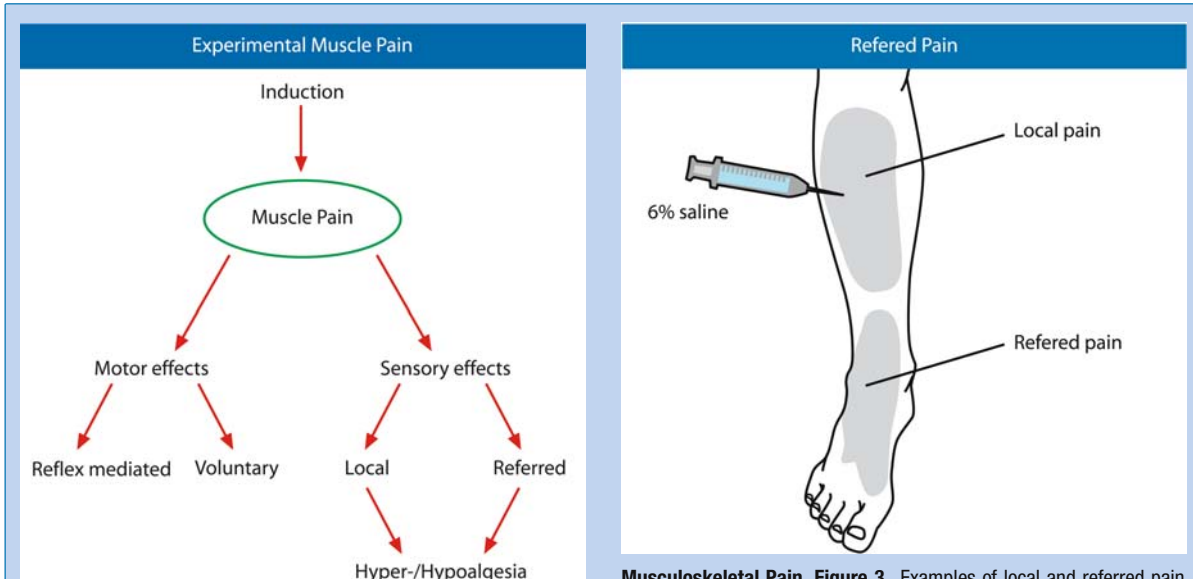
In particular in peripheral neuropathy, the inhibition normally suppressing transmission of nociceptive signals in the spinal cord could be decreased (Woolf and Doubell 1994).

### Increased Excitability (Central Sensitisation)

The increased excitability of postsynaptic neurones may in part be due to an increased efficacy of synaptic transmission from afferent nerve fibres onto postsynaptic neurones. Long-term changes in synaptic efficacy can be increases or decreases. Wall and Woolf (1984) showed that muscle nociceptive afferents seem particularly effective at inducing neurofunctional changes in the spinal cord. Peripheral and central muscular related hyperalgesia is assumed to play an important role in musculoskeletal pain disorders.

### Manifestations of Musculoskeletal Pain

Musculoskeletal pain is manifested by four main components (1) the effect on the motor system, (2) local and referred pain, (3) increased or decreased muscle sensitivity and (4) somatosensory changes in the referred pain area (Fig. 1).



**Musculoskeletal Pain, Figure 1** A sketch of how musculoskeletal pain can be manifested. (1) Muscle pain has effects on the motor system. This involves effects on voluntary contractions, endurance and muscle coordination and on reflex mediated pathways (e.g. stretch reflexes, proprioception, and motor unit firing characteristics). (2) Muscle pain may result in local as well as referred pain areas. (3) In the local muscle pain area, the muscle may have changed sensibility (e.g. hypersensitive to pressure). (4) In the referred area, various somatosensory changes can take place.

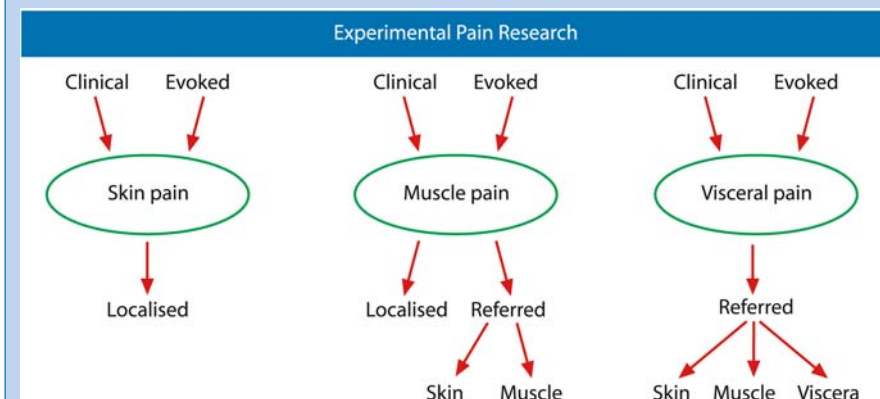
**Musculoskeletal Pain, Figure 3** Examples of local and referred pain patterns in volunteers following intramuscular injections of hypertonic saline (6%, 0.5 ml) into the anterior tibialis muscle. If the area of referred pain is completely blocked by anaesthetic procedures (e.g. a regional block), the referred pain can still be elicited, indicating that referred pain is a central phenomenon. The size of the referred pain area depends on the intensity and duration of the actual muscle stimulus.

In contrast to the localised sharp, burning characteristics of cutaneous pain, muscle pain is described as diffuse aching and cramping. Furthermore, musculoskeletal pain is more complicated to investigate than cutaneous and visceral pain, as muscle pain can consist of both localised pain and referred pain (Fig. 2).

referred pain pattern was initially observed by Kellgren (1938), who injected hypertonic saline into many skeletal muscles and ligaments and characterised the referred pain patterns (Fig. 3). Similar characterisation has been performed clinically when activating **▶ trigger points** in various muscles (Travell and Simons 1992).

Pain localisation is poor in skeletal muscles and patients may be unable to differentiate it from pain arising from tendons, ligaments and bones as well as from joints and their capsules. The characteristically

It is obviously important to distinguish the painful tissue, but it may be very difficult, due to poor localisation and **▶ referred pain**. Examples can be pain from an arthritic hip, which may refer to the thigh muscles or knee joint, a carpal tunnel syndrome may refer to forearm muscles and cervical spondylosis may refer to



**Musculoskeletal Pain, Figure 2** A simple sketch to illustrate the different characteristics and manifestations of cutaneous, muscle and visceral pain. Cutaneous pain is sharp and localised, whereas pain from deep structures is more diffuse. Pain from muscles can be localised to a specific muscle, but can also be referred to another somatic structure. In this referred structure, changes in somatosensibility can occur. Visceral pain is always referred either to somatic structures or *via* viscerovisceral convergent neurones.



arm muscles. Pain from joints and their capsules tends to be more localised than ► **myalgia** and arthralgia is often worsened by passive joint movements. Capsular pain may be present only in specific joint positions. Bone pain also tends to be poorly localised but, unlike myalgia, usually has a deep, boring quality. Furthermore, bone pain is usually worse at night and tends to be unaffected by either movement or muscle activity (Newham et al. 1994). The manifestations related to musculoskeletal pain can be projected pain, spread of pain and referred pain, somatosensory changes in referred pain areas (Vecchiet et al. 1999) and interaction with the motor system (e.g. muscle coordination and activation, postural stability, movement initiation and reflex pathways). Projected muscle pain is normally used as terminology in relationship to nerve fibre damage (e.g. compression) and felt in the innervation territory / myotome of the damaged nerve.

Spread of muscle pain is not clearly defined, but best described by phenomena related to experimental studies. If the muscle nociceptive afferent is repetitively, electrically stimulated by an intramuscular electrode, the area where the muscle pain is experienced expands or spreads as the stimulation progresses (Laursen et al. 1997). A similar manifestation is seen after repetitive visceral electrical stimulation (Arendt-Nielsen et al. 1997).

Referred muscle pain has been known and described for more than a century and is used extensively as a diagnostic tool. Substantial clinical knowledge exists concerning the patterns of referral from various skeletal muscles and after activation of trigger points (Travell and Simons 1992). The referred pain pattern follows the distribution of sclerotomes (muscle, fascia and bone) more frequently than the classical dermatomes. A clear distinction between spread of pain and referred pain is not possible and these phenomena may also share common pathophysiological mechanisms. Firm neurophysiologically based explanations for referred pain do not exist, but it has been shown that wide dynamic range neurones and nociceptive specific neurones in the spinal cord and in the brain stem of animals receive convergent afferent input from the mucosa, skin, muscles, joints and viscera. This may cause a misinterpretation of the afferent information coming from muscle afferents and reaching high levels in the central nervous system and hence be one reason for the diffuse and referred characteristics.

Referred pain is mainly a central phenomenon as it is possible to induce referred pain to limbs with complete sensory loss due to spinal injury or anaesthetic blockade. The size of the referred area to experimental muscle pain stimulation depends on the intensity and duration of the nociceptive musculoskeletal input and the evoked referred area is significantly enlarged

in patients with painful musculoskeletal disorders (fibromyalgia, whiplash, low back pain and osteoarthritis) (Arendt-Nielsen and Svensson 2001; Koelbaek Johansen et al. 1999; Sorensen et al. 1998). Recently it has been emphasised that referred pain and central sensitisation are closely related (Arendt-Nielsen and Graven-Nielsen 2002; Giamberardino 2003).

Somatosensory changes in referred muscle pain areas have been reported – and it seems that the duration and intensity of pain are important for such manifestations. Hypoalgesia as well as hyperalgesia has been reported in referred muscle pain areas. The most consistent finding is muscle hyperalgesia in the referred areas. Referred muscle hyperalgesia can also be a result of visceral pain due to the viscerosomatic convergence. This may occur in e.g. gastrointestinal, gynaecological/urological or in chronic visceral painful conditions without known aetiology (e.g. irritable bowel diseases and endometriosis). It has been shown that the degree of referred muscle hyperalgesia is related to the severity of the visceral pathology and hence the degree of visceral pain. Persistent referred muscle hyperalgesia can be manifested not only by chronic conditions, but also after recurrent painful visceral attacks, such as in dysmenorrhoeic women where lumbar muscles are hyperalgesic to pressure or after colic attacks following calculosis of the upper urinary tract, where hyperalgesia to pressure is found in muscles in the left lumbar region (Giamberardino 1999).

#### Exercise-related Painful Musculoskeletal Conditions

Muscle pain in relation to exercise may increase in intensity until the exercise / contractions stop and the blood flow is restored. This is termed ischaemic pain and is the cause of well-known clinical presentations such as intermittent claudication and angina pectoris. Hypoxia was thought to be the cause of ischaemic pain, but it now seems more likely that accumulation of metabolites is responsible, at least in part. Lactic acid was assumed to be the prime algescic substance, but since patients with myophosphorylase deficiency (patients with McArdle's disease do not produce lactic acid) also experience ischaemic muscle pain during ► **exercise**, other substances such as histamine, acetylcholine, serotonin, bradykinin, potassium and adenosine are most likely involved.

Another manifestation of exercise may be ► **muscle cramps**. Muscle cramps are involuntary, painful, sudden contractions of the skeletal muscles and may also appear after overuse of a muscle. Cramps can occur in normal subjects under a variety of conditions (during a strong voluntary contraction, sleep, sports and pregnancy) and in several pathologies such as myopathies, neuropathies, motoneurone diseases, in tetanus, metabolic disorders, hydroelectrolyte imbal-

ances or endocrine pathologies (e.g. glycolytic disorders) or as a side effect after certain drugs (salbutamol, phenothiazine, vincristine, lithium, cimetidine and bumetanide). Considerable uncertainty is found in the literature regarding the classification and nomenclature of muscle cramps, both because the term “cramp” is used to indicate a variety of clinical features of muscles leading to its use as an imprecise “umbrella” term that includes stiffness, contractures and local pain and because the spectrum of the diseases in which it appears is wide.

If a muscle is exposed to heavy and unaccustomed and especially eccentric exercise, delayed onset muscle pain may peak 1–2 days later. Delayed onset muscle pain / soreness (post exercise soreness) is associated with tenderness to pressure and pain during movement / contraction. The mechanisms underlying post-exercise muscle pain seem different from those of ischaemic muscle pain, as considerable damage such as structural, biochemical, and radioisotopic changes are found (Friden 1984). Post-exercise pain can be inhibited and treated by NSAIDs suggesting that inflammatory mediators belonging to the arachidonic cycle may be involved in this kind of muscle pain.

### Selected Painful Musculoskeletal Disorders

Myofascial pain syndromes are regional muscle pain disorders characterised by localised tenderness and pain and are common causes of persistent regional pain such as back pain, neck pain, shoulder pain, headaches and orofacial pain. The affected muscles often display an increased fatigability, stiffness, subjective weakness, pain in movement and slightly restricted range of motion that is unrelated to joint restrictions. The exact aetiology of myofascial pain syndromes is unclear. The major characteristics of myofascial pain syndromes include tenderness in muscles (trigger points) and local and referred pain. A trigger point is an up to 0.5 cm diameter point of hypersensitivity to pressure in a palpable taut band of skeletal muscle, tendon and ligament. Active trigger points are hypersensitive and display continuous pain in the zone of reference that can be altered with specific palpation. Latent trigger points display only hypersensitivity to pressure with no continuous pain. ▶ **Tender points** differ from trigger points in the sense that they are tender to pressure, do not cause referred pain by activation and can be identified as one of 18 designated soft tissue body sites.

Widespread pain is defined as pain lasting for longer than 3 months, presenting in both sides of the body, above and below the waist. In addition, axial skeletal pain (cervical spine, anterior chest, thoracic spine or low back pain) must be present. Widespread pain

includes classes of syndromes such fibromyalgia, chronic fatigue syndrome and exposure syndromes (e.g. Gulf War Illnesses). Fibromyalgia is a chronic painful musculoskeletal disorder of unknown aetiology and is defined by chronic widespread pain, involving three or more segments of the body plus the finding of at least 11 out of 18 designated tender points. Physical or emotional trauma, infection or surgery have been reported anecdotally to be precipitating factors in fibromyalgia and it is not uncommon for the patients to report the onset of the syndrome in relation to an accident or an injury. Fibromyalgia and the ▶ **whiplash** syndrome therefore share some common features.

Studies of the endocrine profile of fibromyalgia patients have indicated elevated activity of corticotropin releasing hormone (CRH) neurones, which could not only explain some symptoms of fibromyalgia, but may also explain alterations observed in the hormonal axes. Hypothalamic CRH neurones may play a role not only in resetting the various endocrine loops, but possibly also nociceptive and psychological mechanisms as well.

The whiplash syndrome is normally associated with car accidents where the car has been hit from the rear or the side and the persistent chronic pain is localised in the neck, shoulder and back. Patients with fibromyalgia and whiplash show accentuated reactions to a variety of stimulus modalities and in general they are hyperalgesic to experimental muscle stimulation (pressure and infusion of algogenic substances). A feature in many of the chronic musculoskeletal disorders is that the referred pain areas to experimentally induced muscle pain are significantly larger than in pain-free volunteers. Both fibromyalgia (Carli et al. 2002) and whiplash (Curatolo et al. 2001) patients show differentiated hyperalgesia to different sensory stimuli indicating that only specific parts of the sensory and nociceptive systems are influenced and that the sensory disturbances are accentuated as the syndrome progresses (Carli et al. 2002). In recent years these generalised chronic musculoskeletal disorders together with work-related muscle-related disorders have become an increasing challenge for the health care system with an increased socio-economic burden on societies.

Myalgia can be related to a variety of medical conditions (see list below) and common terms for the symptom are stiffness, soreness, aching, spasms or cramps. The associated pain is often described as having a dull, aching quality and can be exacerbated by muscle contractions. The manifestation of pain is, however, in some of the myalgias not the most prominent problem, as in ▶ **myositis** (e.g. ▶ **polymyositis** and ▶ **dermatomyositis**) where muscle weakness is often the prominent feature.

### Clinical Conditions Associated with Myalgia (Newham et al. 1994)

- Trauma and sports injuries
- Primary infective myositis
- Inflammatory myopathies
  - Polymyositis with and without connective tissue disease
  - Dermatomyositis with and without connective tissue disease
  - Viral myositis
  - Polymyalgia rheumatica
- Myalgia of neurogenic origin
- Muscle cramp
- Impaired muscle energy metabolism
- Drug induced myalgia
- Myalgic encephalomyelitis / chronic fatigue syndrome
- Muscle pain of uncertain cause (repetitive strain injury, fibromyalgia)

Myalgia of neurogenic origin can be difficult to dissociate from other manifestations of neuropathic pain. Examples can be cervical radiculopathy with pain radiating into the myotomal distribution of the roots or nerve compressions (e.g. carpal tunnel syndrome) where the pain radiates into the muscles in the region. Little is known specifically related to muscle sensitisation in relation to neuropathic pain, as normally only the cutaneous manifestations (allodynia, hyperalgesia) are investigated.

### Physical Therapies for the Management of Musculoskeletal Pain

A wide range of physical therapies are traditionally used in the repertoire of management regimes offered to patients with chronic musculoskeletal disorders. Such therapies include e.g. ice, heat, massage, acupuncture and ► [transcutaneous electrical nerve stimulation](#). The efficacy of these therapies is not known and has rarely been compared in controlled studies. Acupuncture, electro acupuncture and transcutaneous electrical nerve stimulation have been applied in order to inactivate e.g. trigger points, but again the efficacy is not known. The advantage of e.g. transcutaneous nerve stimulation is that the patients feel that they have some control when they can take the device home and switch it on when needed.

A variety of physiotherapeutic management regimes are developed for different musculoskeletal disorders and, for example, the Quebec task force reviewed available literature on the treatment employed by physical therapists in the management of whiplash injuries (Spitzer et al. 1995). Only two of the commonly employed physiotherapy modalities (exercise, mobilisa-

tion) showed an effect. Unfortunately only a few of the physical therapies commonly used in the clinic for the management of musculoskeletal pain are scientifically validated. However, exercise with instruction from physical therapists seems to be the modality most often resulting in good outcome.

### Gender Differences in Musculoskeletal Pain

Many musculoskeletal disorders and pains are more prevalent in females than males. Sex (referring to biologically determined aspects of femaleness and maleness) and / or gender (referring to modifiable, socio-culturally shaped behaviour and traits such as femininity and masculinity) differences are present, with female predominance in painful musculoskeletal syndromes such as widespread pain, temporomandibular disorders, neck pain, shoulder pain, back pain, joint pain, fibromyalgia, whiplash and headache. Psychological factors operative in chronic painful musculoskeletal disorders cannot be understood within any single frame of reference. It is appropriate to examine emotional, ► [interpersonal pain behaviour](#) and interpersonal relationships in parallel, not as dichotomous concepts. High rates of comorbidity have been reported between e.g. temporomandibular dysfunctions and other clinical musculoskeletal disorders (e.g. fibromyalgia) and are again more common in women than men.

Fluctuations in hormonal levels have been implicated in symptom severity in women with rheumatoid arthritis, temporomandibular disorders and fibromyalgia. One mechanism by which hormones may affect muscle nociceptors sensitisation could be related to nerve growth factor (NGF) and one of its high-affinity receptors (trkA). The trkA receptor expression is influenced by gonadal hormones (Liuzzi et al. 1999). Injection of NGF into the muscle tissue causes muscle tenderness to pressure which lasts for weeks (Svensson et al. 2003). There has been some speculation that hormone replacement therapy may increase a woman's risk of developing musculoskeletal pain (LeResche et al. 1997). Numerous studies indicate that women have greater sensitivity to experimental muscle pain stimuli than men and the pressure pain threshold is generally lower in females. There are indications in the literature that males and females have different results from some drugs. For musculoskeletal pain, the non-steroidal anti-inflammatory drugs (NSAIDs) are commonly used and some studies have indicated that females experience less pain alleviating effect than males.

### Techniques to Assess Sensitivity of Musculoskeletal Structures

Several methods exist to assess the sensitivity of musculoskeletal structures. The methods are based on

standardised application or induction of standardised pain to musculoskeletal structures to evaluate how sensitive the structure is to that specific stimulus modality. Such procedures can be applied to healthy volunteers in the laboratory for basic experimental studies or to patients for clinical examinations (Arendt-Nielsen 1997; Arendt-Nielsen et al. 1997). The standardised pain stimulus can be classified as endogenous pain models (the pain arises from muscles without the involvement of external stimuli) or exogenous models (the pain is evoked by external stimuli) (see list below).

#### **Classification of Experimental Stimulus Modalities That Can Be Used to Induce Muscle Pain Experimentally**

##### **Endogenous**

- Ischaemic
- Exercise-induced
  - Dynamic concentric contraction
  - Isometric contraction
  - Dynamic eccentric contraction

##### **Exogenous**

- Electrical
- Mechanical
- Chemical
- Focused ultrasound

##### **Endogenous Models**

Ischaemic muscle pain is a classically experimental pain model and has been used as an unspecified pain stimulus. A tourniquet is applied and after a period of voluntary muscle contractions a very unpleasant tonic pain sensation develops. The number of contractions, the level of force and the duration are important determinants for the resulting pain. This is a very efficient model to induce pain in muscles, but skin, periosteum and other tissues will contribute. The model is applicable in experimental studies requiring a general tonic pain stimulus for e.g. PET and fMRI experimental studies. ► [Delayed Muscle Soreness](#) is another model used experimentally to investigate endogenous muscle pain and this model is useful for e.g. evaluating drug effect.

##### **Exogenous Models**

Intraneural microstimulation of muscle nociceptive afferents can be performed in laboratory studies and can selectively elicit muscle pain accompanied by referred pain, which is dependent on the stimulation time (temporal summation) and the number of stimulated afferents (spatial summation). Repetitive intramuscular electrical stimulation can evoke localised and referred muscle pain. The local and referred pain areas develop during stimulation with the referred area slightly delayed as compared with the local pain area. The ar-

reas are dependent on stimulus intensity and duration (Laurson et al. 1997).

Intramuscular infusion of algogenic substances (e.g. hypertonic saline, capsaicin, bradykinin) causes local and referred pain. In most experimental human studies, manual bolus infusions of hypertonic saline are used, but more advanced models such as standardised infusion of small volumes by computer-controlled infusion pumps have been used. When this advanced model is used, the infusion rate can be controlled by the pain intensity rating feedback so constant pain intensity can be achieved by continuous adjustment of the infusion rate. Muscle pain induced experimentally by intramuscular infusion of algogenic substances causes cutaneous and muscular sensibility changes in referred pain areas. It is not entirely conclusive which somato-sensory changes occur as both hypo- and hyper-aesthesia have been reported. Furthermore, these changes are stimulus modality specific (Graven-Nielsen et al. 1997). Pressure algometry is the most commonly used technique to induce muscle pain and hence assess tenderness in myofascial tissues and joints such as e.g. tender points, fibromyalgia, work-related myalgia, myofascial pain, strain injuries, myositis, chronic fatigue syndrome, arthritis / orthoses and other muscle / tendon / joint inflammatory conditions (Fischer 1987a; Fischer 1987b). The technique is adequate to quantify and follow the development of given diseases, but has also proven to be instrumental for the documentation of treatment outcome such as local / systemic administration of drugs. Pressure algometry is also suitable for the assessment of joint tenderness.

##### **Assessing Sensory Aspects of Musculoskeletal Pain**

Assessing the sensory aspects of musculoskeletal pain involves both evaluation of the muscle pain and of the somatic structures related to the referred pain area (Fig. 1). Clinical and experimentally induced muscle pain intensity and the implications on e.g. physical performance can be assessed quantitatively by various measures (see list below).

##### **Techniques for Assessment of Experimentally Induced Musculoskeletal Pain and for Assessing Clinical Musculoskeletal Pain**

###### **Sensory Characterisation**

###### **Muscle Sensitivity**

- Verbal assessment
  - Visual analogue scales
  - Verbal descriptor scales
  - McGill Pain Questionnaire
- Psychophysical tests
  - Pain thresholds



- Referred pain
  - Distribution of pain
  - Area (size)
  - Somatosensory changes

#### Motor Effects

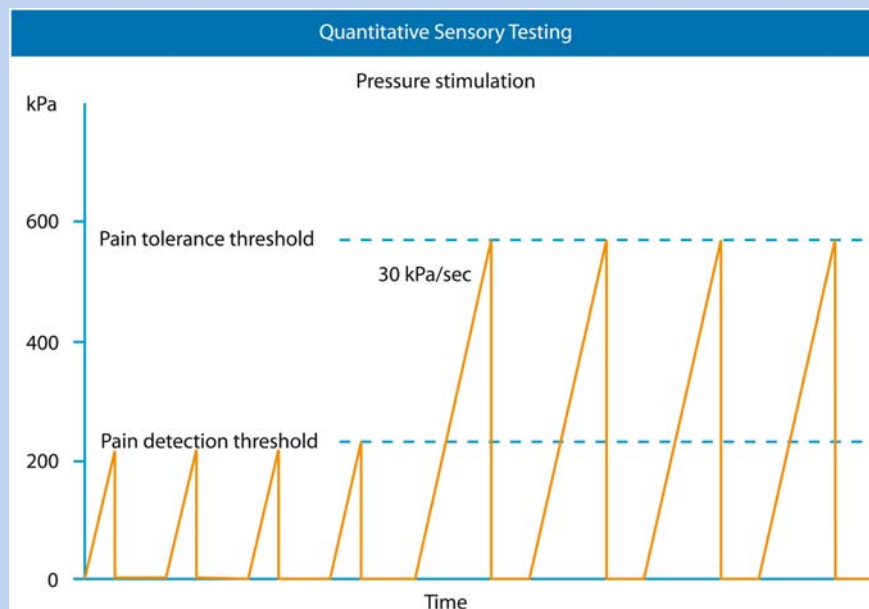
- Electromyography
  - Surface electrodes
  - Needle electrodes
  - Indwelling wire electrodes
- Kinetics and kinematics
  - Sirognathograph (jaw movements)
  - Optoelectronic devices
- Force
  - Dynamometers
  - Force platforms
  - Bite force meters

Musculoskeletal pain has implications in many aspects of daily life and questionnaires for assessment of different dimensions have been developed for general and regional (e.g. back pain and neck pain) pain problems (general function score, Roland and Morris disability scale, ► [Oswestry disability index](#), West Haven-Yale multidimensional pain inventory, Bournemouth questionnaire, ► [fear avoidance beliefs](#), life satisfaction) (Turk and Melzack 1992).

A simple and useful technique is pain drawings where e.g. tender points, trigger points, localised and referred pain areas, hyper- and hypo-algesia are marked. Different colours can eventually be used to characterise different manifestations.

The psychophysical parameters used for the quantification of musculoskeletal pain sensitivity to experimentally applied pressure (pressure algometry) are pain detection, pain tolerance thresholds (Fig. 4) and stimulus-response functions. Stimulus-response functions can provide more information than just a threshold, as sensitisation to low as well as high intensities can be assessed and a shift in parallel of the curve towards the left together with an increased slope as has been found in patients with myofascial pain.

For monitoring purposes quantitative parameters are advantageous as compared with manual palpation. The essence of pressure algometry is that standardised increase in pressure is applied to the part of the body that is being investigated and the outcome is the patient's or volunteer's reaction to the pressure (Fischer 1987a; Fischer 1987b). Pressure rate and pressure area have been shown to be important factors for reliable results. The pressure pain thresholds vary substantially between regions. In some of the commercially available pressure algometers, the pressure application rate can be monitored, which is important for the reliability of the results. For research purposes, advanced computer controlled devices are available where the pressure rate can be pre-defined.



**Musculoskeletal Pain, Figure 4** A schematic figure indicating how the psychophysical thresholds related to pressure pain (pressure algometry) are measured. Using a pressure algometer it is possible to control the rate of force increase (e.g. 30 kPa / s to a 1 cm<sup>2</sup> probe) and determine when the volunteer / patient experience the pressure as just painful (pain detection threshold) and when he / she will not tolerate any further increase in stimulus intensity (pain tolerance threshold).

Thresholds from various clinical pressure pain studies are difficult to compare, as different instrumentations have been used with different probe diameters and shapes and different force increase rates. The probe diameter is of utmost importance as there is not necessarily a simple relation between diameter and threshold since spatial summation plays an important role. The shape and contour of the probe are important, as sharp edges may excite more cutaneous receptors due to high shear forces compared with blunt probes.

Verbal assessments of the musculoskeletal pain intensity and other subjective characteristics of the pain are obviously needed in any clinical and experimental muscle pain studies. Visual analogue scales (VAS), verbal descriptor scales (VDS), McGill pain questionnaire (MPQ) and similar scales and questionnaires may be very helpful for the assessment of perceived pain intensity and quality (Turk and Melzack 1992). Musculoskeletal pain is most frequently characterised by descriptors as “drilling” “aching” “boring” and “taut”. The intensity of musculoskeletal pain is easily measured using visual analogue scales (VAS). However, this is only a one-dimensional aspect of the experienced pain and additional VAS should be applied to monitor e.g. unpleasantness and soreness. Word descriptors on the VAS are important, as muscle tenderness and muscle pain may not reflect the same mechanisms. In addition to verbal assessments, psychophysical tests are valuable adjuncts for the examination of musculoskeletal pain (Turk and Melzack 1992).

### Interaction between Musculoskeletal Pain and Motor Performance

Musculoskeletal pain has implications for motor performance and different electrophysiological and biomechanical methods and disability questionnaires (e.g. Oswestry pain disability index) have been developed to assess this interaction.

After reviewing articles describing motor function in five chronic musculoskeletal pain conditions (temporomandibular disorders, muscle tension headache, fibromyalgia, chronic lower back pain and post-exercise muscle soreness), Lund et al. (1991) concluded that the activity of agonist muscles is often reduced and the activity of the antagonist is slightly increased by musculoskeletal pain. As a consequence of these changes, force production and the range and velocity of movement of the affected body part are often reduced. To explain such changes motor control, Lund et al. (1991) proposed a neurophysiological model based on the phasic modulation of excitatory and inhibitory interneurons supplied by high threshold sensory afferents. They suggested that the “dysfunction”, which is characteristic of several types of chronic musculoskeletal pain, is a normal protective

adaptation and is not a cause of pain. This pain adaptation model has also been verified in experimental studies, where motor strategies have been investigated before and after experimentally induced muscle pain. It seems however that the adaptation pattern mainly occurs in relation to gross, high force movements and to a lesser extent for high precision, low force movements. Johansson and Sojka (1991) suggested another pathophysiological model for chronic muscle pain and tension disorders. The model suggests that, under circumstances when chemosensitive group III-IV muscle afferents, joint afferents or certain descending pathways are activated, the activity of both primary and secondary muscle spindle afferents would be increased *via* fusimotor reflexes. This would have several consequences. Initially, an increased activity in  $\gamma$ -motoneurons would reduce the information transmission capacity of muscle spindles. Secondly, an altered activity in the primary muscle spindle afferents would influence proprioception and thereby sensorimotor control at higher levels. This influence could possibly lead to unfavourable work techniques, such as increased co-contractions and insufficient rest periods, which might further increase the interstitial concentration of substances exciting group III-IV afferents. Thirdly, increased levels of these substances might also excite, *via* chemosensitive group III-IV afferents, the sympathetic outflow to skeletal muscles, which may change the balance between sympathetic vasoconstriction and metabolic vasodilation and thus entail a deficiency in oxygen and nutrients with the consequences.

There is so far little clinical evidence to support this model. Experimental human studies have to some degree verified the interaction between  $\gamma$ -motoneuron excitability and the activation of group III-IV nociceptive afferents. Experimentally induced muscle pain causes excitation of the human stretch reflex, which may indicate such facilitatory interaction (Matre et al. 1998). In chronic muscle pain conditions where group III-IV muscle nociceptors are assumed to be active, muscle spindle responses and hence proprioception, should be affected. Indeed, patients suffering from work related myalgia often exhibit reduced proprioception, disturbed motor control and impaired balance.

- ▶ Disability, Upper Extremity
- ▶ Opioids and Muscle Pain

### References

1. Arendt-Nielsen L (1997) Induction and assessment of experimental pain from human skin, muscle and viscera. In: Jensen TS, Turner JA, Wiesenfeld-Hallin Z (eds) Proceedings of the 8th World Congress on Pain. IASP Press, Seattle, pp 393-425
2. Arendt-Nielsen L, Graven-Nielsen T (2002) Deep tissue hyperalgesia. *J Musculoskel Pain* 10:97-119
3. Arendt-Nielsen L, Svensson P (2001) Referred muscle pain: basic and clinical findings. *Clin J Pain* 17:11-19

4. Arendt-Nielsen L, Svensson P, Graven-Nielsen T (1997) How to assess muscle pain experimentally and clinically. *Eur J Pain* 1:64–65
5. Carli G, Suman AL, Biasi G et al. (2002) Reactivity to superficial and deep stimuli in patients with chronic musculoskeletal pain. *Pain* 100:259–269
6. Curatolo M, Petersen-Felix S, Arendt-Nielsen L et al. (2001) Central hypersensitivity in chronic pain after whiplash injury. *Clin J Pain* 17:306–315
7. Fischer AA (1987a) Pressure algometry over normal muscles. Standard values, validity and reproducibility of pressure threshold. *Pain* 30:115–126
8. Fischer AA (1987b) Reliability of the pressure algometer as a measure of myofascial trigger point sensitivity. *Pain* 28:411–414
9. Friden J (1984) Muscle soreness after exercise: implications of morphological changes. *Int J Sport Med* 5:57–66
10. Giamberardino MA (1999) Recent and forgotten aspects of visceral pain. *Eur J Pain* 3:77–92
11. Giamberardino MA (2003) Referred muscle pain / hyperalgesia and central sensitisation. *J Rehabil Med* 41:85–88
12. Graven-Nielsen T, Arendt-Nielsen L, Svensson P et al. (1997) Stimulus-response functions in areas with experimentally induced referred muscle pain—a psychophysical study. *Brain Res* 2:121–128
13. Johansson H, Sojka P (1991) Pathophysiological mechanisms involved in genesis and spread of muscular tension in occupational muscle pain and in chronic musculoskeletal pain syndromes: A hypothesis. *Medical Hypotheses* 35:196–203
14. Kellgren JH (1938) Observations on referred pain arising from muscle. *Clin Sci* 3:175–190
15. Koelbaek Johansen M, Graven-Nielsen T, Schou Olesen A et al. (1999) Generalised muscular hyperalgesia in chronic whiplash syndrome. *Pain* 83:229–234
16. Laursen RJ, Graven-Nielsen T, Jensen TS et al. (1997) Quantification of local and referred pain in humans induced by intramuscular electrical stimulation. *Eur J Pain* 1:105–113
17. LeResche L, Saunders K, Von Korff MR et al. (1997) Use of exogenous hormones and risk of temporomandibular disorder pain. *Pain* 69:153–160
18. Liuzzi FJ, Scoville SA, Bufton SM (1999) Long term estrogen replacement co-ordinately decreases trkA and beta-PPT mRNA levels in dorsal root ganglion neurons. *Exp Neurol* 155:260–267
19. Lund JP, Donga R, Widmer CG et al. (1991) The pain-adaptation model: a discussion of the relationship between chronic musculoskeletal pain and motor activity. *Can J Physiol Pharmacol* 69:683–694
20. Matre D, Sinkjr T, Svensson P et al. (1998) Experimental muscle pain increases the human stretch reflex. *Pain* 75:331–339
21. Mense S (1993) Nociception from skeletal muscle in relation to clinical muscle pain. *Pain* 54:241–289
22. Mense S, Simons DG (2001) Muscle pain: Understanding its nature, diagnosis and treatment. Lippincott Williams & Wilkins, Baltimore
23. Newham DJ, Edwards RHT, Mills KR (1994) Skeletal muscle pain. In: Wall PD, Melzack R (eds) *Textbook of Pain*, 3rd edn. Churchill Livingstone, UK, pp 423–440
24. Sorensen J, Graven-Nielsen T, Henriksson KG et al. (1998) Hyperexcitability in fibromyalgia. *J Rheumatol* 25:152–1555
25. Spitzer WO, Skovron ML, Salmi LR et al. (1995) Scientific monograph of the Quebec Task Force on Whiplash-Associated Disorders: redefining “whiplash” and its management. *Spine* 20:1–73
26. Svensson P, Cairns BE, Wang K et al. (2003) Injection of nerve growth factor into human masseter muscle evokes long-lasting mechanical allodynia and hyperalgesia. *Pain* 104:241–247
27. Travell JG, Simons DG (1992) Myofascial Pain and Dysfunction: The Trigger Point Manual, vol 1, 2. Williams & Wilkins, Baltimore
28. Turk DC, Melzack R (eds) (1992) *Handbook of pain assessment*. Guilford, New York
29. Vecchiet L, Vecchiet J, Giamberardino MA (1999) Referred Muscle Pain: Clinical and Pathophysiologic Aspects. *Curr Rev Pain* 3:489–498
30. Wall PD, Woolf CJ (1984) Muscle but not cutaneous C-afferent input produces prolonged increases in the excitability of the flexion reflex in the rat. *J Physiol* 356:443–458
31. Woolf CJ, Doubell TP (1994) The pathophysiology of chronic pain—increased sensitivity to low threshold A beta-fibre inputs. *Curr Opin Neurobiol* 4:525–534

M

are required to identify co-morbid conditions or other causes of chronic myalgia.

#### Associated Symptoms of FMS

FMS is associated with sleep disturbance, fatigue, headache, morning stiffness, irritable bowel syndrome (IBS), interstitial cystitis (IC), dyspareunia and mood disturbance. Some of these symptoms are manifestations of referred muscle pain from ► **myofascial trigger points** (headache, ► **dyspareunia**, morning stiffness) and others, such as IBS and IC are ► **viscerosomatic pain syndromes** (Gerwin) that occur in up to 70% of FMS patients. They are by no means unique to FMS and are usually associated with pelvic floor MPS syndromes. Depression may occur in as many as 30% of FMS patients, but is no more common in FMS than in the general population.

#### Fibromyalgia: Etiology

Tenderness in FMS is related to central sensitization with amplification of nociception, resulting in a

broad array of stimuli perceived as being more painful among FMS patients than they are in control subjects (Russell 2001). Alterations in cardiovascular autonomic nervous system function cause orthostatic hypotension or neurally mediated orthostatic tachypnea (Martinez-Lavin 1997). Neuroendocrine abnormalities in the hypothalamic-pituitary-adrenal system and growth hormone deficiency are hormonal deficiency states that may tie together the symptoms of fatigue, pain and sleep and mood disturbances (Dessein et al. 2000).

#### Fibromyalgia: Treatment

Treatment of fibromyalgia includes a wide variety of pharmacologic, nutritional, hormonal, behavioral, cognitive, exercise and physical modalities (Goldenberg et al. 2004). The long-term prognosis for FMS is more favorable than initially thought. Symptoms may persist for years, but patients either learn to cope with the chronic pain or the pain does not progress.

### Myofascial Pain Syndrome: Characteristics

MPS is a muscular pain syndrome that arises from a primary dysfunction in muscle. It is associated with central sensitization and a segmental spread within the spinal cord to give rise to the phenomenon of referred pain or pain that is felt at a distance (Mense 2001). The clinical picture of MPS is one of musculoskeletal pain, limited mobility, weakness and referred pain (Simons et al. 1999). The trigger point has both a motor abnormality in which an abnormal hardness in muscle (the taut band) is felt on palpation, and a sensory abnormality of exquisite tenderness in the taut band. Identification of the trigger point by physical examination has good interrater reliability (Gerwin et al. 1997). The specifics of a MPS depend on which muscles are involved. For example, TrPs in the muscles of the head, neck and shoulders can cause headache. Local or regional myofascial syndrome can spread through the body and become a widespread myofascial syndrome, but does not become fibromyalgia.

### Treatment

Treatment of myofascial pain requires the inactivation of MTrPs by manual trigger point compression or by needling, the restoration of normal muscle length and the elimination or correction of the factors that created or perpetuated the trigger points in the first place. Awareness of ergonomic and postural factors is important in developing a treatment plan. Trigger point needling is done with or without the injection of local anesthetic (Cummings 2001). Injection of other materials such as steroids or ketorolac is inappropriate. Trigger point inactivation must be accompanied by correction of mechanical or structural stresses and of psychological and medical contributing factors.

### Mechanical Causes

Mechanical causes of myalgia include ergonomic, structural and postural pain syndromes.

### Hypermobility Syndromes

Hypermobility syndromes produce multiple mechanical stresses. Structural stress occurs as ligamentous laxity results in poor joint stabilization, muscles then being recruited to maintain joint integrity. This can result in a seemingly disproportionate number of hypermobile persons, mostly women, who have focal or generalized myalgia. The affected muscles always have myofascial trigger points. The mechanism of injury appears to be muscular stress or overload that arises from the effort required to maintain joint integrity. The most effective treatment is strengthening.

### Forward Head Posture

Forward head posture places stress on the extensor muscles of the neck and shoulder (longissimus cervicis, semispinalis capitis and cervicis, splenius capitis and cervicis, the suboccipital muscles at the base of the

skull and the trapezius and levator scapulae muscles). Posterior cervical muscle and shoulder muscle myalgic syndromes are thus frequently associated with head pain and headache.

### Pelvic Torsion-related Pain

Pelvic torsion-related pain is associated with pseudo-leg-length-inequality or with trigger point muscular shortening (pseudoscoliosis). It can be caused by, and in turn either cause or aggravate, myalgia in lumbar muscles and in the pelvic floor muscles.

### SI joint Dysfunction

Sacroiliac joint dysfunction, or sacro-iliac joint hypomobility can cause pelvic and spine dysfunction that results in painful, widespread axial muscle trigger points. Pain may be felt in the sacroiliac joint region (on either the hypomobile or the normal side), referred to the low back or occur because of the secondary development of paraspinal trigger point up the axial spine to the shoulders and neck.

### Static Overload

Static overload occurs when mechanically stressful positions are held for prolonged periods of time, causing fatigue and pain in the persistently activated muscles.

### Nerve Root Compression

Nerve root compression can present with acute or chronic myofascial trigger points. Trigger point pain syndromes can develop acutely when there is an acute disc herniation. Muscle pain is in the distribution of the affected nerve root. It can precede any neurological impairment such as weakness, sensory loss, paresthesia or reflex loss.

### Delayed Onset Muscle Soreness (DOMS)

Delayed onset muscle soreness (DOMS), as is well known, occurs after eccentric exercise, but has been shown to occur after ischemic exercise as well (Barlas et al. 2000). Exercise under these conditions causes injury to the muscle fiber and consequent pain or soreness.

The second major category is systemic medical illness. The relationship of some of these conditions to myalgia has been difficult to confirm. Yet when such an illness is identified and treated and muscle pain improves or resolves, it is tempting to equate the treatment with a successful outcome. Nonetheless, one must be cautious about assuming a causal relationship. The conditions of interest include autoimmune disorders, infectious diseases, allergies, hormonal and nutritional deficiencies, viscerosomatic pain syndromes and iatrogenic drug induced myalgic pain syndromes.

### Autoimmune Disorders

Muscle pain is a common accompanying symptom of many autoimmune disorders, particularly connective tissue diseases like lupus and Sjögren's syndrome.



Polymyalgia rheumatica (PMR) must certainly be considered in any head, neck and shoulder regional muscular pain syndrome in an older (>50 years of age) individual. Chewing-induced pain is an important component of both PMR and MPS, the latter when the temporomandibular joint is involved. Muscle pain may precede other signs of Sjögren's syndrome by several years.

### Infectious Diseases

Lyme disease is perhaps the most prevalent of the infectious diseases associated with myalgia and arthralgia. Post-Lyme disease syndrome is characterized by diffuse arthralgia, myalgia, fatigue and subjective cognitive difficulty (Weinstein and Britchkov 2002). Patients diagnosed with this condition do not show evidence of chronic borrelial infection and they do not respond to a 3 month course of antibiotics any better than a control group treated with placebo. Chronic infections that look like Lyme disease and that may co-infect with Lyme disease are babesiosis, ehrlichiosis and *Bartonella*. Other infectious diseases thought to be related to myalgia are *Mycoplasma pneumoniae* and *Chlamydia pneumoniae*. Interest in these two diseases arises because of a putative association with arthralgia or synovitis and with chronic fatigue. A number of patients with widespread myalgia have parasitic disease, most commonly amebiasis and *Giardia*.

### Allergies

Cases of widespread myalgia (myofascial pain syndrome) have been associated with persons who have had untreated allergies. When the myalgic syndrome is limited to the head, neck and shoulders, forward head posture as described above may be related to allergies and obstruction of the nasal passages may play a role.

### Viscero-somatic Pain Syndromes

Internal organs are associated with somatic segmental referred pain syndromes. Endometriosis, for example, is associated with abdominal myofascial pain (Jarrell and Robert 2003). Interstitial cystitis and irritable bowel syndrome are associated with chronic pelvic pain syndromes (Hetrick et al. 2003; Weiss 2001). Liver disease can cause local abdominal and referred shoulder myofascial pain syndromes that present as a regional pain syndrome responsive to treatment of the trigger points by needling or by manual therapy.

### Brain Tumor and Base of Skull Pain

Posterior fossa mass lesions (primary and metastatic tumors) can present as focal base of skull or upper cervical pain with identifiable myofascial trigger points that transiently respond to trigger point inactivation.

### Nutritional Deficiencies

Vitamin D deficiency was found in 89% of the persons in a group with chronic musculoskeletal pain (Plotnikof

2003). This is an astounding figure that indicates that vitamin D deficiency is extremely common among those with myalgia.

### Iron Deficiency

This causes a metabolic stress that produces fatigue and muscle pain. Muscle is depleted of iron available for energy-producing enzymatic reactions when serum ferritin levels are 15 ng/ml or less. Treatment with iron supplements in women whose serum ferritin level is 20 ng/ml or less results in less fatigue, less coldness and less muscle pain. Iron insufficiency is also associated with restless leg syndrome (RLS), a cause of sleep disturbance. Sleep deprivation also causes myalgia. Thus, iron deficiency can aggravate muscle pain secondarily by causing RLS.

### Drug Induced Myalgia

This is widespread and diffuse, rather than regional. Drug-induced myalgia may or may not be associated with trigger points. Elevation of CK is a marker of muscle tissue breakdown. However, CK is not necessarily elevated when there is drug-induced myalgia. Drugs known to produce myalgia, regardless of whether or not CK is elevated, include propoxyphene and the statin family of cholesterol lowering drugs (Thompson et al. 2003). The risk of acquiring myalgia is increased when a statin drug is taken concomitantly with fibric acid derivatives like gemfibrozil, niacin, cyclosporin, azole B antifungal and macrolide antibiotics, protease inhibitors, nefazodone, verapamil, diltiazem, amiodarone or grapefruit juice (> 1 qt / day).

### Conclusion

Muscle pain can be the result of a wide array of clinical conditions. The inflammatory diseases of muscle, such as polymyositis or the inherited myopathies, can also present with pain. Myoadenylate deaminase deficiency is the most common inherited muscle enzyme disorder, but the role that it plays in muscle pain is still no clearer today than it was 10 years ago. In order to treat patients well, the conditions that produce muscle pain must be identified in order to be specifically addressed.

► [Guillain-Barré Syndrome](#)

► [Muscle Pain Model, Inflammatory Agents-Induced](#)

### References

1. Andreu AL, Hanna MG, Reichman H et al. (1999) Exercise intolerance due to mutations in the cytochrome *b* gene of mitochondrial DNA. *N Eng J Med* 341:1037–1044
2. Barlas P, Walsh DM, Baxter GD et al. (2000) Delayed onset muscle soreness: effect of an ischemic block upon mechanical allodynia in humans. *Pain* 87:221–225
3. Cummings T, White A (2001) Needling therapies in the management of myofascial trigger point pain: a systematic review. *Arch Phys Med Rehabil* 82: 986–992
4. Dessein PH, Shipton EA, Joffe BI et al. (2000) Neuroendocrine deficiency-mediated development and persistence of pain in fibromyalgia: a promising paradigm? *Pain* 86:213–215
5. Gerwin RD (1999) Differential diagnosis of myofascial pain syndrome and fibromyalgia. *J Musculoskeletal Pain* 7:209–215

6. Gerwin RD (2002) Myofascial and visceral pain syndromes: visceral-somatic pain representations. *J Musculoskelet Pain* 10:165–175
7. Gerwin RD, Shannon S, Hong C-Z et al. (1997) Interrater reliability in myofascial trigger point examination. *Pain* 69:65–73
8. Goldenberg DL, Burckhardt C, Crofford L (2004) Management of fibromyalgia syndrome. *JAMA* 292:2388–2395
9. Hetrick DC, Ciol MA, Rothman I et al. (2003) Musculoskeletal dysfunction in men with chronic pelvic pain syndrome type III: a case-control study. *J Urology* 170:828–831
10. Jarrell J, Robert M (2003) Myofascial dysfunction and pelvic pain. *Canadian J CME* Feb:107–116
11. Martinez-Lavin MA, Hermosilla AG, Mendoza C (1997) Orthostatic sympathetic derangement in subjects with fibromyalgia. *J Rheumatology* 24:714–718
12. Mense S, Simons DG (2001) *Muscle Pain*. Lippincott Williams & Wilkins, Baltimore, pp 205–288
13. Plotnikoff GA, Quigley JM (2003) Prevalence of severe hypovitaminosis D in patients with persistent, nonspecific musculoskeletal pain. *Mayo Clin Proc* 78:1463–1470
14. Russell IJ (2001) Fibromyalgia Syndrome. In: Mense S, Simons DG (eds) *Muscle Pain*. Lippincott Williams & Wilkins, Baltimore, pp 289–337
15. Simons DG, Travell JG, Simons LS (1999) *Myofascial Pain and Dysfunction: The Trigger Point Manual*. Williams and Wilkins, Baltimore
16. Thompson PD, Clarkson P, Karas RH (2003) Statin-associated myopathy. *JAMA* 289:1681–1690
17. Weinstein A, Britchkov M (2002) Lyme arthritis and post-Lyme disease syndrome. *Curr Opin Rheumatol* 14:383–387
18. Weiss JM (2001) Pelvic floor myofascial trigger points: manual therapy for interstitial cystitis and the urgency-frequency syndrome. *J Urology* 166:2226–2231
19. Wolfe F, Smythe H, Yunus MB et al (1990) The American College of Rheumatology criteria for the classification of Fibromyalgia. *Arthritis Rheum* 33:160–172

---

## Mycobacterium Leprae

### Definition

*Mycobacterium Leprae* is the causative agent of Hansen's disease. The bacterium was discovered in 1873 by a Norwegian physician named Gerhard Armauer Hansen.

- ▶ [Hansen's Disease](#)

---

## Mycobacterium Species

### Definition

Mycobacteria are a large genus of class of bacteria that are responsible for a multitude of diseases of many species. The most common mycobacterium used in Freund's complete adjuvant is mycobacterium tuberculosis, the organism responsible for tuberculosis in humans. *Mycobacterium butyricum* has also been used in FCA.

- ▶ [Arthritis Model, Adjuvant-induced Arthritis](#)

---

## Myelin

### Definition

Myelin is a specialized cell membrane composed of lipids and proteins that ensheathes axons and fosters rapid electrical conduction.

- ▶ [Demyelination](#)
- ▶ [Hereditary Neuropathies](#)
- ▶ [Postsynaptic Dorsal Column Projection, Anatomical Organization](#)
- ▶ [Spinothalamic Tract Neurons, Morphology](#)
- ▶ [Toxic Neuropathies](#)

---

## Myelinated

### Definition

Medium and large nerve fibers can be wrapped in a variable number of concentric layers of glial membrane that provide for rapid neurotransmission.

- ▶ [Postsynaptic Dorsal Column Projection, Anatomical Organization](#)

---

## Myelination

### Definition

Myelination is a process by which oligodendroglial cells wrap axons with multiple layers of glial cell membrane forming myelin, which electrically insulates the axon increasing axonal conduction velocity.

- ▶ [Mechanoreceptors](#)

---

## Myelitis

### Definition

Myelitis is the inflammation of the spinal cord.

- ▶ [Viral Neuropathies](#)

---

## Myelopathy

### Definition

Myelopathy is the manifestation of systemic vasculitides and the isolated angiitis of the central nervous system.

- ▶ [Headache Due to Arteritis](#)

## Myelotomy

### Definition

Myelotomy or midline or commissural myelotomy is useful for the treatment of bilateral pain syndromes caused by cancer and other illnesses. Second order spinalthalamic tract nociceptive track fibers cross the spinal cord, and a myelotomy is intended to cut these fibers as they decussate in the spinal cord.

- ▶ Cancer Pain Management, Overall Strategy
- ▶ Midline Myelotomy

## Myenteric Plexus

### Definition

The myenteric plexus consists of unmyelinated nerve fibers that are spread out in the muscular part of the intestinal wall of the esophagus, stomach, and intestines. The plexus is involved in the regulation of gut motility.

- ▶ Opioid Therapy in Cancer Pain Management, Route of Administration

## Myocardial Ischemia

- ▶ Visceral Pain Model, Angina Pain

## Myoclonus

### Definition

Myoclonus refers to Irregular, involuntary contraction of a muscle.

- ▶ Opioids and Reflexes

## Myofascial

### Definition

The fascia (the sheath around a muscle).

- ▶ Lower Back Pain, Physical Examination
- ▶ Myofascial Pain

## Myofascial Manipulation

### Definition

Myofascial manipulation is the forceful, passive movement of the musculofascial components through their restrictive direction. Treatment is initiated in the superficial layers and moves into the deeper layers while considering the relationship to the joints involved.

- ▶ Chronic Pelvic Pain, Physical Therapy Approaches and Myofascial Abnormalities

## Myofascial Pain

ROBERT BENNETT

Department of Medicine, Oregon Health and Science University, Portland, OR, USA  
bennetrob1@comcast.net

### Synonyms

Trigger Point Pain; Soft Tissue Rheumatism; Myotomal Pain; Localized Muscle Pain

### Definitions

Myofascial pain: Pain arising from muscles or related fascia.

Active Trigger point: This is a trigger point that results in pain at rest with increased pain on contraction or stretching of the involved muscle.

Latent trigger point: A latent trigger point is a focal area of tenderness and tightness in a muscle that does not result in spontaneous pain. However, a latent trigger point may restrict range of movement and cause weakness of the involved muscle.

### Characteristics

#### Prevalence

Myofascial pain is a universal occurrence commonly developing as a result of muscle injuries, overuse or repetitive strain. In most instances the problem resolves within a few days without any need for medical intervention. When pain persists or worsens, necessitating a medical consultation, it is referred to as a myofascial pain syndrome (Travell and Simons 1983). There have not been any epidemiological studies of myofascial pain problems in the general population. Rather, physicians have reported prevalence figures in specialized situations. For instance, in one internal medicine practice, 30% of patients presenting with pain complaints were diagnosed as having a myofascial pain origin for their symptoms. A report from a clinic specializing in head and neck pain reported a myofascial etiology in 55% of cases. A report from one pain management center attributed a myofascial origin to the symptomatology in 85% of patients. On the other hand, latent trigger points have been found in

the shoulder girdle muscles of 54% of female and 45% of male subjects who were completely asymptomatic (Simons 2001).

### Diagnosis

The clinical diagnosis of myofascial pain is critically dependent on the physician being aware of this diagnosis as a possible cause for the patient's pain complaint (Travell and Simons 1983). Myofascial pain syndromes may mimic a large number of other disorders, thus there is a necessity to perform a thorough physical examination, with appropriate investigations. Myofascial pain characteristically presents as a dull deep aching sensation, which is aggravated by use of the involved muscles as well as psychological stressors that cause increased muscle tension (Alvarez and Rockwell 2002). The defining clinical characteristic of myofascial pain is the finding of a trigger point. This is a well-defined point of focal tenderness within a muscle. Sometimes firm palpation of this focus elicits pain in a referred distribution that reproduces the patient's symptoms. Importantly, referred pain from a trigger point does not follow a nerve root distribution (i.e. it is not dermatomal). Palpation usually reveals a ropelike induration of the associated muscle fibers, often referred to as the "taut band". Sometimes, snapping this band or needling the trigger point produces a localized twitch response of the involved muscle. This twitch response can only be reproducibly elicited in fairly superficial muscles. Importantly, trigger points produce functional consequences in terms of a restriction of range of movement and weakness (probably a reflex inhibition secondary to pain), which is usually associated with easy fatigability of the involved muscle.

### Clinical Syndromes

A myofascial pain syndrome may be due to just one trigger point, but more commonly there are several trigger points responsible for any given regional pain problem. It is not uncommon for the problem to be initiated with a single trigger point, with the subsequent development of satellite trigger points, which evolve over time due to the mechanical imbalance resulting from reduced range of movement and pseudo-weakness. The persistence of a trigger point may lead to neuroplastic changes at the level of the dorsal horn, which results in amplification of the pain sensation (i.e. central sensitization) with a tendency to spread beyond its original boundaries (i.e. expansion of receptive fields) (Graven-Nielsen and Arendt-Nielsen 2002). In some instances segmental central sensitization leads to the phenomena of mirror image pain (i.e. pain on the opposite side of the body in the same segmental distribution), and in other instances a progressive spread of segmental central sensitization gives rise to the widespread pain that characterizes

fibromyalgia (Arendt-Nielsen and Graven-Nielsen 2003).

### Low Back Pain

Acute low back pain has many causes. Some are potentially serious, such as cancer metastases, osteomyelitis, massive disk herniations (e.g. cauda equina syndrome), vertebral fractures, pancreatic cancer and aortic aneurysms. However, the commonest cause of acute back pain is so-called lumbosacral strain. In 95% of cases this resolves within three months. In those cases that do not resolve, the development of a chronic low back pain syndrome is usually accompanied by the finding of active myofascial trigger points. Simons describes 15 torso and pelvic muscles that may be involved in low back pain (Simons 2001). The most commonly involved muscle group is the quadratus lumborum; pain emanating from trigger points in these muscles is felt in the low back with occasional radiation in a sciatic distribution or into the testicles. Trigger points involving the iliopsoas are also a common cause of chronic low back pain. The typical distribution of iliopsoas pain is a vertical band in the low back region and the upper portion of the anterior thigh. Trigger points at the origin of the gluteus medius from the iliac crest are a common cause for low back pain in the sacral and buttock, with a referral pattern to the outer hip region.

### Neck and Shoulder Pain

Latent trigger points are universal findings in many of the muscles of the posterior neck and upper back. Active trigger points commonly involve the upper portion of the trapezius and levator scapula. Upper trapezius trigger points refer pain to the back of the neck and not uncommonly to the angle of jaw. Levator scapula trigger points cause pain at the angle of the neck and shoulder; this pain is often described as lancinating, especially on active use of this muscle. As many of the muscles in this area have an important postural function, they are commonly activated in office workers and developmental problems causing spinal malalignment (e.g. short leg syndrome, hemipelvis and scoliosis). As the upper trapezius and levator scapulae act synergistically with several other muscles in elevation and fixation of the scapula, it is common for a single trigger point in this region to initiate a spread of satellite trigger points through adjacent muscles that are part of the same functional unit.

### Hip Pain

Pain arising from disorders of the hip joint is felt in the groin and the lower medial aspect of the anterior thigh. This distribution is uncommon in myofascial pain syndromes except for iliopsoas pain. The great majority of patients complain of hip pain, and in fact localize their pain to the outer aspect of the hip. In some patients this is due to a trochanteric bursitis, but in the majority of cases it is related to myofascial trigger points in the ad-



jacent muscles. By far the commonest trigger points giving rise to outer hip pain are those in the attachments of the gluteus medius and minimus muscles into the greater trochanter.

### Pelvic Pain

The pelvic floor musculature is a common sight for myofascial trigger points. There is increasing recognition by gynecologists and urologists that pain syndromes described in terms of prostatitis, coccydynia, vulvodynia and endometriosis are often accompanied by active myofascial trigger points. One of the most commonly involved intrapelvic muscles is the levator ani; its pain distribution is central low buttock.

### Headaches

Active myofascial trigger points in the muscles of the shoulder, neck, and face, are a common source of headaches (Borg-Stein 2002). In many instances, the headache has the features of so-called tension headache, but there is increasing acceptance that myofascial trigger points may initiate classical migraine headaches or be part of a mixed tension/migraine headache complex. For instance, sterno-cleido mastoid trigger points refer pain to the anterior face and supraorbital area. Upper trapezius trigger points refer pain to the vertex forehead and temple. Trigger points in the deep cervical muscles of the neck may cause post occipital and retro-orbital pain.

### Jaw Pain

There is a complex interrelationship between temporomandibular joint dysfunction and myofascial trigger points (Fricton et al. 1985). Common trigger points involved in jaw pain syndromes are the masseters, pterygoids, upper trapezius and upper sterno-cleido mastoid.

### Upper Limb Pain

The muscles attached to the scapula are common sites for trigger points that can cause upper limb pain (Gerwin 1997). These include the subscapularis, infraspinatus, teres major and serratus anterior. It is not uncommon for trigger points in these locations to refer pain to the wrist, hand, and fingers. Extension flexion injuries to the neck often activate a trigger point in the pectoralis minor with a radiating pain, or down the ulnar side of the arm and into the little finger. Myofascial pain syndromes of the upper limbs are often misdiagnosed as frozen shoulder, cervical radiculopathy or thoracic outlet syndrome (Simons 2001).

### Lower Limb Pain

Trigger points in the tensor fascia lata and ilio tibial band may be responsible for lateral thigh pain and lateral knee pain, respectively. Anterior knee pain may result from trigger points in various components of the quadriceps

musculature. Posterior knee pain can result from trigger points in the hamstring muscles and popliteus. Trigger points in the anterior tibialis and the peroneus longus muscles may cause pain in the anterior leg and lateral ankle, respectively. Myofascial pain syndromes involving these muscles are often associated with ankle injuries or an excessively pronated foot. Sciatica pain may be mimicked by a trigger point in the posterior portion of the gluteus minimus muscle.

### Chest and Abdominal Pain

Disorders affecting intrathoracic and intra-abdominal organs are some of the commonest problems encountered in internal medicine. For instance, anterior chest pain is a frequent cause for emergency room admissions, but in the majority of patients a myocardial infarction is not found. In some cases, the chest pain is caused by trigger points in the anterior chest wall muscles (Travell and Simons 1992). Pectoralis major trigger points cause ipsilateral anterior chest pain with radiation down the ulnar side of the arm – thus mimicking cardiac ischemic pain. A trigger point in the sternalis muscle typically causes a deep substernal aching sensation. Trigger points at the upper and lower insertions of the rectus abdominus muscles may mimic the discomfort of gall bladder and bladder infections, respectively. It is important to note that myofascial trigger points may accompany disorders of intrathoracic and intra-abdominal viscera, and thus a diagnosis of an isolated myofascial cause for symptoms should never be made without an appropriate workup.

### Pathogenesis

The precise pathophysiological basis for the trigger point phenomena is still not fully understood. There is a general agreement that electromyographic recordings from trigger points show low voltage spontaneous activity resembling endplate spike potentials (Rivner 2001). Simons envisions a myofascial trigger point to be “a cluster of numerous microscopic loci of intense abnormality that are scattered throughout the tender nodule” (Simons 2001). It is thought that these loci result from a focal energy crisis (from injury or repetitive use), which results in contraction of focal sarcomeric units due to calcium release from the sarcoplasmic reticulum. A more detailed coverage of this topic is provided in the essay ► [myofascial trigger point](#). Factors commonly cited as predisposing to trigger point formation include deconditioning, poor posture, repetitive mechanical stress, mechanical imbalance (e.g. leg length inequality), joint disorders, non-restorative sleep and vitamin deficiencies.

### Prognosis

Uncomplicated myofascial pain syndromes usually resolve with appropriate correction of predisposing factors and myofascial treatment (Alvarez and Rockwell

2002). If the symptoms are persistent, due to ineffective management, the development of segmental central sensitization may lead to a stubbornly recalcitrant pain disorder. In some such cases, the spread of central sensitization leads to the widespread pain syndrome of fibromyalgia.

### Treatment

For effective management of myofascial pain, syndromes require attention to the following issues (Alvarez and Rockwell 2002; Rudin 2003):

#### Postural and Ergonomic

The most critical element in the effective management of myofascial pain syndromes is the correction of predisposing factors (see above). These interfere with the ability of the muscle to fully recover and are the commonest reason for treatment failures.

#### Stretching

The muscles involved in myofascial pain syndromes are shortened due to the aforementioned focal contractions of sarcomeric units. It is thought that these focal contractions result in a prolonged ATP consumption, and that the restoration of a muscle to its full stretch length breaks the link between the energy crisis and contraction of sarcomeric units. Effective stretching is most commonly achieved through the technique of spray and stretch (Rudin 2003). This involves the cutaneous application, along the axis of the muscle, of ethyl chloride spray, while at the same time passively stretching the involved muscle. Other techniques to enhance effective stretching include trigger point to pressure release, post isometric relaxation, reciprocal inhibition and deep stroking massage (Simons 2001).

#### Strengthening

Muscles harboring trigger points usually become weak due to the inhibitory effects of pain. A program of slowly progressive strengthening is essential to restore full function and minimize the risk of recurrence and perpetuation of satellite trigger points.

#### Trigger Point Injections

Injection of trigger points is generally considered to be the most effective means of direct inactivation. A peppering technique using a fine needle to inactivate all the foci within a trigger point locus is the critical element of successful trigger point therapy (Hong 1994). Accurate localization of the trigger point is confirmed if a local twitch response is obtained; however, this may not be obvious when needling deeply lying muscles. Successful elimination of the trigger point usually results in a relaxation of the taut band. Although dry needling is effective, the use of a local anesthetic (1% lidocaine or 1% procaine) helps confirm the accuracy of the injection and provides instant gratification for patients (Hong 1994). There is no evidence that the injection of corticosteroids

provides any enhanced effect. A beneficial role for botulinum toxin in trigger point injections has not so far been conclusively demonstrated.

### Medications

There is currently no evidence that any form of drug treatment of men eighths myofascial trigger points (Rudin 2003). NSAIDs and other analgesics usually provide moderate symptomatic relief. Tricyclic antidepressant drugs, which modulate pain at the central level, are often of benefit, especially in those patients with an associated sleep disturbance. In the author's experience, tizanidine (a muscle relaxant that also ameliorates pain by activating alpha 2 adrenergic receptors) is often a useful adjunct in difficult to treat myofascial pain syndromes.

### Psychological Techniques

In severe myofascial pain syndromes that are not responding to treatment, patients often become anxious and depressed. These mood disorders need to be recognized and appropriately treated. Persistent muscle tension exacerbates the pain of myofascial trigger points and can often be effectively managed with EMG biofeedback, cognitive behavioral therapy and hypnotic/meditation relaxation techniques.

### References

1. Alvarez DJ, Rockwell PG (2002) Trigger Points: Diagnosis and Management. *Am Fam Physician* 65:653-660
2. Arendt-Nielsen L, Graven-Nielsen T (2003) Central Sensitization in Fibromyalgia and Other Musculoskeletal Disorders. *Curr Pain Headache Rep* 7:355-361
3. Borg-Stein J (2002) Cervical Myofascial Pain and Headache: *Curr Pain Headache Rep* 6:324-330
4. Friction JR, Kroening R, Haley D et al. (1985) Myofascial Pain Syndrome of the Head and Neck: A Review of Clinical Characteristics of 164 Patients. *Oral Surg Oral Med Oral Pathol* 60:615-623
5. Graven-Nielsen T, Arendt-Nielsen L (2002) Peripheral and Central Sensitization in Musculoskeletal Pain Disorders: An Experimental Approach. *Curr Rheumatol Rep* 4: 313-321
6. Gerwin RD (1997) Myofascial Pain Syndromes in the Upper Extremity. *J Hand Ther* 10:130-136
7. Hong C-Z (1994) Considerations and Recommendations Regarding Myofascial Trigger Point Injection. *J Musculoskeletal Pain* 2:29-59
8. Hong C-Z (1994) Lidocaine Injection versus Dry Needling to Myofascial Trigger Point. The Importance of the Local Twitch Response. *Am J Phys Med Rehabil* 73:256-263
9. Rivner, MH (2001) The Neurophysiology of Myofascial Pain Syndrome. *Curr Pain Headache Rep* 5:432-440
10. Rudin NJ (2003) Evaluation of Treatments for Myofascial Pain Syndrome and Fibromyalgia. *Curr Pain Headache Rep* 7:433-442
11. Simons DG (2001) Myofascial Pain Caused by Trigger Points In: Mense S, Simons DG, Russel IJ (eds) *Muscle Pain: Understanding its Nature, Diagnosis, and Treatment*. Lippincott Williams and Wilkins, Philadelphia, pp 205-288
12. Travell JG, Simons DG (1983) *Myofascial Pain and Dysfunction: The Trigger Point Manual*. Williams and Wilkins, Baltimore
13. Travell J, Simons D (1992) *Myofascial Pain and Dysfunction: The Trigger Point Manual*, vol 2. Williams and Wilkins, Baltimore

## Myofascial Pain Syndrome

### Synonyms

MPS

### Definition

Myofascial pain syndrome is a muscle disorder characterized by the presence of trigger points (TrPs) within the muscle. There is also pain, muscle spasm, tenderness, stiffness, limited range of motion, weakness and/or autonomic dysfunction. Pressure on the trigger point refers pain to an area distant from the trigger point. However, the trigger point itself could and usually is painful.

- ▶ [Chronic Back Pain and Spinal Instability](#)
- ▶ [Chronic Pelvic Pain, Musculoskeletal Syndromes](#)
- ▶ [Chronic Pelvic Pain, Physical Therapy Approaches and Myofascial Abnormalities](#)
- ▶ [Muscle Pain, Fibromyalgia Syndrome \(Primary, Secondary\)](#)
- ▶ [Myalgia](#)
- ▶ [Nocifensive Behaviors \(Muscle and Joint\)](#)
- ▶ [Opioids and Muscle Pain](#)
- ▶ [Sacroiliac Joint Pain](#)
- ▶ [Stretching](#)
- ▶ [Trigger Point](#)

## Myofascial Release

### Definition

Myofascial release can be described as a manual soft tissue technique that can be either direct or indirect, and is frequently combined. As a treatment technique, it utilizes the principles of biomechanical loading of soft tissue, and the neural reflex changes by stimulation of mechanoreceptors in the fascia.

- ▶ [Chronic Pelvic Pain, Physical Therapy Approaches and Myofascial Abnormalities](#)

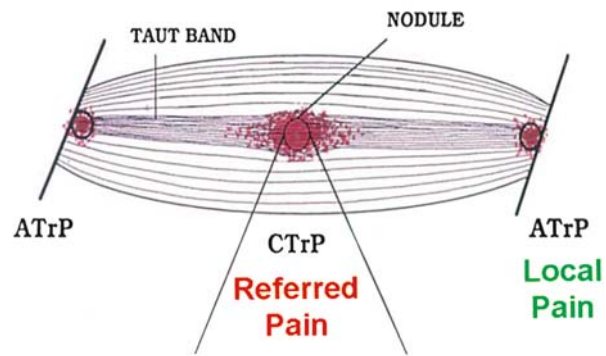
## Myofascial Trigger Points

DAVID G. SIMONS  
Department of Rehabilitation Medicine, Emory University, Atlanta, GA, USA  
loisanddavesimons@earthlink.net

### Synonyms

MTrP

## TRIGGER POINT COMPLEX



**Myofascial Trigger Points, Figure 1** This schematic longitudinal view of muscle illustrates key clinical features of a myofascial trigger point. The central trigger point (CTrP), which is located near the mid-muscle fiber, exhibits outstanding spot tenderness in a palpable taut band and refers pain to a distance. The taut band extends the length of the muscle fibers to its attachments, where the sustained tension of the taut band induces an attachment trigger point (ATrP) enthesopathy (that is sensitive to applied pressure and increased muscle tension). Adapted from Simons et al. (1999).

### Definition

Clinically, a central ▶ [myofascial trigger point](#) (MTrP) is characteristically a very tender, circumscribed, nodule-like spot that is located in the mid-portion of a ▶ [taut band](#) of skeletal muscle fibers and can cause referred pain. Application of digital pressure to the spot typically induces referred pain that is characteristic of that muscle, and is familiar to the subject if the MTrP is active. The indurated tender attachments of taut-band muscle fibers are identified as ▶ [attachment trigger points](#) (see Fig. 1).

Etiologically, the central MTrP is associated with ▶ [endplate noise](#), which originates from a motor endplate that is releasing abnormal amounts of ▶ [acetylcholine](#). Shortened ▶ [sarcomeres](#), in the region of endplates, are associated with local release of sensitizing substances (Shah et al. 2005) that cause pain and tenderness.

### Characteristics

Myofascial trigger points (MTrPs) are only one part of the complex neuromusculoskeletal pain picture, however, that part is probably as important as the nervous system and is certainly the most neglected and overlooked part. The term myofascial pain is often used with two different meanings. Myofascial pain caused by MTrPs is a specific etiological diagnosis, whereas myofascial pain, used in the general sense of regional pain of unidentified etiology in myofascial structures, is only a symptom, not a diagnosis. Musculoskeletal pain is one of the major causes of common human aches and pains such as low back pain and tension type headache.

In one study, of the 32.5 % of the unselected population who were experiencing chronic pain, 94.5 % identified

M

it as musculoskeletal (Wolfe et al. 1998). Myofascial trigger points (MTrPs) are often the major cause of the pain, or a major component in association with well-recognized sources of pain. Any of the approximately 500 skeletal muscles can develop MTrPs. For more detailed information on this subject, consult the two latest volumes of *The Trigger Point Manual* (Simons et al. 1999; Travell and Simons 1992), or the German or Spanish editions, and the *Muscle Pain Book* (Mense et al. 2001).

Active MTrPs cause a clinical pain complaint but latent MTrPs do not – an important clinical distinction. One well-designed article (Hsieh et al. 2000) described 520 muscle examinations of muscles commonly causing low back pain (LBP), both in subjects with LBP and in normal pain-free controls. The authors found MTrPs (some active) in 90 % of low back pain subjects' muscles, and found latent MTrPs (not producing a pain complaint) in 70 % of the control subjects' muscles. Latent MTrPs were common in control subjects.

The natural history of MTrPs is unknown; however, a recent study provided a valuable lead. Among 13 healthy, normal, pain-free hospital personnel, only one subject had no latent MTrPs in the eight muscles examined. Two subjects had MTrPs in seven of the eight muscles (see Table 1). Age was not a significant factor. Note subjects 1 and 2. This small sample suggests that most adults have at least some latent MTrPs; a few adults have many and a few have almost none. This needs

**Myofascial Trigger Points, Table 1** Distribution of latent myofascial trigger points (MTrPs) in eight muscles of 13 pain-free, healthy normal control subjects. Subjects were numbered to correspond to their relative ages, which ranged between 23 and 59 years. Number 1 was the youngest. Age does not appear to be an important factor among these adults and showed no linear regression.

Subject Number	Number of muscles with MTrPs in each subject
2	7
6	7
10	6
8	5
3	5
12	5
5	4
11	3
13	3
4	2
9	2
7	1
1	0

verification. If this study is representative, the natural history of MTrPs could be that we are born with the tendency to develop latent MTrPs upon reading adolescence and, during adulthood, life stresses can convert them into active MTrPs. A simple study, by reasonably skilled investigators, could resolve this issue.

The diagnosis of MTrPs can firstly be approached by answering three questions, which require limited manual skill to determine if MTrPs are a viable differential diagnosis. Could MTrPs of muscle be causing the pain? If so, which muscle(s) should be examined? Does an initial screening exam identify active MTrPs? If so, the patient needs further examination and testing by a skilled practitioner who can also treat the MTrPs as listed below.

Diagnosis of myofascial trigger points (MTrPs)

- Could MTrPs of muscle be causing the pain?
  - Other possibilities: nerves (radiculopathy), joints (somatic dysfunction), central nervous system (fibromyalgia), viscera (renal calculi), etc.
  - Trigger point pain is initiated by: Sudden, unexpected overload (acute onset from fall or motor vehicle accident) Chronic overload (insidious onset from poor posture, poor ergonomic arrangement, repetitive strain)
- Which muscle(s) should be examined?
  - Which muscles were overloaded (history above)—based on knowledge of muscle functions
  - Distorted posture or movements
  - Pain pattern that fits known patterns of suspected muscle(s).
  - Painful restriction in stretch range of motion of involved muscle(s). Involved muscle shows increased stiffness and tension.
- What is a simple initial muscle examination (differential diagnosis screening)?
  - Localized very tender spot in skeletal muscle+
  - Pressure-evoked referred pain that is characteristic of that muscle= a likely latent myofascial trigger point+
  - Patients' recognition of evoked pain as part or all of the primary pain complaint= a likely active myofascial trigger point
- Confirmatory myofascial trigger point examination (training and skill required)
  - Tender spot feels nodular (if located sufficiently superficial)
  - Tender spot located in a palpable taut band, see Fig. 1
  - Tender attachment TrP (enthesopathy) at attachment of taut band.



- Favorable response to specific MTrP treatment
- Occurrence of a local twitch response evoked incidentally by palpation of, or purposely by needle insertion into, the TrP.

The diagnostic process is complicated by the complex neuromusculoskeletal nature of musculoskeletal pain and the lack of a diagnostic gold standard for MTrPs, which are not identifiable by available laboratory or imaging testing. In addition, the appropriate examination depends on the amount and texture of overlying tissue and the skills of the examiner. Different muscles may require quite different examinations.

Initially, the diagnosis depends on medical history, knowledge of MTrP characteristics, and knowledge of muscle anatomy and function. Effective confirmatory examination and treatment depend on clinical skill. A growing body of research studies and clinical experience increasingly substantiates the guidelines presented here.

#### Could MTrPs of Muscle be Causing the Pain?

Commonly, in patients with chronic myofascial pain, the likely diagnoses, except MTrPs, have already been ruled out, often by numerous expensive tests. Chronic progressive MTrP symptoms are perpetuated by mechanical or systemic factors, which need identification and correction – factors that alone, without the activated MTrPs, often do not cause enough symptoms to demand attention. Without a perpetuating factor, acute onset active MTrPs tend to subside to asymptomatic latent MTrPs with gentle, normal, muscle-stretching daily activities.

#### Which Muscle(s) Should be Examined?

Patient posture and modified movements is often a key. Special attention should be paid to problems in the feet that commonly reflect dysfunctions, which extend up the body to the head. Active MTrPs of each muscle project a characteristic referred pain pattern that is variable in time and among individuals. Critically important referred pain patterns from active MTrPs throughout the body are described in books (Travell and Simons 1992; Simons et al. 1999; Dejung et al. 2003), also on wall charts and flip charts, and have been updated for masticatory muscles in a journal article (Wright 2000). The pain patterns help greatly to identify the MTrP cause of the pain. The pain that limits stretch is usually located in the involved muscle, rather than in the referred pain zone.

#### Simple Initial Examination

If palpation with about 3 kilograms of calibrated consistent pressure on a spot of localized tenderness in a suspected muscle elicits referred pain that is familiar to the patient, that spot is likely an active MTrP. MTrPs are then ruled in as a differential diagnosis that requires

a confirmatory examination and, if indicated, treatment by a skilled practitioner. Referral may be necessary. Latent MTrPs can cause muscle inhibition, imbalance, and other motor problems.

#### Confirmatory Myofascial Trigger Point Examination

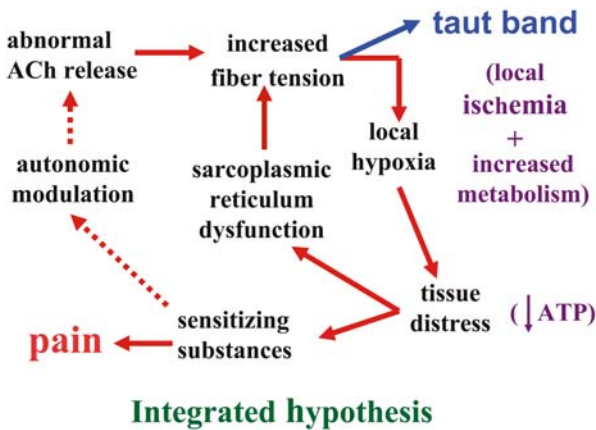
This examination demands skills that usually require considerable training and clinical practice, and are often critical for effective treatment of MTrPs. Clinically, the taut band is considered by skilled and experienced clinicians to be the most distinctive feature of MTrPs, but was one of the most difficult exams in credible interrater reliability studies because of the skill required (Gerwin et al. 1997; Sciotti et al. 2001). Fortunately, confusingly, similar fascial structures are rarely tender. Taut bands are usually indistinguishable in muscle that lies beneath thick layers of fat, firm subcutaneous tissue and/or overlying muscle tissue. Figure 1 schematically illustrates the relationship between the taut band and its central and attachment ► **trigger points**.

The ► **local twitch response** is a sensory-motor spinal reflex that induces a series of motor unit activations only in taut band fibers. It has high specificity but relatively poor reliability in most hands and can be extremely painful to the patient.

The pathophysiology of MTrPs is not totally unknown, but it is not firmly established and has been controversial. An integrated hypothesis (Simons et al. 1999; Mense et al. 2001; Simons 2004) incorporates the available research studies and explains the clinical features of MTrPs. The hypothesis helps to identify what we do know with confidence and what remains to be clarified. Figure 2 outlines and summarizes the hypothesis.

Clinically, compression (radiculopathy) of the motor nerve can facilitate conversion of latent MTrPs to active ones, which are associated with electromyographic evidence of increased acetylcholine (ACh) release. Excessive spontaneous release can be identified by endplate noise (Simons 2001), which is mistakenly considered a normal finding by many electromyographers – a source of controversy. Endplate noise is significantly associated with MTrPs – a fact not generally recognized by electromyographers – but it is not uniquely diagnostic of MTrPs (Couppe et al. 2001; Simons et al. 2002).

Microscopic changes in muscle fibers in the region of the endplate include localized regions of severe sarcomere shortening (contraction disks and contraction knots), with evidence of increased tension of some fibers. The microscopic picture also suggests the possibility of abnormal calcium permeability of the muscle fiber membrane (sarcolemma). Increased tension of many fibers can account for the taut band. The pathological changes and natural history of MTrPs, suggest the possibility of a genetic aberration of calcium channels of variable penetrance in the sarcolemma, and or neurolemma of the nerve terminal.



**Myofascial Trigger Points, Figure 2** The integrated hypothesis postulates a positive feedback cycle, which characteristically involves excessive spontaneous release of acetylcholine in a number of motor endplates associated with a myofascial trigger point. Mechanical stress (muscle overload) and increased autonomic activity can cause or increase abnormal spontaneous acetylcholine release. The strong spontaneous local contractile activity increases fiber tension producing the palpable taut band, increased energy demand and local hypoxia. Together, they deplete the supply of adenosine triphosphate (ATP) and produce tissue distress, which releases sensitizing substances that sensitize nociceptors causing MTrP pain. Shortage of ATP could reduce recovery of calcium into the sarcoplasmic reticulum sustaining contractile activity and increased fiber tension. See text for alternate pathway (broken arrows).

Mechanisms by which the sensitizing substances produce local tenderness and referred pain has been described in detail (Mense et al. 2001) (see Fig. 2). Many substances have been demonstrated histochemically (Shah et al. 2005).

An alternate route to complete the feedback cycle (broken arrows) is presented, because several kinds of studies indicate that increased sympathetic nervous system activity increases the endplate noise (or endplate spikes) of a trigger point. Specific mediators have not been adequately identified for locally modulating autonomic effects, which include release of ACh packets from the nerve terminal. Both routes may occur.

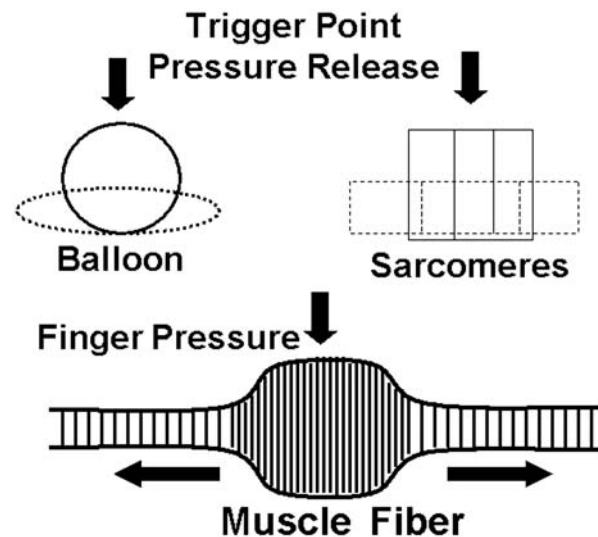
### Treatment

Three manual treatments of MTrPs – contract-release, trigger point pressure release, and vapocoolant spray and release – are usually effective (Simons 2002). In addition, injection or dry needling provides another valuable approach (Simons et al. 1999). A quite new and remarkably effective modality that operates on a poorly explored mechanism is frequency specific microcurrent therapy ([www.frequency-specific.com](http://www.frequency-specific.com)). This has been demonstrated to be effective for MTrPs (McMakin 2004) and in patients who developed fibromyalgia following a whiplash injury (McMakin 2005) as listed below. The patient benefits when treatment begins with manual therapy rather than dry needling or injection. When patients are shown how to perform the manual therapy on themselves, the experience of immediate

pain relief helps to convince them that muscles are causing the pain, gives them a sense of control, and improves compliance for the important home stretching exercises. When the patient receives only dry needling or injection, treatment becomes the clinician's responsibility, not the patient's. A close physician-therapist relationship permits the physician to concentrate on injections when indicated, while the therapist teaches the patient home stretch exercises specific to the involved muscles. Treatments may cause slight discomfort, but should always be pain-free (not over about 2 or 3 on a 10 point visual analog scale) to avoid plasticity changes in the central nervous system, which enhances and prolongs pain perception.

Treatment of myofascial trigger points (MTrPs)

- Manual techniques
  - Trigger point pressure release—finger pressure applied to the MTrP
  - Contract release—alternate voluntary contraction and passive or active stretching of the muscle with the MTrPs
  - Vapocoolant spray and stretch—application of a stream of vapocoolant, or use of a covered edge of ice, to facilitate release
- Needling techniques (require diagnostic skill)
  - Dry needling (as effective as injection, but leaves more post injection soreness)

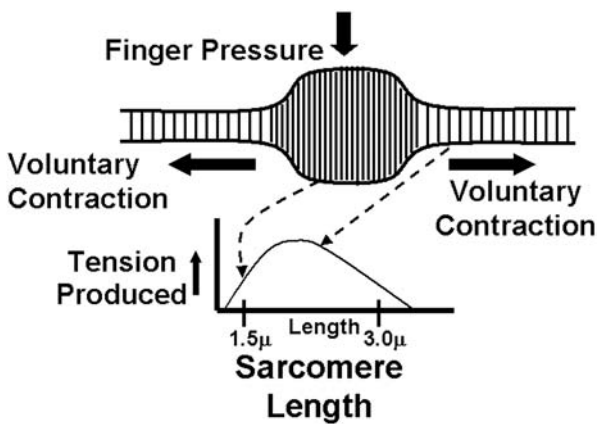


**Myofascial Trigger Points, Figure 3** This schematic illustrates the mechanism by which trigger point pressure release can relieve the tension of the taut band by elongating the shortened sarcomeres, which has the effect of localized stretching of the muscle fibers. Like the balloon, a sarcomere has a nearly constant volume, so flattening elongates it. The contracted fibers in the nodular swelling of muscle fibers represent either a contraction knot or contraction disc. The effect of trigger point pressure release is enhanced by including a gentle voluntary contraction of that muscle, while holding it at positions of progressive gentle passive stretch.

- Injection of 1% lidocaine (reduces post-injection soreness)
- Injection of Botulinum toxin (specifically for muscles with spasticity and MTrPs using electromyographic guidance for endplate noise).
- New possibilities
  - Frequency specific microcurrent therapy
  - Shockwave therapy

Figure 3 shows how ► **trigger point pressure release** can be effective. Shortened sarcomeres are a key part of the cause of MTrP symptoms. The constant-volume balloon is analogous to a sarcomere, showing how gentle but firm pressure on contraction knots (or contraction discs) will flatten and lengthen (normalize) the shortened sarcomeres. As their tension releases, digital pressure is increased. This local stretch reduces actin and myosin overlap, which reduces contractile activity, energy consumption, and ischemia – all of which tend to break the TrP feedback cycle.

► **Contract-release** (also post-isometric relaxation) requires only recognition of the painfully restricted stretch range of motion to which this treatment is then applied (see Fig. 4). This can be learned and used by patients. If necessary, additional release can often be obtained with



**Myofascial Trigger Points, Figure 4** Schematic showing effect of combining trigger point pressure release (Finger Pressure) and contract-release, which takes advantage of the reduction in muscle tightness following a gentle (about 10 % of maximum effort) voluntary contraction. Treatment slowly alternates between gentle voluntary contractions held for several seconds, immediately followed by passive or active stretching of the muscle. This takes up slack that developed following contraction. The contraction-release cycles can be repeated rhythmically, as long as each cycle brings progress. The graph of a characteristic length-tension curve for one sarcomere shows that the strongly shortened sarcomeres produce much less tension than the mid-length sarcomeres throughout the rest of the muscle fiber. The mid-length sarcomeres are both stronger and far outnumber the shortened sarcomeres, so a gentle contraction temporarily increases the length of the shortened sarcomeres. Several cycles of full range of motion help to consolidate treatment gains. The two techniques are combined for increased therapeutic effectiveness.

vapocoolant spray and stretch, dry needling, injection of the MTrP with 1% lidocaine (to reduce post-injection soreness) or with reciprocal inhibition. Following treatment, three full cycles of active range of motion help to normalize function of the treated muscle. If relief is still temporary, perpetuating factors must be investigated and resolved.

Effective injection or dry needling require precise location of the MTrP to enter it with the needle. Elicited pain and local twitch responses assure a more effective treatment. Concentration on just injection encourages neglect of home exercises and perpetuating factors, and the patient usually does not understand the cause of the pain as well.

Since Botulinum toxin inactivates ACh release at the motor endplate, it should be a specific therapy for MTrPs and has been effective. However, it is very expensive, lasts about 3 months, can induce an immune reaction, and is unlikely to be more effective than the other techniques described when they are skillfully applied. It is specifically indicated in muscles that are spastic and also have painful MTrPs. Botulinum toxin is most effectively injected under electromyographic guidance.

Application of shockwave technology for the localization and treatment of MTrPs looks promising. (Bauermeister 2005; Müller-Ehrenberg and Licht 2005).

One reason for the neglect of MTrPs as a muscular source of pain is that no medical specialty takes responsibility for research and training in all medical aspects of muscle as an organ. As a result, clinical and basic research on MTrPs is conspicuous for its scarcity, and MTrP training of medical practitioners is rarely adequately covered in schools. It can be very difficult for patients to find practitioners adequately skilled in the diagnosis and treatment of MTrPs.

M

**Myofascial Trigger Points, Table 2** Number of MEDLINE citations (mainstream medical literature) that were indexed in the past 7 years under *low back pain* compared to the number of trigger point citations retrieved by combining *low back pain and trigger points* with a *low back pain and myofascial trigger point* search.

Year of Publication	Low Back Pain Citations	Trigger Point Citations	Percent Trigger Point (%)
1996	552	2	0,4
1997	312	2	0,5
1998	459	2	0,4
1999	561	0	0
2000	527	3	0,6
2001	537	3	0,6
2002	553	5	0,9
1996–2002	3601	17	0,5

Unfortunately, many practitioners were not trained to include MTrPs as a differential diagnosis for musculoskeletal pain. Low back pain (LBP) causes much human suffering and health care costs. However, of the 3,501 LBP citations retrieved from MEDLINE covering the past seven years, less than 1% were also indexed as including MTrPs (see Table 2). Moreover, much LBP is either caused by MTrPs or has a significant MTrP component. A number of papers that do relate MTrPs and LBP describe MTrPs, but do not identify them in the title or abstract. A few articles that identified MTrPs in LBP were published in journals that are not listed by MEDLINE. Most authors writing about LBP do not include MTrPs as part of their routine differential diagnosis.

A recent series of papers by César Fernández of Spain and colleagues is now appearing in the scientific literature that indicate a strong relationship between MTrPs and several kinds of headache (Fernández et al. 2005; Fernández et al. 2006).

- ▶ Central Trigger Point
- ▶ Chronic Pelvic Pain, Physical Therapy Approaches and Myofascial Abnormalities
- ▶ Dry Needling
- ▶ Myalgia

## References

1. Bauermeister W (2005) Diagnose und Therapie des Myofaszialen Triggerpunkt Syndroms durch Lokalisierung und Stimulation Sensibilisierter Nozizeptoren mit Focussierten Elektrohydraulischen Stosswellen. *MOT* 5:65–74
2. Couppé C, Midttun A, Hilden J et al. (2001) Spontaneous Needle Electromyographic Activity in Myofascial Trigger Points in the Infraspinatus Muscle: A Blinded Assessment. *J Musculoske Pain* 9:7–16
3. Dejung B, Gröbli C, Colla F et al. (2003) Triggerpunkt-Therapie (Trigger Point Therapy). Hans Huber Verlag, Bern
4. Gerwin RD, Shannon S, Hong C-Z et al. (1997) Interrater Reliability in Myofascial Trigger Point Examination. *Pain* 69: 65–73
5. Hsieh C-Y, Hong C-Z, Adams AH et al. (2000) Interexaminer Reliability of the Palpation of Trigger Points in the Trunk and Lower Limb Muscles. *Arch Phys Med Rehabil* 81:258–264
6. Mense S, Simons DG, Russell IJ (2001) Muscle Pain: Its Nature, Diagnosis, and Treatment. Lippincott, Williams & Wilkins, Philadelphia
7. Sciotti VM, Mittak VL, DiMarco L et al. (2001) Clinical Precision of Myofascial Trigger Point Location in the Trapezius Muscle. *Pain* 93:259–266
8. Shah JP, Phillips T, Danoff J et al. (2004) Novel Microanalytical Technique Distinguishes Three Clinically Distinct Groups: 1) Subjects without Pain and without a Myofascial Trigger Point; 2) Subjects without Pain with a Myofascial Trigger Point; 3) Subjects with Pain and a Myofascial Trigger Point. *Am J Phys Med Rehabil* 83:231
9. Simons DG (2001) Do Endplate Noise and Spikes Arise from Normal Motor Endplates? *Am J Phys Med Rehabil* 80:134–140
10. Simons DG (2002) Understanding Effective Treatments of Myofascial Trigger Points. *J Bodywork and Movement Therapy* 6:81–88
11. Simons DG, Hong C-Z, Simons LS (2002) Endplate Potentials are Common to Midfiber Myofascial Trigger Points. *Am J Phys Med Rehabil* 81:212–222
12. Simons DG, Travell JG, Simons LS (1999) Travell & Simons' Myofascial Pain and Dysfunction: The Trigger Point Manual, vol 1, edn 2. Williams & Wilkins, Baltimore
13. Travell JG, Simons DG (1992) Myofascial Pain and Dysfunction: The Trigger Point Manual, vol 2. The Lower Extremities. Williams & Wilkins, Baltimore
14. Wolfe F, Ross K, Anderson J et al. (1998) The Prevalence and Characteristics of Fibromyalgia in the General Population. *Arthritis Rheum* 38:19–28
15. Wright EF (2000) Referred Craniofacial Pain Patterns in Patients with Temporomandibular Disorder. *JADA* 131:1307–1315

## Myofibrositis

- ▶ Myalgia

## Myogelosis

- ▶ Myalgia

## Myositis

DIETER PONGRATZ

Friedrich Baur Institute, Medical Faculty at the Neurological Clinic and Policlinic, Ludwig Maximilians University, Munich, Germany  
dieter.pongratz@fbs.med.uni-muenchen.de

## Synonyms

Inflammatory Myopathies

## Definition

Inflammatory Myopathies represent a small, but from a therapeutical point of view, important group of acquired muscular disorders. With the exception of infectious causes (viral myositis, bacterial myositis, and parasitic myositis) immunogenic forms have to be considered. There are 4 different forms:

1. Dermatomyositis
2. Overlap Syndromes
3. ▶ Polymyositis
4. ▶ Inclusion Body Myositis

## Characteristics

The most prominent clinical symptoms of all immunogenic inflammatory myopathies are muscle weakness and muscle atrophy. Muscle pain is common in ▶ dermatomyositis and overlap syndromes, but is less prominent or even missing in chronic polymyositis and especially inclusion body myositis. From a clinical point of view, there is a predominant involvement of the proximal muscles of the limbs and the arms. Only in inclusion body myositis is the presence of distal muscle weakness, especially of the foot extensors and finger flexors, a diagnostic clue from the beginning.



The pharyngeal and neck flexor muscles are often affected in all forms of myositis causing dysphagia and, at times, difficulties in holding up the head. Muscular wasting develops during the course of the illness, and is pronounced in chronic polymyositis and inclusion body myositis.

### Special Signs of Dermatomyositis

Dermatomyositis is characterized by skin lesions accompanying or preceding muscle symptoms. There is the typical heliotrope erythema (lilac disease), involving especially the eyelids, face, and upper trunk. More chronic skin lesions show depigmentation and hyperpigmentations. As the disease progresses, subcutaneous calcifications occur.

### Laboratory Diagnosis and Differential Diagnoses

Laboratory diagnosis is based on:

1. Measurement of muscle enzymes
2. Electromyography
3. Muscle biopsy
4. In some cases, clinical or laboratory signs of an associated connective tissue disease may be an additional aid (► [overlap syndromes](#))

Muscle MRI with STIR sequence is helpful in chronic forms to establish the best position for performing a muscle biopsy (muscle edema).

The level of muscle enzymes, especially creatine kinase (CK), usually parallels disease activity, and can be elevated in acute stages by as much as 50× above normal. In rare cases of active polymyositis and dermatomyositis, however, CK can also be within normal range. In inclusion body myositis, the level of CK is not usually elevated more than 10-fold, and in some cases it may be normal.

Needle electromyography shows myopathic potentials characterized by short duration, low amplitude and polyphasic configuration on voluntary activation in combination with increased spontaneous activity (fibrillations, positive sharp waves, complex repetitive discharges). This pattern also occurs in a variety of active myopathic processes of other origins, and should therefore not be considered diagnostic for the inflammatory myopathies. Mixed myopathic and neurogenic potentials may be present in some cases as a consequence of inclusion body myositis.

Muscle biopsy is the definitive test, not only for establishing the diagnosis of dermatomyositis, polymyositis or inclusion body myositis, but also for excluding other neuromuscular disorders.

In dermatomyositis inflammatory infiltrates are found predominantly in perivascular and perifascicular regions, producing the characteristic picture of a myositis of the perifascicular type. There are striking lesions of the small intramuscular blood vessels, with endothelial proliferation and so-called tubulovesicular inclusions

seen by electron microscopy. Perifascicular atrophy and fiber damage is diagnostic of dermatomyositis even in the absence of infiltration.

Immunohistological methods show that the cellular infiltrates in this disease consist of B lymphocytes, CD4<sup>+</sup> lymphocytes and macrophages. C5b9 complement deposits within small blood vessels are very characteristic, causing destruction of the capillaries and muscle ischemia.

In polymyositis, infiltrates are predominantly endomysial, producing the picture of a diffuse myositis. There is no evidence of microangiopathy. Immunohistologically, cytotoxic CD8<sup>+</sup> lymphocytes are the predominant cells that invade nonnecrotic muscle fibers. The muscle fibers themselves aberrantly express major histocompatibility complex class I (MHC I) antigen, which is absent in normal muscle.

Inclusion body myositis is characterized by endomysial inflammation with CD8<sup>+</sup> lymphocytes in particular, similar to those seen in polymyositis. In addition, rimmed vacuoles with eosinophilic cytoplasmic inclusions can be found, as a rule, within many muscle fibers. On electron microscopy, the vacuoles correspond to the so-called autophagic vacuoles. In addition, filamentous inclusions in the cytoplasm and nuclei are prominent.

High levels of myositis-associated autoantibodies are found in overlap syndromes.

### Natural Course

The incidence of polymyositis, dermatomyositis and inclusion body myositis is approximately 1/100,000. The natural course of polymyositis and dermatomyositis is relatively unknown because patients are almost always treated with steroids. Inclusion body myositis is relatively resistant to all therapies and, as a rule, slowly progressive.

### Principles of Therapy

As corticosteroids and immunosuppressive drugs seem to be of benefit, polymyositis and dermatomyositis belong to the treatable group of myopathies. In contrast, inclusion body myositis is resistant to most therapies, although treatment with intravenous immunoglobulins may be of some benefit.

- [Muscle Pain in Systemic Inflammation \(Polymyalgia Rheumatica, Giant Cell Arteritis, Rheumatoid Arthritis\)](#)
- [Muscle Pain Model, Inflammatory Agents-Induced](#)
- [Nocifensive Behaviors \(Muscle and Joint\)](#)
- [Opioids and Muscle Pain](#)

### References

1. Dalakas MC, Illa I, Dambrosia JM (1993) A Controlled Trial of High-Dose Intravenous Immune Globulin Infusions as Treatment for Dermatomyositis. *N Eng J Med* 329:1993–2000
2. Dalakas MC (1991) Polymyositis, Dermatomyositis, and Inclusion Body Myositis. *N Eng J Med* 325:1487–1498

3. Dalakas MC, Pongratz D (2003) Inflammatory Myopathies Neurological Disorders – Course and Treatment: Muscle and Peripheral Nervous System, chapter 95, 2<sup>nd</sup> edn. Elsevier Science, USA
4. Pongratz DE (1992) Myositiden. In: Therapiehandbuch. Urban an Schwazzenberg, Munich, Vienna, and Baltimore, MD
5. Walter MC, Lochmüller H, Toepfer M (2000). High Dose Immunoglobulin Therapy in Sporadic Inclusion Body Myositis: A Double-Blind, Placebo-Controlled Study. J Neurol 247:22–28

## Myotomal Pain

### ► Myofascial Pain

## N/O/FQ

- ▶ Orphanin FQ

## N<sub>2</sub>O

- ▶ Nitrous Oxide Antinociception and Opioid Receptors

## Na<sup>+</sup> Channel

### Definition

Na<sup>+</sup> Channel is a voltage-dependent permeation pathway for sodium ions.

- ▶ Trafficking and Localization of Ion Channels

## Na<sup>+</sup>K<sup>+</sup>Cl<sup>-</sup> Cotransporter

### Definition

A transporter protein that mediates the transport of Na<sup>+</sup>, K<sup>+</sup> and Cl<sup>-</sup> into cells encoded by the gene slc12a2.

- ▶ GABA and Glycine in Spinal Nociceptive Processing

## NAcc

- ▶ Nociceptive Processing in the Nucleus Accumbens, Neurophysiology and Behavioral Studies

## nAChr

### Synonym

Nicotinic receptors

### Definition

Acetylcholine (ACh) is released from endothelial cells, keratinocytes and other cells following trauma and can activate nociceptors. In nociceptors, ACh can interact with either muscarinic (mACh) or nicotinic (nACh) receptors. The nicotinic type can directly induce action potentials by the gating of ion channels. The muscarinic type acts via G-protein coupled receptors to either up-regulate or down regulate nociceptor excitability.

- ▶ Nociceptors in the Orofacial Region (Skin/Mucosa)

## Nadolol

### Definition

Nadolol is a beta-blocker.

- ▶ Migraine, Preventive Therapy

## Naloxone

### Definition

Naloxone is an antagonist at the mu opioid receptor with a short duration of action (30–45 minutes). It can be administered for rapid reversal of opioid-induced sedation or respiratory depression, but its administration will also reverse opioid-induced analgesia and may precipitate withdrawal symptoms.

- ▶ Alternative Medicine in Neuropathic Pain
- ▶ Cancer Pain Management, Opioid Side Effects, Uncommon Side Effects

## Narcolepsy

### Definition

Narcolepsy is a condition marked by an uncontrollable desire for sleep, or by sudden attacks of sleep occurring at intervals.

- ▶ Hypothalamus and Nociceptive Pathways

## Narcotic Bowel Syndrome

- ▶ Cancer Pain Management, Gastrointestinal Dysfunction as Opioid Side Effects

## Narcotics, Major Analgesics

- ▶ Oral Opioids

## Natural History

### Definition

Natural course of a disease or a symptom.

- ▶ Placebo Analgesia and Descending Opioid Modulation

## NCCP

### Synonym

Non-cardiac chest pain

### Definition

NCCP is a functional chest pain of esophageal origin without manifestation of pathology. The pain is very similar to cardiac angina.

- ▶ Visceral Pain Model: Esophageal Pain

## Near-Infrared Spectroscopy

### Synonym

NIRS

### Definition

This is a relatively novel technique for measuring functional activation in infants, which is both non-invasive and localized. In order to measure a localized hemodynamic response within the brain in response to peripheral stimulation, paired near-infrared (NIR) light emitters and detectors ('optodes') are placed symmetrically on each side of the head over the somatosensory cortex during stimulation. NIR light at 4 wavelengths is conveyed through the head, and a controlling computer calculates the changes in optic absorption at each wavelength and converts these into changes in oxyhemoglobin, deoxyhemoglobin, and total hemoglobin using known extinction coefficients. In studies on newborn infants, the presence and amplitude of the hemodynamic response is used to elucidate the maturation of cortical processing of stimuli. NIRS is ideally suited to the study

of infants, because the infant skull is thinner than that of the adult so that the optical signal is cleaner and easier to detect.

- ▶ Infant Pain Mechanisms

## Neck Pain

### Definition

Localised neck or back pain is the symptom of a protruding disk frequently heralding a cervical or lumbosacral radiculopathy in spondyloarthritis. Non-specific neck pain is a prominent feature of polymyalgia rheumatica.

- ▶ Muscle Pain in Systemic Inflammation (Polymyalgia Rheumatica, Giant Cell Arteritis, Rheumatoid Arthritis)
- ▶ Radiculopathies

## Necrosis

### Definition

Necrosis is the localized death of living cells.

- ▶ Sacroiliac Joint Pain

## Negative Affectivity

### Definition

The stable disposition to experience negative affect and low mood (neuroticism).

- ▶ Hypervigilance and Attention to Pain

## Negative Mucosal Potential

### Definition

Electrical potential recorded from the respiratory epithelium that reflects the excitation of nociceptive nerve terminals.

- ▶ Nociception in Nose and Oral Mucosa

## Negative or Punishing Responses

### Definition

Negative or punishing responses (e.g. expressions of irritation, ignoring) represent a third category of responses to the expression of pain.

- ▶ Spouse, Role in Chronic Pain



## Negative Reinforcement

### Definition

Negative reinforcement is the removal of an aversive stimulus (tangible or non-tangible) following a behavior, with the goal of increasing future incidents of that behavior.

- ▶ Impact of Familial Factors on Children's Chronic Pain
- ▶ Operant Perspective of Pain

## Negative Responding

- ▶ Spouse, Role in Chronic Pain

## Negative Sensory Phenomenon

### Definition

Negative sensory phenomenon is a clinical sign that is interpreted by the patient as less than when compared to normal bodily function and experiences.

- ▶ Hypoalgesia, Assessment
- ▶ Hypoesthesia, Assessment

## Nematode

### Definition

Nematode is a roundworm, a non-segmented worm phylum.

- ▶ Species Differences in Skin Nociception

## Neocortical

### Definition

Belonging to the top, approximately 2 mm thick layer of the two hemispheres of the brain.

- ▶ Prefrontal Cortex, Effects on Pain-Related Behavior

## Neonatal Inflammation

- ▶ Visceral Pain Model, Irritable Bowel Syndrome Model

## Neonatal Pain

- ▶ Visceral Pain Model, Irritable Bowel Syndrome Model

## Neonate

- ▶ Newborn

## Neospinothalamic Tract

### Definition

Lateral and phylogenetically younger component of the spinothalamic tract, also known as the lateral spinothalamic tract. It is comprised of the axons nociceptive-specific and wide dynamic range neurons. It projects to the ventral posterolateral nucleus of the thalamus and is responsible for the discriminative aspects of pain (location, intensity, duration).

- ▶ Acute Pain Mechanisms
- ▶ Parafascicular Nucleus, Pain Modulation
- ▶ Somatic Pain

## Nerve Blocks by Local Anesthetic Drugs

N

### Definition

Nerve blocks by local anesthetic drugs stop nerve impulse conduction in nerve cells, inhibiting pain impulses from reaching the central nervous system (CNS). They will often also make the pain-free body part numb, with weak or paralyzed muscles.

- ▶ Cancer Pain Management, Anesthesiologic Interventions
- ▶ Epidural Steroid Injections for Chronic Back Pain
- ▶ Postoperative Pain, Acute Pain Management, Principles

## Nerve Compression

### Definition

Nerve compression or nerve entrapment is caused by mechanical obstruction. They usually involve mixed nerves so the symptoms are motor sensory. Compression of pure motor nerves, which carry muscle and joint afferents, may produce deep diffuse discomfort. Pain in the referred territory, numbness, exacerbated by movements are the main symptoms. Nerve compression is more acute than (chronic) nerve entrapment. The treatment of choice is decompression, either pharmacological (dexamethasone) or surgical. Nerve blocks are also useful.

- ▶ Cancer Pain

## Nerve Conduction

### Definition

Nerve conduction is a clinical test of named peripheral nerves, in which all axons are stimulated to threshold, and the responses of the largest cohort of myelinated axons are measured.

- ▶ [Electrodiagnosis and EMG](#)
- ▶ [Hereditary Neuropathies](#)

## Nerve Growth Factor

### Synonym

NGF

### Definition

Nerve growth factor (NGF) belongs to a family of polypeptide growth factors. It consists of alpha, beta and gamma subunits. NGF is a target-derived factor and is essential for survival, differentiation, and maintenance of sympathetic and afferent neurons. In inflamed tissue, NGF biosynthesis is rapidly increased leading to elevated concentrations of NGF in inflamed tissues. It has been shown that NGF is a mediator of inflammatory hyperalgesia and also a modulator of immune cell function. An enhanced retrograde transport of NGF to the DRG leads to an increase in the production of brain-derived neurotrophic factor (BDNF) at the level of gene expression, mainly in *trkA*-expressing small- and medium-sized neurons. During embryonic and early postnatal stages, sensory neurons are dependent on NGF for survival. Although adult sensory neurons do not depend on NGF for survival, the functional properties of some nociceptive sensory neurons, such as responsiveness to capsaicin or noxious heat, are modulated by NGF. NGF can exert its actions either through the high-affinity *trkA* receptor or the low-affinity p75 neurotrophin receptor.

- ▶ [Congenital Insensitivity to Pain with Anhidrosis](#)
- ▶ [ERK Regulation in Sensory Neurons during Inflammation](#)
- ▶ [IB4-Positive Neurons, Role in Inflammatory Pain](#)
- ▶ [Immunocytochemistry of Nociceptors](#)
- ▶ [Nerve Growth Factor, Sensitizing Action on Nociceptors](#)
- ▶ [Neutrophils in Inflammatory Pain](#)
- ▶ [Satellite Cells and Inflammatory Pain](#)
- ▶ [Spinal Cord Nociception, Neurotrophins](#)
- ▶ [TRPV1, Regulation by Nerve Growth Factor](#)
- ▶ [TRPV1, Regulation by Protons](#)
- ▶ [Wallerian Degeneration](#)

## Nerve Growth Factor Overexpressing Mice as Models of Inflammatory Pain

DEREK C. MOLLIVER, KATHRYN M. ALBERS  
Department of Medicine, University of Pittsburgh  
School of Medicine, Pittsburgh, PA, USA  
kaa2@pitt.edu

### Synonyms

Transgenic Mice; NGF-OE mice

### Definitions

#### NGF and Inflammatory Pain

In peripheral tissues, the level of nerve growth factor (NGF) expression is often elevated following inflammation or injury (Heumann et al. 1987; Weskamp and Otten 1987). Studies using rodents have shown that injection of NGF causes behavioral thermal and mechanical ▶ [hyperalgesia](#) (Lewin et al. 1993; Lewin et al. 1994). Increased NGF expression is also accompanied by elevation of other inflammatory mediators such as bradykinin, prostaglandins, serotonin, ATP and protons (Bennett 2001). These changes in the periphery are thought to collectively contribute to sensitization of sensory afferents and central pain processing pathways. The link between NGF and inflammatory pain signaling can be examined using a transgenic mouse model (see ▶ [Nerve Growth Factor Overexpressing Mice as Models of Inflammatory Pain](#)) in which NGF is overexpressed in the skin, a major target of sensory afferents. In these mice (NGF-OE mice), NGF is overexpressed in basal keratinocytes of stratified, keratinizing tissues such as the skin and oral epithelium, using the human keratin K14 promoter and enhancer region to drive expression of the mouse NGF cDNA (Albers et al. 1994). As described below, the increase in NGF expression causes an increase in the developmental survival of neurons that project to K14-expressing epithelium, altering their physiological properties and the expression of genes related to nociceptive signaling.

### Characteristics

#### Anatomical Characteristics of NGF-OE Transgenic Mice

Mice that overexpress NGF in the skin exhibit hypertrophy of both sensory and sympathetic neurons (Albers et al. 1994; Davis et al. 1994; Davis et al. 1997). NGF-OE mice have an approximate 2-fold increase in the number of trigeminal and dorsal root ganglion (DRG) sensory neurons, and a 2.5-fold increase in the number of sympathetic neurons in the superior cervical ganglia. In addition, preferential increases of unmyelinated and thinly myelinated fibers that project to the skin occur (Davis et al. 1997; Stucky et al. 1999), a finding consistent with the types of axons lost in ▶ [ngf<sup>-/-</sup> mice](#) (Crowley et al.

1994). Immunolabeling of skin and DRG have shown a preferential increase of peptidergic sensory neuron subtypes. For example, the percent of TrkA neurons is doubled, as is the percent of calcitonin gene related peptide-positive neurons (Goodness et al. 1997). The population of sensory neurons that bind the plant lectin IB4 is not increased, consistent with the finding that glial cell line-derived growth factor (GDNF) is a major contributor to the trophic support of these neurons (Molliver et al. 1997).

### Electrophysiologic Properties of NGF-OE Cutaneous Afferents

Electrophysiologic properties of cutaneous sensory afferents in the **saphenous nerve** of NGF-OE mice were analyzed using a skin-nerve preparation (Stucky et al. 1999). Large myelinated, low-threshold A $\beta$  fibers showed no change in the proportion of slowly adapting (SA) or rapidly adapting (RA) fibers relative to wildtype animals. In addition, no significant difference in the mechanical stimulus-response properties, or conduction velocity, of SA or RA fibers of NGF-OE mice were found.

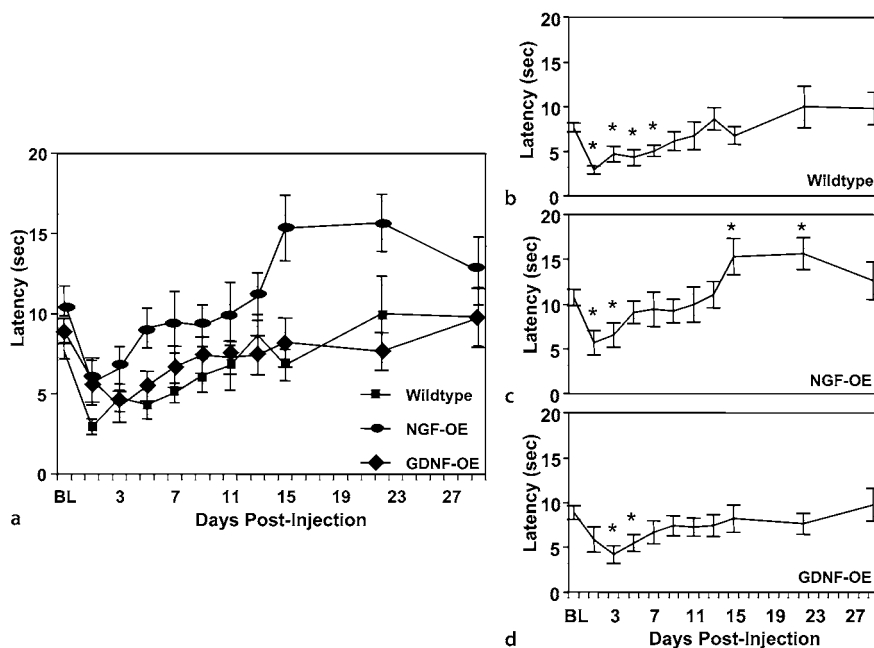
In contrast to A $\beta$  fibers, both A $\delta$  and C fiber nociceptors of NGF-OE mice had altered properties. The percent of A $\delta$  mechanosensitive (AM) nociceptors was significantly increased from control values of 65% of all A $\delta$  fibers analyzed to 97% in NGF-OE mice. Individual AM fibers also showed increased mechanical responsiveness, which was particularly evident at suprathreshold stimuli. A 100–300 mN sustained force evoked discharge rates in NGF-OE AM fibers double those of wildtypes. Though mechanically sensitized, AM fibers were

unchanged with heat sensitivity. No significant difference was measured in the percent of AM fibers that respond to heat, the threshold for a response, or in the mean spikes per heat stimulus.

C fiber afferents showed a 50% increase in total number in the saphenous nerve of NGF-OE mice (Stucky et al. 1999). Nearly all C fibers (96%) responded to heat and showed a four-fold increase in the number of heat evoked action potentials per C fiber. In addition, C fibers in NGF-OE mice exhibited spontaneous activity that was much higher than C fibers of wildtype mice (60% versus 6.5%, respectively). This increase in sensitivity was not global however, since the response of C fibers to mechanical stimulation was half relative to control fibers. Thus, increased NGF in the skin regulates the receptive properties of cutaneous C and A $\delta$  fibers in differential manners.

### Behavioral Phenotype of Naïve NGF-OE Mice

To evaluate the response of NGF-OE mice to inflammatory stimuli, the behavioral response of NGF-OE mice to a focused heat source applied to the foot was measured. Two other types of animals were used for comparison in this analysis: littermate control mice (Blk6/C3H strain) and transgenic mice that overexpress GDNF in the skin (GDNF-OE mice). GDNF-OE mice have an enhancement of GDNF-dependent nociceptor neurons (Zwick et al. 2002). GDNF-dependent neurons are peptide poor neurons, which primarily project to lamina II of the spinal cord (with some overlap in lamina I) and bind the plant lectin IB4 (Vulchanova et al. 2001). During postnatal development, GDNF-dependent neurons switch dependence from NGF to GDNF, and express the



### Nerve Growth Factor Overexpressing Mice as Models of Inflammatory Pain, Figure 1

CFA injections did not cause increased hyperalgesia in NGF-OE and GDNF-OE mice. (a) Comparison of all three genotypes. (b) Wildtype, (c) NGF-OE and (d) GDNF-OE mice were injected with CFA and tested for behavioral heat hyperalgesia over a 1 month time period. Each mouse line exhibited significant hyperalgesia within 3 days of being injected. NGF-OE mice recovered first (by day 5), followed by GDNF-OE mice on day 7. Wildtype mice did not fully recover until day 9. NGF-OE mice also exhibited hypoalgesia on days 15 and 22 (relative to their pre-CFA baseline).  $\nu$ =Wildtype mice;  $\mu$ =NGF-OE mice;  $\omega$ =GDNF-OE mice; BL=Baseline value.

tyrosine kinase receptor Ret and its coreceptor GFR $\alpha$ 1 (Molliver et al. 1997). GDNF dependent neurons have been proposed to primarily modulate responses to ► **neuropathic pain** as opposed to inflammatory pain (Snider and McMahon 1998). To compare NGF and GDNF-dependent nociceptor populations, the behavioral response of NGF-OE, GDNF-OE and wildtype (WT) mice to heat was measured (Fig. 1). This analysis showed NGF-OE mice had slightly longer latencies (they were hypoalgesic) relative to WT and GDNF-OE mice, which had equivalent baselines (Zwick et al. 2003).

### Response of NGF-OE and GDNF-OE Mice to Inflammatory Stimuli

The response of NGF-OE, GDNF-OE and WT mice to inflammatory pain was tested by injecting an emulsion of ► **complete Freund's adjuvant** (CFA) subcutaneously into the plantar skin of the hind paw (Zwick et al. 2003). Sets of 10 animals were tested for heat and mechanical hyperalgesia at various timepoints following CFA injection (Fig. 1). WT and NGF-OE mice showed decreased response times 1 day post-injection (Fig. 1b–d). On day 3, all three genotypes displayed hyperalgesic behavior compared to their respective baselines. All groups of animals showed recovery following the 3-day time-point, with WT mice recovering to normal by day 9, GDNF-OE mice recovering by day 7 and NGF-OE mice recovering by day 5. NGF-OE mice not only recovered faster than wildtype and GDNF-OE mice, they became hypoalgesic between days 15 and 22 relative to their starting baseline. Thus, the increased number of nociceptors in NGF-OE and GDNF-OE transgenic mice did not cause a hyperalgesic phenotype in the naïve or inflamed state. The lack of enhanced behavioral hyperalgesia in NGF-OE and GDNF-OE mice suggested compensatory changes developed in each transgenic mouse line in response to the trophin-induced anatomical and physiological changes. To examine how these analgesic effects could be elicited, mRNA expression for selected genes thought to be involved in nociceptive signaling was analyzed in the L4/L5 dorsal horn and DRG of naïve mice (Tab. 1 and 2) (Zwick et al. 2003). ► **Real time PCR** analysis of reverse transcribed total RNA isolated from the dorsal horn of the spinal cord and lumbar DRG were done. No significant change for any of the genes examined was found in dorsal horn mRNA samples (Tab. 1).

However, in L4/L5 DRG, significant changes were measured for most of the gene products examined (Tab. 2). In NGF-OE DRG, changes were found for the opioid receptors MOR1, DOR1, KOR1 and NR1, NR2B, mGluR1 and the sodium channel Nav1.3. In GDNF-OE DRG, mRNAs encoding DOR1, KOR1 and mGluR1

**Nerve Growth Factor Overexpressing Mice as Models of Inflammatory Pain, Table 1** Change in mRNA abundance in mouse dorsal horn

mRNA	WT vs. NGF-OE (fold change)	WT vs. GDNF-OE (fold change)
MOR1	1.0	+1.2
DOR1	1.0	+1.2
KOR1	+1.3	+1.1
NR1	-1.1	1.0
NR2B	+1.3	+1.3
mGluR1	+1.1	+1.1
DREAM	+1.1	+1.1

All values are reported as fold change relative to wildtype (WT) measurements. A value of "1" indicates no change. Negative values indicate a decrease. None of the observed changes were statistically significant

**Nerve Growth Factor Overexpressing Mice as Models of Inflammatory Pain, Table 2** Change in mRNA abundance in mouse L4-L5 dorsal root ganglia

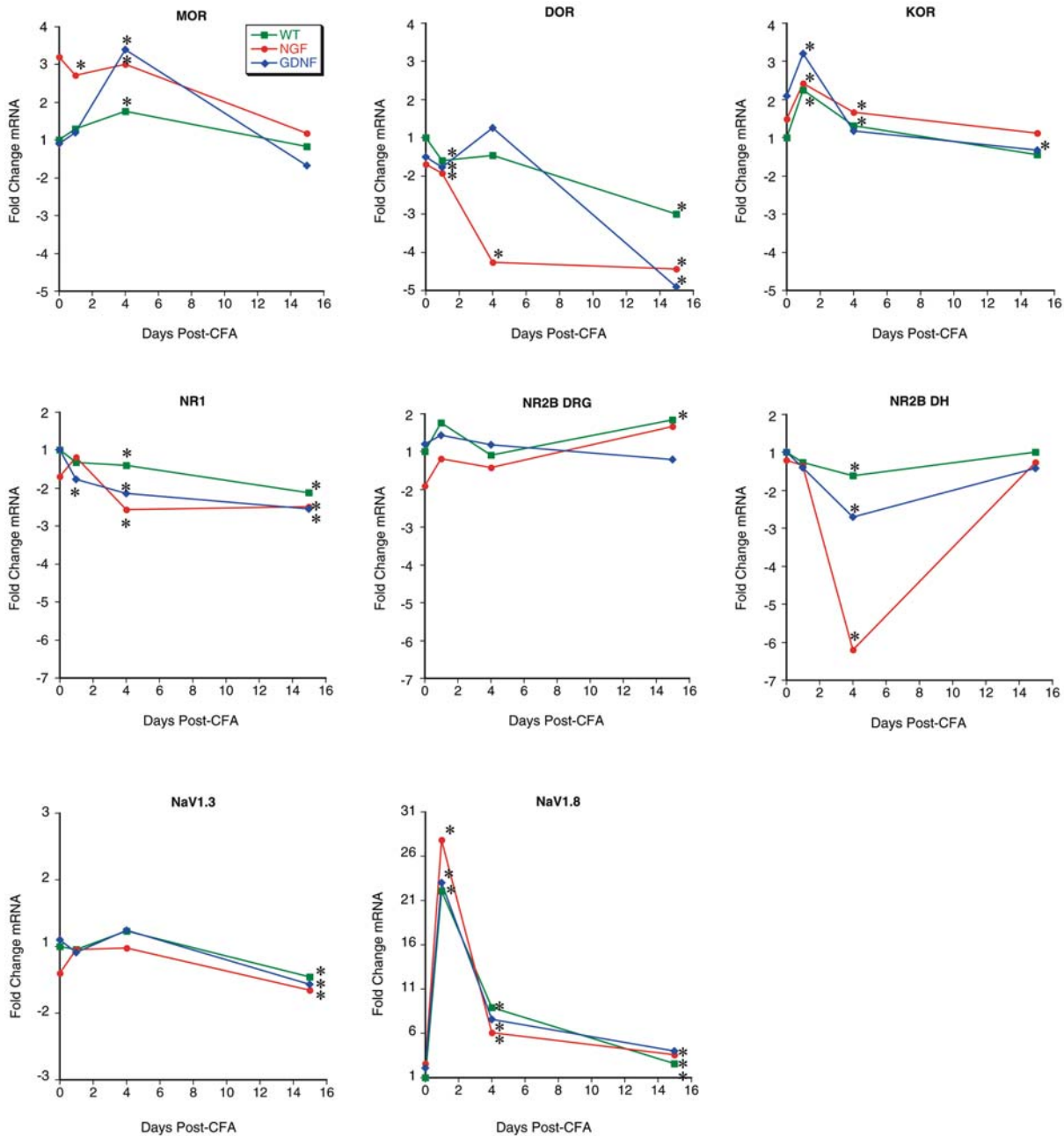
mRNA	WT vs. NGF-OE (fold change)	WT vs. GDNF-OE (fold change)
MOR1	+3.2*	-1.1
DOR1	-1.6*	-1.5*
KOR1	+1.5*	+2.1*
NR1	-1.8*	1.0
NR2B	-1.8*	1.0
mGluR1	+3.1*	+3.7*
Nav 1.8	+2.6	+2.1
Nav 1.3	-1.4*	+1.1

All values are reported as fold change relative to wildtype (WT) measurements. Fold change equal to "1" indicates no change. Negative values indicate a decrease. Asterisk indicates  $p < 0.05$

were changed. Thus, opioid and glutamate signaling in the primary afferent may contribute to the compensatory changes evoked in transgenic OE animals in the naïve state.

How these selected genes changed on the transcriptional level, following CFA injection into the hind paw, was then examined (Molliver et al. 2005). Genes expressed in lumbar DRG of NGF-OE, GDNF-OE and WT animals were assayed using real time PCR (Fig. 2). Measures were done at 0 (baseline), 1-day, 4-day and 15-day time-points, post CFA treatment. These times coincide with the development, maximal expression and resolution of thermal hyperalgesia, as indicated by the behavioral measures (Fig. 1). This analysis showed that opioid receptor mRNA abundance is changed in DRG following CFA injection (Fig. 2). Following CFA injection in





N

**Nerve Growth Factor Overexpressing Mice as Models of Inflammatory Pain, Figure 2** Comparison of the temporal change in mRNA levels of various genes related to nociception in DRG and dorsal horn of wildtype (green line), NGF-OE (red line) and GDNF-OE (blue line) mice following CFA injection in the hind paw. CFA injection was done at day 0 and the relative abundance of mRNAs for each gene determined using real time PCR assays. A significant change from the baseline value determined for each animal type is indicated by an asterisk.

WT mice, MOR mRNA levels were slightly elevated, in contrast to GDNF-OE mice, where a spike at 4 days occurred followed by a decline. Although the abundance of MOR mRNA was increased (3.2 fold) in NGF-OE mice at baseline, a steady decline in MOR levels was also measured in NGF-OE DRG. DOR mRNA was downregulated in WT mice following CFA injection, though an overall greater decline occurred in both OE lines. In all

genotypes, KOR showed a peak rise at 1 day, followed by a decline back to near baseline levels.

For the NMDA receptor subunit NR1, a decrease for all genotypes occurred by the 4-day time-point and continued to the 15-day time-point. The decrease in NR1 in the transgenics is particularly profound, given the increased number of nociceptive neurons in these mice. Notably, both lines of transgenic mice recover from CFA-evoked

hyperalgesia early: NGF-OEs by day 5 and GDNF-OEs by day 7 (Fig. 1). The NR2B subunit showed no significant change in NGF-OE or GDNF-OE ganglia, and was only modestly elevated in WT ganglia at the 15-day timepoint. As NR2B may mediate central sensitization, mRNA abundance was assessed in the dorsal horn (DH) of the lumbar spinal cord. In WT mice, NR2B was slightly decreased in the dorsal horn at 4 days, with a return to baseline by 15 days. In the GDNF-OE and NGF-OE samples, this pattern of regulation was exaggerated, particularly for NGF-OE samples, which showed a near 7-fold decrease at 4 days. Similar to WT animals, both transgenic samples had a return to baseline by day 15. This suggests that NGF-OE mice compensate for the increased nociceptor input by downregulation of NR2B, which presumably restricts second messenger potentiation of NMDA currents, and inhibits sensitization of spinal synapses contributing to hyperalgesia.

The regulation of the sodium channel (Nav1.8 and Nav1.3) mRNA level in DRG of NGF-OE and GDNF-OE lines was very similar to the pattern of change in WT mice, i.e., a sharp rise in Nav1.8 is seen at 2 days post CFA, followed by a decline to near normal level by day 4. In contrast to the response in Nav1.8, Nav1.3 mRNA abundance showed a steady decline, which became significantly lower than baseline levels by day 15.

NGF overexpression in skin results in nociceptive primary sensory neurons that are hyperexcitable and present in substantially increased numbers. However, when tested behaviorally, these mice are resistant to inflammatory hyperalgesia and actually become hypoalgesic. Evidence suggests the resistance in each OE line to inflammatory pain is due to compensatory changes in nociceptive signaling, which act to reduce the impact of the increased nociceptive input. Understanding of how these compensatory changes develop and are regulated following injury will provide insight into the role of NGF in inflammatory pain processes. In particular, this model system has allowed identification of genes that are more susceptible to compensatory regulation. For instance, Nav1.8 is essentially the same in all genotypes after CFA, whereas in transgenic mice the opioid receptors and NMDA receptors exhibit striking alteration, relative to WT mice, in their patterns of transcriptional regulation following an inflammatory challenge. This suggests that specific elements in the transcriptional response to injury are particularly amenable to modulation and that their expression may determine the severity of the injury response, whereas other elements show a more fixed transcriptional response to injury. The NGF-OE mice provide a model system in which to examine this hypothesis. In addition, the OE system provides a means in which to determine how different subpopulations of nociceptive neurons respond to inflammatory stimuli. In this manner, a more global visualization of the role of growth factor

expression in primary afferent sensitization following injury and their use as therapeutic targets can be constructed.

## References

- Albers KM, Wright DE, Davis BM (1994) Overexpression of Nerve Growth Factor in Epidermis of Transgenic Mice Causes Hypertrophy of the Peripheral Nervous System. *J Neurosci* 14:1422–1432
- Bennett DL (2001) Neurotrophic Factors: Important Regulators of Nociceptive Function. *Neuroscientist* 7:13–17
- Crowley C, Spencer SD, Nishimura MC, Chen KS, Pitts-Meek S, Armanini MP, Ling LH, MacMahon SB, Shelton DL, Levinson AD et al. (1994) Mice Lacking Nerve Growth Factor Display Perinatal Loss of Sensory and Sympathetic Neurons yet Develop Basal Forebrain Cholinergic Neurons. *Cell* 76:1001–1011
- Davis BM, Albers KM, Serogy KB, Katz DM (1994) Overexpression of Nerve Growth Factor in Transgenic Mice Induces Novel Sympathetic Projections to Primary Sensory Neurons. *J Comp Neurol* 349:464–474
- Davis BM, Fundin BT, Albers KM, Goodness TP, Cronk KM, Rice FL (1997) Overexpression of Nerve Growth Factor in Skin Causes Preferential Increases Among Innervation to Specific Sensory Targets. *J Comp Neurol* 387:489–506
- Goodness TP, Albers KM, Davis FE, Davis BM (1997) Overexpression of Nerve Growth Factor in Skin Increases Sensory Neuron Size and Modulates Trk Receptor Expression. *Eur J Neurosci* 9:1574–1585
- Heumann R, Korsching S, Bandtlow C, Thoenen H (1987) Changes of Nerve Growth Factor Synthesis in Nonneuronal Cells in Response to Sciatic Nerve Transection. *J Cell Biol* 104:1623–1631
- Lewin GR, Ritter AM, Mendell LM (1993) Nerve Growth Factor-Induced Hyperalgesia in the Neonatal and Adult Rat. *J Neurosci* 13:2136–2148
- Lewin GR, Rueff A, Mendell LM (1994) Peripheral and Central Mechanisms of NGF-Induced Hyperalgesia. *Eur J Neurosci* 6:1903–1912
- Molliver DC, Wright DE, Leitner ML, Parsadanian AS, Doster K, Wen D, Yan Q, Snider WD (1997) IB4-Binding DRG Neurons Switch from NGF to GDNF Dependence in Early Postnatal Life. *Neuron* 19:849–861
- Molliver DC, Lindsay J, Albers KM and Davis BM (2005) Overexpression of NGF or GDNF alters transcriptional plasticity evoked by inflammation. *Pain* 113:277–284
- Snider WD, McMahon SB (1998) Tackling Pain at the Source: New Ideas about Nociceptors. *Neuron* 20:629–632
- Stucky CL, Koltzenburg M, Schneider M, Engle MG, Albers KM, Davis BM (1999) Overexpression of Nerve Growth Factor in Skin Selectively Affects the Survival and Functional Properties of Nociceptors. *J Neurosci* 19:8509–8516
- Vulchanova L, Olson TH, Stone LS, Riedl MS, Elde R, Honda CN (2001) Cytotoxic Targeting of Isolectin IB4-Binding Sensory Neurons. *Neuroscience* 108:143–155
- Weskamp G, Otten U (1987) An Enzyme-Linked Immunoassay for Nerve Growth Factor (NGF): A Tool for Studying Regulatory Mechanisms Involved in NGF Production in Brain and in Peripheral Tissues. *J Neurochem* 48:1779–1786
- Zwick M, Davis BM, Woodbury CJ, Burkett JN, Koerber HR, Simpson JF, Albers KM (2002) Glial Cell Line-Derived Neurotrophic Factor is a Survival Factor for Isolectin B4-Positive, but not Vanilloid Receptor <sup>1</sup>-Positive, Neurons in the Mouse. *J Neurosci* 22:4057–4065
- Zwick M, Molliver DC, Lindsay J, Fairbanks CA, Sengoku T, Albers KM, Davis BM (2003) Transgenic Mice Possessing Increased Numbers of Nociceptors do not Exhibit Increased Behavioral Sensitivity in Models of Inflammatory and Neuropathic Pain. *Pain* 106:491–500

## Nerve Growth Factor, Sensitizing Action on Nociceptors

LORNE M. MENDELL

Department of Neurobiology and Behavior, State University of New York at Stony Brook, Stony Brook, NY, USA

lorne.mendell@sunysb.edu

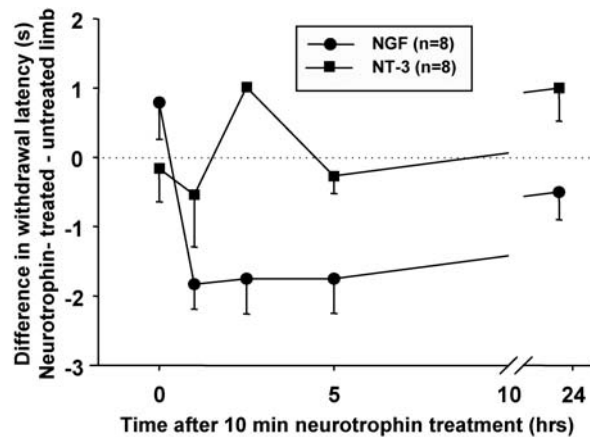
### Definition

The response of the nociceptive system can be sensitized by exposure to a ► **neurotrophin** molecule called ► **nerve growth factor** (NGF). This sensitization has 2 components, one peripheral due to an enhanced response to nociceptive stimuli, and the other central due to increased action of nociceptive impulses in the dorsal horn.

### Characteristics

Nerve Growth Factor is a member of a family of molecules called neurotrophins. Neurotrophins are best known for their function during development, specifically in promoting axonal growth and in assuring cell survival. Cells affected selectively by NGF express a specific receptor tyrosine kinase called ► **trkA** to which NGF binds. Nociceptors express **trkA**, which makes them sensitive to NGF during development (reviewed in Lewin and Mendell 1993; Mendell et al. 1999). Recently, however, a postnatal role for NGF has been established. Administration of NGF to an animal results in enhanced responsiveness to noxious stimulation (► **hyperalgesia**), which is partly due to direct sensitization of nociceptive afferents, i.e. peripheral sensitization. In addition, exposure of the receptive field of sensory neurons to NGF and other sensitizing agents, elicits changes in the cell body in the dorsal root ganglion that increase the central effect of sensory impulses, a phenomenon known as central sensitization. Several findings have established the involvement of endogenous NGF in sensitizing the subsequent response to nociceptive inputs after injury (reviewed in Lewin and Mendell 1993; Mendell et al. 1999). First, is the upregulation of NGF in skin and other peripheral tissues after inflammatory injury. A second is the demonstration that administration of exogenous NGF can elicit hyperalgesia. The third is the finding that inflammatory pain can be significantly reduced by interfering with endogenous NGF action, using either an antibody to NGF or an immunoadhesin (**trkA-IgG**) which sequesters endogenous NGF.

The time course of hyperalgesia elicited by systemically administered NGF (1 µg/g) has revealed 2 phases of the response, an initial thermal component beginning just a few minutes after NGF administration, and a later one beginning several hours after NGF administration that includes mechanical hyperalgesia (Lewin et al. 1994). The early response can also be elicited by local injec-



**Nerve Growth Factor, Sensitizing Action on Nociceptors, Figure 1** Administration of NGF to the foot of the rat makes the affected paw hyperalgesic to noxious heat as measured by a reduced latency to withdrawal from a fixed thermal stimulus. The ordinate represents the mean difference in the latency of response of the affected limb compared to the contralateral limb (negative value implies that it took less time for the thermal stimulus to reach noxious threshold on the treated foot than on the untreated foot). NGF treatment gave a rapid and consistent thermal hyperalgesia lasting at least 1 day. NT-3 produced no change in response to noxious heat. (Adapted from Shu et al. 1999).

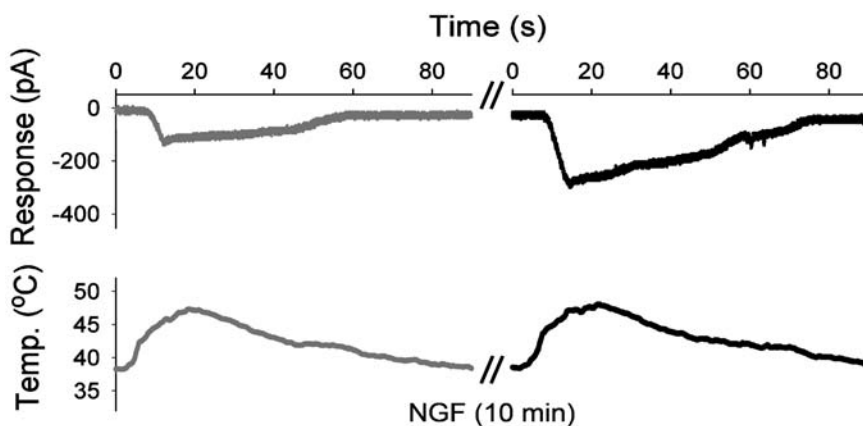
tions of NGF into the periphery (Fig. 1), suggesting that exogenous NGF directly sensitizes thermal nociceptive afferents but not high threshold mechanoreceptors (Shu et al. 1999). These confirm the results of previous recordings from individual nociceptors using a ► **skin-nerve preparation**. In these experiments, it has been found that the response to noxious heat is sensitized, measured as a decrease in threshold, whereas there is no systematic change in the threshold to mechanical stimulation (Rueff and Mendell 1996). This suggests that mechanical hyperalgesia is of central origin (Lewin et al. 1994; see below) although the possibility of a peripheral contribution by increased discharge of high threshold mechanoreceptors is not ruled out by currently available data.

NGF has also been shown to operate as a sensitizing agent in visceral structures such as the bladder or the gut. As in skin, there is upregulation of NGF message and protein in painful inflammatory conditions, brought on by diseases such as interstitial cystitis or in an experimental model of ulcers (e.g. Lamb et al. 2004). Administration of NGF to the visceral periphery results in enhanced afferent activity. Experimental models of arthritis are also characterized by release of NGF into the synovial fluid, indicating a role in joint hyperalgesia (Manni et al. 2003).

A difficulty in determining the mechanism of NGF action from these experiments arises from the multiplicity of cell types in the peripheral target tissues that express **trkA** (the high affinity receptor for NGF) or that release NGF. Many of these cells are non neural, and are believed to interact closely in the inflammatory cascade. For example, ► **mast cells** are known to express **trkA**

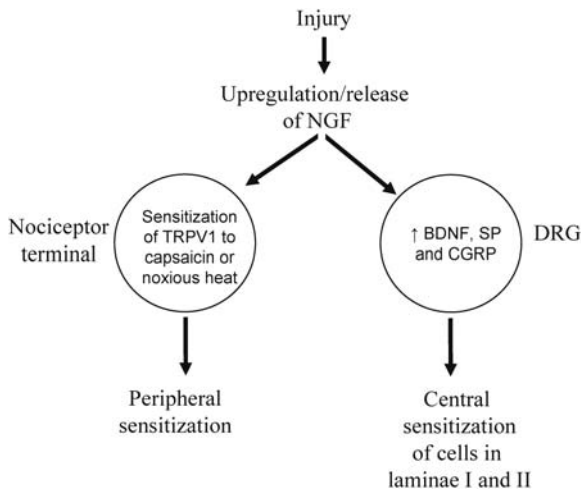
and to release NGF after injury, and ► **keratinocytes** have been shown to release NGF in response to histamine produced by mast cells (reviewed in Mendell et al. 1999). Degranulation of mast cells can diminish the sensitizing action of exogenous NGF and other inflammatory mediators (Lewin et al. 1994). In order to investigate the effect of NGF directly on nociceptors, small diameter cells acutely dissociated from DRG have been studied in culture. The assumption in carrying out such experiments is that the cell body in culture expresses the same receptors as the peripheral terminals *in situ*. A problem with this approach is that the original target (skin, muscle, viscera) can only be identified if it is pre-labeled with a dye transported to the ganglion from the target tissue. However, this still leaves the identity of the receptor type (e.g. for skin: polymodal nociceptor, mechanical nociceptor, D-Hair, etc.) to be determined, since unique molecular identifiers are not yet available at this level of resolution. NGF is now recognized as an inflammatory mediator with a sensitizing action similar to that associated with other inflammatory mediators such as prostaglandin and bradykinin. The sensitizing effect of NGF has been examined most extensively on the response to capsaicin, which is now known to signal via the recently cloned ► **TRPV1 receptor** (also known as VR1). This receptor can also be activated by physiological stimuli, specifically noxious heat and low pH (rev. in Caterina and Julius 2001). Normally, the TRPV1-mediated response studied in isolated cells is smaller to the second of 2 capsaicin or noxious heat stimuli (i.e., exhibits tachyphylaxis) that are separated by as much as 10 or 15 min (Galoyan et al. 2003; Shu and Mendell 1999). However, in the presence of NGF (100 ng/ml), tachyphylaxis does not occur in most cells; rather the second response is larger than the first, i.e. it is sensitized (Shu and Mendell 1999) (Fig. 2). These same studies have revealed that the initial response to noxious heat or capsaicin is larger on the average in the presence of NGF than in its absence. Sensitization by NGF is not accompanied by any systematic change in threshold temperature (Galoyan et al. 2003), unlike sensitization measured in the skin-nerve prepara-

tion (Rueff and Mendell 1996). Thus NGF-induced sensitization is not a property of nociceptors alone; other cells in the skin (keratinocytes, mast cells, etc.) are likely to contribute significantly. It is important to note that administration of NGF alone does not elicit any response from the cell; it merely sensitizes the response evoked by noxious heat or capsaicin. Immunohistochemical analysis of these cells reveals that the ability of NGF to sensitize these responses is strongly correlated with expression of *trkA* (Galoyan et al. 2003), indicating that sensitization to noxious heat by NGF involves an interaction between the ► **trkA receptor** and the TRPV1 receptor. Chuang et al. (2001) have demonstrated that activation of *trkA* disinhibits TRPV1 via action of phospholipase C (PLC) leading to a reduced level of PIP2 which, at normal levels, maintains a tonic level of inhibition of TRPV1. NGF also sensitizes the response of nociceptors by increasing their membrane gain, as determined by an enhanced action potential firing in response to an imposed current (Zhang et al. 2002). This occurs as a result of augmentation of a TTX-resistant Na<sup>+</sup> current known to be expressed in nociceptors. An additional factor underlying this enhanced response to depolarization is inhibition of a K<sup>+</sup> current. NGF mediates these actions on membrane gain by activating the ► **p75 receptor**, rather than *trkA* which is responsible for enhancing the inward current through TRPV1. The p75 receptor is coupled to the sphingomyelin signaling pathway, and exposure to ► **ceramide**, an independent intermediate of this signaling pathway, mimics the effect of NGF on membrane gain. Experiments with independent expression of p75 and TRPV1 in heterologous cells suggest that the p75 receptor is unlikely to be crucial for sensitization of the response of TRPV1 to capsaicin (Chuang et al. 2001). However, some modulatory effect of p75 on the response of *trkA* is not ruled out by these experiments. Thus, NGF can sensitize the response of nociceptors to noxious heat both by enhancing the response of the noxious heat sensitive receptor via *trkA*, and by amplifying the gain of the membrane via the p75 receptor, in effect sensitizing the response of the receptor as well as



**Nerve Growth Factor, Sensitizing Action on Nociceptors, Figure 2** Response of small diameter DRG cell in acute cell culture to noxious heat stimulation. Note that the response to the second pulse of heat (bottom traces) measured 10 min after the initial response in the continuous presence of NGF (100 ng/ml) during the 10 min interval was a larger inward current (top traces) measured in perforated patch clamp mode. This sensitization is never observed under control conditions. (Adapted from Galoyan et al. 2003).





**Nerve Growth Factor, Sensitizing Action on Nociceptors, Figure 3** Schematic diagram illustrating some effects of NGF in causing peripheral sensitization by direct action on nociceptive terminals and indirect central sensitization by upregulating peptides such as brain derived neurotrophic factor (BDNF), substance P (SP) and calcitonin gene related peptide (CGRP).

enhancing the gain of the impulse encoder. Longer term exposure to NGF also induces changes in the **P2X3 Receptor** composition of sensory neurons. Thus NGF can influence the response of these neurons to ATP which is released by non neural cells after damage or noxious stimuli (Scholz and Woolf 2002).

The central action of nociceptors is also sensitized by inflammatory stimuli including NGF (Scholz and Woolf 2002). NGF has not been shown to have any direct effect on spinal neurons in the superficial dorsal horn that are involved in transmitting nociceptive signals (Kerr et al. 1999). Rather, exposure of the peripheral terminals to NGF results in internalization of the NGF-trkA complex and transport to the cell body, where it stimulates upregulation of several peptides including substance P, CGRP and another neurotrophin, **brain derived neurotrophic factor** (BDNF). These peptides are released into the dorsal horn (e.g., Lever et al. 2001) where they can rapidly sensitize the response of dorsal horn neurons in lamina II to subsequent inputs (Garraway et al. 2003). They can also elicit changes in gene expression that are pronociceptive (long term central sensitization, Scholz and Woolf 2002).

Together, these studies indicate that the role of NGF in eliciting sensitization of nociceptors is complex with both direct peripheral and indirect central components (Fig. 3).

## References

1. Caterina MJ, Julius D (2001) The Vanilloid Receptor: A Molecular Gateway to the Pain Pathway. *Ann Rev Neurosci* 24:487–517
2. Chuang HH, Prescott ED, Kong H et al. (2001) Bradykinin and Nerve Growth Factor Release the Capsaicin Receptor from PtdIns(4,5)P<sub>2</sub>-Mediated Inhibition. *Nature* 411:957–962

3. Galoyan SM, Petruska J, Mendell LM (2003) Mechanisms of Sensitization of the Response of Single DRG Cells from Adult Rat to Noxious Heat. *Eur J Neurosci* 18:535–541
4. Garraway SM, Petruska JC, Mendell LM (2003) BDNF Sensitizes the Response of Lamina II Neurons to High Threshold Primary Afferent Inputs. *Eur J Neurosci* 18:2467–2476
5. Kerr BJ, Bradbury EJ, Bennett DL et al. (1999) Brain-Derived Neurotrophic Factor Modulates Nociceptive Sensory Inputs and NMDA-Evoked Responses in the Rat Spinal Cord. *J Neurosci* 19:5138–5148
6. Lamb K, Gebhart GF, Bielefeldt K (2004) Increased Nerve Growth Factor Expression Triggers Bladder Overactivity. *J Pain* 5:150–156
7. Lever IJ, Bradbury EJ, Cunningham JR et al. (2001) Brain-Derived Neurotrophic Factor is released in the Dorsal Horn by Distinctive Patterns of Afferent Fiber Stimulation. *J Neurosci* 21:4469–4477
8. Lewin GR, Mendell LM (1993) Nerve Growth Factor and Nociception. *Trends Neurosci* 16:353–359
9. Lewin GR, Rueff A, Mendell LM (1994) Peripheral and Central Mechanisms of NGF-Induced Hyperalgesia. *Eur J Neurosci* 6:1903–1912
10. Manni L, Lundeberg T, Fiorito S et al. (2003) Nerve Growth Factor Release by Human Synovial Fibroblasts Prior to and Following Exposure to Tumor Necrosis Factor-Alpha, Interleukin-1 Beta and Cholecystokinin-8: The Possible Role of NGF in the Inflammatory Response. *Clin Exp Rheumatol* 21:617–624
11. Mendell LM, Albers KM, Davis BM (1999) Neurotrophins, Nociceptors and Pain. *Microsc Res Tech* 45:252–261
12. Rueff A, Mendell LM (1996) Nerve Growth Factor and NT-5 Induce Increased Thermal Sensitivity of Cutaneous Nociceptors *In Vitro*. *J Neurophysiol* 76:3593–3596
13. Scholz J, Woolf CJ (2002) Can we Conquer Pain? *Nat Neurosci* 5:1062–1067
14. Shu X, Llinas A, Mendell LM (1999) Effects of trkB and trkC Neurotrophin Receptor Agonists on Thermal Nociception: A Behavioural and Electrophysiological Study. *Pain* 80:463–470
15. Shu X, Mendell LM (1999) Nerve Growth Factor Acutely Sensitizes the Response of Adult Rat Sensory Neurons to Capsaicin. *Neurosci Lett* 274:159–62
16. Zhang YH, Vasko MR, Nicol GD (2002) Ceramide, A Putative Second Messenger for Nerve Growth Factor, Modulates the TTX-Resistant Na<sup>(+)</sup> Current and Delayed Rectifier K<sup>(+)</sup> Current in Rat Sensory Neurons. *J Physiol* 544:385–402

N

## Nerve Inflammation

- ▶ Inflammatory Neuritis

## Nerve Injury

- ▶ Retrograde Cellular Changes after Nerve Injury

## Nerve Lesion

### Definition

Lesion to/damage of a peripheral nerve.

- ▶ Causalgia, Assessment

## Nerve Ligation

- ▶ Retrograde Cellular Changes after Nerve Injury

## Nerve Pain

- ▶ Peripheral Neuropathic Pain

## Nerve Pain of Joint and Muscle Origin

- ▶ Neuropathic Pain, Joint and Muscle Origin

## Nerve Stump Pain

- ▶ Neuroma Pain

## Nerve Terminals

### Definition

These axon endings are found in the dermis around the base of hair follicles and close to the surface of the skin (epidermis) where the hair emerges. These free endings contain specialized receptors that respond to changes in temperature and other events (pH) associated with tissue damage.

- ▶ Opioid Receptor Localization

## Nerve Viral Infection

- ▶ Viral Neuropathies

## Nervus Intermedius, Primary Otagia

- ▶ Trigeminal, Glossopharyngeal, and Geniculate Neuralgias

## Neural Blockade

- ▶ Cancer Pain Management, Anesthesiologic Interventions, Neural Blockade

## Neural Compressive Syndrome

- ▶ Lower Back Pain, Physical Examination

## Neural Foramen

### Definition

Neural foramen is a foramen in the spinal canal which is bounded by the intervertebral disc, the pedicles and facet joints of the vertebrae above and below, and the posterior aspect of the vertebral bodies above and below. The nerve root exits through this foramen and the dorsal root ganglion is situated in the foramen.

- ▶ Dorsal Root Ganglionectomy and Dorsal Rhizotomy

## Neural Plasticity

### Definition

The ability of the brain and/or certain parts of the nervous system to change in order to adapt to new conditions such as an injury, and can include changes in synaptic connectivity and strength between cells.

- ▶ Cytokines, Effects on Nociceptors

## Neuralgia

### Definition

Neuralgia is pain that occurs along the distribution of a nerve or nerves initiated or caused by a primary lesion or dysfunction in the nervous system. Common usage often implies a paroxysmal quality, but neuralgia should not be reserved for paroxysmal pains.

- ▶ CRPS, Evidence-Based Treatment
- ▶ Opioids in Geriatric Application
- ▶ Orofacial Pain, Taxonomy/Classification

## Neuralgia, Assessment

RALF BARON

Klinik für Neurologie, Christian Albrecht University  
Kiel, Kiel, Germany

r.baron@neurologie.uni-kiel.de

### Definition

Neuralgia is defined as a pain in the distribution of a nerve or nerves (IASP Pain Terminology 1994) (Merskey and Bogduk 1994). It is mostly associated with neuropathic pain states that occur after nerve lesion. It is a pure descriptive term that does not imply the etiology of the pain generation, nor the underlying pathophysiological mechanism, nor the characteristic of the pain. According to this definition, neuralgia pain may be located superficially in the skin or also in deep somatic structures, it

may be of constant spontaneous type, shooting type or of evoked type ► (hyperalgesia, ► allodynia).

Note: Common usage, especially in Europe, often implies a paroxysmal quality, but neuralgia should not be reserved for paroxysmal pains.

Although the definition clearly states the fact that the pain of neuralgia occurs within the innervation territories, the symptoms may in individual cases spread to some degree beyond the innervation territories. This is particular true for allodynic pain in for example ► postherpetic neuralgia or posttraumatic neuralgia that sometime occurs in formerly unaffected dermatomes or peripheral nerve territories. Thus the symptoms, signs and their distribution can lead to confusion with regard to the diagnosis.

According to the underlying etiology several different terms for neuralgias are commonly used in pain medicine. The following comprises examples of some syndromes without being complete.

### Characteristics

#### Post-traumatic Neuralgia (PTN)

Traumatic mechanical partial injury to a peripheral nerve may lead to PTN. The cardinal symptoms are spontaneous burning pain, shooting pain and hyperalgesia and mechanical and, in some cases severe, cold allodynia. These sensory symptoms are confined to the territory of the affected peripheral nerve, although allodynia may extend beyond the border of nerve territories to a certain degree (Wahren and Torebjörk 1992; Wahren et al. 1991; Wahren et al. 1995).

Special forms of ► post-traumatic neuralgias are chronic compression injuries to peripheral nerves, e.g. spermatic neuralgia and ► meralgia paresthetica.

#### Postherpetic Neuralgia (PHN)

PHN is one of the most common types of neuropathic pain. Its etiology is well known; the recrudescence of the varicella zoster virus (VZV) with inflammation and damage to dorsal root ganglion cells. If the pain lasts more than 3–6 months after the acute shingles, the criteria for PHN are fulfilled. It typically occurs in elderly but otherwise healthy individuals with no previous history of chronic pain. The diagnosis is straightforward, based on the history of a dermatomal rash and the dermatomal distribution of the pain. The incidence of PHN in zoster-affected patients of all age groups is about 15%. The pain of PHN appears as the acute viral infection subsides and persists, often indefinitely. The severity is frequently sufficient to completely disrupt the lives of otherwise healthy individuals. Patients with PHN report one or more of the following: a steady, deep aching pain that often has an abnormal quality, a lancinating pain that is brief, intense and often described in terms reminiscent of ► trigeminal neuralgia and finally, dynamic mechanical allodynia, which is the induction of a sharp pain by light, moving, cutaneous stimuli. In individual pa-

tients, the most unpleasant aspect of their pain may be either a continuous deep aching pain, lancinating pain or allodynia (Dworkin and Portenoy 1994; Fields et al. 1998).

#### Cranial Nerve Neuralgias (Burchiel 2003; Kapur et al. 2003)

##### Trigeminal Neuralgia (TN)

Trigeminal neuralgia (tic douloureux) is a disorder of the fifth cranial (trigeminal) nerve that causes episodes of intense, stabbing, electric shock-like pain in the areas of the face where the branches of the nerve are distributed – lips, eyes, nose, scalp, forehead, upper jaw and lower jaw. The disorder is more common in women than in men and rarely affects anyone younger than 50. The attacks of pain, which generally last several seconds and may be repeated one after the other, may be triggered by talking, brushing teeth, touching the face, chewing or swallowing. The attacks may come and go throughout the day and last for days, weeks or months at a time, and then disappear for months or years. Trigeminal neuralgia is not fatal, but it is universally considered to be the most painful affliction known to medical practice (Fields 1996).

##### Glossopharyngeus Neuralgia (GN)

► Glossopharyngeal neuralgia is described as sharp, jabbing, electric or shock-like pain located deep in the throat on one side. It is generally located near the tonsil, although the pain may extend deep into the ear. It is usually triggered by swallowing or chewing.

##### Facial (Geniculate) Ganglion Neuralgia (FN)

Pain paroxysms are felt in the depth of the ear, lasting for seconds or minutes or intermittently. A trigger zone is present in the posterior wall of the auditory canal. Disorders of lacrimation, salivation and taste sometimes accompany the pain. There is a common association with herpes zoster.

##### Post-sympathectomy Neuralgia (PSN)

► Post-sympathectomy neuralgia is a pain syndrome associated with a lesion at the sympathetic nervous system. 1 to 2 weeks after lumbar or cervicothoracic sympathectomy, up to 35% of the patients develop a deep, boring pain. The pain of PSN characteristically has a proximal location within the innervation territory of the sympathectomized nerves. PNS patients describe a variable degree of deep somatic tenderness in the area of pain, which typically responds to oral cyclooxygenase inhibitors. PSN is often nocturnal and typically remits in a few weeks without specific treatment (Baron et al. 1999).

##### Meralgia Paresthetica

Meralgia paresthetica, a painful mononeuropathy of the lateral femoral cutaneous nerve, is commonly due to focal entrapment of this nerve as it passes through the in-

guinal ligament. It is a purely sensory nerve and has no motor component. Pain associated with paresthesias and numbness in the area of the anterolateral thigh are common symptoms. Rarely, it has other etiologies such as direct trauma, stretch injury or ischemia. It typically occurs in isolation. The clinical history and examination is usually sufficient for making the diagnosis. However, the diagnosis can be confirmed by nerve conduction studies. Treatment is usually supportive.

### Differential Diagnoses

#### Atypical Facial Neuralgia and Post-traumatic Facial Pain

The typical symptom is a continuous, unilateral, deep, aching pain, sometimes with a burning component within the face, most commonly in the area of the second trigeminal branch. More than half the patients with nondescript facial pain report its onset after trauma to the face, often surgical trauma. Orbital enucleations, sinus procedures and complicated dental extractions are the most common procedures that antedate the appearance of pain. Fortunately, for the large majority of the patients, their pain problem is self-limited; within 1–5 years it subsides whether symptomatic treatment is effective or not. The mechanism underlying this disorder presumably involves activation or central pain transmission pathways; how and why this occurs remains to be elucidated (Burchiel 2003; Kapur et al. 2003).

#### Complex Regional Pain Syndrome type II (CRPS II, Causalgia)

Injury of a peripheral nerve may lead to CRPS II. In contrast to patients with post-traumatic neuralgias, CRPS II patients exhibit a more complex clinical picture. They show marked swelling and a tendency for progressive spread of symptoms in the entire distal extremity. Spontaneous and evoked pains are felt superficially as well as deep inside the extremity and the intensity of both is dependent on the position of the extremity (Baron et al. 2002; Janig and Baron 2003; Wasner et al. 1998).

### Assessment of Neuralgia

Since neuralgia is a pure descriptive term defined as a pain that occurs within the innervation territory of a peripheral nerve or a nerve root, there are no objective diagnostic procedures. However, in addition to the pain history and the clinical symptoms clinical signs that are characteristic for neuropathic pain states are also helpful and should be analyzed with quantitative sensory testing to aid the diagnosis of neuropathy (e.g. in postherpetic neuralgia, posttraumatic neuralgia, meralgia paresthetica) (see below) (Baron 2000). However, it should be recognized that in several forms of neuralgia (e.g. idiopathic trigeminal neuralgia) sensory testing does not reveal any abnormalities.

## Symptom-based Classification of Neuropathic Pain. I. General Definitions

### Negative sensory symptoms

- Loss of sensory quality
- Due to system involved: hypoesthesia, hypoalgesia, thermhypoesthesia, pallyhypoesthesia etc...
- Bothering, but not painful

### Positive sensory symptoms

- Paresthesias
- Dysesthesias
- Spontaneous pain (burning ongoing pain, shock-like pain)
- Evoked pain (see below)
  - Allodynia: a normally non-painful stimulus evokes pain
  - Hyperalgesia: a painful stimulus evokes pain of higher intensity

## Symptom-based Classification of Neuropathic Pain. II. Definition of Different Evoked Pains

- Static mechanical allodynia
  - Gentle static pressure stimuli at the skin evokes pain
  - Present in the area of affected (damaged or sensitized) primary afferent nerve endings (primary zone)
- Punctate mechanical allodynia
  - Normally stinging but not painful stimuli (stiff von Frey hair) evoke pain
  - Present in the primary affected zone and spread beyond into unaffected skin areas (secondary zone)
- Dynamic mechanical allodynia
  - Gentle moving stimuli at the skin (brush) evoke pain
  - Present in the primary affected zone and spread beyond into unaffected skin areas (secondary zone)
- Warm allodynia, heat hyperalgesia
  - Warm or heat stimuli at the skin evoke pain
  - Present in the area of affected (damaged or sensitized) primary afferent nerve endings (primary zone)
- Cold allodynia
  - Cold stimuli at the skin evoke pain
  - Characteristic of post-traumatic neuralgia and some polyneuropathies



- Temporal summation
  - Repetitive application of identical single noxious stimuli (interval <3 s) is perceived as increasing pain sensation

### Quantitative Sensory Testing (QST) in Neuralgia

A bedside testing should be part of the physical examination to confirm e.g. loss of afferent function, as well as evoked pain symptoms (e.g. allodynia and hyperalgesia), i.e. dynamic mechanical allodynia (cotton swab). Additionally standardized psychophysical tests (von Frey hairs, thermotest) should be used to detect impairment and changes in warm and cold sensation as well as heat and cold pain thresholds. By these means the function of small myelinated and unmyelinated afferent fibers is assessed.

So far, no characteristic sensoric pattern of patients with neuralgia has been identified. However, the analysis is useful to determine and quantify the individual signs of each patient and to document successful response to treatment.

### References

1. Baron R (2000) Peripheral neuropathic pain: from mechanisms to symptoms. *Clin J Pain* 16:12–20
2. Baron R, Levine JD, Fields HL (1999) Causalgia and reflex sympathetic dystrophy: Does the sympathetic nervous system contribute to the generation of pain? *Muscle Nerve* 22:678–95
3. Baron R, Fields HL, Janig W et al. (2002) National Institutes of Health Workshop: reflex sympathetic dystrophy / complex regional pain syndromes –state-of-the-science. *Anesth Analg* 95: 812–816
4. Burchiel KJ (2003) A new classification for facial pain. *Neurosurgery* 53:1164–1166; discussion 1166–1167
5. Dworkin RH, Portenoy RK (1994) Proposed classification of herpes zoster pain. *Lancet* 343:1648
6. Fields HL (1996) Treatment of trigeminal neuralgia. *N Engl J Med* 334:1125–1126
7. Fields HL, Rowbotham M, Baron R (1998) Postherpetic neuralgia: irritable nociceptors and deafferentation. *Neurobiol Disease* 5:209–227
8. Janig W, Baron R (2003) Complex regional pain syndrome: mystery explained? *Lancet Neurol* 2:687–697
9. Kapur N, Kamel IR, Herlich A (2003) Oral and craniofacial pain: diagnosis, pathophysiology, and treatment. *Int Anesthesiol Clin* 2003 41:115–150
10. Merskey H, Bogduk N (1994) Classification of chronic pain: descriptions of chronic pain syndromes and definition of terms, 2nd edn. IASP Press, Seattle
11. Wahren LK, Torebjörk E (1992) Quantitative sensory tests in patients with neuralgia 11 to 25 years after injury. *Pain* 48:237–44
12. Wahren LK, Torebjörk E, Nystrom B (1991) Quantitative sensory testing before and after regional guanethidine block in patients with neuralgia in the hand. *Pain* 46:23–30
13. Wahren LK, Gordh T Jr, Torebjörk E (1995) Effects of regional intravenous guanethidine in patients with neuralgia in the hand; a follow-up study over a decade. *Pain* 62:379–385
14. Wasner G, Backonja MM, Baron R (1998) Traumatic Neuralgias: Complex Regional Pain Syndromes (Reflex Sympathetic Dystrophy and Causalgia): Clinical Characteristics, Pathophysiological Mechanisms and Therapy. *Neurol Clin* 16:851–868

## Neuralgia, Diagnosis

JAYANTILAL GOVIND

Department of Anesthesia, Pain Clinic, Liverpool Hospital, University of New South Wales, Sydney, NSW, Australia  
jaygovind@bigpond.com

### Synonyms

Neurodynia

### Definition

Pain in the distribution of a nerve, ostensibly due to an intrinsic disorder of that nerve (Merskey and Bogduk 1994).

### Characteristics

The taxonomical distinction between ► **neuralgia** and ► **neuropathic pain** is contentious. The distinction is largely historical, in that the classical neuralgias were named before the entity of neuropathic pain was popularised. Nevertheless, certain semantic, anatomic, and pathologic distinctions apply.

The term – neuralgia – explicitly means pain along a nerve. It neither identifies the aetiology, pathophysiology nor any specific feature e.g. pain quality. Neuropathic pain implies that the affected nerve has a disease, and typically it is associated with features of abnormal nerve function, such as numbness, hyperaesthesia, or allodynia. These latter features are characteristically absent in neuralgias, or are subtle and minor.

Neuralgia should also be distinguished from ► **radicular pain**. Although similar to neuralgia in some respects clinically, radicular pain has certain distinguishing features clinically, and with respect to aetiology and mechanisms (see ► **radicular pain**).

### Archetypical Conditions

There are two archetypical conditions that are different from one another in many respects; and each is representative of other, less common conditions. These are: ► **trigeminal neuralgia**, and its relatives glossopharyngeal and vagal neuralgia; ► **post-herpetic neuralgia**, which is probably a unique condition, and which may exemplify other dorsal root ganglionopathies, such as tabes dorsalis, and possibly Guillan-Barre syndrome.

### Site of Lesion

In trigeminal neuralgia the lesion is in the sensory root. It is not in the ganglion or in the peripheral nerve.

In post-herpetic neuralgia the lesion is largely in the dorsal root ganglion, but may also extend into the peripheral and central nervous systems.

### Histopathology

Trigeminal neuralgia is a focal disorder of the cell membrane of the sensory root of the nerve. Focal demyelination is the primary pathology, located between the ganglion and the dorsal root entry zone of the nerve into the brainstem (Kerr 1967). The remainder of the root is normal (Rappaport et al. 1997). In the majority of cases demyelination is due to irritation of the sensory root by an aberrant blood vessel, typically, the superior cerebellar artery (Loeser 2001). Other causes include: aberrant veins, angiomas, and tumours of the posterior cranial fossa. Intrinsic demyelination may occur in patients with multiple sclerosis.

In post-herpetic neuralgia the fundamental pathology is intrinsic inflammation of the affected dorsal root ganglion. In time, inflammation is replaced by axonal degeneration. Demyelination, degeneration, and fibrosis occur in the dorsal root ganglion, associated with atrophy of the dorsal horn and the dorsal root, which may extend distally into the peripheral nerve, with loss of axons and a lymphocytic response (Watson et al. 1991).

### Pathophysiology

In trigeminal neuralgia, areas of demyelination act as a site for generation of ectopic impulses (“ectogenesis”) and/or abnormal impulse traffic. The ignition hypothesis (Devor et al. 2002) calls for ectopic generation of action potentials. The Calvin model only requires abnormal refractory periods and reflection of normally generated impulses (Calvin et al. 1977). In both models the location of the lesion proximal to the ganglion seems critical. This allows impulses to reflect between the lesion and ganglion, which becomes the basis for the characteristic reverberation of the pain.

In post-herpetic neuralgia, inflammation of the affected nerve may cause pain on the basis of neuritis, but progressive necrosis of peripheral axons and the cell bodies in the dorsal root ganglion may result in deafferentation and disinhibition of dorsal horn neurons. Thereby, post-herpetic neuralgia converts from a peripheral neuropathic pain to a ► [central pain](#).

### Epidemiology

The incidence of trigeminal neuralgia is estimated to be four per 100,000 persons per year (Katusic et al. 1990). Risk factors include multiple sclerosis and hypertension (Katusic et al. 1990). There is a weak association with multiple sclerosis, but multiple sclerosis could be an incidental finding given that vascular compression of the trigeminal root has been reported in individuals as young as seventeen years (Katusic et al. 1991).

Whilst few children develop post-herpetic neuralgia, the risk of contracting this disorder and the intractability of pain increases with age. This susceptibility is attributed to a selective decline in cellular immunity to varicella virus; and recurrences are strongly related to immuno-

suppressive conditions such as HIV and SLE (Head and Campbell 1900).

### Clinical Features

Trigeminal neuralgia is characterised by electric shock-like brief stabbing pains, with pain-free intervals between attacks, during which the patient is completely asymptomatic. Onset is usually abrupt. Pain is restricted to the trigeminal nerve distribution, and idiopathic trigeminal neuralgia is not associated with sensory loss. Non-nociceptive triggering of the pain (light touch, hair movement, chewing, speech, wind puffs) is almost ipsilateral to the pain, and usually from the peri-oral region. Intra-oral trigger zones may be accompanied by a decline in general health.

Patients with PHN present with a constellation of painful sensations including burning, dysaesthesia, aching, itching, or severe paroxysmal of stabbing pain. Allodynia or hyperpathia may occur, and the sensitivity to touch is the most distressing feature to patients. These various features are consistent with loss of nerve fibres, of all types, and ultimately with central disinhibition.

### Treatment

Although trigeminal neuralgia and post-herpetic neuralgia are both called neuralgias, they differ in pathology and pathophysiology. Consequently, they respond differently to treatment. There is no treatment universally applicable to all neuralgias. To be effective treatment should target the known pathomechanisms.

Since trigeminal neuralgia is a membrane disease, membrane-stabilisers (anti-convulsants) are the treatment of first choice. Classical agents include: phenytoin, clonazepam, and carbamazepine. Of these, only carbamazepine has been vindicated in placebo-controlled trials. Baclofen may be used an adjunct, if required. For resistant cases, gabapentin, and lamotrigine are reputedly effective, as is intravenous lignocaine (Sindrup and Jensen 2002).

When the condition is refractory to pharmaceuticals, various surgical interventions are known to be effective. The choice lies with the preference of the operator. They include ganglionolysis, radiofrequency neurotomy, balloon compression, or injection of glycerine or alcohol; and microvascular decompression (see ► [Dorsal root ganglionectomy and dorsal rhizotomy](#)).

For post-herpetic neuralgia, amitriptyline is the drug of first choice (Watson and Evans 1985). It is the only agent for which there is consistent and strong evidence of efficacy, from controlled trials. However, only about 60% of patients obtain reasonable benefit. For resistant cases, a large variety of interventions have been recommended, but few with evidence of efficacy (Kingery 1997). Gabapentin and opioids appear to be effective for resistant cases (Watson 2000). In contrast to their efficacy for trigeminal neuralgia, baclofen,

**Neuralgia, Diagnosis, Table 1** Similarities and differences between trigeminal neuralgia, post-herpetic neuralgia, and radicular pain

DOMAIN	TRIGEMINAL NEURALGIA	POST-HERPETIC NEURALGIA	RADICULAR PAIN
Anatomical site	sensory root	<b>dorsal root ganglion</b>	<b>dorsal root ganglion</b>
Key pathology	demyelination	<b>inflammation</b>	<b>inflammation</b>
Aetiology	<b>extrinsic</b>	intrinsic	extrinsic
Mechanism	reverberating impulses	disinhibition	ectopic discharge
Site	pre-central	central	peripheral
Pain	paroxysmal	constant, burning	intermittent, lancinating
Associated	trigger point	allodynia	nil
Neurological	normal	<b>sensory loss</b>	<b>sensory loss</b>
Treatment	<b>decompression</b> neuro-ablation		<b>decompression</b>
	anticonvulsants	tricyclics	steroids

Bold text indicates features shared by two of the conditions, otherwise features are unique and distinctive

phenytoin, and carbamazepine are usually not helpful in post-herpetic neuralgia (Kingery 1997).

Topical applications of local anaesthetic or capsaicin can be used to palliate the cutaneous sensory symptoms, but these interventions do not target the fundamental mechanism of post-herpetic neuralgia. Topical capsaicin has been vindicated in a placebo-controlled trial (Watson et al. 1993). In extreme cases, surgical interventions can be undertaken (see ► [Dorsal root ganglionectomy and dorsal rhizotomy](#)).

### Comparison

Whilst the ► [neuralgias](#) share certain features, they also share some features with radicular pain, but are distinct in others (Table 1). The similarities invite some practitioners to assume that the conditions belong to the same class, and should respond to the same treatments. However, the differences in pathology and mechanisms predicate distinctly different responses to treatment. Appreciating these differences is pivotal to successful management. Treatments that work for one type of neuralgia, will not work for another. Nor do treatments commonly used for neuralgias work for radicular pain.

### References

- Calvin WJ, Loeser JD, Howe JF (1977) A Neurophysiological Theory for the Pain Mechanism of Tic Douloureux. *Pain* 3:147–154
- Devor M, Amir R, Rappaport ZH (2002) Pathophysiology of Trigeminal Neuralgia: The Ignition Hypothesis. *Clin J Pain* 18:4–13
- Head H, Campbell AW (1900) The Pathology of Herpes Zoster and its Bearing on Sensory Localisation. *Brain* 23:323–353
- Katusic S, Beard M, Bergstralh MS, Kurland LT (1990) The Incidence and Clinical Features of Trigeminal Neuralgia. Rochester, Minnesota, 1945–1984. *Ann Neurol* 27:89–95
- Katusic S, Williams DB, Beard M, Bergstralh EJ, Kurland LT (1991) Epidemiology and Clinical Features of Idiopathic Trigeminal Neuralgia and Glossopharyngeal Neuralgia; Similarities and Differences, Rochester, Minnesota, 1945–1984. *Neuroepidemiology* 10:276–281
- Kerr SWL (1967) Pathology of Trigeminal Neuralgia: Light and Electron Microscopic Observation. *J Neurosurg* 26 (suppl 6):151–156
- Kingery W (1997) A Critical Review of Controlled Trials for Peripheral Neuropathic Pain and Complex Regional Pain Syndromes. *Pain* 73:123–139
- Loeser JD (2001) Cranial Neuralgias. In: Loeser JD (ed) *Bonica's Management of Pain*. Lippincott, Williams & Wilkins, Philadelphia, pp 855–866
- Merskey H, Bogduk N (1994) Classification of Chronic Pain. Descriptions of Chronic Pain Syndromes and Definitions of Pain Terms. International Association for the Study of Pain. IASP Press, Seattle
- Rappaport ZH, Govrin-Lippmann R, Devor M (1997) An Electron Microscopic Analysis of Biopsied Samples of the Trigeminal Root taken during Microvascular Decompressive Surgery. *Stereotact Funct Neurosurg* 68 (1/4 Pt 1):182–186
- Sindrup SH, Jensen TS (2002) Pharmacotherapy of Trigeminal Neuralgia. *Clin J Pain* 18:22–27
- Watson CPN (2000) The Treatment of Neuropathic Pain: Antidepressants and Opioids. *Clin J Pain* 16:S49–S55
- Watson CPN, Deck JS, Morshead C, Van der Koog D, Evans RJ (1991) Post-Herpetic Neuralgia: Further Post-Mortem Studies of Cases with and without Pain. *Pain* 44:105–117
- Watson CPN, Evans RJ (1985) A Comparative Trial of Amitriptyline and Zimelidine in Post-Herpetic Neuralgia. *Pain* 25:387–394
- Watson CPN, Tyler KL, Bicers DR, Millikan LE, Smith S, Coleman E (1993) A Randomized Vehicle-Controlled Trial Capsaicin in the Treatment of Post-herpetic Neuralgia. *Clin Ther* 15:510–526

## Neuralgia of Cranial Nerve V

### ► Tic and Cranial Neuralgias

## Neuralgia of Cranial Nerve VII

- ▶ Tic and Cranial Neuralgias

## Neuralgia of Cranial Nerve IX with or without Cranial Nerve X

- ▶ Tic and Cranial Neuralgias

## Neuraxial Blocks

### Definition

Neuraxial blocks or central neural blockade comprise of intrathecal (spinal) and epidural (cervical, thoracic, lumbar and caudal) blocks. They are the most widely used regional blocks. The blocks have a well-defined end-point and can be reliably produced with a single injection. Most neuraxial blocks are performed in the lumbar region. The arachnoid membrane is a delicate, non-vascular membrane that is closely attached to the outermost layer, the dura mater. Deep to the arachnoid membrane and between the arachnoid mater and the pia mater lies the intrathecal or subarachnoid space. It contains cerebrospinal fluid, the spinal nerve roots, a trabecular network between the two membranes, blood vessels that supply the spinal cord, and the lateral extensions of the pia mater, the dentate ligaments. The epidural space surrounds the dural mater sac. Anteriorly, it is bound by the posterior longitudinal ligament; posteriorly by the ligamenta flava and the periosteum of the laminae; and laterally by the pedicles and the intervertebral foramina with their neural roots. Cranially, the epidural space is closed at the foramen magnum where the spinal dura attaches with the endosteal dura of the cranium. Caudally, the epidural space ends at the sacral hiatus that is closed by the sacrococcygeal ligament. The epidural space contains loose areolar connective tissue, fat, lymphatics, arteries, a plexus of veins, and the spinal nerve roots as they leave the dural sac and pass through the intervertebral foramina. The epidural space communicates freely with the paravertebral space through the intervertebral foramina.

- ▶ [Multimodal Analgesia in Postoperative Pain](#)

## Neuraxial Infusion

### Definition

Neuraxial infusion is the delivery of medications via a catheter inserted into the epidural or intrathecal space.

- ▶ [Cancer Pain Management, Anesthesiologic Interventions, Spinal Cord Stimulation, and Neuraxial Infusion](#)

## Neuraxial Morphine

### Definition

Morphine administered into the cerebrospinal fluid (or epidurally) to reach the spinal cord directly, causing profound analgesia.

- ▶ [Postoperative Pain, Acute Pain Team](#)

## Neuraxis

### Definition

Neuraxis is the term that refers to the entire nervous system, from receptors in periphery to spinal cord and to the subcortical structures and cortex of the brain.

- ▶ [Hypoalgesia, Assessment](#)
- ▶ [Hypoesthesia, Assessment](#)

## Neurectomy

### Definition

Neurectomy is the removal of part of a nerve, implying surgery. This usually refers to the distal, or nerve portion farthest from the brain.

- ▶ [Cancer Pain Management, Neurosurgical Interventions](#)
- ▶ [Trigeminal Neuralgia, Diagnosis and Treatment](#)

## Neuritis

- ▶ [Inflammatory Neuritis](#)

## Neuroablation

### Definition

Neuroablation is an irreversible surgical technique that permanently blocks nerve pathways to the brain by destroying nerves and tissues at the source of the pain. This may be caused by various means, such as thermal or chemical, and occur in various places, such as in peripheral nerve or the brain.

- ▶ [Dorsal Root Ganglionectomy and Dorsal Rhizotomy](#)
- ▶ [Trigeminal Neuralgia, Diagnosis and Treatment](#)



## Neuroactive Substance

### Definition

A substance that can activates cells of the nervous system.

- ▶ Cytokines, Regulation in Inflammation

## Neuroaxial

### Definition

The epidural and intrathecal (spinal) spaces. Neuroaxial analgesic/anesthetic techniques involve the administration of agents into these spaces.

- ▶ Postoperative Pain, Appropriate Management

## Neuro-Behçet

### Definition

Behçet's disease with neurologic manifestations.

- ▶ Headache Due to Arteritis

## Neurobehavioral Scores

### Definition

Neurobehavior testing is a means of assessing neurologic status of the neonate. The United States Food and Drug Administration has mandated the use of a neurobehavior test to assess the neonatal effects of medications on the newborn. The neurologic and adaptive capacity score (NACS) was developed for this purpose and is commonly used in research studies by anesthesiologists.

- ▶ Analgesia During Labor and Delivery

## Neurochemical Markers

- ▶ Immunocytochemistry of Nociceptors

## Neurochemistry

- ▶ Immunocytochemistry of Nociceptors

## Neurodegeneration

### Definition

Neurodegeneration is the continuous and progressive dying of neurons.

- ▶ Viral Neuropathies

## Neurodynia

- ▶ Neuralgia, Diagnosis

## Neurofilament Protein NF200

### Definition

Neurofilaments are a class of intermediate filaments that are found in neurons. They form the structure of the cytoskeleton and are particularly abundant in axons. DRG neurons express low (68 kD), medium (155 kD) and high (200 kD) molecular weight neurofilament proteins. Large light DRG neurons are rich in expression of neurofilaments, especially the high molecular weight (200 kD) protein, whereas the small dark neurons are poor in expression of neurofilaments. The phosphorylated form, the 200 kD neurofilament, is localized specifically to the large light cell population, and therefore, the presence of immunoreactivity for this protein can be used to distinguish large light cells from small dark cells. Since a low level of non-phosphorylated 200 kD neurofilament is found in small and large neurons, an antibody against the non-phosphorylated form of the 200 kD subunit does not distinguish well between the large light and small dark neurons.

- ▶ Immunocytochemistry of Nociceptors

## Neurogenic Claudication

- ▶ Lower Back Pain, Physical Examination

## Neurogenic Inflammation

### Definition

A subset of nociceptive A $\delta$  and C afferents contain pro-inflammatory neuropeptides (mainly "sleeping" nociceptors). If a peptidergic C fiber is activated, it releases neuropeptides from all the nerve terminals, which belong to this C fiber (axonal tree). Since always more than one C fiber will be activated by noxious stimulation, a homogenous area of neurogenic inflammation in the vicinity of the painful stimulus occurs. Release of

these neuropeptides upon nociceptive activation causes inflammatory responses consisting of protein ► **plasma extravasation** (edema; mainly induced by substance P and neurokinin A) and vasodilatation (mainly mediated by CGRP). Endothelial activation and secretion, degranulation of perivascular mast cells and the attraction of leucocytes has additionally been observed in some tissues like the dura mater. This reaction was first described as the axon reflex by Thomas Lewis, and underlies the flare and wheal response often seen surrounding local tissue damage.

- Arthritis Model, Adjuvant-Induced Arthritis
- Cytokines, Effects on Nociceptors
- Formalin Test
- Freezing Model of Cutaneous Hyperalgesia
- Functional Imaging of Cutaneous Pain
- Inflammation, Modulation by Peripheral Cannabinoid Receptors
- Mechano-Insensitive C-Fibres, Biophysics
- Neurogenic Inflammation and Sympathetic Nervous System
- Nociceptor, Axonal Branching
- Nociceptors in the Orofacial Region (Meningeal/Cerebrovascular)
- Quantitative Thermal Sensory Testing of Inflamed Skin
- Substance P Regulation in Inflammation
- Sympathetically Maintained Pain and Inflammation, Human Experimentation

---

## Neurogenic Inflammation and Sympathetic Nervous System

HEINZ-JOACHIM HÄBLER  
FH Bonn-Rhein-Sieg, Rheinbach, Germany  
heinz-joachim.haebler@fh-bonn-rhein-sieg.de

### Synonyms

Neurogenic inflammation, sympathetic nervous system

### Definition

There is evidence that ► **neurogenic inflammation** may be influenced by the sympathetic nervous system. This evidence is based on experiments, mainly on animals, in which neurogenic inflammation was elicited by chemical activation of nociceptors, and the extent of either ► **plasma extravasation** (neurogenic edema) or vasodilation (flare) was measured before and after interventions on the sympathetic nervous system. Pharmacological experiments indicate that the interaction between sympathetic neurons and primary afferent neurons, which may be responsible for sympathetic modulation of neurogenic inflammation, can take place proximal and/or distal to the neurovascular junction, i.e. prejunctionally on the nociceptor terminal, and/or

postjunctionally at the level of the blood vessels. Only a prejunctional interaction can specifically modulate ► **neuropeptide** release from small-diameter afferent terminals, whereas at the postjunctional level, the interaction would occur non-specifically and indirectly via changes in blood flow. However, both modes of interaction may be difficult to distinguish in experiments. Here only sympathetic modulation of neurogenic inflammation is considered likely to occur at the prejunctional level.

### Characteristics

#### Capsaicin-Induced Neurogenic Inflammation in Skin

In healthy humans, after topical application of ► **capsaicin** to forearm skin, the area of flare was significantly decreased during whole-body cooling, which enhances sympathetic vasoconstrictor activity to the skin (Baron et al. 1999). However, capsaicin-induced pain and ► **mechanical hyperalgesia** were not changed, indicating an inhibitory effect of sympathetic activity on the signs of neurogenic inflammation, but not on the corresponding pain symptoms.

In contrast, in animal experiments, the flare response after intradermal capsaicin was found to be partially dependent on the sympathetic nervous system. It was reported that capsaicin injected intradermally into the hind paw of rats elicits dorsal root reflexes in peptidergic afferents, which antidromically evoke vasodilation outside the axon reflex area, as far as 20 mm remote from the capsaicin injection site. This part of the flare response was almost abolished by surgical ► **sympathectomy**, unaffected by decentralization of the postganglionic sympathetic neurons supplying the hind paw, and depended on an  $\alpha_1$ -adrenoceptor-mediated mechanism (Lin et al. 2003). The sympathetic co-transmitter ► **neuropeptide Y (NPY)** via Y2 receptors also seemed to contribute to the flare (Lin et al. 2004). Vasopressin had no effects on the flare response, ruling out the possibility that sympathetic effects on the flare were indirectly due to the evoked cutaneous vasoconstriction. These findings suggest that sympathetic neurons contribute to neurogenic inflammation, and that the integrity of the sympathetic terminals, but not the ongoing activity of postganglionic neurons, may be the crucial factor. Interestingly, an almost identical sympathetic dependence was reported for mechanical hyperalgesia induced by intradermal capsaicin in the same rat model. Intradermal capsaicin injection led to mechanical hyperalgesia at the injection site (► **primary hyperalgesia**) and in areas remote from the injection site (► **secondary hyperalgesia**). Capsaicin-induced secondary hyperalgesia was blocked by the  $\alpha_1$ -adrenoceptor antagonist prazosin but not by the  $\alpha_2$ -adrenoceptor antagonist yohimbine. Surgical sympathectomy before capsaicin injection prevented secondary hyperalgesia (Kinnman and Levine 1995), but decentralization of sympathetic

postganglionic neurons did not affect mechanical hyperalgesia.

### Neurogenic Inflammation of the Rat Knee Joint

Capsaicin injection into the knee joint of rats produces intraarticular plasma extravasation lasting for 30–40 min, which was found to be reduced after chemical or surgical sympathectomy (Coderre et al. 1989). This indicates that small diameter afferent-evoked plasma extravasation in the synovia is in part dependent on the sympathetic nervous system. However, release of norepinephrine from postganglionic sympathetic terminals by joint perfusion with 6-hydroxy-dopamine led to a much larger and prolonged plasma extravasation, which was almost abolished after surgical sympathectomy and after pretreatment with indomethacin, restored in the presence of prostaglandin E<sub>2</sub> but unchanged in rats treated with capsaicin neonatally. Similar results were obtained when bradykinin, instead of 6-hydroxy-dopamine, was injected into the knee joint. Decentralization of postganglionic sympathetic neurons supplying the hind limb left bradykinin-induced plasma extravasation unchanged (Miao et al. 1996). Indirect effects due to changes in blood flow resulting from interventions on the sympathetic nervous system were excluded. These observations led to the concept that neurogenic inflammation in the rat knee joint has two components: a relatively small component depending on primary afferent terminals and in part dependent on sympathetic neurons, and a second larger component depending on the presence of postganglionic sympathetic terminals but not on on-going sympathetic activity nor on capsaicin-sensitive afferents. Inflammatory mediators such as ► bradykinin are thought to release prostaglandins, and possibly other mediators from postganglionic terminals, to elicit this so-called sympathetically dependent neurogenic inflammation (Green et al. 1998).

In contrast, knee joint inflammation in rats induced by kaolin and carrageenan was found to depend, in part, on primary afferents, but was unaffected by sympathectomy (Sluka et al. 1994).

### Prejunctional Control of Neuropeptide Release from Nociceptive Afferents by Sympathetic Transmitters

It is well established that in the superficial dorsal horn, synaptic release of glutamate from small-diameter afferents is inhibited by  $\alpha_2$ -adrenoceptor agonists (e.g. Pan et al. 2002), indicating the presence of presynaptic  $\alpha_2$ -adrenoceptors. Presynaptic inhibition of nociceptors via these receptors is thought to be one mechanism by which descending monoaminergic pathways control input from nociceptors at the level of the spinal cord. The evidence that the release of neuropeptides, such as substance P and CGRP, is inhibited in parallel with that of glutamate at spinal synapses is scarce. However, *in vitro* pharmacological studies on animals indicate

that  $\alpha_2$ -adrenoceptors are also present on the peripheral terminals of capsaicin-sensitive afferents (prejunctional receptors), and inhibit stimulation-induced release of neuropeptides.

In the guinea-pig lower airways, capsaicin-sensitive afferents elicit neurogenic inflammation by liberating ► substance P, ► neurokinin A and ► CGRP. Both CGRP release and neurokinin-evoked bronchoconstriction after a low dose of capsaicin or low frequency (1 Hz) antidromic stimulation of the vagus nerve were attenuated by  $\alpha_2$ -adrenoceptor agonists (Lou et al. 1992). These inhibitory effects were small when high doses of capsaicin or high frequency (10 Hz) electrical stimulation of afferents were used. Similar experiments provided evidence for the presence of inhibitory prejunctional NPY (Y2) receptors on small-diameter afferents (see Lundberg 1996). The effects of both prejunctional  $\alpha_2$ -adrenoceptors and Y2 receptors are likely to be mediated by the opening of large conductance Ca<sup>++</sup>-activated K<sup>+</sup> channels (Stretton et al. 1992). As these observations were made on vagal rather than spinal afferents, it may be questioned whether these results can be generalized to all peptidergic small-diameter afferents.

However, results obtained in other animal models are similar. In the perfused mesenteric vascular bed of the rat, *in vitro* perivascular nerve stimulation elicits vasodilation, which depends on CGRP released from capsaicin-sensitive afferents (Kawasaki et al. 1988) that are mainly of spinal origin. Pharmacological experiments in this model indicate that norepinephrine, released from sympathetic postganglionic terminals, can suppress CGRP release from perivascular afferents by activation of prejunctional  $\alpha_2$ -adrenoceptors, and that NPY also inhibits CGRP release via prejunctional Y receptors (Kawasaki 2002). Thus, results identical to those obtained in the lower airways of the guinea-pig were found in the rat mesentery, and these were confirmed in a number of *in vitro* studies on the control of isolated autonomic targets by neuropeptides originating from capsaicin-sensitive afferents.

Taken together, evidence indicates that the release of neuropeptides, which can elicit neurogenic inflammation from the peripheral terminals of capsaicin-sensitive afferents, is inhibited via prejunctional receptors for sympathetic transmitters. However, it remains to be shown that these prejunctional receptors play any functional role in the intact organism under the conditions of physiological or pathophysiological regulation. Rates of on-going activity in sympathetic neurons are normally low, and in particular, the release of NPY from sympathetic terminals requires a high rate of on-going activity that may rarely occur *in vivo*.

In conclusion, there is evidence that neurogenic inflammation, induced by the liberation of neurokinins and CGRP from peripheral terminals of capsaicin-sensitive afferents, may be influenced by sympathetic

postganglionic neurons by a direct action on peripheral afferent terminals. However, the evidence is not yet conclusive. While in some studies capsaicin-induced neurogenic inflammation in the skin and knee joint of the rat was found to depend, in part, on sympathetic neurons, other studies indicate that there are prejunctional  $\alpha_2$ -adrenoceptors and NPY receptors on afferent terminals that may inhibit neurogenic inflammation.

## References

1. Baron R, Wasner G, Borgstedt R et al. (1999) Effect of Sympathetic Activity on Capsaicin-Evoked Pain, Hyperalgesia, and Vasodilatation. *Neurology* 52:923–932
2. Coderre TJ, Basbaum AI, Levine JD (1989) Neural Control of Vascular Permeability: Interactions between Primary Afferents, Mast Cells, and Sympathetic Efferents. *J Neurophysiol* 62:48–58
3. Green PG, Miao FJ, Strausbaugh H et al. (1998) Endocrine and Vagal Controls of Sympathetically Dependent Neurogenic Inflammation. *Ann NY Acad Sci* 840:282–288
4. Kawasaki H (2002) Regulation of Vascular Function by Perivascular Calcitonin Gene-Related Peptide-Containing Nerves. *Jpn J Pharmacol* 88:39–43
5. Kawasaki H, Takasaki K, Saito A et al. (1988) Calcitonin Gene-Related Peptide acts as a Novel Vasodilator Transmitter in Mesenteric Resistance Vessels of the Rat. *Nature* 335:164–167
6. Kinnman E, Levine JD (1995) Involvement of the Sympathetic Postganglionic Neuron in Capsaicin-Induced Secondary Hyperalgesia in the Rat. *Neuroscience* 65:283–291
7. Lin Q, Zou X, Fang L, Willis WD (2003) Sympathetic Modulation of Acute Cutaneous Flare Induced by Intradermal Injection of Capsaicin in Anesthetized Rats. *J Neurophysiol* 89:853–861
8. Lin Q, Zou X, Ren Y, Wang J et al. (2004) Involvement of Peripheral Neuropeptide Y Receptors in Sympathetic Modulation of Acute Cutaneous Flare Induced by Intradermal Capsaicin. *Neuroscience* 123:337–347
9. Lou YP, Franco-Cereceda, Lundberg JM (1992) Variable  $\alpha_2$ -Adrenoceptor-Mediated Inhibition of Bronchoconstriction and Peptide Release upon Activation of Pulmonary Afferents. *Eur J Pharmacol* 210:173–181
10. Lundberg JM (1996) Pharmacology of Cotransmission in the Autonomic Nervous System: Integrative Aspects on Amines, Neuropeptides, Adenosine Triphosphate, Amino Acids and Nitric Oxide. *Pharmacol Rev* 48:113–178
11. Miao FJ, Jänig W, Levine JD (1996) Role of Sympathetic Postganglionic Neurons in Synovial Plasma Extravasation Induced by Bradykinin. *J Neurophysiol* 75:715–724
12. Pan YZ, Li DP, Pan HL (2002) Inhibition of Glutamatergic Synaptic Input to Spinal Lamina I/II Neurons by Presynaptic  $\alpha_2$ -Adrenergic Receptors. *J Neurophysiol* 87:1938–1947
13. Sluka KA, Lawand NB, Westlund KN (1994) Joint Inflammation is Reduced by Dorsal Rhizotomy and not by Sympathectomy or Spinal Cord Transection. *Ann Rheum Dis* 53:309–314
14. Stretton D, Miura M, Belvisi MG et al. (1992) Calcium-Activated Potassium Channels Mediate Prejunctional Inhibition of Peripheral Sensory Nerves. *Proc Natl Acad Sci USA* 89:1325–1329

## Neurogenic Inflammation, Vascular Regulation

HEINZ-JOACHIM HÄBLER  
FH Bonn-Rhein-Sieg, Rheinbach, Germany  
heinz-joachim.haebler@fh-bonn-rhein-sieg.de

## Definition

► **Neuropeptides**, such as ► **neurokinins** (► **substance P**, neurokinin A) and **CGRP**, are the mediators of ► **neurogenic inflammation**. Their primary targets are blood vessels within the microvasculature where they elicit vasodilation and, by increasing the leakiness of the blood-tissue-barrier, ► **plasma extravasation**. Neurokinin effects may, in part, be mediated indirectly by the activation of mast cells and endothelial cells. At the neurovascular junction, neurokinins and ► **CGRP** interact with sympathetic neurotransmitters, vasoactive hormones and autacoids produced by the endothelium that are involved in the on-going regulation of the vasculature.

## Characteristics

### Vascular Effects of Neurokinins and CGRP

Both neurokinins and CGRP act primarily on blood vessels, but their efficacy in evoking vasodilation and plasma extravasation is different. The neurokinins substance P and neurokinin A are the main mediators of neurogenic plasma extravasation. They act on neurokinin 1 (NK1) receptors on postcapillary venules, and within seconds lead to the opening of circular gaps of about 1.5  $\mu\text{m}$  diameter between endothelial cells, exposing the basement membrane and permitting the leakage of plasma proteins into the interstitial space (McDonald 1998). In addition, substance P also degranulates mast cells, which enhances plasma extravasation by an indirect mechanism involving histamine. CGRP alone does not elicit plasma extravasation. However, it seems to cooperate with neurokinins, since it potentiates neurokinin-induced plasma extravasation, possibly resulting from its vasodilator action or from its inhibitory effect on substance P degradation (Gamse and Saria 1985, Escott and Brain 1993). Generally, neurogenic edema requires longer-lasting and higher frequency stimulation of small-diameter afferents than vasodilation, probably because neurokinin effects are short-lived and a higher amount of neuropeptides may be necessary.

The main mediator of vasodilation in neurogenic inflammation is CGRP, acting via CGRP 1 receptors. CGRP is one of the most potent vasodilators known, and upon brief stimulation of small-diameter afferents, elicits long-lasting vasodilation by relaxing small arteries, arterioles and precapillary sphincters. Most of the vasodilation, in particular during the later phase, can be blocked by the CGRP 1 receptor antagonist CGRP<sub>8-37</sub>, but part of the vasodilation remains, indicating that CGRP is not the only vasodilator involved. Substance P and neurokinin A applied exogenously also evoke strong but short-lasting vasodilation. Their role in the vasodilation elicited by adequate or electrical stimulation of small-diameter afferents has been disputed, because in animal models NK1 receptor an-



tagonists can block vasodilation evoked by exogenous substance P and neurokinin A, but no clear effects of NK1 receptor antagonists on the vasodilation evoked by stimulation of small-diameter afferents was seen (Rinder and Lundberg 1996; Delay-Goyet et al. 1992). However, in the hairy and hairless skin of the rat, it has been possible to demonstrate that an NK1 receptor antagonist can delay antidromic vasodilation elicited by electrical stimulation of small-diameter afferents by several seconds. Furthermore, the NK1 receptor antagonist potentiated the reduction of the amplitude of antidromic vasodilation by CGRP<sub>8-37</sub>, implying that substance P and/or neurokinin A play a role in the early phase of antidromic vasodilation (Häbler et al. 1999).

#### Endothelium Dependence of Vascular Neurokinin and CGRP Effects

The effects of substance P and neurokinin A, when applied exogenously, on vasodilation and plasma extravasation, are probably mediated indirectly, at least in part, via NK1 receptors located on vascular endothelium leading to the production of ► nitric oxide (NO), because these effects can be reduced by blocking NO synthesis (e.g. Whittle et al. 1989). It is, however, unclear whether the effects of neurokinins released upon adequate or antidromic electrical stimulation of small-diameter afferents are endothelium-dependent and involve NO. As perivascular nerves contact vascular smooth muscle on the adventitial side, it is an open question whether neuropeptides released at the neurovascular junction can penetrate the vascular wall to act on receptors located on the endothelium. Experimental studies addressing this issue are scarce. A study on neurogenic edema elicited by antidromic nerve stimulation in the rat found an involvement of NO in the response, but NO was generated by the neuronal isoform rather than the endothelial isoform of NO synthase (Kajekar et al. 1995). In another study on rats, the NK1 receptor dependent component of antidromic vasodilation was unaffected by blocking NO synthesis (Häbler et al. unpublished).

In contrast to the neurokinins, CGRP, applied exogenously or released from small-diameter afferents, exerts its vascular effects in a manner independent of the endothelium in most vascular beds, including that of the skin. Exceptions are the rat aorta and the gastric microcirculation of the rat, where the vasodilator effects of CGRP are partially inhibited by blocking NO synthesis (Holzer et al. 1995).

#### Interaction of Sympathetic Efferents and Small-Diameter Afferents in Vascular Regulation

As the vascular bed of most organs, including skin, is regulated under physiological conditions by low-frequency on-going activity in sympathetic vasoconstrictor fibers, the question arises, how this activity interferes with small-diameter afferent-induced vasodi-

lation. In human skin, antidromic vasodilation evoked by transcutaneous electrical stimulation was decreased under the conditions of body cooling, which raises sympathetic vasoconstrictor activity to skin. This effect was abolished by an anesthetic block of the proximal nerves supplying the skin territory. Other stimuli that are known to increase sympathetic vasoconstrictor activity to skin, such as deep breaths or emotional stress, also transiently reduced antidromic vasodilation (Hornyak et al. 1990). In rat hairless skin, antidromic vasodilation elicited by brief stimulation of the corresponding dorsal root was able to override the vasoconstriction evoked by electrical stimulation of the sympathetic chain, up to a frequency of 3 Hz. Higher sympathetic frequencies suppressed antidromic vasodilation, but this suppression could be overcome by longer-lasting stimulation of the afferents at high frequency (Häbler et al. 1997). These studies show that the vasodilation elicited by thin afferents is likely to dominate over sympathetic vasoconstriction under almost all conditions of normal regulation, and may be reduced only when sympathetic vasoconstrictor activity is exceptionally high. Pharmacological experiments indicate that the interaction of both neural vasomotor systems occurs mainly at the postjunctional level, but inhibitory prejunctional  $\alpha_2$ -adrenoceptors on peripheral terminals of small-diameter afferents may also be involved.

#### Implication of Neuropeptides Derived from Small-Diameter Afferents in Systemic Vascular Regulation

Neuropeptides are released from small-diameter afferents, not only in the context of noxious stimulation and local neurogenic inflammation, but they also appear in the systemic circulation, where they may be of importance for vascular regulation under physiological and pathophysiological conditions. Without any overt noxious stimulation, CGRP is present in the plasma of humans, and CGRP levels increase during exercise (Lind et al. 1996) and in patients with sepsis (Shimizu et al. 2003) and severe hypertension (Edvinsson et al. 1992). Studies on spontaneously hypertensive rats suggest that CGRP release from perivascular nerves may be impaired, implying a role for peptidergic small-diameter afferents in the long-term control of systemic vascular resistance and blood pressure (Kawasaki 2002).

#### References

1. Delay-Goyet P, Satoh H, Lundberg JM (1992) Relative Involvement of Substance P and CGRP Mechanisms in Antidromic Vasodilation in the Rat Skin. *Acta Physiol Scand* 146:537–538
2. Edvinsson L, Erlinge D, Ekman R et al. (1992) Sensory Nerve Terminal Activity in Severe Hypertension as Reflected by Circulating Calcitonin Gene-Related Peptide and Substance P. *Blood Pressure* 1:223–229
3. Escott KJ, Brain SD (1993) Effect of a Calcitonin Gene-Related Peptide Antagonist (CGRP<sub>8-37</sub>) on Skin Vasodilatation and Oedema Induced by Stimulation of the Rat Saphenous Nerve. *Br J Pharmacol* 110:772–776

4. Gamse R, Saria A (1985) Potentiation of Tachykinin-Induced Plasma Protein Extravasation by Calcitonin Gene-Related Peptide. *Eur J Pharmacol* 114:61–66
5. Häbler HJ, Wasner G, Jänig W (1997) Interaction of Sympathetic Vasoconstriction and Antidromic Vasodilatation in the Control of Skin Blood Flow. *Exp Brain Res* 113:402–410
6. Häbler HJ, Timmermann L, Stegmann JU et al. (1999) Involvement of Neurokinins in Antidromic Vasodilatation in Hairy and Hairless Skin of the Rat Hindlimb. *Neuroscience* 89:1259–1268
7. Holzer P, Wachter C, Heinemann A et al. (1995) Sensory Nerves, Nitric Oxide and NANC Vasodilatation. *Arch Int Pharmacodyn Ther* 329:67–79
8. Hornyak ME, Naver HK, Rydenhag B et al. (1990) Sympathetic Activity Influences the Vascular Axon Reflex. *Acta Physiol Scand* 139:77–84
9. Kajekar R, Moore PK, Brain SD (1995) Essential Role for Nitric Oxide in Neurogenic Inflammation in Rat Cutaneous Microcirculation. Evidence for an Endothelium-Independent Mechanism. *Circ Res* 76:441–447
10. Kawasaki (2002) Regulation of Vascular Function by Perivascular Calcitonin Gene-Related Peptide-Containing Nerves. *Jpn J Pharmacol* 88:39–43
11. Lind H, Brudin L, Lindholm L et al. (1996) Different Levels of Sensory Neuropeptides (Calcitonin Gene-Related Peptide and Substance P) During and After Exercise in Man. *Clin Physiol* 16:73–82
12. McDonald DM (1998) Endothelial Gaps: Plasma Leakage during Inflammation. *News Physiol Sci* 13:104–105
13. Rinder J, Lundberg JM (1996) Effects of hCGRP 8-37 and the NK<sup>1</sup>-Receptor Antagonist SR 140.333 on Capsaicin-Evoked Vasodilation in the Pig Nasal Mucosa *In Vivo*. *Acta Physiol Scand* 156:115–122
14. Shimizu T, Hanasawa K, Tani T et al. (2003) Changes in Circulating Levels of Calcitonin Gene-Related Peptide and Nitric Oxide Metabolites in Septic Patients during Direct Hemoperfusion with Polymyxin B-Immobilized Fiber. *Blood Purif* 21:237–243
15. Whittle BJ, Lopez-Belmonte J, Rees DD (1989) Modulation of the Vasodepressor Actions of Acetylcholine, Bradykinin, Substance P and Endothelin in the Rat by a Specific Inhibitor of Nitric Oxide Formation. *Br J Pharmacol* 98:646–652

## Neurogenic Pain

### Definition

A pain syndrome arising after damage to the somatosensory pathways, from peripheral nerves and dorsal roots (peripheral neurogenic pain) to the spinal cord, brainstem, thalamus and cortex as well as the fibers in-between (central neurogenic pain). The denominations deafferentation pain, dysesthetic pain, neuropathic pain (for peripheral type) and central pain are also used. Neurogenic pain is characterized by the following clinical descriptors: 1) pain localization in and around the deafferented body part, 2) pain qualities (pins and needles, electrical discharges, burning, tearing and compressive), and 3) timing of the pain: continuous, intermittent in attacks (lasting a fraction to a few seconds) or in episodes lasting more than a minute. The history and the neurological examination often reveal the evidence and signs of somatosensory damage (hypoesthesia and hypoalgesia). The examination may, however, be normal in some patients if the deficits have been compensated over time. Neurogenic pain responds

specifically to antiepileptics and antidepressants, and represents the most frequent indication for pain surgery in the case of chronicity and resistance to non-invasive therapies.

► [Thalamotomy for Human Pain Relief](#)

## Neurogenic Pain of Joint and Muscle Origin

► [Neuropathic Pain, Joint and Muscle Origin](#)

## Neurogenic Pain, Painful Neuropathy

► [Neuropathic Pain, Diagnosis, Pathology and Management](#)

## Neurogenic Vasodilation

► [Nociceptor, Axonal Branching](#)

## Neuroglial Cells

► [Satellite Cells and Inflammatory Pain](#)

## Neuroimaging

### Definition

Neuroimaging is the production of images of the brain and/or spinal cord. It can include Computerized Tomography (CT) scanning, Magnetic Resonance Imaging (MRI), Photon Emission Computerized Tomography (SPECT) and Positron Emission Tomography (PET).

► [Amygdala, Pain Processing and Behavior in Animals](#)

## Neuroimmune Activation

### Definition

Neuroimmune activation is the adaptive, specific activation of endothelial cells, microglia, and astrocytes leading to the production of cytokines, chemokines, and the expression of surface antigens (Deleo 2001).

► [Viral Neuropathies](#)

## Neuroimmune Interaction

### Definition

Interactions between the immune system and the nervous system.

- ▶ Cytokines, Regulation in Inflammation

## Neuroinflammation

### Definition

Following an immune challenge or an injury in the nervous system, immune cells invade from the vascular system. T-lymphocytes enter the central nervous system where the microglia are activated and express major histocompatibility complexes, particularly class II (MHC II). Blood derived macrophages also become activated and encroach the perivascular space. In the dorsal root ganglia and sympathetic ganglia, where the vasculature is leakier and microglia are absent, the inflammatory response involves activation of endogenous macrophages and invasion of hematogenous ones and T-cells. The role of the immune cells is controversial. The macrophages/activated microglia are phagocytic if neuronal death occurs, but T-cells may be neuroprotective.

- ▶ Viral Neuropathies

## Neurokinin

### Definition

The tachykinins are a family of small biologically active peptides whose principle mammalian members are substance P (11 amino acids) and neurokinin (NK) A and B (10 amino acids). These peptides are derived from precursor proteins, the preprotachykinins, which are encoded by two different genes. Three receptors for tachykinins, the so-called neurokinin receptors NK1, NK2, NK3, have been cloned and characterized to have seven transmembrane spanning segments, to be coupled to G proteins and to be linked to the phosphoinositide signaling pathway. Although NK1 receptors are considered to be substance P-preferring, NK2 receptors NKA-preferring, and NK3 receptors NKB-preferring, substance P, NKA and B are full agonists at all three tachykinin receptors.

- ▶ Cancer Pain Management, Gastrointestinal Dysfunction as Opioid Side Effects
- ▶ Neuropeptide Release in Inflammation
- ▶ Neuropeptide Release in the Skin
- ▶ Substance P Regulation in Inflammation

## Neurological Deficit

### Definition

Neurological deficit refers to loss of function related to the nervous system.

- ▶ Hypoalgesia, Assessment
- ▶ Hypoesthesia, Assessment

## Neurolytic Drugs

### Definition

Neurolytic drugs (usually 50-96% ethanol or 5-7% phenol) destroy nerve cells and stop pain-impulse transmission for days to months.

- ▶ Cancer Pain Management, Anesthesiologic Interventions, Neural Blockade
- ▶ Trigeminal Neuralgia, Etiology, Pathogenesis and Management

## Neuroma

### Definition

When a nerve is cut, the fibers in the nerve distal to the cut die, while the fibers in the nerve that lie closer to the brain survive, and after some time may begin to heal. When both the nerve and its insulation have been cut and the nerve is not fixed, the growing nerve fibers may grow into a ball at the end of the cut, forming a nerve scar or neuroma. A neuroma can be painful and cause an electrical sensation when tapped (Tinel's sign). If the nerve injury was partial such that the insulation was not cut, new fibers may grow down the empty cover of the tissue until reaching a muscle or sensory receptor.

- ▶ Ectopia, Spontaneous
- ▶ Sympathetically Maintained Pain in CRPS II, Human Experimentation

## Neuroma Endbulb

### Definition

Severed axons form swollen terminal endbulbs. This usually occurs as a prelude to sprouting, but endbulbs may persist in the absence of sprouting.

- ▶ Neuroma Pain

## Neuroma Model of Neuropathic Pain

- ▶ Anesthesia Dolorosa Model, Autotomy

## Neuroma Pain

JAMES N. CAMPBELL

Department of Neurosurgery, Johns Hopkins University School of Medicine, Baltimore, MD, USA  
jcampbel@jhmi.edu

### Synonyms

Nerve Stump Pain; Pain Associated with Traumatic Nerve Injury; Traumatic Nerve Endbulb Pain

### Definition

The peripheral nerve consists of nerve fibers, supporting ► **Schwann cells** and associated elements such as blood vessels, extracellular matrix molecules and the nerve sheaths. The cell body of motor fibers (somatic and sympathetic) is in the anterior or intermedio-lateral part of the gray matter of the spinal cord, whereas the cell body of sensory fibers is contained in the paraspinal, dorsal root ganglion. When the peripheral nerve is cut, the injured fibers form terminal endbulbs and outgrowing sprouts (Fawcett and Keynes 1990; Fried et al. 1991). The nerve fibers distal to the cut are not supported by the cell body and as a result they undergo (Wallerian) degeneration. The Schwann cells survive and begin to divide, a process apparently triggered by denervation. When the denervated Schwann cells are encountered by the sprouting fibers, after nerve repair for example, regeneration proceeds in an orderly fashion. When Schwann cells guides cannot be accessed by the outgrowing sprouts, as for example happens in the event of amputation or if there is a large gap between the two ends of the severed nerve, the fibers entangle into an often bulbous mass at the proximal cut end of the nerve. This nerve end structure is known as a neuroma (Fawcett and Keynes 1990; Sunderland 1978).

### Characteristics

Neuromas go through a life-cycle as the nerve fibers continue to grow out into the adjoining tissue. The ultimate appearance of the neuroma depends on milieu, how the nerve was injured and the amount of time that has passed (Campbell 2001). When a nerve is caught by a suture, as may happen inadvertently in surgery, a swollen bulb tends to form at the site, as the outgrowing sprouts are contained by the epineurium and scar tissue. When the nerve is cut and otherwise left alone in a healthy bed of tissue, the neuroma tends to be less discrete, as the outgrowing nerve fibers may advance and spread widely through the host tissue. Variations between full regeneration and a swollen ► **neuroma endbulb** abound, however. These variations may reflect the age of the patient, the nature and point of injury, the nature of the surrounding tissue, vascularization and

genetic factors. All of these parameters can affect the fraction of severed nerve fibers that emit sprouts, the number that regenerate successfully, the number that fan out in local tissues at the nerve end and the number that become trapped within the swollen endbulb (Sunderland 1978). They *may* also affect whether the neuroma will be a source of pain. It is likely that most neuromas are not a source of pain.

Most neuromas, painful and non-painful, are due to nerve trauma caused by penetrating injuries, amputations, burns, bone fractures and surgery. Tumors and vascular insufficiency are also common causes. The location of some nerves, and perhaps their intrinsic biological properties, make them particularly prone to generating a (painful) neuroma. Entrapment may cause a neuroma if severe enough to actually sever axons. In these cases, the clinician observes a significant swelling of the nerve just proximal to the entrapment. After the entrapment is relieved the nerve fibers may regenerate. Morton's "neuroma" actually in most cases represents an entrapment neuropathy and may or may not involve neuroma formation. Pain is associated with neuromas of cutaneous nerves and of nerves that serve muscles. It is uncertain how frequently pain originating in other deep tissues and viscera is related to neuroma formation.

### Causes of Neuroma Pain

Surgeons in the past have followed the logic:

- Nerve injuries lead to neuromas.
- Nerve injuries are painful.
- *Ergo*, neuromas cause pain.

The exploration of this hypothesis has led to a richly complicated understanding of the basis of neuropathic pain. In short what we can say as of now is that yes, the neuroma is an important element in the genesis and perpetuation of pain, but that the biology of this pain goes well beyond the neuroma. A considerable amount of information has been obtained from observations on humans and on animal models, but these studies still leave unanswered questions. Most informative are electrophysiological recordings from injured nerves, from which we can say the following:

- Ectopic impulse activity in C-fibers, presumably nociceptive afferents, arises from the neuroma. Neuroma A-fibers also become abnormally active (Devor 2005).
- Abnormal spontaneous activity also arises in the dorsal root ganglion, though the prevailing data indicate that this activity is primarily in large cells that presumably give rise to A-beta (non-nociceptive) fibers (Devor 2005).
- The nociceptors that share the innervation territory of the injured nerve also become spontaneously active (Ali et al. 1999; Wu et al. 2001).



- Central abnormalities develop (e.g. in the dorsal horn) following nerve injury. It remains unclear to what extent discharges in nociceptive transmission pathways in the spinal cord and brain are dependent on peripheral inputs (Ji et al. 2003).

These considerations leave open the question of how important the neuroma itself is in generating pain. A very simple human experiment can go a long way towards resolving this issue. One may merely anesthetize the nerve injury site and determine whether the pain goes away for the duration of the block. If the pain goes away, then the neuroma generated the relevant neural signals that led to pain. If the pain does not go away, then the pain generator is elsewhere. Amazingly, there remains no comprehensive study of this question. For sure, there are cases where simply anesthetizing the neuroma gives rise to partial if not complete relief of pain. In other cases, however, pain persists (Campbell 2001).

In the instance where the neuroma does indeed directly play a role in generating pain, we still have a question of major clinical significance to consider. The neuroma may induce pain simply by virtue of (Burchiel et al. 1993) inherent spontaneous activity that arises in the nociceptors and/or it may induce pain when activated by virtue of its location. Neuromas have *mechanosensitivity* (Devor 2005; Koschorke et al. 1991; Koschorke et al. 1994). This means that mechanical stimuli applied to the neuroma produce neural activity and pain (the ► **Tinel sign**). Mechanical stimuli can arise in different ways. For example, the neuroma at the end of a stump of an amputated limb may be stimulated by the prosthesis. The neuroma infiltrating muscles or tendons in the hand or adhered to these by scar tissue may be stimulated every time the patient opens and closes his/her hand.

### Treatment Approaches

In the clinical situation, where applying a temporary local anesthetic to the neuroma convincingly removes pain, what should be done? One possibility is to simply remove the neuroma. However, neuroma resection is a misguided surgical mission. As long as the sensory nerve fibers in the proximal nerve end are connected to the dorsal root ganglion, the neuroma reforms. Thus, neuroma resection is in fact *neuroma relocation* to the position of the new nerve cut. Will neuroma relocation work? This depends. If the dominant mechanism of pain production from the neuroma is inherent spontaneous activity, relocating the neuroma would not be expected to be effective. If however, the dominant mechanism is ► **ectopic mechanosensitivity**, then neuroma relocation does indeed make sense, if it is moved to a new location less prone to mechanical stimulation. There are numerous results in the literature about neuroma relocation surgery. Reports of efficacy range from 30 to 100% (Burchiel et al. 1993; Dellon et al. 1995).

If a nerve is only partially severed, intact conducting nerve fibers and severed neuroma sprouts may intermingle forming what may be termed a “► **neuroma-in-continuity**”. Resection in this case may relieve the neuroma pain, but at the cost of residual nerve function. Nerve grafting may be feasible.

Part of the variability of neuroma pain may be due to unexpected peculiarities of the anatomy associated with the nerve’s attempts to regenerate. For example, neuromas may form on the wrong (distal) side of an injured nerve (Belzberg and Campbell 1998). Nerves routinely have nerve branches going back and forth to one another. For example, in the forearm the superficial radial nerve has nerve branches to the lateral antebrachial cutaneous nerve. A nerve branch that makes its way to the distal end of another nerve that has been severed upstream encounters denervated Schwann cells. These denervated Schwann cells appear to attract outgrowing sprouts from the intact nerve. Over time the growing fibers could make their way back upstream along the distal portion of the severed nerve to reach the distal end of the cut nerve. The surgeon would do well to consider the possibility of such scenarios in planning neuroma relocation surgery.

Neuromas may be surgically treated in other ways as well. When a major nerve is involved, the primary approach is to repair the nerve. Clinical experience and some data from experimental animals (Lancelotta et al. 2003) suggest that pain is less when the nerve successfully regenerates. This raises an interesting clinical issue. In the instance where motor recovery is not feasible, for example in the event of proximal lesions involving the lower brachial plexus or sciatic nerve, should nerve repair be considered as a means to relieve pain? The answer is a qualified yes: “qualified” because little data are available to answer this question; “yes” because the rationale is compelling and the other options are less attractive. Painful cutaneous neuromas should be treated with proximal resection (*neuroma relocation surgery*), particularly when diagnostic block indicates that the origin of pain is in the neuroma. This is because the morbidity of the surgical procedure is low, regardless of the fact that efficacy may be as low as 30% (Burchiel et al. 1993; Sunderland 1978).

Other surgical options exist. Surgical sympathectomy may be considered in cases of sympathetically maintained pain. In the case of spinal nerve injury, it might make sense to consider dorsal root rhizotomy or dorsal root ganglionectomy, though these options are notorious for late recurrence of pain. Spinal cord or direct nerve stimulation may have striking palliative benefits. Pain might subside with time. Finally standard pharmacological approaches to neuropathic pain may be useful.

### References

1. Ali Z, Ringkamp M, Hartke TV et al. (1999) Uninjured cutaneous C-fiber nociceptors develop spontaneous activity and alpha

- adrenergic sensitivity following L6 spinal nerve ligation in the monkey. *J Neurophysiology* 81:455–466
2. Belzberg AJ, Campbell JN (1998) Evidence for end-to-side sensory nerve regeneration in a human. Case report. *J Neurosurg* 89:1055–7
  3. Burchiel KJ, Johans TJ, Ochoa J (1993) The surgical treatment of painful traumatic neuromas. *J Neurosurg* 78:714–9
  4. Campbell JN (2001) Nerve lesions and the generation of pain. *Muscle Nerve* 24:1261–73
  5. Devor M (2005) Response of nerves to injury in relation to neuropathic pain. In: McMahon SL, Koltzenburg M (eds) *Wall and Melzack's Textbook of Pain*, 5th edn. Churchill Livingstone, London (in press)
  6. Dellon AL, Mont MA, Krackow KA et al. (1995) Partial denervation for persistent neuroma pain after total knee arthroplasty. *Clin Orthop Relat Res* 316:145–50
  7. Fawcett Y, Keynes R (1990) Peripheral nerve regeneration. *Ann Rev Neurosci* 13:43–60
  8. Fried K, Govrin-Lippmann R, Rosenthal F et al. (1991) Ultrastructure of afferent axon endings in a neuroma. *J Neurocytology* 20:682–701
  9. Ji RR, Kohno T, Moore KA et al. (2003) Central sensitization and LTP: do pain and memory share similar mechanisms? *Trends Neurosci* 26:696–705
  10. Koschorke G, Meyer R, Tillman D et al. (1991) Ectopic excitability of injured nerves in monkey: entrained responses to vibratory stimuli. *J Neurophysiol* 65:693–701
  11. Koschorke GM, Meyer RA, Campbell JN (1994) Cellular components necessary for mechano-electrical transduction are conveyed to primary afferent terminals by fast axonal transport. *Brain Res* 641:99–104
  12. Lancelotta MP, Sheth RN, Meyer RA et al. (2003) Severity and duration of hyperalgesia in rat varies with type of nerve lesion. *Neurosurg* 53:1200–1209
  13. Sunderland S (1978) *Nerves and Nerve Injuries*, 2nd edn. Churchill Livingstone, London
  14. Wu G, Ringkamp M, Hartke TV et al. (2001) Early onset of spontaneous activity in uninjured C-fiber nociceptors after injury to neighboring nerve fibers. *J Neurosci* 21:RC140

## Neuroma-in-Continuity

### Definition

A bulbous swelling in the nerve formed by sprouting axons that are intermixed with nerve fibers that are in continuity. The nerve appears intact to gross inspection but is swollen at the point of pathology.

- ▶ [Neuroma Pain](#)
- ▶ [Neuropathic Pain Model, Chronic Constriction Injury](#)

## Neuromatrix

### Definition

Neuromatrix is the term used by Ronald Melzack to describe a proposed cortical/subcortical network of interconnections, including the limbic system, responsible for pain. See Ronald Melzack, "Gate Control Theory: On the Evolution of Pain Concepts," *Pain Forum* 5 (1996): 128–38.

- ▶ [Ethics of Pain, Culture and Ethnicity](#)

## Neuromodulation

### Definition

The delivery of an electric current (neurostimulation) or drugs (intrathecal drug delivery systems) directly to targeted nerve fibers to treat pain.

- ▶ [Cancer Pain Management, Anesthesiologic Interventions, Spinal Cord Stimulation, and Neuraxial Infusion](#)
- ▶ [Dorsal Root Ganglionectomy and Dorsal Rhizotomy](#)
- ▶ [Stimulation Treatments of Central Pain](#)

## Neuromodulator(s)

### Definition

Neuromodulators are signaling molecules that play a role in the alteration of baseline neural activity. These neural effector molecules can increase or decrease baseline membrane activation. Examples are substance P, dynorphin, enkephalin, galanin, cholecystokinin, and bombesin.

- ▶ [Nociceptive Neurotransmission in the Thalamus](#)
- ▶ [Placebo Analgesia and Descending Opioid Modulation](#)
- ▶ [Spinothalamic Tract Neurons, Peptidergic Input](#)
- ▶ [Thalamic Neurotransmitters and Neuromodulators](#)

## Neuron

### Definition

Peripheral nociceptive neurons are afferent nerve fibers (i.e. A-delta - and C fibers) that transfer nociceptive impulses from the periphery to the dorsal horn. In the central nervous system, nociceptive neurons only respond to stimuli that are noxious or painful.

- ▶ [Allodynia \(Clinical, Experimental\)](#)
- ▶ [Drugs Targeting Voltage-Gated Sodium and Calcium Channels](#)
- ▶ [Hypoalgesia, Assessment](#)
- ▶ [Lateral Thalamic Pain-Related Cells in Humans](#)
- ▶ [Postherpetic Neuralgia, Pharmacological and Non-Pharmacological Treatment Options](#)

## Neuron Restrictive Silencer Factor

### Synonyms

NRSF

### Definition

Is a repressor that is predominantly expressed in non-neuronal cells. NRSF silences neuronal genes in non-neuronal cells by binding to the NRSE (neuron restrictive silencer element) motif.

- ▶ Substance P Regulation in Inflammation

## Neuronal Architecture

- ▶ Spinothalamic Tract Neurons, Morphology

## Neuronal Dysfunction

### Definition

Neuronal dysfunction is a state in which neurons display abnormal properties compared to those observed in normal development. For example, neuronal injuries or various neurodegenerative diseases can change normal neuronal conduction velocity or activation threshold by altering receptor distribution and properties, protein synthesis, activation of secondary messengers, etc.

- ▶ Dietary Variables in Neuropathic Pain

## Neuronal Hyperexcitability

### Definition

Increased responsiveness of central neurons; may include increased activity in response to stimulation, reduced threshold, increased afterdischarge, and expansion of receptive field size.

- ▶ Central Pain, Pharmacological Treatments
- ▶ Post-Seizure Headache

## Neuronal Release

- ▶ Opioid-Induced Release of CCK

## Neuronal Structure

- ▶ Spinothalamic Tract Neurons, Morphology

## Neuronavigation

### Definition

A stereotaxic system used for locating internal structures in 3D space without the need for fixing the patient in a stereotaxic frame.

- ▶ Motor Cortex (M1)
- ▶ Secondary Somatosensory Cortex (S2) and Insula, Effect on Pain Related Behavior in Animals and Humans

## Neuropathic Pain

### Definition

Neuropathic pain is pain initiated or caused by a primary lesion or dysfunction in the nervous system. Although neuropathic pain includes a number of different conditions some characteristics are shared: pain is often described as stabbing or burning, sensory abnormalities are common and treatment is difficult. Neuropathic (neurogenic pain) has been described in about 1% of the population. It is caused by functional abnormalities or structural lesions in the peripheral or central nervous system and occurs without peripheral nociceptor stimulation. It is caused by heterogeneous conditions unexplained by a single etiology or anatomic lesion. There are many different causes of neuropathic pain. Neuropathic pain may arise from infection/inflammation (postherpetic neuralgia, HIV-associated neuralgia, postpoliomyelitis, leprosy, interstitial cystitis, spinal arachnoiditis, acute inflammatory polyradiculopathy); non-infectious illness (multiple sclerosis, diabetic neuropathy, thalamic pain syndrome, essential vulvodinia) and pain associated with pressure/entrapment (neoplasia, trigeminal and glossopharyngeal neuralgia, carpal tunnel) and injury/trauma (surgery, complex regional pain syndrome, spinal cord injury). The etiology may be classified as localized (ischemic neuropathy, Complex Regional Pain Syndrome, phantom limb) or diffuse (toxins, AIDS, alcohol). Damage can affect the peripheral nerves, the cranial nerves, the posterior nerve roots, the spinal cord and certain regions within the brain. A variety of pain-related phenomena (mechanisms) may be operative in an individual patient necessitating mechanistic-based treatment. Patients with chronic NP are over-represented amongst those who are refractory to classic analgesic including opioid therapy. Although NP is not always opioid insensitive, the treatment of choice are tricyclic antidepressants (e.g. amitriptyline) and antiepileptic drugs (e.g. gabapentin).

- ▶ Allodynia (Clinical, Experimental)
- ▶ Alpha( $\alpha$ ) 2-Adrenergic Agonists in Pain Treatment
- ▶ Amygdala, Pain Processing and Behavior in Animals
- ▶ Cancer Pain
- ▶ Cancer Pain Management, Overall Strategy

- ▶ Cancer Pain Management, Treatment of Neuropathic Components
- ▶ Complex Chronic Pain in Children, Interdisciplinary Treatment
- ▶ COX-1 and COX-2 in Pain
- ▶ CRPS, Evidence-Based Treatment
- ▶ Deep Brain Stimulation
- ▶ Diabetic Neuropathy, Treatment
- ▶ Dorsal Root Ganglionectomy and Dorsal Rhizotomy
- ▶ DREZ Procedures
- ▶ Drugs Targeting Voltage-Gated Sodium and Calcium Channels
- ▶ GABA and Glycine in Spinal Nociceptive Processing
- ▶ Guillain-Barré Syndrome
- ▶ Human Thalamic Response to Experimental Pain (Neuroimaging)
- ▶ Hyperalgesia
- ▶ Hyperpathia
- ▶ Hypoesthesia, Assessment
- ▶ Nerve Growth Factor Overexpressing Mice as Models of Inflammatory Pain
- ▶ Neuropathic Pain, Diagnosis, Pathology and Management
- ▶ Neuropathic Pain Model, Diabetic Neuropathy Model
- ▶ Nociceptive Circuitry in the Spinal Cord
- ▶ Opioids and Reflexes
- ▶ Opioids in Geriatric Application
- ▶ Opioids in the Periphery and Analgesia
- ▶ Opioid Modulation of Nociceptive Afferents In Vivo
- ▶ Opioid Responsiveness in Cancer Pain Management
- ▶ Pain Modulatory Systems, History of Discovery
- ▶ Pain Treatment, Intracranial Ablative Procedures
- ▶ PET and fMRI Imaging in Parietal Cortex (SI, SII, Inferior Parietal Cortex BA40)
- ▶ Postherpetic Neuralgia, Pharmacological and Non-Pharmacological Treatment Options
- ▶ Postoperative Pain, Appropriate Management
- ▶ Postoperative Pain, Persistent Acute Pain
- ▶ Postoperative Pain, Postamputation Pain, Treatment and Prevention
- ▶ Rest and Movement Pain
- ▶ Retrograde Cellular Changes after Nerve Injury
- ▶ Spinal Cord Injury Pain

## Neuropathic Pain, Diagnosis, Pathology and Management

ROBERT GASSIN  
Musculoskeletal Medicine Clinic, Frankston, VIC,  
Australia  
rgassin@pen.hotkey.net.au

### Synonyms

Neurogenic Pain, Painful Neuropathy

### Definition

▶ **Neuropathic pain** is pain initiated or caused by a primary lesion or dysfunction in the nervous system (Merskey and Bogduk 1994).

This definition allows neuropathic pain to encompass disorders of either the peripheral nervous system or the central nervous system. In the present context, neuropathic pain refers to pain associated with diseases or injuries of peripheral nerves. Pain associated with disorders of the central nervous system is more specifically referred to as ▶ **central pain**, and covered separately (see ▶ **central pain**).

### Characteristics

Peripheral neuropathic pain occurs in a variety of diseases of peripheral nerves. These include: painful peripheral neuropathies, such as diabetic neuropathy, alcoholic neuropathy, and postherpetic neuralgia. It can also occur after injuries to peripheral nerves, such as avulsions, stretching or crush injury, or nerve transection.

### Diagnosis

The diagnosis of neuropathic pain is suggested by the presence of certain features revealed by the ▶ **medical history** and neurological examination (see ▶ **Diagnosis of Pain, Neurological Examination**). The history reveals certain features about the nature of the pain, and may provide a cause. The examination reveals features of loss of neurological function or exaggerated neurological function.

Neuropathic pain is commonly worse at night. It is often described as shooting, stabbing, lancinating, burning, or searing. It can be continuous, but often presents as paroxysms of pain in the absence of any identifiable stimulus. In some conditions, such as nerve entrapment syndromes, the pain follows a nerve distribution, whereas in others such as neuropathies and poststroke pain, the distribution is more diffuse and may affect more than one body region. Pain experienced in a numb or insensate site (*anaesthesia dolorosa*) is highly suggestive of the diagnosis.

Cardinal to the diagnosis are features of disturbed neurological function. These may be in the form of loss of function, such as numbness, which indicates nerve damage directly; or they may be in the form of exaggerated function, which suggest loss of inhibition, and imply nerve damage. The latter features include: hyperalgesia (increased sensitivity to noxious stimuli), hyperpathia (increase response to minimal noxious stimulation), hyperaesthesia (increased sensitivity to touch), and allodynia (touch or brush is perceived as painful). Sometimes, neuropathic pain can be accompanied by the features of ▶ **complex regional pain syndrome**, such as temperature changes in the skin, swelling, skin colour changes, and increased or decreased sweating. Patients suffering neuropathic pain commonly suffer insomnia,



anxiety, depression, and a significant deterioration in their quality of life.

The diagnosis is essentially made on the basis of these clinical features. The diagnosis is consolidated if the patient has an obvious reason to have pain, such as a nerve injury or a metabolic disorder known to cause peripheral neuropathy. Investigations, such as ► [electrodiagnostic studies](#), are not required, but may help to establish the exact aetiology in cases of peripheral neuropathy.

### Pathology

Nociceptive pain is caused by noxious stimulation of A $\delta$  fibre mechanothermal and C fibre polymodal nociceptors by algogenic substances. In contrast, neuropathic pain results from damage to, or pathological changes in, the axons of peripheral nerves.

The nature of the pathological changes leading to pain is poorly understood. Much of our understanding is based on animal models of neuropathic pain. However, the relevance of such models to the human experience of neuropathic pain, has been questioned.

The physiological and structural changes following nerve injuries have been summarised in several review articles (Siddall and Cousins 1998; Woolf and Mannion 1999). Following peripheral nerve injury, changes include:

1. Hyperexcitability and spontaneous action potential discharges from the damaged primary afferent fibres proximal to the injury, and near the dorsal root ganglion, due to an accumulation of voltage-sensitive sodium channels at the injury site and along the damaged axons;
2. Formation of neuromas where a nerve has been cut, or microneuromas where a nerve has been partially injured, which generates spontaneous action potentials in nociceptive afferents;
3. Sympathetic neo-innervation of the dorsal root ganglia of the damaged primary afferents which may lead to sympathetic activity initiating activity in sensory nerve fibres;
4. Changes in the morphology and physiological properties of dorsal horn neurones;
5. Decreased inhibitory mechanisms within the spinal cord due to several mechanisms, including a reduction of the inhibitory transmitter – GABA, and up-regulation of the expression of CCK: an inhibitor of opioid receptors, and downregulation of GABA and opioid receptors;
6. Sprouting of the central terminals of damaged A $\beta$  touch fibres from Lamina IV of the dorsal horn to lamina II, where normally only nociceptors terminate, and formation of contacts with pain transmission neurones projecting to the brain,
7. Spontaneous firing of pain transmission neurones that project to the brain but have lost their normal peripheral afferent input;

8. Death of interneurons in lamina II of the dorsal horn.

Some combination of these changes are thought to account for at least some of the clinical features of neuropathic pain conditions.

### Prevalence

Neuropathic pain has been estimated to affect at least 0.6% of the United States population (Bennett 1998). However, this is most likely to be an under-estimation, as it does not include sufferers of chronic musculoskeletal conditions such as neck and back pain, including post-surgical patients, who often present with symptoms and signs highly suggestive of neuropathic pain. The true prevalence is thought to be closer to 2%.

### Management

The management of neuropathic pain conditions is dependent on the diagnosis. For certain conditions such as nerve entrapment syndromes, management of the underlying cause of pain, whether it be malignant or non-malignant, often result in rapid improvement in symptoms. With varying degrees of success, neuromas can be resected, buried, or ligated, using a variety of neurosurgical techniques (see ► [Dorsal root ganglionectomy and dorsal rhizotomy](#)).

For most other neuropathic pain conditions, management is not as rewarding, and a multimodal approach is required.

Psychological approaches are geared at challenging and improving patterns of negative thoughts and dysfunctional attitudes, promoting healthy thoughts and emotions and encouraging reactivation, as well as educating the patient regarding their illness and in non-medical pain management strategies such as ► [relaxation](#), imagery and hypnotic techniques.

Physical therapists have a role in maximising function in deactivated patients and in assessing the potential benefit of splints and other aids.

Medical approaches often form the mainstay of treatment, and includes the use of pharmacological agents, ► [nerve blocks](#), ► [intravenous infusions](#), ► [TENS](#), ► [acupuncture](#) and ► [spinal cord stimulation](#).

Pharmacological agents can be administered topically or systemically. Several of the agents presently available for the management of neuropathic conditions are believed to act as blockers of neuronal sodium channels, or by their action on noradrenaline and serotonin re-uptake. For most neuropathic pain conditions, ► [tricyclic antidepressants](#) including amitriptyline and imipramine, and the anticonvulsant – gabapentin, are considered first-line agents. Their effectiveness has been confirmed for postherpetic neuralgia and for painful diabetic neuropathy (Bakonja et al. 1998; Graff-Radford et al. 2000; Max et al. 1987; Rowbotham et al. 1998; Sindrup et al. 1989)

There is increasing evidence for the effectiveness of topical lignocaine in relieving the pain of postherpetic neuralgia and other neuropathic pain conditions (Galer 2001; Sawynok 2003). In view of its good safety profile, this preparation is being increasingly used and gaining acceptance as a first-line agent.

Other pharmacological agents commonly used in the management of neuropathic pain include topical capsaicin, mexiletine, carbamazepine, sodium valproate, tramadol, slow release opioids, intravenous and intranasal ketamine, and subcutaneous lignocaine.

For patients with intractable pain, a programmable intrathecal drug pump allowing continuous delivery of active agents, or spinal cord stimulation are options.

## References

1. Bennett GJ (1998) Neuropathic Pain: New Insights, New Interventions. *Hosp Pract (Off Ed)* 33(10):95–10 passim; online: <http://www.hosprract.com/issues/1998/10/bennett.htm>
2. Backonja M, Beydoun A, Edwards KR, Schwartz SL, Fonseca V, Hes M, LaMoreaux L, Garofalo E (1998) Gabapentin for the symptomatic treatment of painful neuropathy in patients with diabetes mellitus. A randomized controlled trial. *JAMA* 280(21):1831–1836
3. Galer B (2001) Topical medications. In: Loeser JD (ed) *Bonica's Management of Pain*, 3<sup>rd</sup> edn. Philadelphia, Lippincott Williams & Wilkins, pp 1736–1742
4. Graff-Radford SB, Shaw LR, Naliboff BN (2000) Amitriptyline and fluphenazine in the treatment of postherpetic neuralgia. *Clin J Pain* 16:188–192
5. Max MB, Culnane M, Schafer S et al. (1987) Amitriptyline relieves diabetic neuropathy pain in patients with normal or depressed mood. *Neurology* 37:589–596
6. Merskey H, Bogduk N (1994) *Classification of Chronic Pain: Description of Chronic Pain Syndromes and Definitions of Pain Terms*, 2<sup>nd</sup> edn. IASP Press, Seattle, pp 209–214
7. Rowbotham M, Harden N, Stacey B, Bernstein P, Magnus Miller L (1998) Gabapentin for the treatment of postherpetic neuralgia. *JAMA* 280:1837–1842
8. Sawynok J (2003) Topical and Peripherally Acting Analgesics. *Pharmacol Rev* 55:1–20
9. Siddall PJ, Cousins MJ (1998) Clinical Aspects of Present Models of Neuropathic Pain. *Pain Rev* 5:101–123
10. Sindrup SH, Ejlersen B, Frøland A, Sindrup EH, Brøsen K, Gram LF (1989) Imipramine treatment in diabetic neuropathy: relief of subjective symptoms without changes in peripheral and autonomic nerve function. *Eur J Clin Pharmacol* 37:151–153
11. Woolf CJ, Mannion RJ (1999) Neuropathic Pain: Aetiology, Symptoms, Mechanisms, and Management. *Lancet* 353:1959–1964

## Neuropathic Pain, Joint and Muscle Origin

MARTIN MICHAELIS

Sanofi-Aventis Deutschland GmbH, Frankfurt/Main, Germany

[martin.michaelis@sanofi-aventis.com](mailto:martin.michaelis@sanofi-aventis.com)

## Synonyms

Neurogenic Pain of Joint and Muscle Origin; Nerve Pain of Joint and Muscle Origin

## Definition

Pain caused by a lesion or dysfunction of a dorsal root, spinal nerve or peripheral nerve trunk, that is reported by the patient to be originated in muscle or joint tissue (projected neuropathic pain).

Pain caused by a lesion or dysfunction of nerve fibers in consequence of disease processes affecting primarily non-neuronal joint or muscle tissues.

## Characteristics

A typical example of a proximal nerve lesion associated with pain felt in deep somatic tissues is lumbar radiculopathy (sciatica) evoked by herniation of an intervertebral disc. The lesion results from mechanical nerve compression in concert with localized inflammation. Depending on the lumbar root affected, the pain is predominantly felt in the low back, anterior or posterior thigh, knee or lower leg. Many patients describe their pain as aching and cramping, which are characteristics of pain arising from muscle. Others describe their pain as sharp and shooting (Dubuisson 1999). Other injuries affect nerves that supply solely muscle tissue; here the patient's pain is definitely projected neuropathic muscle pain. Examples are iatrogenic injury of a spinal accessory nerve, which occurs as a complication of radical neck dissection or cervical lymph node biopsy (London et al. 1996), and entrapment of a part of the brachial plexus, the subscapular nerve, which is a known cause of the thoracic outlet syndrome (Huang and Zager 2004). Sciatica is painful because the nerve lesion generates extra action potentials in sensory neurons. The magnitude and pattern of the evoked impulse barrage, along with the innervation territory of the affected nerve fibers, determine the quality of the pain sensation and the tissue domain where the patient feels the pain. Neuronal activity may originate in sensory neurons that are directly affected by the nerve lesion. For example, following axotomy, impulse generation occurs in the neuroma and [▶ dorsal root ganglia \(DRGs\)](#) containing axotomized neurons. Mechanisms of [▶ ectopic activity](#) generation in lesioned neurons are outlined elsewhere in this volume.

Preclinical work indicates a specific form of projected neuropathic pain of muscle origin. Following surgically induced nerve lesions in rats, muscle afferents proved to be particularly prone to developing ongoing ectopic discharges originating in DRGs, whereas cutaneous afferents did not (Michaelis et al. 2000). Muscle afferents started to produce this abnormal activity even when they were not directly injured. Lesion of neighboring nerves was sufficient, and the more neighboring afferents were lesioned, the higher were the frequency of the ectopic discharges. Some firing muscle afferents probably had nociceptive function. Ongoing activity in these afferents may therefore generate ongoing muscle pain. Ongoing activity in muscle afferents may in addition contribute

to the development of central sensitization. Intriguingly, input through small diameter muscle afferents appears to produce central sensitization of longer duration than a similar input through cutaneous C fibers, which may be of clinical relevance beyond neuropathic pain (Wall and Woolf 1984). Furthermore, nerve lesion induces increase in brain-derived neurotrophic factor (BDNF) expression in large-diameter DRG neurons (Michael et al. 1999), which may be another key factor for development of central sensitization after nerve lesion (Thompson et al. 1999).

Neuropathic pain that is exclusively projected to a joint is very unlikely, because relatively few sensory neurons supply joints compared to muscle and the likelihood that a process like disc herniation predominantly affects joint afferents is accordingly low. However, projected neuropathic pain often includes joints.

Traumatic nerve lesions are well known triggers for the generation of neuropathic pain. The final treatment option for patients with knee or hip osteoarthritis is surgical joint replacement, which inevitably destroys the distal parts of many nerve fibers, particularly those that had supplied subchondral bone of the removed joint. Intriguingly, the vast majority of patients is completely pain free or report substantial pain reduction soon after replacement surgery (McLain and Weinstein 1999). Thus, joint replacement surgery very probably does not induce neuropathic pain.

The question as to whether or not in the course of chronic painful diseases that affect primarily non-neuronal joint or muscle tissues, a neuropathic component is developing is hard to answer with certainty. This is mainly because the clinical diagnosis of neuropathic pain is difficult when an overt neurological disease (e.g. postherpetic neuralgia or traumatic lesion of a major peripheral nerve) has been ruled out. In a recent study, Rasmussen et al (2004) asked whether signs and symptoms cluster differentially in groups of patients with increasing evidence of neuropathic pain. Patients were first categorized to have definite, possible or unlikely neuropathic pain. Subsequently, patients were examined using pain descriptors, intensity of five categories of pain, questionnaires and sensory tests. This resulted in a considerable overlap concerning signs and symptoms; single pain descriptors could not distinguish between the three categories of patients (Rasmussen et al. 2004). In addition, disease markers for neuropathic pain (e.g. biochemical or functional imaging) are not available yet. Regardless, patients with painful osteoarthritis, by far the most common joint disease, or rheumatoid arthritis are traditionally said to have nociceptive or inflammatory pain, not neuropathic pain (Backonja 2003; Rasmussen et al. 2004).

What can we learn from animal models? Recently, two rat models of osteoarthritis with well-characterized

and human OA-like joint histopathology have been analyzed for pain related behavior (Combe et al. 2004; Fernihough et al. 2004). Surprisingly, at the same time that osteoarthritic joint pathology developed, a marked tactile allodynia was detected. Pharmacological investigations in one of the models, OA induced by intraarticular injection of iodoacetate, revealed that morphine and gabapentin, which are effective in the treatment of neuropathic pain, but not diclofenac were able to diminish the tactile allodynia (Combe et al. 2004; Fernihough et al. 2004). Since tactile allodynia is not a hallmark of OA symptomatology, the relevance of this preclinical result for human OA pain is unclear.

In conclusion, it is not known yet whether neuropathic pain can be caused by a lesion or dysfunction of nerve fibers that innervate joint or muscle tissues.

## References

1. Backonja MM (2003) Defining neuropathic pain. *Anesth Analg* 97:785–790
2. Combe R, Bramwell S, Field MJ (2004) The monosodium iodoacetate model of osteoarthritis: a model of chronic nociceptive pain in rats? *Neurosci Lett* 370:236–240
3. Dubuisson D (1999) Nerve root disorders and arachnoiditis. In: Wall PD, Melzack R (eds) *Textbook of pain*, 4th edn. Churchill Livingstone, New York, pp 851–878
4. Fernihough J, Gentry C, Malcangio M et al. (2004) Pain related behaviour in two models of osteoarthritis in the rat knee. *Pain* 112:83–93
5. Huang J, Zager EL (2004) Thoracic outlet syndrome. *Neurosurgery* 55:897–902
6. London J, London NJ, Kay SP (1996) Iatrogenic accessory nerve injury. *Ann R Coll Surg Engl* 78:146–150
7. McLain RF, Weinstein JN (1999) Orthopedic surgery. In: Wall PD, Melzack R (eds) *Textbook of pain*, 4th edn. Churchill Livingstone, New York, pp 1289–1306
8. Michael GJ, Averill S, Shortland PJ et al. (1999) Axotomy results in major changes in BDNF expression by dorsal root ganglion cells: BDNF expression in large trkB and trkC cells, in pericellular baskets, and in projections to deep dorsal horn and dorsal column nuclei. *Eur J Neurosci* 11:3539–3551
9. Michaelis M, Liu X, Jänig W (2000) Axotomized and intact muscle afferents but no skin afferents develop ongoing discharges of dorsal root ganglion origin after peripheral nerve lesion. *J Neurosci* 20:2742–2748
10. Rasmussen PV, Sindrup SH, Jensen TS et al. (2004) Symptoms and signs in patients with suspected neuropathic pain. *Pain* 110:461–469
11. Thompson SW, Bennett DL, Kerr BJ et al. (1999) Brain-derived neurotrophic factor is an endogenous modulator of nociceptive responses in the spinal cord. *Proc Natl Acad Sci USA* 96:7714–7718
12. Wall PD, Woolf CJ (1984) Muscle but not cutaneous C-afferent input produces prolonged increases in the excitability of the flexion reflex in the rat. *J Physiol* 356 443–458

## Neuropathic Pain Model, Anesthesia Dolorosa Model

► Anesthesia Dolorosa Model, Autotomy

## Neuropathic Pain Model, Chronic Constriction Injury

CLAUDIA SOMMER

Department of Neurology, University of Würzburg, Würzburg, Germany  
sommer@mail.uni-wuerzburg.de

### Synonyms

Bennett Model; chronic constrictive injury; CCI

### Definition

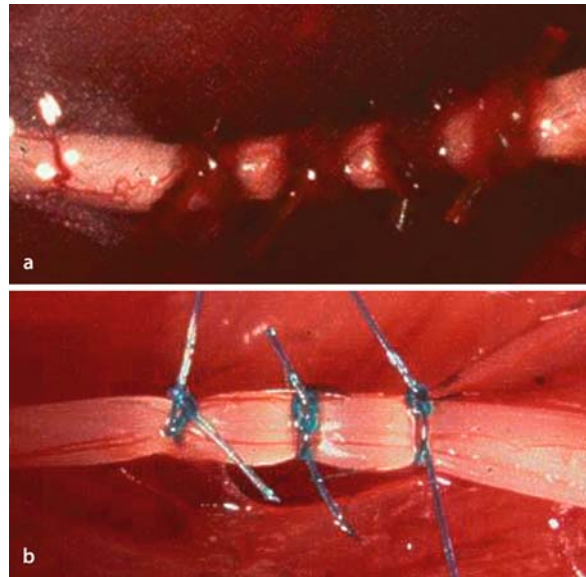
The ► **chronic constriction injury** (CCI) is a partial nerve injury, mostly used in rodents, which is produced by tying several ligatures around a nerve, such that these ligatures slightly constrict the nerve. This induces an incomplete nerve injury, which entails behavioral signs of ► **hyperalgesia** in the animals.

### Characteristics

#### Animals, Technique, and Behavioral Data

Originally, the model was established in rats (Bennett and Xie 1988), but it has since been successfully used in mice (Sommer et al. 1997). Most often, the sciatic nerve is constricted, other nerves that have been used are the infraorbital nerve (Vos et al. 1994) and the median nerve (Day et al. 2001). The nerve is exposed by blunt dissection of the overlying muscles and several ligatures are tied around it such that they slightly constrict the nerve. Originally, four 4.0 chromic gut ligatures were used to constrict the sciatic nerve, which were tied around the nerve above the trifurcation with a spacing of 1 mm (Fig. 1a).

Many investigators have since used modifications of the model, either varying the number of ligatures (between two and four) or the type of ligatures (e.g. silk or vicryl). In mice, prolene (7.0 to 10.0) has been used (Fig. 1b). In spite of minor differences, with most variations it has been possible to produce a reliable model of neuropathic pain. The degree of constriction may be more important than the type of suture in determining the degree and duration of behavioral signs, concomitantly with the degree of nerve injury and the time needed for regeneration (Myers et al. 1993; Lindenlaub and Sommer 2000). The measure of constriction is defined as to 'just barely constrict' the nerve and to retard, but not arrest circulation through the epineurial vessels (Bennett and Xie 1988). Typically, this type of constriction is associated with a short twitch of the respective limb of the animal. In the original description, paw withdrawal latencies to heat returned to normal between 60 and 90 days after the injury (Bennett and Xie 1988). In another early study, guarding behavior, increased responses to heat, cold and pressure returned to normal between six and eight weeks after the injury (Attal et al. 1990), which is very much what most



**Neuropathic Pain Model, Chronic Constriction Injury, Figure 1** (a) Rat sciatic nerve. Four chromic gut sutures are tied around the nerve to produce a CCI. (b) Example of CCI in mouse sciatic nerve using three prolene 8.0 ligatures.

investigators report. Some investigators report mechanical allodynia tested with von Frey hairs to occur less reliably in CCI compared to other models (Kim et al. 1997), however, this is in contrast to our own experience.

### Neuropathology

Obviously, the amount of nerve damage depends upon the degree of nerve constriction by the ligatures, which makes the model quite variable between laboratories. Even if the initial constriction is only slight, the nerve develops edema, self-strangulates between the ligatures and thus develops additional damage. The temporal course of neuropathology of rat sciatic nerve with CCI has been extensively investigated (Munger et al. 1992; Coggeshall et al. 1993; Guilbaud et al. 1993; Sommer et al. 1993; Sommer et al. 1995). In summary, CCI induces the typical process of ► **Wallerian degeneration**. Most myelinated fibers, and about two thirds of the unmyelinated fibers degenerate, with maximum nerve damage during the first two weeks and a slow regeneration which is still incomplete three months after the injury. Remaining long-term changes include the formation of minifascicles and ► **neuroma-in-continuity**. Whereas endoneurial macrophages reflect axonal degeneration and phagocytosis, epineurial macrophages are the result of the foreign body reaction induced by the ligatures, which is one aspect in which CCI differs from models not using foreign material, like crush or partial sciatic nerve transection (Lindenlaub and Sommer 2000). Whether this epineurial inflammation plays a major role in the development of hyperalgesia is still a matter of debate.



CCI induces a large number of anatomical and neurochemical changes in the ► **DRG**, in the spinal cord, and possibly in the CNS. These include sprouting of sympathetic fibers in the DRG, changes in gene expression in DRG neurons, activation of spinal cord glia, changes in cerebral blood flow and many others. Expounding upon these is beyond the scope of this chapter. Correlations between any of these changes and hyperalgesia have to be considered with caution, since these may be general reactions to a nerve injury, irrespective of whether neuropathic pain develops or not.

### Neurophysiology

After CCI, spontaneous activity develops in all fiber types, but more frequently in myelinated fibers, and can originate from the DRG or directly from the injury site (Xie and Xiao 1990; Kajander and Bennett 1992; Tal and Eliav 1996). Furthermore, spontaneous activity can be recorded in the L5/6 dorsal horn of the spinal cord (Sotgiu and Biella 2000). In addition, DRG-neurons from nerves with CCI are more excited by inflammatory mediators (Song et al. 2003). Thus, CCI, like other incomplete nerve injuries, induces a hyperexcitable state in the nerve fibers, which may be underlying the pain related behavior observed in the animals.

The qualities most often investigated in experimental animals with CCI are the withdrawal latencies to heat (► **thermal hyperalgesia**) and the withdrawal thresholds to von-Frey-hairs (► **mechanical allodynia**). Several investigators have tried to determine which qualities are transmitted by which fiber type (A or C fibers), and whether peripheral or central changes are responsible for the respective quality in CCI. At present, the questions are not entirely solved. In summary, exaggerated responses to heat and cold are believed to be mediated by C-fibers, mechanical allodynia and hyperalgesia by A $\beta$  and A<sup>TM</sup>-fibers (Field et al. 1999).

### Human Correlates

CCI has been claimed to be a model for different human pathological conditions that are associated with neuropathic pain. At present, no single disease is exactly modeled by CCI. One condition sharing some symptoms and many pathological features is ► **carpal tunnel syndrome**. Here, the median nerve is constricted, which leads to edema of the nerve, initially associated with hyperexcitability and pain only, later with overt nerve damage and neurologic deficits. Recovery is possible if decompression is performed in time. The difference to CCI is the abrupt onset in the animal model as opposed to the chronic course in the human disease, and, of course, the presence of foreign material in CCI.

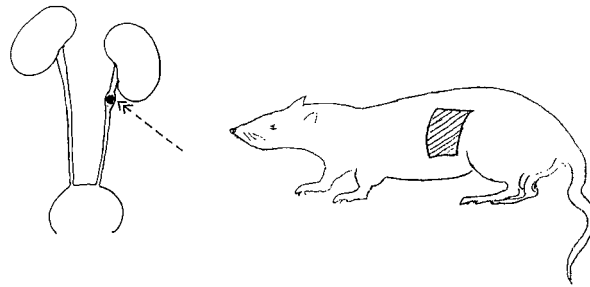
Some parallels have been found with ► **CRPS type II** (Daemen et al. 1998; Suyama et al. 2002), specifically the presence of ► **neurogenic inflammation** and of osteoporosis. Importantly, CCI entails an incomplete injury of a (usually) mixed peripheral nerve, such that injured

and uninjured fibers run in close vicinity in the nerve and that uninjured fibers are exposed to the altered endoneurial microenvironment induced by Wallerian degeneration. This situation is also present in incomplete nerve injuries in humans. One has to keep in mind that, in spite of the ligatures hindering regeneration, peripheral nerve regeneration in a rodent is considerably faster than in humans and that this difference in time course may account for some CCI-specific findings that may not be reflected by human disease.

### References

1. Attal N, Jazat F, Kayser V, Guilbaud G (1990) Further Evidence for 'Pain-Related' Behaviours in a Model of Unilateral Peripheral Mononeuropathy. *Pain* 41:235–251
2. Bennett GJ, Xie YK (1988) A Peripheral Mononeuropathy in Rat that Produces Disorders of Pain Sensation like those Seen in Man. *Pain* 33:87–107
3. Coggeshall RE, Dougherty PM, Pover CM, Carlton SM (1993) Is Large Myelinated Fiber Loss Associated with Hyperalgesia in a Model of Experimental Peripheral Neuropathy in the Rat? *Pain* 52:233–242
4. Daemen M, Kurvers H, Bullens P, Barendse G, Van Kleef M, Van den Wildenberg F (1998) Neurogenic Inflammation and Reflex Sympathetic Dystrophy (*In Vivo* and *In Vitro* Assessment in an Experimental Model). *Acta Orthop Belg* 64:441–447
5. Day A, Lue J, Sun W, Shieh J, Wen C (2001) Abeta-Fiber Intensity Stimulation of Chronically Constricted Median Nerve Induces C-Fos Expression in Thalamic Projection Neurons of the Cuneate Nucleus in Rats with Behavioral Signs of Neuropathic Pain. *Brain Res* 895:194–203
6. Field MJ, Bramwell S, Hughes J, Singh L (1999) Detection of Static and Dynamic Components of Mechanical Allodynia in Rat Models of Neuropathic Pain: Are They Signalled by Distinct Primary Sensory Neurons? *Pain* 83:303–311
7. Guilbaud G, Gautron M, Jazat F, Ratinahirana H, Hassig R, Hauw JJ (1993) Time Course of Degeneration and Regeneration of Myelinated Nerve Fibers Following Chronic Loose Ligatures of the Rat Sciatic Nerve: Can Nerve Lesions be Linked to the Abnormal Pain-Related Behaviors? *Pain* 53:147–158
8. Kajander KC, Bennett GJ (1992) Onset of a Painful Peripheral Neuropathy in Rat: A Partial and Differential Deafferentation and Spontaneous Discharge in A Beta and A Delta Primary Afferent Neurons. *J Neurophysiol* 68:734–744
9. Kim KJ, Yoon YW, Chung JM (1997) Comparison of Three Rodent Neuropathic Pain Models. *Exp Brain Res* 113:200–206
10. Lindenlaub T, Sommer C (2000) Partial Sciatic Nerve Transection as a Model of Neuropathic Pain: A Qualitative and Quantitative Neuropathological Study. *Pain* 89: 97–106
11. Munger B, Bennett G, Kajander K (1992) An Experimental Painful Peripheral Neuropathy due to Nerve Constriction. *Exp Neurol* 118:204–214
12. Myers RR, Yamamoto TY, Yaksh TL, Powell HC (1993) The Role of Focal Nerve Ischemia and Wallerian Degeneration in Peripheral Nerve Injury Producing Hyperesthesia. *Anesthesiology* 78:308–316
13. Sommer C, Galbraith JA, Heckman HM, Myers RR (1993) Pathology of Experimental Compression Neuropathy Producing Hyperesthesia. *J Neuropathol Exp Neurol* 52: 223–233
14. Sommer C, Lalonde A, Heckman HM, Rodriguez M, Myers RR (1995) Quantitative Neuropathology of a Focal Nerve Injury Causing Hyperalgesia. *J Neuropathol Exp Neurol* 54:635–643
15. Sommer C, Schmidt C, George A, Toyka KV (1997) A Metalloprotease-Inhibitor Reduces Pain Associated Behavior in Mice with Experimental Neuropathy. *Neurosci Lett* 237:45–48
16. Song XJ, Zhang JM, Hu SJ, LaMotte RH (2003) Somata of Nerve-Injured Sensory Neurons Exhibit Enhanced Responses to Inflammatory Mediators. *Pain* 104:701–709

17. Sotgiu ML, Biella G (2000) Contribution of Central Sensitization to the Pain-Related Abnormal Activity in Neuropathic Rats. *Somatosens Mot Res* 17: 32–38
18. Suyama H, Moriwaki K, Niida S, Maehara Y, Kawamoto M, Yuge O (2002) Osteoporosis Following Chronic Constriction Injury of Sciatic Nerve in Rats. *J Bone Miner Metab* 20:91–97
19. Tal M, Eliav E (1996) Abnormal Discharge Originates at the Site of Nerve Injury in Experimental Constriction Neuropathy (CCI) in the Rat. *Pain* 64:511–518
20. Vos BP, Strassman AM, Maciewicz RJ (1994) Behavioral Evidence of Trigeminal Neuropathic Pain Following Chronic Constriction Injury to the Rat's Infraorbital Nerve. *J Neurosci* 14:2708–2723
21. Xie Y, Xiao W (1990) Electrophysiological Evidence for Hyperalgesia in the Peripheral Neuropathy. *Sci China B* 33:663–672



Neuropathic Pain Model, Diabetic Neuropathy Model, Figure 1

## Neuropathic Pain Model, Diabetic Neuropathy Model

NIGEL A. CALCUTT<sup>1</sup>, SANDRA CHAPLAN<sup>2</sup>

<sup>1</sup>Department of Pathology, University of California  
San Diego, La Jolla, CA, USA

<sup>2</sup>Johnson & Johnson Pharmaceutical Research &  
Development, San Diego, CA, USA  
ncalcutt@ucsd.edu, schaplan@prius.jnj.com

### Synonyms

Diabetic neuropathy model; Experimental Diabetic Neuropathy

### Definition

Diabetes mellitus is characterized by elevated blood glucose levels. This may be a consequence of either insulin deficiency (Insulin-Dependent Diabetes Mellitus or Type 1 diabetes) or impaired action (Non-Insulin Dependent Diabetes Mellitus or Type 2 diabetes). The term neuropathy implies physical degeneration of the nervous system, although it has been applied more broadly to encompass any neurochemical, physiologic or structural disorders of nerves. Diabetes can affect any combination of the sensory, motor or autonomic components of the peripheral nervous systems, and the central nervous system may also be vulnerable. Classifications of diabetic neuropathy reflect the distribution of nerves showing clinical evidence of dysfunction and the presumed etiology of the disorder (Llewelyn 2003). The most common form of diabetic neuropathy is a distal symmetrical polyneuropathy, which presents as sensory loss and/or pain in the distal extremities and progresses proximally towards the trunk.

### Characteristics

#### Humans

Peripheral nerves obtained by biopsy or autopsy show pathologic changes in most cell types. Schwann cells exhibit reactive and degenerative changes that are presumed to represent early disorders, and precede overt pathologic features such as widening of the nodes of

Ranvier and segmental demyelination. Axons undergo ► **Wallerian degeneration**, which is followed by inefficient regeneration and subsequent fiber loss. The ► **vasa nervorum** display endothelial cell hyperplasia and hypertrophy, which can reduce lumen size, and there is reduplication of the basal lamina. In final stages of diabetic neuropathy there can be almost complete loss of axons, Schwann cells and blood vessels, with the vacated endoneurial space filled by collagen. The physiologic consequences of this progressive degenerative neuropathy include nerve ischemic hypoxia, conduction slowing, progressive loss of sensation, muscle weakness and autonomic dysfunction. Some diabetic patients also describe the occurrence of inappropriate sensations such as pain or paresthesias, usually starting in the feet. Where painful diabetic neuropathy is present, the pain may be spontaneous or evoked by light touch, persistent or sporadic, and is frequently described as having a burning or lancinating quality.

### Animal Models of Diabetes

Diabetes occurs spontaneously in a range of species including domestic companion animals and rodents. The latter have been bred to provide such models as the BB Wistar rat and NOD and db/db mice. Insulin-deficiency can also be induced by injecting animals with the  $\beta$  cell toxins ► **streptozotocin** or alloxan to produce models of severe type 1 diabetes, while hyperglycemia in the presence of normal insulin levels can be induced by dietary overfeeding of sugars such as galactose or fructose. The feature common to all of these models is hyperglycemia, and this is assumed to be a primary pathogenic mechanism underlying diabetic neuropathy.

The streptozotocin-diabetic rat is the most commonly studied animal model of diabetic neuropathy, having the advantages of being cheap, easy to induce and allowing initiation of hyperglycemia at a defined stage of maturity. Disadvantages of the model include the extreme hyperglycemia (20–50 mmol/l) relative to diabetic patients (8–12 mmol/l) that can produce an unrepresentative catabolic dominance and ► **cachexia**. If not treated with insulin, these animals also have a life-span of only a few months. Concerns that nerve disorders in these animals are either unrepresentative of the human condition

or do not have the time to develop, may be addressed by using low level insulin replacement therapy to maintain muscle mass and general health of the animals whilst retaining hyperglycemia.

The relatively short life span of diabetic rodents may help explain why features of overt degenerative neuropathy are rarely reported. There is no significant loss of axons in the major nerve trunks of diabetic rodents within the time frame commonly studied (1–4 months), although diabetic mice develop loss of epidermal innervation (Christianson et al. 2003). Subtle ultrastructural changes may be found in some models and resemble early changes seen in diabetic patients (Kalichman et al. 1998), but in general, diabetic rodents are not faithful models of the pathology of diabetic neuropathy. In contrast, diabetic rodents do show physiologic disorders similar to those seen in diabetic patients. Most prominently, they exhibit slowing of nerve conduction velocities (NCV) by large myelinated motor and sensory fibers within weeks of the onset of hyperglycemia, and this has been used to justify these models as reflecting early stages of diabetic neuropathy. In the absence of the obvious axonal loss, nodal widening or segmental demyelination that is seen in human diabetic neuropathy, NCV slowing in diabetic rodents has been assumed to have a neurochemical or ultrastructural origin. While NCV slowing in diabetic humans and rodents may not necessarily have the same etiology, this defect has been studied extensively, to reveal mechanisms linking it to hyperglycemia and also to screen potential therapeutic agents. Other physiologic and neurochemical disorders that develop within weeks of the onset of hyperglycemia in rodents include increased glucose metabolism by enzymes of the ► [polyol pathway](#), reduced nerve blood flow, increased ► [oxidative stress](#), resistance to ischemic conduction block, decreased slow ► [axonal transport](#) and altered synthesis, transport and release of neuropeptides secondary to impaired ► [neurotrophic support](#). Discovery of these disorders has inspired many hypotheses regarding the pathogenesis of diabetic neuropathy and prompted development of a number of therapeutic strategies, although none as yet have translated successfully to clinical use.

Diabetic rodents have also been used to model states of sensory loss or pain. This carries all of the caveats associated with animal models of ► [neuropathic pain](#), with the additional concern that behavioral indices might also be modified by the parallel effects of hyperglycemia on motor nerve function or on non-neural systems. For example, diabetic rodents exhibit reduced locomotor activity and, when allowed to progress to a state of extreme untreated hyperglycemia, show a general behavioral depression. Nevertheless, there is accumulating evidence to suggest these models display indices of sensory dysfunction that reflect both the sensory loss and allodynia or hyperalgesia seen in diabetic patients.

Diabetic rats react to light touch of the plantar surface of the hind paws, indicating tactile allodynia that is of a magnitude similar to other models of neuropathic pain, such as spinal nerve ligation (Calcutt et al. 1996). This allodynia is frequently used in screening tests for agents designed to alleviate neuropathic pain (reviewed in Calcutt 2002). The etiology of tactile allodynia has not yet been identified, but unlike the majority of other nerve disorders in diabetic rodents, does not appear to be related to glucose metabolism by the polyol pathway (Calcutt et al. 1996).

Limb withdrawal from a more substantial mechanical stimulus is also altered in diabetic rodents, with both the tail pinch and paw pressure tests indicating an increased sensitivity, either by a faster withdrawal from a fixed pressure or a response to lower amounts of pressure. As with tactile allodynia, mechanical hyperalgesia in diabetic rodents has been widely used to evaluate the potential of drugs designed to alleviate pain (see Calcutt 2002), although whether the disorder has a direct correlate in the human condition is not clear.

Thermal hyperalgesia has been described in some diabetic patients, although in most cases there is a progression to thermal hypoalgesia, which is assumed to be associated with loss of epidermal thermal nociceptors (Kennedy et al. 1996). Studies in diabetic rodents have reported thermal hypoalgesia, thermal hyperalgesia or no change relative to controls. This lack of agreement between studies may reflect variations in experimental protocols such as differences in the species, sex, strain, limb tested, heating method and degree or duration of diabetes. We have found that when exposing the hindpaw plantar surface of diabetic rats to a temperature ramp, rising from 30° C at a rate of 1° C per second over 20 seconds, they exhibit a transient thermal hyperalgesia after 4 weeks of hyperglycemia that progresses to thermal hypoalgesia in 2–3 months. Concerns that the progression to hypoalgesia reflects general behavioral depression of ailing animals may be assuaged, by the observation that it can be prevented, by blocking glucose metabolism by the polyol pathway without affecting systemic indices of insulin-deficient diabetes (Calcutt 2002). The etiology of thermal hyperalgesia is unclear, and the hypothesis that the progression to thermal hypoalgesia reflects loss of epidermal thermal nociceptors remains to be confirmed.

Diabetes also modifies other behavioral tests that were developed to study mechanisms of hyperalgesia, particularly those that highlight the role of spinal nociceptive processing (Yaksh 1999). The transient thermal hyperalgesia induced by direct application of substance P to the spinal cord of normal rats is prolonged in diabetic animals (Calcutt et al. 2000a). Injection of dilute formalin into the hindpaw induces a biphasic pattern of defined flinching behavior, in which the second phase incorporates spinal amplification of primary afferent input. In diabetic rats there is more flinching during both phase 2

and the intervening quiescent phase (Calcutt et al 1996). Interestingly, diabetic mice show a loss of responses to formalin (Kamei et al. 1993).

The description of a range of behavioral disorders that are associated with sensory dysfunction in diabetic rats has stimulated a search for underlying electrophysiologic or neurochemical changes in these animals. There is accumulating evidence that both peripheral and spinal sites of nociceptive processing may be involved, while the effects of diabetes on higher processing centers has been poorly studied to date. In the periphery, changes in threshold or firing response to stimuli have been explored (Ahlgren et al. 1992), and while the literature has been divided regarding the occurrence of spontaneous activity in sensory fibers of diabetic rats, some recent reports support this view (Khan et al. 2002). One impediment to the concept of hyperalgesia in diabetic rats being driven by exaggerated peripheral primary afferent activity is that the synthesis, axonal transport and stimulus-evoked release of excitatory neurotransmitters is decreased in diabetic rats, despite concurrent hyperalgesic behavior (Calcutt et al. 2000b). This has prompted consideration of the role of spinal cord hypersensitivity in behavioral allodynia and hyperalgesia (Calcutt 2000a), and increased spontaneous activity has been recorded (Pertovaara et al. 2001; Chen and Pan 2002) along with increased local production of inflammatory mediators (Freshwater et al. 2002).

Diabetic rodents are probably best viewed as modeling the early biochemical and physiologic disorders associated with diabetic neuropathy. Behavioral studies have shown that they exhibit tactile allodynia, mechanical and chemical hyperalgesia and changes in thermal discrimination. The validity of studying the etiology of these disorders, will only be supported when mechanisms suggested in the animal models are identified in patients with diabetic neuropathy, and when drugs screened using these behavioral assays successfully translate to clinical use.

## References

- Llewelyn JG (2003) The Diabetic Neuropathies: Types, Diagnosis and Management. *J Neurol Neurosurg Psychiatry* 74 Suppl 2:ii15–ii19
- Christianson JA, Riekhof JT, Wright DE (2003) Restorative Effects of Neurotrophin Treatment on Diabetes-Induced Cutaneous Axon Loss in Mice. *Exp Neurol* 179:188–199
- Kalichman MW, Powell HC, Mizisin AP (1998) Reactive, Degenerative, and Proliferative Schwann Cell Responses in Experimental Galactose and Human Diabetic Neuropathy. *Acta Neuropathol* 95:47–56
- Calcutt NA, Jorge MC, Yaksh TL, Chaplan SR (1996) Tactile Allodynia and Formalin Hyperalgesia in Streptozotocin-Diabetic Rats: Effects of Insulin, Aldose Reductase Inhibition and Lidocaine. *Pain* 68:293–299
- Calcutt NA (2002) Potential Mechanisms of Neuropathic Pain in Diabetes. *Int Rev Neurobiol* 50: 205–228
- Kennedy WR, Wendelschafer-Crabb G, Johnson T (1996) Quantitation of Epidermal Nerves in Diabetic Neuropathy. *Neurology* 47:1042–1048
- Yaksh TL (1999) Spinal Systems and Pain Processing: Development of Novel Analgesic Drugs with Mechanistically Defined Models. *Trends Pharmacol Sci* 20:329–337
- Calcutt NA, Freshwater JD, O'Brien JS (2000a) Protection of Sensory Function and Antihyperalgesic Properties of a Prosaposin-Derived Peptide in Diabetic Rats. *Anesthesiology* 93:1271–1278
- Kamei J, Hitosugi H, Kasuya Y (1993) Formalin-Induced Nociceptive Responses in Diabetic Mice. *Neurosci Lett* 149:161–164
- Ahlgren SC, White DM, Levine JD (1992) Increased Responsiveness of Sensory Neurons in the Saphenous Nerve of the Streptozotocin-Diabetic Rat. *J Neurophysiol* 68:2077–2085
- Khan GM, Chen SR, Pan HL (2002) Role of Primary Afferent Nerves in Allodynia Caused by Diabetic Neuropathy in Rats. *Neuroscience* 114:291–299
- Calcutt NA, Stiller C, Gustafsson H, Malmberg AB (2000b) Elevated Substance-P-Like Immunoreactivity Levels in Spinal Dialsates During the Formalin Test in Normal and Diabetic Rats. *Brain Res* 856:20–27
- Pertovaara A, Wei H, Kalmari J, Ruotsalainen M (2001) Pain Behavior and Response Properties of Spinal Dorsal Horn Neurons Following Experimental Diabetic Neuropathy in the Rat: Modulation by Nitecapone, a COMT Inhibitor with Antioxidant Properties. *Exp Neurol* 167:425–434
- Chen SR, Pan HL (2002) Hypersensitivity of Spinothalamic Tract Neurons Associated with Diabetic Neuropathic Pain in Rats. *J Neurophysiol* 87:2726–2733
- Freshwater JD, Svensson CI, Malmberg AB, Calcutt NA (2002) Elevated Spinal Cyclooxygenase and Prostaglandin Release During Hyperalgesia in Diabetic Rats. *Diabetes* 51:2249–2255

## Neuropathic Pain Model, Neuritis/Inflammatory Neuropathy

ERIN D. MILLIGAN, STEVEN F. MAIER,  
LINDA R. WATKINS  
Department of Psychology and the Center for  
Neuroscience, University of Colorado, Boulder, CO,  
USA  
emilligan@psych.colorado.edu,  
lwatkins@psych.colorado.edu

### Synonyms

Sciatic Inflammatory Neuropathy; SIN; Sciatic Inflammatory Neuritis

### Definition

Neuropathic pain can arise from frank nerve trauma and/or inflammation of peripheral nerves (Bourque et al. 1985; Said and Hontebeyrie-Joskowicz 1992). In addition, pathological pain can arise from: a) tissues innervated by neighboring healthy nerves, called extra-territorial momepain (Willis 1993) and b) healthy areas contralateral to the site of tissue damage, referred to as mirror pain (Koltzenburg 1999). Animal models have focused on examining mechanisms underlying neuropathic pain associated with nerve damage (Bennett and Xie 1988; Seltzer et al. 1990; Kim and Chung 1992; DeLeo et al. 1994). The sciatic inflammatory neuropathy (► **SIN**) model was recently developed to



examine how inflammatory, extraterritorial and mirror image pain are created without frank nerve trauma (Chacur et al. 2001; Gazda et al. 2001; Milligan et al. 2003; Spataro et al. 2003).

Prior procedures that create inflammation of the sciatic nerve were used as a foundation to develop the SIN model (Eliav et al. 1999; Eliav et al. 2001). Modifications were made to of these prior procedures in order to allow the full time course of ipsilateral and mirror image allodynia to be productively studied, even at their earliest onset, after induction of peri-sciatic immune activation. Further, these modifications allow peri-sciatic immune activation to be induced in freely moving rats without the use of anesthetics, as these drugs can grossly alter immune responses (Lockwood et al. 1993; Sato et al. 1995). Lastly, SIN can be used to examine the responses of peri-sciatic immune cells and spinal cord neurochemical function underlying acute (less than 24 hrs) and extended (up to 14 days) allodynia. This chapter will describe detailed surgical methods for chronic peri-sciatic catheterization, and a brief protocol for induction of inflammation to create SIN.

## Characteristics

### Tools and Supplies for Preparing Peri-Sciatic Catheters, Surgery, Catheter Injectors and Catheter Cleaners

Peri-sciatic catheters are constructed from:

1. Sterile gelfoam sheets (Approximately 2×6 cm; NDC#0009-0315-03; Upjohn, Kalamazoo, MI). Each sheet will produce 4 gelfoam pieces
2. Silastic tubing (1.57 mm inner diameter, 2.41 mm outer diameter; Helix Medical Inc., Carpinteria, CA)
3. Sterile silk suture (4-0 & 3-0) with attached needle (cutting FS-2 and FS-1, respectively; Ethicon, Somerville, NJ)
4. Sterile polyethylene tubing (PE-50, Becton Dickinson, Sparks, MD)
5. #11 scalpel blade
6. Sterile metal metric ruler (15 cm)

Tools used for Chronic Peri-Sciatic Catheter Surgery are:

1. 2 pairs of micro-forceps
2. 1 pair toothed forceps
3. 1 pair blunt dissection scissors
4. suture hemostats with scissors
5. #11 or #10 scalpel blades
6. 1 scalpel handle
7. 2 small towel clips
8. 4–8 glass Pasteur pipettes with the tips previously melted into small hooks
9. 1 hot glass-bead sterilizer (World Precision Instruments, Sarasota, FL) to sterilize tools between use
10. 1 shaver
11. 70% alcohol

12. Exidine-2 surgical scrub solution (undiluted, Baxter Healthcare, Deerfield, IL)
13. Sterile gauze (4×4 inches) to create a drape around the surgical site
14. ~800 ml of both an antibacterial water mixture and water for cleansing hands between surgeries
15. Sterile autoclave paper (12×12 cm) to provide a clean surface for placing sterilized tools
16. 1 sleeve/rat that protects the exteriorized portion of the peri-sciatic catheter (cc-sleeve) described in detail previously (Milligan et al. 1999)

The catheter injector is made from:

1. A sterile 23-gauge, 1-inch hypodermic needle (Becton Dickinson, Franklin Lakes, NJ)
2. PE-50 tubing (Becton Dickinson, Sparks, MD)
3. An autoclaved 100 ul Hamilton glass syringe (Fisher Scientific, Houston, TX)
4. A black permanent fine-tip marker
5. Sterile metal metric ruler (15 cm)
6. Dental probe with a 45° angel (microprobe; Fisher Scientific, Houston, TX)

The catheter cleaners are made from:

1. A sterile 3-cc syringe
2. A 23-gauge needle
3. PE-50 tubing (Becton Dickinson, Sparks, MD)

### Chronic Peri-Sciatic Catheter Construction, Surgery, Injection and Cleaning Procedures

The procedures detailed here are for:

- The construction of supplies required for chronic peri-sciatic catheters
- Chronic peri-sciatic catheter surgeries
- Cleaning and injecting drugs around the sciatic nerve

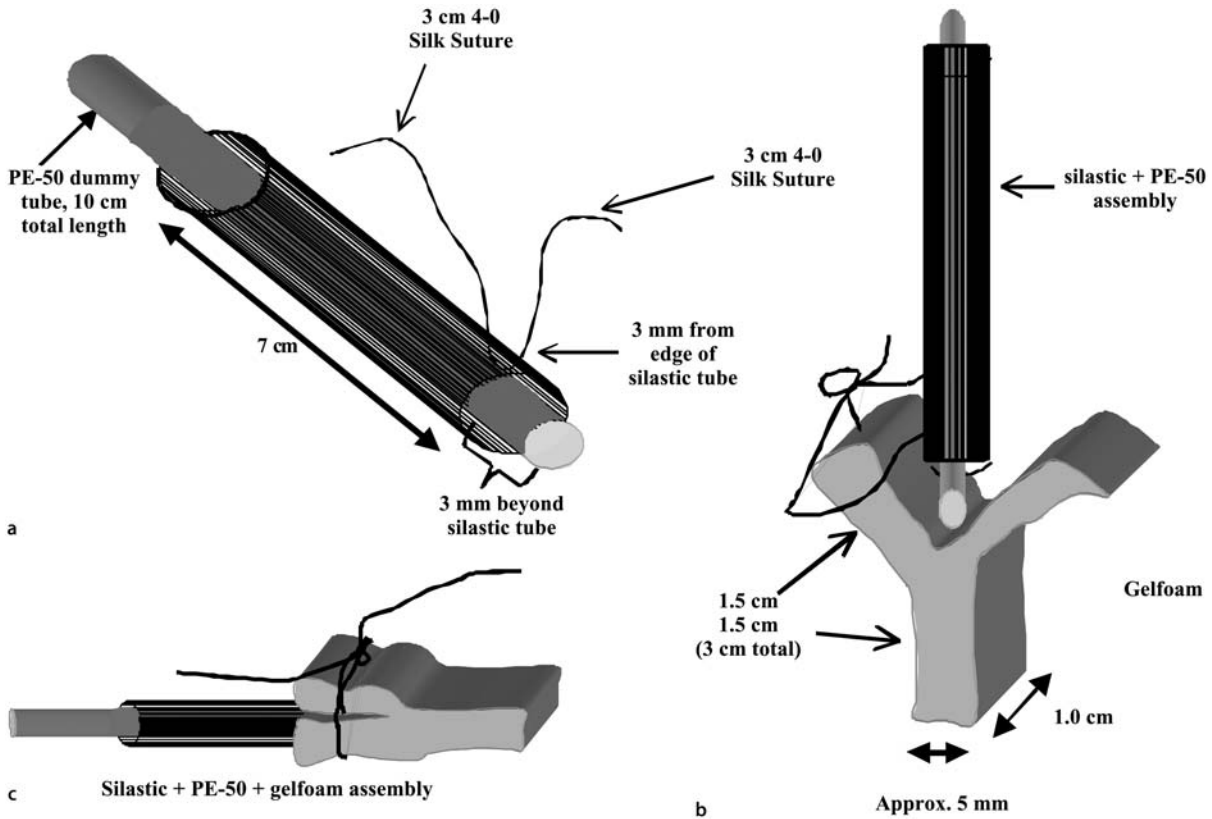
Importantly, all procedures are conducted aseptically. All instruments (forceps, scissors, and scalpels) used to handle or make the supplies are sterile. It is imperative that the catheters for these surgeries are endotoxin free as well as sterile since: (a) endotoxin is not destroyed by autoclaving or gas sterilization and (b) endotoxin and bacterial contamination activates immune cells.

All instruments are sterilized prior to conducting surgery on each animal using a glass bead mini-sterilizer. Hands are washed with antibacterial soap between animals. The skin surrounding the open wound is draped with sterilized gauze or autoclave paper.

#### Constructing Chronic Peri-Sciatic Catheters

All of the following steps should be performed under a sterile cell-culture grade hood.

Step 1: A 7 cm sterile silastic tube is threaded with 10 cm PE-50 tubing (Fig. 1a). One end of the PE-50 tubing remains flush with one end of the silastic tubing. This 10 cm PE-50 tubing serves as a place-holder, to ensure that the silastic tube does not become blocked either by silk su-



**Neuropathic Pain Model, Neuritis/Inflammatory Neuropathy, Figure 1** (a) The silastic+PE-50 gelfoam assembly. This is the assembly immediately prior to attaching it to the gelfoam. (b) Attachment of the silastic+PE-50 gelfoam assembly to the gelfoam. Note that this is the size of the gelfoam after it has been cut from the gelfoam sheet. (c) Attachment of the silastic+PE-50 gelfoam assembly to the gelfoam. Note that this is the size of the gelfoam after it has been cut from the gelfoam sheet. Reprinted with permission (Milligan et al. in press).

tures used for making the silastic tube+gelfoam assembly or by the surgical anchoring step (described below). Step 2: Sterile 4-0 silk suture with needle attached is hooked through a small portion of the silastic tube 3–4 mm from the end, where the PE-50 place-holder is flush with the silastic tube (Fig. 1a).

Use a sterile metal ruler for accuracy. It is critical that the 4-0 silk suture does not pierce the indwelling PE-50 place-holder tubing. The final length of the silk-suture is cut to approximately 6 cm, which is needed to easily tie gelfoam (described below) to the silastic+PE-50 assembly, as well as to tie the gelfoam ends together after enwrapping the sciatic nerve (described below). Store this unit in a sterile 50 ml conical tube (Fisher Scientific, Houston, TX) until needed.

Step 3: The silastic+PE-50 assemblies are stored in a sterile, dry 50 ml conical tube that is tightly capped until the prepared gelfoam is ready to be attached. The peri-sciatic gelfoam is constructed from sterile gelfoam sheets (6 (L) × 0.5 (W) × 2 (H) cm) cut, using a sterile #11 scalpel blade on a sterile metal metric ruler, into 4 equal parts with approximate dimensions of 3 (L) × 0.5 (W) × 1 (H) cm strips. Use a sterile metal ruler for accuracy. One end of the gelfoam strip is bisected

(0.25 cm W) to a depth of 1.5 cm, creating 2 gelfoam flaps.

Step 4: The 4-0 silk suture end of the silastic+PE-50 assembly is inserted between the gelfoam flaps to a depth of approximately 1.5 cm (Fig. 1b).

The gelfoam flaps are tightly closed together around the silastic+PE-50 assembly by tying the 4-0 silk-suture around one gelfoam flap, and again around the opposing flap (Fig. 1c).

The silastic+PE-50+gelfoam assembly is stored in a sterile, dry 50 ml conical tube (which can store up to 6 silastic+PE-50+gelfoam assemblies) until the time of surgery.

#### Chronic Peri-Sciatic Catheter Surgery

Step 1: Surgery is conducted under isoflurane anesthesia (Halocarbon Laboratories, River Edge, NJ), 2.5 volume% in oxygen, which is chosen because it has minimal effects on immune cell function compared to other commonly used anesthetics (Lockwood et al. 1993, Sato et al. 1995).

Step 2: The dorsal aspect of the rat faces up, with the nose facing away from the surgeon, the left and right hind legs are positioned laterally to the left of the surgeon or

splayed laterally to the left and right of the surgeon. The fur is shaved from the left leg and lower back.

Step 3: The exposed skin is cleaned with 70% alcohol-soaked gauze. A small amount of concentrated Exidine-2 surgical scrub solution applied to fresh gauze is then used to further clean the surgical area.

Step 4: A midline incision at the lower back area is then made with either a #10 or #11 surgical scalpel blade and the skin around the cut is separated from its underlying loose connective tissue using blunt dissection scissors. This is done to provide space for subcutaneous implantation of the cc-sleeve (described below).

Step 5: A second incision is made along the lateral aspect of the left thigh and separation of the skin from underlying connective tissue extends beyond the incision site to the midline incision (in Step 4), where the exterior portion of the catheter will be encased by the cc-sleeve.

Step 6: The shaved and cleaned skin surrounding the wound is lightly retracted using small-toothed towel clips and then draped with sterile gauze.

Step 7: Exposure of the sciatic nerve is achieved by blunt dissection, and connective tissue is gently teased apart using glass Pasteur pipette hooks, sterilized in the glass-bead mini-sterilizer before each use.

Step 8: At approximately mid-thigh level, a portion of the sciatic nerve is slightly lifted using a sterile glass Pasteur pipette hook, followed by adding a couple of drops of sterile isotonic, endotoxin-free saline to keep the nerve moist.

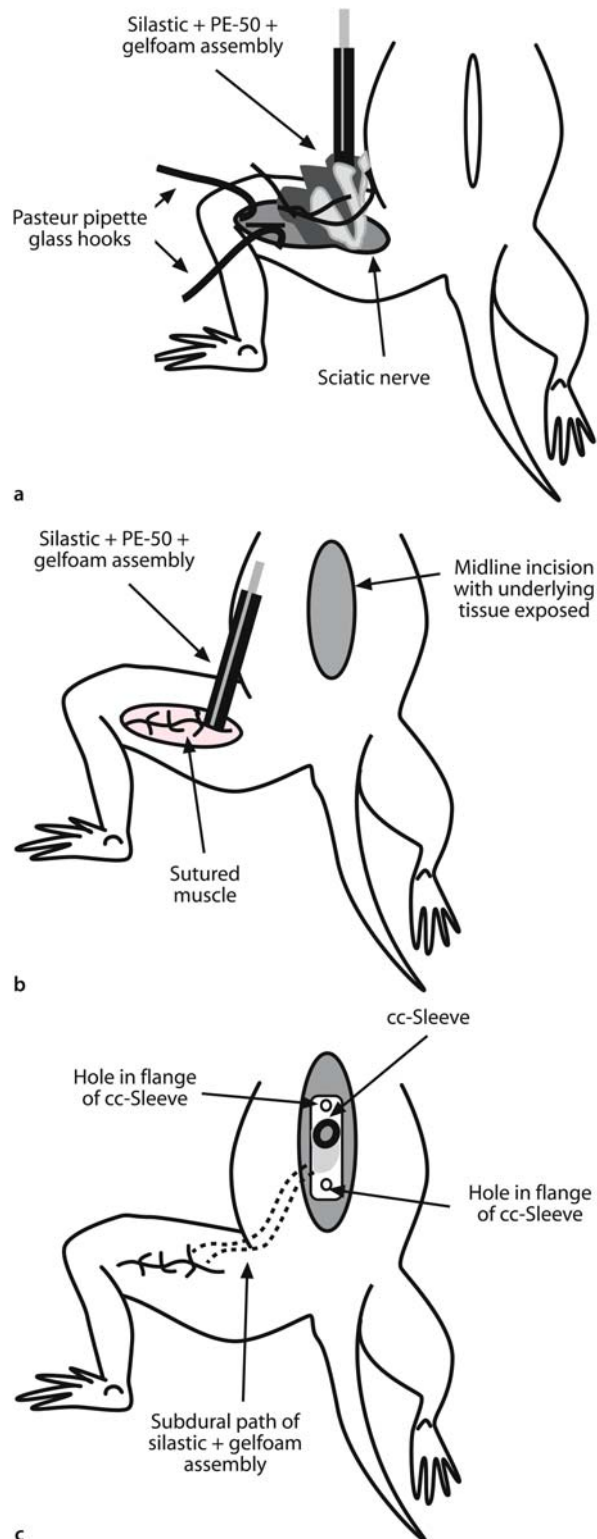
Step 9: The gelfoam of the silastic+PE-50+gelfoam assembly is then gently threaded around the sciatic nerve starting from the quadriceps side to maintain a clear view of the implant site (Fig. 2a). The surrounding muscle walls are maneuvered to support the silastic+PE-50+gelfoam assembly upright.

Step 10: The 4-0 silk-suture that is part of the silastic+PE-50+gelfoam assembly (as previously described Chronic Peri-Sciatic Catheter Construction) is used to tie together the proximal and distal ends of the gelfoam once it forms a U-shape around the sciatic nerve. Precise control is best when using 2 pairs of micro-forceps. The surrounding muscle walls are then closed around the gelfoam-enwrapped sciatic nerve, leaving the silastic+PE-50 portion exteriorized (Fig. 2b).

Step 11: The silastic tube is anchored to the muscle by threading a sterile 4-0 silk suture with attached suture needle through the muscle at the most proximal portion of the dissection site, followed by threading the suture through the silastic tube, avoiding the internal PE-50 place-holder tube, and then through the opposing mus-

cle. The remaining overlying muscle is closed with one or two more sutures through the muscle.

Step 12: The exposed portion of the silastic catheter is tunneled subcutaneously to exit through the lower back incision (Fig. 2c).



► **Neuropathic Pain Model, Neuritis/Inflammatory Neuropathy, Figure 2,** (a) The process of enwrapping the gelfoam portion of silastic+PE-50+gelfoam assembly around the sciatic nerve. (b) Illustrating the exteriorized portion of the silastic+PE-50 catheter after the gelfoam has been implanted and muscle walls sutured closed. (c) cc-Sleeve attachment to the lower back area after the silastic+PE-50+gelfoam assembly has been implanted. Reprinted with permission (Milligan et al. in press).

Step 13: The skin overlaying the sutured muscle is closed with wound clips.

Step 14: The PE-50 dummy catheter is carefully removed while holding the silastic catheter in place, to ensure that the gelfoam does not become torn or displaced.

Step 15: The exposed portion of the silastic catheter is threaded through the cc-sleeve. The reader is referred to the methods paper that describes in detail the construction and use of this cc-sleeve (Milligan et al. 1999). The cc-sleeve is then anchored to the muscle overlaying the lumbosacral area, by threading one or two 3-0 silk sutures with attached suture needle through each flange on the cc-sleeve. The overlying skin is then sutured closed with 3-0 silk.

Step 16: The remaining exteriorized portion of the silastic tube is folded into the cc-sleeve and an air-dried concave plug (part of the cc-sleeve) (Milligan et al. 1999) is inserted inside the tip of the sleeve. A small amount of silastic silicon sealant is coated over the end of the plug and cc-sleeve with a moistened Q-tip.

Step 17: The wound area around the hind leg and lower back are lightly cleaned with 0.9% saline. Total surgical time is typically 15–20 minutes.

Step 18: Beginning 4–5 days following surgery, when catheters are used to induce chronic allodynia for extended periods of time, (the wound areas of the hind leg and lower back are cleaned with 0.9% saline every 2 days for as long as 2 weeks). This decreases the amount of inflammation, such as redness, slight bleeding and scabbing of the skin around the surgical sites. The cc-sleeve and the indwelling peri-sciatic silastic catheter are also cleaned with separate single-use peri-sciatic catheter cleaners.

#### Peri-Sciatic Catheter Injectors

Peri-Sciatic Catheter Injectors are made using the following steps:

Step 1: The beveled end of a sterile 23-gauge, 1-inch hypodermic needle is inserted into one end of a 30 cm PE-50 tube.

Step 2: A mark is made 7.3 cm from the opposite end, using a black permanent fine-tip marker. The mark must line up with the exterior end of the peri-sciatic silastic catheter upon PE-50 tubing insertion. This alignment assures that the interior end of the PE-50 tubing is 3 mm beyond the indwelling silastic catheter within the gelfoam.

Step 3: Prepared peri-sciatic catheter injectors are stored in a sterile, dry place (typically, an autoclavable box) until the time of injections.

#### Peri-Sciatic Catheter Injection Procedures

Peri-sciatic catheter injections are conducted using the following steps:

Step 1: The 23-gauge needle is attached to a sterile Hamilton 1001 micro-syringe.

Step 2: The sterile glass Hamilton micro-syringe and the peri-sciatic catheter injector are flushed with sterile, endotoxin-free water and tightly connected, making the syringe and injector airtight.

Step 3: An air bubble is then created in the 30 cm PE-50 tubing of the peri-sciatic catheter injector by drawing up 1 of air followed by the drug. The length of the injection catheter will vary depending on the volume of drug injection. A 1.0  $\mu$ m volume occupies approximately 0.41 cm of PE-50 tubing.

Step 4: Animals are gently placed in crumpled soft cotton towels and allowed to move freely underneath the towels.

Step 5: The cc-sleeve area is exposed, the indwelling concave rubber plug is removed with a dental probe, and the folded portion of the silastic catheter is exteriorized. The reader is referred to the methods paper that describes in detail the construction and use of this cc-sleeve (Milligan et al. 1999).

Step 6: Fluid that had accumulated in the indwelling silastic catheter is suctioned off with the peri-sciatic catheter cleaner (described below) and discarded.

Step 7: Drug injection is completed using the prepared PE-50 injectors (described above). The PE-50 tubing from the peri-sciatic catheter injector is inserted into the silastic catheter until the 7.3 cm mark on the PE-50 tubing of the peri-sciatic catheter injector is flush with the edge of the silastic catheter. Chronic allodynia is maintained for over 2 weeks by repeated injections every 2 days, which are conducted in steps identical to that described immediately above (steps 1–7).

#### Peri-Sciatic Catheter Cleaning Procedures

In chronic allodynia, an additional step of cleaning the inside of the cc-sleeve with a separate peri-sciatic catheter cleaner is done, to decrease local inflammation/infection around this foreign body. Peri-sciatic catheter and cc-sleeve cleaning followed by drug injections are done every two days to maintain chronic allodynia. Using this paradigm, unilateral and bilateral allodynia remain stable during the entire testing period, in terms of both pattern (i.e., unilateral does not change to bilateral nor the reverse) and magnitude. Peri-sciatic Catheter Cleaners are used to suction out fluid accumulation within the indwelling silastic catheter starting 4–5 days after surgery and prior to drug injections.

Step 1: The catheter cleaners are made from the same supplies as the injectors, except the Hamilton 100 $\mu$ l micro-syringe is replaced with a sterile 3-cc syringe.

Step 2: The cleaners are constructed in the same way as the injectors (described above) except that the 3-cc syringe is attached to the 23-gauge needle. Prepared peri-sciatic catheter cleaners are stored in a sterile, dry place (typically, an autoclavable box) until the time of injections.



## References

1. Bennett GJ, Xie YK (1988) A Peripheral Mononeuropathy in Rat that Produces Disorders of Pain Sensation like those Seen in Man. *Pain* 33:87–107
2. Bourque CN, Anderson BA, Martin del Campo C, Sima AA (1985) Sensorimotor Perineuritis - An Autoimmune Disease? *Can J Neurol Sci* 12:129–133
3. Chacur M, Milligan ED, Gazda LS, Armstrong CA, Wang H, Tracey KJ, Maier SF, Watkins LR (2001) A New Model of Sciatic Inflammatory Neuritis (SIN): Induction of Unilateral and Bilateral Mechanical Allodynia Following Acute Unilateral Peri-Sciatic Immune Activation in Rats. *Pain* 94:231–244
4. DeLeo JA, Coombs DW, Willenbring S, Colburn RW, Fromm C, Wagner R, Twitchell BB (1994) Characterization of a Neuropathic Pain Model: Sciatic Cryoneurolysis in the Rat. *Pain* 56:9–16
5. Eliav E, Benoliel R, Tal M (2001) Inflammation with no Axonal Damage of the Rat Saphenous Nerve Trunk Induces Ectopic Discharge and Mechanosensitivity in Myelinated Axons. *Neurosci Lett* 311:49–52
6. Eliav E, Herzberg U, Ruda MA, Bennett G (1999) Neuropathic Pain from an Experimental Neuritis of the Rat Sciatic Nerve. *Pain* 83:169–182
7. Gazda LS, Milligan ED, Hansen MK, Twining CM, Poulos NM, Chacur M, O'Connor KA, Armstrong CA, Maier SF, Watkins LR, Myers RR (2001) Sciatic Inflammatory Neuritis (SIN): Behavioral Allodynia is Paralleled by Peri-Sciatic Proinflammatory Cytokine and Superoxide Production. *J Peripher Nerv Syst* 6:111–129
8. Kim SH, Chung JM (1992) An Experimental Model for Peripheral Neuropathy Produced by Segmental Spinal Nerve Ligation in the Rat. *Pain* 50:355–363
9. Lockwood LL, Silbert LH, Laudenslager ML, Watkins LR, Maier SF (1993) Anesthesia-Induced Modulation of *In Vivo* Antibody Levels. *Anesth Analg* 77:769–775
10. Milligan ED, Hinde JL, Mehmert KK, Maier SF, Watkins LR (1999) A Method for Increasing the Viability of the External Portion of Lumbar Catheters Placed in the Spinal Subarachnoid Space of Rats. *J Neurosci Methods* 90:81–86
11. Milligan ED, Maier SF, Watkins LR (in press) Sciatic Inflammatory Neuropathy in the Rat. In: Luo D (ed) *Pain Research: Methods and Protocols*. Humana Press, Totowa, NJ
12. Milligan EM, Twining CM, Chacur M, Biedenkopf J, O'Connor KA, Poole S, Tracey KJ, Martin D, Maier SF, Watkins LR (2003) Spinal Glia and Proinflammatory Cytokines Mediate Mirror-Image Neuropathic Pain. *J Neurosci* 23:1026–1040
13. Said G, Hontebeyrie-Joskowicz M (1992) Nerve Lesions Induced by Macrophage Activation. *Res Immunol* 143:589–599
14. Sato W, Enzan K, Masaki Y, Kayaba M, Suzuki M (1995) The Effect of Isoflurane on the Secretion of TNF-Alpha and IL-1 Beta from LPS-Stimulated Human Peripheral Blood Monocytes. *Masui* 44:971–975
15. Seltzer Z, Dubner G, Shir Y (1990) A Novel Behavioral Model of Neuropathic Pain Disorders Produced in Rats by Partial Sciatic Nerve Injury. *Pain* 43:205–218
16. Spataro L, Sloane EM, Milligan ED, Maier SF, Watkins LR (2003) Gap Junctions Mediate Neuropathic Pain Produced by Sciatic Inflammatory Neuropathy (SIN) and Chronic Constriction Injury. In: *Journal of Pain*, vol 4 (suppl 1). Churchill Livingstone, Philadelphia, p 52

USA

jmchung@utmb.edu

## Synonyms

PSL model; Seltzer Model

## Definition

The ► **partial sciatic nerve ligation** (PSL) model of neuropathic pain refers to a rodent ► **neuropathic pain** model that is produced by tightly ligating the dorsal third to half of the common sciatic nerve at the upper-thigh level (Seltzer et al. 1990).

## Characteristics

### Methods for Producing the PSL Model

### Animals

Young adult male rats of various strains are commonly used. Like most other behavioral tests, it is helpful for rats to be acclimated for about a week in the laboratory holding facility with free access to food and water before performing any experiments. It is also convenient to keep rats in a room with a reversed light-dark cycle, allowing behavioral tests to be conducted during their active period.

### Surgical Operation

Rats are deeply anesthetized with general anesthetics and placed in the prone position. Under a dissection microscope, the dorsum of the sciatic nerve is freed from surrounding connective tissues at a proximal site just distal to the point where the posterior biceps semitendinosus nerve branches off. An 8-0 silk suture is inserted into the nerve with a 3/8 curved needle, trapping the dorsal third or half of the nerve. The trapped portion of the nerve dorsal to the suture is tightly ligated. The wound is sutured closed. The original developers of the model (Seltzer et al. 1990) emphasized the importance of the site of ligation, which needs to be proximal enough so that the sciatic nerve is not yet fasciculated into individual nerves. Therefore, sciatic injury is made at a site between the branch point of the posterior biceps semitendinosus and a little fat pad (which is located just distally) since the sciatic nerve becomes fasciculated into branches just distal to the fat pad (Schmalbruch 1986; Seltzer et al. 1990).

### Extent of Injury and Behavioral Outcome

The number of fibers injured by this procedure varies between animals (Seltzer et al. 1990). It is possible that some fibers in the unligated portion of the nerve may undergo degeneration due to secondary events such as: 1) disruption of the perineurium, 2) interference of local blood flow, 3) focal edema and 4) reaction to the ligation, etc. Therefore, variability in the number of injured fibers after partial sciatic nerve ligation comes from the fact that a variable number of fibers are being ligated and

N

## Neuropathic Pain Model, Partial Sciatic Nerve Ligation Model

JIN MO CHUNG

Department of Neuroscience and Cell Biology,  
University of Texas Medical Branch, Galveston, TX,

that presumably variable numbers of unligated fibers are being injured by the above secondary causes.

Operated animals normally do not show severe motor deficits, except for the two lateral toes, which are flexed (Seltzer et al. 1990). At rest, the operated rats guard their operated limb somewhat when placing the limb on the floor; yet they show excessive abnormal grooming behaviors on the operated limb, such as repeated licking of the paw. However, none of operated rats show self-mutilating behavior due to the partially deafferented hind paw. During walking, they do not show obvious limping or any other severe locomotive abnormalities. Practically all operated rats show various behavioral signs of neuropathic pain such as ► **ongoing pain**, ► **heat hyperalgesia**, and mechanical as well as ► **cold allodynia** (Seltzer et al. 1990; Kim et al. 1997). Behaviors believed to represent ► **mechanical allodynia** can be quantified either by measuring foot withdrawal frequency to mechanical stimuli applied to the paw with von Frey filaments (Kim et al. 1997) or by determining the mechanical threshold (Seltzer et al. 1990). Heat hyperalgesia can also be measured by determining the heat threshold of the paw for foot withdrawals or duration of responses to suprathreshold heat stimuli (Seltzer et al. 1990). In addition, behaviors reflecting spontaneous pain have been shown by measuring the duration of foot withdrawals (guarding behaviors) in the absence of any obvious stimuli. Behavior thought to represent cold allodynia was assessed by measuring frequency of foot withdrawals to cold stimuli (e.g. acetone droplet application) applied to the paw (Kim et al. 1997).

Kim et al. (1997) made a comparison between the chronic constriction injury (CCI), spinal nerve ligation (SNL), and PSL models. When magnitudes of behaviors were compared with the CCI and SNL models, the PSL model fell in between the two for mechanical allodynia and spontaneous pain, but the magnitude of cold allodynic behavior was similar in all three models. Behaviors in PSL are partially reversed by sympathectomy (Shir and Seltzer 1991; Seltzer and Shir 1991) suggesting that sympathetic abnormality is involved in producing pain behaviors.

#### Factors Influencing Variability

Many factors influence neuropathic pain behavior in the PSL model as in other models. As shown in the SNL model (Mogil et al. 1999a; Mogil et al. 1999b; Yoon et al. 1999), genetic factors influence pain behaviors in the PSL model (Shir et al. 2001). Another important factor is diet. The effect of diet on neuropathic pain behavior has been studied in detail using the PSL model (Shir et al. 1998; Shir et al. 2002). Although the mechanisms are not clear, a diet with high soybean content reduces the expression of neuropathic pain behaviors. Finding such factors is important not only in terms of future studies on underlying mechanisms but also for potential therapeutic implications.

#### Advantages and Disadvantages of the PSL Model Compared to Others

The PSL model has several advantages over other neuropathic pain models. Tight ligation models such as the PSL provide information about the timing of injury better than loose ligation models. The most attractive feature of the PSL model is that it most closely resembles the original description of causalgia patients with injuries produced by high velocity missile impact (Mitchell 1872).

#### Acknowledgments

This work was supported by NIH Grants NS 31860 and NS 11255.

#### References

1. Kim KJ, Yoon YW, Chung JM (1997) Comparison of three rodent neuropathic pain models. *Exp Brain Res* 113:200–206
2. Mitchell SW (1872) Injuries of nerves and their consequences. JB Lippincott, Philadelphia
3. Mogil JS, Wilson SG, Bon K et al. (1999a) Heritability of nociception I: Responses of 11 inbred mouse strains on 12 measures of nociception. *Pain* 80:67–82
4. Mogil JS, Wilson SG, Bon K et al. (1999b) Heritability of nociception II. “Types” of nociception revealed by genetic correlation analysis. *Pain* 80:83–93
5. Schmalbruch H (1986) Fiber composition of the rat sciatic nerve. *Anat Rec* 215:71–81
6. Seltzer Z, Dubner R, Shir Y (1990) A novel behavioral model of neuropathic pain disorders produced in rats by partial sciatic nerve injury. *Pain* 43:205–218
7. Seltzer Z, Shir Y (1991) Sympathetically-maintained causalgiform disorders in a model for neuropathic pain: a review. *J Basic Clin Physiol Pharmacol* 2:17–61
8. Shir Y, Seltzer Z (1991) Effects of sympathectomy in a model of causalgiform pain produced by partial sciatic nerve injury in rats. *Pain* 45:309–320
9. Shir Y, Ratner A, Raja SN et al. (1998) Neuropathic pain following partial nerve injury in rats is suppressed by dietary soy. *Neurosci Lett* 240:73–76
10. Shir Y, Zeltser R, Vatine JJ et al. (2001) Correlation of intact sensibility and neuropathic pain-related behaviors in eight inbred and outbred rat strains and selection lines. *Pain* 90:75–82
11. Shir Y, Campbell JN, Raja SN et al. (2002) The correlation between dietary soy phytoestrogens and neuropathic pain behavior in rats after partial denervation. *Anesth Analg* 94:421–426
12. Yoon YW, Lee DH, Lee BH et al. (1999) Different strains and substrains of rats show different levels of neuropathic pain behaviors. *Exp Brain Res* 129:167–171

## Neuropathic Pain Model, Spared Nerve Injury

ISABELLE DECOSTERD

Anesthesiology Pain Research Group, Department of Anesthesiology, University Hospital (CHUV) and Department of Cell Biology and Morphology, Lausanne University, Lausanne, Switzerland  
isabelle.decosterd@chuv.ch

#### Synonyms

Spared Nerve Injury Model; SNI Model; Sural Spared Nerve Injury Model; sSNI Model

## Definition

The rodent spared nerve injury model (SNI) consists of the selective injury of two of the three terminal branches of the sciatic nerve (the tibial and common peroneal nerve), leaving the third branch, the sural nerve, intact (Decosterd and Woolf 2000). Rapid and robust pain hypersensitivity to mechanical and thermal external stimuli is produced in the sural nerve skin territory, similar to stimulus-evoked pain observed in clinical ► [neuropathic pain syndromes](#).

## Characteristics

### Description of the Model

Since the original description of ► [anesthesia dolorosa](#) by Wall (Wall et al. 1979), several models of transection/ligation-related injury to peripheral nerves have been described, allowing evaluation of the response to an applied external innocuous or nociceptive stimulus (stimulus-evoked pain) (Mosconi and Kruger 1996; Seltzer et al. 1990; Kim and Chung 1992; Bennett and Xie 1988; Vos et al. 1994). Unlike complete denervation of the paw after a sciatic nerve transection, these models enable assessment of pain sensitivity of the spared intact nerve fibers.

However, in the partial sciatic nerve injury (Seltzer et al. 1990) and the chronic constriction injury (Bennett and Xie 1988), the degree of nerve damage is difficult to reproduce, leading to variability within and between laboratories. Developed by Kim and Chung, the tight ligation of L5 and L6 spinal nerves ostensibly leaves all L4 afferents intact, but the surgery itself may damage or produce an inflammatory reaction to the intact L4 spinal nerve. The SNI model has the advantage of a simple surgical procedure and a high degree of reproducibility (Decosterd and Woolf 2000).

Two of the three terminal branches of the sciatic nerve are completely transected, i.e. the tibial and common

peroneal nerves, and the sural nerve remains intact. If the surgical procedure is well executed, variability depends only on anatomical variation. Pain hypersensitivity is recorded in the skin territory of the spared sural nerve, preferentially on the plantar surface of the paw. Withdrawal threshold modifications are also present in the dorsal hairy sural nerve skin territory, and to a less extent in the saphenous nerve skin territory. The onset of allodynia- and hyperalgesia-like behavior is rapid (within 3 days post injury), and sensitivity changes last for months (up to 6 months). No change in the contralateral paw is observable when compared to same age sham-injured animal recordings. A crush injury to the tibial and common peroneal nerves induces pain hypersensitivity, but within nine weeks withdrawal thresholds return to baseline value. The original model was described in rats.

Despite technical advantages or disadvantages of each model, a distinct pattern should be distinguished in order to better understand specific mechanisms and possible differences between models. The emerging concept that non-injured fibers may participate in the generation and maintenance of neuropathic pain symptoms, as well as chemical cross talk and non-neuronal cell signaling, makes it important to distinguish models in relation to the co-mingling of injured primary sensory neurons/afferent fibers and uninjured neurons/fibers (see Table 1).

### Surgery

Under general anesthesia, the sciatic nerve portion at thigh level is exposed using a longitudinal section through the biceps femoris muscle. The three terminal branches are easily located. Common peroneal and tibial nerves are delicately dissected in order to separate them from the surrounding tissue. The tip of a fine curved forceps is placed under the common peroneal nerve, avoiding any lift up. Five centimeters of 5.0 silk

N

**Neuropathic Pain Model, Spared Nerve Injury, Table 1** Anatomically-related specific patterns of intermingling of primary sensory neuron cell bodies and axons distal to the peripheral nerve injury in animal models of neuropathic pain

Animal model	Sensory ganglia	Peripheral axons distal to injury
Complete sciatic nerve transection (associated or not with femoral nerve transection) <sup>1</sup>	Co-mingling of injured & non-injured neurons in L4 and L5 DRGs	<i>Injured axons only</i>
Chronic constrictive injury of the sciatic nerve or the infra-orbital nerve <sup>2</sup>	Co-mingling of injured & non-injured neurons in L4, L5 DRGs or in trigeminal ganglion	Intermingling of injured A-fiber and intact C-fiber axons
Partial sciatic nerve ligation (PSN) <sup>3</sup>	Co-mingling of injured & non-injured neurons in L4, L5 DRGs	Intermingling of injured and intact nerve fibers
Spinal nerve ligation (SNL) <sup>4</sup>	Non-injured neurons in L4 DRG & injured neurons only in L5 and L6 DRGs, no co-mingling	Intermingling of injured and intact axons
Spared nerve injury (SNI) <sup>5</sup>	Co-mingling of injured & non-injured neurons in L4 and L5 DRG	No intermingling of injured and intact axons

<sup>1</sup> Wall et al. 1979. <sup>2</sup> Bennett and Xie 1988; Vos et al. 1994, Mosconi and Kruger 1996. <sup>3</sup> Kim and Chung 1992. <sup>4</sup> Wall et al. 1979. <sup>5</sup> Decosterd and Woolf 2000.

suture is placed into the forceps' tip and slipped under the nerve. Two tight knots are made and the nerve is distally transected, including the removal of a portion of 2–4 mm. The same procedure is repeated for the tibial nerve. Crush injury is performed as above, except that injured nerves are only crushed for 30 seconds by a pair of small arterial clamps (with smooth protective pads). Special care needs to be taken to prevent any lesion to the spared nerve, and especially to avoid lifting up, touching or stretching the spared sural nerve during the surgical procedure.

### Experimental Conditions

Genetic and environmental factors influence the course of pain behavioral studies (Chesler et al. 2002), and efforts are needed to standardize study conditions when using the SNI model. We try in our laboratory as much as possible to minimize the major variables:

- The investigator: the same investigator conduct a specific study, and he or she must be blind to the treatment/genotype applied
- Young adult male Sprague-Dawley rats (weighting initially 180–200 g, Charles River Inc) are very docile and all animals develop the neuropathy-related behavior. The same vendor and vendor's strain is recommended for each study
- Behavioral assessment of treated and control animals is performed during the same testing session in order to maintain the same experimental environment in both groups
- The behavioral testing is always performed at the same time of the day, the same order of testing is respected in between testing sessions
- The animals are housed and tested in a room of constant temperature and light cycle, and they have free access to food (same diet) and water. Animal transportation is avoided immediately before the testing session. Recordings are performed in a room devoted only to behavioral testing

### Behavioral Assessment

The animals are daily habituated to the environment, testing material and investigator for at least two weeks before the first recordings. Behavioral assessment is performed as described originally (Decosterd and Woolf 2000) before and after SNI surgery. For plantar application, rats are enclosed in a home made transparent Plexiglas observation chamber (22 x 13 x 13 cm) atop a wire mesh floor (mesh of 0.25 cm<sup>2</sup>). For dorsal application, rats are placed on a plane neutral floor. The investigator gently holds the animal and has direct access to the dorsal side of the hind paw.

During a study, mechanical and cold sensitivities were tested consecutively, with a 30 minute time interval between modalities tested. Heat assay are performed the next day and the animals are placed in the same obser-

vation chambers, but onto a transparent glass floor (Ugo Basile, Comerio, Italy).

► **Mechanical allodynia**-like behavior: the threshold is determined at the lowest force that evokes a brisk withdrawal response to one of five stimuli. Von Frey monofilaments are applied perpendicularly to the skin, in ascending force order, in the lateral area of the hind paw. Five stimuli cover the area, and contact with footpad or hairs are carefully avoided. The paw withdrawal threshold is recorded, and decreases significantly after surgery in both hairy and glabrous skin territory of the sural nerve (Fig. 1a and Decosterd and Woolf 2000). There is no contralateral effect of SNI.

► **Cold allodynia**-like behavior: a drop of acetone solution (99.6%) is delicately placed under the plantar lateral side of the paw using a blunt needle. Acetone evaporates and produces a cold sensation. In the affected side, acetone induces long-lasting paw withdrawal as well as paw shaking and licking (Fig. 1b and Decosterd and Woolf 2000). The total duration of paw withdrawal is recorded, with a minimal time at 0.5 s for brief response and a cut-off at 60 s.

► **Mechanical hyperalgesia**-like behavior: a pinprick test is performed in the same skin area, using a safety pin. A single prick was given at a force such that the skin dimpled but was not penetrated. The duration of paw withdrawal was recorded, with a minimal time at 0.5 s for brief response and a maximal cut-off at 60 s. Response duration is increased for the injured paw, but to a lesser extent than after acetone stimulation (Fig. 1b and Decosterd and Woolf 2000).

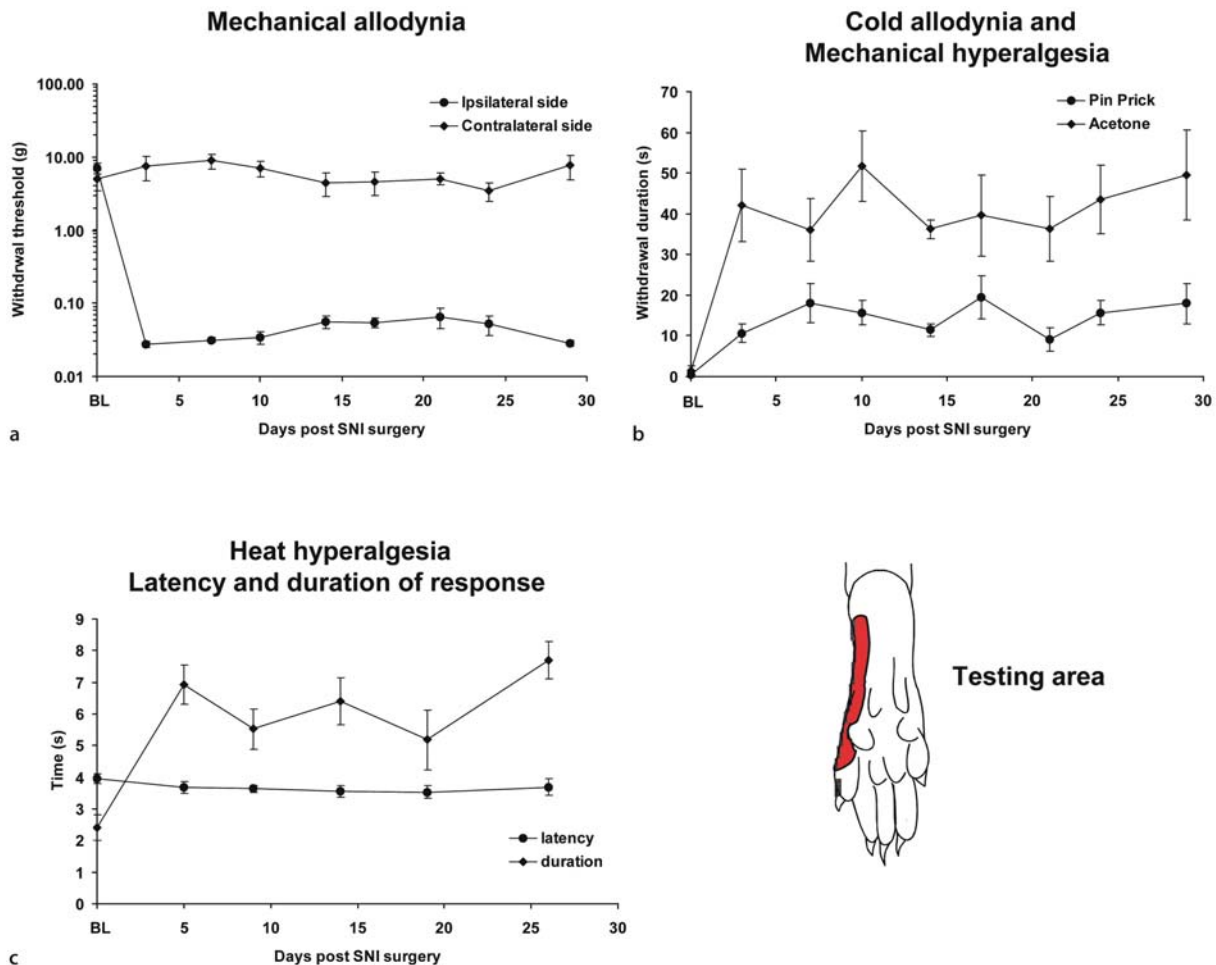
► **Heat hyperalgesia**-like behavior: a movable radiant infrared heat source enables stimulation of the lateral part of the hind paw (Hargreaves et al. 1988)). Withdrawal reflex latency and duration due to heat stimulation are recorded with a 0.5 s minimal and a 60 s cut-off. Latency of stimulation is not modified by SNI, but the duration of the abnormal response is significantly increased (Fig. 1c and Decosterd and Woolf 2000). Although possible, plantar heat stimulation through transparent plane hard floor is difficult for the SNI lesioned paw. The animals refrained from weight bearing on the affected paw, and the foot is everted due to both pain hypersensitivity and neuro-muscular defects. This may lead to loose contact between the floor surface and the paw, altering the transmission of the thermal stimulus.

In summary, the spared sural nerve SNI model is an easily reproducible model of neuropathic pain. Mechanical and cold pain-hypersensitivity are assessable behaviorally, and, therefore, may provide functional information on mechanisms responsible for stimulus-evoked pain in neuropathic pain conditions.

### References

1. Bennett GJ, Xie YK (1988) A Peripheral Mononeuropathy in Rat that Produces Disorders of Pain Sensation Like Those Seen in Man. *Pain* 33:87–107





**Neuropathic Pain Model, Spared Nerve Injury, Figure 1** Mechanical and thermal hypersensitivity recorded in the spared sural nerve territory after SNI. (a) Withdrawal threshold in g determined after application of ascending series of von Frey monofilaments. (b) Withdrawal duration in s after application of acetone or pin prick stimulation. (c) Heat sensitivity (withdrawal latency and duration in s). BL, baseline. Representative series of 12 animals tested before (BL) and after SNI surgery. Results are displayed as the mean value  $\pm$ SEM. ]

- Chesler EJ, Wilson SG, Lariviere WR et al. (2002) Influences of Laboratory Environment on Behavior. *Nat Neurosci* 5:1101–1102
- Decosterd I, Woolf CJ (2000) Spared Nerve Injury: An Animal Model of Persistent Peripheral Neuropathic Pain. *Pain* 87:149–158
- Hargreaves K, Dubner R, Brown F et al. (1988) A New and Sensitive Method for Measuring Thermal Nociception in Cutaneous Hyperalgesia. *Pain* 32:77–88
- Kim SH, Chung JM (1992) An Experimental Model for Peripheral Neuropathy Produced by Segmental Spinal Nerve Ligation in the Rat. *Pain* 50:355–363
- Mosconi T, Kruger L (1996) Fixed-Diameter Polyethylene Cuffs Applied to the Rat Sciatic Nerve Induce a Painful Neuropathy - Ultrastructural Morphometric Analysis Of Axonal Alterations. *Pain* 64:37–57
- Seltzer Z, Dubner R, Shir Y (1990) A Novel Behavioral Model of Neuropathic Pain Disorders Produced in Rats by Partial Sciatic Nerve Injury. *Pain* 43:205–218
- Vos BP, Strassman AM, Maciewicz RJ (1994) Behavioral Evidence of Trigeminal Neuropathic Pain Following Chronic Constriction Injury to the Rat's Infraorbital Nerve. *J Neurosci* 14:2708–2723
- Wall PD, Devor M, Inbal R et al. (1979) Autotomy Following Peripheral Nerve Lesions: Experimental Anaesthesia Dolorosa. *Pain* 7:103–111

## Neuropathic Pain Model, Spinal Nerve Ligation Model

JIN MO CHUNG, KYUNGSOON CHUNG  
Department of Neuroscience and Cell Biology,  
University of Texas Medical Branch, Galveston, TX,  
USA  
jmchung@utmb.edu, kchung@utmb.edu

### Synonyms

Spinal Nerve Ligation Model; SNL Model; Chung model

### Definition

The spinal nerve ligation (SNL) model of **neuropathic pain**, refers to a rodent neuropathic pain model that is produced by tightly ligating the lumbar segmental spinal nerve (L5 alone or both L5 and L6) (Kim and Chung 1992). The lumbar segmental spinal nerve refers to a short length of the peripheral nerve distal to the dorsal

root ganglion before it joins with other segmental nerves to form the lumbar plexus. The lumbar segmental spinal nerve divides into a small dorsal ramus and a large ventral ramus, and the SNL model usually ligates the ventral ramus only since the dorsal ramus is denervated during the surgery.

## Characteristics

### Methods to Produce the SNL Model

**Animals:** Most commonly, young adult male rats of various strains are used (see Factors influencing variability). After purchase, rats are normally acclimated for about a week in the Institutional Animal Care Center, with free access to food and water in a room with a reversed light-dark cycle (dark: 8 A.M.–8 P.M.; light: 8 P.M.–8 A.M.) before experimental manipulation.

**Surgical Operation:** Figure 1 shows the anatomy of the lumbosacral parasagittal region. Rats are anesthetized with either inhalation gas or intraperitoneal injection of sodium pentobarbital and placed in the prone position. Under sterile conditions, a longitudinal incision is made at the lower lumbar/upper sacral level, exposing the parasagittal muscles on the left. Using a pair of small scissors with blunt tips, the parasagittal muscles are isolated and removed from the level of the L5 spinous process to the S1. This opens up the space ventrolateral to the articular processes, dorsal to the L6 transverse process, and medial to the ileum. Connective tissues and remaining muscles are removed with a small scraper. Under a dissecting microscope, the L6 transverse process, which covers the ventral rami of the L4 and L5 spinal nerves, is removed using a small rongeur. Access to the L5 spinal nerve is easier when the transverse process is removed very close to the body of the vertebrae. One can normally visualize the ventral rami of the L4 and L5 spinal

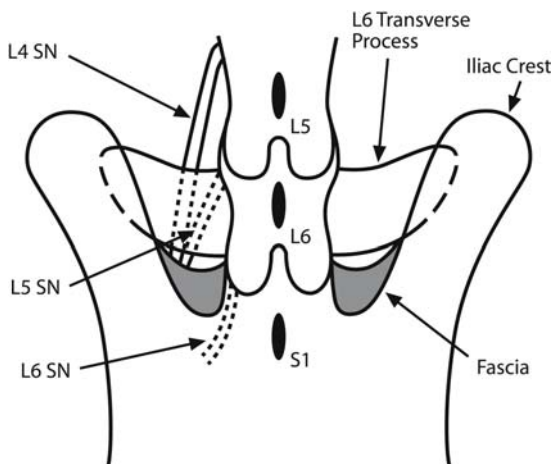
nerves (a thin sheet of connective tissue may cover them in some animals) once the L6 transverse process is carefully removed. The L4 spinal nerve usually runs more laterally (or ventrally in some animals) than the L5, and these two nerves join distally in a common epineurial sheet, however, there is a great deal of individual variability where these two nerves join. Thus, the L4 and L5 spinal nerves need to be separated in some animals to make the L5 spinal nerve accessible for ligation. It is very important not to damage the L4 nerve during this process, because we find that even slight damage to the L4 spinal nerve invariably results in a greatly reduced mechanical sensitivity of the foot. Damage to the L4 spinal nerve can occur with a seemingly mild mechanical trauma (excessive touch, gentle stretch, or slight entrapment within the epineurial sheet). Once enough length of the L5 spinal nerve is freed from the adjacent structure, a piece of 6-0 silk thread is placed around the L5 spinal nerve and the nerve is tightly ligated to interrupt all axons in the nerve. Another option would be to cut the spinal nerve just distal to the ligation to make sure all fibers are interrupted.

The L6 spinal nerve can also be ligated if so desired. The L6 spinal nerve runs underneath the sacrum and is not visible without chipping away a part of the sacrum. Since the sacrum bleeds a lot when chipped, it would be better to approach the L6 spinal nerve blindly without chipping the sacrum. After carefully removing the fascia joining the sacrum to the ileum, one can place a small glass hook underneath the sacrum and gently pull the L6 spinal nerve out into the paravertebral space and ligate it tightly with 6-0 silk thread.

Upon completion of the operation, which normally takes about 10–15 minutes (after some practice), hemostasis is confirmed and the muscles are sutured in layers using silk thread and the skin is closed with metal clips, anesthesia is then discontinued. Animals are then kept in a cage with warm bedding until they completely recover from anesthesia.

**Behavioral Outcome of Surgery:** Successfully operated animals normally do not show any motor deficits beyond a mild inversion of the foot with slightly ventroflexed toes. The most common and obvious motor deficit of unsuccessfully operated animals is dragging the hind limb of the operated side, a sign of paralyzed proximal muscles. This invariably indicates damage to the L4 spinal nerve, since this nerve innervates many proximal muscles of the hind limb.

A successfully operated rat shows various behavioral signs of neuropathic pain such as ongoing pain, heat ► **hyperalgesia**, and mechanical as well as cold ► **allodynia**. Since the SNL model shows a particularly robust sign of mechanical allodynia, one can use the degree of hypersensitivity to gauge the success of the operation. Mechanical sensitivity is quantified either by measuring response frequency to mechanical



**Neuropathic Pain Model, Spinal Nerve Ligation Model, Figure 1** Schematic diagram showing the dorsal view of the bony structures and spinal nerves at the lumbosacral level after removal of parasagittal muscles.

stimuli applied with ► **von Frey filaments** (Kim and Chung 1991; Kim and Chung 1992) or by determining the mechanical threshold (Chaplan et al. 1994). A successful surgical operation will result in a clear sign of mechanical allodynia demonstrated by either: 1) lowering the foot withdrawal threshold below the normal nociceptor activation threshold [below 1.4 g (Leem et al. 1993)], 2) frequent foot withdrawals to mechanical stimulation at a strength below the normal nociceptor activation threshold, or 3) frequent foot withdrawals to obviously innocuous stimulations. On the other hand, sham-operation should not produce any significant changes in mechanical sensitivity, except a mild transient effect lasting one or two days. A significant and long lasting hyperalgesia following sham-operation invariably indicates that the surgery induced damage and/or inflammation to the nerve and is thus an unsuccessful operation.

### Factors Influencing Variability

Multiple factors seem to influence the behavioral outcome after SNL and hence contribute to variability of data. The strain of rats is an important variable. Not only do different strains of rats show different levels of neuropathic pain behaviors, but also different levels of pain behaviors can also be seen in different substrains of Sprague-Dawley rats obtained from different suppliers (Yoon et al. 1999). Another important factor that influences the sign of mechanical allodynia is the exact testing spot on the paw where the mechanical stimulation is applied. To represent the most intensely painful area of a human patient, one must measure the threshold at the most sensitive area of the rat. The most sensitive area of the paw after ligation of the L5 or both the L5 and L6 spinal nerves is the base of the 3<sup>rd</sup> or 4<sup>th</sup> toe (Xie et al. 1995). The most sensitive spot of the paw after spinal nerve ligation is confined to a small area and does not vary much between rats, presumably due to stereotyped denervation of the foot by the surgical procedure. When measuring in the most sensitive area, the threshold is usually well below the 1 g range, whereas the threshold ranges from 2 to 3 g if one measures it by stimulating the mid-plantar area (Chung et al. 2004).

### Advantages and Disadvantages of the SNL Model Compared to Others

The SNL model has several advantages over other models. These include that: 1) the injury is stereotyped, 2) it has successfully adapted to multiple species of animals, and 3) the injured and uninjured afferents are segregated to different spinal segments. Tight ligation is advantageous over loose ligation in terms of knowing the timing of injury, as well as the population of fibers being injured. In addition, a tight ligation of a specific set of nerves in every animal will reduce the variability among animals. Many neuropathic pain models, including the

SNL model, which was originally developed using the rat, are now successfully adapted to the mouse (Mogil et al. 1999). The SNL model has also been successfully applied to the monkey (Carlton et al. 1994). The uniqueness of the SNL model, however, is that spinal inputs of injured and uninjured afferents are segregated at separate spinal segments. This feature allows the investigation of the contribution of injured and uninjured afferent fibers to neuropathic pain.

There are also some disadvantages to the SNL model. These include that: 1) the surgical procedure is invasive, and 2) the model is highly artificial. Because the spinal nerves are located deep, the surgery to expose them requires some level of skill and, hence, may be a source of variability. A particularly technically difficult aspect is to preserve the L4 spinal nerve completely undamaged while ligating the L5 spinal nerve since they are located in close proximity. Since it is rare to find a patient with discrete spinal nerve injury, this model is highly artificial.

Different models tend to produce different behavioral outcomes. A previous study compared the behaviors of 3 different models [SNL, chronic constriction injury (CCI), and partial sciatic nerve ligation (PSL) models] (Kim et al. 1997). The CCI model produced the most robust ongoing pain behaviors, whereas mechanical allodynic behaviors were most prominent in the SNL model.

### References

1. Carlton SM, Lekan HA, Kim SH, Chung JM (1994) Behavioral Manifestations of an Experimental Model for Peripheral Neuropathy Produced by Spinal Nerve Ligation in the Primate. *Pain* 56:155–166
2. Chaplan SR, Bach FW, Pogrel JW, Chung JM, Yaksh TL (1994) Quantitative Assessment of Tactile Allodynia in the Rat Paw. *J Neurosci Methods* 53:55–63
3. Chung JM, Kim HK, Chung K (2004) Segmental Spinal Nerve Ligation Model of Neuropathic Pain in Pain Research: Methods and Protocols. In: ZD Luo (ed) *Methods in Molecular Medicine* series (Serial ed. John M. Walker). The Humana Press Inc, Totowa, NJ (in press)
4. Kim KJ, Yoon YW, Chung JM (1997) Comparison of Three Rodent Neuropathic Pain Models. *Exp Brain Res* 113:200–206
5. Kim SH, Chung JM (1991) Sympathectomy Alleviates Mechanical Allodynia in an Experimental Animal Model for Neuropathy in the Rat. *Neurosci Lett* 134:131–134
6. Kim SH, Chung JM (1992) An Experimental Model for Peripheral Neuropathy Produced by Segmental Spinal Nerve Ligation in the Rat. *Pain* 50:355–363
7. Leem JW, Willis WD, Chung JM (1993) Cutaneous Sensory Receptors in the Rat Foot. *J Neurophysiol* 69:1684–1699
8. Mogil JS, Wilson SG, Bon K, Lee SE, Chung K, Raber P, Pieper JO, Hain HS, Belknap JK, Hubert L, Elmer GI, Chung JM, Devor M (1999) Heritability of Nociception I: Responses of 11 Inbred Mouse Strains on 12 Measures of Nociception. *Pain* 80:67–82
9. Xie J, Yoon YW, Yom SS, Chung JM (1995) Norepinephrine Rekindles Mechanical Allodynia in Sympathectomized Neuropathic Rat. *Analgesia* 1:107–113
10. Yoon YW, Lee DH, Lee BH, Chung K, Chung JM (1999) Different Strains and Substrains of Rats Show Different Levels of Neuropathic Pain Behaviors. *Exp Brain Res* 129:167–171

## Neuropathic Pain Model, Tail Nerve Transection Model

H. S. NA<sup>1</sup>, H. J. KIM<sup>2</sup>, S. K. BACK<sup>1</sup>, B. SUNG<sup>1</sup>,  
Y. I. KIM<sup>1</sup>, Y. W. YOON<sup>1</sup>, H. C. HAN<sup>1</sup>, S. K. HONG<sup>1</sup>

<sup>1</sup>Medical Science Research Center and Department of Physiology, Korea University College of Medicine, Seoul, Korea

<sup>2</sup>Department of Life Science, Yonsei University Wonju Campus, Wonju, Korea  
hsna@korea.ac.kr

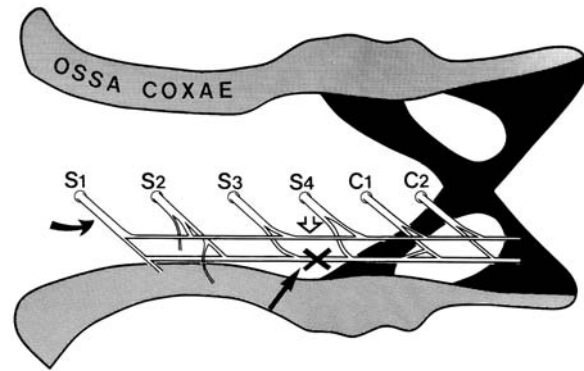
### Definition

The tail nerve transection model is produced by the incomplete injury of the nerves (i.e. the inferior and/or superior caudal trunks) innervating the tail. The model displays chronic neuropathic signs like ► **mechanical allodynia**, ► **cold allodynia** and ► **warm allodynia** in the tail skin.

### Characteristics

The tail nerve transection model is one of the ► **peripheral neuropathic pain** animal models. Peripheral nerve injury sometimes results in neuropathic pain. This type of pain is characterized by spontaneous burning pain accompanied by ► **hyperalgesia** and ► **allodynia** lasting variable times. Several experimental animal models for neuropathic pain, produced by a partial injury of the nerves supplying the rat hind paw, were developed by Bennett & Xie (1988), Seltzer et al. (1990) and Kim & Chung (1992), respectively. Although these models display clear signs of neuropathic pain, there are some inherent problems in performing behavioral tests due to foot deformity. To avoid these problems, the tail nerve transection model, produced by transection of inferior caudal trunk at the level between the S3 and S4 spinal nerve, was developed (Na et al. 1994; Kim et al. 1995). This model shows neuropathic signs without tail deformity. In addition, modified methods, such as the transection of superior caudal trunk (Back et al. 2002) or both trunks (Kim et al. 2001) also showed similar neuropathic changes.

The tail skin is innervated by the inferior and superior caudal trunks, which are located in the ventral and dorsal parts of the pelvic bone, respectively. The two trunks are composed of the dorsal and ventral divisions, respectively, of the four sacral and the first two caudal spinal nerves. To induce neuropathic pain in the tail skin, the inferior and/or superior caudal trunk(s) is (are) exposed carefully from the surrounding tissues and transected at the level between the S3 and S4 spinal nerves. This surgery eliminates the S<sup>1</sup>-S3 spinal nerve innervation of the tail *via* the trunk(s). Figure 1 illustrates schematically how these trunks are composed and the level of the transection of the inferior caudal trunk.



**Neuropathic Pain Model, Tail Nerve Transection Model, Figure 1** A schematic diagram (dorsal view) illustrating how the inferior (black arrow) and superior (open arrow) caudal trunks are composed and the level of transection (X) of the inferior caudal trunk. The curved arrow indicates the S1 spinal nerve.

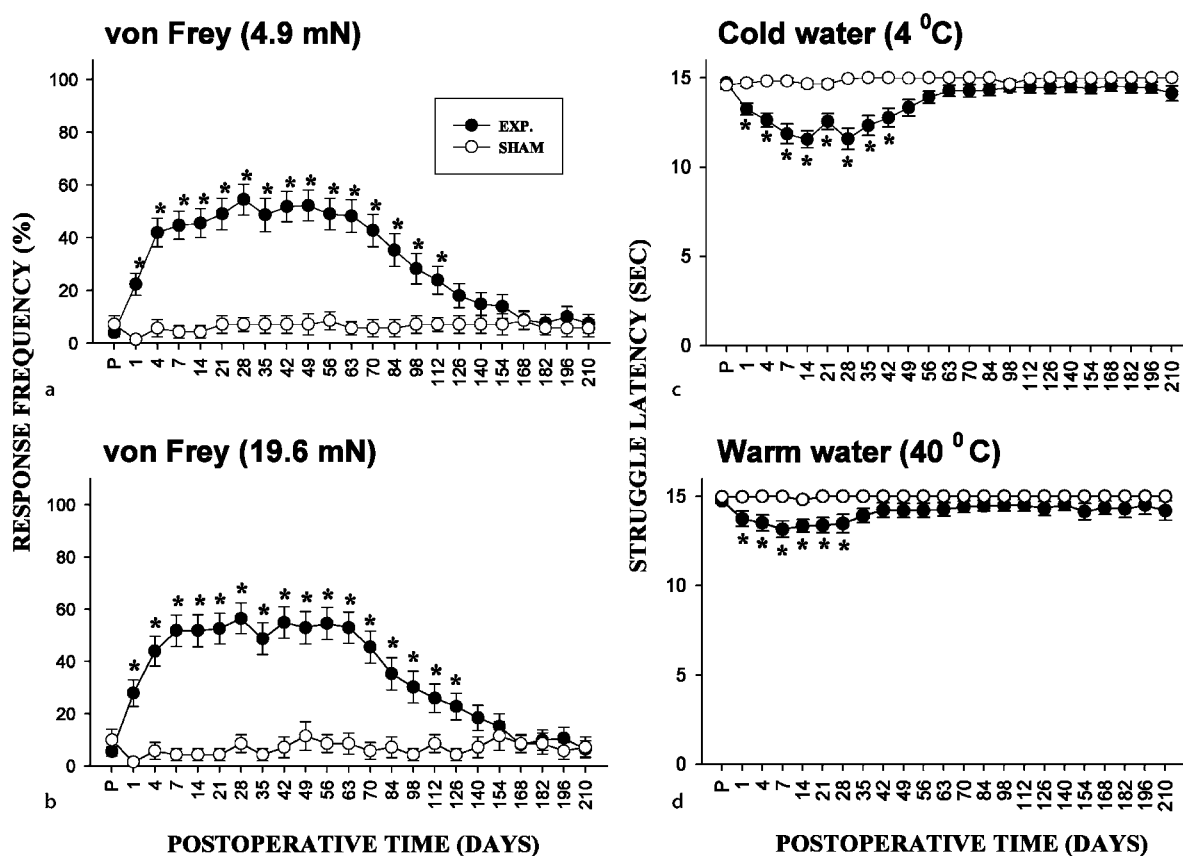
The signs indicative of mechanical allodynia can be sought by applying normally innocuous mechanical stimuli to the tail using ► **von Frey hairs**. For convenient application of the stimuli, the animal is restrained in a transparent plastic tube and the tail is laid on a plate. The most mechanically sensitive spot of the tail is first determined by rubbing various areas of the tail with the shank of the von Frey hair, and then, this area is poked systematically with the von Frey hair to locate the most sensitive spot. An abrupt tail movement of about 0.5–20 cm in response to the von Frey hair stimulation is considered to be an abnormal response, indicative of mechanical allodynia. During repeated trials, the test stimuli are delivered to the same spot without difficulty, since the tail is usually stationary.

Figure 2a and 2b show the data obtained with the von Frey hairs (4.9 mN and 19.6 mN). Prior to the neuropathic surgery, the frequency of the abnormal tail response to von Frey hair stimulation is near 0 percent. However, after the neuropathic surgery, the frequency increases dramatically from 1 day PO (postoperatively) and lasts for at least 4 months, unlike the frequency in sham-operated animals. These results suggest that the partial injury of the nerves innervating the tail leads to mechanical allodynia in the tail.

The signs indicative of cold and warm allodynia can be sought by immersing the tail in 4°C and 40°C water, respectively. The rat is restrained in a plastic tube, and the tail is drooped for convenient application of the thermal stimuli. Following the tail immersion, the investigator measures the latency of the tail withdrawal response with a cut-off time of 15 s. A tail withdrawal response with a latency shorter than the cut-off time is considered to be an abnormal tail response indicative of thermal allodynia. The tail immersion test is repeated 5 times at 5 min intervals to obtain the average tail response latency.

Figure 2c and 2d show the data obtained with the cold (4°C) and warm (40°C) water, respectively. Prior to the





**Neuropathic Pain Model, Tail Nerve Transection Model, Figure 2** Tail responses to mechanical (a, b), cold (c) and warm (d) stimuli. The mean ( $\pm$  SEM) response frequency in the case of mechanical stimulation with von Frey hairs (4.9 mN, 19.6 mN) and the mean ( $\pm$  SEM) response latency in the case of cold (4°C) and warm (40°C) stimulation of experimental (Exp, n=44) and sham (n=14) groups are plotted against the experimental days (P: 1 day before nerve injury). Asterisks indicate the scores significantly different from the preoperative value ( $P < 0.05$  by the Friedman test followed by a pairwise post-hoc test).

neuropathic surgery, most rats did not show abnormal tail responses to the cold or warm water stimuli. However, after the neuropathic surgery the tail response latency significantly decreased from 1 day PO and lasted for 5–7 weeks. These results suggest that the partial injury of the nerves innervating the tail leads to cold and warm allodynia in the tail. The possibility that the abnormal tail responses to the 4°C or 40°C water immersion are due to the mechanical contact of the tail with the water instead of thermal stimulation is essentially ruled out, since 1) in a vast majority of the cases, 30°C water does not induce any abnormal tail responses and 2) the 4°C or 40°C water-induced responses have latencies greater than at least a few seconds, unlike the von Frey hair-evoked responses which had virtually no latencies. The tail nerve transection model, like the previously developed ones, shows chronic neuropathic signs like mechanical and thermal (cold and warm) allodynia. Furthermore, the model offers several advantages in surgical approach and performing the behavioral tests. First, surgical procedures for the model are so simple that even neonatal rats or mice can be used (Back et al.

2002). In fact, although rat models for neuropathic pain have been applied to the mouse (Malmberg and Basbaum 1998; Mansikka et al. 2000; Mogil et al. 1999), there are some problems from the invasiveness of these approaches. Second, since the inferior and superior caudal trunks are composed of the four sacral and the two caudal spinal nerves, the number of injured fibers or the spinal level of injury can be changed according to the transection site. This advantage was helpful to elucidate of the fact that the extent of **sympathetic fiber sprouting** in the **dorsal root ganglion (DRG)** was related to the number of injured nerve fibers (Kim et al. 2001) and the distance between the DRG and injury site (Kim et al. 1996). Third, application of both mechanical and thermal stimuli to the partially denervated area (i.e. the tail) is straightforward. For example, tail immersions into cold or warm water make all thermal receptors in the tail receive the same thermal stimulation simultaneously. In addition, since there is no deformity in the tail after the nerve injury, the mechanically sensitive spot is easily located and blind behavioral tests are available.

## References

1. Back SK, Sung B, Hong SK et al. (2002) A mouse model for peripheral neuropathy produced by a partial injury of the nerve supplying the tail. *Neurosci Lett* 322:153–156
2. Bennett GJ, Xie Y-K (1988) A peripheral mononeuropathy in rat that produces disorders of pain sensation like those seen in man. *Pain* 33:87–107
3. Kim SH, Chung JM (1992) An experimental model for peripheral neuropathy produced by segmental spinal nerve ligation in the rat. *Pain* 50:355–363
4. Kim YI, Na HS, Han JS et al. (1995) Critical role of the capsaicin-sensitive nerve fibers in the development of the causalgic symptoms produced by transecting some but not all of the nerves innervating the rat tail. *J Neurosci* 15:4133–4139
5. Kim HJ, Na HS, Nam HJ et al. (1996) Sprouting of sympathetic nerve fibers into the dorsal root ganglion following peripheral nerve injury depends on the injury site. *Neurosci Lett* 212:191–194
6. Kim HJ, Na HS, Back SK et al. (2001) Sympathetic sprouting in sensory ganglia depends on the number of injured neurons. *NeuroReport* 12(16):3529–3532
7. Malmberg AB, Basbaum AI (1998) Partial sciatic nerve injury in the mouse as a model of neuropathic pain: behavioral and neuroanatomical correlates. *Pain* 76:215–222
8. Mansikka H, Sheth RN, DeVries C et al. (2000) Nerve injury-induced mechanical but not thermal hyperalgesia is attenuated in neurokinin-1 receptor knockout mice. *Exp Neurol* 162:343–349
9. Mogil JW, Wilson SG, Bon K et al. (1999) Heritability of nociception I: Responses of 11 inbred mouse strains on 12 measures of nociception. *Pain* 80:67–82
10. Na HS, Han JS, Ko KH et al. (1994) A behavioral peripheral neuropathy produced in rat's tail by inferior caudal trunk injury. *Neurosci Lett* 177:50–52
11. Seltzer Z, Dubner R, Shir Y (1990) A novel behavioral model of neuropathic pain disorders produced in rats by partial sciatic nerve injury. *Pain* 43:205–218

## Neuropathic Pain Models, CRPS-I Neuropathy Model

JEAN-JACQUES VATINE<sup>1</sup>, JEANNA TSENTER<sup>2</sup>, ZE'EV SELTZER<sup>3</sup>

<sup>1</sup>Outpatient and Research Division, Reuth Medical Center, Tel Aviv, Israel

<sup>2</sup>Department of Physical Medicine and Rehabilitation, Hadassah University Hospital, Jerusalem, Israel

<sup>3</sup>University of Toronto Centre for the Study of Pain, Faculty of Dentistry, Toronto, ON, Canada  
vatinejj@reuth.org.il

### Synonyms

Reflex Sympathetic Dystrophy; Algodystry; Sudeck's Atrophy; CRPS-I neuropathy model

### Definition

Complex regional pain syndrome (CRPS) is a neuropathic pain disorder that usually develops after a noxious event. Pain is frequently described as burning and continuous and exacerbated by movement, continuous stimulation or stress. The syndrome includes spontaneous pain and/or stimulus evoked pain (► **allodynia** and ► **hyperalgesia**), exceeding in both

magnitude and duration the clinical course expected to follow the inciting event. Regardless of the site of injury, the symptoms begin and remain most intense in the distal extremity and are not limited to the distribution of a single peripheral nerve. At some point in time, pain may be associated with edema, changes in skin blood flow and abnormal sudomotor activity in the same area, often resulting in significant impairment of motor function and showing variable progression over time. Two forms of CRPS have been identified. CRPS-I usually develops following trauma with only minor nerve damage or without any demonstrable nerve lesion whereas CRPS-II is associated with a clear nerve injury that can be characterized by abnormal clinical and/or electrodiagnostic findings (Stanton-Hicks et al. 1995). The tetanized sciatic neuropathy (TSN) model is a preparation in rodents that results in allodynia, hyperalgesia and vasomotor disturbances that mimic CRPS-I. This model is produced by activating unmyelinated afferents (C-fibers) at '► **wind up**' (Mendell 1966) parameters, using a 10 min electrical stimulation (i.e. tetanization) of an intact sciatic nerve.

### Characteristics

Harden und Bruehl (2005) recently proposed the following diagnostic algorithm to diagnose CRPS-I in humans. This algorithm is based on presentation of at least one sign in two out of the following four categories: (a) sensory abnormalities; allodynia and/or hyperalgesia, (b) vasomotor abnormalities; temperature asymmetry and/or skin color changes and/or asymmetry, (c) sudomotor abnormalities or edema; swelling and/or altered sweating and/or sweating asymmetry, (d) motor abnormalities or dystrophy; decreased range of motion and/or motor dysfunction (weakness and/or tremor and/or dystonia) and/or trophic changes in hair and/or skin and/or nails. Edema and autonomic dysregulation are usually seen in the early stage of the disease, while movement disorders and trophic changes are more apparent in the later stage. For many decades, sympathetic blockade was the method of choice for the diagnosis and treatment of CRPS-I. Pain relief in response to this procedure has been used as a criterion for diagnosis, hence the term reflex sympathetic dystrophy (RSD). However, it now appears that not all patients may have sympathetically maintained pain in CRPS (Stanton-Hicks et al. 1995). Several animal models have been developed to study the mechanisms underlying neuropathic pain mimicking CRPS-II, including the chronic constriction injury (CCI), partial sciatic ligation (PSL) and spinal nerve ligation (SNL) models. Some of these are described elsewhere in this section. The common denominator of these models is that abnormal sensory responses to stimuli and spontaneous behavior, indicative of neuropathic pain, are produced by partial denervation of a paw, tail or the face. The typical spontaneous pain behaviors include guarding behavior, repeated flicking

of the partially denervated paw, excessive licking and holding the paw in the mouth, claw pulling, elevated paw position and antalgic gait, as well as vocalization, reduced appetite, weight loss and self-mutilation (autotomy). The abnormal sensory responses to stimuli include a reduced withdrawal threshold to a stimulus that is normally non-noxious (allodynia), and exaggerated responses to a stimulus that is normally noxious (hyperalgesia). The latter is manifested as increased duration and robustness of nocifensive responses. A wealth of data on the mechanisms that trigger and underlie the pain in CRPS-II has been gathered from these animal models, since they are all produced by some type of nerve injury that partially denervates a limb. However, since in CRPS-I there is no evidence for such a nerve injury, these models may not be relevant to the study of its mechanisms (Jänig and Baron 2001).

The signals that trigger CRPS-I as well as the mechanisms maintaining the abnormalities that characterize this syndrome are still enigmatic. Since the clinical signs of CRPS-I and CRPS-II are similar, they may be produced by the same triggering input. When sensory fibers are injured, 25–33% of transected axons emit a barrage of impulses termed ► **injury discharge (ID)**. This is the first neural message to notify the CNS that an injury has occurred (Wall et al. 1974). This message comprises a burst of high frequency discharge in A-fibers and of low frequency firing in C-fibers. This burst decays in most A- and C-fibers within minutes after the injury. However, about 10% of injured fibers continue to fire for many hours and may not stop for days (Baik-Han et al. 1990; Blenk et al. 1996; Sackstein et al. 1996). Muscular afferents emit a clearly more robust ID than cutaneous afferents. ID is a distinct signal in the ‘alphabet’ of these fibers, unlike their normal response to natural stimuli, since the peak discharge of ID is 2–6-fold higher than the response to maximal normal stimulation (Sackstein et al. 1996). ID is an important signal in triggering neuropathic pain disorders in some animal models and possibly in humans as well (reviewed by Kissin, 2000).

The TSN model has been developed on the basis of the working hypothesis that CRPS I may be caused by a bodily injury that does not result in frank nerve injury but produces a massive nociceptive input that is similar to ID. The following description provides methodological details of the TSN model.

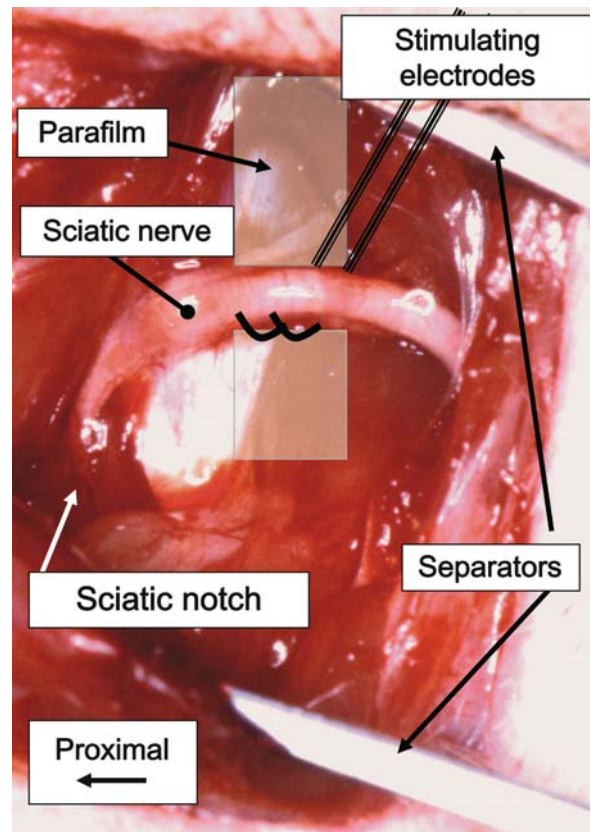
#### Animals

The original model was developed in the rat but it can easily be adapted to the mouse.

#### Preparation of the TSN Model

##### Surgery

Under inhalation anesthesia and aseptic conditions, the sciatic nerve on both sides is exposed at midthigh level and the surgical field is kept widely open with separators, taking care not to pull the posterior biceps semitendi-



**Neuropathic Pain Models, CRPS-I Neuropathy Model, Figure 1** The sciatic nerve is exposed at midthigh level and the surgical field is kept widely open with separators. A sheet of parafilm separates the nerve from neighboring tissues. A pair of stainless steel stimulating electrode hooks is inserted under the nerve.

nus nerve or other thigh nerves. The sciatic nerve is then carefully separated from neighboring tissues (Fig. 1) and a sheet of parafilm is placed under the nerve. A pair of stainless steel stimulating electrode hooks is inserted under the nerve on both sides. The exposed nerves are covered with mineral oil (37°C) to prevent damage by drying. The side that receives the tetanic stimulation should alternate between individual animals, to minimize the bias of the experimenter when testing.

#### Tetanization

Electrical stimulation of intact nerves activates leg jerking that may pull the nerves by the hook electrodes. To prevent the injury, both hind paws, the pelvis and the tail are taped to the surgical board. The tetanization includes a train supramaximally activating C-fibers at a wind-up frequency, in addition to A-fibers (shock duration = 0.5 msec, frequency = 0.5 Hz, intensity = 5 mA, train duration = 10 min, n = 300 shocks). It is noteworthy that no sensory disorders were detected when activating A-fibers only (Vatine et al. 1998). Directly observing the surgical field with a dissecting microscope during the tetanization, the experimenter should verify

that the nerves are not pulled by the electrodes. The contralateral sciatic nerve receives a sham stimulation at the same time as the ipsilateral nerve is tetanized. A separate control group of bilaterally sham-tetanized animals should optimally be included in every experiment.

### Determination of Sensory Disorders

#### Tactile Allodynia

The animal is placed on top of a metal mesh floor, and covered with an opaque plastic cage. This enables the experimenter to introduce the filaments from underneath, preventing the animal from observing the stimulus approaching. Allodynia is assessed with a set of von Frey hairs. These hairs are nylon monofilaments of different diameters that exert defined levels of force when pressed against the plantar skin with sufficient force to cause the hair to bend. Each hair is indented 5 times at a frequency of about 2 Hz. The testing process begins by using the lowest hair in the set, ascending in the series until the animal responds at threshold by lifting the paw, withdrawing from the filament. The set typically ranges from 0.05 to 25 g and needs to be calibrated weekly using a top load balance. Other methods can be used (Bennett et al. 2002). Figure 2a shows that the average group withdrawal threshold (in g) of TSN rats is significantly decreased for a period of about 40 days, compared to sham tetanized rats.

#### Heat Hyperalgesia

Several methods can be used, including the Hargreaves instruments or a laser. For the latter method, a painful

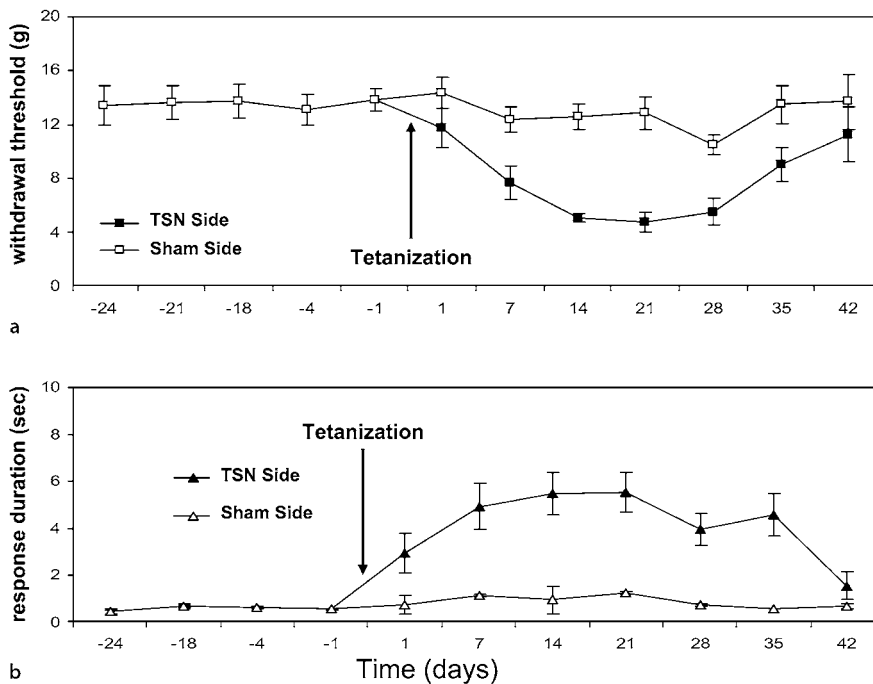
pulse of infrared energy is beamed from a CO<sub>2</sub> laser (120 msec, 5 W, 150 mCal and 1.5 mm in diameter) to the midplantar area of the hind paw from underneath, targeted by the visual aid of a He/Ne laser beam. This intensity causes sharp stinging pain to humans. Sham tetanized rats respond by a momentary paw flick or paw lift lasting less than a second. When stimulated at the TSN side, rats typically respond by immediate withdrawal followed by prolonged licking, paw lifting and claw pulling lasting on average up to 10 sec, depending on the post tetanization day and genetic and environmental variables. Figure 2b shows that the average group response duration (in sec) to stimulation on the TSN side significantly increased for a period of about 40 days, compared to the sham tetanized side.

#### Cold Hyperalgesia

A drop of acetone from a syringe is smeared on the plantar surface of the paw through the mesh floor of the testing chamber. As a control stimulus, a drop of tap water at room temperature is likewise applied, alternating between the acetone and water. The response time to each stimulus is recorded, subtracting the water from the acetone and the net result averaged for the group for each stimulated side. Increased response duration indicates cold hyperalgesia.

#### Mechanical Hyperalgesia

An increased response duration to pinprick applied from underneath to the midplantar area of the hind paw reflects hyperalgesia.



**Neuropathic Pain Models, CRPS-I Neuropathy Model, Figure 2** (a) *Tactile allodynia*. Baseline tactile sensitivity was tested with a set of von Frey hairs. The withdrawal thresholds (g) to repetitive touch on the plantar side of both hind paws were tested on 5 sessions prior to nerve stimulation (days -24, -21, -18, -4 and -1). On day 0, the rats underwent unilateral tetanic stimulation of the sciatic nerve for 10 min. Tactile allodynia developed ipsilaterally, but not on the sham side. (b) *Heat hyperalgesia*. Baseline sensitivity to a noxious heat pulse from a CO<sub>2</sub> laser was tested on days -24, -18, -4 and -1 prior to nerve tetanization in intact rats. On day 0, the rats underwent unilateral tetanic stimulation of the sciatic nerve for 10 min. The significantly increased response duration (in sec) to the noxious stimulus, denotes heat hyperalgesia developed ipsilaterally on the tetanized sciatic side but not on the sham side.



### Determination of Vasomotor Disorders

Since the temperature of the plantar skin area of conscious animals fluctuates, the paw temperature is measured 2 min after the rat is lightly anesthetized with an inhalation gas and 30 sec after the temperature stabilizes. Plantar hind paw temperature is recorded bilaterally using a remote infrared sensing thermometer, while the rat is lying on its ventral side in a room with an ambient temperature maintained at  $21.0 \pm 0.5^\circ\text{C}$ . Unilateral tetanic stimulation of the sciatic nerve causes a relative cooling of the tetanized hind paw.

### Variables Potentially Affecting the TSN Model

#### Genetic Considerations

Work done in other animal models of chronic pain showed that the choice of animals might have a critical effect on the outcome, since genetic variation plays an important role. Some lines may develop robust neuropathic pain, while others may develop very weak, short lasting or even undetectable abnormalities. The original experiments on the TSN model were carried out on male Wistar rats (Vatine et al. 1998) and HA and LA rats (Vatine et al. 2001). The latter lines were selected from a stock of out bred rats (Sabra strain) based on contrasting levels of autotomy behavior following hind paw denervation by sciatic and saphenous transection (Devor and Raber 1990). Strain/line-specific differences in levels of allodynia, hyperalgesia and paw temperature abnormalities were noted. Previous reports showed differences in pain levels using the same model on animals from different vendors but also within vendors over time.

#### Environmental Considerations

The following environmental variables may dramatically affect the levels of neuropathic pain in animal models, including the TSN model. These include organismic variables like age, sex, hormonal status, prior experience with pain or drugs and seizures and variables relating to husbandry, like litter size and sex ratio, age at weaning, caging system, housing density, relation of cage mates, male-male fighting, handling frequency, bedding material, colony health status, prenatal (maternal) stress, maternal deprivation, ambient noise, ambient temperature and illumination. Also important are the circadian phase, circannual phase, meteorological factors, temperature, humidity, barometric pressure, experimenter, testing apparatus, restraint and drug injection method. Variables related to the stimulus can be no less important, including type of noxious stimulus, intensity, location, testing apparatus particularities, dependent measure, repeated testing, data transformation and experimenter proneness to bias. Investigators should exercise extreme care to control these as much as possible.

The TSN model shows similar types and durations of sensory disorders to those produced by intended nerve

injury as in the CCI, PSL, SNL and PNI models. But lack of an overt nerve injury in the TSN model, combined with the appearance of mechanical allodynia, mechanical and thermal hyperalgesia and some vasomotor disturbances resembles the abnormalities of CRPS-I in humans (Stanton-Hicks et al. 1995; Baron et al. 1996), support the suggestion that this preparation can be used to study the mechanisms underlying CRPS-I.

### References

1. Baik-Han EJ, Kim KJ, Chung JM (1990) Prolonged ongoing discharges in sensory nerves as recorded in isolated nerve in the rat. *J Neurosci Res* 27:219–227
2. Baron R, Blumberg H, Jänig W (1996) Clinical characteristics of patients with complex regional pain syndrome in Germany with special emphasis on vasomotor function. In: Jänig W, Stanton-Hicks M (eds) *Reflex Sympathetic Dystrophy: A Reappraisal*. Progress in Pain Research and Management, vol 6. IASP Press, Seattle, pp 25–48
3. Bennett GJ, Chung JM, Seltzer Z (2002) Animal models for painful neuropathies. In: Crawley JN, Gerfen C, McKay R et al. (eds) *Current Protocols in Neuroscience*, Unit 9.14. Wiley Interscience, NY, pp 426–442
4. Blenk KH, Vogel C, Michaelis M et al. (1996). Prolonged injury discharge in unmyelinated nerve fibres following transection of the sural nerve in rats. *Neurosci Lett* 215:185–188
5. Devor M, Raber P (1990) Heritability of symptoms in an experimental model of neuropathic pain. *Pain* 42:51–68
6. Harden R, Bruehl S (2005) Diagnostic criteria: The statistical derivation of the four criterion factors. In: Wilson PR, Stanton-Hicks M, Harden RN (eds) *CRPS: Current Diagnosis and Therapy*. Seattle, IASP Press, pp 45–58
7. Jänig W, Baron R (2001) The value of animal models in research on CRPS. In: Harden RN, Baron R, Jänig W (eds) *Complex Regional Pain Syndrome*. Progress in Pain research and Management. IASP Press, Seattle, p75–85
8. Kissin I (2000) Preemptive analgesia: how can we make it work? In: Devor M, Rowbotham MC, Wiesenfeld-Hallin Z (eds) *Proceedings of 9th World Congress of Pain*. Progress in Pain research and Management. IASP Press, Seattle, p 973–985
9. Mendell LM (1996) Physiological properties of unmyelinated fiber projection to the spinal cord. *Exp Neurol* 16:316–332
10. Sackstein MJ, Ratner A, Seltzer Z (1996) Specific patterns of injury discharge are associated with receptor types in freshly injured sensory myelinated (A-) and unmyelinated (C-) fibers in rat. Abstracts of the 8th World Congress of the International Association for the Study of Pain. IASP Press, Vancouver, Seattle, p 11
11. Stanton-Hicks M, Janig W, Hassenbusch S et al. (1995) Reflex sympathetic dystrophy: changing concepts and taxonomy. *Pain* 63:127–133
12. Vatine JJ, Argov R, Seltzer Z (1998) Short electrical stimulation of c-fibers in rats produces thermal hyperalgesia lasting weeks. *Neurosci Lett* 246:125–8
13. Vatine JJ, Tsenter J, Raber P et al. (2001) A model of CRPS I produced by tetanic electrical stimulation of an intact sciatic nerve in the rat: Genetic and Dietary effects. In: Harden RN, Baron R, Jänig W (eds) *Complex Regional Pain Syndrome*. Progress in Pain research and Management, vol 22. IASP Press, Seattle, pp 53–74
14. Wall PD, Waxman S, Basbaum AI (1974) Ongoing activity in peripheral nerve: Injury discharge. *Exp Neurol* 45:576–589

N

## Neuropathic Syndrome

- Lower Back Pain, Physical Examination

## Neuropathic Pain of Central Origin

ROBERT P. YEZIERSKI

Department of Orthodontics, Comprehensive Center for Pain Research and The McKnight Brain Institute, University of Florida, Gainesville, FL, USA

ryezierski@dental.ufl.edu

The recognition that disease or injury to the central nervous system (CNS) leads to conditions of chronic pain can be traced back to the 1800s. One of the first descriptions of symptoms, including pain, of a condition later to be called Wallenberg's syndrome was reported by Marchet (1811). A number of later reports further documented severe spontaneous pain associated with vascular lesions of the brainstem and ► **thalamus**. Shortly after the turn of the century Dejerine and colleagues presented their classic papers defining the term thalamic syndrome, which included disturbances of superficial and deep sensibility combined with severe, persistent, paroxysmal, often intolerable pain (Dejerine and Egger 1903; Dejerine and Roussy 1906).

Throughout the early 1900s, reports continued to document the condition of pain following injury or disease in the CNS. Head and Holmes (1911) described spontaneous pain associated with lesions of the spinal cord and brainstem. Several years later the term ► **central pain** was used by Holmes (1919). Although the terms "pain of central origin" and "pain due to lesions of the ► **central nervous system**" were used by a number of authors, it wasn't until 1938 that the definition of central pain was firmly established (Riddoch et al. 1938). By the late 1940s, the concept of central pain was firmly entrenched in the medical literature and was characterized by the presence of ► **spontaneous pain**, ► **hyperpathia**, ► **hyperalgesia** and exaggerated motor and autonomic reactions. Interestingly, many of these symptoms are commonly associated with pain following injury to peripheral nerves. Although comparisons have been made, there are sufficient differences pertaining to incidence, prevalence, time of onset and response to therapy to easily justify separate categories for pain with peripheral-central mechanisms (► **neuropathic pain**) versus pain associated solely with disease or injury in the CNS (central pain) (Bonica 1999).

### Definition

The term central pain was initially considered synonymous with thalamic pain and for this reason most descriptions have placed both in the same category. Although thalamic lesions are considered to be one of the most common causes of central pain, it is also recognized that central pain can result from lesions anywhere

along the neuraxis from the spinal cord to the cerebral cortex (Boivie 1989; Cassinari and Pagni 1969; White and Sweet 1969). In 1994 the International Association for the Study of Pain defined central pain as pain initiated or caused by a primary lesion or dysfunction within the CNS.

### Epidemiology

#### Post-Stroke Pain

The incidence of central poststroke pain (CPSP) was estimated in 1991 to be approximately 750,000–1,000,000 patients worldwide (Bonica 1991). This calculation was based on a figure for post-stroke pain of 1–2% as described by Bowsher (1993). Recent reports however, describe this condition as more frequent than previously thought. Andersen et al. (1995) reported that central pain affected 8% of 207 central post-stroke patients with 5% having moderate to severe pain. Kumral et al. (1995) described 9% of patients with thalamic hemorrhage experiencing central pain and CPSP was found in 25% of patients following brainstem infarcts with 49% having somatosensory deficits (MacGowan et al. 1997).

#### Spinal Cord Injury Pain

The prevalence of pain following ► **spinal cord injury** ranged from 34–94% (mean 69%) in ten studies published between 1947 and 1988 (Bonica 1991) and 36–96% (mean 66%) in studies from 1975–1991 (Yeziarski 1996). In recent years the use of more comprehensive pain assessment strategies has raised the overall prevalence of SCI pain to 70–80% (Rintala et al. 1998; Widerström-Noga et al. 1999). In a recent study Siddall and colleagues (1999) reported 91% of subjects with pain of any type 2 weeks after injury. The percentage decreased to 64% 6 months after injury.

#### Surgical Lesions

Surgical lesions involving spinal or supraspinal levels of the neuraxis intended to relieve pain can result in the onset of pain. Although Cassinari and Pagni (1969) reported that the incidence of ► **dysesthesia** and central pain following functional neurosurgery was 10–60%, more conservative numbers have been reported following cordotomy (3–5%) (Lipton 1989; White and Sweet 1969). The incidence of pain after medullary tractotomies was described by Bonica (1991) as 30%, with 70–100% of patients experiencing pain after open mesencephalic tractotomy and 5–10% after stereotaxic mesencephalic tractotomy (Bonica 1991).

#### Other Neurological Disorders

Other central neurological conditions are known to be associated with chronic pain. For example, mul-

tiple sclerosis (see ► [Central Pain in Multiple Sclerosis](#)) causes central pain in 29–75% of patients (Bonica 1991). Although systematic epidemiological studies for pain associated with other types of neurological disorders have not been carried out, other conditions associated with central pain include ► [epilepsy](#) (Young and Blume 1983), ► [Parkinson's disease](#) (Koller 1984) and Huntington's disease (Albin and Young 1988).

### Clinical Characteristics of Central Pain

Spontaneous, persistent (usually burning), diffuse and / or intermittent, shooting, ice-like, aching, lancinating (with or without evoked elements) sensations, i.e. ► [hyperesthesia](#), hyperalgesia, ► [allodynia](#) and hyperpathia, are characteristics commonly associated with central pain. Dysesthesias, hypersensitivity to somatic stimuli, enhancement of pain by emotion, radiation of sensation, summation of repeated stimuli and prolonged aftersensations have also been described as components of central pain (Pagni 1998).

Central pain can develop explosively and usually continues long after stimulation. Pain intensity can vary during the day, often due to external (e.g. touch, vibration, cold) and frequently emotional factors. Spontaneous pain occurs in a large number of cases, varying from uncomfortable ► [paresthesias](#) to aching, shooting, burning pain of great intensity. As a rule, spontaneous pains frequently vary in position and may change in character and are aggravated by somatic or visceral stimulation as well as by stress and emotion, especially anxiety. Auditory, visual, olfactory and visceral stimuli can provoke or exacerbate spontaneous pain.

► [Quantitative sensory testing](#) in a region where pain is localized generally shows a paradoxical lowering of sensitivity to painful stimuli, i.e. ► [hypoalgesia](#). Within this hypoesthetic zone, a painful region is most closely correlated with a zone of decreased sensitivity to thermal stimuli (especially cold) with the intensity of pain being proportional to the loss of thermal sensibility. Studies indicate that there may be two recognizable subclasses of central pain, one signaled by loss of cold, warmth and sharpness sensibilities in which burning pain is experienced and one in which the ongoing pain is described as pricking, shooting and aching where tactile allodynia may predominate.

### Temporal Profile

Central pain can start at any time after insult, although it usually begins within the first 3 months. The time of onset does not appear to depend on the location of the lesion and there are no definite correlations between the time of onset and associated pathology. In general, central pain following stroke develops gradually as sensory impairment and weakness improve. In cases involving ► [ischemia](#) or hematomyelia, pain

has been reported to appear suddenly after insult. Shieff and Nashold (1987) described patients with pain from the time of initial insult as well as intervals varying up to 2 years. Andersen et al. (1995) described cases with pain 1 month after stroke, at 1–6 months and more than 6 months. In Tasker's series of patients (1991) central pain of brain origin was found to have a delayed onset in two-thirds of the cases, being less than 1 year in 50% of patients. Leijon described patients where pain began within 1 day after stroke, during the first month, after 3–12 months, or after 2–3 years (Leijon et al. 1989). Following spinal injury Siddall and colleagues (1999) reported ► [at-level neuropathic pain](#) 2 weeks after injury for 53% of subjects and reported ► [below-level neuropathic pain](#) for 41% of subjects within this same time period. Twenty-four percent of subjects reported neuropathic below level pain 3 months after injury while 18% reported this type of pain 6 months after injury.

### Location of Pain

The distribution of central pain is nearly always related to the somatotopic organization of the brain structure damaged by trauma, disease or vascular insult. Because of this, it is possible to identify the location of the lesion in cases of dorsal horn and bulbar lesions, whereas it is difficult to distinguish between cortical, subcortical and thalamic lesions. In the majority of cases, central pain coincides with all or part of the territory in which sensory loss is clinically observed or revealed by quantitative sensory testing. Central pain is generally described as having a diffuse distribution; however, it can involve only one extremity or a portion of an extremity, e.g. hand or side of the face, and is therefore more accurately described as extensive rather than diffuse (Boivie 1994).

Bilateral girdle pain is found in cases of intramedullary tumors or ► [syringomyelia](#). Spinal injury to the anterolateral quadrant is often referred to the opposite side of the body below the lesion. Dysesthesias from injury to the posterior column or dorsal column nuclei are typically located on the same side, below the lesion and may be unilateral or bilateral. Pain and dysesthesia due to vascular pontomedullary lesions usually have an alternating distribution, face on the lesion side and limbs and trunk contralateral to the lesion. This distribution is largely due to the fact that bulbar pain syndromes commonly result from the involvement of the posterior inferior communicating artery. Bulbar lesions can give rise to bilateral facial pain when the lesion impinges on the descending root of the trigeminal nerve on one side and on the crossed trigeminothalamic fibers coming from the other side. With pontine lesions, pain in the face is most often on the side opposite the lesion as is pain experienced in the limbs and trunk. Follow-

ing mesencephalopontine lesions, pain occurs on the side of the body contralateral to the lesion, typically with a hemiplegic distribution. Pain and dysesthesia due to thalamic lesions also have a hemiplegic distribution and affect the side of the body contralateral to the injured thalamus. Finally, cortical or subcortical lesions result in pain referred to the contralateral distal parts of the body (regions with the most extensive cortical representation).

## Central Pain Syndromes

### Thalamic Syndrome

The major features of thalamic lesions include severe, often intolerable, persistent or paroxysmal pain on the side opposite the lesion (Dejerine and Roussy 1906). This syndrome is characterized by slight hemiparesis, persistent superficial ▶ **hemianesthesia**, mild hemiataxia and astereognosis. While spontaneous pain may be absent in thalamic syndrome, excessive reaction to stimulation of affected body parts is consistent. Pain or discomfort can be evoked by almost any stimulus capable of arousing a sensation and is commonly characterized as intensely disagreeable and unbearable. Aside from spontaneous variations in pain intensity, fluctuations in pain are often exacerbated by environmental changes (especially cold), emotional stress (sudden fear, joy), strong taste or smell, loud noises, bright lights, movements, light touch, smoking and intellectual concentration. Pain is typically prolonged after stimulation and stimuli that normally have no obvious affective qualities may elicit a reaction in patients with thalamic syndrome. Patients with thalamic pain often have signs of autonomic impairment, e.g. vasoconstriction, abnormal sweating, edema (Bowsher et al. 1989).

### Post-Stroke Pain

The most common cause of central pain is vascular abnormalities, e.g. ischemic lesions, with an etiology usually including supratentorial thrombotic stroke. Infarcts are not the only vascular disorders causing pain however, as subarachnoid hemorrhage is also associated with the onset of chronic pain (Bowsher et al. 1989; Tasker et al. 1991). The condition associated with thalamic lesions resulting from stroke was redefined by Leijon et al. (1989) as central poststroke pain (CPSP) and pain originating from extrathalamic lesions was referred to as pseudothalamic pain (Boivie 1994). CPSP is characterized by sensory deficits involving cold and warm stimuli, pinprick and to a lesser extent vibration, touch and 2-point discrimination (Verstergaard et al. 1995). There may be spontaneous or evoked sensory disturbances such as paresthesia, dysesthesias, hyperpathia and allodynia to cold.

The majority of patients with post-stroke pain also have more than one kind of pain which can be de-

scribed as aching, pricking, shooting, stabbing, throbbing, squeezing, stinging, lancinating or lacerating. The pain may be superficial or deep and is typically constant, although it is not uncommon for patients to have intermittent pain and/or pain-free periods lasting a few hours. While there is evidence that a spinothalamic deficit is a necessary condition for post-stroke pain (Andersen et al. 1995; Dejerine and Roussy 1906), it is not a sufficient condition, since spinothalamic deficits are seen in more than 50% of stroke patients who show no signs of pain. However, there is evidence that the development of sensory loss and hyperalgesia in a body part deafferented by stroke is a necessary and sufficient condition for the development of central pain.

### Pain Following Spinal Lesions

Painful sensations are a frequent and troublesome sequela of paraplegia and quadriplegia following partial or complete lesions of the spinal cord. Perhaps the most comprehensive classification of spinal injury pain was proposed by Donovan and colleagues who described five pain syndromes based not only on damage to the cord, but also secondary pathological changes, e.g. spinal nerve damage, overuse of muscles and compromised visceral function, that contribute to the onset of various post-injury pain syndromes (Donovan et al. 1982). This list was amended by Davidoff and Roth (1991) with the addition of lesional pain, reflex sympathetic dystrophy and limb pain secondary to compressive mononeuropathies. Recognizing the need for a simpler classification of different SCI pain syndromes Siddall et al. (2002) proposed a taxonomy consisting of two broad categories (a) nociceptive and (b) neuropathic; with subcategories of (1) musculoskeletal and (2) visceral in the nociceptive category and (1) above-level (2) at-level and (3) below-level in the neuropathic category.

Although there is no question concerning the diversity of different pain states associated with spinal injury, of greater importance is the practical impact of SCI pain on a patient's quality of life. Widerström-Noga et al. (1999) described 37% of patients rating SCI pain as very hard to deal with (rating of 7–10 on a scale of 0–10). In this study, a cluster analysis of different consequences of injury showed a strong interrelationship among ratings for pain, spasticity, abnormal sensations and sadness further supporting the negative impact of pain on quality of life following injury.

### Imaging Central Pain

Central pain patients can be studied with neuroimaging techniques such as ▶ **single photon emission computed tomography (SPECT)**, ▶ **positron emission tomography (PET)**, ▶ **functional magnetic resonance imaging (fMRI)** and magnetic resonance



spectroscopy (MRS), which together with pharmacologic dissection can be helpful in classifying patients according to the pathophysiological mechanism(s) responsible for producing central pain. Unfortunately, there are only a few neurometabolic studies demonstrating the involvement of thalamic and / or cortical hyperactivity associated with central pain (Cesaro et al. 1991; Pagni and Canavero 1995). In PET studies patients with chronic pain show a decrease in thalamic activity (Di Piero et al. 1994). These findings may be compatible with a decrease in thalamic neuronal activity between bursts observed in patients with central pain secondary to spinal injury. Cesaro et al. (1991) in a SPECT study using an amphetamine tracer found hyperactivity in the thalamus contralateral to the pain. In another SPECT study, Canavero et al. (1995) observed hypoactivity in the parietal cortex of a patient with central pain, suggesting that under normal conditions the cortex exerts an inhibitory control over thalamic structures. Consistent with this, four patients with central poststroke pain, two with hyperpathia, showed hyperactivity in the thalamus contralateral to the hyperpathic side. Defining the potential neural and biochemical changes associated with central pain is important in determining the mechanism underlying the onset and maintenance of injury induced pain. Pattany and colleagues (2002) used proton magnetic spectroscopy to study alterations in metabolites resulting from injury induced functional changes in thalamic nuclei following SCI. In patients with pain the concentrations of N-acetyl- and myo-inositol were different compared to those without pain, suggesting anatomical and functional changes in the region of thalamus.

### Lesions Causing Central Pain

Central pain can be caused by any lesion of the nervous system that affects either completely, incompletely or subclinically the spinothalamocortical pathway. Based on an extensive review it was concluded that central pain can be due to lesions localized anywhere along this afferent sensory projection system, irrespective of whether cells or fibers are destroyed (Cassinari and Pagni 1969). Lesions leading to central pain are generally slow developing and the highest prevalence of central pain is reported in cases of lesions in the spinal cord, lower brainstem and ventroposterior part of the thalamus (Boivie 1992; Bonica 1991; Tasker 1991). The most severe injury to the spinal cord is a complete spinal transection following which patients can experience phantom limbs and complain of uncomfortable sensations such as tightness or pain. Severe pain may follow hemisection, but remote pains are rare, usually transient, lasting only a few days and are generally referred to the paralyzed, non-analgesic side of the body, but may be bilateral. Holmes attributed the sponta-

neous pain in these patients to local irritative effects of the lesion. Other lesions of the spinal cord causing central pain include (a) ► [anterolateral cordotomy](#) (b) dorsal root entry zone coagulation (see also ► [Junctional DREZ Coagulation](#)) and (c) cordectomy (Pagni 1998). Spinal contusion (see also ► [Spinal Cord Injury Pain Model, Contusion Injury Model](#)) is the most common cause of spinal injury pain. Spinal tumors can also lead to local pain in the case of extramedullary neoplasms. Local segmental pain with intramedullary tumors is infrequent, but does occur in some cases especially when the tumor arises in the posterior gray matter. One of the most pathologically destructive conditions giving rise to central pain is syringomyelia (Madsen et al. 1994). More than half of patients with delayed onset of central pain following SCI have syringomyelia and it appears that the syrinx rather than the original injury is responsible for the pain (Tasker et al. 1991).

The most common brainstem site for the development of central pain is the medulla. Central pain follows thrombosis of the posterior inferior cerebellar artery (PICA), described as Wallenberg's syndrome and includes analgesia in the trigeminal area on the side of the lesion, which results from damage to the descending nucleus of the fifth nerve and the crossed ascending fibers in the anterolateral system. Garcin (1968) described 56 cases of pain of bulbar origin *versus* 28 of pontine origin. In this analysis the order of frequency of different bulbar lesions included (a) vascular, especially thrombosis of PICA (b) syringobulbia (c) disseminated sclerosis and (d) pontobulbar tumors. Bulbar spinothalamic tractotomy and bulbar trigeminal tractotomy (Sjoqvist's operation) are also associated with central pain. In general, pain from pontobulbar lesions whether spontaneous or evoked has the same general characteristics as pain of thalamic origin. Pontobulbar pain is aggravated by emotional disturbances and whether facial or remote is often chronic and resistant to ► [pharmacotherapy](#). The striking fact that central pain of mesencephalic origin is uncommon may well be due to the absence of sensory nuclei in this region. Except for cases of pontomesencephalic tumors, central pain associated with pure midbrain lesions has not been reported, although surgical lesions following spinothalamic tractotomy at mesencephalic levels have been associated with central pain (Pagni 1998).

Within the thalamus three regions have been implicated in the onset of central pain (a) the ventroposterior part including the posterior and interior nuclei bordering this region (b) the medial-intralaminar region and (c) the reticular nucleus. Damage to the reticular nucleus is thought to release the medial and intralaminar nuclei from their normal control, thereby leading to pain and hypersensitivity (Mauguiere and Desmedt 1988).

Leijon et al. (1989) described nine patients with lesions in the ventroposterior thalamus that were associated with central pain. These reports are consistent with the contention that the posterior inferior part of the ventroposterior region is a critical location for lesions causing central pain. Thalamic pain is usually caused by ischemic and hemorrhagic vascular lesions, less frequently by tumors (Tovi et al. 1961), trauma (Riddoch 1938) or A-V malformations (Waltz and Ehni 1966). Lesions restricted to motor thalamus, medial thalamus and pulvinar do not appear to cause the onset of central pain.

Cortical lesions causing central pain are located primarily in the parietal cortex and perhaps the second sensory cortex where the ► [spinothalamocortical projections](#) are known to terminate. In general pain is rare after cerebral trauma (Marshall 1951), brain tumors, craniotomies or thalamotomies for movement disorders. Whether cortical lesions alone can cause central pain remains controversial, as in most reported cases there is damage to subcortical white matter (Breuer et al. 1981; Sandyk 1985). As a rule pain and hyperpathia occur when both sensory cortex and subcortical white matter are damaged, possibly due to the destruction of inhibitory corticothalamic fibers. Several reports have described patients with combined subcortical and cortical lesions leading to central pain, particularly with lesions in the insular region (Schmahmann and Leifer 1992). These lesions include those caused by infarcts, hematomas, meningiomas and trauma.

### Pathophysiology of Central Pain

A number of theories have been proposed to explain central pain (a) irritation of spinothalamic and lemniscal pathways (Dejerine and Roussy 1906) (b) loss of inhibitory mechanisms controlling pain pathways (Head and Holmes 1911; Jeanmonod et al. 1994) (c) switching of importance from primary to secondary pain pathways (Cassinari and Pagni 1969; Tasker et al. 1980) (d) the emergence of abnormal spontaneous and hyperexcitable cells (secondary to ► [deafferentation](#)) at spinal and/or supraspinal levels of the neuraxis (Pagni 1989) and (e) irritation of the ► [sympathetic nervous system](#). Since most central pain patients have abnormal temperature and pain sensibility, but near normal thresholds to touch, vibration and joint movement (Boivie et al. 1989), it was concluded that central pain occurs only after lesions of projections to the ventroposterior thalamic region (Pagni 1998). The fact that thalamic involvement is believed to be at the center of the mechanism responsible for the emergence of pain is underscored by the fact that anatomical and functional abnormalities are found at the termination site of pathways in this region of the brain. For this reason, central pain

is thought to result primarily from surgical or spontaneous lesions that invariably affect afferent sensory pathways. Therefore, it seems reasonable to conclude that lesions sparing fibers and cells of the spinothalamic and dorsal column system are unlikely to give rise to central pain. Cassinari and Pagni (1969) concluded that lesions of the spinothalamic system may give rise to dysesthesias, pain and hyperpathia, while lesions of the dorsal column system give rise to dysesthesias only and not pain. A critical question regarding the mechanism of central pain concerns the location of neurons responsible for this condition. Neurons within the ventroposterior nuclei have been shown to have increased spontaneous activity characterized by bursts of action potentials in the region of the nucleus representing the painful area of the body (Lenz et al. 1989). Bursting is believed to be a fundamental characteristic of central pain and is found in both lateral and medial thalamus. Whether this abnormal burst activity is due to loss of excitatory afferent drive on postsynaptic receptors or increased activity at ► [NMDA receptors](#) is not known. In patients with thalamic pain, spontaneous neuronal hyperactivity is also found in the mediodorsal, central lateral, central median and parafascicular nuclei (Rinaldi et al. 1991). In patients with central pain secondary to spinal transection, cells without receptive fields due to loss of sensory input show increased bursting, but decreased firing rates between bursts. These findings support the hypothesis that loss of STT input leads to hyperpolarization of these cells with resulting increased burst firing. Since some of these cells are involved in pain signaling pathways, this bursting activity may signal the sensation of pain. Although the hypothesis that abnormal neuronal activity in the ventroposterior thalamic region is important for the onset of central pain, one must reconcile the fact that in some patients this region is completely silent due to existing pathology. In fact some authors contend that this region is precisely where a thalamic lesion must be located in order to precipitate central pain (Leijon et al. 1989). Some thalamic lesions are thought to remove the inhibitory influence exerted by the reticular thalamic nucleus on medial and intralaminar nuclei, thereby releasing abnormal activity leading to pain and hypersensitivity (Cesaro et al. 1991).

The pathophysiology of central pain states may also involve the irritation of cells and fibers of sensory pathways and nuclei that develops at the lesion site. The resulting disruption of normal function is thought to lead to the development of an irritant focus (Dejerine and Roussy 1906; Livingston 1943). This hypothesis however, does not explain pain onset following complete destruction of sensory pathways and nuclei or pain due to section of fiber tracts. One explanation for the sudden disappearance of central pain after focal strokes in

the subparietal white matter suggests that central pain is generated by a disturbance in the normal oscillatory mechanisms between cortex and thalamus (Canavero 1994).

Another proposed mechanism of central pain is based on the ► **disinhibition** hypothesis of Head and Holmes (Craig 2002). This thermosensory disinhibition theory proposes that central pain results from the disinhibition of pain resulting from imbalanced sensory integration caused by the loss of temperature sensation. This theory suggests that central pain is a thermoregulatory disorder that produces a thermal distress signal that is modulated by homeostatic processing. At the heart of this proposal is the fact that loss of input from the lateral spinothalamic tract unmasks a homeostatic spinobulbothalamic pathway to the medial thalamus that is responsible for the development of central pain. This theory proposes that loss of activity in the thermosensory cortex in the dorsolateral mid / posterior insula disinhibits polymodal activation of the medial dorsal nucleus and anterior cingulate cortex, which produces burning pain.

#### Sympathetic Mechanisms

Sympathetic dysfunction is thought to play a role in central pain because signs of abnormal sympathetic activity, e.g. edema, decreased sweating, lowered skin temperature, changes in skin color and trophic skin changes have been described in many patients (Riddoch 1938). Unfortunately sympathetic blockade, which if effective would support a role of sympathetic mechanisms has shown contradictory results with only a small proportion of patients showing pain relief (Loh et al. 1981).

#### Spinal Injury: A Model of Central Pain

A major problem with the study of the pathophysiology and central mechanisms of central pain has been the lack of appropriate experimental models. In recent years this has been addressed with regard to the study of central pain following spinal injury with the development of models with pathological and behavioral characteristics consistent with the clinical profile of SCI (Christensen et al. 1996; Siddall et al. 1995; Vierck and Light 1999; Xu et al. 1992; Yeziarski et al. 1998). One of the similarities between spinal cord injury and peripheral nerve and / or tissue damage is that both result in an increase in spinal levels of ► **excitatory amino acids** (EAAs). With this in mind, it is easy to envision a scenario whereby the physiological changes associated with SCI are linked to the same central injury cascade initiated by peripheral injury (Yeziarski 1996). For example, the hypersensitivity of dorsal horn ► **wide dynamic range neurons** (WDR) described after ischemic and excitotoxic

injury of the spinal cord reflects changes similar to those described following peripheral injury. The fact that these effects are blocked by the non-competitive NMDA receptor antagonist MK-801 implicates glutamate in these changes in functional properties. The abnormal bursting patterns and evoked responses of thalamic neurons in patients with SCI supports the hypothesis that the functional changes after spinal injury are not limited to the spinal cord, but as with peripheral injury can also be found at supraspinal sites.

An important factor contributing to changes in functional state of sensory neurons following SCI is believed to be the loss of spinal inhibitory mechanisms (Wiesenfeld-Hallin et al. 1994). Consistent with this is the reversal of the hypersensitivity of WDR neurons after transient spinal cord ischemia with the GABA<sub>B</sub> agonist baclofen (Hao et al. 1992). Spinal cord injury may therefore have multiple factors contributing to increased neuronal excitability (a) loss of inhibitory tone due to the loss of inhibitory interneurons and (b) changes in membrane properties due to prolonged periods of depolarization (central sensitization). Not to be ignored in this discussion are the physiological effects of deafferentation, which provide yet another factor capable of influencing the functional state of spinal and especially supraspinal neurons following SCI. Attempts to develop models of experimental thalamic pain have included placing electrolytic lesions in different thalamic nuclei (LaBuda et al. 2000; Saade et al. 1999) or excitotoxic lesions in the lateral thalamus (LaBuda et al. 2000) or giving cortical injections of picrotoxin (Oliveras and Montagne-Clavel 1996). All of these models produce heightened responses to peripheral stimuli, thereby providing support for their use in the study of central pain states.

#### Treatment of Central Pain

At present a long-term effective treatment for central pain is not available and for this reason the strategy for treatment is to try all available treatment modalities in order to systematically determine the best approach for an individual patient. The realistic goal of central pain treatment is to reduce the intensity of pain intensity to a tolerable level. With this in mind, it is commonly believed that opiate narcotics are totally ineffective in the treatment of central pain, although more systematic studies are needed. Central pain also responds poorly to most conventional analgesics, better to antidepressants, temporarily to sodium thiopental and propofol and may respond to i.v. pentothal. Agents that enhance norepinephrine and dopamine neurotransmission and anticonvulsants have some therapeutic efficacy. A review of controlled studies related to the efficacy of pharmacological treat-

ments of neuropathic pain is recommended for additional reading (Sindrup and Jensen 1999). In addition to pharmacotherapy a number of other strategies to treat central pain have been used. These include (1) ► **peripheral nerve blocks** (2) peripheral neurectomy and ► **rhizotomy** (3) ► **sympathectomy** and sympathetic blocks (4) ► **spinal block** and (5) stimulation and ablative procedures.

### Conclusion

Chronic pain associated with injury or disease of the central nervous system represents a long-standing enigma that presents a significant challenge to the scientific and health care communities. As a condition that seems to depend on damage to the very substrate required for pain perception, it is one that has defied effective therapeutic intervention and continues to baffle those searching for an underlying mechanism. In spite of efforts to understand the pathophysiology and underlying etiology, there remain many unanswered questions. Parallels between chronic pain states resulting from injury or disease of peripheral and central substrates offers hope for the future. The fact that there are spontaneous and evoked components of central pain suggests multiple mechanisms underlying these and other divergent clinical findings as well as the varied temporal profile and location of pain in patients with different central lesions. The role of disinhibition, sensitization, denervation and other plastic changes in central sensory pathways remain to be addressed. Continued efforts to develop experimental models and strategies to study the human condition will hopefully lead to new insights into the progression of anatomical, chemical and functional changes from the site of injury to higher levels of the neuraxis along with the development of novel treatments.

### References

- Albin RL, Young AB (1988) Somatosensory phenomena in Huntington's disease. *Mov Disord* 3:343–346
- Andersen G, Vestergaard K, Ingeman-Nielsen et al. (1995) Incidence of central post-stroke pain. *Pain* 61:187–193
- Boivie J (1989) On central pain and central pain mechanisms. *Pain* 38:121–122
- Boivie J (1992) Hyperalgesia and allodynia in patients with CNS lesions. In: Willis WD (ed) *Hyperalgesia and Allodynia*. Raven Press, New York, pp 363–373
- Boivie J, Central Pain (1994) In: Wall PD, Melzack R (eds) *Textbook of Pain*. Churchill Livingstone, New York, pp 871–902
- Bonica JJ (1991) Semantic, epidemiologic and educational issues of central pain. In: Casey K (ed) *Pain and Central Nervous System Disease: The Central Pain Syndromes*. Raven Press, New York, pp 13–29
- Bowsher D, Foy PM, Shaw MDM (1989) Central pain following subarachnoid hemorrhage. *Br J Neurosurg* 3:435–442
- Breuer A, Cuervo H, Selkoe DJ (1981) Hyperpathia and sensory level due to parietal lobe arteriovenous malformation. *Arch Neurol* 38:722–724
- Canavero S, Pagni CA, Castellano G et al. (1993) The role of cortex in central pain syndromes preliminary results of a long-term technetium-99 bexamethylpropyleneamineoxime single photon emission computed tomography study. *Neurosurgery* 32:185–191
- Cassinari V, Pagni CA (1969) *Central Pain*. Harvard University Press, Cambridge
- Cesaro P, Mann MW, Moretti JL et al. (1991) Central pain and thalamic hyperactivity. a single photon emission computerized tomographic study. *Pain* 47:329–336
- Christensen MD, Everhart AW, Pickeman J et al. (1996) Mechanical and thermal allodynia in chronic central pain following spinal cord injury. *Pain* 68:97–107
- Craig AD (2002) New and old thoughts on the mechanisms of spinal cord injury pain. In: Yeziarski RP, Burchiel KJ (eds) *Spinal Cord Injury Pain: Assessment, Mechanisms, Management, Progress in Pain Research and Management*, vol 23. IASP Press, Seattle, pp 237–261
- Davidoff G, Roth EJ (1991) Clinical characteristics of central (dysesthetic) pain in spinal cord injury patients. In: Casey KL (ed) *Pain and Central Nervous System Disease: The Central Pain Syndromes*. Raven Press, New York, pp 77–83
- Dejerine J, Egger M (1903) Contribution a l'etude de la physiologie pathologique de l'incoordination motrice. *Rev Neurol* 11:397
- Dejerine J, Roussy G (1906) Le syndrome thalamique. *Rev Neurol (Paris)* 14:521–532
- Di Piero V, Ferracuti S, Sabatini U et al. (1994) A cerebral blood flow study on tonic pain activation in man. *Pain* 56:167–173
- Donovan WH, Dimitrijevic MR, Dahm L et al. (1982) Neurophysiological approaches to chronic pain following spinal cord injury. *Paraplegia* 20:135–146
- Garcin R (1968) Thalamic syndrome and pain of central origin. In: Soulaireac A, Cahn J, Charpentier J (eds) *Pain*, London, Academic Press, pp 321–541
- Hao JX, Xu XJ, Yu YX et al. (1992) Baclofen reverses the hypersensitivity of dorsal horn wide dynamic range neurons to mechanical stimulation after transient spinal cord ischemia: implications for a tonic GABAergic inhibitory control of myelinated fiber input. *J Neurophysiol* 68:392–396
- Head H, Holmes G (1911) Sensory disturbances from cerebral lesions. *Brain* 34:102–254
- Holmes G (1919) Pain of central origin. In: Osler W (ed) *Contributions to medical and biological research*. Paul B. Hoeber, New York, pp 235–246
- Jeanmonod D, Magnin M, Morel A (1994) A thalamic concept of neurogenic pain. In: Gebhart GF, Hammond DL, Jensen TS (eds) *Proceedings 7th World Congress of Pain*, vol 2. IASP Press, Seattle, pp 767–787
- Koller WC (1984) Sensory symptoms in Parkinson's disease. *Neurology* 34:957–959
- Kumral E, Kocaer T, Ertübey NÖ et al. (1995) Thalamic hemorrhage. A prospective study of 100 patients. *Stroke* 26:964–970
- LaBuda CJ, Cutler TD, Dougherty PM et al. (2000) Mechanical and thermal hypersensitivity develops following kainite lesion of the ventral posterior lateral thalamus in rats. *Neurosci Lett* 290:79–81
- Leijon G, Boivie J, Johansson L (1989) Central post-stroke pain: neurological symptoms and pain characteristics. *Pain* 36:13–25
- Lenz FA, Kwan HC, Dostrovsky JO et al. (1989) Characteristics of the bursting pattern of action potential that occurs in the thalamus of patients with central pain. *Brain Res* 496:357–360
- Lenz FA, Seike M, Richardson RT et al. (1993) Thermal and pain sensations evoked by microstimulation in the area of human ventrocaudal nucleus. *J Neurophysiol* 70:200–212
- Lipton S (1989) Percutaneous cordotomy. In: Wall PD, Melzack R (eds) *Textbook of Pain*, 2<sup>nd</sup> edn. Churchill Livingstone, Edinburgh, pp 832–839



31. Livingston WK (1943) Pain mechanisms. Macmillan, New York
32. Loh L, Nathan PW, Schott GD (1981) Pain due to lesions of central nervous system removed by sympathetic block. *BMJ* 282:1026–1028
33. MacGowan DJL, Janal MN, Clark WC et al. (1997) Central post-stroke pain in Wallenberg's lateral medullary infarction: frequency, character and determinants in 63 patients. *Neurology* 49:120–125
34. Madsen PW, Yezierski RP, Holets VR (1994) Syringomyelia: clinical observations and experimental studies. *J Neurotrauma* 11:241–254
35. Marchet A (1811) History of a singular nervous or paralytic affection, attended with anomalous morbid sensations. *Med Chir Tr* 2
36. Marshall J (1951) Sensory disturbances in cortical wounds with special reference to pain. *J Neurol Neurosurg Psych* 14:187–204
37. Mauguiere F and Desmedt JE (1988) Thalamic pain syndrome of Dejerine-Roussy: Differentiation of four subtypes assisted by somatosensory evoked potential data. *Arch Neurol* 45:1312–1320
38. Oliveras JL, Montagne-Clavel J (1996) Picrotoxin produces a "central" pain like syndrome when microinjected into the somato-motor cortex of the rat. *Physiol Behav* 60:1425–1434
39. Pagni CA (1989) Central pain due to spinal cord and brain stem damage. In: Wall PD, Melzack R (eds) *Textbook of Pain*, 2nd edn. Churchill Livingstone, Edinburgh, pp 634–655
40. Pagni CA (1998) Central pain: a neurosurgical challenge. Edizioni Minerva Medica, Torino
41. Pagni CA, Canavero S (1995) Functional thalamic depression in a case of reversible central pain due to a spinal intramedullary cyst. Case report. *J Neurosurg* 83:163–165
42. Pattany PM, Yezierski RP, Widerstrom-Noga EG et al. (2002) Proton magnetic resonance spectroscopy of the thalamus in patients with chronic neuropathic pain after spinal cord injury. *Am J Neuroradiol* 23:901–905
43. Riddoch G (1938) The clinical features of central pain. *Lancet* 234:1093–1098, 1150–1156, 1205–1209
44. Rinaldi PC, Young RF, Albe-Fessard D et al. (1991) Spontaneous neuronal hyperactivity in the medial and intralaminar thalamic nuclei of patients with deafferentation pain. *J Neurosurg* 74:415–421
45. Rintala DH, Loubser PG, Castro J et al. (1998) Chronic pain in a community-based sample of men with spinal cord injury: prevalence, severity, and relationship with impairment, disability, handicap, and subjective well-being. *Arch Phys Med Rehabil* 79:604–614
46. Saade NE, Katroum AL, Saab CY et al. (1999) Chronic thalamotomy increases pain-related behavior in rats. *Pain* 83:401–409
47. Sandyk R (1985) Spontaneous pain, hyperpathia and wasting of the hand due to parietal lobe hemorrhage. *Eur Neurol* 24:1–3
48. Schmahmann JD, Leifer D (1992) Parietal pseudothalamic pain syndrome: clinical features and anatomic correlates. *Arch Neurol* 49:1032–1037
49. Shieff C, Nashold BS (1987) Stereotactic mesencephalic tractotomy for thalamic pain. *Neurol Res* 9:101–104
50. Siddall P, Xu CL, Cousins M (1995) Allodynia following traumatic spinal cord injury in the rat. *Neuroreport* 6:1241–1244
51. Siddall PJ, Taylor DA, McClelland JM et al. (1999) Pain report and the relationship of pain to physical factors in the first 6 months following spinal cord injury. *Pain* 81:187–197
52. Siddall PJ, Yezierski RP, Loeser JDT (2002) Axiology and epidemiology of spinal cord injury pain. In: Yezierski RP, Burchiel KJ (eds) *Spinal Cord Injury Pain: Assessment, Mechanisms, Management, Progress in Pain Research and Management*, vol 23. IASP Press, Seattle, pp 9–24
53. Sindrup SH, Jensen TS (1999) Efficacy of pharmacological treatments of neuropathic pain: an update and effect related to mechanism of drug action. *Pain* 83:389–400
54. Tasker RR (1991) Deafferentation pain syndromes. In: Nashold BS, Ovelmen-Levitt J (eds) *Deafferentation pain syndromes. Pathophysiology and treatment*. Raven Press, New York, pp 241–258
55. Tasker RR, Dostrovsky JO (1989) Deafferentation and central pain. In: Wall PD, Melzack R (eds) *Textbook of pain*, 2nd edn. Churchill-Livingstone, Edinburgh, pp 154–180
56. Tasker RR, Organ LW, Hawrylyshyn P (1980) Deafferentation and causalgia. In: Bonica JJ (ed) *Pain*. Raven Press, New York, pp 305–329
57. Tasker RR, DeCarvalho G, Dostrovsky JO (1991) The history of central pain syndromes, with observations concerning pathophysiology and treatment. In: Casey KL (ed) *Pain and central nervous system disease: The central pain syndromes*. Raven Press, New York, pp 31–58
58. Tovi D, Schisano G, Liljequist B (1961) Primary tumors in the region of the thalamus. *J Neurosurg* 18:730–740
59. Vestergaard K, Nielsen J, Andersen G et al. (1995) Sensory abnormalities in consecutive, unselected patients with central post-stroke pain. *Pain* 61:177–86
60. Vierck CJ, Light AR (1999) Effects of combined hemotoxic and anterolateral spinal lesions on nociceptive sensitivity. *Pain* 83:447–457
61. Waltz TA, Ehni G (1966) The thalamic syndrome and its mechanisms. Report of two cases, one due to arteriovenous malformation in the thalamus. *J Neurosurg* 24:735–742
62. White JC, Sweet WH (1969) Pain and the neurosurgeon. A forty-year experience. Thomas CC, Springfield
63. Widerstrom-Noga EG, Felipe-Cuervo E, Broton JG et al. (1999) Perceived difficulty in dealing with consequences of spinal cord injury. *Arch Phys Med Rehabil* 80:580–586
64. Wiesenfeld-Hallin Z, Hao J-X, Aldskogius H et al. (1994) Allodynia-like symptoms in rats after spinal cord ischemia: an animal model of central pain. In: Boivie J, Hansson P, Lindblom U (eds) *Touch, Temperature and Pain in Health and Disease: Mechanisms and Assessments. Progress in Pain Research and Management*. IASP Press, Seattle, pp 355–372
65. Xu X-J, Hao J-X, Aldskogius H et al. (1992) Chronic pain-related syndrome in rats after ischemic spinal cord lesion: a possible animal model for pain in patients with spinal cord injury. *Pain* 48:279–290
66. Yezierski RP (1996) Pain following spinal cord injury: the clinical problem and experimental studies. *Pain* 68:185–194
67. Yezierski RP, Liu S, Ruenes GL et al. (1998) Excitotoxic spinal cord injury: behavioral and morphological characteristics of a central pain model. *Pain* 75:141–155
68. Young GB, Blume WT (1983) Painful epileptic seizures. *Brain* 106:537–554

## Neuropathy

### Definition

Neuropathy is a disturbance of function or pathological change in a nerve (Merskey and Bogduk

1994). Mononeuropathy refers to affection of a single nerve, mononeuritis multiplex to several nerves, and polyneuropathy to diffuse involvement of the peripheral nerves.

- ▶ [Descending Modulation and Persistent Pain](#)
- ▶ [Guillain-Barré Syndrome](#)

- ▶ Hereditary Neuropathies
- ▶ Toxic Neuropathies

## References

1. Merskey H, Bogduk N (Eds.) (1994): Classification of Chronic Pain, 2<sup>nd</sup> Ed., IASP Press, Seattle

## Neuropathy Due to HAART

- ▶ Pain in Human Immunodeficiency Virus Infection and Acquired Immune Deficiency Syndrome

## Neuropeptide Release in Inflammation

BEATE AVERBECK

Sanofi-Aventis Deutschland GmbH, Frankfurt, Germany

beate.averbeck@sanofi-aventis.com

### Synonyms

Inflammation, Neuropeptide Release

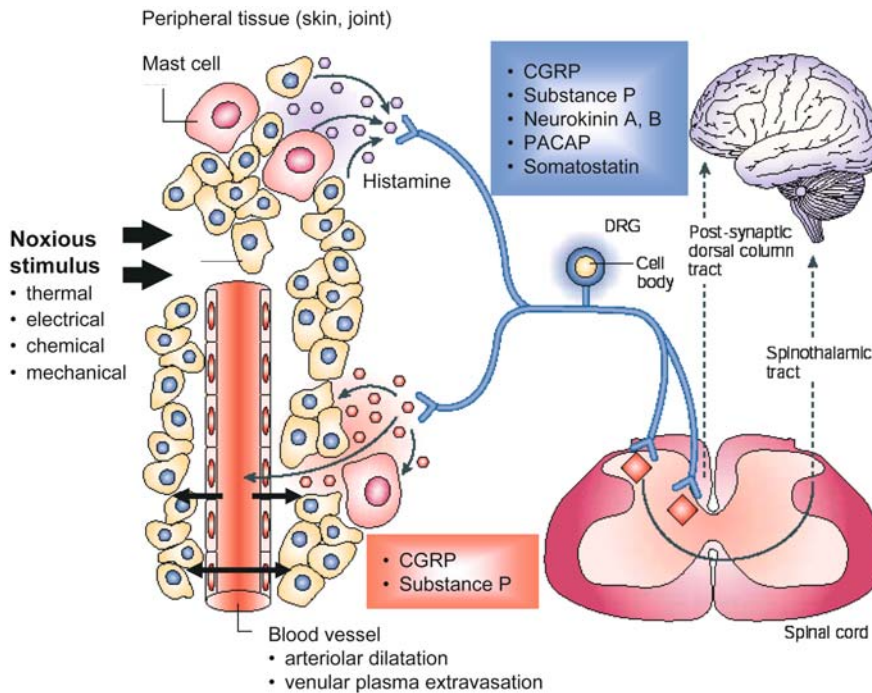
### Definition

▶ **Neuropeptides** are a group of small peptides with 4 to more than 40 amino acids found in the central and peripheral nervous system. This essay focuses on neuropeptides that are released into peripheral tissues upon neuronal activation; that is the case, for example, during an ▶ **inflammation**. The neuropeptides are synthesized in the cell body of primary afferent (sensory) neurons located in the ▶ **dorsal root ganglia** and are transported through the axons into preferentially the peripheral nerve endings. The best-known neuropeptides in primary afferent neurons are ▶ **substance P** and ▶ **calcitonin gene-related peptide**.

### Characteristics

▶ **Nociceptors** are primary afferent neurons many of which are characterized by their ability to release neuropeptides such as substance P (SP, 11 amino acids), calcitonin gene-related peptide (CGRP, 37 amino acids) and ▶ **neurokinins** (10 amino acids) from their peripheral terminals upon noxious stimulation (Maggi et al. 1995). In isolated tissue preparations (e.g. skin and dura), the release of SP and CGRP was shown to be induced by noxious stimulation with ▶ **inflammatory mediators** (▶ **bradykinin**, ▶ **serotonin**, ▶ **histamine**, ▶ **prostaglandins** and protons) (Averbeck and Reeh 2001; Ebersberger et al. 1999). In addition, electrical stimulation of cutaneous nociceptors was demonstrated to cause neuropeptide release from the skin (Kress et al. 1999). The release of SP and CGRP leads to arteriolar vasodilatation, which becomes visible as a

flare surrounding a site of injury, and to plasma extravasation from post-capillary venules, which may become apparent as a wheal at the site of injury. Since these inflammatory signs depend on the function and integrity of the peripheral sensory nervous system, the response has been termed ▶ **neurogenic inflammation**. By means of this mechanism, neuropeptides are able to induce the release of secondary mediators like prostaglandins, cytokines and histamine from endothelial and inflammatory cells (monocytes, mast cells) thereby maintaining inflammation. In addition, neuropeptides show immunomodulatory and trophic effects and thus play a role in tissue repair. A direct exciting effect on nociceptors could not be found for neuropeptides, whereas sensitizing effects have been described in the literature. SP was shown to sensitize nociceptors to mechanical stimulation in the knee joint of anesthetized cats (Herbert and Schmidt 2001) and preliminary data point to CGRP sensitizing nociceptors to heat stimulation in the isolated rat skin. The biological actions of neuropeptides are limited by degradation caused by neutral endopeptidases located in many tissues surrounding the primary afferent nerve fibers. Inflammation is a critical protective reaction to irritation, injury or infection, characterized by redness (*rubor*), heat (*calor*) swelling (*tumor*), loss of function (*functio laesa*) and pain (*dolor*). During inflammation, inflammatory mediators reach the nerve terminals, causing excitation and sensitization of nociceptors, which results in ▶ **hyperalgesia** and pain. Due to the fact that inflammatory mediators induce neuropeptide release by acting directly on nociceptors, inflammation is linked to an increased neuropeptide release from inflamed tissue. In addition, inflammation may result in an up-regulation of neuropeptide levels in primary afferent nerves, due to an enhanced neuropeptide biosynthesis in the dorsal root ganglion cells. In rats with ▶ **adjuvant-induced arthritis**, the levels of CGRP were found to be increased in the dorsal root ganglia and in the sciatic nerves, particularly in those fibers that innervate the inflamed area (Kuraishi et al. 1989). In contrast, the synovia of the arthritic joints of these animals showed less immunostaining for SP and CGRP, pointing to an increased neuropeptide release from the nerve terminals into the synovial fluid (Konttinen et al. 1990). The phenomenon of low neuropeptide immunostaining in the synovia and high neuropeptide levels in the synovial fluid was also found in patients with rheumatoid arthritis (Menkes et al. 1993). In experimental ▶ **colitis** in rats, a significant reduction of CGRP- and SP-immunoreactive nerve fibers was observed in the mucosa, again pointing to an enhanced neuronal neuropeptide release in inflammation (Miampamba and Sharkey 1998). The observation that the intensity and density of neuropeptide containing nerve fibers increased in the circular muscle 7 days after the induction of colitis suggests their possible involvement in tissue repair (Miampamba and Sharkey 1998).



**Neuropeptide Release in Inflammation, Figure 1** Neuropeptides in inflammation. Neurogenic inflammation. Painful stimuli on peripheral tissues are detected by primary afferent neurons (nociceptors), the cell bodies of which lie in the dorsal root ganglion (DRG). The painful signal is then transmitted to neurons in the spinal cord and further on to higher centers of the brain. Nociceptor activation results in the release of neuropeptides, which are synthesized in the nociceptors' cell bodies and transported to the central and peripheral nerve endings. The release of neuropeptides, such as substance P (SP) and calcitonin gene-related peptide (CGRP), from the peripheral nerve endings causes arteriolar vasodilatation and plasma extravasation from post-capillary venules, seen as typical signs of neurogenic inflammation: local edema, hyperemia and an erythema which extends beyond the site of stimulation (so-called flare response). The neuropeptides released maintain inflammation by releasing secondary mediators, e.g. histamine by mast cell degranulation. (Modified from Mantyh et al. 2002; reprinted by permission from Nat Rev Cancer 2: 201-209 copyright 2002 Macmillan Magazines Ltd).

N

In inflammatory skin diseases, certain neuropeptides have been found to be enhanced, for example SP and CGRP in ► [urticaria](#), and SP and pituitary adenylate cyclase activating polypeptide (PACAP) in ► [psoriasis](#) (Steinhoff et al. 2003). Thus, the increased number of mast cells and their characteristic degranulation observed in early psoriasis might be due to pathological neuropeptide release.

Blocking the neuropeptide response by blocking the neuropeptide binding sites may have anti-inflammatory and analgesic effects. A CGRP antagonist being clinically tested in ► [migraine](#) headache revealed an analgesic effect (Olesen et al. 2004). Thus, blocking CGRP effects postjunctionally (e.g. on blood vessels) seems to be an effective antinociceptive mechanism, at least in migraine. Another analgesic principle would be the use of anti-inflammatory neuropeptides. Somatostatin (SOM, 14 amino acids) which is synthesized in primary afferent neurons, but also in most major peripheral organs, revealed anti-inflammatory effects in inflammatory pain models (Heppelmann and Pawlak 1997). SOM, like SP and CGRP, is released upon nerve fiber activation and in inflammation. In rats, SOM was demonstrated to be released into the blood circulation upon electrical stimulation of nociceptors, revealing

a systemic anti-inflammatory action (Szolcsányi et al. 1998). As the clinical use of SOM is limited by its rapid degradation after systemic injection and its neurotoxicity when applied intrathecally, a new analgesic strategy for inflammatory pain involving the modulation of localized release of SOM is under discussion.

## References

1. Averbeck B, Reeh PW (2001) Interactions of inflammatory mediators stimulating release of calcitonin gene-related peptide, substance P and prostaglandin E2 from isolated rat skin. *Neuropharmacology* 40:416-423
2. Brain SD, Williams TJ (1989) Interactions between tachykinins and calcitonin gene-related peptide lead to oedema formation and blood flow in rat skin. *Br J Pharmacol* 97:77-82
3. Ebersberger A, Averbeck B, Messlinger K et al. (1999) Release of substance P, calcitonin gene-related peptide and prostaglandin E2 from rat dura mater encephali following electrical and chemical stimulation in vitro. *Neuroscience* 89:901-907
4. Heppelmann B, Pawlak M (1997) Inhibitory effect of somatostatin on the mechanosensitivity of articular afferents in normal and inflamed knee joints of the rat. *Pain* 73:377-382
5. Herbert MK, Schmidt RF (2001) Sensitization of group III articular afferents to mechanical stimuli by substance P. *Inflamm Res* 50:257-282
6. Kontinen YT, Rees R, Hukkanen M et al. (1990) Nerves in inflammatory synovium: immunohistochemical observations on the adjuvant arthritis rat model. *J Rheumatol* 17:1586-1591



7. Kress M, Guthmann C, Averbeck B et al. (1999) Calcitonin gene-related peptide, substance P and prostaglandin E2 release induced by antidromic nerve stimulation from rat skin, in vitro. *Neuroscience* 89:303–310
8. Kuraishi Y, Nanayama T, Ohno H et al. (1989) Calcitonin gene-related peptide increases in the dorsal root ganglia of adjuvant arthritic rat. *Peptides* 10:447–452
9. Maggi CA (1995) Tachykinins and calcitonin gene-related peptide (CGRP) as cotransmitters released from peripheral endings of sensory nerves. *Prog Neurobiol* 45:1–98
10. Mantyh PW, Clohisey DR, Koltzenburg M et al. (2002) Molecular mechanisms of cancer pain. *Nat Rev Cancer* 2:201–209
11. Menkes CJ, Renoux M, Laoussadi S et al. (1993) Substance P levels in the synovium and synovial fluid from patients with rheumatoid arthritis and osteoarthritis. *J Rheumatol* 20:714–717
12. Miampamba M, Sharkey KA (1998) Distribution of calcitonin gene-related peptide, somatostatin, substance P and vasoactive intestinal polypeptide in experimental colitis in rats. *Neurogastroenterol Motil* 10:315–29
13. Olesen J, Diener HC, Husstedt IW et al. (2004) Calcitonin gene-related peptide receptor antagonist BIBN 4096 BS for the acute treatment of migraine. *N Engl J Med* 350:1104–1110
14. Steinhoff M, Ständer S, Seeliger S et al. (2003) Modern aspects of cutaneous neurogenic inflammation. *Arch Dermatol* 139:1478–1488
15. Szolcsányi J, Helyes Z, Oroszi G et al. (1998) Release of somatostatin and its role in the mediation of the anti-inflammatory effect induced by antidromic stimulation of sensory fibres of rat sciatic nerve. *Br J Pharmacol* 123:936–942

► **neuropeptides** released from the peripheral endings of these nociceptive afferents. An overview of the functions of sensory neuropeptides in the skin is given in Table 1.

In 1927, T. Lewis had already described the “triple response” (Brain 1996) as when a noxious stimulus is applied to the skin, instantaneous erythema and wheal develop at the site of injury followed by a flare that spreads beyond the injured area. Much later it was shown that this response depends on the integrity of polymodal nociceptors and the release of neuropeptides, mainly ► **substance P** and ► **calcitonin gene-related peptide (CGRP)** (Holzer 1997). The current concept holds that noxious stimulation of polymodal nociceptors or heat nociceptors leads to an axon reflex, which is depicted in Figure 1. The evoked action potential travels not only centrally, but also invades – in a retrograde direction – intracutaneous axon collaterals where substance P and CGRP are released. Substance P binds to specific ► **tachykinin NK<sub>1</sub>** receptors on nearby arterioles, to induce rapid vasodilatation mediated by production of ► **nitric oxide (NO)** in endothelial cells. Action on venules leads to extravasation of plasma proteins into the perivascular tissue with consecutive development of a local oedema, the wheal. Furthermore, substance P causes mast cells to degranulate and to release a cocktail of inflammatory mediators, which can also contribute to the formation of oedema. The slower spreading flare reaction, however, is attributed to CGRP. This neuropeptide is a potent vasodilator with a much longer duration of action than substance P. Moreover, CGRP can potentiate the effects of substance P, because it inhibits the latter’s degradation by peptidases.

In order to elicit this combination of reactions, also called “neurogenic inflammation”, it is sufficient to stimulate a single afferent C-fibre unit. The evoked flare relies on nerve conduction and does not spread beyond the boundaries of the unit’s receptive field (Lynn 1996). The axon reflex is a good explanation for the underlying anatomical arrangement. However, recently Lin et al. (1999) showed that in some cases the reflex arc includes the spinal cord.

Mediation of the triple response is not the only action of sensory neuropeptides released by noxious stimuli. These peptides influence most cell types occurring in the skin (Table 1). Endothelial cells are stimulated to produce adhesion molecules, thereby leading to accumulation of granulocytes with consecutive metabolism of arachidonic acid to prostaglandins, leukotrienes and thromboxanes as well as production of proinflammatory cytokines. Similarly, keratinocytes are induced to synthesize proinflammatory cytokines. These are the first steps of the pathophysiologic mechanisms leading to long-term inflammation of the skin. Furthermore, fibroblasts and keratinocytes start to proliferate in response to substance P or ► **vasoactive intestinal polypeptide (VIP)**, which is an important component

## Neuropeptide Release in the Skin

ULRIKE HOLZER-PETSCHÉ

Department of Experimental and Clinical Pharmacology, Medical University of Graz, Graz, Austria

ulrike.holzer@meduni-graz.at

### Definition

Cutaneous nerves release small peptides into the skin that are important mediators in inflammation, peripheral hyperalgesia and immune reactions. Nociceptive afferent nerve endings constitute the largest neuronal source of such peptides.

### Characteristics

#### Neuropeptide Release from Sensory Nerve Endings

The skin is densely innervated by nociceptive nerve fibres that can be regarded as the first line of defence against potentially damaging stimuli. Large proportions of these afferents have unmyelinated (► **C-fibre**) axons, and terminate as free nerve endings in all layers of the skin. Many belong to the group of polymodal nociceptors, which are activated by thermal as well as mechanical and chemical stimuli of high intensity. While their obvious function is the afferent transmission of nociceptive information via the spinal and trigeminal ganglia to the central nervous system, they have a second, efferent role in mediating local defence reactions in the skin. The latter effects are mediated by



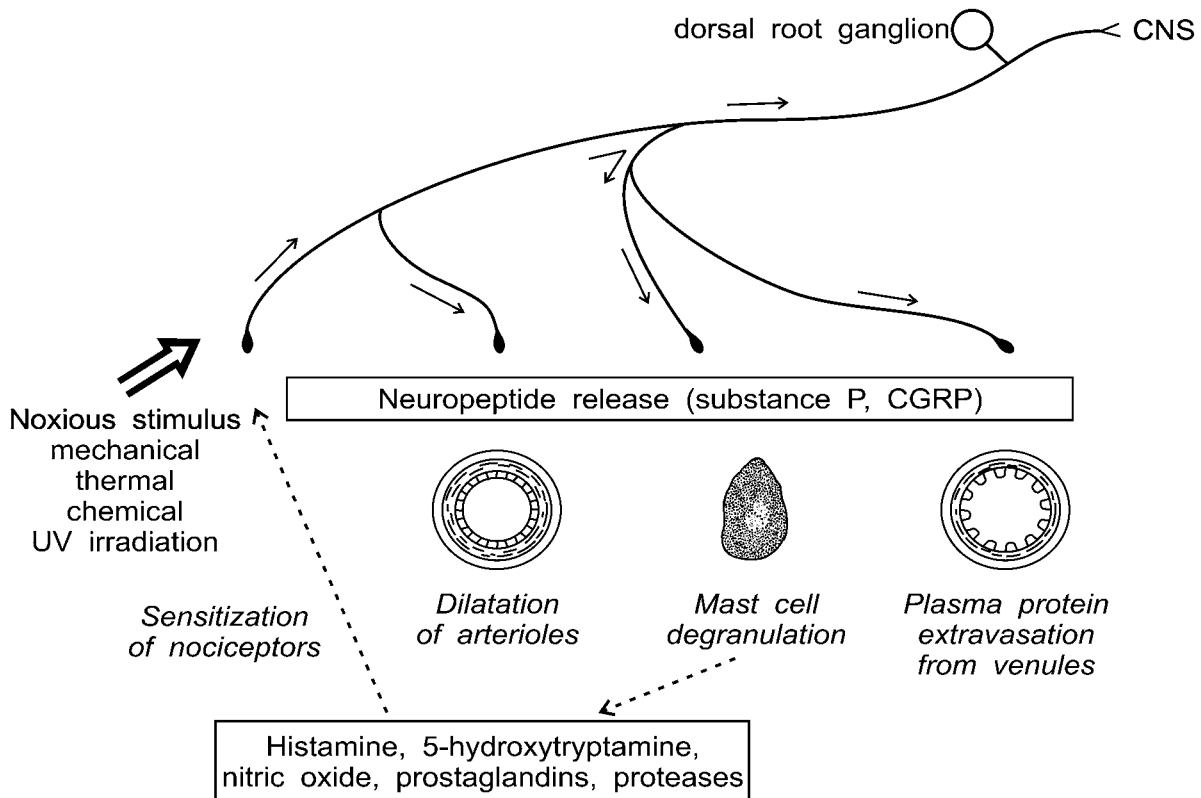
**Neuropeptide Release in the Skin, Table 1** Neuropeptides released from sensory nerves in the skin and their effects on cutaneous structures (Wallengren et al. 1987; Brain 1996; Holzer 1997; Scholzen et al. 1998; Steinhoff et al. 2003)

Neuropeptide	Target in skin	Effect
Substance P	arterioles	endothelium-mediated vasodilatation, proliferation of endothelial cells, upregulation of adhesion molecules, accumulation of granulocytes with release of cytokines, prostaglandins, leukotrienes, thromboxanes, NO, opioid peptides <sup>1</sup>
	venules	plasma protein extravasation
	mast cells	degranulation with release of histamine, 5-hydroxytryptamine, prostaglandins, leukotrienes, tumour necrosis factor $\alpha$ , proteases, NO
	monocytes	chemotaxis, release of interleukin-1, tumour necrosis factor $\alpha$ , prostaglandins, leukotrienes, thromboxanes
	keratinocytes	proliferation, upregulation of adhesion molecules, production of proinflammatory cytokines
	fibroblasts	chemotaxis, enhancement of cytokine-induced proliferation
▶ Neurokinin A	venules	plasma protein extravasation
	keratinocytes	production of proinflammatory cytokines, upregulation of NGF expression
Calcitonin gene-related peptide (CGRP)	arterioles	vasodilatation (relaxation of smooth muscle), proliferation of endothelial cells, leukocyte adhesion
	leukocytes	antagonism of substance P-induced intravascular accumulation
	T-lymphocytes (human) (mouse)	chemotaxis inhibition of proliferation and production of interleukin-2
	keratinocytes	proliferation, cytokine production
	Langerhans cells	inhibition of antigen presentation
Somatostatin <sup>2</sup>	mast cells	degranulation
	nociceptive afferent endings	presynaptic inhibition of substance P/CGRP release
Vasoactive intestinal polypeptide (VIP)	arterioles	vasodilatation
	endothelial cells	expression of adhesion molecules, neutrophil accumulation
	mast cells	degranulation
	macrophages	suppression of phagocytosis
	keratinocytes	proliferation, migration
PACAP	arterioles	vasodilatation
	mast cells	histamine release
	T-lymphocytes, macrophages	suppression of cytokine production
Galanin	nociceptive afferent endings	presynaptic inhibition of neuropeptide release

<sup>1</sup> in inflamed tissue<sup>2</sup> in humans it is most likely only in skin disease, not in healthy skin (Wallengren et al. 1987)

of wound healing. In fact, the impaired wound healing and development of spontaneous skin ulcers in patients with diabetic neuropathy are attributed to the loss of peptidergic afferent nerve fibres (Gibran et al. 2002). However, sensory neuropeptides are not generally proinflammatory agents. CGRP, for example, reduces intravascular accumulation of granulocytes and inhibits antigen presentation by ▶ **Langerhans cells**.

Injury to, or inflammation of, the skin is usually accompanied by local hyperalgesia. This is caused by a feedback mechanism of various mediators released from the target cells of neuropeptides. Nociceptive nerve endings are equipped with specific receptors for neuropeptides, prostaglandins, 5-hydroxytryptamine, cytokines, growth factors, ▶ **vanilloids**, protons, as well as with ▶ **proteinase-activated receptor-1** and **-2**.



**Neuropeptide Release in the Skin, Figure 1** Schematic representation of the axon reflex as the basis for neurogenic inflammation.

During an inflammatory reaction, agonists for these receptors are released by mast cells or leukocytes, while ► **nerve growth factor** (NGF) is produced by stimulated keratinocytes. All of them can sensitize the nociceptive nerve endings by reducing their stimulation threshold, or even induce further neuropeptide release (Handwerker and Reeh 1992; Richardson and Vasko 2002). Moreover, growth factors produced in inflamed skin increase the production and release of sensory neuropeptides. Other sensory neuropeptides, such as ► **somatostatin** and ► **galanin**, act on presynaptic receptors to inhibit further release of substance P and CGRP (Szolcsányi et al. 1998; Xu et al. 1991).

#### Neuropeptide Release from Autonomic Efferents

Neuropeptides occur not only in afferent nerves but also in autonomic efferents. A painful stimulus also activates the sympathetic nervous system. In sympathetic efferents, ► **neuropeptide Y** (NPY) coexists with noradrenaline and is responsible for the long-lasting vasoconstriction seen after peripheral nerve stimulation. Recently, NPY Y1 receptors have been localized to CGRP-containing sensory nerves in rat skin, where NPY is likely to facilitate the release of substance P and CGRP (Brumovsky et al. 2002). Moreover, NPY influences a variety of immune mechanisms (Bedoui et al. 2003). The sympathetic cholinergic fi-

bres innervating the sweat glands contain VIP as a co-transmitter.

In the parasympathetic neurons, VIP and ► **PACAP** coexist with acetylcholine. These neuropeptides, however, are also localized in sensory neurons, and so far no data exists about a differential action depending on their release from sensory or autonomic cutaneous nerves.

#### Release of Opioid Peptides from Non-Neuronal Sources in the Skin

While in healthy skin less than a third of unmyelinated axons express functional  $\mu$ -opioid receptors, all three types of opioid receptors are expressed on the peripheral endings of sensory nerves in inflamed tissue (Stein et al. 2003). Opioid peptides, such as  $\beta$  ► **-endorphin**, enkephalins and ► **dynorphin**, are released from immune cells, activated by, e.g. interleukin-1, and mediate local analgesia by reducing the sensitivity of the nociceptors.

#### References

1. Bedoui S, Kawamura N, Straub RH, Pabst R, Yamamura T, von Horsten S (2003) Relevance of Neuropeptide Y for the Neuroimmune Crosstalk. *J Neuroimmunol* 134:1–11
2. Brain SD (1996) Sensory Neuropeptides in the Skin. In: Geppetti P, Holzer P (eds) *Neurogenic Inflammation*. CRC Press, Boca Raton, pp 229–244

3. Brumovsky PR, Shi TJ, Matsuda H, Kopp J, Villar MJ, Hökfelt T (2002) NPY Y1 Receptors are Present in Axonal Processes of DRG Neurons. *Exp Neurol* 174:1–10
4. Gibran NS, Jang YC, Isik FF, Greenhalgh DG, Muffley LA, Underwood RA, Usui ML, Larsen J, Smith DG, Bunnett N, Ansel JC, Olerud JE (2002) Diminished Neuropeptide Levels Contribute to the Impaired Cutaneous Healing Response Associated with Diabetes Mellitus. *J Surg Res* 108:122–128
5. Handwerker HO, Reeh PW (1992) Nociceptors. Chemosensitivity and Sensitization by Chemical Agents. In: Willis Jr WD (ed) *Hyperalgesia and Allodynia*. Raven Press, New York, pp 107–115
6. Holzer P (1997) Control of the Cutaneous Vascular System by Afferent Neurons. In: Morris JL, Gibbins IL (eds) *Autonomic Innervation of the Skin*. Harwood Academic Publishers, Amsterdam, pp 213–267
7. Lin Q, Wu J, Willis WD (1999) Dorsal Root Reflexes and Cutaneous Neurogenic Inflammation after Intradermal Injection of Capsaicin in Rats. *J Neurophysiol* 82:2602–2611
8. Lynn B (1996) Neurogenic Inflammation Caused by Cutaneous Polymodal Receptors. *Prog Brain Res* 113:361–368
9. Richardson JD, Vasko MR (2002) Cellular Mechanisms of Neurogenic Inflammation. *J Pharmacol Exp Ther* 302:839–845
10. Scholzen T, Armstrong CA, Bunnett NW, Luger TA, Olerud JE, Ansel JC (1998) Neuropeptides in the Skin: Interactions between the Neuroendocrine and the Skin Immune Systems. *Exp Dermatol* 7:81–96
11. Stein C, Schäfer M, Machelska H (2003) Attacking Pain at its Source: New Perspectives on Opioids. *Nat Med* 9:1003–1008
12. Steinhoff M, Ständer S, Seeliger S, Ansel JC, Schmelz M, Luger T (2003) Modern Aspects of Cutaneous Neurogenic Inflammation. *Arch Dermatol* 139:1479–1488
13. Szolcsányi J, Helyes Z, Oroszi G, Németh J, Pintér E (1998) Release of Somatostatin and its Role in the Mediation of the Anti-Inflammatory Effect Induced by Antidromic Stimulation of Sensory Fibres of Rat Sciatic Nerve. *Brit J Pharmacol* 123:936–942
14. Wallengren J (1997) Vasoactive Peptides in the Skin. *J Invest Dermatol Symp Proc* 2:49–55
15. Xu XJ, Hao JX, Wiesenfeld-Hallin Z, Håkanson R, Folkers K, Hökfelt T (1991) Spantide II, A Novel Tachykinin Antagonist, and Galanin Inhibit Plasma Extravasation Induced by Antidromic C-Fiber Stimulation in Rat Hindpaw. *Neuroscience* 42:731–737

## Neuropeptide Y

### Synonym

NPY

### Definition

Neuropeptide Y (NPY) is a 36-amino acid peptide containing many tyrosine (Y) residues. NPY is a co-transmitter of noradrenaline in sympathetic neurons, with long-lasting vasoconstrictor effects and potent influences on the immune system. It is not contained in sensory afferents. It is the most abundant neuropeptide known in the brain. NPY modulates pain sensation as well as other neuronal processes, and is involved in the regulation of food intake and energy expenditure, in the central control of reproductive hormones, and in anxiolytic and antiepileptic control circuits.

- ▶ [Neuropeptide Release in the Skin](#)
- ▶ [Peptides in Neuropathic Pain States](#)

## Neuropeptides

### Definition

Neuropeptides are bioactive molecules built up of a varying number of amino acids (2 to > 40), synthesized (mostly, but not exclusively) in and released from neurons. The final, pharmacologically active peptides are cleaved from large precursor peptides. Over the past two decades, more than 40 biologically active polypeptides, termed neuropeptides, have been found in the central and peripheral nervous system. Neuropeptides such as substance P (SP), calcitonin gene-related peptide (CGRP), neurokinin (NK) A and B (10 amino acids), somatostatin (SOM), vasoactive intestinal peptide (VIP), neuropeptide Y and cholecystokinin (CCK) are synthesized in the cell body of autonomic and sensory neurons located in the autonomic or sensory (dorsal root) ganglia. As they are released upon neuronal activation, neuropeptides act centrally as neurotransmitters or neuromodulators. In the periphery, neuropeptides have various functions like vasodilatation, plasma extravasation, sweat gland stimulation, mast cell degranulation, immunomodulation and trophic effects, thereby playing an important role in inflammation. Neuropeptides are metabolically more stable than amine transmitters, therefore they have a longer duration of action and can diffuse over longer distances. Neurons may contain several neuropeptides coexisting with small molecule transmitters.

- ▶ [Cytokines, Effects on Nociceptors](#)
- ▶ [Descending Circuitry, Transmitters and Receptors](#)
- ▶ [Neuropeptide Release in Inflammation](#)
- ▶ [Neuropeptide Release in the Skin](#)
- ▶ [Nociceptive Neurotransmission in the Thalamus](#)
- ▶ [Nociceptor Generator Potential](#)
- ▶ [Opioid Modulation of Nociceptive Afferents In Vivo](#)
- ▶ [Retrograde Cellular Changes after Nerve Injury](#)
- ▶ [Sensitization of Muscular and Articular Nociceptors](#)
- ▶ [Spinothalamic Tract Neurons, Peptidergic Input](#)
- ▶ [Thalamic Neurotransmitters and Neuromodulators](#)

## Neuropeptides in Neuropathic Pain States

- ▶ [Peptides in Neuropathic Pain States](#)

## Neuropile

### Definition

Neuropile is the complex network of axonal, dendritic, and glial arborisations in nuclei and laminae of the CNS containing the cell bodies

- ▶ [Deafferentation Pain](#)

## Neuroplasticity

### Definition

Neuroplasticity is a general term referring to persistent changes in neural activity or function. A neuroplastic change is caused by frequent usage of a neuron or a neuronal connection, which stays for a longer period of time after the end of the neuronal activity that started the change. Memory processes and the transition from acute to chronic pain are examples of neuroplastic changes.

- ▶ Amygdala, Pain Processing and Behavior in Animals
- ▶ Arthritis Model, Kaolin-Carrageenan Induced Arthritis (Knee)
- ▶ Metabotropic Glutamate Receptors in Spinal Nociceptive Processing
- ▶ Nociceptive Processing in the Amygdala, Neurophysiology and Neuropharmacology
- ▶ Sensitization of Muscular and Articular Nociceptors
- ▶ Transition from Acute to Chronic Pain
- ▶ Trigeminal Brainstem Nuclear Complex, Immunohistochemistry and Neurochemistry

## Neurosecretion

### Definition

Neurosecretion is the active process of releasing signaling molecules from nerve terminals by exocytosis.

- ▶ Inflammation, Modulation by Peripheral Cannabinoid Receptors

## Neurosensory Testing

### Synonyms

NST

### Definition

This is a form of Quantitative Sensory Testing that refers to the use of the Pressure-Specified Sensory Device to measure the cutaneous pressure threshold of the large myelinated fibers for both moving (quickly-adapting fibers) and static (slowly-adapting fibers) touch. The pressure required to discriminate one from two static touch stimuli is the first to become abnormal in the patient with a chronic nerve compression, like carpal or tarsal tunnel syndrome. All QST, by definition, is subjective, requiring cognitive input from the person being tested to identify the end-point of the test.

- ▶ Carpal Tunnel Syndrome

## Neurosteroids

### Definition

Steroid hormones with neurotransmitter-like actions produced in the central nervous system via metabolism of parent steroids or by local synthesis from cholesterol.

- ▶ Premenstrual Syndrome

## Neurostimulation

- ▶ Stimulation Treatments of Central Pain

## Neurosurgery for Pain

### Definition

Is a part of so-called “Functional Neurosurgery“. Functional Neurosurgery was defined in 1956 by P. Wertheimer from LYON as follows : “Functional Neurosurgery aims at correcting the functional disorders which cannot be normalized by direct cure of the causative lesion. Operations are based on neurophysiological information. Procedures consist of removing irritative foci or interrupting excitatory pathways to compensate failing inhibitory systems“ (Pierre Wertheimer 1956).

- ▶ Brachial Plexus Avulsion and Dorsal Root Entry Zone

### References

1. Wertheimer P. (1956) Functional Neurosurgery. Masson et Cie, Paris

## Neurosurgery for Pain in the DREZ

- ▶ Brachial Plexus Avulsion and Dorsal Root Entry Zone

## Neurotomy

### Definition

The dissection, or anatomy, of the nervous system.

- ▶ Facet Joint Pain



## Neurosurgical Treatment of Pain

FRED A. LENZ

Departments of Neurosurgery, Johns Hopkins University, Baltimore, MD, USA  
flenzi1@jhmi.edu

### Introduction

Since the 1970s there have been significant changes in neurosurgical approaches to the treatment of pain. Specifically, there has been a substantial decrease in the numbers of ablative procedures and an increase in the numbers of stimulation or augmentative procedures for treatment of chronic pain. The decrease in ablative procedures is in part due to the recognition of the occurrence of ► **neuropathic pain** following surgical injuries to the nervous system (Boivie 1999; Tasker 1984). Ablative procedures, which have survived have often been associated with a clearer understanding of the rationale and indications for the surgery. This is so in the case of sympathetically maintained pain treated by ► **sympathectomy**. Other current ablative procedures are associated with a high degree of efficacy are ► **cordotomy** for cancer pain or surgical treatments for tic douloureux. This review is derived, in part, from the topical essays included in this section

### Ablative Neurosurgical Procedures with Improved Rationales

The practice of surgery on the sympathetic nervous system has been altered by advances in the understanding of the ► **sympathetically maintained pain** (SMP), a subset of patients with ► **complex regional pain syndrome** (CRPS). CRPS typically occurs after trauma without (CRPS type 1) or with concomitant nerve injury (CRPS type 2). In SMP the distal extremities, areas rich in sympathetic innervation, can be affected with edema, hyperalgesia and cool and sweaty skin. The dramatic relief of pain that occurs with selective blockage of the sympathetic nervous system defines SMP.

The mechanism of SMP depends upon  $\alpha_1$ -adrenergic receptors as demonstrated by the relief of hyperalgesia produced by application of an  $\alpha_2$  agonist to the painful skin in patients with SMP (Davis et al. 1991). Binding at the  $\alpha_2$ -adrenergic receptors, located on sympathetic terminals blocks norepinephrine release. When phenylephrine, a selective  $\alpha_1$ -adrenergic agonist was applied to the clonidine treated area, pain was rekindled. The density of  $\alpha_1$ -adrenoceptors in the epidermis of the hyperalgesic skin of patients with CRPS is increased (Drummond et al. 1996). Thus, the data suggest that the  $\alpha_1$ -adrenergic receptor plays a pivotal role in SMP. Sympathetic mechanisms may also play a role in other types of pain. For example, injection of

noradrenaline around stump neuromas or skin in patients with postherpetic neuralgia induces an increase in spontaneous pain (Chabal et al. 1992; Choi and Rowbotham 1997; Raja et al. 1998).

The gold standard for diagnosing SMP has been determination of the response to blockade of the appropriate level of the sympathetic chain (► **sympathetic block**) with local anesthetic. An intravenous infusion of phentolamine, an  $\alpha$ -adrenergic antagonist, (► **phentolamine test**) given systemically has proven to be a safe, specific test for SMP. Skin temperature is monitored. If the skin temperature does not rise with phentolamine, then a higher dose of phentolamine may have to be given. A positive result is the finding that phentolamine relieves pain, which result identifies patients with SMP (Arner 1991; Raja et al. 1991).

By definition, SMP is relieved by performance of a sympathetic block. The pain relief of sympathetic block often outlives the pharmacological action of the block. Similar, long lasting pain relief has also been reported following systemic phentolamine infusion (Galer et al. 1992). In cases where sympathetic blockade provides only transient pain relief, surgical ► **sympathectomy** may offer lasting pain relief (Singh et al. 2003). Thus, recent research findings have advanced our understanding of the basis of SMP and rationalized surgical therapy, which has led to a resurgence of this surgical treatment.

### Ablative Neurosurgical Procedures with High Efficacy

► **Percutaneous cordotomy** produces relief of pain by interrupting the transmission of signals in the ► **spinothalamic tract** (STT) from below the level of intervention and caused by cancer. It is not helpful for the steady burning element of neuropathic pain. It may, however, be useful for the relief of allodynia, hyperpathia and neuralgic pain associated with ► **neuropathic pain** syndromes (Tasker and Dostrovsky 1989; Tasker et al. 1992). It is usually unsuccessful if done in the lower cervical area in relieving pain above the C5 dermatome.

Published data suggests a 63–77% range of complete, 68–96% significant, contralateral pain relief (Tasker 1988). Complete pain relief was found in 90% of patients immediately post operatively, 84% after 3 months, 61% at 1 year, 43% between 1 and 5 years and 37% between 5 and 10 years (Tasker 1988). If the expected rate of immediate significant pain relief with unilateral cordotomy is 80% then that after bilateral surgery is 80%  $\times$  80% or 64%. If the first procedure interfered with automatic respiration ipsilaterally, it is unwise to proceed on the other side. The efficacy of this technique in the face of intense, refractory pain due to cancer makes it a viable procedure in patients with a limited survival.

The surgery of ► **tic douloureux** has been revolutionized by a number of ‘minimally destructive procedures’ such as stereotactic radiosurgery, percutaneous ganglion level procedures including RF thermocoagulation, glycerolysis and balloon compression. The surgery of tic douloureux also includes ► **microvascular decompression** (MVD) procedures. Some of these latter procedures, such as MVD, for treatment of intracranial neuralgias were reinvented in the 1960s and found to be effective and safe procedures, although they are not without significant risks (McLaughlin et al. 1999; Patel et al. 2002).

These procedures are strikingly effective for the treatment of typical pain of tic douloureux. Ganglion level procedures had high initial levels of initial pain relief (91–99%) with subsequent recurrence rates of 10–25% over the various study times (25% at 14 years) (Peters and Nurmikko 2002). Stereotactic radiosurgery has recently been promoted and found to produce complete pain relief without medication in 57% at 1 year, and 55% at 3 years in a group of whom 60% had previously been operated on. The long-term effects of radiation therapy close to the brainstem are unknown. The first line of treatment for young healthy patients is MVD and glycerol rhizotomy procedures (Peters and Nurmikko 2002; Pollock et al. 2002). The striking effectiveness of these procedures in the treatment of the medically intractable pain of typical tic douloureux has supported the present high rates of performance of these procedures.

#### **Ablative Neurosurgical Procedures with Tighter Indications**

Spinal and ► **nucleus caudalis DREZ** lesioning procedures can be an effective means of treating deafferentation pain syndromes in carefully selected patients. Traumatic ► **brachial plexus avulsions** frequently result in a characteristic pain syndrome, which must be confirmed clinically, as peripheral nerve injury pain does not respond to DREZ lesions. This is the best indication for the ► **DREZ procedure**. In spinal cord injury, radicular or segmental pain syndromes occurring in the partially deafferented levels adjacent to the level of injury also respond well to DREZ procedures. Diffuse pain occurring below the level of injury, especially constant burning pain in the sacral dermatomes does not respond to DREZ procedures. In the case of injuries to the conus medullaris and cauda equina at the T12 to L1 levels, the best results are observed in patients with incomplete neurological deficits and those with ‘electric’ pain. Finally, patients suffering phantom pain after limb amputation respond well to DREZ procedures, significantly better than those with stump pain.

Overall, larger series report long-term pain relief in over 60–90% (Dreval 1993; Rath et al. 1997; Sindou

et al. 2001; Thomas and Kitchen 1994). Variations in results can be attributed to differences between criteria for patient selection, outcome measures, times of follow-up and techniques (Dreval 1993; Friedman et al. 1988; Iskandar and Nashold 1998; Nashold and El-Naggar 1992; Sampson et al. 1995; Sindou 2002; Spaic et al. 2002; Thomas and Kitchen 1994). Careful selection of patients is critical since complication rates can be significant, especially following DREZ lesions for brachial plexus avulsion pain. Of this group, 41% experienced objective sensory deficits and 41% objective motor deficits (Friedman et al. 1988). Overall, the better defined indications for DREZ procedures has led to better outcomes and a resurgence of interest in these procedures.

Selection of the proper patients for intracranial ablative procedures is focused on patients with pain involving the head and / or neck, upper extremities or pain that is widespread throughout the body. The etiology of the pain must be clearly defined and the severity of the pain must be consistent with the etiology (Gildenberg 1973; Gildenberg and DeVaul 1985). Ordinarily, such surgery is reserved for persistent pain accompanying serious conditions, such as head or neck cancer. Patients must be free of significant psychological issues.

Intracranial procedures include lesions in the spinothalamic tract by stereotactic ► **mesencephalotomy** (Gildenberg 1974) and lesions of the mesencephalic central grey (Nashold et al. 1969). The spinoreticulothalamic pathways may be lesioned in the intralaminar and centromedian nuclei and posteriorly adjacent nuclei (Gybels and Sweet 1989; Jeanmonod et al. 1993). A common target for psychosurgery of the limbic system is the anterior portion of the cingulate bundle as it wraps around the anterior end of the corpus callosum. Ablation of that same area has been successful in alleviating severe persistent pain, particularly that of cancer and particularly in patients with severe emotional distress (Hassenbusch 1998). Thus the improved indications for surgery have led to an improved rationale for these uncommon procedures.

#### **Stimulation Procedures – Improved Indications and Demonstrated Efficacy**

Since the 1970s stimulation of the nervous system has largely supplanted lesioning of the nervous system for control of pain (Gybels and Sweet 1989; White and Sweet 1969). The increase in the numbers of augmentative or stimulation procedures for the treatment of chronic pain arises from their effectiveness and reversibility. The term augmentative refers to the characteristics of procedures that are not destructive, as in the case of implanted nervous system stimulators and drug

pumps. Some of these procedures are characterized by the use of clinical or pharmacologic criteria to identify patients who are candidates for these surgeries. For example, successful pain relief by ► [motor cortex stimulation](#) may be predicted if patients have significant pain relief in response to infusions of intravenous thiamylal (Yamamoto et al. 1997). Additionally an intact motor system, but not an intact somatosensory system is required.

The most commonly used stimulation modality is ► [spinal cord stimulation](#) (SCS), which is indicated only when pharmacological or surgical treatment options for chronic pain have been exhausted. In general, good results, defined as >50% reduction in chronic pain are reported by 60–70% of the patients (Meyerson and Linderth 2000; Simpson 1994). Large numbers of retrospective analyses have demonstrated reduction in chronic pain as demonstrated by reduction in analgesic medication and by patient satisfaction.

The most common indication is ► [lumbo-sacral rhizopathy](#), a diagnosis that often represents a mix of nociceptive, neuropathic and inflammatory pain located in the lumbar region. This “low back pain” is less likely to respond to SCS than is the “radiating leg pain” that is amenable to SCS (North et al. 1993). The second common indication is pain following peripheral nerve injury or disease. Of the many forms of neuropathy due to metabolic disease, ► [diabetic polyneuropathy](#) is the most common and it is likely to respond to SCS. Pain due to peripheral nerve injury, which sometimes presents as ► [complex regional pain syndrome](#) (CPRS) is also considered to be a good indication (Kumar et al. 1997). A recent trend is the treatment of the pain of ► [peripheral vascular disease](#) or ► [angina pectoris](#) by SCS; this is performed at a small number of centers, mostly in Europe.

Stimulation of the thalamus or midbrain for treatment of chronic pain has a 50-year history. Patient selection for placement of DBS is an important part of current treatment using this modality (Hosobuchi 1986; Levy et al. 1987; Young and Rinaldi 1997). In many published studies, patients have been assessed by intravenous morphine infusion tests, based on the hypothesis that nociceptive but not neuropathic pain responds to opioids. Then ► [nociceptive pain](#) is treated by ► [periaqueductal gray](#) (PAG) stimulation and ► [neuropathic pain](#) is treated with thalamic stimulation.

There are a number of large studies demonstrating that DBS can be effective for both neuropathic and nociceptive pain (Hosobuchi 1986; Levy et al. 1987; Young and Rinaldi 1997). A meta-analysis of 13 studies (1114 patients) evaluating DBS for the treatment of chronic pain reported that 50% of all patients experienced long-term pain relief. Patients with nociceptive pain expe-

rienced a 60% long-term relief from pain with PAG stimulation, while those with neuropathic pain experienced a 56% long-term success rate with Vc stimulation.

Stimulation of motor cortex for relief of neuropathic pain of the head, neck or upper extremity has recently emerged as an option for patients with chronic pain. The first series, based on studies in animals was carried out by Tsubokawa who reviewed a series of 11 patients with central pain after putaminal or thalamic hemorrhage treated with ► [motor cortex stimulation](#) for 2 years with significant (> 80%) pain relief, sustained in 45% of patients (Tsubokawa et al. 1993). As in the stimulation modalities described above, there are well-described protocols for selection of patients to be treated by motor cortical stimulation. For example, Yamamoto and coworkers (Yamamoto et al. 1997) noted that successful pain relief by motor cortex stimulation could be predicted if patients responded by at least 40% pain relief to incremental infusions of intravenous thiamylal to a maximum dose of 250 mg, but not to morphine in doses of up to 18 gm given over 5 hours (Yamamoto et al. 1997). Additionally, motor cortex stimulation requires an intact motor system to be effective, but not an intact somatosensory system. Thus current stimulation procedures are based upon improved indications and demonstrated efficacy, as in the case of current ablative procedures.

It seems likely that the future will reflect the fact that the conditions we are now treating surgically are all ultimately dependent upon the chemical mechanisms. Surgical treatment of these conditions will be elaborations of the currently available drug pump technology. These therapies will involve selective intrathecal administration to of a drug or drugs (Rainov et al. 2001) specific to the condition being treated (Penn 2003; Weiss et al. 2003). Examples of such tailored drug administration are found in the case of patients with pain due to spasticity (Middleton et al. 1996) or with pain following spinal cord injury or of patients in opiate withdrawal (Lorenz et al. 2002). The possibility of anatomic as well as chemical approaches to surgical targets within the forebrain will shortly be a possibility. Intra-axial administration is becoming practical for delivery of drugs to anatomically or physiologically defined structures. The feasibility of this approach for selectively lesioning neurons but not axons by convection delivery through an intracerebral catheter has been demonstrated in primate models of Parkinson's disease (Lieberman et al. 1999). The intracerebral delivery of neurotransmitters or proteins, such as growth factors or neurotransmitters, into defined structures can also be accomplished by stereotactically placed catheters or by implantation of other novel drug delivery systems (Gouhier et al. 2002; Pappas et al. 1997).

These technologies promise to revolutionize the neurosurgical treatment of pain in the future.

### Acknowledgement

Supported by grants to FAL from the NIH: NS39498 and NS40059.

### References

- Arner S (1991) Intravenous phentolamine test: diagnostic and prognostic use in reflex sympathetic dystrophy. *Pain* 46:17–22
- Boivie J (1999) Central pain. In: Wall PD, Melzack R (eds) *Textbook of pain*. Churchill Livingstone, Edinburgh, pp 879–914
- Chabal C, Jacobson L, Russell LC et al. (1992) Pain response to perineuromal injection of normal saline, epinephrine, and lidocaine in humans. *Pain* 49:9–12
- Choi B, Rowbotham MC (1997) Effect of adrenergic receptor activation on post-herpetic neuralgia pain and sensory disturbances. *Pain* 69:55–63
- Davis KD, Treede RD, Raja SN et al. (1991) Topical application of clonidine relieves hyperalgesia in patients with sympathetically maintained pain. *Pain* 47:309–317
- Dreval ON (1993) Ultrasonic DREZ-operations for treatment of pain due to brachial plexus avulsion. *Acta Neurochir* 122:76–81
- Drummond PD, Skipworth S, Finch PM (1996)  $\alpha_1$ -adrenoceptors in normal and hyperalgesic human skin. *Clin Sci* 91:73–77
- Friedman AH, Nashold BS Jr, Bronec PR (1988) Dorsal root entry zone lesions for the treatment of brachial plexus avulsion injuries: a follow-up study. *Neurosurg* 22:369–373
- Galer BS, Rowbotham MC, Von Miller K et al. (1992) Treatment of inflammatory, neuropathic and sympathetically maintained pain in a patient with Sjögren's syndrome. *Pain* 50:205–208
- Gildenberg PL (1973) General and psychological assessment of the pain patient. In: Tindall GT, Cooper PR, Barrow DL (eds) *The practice of neurosurgery*. Williams and Wilkins, Baltimore, pp 2987–2996
- Gildenberg PL (1974) Percutaneous cervical cordotomy. *Clin Neurosurg* 21:246–256
- Gildenberg PL, DeVaul RA (1985) The chronic pain patient. Evaluation and management. Karger, Basel
- Gouhier C, Chalon S, Aubert-Pouessel A et al. (2002) Protection of dopaminergic nigrostriatal afferents by GDNF delivered by microspheres in a rodent model of Parkinson's disease. *Synapse* 44:124–131
- Gybels JM, Sweet WH (1989) Neurosurgical treatment of persistent pain. Physiological and pathological mechanisms of human pain. Karger, Basel
- Hassenbusch SJ (1998) Cingulotomy for cancer pain. In: Gildenberg PL, Tasker RR (eds) *Stereotactic and functional neurosurgery*. McGraw-Hill, New York, pp 1447–1451
- Hosobuchi Y (1986) Subcortical electrical stimulation for control of intractable pain in humans. Report of 122 cases (1970–1984). *J Neurosurg* 64:543–553
- Iskandar BJ, Nashold BS (1998) Spinal and trigeminal DREZ lesions. In: Gildenberg PL, Tasker RR (eds) *Textbook of stereotactic and functional neurosurgery*. McGraw-Hill, Health professional division, New York, pp 1573–1583
- Jeanmonod D, Magnin M, Morel A (1993) Thalamus and neurogenic pain: physiological, anatomical and clinical data. *Neurorep* 4:475–478
- Kumar K, Nath RK, Toth C (1997) Spinal cord stimulation is effective in the management of reflex sympathetic dystrophy. *Neurosurg* 40:503–508
- Levy RM, Lamb S, Adams JE (1987) Treatment of Chronic Pain by Deep Brain Stimulation: Long Term Follow-up and Review of the Literature. *Neurosurg* 21:885–893
- Lieberman DM, Cortesy ME, Cummins A et al. (1999) Reversal of experimental parkinsonism by using selective chemical ablation of the medial globus pallidus. *J Neurosurg* 90:928–934
- Lorenz M, Hussein S, Verner L (2002) Continuous intraventricular clonidine infusion in controlled morphine withdrawal – case report. *Pain* 98:335–338
- McLaughlin MR, Jannetta PJ, Clyde BL et al. (1999) Microvascular decompression of cranial nerves: lessons learned after 4400 operations. *J Neurosurg* 90:1–8
- Meyerson BA, Linderorth B (2000) Spinal cord stimulation. In: Loeser JD (ed) *Bonica's Management of Pain*. Lippincott Williams & Wilkins, Philadelphia, pp 1857–1987
- Middleton JW, Siddall PJ, Walker S et al. (1996) Intrathecal clonidine and baclofen in the management of spasticity and neuropathic pain following spinal cord injury: a case study. *Arch Phys Med Rehabil* 77:824–826
- Nashold BS, El-Naggar AO (1992) Dorsal root entry zone (DREZ) lesioning. In: Rengachary SS, Wilkins RH (eds) *Neurosurgical operative atlas*. Williams & Wilkins, Baltimore, pp 9–24
- Nashold BS, Jr., Wilson WP, Slaughter DG (1969) Stereotaxic midbrain lesions for central dysesthesia and phantom pain. Preliminary report. *J Neurosurg* 30:116–126
- North RB, Kidd DH, Zahurak M et al. (1993) Spinal cord stimulation for chronic intractable pain: experience over two decades. *J Neurosurg* 32:384–395
- Pappas GD, Lazorthes Y, Bes JC et al. (1997) Relief of intractable cancer pain by human chromaffin cell transplants: experience at two medical centers. *Neurol Res* 19:71–77
- Patel A, Kassam A, Horowitz M et al. (2002) Microvascular decompression in the management of glossopharyngeal neuralgia: analysis of 217 cases. *Neurosurg* 50:705–710
- Penn RD (2003) Intrathecal medication delivery. *Neurosurg Clin N Am* 14:381–387
- Peters G, Nurmikko TJ (2002) Peripheral and gasserian ganglion-level procedures for the treatment of trigeminal neuralgia. *Clin J Pain* 18:28–34
- Pollock BE, Phuong LK, Gorman DA et al. (2002) Stereotactic radiosurgery for idiopathic trigeminal neuralgia. *J Neurosurg* 97:347–353
- Rainov NG, Heidecke V, Burkert W (2001) Long-term intrathecal infusion of drug combinations for chronic back and leg pain. *J Pain Symptom Manage* 22:862–871
- Raja SN, Abatzis V, Frank S (1998) Role of  $\alpha$ -adrenoceptors in neuroma pain in amputees. *Amer Soc Anesthesiologists, Abstracts*
- Raja SN, Treede RD, Davis KD et al. (1991) Systemic alpha-adrenergic blockade with phentolamine: a diagnostic test for sympathetically maintained pain. *Anesthesiology* 74:691–698
- Rath SA, Seitz K, Soliman N et al. (1997) DREZ coagulations for deafferentation pain related to spinal and peripheral nerve lesions: indication and results of 79 consecutive procedures. *Stereotact Funct Neurosurg* 68:161–167
- Sampson JH, Cashman RE, Nashold BS Jr et al. (1995) Dorsal root entry zone lesions for intractable pain after trauma to the conus medullaris and cauda equina. *J Neurosurg* 82:28–34
- Simpson BA (1994) Spinal cord stimulation. *Pain Rev* 1:199–230
- Sindou M, Mertens P, Wael M (2001) Microsurgical DREZotomy for pain due to spinal cord and / or cauda equina injuries: long-term results in a series of 44 patients. *Pain* 92:159–171
- Sindou MP (2002) Dorsal root entry zone lesions. In: Burchiel KJ (ed) *Surgical management of pain*. Thieme Medical Publishers, New York, pp 701–713
- Singh B, Moodley J, Shaik AS et al. (2003) Sympathectomy for complex regional pain syndrome. *J Vasc Surg* 37:508–511
- Spaic M, Markovic N, Tadic R (2002) Microsurgical DREZotomy for pain of spinal cord and Cauda equina injury origin: clinical characteristics of pain and implications for surgery in a series of 26 patients. *Acta Neurochir* 144:453–462



44. Tasker RR (1984) Deafferentation. In: Wall PD, Melzack R (eds) Textbook of pain. Churchill Livingstone, Edinburgh, London, Melbourne and New York, pp 119–132
45. Tasker RR (1988) Percutaneous Cordotomy: The Lateral High Cervical Technique. In: Schmidek HH, Sweet WH (eds) Operative Neurosurgical Techniques Indications, Methods, and Results. Saunders WB, Philadelphia, pp 1191–1205
46. Tasker RR, Dostrovsky JO (1989) Deafferentation and Central Pain. In: Wall PD, Melzack R (eds) Textbook of Pain. Churchill Livingstone, Edinburgh London Melbourne and New York, pp 154–180
47. Tasker RR, DeCarvalho GT, Dolan EJ (1992) Intractable pain of spinal cord origin: clinical features and implications for surgery. *J Neurosurg* 77:373–378
48. Thomas DG, Kitchen ND (1994) Long-term follow up of dorsal root entry zone lesions in brachial plexus avulsion. *J Neurol Neurosurg Psychiatry* 57:737–738
49. Tsubokawa T, Katayama Y, Yamamoto T et al. (1993) Chronic motor cortex stimulation in patients with thalamic pain. *J Neurosurg* 78:393–401
50. Weiss N, North RB, Ohara S et al. (2003) Attenuation of cerebellar tremor with implantation of an intrathecal baclofen pump: the role of gamma-aminobutyric acidergic pathways. Case report. *J Neurosurg* 99:768–771
51. White JC, Sweet WH (1969) Pain and the neurosurgeon: a forty year experience. Charles C Thomas, Springfield
52. Yamamoto T, Katayama Y, Hirayama T et al. (1997) Pharmacological classification of central post-stroke pain: comparison with the results of chronic motor cortex stimulation therapy. *Pain* 72:5–12
53. Young RF, Rinaldi PC (1997) Brain stimulation. In: North RB, Levy RM (eds) Neurosurgical management of pain. Springer-Verlag, New York, Berlin, Heidelberg, pp 283–301

## Neurotransmitter

### Definition

A neurotransmitter is a chemical released from a neuron into the synaptic cleft, which can trigger a response in the adjacent neuron on the opposite side of the cleft. Neurotransmitters may excite, inhibit, or otherwise influence the activity of cells.

- ▶ Cell Therapy in the Treatment of Central Pain
- ▶ Pain Treatment, Implantable Pumps for Drug Delivery
- ▶ Somatic Pain

## Neurotransmitter Receptors

### Definition

Neurotransmitter receptors are membrane proteins to which synaptic transmitters bind, leading to a physiological response in the postsynaptic cell. Neurotransmitter receptors can be ionotropic and cause a change in membrane conductance by an action on membrane channels or they can be metabotropic, causing activation of intracellular second messenger systems. Metabotropic receptors are often coupled to metabolic pathways through G proteins.

- ▶ Spinothalamic Tract Neurons, Role of Nitric Oxide

## Neurotrophic Factors

### Definition

Molecules by which tissues or cells affect nerve cell survival and/or phenotype.

- ▶ Wallerian Degeneration

## Neurotrophic Support

### Definition

Both developing and mature neurons require the ongoing delivery of a range of factors such as cytokines and neurotrophic factors to facilitate survival and maintain the phenotype of the neuron. This neurotrophic support may be supplied directly by cells of the target organ for the neuron, other cells adjacent to the axon or cell body or via the blood supply. Changes in neurotrophic support can induce changes in phenotype such as altered patterns of neurotransmitter synthesis or potential death of the neuron. Loss of neurotrophic support has been implicated in the etiology of diabetic neuropathy.

- ▶ Neuropathic Pain Model, Diabetic Neuropathy Model

## Neurotrophin

### Definition

Neurotrophins are dimeric growth factors that regulate development and maintenance of central and peripheral nervous systems. Members of this protein family include nerve growth factor (NGF), neurotrophin-3 (NT-3), brain-derived neurotrophic factor (BDNF), and neurotrophin-4/5 (NT-4/5). They regulate growth, survival, differentiation of neurons, and many other neuroectoderm tissues. All bind with low affinity to the p75 receptor and with high affinity to three structurally related receptor tyrosine kinases, named Trk receptors. NGF specifically activates TrkA, whereas BDNF and NT-4/5 specifically activate TrkB. NT-3 primarily activates TrkC, but recognizes both TrkA and TrkB to a lesser extent. Trk receptors consist of an extracellular ligand-binding domain, a single transmembrane region and an intracellular tyrosine kinase (TK) domain. Ligand binding to Trk receptors results in dimerization of

receptor molecules followed by autophosphorylation of their cytoplasmic tyrosine residues.

- ▶ Cell Therapy in the Treatment of Central Pain
- ▶ Congenital Insensitivity to Pain with Anhidrosis
- ▶ Nerve Growth Factor, Sensitizing Action on Nociceptors
- ▶ NGF, Regulation during Inflammation
- ▶ Spinal Cord Nociception, Neurotrophins
- ▶ Trigeminal Brainstem Nuclear Complex, Immunohistochemistry and Neurochemistry

## Neurotrophin Receptors

### Definition

Two types of neurotrophin receptors are involved in retrograde neurotrophin signaling, the low affinity p75 (NTR) receptor, also referred to as Nerve Growth Factor Receptor (NGFR), which binds with all the above neurotrophins, and the high affinity tyrosine kinase (Trk) receptors. The tropomyosin receptor kinase TrkA (NTRK1) is the signaling receptor for NGF, TrkB (NTRK2) is the signaling receptor for BDNF and NT-4/-5, TrkC (NTRK3) is the primary receptor for NT-3, although NT-3 also binds to TrkA and TrkB, yet with lower affinity.

- ▶ Congenital Insensitivity to Pain with Anhidrosis

### References

1. Patapoutian A, Reichardt LF (2001) Trk receptors: mediators of neurotrophin action. *Curr Opin Neurobiol* 11:272–280
2. Bibel M, Barde YA (2000) Neurotrophins: key regulators of cell fate and cell shape in the vertebrate nervous system. *Genes Dev* 14:2919–2937
3. Indo Y (2002) Genetics of congenital insensitivity to pain with anhidrosis (CIPA) or hereditary sensory and autonomic neuropathy type IV. Clinical, biological and molecular aspects of mutations in TRKA (NTRK1) gene encoding the receptor tyrosine kinase for nerve growth factor. *Clin Auton Res* 12 Suppl 1:120–132

## Neurotrophins in Spinal Cord Nociception

- ▶ Spinal Cord Nociception, Neurotrophins

## Neutral Cell (RVM)

### Definition

Third class of RVM neurons, defined by the lack of reflex-related activity. Neutral cells do not respond to mu-opioid agonists. RVM serotonergic neurons behave as neutral cells, although some authors prefer to consider serotonergic cells as a fourth class of RVM neurons, distinct from neutral cells. Neutral cells as

defined *in vivo* are likely to be a subset of primary cells defined *in vitro*.

- ▶ Opiates, Rostral Ventromedial Medulla and Descending Control

## Neutral Medical Examination

- ▶ Independent Medical Examinations

## Neutrophils in Inflammatory Pain

RAINER AMANN

Medical University Graz, Graz, Austria  
rainer.amann@meduni-graz.at

### Definition

The initial stages of the inflammatory response are characterized by the vascular reaction and the local biosynthesis of mediators that sensitize primary afferent neurons. Thereafter, immune cells are attracted to the site of injury, initiating processes that lead to either tissue repair or destruction. Immigration of polymorphonuclear neutrophil granulocytes (PMN), already in the early cellular phase of inflammation, serves to destroy infectious agents and/or cellular debris. In addition, PMNs are sources of various mediators that can affect, directly or indirectly, the sensitivity of primary afferent neurons.

### Characteristics

Tissue injury triggers the release of a large number of mediators from neuronal and non-neuronal resident cells, resulting in microvascular changes and increased afferent neuronal sensitivity, effects that provide the basis of key symptoms of inflammation, redness, edema, and pain. Arachidonic acid metabolites are central in this initial response. Conversion of arachidonic acid through the cyclooxygenase pathway leads to enhanced biosynthesis of ▶ **prostanoids**, which increase tissue perfusion and sensitize primary afferent neurons. Pharmacological inhibition of cyclooxygenase activity by ▶ **NSAIDs**, *Survey* (NSAIDs) is, therefore, effectively used to alleviate inflammatory pain and edema.

In addition to mediators that serve the initial vascular and neuronal defense reaction, compounds with chemotactic activity are produced by injured tissue. This leads to immigration of PMN to the site of injury, a process that involves a cascade of events, primarily consisting of leukocyte rolling along the endothelial layer, adherence to, and transmigration through the endothelium and vascular wall. This process is under control of various

► **cytokines**, ► **chemoattractants**, and ► **chemokines** (Wagner and Roth 2000).

PMNs can produce a wide range of mediators (e.g. arachidonic acid metabolites, various cytokines, proteases, reactive oxygen intermediaries, and nitric oxide) (Sampson 2000) that serve to initiate the immune response and destroy infectious agents and/or cellular debris. It is evident that, in chronic inflammatory disease, the severity of the cellular inflammatory response and accompanying tissue destruction correlates with inflammatory pain. This provides a rationale for the use of ► **disease modifying anti-rheumatic drugs** (DMARDs), which primarily target immune cell function, in diseases such as rheumatoid arthritis. However, there are reasons to assume that PMNs are involved in the development of inflammatory pain at earlier stages of inflammation, a concept that is primarily based on a number of studies by Levine and associates (Levine et al. 1984; Levine et al. 1986).

With regard to the role of PMN in inflammatory pain, one chemoattractant is of particular interest, ► **leukotriene** (LT) B<sub>4</sub>, which has been shown to be present in inflammatory exudates in human inflammatory diseases such as ► **rheumatoid arthritis** (Davidson et al. 1983). LTB<sub>4</sub> is a product of the 5-lipoxygenase pathway of arachidonic acid metabolism; it is a potent chemoattractant for neutrophils, which, in turn, are also major sources of LTB<sub>4</sub>. In experimental inflammation, it has been shown that LTB<sub>4</sub> produces ► **hyperalgesia**, which is not prevented by ► **Cyclooxygenases** inhibitors (Levine et al. 1984). In the presence of LTB<sub>4</sub>, PMNs release a 15-lipoxygenase product of arachidonic acid, (8R, 15S)-Dihydroxyeicosa-(5E-9,11,13Z)-tetraenoic acid [8R,15S]-diHETE], which directly sensitizes ► **primary afferent neurons** (Levine et al. 1986). Since it has been shown that the hyperalgesic activity of exogenous LTB<sub>4</sub> is dependent on the presence of PMN (Levine et al. 1984), it seems likely that the final mediator of LTB<sub>4</sub>-induced hyperalgesia is a product of PMN 15-lipoxygenase. According to this concept, PMNs would promote inflammatory hyperalgesia in a dual fashion, as sources and as targets of LTB<sub>4</sub>.

In view of these experimental data, inhibition of LTB<sub>4</sub> biosynthesis would be expected to show analgesic effects. In fact, there are studies showing analgesic effects of 5-lipoxygenase inhibition in some models of experimental inflammation. Thus, it has been shown in rodents, that ► **nerve growth factor** (NGF) elicits ► **thermal hyperalgesia**, which is dependent on PMNs and is blocked by inhibition of the 5-lipoxygenase (Amann et al. 1996, Bennett et al. 1998, Schuligoi 1988). The demonstration of PMN-dependent hyperalgesia induced by NGF may be important, because NGF has been shown to contribute to inflammatory hyperalgesia and bronchial hyperreflexia (Renz 2001). However, the studies mentioned above were conducted using exogenous NGF, and, therefore, did not provide

direct evidence for the presence of a PMN-dependent, 5-lipoxygenase mediated mechanism in inflammatory pain.

In a more recent study, Cunha et al. (2003) have shown that mechanical hypersensitivity, induced by antigen challenge in rats immunized with ovalbumin, is suppressed by inhibition of 5-lipoxygenase and a LTB<sub>4</sub> receptor antagonist. Although in this study the participation of PMNs as sources of LTB<sub>4</sub> was not addressed, the observation that, at later stages of the inflammatory response, LTB<sub>4</sub> was the principal mediator of hyperalgesia points to the involvement of PMNs.

In contrast to these experimental studies in rodents, which are suggestive of involvement of PMN 5-lipoxygenase in inflammatory hyperalgesia, there is no firm evidence that 5-lipoxygenase inhibition can attenuate inflammatory pain in patients, although selective inhibitors of 5-lipoxygenase have been available for a number of years. Therefore, the pathophysiological relevance of PMN lipoxygenases as sources of hyperalgesia-inducing factors in inflammatory pain remains doubtful.

In recent years a novel concept has emerged, suggesting that PMNs play an important role in the generation of lipoxins, lipid mediators that promote the resolution of the inflammatory process (Levy et al. 2001). According to this concept, 15-lipoxygenase products of arachidonic acid [15S-hydroxyperoxyeicosatetraenoic acid (15S-H(p)ETE), or the reduced alcohol form 15S-hydroxyeicosatetraenoic acid (15S-HETE)], derived from epithelial cells, eosinophils or monocytes serve as substrates for PMN 5-lipoxygenase, which results in the generation of lipoxin (LX)A<sub>4</sub> and LXB<sub>4</sub>. During the synthesis of lipoxins, leukotriene synthesis is blocked at the 5-lipoxygenase level in PMN, resulting in an inverse relationship of lipoxin and LT biosynthesis. An alternative pathway involves an interaction between PMN and platelets, which convert PMN 5-lipoxygenase-derived LTA<sub>2</sub> via 12-lipoxygenase to LXA<sub>4</sub> and LXB<sub>4</sub> (Serhan 1997).

Lipoxins contribute to the resolution of inflammation by inhibiting neutrophil chemotaxis, and transmigration (Takano et al. 1997), stimulation of macrophage clearance of apoptotic PMN from an inflammatory focus (Godson et al. 2000), inhibition of cell proliferation, and modulation of metalloproteinase activity (Sodin-Semrl et al. 2000). Although there are no studies on the possible effects of lipoxins on the nociceptive threshold of primary afferent neurons, it can be expected that, by attenuating the inflammatory response, they can indirectly reduce inflammatory pain.

Since PMN 5-lipoxygenase is a key enzyme in the biosynthesis of lipoxins, pharmacological inhibition of 5-lipoxygenase in PMNs may in fact counteract processes that are involved in the resolution of inflammation. Theoretically, this may also be one possible explanation for the absence of obvious analgesic ef-

fects of 5-lipoxygenase inhibition in most types of inflammation.

## References

- Amann R, Schuligoi R, Lanz I, Peskar BA (1996) Effect of a 5-Lipoxygenase Inhibitor on Nerve Growth Factor-Induced Thermal Hyperalgesia in the Rat. *Eur J Pharmacol* 306:89–91
- Bennett G, al-Rashed S, Hoult JR, Brain SD (1998) Nerve Growth Factor Induced Hyperalgesia in the Rat Hind Paw is Dependent on Circulating Neutrophils. *Pain* 77:315–322
- Cunha JM, Sachs D, Canetti CA, Poole S, Ferreira SH, Cunha FQ (2003) The Critical Role of Leukotriene B4 in Antigen-Induced Mechanical Hyperalgesia in Immunised Rats. *Br J Pharmacol* 139:1135–1145
- Davidson EM, Rae SA, Smith MJ (1983) Leukotriene B4, A Mediator of Inflammation Present in Synovial Fluid in Rheumatoid Arthritis. *Ann Rheum Dis* 42:677–679
- Godson C, Mitchell S, Harvey K, Petasis NA, Hogg N, Brady HR (2000) Cutting Edge: Lipoxins Rapidly Stimulate Nonphlogistic Phagocytosis of Apoptotic Neutrophils by Monocyte-Derived Macrophages. *J Immunol* 164:1663–1667
- Levine JD, Lam D, Taiwo YO, Donatoni P, Goetzl EJ (1986) Hyperalgesic Properties of 15-Lipoxygenase Products of Arachidonic Acid. *Proc Natl Acad Sci USA* 83:5331–5334
- Levine JD, Lau W, Kwiat G, Goetzl EJ (1984) Leukotriene B4 Produces Hyperalgesia that is Dependent on Polymorphonuclear Leukocytes. *Science* 225:743–745
- Levy BD, Clish CB, Schmidt B, Gronert K, Serhan CN. (2001) Lipid Mediator Class Switching During Acute Inflammation: Signals in Resolution. *Nat Immunol* 2 612–619
- Renz H (2001) The Role of Neutrophins in Bronchial Asthma. *Eur. J. Pharmacol.*429:231–237
- Sampson AP (2000) The Role of Eosinophils and Neutrophils in Inflammation *Clin Exp Allergy* 30 Suppl 1:22–27
- Schuligoi R (1998) Effect of Colchicine on Nerve Growth Factor-Induced Leukocyte Accumulation and Thermal Hyperalgesia in the Rat. *Naunyn Schmiedebergs Arch Pharmacol* 358:264–269
- Serhan CN (1997) Lipoxins and Novel Aspirin-Triggered 15-Epi-Lipoxins (ATL): A Jungle of Cell-Cell Interactions or a Therapeutic Opportunity? *Prostaglandins* 53:107–37
- Sodin-Semrl S, Taddeo B, Tseng D, Varga J, Fiore S (2000) Lipoxin A4 Inhibits IL-1 Beta-Induced IL-6, IL-8, and Matrix Metalloproteinase-3 Production in Human Synovial Fibroblasts and Enhances Synthesis of Tissue Inhibitors of Metalloproteinases. *J Immunol* 164:2660–2666
- Takano T, Fiore S, Maddox JF, Brady HR, Petasis NA, Serhan CN (1997) Aspirin-Triggered 15-Epi-Lipoxin A4 (LXA4) and LXA4 Stable Analogues are Potent Inhibitors of Acute Inflammation: Evidence for Anti-Inflammatory Receptors. *J Exp Med* 185:1693–1704
- Wagner JG, Roth RA (2000) Neutrophil Migration Mechanisms, with an Emphasis on the Pulmonary Vasculature. *Pharmacol Rev* 52:349–374

## New Daily Persistent Headache

TODD D. ROZEN  
Michigan Head-Pain and Neurological Institute, Ann Arbor, MI, USA  
tdrozmigraine@yahoo.com

## Synonyms

Chronic Daily Headache; Daily Persistent Headache

## Definition

New daily persistent headache (NDPH) is a form of chronic daily headache along with ► [chronic migraine](#), ► [chronic tension-type headache](#) and ► [hemicrania continua](#). The defining symptom of NDPH is a daily headache from onset, typically in an individual with minimal or no prior headache history. The headache will start one day and in most instances continue as daily unremitting pain.

## Characteristics

New daily persistent headache (NDPH) was first described by Vanast in 1986 as a benign form of chronic daily headache that improved without therapy. Very little is known about this syndrome and only recently has it been recognized as a distinct entity by headache specialists. It is unique in that the headache begins daily from onset, typically in a patient with no prior headache history and can continue for years, without any sign of alleviation despite aggressive treatment. Proposed diagnostic criteria for NDPH are listed below. It appears that there maybe two subtypes of NDPH, a self-limited form, which typically goes away within several months without any therapy and never presents to a physician's office and a refractory form, which is basically resistant to aggressive outpatient and inpatient treatment schemes.

### Proposed Criteria for New Daily Persistent Headache (Rozen)

- A Daily head pain for >2 months
- B Average headache duration of >4 h per day (if untreated). Frequently constant pain without medication
- C No history of migraine or TTH that is increasing in frequency in association with a new daily persistent headache
- D Prior history of any headache disorder is uncommon
- Acute onset of constant unremitting headache (daily from onset)
  - At least 2 of the following pain characteristics
  - Pulsating or pressing/tightening quality
  - Moderate or severe pain intensity
  - Bilateral pain location
  - Aggravation by walking upstairs or similar routine physical activity
- E At least one of the following
- Nausea and / or vomiting
  - Photophobia or phonophobia

F Does not fit the criteria for hemicrania continua

There are only two case series in the literature dedicated to describing the clinical characteristics of NDPH, the largest completed by Li and Rozen in 2002. A retrospec-



tive chart review was carried out using a computerized database of patients from the Jefferson Headache Center (a large university based headache specialty unit). All patients who were seen at Jefferson between August 1997 and May 2000 and who met the criteria for NDPH were included. Unique to NDPH is that most patients are able to pinpoint the exact date when their headache started. Headache onset occurs in relation to an infection or flu-like illness in 30%, extracranial surgery (e.g. hysterectomy) in 12% and a stressful life event in 12%. Over one-third of patients cannot identify any precipitating event. NDPH had a female predominance (female to male ratio: 2.5:1). The peak age of onset of NDPH in women is in the second and third decades of life, while the largest incidence of NDPH in men comes in the third to fifth decade. A prior headache history is found in about 40% of patients, with episodic ► [migraine](#) being the most common type. In the majority of patients, the pain of NDPH is continuous throughout the day with no pain-free time noted. Baseline average pain intensity is moderate in most, while some patients experience severe pain all of the time. Headache location is typically bilateral and pain can occur anywhere on the head. Headache quality is usually throbbing or pressure-like. With regard to associated symptoms, nausea, photophobia, phonophobia or lightheadedness occur in more than 50% of patients. ► [Aura](#)-type symptoms can also occur but are uncommon. A family history of headache is documented in 30% of patients. In almost all instances, general and neurological examinations are normal. Neuroimaging and lumbar puncture are almost always negative studies.

### Epidemiology

Even though NDPH has probably been around for centuries, it has only recently been diagnosed as an entity separate from chronic tension-type headache, hemi-crania continua and chronic migraine. The prevalence of CDH from population-based studies in the United States, Asia and Europe is about 4% (Silberstein et al. 2001). In those epidemiologic investigations, primary CDH types are sometimes not mentioned in the analysis and NDPH is rarely stratified out from the data. Several studies have documented the prevalence of NDPH; Castillo et al. (1999) looked at the prevalence of CDH in 2,252 subjects in Spain and found that 4.7% of the population has CDH, of which 0.1% had NDPH. Bigal et al. (2002) noted that 10.8% of 638 patients with CDH in a headache specialty clinic had NDPH, while Koenig et al. (2002) found that 13% of a pediatric CDH population, surveyed from selected pediatric headache specialty clinics, had NDPH.

### Etiology of NDPH

As at least a third of NDPH patients have a cold or flu-like illness when their headaches begin, an infectious etiology for NDPH has been hypothesized. Some

authors have linked Epstein-Barr virus (EBV) infection with NDPH. Diaz-Mitoma et al. (1987) identified oropharyngeal secretions of EBV in 20 of 32 patients with NDPH compared with 4 of 32 age- and gender-matched controls. A history of mononucleosis was identified in 12 of the patients with NDPH. Almost 85% of the NDPH patients were found to have an active EBV infection as opposed to 8 in the control group. The authors hypothesized that activation of a latent EBV infection may have been the trigger for the development of a chronic daily headache from onset. Santoni and Santoni-Williams (1993) demonstrated evidence of systemic infection in 108 patients with NDPH including *Salmonella*, adenovirus, toxoplasmosis, herpes zoster, EBV and *E.coli* urinary tract infections. How an infection can induce NDPH is unknown. One may hypothesize an activated immune response to a new or reactivated viral or bacterial infection leading to an autoimmune-triggered headache, possibly by setting up a state of continuous neurogenic inflammation. The virus itself could in some way activate and damage the trigeminal system leading to daily pain.

### Differential Diagnosis of NDPH

A diagnosis of primary NDPH is made only after secondary causes have been ruled out. Two disorders in particular can mimic the presentation of NDPH, ► [spontaneous cerebrospinal fluid leak \(CSF\)](#) and cerebral venous sinus thrombosis. Spontaneous CSF leaks typically present as a daily headache with a positional component (headache improved in a supine position, worsens in a sitting or standing position). However, the longer a patient suffers with a CSF leak-induced headache the less pronounced the positional component becomes. Thus if a patient is seen in a physician's office months to years after onset of a CSF leak, that patient may not even divulge a history of positional headaches, as that trigger may not have been evident to the patient for a very long time. In this setting, the CSF leak headache may mimic a primary NDPH picture.

In the patient who presents with new daily headache and is subsequently found to have cerebral venous thrombosis, in many instances none of the typical features recognized for cerebral venous thrombosis are present, including no history of new onset seizures, focal neurological deficits, change of consciousness, cranial nerve palsies or bilateral cortical signs and no evidence of papilledema on fundoscopic examination. The patient will just have a new headache that is daily from onset.

The evaluation of an NDPH patient should include neuroimaging, specifically brain MRI without and with gadolinium and MR venography (MRV). Gadolinium must be given to look for the ► [pachymeningeal enhancement](#) associated with spontaneous CSF leaks while MRV will help make the diagnosis of cerebral venous thrombosis. If a new daily headache begins after the age of 50 years, then giant cell arteritis must

be ruled-out. Headache is the most common reported symptom of the disorder occurring in up to 90% of individuals.

### Treatment

NDPH can continue for years to decades after onset and be extremely disabling to the patient. Even with aggressive treatment many NDPH patients do not improve. In many circles, primary NDPH is felt to be the most treatment refractory of all headache disorders. Many patients with NDPH will fail every possible class of abortive and preventive medications without any sign of pain relief. Recently Rozen (2002) presented five patient cases in which successful treatment of NDPH was obtained with gabapentin or topiramate. This was the first ever published study recognizing a positive treatment response for the refractory form of NDPH (the self-limited form will alleviate without any therapy).

► [Chronic Daily Headache in Children](#)

### References

1. Bigal ME, Sheftell FD, Rapoport AM et al. (2002) Chronic daily headache in a tertiary care population: correlation between the international headache society diagnostic criteria and proposed revisions of criteria for chronic daily headache. *Cephalalgia* 22:432–438
2. Castillo J, Munoz P, Guitera V et al. (1999) Epidemiology of chronic daily headache in the general population. *Headache* 38:497–506
3. Diaz-Mitoma F, Vanast WJ, Tyrell DL (1987) Increased frequency of Epstein-Barr virus excretion in patients with new daily persistent headaches. *Lancet* 1:411–415
4. Koenig MA, Gladstein J, McCarter RJ et al. and the pediatric committee of the American Headache Society (2002) Chronic daily headache in children and adolescents presenting to tertiary headache clinics. *Headache* 42:491–500
5. Li D, Rozen TD (2002) The Clinical Characteristics of New Daily Persistent Headache. *Cephalalgia* 22:66–69
6. Rozen TD (2002) Successful Treatment of New Daily Persistent Headache with Gabapentin and Topiramate. *Headache* 42:433
7. Santoni JR, Santoni-Williams CJ (1993) Headache and painful lymphadenopathy in extracranial or systemic infection: etiology of new daily persistent headaches. *Intern Med* 32:530–533
8. Silberstein SD, Lipton RB (2001) Chronic daily headache, including transformed migraine, chronic tension-type headache and medication overuse. In: Silberstein SD, Lipton RB, Dalesio DJ (eds) *Wolff's Headache and other head pain*. Oxford University Press, Oxford, pp 247–282
9. Vanast WJ (1986) New daily persistent headaches: Definition of a benign syndrome. *Headache* 26:317

## Newborn

### Synonym

Neonate

### Definition

Newborn infant who is less than 1 month postnatal age.

► [Pain Assessment in Neonates](#)

## NGF

► [Nerve Growth Factor](#)

## NGF -/- Mice

### Definition

Mice that lack a functional gene encoding nerve growth factor, i.e. NGF knockout mice.

► [Nerve Growth Factor Overexpressing Mice as Models of Inflammatory Pain](#)

## NGF-OE mice

► [Nerve Growth Factor Overexpressing Mice as Models of Inflammatory Pain](#)

## NGF, Regulation during Inflammation

RAINER AMANN

Medical University Graz, Graz, Austria  
rainer.amann@meduni-graz.at

### Definition

In inflamed tissue, there is increased expression of ► [nerve growth factor](#) (NGF), which affects afferent neuron function, and contributes to the development and resolution of the inflammatory process. Pharmacological tools that can modify inflammation-induced NGF biosynthesis are, therefore, of potential therapeutic value.

### Characteristics

Nerve growth factor (NGF) belongs to a family of structurally related ► [neurotrophins](#). During inflammation, there is a rapid increase in local NGF biosynthesis. The local increase in NGF in inflamed tissues leads to changes in the phenotype of a subset of ► [primary afferent neurons](#), with consequences for the transmission of noxious afferent input (Mendell et al. 1999).

In addition to its neurotrophic properties, NGF has been shown to affect immune cell function (Aloe et al. 1999). Direct neuronal effects (Mendell et al. 1999), as well as effects on immune cells (Bennett et al. 1998; Schuligoi 1998), seem to contribute to NGF-induced sensitization of primary afferent neurons, which manifests itself as inflammatory ► [hyperalgesia](#) in the skin or bronchial hyperreactivity in the respiratory system (Renz 2001). Furthermore, it has been suggested that, by promoting keratinocyte proliferation and vascular neoangiogenesis, NGF contributes to cutaneous morphogenesis,

wound healing, and tissue response to inflammation (Aloe 2004).

### Inhibition of NGF Biosynthesis

Attenuation of the inflammation-induced rise in tissue NGF may be effective in preventing longer-lasting hyperalgesic effects of NGF. Therefore, a number of studies were conducted in order to investigate the effects of anti-inflammatory drugs on NGF biosynthesis in inflamed tissue.

**Glucocorticoids** have been shown to suppress inflammatory edema as well as the inflammation-induced increase in NGF biosynthesis. This is in contrast to non-inflamed tissues, where acute glucocorticoid treatment seems to have no inhibitory effect on NGF biosynthesis (Safieh-Garabedian et al. 1995).

**Non-steroidal anti-inflammatory drugs** (► NSAIDs), belonging to the group of ► Cyclooxygenases (COX) inhibitors, suppress prostanoid biosynthesis, thereby reducing edema and pain. Therefore, it seems interesting that inhibition of prostanoid biosynthesis, although suppressing inflammatory edema, has no significant effect on NGF expression in inflamed paw tissue of the rat (Amann et al. 1996). This suggests that the potency of anti-inflammatory drugs to inhibit inflammatory edema, is not necessarily predictive of their ability to reduce the inflammation-induced increase in NGF. In contrast to the absence of significant influence on inflammation-induced NGF expression by COX inhibition, high dose NSAID treatment of rats has been shown to be effective in decreasing NGF in inflamed tissue (Safieh-Garabedian et al. 1995), an effect that may be ascribed to drug actions not related to COX inhibition (Tegeeder et al. 2001).

### Drugs Acting at Adrenergic Receptors

It has been shown that treatment of rats with adrenergic antagonists inhibits the increase in NGF observed in endotoxin-induced paw inflammation (Safieh-Garabedian et al. 2002), suggesting that endogenous adrenergic tone can be sufficient to stimulate local NGF biosynthesis (see “Stimulation of NGF biosynthesis”). However, a participation of endogenous adrenergic mechanisms in stimulating NGF biosynthesis in inflamed tissues does not seem to be a general feature of the inflammatory response. In contrast, there are even models of inflammation where adrenergic agonists can attenuate the inflammation-induced rise in NGF:

a) In allergic inflammation of the rat paw or respiratory system, the beta adrenoceptor agonist terbutaline attenuates edema as well as the increase in local NGF formation. In contrast to its inhibitory effect in allergic inflammation, terbutaline does not significantly affect NGF in carrageenan-induced inflammation of the rat paw, suggesting no general inhibitory effects of terbutaline on NGF biosynthesis in inflammation (Amann et al. 2001).

b) Neurogenic inflammation is caused by experimental stimulation of capsaicin-sensitive primary afferent neurons, leading to the peripheral release of neuropeptides (e.g. calcitonin gene-related peptide and ► tachykinins) that cause vasodilation, plasma protein extravasation, and also an increase in the NGF content of the innervated skin (see “Stimulation of NGF biosynthesis”). It can be shown that terbutaline inhibits the increase in NGF of rat skin in capsaicin-induced neurogenic inflammation, and the NGF increase following local injection of the tachykinin NK1 receptor agonist substance P (Amann et al. 2004).

At the transcriptional level, beta adrenergic agonists can stimulate rather than decrease the expression of NGF (see “Stimulation of NGF biosynthesis”). The observed inhibitory effects on NGF biosynthesis of beta adrenergic stimulation in the abovementioned studies are, therefore, not caused by specifically inhibiting NGF transcription, but by interference with the inflammatory stimulus itself.

**Tachykinin NK1 receptor antagonists** inhibit the increase in NGF caused by experimental neurogenic inflammation, but do not detectably affect the NGF response to carrageenan or allergic inflammation. In non-inflamed skin, treatment with tachykinin NK1 receptor antagonists has no detectable effect on NGF biosynthesis (Amann et al. 2000).

### Stimulation of NGF Biosynthesis

#### Beta Adrenergic Agonists

A number of studies have shown that, depending on cell type, beta adrenergic agonists stimulate the expression of NGF mRNA and protein. These effects seem to be caused by an agonist-induced rise in intracellular cAMP and activation of ► protein kinase A, which causes an increase in early inducible genes such as ► c-fos and the associated AP-1 binding. The AP-1 element is present within intron 1 of the NGF gene. In addition, the transcription factor C/EBP $\delta$  is activated by elevated cAMP levels and is one of the transcription factors for induced NGF expression (Riaz and Tomlinson 2000).

#### Vitamin D Receptor Agonists

There are several studies showing that vitamin D analogs, acting at vitamin D receptors, stimulate the expression of NGF mRNA, probably due to increased AP-1 binding. Vitamin D analogues may indirectly modulate NGF mRNA levels through increasing intracellular Ca<sup>2+</sup> and promoting c-fos and c-jun induction; these ► immediate early genes are postulated to enhance NGF expression (Riaz and Tomlinson 2000).

#### Tachykinin NK1 Receptor Agonists

It has been shown in rodents that an intraplantar injection of the endogenous NK1 receptor agonist substance P stimulates NGF biosynthesis in the paw skin. The effect of substance P is blocked by a selective tachykinin NK1

receptor antagonist, indicating that NK1 receptor activation stimulates the NGF increase. Further experiments have provided evidence of the involvement of NK1 receptors in the NGF increase caused by neurogenic inflammation, suggesting that endogenous substance P, released from primary afferent nerve terminals during stimulation, acts on NK1 receptors to increase tissue NGF (Amann et al. 2000).

It seems to be of particular interest that primary afferent neuron activation, through local release of neurotransmitters, augments NGF biosynthesis. This may not only constitute a regulatory feed back by which enhanced peripheral release of neuropeptides is signaled to dorsal root ganglia where NGF stimulates neuropeptide biosynthesis (Donnerer et al. 1993), but may be of importance in inflammation and/or the local response to tissue injury. However, the ► **cellular targets of substance P** have not been determined so far.

The vanilloid ► **VR1 receptor** agonist ► **capsaicin** is a potent stimulant to induce excitation and local neuropeptide release from small-diameter primary afferent neurons, and thus induces neurogenic inflammation. When applied by either intraplantar injection (Saade et al. 2003) or by topical application to the paw skin (Amann et al. 2004), capsaicin stimulates NGF biosynthesis in the skin. NK1 receptor antagonists prevent this effect of capsaicin, indicating that substance P, released from primary afferent neurons, is the mediator of the capsaicin-induced NGF response. Capsaicin would seem, therefore, to be a suitable pharmacological tool to increase skin NGF biosynthesis, especially since it is a constituent of various drug formulations made for topical administration to the skin. However, a single topical application of capsaicin to the skin results in reduced responsiveness to subsequent applications of capsaicin (Amann et al. 2004). Desensitization may, therefore, limit the use of vanilloid receptor agonists as tools for producing longer lasting stimulation of skin NGF biosynthesis.

## References

1. Aloe L (2004) Nerve Growth Factor, Human Skin Ulcers and Vascularization. Our Experience. *Prog Brain Res* 146:515–522
2. Aloe L, Simone MD, Properzi F (1999) Nerve Growth Factor: A Neurotrophin with Activity on Cells of the Immune System. *Microsc Res Tech* 45:285–291
3. Amann R, Egger T, Schuligoi R (2000) The Tachykinin NK(1) Receptor Antagonist SR140333 Prevents the Increase of Nerve Growth Factor in Rat Paw Skin Induced by Substance P or Neurogenic Inflammation. *Neuroscience* 100:611–615
4. Amann R, Peskar BA, Schuligoi R (2001) Effects of Terbutaline on NGF Formation in Allergic Inflammation of the Rat. *Br J Pharmacol* 133:186–192
5. Amann R, Schuligoi R (2004) Beta adrenergic inhibition of capsaicin-induced, NK1 receptor-mediated nerve growth factor biosynthesis in rat skin. *Pain* 112:76–82
6. Amann R, Schuligoi R, Herzog G, Donnerer J (1996) Intraplantar Injection of Nerve Growth Factor into the Rat Hind Paw: Local Edema and Effects on Thermal Nociceptive Threshold. *Pain* 64:323–329
7. Bennett G, al-Rashed S, Hoult JR, Brain SD (1998) Nerve Growth Factor Induced Hyperalgesia in the Rat Hind Paw is Dependent on Circulating Neutrophils. *Pain* 77:315–322
8. Donnerer J, Schuligoi R, Stein C, Amann R (1993) Upregulation, Release and Axonal Transport of Substance P and Calcitonin Gene-Related Peptide in Adjuvant Inflammation and Regulatory Function of Nerve Growth Factor. *Regul Pept* 46:150–154
9. Mendell LM, Albers KM, Davis BM (1999) Neurotrophins, Nociceptors, and Pain. *Microsc Res Tech* 45:252–261
10. Renz H (2001) The Role of Neurotrophins in Bronchial Asthma. *Eur J Pharmacol* 429:231–237
11. Riaz SS, Tomlinson DR (2000) Pharmacological Modulation of Nerve Growth Factor Synthesis: A Mechanistic Comparison of Vitamin D Receptor and Beta(2)-Adrenoceptor Agonists. *Mol Brain Res* 85:179–188
12. Saade NE, Massaad CA, Ochoa-Chaar CI, Jabbur SJ, Safieh-Garabedian B, Atweh SF (2002) Upregulation of Proinflammatory Cytokines and Nerve Growth Factor by Intraplantar Injection of Capsaicin in Rats. *J Physiol* 545:241–253
13. Safieh-Garabedian B, Poole S, Allchorne A, Winter J, Woolf CJ (1995) Contribution of Interleukin-1 Beta to the Inflammation-Induced Increase in Nerve Growth Factor Levels and Inflammatory Hyperalgesia. *Br J Pharmacol* 115:1265–1275
14. Safieh-Garabedian B, Poole S, Haddad JJ, Massaad CA, Jabbur SJ, Saade NE (2002) The Role of the Sympathetic Efferents in Endotoxin-Induced Localized Inflammatory Hyperalgesia and Cytokine Upregulation. *Neuropharmacology* 42:864–872
15. Schuligoi R (1998) Effect of Colchicine on Nerve Growth Factor-Induced Leukocyte Accumulation and Thermal Hyperalgesia in the Rat. *Naunyn Schmiedebergs Arch Pharmacol.* 358:264–269
16. Tegeder I, Pfeilschifter J, Geisslinger G (2001) Cyclooxygenase-Independent Actions of Cyclooxygenase Inhibitors. *FASEB J* 15:2057–2072

## NGF, Sensitization of Nociceptors

DAVID BENNETT

Department of Neurology, King's College Hospital, London, UK

dlhbennett@talk21.com

### Definition

NGF is a secreted protein of molecular mass of 13 kD which exists as a homodimer. It is a member of the neurotrophin family, which also includes brain derived neurotrophic factor (BDNF), neurotrophin-3 (NT3) and neurotrophin-4/5 (NT4/5). NGF binds to both a high affinity tyrosine kinase receptor trkA and a low affinity receptor p75. Nociceptors are primary afferent neurons that respond to potentially tissue damaging stimuli. NGF can sensitize these neurons so that they show an increased response to thermal and chemical stimuli.

### Characteristics

It has now been established that NGF is a key mediator involved in the generation of inflammatory pain; for a full discussion of this please see the chapter 'Inflammatory pain and NGF'. Administration of NGF either locally or systemically results in both thermal and mechanical hyperalgesia. NGF administration produces both a peripheral sensitization (increased response of primary

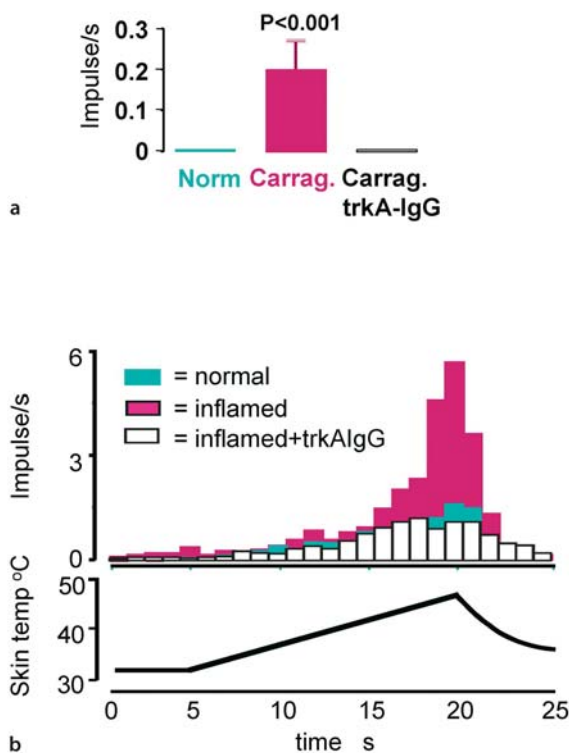


afferent neurons to noxious stimuli) and central sensitization (a facilitation of the spinal processing of noxious stimuli). This chapter will deal with the mechanisms by which NGF sensitizes nociceptors.

An *in vitro* skin nerve preparation has been used to study the effects of NGF on cutaneous nociceptors. Direct application of NGF to the receptive fields of these afferents increased their sensitivity to noxious thermal stimuli but had no effect on their mechanical sensitivity (Rueff and Mendell 1996). In particular some fibres, which were thermally insensitive, developed a novel, heat sensitivity after NGF treatment. NGF administration did not induce ongoing activity. Application of NGF to dissociated DRG cells results in a sensitization of these neurons to noxious heat and capsaicin that occurs within minutes (Shu and Mendell 2001; Galoyan et al. 2003). NGF potentiates the response to a given heat stimulus and prevents the tachyphylaxis normally seen when paired stimuli are given. Visceral afferents innervating the bladder have been shown to display increased mechanical sensitivity following NGF administration (Dmitrieva et al. 1997) and high threshold group IV muscle afferents de-

velop ongoing activity following intramuscular NGF injection (Hoheisel et al. 2005).

We have studied the role of NGF in producing primary afferent sensitisation following intraplantar carrageenan, which evokes an acute inflammatory reaction (Koltzenburg et al. 1999). A trkA-IgG fusion protein was used to sequester endogenous NGF. 3 h after carrageenan administration there was a marked increase in spontaneous activity (50% of nociceptors innervating inflamed skin vs 4% in control). This could be almost completely prevented by administration of trkA-IgG (Fig. 1). Interestingly, as described above, NGF administration alone does not induce spontaneous activity in nociceptors and therefore in the context of inflammation it must be acting co-operatively with other chemical mediators. Inflammation also produced an increased response of nociceptors to a standard heat ramp and the proportion of fibres responding to the inflammatory mediator bradykinin increased. Both of these changes could be prevented by administration of trkA-IgG (Fig. 1). We did not find any significant mechanical sensitisation of cutaneous nociceptors following inflammation. Other groups have found varying degrees of mechanical sensitisation following inflammation. It is likely that the mechanical hyperalgesia seen after NGF administration is due to central mechanisms.

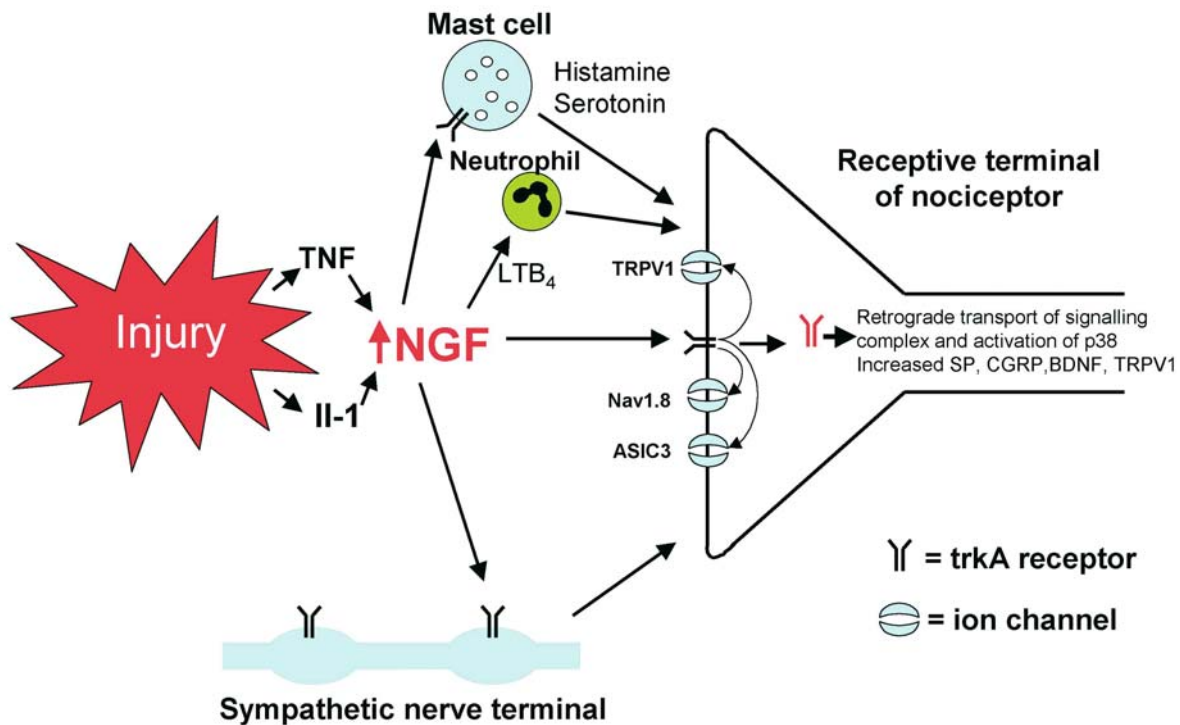


**NGF, Sensitization of Nociceptors, Figure 1** The effects of carrageenan inflammation on the properties of primary afferent nociceptors. Recordings were made from an isolated skin-nerve preparation. Carrageenan inflammation led to increased spontaneous activity in primary afferents (a), which could be blocked by trkA-IgG treatment. Afferents were also tested for their response to a ramp increase in skin temperature (b). Afferents innervating inflamed skin showed an enhanced response to this heat ramp. This thermal sensitisation was prevented by administration of a trkA-IgG, which sequesters endogenous NGF. Figure adapted from Koltzenburg et al. 1999.

#### Cell Types Involved in the Generation of NGF Mediated Hyperalgesia

As described in chapter 'Inflammatory pain and NGF' there are two receptors for NGF, a high affinity tyrosine kinase receptor trkA and a low affinity receptor p75. It is likely that the hyperalgesic effects of NGF are principally mediated by binding to trkA. Animals that lack p75 continue to develop thermal and mechanical hyperalgesia in response to NGF. A substantial proportion of peripheral nociceptor terminals express the trkA receptor and I will discuss the direct sensitizing action of NGF on these neurons in the following section. A number of other cellular elements within peripheral tissues also express trkA and some of the sensitizing actions of NGF may therefore be indirect (for a schematic representation of the sensitizing effects of NGF on nociceptors see Fig. 2).

Mast cells expressing trkA and NGF can induce mast cell degranulation (resulting in the release of histamine and serotonin) and the expression of a number of cytokines including IL-3, IL-4, IL-10 and TNF $\alpha$ . Mast cell degranulators and serotonin antagonists have been shown to reduce the thermal, but not the mechanical, hyperalgesia that occurs following NGF administration (Lewin et al. 1994; Woolf et al. 1996). There may also be an interaction between NGF and sympathetic efferents, which also express the trkA receptor. Surgical or chemical sympathectomy can reduce the short latency thermal and mechanical hyperalgesia evoked by NGF (Andreev et al. 1995; Woolf et al. 1996). The produc-



**NGF, Sensitization of Nociceptors, Figure 2** Schematic representation of the role of NGF in nociceptor sensitisation. Following tissue injury there is a rapid increase in NGF expression, which is secondary to increased levels of IL-1 and TNF $\alpha$ . Some of the effects of NGF on nociceptor terminals are mediated indirectly *via* mast cells, sympathetic efferents and neutrophil chemotaxis. NGF can also act directly on nociceptors following binding to the trkA receptor. This leads to activation of multiple second messenger pathways resulting in the potentiation of a number of ion channels including TRPV1, Nav 1.8 and ASIC3. An activated trkA-NGF complex is also transported to the cell nucleus and modulates gene expression causing more long-term effects on nociceptor excitability and function. See text for details.

tion of eicosanoids by sympathetic efferents has been suggested to contribute to hyperalgesia under some inflammatory conditions. This does not appear to be the case for NGF induced hyperalgesia as this is unaffected by treatment with non-steroidal anti-inflammatory agents.

A further mechanism by which NGF produces peripheral sensitization is through activation of the 5-lipoxygenase pathway. The enzyme 5-lipoxygenase converts arachidonic acid into leukotrienes. Leukotriene B<sub>4</sub> (LTB<sub>4</sub>) is a powerful chemotactic factor for neutrophils and has been shown to sensitize nociceptive afferents to thermal and mechanical stimuli. NGF increases the production of (LTB<sub>4</sub>) in the skin and inhibitors of the 5-lipoxygenase enzyme prevent the development of thermal hyperalgesia following intraplantar NGF injection (Amann et al. 1996).

#### Direct Actions of NGF on Nociceptor Function

40% of adult DRG cells express trkA and it is selectively expressed in a population of small diameter DRG cells which express neuropeptides such as CGRP and which are predominantly nociceptors. The recent rapid advances in characterising both the second messenger

pathways and the molecular identities of signal transducing elements within nociceptors has led to a much greater understanding of the sensitising actions of NGF on these neurons.

NGF binding to trkA results in the cross-linking of two adjacent receptors. This triggers each trkA molecule to phosphorylate tyrosine residues on the cytoplasmic domain of its cross-linked neighbour. Phosphorylation causes conformational changes, which expose binding sites for proteins with SH2 domains. Multiple second messenger pathways are subsequently activated including phospholipase C- $\gamma$  (PLC- $\gamma$ ), protein kinase C and members of the mitogen-activated protein kinase (MAPK) pathway. NGF can have acute effects on ion channel function *via* posttranslational modification such as phosphorylation and long-term effects based on transcriptional regulation and transport of ion channels to the nerve terminal.

One of the most intensively studied areas which demonstrating these multiple levels of regulation by NGF is the potentiation of TRPV1 function. TRPV1 is expressed in nociceptors and is a capsaicin- and proton-sensitive cation-selective channel that transduces noxious heat stimuli. Although its role in thermal nociception in the normal state is controversial, it has been shown to

be important in the generation of thermal hyperalgesia following inflammation and following NGF administration (Chuang et al. 2001). NGF rapidly (within minutes) sensitises TRPV1 responses to low pH, capsaicin and noxious heat. This sensitising effect of NGF is clearly established, however there is some confusion in the literature as to the exact second messenger pathways mediating this effect. One proposed pathway is *via* activation of phospholipase C (PLC). PLC- $\gamma$  activation results in reduced levels of phosphatidylinositol-4,5-bisphosphate (PtdIns(4,5)P<sub>2</sub>) in the plasma membrane. As PtdIns(4,5)P<sub>2</sub> exerts a tonic inhibitory action on TRPV1 this can rapidly enhance the sensitivity of TRPV1 and this effect has been demonstrated both in heterologous cells expressing TRPV1 and DRG cells (Chuang et al. 2001; Galoyan et al. 2003). Another second messenger pathway activated by NGF is phosphatidyl 3-kinase (PI3K). This is a lipid kinase that phosphorylates the D-3 position of phosphatidylinositol lipids to produce PI(3,4,5)P<sub>3</sub>. One of the downstream effects of PI3K activation is activation of extracellular signal-regulated protein kinase (ERK) a member of the MAPK family. NGF activates PI3K and ERK in DRG cells. These pathways have been shown to have a role in mediating both the potentiation of TRPV1 current and the thermal hyperalgesia induced by NGF (Zhuang, Xu et al., 2004). Another group studying the sensitization of capsaicin-induced [Ca<sup>2+</sup>]<sub>i</sub> by NGF in neonatal DRG cells also reported an important role for PI3K and also for PKC, but did not find any effect of blocking PLC (Bonnington and McNaughton 2003).

Following binding of NGF to trkA at the nerve terminal, the complex is internalised and retrogradely transported in a signalling endosome to the cell body, where it regulates further second messenger pathways. Signals may also be activated by NGF at the cell surface and then transported back to the cell body in the absence of NGF. Once this signal has reached the cell body, it can modulate gene transcription and the targeting of signal transducing molecules back to nociceptor terminals. 24 h after induction of inflammation, there is an activation of p38 MAP kinase within DRG cell bodies that has been shown to be NGF dependent. This activation of p38 by NGF results in increased levels of TRPV1 protein (but not mRNA), which is transported to the peripheral terminals of C-fibres. This increased TRPV1 expression makes a contribution to the late phase of thermal hyperalgesia during inflammation (Ji et al. 2002).

A second group of molecular targets within sensory neurons that are regulated by NGF are the tetrodotoxin resistant (TTXR) sodium channels (Nav 1.8 and 1.9). These are exclusively expressed within nociceptive neurons. Inflammatory mediators have been shown to increase the TTXR current in DRG cells. Post-translational modulation of TTXR is *via* phosphorylation of the channel mediated by both PKA and PKC (Gold et al. 1998). NGF may also regulate the expression of Nav 1.8 in DRG cells.

The importance of this mechanism in mediating the sensitising effects of NGF on nociceptive neurons is demonstrated by the fact that animals that carry a null mutation of the Nav 1.8 gene show reduced thermal hyperalgesia following NGF administration (Kerr et al. 2001). NGF can also regulate the expression of other ion channels such as the acid sensing ion channel ASIC 3 within nociceptors. This and the potentiation in TRPV1 function (which is also activated by protons) are likely to increase the sensitivity of nociceptors to the low pH seen in inflammatory tissue.

In summary, NGF has been shown convincingly to sensitise nociceptive afferents to thermal stimuli and in the context of inflammation also contributes to the development of ongoing activity. There are likely to be a number of direct and indirect mechanisms that lead to such sensitisation. A greater understanding of this process, and in particular the means by which NGF potentiates the function of TRPV1 and Nav 1.8 in nociceptors, may ultimately lead to novel analgesic therapies for inflammatory pain.

## References

1. Amann R, Schuligoi R, Lanz I et al. (1996) Effect of a 5-lipoxygenase inhibitor on nerve growth factor-induced thermal hyperalgesia in the rat. *Eur J Pharmacol* 306:89–91
2. Andreev NY, Dimitrieva N, Koltzenburg M et al. (1995) Peripheral administration of nerve growth factor in the adult rat produces a thermal hyperalgesia that requires the presence of sympathetic post-ganglionic neurones. *Pain* 63:109–115
3. Bonnington JK, McNaughton PA (2003) Signalling pathways involved in the sensitisation of mouse nociceptive neurones by nerve growth factor. *J Physiol* 551:433–446
4. Chuang HH, Prescott ED, Kong H et al. (2001) Bradykinin and nerve growth factor release the capsaicin receptor from PtdIns(4,5)P<sub>2</sub>-mediated inhibition. *Nature* 411:957–962
5. Dimitrieva N, Shelton D, Rice AS et al. (1997) The role of nerve growth factor in a model of visceral inflammation. *Neuroscience* 78:449–459
6. Galoyan SM, Petruska JC, Mendell LM (2003) Mechanisms of sensitization of the response of single dorsal root ganglion cells from adult rat to noxious heat. *Eur J Neurosci* 18:535–541
7. Gold MS, Levine JD, Correa AM (1998) Modulation of TTX-R INa by PKC and PKA and their role in PGE<sub>2</sub>-induced sensitization of rat sensory neurons *in vitro*. *J Neurosci* 18:10345–10355
8. Hoheisel U, Unger T, Mense S (2005) Excitatory and modulatory effects of inflammatory cytokines and neurotrophins on mechanosensitive group IV muscle afferents in the rat. *Pain* 114:168–176
9. Ji RR, Samad TA, Jin SX et al. (2002) p38 MAPK activation by NGF in primary sensory neurons after inflammation increases TRPV1 levels and maintains heat hyperalgesia. *Neuron* 36:57–68
10. Kerr BJ, Souslova V, McMahon SB et al. (2001) A role for the TTX-resistant sodium channel Nav 1.8 in NGF-induced hyperalgesia, but not neuropathic pain. *Neuroreport* 12:3077–3080
11. Koltzenburg M, Bennett DL, Shelton DL et al. (1999) Neutralization of endogenous NGF prevents the sensitization of nociceptors supplying inflamed skin. *Eur J Neurosci* 11:1698–1704
12. Lewin GR, Rueff A, Mendell LM (1994) Peripheral and central mechanisms of NGF-induced hyperalgesia. *Eur J Neurosci* 6:1903–1912
13. Rueff A, Mendell LM (1996) Nerve growth factor NT-5 induce increased thermal sensitivity of cutaneous nociceptors *in vitro*. *J Neurophysiol* 76:3593–3596

14. Shu X, Mendell LM (2001) Acute sensitization by NGF of the response of small-diameter sensory neurons to capsaicin. *J Neurophysiol* 86:2931–2938
15. Woolf CJ, Ma QP, Allchorne A et al. (1996) Peripheral cell types contributing to the hyperalgesic action of nerve growth factor in inflammation. *J Neurosci* 16:2716–2723
16. Zhuang ZY, Xu H, Clapham DE et al. (2004) Phosphatidylinositol 3-kinase activates ERK in primary sensory neurons and mediates inflammatory heat hyperalgesia through TRPV1 sensitization. *J Neurosci* 24:8300–8309

## Nick Model of Cutaneous Pain and Hyperalgesia

ESTHER M. POGATZKI-ZAHN

Department of Anesthesiology and Intensive Care Medicine, University Muenster, Muenster, Germany  
pogatzki@anit.uni-muenster.de

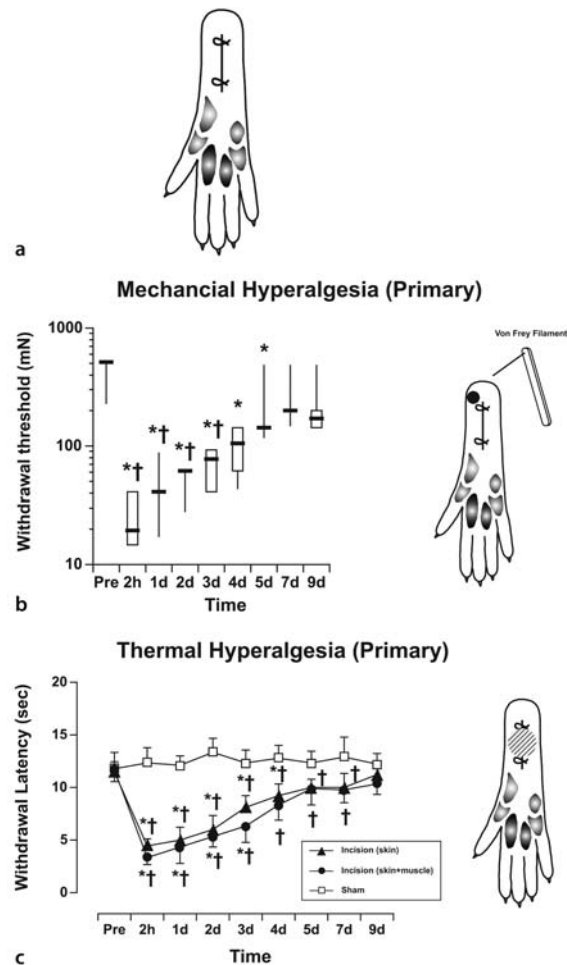
### Synonyms

Plantar Incision Model; Incision Model for Postoperative Pain; Postoperative Pain Model; Brennan Pain Model

### Definition

Postoperative pain is a unique and common form of acute pain. There is ample evidence that pains caused by inflammation, nerve injury or incision is based on different pathophysiological mechanisms. This explains why many treatment strategies are efficacious only against specific types of persistent pain (Hunt and Mantyh 2001). Recognizing this gap between preclinical models of persistent pain and postsurgical pain, new rodent skin incision models have been developed (Brennan et al. 1996; Martin et al. 2004; Pogatzki et al. 2002b). In the plantar incision model developed by Brennan and co-workers, a simple incision is made in the plantar aspect of the hind paw of a rat (Brennan et al. 1996). The plantar hind paw incision is performed under halogenated volatile anesthesia using sterile technique. After induction of anesthesia, a 1 cm longitudinal incision is made with a number 11 blade, through skin and fascia of the paw, starting 0.5 cm from the proximal edge of the heel and extending toward the digits (Fig. 1a). Subsequently, the underlying flexor muscle is elevated with the forceps and incised longitudinally with the scalpel blade. The muscle origin and insertion remain intact. After hemostasis with gentle pressure, the skin is apposed with two mattress sutures of 5-0 nylon and the wound site is covered with antibiotic ointment. The rats recover for 30 min to 1 hr from anesthesia in clean bedding. Nylon is used for closure to minimize the inflammatory response to the suture material. The sutures are removed on postoperative day 2 to prevent any persistent responses caused by the sutures.

Mouse models of postoperative pain have been performed (Pogatzki and Raja 2003). The behaviors caused



**Nick Model of Cutaneous Pain and Hyperalgesia, Figure 1** Mechanical and thermal hyperalgesia after incision. (a) Schematic of the incision in the plantar aspect of the rat foot. (b) Punctate mechanical hyperalgesia adjacent to the incision. The results are expressed as median (horizontal line) with 1st and 3rd quartiles (boxes), and 10th and 90th percentiles (vertical lines). Primary punctate hyperalgesia after an incision of skin, fascia and muscle. The site of incision and of testing is illustrated in a schematic accompanying the graph. \* $P < 0.05$  vs. pre; † $P < 0.05$  vs. sham. (c) Heat hyperalgesia after incision. Primary heat hyperalgesia after an incision of skin, fascia and muscle. The site of testing and incision are illustrated to the right of the graph. \* $P < 0.05$  vs. pre; † $P < 0.05$  vs. sham. The symbols represent the mean  $\pm$  standard deviation (SD).

by plantar incision in the mouse roughly parallel those in the rat.

### Characteristics

#### Primary and Secondary Hyperalgesia after Incision Injury

An incision made in the plantar aspect of the rat hind paw causes persistent, reduced withdrawal thresholds to mechanical stimuli suggesting hyperalgesia (decreased pain threshold to suprathreshold stimuli). Primary mechanical and heat hyperalgesia, enhanced pain to mechanical and thermal stimuli in the area of the incision, is present after a surgical incision in this model (Fig.



1b, c). Whereas primary mechanical hyperalgesia after plantar incision in rodents lasts for 2 to 3 days, primary heat hyperalgesia lasts up to 7 days after incision (Zahn and Brennan 1999b).

► **Secondary hyperalgesia**, enhanced pain to stimuli applied adjacent to the area of incision, was observed to punctate mechanical stimuli but not to a blunt mechanical probe or to a thermal stimulus (Pogatzki et al. 2002b; Zahn and Brennan 1999b).

Increased mechanical sensitivity after incision in rodents has striking similarities to an experimental incision in humans (Kawamata et al. 2002) and to patients' pain reports after surgery (Stubhaug et al. 1997). Hyperalgesia from the area of incision (► **primary hyperalgesia**) probably contributes to mechanically evoked pain in postoperative patients. A reduction of primary hyperalgesia with a specific treatment should therefore affect pain induced by mechanical stimuli (e.g. coughing, movement or ambulation after surgery).

#### Peripheral and Central Sensitization After Incision Injury

A number of neurophysiological studies using the rodent incision models have revealed some of the underlying mechanisms inherent in incision-induced pain. From these studies mechanical hyperalgesia after incision appears to involve activation and sensitization of primary afferent ► **nociceptors** (► **peripheral sensitization**) (Pogatzki et al. 2002a), and neurons in the spinal dorsal horn (central sensitization) (Vandermeulen and Brennan 2000; Zahn and Brennan 1999a).

#### Peripheral Sensitization after Incision (Fig. 2a–c):

In general, the characteristic features of experimentally induced peripheral sensitization of primary afferent fibers are a lowering of response threshold, an increase in response magnitude to suprathreshold stimuli, an increase in spontaneous activity or an increase in RF size. Recording mechanosensitive afferent fibers innervating the plantar aspect of the rat hind paw using standard teased-fiber techniques revealed an increase in the ► **receptive field** size and the occurrence of spontaneous activity of A-delta and C fibers after incision; activation thresholds of A-delta fibers, but not of C-fiber nociceptors, decreased after incision (Pogatzki et al. 2002a). Importantly, the conversion of mechanical insensitive ► **silent nociceptors** to mechanically activated fibers was indicated 24 h after incision (Pogatzki et al. 2002a). A-beta fibers did not sensitize after an incision. In conclusion, spatial summation of modestly increased response magnitude may contribute to the reduced withdrawal threshold after incision. Spontaneous activity in A-delta- and C-fibers may not only account for spontaneous pain behavior but may also contribute to mechanical hyperalgesia by amplifying responses centrally. Furthermore, the conversion of mechanical insensitive silent nociceptors to mechanically acti-

vated fibers probably has a role in the maintenance of hyperalgesia after an incision.

#### Spinal Sensitization after Incision (Fig. 2d):

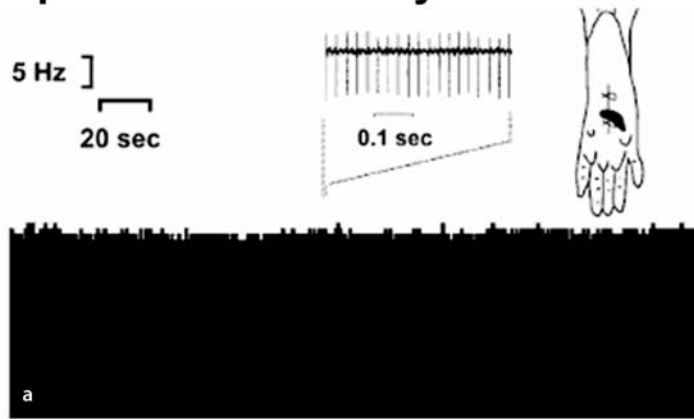
Recording action potentials from dorsal horn neurons (DHN) after incision revealed unique characteristics of ► **spinal sensitization** defined by decreased withdrawal thresholds, increased neuronal activity, enlarged receptive field (RF) size and increased background activity. DHNs receiving input from the plantar aspect of the hind paw using natural stimuli in anesthetized rats were characterized as ► **wide-dynamic-range** (WDR), and ► **high-threshold (HT) neurons** based on their responses to brush and pinch. WDR neurons respond to both brush and pinch whereas HT neurons respond only to pinch. The results from DHN recording demonstrate that a plantar incision caused dorsal horn cell activation and central sensitization (Vandermeulen and Brennan 2000; Zahn and Brennan 1999a). Both WDR and HT neurons have increased background activity that is driven by activated primary afferent fibers from the incision area (Pogatzki et al. 2002c) and probably transmits evidence for nonevoked ongoing pain like guarding behaviors. Because the threshold of HT neurons did not decrease to the range of the withdrawal responses in behavioral experiments, particular WDR dorsal horn neurons probably contribute to the reduced withdrawal threshold observed in behavioral experiments. In contrast to other tissue injuries there is no evidence that after an incision HT neurons convert to WDR cells or low threshold neurons are sensitized.

#### Pharmacology of Incisional Pain

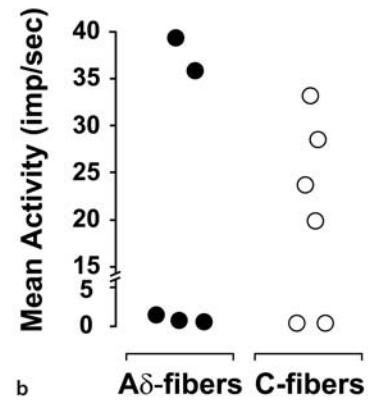
Excitatory amino acids (EAA), such as glutamate and aspartate, are important in the processing of nociceptive inputs in the dorsal horn of the spinal cord. These EAA, contained in primary afferent fibers and spinal interneurons, activate spinal N-methyl-D-aspartate (NMDA), non-NMDA and metabotropic EAA receptors to facilitate transmission of sensory inputs and contribute to the enhanced excitability of nociceptive pathways in the dorsal horn of the spinal cord in persistent pain states. These neurotransmitters are also candidates to facilitate dorsal horn neuron activity and contribute to the hyperalgesia following surgical injury.

Pharmacological studies (Zahn et al. 2002) demonstrated that intrathecally administered non-NMDA receptor antagonists blocked non-evoked pain behaviors and mechanical hyperalgesia after incision (Fig. 3b). In contrast to other tissue injuries, both the ongoing pain behavior and primary mechanical hyperalgesia that occurs after incision were found not to be dependent on activation of spinal NMDA receptors or spinal metabotropic EAA receptors (Fig. 3c). Furthermore, studying the role of different glutamate receptors for secondary hyperalgesia after incision indicates that non-NMDA receptors, but not NMDA receptors, are

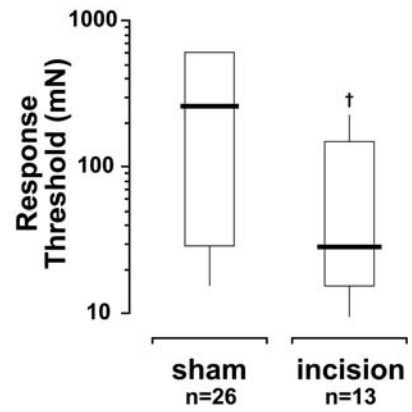
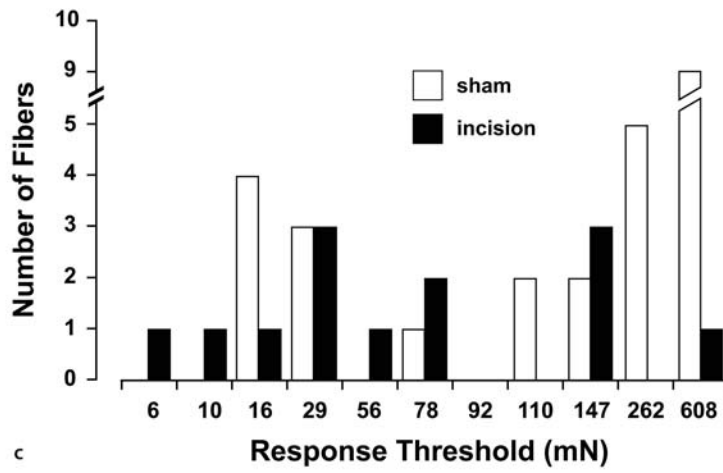
### Spontaneous activity: C-fiber



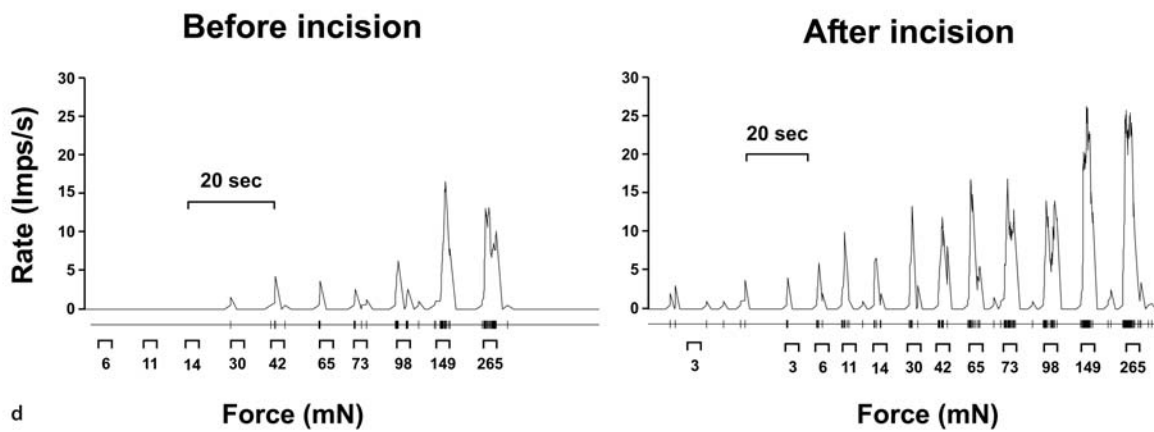
### A $\delta$ - and C-fibers



### Response threshold: A $\delta$ -fibers



### Dorsal horn neuron activity



d

◀ **Nick Model of Cutaneous Pain and Hyperalgesia, Figure 2**, (a-d) Sensitization of peripheral afferent fibers and dorsal horn neurons after incision. (a, b) Spontaneous activity of afferent fibers 1 day after plantar incision. A total of 67 fibers have been recorded. None of 39 fibers in the sham group had spontaneous activity, whereas 11 of 28 fibers (39%) in the incision group were spontaneously active. Both A-delta - and C-fibers in incised rats exhibited spontaneous activity. An example of a spontaneously active C-fiber with a high rate of activity is shown in (a); Mean firing frequency in this example was 33.2 imp/s. The mechanical receptive field (RF) of this fiber (black area) includes the incision. (b) The mean activity (imp/s averaged over 5 min) of 11 spontaneously active fibers in the incision group is shown. Two of 5 spontaneously active A-delta fibers, and 4 of 6 spontaneously active C-fibers had firing rates greater than 15 imp/s. (c) Mechanical response thresholds of 39 A-delta fibers. Median response thresholds of A-delta fibers after incision (n=13) were significantly decreased compared to A-delta fiber response thresholds after sham procedures (n=26). The results are expressed as median (horizontal line) with 1st and 3rd quartiles (boxes), and 10th and 90th percentiles (vertical lines). †P < 0.05 vs. sham. (d) Recording of dorsal horn neurons. Increased activity to mechanical stimuli of one WDR dorsal horn neurons and 1 hour after incision.

important for enhanced mechanical responses outside the area of an incision. Recently it has been demonstrated that spinally administered jorospider toxin (JSTX), an antagonist for calcium-permeable non-NMDA receptors, reduced secondary but not primary hyperalgesia after incision. This, again, differs from other types of tissue injuries. Furthermore, these data indicate that different spinal receptors are involved in maintaining primary and secondary hyperalgesia after an incision (Pogatzki et al. 2003).

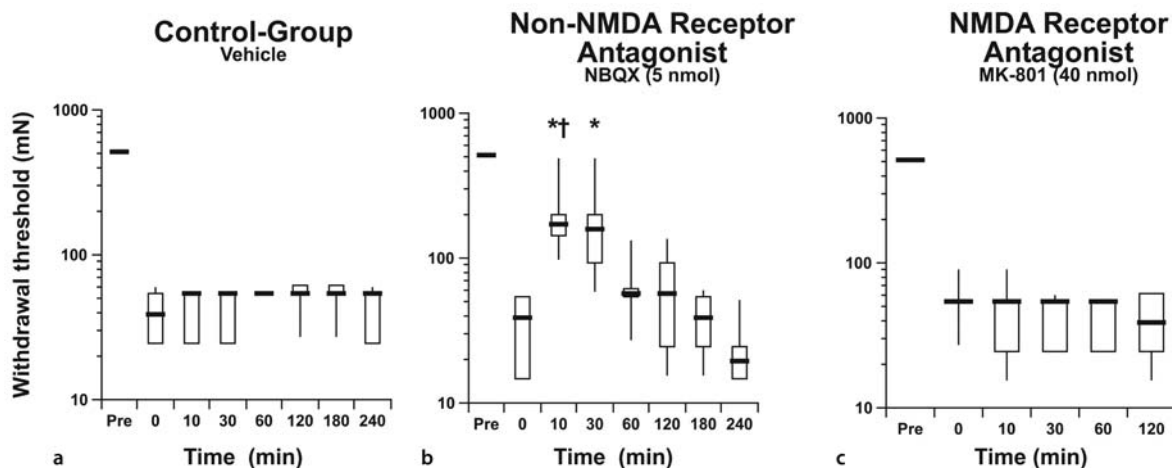
Thus, the mechanism(s) for maintaining pain behaviors following an incision are different from mechanisms described for inflammatory or neuropathic models of hyperalgesia; only the non-NMDA EAA receptors are required for the maintenance of pain behaviors after plantar incision. These data also suggest that models that rely on different receptor systems for the development and maintenance of pain behavior may not predict analgesia for patients with postoperative pain.

Other spinally administered drugs producing analgesia in this model include L-type calcium channel receptor antagonists (Wang et al. 2000), alpha-2 adrenoceptor antagonists (Onttonen and Pertovaara 2000), and prostaglandin receptor antagonists (Omote et al. 2002).

### Pre-emptive Analgesia

Because central sensitization may be important for postoperative pain, many have proposed that a blockade of noxious input to the spinal cord before the tissue injury will reduce postoperative pain more than blockade after injury (▶ pre-emptive analgesia).

The usefulness of pre-emptive analgesia has been reported in several animal models of inflammation, chemical irritation or neuropathic pain but results from clinical studies on postoperative pain have been disappointing (Moiniche et al. 2002). In the incision model spinal administration of morphine, bupivacaine, and EAA receptor antagonists did not reduce pain behaviors beyond the expected duration of the analgesic effect (Zahn et al. 2002). These data indicate that when the early effect of a pharmacological treatment diminishes, the surgical wound appears capable of generating pain behaviors equivalent to the untreated group. In fact, ongoing input from the periphery after incision, not the afferent barrage during the injury, is critical for the expression of behaviors and sensitization of DHN after incision (Pogatzki et al. 2002c). This may explain why clinical studies using treatments attempting to prevent the development of postoperative pain have yielded mostly negative results.



**Nick Model of Cutaneous Pain and Hyperalgesia, Figure 3** Effect of IT vehicle, NBQX (non-NMDA receptor antagonist) and MK-801 (NMDA receptor antagonist) on punctate mechanical hyperalgesia caused by incision. The results are expressed as median (horizontal line) with 1st and 3rd quartiles (boxes), and 10th and 90th percentiles (vertical lines). Withdrawal threshold after incision in rats treated with vehicle (a), 5 nmol of NBQX (b) and 40 nmol MK-801 (c) on the day of surgery. \*P < 0.05 vs. 0 min by Friedman and Dunnett's test. †P < 0.05 vs. saline by Kruskal-Wallis and Dunnett's test. POD1=postoperative day 1.

Duration of treatment, rather than time initiated, may be important.

### Conclusion

In conclusion, it is important to recognize that pain caused by different tissue injuries is probably a result of distinct neurochemical and electrophysiological mechanisms. Basic scientific studies on mechanisms of incisional pain have called attention to postoperative pain as an important clinical problem, distinguish postoperative pain from other experimental models by mechanism(s) and have facilitated pharmaceutical research aimed specifically towards treating incisional pain. Pain and hyperalgesia even from a simple cutaneous incision are only beginning to be understood; therefore, it is not surprising that despite the simple nature of incisional pain, postoperative pain remains a costly, poorly understood problem.

### References

- Brennan TJ, Vandermeulen EP, Gebhart GF (1996) Characterization of a rat model of incisional pain. *Pain* 64:493–501
- Hunt SP, Mantyh PW (2001) The molecular dynamics of pain control. *Nature Rev Neurosci* 2:83–91
- Kawamata M, Watanabe H, Nishikawa K et al. (2002) Different mechanisms of development and maintenance of experimental incision-induced hyperalgesia in human skin. *Anesthesiology* 97:550–559
- Martin TJ, Buechler NL, Kahn W et al. (2004) Effects of laparotomy on spontaneous exploratory activity and conditioned operant responding in the rat: a model for postoperative pain. *Anesthesiology* 101:191–203
- Moiniche S, Kehlet H, Dahl JB (2002) A qualitative and quantitative systemic review of preemptive analgesia for postoperative pain relief: the role of timing of analgesia. *Anesthesiology* 96:725–741
- Omote K, Yamamoto H, Kawamata T et al. (2002) The effects of intrathecal administration of an antagonist for prostaglandin E receptor subtype EP(1) on mechanical and thermal hyperalgesia in a rat model of postoperative pain. *Anesth Analg* 95:1708–1712
- Onttonen T, Pertovaara A (2000) The mechanical antihyperalgesic effect of intrathecally administered MPV-2426, a novel  $\alpha_2$ -adrenoceptor agonist, in a rat model of postoperative pain. *Anesthesiology* 92:1740–1745
- Pogatzki EM, Gebhart GF, Brennan TJ (2002a) Characterization of A- $\delta$  and C-fibers innervating the plantar rat hindpaw one day after an incision. *J Neurophys* 87:721–731
- Pogatzki EM, Niemeier JS, Brennan TJ (2002b) Persistent secondary hyperalgesia after gastrocnemius incision in the rat. *Eur J Pain* 6:295–305
- Pogatzki EM, Vandermeulen EP, Brennan TJ (2002c) Effect of plantar local anesthetic injection on dorsal horn neuron activity and pain behaviors caused by incision. *Pain* 97:151–161
- Pogatzki EM, Raja SN (2003) A mouse model of incisional pain. *Anesthesiology* 99:1023–1027
- Pogatzki EM, Niemeier JS, Sorkin LS et al. (2003) Spinal glutamate receptor antagonists differentiate primary and secondary mechanical hyperalgesia caused by incision. *Pain* 105:97–107
- Stubhaug A, Breivik H, Eide PK et al. (1997) Mapping of punctate hyperalgesia around a surgical incision demonstrates that ketamine is a powerful suppressor of central sensitization to pain following surgery. *Acta Anaesthesiol Scand* 41:1124–1132
- Vandermeulen EP, Brennan TJ (2000) Alterations in ascending dorsal horn neurons by a surgical incision in the rat foot. *Anesthesiology* 93:1294–302
- Wang YX, Pettus M, Gao D et al. (2000) Effects of intrathecal administration of ziconotide, a selective neuronal N-type calcium channel blocker, on mechanical allodynia and heat hyperalgesia in a rat model of postoperative pain. *Pain* 84:151–158
- Zahn PK, Brennan TJ (1999a) Incision-induced changes in receptive field properties of rat dorsal horn neurons. *Anesthesiology* 91:772–785
- Zahn PK, Brennan TJ (1999b) Primary and secondary hyperalgesia in a rat model of postoperative pain. *Anesthesiology* 90:863–872
- Zahn PK, Pogatzki EM, Brennan TJ (2002) Mechanisms for pain caused by incisions. *Reg Anesth Pain Med* 27:514–516

## Nicotinic receptors

### ► nAChr

## NIRS

### ► Near-Infrared Spectroscopy

## Nitric Oxide (NO)

### Definition

Nitric oxide is a colorless, radical-free gas that reacts rapidly with O<sub>2</sub> to form other nitrogen oxides (e.g. NO<sub>2</sub>, N<sub>2</sub>O<sub>2</sub>, and N<sub>2</sub>O<sub>4</sub>) and ultimately is converted to nitrite (NO<sub>2</sub><sup>-</sup>) and nitrate (NO<sub>3</sub><sup>-</sup>). Nitric oxide itself is formed from L-arginine in bone, brain, endothelium, granulocytes, pancreatic beta cells, and peripheral nerves by a constitutive nitric oxide synthase, and in hepatocytes, Kupffer cells, macrophages, and smooth muscle by an inducible nitric oxide synthase (e.g. induced by endotoxin). NO- activates soluble guanylate cyclase. Nitric oxide is a gaseous mediator of cell-to-cell communication and acts as a second messenger in some neurons. It can diffuse from one neuron to another, and so participates not only in intracellular signaling but also in intercellular signaling. It may be the first known retrograde neurotransmitter. Nitric oxide is also a potent vasodilator, mediates penile erection, and it can participate as a reactive oxygen species in free radical actions.

- Headache Attributed to a Substance or its Withdrawal
- Opiates During Development
- Satellite Cells and Inflammatory Pain
- Spinothalamic Tract Neurons, Role of Nitric Oxide

## Nitric Oxide Synthase

### Synonyms

NOS



## Definition

Nitric oxide synthase is an enzyme that synthesizes nitric oxide. The reaction involves arginine, which is transformed into citrulline accompanied by the release of nitric oxide.

► [Spinothalamic Tract Neurons, Role of Nitric Oxide](#)

## Nitrous Oxide Antinociception and Opioid Receptors

LINDA K. VAUGHN<sup>1</sup>, RAYMOND M. QUOCK<sup>2</sup>

<sup>1</sup>Department of Biomedical Sciences, Marquette University, Milwaukee, WI, USA

<sup>2</sup>Department of Pharmaceutical Sciences, Washington State University, Pullman, WA, USA

[linda.vaughn@marquette.edu](mailto:linda.vaughn@marquette.edu), [quockr@wsu.edu](mailto:quockr@wsu.edu)

## Synonyms

N<sub>2</sub>O; Laughing Gas

## Definition

An inorganic chemical gas with clinical anesthetic, analgesic and anxiolytic properties, as well as potential for inhalant abuse and chemical dependency.

## Characteristics

Inhalation of N<sub>2</sub>O results in activation of a number of neuronal systems and neurotransmitter receptors in the central nervous system. The actual molecular action of N<sub>2</sub>O is not known, but many of these receptors appear to lie distal to the main sites of action of N<sub>2</sub>O. One mechanism that has been extensively studied is that of the antinociceptive action of N<sub>2</sub>O in animals. There is a substantial body of evidence that suggests that N<sub>2</sub>O produces analgesia in humans through opioid mechanisms.

The analgesic properties of N<sub>2</sub>O have been known for over two hundred years (Frost 1985). The English scientist Humphry Davy conducted N<sub>2</sub>O experiments on himself, and suggested that N<sub>2</sub>O might “probably be used with advantage during surgical operations in which no great effusion of blood takes place.” However, it was some four decades later when the American dentist Horace Wells advocated N<sub>2</sub>O for analgesia in dental procedures, and was the first to clinically demonstrate its use by having one of his own teeth extracted without pain. The first significant insight into the mechanism of action of N<sub>2</sub>O analgesia was provided by Berkowitz and his research group. N<sub>2</sub>O ► [antinociception](#) in the mouse abdominal constriction test was partly antagonized by the ► [opioid antagonist](#) naloxone, thus implicating an opioid mechanism (Berkowitz et al. 1976). They also uncovered a unilateral cross-tolerance, in which mice and rats that were tolerant to morphine were cross-tolerant to N<sub>2</sub>O, but animals tolerant to N<sub>2</sub>O were not tolerant

to morphine, leading to the hypothesis that N<sub>2</sub>O caused the release of ► [endogenous opioid peptides](#) with subsequent activation of opioid receptors. Tolerance to N<sub>2</sub>O resulted from exhaustion of the reservoir of opioid peptide, leaving the response to exogenously applied morphine intact (Berkowitz et al. 1979). Berkowitz’ findings were soon reproduced in human subjects and also in various ► [Antinociceptive Models](#) using experimental animals.

Early studies of N<sub>2</sub>O–induced antinociception utilized the non-selective opioid antagonist naloxone. The introduction of newer, subtype-selective opioid antagonists has made it possible to identify the ► [endogenous opioid receptors](#) that mediate N<sub>2</sub>O antinociception. The most systematic investigation of opioid receptors and N<sub>2</sub>O antinociception has been conducted employing the mouse abdominal constriction test (Quock and Vaughn 1995). N<sub>2</sub>O antinociception was attenuated by (–)–naloxone but not (+)–naloxone, demonstrating that the antagonism is stereo-specific and attributable to blockade of opioid receptors. N<sub>2</sub>O antinociception was also antagonized by naltrexone, a longer acting analog of naloxone, but not by systemically administered methyl naltrexone, the quaternary ammonium derivative of naltrexone that cannot cross the blood-brain barrier. Continuing studies in the abdominal constriction test have implicated ► [κ opioid receptors](#) in N<sub>2</sub>O antinociception (Quock and Vaughn 1995). MR–2266, which blocks both κ and ► [μ opioid receptors](#), reduced the antinociceptive response to N<sub>2</sub>O. Norbinaltorphimine, which is highly selective for κ opioid receptors, also antagonized N<sub>2</sub>O antinociception following either ► [intracerebral](#) (i.c.) or ► [intrathecal](#) (i.t.) pretreatment, thus implicating both supraspinal and spinal cord κ opioid receptors. However, β–funaltrexamine, a selective μ opioid antagonist, was without effect on N<sub>2</sub>O antinociception after either i.c. or i.t. pretreatment. CXBK/ByJ mice, which are deficient in μ opioid receptors, were eight times less responsive to morphine antinociception than control mice, but when exposed to N<sub>2</sub>O exhibited a strong antinociceptive response (Quock et al. 1993). These findings collectively supported the view that κ but not μ opioid receptors are involved in N<sub>2</sub>O antinociception in the mouse abdominal constriction test.

Results of *in vivo* receptor protection experiments also supported the involvement of κ over μ opioid receptors in N<sub>2</sub>O antinociception (Quock and Mueller 1991). ► [Intracerebroventricular](#) (i.c.v.) administration of β–chlornaltrexamine (β–CNA), a non-selective, non-equilibrium opioid receptor blocker, alkylates — μ, δ and κ opioid receptors and abolishes the antinociceptive response of mice to N<sub>2</sub>O. When the κ opioid ligand U–50,488H was co-administered with β–CNA, the κ opioid receptors were spared from alkylation, and N<sub>2</sub>O evoked its expected antinociceptive response. When the μ opioid ligand CTOP was co-administered

with  $\beta$ -CNA, the  $\mu$  opioid receptors were protected from alkylation, yet the mice failed to exhibit an antinociceptive response to  $N_2O$ .

Results implicating other opioid receptor subtypes were apparent in other antinociceptive models. It required fairly high concentrations of  $N_2O$  to cause antinociception in rats in the 55°C hot plate test. The prolongation in response time was significantly reduced by i.c.v.-administered naltrexone, CTOP (a  $\mu$  opioid antagonist) and  $\beta$ -endorphin<sub>1-27</sub> (a putative  $\epsilon$  opioid partial agonist/antagonist), but not by the  $\delta$  opioid antagonist naltrindole or the  $\kappa$  opioid antagonist norbinaltorphimine (Quock et al. 1993). Yet in another thermal nociceptive test — the warm water tail withdrawal test, the prolongation in latency time was blocked by the  $\mu$  and  $\kappa$  opioid antagonist MR-2266, and the  $\delta$  opioid antagonist ICI-174,864, but not by  $\beta$ -funtrexamine (Quock et al. 1993). These studies indicate the specific opioid receptors involved in  $N_2O$  antinociception may be dependent on the antinociceptive model that is used, and/or the animal species being studied.

No such studies have been carried out to identify the type of opioid receptor that mediates cerebrospinal fluid analgesia in humans. However, the ability of  $N_2O$  to ameliorate abstinence symptoms from the mixed ( $\kappa$ ) agonist/( $\mu$ ) antagonist drug pentazocine (Kripke and Hechtman 1972), strongly suggests that  $\kappa$  opioid mechanisms may play a major role in the pharmacology of  $N_2O$  in humans.

Exposure to  $N_2O$ , increased levels of immunoreactive methionine-enkephalin (ME) in an artificial cerebrospinal fluid (CSF) perfusate collected from anesthetized, ventricular-cisternally-perfused rats (Quock et al. 1985). This was the first chemical evidence in support of Berkowitz' hypothesis that  $N_2O$  might induce release of opioid peptides. Selective increases in levels of ME and ME-Arg<sup>6</sup>-Phe<sup>7</sup>, but not other opioid peptides, were found in CSF collected from the third cerebral ventricle of dogs exposed to  $N_2O$  (Finck et al. 1990). However, increasing concentrations of  $N_2O$  increased the release of ► **Beta( $\beta$ )-Endorphin** from superfused rat basal hypothalamic cells *in vitro* (Zuniga et al. 1987). The release of ► **dynorphins** by  $N_2O$  has not been shown directly; however, antisera against various fragments of rat dynorphins, but not other opioid peptides, significantly reduced the antinociceptive response of mice to  $N_2O$  (Branda et al. 2000; Cahill et al. 2000). Further, pretreatment with phosphoramidon, an inhibitor of endopeptidase 24.11, which is involved in the degradation of dynorphin, significantly enhanced  $N_2O$  antinociception (Branda et al. 2000). These findings suggest that opioid receptors are largely activated by  $N_2O$  indirectly, i.e. via stimulated neuronal release of multiple endogenous opioid peptides.

There is mounting evidence that the activation of central opioid receptors in the ► **periaqueductal gray** by  $N_2O$ , results in the activation of a ► **descending no-**

**adrenergic pathway** that modulates pain pathways in the spinal cord (Fujinaga and Maze 2002). Blockade of  $\alpha_2$  adrenergic receptors by yohimbine reversed  $N_2O$  antinociception in the rat tail-flick test (Orii et al. 2002).  $N_2O$  induced a naltrexone-sensitive increase in the norepinephrine concentration in the rat spinal cord (Fujinaga and Maze 2002). Depletion of norepinephrine in the spinal cord reduced the responsiveness of rats to  $N_2O$  antinociception. These descending noradrenergic pathways also appear to be modulated directly by GABAergic neurons at supraspinal and spinal levels (Hashimoto et al. 2001; Orii et al. 2003).

In conclusion, there is evidence that  $N_2O$  can stimulate the neuronal release of endogenous opioid peptides. Dynorphin and  $\kappa$  opioid receptors are involved in the antinociceptive effect of  $N_2O$  in the mouse abdominal constriction test. Other opioid receptors may be involved in other species and other antinociceptive models. Further,  $N_2O$  activation of central opioid receptors may produce some of their effect by activating descending noradrenergic pathways that modulate spinal cord processing of pain.

## References

1. Berkowitz BA, Finck AD, Hynes MD III, Ngai SH (1979) Tolerance to nitrous oxide analgesia in rats and mice. *Anesthesiol* 51:309–312
2. Berkowitz BA, Ngai SH, Finck AD (1976) Nitrous oxide 'analgesia': resemblance to opiate action. *Science* 194:967–968
3. Branda EM, Ramza JT, Cahill FJ, Tseng LF, Quock RM (2000) Role of brain dynorphin in nitrous oxide antinociception in mice. *Pharmacol Biochem Behav* 65:217–222
4. Cahill FJ, Ellenberger EA, Mueller JL, Tseng LF, Quock RM (2000) Antagonism of nitrous oxide antinociception in mice by intrathecally administered opioid peptide antisera. *J Biomed Sci* 7:299–303
5. Finck AD, Samaniego E, Ngai SH (1990) Nitrous oxide selectively releases Met<sup>5</sup>-enkephalin and Met<sup>5</sup>-enkephalin-Arg<sup>6</sup>-Phe<sup>7</sup> into canine third ventricular cerebrospinal fluid. *Anesth Analg* 80:664–670
6. Frost EAM (1985) A history of nitrous oxide. In: Eger EI (ed) *Nitrous Oxide/ N<sub>2</sub>O*, 2<sup>nd</sup> edn. Elsevier, New York, pp 1–22
7. Fujinaga M, Maze M (2002) Neurobiology of nitrous oxide-induced antinociceptive effects. *Mol Neurobiol* 25:167–189
8. Hashimoto T, Maze M, Ohashi Y, Fujinaga M (2001) Nitrous oxide activates GABAergic neurons in the spinal cord in Fischer rats. *Anesthesiology* 95:463–469
9. Kripke BJ, Hechtman HB (1972) Nitrous oxide for pentazocine addiction and for intractable pain: report of case. *Anesth Analg* 51:520–527
10. Orii R, Ohashi Y, Guo T, Nelson LE, Hashimoto T, Maze M, Fujinaga M (2002) Evidence for the involvement of spinal cord alpha<sub>1</sub> adrenoceptors in nitrous oxide-induced antinociceptive effects in Fischer rats. *Anesthesiology* 97:1458–1465
11. Orii R, Ohashi Y, Halder S, Giombini M, Maze M, Fujinaga M (2003) GABAergic interneurons at supraspinal and spinal levels differentially modulate the antinociceptive effect of nitrous oxide in Fischer rats. *Anesthesiology* 98:1223–1230
12. Quock RM, Kouchich FJ, Tseng LF (1985) Does nitrous oxide induce release of brain opioid peptides? *Pharmacology* 30:95–99
13. Quock RM, Mueller JL (1991) Protection by U-50,488H against beta-chlornaltrexamine antagonism of nitrous oxide antinociception in mice. *Brain Res* 549:162–4

14. Quock RM, Mueller JL, Vaughn LK (1993) Strain-dependent differences in responsiveness of mice to nitrous oxide antinociception. *Brain Res* 614:52–56
15. Quock RM, Vaughn LK (1995) Nitrous oxide: Mechanism of its antinociceptive action. *Analgesia* 1:151–159
16. Zuniga JR, Joseph SA, Knigge KM (1987) The effects of nitrous oxide on the secretory activity of pro-opiomelanocortin peptides from basal hypothalamic cells attached to cytodex beads in a superfusion *in vitro* system. *Brain Res* 420:66–72

## NK–1 Blockers

### Definition

Neurokinin–1 (NK–1) receptor inhibitors lessen emesis after cisplatin, ipecac, copper sulfate, apomorphine, and radiation therapy; e.g. aprepitant.

- ▶ [Cancer Pain Management, Chemotherapy](#)

## NK-1 Receptor

### Definition

One of the three types of G-protein coupled receptors where tachykinins act. Substance P is the preferred ligand, although neurokinin A (NKA) can also activate the NK1 receptor.

- ▶ [Wind-Up of Spinal Cord Neurons](#)

## NMDA

### Definition

N-methyl-D-aspartate (NMDA), a chemical analogue of glutamate that gives its name to the receptor. This receptor is formed of at least 4 subtypes, one of which is the NR2B.

- ▶ [GABA and Glycine in Spinal Nociceptive Processing](#)
- ▶ [N-methyl-D-aspartate](#)
- ▶ [Opioids in the Spinal Cord and Central Sensitization](#)

## NMDA Glutamate Receptor(s)

### Synonyms

N-methyl-D-aspartate receptor; NMDA Receptor

### Definition

One of 4 general classes of glutamate receptors. Activated by N-methyl-D-aspartate with high affinity. It is involved in inducing long-term changes in the function of the neurons due to an influx of  $Ca^{++}$  through it. This receptor requires a release of glutamate (ligand-gated) and a change in the membrane voltage (voltage-gated) concomitantly to be activated. The NMDA receptor is found in high concentrations in the anterior horn of the spinal cord, where it is associated with the process of central sensitization, one of the precursors of neuropathic pain. Agonists include glutamate and aspartate, and antagonists include ketamine and dextromethorphan, and to a much lesser extent methadone. The receptors may be the site of action of dissociative anesthetics such as ketamine. The NMDA ion channel has a relatively high  $Ca^{2+}$  permeability, and this may be important in the initiation of plastic changes necessary for several types of learning and memory.

- ▶ [Acute Pain Mechanisms](#)
- ▶ [Amygdala, Pain Processing and Behavior in Animals](#)
- ▶ [Descending Modulation and Persistent Pain](#)
- ▶ [GABA and Glycine in Spinal Nociceptive Processing](#)
- ▶ [Metabotropic Glutamate Receptors in the Thalamus](#)
- ▶ [Nociceptive Neurotransmission in the Thalamus](#)
- ▶ [NSAIDs, Adverse Effects](#)
- ▶ [Opiates During Development](#)
- ▶ [Opioids in the Spinal Cord and Central Sensitization](#)
- ▶ [Pain Control in Children with Burns](#)
- ▶ [Pain Modulatory Systems, History of Discovery](#)
- ▶ [Postoperative Pain, Transition from Parenteral to Oral](#)
- ▶ [Somatic Pain](#)
- ▶ [Wind-Up of Spinal Cord Neurons](#)

## NMDA Receptors in Spinal Nociceptive Processing

HORACIO VANEGAS<sup>1</sup>, HANS-GEORG SCHAIBLE<sup>2</sup>

<sup>1</sup>Instituto Venezolano de Investigaciones Cientificas (IVIC), Caracas, Venezuela

<sup>2</sup>Department of Physiology, Friedrich Schiller University, Jena, Germany

hvanegas@ivic.ve,

hans-georg.schaible@mti.uni-jena.de

### Synonyms

Glutamate receptors; spinal dorsal horn; calcium channel; ionotropic receptor

### Definition

The NMDA receptor is a tetrameric molecule provided with a channel that upon glutamate binding allows the outflow of potassium ions as well as the inflow of sodium and, characteristically, calcium ions across the neuronal

membrane. The NMDA receptor is responsible for excitatory synaptic transmission in nociceptive pathways and circuits.

### Characteristics

Glutamate is the main excitatory transmitter in the central nervous system. When released by presynaptic terminals, glutamate reaches the postsynaptic membrane, where various types of receptor molecules may be found. Glutamate receptor molecules can be divided in two broad types, the ionotropic type, which possesses an ion channel that opens upon glutamate binding, and the metabotropic type, which has no channel but is coupled to G-proteins that transduce glutamate binding into modifications of intracellular messengers and enzymes.

### Molecular Biology and Biophysics of NMDA Receptors

The ionotropic glutamate receptors (Kandel and Siegelbaum 2000) are named after their main pharmacological ligands, that is AMPA ( $\alpha$ -amino-3-hydroxy-5-methylisoxazole-4-propionic acid), kainate and NMDA (*N*-methyl-D-aspartate). In all three types, the ion channel permits the flow of sodium and potassium ions. Although a minority of AMPA receptors also permit the flow of calcium ions, a large calcium inflow is characteristic of all NMDA receptors and constitutes the key to their physiological role. NMDA receptors are also characterized by the fact that, at resting membrane potential (*ca.* -65 mV), the entrance to the ion channel is blocked by a magnesium ion. At resting membrane potential, glutamate binding does not lead to any ion current through the NMDA receptor; first the magnesium ion must be dislodged from this channel. The ionotropic glutamate receptors then function in the following manner.

The glutamate released from presynaptic terminals first activates AMPA and kainate receptors (usually called non-NMDA receptors), which leads to a fast flow of sodium and potassium ions and thus to depolarization of the postsynaptic neuron. If (and only if) this depolarization is large enough, the magnesium ion will no longer be attracted into the NMDA channel entrance and the channel will finally become free for sodium and potassium to flow through; this causes a prolonged depolarization. Most importantly, the unblocked NMDA channel now lets large amounts of calcium ions flow into the neuron.

Ionotropic glutamate receptor molecules are made of two pairs of subunits, each subunit in turn with four intramembranous segments. Subunits in NMDA receptors are called NR1, NR2 and NR3. The predominant NR2 subunit is the NR2B. These subunits can be sensitized through phosphorylation by protein kinases (see below). NR1 binds glycine and NR2 binds glutamate (Furukawa et al. 2005). Glycine is essential for the NMDA receptor to function. Normally there is enough

glycine in the extracellular fluid and the function of the NMDA receptor then depends only on the glutamate released presynaptically and on the membrane potential of the postsynaptic neuron (Kandel and Siegelbaum 2000).

### Involvement of NMDA Receptors in Normal Nociception

Some authors have found that NMDA receptor antagonists, whether given systemically or intrathecally onto the spinal cord, do not modify behavioral baseline responses to acutely painful stimuli (Yaksh 1999). Also, conditional deletion of the NR1 subunit in the spinal cord had no influence upon behavioral responses to tactile stimulation or to acute, high intensity non-damaging thermal stimuli applied to the skin (South et al. 2003). However, recordings from spinal cord nociceptive neurons have shown (Dougherty et al. 1992; Neugebauer et al. 1993a; Neugebauer et al. 1993b) that NMDA receptors participate in responses to various types of cutaneous and deep somatic noxious stimuli. It therefore seems that NMDA receptors will contribute to normal nociception whenever the postsynaptic neurons become sufficiently depolarized for the magnesium ion to be dislodged from the receptor. This will of course be more intense in cases of persistent nociception.

### Involvement of NMDA Receptors in Persistent Nociception

In cases of persistent damage to a peripheral tissue, such as during inflammation, trauma or nerve lesions, the continuous and often large barrage of action potentials coming into the spinal cord causes a considerable release of glutamate and this in turn, *via* non-NMDA receptors, causes a sufficiently large neuronal depolarization for the magnesium ion to be evicted from the NMDA channel. Calcium then flows into the postsynaptic neurons and a whole series of events is triggered, which results in a considerable and long lasting increase in spinal neuronal excitability (central sensitization). The hyperalgesia (increased pain upon noxious stimulation) and allodynia (pain elicited by normally non-painful stimuli) of chronic pain conditions are thus thought to arise not only from an increased nociceptive input into the spinal cord, but also from an increased synaptic relay of nociceptive messages towards supraspinal structures.

It must be made clear that activation of NMDA receptors is not the only mechanism whereby central sensitization comes about. Concomitant mechanisms are, for example: (1) activation of receptors for pronociceptive neuropeptides such as ► [substance P](#) (NK1), neurokinin A (NK2), ► [calcitonin gene related peptide](#) (CGRP receptor), cholecystokinin (mainly CCK<sub>B</sub>) and vasoactive intestinal peptide (VIP receptor); and (2) induction of cyclooxygenase-2 (Vanegas and Schaible 2001), with the resulting enhancement of the pronociceptive effects of prostaglandins and thromboxanes (► [Prostaglandins, Spinal Effects](#)). It must also be made clear that, in addition to the NMDA receptor, there are voltage activated



calcium channels (Vanegas and Schaible 2000) through which considerable amounts of calcium can flow into the depolarized neuron (► [Calcium Channels in the Spinal Processing of Nociceptive Input](#)). Compounds that antagonize NMDA receptors or the other mechanisms just mentioned have been shown to attenuate pain messages and are, of course, potential analgesic agents.

### Electrically Induced Spinal Neuronal Hyperexcitability

Two types of electrophysiological manipulation have shown that the NMDA receptor plays a key role in spinal neuronal hyperexcitability. Both of these involve stimulating the primary afferents with electrical pulses whose intensities are generally large enough to fire all fiber types, from A $\beta$  to C. Each stimulus pulse elicits in spinal cord neurons a depolarizing synaptic potential that lasts up to 20 s and is due to the activation of non-NMDA, NMDA and substance P receptors (Woolf 1996). If the pulse is applied about once per second, these potentials summate one on top of the other, thus giving rise to increasingly larger neuronal discharges. This is known as windup and shows that the excitability of neurons may increase as result of previous activity (thus a form of “learning”), that this involves NMDA receptors and that low frequency but persistent discharges in pain afferent fibers may cause increasing pain. Windup is not a product of neuronal plasticity; it happens by virtue of mechanisms that are normally present in the spinal cord. The enhanced excitability quickly returns to baseline if the electrical stimulation is terminated.

On the other hand, an increase in synaptic strength that may last for hours can be obtained if the stimulus pulse is applied about 100 times per second during a few seconds. This is known as long-term potentiation (LTP), and is the most widely and deeply studied form of activity dependent synaptic enhancement (the basis of learning) (Sandkühler 2000). The presence of LTP is shown after the inducing pulse train by applying a single test pulse to the presynaptic axons every few minutes - each test pulse elicits an enhanced excitatory postsynaptic response in the recorded neuron. Antagonists to NMDA, NK1 or glutamate metabotropic receptors prevent induction of LTP.

### Induction of Hyperexcitability by Persistent Tissue Damage

In the spinal cord, LTP of responses to electrical pulses can be elicited by strong “natural” noxious stimuli (burning or crushing of paws, crushing of nerves) in anesthetized rats (Sandkühler 2000), provided that the nociceptive inhibition that normally descends from the brain stem is blocked (► [Long-Term Potentiation and Long-Term Depression in the Spinal Cord](#)). Another way of investigating the role of NMDA receptors in central sensitization and hyperalgesia is to use natural noxious stimuli instead of electrical pulses to test the responses of dor-

sal horn nociceptive neurons in anesthetized animals or the behavioral nociceptive responses in conscious animals. As mentioned above, inflammation or trauma of peripheral tissues or lesions to peripheral nerves induce an enhancement of spinal nociceptive responses in animals that is akin to the hyperalgesia and allodynia of clinical chronic pain conditions.

### Plasticity of the NMDA Receptor

During persistent damage or LTP, the key to an increase in neuronal excitability is an increase in intracellular calcium concentration. This is brought about not only by the inflow of calcium through the NMDA receptor channel, but also by inflow through voltage dependent calcium channels or calcium permeable AMPA receptors and by activation of G-protein coupled receptors (to glutamate, prostaglandins, substance P), which results in calcium inflow and/or release from intracellular stores towards the cytosol (Ikeda et al. 2003; Woolf and Salter 2000). The paramount role of NMDA receptor activation, however, has been demonstrated in numerous studies where application of pharmacological antagonists or deletion of the NR1 subunit of the NMDA receptor in the spinal cord completely prevent induction of LTP or central sensitization (Sandkühler 2000; South et al. 2003; Woolf and Salter 2000). Nevertheless, blockade of other receptors, like the NK1 receptor, may also prevent LTP (Ikeda et al. 2003; Woolf 1996).

The increased intracellular calcium leads to activation of calcium-calmodulin dependent protein kinase II (CaMKII), protein kinase A (PKA) and protein kinase C (PKC), as well as nitric oxide synthase and the cyclooxygenases (Sandkühler 2000; Woolf 1996; Woolf and Salter 2000). This in turn leads to several events, including sensitization of both NMDA and non-NMDA receptors.

In spinal cord neurons, one important point of convergence for various intracellular pathways is PKC. CaMKII, another serine/threonine kinase that plays a key role in hippocampal and neocortical plasticity is less important in the spinal dorsal horn (Woolf and Salter 2000). Protein kinases phosphorylate the NMDA receptor and thereby sensitize it and partially dislodge the magnesium ion from the channel (Woolf 1996); as a result, binding of glutamate to the NMDA receptor will more easily cause calcium inflow. Tyrosine kinases such as Src also potentiate NMDA currents (Woolf and Salter 2000). Indeed, Src and PKC are involved in phosphorylation of the NR2B subunit induced by brain derived neurotrophic factor (BDNF) (Guo et al. 2004a), which binds to the tyrosine kinase B (trkB) receptor. Since peripheral inflammation induces expression of BDNF in primary afferents, this would contribute to central sensitization. It must be noted that increases in intracellular calcium as well as other forms of protein kinase activation do not necessarily result from an activation of the NMDA receptor and yet they feed back

and sensitize it. Indeed, activation of NK1, glutamate metabotropic and tyrosine kinase receptors may lead to nociceptive neuronal sensitization (Ikeda et al. 2003) and this has been shown to be associated with phosphorylation of the NMDA receptor (Guo et al. 2004a; Guo et al. 2004b).

Activation of spinal neuronal NMDA, glutamate metabotropic, NK1 and trkB receptors as a result of peripheral noxious stimulation and inflammation eventually leads to activation of ERK (extracellular signal regulated protein kinase, a mitogen activated protein or MAP kinase). ERK activation, by way of the cAMP responsive element binding (CREB) protein in the cell nucleus, results in gene expression mediated by the cAMP responsive element (CRE). This may in turn lead to medium- and long-term persistence of central sensitization to painful stimulation (Kawasaki et al. 2004) and to transition to chronicity in clinical pain.

## References

- Dougherty PM, Palecek J, Sorkin LS et al. (1992) The role of NMDA and no-NMDA excitatory amino acid receptors in the excitation of primate spinothalamic tract neurons by mechanical, chemical, thermal, and electrical stimuli. *J Neurosci* 12:3025-3041
- Furukawa H, Singh SK, Mancusso R et al. (2005) Subunit arrangement and function in NMDA receptors. *Nature* 438:185-192
- Guo W, Wei F, Zou S-P et al. (2004a) Effect of brain-derived neurotrophic factor on N-methyl-D-aspartate receptor subunit NR2B tyrosine phosphorylation in the rat spinal dorsal horn. *Abstr View/Itin Plann, Society of Neuroscience, Progr No* 864.811
- Guo W, Wei F, Zou S-P et al. (2004b) Group I metabotropic glutamate receptor NMDA receptor coupling and signaling cascade mediate spinal dorsal horn NMDA receptor 2B tyrosine phosphorylation associated with inflammatory hyperalgesia. *J Neurosci* 24:9161-9173
- Ikeda H, Heinke B, Ruscheweyh R et al. (2003) Synaptic plasticity in spinal lamina I projection neurons that mediate hyperalgesia. *Science* 299:1237-1240
- Kandel ER, Siegelbaum SA (2000) Synaptic integration. In: Kandel ER, Schwartz JH, Jessell TM (eds) *Principles of Neural Science*. McGraw-Hill, New York, pp 207-228
- Kawasaki Y, Kohno T, Zhuang Z-Y et al. (2004) Ionotropic and metabotropic receptors, protein kinase A, protein kinase C, and Src contribute to C-fiber-induced ERK activation and cAMP response element-binding protein phosphorylation in dorsal horn neurons, leading to central sensitization. *J Neurosci* 24:8310-8321
- Neugebauer V, Lücke T, Schaible H-G (1993a) Differential effects of N-methyl-D-aspartate (NMDA) and non-NMDA receptor antagonists on the responses of rat spinal neurons with joint input. *Neurosci Lett* 155:29-32
- Neugebauer V, Lücke T, Schaible H-G (1993b) N-methyl-D-aspartate (NMDA) and non-NMDA receptor antagonists block the hyperexcitability of dorsal horn neurons during development of acute arthritis in rat's knee joint. *J Neurophysiol* 70:1365-1377
- Sandkühler J (2000) Learning and memory in pain pathways. *Pain* 88:113-118
- South SM, Kohno T, Kaspar BK et al. (2003) A conditional deletion of the NR1 subunit of the NMDA receptor in adult spinal cord dorsal horn reduces NMDA currents and injury-induced pain. *J Neurosci* 23:5040-5031
- Vanegas H, Schaible H-G (2000) Effects of antagonists to high-threshold calcium channels upon spinal mechanisms of pain, hyperalgesia and allodynia. *Pain* 85:9-18
- Vanegas H, Schaible H-G (2001) Prostaglandins and cyclooxygenases in the spinal cord. *Prog Neurobiol* 64:327-363
- Woolf CJ (1996) Windup and central sensitization are not equivalent. *Pain* 66:105-108
- Woolf CJ, Salter MW (2000) Neuronal plasticity: increasing the gain in pain. *Science* 288:1765-1768
- Yaksh TL (1999) Spinal systems and pain processing: development of novel analgesic drugs with mechanistically defined models. *Trends Neurosci* 20:329-337

## N-methyl-D-aspartate

### Synonym

NMDA

### Definition

N-methyl-D-aspartate (NMDA), a chemical analogue of glutamate that gives its name to the receptor. Agonist for the NMDA receptor for glutamate, which is the major excitatory neurotransmitter in the CNS.

- ▶ [GABA and Glycine in Spinal Nociceptive Processing](#)
- ▶ [Opioids in the Spinal Cord and Central Sensitization](#)
- ▶ [Spinal Cord Nociception, Neurotrophins](#)

## N-methyl-D-aspartate (NMDA) Antagonist

### Definition

There is accumulating evidence to implicate the importance of N-methyl-D-aspartate (NMDA) receptors to the induction and maintenance of central sensitization during pain states. However, NMDA receptors may also mediate peripheral sensitization and visceral pain. NMDA receptors are composed of NR1, NR2 (A, B, C, and D), and NR3 (A and B) subunits, which determine the functional properties of native NMDA receptors. Antagonists acting at the N-methyl-D-aspartate (NMDA) receptor can block the development of tolerance to the analgesic effects of  $[\mu]$  opioid receptor (MOR) ligands, such as morphine, and can also enhance the analgesic efficacy of opioids. The last decade has seen significant progress in our understanding of the NMDA receptor complex and the site(s) of action of various uncompetitive antagonists. This has led to the development of a family of low-affinity, uncompetitive, cation channel antagonists that seem to offer many of the benefits of the older channel blockers but with a more acceptable adverse effect profile. Drugs such as memantine have shown beneficial effects in clinical trials for Alzheimer's disease and ischemia, with few adverse effects. Likewise, the NMDA receptor NR2B subunit antagonists derived from drugs such as ifenprodil, have proven beneficial in the treatment of neuropathic pain, and are also associated with few adverse effects.

- ▶ [Multimodal Analgesia in Postoperative Pain](#)

## N-methyl-D-aspartate (NMDA) Receptor

### Definition

Activation of the NMDA receptor sets in motion a series of events that increase the responsiveness of the nociceptive system (central sensitization). NMDA receptors are composed of NR1, NR2 (A, B, C, and D), and NR3 (A and B) subunits, which determine the functional properties of native NMDA receptors. Central sensitization lowers the activation thresholds of spinal neurones and is characterized by wind-up, whereby repeated C-fiber volleys result in a progressive increase in discharge of secondary dorsal horn nociceptive neurones. This contributes to the hyperalgesia. The N-methyl-D-aspartate (NMDA) receptor, at physiological  $Mg^{++}$  levels is initially unresponsive to glutamate, but following depolarization at the amino methyl propionic acid (AMPA) receptor by glutamate or the Neurokinin-1 receptor by Substance P, and the trkB receptor by brain-derived neurotropic factor (BDNF), it becomes responsive to glutamate, allowing  $Ca^{++}$  influx. The action of glutamate on the metabotropic receptor (modulated by glycine) stimulates G-protein-mediated activation of phospholipase C (PLC), which catalyses the hydrolysis of phosphatidylinositol 4,5-bisphosphate (PIP2) to produce inositol triphosphate (IP3) and diacylglycerol (DAG). DAG stimulates production of protein kinase C (PKC), which is activated in the presence of high levels of intracellular  $Ca^{++}$ . IP3 stimulates the release of  $Ca^{++}$  from intracellular stores within the endoplasmic reticulum. Increased PKC induces a sustained increase in membrane permeability, with  $Ca^{++}$  leading to the expression of proto-oncogenes (c-fos, c-jun). The proteins produced encode a number of peptides (enkephalins, dynorphins, tachykinins). Increased intracellular  $Ca^{++}$  leads to the activation of calcium/calmodulin-dependent protein kinase (which briefly increases membrane permeability), to the activation of phospholipase A-2 (PLA-2), as well as to the activation of nitric oxide synthetase (NOS) (via a calcium/calmodulin mechanism). The conversion of phosphatidyl choline to prostaglandins and thromboxane is catalyzed by PLA2. The lipooxygenase pathway also produces leukotrienes. NOS catalyses the production of nitric oxide (NO) and L-citrulline from L-arginine. NO activates soluble guanylate cyclase, increasing the intracellular content of cyclic GMP, leading to the production of protein kinases and alterations in gene expression. NO diffuses out of the cell to the primary afferent terminal, where, via a guanylate cyclase/cyclic-GMP mechanism, it increases glutamate release. NO is responsible for the cell death demonstrated after prolonged activation of nociceptor afferents. Among NMDA receptor subtypes, the NR2B subunit-containing receptors appear particularly

important for nociception, leading to the possibility that NR2B-selective antagonists may be useful in the treatment of chronic pain.

- ▶ Opioid Responsiveness in Cancer Pain Management
- ▶ Postoperative Pain, Persistent Acute Pain
- ▶ Postoperative Pain, Postamputation Pain, Treatment and Prevention
- ▶ Spinothalamic Tract Neurons, Glutamatergic Input

### NMR

- ▶ Magnetic Resonance Imaging

### NNT

#### Definition

The NNT of oxycodone 15 mg is 2.3.

- ▶ Number Needed to Treat
- ▶ Postoperative Pain, Oxycodone

### Nocebo

### N

#### Definition

Nocebo (from the Latin: "I shall harm") can be thought of as an agent or intervention that results in harm, either in the form of adverse outcomes or adverse side-effects. A nocebo effect is the effect that such an agent or intervention ostensibly exerts.

The term – nocebo effect, is most commonly used to describe side-effects that occur in response to interventions for which there is no physiological mechanism, such as a placebo. These side-effects are the same as, and may be more prevalent, than those encountered with the active medication. Interestingly, the side-effect profile of placebos mimic the active drug that it is being compared with and also appear to be disease-specific (e.g. dizziness in psychiatric disorders, headache in angina, gastro-intestinal disturbance in peptic disease (Barsky et al. 2002). This is thought to be due to patients being informed, and therefore cued, to expect potential adverse effects of the medication that they might be taking in the research project. Suggestion, expectation and conditioning are the likely reasons. It is commonly seen in clinical practice when some patients assiduously study their consumer product information in their medicine packets, and read about all the possible side-effects of the medicine they have been prescribed. Upon taking the medication, they believe that they experience the expected side-effect.

The nocebo effect can be reduced by some simple steps (Weihrauch and Gauler 1999). Firstly, if patients with negative expectations can be identified, especially

in conditions such as anxiety, depression and somatisation, it is worthwhile attempting to shift their cognition to more positive expectations. For example, with serotonin uptake inhibitors, telling patients that the nausea they are likely to experience is a good sign (since it shows serotonin is increasing and, therefore, the drug is working) makes it more likely they will continue taking the medication. Secondly, commencing with low doses and increasing them slowly reduces the risk of side-effects. Thirdly, using other health-care professionals who will reinforce the messages given to the patient lessens the risk of nocebo.

The term – nocebo response, is used in another fashion, to describe the response of patients who know that they have been given or allocated to an inferior treatment. Under those conditions, they report failure to improve in order to indicate indirectly their disaffection with the way that they have been treated.

### References

1. Wehrauch T, Gauler T (1999) Placebo – Efficacy and Adverse Effects in Controlled Clinical Trials. *Arzneimittelforschung* 49:385-393
2. Barsky AJ, Saintfort R, Rogers MP, Borus JF (2002) Nonspecific Medication Side-Effects and the Nocebo Phenomenon. *JAMA* 287:622-627

## Nocebo Effect

### Definition

Harmful effects occurring from placebos.

- ▶ [Placebo](#)

## Nociceptin

- ▶ [Orphanin FQ](#)

## Nociception

### Definition

Nociception (from the Latin word *nocere*, to injure) is the transduction, encoding, and transmission of neural information about tissue damage, or impending tissue damage, which would occur if a stimulus was maintained over time. Cognitive central processing identifies the location of the stimulus, its general character, and the severity of the associated tissue injury. Some of the biological participants in this process include: unmyelinated dorsal horn neurons [like A-delta and C-fibers], excitatory amino acids, neuropeptides, zinc, biogenic amines, nitric oxide, wide-dynamic range spinal neurons, the limbic system of the brain, and several regions of the cerebral neocortex. Normal nociception

depends on a delicate balance between pronociceptive and antinociceptive forces. Chronic noxious stimulation causes ▶ [central sensitization](#) in which there is an increase in sensitivity of nociceptive neurons function nociceptively [recruitment] and new, semi-permanent neural connections develop [neuroplasticity].

- ▶ [Allodynia and Alloknesis](#)
- ▶ [Amygdala, Pain Processing and Behavior in Animals](#)
- ▶ [Consciousness and Pain](#)
- ▶ [Ethics of Pain, Culture and Ethnicity](#)
- ▶ [Forebrain Modulation of the Periaqueductal Gray](#)
- ▶ [Muscle Pain, Fibromyalgia Syndrome \(Primary, Secondary\)](#)
- ▶ [Nociceptive Withdrawal Reflex](#)
- ▶ [Pain in Humans, Psychophysical Law](#)
- ▶ [Psychological Aspects of Pain in Women](#)
- ▶ [Secondary Somatosensory Cortex \(S2\) and Insula, Effect on Pain Related Behavior in Animals and Humans](#)
- ▶ [Spinothalamic Tract Neurons, in Deep Dorsal Horn](#)
- ▶ [Spinothalamocortical Projections from SM](#)
- ▶ [Transition from Acute to Chronic Pain](#)

## Nociception in Genital Mucosa

- ▶ [Nociception in Mucosa of Sexual Organs](#)

## Nociception in Mucosa of Sexual Organs

MARITA HILLIGES

Halmstad University, Halmstad, Sweden

marita.hilliges@set.hh.se

### Synonyms

Nociception in Genital Mucosa; Genital Mucosa, Nociception; Mucosa of Sexual Organs, Nociception

### Definition

Pain perception and nociceptors in mucosal lining, including epithelium and underlying connective tissue, of human external genital organs. The external genital organs covered by mucosa comprise vulvar vestibule, clitoris and glans penis. The vagina belongs to the internal female genital organs but is included since it has partly somatic innervation.

### Characteristics

#### Pain Perception in Sexual Mucosa

The vestibule is by origin visceral tissue but is considered to have a somatic innervation (Cervero 1994). Sensations for touch, temperature and pain are therefore similar to sensations evoked in skin. Heat pain threshold is approximately 43° C, which is slightly below heat pain thresholds in skin (45–46°C). There are



limited data on cold pain threshold. Mechanical pain assessment has been performed using various methods and devices. Normal values with von Frey monofilaments are defined in two independent studies using slightly different experimental setups. The results show a wide range in punctuate mechanical pain thresholds (185–430 mN) in healthy fertile women (Bohm-Starke et al. 2001; Pukall et al. 2002; Lowenstein et al. 2004; Giesecke et al. 2004).

Experimental data on pain thresholds in the vagina are sparse. However, in clinical practice it is obvious that thermal pain perception exists, although spatial discrimination is poor. Furthermore while it is possible to perform unanaesthetized surgical interventions such as biopsies without eliciting pain in the proximal vagina, pain is easily evoked in the distal part close to the introitus. Mean mechanical pain threshold in the lateral vaginal wall using a 12 mm diameter probe is 10.7 N (range 4.3–25.3) in healthy women (Baguley et al. 2003). The vagina, although considered a visceral organ, is not sensitive to distension (Bohm-Starke et al. 2001).

On the glans penis mechanically as well as temperature induced pain can be elicited. Mechanical detection thresholds seem to coincide with pain thresholds (Halata and Munger 1986).

#### Nociceptors in Sexual Mucosa

The external genital area is supplied both with myelinated and unmyelinated nerves. Free nerve endings are most frequently found at the labia minora lateral to Hart's line (Krantz 1958). Biopsies from young healthy women taken from the posterior vestibule revealed that the intraepithelial free nerve endings rarely branch and penetrate two thirds of the epithelium. These intraepithelial nerve fibres are not evenly distributed. Some areas are almost devoid of nerves, whereas other parts of the epithelium are densely innervated. In addition, one population of free nerve endings terminate within the basal layer of the epithelium. The intraepithelial nerves are immunoreactive to CGRP. Nerve fibres are also encountered in the subepithelial connective tissue. In this area it is, however, more difficult to evaluate the existence of free nerve endings. Most nerve fibres are found in connection to vascular or glandular elements (Bohm-Starke et al. 1998; Bohm-Starke et al. 1999; Tympanidis et al. 2003). The clitoris and the female urethral meatus are richly innervated by free nerve endings. They are located in or just below the basal layer of the epithelium (Krantz 1958). Free nerve endings in the vagina are rare and found in the distal part, the anterior wall being more densely innervated than the posterior. Most of these nerve terminals end after penetrating two thirds of the epithelium; however some terminate just a few cell layers from the surface (Hilliges et al. 1995). The hymenal ring is richly supplied with free nerve endings (Krantz 1958).

The human glans penis is richly innervated by free nerve endings. These endings are found in almost every connective tissue papilla (Halata and Munger 1986).

#### References

1. Baguley SDK, Curnow JSH, Morrison GD et al. (2003) Vaginal algometer: development and application of a device to monitor vaginal wall pressure pain threshold. *Physiol Meas* 24:833–836
2. Bohm-Starke N, Hilliges M, Falconer C et al. (1998) Increased intraepithelial innervation in women with vulvar vestibulitis syndrome. *Gynecol Obst Invest* 46:256–260
3. Bohm-Starke N, Hilliges M, Falconer C et al. (1999) Neurochemical characterization of the vestibular nerves in women with vulvar vestibulitis syndrome. *Gynecol Obst Invest* 48:270–275
4. Bohm-Starke N, Hilliges M, Brodda-Jansen G et al. (2001) Psychophysical evidence of nociceptor sensitization in vulvar vestibulitis syndrome. *Pain* 94:177–183
5. Cervero F (1994) Sensory innervation of the viscera: peripheral basis of visceral pain. *Physiol Rev* 74:95–138
6. Giesecke J, Reed BD, Haefner HK et al. (2004) Quantitative sensory testing in vulvodynia patients and increased peripheral pressure pain sensitivity. *Obstet Gynecol* 104:126–133
7. Halata Z, Munger BL (1986) The neuroanatomical basis for the protopathic sensibility of the human glans penis. *Brain Res* 371:205–230
8. Hilliges M, Falconer C, Ekman-Ordeberg G et al. (1995) Innervation of the human vaginal mucosa as revealed by PGP 9.5 immunohistochemistry. *Acta Anat* 153:119–126
9. Krantz KE (1958) Innervation of the human vulva and vagina. *Obstet Gynecol* 12:382–396
10. Lowenstein L, Vardi Y, Deutsch M et al. (2004) Vulvar vestibulitis severity – assessment by sensory and pain testing modalities. *Pain* 107:47–53
11. Pukall CF, Binik YM, Khalifé S et al. (2002) Vestibular tactile and pain thresholds in women with vulvar vestibulitis syndrome. *Pain* 96:163–175
12. Tympanidis P, Terenghi G, Dowd P (2003) Increased innervation of the vulval vestibule in patients with vulvodynia. *Br J Dermatol* 148:1021–1027

N

## Nociception in Nose and Oral Mucosa

THOMAS HUMMEL<sup>1</sup>, BARRY GREEN<sup>2</sup>

<sup>1</sup>Department of Otorhinolaryngology, Smell and Taste Clinic, University of Dresden Medical School, Dresden, Germany

<sup>2</sup>Pierce Laboratory, Yale School of Medicine, New Haven, CT, USA

thummel@rcs.urz.tu-dresden.de, green@jbpierce.org

#### Definition

Nociception in the oral and nasal cavities is predominantly mediated through fibers of the ► **trigeminal nerve**. Different from other areas of the body, ► **nociceptive afferents** are easily accessible as they are not covered, e.g. by a corneal layer of epidermis. Trigeminal input is intimately involved in the processing of both olfactory and gustatory information. In turn, trigeminal sensitivity appears to depend on olfactory/gustatory stimulation that may play a role in, for example, ► **Burning Mouth Syndrome**.

## Characteristics

### Nasal Cavity

#### Anatomy of Nasal Trigeminal Afferents

The nasal cavity is innervated by the ophthalmic (1<sup>st</sup> branch of the 5<sup>th</sup> cranial nerve: V<sub>1</sub>) and maxillary (V<sub>2</sub>) branches of the trigeminal nerve. V<sub>1</sub> (anterior ethmoidal and infraorbital nerves) innervates the anterior portion of the nasal cavity; the posterior part of the nasal cavity is innervated by V<sub>2</sub> (posterior superior medial nasal and nasopalatine nerves). Cell bodies of trigeminal afferents lie in the Gasserian ganglion. Axons project to the trigeminal sensory nucleus extending from the rostral spinal cord to the midbrain. ► **Chemosensory** fibers from the nasal cavity have been shown to project to the subnucleus caudalis and subnucleus interpolaris (Anton et al. 1991). Trigeminal information is relayed to the amygdala via the lateral parabrachial complex. Neurons of the spinal nucleus project to the ventral posterior medial, intralaminar, and mediodorsal nuclei of the thalamus. While most ascending fibers cross to the contralateral side, some fibers also ascend ipsilaterally (Barnett et al. 1995) – similar to the olfactory system. Apart from projections to the ► **primary somatosensory cortex** (SI), trigeminal stimulation also produces activation of SII. Further, trigeminal stimulation leads to activity in the insular cortex and the ventral orbital cortex, with stronger right-sided activity.

#### Intranasal Pain Fibers

The nasal mucosa is highly sensitive to painful stimuli. This seems to be partly due to the fact that, other than in the skin, nociceptors innervating the mucosa are not covered by squamous epithelium, giving nociceptive stimuli almost direct access to the nerve endings (Finger et al. 1990). Compared to noxious thermal or mechanical stimuli, this is of particular importance with regard to chemical irritants. Trigeminal chemoreceptors act as a sentinel of the airways, where they prevent inhalation of potentially life-threatening substances, with intranasal trigeminal activation producing an inspiratory stop. This correlates with the finding of an area of increased chemosensitivity in the anterior third of the nasal cavity, whereas the posterior nasal mucosa is more sensitive to mechanical stimuli.

The physico-chemical properties of most chemicals (e.g. molecular size, lipophilicity) determine the degree to which they activate the intranasal trigeminal system (Abraham et al. 1998). Nevertheless, chemical stimulation may also activate specific receptor types. Stinging sensations are likely to be mediated by A<sub>delta</sub>-fibers, whereas burning sensations are largely mediated by ► **C Fiber**. In addition, a variety of receptors are involved in the coding of different qualities of trigeminal mediated sensations, e.g. tingling, stinging, or burning. These receptive structures include the ► **TRPV1 re-**

**ceptor**, the nicotinic receptor (which can be activated in a stereoselective manner), the ASIC receptors, the M2 receptor, and the ► **P2X receptor**. Most excitingly, solitary chemosensory receptor cells have been found to be attached to trigeminal afferents (Finger et al. 2003). Thus, it seems that the trigeminal system allows discrimination between numerous different chemical stimuli – although the number of discriminable stimulus qualities is an order of magnitude below that of the olfactory system.

#### Measures of Nasal Nociceptive Sensation

Techniques to study intranasal trigeminal function in humans include the psychophysical lateralization paradigm, electrophysiological recordings of the ► **negative mucosal potential**, or recordings of the ► **EEG-based ► event-related potential** (Hummel 2000). However, especially in a clinical context, to date there is no rapid and reliable standardized test of trigeminal function in humans. A major limitation of many studies, however, is that only CO<sub>2</sub> has been used as the chemical pain stimulant, although this gas has the advantages of being virtually odorless, inexpensive, and non-toxic. Other stimuli of the intranasal trigeminal system include ► **capsaicin**, ► **menthol**, or nicotine. Recent research on the genetic variability of trigeminal receptors (e.g. TRPV1 polymorphisms), or opioid receptor polymorphisms helps to explain the heterogeneity of individual responses to trigeminal stimulation.

#### Intranasal Trigeminal Sensations and Smell

Intranasal trigeminal activation has been shown to influence the perception of odors, although suppression between the olfactory and the trigeminal systems can be mutual. Importantly, odors typically produce trigeminally mediated sensations when presented at higher stimulus concentrations. In a clinical context, it has been shown that olfactory activation increases sensitivity to trigeminally mediated stimuli. In turn, ► **loss of olfactory function** may result in a decrease of trigeminal responsiveness. Several possible mechanisms have been identified by which trigeminal activity may influence olfactory processing (Hummel and Livermore 2002). The systems may interact centrally (e.g. mediodorsal thalamus), at the level of the olfactory bulb, at the level of the olfactory epithelium through the release of substance P/other peptides from trigeminal fibers, or indirectly via reflexes designed to minimize potentially damaging exposure of the olfactory epithelium to noxious substances (e.g. alteration of nasal patency, change of the constitution of the olfactory mucus).

### Oral Cavity

#### Anatomy of Oral Pain

Three cranial nerves serve oral pain. The two most important are the trigeminal (V) and the glossophar-

ryngeal (IX) nerves. The trigeminal nerve, which also innervates the nasal cavity, the face, and much of the scalp, provides sensitivity to temperature, touch and pain from the base of the tongue forward. The trigeminal nerve projects to the tongue via the lingual nerve, which it shares with the chorda tympani nerve (VII), a taste nerve that innervates the front of the tongue. The density of trigeminal endings is greatest in the fungiform taste **papillae** at the tip and sides of the tongue, where they greatly outnumber chorda tympani nerve endings. Two other branches of V, the maxillary (V2) and the mandibular (V3) nerves, innervate the upper and lower surfaces of the anterior oral cavity (e.g. the gingiva, buccal mucosa, and lips), and thus mediate all non-lingual oral pain, including dental pain. The glossopharyngeal nerve innervates the posterior 1/3 of the tongue as well as the soft palate, palatal arch, and anterior oral pharynx. Glossopharyngeal innervation is particularly dense in circumvallate taste papillae on the back of the tongue. Classified as a visceral nerve, the glossopharyngeal differs from the trigeminal in that it contains gustatory as well as somatosensory fibers. The receptive field of the vagus nerve (X) overlaps with the glossopharyngeal in the oral pharynx and posterior soft palate. The vagus is also sensitive to touch, temperature and pain, but appears not to contribute to taste perception in humans. The vagus, nevertheless, contributes to the perception of the somatosensory qualities of all foods and beverages as they are swallowed. Accordingly, IX and X function as the final gatekeepers of the upper alimentary canal, and trigger the protective reflexes of gagging and coughing.

### Intra-Oral Pain Fibers

Although concentrated in the fungiform and circumvallate papillae, lingual pain fibers are present throughout the oral mucosa and gingiva. Evidence of TRPV1 and peptidergic C-fiber nociceptors has been found in both types of papillae (Ishida et al. 2002). In addition to signaling acute pain, neurons that express TRPV1 also contribute to hyperalgesia to temperature caused by inflammation. Evidence of other types of nociceptors, including some that respond to cold, menthol, carbonation, nicotine and high concentrations of salts (e.g. NaCl, KCl) and acids (e.g. citric acid), have also been found in various lingual nerve preparations (Wang et al. 1993).

Consistent with the variety of nociceptors that have been identified in the lingual nerve, salts and acids as well as menthol, carbonation, cinnamic acid and nicotine can produce burning, stinging or tingling when applied to the anterior tongue. Collectively, the sensitivity to all chemicals that produce sensations, other than (or in addition to) taste or smell, is referred to as **chemesthesis** (Green 2002).

### Measures of Oral Nociception

By far the best studied oral pain stimulus is the vanilloid capsaicin, which has been used as a model for oral pain. As it occurs naturally in red ("hot") peppers, capsaicin is also of interest as a flavor stimulus. Not surprisingly, capsaicin, which acts via TRPV1, is perceived most acutely in the areas of the mouth most heavily innervated by the trigeminal nerve, such as the tongue tip. In addition, as TRPV1 is expressed on C-polymodal nociceptors, capsaicin also serves as an indicator of sensitivity to nonchemical pain stimuli such as intense heat. Thus, heat sensitivity is also greatest in the front of the mouth, particularly on the tongue tip and lips. Pain sensitivity is lowest in the superficial buccal mucosa. The sensitivity to chemical irritants and heat is also less acute on the back of the tongue, where most glossopharyngeal pain fibers are located in the basement membranes of the circumvallate papillae. Interestingly, however, swallowing capsaicin or piperine (black pepper) produces burning sensations in the throat, which are at least as strong as those produced on the front of the tongue (Rentmeister-Bryant and Green 1997), indicating that the glossopharyngeal and vagus nerves contribute significantly to chemical pain during consumption.

As capsaicin has the capacity to desensitize the neurons it stimulates (Szolcsanyi 1993), desensitization has been used to determine the importance of capsaicin-sensitive neurons for perception of chemical irritants. The results have shown that much, but not all, of oral chemesthesis is mediated by such fibers.

### Oral Chemesthesis and Taste

Like olfactory stimuli, most taste stimuli evoke chemesthetic sensations as well as taste, particularly at high concentrations. Notable in this regard are acids, salts and alcohols, which can produce burning, stinging or tingling even at moderate concentrations. On the other hand, some taste stimuli (particularly sucrose) have been shown to partially suppress the burn of capsaicin, suggesting that taste stimulation has the potential to inhibit some types of oral pain.

### Oral Pain Syndromes

Injuries to cranial nerves V, IX or X can result in oral neuropathologies that range in severity from annoying to debilitating. Trigeminal and glossopharyngeal neuralgias can occur following injuries or insults to the deep tissue of the mouth or mandible (e.g. dental extractions), or inflammatory disorders such as herpes zoster. However, trigeminal neuralgias most often affect perioral and facial skin rather than oral structures. Glossopharyngeal neuralgias, which are relatively rare, are usually secondary to pathologies such as abscesses and tumors that affect IX, are characterized by pain at the base of the tongue, the pharynx, or soft palate.

Perhaps the most common oral pain disorder is Burning Mouth Syndrome (BMS), which manifests as consistent or episodic burning or tingling localized in the front of the mouth, particularly the tongue and/or lips (Kapur et al. 2003). BMS generally occurs in older individuals (>50 years old), and is much more common in women than in men. Although it is believed to have more than one etiology, recent research has pointed to an association between BMS and a loss of taste function, particularly in post-menopausal women (Grushka et al. 2003). Such a link is consistent with other evidence that the taste system may normally exert an inhibitory effect on the oral pain system.

## References

1. Abraham MH, Kumarsingh R, Cometto-Muniz JE, Cain WS (1998) An Algorithm for Nasal Pungency Thresholds in Man. *Arch Toxicol* 72:227–232
2. Anton F, Peppel P, Euchner I et al. (1991) Controlled Noxious Chemical Stimulation: Responses of Rat Trigeminal Brainstem Neurons to CO<sub>2</sub> Pulses Applied to the Nasal Mucosa. *Neurosci Lett* 123:208–211
3. Barnett EM, Evans GD, Sun N et al. (1995) Anterograde Tracing of Trigeminal Afferent Pathways from the Murine Tooth Pulp to Cortex using Herpes Simplex Virus Type I. *J Neurosci* 15:2972–2984
4. Finger TE, Botzger B, Hansen A et al. (2003) Solitary Chemoreceptor Cells in the Nasal Cavity Serve as Sentinels of Respiration. *Proc Natl Acad Sci USA* 100:8981–8986
5. Finger TE, Getchell ML, Getchell TV et al. (1990) Afferent and Effector Functions of Peptidergic Innervation of the Nasal Cavity. In: Green BG, Mason JR, and Kare MR (eds) *Chemical Senses: Irritation*. Marcel Dekker, New York, pp 1–20
6. Green BG (2002) Psychophysical Assessment of Oral Chemesthesis. In: Simon SA and Nicolelis MA (eds) *Methods in Chemosensory Research*. CRC Press, New York, pp 3–20
7. Grushka M, Epstein JB, Gorsky M (2003) Burning Mouth Syndrome and Other Oral Sensory Disorders: A Unifying Hypothesis. *Pain Res Manag* 8:133–135
8. Hummel T (2000) Assessment of Intranasal Trigeminal Function. *Int J Psychophysiol* 36:147–155
9. Hummel T, Livermore A (2002) Intranasal Chemosensory Function of the Trigeminal Nerve and Aspects of its Relation to Olfaction. *Int Arch Occ Env Health* 75:305–313
10. Ishida Y, Ugawa S, Ueda T et al. (2002) Vanilloid Receptor Subtype-1 (VR1) is Specifically Localized to Taste Papillae. *Brain Res Mol Brain Res* 107:17–22
11. Kapur N, Kamel IR, Herlich A (2003) Oral and Craniofacial Pain: Diagnosis, Pathophysiology, and Treatment. *Int Anesthesiol Clin* 41:115–150
12. Rentmeister-Bryant H, Green BG (1997) Perceived Irritation during Ingestion of Capsaicin or Piperine: Comparison of Trigeminal and Non-Trigeminal Areas. *Chem Senses* 22:257–266
13. Szolcsanyi J (1993) Actions of Capsaicin on Sensory Receptors. In: Wood JN (ed) *Capsaicin in the study of pain*. Academic Press, New York, pp 1–26
14. Wang Y, Erickson RP, Simon SA (1993) Selectivity of Lingual Nerve Fibers to Chemical Stimuli. *J Gen Physiol* 101:843–866

## Nociception Induced by Injection of Dilute Formaldehyde

- ▶ **Formalin Test**

## Nociceptive

### Definition

Related to the neuronal mechanisms involved in the detection, encoding and transmission of noxious stimuli and hence to the sensation of pain or pain behavior. A nociceptive stimulus elicits pain or pain behavior such as withdrawal, vocalization, etc. and might be potentially or overtly injurious (from the Latin word *nocere*, to injure).

- ▶ Allodynia and Alloknesis
- ▶ Chronic Pelvic Pain, Musculoskeletal Syndromes
- ▶ Insular Cortex, Neurophysiology and Functional Imaging of Nociceptive Processing
- ▶ Nociception
- ▶ Nociceptive Processing in the Amygdala, Neurophysiology and Neuropharmacology

## Nociceptive Afferents

- ▶ Nociception in Nose and Oral Mucosa
- ▶ Nociceptive Circuitry in the Spinal Cord
- ▶ Nociceptive in Mucosa of Sexual Organs
- ▶ Nociceptive Sensory Neurons

## Nociceptive Circuitry in the Spinal Cord

ANDREW J. TODD

Spinal Cord Group, Institute of Biomedical and Life Sciences, University of Glasgow, Glasgow, UK  
a.todd@bio.gla.ac.uk

### Definition

Pain is generally perceived as a result of stimuli that either damage or threaten to damage peripheral tissues. Sensory information resulting from tissue damage in the limbs and trunk is transmitted through nociceptive primary afferent axons to the dorsal horn of the spinal cord, and subsequently relayed to various sites in the brain, including the thalamus. The term nociceptive circuitry is used to describe the arrangement and functional interconnections of neurons that are responsible for conveying this information. Nociceptive circuits, including those in the dorsal horn, also involve inhibitory control mechanisms.

### Characteristics

#### Background

Nociceptive primary afferent axons terminate in the dorsal horn of the spinal cord, and this region therefore contains the first synapse in pathways that convey nociceptive information to the brain, as well as those



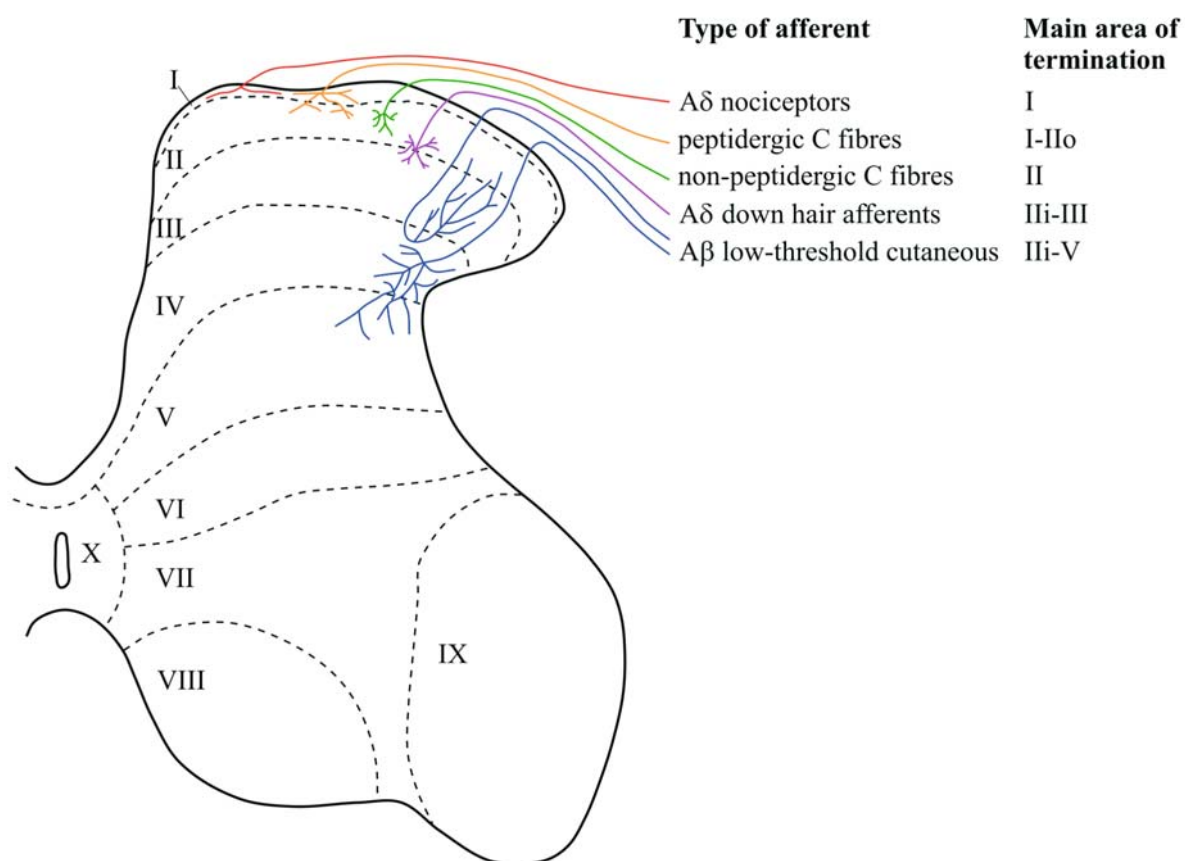
involved in reflexes. The dorsal horn is also an important site for modulation of sensory input. This modulation involves both local neurons and axons that descend from the brainstem and is thought to contribute to various types of analgesia. Changes affecting dorsal horn neurons occur in certain pathological states and are likely to contribute to the abnormal pain that follows peripheral inflammation and certain types of nerve injury. A knowledge of the nociceptive circuits in the dorsal horn would therefore be of fundamental importance for our understanding of the mechanisms underlying pain and analgesia and also for the development of new treatments for pain. However, despite extensive research on this subject we still know very little about the neuronal organisation and circuitry of the spinal dorsal horn.

#### Neuronal Components in the Dorsal Horn

Rexed (1952) divided the grey matter of the ► **Rexed's laminae**, (► **ADLs laminae**) and this scheme is generally used in anatomical studies (Fig. 1). The dorsal horn contains four different neuronal components: (1) central terminals of primary afferent axons, (2) ► **projection**

neurons, (3) ► **interneurons** and (4) axons that descend from various brain regions.

All primary afferent axons that innervate tissues in the trunk and limbs form synapses in the spinal dorsal horn. Many different classes of primary afferent can be recognised based on the peripheral tissue that they innervate, the types of stimulus that activate them, their axonal diameter and the chemical messengers that they use (Todd and Koerber 2004). Each type of primary afferent has a characteristic distribution pattern within the dorsal horn (Fig. 1). The majority of nociceptive afferents have unmyelinated or fine myelinated axons, and these are referred to as C and A $\delta$  fibres, respectively. Intra-axonal injection of A $\delta$  nociceptive afferents has shown that these terminate mainly in lamina I, although they also give rise to terminals in lamina V (Light and Perl 1979). Because of their small size, intracellular labelling of C fibres has proved extremely difficult, and most anatomical studies of these afferents have used an indirect "neurochemical" approach. Many fine afferents, including approximately half of those that give rise to C fibres, express neuropeptides, such as ► **substance P** (SP) and



**Nociceptive Circuitry in the Spinal Cord, Figure 1** A diagrammatic representation of the laminar distribution of certain types of primary afferent in the spinal cord. The dorsal horn is divided into 6 parallel laminae, and each type of afferent has a characteristic area of termination in one or more of these laminae. Note that the mediolateral and rostrocaudal distribution of afferents is related to the region of the body that they innervate. The body is thus "mapped" onto the spinal cord in these two dimensions.

► **calcitonin gene-related peptide (CGRP)**. In the rat, all CGRP-containing axons in the dorsal horn are primary afferents, and these can be identified by immunocytochemistry. C fibres that do not express peptides can be labelled with a lectin (IB4) derived from *Bandeiraea simplicifolia*. Both types of C fibre terminate in the superficial laminae of the dorsal horn; those with peptides end mainly in lamina I and the outer part of lamina II (lamina IIo), while those that lack peptides arborise in the central part of lamina II. It is likely that the majority of both peptidergic and non-peptidergic C fibres function as nociceptors. However, little is known about the functional differences between the two classes. Tactile and hair afferents convey innocuous (low-threshold) information from the skin and most have myelinated axons. In some pathological conditions (e.g. ► **neuropathic pain**), activation of these afferents can be perceived as painful. The majority of low-threshold cutaneous afferents have large myelinated (A $\beta$ ) fibres and these terminate in a zone extending from the inner part of lamina II (lamina IIi) to lamina V. Fine myelinated afferents that innervate down hairs have a more restricted central distribution in laminae III and III.

Projection neurons in the dorsal horn send their axons to several brain regions, including the thalamus, the periaqueductal grey matter of the midbrain, the lateral parabrachial area in the pons, and various parts of the brainstem reticular formation (Willis and Coggeshall 2004; Villanueva and Bernard 1999). It is likely that many projection neurons send axons to more than one of these targets (Spike et al. 2003). Projection neurons are concentrated in lamina I of the dorsal horn, and are also scattered throughout the deeper parts of the grey matter (laminae III-VII). However, in all parts of the spinal cord they are greatly outnumbered by interneurons. For example, it has been estimated that only around 5% of neurons in lamina I are projection cells (Spike et al. 2003). Projection neurons in lamina I have received considerable attention, as they are relatively numerous and most respond to noxious stimulation. The majority of projection neurons in lamina I, as well as some of those in laminae III and IV, express the neurokinin 1 (NK1) receptor, on which substance P acts. Substance P is present in many nociceptive primary afferents and is released into the dorsal horn following noxious stimulation. Intrathecal administration of substance P conjugated to the cytotoxin saporin leads to death of NK1 receptor-expressing neurons in the dorsal horn, as well as a dramatic reduction of ► **hyperalgesia** in both inflammatory and neuropathic conditions (Mantyh et al. 1997). This suggests that projection neurons with the NK1 receptor play an important role in the generation of hyperalgesia.

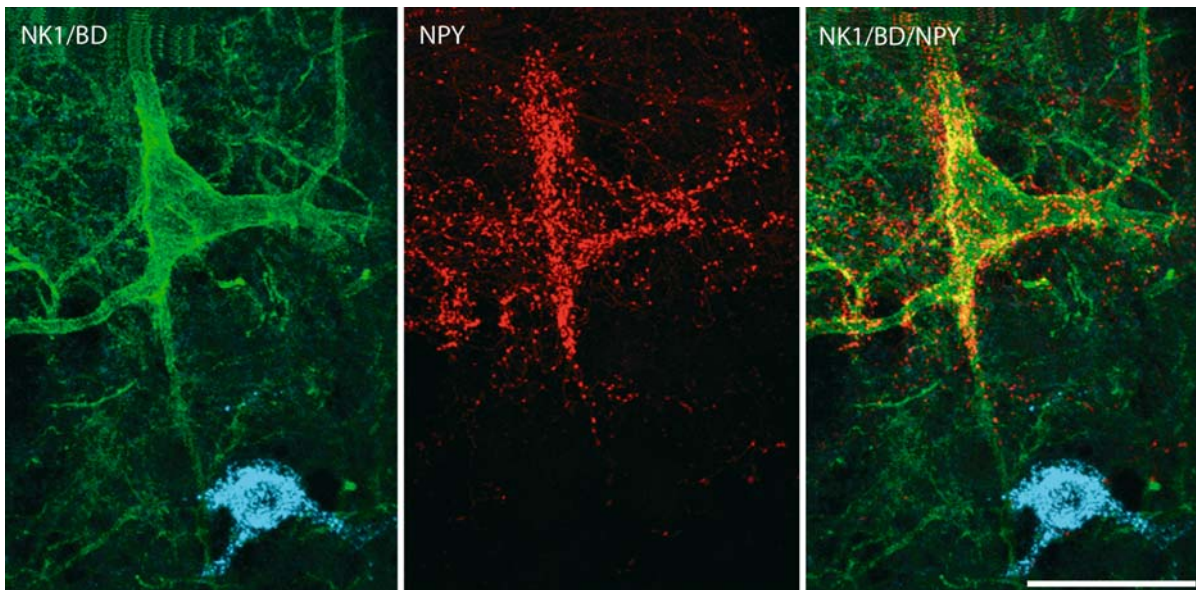
Interneurons make up the great majority of the neuronal population in each lamina of the dorsal horn and most are thought to have axons that arborise close

to the cell body. These cells are therefore involved in local processing of information. Interneurons can be divided into two main classes, inhibitory cells, which use GABA and/or glycine as their neurotransmitter(s) and excitatory (glutamatergic) cells. Laminae I-III of the dorsal horn contain a particularly high density of small interneurons, and the majority of these (60-75%, depending on the lamina) are excitatory. The axons of inhibitory interneurons form two types of synaptic connection: (1) axoaxonic synapses, where they are presynaptic to a primary afferent terminal on which they exert presynaptic inhibition and (2) axodendritic or axosomatic synapses onto other dorsal horn neurons, which are responsible for post-synaptic inhibition. Blocking the actions of GABA or glycine with intrathecal antagonists leads to ► **allodynia** (Yaksh 1989), and this suggests that one of the roles of inhibitory interneurons is to prevent activity conducted in tactile and hair afferents from being perceived as painful. Much less is known about the function of excitatory interneurons, although it is thought that they convey information from primary afferents to other dorsal horn neurons through polysynaptic pathways. For example, they are likely to be responsible for transmitting nociceptive information from C fibres (which terminate mainly in laminae I-II) to neurons in deeper laminae. The organisation of dorsal horn interneurons is very complex (Todd and Koerber, 2004); for example Grudt and Perl (2002) have described 7 different populations in lamina II on the basis of physiological and morphological criteria. It is also possible to identify interneuron populations using neurochemical characteristics, for example patterns of neuropeptide or receptor expression.

Among the various populations of descending axons, those that contain the monoamine transmitters serotonin or norepinephrine have attracted particular attention, because of their role in stimulation-produced analgesia. Serotonergic axons arise from cells in the raphe nuclei of the medulla, while those with norepinephrine are derived from cells in and around the locus coeruleus of the pons. Both types of axon are distributed throughout the dorsal horn, but are concentrated in the superficial laminae (I-II). The monoamine transmitters are likely to act through ► **volume transmission**, and therefore knowing the distribution of monoamine receptors on dorsal horn neurons will be important for understanding their roles in modulating sensory transmission.

#### What We Know About Neuronal Circuitry in the Spinal Cord

As stated above, our knowledge of specific neuronal circuits within the dorsal horn is still very limited. It has been shown that primary afferents that contain substance P form numerous synapses with projection neurons in laminae I and III that express the NK1 receptor (Todd et al. 2002). Since all substance P-containing



**Nociceptive Circuitry in the Spinal Cord, Figure 2** This figure shows selective innervation of one of two different types of projection neuron in lamina III of the dorsal horn by axons belonging to a population of inhibitory interneurons. Two cells can be seen in the left image: the large cell in the upper part of the field is stained with an antibody against the NK1 receptor (green). All cells of this type are projection neurons. The lower cell was retrogradely labelled with biotin dextran (BD; blue) injected into the gracile nucleus and therefore belongs to the post-synaptic dorsal column (PSDC) pathway. The middle image shows the same field scanned to reveal axons that contain neuropeptide Y (NPY), and the image on the right is a merge of the three colours. NPY-containing axons in the dorsal horn are derived from a population of GABAergic interneurons in laminae I and II, and these axons can be seen to form numerous contacts with the NK1 receptor-immunoreactive cell, but not with the PSDC neuron. Scale bar = 50  $\mu\text{m}$ . (Modified from Polgár et al. 1999, *J Neurosci* 19:2637-2646. Copyright 1999 by the Society for Neuroscience).

N

afferents respond to noxious stimulation (Lawson et al. 1997), this provides a direct route through which nociceptors can activate brain regions involved in pain mechanisms. The nociceptive afferents release both glutamate and substance P and these act through different mechanisms. Glutamate will be released across the synaptic cleft and act on receptors in the postsynaptic membrane, whereas substance P will diffuse to nearby NK1 receptors (► [volume transmission](#)). Nociceptive primary afferents presumably also form synapses with both excitatory and inhibitory interneurons, although much less is known about these connections.

There is some evidence to indicate that different populations of inhibitory interneurons have specific postsynaptic targets. One group of inhibitory cells in laminae I and II is characterised by the presence of GABA and neuropeptide Y. Axons of these cells form numerous synapses with projection neurons in laminae III and IV that express the NK1 receptor, but not with another population of projection cells that occupy the same laminae, those belonging to the ► [post-synaptic dorsal column pathway](#) (Polgár et al. 1999) (Fig. 2). As mentioned above, axoaxonic synapses are responsible for presynaptic inhibition of primary afferent terminals. Different classes of primary afferent appear to receive axoaxonic synapses from axons belonging to different types of inhibitory interneuron (Todd and Koerber 2004).

Much less is known about the synaptic connections between different types of interneuron, or between excitatory interneurons and projection neurons. It is likely that these are fairly specific (at least in some cases) and also very complex. Clearly, a great deal of research will be needed to unravel the details of nociceptive circuits in the spinal cord.

#### ► Nociceptive Processing in the Spinal Cord

#### References

1. Grudt TJ, Perl ER (2002) Correlations between neuronal morphology and electrophysiological features in the rodent superficial dorsal horn. *J Physiol* 540:189–207
2. Lawson SN, Crepps BA, Perl ER (1997) Relationship of substance P to afferent characteristics of dorsal root ganglion neurones in guinea-pig. *J Physiol* 505:177–191
3. Light AR, Perl ER (1979) Spinal termination of functionally identified primary afferent neurons with slowly conducting myelinated fibers. *J Comp Neurol* 186:133–150
4. Mantyh PW, Rogers SD, Honore P et al. (1997) Ablation of lamina I spinal neurons expressing the substance P receptor profoundly inhibits hyperalgesia. *Science* 278:275–279
5. Polgár E, Shehab SAS, Watt C et al. (1999) GABAergic neurons that contain neuropeptide Y selectively target cells with the neurokinin 1 receptor in laminae III and IV of the rat spinal cord. *J Neurosci* 19:2637–2646
6. Rexed B (1952) The cytoarchitectonic organization of the spinal cord in the cat. *J Comp Neurol* 96:415–495
7. Spike RC, Puskár Z, Andrew D et al. (2003) A quantitative and morphological study of projection neurons in lamina I of the rat lumbar spinal cord. *Eur J Neurosci* 18:2433–2448
8. Todd AJ, Puskár Z, Spike RC et al. (2002) Projection neurons in lamina I of rat spinal cord with the neurokinin 1 receptor are

- selectively innervated by substance P-containing afferents and respond to noxious stimulation. *J Neurosci* 22:4103–4113
9. Todd AJ, Koerber R (2004) Neuroanatomical substrates of spinal nociception. In: McMahon S, Koltzenburg M (eds) *Melzack and Wall's textbook of pain*, 5th edn, Churchill Livingstone, Edinburgh, UK, pp 73–90
  10. Villanueva L, Bernard J-F (1999) The multiplicity of ascending pain pathways. In: Lydic R, Baghdoyan HA (eds) *Handbook of behavioral state control: cellular and molecular mechanisms*. pp 569–585 CRC Press LLC, Boca Raton, FL
  11. Willis WD, Coggeshall RE (2004) *Sensory mechanisms of the spinal cord*, 3th edn. Kluwer Academic Plenum Publishers, New York
  12. Yaksh TL (1989) Behavioral and autonomic correlates of the tactile evoked allodynia produced by spinal glycine inhibition: effects of modulatory receptor systems and excitatory amino acid antagonists. *Pain* 37:111–123

## Nociceptive Coding in Lateral Thalamus

- ▶ [Thalamic Nuclei Involved in Pain, Human and Monkey](#)

## Nociceptive Masseter Muscle Afferents

- ▶ [Nociceptors in the Orofacial Region \(Temporo-mandibular Joint and Masseter Muscle\)](#)

## Nociceptive Nerve Endings

### Definition

The terminal branches of the peripheral axon of nociceptive neurons located in sensory ganglia.

- ▶ [Nociceptor Generator Potential](#)

## Nociceptive Neuroplasticity

### Definition

At its most general level, nociceptive neuroplasticity denotes the changes in nervous system processing resulting from nociceptive inputs. Used in this way, the term includes both functional and structural, reversible and irreversible changes. Other groups would use this term in a narrower sense, and only include alterations in nervous system function that are due to structural change.

- ▶ [Central Sensitisation](#)
- ▶ [Quantitative Sensory Testing](#)

## Nociceptive Neurotransmission in the Thalamus

THOMAS E. SALT

Institute of Ophthalmology, University College London, London, UK  
t.salt@ucl.ac.uk

### Synonyms

Chemical Transmitter; neuromodulator; Thalamus, Nociceptive Neurotransmission

### Definition

Neurotransmitters are chemical messengers that are released from one neural element (e.g. a nerve terminal) to then act upon a receptor located on or in another neural element (e.g. a dendrite). This transfer of information is neurotransmission, and this contribution describes neurotransmitter mechanisms which mediate the transmission and integration of nociceptive information in the thalamus.

### Characteristics

The integrative role of the thalamus in the processing of nociceptive information is complex and diverse. A variety of different neurotransmitters and an array of receptors take part in this process, and it has become clear that the nature of these processes is pivotal to the function of the thalamo-cortico-thalamic circuitry (McCormick 1992; Broman 1994; Salt and Eaton 1996; Millan 1999). The majority of work carried out in the field of thalamic neurotransmitters has been in the so-called relay nuclei, of which the ventrobasal complex (ventroposterolateral and ventroposteromedial nuclei) is the somatosensory representative. Some of this function pertains to nociception, but it is important to remember that the ventrobasal complex (VB) has an important role in the processing of non-nociceptive somatosensory information and that many other thalamic nuclei (whose detailed transmitter functions are much less well studied) also participate in nociceptive functions.

### Ascending Sensory Input

There is overwhelming neuroanatomical evidence, at both the light-microscopical and ultrastructural levels, to favour a neurotransmitter role for glutamate in the ascending afferent fibres in several mammalian species including rodents and primates (Broman 1994). These fibres impinge upon ionotropic [▶ glutamate receptors](#) of the [▶ NMDA](#) and [▶ AMPA](#) varieties located upon proximal dendrites of VB thalamic relay neurones (Broman 1994; Liu 1997). Ascending afferents to other thalamic nuclei that may be important in nociception are probably also glutamatergic (Broman 1994). Electrophysiological studies confirm a functional role for



these receptor types in somatosensory transmission to the VB in rodents and primates (Salt and Eaton 1991; Dougherty et al. 1996) and it appears probable that, as in many other central synapses, the initial synaptic response is mediated *via* ► **AMPA receptors** with a following longer duration NMDA receptor mediated component which may become more prominent upon repetitive stimulation (Salt and Eaton 1991).

### Cortico-Thalamic Input

The cortical inputs to thalamic relay neurones have been a focus of much study and speculation over many years (Sherman and Guillery 2000). Electrophysiological studies of these pathways have focussed on the role of NMDA receptors and, latterly, ► **metabotropic glutamate (mGlu) receptors** (Salt 2002). A particular focus has been the function of mGlu1 receptors, as these have been localised postsynaptically beneath terminals of cortico-thalamic fibres (Martin et al. 1992). However, it is also evident that there is a contribution from AMPA receptors to cortico-thalamic transmission (Golshani et al. 2001), a finding supported by ultrastructural evidence which indicates that there are AMPA receptor subunits that are predominantly GluR2/3 and GluR4 located postsynaptically at cortico-thalamic synapses in VB (Golshani et al. 2001). More recently a low level of ► **kainate receptor** subunits (GluR5/6/7) has been found postsynaptically beneath corticothalamic synapses in VB, although a synaptic role for these receptors has not been detected at this location.

### Inhibitory Interneurons

► **GABAergic inhibitory interneurons** are a prominent feature of thalamic relay nuclei, and it is well known that ► **GABAA** and ► **GABAB receptors** play a prominent part in synaptic processing at both the pre- and post-synaptic level (Crunelli and Leresche 1991). There are two major groups of GABAergic neurones in the thalamic relay nuclei: the intrinsic Golgi II type interneurons, and the neurones of the ► **thalamic reticular nucleus** (TRN) which exert their influence *via* their projection into the relay nuclei (Ralston 1983). In rodents, only the latter population appears to be present (Ralston 1983) and performs a profound gating function upon thalamic transmission (Sherman and Guillery 2000). These GABAergic mechanisms may play an important part in the processing of sensory information in both acute and chronic nociception (Roberts et al. 1992). Intriguingly the GABAergic output from TRN is itself modulated by metabotropic ► **glutamate receptors** (Salt 2002) and ► **kainate receptors** (Binns et al. 2003). Such mechanisms indicate that sensory transmission through VB is not only dependent upon excitatory transmission, but that reduction of inhibitory transmission (i.e. functional disinhibition) could also have a significant potentiating influence on transmission.

### Glia

The concept that glial cells or astrocytes may be active participants in brain function is supported by several findings, including that astrocytes possess ion channels and neurotransmitter receptors for a variety of neurotransmitters, and that astrocytes contain and can release excitatory amino acids such as glutamate and homocysteate (Haydon 2001). It is known that, in the ventrobasal thalamus, activity in astrocytes can evoke NMDA-receptor mediated responses in thalamic relay neurones *in vitro* (Parri et al. 2001), and that homocysteate can be released from thalamus *in vivo* and activate NMDA receptors (Do et al. 2004). This raises the possibility that astrocytes play a key role in the responses of thalamic neurones to sensory stimuli.

### Neurotransmitters and Thalamic Integrative Function in Nociception

A role for NMDA receptors in the signalling of acute thermal and mechanical nociceptive responses in the VB thalamus at the single-neurone and behavioural level is now well established (Salt and Eaton 1996; Millan 1990). However, it is important to note that transmission of non-nociceptive sensory information to the thalamus can also show substantial NMDA receptor involvement (Salt and Eaton 1996). In addition, *both* Group I mGlu (mGlu1 and mGlu5) receptors also participate in the signalling of acute nociceptive information but not in the signalling of non-nociceptive mechanoreceptor input to the VB thalamus (Salt and Binns 2000). This functional distinction is intriguing, as there appears to be remarkable anatomical and neurochemical similarity between lemniscal (which carries non-nociceptive information) and spinothalamic (which carries nociceptive and convergent multimodal somatosensory information) inputs to the ventrobasal thalamus (Ralston 1983; Ma et al. 1987; Liu 1997). In view of this, it is conceivable that the recruitment of additional neural circuitry during noxious stimuli underlies the Group I mGlu receptor involvement in nociceptive responses. A possible source of this additional input could be the dense cortico-thalamic projection (Eaton and Salt 1995), which is known to be glutamatergic and which impinges upon mGlu receptors, particularly mGlu1 (see above). This is a particularly attractive hypothesis in the case of mGlu1 receptors, as these are restricted to corticothalamic synapses and because NMDA-receptor mediated responses have been shown to be modulated by activation of Group I (i.e. mGlu1 / mGlu5) receptors in several brain areas, as has modulation of AMPA-receptor mediated responses. In the VB, activation of mGlu1 receptors potentiates responses mediated *via* either AMPA or NMDA receptors *in vivo* (Salt and Binns 2000). It is probable that this is due to the direct effects of mGlu1 activation on neuronal membrane potential and resistance rather than a specific interaction at the receptor level, or that the potentiation that is seen is

a combination of these factors (Salt and Binns 2000). Thus the cortico-thalamic input would be able to exert a profound influence on ionotropic receptor mediated responses, if the sensory stimulus was appropriate to recruit activity in the cortico-thalamic output. This may well be the case for nociceptive stimuli (Eaton and Salt 1995; Millan 1999). A further enabling factor could be the removal of the inhibitory influence arising from the TRN (see above) (Roberts et al. 1992), and in this respect it is interesting to note that TRN neurones are inhibited by noxious peripheral stimulation (Peschanski et al. 1980).

### Modulatory Systems

Transmission through the thalamic relay nuclei, including those serving somatosensation and nociception, can be modulated by amine neurotransmitters such as serotonin, noradrenaline or acetylcholine (McCormick 1992). These systems appear to be associated with activating systems that govern states of wakefulness and arousal, and it is unclear to what extent these specifically affect nociceptive processing at the thalamic level. In addition, the nitric oxide (NO) system is associated with some of these activating systems (Vincent 2000), and it has been shown that NO can modulate somatosensory transmission through the thalamus (Shaw and Salt 1997). Similarly, a number of ► **neuropeptides** have been located in thalamic nuclei and afferents, but their function remains unclear (Sherman and Guillery 2000). Of particular interest to nociceptive processing is the finding that ► **cannabinoid receptors** modulate acute nociceptive responses of VB neurones in the rat (Martin et al. 1996). However the precise mechanisms of this action remain to be elucidated.

### Thalamic Transmitter Mechanisms and Adaptive Changes

It is known that thalamic neurones change their response and firing characteristics in conditions of chronic pain or chronic pain models, and a role for mGlu receptors and NMDA receptors in models of synaptic plasticity has been known for some time. Thus it is conceivable that changes in thalamic neurone responses may be due to changes in glutamate receptor function and may even be a consequence of activation of these receptors as has been suggested for the spinal cord (Willis 2002). Indeed there is already evidence to suggest that NMDA receptors in the thalamus are involved in inflammation-produced hyperalgesia in the rat. In arthritic rats, decreases in thalamic expression (including VB) of mRNA for mGlu1, mGlu4 and mGlu7 receptors have been observed (Neto et al. 2000). Interestingly, in these same animals, mGlu3 mRNA expression is elevated in the TRN and this expression appears to be both in presumed GABAergic neurones and in glial cells (Neto et al. 2000). Furthermore, injection into TRN of an antagonist for this receptor was found to be anti-hyperalgesic in such rats (Neto and Castro-Lopes 2000). Thus it may be that

thalamic mGlu receptor mechanisms are important in both the induction of hyperalgesia and in the expression of hyperalgesic behaviours. It is noteworthy, however, that changes in other thalamic transmitter systems may also occur in chronic pain conditions, for example in the serotonergic system (Goettl et al. 2002). It is therefore important to note that transmitter systems should not be regarded in isolation.

### Conclusions

It is evident that glutamate receptors are of fundamental importance in the transmission of nociceptive and other sensory information through the thalamus. Activation of NMDA receptors and certain mGlu receptors may be particularly important in the signalling and processing of nociceptive information, as well as in the induction of longer-term plastic changes in response to chronic noxious stimulation or injury. Molecular intervention at some of these sites may have considerable therapeutic potential.

### References

1. Binns KE, Turner JP, Salt TE (2003) Kainate receptor (GluR5)-mediated disinhibition of responses in rat ventrobasal thalamus allows a novel sensory processing mechanism. *J Physiol (Lond)* 551:525–537
2. Broman J (1994) Neurotransmitters in subcortical somatosensory pathways. *Anat Embryol* 189:181–214
3. Crunelli V, Leresche N (1991) A role for GABAB receptors in excitation and inhibition of thalamocortical cells. *Trends Neurosci* 14:16–21
4. Do KQ, Benz B, Binns KE, Eaton SA, Salt TE (2004) Release of homocysteic acid from rat thalamus following stimulation of somatosensory afferents in vivo: feasibility of glial participation in synaptic transmission. *Neurosci* 124:387–93
5. Dougherty PM, Li YJ, Lenz FA, Rowland L, Mittman S (1996) Evidence That Excitatory Amino Acids Mediate Afferent Input to the Primate Somatosensory Thalamus. *Brain Res* 728:267–273
6. Eaton SA, Salt TE (1995). The role of excitatory amino acid receptors in thalamic nociception. In: Besson JM, Guilbaud G, Ollat H (eds) *Forebrain areas involved in pain processing*. John Libbey Eurotext, Paris, pp 131–141
7. Goettl VM, Huang Y, Hackshaw KV et al. (2002) Reduced basal release of serotonin from the ventrobasal thalamus of the rat in a model of neuropathic pain. *Pain* 99:359–366
8. Golshani P, Liu XB, Jones EG (2001) Differences in Quantal Amplitude Reflect GluR4-Subunit Number at Corticothalamic Synapses on Two Populations of Thalamic Neurons. *Proceedings of the National Academy of Sciences of the United States of America* 98:4172–4177
9. Haydon PG (2001) Glia: listening and talking to the synapse. *Nat Rev Neurosci* 2:185–193
10. Liu XB (1997) Subcellular distribution of AMPA and NMDA receptor subunit immunoreactivity in ventral posterior and reticular nuclei of rat and cat thalamus. *J Comp Neurol* 388:587–602
11. Ma W, Peschanski M, Ralston III HJ (1987) The differential synaptic organization of the spinal and lemniscal projections to the ventrobasal complex of the rat thalamus. Evidence for convergence of the two systems upon single thalamic neurons. *Neurosci* 22:925–934
12. Martin LJ, Blackstone CD, Haganir RL et al. (1992) Cellular localization of a metabotropic glutamate receptor in rat brain. *Neuron* 9:259–270
13. Martin WJ, Hohmann AG, Walker JM (1996) Suppression of noxious stimulus-evoked activity in the ventral posterolateral nucleus of the thalamus by a cannabinoid agonist: Correlation be-

- tween electrophysiological and antinociceptive effects. *J Neurosci* 16:6601–6611
14. McCormick DA (1992) Neurotransmitter actions in the thalamus and cerebral cortex and their role in neuromodulation of thalamocortical activity. *Prog Neurobiol* 39:337–388
  15. Millan MJ (1999) The induction of Pain: an integrative review. *Progress in Neurobiology* 57:1–164
  16. Neto FL, Castro-Lopes JM (2000) Antinociceptive effect of a group II metabotropic glutamate receptor antagonist in the thalamus of monoarthritic rats. *Neurosci Lett* 296:25–28
  17. Neto FL, Schadrack J, Platzer S et al. (2000) Expression of metabotropic glutamate receptors mRNA in the thalamus and brainstem of monoarthritic rats. *Mol Brain Res* 81:140–154
  18. Parri HR, Gould TM, Crunelli V (2001) Spontaneous Astrocytic  $Ca^{2+}$  Oscillations in Situ Drive NMDA-Mediated Neuronal Excitation. *Nature Neuroscience* 4:803–812
  19. Peschanski M, Guilbaud G, Gautron M (1980) Neuronal responses to cutaneous electrical and noxious mechanical stimuli in the nucleus reticularis thalami of the rat. *Neurosci Lett* 20:165–170
  20. Ralston III HJ (1983). The synaptic organization of the ventrobasal thalamus in the rat, cat and monkey. In: Macchi G, Rustioni A, Spreafico R (eds) *Somatosensory Integration in the Thalamus*. Elsevier Science Publishers, Amsterdam, pp 241–250
  21. Roberts WA, Eaton SA, Salt TE (1992) Widely distributed GABA-mediated afferent inhibition processes within the ventrobasal thalamus of rat and their possible relevance to pathological pain states and somatotopic plasticity. *Experimental Brain Research* 89:363–372
  22. Salt TE (2002) Glutamate Receptor Functions in Sensory Relay in the Thalamus. *Philosophical Transactions of the Royal Society of London Series B-Biological Sciences* 357, 1759–1766
  23. Salt TE, Binns KE (2000) Contributions of mGlu1 and mGlu5 receptors to interactions with N-methyl-D-aspartate receptor-mediated responses and nociceptive sensory responses of rat thalamic neurones. *Neuroscience* 100:375–380
  24. Salt TE, Eaton SA (1996) Functions of ionotropic and metabotropic glutamate receptors in sensory transmission in the mammalian thalamus. *Progress in Neurobiology* 48:55–72
  25. Salt TE, Eaton SA (1991) Sensory excitatory postsynaptic potentials mediated by NMDA and non-NMDA receptors in the thalamus *in vivo*. *Eur J Neurosci* 3:296–300
  26. Shaw PJ, Salt TE (1997) Modulation of Sensory and Excitatory Amino Acid Responses by Nitric Oxide Donors and Glutathione in the Ventrobasal Thalamus of the Rat. *Eur J Neurosci* 9:1507–1513
  27. Sherman SM, Guillery RW (2000) *Exploring the Thalamus*. Academic Press, New York
  28. Vincent SR (2000) The ascending reticular activating system – from aminergic neurons to nitric oxide. *J Chem Neuroanat* 18:23–30
  29. Willis WD (2002) Long-term potentiation in spinothalamic neurons. *Brain Res Rev* 40:202–214

- ▶ [Complex Chronic Pain in Children, Interdisciplinary Treatment](#)
- ▶ [Guillain-Barré Syndrome](#)
- ▶ [Opioids in Geriatric Application](#)
- ▶ [Opioid Responsiveness in Cancer Pain Management](#)

## Nociceptive Pathways

### Definition

Neural circuits, including long sensory tracts, which convey information related to noxious stimuli are called nociceptive pathways. The consequences of nociceptive processing can include pain sensation, motivational-affective responses, reflex behavior, endocrine changes, and learning and memory of painful events.

- ▶ [Nociceptive Circuitry in the Spinal Cord](#)
- ▶ [Spinothalamic Tract Neurons, Descending Control by Brainstem Neurons](#)

## Nociceptive Primary Afferents

N

### Definition

Primary afferent neurons that respond to tissue damaging stimuli.

- ▶ [Nociceptive Afferents](#)
- ▶ [Opioid receptors at postsynaptic sites](#)

## Nociceptive Processing in the Amygdala, Neurophysiology and Neuropharmacology

VOLKER NEUGEBAUER  
 Department of Neuroscience and Cell Biology,  
 University of Texas Medical Branch, Galveston, TX,  
 USA  
 voneugeb@utmb.edu

### Synonyms

Amygdala, Nociceptive Processing

### Definition

The amygdala is an almond-shaped structure in the medial temporal lobe and consists of several functionally and pharmacologically distinct nuclei. The central nucleus of the amygdala (CeA), which has been designated as the “▶ nociceptive amygdala”, plays an important role in pain processing and pain modulation.

## Nociceptive Pain

### Definition

Pain caused by ongoing activation of A $\delta$  and C nociceptors in response to a noxious stimulus of somatic or visceral structures such as inflammation, trauma, or disease.

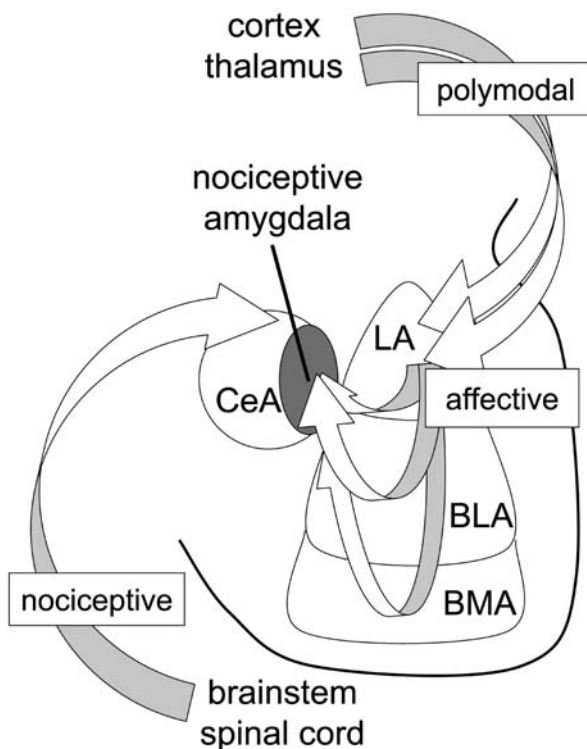
- ▶ [Analgesic Guidelines for Infants and Children](#)
- ▶ [Cancer Pain, Goals of a Comprehensive Assessment](#)
- ▶ [Cancer Pain Management, Treatment of Neuropathic Components](#)

## Characteristics

As part of the limbic system the amygdala plays a key role in attaching emotional significance to sensory stimuli, emotional learning and memory and affective states and disorders. The amygdala receives information from all sensory modalities; it also processes nociceptive information and projects to pain modulatory systems through forebrain and brainstem connections. Accumulating evidence suggests that the amygdala integrates nociceptive information with affective content, contributes to the emotional response to pain and serves as a neuronal interface for the reciprocal relationship between pain and affective states and disorders.

## Anatomy and Circuitry

The amygdala includes at least 12 different nuclei. The lateral, basolateral, basomedial and central nuclei of the amygdala (LA, BLA, BMA and CeA, respectively) are of particular importance for the processing and evaluation of sensory information (Fig. 1). The LA is an in-



**Nociceptive Processing in the Amygdala, Neurophysiology and Neuropharmacology, Figure 1** Circuitry of information processing in the principal sensory nuclei of the amygdala. The lateral nucleus of the amygdala (LA) receives and integrates polymodal information from thalamic and cortical areas. This highly processed information with affective content is then distributed to other amygdaloid nuclei, including the central nucleus (CeA), either directly or through the basolateral (BLA) and basomedial (BMA) nuclei. The CeA is the major output nucleus of the amygdala and forms widespread connections with forebrain and brainstem areas. The latero-capsular division of the CeA represents the “nociceptive amygdala”.

put region; receiving sensory information from the thalamus; particularly the posterior areas and cortex, including insular cortex and association cortical areas (LeDoux 2000; Neugebauer et al. 2004; Pare et al. 2004; Price 2003). The LA represents the initial site of sensory convergence, processing and associative learning and plasticity in the amygdala (LeDoux 2000; Pare et al. 2004; Shi and Davis 1999). This highly processed information, which is a key element of the fear- and anxiety-related circuitry, is then transmitted to other amygdaloid nuclei, including the CeA (LeDoux 2000; Neugebauer et al. 2004; Pare et al. 2004).

The CeA serves as the output nucleus of major amygdala functions. The CeA integrates inputs from other amygdala nuclei without forming reciprocal intra-amygdaloid connections. Sensory information reaches the CeA from the LA, either directly or indirectly, as well as from the brainstem (parabrachial area, PB) and spinal cord (Bernard et al. 1996; Burstein and Potrebic 1993; Gauriau and Bernard 2002; Neugebauer et al. 2004). Contextual representations are transmitted from the hippocampus to the CeA through the BLA and BMA (LeDoux 2000).

The CeA forms widespread connections with various forebrain and brainstem areas that are involved in emotional behavior and emotional experience and regulate autonomic and somatomotor functions. Targets of CeA projections include the cholinergic basal forebrain nuclei and the ► **bed nucleus of the stria terminalis**, midline and mediadorsal thalamic nuclei and paraventricular hypothalamus via the ► **stria terminalis** and lateral hypothalamus and brainstem areas such as periaqueductal gray (PAG) and parabrachial area (PB) via the ► **ventral amygdaloid pathway** (LeDoux 2000; Neugebauer et al. 2004; Price 2003).

## Nociception and Nociceptive Plasticity

Within the CeA, the latero-capsular division is defined as the “nociceptive amygdala” because of the high content of neurons that respond exclusively or predominantly to ► **noxious stimuli** (Bernard et al. 1996; Neugebauer et al. 2004). The latero-capsular CeA receives nociceptive-specific information from the spinal cord and brainstem through the spino-parabrachio-amygdaloid pain pathway (Bernard et al. 1996; Gauriau and Bernard 2002) as well as through direct projections from the spinal cord (Burstein and Potrebic 1993).

Electrophysiological single-unit analysis in anesthetized rats has shown several characteristics of neurons in the nociceptive amygdala (Bernard et al. 1996; Gauriau and Bernard 2002; Neugebauer et al. 2004; Neugebauer and Li 2002). The majority of these neurons (80%) respond either exclusively (“nociceptive-specific” [NS] neurons) or predominantly (“multireceptive” [MR] neurons) to noxious stimuli. More neurons are excited than inhibited by noxious stimuli. A significant number



of “non-responsive” (NR) neurons (up to 20%) also exist in the latero-capsular CeA; they do not respond to somatic stimuli. NS and MR CeA neurons have large, mostly symmetrical bilateral receptive fields in the superficial and deep tissue; they respond to mechanical and thermal stimuli. Their stimulus-response functions are not monotonically increasing linearly but sigmoidally. These properties argue against a sensory-discriminative function of CeA neurons. Among neurons with predominantly cutaneous input, there appear to be more NS than MR neurons whereas a larger percentage of MR neurons can be found among neurons with receptive fields mainly in the deep tissue. It is believed that NS neurons receive input from the spino-parabrachio-amygdaloid pathway whereas MR neurons integrate nociceptive information with affective content from the polymodal LA-BLA circuitry (Fig. 1).

Accumulating evidence now suggests that neurons in the nociceptive amygdala develop plasticity in models of persistent inflammatory pain such as arthritis and colitis (Bird et al. 2005; Han and Neugebauer 2004; Han et al. 2005; Neugebauer and Li 2003; Neugebauer et al. 2003). Extracellular single-unit recordings in anesthetized rats showed that MR neurons and NR neurons, but not NS neurons, become sensitized to afferent inputs in a model of arthritis pain induced in one knee joint by the intraarticular injection of kaolin and carrageenan. Characteristics of the pain-related sensitization of MR neurons are as follows: the processing of mechanical, but not thermal, pain-related information is increased (upward shift of the stimulus-response functions); responses to stimulation of the arthritic knee as well as of non-injured tissue in other parts of the body are enhanced; the total size of the receptive field expands; a constant input evoked by orthodromic electrical stimulation in the PB produces greater activation; background activity is increased. Unlike changes in the peripheral nervous system and spinal cord in this arthritis model, changes in MR amygdala neurons develop with a biphasic time course; the first phase (1–3 h) reflects changes at the spinal cord and brainstem levels whereas the persistent plateau phase (>5 h) involves intra-amygdala plasticity. MR neurons serve to integrate and evaluate sensory-affective information in the context of pain. NS neurons would continue to distinguish between noxious and ► [Innocuous Input/Stimulus](#) at the stage of plasticity.

Evidence that the sensitization of amygdala neurons involves plastic changes within the amygdala comes from electrophysiological studies in brain slices *in vitro*. Coronal slices containing the amygdala were obtained from normal rats, from rats with a ► [Kaolin-Carrageenan Induced Arthritis](#) and from rats with a zymosan-induced colitis (Han and Neugebauer 2004; Han et al. 2004; Neugebauer et al. 2003). Whole-cell patch-clamp recordings in slices from rats with arthritis or colitis (6 h post induction) showed enhanced synap-

tic transmission and increased neuronal excitability of CeA neurons with input from the PB and from the BLA (resembling the MR neurons *in vivo*). Synaptic plasticity in the reduced preparation is thus maintained at least in part independently of continuous input from the site of the somatic or visceral inflammation.

### Pharmacology of Nociception and Plasticity

The roles of ionotropic and metabotropic glutamate receptors in brief nociceptive processing and persistent pain have been studied in CeA neurons.

#### Ionotropic Glutamate Receptors (Bird et al. 2005; Li and Neugebauer 2004b)

Extracellular single-unit recordings of CeA neurons in anesthetized animals showed that non-NMDA receptors are involved in the responses to innocuous and brief (15 s) noxious stimuli whereas NMDA receptors contribute only to the processing of nociceptive information. In the kaolin / carrageenan arthritis pain model (6 h post induction), activation of NMDA and non-NMDA receptors is required for the pain-related sensitization of CeA neurons. In these studies, antagonists at NMDA receptors (AP5) and non-NMDA (NBQX) receptors were administered into the CeA by microdialysis.

Pain-related synaptic plasticity recorded (patch-clamp) in the CeA in brain slices from arthritic rats involves enhanced function of postsynaptic NMDA receptors through PKA-dependent phosphorylation of the NR1 subunit.

#### Metabotropic Glutamate Receptors (Li and Neugebauer 2004a; Neugebauer et al. 2003)

Electrophysiological studies of amygdala neurons *in vivo* and *in vitro* have shown an important role of group I metabotropic glutamate receptors (mGluRs), which include the mGluR1 and mGluR5 subtypes and couple to G-proteins to activate phospholipase C, PKC and MAP kinases such as ERK. Extracellular single-unit recordings of CeA neurons in anesthetized rats suggest a change of mGluR1 function in the amygdala in pain-related sensitization, whereas mGluR5 is involved in brief as well as prolonged nociception. Activation of group I mGluR1 and mGluR5 by the agonist DHPG enhances the responses of CeA neurons to brief (15 s) innocuous and noxious stimuli under normal conditions. This effect can be mimicked by an mGluR5 agonist (CHPG). In the kaolin / carrageenan arthritis pain model (6 h post induction), the facilitatory effects of DHPG, but not CHPG, increased. Block of mGluR1 by CPCCOEt inhibits the responses of sensitized CeA neurons in the arthritis pain state but has no effect under normal conditions before arthritis. An mGluR5 antagonist (MPEP) inhibits both brief nociceptive responses under normal conditions and prolonged nociception in the arthritis pain model. Agonists and antagonists were

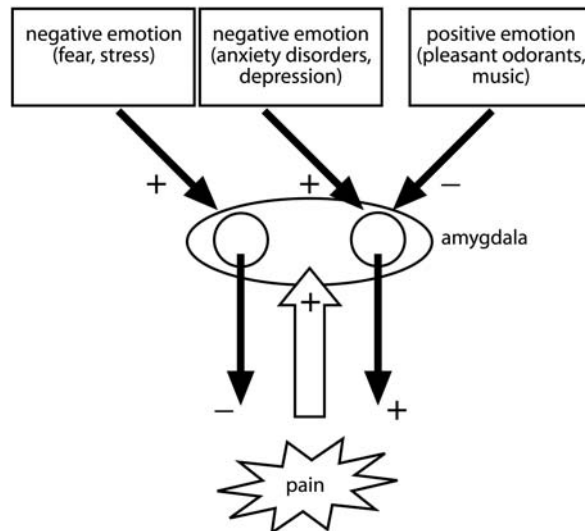
administered into the CeA by microdialysis. The roles of group II and III mGluRs in nociception and plasticity in the amygdala are not yet clear.

The contribution of group I mGluRs to normal synaptic transmission and pain-related synaptic plasticity in the amygdala was analyzed in brain slices *in vitro* using whole-cell voltage-clamp recordings of neurons in the nociceptive amygdala (Neugebauer et al. 2003). Synaptic transmission was studied at the nociceptive PB-CeA synapse and the polymodal-affective BLA-CeA synapse (Fig. 1). A group I mGluR1 and mGluR5 agonist (DHPG) and a mGluR5 agonist (CHPG) potentiate normal synaptic transmission similarly in CeA neurons in slices from normal rats. In slices from arthritic rats (6 h post induction), the effects of DHPG, but not CHPG, are increased, suggesting an enhanced function of mGluR1 rather than mGluR5. Block of mGluR1 with an antagonist (CPCCOEt) has no effect on synaptic transmission in CeA neurons in slices from normal rats but inhibits synaptic plasticity in slices from arthritic rats. An mGluR5 antagonist (MPEP) inhibits basal synaptic transmission in CeA neurons in slices from normal rats and synaptic plasticity in slices from arthritic rats. Thus, enhanced receptor activation of mGluR1 appears to be a key mechanism of pain-related synaptic plasticity in the CeA. Importantly, these agents had no effect on membrane properties and neuronal excitability but affected paired-pulse facilitation, suggesting a pre- rather than post-synaptic site of action. These data suggest that pain-related plastic changes in the amygdala involve a critical switch of presynaptic mGluR1 function.

### Pain Modulation by the Amygdala

As part of the pain system and a key player in affective states and disorders, the amygdala contributes to the emotional response to pain and its modulation by affective state (Fig. 2). The CeA, including the latero-capsular division, forms direct and indirect connections with descending pain-modulating systems in the brainstem (Neugebauer et al. 2004). Descending pain control can be facilitatory (pro-nociceptive) and inhibitory (anti-nociceptive) (Gebhart 2004; Heinricher and McGaraughty 1999). Recent behavioral studies suggest that the consequence of pain-related plasticity in the CeA is increased pain. Pharmacologic inactivation of the CeA with mGluR1, mGluR5 or CGRP1 receptor antagonists inhibited pain behavior of arthritic rats (Han and Neugebauer 2005; Han et al. 2005).

Activity in the amygdala can be modified by negative and positive emotions, which in turn are known to reduce (stress, fear; music) or enhance (anxiety) pain (Fig. 2). The dependence of amygdala activity on affective state and the dual coupling of the amygdala to inhibitory and facilitatory pain control may explain some of the differential effects of amygdala stimulation and / or activation on pain behavior.



**Nociceptive Processing in the Amygdala, Neurophysiology and Neuropharmacology, Figure 2** Pain, emotions, and the amygdala: a hypothetical model. Pain produces plastic changes in the amygdala. Affective states also modify activity in the amygdala; negative emotions generally increase amygdala activity, whereas positive emotions have been shown to deactivate the amygdala. The amygdala is linked to facilitatory and inhibitory pathways to modulate pain. Negative emotions associated with pain reduction (fear and stress) would activate amygdala-linked inhibitory control systems, whereas negative affective states that correlate with increased pain (depression and anxiety disorders) would activate pain-facilitating pathways. Positive emotions inhibit amygdala coupling to pain facilitation. Reprinted with permission of Sage Publications, Inc., from Neugebauer et al. (2004) The amygdala and persistent pain. *Neuroscientist* 10, p 232.

### References

- Bernard J-F, Bester H, Besson JM (1996) Involvement of the spino-parabrachio-amygdaloid and -hypothalamic pathways in the autonomic and affective emotional aspects of pain. *Prog Brain Res* 107:243–255
- Bird GC, Lash LL, Han JS, Zou X, Willis WD, Neugebauer (2005) PKA-dependent enhanced NMDA receptor function in pain-related synaptic plasticity in amygdala neurons. *J Physiol* 564.3:907–921
- Burstein R, Potrebic S (1993) Retrograde labeling of neurons in the spinal cord that project directly to the amygdala or the orbital cortex in the rat. *J Comp Neurol* 335:469–485
- Gauriau C, Bernard J-F (2002) Pain pathways and parabrachial circuits in the rat. *Exp Physiol* 87:251–258
- Gebhart GF (2004) Descending modulation of pain. *Neurosci Biobehav Rev* 27:729–737
- Han JS, Neugebauer V (2004) Synaptic plasticity in the amygdala in a visceral pain model in rats. *Neurosci Lett* 361:254–257
- Han JS, Neugebauer V (2005) mGluR1 and mGluR5 antagonists in the amygdala inhibit different components of audible and ultrasonic vocalizations in a model of arthritic pain. *Pain* 113:211–222
- Han JS, Bird GC, Neugebauer V (2004) Enhanced group III mGluR-mediated inhibition of pain-related synaptic plasticity in the amygdala. *Neuropharmacology* 46:918–926
- Han JS, Li W, Neugebauer V (2005) Critical role of calcitonin gene-related peptide 1 receptors in the amygdala in synaptic plasticity and pain behavior. *J Neurosci* 25:10717–28
- Heinricher MM, McGaraughty S (1999) Pain-modulating neurons and behavioral state. In: Lydic R, Baghdoyan HA (eds) *Handbook of Behavioral State Control*. CRC Press, New York, pp 487–503

11. LeDoux JE (2000) Emotion circuits in the brain. *Annu Rev Neurosci* 23:155–184
12. Li W, Neugebauer V (2004a) Differential roles of mGluR1 and mGluR5 in brief and prolonged nociceptive processing in central amygdala neurons. *J Neurophysiol* 91:13–24
13. Li W, Neugebauer V (2004b) Block of NMDA and non-NMDA receptor activation results in reduced background and evoked activity of central amygdala neurons in a model of arthritic pain. *Pain* 110:112–122
14. Neugebauer V, Li W (2002) Processing of nociceptive mechanical and thermal information in central amygdala neurons with knee-joint input. *J Neurophysiol* 87:103–112
15. Neugebauer V, Li W (2003) Differential sensitization of amygdala neurons to afferent inputs in a model of arthritic pain. *J Neurophysiol* 89:716–727
16. Neugebauer V, Li W, Bird GC et al. (2003) Synaptic plasticity in the amygdala in a model of arthritic pain: differential roles of metabotropic glutamate receptors 1 and 5. *J Neurosci* 23:52–63
17. Neugebauer V, Li W, Bird GC et al. (2004) The amygdala and persistent pain. *Neuroscientist* 10:221–234
18. Pare D, Quirk GJ, Ledoux JE (2004) New vistas on amygdala networks in conditioned fear. *J Neurophysiol* 92:1–9
19. Price JL (2003) Comparative aspects of amygdala connectivity. In: Shinnick-Gallagher P, Pitkanen A, Shekhar A et al (eds) *The amygdala in brain function. Basic and clinical approaches*, vol 985. The New York Academy of Sciences, New York, pp 50–58
20. Shi C, Davis M (1999) Pain pathways involved in fear conditioning measured with fear-potentiated startle: lesion studies. *J Neurosci* 19:420–430

## Nociceptive Processing in the Cingulate Cortex, Behavioral Studies in Animals

- ▶ Cingulate Cortex, Nociceptive Processing, Behavioral Studies in Animals

## Nociceptive Processing in the Cingulate Cortex, Behavioral Studies in Human

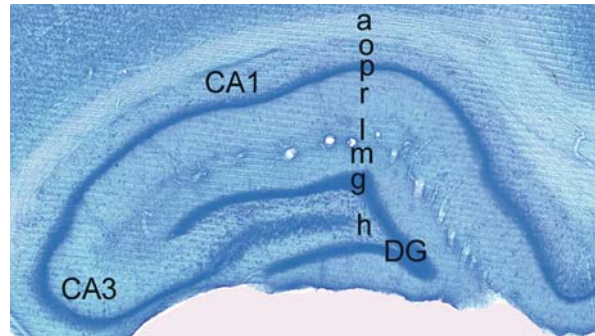
- ▶ Pain Processing in the Cingulate Cortex, Behavioral Studies in Humans

## Nociceptive Processing in the Hippocampus and Entorhinal Cortex, Neurophysiology and Pharmacology

SANJAY KHANNA  
Department of Physiology, National University of Singapore, Singapore  
phsks@nus.edu.sg

### Definition

The hippocampus is the simplest part of the cortex, the ▶ **allocortex**, which, in humans, is arched around the mesencephalon, while in rodents it arches over the thalamus (Amaral and Witter 1995). The various fields of the hippocampus and its layers are illustrated in Figure 1. The principal neurons in the hippocampus are



**Nociceptive Processing in the Hippocampus and Entorhinal Cortex, Neurophysiology and Pharmacology, Figure 1** Digitized image of Nissl stained transverse section taken through dorsal hippocampus and dentate gyrus (DG) of rat. The hippocampus is sub-divided into various fields, of which the prominent ones are CA1 and CA3. In a dorsal to ventral order in the transverse section, the layers of the hippocampus and DG are: a, alveus (which is as a fiber bundle marking the outer boundary of the hippocampus); o, stratum oriens; p, stratum pyramidale; r, stratum radiatum; l, stratum lacunosum-moleculare; m, stratum moleculare; g, stratum granulosum; h, hilus.

the ▶ **pyramidal cells** that are localized in the stratum pyramidale (Fig. 1).

Both anatomical and physiological studies suggest that the entorhinal cortex is a major source of afferent input to the hippocampus, either directly or indirectly via the dentate gyrus (Amaral and Witter 1995). Indeed, stimulation of perforant path fibers from the entorhinal cortex evokes both short- and long-latency excitatory responses in CA1, which are suggested to involve direct entorhinal to CA1 projection, and a ▶ **sequential relay** from the entorhinal cortex to CA1 via the dentate gyrus and CA3, respectively.

### Characteristics

Melzack and Casey (1968) proposed that the limbic forebrain structures, including the hippocampus, are involved in ‘aversive drive and affect that comprise the motivational dimension of pain’. Indeed, lesions of the hippocampus-dentate gyrus region reduce aversive foot shock-induced ▶ **conditioned place avoidance** (Selden et al. 1991), while intra-hippocampal administration of a NMDA receptor antagonist attenuated nociceptive behaviors to hind paw injection of the algogen formalin (▶ **formalin test**), a model of persistent clinical inflammatory pain (McKenna and Melzack 2001).

Consistent with a role in affect-motivation, a functional magnetic resonance imaging study reported that the anxiety-induced hyperalgesia in man was associated with bilateral activation in the entorhinal area, which correlated with activity in anterior cingulate cortex and insular cortex (Ploghaus et al. 2001). Furthermore, the hippocampus was also activated on peripheral application of high intensity noxious heat stimulation, relative to similar application of the stimulus at a lower intensity (Ploghaus et al. 2001). Indeed, and consistent with a role as a central intensity monitor, electrophys-



## Nociceptive Processing in the Brainstem

JONATHAN O. DOSTROVSKY<sup>1</sup>,  
BARRY J. SESSLE<sup>1, 2</sup>

<sup>1</sup>Department of Physiology, Faculty of Medicine,  
University of Toronto, Toronto, ON, Canada

<sup>2</sup>Faculty of Dentistry, University of Toronto,  
Toronto, ON, Canada  
j.dostrovsky@utoronto.ca,  
barry.sessle@utoronto.ca

### Introduction

The craniofacial region is principally innervated by the trigeminal (V) nerve, which terminates in the trigeminal brainstem nuclear complex (TBNC). The caudal portion of the TBNC is largely homologous to the spinal cord dorsal horn in terms of anatomy, neurochemistry and physiology and is termed the subnucleus caudalis (Vc) or medullary dorsal horn. It is the major region involved in the processing of pain and temperature sensations from the head. However, the more rostrally located subnuclei interpolaris (Vi) and oralis (Vo) also receive some nociceptive afferents and contain neurons responding to noxious stimuli. There is evidence that these subnuclei contribute to the perception of pain and especially pain of intraoral origin. There is no obvious homologous region in the spinal cord.

The craniofacial region contains several unique structures which include the tooth pulp and the cornea, as well as several other deep and intraoral tissues such as the temporomandibular joint (TMJ), the intracranial meninges and vessels and the intraoral mucosa. Pathological changes in these structures or their central representations can result in several pain conditions unique to the trigeminal region and these are described in the field ► [orofacial pain](#). There is mounting evidence for sex differences in pain and analgesia, e.g. temporomandibular disorders (TMD) and migraine headaches are much more prevalent in females. Experimental studies in both animals and humans are revealing clear sex differences in peripheral and central neural processes underlying craniofacial nociception (e.g. Cairns et al. 2003; Okamoto et al. 2003). For further details see ► [trigeminal brainstem nuclear complex, anatomy](#) ► [trigeminal brainstem nuclear complex, physiology](#) ► [trigeminal brainstem nuclear complex](#) ► [immunohistochemistry and neurochemistry](#) ► [nociceptors in the dental pulp](#) ► [ocular nociceptors](#) ► [nociceptors in the orofacial region \(temporomandibular joint and masseter muscle\)](#) ► [nociceptors in the orofacial region \(meningeal/cerebrovascular\)](#) ► [nociceptors in the orofacial Region \(skin/mucosa\)](#).

### Role of the Vc in Orofacial Nociceptive Processing

Several of the essays point out that most of the small diameter trigeminal (V) primary afferents terminate in the Vc, which is a laminated structure with many morphological and functional similarities with the spinal dorsal horn (although see below). There are 7 lines of evidence that the Vc is critical in V brainstem nociceptive processing. These include a direct projection to higher brain centers involved in pain perception and other aspects of pain behavior. In addition, by virtue of these ascending projections, the Vc has recently been documented to be essential for the expression of central sensitization in rostral elements of the V brainstem complex and ventrobasal thalamus (e.g. the Vo) (Chiang et al. 2002; Chiang et al. 2003). The extensive range of convergent afferent inputs to the Vc contributes to the development of the central sensitization that can be induced by inflammation or injury of peripheral tissues or nerves. Moreover, most Vc nociceptive neurons have in addition to a cutaneous receptive field (RF) also a deep RF (e.g. in the TMJ, muscle, tooth pulp, dura). The particular efficacy of deep nociceptive afferent inputs in inducing central sensitization, including an expansion of both their cutaneous and deep RFs, represent neuronal properties that may explain the poor localization of deep pain, as well as contribute to the spread and referral of pains that are typical of deep pain conditions such as TMD, toothaches and headaches (see ► [orofacial pain](#)).

The neurons in the Trigeminal Complex (TBNC) and particularly those in the Vc are subject to modulatory influences originating locally within the Vc or in more rostral parts of the complex as well as descending modulatory influences from brainstem, in particular the rostral ventromedial medulla (RVM) (Dubner and Ren 2004). These descending influences are very similar to those directed at the spinal dorsal horn and are described in ► [descending modulation of nociceptive processing](#).

As mentioned above, a unique feature of the V system is the processing of nociceptive inputs from afferents supplying structures not found elsewhere in the body; these include the tooth pulp, periodontal tissues, cornea and nasal mucosa. Another unique feature is the dual organization of the Vc in the representation of some orofacial tissues. Some noxious stimuli (e.g. to cornea or TMJ) evoke a bimodal distribution of c-fos labeled neurons in the Vc that includes c-fos expression in the rostral Vc / caudal Vi transitional zone as well as in the transitional region between the caudal part of the Vc and the upper cervical spinal cord (see Bereiter et al. 2000; Dubner and Ren 2004). These findings are consistent with electrophysiological evidence of neurons responsive to corneal or TMJ inputs in one or both of these regions. The caudal Vc merges



without clear boundaries with the cervical dorsal horn, while the rostral Vc forms a distinctive transition region with the Vi. This transition region has a ventral Vi / Vc transition area, which is especially clear in rodents, and a dorsomedial transition area. It is becoming apparent that these 2 areas of the rostral Vc and the caudal Vc each have their own unique morphological and functional features that may be differentially involved in contributing to perceptual, autonomic, endocrine and muscle reflex responses to noxious stimulation of different orofacial tissues, in particular involving ophthalmic structures (Bereiter et al. 2000; Dubner and Ren 2004).

Further investigation of these different areas within the Vc, as well as caudal to the Vc, is needed to determine their specific functional roles in orofacial pain processes. It has been over 50 years since the trigeminal spinal nucleus was divided into Vo, Vi and Vc subdivisions and over 25 years since the structural homologies between the Vc and the spinal dorsal horn were emphasized. These studies have shaped discussions of the special relationship between the Vc and craniofacial pain (see Sessle 2000; Sessle 2005), although this useful homology may need some revision as recent evidence cited above indicates that select portions of the Vc are organized differently from the spinal system. The region ventral to the Vc, which is part of the medullary reticular formation and is outside the main projection area of trigeminal primary afferents, also contains neurons that respond to noxious facial stimulation. Their receptive fields are usually larger than those in Vc, often bilateral and sometimes include the entire body (e.g. see Fujino et al. 1996; Nord and Kyler 1968; Yokota et al. 1991). In the rat, a population of neurons with large nociceptive receptive fields including the face is located in the subnucleus reticularis dorsalis. It has been suggested that this region is involved in circuits mediating ► **diffuse noxious inhibitory controls** (Villanueva et al. 1996).

#### **Role of Rostral Components of V Brainstem Complex**

Morphological, physiological, neurochemical and behavioral evidence support the involvement of more rostral components of the TBNC in orofacial nociceptive processing, especially in the case of the Vo. For example, lesions of rostral components may disrupt some pain behaviors and substantial numbers of NS and WDR neurons exist in the rostral components. These neurons have cutaneous RFs that are usually localized to intraoral or perioral areas and many can be activated by tooth pulp stimulation. These findings have raised the possibility that the rostral nociceptive neurons, particularly those in the Vo, are principally involved in intraoral and perioral nociceptive processing. Moreover, it is probable that their nociceptive afferent

inputs are predominantly relayed through more caudal regions, such as the Vc, which exerts a considerable modulatory influence over Vo nociceptive processes. Although some rostral neurons may directly receive primary afferent inputs from the tooth pulp, it is not clear that these inputs are nociceptive. How then can nociceptive phenomena occur in the rostral components when, especially in the case of the Vo, they lack an anatomical and in many instances a neurochemical substrate generally considered necessary for nociceptive processing? One possible explanation is that these substrates, although typical of the Vc and the spinal dorsal horn, are not essential for all types of nociceptive phenomena. In support of this possibility are the observations that nociceptive neurons contributing to nociceptive behavior occur in some spinal cord and brainstem areas devoid of some of these substrates (e.g. lateral cervical nucleus, reticular formation) (Dubner and Bennett 1983).

Another explanation lies in the anatomical and neurochemical framework for nociceptive processing that typifies the Vc and in its ascending projections to the rostral components of the TBNC. Parada et al. (1997) have argued that the cutaneous C fiber related nociceptive responses of Vo cutaneous nociceptive neurons that can be blocked by systemic administration of the NMDA antagonist MK-801 may depend on the well-documented ascending projection from the Vc that exerts a net facilitatory modulatory influence on Vo neurons (for review see Sessle 2000), since the Vc does have the features (NMDA receptors, C-fiber afferent terminals, substantia gelatinosa) considered necessary for these nociceptive phenomena. Furthermore, local application of MK-801 or morphine to the Vc can block the C-fiber related activity of some Vo nociceptive neurons. An analogous argument has also been used as an explanation for the neuroplastic changes that have been documented in the Vo and in the main sensory nucleus subsequent to C-fiber depletion induced by the neonatal application of capsaicin. Nonetheless, MK-801 applied directly to the Vo itself can antagonize Vo nociceptive neuronal changes induced by afferent inputs evoked from the tooth pulp (Park et al. 2001), which suggests that NMDA receptor mechanisms do operate within the Vo (see Sessle 2000 for references and further details).

Collectively, these various findings raise the possibility that, on the one hand, the cutaneous RF and response properties of rostral nociceptive neurons, particularly in the Vo, may be dependent on caudal regions such as the Vc for the relay of nociceptive signals from primary afferents supplying superficial craniofacial tissues. On the other hand, some of the extensive pulp afferent inputs to and effects upon neurons in the rostral TBNC may be dependent on relays in both rostral and

caudal components. Such a view, nonetheless, is still largely speculative and the relative roles of the rostral and caudal TBNC components, not only in cutaneous nociceptive mechanisms but also in nociceptive responses to noxious stimulation of deep craniofacial tissues and tooth pulp, represent an important issue requiring further research.

#### Ascending Projections and Higher Level Processing of Trigeminal Nociceptive Inputs

The nociceptive signals from the TBNC are relayed on to higher levels and in particular to the thalamus and from there to cerebral cortex. The thalamus receives direct contralateral input from each of the TBNC subnuclei (Kemplay and Webster 1989; Mantle-St John and Tracey 1987). The majority of the TBNC neurons projecting to the contralateral thalamus are found in the trigeminal principal nucleus, terminate in the ventroposterior medial nucleus (VPM) and are primarily involved in tactile sensation. The remaining neurons are located in the Vi, the Vo and the Vc. However, the major thalamic projection related to pain and temperature perception arises from neurons in the contralateral Vc and is equivalent to the spinothalamic tract (for references see Discussion in Craig 2004).

The trigeminothalamic neurons in the Vc are located primarily in laminae I and V. Those in lamina V have a major projection to the VPM (or its borders in the cat), but those in lamina I terminate in several other regions, which are species dependent. For example, in the monkey, lamina I neurons project primarily to the posterior ventromedial nucleus (VMpo) as well as to the ventrocaudal medialis dorsalis (MDvc), but have only a sparse projection to the VPM (Craig 2004). In the cat, the main projections of lamina I neurons are to the ventral border of the VPM and adjacent nuclei, the dorsomedial VPM and the nucleus submedius (Craig 2003). In the rat, lamina I neurons project largely to the VPM, the nucleus submedius, the posterior nucleus and the posterior triangular nucleus (Iwata et al. 1992; Jasmin et al. 2004; Yoshida et al. 1991).

The main cortical targets of thalamic nuclei receiving nociceptive inputs are the insula, the primary and secondary somatosensory cortices and the cingulate. There are extensive connections between cortex and thalamus, which play an important although poorly understood role in processing nociceptive inputs. Most of the electrophysiological studies on responses of thalamic and cortical neurons to noxious stimuli have focused on inputs from the limbs and have revealed neurons with both NS and WDR type responses. These responses are generally similar to those of neurons in the spinal dorsal horn and the trigeminal Vc, but tend to have increased and fluctuating spontaneous activity (see reviews by Kenshalo and Willis 1991; Willis

1997). Sections ► [Nociceptive Processing in the Thalamus](#) and ► [Cortical and Limbic Mechanisms Mediating Pain and Pain-Related Behavior](#) provide further details of the roles of thalamus and cortex in pain.

In addition to the thalamus, TBNC neurons also project to several diencephalic and brain stem areas that are involved in regulation of autonomic, endocrine, affective and motor functions. In the rat, all TBNC subnuclei contain neurons that project directly to the hypothalamus (Malick and Burstein 1998). Most of these hypothalamic tract neurons in the Vc and C1-2 respond preferentially or exclusively to noxious mechanical and thermal stimulation to the facial skin and to electrical, mechanical and chemical stimulation of the dura mater (Burstein et al. 1998). There also are projections from the TBNC to the parabrachial and Kölliker-Fuse nuclei (Bernard et al. 1989; Feil and Herbert 1995; Hayashi and Tabata 1990). In particular, neurons in the Vc, including those in the superficial laminae, project to the external portion of the lateral parabrachial area, where many respond exclusively to noxious stimuli (Hayashi and Tabata 1990). It has been proposed that this projection is part of a trigeminopontoamygdaloid pathway involved in the affective, behavioral and autonomic reactions to noxious stimuli (Bernard et al. 1989). Anatomical studies also have shown that there are projections from the TBNC to the adjacent reticular formation, the RVM, the periaqueductal gray, various brain stem autonomic nuclei, the superior colliculus, the ipsilateral cerebellum, the contralateral inferior olive and the nucleus of the solitary tract (Bruce et al. 1987; Craig 1995; Jacquin et al. 1989; Mantle-St John and Tracey 1987; Marfurt and Rajchert 1991; Key and Bandler 1998; Renuhan et al. 1986). Several of these projections are likely to be important in mediating nonperceptual (e.g. autonomic) effects elicited by nociceptive stimuli.

In summary, a great deal of information regarding the representation and processing of craniofacial nociceptive inputs in the TBNC and higher levels has been gained in recent years. Although there are many similarities between the spinal and trigeminal systems, there are also some important differences and some of these relate to unique structures and likely contribute to these pain conditions that are unique to this region. Nevertheless, there are still important gaps in our knowledge and further experimental studies are necessary to fully understand the mechanisms underlying the normal and pathological processing in the TBNC of nociceptive inputs from the craniofacial region.

#### References

1. Bereiter DA, Hirata H, Hu JW (2000) Trigeminal subnucleus caudalis: beyond homologies with the spinal dorsal horn. *Pain* 88:221–224

2. Bernard JF, Peschanski M, Besson JM (1989) A possible spino (trigemino)-ponto-amygdaloid pathway for pain. *Neurosci Lett* 100:83–88
3. Bruce LL, McHaffie JG, Stein BE (1987) The organization of trigeminothalamic and trigeminothalamic neurons in rodents: a double-labeling study with fluorescent dyes. *J Comp Neurol* 262:315–330
4. Burstein R, Yamamura H, Malick A et al. (1998) Chemical stimulation of the intracranial dura induces enhanced responses to facial stimulation in brain stem trigeminal neurons. *J Neurophysiol* 79:964–982
5. Cairns BE, Wang K, Hu JW et al. (2003) The effect of glutamate-evoked masseter muscle pain on the human jaw-stretch reflex differs in men and women. *J Orofac Pain* 17:317–325
6. Chiang CY, Hu B, Hu JW et al. (2002) Central sensitization of nociceptive neurons in trigeminal subnucleus oralis depends on integrity of subnucleus caudalis. *J Neurophysiol* 88:256–264
7. Chiang CY, Hu B, Park SJ et al. (2003) Purinergic and NMDA-receptor mechanisms underlying tooth pulp stimulation-induced central sensitization in trigeminal nociceptive neurons. Proceedings of the 10th World Congress on Pain. IASP Press, Seattle, pp 345–354
8. Craig AD (1995) Distribution of brainstem projections from spinal lamina I neurons in the cat and the monkey. *J Comp Neurol* 361:225–248
9. Craig AD (2003) Distribution of trigeminothalamic and spinothalamic lamina I terminations in the cat. *Somatosens Mot Res* 20:209–222
10. Craig AD (2004) Distribution of trigeminothalamic and spinothalamic lamina I terminations in the macaque monkey. *J Comp Neurol* 477:119–148
11. Dubner R, Bennett GJ (1983) Spinal and trigeminal mechanisms of nociception. *Annu Rev Neurosci* 6:381–418
12. Dubner R, Ren K (2004) Brainstem mechanisms of persistent pain following injury. *J Orofac Pain* 18:299–305
13. Feil K, Herbert H (1995) Topographic organization of spinal and trigeminal somatosensory pathways to the rat parabrachial and Kolliker-Fuse nuclei. *J Comp Neurol* 353:506–528
14. Fujino Y, Koyama N, Yokota T (1996) Differential distribution of three types of nociceptive neurons within the caudal bulbar reticular formation in the cat. *Brain Res* 715:225–229
15. Hayashi H, Tabata T (1990) Pulpal and cutaneous inputs to somatosensory neurons in the parabrachial area of the cat. *Brain Res* 511:177–179
16. Iwata K, Kenshalo DR Jr, Dubner R et al. (1992) Diencephalic projections from the superficial and deep laminae of the medullary dorsal horn in the rat. *J Comp Neurol* 321:404–420
17. Jacquin MF, Barcia M, Rhoades RW (1989) Structure-function relationships in rat brainstem subnucleus interpolaris: IV. Projection neurons. *J Comp Neurol* 282:45–62
18. Jasmin L, Granato A, Ohara PT (2004) Rostral agranular insular cortex and pain areas of the central nervous system: a tract-tracing study in the rat. *J Comp Neurol* 468:425–440
19. Keay KA, Bandler R (1998) Vascular head pain selectively activates ventrolateral periaqueductal gray in the cat. *Neurosci Lett* 245:58–60
20. Kemplay S, Webster KE (1989) A quantitative study of the projections of the gracile, cuneate and trigeminal nuclei and of the medullary reticular formation to the thalamus in the rat. *Neuroscience* 32:153–167
21. Kenshalo DR Jr, Willis WD Jr (1991) The role of the cerebral cortex in pain sensation. In: Jones EG, Peters A (eds) *Cerebral Cortex*. Plenum, New York, pp 151–212
22. Malick A, Burstein R (1998) Cells of origin of the trigeminothalamic tract in the rat. *J Comp Neurol* 400:125–144
23. Mantle-St John LA, Tracey DJ (1987) Somatosensory nuclei in the brainstem of the rat: independent projections to the thalamus and cerebellum. *J Comp Neurol* 255:259–271
24. Marfurt CF, Rajchert DM (1991) Trigeminal primary afferent projections to “non-trigeminal” areas of the rat central nervous system. *J Comp Neurol* 303:489–511
25. Nord SG, Kyler HJ (1968) A single unit analysis of trigeminal projections to bulbar reticular nuclei of the rat. *J Comp Neurol* 134:485–494
26. Okamoto K, Hirata H, Takeshita S et al. (2003) Response properties of TMJ units in superficial laminae at the spinomedullary junction of female rats vary over the estrous cycle. *J Neurophysiol* 89:1467–1477
27. Parada CA, Luccarini P, Woda A (1997) Effect of an NMDA receptor antagonist on the wind-up of neurons in the trigeminal oralis subnucleus. *Brain Res* 761:313–320
28. Park SJ, Chiang CY, Hu JW et al. (2001) Neuroplasticity induced by tooth pulp stimulation in trigeminal subnucleus oralis involves NMDA receptor mechanisms. *J Neurophysiol* 85:1836–1846
29. Sessle BJ (2005) Orofacial pain. In: Merskey H (ed) *Pathways of Pain*. IASP Press, Seattle
30. Sessle BJ (2000) Acute and chronic craniofacial pain: brainstem mechanisms of nociceptive transmission and neuroplasticity, and their clinical correlates. *Crit Rev Oral Biol Med* 11:57–91
31. Villanueva L, Bouhassira D, Le BD (1996) The medullary subnucleus reticularis dorsalis (SRD) as a key link in both the transmission and modulation of pain signals. *Pain* 67:231–240
32. Willis WD Jr (1997) Nociceptive functions of thalamic neurons. In: Steriade M, Jones EG, McCormick DA (eds) *Thalamus, Volume II Experimental and Clinical Aspects*. Elsevier Science Ltd, Oxford, pp 373–424
33. Yokota T, Koyama N, Nishikawa Y et al. (1991) Trigeminal nociceptive neurons in the subnucleus reticularis ventralis. I. Response properties and afferent connections. *Neurosci Res* 11:117
34. Yoshida A, Dostrovsky JO, Sessle BJ et al. (1991) Trigeminal projections to the nucleus submedialis of the thalamus in the rat. *J Comp Neurol* 307:609–625



iological studies conducted in anaesthetized rat provided evidence that noxious stimulus evoked intensity-dependent changes in ► **excitability** of CA1 pyramidal cells (Khanna and Sinclair 1989, Wei et al. 2000) that were ► **non-topographic** (Khanna and Sinclair 1992). Interestingly, Khanna (1997) reported that following hind paw injection of formalin, a population of dorsal CA1 putative pyramidal cells was selectively excited against the background of widespread pyramidal cell suppression, reflecting ‘signal-to-noise’ processing by

the hippocampal network that enhanced the ‘signal’ to noxious stimulus relative to ‘background’ noise. Such processing was observed in correlation with ► **theta ► rhythm** (Khanna 1997), which is sinusoidal rhythmic extracellular oscillations that reflect rhythmic oscillations of CA1 neurons in processing of information. Hippocampal theta activation has been linked to ► **sensorimotor integration** and animal motivated behavior (Bland and Oddie 2001). In addition, CA1 ‘signal-to-noise’ processing, in parallel with theta acti-

vation, has been linked to ► **mnemonic function** of the hippocampus (Buzsaki 1989). In this context, a noxious stimuli-induced increase in levels of the transcription protein Egr1 has been observed in the hippocampus, especially in field CA1 (Wei et al. 2000). The enhanced level of Egr1 in CA1 was linked to facilitation of ► **long-term potentiation** (LTP) of excitatory synaptic transmission in the region (Wei et al. 2000), LTP being a cellular model of learning and memory.

Consistent with findings from electrophysiological studies, ► **c-Fos** mapping techniques in anaesthetized and behaving rats also indicated that neural changes in hippocampus, especially field CA1 and medial entorhinal cortex, are noxious intensity-dependent (Funahashi et al. 1999, Khanna et al. 2004). The changes in CA1 were bilateral and were observed along the length of the region. However, the noxious stimuli-induced effect in entorhinal cortex was significant only ipsilateral to the stimuli, though a trend was also observed in the contralateral entorhinal cortex (Funahashi et al. 1999).

A role for acetylcholine in hippocampal nociceptive processing has been proposed. In this context, acetylcholine is released in the hippocampus in the formalin test (Ceccarelli et al. 1999), and intra-hippocampal administration of the muscarinic antagonist, atropine, attenuates peripheral noxious heat-induced suppression of CA1 pyramidal cell synaptic excitability (Zheng and Khanna 2001). Furthermore, destruction of ► **cholinergic input** to the hippocampus attenuated the pyramidal cell suppression, without an apparent effect on cell excitation to hind paw injection of formalin (Zheng and Khanna 2001). This points to the possibility that the hippocampal cholinergic input influences the background 'noise' of 'signal-to-noise' processing to formalin.

The evidence, that intra-hippocampal administration of NMDA antagonist attenuated animal behavior in the formalin test (McKenna and Melzack 2001), favors a role for glutamate in nociceptive processing in the hippocampus-dentate gyrus. Further, the noxious stimuli-induced increase in Egr1 in hippocampus was blocked by systemic administration of an NMDA receptor antagonist (Wei et al. 2000). Another molecule that has drawn some attention and may be in a position to influence hippocampal processing of noxious information is the cytokine, ► **tumor necrosis factor-alpha** (TNF $\alpha$ ). The levels of this molecule are elevated in the hippocampus-dentate gyrus region after the development of thermal ► **hyperalgesia** in the rat chronic constriction nerve injury animal model of neuropathic pain (see ► **Neuropathic Pain Model, Chronic Constriction Injury**) (Ignatowski et al. 1999). Interestingly, TNF $\alpha$  induces thermal hyperalgesia when administered intracerebroventricularly in otherwise normal animals. In summary, the evidence so far suggests that nociceptive processing in hippocampus and the entorhinal cortex is,

at least in part, distributed, non-topographic, and noxious stimulus intensity-dependent, which is in line with the postulated role of these regions in affect-motivation to pain. The processing of noxious information in these regions is likely to be influenced by multiple transmitters/modulators.

## References

1. Amaral DG, Witter MP (1995) Hippocampal Formation. In: Paxinos G (ed) *The Rat Nervous System*. Academic Press, San Diego, pp 443–493
2. Bland BH, Oddie SD (2001) Theta Band Oscillation and Synchrony in the Hippocampal Formation and Associated Structures: The Case for its Role in Sensorimotor Integration. *Behav Brain Res* 127:119–136
3. Buzsaki G (1989) Two-Stage Model of Memory Trace Formation: A Role for 'Noisy' Brain States. *Neurosci* 31:551–570
4. Ceccarelli I, Casamenti F, Massafra C et al. (1999) Effects of Novelty and Pain on Behavior and Hippocampal Extracellular Ach Levels in Male and Female Rats. *Brain Res* 815:169–176
5. Funahashi M, He Y-F, Sugimoto T et al. (1999) Noxious Tooth Pulp Stimulation Suppresses C-Fos Expression in the Rat Hippocampal Formation. *Brain Res* 827:215–220
6. Ignatowski TA, Covey WC, Knight PR et al. (1999) Brain-Derived TNF $\alpha$  Mediates Neuropathic Pain. *Brain Res* 841:70–77
7. Khanna S (1997) Dorsal Hippocampus Field CA1 Pyramidal Cell Responses to a Persistent versus an Acute Nociceptive Stimulus and their Septal Modulation. *Neurosci* 77:713–721
8. Khanna S, Chang S, Jiang F et al. (2004) Nociception-Driven Decreased Induction of Fos Protein in Ventral Hippocampus Field CA1 of the Rat. *Brain Res* 1004:167–176
9. Khanna S, Sinclair JG (1992) Responses in the CA1 region of the rat hippocampus to a noxious stimulus. *Exp Neurol* 117:28–35
10. Khanna S, Sinclair JG (1989) Noxious Stimuli Produce Prolonged Changes in the CA1 Region of the Rat Hippocampus. *Pain* 39:337–343
11. McKenna JE, Melzack R (2001) Blocking NMDA Receptors in the Hippocampal Dentate Gyrus with AP5 Produces Analgesia in the Formalin Pain Test. *Expl Neurol* 172:92–99
12. Melzack R, Casey KL (1968) Sensory, Motivational and Central Control Determinants of Pain. In: Kenshalo DR (ed) *The Skin Senses*. Thomas, Springfield, IL, pp 423–443
13. Ploghaus A, Narain C, Beckmann CF et al. (2001) Exacerbation of Pain by Anxiety is Associated with Activity in a Hippocampal Network. *J Neurosci* 21:9896–9903
14. Selden NRW, Everitt BJ, Jarrard LE et al. (1991) Complementary Roles for the Amygdala and Hippocampus in Aversive Conditioning to Explicit and Contextual Cues. *Neurosci* 42:335–350
15. Wei F, Xu ZC, Qu Z et al. (2000) Role of EGR1 in Hippocampal Synaptic Enhancement Induced by Tetanic Stimulation and Amputation. *J Cell Biol* 149:1325–1333
16. Zheng F, Khanna S (2001) Selective Destruction of Medial Septal Cholinergic Neurons Attenuates Pyramidal Cell Suppression, but not Excitation in Dorsal Hippocampus Field CA1 Induced by Subcutaneous Injection of Formalin. *Neurosci* 103:985–998

## Nociceptive Processing in the Nucleus Accumbens, Neurophysiology and Behavioral Studies

LINO BECERRA, MARNIE SHAW, DAVID BORSOOK  
Brain Imaging Center, McLean Hospital-Harvard  
Medical School, Belmont, MA, USA  
lbecerra@mclean.harvard.edu



## Synonyms

Nucleus Accumbens; NAcc

## Definition

The nucleus accumbens (NAcc) is a brain structure that forms part of the ventral striatum. It has been established that the NAcc is a critical structure for the rewarding and reinforcing properties of addictive drugs. It also appears to play an important role in modulating pain sensations.

## Characteristics

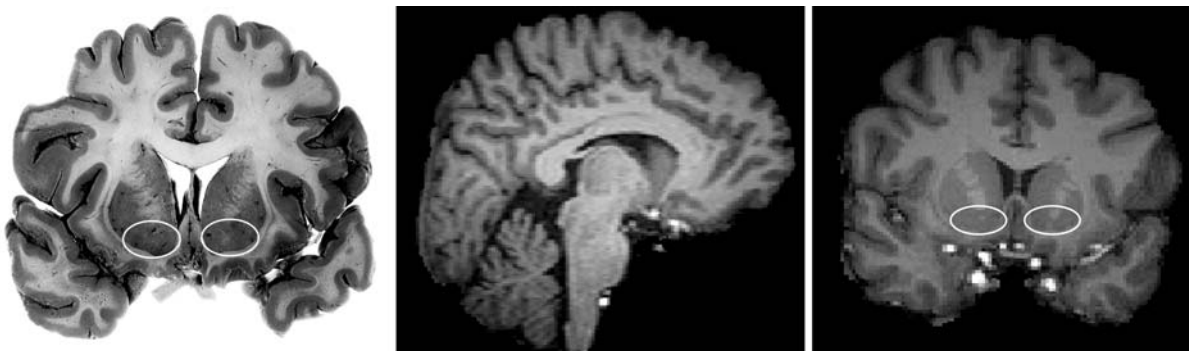
The human ventral striatum encompasses a series of structures of which the nucleus accumbens (NAcc) is the primary one (Nolte 2002). This definition is functionally based on its connectivity. In rodents, the NAcc has been clearly defined by cytoarchitecture, neuroactive transmitters and receptor distributions (Otake and Nakamura 2000). Two main substructures have been identified, a core and a shell. The core is located in the dorsolateral portion of the ventral striatum and the shell is in the medioventral portion (Otake and Nakamura 2000). The core projects directly to the lateral ► **ventral tegmental area** (VTA), while the shell projects to the ventromedial ventral pallidum, which in turn projects to the VTA. In primates, however, the core region appears contiguous with the rest of the striatum and cannot be easily distinguished. The shell has several histochemical features that make it different from the rest of the striatum (Prensa et al. 2003). The NAcc in humans is located at the base of the ► **caudate nucleus** and the ► **putamen** (Fig. 1) (see Buchsbaum et al. 1998 for a systematic approach to identify the NAcc in MRI images). In humans, several histological and chemical studies have given mixed results and concluded that separation of core and shell substructures is difficult, probably due to the complexity and heterogeneity of the structure and its innervation (Prensa et al. 2003). The NAcc is involved in evaluating probability assessments and the emotional valence of information. Disturbances at this level have been implicated in a number

of affective disorders including drug abuse (Altier and Stewart 1999). Recent functional imaging investigations in humans have shown that the NAcc is activated in situations related to drug-associated reward and to monetary, and other rewarding stimuli (Breiter et al. 1997; Zink et al. 2004).

Opioids such as morphine and heroin and psychostimulants such as amphetamine are known drugs of potential abuse. However, it is also clinically known that these drugs are effective in the treatment of pain (Altier and Stewart 1999). These results suggest that reward and aversion share a common neural substrate. Opioids are known to inhibit neural systems that transmit nociceptive information (Fields 2004); the descending pain pathway relays information from the ► **periaqueductal gray** (PAG) to the ► **rostromedial medulla** (RVM) and through the spinal cord to the dorsal horn, where peripheral nociceptive information is inhibited from reaching supraspinal structures (Fields 2004). Microinjections of morphine into the PAG produce deep analgesia allowing the performance of major surgery on subjects. Interestingly, opioids as well as psychostimulant drugs increase transmission in mesocorticolimbic dopamine (DA) neurons that are known to be activated by rewards such as food or sex (Altier and Stewart 1999). These neurons arise from cell bodies in the ventral tegmental area (VTA) and project to various sites, among them the NAcc, amygdala and frontal cortex.

A number of studies have suggested a significant role for the NAcc in the processing of pain and analgesia. Experiments in rodents subjected to the ► **formalin test** (subcutaneous injection of diluted formalin into an animal's hind paw to produce persistent nociceptive pain) have been performed to elucidate the role of NAcc in analgesia. Injection of morphine, amphetamine or substance P agonist into the VTA produces analgesia, i.e., the animal displays fewer effects of pain due to the formalin injection. However, lesions of the NAcc or injection of DA receptor antagonists in the NAcc diminishes the analgesia produced following intra-VTA injections (Altier and Stewart 1999).

N



**Nociceptive Processing in the Nucleus Accumbens, Neurophysiology and Behavioral Studies, Figure 1** Histological and MRI slices of the NAcc. Left panel depicts a brain slice through the anterior part of the caudate nucleus and putamen with the NAcc bridging both structures (Adapted from DE Haines, Neuroanatomy). Right panel shows a corresponding MRI slice of the NAcc.

The role of the NAcc in aversive stimuli such as pain may be as a result of both dopaminergic projections from the VTA region and inputs from spinal levels. Dopamine release in the NAcc modulates information about tonic noxious stimulation coming from the periphery. The broader neuroanatomical circuitry underlying this effect may be explained by looking at the NAcc afferent and efferent connections. One possibility arises from direct projections of spinal cord neurons into the NAcc (Cliffer et al. 1991). Several studies have implicated an ascending pain control pathway that produces analgesia if stimulated by intense noxious stimuli or by peripheral injection of local anesthetic or opioids (Gear and Levine 1995). Another possibility arises from NAcc projections into the medial thalamus known to receive input from dorsal horn neurons sensitive to noxious stimuli. The NAcc has projections to the amygdala, which has connection to the brainstem and from there to the spinal cord (Altier and Stewart 1999).

Other mechanisms, besides dopaminergic ones, have been found to be involved in processing pain by the NAcc. In a series of experiments, animals were subjected to intense noxious stimuli (injection of high concentrations of capsaicin subcutaneously or immersion of hind paws in hot water) and tested for pain in a different body part (Gear and Levine 1995). Under intense stimuli, animals displayed less pain in the stimulated body part than without the stimuli. The mechanism is based on an ascending pain pathway projecting to the NAcc that disinhibits opioid neurons in the NAcc and produces antinociception. There is no direct connection between the NAcc and the RVM; however, the NAcc projects to other structures such as the hypothalamus, which in turn sends projections to the brainstem (Gear and Levine 1995).

In animal studies, it has been established that the NAcc plays an important role in processing pain and several mechanisms have been elucidated and are continuously studied. Human studies, however, present a much larger challenge, given that none of the manipulations done in animals are possible. Yet new neuroimaging techniques have made possible the study of responses in the CNS, including the NAcc, non-invasively in conscious human subjects (Becerra et al. 2001; Breiter et al. 1997). Most of the studies reporting NAcc activation have been devoted to the role of NAcc in processing rewarding stimuli such as drugs of abuse (Breiter et al. 1997) or monetary reward (Zink et al. 2004). For positive valence hedonic stimuli (e.g. food, money), the NAcc was found to produce a positive signal change in ► **functional MRI (fMRI)** studies (Zink et al. 2004).

Recently, fMRI studies of noxious stimuli in normal subjects have indicated that the NAcc displays negative signal changes (Becerra et al. 2001), opposite to those observed for rewarding stimuli. Further studies will allow dissection of the role of the NAcc in human physiological and pathological pain processing. In a broader scope,

the NAcc is part of a group of structures involved in the processing of motivational and emotional information and the structure may be implicated in maladaptive behaviors observed in chronic pain such as depression and anxiety.

## References

1. Altier N, Stewart J (1999) The role of dopamine in the nucleus accumbens in analgesia. *Life Sci* 65:2269–2287
2. Becerra L, Breiter HC, Wise R et al. (2001) Reward circuitry activation by noxious thermal stimuli. *Neuron* 32:927–946
3. Breiter HC, Gollub RL, Weisskoff RM et al. (1997) Acute effects of cocaine on human brain activity and emotion. *Neuron* 19:591–611
4. Buchsbaum MS, Fallon JH, Wei TC et al. (1998) A method of basal forebrain anatomical standardization for functional image analysis. *Psychiatry Res* 84:113–125
5. Cliffer KD, Burstein R, Giesler GJ Jr (1991) Distributions of spinothalamic, spinohypothalamic, and spinothalencephalic fibers revealed by anterograde transport of PHA-L in rats. *J Neurosci* 11:852–868
6. Fields H (2004) State-dependent opioid control of pain. *Nat Rev Neurosci* 5:565–575
7. Gear RW, Levine JD (1995) Antinociception produced by an ascending spino-supraspinal pathway. *J Neurosci* 15:3154–3161
8. Haines DE (2004) *Neuroanatomy*, 6<sup>th</sup> edn. Lippincott Williams & Wilkins, Philadelphia
9. Nolte J (2002) *The Human Brain*. Mosby, Inc. St. Louis
10. Otake K, Nakamura Y (2000) Possible pathways through which neurons of the shell of the nucleus accumbens influence the outflow of the core of the nucleus accumbens. *Brain Dev* 22:17–26
11. Prensa L, Richard S, Parent A (2003) Chemical anatomy of the human ventral striatum and adjacent basal forebrain structures. *J Comp Neurol* 460:345–367
12. Zink CF, Pagnoni G, Martin-Skurski ME et al. (2004) Human striatal responses to monetary reward depend on saliency. *Neuron* 42:509–517

## Nociceptive Processing in the Secondary Somatosensory Cortex

ROLF-DETLEF TREEDE<sup>1</sup>, ULF BAUMGÄRTNER<sup>1</sup>,  
FREDERICK A. LENZ<sup>2</sup>

<sup>1</sup>Institute of Physiology and Pathophysiology,  
Johannes Gutenberg University, Mainz, Germany

<sup>2</sup>Department of Neurosurgery, Johns Hopkins Hospital,  
Baltimore, MD, USA

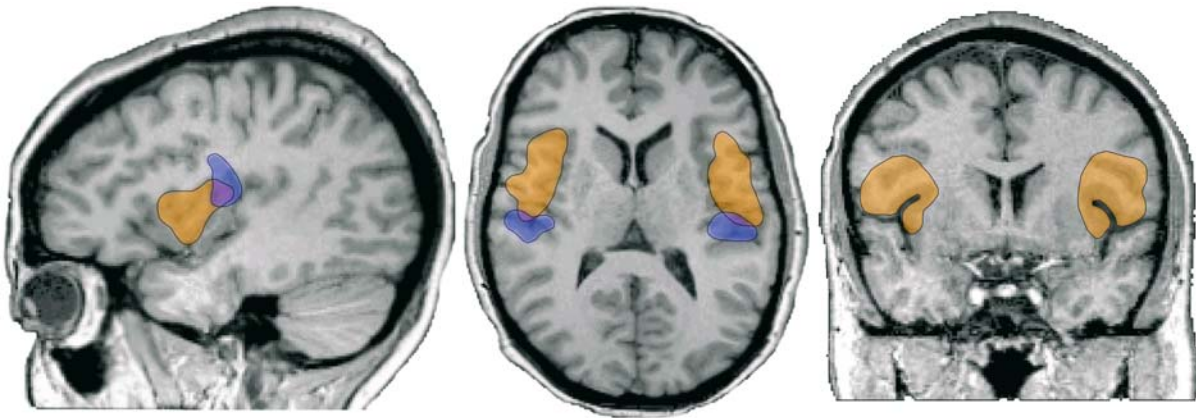
treede@uni-mainz.de, flenz1@jhmi.edu

## Synonyms

Secondary Somatosensory Cortex; second somatosensory cortex; second somatic area; S2; SII; SII/PV

## Definition

The term “secondary somatosensory cortex” refers to a cortical representation of the body outside the primary somatosensory cortex (SI). Such a secondary representation was initially found in two separate locations (for detail see Burton 1986; Caselli 1993), near the midline in the human parietal lobe (supplementary sensory



**Nociceptive Processing in the Secondary Somatosensory Cortex, Figure 1** Location of the secondary somatosensory cortex in the human brain. This figure shows schematic drawings of the classical secondary somatosensory area SII as identified using tactile stimulation (blue) in comparison with those areas in the operculo-insular cortex that respond to nociceptive stimulation (orange). Note that the nociceptive cortex extends further anterior than the tactile areas and includes both opercular and insular parts. Left: Sagittal section passing slightly medial of SII in order to show the insula also. Centre: horizontal section through SII. Right: Coronal section through nociceptive regions in the anterior insula and in the inner vertical face of the frontal operculum.

area) and within the parietal ► **operculum** in the superior bank of the Sylvian or lateral fissure (secondary somatosensory area SII); additional somatosensory areas are situated in the superior parietal lobule and in the ► **insula**. The somatosensory area in the parietal operculum (Fig. 1) has retained the designation as SII, because historically it was the first example of a second representation of any of the senses in the brain (Adrian 1941).

### Characteristics

SII is located on the lateral curvature of parietal cortex in rodents and rabbits, in the anterior ectosylvian gyrus in cats and dogs and along the superior bank of the ► **Sylvian fissure** in primates (Burton 1986). Human SII does not usually reach the convexity of the brain, but was explored by Wilder Penfield during procedures in which it did reach the convexity or in which the fissure was split (Penfield and Jasper 1954). Functional localization of SII in humans with imaging techniques such as PET and fMRI confirmed its location predominantly in the upper bank of the Sylvian fissure (Burton et al. 1993), opposite the auditory cortex in Heschl's convolutions (Özcan et al. 2005).

The SII region probably contains more than one somatosensory area as suggested by the presence of two separate face areas in the lateral parietal operculum and a common foot area in medial parietal operculum. SII proper is in the caudal (posterior) part of this region, the parietal ventral area PV may be in its rostral (anterior) portion (Disbrow et al. 2000; Fitzgerald et al. 2004). Cytoarchitectonic classification of the parietal operculum has been undertaken only recently (Young et al. 2004), yielding four subregions OP1–OP4, of which SII is probably situated in OP1 / 2 and PV in OP3 / 4. Brodmann areas are not defined in this region. In the

stereotactic coordinates of the atlas of Talairach and Tournoux, SII extends 40–60 mm lateral of the midline, 15–30 mm behind the anterior commissure (AC) and 5–25 mm above the AC-PC line. The Sylvian fissure runs obliquely through this coordinate system and its location varies considerably across individuals (Özcan et al. 2005). Therefore, either the auditory cortex or the Sylvian fissure and the central sulcus should be used as anatomical landmarks when referring to the location of SII.

The secondary somatosensory cortex receives direct thalamocortical input from the ventral posterior nuclear group, in particular the ventro-postero-inferior nucleus VPI (Apkarian and Shi 1994; Gauriau and Bernard 2004; Jones and Burton 1976). In addition, there is a prominent projection from SI to SII, particularly in primates (Friedman et al. 1986; Jones et al. 1978).

Single neuron recordings in SII have largely focussed on the tactile representation (Fitzgerald et al. 2004; Robinson and Burton 1980). Although most neurons in SII have contralateral ► **receptive fields**, a sizable proportion of bilateral receptive fields has been observed. Most imaging and electrophysiological studies in humans have found a bilateral response to unilateral stimulation, with a contralateral preponderance. Functionally, SII is considered to play a role in tactile object recognition and memory (Caselli 1993), as well as the perception of vibrotactile stimuli (Burton et al. 1993; Ferrington and Rowe 1980). The cortico-cortical output connections of SII into the insula and parahippocampal gyrus are similar to those of the inferior temporal cortex, which is implicated in visual object recognition (Friedman et al. 1986).

In human imaging studies, enhanced perfusion as a sign of activation by phasic nociceptive stimuli was found more regularly in SII and adjacent parts of the insula than



in SI (Peyron et al. 2002; Treede et al. 2000). Evoked potential recordings showed that SII was activated simultaneously with or even earlier than SI (Schlereth et al. 2003). Hence, SII appears as a major site for the early cortical encoding of pain in the human brain. SII is considered to be important for the recognition of the noxious nature of a painful stimulus, for intensity coding and other sensory-discriminative aspects of pain and as part of a sensory-limbic pathway for pain memory and affective motivational aspects of pain (Berthier et al. 1988; Lenz et al. 1997; Treede et al. 2000; Ohara et al. 2004). In contrast to the abundance of evidence for nociceptive activation of the SII region from human evoked potential and imaging studies, there are few single neuron recordings in this region showing specific nociceptive responses (Dong et al. 1994). In monkey, some cells in the SII region respond to the approach of a sharp object to the face, suggesting that this region may represent the position of a painful or threatening stimulus in extrapersonal space. These neurons, however, were located in area 7b, which is adjacent to SII in monkey but not in humans, in whom Brodmann areas 39 and 40 separate SII and area 7b. Since search stimuli in all these animal studies were tactile, an intriguing alternative possibility is that tactile and nociceptive inputs are represented in different areas within the SII region (Treede et al. 2000). The insula has been suggested to contain such a separate representation of nociception at its dorsal junction with the parietal and frontal operculum (Craig 2002). The insula subserves sensory integrative functions for pain, taste and other visceral sensations, as well as visceral motor and other autonomic functions (Treede et al. 2000). Direct comparisons of vibrotactile and painful heat stimulation in humans showed activation of SII by both stimuli and a more pronounced activation in anterior insula by painful stimuli (Coghill et al. 1994). It has been suggested that the dorsal and anterior insula may be part of a multisensory interoceptive pathway signalling the internal state of the body. In this view, pain is an emotion or interoceptive sensation resulting from disequilibrium of this internal state (Craig 2002). This hypothesis is called into question by recent studies suggesting that interoceptive sensations and emotions are infrequently evoked by stimulation of this system (Lenz et al. 2004). Subdural and depth electrophysiological recordings in patients undergoing epilepsy surgery have identified a region in the inner vertical face of the frontal operculum that receives nociceptive input with a latency of about 150 ms, corresponding to the earliest portion of the whole cerebral response (Frot and Maguiere 2003; Vogel 2003). The centre of this region is located about 15–20 mm anterior of the tactile SII area, and lateral of the anterior insula which lies on the other side of the circular sulcus of the insula (Fig. 1). Because of this proximity, many neuroimaging studies may mislabel the inner vertical face of the frontal operculum as either SII or anterior insula. In current meta-analyses

of neuroimaging studies (PET, fMRI, MEG and EEG source analysis) it was found that the resolution of the techniques was not sufficient to separate insular from opercular activity (Peyron et al. 2002). More studies are needed to clarify how many functionally and cytoarchitecturally separate areas are contained within the parasyllvian cortex. It is evident, however, that the parasyllvian cortex plays an important role in the cortical representation of pain. This region includes SII, but extends further anterior into the frontal operculum and medially into the insula.

### Acknowledgements

Drs Treede, Baumgärtner and Lenz and some of the studies reviewed here were supported by DFG Tr 236 / 13-3 and by NIH-NINDS 38493.

### References

1. Adrian ED (1941) Afferent discharges to the cerebral cortex from peripheral sense organs. *J Physiol* 100:159–191
2. Apkarian AV, Shi T (1994) Squirrel monkey lateral thalamus. I. Somatic nociresponsive neurons and their relation to spinothalamic terminals. *J Neurosci* 14:6779–6795
3. Berthier M, Starkstein S, Leiguarda R (1988) Asymbolia for pain: a sensory-limbic disconnection syndrome. *Ann Neurol* 24:41–49
4. Burton H (1986) Second somatosensory cortex and related areas. In: Jones EG, Peters A (eds) *Cerebral Cortex*, vol 5, *Sensory-Motor Areas and Aspects of Cortical Connectivity*. Plenum Press, New York, pp 31–98
5. Burton H, Videen TO, Raichle ME (1993) Tactile-vibration-activated foci in insular and parietal-opercular cortex studied with positron emission tomography –mapping the 2<sup>nd</sup> somatosensory area in humans. *Somatosens Motor Res* 10:297–308
6. Caselli RJ (1993) Ventrolateral and dorsomedial somatosensory association cortex damage produces distinct somesthetic syndromes in humans. *Neurology* 43:762–771
7. Coghill RC, Talbot JD, Evans AC et al. (1994) Distributed processing of pain and vibration by the human brain. *J Neurosci* 14:4095–4108
8. Craig AD (2002) How do you feel? Interoception: the sense of the physiological condition of the body. *Nat Rev* 3:655–666
9. Disbrow E, Roberts T, Krubitzer L (2000) Somatotopic organization of cortical fields in the lateral sulcus of homo sapiens: evidence for SII and PV. *J Comp Neurol* 418:1–21
10. Dong WK, Chudler EH, Sugiyama K et al. (1994) Somatosensory, multisensory, and task-related neurons in cortical area 7b (PF) of unanesthetized monkeys. *J Neurophysiol* 72:542–564
11. Ferrington DG, Rowe M (1980) Differential contributions to coding of cutaneous vibratory information by cortical somatosensory areas I and II. *J Neurophysiol* 43:310–331
12. Fitzgerald PJ, Lane JW, Thakur PH et al. (2004) Receptive field properties of the macaque second somatosensory cortex: evidence for multiple functional areas. *J Neurosci* 24:11193–11204
13. Friedman DP, Murray EA, O'Neill JB et al. (1986) Cortical connections of the somatosensory fields of the lateral sulcus of macaques: evidence for a corticolimbic pathway for touch. *J Comp Neurol* 252:323–347
14. Frot M, Mauguière F (2003) Dual representation of pain in the operculo-insular cortex in humans. *Brain* 126:438–450
15. Gauriau C, Bernard JF (2004) Posterior triangular thalamic neurons convey nociceptive messages to the secondary somatosensory and insular cortices in the rat. *J Neurosci* 24:752–761
16. Jones EG, Burton H (1976) Areal differences in the laminar distribution of thalamic afferents in cortical fields of the insu-



- lar, parietal and temporal regions of primates. *J Comp Neurol* 168:197–248
17. Jones EG, Coulter JD, Hendry SHC (1978) Intracortical connectivity of architectonic fields in the somatic sensory, motor and parietal cortex of monkeys. *J Comp Neurol* 181:291–348
  18. Lenz FA, Gracely RH, Zirh AT et al. (1997) The sensory-limbic model of pain memory. *Pain Forum* 6:22–31
  19. Lenz FA, Ohara S, Gracely RH et al. (2004) Pain encoding in the human forebrain: binary and analog exteroceptive channels. *J Neurosci* 24:6540–6544
  20. Ohara S, Crone NE, Weiss N, Treede R-D, Lenz FA (2004) Amplitudes of laser evoked potential recorded from primary somatosensory, parasyllian and medial frontal cortex are graded with stimulus intensity. *Pain* 110:318–328
  21. Özcan M, Baumgärtner U, Vucurevic G et al. (2005) Spatial resolution of fMRI in the human parasyllian cortex: comparison of somatosensory and auditory stimulation. *Neuroimage* 25:877–887
  22. Penfield W, Jasper H (1954) *Epilepsy and the functional anatomy of the human brain*. Little Brown, Boston
  23. Peyron R, Frot M, Schneider F et al. (2002) Role of operculoin-sular cortices in human pain processing: converging evidence from PET, fMRI, dipole modeling, and intracerebral recordings of evoked potentials. *Neuroimage* 17:1336–1346
  24. Robinson CJ, Burton H (1980) Organization of somatosensory receptive fields in cortical areas 7b, retroinsula, postauditory and granular insula of M. fascicularis. *J Comp Neurol* 192:69–92
  25. Schlereth T, Baumgärtner U, Magerl W et al. (2003). Left-hemisphere dominance in early nociceptive processing in the human parasyllian cortex. *Neuroimage* 20:441–454
  26. Treede RD, Apkarian AV, Bromm B et al. (2000) Cortical representation of pain: functional characterization of nociceptive areas near the lateral sulcus. *Pain* 87:113–119
  27. Vogel H, Port JD, Lenz FA et al. (2003) Dipole source analysis of laser-evoked subdural potentials recorded from parasyllian cortex in humans. *J Neurophysiol* 89:3051–3060
  28. Young JP, Herath P, Eickhoff S et al. (2004) Somatotopy and attentional modulation of the human parietal and opercular regions. *J Neurosci* 24:5391–5399

## Nociceptive Projecting Neurons

- ▶ Spinoannular
- ▶ Spinohypothalamic Tract, Anatomical Organization and Response Properties
- ▶ Spinomesencephalic Tract
- ▶ Spinoparabrachial Tract
- ▶ Spinoreticular Neurons
- ▶ Spinothalamic Tract Neurons, Visceral Input

## Nociceptive Reflex

### Definition

A reflex that is elicited by noxious stimuli, is mediated by nociceptive (A $\delta$ , C) afferents, and exerts a defense reaction.

- ▶ Jaw-Muscle Silent Periods (Exteroceptive Suppression)
- ▶ Nociceptive Withdrawal Reflex

## Nociceptive Selective Stimulation

### Definition

Stimulation selectively activates nociceptive (A $\delta$ , C) fibers without simultaneously activating tactile-mediated large myelinated A $\beta$  fibers, e.g. laser stimulation.

- ▶ Insular Cortex, Neurophysiology and Functional Imaging of Nociceptive Processing

## Nociceptive Sensory Neurons

### Definition

Nociceptive sensory neurones are specialized sensory nerve fibers innervating peripheral tissues that are normally only activated by noxious stimuli (i.e. the stimuli capable of causing tissue damage) and not innocuous stimuli.

- ▶ Inflammation, Modulation by Peripheral Cannabinoid Receptors
- ▶ Nociceptive Afferents
- ▶ Nociceptors
- ▶ Nociceptors, Action Potentials and Post-Firing Excitability Changes

## Nociceptive Specific Neurons

### Definition

Nociceptive specific sensory neurons are a type of nociceptive neuron, which are excited by stimulus intensities that are sufficiently intense to cause injury to the body if sustained for a sufficiently long period of time. In the absence of injury, this type of neuron will not normally respond to innocuous thermal or innocuous mechanical stimulation of its receptive field. This type of neuron is defined physiologically by its response properties and can be found at spinal, thalamic, and cortical sites important in the processing of noxious information.

- ▶ Arthritis Model, Kaolin-Carrageenan Induced Arthritis (Knee)
- ▶ Encoding of Noxious Information in the Spinal Cord
- ▶ Freezing Model of Cutaneous Hyperalgesia
- ▶ Human Thalamic Nociceptive Neurons
- ▶ Referred Muscle Pain, Assessment
- ▶ Thalamic Nuclei Involved in Pain, Human and Monkey
- ▶ Thalamus, Nociceptive Cells in VPI, Cat and Rat
- ▶ Trigeminal Brainstem Nuclear Complex, Physiology

## Nociceptive Processing in the Spinal Cord

HANS-GEORG SCHAIBLE

Department of Physiology, University of Jena, Jena, Germany

hans-georg.schaible@mti.uni-jena.de

### Nociceptive Functions of the Spinal Cord

Nociceptive primary afferent fibres project to the spinal cord, where they form synapses with second order neurons. The spinal cord has several functions in nociceptive processing. Firstly, ascending axons of nociceptive neurons in the gray matter project to supraspinal sites. These projections activate neuronal circuits in the brainstem that are involved in descending inhibition and facilitation and they activate the thalamocortical system that produces the complex conscious pain response. Secondly, the spinal cord generates motor responses to noxious stimuli. Motor responses are nociceptive reflexes and also more complex motor behaviour such as avoidance of movements. Thirdly, the spinal cord is involved in the generation of autonomic reflexes that are elicited by noxious stimuli.

Nociceptive sensory spinal cord neurons are located in the superficial and deep dorsal horn. Neurons with nociceptive properties are also found in the ventral horn. The majority of nociceptive neurons are interneurons that do not project to supraspinal sites (Willis and Coggeshall 2004).

### Structure of the Dorsal Horn and Spinal Projection of Nociceptive Afferents

The spinal cord gray matter contains neuronal cell bodies and fibres, whereas the white matter consists of fibres including axons of ascending and descending tracts. The gray matter has been divided into laminae I–X by ► **Rexed's Laminae** (1952, 1954). The dorsal horn consists of laminae I–VI. For a detailed description see ► **nociceptive circuitry in the spinal cord**.

#### Laminae I–VI

Lamina I (► **Laminae I and V Neurones**), also called the marginal zone of the dorsal horn, is characterized by large horizontal neurons (the Waldeyer cells) and a plexus of numerous horizontally arranged fine axons and dendrites. However, many cells appear much smaller. Lamina II (► **Laminae II<sub>outer</sub> and Lamina II<sub>inner</sub>**), also called ► **substantia gelatinosa**, consists of numerous small neurons and their processes; myelinated axons are almost absent. Stalked cells and islet cells have been identified, but many interneurons have other morphologies. ► **Lamina III** forms a broad band across the dorsal horn, and it has slightly larger and

more widely spaced cells. Lamina III contains many myelinated fibres. ► **Lamina IV** is relatively thick and contains many small and numerous large neurons. Lamina V (► **lamina I and V neurones**) extends as a thick band across the narrowest part of the dorsal horn. Its lateral boundary is indistinct because of the many bundles of myelinated fibres coursing longitudinally through this area, giving the lateral part of this lamina a reticulated appearance. Cells are more varied than in lamina IV. Lamina VI cells are arranged much like those in lamina V (Rexed 1952, 1954; Willis and Coggeshall 2004).

#### Spinal Termination of Non-nociceptive and Nociceptive Primary Afferent Fibres

In general, non-nociceptive and nociceptive primary afferent fibres have different termination sites in the dorsal horn. Nociceptive A $\delta$  fibres (see ► **A Afferent Fibers (Neurons)**) project mainly to lamina I (and II). Some A $\delta$  fibres have further projections into lamina V. C fibres (► **C afferent axons/fibers**) project mainly to lamina II. By contrast, non-nociceptive primary afferents with A $\beta$  fibres (► **A afferent fibers**) project to lamina III and deeper (Willis and Coggeshall 2004).

It should be noted that the patterns of inputs from different tissues are not identical. The main inputs into lamina II are primary afferents from skin, but visceral and muscular unmyelinated afferents project to lamina II as well (Sugiura et al. 1989). However, visceral and muscular afferents also terminate in laminae I and deeper laminae. It is thought that visceral afferents distribute to a wider area of the cord, but that numbers of terminals for each fibre are much sparser for visceral than for cutaneous fibres (Sugiura et al. 1989).

#### Inputs of Neurons in Laminae I–VI

Lamina I neurons get inputs from primary afferent fibres, interneurons and descending fibres. Approximately 50% of the synapses are lost following dorsal rhizotomy and thus arise presumably from primary afferents (Chung et al. 1989). All of the primary afferents entering lamina I arise from A $\delta$  and C fibres. The input to lamina II consists of unmyelinated fine primary afferent fibres arising from the tract of Lissauer and the marginal plexus, from propriospinal neurons and from descending fibres. About 50% of the synapses in lamina II survive dorsal rhizotomy (Chung et al. 1989). The primary afferent input into lamina III is largely from collaterals of large sensory axons (Scheibel and Scheibel 1968). These are from different types of non-nociceptive primary afferents such as hair follicle afferents, Pacinian corpuscle afferents, rapidly and slowly adapting afferents etc. However, some projection of fine primary fibre input into lamina III has also been noted (Sugiura et al. 1986). Many of the large neurons

in lamina IV and lamina V have long spiny dendrites that pass dorsally, laterally and ventrally. The dorsal dendrites penetrate the substantia gelatinosa to be contacted by axons from interneurons and from fine primary afferents. In addition they receive inputs from terminal ramifications of large myelinated primary afferent fibres that make synaptic contacts to lamina IV cells. There is not much fine primary afferent input directly into lamina IV. Neurons in lamina VI often send dendrites across the width of the dorsal horn but the dendrites do not penetrate laminae I and II. The primary afferent input is from collaterals from primary afferent axons destined to reach ventral horn cells (for references see Willis and Coggeshall 2004).

#### Output of Neurons in Laminae I–VI

Most neurons are interneurons with axons ending in the same or adjacent laminae. For example, some of the laminae III–V cells are antenna-type neurons that send dendrites to lamina II and are thus output neurons from lamina II. However, lamina I, includes the dendrites to lamina III–VI neurons that form long axons projecting to supraspinal sites (Willis and Coggeshall 2004). Lamina I neurons project to various sites in the brain stem. Within laminae III to VI are spinocervical tract neurons and ► [postsynaptic dorsal column cells](#). Neurons in laminae IV to VI send their axons into the lateral white column or across the midline, presumably to the opposite ► [spinothalamic tract](#) through the anterior white commissure. They may bifurcate before they go to the white matter and collaterals of these axons ramify in laminae III–V and deeper laminae, including the contralateral side and lamina X.

#### Response Properties of Nociceptive Spinal Cord Neurons

Recordings have shown responses of spinal cord neurons to electrical stimulation of nerve fibres and to natural innocuous and noxious stimulation (for references see Willis and Coggeshall 2004). Upon electrical nerve stimulation lamina I neurons were excited by cutaneous A $\delta$  fibres and sometimes by volleys in C fibres, in line with the morphological studies. However, some neurons were excited (polysynaptically?) by A $\beta$  fibre stimulation. Neurons in the substantia gelatinosa were activated primarily by C fibres; however, A $\beta$  and A $\delta$  fibre stimulation also activated some of them. Neurons in laminae III to VI respond either to A and C fibre or only to A fibre stimulation. Many neurons show convergence of A $\beta$ , A $\delta$  and C fibre inputs.

It is noteworthy that neurons in laminae I and V in the thoracic and sacral spinal cord also show responses to stimulation of visceral nerves and neurons in the superficial and deep lumbosacral enlargement are activated

by cutaneous fibres, muscular group III fibres and joint afferents.

Neuronal responses were also recorded during natural stimulation (for references see Willis and Coggeshall 2004). It appeared that neurons in the different laminae are heterogeneous in their response properties. This is not surprising on the one hand, because each of the A $\beta$ , A $\delta$  and C fibre classes has different modalities (mechanoreception, nociception, thermoreception). On the other hand, the response properties do not seem simply to reflect the input into the laminae. This has to be expected because only about 50% of the synapses are from primary afferent fibres. Lamina I contains neurons that are only activated by intense mechanical stimulation of the skin, neurons that are activated by intense mechanical stimulation of skin and noxious heat applied to the skin and non-nociceptive thermoreceptive neurons that respond to innocuous warming or cooling. Other neurons are wide dynamic range neurons responding weakly to innocuous and strongly to noxious stimulation. Furthermore, neurons in lamina I show convergent inputs from cutaneous and deep tissue or convergence from cutaneous and visceral inputs.

Information on identified lamina II neurons is sparse. Cells were excited by innocuous or noxious mechanical stimuli. However, several authors reported that spontaneously active neurons in this lamina were inhibited by natural stimulation or they were inhibited and then excited by weak mechanical stimuli. Furthermore, neurons showed phenomena such habituation, long afterdischarges following brief stimuli and variable receptive fields.

Neurons in laminae III–VI are of different types. Concerning thresholds and encoding ranges some neurons are low threshold, responding only to innocuous stimulation. Many of these neurons are located in laminae III and IV. Most neurons are wide dynamic range, responding weakly to innocuous stimuli and strongly to noxious stimuli and a further group of neurons are high threshold responding only to noxious intensities. Thus, at least the wide dynamic range neurons seem to receive inputs from non-nociceptive as well as from nociceptive afferents, in line with morphological studies showing projection of non-nociceptive afferents into deep laminae, extension of dendrites of deep cells up to the superficial laminae and interneurons transmitting information from superficial into deeper laminae. Many neurons in laminae III–VI receive inputs from deep tissue. These cells are solely excited by deep tissue stimulation or show convergent inputs from deep tissue and skin, or they are excited from skin and viscera. All neurons with visceral input seem to receive input from the skin as well. Lamina X neurons are also either low threshold,

wide dynamic range or high threshold. Many of these neurons respond to visceral stimulation such as colorectal distension, in addition to cutaneous stimuli. Some cells in lamina X have bilateral receptive fields.

### Encoding of Noxious Stimuli in the Spinal Cord

The understanding of the encoding of nociceptive information in the spinal cord is not very advanced. On the basis of single neuron recordings both ► **wide dynamic range neurons** and ► **nociceptive specific neurons** seem to be suitable to encode the intensity of a noxious stimulus to a specific site. However, wide dynamic range neurons in particular often have large receptive fields and a stimulus of a defined intensity may elicit differently strong responses when applied to different sites in the receptive field. It is questionable whether the activity of a single neuron reflects more the magnitude of a stimulus or the site in the receptive area where a stimulus of a defined intensity is applied. Furthermore, the situation becomes more complicated when inputs from different tissues to a neuron are studied. It seems impossible that e.g. a single wide dynamic range neuron with convergent cutaneous and visceral inputs can unequivocally signal that the skin or a visceral organ has been challenged with a noxious stimulus. This uncertainty in the message of a neuron could in fact be the reason why pain in viscera and to some extent in the deep tissue is often referred to a cutaneous area, namely into a so-called Heat zone. However, it is quite clear that the precise location of a noxious stimulus, its intensity and character cannot be encoded by a single nociceptive neuron. It is assumed therefore, that encoding of a noxious stimulus is only achieved by a population of nociceptive neurons (for further discussion see Price et al. 2003). This topic is addressed in detail in ► **encoding of noxious information in the spinal cord**. Samples of neurons were studied by the recording of field potentials in the dorsal horn, but these data have not contributed to the understanding of encoding. Furthermore, changes in metabolic activity and the expression of immediate early genes such as ► **C-Fos** have been used to map regions in the spinal cord that are activated by a noxious stimulus. The expression of FOS protein (► **c-fos**) has been used extensively because individual neurons can be visualised. The expression of C-FOS in a neuron is thought to show its activation (Willis and Coggeshall 2004). For example, noxious heat stimulation evokes expression of C-FOS in the superficial dorsal horn within a few minutes and staining shifts to deeper laminae of the dorsal horn thereafter (Menetréy et al. 1989; Williams et al. 1990). Noxious visceral stimulation evokes C-FOS expression in laminae I, V and X, thus resembling the projection area of visceral afferent fibres and injection of mustard oil into

muscle elicits C-FOS expression in laminae I and IV to VI (Hunt et al. 1987; Menetréy et al. 1989). These data show therefore, in which spinal laminae and segments neurons were activated by noxious stimulation. It should be noted however, that excitatory as well as inhibitory neurons may express C-FOS.

### Plasticity in the Nociceptive Processing in the Spinal Cord

Importantly, spinal cord neurons show changes in their response properties, including the size of their receptive fields, when the peripheral tissue is sufficiently activated by noxious stimuli or when thin fibres in a nerve are electrically stimulated. In general, it is thought that plasticity in the spinal cord contributes significantly to clinically relevant pain states.

#### Wind-up

► **Wind-up** is the increase in the response of a spinal cord neuron when electrical stimulation of C-fibres is repeated at intervals of about 1 s (Mendell 1966; Mendell and Wall 1965). The basis of wind-up is a prolonged EPSP that builds up as a result of a repetitive C-fibre volley and thus it rests on temporal summation of synaptic potentials within the cord (Sivilotti et al. 1993). Other neurons show wind-down (Alarcon and Cervero 1990; Fitzgerald and Wall 1980; Woolf and King 1987). Wind-up disappears quickly when repetitive stimulation is stopped. Wind-up is likely to contribute to short lasting increases in response to painful stimulation (see ► **wind-up of spinal cord neurons**).

#### Long-term Potentiation (LTP) and Long-term Depression (LTD)

These are long lasting changes in synaptic activity after peripheral nerve stimulation (Randic et al. 1993; Rygh et al. 1999; Sandkühler and Liu 1998; Svendsen et al. 1997). They can be observed as increases in field potentials in the superficial dorsal horn. The most pronounced ► **LTP** with a short latency can be elicited after application of a high frequency train of electrical stimuli that are suprathreshold for C-fibres when the spinal cord has been transected in order to interrupt descending inhibitory influences from the brain stem. However, LTP can also be elicited with natural noxious stimulation, although the time course is much slower (Rygh et al. 1999). By contrast, LTD in the superficial dorsal horn is elicited by electrical stimulation of A $\delta$  fibres. This latter form of plasticity may be a basis of inhibitory mechanisms that counteract responses to noxious stimulation (Sandkühler et al. 1997). LTP and LTD will be addressed in detail in the essay ► **long-term potentiation and long-term depression in the spinal cord**.



### Central Sensitization in the Course of Inflammation and Nerve Damage

Changes in responses of spinal cord neurons have been studied in models of inflammation and neuropathy. Pronounced changes in response properties of neurons in the superficial dorsal horn, the deep dorsal horn and the ventral cord have been described. ► **Central sensitization**, originally described by Woolf (1983), has been observed in neurons with cutaneous input during cutaneous inflammation and other forms of cutaneous irritation such as capsaicin application. Pronounced central sensitisation of spinal cord neurons with deep input has been shown during inflammation in joints, muscle and viscera. Typical changes in responses of individual neurons are (a) increased responses to noxious stimulation of inflamed tissue, (b) lowering of the threshold of spinal cord neurons with an initially high threshold (initially nociceptive spinal neurons will change into wide dynamic range neurons), (c) increased responses to stimuli applied to non-inflamed tissue surrounding the inflamed site and (d) expansion of the receptive field. In particular the enhanced responses to stimuli applied to non-inflamed tissue in the vicinity of the inflamed zone indicate that the sensitivity of the spinal cord neurons is enhanced, so that previously sub-threshold input is sufficient to activate the neuron under inflammatory conditions. The sensitisation of individual spinal cord neurons will lead to an increased percentage of neurons in a segment that respond to stimulation of an inflamed tissue. Thus the population of responsive neurons increases. Central sensitisation can persist for weeks judging from the recording of neurons at different stages of acute and chronic inflammation (for review seeCoderre et al. 1993; Dubner and Ruda 1992; Mense 1993; Schaible and Grubb 1993).

In ► **neuropathic pain states**, findings in the spinal cord are dependent on the neuropathic model used. Evidence for central sensitisation has been observed in neuropathic pain states in which conduction in the nerve remains present and thus a receptive field of neurons can be identified. In these models, more neurons show ongoing discharges and on average higher responses can be elicited by innocuous stimulation of receptive fields (Laird and Bennett 1993; Palacek 1992 a, b). In some models of neuropathy, neurons with abnormal discharge properties can be observed. For more information see chapters on neuropathic pain.

During inflammation and neuropathy, more neurons that express C-FOS are observed in the spinal cord, supporting the finding that a large number of neurons are activated. At least at some time points, enhanced ► **metabolism** can be seen in the spinal cord during inflammation and neuropathy. Both of these findings underscore the plasticity that occurs in the spinal cord un-

der these conditions (Price et al. 1991; Schadrack et al. 1999).

### Transmitters and Receptors Involved in the Spinal Nociceptive Processing

Numerous transmitters and receptors are involved in spinal nociceptive processing. They mediate processing of noxious information arising from noxious stimulation of normal tissue and they are involved in plastic changes in spinal cord neuronal responses when the peripheral tissue is inflamed or when a nerve is damaged in a neuropathic fashion. Other transmitters are inhibitory and control spinal processing. In general, transmitter actions have either fast kinetics (action of glutamate on ionotropic AMPA and kainate receptors, action of ATP at ionotropic purinergic receptors, action of GABA at ionotropic GABA receptors) or slower kinetics (in particular neuropeptides that act through G-protein coupled metabotropic receptors). Actions with fast kinetics evoke immediate and short-term effects on neurons, thus encoding the input to the neuron, whereas actions with slow kinetics rather modulate synaptic processing (Millan 1999; Willis and Coggeshall 2004). The following paragraphs summarize the main findings on synaptic transmission of nociceptive information (for references see Willis and Coggeshall 2004).

#### Glutamate

This excitatory amino acid is a principal transmitter in the spinal cord that produces fast synaptic transmission. ► **Glutamate** is a transmitter of primary afferent neurons and of dorsal horn interneurons. Many spinal cord interneurons are excited by glutamate and by agonists at glutamate receptors. Glutamate activates ionotropic AMPA / kainate (non-NMDA) and ► **NMDA receptors** as well as ► **metabotropic glutamate receptors**. They are expressed all over the spinal cord grey matter, although differences in regional densities are found. Glutamate receptors are found in both excitatory and inhibitory interneurons.

Glutamate receptors are involved in the excitation of substantia gelatinosa neurons by A $\delta$  and C fibres in slice preparations. Usually these actions are mainly blocked by CNQX, an antagonist at non-NMDA receptors, whereas ► **NMDA receptor antagonists** usually cause a small reduction in EPSPs and reduce later components of the EPSP. *In vivo* recordings showed that both non-NMDA and NMDA receptors are involved in the synaptic activation of neurons by noxious stimuli. In addition, both of these receptors are involved in forms of functional plasticity. For example, both wind-up and central sensitisation by inflammation are blocked by spinal application of NMDA antagonists (and non-NMDA antagonists). Metabotropic glu-

tamate receptors can potentiate the action of ionotropic glutamate receptors (for review see Fundytus 2001; Millan 1999; Willis and Coggeshall 2004). A detailed discussion of glutamate receptors is provided by the essays ► [NMDA receptors in spinal nociceptive processing](#) and ► [metabotropic glutamate receptors in spinal nociceptive processing](#).

#### Adenosine Triphosphate

► ATP depolarises some dorsal horn neurons in the superficial dorsal horn. ATP has been implicated in the fast synaptic transmission of innocuous mechanoreceptive input but evidence has also been provided for an involvement in nociceptive synaptic transmission. Some spinal cord neurons seem to express purinergic receptors for actions of ATP, but other reports rather described presynaptic actions of ATP that caused an enhanced release of glutamate. The latter finding is consistent with the localisation of purinergic receptors in dorsal root ganglion cells. ► [P2X3 Receptor](#) immunoreactivity in the inner part of lamina II is reduced following dorsal rhizotomy (for review see Willis and Coggeshall 2004).

#### GABA and Glycine

► GABA is probably the most important fast inhibitory transmitter in the spinal cord. Application of GABA to neurons causes IPSPs and inhibition of the activity of spinal cord neurons. GABA occurs in inhibitory interneurons throughout the spinal cord. ► [GABAergic inhibitory interneurons](#) can be synaptically activated by primary afferent fibres and this explains why strong nociceptive inputs can induce, in addition to excitation, inhibition of neurons (usually following initial excitation) that are under the control of these inhibitory interneurons. Noxious stimuli can cause FOS expression in GABAergic interneurons. Some of the GABAergic interneurons also contain other mediators such as glycine, acetylcholine, enkephalin, galanin, neuropeptide Y or nitric oxide synthase (NOS).

Both the ionotropic ► [GABAA receptor](#) and the metabotropic ► [GABAB receptor](#) are located presynaptically on primary afferent neurons or postsynaptically on dorsal horn neurons. Responses to both innocuous mechanical and noxious stimuli can be reduced by GABA receptor agonists (for review see Willis and Coggeshall 2004). It is under discussion whether reduced inhibition may be a mechanism of neuropathic pain (Polgár et al. 2004).

Some of the inhibitory effects are due to glycine and indeed, the ventral and the dorsal horn contain numerous glycinergic neurons. Glycine may be colocalized with GABA in synaptic terminals. The roles of GABA and glycine are addressed in more detail in ► [GABA and glycine in spinal nociceptive processing](#).

#### Acetylcholine

Many small DRG neurons, some large DRG ones and some neurons in the dorsal horn are cholinergic. *Vice versa*, many DRG neurons and neurons in the dorsal horn express nicotinic and muscarinic receptors. Application of ► [acetylcholine](#) to the skin is pronociceptive (*via* nicotinic and muscarinic receptors) whereas spinal acetylcholine produces pro- or anti-nociception (for review see Willis and Coggeshall 2004).

#### Excitatory Neuropeptides

A number of peptides are colocalised with excitatory transmitters, in particular with glutamate. Excitatory neuropeptides evoke EPSPs, but these differ from EPSPs evoked by glutamate in several respects. Usually they occur after a latency of seconds, but they last longer. They may not be sufficient to evoke action potential generation. Because glutamate and excitatory peptides are coreleased from synaptic endings, they are thought to act in a synergistic way (Urban et al. 1994).

#### Substance P

This excitatory peptide is colocalized with glutamate in a proportion of thin diameter primary afferents and in a proportion of spinal cord interneurons. SP-containing endings are concentrated in laminae I and II and in lamina X. They terminate on cell bodies and dendrites of dorsal horn neurons. SP is released mainly in the superficial dorsal horn following electrical stimulation of unmyelinated fibres and during noxious mechanical, thermal or chemical stimulation of the skin and deep tissues such as the joints. In part, release of SP is dependent on NMDA receptors on primary afferent endings (for review see Willis and Coggeshall 2004).

SP acts on ► [neurokinin-1 \(NK-1\) receptors](#) that are located on dendrites and cell bodies of dorsal horn neurons in laminae I, IV–VI and X. Fewer neurons in laminae II and III have NK-1 receptors. The vast majority of neurons with NK-1 receptors are excitatory, while a few contain GABA and glycine and are thus inhibitory. Some of the neurons with NK-1 receptors are projection neurons including spinothalamic, spinoreticular and spinobrachial neurons. Upon strong activation by SP, NK-1 receptors can be internalized. Such an internalization is blocked by NK-1 receptor antagonists and by NMDA receptor antagonists.

NK-1 receptors are G-protein coupled receptors, i.e. the action of SP on ion channels is indirect. Application of SP evokes a prolonged excitation of nociceptive dorsal horn neurons. These depolarizations are presumably caused by  $Ca^{2+}$  inward currents and inhibition of  $K^{+}$  currents and possibly by other currents. Several second messengers such as PKA and PKC are involved.

There is general agreement that SP and NK-1 receptors are involved in the plasticity of nociceptive processing, whereas the involvement of this system in normal nociception is controversial. Responses of dorsal horn neurons to C-fibre volleys and to noxious stimulation of skin and deep tissue are enhanced by SP and receptive fields can show an expansion. Antagonists at NK-1 receptors reduce responses to C-fibre volleys and to noxious stimulation of skin and deep tissue and they attenuate central sensitisation. Mice with a deletion of preprotachykinin A have intact responses to mildly noxious stimuli but reduced responses to moderate and intensely noxious stimuli. Mice with a deletion of the gene responsible for the production of NK-1 receptors respond to acutely painful stimuli, but lack intensity coding for pain and wind-up (for review see Willis and Coggeshall 2004).

#### Neurokinin A

In addition to substance P, neurokinin A (NKA) is found in small DRG cells and in the spinal dorsal horn. NKA is released in the spinal cord upon noxious stimulation. Due to its resistance to enzymatic degradation, NKA spreads throughout the grey matter. Interestingly, it has not so far been possible to identify NK-2 receptors immunohistochemically in the dorsal horn, leading to the unresolved question as to where NKA acts. It was proposed that NKA activates NK-1 receptors, because these are internalized after application of both SP and NKA. However, specific NK-2 receptor antagonists suggest that specific binding sites for NKA should be present.

The literature on NKA effects is controversial, because some authors found an involvement of NKA in nociceptive processing whereas others did not. Intrathecal application of NKA produces nocifensive behaviour and iontophoretic application of NKA activates nociceptive and non-nociceptive dorsal horn neurons. NKA facilitates behavioural nociceptive responses to heat stimulation, which are blocked by NK-2 receptor antagonists. While some authors could not antagonize responses of dorsal horn neurons to noxious mechanical stimulation, others were able to show such an effect. Antagonists at NK-2 receptors were able to attenuate central sensitisation during knee inflammation and colon inflammation (for review see Willis and Coggeshall 2004).

#### Neurokinin B

This peptide is found in synaptic terminals and dendrites in laminae I–III, independently of SP-containing elements and is not contained in dorsal root ganglion cells. NK-3 receptors are found in the most superficial part of the dorsal horn. Their function is unclear.

#### Calcitonin Gene-Related Peptide (CGRP)

This peptide is found in many small DRG neurons and is often colocalized with substance P. Probably the primary afferent neurons are the only source of CGRP in the dorsal horn. CGRP-containing afferents project mainly to laminae I, II and V. However, CGRP is also contained in motoneurons. CGRP is released in the spinal cord by electrical stimulation of thin fibres and by noxious mechanical and thermal stimulation. During joint inflammation, the pattern of CGRP release changes in that innocuous stimuli to the joint are sufficient to elicit CGRP release.

CGRP binding sites are concentrated in lamina I and in the deep dorsal horn. CGRP enhances actions of substance P. It inhibits enzymatic degradation of SP and it seems to potentiate release of SP. Enhanced  $Ca^{2+}$  influx may be important in this respect. CGRP activates nociceptive dorsal horn neurons with a slow time course. Blockade of CGRP effects reduces nociceptive responses and attenuates inflammation evoked central sensitisation. The effects of CGRP are discussed in more detail in the essay ► [CGRP and spinal cord nociception](#).

#### Vasoactive Intestinal Polypeptide (VIP)

► [Vasoactive intestinal polypeptide](#) is found in small diameter afferent fibres especially in the sacral spinal cord. Terminals with VIP are concentrated in laminae I, II, V, VII and X. In addition, neurons with VIP are located in laminae II–IV and X. VIP binding sites are concentrated in laminae I and II. VIP excites nociceptive dorsal horn neurons.

#### Neurotensin

Neurotensin is located in interneurons in lamina I and the substantia gelatinosa and neurotensin binding sites are present in the dorsal horn. The peptide excites neurons in the superficial dorsal horn.

#### Cholecystokinin (CCK)

► [Cholecystokinin](#) (CCK) is located in DRG neurons and in neurons in several laminae of the dorsal horn. Binding sites reach their highest concentration in laminae I and II. CCK can excite neurons in laminae I–VII and an antagonist at CCK-B receptors is antinociceptive. Antinociceptive effects of CCK have also been described.

#### Thyrotropin Releasing Hormone (TRH)

Thyrotropin releasing hormone (TRH) is located in the ventral and dorsal horn. Many TRH-containing neurons also contain GABA. TRH facilitates responses of nociceptive neurons to glutamate at NMDA receptors, wind-up and responses to noxious stimuli.

**Corticotropin-releasing hormone (CRH)**

(CRH)-immunoreactive fibres are present in the sacral spinal cord (laminae I, V–VII, X, intermediolateral column) and CRH immunostaining is abolished after dorsal rhizotomy. CRH binding sites are found in the superficial dorsal horn.

**Pituitary Adenylate Cyclase Activating Polypeptide (PACAP)**

► **Pituitary adenylate cyclase activating polypeptide (PACAP)** is localized in small DRG cells and many axons in the superficial dorsal horn. PACAP is released after intrathecal capsaicin, and intrathecal PACAP causes nociceptive behaviour. Nociceptive dorsal horn neurons are excited by PACAP (for review see Willis and Coggeshall 2004).

**Inhibitory Neuropeptides**

Numerous neuropeptides are inhibitory. They may reduce release of transmitters by presynaptic actions or inhibit postsynaptic neurons.

**Opioid Peptides**

The dorsal horn contains leu-enkephalin and met-enkephalin, ► **dynorphin** and ► **endomorphins 1 and 2**. Enkephalin containing neurons are particularly located in laminae I and II and dynorphin containing neurons in laminae I, II and V. Endomorphin II has been visualised in terminals of primary afferent neurons in the superficial dorsal horn and in dorsal root ganglia but also in postsynaptic neurons.

► **Opiate Receptors** ( $\mu$ ,  $\delta$ ,  $\kappa$ ) are concentrated in the superficial dorsal horn and in particular  $\mu$  and  $\delta$  receptors are not only located in interneurons but also on primary afferent fibres. The activation of these opiate receptors reduces release of mediators from primary afferents (presynaptic effect). This effect is mediated by inhibition of  $Ca^{2+}$  channels. Other opiate receptors are located on intrinsic spinal cord neurons and mediate postsynaptic effects. The activation of a  $K^+$  conductance could be the relevant mechanism. In general, enkephalins are ligands at  $\delta$ -receptors, endomorphins are ligands at  $\mu$ -receptors and dynorphin is a ligand at  $\kappa$ -receptors. However, dynorphin may also activate NMDA receptors. Actions of all opiates are antagonized by naloxone. Specific antagonists at different receptors are available (Waldhoer et al. 2004).

Application of opioids into the dorsal horn reduces responses to (innocuous) and noxious stimulation and responses of neurons to iontophoretic application of excitatory amino acids, showing postsynaptic effects of opioids. Depending on the site of application (superficial or deep laminae),  $\mu$ -,  $\kappa$ - or  $\delta$ -receptor ligands are more or less effective in producing neuronal effects. In

addition many dorsal horn neurons are hyperpolarised by opiates. While agonists at  $\mu$ - and  $\delta$ -receptors usually evoke inhibitory effects, dynorphin may produce either inhibitory or excitatory effects.

In addition to these “classical” opiate receptors, nociceptin / orphanin FQ receptors (see ► **Orphanin FQ**) have recently been discovered. These proteins share greater than 90% sequence identity and about 60% homology with the classical opiate receptors (Waldhoer et al. 2004). An endogenous ligand at these receptors is ► **Nociceptin**. This peptide has similar cellular actions to classical opioid peptides. It causes presynaptic inhibition of glutamate release in the spinal cord and reduces FOS expression in the superficial dorsal horn. However, pronociceptive effects have also been described. A related peptide is nocistatin. At present it is unknown at which receptor nocistatin acts (for review see Willis and Coggeshall 2004).

**Somatostatin**

This peptide is expressed in primary afferent neurons, in dorsal horn interneurons and in axons that descend from the medulla. ► **Somatostatin** is released mainly in the substantia gelatinosa, by heat stimulation. Actions of somatostatin on nociceptive neurons in the dorsal horn are inhibitory. It is an intriguing question as to whether inhibitory somatostatin is released in the spinal cord from primary afferent fibres or from interneurons.

**Galanin**

This peptide is expressed in a subpopulation of small DRG neurons and galanin binding sites are also expressed on DRG neurons. Both facilitatory and inhibitory effects of galanin have been described in inflammatory and neuropathic pain states.

**Neuropeptide Y**

This is normally only expressed at very low levels in DRG neurons, but DRG neurons express Y1 and Y2 receptors. It was proposed that Y1 and Y2 receptors contribute to presynaptic inhibition.

**Other Mediators**

A number of other mediators influence synaptic transmission in the spinal dorsal horn. Most attention has given to ► **NO**, ► **prostaglandins** and ► **neurotrophins**. These mediators have actions in non-neuronal tissues as well as in neuronal tissues in the peripheral and central nervous systems including the spinal cord. They play significant roles in pathophysiological pain states. The role of prostaglandins is addressed in another section, and a recent review (Vanegas and Schaible 2001) provides a comprehensive summary. The role of



neurotrophins is addressed in the essay ► [spinal cord nociception, neurotrophins](#).

**Involvement of Calcium Channels in Release of Transmitter and Postsynaptic Excitability**

The release of transmitters is dependent on the influx of Ca<sup>2+</sup> into the presynaptic ending through ► [Voltage-Dependent Calcium Channels](#). In addition Ca<sup>2+</sup> also regulates excitability of postsynaptic neurons. High voltage activated N-type channels, which are mainly located presynaptically but also on the postsynaptic side and P / Q-type channels that are located on the presynaptic side are important for nociceptive processing. In particular, blockers of N-type channels reduce responses of spinal cord neurons and behavioural responses to noxious stimulation of normal and inflamed tissue and blockade of N-type channels can also reduce neuropathic pain. There is some evidence that P/Q-type channels are mainly involved in the generation of pathophysiological pain states. A role for high voltage activated L-type channels and low voltage activated T-type channels has also been discussed. The role of calcium channels is addressed in detail in the essay ► [calcium channels in the spinal processing of nociceptive input](#).

**Final conclusions**

This review concentrated on spinal cord neurons that are excited by noxious stimuli applied to the peripheral tissue. The significance of particular types of neurons in the transmission of sensory information to supraspinal sites through ascending tracts will be addressed in another section. The modulation of responses of spinal cord cells by descending inhibition and facilitation is described in another section. In addition, the particular aspects concerning deep somatic and visceral pain are also covered elsewhere. As briefly outlined here, the spinal cord is subject to considerable changes during pathophysiological pain states. These changes will also be addressed in other sections. Moreover, the spinal cord is the major site at which antinociceptive compounds work. Again this will be addressed in other sections.

**References**

1. Alarcon G, Cervero F (1990) The effects of electrical stimulation of A and C visceral afferent fibres on the excitability of viscerosomatic neurones in the thoracic spinal cord of the cat. *Brain Res* 509:24–30
2. Chung K, McNeill DL, Hulsebosch CR et al. (1989) Changes in dorsal horn synaptic disc numbers following unilateral dorsal rhizotomy. *J Comp Neurol* 283:568–577
- 3.Coderre TJ, Katz J, Vaccarino AL et al. (1993) Contribution of central neuroplasticity to pathological pain:review of clinical and experimental evidence. *Pain* 52:259–285
4. Dubner R, Ruda MA (1992) Activity-dependent neuronal plasticity following tissue injury and inflammation. *Trends Neurosci* 15:96–103

5. Fitzgerald M, Wall PD (1980) The laminar organization of dorsal horn cells responding to peripheral C fibre stimulation. *Exp Brain Res* 41:36–44
6. Fundytus ME (2001) Glutamate receptors and nociception. *CNS Drugs* 15:29–58
7. Laird JMA, Bennett GJ (1993) An electrophysiological study of dorsal horn neurons in the spinal cord of rats with an experimental peripheral neuropathy. *J Neurophysiol* 69:2072–2085
8. McMahon SB, Wall PD (1983) A system of rat spinal cord lamina I cells projecting through the contralateral dorsolateral funiculus. *J Comp Neurol* 214:217–223
9. Mendell LM (1966) Physiological properties of unmyelinated fiber projection to the spinal cord. *Exp Neurol* 16:316–332
10. Mendell LM, Wall PD (1965) Responses of single dorsal cord cells to peripheral cutaneous unmyelinated fibers. *Nature* 206:97–99
11. Menetrey D, Gannon JD, Levine JD et al. (1989) Expression of c-fos protein in interneurons and projection neurons of the rat spinal cord in response to noxious somatic, articular, and visceral stimulation. *J Comp Neurol* 285:177–195
12. Mense S (1993) Nociception from skeletal muscle in relation to clinical muscle pain. *Pain* 54:241–289
13. Millan MJ (1999) The induction of pain: an integrative review. *Progr Neurobiol* 57:1–164
14. Palacek J, Dougherty PM, Kim SH et al. (1992b) Responses of spinothalamic tract neurons to mechanical and thermal stimuli in an experimental model of peripheral neuropathy in primates. *J Neurophysiol* 68:1951–1966
15. Palacek J, Paleckova V, Dougherty PM et al. (1992a) Responses of spinothalamic tract cells to mechanical and thermal stimulation of skin in rats with experimental peripheral neuropathy. *J Neurophysiol* 67:1562–1573
16. Polgar E, Gray S, Riddell JS et al. (2004) Lack of evidence for significant neuronal loss in laminae I–III of the spinal dorsal horn of the rat in the chronic constriction injury model. *Pain* 111:144–150
17. Price DD, Mao J, Coghill RC et al. (1991) Regional changes in spinal cord glucose metabolism in a rat model of painful neuropathy. *Brain Res* 564:314–318
18. Price DD, Greenspan JD, Dubner R (2003) Neurons involved in the exteroceptive function of pain. *Pain* 106:215–219
19. Randic M, Jiang MC, Cerne R (1993) Long-term potentiation and long-term depression of primary afferent neurotransmission in the rat spinal cord. *J Neurosci* 13:5228–5241
20. Rexed B (1952) The cytoarchitectonic organization of the spinal cord in the rat. *J Comp Neurol* 96:415–466
21. Rexed B (1954) A cytoarchitectonic atlas of the spinal cord in the cat. *J Comp Neurol* 100:297–380
22. Rygh LJ, Svendsen F, Hole K et al. (1999) Natural noxious stimulation can induce long-term increase of spinal nociceptive responses. *Pain* 82:305–310
23. Sandkühler J, Liu X (1998) Induction of long-term potentiation at spinal synapses by noxious stimulation or nerve injury. *Eur J Neurosci* 10:2476–2480
24. Sandkühler J, Chen JG, Cheng G et al. (1997) Low-frequency stimulation of afferent Aδ-fibers induces long-term depression at primary afferent synapses with substantia gelatinosa neurons in the rat. *J Neurosci* 17:6483–6491
25. Schadrack J, Neto FL, Ableitner A et al. (1999) Metabolic activity changes in the rat spinal cord during adjuvant monoarthritis. *Neuroscience* 94:595–605
26. Schaible H-G, Grubb BD (1993) Afferent and spinal mechanisms of joint pain. *Pain* 55:5–54
27. Scheibel ME, Scheibel AB (1968) Terminal axon patterns in cat spinal cord: II. The dorsal horn. *Brain Res* 9:32–58
28. Sivilotti LG, Thompson SWN, Woolf CJ (1993) The rate of rise of the cumulative depolarization evoked by repetitive stimulation of small-calibre afferents is a predictor of action po-



- tential windup in rat spinal neurons *in vitro*. J Neurophysiol 69:1621–1631
30. Sugiura Y, Lee CL, Perl ER (1986) Central projections of identified, unmyelinated (C) afferent fibres innervating mammalian skin. Science 234:358–361
  31. Sugiura Y, Terui N, Hosoya Y (1989) Difference in the distribution of central terminals between visceral and somatic unmyelinated (C) primary afferent fibres. J Neurophysiol 62:834–840
  32. Svendsen F, Tjolsen A, Hole K (1997) LTP of spinal A $\beta$  and C-fibre evoked responses after electrical sciatic nerve stimulation. Neuroreport 8:3427–2430
  33. Urban L, Thompson SWN, Dray A (1994) Modulation of spinal excitability: cooperation between neurokinin and excitatory amino acid transmitters. Trends Neurosci 17:432–438
  34. Vanegas H, Schaible H-G (2001) Prostaglandins and cyclooxygenases in the spinal cord. Progr Neurobiol 64:327–363
  35. Waldhoer M, Bartlett SE, Whistler JL (2004) Opioid receptors. Annu Rev Biochem 73:953–990
  36. Williams S, Ean GL, Hunt SP (1990) Changing pattern of c-fos induction following thermal cutaneous stimulation in the rat. Neuroscience 36:73–81
  37. Willis WD, Coggeshall RE (2004) Sensory Mechanisms of the Spinal Cord 3rd edn. Volume 1, Kluwer Academic / Plenum Publishers. New York
  38. Woolf CJ (1983) Evidence for a central component of post-injury pain hypersensitivity. Nature 306:686–688
  39. Woolf CJ, King AE (1987) Physiology and morphology of multireceptive neurons with C-afferent inputs in the deep dorsal horn of the rat lumbar spinal cord. J Neurophysiol 58:460–479

## Nociceptive System

### Definition

Peripheral, spinal and cerebral structures involved in the processing of noxious stimuli. Sensory-discriminative aspect of pain: Perceptual component of pain perception including the perception of location, quality, intensity and duration of the painful stimulus.

- ▶ Noxious Stimulus
- ▶ Primary Somatosensory Cortex (S1), Effect on Pain-Related Behavior in Humans

## Nociceptive Temporomandibular Joint Afferents

- ▶ Nociceptors in the Orofacial Region (Temporomandibular Joint and Masseter Muscle)

## Nociceptive Threshold

### Definition

Nociceptive thresholds in experimental animals are usually defined as the threshold (temperature, mechanical force) at which a withdrawal response is evoked, measured either by active withdrawal of a limb or the tail, for example, or measurement of the electrical activity of a muscle in an anaesthetized animal.

- ▶ Arthritis Model, Adjuvant-Induced Arthritis

## Nociceptive Transduction

### Definition

Generation of the nociceptive information in nociceptors in response to noxious stimuli by generation of depolarizing currents.

- ▶ Nociceptor Generator Potential
- ▶ NSAIDs, Mode of Action

## Nociceptive Withdrawal Reflex

### Definition

Nociceptive withdrawal reflexes denote an integrated reflex to avoid potential tissue injury. The reflex response is dependent on stimulus site, stimulus intensity, and functional context. During standardized experimental conditions, the reflex is correlated to the pain intensity.

- ▶ Pain in Humans, Electrical Stimulation (Skin, Muscle and Viscera)

## Nociceptor Accommodation

- ▶ Nociceptor, Adaptation

## Nociceptor Desensitization

### Definition

Decreased sensitivity to noxious stimuli elicited by application of capsaicin. Short-term desensitization is due to the inactivation of TRPV1, preventing the generation of action potentials. On the other hand, long-term desensitization evoked by large doses of capsaicin onto polymodal nociceptor endings, is due to the destruction of a subset of small diameter primary afferent fibers and their cell bodies.

- ▶ Polymodal Nociceptors, Heat Transduction
- ▶ TRPV1 Receptor

## Nociceptive Processing in the Thalamus

A. VANIA APKARIAN

Department of Physiology, Northwestern University  
Feinberg School of Medicine, Chicago, IL, USA  
a-apkarian@northwestern.edu

The thalamus (Jones 1985) is the primary gateway for nociceptive information transmission to the cortex, similarly to most other sensory systems other than olfaction. However, in contrast to other sensory systems, nociceptive information is also transmitted to the cortex through pathways outside of the ► **spinothalamic-thalamocortical** projections. Recent new advances have pointed to nociceptive inputs to the brainstem, which in turn project to the thalamus and then to the cortex in a very different pattern from that of the spinothalamic inputs. Nociceptive information transmission to the cortex through thalamocortical projections remains the most thoroughly examined, even though substantial gaps remain in current understanding of this system. The thalamus is the only CNS structure that contains ► **mast cells**. Their exact role remains unclear but they exist in thalamic nuclei with cortical projections and seem to increase or decrease in number under different conditions. They may be involved in regulating the ► **blood-brain barrier**. They are probably important in neural-endocrine interactions. (see ► **spinothalamic projections in rat**). The state of current knowledge regarding the properties of nociceptive processing in the thalamus is outlined here, emphasizing the best-established facts, gaps in current knowledge and points of contention.

### Cells of Origin and Tracts

► **Spinothalamic** and ► **trigeminothalamic** pathways are the main direct source of nociceptive information input to the thalamus. Multi-synaptic projections through the ► **brainstem** provide additional nociceptive inputs to the thalamus. Specific subpopulations of spinal cord cells within laminae I, V–VI and VII–VIII project contralaterally through the spinothalamic pathway and transmit mainly nociceptive inputs to medial and lateral thalamic nuclei. The axons of the spinothalamic tract show a topographic organization and a dorsoventral segregation, with axons of superficial lamina spinothalamic cells being located more dorsally than axons of deeper lamina spinothalamic cells. The vast majority of spinothalamic cells respond to nociceptive stimuli. These responses may be uniquely nociceptive and thus called nociceptive specific or convergently responding to both noxious and innocuous stimuli, called ► **wide dynamic range** type. The responses may be to heat, cold or tactile stimuli specifically or convergently. There is little evidence as to the

spinothalamic cell responses to chemical irritants (see ► **spinothalamic input, cells of origin (monkey)**).

### Spinothalamic Targets

The differential projections for innocuous and nociceptive inputs to the thalamus were first noted when the functional distinctions between the dorsal columns and the anterolateral tract were observed in humans following cordotomies, over a 100 years ago. The terminations of the spinothalamic pathway still remain controversial. There is disagreement as to the terminations of the pathway in the lateral and medial thalamus. In 1980s, the ► **nucleus submedius (SM)** in the medial thalamus was claimed to be the nociceptive specific nucleus of the thalamus (Craig and Burton 1981), since it was thought to receive inputs only from spinal cord lamina I nociceptive neurons. This idea has been mostly discounted, at least in the rat and monkey. However, the primary medial thalamic termination site, which has traditionally been reported to be in ► **MD** has been put into doubt in recent reports as well; instead it is claimed that the main spinothalamic input is to ► **CL**. Lateral thalamic terminations have classically been reported to target ► **VP, VPI** and ► **PO** and there is ample evidence for this idea. However, this was recently challenged by the claimed existence of another nociception, thermoception and itch specific nucleus ► **VMpo** within the lateral thalamus, which seems to receive spinal cord and trigeminal lamina I inputs somatotopically and is most evident in the monkey and man (Craig et al. 1994). This notion has recently been questioned as well, by demonstrating that VMpo may simply be part of the periphery of ► **VPM**. At one level, these disputes seem simply a consequence of disagreements over how one delineates various borders of thalamic nuclei, which are invariably ambiguous and poorly defined, especially the transition zones between nuclei. On the other hand, they reflect philosophical differences as to the rules of the organization of the central nervous system regarding pain perception. The claim of the existence of nociceptive specific nuclei in the thalamus has the consequence of implying that these regions together with their inputs and output targets constitute the pain specific network of the brain. This claim in turn denies the contribution of other thalamic nuclei and their inputs and outputs to pain perception (see ► **Spinothalamic Projections from SM**).

### Periphery of VP, Rod and Matrix of VP and VMpo

Staining thalamic tissue for ► **cytochrome oxidase (CO)** showed that lateral thalamic somatosensory regions, VP and its surrounding nuclei, can be subdivided into two compartments, a region densely la-

beled with CO and a surrounding periphery (VPp) labeled weakly with CO. This observation was first made in Kniffki's lab for the cat thalamus, in the late 1980s. Independently, E.G. Jones noted the same CO staining based distinction in the monkey lateral thalamus and extended the parcellation by combining CO staining with two calcium binding proteins (▶ [calbindin](#) and ▶ [parvalbumin](#)), which preferentially label the CO dense and CO sparse domains of ▶ [VP](#) and its periphery. Jones advanced the hypothesis that the CO dense region, dubbed the rod region, was involved in sensory information transmission to the cortex by terminating in layer IV, while the CO weakly labeled region, dubbed the matrix region, projected mainly to layer I of the cortex and was involved in modulating cortical responses. A subsequent study did not substantiate this idea (Shi et al. 1993). Kniffki and colleagues hypothesized, mainly by relating terminations of the spinothalamic tract to the CO sparse region of the cat VP, that neurons in the VP periphery (VPp) are mainly nociceptive, while the CO dense region receives inputs from the medial lemniscus and signals innocuous somatosensory information to the cortex. A series of studies indicated that the cat VP does not have nociceptive cells. However, the opposite claim has been harder to prove since the number of nociceptive cells characterized in the VPp of the cat has remained small (Horn et al. 1999; Martin et al. 1990). To further explore the segregation of VP and its periphery in the monkey, electrophysiological studies contrasted nociceptive neurons in the squirrel monkey VP and VPI (equivalent to VPp in the cat) and observed that most VP nociceptive cells were WDR type while VPI nociceptive cells were both NS and WDR types. Given the distinct white matter localization of spinal cord lamina I *vs.* deeper spinothalamic cells and the evidence that most NS type cells in the spinal cord are localized to lamina I, it was proposed that the monkey periphery of VP preferentially or exclusively receives inputs from spinal cord lamina I cells, while the VP proper receives inputs from deeper laminae spinothalamic cells. This claim remains unproven and does not match with earlier reports (in the macaque) that VP nociceptive cells are of both NS and WDR types; it also does not match with the prevalences of NS and WDR type spinothalamic cells in the monkey, which do not seem to differ between spinal cord laminae. Craig and colleagues extended these ideas to the extreme and proposed the existence of VMpo, a unique lateral thalamic nucleus that provides pain specific inputs to the insular cortex. The corollary to this idea is that nociceptive inputs to VP proper are modulatory in nature and do not signal nociceptive sensory information. This idea has been criticized by various groups and remains controversial. Human imaging shows robust activation of SII and posterior insula and more variable responses

in SI for experimental pain in healthy humans. A recent meta-analysis, however, indicates no significant difference in activation incidence between these structures (Apkarian et al. 2005). Even if one assumes that posterior insular activity is due to inputs from VMpo, nociceptive inputs to SI and SII are undoubtedly from VP and VPI and hence nociceptive inputs to the latter nuclei participate in the cortical activity associated with pain perception (see essays ▶ [corticothalamic and thalamocortical interactions](#); ▶ [spinothalamic terminations, core and matrix](#); ▶ [thalamic nuclei involved in pain, human and monkey](#); ▶ [spinothalamic projections in rat](#); ▶ [spinothalamic input, cells of origin \(monkey\)](#); ▶ [thalamic nuclei involved in pain, cat and rat](#); ▶ [spinothalamic projections to ventromedial and parafascicular nuclei](#); ▶ [thalamus, nociceptive cells in VPI, cat and rat](#)).

Generally, this debate is the most modern version of specificity *vs.* pattern theories of coding for pain in the nervous system, a debate that goes back to Helmholtz, Von Frey and Goldscheider, who were battling pain representation models based on the discovery of punctate receptive fields on the human skin. In the 1960s, the debate moved from psychophysics to the properties of spinal cord neurons and the contribution of nociceptive specific *vs.* wide dynamic range type cells to pain perception. One group of scientists staked the claim that the wide dynamic range neurons were necessary and sufficient for pain perception, while another group claimed that nociceptive specific cells were all that was needed for pain perception. There was probably always a silent majority of scientists who simply accepted that both types of neurons are involved in pain perception and that these cell types complement each other in the range of stimuli that could evoke pain perception. Thus, VMpo and its connectivity represent the latest effort in pinpointing a specific group of cells from the skin to the cortex that uniquely signal pain from neurons that are specifically involved in coding noxious, thermal and itch stimuli. The opponents of this idea question whether VMpo exists as a unique thalamic nucleus and argue that there is ample evidence that other spinal cord neurons, thalamic nuclei and cortical regions have repeatedly been demonstrated to have all the necessary characteristics to encode nociceptive information.

### Brainstem Inputs

Spinoreticulothalamic projections, which are pathways conveying spinal cord inputs to different brainstem targets and then in turn projecting to the thalamus have been studied best in the rat. Some of these pathways seem specifically involved in conveying whole body nociceptive information to the thalamus. In the medullary brainstem, the subnucleus reticularis dor-



salis (SRD) seems to be one of the main nociceptive relays to the thalamus. Neurons from the SRD project to VMI and ► PF in the ► medial thalamus and neurons in VMI in turn project to the layer I of the ventrolateral cortex, while projections from PF project to the ► basal ganglia, the subthalamic nucleus and parts of the motor and parietal cortex (see ► brainstem subnucleus reticularis dorsalis neuron).

Another brainstem-thalamic projection, described in the rat, is through the internal lateral parabrachial nucleus, which receives nociceptive inputs from deep laminae of the spinal cord and projects to medial thalamic nuclei PC, CM and PF. Traditionally, CM and PF have been grouped together and implicated in affective modulation of pain. A large proportion of PF cells respond to nociceptive stimuli and stimulation in the region evokes pain-like reports in humans and pain-like behavior in animals. In humans, medial thalamic stimulation or lesioning has been used for pain relief and has targeted the CM-PF region. Such procedures report a fair incidence of success. PF and amygdala receive serotonergic inputs from ventral PAG and the three structures seem to interact in modulating the affective component of pain. Suppression of rats' affective reaction to noxious stimuli by injection of morphine into the ventral PAG is reversed by serotonin antagonists applied either to PF or amygdala (see ► parafascicular nucleus, pain modulation ► thalamus, nociceptive inputs in the rat (spinal) ► thalamo-amygdala interactions and pain).

### Spinothalamo-Cortical Connectivity

Although the suggested role of the nucleus submedius (SM) in nociception has diminished over the years, its projection targets show that SM neurons (in the rat) terminate in the ventrolateral orbital cortex (VLO), a region where nociceptive neurons have been described in the rat. The VLO nucleus also receives inputs from the ventral ► periaqueductal gray (PAG) and dorsal raphe. A similar but smaller brainstem projection seems to exist for the SM as well. The rat SM does not receive spinal cord lamina I inputs as originally claimed; instead its inputs are from deeper laminae. Although a nucleus equivalent to SM was originally described in the monkey, this claim has been repeatedly refuted (see ► thalamus, nociceptive inputs in the rat (spinal); ► spino-thalamocortical projections from SM).

Potential connectivity between thalamocortical projecting neurons and spinothalamic terminations has been studied probabilistically at the light microscopy level (Gingold et al. 1991). Hand primary somatosensory cortex projecting cells are labeled retrogradely with a given marker and spinothalamic terminations from the upper cervical enlargement labeled antero-

gradely with a different marker. Given the known dendritic branching pattern of thalamocortical cells, one can then calculate how many of these cells can potentially receive spinothalamic inputs on their dendritic perimeter. Although such an analysis cannot establish the presence or absence of synapses, it provides quantitative bounds as to the influence of nociceptive inputs through the spinothalamic projections to the cortical target. The analysis shows that 87% of cervical enlargement spinothalamic terminations are localized to VPL, VPI and CL and 24% of the hand region of the primary somatosensory cortex is putatively contacted by these spinothalamic terminations. A more recent study examined connectivity between thalamic cells and spinothalamic afferents by intracellularly labeling individual thalamic neurons and examining the proximity of the labeled dendrites to spinothalamic terminals (Shi and Apkarian 1995). A similar study has also been done electrophysiologically and indicates that the probability of encountering spinothalamic terminations in the vicinity of nociceptive cells in VP is 33% while in VPI it is 73% (Apkarian and Shi 1994).

### Synaptic Connectivity

Synaptic morphology, using electron microscopy, has been studied for spinothalamic inputs and contrasted to dorsal column inputs in VP (Ralston 2003). The study examined synapses for spinothalamic projections onto VP proper cells and contrasted them to medial lemniscal synapses. Spinothalamic synapses were found to be mainly on dendrites of projecting cells, in contrast to medial lemniscal synapses that formed triads between terminals and projecting and local GABAergic cells. This distinction between afferent input types and synapses is congruent with physiological connectivity differences observed for VP cell groups with and without nociceptive inputs (see ► thalamus, dynamics of nociception). More recently, similar electron microscopic studies were also done for spinal cord lamina I inputs to VMpo (Beggs et al. 2003). The synaptic profiles in VMpo were almost always triadic. Thus, the lamina I spinothalamic inputs to VMpo are different from spinothalamic inputs to VP. The difference is partly attributed to the targets and partly to inputs. Most likely most of the inputs examined in VP reflected terminations from deeper laminae than lamina I. These differences are consistent with the light microscopic observation regarding proximity of spinothalamic terminations to nociceptive cells in VP vs. VPI.

### Species Differences

There are important species differences regarding the spinothalamic pathway, its terminations in the thalamus and response properties of thalamic nociceptive

cells. The rat spinothalamic tract (see ► [Spinothalamic Projections in Rat](#)) is composed of a third fewer cells than that of the monkey. Rat lateral thalamic nuclei are devoid of local interneurons. Thus, one can assert that terminations in these nuclei are synapses on cortex projecting cells. Also, the rat VP was not traditionally subdivided into a core and a periphery; as a result there is no doubt that some spinothalamic terminals are on VP cells that project to the primary or secondary somatosensory cortex. Rat spinothalamic terminations in the medial thalamus generally target the same nuclei as in the cat or monkey, perhaps with the exception of SM, which does not seem to receive spinal cord lamina I inputs. In the spinal cord, the lateral cervical nucleus (LCN) seems more prominent in the rat and these cells do project to the thalamus, although their functional role has remained unclear.

More recent studies have unraveled differences in terminations of superficial laminar spinal cord cells and deeper ones as to their targets in the rat thalamus. Lamina I inputs seem to be limited to lateral thalamic targets, where the region is subdivided into VP, VPpc, Po and PoT, where VPpc and PoT probably correspond to different portions of VP periphery. Direct deeper laminae projections in the rat seem to be limited to PoT and CL. (see ► [thalamus, nociceptive inputs in the rat \(spinal\)](#) ► [spinothalamic projections in rat](#)).

### Neurotransmitters and Neuromodulators

Like other sensory inputs to the thalamus, ► [glutamatergic neurotransmission](#) is assumed to transmit nociceptive information. Although such transmission has been demonstrated for other sensory modalities, as in somatosensory transmission, it is not proven in the case of nociception. The thalamocortical efferent pathway is made of neurons that are glutamatergic. Cortical inputs to the thalamus seem to be mediated through ► [AMPA](#) and ► [mGLU](#) receptors. ► [GABAergic inhibitory interneurons](#) and GABAergic thalamic reticular nucleus innervation provide inhibition on projecting neurons through ► [GABA<sub>A</sub>](#) and ► [GABA<sub>A</sub> receptors](#). Most current knowledge regarding nociceptive neurotransmission is based on studies of VB neuronal properties and indicates that ► [NMDA receptors](#) signal acute thermal and mechanical responses. There is also evidence that thalamic mGLU receptor mechanisms are important in inflammation-induced hyperalgesia and in the expression of such behavior (see ► [metabotropic glutamate receptors in the thalamus](#)).

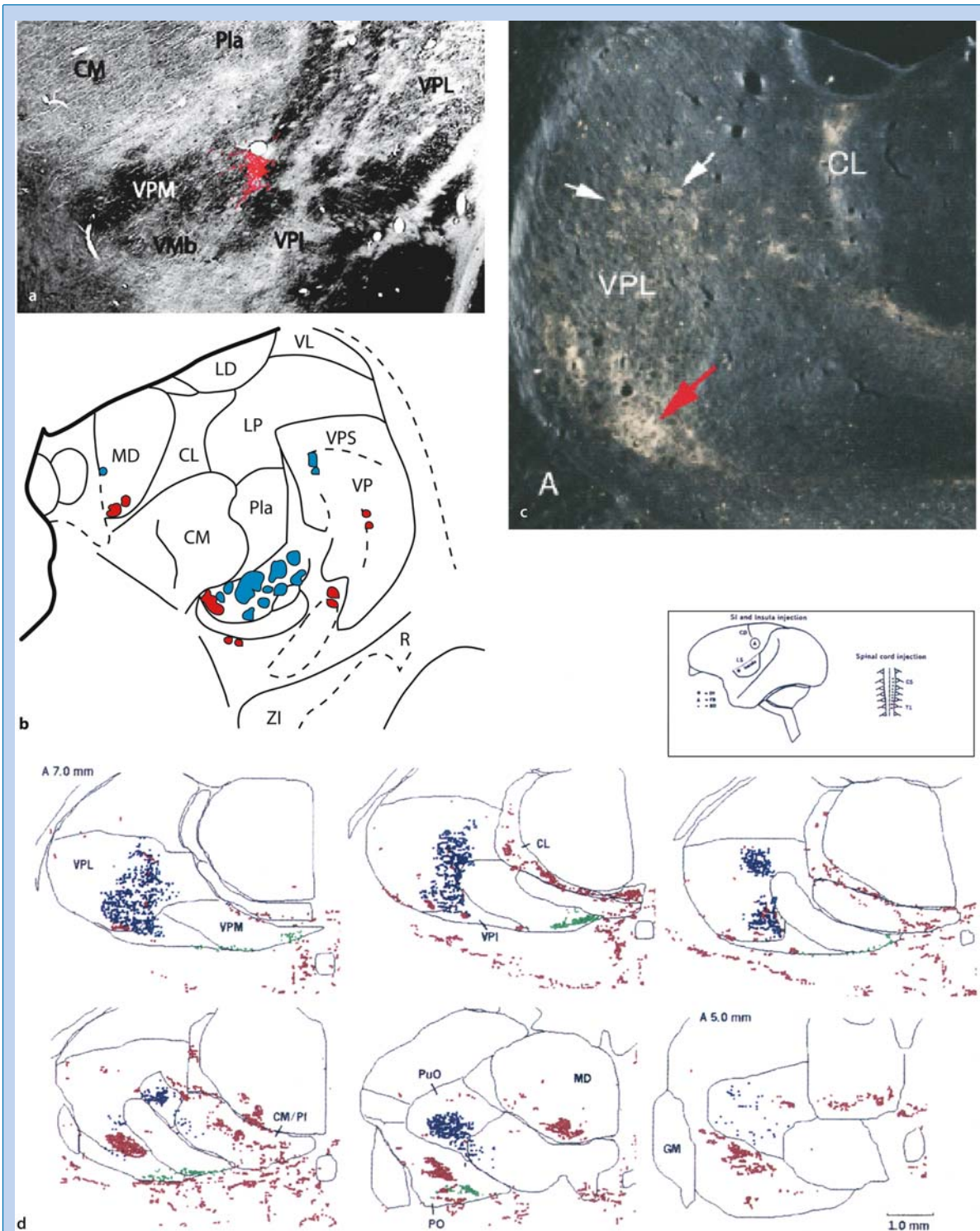
Eight metabotropic glutamate receptor subtypes (mGLU1–mGLU8) have been characterized, are divided into three groups (I, II, III) and are all found in the thalamus. Group I receptors mediate mainly postsynaptic actions, while Groups II and III regulate

presynaptic transmitter release. Different subtypes are important in either cortico-thalamic inputs or thalamic reticular neuronal modulating of GABAergic transmission. Thus, mGLU receptors have a minimal role in ascending sensory transmission but are more important in modulating this transmission (see ► [nociceptive neurotransmission in the thalamus](#)).

Spinothalamic neurons contain glutamate and various ► [neuropeptides](#). Of the large list of neuropeptides seen in spinothalamic cells, ► [substance P \(SP\)](#) is found abundantly in the medial thalamus, some of which may be due to spinothalamic inputs. Cholinergic, ► [serotonergic](#) and ► [noradrenergic](#) inputs from the brainstem are also found in the thalamus, all of which are probably part of the arousal modulatory system. Intrinsic SP neurons are described in thalamic regions receiving spinothalamic inputs. ► [CGRP](#) neurons are found in the periphery of VP and described as projecting to the amygdala or insula (see ► [thalamus, visceral representation](#) ► [parafascicular nucleus, pain modulation](#) ► [thalamic neurotransmitters and neurochemical effector molecules](#)).

### Somatic Representation

Nociceptive representation in the thalamus has been described in multiple species, primarily in rat, cat and monkey and mainly in anesthetized preparations. The overall number of nociceptive cells described remains relatively small and the properties of cells located in medial in contrast to lateral thalamic nuclei seem distinct. Nociceptive cells found in the medial thalamic nuclei tend to have more nociceptive specific responses, with response patterns that are modulated with the sleep-wakefulness cycle, level of anesthesia and attentional manipulations. In contrast, nociceptive cells in the lateral thalamus have more divergent inputs, they can be nociceptive specific or wide dynamic range types, with response properties that seem more reproducible and less dependent on attentional manipulations. The receptive field size, location and properties seem labile in medial thalamic cells, while in lateral thalamic cells they seem more constant and correspond to the properties of similar cells described in the spinal cord or trigeminal nuclei. These response differences are generally consistent with the notion that medial thalamic nociceptive information may be providing cortical signals regarding the affective properties of pain and also providing a more general modulatory signal that may be important in biasing the cortex and in modulating the attentional circuitry of the cortex. In contrast, lateral thalamic nociceptive signals are consistent with the general idea that these are the ► [sensory-discriminative](#) information being transmitted to cortical regions specifically involved in pain perception. Even though both notions may generally be



N

true, there are important deviations regarding input-output properties and response properties of nociceptive cells in specific thalamic nuclei, implying that the medial vs. lateral thalamic functional differentiation

is most probably too simplistic (see ► [parafascicular nucleus, pain modulation](#) ► [thalamus, nociceptive inputs in the rat \(spinal\)](#) ► [spinothalamic input, cells of origin \(monkey\)](#)).



◀ **Nociceptive Processing in the Thalamus, Figure 1**, Spinothalamic inputs to the lateral thalamus. Data are presented from four different labs. (a) A recent study (Graziano and Jones 2004) shows that trigeminothalamic projections in the monkey terminate in the periphery of VP, asserts that these terminations in turn project to primary and secondary somatosensory cortex and thus questions whether VMpo is a unique thalamic nucleus (from Graziano and Jones 2004). (b) An extensive study of spinal and trigeminal lamina I projections to the thalamus shows the location of VMpo and the somatotopic terminations within it (Craig 2004). Terminations from the cervical enlargement are in red, while those from trigeminal nucleus caudalis are in blue (from Craig 2004). (c) Site of dense terminations from cervical enlargement in monkey (Ralston 2003). The spinal cord injection does not distinguish between laminae. The author illustrates that the dense terminations in this case are more lateral and anterior than VMpo (from Ralston 2003). (d) Terminations from cervical enlargement in the monkey, in relation to neurons projecting to the hand region of the primary somatosensory cortex and in relation to neurons projecting to the insula (Apkarian and Shi 1998). Spinothalamic terminations are in red, cells projecting to hand primary somatosensory cortex in blue, cells projecting to insula green. Spinothalamic terminations in slice 4 from the most anterior section show a dense terminal patch at the border of VPL and VPI, closely corresponding to the labeling illustrated in (c). On the other hand, spinothalamic terminals in slice 6 are very similar to the labeling shown in (b), thus matching the VMpo label. At least at this slice location and from the specific insular injection, there is no overlap between these terminations and insular projecting cells. More anteriorly, there is some overlap between spinothalamic terminations and insula projecting cells. However, the overlap between primary somatosensory cortex projecting cells and spinothalamic terminations is more extensive. Comparing the four panels it should be evident that spinothalamic terminations in the lateral thalamus extend from VP proper to VPI and other VP periphery regions and most posteriorly are located at the interface between VP and PO, a region that has been called VMpo. At least in (d) this labeling seems continuous antero-posteriorly, casting doubt on the notion that the VMpo region is a unique nucleus with distinct projections to the insula. Figure from Apkarian and Shi, 1998.

### Visceral Representation

Visceral stimulation induced thalamic activity is demonstrated in the thalamus in humans with brain imaging studies and in animals using electrophysiology. Visceral responsive cells are found in and around VP with no evidence for viscerotopy, although visceral topography for baro- and chemo-receptors has been suggested. Visceral responsive cells are also reported in the medial thalamus. However, thalamic regions with inputs from SRD seem to lack visceral inputs (see ► [thalamus, visceral representation](#) ► [thalamus and visceral pain processing \(human imaging\)](#) ► [thalamus, clinical visceral pain, human imaging](#) ► [thalamus, nociceptive cells in VPI, cat and rat](#) ► [spinothalamocortical projections to ventromedial and parafascicular nuclei](#)).

### Thalamic Lesions in Animals

Thalamic lesions (thalamotomy) are used to relieve chronic pain in humans. On the other hand, stimulation within the human thalamus gives rise to pain sensations. Recent animal studies examined the behavioral effects of thalamic lesions, targeting either the lateral thalamus or both the lateral and medial thalamus. Generally, it seems, at least in the rat, that lesions involving any part of the thalamus give rise to increased sensitivity to mechanical and thermal noxious stimuli, reminiscent of 'thalamic syndrome' outcomes in humans. Moreover, when thalamic lesions are performed in animals with neuropathic pain-like behavior (partial peripheral nerve injury), this behavior is diminished only transiently and when the neuropathic injury is performed after a thalamic lesion, no significant change in neuropathic behavior is observed. These results challenge the idea that the thalamus is the main sensory transmission pathway for nociception, at least in the rat (see ► [lateral thalamic lesions, pain behavior in animals](#) ► [thalamotomy, pain behavior in animals](#)).

### Thalamic Plasticity

Plasticity of thalamic representation of innocuous and noxious inputs has been demonstrated following a variety of deafferentation procedures. The main effect is an expansion of intact adjacently represented regions into the areas of deafferentation. Spinothalamic tract lesions seem to increase spontaneous firing rates and increase sensitivity and bursting of thalamic cells with innocuous inputs. Similar observations have been made in humans with chronic pain (see ► [thalamic plasticity and chronic pain](#)).

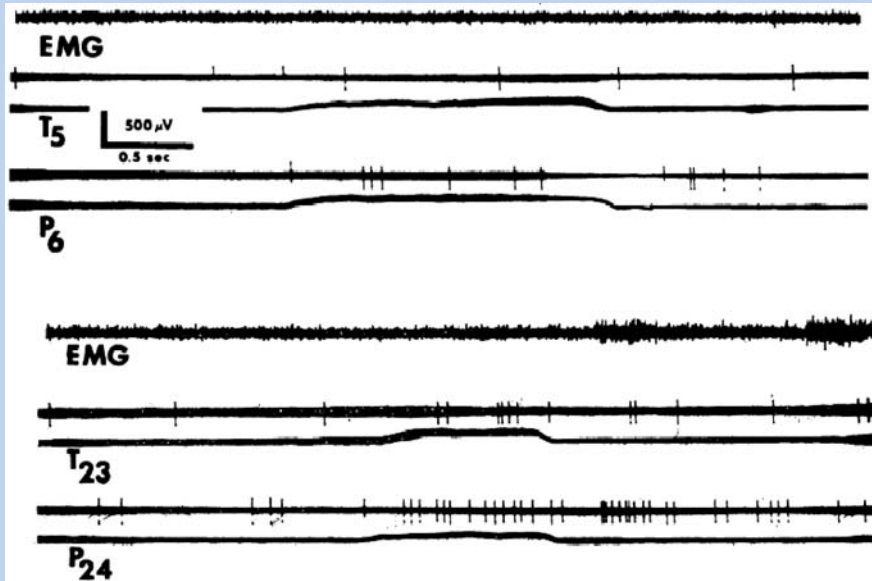
### Dynamics of Thalamic Coding for Nociception

A major function of the thalamus is state dependent modulation of incoming sensory information. Changes in intrinsic response properties of thalamic cells with the sleep and wake cycle have been documented extensively in many regions of the thalamus (Steriade et al. 1990). However, there is minimal such information regarding nociceptive inputs, the difficulty being that most thalamic nociceptive neurons are studied under anesthesia.

Thalamic neurons fire in two distinct modes, tonic and bursting. The bursting mode is due to a T-type calcium channel and such bursting activity is seen in conscious chronic pain patients. During sleep, thalamic neurons are mostly in burst mode and shift to tonic mode with wakefulness. Bursting activity in the conscious state is termed ► [thalamocortical dysrhythmia](#) and suggested to be a basis for pain and other neurological disorders (see ► [burst activity in thalamus and pain](#)).

A very early report documented that most nociceptive neurons in the thalamus switch response modes with the sleep cycle. Of 8 neurons that were characterized at different states of wakefulness, 5 began to respond to innocuous stimuli as well when the animal was more awake and 3 responded more specifically to noxious stimuli with increased wakefulness (Casey 1966).





**Noiceptive Processing in the Thalamus, Figure 2** Response properties of a neuron recorded in MD, in a conscious monkey (Casey 1966). Responses to innocuous and noxious stimuli are modulated with the wakefulness of the animal. In the top panel the animal is drowsy or lightly asleep, as a result the painful stimulus (delivered to the arm) does not evoke an EMG response. Tactile stimulation (T5) does not activate the neuron, but a painful stimulus does (P6). When the animal becomes more awake, the neuron responds at a higher frequency to both tactile (T23) and painful (P24) stimuli. Figure from Casey 1966.

Moreover, the author noticed and described changes in firing patterns for these nociceptive cells before and after the animal was given either an auditory or visual stimulus, which also changed the responses of the nociceptive cells to the noxious or innocuous somatic stimuli. Casey presented these results as evidence for refuting the notion of specificity of pain processing in the CNS. It is noteworthy that most neurons that changed responses with the state of wakefulness were located in the medial thalamus. Unfortunately, there are no new systematic studies on the topic. The effects of anesthesia on transmission of somatosensory inputs have recently been examined in VP, mainly for somatic innocuous inputs (Vahle-Hinz and Detsch 2002). Simultaneous recordings from groups of neighboring neurons in and around the VP in the anesthetized monkey indicate that the firing patterns of such cells change dynamically with every stimulus (see ► [thalamus, dynamics of nociception](#)).

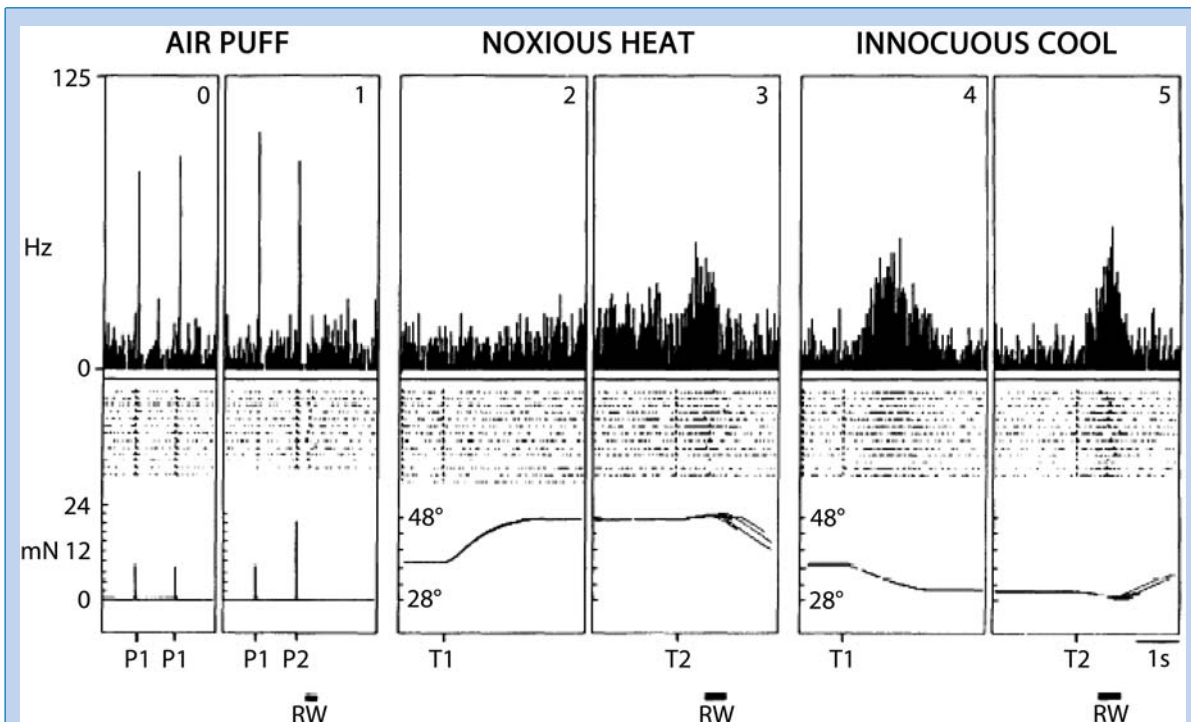
Bushnell and colleagues (Bushnell et al. 1993) performed electrophysiological recordings in conscious monkeys trained in a thermal discrimination task on the lip. The recordings were mostly from the medial border region of VPM (which proponents of VMpo now claim was mislabeled and that in fact these were recordings from VMpo). They found 22 cells responding to heat, the majority of which also responded to noxious heat; some responded to mechanical stimuli and / or cooling. Thus, neurons in this region had both NS-type responses and WDR-type responses. The group average of some of the nociceptive responsive cells showed

a well-defined threshold and a linear increase in firing rate above threshold. Importantly, cells in this region were tested for modulation by attentional shifts and, in contrast to the observations by Casey (Casey 1966), these VPM cells were not affected by attention towards or away from the stimulus.

The most comprehensive physiological study of nociceptive thalamic neurons was done in anesthetized monkeys, where 73 nociceptive cells were characterized in 26 animals (Kenshalo et al. 1980). The study explored neurons in VPL and showed that nociceptive cells' receptive field properties generally matched the somatotopic organization of this nucleus, with nociceptive cells in medial VPL having somatic fields localized to the forelimbs, while nociceptive cells in lateral VPL usually had receptive fields limited to the lower body. They also showed that repeated thermal stimulation of these cells increased their responses, implying that such neurons may participate in perceptions associated with thermal sensitization. Moreover, the authors showed that only spinal cord lesions that severed the ventrolateral white matter ipsilateral to the recording in the thalamus and contralateral to the location of the receptive field on the skin would abolish the responses of these cells to noxious stimuli applied within the receptive field.

The stimulus-response curves for noxious thermal stimuli from Kenshalo et al. (Kenshalo et al. 1980) and from Bushnell et al. (1993) are presented together to emphasize the similarity of the results obtained in anesthetized and conscious monkeys and to show the sim-





**Nociceptive Processing in the Thalamus, Figure 3** Response properties of a neuron recorded from VPM in conscious monkey (Bushnell et al. 1993). The neuron responds to air puffs (a), to noxious heat (b) and to innocuous cooling (c) of the skin on the maxilla. The initial heat response at 4°C is small but increases with continued heating. The second heat change (T2 of 0.4, 0.8 or 1.0°C) results in a robust response. From Fig. 2 of Bushnell et al. 1993.

ilarity of responses for nociceptive cells in VPL and VPM thalamic nuclei. Both group-averaged curves increased positively for stimuli above 47°C at approximately the same rate, although in the conscious preparation, threshold to painful thermal stimulus-responses seemed closer to 47°C than in the anesthetized monkey, where the threshold was around 43–45°C. Thus, in the lateral thalamus, nociceptive cells respond to thermal stimuli within a range that generally corresponds to human psychophysical studies for heat pain perception and at least the threshold of these neurons also corresponds to the heat response thresholds for peripheral nociceptive afferents.

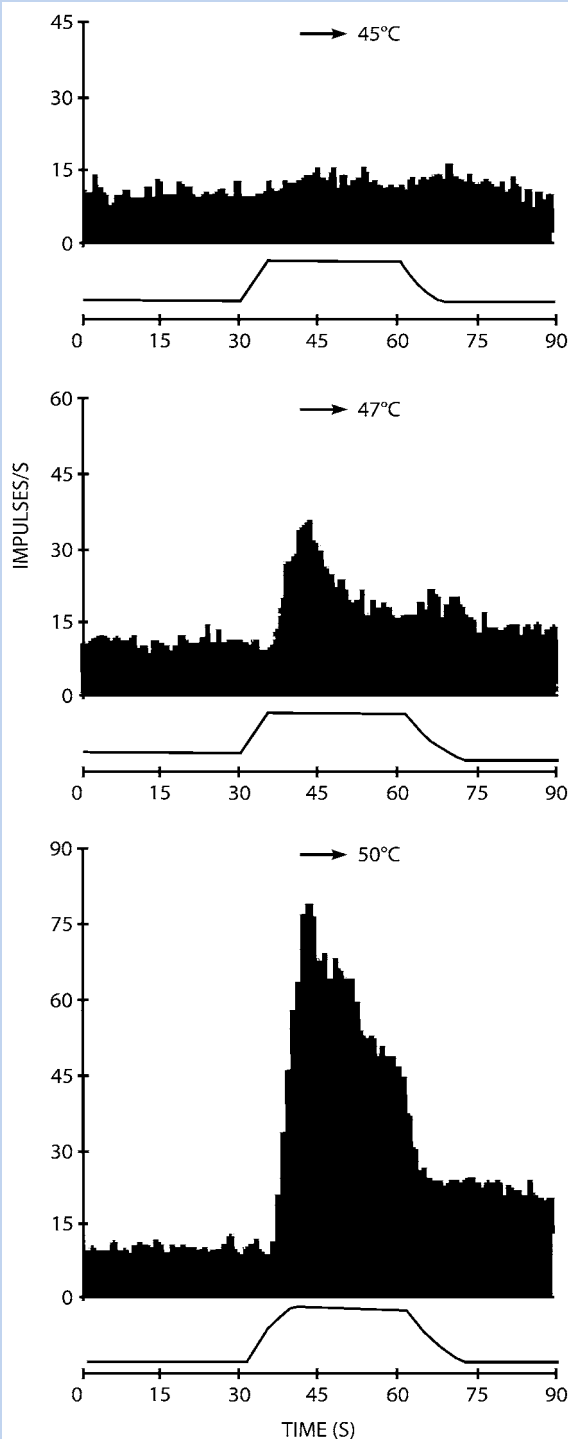
Thalamic physiology, especially for nociception, has traditionally emphasized the response properties of individual neurons. Establishing such properties provides the basis for the kinds of information that different neurons in different parts of the thalamus have access to, but it by no means demonstrates the dynamic properties of such neurons when neurons are considered as part of a population and where interactions between members and modulatory influences from remote sites would change stimulus-response properties in time and space within and across neuronal assemblies. Populational recording studies show that even the notion of a receptive field is a function of the group of neurons and the time point at which the group interactions are considered and neighboring groups of

VP cells with and without nociceptive inputs have distinct spatio-temporal response properties. Such populational coding properties must also be modulated with intrinsic thalamic conditions (burst or tonic mode), as well as modulatory functions of cortical and brainstem inputs (see ► [thalamus, dynamics of nociception](#)).

At a higher level of integration, one needs to consider the mode of interaction between cortical areas, especially given that a diverse set of cortical regions have been shown to participate in pain perception. The cortico-cortical interactions are usually assumed to be direct. Recent models, however, propose that all such interactions may be mediated through thalamocortical – corticothalamic chained loops. Such models have been advanced mainly for the visual thalamus and cortex and remain to be tested for pain (see ► [thalamocortical loops and information processing](#)).

### Human Imaging Studies — Visceral

The participation of the human thalamus in various innocuous and noxious visceral sensations has now been demonstrated in human brain imaging studies. Thalamic activity in humans has now been observed in angina, silent ischemia and syndrome X, as well as in noxious esophageal stimulation, gastric distension and noxious gastrointestinal distension in healthy



**Noiceptive Processing in the Thalamus, Figure 4** Average responses of 10 neurons in anesthetized monkey (Kenshalo et al. 1980). Recordings are from VPL. Responses to 45, 47 and 50°C thermal stimuli are shown. The stimulus time course is shown below each response. Figure from Fig. 5 of Kenshalo et al. 1980.

subjects and in irritable bowel syndrome patients (see ► [thalamus and visceral pain processing \(human imaging\)](#)).

ing) ► [thalamus, clinical visceral pain, human imaging](#)).

**Human Imaging Studies — Acute Pain and Clinical Conditions**

Thalamic activity has been observed in some of the earliest brain imaging studies of pain (Jones al. 1991). There is now ample evidence that thalamic activity can be reproducibly observed in human studies of acute or experimental conditions. More recent studies have attempted to parcel this activity into lateral and medial activations. Spatial resolution of this technology limits our ability to state the specific thalamic nuclei activated in the human brain (see ► [human thalamic response to experimental pain \(neuroimaging\)](#)).

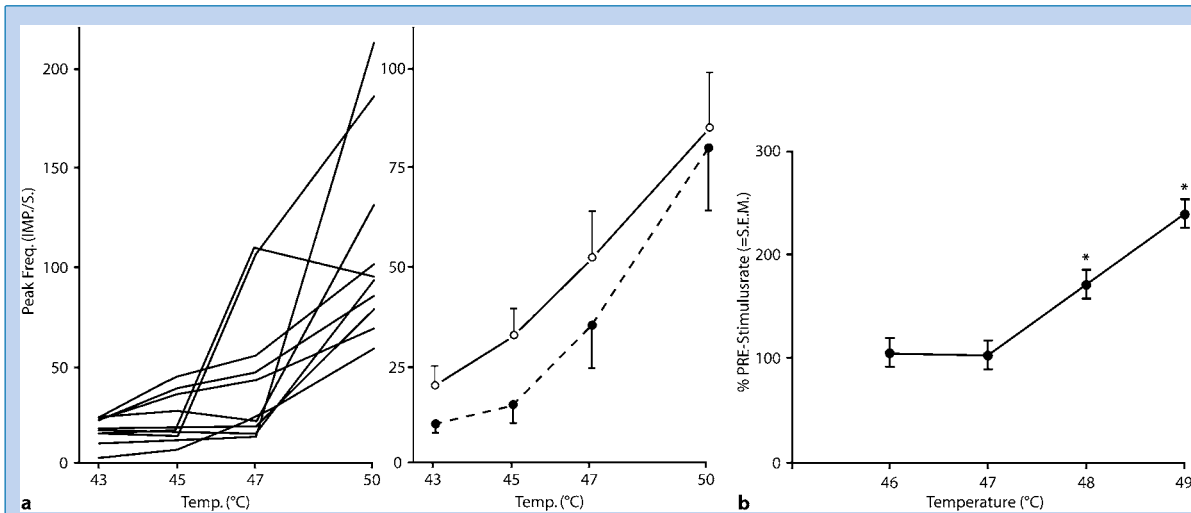
Inflammatory pain conditions vs. neuropathic pain conditions in animals show distinct reorganization of the peripheral and spinal cord circuitry. This has been only minimally studied in the thalamus (Vos et al. 2000) and the results indicate increased rates and more nociceptive responses for VP cells in neuropathic rats. Human brain imaging studies generally show a decreased baseline activity, noxious stimulus evoked activity and atrophy in chronic clinical pain states, but there is no evidence as to whether this pattern is generally applicable for inflammatory pain conditions as well (see ► [thalamus, clinical pain, human imaging](#)).

**Human Thalamus: Recording, Stimulation and Lesion**

Neurosurgical attempts to control chronic pain and tremor by thalamic lesions or stimulation, such as ► [thalamotomy](#), ► [deep brain stimulation](#), ► [gamma knife](#) procedures or stereotactic surgeries targeting the thalamus provide the opportunity to study thalamic neuronal properties in conscious humans or to examine the effects of localized electrical stimulation evoked perceptions. In the lateral thalamic ► [Vc](#) region, the human equivalent of VP, WDR and NS type nociceptive cells are described. A few nociceptive cells are also found in human medial thalamus. Unfortunately, the human studies cannot pinpoint the exact location of such neurons. In subjects with a history of existing painful conditions, there is now good evidence that incidence of stimulation-evoked pain is enhanced in Vc and this increase may be more prominent in the periphery of Vc (posterior-inferior area) (see ► [lateral thalamic pain-related cells in humans](#); ► [human thalamic nociceptive neurons](#))

Based on different traditions and theoretical ideas, different neurosurgeons have had their preferred targets for thalamic stimulation or lesion for pain relief. Jeanmonod and colleagues have targeted the CL region and within that region especially neurons that exhibit low threshold calcium spike bursts since they believe that





**Nociceptive Processing in the Thalamus, Figure 5** (a) Stimulus-response for 10 neurons found in VPL in the anesthetized monkey (Kenshalo et al. 1980). The peak impulses / second are plotted for each corresponding temperature. Left panel are individual neurons, right panel is group average (from Fig. 4 of Kenshalo et al. 1980). (b) Average stimulus-response curve of 6 heat activated and heat / cold activated neurons to temperatures of 46–49°C, as compared to baseline activity (Bushnell et al. 1993). The neurons were characterized in the conscious monkey VPM. Stimulus-responses increase only for 48 and 49°C. Figure from Fig. 6 of Bushnell et al. 1993.

neurogenic pain of central or peripheral origin can be adequately controlled by silencing these neurons with a central lateral thalamotomy (CLT). Other neurosurgeons have targeted the CM-PF region. Lenz and colleagues, on the other hand, have targeted the Vc region and its periphery, based on observing increased bursting activity in the region in chronic pain conditions in humans and in monkey studies. Increased bursting activity seems most prominent in patients with spinal transection or thalamic cells that do not have receptive fields and that are located in the representation of the anesthetic part of the body. Given the location of these bursting cells, their specific role in pain perception remains to be established (see ► [thalamotomy for human pain relief](#); ► [thalamic bursting activity, chronic pain](#)). Electrophysiological mapping of the thalamus during neurosurgical procedures provides the opportunity to characterize the neurons' receptive fields (RF) and compare them to the perceived location and quality of sensations evoked by stimulating these neurons (projected field or PF maps). This method can reveal plasticity of thalamic organization in humans with chronic pain. Such studies have been done mainly for Vc and its periphery. In chronic pain patients, in and around Vc, there is often a mismatch between RF and PF especially at the zone between the anesthetic site, the site of sensory loss and the transition to sites with normal sensations. Moreover, electrical stimulation in and around Vc has a higher probability of evoking pain in patients with chronic pain. These plastic changes probably contribute to the chronic pain condition (see ► [thalamus, receptive fields, projected fields, human](#)).

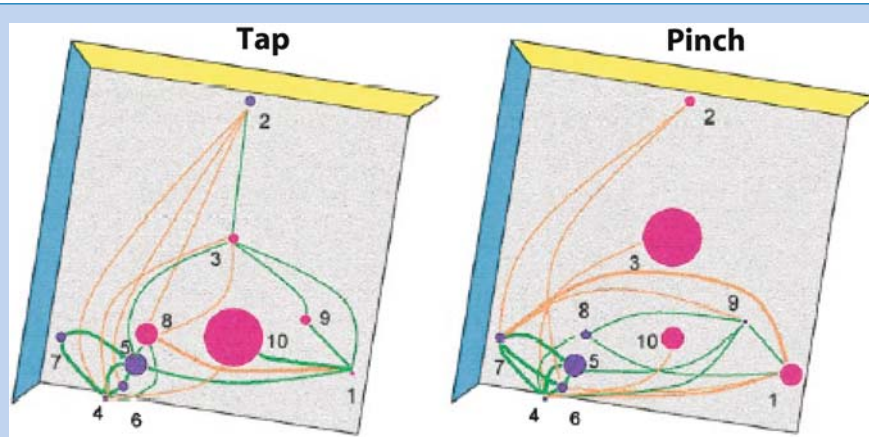
Nociceptive responsive cells have been described in and around Vc in humans. Most nociceptive cells in

this region are characterized as WDR-type. Some respond to mechanical and heat stimuli, others to mechanical and cold. Microstimulation in the same region of the human thalamus results in sensations of pain and/or heat. Nociceptive neurons in the human CM-PF have also been described, most responding to noxious pinprick but not innocuous touch (see ► [parafascicular nucleus, pain modulation](#) ► [human thalamic nociceptive neurons](#) ► [Lateral thalamic pain-related cells in humans](#)). In a subject suffering from angina, thalamic micro-stimulation evoked a pain 'almost identical' to her angina, which started and ended in exact relationship to the electrical stimulation. The stimulation site was in the periphery of Vc. Thus, this region and its cortical connectivity can access the memory of angina pain (see ► [angina pectoris, neurophysiology and psychophysics](#)).

### Overview

It should be clear from this overview that there remain large gaps in our knowledge regarding the role of the thalamus in nociception. Unfortunately, animal studies of the thalamic physiology of pain have dramatically decreased in the last few years. Perhaps this is due to the success of human brain imaging studies that provide us with information regarding thalamus and cortex in conscious human pain perception. There is no doubt that human brain imaging is providing exciting new insights into the role of the CNS in pain. On the other hand, the spatial and temporal resolution of these techniques severely limit the detailed information on neuronal and glial processes that remain to be uncovered





**Noiceptive Processing in the Thalamus, Figure 6** Dynamics of nociceptive responses in a group of neurons in the lateral thalamus in the monkey (Apkarian et al. 2000). Responses of 10 neurons studied simultaneously in a 100 micron<sup>3</sup> space are shown. The relative locations are shown by the circles, the size and color indicate stimulus responses (red increased activity, blue decreased activity). Connections between cells indicate strength of correlations (orange positive, green negative). The figure illustrates that response magnitude and connectivity change dynamically with different types of stimuli for a cluster of cells that are involved in coding nociceptive inputs (from Apkarian et al. 2000).

in order to properly understand the functional roles of various thalamic structures and their interconnections with the cortex in pain perception.

**References**

1. Apkarian AV, Shi T (1994) Squirrel monkey lateral thalamus. I. Somatic nociceptive neurons and their relation to spinothalamic terminals. *J Neurosci* 14:6779–6795
2. Apkarian AV, Shi T (1998) Thalamocortical connections of the cingulate and insula in relation to nociceptive inputs to the cortex. In: Ayrapetyan SN, Apkarian AV (eds) *Pain mechanisms and management*. IOS Press, Amsterdam, pp 212–221
3. Apkarian AV, Shi T, Bruggemann J et al. (2000) Segregation of nociceptive and non-nociceptive networks in the squirrel monkey somatosensory thalamus. *J Neurophysiol* 84:484–494
4. Apkarian AV, Bushnell MC, Treede RD et al. (2005) Human brain mechanisms of pain perception and regulation in health and disease. *Eur J Pain* 9:463–484
5. Beggs J, Jordan S, Ericson AC et al. (2003) Synaptology of trigemino- and spinothalamic lamina I terminations in the posterior ventral medial nucleus of the macaque. *J Comp Neurol* 459:334–354
6. Bushnell MC, Duncan GH, Tremblay N (1993) Thalamic VPM nucleus in the behaving monkey. I. Multimodal and discriminative properties of thermosensitive neurons. *J Neurophysiol* 69:739–752
7. Casey KL (1966) Unit analysis of nociceptive mechanisms in the thalamus of the awake squirrel monkey. *J Neurophysiol* 29:727–750
8. Craig AD (2004) Distribution of trigeminothalamic and spinothalamic lamina I terminations in the macaque monkey. *J Comp Neurol* 477:119–148
9. Craig AD Jr, Burton H (1981) Spinal and medullary lamina I projection to nucleus submedialis in medial thalamus: a possible pain center. *J Neurophysiol* 45:443–466
10. Craig AD, Bushnell MC, Zhang ET et al. (1994) A thalamic nucleus specific for pain and temperature sensation. *Nature* 372:770–773
11. Gingold SI, Greenspan JD, Apkarian AV (1991) Anatomic evidence of nociceptive inputs to primary somatosensory cortex: relationship between spinothalamic terminals and thalamocortical cells in squirrel monkeys. *J Comp Neurol* 308:467–490
12. Graziano A, Jones EG (2004) Widespread thalamic terminations of fibers arising in the superficial medullary dorsal horn of monkeys and their relation to calbindin immunoreactivity. *J Neurosci* 24:248–256
13. Horn AC, Vahle-Hinz C, Bruggemann J et al. (1999) Responses of neurons in the lateral thalamus of the cat to stimulation of urinary bladder, colon, esophagus, and skin. *Brain Res* 851:164–174
14. Jones EG (1985) *The Thalamus*. Plenum, New York
15. Jones AK, Brown WD, Friston KJ et al. (1991) Cortical and subcortical localization of response to pain in man using positron emission tomography. *Proc Biol Sci* 244: 39–44
16. Kenshalo DR Jr, Giesler GJ Jr, Leonard RB et al. (1980) Responses of neurons in primate ventral posterior lateral nucleus to noxious stimuli. *J Neurophysiol* 43:1594–1614
17. Martin RJ, Apkarian AV, Hodge CJ Jr (1990) Ventrolateral and dorsolateral ascending spinal cord pathway influence on thalamic nociception in cat. *J Neurophysiol* 64:1400–1412
18. Ralston HJ, III (2003) Pain, the brain, and the (calbindin) stain. *J Comp Neurol* 459:329–333
19. Shi T, Apkarian AV (1995) Morphology of thalamocortical neurons projecting to the primary somatosensory cortex and their relationship to spinothalamic terminals in the squirrel monkey. *J Comp Neurol* 361:1–24
20. Shi T, Stevens RT, Tessier J et al. (1993) Spinothalamic cortical inputs nonpreferentially innervate the superficial and deep cortical layers of SI. *Neurosci Lett* 160:209–213
21. Steriade M, Jones EG, Llinas RR (1990) *Thalamic oscillations and signaling*. Wiley Neuroscience, New York
22. Vahle-Hinz C, Detsch O (2002) What can *in vivo* electrophysiology in animal models tell us about mechanisms of anaesthesia? *Br J Anaesth* 89:123–142
23. Vos BP, Benoist JM, Gautron M et al. (2000) Changes in neuronal activities in the two ventral posterior medial thalamic nuclei in an experimental model of trigeminal pain in the rat by constriction of one infraorbital nerve. *Somatosens Mot Res* 17:109–122



## Nociceptor Generator Potential

CARLOS BELMONTE

Instituto de Neurociencias de Alicante, University Miguel Hernández-CSIC, San Juan de Alicante, Spain  
carlos.belmonte@umh.es

### Synonyms

Receptor potential; generator current

### Definition

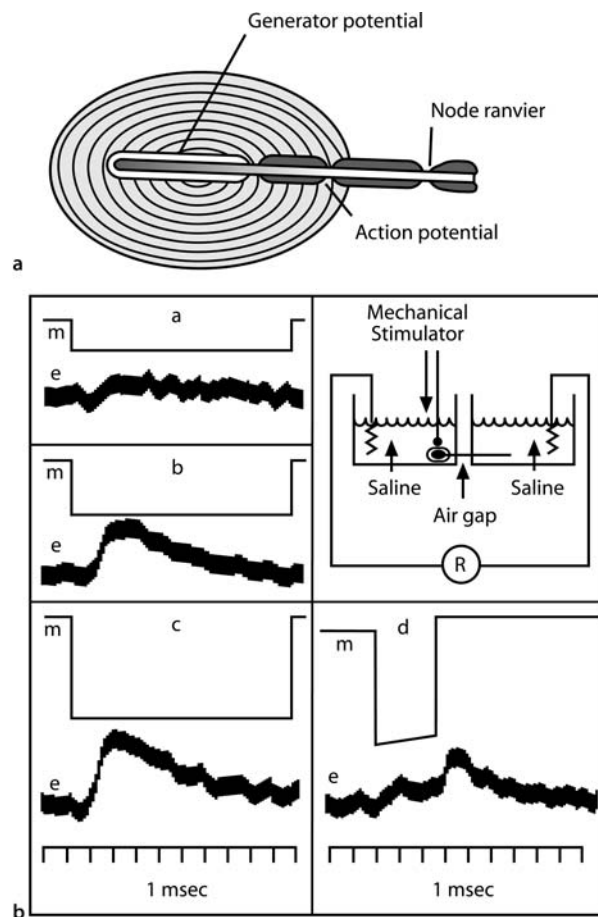
The local change in ► **membrane potential** caused by the opening of ion channels in the peripheral terminals of nociceptor neurons, when natural stimuli (mechanical, thermal, chemical) activate their transduction mechanisms.

### Characteristics

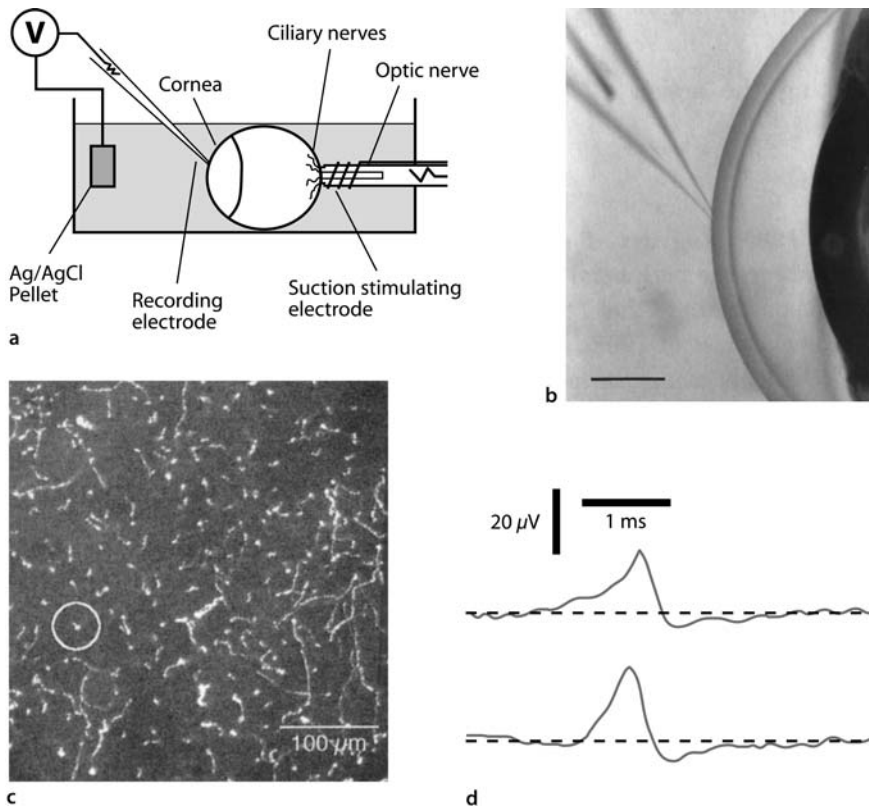
Transduction of natural stimuli by the specialized membrane of sensory receptor cells leads ultimately to the opening and closing (gating) of ion channels and to the generation of local electrical signals. These were already described in early studies using invertebrate stretch receptor cells (Eyzaguirre and Kuffler 1955) as well as in the receptor cells of specialized sensory organs in mammals, such as the cochlear hair cells, the olfactory neurons or the retinal photoreceptors, taking advantage of their accessibility to direct electrophysiological recording (for review see Gardner and Martin 2000). In all cases, the gating of ► **transduction channels** triggered by the stimulus caused charge transfer across the membrane and a gradual depolarization (or hyperpolarization) of an amplitude proportional to the intensity of the stimulus called the 'receptor or generator potential'.

The receptor endings of primary sensory neurons in mammals are not easily accessible to the conventional biophysical methods that were successfully applied to the cell soma. An indirect approach aimed at recording the small current flows associated with the opening of transduction channels in sensory endings was made in the middle of the 20th century using the pacinian corpuscle, a specialized mechanoreceptor that responds to very low mechanical forces and can be easily visualized and isolated from the mesentery of the cat. The pacinian corpuscle is formed by the nerve terminal of a large myelinated sensory axon surrounded by a number of concentric lamellae, which loses its myelin sheath and Schwann cells upon entering the corpuscle, running subsequently as a straight, bare nerve ending. In a series of classical studies (Gray and Sato 1953; Loewenstein 1961), the pacinian corpuscle isolated 'in vitro' was employed to record extracellularly the ► **membrane potential** changes associated with mechanical stimulation of the corpuscle surface, establishing that in the most distal part of the nerve terminal the stimulus

evoked a flow of generator current of an amplitude proportional to the magnitude of indentation (Fig. 1). ► **Generator currents** could summate temporally and propagate electrotonically (i.e. declining exponentially with distance) along the length of the axon. When the amplitude of the depolarization reaching the first node of Ranvier (located inside the corpuscle near to the point of entrance of the nerve) attained a critical level, an ► **action potential** was generated (Fig. 1). The conclusion of these and subsequent studies, was that the generator process in sensory receptor fibers takes place in a terminal portion of the nerve membrane that is not electrically excitable, i.e. cannot support a regenerative change in sodium conductance and that the process of transduction that leads to the generator potential is spatially separated from the point where propagated action potentials are produced. The firing frequency and the duration of the impulse discharge are proportional



**Nociceptor Generator Potential, Figure 1** (a) The pacinian corpuscle. (b) Generator potentials recorded extracellularly in a pacinian corpuscle, 'in vitro'. a, b, and c, generator potentials (e) elicited by mechanical compressions of increasing magnitude shown in m. d. Short mechanical pulses elicit both "on" and "off" responses which sum. ((a) from Schmidt RF & Thews G, 1990, *Physiologie des Menschen*, 24. Auflage, Springer Verlag; (b) after Gray JAB & Sato M, 1953, *J Physiol* 122:610–636)



**Nociceptor Generator Potential, Figure 2** Recording of nerve terminal impulses in the guinea pig cornea. Schematic diagram of recording set-up (a) and photomicrograph (b) showing the location of the recording electrode. (c) confocal micrograph of nerve terminals in the cornea. (d) averages of spontaneously occurring nerve terminal impulses recorded from a mechano-nociceptor (upper trace) and a polymodal nociceptor (lower trace).

N

to the amplitude and duration of the generator potential (for details see Patton 1966; Gardner and Martin 2000). It has been speculated that the sequence of phenomena observed in the transduction process of mechanoreceptor fibers is general to all mammalian sensory receptor endings, including nociceptive terminals, where the transduction channels opened by mechanical, thermal or chemical stimuli are thought to generate a local receptor or generator potential that will ultimately lead to impulse firing in the parent axon (Belmonte 1996). However, direct evidence for this extrapolation is still lacking, due to the difficulty of applying the intracellular or extracellular recording techniques used in other receptor classes to nociceptive nerve fibers intimately embedded in their surrounding tissues and with a diameter below  $1\ \mu\text{m}$ .

In recent years new technical approaches have offered indirect evidence of the presence of generator currents in nociceptive terminals. Extracellular activity of single ► [nociceptive nerve endings](#) was successfully recorded in the cornea of the eye (Fig. 2) using a large tip microelectrode tightly applied against the corneal surface (Brock et al. 1998). Terminal sensory branches run between corneal epithelium cells ending close to the most superficial epithelium layers; the high resistance seal formed by the electrode allowed the recording of the spontaneous and stimulus-evoked propagated impulse activity of the ending located immediately below the

electrode tip. In these experiments, a depolarization preceding the propagated nerve terminal impulse, suggestive of a local generator current was occasionally observed in polymodal nociceptor endings (Brock et al. 1998). Likewise, in single nociceptive fibers of the rat skin, Sauer et al. (2004) using the ‘threshold tracking technique’ reported that heat and ► [bradykinin](#) stimulation of polymodal nociceptor endings was preceded by a reduction of threshold suggestive of a local depolarization presumably corresponding to the generator potential.

Nevertheless, the location in nociceptors of the transformation site where generator currents give rise to propagated impulses when the depolarization exceeds threshold remains unknown. It has been suggested, based on morphological evidence that the patches of axonal membrane devoid of Schwann cell coating observed in the terminal portion of ► [knee joint nociceptors](#) correspond to the ► [transduction sites](#) where receptor potentials would be generated (Heppelmann et al. 1990) while action potentials occur at a more central point. However, in corneal polymodal nociceptor endings it has been shown that the most distant portion of the terminal possess sufficient density of ► [tetrodotoxin-resistant sodium channels](#) to sustain propagated action potentials (Brock et al. 1998), a characteristic that is not shared by cold-sensitive nerve fibers, whose peripheral terminals seem to lack regenerative properties

(Brock et al. 2001). Thus, the possibility exists that in nociceptor terminals, the ion channels responsible for generator currents and those sustaining the production of propagated action potentials are not spatially segregated. This may have a functional significance in the profusely ramified nociceptor fibers. Action potentials originated at the peripheral endings by a direct action of the stimulus also propagate antidromically and invade terminals of the same parent axon that were not directly excited by the stimulus. A large proportion of nociceptor terminals contain vesicles filled with ► **neuropeptides** (CGRP, SP), that are released by the entrance of calcium ions driven by the invading antidromic action potential, thereby contributing to neurogenic inflammation.

### References

1. Belmonte C (1996) Signal transduction in nociceptors: General principles. In: Belmonte C, Cervero F (eds) *Neurobiology of nociceptors*. Oxford University Press, Oxford, pp 243–257
2. Brock J, McLachlan EM, Belmonte C (1998) Tetrodotoxin-resistant impulses in single nerve terminals signalling pain. *J Physiol* 512:211–217
3. Brock JA, Pianova S, Belmonte C (2001) Differences between nerve terminal impulses of polymodal nociceptors and cold sensory receptors of the guinea-pig cornea. *J Physiol* 533:493–501
4. Eyzaguirre C, Kuffler SW (1955) Processes of excitation in the dendrites and in the soma of single isolated sensory nerve cells of the lobster and crayfish. *J Gen Physiol* 39:87–119
5. Gardner EP, Martin JH (2000) Coding of sensory information. In: Kandel E, Schwartz JH, Jessell TM (eds) *Principles of Neural Sciences*, 4<sup>th</sup> edn. McGraw-Hill, New York, pp 411–625
6. Gray JAB, Sato M (1953) Properties of the receptor potential in pacinian corpuscles. *J Physiol* 122:610–636
7. Heppelmann B, Messlinger K, Neiss WF, Schmidt RF (1990) Ultrastructural three-dimensional reconstruction of group III and group IV sensory nerve endings ("free nerve endings") in the knee joint capsule of the cat: evidence for multiple receptive sites. *J Comp Neurol* 292:103–16
8. Loewenstein WR (1959) The generation of electric activity in a nerve ending. *Ann New York Acad Sc* 81:367–387
9. Patton DH (1966) Receptor Mechanisms. In: Ruch TC and Patton HD (eds) *Physiology and Biophysics*. WB Saunders Co., Philadelphia and London, pp 95–112
10. Sauer SK, Weidner C, Averbeck B et al. (2004) Are generator potentials of rat cutaneous nociceptive terminals accessible to threshold tracking? *J Neurophysiol* (in press)

## Nociceptor Inactivation

- Nociceptor, Adaptation

## Nociceptor Sensitization

### Definition

Process by which there is a decrease in nociceptor threshold and enhanced responses to suprathreshold stimuli. This phenomenon is an increment of the excitability of the nociceptor, due to a metabolic change induced by sensitizing agents such as pro-inflammatory mediators.

- Capsaicin Receptor
- Polymodal Nociceptors, Heat Transduction
- Thalamus, Clinical Pain, Human Imaging

## Nociceptor(s)

### Definition

Harmful stimuli activate the peripheral endings of primary afferent neurons, also called nociceptors. Their cell bodies lie in the dorsal root ganglia (DRG) or the trigeminal ganglia. Distinct classes of nociceptors encode discrete intensities and modalities of noxious stimuli. Receptor molecules that lend these specific properties to diverse classes of nociceptors and mediate transduction have been cloned. One important molecule is the vanilloid receptor TRPV1, which serves as a transducer of noxious thermal and chemical (e.g. protons) stimuli, and can be activated by capsaicin, the active ingredient of hot chili peppers. Conduction of nociceptive signals in nociceptors is mediated via activation of voltage-gated sodium channels. A family of nociceptor-specific tetrodotoxin (TTX)-resistant sodium channels modulates the excitability of primary afferents and likely mediates pathophysiological alterations thereof.

- Acute Pain Mechanisms
- Cancer Pain, Animal Models
- Cancer Pain Management, Nonopioid Analgesics
- COX-1 and COX-2 in Pain
- Cytokines, Effects on Nociceptors
- Descending Modulation and Persistent Pain
- Dorsal Root Ganglionectomy and Dorsal Rhizotomy
- Drugs Targeting Voltage-Gated Sodium and Calcium Channels
- Fibromyalgia, Mechanisms and Treatment
- Freezing Model of Cutaneous Hyperalgesia
- Functional Imaging of Cutaneous Pain
- Hypoalgesia, Assessment
- Mechanonociceptors
- Muscle Pain Model, Inflammatory Agents-Induced
- Nociceptor, Axonal Branching
- Nociceptor, Categorization
- Nociceptors, Cold Thermotransduction
- Nociceptors in the Dental Pulp
- NSAIDs, Mode of Action
- Opioids, Effects of Systemic Morphine on Evoked Pain
- Opioids in the Periphery and Analgesia
- Postherpetic Neuralgia, Pharmacological and Non-Pharmacological Treatment Options
- Postoperative Pain, Acute Pain Management, Principles
- Postoperative Pain, Acute Pain Team
- Somatic Pain
- Spinothalamic Tract, Anatomical Organization and Response Properties



- ▶ Spinothalamic Tract, Anatomical Organization and Response Properties
- ▶ Thalamic Nuclei Involved in Pain, Cat and Rat
- ▶ Tourniquet Test
- ▶ TRPV1 Modulation by p2Y Receptors
- ▶ Visceral Nociception and Pain
- ▶ Visceral Pain and Nociception

## Nociceptor, Adaptation

RICHARD A. MEYER, MATTHIAS RINGKAMP  
Department of Neurosurgery, School of Medicine,  
Johns Hopkins University, Baltimore, MD, USA  
rmeyer@jhmi.edu, platelet@jhmi.edu

### Synonyms

Nociceptor Accommodation; Nociceptor Inactivation

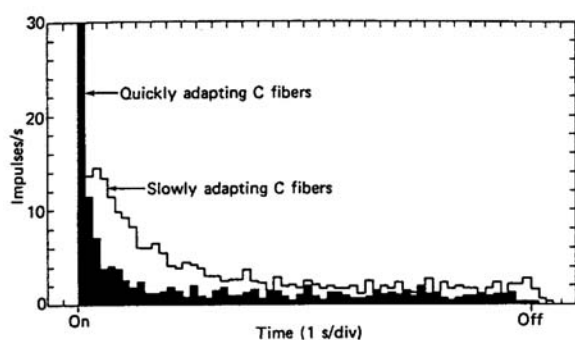
### Definition

The gradual decrease over time in the response of a nociceptor to a maintained noxious stimulus of fixed intensity.

Nociceptors Action Potentials and Post-Firing Excitability Changes

### Characteristics

The response of nociceptors to a constant-temperature heat stimulus adapts with time. Unmyelinated nociceptors innervating the hairy skin of monkey can be separated into two classes based on the rate of adaptation to heat stimuli (Fig. 1). In response to a 53°C stimulus, the discharge rate of quickly adapting C fibers is 20% of the peak response within 4s, whereas slowly adapting C fibers take more than 15 s to reach this level (Meyer and Campbell 1981). Myelinated fibers can also be separated into two classes based on their heat response: Type II fibers adapt quickly in a manner similar to quickly adapting C-fibers, whereas Type I fibers actually exhibit an increase in their response with time (Treede et al. 1998).



**Nociceptor, Adaptation, Figure 1** Adaptation of response to heat (53°C) in C-fiber nociceptor afferents in the monkey (From Meyer and Campbell 1981).

Nociceptors also exhibit a slowly adapting response to mechanical stimuli applied to their receptive field (Slugg et al. 2000). An exception to this rule exists for mechanically-insensitive nociceptors, which can develop a response to tonic pressure (Schmidt et al. 2000). The mechanisms underlying adaptation in nociceptors are not well understood, but calcium-dependent and -independent mechanisms appear to be involved.

- ▶ Nociceptors Action Potentials and Postfiring Excitability Changes

### References

1. Meyer RA, Campbell JN (1981) Evidence for Two Distinct Classes of Unmyelinated Nociceptive Afferents in Monkey. *Brain Res* 224:149–152
2. Schmidt R, Schmelz M, Torebjörk HE et al. (2000) Mechano-Insensitive Nociceptors Encode Pain Evoked by Tonic Pressure to Human Skin. *Neuroscience* 98:793–800
3. Slugg RM, Meyer RA, Campbell JN (2000) Response of Cutaneous A- and C-Fiber Nociceptors in the Monkey to Controlled-Force Stimuli. *J Neurophysiol* 83:2179–2191
4. Treede R-D, Meyer RA, Campbell JN (1998) Myelinated Mechanically Insensitive Afferents from Monkey Hairy Skin: Heat-Response Properties. *J Neurophysiol* 80:1082–1093

## Nociceptor, Axonal Branching

MARTIN SCHMELZ

Institute of Anaesthesiology, Operative Intensive  
Medicine and Pain Research, Faculty for Clinical  
Medicine Mannheim, University of Heidelberg,  
Mannheim, Germany  
martin.schmelz@anaes.ma.uni-heidelberg.de

### Synonyms

Axon reflex; neurogenic inflammation; Flare; Neurogenic Vasodilation; protein extravasation

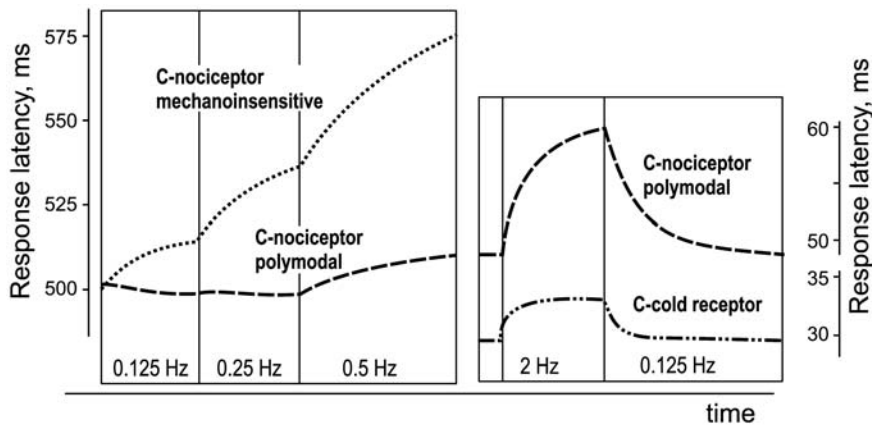
### Definition

Single nociceptive nerve fibers branch extensively in the periphery to form their receptive fields: branches can measure up to 9 cm in human skin. In addition, their terminal endings can also inhibit extensive branching in the micrometer range. Axonal branching is the structural basis for antidromic action potential propagation (axon reflex), leading to neurogenic inflammation.

### Characteristics

#### Innervation Territories of Nociceptors

The receptive field of primary afferent nociceptors has been found to be very small in rodents. However, in humans, skin innervation territories measuring up to 9 cm in diameter have been found (Schmelz et al. 1997). Most of the available data on the structure of innervation territories and branching derive from skin, as they can more easily be analyzed as compared to deep somatic or visceral nociceptors. Extensive branching of skin nociceptors has also been found in monkey skin, with branching



**Nociceptor, Axonal Branching, Figure 1** Response latency of action potentials between electrical stimulation of the receptive endings in the skin and recording in the peripheral nerve (n. peroneus) is shown. Left panel: Electrical stimulation at increasing frequency provokes increased response latency for different classes of afferent C-fibers (activity dependent slowing). The activity dependent slowing is most pronounced in mechano-insensitive C-nociceptors which slow down in conduction velocity even at low stimulatory frequencies of 0.125 or 0.25 Hz. The slowing of traditional mechano-responsive C-nociceptors (“polymodal”) is far less pronounced and clearly separates between the two nociceptor classes (modified from Weidner et al. 1999). Right panel: At higher stimulation frequencies of 2 Hz polymodal nociceptors show a pronounced activity dependent slowing which clearly separates them from cold-sensitive C-fibers (C-cold receptor), which only slightly increase their response latency when stimulated at 2 Hz (modified from Serra et al. 1999).

points being rather proximal from the actual receptive field; interestingly, frequently unmyelinated branches of A delta fibers were found, which had a length of about 5 cm (Peng et al. 1999).

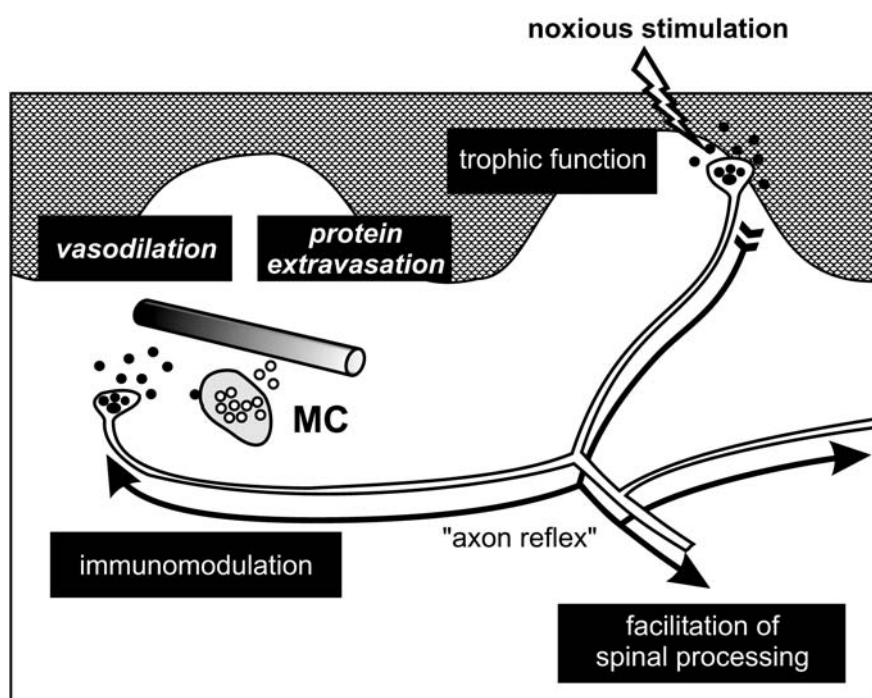
#### Axonal Properties of Different Nociceptor Classes

In human skin unmyelinated nociceptors fall into two basic classes: the majority of the fibers are mechano-heat sensitive polymodal nociceptors; however, about 20% are unresponsive to mechanical stimulation (Schmidt et al. 1995). These “silent” or “sleeping” nociceptors differ from conventional polymodal nociceptors in their receptive properties, their biophysical characteristics and their function. They have higher activation thresholds for heat and are not activated even by intense mechanical stimuli (Schmidt et al. 1995). Their innervation territories in the leg are larger (6 vs. 2 cm<sup>2</sup>), and conduction velocity is lower (0.8 vs. 1 m/s,) than in polymodal fibers (Schmidt et al. 1995). Most interestingly, their high transcutaneous electrical thresholds and their activity dependent hyperpolarization by far exceed the values observed in polymodal nociceptors. Although based on the axonal properties, analysis of activity dependent hyperpolarization allows classification of these two nociceptor classes (Weidner et al. 1999), and thus predicts sensory properties of their endings. Moreover, activity dependent hyperpolarization has also been shown to separate C-cold thermoreceptors from C-polymodal nociceptors (Fig. 1). It should be pointed out that this unexpected correlation between specific axonal properties and characteristics of sensory endings has a variety of implications. As mechanisms of activity-dependent hyperpolarization are currently being clarified on a molecular level, immunohistochemistry might in the future enable dif-

ferential staining and functional identification of axons. First clinical results confirm that this approach can be used to improve characterization of neuropathic axonal changes (Boettger et al. 2002).

#### Neurogenic Inflammation

Decades ago Thomas Lewis described the erythema arising in human skin in the surroundings of trauma as part of the “triple response” to noxious stimuli (Lewis et al. 1927). This “flare response” is dependent on the integrity of primary afferent nerves, but not on their central nervous connections. From his own findings and earlier work Lewis developed the concept of “axon reflex flare”, i.e. the notion that “nocifensive” nerve fibers excited by a trauma send impulses not only into the central nervous system, but also via axon branches into the surrounding skin, where they trigger the release of a vasodilating substance from the nerve endings. Neuropeptides are now held responsible for the vasodilatation, which are produced by small dorsal root ganglion cells and transported in their thin axons to the central and peripheral nerve terminals. The main vasodilatory agent is probably CGRP which induces vasodilatation, but no plasma extravasation (Brain 1996). The edema, caused by increased permeability of the endothelia for plasma proteins (neurogenic protein extravasation) can be attributed to the release of substance P. However, a variety of other neuropeptides like neurokinin A, neurokinin B, somatostatin, galanin, and recently, endomorphins have been also be found in primary afferent neurons. It should also be noted that in addition to the acute vascular effects, neuropeptides have important trophic functions and modulate the activity of local immune cells (Fig. 2).



**Nociceptor, Axonal Branching, Figure 2** Schematic drawing of mechanisms involved in dermal neurogenic inflammation. Noxious stimulation of the skin (hatched area) results in generation of action potentials in nociceptors. The action potentials reach the arborisations of the axonal tree via the axon reflex (black arrows). By depolarization of the terminals, neuropeptides (black circles) are released. Key effects of neuropeptides are given in black squares. The involvement of mast cell mediators (MC, open circles) in vasodilation and protein extravasation in neurogenic inflammation is controversial.

### Analysis of Neurogenic Inflammation

Chemical, thermal, and electrical stimulation has been widely used to elicit neurogenic inflammation, and direct evidence of neuropeptide release has been obtained using capsaicin as well as antidromic electrical nerve stimulation. In rodents, activation of polymodal nociceptors was sufficient to cause neurogenic inflammation (Gee et al. 1997). In contrast, mechano-insensitive, but heat- and chemosensitive C-nociceptors have been found responsible for the neurogenic vasodilation in pig skin (Gee et al. 1997; Lynn et al. 1996) and human (Sauerstein et al. 2000). The extent of the neurogenic erythema nicely matches the large cutaneous receptive fields of mechanoinsensitive nociceptors, and their high electrical thresholds also match the strong currents required to provoke neurogenic flare electrically. Thus, neurogenic inflammation in human differs from rodents, in which the neurogenic inflammation can be elicited by polymodal C nociceptors, and consists of a combination of vasodilation and protein extravasation (Sauerstein et al. 2000). In healthy volunteers no neurogenic protein extravasation could be induced (Sauerstein et al. 2000), but may develop under pathophysiological conditions (Weber et al. 2001).

### Neurogenic Inflammation and Secondary Hyperalgesia

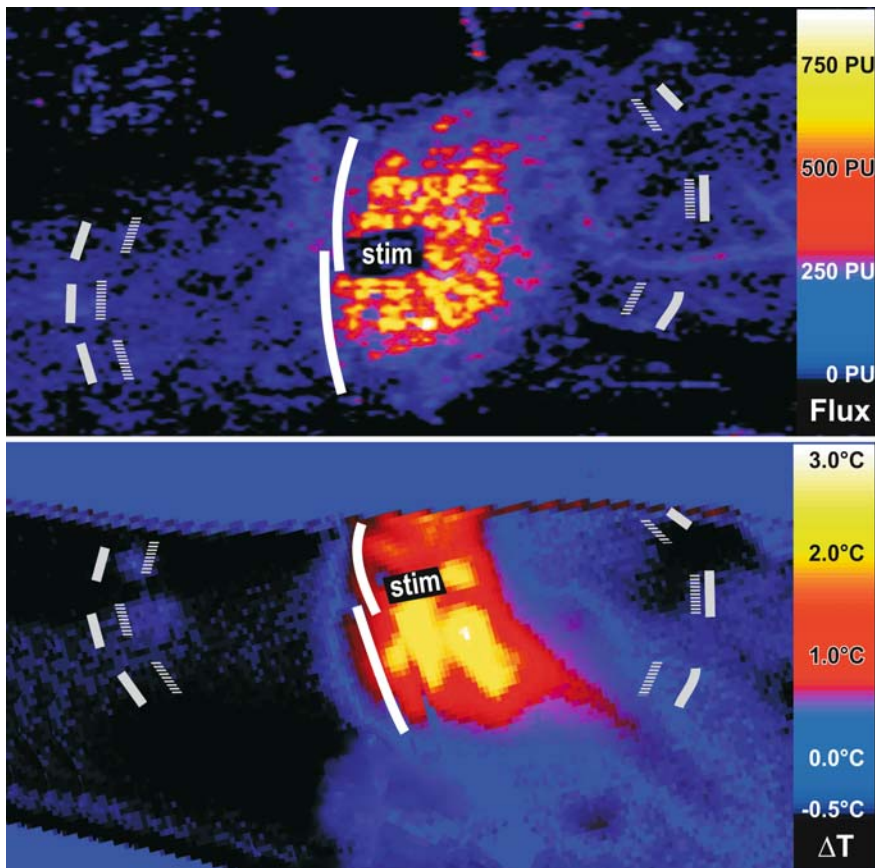
The areas of vasodilation and warming around a noxious stimulation site have been found to be similar to the areas of secondary mechanical hyperalgesia (punctate hyperalgesia) (Serra et al. 1998). However, recent results would suggest, that by blocking axonal action potential propagation by a local anesthetic, only the spread of axon

reflex vasodilation and warming can be blocked. In contrast, areas of punctate hyperalgesia developed symmetrically, even beyond a peripherally located “anesthetic strip” (Fig. 3).

### Epidermal Axonal Branching

Under physiological conditions unmyelinated human nerve fibers entering the epidermis are found to be oriented straight up, and reach the outermost layers of viable skin without pronounced branching (Hilliges et al. 1995). Interestingly, in some human skin diseases extensive branching of epidermal nerve fibers has been described. Increased intradermal nerve fiber density has been found in patients with chronic pruritus. In addition, increased epidermal levels of neurotrophin 4 (NT4) have been found in patients with atopic dermatitis, and massively increased serum levels of NGF and SP have been found to correlate with the severity of the disease in such patients (Toyoda et al. 2002). Increased fiber density and higher local NGF concentrations were also found in patients with contact dermatitis. Most interestingly, intraepidermal sprouting has also been found as a physiological response to circular skin incision (Rajan et al. 2003): „collateral sprouting“ from axons at the incision margins lead to centripetal reconstituting of skin innervation, probably due to higher local NGF concentrations in the denervated skin (Rajan et al. 2003). A similar mechanism might also explain findings in patients with diabetic neuropathy characterized by reduced epidermal innervation density, but higher degree of epidermal branching (Polydefkis et al. 2003). It will be of major interest in the future to assess the





**Nociceptor, Axonal Branching, Figure 3** Specimen of transcutaneous electrical stimulation (1 Hz, 50 mA, 0,5 ms; stimulation site ["stim"] is marked by a rectangle) provoking an area of increased superficial blood flow as assessed with a laser Doppler scanner (upper panel) and with an infrared thermocamera (lower panel). An anesthetic strip was induced by perfusing two intradermal microdialysis membranes (vertical white lines) with 2% lidocaine. The borders of hyperalgesia to punctate stimuli (grey lines) and to light stroking (dotted lines) are shown in the laser Doppler scan and the thermogram. (Modified from Klede et al. 2003).

effects of the local sprouting on the sensory function of the nociceptors. There is already evidence of increased epidermal nerve fiber sprouting in vulvodinia, and moreover, signs of nociceptor sensitization (Bohm-Starke et al. 2001). Taken together, these data would suggest that local inflammatory processes could initiate nociceptor sprouting and sensitization by increased NGF production.

## References

- Boettger MK, Till S, Chen MX (2002) Calcium-Activated Potassium Channel SK<sup>1</sup>- and IK<sup>1</sup>-Like Immunoreactivity in Injured Human Sensory Neurones and its Regulation by Neurotrophic Factors. *Brain* 125:252–263
- Bohm-Starke N, Hilliges M, Brodda-Jansen G et al. (2001) Psychophysical Evidence of Nociceptor Sensitization in Vulvar Vestibulitis Syndrome. *Pain* 94:177–183
- Brain SD (1996) Sensory Neuropeptides in the Skin, pp 229–244
- Gee MD, Lynn B, Cotsell B (1997) The Relationship between Cutaneous C Fibre Type and Antidromic Vasodilatation in the Rabbit and the Rat. *J Physiol* 503:31–44
- Hilliges M, Wang L, Johansson O (1995) Ultrastructural Evidence for Nerve Fibers Within All Vital Layers of the Human Epidermis. *J Invest Dermatol*: 134–137
- Klede M, Handwerker HO, Schmelz M (2003) Central Origin of Secondary Mechanical Hyperalgesia. *J Neurophysiol* 90:353–359
- Lewis T, Harris KE, Grant RT (1927) Observations Relating to the Influence of the Cutaneous Nerves on Various Reactions of the Cutaneous Vessels. *Heart* 14:1–17
- Lynn B, Schutterle S, Pierau FK (1996) The Vasodilator Component of Neurogenic Inflammation is Caused by a Special Subclass of Heat-Sensitive Nociceptors in the Skin of the Pig. *J Physiol* 494:587–593
- Peng YB, Ringkamp M, Campbell JN et al. (1999) Electrophysiological Assessment of the Cutaneous Arborization of Adelta-Fiber Nociceptors. *J Neurophysiol* 82:1164–1177
- Polydefkis M, Griffin JW, McArthur J (2003) New Insights into Diabetic Polyneuropathy. *JAMA* 290:1371–376
- Rajan B, Polydefkis M, Hauer P et al. (2003) Epidermal Reinnervation after Intracutaneous Axotomy in Man. *J Comp Neurol* 457:24–36
- Sauerstein K, Klede M, Hilliges M et al. (2000) Electrically Evoked Neuropeptide Release and Neurogenic Inflammation Differ between Rat and Human Skin. *J Physiol* 529:803–810
- Schmelz M, Schmidt R, Bickel A et al. (1997) Specific C-Receptors for Itch in Human Skin. *J Neurosci* 17:8003–8008
- Schmidt R, Schmelz M, Forster C et al. (1995) Novel Classes of Responsive and Unresponsive C Nociceptors in Human Skin. *J Neurosci* 1995:333–341
- Serra J, Campero M, Ochoa J (1998) Flare and Hyperalgesia after Intradermal Capsaicin Injection in Human Skin. *J Neurophysiol* 80:2801–2810
- Serra J, Campero M, Ochoa J et al. (1999) Activity-Dependent Slowing of Conduction Differentiates Functional Subtypes of C Fibres Innervating Human Skin. *J Physiol* 515:799–811
- Toyoda M, Nakamura M, Makino T et al. (2002) Nerve Growth Factor and Substance P are Useful Plasma Markers of Disease Activity in Atopic Dermatitis. *Br J Dermatol* 147:71–79
- Weber M, Bircklein F, Neundorfer B et al. (2001) Facilitated Neurogenic Inflammation in Complex Regional Pain Syndrome. *Pain* 91:251–257



19. Weidner C, Schmelz M, Schmidt R et al. (1999) Functional Attributes Discriminating Mechano-Insensitive and Mechano-Responsive C Nociceptors in Human Skin. *J Neurosci* 19:10184–10190

## Nociceptor, Categorization

EDWARD PERL

Department of Cell and Molecular Physiology, School of Medicine, University of North Carolina, Chapel Hill, NC, USA  
erp@med.unc.edu

### Synonyms

Categorization of Nociceptors

### Definition

Why categorize a mixed set of primary afferent neurons? As Lynn (1996) pointed out, classifying the components of a neuronal population into categories on the basis of shared features does more than one service. It facilitates communication by providing a shorthand to designate a subset with certain features. It also provides a way to deal with the large number of neurons in the mammalian nervous system that serves common functions. Moreover, appropriate classification of neurons can help facilitate concepts on development and the functional organization of nervous mechanisms.

### Characteristics

#### Noxious and Nociceptor

Definition of certain classes of stimuli as noxious and creation of the term nociceptor (noci-receptor) were outgrowths of the dispute in the late 19<sup>th</sup> Century about the sensory nature of pain. Physicians and physiologists of those days generally accepted pain to be a sensation. On the other hand, philosophical critics of this idea argued that in contrast to accepted sensations, pain does not have a “well defined” physical or chemical stimulus (Perl 1996). Mechanical events, heat, cold, and chemical agents can all produce it. Charles Sherrington (1906), an eminent physiologist of the time, proposed an answer to this criticism with the logic that pain ordinarily results from tissue injury. Consequently, tissue damage represents a common denominator of natural stimuli for pain. He suggested that events producing disruption of tissue or representing a physical threat to its integrity could be labeled noxious regardless of their nature, thereby providing an encompassing definition for the stimuli evoking pain. In this concept, sense organs signaling the presence of noxious events were labeled noci-receptors (now shortened to nociceptors). Designation of stimuli as noxious creates its own problems. Tissues of the mammalian body are diverse with widely differing mechanical and thermal characteristics.

This means that quantitatively the intensity of an environmental or circumstantial event necessary to cause tissue damage varies over a substantial range. Compare mechanical durability of the cornea of the human eye to the skin on the sole of a human foot. Furthermore, subcutaneous tissues and organs are protected from many environmental changes and potential insults; their exposure to some conditions that are innocuous for the skin would lead to tissue injury and thereby should be considered noxious. Thus, the nature of noxious events and their signaling by sense organs must be considered in the context of tissue type and location.

#### Classification of Sense Organs as Nociceptors

A primary afferent neuron is appropriately considered to be a nociceptor if the intensity of the most effective “natural” stimulus that evokes conducted action potentials approaches or exceeds the noxious (damaging) level for the innervated tissue. This criterion implies that such sensory units respond weakly or not all to innocuous stimuli of any type. Since the nature and intensity of noxious stimuli will vary for different tissues, the responsive characteristics of nociceptors will differ from one tissue to another.

Observations demonstrating nociceptors to be distinctive categories of somatic sense organs provide evidence that more than one type innervate many tissues. How are these different types distinguished? Actually, nociceptor classification has evolved as information about them expands and the changing criteria sometimes have led to ambiguity. Given the view that the function of nociceptors is to transmit to the central nervous system information about events dangerous to the physical integrity of the tissue they innervate, a first order in their classification, and one commonly used, is the nature of effective stimuli or the events signaled.

#### Classification of Nociceptors by Effective Stimuli

Much information about nociceptors has come from study of the innervation of epithelial tissue, particularly the skin. Early in the documentation of cutaneous nociceptors as distinctive types of sense organs, it became evident that the skin is innervated by more than one type (Perl 1996). As already suggested, nociceptors can be distinguished and classified according to the nature of stimuli activating them. On this basis, several categories are demonstrable in mammalian skin (Perl 1996; Campbell and Meyer 1996). In terms of effective stimuli, the cornea, another epithelial tissue, is innervated by closely similar varieties (Belmonte and Gallar 1996). One kind of cutaneous nociceptor responds vigorously to strong mechanical stimulation, positively grading the frequency and number of impulses in proportion to stimulus intensity. Extreme temperatures (e.g., noxious heat, freezing) excite such mechanical nociceptors (high threshold mechanoreceptors) only after a delay. A second category of cutaneous nociceptor responds more

N

globally, being promptly activated by heat, mechanical distortion and irritant chemicals including protons. The latter response pattern led to the designation of this class as polymodal nociceptors. A third kind, prominent in the innervation of glabrous skin, is excited by mechanical distortion and elevated skin temperature (mechanical-heat), but does not promptly respond to surface application of irritant chemicals or acid. A fourth type responds both to low skin temperatures and to noxious mechanical stimuli (mechanical-cold). In addition to these four categories, evidence exists for a class of primary afferents (labeled 'silent' nociceptors) that are only excited by mechanical stimuli when sensitized by local inflammation and for another category selectively excited by ► [histamine](#) (pruritus receptors).

#### Characterization by Conduction Velocity

Whereas the nature of effective stimuli represents an approach to classifying nociceptors that relates to function, it is not the only important criterion. Indications that peripheral stimuli evoke pain after distinctly different delays existed prior to documentation of nociceptors as a special set of peripheral sense organs. Transient application of a noxious mechanical or heat stimulus to distally located skin anecdotally and experimentally was noted to provoke a double pain response, one of short latency and a second delayed; these differences in latency can be attributed to differences in ► [conduction velocity](#) of peripheral nerve fibers responsible for the afferent messages. In addition to these distinctions of delay, "first" and "second" pain is reported to differ in quality of the sensation. This circumstantial evidence for conduction differences is consistent with findings that some categories of nociceptors have myelinated (A) and others unmyelinated (C) afferent fibers. Those with ► [A fibers](#) conduct much more rapidly (10–50×) than the ► [C Fiber](#) groups, and even though most A nociceptors have thinly myelinated fibers (A $\delta$ ), a number from distal limb regions are in the medium myelinated range with A $\beta$  (35–50 m/s) conduction velocities. A fiber and C fiber nociceptors also differ in other ways. For instance, several sets of C-fiber nociceptors express peptide mediators (e.g., substance P, CGRP) that are apparently absent in myelinated nociceptors. Furthermore, the central projections of A and C fiber nociceptors differ. These distinctions are consistent with certain differences in functions initiated by the A and C fiber categories.

#### Characterization by Tissue of Origin

Primary afferent neurons with responsive features of nociceptors innervate many mammalian tissues or organs, both somatic and visceral. In addition to skin and cornea these include teeth, skeletal muscle, tendon, joints, bone, urethra, ureter, urinary bladder, blood vessels, bronchi, heart, pleura and peritoneum, segments of the alimentary tract, meninges, and testis (Cervero 1996). These tissues differ substantially in physical and

chemical attributes, differences that are reflected in part in the responsive and signaling features of innervating nociceptive fibers. The testis is innervated by nociceptors mimicking the broad activation of cutaneous polymodal nociceptors by being responsive to noxious mechanical, heat and chemical stimuli (Kumazawa 1996). In contractile tissues, unusually high tension is an effective excitant for part of the nociceptive innervation. Similarly, lowered pH (protons), by itself or in combination with anoxemia, activate or enhance the responsiveness of certain nociceptive afferents of skeletal muscle (Mense 1996). Circumstantial evidence suggests that subcutaneous tissues such as joints and muscle contain a number of primary afferent fibers that are unresponsive to mechanical or thermal stimuli until injury has induced inflammation and its chemical environment (Schaible and Schmidt 1996). The latter can be considered types of chemoreceptor. Thus, the classification of nociceptors must take into account the tissue innervated in addition to effective stimuli, and the diameter (conduction velocity) of the afferent fiber.

#### Characterization by Molecular Features

A presumption underlying hypotheses about differentiation and specialization of biological cells, in our case neurons, is that these processes are guided and controlled by the presence and expression of particular molecular entities. Relating factors associated with molecular expression to functionally important features of nociceptors is an ongoing effort and at present represents at most an emerging story with promise for future insights.

In one example, the heat responsiveness of polymodal nociceptors is attributed to a membrane receptor, ► [TRPV1](#) (Caterina and Julius 2002). TRPV1 donates such reactivity when expressed in heterologous cells. TRPV1 is the endogenous receptor that is selectively activated by capsaicin, the substance that gives the sensation of heat upon ingestion of "hot" pepper. A structurally related membrane receptor, ► [TRPV2](#), is predominantly expressed in different primary afferent neurons than TRPV1, and is proposed to provide a higher threshold heat response for a set of nociceptors different from the polymodal type. TRPV2 is neither excited by capsaicin nor acid (Caterina and Julius 2002). Other relationships between molecular features and categories of nociceptors include the immunocytochemical labeling of a subset of small diameter dorsal root ganglia (DRG) neurons and their processes for the peptides, ► [substance P](#) and ► [CGRP](#). Both circumstantial and direct correlations indicate that at least some peptide-labeled elements are polymodal or mechanical-heat nociceptors (Lawson 1996; Lawson et al. 1997). The small substance P-containing neurons are mostly distinct from an isolectin IB4-binding population of presumed nociceptors (Lawson 1996). Thus, evidence for the common presence of TRPV1, TRPV2, or any other unique cellular constituent links the nociceptors

in question by a shared feature, and represents a basis for categorization.

### Characterization by Central Projection

Nociceptors, as primary afferent neurons, project to the spinal cord or the brainstem with a heavy concentration of synaptic terminations in the superficial dorsal horn or the trigeminal equivalent. The bulk of nociceptors enter the spinal cord through the ► **lateral division (of the spinal dorsal root)**. There is a distinct layering of terminations from different nociceptor subsets as defined by other criteria. Substance P (and CGRP)-labeled endings concentrate in the marginal zone (► **lamina I**) and outer ► **substantia gelatinosa** (► **lamina II**), as do the non-peptide terminations of cutaneous myelinated-fiber, mechanical nociceptors (Light 1992; Perl 1984). IB4-labeled fibers generally terminate more deeply in lamina II than the concentration of substance P terminals (Woodbury et al. 2000). In addition to these superficial dorsal horn terminations, nociceptive primary afferents contribute to other dorsal horn regions. Whereas these terminal synaptic regions are not definitive markers of receptive category, they have been used as guides to relate participation by particular types of nociceptors in experimental analyses.

### Summary

Categorization of nociceptors is a multifactorial task. To be of value in facilitating understanding of their biology and place in function, categorization of nociceptive afferents should consider the nature of events signaled, the structural and functional details of the neuron (including its afferent fiber), the presence of unique molecules and features of the peripheral and central connections.

### References

1. Belmonte C, Gallar J (1996) Corneal Nociceptors. In: Belmonte C, Cervero F (eds) *Neurobiology of Nociceptors*. Oxford University Press, Oxford, pp 146–183
2. Campbell JN, Meyer RA (1996) Cutaneous Nociceptors. In: Belmonte C, Cervero F (eds) *Neurobiology of Nociceptors*. Oxford University Press, Oxford, pp 117–145
3. Caterina MJ, Julius D (2001) The Vanilloid Receptor: A Molecular Gateway to the Pain Pathway. *Annu Rev Neurosci* 24:487–517
4. Cervero F (1996) Visceral Nociceptors. In: Belmonte C, Cervero F (eds) *Neurobiology of Nociceptors*. Oxford University Press, Oxford, pp 220–242
5. Kumazawa T (1996) Sensitization of Polymodal Receptors. In: Belmonte C, Cervero F (eds) *Neurobiology of Nociceptors*. Oxford University Press, Oxford, pp 325–345
6. Lawson SN (1996) Neurochemistry of Cutaneous Nociceptors. In: Belmonte C, Cervero F (eds) *Neurobiology of Nociceptors*. Oxford University Press, Oxford, pp 72–91
7. Lawson SN, Crepps BA, Perl ER (1997) Relationship of Substance P to Afferent Characteristics of Dorsal Root Ganglion Neurons in Guinea Pig. *J Physiol* 505:177–191
8. Light AR (1992) *The Initial Processing of Pain and Its Descending Control: Spinal and Trigeminal Systems*. Karger, Basel
9. Lynn B (1996) Principles of Classification and Nomenclature Relevant to Studies of Nociceptive Neurons. In: Belmonte C, Cervero F (eds) *Neurobiology of Nociceptors*. Oxford University Press, Oxford, pp 1–2
10. Mense S (1996) Nociceptors in Skeletal Muscle and Their Reaction to Pathological Tissue Changes. In: Belmonte C, Cervero F (eds) *Neurobiology of Nociceptors*. Oxford University Press, Oxford, pp 184–201
11. Perl ER (1984) Pain and Nociception. In: Darian-Smith I (ed) *Handbook of Physiology. The Nervous System*, vol 3. American Physiological Society, Bethesda, MD, pp 915–975
12. Perl E (1996) Pain and Discovery of Nociceptors. In: Belmonte C, Cervero F (eds) *Neurobiology of Nociceptors*. Oxford University Press, Oxford, pp 5–36
13. Schaible H-G, Schmidt RF (1996) Neurobiology of Articular Nociceptors. In: Belmonte C, Cervero F (eds) *Neurobiology of Nociceptors*. Oxford University Press, Oxford, pp 202–219
14. Sherrington CS (1906) *The Integrative Action of the Nervous System*. Scribner, New York
15. Woodbury CJ, Ritter AM, Koerber HR (2000) On the problem of lamination in the superficial dorsal horn of mammals: a reappraisal of the substantia gelatinosa in postnatal life. *J Comp Neurol* 417:88–102

## Nociceptor, Fatigue

RICHARD A. MEYER, MATTHIAS RINGKAMP  
Department of Neurosurgery, School of Medicine,  
Johns Hopkins University, Baltimore, MD, USA  
rmeyer@jhmi.edu, platelet@jhmi.edu

### Synonyms

Tachyphylaxis; deactivation; desensitization; suppression

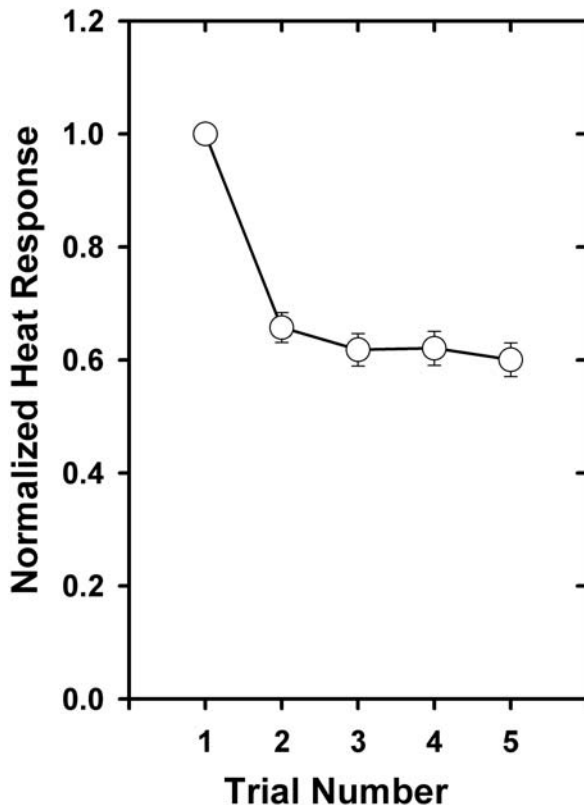
### Definition

The decrement in response of nociceptors to natural stimuli that occurs upon repeated stimulation.

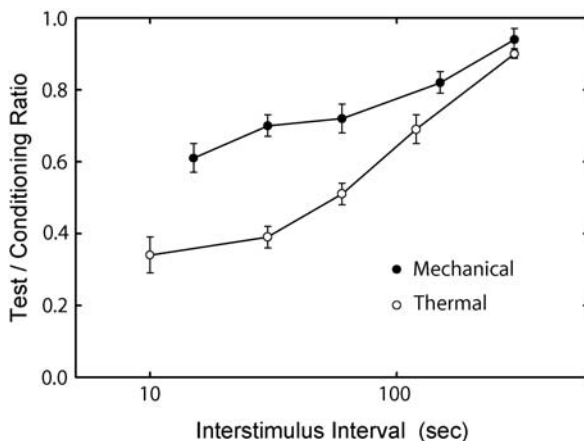
### Characteristics

The response of a primary afferent nociceptor to a given stimulus is greatly reduced when the stimulus is applied a second time. For example, the response of a nociceptor to a heat stimulus applied to its receptive field is reduced by about 40% when presented a second time within 60 s of the first presentation (Fig. 1). Nociceptors exhibit fatigue to all stimuli that activate them, including heat, mechanical and chemical stimuli (Liang et al. 2001; Slugg et al. 2000; Tillman 1992). The magnitude of fatigue is dependent on the number of action potentials evoked by the conditioning stimulus, but is independent of the frequency of the evoked action potentials. Consequently, the magnitude of fatigue increases with the intensity of the applied stimulus (LaMotte and Campbell 1978; Peng et al. 2003). The time course for recovery from fatigue is slow, with full recovery taking more than 5 min (Fig. 2). Fatigue is also seen for repeated stimuli that have been applied to isolated dorsal root ganglion cells (Schwarz et al. 2000).

The psychophysical correlate of fatigue is suppression. Suppression corresponds to the decrement in pain rating to a noxious stimulus that occurs upon repeated stimulation at the same location. For example, the pain rating to a



**Nociceptor, Fatigue, Figure 1** Normalized response of C-fiber mechano-heat sensitive nociceptors to five presentations of a heat stimulus with a repetition period of 60s. The response decreased between trials 1 and 2 and stabilized to about 60% of the response to the first heat stimulus. (Adapted from Peng et al. 2003).



**Nociceptor, Fatigue, Figure 2** Slow recovery from fatigue. The magnitude of fatigue is dependent on the time between the conditioning and the test stimulus. The response to the test stimulus approaches the response to the initial identical conditioning stimulus as the interstimulus interval increases. The fatigue to heat stimuli is greater than the fatigue to mechanical stimuli (Adapted from Slugg et al. 2000; Tillman 1992).

heat stimulus applied to the hand is significantly lower than the pain rating to the same stimulus applied 30 s earlier (LaMotte and Campbell 1978). The time for full recovery is greater than 5 min.

Most nociceptors are polymodal and respond to more than one stimulus modality. Cross-modal fatigue occurs such that stimulation with one stimulus modality (e.g. mechanical stimuli) will lead to a decrement in response to another stimulus modality (e.g. heat). In addition, stimulation to one part of the receptive field can lead to fatigue in another part of the receptive field, presumably due to ► **antidromic invasion** of the adjacent terminals. The magnitude of fatigue is less, and recovery time is quicker, for cross modal fatigue compared to unimodal fatigue (Peng et al. 2003).

Fatigue may occur at the stimulus transduction and/or at the spike initiation site and may involve calcium-dependent and independent mechanisms.

### References

1. LaMotte RH, Campbell JN (1978) Comparison of Responses of Warm and Nociceptive C-Fiber Afferents in Monkey with Human Judgements of Thermal Pain. *J Neurophysiol* 41:509–528
2. Liang YF, Haake B, Reeh PW (2001) Sustained Sensitization and Recruitment of Rat Cutaneous Nociceptors by Bradykinin and a Novel Theory of its Excitatory Action. *J Physiol* 532:229–239
3. Peng YB, Ringkamp M, Meyer RA et al. (2003) Fatigue and Paradoxical Enhancement of Heat Response in C-Fiber Nociceptors from Cross-Modal Excitation. *J Neurosci* 23:4766–4774
4. Schwarz S, Greffrath W, Busselberg D et al. (2000) Inactivation and Tachyphylaxis of Heat-Evoked Inward Currents in Nociceptive Primary Sensory Neurons of Rats. *J Physiol* 528:539–549
5. Slugg RM, Meyer RA, Campbell JN (2000) Response of Cutaneous A- and C-Fiber Nociceptors in the Monkey to Controlled-Force Stimuli. *J Neurophysiol* 83:2179–2191
6. Tillman DB (1992) Heat Response Properties of Unmyelinated Nociceptors. Ph.D. Dissertation, The Johns Hopkins University, pp 1–187

## Nociceptors, Action Potentials and Post-Firing Excitability Changes

BRUCE LYNN

Department of Physiology, University College London, London, UK

b.lynn@ucl.ac.uk

### Synonyms

Action Potential in Different Nociceptor Populations; Post-Firing Excitability Changes in Different Nociceptor Populations

### Definition

The electrophysiological properties of nociceptive neurones.

primary afferent

### Characteristics

This essay will consider the electrical properties of mammalian nociceptive neurones, covering both the action potential itself and the changes in excitability that follow it. Much of the work in this area has been concerned with major differences between nociceptors



on the one hand, and non-nociceptive afferent neurones on the other. There has also been a relatively small amount of work showing clear differences within nociceptor subclasses. As well as describing differences in such properties as time course or amplitude, an attempt will be made to look at likely differences in underlying membrane properties, especially in the sub-classes of **ion channel** present. Differences in electrical properties directly affect the ability of nociceptive neurones to encode information about stimuli, for example by limiting firing rates. In addition, however, the finding of differences in the key proteins controlling excitability between nociceptors and non-nociceptors, and between sub-classes of nociceptor, opens up important possibilities for the development of selective analgesic agents.

**Action Potentials in Nociceptive Neurones**

**Axonal Action Potentials**

Extracellular recordings from unmyelinated fibres have revealed that there are differences in the action potential time course between sub-classes of nociceptor (Fig. 1). The only extensive study has been in the pig (Gee et al. 1999), where 2 major classes of C-fibre nociceptor have been found in the skin. Polymodal nociceptors respond to all types of nociceptive stimuli, whereas heat nociceptors respond to heat and chemicals, but not to pressure. The heat nociceptors have **spikes** of longer duration and with longer after potentials than do the polymodal nociceptors (Fig. 1). In the rat, there are mainly polymodal nociceptors, and these have wide spikes compared with non-nociceptive afferents (Gee et al. 1999). However, no comparisons have been made with other classes of C-fibre nociceptor in this species.

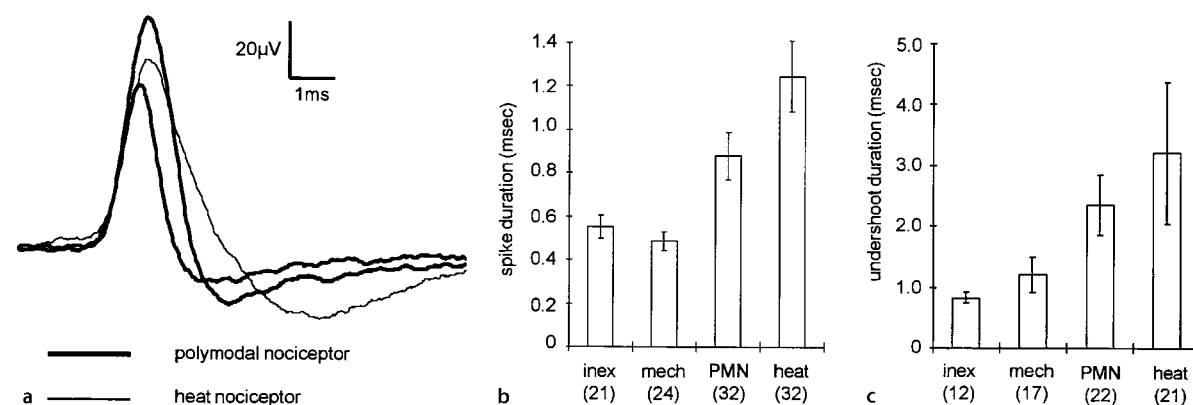
In both pig and rat there are also A-fibre nociceptors, and these have narrow spikes compared with C-fibre nociceptors, as one would expect from the generally faster excitability changes seen in myelinated compared with unmyelinated **axons**. In man, microneurographic recordings have again revealed longer duration action potentials in C-nociceptor axons compared with C-cold afferent axons (Serra et al. 1999). Interestingly, a group of mechanically insensitive axons with small, short duration spikes was also observed (Serra et al. 1999). The functional identity of these fibres has not been established, but they might be a second group of very mechanically insensitive nociceptors with different axonal properties.

**Soma Action Potentials**

Intracellular recordings from dorsal root ganglion cells reveal that, as described above for the axons, nociceptive neurones have spikes with a slower time course than mechanoreceptor neurones with a similar conduction velocity (Lawson 2002). This is true for the **soma** spikes of neurones with myelinated and unmyelinated axons. Often the broad spikes of nociceptive neurones have a distinct inflexion (or “shoulder”) on the falling phase. After-potentials are also of longer duration. No studies have been made of soma spike shape for sub-classes of nociceptor. One interesting observation is that following peripheral inflammation in the innervation territory of the neurone, the soma spike becomes shorter in duration (Djoughri and Lawson 1999).

**Mechanism of Differences in Action Potential Duration**

The longer action potential durations in nociceptive neurones may be due to a combination of slower



**Nociceptors, Action Potentials and Post-Firing Excitability Changes, Figure 1** Axonal action potentials recorded from the saphenous nerve of the anaesthetised pig. (a) Examples of three C-fibre spikes recorded from the same filament. Two (thick lines) were polymodal nociceptor units, and one (wider spike with thinner line) was a heat nociceptor. (b) Duration of the main peak of the action potential at half maximum amplitude for different types of C-fibre (mean ± s.e.). Analysis of variance showed that heat nociceptors had significantly longer duration spikes than polymodal nociceptors, and that both classes of nociceptor had longer duration spikes than the 2 non-nociceptor classes. (c) Duration of action potential undershoots at half maximum amplitude. Analysis of variance showed that the two classes of nociceptor had longer duration after potentials than the non-nociceptors, but no significant difference between heat and polymodal nociceptors. Class labels: inex – unit with no afferent field to pressure or heat; mech – sensitive mechanoreceptor (non-nociceptive); PMN – polymodal nociceptor; heat – heat nociceptor. Number of units in brackets below the class labels. From Gee et al (1999).

sodium channel kinetics and an additional calcium current (Blair and Bean 2002). The somas of nociceptive neurones contain much higher levels of the sodium channels NaV1.7, NaV 1.8 and NaV 1.9 (Djouhri et al. 2003a; Djouhri et al. 2003b; Fang et al. 2002). Of these, the ► **TTX** resistant channel NaV 1.8 (SNS) is probably the most important contributor to the action potential (Wood et al. 2004). This channel has slower kinetics than the TTX sensitive channels that dominate in non-nociceptive neurones, so may be part of the reason that spikes have a slower rise time and longer durations. There is also evidence that C-fibre, presumed nociceptor, axons have both TTX-resistant sodium current and calcium transients, so similar factors may operate at an axonal level as in the soma (Grosskreutz et al. 1996; Mayer et al. 1999).

#### Post-Firing Excitability Changes in Nociceptive Neurones

Following an action potential, the excitability of neurones undergoes a series of fluctuations. Typically, a period of subnormal excitability is followed by a supernormal period of slightly increased excitability, and then sometimes a further period of slightly reduced excitability. The effects of one action potential can be detected in some neurones for several minutes. A readily observed effect of these excitability changes is that subsequent action potentials propagate with a slowed conduction velocity during periods of subnormal excitability, and with a faster conduction velocity during the supernormal period.

#### Analysis of Conduction Velocity Slowing in C-Fibres

Conduction velocity changes during repetitive firing of both A-fibre and C-fibre afferents are clearly greater in nociceptors than in non-nociceptive axons (Gee et al. 1996). In human nerves, there are also differences between subclasses of nociceptor. Conduction velocity slowing is more marked in mechanically inexcitable C-fibre afferents (CMi) than in those with noxious pressure receptive fields (C-responsive or CMR). Note that such neurones are also usually heat sensitive, so correspond to C-polymodal nociceptors or may be designated CMH (Weidner et al. 1999). Conduction velocity slowing is also more marked in terminal branches of C-fibres than in the axons within the main nerve trunk (Weidner et al. 2003). A supernormal period is also seen at all stimulus frequencies in CMi afferents, whilst it was only present at faster stimulation frequencies, with greater pre-existing slowing, in CMH fibres. The supernormal period in C-nociceptor axons has the intriguing effect of causing action potentials to catch each other up at high frequencies of stimulation, from approximately 20 Hz upwards. This means that two stimuli given at, say, 50 ms intervals evoke action potentials that are only 10 ms apart by the time they reach the central nervous system (they cannot catch up completely as the short term subnormal period corresponding to the relative

refractory period sets an upper limit to firing rate). This substantial change in frequency of firing could well increase the effectiveness of such inputs at synapses. In contrast, at lower frequencies, typically less than 10 Hz, spikes are in the late subnormal period and some slight decrease in final firing rate will occur during propagation of spikes to the central nervous system. Weidner et al. (2002) suggest that this phenomenon may lead to a degree of contrast enhancement, with the apparent firing rate for strong stimuli being enhanced relative to the firing evoked by weaker stimulation.

#### Mechanisms Underlying Post-Firing Changes in Nociceptor Excitability

The slow changes in excitability after an action potential will reflect: (a) which particular ion channels are operating, (b) any accumulation of ions intracellularly or in the immediate extracellular space, and (c) hyperpolarisation due to increased activity of the ► **sodium pump**. Immediate post-firing subnormal excitability is caused by residual sodium channel inactivation plus delay in closing of depolarisation-activated potassium channels. The supernormal period appears to be a passive consequence of the long time constant (around 100 ms) of the C-fibre membrane (Bostock et al. 2003; Weidner et al. 2002). In this respect, mammalian C-fibres resemble the internodal membrane of myelinated fibres. The very long term subnormality appears to reflect the hyperpolarising action of the sodium pump (Bostock et al. 2003). The studies to date have not examined why CMi neurones have greater subnormality at long interstimulus intervals than CMR neurones, but this may reflect either some difference in sodium pumping or other very slowly changing ion channels. In sympathetic C-fibres, hyperpolarisation-activated inward currents (I<sub>h</sub>) appear to play a role. However, double pulse experiments with nociceptive C-fibres did not show any changes attributable to I<sub>h</sub> (Bostock et al. 2003).

#### Concluding Comments

The action potentials, both in the axons and the soma, are of longer duration in nociceptors than in other classes of somatosensory afferent neurone. Intriguing differences also exist between sub-classes of nociceptor in their action potential shape and in their post-firing excitability changes. In general, the mechanically insensitive nociceptors show longer duration axonal spikes and more profound depression of excitability by slow (2 Hz or less) activation. The differences between nociceptors and non-nociceptors may reflect the presence of slower TTX-resistant currents, plus significant calcium influx, during nociceptor action potentials. The reasons why CMi differ from CMR nociceptors are not known. The importance of CMi fibres for ► **secondary hyperalgesia** (Serra et al. 2004), and their involvement in chronic pain conditions (Orstavik et al. 2003) makes

these differences worthy of further study. A tantalising possibility is that differences in electrophysiological properties between nociceptors and non-nociceptors, or even possibly between sub-classes of nociceptor, might provide a basis for novel analgesic drugs. Some work on ► [sodium channel blockers](#) is already published and this is likely to remain an active research field (Wood et al. 2004)

## References

- Blair NT, Bean BP (2002) Roles of Tetrodotoxin (TTX)-Sensitive Na<sup>+</sup> Current, TTX-Resistant Na<sup>+</sup> Current, and Ca<sup>2+</sup> Current in the Action Potentials of Nociceptive Sensory Neurons. *J Neurosci* 22:10277–10290
- Bostock H, Campero M, Serra J et al. (2003) Velocity Recovery Cycles of C Fibres Innervating Human Skin. *J Physiol* 553:649–663
- Djoughri L, Fang X, Okuse K et al. (2003a) The TTX-Resistant Sodium Channel Nav1.8 (SNS/PN3): Expression and Correlation with Membrane Properties in Rat Nociceptive Primary Afferent Neurons. *J Physiol* 550:739–752
- Djoughri L, Lawson SN (1999) Changes in Somatic Action Potential Shape in Guinea-Pig Nociceptive Primary Afferent Neurons during Inflammation *In Vivo*. *J Physiol* 520:565–576
- Djoughri L, Newton R, Levinson SR et al. (2003b) Sensory and Electrophysiological Properties of Guinea-Pig Sensory Neurons Expressing Nav 1.7 (PN1) Na<sup>+</sup> Channel Alpha Subunit Protein. *J Physiol* 546:565–576
- Fang X, Djoughri L, Black JA et al. (2002) The Presence and Role of the Tetrodotoxin-Resistant Sodium Channel Na(v)1.9 (NaN) in Nociceptive Primary Afferent Neurons. *J Neurosci* 22:7425–7433
- Gee MD, Lynn B, Basile S et al. (1999) The Relationship between Axonal Spike Shape and Functional Modality in Cutaneous C-Fibres in the Pig and Rat. *Neuroscience* 90:509–518
- Gee MD, Lynn B, Cotsell B (1996) Activity-Dependent Slowing of Conduction Velocity Provides a Method for Identifying Different Functional Classes of C-Fibre in the Rat Saphenous Nerve. *Neuroscience* 73:667–675
- Grosskreutz J, Quasthoff S, Kuhn M et al. (1996) Capsaicin Blocks Tetrodotoxin-Resistant Sodium Potentials and Calcium Potentials in Unmyelinated C Fibres of Biopsied Human Sural Nerve *In Vitro*. *Neurosci Lett* 208:49–52
- Lawson SN (2002) Phenotype and Function of Somatic Primary Afferent Nociceptive Neurons with C-, Adelta- or Aalpha/Beta-Fibres. *Exp Physiol* 87:239–244
- Mayer C, Quasthoff S, Grafe P (1999) Confocal Imaging Reveals Activity-Dependent Intracellular Ca<sup>2+</sup> Transients in Nociceptive Human C Fibres. *Pain* 81:317–322
- Orstavik K, Weidner C, Schmidt R et al. (2003) Pathological C-Fibres in Patients with a Chronic Painful Condition. *Brain* 126:567–578
- Serra J, Campero M, Bostock H et al. (2004) Two Types of C Nociceptors in Human Skin and their Behavior in Areas of Capsaicin-Induced Secondary Hyperalgesia. *J Neurophysiol* 91:2770–2781
- Serra J, Campero M, Ochoa J et al. (1999) Activity-Dependent Slowing of Conduction Differentiates Functional Subtypes of C Fibres Innervating Human Skin [see comments]. *J Physiol* 515:799–811
- Weidner C, Schmeltz M, Schmidt R et al. (2002) Neural Signal Processing: The Underestimated Contribution of Peripheral Human C-Fibers. *J Neurosci* 22:6704–6712
- Weidner C, Schmeltz M, Schmidt R et al. (1999) Functional Attributes Discriminating Mechano-Insensitive and Mechano-Responsive C Nociceptors in Human Skin. *J Neurosci* 19:10184–10190
- Weidner C, Schmidt R, Schmeltz M et al. (2003) Action Potential Conduction in the Terminal Arborisation of Nociceptive C-Fibre Afferents. *J Physiol* 547:931–940
- Wood JN, Boorman JP, Okuse K et al. (2004) Voltage-Gated Sodium Channels and Pain Pathways. *J Neurobiol* 61:55–71

## Nociceptors, Cold Thermotransduction

FÉLIX VIANA, ELVIRA DE LA PEÑA  
Instituto de Neurociencias de Alicante, Universidad Miguel Hernández-CSIC, Alicante, Spain  
felix.viana@umh.es, elvirap@umh.es

### Synonyms

Cold Nociception; Noxious Cold Receptor; Cold Thermotransduction

### Definition

A large fraction of nociceptors can be excited by application of cold temperatures to their peripheral endings. Most have the functional properties of C-type polymodal nociceptors. The molecular sensors involved in transducing strong cooling stimuli into an electrical signal are still unresolved; ► [TRPA1](#) channels are contested candidates. Noxious and thermal signals are further processed in the brain to establish the intensity and quality of the sensation. Peripheral nerve injury can modify the process to give rise to ► [cold allodynia](#) or ► [hyperalgesia](#).

### Characteristics

Humans can feel a wide range of ambient temperatures. This capacity is fundamental for tactile recognition of objects and thermoregulation. Within the cold temperature range, the qualities of sensations evoked vary from pleasantly cool to extremely painful. The neutral zone, evoking no sensation upon temperature change of the skin ranges between 35°C and 31°C. Cutaneous temperatures of 30–15°C are generally perceived as cool to cold. Upon further temperature reduction, the perceptual qualities of the sensation change, becoming painful. The sensation of cold pain can have a burning, aching, prickling or stinging quality, depending on temperature and stimulus duration, possibly reflecting the activation of different classes of afferents. In contrast to the sharp threshold temperature for heat pain, the threshold for cold pain is less clearly defined and influenced by several factors such as rate of temperature change and stimulus area, indicating that mechanisms of temporal and spatial summation participate in encoding these sensations. Generally, the sensation turns painful only after a considerable delay, many seconds after cold application, which further complicates the definition of a threshold. Focal skin temperatures above approximately 43–45°C also evoke a ► [paradoxical cold sensation](#) in many individuals.

While significant advances in the cellular and molecular mechanisms responsible for temperature transduction by nerve terminals have taken place in recent years

(reviewed by Jordt et al. 2003; Patapoutian et al. 2003; Reid 2005), many important aspects of the function of ► **cold thermoreceptors** and nociceptors and how cold pain is encoded remain obscure. Thus, it is unknown which molecular and cellular factors determine the different temperature thresholds of individual sensory terminals. Also, the mechanisms involved in the development of pain by moderate cooling after nerve injury (► **cold hyperalgesia**) remain mysterious. These are important questions with implications in the treatment of disorders in which cold temperatures evoke pain.

The existence of separate, small, cold and warm cutaneous sensory spots has been known since the late 19<sup>th</sup> century. These findings lend support to von Frey's specificity theory of somesthesia, according to which sensory nerve fibers of the skin were sensitive to only one form of stimulation and acted as "labeled lines" for the transmission of information encoding a single perceptual quality. In contrast to the strict labeled line hypothesis, many studies also indicated that the perceptual quality of cold-evoked painful sensations is determined by the integrated activity of both nociceptive and non-nociceptive systems.

Psychophysical studies suggest that pure cooling and cold pain sensations result from the activation of different populations of receptors. In support of this view, humans show better detection ability in the innocuous cold compared to the noxious cold temperature range. Compression block of myelinated fiber conduction in cold-sensitive afferents shifts the pain threshold of cold stimulation towards higher temperatures, pointing to a convergent processing of thermal and nociceptive inputs (Yarnitsky and Ochoa 1990). The same occurs in certain diseases, including peripheral nerve lesions and neuropathic pain syndromes, which are often associated with cold hyperalgesia.

The anatomical substrates for these cold-sensitive spots are free nerve endings branching inside the superficial skin layers. Functional studies suggest that receptors sensing noxious cold may be located more deeply within the skin, some located along vein walls (Klement and Arndt 1992). The difference in location has important implications for interpreting experimental findings; the deeper location of nociceptive endings will result in a large discrepancy between the actual temperature of the receptor and the readings of the surface probe used to apply the cold stimulus. This lag in thermal readings will overestimate the apparent low temperature of activation of nociceptors to cold. As a matter of fact, temperature recordings inside the skin indicate that cold pain may be evoked with intracutaneous temperatures as high as 28°C (Klement and Arndt 1992).

#### Cold-Sensitive Fibers

Extending the psychophysical studies, single fiber recordings in various species, including primates, have identified a population of myelinated A $\delta$  fibers excited

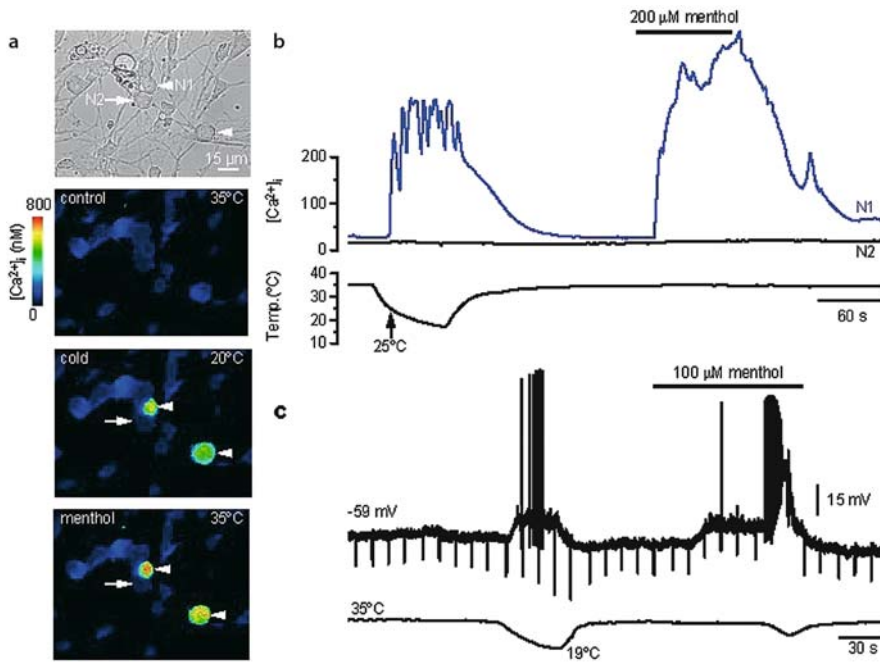
by moderate decreases in the temperature of their receptive field. These fibers are insensitive to mechanical stimuli. They are the prototypical "low-threshold" cold thermoreceptors (Hensel 1981). At normal skin temperatures (33–34°C), cold thermoreceptors show a static ongoing discharge. On sudden cooling, they display a transient peak in firing that adapts to a new static level, often characterized by short bursts of impulses separated by silent intervals. Rewarming of the skin leads to silencing of the receptors. A mirror response is observed in warm receptors. Activation of these receptors is the probable mechanism responsible for the sensation of innocuous cold. In humans, microneurographic recordings confirmed the existence of cold thermoreceptors; the principal difference in primates was the lower conduction velocity and the regular pattern of discharge (Campero et al. 2001). ► **Menthol**, a natural substance found in leaves of certain plants, evokes cold sensations when applied at low doses to skin and mucosae. This effect is due to sensitization of cold thermoreceptors; they shift their threshold of activation to higher temperatures. However, other studies also show that topical application of high concentrations of menthol can sensitize nociceptors and evoke pain (Green 1992; Wasner et al. 2004).

Greater decreases in temperature recruit an additional population of receptors. Many of these high-threshold cold-sensitive fibers are also heat- and mechano-sensitive and conduct slowly, which would classify them as C-type polymodal nociceptors. In humans, they are characterized by low and irregular firing rates (< 1 impulse/s) during cooling (Campero et al. 1996). Activation of these nociceptors is thought to underlie the sensation of cold pain. However, other fiber types also augment their discharge during strong cold stimuli, including high threshold cold receptors and a fraction of slowly adapting low threshold mechanoreceptors. Thus, it is still an open question as to the contribution of these various fibers to noxious cold sensations. Terminal stumps of damaged sensory fibers can be excited by moderate cooling stimuli. The majority are C-type and many are also menthol sensitive (Roza et al. 2006). Parallel input from primary sensory neurons carrying innocuous and noxious thermal information to the brain is suggested by the existence of anatomically and functionally distinct second-order neurons in lamina I of the spinal cord responsive to innocuous cooling, pure nociceptive stimuli or multimodal thermal and mechanical stimuli.

#### Cold Sensitive Neurons

To investigate the cellular mechanisms underlying cold sensing, many laboratories have turned to models that use primary sensory neurons maintained in culture (reviewed by Reid 2005). Activity in these cells can be monitored with calcium-sensitive fluorescent dyes (Fig. 1). Only a small fraction (10–15%) of sensory





**Nociceptors, Cold Thermotransduction, Figure 1** Identification and response characteristics of cold sensitive trigeminal neurons in culture. (a) A neuronal culture (1 day *in vitro*) obtained from the trigeminal ganglion showing the bright-field image (top) and (in descending order) the pseudocolor images of the fura-2 ratio intensity at 35°C, 20°C and 35°C in the presence of 200  $\mu$ M menthol. Two of the neurons (marked with arrowheads) increased their resting calcium level during the cold stimulus, while the remaining cells did not change their calcium levels. (b) Intracellular calcium response to a cold ramp and 200  $\mu$ M menthol application in the two neurons marked in (a). Only one of the cells responded to the stimuli. (c) Whole cell current clamp recordings of a cold sensitive neuron showing the potentiation of the cold response and the shift in temperature threshold by menthol.

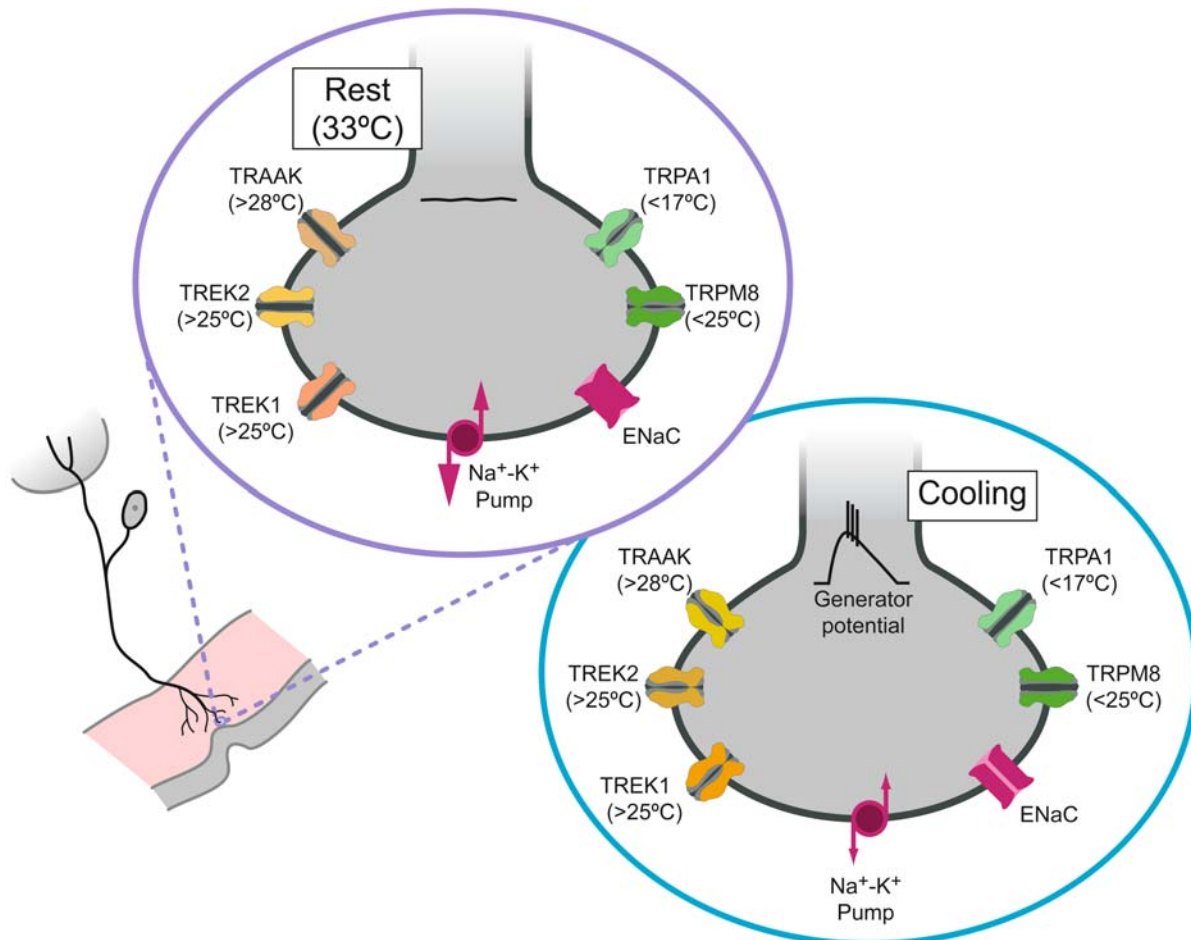
neurons respond to application of cold stimuli with an elevation in their intracellular calcium concentration. Many of these cold sensitive neurons are also activated by cooling compounds like menthol (Fig. 1), suggesting that they are indeed cold thermoreceptors (Viana et al. 2002; McKemy et al. 2002; Reid et al. 2002). These studies further showed that cold sensitive neurons have distinct electrophysiological properties. A hallmark is their high excitability; they require minute excitatory currents to reach firing threshold. The increased excitability reflects the relative low expression of subthreshold voltage gated potassium currents in comparison with other sensory neurons. A high percentage of cold and menthol sensitive neurons are also excited by the algescic compound capsaicin, which can be interpreted as further evidence for the expression and role of **TRPM8 channels** in polymodal nociceptive neurons (Viana et al. 2002; McKemy et al. 2002).

#### Molecular Sensors for Cold

Work in the 1970's attributed the activation of nerve terminals by cooling to the depolarization produced by inhibition of the  $Na^+/K^+$  pump. However, the realization that individual terminals can be activated by variable low temperatures hinted at the existence of more specific mechanisms, such as membrane ion channels with distinct temperature thresholds of activation, as likely molecular sensors of innocuous and painful cold signals. In principle, excitation of nerve terminals by a cold temperature could involve opening of cation channels or closure of resting potassium channels (Fig. 2). In either case, the net result is a depolarizing generator potential and firing of action potentials by the terminal.

Following on the landmark identification of **TRPV1**, a cation channel activated by heat and capsaicin (Caterina et al. 1997), two research groups cloned two additional transient receptor potential (TRP) channels activated by decreases in temperature. These two ion channels, known as **TRPM8** and **TRPA1**, are expressed in discrete, non-overlapping, subpopulations of primary sensory neurons (Story et al. 2003). So far, the best characterized channel in the molecular machinery for neuronal cold sensing is TRPM8. The data argue strongly for a primary role of TRPM8 in non-noxious cold detection. TRPM8 is a calcium permeable, voltage gated, non-selective cation channel that is activated by temperature and natural cooling compounds like menthol and eucalyptol (McKemy et al. 2002; Peier et al. 2002). TRPM8 is expressed selectively in a small population (10–15%) of primary sensory neurons of small diameter and most cold sensitive neurons are also excited by menthol. Many of the same neurons also express TRPM8 mRNA transcripts. Moreover, many cold sensitive neurons manifest a non-selective cation current with many biophysical and pharmacological properties consistent with the properties of TRPM8-dependent currents (reviewed by Reid 2005).

One important difference between native cold activated currents and cloned **TRPM8 channels** is the temperature threshold (de la Pena et al. 2005). Activation threshold of TRPM8 channels is around 25°C, a surprisingly low value. This is not a trivial issue for two reasons. First, it leaves unexplained the ability of many cold thermoreceptors to sense temperature decreases in the 33 to 26°C range. Second, the high threshold observed suggests that TRPM8 may also be a candidate for thermal nociception



**Nociceptors, Cold Thermotransduction, Figure 2** Cold sensing molecules in peripheral nerve endings. A schematic representation of a thin sensory fiber innervating the skin. The transduction of cold temperatures into an electrical signal takes place at free nerve endings. A free nerve ending with all the putative cold-sensing channels and their temperature thresholds. In the case of  $K^+$  channels, closed by low temperature, the “threshold” value represents the lowest temperature at which the channels display significant activity. At normal skin temperatures, the terminal is kept hyperpolarized by the background activity of  $K^+$  channels. Activity in the electrogenic  $Na^+-K^+$  pump contributes to the hyperpolarization. Upon cooling,  $K^+$  channels close and thermosensitive TRPs open, with a decrease in  $Na^+-K^+$  pump activity, leading to a depolarizing receptor potential and spike firing.

as well. As already mentioned, this hypothesis is supported by some psychophysical studies in humans (Wagner et al. 2004; Green 1992). In turn, the discrepancy in thresholds may be explained by intrinsic modulation of TRPM8 channels by endogenous factors.

The identification of cold sensitive neurons that are insensitive to menthol points to additional cellular mechanisms in neuronal cold sensing (reviewed by Reid 2005). As a matter of fact, many high threshold cold sensitive neurons lack TRPM8 expression. The second cold sensitive TRP channel identified, **TRPA1**, is activated by much lower temperatures ( $< 17^\circ\text{C}$ ) than TRPM8 and has therefore been suggested to be important in the transduction of high threshold, painful, cold stimuli (Story et al. 2003). This channel is not activated by menthol but is potently activated by pungent compounds like cinnamaldehyde and isothiocyanates present in cinnamon oil, wasabi and mustard oil. However, other investigators have not been able to replicate

the cold sensitivity of TRPA1 channels (Jordt et al. 2004). Furthermore, the population of high threshold, menthol insensitive, cold activated neurons is not activated by mustard oil, which would suggest that their activation is not dependent upon TRPA1 activity (Babes et al. 2004). These findings make TRPA1 an uncertain candidate as a molecular sensor for noxious cold. In an interesting twist of events, recent studies suggest that TRPA1 channels are part of the mechanotransduction complex of vertebrate hair cells.

Cooling also activates ENaC channels, a member of the amiloride sensitive epithelial sodium channel family. However, a cold sensitive current matching the pharmacological profile of ENaC channels has not been documented in sensory neurons.

Alternatively, neuronal cold sensing may involve the closure of background potassium channels by cold (Fig. 2). TREK-1, TREK-2 and TRAAK, **Two Pore Domain  $K^+$  Channels** activated by fatty acids and me-

chanical stimuli, expressed in sensory neurons and with high sensitivity to temperature are good molecular candidates for this role (Kang et al. 2005; Maingret et al. 2000). The steep, rapid and gradual decrease in current flowing through these channels in a broad physiological temperature range (44–24°C) make them excellent candidates for thermal sensing in those terminals harboring them. In contrast to the direct temperature sensitivity of ► **TRP channels**, cell integrity is required for temperature sensitivity of these K<sup>+</sup> channels. Other background K<sup>+</sup> channels (i.e. TASK) are minimally affected by temperature. Experimental data implicating the closure of background potassium channels in cold transduction have been obtained in trigeminal and DRG neurons (Viana et al. 2002; Reid and Flonta 2001). However, the pharmacology or molecular nature of the conductance closed by cold temperature has not been addressed directly.

It is interesting that blockade of certain types of voltage-gated K<sup>+</sup> channels can render a population of sensory neurons cold sensitive. Experiments in trigeminal neurons showed that a slowly inactivating potassium current can act as a brake on excitability, reducing cold sensitivity (Viana et al. 2002). Neurons insensitive to cold and ► **menthol** could be transformed into cold sensitive neurons in the presence of low concentrations of 4-AP, a blocker for these channels.

It is important to emphasize that the various ionic mechanisms postulated in cold transduction are not mutually exclusive; if present in the same nerve terminal they could act synergistically to expand the dynamic range of temperature detection. Alternatively, activity of thermosensitive K<sup>+</sup> channels in those terminals with TRP channels opened by heat (i.e. TRPV2, TRPV3, TRPV4, TRPV1) would act as a brake on the excitatory actions of the latter.

Unfortunately, most recent data on thermosensitive ion channels have been obtained during *in vitro* animal studies, precluding a direct translation of these results to human physiology and pathophysiology. Much remains to be learnt about the differential expression pattern of the different thermosensitive channels and the functional properties of the sensory fibers expressing them. It is likely that other thermosensitive channels will be uncovered in the next few years, expanding the palette of putative molecular candidates for cold sensing.

In summary, psychophysical studies indicate that input from non-noxious thermal systems is essential for the thermal quality and the intensity of the pain sensation evoked by cold. Thermosensory afferent input normally inhibits cold evoked pain. At the molecular level, the diverse functional characteristics and broad range of temperature thresholds in the different afferent fibers suggests that each class of nerve terminal may operate with a combinatorial code of sensory receptors. The available evidence supports an important role for TRPM8 in sensing of innocuous cold temperatures in peripheral re-

ceptors (evidence reviewed by Reid, 2005). In addition, the participation of TRPM8 channels in certain forms of cold pain is a distinct possibility. Lacking genetic evidence (i.e. TRPM8-deficient mice) or specific pharmacological tools, this conclusion is not firm. The role of TRPA1 channels in the transduction of noxious cold pain is uncertain. Activity of background K<sup>+</sup> channels can certainly influence cold sensitivity, but their role as primary transducers has not been addressed directly. Not surprisingly, interest in the pharmacological profile of thermosensitive channels is very high. It is anticipated that modulators of these channels will provide new therapeutic options with which to treat certain forms of pain, including cold hyperalgesia and allodynia.

## References

1. Campero M, Serra J, Bostock H et al. (2001) Slowly conducting afferents activated by innocuous low temperature in human skin. *J Physiol* 535:855–865
2. Campero M, Serra J, Ochoa JL (1996) C-polymodal nociceptors activated by noxious low temperature in human skin. *J Physiol* 497:565–572
3. Caterina MJ, Schumacher MA, Tominaga M et al. (1997) The capsaicin receptor: a heat-activated ion channel in the pain pathway. *Nature* 389:816–824
4. de la Peña E, Malkia A, Cabedo H et al. (2005) The contribution of TRPM8 channels to cold sensing in mammalian neurones. *J Physiol* 567:415–426
5. Green BG (1992) The sensory effects of 1-menthol on human skin. *Somatosens Mot Res* 9:235–244
6. Hensel H (1981) Thermoreception and temperature regulation. *Monogr Physiol Soc* 38:1–321
7. Jordt SE, McKemy DD, Julius D (2003) Lessons from peppers and peppermint: the molecular logic of thermosensation. *Curr Opin Neurobiol* 13:487–492
8. Kang D, Choe C, Kim D (2005) Thermosensitivity of the two-pore domain K<sup>+</sup> channels TREK-2 and TRAAK. *J Physiol* 564:103–116
9. Klement W, Arndt JO (1992) The role of nociceptors of cutaneous veins in the mediation of cold pain in man. *J Physiol* 449:73–83
10. Maingret F, Lauritzen I, Patel AJ et al. (2000) TREK-1 is a heat-activated background K(+) channel. *EMBO J* 19:2483–2491
11. McKemy DD, Neuhauser WM, Julius D (2002) Identification of a cold receptor reveals a general role for TRP channels in thermosensation. *Nature* 416:52–58
12. Patapoutian A, Peier AM, Story GM et al. (2003) ThermoTRP channels and beyond: mechanisms of temperature sensation. *Nat Rev Neurosci* 4:529–539
13. Peier AM, Moqrich A, Hergarden AC et al. (2002) A TRP channel that senses cold stimuli and menthol. *Cell* 108:705–715
14. Reid G (2005) ThermoTRP channels and cold sensing: what are they really up to? *Pflugers Arch* 451:250–263
15. Reid G, Babes A, Pluteanu F (2002) A cold- and menthol-activated current in rat dorsal root ganglion neurones: properties and role in cold transduction. *J Physiol* 545:595–614
16. Roza C, Belmonte C, Viana F (2006) Cold sensitivity in axotomized fibers of experimental neuromas in mice. *Pain* 120:24–35
17. Story GM, Peier AM, Reeve AJ et al. (2003) ANKTM1, a TRP-like channel expressed in nociceptive neurons, is activated by cold temperatures. *Cell* 112:819–829
18. Viana F, de la Peña E, Belmonte C (2002) Specificity of cold thermotransduction is determined by differential ionic channel expression. *Nat Neurosci* 5:254–260
19. Wasner G, Schattschneider J, Binder A et al. (2004) Topical menthol—a human model for cold pain by activation and sensitization of C nociceptors. *Brain* 127:1159–1171
20. Yarnitsky D, Ochoa JL (1990) Release of cold-induced burning pain by block of cold-specific afferent input. *Brain* 113:893–902



## Nociceptors, Immunocytochemistry

### ► Immunocytochemistry of Nociceptors

## Nociceptors in the Dental Pulp

MATTI V. O. NÄRHI

Department of Physiology, University of Kuopio,  
Kuopio, Finland  
matti.narhi@uku.fi

### Synonyms

Intradental Nociceptors; Pulpal Nociceptors

### Definition

► **Nociceptors** that are located inside the tooth in the ► **dental pulp** and in the ► **dentinal tubules** in the most inner layers of ► **dentin**. The intradental afferent innervation consists of both myelinated and unmyelinated nerve fibers, which are mostly, if not exclusively, nociceptive. The nerve fibers originate from the mandibular (lower jaw) and maxillary (upper jaw) branches of the trigeminal nerve, and have their cell bodies in the ► **trigeminal ganglion**.

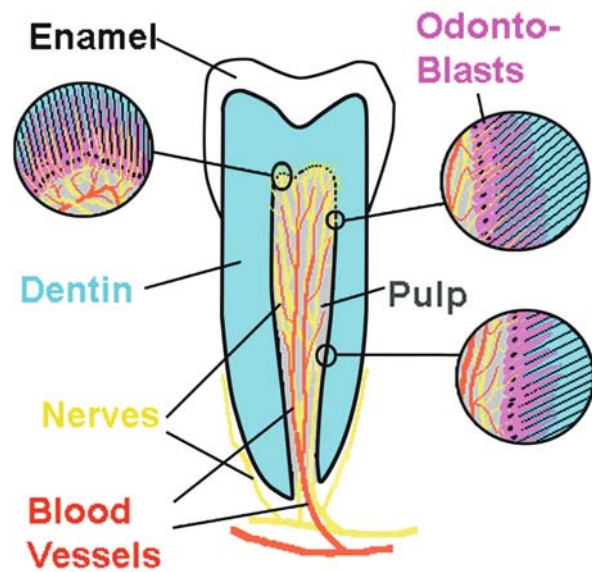
### Characteristics

Pulpal inflammation can be extremely painful. Also, the intensity of the pain responses induced from teeth, e.g. from exposed dentin, by external stimulation can reach the maximum level of any pain score. The structure of the intradental innervation gives a basis for such high sensitivity. It should also be noted that pain is the predominant, if not the only, sensation that can be evoked by activation of intradental nerves.

### Structure of Intradental Innervation

The innervation of the dental pulp is exceptionally rich (Fig. 1). Several hundred nerve fibers enter each tooth (Byers 1984). Approximately 20–30% of them are myelinated, mostly of smaller diameter, A- $\delta$  type, although there are also some larger A- $\beta$  type axons. A great majority of the pulp nerve fibers are unmyelinated (C-fibers). A small proportion, approximately 10%, of the unmyelinated fibers are sympathetic efferents (see Byers and Närhi 1999). Their activation causes vasoconstriction and consequently reduction in the pulpal blood flow (Olgart 1996).

All intradental axons terminate as free nerve endings, the C-fibers in the pulp proper and A-fibers both in the pulp and a great number of them also in the ► **predentin** and inner layers of dentin (Fig. 1.). The myelinated nerve fibers branch abundantly and one axon may have endings in more than a hundred dentinal tubules (Byers 1984). The maximum distance that the fibers penetrate into the tubules is approximately 100 – 150



**Nociceptors in the Dental Pulp, Figure 1** Schematic presentation of the intradental innervation. A few branches from the alveolar nerve enter the pulp through the apical foramen. These bundles extend further through the root pulp and branch extensively, especially in the coronal pulp. The terminal branches of the axons are free nerve endings, and are located either in the pulp (especially the C-fibers) or in the tubules of the predentin and inner layers of dentin (many of the A-fibers). See text for more details.

$\mu\text{m}$  in the horns or tip of the coronal pulp. The pulp horns are also the most densely innervated areas of the pulp. At the pulp tip, approximately 50% of the tubules contain nerve terminals, some of them even multiple endings (Byers 1984). As there are 30000–40000 tubules/ $\text{mm}^2$  of dentin (Brännström 1981), the density of the innervation of the pulp-dentin border at the tip of the coronal pulp is exceptionally dense. However, there are fewer nerve endings at the pulp-dentin border of the cervical region, and yet exposed dentin in these areas can be extremely sensitive, with innervation in the root being especially sparse (Fig. 1) (Brännström 1981).

### Function of Intradental Nociceptors

The similarity of the structure of the intradental innervation in human teeth to that in cats, dogs and monkeys (Byers 1984) gives a morphological basis for studies, where the function of intradental nerves in experimental animals have been compared to the sensations evoked by dental stimulation in man. Electrophysiological recordings have revealed that A- and C-fibers of the pulp are functionally different (Närhi 1985; Byers and Närhi 1999). Comparison of those results to the sensory responses evoked by stimulation of human teeth also indicated that activation of pulpal A- and C-fibers may induce different types of pain sensations, namely sharp and dull pain, respectively (Ahlquist et al. 1985; Jyväsjärvi and Kniffki 1987). The intradental nerve activity recordings in human teeth indicate that the nerve function resembles that of experimental animals



(Edwall and Olgart 1976). The results of the single fiber recordings in cat and dog teeth also indicate that A-fibers are responsible for the sensitivity of dentin (Närhi 1985; Närhi et al. 1992), and that the intradental A $\beta$ - and A $\delta$ -fibers respond in a similar way to noxious dental stimulation (Närhi et al. 1992). Accordingly, they belong to the same functional group (Närhi et al. 1992 1996).

Pulpal A-fibers can be activated by a number of different stimuli applied at the tooth surface. Their responses are greatly enhanced if the dentin is exposed and the dentinal tubules are open (Närhi et al. 1992). Heat, cold, hypertonic solutions of various chemicals and desiccating air blasts, for example, applied to exposed dentin, evoke nerve responses with quite a similar pattern. The nerve firing starts immediately, or within a couple of seconds after the stimulus is applied, far before the stimuli, e.g. heat or cold, have reached the most inner layers of dentin and the pulp, where the nociceptors are located. So, the responses cannot be caused by a direct effect of the applied stimuli on the intradental nerve endings.

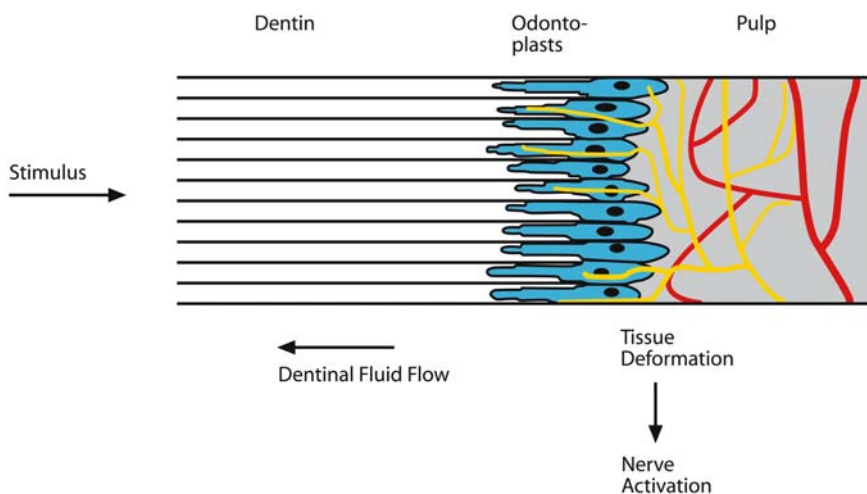
The stimuli, which induce pain from human teeth and activate the intradental nerves in experimental animals, are able to induce fluid flow in the dentinal tubules (Brännström 1981). Moreover, the fluid flow and the nerve responses induced by hydrostatic pressure are directly related (Vongsavan and Matthews 1994). Also, both the induction of the fluid flow, and the sensitivity of dentin are, to a great extent, dependent on the openness of the dentinal tubules (Brännström 1981; Närhi et al. 1992). Accordingly, the final stimulus for the nociceptors, which are responsible for the sensitivity of dentin (intradental A-fibers), seems to be the fluid flow in the tubules and, probably, the consequent mechanical deformation of the tissue and nerve endings in the pulp-dentin border (the so-called hydrodynamic mechanism of pulp nerve activation, Brännström 1981) (Fig. 2).

The hydrodynamic fluid flow is based on the strong capillary forces in the thin dentinal tubules (Brännström 1981). If dentinal fluid is extracted from the outer end of an open tubule by any stimulus, it is immediately replaced by a rapid outward fluid shift e.g. air-drying of dentine induces outward fluid flow and intense firing of the pulpal A-fibers (Närhi 1985). It also causes disruption of the tissues in the peripheral pulp (Brännström 1981). Thus, the capillary and hydrodynamic forces can considerably intensify the effect of the applied stimuli, and even a light stimulus such as an air blast can turn out to be noxious to the pulp.

The pulpal C-nociceptors are polymodal, and only activated if the external stimuli reach the pulp proper (Närhi 1985; Närhi et al. 1996). They do not respond to hydrodynamic stimulation. The C-fibers are activated by intense cold and heat applied to the tooth crown (Närhi et al. 1982; Jyväsjärvi and Kniffki 1987; Närhi et al. 1996). The response latencies are quite long, because the thermal stimuli have to reach the pulp where the nerve endings are located (Närhi 1985; Jyväsjärvi and Kniffki 1987; Närhi et al. 1996). The responses seem to be induced by a direct effect of heat and cold on the nerve endings. The C-nociceptors also respond to intense mechanical stimulation as well as to bradykinin, histamine and capsaicin applied to the exposed pulp (Närhi 1984; Närhi et al. 1992; Närhi et al. 1996).

#### Inflammation-Induced Changes in Pulpal Nociceptor Function

In healthy teeth the intradental nociceptors are well protected by the dental hard tissues and difficult to activate. Thus, pain is seldom induced from teeth during everyday activities. However, this is not the case when dentin with open tubules is exposed, because the effects of external stimuli are intensified by the hydrodynamic forces (Brännström 1981; Närhi et al. 1992). As in other tissue injuries, inflammation of the dental pulp can considerably sensitize the nociceptors (Brännström 1981;



**Nociceptors in the Dental Pulp, Figure 2** Activation of the intradental A-fibers by the hydrodynamic mechanism. Various stimuli applied to the exposed dentin surface are able to remove fluid from the outer ends of the dentinal tubules. Due to the high capillary force within the thin tubules the removed fluid is immediately replaced by a rapid outward fluid shift. This, in turn, distorts the tissue in the pulp-dentin border and, consequently, activates the nociceptors in the area.

Närhi et al. 1996). This may lead to extremely intense spontaneous pain (toothache), and exaggerated painful responses to external stimuli e.g. to hot or cold food or drinks. The change in pulpal nociceptor activity and sensitivity is caused by a number of different inflammatory mediators, which are released and/or synthesized in response to the tissue injury (Närhi et al. 1996; Byers and Närhi 1999).

Intradental A- and C-nociceptors are activated and sensitized by inflammatory mediators in the initial stages of inflammation, which include neurogenic reactions, e.g. ► **axon reflexes** (Närhi 1984; Närhi et al. 1992; Närhi et al. 1996; Olgart 1996). However, there are other longer-term neurogenic mechanisms which may contribute to the increased sensitivity (Byers and Närhi 1999). These include activation of silent pulpal nociceptors (Närhi et al. 1996; Byers and Närhi 1999), i.e. the proportion of pulpal A-fibers responding to dentinal stimulation is significantly higher in inflamed compared to normal teeth, and is especially profound among the slow-conducting A $\delta$  fibers (Närhi et al. 1996). Moreover, the receptive fields of the single nerve fibers in inflamed teeth become expanded (Närhi et al. 1996). Both of these changes may be related to sprouting of the nociceptive nerve fibers (Kimberly and Byers 1988) and/or activation of normally unresponsive nerve terminals. These changes may contribute to the increased sensitivity of inflamed teeth.

In view of the dense innervation of the dental pulp, and the structural neural changes that can occur in inflamed teeth, it is clinically puzzling to find that pulpitis may frequently be almost or even completely asymptomatic. This can be partially due to central regulatory mechanisms, which may inhibit the impulse transmission in the trigeminal pain pathways (Sessle 2000). However, local mechanisms also seem to exist in the dental pulp itself, which may be important not only for the regulation of the inflammatory reactions, but also the sensitivity of the nociceptors (Närhi et al. 1996; Olgart 1996; Byers and Närhi 1999; Dionne et al. 2001). Endogenous opioids may inhibit the nerve activation and neuropeptide release from the nociceptive nerve endings. Also, somatostatin may have an inhibitory effect on the nociceptor activation. Furthermore, sympathetic nerve fibers seem to prevent the release of the neuropeptides, by virtue of their preterminal connections to the nociceptive nerve endings (Olgart 1996). Accordingly, a number of different central and peripheral regulatory mechanisms may be operating, and contribute to the great variability of the pain symptoms connected with pulpal inflammation.

## References

- Ahlquist ML, Franzen OG, Edwall LGA, Forss UG, Haegerstam GAT (1985) Quality of Pain Sensations Following Local Application of Allogenic Agents on the Exposed Human Tooth Pulp: A Psycho Physiological and Electrophysiological Study. In: Fields HL (ed) *Advances in Pain Research and Therapy*, vol 9. Raven Press, New York, pp 351–359
- Beasley WL, Holland GR (1978) A Quantitative Analysis of the Innervation of the Pulp of Cat's Canine Tooth. *J Comp Neurol* 178:487–494
- Brännstöm M (1981) *Dentin and Pulp in Restorative Dentistry*. Dental Therapeutics AB, Nacka, Sweden
- Byers MR (1984) Dental Sensory Receptors. *Int Rev Neurobiol* 25:39–94
- Byers MR, Närhi M (1999) Dental Injury Models: Experimental Tools for Understanding Neuroinflammatory Interactions and Polymodal Nociceptor Function. *Crit Rev Oral Biol Med* 10:4–39
- Dionne RA, Lepinski AM, Jaber L, Gordon SM, Brahim JS, Hargreaves KM (2001) Analgesic Effects of Peripherally Administered Opioids in Clinical Models of Acute and Chronic Inflammation. *Clin Pharmacol Ther* 70:66–73
- Edwall L, Olgart LM (1977) A New Technique for Recording of Intradental Sensory Nerve Activity in Man. *Pain* 3:121–126
- Jyväsjärvi E, Kniffki K-D (1987) Cold Stimulation of Teeth: A Comparison between the Responses of Cat Intradental A $\delta$  and C Fibres and Human Sensation. *J Physiol* 391:193–207
- Kimberly CL, Byers MR (1988) Inflammation of Rat Molar Pulp and Periodontium Causes Increased Calcitonin Gene-Related Peptide and Axonal Sprouting. *Anat Rec* 222:289–300
- Närhi MVO (1985) The Characteristics of Intradental Sensory Units and their Responses to Stimulation. *J Dent Res* 64:564–571
- Närhi MVO (2001) Local Application of Morphine Inhibits the Intradental Nociceptor Responses to Mustard Oil but Not to Hydrodynamic Stimulation of Dentin. *Society of Oral Physiology, Abstracts*
- Närhi M, Kontturi-Närhi V, Hirvonen T, Ngassapa D (1992) Neurophysiological Mechanisms of Dentin Hypersensitivity. *Proc Finn Dent Soc* 88:15–22
- Närhi M, Yamamoto H, Ngassapa D (1996) Function of Intradental Nociceptors in Normal and Inflamed Teeth. In: Shimono M, Maeda T, Suda H and Takahashi K (eds) *Dentin/pulp Complex*. Quintessence Publ Co Tokyo, pp136–140
- Olgart L (1996) Neurogenic Components of Pulp Inflammation. In: Shimono M, Maeda T, Suda H and Takahashi K (eds) *Dentin/pulp Complex*. Quintessence Publ Co Tokyo, pp 169–175
- Sessle BJ (2000) Acute and Chronic Orofacial Pain: Brainstem Mechanisms of Nociceptive Transmission and Neuroplasticity and their Clinical Correlates. *Crit Rev Oral Biol Med* 11:57–91
- Vongsavan N, Matthews B (1994) The Relationship between Fluid Flow in Dentine and the Discharge of Intradental Nerves. *Archs Oral Biol* 39 140S

## Nociceptors in the Mucosa

- [Nociceptors in the Orofacial Region \(Skin/Mucosa\)](#)

## Nociceptors in the Orofacial Region (Meningeal/Cerebrovascular)

KARL MESSLINGER

University of Erlangen-Nürnberg, Nürnberg, Germany  
messlinger@physiologie1.uni-erlangen.de

## Synonyms

Meningeal Afferents; Meningeal Nociceptors; Intracranial Nociceptors; Dural Receptors

## Definition

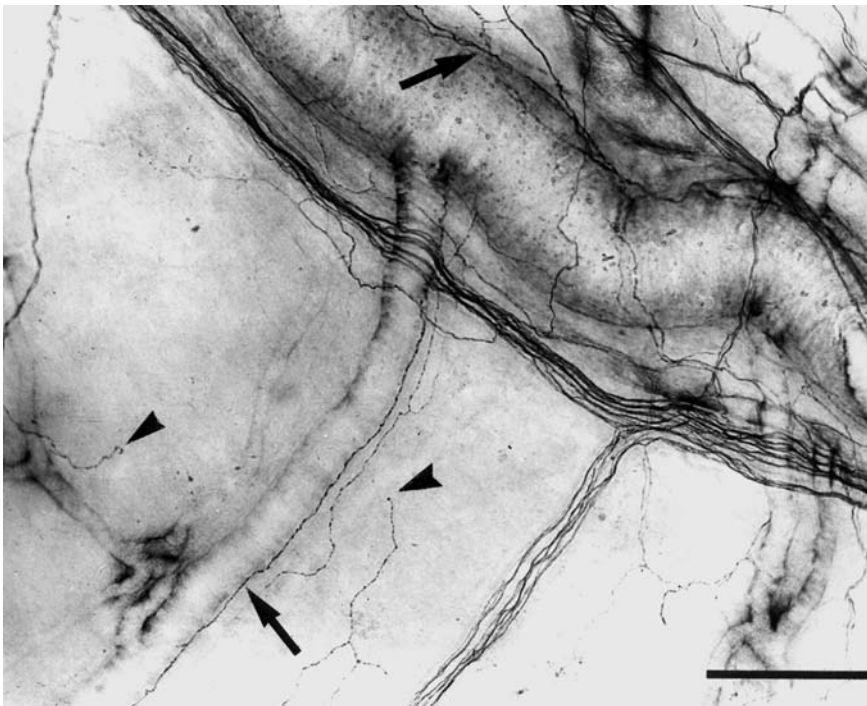
Trigeminal afferents that respond to noxious (painful) stimulation of intracranial structures (cranial meninges and intracranial blood vessels). These afferents originate in the trigeminal ganglion and project centrally to the spinal trigeminal nucleus, and to some extent to the spinal dorsal horn of the first cervical segments. Activation of meningeal afferents produces the sensation of headache.

## Characteristics

The afferent innervation of the meninges and intracranial blood vessels has long been associated with the generation of ► **headaches**. Intraoperative exploration of patients undergoing open head surgery has revealed that intracranial structures are differentially sensitive to various stimuli (Ray and Wolff 1940). Noxious mechanical, thermal or electrical stimulation of dural blood vessels and the main intracerebral arteries, but not other intracranial tissues, has been reported to be painful in these experiments. Since headache-like pain was the only sensation evoked from stimulation of these intracranial structures, meningeal afferents are generally attributed a nociceptive function. This concept has been confirmed by morphological findings. Afferent innervation of intracranial structures is restricted to A $\delta$  and C fibres, which are known to terminate as ► **non-corporcular sensory endings**. These nerve endings do not form distinct corporcular end structures but disperse as small bundles of sensory fibres, partly encased by peripheral glia (Schwann

cells), along dural blood vessels and into the dural connective tissue (MeSSLinger et al. 1993; Fricke et al. 2001). Immunohistochemical preparations have shown that a considerable proportion of intracranial afferent fibres contain vasoactive neuropeptides, particularly ► **calcitonin gene-related peptide (CGRP)** (MeSSLinger et al. 1993). This vasodilatory neuropeptide is released from activated intracranial afferents, and has been suggested to be involved in the generation of ► **migraine** and other primary headaches (Edvinsson and Goadsby 1998). Experimentally, CGRP release from cranial dura mater can be quantitatively assessed *in vitro* and used as a measure for the activation of meningeal afferents by noxious stimuli. Using this method, it has been shown that not only classical noxious stimuli such as inflammatory mediators (Ebersberger et al. 1999); capsaicin, protons or heat, but also nitric oxide (NO) (Strecker et al. 2002) is able to release CGRP from rodent cranial dura. Another neuropeptide that has been identified immunohistochemically, in a smaller proportion of meningeal afferents, is substance P (MeSSLinger et al. 1993). Peripheral release of substance P is known to cause ► **neurogenic inflammation**, characterised by protein plasma extravasation, as well as other endothelial and perivascular changes. Neurogenic inflammation has been proposed to be a key factor in migraine pathophysiology (Moskowitz and Macfarlane 1993), but substance P was not found to be elevated during migraine attacks (Edvinsson and Goadsby 1998). In animal experiments, noxious stimulation of the meninges has failed to release detectable amounts of substance P in the periphery (Ebersberger et al. 1999), however, in

N



**Nociceptors in the Orofacial Region (Meningeal/Cerebrovascular), Figure 1** Meningeal Afferents. CGRP immunoreactive nerve fibres in the rat dura mater encephali. Bundles and single immunopositive nerve fibres (arrows) run along the middle meningeal artery (MMA) and its branches, and terminate close to blood vessels (arrowheads). Scale bar 100  $\mu$ m. Modified from (MeSSLinger et al. 1993).



the spinal trigeminal nucleus, increased substance P release during stimulation of rat dura mater with acidic solutions has been shown using a sensitive microprobe technique (Schaible et al. 1997). Therefore, substance P (and possibly CGRP), released from the central terminals of activated meningeal afferents, can be assumed to contribute to nociceptive transmission in the central trigeminal system.

Only a few direct electrophysiological recordings from intracranial afferents have been made in animal experiments. The teased fibre technique has been used to record from intracranial afferents running in the nasociliary nerve, which innervate fronto-medial parts of the supratentorial dura mater of the guinea pig (Bove and Moskowitz 1997). Another approach has been made in the rat to record with microelectrodes from the trigeminal ganglion, selecting neurons with dural receptive fields located around the middle meningeal artery or the large sinuses (Dostrovsky et al. 1991; Strassman et al. 1996). These studies are in accordance with the release studies mentioned above, and have shown afferent activation caused by noxious chemical stimuli (inflammatory mediators, capsaicin, and acidic buffer), heat and cold stimuli applied to the exposed dura mater, as well as mechanical stimulation of dural receptive fields. These studies also suggest that most, if not all, meningeal afferents can be regarded as ► **polymodal nociceptors**, which can be sensitized to mechanical stimuli through a cAMP mediated intracellular mechanism (Levy and Strassman 2002). There is evidence that most meningeal sensory endings express tetrodotoxin-resistant sodium channels, as has been reported frequently for visceral nociceptors (Strassman and Raymond 1999). In a new *in vitro* preparation of rat cranial dura, electrophysiological recordings from meningeal nerves are now made routinely in our laboratory. These experiments will provide additional insight into the response properties of meningeal afferents to stimuli such as nitric oxide and histamine, which are suggested to be key mediators in the generation of primary headaches.

Extracellular recordings from second-order neurones in the cat and the rat spinal trigeminal nucleus have shown that there is high convergence of afferent input from the meninges and orofacial region, most typically from the periorbital area (Davis and Dostrovsky 1988; Schepelmann et al. 1999). This observation has led investigators to assume that ► **referred pain** and hyperalgesia associated with headache may result from a ► **central sensitization** (Yamamura et al. 1999; Ellrich et al. 1999). The morphological and electrophysiological data taken from meningeal afferents suggest that intracranial pain (headache) may share more characteristics with visceral, rather than somatic, nociception and pain.

## References

1. Bove GM, Moskowitz MA (1997) Primary Afferent Neurons Innervating Guinea Pig Dura. *J Neurophysiol* 77:299–308
2. Davis KD, Dostrovsky JO (1988) Responses of Feline Trigeminal Spinal Tract Nucleus Neurons to Stimulation of the Middle Meningeal Artery and Sagittal Sinus. *J Neurophysiol* 59:648–666
3. Dostrovsky JO, Davis KD, Kawakita K (1991) Central Mechanisms of Vascular Headaches. *Can J Physiol Pharmacol* 69:652–658
4. Ebersberger A, Averbeck B, Messlinger K, Reeh PW (1999) Release of Substance P, Calcitonin Gene-Related Peptide and Prostaglandin E<sub>2</sub> from Rat Dura Mater Encephali Following Electrical and Chemical Stimulation. *In Vitro. Neuroscience* 89:901–907
5. Edvinsson L, Goadsby PJ (1998) Neuropeptides in Headache. *Eur J Neurol* 5:329–341
6. Ellrich J, Andersen OK, Messlinger K, Arendt-Nielsen LA (1999) Convergence of Meningeal and Facial Afferents onto Trigeminal Brainstem Neurons: An Electrophysiological Study in Rat and Man. *Pain* 82:229–237
7. Fricke B, Andres KH, von Düring M (2001) Nerve Fibres Innervating the Cranial and Spinal Meninges: Morphology of Nerve Fiber Terminals and their Structural Integration. *Microsc Res Technique* 53:96–105
8. Levy D, Strassman AM (2002) Distinct Sensitizing Effects of the cAMP-PKA Second Messenger Cascade on Rat Dural Mechanonociceptors. *J Physiol* 538.2:483–493
9. Messlinger K, Hanesch U, Baumgärtel M, Trost B, Schmidt RF (1993) Innervation of the Dura Mater Encephali of Cat and Rat: Ultrastructure and CGRP/SP-Like Immunoreactivity. *Anat Embryol* 188:219–237
10. Moskowitz MA, Macfarlane R (1993) Neurovascular and Molecular Mechanisms in Migraine Headaches. *Cerebrovasc Brain Metab Rev* 5:159–177
11. Ray BS, Wolff HG (1940) Experimental Studies on Headache: Pain Sensitive Structures of the Head and their Significance in Headache. *Arch Surg* 1:813–856
12. Schaible H-G, Ebersberger A, Poppel P, Beck U, Messlinger K (1997) Release of Immunoreactive Substance P in the Trigeminal Brain Stem Nuclear Complex Evoked by Chemical Stimulation of the Nasal Mucosa and the Dura Mater Encephali - A Study with Antibody Microprobes. *Neuroscience* 76:273–284
13. Schepelmann K, Ebersberger A, Pawlak M, Oppmann M, Messlinger K (1999) Response Properties of Trigeminal Brain Stem Neurons with Input from Dura Mater Encephali in the Rat. *Neuroscience* 90:543–554
14. Strassman AM, Raymond SA, Burstein R (1996) Sensitization of Meningeal Sensory Neurons and the Origin of Headaches. *Nature* 384:560–564
15. Strassman AM, Raymond SA (1999) Electrophysiological Evidence for Tetrodotoxin-Resistant Sodium Channels in Slowly Conducting Dural Sensory Fibres. *J Neurophysiol* 81:413–424
16. Strecker T, Dux M, Messlinger K (2002) Nitric Oxide Releases Calcitonin Gene-Related Peptide from Rat Dura Mater Encephali Promoting Increases in Meningeal Blood Flow. *J Vasc Res* 39:489–496
17. Yamamura H, Malick A, Chamberlin NL, Burstein R (1999) Cardiovascular and Neuronal Responses to Head Stimulation Reflect Central Sensitization and Cutaneous Allodynia in a Rat Model of Migraine. *J Neurophysiol* 81:479–493

## Nociceptors in the Orofacial Region (Skin/Mucosa)

BRIAN Y. COOPER

Department of Oral and Maxillofacial Surgery,  
University of Florida, Gainesville, FL, USA  
bcooper@dental.ufl.edu



**Synonyms**

Polymodal nociceptor; High Threshold Mechanoreceptor; mechanonociceptor; Mechanoheat Nociceptor; nociceptors in the skin; Nociceptors in the Mucosa

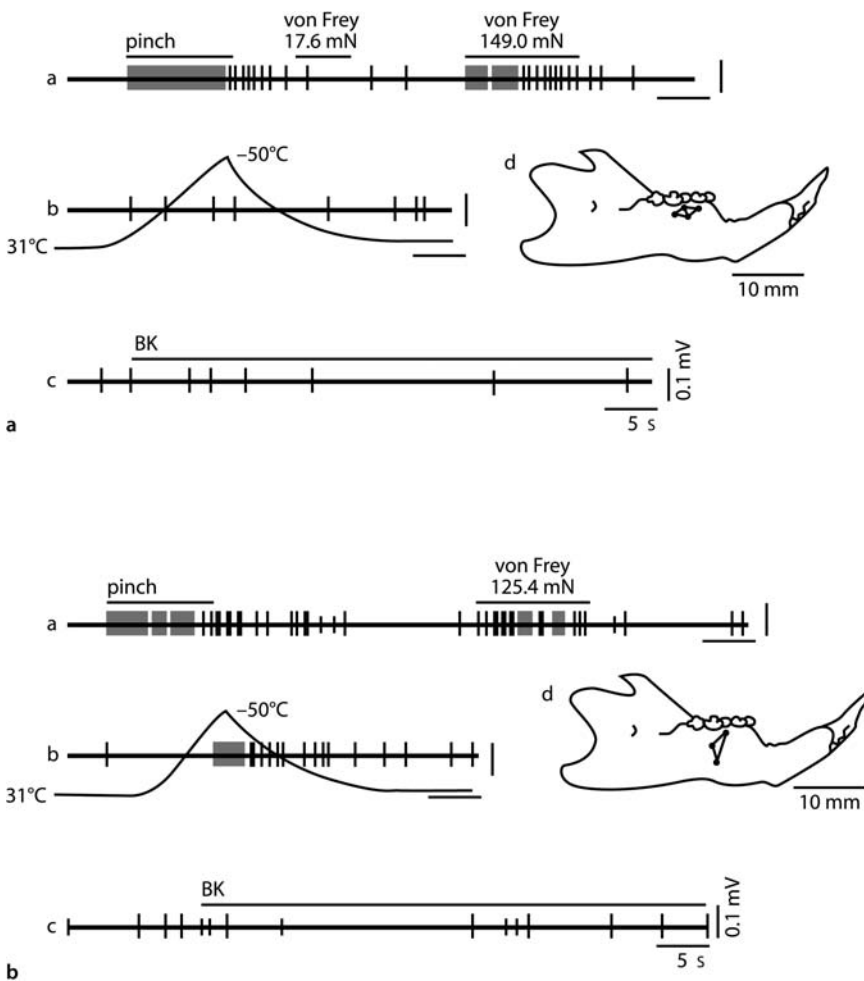
**Definition**

Nociceptors detect and encode stimuli with actual or potential tissue damaging properties. Many are also responsive to chemicals released from traumatized tissue, inflammatory and immune system cells. Nociceptors are notable among sensory afferents for their plasticity. Detection and encoding capacities undergo rapid quantitative and slower qualitative up regulatory adaptations (sensitization). These contribute to both peripheral and central nervous system changes, which mediate increased pain sensitivity following tissue or nervous system injury. These adaptations serve to protect tissue from further damage and promote healing. Orofacial nociceptors supply a diverse set of tissues that include skin, muscle, bone and joints, but also highly specialized structures such as cornea, mucosa (oral and nasal) and teeth. Accordingly, some of the

anatomic and physiologic features are unique. The reader should examine the essays on corneal and tooth ► [pulp nociceptors](#) for further details.

**Characteristics**

Trigeminal nociceptors of skin and mucosa are a diverse population of mechanical, thermal and chemically responsive afferents that detect and encode intense physical, thermal and chemical events associated with actual or near tissue damage. The trigeminal root ganglion (TRG, gasserian ganglion, semilunar ganglion) contains cell bodies of orofacial skin and mucosal nociceptors. Trigeminal nociceptors are anatomically distinct from spinal nociceptors (derived from dorsal root ganglia), in that their central projections terminate in the brainstem rather than in the spinal cord. In other respects, they are very similar (Hu 2000; Sessle 2000). In addition to detection and encoding of noxious stimuli, nociceptors of the skin and mucosa are able to release neuropeptides at both the peripheral and central processes. Peripherally, these peptides are involved in a variety of pro-inflammatory events (► [plasma extravasation](#), mast cell degranulation, PLA<sub>2</sub> activation, healing),



**Nociceptors in the Orofacial Region (Skin/Mucosa), Figure 1** Mucosal nociceptors respond differentially to mechanical, chemical and thermal stimulation. (a) Brisk response of an A $\delta$  HTM of the rat mucosa to mechanical stimulation. The fiber is less responsive to other modalities. (b) An A $\delta$  MH responds to both mechanical and thermal stimuli. Reprinted from *Neuroscience Letters* 228, K. Toda, N. Ishii and Y. Nakamura, 'Characteristics of mucosal nociceptors in the rat oral cavity: an in vitro study', pp. 95-98, 1997 with permission from Elsevier. BK, bradykinin 0.1  $\mu$ M.

while centrally they are released with primary neurotransmitters (e.g. glutamate) to modify the synaptic pain message at the first synapse (Cooper and Sessle 1993). The neuropeptides substance P and/or CGRP (calcitonin gene related peptide) are expressed in nociceptors; including, myelinated and unmyelinated nociceptors (A $\delta$  and C class) that have been described in both facial and oral mucosa tissues (A $\delta$  ► HTM, A $\delta$  ► MH, A $\delta$  PMN, C PMN) (see ► MH, ► HTM, ► PMN) (Cooper et al. 1991; Bongenhielm and Robinson 1996; Toda et al. 1997; Flores et al. 2001). Many nociceptors contain neither of these peptides. In the trigeminal ganglion, the small and medium sized cells represent the main populations of nociceptive neurons. The large neurons of the TRG may also contain nociceptive populations. Nociceptors are highly specialized to detect chemical agents associated with tissue trauma, and may sensitize following exposure to chemical algesics. Both peptidergic and non-peptidergic nociceptive afferents express cholinergic (► nAChR) (Liu et al. 1993; Carstens et al. 2000), ► purinergic (► P2X3 ; Eriksson et al. 1998, Xiang et al. 1998) or acid sensitive receptors and ► ion channels (► ASIC) (Ichikawa and Sugimoto 2002). These channels enable nociceptors to detect the presence of ATP, ACh or protons that are associated with tissue damage and inflammation. ATP and ACh are released from damaged cells, while high levels of protons may be associated with infection or ischemia due to compromise of the vascular supply. Many of these same populations express the ► capsaicin sensitive protein ► VR1 or the capsaicin insensitive ► VRL1 (TRPV1, TRPV2) (see ► VR1, ► VRL1, ► TRPV1, ► TRPV2), which transduce noxious heat stimuli and are critical to the development of heat sensitization (Ichikawa and Sugimoto 2000; Stenholm et al. 2002). Responses to cooling, ► bradykinin, ► PGE2 and histamine have also been described (Toda et al. 1997; Viana et al. 2002) (Fig. 1).

## References

- Bongenhielm U, Robinson PP (1996) Spontaneous and Mechanically Evoked Afferent Activity Originating from Myelinated Fibres in Ferret Inferior Alveolar Nerve Neuromas. *Pain* 67:399–406
- Carstens E, Simons CT, Dessirier JM, Carstens MI, Jinks SL (2000) Role of Neuronal Nicotinic-Acetylcholine Receptors in the Activation of Neurons in Trigeminal Subnucleus Caudalis by Nicotine Delivered to the Oral Mucosa. *Exp Brain Res* 132:375–383
- Cooper BY, Ahlquist ML, Friedman RM, Loughner BA, Heft MW (1991) Properties of High-Threshold Mechanoreceptors in the Gingival Mucosa I: Responses to Dynamic and Static Pressure. *J Neurophysiol* 66:1272–1279
- Cooper, BY, Sessle BJ (1993) Physiology of Nociception in the Trigeminal System. In: Olesen J, Tfelt-Hansen P, Welch KMA (eds) *The Headaches*. Raven Press Ltd, New York, pp 87–92
- Eriksson J, Bongenhielm U, Kidd E, Matthews B, Fried K (1998) Distribution of P2X3 Receptors in the Rat Trigeminal Ganglion after Inferior Alveolar Nerve Injury. *Neurosci Lett* 254:37–40
- Flores CM, Leong AS, Dussor GO, Harding-Rose C, Hargreaves KM, Kilo S (2001) Capsaicin-Evoked CGRP Release from Rat Buccal Mucosa: Development of a Model System for Studying Trigeminal Mechanisms of Neurogenic Inflammation. *Eur J Neurosci* 14:1113–1120
- Hu JW (2000) Neurophysiological Mechanism of Head Face and Neck Pain. In: Vernon H (ed) *The cranio-cervical syndrome: mechanisms, assessment and treatment*. Oxford, Boston, pp 31–48
- Ichikawa H, Sugimoto T (2000) Vanilloid Receptor 1-Like Receptor-Immunoreactive Primary Sensory Neurons in the Rat Trigeminal Nervous System. *Neuroscience* 101:719–725
- Ichikawa H, Sugimoto T (2002) The Co-Expression of ASIC3 with Calcitonin Gene-Related Peptide and Parvalbumin in the Rat Trigeminal Ganglion. *Brain Res* 943:287–291
- Liu L, Pugh W, Ma H, Simon SA (1993) Identification of Acetylcholine Receptors in Adult Rat Trigeminal Ganglion Neurons. *Brain Res* 617:37–42
- Sessle BJ (2000) Acute and Chronic Craniofacial Pain: Brainstem Mechanisms of Nociceptive Transmission and Neuroplasticity, and their Clinical Correlates. *Crit Rev Oral Biol Med* 11:57–91
- Stenholm E, Bongenhielm U, Ahlquist M, Fried K (2002) VRI- and VRL-1-Like Immunoreactivity in Normal and Injured Trigeminal Dental Primary Sensory Neurons of the Rat. *Acta Odontol Scand* 60:72–79
- Toda K, Ishii N, Nakamura Y (1997) Characteristics of Mucosal Nociceptors in the Rat Oral Cavity: An *In Vitro* Study. *Neurosci Lett* 228:95–98
- Viana F, de la Pena E, Belmonte C (2002) Specificity of Cold Thermotransduction is Determined by Differential Ionic Channel Expression. *Nat Neurosci* 5:254–260
- Xiang Z, Bo X, Burnstock G (1998) Localization of ATP-Gated P2X Receptor Immunoreactivity in Rat Sensory and Sympathetic Ganglia. *Neurosci Lett* 256:105–108

## Nociceptors in the Orofacial Region (Temporomandibular Joint and Masseter Muscle)

BRIAN E. CAIRNS

Faculty of Pharmaceutical Sciences, University of British Columbia, Vancouver, BC, Canada  
brcairns@interchange.ubc.ca

### Synonyms

Nociceptive Temporomandibular Joint Afferents; Nociceptive Masseter Muscle Afferents

### Definition

Primary afferent fibers that innervate the ► **temporomandibular joint** (TMJ) and masticatory muscles, and are activated by noxious mechanical, chemical or thermal stimuli applied to these tissues. These afferent fibers transduce and convey information about potential or actual tissue injury from the orofacial region to the central nervous system.

### Characteristics

#### TMJ Nociceptors

The TMJ is innervated by thinly myelinated and unmyelinated afferent fibers, with non-specialized endings, which contain clear and dense core vesicles. This

suggests some of these afferent fibers release neurotransmitters and neuropeptides, such as calcitonin gene related peptide (CGRP) and substance P, from their terminal endings (Kido et al. 1995). These small-diameter afferent fibers project, via the gasserian or trigeminal ganglion, to the trigeminal subnuclei interpolaris and caudalis (Casatti et al. 1999; Capra 1987; Widenfalk and Wiberg 1990), areas of the caudal brainstem which appear to be most important for the integration of nociceptive input from deep orofacial tissues. Electrophysiological studies have confirmed the projection of a subpopulation of TMJ afferent fibres with conduction velocities of less than 25 m/sec (A $\delta$  and C fibres) to the caudal brainstem (Cairns et al. 2001 a,b). These fibres are activated by noxious mechanical and/or chemical stimuli and appear to function as nociceptors (Cairns et al. 2001 a,b).

TMJ afferent fibers, identified as mechanical nociceptors by their response to noxious protrusion or lateral movement of the TMJ, have been described (Cairns et al. 2001a; Loughner B et al. 1997). These fibers are not activated by innocuous jaw opening, but begin to discharge as lateral rotation of the jaw exceeds the normal range, and exhibit a progressively increased discharge with supra-normal rotation of the jaw. Some of these nociceptors also appear to encode rate of jaw rotation (Loughner B et al. 1997). The threshold of TMJ nociceptors to noxious mechanical rotation of the jaw is lower in females than males; however, this is apparently due to sex-related differences in the biomechanical properties of the TMJ tissues (Loughner B et al. 1997).

TMJ nociceptors respond to injection of algogenic substances such as mustard oil, potassium chloride and **▶ glutamate** into the TMJ, which also evokes a **▶ nociceptive reflex** response in the jaw muscles (Cairns et al. 2001a; Cairns et al. 1998) The activity of TMJ nociceptors precedes, but has a markedly shorter duration, than reflex jaw muscle activity evoked by injection of glutamate into the TMJ. This finding has led to the speculation that a brief activation of TMJ nociceptors, by algogenic compounds such as glutamate, is sufficient to induce **▶ central sensitization**, a period of prolonged increase in the excitability of trigeminal subnucleus caudalis neurons (Cairns et al. 2001a). Such a phenomenon may explain the diffuse referral pattern of TMJ pain, which may spread to include the masticatory and neck muscles, and why acute joint pain can sometimes significantly outlast the duration of nociceptive stimulation.

Sex-related differences in the chemical response characteristics of TMJ nociceptors have also been noted. The greatest response to algogenic compounds has been observed in small, mechanically sensitive afferent fibers with conduction velocities of less than 10 m/s, which suggests that these particular fibers function as polymodal nociceptors, i.e. nociceptors that respond

to more than one type of noxious stimulation. Sex-related differences in response to injection of glutamate into the TMJ have been best characterized. Injection of glutamate into the TMJ has been found to evoke significantly greater nociceptive reflex responses and discharge in polymodal nociceptors in females than in males (Cairns et al. 2001a) Such sex-related differences in TMJ nociceptor excitability may explain, in part, the increased prevalence of certain orofacial pain syndromes in women (Dao and LeResche 2000).

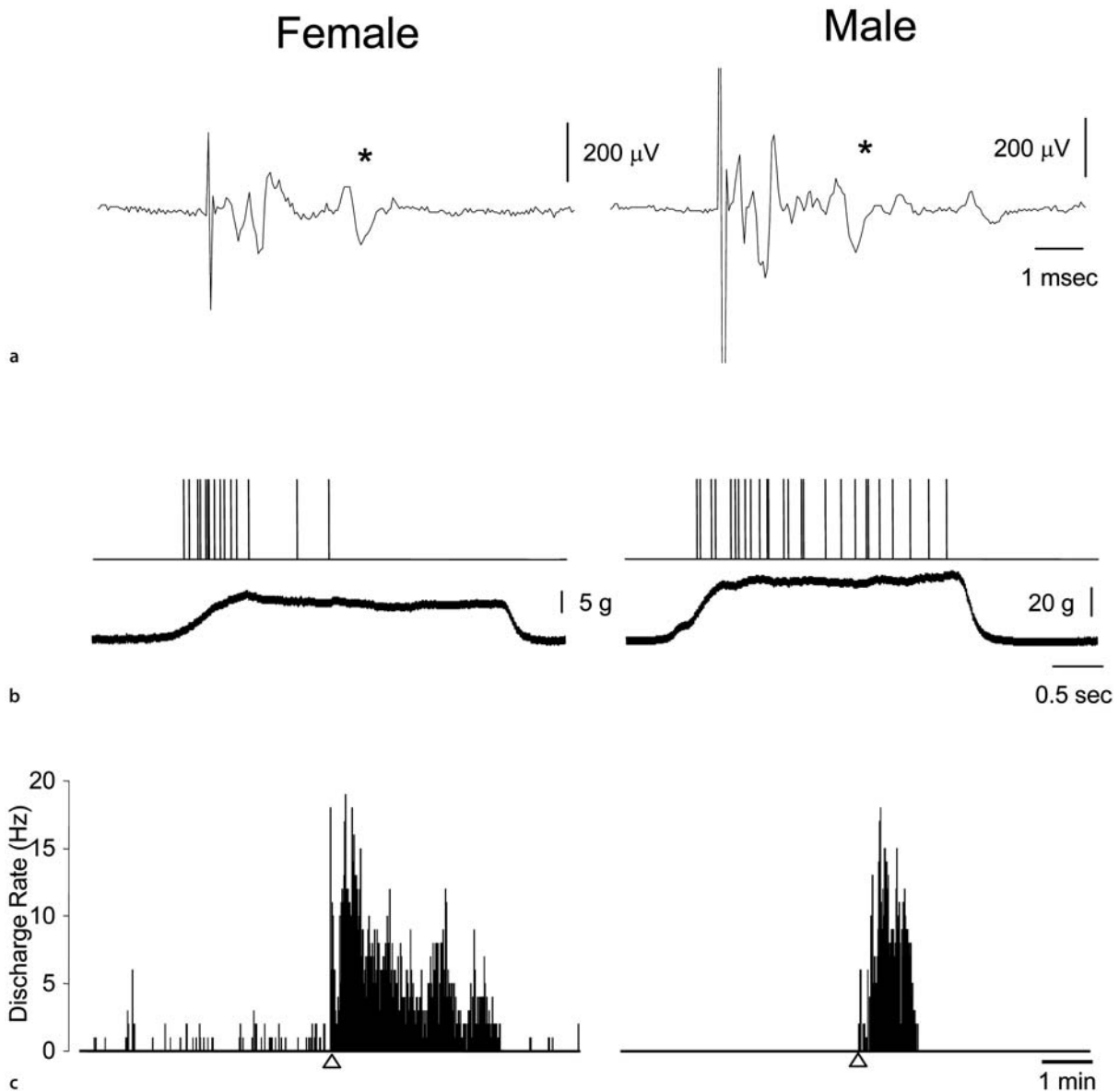
Algogenic compounds, such as mustard oil and glutamate, excite TMJ nociceptors in part through activation of peripheral NMDA and non-NMDA receptors (Cairns et al. 1998). This suggests that peripheral glutamate receptor antagonists may be of use in modifying the excitability of TMJ nociceptors under certain pathological conditions. In contrast, the peripheral endings of TMJ nociceptors are not excited by  $\gamma$ -**▶ aminobutyric acid** (GABA), which is thought to depolarize the central endings of nociceptors (Cairns et al. 2001a). Indeed, the current evidence suggests that GABA may in fact decrease the excitability of TMJ nociceptors through activation of peripheral GABA<sub>A</sub> receptors (Cairns et al. 1999). This unexpected effect of GABA suggests that the activation of peripheral GABA<sub>A</sub> receptors may result in a local analgesia of the TMJ.

#### Masseter Muscle Nociceptors

Anatomical and electrophysiological studies have indicated that the **▶ masseter muscle** is also innervated by thinly myelinated and unmyelinated trigeminal afferent fibers with non-specialized endings, which project to the trigeminal subnucleus interpolaris and caudalis (Cairns et al. 2002; Cairns et al. 2001b; Cairns et al. 2003; Capra and Wax 1989; Nishimori et al. 1986) These fibers are activated by noxious mechanical and/or chemical stimuli and appear to function as nociceptors (Cairns et al. 2002; Cairns et al. 2001b; Cairns et al. 2003).

About one-third of masseter muscle afferent fibers that project to subnucleus caudalis have mechanical thresholds that exceed the human pressure pain threshold (Cairns et al. 2003; Svensson et al. 2003). In uninjured masseter muscle, these nociceptors are predominantly A $\delta$  fibers with conduction velocities of less than 10 m/sec (Cairns et al. 2002; Cairns et al. 2003). Most of these nociceptors exhibit slowly adapting responses to sustained noxious mechanical stimulation (Fig. 1). A significant sex-related difference in the mechanical threshold of these nociceptors has not been found.

Like TMJ nociceptors (see above), masseter muscle mechanical nociceptors also respond to the injection of algogenic substances such as **▶ hypertonic saline** and glutamate, but not GABA, into their mechanoreceptive field (Cairns et al. 2002; Cairns et al. 2001; Cairns et al. 2003). The afferent discharge evoked by these algogenic substances is greatest in C fibers and in A $\delta$  fibers with con-



**Nociceptors in the Orofacial Region (Temporomandibular Joint and Masseter Muscle), Figure 1** Examples of deep orofacial tissue nociceptor response characteristics. (a) The line drawing illustrates antidromic action potentials (\*), evoked by electrical stimulation of the caudal brainstem, to confirm the central projection target of these masseter muscle A $\delta$  nociceptors. (b) Sustained noxious mechanical stimulation of the masseter muscle with an electronic Von Frey hair (lower trace), resulted in a slowly adapting discharge (upper trace). (c) The peri-stimulus histograms illustrate the effect of injection of the algogenic substance glutamate into the masseter muscle. Note that glutamate-evoked nociceptor discharge was markedly greater in the female than in the male.

duction velocities of less than 10 m/s. Thus, these particular fibers appear to function as polymodal nociceptors. Glutamate consistently evokes significantly greater nociceptor discharges and pain responses in females than in males (Cairns et al. 2002; Cairns et al. 2001; Cairns et al. 2003) (see examples, Fig. 1). Thus, sex-related differences in masseter muscle nociceptor excitability appear to underlie, at least in part, the increased prevalence of masticatory muscle pain conditions suffered by women (Dao and LeResche 2000). Prolonged mechanical sensitization of the masseter muscle and its nociceptors has

also been demonstrated to occur after injection of glutamate into the masseter muscle, although there do not appear to be sex-related differences in this phenomenon (Cairns et al. 2002; Svensson et al. 2003).

Unlike TMJ nociceptors, current evidence suggests that glutamate-evoked afferent discharge in masseter nociceptors is predominantly mediated through activation of peripheral NMDA receptors (Cairns et al. 2003). Glutamate-induced mechanical sensitization is also mediated through activation of peripheral glutamate receptors (Cairns et al. 2002). Thus, peripheral NMDA



receptor antagonists may prove to be particularly effective analgesics for the treatment of masticatory muscle pain.

### Conclusion

The role of orofacial nociceptors is to transduce and convey information about the intensity and quality of orofacial pain. The characteristics of TMJ and masseter muscle nociceptors suggest that they may play a role not only in the development, but also in the maintenance of certain types of orofacial pain, and contribution to sex differences in TMJ and masticatory muscle pain.

### References

- Cairns BE, Sessle BJ, Hu JW (1998) Evidence that Excitatory Amino Acid Receptors within the Temporomandibular Joint Region are Involved in the Reflex Activation of the Jaw Muscles. *J Neurosci* 18:8056–8064
- Cairns BE, Sessle BJ, Hu JW (1999) Activation of Peripheral GABAA Receptors Inhibits Temporomandibular Joint-Evoked Jaw Muscle Activity. *J Neurophysiol* 81:1966–1969
- Cairns BE, Sessle BJ, Hu JW (2001a) Characteristics of Glutamate-Evoked Temporomandibular Joint Afferent Activity in the Rat. *J Neurophysiol* 85:2446–2454
- Cairns BE, Hu JW, Arendt-Nielsen L, Sessle BJ, Svensson P (2001b) Sex-Related Differences in Human Pain Perception and Rat Afferent Discharge Evoked by Injection of Glutamate into the Masseter Muscle. *J Neurophysiol* 86:782–791
- Cairns BE, Gambarota G, Svensson P, Arendt-Nielsen L, Berde CB (2002) Glutamate-Induced Sensitization of Rat Masseter Muscle Fibers. *Neuroscience* 109:389–399
- Cairns BE, Svensson P, Wang K, Hupfeld S, Graven-Nielsen T, Sessle BJ, Berde CB, Arendt-Nielsen I (2003) Activation of Peripheral NMDA Receptors Contributes to Human Pain and Rat Afferent Discharges Evoked by Injection of Glutamate into the Masseter Muscle. *J Neurophysiol* 90:2098–2105
- Capra NF (1987) Localization and Central Projections of Primary Afferent Neurons that Innervate the Temporomandibular Joint in Cats. *Somatosens Res* 4:201–213
- Capra NF, Wax TD (1989) Distribution and Central Projections of Primary Afferent Neurons that Innervate the Masseter Muscle and Mandibular Periodontium: A Double-Label Study. *J Comp Neurol* 279:341–352
- Casatti CA, Frigo L, Bauer JA (1999) Origin of Sensory and Autonomic Innervation of the Rat Temporomandibular Joint: A Retrograde Axonal Tracing Study with the Fluorescent Dye Fast Blue. *J Dent Res* 78:776–783
- Dao TTT, LeResche L (2000) Gender Differences in Pain. *J Orofac Pain* 14:169–184
- Dateoka Y, Shigenaga Y (1986) The Distribution of Muscle Primary Afferents from the Masseter Nerve to the Trigeminal Sensory Nuclei. *Brain Res* 372:375–381
- Kido MA, Kiyoshima T, Ibuki T, Shimizu S, Kondo T, Terada Y, Tanaka T (1995) A Topographical and Ultrastructural Study of Sensory Trigeminal Nerve Endings in the Rat Temporomandibular Joint as Demonstrated by Anterograde Transport of Wheat Germ Agglutinin-Horseradish Peroxidase (WGA-HRP). *J Dent Res* 74:1353–1359
- Loughner B, Miller J, Broumand V, Cooper B (1997) The Development of Strains, Forces and Nociceptor Activity in Retrodiscal Tissues of the Temporomandibular Joint of Male and Female Goats. *Exp Brain Res* 113:311–326
- Nishimori T, Sera M, Suemune S, Yoshida A, Tsuru K, Tsuiji Y, Akisaka T, Okamoto T, Svensson P, Cairns BE, Wang K, Hu JW, Graven-Nielsen T, Arendt-Nielsen L, Sessle BJ (2003) Glutamate-Evoked Pain and Mechanical Allodynia in the Human Masseter Muscle. *Pain* 101:221–227
- Widenfalk B, Wiberg M (1990) Origin of Sympathetic and Sensory Innervation of the Temporo-Mandibular Joint. A Retrograde Axonal Tracing Study in the Rat. *Neurosci Lett* 109:30–35

## Nociceptors, Perireceptor Elements

### ► Perireceptor Elements

## Nocifensive

### Definition

Denoting a process or mechanism that acts to protect the body from injury.

- [Nocifensive Behaviors of the Urinary Bladder](#)
- [Secondary Somatosensory Cortex \(S2\) and Insula, Effect on Pain Related Behavior in Animals and Humans](#)



## Nocifensive Behavior

### Definition

Nocifensive behaviors are those that are evoked by stimuli that activate the nociceptive sensory apparatus. They are associated with protection against insult and injury typically in response to a noxious stimulus. Responses to noxious stimuli in animals may include behaviors resembling responses to pain in humans, such as limping, flinching, vocalization and reflexive withdrawal. Other specific pain-related responses in animals include tail and paw flicks, licking, and scratching. Responses to increased deep muscle and joint pain may include reduced exploration activity. In the viscera, nocifensive behaviors can be produced by hollow organ distension, ischemia, traction on the mesentery or stimulation of inflamed organs.

- [Muscle Pain Model, Inflammatory Agents-Induced](#)
- [Nocifensive Behaviors \(Muscle and Joint\)](#)
- [Sensitization of Visceral Nociceptors](#)

## Nocifensive Behaviors Evoked by Myositis

- [Muscle Pain Model, Inflammatory Agents-Induced](#)

## Nocifensive Behaviors, Gastrointestinal Tract

GERALD F. GEBHART

Department of Pharmacology, University of Pittsburgh,  
Pittsburgh, PA, USA  
gf-gebhart@uiowa.edu

### Synonyms

Pseudodffective; pseudoffective; Gastrointestinal Tract,  
Nocifensive Behaviors

### Definition

Nocifensor, a term introduced by Lewis (1936; see Lewis 1942; LaMotte 1992 for discussion), describes a system of “nerves” associated with local defense against injury. Nocifensive has since expanded as a term to describe behaviors associated with protection against insult and injury. Nocifensive behaviors are more complex than simple nociceptive flexor withdrawal reflexes, such as the tailflick reflex, and the term is particularly appropriate in the visceral realm, where stimuli considered to be adequate (e.g. hollow organ distension, ischemia, traction on the mesentery) are different from those Sherrington (1906) defined as adequate for activation of cutaneous nociceptors. The nocifensive behaviors produced by visceral stimulation are also considered pseudodffective (Sherrington 1906) (pseudoffective), because responses to visceral stimulation are organized supraspinally.

### Characteristics

Balloon distension of gastrointestinal tract organs has been widely employed in both human and non-human animal studies. Significantly, balloon distension of the esophagus, stomach or large bowel reproduces in humans the distribution of referred sensations, as well as the quality and intensity of discomfort and pain, arising from pathological visceral disorders (see Ness and Gebhart 1990 for review). In addition, balloon distension of hollow organs is a stimulus that is easy to control in terms of onset, duration and intensity, as opposed, for example, to a chemical or ischemic visceral stimulus. The nocifensive behaviors produced by balloon distension of hollow organs include changes in blood pressure, heart rate and respiration, and visceromotor reflexes (► [visceromotor reflex/response](#)). All of these responses are absent in spinally transected animals, but present following mid-collicular decerebration, thus revealing that they are responses integrated in the brainstem. All of these response measures are intensity-dependent and can be quantified as indices of visceral nociception.

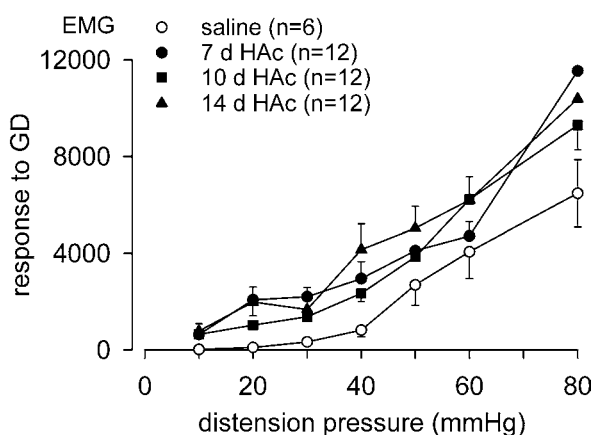
Although balloon distension of hollow organs has been widely used, it wasn't until Ness parametrically characterized in the rat responses to colorectal distension that

this model of visceral pain became widely accepted and widely used (Ness and Gebhart 1988). Similar parametric evaluation of responses to colorectal distension in the mouse (Kamp et al. 2003) and gastric distension in the rat (Ozaki et al. 2002) have since been described.

### Colorectal Distension (CRD)

Balloons of different lengths and varying durations of distension have been reported in the literature. As Lewis (1942) noted, distension of hollow organs is most painful in humans when long, continuous segments of the gut are distended, which emphasizes the importance of ► [spatial summation](#) as an important consideration in CRD as a stimulus. Results using different length balloons in the rat are qualitatively similar, although greater intensities of stimulation are generally required with smaller balloons to produce quantitatively equivalent responses. The human literature (see Ness and Gebhart 1990 for citations and discussion) also established that constant pressure distension, rather than constant volume, was the appropriate stimulus. It should be appreciated that hollow organs throughout the viscera, and particularly within the gastrointestinal tract, accommodate as they fill. Thus, constant volume distension produces an inconstant intensity of stimulation as the organ musculature relaxes.

Balloon CRD produces contraction of the peritoneal musculature, representing what has been termed a visceromotor reflex. Among the responses to CRD, the visceromotor reflex recorded from the external oblique peritoneal musculature is perhaps the most reliable and experimentally least complicated measure to quantify. Indwelling arterial catheters to measure changes in blood pressure or heart rate produce equally robust and quantifiable measures of response to distension, but are more difficult to maintain than electromyographic electrodes sewn into the peritoneal musculature. Figure 1 illustrates graded visceromotor responses to increasing intensities of CRD in the mouse. The response threshold for CRD is typically between 20 mmHg and 25 mmHg in normal rat colon. In consideration of the response threshold for a subset of pelvic nerve afferent fibers that innervate the colon and spinal dorsal horn neuron responses to CRD, the intensity of CRD in the rat considered to be noxious is  $\geq 30$  mmHg. This interpretation is consistent with results from psychophysical studies in humans (e.g. Ness et al. 1990), in which increases in heart rate and blood pressure were produced by colon distension at intensities of distension less than reported as painful. Accordingly, quantification of pseudodffective responses to visceral stimulation requires interpretation with respect to the quality of the nocifensive behavior produced (e.g. visceromotor response). That is, changes in response measures may be apparent before a behavior is nocifensive, although thresholds for response are similar.



**Nocifensive Behaviors, Gastrointestinal Tract, Figure 1** Visceromotor responses recorded as electromyographic activity in the peritoneal musculature of the mouse to graded intensities of colon distension. Distending pressures (15–60 mmHg) are illustrated; the period of colorectal distension is 20 sec.

### Gastric Distension (GD)

Unlike CRD, in which a lubricated balloon can be inserted via the anus into the descending colon and rectum of a rodent, insertion of balloons for GD requires a surgical procedure in advance of the experiment. Like CRD, responses to balloon GD in the rat are graded with stimulus intensity (Ozaki et al. 2002). The visceromotor response in studies of GD is recorded from the acromiotrapezius muscle; responses to GD recorded in other muscles (e.g. external oblique peritoneal muscles, spinotrapezius muscles or sternomastoideus muscles) were unreliable and not graded with stimulus intensity. In addition to being able to surgically implant a balloon into the stomach, one can surgically place a small diameter polyethylene tube into the stomach to deliver chemical substances. Thus, one can examine the effect of chemical stimulation of the stomach in the absence or presence of an ulcer, and/or before and after GD. For example, intragastric administration of hydrochloric acid produces concentration-dependent (0.05–0.3 mol/l) activity in the acromiotrapezius muscle, which can be quantified and used to assess a chemically-evoked nocifensive behavior. Interestingly, we (Lamb et al. 2003) were able to show that responses to balloon gastric distension were conveyed to the central nervous system by the splanchnic innervation of the stomach, whereas chemonociceptive stimulation of the stomach by hydrochloric acid was conveyed to the central nervous system via the vagus nerve. The importance of these observations relates to support for a role of the vagus nerve in chemonociception, an area of growing investigation.

### Small Bowel Distension

Balloon distension of the small bowel has also been studied in rodents. Colburn and colleagues (1989) described a model of duodenal distension in which responses to

distension were graded from 0–4, based on interpretation of the nocifensive behavior produced. A difficulty with models of small bowel distension is that permanent implantation of balloons tends to lead to obstruction. This is avoided in studies of GD by placing the balloon in the antrum, where it does not significantly interfere with ingestion of food or weight gain.

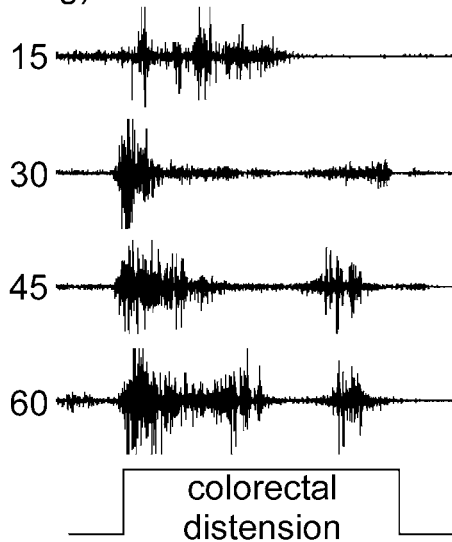
### Pseudoaffective Reflexes and Anesthesia

The concept of a nocifensive behavior implies evaluation of response to stimulation in the awake animal. However, changes in blood pressure, heart rate or the visceromotor response can also be interpreted as a behavior, and responses to gastrointestinal distension have been carried out in anesthetized animals. As initially reported by Ness and Gebhart (1988), the presence of anesthesia typically converts pressor and tachycardic responses to CRD to depressor and bradycardic responses, and attenuates the visceromotor response to distension. Depressor and bradycardic responses to CRD in anesthetized rats have been quantified and reported, but their relevance to nociception and pain is less clear than vigorous nocifensive behaviors produced in the awake, behaving animal.

### Gastrointestinal Hypersensitivity

Responses to balloon distension of the gastrointestinal tract have been well characterized in behavioral and electrophysiological studies (and results from both behavioral and electrophysiological studies have been important to understanding mechanisms of visceral nociception). Gastrointestinal hypersensitivity, such as associated with dyspepsia and gastrointestinal inflammatory disorders, in addition to so-called functional disorders, which are not associated with either biochemical or pathological markers of organ pathology, comprise a significant proportion of patients reporting gastrointestinal discomfort and pain. Accordingly, a variety of models of gastrointestinal organ irritation and insult have been reported, and thus to study the presumed processes underlying visceral hypersensitivity. Experimental gastric ulceration or gastritis produced by ingestion of a dilute solution of iodoacetamide both produced long-lasting gastric hypersensitivity, as assessed by balloon distension and quantification of the visceromotor response (Fig. 2). Importantly, the gastric hypersensitivity to balloon distension in these models long outlasts recovery from ulceration or gastritis (Ozaki et al. 2002). In the colon, a variety of chemicals have been instilled into the lumen to produce insult ranging from mild irritation to ulceration. In such models, in which substances such as mustard oil, turpentine, zymosan, trinitrobenzene sulfonic acid, etc. have been placed intracolonicly, hypersensitivity to balloon CRD can be shown within hours, and can last for days to weeks. For example, in the mouse, intracolonic instillation of zymosan can produce hypersensitivity to

## distending pressure (mmHg)



**Nocifensive Behaviors, Gastrointestinal Tract, Figure 2** Responses to gastric distension (GD) 7–14 days after injection of acetic acid (HAc) into the stomach wall. Relative to saline-injected animals, the visceromotor response, quantified as the EMG recorded in the acromiotrapezius muscle, responses to gastric distension are significantly increased after ulceration of the stomach.

balloon CRD that lasts for 5–7 weeks, and does so in the absence of histological evidence of damage to the colon (R.C.W. Jones III and G.F. Gebhart, unpublished observations). In addition to these models of relatively acute to chronic colon hypersensitivity, models have also been developed which are intended to, or closely replicate, contributions to gastrointestinal hypersensitivity in humans. For example, about 30% of individuals with irritable bowel syndrome report a previous gastrointestinal infectious event, and models of gastrointestinal infection (e.g. *Trichinella spiralis*) have been developed in which both changes in gastrointestinal motility and sensation are altered (Barbara et al. 1997). Patients that suffer from irritable bowel syndrome also often report that symptoms are exacerbated by stressful life events, and a model of maternal separation of rat pups produced visceral hypersensitivity in adult rats as assessed by visceromotor responses to CRD (Coutinho et al. 2002). Al Chaer and colleagues (2000) exposed rat pups to either mechanical balloon distension of the colon, or treatment with mustard oil during a critical neonatal period, and were able to document hypersensitive responses to CRD in adult rats.

### Conclusions

Balloon distension, at constant pressure, produces robust and readily quantifiable pseudoaffective responses and nocifensive behaviors. Development and use of these models has improved understanding of visceral nociceptive mechanisms, visceral hypersensitivity, and

modulation by pharmacological and other manipulations.

### References

1. Al Chaer ED, Kawasaki M, Pasricha PJ (2000) A New Model of Chronic Visceral Hypersensitivity in Adult Rats Induced by Colon Irritation during Postnatal Development. *Gastroenterology* 119:1276–1285
2. Barbara G, Vallance BA, Collins SM (1997) Persistent Intestinal Neuromuscular Dysfunction after Acute Nematode Infection in Mice. *Gastroenterology* 113:1224–1232
3. Colburn RW, Coombs DW, Degnan CC et al. (1989) Mechanical Visceral Pain Model: Chronic Intermittent Intestinal Distension in the Rat. *Physiol Behav* 45:191
4. Coutinho SV, Plotsky PM, Sablad M et al. (2002) Neonatal Maternal Separation Alters Stress-Induced Responses to Viscerosomatic Nociceptive Stimuli in Rat. *Am J Physiol* 282:G307
5. Kamp EH, Jones RCW 3rd, Tillman SR et al. (2003) Quantitative Assessment and Characterization of Visceral Nociception and Hyperalgesia in the Mouse. *Am J Physiol Gastrointest Liver Physiol* 284:G434–G444
6. LaMotte RH (1992) Subpopulations of ‘Nocifensor Neurons’ Contributing to Pain and Allodynia, Itch and Allokinesis. *Am Pain Soc J* 1:115–126
7. Lamb K, Kang YM, Gebhart GF et al. (2003) Gastric Inflammation Triggers Hypersensitivity to Acid in Awake Rats. *Gastroenterol* 125:1410–1418
8. Lewis T (1936) Experiments Relating to Cutaneous Hyperalgesia and its Spread through Somatic Nerves. *Clin Sci* 2:373–423
9. Lewis T (1942) *Pain*. Macmillan Press Ltd, London
10. Ness TJ, Gebhart GF (1988) Colorectal Distension as a Noxious Visceral Stimulus: Physiologic and Pharmacologic Characterization of Pseudoaffective Reflexes in the Rat. *Brain Res* 450:153–169
11. Ness TJ, Gebhart GF (1990) Visceral Pain: A Review of Experimental Studies. *Pain* 41:167–234
12. Ness TJ, Metcalf AM, Gebhart GF (1990) A Psychophysiological Study in Humans using Phasic Colonic Distension as a Noxious Visceral Stimulus. *Pain* 43:377–386
13. Ozaki N, Bielfeldt K, Sengupta JN et al. (2002) Models of Gastric Hyperalgesia in the Rat. *Am J Physiol Gastrointest Liver Physiol* 283:G666–G676
14. Sherrington (1906) *The Integrative Action of the Nervous System*. Scribner, New York

## Nocifensive Behaviors, Muscle and Joint

KATHLEEN A. SLUKA<sup>1</sup>, KARIN N. WESTLUND<sup>2</sup>  
<sup>1</sup>Physical Therapy and Rehabilitation Science Graduate Program, University of Iowa, Iowa City, IA, USA

<sup>2</sup>Department of Neurosciences and Cell Biology, University of Texas Medical Branch, Galveston, TX, USA

kathleen-sluka@uiowa.edu, kwhigh@utmb.edu

### Synonyms

Hyperalgesia; Guarding; spontaneous pain

### Definition

Nocifensive behaviors are the response of the animal to noxious or painful stimuli.



## Characteristics

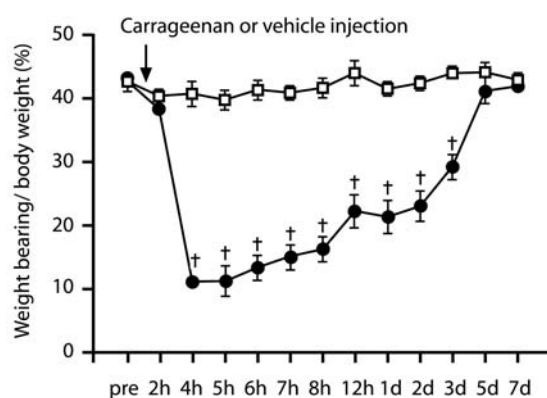
There are several animal models of muscle and joint pain utilized to study ► [nocifensive behaviors](#). These include carrageenan (or kaolin/carrageenan) inflammation of the knee joint or the muscle (gastrocnemius, triceps). Carrageenan inflammation results in an initial acute phase of inflammation that converts to a chronic phase within 1 week after induction (Radhakrishnan et al. 2003). Alternatively, ► [complete Freund's adjuvant](#) (CFA) or capsaicin can be injected into the joint or muscle to produce inflammation and behavioral changes (Yu et al. 2002; Sluka 2002). A non-inflammatory model of muscle pain is induced by two injections of acidic saline (Sluka et al. 2001).

## Joint Inflammation

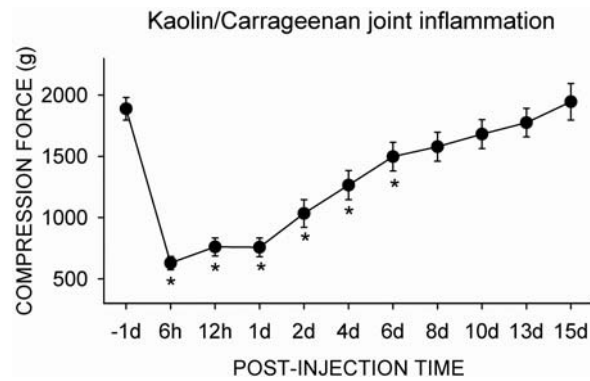
Nocifensive responses include spontaneous pain behaviors, ► [primary and secondary hyperalgesia](#) and ► [allodynia](#). Spontaneous pain behaviors are observed following knee joint inflammation with carrageenan. These include decreased weight bearing and guarding of the limb, which are most pronounced during the acute phase of inflammation (Sluka and Westlund 1993; Scott et al. 1994; Min et al. 2001; Radhakrishnan et al. 2003) (Fig. 1). When the temporomandibular joint (TMJ) is inflamed with CFA, changes in meal pattern occur such that there is an increase in duration of the meal, and a decrease in food intake (Kerine et al. 2003).

## Primary Hyperalgesia

Primary hyperalgesia of the knee joint is measured by the response to compression applied to the medial and lateral aspects of the knee joint with a pair of tweezers. This results in a lower threshold to vocalization within 4 hours after induction of inflammation, and lasts for several days (Yu et al. 2002) (Fig. 2). Similar responses are



**Nocifensive Behaviors, Muscle and Joint, Figure 1** The time course for the decreased threshold to vocalization from compression of the knee joint before and after injection of kaolin and carrageenan into the knee joint. There is a decrease in vocalization threshold within 6 hours that lasts for approximately 1 wk. From Yu et al. 2002. Reprinted with permission of Elsevier Science.



**Nocifensive Behaviors, Muscle and Joint, Figure 2** Time course for the decrease in grip force that occurs after inflaming the triceps surae muscle with carrageenan. There is a decrease in grip force by 12h after induction that lasts for 36h. From Kehl et al. 2000. Reprinted with permission of Elsevier Science.

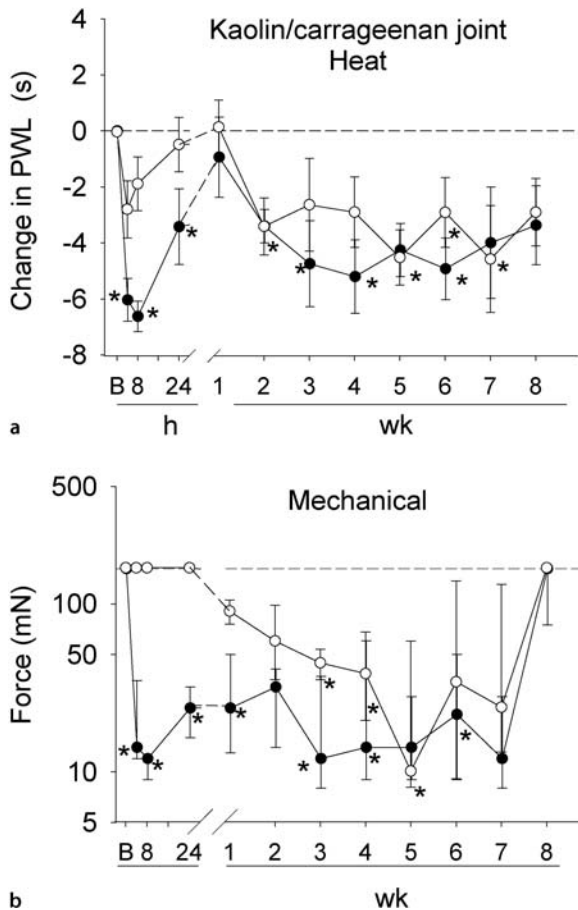
observed after injection of CFA into the knee joint (Yu et al. 2002).

## Secondary Hyperalgesia

Secondary hyperalgesia to heat stimuli is measured with a radiant heat source applied to the paw following inflammation of the knee joint. Secondary mechanical hyperalgesia is measured by assessing the withdrawal threshold to von Frey filaments applied to the paw. Following carrageenan (3%) inflammation, there is decreased withdrawal latency to heat and decreased threshold to mechanical stimuli, ipsilaterally, that is long-lasting (weeks). Within 1–2 weeks, a time that corresponds to the conversion to chronic inflammation, the hyperalgesia to both mechanical and heat stimuli spreads to the contralateral limb (Radhakrishnan et al. 2003) (Fig. 3). The length of hyperalgesia and the contralateral spread are dose-dependent, such that lower concentrations of carrageenan produce shorter lasting hyperalgesia that remains unilateral (Radhakrishnan et al. 2003). Capsaicin is also utilized to inflame the joint and produces an acute inflammatory response that is associated with a decreased withdrawal threshold to mechanical stimuli, and an increased withdrawal latency to heat stimuli outside the site of injury (Sluka 2002). This secondary hyperalgesia to mechanical stimuli lasts for weeks and spreads to the contralateral limb. The time course and contralateral spread following joint inflammation are distinctly different from the hyperalgesia associated with injection of capsaicin into the skin. Injection of capsaicin into the skin produces a short lasting (hours) hyperalgesia and remains unilateral (Sluka 2002).

## Muscle Pain

Two models of muscle pain, inflammatory and non-inflammatory, are utilized to study nocifensive behaviors resulting from muscle insult. Inflammation is induced by injection of carrageenan or capsaicin into

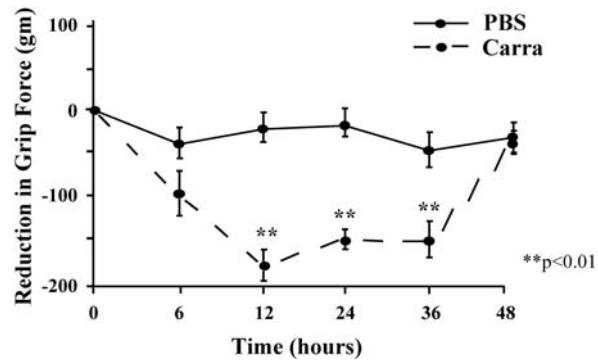


**Nocifensive Behaviors, Muscle and Joint, Figure 3** Time course for the change in paw withdrawal latency to heat (a), and the withdrawal threshold to mechanical stimuli (b) following injection of 3% carrageenan into the knee joint. The hyperalgesia is initially unilateral and spreads to include the contralateral side within 1–2 weeks after induction of inflammation. Modified from Radhakrishnan et al. 2003. Reprinted with permission of Elsevier Science.

muscle tissue. Injection of carrageenan into the muscle results in an initial acute inflammatory response, which converts to a chronic inflammation by 1 week (Radhakrishnan et al. 2003). Spontaneous pain behaviors assessed by limb guarding occur during the first 24–48h, and are less severe than those following the same dose of carrageenan injected into the knee joint.

### Primary Hyperalgesia

Primary hyperalgesia of the muscle is measured by examining grip force of the limb. There is a decrease in grip force after carrageenan inflammation of the triceps muscle within 12h that lasts for 36h (Fig. 4). Similarly, intramuscular injection of tumor necrosis factor alpha (TNF- $\alpha$ ) and intramuscular formalin injection, reduced grip force for up to 1 day (Schäfers et al. 2003). Alternatively, measurement of withdrawal/vocalization threshold to pressure applied over the belly of the muscle has also been utilized to assess primary hyperalgesia



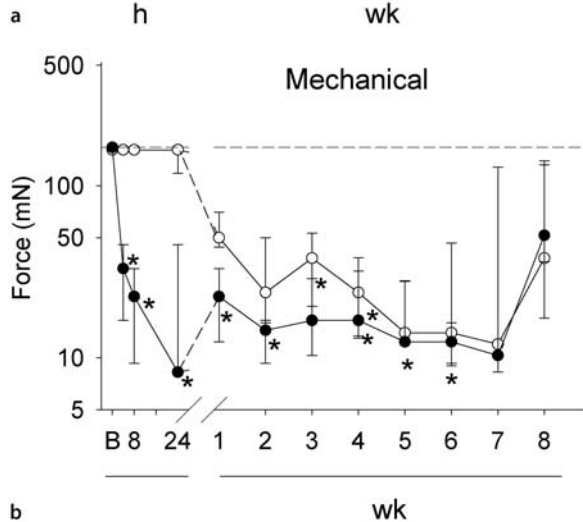
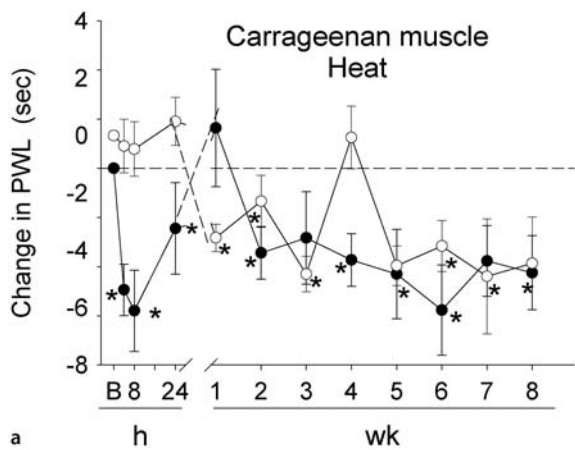
**Nocifensive Behaviors, Muscle and Joint, Figure 4** Time course for the change in paw withdrawal latency to heat (a), and the withdrawal threshold to mechanical stimuli (b) following injection of 3% carrageenan into the gastrocnemius muscle. The hyperalgesia is initially unilateral and spreads to include the contralateral side within 1–2 weeks after induction of inflammation. Modified from Radhakrishnan et al. 2003. Reprinted with permission of Elsevier Science.

(Schäfers et al. 2003). When TNF- $\alpha$  or formalin is injected into the muscle, decreases in the mechanical threshold applied to the muscle persist for at least 1 day.

### Secondary Hyperalgesia

Secondary hyperalgesia is measured in a manner similar to that described above for joint inflammation, but outside the site of injury such as on the paw of the rat. Specifically, after inflammation of the gastrocnemius muscle with carrageenan, there is a decrease in mechanical withdrawal threshold and decreased latency to radiant heat on the paw, ipsilateral to the inflamed knee joint, within 4h that lasts for weeks (Fig. 5) (Radhakrishnan et al. 2003). After 1–2 weeks, when the inflammation becomes chronic, this hyperalgesia to mechanical and heat stimuli will spread to the contralateral limb (Radhakrishnan et al. 2003). A similar long-lasting, bilateral mechanical hyperalgesia occurs when capsaicin is injected into the plantar muscles of the paw (Sluka 2002). The effect of carrageenan muscle injection, and particularly the bilateral spread of hyperalgesia, is dose-dependent. Lower doses of intramuscular carrageenan produce only unilateral hyperalgesia that is shorter in duration (Radhakrishnan et al. 2003). As a model of chronic non-inflammatory muscle pain, two injections of acidic saline injected 2–5 days apart, results in a bilateral, long-lasting mechanical, but not heat, hyperalgesia of the paw (Sluka et al. 2001). This hyperalgesia is not associated with muscle tissue damage or inflammation, and once developed the hyperalgesia is independent of continued primary afferent input (Sluka et al. 2001). In contrast, injection of TNF- $\alpha$  or formalin into the muscle does not produce secondary hyperalgesia to mechanical or heat stimuli, as observed with the other models listed above (i.e. carrageenan, acid) (Schäfers et al. 2003).

In summary, nocifensive behaviors after injury to muscle or joint include spontaneous pain behaviors, primary

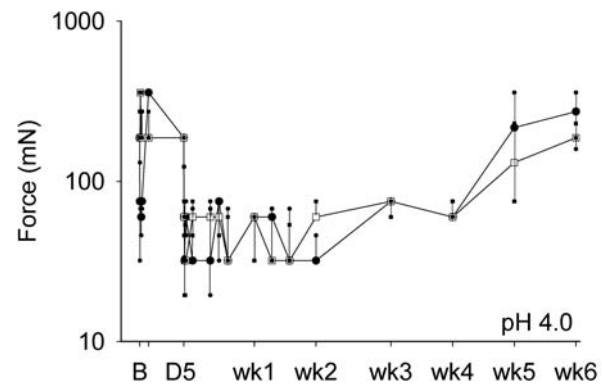


**Nocifensive Behaviors, Muscle and Joint, Figure 5** Time course for the decrease in mechanical withdrawal threshold following two acid injections (Day 0 and Day 5) into the gastrocnemius muscle. A bilateral, long-lasting decrease in mechanical withdrawal threshold occurs following repeated acid injection. From Sluka et al. 2001. Reprinted with permission of Wiley Publishing.

hyperalgesia, and secondary hyperalgesia. These behaviors are longer lasting than when the same stimulus is applied to the skin, and there is a bilateral spread of the secondary hyperalgesia. The development of hyperalgesia (primary vs. secondary OR mechanical vs. heat) and contralateral hyperalgesia is stimulus-dependent and dose-dependent.

### Musculoskeletal Pain in Humans

Musculoskeletal pain can arise from a variety of disorders including ► [myofascial pain](#), ► [fibromyalgia](#), ► [myositis](#), or ► [arthritis](#). The quality of pain associated with injury to a muscle or joint differs from that associated with injury to the skin. Injury to deep structures results in diffuse, difficult to localize, aching pain (reviewed in Graven-Nielsen and Arendt-Nielsen 2002). In contrast, injury to skin usually produces well-localized, sharp, stabbing or burning pain. Using microneurography, intraneuronal stimulation of muscle nerve fascicles



**Nocifensive Behaviors, Muscle and Joint, Figure 6** Time course for the changes in weight bearing of the inflamed and contralateral hindlimb after unilateral injection of carrageenan into the knee joint. From Min et al. 2001. Reprinted with permission of Elsevier Science.

produces only the sensation of deep cramp-like pain (in contrast to stimulation of cutaneous C-fibers [Group IV] which produces burning pain). For muscle pain, the size of the area of ► [referred pain](#) correlates with the intensity and duration of the primary muscle pain (reviewed in Graven-Nielsen and Arendt-Nielsen 2002). In human subjects, painful intramuscular stimulation is rated as more unpleasant than painful cutaneous stimulation (Svensson et al. 1997), pain is longer lasting, and referred pain is more frequent (see Graven-Nielsen and Arendt-Nielsen 2002). In patients with fibromyalgia or knee osteoarthritis there is more pain, and a larger and more diffuse area of referred pain following infusion of hypertonic saline into the tibialis anterior muscle when compared to subjects without pain. Similarly, in patients with chronic whiplash pain, there is an extended area of referred pain following infusion of hypertonic saline into the infraspinatus muscle of the shoulder or a distal muscle of the leg (tibialis anterior muscle) suggesting changes in central processing. Thus, pain associated with injury to skin would be expected to differ in quality to pain associated with injury to deeper tissues such as muscle, and results in diffuse widespread increases in sensitivity to noxious stimuli.

### Primary Hyperalgesia

In humans, muscle hyperalgesia is assessed by measuring threshold to pain from application of deep pressure, or by threshold to pain from intramuscular electrical stimulation (reviewed in Graven-Nielsen and Arendt-Nielsen 2002). Decreased pressure pain thresholds occur following intramuscular injection of capsaicin, hypertonic saline, serotonin and bradykinin. ► [Delayed onset muscle soreness \(DOMS\)](#) as a model of inflammatory muscle pain, results in decreased muscle function and increased pain to pressure.

### Secondary Hyperalgesia

Secondary hyperalgesia in deep tissue and skin occurs following painful stimulation of deep somatic tissue, as

well as in patients with chronic musculoskeletal pain conditions (reviewed in Graven-Neilsen and Arendt-Neilsen 2002). Infusion of hypertonic saline in muscle results in increased sensitivity to electrical or mechanical stimulation of the skin, or to deep pressure outside the site of infusion, i.e. secondary hyperalgesia. In patients with chronic cervical injury, there is an increased sensitivity to intramuscular electrical stimulation of the anterior tibialis muscle of the leg, and an increased response to pressure in the referred pain area. Several studies show an increased heat and/or mechanical sensitivity both at the site of an arthritic joint and at a distance from the joint (O'Driscoll and Jayson 1974; Farrell et al. 2000; Kosek and Orderberg, 2000; reviewed in Graven-Nielsen and Arendt-Nielsen 2002; Hendiani et al. 2003). The increased sensitivity to mechanical pressure is found in patients with arthritic pain for greater than five years, but not those with arthritic pain for less than one year. However, people with arthritis have higher mechanical sensation thresholds (measured with Frey filaments) simultaneously with lower mechanical pain thresholds (measured with von Frey filaments), suggesting that there is an increased activation of descending inhibitory processes in addition to central sensitization.

Thus, secondary hyperalgesia to heat and mechanical stimuli are found in patients with deep tissue pain, similar to that found in animal models of pain.

## References

- Farrell M, Gibson S, McMeeken J, Helme R (2000) Pain and Hyperalgesia in Osteoarthritis of the Hands. *J Rheumatol* 27:441–447
- Graven-Nielsen T, Arendt-Nielsen L (2002) Peripheral and Central Sensitization in Musculoskeletal Pain Disorders: An Experimental Approach. *Curr Rheumatol Rep* 4:313–321
- Hendiani JA, Westlund KN, Lawand N, Goel N, Lisse J, McNearney T (2003) Mechanical Sensation and Pain Thresholds in Patients with Chronic Arthropathies. *J Pain* 4:203–211
- Kerine CA, Carlson DS, McIntosh JE, Bellinger LL (2003) Meal Pattern Changes Associated with Temporomandibular Joint Inflammation/Pain in Rats; Analgesic Effects. *Pharmacol Biochem Behav* 75:181–189
- Kosek E and Ordeberg G (2000) Abnormalities of Somatosensory Perception in Patients with Painful Osteoarthritis Normalize following Successful Treatment. *Europ J Pain* 4:229–238
- Min SS, Han JS, Kim YI, Na HS, Yoon YW, Hong SK, Han HC (2001) A Novel Method for Convenient Assessment of Arthritic Pain in Voluntarily Walking Rats. *Neurosci Lett* 3:308:95–98
- O'Driscoll SL, Jayson MIV (1974) Pain Threshold Analysis in Patients with Osteoarthritis of the hip. *Br Med J* 3:714–715
- Radhakrishnan R, Moore SA, Sluka KA (2003) Unilateral Carageenan Injection into Muscle or Joint Induces Chronic Bilateral Hyperalgesia in Rats. *Pain* 104:567–577
- Schäfers M, Sorkin, LS, Sommer C (2003) Intramuscular Injection of Tumor Necrosis Factor-Alpha Induces Muscle Hyperalgesia in Rats. *Pain* (104:579-588)
- Schott E, Berge OG, Angeby-Moller K, Hammarstrom G, Dalsgaard CJ, Brodin E (1994) Weight Bearing as an Objective Measure of Arthritic Pain in the Rat. *J Pharmacol Toxicol Methods* 31:79–83
- Sluka KA (2002) Stimulation of Deep Somatic Tissue with Capsaicin Produces Long-Lasting Mechanical Allodynia and Heat Hypoalgesia that Depends on Early Activation of the cAMP Pathway. *J Neurosci* 2:5687–693
- Sluka KA, Kalra A, Moore SA (2001) Repeated Intramuscular Injections of Acidic Saline Produce a Bilateral, Long-Lasting Hyperalgesia. *Muscle Nerve* 4:37–6
- Sluka KA, Westlund KN (1993) Behavioral and Immunocytochemical Changes in an Experimental Arthritis Model in Rats. *Pain* 55:367–77
- Svensson P, Beydoun A, Morrow TJ, Casey KL (1997) Human Intramuscular and Cutaneous Pain: Psychophysical Comparisons. *Exp Brain Res* 114:390–392
- Yu YC, Koo ST, Kim CH, Lyu Y, Grady JJ, Chung JM (2002) Two Variables that can be used as Pain Indices in Experimental Animal Models of Arthritis. *J Neurosci Methods* 115:107–13

## Nocifensive Behaviors of the Urinary Bladder

TIMOTHY NESS

Department of Anesthesiology, University of Alabama at Birmingham, Birmingham, AL, USA  
loch@uab.edu

### Synonyms

Pseudoaffective response; pseudoaffective response; Urinary Bladder Nocifensive Behaviors

### Definition

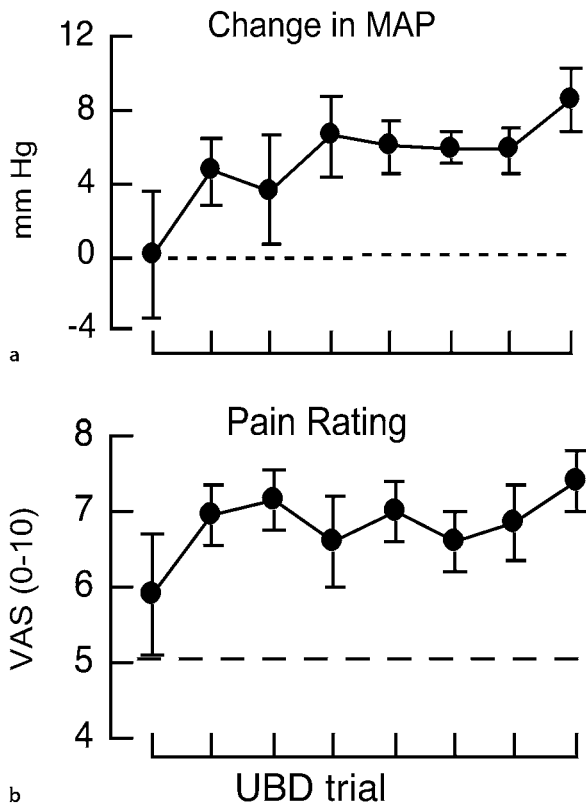
► **Nocifensive** reflexes are those reflexes evoked by noxious stimuli. Most acute motor responses to noxious cutaneous stimuli are nocifensive. For visceral systems in general, and the urinary bladder-related systems in particular, similar reflexes are not obvious. Micturition reflexes enhanced by local inflammation can expel toxic urinary contents and so may serve a protective function, but may also increase pain (unlike cutaneous nocifensive reflexes). Many responses to urinary bladder stimulation in non-human animals correlate with nociception in humans, and in this way are similar to nocifensive reflexes. These include biting/scratching behaviors, changes in heart rate, blood pressure, respiration and abdominal muscular tone. These behaviors/reflexes are collectively called pseud(o)affective responses.

### Characteristics

#### Clinical Observations and Psychophysical Studies

The urinary bladder is a common site of visceral pain generation in humans. Urinary tract infections, inflammation produced by radiation, the action of irritating constituents of urine or acute obstruction of outflow from the bladder can all lead to severe pain localized to the lower abdomen, suprapubic region and perineum. At the same time, there is typically a sense of urgency (a need to void) and increased frequency of urination. When the bladder is inflamed, the act of urinating may





**Nocifensive Behaviors of the Urinary Bladder, Figure 1** (a) Pressor responses to urinary bladder distension (UBD) in humans, an example of a nociceptive reflex response. In non-human animals this would be termed a pseudoaffective response. Repeated presentation of a UBD stimulus that produced progressively vigorous increases in mean arterial blood pressure (MAP). (b) Reports of pain to the same stimulus paralleled the pressor response with increased vigor of responses with repeated presentation of the UBD stimulus. Data from Ness et al. 1998.

become painful and frequently there is a sensation of incomplete emptying. Autonomic responses such as heart rate changes, sweating and increases or decreases in blood pressure may precede, accompany and outlast the discomforting sensations. Psychophysical studies using fluid distension of the bladder via a urethral catheter have evoked reports of pain in humans as well as increases in blood pressure (e.g. Fig. 1), increases in abdominal tone and respiratory changes (Ness et al. 1998). Functional imaging has also demonstrated activation of numerous cortical sites of sensory processing, including sensory and motor cortices, the anterior cingulate cortex and the insular cortex (Athwal et al. 2001). Chemical stimulation of the bladder using ► **intravesical** capsaicin has similarly produced reports of pain and autonomic responses (e.g. Giannantoni et al. 2002). Similar physiological responses have been noted in non-human animals.

#### Micturition Reflexes

Micturition reflexes are reflexes involved in the emptying of the urinary bladder when full. They consist

of a reflex contraction of the bladder itself, coupled with a relaxation of the sphincters and associated pelvic floor musculature which block outflow from the bladder. A lack of coordination of these two components can lead to painful contractions of the bladder and incomplete bladder emptying. When the urinary bladder becomes inflamed by local infection or other irritant action, micturition reflexes become enhanced with lower volume/pressure thresholds for activation. Micturition reflexes enhanced by noxious bladder stimulation could be viewed as “nocifensive”, in that they may remove the irritating stimulus causing the pain by emptying the bladder. However, micturition reflexes normally occur in the absence of pain-producing stimuli, and the presence of irritating factors may paradoxically increase pain by increasing mechanical stimulation of the bladder through enhanced contractile activity. In this way, micturition reflexes may enhance nociception unlike cutaneous nocifensive reflexes.

As an assessment of micturition reflexes, distension of the bladder may be allowed to occur secondary to urine production and measures made of spontaneous voiding frequency and volume. Evoked micturition reflexes can be produced by the introduction of a catheter, which infuses fluid directly into the bladder at a rate higher than that typically produced by spontaneous urine formation. This catheter may be placed in a relatively non-invasive fashion via the urethra, or in non-human animals may also be surgically placed via an abdominal incision (Abelli et al. 1989.) A cystometrogram can then be performed by slow infusion of fluid into the bladder with simultaneous measurement of intravesical pressure. Micturition reflexes are identified as sharp increases in intravesical pressure coupled with the appearance of urine.

#### Pseud(o)Affective Reflexes

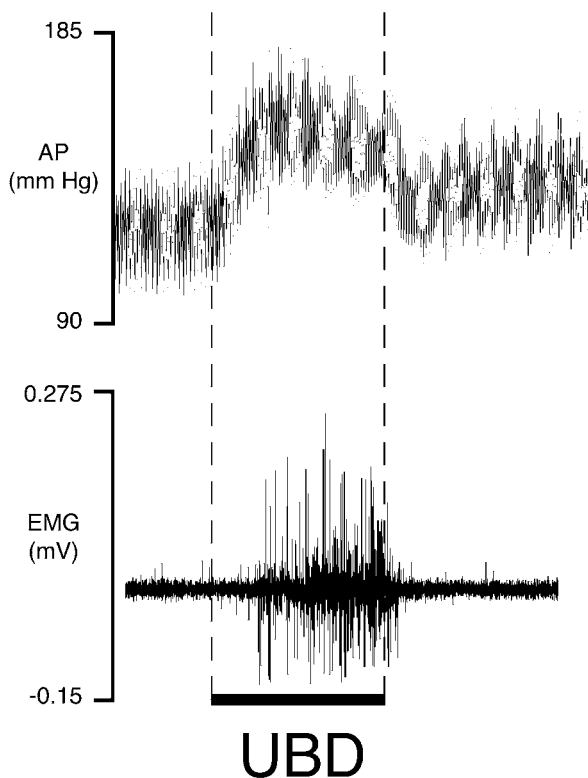
Highly localized motor reflexes such as a flexion-withdrawal response to a pinprick of the foot are nocifensive. The limb is reflexively pulled away from the damaging stimulus, the threat to the body is removed and pain generation is minimized. In visceral systems, a similar, direct link between tissue damage and protective behaviors is not obvious. There are typical behaviors in non-human animals evoked by visceral stimuli that would be pain-producing in humans, but these responses do not generally remove the threat to the organism. Abdominal licking, contractions of abdominal muscles and changes in heart rate, blood pressure, and respiratory pattern can all be evoked by stimulation of the urinary bladder of rats. These types of responses were called pseudoaffective responses by Sherrington, in that they appeared to be reflex correlates to emotional responses to painful stimuli (Woodworth and Sherrington 1904). Pseudoaffective responses are not specific to pain-producing stimuli, but when it can be demonstrated that they are inhibited by pharma-

cological manipulations known to be analgesic (i.e. morphine) the case for their correlation with accepted nocifensive reflexes becomes stronger.

There have been numerous characterizations of responses to noxious urinary bladder stimulation in non-human animals, many of which have been utilized as models of urinary bladder pain. The stimuli for these models can be broadly stratified into those that use mechanical stimuli to activate afferents arising in the bladder (typically by air or fluid distension using a catheter), and those which chemically activate/sensitize afferents arising in the bladder using irritants. These irritants may be administered directly into the bladder using a catheter, or indirectly by the renal excretion of irritating urinary constituents.

### Responses to Urinary Bladder Distension (UBD)

Pseudoaffective responses to UBD (vigorous cardiovascular and visceromotor reflexes) have been demonstrated in numerous species including rats, mice, guinea pigs, rabbits, cats, dogs and monkeys. Such studies related to nociception have commonly used a progressively increasing UBD stimulus, similar to that used in studies of micturition but at a much faster rate of filling, or have produced a phasic (on-off) stimulus



**Nocifensive Behaviors of the Urinary Bladder, Figure 2** Examples of cardiovascular (arterial pressure AP; above) and distension (UBD) in a halothane-anesthetized rat. Visceromotor responses can be measured by direct visualization or electromyographically (EMGs), as in the figure. Responses are graded in response to graded UBD.

through the use of a rapid, near instantaneous, infusion of air or saline. In anesthetized animals, vigorous neuronal and reflex responses can be evoked (e.g. Westropp and Buffington 2002). These responses can be inhibited by analgesics. Reliable and reproducible pressor responses and contractions of the abdominal musculature (► **visceromotor responses** measured by electromyogram) evoked by UBDs have been characterized (e.g. Ness et al. 2001) (Fig. 2) with gender differences (see ► **Gender and Pain**) and gonadal hormonal influences apparent. Genetic models of painful bladder disorders such as the feline interstitial cystitis model have utilized such responses to bladder stimulation as endpoints (Westropp and Buffington 2002.) Sensitizing chemicals associated with inflammation when administered into the urinary bladder lead to more vigorous responses to UBD, particularly at low intensities of stimulation (Dmitrieva and McMahon 1996).

### Responses to the Intravesical Instillation of Proinflammatory Compounds

Inflammation of the bladder commonly produces reports of pain and urgency in patients suffering from a urinary tract infection. Enhanced micturition reflexes lead to spasms of pain. Experiments in non-human animals have artificially inflamed or sensitized the bladder with the intravesical administration of inflammation-inducing compounds such as turpentine, mustard oil, croton oil and neurotrophic agents. Such irritation has been demonstrated to produce alterations in the spontaneous activity of primary afferent neurons encoding for bladder stimuli (e.g. Dmitrieva and McMahon 1996) and spontaneous behavioral responses. Most reflex studies have been performed in rats, although behavioral and neurophysiological studies have been performed in primates and cats.

McMahon and Abel (1987) characterized visceromotor and altered micturition reflexes in chronically decerebrate rats, and demonstrated that following the administration of an irritant, the magnitude of responses to UBD correlated with measures of inflammation such as tissue edema, plasma extravasation and leukocyte infiltration. While becoming more sensitive to bladder-related stimuli, the rats at the same time became hypersensitive to noxious stimuli applied to the lower abdomen, perineum and tail, as measured by the number of “kicks” evoked by a given stimulus. The model of McMahon and Abel (1987) has been modified to examine pharmacologically novel mechanisms related to visceral hyper-reflexia (altered cystometrograms) or secondary hyperalgesia (decreased thresholds to heat stimuli in hindlimbs). Modulatory effects of glutamate-receptor antagonists, nitric oxide synthase inhibitors, neurotrophic antagonists, cannabinoids and bradykinin receptor antagonists have all been noted (e.g. Jagger et al. 1999).

### Responses to the Direct Application of Irritants

Administration of intravesical irritants via a chronically implanted intravesical catheter was described by Abelli et al. (1989) and modified by Craft et al. (1993). An injection of xylene, capsaicin or its related compound resiniferatoxin is performed via an intravesical cannula placed a day earlier. Immediate responses include abdominal/perineal licking, headturns, hindlimb hyperextension, head grooming, biting, vocalization, defecation, scratching and salivation, all of which can be independently measured and graded. The time to onset, incidence and number of individual behavioral responses are recorded for fifteen minutes or more following intravesical drug administration. Baclofen, mu/kappa/delta opioid receptor agonists and intravesical tetracaine have all been demonstrated to inhibit these behavioral responses. Bladder denervation abolishes all behavioral responses.

### Responses to Cyclophosphamide (Chemotherapy-Induced Cystitis)

Subacute, irritant-induced urinary bladder inflammation occurs secondary to antineoplastic regimens that include the chemotherapeutic agent cyclophosphamide (CP). In humans, pain and increased urgency/frequency are sequelae of this treatment, although use of sodium 2-mercaptoethane sulfonate reduces the metabolite of CP that is the actual irritant, acrolein. In non-human animal models, CP is administered intraperitoneally, which evokes behavioral responses such as hypolocomotion and alterations in position (e.g. Lanteri-Minet et al. 1995). Chronic (2 week) treatments with CP have also been described with numerous physiological and biochemical alterations (e.g. Vizzard et al. 1996). Olivar and Laird (1999) have characterized similar responses to acutely administered CP in mice.

### Conclusions

Numerous responses to urinary bladder stimulation have been noted. Other than enhanced micturition reflexes, none of these responses fit the precise criteria of nocifensive reflexes, in that they are not generally protective reflexes that remove the noxious stimulus. They are nociceptive reflexes in that they do appear to be representative of the sensory processing related to pain from the bladder, and should be expected to be predictive of pharmacological or procedural manipulations intended to treat urinary bladder pain.

### References

- Abelli L, Conte B, Somme V, Maggi CA, Girliani S, Meli A (1989) A Method for Studying Pain Arising from the Urinary Bladder in Conscious, Freely-Moving Rats. *J Urol* 141:148-151
- Athwal BS, Berkley KJ, Hussain I et al. (2001) Brain Responses to Changes in Bladder Volume and Urge to Void in Healthy Men. *Brain* 124:369-377
- Craft RM, Carlisi VJ, Mattia A, Herman RM, Porreca F (1993) Behavioral Characterization of the Excitatory and Desensitizing Effects of Intravesical Capsaicin and Resiniferatoxin in the Rat. *Pain* 55:205-215
- Dmitrieva N, McMahon SB (1996) Sensitisation of Visceral Afferents by Nerve Growth Factor in the Adult Rat. *Pain* 66 87-97
- Giannantoni A, Di Stasi SM, Stephen RL, Navarra P, Scivoletto G, Mearini E, Porena M. (2002) Intravesical Capsaicin versus Resiniferatoxin in Patients with Detrusor Hyperreflexia: A Prospective Randomized Study. *J Urol* 167:1710-1714
- Jaggar SI, Scott HCF, Rice ASC (1999) Inflammation of the Rat Urinary Bladder is Associated with a Referred Hyperalgesia which is NGF Dependent. *Br J Anaesth* 83:442-448
- Lanteri-Minet M, Bon K, de Pommery J, Michiels JF, Menetrey D (1995) Cyclophosphamide Cystitis as a Model of Visceral Pain in Rats: Model Elaboration and Spinal Structures Involved as Revealed by the Expression of c-Fos and Krox-24 Proteins. *Exp Brain Res* 105:220-232
- McMahon SB, Abel C (1987) A Model for the Study of Visceral Pain States: Chronic Inflammation of the Chronic Decerebrate Rat Urinary Bladder by Irritant Chemicals. *Pain* 28:109-127
- Ness TJ, Gebhart GF (2001) Methods in Visceral Pain Research. In: Kruger L (ed) *Methods in Pain Research*. CRC Press, New York, pp 93-108
- Ness TJ, Lewis-Sides A, Castroman PJ (2001) Characterization of Pseudoaffective Responses to Urinary Bladder Distension in the Rat: Sources of Variability and Effect of Analgesics. *J Urol* 165:968-974
- Ness TJ, Richter HE, Varner RE et al. (1998) A Psychophysical Study of Discomfort Produced by Repeated Filling of the Urinary Bladder. *Pain* 76:61-69
- Olivar T, Laird JM (1999) Cyclophosphamide Cystitis in Mice: Behavioral Characterization and Correlation with Bladder Inflammation. *Eur J Pain* 3:141-149
- Vizzard MA, Erdman SL, de Groat WC (1996) Increased Expression of Neuronal Nitric Oxide Synthetase in Bladder Afferent Pathways following Chronic Bladder Irritation. *J Comp Neurol* 370:191-202
- Westropp JL, Buffington CAT (2002) *In Vivo* Models of Interstitial Cystitis. *J Urol* 167:694-702
- Woodworth RS, Sherrington CS (1904) A Pseudoaffective Reflex and its Spinal Path. *J Physiol (Lond)* 31:234-243

## Nodes of Ranvier

### Definition

Axonal zones within gaps in myelin in which excitation occurs.

- ▶ Trafficking and Localization of Ion Channels

## Nodose Ganglia

### Definition

Vagal ganglia containing cell bodies of vagal afferent fibers.

- ▶ Visceral Pain Model, Esophageal Pain

## Nomogenic Symptoms and Signs

- ▶ Non-Organic Symptoms and Signs

## Non-Anatomic Symptoms and Signs

- ▶ Non-Organic Symptoms and Signs

## Non-Cardiac Chest Pain

- ▶ NCCP

## Non-Competitive Antagonist

### Definition

Non-competitive antagonist is a compound that inhibits receptor function without directly acting at the endogenous ligand binding site.

- ▶ Metabotropic Glutamate Receptors in Spinal Nociceptive Processing

## Non-Corpuscular Sensory Endings

### Synonyms

Free nerve endings

### Definition

The peripheral end structures of unmyelinated (C or Group IV) and thinly myelinated (A $\delta$  or Group III) sensory fibers that encode noxious, cold or warm stimuli, that consist of either single fibers or bundles of sensory axons associated with peripheral glia (Schwann cells), and that are characterized by their lack of perineurium and the loss of myelination in A $\delta$  endings. Typically, the sensory axons of nociceptive sensory endings have exposed membrane areas that are not covered by Schwann cell processes and can be regarded as chemoreceptive sites.

- ▶ Nociceptors in the Orofacial Region (Meningeal/Cerebrovascular)
- ▶ Toxic Neuropathies

## Non-Drug Treatment

- ▶ Psychological Treatment of Headache

## Nonexertional Capability

### Definition

Capability to perform any of the nonexertional activities, which are activities other than any of the seven strength demands of work.

- ▶ Disability Evaluation in the Social Security Administration

## Nonexertional Limitations and Restrictions

### Definition

Limitations or restrictions that affect the capability to perform a work-related function that is not exertional, i.e. a limitation or restriction of mental abilities, vision, hearing, speech, climbing, balancing, stooping, kneeling, crouching, crawling, reaching, handling, fingering, and feeling, or an environmental restriction.

- ▶ Disability Evaluation in the Social Security Administration

## Non-Neurogenic Inflammation

### Definition

Inflammatory processes that are not specifically initiated by activity in primary afferent C-fibers; typically this includes inflammatory processes initiated by mediators released from resident or circulating monocytes and leukocytes, including prostaglandins, prostacyclins, leukotrienes, and cytokines, to name a few.

- ▶ Formalin Test

## Non-Nutritive Sucking

### Definition

Placing an object (e.g. pacifier, non-lactating nipple) into an infant's mouth to stimulate sucking behaviors during a painful event.

- ▶ Acute Pain Management in Infants

## Nonopioid Analgesia

### Definition

Type of pain inhibition NOT meeting any of the criteria for opiate mediated effects (including blockade by opiate antagonists and cross-tolerance with opiate agonists).

- ▶ Pain Modulatory Systems, History of Discovery



## Non-Migraine Headaches

HANS-CHRISTOPH DIENER

Department of Neurology, University of  
Duisburg-Essen, Essen, Germany  
h.diener@uni-essen.de

► **Migraine** is the best investigated and understood headache entity. About 50% of all headache publications deal with migraine. The International Headache Society created a headache classification in 1988 (Headache Classification Committee 1998), which was updated in 2004 (Olesen et al. 2004). This classification contains all other headaches in addition to migraine and provides operational criteria for diagnosis. Headaches are grouped into primary and secondary headaches. Primary headaches are migraine, ► **tension type headache** and the trigemino-autonomic headaches.

Tension type headache is the most frequent headache. The new classification distinguishes infrequent from frequent episodic tension type headache. ► **Chronic tension type headache** is diagnosed when >180 headache days/year are occurring. The group of trigemino-autonomic headaches is characterised by headaches with autonomic features, e.g. conjunctival injection, lacrimation, nasal congestion, rhinorrhoea, forehead and facial sweating, miosis, ptosis or eyelid oedema (Goadsby and Lipton 1997). This group of headaches includes paroxysmal and chronic cluster headaches, episodic and ► **chronic paroxysmal hemicrania** (Sjaastad and Dale 1976) and short lasting unilateral neuralgiform headache attacks with conjunctival injection and tearing (► **SUNCT**) (Sjaastad et al. 1991). Other primary headaches include primary stabbing headache (Pareja et al. 1996), ► **primary cough headache** (Symonds 1956), ► **primary exertional headache**, primary headache associated with sexual activity (Pascual et al. 1996) and ► **hypnic headache**. In all headaches with provocation by physical activity, a secondary headache such as subarachnoidal haemorrhage has to be excluded. Hypnic headache occurs in elderly women during the nighttime and responds to treatment with lithium (Raskin 1988; Newman et al. 1990). New entities in this group are ► **hemicrania continua** (Sjaastad and Spierings 1984), a chronic headache and new daily persistent headache (Li and Rozen 2001). ► **New daily persistent headache** has similar characteristics to chronic tension headache but an abrupt onset without improvement.

Secondary headaches are related to physical changes to the brain, the head or the neck. Headache attributed to head and/or neck trauma is divided into acute and chronic headache. This group includes acute and

chronic post-traumatic headache (Young and Packard 1997), acute headache attributed to whiplash injury, headache attributed to intracranial haematomas (subdural, epidural), headache attributed to other head and/or neck trauma and postcraniectomy headache.

A large group of secondary headaches are headaches attributed to cranial or cervical vascular disorders. Headache in these cases can be due to cerebral ischaemia, cerebral bleedings or an unruptured AV malformation or aneurysm. Other reasons for headache are arteriitis (giant cell and intracranial arteriitis), cerebral venous thrombosis and dissections of the carotid or vertebral arteries. Migraine is a risk factor for stroke and may lead to an ischaemic stroke during the aura phase (Diener et al. 2004).

The next group in the classification defines headaches attributed to intracranial non-vascular causes. High (Wall 1990) as well as low (Lay et al. 1997) intracranial pressure causes headache. ► **Headache attributed to low cerebrospinal fluid pressure** can occur spontaneously or be the result of lumbar puncture. Increased intracranial pressure is due in most cases to intracranial neoplasms or hydrocephalus. Headache attributed to non-infectious inflammatory disease can be due to neurosarcoidosis, aseptic meningitis or lymphocytic hypophysitis. Another interesting association exists between epilepsy and migraine (Leniger et al. 2003). Migraine auras can lead to a seizure and a tonic-clonic seizures may trigger a migraine attack.

A major revision took place in the classification of ► **headaches attributed to substance use or withdrawal**. This section includes acute headache provoked by drugs or chemical substances such as nitric oxide donors, phosphodiesterase inhibitors or carbon monoxide, but also food components, e.g. alcohol or monosodium glutamate. Recreational drugs such as heroin, cocaine and cannabis can cause headache. A new concept is medication overuse headache (Diener and Limmroth 2004). The frequent or regular use of drugs to treat acute headaches can lead to a chronic headache or deterioration of a pre-existing headache. Medication overuse headache can be due to analgesics, combination drugs, ergots, triptans or opioids. Withdrawal of substances, e.g. caffeine, oestrogen or opioids can also result in headache.

Headache attributed to infections is associated with bacterial meningitis, lymphocytic meningitis, encephalitis, brain abscess or subdural empyema. Headache can also be due to systemic infection with bacteria, viruses (including HIV) or other systemic infections.

Group 10 summarizes headaches associated with disorders of homeostasis. In this group are headaches due to hypoxia and/or hypercapnia, to arterial hypertension, hypothyroidism and fasting. Headache and facial

pain attributed to disorders of cranium, neck, eye, ears nose, sinuses, teeth, mouth or other facial or cranial structures will be covered in another part of the encyclopedia.

### References

1. Diener HC, Limmroth V (2004) Medication-overuse headache: a worldwide problem. *Lancet Neurology* 3:475–483
2. Diener H, Welch K, Mohr JP (2004) Migraine and stroke. In: Mohr J, Choi D, Grotta J et al. (eds) *Stroke. Pathophysiology, diagnosis and management*. Churchill Livingstone, Philadelphia
3. Goadsby PJ, Lipton RB (1997) A review of paroxysmal hemiplegias, SUNCT syndrome and other short-lasting headaches with autonomic features, including new cases. *Brain* 120:193–209
4. Headache Classification Committee of the International Headache Society (1988) Classification and diagnostic criteria for headache disorders, cranial neuralgias and facial pain. *Cephalalgia* 8 (Suppl.7):1–93
5. Lay CL, Campbell JK, Mokri B (1997) Low cerebrospinal fluid pressure headache. In: Silberstein SD, Goadsby P (eds) *Headache*. Butterworth-Heinemann, Newton, pp 359–368
6. Leniger T, von den Driesch S, Isbruch K et al. (2003) Clinical characteristics of patients with comorbidity of migraine and epilepsy. *Headache* 43:672–677
7. Li D, Rozen TD (2001) The clinical characteristics of new daily persistent headache. *Neurology* 56 (Suppl 3):A452–A453
8. Newman LC, Lipton RB, Solomon S (1990) The hypnic headache syndrome: a benign headache disorder of the elderly. *Neurol* 40:1904–1905
9. Olesen J, Bousser M-G, Diener H et al. for the International Headache Society (2004). *The International Classification of Headache Disorders*. 2nd edn. Cephalalgia 24 (Suppl 1):1–160
10. Pareja JA, Ruiz J, Deisla C et al. (1996) Idiopathic stabbing headache (jabs and jolts syndrome). *Cephalalgia* 16:93–96
11. Pascual J, Iglesias F, Oterino A et al. (1996) Cough, exertional, and sexual headaches: an analysis of 72 benign and symptomatic cases. *Neurol* 46:1520–1524
12. Raskin NH (1988) The hypnic headache syndrome. *Headache* 28:534–536
13. Sjaastad O, Dale I (1976) A new (?) clinical headache entity “chronic paroxysmal hemicrania” *Acta Neurol Scand* 54:140–159
14. Sjaastad O, Spierings EL (1984) Hemicrania continua: another headache absolutely responsive to indomethacin. *Cephalalgia* 4:65–70
15. Sjaastad O, Zhao JM, Kruszewski P et al. (1991) Short-lasting unilateral neuralgiform headache attacks with conjunctival injection, tearing, etc. (SUNCT): III. Another Norwegian case. *Headache* 31:175–177
16. Symonds C (1956) Cough headache. *Brain* 79:557–568
17. Wall M (1990) The headache profile of idiopathic intracranial hypertension. *Cephalalgia* 10:331–335
18. Young WB, Packard RC (1997) Posttraumatic headache and posttraumatic syndrome. In: Goadsby PJ, Silberstein SD (eds) *Headache*. Butterworth-Heinemann, New York

## Nonopioid Analgesic Drug

### Definition

Drugs that relieve pain by other mechanisms than interacting with opioid receptors, e.g. paracetamol and NSAIDs.

- ▶ Cancer Pain Management
- ▶ NSAIDs, Survey
- ▶ Postoperative Pain, Acute Pain Management, Principles

## Nonorganic Physical Findings (Waddell Signs)

### Definition

A group of low back pain physical signs that were identified in the past as being nonorganic, and therefore the presence of which has historically indicated that the patient is either suffering from conversion disorder or malingering.

## Non-Organic Symptoms and Signs

GORDON WADDELL  
University of Glasgow, Glasgow, UK  
gordon.waddell@virgin.net

### Synonyms

Behavioral Responses to Examination; Behavioral Descriptions of Symptoms; Inappropriate Symptoms and Signs; Inconsistent Symptoms and Signs; Medically Incongruent Symptoms and Signs; Non-Anatomic Symptoms and Signs; Nomogenic Symptoms and Signs; Waddell Signs

### Definition

Descriptions of symptoms and responses to clinical examination in patients with low back pain, which relate more to cognitive-behavioral processes than to physical pathology.

### Characteristics

Clinical assessment and diagnosis are based on the recognition of patterns of symptoms and signs, which in most patients fit to a greater or lesser degree with anatomy, mechanics and pathology. Occasional patients, however, present symptoms and signs that are not only vague and ill-localized, lack the normal relationship with time and activity, and appear out of proportion to the physical injury or pathology, but positively contradict normal anatomic boundaries and biomechanics.

Non-organic signs in low back pain have been recognized since the beginning of the 20<sup>th</sup> century, initially in the context of compensation assessment, where any

**Non-Organic Symptoms and Signs, Table 1** Standardized battery of non-organic signs in low back pain

tenderness	superficial
	non-anatomic
simulation	axial loading
	simulated rotation
distraction	straight leg raising
regional	weakness
	sensory disturbance
over-reaction to examination	Subsequently replaced by overt pain behavior (Keefe and Block 1982)
	Grimacing, sighing, guarding, bracing, rubbing

clinical findings that were judged excessive or not entirely consistent with physical injury, were interpreted as evidence of malingering. That over-simplification gradually became discredited. The modern description by Waddell et al. (1980) standardized a battery of non-organic signs (Table 1), and re-interpreted them in the light of modern understanding of illness behavior. Waddell et al. (1984) subsequently developed a corresponding battery of non-organic or behavioral descriptions of symptoms in low back pain (see list below), though these have never received as much attention or use as the non-organic signs.

Non-organic or behavioral descriptions of symptoms in low back pain:

- Pain at the tip of the tailbone
- Whole leg pain
- Whole leg numbness
- Whole leg giving way
- Complete absence of any spells with very little pain in the past year
- Intolerance of, or reactions to, many treatments
- Emergency admission(s) to hospital with nonspecific low back pain.

These groups of non-organic symptoms and signs were demonstrated to be reliable, internally consistent, separable from the standard symptoms and signs of physical pathology, and related to psychological distress and other measures of illness behavior. Independent studies (reviewed in detail in Waddell 2004) have since confirmed that they relate to: measures of physical impairment, severity of pain and poorer physical performance (though there is debate about the extent to which these reflect physical impairment or illness behavior); affective measures of pain and psychological distress; other measures of illness behavior (the pain drawing, overt pain behavior, UAB pain behavior scale, and various scales of

the Illness Behavior Questionnaire); disability and incapacity; and the prediction of clinical outcomes (but not occupational outcomes) of conservative and surgical treatment and rehabilitation. Non-organic symptoms and signs were initially observed in patients with chronic low back pain, and illness behavior was considered to be the consequence of chronicity. It is now clear that they can occur at a much earlier stage, reflecting the involvement of illness behavior in the process of chronification. Illness behavior is learned and a form of communication between patients and health professionals.

Non-organic symptoms and signs can help to clarify clinical assessment by:

- Distinguishing and hence permitting separate assessment of physical and behavioral elements in the clinical presentation
- Providing a simple clinical screen for psychological and behavioral issues in the clinical presentation, indicating the need for more detailed psychological assessment
- Clarifying clinical decision making - helping to direct physical treatment to treatable pathology, and reducing inappropriate physical treatment; helping to identify patients who may need more psychological support

N

However, there are a number of important caveats to their use (Main and Waddell 1998; Waddell 2004):

1. Diagnostic triage should be performed first, to exclude serious spinal pathology (such as tumor or infection), widespread neurological disorders (involving multiple nerve roots) or major psychiatric disorders (e.g. psychosis or major depression) before assessing non-organic symptoms and signs.
2. Clinical observation of illness behavior depends on careful technique and it is important to minimize observer bias.
3. Isolated behavioral symptoms and signs are common in normal patients and of no clinical, psychological or behavioral significance. Only multiple positive findings (preferably of several different dimensions of illness behavior) are clinically significant.
4. Behavioral symptoms and signs do not provide any information about the original cause of the pain: they do not mean that the patient's pain is 'not real', 'psychogenic' or 'hysterical'.
5. It is not a differential diagnosis between physical disease and illness behavior: most patients have both a physical problem in their backs and varying degrees of illness behavior. Inability to demonstrate the physical basis of the pain does not mean that the pain is psychogenic, any more than the presence of illness behavior excludes a treatable physical problem. Diagnosis of psychological dysfunction and illness behavior depends on positive psychological and behavioral findings.

6. Non-organic symptoms and signs are only a preliminary clinical screening test, indicating the need for more detailed clinical and psychological assessment. Clinical observations of illness behavior do not provide a complete psychological assessment or a psychological or psychiatric diagnosis. They are less sensitive than psychometric measures for detecting distress, so there is a significant false negative rate.
7. Non-organic symptoms and signs are not lie-detectors, but observations of normal human behavior in illness. They do not necessarily mean that the patient is acting, faking or malingering. Most illness behavior occurs in pain patients who have no claim for compensation or any question of secondary gain.

This was summarized in the original article (Waddell et al. 1980):

It is safer to assume that all patients complaining of back pain have a physical source of pain in their back. Equally, all patients with pain show some emotional and behavioral reaction. Physical pathology and non-organic reactions are discrete and yet frequently interacting dimensions; they are not alternative diagnoses but should each be assessed separately.

Non-organic signs are widely used – and misused – in surgical, compensation and medico-legal practice, but there is continuing controversy about their value and interpretation. There are two main criticisms (which are mutually exclusive):

1. Pain specialists have argued that modern neurophysiologic and clinical understanding of chronic pain provides a purely biologic explanation for these findings (Merskey 1988; Margoles 1990; Fishbain et al. 2003). Neurophysiologic mechanisms can produce spread of pain and tenderness, hypersensitivity, altered sensation and inhibition of motor activity, in the absence of other evidence of illness behavior. That is why non-organic symptoms and signs must be elicited and interpreted with care, and isolated findings should not be over-interpreted. However, non-organic symptoms and signs often spread far beyond any likely neurophysiologic mechanism and fit better with body image patterns, they form part of a constellation of other illness behaviors and correlate with other psychological findings.
2. On the contrary, many medicolegal experts claim that non-organic symptoms and signs demonstrate conscious and deliberate attempts to deceive the examiner, and evidence of faking or malingering. The scientific evidence in this area is weak (Fishbain et al. 1999; Waddell 2004) but this is a legal rather than a clinical matter. Case law leaves no doubt that non-organic symptoms and signs can occur in patients with other evidence of lack of credibility and represent conscious attempts to exaggerate the severity of pain and disability. However, there is

a wealth of clinical and legal evidence that illness behavior can also be produced by unconscious, psychological mechanisms. Thus, non-organic signs per se do not provide sufficient evidence to prove malingering. As in the clinical setting, non-organic signs are a screening tool: they may raise the question of credibility, but they do not provide an answer – that depends on thorough assessment and judgment of all the clinical, psychological and legal evidence.

Non-organic symptoms and signs have only been standardized in white Anglo-Saxon patients of working age with chronic low back pain. Further research would be required before they can be used in younger or older patients, in non-white patients, or in different cultures. In principle, it appears likely that the concept of non-organic symptoms and signs may be equally applicable to other pain conditions, although there have only been a few preliminary studies in neck pain, other musculoskeletal conditions and cardiac pain and their use without low back pain is not established.

Non-organic symptoms and signs are a powerful tool to extend the scope of routine clinical assessment of patients with low back pain, provided care is taken to define what they are and what they are not, and to recognize their strengths and their limitations. Like all clinical tools, they must be used with care and compassion.

## References

1. Fishbain DA, Cole B, Cutler RB, Lewis J, Rosmoff HL, Rosomoff RS (2003) A Structured, Evidence-Based Review of the Meaning of Non-organic Physical Signs: Waddell Signs. *Pain Med* 4:141–181
2. Fishbain DA, Cutler R, Rosomoff HL, Rosomoff RS (1999) Chronic Pain Disability Exaggeration/Malingering and Submaximal Effort Research. *Clin J Pain* 15:244–274
3. Keefe FJ, Block AR (1982) Development of an Observation Method for Assessing Pain Behavior in Chronic Low Back Pain Patients. *Behav Ther* 13:363–375
4. Main CJ, Waddell G (1998) Behavioral Responses to Examination. A Reappraisal of the Interpretation of “Non-organic Signs” *Spine* 23:2367–2371
5. Margoles MS (1990) Clinical Assessment and Interpretation of Abnormal Illness Behaviour in Low Back Pain. Letter to the Editor. *Pain* 42:258–259
6. Merskey H (1988) Regional Pain is Rarely Hysterical. *Arch Neurol* 45:915–918
7. Waddell G (2004) *The Back Pain Revolution*, 2<sup>nd</sup> edn. Churchill Livingstone, Edinburgh
8. Waddell G, Main CJ, Morris EW, Di Paola MP, Gray ICM (1984) Chronic Low Back Pain, Psychological Distress, and Illness Behavior. *Spine* 9:209–213
9. Waddell G, McCulloch JA, Kummel E, Venner RM (1980) Non-Organic Physical Signs in Low Back Pain. *Spine* 5:117–125

## Non-Pharmacologic Pain Management

### Definition

Non-pharmacologic pain management includes all approaches to pain control that don't involve drug therapies, such as distraction (e.g. music), psychological



interventions (e.g. imaging/visualization, relaxation, meditation), biofeedback, massage, aromatherapy, physical modalities (electrical stimulation, heat, cold), etc.

- ▶ Opioids in Geriatric Application

## Non-Pharmacological Interventions

### Definition

Non-pharmacological interventions are used to prevent and manage newborn pain and distress. It refers to the use of comfort measures and the modification of environmental factors. Comfort measures may include flexed positioning with limb containment, non-nutritive sucking, skin-to-skin contact, rocking, holding, breast feeding and sucrose. Environment and caregiving (provided by health professionals) strategies include the use of light touch and reducing ambient sound and light levels.

- ▶ Pain Assessment in Neonates

## Non-Pharmacological Treatment

### Definition

Nonmedical, psychologically-based treatments that teach individuals skills so that they may handle pain in a more optimal manner.

- ▶ Biofeedback in the Treatment of Pain
- ▶ Psychological Treatment of Headache

## Non-Selective COX-Inhibitors

- ▶ NSAIDs, Mode of Action

## Non-Specific Low Back Pain

### Definition

Low back pain that is not due to specific pathology such as tumor, fracture, inflammation, osteoporosis, or rheumatoid arthritis.

- ▶ Back Pain in the Workplace
- ▶ Lumbar Traction

## Non-Steroidal Anti-Rheumatic Drugs

- ▶ Non-Steroidal Anti-Inflammatory Drugs (NSAIDs)
- ▶ NSAIDs, Adverse Effects

## Non-Structural Disorders

- ▶ Visceral Pain Model, Irritable Bowel Syndrome Model

## Non-Systemic (Isolated) Vasculitic Neuropathy

### Synonyms

NVNP

### Definition

Neuropathy caused by vasculitis confined to the peripheral nervous system.

- ▶ Vascular Neuropathies

## Nonthermal Effects

### Definition

Effects produced by nominally thermal agents that do not directly result from heating or cooling. Examples of nonthermal effects include cavitation (the production of bubbles in liquids and tissues) in ultrasound, as well as the proposed and established benefits of low intensity pulsed delivery of the diathermies.

- ▶ Therapeutic Heat, Microwaves and Cold

## Non-Topographic

### Definition

Non-topographic organization contrasts with topographic/somatotopic organization and favors the notion that the region is involved in affect-motivation. Khanna and Sinclair (1992) reported that a noxious heat stimulus, whether applied to the hind paw or the tail, suppressed CA3 stimulation-elicited CA1 pyramidal cell excitation at a given site in the hippocampus.

- ▶ Nociceptive Processing in the Hippocampus and Entorhinal Cortex, Neurophysiology and Pharmacology

## Non-Traditional Medicine

- ▶ Alternative Medicine in Neuropathic Pain

## Non-Steroidal Anti-Inflammatory Drugs (NSAIDs)

GERD GEISSLINGER

Institute for Clinical Pharmacology, pharmazentrum Frankfurt/ZAFES, Clinical Centre of the Johann Wolfgang Goethe University Frankfurt am Main, Frankfurt, Germany  
geisslinger@em.uni-frankfurt.de

### Synonyms

NSAIDs; non-steroidal anti-inflammatory drugs; Non-Steroidal Anti-Rheumatic Drugs; NSAR; Aspirin-Like Drugs; non-opioid analgesics

### Definition

Non-opioid analgesic agents can be divided into two groups. The first group contains substances having anti-inflammatory effects in addition to their analgesic and antipyretic activity and are called non-steroidal anti-inflammatory drugs (NSAIDs). The members of this group, and one substance (lumiracoxib) within the group of selective inhibitors of cyclooxygenase 2 (COX-2), are acids. Acidic NSAIDs, which include salicylates, derivatives of acetic acid and propionic acid and oxicams among others, comprise molecules containing a lipophilic and a hydrophilic region and are more than 99% bound to plasma proteins. The second group of non-opioid analgesics, which are not classified as NSAIDs, consists of substances that lack anti-inflammatory properties, such as phenazones, metamizole (= dipyrone) and paracetamol. Their molecules are neutral or weakly basic, have no hydrophilic polarity and are much less strongly bound to plasma proteins than NSAIDs (see ► [NSAIDs, chemical structure and molecular mode of action](#)).

### Mechanism of Action

In the 1970s, NSAIDs were shown to interfere with the biosynthesis of prostaglandins (Vane 1971). NSAIDs block cyclooxygenases (COX) that catalyze the formation of cyclic endoperoxides from arachidonic acid. Cyclic endoperoxides are precursors of the prostaglandins, thromboxane A<sub>2</sub> and prostacyclin. Prostaglandins have a major role in the pathogenesis of pain, fever and inflammation. Inhibition of their biosynthesis would therefore be expected to result in analgesic, antipyretic and anti-inflammatory activity. However, since prostaglandins are synthesised in most tissues and have a variety of physiological functions, inhibition of their biosynthesis also causes unwanted effects. The clinically most important of these are gastrointestinal erosion and ulceration with

bleeding and perforation and kidney disorders with retention of sodium ions and water. About 30 years ago the principle mode of the antinociceptive action of NSAIDs was related to their anti-inflammatory activity and attributed to the inhibition of the production of prostaglandins at the peripheral site of inflammation. The traditional belief in the exclusively peripheral action of NSAIDs, however, has been challenged by the growing evidence that prostaglandins are key players in spinal nociceptive processing. Thus, NSAIDs have a peripheral and central component of antinociceptive activity (see essays on ► [history of analgesics](#); ► [COX-1 and COX-2 in pain](#); ► [NSAIDs and their indications](#); ► [prostaglandins, spinal effects](#); ► [NSAIDs, adverse effects](#)).

Moreover, there are cyclooxygenase independent effects of NSAIDs potentially contributing to the activity of NSAIDs (for review, see Tegeder et al. 2001) (see also ► [NSAIDs, COX-independent actions](#); ► [NSAIDs and cancer](#)).

The identification of two distinct types of cyclooxygenases in 1990 (Fu et al. 1990) encouraged the search for NSAIDs devoid of the side effects associated with COX-1 inhibition. The cyclooxygenase isoform COX-1 is physiologically expressed in the stomach, platelets and the kidney and is there responsible for the synthesis of prostaglandins needed for normal organ function. Its inhibition by conventional NSAIDs causes side effects e.g. inhibition of prostaglandin synthesis in the gastrointestinal tract results in a loss of protection in the gastrointestinal mucosa and ulcerations. The cyclooxygenase isoform, COX-2 is rapidly induced by various factors including cytokines and its expression is triggered by inflammation, pain or tissue damage. It is clear from this division of cyclooxygenases into COX-1 and an inducible COX-2 that the anti-inflammatory, analgesic and antipyretic effects of the NSAIDs are mainly attributable to inhibition of COX-2 whereas inhibition of COX-1 is associated with most of the unwanted effects of the NSAIDs. It follows that drugs that selectively inhibit COX-2 should cause fewer side effects than those that inhibit both COX-1 and COX-2. At therapeutic doses, all currently available NSAIDs, with the exception of coxibs, are nonselective and inhibit both COX isoforms (see ► [NSAIDs, chemical structure and molecular mode of action](#)).

Newer research has shown that the assignment of physiological activity exclusively to COX-1 and pathophysiological activity exclusively to COX-2 is not strictly valid, since COX-2 is expressed constitutively in organs such as spinal cord, kidney and uterus. Furthermore, COX-2 is formed during various physiological adaptation processes, such as the healing of wounds and ulcers.

### Clinical Use and Side Effects

NSAIDs are indicated in the treatment of:

- various pain states (e.g. headache, toothache and migraine), primarily pathophysiological pain involving nociceptors e.g. rheumatic pain and pain caused by bone metastases,
- defects of the ductus arteriosus Botalli (short circuit connection between arteria pulmonalis and aorta; non-closure after birth)
- fever (see ► [NSAIDs and their indications](#))

Side effects of NSAIDs include:

- gastrointestinal disorders (e.g. dyspepsia), gastrointestinal erosion with bleeding, ulceration and perforation,
- kidney malfunctions with retention of sodium and water, hypertension
- inhibition of platelet aggregation,
- central nervous symptoms such as dizziness and headache,
- disturbance of uterine motility,
- skin reactions,
- triggering of asthma attacks in asthmatics. This side effect is a pseudo-allergic reaction where COX-inhibition increases the availability of substrates for lipoxygenase that are converted to bronchoconstrictive leukotrienes (see ► [NSAIDs, adverse effects](#) and ► [NSAID-Induced Lesions of the Gastrointestinal Tract](#)).

Non-selective inhibitors of prostaglandin synthesis are contraindicated:

- in gastric and duodenal ulcer,
- in asthma,
- in bleeding disorders,
- during the last few weeks of pregnancy because of the danger of early sealing of the ductus Botalli.

Glucocorticoids increase the risk of gastrointestinal complications. Considerable caution is necessary when using NSAIDs in patients with severe liver and kidney damage and they should not be combined with coumatins. Owing to the limited experience obtained, these precautions and contraindications also apply to COX-2 selective inhibitors.

The following drug interactions are the most important that can occur when conventional NSAIDs are co-administered with other agents:

- the uricosuric effect of probenecid is reduced
- the diuretic effect of saluretics is weakened,
- the blood glucose lowering effect of oral antidiabetics is increased,
- the elimination of methotrexate is delayed and its toxicity is increased,

- the elimination of lithium ions is delayed,
- the anti-coagulation effect of coumatin derivatives is enhanced and
- the antihypertensive effect of ACE-inhibitors is reduced (see ► [NSAIDs, pharmacokinetics](#)).

Due to the short period of clinical use, the interaction profile of COX-2 selective inhibitors cannot be described at the present time.

### Derivatives of Salicylic Acid

Salicylic acid for systemic use has been replaced by acetylsalicylic acid, amides of salicylic acid (salicylamide, ethenzamide, salacetamide), salsalate and diflunisal.

### Acetylsalicylic Acid (Aspirin)

The esterification of the phenolic hydroxyl group in salicylic acid with acetic acid results not only in an agent with improved local tolerability, but also with greater antipyretic and anti-inflammatory activity and, in particular, more marked inhibitory effects on platelet aggregation (inhibition of thromboxane-A<sub>2</sub> synthesis). Because of these qualities, acetylsalicylic acid is one of the most frequently used non-opioid analgesics and the most important inhibitor of platelet aggregation. Acetylsalicylic acid irreversibly inhibits both COX-1 and COX-2 by acetylating the enzymes. Since mature platelets lack a nucleus, they are unable to synthesize new enzyme. The anti-platelet effects of acetylsalicylic acid therefore persist throughout the lifetime of the platelet and the half-life of this effect is thus much longer than the elimination half-life of acetylsalicylic acid (15 min). Since new platelets are continuously launched into the circulation, the clinically relevant anti-platelet effect of aspirin lasts for up to 5 days. This is the reason why low doses of acetylsalicylic acid (ca. 100 mg per day) are sufficient in the prophylaxis of heart attacks.

After oral administration, acetylsalicylic acid is rapidly and almost completely absorbed, but in the intestinal mucosa it is partly deacetylated to salicylic acid, which also exhibits analgesic activity. The plasma half-life of acetylsalicylic acid is approximately 15 min, whereas that of salicylic acid at therapeutic dosages of acetylsalicylic acid is 2–3 h. Salicylic acid is eliminated more slowly when acetylsalicylic acid is administered at high dose rates because of saturation of the liver enzymes. The metabolites are mainly excreted via the kidney. The dosage of acetylsalicylic acid in the treatment of pain and fever is 1.5–3 g daily and in the prophylaxis of heart attacks 30–100 mg daily. Side effects of acetylsalicylic acid administration include buzzing in the ears, loss of hearing, dizziness, nausea, vomiting and most importantly gastrointesti-

nal bleeding and gastrointestinal ulcerations including gastric perforation. The administration of acetylsalicylic acid in children with viral infections can, in rare cases, produce Reye's syndrome, involving liver damage, encephalopathy and a mortality rate exceeding 50%. Acute salicylate poisoning results in hyperventilation, marked sweating and irritability followed by respiratory paralysis, unconsciousness, hyperthermia and dehydration.

#### Derivatives of Acetic Acid

##### Indomethacin

Indomethacin is a strong inhibitor of both cyclooxygenase isoforms with a slight stronger effect in the case of COX-1. It is rapidly and almost completely absorbed from the gastrointestinal tract and has high plasma protein binding. The plasma half-life of indomethacin varies from 3 to 11 h due to intense enterohepatic cycling. Only about 15% of the substance is eliminated unchanged in the urine, the remainder being eliminated in urine and bile as inactive metabolites (O-demethylation, glucuronidation, N-deacylation). The daily oral dose of indomethacin is 50–150 mg (up to 200 mg).

Indomethacin treatment is associated with a high incidence (30%) of side effects typical for those seen with other NSAIDs (see above). Gastrointestinal side effects, in particular, are more frequently observed after indomethacin than after administration of other NSAIDs. The market share of indomethacin (approximately 5%) is therefore low as compared to that for other non-steroidal antirheumatic agents.

##### Diclofenac

Diclofenac is an exceedingly potent cyclooxygenase inhibitor slightly more efficacious against COX-2 than COX-1. Its absorption from the gastrointestinal tract varies according to the type of pharmaceutical formulation used. The oral bioavailability is only 30–80% due to a first-pass effect. Diclofenac is rapidly metabolised (hydroxylation and conjugation) and has a plasma half-life of 1.5 h. The metabolites are excreted renally and via the bile.

Epidemiological studies have demonstrated that diclofenac causes less serious gastrointestinal complications than indomethacin. However, a rise in plasma liver enzymes occurs more frequently with diclofenac than with other NSAIDs. The daily oral dose of diclofenac is 50–150 mg. Diclofenac is also available as eye-drops for the treatment of non-specific inflammation of the eye and for the local therapy of eye pain (see ► NSAIDs, pharmacokinetics).

#### Derivatives of Arylpropionic Acid

2-arylpropionic acid derivatives possess an asymmetrical carbon atom, giving rise to S- and R-enantiomers.

The S-enantiomer inhibits cyclooxygenases 2–3 orders of magnitude more potently than the corresponding R-enantiomer. This finding has led to the marketing of pure S-enantiomers (e.g. S-ibuprofen and S-ketoprofen) in some countries in addition to the racemates where the R-enantiomer is considered as “ballast”. However, it is not yet proven whether 2-arylpropionic acids are better tolerated when given as S-enantiomer than as the racemate. Naproxen, for example, which is clinically available only as the S-enantiomer, does not cause less serious gastrointestinal side effects than, e.g. ibuprofen racemate.

Ibuprofen is the most thoroughly researched 2-arylpropionic acid. It is a relatively weak, nonselective inhibitor of COX. In epidemiological studies, ibuprofen compared to all other conventional NSAIDs, has the lowest relative risk of causing severe gastrointestinal side effects. Because of this, ibuprofen is the most frequently used OTC (“over the counter”, sale available without prescription) analgesic. Ibuprofen is highly bound to plasma proteins and has a relatively short elimination half-life (approximately 2 h). It is mainly glucuronidated to inactive metabolites that are eliminated via the kidney. The typical single oral dose of ibuprofen as an OTC analgesic is 200–400 mg and 400–800 mg when used in anti-rheumatic therapy. The corresponding maximum daily doses are 1200 or 2400 mg, respectively but the dose in anti-rheumatic therapy in some countries can be as high as 3200 mg daily.

Other arylpropionic acids include naproxen, ketoprofen and flurbiprofen. They share most of the properties of ibuprofen. The daily oral dose of ketoprofen is 50–150 mg, 150–200 mg for flurbiprofen and 250–1000 mg for naproxen. Whereas the plasma elimination half-life of ketoprofen and flurbiprofen are similar to that of ibuprofen (1.5–2.5 h and 2.4–4 h, respectively), naproxen is eliminated much more slowly with a half-life of 13–15 h (see ► NSAIDs, pharmacokinetics).

#### Oxicams

Oxicams e.g. piroxicam, tenoxicam, meloxicam and lornoxicam are non-selective inhibitors of cyclooxygenases. Like diclofenac, meloxicam inhibits COX-2 slightly more potently than COX-1. This property can be exploited clinically with doses up to 7.5 mg per day, but at higher doses COX-1 inhibition becomes clinically relevant. Since the dose of meloxicam commonly used is 15 mg daily, this agent cannot be regarded as a COX-2 selective NSAID and considerable caution needs to be exercised when making comparisons between the actions of meloxicam and those of other conventional NSAIDs. The average daily dose in anti-rheumatic therapy is 20 mg for pi-



roxicam and tenoxicam, 7.5–15 mg for meloxicam and 12–16 mg for lornoxicam. Some oxicams have long elimination half-lives (lornoxicam 3–5 h, meloxicam approximately 20 h, piroxicam approximately 40 h and tenoxicam approximately 70 h).

### COX-2 Selective NSAIDs (COXIBs)

The development of the COXIBs has been based on the hypothesis that COX-1 is the physiological COX and COX-2 the pathophysiological isoenzyme. Inhibition of the pathophysiological COX-2 only is assumed to result in fewer side effects as compared to non-selective inhibition of both COX isoenzymes. Rofecoxib and celecoxib were the first substances approved that inhibit only COX-2 at therapeutic doses. Substances with higher COX-2-selectivity than rofecoxib and celecoxib have been recently approved or will shortly be approved (e.g. etoricoxib, parecoxib, lumiracoxib).

Unlike conventional NSAIDs, with the exception of lumiracoxib the “COXIBs” have no functional acidic group. The indications for these agents are in principle identical to those of the non-selective NSAIDs, although they have not yet received approval for the whole spectrum of indications of the conventional NSAIDs. Because they lack COX-1-inhibiting properties, COX-2-selective inhibitors show fewer side effects than conventional NSAIDs. However, they are not free of side effects because COX-2 has physiological functions that are blocked by the COX-2-inhibitors. The most frequently observed side effects are infections of the upper respiratory tract, diarrhoea, dyspepsia, abdominal discomfort and headache. Peripheral oedema is as frequent as with conventional NSAIDs. The frequency of gastrointestinal complications is approximately half that observed with conventional NSAIDs. The precise side effect profile of the selective COX-2-inhibitors, however, will only be known after several years of clinical use (see ► [NSAID induced lesions of the gastrointestinal tract](#)).

On September 30, 2004, MSD voluntarily withdrew rofecoxib from the market because of a colon cancer prevention study (APPROVe) suggesting that rofecoxib nearly doubled the rate of myocardial infarction and strokes as compared to placebo. Celecoxib, a less potent selective COX-2-inhibitor with a shorter half life showed a similar dose related problem in another colon cancer prevention trial (APC), but did not show an increased risk in an Alzheimer prevention trial (ADAPT) or in another colon cancer study (PreSAP). The reasons for these discrepancies are a matter of scientific debate (Tegeger, Geisslinger 2006). Many scientists favour a group effect of all coxibs, because the balance between two fatty acids, prostacyclin and thrombox-

ane A2 that control blood clotting and vasodilation may be disturbed after intake of selective COX-2-inhibitors. As a result of this possible imbalance, the risk for cardiovascular events may increase. However, there are also data suggesting that nonselective NSAIDs are also not safe with respect to thromboembolic events. In the aforementioned ADAPT trial, the nonselective NSAID naproxen significantly increased the risk of heart attacks and stroke (see ► [NSAIDs, chemical structure and molecular mode of action](#); ► [NSAIDs and their indications](#); ► [NSAIDs, pharmacokinetics](#); ► [NSAIDs, adverse effects](#); ► [NSAIDs and cardio-vascular effects](#)).

More than 20 years ago it was shown for the first time that chronic use of NSAIDs reduces the risk of colon cancer. The molecular mechanisms of the anti-carcinogenic effects of NSAIDs are still not fully understood. Predominantly, these effects have been suggested to be due to their COX-inhibiting activity. This notion is based on the observation that COX-2 is over-expressed in more than 80% of colon carcinomas and other cancer types and that an enhanced production of prostaglandins plays a crucial role in cell proliferation and angiogenesis. However, several *in vitro* and *in vivo* results cannot be explained by an enhanced COX-2 expression and PG-synthesis indicating that COX-2 independent mechanisms must also be involved. Until now five selective COX-2 inhibitors have been developed and partly introduced into clinical practice. Of these, only celecoxib has been approved by the FDA for adjuvant treatment of patients with familial adenomatous polyposis.

It has been shown that the antiproliferative effects of celecoxib are at least in part mediated through induction of a cell-cycle block (in G<sub>1</sub>-phase) and apoptosis. These effects occurred in COX-2 expressing as well as in COX-2 deficient colon carcinoma cells (see ► [NSAIDs, COX-independent actions](#) and ► [NSAIDs and cancer](#)).

### References

1. Ferreira SH, Moncada S, Vane JR (1971) Indomethacin and aspirin abolish prostaglandin release from the spleen. *Nat New Biol* 231:237–239
2. Fu JY, Masferrer JL, Seibert K et al. (1990) The induction and suppression of prostaglandin H<sub>2</sub> synthase (cyclooxygenase) in human monocytes. *J Biol Chem* 265:16737–16740
3. Tegeger I, Pfeilschifter J, Geisslinger G (2001) Cyclooxygenase-independent actions of cyclooxygenase inhibitors. *FASEB J* 15:2057–2072
4. Tegeger I, Geisslinger G (2006) Cardiovascular risk with cyclooxygenase inhibitors: general problem with substance specific differences? *Naunyn-Schmiedeberg's Arch Pharmacol* (373):1019
5. Vane JR (1971) Inhibition of prostaglandin synthesis as a mechanism of action for aspirin-like drugs. *Nat New Biol* 231:232–235

## NOP Receptor

### Definition

The term NOP or ORL1 receptor (N for ► [Nociceptin](#) or ► [orphanin-FQ N/OFQ](#)) represents the G-protein coupled receptor that is closely related to MOP, DOP and KOP receptors, but responds to the peptide N/OFQ rather than any of the classical opioid drugs or peptides. It is expressed in many areas of the nervous system and has effects that may be analgesic or hyperalgesic depending on the anatomical region. The NOP receptor protein is produced by a single gene. When activated, the NOP receptor predominantly transduces cellular actions via inhibitory G-proteins. The electrophysiological consequences of NOP receptor activation are usually inhibitory.

- [Opioid Electrophysiology in PAG](#)

## Noradrenaline

### Definition

Noradrenaline is a catecholamine that acts as a neurotransmitter both centrally and peripherally by binding to adrenergic receptors. It is also known as norepinephrine.

- [Descending Circuitry, Transmitters and Receptors](#)

## Noradrenergic

### Definition

Neurons containing norepinephrine.

- [Stimulation-Produced Analgesia](#)

## Noradrenergic and Serotonergic Inhibitory Pathways

### Definition

Noradrenaline (acting via  $\alpha_2$  receptors) and Serotonin (acting mainly via 5-HT<sub>1</sub> receptors) both exert inhibitory effects on nociception in the dorsal horn.

- [Postoperative Pain, Transition from Parenteral to Oral Drugs](#)

## NOS

- [Nitric Oxide Synthase](#)

## Noxious Cold Receptor

- [Nociceptors, Cold Thermotransduction](#)

## Noxious Stimulus

A noxious stimulus is one that is painful and potentially damaging to normal tissues. Stimuli that are painful can be thermal, mechanical or chemical.

- [Acute Pain Mechanisms](#)
- [Arthritis Model, Kaolin-Carrageenan Induced Arthritis \(Knee\)](#)
- [Descending Modulation and Persistent Pain](#)
- [Functional Imaging of Cutaneous Pain](#)
- [Gynecological Pain, Neural Mechanisms](#)
- [Human Thalamic Response to Experimental Pain \(Neuroimaging\)](#)
- [Metabotropic Glutamate Receptors in Spinal Nociceptive Processing](#)
- [Nociceptive Processing in the Amygdala, Neurophysiology and Neuropharmacology](#)
- [Polymodal Nociceptors, Heat Transduction](#)
- [Postoperative Pain, Acute Pain Management, Principles](#)
- [Postoperative Pain, Acute Pain Team](#)
- [Postoperative Pain, Pre-Emptive or Preventive Analgesia](#)
- [Psychological Aspects of Pain in Women](#)
- [Referred Muscle Pain, Assessment](#)
- [Somatic Pain](#)
- [Thalamic Nuclei Involved in Pain, Cat and Rat](#)

## Noxious Stimulus Intensity

### Definition

The physical magnitude of a potentially injurious stimulus that is being applied to the body. This could be the amount of energy deposited from a mechanical or thermal stimulus, or a concentration of chemicals.

- [Encoding of Noxious Information in the Spinal Cord](#)

## Noxious Stimulus Location

### Definition

The body region that is being affected by a potentially injurious stimulus.

- [Encoding of Noxious Information in the Spinal Cord](#)

**NPY**

- ▶ Neuropeptide Y

**NRS**

- ▶ Numerical Rating Scale

**NRSF**

- ▶ Neuron Restrictive Silencer Factor

## NSAID-Induced Lesions of the Gastrointestinal Tract

JOACHIM MÖSSNER  
Medical Clinic and Policlinic II, University Clinical  
Center Leipzig AöR, Leipzig, Germany  
moej@medizin.uni-leipzig.de

**Definition**

Definition of gastrointestinal complications due to application of non-steroidal antiinflammatory drugs (▶ NSAIDs): erosions, ulcers, bleeding erosions or bleeding ulcers, ulcer perforations. These lesions are mostly located in the stomach, less common in the upper duodenum. However, lesions are possible along the entire gastrointestinal tract, i.e. small gut and colon.

**Characteristics****Pathogenesis of NSAID Induced Peptic Ulcers**

Inhibition of prostaglandin synthesis in the stomach by NSAIDs seems to be the key pathogenetic factor. Prostaglandins of the E-type stimulate gastric blood circulation, mucus secretion and cell regeneration and inhibit acid secretion. Furthermore, NSAIDs exert direct side effects at the gastric mucosa besides this systemic effect. NSAIDs are weak acids. Within an acidic environment NSAIDs are not dissociated. As lipophilic substances they may penetrate the mucus and exert direct damaging effects.

**Gastrointestinal Side Effects Due to Therapy with Non-Steroidal Anti-Inflammatory Drugs (NSAIDs)**

Treatment with NSAIDs may cause life-threatening complications in the gastrointestinal tract such as bleeding or perforation. In many cases no symptoms precede. In a study by Sing et al. including 1,921 patients, 81% had no preceding symptoms (Sing et al. 1996). Very often complications affect rather old patients with comorbidities. Thus, a rather high mortality may be a

consequence. In patients on NSAIDs accessory risk factors increase the odds ratio of risk of peptic ulcer bleeding (Weil et al. 2000). In a case control study on 1,121 patients with bleeding ulcers, therapy with anti-coagulants increased the risk by 7.8, history of peptic ulcer by 3.8, heart insufficiency by 5.9, oral glucocorticosteroids by 3.1 and smoking by 1.6. The odds ratio increased multiplicatively when in addition to these risk factors NSAIDs were administered (Weil et al. 2000).

**Primary Prophylaxis, Therapy, Secondary Prophylaxis of NSAID Induced Gastrointestinal Lesions**

In primary prophylaxis of NSAID induced gastrointestinal lesions, one has to discuss the roles of coxibs, ▶ *Helicobacter pylori* eradication and prophylactic therapy with either misoprostol, histamine-2-receptor-antagonists (H<sub>2</sub>-blockers) or proton pump inhibitors (PPIs). In acute treatment of bleeding ulcers, endoscopic therapy is one of the most important mainstays. For treatment of NSAID induced gastrointestinal lesions, one has to compare the effectiveness of H<sub>2</sub>-blockers with that of misoprostol or PPIs. In secondary prophylaxis, H<sub>2</sub>-blockers have again to be compared with misoprostol, PPIs and *H. pylori* eradication. 15–20% of ulcers rebleed after successful endoscopic therapy. In primary prevention of NSAID induced gastrointestinal lesions one has to discuss the role of coxibs, -antagonists, and proton pump inhibitors (PPIs).

Intravenous omeprazole reduced this risk of recurrent bleeding after successful endoscopic treatment of bleeding peptic ulcers (Lau et al. 2000).

240 patients were randomly assigned to either placebo or omeprazole (80 mg bolus intravenously followed by 8 mg / h for 72 h). Thereafter, both groups received omeprazole 20 mg orally for 4 weeks. In the PPI group, 8 patients rebled (6.7%) within 30 days versus 27 (22.5%) (p < 0,001) in the placebo group. 5 patients died in the PPI group (4.2%) as compared to 12 (10%) in the placebo group. This difference did not reach statistical significance (p = 0.13).

In primary prevention of diclofenac associated ulcers and dyspepsia, omeprazole was compared with triple therapy in *H. pylori* positive patients (Labenz et al. 2002). Patients had no history of ulcer disease. Patients were on continuous NSAID therapy (diclofenac 2 × 50 mg / day). They received either French triple therapy for *H. pylori* eradication (PPI plus clarithromycin plus amoxicillin) followed by placebo or omeprazole or omeprazole alone or placebo alone. Ulcer incidence after 5 weeks was 1.2% vs 1.2% vs 0% vs 5.8% respectively. Thus, persistence of *H. pylori* gastritis and no inhibition of acid secretion were associated with an increased risk of ulcer development due to diclofenac therapy. In another study from China, *H. pylori* eradication decreased the risk of ulcer development when NSAID naive patients received long term NSAID therapy (Chan et al. 2002a).

A key question in prophylaxis is not only prevention of gastric or duodenal ulcers in patients on NSAID therapy but also prevention of serious ulcer complications such as bleeding or perforation. For misoprostol it has been clearly demonstrated that this substance reduces serious gastrointestinal complications in patients with rheumatoid arthritis receiving nonsteroidal anti-inflammatory drugs (Silverstein et al. 1995). 8,843 patients on NSAIDs were randomly assigned to either misoprostol ( $4 \times 200 \mu\text{g} / \text{day}$ ) versus placebo. 25 out of 4,404 patients on misoprostol developed ulcer complications as compared to 42 out of 4,439 in the placebo group (risk reduction around 40%; odds ratio 0.598 (95% CI, 0.364–0.982;  $P < 0.049$ ). However, 20% of patients on misoprostol terminated the therapy due to side effects such as severe diarrhea, as compared to 15% on placebo.

#### Therapy of NSAID Induced Peptic Ulcers

H<sub>2</sub>-antagonists, misoprostol and PPIs have been shown to be effective in healing gastric and duodenal ulcers. Omeprazole has been compared with the prostaglandin analogue misoprostol for ulcers associated with nonsteroidal anti-inflammatory drugs (Hawkey et al. 1998). Omeprazole was superior to misoprostol with regard to the percentage of healed ulcers after 4 weeks. A concomitant *H. pylori* gastritis favors the healing rates with a PPI. This effect could be due to endogenous prostaglandin synthesis induced by the gastritis and / or to the gastric acid buffering by ammonia produced by *H. pylori*.

When omeprazole was compared with ranitidine, the PPI therapy was significantly superior to the H<sub>2</sub>-receptor antagonist therapy in healing NSAID induced gastric or duodenal ulcers (Yeomans et al. 1998).

#### Secondary Prophylaxis of Gastrointestinal Complications Due to NSAIDs

The most efficient prophylaxis is certainly termination of any NSAID administration. However, this is not possible in many cases due to the underlying diseases. Further options are *H. pylori* eradication since an underlying *H. pylori* gastritis may increase the risk of NSAID induced lesions. Other options are administration of inhibitors of acid secretion such as PPIs or H<sub>2</sub>-blockers, treatment with misoprostol or switching from non-selective NSAIDs to coxibs. The choice of the most efficient prophylaxis can be based on the results of several controlled prospective studies but the reduction of risk by a switch to coxibs and additional acid inhibition by PPIs has not been studied.

#### *H. pylori* Eradication versus PPI

400 patients with a history of a bleeding ulcer due to NSAIDs or aspirin and concomitant *H. pylori* gastritis were randomly assigned to either *H. pylori* eradica-

tion or acid inhibition by omeprazole (20 mg per day). NSAID therapy (250 patients, naproxen  $2 \times 500 \text{ mg}$  per day) or aspirin (150 patients, aspirin 80 mg per day) was continued for 6 months (Chan et al. 2001). The bleeding probability within 6 months in the aspirin group was 0.9% when omeprazole was used and 1.9% after *H. pylori* eradication. The difference was not statistically significant. Thus, *H. pylori* eradication is as efficient as inhibition of acid secretion when low dose aspirin is used. However, in the naproxen group, 18.8% rebled when *H. pylori* was eradicated as compared to 4.4% when omeprazole was used as prophylaxis. Thus, *H. pylori* eradication does not protect against ulcer recurrences when NSAID therapy is continued. In another study, patients with *H. pylori* gastritis who developed an ulcer complication under long-term therapy with aspirin ( $< 325 \text{ mg}$  per day) were enrolled (Lai et al. 2002). *H. pylori* was eradicated and after healing of the ulcers aspirin (100 mg per day) was continued. The PPI lansoprazole (30 mg per day) was compared to placebo for up to 12 months or until the occurrence of the next complication. 9 out of 61 (14.8%) patients developed an ulcer complication in the placebo group versus 1 out of 62 (1.2%) in the PPI group. 4 out of 10 patients had a re-infection by *H. pylori*, 2 out of 10 used further NSAIDs. Thus, in countries with a rather high risk of *H. pylori* re-infection or in cases of uncontrolled concomitant NSAID use, acid inhibition by PPIs seems to be more effective than *H. pylori* eradication alone when aspirin is continued. In a recent study from Hong Kong, patients who experienced ulcer bleeding after aspirin were switched to either clopidogrel (75 mg per day) or aspirin (80 mg per day) together with the pure enantiomer of omeprazole esomeprazole ( $2 \times 20 \text{ mg}$  per day). Both groups were *H. pylori* negative. 13 out of 161 rebled in the clopidogrel group versus 1 out of 159 in the aspirin plus esomeprazole group. Thus, a switch to clopidogrel does not offer any protection in contrast to efficient acid inhibition by esomeprazole (Chan et al. 2005).

#### Misoprostol versus PPI

When omeprazole was compared with misoprostol for ulcers associated with nonsteroidal anti-inflammatory drugs, misoprostol was slightly less effective than omeprazole in healing gastric and duodenal ulcers. In secondary prevention, omeprazole was superior. Furthermore, patients given omeprazole experienced fewer side effects (Hawkey et al. 1998).

#### Selective Cyclooxygenase-2 (COX-2) Inhibitors, So-called Coxibs, Solution of the Problem?

Coxibs do not inhibit aggregation of platelets. The gastrointestinal bleeding risk seems to be decreased. However, these drugs may increase the risk of cardiovascular diseases such as myocardial infarction



and stroke. Prostaglandins of the E-type are gastroprotective. They stimulate gastrointestinal blood flow, cell regeneration and mucus secretion and are weak inhibitors of gastric acid secretion. Selective COX-2 inhibitors, so-called coxibs, are supposed mainly to inhibit prostaglandin synthesis in inflammation but not constitutive prostaglandin synthesis by cyclooxygenase-1. Thus, coxibs should offer less gastrointestinal toxicity. Celecoxib was compared with diclofenac in long-term management of rheumatoid arthritis (Emery et al. 1999). 655 patients with rheumatoid arthritis received either celecoxib (2 × 200 mg per day) or diclofenac (slow release 2 × 75 mg) for 24 weeks. Gastroduodenal ulcers developed in 4% in the celecoxib group and in 15% given diclofenac. The CLASS study evaluated gastrointestinal toxicity with celecoxib *versus* nonsteroidal anti-inflammatory drugs in patients suffering from osteoarthritis and rheumatoid arthritis. 4,573 patients received either celecoxib (2 × 400 mg per day) or ibuprofen (3 × 800 mg per day) or diclofenac (2 × 75 mg per day) for 6 months. Aspirin (<375 mg per day) was permitted. Ulcer complications were seen in the celecoxib group in 0.76% *vs* 1.45% in the NSAID group. The difference was not significant ( $p < 0.09$ ). Symptomatic ulcers were fewer in the celecoxib group, 2.08% *versus* 3.54% ( $p < 0.02$ ). Less gastrointestinal toxicity was only seen in patients who did not take aspirin in addition (complicated ulcers, no aspirin 0.44% *versus* 1.27% ( $p < 0.04$ ); symptomatic ulcers, 1.40% *versus* 2.91% ( $p < 0.02$ ); with aspirin 2.01% *versus* 2.12% ( $p < 0.92$ ) and 4.70% *versus* 6.00% ( $p < 0.49$ )) (Silverstein et al. 2000). The data after 1 year of treatment (not published but available *via* internet) are less impressive with regard to less gastrointestinal toxicity with celecoxib. Moreover, celecoxib was evaluated in a meta-analysis (Goldstein et al. 2000). 14 multicenter studies on 11,008 patients who had been treated for 2–24 weeks and 5,155 patients on therapy for up to 2 years demonstrated ulcer complications such as bleeding, perforation and obstruction in the placebo group in none out of 1,864 patients, in the celecoxib group in 2 out of 6,376 and in the NSAID group in 9 out of 2,768 patients. Thus, the incidence of ulcer complications is reduced by a factor of 8 by celecoxib. Rofecoxib (25 mg and 50 mg per day) was compared with ibuprofen (3 × 800 mg per day) and placebo in 775 patients with osteoarthritis (Hawkey et al. 2000). The endpoint of this prospective study was gastric or duodenal ulcers. In the ibuprofen group, 29.2% of patients developed ulcers after 12 weeks and 46.8% after 24 weeks *versus* 5.3 and 8.8% in the low dose rofecoxib group and 9.9 and 12.4% in the 50 mg group. Thus, rofecoxib is clearly much safer as regards gastroduodenal ulcers than ibuprofen. However, not all endoscopically demonstrated ulcers may be clinically relevant.

In another study rofecoxib (50 mg per day) was compared with naproxen (2 × 500 mg per day) with special emphasis on ulcer complications such as bleeding, stenosis, perforation or symptomatic ulcers in patients with rheumatoid arthritis (Bombardier et al. 2000). 8,076 patients older than 50 years, or 40 years when on steroids in addition, were enrolled. In the rofecoxib group, 2.1 ulcers (0.6 life threatening) developed within 9 months in 100 patient years and 4.1 (1.4 threatening) with naproxen. However, myocardial infarction was observed in 0.4% *versus* 0.1% with naproxen. When valdecoxib (2 × 40 mg per day), another coxib, was compared with naproxen (2 × 500 mg per day) and placebo in a multicenter study with 62 patients per group, gastroduodenal ulcerations were seen in 3% with placebo, 0% with valdecoxib and 18% with naproxen (Goldstein et al. 2003). Thus, the risk of developing gastroduodenal ulcerations is clearly lower during treatment with coxibs as compared to non-selective NSAIDs. However, a larger prospective trial is still warranted to clarify the key question as to whether the rate of life threatening ulcer complications is really markedly decreased when treatment is with coxibs *versus* non-selective NSAIDs. The risk reduction for gastroduodenal ulcers has to be compared with the risk elevation of cardiovascular side effects attributed to treatment with coxibs. This risk has led to the withdrawal of rofecoxib from the market. The elevated risk of cardiovascular side effects is possibly a class effect of coxibs and not solely seen under rofecoxib. A trial to reduce the incidence of new colon adenomas by celecoxib after endoscopic polypectomy had to be stopped. In this trial (*ca.* 2,000 patients), with placebo 6 cardiovascular events were seen *versus* 15 in the low dose celecoxib group (2 × 200 mg per day) and 20 in the high dose celecoxib group (2 × 400 mg per day). In another trial in which celecoxib was used to treat Alzheimer disease, no elevated cardiovascular risk was seen. In a population-based observation, 1,005 patients used COX-2 inhibitors and 5,245 patients used a non-naproxen NSAID. Of the 6,250 patients, 70% were female, 50% were African American and 30% were older than 50 years. Overall, 12% of the patients had at least 1 cardiovascular thrombotic event after treatment within the follow-up period. The propensity adjusted odds ratio showed no significant effect of COX-2 inhibitor use on this percentage of patients (odds ratio, 1.09; 95% confidence interval, 0.90–1.33). The authors conclude that coxibs do not increase cardiovascular risk over non-naproxen NSAIDs in a high-risk Medicaid population (Shaya et al. 2005).

Several questions are still not solved. NSAIDs may lead to lesions in the jejunum and ileum that cannot be prevented by the addition of proton pump inhibitors. In a small study on 21 chronic NSAID users and 20 controls, a small video capsule was used to look for lesions in the small intestine. Small-bowel injury was seen in 71% of

NSAID users compared with 10% of controls ( $P < 0.001$ ). The injury was mild (few or no erosions, absence of large erosions / ulcers) in 10 NSAID users compared with 2 controls. 5 NSAID users had major ( $>4$  erosions or large ulcers) damage compared with none in the control group. The authors conclude that endoscopically evident small intestinal mucosal injury is very common among chronic NSAID users (Graham et al. 2005). However, the clinical significance and quantitative risk of lesions in the small intestine due to non-selective NSAIDs is still not known.

Co-treatment with aspirin to overcome the coxibs' possible cardiovascular risk does not solve the problem since the gastroprotective effect is lost (Laine et al. 2004). Low dose aspirin plus rofecoxib resulted in ulcers within 12 weeks in 16%, similar to aspirin plus ibuprofen. Furthermore, it is not clear whether the elevated cardiovascular risk with rofecoxib can be decreased by aspirin.

Addition of proton pump inhibitors to non-selective NSAIDs causes a similar risk reduction to that seen under treatment with coxibs. This has been demonstrated in a double-blinded randomized comparison of celecoxib versus omeprazole and diclofenac for secondary prevention of ulcer bleeding in chronic NSAID users (Chan et al. 2002b). Rebleeding occurred in the celecoxib group in 4.9% (7 / 144 patients) versus 6.4% (9 / 143 patients) in the omeprazole plus diclofenac group. The difference was not significant. Finally, one has to be aware that prostaglandins are needed for ulcer healing. Thus, coxibs may delay gastric ulcer healing when one switches from non selective NSAIDs to coxibs due to abdominal pain, not knowing whether an ulcer is present or not.

In summary, coxibs decrease the risk of gastroduodenal ulcers when compared with non-selective NSAIDs. However, this risk reduction has to be balanced against the possible elevated risk of severe cardiovascular side effects. Addition of proton pump inhibitors to NSAIDs causes a similar risk reduction to that of coxibs. However, lesions in the small intestine due to NSAIDs cannot be prevented by PPIs. The overall risk and clinical relevance of lesions in the small intestine has still to be clarified in larger trials.

## References

- Bombardier C, Laine L, Reicin A et al., VIGOR Study Group (2000) Comparison of upper gastrointestinal toxicity of rofecoxib and naproxen in patients with rheumatoid arthritis. VIGOR Study Group. *N Engl J Med* 343:1520–1528
- Chan FK, Chung SC, Suen BY et al. (2001) Preventing recurrent upper gastrointestinal bleeding in patients with *Helicobacter pylori* infection who are taking low-dose aspirin or naproxen. *N Engl J Med* 344:967–973
- Chan FK, To KF, Wu JC et al. (2002a) Eradication of *Helicobacter pylori* and risk of peptic ulcers in patients starting long-term treatment with non-steroidal anti-inflammatory drugs: a randomised trial. *Lancet* 359:9–13
- Chan FK, Hung LC, Suen BY et al. (2002b) Celecoxib versus diclofenac and omeprazole in reducing the risk of recurrent ulcer bleeding in patients with arthritis. *N Engl J Med* 347:2104–2110
- Chan FK, Ching JY, Hung LC et al. (2005) Clopidogrel versus aspirin and esomeprazole to prevent recurrent ulcer bleeding. *N Engl J Med* 352:238–244
- Emery P, Zeidler H, Kvien TK et al. (1999) Celecoxib versus diclofenac in long-term management of rheumatoid arthritis: randomised double-blind comparison. *Lancet* 354:2106–2111
- Goldstein JL, Silverstein FE, Agrawal NM et al. (2000) Reduced risk of upper gastrointestinal ulcer complications with celecoxib, a novel COX-2 inhibitor. *Am J Gastroenterol* 95:1681–1690
- Goldstein JL, Kivitz AJ, Verburg KM et al. (2003) A comparison of the upper gastrointestinal mucosal effects of valdecoxib, naproxen and placebo in healthy elderly subjects. *Aliment Pharmacol Ther* 18:125–132
- Graham DY, Opekun AR, Willingham FF et al. (2005) Visible small-intestinal mucosal injury in chronic NSAID users. *Clin Gastroenterol Hepatol* 3:55–59
- Hawkey CJ, Karrasch JA, Szczepanski L et al. (1998) Omeprazole compared with misoprostol for ulcers associated with non-steroidal antiinflammatory drugs. Omeprazole versus Misoprostol for NSAID-induced Ulcer Management (OMNIUM) Study Group. *N Engl J Med* 338:727–734
- Hawkey C, Laine L, Simon T et al. (2000) Comparison of the effect of rofecoxib (a cyclooxygenase 2 inhibitor), ibuprofen, and placebo on the gastroduodenal mucosa of patients with osteoarthritis: a randomized, double-blind, placebo-controlled trial. The Rofecoxib Osteoarthritis Endoscopy Multinational Study Group. *Arthritis Rheum* 43:370–377
- Labenz J, Blum AL, Bolten WW et al. (2002) Primary prevention of diclofenac associated ulcers and dyspepsia by omeprazole or triple therapy in *Helicobacter pylori* positive patients: a randomised, double blind, placebo controlled, clinical trial. *Gut* 51:329–335
- Lai KC, Lam SK, Chu KM et al. (2002) Lansoprazole for the prevention of recurrences of ulcer complications from long-term low-dose aspirin use. *N Engl J Med* 346:2033–2038
- Laine L, Maller ES, Yu C et al. (2004) Ulcer formation with low-dose enteric-coated aspirin and the effect of COX-2 selective inhibition: a double-blind trial. *Gastroenterology* 127:395–402
- Lau JY, Sung JJ, Lee KK et al. (2000) Effect of intravenous omeprazole on recurrent bleeding after endoscopic treatment of bleeding peptic ulcers. *New Engl J Med* 343:310–316
- Shaya FT, Blume SW, Blanchette CM et al. (2005) Selective cyclooxygenase-2 inhibition and cardiovascular effects: an observational study of a Medicaid population. *Arch Intern Med* 24:181–186
- Silverstein FE, Graham DY, Senior JR et al. (1995) Misoprostol reduces serious gastrointestinal complications in patients with rheumatoid arthritis receiving nonsteroidal anti-inflammatory drugs. A randomized, double-blind, placebo-controlled trial. *Ann Int Med* 123:241–249
- Silverstein FE, Faich G, Goldstein JL et al. (2000) Gastrointestinal toxicity with celecoxib vs nonsteroidal anti-inflammatory drugs for osteoarthritis and rheumatoid arthritis: the CLASS study: A randomized controlled trial. Celecoxib Long-term Arthritis Safety Study. *JAMA* 284:1247–1255
- Sing G, Ramey DR, Morfeld D et al. (1996) Gastrointestinal tract complications of nonsteroidal anti-inflammatory drug treatment in rheumatoid arthritis. A prospective observational cohort study. *Arch Intern Med* 156:1530–1536
- Weil J, Langman MJ, Wainwright P et al. (2000) Peptic ulcer bleeding: accessory risk factors and interactions with non-steroidal anti-inflammatory drugs. *Gut* 46:27–31
- Yeomans ND, Tulassay Z, Juhasz L et al. (1998) A comparison of omeprazole with ranitidine for ulcers associated with nonsteroidal antiinflammatory drugs. Acid Suppression Trial: Ranitidine versus Omeprazole for NSAID-associated Ulcer Treatment (ASTRONAUT) Study Group. *New Engl J Med* 338:719–726

## NSAIDs

- ▶ COX-2 Inhibitor
- ▶ Non-Steroidal Anti-Inflammatory Drugs (NSAIDs)
- ▶ NSAIDs, Adverse Effects
- ▶ NSAIDs and Cancer
- ▶ NSAIDs and Cardio-Vascular Effects
- ▶ NSAIDs, COX-Independent Actions
- ▶ NSAIDs, Mode of Action
- ▶ NSAIDs, Survey
- ▶ Postoperative Pain, Non Steroidal Anti-Inflammatory Drugs

## NSAIDs and Cancer

SABINE GRÖSCH, THORSTEN J. MAIER  
Pharmacological Center Frankfurt, Clinical Center  
Johann-Wolfgang Goethe University, Frankfurt,  
Germany  
groesch@em.uni-frankfurt.de

### Synonyms

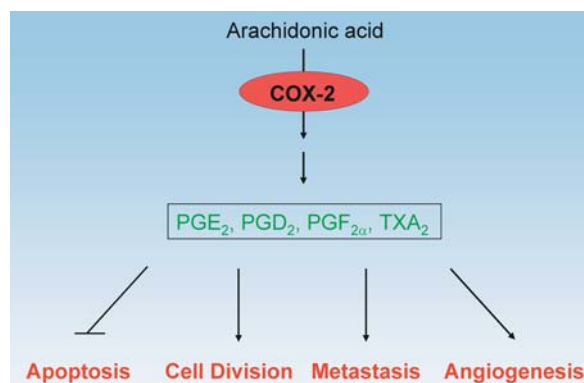
Cyclooxygenase Inhibitors; NSAIDs; non-steroidal anti-inflammatory drugs

### Definition

NSAIDs are inhibitors of the ▶ **Cyclooxygenases-1** (COX-1) and/or -2 (COX-2). While COX-1 is constitutively expressed in a wide range of tissues, COX-2 is predominantly cytokine and stress-inducible. Interestingly, in numerous cancer types the regulatory mechanisms of COX-2 expression are abrogated, leading to an overexpression of the COX-2 protein and enhanced prostaglandin production. Especially in the case of colon cancer, an upregulation of COX-2 has been shown to occur already in the early ▶ **adenoma** stage, and is therefore one of the first deregulation mechanisms in tumor development (Shiff and Rigas 1999). Enhanced COX-2 expression has been attributed a key role in the development of cancer by promoting cell division, inhibiting ▶ **apoptosis**, altering ▶ **cell adhesion**, enhancing ▶ **metastasis** and neo ▶ **vascularization** (Fig. 1) (Trifan and Hla 2003). Therefore, inhibition of COX-2 activity by NSAIDs thwarts all these effects, and accounts for the anticarcinogenic effect of these drugs.

### Characteristics

Publications in recent years, investigating the molecular pathway of the anticarcinogenic effects of NSAIDs, revealed that next to COX-2 inhibition, COX-2-independent mechanisms are also responsible for the anti-neoplastic effects of these substances. The main arguments for this hypothesis are:

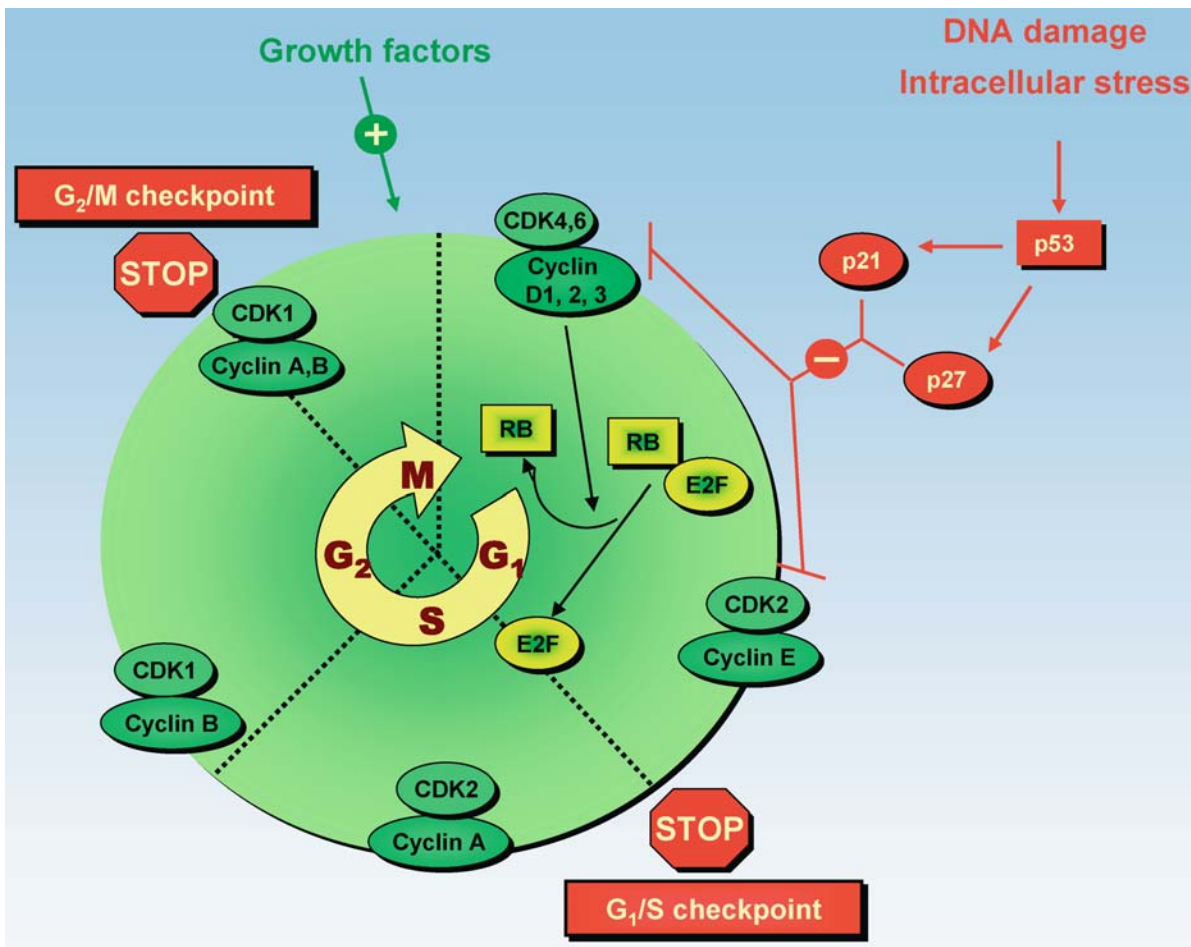


**NSAIDs and Cancer, Figure 1** The COX-2 pathway. The cyclooxygenase-2 catalyses the conversion of arachidonic acid to prostaglandin H<sub>2</sub> (PGH<sub>2</sub>) which is further converted by different prostaglandin synthases to PGE<sub>2</sub>, PGD<sub>2</sub>, PGF<sub>2</sub> α and TXA<sub>2</sub>. These prostaglandins promote cell division, metastasis and angiogenesis and inhibit apoptosis leading to an enhanced tumor growth.

1. NSAIDs inhibit growth of tumor cells which do not express COX-2 *in vitro* and *in vivo* (Grösch et al. 2001)
2. NSAIDs which exhibit no COX-2 inhibitory efficacy nevertheless cause anticarcinogenic effects (Grösch et al. 2003)

In the literature, various molecular mechanisms were described to be involved in the anticarcinogenic effect of different NSAIDs, whereas each NSAID seems to have its specific COX-independent mode of action. An overview is given in a separate chapter of this issue (Tegeger and Niederberger) and also in Tegeger et al. 2001.

For cancer therapy we have to bear in mind that anticarcinogenic treatment regimes are usually carried out for a long time (months to years). Therefore, a reasonable benefit-risk ratio of the substances used is of vital importance. Unfortunately, long-term use of classical non-selective NSAIDs, which inhibit both COX-1 and COX-2, is associated with serious gastrointestinal side effects such as ▶ **ulcerations** of the gastric mucosa. These side effects are thought to arise from the inhibition of the constitutive cyclooxygenase isoform (COX-1), which is mainly responsible for the maintenance of the physiologically important prostaglandin synthesis in the gastrointestinal mucosa. To circumvent this problem, selective COX-2 inhibitors such as celecoxib, rofecoxib, etoricoxib, valdecoxib and lumiracoxib have been developed and introduced into clinical practice. However, due to the withdrawal of rofecoxib and valdecoxib from the pharmaceutical market in September 2004 and April 2005, respectively, the whole group of Coxibs is being reviewed regarding their potential risk to evoke cardiovascular side effects. Very recently, the European Medicines Agency (EMA), as well as the Food and Drug Administration (FDA), scrutinized whether these side effects, which appeared with some



**NSAIDs and Cancer, Figure 2** A simplified diagram of cell cycle control. The cell cycle is divided in four phases: the  $G_1$ -phase, S-phase,  $G_2$ -phase and M-phase. The cell cycle transition is controlled by different cyclins, cyclin-dependent kinases (CDKs) and cell cycle inhibitors such as p21 and p27.

Coxibs, should be regarded as a class effect. In February 2005 the EMEA and the FDA committee, evaluating the cardiovascular risk of Coxibs, arrived at the decision that despite the cardiovascular risk of these substances, Coxibs should not be withdrawn from the market, but should be labeled with contraindications and warnings. Nevertheless, celecoxib is the only NSAID that was approved in December 1999 by the FDA for ► [adjuvant treatment of patients with ► familial adenomatous polyposis](#) and is, therefore, the only NSAID which is admitted for cancer therapy (Koehne and Dubois 2004). The anticarcinogenic properties of celecoxib are based on its ability to inhibit cell cycle progression and ► [angiogenesis](#) and to induce apoptosis. These effects are certainly on the one hand due to its COX-2-inhibiting potency according to the mechanism mentioned above, but on the other hand COX-2-independent mechanisms also seem to be responsible.

#### Inhibition of Cell Cycle Progression

The cell cycle transition is controlled by different regulatory proteins such as cyclins and cyclin-dependent

kinases as well as by cell cycle inhibitors (Fig. 2). Treatment of different tumor cell lines with celecoxib caused downregulation of cyclins and cyclin-dependent kinases and an increase in the expression of various cell cycle inhibitors (Table 1), resulting in a cell cycle block in the  $G_1$ -phase. However, the precise target(s) responsible for these effects are still unknown.

#### Induction of Apoptosis

Apoptosis, or programmed cell death, can be induced either by the extrinsic pathway via activation of death receptors, or the intrinsic pathway via releasing of cytochrome c from the mitochondria (Green and Evan 2002). Both pathways finally lead to the activation of various ► [caspases](#) which, as the executors of apoptosis, cleave different cellular substrates and cause DNA-fragmentation (Fig. 3). After treatment of cancer cells with celecoxib, it has been shown that the expression of various anti-apoptotic proteins such as ► [Bcl-2](#), ► [Mcl-1](#) and ► [survivin](#) decreases, whereas the expression of the pro-apoptotic protein Bad is up-regulated. This was further accompanied by a rapid



**NSAIDs and Cancer, Table 1** Effect of celecoxib on proteins involved in apoptosis, cell cycle regulation and angiogenesis

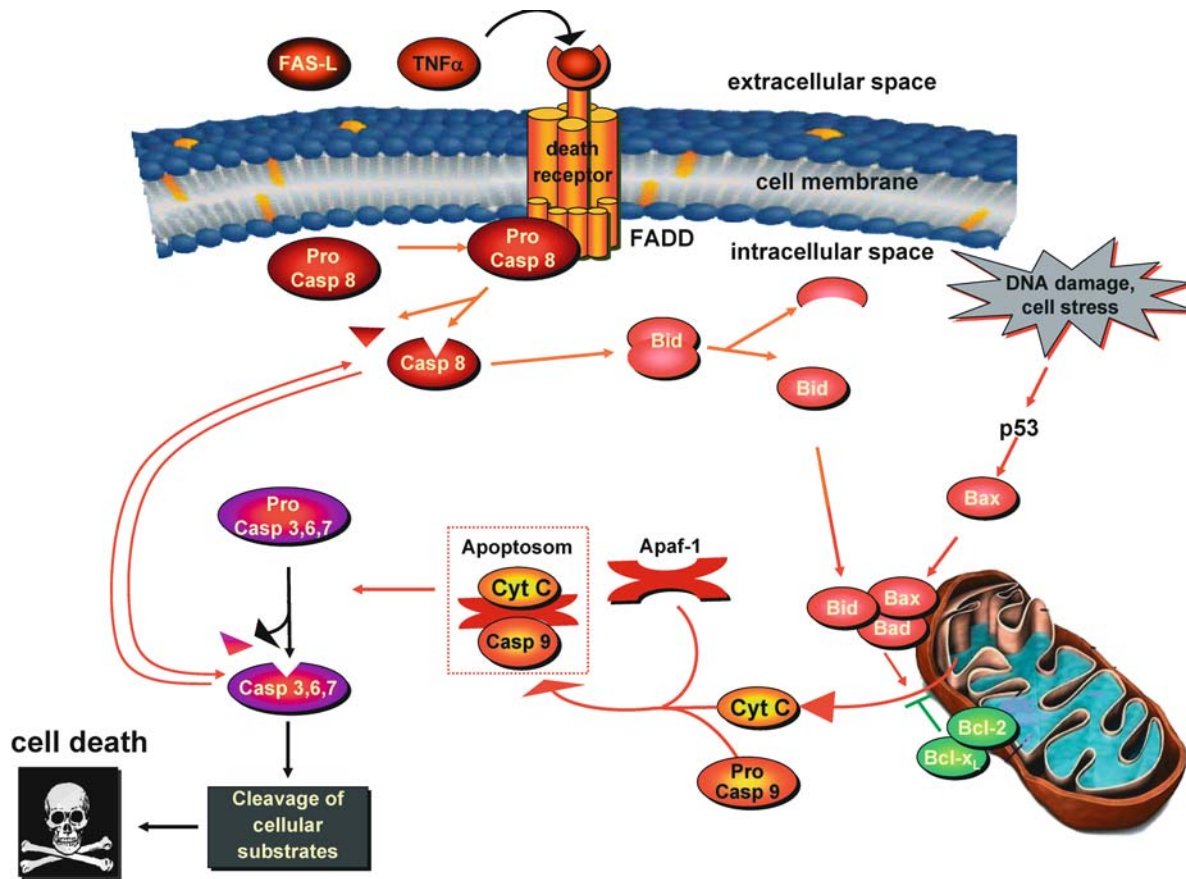
Apoptosis	Cell cycle	Angiogenesis/ Metastasis	Kinases	Transcription factors
Caspase 3 ↑	Cyclin D1 ↓	VEGF ↓	PK1 activity ↓	NF-κB ↓
Caspase 8 ↑	Cyclin A ↓	phospho EGFR ↓	AKT/PKB activity ↓	PPAR $\gamma$ ↑
Caspase 9 ↑	Cyclin B ↓	MMP-1 ↓	phospho SAPK ↓	SP-1 ↓
Bcl-2 ↓	p21 ↑	MMP-2 ↓		Egr-1 ↓
Bcl-xL ↓	p27 ↑	MMP-3 ↓		c-Fos ↓
Survivin ↓	Rb ↑	MMP-9 ↓		
Mcl-1 ↓	Rb ↑			
Bad ↑ Ceramide ↑	Ornithine decarboxylase ↓			
Apaf-1 ↑				

release of cytochrome c from mitochondria and subsequent activation of caspase-3, -8 and -9 (see also Table 1). These data provide evidence that after celecoxib treatment apoptosis is induced by activation of the intrinsic pathway. Currently, several cellular pathways have been identified which play a role for the apoptosis-inducing potency of celecoxib. It has been shown that celecoxib treatment leads to inhibition of the 3-phosphoinositide-dependent-kinase 1 (PDK1) or its downstream substrate protein kinase B (PKB/AKT). Due to the anti-apoptotic potency of these enzymes, inhibition of these kinases promotes apoptosis. Another recently identified target of celecoxib is the endoplasmic reticulum  $\text{Ca}^{2+}$ -ATPase, which is strongly inhibited by celecoxib. As a consequence,  $\text{Ca}^{2+}$ -reuptake in the endoplasmic reticulum is prevented, leading to an elevated cytoplasmic  $\text{Ca}^{2+}$ -concentration.  $\text{Ca}^{2+}$  may then trigger the induction of apoptosis by activating  $\text{Ca}^{2+}$ -sensitive proteases, endonucleases and caspases, and by opening  $\text{Ca}^{2+}$ -sensitive mitochondrial permeability transition pores, resulting in cytochrome c release.

Furthermore, nanomolar concentrations of celecoxib and valdecoxib have been shown to inhibit members of the carbonic anhydrase (CA) family such as CA I, II, IV and IX. This effect is closely associated with the presence of an arylsulfonamide-group in both drugs, which seems to be responsible for this effect (Weber et al. 2004). CA II as well as CA IX have been described to play a pivotal role in tumor growth and development, and represent potential biomarkers for various tumor types. Carbonic anhydrases catalyze the reversible hydration of carbon dioxide, thereby buffering protons that protect the cell from undergoing intracellular acidification. Since the growth of tumor cells requires a high bicarbonate flux, inhibition of carbonic anhydrases by celecoxib could lead to an acidification, and subsequently to growth regression.

### Inhibition of Angiogenesis

Early tumor growth is divided into several stages. In stage one the malignant cells form small tumors of limited size due to an inadequate supply of oxygen ( $\blacktriangleright$  hypoxia). In stage two, hypoxia triggers a drastic change in gene expression leading to the formation of new blood vessels. Overexpression of COX-2 in tumor cells has a decisive impact on angiogenesis: a) The eicosanoid  $\text{TXA}_2$  stimulates endothelial cell migration and b) Prostaglandin  $\text{E}_2$  ( $\text{PGE}_2$ ) causes a release of the vascular endothelial growth factor (VEGF), thereby promoting endothelial cell proliferation. Both mechanisms play a pivotal role in the formation of new blood vessels. Therefore, inhibition of COX-2-activity by celecoxib represses the effects mentioned above, and leads to inhibition of angiogenesis and diminished tumor growth (Gately and Li 2004). Nevertheless, COX-2-independent mechanisms also contribute to the anti-angiogenic effect of celecoxib. It has been shown that celecoxib inhibits the activation of the early growth response factor (Egr-1) (Table 1). Egr-1 is a  $\blacktriangleright$  transcription factor which is rapidly activated by multiple extracellular agonists (such as growth factors and cytokines) and environmental stresses (hypoxia, vascular injury). As a major activator of pro-angiogenic genes, such as fibroblast growth factor (FGF), cytokines and receptors, Egr-1 is essentially involved in angiogenesis and promotion of tumor development. Furthermore, it has been shown that inhibition of angiogenesis after celecoxib treatment is associated with suppression of VEGF expression due to the inhibition of the transcription factor Sp1. Celecoxib treatment reduced both Sp1 DNA binding activity and transactivating activity, which correlated with reduced Sp1 protein expression and its phosphorylation. The  $\blacktriangleright$  promoter region of VEGF contains a Sp1-binding site that seems to be crucial for VEGF expression. Taken together, COX-2-independent mechanisms, such as the inhibition of



**NSAIDs and Cancer, Figure 3** A simplified diagram of apoptosis. Apoptosis (programmed cell death) is a succession of controlled molecular events leading to the suicide of the cell. Apoptosis can be initiated from the cell surface membrane (extrinsic pathway) via activation of death-receptors and subsequent activation of caspase 8 (and others) or by intracellular stress (e.g. DNA-damage) leading to the release of cytochrome c from the mitochondria and activation of the apoptosome (intrinsic pathway). Both pathways finally lead to caspase-mediated cleavage of different cellular substrates (proteins, DNA) and subsequent cell death.

Sp1 and Erg-1 transcriptional activity, may explain the antiangiogenic effects of celecoxib.

#### Implications for Clinical Management

In light of the recent information on the cardiovascular risks associated with COX-2-selective inhibitors the view about the usage of these substances in clinical practice has changed dramatically. In the last few years a lot of studies were planned and performed to investigate the anticarcinogenic effects of rofecoxib or celecoxib in different tumor types. Owing to the withdrawal of rofecoxib and valdecoxib from the pharmaceutical market, the other Coxibs are also now under critical observation. In December 2004 the National Cancer Institute cancelled the “Adenoma Prevention with Celebrex” (APC) Study due to the occurrence of a statistically significant increase of cardiovascular side effects under celecoxib treatment. This discussion prompted Pfizer Inc. to delay the launch of Onsenal<sup>®</sup> (celecoxib) in the European Union (EU) for the treatment of intestinal polyps in FAP-patients. In contrast, two large ongoing trials with celecoxib, the “Prevention

of Spontaneous Adenomatous Polyps Trials” (PRE-SAP) and the “Alzheimer’s Disease Anti-inflammatory Prevention Trial” (ADAPT), which were also evaluated by the Data Safety Monitoring Board (DSMB), revealed no increased risk of cardiovascular side effects for celecoxib. Therefore, these studies will contribute to appraise the potential cardiovascular risk of celecoxib, as well as its benefit for cancer and Alzheimer patients. Despite the current discussion, we have to consider that patients that have an increased risk of developing cancer probably benefit more from the chemopreventive potency of celecoxib than they have the risk to develop cardiovascular side effects. For cancer patients, the combination of celecoxib with standard chemo- or radiotherapy might also be advantageous, due to the possibility of reducing the dose of classical chemotherapeutics and drug-associated side effects.

#### References

1. Gately S, Li WW (2004) Multiple Roles of COX-2 in Tumor Angiogenesis: A Target for Antiangiogenic Therapy. *Semin Oncol* 31:2–11

2. Green DR, Evan GI (2002) A Matter of Life and Death. *Cancer Cell* 1:19–30
3. Grösch S, Tegeder I, Niederberger E et al. (2001) COX-2 Independent Induction of Cell Cycle Arrest and Apoptosis in Colon Cancer Cells by the Selective COX-2 Inhibitor Celecoxib. *FASEB J* 15:2742–2744
4. Grösch S, Tegeder I, Schilling K et al. (2003) Activation of c-Jun-N-terminal-Kinase is Crucial for the Induction of a Cell Cycle Arrest in Human Colon Carcinoma Cells caused by Flurbiprofen Enantiomers. *FASEB J* 17:1316–1318
5. Koehne CH, Dubois RN (2004) COX-2 Inhibition and Colorectal Cancer. *Semin Oncol* 31:12–21
6. Shiff SJ, Rigas B (1999) The Role of Cyclooxygenase Inhibition in the Antineoplastic Effects of Nonsteroidal Antiinflammatory Drugs (NSAIDs). *J Exp Med* 190:445–450
7. Tegeder I, Pfeilschifter J, Geisslinger G (2001) Cyclooxygenase-Independent Actions of Cyclooxygenase Inhibitors. *FASEB J* 15:2057–2072
8. Trifan OC, Hla T (2003) Cyclooxygenase-2 Modulates Cellular Growth and Promotes Tumorigenesis. *J Cell Mol Med* 7:207–222
9. Weber A, Casini A, Heine A et al. (2004) Unexpected Nanomolar Inhibition of Carbonic Anhydrase by COX-2-Selective Celecoxib: New Pharmacological Opportunities due to Related Binding Site Recognition. *J Med Chem* 47:550–557

## NSAIDs and Cardio-Vascular Effects

KAY BRUNE

Institute for Experimental and Clinical Pharmacology and Toxicology, Friedrich Alexander University Erlangen-Nürnberg, Erlangen, Germany  
kay.brune@pharmakologie.uni-erlangen.de

### Synonym

NSAIDS; Non-steroidal anti-inflammatory drugs; Cyclooxygenase Inhibitors

### Definition

Non-steroidal anti-inflammatory drugs (► NSAIDs), alternatively called cyclooxygenase inhibitors, are the most widely used drugs worldwide. They comprise the mainstay of the management of pain associated with inflammation, as in e.g. rheumatoid diseases (Johnson 1997; Brune and Hinz 2004). NSAIDs exert their pharmacological actions through the inhibition of the enzyme cyclooxygenase, which exists as 2 isoforms, Cox1 and Cox2 (Hawkey 1999; Flower 2003). Cox1 is constitutively expressed in all tissues in the body, including platelets (Simmons et al. 2004). Cox2 is, as we now know, expressed at low levels in most normal tissues, but is induced rapidly if they are subjected to stress including trauma and inflammation (Simmons et al. 2004). The vascular system is a dominant source of vasoactive mediators that modulate and regulate the vascular tone as well as kidney and heart function (Francois and Coffman 2000; Simmons et al. 2004; Hennan et al. 2001). These regulatory mediators include prostacyclin (PGI<sub>2</sub>), prostaglandins (PGE<sub>2</sub>, PGF<sub>2α</sub>) and thromboxanes (TXA<sub>2</sub>) – to name just a few.

### Characteristics

Whilst thromboxane is almost exclusively produced in platelets by cyclooxygenase–1, prostacyclin is also a product of constitutively expressed Cox2 of the vascular endothelium (McAdam et al. 1999; FitzGerald 2002; Cipollone et al. 2004). Similarly, the adult kidney demonstrates a relatively high level of constitutively expressed Cox2 (Harris et al. 2004). From the theoretical point of view, non-selective and selective inhibition of Cox1 and –2, or Cox2 exclusively, is likely to affect the function of the cardio-vascular system. It is conceivable that selective, in contrast to non-selective, inhibitors, the latter interfering with the balance of e.g. the prothrombotic TXA<sub>2</sub> and antithrombotic PGI<sub>2</sub>, may show different clinical effects (FitzGerald 2002). Since evidence-based consensus on the role of NSAIDs on the cardio-vascular system has not been reached, we shall concentrate on compiling the theoretical, experimental and clinical evidence of cardio-vascular effects of NSAIDs.

### Theoretical Considerations

The cardio-vascular system is exposed to the prostaglandins PGI<sub>2</sub>, E<sub>2</sub> and F<sub>2α</sub>, in addition to the thromboxane A<sub>2</sub> (TX) and the lipoxygenase products leucotrien (LT) B<sub>4</sub>, D<sub>4</sub> and E<sub>4</sub> (the situation concerning endocannabinoids and lipoxins is as yet not clear enough for further discussion). Whilst thromboxane initiates vasoconstriction, platelet aggregation and possibly bradycardia (Wacker et al. 2002), prostaglandin E<sub>2</sub> and I<sub>2</sub> cause vasodilatation. Prostacyclin also inhibits platelet aggregation. PGF<sub>2α</sub> is less important for the cardio-vascular system. Moreover, PGE<sub>2</sub> and PGF<sub>2α</sub> may interfere with the release of norepinephrine from the sympathetic nervous system (Malic and Sehic 1990). Conversely, Cox2 expression in the macula densa is regulated by angiotensin 2, and Cox2 derived PGs reduce renin release from the macula densa (Harris and Breyer 2001). PGI<sub>2</sub> finally interferes with the activation of angotensin 2 and aldosterone (Harris et al. 2004). The situation becomes more complex due to the fact that there are different receptors for the eicosonoids, which may show a differential distribution in the cardio-vascular system and kidney. Nevertheless, it is obvious that the general inhibition of all prostaglandins, including TXA<sub>2</sub> and PGI<sub>2</sub>, may have other consequences than the selective inhibition of the production of PGI<sub>2</sub> in the endothelium alone. Moreover, selective inhibition may shunt more substrate (arachidonic acid) into alternative pathways, i.e. Cox1 and 5–lipoxygenase.

In conclusion, from the theoretical point of view, the normal physiology of the cardiovascular system of the human body will be influenced by both selective and non-selective inhibitors. Selective inhibition, however, may have a different profile than non-selective inhi-

bition. For example, blood coagulation will remain unimpaired whilst blood pressure is influenced in a similar manner by selective inhibitors. On the other hand, the propensity for cardiac infarction or ischemic stroke may be furthered by selective inhibition (see below).

### Experimental Pharmacology

A large number of experimental pharmacological data are available supporting the view that both selective and non-selective Cox-inhibitors may interfere with the cardio-vascular system (for review Simmons et al. 2004). Experiments in mice lacking either Cox1 or Cox2, as well as those lacking the corresponding receptors, demonstrate that:

Cox2 is necessary for the closure of the ductus arteriosus Botalli (Loftin et al. 2001)

Cox2 is needed for renal adaptation and protection from hyperosmolarity (Harris and Breyer 2001)

PGI<sub>2</sub> via IR receptors leads to vasodilatation, but also attenuation of ischemic injury and cardiac hypertrophy due to pressure overload (Hara et al. 2003)

PGE<sub>2</sub> via EP<sub>3</sub> and EP<sub>4</sub> receptors mediates cardioprotection during ischemic injury (Hara et al. 2003). It is also involved in thromboembolic events via (EP<sub>2</sub>) receptors.

EP<sub>2</sub> receptors also appear to mediate blood pressure control under high salt intake (Ushicubi et al. 2000)

PGI<sub>2</sub> and PGE<sub>2</sub> in the kidney tubules enhance renal blood flow and increase water and electrolyte excretion. (Cox2 appears more important than Cox1; Komhoff et al. 1997; Harris and Breyer, 2001). The latter effect may be sex-hormone regulated, and mediated via EP<sub>1</sub> receptors in males (Ushikubi et al. 2000).

Thromboxane activates platelet aggregation via TP receptors (Narumiya et al. 1999). In platelets TXA<sub>2</sub> production is almost exclusively Cox1 dependent (Baignent and Patrono, 2003).

TXA<sub>2</sub> appears to initiate bradycardia and reduction of blood pressure via a vagal reflex (Wacker et al. 2002). Cox1 dependent prostaglandins support the development of atherosclerosis (Pratico et al. 2001).

These complex synergistic or antagonistic effects of prostanoids in the cardio-vascular system allow for the assumption that lack of inhibition of Cox1 along with blockade of Cox2 may reduce bleeding, but may have complex effects which support the development of hypertension, renal failure, thrombosis, myocardial infarction and ischemic stroke (FitzGerald 2002).

### Clinical Pharmacology

Many occasional observations as well as clinical studies, support the view that selective and non-selective inhibition of cyclooxygenases in man may result in serious consequences in patients at specific risk. Three effects appear well documented and should be taken into consideration when administering NSAIDs (non-selective or selective) to patients:

### Non-Selective/Classical NSAIDs

It is widely accepted that all non-selective inhibitors of both cyclooxygenases may increase systolic and diastolic blood pressure. Long-term therapy with these compounds, particularly when given at high doses (2.4 g ibuprofen / day) for prolonged periods of time (in particular NSAIDs with long elimination half-life, e.g. piroxicam), may enhance the risk of stroke, but also cardiac infarction (Johnson 1997; Johnson et al. 2003). These drugs may also interfere with the activity of the blood pressure lowering diuretics, ACE inhibitors and AT-1 receptor blockers (Cipollone et al. 2004).

Aspirin, due to its permanent acetylation of Cox1 in blood platelets, interferes with blood coagulation for days, thus enhancing the risk of bleeds following surgical interventions (Merritt et al. 2004). Reversible inhibitors of platelet Cox1, such as ibuprofen, furbiprofen and naproxen, may exert similar effects, however, for shorter periods of time.

Weak, non-selective or indirect inhibitors, such as acetaminophen, phenazone and propyphenazone are devoid of these bleeding enhancing activities. The literature, however, is scarce (see below).

### Selective Inhibitors

These drugs, including celecoxib, etoricoxib, rofecoxib, valdecoxib and lumiracoxib do not interfere with blood coagulation. They can be used safely (with respect to bleeding) in the perioperative time period (Hegi et al. 2004). Recent observations suggest that compounds with slow elimination may be safely and advantageously given before surgical intervention in order to decrease the postinterventional need for opioids (Reuben and Connelly 2004). Contraindications, however, have to be obeyed.

Selective Cox2 inhibitors appear not to differ from non-selective cyclooxygenase blockers with respect to impairment of renal function. Many clinical investigations have equivocally shown that they do increase blood pressure (systolic and diastolic) as non-selective inhibitors (Schwartz et al. 2002), lead to fluid and water retention, and interfere with the activity of diuretics, ACE inhibitors and AT1-receptor antagonists (Brater 2002). These effects appear to be limited to the time of presence of the compounds in the blood and kidney (compare e.g. White et al. 2002; Fig. 3).

Recent evidence indicates that beyond effects on blood pressure and blood coagulation, selective Cox2 inhibitors may enhance the risk of cardiac infarctions, venous thromboses and ischemic stroke in patients at risk. A first report indicated that patients suffering from connective tissue diseases may be particularly prone to venous thrombosis following the administration of Cox2 inhibitors, as, for example, celecoxib (Croford et al. 2000). The VIGOR study demonstrated a four times increase of cardiac infarctions in the group of patients receiving rofecoxib (rheumatoid arthritis)



(Bombardier et al. 2000). Valdecoxib, given to patients undergoing coronary bypass surgery, was associated with an increased frequency of cerebro-vascular and renal complications (Ott et al. 2003). Patients receiving high doses of rofecoxib appear to die from sudden cardiac death more frequently than those that have not been exposed to cyclooxygenase inhibition (Graham et al. 2004). Similarly, a recent outcome study signalled more cardiac infarctions during long-term treatment with a Cox2 inhibitor (lumiracoxib), as compared to the naproxen treated control group (Farkouh et al. 2004). Nested case control studies (e.g. Hippisley-Cox et al. BMJ 2005) indicate, however, that a similar increase in risk of CV-events is seen with widely used non-selective inhibitors such as diclofenac or ibuprofen.

### Conclusion

Theoretical, clinical and experimental evidence shows that effects of non-steroidal, anti-inflammatory drugs on the cardio-vascular system are of major clinical importance. The impact of these drugs on blood coagulation is well defined. Moreover, selective and non-selective NSAIDs increase blood pressure and lead to water and fluid retention, at least in some patients. The importance of the effect of selective Cox2 inhibitors on thrombosis, cardiac infarction and stroke is not completely clear. Nevertheless, these effective drugs should be used in patients at risk with caution and at low doses, for short periods of time.

### References

- Baigent C, Patrono C (2003) Selective Cyclooxygenase-2-Inhibitors, Aspirin, and Cardiovascular Disease: A Reappraisal. *Arthritis Rheum* 48:12–20
- Bombardier C, Laine L, Reicin A, Shapiro D, Burgos-Vargas R, Davis B, Day R, Ferraz MB, Hawkey CJ, Hochberg MC, Kvien TK, Schnitzer TJ (2000) VIGOR Study Group. Comparison of Upper Gastrointestinal Toxicity of Rofecoxib and Naproxen in Patients with Rheumatoid Arthritis. VIGOR Study Group. *N Engl J Med* 343:1520–1528; pp following 1528
- Brater DC (2002) Anti-Inflammatory Agents and Renal Function. *Semin Arthritis Rheum* 32:33–42
- Brune K, Hinz B (2004) The Discovery and Development of Antiinflammatory Drugs. *Arthritis Rheum* 50:2391–2399
- Cipollone F, Rocca B, Patrono C (2004) Cyclooxygenase-2 Expression and Inhibition in Atherothrombosis. *Arterioscler Thromb Vasc Biol* 24:246–255
- Crofford LJ, Lipsky PE, Brooks P, Abramson SB, Simon LS, van de Putte LB (2000) Basic Biology and Clinical Application of Specific Cyclooxygenase-2 Inhibitors. *Arthritis Rheum* 43:4–13
- Farkouh ME, Kirshner H, Harrington RA, Ruland S, Verheugt FW, Schnitzer TJ, Burmester GR, Mysler E, Hochberg MC, Doherty M, Ehsam E, Gitton X, Krammer G, Mellein B, Gimona A, Matchaba P, Hawkey CJ, Chesebro JH (2004) TARGET Study Group. Comparison of Lumiracoxib with Naproxen and Ibuprofen, in the Therapeutic Arthritis Research and Gastrointestinal Event Trial (TARGET), Cardiovascular Outcomes: Randomised Controlled Trial. *Lancet* 364:675–684
- FitzGerald GA (2002). The Choreography of Cyclooxygenases in the Kidney. *J Clin Invest* 110:33–34
- Flower RJ (2003) The Development of COX2 Inhibitors. *Nat Rev Drug Discov* 2:179–191
- Francois H, Coffman TM (2004) Prostanoids and Blood Pressure: Which Way is Up? *J Clin Invest* 114:757–759
- Graham DJ, Campen D, Cheetham C, Hui R, Spence M, Ray WA (2004) Risk of Acute Cardiac Events among Patients Treated with Cyclooxygenase-2 selective and Non-Selective Nonsteroidal Antiinflammatory Drugs [Abstract 571]. The 20<sup>th</sup> International Conference on Pharmacoepidemiology & Therapeutic Risk Management, August 22–25, 2004. Bordeaux, France
- Hara A, Yuhki K, Fujino T, Narumiya S, Ushikubi F (2003) Pathophysiological Roles of the Prostanoids in the Cardiovascular System: Studies Using Mice Deficient in Prostanoid Receptors. *Nippon Yakurigaku Zasshi* 122:384–390
- Harris RC, Breyer MD (2001). Physiological Regulation of Cyclooxygenase-2 in the Kidney. *Am J Physiol Renal Physiol* 281:F1–11
- Harris RC, Zhang MZ, Cheng HF (2004) Cyclooxygenase-2 and the Renal Renin-Angiotensin System. *Acta Physiol Scand* 181(4):543–547
- Hawkey CJ (1999) COX2 Inhibitors. *Lancet* 353(9149):307–314
- Hegi TR, Bombeli T, Seifert B, Baumann PC, Haller U, Zalunardo MP, Pasch T, Spahn DR (2004) Effect of Rofecoxib on Platelet Aggregation and Blood Loss in Gynaecological and Breast Surgery Compared with Diclofenac. *Br J Anaesth* 92:523–531
- Hennan JK, Huang J, Barrett TD, Driscoll EM, Willens DE, Park AM, Crofford LJ, Lucchesi BR (2001) Effects of Selective Cyclooxygenase-2 Inhibition on Vascular Responses and Thrombosis in Canine Coronary Arteries. *Circulation* 104:820–825
- Johnson AG (1997) NSAIDs and Increased Blood Pressure. What is the Clinical Significance? *Drug Saf* 17:277–289
- Johnson DL, Hisel TM, Phillips BB (2003) Effect of Cyclooxygenase-2 inhibitors on Blood Pressure. *Ann Pharmacother* 37:442–446
- Komhoff M, Grone HJ, Klein T, Seyberth HW, Nusing RM (1997) Localization of Cyclooxygenase-1 and -2 in Adult and Fetal Human Kidney: Implication for Renal Function. *Am J Physiol* 272:F460–468
- Loftin CD, Trivedi DB, Tiano HF, Clark JA, Lee CA, Epstein JA, Morham SG, Breyer MD, Nguyen M, Hawkins BM, Goulet JL, Smithies O, Koller BH, Langenbach R (2001) Failure of Ductus Arteriosus Closure and Remodeling in Neonatal Mice Deficient in Cyclooxygenase-1 and Cyclooxygenase-2. *Proc Natl Acad Sci USA* 98:1059–1064
- Malik KU, Sehic E (1990) Prostaglandins and the Release of the Adrenergic Transmitter. *Ann N Y Acad Sci* 604:222–236
- McAdam BF, Catella-Lawson F, Mardini IA, Kapoor S, Lawson JA, FitzGerald GA (1999) Systemic Biosynthesis of Prostaglandin by Cyclooxygenase (COX)-2: The Human Pharmacology of a Selective Inhibitor of COX2. *Proc Natl Acad Sci USA* 96:272–277. Erratum in: *Proc Natl Acad Sci USA* 96:5890
- Merritt JC, Bhatt DL (2004) The Efficacy and Safety of Perioperative Antiplatelet Therapy. *J Thromb Thrombolysis* 17:21–27
- Narumiya S, Sugimoto Y, Ushikubi F (1999) Prostanoid Receptors: Structures, Properties, and Functions. *Physiol Rev* 79:1193–1226
- Ott E, Nussmeier NA, Duke PC, Feneck RO, Alston RP, Snabes MC, Hubbard RC, Hsu PH, Saidman LJ, Mangano DT (2003) Multicenter Study of Perioperative Ischemia (McSPI) Research Group; Ischemia Research and Education Foundation (IREF) Investigators. Efficacy and Safety of the Cyclooxygenase-2 inhibitors Parecoxib and Valdecoxib in Patients Undergoing Coronary Artery Bypass Surgery. *J Thorac Cardiovasc Surg* 125:1481–1492
- Pratico D, Tillmann C, Zhang ZB, Li H, FitzGerald GA (2001) Acceleration of Atherogenesis by COX1-Dependent Prostanoid Formation in Low Density Lipoprotein Receptor Knockout Mice. *Proc Natl Acad Sci USA* 98:3358–3363
- Reuben SS, Connelly NR (2004). The Perioperative Use of Cyclooxygenase-2 Selective Nonsteroidal Antiinflammatory Drugs May Offer a Safer Alternative. *Anesthesiology* 100:748
- Schwartz JI, Vandormael K, Malice MP, Kalyani RN, Lasseter KC, Holmes GB, Gertz BJ, Gottesdiener KM, Laurenzi M, Redfern KJ, Brune K (2002) Comparison of Rofecoxib, Celecoxib, and Naproxen on Renal Function in Elderly Subjects receiving a Normal-Salt Diet. *Clin Pharmacol Ther* 72:50–61

30. Simmons DL, Botting RM, Hla T (2004) Cyclooxygenase Isozymes: The Biology of Prostaglandin Synthesis and Inhibition. *Pharmacol Rev* 56:387–437
31. Ushikubi F, Sugimoto Y, Ichikawa A, Narumiya S (2000) Roles of Prostanoids Revealed from Studies Using Mice Lacking Specific Prostanoid Receptors. *Jpn J Pharmacol* 83:279–285
32. Wacker MJ, Tehrani RN, Smoot RL, Orr JA (2002) Thromboxane A(2) Mimetic Evokes a Bradycardia Mediated by Stimulation of Cardiac Vagal Afferent Nerves. *Am J Physiol Heart Circ Physiol* 282:H482–490
33. White WB, Kent J, Taylor A, Verburg KM, Lefkowitz JB, Whelton A (2002) Effects of Celecoxib on Ambulatory Blood Pressure in Hypertensive Patients on ACE Inhibitors. *Hypertension* 39:929–934

## NSAIDs and Coxibs

### ► Coxibs and Novel Compounds, Chemistry

## NSAIDs and their Indications

RICHARD O. DAY, GARRY G. GRAHAM  
Department of Physiology and Pharmacology, School of Medical Sciences and Department of Clinical Pharmacology, University of New South Wales, St Vincent's Hospital, Sydney, NSW, Australia  
r.day@unsw.edu.au, ggraham@stvincents.com.au

### Synonyms

Non-Steroidal Anti-Inflammatory Drugs and their indications; Antipyretic Analgesics; Aspirin-Like Drugs; simple analgesics; COX-2 selective inhibitors

### Definitions

The term Non-Steroidal Anti-Inflammatory Drugs, NSAIDs, refers to a group of drugs whose major therapeutic activities are the suppression of pain (analgesia), reduced body temperature in fever (antipyresis) and decreased signs of inflammation (anti-inflammatory activity).

### Characteristics

The NSAIDs can be separated into two major groups:

- non-selective NSAIDs, such as aspirin, ibuprofen and indomethacin, which also produce gastrointestinal damage, inhibit the aggregation of platelets, decrease kidney function in some patients and precipitate aspirin-induced asthma. The activity of these drugs is due to inhibition of two central enzymes involved in the synthesis of ► **prostaglandins** and related compounds. These central enzymes are cyclooxygenase-1 (COX-1) and COX-2.
- COX-2 selective inhibitors (coxibs or COX-1 sparing agents, CSIs) such as celecoxib, which have similar activities to the non-selective NSAIDs but have improved gastrointestinal tolerance, little or no effect

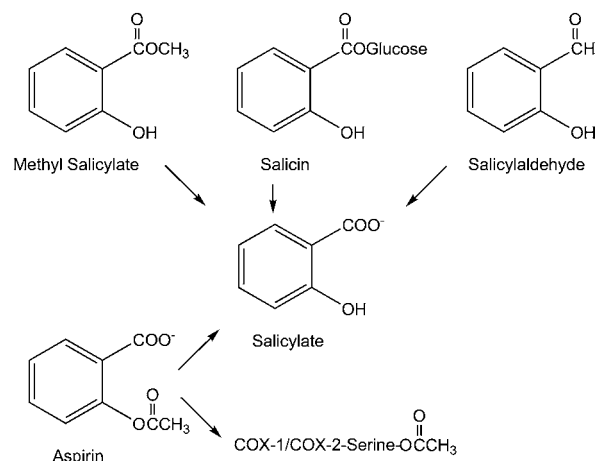
on platelets and, from present studies, no tendency to produce asthma. The COX-2 selective inhibitors tend to increase the incidence of heart attack and stroke although the incidence of these reactions is low and may not be significant at analgesic doses of all the COX-2 selective inhibitors.

In addition, there is the unique drug, paracetamol (acetaminophen), which has similar activities to the COX-2 selective inhibitors but has weaker anti-inflammatory activity.

### History

Three well-known plant compounds, salicin, salicylaldehyde and methyl salicylate, are active analgesics, antipyretics and anti-inflammatory agents. All three owe their pharmacological activity to their metabolism to salicylate (Fig. 1). Salicin is the most well known because it is present in the bark of the willow tree, and in several other plants which were used in the treatment of pain and fever. The modern use of willow bark started in 1763, although it had been used in earlier times. Methyl salicylate is still widely used in liniments while salicylaldehyde has little modern use although, like salicin, it is still used in herbal preparations.

In the nineteenth century, salicin was superseded by synthetic salicylic acid and its salt, sodium salicylate (Fig. 1). In turn, the purely synthetic compound, aspirin, largely replaced salicylic acid and its salts. However, sodium salicylate continued to be used for many years in the treatment of rheumatic fever and, until recently, sodium and other salicylate salts were used as anti-inflammatory drugs for ► **rheumatoid arthri-**



**NSAIDs and their Indications, Figure 1** Structures of the naturally occurring salicylate derivatives and the synthetic drug, aspirin. All compounds are metabolized to the pharmacologically active salicylate (the ionised form of salicylic acid). The effect of aspirin is due to the metabolite, salicylate, and also to the reaction in which a serine at the active site of both COX-1 and COX-2 is acetylated. The effect of aspirin is prolonged because of this covalent binding to COX-1 and COX-2, and also because the half life of salicylate is longer than that of aspirin.

tis. Salicylate is still of interest because it is an active metabolite of aspirin.

### Mechanism of Action

The older, non-selective NSAIDs inhibit both COX-1 and COX-2 and, therefore, decrease the synthesis of all prostaglandins and related compounds, such as ► [Thromboxane A2](#) and ► [prostacyclin](#). The prostaglandins and related compounds are factors which can be synthesized widely throughout the body and produce a variety of physiological effects. For example, they potentiate the actions of painful mediators, such as bradykinin. Thus, by inhibiting the synthesis of prostaglandins, the non-selective NSAIDs are analgesic. Inhibition of the synthesis of prostaglandin also explains the antipyretic and anti-inflammatory actions of NSAIDs, as well as their common adverse effects (see below).

The discovery of two COX isoenzymes led to the development of the COX-2 selective inhibitors which retain the analgesic, antipyretic and anti-inflammatory activities, but have a much reduced risk of gastrointestinal toxicity, and do not inhibit platelet function or precipitate aspirin-induced asthma.

Both salicylate and paracetamol are poor inhibitors of COX-1 and COX-2 in broken cell preparations, but both drugs inhibit the production of prostaglandins by intact cells when the levels of the precursor, arachidonic acid, are low (Graham and Scott 2003). Consequently, it now appears that salicylate and paracetamol both produce their pharmacological effects by inhibition of prostaglandin synthesis. The pharmacological activities of paracetamol and salicylate are generally similar to those of the COX-2 selective inhibitors, but the actions of paracetamol and salicylate at a molecular level are not known.

The activity of aspirin is due, in part, to its metabolism to salicylate, but aspirin also inhibits both COX-1 and COX-2. In this regard, the acetyl group of aspirin is transferred to COX-1 and COX-2, the result being irreversible inhibition of both enzymes (Fig. 1). Although aspirin is rapidly hydrolyzed to salicylate *in vivo*, the irreversible inhibition of COX-1 leads to prolonged inhibition of platelet aggregation, an initial step in the coagulation of blood.

### Clinical Uses of the NSAIDs

#### Pain

The NSAIDs are indicated for a wide variety of painful states affecting all organ systems and all ages of patients, and are particularly indicated when inflammation is a significant contributor to the painful state. Alone, they are not useful for severe, acute pain, for example pain of bone fractures, surgical procedures or myocardial infarction. In these cases, the opioids, such as morphine, are more effective analgesics. The opioids are very useful for the treatment of the pain of cancer, although

they may be used with the NSAIDs for this indication. Although very effective analgesics, the opioids depress the function of the central nervous system and have well known addictive properties, actions which are not shown by the NSAIDs.

Musculoskeletal pain is the major indication for NSAIDs. Surveys have shown that 15–20% of individuals over the age of 65 years take NSAIDs regularly, and this is largely for musculoskeletal pain. ► [Osteoarthritis](#) has a prevalence of about 10% in western populations, and afflicts elderly people. Although osteoarthritis is not primarily an inflammatory disorder, NSAIDs are moderately effective at relieving pain and the muscle stiffness associated with osteoarthritis.

Paracetamol is a widely used analgesic and antipyretic drug, but without significant anti-inflammatory actions in usual doses in rheumatoid arthritis, although it does reduce swelling after oral surgery. Although the NSAIDs are, on average, somewhat more efficacious than paracetamol (Pincus et al. 2004), paracetamol is still recommended as first line treatment for osteoarthritis, not only because it is effective, but also because it is better tolerated than the NSAIDs. Inflammation is a relatively minor component of the pathophysiology of osteoarthritis, and this might explain the small advantage that NSAIDs demonstrate compared to paracetamol. Although little work has been done to evaluate the utility of combining NSAIDs with paracetamol, this practice has no obvious disadvantages and may control pain better than either drug alone. NSAIDs are also indicated for spinal pain, particularly lumbar and cervical mechanical origin pain, prevalent in middle to old age. So called ‘soft tissue’ rheumatic problems are common and include muscle strains and aches, tennis elbow, and many others. NSAIDs can be helpful if paracetamol is insufficient, along with physical and other non-pharmacological therapies. There is some controversy about whether continuous therapy with NSAIDs slow or increase the loss of cartilage from weight bearing joints in patients with osteoarthritis (Rashad et al. 1989). This issue remains to be resolved. Good pain relief has been achieved with NSAIDs in conditions of painful, often obstructed contraction, of smooth muscle. Examples are renal and biliary colic. This is because the smooth muscle contractions are dependent on prostaglandin synthesis. Again, NSAIDs outperform the opioids which have been traditionally used for these indications.

In a similar way, the pain associated with menstruation is dependent on prostaglandin synthesis and is therefore amenable to treatment with the non-selective NSAIDs. The COX-2 selective drugs relieve the pain of this condition and, because they have no significant anti-platelet effect, they do not increase menstruation related bleeding (Daniels et al. 2002).

A major, relatively new indication for the NSAIDs is perioperative pain. This has evolved with the availability of

the COX-2 selective inhibitors. In contrast to NSAIDs, including aspirin, the COX-2 selective inhibitors do not inhibit platelet aggregation so that blood clots normally. This property is particularly useful with the major shift to 'day only' surgery (Buvanendran et al. 2003). Renal function may, however, be decreased by NSAIDs after surgery (see below), and they should be used carefully in this situation.

### Inflammation

Inflammatory rheumatic disorders exemplified by rheumatoid arthritis (RA) are an important indication for NSAIDs. Pain and stiffness especially in the morning are characteristic and debilitating. These symptoms are relieved by the non-selective NSAIDs or the COX-2 selective drugs, but there is no clear effect of either group on the progression of the condition to joint damage and loss of function. However, the NSAIDs have much to offer symptomatically to patients with rheumatoid arthritis. Consequently, the NSAIDs are very commonly used with the ► [disease-modifying anti-rheumatic drugs](#) (DMARDs). These are drugs which slow the progression of rheumatic arthritis in many patients. NSAIDs also have well defined roles in many other inflammatory, painful, arthritic states, including acute gout, ► [ankylosing spondylitis](#) and the arthritis often associated with psoriasis.

### Migraine

The non-selective NSAIDs and the COX-2 selective inhibitors are good analgesics and, consequently, have an important place in the treatment of migraine (Goadsby et al. 2002). Their use soon after onset of an acute attack of migraine is most effective. Combination with an antiemetic is often required in order to suppress vomiting.

### Other Clinical Uses

The non-selective NSAIDs have antithrombotic effects due to their inhibition of the formation of thromboxane A<sub>2</sub>, a prostaglandin-like compound which leads to the aggregation of platelets and, therefore, the initiation of clotting of blood. Thromboxane A<sub>2</sub> is synthesized by a COX-1 dependent pathway in platelets and, therefore, all the non-selective NSAIDs have antithrombotic activity. Aspirin is, however, the preferred anti-platelet agent because of its long duration of action. As thromboxane A<sub>2</sub> is synthesized by a COX-1-dependent pathway, the COX-2 selective inhibitors do not have significant antithrombotic activity. This lack of antithrombotic activity may, however, be a cause for the major adverse reactions of these new NSAIDs, as is outlined below.

### Adverse Effects

#### Gastrointestinal

Prostaglandins are cytoprotective in the stomach and small intestine. Thus, they are important in developing

mechanisms which protect the gastrointestinal tract from damage from the digestive enzymes and, in the stomach and duodenum, from the acidic contents. The non-selective NSAIDs commonly cause a variety of serious adverse reactions in the gastrointestinal tract, most importantly, perforations, ulceration and bleeding. Serious cases of gastrointestinal damage affect nearly 1% of chronic users of the older NSAIDs per year. Older, sicker patients, particularly those with previous peptic ulceration are most at risk.

Gastrointestinal tolerance is improved with ► [enteric coating](#), co-prescription of antacids, ingestion with food, or rectal or parental routes of administration, but the risk of serious upper gastrointestinal bleeding remains. Another approach is to use the non-selective NSAIDs with prostaglandin analogues which are cytoprotective, or with drugs which decrease acid secretion by the stomach. A further approach is to use the COX-2 selective inhibitors or paracetamol. The COX-2 selective inhibitors were developed in order to decrease the gastrointestinal toxicity of the NSAIDs. This was successful and the use of the selective inhibitors, in preference to the non-selective NSAIDs, reduces the incidence of serious gastrointestinal damage (Silverstein et al. 2000).

A particular problem arises for patients who require long-term dosage with both low dose aspirin as an antithrombotic and a NSAID. It now appears that low doses of aspirin decrease the gastrointestinal sparing effects of the COX-2 selective inhibitors (Schmidt et al. 2004). Consequently, patients who require both an analgesic and low-dose aspirin are now often prescribed a non-selective NSAID and a cytoprotective drug, as well as aspirin (Barraclough et al. 2002).

### Thrombosis

As discussed above, thromboxane A<sub>2</sub> is synthesized by a COX-1 dependent pathway in platelets, and therefore not affected by the COX-2 selective inhibitors. However, the selective COX-2 inhibitors may block the synthesis of prostacyclin, a vasodilator and antiplatelet factor which is largely synthesized through COX-2. Thus, there has been considerable concern that the selective COX-2 inhibitors may increase the incidence of ► [thrombosis](#), causing myocardial infarction, for example. This concern has been confirmed by the withdrawal of one COX-2 selective inhibitor, rofecoxib, because of the increased occurrence of myocardial infarction during long term therapy (FitzGerald 2004). On the other hand, blood clotting often develops at atherosclerotic plaques in arteries. The development of atherosclerosis or reactions following thrombosis in the heart, in part, may be inflammatory processes, and the COX-2 selective inhibitors may usefully reduce this inflammation. Much research is presently directed at examining this possibility.



## Renal Impairment and Hypertension

The NSAIDs and the COX-2 selective drugs both may precipitate renal failure. Risk factors include: age over 60, pre-existing renal impairment, dehydration, cirrhosis, congestive cardiac failure, salt restricted diets, or concomitant treatment with diuretics or inhibitors of angiotensin formation or action (Barracough et al. 2002). The renal function of patients in these situations is considered to be more dependent on the function of prostaglandins than normal subjects and, therefore, inhibition of prostaglandin synthesis may produce marked depressant effects on renal function. Blood pressure may rise, in some cases quite substantially, during treatment with either the non-selective NSAIDs or the COX-2 selective agents (Barracough et al. 2002; Whelton et al. 2002). Consequently, it is now recommended that blood pressure should be monitored if dosage with the non-selective NSAIDs or the COX-2 selective drugs is commenced in patients taking antihypertensives, and the dosage of antihypertensives increased if blood pressure rises.

## Asthma

Asthma is precipitated in up to 20% of asthmatics by aspirin and other non-selective NSAIDs. This reaction is produced by inhibition of COX-1 because asthma is not induced by the COX-2 selective inhibitors (West and Fernandez 2003). Paracetamol is also safer in aspirin-sensitive asthmatics, but does produce mild asthma in occasional patients (Jenkins 2000).

## References

- Barracough DR, Bertouch JV, Brooks P et al. (2002) Considerations for the Safe Prescribing and Use of COX-2-Specific Inhibitors. *Med J Aust* 176:328–331
- Buvanendran A, Kroin JS, Tuman KJ et al. (2003) Effects of Perioperative Administration of a Selective Cyclooxygenase-2-Inhibitor on Pain Management and Recovery of Function after Knee Replacement: A Randomized Controlled Trial. *JAMA* 290:2411–2418
- Daniels SE, Talwalker S, Torri S et al. (2002) Valdecoxib, A Cyclooxygenase-2-Specific Inhibitor, is Effective in Treating Primary Dysmenorrhea. *Obstet Gynecol* 100:350–358
- FitzGerald GA (2004) Coxibs and Cardiovascular Disease. *N Engl J Med* 351:1709–1711
- Goadsby PJ, Lipton RB, Ferrari MD (2002) Migraine – Current Understanding and Treatment. *N Engl J Med* 346:257–270.
- Graham GG, Scott KF (2003) Mechanisms of Action of Paracetamol and Related Analgesics. *Inflammopharmacology* 11:401–412
- Jenkins C (2000) Recommending Analgesics for People with Asthma. *Am J Therapeut* 7:55–61
- Pincus T, Koch G, Lei H et al. (2004) Patient Preference for Placebo, Acetaminophen (paracetamol) or Celecoxib Efficacy Studies (PACES): Two Randomised, Double Blind, Placebo Controlled, Crossover Clinical Trials in Patients with Knee or Hip Osteoarthritis. *Ann Rheum Dis* 63:931–939
- Rashad S, Revell P, Hemingway A et al. (1989) Effect of Non-Steroidal Anti-Inflammatory Drugs on the Course of Osteoarthritis. *Lancet* 2:519–522
- Schmidt H, Woodcock BG, Geisslinger G (2004) Benefit-Risk Assessment of Rofecoxib in the Treatment of Osteoarthritis. *Drug Safety* 27:185–196
- Silverstein FE, Faich G, Goldstein JL et al. (2000) Gastrointestinal Toxicity with Celecoxib vs. Nonsteroidal Anti-Inflammatory Drugs for Osteoarthritis and Rheumatoid Arthritis: The Class Study: A Randomized Trial. *JAMA* 284:1247–1255
- West PM, Fernandez C (2003) Safety of COX-2 Inhibitors in Asthma Patients with Aspirin Hypersensitivity. *Ann Pharmacother* 37:1497–1501
- Whelton A, White WB, Bello AE et al. (2002) Effects of Celecoxib and Rofecoxib on Blood Pressure and Edema in Patients > 65 Years of Age with Systemic Hypertension and Osteoarthritis. *Am J Cardiol* 90:959–963

## NSAIDs, Adverse Effects

IRMGARD TEGEDER

Center of Pharmacology, University Clinic Frankfurt, Frankfurt, Germany  
tegeder@em.uni-frankfurt.de

## Synonyms

NSAIDs; non-steroidal anti-inflammatory drugs; Non-Steroidal Anti-Rheumatic Drugs; cyclooxygenase inhibitors; NSAIDs, Side Effects

## Definition

NSAIDs constitute a large group of chemically diverse substances that inhibit ► **Cyclooxygenases** activity and thereby prostaglandin synthesis. Traditional NSAIDs inhibit both COX-isoenzymes (COX-1 and COX-2). Novel NSAIDs ("coxibs") inhibit only COX-2. NSAIDs are mainly used as analgesics.

## Characteristics

### Overview

► **Adverse effects** of NSAIDs arise from the fact that it is impossible to inhibit exclusively the synthesis of ► **prostaglandins** that cause pain and inflammation. The inhibition of cyclooxygenases will always also affect the synthesis of prostaglandins and ► **thromboxanes** that are needed for physiological processes. In addition, COX inhibition may shift arachidonic acid metabolism to ► **leukotriene** synthesis because of the excess supply of substrate. This rule particularly applies to traditional NSAIDs that inhibit both COX-isoenzymes, but also holds true for COX-2 specific inhibitors.

COX-1 and COX-2 perform different tasks; this is allowed for by a different localization and regulation. COX-1 is expressed in all tissues and mainly produces prostaglandins and thromboxanes that are needed for the maintenance of physiological functions. COX-2 is not expressed in most healthy tissue but is upregulated after stimulation, which may be any kind of tissue damage. Hence, exclusively targeting COX-2 will not affect COX-1 derived physiological prostaglandins, and will therefore avoid many adverse effects that are typical for traditional NSAIDs. However, COX-2 is also constitutively expressed (see ► **Constitutive Gene**) in

some tissues, so that COX-2 selective NSAIDs are not able to spare physiological prostaglandin production completely. In addition to common adverse effects, some substance specific side effects may occur, so the individual tolerability of NSAIDs may vary among patients.

### Gastrointestinal Toxicity

Physiological prostaglandin E<sub>2</sub> (PGE<sub>2</sub>) and prostacyclin (PGI<sub>2</sub>) in the stomach play an important role in the gastric defense mechanisms that protect the gastric epithelium from the acidic environment. PGE<sub>2</sub> increases the production of gastric mucus, which builds a protective layer on the epithelium, while PGI<sub>2</sub> maintains gastric blood flow. Inhibition of PG synthesis in the stomach causes serious adverse effects such as gastric erosions, bleeding, ulceration and perforation. A single dose of aspirin is sufficient to cause small erosions. The risk for serious GI toxicity increases considerably with long-term use of traditional NSAIDs and concomitant use of glucocorticoids.

Multiple clinical trials have demonstrated that COX-2 selective inhibitors cause less gastrointestinal toxicity than traditional NSAIDs. Particularly, serious side effects are reduced to the placebo level, suggesting that the physiological PG production in the stomach is mediated primarily by the COX-1 pathway. However, experimental studies have revealed that gastric damage only occurs if both COX-enzymes are inhibited collectively, but not with COX-1 or COX-2 inhibition alone. This indicates that COX-2 also is important for protection of the gastric mucosa (Halter et al. 2001). This idea is further supported by studies showing that COX-2 is **upregulated** in the stomach in the case of ulceration (Schmassmann et al. 1998) or other epithelial damage such as **Helicobacter pylori** infection (Seo et al. 2002), and contributes to the production of prostaglandins that are involved in healing processes such as PGJ<sub>2</sub> (Gilroy et al. 1999). Hence, although COX-2 selective inhibitors are relatively safe for the healthy stomach, they may impair ulcer healing (Jones et al. 1999).

### Renal Toxicity

COX-2 is constitutively expressed in the kidney and is highly regulated in response to alterations in intravascular volume (Harris et al. 1994). COX-2-derived PGs signal the release of **renin** from the renal **juxtaglomerular apparatus**, especially during volume depletion. PGs also maintain renal blood flow and regulate salt and water excretion.

COX-2 inhibition, both with traditional NSAIDs or selective COX-2 inhibitors, may transiently decrease urine sodium excretion in some subjects and induce mild to moderate elevation of blood pressure. Substance specific differences have been suggested. For example, rofecoxib users were at a significantly increased relative

risk of new onset hypertension compared with patients taking celecoxib, nonspecific NSAIDs or no NSAID (Solomon et al. 2004). The risk for renal side effects is increased in patients with pre-existing renal or heart disease.

### Platelet Aggregation and Cardiovascular System

Thrombocyte aggregation depends on thromboxane A<sub>2</sub> (TXA<sub>2</sub>), which is produced by the COX-1 pathway in platelets. Hence, traditional NSAIDs inhibit platelet aggregation, and particularly aspirin, the irreversible unselective COX-inhibitor, causes a long-lasting prolongation of the bleeding time, which may increase the risk of bleeding e.g. during or after surgery. On the other hand, inhibition of thrombocyte aggregation may be the desired therapeutic effect of aspirin for patients with increased risk of thrombosis such as coronary heart disease, or it may be a welcome side-effect of traditional NSAIDs.

The activation of platelets by TXA<sub>2</sub> is counterbalanced by vascular prostacyclin (PGI<sub>2</sub>) under physiological conditions. Systemic PGI<sub>2</sub> is mainly produced through the COX-2 pathway (McAdam et al. 1999). Specific COX-2 inhibitors may therefore shift the balance between TXA<sub>2</sub> and PGI<sub>2</sub> towards TXA<sub>2</sub> mediated thrombocyte aggregation. This may result in an increased risk of **thrombotic events** in predisposed patients. Recent large clinical trials have revealed an increased risk for thrombotic cardiovascular effects with rofecoxib and other COX-2 inhibitors. However, observational studies reported a similar risk with selective and unselective COX-inhibitors, suggesting that an imbalance between PGJ<sub>2</sub> and TXA<sub>2</sub> does not sufficiently explain the increased cardiovascular risk with these analgesics.

### Bone Healing

PGs participate in inflammatory responses in the bone, increased **osteoclast** activity and subsequent bone resorption, and increased **osteoblast** activity and new bone formation.

Data from animal studies suggest that both non-specific and specific inhibitors of cyclooxygenases impair fracture healing. This is due to the inhibition of COX-2 (Zhang et al. 2002). Although these data raise concerns about the use of traditional NSAIDs and COX-2-specific inhibitors as anti-inflammatory or anti-analgesic drugs in patients undergoing bone repair, clinical reports have been inconclusive.

### Aspirin Asthma

Inhibition of cyclooxygenase activity reduces arachidonic acid consumption for prostaglandin synthesis, and hence yields more substrate for leukotriene and endocannabinoid synthesis. While **endocannabinoids** may enhance the analgesic effects of certain NSAIDs (Ates et al. 2003), overproduction of cysteinyl leukotrienes may cause bronchial constriction and trigger asthma

attacks in “aspirin-sensitive” patients (Szczeklik et al. 2001). Aspirin asthma has also been observed with other non-selective NSAIDs but not with COX-2 selective drugs. Similar mechanisms also account for the NSAID-evoked ► [urticaria](#) (Mastalerz et al. 2004).

### Ototoxicity

A recent study suggested that salicylate induced tinnitus is mediated through an indirect activation of ► [NMDA receptors](#) in the cochlea, causing an increase of spontaneous auditory nerve activity. NMDA receptor activation is probably mediated by inhibition of prostaglandin synthesis (Guitton et al. 2003), and hence is not specific for salicylate. ► [Tinnitus](#) occurs at high plasma concentrations.

### Pregnancy

COX-2-derived prostaglandins play a prominent role at all stages of female reproduction, from ovulation to implantation, ► [decidualization](#) and delivery. The regulation of prostaglandin release is mediated by transcriptional control of COX-2 and microsomal prostaglandin E synthase. Elevated uterine PGs or the enhanced sensitivity of the myometrium to PGs leads to contractions and labor. Hence, traditional NSAIDs as well as COX-2 inhibitors may prolong parturition, or may be used in the treatment of preterm labor (McWhorter et al. 2004). In addition, prostaglandins regulate the transition to pulmonary respiration following birth that requires closure and remodeling of the ► [ductus arteriosus](#). The maintenance of the ductus arteriosus in the open, or patent, state is dependent on prostaglandin synthesis, and the neonatal drop in prostaglandin E<sub>2</sub> that triggers ductal closure is sensed through the EP4 receptor (Nguyen et al. 1997). Hence, NSAIDs may cause a premature DA closure if taken during late pregnancy, or may be used to induce DA closure in preterm infants.

### References

1. Ates M, Hamza M, Seidel K et al. (2003) Intrathecally Applied Flurbiprofen Produces an Endocannabinoid-Dependent Antinociception in the Rat Formalin Test. *Eur J Neurosci* 17:597–604
2. Gilroy DW, Colville-Nash PR, Willis D et al. (1999) Inducible Cyclooxygenase may have Anti-Inflammatory Properties. *Nat Med* 5:698–701
3. Guitton MJ, Caston J, Ruel J et al. (2003) Salicylate Induces Tinnitus through Activation of Cochlear NMDA Receptors. *J Neurosci* 23:3944–3952
4. Halter F, Tarnawski AS, Schmassmann A et al. (2001) Cyclooxygenase-2 Implications on Maintenance of Gastric Mucosal Integrity and Ulcer Healing: Controversial Issues and Perspectives. *Gut* 49:443–453
5. Harris RC, McKanna JA, Akai Y et al. (1994) Cyclooxygenase-2 is Associated with the Macula Densa of Rat Kidney and Increases with Salt Restriction. *J Clin Invest* 94:2504–2510
6. Jones MK, Wang H, Peskar BM et al. (1999) Inhibition of Angiogenesis by Nonsteroidal Anti-Inflammatory Drugs: Insight into Mechanisms and Implications for Cancer Growth and Ulcer Healing. *Nat Med* 5:1418–1423
7. Mastalerz L, Setkowicz M, Sanak M et al. (2004) Hypersensitivity to Aspirin: Common Eicosanoid Alterations in Urticaria and Asthma. *J Allergy Clin Immunol* 113:771–775
8. McAdam BF, Catella-Lawson F, Mardini IA et al. (1999) Systemic Biosynthesis of Prostacyclin by Cyclooxygenase (COX)-2: the Human Pharmacology of a Selective Inhibitor of COX-2. *Proc Natl Acad Sci USA* 96:272–277
9. McWhorter J, Carlan SJ, Richichi K et al. (2004) Rofecoxib versus Magnesium Sulfate to Arrest Preterm Labor: A Randomized Trial. *Obstet Gynecol* 103:923–930
10. Nguyen M, Camenisch T, Snouwaert JN et al. (1997) The Prostaglandin Receptor EP4 Triggers Remodelling of the Cardiovascular System at Birth. *Nature* 390:78–81
11. Schmassmann A, Peskar BM, Stettler C et al. (1998) Effects of Inhibition of Prostaglandin Endoperoxide Synthase-2 in Chronic Gastro-Intestinal Ulcer Models in Rats. *Br J Pharmacol* 123:795–804
12. Seo JH, Kim H, Kim KH (2002) Cyclooxygenase-2 Expression by Transcription Factors in Helicobacter Pylori-Infected Gastric Epithelial Cells: Comparison between HP 99 and NCTC 11637. *Ann NY Acad Sci* 973:477–480
13. Solomon DH, Schneeweiss S, Levin R et al. (2004) Relationship between COX-2 Specific Inhibitors and Hypertension. *Hypertension* 44:140–145
14. Szczeklik A, Nizankowska E, Sanak M et al. (2001) Aspirin-Induced Rhinitis and Asthma. *Curr Opin Allergy Clin Immunol* 1:27–33
15. Weir MR, Sperling RS, Reicin A et al. (2003) Selective COX-2 Inhibition and Cardiovascular Effects: A Review of the Rofecoxib Development Program. *Am Heart J* 146:591–604
16. Zhang X, Schwarz EM, Young DA et al. (2002) Cyclooxygenase-2 Regulates Mesenchymal Cell Differentiation into the Osteoblast Lineage and is Critically Involved in Bone Repair. *J Clin Invest* 109:1405–1415

N

## NSAIDs, Chemical Structure and Molecular Mode of Action

STEFAN A. LAUFER

Institute of Pharmacy, Eberhard-Karls University of Tuebingen, Tuebingen, Germany  
stefan.laufer@uni-tuebingen.de

### Definition

#### Structure and Metabolic Function of COX-1

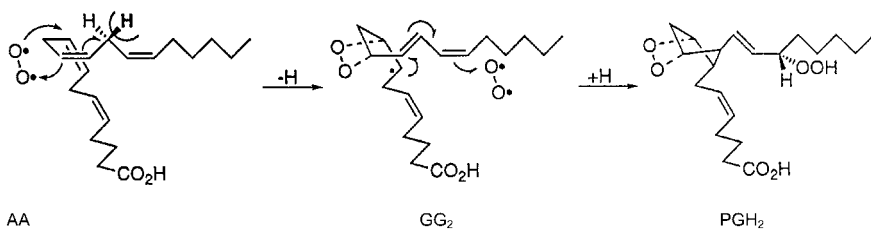
COX-1 is a 70 kD enzyme, catalyzing the reaction of ► [arachidonic acid](#) to PGG<sub>2</sub> (cyclooxygenase reaction) and consecutively PGG<sub>2</sub> to PGH<sub>2</sub> (peroxidase reaction) as outlined in Fig. 1.

There are distinct active sites for the ► [Cyclooxygenases](#) (COX) and the peroxidase reactions (Fig. 2).

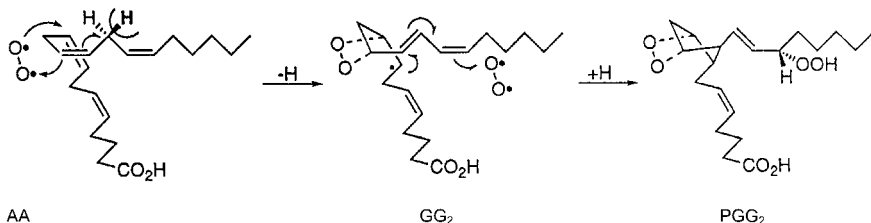
### Characteristics

#### Inhibitors of Cyclooxygenases

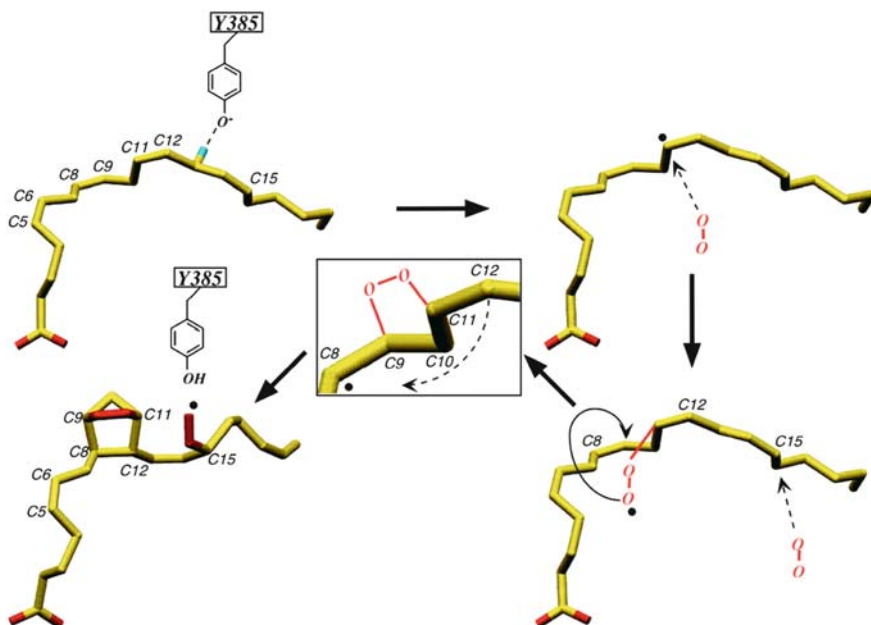
Different chemical classes can provide the structural features necessary to mimic arachidonic acid at the active site. The substrate, arachidonic acid is a C<sub>20</sub> carboxylic acid with 4 isolated double bonds at positions 5, 8, 11 and 14. For the enzyme reaction, arachidonic acid must adapt to a “folded” conformation, allowing the oxygen to insert between C<sub>9</sub> and C<sub>11</sub> and the ring closure between C<sub>8</sub> and C<sub>12</sub> (Fig. 3).



NSAIDs, Chemical Structure and Molecular Mode of Action, Figure 1 Reaction catalyzed by COX enzymes.



NSAIDs, Chemical Structure and Molecular Mode of Action, Figure 2 A ribbon representation of the  $\text{Co}^{3+}$ -oPGHS-1 monomer with AA bound in the COX channel. The EGF domain, MBD, and catalytic domain are shown in green, orange and blue, respectively;  $\text{Co}^{3+}$ -protoporphyrin IX is depicted in red, disulfide bonds (Cys36-Cys47, Cys37-Cys159, Cys4<sup>1</sup>-Cys57, Cys59-Cys69, and Cys569-Cys575) in dark blue and side chain atoms for COX channel residues Arg120, Tyr355 and Tyr385 in magenta (from Malkowski et al. (2000)).



NSAIDs, Chemical Structure and Molecular Mode of Action, Figure 3 Mechanistic sequence for converting AA to PGG<sub>2</sub>. Abstraction of the 13-proS hydrogen by the tyrosyl radical leads to the migration of the radical to C-11 on AA. The attack of molecular oxygen, coming from the base of the COX channel, occurs on the side interfacial to hydrogen abstraction. As the 11R-peroxyl radical swings over C-8 for an R-side attack on C-9 to form the endoperoxide bridge, C-12 is brought closer to C-8 *via* rotation about the C-10/C-11 bond, allowing the formation of the cyclopentane ring. The movement of C-12 also positions C-15 optimally for addition of a second molecule of oxygen, formation of PGG<sub>2</sub> and the migration of the radical back to Tyr385 (from Malkowski et al. (2000)).

To fix arachidonic acid in such a conformation, several interactions with the active site of the enzyme are necessary, e.g. ionic interaction (a salt bridge) between the carboxylic group and arginine 120,  $\pi$ - $\pi$  interactions between the double bonds of arachidonic acid and aromatic amino acids and numerous hydrophobic interactions (Fig. 4).

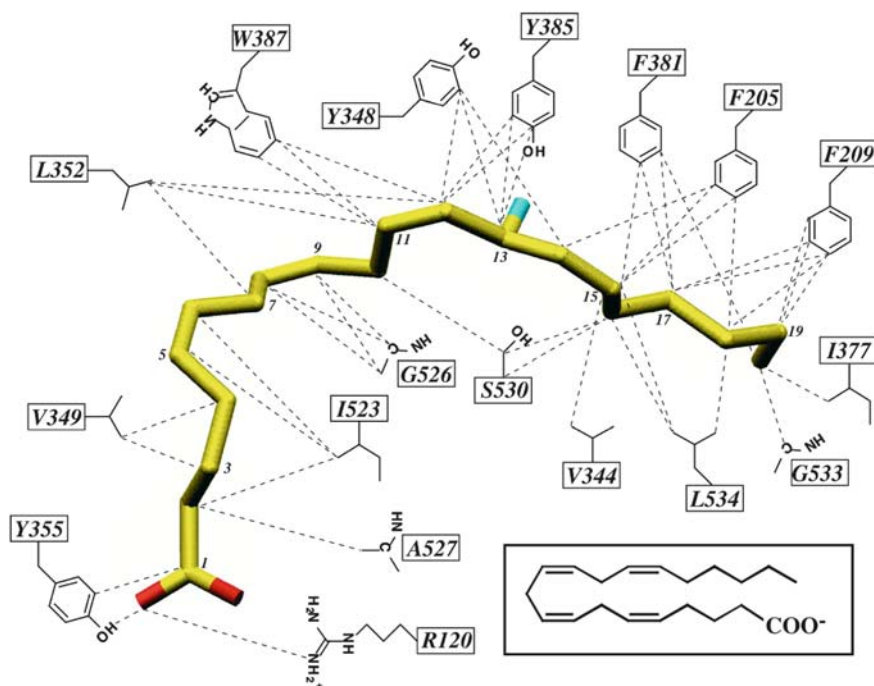
All these structural features can be identified in many **▶ NSAID**s. Most acidic NSAIDs are therefore believed to mimic arachidonic acid in its folded conformation at the active site of COX. Structure activity relationships follow these structural constrictions closely.

The activity against COX-1 clearly correlates with torsion angles around the  $\pi$ -electron systems and the overall lipophilicity of the molecule (Moser et al. 1990).

Two classes of compounds however have a distinctly different molecular mode of action,

- ASS acetylates Ser 530 irreversibly at the active site of the enzyme
- The oxicams are believed to interfere with the peroxidase active site, which also explains their structural difference.





**NSAIDs, Chemical Structure and Molecular Mode of Action, Figure 4** A schematic of interactions between AA and COX channel residues. Carbon atoms of AA are yellow, oxygen atoms red and the 13proS hydrogen blue. All dashed lines represent interactions within 4.0 Å between the specific side chain atom of the protein and AA (from Malkowski et al. (2000)).

Most of the currently used NSAIDs, including diclofenac, ibuprofen, naproxen, piroxicam and indomethacin for instance, may produce full inhibition of both COX-1 and COX-2 with relatively poor selectivity under therapeutic conditions (Warner et al. 1999).

Acidic NSAIDs like diclofenac accumulate particularly in blood, liver, milt and bone marrow, but also in tissue with acidic extracellular pH values. Such tissues are mainly inflamed tissues such as gastric tissue and the manifolds of the kidney. In inflamed tissue, NSAIDs inhibit the pathological overproduction of prostaglandins. In contrast, neutral NSAIDs (paracetamol) and weakly acidic NSAIDs (metamizol) distribute themselves quickly and homogeneously in the organism. They also penetrate the blood-brain-barrier.

#### Fenamate Group

The core structure is 2-aminobenzoic acid (anthranilic acid). The 2-amino group is substituted with aromatic residues.

- flufenamic acid
- mefenamic acid
- meclofenamic acid
- niflumonic acid (core structure: 2-amino-pyridyl-3-carboxylic acid)

For topical application, the carboxylic acid group is esterified with diethyleneglycol

- etofenamate

#### Fenac Group

The core structure is 2-aminophenylacetic acid. The 2-amino group is substituted with aromatic residues.

- diclofenac
- felbinac (only used topically)

#### Heteroaryl Acetic Acid Group

- indomethacin
- acemetacine
- proglumetacine
- tolmetin (and its ring closed analog ketorolac)
- ionazolac

#### Profene Group

The core structure is 2-arylpropionic acid

- ibuprofen
- ketoprofen
- thiaprofen
- naproxen
- ketorolac (can be seen formally as a ring closed profene)

#### Oxicam Group

The core structure is 1,2-benzothiazine

- piroxicam
- tenoxicam
- lornoxicam
- droxicam

- cinoxicam
- sudoxicam
- meloxicam

### Pyrazolone Group

The mode of action of the pyrazolones remains unclear. It is thought that they may not be involved in the inhibition of COX-1 or COX-2. The compounds of the pyrazol-3-on series at least are neutral molecules with no acidity. A central mode of action is suggested. They also act antispasmodically and are effective in visceral pain. In the past, pyrazolones were very frequently used nonsteroidal anti-inflammatory drugs. They show a high plasma protein binding and therefore have a high rate of interaction with other pharmaceuticals. Agranulocytosis is a rare but severe side effect.

The core structure is 3*H*-pyrazol-3-on

- propyphenazone
- metamizol-Na
- phenazone

### Pyrazolidindione

The core structure is pyrazolidin-3,5-dion

- phenylbutazone
- mofebutazone

### COX-2 Selective Inhibitors

The isoform 2 of the COX enzyme catalyzes the identical reaction AA to PGG<sub>2</sub>, the active site however is slightly different from COX-1 (Fig. 5).

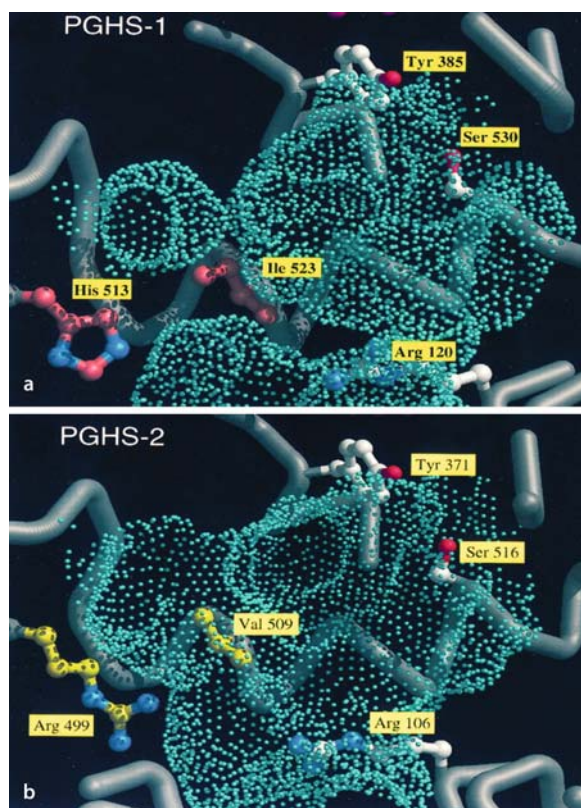
Isoleucine 523 is replaced by valine 509, making the active site of COX-2 more "spacious". This difference can be used to generate COX-2 selective inhibitors, as this active site tolerates more bulky molecules. Celecoxib is capable of producing full inhibition of COX-1 and COX-2. However it shows a preferential selectivity toward COX-2 (>5 fold). The newer coxibs like rofecoxib strongly inhibit COX-2 with only weak activity against COX-1 (Warner et al. 1999).

A common pharmacophore cannot be identified, however vicinal diaryl systems (celecoxib, rofecoxib, valdecoxib) and sulfone or sulphonamide groups seem to be advantageous (Laufer et al. 2000). Lumiracoxib however is an excellent example of the fact that spatial demanding substituents (bulky groups) alone are sufficient to generate selectivity, even with a diclofenac-like pharmacophore.

### Structural Features of Selective COX-2 Inhibitors

Sulfonamide structure

- celecoxib
- valdecoxib



**NSAIDs, Chemical Structure and Molecular Mode of Action, Figure 5** Comparison of the active site of COX-1 (PGHS-1) and COX-2 (PGHS-2) (from Wong et al. 1997).

Methylsulfone structure

- rofecoxib
- etoricoxib

Aryl acetic acid

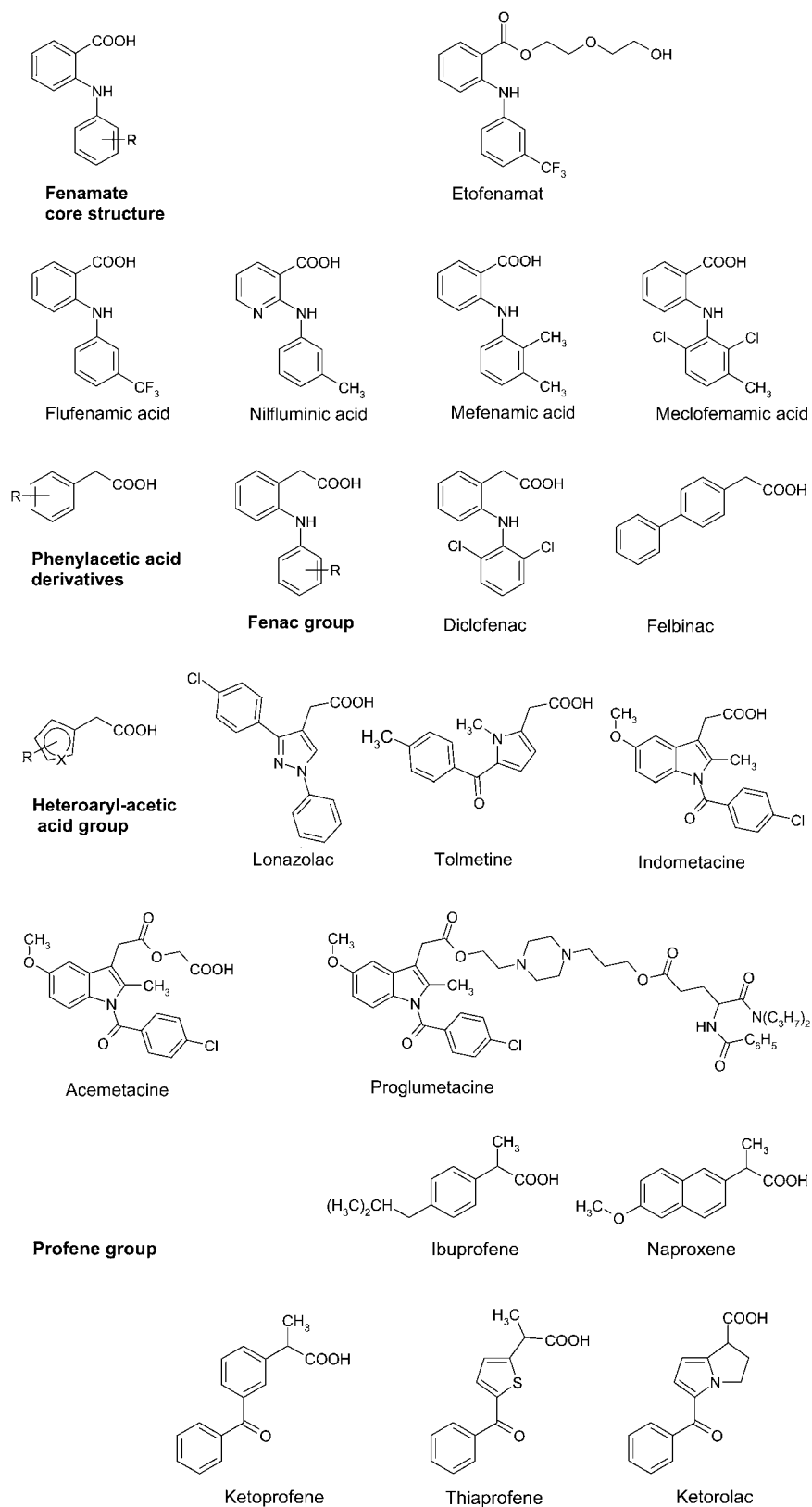
- Lumiracoxib

Others:

- parecoxib (water soluble prodrug for parenteral application, rapidly metabolized to valdecoxib)

### References

1. Moser P, Sallmann A, Wiesenberg L (1990) Synthesis and quantitative structure-activity relationships of diclofenac analogues. *J Med Chem* 33:2358–2368
2. Warner T, Giuliano F, Vojnovic I et al. (1999) Nonsteroid drug selectivities for cyclo-oxygenase-1 rather than cyclo-oxygenase 2 are associated with human gastrointestinal toxicity: A full in vitro analysis. *Proc. Natl Acad Sci USA* 96:7563–7568
3. Dannhardt G and Laufer S (2000) Structural approaches to explain the selectivity of COX-2 inhibitors: Is there a common pharmacophore? *Current Medicinal Chemistry* 7:1101–1112
4. Malkowski M; Ginell SL, Smith WL, Garavito RM (2000) The Productive Conformation of Arachidonic Acid Bound to Prostaglandin Synthase. *Science* 289:1933–1937
5. Wong E, Bayly E, Waterman HL et al. (1997) Conversion of prostaglandin G/H synthase-1 into an enzyme sensitive to PGHS-2-selective inhibitors by a double His<sup>513</sup> → Arg and Ile<sup>523</sup> → Val mutation. *J Biol Chem* 272:9280–9286



NSAIDs, Chemical Structure and Molecular Mode of Action, Figure 6 Chemical structures of NSAIDs.

## NSAIDs, COX-Independent Actions

ELLEN NIEDERBERGER, IRMGARD TEGEDER  
Pharmacological Center Frankfurt, Clinical Center  
Johann-Wolfgang Goethe University, Frankfurt,  
Germany  
e.niederberger@em.uni-frankfurt.de,  
tegeder@em.uni-frankfurt.de

### Synonyms

NSAIDs; non-steroidal anti-inflammatory drugs; COX; cyclooxygenase; PGH-Synthase; Prostaglandin H Synthase

### Definition

NSAIDs are among the most commonly used ► [analgesics](#) and anti-inflammatory drugs. The major mechanism of action is supposed to be the inhibition of cyclooxygenase (COX) 1 and 2 enzymes, and thereby prostaglandin synthesis. However, since aspirin was reported to inhibit nuclear factor kappa B (NF-κB) activation (Kopp and Ghosh 1994), it is increasingly recognized that certain NSAIDs have various biological effects that are independent of cyclooxygenase activity and prostaglandin synthesis, and may account, at least in part, for their analgesic, anti-inflammatory and antiproliferative effects. These effects mainly occur at drug concentrations beyond the IC<sub>50</sub> (► [IC50 value](#)) for COX-inhibition, and therefore probably occur primarily at high concentrations. Various mechanisms have been shown to be involved (Tegeder et al. 2001) and are summarized in this essay. A schematic overview over these mechanisms is shown in figure 1.

### Characteristics

#### Effects on Transcription Factors

##### Nuclear Factor Kappa B (NF-κB)

NF-κB is an important mediator of the cellular response to a variety of extracellular stress stimuli. As homodimers and heterodimers, Rel/NF-κB proteins bind to DNA target sites and regulate gene transcription of pro-inflammatory mediators and proteins that are involved in cell death or survival. Various NSAIDs including salicylates, sulindac, ibuprofen and R- and S-flurbiprofen, inhibit NF-κB activation. While aspirin, ibuprofen and sulindac also inhibit COX-activity, R-flurbiprofen and salicylic acid are inactive in this regard, and therefore do not cause typical NSAID-evoked side effects that are due to COX-inhibition. Indomethacin, ketoprofen and ketorolac do not inhibit NF-κB. Hence, in contrast to COX-inhibition, NF-κB inhibition is not a “class-effect” The COX-2 selective inhibitors rofecoxib and celecoxib have different effects on NF-κB. While rofecoxib inhibits its activation in RAW 264.7 macrophages (Niederberger et al. 2003), celecoxib

further increases LPS-induced NF-κB-activation. The latter effect of celecoxib results in a loss of its anti-inflammatory efficacy at high doses in an experimental inflammatory model in rats (Niederberger et al. 2003), suggesting that effects on NF-κB are important for the anti-inflammatory efficacy of some COX-inhibitors.

As a stress signalling molecule, NF-κB is also involved in the regulation of cell death and survival, either as being essential for the induction of ► [apoptosis](#) or more commonly as an inhibitor of apoptosis. Whether NF-κB promotes or inhibits apoptosis appears to depend on the cell type and the type of inducer. NF-κB is persistently active in numerous human cancer cells. This is suggested to contribute to increased resistance towards chemo- or radiotherapy. NSAIDs that inhibit NF-κB may eliminate this resistance mechanism and thereby re-increase cancer cell sensitivity towards apoptosis inducing treatments. Hence, inhibition of NF-κB in tumour cells may contribute to the observed anti-tumour activity of various NSAIDs including S- and R-Flurbiprofen (Wechter et al. 1997), celecoxib (Grosch et al. 2001), sulindac and aspirin (Thun et al. 1991).

##### AP-1

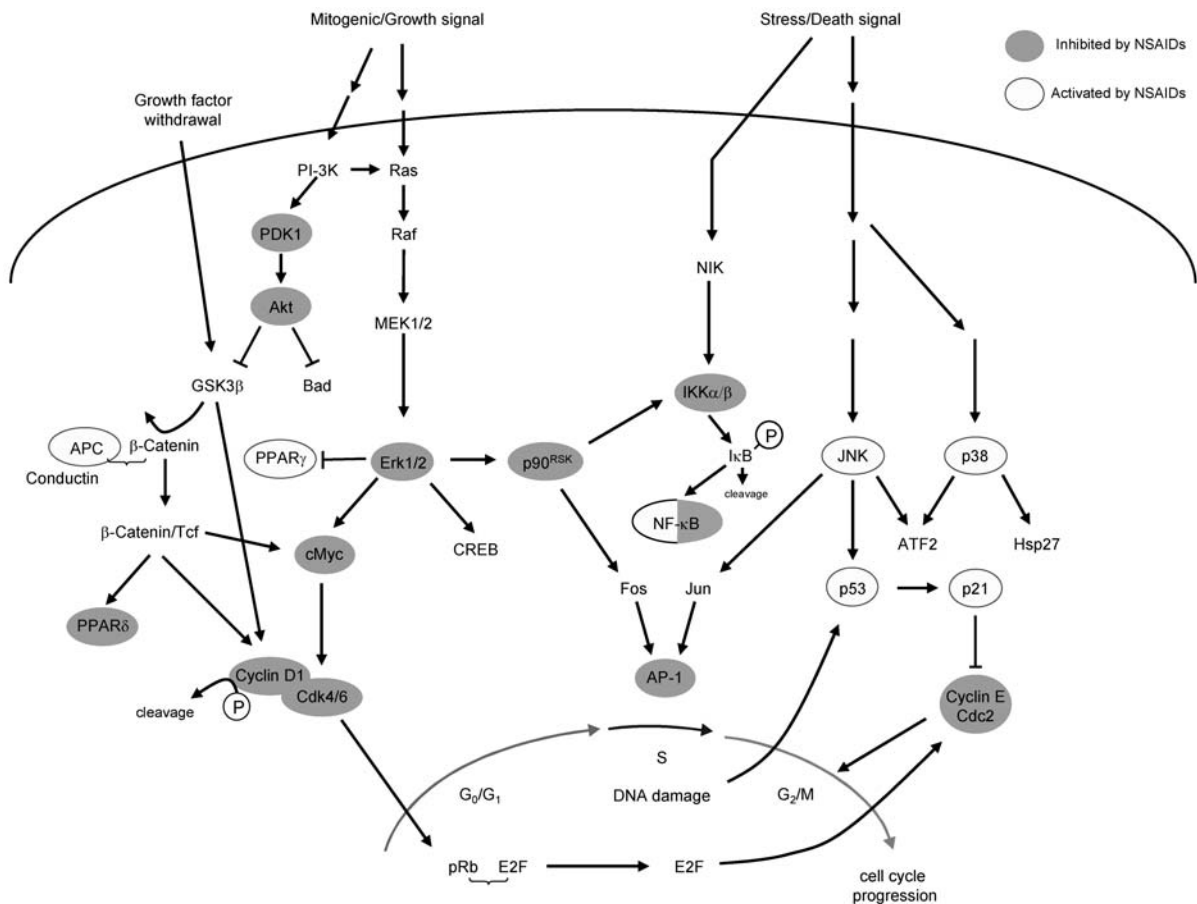
The transcription factor AP-1 is a homo- or heterodimer of Jun, Fos and Fra oncogenes. AP-1 is activated by various stimuli including UV-irradiation, growth factors and inflammatory cytokines. Some of the genes known to be regulated by AP-1 are involved in the immune and inflammatory responses or tumour formation and progression. AP-1 regulated genes partially overlap with genes that are regulated by NF-κB. Inhibition of AP-1 has been shown for aspirin, sodium salicylate, piroxicam, R-flurbiprofen and the selective COX-2 inhibitors celecoxib and NS398 in various cell types. However, it is not presently known to what extent effects on AP-1 contribute to the anti-inflammatory or anti-proliferative effects of NSAIDs, because different AP-1 homo- and heterodimers may have either stimulating or inhibiting effects on gene transcription (Grosch et al. 2003), and the number of genes that are regulated by AP-1 is high. Therefore, the result of NSAID-induced AP-1 inhibition may greatly vary.

#### Effects on Cellular Kinases

##### Inhibitor Kappa B Kinase Complex (IKK)

In most cells NF-κB exists in the cytoplasm in an inactive complex bound to inhibitor IκB proteins. NF-κB is activated upon phosphorylation and subsequent proteasome-mediated proteolysis of IκB. The key regulatory step in this pathway is the activation of an IκB kinase (IKK) complex. IKK consists of two catalytic subunits, IKKα and IKKβ, and a regulatory subunit (IKKγ) that regulates binding of activators. Liberated NF-κB translocates from the cytoplasm to the nucleus where it binds to the κB-sites of target genes and reg-





**NSAIDs, COX-Independent Actions, Figure 1.** Systematic overview of COX-independent NSAIDs effects. → activation or induction; — inhibition ● inhibited by NSAIDs; ○ activated by NSAIDs Abbreviations: Akt/PKB, protein kinase B; APC adenomatous polyposis coli tumor suppressor gene; AP-1 activator protein-1; Cdk, cyclin dependent kinase; CREB, cAMP response element binding protein; Erk, extracellular signal regulated kinase; GSK3β, glycogen synthase kinase 3 beta; Hsp, heat shock protein; IKK, I-kappa kinase; JNK, Jun N-terminal kinase; MAPK, mitogen activated kinase; MEK/MKK, mitogen-activated protein kinase kinase; NIK, nuclear factor-kappaB inducing kinase; NF-κB, nuclear factor kappa B; PDK, phosphoinositol-dependent kinase; PI-3K, phosphatidylinositol-3-kinase; PKC, protein kinase C; PPAR, peroxisome proliferator activated receptor; pRb, retinoblastoma protein; p90RSK, ribosomal S6 kinase; Tcf, T cell factor.

ulates their transcription. Various NSAIDs including aspirin, sodium salicylate and sulindac inhibit the ATP binding to IKKβ, and thereby its catalytic activity (Yin et al. 1998). However, the IKK inhibitory potency of these NSAIDs is low, and the specificity of aspirin-induced IKK, and thereby NF-κB inhibition, has been doubted.

#### Mitogen Activated Protein (MAP)-Kinase Cascade

MAP-kinases (MAPK) play a central role in the differentiation and proliferation of several cell types, and can be activated by various extracellular stimuli. AP-1 is one downstream target of the MAP-kinase family members including extracellular signal regulated kinases (Erk-1 and -2; p42/p44 MAPK), c-Jun N-terminal kinases (JNK1-3) and p38 MAPK. Erk activation has been implicated in growth promotion and cell survival, whereas JNK and p38 MAPK activation are associated with stress responses and apoptosis. Recent results have shown that the effect of NSAIDs on MAP-kinases

largely depends on the cellular context. In cancer cells, the ability of NSAIDs to modulate MAPK activities may play an important role in the cytotoxicity and induction of apoptosis.

Aspirin and sodium salicylate were shown to inhibit activation of Erk-1 and -2 under certain circumstances. Inhibition of angiogenesis by COX-2 selective and unselective NSAIDs has been shown to be mediated through inhibition of Erk-2 activity and interference with its nuclear translocation in vascular endothelial cells (Tsuji et al. 1998). p38 MAPK was reported to be activated by sodium salicylate in human fibroblasts leading to induction of apoptosis. TNFα-induced JNK activation was also inhibited by salicylate in human fibroblasts. Oppositely, in HT-29 colon cancer and COS-1 cells, salicylate treatment resulted in activation of JNK.

#### Protein Kinase B (PKB/Akt)

The protein kinase B (PKB/Akt) promotes cell proliferation and survival, thereby contributing to cancer

progression. Activation of Akt occurs by translocation of the kinase to the cell membrane and phosphorylation through phospho-inositide-dependent kinase 1 (PDK1). The COX-2 selective inhibitor celecoxib has been shown to induce apoptosis in prostate carcinoma (Hsu et al. 2000), hepatocarcinoma and colon carcinoma cells by inhibiting the phosphorylation of PKB/Akt, thereby blocking its anti-apoptotic activity. The effects of celecoxib on Akt depended in part on the inhibition of PDK1. Inhibition of PKB/Akt by celecoxib has also been observed in vascular smooth muscle cells leading to inhibition of neointima formation after balloon injury. Similarly, sulindac has been described to inhibit Akt-phosphorylation in lung adenocarcinoma cells. Aspirin has been shown to either activate or inhibit Akt-activation, dependent on the cell type.

### Effects on Cell Cycle Proteins

The progression through the various phases of the cell cycle is regulated by cyclins and cyclin-dependent kinases (Cdks). The function of cyclins is primarily controlled by changes in cyclin transcription, while Cdks are regulated by phosphorylation. The activity of the Cdk/cyclin complex is inhibited by p21 and p27. Sodium salicylate inhibits the proliferation of vascular smooth muscle cells through up-regulation of these cell cycle inhibitors. This is probably caused by salicylate-induced up-regulation of p53, which is the primary regulator of p21 transcription. Similar to salicylates, sulindac, sulindac sulfide and celecoxib inhibited the proliferation of colon carcinoma cells and caused them to accumulate in the G<sub>0</sub>/G<sub>1</sub> phase. This effect was attributed to inhibition of cyclin-dependent kinases and/or up-regulation of p27 and p21.

### Modulation of the Activity of Nuclear Receptor Family Members

#### Activation of Peroxisome Proliferator Activated Receptor (PPAR)

PPARs  $\alpha$ ,  $\delta$  and  $\gamma$  are nuclear hormone receptors that control the transcription of genes involved in energy metabolism, cell differentiation, apoptosis and inflammation. PPARs bind to sequence-specific DNA response elements as a heterodimer with the retinoic acid receptor (RXR). PPAR $\gamma$  is highly expressed in adipose tissue, and plays an important role in the regulation of genes involved in lipid utilization and storage, adipocyte differentiation, insulin action and inflammation. Indomethacin binds to PPAR $\gamma$  and induces the differentiation of mesenchymal stem cells into adipocytes ► *in vitro*. Some other NSAIDs including ibuprofen, fenoprofen and flufenamic acid also bind and activate PPAR $\gamma$ . However, they are less potent than indomethacin.

In addition to the role in adipogenesis and inflammation, PPAR $\gamma$  is highly expressed in normal large intestine and in breast, colon and prostate cancer. PPAR $\gamma$ -agonists such as troglitazone and 15deoxy-PGJ<sub>2</sub> were able to

induce differentiation and apoptosis in tumour cells, suggesting that PPAR $\gamma$  suppresses tumour cell proliferation. Indomethacin was shown to reduce the colonogenic activity of prostate cancer cells and increased the antiproliferative effect of 5-fluorouracil in colon cancer cells. This effect was supposed to be mediated through activation of PPAR $\gamma$ .

PPAR $\delta$  is a nuclear transcription factor that is activated by prostacyclin. Inhibition of COX-activity with aspirin or other NSAIDs causes inhibition of PPAR $\delta$ , which has been identified as one of the downstream targets of the WNT- $\beta$ -catenin pathway (He et al. 1999). This pathway plays a crucial role in embryonic development and carcinogenesis. PPAR $\delta$  expression is normally controlled by the APC tumour suppressor. However, during colon carcinogenesis, APC function is almost always lost, leading to a dysfunction of  $\beta$ -catenin and uncontrolled PPAR $\delta$  expression. This is considered as a crucial initiating step in tumour transformation. The suppression of PPAR $\delta$  activity by various NSAIDs, including aspirin and sulindac, can compensate for the loss of APC or  $\beta$ -catenin dysfunction and thereby reduce colon carcinogenesis. Hence, the inhibition of PPAR $\delta$  activity may contribute to the chemopreventive effects of some NSAIDs.

### Other Targets

#### Intracellular Carbonic Anhydrase

Carbonic anhydrases play an important role in the extracellular acidification. Several studies suggest a possible involvement of these enzymes in tumour progression resulting from the acidic extracellular pH. Celecoxib and valdecoxib inhibit carbonic anhydrases. This effect is supposed to depend on their sulfonamide structure, and is therefore not shared by rofecoxib or etoricoxib.

#### Acid Sensing Ion Channels (ASICs)

H<sup>+</sup>-gated currents mediated by acid sensing ion channels (ASICs) are involved in acidosis which occurs under inflammatory conditions and in tumours. Various NSAIDs including aspirin, salicylic acid, flurbiprofen, ibuprofen and diclofenac are inhibitors of these H<sup>+</sup>-gated channels, thereby inhibiting acid induced pain reaction and inflammatory responses.

#### Ca<sup>2+</sup>-Release

Treatment with some COX-2 inhibitors increased intracellular calcium levels in osteoblasts, PC-12 and HUVEC cells. This effect might be mediated by a block of endoplasmatic reticulum Ca<sup>2+</sup>-ATPases, and may increase the risk of cardiovascular events in predisposed patients.

### References

1. Grosch S, Tegeder I, Niederberger E et al. (2001) COX-2 Independent Induction of Cell Cycle Arrest and Apoptosis in Colon Cancer Cells by the Selective COX-2 Inhibitor Celecoxib. *FASEB J* 15:2742–2744

2. Grosch S, Tegeder I, Schilling K et al. (2003) Activation of c-Jun-N-terminal-Kinase is Crucial for the Induction of a Cell Cycle Arrest in Human Colon Carcinoma Cells caused by Flurbiprofen Enantiomers. *FASEB J* 17:1316–1318
3. He TC, Chan TA, Vogelstein B et al. (1999) PPARdelta is an APC-Regulated Target of Nonsteroidal Anti-Inflammatory Drugs. *Cell* 99:335–345
4. Hsu AL, Ching TT, Wang DS et al. (2000) The Cyclooxygenase-2 Inhibitor Celecoxib Induces Apoptosis by Blocking Akt Activation in Human Prostate Cancer Cells Independently of Bcl-2. *J Biol Chem* 275:11397–11403
5. Kopp E, Ghosh S (1994) Inhibition of NF-Kappa B by Sodium Salicylate and Aspirin. *Science* 265:956–959
6. Niederberger E, Tegeder I, Schafer C et al. (2003) Opposite Effects of Rofecoxib on Nuclear Factor-kappa B and Activating Protein-1 Activation. *J Pharmacol Exp Ther* 304:1153–1160
7. Tegeder I, Pfeilschifter J, Geisslinger G (2001) Cyclooxygenase-Independent Actions of Cyclooxygenase Inhibitors. *FASEB J* 15:2057–2072
8. Thun MJ, Namboodiri MM, Heath CW Jr (1991) Aspirin Use and Reduced Risk of Fatal Colon Cancer. *N Engl J Med* 325:1593–1596
9. Tsujii M, Kawano S, Tsuji S et al. (1998) Cyclooxygenase Regulates Angiogenesis Induced by Colon Cancer Cells. *Cell* 93:705–716
10. Wechter WJ, Kantoci D, Murray ED Jr et al. (1997) R-Flurbiprofen Chemoprevention and Treatment of Intestinal Adenomas in the APC(Min)/+ Mouse Model: Implications for Prophylaxis and Treatment of Colon Cancer. *Cancer Res* 57:4316–4324
11. Yin MJ, Yamamoto Y, Gaynor RB (1998) The Anti-Inflammatory Agents Aspirin and Salicylate Inhibit the Activity of I(kappa)B Kinase-Beta. *Nature* 396:77–80

## NSAIDs, Mode of Action

MARIA BURIAN  
Pharmacological Center Frankfurt, Clinical Center  
Johann-Wolfgang Goethe University, Frankfurt,  
Germany  
burian@em.uni-frankfurt.de

### Synonyms

NSAIDs; non-steroidal anti-inflammatory drugs; Aspirin-Like Drugs; Non-Selective COX-Inhibitors; cyclooxygenase; COX; Prostaglandin H Synthase; PGHS

### Definition

Non-steroidal anti-inflammatory drugs (NSAIDs) are among the most widely prescribed and used drugs for the management of pain, especially of pain in inflammatory conditions. Despite the wide use of NSAIDs over the last century, little was known on the mode of actions of these drugs for a long time. Initially, the principle mode of the antinociceptive action of NSAIDs was related to their anti-inflammatory activity, and attributed to the inhibition of the production of prostaglandins at the peripheral site of inflammation (peripheral mode of action) (Vane 1971). The traditional belief in the exclusively peripheral action of NSAIDs, however, has been challenged by the growing evidence showing

the dissociation between the anti-inflammatory and antinociceptive effects of NSAIDs (McCormack and Brune 1991). This is the basis for the hypothesis of additional antinociceptive mechanisms existing with NSAIDs, where the inhibition of prostaglandin synthesis in CNS appears to be universally applicable for all NSAIDs (central mode of action).

While inhibiting prostanoid synthesis, NSAIDs do not typically elevate the normal pain threshold, but mainly normalize the increased pain threshold observed in ► inflammatory pain (► hyperalgesia), so that their antinociceptive effect should rather be defined as anti-hyperalgesic instead of analgesic.

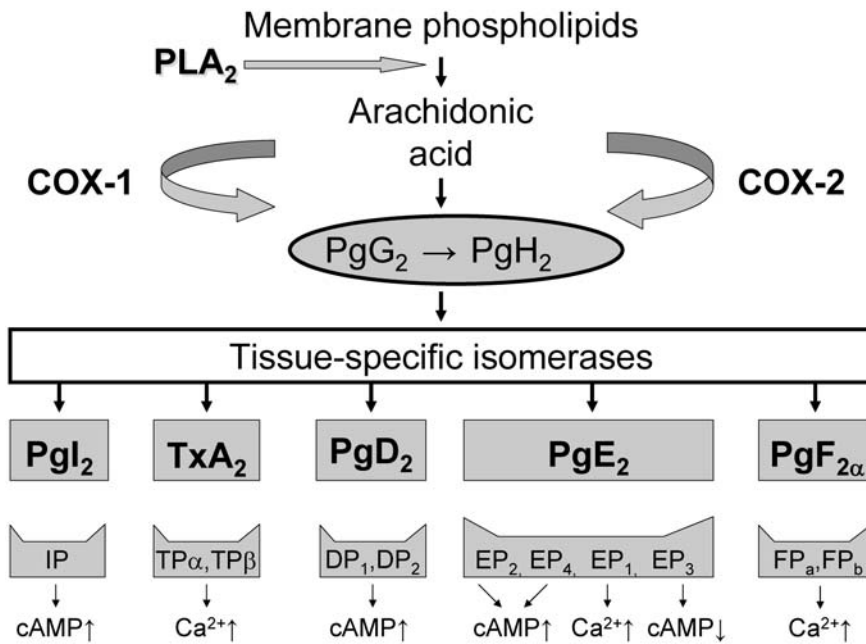
### Characteristics

#### Prostanoid Synthesis

Despite the diverse chemical structure of aspirin-like drugs, all NSAIDs bear a common pharmacological property of inhibiting the formation of prostanoids. Prostanoids are formed by most cells and act as lipid mediators. They are synthesized from membrane-released arachidonic acid mobilized by phospholipases (PLA<sub>2</sub>) when cells are activated by mechanical trauma, cytokines, growth factors, etc. (Fig. 1). Conversion of arachidonic acid to prostanoid end-products occurs by cyclooxygenases (COX), an enzyme also known as prostaglandin H synthase (PGHS), at two different sites of the enzyme. It is initially cyclized and oxidized to the endoperoxide PGG<sub>2</sub> at the cyclooxygenase site of the COX. This product is then reduced to a second endoperoxide, PGH<sub>2</sub>, at the peroxidase site of the COX enzyme. Subsequent formation of prostaglandin end-products from PGH<sub>2</sub> depends on the presence of the specific synthase enzymes that produce functionally important prostanoids PGD<sub>2</sub>, PGE<sub>2</sub>, PGF<sub>2</sub> α, PGI<sub>2</sub> (prostacyclin) and TXA<sub>2</sub> (thromboxane), which mediate their effects through the specific receptors: PGD<sub>2</sub> (DP<sub>1</sub>, DP<sub>2</sub> receptors), PGE<sub>2</sub> (EP<sub>1</sub>, EP<sub>2</sub>, EP<sub>3</sub>, EP<sub>4</sub> receptors), PGF<sub>2</sub> α (FP receptor), PGI<sub>2</sub> (IP receptors) and TXA<sub>2</sub> (TP<sub>α</sub> and TP<sub>β</sub> receptors).

#### Inhibition of Cyclooxygenases by NSAIDs

NSAIDs inhibit the formation of prostanoids by several different effects on COX, including irreversible inactivation of COX (e.g. aspirin) or reversible competitive inhibition (e.g. ibuprofen). COX is represented by two isoforms, COX-1 and COX-2, which are membrane-associated enzymes with a 63% amino acid sequence similarity. The identification of two isoforms of COX in the early 1990s offered a simple and attractive hypothesis: COX-1, being found in almost all cells, is the constitutive “house-keeping” enzyme responsible for production of basal “beneficial” PGs, which are vital for protecting the stomach through mucus production or maintenance of renal blood flow. In contrast, COX-2, in which expression is low or undetectable in most cells but increased dramatically in a variety of pathological



**NSAIDs, Mode of Action, Figure 1** Prostanoids are synthesized from membrane-released arachidonic acid mobilized by phospholipases (PLA<sub>2</sub>). Conversion of arachidonic acid to prostanoid end-products occurs by COX-1 and COX-2 at two different sites of the enzyme. It is initially cyclized and oxidized to the endoperoxide PGG<sub>2</sub> at the cyclooxygenase site of the COX and then reduced to a second endoperoxide, PGH<sub>2</sub> at the peroxidase site of the COX enzyme. Tissue-specific isomerases catalyze subsequent formation of prostaglandin end-products including PGD<sub>2</sub>, PGE<sub>2</sub>, PGF<sub>2α</sub>, PGI<sub>2</sub> (prostaglandin) and TXA<sub>2</sub> (thromboxane). These prostanoids exert their effects by acting through the specific receptors: PGD<sub>2</sub> (DP<sub>1</sub>, DP<sub>2</sub> receptors), PGE<sub>2</sub> (EP<sub>1</sub>, EP<sub>2</sub>, EP<sub>3</sub>, EP<sub>4</sub> receptors), PGF<sub>2α</sub> (FP receptor), PGI<sub>2</sub> (IP receptors) and TXA<sub>2</sub> (TP<sub>α</sub> and TP<sub>β</sub> receptors). The “relaxant” receptors IP, DP<sub>1</sub>, EP<sub>2</sub> and EP<sub>4</sub> signal through G<sub>s</sub>-mediated increases in intracellular cyclic adenosine monophosphate (cAMP). The “contractile” receptors EP<sub>1</sub>, FP and TP signal through G<sub>q</sub>-mediated increases in intracellular calcium. The EP<sub>3</sub> receptor is regarded as an “inhibitory” receptor that couples to Gi and decrease cAMP formation.

conditions, is the inducible enzyme responsible for “pathological” production of prostanoids in different conditions ranging from inflammation to cancer.

NSAIDs are non-selective inhibitors of COX (both COX-1 and COX-2). Initially, the favourable anti-inflammatory, anti-nociceptive and antipyretic effects of NSAIDs were solely attributed to the inhibition of COX-2, while the concomitant inhibition of COX-1 was supposed to lead to adverse reactions of the drugs (gastrointestinal and renal toxicities). With time, especially along with the introduction/gaining experience of selective COX-2 inhibitors (e.g. celecoxib, rofecoxib, etc.), this concept turned out to be more complicated than initially thought, indicating that both COX-1 and COX-2 have physiological and pathological roles, so that the inhibition of both isoforms may be responsible for favourable and unfavourable pharmacological effects of NSAIDs.

#### Cyclooxygenases and Prostanoids at the Peripheral Site

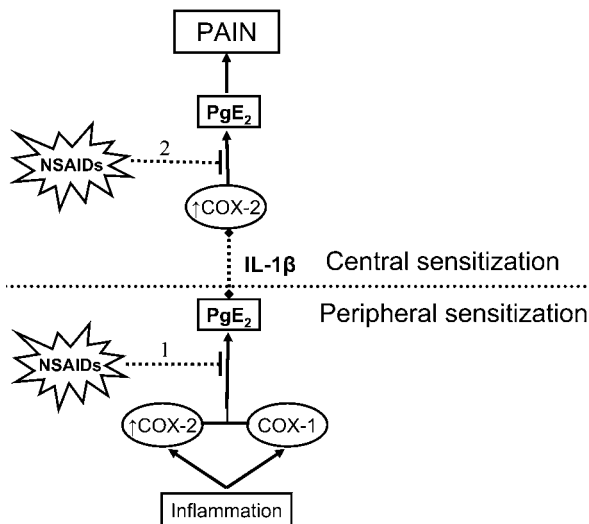
In injured tissue, COX-2 is the predominant isoform expressed and a main source of prostanoids during inflammation. The significant induction of COX-2 is found in activated polymorphonuclear leucocytes, phagocytosing mononuclear cells and fibroblasts, which are abundantly present at the site of inflammation. However, COX-1 is also involved in the modulation of the

inflammatory response, and is mainly increased in circulating monocytes and stimulated mast cells at the early inflammatory phase. Thus, both COX isoforms are involved in the inflammatory reaction in the periphery, and may contribute to the generation and maintenance of inflammatory pain. The earliest prostanoid response is dependent on COX-1, but COX-2 becomes a major source of prostanoids along with the progression of inflammation. NSAIDs-mediated inhibition of COX-1 and COX-2 at the site of inflammation results in the attenuation of peripheral **sensitization** associated with inflammatory pain (Fig. 2).

#### Cyclooxygenase and Prostanoids in CNS

In contrast to the periphery, in the CNS both COX-1 and COX-2 are expressed constitutively (Beiche et al. 1996). These isoforms are present in neurons and non-neuronal elements of the spinal cord and brain (Maihofner et al. 2000). The peripheral inflammatory reactions associated with tissue injury result in the release of pro-inflammatory cytokines, such as IL-1 $\beta$ , which may enhance the up-regulation of COX-2 in the CNS (Samad et al. 2001). This up-regulation is paralleled to the substantial elevation of prostanoids in the cerebrospinal fluid and typical nociceptive behaviour of the animals in experimental pain models. Therefore, COX-2 appears to be mainly responsible





**NSAIDs, Mode of Action, Figure 2** The inhibition of prostaglandin synthesis by NSAIDs takes place at both the site of peripheral inflammation (1) and at the spinal level (2), indicating that peripheral and central mechanisms may be responsible for their antinociceptive action. NSAIDs-mediated inhibition of COX-1 and COX-2 at the peripheral site results in the attenuation of peripheral sensitization, whereas inhibition of the up-regulated COX-2 in CNS leads to the attenuation of central hyperalgesia. Peripheral and central hyperalgesia are hallmarks of inflammatory pain.

for the central processing of pain after peripheral inflammation. COX-1, however, can also become the source of spinal prostaglandins in response to peripheral inflammation under specific conditions, as has been particularly demonstrated in COX-2 deficient knockout mice. NSAIDs-mediated inhibition of COX-1 and COX-2 in CNS results in the attenuation of central sensitization associated with inflammatory pain (Fig. 2).

### Mechanisms of Prostaglandin-Mediated Hyperalgesia

Prostaglandins are potent sensitizing agents, which are able to modulate multiple sites along the nociceptive pathway enhancing transduction (peripheral sensitization), as well as transmission (central sensitization), of the nociceptive information (Woolf 1983).

### Peripheral Sensitization

Direct and indirect mechanisms of the peripheral sensitizing action of prostanoids have been suggested. The direct effects are mediated by their action upon prostaglandin receptors and modulation of ion channels in ► **nociceptors**. The indirect effects are produced through enhancing the sensitivity of nociceptors to noxious agents, including heat and bradykinin. Both direct and indirect sensitizing effects of prostanoids lead to the enhanced transduction of the nociceptive information and manifest as peripheral hyperalgesia. NSAIDs-mediated inhibition of prostaglandin synthesis in the periphery results in the attenuation of peripheral hyperalgesia associated with inflammatory pain (peripheral ► **antihyperalgesic effect**).

### Central Sensitization

The sensitizing effects of prostanoids in CNS are mediated by their action on presynaptic and postsynaptic membranes of the primary afferent synapse in the dorsal horn of the spinal cord. Acting via prostanoid receptors located on the presynaptic membrane, prostanoids may cause the enhancement of nociception via facilitation of the spinal release of the excitatory neurotransmitter ► **glutamate** and neuropeptides (► **substance-P** and/or ► **calcitonin gene-related peptide**). At the postsynaptic level, prostanoids can directly activate deep dorsal horn neurons and/or block the inhibitory glycinergic neurotransmission onto dorsal horn neurons. All this leads to the enhanced transmission of the nociceptive activity to the brain, and manifests as central hyperalgesia. NSAIDs-mediated inhibition of prostaglandin synthesis in CNS results in the attenuation of central hyperalgesia associated with inflammatory pain (central antihyperalgesic effect).

### Central and Peripheral Antihyperalgesic Effects of NSAIDs

From the pharmacological point of view, the contribution of the central versus peripheral mechanisms to the overall antihyperalgesic effects of NSAIDs depends on:

- the site of drug delivery (e.g. systemic, local-peripheral, epidural, spinal intracerebro-ventricular);
- uptake and distribution from the site of drug delivery, as determined by factors including the drug's physical and chemical properties, specific transport mechanisms, local and systemic blood flow, and tissue barriers to drug permeation, such as the blood-brain barrier.

One of the accepted approaches to prove that NSAIDs act upon CNS to alleviate pain is an assessment of their antinociceptive activity, following a direct application of NSAIDs to spinal or supraspinal structures. This approach has gained its particular importance in behavioural animal studies. The intrathecal delivery of various NSAIDs has been shown to be effective in the reduction of behavioural hyperalgesia in several animal models of acute, short-term and long-term inflammatory pain (Brune et al. 1991). The antihyperalgesic effects have been observed with doses that are significantly lower than those needed to produce the similar degree of antinociception by systemic administration. Clinical relevance of the central antinociceptive mechanisms of the antinociceptive action of NSAIDs has been demonstrated in patients with intractable pain due to various types of cancer conditions. In these patients, intrathecal administration of small doses of lysine-acetylsalicylate (equivalent to acetylsalicylic acid 500 µg/kg) has been shown to bring rapid and prolonged pain relief (Pellerin et al. 1987).

The evidence for a clinically relevant peripheral antinociceptive action has been obtained with locally applied NSAIDs, where the effective antinociceptive

effect of NSAIDs versus placebo has been established with intra-articular and topical applications of NSAIDs (Romsing et al. 2000).

The contribution of central versus peripheral mechanisms to the total antihyperalgesic effect of NSAIDs has been studied in the human experimental pain model of “freeze lesion”. The experimental hyperalgesia in this model was produced by short-lasting freezing of volunteer’s skin. The relative contribution of the central component of orally administered diclofenac has accounted for approximately 40% of the total antihyperalgesic efficacy of the drug (Burian et al. 2003).

### Conclusion

NSAIDs are potent antinociceptive agents, whose efficacy in reducing pain is widely recognized in various pain conditions, including post-surgical pain and persistent pain states, such as arthritis and cancer. Although NSAIDs have long been used in clinical practice, the mechanism of their antihyperalgesic action remains controversial. It appears that the inhibition of prostaglandin synthesis by NSAIDs takes place both at the site of peripheral inflammation and at the spinal level, indicating that peripheral and central mechanisms are responsible for their antinociceptive action. The contribution of peripheral and central COX-dependent mechanisms to the overall antinociceptive action of NSAIDs is individual for each drug, and is dependent on the site of drug delivery, as well as pharmacokinetic characteristics of the drug determining its penetration to the sites of action (e.g. peripheral and spinal COX).

### References

1. Beiche F, Scheuerer S, Brune K et al. (1996) Up-Regulation of Cyclooxygenase-2 mRNA in the Rat Spinal Cord following Peripheral Inflammation. *FEBS Lett* 390:165–169
2. Brune K, Beck WS, Geisslinger G et al. (1991) Aspirin-Like Drugs may Block Pain Independently of Prostaglandin Synthesis Inhibition. *Experientia* 47:257–261
3. Burian M, Tegeder I, Seegel M et al. (2003) Peripheral and Central Antihyperalgesic Effects of Diclofenac in a Model of Human Inflammatory Pain. *Clin Pharmacol Ther* 74:113–120
4. Maihofner C, Tegeder I, Euchenhofer C et al. (2000) Localization and Regulation of Cyclooxygenase-1 and -2 and Neuronal Nitric Oxide Synthase in Mouse Spinal Cord. *Neuroscience* 101:1093–1108
5. McCormack K, Brune K (1991) Dissociation between the Antinociceptive and Anti-Inflammatory Effects of the Non-Steroidal Anti-Inflammatory Drugs. A Survey of their Analgesic Efficacy. *Drugs* 41:533–457
6. Pellerin M, Hardy F, Abergel A et al. (1987) Chronic Refractory Pain in Cancer Patients. Value of the Spinal Injection of Lysine Acetylsalicylate. 60 Cases. *Presse Med* 16:1465–1468
7. Romsing J, Moiniche S, Ostergaard D et al. (2000) Local Infiltration with NSAIDs for Postoperative Analgesia: Evidence for a Peripheral Analgesic Action. *Acta Anaesthesiol Scand* 44:672–683
8. Samad TA, Moore KA, Sapirstein A et al. (2001) Interleukin-1 $\beta$ -Mediated Induction of Cox-2 in the CNS Contributes to Inflammatory Pain Hypersensitivity. *Nature* 410:471–475
9. Vane JR (1971) Inhibition of Prostaglandin Synthesis as a Mechanism of Action for Aspirin-Like Drugs. *Nat New Biol* 231:232–235
10. Woolf CJ (1983) Evidence for a Central Component of Post-Injury Pain Hypersensitivity. *Nature* 306:686–688

## NSAIDs, Pharmacogenetics

CARSTEN SKARKE

Institute of Clinical Pharmacology, pharmazentrum frankfurt/ZAFES, Institute of Clinical Pharmacology, Johann-Wolfgang Goethe University, Frankfurt, Germany  
skarke@em.uni-frankfurt.de

### Synonyms

Inherited Variability of Drug Response; Pharmacogenetics of NSAIDs

### Definition

Pharmacogenetics seeks to explore how genetic variants influence the pharmacokinetic and pharmacodynamic properties of a given drug, by determining how mutations in the genes that encode drug metabolizing enzymes, drug targets and drug transporters influence drug response.

### Characteristics

Nonsteroidal anti-inflammatory drugs (NSAID) block the formation of prostaglandins by inhibiting the rate-limiting cyclooxygenase (COX) enzymes, COX-1 and COX-2, also known as prostaglandin H<sub>2</sub> synthases (PGHS1 and PGHS2). Since prostaglandins participate in mediating the inflammatory response, the pharmacological activity of NSAIDs consists mainly of antinociceptive, anti-inflammatory and antipyretic properties. Variations of this pharmacological activity can arise as a basic principle from mutations in proteins, which (i) influence the bioavailability of a drug, (ii) vary the binding affinity to the drug target, or (iii) modify drug elimination. Since NSAIDs possess a high solubility and high permeability (Yazdaniyan et al. 2004), and were not found to be a substrate of drug efflux transporters, it is unlikely that the disposition varies on a genetic basis. Far more expected are mutations in the cyclooxygenase enzymes as drug targets and the metabolizing enzymes as determinants of drug elimination. The majority of such mutations are ► [single nucleotide polymorphisms \(SNP\)](#), which consist of an exchange of one nucleotide often, but not always, leading to an alteration in the amino-acid sequence of the resulting protein, provided that the SNP is located within the coding region of the ► [gene](#).

### Polymorphisms in the Cyclooxygenase-1 Gene

The COX-1 gene is located on ► [chromosome 9](#) and consists of 11 exons. Several SNPs have been described (Halushka et al. 2003), of which so far only some single

nucleotide polymorphisms have drawn attention regarding a possible functional consequence leading to a decreased enzyme function or binding affinity. This was based on a computerized evaluation of the likelihood that a resulting amino acid exchange would lead to a phenotypic alteration (Ulrich et al. 2002). The SNPs 22C>T (arginine to tryptophan at position 8, R8W) and 50>T (proline to leucine at position 17, P17L) in ► **exon 2** and the SNPs 688G>A (glycine to serine at position 230, G230S) and 709C>A (leucine to methionine at position 237, L237M) in **exon 7** were considered as first-line candidates. Using human platelets as a system to study COX-1 activity, ► **heterozygous carriers** of the SNP 50C>T were determined to show a significantly greater inhibition of prostaglandin H<sub>2</sub> production after aspirin exposure than carriers of the CC50 ► **genotype**. The possible mechanism for the increased sensitivity to aspirin was seen in a decrease of COX-1 enzyme levels. Since the 50C>T was found in complete ► **linkage disequilibrium** with -842A>G, a mutation in the COX-1 promoter, this SNP may also account for the functional impact, possibly because ► **gene transcription** is repressed (Halushka et al. 2003). However, with an allele frequency of 18% in Caucasians, a multitude of patients would be affected, but the overall contribution of these SNPs in explaining the interindividual variability of the pharmacological response to NSAIDs still remains to be determined.

#### Polymorphisms in the Cyclooxygenase-2 Gene

For the COX-2 gene on chromosome 1, a substantial number of SNPs was described for the promoter and the ten exons. However, so far, only the polymorphism -765G>C in the promoter was linked to a significantly lower promoter activity for carriers of the -765C- ► **allele**, displaying decreased plasma levels of the C-reactive protein in patients with coronary heart surgery (Papafili et al. 2002). How this polymorphism may eventually interfere with NSAID-induced effects still remains unclear, but because carriers of the CC-765 genotype presented with a more severe course of aspirin-induced asthma, reflected by an increased consumption of oral corticosteroids (Szczyklik et al. 2004), a possible relevance is under consideration.

#### Polymorphisms in Metabolizing Enzyme Genes

Many NSAIDs are hepatically metabolized by the cytochrome P450 (CYP) system. Diclofenac, ibuprofen, flurbiprofen, naproxen, piroxicam, tenoxicam, meloxicam, mefenamic acid and celecoxib are listed as substrates for one of the most important isoforms, CYP2C9. Polymorphisms in the CYP2C9 gene are recognized to account for variable NSAID pharmacokinetics. Among numerous mutations, the alleles CYP2C9\*2 (Cys144, Ile359, Asp360) and CYP2C9\*3 (Arg144, Leu359, Asp360) are of particular importance in the Caucasian population, due to the reduced intrinsic

metabolic activity combined with a high allele frequency of 8–14% and 4–16%, respectively. For flurbiprofen, which is exclusively metabolized by CYP2C9, most of the pharmacokinetic variability could be explained by the CYP2C9 genotype, with most pronounced effects in carriers of the CYP2C9\*3-allele (Lee et al. 2003). That the CYP2C9\*3-allele is mostly responsible for the interindividual variability was also seen when the oral clearance of celecoxib was reduced more than two-fold in ► **homozygous carriers** of the CYP2C9\*3 allele as compared to the non-mutated volunteers, while no significant influence was determined for the CYP2C9\*2 allele (Kirchheiner et al. 2003). In the presence of non-functional CYP2C9-alleles, other cytochrome isoforms (CYP3A4) might compensate by increasing their contribution. This might be the reason why no evidence was seen that CYP2C9 mutations were a determinant for the diclofenac-induced hepatotoxicity (Aithal et al. 2000). Significant pharmacokinetic differences were also seen for racemic and S-(+)-ibuprofen between carriers of one or two CYP2C9\*3 alleles and non-mutated alleles (Kirchheiner et al. 2002), while the CYP2C9\*2 variant only displayed a compromised metabolic activity when found in combination with the CYP2C8\*3 (K139, R399) mutation (Garcia-Martin et al. 2004). In fact, the two alleles CYP2C9\*2 and CYP2C8\*3 were shown to be in linkage disequilibrium (Yasar et al. 2002). Further information about CYP450 alleles is available at <http://www.imm.ki.se/CYPalleles/>.

The metabolism of NSAIDs further involves glucuronidation by uridine 5'-diphosphoglucose glucuronosyl transferase (UGT) enzymes. Since most NSAIDs first undergo CYP450-mediated transformation to inactive metabolites, it is rather unlikely that UGT-alleles with a compromised catalytic activity cause a change in drug response due to drug accumulation. However, this perception may be challenged by rofecoxib, which after UGT2B15-mediated glucuronidation with minor contribution of UGT2B7 and UGT1A9 (Zhang et al. 2003), and deglucuronidation in the lower gastrointestinal tract, may cycle enterohepatically and reappear again in the plasma as rofecoxib. This explains the observed second maximum concentration peak in the concentration-time curves (Baillie et al. 2001), and serves as an example that mutations rendering the UGT less metabolically active could gain clinical importance in special circumstances. The current nomenclature can be accessed at [http://som.flinders.edu.au/FUSA/ClinPharm/UGT/allele\\_table.html](http://som.flinders.edu.au/FUSA/ClinPharm/UGT/allele_table.html).

Substrates of the N-acetyltransferase 2 (NAT2) show three different acetylation phenotypes depending on the possession of two non-mutated alleles (fast), two mutated alleles (slow) or one non-mutated allele combined with a mutated allele (intermediate). The current knowledge that alleles are associated with a compromised catalytic function can be retrieved from

<http://www.louisville.edu/medschool/pharmacology/NAT.html>. NAT2 plays an important role in the detoxification of sulfasalazine metabolites; hence accumulation in slow acetylator genotypes was associated with the onset of adverse reactions such as infectious mononucleosis-like syndrome (Ohtani et al. 2003), acute pancreatitis (Tanigawara et al. 2002), discoid (Sabbagh et al. 1997) or systemic lupus erythematosus (Gunnarsson et al. 1997). Metamizol (dipyrone) also qualifies as an NAT2-substrate, but differences in drug response according to the acetylation ► [phenotype](#) have not yet been reported. The distribution of the polymorphic alleles in the NAT2 gene is an example of the relevance of the ethnic background, since frequency of genotypes associated with fast or intermediate acetylation ranges from approx. 40% in the European population to approx. 90% in the Japanese.

#### Impact of Non-Functional Alleles on Drug-Drug-Interaction

A patient genotyped as a compound carrier of non-functional CYP2C9\*2/\*3 alleles presented with normal INR values after therapeutic warfarin dosing. However, when a concomitant analgesic therapy was introduced with celecoxib, the INR rapidly increased (>10) with extensive ecchymosis (Malhi et al. 2004). The impaired warfarin-metabolizing capacity of the CYP2C9\*2/\*3 alleles had no clinically significant effect on the INR, but when these CYP2C9\*2/\*3 alleles were challenged by the second substrate celecoxib, which in addition exhibits a high affinity for CYP2C9, the metabolizing rate of (S)-warfarin via CYP2C9 rapidly decreased, while the metabolism of the 2–5 × less potent (R)-warfarin by CYP 1A2 and 2C19 was not affected. This observation should represent a possible mechanism for how a drug interaction may be elicited in the drug metabolizing system. However, in this particular observation this has to be further elucidated, since the warfarin-celecoxib interaction was not seen in healthy volunteers (Karim et al. 2000).

Celecoxib was shown to inhibit the CYP2D6-mediated metabolism of metoprolol in healthy volunteers, with a more pronounced rise in the plasma concentration-time profile in carriers of two functional alleles as compared to one allele. Such an effect is not anticipated with two mutated alleles leading to a minimum of CYP2D6 catalytic function (poor metabolizer). (Werner et al. 2003). Although little information is available of such induced drug interactions, further research may elucidate more, since over 40 drugs are listed as CYP2D6 substrates (see <http://medicine.iupui.edu/flockhart/table.htm>).

#### Aspirin-Induced Asthma

Patients with aspirin-induced asthma represent about 10% of all asthma-diseased adults. Inhibition of COX–1 leads to an excess supply of substrate for lipoxygenases which causes a surplus of bronchoconstrictory leukotrienes, of which cysteinyl-leukotrienes (Cys-LT)

were determined as major mediators. The formation of Cys-LTs is regulated by the leukotriene (LT) C4-synthase gene, where a polymorphism in the promoter (-444A>C) was significantly more frequent in aspirin-induced asthma patients (Sanak et al. 1997; Sanak et al. 2000). However, since a relation of this polymorphism to disease severity or aspirin intolerance was not seen in a large cohort of asthma patients and healthy controls, the functional consequence of the C-444 genotype remains to be determined.

#### Conclusion

So far, little is known about the impact of pharmacogenetics on the therapeutic effect of NSAIDs. There is evidence that polymorphisms in the major drug metabolizing enzyme cytochrome P450 2C9 lead to a modified pharmacokinetic profile of its substrates, of which diclofenac, ibuprofen, naproxen and celecoxib are the most important ones. Polymorphisms in the drug targets COX–1 and COX–2 might alter drug response, but due to the preliminary character of such data, it is still too early to estimate the clinical relevance.

#### References

1. Aithal GP, Day CP, Leathart JB et al. (2000) Relationship of Polymorphism in CYP2C9 to Genetic Susceptibility to Diclofenac-Induced Hepatitis. *Pharmacogenetics* 10:511–518
2. Baillie TA, Halpin RA, Matuszewski BK et al. (2001) Mechanistic Studies on the Reversible Metabolism of Rofecoxib to 5-Hydroxyrofecoxib in the Rat: Evidence for Transient Ring Opening of a Substituted 2-Furanone Derivative using Stable Isotope-Labeling Techniques. *Drug Metab Dispos* 29:1614–1628
3. Garcia-Martin E, Martinez C, Tabares B et al. (2004) Interindividual Variability in Ibuprofen Pharmacokinetics is Related to Interaction of Cytochrome P450 2C8 and 2C9 Amino Acid Polymorphisms. *Clin Pharmacol Ther* 76:119–127
4. Gunnarsson I, Kanerud L, Pettersson E et al. (1997) Predisposing Factors in Sulphasalazine-Induced Systemic Lupus Erythematosus. *Br J Rheumatol* 36:1089–1094
5. Halushka MK, Walker LP, Halushka PV (2003) Genetic Variation in Cyclooxygenase 1: Effects on Response to Aspirin. *Clin Pharmacol Ther* 73:122–130
6. Karim A, Tolbert D, Piergies A et al. (2000) Celecoxib does not Significantly Alter the Pharmacokinetics or Hypoprothrombinemic Effect of Warfarin in Healthy Subjects. *J Clin Pharmacol* 40:655–663
7. Kirchheiner J, Meineke I, Freytag G et al. (2002) Enantiospecific Effects of Cytochrome P450 2C9 Amino Acid Variants on Ibuprofen Pharmacokinetics and on the Inhibition of Cyclooxygenases 1 and 2. *Clin Pharmacol Ther* 72:62–75
8. Kirchheiner J, Stormer E, Meisel C et al. (2003) Influence of CYP2C9 Genetic Polymorphisms on Pharmacokinetics of Celecoxib and its Metabolites. *Pharmacogenetics* 13:473–480
9. Lee CR, Pieper JA, Frye RF et al. (2003) Differences in Flurbiprofen Pharmacokinetics between CYP2C9\*1/\*1, \*1/\*2, and \*1/\*3 Genotypes. *Eur J Clin Pharmacol* 58:791–794
10. Malhi H, Atac B, Daly AK et al. (2004) Warfarin and Celecoxib Interaction in the Setting of Cytochrome P450 (CYP2C9) Polymorphism with Bleeding Complication. *Postgrad Med J* 80:107–109
11. Ohtani, T., A. Hiroi, M. Sakurane and F. Furukawa (2003) Slow Acetylator Genotypes as a Possible Risk Factor for Infectious Mononucleosis-Like Syndrome Induced by Salazosulfapyridine. *Br J Dermatol* 148:1035–1039
12. Papafili A, Hill MR, Brull DJ et al. (2002) Common Promoter Variant in Cyclooxygenase-2 Represses Gene Expression: Ev-



- idence of Role in Acute-Phase Inflammatory Response. *Arterioscler Thromb Vasc Biol* 22:1631–1636
13. Sabbagh N, Delaporte E, Marez D et al. (1997) NAT2 Genotyping and Efficacy of Sulfasalazine in Patients with Chronic Discoid Lupus Erythematosus. *Pharmacogenetics* 7:131–135
  14. Sanak M, Pierzchalska M, Bazan-Socha S et al. (2000) Enhanced Expression of the Leukotriene C(4) Synthase due to Overactive Transcription of an Allelic Variant Associated with Aspirin-Intolerant Asthma. *Am J Respir Cell Mol Biol* 23:290–296
  15. Sanak M, Simon HU, Szczeklik A (1997) Leukotriene C4 Synthase Promoter Polymorphism and Risk of Aspirin-Induced Asthma. *Lancet* 350:1599–1600
  16. Szczeklik W, Sanak M, Szczeklik A (2004) Functional Effects and Gender Association of COX-2 Gene Polymorphism G-765C in Bronchial Asthma. *J Allergy Clin Immunol* 114:248–253
  17. Tanigawara Y, Kita T, Aoyama N et al. (2002) N-acetyltransferase 2 Genotype-Related Sulfapyridine Acetylation and its Adverse Events. *Biol Pharm Bull* 25:1058–1062
  18. Ulrich CM, Bigler J, Sibert J et al. (2002) Cyclooxygenase-1 (COX1) Polymorphisms in African-American and Caucasian Populations. *Hum Mutat* 20:409–410
  19. Werner U, Werner D, Rau T et al. (2003) Celecoxib Inhibits Metabolism of Cytochrome P450 2D6 Substrate Metoprolol in Humans. *Clin Pharmacol Ther* 74:130–137
  20. Yasar U, Lundgren S, Eliasson E et al. (2002) Linkage between the CYP2C8 and CYP2C9 Genetic Polymorphisms. *Biochem Biophys Res Commun* 299:25–28
  21. Yazdani M, Briggs K, Jankovsky C et al. (2004) The “High Solubility” Definition of the Current FDA Guidance on Biopharmaceutical Classification System may be too Strict for Acidic Drugs. *Pharm Res* 21:293–299
  22. Zhang JY, Zhan J, Cook CS et al. (2003) Involvement of Human UGT2B7 and 2B15 in Rofecoxib Metabolism. *Drug Metab Dispos* 31:652–658

## NSAIDs, Pharmacokinetics

BRUNO OERTEL, JÖRN LÖTSCH  
 Institute for Clinical Pharmacology, Pharmaceutical  
 Center Frankfurt, Johann Wolfgang Goethe University,  
 Frankfurt, Germany  
 j.loetsch@em.uni-frankfurt.de

### Synonyms

Plasma Concentration Versus Time Profiles; Pharmacokinetics of the NSAIDs

### Definition

The pharmacokinetics describes the journey of a drug molecule through the body. The journey includes its release from the drug product, its ► **absorption** into the body system, for some substances its bio-activation via ► **metabolism**, the ► **distribution** to its site of action and back into the blood, and its ► **elimination** from the body either via transformation into inactive metabolites, which are then excreted, or direct excretion of the active entity. The goal of pharmacokinetics is to describe the time course of the drug concentrations in the organism in order to derive dosing regimens that provide most effective clinical drug actions with least side effects.

### Characteristics

NSAIDs are mainly administered orally. Formulations for intravenous, intramuscular, topical, rectal or intraocular administration are also available for some NSAIDs. The pharmacokinetics of the NSAIDs is best described by the LADME model, which describes the Liberation, Absorption, Distribution, Metabolism and Elimination of a drug. The concentration versus time profiles of the drug depends on these five processes.

The ► **liberation** of the active ingredient from a pharmaceutical product is mainly the result of the galenic engineering (tablet coating, tablet disintegration, particle size, etc.). Enteric- and sustained release-coatings are often used with NSAIDs to reduce their gastrointestinal toxicity. While the effectiveness of the coating for reduction of the toxicity is doubted, its influence on the absorption of the drug due to delayed release is clear. Once freed from the pharmaceutical formulation, the absorption of a drug is mainly defined by its physicochemical properties. Most of the NSAIDs are carbonic acids, or at least have an acidic function in their molecular structure. They pass the gastrointestinal wall by a passive ► **diffusion** process and are rapidly and extensively absorbed from the stomach and proximal small intestine, with peak plasma concentrations generally occurring within 2–3 h post-administration, or within 30 min in the case of fast release formulations. However, although absorption is extensive, some NSAIDs (e.g. diclofenac) have a low ► **bioavailability** because they are subject to a considerable ► **First-Pass Metabolism** that takes place in the intestinal wall and in the liver. Most NSAIDs are metabolised by ► **phase-1 metabolic reactions** such as oxidation, hydroxylation, demethylation, deacetylation, and hepatic conjugations (► **phase-2 metabolic reactions** such as glucuronidation and sulphation), or both, with subsequent excretion into urine or bile. In addition, acetyl salicylic acid is deacetylated directly in the blood. The lower the bioavailability is, the fewer molecules reach the circulation and are available for transport to their site of action. Once the molecules of the NSAIDs have reached the blood, they are extensively bound to plasma proteins, especially to albumin. Their ► **volume of distribution (Vd)** is usually small, mainly between 0.1 and 0.3 l/kg body weight, which approximates plasma volume. After excretion into the bile, several NSAIDs undergo an ► **enterohepatic recirculation**. That is, they are re-absorbed from the intestine after cleavage of the phase-2-conjugates (i.e. glucuronides or sulphates) by intestinal human or bacterial glucuronidases or sulfatases. Depending on the elimination process (metabolism or excretion via the kidney or the bile), NSAIDs differ in their speed of elimination, which is usually numerically characterized by the ► **elimination half-life** values ( $t_{1/2}$ ). The half-life of the NSAIDs can vary within and between individuals due to organ damage (i.e. kidney or liver

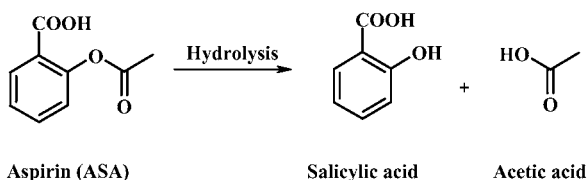
failure) or due to genetic polymorphisms of the enzymes involved in the metabolism of the NSAIDs. For example, some NSAIDs are metabolised via cytochrome P450 2C9 (CYP2C9), for which mutations resulting in a less-functional or non-functional enzyme have been described. Furthermore, pharmacokinetic drug-drug interactions can occur that results in inhibition of enzymes or of transporters involved in the elimination of the NSAIDs, with the consequence of altered, often decreased, rates of elimination, and thus increased half-lives of the NSAIDs (Davies and Skjodt 2000).

In the following, the pharmacokinetic properties will be described in more detail for the particular class of NSAIDs.

### Salicylic Acid Derivatives

The salicylic acid derivatives are rapidly and completely absorbed after oral administration. The reduced bioavailability and very short elimination half-life of acetyl salicylic acid is the result of an extensive first-pass metabolism by hydrolysis of acetyl salicylic acid to salicylic acid and acetic acid (Fig. 1), which takes place while passing the gastrointestinal mucosa, in the liver and in the blood. Due to the irreversible acetylation of the amino acid serine at position 530 of the COX-1 protein in platelets, the half-life of the anti-thrombotic effect of acetyl salicylic acid is much longer than the half-life of acetyl salicylic acid in plasma. Thus, a clinically relevant aggregation of platelets will only be re-established after enough new platelets have been produced, which is several days after administration of acetyl salicylic acid, at a time when the drug has already completely been eliminated from plasma for some days.

Salicylic acid is an active metabolite of acetyl salicylic acid. It has a longer elimination half-life than acetyl salicylic acid. During treatment with high or repetitive doses of salicylic acid or diflunisal, the elimination half-life can increase due to saturation of liver enzymes involved in the metabolism (non-linear kinetic). Salicylic acid and its metabolites are excreted via the kidney. The renal elimination rate of salicylic acid is influenced by the urinary pH. Therefore, acidifying agents (e.g. ammonium chloride) decrease its excretion, while alkalising agents such as sodium bicarbonate increase the urinary excretion. Salicylates can displace the anticonvulsants phenytoin and valproic acid from their plasma protein binding sites, and prevents the elimination of



NSAIDs, Pharmacokinetics, Figure 1 Hydrolysis of acetyl salicylic acid.

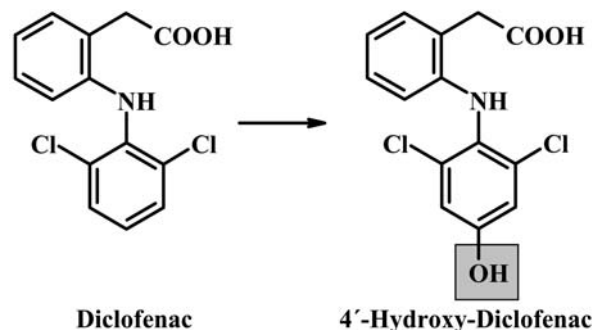
valproic acid due to inhibition of its main metabolic pathway, the  $\beta$ -oxidation. To prevent intoxication due to increased free plasma levels, combination of the drugs should be avoided (Brouwers and de Smet 1994; Needs and Brooks 1985).

In contrast to other salicylic acid derivatives, sulfasalazine and its active metabolite 5-aminosalicylic acid are only poorly absorbed, and therefore remain mainly within the gastrointestinal tract. Sulfasalazine and salsalat are prodrugs, and are mainly used for the treatment of ulcerative colitis and Crohn's disease. While salsalat is an ester of two salicylic acid molecules, which is rapidly absorbed and then hydrolysed, the anti-inflammatory effect of sulfasalazine is probably attributed to its metabolite 5-aminosalicylic acid.

### Arylpropionic Acids

Chirality results when three-dimensional repositioning produces different forms (enantiomers) of the same molecule. A chiral drug exists as a pair of molecules that are each other's mirror image, called S-enantiomer and R-enantiomer. The most common example of chirality is a  $sp^3$ -hybridised tetrahedral carbon atom, to which 4 different atoms are attached (Fig. 2). Such a  $sp^3$ -hybridised tetrahedral chiral carbon atom is the common structural feature of the arylpropionic acids, and is located within their propionic acid side chain. Most of the arylpropionic acids are marketed as racemates, i.e. as mixtures of both enantiomers. In addition, pure S-enantiomers are available for ibuprofen and ketoprofen. Naproxen is available and clinically used only as S-enantiomer. This is because the S-enantiomers have been shown to possess almost the whole pharmacologic activity. However, more recent studies have also demonstrated some pharmacologic effects of the R-enantiomers.

Enantiomers of arylpropionic acids have different physical properties such as water solubility and differ in their pharmacokinetics. For example, a stereoselectivity, i.e., a different pharmacokinetic behaviour of the S- and R-enantiomers of ibuprofen and flurbiprofen has been reported (Davies and Skjodt 2000). Some arylpropionic



NSAIDs, Pharmacokinetics, Figure 2 Chirality of the arylpropionic acids.

**NSAIDs, Pharmacokinetics, Table 1** Pharmacokinetics of the salicylic acid derivatives

Drug	F [%]	PB [%]	$t_{Max}$ [h]	Vd [L/kg]	CL [L/h/kg]	$t_{1/2}$ [h]	Active Metabolites	Remarks
Salicylic acid (SA)	100	80–90	0.5–2	0.17	4.2	2–3 (–30)	No	Dose-dependent half-life due to saturation of liver enzymes involved in the metabolism
Aspirin (ASA)	68	85–95	0.4–0.5	0.15	0.6–3.6	14–20 min	Salicylic acid (SA)	Hydrolysis through non-specific esterases while passing the gut wall, in plasma and liver
Diflunisal	100	99.8	2–3	0.10	0.0066	5–20	No	Dose-dependent half-life due to saturation of liver enzymes involved in the metabolism
Sulfasalazine (Prodrug)	<15	>99.3	3–12	NR	1	4–11	5-Aminosalicylic acid (F = 10–30%, $t_{Max}$ 10 h)	Bacteria mediated splitting in anti-inflammatory active 5-Aminosalicylic acid and sulfapyridine Half-life dependent on slow or fast acetylation by polymorphic enzyme
Salsalate (Prodrug)	100	NR	1.5	NR	NR	1.1(–16)	Salicylic acid (SA)	Rapid esterase hydrolysis in two molecules of salicylic acid in the small intestine and plasma

F: oral bioavailability, PB: binding to plasma proteins,  $t_{Max}$ : time from administration until maximum plasma concentrations are reached, Vd/F: volume of distribution, divided by bioavailability (because data from systemic administration that are needed to calculate the true Vd are usually not available, and the volumes are derived from data after oral drug administration, and have therefore been corrected for bioavailability), CL: Drug clearance, describing the speed of its elimination from the body,  $t_{1/2}$ : half-life in plasma

**NSAIDs, Pharmacokinetics, Table 2** Pharmacokinetics of the arylpropionic acid derivatives

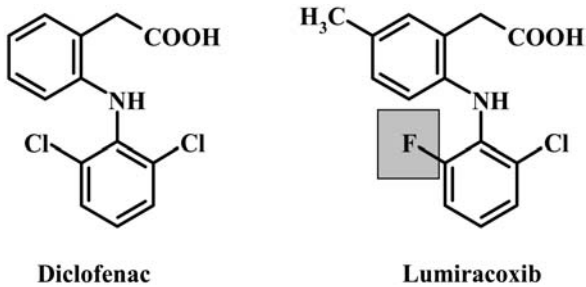
Drug	F [%]	PB [%]	$t_{Max}$ [h]	Vd [L/kg]	CL [L/h/kg]	$t_{1/2}$ [h]	Active Metabolites	Remarks
Ibuprofen (Rac/S) *	100	98–99	1–2	0.15	0.045	1.5–3	No	Unidirectional inversion to S-(+)-enantiomer with an inversion-rate R:S=50-80% Metabolising enzymes (Phase 1): CYP2C9 Dose-dependent binding to plasma proteins
Flurbiprofen (Rac) *	100	>99	1.5	0.1	0.018	3–6	No	Unidirectional inversion to S-(+)-enantiomer Inversion-rate R:S=0-5%
Ketoprofen (Rac/S) *	81-84	98.7	0.5-3	0.11	0.072	2–4	No	Unidirectional inversion to S-(+)-enantiomer Inversion-rate R:S 10%
Naproxen (S) *	100	>99	2–4	0.10–0.16	0.0042	12–15	No	Dose-dependent binding to plasma proteins
Tiaprofenic acid (Rac) *	100	98	NR	0.4–1	0.036–0.084	3-6	No	Negligible R to S conversion upon oral administration
Fenoprofen (Rac) *	NR	>99	2	0.08–0.11	NR	1.5–3	NR	

\* available as racemate and/or single S-(+)-enantiomer

F: oral bioavailability, PB: binding to plasma proteins,  $t_{Max}$ : time from administration until maximum plasma concentrations are reached, Vd/F: volume of distribution, divided by bioavailability (because data from systemic administration that are needed to calculate the true Vd are usually not available, and the volumes are derived from data after oral drug administration, and have therefore been corrected for bioavailability), CL: Drug clearance, describing the speed of its elimination from the body,  $t_{1/2}$ : half-life in plasma

acids undergo a unidirectional inversion of the inactive R-enantiomer to the active S- enantiomer (Fig. 3). The extent of the inversion is variable from drug to drug and

is most substantial for R-(–)-ibuprofen, while it is negligible for R-(–)-flurbiprofen (Table 2) (Geisslinger et al. 1994).



NSAIDs, Pharmacokinetics, **Figure 3** Unidirectional inversion of the arylpropionic acids.

The arylpropionic acids get fast and near complete absorption. They have no extensive first-pass metabolism and their elimination is, with the exception of naproxen, quite fast. Ibuprofen and naproxen bind in a concentration-dependent manner to plasma proteins. There is an increase in the unbound fraction of the drug at doses greater than 600 mg and 500 mg, respectively, resulting in an increased **clearance** and reduced area under curve (AUC) of the total-drug. A decreased clearance of S-(+)-ibuprofen is reported in carriers of certain genetic polymorphisms, which results in a CYP2C9 enzyme with decreased or absent functionality (see **NSAIDs, Pharmacogenetics**).

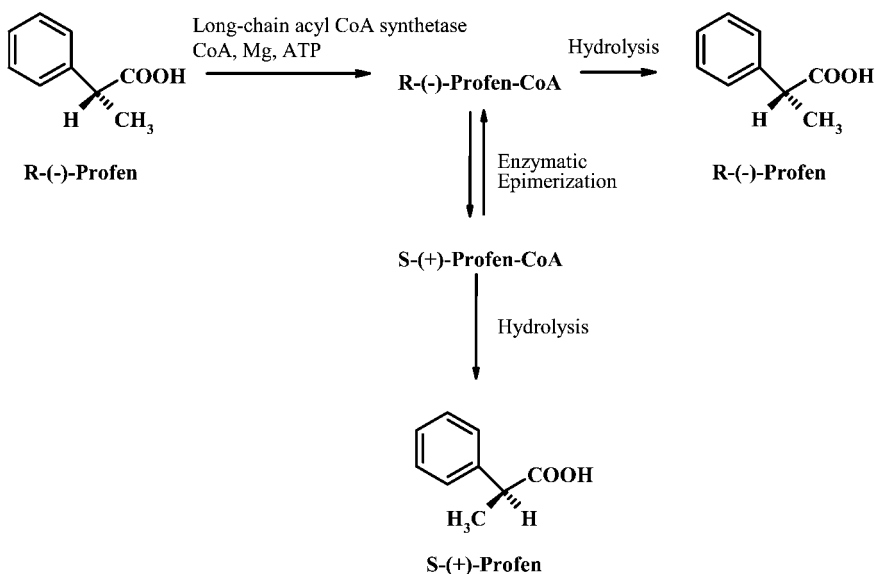
#### Heteroaryl Acetic Acids

Diclofenac, aceclofenac, ketorolac and lumiracoxib are heteroaryl acetic acids. They are fast and nearly completely absorbed. Due to an extensive first pass metabolism, diclofenac has a decreased systemic availability. The primary metabolite of diclofenac, 4'-hydroxy-diclofenac (Fig. 4), is produced by the genetically polymorphic CYP2C9. The amount of 4'-hydroxy-diclofenac excreted in urine and bile accounts

for 30% and 10–20%, respectively, of an oral dose of diclofenac (van der Marel et al. 2004). Data from experiments in laboratory animals suggest that 4'-hydroxy-diclofenac has 30% of the anti-inflammatory and antipyretic activity of diclofenac. Aceclofenac, an ester of diclofenac, appears to inhibit both COX isoforms through conversion into diclofenac and its metabolite 4'-hydroxy-diclofenac (Hinze et al. 2003). Ketorolac is a chiral NSAID and is marketed as a racemic mixture of the S-(-)- and the R-(+)-enantiomeric isoforms. The S-(-)-form possesses the analgesic and ulcerogenic activity. There is no evidence for an inversion of R-(+)-ketorolac to S-(-)-ketorolac in man, but the pharmacokinetics of ketorolac shows enantioselectivity. The S-(-)-form has a two times shorter plasma half-life and greater clearance in adults than the R-(+)-Form, and the elimination half-life of S-(-)-ketorolac seems to be further increased in children (Kauffman et al. 1999; Mroczak et al. 1996). While the other heteroaryl acetic acids are classical NSAIDs, lumiracoxib is a selective inhibitor of COX-2. Its molecular structure is very similar to that of diclofenac (Fig. 5) and very different from the other COX-2 selective agents (diarylheterocycles). This difference is reflected in the pharmacokinetic properties of lumiracoxib, which are more similar to those of the classical acidic NSAIDs than to the diarylheterocycles.

#### Diarylheterocycles

The diarylheterocycles (celecoxib, rofecoxib, etoricoxib, and oxaprozin) have a higher selectivity to the COX-2 isoform compared to the classical NSAIDs. With the exception of oxaprozin, the diarylheterocycles do not possess an acidic function in their molecule. They are very lipophilic and poorly water-soluble. Since absorption of the drug molecules requires their



NSAIDs, Pharmacokinetics, **Figure 4** Primary metabolite of diclofenac.



**NSAIDs, Pharmacokinetics, Table 3** Pharmacokinetics of the Heteroaryl acetic acids

Drug	F [%]	PB [%]	$t_{Max}$ [h]	Vd [L/kg]	CL [L/h/kg]	$t_{1/2}$ [h]	Active Metabolites	Remarks
Diclofenac	30–80	>99	0.37–89	0.1–0.2	0.26–0.45	1.1–1.7	4'-Hydroxy-Diclofenac (30% activity of diclofenac in animal models)	Extensive first-pass metabolism Metabolising enzymes (Phase 1): CYP2C9, CYP3A4, CYP3A5 Prodrug of diclofenac: Aceclofenac
Tolmetin	100	99-	0.5–1	0.1	NR	2 ( 5)	No	Biphasic elimination with a rapid phase ( $t_{1/2} = 2$ h), followed by a slow phase ( $t_{1/2} = 5$ h)
Ketorolac (Rac)	80–100	>99	0.3–1	0.1–0.3	0.03	2.1–2.9(S) 3.3–6.7 <sup>®</sup>	No	S(-)-Ketorolac is the active enantiomer Stereoselective metabolism with increased clearance for the active S(-)-enantiomer
Lumiracoxib	66–80.8	>98	1-4	7.3–10.7 (L)	NR	3-6	4'-Hydroxy-Lumiracoxib (Potency and selectivity is similar to Lumiracoxib)	Metabolising enzymes (Phase 1): CYP2C9

F: oral bioavailability, PB: binding to plasma proteins,  $t_{Max}$ : time from administration until maximum plasma concentrations are reached, Vd/F: volume of distribution, divided by bioavailability (because data from systemic administration that are needed to calculate the true Vd are usually not available, and the volumes are derived from data after oral drug administration, and have therefore been corrected for bioavailability), CL: Drug clearance, describing the speed of its elimination from the body,  $t_{1/2}$ : half-life in plasma

N

**NSAIDs, Pharmacokinetics, Table 4** Pharmacokinetics of the Diarylheterocycles

Drug	F [%]	PB [%]	$t_{Max}$ [h]	Vd [L]	CL [L/h]	$t_{1/2}$ [h]	Active Metabolites	Remarks
Celecoxib	NR (22–40 in dogs)	>97	2–3	339–571	23.7–27.8	8–12	No	Metabolising enzymes (Phase 1): CYP2C9, CYP3A4
Rofecoxib	92–93	85	2–4	86–91	7.2–8.5	10–17	No	Metabolism: Cytosolic Reduction
Valdecoxib	83	>98	3	54.5	6	8-11	Yes (10% of the Valdecoxib dose with decreased anti-inflammatory activity)	Prodrug of Valdecoxib: Parecoxib (i.v.) Metabolising enzymes (Phase 1): CYP2C9, CYP3A4, Non-CYP450
Etoricoxib	100	NR	0.5–1.5	82–156	4.92–8.04	18.9–30.9	NR	-
Oxaprozin	95	99	2.4–3.1	0.16–0.24 (L/kg)	0.15–0.3 (L/h/kg)	41.4–54.9	No	-

F: oral bioavailability, PB: binding to plasma proteins,  $t_{Max}$ : time from administration until maximum plasma concentrations are reached, Vd/F: volume of distribution, divided by bioavailability (because data from systemic administration that are needed to calculate the true Vd are usually not available, and the volumes are derived from data after oral drug administration, and have therefore been corrected for bioavailability), CL: Drug clearance, describing the speed of its elimination from the body,  $t_{1/2}$ : half-life in plasma

dissolution in fluids, special formulations have had to be developed to enhance their water solubility, and thus to ensure their absorption. Compared to the classical NSAIDs, diarylheterocycles show very different pharmacokinetics, particularly the volume of distribution, the plasma clearance and the elimination half-life (Ahuja et al. 2003; Alsalamah et al. 2003).

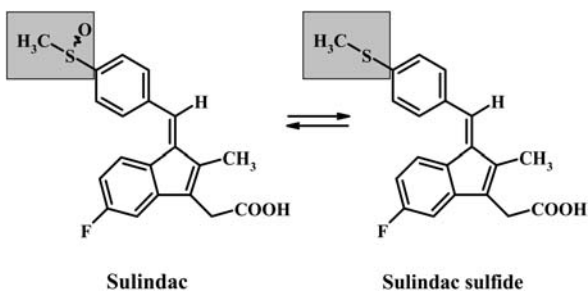
### Enolic Acids

Members of the enolic acids family (piroxicam, meloxicam, tenoxicam, lornoxicam) are weakly acidic by virtue of the enolic 4-hydroxy substituent (Fig. 6). They are well absorbed and extensively bound to plasma proteins. Due to this plasma protein binding, their apparent volumes of distribution are small. They are

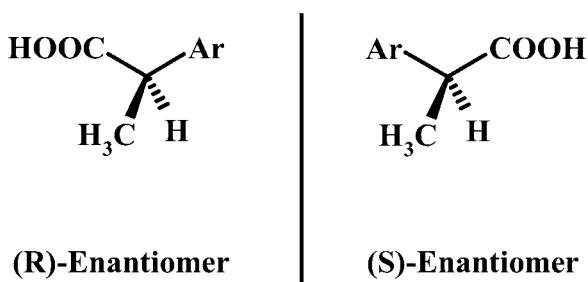
NSAIDs, Pharmacokinetics, Table 5 Pharmacokinetics of the Enolic acids

Drug	F [%]	PB [%]	$t_{Max}$ [h]	Vd [L/kg]	CL [L/h/kg]	$t_{1/2}$ [h]	Active Metabolites	Remarks
Piroxicam	NR (100)	99	2–3	0.1–0.2	0.002–0.003	30–70	No	Prodrugs of piroxicam: Ampiroxicam, droxicam, pivoxicam
Meloxicam	100	>99.5	3–9	0.1–0.2	0.0066	20	No	Metabolising enzymes (Phase 1): CYP2C9
Tenoxicam	100	>98.5	2	0.15	0.001–0.002	49–81	No	Metabolising enzymes (Phase 1): CYP2C9
Isoxicam	100	98	10	0.1–0.2	0.3 (L/h)	30–50	No	Increased $t_{1/2}$ for about 10% of a population, eventually due to polymorphic enzyme
Lornoxicam	NR	99.7	0.5–2.5	0.1–0.2	1.5–3.4 (L/h)	3–5	NR	Metabolising enzymes (Phase 1): CYP2C9
Azapropazone	60–100	>99.5	3–6	8.4–15.4 (L)	0.48–0.73 (L/h)	11.5–17.1	NR	-
Phenylbutazone	90	>98	NR	0.02–0.15	0.09 (L/h)	29–175	Oxyphenbutazone $\gamma$ -Hydroxyphenylbutazone	Dose-dependent half-life
Oxyphenbutazone	NR	97–98	NR	0.15	NR	27–64	NR	-

F: oral bioavailability, PB: binding to plasma proteins,  $t_{Max}$ : time from administration until maximum plasma concentrations are reached, Vd/F: volume of distribution, divided by bioavailability (because data from systemic administration that are needed to calculate the true Vd are usually not available and the volumes are derived from data after oral drug administration and have therefore to be corrected for bioavailability), CL: Drug clearance, describing the speed of its elimination from the body,  $t_{1/2}$ : half-life in plasma



NSAIDs, Pharmacokinetics, Figure 5 Structural similarity of lumiracoxib to classical NSAIDs.



NSAIDs, Pharmacokinetics, Figure 6 Acidic nature of piroxicam.

mainly eliminated by hepatic metabolism (Oikkola et al. 1994). The polymorphic CYP2C9 provides the major catabolic pathway for tenoxicam and meloxicam, and

are therefore candidates for an altered pharmacokinetic due to genetic polymorphisms (see ► NSAIDs, Pharmacogenetics). The elimination is usually slow. The elimination half-lives of the oxicams are long, with the exception of lornoxicam. Therefore, the oxicams have a tendency to accumulate in patients.

Phenylbutazone and oxyphenbutazone tend to accumulate due to the slow metabolism and renal elimination. In addition, they have a high potential to interact with other drugs, particularly with oral anticoagulants, anticonvulsants and oral antihyperglycaemic agents, by either inhibiting metabolic pathways or by displacement from plasma protein binding sites (Brouwers and de Smet 1994).

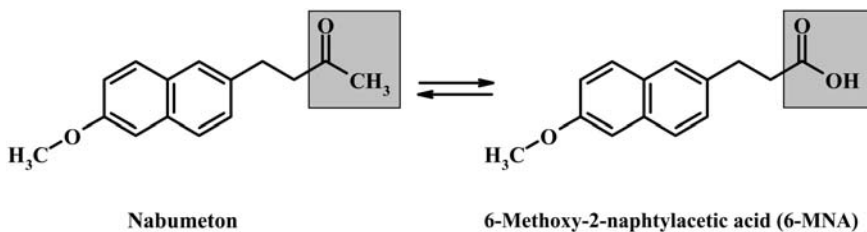
#### Indole and Indene Acetic Acids

Indomethacin, its prodrug acemetacin, sulindac and etodolac are all accounted to the indole and indene acetic acids. Their bioavailability is high and their binding to plasma proteins after absorption is extensive. They undergo extensive enterohepatic circulation, which results in a prolonged elimination half-life compared to the other NSAIDs because the already eliminated drug is re-absorbed. About 60% of an oral dose of indomethacin is excreted in the urine, while about 40% is excreted in the faeces after biliary secretion (Helleberg 1981).

**NSAIDs, Pharmacokinetics, Table 6** Pharmacokinetics of the Indole and indene acetic acids

Drug	F [%]	PB [%]	$t_{Max}$ [h]	Vd [L/kg]	CL [L/h/kg]	$t_{1/2}$ [h]	Active Metabolites	Remarks
Indomethacin	100	>90	1–2	0.12	0.044–0.11	3–11	No	Biphasic elimination due to Enterohepatic cycling Prodrug of Indomethacin: Acemetacin
Sulindac (Prodrug/Rac)	> 90	93.1	1	NR	NR	1.7–7	Sulindac sulfide (PB=95.4, $t_{Max}$ = 2–4, $t_{1/2}$ = 16–18)	Enterohepatic cycling Slower elimination in liver failure
Etodolac (Rac)	( 100)	99	1–2	1.6(S) 0.21 <sup>®</sup>	0.3(S) 0.02 <sup>®</sup>	4.3(S) 6.6 <sup>®</sup>	No	S-(+)-Etodolac is the active enantiomer Less binding to plasma proteins, higher volume of distribution and clearance for S-(+)-Etodolac

F: oral bioavailability, PB: binding to plasma proteins,  $t_{Max}$ : time from administration until maximum plasma concentrations are reached, Vd/F: volume of distribution, divided by bioavailability (because data from systemic administration that are needed to calculate the true Vd are usually not available, and the volumes are derived from data after oral drug administration, and have therefore been corrected for bioavailability), CL: Drug clearance, describing the speed of its elimination from the body,  $t_{1/2}$ : half-life in plasma

**NSAIDs, Pharmacokinetics, Figure 7** Bioactivation of sulindac.

N

**NSAIDs, Pharmacokinetics, Table 7** Pharmacokinetics of the alkanones

Drug	F [%]	PB [%]	$t_{Max}$ [h]	Vd/F [L/kg]	CL [L/h/kg]	$t_{1/2}$ [h]	Active Metabolites	Remarks
Nabumetone <sup>1</sup> (Prodrug)	80 (35)*	>99	2.5–4	0.83	NR	20–30	6-methoxy-2-naphthylacetic acid (6-MNA)	Nabumetone is inactive, but is rapidly converted to the active 6-MNA 80% of a radiolabeled nabumetone dose can be found as metabolites in urine, 35% of nabumetone gets converted in the active 6-MNA

F: oral bioavailability, PB: binding to plasma proteins,  $t_{Max}$ : time from administration until maximum plasma concentrations are reached, Vd/F: volume of distribution, divided by bioavailability (because data from systemic administration that are needed to calculate the true Vd are usually not available, and the volumes are derived from data after oral drug administration, and have therefore been corrected for bioavailability), CL: Drug clearance, describing the speed of its elimination from the body,  $t_{1/2}$ : half-life in plasma

<sup>1</sup>Kinetic Parameters related to 6-MNA

Sulindac has a chiral sulphur atom and is marketed as racemat. It is a prodrug and is bioactivated in the kidney and liver to its active sulphide metabolite (Fig. 7), which has an increased elimination half-life compared to sulindac. It tends to accumulate after repeated administration, with an even greater tendency in elderly patients (Davies and Watson 1997). Etodolac is a chiral NSAID due to a chiral carbon atom and is marketed as the racemate. Similar to other chiral NSAIDs, it possesses some unique disposition features due to its stereoselective pharmacokinetics. The volume of distribution for the racemic etodolac is greater than that of other NSAIDs, mainly because of the extensive distribution of the active S-(+)-

etodolac. Therefore, the concentrations of the inactive R-(-)-enantiomer are about 10-fold higher than the active S-(+)-enantiomer in plasma (Brocks and Jamali 1994).

### Alkanones

After absorption from the gastrointestinal tract, the prodrug nabumetone undergoes an extensive hepatic metabolism to its active metabolite 6-methoxy-2-naphthylacetic acid (6-MNA) (Fig. 8), which is structurally related to naproxen. Approximately 35% of a single dose is converted into 6-MNA. Co-administration of food seems to increase the bioavailability of nabume-

NSAIDs, Pharmacokinetics, Table 8 Pharmacokinetics of the sulfanilides

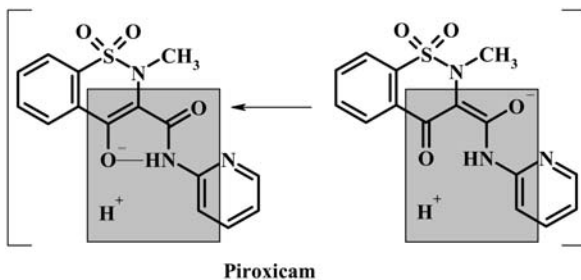
Drug	F [%]	PB [%]	$t_{Max}$ [h]	Vd/F [L/kg]	CL [L/h/kg]	$t_{1/2}$ [h]	Active Metabolites	Remarks
Nimesulide	NR	99	1.2–2.7	0.18–0.39	0.03–0.11	1.8–4.7	Yes, NR	Dose reduction (4–5 ×) in patients with hepatic impairment needed, due to increased elimination half-life

F: oral bioavailability, PB: binding to plasma proteins,  $t_{Max}$ : time from administration until maximum plasma concentrations are reached, Vd/F: volume of distribution, divided by bioavailability (because data from systemic administration that are needed to calculate the true Vd are usually not available, and the volumes are derived from data after oral drug administration, and have therefore been corrected for bioavailability), CL: Drug clearance, describing the speed of its elimination from the body,  $t_{1/2}$ : half-life in plasma

NSAIDs, Pharmacokinetics, Table 9 Pharmacokinetics of the anthranilic acids

Drug	F [%]	PB [%]	$t_{Max}$ [h]	Vd/F [L/kg]	CL [L/h]	$t_{1/2}$ [h]	Active Metabolites	Remarks
Mefenamic acid	NR	99	2–4	1.06	21.23	2–4	NR	Metabolising enzymes (Phase 1): CYP2C9
Meclofenamat sodium	NR	>99	0.5–2	0.13–0.62	7.6–20.5	0.8–5.3	3-Hydroxymethyl-MA (20% activity of MA, $t_{1/2}$ = 15 h)	Extensively metabolized to the still active metabolite 3-hydroxymethyl-MA
Flufenamic acid	NR	NR	1.5	NR	4.8–9	5–22	NR	Large interindividual variations in the pharmacokinetic parameters

F: oral bioavailability, PB: binding to plasma proteins,  $t_{Max}$ : time from administration until maximum plasma concentrations are reached, Vd/F: volume of distribution, divided by bioavailability (because data from systemic administration that are needed to calculate the true Vd are usually not available, and the volumes are derived from data after oral drug administration, and have therefore been corrected for bioavailability), CL: Drug clearance, describing the speed of its elimination from the body,  $t_{1/2}$ : half-life in plasma



NSAIDs, Pharmacokinetics, Figure 8 Hepatic activation of nabumetone.

tone and subsequent the appearance of 6-MNA. 6-MNA is highly bound to plasma proteins.

### Sulfanilides

Nimesulide inhibits preferably the COX-2 enzyme. Its selectivity for the COX-2 enzyme seems to be as high as that of celecoxib. It is largely eliminated via the metabolism into several minor active metabolites with anti-inflammatory and analgesic actions. Hepatic insufficiency decreased the elimination of nimesulide pharmacokinetics, and therefore a dose-reduction (4–5 ×) for patients with hepatic impairment is required (Bernareggi 1998; Warner and Mitchell 2004).

### Anthranilic Acids

The anthranilic acids are structurally related to the salicylic acids and heteroaryl acetic acids. Their physico-

chemical properties and their analgesic activities are very similar to the other NSAIDs. Since they do not show comparable anti-inflammatory activity, but have a similar occurrence of side-effects, their application in the clinic is restricted.

### References

- Ahuja N, Singh A, Singh B (2003) Rofecoxib: An Update on Physicochemical, Pharmaceutical, Pharmacodynamic and Pharmacokinetic Aspects. *J Pharm Pharmacol* 55:859–94
- Alsalameh S, Burian M, Mahr G et al. (2003) Review Article: The Pharmacological Properties and Clinical Use of Valdecoxib, a New Cyclo-Oxygenase-2-Selective Inhibitor. *Aliment Pharmacol Ther* 17:489–501
- Bernareggi A (1998) Clinical Pharmacokinetics of Nimesulide. *Clin Pharmacokinet* 35:247–274
- Brocks DR, Jamali F (1994) Etodolac Clinical Pharmacokinetics. *Clin Pharmacokinet* 26:259–274
- Brouwers JR, Smet PA de (1994) Pharmacokinetic-Pharmacodynamic Drug Interactions with Nonsteroidal Anti-Inflammatory Drugs. *Clin Pharmacokinet* 27:462–485
- Davies NM, Skjoldt NM (2000) Choosing the Right Nonsteroidal Anti-Inflammatory Drug for the Right Patient: A Pharmacokinetic Approach. *Clin Pharmacokinet* 38:377–392
- Davies NM, Watson MS (1997) Clinical Pharmacokinetics of Sulindac. A Dynamic Old Drug. *Clin Pharmacokinet* 32:437–459
- Geisslinger G, Lotsch J, Menzel S et al. (1994) Stereoselective Disposition of Flurbiprofen in Healthy Subjects following Administration of the Single Enantiomers. *Br J Clin Pharmacol* 37:392–394
- Helleberg L (1981) Clinical Pharmacokinetics of Indomethacin. *Clin Pharmacokinet* 6:245–258
- Hinz B, Rau T, Auge D et al. (2003) Aceclofenac Spares Cyclooxygenase-1 as a Result of Limited but Sustained Bio-transformation to Diclofenac. *Clin Pharmacol Ther* 74:222–235



11. Kauffman RE, Lieh-Lai MW, Uy HG et al. (1999) Enantiomer-Selective Pharmacokinetics and Metabolism of Ketorolac in Children. *Clin Pharmacol Ther* 65:382–388
12. Mroszczak E, Combs D, Chaplin M et al. (1996) Chiral Kinetics and Dynamics of Ketorolac. *J Clin Pharmacol* 36:521–539
13. Needs CJ, Brooks PM (1985) Clinical Pharmacokinetics of the Salicylates. *Clin Pharmacokinet* 10:164–177
14. Olkkola KT, Brunetto AV, Mattila MJ (1994) Pharmacokinetics of Oxicam Nonsteroidal Anti-Inflammatory Agents. *Clin Pharmacokinet* 26:107–120
15. Marel CD van der, Anderson BJ, Romsing J et al. (2004) Diclofenac and Metabolite Pharmacokinetics in Children. *Paediatr Anaesth* 14:443–451
16. Warner TD, Mitchell JA (2004) Cyclooxygenases: New Forms, New Inhibitors, and Lessons from the Clinic. *Faseb J* 18:790–804

## NSAIDs, Side Effects

### ► NSAIDs, Adverse Effects

## NSAIDs, Survey

GIRESH KANJI  
Wellington, New Zealand  
dr.kanji@actrix.co.nz

### Synonyms

Non-steroidal anti-inflammatory drugs NSAIDs; Anti-Inflammatories

### Definition

Non-Steroidal Anti-inflammatory Drugs (► NSAIDs) are a group of drugs derived from salicylates, which occur naturally in the bark of the willow tree. They encompass salicylic acid (aspirin) and a variety of more recent, synthesized agents.

### Characteristics

NSAIDs have analgesic, anti-inflammatory, anti-pyretic properties, and inhibit the aggregation of thrombocytes. They have traditionally been used to treat pain and inflammation. They do not alter the disease process that is giving rise to pain, but interfere with the mechanisms that produce pain and inflammation.

The original NSAID was salicylic acid, marketed as aspirin. It has been synthesized by Bayer for over 100 years. As the mechanism of action of NSAIDs has been progressively elucidated, new agents have been developed, giving rise to different families of NSAIDs.

### Mechanism of Action

The therapeutic and adverse effects of NSAIDs result from decreased production of prostaglandins from arachidonic acid, due to the inhibition of the cyclooxygenase (COX). The COX enzyme has two isotypes: COX 1 and COX 2. COX 1 is constitutively expressed by various tissues, including the gastrointestinal tract, the

kidney and the platelet, where its functions include preserving the gastric mucosa, diminishing renal vascular resistance, and maintaining homeostasis respectively. COX 2 is an enzyme induced by injury, and produces large amounts of prostanoids involved in the pain and inflammation pathways (Lipsky 1999).

Non-selective, earlier NSAIDs (e.g. Diclofenac, Ibuprofen, Indomethacin, and Naproxen) inhibit both COX 1 and COX 2 isotypes. Newer agents (e.g. Celecoxib, Rofecoxib) specifically inhibit the COX 2 isotype.

Central analgesic effects, independent of COX inhibition, have also been described for NSAIDs, but their mechanisms are not well understood. Analgesic effects are a combination of central and peripheral actions.

### Routes of Administration

Oral, rectal, intramuscular, intravenous, and topical routes of administration are available. The oral is the preferred route.

### Applications

NSAIDs are commonly used for a variety of pain states, including somatic and visceral pain. They are used temporarily for immediate relief of acute pain, such as occurs after muscle sprains, gout, and dysmenorrhoea; for headache; and for post-operative pain. They are used long-term for persisting pain, such as occurs in osteoarthritis, rheumatoid arthritis, and other arthritides. Amongst individuals over the age of 65, the use of NSAIDs is in the order of 20%, due to the common occurrence of osteoarthritis (Day et al. 1999).

### Side Effects

Side effects of NSAIDs are related to the inhibition of the constitutively expressed COX 1 enzyme, which in turn suppresses the synthesis of prostanoids that have several important homeostatic functions. Gastric ulceration, inhibition of platelet aggregation, and renal dysfunction are the most important side effects.

Prostaglandin E is known to protect the gastro-intestinal mucosa and limit gastric acid output (Raskin 1999). Gastrointestinal ulceration is the most common side effect of non-specific COX 1 and COX 2 inhibiting NSAIDs, with up to 2% of patients taking NSAIDs for 12 months developing a significant gastrointestinal bleed (Hawkey et al. 2000). The prevalence of gastric and duodenal ulcers varies from 9% to 22%, with 1 in 10 being complicated by obstruction, perforation or haemorrhage (Raskin 1999). In studies assessing gastroduodenal ulceration using endoscopy, approximately 45% of patients taking a non-specific NSAID developed an ulcer greater than 3 mm in length, compared to approximately 9% taking a specific COX 2 NSAID (Hawkey et al. 2000).

In Australia, with a population of 18 million, it is estimated that there are 4500 hospital admissions per year for serious upper gastro-intestinal side effects,

and it is estimated that 10% of these may die with between 200 and 400 deaths per annum (Day et al. 1999). Estimates in the United States of NSAID-induced gastroduodenal injury are: 107,000 hospitalisations and approximately 16,000 deaths per year (Singh and Rosen-Ramey 1998).

Prevention of gastroduodenal side-effects center on the use of proton pump inhibitors such as omeprazole, H<sub>2</sub> receptor agonists such as ranitidine, and the PGE<sub>1</sub> analogue misoprostol. Omeprazole seems the most effective in prophylaxis and treatment of NSAID-induced gastroduodenal ulceration (Raskin 1999). Prophylaxis is, however, not cost-effective for all patients, with the cost-effectiveness of misoprostol estimated to be £27,300 (sterling) per gastro-intestinal event avoided (Freemantle 2000).

NSAIDs can inhibit normal platelet function. Thromboxane A<sub>2</sub> is a platelet activator that is suppressed by COX 1 inhibition. Aspirin irreversibly inactivates the COX enzyme and its action lasts for the lifespan of the platelet, 7–10 days. Other NSAIDs are reversible inhibitors of COX, and durations of action depend on clearance of drug from the circulation. Bleeding is not a significant side effect, as thromboxane A<sub>2</sub> is only one of several mediators of platelet activation (Schafer 1999). The anti-thrombotic effect is important in the presence of coexisting bleeding disorders, and the simultaneous use of alcohol or anticoagulants.

The role of renal prostaglandin production for maintenance of stable renal haemodynamic function is limited. The prevalence of nephrotoxicity from NSAIDs is relatively low, but the risk is greater when renal perfusion is reduced, as in the aged population, in cardiovascular disease, and during dehydration. In these circumstances, a variety of clinical syndromes can include fluid and electrolyte imbalance, acute renal dysfunction, nephrotic syndrome, interstitial nephritis, and renal papillary necrosis (Whelton 1999).

NSAIDs adversely affect blood pressure control for those taking angiotensin converting enzyme inhibitors, diuretics and beta blockers. The risk of developing congestive cardiac failure also increases with NSAIDs in patients receiving diuretics.

### Efficacy

Systematic reviews have found no important differences in analgesic effect between different NSAIDs (Gotzsche 2000), and the newer specific COX 2 inhibitors are of similar efficacy to older NSAIDs (Cannon et al. 2000). However, for specific conditions, the data on efficacy varies.

A Cochrane review for back pain (Van Tulder et al. 2003) collected evidence from 51 trials. It found that NSAIDs are more effective than placebo for short-term symptomatic relief in patients with acute low back pain. Sufficient evidence on chronic low back pain is still lacking. Qualitative analysis showed there is conflict-

ing evidence that NSAIDs are more effective than paracetamol for acute low back pain.

For osteoarthritis of the knee, a review of randomised controlled trials (Towheed and Hochberg 1997) concluded that NSAIDs were superior to placebo in all short-term trials. Acetaminophen was also found to be superior to placebo, and comparably efficacious to low-dose naproxen and ibuprofen. Few studies have shown superiority of NSAIDs when compared to other analgesics (Watson et al. 2003).

A Cochrane review of lateral elbow pain concluded there is insufficient evidence to recommend or discourage the use of oral NSAIDs to relieve lateral elbow pain (Green et al. 2003). They found there was some evidence for the use of topical NSAIDs, and that a trial comparing oral administration with topical administration has not been performed.

### Cost

The high comparative cost of newer COX 2 selective NSAIDs compared to non-selective older NSAIDs would significantly increase health care costs. The number needed to treat has been calculated as 133 for 6 months regular therapy with a COX 2 rather than a traditional NSAID to avoid a serious gastrointestinal event, and 1333 to avoid a death. It appears that it is not cost effective to change all patients from older non-selective medications to newer COX 1 selective agents.

### Indications

In most conditions such as osteoarthritis, back pain, muscle strains and tendon strains it is well accepted that simple analgesics should be tried before trying NSAIDs. The American College Of Rheumatology guidelines (ACR subcommittee on Osteoarthritis Guidelines 2000) recommend acetaminophen as first-line therapy for the treatment of symptomatic osteoarthritis due to the significant side effects of NSAIDs, and the lack of data confirming the superior efficacy of NSAIDs over simple analgesics.

### References

1. ACR subcommittee on Osteoarthritis Guidelines (2000) Recommendations for the Medical Management of Osteoarthritis of the Hip and Knee. *Arthr Rheum* 43:1905–1915
2. Cannon GW, Caldwell JR, Holt P, Mclean B, Seidenberg B, Bolognese J, Ehrich E, Mukhopadhyay, Daniels B (2000) Rofecoxib, A Specific Inhibitor of Cyclooxygenase 2, with Clinical Efficacy Comparable with that of Diclofenac Sodium. *Arthr Rheum* 43:978–987
3. Day R, Rowett D, Roughead EE (1999) Towards the Safer Use of Non-Steroidal Inflammatory Drugs. *J Qual Clin Practice* 19:51–53
4. Freemantle P (2000) Cost-Effectiveness of Non-Steroidal Anti-Inflammatory Drugs (NSAIDs) – What Makes a NSAID Good Value for Money. *Rheumatology* 39:232–234
5. Green S, Buchbinder R, Barnsley L, Hall S, White M, Smidt N, Assendelft W (2003) Non-Steroidal Anti-Inflammatory Drugs (NSAIDs) for Treating Lateral Elbow Pain in Adults (Cochrane Review). In: *Cochrane Library*, Issue 3. Update Software, Oxford

6. Gotzsche PC (2000) Extracts from Clinical Evidence: Non-Steroidal Anti-Inflammatory Drugs. *BMJ* 320:1058–1061
7. Hawkey C, Laine L, Simon T, Beaulieu A, Maldonado-Cocco J, Acevedo E, Shahane A, Quan H, Bolognese J, Mortensen E (2000) Comparison of the Effect of Rofecoxib (A Cyclooxygenase 2 Inhibitor), Ibuprofen, and Placebo on the Gastrointestinal Mucosa of Patients with Osteoarthritis: A Randomized, Double-Blind, Placebo-Controlled Trial. *Arthr Rheum* 2:370–377
8. Lipsky PE (1999) The Clinical Potential of Cyclooxygenase-2-Specific Inhibitors. *The Am J Med* 106:5B:51S–57S
9. Raskin JB (1999) Gastrointestinal Effects of Non-Steroidal Anti-Inflammatory Therapy. *Am J Med* 106:5B:3S–12S
10. Schafer AI (1999) Effects of Non-Steroidal Anti-Inflammatory Therapy on Platelets. *Am J Med* 106:5B:25S–36S
11. Singh G, Rosen-Ramey D (1998) NSAID Induced Gastrointestinal Complications: The ARAMIS Perspective 1997. *J Rheumatol Suppl* 51:8–16
12. Towheed TE, Hochberg MC (1997) A Systematic Review of Randomised Controlled Trials of Pharmacological Therapy in Osteoarthritis of the Knee, with an Emphasis on Trial Methodology. *Sem Arthr Rheum* 2:755–770
13. van Tulder MW, Scholten RJPM, Koes BW, Deyo RA (2003) Non-Steroidal Anti-Inflammatory Drugs for Low Back Pain (Cochrane Review). In: *Cochrane Library, Issue 3*. Update Software, Oxford
14. Watson MC, Brookes ST, Kirwan JR, Faulkner A (2003) Non Aspirin Non-Steroidal Anti-Inflammatory Drugs for Treating Osteoarthritis of the Knee (Cochrane Review). In: *The Cochrane Library, Issue 3*. Update Software, Oxford
15. Whelton A (1999) Nephrotoxicity of Non-Steroidal Anti-Inflammatory Drugs: Physiologic Foundations and Clinical Implications. *Am J Med* 106:5B:13S–24S

## NSAR

- ▶ Non-Steroidal Anti-Inflammatory Drugs (NSAIDs)

## NST

- ▶ Neurosensory Testing

## NT-3 Neurotrophin 3

### Definition

Neurotrophic factor that belongs to the Neurotrophin family.

- ▶ Spinal Cord Nociception, Neurotrophins

## NTT

- ▶ Attributable Effect and Number Needed to Treat

## Nuclear Magnetic Resonance

- ▶ Magnetic Resonance Imaging

## Nucleoplasty

### Definition

A non-heat driven process using Coblation technology, where a bipolar radiofrequency device is used to dissolve the disc nucleus, thus decreasing the disc volume and decompressing the disc.

- ▶ Discogenic Back Pain

## Nucleotide

### Definition

Originally a combination of a (nucleic acid) purine or pyrimidine, one sugar (usually ribose or deoxyribose), and a phosphoric group; by extension, any compound containing a heterocyclic compound bound by an N-glycosol line (e.g. adenosine monophosphate, NAD+).

- ▶ Headache Attributed to a Substance or its Withdrawal

## Nucleotide Receptors

- ▶ Purine Receptor Targets in the Treatment of Neuro-pathic Pain

**N**

## Nucleus Accumbens

- ▶ Nociceptive Processing in the Nucleus Accumbens, Neurophysiology and Behavioral Studies

## Nucleus Caudalis DREZ

- ▶ DREZ Procedures

## Nucleus Gelatinosus

- ▶ Nucleus Submedius (SM)
- ▶ Spinothalamocortical Projections from SM

## Nucleus Gracilis

### Definition

An area of cell bodies within the medulla that receive inputs from large afferent fibers; relays touch and vibration sensation.

- ▶ Peptides in Neuropathic Pain States

## Nucleus Pulposus

### Definition

The nucleus pulposus is a centrally located gelatinous mass that comprises of the central portion of the intervertebral disc. It serves to resist compressive forces and allows the spine to have increased mobility. The nucleus pulposus is encircled by layers of collagen referred to as the annulus fibrosis. Together the nucleus pulposus and the annulus fibrosis comprise the intervertebral disc.

- ▶ Cytokines as Targets in the Treatment of Neuropathic Pain
- ▶ Evoked and Movement-Related Neuropathic Pain

## Nucleus Raphe Magnus

### Definition

The nucleus raphe magnus is one of several midline structures in the brainstem that contain serotonergic neurons, among others. Neurons in this region are hypothesized to provide descending modulation of pain.

- ▶ Stimulation Produced Analgesia
- ▶ Vagal Input and Descending Modulation

## Nucleus Submedius (SM)

### Definition

A small oblong nucleus in the medial thalamus postulated to play a role in nociception, because trigeminal and spinal nociceptive neurons project to this thalamic region.

- ▶ Spinothalamocortical Projections from SM

## Nucleus Tractus Solitarius

### Definition

Bilateral sensory nuclei of the caudal medulla that receive input from several cranial nerves including the facial nerve (CN VII), glossopharyngeal nerve (CN IX), and the vagus nerve (CNX).

- ▶ Vagal Input and Descending Modulation

## Number Needed to Treat

### Synonyms

NNT

### Definition

This is a measure of clinical meaningfulness in clinical trials, and is defined as the number of patients needed to be treated to obtain one patient with moderate or better improvement (50% or greater improvement) over and above placebo. This is a useful concept that allows the comparison, efficacy of analgesics that have different modes of action, as well as those from similar groups. It describes the magnitude of the difference between the active drug and the control. It can be calculated from:

$$NNT = 1 / ((IMP_{act} / TOT_{act}) - (IMP_{con} / TOT_{con})),$$

Where:

IMP<sub>act</sub> = number of patients given active treatment achieving target (e.g. 50% pain relief);

TOT<sub>act</sub> = total number of patients given active treatment;

IMP<sub>con</sub> = number of patients given control treatment achieving target;

TOT<sub>con</sub> = total number of patients given control treatment.

The NNT of oxycodone 15 mg is 2.3.

- ▶ Antidepressants in Neuropathic Pain
- ▶ Attributable Effect and Number Needed to Treat
- ▶ Central Pain, Pharmacological Treatments
- ▶ Postherpetic Neuralgia, Etiology, Pathogenesis and Management
- ▶ Postoperative Pain, COX-2 Inhibitors
- ▶ Postoperative Pain, Oxycodone

## Number Needed to Harm

### Definition

The number of patients needed to treat with a certain drug before one patient will experience a defined degree of side effects, e.g. drop out of the drug trial due to side effects. It is calculated as the reciprocal value of the difference in drop-out rate on active treatment and placebo.

- ▶ Antidepressants in Neuropathic Pain

## Numerical Rating Scale

### Synonyms

NRS

### Definition

A NRS allows a person to describe the intensity of his/her pain as a number usually ranging from 0 to 10, where "0" means "no pain" and "10" means pain as "bad as it could be".

- ▶ Central Pain, Outcome Measures in Clinical Trials



## Nursing Home Residents

### Definition

Chronic pain is more frequent in nursing home residents than in a community sample. Uncontrolled pain is a frequent cause of admission to nursing homes.

► [Psychological Treatment of Pain in Older Populations](#)

## Nutraceuticals

SCOTT MASTERS

Caloundra Spinal and Sports Medicine Centre,  
Caloundra, QLD, Australia  
scotty1@ozemail.com.au

### Synonyms

Glucosamine; chondroitin; Avocado-Soybean-Unsaponifiables

### Definition

► [Nutraceuticals](#) are loosely defined as foods with a health benefit. They are naturally occurring substances that can be used as drugs in order to treat specific symptoms, or to modify disease processes. In the field of osteoarthritis, four nutraceuticals have been recognised and studied: ► [glucosamine](#), ► [chondroitin](#), glycosaminoglycan polysulfuric acid, and ► [Avocado-Soybean-Unsaponifiables](#) (ASU).

Glucosamine is a hexosamine sugar that is a component of almost all human tissues. It is one of the two molecules that form the repeating units of certain glycosaminoglycans, which in turn form the matrix of all connective tissues (Deal and Moskowitz 1999). Glycosaminoglycans, and therefore glucosamine, form a large component of articular cartilage, which is the tissue that is primarily damaged in osteoarthritis.

Chondroitin sulphate is the principal glycosaminoglycan found in articular cartilage. It is composed of a long unbranched polysaccharide chain, with a repeating disaccharide structure of N-acetyl galactosamine and glucuronic acid (Deal and Moskowitz 1999). Chondroitin sulphate is a strongly charged polyanion, which endows cartilage with water-binding properties. Functionally, this allows the cartilage matrix to absorb compression forces, and thereby protect the underlying bone from damage.

Glycosaminoglycan polysulfuric acid is an extract from bovine cartilage and bone marrow, which contains a variety of glycosaminoglycans, including chondroitin and chondroitin sulphate (Pavelka et al. 1995; Pavelka et al. 2000).

ASUs are unsaponifiable fractions of one-third avocado oil and two-thirds soybean oil (Maheu et al. 1998; Blotman et al. 1997; Appleboom et al. 2001).

### Characteristics

#### Mechanism

Glucosamine has been shown to reach the articular cartilage after oral, intra-muscular and intravenous administration (Deal and Moskowitz 1999; McAlindon et al. 2000; Pavelka et al. 2003). It is preferentially incorporated by human chondrocytes into GAGS (Deal and Moskowitz 1999; Pavelka et al. 2003), and stimulates the synthesis of proteoglycans (Deal and Moskowitz 1999; McAlindon et al. 2000; Pavelka et al. 2003; Reginster et al. 2001).

Glucosamine and chondroitin sulphate have been shown to have anti-inflammatory effects (Deal and Moskowitz 1999; Pavelka et al. 2003; Reginster et al. 2001), positive effects on cartilage metabolism *in vitro*, and anti-arthritis effects in animal models (Deal and Moskowitz 1999; McAlindon et al. 2000; Towheed et al. 2002). These results suggest possible structure-modifying and disease-modifying roles for glucosamine and chondroitin in osteoarthritis.

In laboratory studies, glycosaminoglycan polysulfuric acid has been found to stimulate cartilage metabolism, and to inhibit the catabolic effects of interleukin-1 (Pavelka et al. 1995; Pavelka et al. 2000).

ASUs have also shown some anti-osteoarthritis properties both *in vitro* and *in vivo* (Maheu et al. 1998; Blotman et al. 1997; Appleboom et al. 2001).

#### Application

Nutraceuticals have been promoted for the treatment of osteoarthritis, on the grounds that they are natural substances that might promote healing or impede further deterioration of damaged cartilage.

Nutraceuticals are mainly taken by the oral route, as a tablet capsule or powder, and are also available as a cream. Although the majority of trials have focused on osteoarthritis of the knee, nutraceuticals are marketed for relief in a wide variety of conditions e.g. arthritis pain, fibromyalgia, and joint swelling.

#### Efficacy

One pragmatic (Deal and Moskowitz 1999) and four systematic reviews (McAlindon et al. 2000; Towheed et al. 2002; Richy et al. 2003; Leeb et al. 2000) in the last five years on the use of glucosamine and chondroitin in osteoarthritis reached similar conclusions. A number of randomised controlled trials showed benefits from these agents greater than that of placebo, in terms of reduction of pain and increased function. Others showed equivalent or better efficacy than treatment with ► [non-steroidal anti-inflammatory drugs \(NSAIDs\)](#). However, the reviews offer caution regarding the methodological problems associated with many of the studies, and advise that the treatment effects are probably exaggerated.

Important points raised by these reviews include:

- The ► **effect-sizes** in the larger and better quality studies are smaller than those of other studies.
- Many trials suffer from inadequate blinding and absence of intention-to-treat analysis of results.
- Publication bias may apply, in that studies with statistically significant and positive results are more likely to be published than studies with negative results.
- Manufacturer support was prevalent in many of the early trials.

These problems are not unique to trials of nutraceuticals, for they have also been noted in trials of drugs for osteoarthritis. Nevertheless, they constitute grounds for caution when interpreting or stating the results of trials. A further factor is that all of the early trials with positive results were of European origin. Later studies, conducted in the USA and in England, have found glucosamine to be no more effective than placebo for the relief of pain (Rindone et al. 2000; Hughes and Carr 2002).

Less contentious is the effect of glucosamine on the prevention of disease progression. Two randomised controlled trials have assessed the long-term effects of glucosamine sulphate on knee osteoarthritis (Pavelka et al. 2003; Reginster et al. 2001). Both studies compared the effects of placebo with that of 1500 mg glucosamine sulphate daily for three years. In both studies, patients treated with glucosamine showed greater reductions in pain, and greater improvements in function, as measured by the Western Ontario and McMaster Universities osteoarthritis index (WOMAC). Both studies also demonstrated significantly less loss of joint space width in those patients treated with glucosamine. The second study (Pavelka et al. 2003) showed that the ► **NNT** for preventing clinically substantial loss of joint space was 11.

For glycosaminoglycan polysulfuric acid the evidence has not been favourable. For the relief of pain it is no more effective than placebo (Pavelka et al. 1995). It does not protect against loss of joint space (Pavelka et al. 2000). Three studies of ASUs found greater reductions in pain and greater improvements in function than those following treatment with placebo ((Maheu et al. 1998; Blotman et al. 1997; Appleboom et al. 2001). These agents also had significant effects in reducing the need of patients to use NSAIDs.

### Safety

No major toxicity problems have emerged with the use of these nutraceuticals. In particular, glucosamine has been shown to be safe in the two trials with three-year follow-up (Pavelka et al. 2003; Reginster et al. 2001). Side effects were similar to those of placebo, and no specifically adverse effects were uncovered.

Some chondroitin preparations are derived from bovine cartilage. Due to the recent European epidemic of bovine spongiform encephalopathy (BSE) and its transmission to humans (resulting in variant Creutzfeldt-Jakob disease), all bovine derived products are being re-evaluated for potential transmission risks. On the List of Tissues with Suspected Infectivity (World Health Organisation), bovine cartilage is listed as Category IV (no detectable infectivity). Most other commercially available chondroitin products are derived from shark cartilage.

### Conclusions

The evidence for the use of nutraceuticals in the treatment of OA of the knee is growing. However, doubts remain about their effect-size when compared with placebo; and the efficacy of these agents has not been compared with other regimens of long-term treatment of osteoarthritis. It is still not evident if they are a cost-effective substitute for treatment with NSAIDs or exercise; or if they are a worthwhile addition to such treatment. Nor has their efficacy been determined for osteoarthritis of joints other than those studied to date, or for other painful conditions.

### References

1. Appleboom T, Scheuermans J, Verbruggen G, Henroitin Y, Reginster JY (2001) Symptoms Modifying Effect of Avocado/Soybean Unsaponifiables (ASU) in Knee Osteoarthritis. A Double Blind, Prospective, Placebo-Controlled Study. *Scand J Rheumatol* 30:242–247
2. Blotman F, Maheu E, Wulwik A, Caspard H, Lopez A (1997) Efficacy and Safety of Avocado/Soybean Unsaponifiables in the Treatment of Symptomatic Osteoarthritis of the Knee and Hip. A Prospective, Multicenter, Three-Month, Randomized, Double-Blind, Placebo-Controlled Trial. *Rev Rhum (Engl Ed)* 64:825–834
3. Deal CL, Moskowitz RW (1999) Nutraceuticals as Therapeutic Agents in Osteoarthritis. The Role of Glucosamine, Chondroitin Sulfate, and Collagen Hydrolysate. *Rheum Disc Clin N Am* 25:379–395
4. Hughes R, Carr A (2002) A Randomised, Double-Blind, Placebo-Controlled Trial of Glucosamine Sulphate as an Analgesic in Osteoarthritis of the Knee. *Rheumatology* 41:279–284
5. Leeb B, Schweitzer H, Mantag, Smolen JS (2000) A Metaanalysis of Chondroitin Sulfate in the Treatment of Osteoarthritis. *J Rheumatol* 27:205–211
6. Maheu E, Mazieres B, Valat JP, Loyau G, Le Loet X, Bourgeois P, Grouin JM, Rozenberg S (1998) Symptomatic Efficacy of ASU in the Treatment of Osteoarthritis of the Knee and Hip. *Arthritis Rheum* 41:81–91
7. McAlindon DM, LaValley MP, Gulin JP, Felson DT (2000) Glucosamine and Chondroitin for Treatment of Osteoarthritis. *JAMA* 283:1469–1475
8. Pavelka K, Gatterova J, Gollarova V, Urbanova Z, Sedlackova M, Altman RD (2000) A 5-Year Randomised Controlled, Double-Blind Study of Glycosaminoglycan Polysulfuric Acid Complex (Rumalon®) as a Structure Modifying Therapy in Osteoarthritis of the Hip and Knee. *Osteoarthritis Cartilage* 8:335–342

9. Pavelka K, Gatterova J, Olejarova M, Machacek S, Giacobelli G, Rovati L (2003) Glucosamine Sulphate Use and Delay of Progression of Knee Osteoarthritis. *Arch Intern Med* 162:2113–2123
10. Pavelka K, Sedlackova M, Gatterova J, Becvar R, Pavelka K (1995) Glycosaminoglycan Polysulfuric Acid (GAGPS) in Osteoarthritis of the Knee. *Osteoarthritis Cartilage* 3:15–23
11. Reginster JY, Deroisy R, Rovati LC, Lee RL, Lejeune E, Bruyere O, Giacobelli G, Henrotin Y, Dacre JE, Gossett C (2001) Long-Term Effects of Glucosamine Sulphate on Osteoarthritis Progression: A Randomised, Placebo-Controlled Clinical Trial. *Lancet* 357:251–256
12. Richey F, Bruyere O, Ethgen O, Cucherat M, Henrotin Y, Reginster JY (2003) Structural and Symptomatic Efficacy of Glucosamine and Chondroitin in Knee Osteoarthritis: A Comprehensive Meta-Analysis. *Arch Intern Med* 163:1514–1522
13. Rindone JP, Hiller D, Collacott E, Nordhaugen N, Ariola G (2000) Randomized, Controlled Trial of Glucosamine for Treating Osteoarthritis of the Knee. *West J Med* 172:91–94
14. Towheed TE, Anastassiades TP, Shea B, Houpt J, Welch V, Hochberg MC. (2002) Glucosamine Therapy for Treating Osteoarthritis (Cochrane Review). In: *The Cochrane Library*, Issue 1, Update Software, Oxford

---

## Nutriceutical

### Definition

The use of supplements and other substances like herbs and foods that are ingested or otherwise absorbed into the tissues to promote health.

- ▶ [Alternative Medicine in Neuropathic Pain](#)

---

## Nutritional Neuropathies

- ▶ [Metabolic and Nutritional Neuropathies](#)

---

## NVNP

- ▶ [Non-Systemic \(Isolated\) Vasculitic Neuropathy](#)





## Objective Factors

### Definition

Objective factors are those that contribute to disability, and can be assessed objectively by an examiner. They include laboratory findings, imaging findings, and some physical examination findings.

- ▶ Impairment, Pain-Related

## Objective Judgment

### Definition

Objective judgment is the process of observing and transmitting impersonal knowledge that is free from bias in judgment and that is readily quantifiable.

- ▶ Pain Assessment in Neonates

## Objective Medical Evidence

### Definition

Medical signs and laboratory findings.

- ▶ Disability Evaluation in the Social Security Administration

## Observation of Pain Behavior

- ▶ Assessment of Pain Behaviors

## Observational Learning

- ▶ Modeling, Social Learning in Pain

## Obstetric Brachial Palsy

- ▶ Plexus Injuries and Deafferentation Pain

## Obstetric Pain

JOHN S. MCDONALD

Department of Anesthesiology, Obstetrics and Gynecology, Torrance, CA, USA  
jsm5525@ucla.edu

### Synonym

Labor Pain

### Definition

Obstetric pain is an acute pain that is limited to the few hours a mother spends in labor and delivery of her baby. The pain is of a severe nature i.e. pain scores on the 7–10 scale during the later phases of the first stage of labor and then continuing during the actual delivery of the baby in culmination of the second stage. The pain emanates from the T10-L-2 cord levels for the first stage and the S2-S4 cord levels for the second stage.

### Characteristics

#### Introduction

The surge of interest in obstetric pain relief by anesthesiologists, obstetricians, pediatricians, neonatologists, and labor nurses continues to penetrate the early years of the 21<sup>st</sup> century. Mothers today receive significant instruction from natural childbirth advocates, and are often educated by lectures where anesthesiologists are included early on to outline the benefits of analgesia for labor and discuss the now built in safety.

The clinical practice of obstetric anesthesia in the early years of the 2000s is healthy and resilient, with more appreciation now recognized by colleagues; namely, the obstetricians, and neonatologists in regard to our contribution to the health and wellbeing of the mother and baby, by the fact that anesthesiologists now offer a safe harbor for both maternal and newborn care. It is important to remember that today's modern mother wants to have pain relief, but she also demands, above all, safety for her unborn baby.

#### Pain of the First Stage of Labor

First stage of labor pain is due to uterine contractions and stretching of the cervix. This is based on early works of

## Obstetric and Gynecological Pain

URSULA WESSELMANN

Departments of Neurology, Neurological Surgery and Biomedical Engineering, The Johns Hopkins University School of Medicine, Baltimore, MD, USA  
pain@jhmi.edu

### Introduction

Over the last 25 years there has been a growing recognition in the field of gynecology that pain is not only a symptom of pelvic disease, but that women are suffering from a ► **chronic pelvic pain** syndrome (Wessellmann 1999a; Wessellmann 1999b), where “pain” is the prominent symptom of the chronic visceral pain syndrome (Cervero and Laird 1999). Recognizing the existence of the chronic gynecological pain syndromes has resulted in the development of novel animal models to study the pathophysiological mechanisms of chronic gynecological pain syndromes (Giamberardino and Vecchiet 1994) and in clinical studies to assess pain treatment options. While previously most clinical efforts had focused on finding a specific etiology and specific pathological markers for pelvic disease in patients complaining of pelvic pain, many of these women are now offered pain treatment similar to patients suffering from other chronic pain syndromes. In addition there have been enormous advances in ► **obstetric pain** relief. Women can obtain almost complete relief from the pain of labor and the use of analgesia during labor and delivery is now safer than ever before (Hawkins et al. 1997). The purpose of this section review is to introduce this previously under recognized and understudied novel field of obstetric and gynecological pain and to highlight advances in basic science and clinical research, recent epidemiological studies and advances in pain treatment options for this patient population.

### Obstetric Pain, Analgesia during Labor and Delivery, Postpartum Pain

Traditionally women have been expected to suffer from severe pain during labor and delivery, some enduring the process more stoically than others. There are three distinct stages of ► **Labor Pain** related to uterine contractions, cervical stretching and distension of the vaginal canal during fetal descent. Pain of the first stage of labor is mediated by neural pathways involving the T10 to L1 spinal cord segments, while pain of the second and third stages of labor involves spinal cord segments S2 to S4. Nowadays pain relief can be offered during all stages of labor and delivery, targeted to the individual needs and wishes of the pregnant woman, without com-

promising the safety of her or of her unborn child. The most popular method for analgesia during labor and delivery is ► **epidural analgesia** using a combination of local anesthetics and opioids. Drugs can be applied as continuous epidural infusions or as ► **patient controlled epidural analgesia**. ► **Combined spinal epidural techniques** offer the advantage of a very rapid onset of analgesia with minimal motor block. Older techniques, which are rarely used today and are mainly reserved for obstetric pain not managed by ► **regional anesthesia** methods, include inhalation anesthesia and opioid analgesia *via* the intramuscular or intravenous route. Psychological methods to reduce obstetric pain and the concept of natural childbirth were initially introduced by Dick-Read sixty years ago (Dick-Read 1953) and play an important role either in conjunction with anesthetic methods or as a primary approach.

There is increasing awareness that obstetric pain is not only related to the process of labor and delivery. Women report significant pains in many sites of the body after delivery, a phenomenon defined as ► **postpartum pain**. Postpartum pains may include urogenital, pelvic, back and breast pains as well as headaches (Audit Commission 1997) persisting for months to years after labor and delivery. Anesthetic techniques during labor and delivery and gonadal hormonal changes may play a role in the etiology of these pain complaints.

### Chronic Gynecological Pain Syndromes

#### Definitions of Chronic Gynecological Pain Syndromes

Definitions are important, if a body of reliable information is to be built up in the scientific literature, which will eventually lead to a better understanding of the pathophysiology of ► **chronic pelvic pain**. One of the major problems of research into chronic pelvic pain is the lack of agreed upon definitions, which would allow comparison between studies. However, since there is a lack of understanding of the pathophysiological etiology of pelvic pain, it is difficult to decide on criteria to define chronic pelvic pain conditions.

There is no generally accepted definition of chronic pelvic pain. The International Association for the Study of Pain (IASP) defines chronic pelvic pain without obvious pathology as chronic or recurrent pelvic pain that apparently has a gynecological origin, but for which no definitive lesion or cause is found (Merskey 1994). This definition for pelvic pain has not been widely used in the literature (Campbell and Collett 1994), since it implies absence of pathology, which might not necessarily be the case and it also excludes cases where pathology is present although not necessarily the cause of pain. Similar to other chronic pain syndromes (i.e. chronic back pain) the exact relation-

ship of the pain complaint to the presence of pathology is often unclear in women with chronic pelvic pain. Given the difficulties of applying the IASP pelvic pain definition to clinical research, several medical societies have recently taken a lead in revising the definition of chronic pelvic pain. The International Continence Society has defined “pelvic pain syndrome” as the occurrence of persistent or recurrent episodic pelvic pain associated with symptoms suggestive of lower urinary tract, sexual, bowel or gynecological dysfunction in the absence of proven infection or other obvious pathology (Abrams 2002). The European Association of Urology has suggested to extend this definition by considering two subgroups based on the presence or absence of well-defined conditions that produce pain (Fall 2004). The American College of Obstetricians and Gynecologists has proposed the following definition: chronic pelvic pain is non-cyclic pelvic pain of 6 or more months duration that localizes to the anatomic pelvis, anterior abdominal wall at or below the umbilicus, the lumbosacral back or the buttocks and is of sufficient severity to cause functional disability or lead to medical care. A lack of physical findings does not negate the significance of a patient’s pain, and normal examination results do not preclude the possibility of finding pelvic pathology (ACOG 2004).

Some chronic gynecological pain syndromes present with very specific clinical characteristics. ▶ **Interstitial cystitis** is a chronic pelvic pain syndrome characterized by urinary frequency, urgency and pelvic pain. Women are 10 times more frequently affected than men. Clemons et al. (2002) found that 38% of women presenting with chronic pelvic pain and undergoing laparoscopic evaluation are ultimately diagnosed with interstitial cystitis. Certain chronic gynecological pain syndromes are related to specific phases of the menstrual cycle. ▶ **Premenstrual syndrome** (ACOG 2000) and ▶ **dysmenorrhea** are cyclic gynecological pain syndromes associated with gonadal hormonal changes during the menstrual cycle. In the majority of chronic pelvic pain patients no specific pathology can be identified that might account for the pain complaint. However, it is important to keep in mind that chronic pelvic pain can be a typical symptom of certain pelvic diseases and it is imperative to work-up patients appropriately. In women who undergo a ▶ **laparoscopy** to evaluate chronic pelvic pain, the prevalence of endometriosis is about 33% (Howard 1993). Chronic pelvic pain and pelvic adhesions are well-known sequelae of ▶ **pelvic inflammatory disease** (PID ▶ **Chronic Pelvic Pain, Pelvic Inflammatory Disease and Adhesion**). Chronic pelvic pain occurs in up to 36% of women who have suffered from PID and in up to 67% after three or more episodes of PID (Safrin et al. 1992).

In addition to gynecological pain syndromes characterized by pain localized to the pelvic cavity, gynecological pain syndromes localized to the urogenital floor have been described. Specific terms have been coined for these conditions; however, similar to the definitions of chronic pelvic pain, many of these definitions are currently being revised. Chronic perineal pain is referred to as ▶ **pudendal neuralgia**, if electrophysiological evaluation confirms impairment of the ▶ **pudendal nerve** (Bensignor et al. 1993). Vulvar pain occurring in the absence of an underlying recognizable disease has become an increasingly common clinical problem and is referred to as ▶ **vulvodynia**. Two subgroups are recognized (Moyal-Barracco and Lynch 2004), generalized vulvodynia and localized vulvodynia, including pain localized to the vulvar vestibule – ▶ **vestibulodynia** (vulvar vestibulitis) and to the clitoris – ▶ **clitorodynia (clitoral pain)** (Gordon 2002). ▶ **Dyspareunia** is defined as “recurring genital pain associated with sexual activity”. The most common form of superficial dyspareunia in pre-menopausal women is provoked vestibulodynia (Harlow et al. 2001). Vaginismus (see ▶ **dyspareunia and vaginismus**) is defined as recurrent or persistent involuntary ▶ **Muscle Spasm** of the outer third of the vagina interfering with ▶ **sexual intercourse**. Like women with dyspareunia, these patients have difficulty with and pain during vaginal penetration activities.

#### Epidemiology of Chronic Gynecological Pain Syndromes

Epidemiological studies of chronic gynecological pain syndromes are difficult, due to the lack of agreed upon definitions, as discussed above. Epidemiological data from the USA showed that 14.7% of women in their reproductive ages reported chronic pelvic pain (Mathias et al. 1996). Extrapolating to the total female population suggested an estimated 9.2 million chronic pelvic pain sufferers in the United States alone. Analysis of a large primary care database from the United Kingdom demonstrated that the annual prevalence rate of chronic pelvic pain (see ▶ **epidemiology of chronic pelvic pain**) in women is 38 / 1000, which is comparable to the prevalence rate of asthma (Zondervan et al. 1999a). Diagnoses related to the urinary or gastrointestinal tracts were more common than gynecologic causes (Zondervan et al. 1999b). Populations at risk of having chronic pelvic pain seem to be women with a history of pelvic inflammatory disease, endometriosis, interstitial cystitis, irritable bowel syndrome, obstetric history, previous abdominopelvic surgery, musculoskeletal disorders and physical and sexual abuse (Abrams et al. 2002).

A survey of ▶ **Sexual Dysfunctions**, analyzing data from the National Health and Social Life Survey, reported that 16% of women between the ages of 18 and

59 years living in households throughout the United States experience pain during sex (Laumann et al. 1999). When these data were analyzed by age group, the highest number of women reporting pain during sex was in the 18–29 years age group. The location and etiology of pain was not analyzed in this study. Approximately 15% of pre-menopausal women suffer from vulvar vestibulitis (provoked vestibulodynia), the most common form of superficial dyspareunia (Harlow et al. 2001; Goetsch 1991).

### Neurobiology of Gynecological Pain

Over the last 20 years the basic neurobiology of the pelvis, despite the complexity of this region of the body, has come to be a reasonably well-developed discipline (Berkley 2001; Burnett and Wesselmann 1999). In general, the pelvis and the pelvic floor are innervated by both divisions of the autonomic nervous system, the sympathetic and ► **parasympathetic** divisions, as well as by the somatic and sensory nervous systems. In a broad anatomical view, dual projections from the thoracolumbar and sacral segments of the spinal cord carry out this innervation, converging primarily into discrete peripheral neuronal plexuses before distributing nerve fibers throughout the pelvis (Fig. 1). Interactive neuronal pathways routing from higher origins in the brain through the spinal cord add to the complexity of neuronal regulation in the pelvis.

The inferior hypogastric plexus is considered to be the major neuronal integrative center, innervating multiple pelvic organs, including the genital and reproductive tract structures, the urinary bladder, proximal urethra, distal ureter, rectum and internal anal sphincter. The inferior hypogastric plexus receives sympathetic and parasympathetic input. Sympathetic nerves originate in the thoracolumbar segments of the spinal cord (T10-L1) and condense into the ► **superior hypogastric plexus**. Nerve fibers project from the superior hypogastric plexus as paired hypogastric plexuses destined for the inferior hypogastric plexuses. Parasympathetic preganglionic efferents arise from sacral spinal cord segments S2-S4 and fuse as the pelvic splanchnic nerve before entering the inferior hypogastric plexus. Parasympathetic afferents have cell bodies located in the S2-S4 dorsal root ganglia and course also within the pelvic splanchnic nerve. In addition to its parasympathetic efferent and afferent component, the pelvic splanchnic nerve also receives postganglionic axons from the caudal sympathetic chain ganglia. Somatic efferent and afferent innervation to the pelvis is supplied through the sacral nerve roots (S2-S4) and their ramifications. The sacral nerve roots emerge from the spinal cord forming the sacral plexus, from which the pudendal nerve diverges (S2-S3). Traditionally it was thought that ascending pathways for visceral and other types

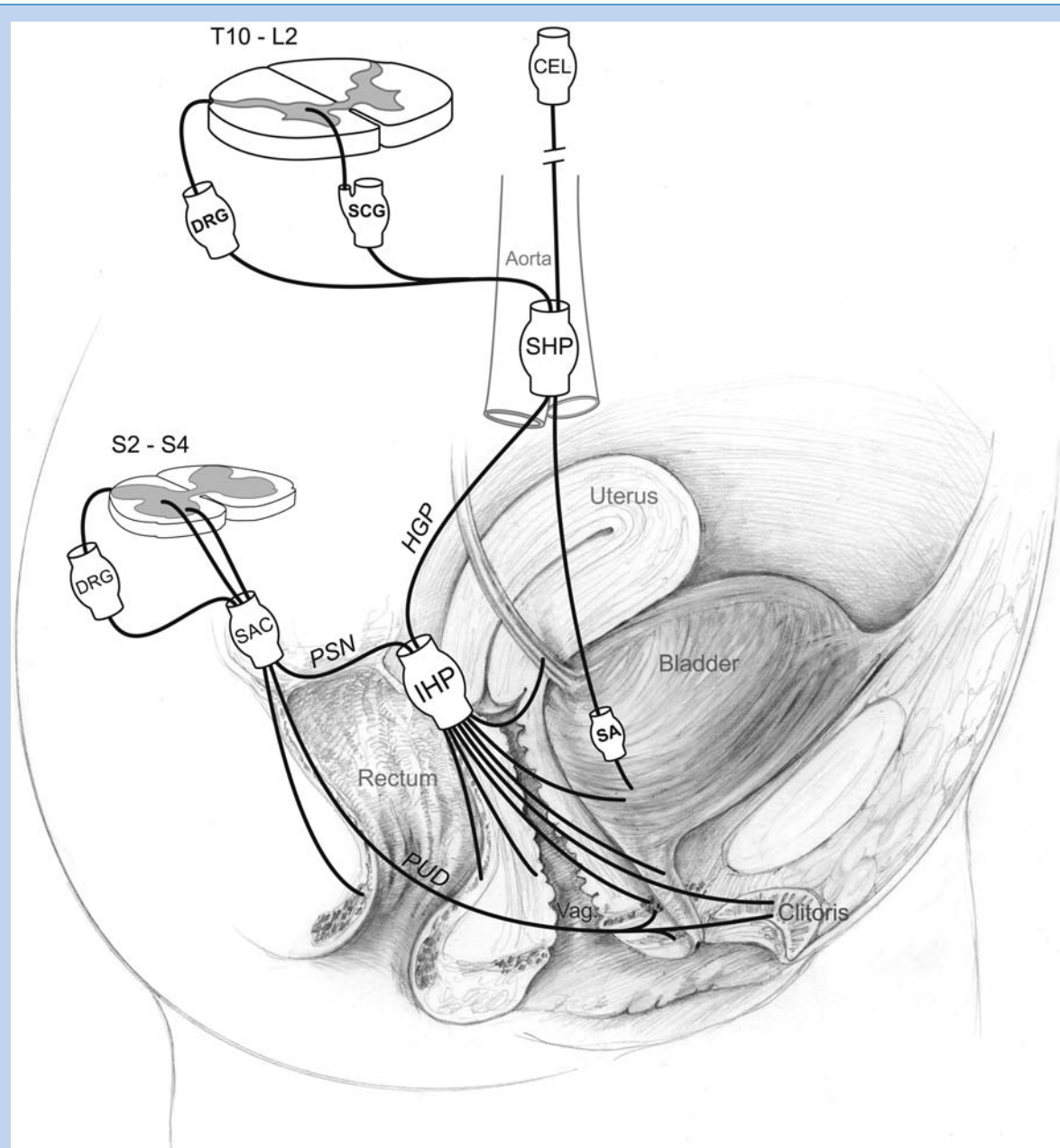
of pain were mainly the spinothalamic and spinoreticular tracts. However, three previously undescribed pathways that carry visceral nociceptive information have been discovered, the dorsal column pathway, the spino(trigemino)-parabrachio-amygdaloid pathway and the spino-hypothalamic pathway (Cervero and Laird 1999). Specifically the dorsal column pathways play a key role in the processing of pelvic pain and neurosurgeons have successfully used punctate midline myelotomy to relieve pelvic pain due to cancer (Willis and Westlund 2001).

The gynecological pain syndromes belong to the category of visceral pain syndromes (Wesselmann 1999a). Research in animal models of visceral pain has shown that several kinds of sensory receptors exist in most internal organs and that different pain states are mediated by different neurophysiological mechanisms (Cervero and Jänig 1992). Acute visceral pain is triggered by the activation of high threshold visceral afferents and by the high frequency bursts that these stimuli evoke in intensity coding afferent fibers, which are afferents with a range of responsiveness in the innocuous and noxious ranges. Prolonged forms of visceral stimulation result in sensitization of high-threshold receptors and activation of previously unresponsive afferent fibers, ► **silent nociceptors** (Häbler et al. 1988). This increased afferent activity enhances the excitability of central neurons and leads to the development of persistent pain states. There are two components of visceral pain: “true visceral pain” – deep visceral pain arising from inside the body and “► **visceral referred pain**” – pain that is referred to segmentally related somatic and also other visceral structures. Referred visceral-somatic pain mechanisms have been demonstrated to occur within minutes after uterine inflammation in an animal model of pelvic pain (Wesselmann and Lai 1997).

► **Secondary hyperalgesia** ► **(referred hyperalgesia)** usually develops at the referred site (Giamberardino and Vecchiet 1994). When examining and treating a woman with chronic gynecological pain it is important to consider both aspects of the pain syndrome (true and referred pain) including the pain deep in the pelvic cavity and pain referred to somatic structures (lower back and legs) and other visceral organs. The mechanisms of referred viscerovisceral pain (see ► **visceral referred pain**) might explain the substantial overlap observed between chronic pelvic pain and other abdominal symptoms (Abrams et al. 2002). Considering the concept of referred visceral pain will allow the physician to look at the global picture of visceral dysfunction, rather than “chasing” one aspect of the visceral pain syndrome out of context.

There is increasing evidence derived from studies in rodents that gynecological pain perception is subject to dynamic processes including ► **cross-system**





**Obstetric and Gynecological Pain, Figure 1** Schematic drawing showing the innervation of the pelvic area in females. Although this diagram attempts to show the innervation in humans, much of the anatomical information is derived from animal data. CEL, celiac plexus; DRG, dorsal root ganglion; HGP, hypogastric plexus; IHP, inferior hypogastric plexus; PSN, pelvic splanchnic nerve; PUD, pudendal nerve; SA, short adrenergic projections; SAC, sacral plexus; SCG, sympathetic chain ganglion; SHP, superior hypogastric plexus; Vag., Vagina (From Wesselmann et al. 1997; with permission of the International Association for the Study of Pain).

► **viscero-visceral and viscero-somatic convergence**, wide-spread divergence and convergence of information flow throughout the CNS, ► **central sensitization** and hormonal modulation (Berkeley 2001). This dynamic view allows the explanation of some of the puzzling and confusing aspects of chronic gynecological pain syndromes, including poor correlation of pathology and pain intensity, referred pain phenomena and

co-existence of gynecological pain with painful conditions associated with different systems.

#### **Chronic Gynecological Pain and Psychological Aspects**

There is a growing literature focusing on the role of abusive experiences in gynecological pain syndromes including ► **physical abuse** and ► **sexual abuse** during childhood and adulthood. These studies are often

difficult to compare due to the lack of uniformly agreed upon definitions of sexual and physical abuse. In addition many studies are flawed by the lack of appropriate control groups utilizing pain patients, small sample sizes and samples with significant self-selection factors. In contrast to retrospective studies based on recall, which have documented a relationship between abusive experiences and chronic gynecological pain syndromes, a recent prospective study of childhood sexual and physical abuse found no association with adult pain symptoms (Raphael et al. 2001). Clearly, further research into the complex interactions between abuse in child and adulthood and chronic gynecological pain syndromes is urgently needed, in order to address these complex psychosocial factors appropriately when treating women with chronic gynecological pain syndromes. Gynecological pain syndromes can have a significant impact on sexual functioning ► (Gynecological Pain and Sexual Functioning) and this impact might be modulated by the etiology, duration and location of pain, previous sexual function and psychosocial as well as partner related factors (Berman et al. 2003; Weijmar Schultz et al. 2003). While there are anecdotal reports that women with chronic pelvic pain are more psychologically impaired and difficult to manage, a recent study did not confirm this impression. When compared to pain controls, women with chronic pelvic pain did not score higher on a measure of depressive symptoms, did not report more pain-related disability and did not exhibit unique or different coping strategies (Heinberg et al. 2004).

#### Gynecological Pain: Assessment and Treatment

Chronic pelvic pain is often thought to be primarily of gynecological origin. However, it is important to realize that all other structures in the pelvic cavity including the urinary tract, the lower gastrointestinal tract and the pelvic blood vessels have to be included in the differential diagnosis. Musculoskeletal, neurological and psychiatric etiologies have to be considered. Thus the differential diagnosis is complicated and a thorough work-up is necessary. Since history and physical examination often do not allow the identification of an etiology for the chronic pain syndrome, laparoscopy has been the routine tool in the investigation of chronic pelvic pain for diagnostic confirmation, histological documentation and patient reassurance (Howard 1993). Endometriosis and adhesions ► (Chronic Pelvic Pain, Pelvic Inflammatory Disease and Adhesions) are the most common findings; however, the extent of pelvic pathology is often not correlated to the intensity of the pelvic pain complaint. ► Laparoscopic Pain Mapping is a diagnostic laparoscopy under local anesthesia, with or without conscious sedation, aimed at identifying sources or

generators of pain in women with chronic pelvic pain. A ► superior hypogastric plexus block applied at the time of laparoscopic pain mapping may improve the predictability of the efficacy of presacral neurectomy (Steege 1998). However, prospective randomized studies will be necessary to determine whether this novel technique of laparoscopic pain mapping improves outcomes in patients with chronic pelvic pain leading to more specific medical and surgical treatments. Treatment for chronic gynecological pain is directed towards symptomatic pain management and includes a wide range of approaches (see review in Wessermann 2001). The absence of standardized and validated treatment protocols for chronic gynecological pain syndromes continues to frustrate patients and physicians. Physicians need to be aware that patient outcomes in chronic pelvic pain are influenced by the quality of the doctor-patient interaction ► (Chronic Gynaecological Pain, Doctor-Patient Interaction) (Selfe et al. 1998). Traditionally surgical approaches towards the treatment of chronic gynecological pain syndromes have been very common. However, since it has been realized that there is not a linear correlation between the intensity of pelvic pain and pelvic pathology (if any), indications for surgery have been limited to women where pelvic pathology that might account for the pain complaint has been clearly identified. Despite the fact that it is a very common chronic pain syndrome, very little is known about effective pharmacological treatment for chronic gynecological pain. Further research on the pathophysiological mechanisms and controlled clinical trials are desperately needed to design improved pharmacological treatment strategies. Despite these limitations and need for improvement, currently available pharmacological treatment strategies, which have mainly been evaluated for other chronic pain syndromes, can be successfully applied to women with chronic gynecological pain, including NSAIDs, ► antidepressant drugs, ► Anticonvulsant (Agent), local anesthetic antiarrhythmics and ► opioids. Nerve blocks employed for chronic gynecological pain syndromes include ► superior hypogastric plexus blocks for pain in the pelvic cavity and ► pudendal nerve blocks for perineal pain syndromes. A typical characteristic of chronic pelvic pain is that patients not only present with deep pelvic pain, but also with referred pain to somatic structures. ► Physical Therapy and ► trigger point injections have been reported to be successful in the relief of ► myofascial pain associated with chronic gynecological pain syndromes (Weiss 2001). Neurosurgical approaches include presacral neurectomy for gynecological pain syndromes in the pelvic cavity, surgical decompression of the ► pudendal nerve in intractable pudendal neuralgias and limited midline myelotomy for the relief of malig-

nant pelvic pain (Willis and Westlund 2001). Psychological treatment should be part of the treatment plan early on, addressing pain, depression, sexual functioning and abusive experiences.

### Conclusions

There have been significant advances in the field of obstetric and gynecological pain. Pain during labor and delivery has been recognized as a treatable condition and regional anesthesia approaches and drugs are available to provide almost complete relief from the pain of labor and delivery. In addition it has been recognized that chronic gynecological pain presents with the typical features of chronic visceral pain. Patients with chronic gynecological pain are a heterogeneous population and therefore attempts to ascribe all cases to a particular cause or mechanism will undoubtedly fail. As the neural mechanisms of gynecological pain (► [Gynecological Pain, Neural Mechanisms](#)) explored in basic science research provide an explanation for some of the clinical phenomena observed in patients, additional, revived and new concepts have emerged: (1) A spectrum of different insults might lead to chronic gynecological pain, (2) different underlying pathogenic pain mechanisms may require different pain treatment strategies for patients presenting with gynecological pain and (3) multiple different pathogenic pain mechanisms may coexist in the same patient presenting with chronic gynecological pain, requiring several different pain treatment strategies (perhaps concomitantly) to treat the chronic pain syndrome successfully (Wesselmann 1999b).

### Acknowledgements

Ursula Wesselmann is supported by NIH grants DK57315 (NIDDK), DK066641 (NIDDK), HD39699 (NICHD, Office of Research for Women's Health) and the National Vulvodynia Association.

### References

- Abrams P, Cardozo L, Fall M et al. (2002) The standardisation of terminology of lower urinary tract function: report from the Standardisation Sub-committee of the International Continence Society. *Neurourol Urodyn* 21:167–178
- ACOG Practice Bulletin (2000) Premenstrual Syndrome. *Compendium of Selected Publications* 15:1–9
- ACOG Practice Bulletin No. 51 (2004) Chronic pelvic pain. *Obstet Gynecol* 103:589–605
- Audit Commission (1997) *First Class Delivery: improving maternity services in England and Wales*, London
- Bensignor-Le Henaff M, Labat JJ, Robert T et al. (1993) Perineal pain and lesions of the internal pudendal nerves. *Cah Anesthesiol* 41:111–114
- Berkley KJ (2001) Multiple mechanisms of pelvic pain: lessons from basic research. In: MacLean A, Stones RW, Thornton S (eds) *Pain in Obstetrics and Gynaecology*. RCOG Press, London, pp 26–38
- Berman L, Berman J, Felder S et al. (2003) Seeking help for sexual function complaints: what gynecologists need to know about the female patient's experience. *Fertil Steril* 79:572–576
- Burnett AL, Wesselmann U (1999) History of the neurobiology of the pelvis. *Urology* 53:1082–1089
- Campbell F, Collett BJ (1994) Chronic pelvic pain. *Br J Anaesth* 73:571–573
- Cervero F, Jänig W (1992) Visceral nociceptors: a new world order? *Trends Neurosci* 15:374–378
- Cervero F, Laird JM (1999) Visceral pain. *Lancet* 353:2145–2148
- Clemons JL, Arya LA, Myers DL (2002) Diagnosing interstitial cystitis in women with chronic pelvic pain. *Obstet Gynecol* 100:337–341
- Dick-Read G (1953) *Childbirth without fear*. Harper, New York
- Fall M, Baranowski AP, Fowler CJ et al. (2004) EAU guidelines on chronic pelvic pain. *Eur Urol* 46:681–689
- Giamberardino MA, Vecchiet L (1994) Experimental studies on pelvic pain. *Pain Reviews* 1:102–115
- Goetsch MF (1991) Vulvar vestibulitis: prevalence and historic features in a general gynecologic practice population. *Am J Obstet Gynecol* 164:1609–1614; discussion 1614–1606
- Gordon AS (2002) Clitoral pain: the great unexplored pain in women. *J Sex Marital Ther* 28 Suppl 1:123–128
- Häbler HJ, Jänig W, Koltzenburg M (1988) A novel type of unmyelinated chemosensitive nociceptor in the acutely inflamed urinary bladder. *Agents Actions* 25:219–221
- Harlow BL, Wise LA, Stewart EG (2001) Prevalence and predictors of chronic lower genital tract discomfort. *Am J Obstet Gynecol* 185:545–550
- Hawkins JL, Koonin LM, Palmer SK et al. (1997) Anesthesia-related deaths during obstetric delivery in the United States 1979–1990. *Anesthesiology* 86:277–284
- Heinberg LJ, Fisher BJ, Wesselmann U et al. (2004) Psychological factors in pelvic / urogenital pain: the influence of site of pain versus sex. *Pain* 108:88–94
- Howard FM (1993) The role of laparoscopy in chronic pelvic pain: promise and pitfalls. *Obstet Gynecol Surv* 48:357–387
- Laumann EO, Paik A, Rosen RC (1999) Sexual dysfunction in the United States: prevalence and predictors. *JAMA* 281:537–544
- Mathias SD, Kuppermann M, Liberman RF et al. (1996) Chronic pelvic pain: prevalence, health-related quality of life, and economic correlates. *Obstet Gynecol* 87:321–327
- Merskey H, Bogduk N (1994) *Classification of Chronic Pain*. IASP Press, Seattle, WA
- Moyal-Barracco M, Lynch PJ (2004) 2003 ISSVD terminology and classification of vulvodynia: a historical perspective. *J Reprod Med* 49:772–777
- Raphael KG, Widom CS, Lange G (2001) Childhood victimization and pain in adulthood: a prospective investigation. *Pain* 92:283–293
- Safrin S, Schachter J, Dahrouge D et al. (1992) Long-term sequelae of acute pelvic inflammatory disease. A retrospective cohort study. *Am J Obstet Gynecol* 166:1300–1305
- Selfe SA, Van Vugt M, Stones RW (1998) Chronic gynaecological pain: an exploration of medical attitudes. *Pain* 77:215–225
- Steege JF (1998) Superior hypogastric block during micro-laparoscopic pain mapping. *J Am Assoc Gynecol Laparosc* 5:265–267
- Weijmar Schultz WC, Van De Wiel HB (2003) Sexuality, intimacy, and gynecological cancer. *J Sex Marital Ther* 29:121–128
- Weiss JM (2001) Pelvic floor myofascial trigger points: manual therapy for interstitial cystitis and the urgency-frequency syndrome. *J Urol* 166:2226–2231
- Wesselmann U (1999a) A call for recognizing, legitimizing and treating chronic visceral pain syndromes. *Pain Forum* 8:146–150
- Wesselmann U (1999b) Guest Editorial: Pain –the neglected aspect of visceral disease. *Eur J Pain* 3:189–191

35. Wesselmann U (2001) Chronic pelvic pain. In: Turk DC, Melzack R (eds) *Handbook of Pain Assessment*. Guilford Press, New York, pp 567–578
36. Wesselmann U, Lai J (1997) Mechanisms of referred visceral pain: uterine inflammation in the adult virgin rat results in neurogenic plasma extravasation in the skin. *Pain* 73:309–317
37. Willis WD, Jr., Westlund KN (2001) The role of the dorsal column pathway in visceral nociception. *Curr Pain Headache Rep* 5:20–26
38. Zondervan KT, Yudkin PL, Vessey MP et al. (1999a) Prevalence and incidence of chronic pelvic pain in primary care: evidence from a national general practice database. *Br J Obstet Gynaecol* 106:1149–1155
39. Zondervan KT, Yudkin PL, Vessey MP et al. (1999b) Patterns of diagnosis and referral in women consulting for chronic pelvic pain in UK primary care. *Br J Obstet Gynaecol* 106:1156–1161

Head (1893) and Cleland (1949). Some of these investigators, such as Berkeley and associates, have carried out a systematic and comprehensive series of experiments of the nerve supply of the uterus and other pelvic organs. The pain of the first stage of labor is located in the neural pathways of the T 10-L-1 spinal segments.

#### **Pain of the Second and Third Stages of Labor**

The pain that develops in the second stage emanates from continued distention of the entire vaginal canal as the fetus descends toward the vaginal outlet. Some of the painful signaling comes from muscular dilatation and tension and tearing during the final fetal descent and dilatation of the birth canal. The nociceptive pathways are carried by the pudendal nerves to the dorsal root ganglia located at the S2–4 levels.

Analgesia can be accomplished in the form of an epidural regional block with sacral distribution or a caudal regional analgesic method. As noted earlier, the neural pathways for the second and third stages of labor involve S2, S3, and S4 spinal segments.

#### **Current Methods for Relief of Childbirth Pain**

At the outset it should be stated that a sophisticated level of anesthesia care is not necessary for all women for their labor and delivery; some women who wish to have pain relief for labor may want only minimal relief. Some mothers in fact want to feel the movements, rotations, and downward progress of their baby in the birth canal. It should be the goal of the individual obstetric anesthesia unit to match the needs of the patient to the resources of the specific delivery unit. Today we are fortunate to be able to provide adequate maternal analgesia with minimal motor blockade. This is largely due to the administration of minimal local anesthetic concentrations, mixtures with opioids, and use of pumps that deliver constant small amounts of medication. Many drugs and techniques are currently available to provide relief of childbirth pain. These can be classified into four categories:

1. Psychological Methods
2. Pharmacological analgesia
3. Inhalation analgesia
4. Regional analgesia

#### **Psychological Methods**

##### **Natural Childbirth and Psychoprophylactic Method**

Dick-Read popularized natural childbirth at a time when little else could be offered for pain relief, and for that contribution he should be appreciated. His original emphasis was centered entirely upon the mother (Dick-Read 1953). It was paramount that she was in excellent physical condition so that she could endure the challenge of labor. This method was greatly enhanced by the cooperation of a friendly and helpful nurse, who would act as a coach and facilitator for the patient during stressful times. The Psychoprophylactic Method of analgesia modified the Dick-Read method, with another method of analgesia that was popularized in Russia. By the middle of the century, the psychological methods were known by many different names, but the most popular names were Psychoprophylaxis and Childbirth without Pain, as Dick-Read originally described it. The method was popularized by Lamaze (Lamaze 1956) of France, who successfully introduced it to the United States around the same time that regional anesthesia was being reintroduced, thanks to pioneers such as Bonica (1967, 1969), and Cleland (1949).

#### **Pharmacological Analgesia**

Opioids are the primary agents used for pain relief in labor not managed by regional analgesic methods. These agents are simple to use with intravenous or intramuscular delivery in labor when necessary. Additional drugs, such as morphine, alphaprodine, nalbuphine and fentanyl can be used. Although these narcotics were initially used via the intramuscular route in earlier years, they are now given in small intravenous doses to decrease the total amount needed for labor pain, and thus decrease the amount available for effect upon the fetus.

#### **Inhalation Analgesia/Anesthesia**

The next logical step up from systemic analgesia is inhalation analgesia. Today it is a rarely used method of relieving labor pain. It is mentioned here for completeness only. Commonly used agents such as 40–50% nitrous oxide in oxygen, or sevoflurane or desflurane in oxygen can be used. Nitrous oxide can be administered intermittently during uterine contractions (Carstoniu et



al. 1994). Inhalation anesthesia for very brief time periods and for actual delivery can still be employed, because it can be rapidly delivered and affords maximum control of depth and duration of action and is rapidly eliminated. Some have advocated the use of the laryngeal mask airway to administer anesthesia in cases where intubation by the normal means is difficult or impossible. This is a controversial issue at this time, as there is not enough experience with the use of the laryngeal mask airway in obstetrics to make claims for the safety of the mother.

### Epidural Analgesia Block

Today's practice makes use of small doses of local anesthetics often mixed with opioids, and these are combined with continuous pumping methods throughout the remainder of the labor and even into the delivery period. Thus, the problem of each injection of local anesthetic producing a transitory decrease in uterine activity and weakness, or even paralysis of the lower limbs and perineal muscles, has been obviated. Here again, a number of studies point toward the fact that low concentrations of epidural local anesthetics with opioids when compared to the higher concentrations of epidural local anesthetics are associated with reduced motor block. Gone is the impact on the perineal muscles with resultant weakness or paralysis that diminished the resistant forces essential for internal rotation of the baby. Intense sacral anesthesia too early also eliminated the afferent limb of the reflex urge to bear down. So when it comes down to it, there are several options available today for analgesia and anesthesia for labor and delivery, and these include the following:

1. Single-bolus epidural, then top up as needed.
2. Loading dosage bolus, then begins pump delivery with diluted local anesthetic plus opioid. Repeat as needed.
3. Loading dosage bolus, then begins pump delivery with diluted local anesthetic plus opioid. Further needs are taken care of by patient controlled analgesic system.
4. Variation on the themes of the above with a combination.

There is a consensus that labor and delivery analgesia and anesthesia should be managed by a strict case by case analysis of the factors involved such as prior problems with the pregnancy to date, any fetal problems, any maternal problems, and last but not least any special requirements by the mother and/or father regarding anesthesia

### Continuous Epidural Infusion

Detailed description of the technique of achieving lumbar epidural analgesia is beyond the scope of this brief descriptive. Most clinicians use a single catheter placed with its tip in the upper lumbar epidural space (Gieraerts et al. 1992). To introduce the catheter, I prefer the use of

a Touhy type needle via the paramedian technique (Bonica 1980).

Rather than dictate specific agents and combinations, the reader is referred to recent articles with sufficient variation for their own choosing to be used in their specific circumstances and situations. One preferred continuous infusion solution contains .0625% bupivacaine and 0.002% fentanyl (2 mcg/ml). This can be initiated at a rate of 10–12 ml/h; the solution can subsequently be increased or decreased to maintain analgesia with the upper level at T10. A small bag container with a total of 120 ml of solution is usually prepared. The pharmacy can prepare such a mixture by combining 30 ml of 0.25% bupivacaine, 60 mcg of sufentanyl and 200 mcg of epinephrine in a total bag mixture of 120 ml volume (McIntosh and Rayburn 1991). With each subsequent hour, the extent of cephalad level of analgesia remains fairly constant at T10, but the caudal level tends to extend. After about the third or fourth hour, analgesia usually involves all of the lumbar and sacral segments. In about 50 – 60% of the parturients, the sacral analgesia is sufficient for perineal analgesia; this means a comfortable and pain free completion of second stage. If the patient is examined prior to delivery and sacral analgesia is incomplete, 10 ml of 3% ropivacaine, 2% lidocaine, or 2% chloroprocaine can be given with the patient in the semi-sitting position.

### Spinal-Epidural Method

One last technique is included, because it has gained some popularity, and this is the spinal-epidural combination technique, where a 27 G spinal needle is passed via the standard 18 G thin-walled epidural needle for delivery of a small amount of subarachnoid opioid. First the lumbar epidural needle is placed and the usual entry into the epidural space is assured. Next the small gauge spinal needle is passed through the epidural needle until the dura is contacted. After the spinal needle contacts the dura a puncture is made, and a small amount of opioid is injected for the purpose of providing analgesia without significant sympathetic blockade or motor paralysis (Norris et al. 1998). It would seem the combined spinal-epidural technique provides effective analgesia almost instantly, because opioid is being injected into the subarachnoid space where action is immediate. It therefore makes sense to use it in cases where the patient is far along in her labor as a primipara or near seven centimeters dilatation as a multipara; in such cases the patient can benefit from rapid analgesia and the second stage can be managed with the epidural catheter that is placed through the epidural needle. At this time there are numerous reports of the efficacy of this method.

### References

1. Bonica JJ (1967) Principles and Practice of Obstetric Analgesia and Anesthesia, vol 1. FA Davis, Philadelphia

2. Bonica JJ (1969) Principles and Practice of Obstetric Analgesia and Anesthesia, vol 1 and 2. Philadelphia, FA Davis
3. Bonica JJ (1980) Obstetric Analgesia and Anesthesia, 2<sup>nd</sup> edn. World Federation of Societies of Anaesthesiologists, Amsterdam/University of Washington Press, Seattle
4. Carstoniu J, Levytam S, Normal P et al. (1994) Nitrous Oxide in Labor: Safety and Efficacy Assessed by a Double-Lined Placebo Controlled Study. *Anesthesiology* 80:30–35
5. Cleland JGP (1949) Continuous Peridural and Caudal Analgesia in Obstetrics. *CurT Res Anesth Analg* 28:61
6. Dick-Read G (1953) Childbirth without Fear. Harper, New York
7. Gieraerts R, Van Zundert A, De Wolf A et al. (1992) Ten ml Bupivacaine 0.125% with 12.5  $\mu$  Epinephrine is a Reliable Epidural Test Dose to Detect Inadvertent Intravascular Injection in Obstetric Patients. A Double-Blind Study. *Acta Anaesth Scand* 36:656–659
8. Lamaze F (1956) Qu'est-ce que L'accouchement Sans Douleur par la Méthode Psychoprophylactique? Ses Principes, sa Réalisation, ses Résultats. Savoir et Connaitre, Paris
9. McIntosh DG, Rayburn WF (1991) Patient Controlled Analgesia in Obstetrics and Gynecology. *Obstet Gynecol* 70:202–204
10. Norris MC, Fogel ST, Holtman B (1998) Intrathecal Sufentanil (5 vs. 10 microg) for Labor Analgesia: Efficacy and Side Effects. *Reg Anesth Pain Med* 23:252–257

## Obstipation

### Definition

Obstipation refers to severe constipation or reduction in bowel motility, oftentimes requiring enemas and manual disimpaction of feces from the distal rectum.

- ▶ Opioids in Geriatric Application

## Occlusal Force

### Definition

Force is generated between the teeth during voluntary, usually maximal activation, of the jaw-closing muscles. Measurement requires insertion of a transducer between the upper and lower teeth.

- ▶ Orofacial Pain, Movement Disorders

## Occupational Behavior

### Definition

Occupational behavior is the client's emotional reactions, e.g. emotional, stress and physical reactions to occupational demands, work organization and psychosocial work environment. Important occupational behavior for performing job tasks is motivation, initiative, concentration, attendance, attention span, decision-making, responsibility for production, physical stamina and ability to accept supervision and criticism, and interpersonal relationships with workmates and manager.

- ▶ Vocational Counselling

## Occupational Capacity Evaluation

- ▶ Disability, Functional Capacity Evaluations

## Occupational Pain

- ▶ Pain in the Workplace, Risk Factors for Chronicity, Job Demands

## Occupational Stressors

- ▶ Stress and Pain

## Occupational Therapist

### Definition

An Occupational Therapist is an allied health professional working primarily with the activity domain in rehabilitation, especially with activities of daily living.

- ▶ Physical Medicine and Rehabilitation, Team-Oriented Approach

## Occupational Therapy in Children

- ▶ Chronic Pain in Children, Physical Medicine and Rehabilitation

## Ocular Nociceptors

CARLOS BELMONTE

Instituto de Neurociencias de Alicante, University Miguel Hernández-CSIC, San Juan de Alicante, Spain  
carlos.belmonte@umh.es

### Synonyms

Eye Pain Receptors; Ocular Pain Receptors; Eye Nociceptors

### Definition

Sensory afferent fibers that innervate the various tissues of the eye and are activated by physical and chemical stimuli of intensity near or within the noxious range, giving rise to sensations of discomfort or pain referred to the eye and/or the periocular region.

## Characteristics

### Anatomy of Ocular Innervation

The cell bodies of the ocular sensory afferents, most of which are of small or medium size, are located in the ipsilateral trigeminal ganglion chiefly clustered in the ophthalmic (medial) region of the ganglion. The axons of these pseudomonopolar neurones divide into a peripheral branch that projects to the peripheral target tissues and a central branch that enters the brainstem to reach the trigeminal brainstem sensory nuclear complex. Sensory nerve fibers directed to the ocular region run with the ophthalmic nerve, which branches into nasociliary, frontal and lacrimal nerves. The ciliary nerves, originate in the nasociliary nerve and travel to the eyeball, where they innervate connective tissue, epithelia and blood vessels of the uvea, ciliary body, choroid, scleral spur, lids, sclera, cornea and bulbar conjunctiva. The richest nerve density is found in the cornea. The lens and the retina do not receive direct trigeminal sensory innervation. The remaining ophthalmic nerve branches carry sensory nerve fibers that originate in orbital tissues, extraocular muscles, palpebral conjunctiva, lids, lacrimal gland, periocular skin and mucosae of the nose, frontal sinus and the lacrimal sac.

A small proportion of ocular sensory fibers are large-diameter, myelinated axons that possess morphological specializations at their terminal portion typical of mechanoreceptors. Most of them however are thin myelinated and unmyelinated fibers.

In the cornea, sensory axons are grouped in a variable number of radially-oriented nerve bundles that branch extensively and form the subbasal plexus below the basal epithelial cells. From this plexus, naked single fibers ascend vertically between the epithelial cells ending at variable depths (for review see Müller et al. 2003).

Immunocytochemical staining reveals the presence of different ► **neuropeptides** in the cell soma and axons of the ocular sensory neurons. About 50 % of corneal neurons are immunoreactive to calcitonin gene-related peptide (► **CGRP**), of which 20 % also contain ► **substance P** (SP) (de Felipe et al. 1999). Small amounts of other neuropeptides such as cholecystokinin, vasopressin, neurotensin, and  $\beta$ -endorphin have been also reported in ocular sensory neurons. Neurotrophins such as nerve growth factor (NGF), glial cell line-derived ► **neurotrophic factor** (GDNF, Artemin), brain-derived neurotrophic factor (BDNF), neurotrophin-3 (NT-3), opioid growth factor (OGF), ciliary neurotrophic factor (CNTF) and pigment epithelium derived factor (PEDF) are found in the cornea (for review see Müller et al. 2003). They may participate, as target tissue-derived growth factors, in the development, maintenance and regeneration of nerves (Bonini et al. 2003). Also, an accumulating evidence suggests that neuropeptides, in particular SP, and CGRP, and

neurotrophins (especially NGF), promote corneal healing and/or maintenance of epithelial integrity either alone or in combination with other growth factors (like insulin-like growth factor) (Gallar et al. 1990; Garcia-Hirschfeld et al. 1994; Lambiase et al. 2000; Bonini et al. 2003; Mueller et al. 2003).

### Functional Properties of Ocular Sensory Receptors

Functional studies of ocular sensory fibers have been performed mainly in the cornea. The majority of corneal sensory nerve fibres, about 70 %, are ► **polymodal nociceptors**. They are activated by near-noxious mechanical energy, heat, chemical irritants and by a large variety of endogenous chemical mediators released by damaged corneal tissue, resident inflammatory cells or which leak from vessels in the periphery of the cornea (the limbus). Some of the polymodal nociceptor fibres belong to the group of thin myelinated (A-delta) nerve fibers but most of them are of the C type. Polymodal nociceptors respond to their natural stimuli with a continuous, irregular discharge of nerve impulses that persist as long as the stimulus is maintained. They have a firing frequency roughly proportional to the intensity of the stimulating force. Therefore, the impulse discharge of polymodal nociceptors does not only signal the presence of a noxious stimulus, but it also encodes to a certain degree its intensity and duration. Polymodal nociceptors have a mechanical threshold slightly lower than ► **mechanonociceptors** (see below) and when stimulated with heat, they begin to fire at temperatures over 39°–40 °C. A fraction of polymodal fibres (around 50 %), also increase their firing rate when the corneal temperature is reduced below 29 °C (Belmonte and Giraldez 1981; Acosta et al. 2001). Many chemical agents known to excite polymodal nociceptors of other territories also activate ocular nociceptors. Acidic solutions (of pH 5.0–6.5), or gas jets containing increasing concentrations of CO<sub>2</sub> (carbonic acid formation at the corneal surface drops the local pH), evoke an impulse discharge in corneal polymodal nociceptors (Belmonte and Giraldez 1981; Belmonte et al. 1991; Gallar et al. 1993; McIver and Tanelian 1993; Chen et al. 1995; Acosta et al. 2001; for review see Belmonte et al. 1997; Belmonte et al. 2004).

About 15–20 % of the axons innervating the cornea (all thin myelinated) respond only to mechanical forces in the order of magnitude close to that required to damage corneal epithelial cells. Accordingly, they belong to the mechano-nociceptor type. The fibers of this class of receptor fire one or a few nerve impulses either in response to brief or sustained indentations of the corneal surface and often, also when the stimulus is removed. Thus they are ‘phasic sensory receptors’, that signal the presence of the stimulus and, in a very limited degree its intensity and duration (Belmonte et al. 1997, McIver and Tanelian 1993). The threshold force required to activate mechano-nociceptors is apparently low (about 0.6 mN) far below the force that activates

mechano-nociceptor fibres in the skin. However, this intensity might be sufficient to damage unkeratinised corneal epithelium. Mechano-nociceptors in the cornea are probably responsible for the acute, sharp sensation of pain produced by touching the corneal surface. The after-sensations of pain elicited by noxious stimuli are probably explained by the more sustained activity exhibited by polymodal nociceptors.

Another category of corneal nerve fibres that represents 10–15 % of the total population are cold-sensitive thermal receptors. These are A-delta and C fibres that discharge spontaneously at rest and increase their firing rate when the normal temperature of the corneal surface (around 33 °C) is reduced, while they are transiently silenced upon warming (Tanelian and Beuerman 1984; Gallar et al. 1993; Brock et al. 1998). They also increase their firing rate as soon as the temperature of the cornea drops because of evaporation at the corneal surface, application of cold solutions or blowing of cold air on the cornea. Cold receptor fibres are able to detect and encode as a change in impulse frequency, small temperature variations of 0.1 °C or less (Gallar et al. 1993; Gallar et al. 2003), thus allowing for the perception of decreases in corneal temperature as a conscious sensation of innocuous cooling. (Acosta et al. 2001)

Finally, it has been suggested that the cornea possesses mechanically-insensitive, 'silent' nociceptors i.e., nerve terminals that are not activated by mechanical or thermal stimuli when the tissue is intact but in the case of local inflammation, they become responsive to these exogenous stimuli as well as to a variety of endogenous chemicals. Although the experimental evidence for their presence in the cornea is only indirect, they have been identified in virtually all other somatic tissues. Thus, it seems likely that such nociceptors also exist in the cornea.

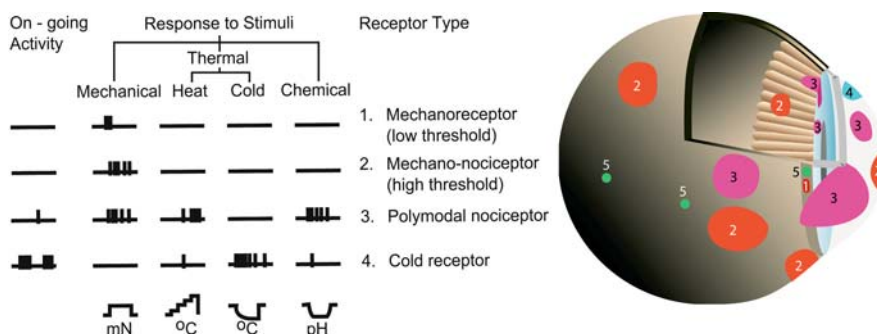
Variable activation of the different populations of corneal sensory afferents by stimuli of different modalities evokes sensations that also differ qualitatively. Sensations resulting from the excitation of mechano- and polymodal nociceptors always have an irritative

component. Only when cold fibers are stimulated separately with small temperature decreases are non-noxious sensations of cooling evoked. Large temperature decreases also recruit polymodal nociceptors, resulting in an irritating cooling sensation (Acosta et al. 2001).

Electrophysiological studies dedicated to identify sensory receptor types in ocular structures have shown that the same main functional classes of sensory afferents identified in the cornea and the episclera i.e., mechano-nociceptors, polymodal nociceptors and ► cold receptors are also present in the bulbar conjunctiva (Belmonte and Giraldez 1981), the scleral surface (Gallar 1991), the iris and the ciliary body (Mintening et al. 1995). Cold fibres with response properties similar to the thermal receptors present in the cornea and limbus are also found in unexposed areas of the iris and posterior sclera. It has been hypothesized that such scleral cold receptors contribute to the detection of choroidal and retinal blood flow changes for reflex blood flow regulation rather than to the production of conscious thermal sensations (Gallar et al. 2003). Likewise, endings in the chamber angle with the appearance of mechanosensory terminals have been associated with neural regulation of intraocular pressure (Belmonte et al. 1973). Figure 1 represents schematically the functional types of sensory endings identified electrophysiologically in the various structures of the cat's eye.

Polymodal nociceptors of the cornea and the uvea not only encode the intensity of noxious stimuli but also become sensitized following injurious stimulation (Belmonte and Giraldez 1981; Gallar et al. 1993; Mintening et al. 1995). These characteristics explain the acute pain sensations and the development of primary hyperalgesia following injuries of the ocular surface, as well as the pain reported when the iris is touched accidentally during ocular surgery or often when argon laser pulses are applied to the posterior uvea (for review see Belmonte et al. 2004).

Intense ocular pain is also observed in parallel with the rise in intraocular pressure that takes place in congestive



**Ocular Nociceptors, Figure 1** Functional types of sensory fibers innervating the eye. The left hand side of the figure represents the pattern of impulse discharge, either spontaneous or evoked by the different modalities of stimuli, produced by each functional receptor type. The right hand side shows schematically the location and relative size of the receptive fields of the various classes of ocular sensory receptors (modified from Belmonte et al. 1997).



glaucoma (see below). However, artificial increases of intraocular pressure up to 100 mm Hg in the intact cat resulted in transient impulse discharges in most corneal, scleral and iridal sensory fibers with only a small proportion of them giving a sustained firing (Zuazo et al. 1986). Possibly, in the non-inflamed eye very high intraocular pressures are required to effectively stimulate the mechanosensory and polymodal fibers that innervate the eye coats. When uveal inflammation develops as during congestive glaucoma, sensitization of nociceptors increases their excitability to mechanical stimulation, making them more responsive to pressure.

## References

1. Acosta MC, Belmonte C, Gallar J (2001) Sensory experiences in humans and single-unit activity in cats evoked by polymodal stimulation of the cornea. *J Physiol* 534:511–525
2. Belmonte C, Giraldez F (1981) Responses of cat corneal sensory receptors to mechanical and thermal stimulation. *J Physiol* 321:355–368
3. Belmonte C, Gallar J, Pozo MA et al. (1991) Excitation by irritant chemical substances of sensory afferent units in the cat's cornea. *J Physiol* 437:709–725
4. Belmonte C, Garcia-Hirschfeld J, Gallar J (1997) Neurobiology of ocular pain. *Progr Ret Eye Res* 16:117–156
5. Bonini S, Rama P, Olzi D et al. (2003) Neurotrophic keratitis. *Eye* 17:989–995
6. Brock JA, McLachlan EM, Belmonte C (1998) Tetrodotoxin-resistant impulses in single nociceptor nerve terminals in guinea-pig cornea. *J Physiol* 512:211–217
7. Chen X, Gallar J, Pozo MA et al. (1995) CO<sub>2</sub> stimulation of the cornea: A comparison between human sensation and nerve activity in polymodal nociceptive afferents of the cat. *Eur J Neurosci* 7:1154–1163
8. De Felipe C, González GG, Gallar J et al. (1999). Quantification and immunocytochemical characteristics of trigeminal ganglion neurons projecting to the cornea: effect of corneal wounding. *Eur J Pain* 3:31–39
9. Gallar J, Pozo MA, Rebollo I, Belmonte C (1990) Effects of capsaicin on corneal wound healing. *Invest Ophthalmol Vis Sci* 31:1968–1974
10. Gallar J, Pozo MA, Tuckett RP et al. (1993) Response of sensory units with unmyelinated fibres to mechanical, thermal and chemical stimulation of the cat's cornea. *J Physiol* 468:609–622
11. Gallar J, Acosta MC, Belmonte C (2003) Activation of scleral cold thermoreceptors by temperature and blood flow changes. *Invest Ophthalmol Vis Sci* 44:697–705
12. MacIver MB, Tanelian DL (1993) Structural and functional specialization of A-delta and C fibre free nerve endings innervating rabbit corneal epithelium. *J Neurosci* 13:4511–4524
13. Mintenig GM, Sanchez-Vives MV, Martin C et al. (1995) Sensory receptors in the anterior uvea of the cat's eye. An *in vitro* study. *Invest Ophthalmol Vis Sci* 36:1615–1624
14. Müller LJ, Marfurt CF, Kruse F et al. (2003) Corneal nerves: structure, contents and function. *Exp Eye Res* 76:521–542
15. Tanelian DL, Beuerman RW (1984) Responses of rabbit corneal nociceptors to mechanical and thermal stimulation. *Exp Neurol* 84:165–178
16. Zuazo A, Ibañez J, Belmonte C (1986) Sensory nerve responses elicited by experimental ocular hypertension. *Exp Eye Res* 43:759–769

## Ocular Pain Receptors

- ▶ Ocular Nociceptors

## ODAC

- ▶ On-Demand Analgesia Computer

## Odds Ratio

### Definition

This is a calculation of the degree to which the probability of a given outcome in a sample exceeds the probability of the outcome in the control group.

- ▶ [Psychiatric Aspects of the Epidemiology of Pain](#)

## ODI

- ▶ Oswestry Disability Index

## Odorant

### Definition

Molecule capable of eliciting responses from receptors in the olfactory mucosa.

- ▶ [Perireceptor Elements](#)

## Off-Cells (RVM)

### Definition

RVM neurons in the rostroventral medulla defined by a sudden pause in firing that begins just prior to execution of the tail flick, paw withdrawal or other nocifensive reflex. Spontaneous activity is variable with time, and an off-cell can only be identified if it is firing at the time at which the reflex is evoked. Off-cells are not directly responsive to mu-opioids, but are activated indirectly by mu-opioids given systemically, or by microinjection into the PAG, basolateral amygdala or in the RVM itself. RVM off-cells, as defined *in vivo*, are presumed to be a subset of primary cells defined *in vitro*.

- ▶ [Opiates - Pharmacology of Pain](#)
- ▶ [Opiates, Rostral Ventromedial Medulla and Descending Control](#)
- ▶ [Pain Modulatory Systems, History of Discovery](#)

## OFQ

- ▶ Orphanin FQ

## OFQ/N

- ▶ Orphanin FQ

## O'Leary-Sant Interstitial Cystitis Symptom Index

- ▶ ICSI

## Oligonucleotide Array

### Definition

Also called „gene chip“, this is a technology that permits simultaneous semi-quantitative evaluation of the degree of expression of large numbers of genes in a tissue sample of choice.

- ▶ Central Changes after Peripheral Nerve Injury

## On-Cells (RVM)

### Definition

On-Cells are RVM neurons in the rostroventral medulla defined by a sudden burst of activity that begins just prior to execution of the tail flick, paw withdrawal or other nocifensive reflex. Spontaneous activity is variable with time, so that the reflex-related burst may not be discernible if the reflex is evoked at a time when the neuron is already firing spontaneously. On-cells are directly sensitive to mu-opioid agonists, and are inhibited by morphine or mu-agonists given systemically, or by microinjection into the PAG, basolateral amygdala or in the RVM itself. RVM on-cells, as defined *in vivo*, are assumed to map to secondary cells defined *in vitro*.

- ▶ Opiates - Pharmacology of Pain
- ▶ Opiates, Rostral Ventromedial Medulla and Descending Control
- ▶ Pain Modulatory Systems, History of Discovery

## Oncological Pain

- ▶ Cancer Pain
- ▶ Cancer Pain Management, Overall Strategy

## Ondansetron

### Definition

Ondansetron, a 5HT<sub>3</sub> receptor antagonist and an anti-emetic agent commonly used for post anesthetic nausea and vomiting, reduces the overall analgesic effect of tramadol by approximately 25%, probably by blocking spinal 5HT<sub>3</sub> receptors.

- ▶ Post-Operative Pain, Tramadol

## On-Demand Analgesia

- ▶ Postoperative Pain, Patient Controlled Analgesia Devices, Epidural

## On-Demand Analgesia Computer

- ▶ Postoperative Pain, Patient Controlled Analgesia Devices, Parenteral

## On-Demand Epidural Analgesia

- ▶ Postoperative Pain, Patient Controlled Analgesia Devices, Epidural

## Ondine's Curse

### Definition

Ondine's curse is the loss of involuntary respiration by an injury to the reticulospinal tract that may be produced by a lesion of the spinothalamic tract that is located nearby. Radio frequency current lesion making: localized heating of neural, or other tissue, by delivery of a radiofrequency lesion through an electrode temporarily placed in that tissue for this purpose.

- ▶ Percutaneous Cordotomy

## Ongoing Pain

### Definition

Baseline pain without any obvious external stimuli, which is constant in nature, described as dull, aching and throbbing in character, and with progressive severity in accordance with disease.

- ▶ Cancer Pain, Animal Models
- ▶ Neuropathic Pain Model, Partial Sciatic Nerve Ligation Model

## On-the-Job Site Evaluation

### Definition

On-the-job-evaluation is performed in a variety of job-related realistic work environments. e.g. workshop at a rehabilitation clinic, or a cafeteria. The client is systematically observed during performance of simulated work tasks or work samples. Job analysis and reports of the client's health-related occupational behavior are recorded.

- ▶ Vocational Counselling

## Oocyte

### Definition

An oocyte is a female gametocyte that develops into an ovum after two meiotic divisions.

- ▶ Perireceptor Elements

## OP1 Receptors

- ▶ Delta Opioid Receptor(s)

## Operant

### Definition

Operant theory (also called behavior analysis) focuses on the relationship between behavior and the contingent consequences (reinforcers) associated with it. The theory distinguishes four broad classes of reinforcement: positive, negative, punishment and extinction. Positive and negative reinforcement contingencies increase the likelihood of a behavior occurring; punishment and extinction contingencies decrease the likelihood of the preceding behavior. Operant theory also analyses the events that signal that contingencies between the behavior and the consequences are active (discriminative stimuli and setting events).

- ▶ Operant Perspective of Pain
- ▶ Psychology of Pain, Efficacy

## Operant-Behavioral Treatment

- ▶ Operant Treatment of Chronic Pain

## Operant Conditioning

### Definition

Operant conditioning is a psychological theory in which learning occurs when a response to a stimulus is reinforced. If a reward or reinforcement follows the response to a stimulus, then the response becomes more probable in the future.

- ▶ Impact of Familial Factors on Children's Chronic Pain
- ▶ Muscle Pain, Fear-Avoidance Model

## Operant Conditioning Approaches to Chronic Pain

- ▶ Behavioral Therapies to Reduce Disability

## Operant Conditioning Model of Chronic Pain

### Definition

Operant conditioning model of chronic pain hypothesizes that pain and pain-related disability may be maintained by environmental contingencies for overt, observable demonstrations of pain.

- ▶ Spouse, Role in Chronic Pain

## Operant Conditioning or Learning Models of Pain

- ▶ Operant Perspective of Pain

## Operant Escape

### Definition

An intentional response that terminates aversive stimulation. Operant conditioning involves learning to manipulate the environment in order to achieve a desired (motivated) result.

- ▶ Opioids, Effects of Systemic Morphine on Evoked Pain

## Operant Perspective of Pain

MICHAEL K. NICHOLAS

University of Sydney, Royal North Shore Hospital, St. Leonards, NSW, Australia  
miken@med.usyd.edu.au

### Synonyms

Operant Conditioning or Learning Models of Pain

### Definition

The behaviours displayed by people in pain may be modified and maintained by their consequences, to some extent independent of any nociceptive or neuropathic stimuli.

### Characteristics

The ► **operant** model of behaviour holds that behaviours can be learned and maintained by their consequences. Two main types of consequences are: ► **positive reinforcement**, where the consequence involves the addition of a stimulus or event; and ► **negative reinforcement**, where the consequence involves a stimulus or event being withdrawn. Thus, in positive reinforcement the consequence might be attention from others or food. In negative reinforcement, the consequence might be cessation of a noxious stimulus. Both types of reinforcement act to strengthen or maintain the behaviour they follow.

The learning process of behaviours being acquired through reinforcing consequences is known as operant ► **conditioning**. This is contrasted with ► **respondent conditioning**, in which a behaviour or response is elicited by a previously neutral stimulus that has been paired with a stimulus that normally elicits the behaviour, as described initially by Pavlov (1927). In Pavlov's study, dogs learned to salivate to the sound of a bell after the bell had been repeatedly rung shortly before the dogs' food was presented. While more recent studies of operant and respondent conditioning have led to further elaboration of these learning processes, the fundamental relationship between responses and subsequent stimuli (not necessarily immediate) remains a key feature of operant conditioning.

Fordyce (1976) argued that while pain was a subjective experience, patients in pain often display behaviours that communicate the presence of pain to others. He termed such behaviours as '► **pain behaviours**'. Fordyce proposed that, like other overt behaviours, pain behaviours could be subject to the influence of operant conditioning. As a result, he argued that pain behaviours could become maintained by reinforcement and, to some extent, independent of nociception.

Fordyce proposed that, unlike the ► **subjective pain experience**, pain behaviours were amenable to observation, and thus recording and measurement. Pain be-

haviours in Fordyce's view included: verbal complaints of pain (this would include pain intensity ratings); para-verbal sounds (e.g. moans); body posturing and gestures (e.g. limping, grimacing); display of functional limitations (e.g. lying down during the day); behaviours concerned with pain reduction (e.g. use of analgesic medication, treatment seeking). Actual delineation of pain behaviours varies from study to study, with some focussing on specific behaviours, such as counting the number of grimaces or moans displayed in a given period (e.g. Keefe and Block 1982), while others address larger categories of behaviour, such as general activity avoidance or withdrawal from social activities.

Fordyce identified attention from others (positive reinforcement), relief of pain (negative reinforcement), and financial gain (positive reinforcement) as potential reinforcers for ► **chronic pain** behaviour, but the list of possible reinforcers is long and varies between individuals. In treatments based on the operant model, the focus of treatment is not the original pathological cause of nociception, or ongoing neuropathic processes, but rather the identification and reversal of the reinforcement contingencies (the relationship between the behaviours and their reinforcing consequences) that are thought to be maintaining the persisting pain behaviours. At the same time, well behaviours (activities normally incompatible with pain behaviours, such as exercise and work-related activities) are encouraged instead (e.g. Gil et al. 1988). Well-behaviours may be reinforced directly by praise from treatment providers, but they may also be intrinsically reinforcing for pain patients, especially when they represent improvement or the achievement of personally-relevant goals. Treatments for chronic pain utilising operant methods have reported considerable success in increasing the activity levels of chronic pain patients, as well as decreasing distress and pain behaviours, such as medication use, lying down during the day, and reports of pain severity (Morley et al. 1999).

One reinforcer of pain behaviour that has been successfully targeted in operant treatments is the verbal response of others (Latimer 1982). White and Sanders (1986), for example, found that the pain reports of four chronic pain patients were significantly reduced by systematically reinforcing 'well' talk with positive verbal responses by staff. Similarly Cairns and Pasino (1977), using a sample of chronic pain patients, found that significant increases in daily walking and exercise tolerance were obtained by verbal reinforcement alone, and in combination with visual feedback using graphs.

Despite the effectiveness of the operant treatments in modifying pain behaviours, treatment studies cannot demonstrate that reinforcement contingencies played a role in the development and ► **maintenance** of pain behaviours, nor can they control any ► **noxious stimuli** that may be contributing to the patients' pain. In contrast,



laboratory studies allow closer control of the noxious stimulus and extraneous variables. However, laboratory studies are also limited by ethical constraints, and the degree to which they can simulate the environment of the chronic pain sufferer.

Acknowledging the limitations of laboratory studies, Linton and Gotestam (1985) reported inducing learned pain responses in healthy individuals with no existing learned pain responses. Over fifteen trials they verbally reinforced (with praise) the pain reports of subjects in the presence of a noxious stimulus (a blood pressure cuff which was inflated to a painful level). In their first experiment they found that pain reports could be operantly conditioned to increase and decrease, relative to a control condition, even though the intensity of the cuff pressure was kept stable across trials. In their second experiment the experimenters found that, with verbal reinforcement for reports of increased pain, the pain reports of subjects were maintained and increased even when the intensity of the noxious stimulus decreased. In contrast, for those in the control condition who were not given verbal reinforcement for reports of increased pain, subjects' pain reports decreased as the intensity of the painful stimulus decreased.

Schmidt et al. (1989) argued that instead of providing support for the reinforcement hypothesis, Linton and Gotestam's findings could have been interpreted as evidence of augmentation and amplification of sensations. However, this is unlikely, since Linton and Gotestam (1985) found that the pain reports of subjects could be positively reinforced up and down in the presence of a stable noxious stimulus.

Lousberg et al. (1996) reported a replication study based on Linton and Gotestam's (1985) paradigm, but using brief electric shocks as the noxious stimulus with a sample of healthy volunteers. In addition to pain ratings, Lousberg et al. also used psychophysiological measures of skin conductance response and skin conductance level. The results replicated those found previously by Linton and Gotestam, with the experimental group reporting significantly increased pain levels, relative to the control group. Interestingly, the experimenters also found a similar effect in skin conductance responses, although not on skin conductance levels. Thus, Lousberg et al's results revealed an effect of verbal conditioning not only on pain ratings but on a physiological measure as well.

Interestingly, Lousberg (1994) reported failure at an attempted replication of their results. Lousberg et al. (1996) also reported failure in an attempt to 'down condition' (train reductions in pain reporting). They considered that these findings may have been due to modified 'punishing responses' (expressions of surprise that pain was lower) for lower pain ratings in the experimental group during 'up-conditioning'. However, the variable findings clearly called for further investigation.

Flor et al. (2002) replicated Linton and Gotestam's earlier findings with a sample of chronic pain patients and normal, matched control subjects. Like Lousberg et al. (1996) they used an aversive electrical stimulus, but also recorded EEG, EOG, heart rate, skin conductance and muscle tension levels. Flor et al. used a similar reinforcement paradigm to that described by Linton and Gotestam, but the reinforcer in this case was a 'smiley' face on a computer screen whose mouth could be modified (up for positive feedback and down for negative feedback). Flor et al. also provided (or withdrew) tokens that could be exchanged for small amounts of money as additional sources of reinforcement. Flor et al. also examined reinforcement for increased and decreased pain reports. Their results showed that both patient and normal groups responded according to the reinforcement contingencies, in both directions (increased and decreased pain). Interestingly, Flor et al. also found that extinction of both the (previously reinforced) increased verbal pain reports and associated cortical responses (measured N150-component of somatosensory evoked potentials) took longer in the patient group. The patient group also displayed prolonged elevated electromyogram levels in this task, relative to the normal controls. Flor et al. concluded that their data provided support for the operant conditioning of pain responses, and indicated that chronic back pain patients are more easily influenced by reinforcement contingencies than healthy controls.

In a similar vein to these earlier studies, Chambers et al. (2002) demonstrated that the interactions of mothers with their daughters, but not sons, could also modulate (up and down) the experience of pain in children subjected to cold-pressor pain in the laboratory. Importantly, Chambers et al. demonstrated this effect with observed facial activity as a non-verbal pain measure and not just self-reported pain ratings.

Recently, Jolliffe and Nicholas (2004) also replicated Linton and Gotestam's original findings. They used a similar paradigm, but a larger sample size and tests for the influence of other possible confounding factors, such as awareness of the response-reinforcement contingencies, heightened somatic awareness, anxiety, gender and locus of control. None of these variables was found to influence the results that supported those reported by the earlier researchers.

Taken together, these studies provide general support for the thesis that pain reports can be operantly conditioned and this effect can be reflected in measures of skin conductance responses, facial activity and cortical responses as well. These studies also support Fordyce's original contention that pain responses (or behaviours) could be, to some extent, independent of any noxious stimulus. The treatment implications are that those interacting with chronic pain patients should be alert to the possibility that their responses to reports of pain by patients could well act to reinforce

and maintain such behaviours, and may complicate the clinical presentation and assessment/management of such cases.

## References

1. Cairns D, Pasino JA Comparison of Verbal Reinforcement and Feedback in the Operant Treatment of Disability due to Chronic Low Back Pain. *Behav Ther* 197 8:621–630
2. Chambers CT, Craig KD, Bennett SM (2002) The Impact of Maternal Behavior on Children's Pain Experiences: An Experimental Analysis. *J Pediatr Psychol* 27:293–301
3. Flor H, Knost B, Birbaumer N (2002) The Role of Operant Conditioning in Chronic Pain: An Experimental Investigation. *Pain* 95:111–118
4. Fordyce WE (1976) *Behavioural Methods for Chronic Pain and Illness*. Mosby, St. Louis
5. Gil KM, Ross SL, Keefe FJ (1988) Behavioral Treatment of Chronic Pain: Four Pain Management Protocols. In: France RD, Krishnan KRR (eds) *Chronic Pain*. American Psychiatric Press, Washington, pp 376–413
6. Jolliffe CD, Nicholas MK (2004) Verbally Reinforcing Pain Reports: An Experimental Test of the Operant Model of Chronic Pain. *Pain* 107:167–175
7. Keefe FJ, Block AR (1982) Development of an Observation Method for Assessing Pain Behavior in Chronic Low Back Pain Patients. *Behav Ther* 13:363–375
8. Latimer PR (1982) External Contingency Management for Chronic Pain: Critical Review of Evidence. *Am J Psychiatry* 139:1308–1312
9. Linton SJ, Gøtestam KG (1985) Controlling Pain Reports through Operant Conditioning: A Laboratory Demonstration. *Percept Motor Skills* 60:427–437
10. Lousberg R (1994) *Chronic Pain: Multiaxial Diagnostics and Behavioral Mechanisms*. PhD thesis. Universitaire Pers Maastricht, Maastricht
11. Lousberg R, Groenman NH, Schmidt AJM et al. (1996) Operant Conditioning of the Pain Experience. *Percept Motor Skills* 83:883–900
12. Morley S, Eccleston C, Williams (1999) A Systematic Review and Meta Analysis of Randomised Control Trials of Cognitive Behavioural Therapy for Chronic Pain in Adults, Excluding Headache. *Pain* 80:1–13
13. Pavlov IP (1927) *Conditioned Reflexes*. Trans. GV Anrep. Oxford University Press
14. Schmidt AJM, Gierlings REH, Peters ML (1989) Environmental and Interoceptive Influences on Chronic Low Back Pain Behaviour. *Pain* 38:137–143
15. White B, Sanders SH (1986) The Influence of Patient's Pain Intensity Ratings of Antecedent Reinforcement of Pain Talk or Well Talk. *J Behav Ther Exp Psychiatry* 17:155–159

## Operant Process

- ▶ Operant Treatment of Chronic Pain
- ▶ Respondent Conditioning of Chronic Pain

## Operant Treatment

- ▶ Psychological Treatment of Pain in Children

## Operant Treatment of Chronic Pain

HERTA FLOR

Department of Clinical and Cognitive Neuroscience at the University of Heidelberg, Central Institute of Mental Health, Mannheim, Germany  
flor@zi-mannheim.de

### Synonyms

Behavioral Treatment; Operant-Behavioral Treatment

### Definition

The operant treatment of pain is based on Fordyce's operant conditioning model of pain, and involves behavioral exercises to reduce pain behaviors and to increase healthy behaviors in many areas of life, including medication reduction.

### Characteristics

The operant conditioning formulation proposed by Fordyce (1976, 1988) has substantially contributed to our understanding of chronic pain and has had a significant impact on treatment and rehabilitation. The operant model of chronic pain is presented in the essay ▶ operant perspective on pain. This article will focus on operant treatment. Based on the assumption that pain behaviors have been positively reinforced and health behaviors have not been adequately reinforced, extinguished or punished, the operant approach focuses on the restructuring of pain-incompatible behaviors, and the reduction of pain behaviors such as lack of physical activity, guarding and bracing, excessive use of medication, and emphasizes the responses of the patients' significant others to pain. Three areas of intervention are primarily addressed: (1) modification of the response of significant others to the patient's pain-related and health-related behaviors; (2) decrease of observable pain behaviors and increase of activity levels of the patient in areas such as activities at home, work-related behaviors, social and leisure time behaviors (including social skills training), and interaction with significant others and health care providers; and (3) modification of medication-intake and other illness-related behaviors. In the original studies, the operant treatment was usually conducted in an inpatient setting because of greater control of the environment and the contingencies of reinforcement. More recently, operant treatments have also been used in outpatient settings. They have the advantage that the home is a more natural environment than the hospital, the patient can practice in his or her own home environment, and it is easier to involve significant others in treatment. Thus, outpatient treatment gains should be more readily maintained. It is, moreover, more cost-effective, especially if it is delivered in a group setting.

Group settings have the additional advantage that patients can be models to each other, and that the group members can be involved in the treatment as additional reinforcing agents.

Fordyce (1976) suggested that patients should only be accepted into operant treatment if they had a spouse who was willing to become involved in the treatment, if they were willing to reduce pain-related medication, and if no compensation payments were involved. The latter point is not as strictly adhered to by everyone, since patients can improve their personal pain coping skills without having to give up pain-related compensation, if this status is preferable to them. Although primarily designed to alter observable pain behaviors, successful operant treatment should also change the patients' attitude towards pain and the psychophysiological response to pain. Just like biofeedback and cognitive-behavioral treatments, the operant treatment involves altering the patients' responses from passive recipients of health care into individuals who actively engage in altering their own behavior.

A first important task in an operant group treatment program is the identification and reduction of ► [pain behaviors](#) and the identification and increase of ► [well behaviors](#). The best identification of pain behaviors comes from viewing one's own behavior on a video tape. The patients need to understand that many exercises are necessary because pain behaviors have had a long time to become established, and have become so automated that neither the patient nor the spouse can easily detect and modify them. Significant others are involved in the treatment because they can give important assistance in modifying pain behaviors in the patients' everyday lives. A brief list of topics that are addressed and practiced in a standard outpatient operant treatment program is listed below:

- how to deal with medication
- increase in physical activity, correct body posture
- decrease of interference in the family
- decrease of interference in work/housework
- decrease of interference in leisure time
- decrease of interference in everyday activities/social activities
- how to deal with the health care system

Group treatment is preferred to individual therapy sessions because patients can assist each other and there is an opportunity for modeling of appropriate behavior to occur. It is important to convey to the patients that they are not in a pain but a "health" group. All behaviors that are good for the patients' health are to be rewarded; all behaviors that increase pain are ignored. To make this reinforcement process easier, and to keep everybody thinking about those goals, red and green cards can be introduced that signify "pain behavior!" (red card) or "well behavior!" (green card). Therapists and patients

may use these cards and give them to the patients when they observe the respective behavior. The group can obtain larger reinforcers by completely eliminating red cards.

Increasing physical activity levels is a core goal of the operant approach, but is often met with considerable resistance by the patients who are often fearful that their pain will become more severe or that they will injure themselves. The most important principle in the increase of activity is that pain and activity have to be separated in time. Consider the behavior of a typical pain patient: With the advice of the physician to continue as long as they can, they often pursue activities well beyond the pain limit, and subsequently stop the activity, which in turn reduces the pain. This is the classical case for negative reinforcement of pain behaviors: a negative state – pain – is reduced by the cessation of activity, hence, the inactivity and rest increases in frequency. The solution to this negative reinforcement problem is the temporal separation of pain and activity. The patients and the therapists define activity goals that do not excessively increase the patient's pain, and the patient rests not when the pain increases but at certain fixed time intervals. An additional complicating factor related to activity is that over time patients develop fear of movement, and subsequently avoid all movement or any activity that has been found to be pain-eliciting or is thought to be pain-eliciting (Vlaeyen 1999). Fear of movement and of movement-related pain is a main predictor of levels of patient disability (Vlaeyen and Linton 2000).

Physical therapists have been routinely included in operant treatment programs. It is, however, important that they understand the principles of operant conditioning to the extent that they implement physical exercises in an operant-compatible way. Most important here is that they also adhere to the quota system, and do not let the patient rest contingent on the expression of pain. The increase of tolerance levels regarding physical activity and pain is a treatment goal to which the physical therapists can make significant contributions.

The significant other is usually the most important reinforcing agent for the chronic pain patient. Altering ► [significant others' responses to pain](#) is therefore one of the most important goals in operant pain treatment. For patients who do not have spouses, a close friend or a child may take the role of the significant other in the operant group treatment. In the initial stage, the therapists should let all dyads display typical pain behaviors and typical responses to the pain. The next step is to have the significant others ignore pain behaviors, and subsequently have the patients stop displaying pain behaviors and let the spouses positively reinforce the absence of pain and the presence of well behaviors. The therapists can then provide some examples of responses to pain behaviors taken from the dyads' ► [role plays](#)

that had been videotaped for analysis, and list: 1) what were visible pain behaviors, 2) how were the responses (reinforcing, punishing, ignoring, distracting). Therapists and patients then think of alternate responses to the ones that have been observed, responses that would not reinforce pain behaviors and the significant others and patients practice these in role plays. It is important to emphasize throughout that the non-response to pain behaviors serves the sole purpose of reducing pain and pain behaviors, and is therefore a positive response by the significant other. It is important to then engage in the next step of teaching the patient the cessation of pain behaviors and the display of well behaviors, and have the significant other positively reinforce this step. The therapists and couples should construct lists of alternative behaviors to pain behaviors and also construct lists of reinforcing the significant other's responses. Then these alternate behaviors should be practiced in role plays.

In addition to the modification of specific significant others' behaviors, another important goal of the operant group training is to enlist significant others' support for the behavioral changes that have been planned for the patients. The significant others need to be informed in detail about the treatment goals that have been defined with the patient, and they need to be able to voice concerns about certain areas of change they view as problematic. In the later sessions, the focus should shift from simple pain behaviors and their reinforcement to family and marital interaction around the pain and potential problems in sexual interaction. It is important to check if the reinforcement the spouse is giving is really genuine or if it is a "mixed message". Spouses need to learn to genuinely reinforce well behaviors and to express concerns or criticisms directly, not by means of pain-related responses. Another area of joint goal formulation and practice are leisure activities. Often the pain has been very detrimental for all leisure and social activities and they may have been reduced to a minimum.

The intake of medication may often be a behavior that has been negatively reinforced. If a patient waits until the pain increases to a certain level (often prompted by a well-meaning physician who may instruct the patients to take the medication only when he or she really needs it) then the intake of medication reduces the pain, an aversive state is terminated, and the behavior that led to the end of the unpleasant state, the taking of medication, will increase in frequency, and will over time occur earlier and earlier in order to prevent pain onset and/or exacerbation. From a pharmacological point of view, the prescription of analgesic medication as needed (prn) is just as problematic as from a behavioral learning point of view. If the medication is only taken when the pain level is very high, the maximum effectiveness of the medication may not be achieved. Thus, switching the patients

from a ► prn to a ► time-locked medication intake is the first goal. As suggested by Fordyce (1976), a prn baseline is taken by having the patients keep a medication diary or, if they are inpatients, by carefully noting the medication that is dispensed to them by the staff who have previously been instructed to give medication as needed.

To what extent all medication should be eliminated, or to what extent medication should be used as an adjunct therapy, is a matter of much debate. Analgesic medication should be continued when the underlying disease process prevents the patients from relying on alternative methods, or when the patient is unable to obtain sufficient pain relief. In inpatient treatment, the "► pain cocktail", as described by Fordyce (1976), is usually implemented to reduce medication intake. The pain cocktail consists of a colorless and taste-masking vehicle such as raspberry syrup to which the medication the patient is to receive is added. The amount of active medication in the cocktail is successively reduced on a predetermined basis, which has been decided upon in a joint agreement with the attending physician. The most important characteristic of the pain cocktail is that it is given not on a prn but at consistent time intervals around the clock. The amount of active ingredient initially consists of about the same or slightly exceeds the amount recorded in the baseline phase, with the only difference that time-contingent delivery is used. In outpatient treatment, a pain cocktail is usually not employed, rather a prescribed time-contingent medication usage and subsequent medication reduction on a fixed schedule, as determined by the therapist in cooperation with the patient and his or her physician, are used. Prerequisite for this reduction regimen is a very exact medication baseline the patient notes in his or her pain diary which should cover a period of at least 3 weeks. A simplified explanation of both the psychological and pharmacological reasons for giving medication on a time-contingent basis should be given.

Each patient receives an individualized plan for medication reduction that has been previously determined from the patient's diary and discussions with his or her physician. The intake of medication must be noted in the pain diary. One aspect that may be considered in the new medication reduction regimen is that the intake of medication may itself have become a conditioned activity, and many intake-associated aspects such as the sight or feel of the medication, the carton, the place where it is usually taken, may have become conditioned stimuli and should be changed.

An extension of the increase in overall activity levels applies to activity at the workplace. Before the generalization of increased activity levels to the workplace can be accomplished, a very careful analysis of the activities the patient typically engages in at the workplace is necessary. Most important here is the assessment of repet-



itive work, of the number and distribution of breaks, of the patient's activity during the breaks, the responses of colleagues and supervisors to the patient's behavior, and the overall level of stress at the workplace.

Based on this, increases in work-related activity can be planned. Very often, however, it is less an increase of activity but in general a better timing of activity and rest phases is needed. In certain cases where the patient has problems with the supervisor the therapist may offer to talk to him or her. In general, however, the patients are well able to defend the activity plans that have been devised for them, especially when assertiveness training has been included in the treatment.

For patients who are unemployed, on compensation or involved in litigation, it will have to be determined to what extent return to work can be a desirable goal. This decision depends on numerous factors such as the patient's willingness to work, his or her age and level of qualification, the current state of the economy or the cooperation of employers. If the patients are close to retirement age and engaged in physically or psychologically stressful employment, and the patients do not show a major desire to continue work, early retirement may be an option while at the same time teaching patients how to better cope with the remaining pain problem. In younger and work-motivated patients, high emphasis should be placed on the acquisition of skills that will allow them to return to work.

A major problem of chronic pain patients is the overreliance on the health care system and constant doctor shopping. An important treatment goal is therefore to reduce health-care seeking behaviors with respect to the pain problem. A first step is to exclude any additional treatments from being delivered during the course of the pain-treatment program, except for active physical therapy or active occupational therapy. This will give the patient an opportunity to discover that he or she can do without these additional interventions. Moreover, problems of attribution of the treatment success can thus be avoided. Specific exercises involving dealing with the health care system are used to teach the patients more reliance on their own means and more independence from passive treatments. For example, role plays are used to help the patient express the wish to discontinue additional treatment, or to refuse the treatment with additional analgesic medication.

It is important for the therapist to note that the pain problems of the participants are chronic, that there is usually no danger of injury, nor is there a high probability of complete recovery (that is freedom from pain). The patients must, however, be careful to note new types of pain or unusual exacerbations, and report those to their physician.

An important aspect of the ► **transfer and generalization** of operant behavior change is that the new behaviors are sufficiently reinforced. In the group sessions, re-

inforcement is provided by the therapist and the group members. An additional possibility for reinforcement is ► **self-reinforcement** by the patients. The patients can practice self-reinforcement skills in role plays.

Several studies have shown that operant behavioral treatment is effective in reducing pain behaviors and excess disability. Several controlled studies demonstrated the efficacy of operant-behavioral treatments for ► **low back pain** (e.g. Kole-Snijders et al. 1999; Nicholas et al. 1991, Turner and Clancy 1988, Vlaeyen et al. 1995), although operant treatment may not be superior to other types of interventions (see Ostelo et al. 2005). In their ► **meta-analysis** Flor, Fydrich and Turk (1992) found operant behavioral treatments to be the most effective treatment for back pain, and a Cochrane review (van Tulder et al. 2001) also reported the efficacy of behavioral treatment. In ► **fibromyalgia** patients, Thieme, Gromnica-Ihle and Flor (2003) reported very high effect sizes for an operant behavioral compared to a standard medical treatment. New developments of the operant approach emphasize the exposure to feared movements (Boersma et al. 2004) and behaviors, and there are also attempts to use behavioral treatments to modify pain memories (Flor 2000).

## References

1. Boersma K, Linton S, Overmeier T et al. (2004) Lowering Fear-Avoidance and Enhancing Function through Exposure *In Vivo*. A Multiple Baseline Study across Six Patients with Back Pain. *Pain* 108:8–16
2. Flor H (2000) The Functional Organization of the Brain in Pain. *Progr Brain Res* 129:313–322
3. Flor H, Fydrich T, Turk DC (1992) Efficacy of Multi-Disciplinary Pain Treatment Centers: A Meta-Analytic Review. *Pain* 49:221–230
4. Fordyce WE (1976) *Behavioral Methods in Chronic Pain and Illness*. Mosby; St. Louis
5. Fordyce WE (1988) Pain and Suffering: A Reappraisal. *Am Psychol* 43:276–283
6. Kole-Snijders AM, Vlaeyen JW, Goossens ME et al. (1999) Chronic Low-Back Pain: What Does Cognitive Coping Skills Training Add to Operant Behavioral Treatment? Results of a Randomized Clinical Trial. *J Consult Clin Psychol* 67:931–944
7. Nicholas MK, Wilson PH, Goyen J (1991) Operant-Behavioural and Cognitive-Behavioural Treatment for Chronic Low Back Pain. *Behav Res Ther* 29:225–238
8. Ostelo RW, Tulder MW van, Vlaeyen JW et al. (2005) Behavioural Treatment for Chronic Low-Back Pain. *Cochrane Database Syst Rev* 1, CD002014
9. Thieme K, Gromnica-Ihle E, Flor H (2003) Operant Behavioral Treatment of Fibromyalgia: A Controlled Study. *Arthritis Rheum* 49:314–320
10. Tulder MW van, Ostelo R, Vlaeyen JW et al. (2001) Behavioral Treatment for Chronic Low Back Pain: A Systematic Review within the Framework of the Cochrane Back Review Group. *Spine* 26:270–281
11. Turner JA, Clancy S (1988) Comparison of Operant Behavioral and Cognitive-Behavioral Treatment for Chronic Low-Back Pain. *J Consult Clin Psychol* 56:261–266
12. Vlaeyen JWS, Haazen IWCJ, Kole-Snijders AMJ et al. (1995) Behavioral Rehabilitation of Chronic Low Back Pain: Comparison of an Operant Treatment, an Operant-Respondent Treatment. *Br J Clin Psychol* 34:95–118

13. Vlaeyen JW, Linton SJ (2000) Fear-Avoidance and its Consequences in Chronic Musculoskeletal Pain: A State of the Art. *Pain* 85:317–332

## Operants

### Definition

Exercise or body movement involves striated or voluntary muscle activity. They operate on the environment leading, on the basis of past experience or prior learning, to reinforcing consequences.

- ▶ [Training by Quotas](#)

## Operculum

### Definition

Part of the brain that covers the insula, consisting of frontal, parietal and temporal operculum as part of the corresponding lobes of the cerebral cortex.

- ▶ [Insular Cortex, Neurophysiology and Functional Imaging of Nociceptive Processing](#)
- ▶ [Nociceptive Processing in the Secondary Somatosensory Cortex](#)

## Ophthalmodynia Periodica

- ▶ [Primary Stabbing Headache](#)

## Ophthalmoplegic Migraine

### Definition

This condition consists of painful ophthalmoplegia with or without headache. Usually the ophthalmoplegia is transient; however, it can become permanent, especially after repeated attacks. Since headache was often associated with attacks, it was felt to be a variant of migraine. This is no longer felt to be true, because many reports have shown abnormalities of the ocular motor nerve using magnetic resonance imaging (MRI) in children with recurrent painful ophthalmoplegia fulfilling the previous criteria for ophthalmoplegic „migraine“.

- ▶ [Migraine, Childhood Syndromes](#)

## Opiate

- ▶ [Opioid Electrophysiology in PAG](#)
- ▶ [Opioid Peptide Co-Localization and Release](#)
- ▶ [Postoperative Pain, Opioids](#)

## Opiate Receptors

- ▶ [Opioid Receptors](#)

## Opiates During Development

GORDON A. BARR

Department of Psychology, Hunter College, Graduate Center, and Department of Developmental Psychobiology, New York State Psychiatric Institute, Department of Psychiatry, Columbia University Medical Center, City University of New York, New York, NY, USA

gbarr@hunter.cuny.edu

### Definition

#### Opiates and Development

Opioids are a class of peptides that bind to specific membrane bound receptors. There are three major receptor types for opioids:  $\mu$  (MOP),  $\delta$  (DOP), and  $\kappa$  (KOP), and a number of subtypes for each of the major classes. The peptides that interact with each receptor do so preferentially but not exclusively. These are the ▶ [endomorphins](#) ( $\mu$ ), ▶ [enkephalins](#) ( $\delta$ ) and ▶ [dynorphins](#) ( $\kappa$ ).  $\beta$ - ▶ [Endorphin](#) also interacts preferentially with the MOP receptor. A historic review of the opioid field has recently been published (Snyder and Pasternak 2003).

Historically, infant patients have been under-medicated for pain. In part, this has been because it was assumed that infants, due to the immaturity of the nervous system, were incapable of experiencing pain. Moreover, the untoward side-effects of opiates, respiratory depression, chest wall rigidity and constipation, complicated treatment of severely ill infants. Indeed, there is still ongoing debate as to whether or not neonates and prematurely born infants can experience a complex perception such as pain (Anand and Craig 1996; Derbyshire 2001; van Lingen et al. 2002). What is not debatable any longer is that adequate and even aggressive opiate treatment for invasive procedures reduces mortality and morbidity (Anand and Hickey 1987; Anand et al. 1987). Nonetheless, even with convincing evidence that adequate analgesia is medically necessary for appropriate clinical care, the use of opiates is complicated because of the immaturity of the infant.

### Characteristics

#### Development of Opioid Receptors and Peptides

The development of opioid peptides and their receptors is precocious. The exact age at which they are first detectable, and the pattern in which they develop, is dependent on the specific receptor or peptide, and on the re-

## Opiates - Pharmacology of Pain

FRANK PORRECA

Departments of Pharmacology and Anesthesiology,  
University of Arizona, Health Sciences Center,  
Tucson, AZ, USA  
frankp@u.arizona.edu

### Introduction

The efficacy of the opioid alkaloids, morphine and codeine, as well as that of their derivatives, as analgesics in conditions of acute pain is well established in clinical practice. Morphine, the major opiate alkaloid, is the prototypic analgesic and serves as the reference standard against which the analgesic activity of pain treatments are measured in clinical and preclinical paradigms. Opiate analgesics are routinely used in post-operative pain and in the treatment of many painful conditions of short and medium term duration and are gaining acceptance in the treatment of some chronic pain states as well. A complicating factor in the use of opioids to manage chronic pain conditions is the decrease in analgesic activity observed over time, at least in some patients, indicative of the phenomenon of analgesic ► **tolerance**. Opioids exert their antinociceptive activity through peripheral, spinal and supraspinal sites and adaptations induced by opioids at these multiple levels of the neuraxis may be contributing factors in the expression of tolerance. There is evidence to indicate that long-term opioid exposure may result in activation of pain facilitatory systems from medullary sites that oppose the analgesic actions of these compounds. The engagement of descending pain facilitatory mechanisms can paradoxically result in the expression of a hyperalgesic state, which can act as a “physiological antagonist” of analgesia, in essence manifesting as “antinociceptive tolerance.” The chapters included in this section discuss many different aspects of opioid mediated action and the neurophysiological adaptations that can contribute to the effects of these compounds over time.

### Opioid Receptors and Endogenous Opioids

The discovery of a receptor selective for opioids was reported almost simultaneously by three different groups in 1973 (Pert and Snyder 1973a; Pert and Snyder 1973b; Simon 1973) and precipitated an increased interest in the field of pain research. This discovery was rapidly followed by the identification and characterization of endogenous ligands for this receptor. Almost immediately thereafter, the pentapeptide ► **enkephalins** (Hughes et al. 1975; Kosterlitz and Hughes 1975), the ► **endorphins** (Cox et al. 1975) and ► **dynorphin** (Goldstein et al. 1979) were described.

Concurrently, behavioral studies and experiments performed with isolated tissue preparations revealed the existence of three subtypes of the ► **opioid receptor**, identified as mu, kappa and delta (Lord et al. 1977; Martin et al. 1976; Waterfield et al. 1978); this was later confirmed through cloning techniques (Zaki et al. 1996). Although different subtypes have not been cloned, it is possible for example that post-transcriptional events may occur to produce these subtypes (Zaki et al. 1996). The production of antibodies to these receptors allowed for anatomical location (Arvidson et al. 1995; Kalyuzhny et al. 1996; Mansour et al. 1994, 1995) and this led to localization of these receptors in pain pathways including the central and peripheral terminations of sensory fibers and in ascending pain transmission pathways as well as in descending pain modulatory systems. Collectively, these findings suggested that opioids may exert their antinociceptive activity through several mechanisms, providing their overall analgesic actions through anatomical synergy. These discoveries also provided strong evidence for the existence of an ► **endogenous pain control system**, with implications for the understanding of tolerance, dependence and withdrawal.

### The Distributions of the Opioid Receptors Are Consistent with Pain Pathways

#### Spinal Sites of Action

The distribution and anatomical localization of the opioid receptors have been extensively explored through immunohistochemistry, autoradiography, radioligand binding and *in situ* hybridization of message for the receptors (Bzdega et al. 1993; Mansour et al. 1995). The distribution of opioid receptors is consistent with known pathways related to the processing of nociceptive signals. The opioid receptors are predominant in the outer laminae of the spinal dorsal horn, with a less extensive distribution in lamina V and around the central canal and are sparse within the intermediate laminae (Besse et al. 1991; Quirion et al. 1983). These sites are consistent with the distribution of the terminals of nociceptors from the periphery and viscera. Studies employing a variety of techniques established that a substantial proportion of the opioid receptors found in the outer laminae reside on the terminals of primary afferent nociceptive C-fibers and that message for the opioid receptors is found principally in nociceptive C- and A-delta dorsal root ganglia (DRG) neurons (Arvidsson et al. 1995; Besse et al. 1991; Ji et al. 1995). This distribution is consistent with a role in the regulation of nociceptive inputs without altering innocuous sensory signals. Accordingly, it was found that activation of mu-opioid receptors predictably inhibited Ca<sup>++</sup> channels of small diameter nociceptors and not of

large diameter myelinated A-beta cells and suggested that mu-receptor activation selectively inhibits the activity of C-fibers (Taddese et al. 1995). Approximately 20–30% of spinal opioid receptors reside on either interneurons or on cell bodies of second order neurons that transmit nociceptive inputs to supraspinal sites that process nociceptive signals (Besse et al. 1991). The presence of opioid receptors in the spinal cord suggests a direct spinal antinociceptive action of opioids. The direct spinal application of morphine or of enkephalins into the spinal space produced dose dependent, ► **naloxone** reversible antinociception to noxious thermal stimuli (Yaksh et al. 1977a). Mid-thoracic spinalization reduced the potency of systemic, but not of spinal, morphine against a noxious evoked spinal reflex (Advokat 1989). The iontophoretic application of morphine into the outer laminae of the dorsal horns of the spinal cord also attenuated the responses of dorsal horn units to noxious stimuli (Duggan et al. 1976). These observations supported the hypothesis that opioids may act directly at spinal sites to modulate nociceptive spinal reflexes and nociceptive inputs and the spinal administration of morphine has now become routine medical practice in the treatment of pain.

#### Supraspinal Sites of Action

The microinjection of opioids into the cerebral ventricles has been shown to produce dose dependent antinociception in several species, including mice and rats, suggesting a supraspinal modulation of nociceptive inputs (Erspamer et al. 1989; Jiang et al. 1990; Miaskowski et al. 1991; Porreca et al. 1984). Autoradiographic studies have demonstrated that there are significant levels of opioid receptor mRNA in many cortical, diencephalic and brainstem regions in addition to spinal loci (Mansour et al. 1994; Mansour et al. 1995). In particular, significant expression of message for opioid receptors was found in the periaqueductal gray (PAG) and the rostral ventromedial medulla (RVM), regions that are critical to expression of supraspinal antinociceptive manipulations (Basbaum et al. 1978; Basbaum and Fields 1978; Fields and Anderson 1978). The microinjection of morphine into the PAG produced dose dependent, naloxone reversible antinociception to peripheral noxious stimuli (Lewis and Gebhart 1977; Yaksh et al. 1976). Moreover, PAG sites that were responsive to morphine also produced antinociception in response to electrical stimulation (Lewis and Gebhart 1977; Yeung et al. 1977). The microinjection of morphine into the PAG attenuated the activity of projection neurons in the dorsal horn in response to peripheral nociceptive stimuli (Bennett and Mayer 1979).

The RVM is recognized as a critical region with respect to nociceptive processing and modulation, re-

ceiving inputs from the spinal dorsal horn and from rostral sites as well (Fields and Basbaum 1999; Fields and Heinricher 1985; Fields et al. 1983). Electrophysiological studies on the responses of RVM neurons to noxious thermal stimulation have identified the existence of ► **on-cells** and ► **off-cells** (Fields 1992; Fields and Basbaum 1999; Heinricher et al. 2003). The off-cells are tonically active and pause in firing immediately before the animal withdraws from the noxious thermal stimulus, whereas the on-cells accelerate firing immediately before the nociceptive reflex occurs. An additional class, the “neutral” cells were initially characterized by the absence of response to noxious thermal stimulation. It is now generally understood that the activity of the off-cells correlates with inhibition of nociceptive input and nocifensive responses and these neurons may be the source of descending inhibition of nociceptive inputs (Fields 1992; Fields and Basbaum 1999; Heinricher et al. 2003). In contrast, the response characteristics of the on-cells suggest that these neurons are the source of descending facilitation of nociception (Fields 1992; Fields and Basbaum 1999; Heinricher et al. 2003; McNally 1999;). Accordingly, manipulations that facilitate responses to nociceptive stimuli also increase on-cell activity (Fields and Basbaum 1999; Fields 2000; Heinricher and Roychowdhury 1997; Heinricher et al. 2003;). For example, prolonged delivery of a noxious thermal stimulus produced increased on-cell activity along with a facilitation of nociceptive reflexes (Morgan and Fields 1994). Moreover, inactivation of RVM neuronal activity with lidocaine blocked the facilitated withdrawal response (Morgan and Fields 1994). It is now generally accepted that a spino-bulbo-spinal loop may be important to the development and maintenance of exaggerated pain behaviors produced by persistent noxious stimuli (Heinricher et al. 2003; Ossipov et al. 2001; Suzuki et al. 2002; Suzuki et al. 2004). Morphine microinjection or electrical stimulation in the RVM has produced naloxone sensitive antinociception by activating spinopetal mechanisms (Kiefel et al. 1993; McGowan and Hammond 1993; Rossi et al. 1993). Studies employing retrograde tracing methods demonstrated the existence of opioid expressing neurons that project from the RVM to the spinal cord to provide a descending inhibition of nociceptive inputs (Kalyuzhny et al. 1996). It was also proposed that opioids exert indirect effects on RVM projection neurons and have both direct and indirect effects on bulbospinal neurons (Kalyuzhny et al. 1996).

#### Synergistic Actions at Spinal / Supraspinal Sites

An important aspect of morphine-mediated antinociception is the existence of a synergistic interaction



between morphine given spinally and supraspinally. The administration of a 1:1 fixed ratio of morphine administered intrathecally and into the cerebral ventricles produced an approximate 30-fold increase in potency when evaluated in the tail-flick test and a 45-fold increase in the hot plate test compared to supraspinal morphine alone (Yeung and Rudy 1980). Isobolographic analyses employing several dose ratios demonstrated a hyperbolic function with a strong degree of curvature and it was concluded that potentiation would occur at all possible combinations of spinal and supraspinal levels of morphine after systemic injection (Miyamoto et al. 1991; Roerig and Fujimoto 1988; Yeung and Rudy 1980). Situations where the antinociceptive effect of morphine was diminished corresponded with a loss of spinal / supraspinal synergy. For example, repeated exposure to systemic morphine abolished the synergistic antinociceptive effect of morphine given into the PAG and spinally (Siuciak and Advokat 1989). Similarly, rats with peripheral nerve injury demonstrate a loss of spinal morphine potency along with a loss of the spinal / supraspinal synergy (Bian et al. 1999). Restoration of the spinal site of morphine activity with an NMDA antagonist restored supraspinal-spinal synergy and increased the potency of systemically given morphine in animals with nerve injury (Bian et al. 1999).

### Paradoxical Opioid Induced Hyperalgesia

A number of clinical reports exist that show that opioid administration can paradoxically elicit abnormally heightened pain sensations. Long-term spinal morphine provoked hyperesthesias and allodynia that were unrelated to the original pain complaint in cancer patients (Ali 1986; Arner et al. 1988; De Conno et al. 1991). The spinal infusion of sufentanil in a patient with neuropathic pain secondary to arachnoiditis and laminectomy evoked hyperesthesias in the lower extremities (Devulder 1997). This abnormal pain state was described as being qualitatively different from the original complaint and included the back, abdomen and both legs. Cancer patients who received high doses of intrathecal morphine by bolus injections also reported paradoxical intense pain within 0.5 hour of the injections (Stillman et al. 1987).

Animal studies have clearly demonstrated that opioid administration may produce an abnormal, paradoxical hyperalgesic state (Gardell et al. 2002b; Mao et al. 1994; Mayer et al. 1995a; Vanderah et al. 2000; Vanderah et al. 2001b). The repeated daily injection of spinal or systemic morphine produced enhanced responses of the tail or hind paw to noxious thermal stimuli within 8 days (Mayer et al. 1995b; Trujillo and

Akil 1994). The continuous exposure to opioids produced behavioral signs of exaggerated pain and importantly, such pain occurred while the opioid was continuously present in the system (Gardell et al. 2002b; Vanderah et al. 2000; Vanderah et al. 2001b). The continuous spinal infusion of [D-Ala<sup>2</sup>,N-Me-Phe<sup>4</sup>,Gly-oil<sup>5</sup>]enkephalin (DAMGO) delivered through an osmotic minipump or of morphine administered by subcutaneous pellets produced antinociceptive tolerance to spinal DAMGO or morphine (Vanderah et al. 2000). These animals expressed tactile and thermal hypersensitivities (Vanderah et al. 2000; Vanderah et al. 2001b) while the opioids were still being administered (Vanderah et al. 2000; Vanderah et al. 2001b) and changes did not result from changes in metabolism or metabolites since blood levels of opiates were constant over the period of infusion (Ossipov, Stiller and Porreca, unpublished observations).

This paradoxical hyperalgesia and the neurobiological adaptations which underlie this state may play an important role in the requirement for increased levels of opioids to maintain a constant degree of antinociception, perhaps reflecting the expression of antinociceptive tolerance (Gardell et al. 2002b; Vanderah et al. 2000; Vanderah et al. 2001a; Vanderah et al. 2001b). Clinically, the need for increasing doses of opioids in cases of chronic pain, at least in some patients, is well documented and can present a major obstacle to providing adequate pain relief over a long period of time (Cherney and Portenoy 1999; Foley 1993; Foley 1995). In spite of much intensive research, however, the mechanisms that underlie the development of tolerance to the analgesic effects of opioids remain largely unknown. Many studies have focused on changes occurring at the cellular level in order to gain an appreciation of the mechanisms that drive the development of antinociceptive tolerance (e.g. Childers 1991; Sabbe and Yaksh 1990). Although alterations in subcellular processes appear potentially to contribute to the phenomenon of tolerance, the present level of understanding of such processes is insufficient to allow for the direct correlation of intracellular changes with those occurring at the level of the neuronal circuits mediating antinociception or analgesia. Nevertheless, opioid induced up-regulation of peptidic neuromodulators such as cholecystinin (CCK) or dynorphin may supply endogenous physiological antagonists to endogenous or exogenous opioid activity. These changes may be related to the activation of descending facilitation of nociception. Consequently, pain may be considered as a physiological antagonist of analgesia and increased states of pain require increased levels of pain relieving opiate, resulting in "opiate tolerance" (Vanderah et al. 2001a).

### Opioid Induced Paradoxical Pain Is Promoted by Descending Facilitation from the RVM

As noted above, the on-cells of the RVM are an important source of descending pain facilitatory projections. The microinjection of CCK into the RVM has enhanced nociceptive input and attenuated the morphine induced reduction of on-cell responses to nociception, suggesting that these neurons may be activated by CCK (Heinricher and McGaraughty 1996). The microinjection of lidocaine into the RVM of rats with persistent exposure to morphine produced a reversible block of both tactile and thermal hyperesthesias and abolished antinociceptive tolerance to morphine (Vanderah et al. 2001b). Prolonged morphine exposure elicited a 5-fold increase in basal CCK in the RVM (Xie et al. 2005). The microinjection of CCK into the RVM produced tactile and thermal hyperesthesias whereas a CCK<sub>2</sub> antagonist in the RVM abolished opioid induced hyperesthesias (Xie et al. 2005). Moreover, the microinjection of a CCK<sub>2</sub> antagonist into RVM or lesions of the dorso-lateral funiculus abolished both behavioral signs of enhanced pain and antinociceptive tolerance in response to persistent morphine exposure (Xie et al. 2005).

### Spinal Dynorphin and Opioid Induced Paradoxical Pain

Considerable evidence has demonstrated that enhanced expression of spinal dynorphin is pronociceptive and promotes facilitated pain states. A single spinal injection of dynorphin has produced long lasting tactile allodynia in rats and mice (Laughlin et al. 1997; Vanderah et al. 1996). Elevations in spinal dynorphin content are also seen in animals with prolonged, constant exposure to opioids either systemically or spinally (Gardell et al. 2002b; Vanderah et al. 2001a; Vanderah et al. 2001b). Spinal infusion of DAMGO elicited enhanced responses to tactile and noxious thermal stimuli and also caused an elevation in dynorphin content in the lumbar cord (Vanderah et al. 2000). The spinal injection of antiserum to dynorphin blocked enhanced responses in the DAMGO-treated rats and unmasked the antinociceptive action of the DAMGO that was still infused (Vanderah et al. 2000). Furthermore, dynorphin antiserum blocked the rightward displacement of the dose-effect curve for spinal morphine in DAMGO infused rats, indicating a blockade of antinociceptive tolerance (Vanderah et al. 2000). Bilateral lesions of the DLF, which were shown to block abnormal pain and tolerance to the antinociceptive effect of morphine, also prevented the up-regulation of spinal dynorphin (Gardell et al. 2003). Thus, manipulations that block opioid induced pain, in this case due to spinal infusion of opioid, also block the behavioral manifestation of antinociceptive tolerance. The data show that sustained

opioid administration leads to elevated spinal dynorphin content, which in turn promotes an abnormal pain state and increases the requirement for opioid dose in order to produce a comparable antinociceptive effect to that in animals without increased nociception, resulting in an apparent manifestation of antinociceptive tolerance.

The precise mechanisms through which increased spinal dynorphin expression promotes pain and consequently the manifestation of opioid tolerance remain to be elucidated but appear to be related to an enhanced release of transmitters from primary afferent terminals. Dynorphin produced a dose dependent release of glutamate and aspartate elicited by exogenous dynorphin in the hippocampus and spinal cord (Faden 1992; Skilling et al. 1992). More recently, the capsaicin stimulated release of calcitonin gene related peptide (CGRP) was potentiated by dynorphin A<sub>(2-13)</sub>, a non-opioid fragment, in spinal cord sections *in vitro* (Claude et al. 1999; Gardell et al. 2002a; Gardell et al. 2003). In addition, dynorphin also facilitated capsaicin evoked substance P release from trigeminal nuclear slices and this effect was abolished by MK-801, but not by opioid antagonists (Arcaya et al. 1999). Most recently, it was demonstrated that persistent exposure to morphine pellets implanted subcutaneously produced enhanced capsaicin evoked release of CGRP from spinal tissue (Gardell et al. 2002b; Gardell et al. 2003). This enhanced, evoked release was blocked by the addition of antiserum to dynorphin in the perfusion medium. Moreover, the disruption of descending facilitation from supraspinal sites by selective ablation of RVM neurons that express the mu-opioid receptor or by surgical lesions of the DLF prevented opioid induced abnormal pain, spinal dynorphin up-regulation and enhanced capsaicin evoked release of CGRP (Gardell et al. 2002b; Gardell et al. 2003). Finally, enhanced capsaicin evoked release of CGRP was also blocked by the NMDA antagonist MK-801 (Gardell et al. 2002b; Gardell et al. 2003). More recently, the introduction of NMDA, dynorphin A<sub>(1-17)</sub> or dynorphin A<sub>(2-17)</sub> into the lumbar spinal cord through a microdialysis catheter elicited a prolonged release of prostaglandin E<sub>2</sub> and of excitatory amino acids (Koetznner et al. 2004). These observations provide a mechanism through which pathologically elevated levels of spinal dynorphin may promote enhanced pain (Koetznner et al. 2004).

### Summary

The opioid analgesics have been employed throughout our history for the treatment and control of pain. The opioids, exemplified by the prototype morphine, represent the most efficacious means of controlling pain at the present time. The analgesic activity of opioids

is mediated through activity at spinal and supraspinal sites. Opioids may act directly at the spinal level to block incoming nociceptive inputs. Alternatively, opioids may activate supraspinal sites that activate descending pain inhibitory systems to block the transmission of nociceptive signals to supraspinal structures. Paradoxically, the very same substances that are so efficacious against pain may actually cause an abnormal pain phenomenon themselves by eliciting the activation of endogenous pronociceptive systems. Persistent exposure to the opioids causes an increase in the presence of the pronociceptive neurotransmitter CCK, which acts as an endogenous modulator of antinociceptive activity. One means through which this is achieved is through the activation of a descending facilitation from the RVM. These findings reveal the complex neurobiological adaptations that result from opioid administration and raise questions as to the optimal use of opioids for the management of pain in humans, as well as suggesting alternative approaches to improve the use of this class of compounds for the management of chronic pain states.

## References

- Advokat C (1989) Tolerance to the antinociceptive effect of morphine in spinally transected rats. *Behav Neurosci* 103:1091–1098
- Ali NM (1986) Hyperalgesic response in a patient receiving high concentrations of spinal morphine. *Anesthesiology* 65:449
- Arcaya JL, Cano G, Gomez G et al. (1999) Dynorphin A increases substance P release from trigeminal primary afferent C-fibers. *Eur J Pharmacol* 366:27–34
- Arner S, Rawal N, Gustafsson LL (1988) Clinical experience of long-term treatment with epidural and intrathecal opioids – a nationwide survey. *Acta Anaesthesiol Scand* 32:253–259
- Arvidsson U, Dado RJ, Riedl M et al. (1995) delta-Opioid receptor immunoreactivity: distribution in brainstem and spinal cord, and relationship to biogenic amines and enkephalin. *J Neurosci* 15:1215–1235
- Basbaum AI, Fields HL (1978) Endogenous pain control mechanisms: review and hypothesis. *Ann Neurol* 4:451–462
- Basbaum AI, Clanton CH, Fields HL (1978) Three bulbospinal pathways from the rostral medulla of the cat: an autoradiographic study of pain modulating systems. *J Comp Neurol* 178:209–224
- Bennett GJ, Mayer DJ (1979) Inhibition of spinal cord interneurons by narcotic microinjection and focal electrical stimulation in the periaqueductal central gray matter. *Brain Res* 172:243–257
- Besse D, Lombard MC, Besson JM (1991) Autoradiographic distribution of mu, delta and kappa opioid binding sites in the superficial dorsal horn, over the rostrocaudal axis of the rat spinal cord. *Brain Res* 548:287–291
- Bian D, Ossipov MH, Ibrahim M et al. (1999) Loss of antiallo-dynic and antinociceptive spinal / supraspinal morphine synergy in nerve-injured rats: restoration by MK-801 or dynorphin antiserum. *Brain Res* 831:55–63
- Bzdega T, Chin H, Kim H et al. (1993) Regional expression and chromosomal localization of the delta opiate receptor gene. *Proc Natl Acad Sci USA* 90:9305–9309
- Cherney NI, Portenoy RK (1999) Practical issues in the management of cancer pain. In: Wall PD, Melzack R (eds) *Textbook of Pain*. Churchill Livingstone, Edinburgh, pp 1479–1522
- Childers SR (1991) Opioid receptor-coupled second messenger systems. *Life Sci* 48:1991–2003
- Claude P, Gracia N, Wagner L et al. (1999) Effect of dynorphin on ICGRP release from capsaicin-sensitive fibers. Abstracts of the 9th World Congress on Pain 9:262
- Cox BM, Opheim KE, Teschemacher H et al. (1975) A peptide-like substance from pituitary that acts like morphine. 2. Purification and properties. *Life Sci* 16:1777–1782
- De Conno F, Caraceni A, Martini C et al. (1991) Hyperalgesia and myoclonus with intrathecal infusion of high-dose morphine. *Pain* 47:337–339
- Devulder J (1997) Hyperalgesia induced by high-dose intrathecal sufentanil in neuropathic pain. *J Neurosurg Anesthesiol* 9:146–148
- Duggan AW, Davies J, Hall JG (1976) Effects of opiate agonists and antagonists on central neurons of the cat. *J Pharmacol Exp Ther* 196:107–120
- Erspamer V, Melchiorri P, Falconieri-Erspamer G et al. (1989) Deltorphins: a family of naturally occurring peptides with high affinity and selectivity for delta opioid binding sites. *Proc Natl Acad Sci USA* 86:5188–5192
- Faden AI (1992) Dynorphin increases extracellular levels of excitatory amino acids in the brain through a non-opioid mechanism. *J Neurosci* 12:425–429
- Fernandes M, Kluge S, Coper H (1977) The development of tolerance to morphine in the rat. *Psychopharmacology* 54:197–201
- Fields HL (1992) Is there a facilitating component to central pain modulation? *APS Journal* 1:71–78
- Fields HL (2000) Pain modulation: expectation, opioid analgesia and virtual pain. *Prog Brain Res* 122:245–253
- Fields HL, Anderson SD (1978) Evidence that raphe-spinal neurons mediate opiate and midbrain stimulation-produced analgesias. *Pain* 5:333–349
- Fields HL, Basbaum AI (1999) Central nervous system mechanisms of pain modulation. In: Wall PD, Melzack R (eds) *Textbook of Pain*. Churchill Livingstone, Edinburgh, pp 309–329
- Fields HL, Heinricher MM (1985) Anatomy and physiology of a nociceptive modulatory system. *Philos Trans R Soc Lond B Biol Sci* 308:361–374
- Fields HL, Bry J, Hentall I et al. (1983) The activity of neurons in the rostral medulla of the rat during withdrawal from noxious heat. *J Neurosci* 3:2545–2552
- Foley KM (1993) Opioids. *Neurol Clin* 11:503–522
- Foley KM (1995) Misconceptions and controversies regarding the use of opioids in cancer pain. *Anticancer Drugs* 6:4–13
- Gardell LR, Burgess SE, Dogrul A et al. (2002a) Pronociceptive effects of spinal dynorphin promote cannabinoid-induced pain and antinociceptive tolerance. *Pain* 98:79–88
- Gardell LR, Wang R, Burgess SE et al. (2002b) Sustained morphine exposure induces a spinal dynorphin-dependent enhancement of excitatory transmitter release from primary afferent fibers. *J Neurosci* 22:6747–6755
- Gardell LR, Vanderah TW, Gardell SE et al. (2003) Enhanced evoked excitatory transmitter release in experimental neuropathy requires descending facilitation. *J Neurosci* 23:8370–8379
- Goldstein A, Tachibana S, Lowney LI et al. (1979) Dynorphin-(1–13), an extraordinarily potent opioid peptide. *Proc Natl Acad Sci USA* 76:6666–6670
- Heinricher MM, McGaraughty S (1996) CCK modulates the antinociceptive actions of opioids by an action within the rostral ventromedial medulla: a combined electrophysiological and behavioral study. In: Abstracts of the 8th World Congress on Pain, Vancouver. IASP Press, Seattle, p 472
- Heinricher MM, Roychowdhury SM (1997) Reflex-related activation of putative pain facilitating neurons in rostral ventromedial medulla requires excitatory amino acid transmission. *Neuroscience* 78:1159–1165



36. Heinricher MM, Pertovaara A, Ossipov MH (2003) Descending modulation after injury. In: Dostrovsky DO, Carr DB, Koltzenburg M (eds) Proceedings of the 10th World Congress on Pain. IASP Press, Seattle, pp 251–260
37. Hughes J, Smith T, Morgan B et al. (1975) Purification and properties of enkephalin –the possible endogenous ligand for the morphine receptor. *Life Sci* 16:1753–1758
38. Ji RR, Zhang Q, Law PY et al. (1995) Expression of mu-, delta-, and kappa-opioid receptor-like immunoreactivities in rat dorsal root ganglia after carrageenan-induced inflammation. *J Neurosci* 15:8156–8166
39. Jiang Q, Mosberg HI, Porreca F (1990) Antinociceptive effects of [D-Ala<sup>2</sup>]deltorphin II, a highly selective delta agonist *in vivo*. *Life Sci* 47:PL43–47
40. Kalyuzhny AE, Arvidsson U, Wu W et al. (1996) mu-Opioid and delta-opioid receptors are expressed in brainstem antinociceptive circuits: studies using immunocytochemistry and retrograde tract-tracing. *J Neurosci* 16:6490–6503
41. Kiefel JM, Rossi GC, Bodnar RJ (1993) Medullary mu and delta opioid receptors modulate mesencephalic morphine analgesia in rats. *Brain Res* 624:151–161
42. Koetzner L, Hua XY, Lai J et al. (2004) Nonopioid actions of intrathecal dynorphin evoke spinal excitatory amino acid and prostaglandin E<sub>2</sub> release mediated by cyclooxygenase-1 and -2. *J Neurosci* 24:1451–1458
43. Kosterlitz HW, Hughes J (1975) Some thoughts on the significance of enkephalin, the endogenous ligand. *Life Sci* 17:91–96
44. Laughlin TM, Vanderah TW, Lashbrook J et al. (1997) Spinally administered dynorphin A produces long-lasting allodynia: involvement of NMDA but not opioid receptors. *Pain* 72:253–260
45. Lewis VA, Gebhart GF (1977) Morphine-induced and stimulation-produced analgesias at coincident periaqueductal central gray loci: evaluation of analgesic congruence, tolerance, and cross-tolerance. *Exp Neurol* 57:934–955
46. Lord JA, Waterfield AA, Hughes J et al. (1977) Endogenous opioid peptides: multiple agonists and receptors. *Nature* 267:495–499
47. Mansour A, Fox CA, Burke S et al. (1994) Mu, delta, and kappa opioid receptor mRNA expression in the rat CNS: an *in situ* hybridization study. *J Comp Neurol* 350:412–438
48. Mansour A, Fox CA, Akil H et al. (1995) Opioid-receptor mRNA expression in the rat CNS: anatomical and functional implications. *Trends Neurosci* 18:22–29
49. Mao J, Price DD, Mayer DJ (1994) Thermal hyperalgesia in association with the development of morphine tolerance in rats: roles of excitatory amino acid receptors and protein kinase C. *J Neurosci* 14:2301–2312
50. Martin WR, Eades CG, Thompson JA et al. (1976) The effects of morphine- and nalorphine- like drugs in the nondependent and morphine-dependent chronic spinal dog. *J Pharmacol Exp Ther* 197:517–532
51. Mayer DJ, Mao J, Price DD (1995a) The development of morphine tolerance and dependence is associated with translocation of protein kinase C. *Pain* 61:365–374
52. Mayer DJ, Mao J, Price DD (1995b) The development of morphine tolerance and dependence is associated with translocation of protein kinase C. *Pain* 61:365–374
53. McGowan MK, Hammond DL (1993) Antinociception produced by microinjection of L-glutamate into the ventromedial medulla of the rat: mediation by spinal GABA<sub>A</sub> receptors. *Brain Res* 620:86–96
54. McNally GP (1999) Pain facilitatory circuits in the mammalian central nervous system: their behavioral significance and role in morphine analgesic tolerance. *Neurosci Biobehav Rev* 23:1059–1078
55. Miaskowski C, Taiwo YO, Levine JD (1991) Contribution of supraspinal mu- and delta-opioid receptors to antinociception in the rat. *Eur J Pharmacol* 205:247–252
56. Miyamoto Y, Morita N, Kitabata Y et al. (1991) Antinociceptive synergism between supraspinal and spinal sites after subcutaneous morphine evidenced by CNS morphine content. *Brain Res* 552:136–140
57. Morgan MM, Fields HL (1994) Pronounced changes in the activity of nociceptive modulatory neurons in the rostral ventromedial medulla in response to prolonged thermal noxious stimuli. *J Neurophysiol* 72:1161–1170
58. Ossipov MH, Lai J, Malan TP Jr et al. (2001) Tonic descending facilitation as a mechanism of neuropathic pain. In: Hansson PT, Fields HL, Hill RG et al. (eds) *Neuropathic Pain: Pathophysiology and Treatment*. IASP Press, Seattle, pp 107–124
59. Pert CB, Snyder SH (1973a) Opiate receptor: demonstration in nervous tissue. *Science* 179:1011–1014
60. Pert CB, Snyder SH (1973b) Properties of opiate-receptor binding in rat brain. *Proc Natl Acad Sci USA* 70:2243–2247
61. Porreca F, Mosberg HI, Hurst R et al. (1984) Roles of mu, delta and kappa opioid receptors in spinal and supraspinal mediation of gastrointestinal transit effects and hot-plate analgesia in the mouse. *J Pharmacol Exp Ther* 230:341–348
62. Quirion R, Zajac JM, Morgat JL et al. (1983) Autoradiographic distribution of mu and delta opiate receptors in rat brain using highly selective ligands. *Life Sci* 33 Suppl 1:227–230
63. Roerig SC, Fujimoto JM (1988) Morphine antinociception in different strains of mice: relationship of supraspinal-spinal multiplicative interaction to tolerance. *J Pharmacol Exp Ther* 247:603–608
64. Rossi GC, Pasternak GW, Bodnar RJ (1993) Synergistic brainstem interactions for morphine analgesia. *Brain Res* 624:171–180
65. Sabbe MB, Yaksh TL (1990) Pharmacology of spinal opioids. *J Pain Symptom Manage* 5:191–203
66. Simon EJ (1973) In search of the opiate receptor. *Am J Med Sci* 266:160–168
67. Siuciak JA, Advokat C (1989) The synergistic effect of concurrent spinal and supraspinal opiate agonisms is reduced by both nociceptive and morphine pretreatment. *Pharmacol Biochem Behav* 34:265–273
68. Skilling SR, Sun X, Kurtz HJ et al. (1992) Selective potentiation of NMDA-induced activity and release of excitatory amino acids by dynorphin: possible roles in paralysis and neurotoxicity. *Brain Res* 575:272–278
69. Stillman MJ, Moulin DE, Foley KM (1987) Paradoxical pain following high-dose spinal morphine. *Pain* 4
70. Suzuki R, Morcuende S, Webber M et al. (2002) Superficial NK<sup>1</sup>-expressing neurons control spinal excitability through activation of descending pathways. *Nat Neurosci* 5:1319–1326
71. Suzuki R, Rahman W, Hunt SP et al. (2004) Descending facilitatory control of mechanically evoked responses is enhanced in deep dorsal horn neurones following peripheral nerve injury. *Brain Res* 1019:68–76
72. Taddese A, Nah SY, McCleskey EW (1995) Selective opioid inhibition of small nociceptive neurons. *Science* 270:1366–1369
73. Trujillo KA, Akil H (1994) Inhibition of opiate tolerance by non-competitive N-methyl-D-aspartate receptor antagonists. *Brain Res* 633:178–188
74. Vanderah TW, Laughlin T, Lashbrook JM et al. (1996) Single intrathecal injections of dynorphin A or des-Tyr-dynorphins produce long-lasting allodynia in rats: blockade by MK-801 but not naloxone. *Pain* 68:275–281
75. Vanderah TW, Gardell LR, Burgess SE et al. (2000) Dynorphin promotes abnormal pain and spinal opioid antinociceptive tolerance. *J Neurosci* 20:7074–7079
76. Vanderah TW, Ossipov MH, Lai J et al. (2001a) Mechanisms of opioid-induced pain and antinociceptive tolerance: descending facilitation and spinal dynorphin. *Pain* 92:5–9
77. Vanderah TW, Suenaga NM, Ossipov MH et al. (2001b) Tonic descending facilitation from the rostral ventromedial medulla mediates opioid-induced abnormal pain and antinociceptive tolerance. *J Neurosci* 21:279–286



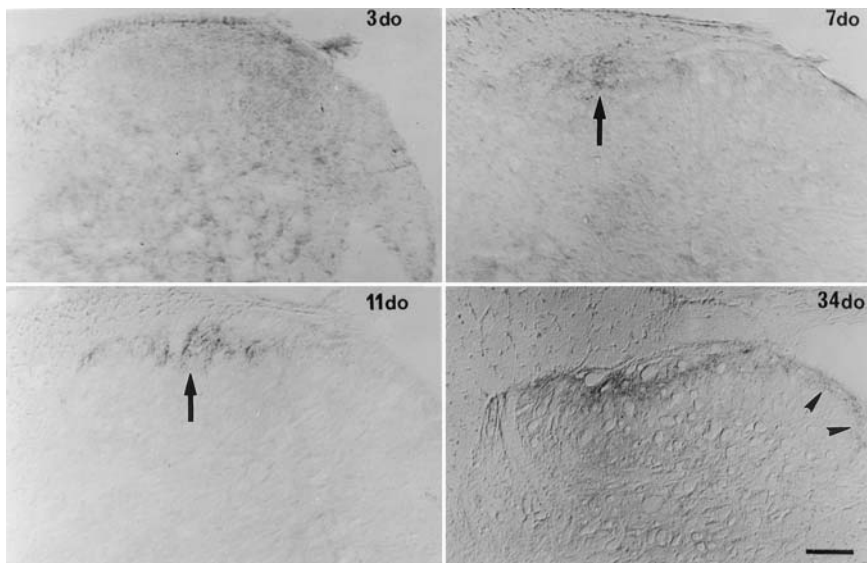
78. Waterfield AA, Lord JA, Hughes J et al. (1978) Differences in the inhibitory effects of normorphine and opioid peptides on the responses of the vasa deferentia of two strains of mice. *Eur J Pharmacol* 47
79. Xie JY, Herman DS, Stiller CO et al. (2005) Cholecystokinin in the rostral ventromedial medulla mediates opioid-induced hyperalgesia and antinociceptive tolerance. *J Neurosci* 25:409–416
80. Yaksh TL, Yeung JC, Rudy TA (1976) Systematic examination in the rat of brain sites sensitive to the direct application of morphine: observation of differential effects within the periaqueductal gray. *Brain Res* 114:83–103
81. Yaksh TL, Huang SP, Rudy TA (1977a) The direct and specific opiate-like effect of met5-enkephalin and analogues on the spinal cord. *Neuroscience* 2:593–596
82. Yaksh TL, Kohl RL, Rudy TA (1977b) Induction of tolerance and withdrawal in rats receiving morphine in the spinal subarachnoid space. *Eur J Pharmacol* 42:275–284
83. Yeung JC, Rudy TA (1980) Multiplicative interaction between narcotic agonisms expressed at spinal and supraspinal sites of antinociceptive action as revealed by concurrent intrathecal and intracerebroventricular injections of morphine. *J Pharmacol Exp Ther* 215:633–642
84. Yeung JC, Yaksh TL, Rudy TA (1977) Concurrent mapping of brain sites for sensitivity to the direct application of morphine and focal electrical stimulation in the production of antinociception in the rat. *Pain* 4:23–40
85. Zaki PA, Bilsky EJ, Vanderah TW et al. (1996) Opioid receptor types and subtypes: the delta receptor as a model. *Annu Rev Pharmacol Toxicol* 36:379–401

gion of the central nervous system under consideration. In general, MOP and KOP receptors develop early in rodents and humans and the  $\delta$  receptor appears later. In the human fetus,  $\mu$  and  $\kappa$  opioid receptors appear at the start of the second trimester and mature through prenatal life. ► **Delta opioid receptors** (DOP) are generally absent prenatally in the human, although they can be transiently expressed. In the rat and other non-primate species, results are comparable: early appearance of MOP and KOP opioid receptors that peak between one and two weeks after birth, at which time the numbers decrease until adult levels are reached shortly thereafter. DOP receptors are first detected at the end of the first week after birth and are not likely to be fully functional until even later. In all cases, receptor affinity remains unchanged with age. Peptide development in general is also early and regionally specific, although the endomorphins mature relatively late (figure 1). Met-enkephalin-, dynorphin- and  $\beta$ -endorphin-like proteins can be detected by day 11.5 in the rat embryo, preceding the maturation of the recep-

tors, although in some regions opioids appear at the end of the first postnatal week.

#### Pharmacokinetics of Morphine

Morphine kinetics differ with both age and with body weight. In the adult, the major active metabolites of morphine are morphine-3-glucuronide (M3G) and morphine-6-glucuronide (M6G). M3G may have anti-opioid properties whereas M6G has analgesic effects (Christrup 1997). In the infant, M3G is the major metabolite. Although neither M3G nor M6G readily cross the blood brain barrier in the adult, whether they do or not in the infant is not known. Steady state morphine levels require 24–48 h of treatment for morphine, and at least 5 days of treatment for the metabolites (Saarenmaa et al. 2000). At six months of age, the full body clearance rate for morphine is about 80% of that of the adult (Bouwmeester et al. 2004). Metabolite clearance likewise increases with age. Thus, morphine doses in the infant must, out of necessity, be lower for



**Opiates During Development, Figure 1** Maturation of endomorphin-2-like immunoreactivity in the lumbar dorsal horn of the rat at 4 different ages. Note the absence of staining at 3 days and the light and limited distribution of staining at 7 and 11 days (arrows). Staining at 34 days of age is more widely distributed in the lateral aspects of the dorsal horn (arrowheads). Bar is 100  $\mu$ m. From Barr and Zadina, *Neuroreport*, 1999.

the premature infant or neonate than the older infant. Like morphine, fentanyl clearance is slower in the infant than in the older child and adult.

### Development of Analgesia

In animal models (mostly rodent), the infant is generally more responsive to noxious stimuli (e.g. more likely to experience “pain”) than the older animal, and is differentially responsive to opiate-induced analgesia. Although it is not known for certain why the infant is more sensitive to injury, the organization of the nervous system is clearly different in the infant than the adult (Fitzgerald 1991). ► **Receptive fields** of the infant, human or rodent, are larger and more diffuse. The afferent input of noxious stimulation in the infant is by ► **A-fibers** rather than ► **C Fiber** and the A fibers terminate in lamina 2 of the spinal cord ► **dorsal horn**. In the rat, these inappropriately targeted fibers retract and are replaced by C-fibers over the first three weeks of life. Further, inhibitory processes are not mature in the infant. Descending inhibitory processes engaged by opiates develop late in the infant rat, around the end of the second week of life, due to the late growth of functional descending bulbospinal projections. Diffuse noxious inhibitory processes within the spinal cord, where injury to one limb reduces nociception in a heterotopic region, also do not appear until sometime in the third week of life. Thus, in the absence of multiple inhibitory processes, the infant is unable to dampen the effects of injury (Fitzgerald 1991).

Opiates, despite the immaturity of the opioid peptides and receptors, are quite effective analgesics in the infant. This has been demonstrated numerous times in many paradigms. Morphine and fentanyl are the most effective treatments for pain in human neonates undergoing invasive medical treatment and postoperative care. Infants treated aggressively with opiates during and after surgery show decreased morbidity and mortality (Anand and Hickey 1987; Anand et al. 1987). Nonetheless, little detail is known of the best opiate, dose, dosing regimen, and match of opiate to type of pain. Issues of gestational age, body weight, and criticalness of illness only add to these complications (van Lingen et al. 2002).

The immaturity of the blood brain barrier may also contribute to the differential effectiveness of the opiate in the infant, by allowing more opiate to enter the central nervous system. There may also be yet undefined pharmacodynamic factors that account for this increased sensitivity. However, in the infant even more than the adult, the effectiveness of particular opiates is dependent on the type of nociceptive test and the intensity of the noxious stimulus. Intense thermal stimuli are less amenable to relief by morphine in the newborn rat pup, whereas analgesia to lower the intensity of mechanical noxious stimuli occurs quite early. The complexity is well illustrated by data showing that the relative analgesic effectiveness of buprenorphine, fentanyl and morphine in the infant compared to the adult is dependent on the type

of analgesic test. Morphine is most effective in the infant in thermal tests, but buprenorphine is most effective in tests of pain that are models for inflammatory insult (McLaughlin and Dewey 1994).

Moreover, there is regional specificity to the actions of the opiates. For example, due to the lack of descending inhibition, brain administration is less effective than spinal administration in the infant rat, although that is dependent on the type of analgesic test. In rats, administration of opiates in a manner that targets the spinal cord is quite effective as an analgesic (Barr et al. 1992; Marsh et al. 1999). In human children, these procedures are not common, but the clinical literature suggests that they are effective (e.g. Collins et al. 1995).

In both the adult and the infant, there are untoward side-effects that affect treatment. One of these is respiratory depression, a well-known effect of opiates. Initially part of the reluctance to treat infants was out of concern for these actions. Although still a concern, infants are not likely to be more sensitive to the respiratory effects of opiates than are adults. Two other concerns are dependence and ► **tolerance** that occur with repeated exposure.

### Dependence

As in the adult, opiates such as morphine produce ► **physical dependence**. The human infant can become dependent due to medical treatment with opiates or by passive exposure through placental transfer, if the mother uses heroin or other opiates. When therapeutic opiate treatment is discontinued or when the opiate dependent mother gives birth, the infant shows a clear withdrawal syndrome that consists of increased irritability, disruption of sleep/wake states, incessant crying, and other physical signs. This is termed the “narcotic abstinence syndrome”. As might be expected, higher doses and longer exposure increase risk for this syndrome.

In the rodent, withdrawal exists quite early, even in utero. In the infant rat, withdrawal is clearly different from withdrawal in the adult rat, and is characterized by increased separation-induced ultrasonic vocalizations (crying), increased activity and a unique set of behaviors not normally seen in pups not in withdrawal. The dysphoric state induced by opiate withdrawal occurs later, around the second week of life in the infant rat. Autonomic signs are minimal. In the adult, ► **NMDA glutamate receptor** antagonists, when given concomitantly with morphine, reduce withdrawal; but in the infant that treatment is ineffective (Zhu and Barr 2001). In contrast, AMPA blockers or ► **nitric oxide** inhibitors reduce dependence in the infant as they do in the adult. Thus, it is likely that the fundamental mechanisms mediating the chronic effects of opiates differ in the neonate.

Treatment with opiates is the preferred initial therapy for narcotic abstinence syndrome, and the only treatment

for which there is evidence of efficacy. Morphine and methadone are currently the most commonly prescribed opioids to treat infant withdrawal, but which is more effective has not been determined. Clinically, there are no accepted or proven non-opioid treatments for the withdrawal syndrome. Barbiturate, benzodiazepines, and other sedatives are ineffective. The preclinical data suggest that NMDA antagonists, effective in the adult, are not likely to work in the human infant.

### Tolerance

Tolerance also occurs to chronic opiate use in both human and animal infants. The tolerance is substantially less than that seen in the adult for reasons that are not understood. There are differences in intracellular signaling mechanisms that are age dependent that might account for this; as for dependence, tolerance to morphine in the infant is not NMDA receptor mediated.

### Summary

Opioid receptors and peptides mature early during development but in a complex manner. Opiates are effective well-characterized drugs for the treatment of pain in the premature and full term infant. Regardless of the philosophical debate as to whether or not the infant can experience “pain”, opiate treatment reduces morbidity and mortality in the infant patient. Opiates tend to be cleared more slowly in the premature or newborn full-term infant, and issues of the unique developmental effects of metabolites remain unaddressed. Whether or not different opiates are differentially effective for different painful procedures is not known. As in the adult, there are problems with iatrogenically induced tolerance and dependence, and with dependence in infants born of opiate using mothers. The most effective treatments are opiate based.

### References

- Anand KJ, Hickey PR (1987) Pain and its Effects in the Human Neonate and Fetus. *N Engl J Med* 317:1321–1329
- Anand KJ, Sippell WG, Aynsley-Green A (1987) Randomised Trial of Fentanyl Anaesthesia in Preterm Babies Undergoing Surgery: Effects on the Stress Response. *Lancet* 1:62–66
- Anand KJS, Craig KD (1996) New Perspectives on the Definition of Pain. *Pain* 67:3–6
- Barr GA, Miya DY, Paredes W (1992) Analgesic Effects of Intraventricular and Intrathecal Injection of Morphine and Ketocyclazocine in the Infant Rat. *Brain Res* 584:83–91
- Barr GA, Zadina JE (1999) Maturation of endomorphin-2 in the dorsal horn of the medulla and spinal cord of the rat. *Neuroreport* 10:3857–60
- Bouwmeester NJ, Anderson BJ, Tibboel D et al. (2004) Developmental Pharmacokinetics of Morphine and its Metabolites in Neonates, Infants and Young Children. *Br J Anaesth* 92:208–217
- Christrup LL (1997) Morphine Metabolites. *Acta Anaesthesiol Scand* 41:116–122
- Collins JJ, Grier HE, Kinney HC et al. (1995) Control of Severe Pain in Children with Terminal Malignancy. *J Pediatr* 126:653–657
- Derbyshire SW (2001) Fetal Pain: An Infantile Debate. *Bioethics* 15: 77–84.
- Fitzgerald M (1991) Development of Pain Mechanisms. *Brit Med Bull* 47:667–675
- Lingen RA van, Simons SH, Anderson BJ et al. (2002) The Effects of Analgesia in the Vulnerable Infant during the Perinatal Period. *Clin Perinatol* 29:511–534
- Marsh D, Dickenson A, Hatch D et al. (1999) Epidural Opioid Analgesia in Infant Rats I: Mechanical and Heat Responses. *Pain* 82:23–32
- McLaughlin CR, Dewey WL (1994) A Comparison of the Antinociceptive Effects of Opioid Agonists in Neonatal and Adult Rats in Phasic and Tonic Nociceptive Tests. *Pharmacol Biochem Behav* 49:1017–1023
- Saarenmaa E, Neuvonen PJ, Rosenberg P et al. (2000) Morphine Clearance and Effects in Newborn Infants in Relation to Gestational Age. *Clin Pharmacol Ther* 68:160–166
- Snyder SH, Pasternak GW (2003) Historical Review: Opioid Receptors. *Trends Pharmacol Sci* 24:198–205
- Zhu H, Barr GA (2001) Opiate Withdrawal during Development: Are NMDA Receptors Indispensable? *Trends Pharmacol Sci* 22:404–408

## Opiates, Rostral Ventromedial Medulla and Descending Control

MARY M. HEINRICHER

Department of Neurological Surgery, Oregon Health Science University, Portland, OR, USA  
heinricm@ohsu.edu

### Definition

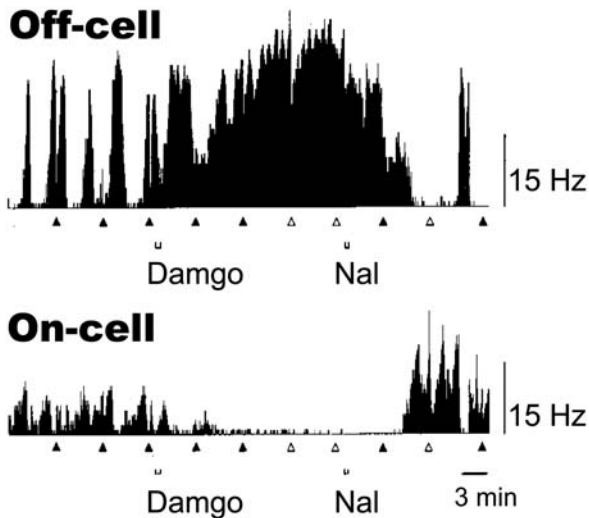
The recognition that supraspinal structures can exert control over sensory processing at the level of the spinal cord has a long history. However, the realization that descending controls have a specific role in the regulation of spinal pain processing achieved prominence in 1969, with the demonstration of analgesia during electrical stimulation of the midbrain periaqueductal gray (PAG) (Reynolds 1969). This phenomenon came to be called “stimulation-produced analgesia” (SPA). Subsequent intensive investigations of SPA led to the definition of a central pain modulatory network, now known to span the neuraxis, with critical links in the PAG and **rostral ventromedial medulla (RVM)** (Fields and Basbaum 1999). Non-selective activation of the RVM was shown to inhibit behavioral responses to noxious stimuli, and this antinociception is in large part due to interference with nociceptive processing at the level of the spinal cord. Moreover, further investigation has now demonstrated that the RVM exerts bidirectional control over nociception. The best current evidence, as described below, is that different physiologically defined populations of RVM neurons mediate antinociceptive and pronociceptive effects of RVM manipulation. The anatomical substrate for spinal modulation of nociception from the RVM is a large projection from this region to the dorsal horn. The projection travels through the dorsolateral funiculus, and terminates at all levels of the spinal cord, in laminae known to be involved in nociception. The specifics of how the RVM projection interfaces with nociceptive circuitry at the level of the dorsal horn to alter nociception remain unresolved. A

major input to the RVM is the PAG, which channels input from higher structures, including hypothalamus and amygdala, to the RVM.

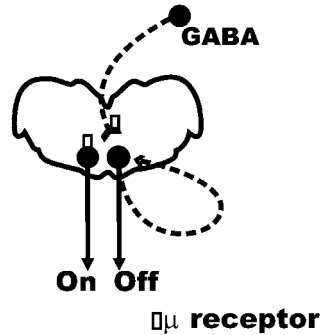
The delineation of this brainstem pain modulating system has thus been a major breakthrough in defining pain modulation as a separable function of the nervous system, and in showing that the influence of psychological variables on pain could have an understandable neural basis.

### Characteristics

Interest in the PAG/RVM descending modulatory network was heightened when it became apparent that this system was also an important substrate for opioid analgesia. The RVM, and especially the PAG, are rich in opioid receptors and opioid peptides. The RVM is required for the full analgesic action of systemically administered morphine, and focal application of morphine or mu-opioid agonists within the RVM is sufficient to produce potent behavioral analgesia (Yaksh et al. 1988). The neural basis of mu-opioid analgesia within the RVM has been studied in depth. There is now clear evidence that the antinociceptive effects of mu-opioid agonists within the RVM require activation of a class of RVM neurons termed "▶ off-cells (RVM)" (Fig. 1), which exert a net inhibitory effect on nociception (Heinricher et al. 1994). The proximal event in opioid activation of



**Opiates, Rostral Ventromedial Medulla and Descending Control, Figure 1** Focal application of the mu-opioid agonist DAMGO within the RVM activates an off-cell whilst inhibiting an on-cell recorded simultaneously on the same electrode. Ratemeter records show firing rate in 1 s bins, with tail flick trials performed at 5min intervals (indicated by triangles below the trace). DAMGO was infused following a baseline period, and resulted in activation of the off-cell and suppression of on-cell firing. Inhibition of the tail flick reflex ("analgesia") is indicated by open triangles at 15 and 20 min after DAMGO. Changes in cell activity and antinociception were reversed by systemic administration of naloxone (1 mg/kg). Adapted with permission from Heinricher et al. (1994) Disinhibition of off-cells and antinociception produced by an opioid action within the rostral ventromedial medulla. *Neuroscience* 63:279–288.



**Opiates, Rostral Ventromedial Medulla and Descending Control, Figure 2** Off-cell activation is triggered by presynaptic inhibition of a GABAergic input originating from outside of the RVM, and reinforced by an excitatory input (mediated by an NMDA receptor, not shown). The excitatory link could be within the RVM (i.e. mutual excitation among off-cells) or via extra-RVM pathways. Parallel inhibition of on-cells by the opioid likely contributes to antinociception, although under normal conditions on-cell inhibition is not sufficient to produce antinociception. Mu-opioid receptors are thus located both presynaptically (on inhibitory inputs to off-cells) and post-synaptically (on on-cells).

the off-cells is disinhibition. That is, the direct effect of mu-opioid agonists is to inhibit a GABAergic input to the off-cells. This disinhibition in turn leads to a positive feedback process, resulting in further off-cell activation and behavioral antinociception (Fig. 2) (Heinricher et al. 2001; Heinricher and Tortorici 1994; Pan et al. 1990). In addition to the indirect activation of off-cells, mu-opioid agonists inhibit another class of neurons in RVM, termed "▶ on-cells (RVM)" (Fig. 1). It was originally thought that on-cells served as inhibitory interneurons within the RVM. However, on-cells are known to project to the dorsal horn, and the recent demonstration that blocking the reflex-related activity of on-cells does not disinhibit off-cells, argues very strongly that on-cells are not inhibitory interneurons. Rather, they are now thought to constitute a descending influence that is in parallel with the antinociceptive output of the off-cells (Fig. 2). Given that suppression of on-cell discharge is not by itself sufficient to produce measurable behavioral antinociception (Heinricher et al. 1999), it is unlikely that on-cells exert a potent tonic effect on nociception under normal conditions. However, direct opioid inhibition of on-cells may assume an important role in inflammatory or other abnormal pain states, in which these neurons are very likely to contribute to hyperalgesia.

A third class of RVM neurons - "▶ neutral cells (RVM)" - do not respond to noxious stimulation or to opioid application. Their role in pain modulation is unknown. It is likely that neutral cells comprise a heterogeneous group that includes the serotonergic neurons in this region. The idea that RVM serotonergic neurons do not respond to opioids has presented something of an enigma, since pharmacological studies point to descending serotonergic projections as cen-



tral to descending pain modulation, including opioid analgesia. One possible way to reconcile the behavioral and physiological observations is to propose that the serotonergic outflow enables or “gates” other descending influences that are directly inhibitory or facilitatory.

#### Delta Opioid Actions in the RVM

Insight into the role of the delta opioid receptor in the RVM remains at an early stage, at least in comparison to our understanding of the mu receptor (Heinricher and Fields 2003). Delta receptors are found in the RVM, although there is some disagreement as to whether they are localized to cell bodies or exclusively to axon terminals. Direct microinjection of delta opioid receptor agonists, especially delta2 agonists, within the RVM produces a modest hypoalgesia in behavioral tests. Given the presence of delta receptors and evidence for a behavioral effect of delta agonists in the RVM, it is somewhat surprising that *in vitro* electrophysiological studies have found no evidence for delta receptor effects on RVM neurons. *In vivo*, identified on- and off-cells exhibit only modest changes in response patterns after microinjection of the delta2 agonist deltorphin. Although subtle compared to the effects of mu agonists within the RVM, these alterations in neuronal firing are consistent with the relatively small behavioral change produced by delta agonists in this region.

#### Kappa Opioid Actions in the RVM

The role of the kappa receptor within the RVM is at present somewhat controversial. Focal application of kappa agonists within the RVM has been reported to produce potent analgesia by one group (Ackley et al. 2001), while other investigators find that kappa compounds have no effect by themselves on nociception, but interfere with the analgesic actions of mu-opioids (that is, that they have an “anti-analgesic” effect) (Pan 1998). While the sex of the subjects may account for some of the discrepant results, it does not appear to be a complete explanation.

As with the behavioral analyses, electrophysiological findings are also controversial. Only *in vitro* studies have been reported to date. Pan and colleagues found that mu and kappa receptors are expressed by separate populations of RVM neurons (referred to as ► **secondary cells (RVM)** and ► **primary cells (RVM)**, respectively). They therefore proposed that the behavioral anti-analgesic effect of kappa agonists given by microinjection in the RVM could be explained by kappa inhibition of off-cells, the inhibitory output neurons of the RVM (Pan 1998). However, it is not known whether off-cells respond to kappa agonists, as this has not been tested *in vivo*. Moreover, recent work in the RVM slice by Marinelli et al. (Marinelli et al. 2002) showed that mu- and kappa-opioid receptor types are commonly co-expressed by spinally projecting RVM neurons, with

only a small subset demonstrating kappa responses in the absence of mu responses. Other workers have shown that kappa agonists act presynaptically within the RVM (Ackley et al. 2001).

#### Physiological Recruitment of Opioids within the RVM

What is the physiological role of opioids within the RVM? Opioid receptor antagonists, microinjected into the RVM, do not alter nociceptive responses, indicating that endogenous opioids do not maintain an ongoing tone under normal conditions. Endogenous opioid-mediated effects are likely to be important in stress-induced analgesia, although relatively few studies have focused specifically on the RVM. Interestingly, enhanced delta activity is thought to contribute to the well-documented increase in the analgesic potency of opioids in inflammatory pain states. Hurley and Hammond (2001) suggest a novel interaction of mu- and delta-receptor mediated effects within the RVM following inflammation.

Among the other neurotransmitters and neuropeptides known to influence opioid-sensitive pain modulating circuits within the RVM are ► **acetylcholine**, ► **serotonin**, neurotensin, norepinephrine, ► **cholecystokinin** and ► **orphanin FQ/nociceptin**. Understanding the many inputs to the RVM, and how these systems are recruited and modified to interact with opioid actions under physiological and pathophysiological conditions, remain important areas for future work.

0

#### References

1. Ackley MA, Hurley RW, Virnich DE et al. (2001) A Cellular Mechanism for the Antinociceptive Effect of a Kappa Opioid Receptor Agonist. *Pain* 91:377–388
2. Fields HL, Basbaum AI, Heinricher MM (2005) Central nervous system mechanisms of pain modulation. In: McMahon S and Koltzenburg M (eds) *Wall PD, Melzack's Textbook of Pain*, 5<sup>th</sup> edn. Elsevier, London, pp 125–142
3. Heinricher MM, Fields HL (2003) The Delta Opioid Receptor and Brain Pain-Modulating Circuits. In: Chang KJ, Porreca F, Woods J (eds) *The Delta Receptor: Molecular and Effect of Delta Opioid Compounds*. Marcel Dekker, New York, pp 467–480
4. Heinricher MM, McGaraughty S, Farr DA (1999) The Role of Excitatory Amino Acid Transmission within the Rostral Ventromedial Medulla in the Antinociceptive Actions of Systemically Administered Morphine. *Pain* 81:57–65
5. Heinricher MM, Morgan MM, Tortorici V et al. (1994) Disinhibition of Off-Cells and Antinociception Produced by an Opioid Action within the Rostral Ventromedial Medulla. *Neuroscience* 63:279–288
6. Heinricher MM, Schouten JC, Jobst EE (2001) Activation of Brainstem N-methyl-D-aspartate Receptors is required for the Analgesic Actions of Morphine given Systemically. *Pain* 92:129–138.
7. Heinricher MM, Tortorici V (1994) Interference with GABA Transmission in the Rostral Ventromedial Medulla: Disinhibition of Off-Cells as a Central Mechanism in Nociceptive Modulation. *Neuroscience* 63:533–546
8. Hurley RW, Hammond DL (2001) Contribution of Endogenous Enkephalins to the Enhanced Analgesic Effects of Supraspinal Mu-opioid Receptor Agonists after Inflammatory Injury. *J Neurosci* 21:2536–2545

9. Marinelli S, Vaughan CW, Schnell SA et al. (2002) Rostral Ventromedial Medulla Neurons that Project to the Spinal Cord Express Multiple Opioid Receptor Phenotypes. *J Neurosci* 22:10847–10855
10. Pan ZZ (1998)  $\mu$ -Opposing Actions of the Kappa-Opioid Receptor. *Trends Pharmacol Sci* 19:94–98
11. Pan ZZ, Williams JT, Osborne PB (1990) Opioid Actions on Single Nucleus Raphe Magnus Neurons from Rat and Guinea-Pig *In Vitro*. *J Physiol* 427:519–532
12. Reynolds DV (1969) Surgery in the Rat during Electrical Analgesia Induced by Focal Brain Stimulation. *Science* 154:444–445
13. Yaksh TL, Al-Rodhan NRF, Jensen TS (1988) Sites of Action of Opiates in Production of Analgesia. *Prog Brain Res* 77:371–394

## Opioid

### Definition

A class of drugs with a molecular structure similar to opium. All opiates have analgesic effects and other effects, some of them adverse. Examples of opiates include morphine, codeine and fentanyl. Opioid is a generic term that refers to all molecules, either natural or synthetic, either small molecule or peptide, which exert morphine-like pharmacological actions. The predominant pharmacologic property of therapeutic interest is analgesia, the selective relief of pain. Other pharmacologic actions include sedation, respiratory depression, decreased gastrointestinal motility, nausea, and vomiting. Opioids exert their actions through a family of seven-transmembrane,  $G_i/G_o$ -coupled receptors, traditionally identified as  $\mu$ ,  $\kappa$ , and  $\delta$  (a.k.a. MOR, KOR, and DOR). Morphine is the prototypical  $\mu$  opioid agonist.

- ▶ [Analgesia During Labor and Delivery](#)
- ▶ [Cancer Pain Management, Cancer-Related Breakthrough Pain, Therapy](#)
- ▶ [Cancer Pain Management, Principles of Opioid Therapy, Dosing Guidelines](#)
- ▶ [Cancer Pain Management, Principles of Opioid Therapy, Drug Selection](#)
- ▶ [Cytokine Modulation of Opioid Action](#)
- ▶ [Deep Brain Stimulation](#)
- ▶ [Forebrain Modulation of the Periaqueductal Gray](#)
- ▶ [Hot Plate Test \(Assay\)](#)
- ▶ [Opioids, Clinical Opioid Tolerance](#)
- ▶ [Opioid Peptide Co-Localization and Release](#)
- ▶ [Opioid Receptor Localization](#)
- ▶ [Pain Treatment, Implantable Pumps for Drug Delivery](#)
- ▶ [Postoperative Pain, Acute Pain Management, Principles](#)
- ▶ [Postoperative Pain, Opioids](#)
- ▶ [Postoperative Pain, Postamputation Pain, Treatment and Prevention](#)

## Opioid Adverse Effects

### Definition

Unwanted and unpleasant effects of opioid drugs when used in pain management.

- ▶ [Cancer Pain Management, Principles of Opioid Therapy, Drug Selection](#)

## Opioid Analgesia

### Definition

Pain-inhibitory effects of opioid drugs such as morphine or opioid-receptor agonist drugs.

- ▶ [Opioid Analgesia, Strain Differences](#)
- ▶ [Psychological Aspects of Pain in Women](#)

## Opioid Analgesia and Sex Differences

- ▶ [Sex Differences in Opioid Analgesia](#)

## Opioid Analgesia, Strain Differences

JEFFREY S. MOGIL

Department of Psychology, McGill University,  
Montreal, QC, Canada  
jeffrey.mogil@mcgill.ca

### Synonyms

Opioid analgesia; Genotypic Influences on Opioid Analgesia; Genetic Factors Contributing to Opioid Analgesia

### Definition

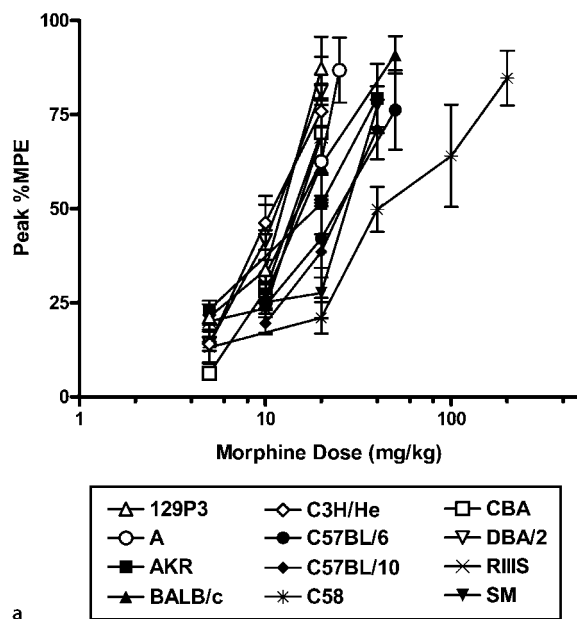
The efficacy of the pain-inhibitory neural circuitry activated by opioid compounds differs among individuals. The contribution of inherited genetic factors to such interindividual variability in responses to drugs (i.e. ▶ [pharmacogenetics](#)) is most easily studied by comparing subpopulations of a species, especially ▶ [inbred strains](#). Robust strain differences in the magnitude and neurochemical mediation of opioid analgesia have been observed in both mice and rats. The genes underlying these strain differences are starting to be identified, and appear to play similar roles in analgesic variability in humans.

## Characteristics

Morphine at standard doses exhibits a wide range of clinical efficacies against postoperative and chronic pain. A human twin study revealed that morphine inhibition of experimental pain is likely to be **▶ heritable** (Liston et al. 1981), and successful selective breeding has demonstrated the heritability of opioid analgesia in mice (see Mogil et al. 1996b). The identification of genes (and their common DNA sequence variants, or **▶ alleles**) underlying the variable pharmacodynamic and pharmacokinetic properties of opioid analgesics would allow individualized treatment of pain, to maximize efficacy and minimize side effects in each patient.

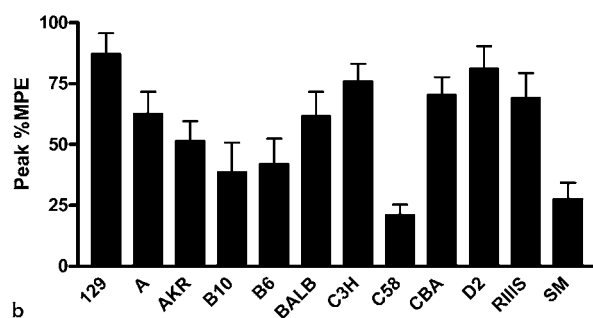
Differential sensitivity of laboratory mouse and rat populations to opioid drugs has long been noted (see Mogil 1999). The genetic contribution to such variability can be assessed using inbred strains, in which repeated brother–sister matings have eliminated genetic **▶ heterozygosity**, rendering each individual virtually isogenic to (i.e. a clone of) all others of that strain. By comparing multiple strains tested simultaneously, genetic components (differences between strain means) and environmental components (within–strain error) of analgesic variability can be partitioned. Large “strain surveys” of opioid analgesia have been performed in the mouse (Wilson et al. 2003) and rat (Morgan et al. 1999). Robust differences in half–maximal analgesic doses ( $AD_{50}$ s) were noted; in one study of morphine ranged almost 4–fold among 12 inbred strains (see Fig. 1). Strain differences can be observed regardless of the route of opioid administration. The magnitude of strain differences has been shown to depend on opioid efficacy and stimulus intensity (Morgan et al. 1999). Genotype-dependence of analgesia is not limited to exogenous opioids; with strain differences also being documented for stress–induced analgesia and non–opioid drug analgesia (see Mogil 1999). In the few studies that have ever looked, pharmacokinetic considerations do not appear to explain these strain differences (e.g. Mas et al. 2000). In addition to analgesic magnitude, the physiological processing of analgesia also appears to be strain-dependent. For example, forced swims in 15°C water produce opioid-mediated (naloxone-sensitive) analgesia in male DBA/2J mice, but non-opioid-mediated analgesia in male C57BL/6J mice (Mogil and Belknap 1997). Similarly, analgesia from the  $\kappa$ -opioid agonist, U50,488, is reversed by the *N*-methyl-D-aspartate receptor antagonist, MK–801, in male mice of a number of strains, but not in C3HeB/FeJ mice (unpublished data). Elegant pharmacological studies have shown that heroin analgesia is predominantly mediated by  $\mu$  receptors in three inbred strains, by  $\kappa$  receptors in two others, and by  $\delta$  receptors in yet another (Rady et al. 1998). Such qualitative differences among strains suggest differential neural circuit organization, as has been demonstrated for coeruleospinal projections (Clark and Proudfit 1992).

## Dose-Response Curves



a

## 20 mg/kg Morphine



b

**Opioid Analgesia, Strain Differences, Figure 1** Genotype-dependent sensitivity to systemic morphine analgesia in 12 inbred mouse strains (all “J” substrains; from Wilson et al. 2003). All mice were tested for baseline sensitivity on the 49°C hot water tail-withdrawal assay, administered 5–200 mg/kg (i.p.) morphine sulfate, and retested 15, 30 and 60 min. post-injection. Symbols in (a) represent mean  $\pm$  S.E.M. peak (over the 60 min. time course) percentage of the maximum possible effect (%MPE) at each dose. Associated  $AD_{50}$ s range from 10.5 mg/kg (129P3) to 38.5 mg/kg (C58). The 12 strains appear to group into three clusters: a sensitive group (open symbols), a resistant group (closed symbols and cross), and the very resistant C58 strain (asterisk). The peak %MPE at one dose common to all strains, 20 mg/kg, is shown in (b).

The strongest predictor of strain-dependent morphine  $AD_{50}$  is the baseline sensitivity to the noxious stimulus being inhibited by morphine. Generally speaking, strains sensitive to nociception are resistant to analgesia, and strains resistant to nociception are sensitive to analgesia (Mogil et al. 1996a). This might imply that the underlying genetic contribution is to **▶ opioid tone** and/or related to **▶ fractional receptor occupancy** of opioid receptors (Elmer et al. 1998). The phenomenon is not limited to morphine anal-

**Opioid Analgesia, Strain Differences, Table 1** QTLs for morphine inhibition of hot-plate nociception in DBA/2 and C57BL/6 mice.

Chrom.	Loc. <sup>a</sup>	LOD <sup>b</sup>	Candidate Gene/Protein <sup>c</sup>	Reference
1	10 cM	4.7†	<i>Oprk1</i> , $\kappa$ -opioid receptor (6 cM)	Mogil et al. unpublished data
9*	20 cM	5.2†	—	—
9*	42 cM	4.5	<i>Htr1b</i> , serotonin-1B receptor (46 cM)	Hain et al. 1999 J. Pharmacol. Exp. Ther. 291:444–449
10*	9 cM	7.5	<i>Oprm</i> , $\mu$ -opioid receptor (8 cM)	Belknap et al. 1995 Life Sci. 57:PL117–PL124

<sup>a</sup>Location in centiMorgans (cM; approximately 1 million base pairs) from the proximal end of the chromosome of the peak statistical evidence for genetic linkage. The 95% confidence intervals in this type of study are generally very large, however

<sup>b</sup>Logarithm of the odds (LOD) score for linkage of morphine analgesia to the defined genomic region. The conservative threshold for “significant” linkage is LOD = 4.3

<sup>c</sup>Gene and the protein it codes that may underlie the QTL, supported by evidence presented in the cited reference. The gene’s chromosomal location in cM is given in parentheses

\*The existence of these QTLs was independently replicated in a different laboratory using different progenitor strains (A/J and SM/J) (Mizuo et al. 2000, *International Narcotics Research Conference*, Seattle)

†Significant linkage in female mice only; no evidence for linkage whatsoever was obtained in male mice

gesia, however, having also been demonstrated for clonidine, epibatidine, U50,488, and the cannabinoid agonist, WIN55–212,2 (Wilson et al. 2003). In fact, these five analgesics show a high degree of genetic correlation with each other, suggestive of the existence of “master” genes responsible for variability in both nociception and analgesia across a wide range of compounds (Wilson et al. 2003).

When male and female subjects have been tested simultaneously for opioid analgesia, a strong interaction between genotype and sex has been noted (see Mogil 2003). Sex differences (see ► [Gender and Pain](#)) can be demonstrated in some genotypes but not others, and even the direction of the sex difference may depend on the subject’s genotype. The converse is, of course, also true: some strain differences are much larger in one sex than the other.

Different physiological effects of a drug may have independent genetic bases. For example, in a study comparing the sensitivity of three inbred strains on six behavioral effects of morphine (analgesia, hyperlocomotion, hypothermia, muscular rigidity, antidiuresis and constipation), almost every possible rank-ordering of strain was observed (Belknap et al. 1989). With respect to analgesia specifically, strains sensitive to morphine inhibition of thermal nociception on the tail-withdrawal or hot-plate tests, are *not* necessarily the same strains sensitive to morphine inhibition of chemical nociception on the formalin or abdominal constriction tests (Mogil et al. 1996a; Elmer et al. 1998). The dependence of analgesia pharmacogenetics on the type of pain being inhibited is a generalizable phenomenon, also applicable to clonidine (Wilson et al. 2003) and pregabalin (manuscript submitted).

Of opioid analgesics, only morphine and U50,488 have been subjected to ► [quantitative trait locus \(QTL\) mapping](#), a technique allowing the broad localization of trait variability genes to chromosomal regions as the

first step towards their identification. Once the genes underlying the QTLs are identified, one can search for the DNA sequence variants (e.g. ► [single-nucleotide polymorphisms](#)) responsible for the strain difference. Although it is not necessarily true that murine polymorphisms will be preserved in humans, there is some reason to expect that similar genes will be trait-relevant and genetically variable in both rodents and humans. For morphine inhibition of thermal (hot plate) nociception, using the sensitive DBA/2 and resistant C57BL/6 strains (see Fig. 1) as parental genotypes, four significant QTLs have been uncovered, that together account for two-thirds of the additive genetic variance and one-quarter of the overall trait variance (Bergeson et al. 2001). These QTLs, and the genes likely underlying each QTL, are shown in Table 1. As can be seen, in two cases the QTLs are sex-specific. A female-specific QTL was also uncovered for U50,488 inhibition of hot water tail-withdrawal nociception (Mogil et al. 2003). This QTL, on distal mouse chromosome 8, was determined by convergent mouse mutant and pharmacological data to be *Mc1r*, encoding the melanocortin-1 receptor (Mogil et al. 2003).

Success in identifying genes responsible for mouse or rat strain differences will be of purely academic interest unless those same genes are shown to be relevant to human individual differences. Thus, more attention is being paid to “translational” genetic strategies. If a particular gene is postulated to be important for a trait, and that gene has known sequence variants in humans, an association or ► [allele dosage study](#) can be performed. The possible roles of the human *OPRM1* ( $\mu$ -opioid receptor) and *OPRD1* ( $\delta$ -opioid receptor) genes are currently being investigated. Following the determination that the mouse *Mc1r* gene affected  $\kappa$ -opioid analgesia in female mice, the human *MC1R* gene (also responsible for red hair and fair skin) was found to affect pentazocine inhibition of experimental pain in human women (Mogil et



al. 2003). Findings such as these may revolutionize pain treatment, by allowing more effective usage of existing compounds, identifying new molecular targets for drug development, and facilitating the regulatory approval of new drugs based on the ability to identify likely “responders.”

## References

1. Belknap JK, Noordewier B, Lamé M (1989) Genetic Dissociation of Multiple Morphine Effects among C57BL/6J, DBA/2J and C3H/HeJ Inbred Mouse Strains. *Physiol Behav* 46:69–74
2. Bergeson SE, Helms ML, O’Toole LA, Jarvis MW, Hain HS, Mogil JS, Belknap JK (2001) Quantitative Trait Loci Influencing Morphine Antinociception in Four Mapping Populations. *Mamm Genome* 12:546–553
3. Chesler EJ, Ritchie J, Kokajeff A et al. (2003) Genotype-dependence of gabapentin and pregabalin sensitivity: the pharmacogenetic mediation of analgesia is specific to the type of pain being inhibited. *Pain* 106:325–35
4. Clark FM, Proudfit HK (1992) Anatomical Evidence for Genetic Differences in the Innervation of the Rat Spinal Cord by Noradrenergic Locus Coeruleus Neurons. *Brain Res* 591:44–53
5. Elmer GI, Pieper JO, Negus SS, Woods JH (1998) Genetic Variance in Nociception and its Relationship to the Potency of Morphine-Induced Analgesia in Thermal and Chemical Tests. *Pain* 75:129–140
6. Liston EH, Simpson JH, Jarvik LF, Guthrie D (1981) Morphine and Experimental Pain in Identical Twins. *Prog Clin Biol Res* 69:105–116
7. Mas M, Sabater E, Olaso MJ, Horga JF, Faura CC (2000) Genetic Variability in Morphine Sensitivity and Tolerance between Different Strains of Rats. *Brain Res* 866:109–115
8. Mogil JS (1999) The Genetic Mediation of Individual Differences in Sensitivity to Pain and its Inhibition. *Proc Natl Acad Sci USA* 96:7744–7751
9. Mogil JS (2004) The Interaction between Sex and Genotype in the Mediation of Pain and Pain Inhibition. *Pain Med* 1:197–205
10. Mogil JS, Belknap JK (1997) Sex and Genotype Determine the Selective Activation of Neurochemically-Distinct Mechanisms of Swim Stress-Induced Analgesia. *Pharmacol Biochem Behav* 56:61–66
11. Mogil JS, Kest B, Sadowski B, Belknap JK (1996a) Differential Genetic Mediation of Sensitivity to Morphine in Genetic Models of Opiate Antinociception: Influence of Nociceptive Assay. *J Pharmacol. Exp Ther* 276:532–544
12. Mogil JS, Sternberg WF, Marek P, Sadowski B, Belknap JK, Liebeskind JC (1996b) The Genetics of Pain and Pain Inhibition. *Proc Natl Acad Sci USA* 93:3048–3055
13. Mogil JS, Wilson SG, Chesler EJ, Rankin AL, Nemmani KVS, Lariviere WR, Groce MK, Wallace MR, Kaplan L, Staud R, Ness TJ, Glover TL, Stankova M, Mayorov A, Hraby VJ, Grisel JE, Fillingim RB (2003) The Melanocortin-1 Receptor Gene Mediates Female-Specific Mechanisms of Analgesia in Mice and Humans. *Proc Natl Acad Sci USA* 100:4867–4872
14. Morgan D, Cook CD, Picker MJ (1999) Sensitivity to the Discriminative Stimulus and Antinociceptive Effects of  $\mu$ -Opioids: Role of Strain of Rat, Stimulus Intensity, and Intrinsic Efficacy at the  $\mu$ -Opioid Receptor. *J Pharmacol Exp Ther* 289:965–975
15. Rady JJ, Elmer GI, Fujimoto JM (1998) Opioid Receptor Selectivity of Heroin Given Intracerebroventricularly Differs in Six Strains of Inbred Mice. *J Pharmacol Exp Ther* 288:438–445
16. Wilson SG, Smith SB, Chesler EJ, Melton KA, Haas JJ, Mitton BA, Strasburg K, Hubert L, Rodriguez-Zas SL, Mogil JS (2003) The Heritability of Antinociception: Common Pharmacogenetic Mediation of Five Neurochemically-Distinct Analgesics. *J Pharmacol Exp Ther* 304:547–559

## Opioid Analgesic

### Definition

Opioid analgesics are pharmacologic agents whose mechanism of action involves interaction with receptors for endogenous opioids. Opioid receptors located in the central nervous system, with their endogenous ligands, including enkephalin,  $\beta$ -endorphin, and dynorphin, form part of an endogenous system modulating nociception.

- [Cancer Pain Management, Opioid Side Effects, Uncommon Side Effects](#)

## Opioid Analgesic Actions Outside the Central Nervous System

- [Opioids in the Periphery and Analgesia](#)

## Opioid Antagonists

0

### Definition

Naloxone is generally recognized as the classical opioid antagonist drug, which possesses affinity but lacks efficacy for opioid receptors. At sufficient doses, naloxone will block  $\mu$ ,  $\delta$  and  $\kappa$  opioid receptors, although low doses are reportedly more selective for  $\mu$  opioid receptors. Naltrexone and  $\beta$ -chlornaltrexamine are other examples of non-selective opioid antagonist drugs. Newer drugs possess greater selectivity for one or another opioid receptor subtypes. For instance,  $\beta$ -funaltrexamine and CTOP are selective  $\mu$  opioid antagonists, naltrindole and naltriben are selective  $\delta$  opioid antagonists, and norbinaltorphimine is a selective  $\kappa$  opioid antagonist.

- [Nitrous Oxide Antinociception and Opioid Receptors](#)

## Opioid Dose Titration

### Definition

The clinical practice of increasing opioid dosage to achieve analgesia without unwanted adverse effects.

- [Cancer Pain Management, Principles of Opioid Therapy, Drug Selection](#)

## Opioid Electrophysiology in PAG

MACDONALD J. CHRISTIE, P.B. OSBORNE  
Pain Management Research Institute and Kolling  
Institute, University of Sydney, Sydney, NSW,  
Australia  
macc@med.usyd.edu.au

### Synonyms

Periaqueductal grey; periaqueductal gray; central grey;  
Central Gray/Central Grey; opiate

### Definition

The midbrain periaqueductal grey (PAG) is one of the major brain targets for the analgesic actions of opioid drugs and endogenously released opioids. The PAG contributes to a descending inhibitory neural network. When PAG output neurons are activated, nociceptive neurotransmission at the level of the dorsal horn of the spinal cord is inhibited. Opioids are thought to produce analgesia in the PAG by a disinhibitory mechanism via direct inhibition of GABAergic neurotransmission impinging on descending output neurons.

### Characteristics

The PAG, as the name suggests, is a cell dense region surrounding the cerebral aqueduct extending from the third ventricle to the pontine division of the fourth ventricle. Anatomical, physiological and behavioural studies all indicate that the PAG is organized into distinct functional columns that extend along the rostrocaudal axis. The different functional columns are considered to be involved in the expression of distinct patterns of autonomic and behavioural responses (Bandler and Shipley 1994).

All of the major types of opioid receptor,  $\mu$ - (**MOP**),  $\delta$ - (**DOP**) and  $\kappa$ - (**KOP**) and N/OFQ (**NOP**) receptors, are expressed abundantly in PAG (Mansour et al. 1995). The first three of these are considered to mediate antinociceptive actions in PAG, with the  $\mu$ -receptor mediating the analgesic actions of most clinically useful opioids. The N/OFQ receptor is closely related to  $\mu$ -,  $\delta$ - and  $\kappa$ -receptors, but is not activated by classical opioid agonists. Activation of the N/OFQ receptor in PAG functionally antagonizes the effects of morphine. Endogenous opioids derived from each of the major pro-hormone precursors are also richly expressed within the PAG (Fallon and Leslie 1986). These include pro-opiomelanocortin (POMC), which produces  **$\beta$ -endorphin** from nerve terminals of hypothalamic neurons, proenkephalin from intrinsic neurons and projections from several brain regions, and pro-dynorphin also from intrinsic neurons and projections from several brain regions.

Direct microinjection of opioid receptor agonists into the PAG produces analgesia in experimental animals. Agonists for each receptor type have antinociceptive

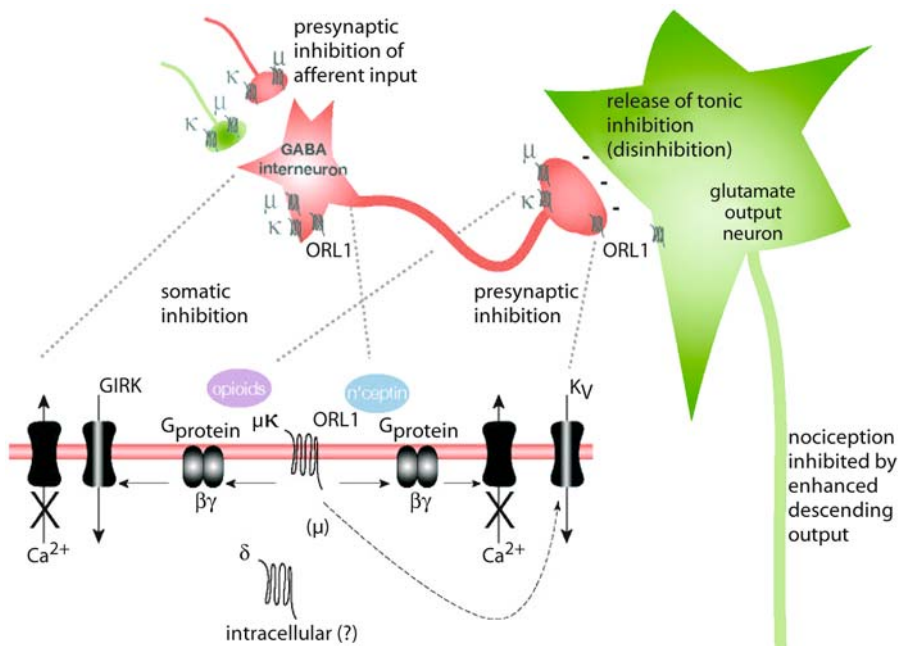
actions when microinjected into PAG (Ossipov et al. 1995). However,  $\mu$ -receptor agonists are more efficacious than  $\delta$ - or  $\kappa$ -agonists. Microinjected opioids produce antinociception more effectively in the ventrolateral PAG, particularly in the most caudal area, than in lateral or dorsal columns (Jansen and Yaksh 1985). Electrical stimulation of the PAG in experimental animals and humans also produces analgesia that can be reversed by opioid receptor antagonists such as naloxone, but only when stimulation is located in the ventrolateral area. This implies that electrical stimulation of ventrolateral PAG releases endogenous opioids. Stimulation of other areas of the PAG can also produce antinociception, but the effects are generally not reversed by opioid antagonists (see Bandler and Shipley 1994).

The mechanisms by which opioids modulate electrical excitability in PAG are summarized in Figure 1. These mechanisms provide a general explanation for the analgesic actions of  $\mu$ - and  $\kappa$ -opioid agonists in PAG, as well as the anti-opioid actions of N/OFQ.

### Postsynaptic Actions of Opioids in PAG

Opioid receptors, where expressed on the somatic membrane, inhibit electrical excitability of PAG neurons (see Williams et al. 2001 for review). Inhibition occurs via actions that are typical of the subfamily of inhibitory G-protein coupled receptors, to which all of the opioid receptors belong. Opioid agonists activate inhibitory G-proteins (predominantly  $G_i$ ) to simultaneously reduce currents through voltage-gated calcium channels, and enhance currents through inwardly rectifying potassium channels in PAG neurons. Both actions inhibit neuronal excitability. The principal calcium channels inhibited by opioids are the N- and **P/Q channels**, which play a major role in regulation of membrane excitability as well as neurotransmitter release. The potassium channel is probably a **GIRK** subtype that hyperpolarizes the membrane to reduce excitability. Opioid agonists also inhibit adenylyl cyclase in PAG. While this has little effect on excitability under basal conditions, it reduces currents through a protein kinase A dependent, non-selective cation channel that is activated when adenylyl cyclase and hence cAMP levels are elevated in the neuron. The latter mechanism of opioid action is also inhibitory.

Opioids display the actions described above only in a subpopulation of neurons in PAG. Actions mediated by  $\mu$ -receptors have been observed in brain slices and isolated neurons from rat PAG. Although  $\mu$ -agonists act on approximately 30% of all lateral and ventrolateral PAG neurons, only 14% of those in the ventrolateral PAG that project to the rostral ventromedial medulla are sensitive to  $\mu$ -agonists (Osborne et al. 1996). This observation supports the proposal (see Williams et al. 2001) that  $\mu$ -opioids act predominantly on GABAergic interneurons in PAG, and not on neurons that form part of the descending projection to the rostral ventromedial medulla.



**Opioid Electrophysiology in PAG, Figure 1** Cellular actions of opioids in PAG.

However, it should be noted that in the same study, 56% of descending projection neurons in the lateral PAG were sensitive to  $\mu$ -agonists, so the interpretation may only be true for the ventrolateral PAG which mediates opioid antinociception.

Almost all PAG neurons of the rat are inhibited via the same mechanisms described above by the ORL1 agonist, N/OFQ. By contrast, no electrophysiological effects of  $\kappa$ - or  $\delta$ -receptor agonists were observed in rat PAG, although both receptors are expressed in the region. Failure of  $\delta$ -receptors to affect membrane currents is probably due to their largely intracellular localisation (Commons 2003). Density of  $\kappa$ -receptors in rat PAG might not be sufficiently high to produce robust cellular physiological effects in rats. In mouse PAG, opioids act on  $\mu$ -,  $\delta$ - and  $\kappa$ -receptors in about 80%, 20%, and 20% of PAG neurons, respectively (Vaughan et al. 2003). It should be noted that  $\kappa$ - and  $\delta$ -receptor agonists produce physiological effects including antinociception when microinjected into rat PAG, although these are generally weaker than  $\mu$ -receptor actions. Failure to detect actions on membrane currents or synaptic transmission (see below) may, therefore, indicate that these cellular measures are not sufficiently sensitive to detect small effects on large populations of cells, or during specific physiological conditions such as stress, which induces translocation of  $\delta$ -receptors to the surface membrane in PAG (Commons 2003).

#### Presynaptic Actions of Opioids in PAG

Opioid receptors are also abundantly expressed on nerve terminals in PAG (Commons 2003). Opioids acting on  $\mu$ -receptors presynaptically inhibit both GABAergic

and glutamatergic synapses impinging on all PAG neurons, and the maximum inhibition is similar for both types of synapse (Vaughan et al. 1997b). Inhibition is due to a reduction in probability of transmitter release that reduces both electrically-evoked and spontaneous synaptic transmission in both terminal types. However, the intracellular mechanisms of opioid action differ between GABAergic and glutamatergic synapses. In glutamatergic synapses, the mechanisms coupling opioid receptors to reduced probability of quantal release of glutamate have not been resolved, with the exception of some dependence on inhibition of voltage-gated calcium channels under conditions of exaggerated calcium entry into the nerve terminal. In GABAergic nerve terminals, presynaptic inhibition is mediated by activation of a voltage-gated potassium channel, ( $\text{Kv}$ ) and that inhibition can be prevented by the  $\text{Kv}$  blockers, 4-aminopyridine and  $\alpha$ -dendrotoxin (Vaughan et al. 1997b). The mechanism that couples opioid receptors to the  $\text{Kv}$  channel involves activation of phospholipase  $\text{A}_2$  that mobilizes arachidonic acid, followed by formation of its metabolites via 12-lipoxygenase. Inhibitors of 5-lipoxygenase and cyclooxygenase potentiate presynaptic inhibition by opioids in PAG, presumably by shunting metabolism of arachidonic acid through the 5-lipoxygenase pathway. This process could provide one of the mechanisms of non-steroidal analgesia in the central nervous system. In addition to this mechanism,  $\mu$ -opioids inhibit GABAergic synapses in PAG via inhibition of voltage-gated calcium channels, under conditions of exaggerated calcium entry into the nerve terminal (CW Vaughan, unpublished observations).

Opioids acting on  $\kappa$ - and  $\delta$ -receptors do not produce presynaptic inhibition in rat PAG, and ORL1 agonists inhibit synaptic transmission in about 50% of recordings (Vaughan et al. 1997a). In mouse PAG,  $\mu$ -opioids inhibit GABAergic synapses in all neurons, while  $\kappa$ -receptor agonists do so in about 50% of neurons, and  $\delta$ -agonists are without effect.

### Functional Consequences of Cellular Actions of Opioids in PAG

Although opioids inhibit both inhibitory (GABAergic) and excitatory (glutamatergic) synapses, the dominant action is probably on GABAergic synapses, because there is a large GABAergic tone in PAG (Chieng and Christie 1994). This would explain observations (e.g. Behbehani et al. 1990) that  $\mu$ -opioids produce excitatory actions on PAG neurons under recording conditions that enhance GABAergic tone. Opioids also inhibit the soma of very few neurons in ventrolateral PAG that descend to the rostral ventromedial medulla, suggesting that the major effect of opioids is to disinhibit these output neurons. Disinhibition of descending output from the PAG *in vivo* is known to produce antinociception, so this is presumably the mechanism of action of  $\mu$ -opioids to produce analgesia in PAG. However, the actions of  $\mu$ -opioids on glutamatergic synapses, as well as descending projection neurons in the lateral PAG, still require explanation.

Stimulation of ORL1 receptors inhibits GABAergic and glutamatergic synapses in some PAG neurons, and might be expected to produce antinociception (Vaughan et al. 1997a). However, these receptors are also located on the cell bodies of all PAG neurons, including output neurons. Thus, any disinhibition produced presynaptically on output neurons would be expected to be blocked by the direct somatic inhibitory actions of N/OFQ on output neurons. This organisation of receptors would predict that ORL1 receptor stimulation in PAG would be expected to block the antinociceptive actions of opioids, which has been observed in microinjection studies (Morgan et al. 1997).

All of the major opioid receptor types are expressed in PAG neurons. The membrane actions are summarized below. Opioids couple to inhibition of voltage-gated calcium channels and activation of potassium channels via Gi-protein  $\beta\gamma$ -subunits in the membrane of PAG neurons and nerve terminals, although different potassium channels are involved in the soma (GIRK) and nerve terminal (Kv). Opioids inhibit both soma and nerve terminal excitability of intrinsic (presumably GABAergic) neurons, but not neurons that project the rostral ventromedial medulla. This disinhibits these output neurons to produce antinociception. The exception is the ORL1 receptor, which directly inhibits the output neurons to block opioid antinociception.

### References

1. Bandler R, Shipley MT (1994) Columnar Organization in the Midbrain Periaqueductal Gray: Modules for Emotional Expression? *Trends Neurosci* 17:379–389
2. Behbehani MM, Jiang M, Chandler SD (1990) The Effect of [Met]enkephalin on the Periaqueductal Gray Neurons of the Rat: An *In Vitro* Study. *Neuroscience* 38:373–80
3. Chieng B, Christie MJ (1994) Inhibition by Opioids Acting on  $\mu$ -Receptors of GABAergic and Glutamatergic Postsynaptic Potentials in Single Rat Periaqueductal Gray Neurons *In Vitro*. *Br J Pharmacol* 113:303–9
4. Commons KG (2003) Translocation of Presynaptic Delta Opioid Receptors in the Ventrolateral Periaqueductal Gray after Swim Stress. *J Comp Neurol* 464:197–203
5. Fallon JH, Leslie FM (1986) Distribution of Dynorphin and Enkephalin Peptides in the Rat Brain. *J Comp Neurol* 249:293–336
6. Jensen TS, Yaksh TL (1986) Comparison of Antinociceptive Action of Morphine in the Periaqueductal Gray, Medial and Paramedial Medulla in Rat. *Brain Res* 36:99–113
7. Mansour A, Fox CA, Akil H, Watson SJ (1995) Opioid-Receptor mRNA Expression in the Rat CNS: Anatomical and Functional Implications. *Trends Neurosci* 18:22–9
8. Morgan MM, Grisel JE, Robbins CS, Grandy DK (1997) Antinociception Mediated by the Periaqueductal Gray is Attenuated by Orphanin FQ. *Neuroreport* 8:3431–4
9. Osborne PB, Vaughan CW, Wilson HI, Christie MJ (1996) Opioid Inhibition of Rat Periaqueductal Gray Neurons with Identified Projections to Rostral Ventromedial Medulla *In Vitro*. *J Physiol* 490:383–9
10. Ossipov MH, Kovelowski CJ, Nichols ML, Hruby VJ, Porreca F (1995) Characterization of Supraspinal Antinociceptive Actions of Opioid Delta Agonists in the Rat. *Pain* 62:287–93
11. Vaughan CW, Ingram SL, Christie MJ (1997a) Actions of the ORL1 Receptor Ligand Nociception on Membrane Properties of Rat Periaqueductal Gray Neurons *In Vitro*. *J Neurosci* 17:996–1003
12. Vaughan CW, Ingram SL, Connor MA, Christie MJ (1997b) How Opioids Inhibit GABA-Mediated Neurotransmission. *Nature* 390:611–614
13. Vaughan CW, Bagley EE, Drew GM, Schuller A, Pintar JE, Hack SP, Christie MJ (2003) Cellular Actions of Opioids on Periaqueductal Gray Neurons from C57B16/J Mice and Mutant Mice Lacking MOR-1. *Br J Pharmacol* 139:362–367
14. Williams JT, Christie MJ, Manzoni O (2001) Cellular and Synaptic Adaptations Mediating Opioid Dependence. *Physiol Rev* 81:299–343

## Opioid Hyperexcitability

### Definition

Opioid hyperexcitability is a syndrome that includes whole body hyperalgesia and allodynia, abdominal muscle spasms and symmetrical jerking of legs; methadone is preferred.

► Postoperative Pain, Opioids

## Opioid Hypoalgesia

► Opioids, Effects of Systemic Morphine on Evoked Pain



## Opioid-Induced Analgesia

### Definition

Analgesia produced by administration of opioids.  
 ▶ Forebrain Modulation of the Periaqueductal Gray

## Opioid-Induced Bowel Dysfunction

▶ Cancer Pain Management, Gastrointestinal Dysfunction as Opioid Side Effects

## Opioid-Induced Neurotoxicity

### Definition

A syndrome of neuropsychiatric consequences of opioid administration. The features of OIN include cognitive impairment, severe sedation, hallucinosis, delirium, myoclonus, seizures, hyperalgesia, and allodynia.  
 ▶ Cancer Pain Management, Opioid Side Effects, Cognitive Dysfunction

## Opioid-Induced Release of CCK

CARL-OLAV STILLER  
 Division of Clinical Pharmacology and Department of Medicine, Karolinska University Hospital, Stockholm, Sweden  
 carl-olav.stiller@ki.se

### Synonyms

Neuronal Release; increased extracellular levels; release of CCK

### Definition

Cholecystokinin (CCK) was first identified as a gastrointestinal hormone, contracting the gallbladder and stimulating the secretion of the exocrine pancreas (Jorpes and Mutt 1966). CCK (or gastrin-like immunoreactivity) was demonstrated in the CNS (Vanderhaeghen et al 1975). The predominant form of CCK in gastrointestinal tissue is CCK-33, whereas the predominant form in the CNS is the sulphated CCK-8 (Rehfeld 1978). "Release of CCK" refers to neuronal release. However, a direct measurement of synaptic release of CCK in nervous tissue has so far not been possible. Instead, information on release has to be obtained by indirect measures. This assay is based on *in vivo* microdialysis (▶ *In vivo* CCK release by microdialysis), *in vitro* release (▶ *In vitro* CCK release) and receptor ▶ binding studies. Studies of the behavioral effects of

CCK-antagonists in combination with opioids are not addressed here.

### Characteristics

#### In Vitro Release Studies

The effect of opioids on CCK-like immunoreactivity (CCK-LI) release *in vitro* may seem confusing, since not only inhibition (Table 1), but also potentiation (Table 2) or a biphasic effect (Table 3) on potassium induced release have been reported.

Even though an opioid induced inhibition of potassium induced release of CCK in tissue sections may seem to be a good indicator for the drug effect *in vivo*, it has to be kept in mind that potassium stimulation induces a depolarization of both inhibitory and excitatory neurons. Thus, the interpretation of inhibited potassium induced release by opioids is difficult.

#### In Vivo Release Studies

With regard to clinical relevance, an *in vivo* situation, preferably using awake animals, may seem more appropriate. Furthermore, studies on the effect of opioids on CCK release should focus on the basal non-stimulated release.

Systemic administration of morphine, at doses ranging from 2.5 mg/kg to 10 mg/kg, have been demonstrated to induce an increased outflow of CCK-LI in the frontal cortex (Becker et al. 1999), the nucleus accumbens (Hamilton et al. 2000), and the dorsal horn of the spinal cord in the rat *in vivo* (de Araujo Lucas et al. 1998; Gustafsson et al. 1999).

#### Opioid Receptors Mediating CCK – LI Release

In order to determine which opioid receptor mediates CCK-LI release *in vivo*, the effect of different opioid antagonists on morphine induced release has been studied (Table 4).

δ-opioid antagonists blocked the CCK-LI release of morphine, and δ-opioid agonists mimicked the CCK-LI releasing effect of morphine. A delta mediated inhibition of CCK-LI release is also supported by some *in vitro* experiments (Table 2).

With regard to the effect of μ-opioid receptor activation on CCK-LI release, this opioid receptor does not seem to induce CCK-LI release. The *in vitro* data indicate an inhibitory effect on the potassium evoked release (Table 1). We could not demonstrate an increased non-stimulated CCK-LI level in the dorsal horn *in vivo* during local (1 μM in the microdialysis perfusion medium) or systemic (1 mg/kg s.c.) administration of the selective μ-opioid receptor agonist DAMGO (Gustafsson et al. 2001). However, since the basal CCK-LI level in the microdialysate was close to the detection limit of the RIA, the possibility of μ-opioid receptor mediated inhibition of CCK-release should not be excluded.

**Opioid-Induced Release of CCK, Table 1** Opioid induced inhibition of potassium induced release of CCK-LI *in vitro*

Region (species)	Opioid agonist	Agonist concentration in perfusate [M]	Effect reversed by antagonist	Reference
Hypothalamus (cat/rat)	Non selective: Morphine	$10^{-11}$ – $10^{-8}$ + $10^{-5}$	Non selective: Naloxone	(Micevych et al. 1982, 1984, 1985)
	$\delta$ -opioid agonist: DADL	$10^{-12}$ – $10^{-10}$	Non selective: Naloxone	
Substantia nigra (rat)	$\mu$ -opioid agonist:			(Benoliel et al. 1992)
	DAGO	$10^{-5}$	Non selective: Naloxone	
	Morphiceptin (PL017)	$10^{-5}$	Non selective: Naloxone	
Dorsal lumbar spinal cord (rat)	$\mu$ -opioid agonist: DAGO	$10^{-8}$ – $10^{-5}$	Non selective: Naloxone	(Benoliel et al. 1994)

**Opioid-Induced Release of CCK, Table 2** Opioid induced potentiation of potassium induced release of CCK-LI *in vitro*

Region (species)	Opioid agonist	Agonist concentration in perfusate [M]	Effect reversed by antagonist	Reference
Substantia nigra (rat)	$\delta$ -agonist:			(Benoliel et al. 1992)
	D-Pen2, D-Pen5-enkephalin	$5 \times 10^{-5}$		
	Tyr-D-Thr-Gly-Phe-Leu-Thr (DTLET)	$3 \times 10^{-6}$	$\delta$ -antagonist: ICI-154129	
Dorsal lumbar spinal cord (rat)	Non-selective: Morphine	$10^{-5}$		(Benoliel et al. 1991)

**Opioid-Induced Release of CCK, Table 3** Biphasic effect of opioids on potassium induced release of CCK-LI *in vitro*

Region (species)	Opioid agonist	Agonist concentration for inhibition [M]	Agonist concentration for excitation [M]	Antagonist for reversal of effect	Reference
Dorsal lumbar spinal cord (rat)	$\delta$ -agonist: DTLET	$10^{-8}$ – $3 \times 10^{-6}$	$10^{-5}$	$\delta$ -antagonist: Naltrindole ICI 154129	(Benoliel et al. 1991, 1994)
	Non-selective: Morphine	$10^{-8}$ – $10^{-7}$	$10^{-5}$	Inhibition: Naloxone Excitation: Naltrindole ICI 154129	

**Opioid-Induced Release of CCK, Table 4** Reversal of opioid induced *in vivo* release of CCK-LI by opioid antagonists

Region (species)	Opioid agonist (dose)	Effect reversed by antagonist	Effect not affected by	Reference
Frontal cortex (rat)	Non-selective: Morphine (10 mg/kg i.p.)	Non-selective: Naloxone (1.5 mg/kg i.p.) (10 $\mu$ M)	$\mu$ -antagonist: CTOP (10 $\mu$ M)	(Becker et al. 1999)
		$\delta$ -antagonist: Naltrindole: 10 $\mu$ M	$\kappa$ -antagonist: nor-BNI: 10 $\mu$ M	
		$\delta_2$ -antagonist: Naltriben: 10 $\mu$ M	$\delta_1$ -antagonist: BNTX: 10 $\mu$ M	
Dorsal lumbar spinal cord (rat)	Non-selective: Morphine (5 mg/kg s.c.)	Non-selective: Naloxone: 2 mg/kg s.c. ; 10 $\mu$ M	$\mu$ -antagonist: CTOP: 10 $\mu$ M	(Gustafsson et al. 1999, 2001)
		$\delta$ -antagonist: Naltrindole: 10 $\mu$ M	$\kappa$ -antagonist: nor-BNI: 10 $\mu$ M	
		$\delta$ -agonist: BW373U86 (1 mg/kg s.c.)	$\delta$ -antagonist: Naltrindole; 10 $\mu$ M	
	$\delta_2$ -agonist: [D-Ala <sup>2</sup> ] deltorphin II (1 $\mu$ M)			

An indirect indication of  $\delta$ -opioid receptor mediated release of CCK is also provided by a receptor binding study with a selective CCK-B radioligand (Ruiz-Gayo et al. 1992). Following an intracerebroventricular (ICV) injection of the  $\delta$ -opioid receptor agonist BUBUC, but not the  $\mu$ -opioid receptor agonist DAMGO, the specific binding of the CCK-B radioligand decreased. According to the author's interpretation, an endogenous release of CCK competes with the radioligand for the receptor and decreases the specific binding.

The combined experimental evidence indicates that agonist activation of  $\delta$ -opioid receptors, probably of the  $\delta_2$ -opioid receptor subtype, induces release of CCK. A decrease of CCK-release by opioids is only reported in conditions of potassium stimulation.

### Mechanisms of Opioid-Induced Release of CCK-LI

The exact mechanisms responsible for the opioid induced release of CCK-LI have not been determined so far. The morphine-induced release of CCK-LI is calcium dependent, indicating a neuronal origin. Furthermore, we have demonstrated that an influx of calcium at presynaptic terminals, through voltage-dependent calcium channels (VDCCs) of the L- and N-type, is essential for morphine-induced release of CCK-LI in the dorsal horn (Gustafsson et al. 1999).

Since opioid-receptor activation normally induces inhibition of neuronal activity and reduces transmitter release, a disinhibition of local inhibitory neurons (i.e. GABA-neurons), a mechanism which has been demonstrated in the periaqueductal gray *in vivo* (Stiller et al. 1996), could be an alternative. However, no evidence for this mechanism in the dorsal horn has been provided so far. Furthermore, we could not demonstrate that perfusion of the dialysis probe with the GABA-A antagonist bicuculline (100  $\mu$ M in the perfusion medium) increased the extracellular levels of CCK-LI in the spinal cord (Gustafsson 2001). An opioid mediated disinhibition of other inhibitory neurotransmitters (e.g. glycine) could still be an option.

However, opioid receptor activation may not only mediate an inhibition, but also excitation (for review see Crain and Shen 1990). If  $\delta$ -opioid receptors are present in CCK-containing nerve cells in the dorsal horn, a direct activation of  $\delta$ -opioid receptors should release CCK-LI in this region. Such a mechanism should be insensitive to the sodium channel blocking agent tetrodotoxin (TTX). However, TTX inhibited the morphine induced CCK-LI release (Gustafsson et al. 1999), suggesting that a local propagation of action potentials in the dorsal horn seems to be a prerequisite for the opioid induced release of CCK. It is possible that the opioid induced CCK-LI release involves several neurons.

An opioid induced release of excitatory amino acids, which in turn stimulate the release of CCK, is indicated by the observation that administration of NMDA or AMPA antagonists prevents the morphine-induced re-

lease of CCK-LI in the dorsal horn (Gustafsson 2001). In addition, spinal morphine (100  $\mu$ M in the perfusion fluid) induced a several fold increase of the extracellular glutamate concentration in the dorsal horn *in vivo* (Gustafsson 2001).

### References

1. Becker C, Hamon M, Cesselin F, Benoliel JJ (1999) Delta(2)-Opioid Receptor Mediation of Morphine-Induced CCK Release in the Frontal Cortex of the Freely Moving Rat. *Synapse* 34:47–54
2. Benoliel JJ, Bourgoin S, Mauborgne A, Legrand JC, Hamon M, Cesselin F (1991) Differential Inhibitory/Stimulatory Modulation of Spinal CCK Release by mu and delta Opioid Agonists, and Selective Blockade of mu-Dependent Inhibition by Kappa Receptor Stimulation. *Neurosci Lett* 124:204–207
3. Benoliel JJ, Collin E, Mauborgne A, Bourgoin S, Legrand JC, Hamon M, Cesselin F (1994) Mu and delta Opioid Receptors Mediate Opposite Modulations by Morphine of the Spinal Release of Cholecystokinin-Like Material. *Brain Res* 653:81–91
4. Benoliel JJ, Mauborgne A, Bourgoin S, Legrand JC, Hamon M, Cesselin F (1992) Opioid Control of the *In Vitro* Release of Cholecystokinin-Like Material from the Rat Substantia Nigra. *J Neurochem* 58:916–922
5. Crain SM, Shen KF (1990) Opioids Can Evoke Direct Receptor-Mediated Excitatory Effects on Sensory Neurons. *Trends Pharmacol Sci* 11:77–81
6. de Araujo Lucas G, Alster P, Brodin E, Wiesenfeld-Hallin Z (1998) Differential Release of Cholecystokinin by Morphine in Rat Spinal Cord. *Neurosci Lett* 245:13–16
7. Gustafsson H (2001), Opioid-Induced Cholecystokinin Release in the CNS-Neurochemical Mechanisms and Effects of Sciatic Nerve Lesion; PhD thesis, Karolinska Institutet; ISBN 91-628-4440-7
8. Gustafsson H, Afrah A, Brodin E, Stiller CO (1999) Pharmacological Characterization of Morphine-Induced *In Vivo* Release of Cholecystokinin in Rat Dorsal Horn: Effects of Ion Channel Blockers. *J Neurochem* 73:1145–1154
9. Gustafsson H, Afrah AW, Stiller CO (2001) Morphine-Induced *In Vivo* Release of Spinal Cholecystokinin is Mediated by delta-Opioid Receptors-Effect of Peripheral Axotomy. *J Neurochem* 78:55–63
10. Hamilton ME, Redondo JL, Freeman AS (2000) Overflow of Dopamine and Cholecystokinin in Rat Nucleus Accumbens in Response to Acute Drug Administration. *Synapse* 38:238–242
11. Jorpes E, Mutt V (1966) Cholecystokinin and pancreozymin, one single hormone? *Acta Physiol Scand* 66:196–202
12. Micevych PE, Yaksh TL, Go VL (1982) Opiate-Mediated Inhibition of the Release of Cholecystokinin and Substance P, but not Neurotensin from Cat Hypothalamic Slices. *Brain Res* 250:283–289
13. Micevych PE, Yaksh TL, Go VL (1984) Studies on the Opiate Receptor-Mediated Inhibition of  $K^+$ -Stimulated Cholecystokinin and Substance P Release from Cat Hypothalamus *In Vitro*. *Brain Res* 290:87–94
14. Micevych PE, Yaksh TL, Go VW, Finkelstein JA (1985) Effect of Opiates on the Release of Cholecystokinin from *In Vitro* Hypothalamus and Frontal Cortex of Zucker Lean (Fa<sup>-</sup>) and Obese (fa/fa) Rats. *Brain Res* 337:382–385
15. Rehfeld JF (1978) Localisation of gastrins to neuro- and adeno-hypophysis. *Nature* 271:771–773
16. Ruiz-Gayo M, Durieux C, Fournié-Zaluski MC, Roques BP (1992) Stimulation of delta-Opioid Receptors Reduces the *In Vivo* Binding of the Cholecystokinin (CCK)-B-Selective Agonist [<sup>3</sup>H]pBC 264: Evidence for a Physiological Regulation of CCKergic Systems by Endogenous Enkephalins. *J Neurochem* 59:1805–1811
17. Stiller CO, Bergquist J, Beck O, Ekman R, Brodin E (1996) Local Administration of Morphine Decreases the Extracellular Level of GABA in the Periaqueductal Gray Matter of Freely Moving Rats. *Neurosci Lett* 209:165–168

18. Vanderhaeghen JJ, Signeau JC, Gepts W (1975) New peptide in the vertebrate CNS reacting with antigestrin antibodies. *Nature* 257:604–605

## Opioid Modulation by Cytokines

### ► Cytokine Modulation of Opioid Action

## Opioid Modulation of Nociceptive Afferents In Vivo

DAVID C. YEOMANS<sup>1</sup>, ALEXANDER TZABAZIS<sup>2</sup>

<sup>1</sup>Department of Anesthesia, Stanford University, Stanford, CA, USA

<sup>2</sup>Department of Anesthesia, University of Erlangen, Erlangen, Germany  
dcyeomans@stanford.edu, tzabazis@web.de

### Synonyms

Opioid therapy for primary afferents; first order sensory neurons

### Definition

Modulation of primary afferents by endogenous or exogenous opioids. Primary afferents are sensory neurons with one peripheral process innervating a peripheral tissue area (► [receptive field](#)), and one central process that enters the dorsal horn of the spinal cord via a dorsal root. The cell bodies of primary afferents are located in the ► [dorsal root ganglia](#) (DRG) or trigeminal ganglia (TG). Opioid targets are either receptors on pre- or postsynaptic membranes of central terminals in the dorsal horn, and/or peripheral opioid receptors on nociceptive endings in the innervated tissue. Modulation can be achieved by systemic or local application of drugs (agonists or antagonists) or gene therapy (de novo or altered expression of an “antinociceptive” gene or knockdown of a “pronociceptive” gene).

### Characteristics

#### Physiology of the spinal and peripheral opioid system

In 1976, Yaksh and Rudy discovered that spinally administered opioids could produce analgesia. Due to reduced side effects, this new route of administration for opioids became the gold standard for relief of severe pain. Antinociceptive effects of spinally applied opioids are predominantly mediated by pre- and/or postsynaptic  $\mu$ -opioid receptors, ►  [\$\delta\$ -opioid receptors](#) and ►  [\$\kappa\$ -opioid receptors](#), mainly in laminae 1 and 2 (Rexed) of the dorsal horn of the spinal cord. Methionine (met-) and leucine (leu)-enkephalin, ► [Beta\( \$\beta\$ \)-Endorphin](#), ► [dynorphin](#),  $\alpha$ -neoendorphin and ► [endomorphin I and II](#) are all endogenous opioids with different affinities for the different opioid

receptor subtypes. The preferential endogenous ligand for  $\mu$ -opioid receptors are  $\beta$ -endorphin and endomorphin I and II. Enkephalins favour  $\delta$ -, and dynorphins have the highest affinity for  $\kappa$ -opioid receptors. However, one should keep in mind that receptor affinity depends on the type of fragment that is released by the enzymatic cleavage from the precursor, which again depends on the tissue where this process has taken place (Zaki et al. 1996; Wall and Melzack 1999).

Opioid receptors can also be found on peripheral nociceptive endings (Fields et al. 1980). These receptors are upregulated by peripheral inflammation, which enhances the potency of endogenous and exogenous opioids. The appearance of opioid receptors within minutes to hours after onset of inflammation suggests their pre-existence, although they cannot be readily detected in uninjured tissue. A possible explanation for this sudden availability of opioid receptors on nociceptive terminals, might be an unblocking of the perineurium at a very early stage of inflammation within 12 hours (Antonijevic et al. 1995), and/or at a later time point by sprouting of the terminals.

Studies in knockout mice reveal different contributions of opioid receptors and endogenous opioids in mediating nociceptive behaviour (Table 1) (Kieffer and Gaveriaux-Ruff 2002). Activation of the  $\mu$ -opioid receptor induces both desirable analgesic effects, as well as undesirable effects of exogenous opioids like respiratory depression and constipation, making this receptor a difficult but widely used therapeutic target for systemic drug treatment.

Opioid receptors are ► [Type-II Receptors](#), i.e. their action is carried forward by a second messenger G-protein. Stimulation of presynaptic  $\mu$ - and  $\delta$ -receptors is associated with a reduction in calcium influx ( $\text{Ca}^{2+}$ ) leading to a hyperpolarization of the terminal, and a reduced release of neurotransmitters such as ► [glutamate](#), and ► [neuropeptides](#) such as ► [substance P](#). Activated postsynaptic opioid receptors stabilize membrane potentials by enhancing the outward flow of potassium ( $\text{K}^+$ ), and decreasing the amplitude of excitatory postsynaptic potentials.

Intrathecal administered pertussis toxin (PTX) produces thermal hyperalgesia and allodynia in mice (Womer et al. 1997) by inactivation of the inhibitory  $\text{G}_i$  and  $\text{G}_o$  proteins that are involved in the intracellular signalling process. This disinhibition leads to a predominance of excitation, ► [wind-up](#), and reduces the analgesic potency of many  $\mu$ -agonists, like morphine and DAMGO. Antinociception mediated by mixed  $\mu$ -agonists/antagonists like buprenorphine, however, is less affected. The effectiveness of buprenorphine as opposed to other exogenous  $\mu$ -agonists, even after intrathecal PTX, indicates that the mechanism of action of buprenorphine does not entirely depend on PTX-sensitive, intracellular signalling pathways,



**Opioid Modulation of Nociceptive Afferents In Vivo, Table 1** Changes in nociception as observed in different knockout mice (Kieffer and Gavériaux-Ruff 2002)

Pain/ hyperalgesia	MOR <sup>-/-</sup>	DOR <sup>-/-</sup>	KOR <sup>-/-</sup>	β end <sup>-</sup>	Penk <sup>-</sup>	Pdyn <sup>-</sup>
thermal	↑	↔	↔	↔	↑	↑
mechanical	↔	↔	↔	n/a	n/a	↔
chemical	↓	n/a	↑	n/a	↓	↔
inflammatory	shorter duration of hyperalgesia	n/a	n/a	n/a	n/a	n/a
neuropathic	n/a	n/a	n/a	n/a	n/a	shorter duration of hyperalgesia

Abbreviations: MOR, μ-opioid receptor; DOR, δ-opioid receptor; KOR, κ-opioid receptor; βend, β-endorphin; Penk, preproenkephalin; Pdyn, prodynorphin.

which might explain its special role in the treatment of ► **neuropathic pain** (McCormack et al. 1998).

### Modulation of central projections

As with endogenous opioids, intrathecally applied exogenous opioids also have different affinities for different opioid receptors (Table 2). Whereas κ-agonists do not attenuate either Aδ- or C-thermonociceptor-mediated responses, μ-, δ1- and δ2-opioid agonists are effective on both. DPDPE (δ1-selective agonist) showed parallel dose-response curves for Aδ- and C-mediated antinociception, indicating similar mechanisms of action. On the other hand, μ-agonists (DAMGO and morphine) and a δ2-selective agonist (DSLET) produced non-parallel dose-response curves, indicating that the mechanisms by which these drugs act are different for the two types of nociception. Specifically, μ- and δ2-agonists seem to act presynaptically on C-fiber afferent terminals, but they attenuate responses to Aδ-mediated nociception on dorsal horn neurones, i.e. postsynaptically (Lu et al. 1997). It has recently been shown (Jones et al. 2003) that knockdown of μ-opioid receptors in primary afferents, by way of a recombinant herpes vector, attenuates the potency of μ-receptor-selective agonists for C-, but not for Aδ-fibers. These findings support the observations of Lu et al., as herpes viruses usually do not jump synapses, i.e. they act on primary afferents only

(Lu et al. 1997). Consistent with these results are the observations of Taddese et al., that activation of the μ-opioid receptor inhibited presynaptic calcium channels preferentially on small nociceptors, but had minimal effects on larger nociceptors, whereas ► **somatostatin** had the opposite effects (Taddese et al. 1995).

Several groups (Wilson et al. 1999; Bras et al. 2001; Wilson and Yeomans 2002; Glorioso et al. 2003) have used herpes virus-based vectors for delivery of transgenes to the nervous system. The natural properties of the herpes simplex virus to enter dorsal root ganglia via peripheral infection, and to become latent there, allows a phenotypic alteration of the first cell in the pathway of nociception. Pain therapy, based on this technology, should minimize adverse side effects of opioids like constipation or respiratory depression. Delivery of a transgene-encoding opioid peptide precursor (human preproenkephalin) leads to synthesis of enkephalin peptides in sensory neurons in mice (Figure 1) (Wilson et al. 1999). Baseline withdrawal latencies to noxious radiant heat were similar in animals infected with proenkephalin-encoding and control viruses. However, after sensitization of C-fibers with ► **capsaicin** and Aδ-fibers with ► **dimethylsulfoxide** (DMSO), thermal hyperalgesia was reduced or eliminated in mice infected with proenkephalin-encoding virus for at least 7 weeks.

0

**Opioid Modulation of Nociceptive Afferents In Vivo, Table 2** Antinociceptive potency of exogenous opioids on Aδ- and C-fiber mediated behavior in the paw withdrawal test. Parallel dose-response curves indicate similar mechanisms of action, which allows comparison of potencies on Aδ- and C-mediated analgesia

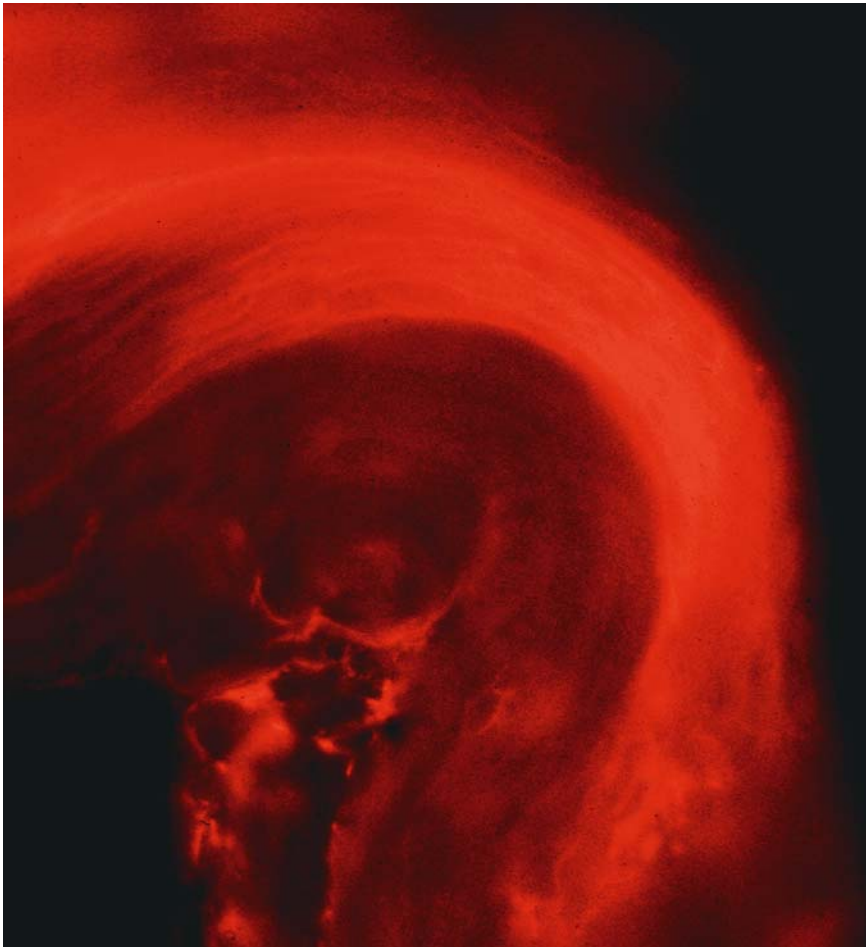
Substance	A δ	C	dose-response curves
Morphine (μ-agonist)	++*	++*	non-parallel
DAMGO (μ-agonist)	+++*	+++*	non-parallel
DPDPE (δ1-agonist)	+*	++*	parallel
DSLET (δ2-agonist)	+*	+*	non-parallel
U50488 (κ-agonist)	0	0	-

\* indicates reversibility by μ-, δ1- and δ2-antagonists, respectively

### Modulation of nociceptive terminals

Peripheral localized administration of endogenous and exogenous opioids have been shown to mediate antinociception in models of inflammatory and neuropathic pain (Stein et al. 2003). For example, intra-articular application of morphine during knee surgery, with a dose that does not lead to systemic effects, produced a significant, naloxone-reversible and long lasting analgesic effect (Stein 1995).

Similarly, after infection of primary afferents with a viral vector encoding for preproenkephalin A (HSVLatEnk1), the majority of met-enkephalin-like material accumulated at the proximal side of the ligatured sciatic nerve, while much less was seen in ligatured L4-L5 roots (Bras et al. 2001). In HSVLatEnk1-infected animals



**Opioid Modulation of Nociceptive Afferents In Vivo, Figure 1** Human pro-enkephalin immunofluorescence in primary afferent fibers of mouse dorsal root 6 weeks after application of a human preproenkephalin-encoding herpes vector to the skin.

without sciatic nerve ligation, subcutaneous microdialysis showed significantly higher basal levels of met-enkephalin-like material in the interstitial fluid of the hindpaw, indicating that overexpressed peptides have reached a releasable compartment. Electrical stimulation of the sciatic nerve revealed an approximately three-fold higher overflow of met-enkephalin-like material in HSVLatEnk1-infected rats as compared to control rats. These data suggest that overexpression of antinociceptive genes like preproenkephalin in primary afferents leads to a combined analgesic effect, i.e. effects on nociceptive terminals and central projections. Expression and release of opioid peptides are also very likely to be induced by hormones (e.g. corticotropin-releasing hormone, CRH) and cytokines (Interleukin 1, IL-1) in ► **immune cells** (B and T lymphocytes, macrophages, and monocytes) (Stein et al. 2003). The released endogenous opioids from immune cells can interact with peripheral receptors on nociceptive terminals. As many painful conditions are accompanied or sustained by inflammatory processes, inducing overexpression of endogenous opioids in immune cells could provide a promising therapeutic approach to the treatment of pain.

## References

1. Antonijevic I, Mousa SA, Schäfer M, Stein C (1995) Perineurial Defect and Peripheral Opioid Analgesia in Inflammation. *J Neurosci* 15:165–172
2. Bras J-MA, Becker C, Bourgoin S, Lombard M-C, Cesselin F, Hamon N, Pohl M (2001) Met-Enkephalin is Preferentially Transported into the Peripheral Processes of Primary Afferent Fibres in Both Control and HSV1-Driven Proenkephalin A Overexpressing Rats. *Neurosci* 103:1073–1083
3. Fields HL, Emson PC, Leigh BK, Gilbert RFT, Iversen LL (1980) Multiple Opiate Receptor Sites on Primary Afferent Fibers. *Nature* 284:351–353
4. Glorioso JC, Mata M, Fink DJ (2003) Exploiting the Neurotherapeutic Potential of Peptides: Targeted Delivery using HSV Vectors. *Expert Opin Biol Ther* 3:1233–1239
5. Jones TL, Sweitzer SM, Wilson SP, Yeomans DC (2003) Afferent Fiber-Selective Shift in Opiate Potency following Targeted Opioid Receptor Knockdown. *Pain* 106:365–371
6. Kieffer BL, Gaveriaux-Ruff C (2002) Exploring the Opioid System by Gene Knockout. *Prog Neurobiol* 66:285–306
7. Lu Y, Pirec V, Yeomans DC (1997) Differential Antinociceptive Effects of Spinal Opioids on Foot Withdrawal Responses Evoked by C Fibre or A Delta Nociceptor Activation. *Br J Pharmacol* 121:1210–1216
8. McCormack K, Prather P, Chapleo C (1998) Some New Insights into the Effects of Opioids in Phasic and Tonic Nociceptive Tests. *Pain* 78:79–98
9. Stein C (1995) The Control of Pain in Peripheral Tissue by Opioids. *N Eng J Med* 332:1685–1690

10. Stein C, Schäfer M, Machelska H (2003) Attacking Pain at its Source: New Perspectives on Opioids. *Nat Med* 9:1003–1008
11. Taddese A, Nah S-Y, McCleskey EW (1995) Selective Opioid Inhibition of Small Nociceptive Neurons. *Science* 270:1366–1369
12. Wall PD, Melzack R (1999) *Textbook of Pain*. WB Saunders, Philadelphia
13. Wilson SP, Yeomans DC (2002) Virally Mediated Delivery of Enkephalin and Other Neuropeptide Transgenes in Experimental Pain Models. *Ann NY Acad Sci* 917:515–521
14. Wilson SP, Yeomans DC, Bender MA, Lu Y, Goins WF, Glorioso JC (1999) Antihyperalgesic Effects of Infection with a Preproenkephalin-Encoding Herpes Virus. *Proc Natl Acad Sci USA* 96:3211–3216
15. Womer DE, DeLapp NW, Shannon HE (1997) Intrathecal Pertussis Toxin Produces Hyperalgesia and Allodynia in Mice. *Pain* 70:223–228
16. Zaki PA, Bilsky EJ, Vanderah TW, Lai J, Evans CJ, Porecca F (1996) Opioid Receptor Types and Subtypes: The Delta Receptor as a Model. *Annu Rev Pharmacol Toxicol* 36:379–401

## Opioid Peptide

### Definition

The endogenous opioid ligands consist of four peptide families. Three are derived from the known precursors proopiomelanocortin (POMC; encoding  $\beta$ -endorphin), proenkephalin (encoding Met-enkephalin and Leu-enkephalin) and prodynorphin (encoding dynorphins). These peptides contain the common Tyr-Gly-Gly-Phe-[Met/Leu] sequence at their amino terminals, known as the opioid motif.  $\beta$ -Endorphin and the enkephalins are potent antinociceptive agents acting at  $\mu$  and  $\delta$  receptors. Dynorphins can elicit both pro- and antinociceptive effects via  $\kappa$ -opioid and/or NMDA receptors. A fourth group of tetrapeptides termed endomorphins (with yet unknown precursors) do not contain the pan-opioid motif, but they bind to  $\mu$ -receptors with high selectivity. Opioid peptides are expressed throughout the central and peripheral nervous system, in neuroendocrine tissues, and in immune cells

- ▶ [Opioids in the Periphery and Analgesia](#)
- ▶ [Opioid Peptide Co-Localization and Release](#)
- ▶ [Opioid Peptides from the Amphibian Skin](#)
- ▶ [Opioid Receptors at Postsynaptic Sites](#)
- ▶ [Stimulation-Produced Analgesia](#)

## Opioid Peptide Co-Localization and Release

SARAH V. HOLDRIDGE, NOUFISSA KABLI,  
CATHERINE M. CAHILL  
Department of Pharmacology and Toxicology, Queen's  
University, Kingston, ON, Canada  
cahillc@post.queensu.ca

### Synonyms

Opioid; opiate; narcotic; Opioid Peptide Release

### Definition

Opioid peptides are a family of neuropeptides processed from three large precursor proteins known as proopiomelanocortin, preproenkephalin and preprodynorphin. The gene products, ▶ [beta-endorphin](#) (END), ▶ [enkephalin](#) (ENK), and ▶ [dynorphin](#) (DYN), share a common N-terminal sequence (Tyr-Gly-Gly-Phe-Leu/Met), which interacts with ▶ [Mu\( \$\mu\$ \)-Opioid Receptor](#), ▶ [delta-opioid receptors](#) and ▶ [kappa-opioid receptors](#) (OR) with varying, but relatively non-selective, binding affinities for the different receptor types. The subsequent discovery of a novel group of peptides, the ▶ [endomorphins](#) (▶ [endomorphin-1](#) and ▶ [-2](#)), has expanded the opioid peptide family. The endomorphins are unique within the opioid peptide family as they possess an atypical peptide sequence, and a very high selectivity for the  $\mu$ -OR. A further opioid-like 17-amino-acid peptide that resembles DYN, named '▶ [orphanin FQ](#)' or '▶ [Nociceptin](#)', was also described in recent years and acts at opioid receptor-like (ORL-1) receptors.

### Characteristics

The discovery of various endogenous opioid peptides, their anatomical distribution, and the characteristics of the multiple receptors with which they interact, has enhanced our understanding of the role of opioid peptide systems, including their integration in neural circuits that modulate the cognitive and affective aspects of the pain experience (for review see Przewlocki and Przewlocka (2001) and citations therein).

### Localization and Co-expression

Opioid peptides have distinct but overlapping distribution in the central nervous system (CNS) (Mansour et al. 1988). Nociceptin/orphanin FQ and the opioid peptides show overlapping distributions, but not co-localization, in pain-modulatory brain regions (Schulz et al. 1996). Immunohistochemical labeling revealed a similar pattern of nerve fiber and terminal labeling within the spinal cord dorsal horn, sensory trigeminal complex, raphe nuclei, locus coeruleus, periaqueductal gray, amygdala, and hypothalamic region reflecting their potential role in many major processes including perception of pain, autonomic, neuroendocrine, homeostatic functions, and affective states. However, while the distributions are similar, critical evaluation of immunopositive labeling via confocal microscopy showed no instances of co-localization of nociceptin and opioid peptides in any of the spinal or brain regions examined (Schulz et al. 1996). Similarly, Martin-Schild and colleagues reported that although often present in the same brain nuclei, endomorphin-1 and -2-immunopositive neuronal elements were not identically distributed in the CNS (Martin-Schild et al. 1999).

While reports from rodent and primate studies have not identified co-localization of opioid peptides, despite their similarity in regional distribution particularly

in nociceptive pathways, co-localization was found to be induced under certain conditions. For example, experimental arthritis or other chronic inflammatory conditions resulted in detection of opioid peptide or peptide mRNA co-localization. Hence, co-localization of pro-enkephalin and pro-dynorphin opioid peptides was identified in deep dorsal horn neurons of polyarthritic, but not normal, rats (Weihe et al. 1988). Various studies have subsequently demonstrated that chronic pain states, including nerve section, produce dramatic changes in neuronal activity in response to the injury, leading to changes in gene expression of neuropeptides (Calza et al. 1998). Changes in opioid peptide expression are also dramatically modulated by various injuries. Peripheral inflammation, chronic arthritis, peripheral nerve injury or damage to the spinal cord elicits profound alterations in dynorphin biosynthesis. While the functional significance of changes in opioid peptide expression are yet to be fully elucidated, it will undoubtedly provide further insight into their functional role in pain modulation.

### Release

Hökfelt proposed that peptide release requires bursting or high-frequency activities, whereas individual action potentials firing at low frequencies will not induce the release of peptides (Hökfelt 1991). The facilitation of peptide release by high-frequency stimulation was considered to be due to the lengthening of the action potential duration, together with the increase in frequency, leading to an increase in calcium accumulation within the terminal, and therefore dictating the amount of secretion per unit of action potential. This rule also applies to most, if not all, opioid peptides released from afferent terminals in various regions of the CNS. However, recent evidence suggests that frequency requirements for opioid peptide release can vary for different peptides. For example, analgesia was induced by low-frequency (4 Hz), but not by high-frequency (200 Hz), stimulation, and was inhibited by low doses of the opioid antagonist naloxone, suggesting that low-frequency stimulation can increase the release of opioid peptides in the CNS (Han 2003). In recent years, a novel approach to the study of opioid peptide release was undertaken. Initially, the discovery of opioid peptides and their receptors made it possible, in principle, to trace causal links between stimuli, opioid release, OR activation, and analgesic responses. However, traditional approaches for studying opioid release have been limited by their inability to predict: (i) OR activation, (ii) precise concentration of the peptide at the receptor, and (iii) the individual actions of the opioid peptide, since more than one opioid peptide may be released. Using an approach effectively used to study the activation of neurokinin-1 receptors by neurokinins following noxious stimulation, OR internalization has been used successfully to assess the release of endogenous opioids by various stimuli. The inherent limitation of this tech-

nique lies in the promiscuity of opioid peptides to activate multiple OR types, with the exception of the highly selective endomorphins.

Mu OR internalization attributable to opioid release was demonstrated in hypothalamic neurons after estrogen treatment (Eckersell et al. 1998) and in myenteric plexus neurons following electrical stimulation (Sternini et al. 2000), but was not evident in dorsal spinal cord neurons following primary afferent stimulation or noxious mechanical stimulation (Trafton et al. 2000), although both of these stimuli were shown to evoke the spinal release of ENK. In a more recent study, mu OR internalization was noted following dorsal horn stimulation of rat spinal cord slices, but only in the presence of peptidase inhibitors (Song and Marvizon 2003). The internalization was attributed to opioid release, because it was abolished by the selective MOR antagonist CTAP (D-Phe-Cys-Tyr-D-Trp-Arg-Thr-Pen-Thr-NH<sub>2</sub>), and was shown to be dependent on extracellular calcium. These findings support the notion that peptidases normally prevent the activation of extra-synaptic mu OR in dorsal horn neurons, causing degradation prior to their activation of receptors to elicit an effect. This latter report suggests that there is no significant difference in the potency at which an opioid peptide activates its receptor to elicit a pharmacological effect, and the ability to cause ligand-dependent receptor internalization.

Opioid peptide release has also been extensively studied outside the CNS. Localized inflammation of a rat's hindpaw elicits an accumulation of END-containing immune cells, which release END following stimulation via pro-inflammatory cytokines (Cabot et al. 1997). In this study, END release was receptor-specific, calcium-dependent, and mimicked by potassium, consistent with vesicular release and thus similar to release in the CNS. It has been proposed that the activation of opioid peptide biosynthesis and release from immune cells may validate the development of peripherally acting opioid analgesics (Machelska and Stein 2000). Moreover, as such drugs would target events in peripheral injured tissue and not cross the blood brain barrier, these novel analgesics should lack unwanted central side effects typically associated with most clinically available opiates to date.

### Other Considerations

In addition to the localization of opioid peptides in nociceptive pathways, they are also present in many CNS nuclei including the hippocampus, where they have been proposed to play a role in functional plasticity (Morris and Johnson 1995). High-frequency stimulation of pre-synaptic fibers in various regions of the hippocampus produces a long lasting increase in the response of the post-synaptic neurons to subsequent pre-synaptic activity (▶ [long term potentiation](#), LTP). The mossy fibers of the hippocampus, in addition to containing the excitatory amino acid glutamate, also release opioid peptides. It has been documented that all granule cells ex-



press the pro-dynorphin gene, and a high level of DYN is observed in the mossy fiber terminals. In addition, a subset of granule cells in the dentate gyrus expresses the pro-enkephalin gene. Activation of OR in the hippocampus via ENKs acting at mu OR produces an excitatory action via disinhibition of GABAergic interneurons, resulting in a reduction in the number of high-frequency stimuli required to induce LTP. However, activation of kappa OR following release of DYN has been shown to produce the opposite effect on excitability, and hence, the endogenous opioid peptides have opposite effects on modulating synaptic strength.

Opposing effects of opioid peptides have also been noted in nociceptive pathways, whereby intracerebroventricular administration of nociceptin produces hyperalgesia, but ENKs produce analgesia. Nociceptin and ENKs are released from distinct terminals, yet localized in similar brain nuclei, suggesting that nociceptin is likely to modulate pain signals opposite to other endogenous opioids. Due to the inherent ability of opioid peptides to produce opposing actions in the CNS, and their potential to modulate synaptic efficacy, changes in opioid peptide translation and release may contribute to the genesis of chronic pain states, as synaptic modulation and modification have been identified in such pathological conditions.

## References

- Cabot PJ, Carter L, Gaiddon C, Zhang Q, Schafer M, Loeffler JP, Stein C (1997) Immune Cell-Derived Beta-Endorphin Production, Release, and Control of Inflammatory Pain in Rats. *J Clin Invest* 100:142–148
- Calza L, Pozza M, Zanni M, Manzini CU, Manzini E, Hökfelt T (1998) Peptide Plasticity in Primary Sensory Neurons and Spinal Cord during Adjuvant-Induced Arthritis in the Rat: An Immunocytochemical and In Situ Hybridization Study. *Neuroscience* 82:575–589
- Eckersell CB, Popper P, Micevych PE (1998) Estrogen-Induced Alteration of mu-Opioid Receptor Immunoreactivity in the Medial Preoptic Nucleus and Medial Amygdala. *J Neurosci* 18:3967–3976
- Han J-S (2003) Acupuncture: Neuropeptide Release Produced by Electrical Stimulation of Different Frequencies. *Trends Neurosci* 26:17–22
- Hökfelt T (1991) Neuropeptides in Perspective: The Last Ten Years. *Neuron* 7:867–879
- Machelska H, Stein C (2000) Pain Control by Immune-Derived Opioids. *Clin Exp Pharmacol Physiol* 27:533–536
- Mansour A, Khachaturian H, Lewis ME, Akil H, Watson SJ (1988) Anatomy of CNS Opioid Receptors. *Trends Neurosci* 11:308–314
- Martin-Schild S, Gerall AA, Kastin AJ, Zadina JE (1999) Differential Distribution of Endomorphin 1- and Endomorphin 2-Like Immunoreactivities in the CNS of the Rodent. *J Comp Neurol* 405:450–471
- Morris BJ, Johnson HM (1995) A Role for Hippocampal Opioids in Long-Term Functional Plasticity. *Trends Neurosci* 18:350–355
- Przewlocki R, Przewlocka B (2001) Opioids in Chronic Pain. *Eur J Pharmacol* 429:79–91
- Schulz S, Schreff M, Nuss D, Gramsch C, Höllt V (1996) Nociceptin/Orphanin FQ and Opioid Peptides show Overlapping Distribution but not Co-Localization in Pain-Modulatory Brain Regions. *Neuroreport* 7:3021–3025
- Song B, Marvizon JC (2003) Peptidases Prevent mu-Opioid Receptor Internalization in Dorsal Horn Neurons by Endogenously Released Opioids. *J Neurosci* 23:1847–1858
- Sternini C, Brecha NC, Minnis J, D'Agostino G, Balestra B, Fiori E, Tonini M (2000) Role of Agonist-Dependent Receptor Internalization in the Regulation of mu-Opioid Receptors. *Neuroscience* 98:233–241
- Trafton JA, Abbadie C, Marek K, Basbaum AI (2000) Postsynaptic Signaling via the [mu]-Opioid Receptor: Responses of Dorsal Horn Neurons to Exogenous Opioids and Noxious Stimulation. *J Neurosci* 20:8578–8584
- Weihe E, Millan MJ, Leibold A, Nohr D, Herz A (1988) Co-localization of Proenkephalin- and Prodynorphin-Derived Opioid Peptides in Laminar IV/V Spinal Neurons Revealed in Arthritic Rats. *Neurosci Lett* 85:187–192

## Opioid Peptide Release

### ► Opioid Peptide Co-Localization and Release

## Opioid Peptides from the Amphibian Skin

LUCIA NEGRI

Department of Human Physiology and Pharmacology, University "La Sapienza" of Rome, Rome, Italy  
lucia.negri@uniroma1.it

0

### Definition

Amphibian opioids are small peptides (► [amphibian peptides](#)) found in the skin of South American hyliid frogs belonging to the subfamily *Phyllomedusinae* (*Phyllomedusa*, *Agalychnis* and *Pachymedusa species*). They are codified by different genes and secreted by the syncytial cells forming the luminal wall of serous holocrine glands in the frog integument. Two subfamilies of opioid peptides have been distinguished according to their selectivity for the mu and delta opioid receptors, the mu selective dermorphins and the delta selective deltorphins.

All amphibian opioid peptides contain the N-terminal sequence Tyr-D-Xaa-Phe, where the amino acids Tyr<sup>1</sup> and Phe<sup>3</sup> are of L-configuration and D-Xaa<sup>2</sup> is a D-amino acid. Because the D-enantiomer is encoded by the codon for the L-isomer in the precursor cDNA, the translated L-Xaa<sup>2</sup> must be converted to D-Xaa<sup>2</sup> by an unusual post-translational reaction that takes place in the precursor itself. C-terminal amino acids in deltorphin and dermorphin sequences are usually amidated. The presence of a D-amino acid in the N-terminal sequence restricts peptide conformation and together with C-terminal amidation confers resistance against enzyme degradation.

### Characteristics

Although Vittorio Erspamer and his colleagues discovered these opiates (Erspamer 1994) in Amazonian frogs

**Opioid Peptides from the Amphibian Skin, Table 1** Natural occurring opioid peptides and their origin

Dermorphins				
1	Tyr-D-Ala-Phe-Gly-Tyr-Pro-Ser-NH <sub>2</sub>	dermorphin		<i>Ph. sauvagei, burmeisteri, rohdei, hypochondrialis, tarsius, Agalychnis</i> [Montecuchi et al. 1981, Broccardo et al. 1981]
2	Tyr-D-Ala-Phe-Gly-Tyr-Hyp-Ser-NH <sub>2</sub>	[Hyp <sup>6</sup> ]-derm		
3	Tyr-D-Ala-Phe-Gly-Tyr-Pro-Lys-OH	[Lys <sup>7</sup> -OH]-derm		<i>Ph. bicolor</i> [Negri et al. 1992]
4	Tyr-D-Ala-Phe-Trp-Tyr-Pro-Asn-OH	[Trp <sup>4</sup> ,Asn <sup>7</sup> -OH]-derm		
5	Tyr-D-Ala-Phe-Trp-Asn-OH	[Trp <sup>4</sup> ,Asn <sup>5</sup> -OH]-derm		
6	Dermorphin-Gly-Glu-Ala-OH	Y10A		<i>Ph. sauvagei</i> [Erspamer 1994, Kovolevski et al. 1999]
7	Dermorphin-Gly-Glu-Ala-Lys-Lys-Ile-OH	Y131		
Deltorphins				
8	Tyr-D-Met-Phe-His-Leu-Met-Asp-NH <sub>2</sub>	D-Met-deltorphin		<i>Ph. sauvagei, burmeisteri, rohdei, tarsius</i> [Kreil et al. 1989]
9	Tyr-D-Ala-Phe-Asp-Val-Val-Gly-NH <sub>2</sub>	D-Ala-deltorphin-I		<i>Ph. bicolor</i> [Erspamer et al. 1989]
10	Tyr-D-Ala-Phe-Glu-Val-Val-Gly-NH <sub>2</sub>	D-Ala-deltorphin-II		
11	Tyr-D-Leu-Phe-Ala-Asp-Val-Ala-Ser-Thr-Ile-Gly-Asp-Phe-Phe-His-Ser-Ile-NH <sub>2</sub>	D-Leu-deltorphin		<i>Ph. burmeisteri</i> [Barra et al. 1994]
12	Tyr-D-Ile-Phe-His-Leu-Met-Asp-NH <sub>2</sub>	D-Ile-deltorphin		<i>Pachymedusa dacnicolor, Agalychnis annae</i> [Wechselberger et al. 1998]

only in the 1980s, the Matses of the upper Amazonian basin unveiled the pharmacological properties of amphibian skin opiates long ago. For centuries they had habitually applied the dried skin secretions of *Phyllomedusa bicolor*, called “sapo” (the Spanish word for ‘toad’), to cuts in their skin during shamanistic hunting rituals. The abundance of deltorphins and dermorphins in “sapo” probably caused the hunters analgesia and behavioral excitation.

The first to be discovered were two dermorphins (Table 1; 1 and 2) identified in the skin of *Ph. sauvagei*, *Ph. rohdei* and *Ph. burmeisteri* (Broccardo et al. 1981; Montecucchi et al. 1981). The very high dermorphin content in the skin of these *Phyllomedusinae*, about 50–80 µg/g of fresh skin, made it easy to purify and sequence the peptides.

Eight years later deltorphins, a family of highly selective delta opioid peptides, were identified either by cloning the cDNA from the skin of *Ph. sauvagei* (Table 1; 8) (Kreil et al. 1989) or by extracting the mature peptides from the skin of *Ph. bicolor* (Table 1; 9 and 10) (Erspamer et al. 1989). Chromatographic separation of skin extracts and screening of cDNA libraries from the skin of various species of *Phyllomedusinae* led to the identification of other opioid peptides belonging to the dermorphin and deltorphin families (see Table 1) (Negri et al. 1992; Barra et al. 1994; Wechselberger 1998).

Despite the common N-terminal tripeptide (Tyr-D-Xaa-Phe) the two families of amphibian opioids differ widely in ▶ **receptor selectivity** but bind to their own receptors with similar affinities (▶ **receptor affinity**). The N-terminal domain contains the minimum sequence essential for opioid receptor binding, whereas the C-terminal domain contains the address requisites for receptor selectivity. The presence of negatively charged amino acid residues (Asp 114, Asp 147) that contribute to ligand binding, within the putative transmembrane domains II and III of the mu receptor protein may explain why positively charged dermorphins have high mu opioid receptor selectivity and why amidation of their terminal carboxyl group increases their affinity and potency. Similarly, the negatively charged C-terminal tetrapeptide of deltorphins enhances deltorphin selectivity for the delta opioid receptor by electrostatic attraction to the positively charged binding site of the delta receptor (Arg 292) and electrostatic repulsion from the negatively charged mu receptor site. Electrostatic attraction within the peptide molecule may explain why deltorphins have a folded structure, whereas dermorphins have a more distended and flexible structure. Unlike the positively charged C-terminus of dermorphins, the negatively charged C-terminal tail of deltorphins comes into close contact with the positively charged N-terminal tripeptide of the molecule and folds the backbone, thus placing the Tyr<sup>1</sup>

**Opioid Peptides from the Amphibian Skin, Table 2** Affinity and selectivity for mu and delta opioid receptors, biological activities on guinea pig ileum (GPI) and mouse vas deferens (MVD) preparations and analgesic potency of dermorphins and deltorphins

Compounds	K <sub>i</sub> , nM (mean ± S.E.)		μ / δ	IC <sub>50</sub> , nM (mean ± S.E.)		Analgesia AD <sub>50</sub> nmol/rat
	μ -system	δ -system		GPI	MVD	
<b>Morphine</b>	11±1.5	500±48	22 × 10 <sup>-3</sup>	150±18.5	1215±115	8.7±1.1
<b>Dermorphin</b>						
dermorphin	0.6±0.02	929±41	6.1 × 10 <sup>-4</sup>	1.29±0.11	16.5±1.3	0.035±0.01
[Hyp <sup>6</sup> ]derm	0.7±0.03	1200±131	5.8 × 10 <sup>-4</sup>	1.6±0.12	18.1±2.9	
[Lys <sup>7</sup> ]derm	0.09±0.008	1105±185	8.1 × 10 <sup>-5</sup>	1.15±0.13	13.6±1.5	0.026±0.009
[Lys <sup>7</sup> -OH]derm	5.7 ±0.51	1150±172	4.9 × 10 <sup>-3</sup>	3.82±0.45	56.3±7.8	
[Trp <sup>4</sup> ,Asn <sup>5</sup> ]derm	0.9±0.052	480±45	1.9 × 10 <sup>-3</sup>	5.00±0.52	73.7±9.1	0.43±0.04
[Trp <sup>4</sup> ,Asn <sup>7</sup> ]derm	0.32±0.026	690±57	4.6 × 10 <sup>-4</sup>	0.58±0.06	6.6±0.9	2.086±0.31
<b>Deltorphin</b>						
D-Ala <sup>2</sup> -delt I	1985±224	0.78±0.08	2545	1239±203	0.18±0.02	15±3.0
D-Ala <sup>2</sup> -delt II	2222±233	1.03±1.09	2157	2500±170	0.37±0.03	54±6.0
D-Ala <sup>2</sup> ,Gly <sup>4</sup> -delt	13.5±2.1	3.26± 0.7	4.14	22±3	2.62±0.32	2.5±0.3
D-Met <sup>2</sup> -delt	693±37	1.18±0.21	587	1476±185	0.97±0.05	20±5.0
D-Leu <sup>2</sup> -delt	>10000	>10000	-	> 5000	2480±378	
D-Leu <sup>2</sup> -delt(1-10)	-	-	-	1684±403	37.0±3.9	
D-Ile <sup>2</sup> -delt	1021±57	24±3	42.6	4200±475	7.0±0.9	6.7±1.0
D-alle <sup>2</sup> -delt	452±68	54±65	8.4	3200±307	70±8.2	9.8±1.2

K<sub>i</sub>, equilibrium inhibition constant of the competing ligand; mu-opioid receptors have been labeled with [<sup>3</sup>H]DAMGO, 0.5 nM; delta opioid receptors have been labeled with [<sup>3</sup>H]deltorphin I, 0.3 nM; μ/δ represents selectivity for the mu receptors *versus* delta receptors.

and Phe<sup>3</sup> aromatic rings in definite orientations best suited for delta receptor docking (Negri and Giannini 2003).

Dermorphin affinity for mu opioid receptors and its opioid potency in guinea pig ileum preparations (GPI) (see ► [GPI \(guinea pig ileum\)](#) and [MVD \(mouse vas deferens\)](#)) are 20 and 100 times higher respectively than those of morphine. Among other dermorphins, [Lys<sup>7</sup>]dermorphin shows an affinity and selectivity for mu opiate receptors 6 times higher than dermorphin and 100 times higher than morphine (Table 2). Like mu opiate agonists, dermorphins produce antinociception but also catalepsy, respiratory depression, constipation, tolerance and dependence, albeit to a lower degree than morphine. Dermorphin induced antinociception takes place at supraspinal and spinal levels. Owing to its low CNS permeability and bioavailability, the analgesic potency of dermorphin is about 250 times higher than that of morphine after icv injection but comparable to that of morphine after sc injection. [Lys<sup>7</sup>]dermorphin and some synthetic analogs bearing a hydrophilic group (a basic amino acid or a glycosyl residue) at the C-terminal end of the molecule enter the CNS in 7 to 10 times

higher amounts than dermorphin, suggesting facilitated transport across the blood brain barrier by a carrier or endocytosis. The amphibian opioid with the highest analgesic potency and efficacy is [Lys<sup>7</sup>]dermorphin (AD<sub>50</sub> 30 pmol/rat by the intracerebroventricular route (icv), 0.22 μmol/kg by the subcutaneous route (sc)). The ratio of antinociceptive to respiratory depressant ED<sub>50</sub> doses was 17 times lower for [Lys<sup>7</sup>]dermorphin than for morphine. Indeed, [Lys<sup>7</sup>]dermorphin, in the range of analgesic doses (36–120 pmol, icv, 0.12–4.7 μmol/kg, sc) significantly increases respiratory frequency and minute volume of rats breathing air or hypoxic inspirates. The early onset ventilatory stimulation produced by [Lys<sup>7</sup>]dermorphin and ascribed to the intact peptide is mediated by serotonergic descending excitatory pathways that stimulate neurons of the brainstem respiratory network (Negri et al. 1998). In rats and mice, central or peripheral administration of the dermorphin-like peptides induces a significantly slower development of tolerance to the antinociceptive effect than with morphine. Withdrawal symptoms precipitated by naloxone are less intense in peptide dependent than in morphine dependent rats (Negri et al. 2000).

The discovery of deltorphins provided the tools for the functional characterization of the delta opiate system. While D-Ala<sup>2</sup>-deltorphins have delta binding affinity similar to D-Met<sup>2</sup>-deltorphin, they consistently have the highest delta opiate selectivity (Table 2). The rank order of selectivity ( $K_{i\delta} / K_{i\mu}$ ) is D-Ala<sup>2</sup>-deltorphin I = D-Ala<sup>2</sup>-deltorphin II > D-Met<sup>2</sup>-deltorphin >> D-Ile<sup>2</sup>-deltorphin >> D-Leu<sup>2</sup>-deltorphin heptadecapeptide or its N-terminal decapeptide fragment. Both D-Met<sup>2</sup>-deltorphin and D-Ala<sup>2</sup>-deltorphins are highly resistant to enzyme degradation. D-Ala<sup>2</sup>-deltorphins I and II cross the blood-brain barrier *in vivo* and *in vitro* (Fiori et al. 1997). Recently, D-Ala<sup>2</sup>-deltorphin II was identified as a transport substrate of organic anion transporting polypeptides (Oatp/OATP), a family of polyspecific membrane transporters, strongly expressed in the rat and human blood-brain barrier (Negri and Giannini 2003).

In mice, D-Ala<sup>2</sup>-deltorphin II by the icv route ( $EC_{50}$  = 2.1 nmol/mouse) is half as potent as morphine and the analgesic effect is antagonized by the delta selective antagonist, naltrindole. Repeated injection of D-Ala<sup>2</sup>-deltorphin II induces tolerance to the antinociceptive effect. Isobolographic analysis shows that the supraspinal antinociception induced by the delta opioid agonist DPDPE and the spinal antinociception induced by D-Ala<sup>2</sup>-deltorphin II are synergistic in many nociceptive tests, suggesting that the compounds act on distinct delta opiate receptors (Kovolevski et al. 1999). In rats, intrathecal injections of D-Ala<sup>2</sup>-deltorphin II (from 0.6 nmol/rat) produce a naltrindole reversible antinociception, by inhibiting the nociceptive neurons in the superficial and deeper dorsal horn of the medulla. Conversely, when injected icv in rats, D-Ala<sup>2</sup>-deltorphin II was a weak partial agonist (> 30 nmol/rat) and induces fleeting naloxone sensitive antinociception. Both D-Ala<sup>2</sup>-deltorphin I and D-Met<sup>2</sup>-deltorphin at doses between 6.5 and 52 nmol/rat induce a naloxone sensitive analgesia. Data suggest that the delta agonists play a predominantly modulatory role in antinociception rather than a primary role. In mice and in rats, the intensity of delta opiate analgesia depends on coactivation of mu opiate receptors by endogenous or exogenous opiates. Deltorphin induced analgesia is weaker in homozygote mice with a disrupted mu opiate receptor gene than in wild type mice.

Injections of the deltorphins into the rat brain ventricles, ventral tegmental area and nucleus accumbens at doses 10–100 times lower than those inducing analgesia (0.06 to 3.8 nmol/rat) invariably increase locomotor activity and induce stereotyped behavior. Deltorphin induced motor activity is antagonized by the delta selective antagonist, naltrindole. Repeated icv injections of D-Ala<sup>2</sup>-deltorphin II in naive rats induce tolerance to the stimulant effects. High doses (10–50 nmol/rat) of all the D-Met<sup>2</sup>-deltorphin analogs and His<sup>4</sup>-substituted D-Ala<sup>2</sup>-deltorphins induce non-opioid motor dysfunc-

tion that is completely blocked by the non-competitive NMDA antagonist, dextrorphan. Because the deltorphin peptides do not induce dependence, and because they stimulate respiratory activity and leave the rate of transit through the small intestine unchanged (Negri et al. 2000; Negri and Giannini 2003), they are excellent candidates as drugs to relieve acute or chronic pain in humans.

## References

- Barra D, Mignogna G, Simmaco M et al. (1994) [D-Leu<sup>2</sup>]Deltorphin, a 17 amino acid opioid peptide from the skin of the Brazilian hydrid frog, *Phyllomedusa burmeisteri*. *Peptides* 15:199–202
- Broccardo M, Erspamer V, Falconieri-Erspamer G et al. (1981) Pharmacological data on dermorphins, a new class of potent opioid peptides from amphibian skin. *Br J Pharmacol* 73:625–31
- Erspamer V (1994) Bioactive secretions of the Amphibian integument. In: Heatwole H (ed) *Amphibian Biology*. Surrey Beatty & Son, Chipping Norton, pp 178–350
- Erspamer V, Melchiorri P, Falconieri-Erspamer G et al. (1989) Deltorphins: a family of naturally occurring peptide with high affinity and selectivity for delta-opioid binding sites. *Proc Natl Acad Sci USA* 86:5188–92
- Fiori A, Cardelli P, Negri L et al. (1997) Deltorphin transport across the blood-brain barrier. *Proc Natl Acad Sci USA* 94:9469–74
- Kovolevski CJ, Bian D, Ruby H et al. (1999) Selective opioid delta agonists elicit antinociceptive supraspinal/ spinal synergy in the rat. *Brain Res* 843:12–17
- Kreil G, Barra D, Simmaco M et al. (1989) Deltorphin, a novel amphibian skin peptide with high selectivity and affinity for delta-opioid receptors. *Eur J Pharmacol* 162:123–8
- Montecucchi PC, De Castiglione R, Erspamer V (1981) Identification of dermorphin and Hyp-dermorphin in skin extract of the Brazilian frog *Phyllomedusa rohdeii*. *Int J Peptide Prot Res* 17:316–21
- Negri L and Giannini E (2003) Deltorphins. In: Chang KJ, Porreca F, Woods JH (eds) *The delta receptors, molecule and effects of delta opioid compounds*. Marcel Dekker Book Chapters, pp 175–189
- Negri L, Falconieri-Erspamer G, Severini C et al. (1992) Dermorphin related peptides from the skin of *Phyllomedusa bicolor* and their amidated analogs activate two mu-opioid receptor subtypes which modulate antinociception and catalepsy, in the rat. *Proc Natl Acad Sci USA* 89:7203–7
- Negri L, Lattanzi R, Tabacco F et al. (1998) Respiratory and cardiovascular effects of the mu-opioid receptor agonist [Lys<sup>7</sup>]dermorphin in awake rats. *Br J Pharmacol* 124:345–55
- Negri L, Melchiorri P, Lattanzi R (2000) Pharmacology of Amphibian opiate peptides. *Peptides* 21:1639–47
- Wechselberger C, Severini C, Kreil G et al. (1998) A new opioid peptide predicted from clone cDNAs from skin of *Pachymedusa dactinicolor* and *Agalychnis annae*. *FEBS Lett* 429:41–3

## Opioid Pseudo-Pharmacological Ceiling Dose

### Definition

The results of adverse effects on dose titration of pure opioid agonists.

► **Cancer Pain Management, Principles of Opioid Therapy, Drug Selection**



## Opioid Receptor Localization

CATHERINE ABBADIE<sup>1</sup>, GAVRIL W. PASTERNAK<sup>2</sup>

<sup>1</sup>Department of Pharmacology, Merck Research Laboratories, Rahway, NJ, USA

<sup>2</sup>Laboratory of Molecular Neuropharmacology, Memorial Sloan-Kettering Cancer Center, New York, NY, USA  
catherine\_abbadie@merck.com, pasterng@mskcc.org

### Definition

Opioids have long played a major role in pharmacology, representing one of the oldest classes of clinically important pharmaceuticals (Pasternak 1993; Reisine and Pasternak 1996). Opioid receptor binding to brain membranes was first demonstrated in 1973, and represents one of the earliest neurotransmitter receptors localized within the central nervous system using autoradiographic techniques. Presently, three distinct classes of opioid receptors have been identified. All three classes of opioid receptors are members of the ► **G-protein-coupled receptor** family, and have the typical seven transmembrane domains seen with this large family of membrane receptors. Opioids bind to the extracellular face of the receptor and activate intracellular G-proteins. The opioid receptors are almost exclusively inhibitory, activating primarily G<sub>o</sub> and G<sub>i</sub>. The three opioid receptor classes are structurally homologous, but each is encoded by a separate gene.

Early autoradiographic studies of the brain, defining the regional distribution of opioid receptors, used a variety of radioligands that we now know are not very selective. Although these initial studies firmly established the presence of opioid binding sites in brain regions known to be important in mediating opioid actions, it is almost certain that they were labeling more than one class of binding site. With the cloning of the receptors (for review see Pasternak 2001; Kieffer and Gaveriaux-Ruff 2002; Wei and Loh 2002), it is now possible to selectively localize them at the mRNA level using *in situ* hybridization, and at the protein level immunohistochemically.

### Mu Receptors

Morphine and most clinical opioid analgesics act through the mu- ► **opiate** receptors, making these receptors particularly important. However, this class of receptor is complex, with over a dozen different splice variants of the mu receptor having been cloned. While these may provide potential insights into early pharmacological studies implying different mu receptor subtypes for morphine analgesia versus respiratory depression or constipation, it complicates the interpretation their distributions.

### Delta Receptors

Delta receptors were first proposed shortly after the discovery of the enkephalins, their endogenous ligand. The

development of highly selective, stable delta compounds has greatly facilitated studies of the pharmacology of this receptor, and the cloning of the DOR-1 has enabled studies of this receptor at the molecular level. Delta opioids produce analgesia, but with far less respiratory depression and constipation. There is strong pharmacological evidence for delta receptor subtypes, but functional splice variants have not yet been reported.

### Kappa<sub>1</sub> Receptors

Kappa receptors were initially suggested from classical *in vivo* pharmacological studies long before the identification of its endogenous ligand, dynorphin A. The synthesis of highly selective ligands has helped to define the kappa<sub>1</sub> receptor, both biochemically and pharmacologically. Kappa<sub>1</sub> receptors can produce analgesia, but through mechanisms distinct from those of the other receptor classes. However, the clinical use of kappa receptor ligands has been limited by their psychotomimetic side-effects.

A kappa receptor with the appropriate pharmacological profile has been cloned, KOR-1, and it has high homology with the other opiate receptors. In addition to the nervous system, kappa<sub>1</sub> receptors are also present in other tissues, particularly immune cells.

### Other Kappa Receptors

Several other kappa receptor classes have been proposed. U50,488H is a potent, and highly selective, kappa<sub>1</sub> receptor agonist. Kappa<sub>2</sub> receptors, initially defined by their insensitivity to traditional mu, delta and kappa<sub>1</sub> opioids, display a unique binding profile and may correspond to dimers of KOR-1 and DOR-1 receptors. Kappa<sub>3</sub> receptors represent another class of U50,488H-insensitive receptors totally distinct from any other class.

### Opioid-Receptor-Like (ORL-1) Receptor

A fourth member of the opiate receptor family has been cloned that is highly selective for the peptide orphanin FQ/nociceptin (► **OFQ/N**). The pharmacology of OFQ/N is complex, with actions depending upon both dose and route. Despite the similarity of the cloned receptor with other members of the opioid receptor family, OFQ/N shows no appreciable affinity for traditional opioid receptors and opioids bind very poorly to the ORL-1 receptor. However, the ORL-1 receptor will dimerize with MOR-1, yielding a complex with a profoundly different binding profile, in which traditional mu opioids potentially compete with OFQ/N and vice versa.

### Conclusion

The opioid system is comprised of three major classes of receptors, with each being encoded by a different gene, as well as the ORL-1 receptor. Furthermore, the gene encoding MOR-1 generates a large number of variants, many of which bind morphine and related mu opioids

with high affinity. Their close structural and ligand binding characteristics make it difficult to localize a single variant.

### Characteristics

The first attempt to look at opioid distribution in the brain used autoradiographic approaches. These early studies defining their distributions used various opioid ligands, and quickly established the presence of opioid binding sites in brain regions presumed to be important in mediating opioid actions. However, as our understanding of opioid receptors has expanded, it has become apparent that opioids act through a family of receptors, as described earlier. Equally important, many of the ligands initially thought to be “selective” are now known not to be, complicating the interpretation of these earlier studies.

Following the cloning of the opioid receptors, their distributions within the brain were evaluated using *in situ* hybridization and immunohistochemistry. Unlike traditional receptor autoradiography, the selectivity of both techniques is excellent. *In situ* hybridization labels mRNA and identifies the cell bodies responsible for synthesizing the receptors. However, the receptors themselves are often transported long distances along axons. Thus, it is also important to localize with subcellular resolution the receptors at protein level. The epitopes identified from the cloned receptors has provided unique, and very selective, tools for immunohistochemistry. However, even some of antisera do not distinguish among some of the splice variants. Thus, even now, localization studies must be interpreted cautiously, taking into account the possibility that a specific epitope might be contained within more than one variant.

A complete description of the distribution of opioid receptors is beyond the scope of this entry. Detailed descriptions of the mRNA of MOR-1 have been published, (Mansour et al. 1994), as have the distributions of the peptides (Ding et al. 1996), DOR-1 (Arvidsson et al. 1995a) and KOR-1 (Arvidsson et al. 1995b). The descriptions below refer primarily to opioid receptor localization in relationship to pain pathways and are based primarily upon studies with rodents, although the distributions in human tissues are quite similar (Fig. 1).

### Peripheral Opioid Receptors

Mu, delta and kappa opioid receptors have been identified in rat and human ► [nerve terminals](#) in the skin (for review see Stein et al. 2001). These fibers are the peripheral terminals of neuronal cell bodies that are localized in the ► [dorsal root ganglia](#) (DRG). Within the DRG, approximately 50% of all neurons express MOR-1, whereas only 20% express DOR-1 or KOR-1. MOR-1 and KOR-1 are found almost exclusively in small diameter myelinated (A $\delta$  fibers) and unmyeli-

nated (C fibers) axons, whereas DOR-1 is also found in large diameter fibers (A $\alpha\beta$  fibers). Opioid receptors are synthesized in the DRG and then transported to the nerve endings, both in the periphery and centrally in the ► [spinal cord](#), via axonal transport. In inflammatory states, all three types of receptors have been shown to be upregulated, facilitating peripheral-mediated opioid analgesia.

It has been suggested that opioid receptors are also located on sympathetic post-ganglionic terminals, and that they contribute to opioid antinociception. However, direct attempts to localize opioid receptors in sympathetic ganglia have failed. Additionally, chemical sympathectomy with 6-hydroxydopamine does not modify opioid receptor expression in the dorsal root ganglia, nor does it change the analgesic effect of either mu, delta or kappa agonists in an inflammatory model of pain. Immune cells have also been shown to express opioid receptors; however, their role in mediating analgesia remains unclear.

### Spinal Cord

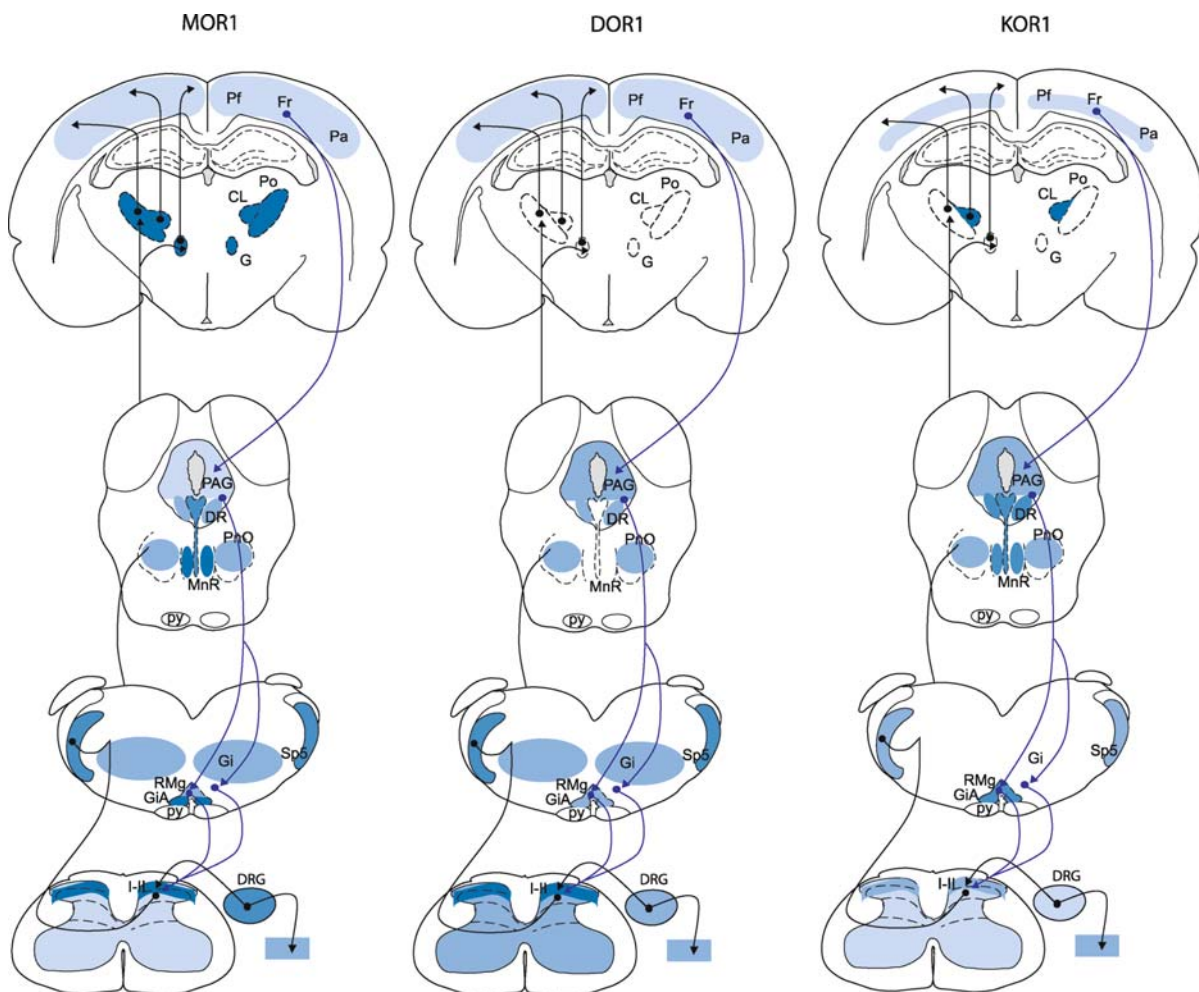
In the spinal dorsal horn, expression of mu, delta and kappa opioid receptors is intense in the superficial laminae (laminae I–II), where nociceptive A $\delta$  and C fibers terminate. Opioid receptors are located pre-synaptically on axons from the DRG neurons, as well as post-synaptically on cell bodies that can be visualized by *in situ* hybridization, and immunohistochemically. In deeper laminae of the dorsal horn, and in the ventral horn, mu and kappa opioid receptor expression is weaker, whereas delta receptors are found throughout the dorsal and ventral horns including motoneurons. Two splice variants of the mu opioid receptor, MOR-1C and MOR-1D, are expressed almost exclusively in unmyelinated axons in the superficial laminae of the spinal cord (Abbadie et al. 2001). Furthermore, confocal studies indicate that neurons in the dorsal horn express either MOR-1 or MOR-1C, but rarely both.

In pain pathways, ascending projections originating from the deep laminae terminate in different areas than projections originating from lamina I (Gauriau and Bernard 2002). Deep laminae neurons project to caudal reticular areas, including the lateral reticular nucleus, the subnucleus reticularis dorsalis, and the gigantocellular lateral paragigantocellular reticular nuclei. Lamina I neurons project to the thalamus, including the ventral posterolateral nucleus, ventral posteromedial, posterior nuclear group and triangular posterior nuclei (Willis and Westlund 1997). Lamina I neurons also project to the lateral parabrachial area.

The distribution of opioid receptors in the spinal trigeminal nucleus is similar to the distribution in the spinal cord.

### Brainstem

Moderate expression of MOR-1 is observed in regions of the pons and medulla, particularly those involved in



0

**Opioid Receptor Localization, Figure 1** Opioid receptor distribution in relationship with pain pathways. These schematics represent the ascending (arrows on the left side) and descending (arrows on the right side) pain pathways. Distributions of MOR-1, DOR-1 and KOR-1, based on *in situ* hybridization and immunohistochemistry studies are indicated by the blue shading. Nociceptive information is transmitted from the periphery to the spinal cord. Pain perception mainly depends upon the activation of the spinothalamic tract. Neurons in the spinal cord project to thalamic nuclei, which in turn project to subcortical and cortical areas, particularly those within the limbic system. Nociceptive information is also transmitted by the spino-parabrachial tract (not represented in this schematic) which projects to the amygdala and hypothalamus. There are also spino-limbic pathways that contribute to different aspects of pain (emotional, autonomic) by influencing different cortical areas. These ascending pain sensory pathways are subject to modulatory control by descending modulatory circuits. These circuits originate in the limbic forebrain, and via brainstem connections, control the transmission of pain signals at their first central relay in the spinal cord. These modulatory circuits mediate the action of morphine and their action is mediated by the release of endogenous opioid peptides. Abbreviations, I-II, superficial laminae of the spinal cord; CL, centrolateral thalamic nucleus; DR, dorsal raphe nucleus; DRG, dorsal root ganglia; Fr, frontal cortex; G, gelatinosus nucleus; Gi, gigantocellular reticular nucleus; GiA, gigantocellular reticular nucleus part alpha; MnR, median raphe nucleus; Pa, parietal cortex; PAG, periaqueductal grey; Pf, prefrontal cortex; PnO, pontine reticular nucleus; Po, posterior thalamic nuclear group; py, pyramidal tract; RMg, raphe magnus nucleus; Sp5, spinal trigeminal nucleus. Schematics are modified from (Paxinos and Watson 1997).

mediating analgesia such as the raphe magnus, intermediate reticular, gigantocellular reticular and lateral paraventricular nuclei. Opioids also act on regions of the brainstem to activate descending pain inhibitory systems, which consist of descending serotonergic and noradrenergic neurons (Basbaum and Fields 1984). Indeed microinjections of morphine into the lateral paraventricular nucleus, raphe magnus nucleus and periaqueductal grey induce profound analgesic effects. The periaqueductal grey, medial and dorsal raphe nuclei

also contain moderate MOR-1, but intense KOR-1 labeling.

Intense expression of MOR-1 is also seen in the nucleus of the solitary tract, ambiguous nucleus and parabrachial nucleus. These brainstem structures mediate the respiratory and cardiovascular side effects of opioids. Neurons in the lateral parabrachial area project to the extended amygdala, the hypothalamus, the periaqueductal grey matter, and the ventrolateral medulla and have been implicated in emotional and autonomic aspects of pain



(Willis and Westlund 1997; Gauriau and Bernard 2002). DOR-1 expression is low or absent in all hindbrain and midbrain structures such as the periaqueductal grey, raphe nucleus or parabrachial nucleus.

#### Midbrain and Forebrain

MOR-1 expression has been demonstrated in the thalamic nuclei involved in the transmission of nociceptive information, including the centrolateral, ventrolateral and ventromedial thalamic nuclei and posterior thalamic nuclear group. Only the centrolateral and geniculate nuclei express KOR. Little or no expression of DOR-1 is observed in the rodent thalamus. In the hypothalamus, one splice variant of MOR-1 is found in various nuclei, whereas MOR-1 distribution is limited (Abbadie et al. 2000).

In the ► **cerebral cortex**, MOR-1 is weakly expressed in layers II–IV, while DOR-1 expression is moderate to intense in layers II, III, V and VI, and KOR-1 is only found in layer VI.

#### Conclusion

Overall, there is an excellent correlation between the localization of opioid receptors and pain pathways. Opioid receptors are distributed at various sites from nerve endings in the skin, to the cerebral cortex and various nuclei located along nociceptive pathways, such as the dorsal raphe or the lateral parabrachial nucleus.

#### References

- Abbadie C, Pan YX, Pasternak GW (2000) Differential Distribution in Rat Brain of mu-Opioid Receptor Carboxy Terminal Splice Variants MOR-1C-Like and MOR-1-Like Immunoreactivity: Evidence for Region-Specific Processing. *J Comp Neurol* 419:244–256
- Abbadie C, Pasternak GW, Aicher SA (2001) Presynaptic Localization of the Carboxy-Terminus Epitopes of the mu-Opioid Receptor Splice Variants MOR-1C and MOR-1D in the Superficial Laminae of the Rat Spinal Cord. *Neuroscience* 106:833–842
- Arvidsson U, Dado RJ, Riedl M, Lee JH, Law PY, Loh HH, Elde R, Wessendorf MW (1995a) delta-Opioid Receptor Immunoreactivity: Distribution in Brainstem and Spinal Cord, and Relationship to Biogenic Amines and Enkephalin. *J Neurosci* 15:1215–1235
- Arvidsson U, Riedl M, Chakrabarti S, Vulchanova L, Lee JH, Nakano AH, Lin X, Loh HH, Law PY, Wessendorf MW, et al. (1995b) The kappa-Opioid Receptor is Primarily Postsynaptic: Combined Immunohistochemical Localization of the Receptor and Endogenous Opioids. *Proc Natl Acad Sci USA* 92:5062–5066
- Basbaum AI, Fields HL (1984) Endogenous Pain Control Systems: Brainstem Spinal Pathways and Endorphin Circuitry. *Annu Rev Neurosci* 7:309–338
- Ding YQ, Kaneko T, Nomura S, Mizuno N (1996) Immunohistochemical Localization of mu-Opioid Receptors in the Central Nervous System of the Rat. *J Comp Neurol* 367:375–402
- Gauriau C, Bernard JF (2002) Pain Pathways and Parabrachial Circuits in the Rat. *Exp Physiol* 87:251–258
- Kieffer BL, Gaveriaux-Ruff C (2002) Exploring the Opioid System by Gene Knockout. *Prog Neurobiol* 66:285–306
- Mansour A, Fox CA, Burke S, Meng F, Thompson RC, Akil H, Watson SJ (1994) Mu, delta, and kappa Opioid Receptor mRNA Expression in the Rat CNS: An In Situ Hybridization Study. *J Comp Neurol* 350:412–438
- Pasternak GW (1993) Pharmacological Mechanisms of Opioid Analgesics. *Clin Neuropharmacol* 16:1–18
- Pasternak GW (2001) Insights into mu-Opioid Pharmacology: The Role of mu-Opioid Receptor Subtypes. *Life Sci* 68:2213–2219
- Paxinos G, Watson C (1997) *The Rat Brain in Stereotaxic Coordinates*. Academic Press, San Diego, CA
- Reisine T, Pasternak GW (1996) Opioid Analgesics and Antagonists. In: Hardman JG, Limbird LE (eds) *Goodman and Gilman's: The Pharmacological Basis of Therapeutics*. McGraw-Hill, New York, pp 521–556
- Stein C, Machelska H, Schafer M (2001) Peripheral Analgesic and Anti-Inflammatory Effects of Opioids. *Z Rheumatol* 60:416–424
- Wei LN, Loh HH (2002) Regulation of Opioid Receptor Expression. *Curr Opin Pharmacol* 2:69–75
- Willis WD, Westlund KN (1997) Neuroanatomy of the Pain System and of the Pathways that Modulate Pain. *J Clin Neurophysiol* 14:2–31

## Opioid Receptor Trafficking in Pain States

CATHERINE M. CAHILL<sup>1</sup>, ANNE MORINVILLE<sup>2</sup>, ALAIN BEAUDET<sup>2</sup>

<sup>1</sup>Queen's University, Kingston, ON, Canada

<sup>2</sup>Montreal Neurological Institute, McGill University, Montreal, QC, Canada

cahillc@post.queensu.ca, annemorinville@yahoo.ca, abeaudet@frsq.gouv.gc.ca

#### Synonyms

Trafficking; opioid receptor targeting; opioid receptor recruitment; opioid receptor sorting; opioid receptor redistribution

#### Definition

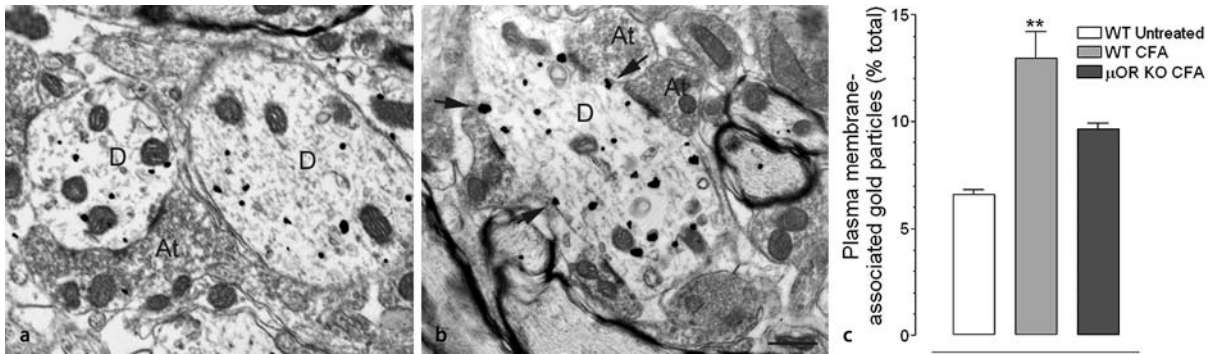
Receptor ► **trafficking** is the constitutive or regulated movement of a receptor protein within the cell, whether between sub-cellular compartments, or towards or away from plasma membranes. The presence of opioid receptors (OR) at the cell surface is essential for regulating opioid signal transduction and subsequent cellular functions. Following agonist activation, receptor ► **internalization** plays an important role in cellular responsiveness, by depleting the cell surface of receptors and contributing to the processes of receptor ► **desensitization** and re-sensitization. Likewise, receptor insertion in plasma membranes through recycling of internalized receptors, and/or targeting of reserve receptors from intracellular stores, is critical for controlling the number of plasma membrane receptors accessible for stimulation, and thereby for regulating various neuronal responses including pain transmission.

#### Characteristics

#### Background

Three genes have been identified to encode for three opioid receptors (OR): ► **mu** ( $\mu$ ), ► **delta** ( $\delta$ ), and ► **kappa**





**Opioid Receptor Trafficking in Pain States, Figure 1** Trafficking of  $\delta$ OR to neuronal plasma membranes of postsynaptic neurons in the dorsal spinal cord following induction of peripheral inflammation. Electron microscopic distribution of  $\delta$ OR in dendrites from the ipsilateral dorsal spinal cord of sham-injected (a) versus CFA-injected (b) rats. Silver-intensified immunogold labeling of  $\delta$ OR demonstrates a predominantly intracellular localization of the receptor in both conditions. However, the number of gold particles is higher over the plasma membrane of dendrites in CFA-treated than in sham-injected animals (arrows). (c) Quantitative analysis of the subcellular distribution of immunoreactive  $\delta$ OR in dendrites from the lumbar spinal cord of untreated wild-type (WT), CFA-treated WT, and  $\mu$ OR knock-out (KO) mice. Data are expressed as the percentage of dendrite-associated gold particles present on plasma membranes. Note that the percentage of membrane-associated  $\delta$ OR is significantly higher in CFA-injected than in sham-treated WT mice, and that this effect is absent in CFA-treated  $\mu$ OR KO mice. D, dendrite; At, axon terminal. Scale bar = 0.4  $\mu$ m.

( $\kappa$ ). All OR inhibit the transmission of pain and are located on peripheral and central branches of somatic and visceral sensory afferents, as well as at various locations within the central nervous system including the spinal cord, midbrain, and cerebral cortex. Within the last few decades, great advances have been made in our understanding of the physiological and pharmacological properties of OR, as well as of their implication in mechanisms of acute and chronic pain. By comparison, much less is known about the mechanisms of OR intraneuronal trafficking, specifically, the physiological function or maladaptive processes that are linked to these trafficking events (for reviews see Roth et al. 1998; von Zastrow et al. 2003).

The first documentation of OR trafficking in models of persistent and chronic pain was generated by studies on axonal transport in peripheral sensory afferents. Thus, autoradiographic and immunohistochemical studies have demonstrated that induction of inflammatory pain via local injection of chemical irritants, antigens, or cytokines resulted in an increase in the synthesis and expression of OR in the cell bodies of sensory afferent neurons (▶ [dorsal root ganglia](#), DRG). This increased expression led, in turn, to enhanced axonal transport of OR in the sciatic nerve, and hence to an increase in their density in the inflamed tissue (Hassan et al. 1993; Ji et al. 1995). Ligation of the nerve following induction of tissue inflammation resulted in an accumulation of all three OR in the sciatic nerve, both proximal and distal to site of ligation, indicating both antero- and ▶ [retrograde transport](#) of multiple OR. This enhanced transport was postulated to underlie the augmented antinociceptive potency of OR agonists following either spinal or local administration of opiates in models of inflammation (Antonijevic et al. 1995; Cahill et al. 2003). Similarly,  $\mu$ OR were found to be up-regulated in DRG

▶ [ipsilateral](#) to the site of nerve injury in a model of neuropathic pain (Truong et al. 2003). In this latter study, the OR protein was trafficked to axonal endbulbs of Cajal just proximal to the site of nerve injury, within aberrantly regenerating small axons in the epineurial sheath, and in residual small axons distal to the nerve constriction. These changes resulted in an increase in anti-allodynic and anti-hyperalgesic effects of locally or peripherally applied opioid agonists, suggesting that the accumulation of  $\mu$ OR to sites of neuromas, and concomitant disruption of the blood–nerve barrier, provided a means for enhanced agonist access to the receptors (Antonijevic et al. 1995).

#### Cell Trafficking of $\delta$ OR in Chronic Pain

We postulated that, likewise, changes in receptor trafficking might underlie the enhanced antinociceptive potency of  $\delta$ OR agonists administered intrathecally in rodents with unilateral hind paw inflammation (Hylden et al. 1991; Qiu et al. 2000). To test this hypothesis, we used electron microscopic immunocytochemistry to quantify the ultrastructural distribution of  $\delta$ OR in neurons of the dorsal spinal cord of rats and mice, subjected, or not, to peripheral inflammation via intraplantar injection of Complete Freund's Adjuvant (CFA). In non-treated animals, the bulk of  $\delta$ OR immunoreactivity was associated with neuronal cell bodies and ▶ [dendrites](#), in conformity with *in situ* hybridization and radioligand binding data (Cahill et al. 2001a). Within these structures, only a small proportion of immunoreactive receptors were found on the plasma membrane, the majority being associated with intracellular vesicular stores (Cahill et al. 2001a; Cheng et al. 1997). By contrast, 72h after CFA injection, the proportion of  $\delta$ OR associated with plasma membranes was significantly increased in both species within dendrites from lam-

inae III–V of the dorsal horn ipsilateral to the side of inflammation, compared to both untreated controls and to the ► **contralateral** spinal cord (Cahill et al. 2003; Morinville et al. 2004a). This change in sub-cellular compartmentalization was positively correlated with an augmented antinociceptive effect of  $\delta$ OR agonists following spinal administration (Cahill et al. 2003). The increase in  $\delta$ OR plasma membrane density was partly due to recruitment of reserve receptors from intracellular reserve stores, since it was accompanied by a statistical decrease in the mean distance separating intracellular receptors from the closest plasma membrane.

A similar increase in the targeting of  $\delta$ OR to neuronal plasma membranes had previously been documented by us in rats and mice subjected to sustained treatment with morphine for 48h (Cahill et al. 2001b; Morinville et al. 2003). Similar to the results obtained in CFA-treated mice, this increase in  $\delta$ OR targeting was not accompanied by corresponding augmentations in either  $\delta$ OR mRNA, protein expression, or [ $^{125}$ I]-deltorphin binding levels, suggesting that it was not due to enhanced receptor production, but solely to increased recruitment to the surface (Morinville et al. 2004b). Most importantly, this targeting effect of morphine was the result of a selective stimulation of  $\mu$ OR, as it was no longer observed in  $\mu$ OR-KO mice (Morinville et al. 2003).

To determine whether the CFA-induced targeting of  $\delta$ OR to dendritic membranes was also due to stimulation of  $\mu$ OR, we repeated the CFA experiments in transgenic  $\mu$ OR knock-out animals. The CFA-induced recruitment of  $\delta$ OR to neuronal plasma membranes was totally abolished in these animals, suggesting that it was dependent on the activation of  $\mu$ OR through pain-induced release of endogenous  $\mu$ OR-acting peptides (Morinville et al. 2004a).

### Functional Significance

In summary, alterations in the sub-cellular distribution of OR, as the result of either acute or chronic stimulation, or of adaptive changes in response to injury, can have dramatic pathophysiological consequences on pain transmission. In the case of  $\delta$ OR, the increase in cell surface receptor density induced by the chronic inflammatory pain process has major pharmacological implications in allowing for increased therapeutic efficacy of analgesic drugs selective for the  $\delta$ OR. In other pain model systems, OR have been demonstrated to be involved in activity-dependent synaptic plasticity, a process known to be fundamental to the development of chronic pain states (Woolf & Salter 2000). Studying phenomena of receptor trafficking and internalization will hopefully provide another venue that allows either better diagnostic, or alternative novel, strategies for the treatment of chronic pain syndromes.

### References

1. Antonijevic I, Mousa SA, Schafer M., Stein C (1995) Perineurial Defect and Peripheral Opioid Analgesia in Inflammation. *J Neurosci* 15:165–172
2. Cahill CM, McClellan KA, Morinville A, Hoffert C, Hubatsch D, O'Donnell D, Beaudet A (2001a) Immunocytochemical Distribution of delta Opioid Receptors in Rat Brain: Antigen-Specific Sub-Cellular Compartmentalization. *J CompNeurol* 440:65–84
3. Cahill CM, Morinville A, Hoffert C, Hubatsch D, O'Donnell D, Beaudet A (2003) Up-Regulation and Trafficking of  $\delta$ OR in a Model of Chronic Inflammatory Pain; Positive Correlation with Enhanced D-[Ala2]deltorphin-Induced Antinociception. *Pain* 101:199–208
4. Cahill CM, Morinville A, Lee M-C, Vincent JP, Beaudet A (2001b) Targeting of delta Opioid Receptor to the Plasma Membrane following Chronic Morphine Treatment. *J Neurosci* 21:7598–7607
5. Cheng PY, Liu-Chen LY, Pickel VM (1997) Dual Ultrastructural Immunocytochemical Labeling of mu and delta Opioid Receptors in the Superficial Layers of the Rat Cervical Spinal Cord. *Brain Res* 778:367–380
6. Hassan AH, Ableitner A, Stein C, Herz A (1993) Inflammation of the Rat Paw Enhances Axonal Transport of Opioid Receptors in the Sciatic Nerve and Increases their Density in the Inflamed Tissue. *Neuroscience* 55:185–195
7. Hylden JL, Thomas DA, Iadarola MJ, Nahin RL, Dubner R (1991). Spinal Opioid Analgesic Effects are Enhanced in a Model of Unilateral Inflammation/Hyperalgesia: Possible Involvement of Noradrenergic Mechanisms. *Eur J Pharmacol* 194:135–143
8. Ji RR, Zhang Q, Law PY, Loh HH, Elde R, Hökfelt T (1995) Expression of mu-, delta-, and kappa-Opioid Receptor-Like Immunoreactivities in Rat Dorsal Root Ganglia after Carrageenan-Induced Inflammation. *J Neurosci* 15:8156–8166
9. Morinville A, Cahill CM, Esdaile MJ, Aibak H, Collier B, Kieffer BL, Beaudet A (2003) Regulation of delta Opioid Receptor Trafficking through mu-Opioid Receptor Stimulation: Evidence from mu-Opioid Receptor Knock-Out Mice. *J Neurosci* 23:4888–4898
10. Morinville A, Cahill CM, Kieffer B, Collier B, Beaudet A (2004) Mu Opioid Receptor Knockout Prevents Changes in delta-Opioid Receptor Trafficking Induced by Chronic Inflammatory Pain. *Pain* 109:266–273
11. Morinville A, Cahill CM, Aibak H et al. (2004b) Morphine-induced changes in delta opioid receptor trafficking are linked to somatosensory processing in the rat spinal cord. *J Neurosci* 24:5549–5559
12. Qiu C, Sora I, Ren K, Uhl G, Dubner R (2000) Enhanced delta-Opioid Receptor-Mediated Antinociception in mu-Opioid Receptor-Deficient Mice. *Eur J Pharmacol* 387:163–169
13. Roth BL, Willins DL, Kroeze WK (1998) G Protein-Coupled Receptor (GPCR) Trafficking in the Central Nervous System: Relevance for Drugs of Abuse. *Drug Alcohol Depend* 51:73–85
14. Truong W, Cheng C, Xu QG, Li XQ, Zochodne DW (2003) Mu Opioid Receptors and Analgesia at the Site of a Peripheral Nerve Injury. *Ann Neurol* 53:366–375
15. von Zastrow M, Svingos A, Haberstock-Debic H, Evans C (2003) Regulated Endocytosis of Opioid Receptors: Cellular Mechanisms and Proposed Roles in Physiological Adaptation to Opiate Drugs. *Curr Opin Neurobiol* 13:348–353
16. Woolf, C.J., Salter, M.W. (2000). Neuronal Plasticity: Increasing the Gain in Pain. *Science* 288:1765–1769

### Opioid Receptors

GAVRIL W. PASTERNAK

Department of Neurology, Memorial Sloan-Kettering Cancer Center, New York, NY, USA

pasterng@mskcc.org

## Synonyms

Opiate Receptors; MOR-1; DOR-1; KOR-1

## Definition

Opioid receptors are proteins located on the surface of cells that bind opiate and opioid peptide drugs selectively and with high affinity.

## Characteristics

Opioids act by interacting with specific recognition sites on the surface of the cell termed receptors. The concept of opiate receptors goes back over fifty years. The first opioids, morphine and codeine, were isolated from opium over a hundred years ago, which was followed by the synthesis of thousands of derivatives in an effort to dissociate analgesia from side-effects. The rigid structure activity relationships of these compounds led to the suggestion of very specific binding sites. Indeed, these structure-activity relationships led to models of the binding pocket decades before the receptors were cloned. The classification of these receptors became more complex with the observations of the interactions between nalorphine and morphine. Differing only by the substitution of the N-methyl group by an N-allyl group, the two drugs were quite distinct pharmacologically. Whereas morphine is an effective analgesic, nalorphine was one of the first antagonists. However, if given at sufficiently high doses, nalorphine was also able to elicit analgesia, leading Martin to propose two subtypes of opioid receptors. He suggested that nalorphine was an antagonist at the M, or morphine receptor, and an agonist at the N, or nalorphine, receptor. Martin extended this classification based upon detailed pharmacological observations *in vivo*, to propose specific receptors for morphine ( $\mu$ ) and for ketocyclazocine ( $\kappa$ ) (Martin et al. 1976). The subsequent discovery of the endogenous opioid peptides (Table 1), led Kosterlitz and co-workers to propose an **enkephalin-selective receptor**, termed delta (Lord et al. 1977) (**delta opioid receptor**). Goldstein and colleagues then identified

dynorphin A as the endogenous ligand for the kappa receptor (**kappa opioid receptor**). Pharmacological studies have suggested these three major families of receptors, as well as subtypes (Table 2).

## Opiate Receptor Binding Sites

The initial concept of opioid receptors, and the suggestion of receptor classes, had been inferred by classical pharmacological studies. Receptor binding studies provided the verification of these sites at the biochemical level. Opioid binding sites within the nervous system were first reported in 1973 using  $\mu$  ligands (Snyder and Pasternak 2003). In these initial studies, the receptors were labeled by incubating brain membranes with radiolabeled opioids of high specific activity, and washing away the unbound drug. Specificity of the labeled sites was established by demonstrating that only active opioids completed the binding. A number of studies then explored the nature of the binding, demonstrating its protein nature, and differences in the binding of agonists and antagonists. As the kappa and delta classes of opioid receptors were described and suitable radioligands became available, they, too, were verified in binding studies.

During the course of these studies exploring the binding of a variety of opioids, evidence surfaced for subpopulations of sites, starting with  $\mu$  receptors (Wolozin and Pasternak 1981; Pasternak and Snyder 1975). Early binding studies identified a very high affinity binding component, which was subsequently found to be uniquely sensitive to the antagonists naloxonazine and naloxazone. Under conditions *in vivo*, in which this high affinity binding site was blocked, naloxonazine was able to antagonize selected  $\mu$  actions, such as supraspinal analgesia, but not others, such as respiratory depression or the inhibition of gastrointestinal transit. The  $\mu$  binding and  $\mu$  actions sensitive to naloxonazine were termed  $\mu_1$ , and those  $\mu$  sites and functions that were insensitive were termed  $\mu_2$  (Wolozin and Pasternak 1981). The complexity of

0

**Opioid Receptors, Table 1** Selected Opioid Peptides

Opioid Peptide	Amino Acid Sequence
[Leu <sup>5</sup> ]enkephalin	Tyr –Gly –Gly –Phe –Leu
[Met <sup>5</sup> ]enkephalin	Tyr –Gly –Gly –Phe –Met
Dynorphin A	Tyr –Gly –Gly –Phe –Leu–Arg–Arg–Ile–Arg—Pro–Lys–Leu–Lys–Trp–Asp–Asn–Gln
Dynorphin B	Tyr –Gly –Gly –Phe –Leu–Arg–Arg–Gln–Phe–Lys–Val–Val–Thr
$\alpha$ -Neoendorphin	Tyr –Gly –Gly –Phe –Leu–Arg–Lys–Tyr–Pro–Lys
$\beta_1$ -Endorphin	Tyr –Gly –Gly –Phe –Met–Thr–Ser–Glu–Lys–Ser–Gln–Thr–Pro–Leu–Val–Thr–Leu–Phe–Lys–Asn–Ala–Ile–Ile–Lys–Asn–Ala–Tyr–Lys–Lys–Gly–Glu
Endomorphin-1	Tyr–Pro–Trp–Phe–NH <sub>2</sub>
Endomorphin-2	Tyr–Pro–Phe–Phe–NH <sub>2</sub>

**Opioid Receptors, Table 2** Pharmacological classification of opioid receptors and their actions

Receptor	Clone	Actions
Mu	MOR-1	Sedation
Mu <sub>1</sub>		Supraspinal and peripheral analgesia
		Prolactin release; Feeding
Mu <sub>2</sub>		Spinal Analgesia; Respiratory depression,
		Inhibition of gastrointestinal transit,
		Guinea pig ileum bioassay; Feeding
Kappa		
Kappa <sub>1</sub>	KOR-1	Analgesia; Dysphoria; Diuresis; Feeding
Kappa <sub>2</sub>	(KOR-1/DOR-1 dimer)	Unknown
Kappa <sub>3</sub>		Analgesia
Delta	DOR-1	Mouse vas deferens bioassay, feeding
Delta <sub>1</sub>		Supraspinal analgesia
Delta <sub>2</sub>		Spinal & supraspinal analgesia

Some actions assigned to general families have not yet been correlated with a specific subtype. Some pharmacologically defined subtypes have not been correlated with specific clones.

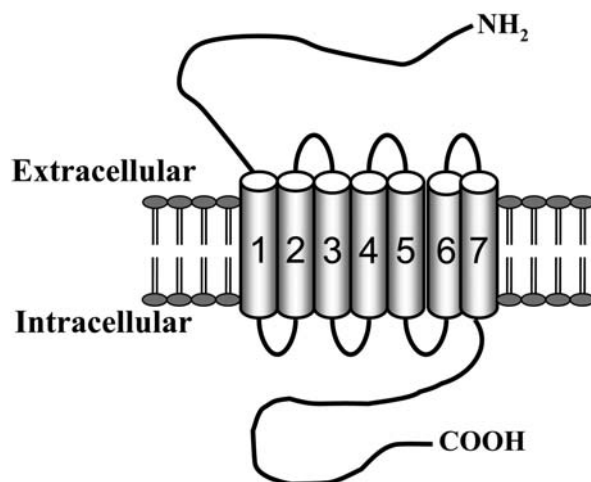
mu subtypes increased with studies of the morphine metabolite morphine-6 $\beta$ -glucuronide, a highly selective mu opioid with a pharmacology distinct from that of morphine (Pasternak 2001b).

The suggestion of receptor subtypes was not limited to mu receptors. Using selective delta ligands, investigators also demonstrated differences suggesting the existence of delta receptor subtypes (Mattia et al. 1991). Kappa receptor subtypes were proposed by several groups. These distinctions were based in a large part upon the kappa-selective drug U50,488H. First, the kappa receptors were separated into U50,488H-sensitive and insensitive sites (Zukin et al. 1988). The U50,488H sensitive sites were designated as kappa<sub>1</sub>. These kappa<sub>1</sub> receptors were further subdivided by their sensitivity towards several endogenous opioids,  $\alpha$ -neoendorphin and dynorphin B (Clark et al. 1989). Dynorphin A is the endogenous ligand for kappa<sub>1</sub>, and competes at all kappa<sub>1</sub> sites with high affinity. In contrast, there are subpopulations of kappa<sub>1</sub> binding sites that are sensitive to dynorphin B and  $\alpha$ -neoendorphin and those that are not. Two subdivisions of the U50,488H insensitive sites have also been suggested. The kappa<sub>2</sub> receptors were defined by the benzomorphan ethylketocyclazocine, while the kappa<sub>3</sub> receptor was defined in both binding studies and pharmacologically using the novel opioid nalox-

one benzoylhydrazone. Similar conclusions came from detailed computer modeling (Rothman et al. 1992)

### Molecular Biology of Opioid Receptors

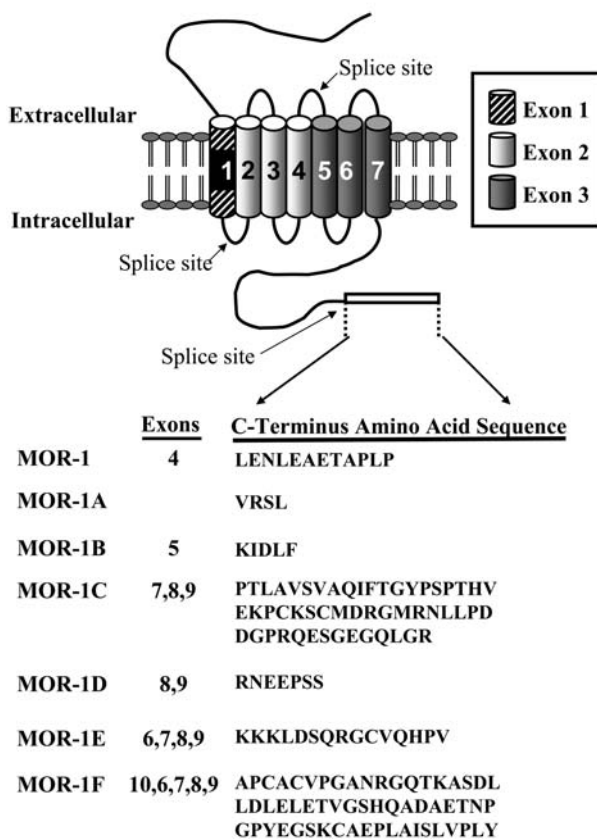
The various opioid receptor classes were initially defined pharmacologically and in receptor binding assays. It took almost twenty years for the receptors to be cloned (Uhl et al. 1994). The delta receptor ( $\blacktriangleright$  DOR-1) was the first one to be cloned (Evans et al. 1992; Kieffer et al. 1992), followed quickly by mu ( $\blacktriangleright$  MOR-1) and kappa<sub>1</sub> ( $\blacktriangleright$  KOR-1) receptors. All the opioid receptors are traditional G protein coupled receptors, with seven transmembrane domains, an extracellular amino (N) terminus and an intracellular carboxy (C) terminus (Fig. 1). The three clones predicted very similar proteins, particularly within the transmembrane domains. DOR-1 and KOR-1 are comprised of three exons that encode the full protein, with the first encoding the NH<sub>2</sub>-terminus through the first transmembrane domain, the second encoding the next three transmembrane domains, and the third encoding the last three transmembrane domains and the COOH-terminus. MOR-1 is similar in that there are three exons that encode the NH<sub>2</sub>-terminus, all seven transmembrane domains and most of the intracellular COOH-terminus. However, it differs from the others in that there are twelve additional amino acids at the tip of the COOH-terminus encoded by exon 4. The binding pocket is within the membrane and is comprised of the seven transmembrane domains of the receptor. When expressed, each receptor showed the anticipated selectivity in receptor binding assays, and sensitivity



**Opioid Receptors, Figure 1** Schematic of the opioid receptors. Like traditional G-protein coupled receptors, the opioid receptors have seven transmembrane (TM) domains. DOR-1 and KOR-1 both have three exons that encode the receptor protein. The first TM is encoded by the first translated exon, the next three TM by the second and the last three TM by the third translated exon. Although MOR-1 has this same exon structure from the extracellular N-terminus through to the seven TM regions, MOR-1 has an additional exon that encodes the terminal 12 amino acids in the C-terminus. The structure of this region is more complex with the MOR-1 variants.



## Mouse MOR-1 3'-Splice variants



**Opioid Receptors, Figure 2** Schematic of the mouse MOR-1 variants. MOR-1 undergoes alternative splicing at the C-terminus inside the cell. The exons responsible for encoding the terminal amino acids and its sequence are presented.

in functional assays when looking at their ability to activate G-proteins.

Pharmacological studies strongly implied the existence of subtypes of the receptors. With regards to mu receptors, this concept is supported with the isolation of a number of different splice variants of MOR-1 in mice, rats and humans (Pasternak 2001a). Many of the variants generate full length receptors that differ only in the tip of the intracellular C-terminus. As noted above, in MOR-1 the terminal 12 amino acids are encoded by exon 4. These other variants have alternative exons instead of exon 4 that encode sequences of different lengths and amino acid composition (Fig. 2). All the variants contain the same first three exons that encode transmembrane domains that define the binding pocket. Thus, it is not surprising that they all show high affinity and selectivity for mu opioids. However, functional studies have shown differences in the sensitivity of these variants to different opioid ligands. Thus, the concept of multiple **Mu( $\mu$ )-Opioid Receptor** has been confirmed at the molecular level, although the relation-

ship between these variants and the pharmacologically defined subtypes is still not certain.

The situation is less clear with the delta receptor subtypes. Although DOR-1 undergoes splicing, no functional splice variants have been uncovered. KOR-1 corresponds to the kappa<sub>1</sub> subtype. Again, despite the presence of alternative splicing, there are no additional functional KOR-1 variants. There is evidence to suggest that kappa<sub>2</sub> receptors are generated by a dimer of KOR-1/DOR-1. The kappa<sub>3</sub> receptors are the least understood of all the pharmacologically defined variants. Antisense mapping studies have suggested an association with the receptor for orphanin FQ/nociceptin, but the two receptors are clearly not identical.

### Functional Studies

The overall pharmacology of these agents is quite complex (Reisine and Pasternak 1996). Highly selective agonists and antagonists are available for these drugs, permitting the evaluation of the actions of individual classes of opioid receptors. All the opioid receptor classes, and even all the proposed subtypes, have been implicated in analgesia, with many involved with other actions as well. With mu opioids, these actions include respiratory depression, sedation and the inhibition of gastrointestinal transit. The actions of the kappa and delta drugs are less well studied clinically.

Analgesia results from the activation of opioid receptors in the brain, spinal cord or periphery. However, the simultaneous activation of more than one site, such as when the drugs are given systemically, leads to more profound responses due to synergistic interactions among the sites. This was first demonstrated between the brain and the spinal cord, and has been extended to peripheral sites as well. Chronic administration of opioids leads to a progressive decline in activity, or **tolerance**. Drugs within the same class show cross tolerance, but agents from different classes do not. **Dependence** is also seen with chronic administration. Unlike **addiction**, which implies drug-seeking behaviors, dependence is a physiological response to the chronic administration of the agents and is observed with all subjects.

Correlating these opioid actions with the cloned receptors has been a major goal. Shortly after the initial cloning of MOR-1, antisense approaches demonstrated the importance of the MOR-1 gene in morphine analgesia. This was further confirmed using knockout models (**knockout mice**). Several different animal models were generated that were deficient in MOR-1. All the animal models revealed the absence of morphine analgesia as well as other morphine effects. However, one of these animal models was quite unusual. Despite the disruption of exon 1, additional mRNA transcripts from the MOR-1 gene continued to be made. Furthermore, although morphine was inactive in this animal model at the highest doses tested, some mu opioids, such as morphine-6 $\beta$ -glucuronide and heroin, retained their

analgesic potential despite the inactivity of morphine. This provides further evidence supporting the existence of pharmacologically distinct mu receptor subtypes. Knockout models have also been evaluated for delta (DOR-1) and kappa<sub>1</sub> (KOR-1) receptors. The loss of the receptors in both cases led to the loss of activity of their respective classes of drugs. Together, these experiments confirm the importance of each of these receptors in the analgesic actions of the drugs involved.

### Conclusion

The concept of opiate receptors goes back many years. Initial studies, based upon traditional pharmacological approaches, implied the existence of several families of receptors and subtypes which have now been confirmed with the cloning of these receptors. The concept of subtypes of mu receptors is supported by the identification of splice variants of MOR-1.

- ▶ [Opioids in the Periphery and Analgesia](#)
- ▶ [Opioids in the Spinal Cord and Modulation of Ascending Pathways \(N. gracilis\)](#)
- ▶ [Postoperative Pain, Opioids](#)

### References

1. Clark JA, Liu L, Price M, Hersh B, Edelson M, Pasternak GW (1989) Kappa opiate receptor multiplicity: Evidence for two U50,488-sensitive kappa<sub>1</sub> subtypes and a novel kappa<sub>3</sub> subtype. *J Pharmacol Exp Ther* 251:461–468
2. Evans CJ, Keith DE, Jr, Morrison H, Magendzo K, Edwards RH (1992) Cloning of a delta opiate receptor by functional expression. *Science* 258:1952–1955
3. Kieffer BL, Befort K, Gaveriaux-Ruff C, Hirth CG (1992) The δ-opioid receptor: Isolation of a cDNA by expression cloning and pharmacological characterization. *Proc Natl Acad Sci USA* 89:12048–12052
4. Lord JAH, Waterfield AA, Hughes J, Kosterlitz HW (1977) Endogenous opioid peptides: multiple agonists and receptors. *Nature* 267:495–499
5. Martin WR, Eades CG, Thompson JA, Huppler RE, Gilbert PE (1976) The effects of morphine and nalorphine-like drugs in the nondependent and morphine-dependent chronic spinal dog. *J Pharmacol Exp Ther* 197:517–532
6. Mattia A, Vanderah T, Mosberg HI, Porreca F (1991) Lack of antinociceptive cross tolerance between [D-Pen<sup>2</sup>, D-Pen<sup>5</sup>]enkephalin and [D-Ala<sup>2</sup>]deltorphin II in mice: evidence for delta receptor subtypes. *J Pharmacol Exp Ther* 258:583–587
7. Pasternak GW (2001a) Incomplete cross tolerance and multiple mu opioid peptide receptors. *Trends Pharmacol Sci* 22:67–70
8. Pasternak GW (2001b) Insights into mu opioid pharmacology - The role of mu opioid receptor subtypes. *Life Sci* 68:2213–2219
9. Pasternak GW, Snyder SH (1975) Identification of a novel high affinity opiate receptor binding in rat brain. *Nature* 253:563–565
10. Reisine T, Pasternak GW (1996) Opioid analgesics and antagonists. In: Hardman JG, Limbird LE (eds) *Goodman & Gilman's the Pharmacological Basis of Therapeutics*. McGraw-Hill, New York, pp 521–556
11. Rothman RB, Bykov V, Xue BG, Xu H, De Costa BR, Jacobson AE, Rice KC, Kleinman JE, Brady LS (1992) Interaction of opioid peptides and other drugs with multiple kappa receptors in rat and human brain. Evidence for species differences. *Peptides* 13:977–987
12. Snyder SH and Pasternak GW (2003) Historical review: Opioid receptors. *Trends Pharmacol Sci* 24:198–205.
13. Uhl GR, Childers S, Pasternak GW (1994) An opiate-receptor gene family reunion. *Trends Neurosci* 17:89–93
14. Wolozin BL and Pasternak GW (1981) Classification of multiple morphine and enkephalin binding sites in the central nervous system. *Proc Natl Acad Sci USA* 78:6181–6185
15. Zukin RS, Eghbali M, Olive D, Unterwald E, Tempel A (1988) Characterization and visualization of rat and guinea pig brain kappa opioid receptors: Evidence for kappa<sub>1</sub> and kappa<sub>2</sub> opioid receptors. *Proc Natl Acad Sci USA* 85:4061–4065

## Opioid Receptors at Postsynaptic Sites

ANDREW J. TODD

Spinal Cord Group, Institute of Biomedical and Life Sciences, University of Glasgow, Glasgow, UK  
a.todd@bio.gla.ac.uk

### Synonyms

Postsynaptic Opioid Receptors

### Definition

Postsynaptic opioid receptors are those that are located on the cell bodies and dendrites of neurons, rather than on their axon terminals. Opioids administered to the spinal cord can produce analgesia, and part of this effect is mediated by opioid receptors on the terminals of ▶ [nociceptive primary afferents](#). Activation of these receptors reduces the release of excitatory neurotransmitter from the nociceptive afferents, and this is referred to as a presynaptic action. However, opioid receptors are also present on certain neurons in the spinal cord (post-synaptic opioid receptors), and these are thought to contribute to opioid analgesia.

### Characteristics

#### Anatomical Distribution of Opioid Receptors in the Spinal Cord

The distribution of opioid receptors in the spinal cord was initially investigated by using ▶ [radio-ligand binding](#). Numerous studies were carried out with this method, and these showed that the highest concentration of receptors was in the superficial part of the dorsal horn (▶ [Rexed's laminae I and II](#)). Transection of dorsal roots led to a substantial reduction of this opioid binding, presumably due to loss of presynaptic receptors on primary afferent terminals. However, significant binding was still seen in the superficial dorsal horn after rhizotomy, and this was thought to result from the presence of opioid receptors on spinal cord neurons. The cloning of μ, δ and κ opioid receptors meant that antibodies could be raised against them and used to investigate their distribution in the spinal cord by means of ▶ [immunocytochemistry](#) (Arvidsson et al. 1995a; Arvidsson et al. 1995b; Kemp et al. 1996; Harris and Drake 2001; Spike et al. 2002). With this approach, all 3 receptors have been found to be concentrated in laminae I and II of the dorsal horn, which matches the results obtained with radio-ligand binding. Immunocytochemical studies have shown that μ and κ receptors are present

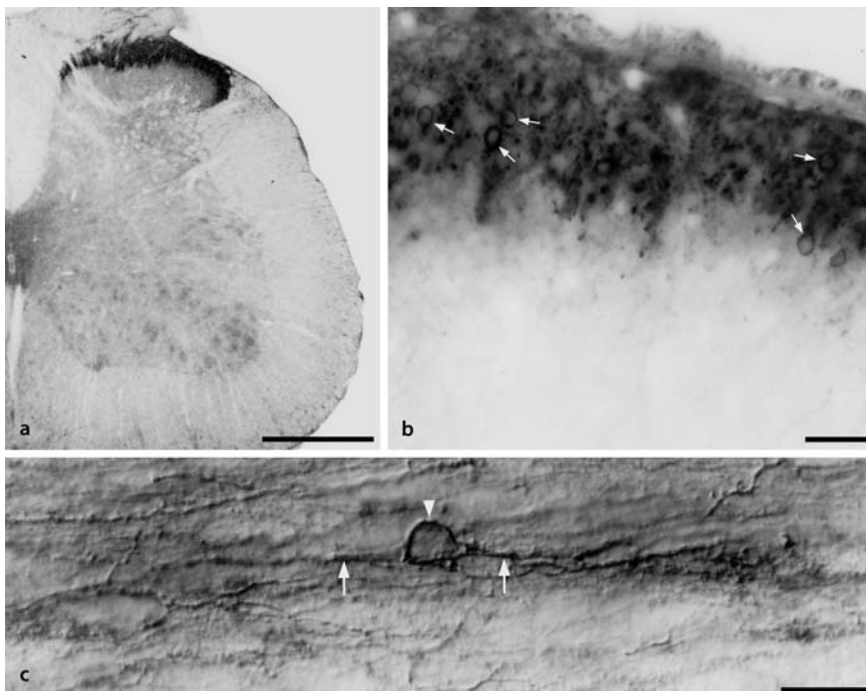
on both dorsal horn neurons (postsynaptic opioid receptors) and primary afferents (presynaptic receptors) (Arvidsson et al. 1995b; Kemp et al. 1996; Harris and Drake 2001; Spike et al. 2002), while  $\delta$  receptors in the dorsal horn appear to be restricted to the terminals of primary afferents (Arvidsson et al. 1995b). Relatively little is known about postsynaptic  $\kappa$  opioid receptors, except that they have been seen on a few neuronal cell bodies in laminae I and II (Harris and Drake 2001). In contrast, several studies have demonstrated  $\mu$  opioid receptors on dorsal horn neurons. Since  $\mu$  opioid receptors play a fundamental role in opioid analgesia and more is known about their distribution, they will be the main focus of this article. Most of the studies on  $\mu$  opioid receptors have been carried out with an antibody raised against the first identified form of the protein (MOR1), and these have shown that numerous immunoreactive cells are present in the superficial part of the dorsal horn (Arvidsson et al. 1995b; Kemp et al. 1996; Spike et al. 2002) (Fig. 1). MOR1-immunoreactivity is present on small neurons that are generally located in lamina II, where they make up approximately 10% of the neuronal population (Spike et al. 2002). As very few **projection neurons** are seen in this lamina, it is likely that the cells with MOR1 are interneurons, with axons that terminate locally in the spinal cord. Lamina II contains both excitatory (**glutamatergic**) and inhibitory (**GABAergic**) interneurons. The great majority of cells with MOR1 do not contain GABA (Kemp et al. 1996), and it is therefore likely that most of them are excitatory interneurons. The responses of MOR1-expressing neurons in lamina II have been investigated by examining activation

of the immediate early gene **c-fos** after different forms of noxious stimulation (Spike et al. 2002). It was found that although approximately 15% of these cells up-regulated *c-fos* in response to noxious thermal stimulation, very few did so following mechanical or chemical noxious stimuli. This suggests that at least some of the MOR1-expressing neurons in lamina II of the spinal dorsal horn may be selectively activated by noxious thermal stimuli.

Although most immunocytochemical studies have used antibodies raised against MOR1, it is now known that there are several other **splice variants** of the  $\mu$  opioid receptor and two of these, known as MOR1C and MOR1D, have been found in the spinal cord (Abbadie et al. 2000). Like MOR1 itself, these splice variants were both present at highest concentrations in the superficial laminae; however, significant amounts of MOR1C were also observed near the central canal. MOR1C (like MOR1) was found on cell bodies in lamina II, and was also present on primary afferents. In contrast, MOR1D-immunoreactivity was seen on neurons in lamina I, but not on primary afferents (Abbadie et al. 2000). Lamina I contains many projection neurons, and this therefore raises the possibility that some of these might express MOR1D, which would allow a direct inhibitory action of  $\mu$  opioid agonists on the output cells of the dorsal horn.

*In situ* hybridisation histochemistry has also been used to investigate the locations of cells that express the 3 opioid receptors (Maekawa et al. 1994; Mansour et al. 1994; Schafer et al. 1994); however, the results with this approach have been inconsistent. Thus, one study reported

0



**Opioid Receptors at Postsynaptic Sites, Figure 1** The appearance of MOR1 in the rat spinal cord revealed with immunocytochemistry. (a) In a transverse section of the spinal cord, MOR1-immunoreactivity is seen to be highly concentrated in the upper part of the dorsal horn (laminae I and II). (b) At higher magnification it is possible to see several MOR1-immunoreactive cell bodies (some of which are marked with arrows). (c) This image shows part of a longitudinal (parasagittal) section through the spinal cord. The cell body (arrowhead) and dendrites (arrows) of a MOR1-immunoreactive neuron can be seen. Scale bars: a = 500  $\mu$ m; b, c = 20  $\mu$ m. (Reprinted from *Neuroscience*, 75, Kemp et al. The  $\mu$ -opioid receptor (MOR-1) is mainly restricted to neurons that do not contain GABA or glycine in the superficial dorsal horn of the rat spinal cord, pp 1231–1238, Copyright (1996), with permission from Elsevier).



that neurons with mRNA for the  $\mu$  receptor are present throughout the dorsal horn, with the highest levels in the superficial laminae (Maekawa et al. 1994), while another found that they were present in the deeper laminae of the dorsal horn with few in the superficial part (Mansour et al. 1994). Neurons with mRNA for the  $\kappa$  receptor have been seen concentrated in the superficial laminae (Schafer et al. 1994), throughout the spinal grey matter (Maekawa et al. 1994), and in the deeper parts of the dorsal horn but not the superficial part (Mansour et al. 1994). The reasons for these discrepancies are unknown.

### Responses of Dorsal Horn Neurons to Drugs that Act on the $\mu$ Opioid Receptor

The actions of opioid agonists on neurons in the superficial dorsal horn have been studied *in vitro* in slices of spinal cord and brainstem. Yoshimura and North (1983) demonstrated that **▶ opioid peptides** could hyperpolarise many neurons in lamina II of the spinal cord, and that this effect was mediated by an increase in  $K^+$  conductance. Subsequent studies have shown that this involves  $\mu$  (rather than  $\delta$ ) opioid receptors (Jeftinija 1988; Grudt and Williams 1994; Schneider et al. 1998), which is consistent with anatomical observations that  $\mu$ , but not  $\delta$ , receptors are present on dorsal horn neurons. Hyperpolarisation resulting from activation of  $\mu$  opioid receptors will have an inhibitory effect on these neurons. This, taken together with the fact that many of the lamina II cells with MOR1 are excitatory (Kemp et al. 1996), and that at least some respond to noxious stimuli (Spike et al. 2002), has led to the suggestion that excitatory interneurons with  $\mu$  opioid receptors in lamina II normally play a role in conveying nociceptive information to projection cells in other laminae of the dorsal horn. Inhibition of these interneurons by  $\mu$  opioid agonists would therefore reduce the input to projection neurons following noxious stimuli, and this would result in analgesia (reduced perception of pain). Although the hyperpolarising effect of  $\mu$  opioid agonists on lamina II neurons appears at first sight to be compatible with the results of anatomical studies, there are certain discrepancies. Firstly, while only 10% of lamina II neurons are MOR1-immunoreactive (Spike et al. 2002), effects of  $\mu$  agonists are seen on a much higher proportion of neurons. The proportion of lamina II neurons hyperpolarised by  $\mu$  agonists has been variously estimated as 39% (Schneider et al. 1998), 50% (Yoshimura and North 1983) or 75% (Jeftinija 1988) for the rat spinal cord, 60% for hamster spinal cord (Schneider et al. 1998), and 86–90% for the trigeminal nucleus of rat and guinea pig (Grudt and Williams 1994). While sampling bias in recording experiments may contribute to this effect, it is unlikely to explain such a dramatic difference. It is possible that MOR1C is present on some neurons that are not MOR1-immunoreactive, and this could increase the proportion of cells with functional  $\mu$  opioid receptors. Secondly, a “post-synaptic” action of

$\mu$  agonists has been reported on many cells in deeper laminae of the dorsal horn, in areas where radio-ligand binding and immunocytochemistry both suggest that there are low levels of opioid receptors.

### Internalisation of MOR1 as a Means of Studying its Activation

Activation of receptors on the surface of neurons sometimes causes them to leave the plasma membrane and enter the cytoplasm on small membrane-bound vesicles (endosomes). Since internalised receptors can be identified with immunocytochemistry, this phenomenon can be used to investigate various aspects of receptor activation, for example dose-response relationships and time-course. It has been found that various  $\mu$ -selective agonists cause internalisation of MOR1 on lamina II neurons, although morphine did not produce this effect (Trafton et al. 2000). The doses of  $\mu$  agonists that were needed to cause MOR1 internalisation were similar to those that have been shown to produce hyperpolarisation of lamina II neurons (Grudt and Williams 1994), and also to doses that produced analgesia in behavioural tests (Trafton et al. 2000). Although this does not prove that postsynaptic actions of  $\mu$  opioid drugs contribute to spinal opioid analgesia, they are compatible with this suggestion. Interestingly, noxious stimulation did not evoke MOR1 internalisation, either in normal animals or in those with a chronic inflammation (Trafton et al. 2000). This suggests that although postsynaptic  $\mu$  opioid receptors may be involved in analgesia produced by the administration of opioid drugs, endogenous opioid peptides that act on  $\mu$  receptors are not released in sufficient amounts to activate this system following noxious stimulation. It has recently been shown that direct electrical stimulation of the dorsal horn *in vitro* can cause internalisation of MOR1 in lamina II neurons (Song and Marvizon 2003), which suggests that in some circumstances neurons in the dorsal horn are able to release sufficient quantities of opioid peptides to activate postsynaptic receptors. It remains to be shown whether this occurs under physiological or pathological conditions.

### References

1. Abbadié C, Pan Y, Drake CT et al. (2000) Comparative Immunohistochemical Distributions of Carboxy Terminus Epitopes from the  $\mu$ -Opioid Receptor Splice Variants MOR-1D, MOR-1 and MOR-1C in the Mouse and Rat CNS. *Neuroscience* 100:141–153
2. Arvidsson U, Dado RJ, Riedl M et al. (1995a)  $\delta$ -Opioid Receptor Immunoreactivity: Distribution in Brainstem and Spinal Cord, and Relationship to Biogenic Amines and Enkephalin. *J Neurosci* 15:1215–1235
3. Arvidsson U, Riedl M, Chakrabarti S et al. (1995b) Distribution and Targeting of a  $\mu$ -Opioid Receptor (MOR1) in Brain and Spinal Cord. *J Neurosci* 15:3328–3341
4. Grudt TJ, Williams JT (1994)  $\mu$ -Opioid Agonists Inhibit Spinal Trigeminal Substantia Gelatinosa Neurons in Guinea Pig and Rat. *J Neurosci* 14:1646–1654
5. Harris JA, Drake CT (2001) Kappa Opioid Receptor Density is Consistent along the Rostrocaudal Axis of the Female Rat Spinal Cord. *Brain Res* 905:236–239



6. Jeftinija S (1988) Enkephalins Modulate Excitatory Synaptic Transmission in the Superficial Dorsal Horn by Acting at  $\mu$ -Opioid Receptor Sites. *Brain Res* 460:260–268
7. Kemp T, Spike RC, Watt C et al. (1996) The  $\mu$ -Opioid Receptor (MOR1) is Mainly Restricted to Neurons that do not Contain GABA or Glycine in the Superficial Dorsal Horn of the Rat Spinal Cord. *Neuroscience* 75:1231–1238
8. Maekawa K, Minami M, Yabuuchi K et al. (1994) *In Situ* Hybridization Study of  $\mu$ - and  $\kappa$ -Opioid Receptor mRNAs in the Rat Spinal Cord and Dorsal Root Ganglia. *Neurosci Lett* 168:97–100
9. Mansour A, Fox CA, Burke S et al (1994) Mu, Delta, and Kappa Opioid Receptor mRNA Expression in the Rat CNS: an *In Situ* Hybridization Study. *J Comp Neurol* 350:412–438
10. Schafer MK, Bette M, Romeo H et al. (1994) Localization of  $\kappa$ -Opioid Receptor mRNA in Neuronal Subpopulations of Rat Sensory Ganglia and Spinal Cord. *Neurosci Lett* 167:137–140
11. Schneider SP, Eckert WA III, Light AR (1998) Opioid-Activated Postsynaptic, Inward Rectifying Potassium Currents in Whole Cell Recordings in Substantia Gelatinosa Neurons. *J Neurophysiol* 80:2954–2962
12. Song B, Marvizon JC (2003) Dorsal Horn Neurons Firing at High Frequency, but not Primary Afferents, Release Opioid Peptides that Produce  $\mu$ -Opioid Receptor Internalization in the Rat Spinal Cord. *J Neurosci* 23:9171–9184
13. Spike RC, Puskar Z, Sakamoto H et al. (2002) MOR-<sup>1</sup>-Immunoreactive Neurons in the Dorsal Horn of the Rat Spinal Cord: Evidence for Nonsynaptic Innervation by Substance P-Containing Primary Afferents and for Selective Activation by Noxious Thermal Stimuli. *Eur J Neurosci* 15:1306–1316
14. Trafton JA, Abbadie C, Marek K et al. (2000) Postsynaptic Signaling via the  $\mu$ -Opioid Receptor: Responses of Dorsal Horn Neurons to Exogenous Opioids and Noxious Stimulation. *J Neurosci* 20:8578–8584
15. Yoshimura M, North RA (1983) Substantia Gelatinosa Neurons Hyperpolarized *In Vitro* by Enkephalin. *Nature* 305:529–530

## Opioid Responsiveness

### Definition

Opioid responsiveness is the probability that adequate analgesia without intolerable and unmanageable side effects can be obtained during opioid dose titration.

- ▶ [Cancer Pain Management, Principles of Opioid Therapy, Drug Selection](#)
- ▶ [Opioid Rotation](#)
- ▶ [Opioid Rotation in Cancer Pain Management](#)

## Opioid Responsiveness in Cancer Pain Management

SEBASTIANO MERCADANTE  
La Maddalena Cancer Pain Relief & Palliative Care Unit Center, Palermo, Italy  
terapiadeldolore@la-maddalena.it

### Definition

The degree of analgesia obtained following dose escalation to an endpoint determined by either analgesia or intolerable adverse effects. It is a continuum of response

rather than a quantal, yes or no, phenomenon, consistent with the inter-individual variability that characterizes opioid analgesia, and the occurrence of dose-dependent effects.

### Characteristics

Chronic opioid therapy has been recognized as standard management for cancer pain. Analgesia can be achieved with different opioid dosages in individuals, as there is effectively no ceiling to their analgesic effect. However, the proportion of adverse effects that the patient can tolerate may limit this process. Several factors can interfere with an appropriate analgesic opioid response. The unpredictable individual response in terms of analgesia and toxicity depends on patient-related factors, drug-selective effects, and pain-related factors (Portenoy et al. 1990). The need for opioid escalation may indicate an abrupt change in the underlying disease, or reveal a previously unknown complication, indicating a change in the relation between dose and response. Primary tumors may have different evolutions in terms of distant metastases and then pain mechanisms, and can also modify the opioid response through the intervention of some metabolic factors, like cytokines. Several studies have indicated that increases in opioid doses during a chronic morphine treatment were related to a progression of disease, generating an increase in pain (Collin et al. 1993), supporting the view that development of ▶ [tolerance](#) to opioids is unlikely to be the driving force for loss of analgesia in patients who have alternative reasons for increasing pain. On the other hand, a reduced potency of the analgesic effects of opioids following its repeated administration may occur, reflecting the development of tolerance. Tolerance to analgesic and non-analgesic effects commonly occur, although other factors may be operant that allow the patient to tolerate higher doses of opioids (Portenoy 1995). Opioid response may also be drug-selective, a possibility suggested by the remarkable variability of individual patients and their response to different drugs. Different receptorial attitudes may explain these differences among opioids, in terms of ▶ [efficacy](#). Moreover, asymmetric tolerance among opioids exists.

The pain mechanism may influence the opioid response. ▶ [Neuropathic pain](#) is considered to be less responsive to opioid treatment in comparison to ▶ [nociceptive pain](#). Recent evidence suggests that hyperalgesia consequent to nerve injury and tolerance, both involve the ▶ [N-methyl-D-aspartate \(NMDA\)-receptor](#) and share part of intracellular events producing a state of neural hyperexcitation (Mao et al. 1995). Neuropathic pain has been shown to require higher doses of opioids to achieve acceptable analgesia, which is often accompanied by greater toxicity and rapid tolerance. Opioid-related side effects are often associated with neuropathic cancer pain syndromes. The clinical characteristics of neuropathic pain do not predict responses to opioids. Indeed,

patients with neuropathic pain did not show a particular disadvantage compared to those exhibiting nociceptive pain, unless associated with neurological impairment (Mercadante et al. 1999). Thus, neuropathic pain can still be responsive to analgesic treatment and does not result in an inherent resistance to opioids (Portenoy et al. 1990; Bruera et al. 1995; Mercadante et al. 1992). The temporal pattern of pain may also limit the opioid response. ► **Breakthrough pain**, episodic pain that interrupts basal analgesia, is commonly associated with a poor prognosis (Portenoy and Hagen 1990). The difficulty in the treatment consists in the temporal pattern of this kind of pain, involving almost the same site of basal pain. ► **Breakthrough pain** may be spontaneous, occurring without an identifiable precipitating event, and precipitant factors, volitional and non-volitional, have been identified in more than 50% of patients. The most well known form of breakthrough pain is incident pain, due to movement and commonly caused by bone metastases. The difficulty with incident pain is not a lack of response to systemic opioids, but rather that the doses required to control the incident pain produce unacceptable adverse effects when the patient is at rest or pain spontaneously stops (Mercadante et al. 2002).

Absorption, metabolism, and elimination may alter the opioid responsiveness. For example, patients with a gastrointestinal tract that is not functioning normally because of a mucosal damage or bowel resection may have a reduction in absorption of drugs, therefore requiring an increase in opioid dosage. Morphine metabolites are involved in various ways in determining the complex effects of morphine, both favourable and adverse, and may complicate the clinical use of morphine in the treatment of cancer pain. While morphine-6-glucuronide (M6G) binds the opioid receptors exerting a relevant analgesic activity, the principal morphine metabolite morphine-3-glucuronide (M3G), has been shown to functionally antagonize the analgesic effects of morphine, possibly contributing to the development of tolerance. Such metabolites are hydrophilic substances eliminated by the kidney. The accumulation of toxic metabolites during chronic morphine therapy can reduce the opioid response, leading to severe and intolerable adverse effects, even in patients with apparently normal renal function (Mercadante and Portenoy 2001).

### Strategies to Improve the Opioid Response

Considering the importance of opioids in the management of chronic pain, countermeasures should be taken to limit the interference with opioid responsiveness. The countermeasures begin with a comprehensive evaluation of the causes that can contribute to worsening pain or altered pain perception, including recurrent disease, psychological distress, and the history of previous opioid use. These approaches may produce either a leftward shift of the analgesia curve or a rightward shift of the toxicity curve (Portenoy 1996).

One approach to the patient with pain that is poorly responsive to opioids is the co-administration of adjuvants, such as antidepressants and anticonvulsants. Antidepressants may improve depression, enhance sleep and provide decreases in perception of pain. The analgesic effect of tricyclics is not directly related to antidepressant activity. The analgesic ► **efficacy** of the tricyclic antidepressants has been established in many painful disorders with a neuropathic mechanism (Portenoy 1996). These substances are commonly used, although no scientific evidence exists of their advantages when added to opioids for cancer pain. Combination with opioids may introduce further risks of toxicity. Anti-inflammatory drugs have some opioid sparing effect, and may allow the lowering of opioid doses, reducing the risk of toxicity.

Another strategy to address poor opioid response is the aggressive management of adverse effects. This approach may open the therapeutic window and allow higher and more effective opioid doses. Different symptomatic drugs have been used, although few studies could demonstrate the validity of this approach (Cherny et al. 2002).

Alternately, the poor opioid response could be managed targeting analgesic tolerance and attempt to reduce or prevent it. Agents that block the activity of NMDA-receptors may provide new tools for the treatment of poorly responsive pain syndromes, particularly neuropathic ones. There are clinical reports about the use of ketamine, although this drug is hard to manage due to its excitatory adverse effects and should be used by skilled people (Mercadante and Portenoy 2001).

The treatment of breakthrough pain is challenging for physicians. A rescue dose of an opioid can provide a means to treat breakthrough pain in patients already stabilized on a baseline opioid regimen. Most opioids administered by oral route, including morphine, oxycodone and hydromorphone, have a relatively slow onset of effect (about 30–45 minutes), and the pain onset may be so rapid that an oral dose may not provide sufficiently prompt relief, even if taken as needed. Subcutaneous or intravenous administration is timely and an effective route of administration. Oral transmucosal dosing is a noninvasive approach to the rapid onset of analgesia. Fentanyl, incorporated in a hard matrix on a handle, is rapidly absorbed and has been shown to have an onset of pain relief similar to intravenous morphine, i.e. within 10 minutes. Titration of the rescue dose should be attempted in an individual way to identify the most appropriate dose, as no relationship between basal dose and rescue dose has been found in studies with transmucosal fentanyl (Mercadante et al. 2002). Most patients receive morphine as the first drug for their pain conditions. The ratio of metabolites to the parent compound is less during parenteral administration than oral administration. In some situations, this difference in the production of metabolites could account for the

occurrence of fewer adverse effects during parenteral morphine administration. Thus, ► **switching** from oral administration to a continuous parenteral administration, both subcutaneously or intravenously may reduce the metabolite-morphine relationship and decrease the toxicity due to accumulation of the metabolites. Adverse effects may also be reduced in intensity with the use of the spinal route, although the administration of local anesthetics with an opioid may provide additional analgesia, and permit the recapture of patients unresponsive to spinal morphine administered alone. Epidural clonidine in combination with morphine has demonstrated some benefit in neuropathic pain conditions (Mercadante 1999). Many simple procedures of regional anesthesia may be helpful in some selected cases.

As opioids have differential effects on selective subsets of opioid receptors in the central nervous system, and cross tolerance between opioids is incomplete, a shift from one opioid to another is a useful option when the side effect-analgesic relationship is inconvenient. This pharmacological approach is named opioid rotation or switching. To restore a more advantageous analgesia-toxicity relationship, sequential trials of different opioids have been suggested. The degree of cross-tolerance may change as opioid doses are escalated, and care must be taken in applying an equianalgesic dose table to patients on high doses of opioids (Bruera et al. 1996).

Finally, cancer pain is a complex experience, which involves personality, learning, and situational components. Although difficult to assess, psychological status plays an important role in the experience of cancer pain and may influence the need for opioid escalation. The degree of psychological distress has been reported as a major negative prognostic factor for opioid responsiveness. It is possible to attain better analgesia following the introduction of psychological interventions or psychotropic medication.

## References

1. Bruera E, Schoeller T, Wenk R, MacEachern T, Marcellino S, Hanson J, Suarez-Almazor M (1995) A Prospective Multicenter Assessment of the Edmonton Staging System for Cancer Pain. *J Pain Symptom Manage* 10:348–355
2. Bruera E, Pereira J, Watanabe S, Belzile M, Kuehn N, Hanson J (1996) Opioid Rotation in Patients with Cancer Pain: A Retrospective Comparison of Dose Ratios Between Methadone, Hydromorphone, and Morphine. *Cancer* 78:852–857
3. Cherny N, Ripamonti C, Pereira J et al. (2001) Strategies to Manage the Adverse Effects of Oral Morphine: An Evidence-Based Report. *J Clin Oncol* 19:2542–2554
4. Collin E, Poulain P, Gauvain-Piquard A, Petit G, Pichard-Leandri E (1993) Is Disease Progression the Major Factor in Morphine “Tolerance” in Cancer Pain Treatment? *Pain* 55:319–326
5. Mao J, Price D, Mayer DJ (1995) Experimental Mononeuropathy Reduces the Antinociceptive Effects of Morphine: Implications for Common Intracellular Mechanisms Involved in Morphine Tolerance and Neuropathic Pain. *Pain* 61:353–364
6. Mercadante S, Maddaloni S, Roccella S, Salvaggio L (1992) Predictive Factors in Advanced Cancer Pain Treated only by Analgesics. *Pain* 50:51–155
7. Mercadante S (1999) Problems of Long-Term Spinal Opioid Treatment in Advanced Cancer Patients. *Pain* 79:1–13
8. Mercadante S, Portenoy RK (2001) Opioid poorly responsive cancer pain. Part 3. Clinical strategies to improve opioid responsiveness. *J Pain Symptom Manage* 21:338–354
9. Mercadante S, Radbruch L, Caraceni A et al. (2002) Episodic (Breakthrough) Pain. *Cancer* 94:832–839
10. Portenoy RK, Hagen NA (1990) Breakthrough Pain: Definition, Prevalence, and Characteristics. *Pain* 41:273–281
11. Portenoy RK, Foley KM, Inturrisi CE (1990) The Nature of Opioid Responsiveness and its Implications for Neuropathic Pain: New Hypotheses Derived from Studies of Opioid Infusions. *Pain* 43:273–286
12. Portenoy RK (1995) Tolerance to Opioid Analgesics: Clinical Aspects. *Cancer Surveys* 21:49–65
13. Portenoy RK (1996) Adjuvant Analgesic Agents. *Hematol Oncol Clin North Am* 10:103–119

## Opioid Rotation

CHARLES E. INTURRISI

Department of Pharmacology, Weill Medical College of Cornell University and The Pain and Palliative Care Service, Memorial Sloan-Kettering Cancer Center, New York, NY, USA

ceintur@med.cornell.edu

### Definition

► **Opioid rotation** refers to the substitution or switching from one opioid to another to achieve a more favorable therapeutic outcome.

### Characteristics

The individualization of the dose of an opioid is essential for the appropriate and successful management of pain with these drugs (Inturrisi 2002). When gradual ► **dose titration** is limited by adverse effects, opioid rotation is one of the alternative therapeutic strategies that should be employed (Indelicato and Portenoy 2002). This approach is based on clinical observations that the interindividual response to opioids varies widely, and that the switch to an alternative opioid often results in an “opening in the therapeutic window” by reducing limiting adverse effects (Pereira et al. 2001; Indelicato and Portenoy 2002; Inturrisi 2002). Unfortunately, while there is general agreement about the utility of opioid rotation, the factors underlying interindividual variation cannot yet be readily identified in most patients, and therefore no consensus has been reached on the steps that should be used in converting the dose from one opioid to the alternative (Ripamonti et al. 1998; Mercadante 1999; Pereira et al. 2001; Indelicato and Portenoy 2002). However, a rational pharmacological approach begins with the recognition that opioid rotation requires knowledge of the ► **relative potency** relationship between the two opioids involved in the therapeutic situation. Relative potency refers to the ratio of doses of two drugs required to produce the same level of effect (► **Equianalgesic Dose**) (Houde et

al. 1965). As defined, it can only be obtained from dose-response data. The most reliable data is obtained from randomized, double blind, crossover studies, where the dose-response curves are generated and comparisons are made in the equianalgesic effect range to reduce errors associated with extrapolation (Houde et al. 1965). An equianalgesic dose table provides evidence based values for estimates of the relative potency of different opioids administered by commonly used routes of administration (for example, see Table 1). Importantly, the table simplifies comparisons, by relating the potency of each opioid to that of a 10 mg intramuscular dose of morphine. Nevertheless, an equianalgesic dose table does not provide all of the essential information needed for dose conversion in individual patients. The table (Table 1) presents the mean estimate of relative potency, but not the confidence limits which define the range of values where the estimate will fall 95 percent of the time. If the confidence limits are wide, as they are for the estimates used to construct the table (Houde et al. 1965), then any ratio number derived from the table and used as the sole means of calculating the equianalgesic dose for opioid rotation will be subject to this variation. The table (Table 1) was originally intended as the starting point for the estimation of the conversion dose ratio, with the consideration of indi-

vidual patient factors and clinical experience to guide the final dose selection. Some of the factors affecting opioid response, and therefore the equianalgesic dose, are intrinsic to the patient and some are intrinsic to the drug. For example, with repetitive dosing the opioid will accumulate until steady-state is reached. Opioids with a short ► **elimination half-life** will reach steady-state sooner than those with a longer elimination half-life (Inturrisi 2002). Even at an apparent steady-state, the analgesic responses vary widely among cancer patients. Estimates of the concentration of methadone required to produce 50% pain relief at steady-state vary nearly 10 fold (Inturrisi et al. 1990). For some opioids, including morphine, active metabolites can accumulate with repetitive dosing, and their contribution to the therapeutic and adverse effects of these opioids remains controversial (Penson et al. 2000; Skarke et al. 2003). Some opioids have nonopioid effects that can influence opioid responses. Methadone has NMDA receptor antagonist activity in animal studies that are not seen with morphine or hydromorphone. NMDA receptor antagonists prevent or reverse opioid tolerance, and are antihyperalgesic in models of injury-induced pain (Davis and Inturrisi 1999). Factors intrinsic to the patient that can influence ► **opioid responsiveness** include the mechanism and intensity of the patient's

**Opioid Rotation, Table 1** Opioid Analgesics used for Severe Pain

Name	Equianalgesic im Dose (a)	Starting Oral Dose Range (mg) (a)	Comments	Precautions
morphine	10	30	Standard of comparison for opioid analgesics. Several sustained-release dosage forms	lower doses for aged patients; impaired ventilation; bronchial asthma; increased intracranial pressure; liver failure
hydromorphone	1.5	4–8	Slightly shorter acting. HP im dosage form for tolerant patients	like morphine
oxycodone	10	15–30	Immediate- release and sustained-release dosage forms.	like morphine
methadone	10	10	good oral potency; long plasma half-life	like morphine; may accumulate with repetitive dosing causing excessive sedation
levorphanol	2	2–4	like methadone	like methadone
fentanyl	0.1	–	Transdermal preparation. See package insert for equianalgesic dosing	Transdermal creates skin reservoir of drug-12-hour delay in onset and offset. Fever increases absorption
meperidine	75	not recommended	slightly shorter acting; used orally for less severe pain	normeperidine (toxic metabolite) accumulates with repetitive dosing causing CNS excitation; not for patients with impaired renal function or receiving monoamine oxidase inhibitors

For these equianalgesic im doses (also see comments) the time of peak analgesia in nontolerant patients ranges from one-half to one hour and the duration from four to six hours. The peak analgesic effect is delayed and the duration prolonged after oral administration.

(a) These doses are recommended starting doses from which the optimal dose for each patient is determined by titration and the maximal dose limited by adverse effects. For single IV bolus doses use half the im dose.

Im, intramuscular; po, oral

Adapted from, Table 1, Inturrisi, C.E., Clin. J. Pain, 18 (2002) S3–S13



pain. It is generally recognized that pain generated by injury to the nervous system, i.e. neuropathic pain, is often less responsive to opioids (Portenoy et al. 1990). Advanced age and decreased renal function can increase opioid responsiveness, while the development of opioid tolerance decreases the response to opioids (Inturrisi 2002). Current information is not sufficient to assure us that any one of these factors equally affect the response to each opioid in the table, and therefore can be ignored while calculating a ratio. Thus, it is generally accepted that tolerance does not appear to develop at the same rate to all opioids (Pasternak 2001). Indeed, this concept of ► **incomplete cross tolerance** among opioids provides one of the rationales for opioid rotation, but also needs to be accounted for in the calculation of the rotation dose. Many of the pharmacokinetic and pharmacodynamic factors outlined above can be expected to make a significant contribution to the response seen after multiple dosing with the alternate drug rather than after a single dose. A systemic review of estimates of the ► **equianalgesic dose ratios** reported in studies that utilized chronic opioid administration was conducted by Pereira et al. (2001). This review identified many of the issues discussed above, and also noted that the equianalgesic dose ratio may change according to the direction of the opioid switch. This complication is neither well appreciated nor has it been systematically evaluated.

Given these caveats, two principles that clearly emerge are that the rotation dose should be some fraction of the equianalgesic dose calculated from Table 1, and that some form of ► **dose titration** is required to provide a margin of safety (Ripamonti et al. 1998; Mercadante 1999; Pereira et al. 2001; Indelicato and Portenoy 2002). The overarching consideration in selecting a dosing schedule for opioid rotation is first to limit the risk of overdose as one opioid is discontinued and the substitute is introduced. The dose of the new opioid is calculated from the equianalgesic dose table (Table 1). This estimated dose is then reduced by 25 to 50% for opioids other than methadone (Indelicato and Portenoy 2002; Inturrisi 2002). For methadone, the estimated dose is reduced by 75 to 90% (Indelicato and Portenoy 2002). This estimated dose may also be adjusted based on the medical condition of the patient and the severity of the pain (Indelicato and Portenoy 2002). Ripamonti (Ripamonti et al. 1998) observed that in cancer patients the estimated equianalgesic dose ratio of morphine to methadone increased as a function of the prior morphine dose, so that no single dose ratio was appropriate for both opioid-naïve patients and patients who were receiving short or longer duration morphine therapy at the time they were switched to methadone. The data indicate that those patients who were receiving the highest doses of morphine were relatively more sensitive to the analgesic effects of methadone than predicted by the dose ratio derived from the table.

Therefore, patients with prior morphine experience require a greater reduction in the estimated methadone dose than relatively morphine-naïve patients. It is not known whether this variability in the estimated dose ratio between morphine and methadone is unidirectional, or if it should also be considered when switching from methadone to morphine. Recognition of the complexity of estimating the equianalgesic dose has led several investigators to conduct both prospective and retrospective studies aimed at better defining the equianalgesic dose ratios. Thus, from retrospective studies in palliative care patients, the ratio of morphine to hydromorphone was estimated to be approximately 5 to 1 (Pereira et al. 2001). However, this ratio (morphine to hydromorphone) was only approximately 3.5 to 1 when patients were shifted from hydromorphone to morphine (Pereira et al. 2001). This led to the suggestion that the values in Table 1 should be modified to reflect these estimates (Pereira et al. 2001). This change in the relative potency estimates could decrease or eliminate the need to reduce the dose calculated from the table in the manner described above. Whether this provides a safer and more convenient approach remains to be verified. Nevertheless, anyone planning to use opioid rotation should carefully consider these approaches (Ripamonti et al. 1998; Mercadante 1999; Pereira et al. 2001).

The ► **dosing regimen** to be employed should also reflect the understanding that the estimated dose is just that, a starting dose from which the optimal dose for that patient will be achieved by careful dose titration up or down. Alternatively, the dose can be fixed and the ► **dosing interval** adjusted to optimize the response. Usually some combination of these two approaches provides the necessary flexibility. Where both opioids have relatively short ► **elimination half lives** (e.g. morphine and hydromorphone), the final estimated dose of the new opioid can be substituted for current opioid, provision made for a rescue dose (usually 5 to 15% of the total daily dose) and titration with the new opioid begun (Indelicato and Portenoy 2002). Often the new opioid is administered on a fixed interval schedule as was the previous opioid (Indelicato and Portenoy 2002). An important exception to this approach are the opioids with relatively long elimination half lives (see Inturrisi 2002). The most important of these is methadone, whose half-life is much longer than that of morphine and subject to significant interindividual variation (Inturrisi 2002). Early studies employed a patient-controlled dosage regimen of oral methadone, which fixed the dose of methadone but allowed the dosing interval to be determined by the duration of the patient's pain relief after methadone (Sawe et al. 1981). This “► **as needed dosage regimen** during the titration phase of rotation to methadone is still advocated” (Foley and Houde 1998). More recent versions of the fixed dose with an “as needed” interval approach for methadone rotation have been described (Morley et al. 1993; Mercadante 1999).

Others have proposed that the switch from morphine to methadone be more gradual, over 3 to 4 days, and that a portion of the morphine dose (1/3) be substituted with methadone each day (Bruera et al. 1995; Ripamonti et al. 1998). These approaches also incorporate our current understanding of the need to further reduce the dose of methadone from the estimate obtained using the unmodified table (Table 1) (Morley et al. 1993; Bruera et al. 1995; Mercadante 1999) and they take into account the complex relationship discussed above between prior morphine experience and the response to methadone (Ripamonti et al. 1998).

This discussion has focused on the rotation of opioids by the oral route of administration because most of the studies have employed this route.

However, some data are available on opioid rotation that involves the transdermal and the parenteral routes (Mercadante 1999; Pereira et al. 2001; Indelicato and Portenoy 2002).

Given the current limitations in our knowledge of dose conversion strategies, additional controlled studies of opioid rotation are essential so that more specific guidelines for opioid rotation can be developed, and this useful method of optimizing pain relief can be both improved and simplified.

## References

- Bruera E, Watanabe S, Fainsinger RL, Spachynski K, Suarez-Almazor M, Inturrisi C (1995) Custom-Made Capsules and Suppositories of Methadone for Patients on High-Dose Opioids for Cancer Pain. *Pain* 62: 141–146
- Davis AM, Inturrisi CE (1999) d-Methadone Blocks Morphine Tolerance and N-methyl-D-aspartate-induced Hyperalgesia. *J Pharmacol Exp Ther* 289: 1048–1053
- Foley KM, Houde RW (1998) Methadone in Cancer Pain Management: Individualize Dose and Titrate to Effect. *J Clin Oncol* 16: 3213–3215
- Houde RW, Wallenstein SL, Beaver WT (1965) Clinical Measurement of Pain. In: deStevens G (ed) *Analgesics*. Academic Press, Inc., New York, pp 75–122
- Indelicato RA, Portenoy RK (2002) Opioid Rotation in the Management of Refractory Cancer Pain. *J Clin Oncol* 20: 348–352
- Inturrisi CE (2002) Clinical Pharmacology of Opioids for Pain. *Clin J Pain* 18: S3–S13
- Inturrisi CE, Portenoy RK, Max MB, Colburn WA, Foley KM (1990) Pharmacokinetic-Pharmacodynamic Relationships of Methadone Infusions in Patients with Cancer Pain. *Clin Pharmacol Ther* 47: 565–577
- Mercadante S (1999) Opioid Rotation for Cancer Pain: Rationale and Clinical Aspects. *Cancer* 86: 1856–1866
- Morley JS, Watt JW, Wells JC, Miles JB, Finnegan MJ, Leng G (1993) Methadone in Pain Uncontrolled by Morphine. *Lancet* 342: 1243
- Pasternak GW (2001) Incomplete Cross Tolerance and Multiple  $\mu$  Opioid Peptide Receptors. *Trends Pharmacol Sci* 22: 67–70
- Penson RT, Joel SP, Bakhshi K, Clark SJ, Langford RM, Slevin ML (2000) Randomized Placebo-Controlled Trial of the Activity of the Morphine Glucuronides. *Clin Pharmacol Ther* 68: 667–676
- Pereira J, Lawlor P, Vigano A, Dorgan M, Bruera E (2001) Equianalgesic Dose Ratios for Opioids. A Critical Review and Proposals for Long-Term Dosing. *J Pain Symptom Manage* 22: 672–687
- Portenoy RK, Foley KM, Inturrisi CE (1990) The Nature of Opioid Responsiveness and its Implications for Neuropathic Pain: New Hypotheses Derived from Studies of Opioid Infusions. *Pain* 43: 273–286
- Ripamonti C, Groff L, Brunelli C, Polastra D, Stavrakis A, De Conno F (1998) Switching from Morphine to Oral Methadone in Treating Cancer Pain: What is the Equianalgesic Dose Ratio? *J Clin Oncol* 16: 3216–3221
- Sawe J, Hansen J, Ginman C, Hartvig P, Jakobsson PA, Nilsson MI, Rane A, Anggard E (1981) Patient-Controlled Dose Regimen of Methadone for Chronic Cancer Pain. *Br Med J (Clin Res Ed)* 282: 771–773
- Skarke C, Darimont J, Schmidt H, Geisslinger G, Lotsch J (2003) Analgesic Effects of Morphine and Morphine-6-glucuronide in a Transcutaneous Electrical Pain Model in Healthy Volunteers. *Clin Pharmacol Ther* 73: 107–121

## Opioid Rotation in Cancer Pain Management

ROSE-ANNE INDELICATO, RUSSELL K. PORTENOY  
Department of Pain and Palliative Care, Beth Israel  
Medical Center, New York, NY, USA  
rportenoy@chpnet.org

### Definition

Converting from one opioid to an alternative opioid with the goal of achieving a more favorable balance between analgesia and side effects.

### Characteristics

Chronic opioid therapy remains the cornerstone of treatment for moderate to severe cancer pain. Optimization of therapy relies on individualization of opioid dosing. This process involves gradual dose titration until adequate analgesia or the development of unmanageable side effects has been reached. ► **Opioid responsiveness** refers to the likelihood that a favorable balance between pain relief and side effects can be achieved during dose titration (Portenoy 2000). Poor responsiveness can be due to a number of factors, including co-morbid medical conditions that predispose to toxicity, pain pathophysiology associated with limited analgesic response, and pharmacological effects such as active metabolite accumulation associated with dehydration or renal insufficiency (Portenoy 1999; Mercadante and Portenoy 2001a; Mercadante and Portenoy 2001b).

The management of a patient who experiences a poor response to an opioid drug begins with a comprehensive pain assessment, including physical examination. Based on this assessment, the clinician may implement one of the following strategies (Indelicato and Portenoy 2002):

- More aggressive therapy for side effects.
- Administration of a co-analgesic (non-opioid or ► **adjuvant analgesic**) with the goal of reducing the systemic opioid requirement.
- Intraspinal therapy to reduce the systemic opioid requirement.

- Nonpharmacological interventions, such as transcutaneous nerve stimulation (TENS), neural blockade, cognitive approaches, or complementary therapies to reduce systemic opioid requirement.
- Opioid rotation to a different opioid with the hope of a more favorable balance between analgesia and side effects.

Opioid rotation is based on the variability of response to different opioids. As a result of this variation, a switch to an alternative drug may produce a better balance between analgesia and side effects (Galer et al. 1992, Cherny et al. 1995; Bruera et al. 1996a).

To reduce the risk of overdosing or underdosing as one opioid is discontinued and another is started, the clinician must have a working knowledge of the ► [equianalgesic dose table](#). This dosing table provides evidence-based values for the relative potencies among different opioid drugs and routes of administration. These values were established from well-controlled single-dose assays conducted in cancer populations with limited exposure to opioid analgesics (Houde et al. 1966). The standard to which all relative potencies are compared is defined as morphine 10 mg parenterally. The equianalgesic table offers a broad guide for dose selection when switching from one opioid to another. The clinician must first calculate the total daily dosage of the current opioid, including the fixed schedule dosing and the supplemental doses taken as needed for breakthrough pain.

In many cases, the calculated dose of the new opioid must be reduced to minimize the risk of overdosage (Derby et al. 1998, Anderson et al. 2001). The usual starting point for dose reduction from the calculated equianalgesic dose is 25–50%. The following guidelines should be followed when converting from one opioid analgesic to another (Indelicato and Portenoy 2002):

- Calculate the equianalgesic dose of the new opioid based on the equianalgesic table.
- If switching to any opioid other than methadone or fentanyl, decrease the equianalgesic dose by 25–50%.
- If switching to methadone, reduce the dose by 75–90%.
- If switching to transdermal fentanyl (Duragesic®), do not reduce the equianalgesic dose.
- Consider further changes in the adjusted equianalgesic dose based on medical condition and pain:
  - If the patient is elderly or has significant cardiopulmonary, hepatic or renal disease, consider further dose reduction.
  - If the patient has severe pain, consider a lesser dosage reduction or forego any dose reduction.
- Calculate a rescue dose as 5–15% of the total daily opioid dose and administer at an appropriate interval.
- Reassess and titrate the new opioid as needed.

This reduction is justified by:

- The potential for incomplete cross-tolerance between opioid drugs (potentially leading to effects, including side effects that would be greater than expected when a switch to a new analgesic is implemented).
- The interindividual variability in the relative potencies among opioids (ratios listed on the equianalgesic table may be more or less than the ratio that would be found if a single dose study was done in the individual patient).
- The need for dosage adjustment for conditions that increase opioid risk (including advanced age and medical co-morbidities).
- The possible difference in relative potencies in single dose assays compared to repeated dose assays.

There are exceptions to the dosage reductions previously mentioned. The first is a conversion to a transdermal fentanyl system (TFS). When this formulation was developed, conversion guidelines were created that incorporated a safety factor, precluding the need for additional dose reduction in most patients.

The second exception occurs with a conversion to methadone. A larger dosage reduction in the calculated equianalgesic dose (75–90%) is supported by data that demonstrate a much higher potency than expected when switching to methadone from another pure mu agonist, such as morphine (Ripamonti et al. 1998; Bruera et al. 1996b; Shimoyama et al. 1997). These data suggest that the potency of methadone following a switch from another mu agonist is dependent on the dose of the prior drug (Bruera et al. 1996b; Shimoyama et al. 1997); a dose of 500 mg or more of morphine requires a larger dose reduction (90%) than a smaller dose. This greater-than-expected potency is thought to be related to the d-isomer which represents 50% of the commercially available racemic mixture in the United States. This isomer blocks the N-methyl-D-aspartate (NMDA) receptor, and in turn may produce analgesic effects and partially reverse opioid tolerance (Elliot et al. 1994; Hagen and Wasylenko 1999).

#### Conversion Example

Mr. J was a 64-year-old man with a history of prostate cancer and metastases to the thoracic spine. His back pain had been well controlled with modified-release oxycodone 80 mg every 12 h and oxycodone 5 mg, 1–2 tablets every 4 h as needed for breakthrough pain. He usually took 4 tablets per day. He developed an increase in the intensity of his back pain. Physical exam and MRI ruled out spinal cord compression. He had no other medical co-morbidities. His dosage of oxycodone was initially increased to 80 mg every 12 h and his oxycodone dose was increased to 4–5 tablets per dose, which he took twice daily. This change improved pain relief, but he developed sedation and dizziness. The plan was to switch to oral morphine.

- Calculate the 24 h total of oxycodone:  
(modified-release oxycodone 80 mg  $\times$  2) + (oxycodone 20 mg  $\times$  2)  
160 mg + 40 mg = 200 mg of oxycodone/day
- Convert to the oral morphine equivalent using the equianalgesic table:  
oxycodone 20 mg = morphine 30 mg  
oxycodone 200 mg = morphine 300 mg
- Decrease the morphine dosage by 25%:  
morphine 300 mg  $\times$  25% = 75 mg  
morphine 300 mg - 75 mg = 225 mg
- Convert the 24 h total to a fixed schedule:  
morphine 225 mg/24 h = modified-release morphine 120 mg every 12 h. The dosage has been rounded up given the tablet dosage size available.
- Calculate a rescue dose. The rescue dose may be calculated as a dose that is 5–15% of the total daily dose:  
morphine 240 mg/d  $\times$  5% = 12 mg; morphine 240 mg/d  $\times$  10% = 24 mg; and morphine 240 mg/d  $\times$  15% = 36 mg  
A rescue dose of 30 mg every 4 h as needed is reasonable.

## References

- Anderson R, Saiers JH, Abram S et al. (2001) Accuracy in Equianalgesic Dosing: Conversion Dilemmas. *J Pain Symptom Manage* 21:397–406
- Bruera EB, Pereira J, Watanabe S et al. (1996a) Systemic Opioid Therapy for Chronic Cancer Pain: Practical Guidelines for Converting Drugs and Routes. *Cancer* 78:852–857
- Bruera EB, Pereira J, Watanabe S et al. (1996b) Opioid Rotation in Patients with Cancer Pain. *Cancer* 78:852–857
- Cherny NI, Chang V, Frager G et al. (1995) Opioid Pharmacotherapy in the Management of Cancer Pain: A Survey of Strategies used by Pain Physicians for the Selection of Analgesic Drugs and Routes of Administration. *Cancer* 76:1288–1293
- Derby S, Chin J, Portenoy RK (1998) Systemic Opioid Therapy for Chronic Cancer Pain: Practical Guidelines for Converting Drugs and Routes of Administration. *CNS Drugs* 9:99–109
- Elliot K, Hynanski A, Inturrisi CE (1994) Dextromethorphan Attenuates and Reverses Analgesic Tolerance to Morphine. *Pain* 59:361–368
- Galer BS, Coyle N, Pasternak GW et al. (1992) Individual Variability in the Response to Different Opioids: Report of Five Cases. *Pain* 49:87–91
- Hagen NA, Wasylenko E (1999) Methadone: Outpatient Titration and Monitoring Strategies in Cancer Patients. *J Pain Symptom Manage* 18:369–375
- Houde RW, Wallenstein SL, Beaver WT (1966) Evaluation of Analgesics in Patients with Cancer Pain. In: Lasagna L (ed) *International Encyclopedia of Pharmacology and Therapeutics*. Pergamon Press, Oxford, pp 59–98
- Indelicato RA, Portenoy, RK (2002) Opioid Rotation in the Management of Refractory Cancer Pain. *J Clin Oncol* 20:348–352
- Mercadante S, Portenoy RK (2001a) Opioid Poorly Responsive Cancer Pain. Part 3: Clinical Strategies to Improve Opioid Responsiveness. *J Pain Symptom Manage* 21:338–354
- Mercadante S, Portenoy RK (2001b) Opioid Poorly-Responsive Cancer Pain. Part 1: Clinical Considerations. *J Pain Symptom Manage* 21:144–150
- Portenoy RK (2000) *Contemporary Diagnosis and Management of Pain in Oncologic and AIDS Patients*, 3<sup>rd</sup> edn. Handbooks in Health Care Company, Newtown, PA
- Portenoy RK (1999) Managing Cancer Pain Poorly Responsive to Systemic Opioid Therapy. *Oncology* 13:25–29
- Ripamonti C, Groff L, Brunelli C et al. (1998) Switching from Morphine to Oral Methadone in Treating Cancer Pain: What is the Equianalgesic Ratio? *J Clin Oncol* 16:3216–3221
- Shimoyama N, Shimoyama M, Megumi S et al. (1997) D-Methadone is Antinociceptive in Rat Formalin Test. *J Pharmacol Exp Ther* 283:648–652

## Opioid Switch

### Definition

Clinical practice of changing from one opioid to another, s. also Opioid Rotation.

► [Cancer Pain Management, Principles of Opioid Therapy, Drug Selection](#)

## Opioid Therapy in Cancer Pain Management, Route of Administration

LUKAS RADBRUCH

Department of Palliative Medicine, University of Aachen, Aachen, Germany

lradbruch@ukaachen.de

### Synonyms

Application route; delivery route

### Definition

Before they can effect their analgesic activity, opioids must be transferred to their sites of action, usually the opioid receptors in the dorsal horn of the spinal cord or brain. The route of administration is the method by which the opioid enters the body. By altering the pharmacokinetics of the opioid, the route also influences the effects (or pharmacodynamics). The course of analgesia is different for oral, subcutaneous or intrathecal application (Table 1). The side effect profile may be different for different application routes. Preference for a given application route in an individual patient may influence the choice of the opioid.

### Characteristics

#### Oral Administration

The administration of opioids “by the mouth” is one of the major recommendations of the World Health Organization (1996). The oral route as the first-line approach has been confirmed by other cancer pain guidelines (Agency for Health Care Policy and Research, US Department of Health and Human Services 1994; Hanks et al. 2001). The approach is easy and comfortable and finds high acceptance with the patients. No technical



**Opioid Therapy in Cancer Pain Management, Route of Administration, Table 1** Potency of different opioids used in cancer pain management in relationship to the application route

Opioid	Route					
	oral	transdermal	subcutaneously	intravenously	epidurally	intrathecal
Morphine	1		2–3	2–3	30	100
Oxycodone	2					
Hydromorphone	5–7.5		7.5	7.5		
Fentanyl	transmucosal: 50	100		100	100	1000
Buprenorphine	sublingual: 50	50		50		
Methadone	4–12					
Levomethadone	8–20					

equipment or special skills are needed. For opioid therapy, where dosage has to be titrated individually and sometimes up to high ranges, the inherent safety of the oral route provides an additional advantage. Sedation and nausea are the predominant side effects with an overdose, and with increasing somnolence, patients will sleep through subsequent doses, and with nausea and vomiting, opioid uptake will be reduced from the gastrointestinal tract. The oral route is ideally suited for patients treated at home, provided that they can swallow the medication and have no impediment of the enteral uptake of the drug.

Opioids given orally are absorbed predominantly in the upper ileum. They may bind to opioid receptors in the ► **myenteric plexus** before they are taken up by the circulation of the portal venous system. For some opioids, such as morphine or fentanyl, the first pass effect in the liver reduces bioavailability considerably.

In most countries, morphine is the opioid used predominantly for the oral route of application. With a normal release form, the time to the onset of the analgesic action is usually approximately 30 min, and the time to peak concentration is about 1 h. The analgesic effect lasts only 3–4 h. Modified-release formulations have an onset time of 1 h, time to peak concentration of up to 4 h, and duration of up to 24 h. Oxycodone is also available in normal release and modified-release forms. The modified-release form has a biphasic profile of action, providing an initial rapid onset in less than 1 h, and a prolonged second phase providing analgesia to 12 h.

Patients with cancer of the head and neck region or the esophagus, and patients with neurological diseases such as amyotrophic lateral sclerosis, may have difficulties swallowing medication due to progression of the disease. Oral opioids can be continued as long as the intake of fluids is still possible. Sometimes, the oral formulation must be changed, for example, from tablets to liquids. For morphine, a modified-release solution is available in some countries, which can provide analgesia for up to 24 h.

For patients receiving nutrition and fluids via gastrointestinal tubes or catheters, opioids can be administered through these lines. As long as the catheter tip lies in the stomach or duodenum, pharmacokinetics with the enteral administration will not be different from the oral. Tablets must be crushed to pass through the line, and modified-release kinetics will be lost with crushing. However, the modified-release solution of morphine, as well as capsules that can be opened without changing the modified-release properties of the small beads inside, can be used via feeding tube without losing the sustained effects.

#### Transdermal Administration

The introduction of a transdermal delivery system with fentanyl 13 years ago offered an alternative to the oral route. A transdermal delivery system with buprenorphine has been introduced recently. The transdermal systems are non-invasive, easy to apply, safe and comfortable. They may provide stable analgesia for three to four days.

The transdermal therapeutic system is applied on the skin, usually on the chest or back, upper arms or upper legs. The fentanyl patch is a depot system. From the reservoir in the patch, fentanyl diffuses through the adhesive layer into the skin. A rate control membrane in the patch system prevents excessive fluctuations in the delivery rate. The buprenorphine patch is a matrix system, with buprenorphine dissolved in the adhesive layer. A matrix patch for fentanyl has recently been released.

The main barrier in transdermal opioid delivery is the penetration of the intact skin. The pharmacological properties of fentanyl and buprenorphine allow sufficient diffusion rates to provide analgesia, as these opioids are small, lipophilic molecules with high analgesic potency. However, diffusion rates are low and the opioid pools in the uppermost skin layer, the ► **stratum corneum**. From this depot the opioid slowly diffuses to lower skin regions, where it is taken up via capillary

blood vessels into the systemic circulation. The depot in the stratum corneum is responsible for the slow pharmacokinetics of the transdermal application. It takes 2–4 h after application of the patch until measurable opioid concentrations are found in the blood, and up to 24 h to reach stable serum concentrations. The elimination of fentanyl after removal of the patch is also slow, with a half-life of 16 h, as the intracutaneous depot will only be drained slowly. The slow pharmacokinetic profile may provide stable analgesia, but also has to be considered during dose titration, as increases and decreases of the dosage will be effective only after 24 h.

The transdermal systems with fentanyl and buprenorphine are available in different sizes. Several patches may be combined reaching dosages of more than 10 mg/day fentanyl. The highest dosage used in our pain clinic for a cancer pain patient was 28.8 mg/day fentanyl. Patches must be applied on intact skin. If the skin at the application site is damaged, uptake rates may increase considerably. Heating of the application site may also increase the diffusion rate, and case reports have described an overdose with excessive heating.

The available transdermal systems are only indicated for patients with continuous stable pain syndromes. In addition to the transdermal opioids, an oral or parenteral opioid with a fast onset should be available for the treatment of ► **breakthrough pain**. More than half of the patients with continuous cancer pain will need additional medication for breakthrough pain every day or nearly every day. As examples, oral or subcutaneous administration of immediate-release morphine or oral transmucosal fentanyl citrate have often been used with transdermal fentanyl, and immediate-release morphine or sublingual buprenorphine have been used with transdermal buprenorphine.

### Transmucosal Administration

Opioid application is also possible through the mucosa of the oral cavity or the nose. However, the pharmacokinetics seem to be more variable than with oral application. Most patients will swallow part of the drug with the saliva, meaning that only a fraction of the opioid will be taken up through the oral mucosa, whereas the swallowed fraction will undergo the same pharmacokinetics seen with oral application.

Opioids have also been applied successfully via the rectal route. Opioid uptake is possible through the rectal mucosa as easily as through other intestinal sections. However, the rectal mucosa is drained by several venous systems, with the upper section processed through the enterohepatic circulation, and the lower sections drained directly into the inferior vena cava. Therefore, the amount of first-pass effect in the liver varies considerably after rectal administration, resulting in even larger variability of bioavailability compared to oral application. For chronic cancer pain, repeated rectal

application is uncomfortable and will be accepted by only a few patients (Ripamonti and Bruera 1991).

### Sublingual and Buccal

Buprenorphine has a very low bioavailability via the oral route. However, sublingual application results in fast uptake of approximately 60% of the opioid. The tablets will take nearly 20 min to dissolve, and patients may find it cumbersome to have the tablets beneath the tongue for longer times. Sublingual forms for other opioids have to be prepared by the pharmacist, and sublingual morphine has been used with good effect in postoperative pain in children. However, uptake through the mucosa of oral cavity or nose is low for hydrophilic opioids such as morphine, making the use of lipophilic opioids such as buprenorphine or fentanyl advantageous for these application routes.

A transmucosal system with fentanyl citrate was recently introduced. Fentanyl citrate is pressed around a plastic stick, with dosages ranging from 200–1600 µg per unit. After being placed in the oral cavity, about one-third of the fentanyl is absorbed through the oral mucosa. The rest is swallowed with the saliva, and approximately half of that amount is absorbed from the intestinal tract. The onset of analgesia is fast and the transmucosal system has been recommended for treatment of breakthrough pain. Clinical trials have found little correlation between the dosage of the continuous opioid drug and transmucosal fentanyl (Coluzzi et al. 2001). This means that individual titration of transmucosal breakthrough medication is required.

### Intranasal

Fentanyl has also been used in some patients for intranasal application. The pharmacokinetics of intranasal application of fentanyl have a fast and high peak in serum concentration, similar to intravenous administration (Striebel et al. 1992). Nasal sprays or intranasal application with a patient-controlled pump have been used. However, the intranasal application is often uncomfortable to the patient, therefore this application route has not advanced into routine clinical practice.

### Subcutaneous Administration

In a large series of cancer pain patients, oral administration was no longer possible in half of the patients at the last follow-up before death (Zech et al. 1995). Patients suffering from nausea or vomiting in spite of adequate antiemetic therapy may not be able to retain oral drugs in the gastrointestinal tract long enough to obtain adequate analgesia. Gastrointestinal obstruction may also impede the uptake of drugs from the gastrointestinal tract. Patients with ► **dysphagia** due to cancer progression in the head and neck area may not be able to swallow tablets or even liquids.

For these patients, the subcutaneous route offers an easy and effective alternative. For conversion from

oral to subcutaneous morphine, an average ratio between 1:2 and 1:3 has been recommended (Hanks et al. 2001). An oral daily dosage of 60 mg morphine would be equianalgesic to 20–30 mg subcutaneously. Conversion ratios between the oral and subcutaneous routes depend on oral bioavailability, and opioids with higher oral bioavailability, such as hydromorphone or methadone, will have lower conversion ratios compared to morphine. Morphine is used most frequently for subcutaneous application, but other opioids, such as buprenorphine, fentanyl, hydromorphone, methadone or oxycodone, have also been used with good effect. Subcutaneous administration of analgesics is usually only indicated for the last days of life, but long-term treatment for several months has also been reported (Drexel et al. 1989; Vermeire et al. 1998).

For long-term analgesic therapy, opioids can be administered by continuous subcutaneous infusion or with repeated bolus injections. Indwelling subcutaneous needles can be used for up to seven days, and may be used not only for continuous infusions, but also for repeated bolus injections. With continuous infusions, other drugs such as dipyrone or haloperidol can be combined with opioids. For patients requiring parenteral fluid substitution, 500–1000 ml saline or dextrose infusion can be administered daily via the subcutaneous route. Addition of hyaluronidase may be necessary to prevent induration in the subcutaneous tissue with larger amounts of infusion.

#### Intravenous Administration

The intravenous route offers another alternative if oral administration is no longer possible. Compared to subcutaneous administration, the intravenous route offers little advantage and requires higher technical standards. Dislocation of an intravenous line will burden the patient more than dislocation of a subcutaneous needle. The faster onset of analgesia after intravenous application provides no additional benefit for patients with continuous pain who require continuous opioid medication (Moulin et al. 1991).

However, in some patients subcutaneous application may be impaired by generalized edema, poor peripheral circulation, coagulation disorders or skin conditions. In these patients, intravenous administration can be advantageous. Patients may already have an indwelling intravenous line, e.g. for parenteral nutrition. For these patients, opioids may be implemented in the intravenous infusion regimen. As with the subcutaneous route, the average relative potency ratio of oral to intravenous morphine is between 1:2 and 1:3 (Hanks et al. 2001). For hydromorphone, the average relative potency ratio of oral to intravenous application is the same as for oral to subcutaneous.

The short time to peak concentration after intravenous bolus injection may be advantageous for patients with severe pain exacerbations. Intravenous titration with repeated bolus injection will provide pain relief more

rapidly than titration via other application routes. Experienced physicians can perform intravenous titration at the bedside or even at home.

#### Spinal Administration

Opioid receptors are found throughout the central nervous system. An area with high density of opioid receptors is the ► **substantia gelatinosa** of the dorsal horn, where the receptors are located on short interneurons, inhibiting pain transmission. Systemic administration delivers opioids into the bloodstream, which reach these receptors in the spinal cord from the circulation. Delivering the opioid directly into the intrathecal or epidural space will result in higher concentrations at the receptors than with systemic application. This means that less of the drug is required to provide analgesia, and lower opioid dosages may be correlated with fewer side effects. However, spinal administration is not devoid of side effects, and some side effects such as pruritus may be reported even more frequently with spinal application than with systemic opioid therapy. Technical and staff resources are required for the initiation of spinal therapy and special training is required for maintenance. Costs will be higher in the initial phase, as the implantation of catheter and pump systems is expensive. With long-term treatment over several months, lower drug costs will make spinal treatment cheaper than systemic opioid therapy. However, patients with intractable cancer pain and an indication for spinal opioid therapy often have poor life expectancies.

The place of spinal opioid therapy in cancer pain management is still under discussion. In a large series of 2118 cancer patients treated in a tertiary pain management unit only 74 patients (3%) required epidural or intrathecal opioids for a mean duration of  $41 \pm 48$  days (Zech et al. 1995).

#### Intrathecal

The pharmacokinetics of spinal opioid application vary in relation to lipophilicity and site of application. The intrathecal space is filled with the cerebrospinal fluid and is separated by the dura mater, a fibrinous membrane, from the epidural space filled with fatty tissue, and from blood vessels.

Lipophilic opioids such as fentanyl will penetrate easily into dorsal horn to the receptors in the substantia gelatinosa following injection into the subarachnoid space. Analgesic activity may be restricted to the spinal cord levels around the site of injection. The duration of analgesia is approximately 4–6 h after a fentanyl bolus. Intrathecal fentanyl may be advantageous for patients with regional pain problems such as pain from lumbar plexus infiltration.

Hydrophilic opioids such as morphine are slower to penetrate the dorsal horn. A large fraction of morphine is transported rostrally with the cerebrospinal fluid circulation. This fraction eventually reaches supraspinal opioid

receptors in the brainstem and the cortex. Rostral transport and supraspinal analgesic activity will provide analgesia that is not restricted to the level of injection. However, rostral transport is also responsible for side effects and complications from brainstem receptor sites. Late respiratory depression has been reported 24 h after intrathecal injection of morphine. Nausea and vomiting as well as pruritus are also late side effects related to higher morphine concentrations reaching receptors in the brainstem. Distribution throughout the central nervous system is also responsible for the long duration of action, as a single injection of morphine will provide analgesia for up to 24 h.

In many countries, morphine is the only opioid released for intrathecal treatment of chronic pain. However, many other opioids have been used for intrathecal application, including hydromorphone (hydrophilic); meperidine and methadone (moderately lipophilic); and buprenorphine, fentanyl, and sufentanil (very lipophilic). Diacetylmorphine (heroin) is frequently used in the United Kingdom for intrathecal opioid therapy. Diacetylmorphine has moderate lipophilicity, making it a compromise between morphine and fentanyl.

Long-term intrathecal application usually requires continuous administration via an intrathecal catheter and implanted pump system. With these systems, the intrathecal catheter is connected with a reservoir pump implanted subcutaneously in the abdominal or thoracic wall. As the whole system is concealed under the skin, and the skin barrier is only broken when the reservoir of the pump is filled, infections such as meningoen- cephalitis, as well as loss of cerebrospinal fluid from catheter dislocation, are rare. Dislocation or obstruction are possible complications, requiring replacement of the catheter. Modern pumps use ► **telemetric** programming, so that the delivery rate can be changed without an invasive procedure. However, implanted pumps will deliver only continuous rates, and patients have to use systemic opioids for breakthrough pain. Patients will also be dependent on specialist care, as refilling and programming of the pumps has to be done in specialized centers.

Intrathecal opioid therapy is indicated for patients with severe and intractable stable cancer pain, whose pain is not relieved by systemic opioid therapy with adequate doses and administration times, or when systemic opioid dosage cannot be increased into an effective dose range because of intolerable side effects.

### **Epidural**

Following epidural injection, a hydrophilic opioid such as morphine penetrates the dura mater more easily than a lipophilic opioid such as fentanyl. However, even though a larger amount of morphine will pass to the subarachnoid space, only a small fraction will proceed into the spinal dorsal horn, while the rest is

transported rostrally with the cerebrospinal fluid. On the other hand, lipophilic opioids such as fentanyl or sufentanil will, to a large extent, be taken up by the blood vessels in the epidural space. Some studies have found comparable serum concentrations after epidural and intravenous injection of fentanyl (Baxter et al. 1994) and sufentanil (Camann et al. 1992; Miguel et al. 1994). As with intrathecal application, hydrophilic opioids will have a slow onset (morphine: 30–90 min) and a long duration of action (morphine: 12–24 h) compared to lipophilic opioids (fentanyl onset: 5–10 min, duration 2–4 h) (Grass 1992). Side effects, such as nausea, pruritus, urinary retention or respiratory depression, are more frequent with hydrophilic opioids. Nausea may be reported by as much as 60% of the patients, and prevalence of pruritus may be even higher (Grass 1992). As with intrathecal application, epidural application of opioids can be combined with other drugs, such as local anesthetics or clonidine. For example, patients with neuropathic pain from tumor infiltration of the lumbar plexus may benefit from these combinations.

Dosages for epidural opioid therapy are about tenfold higher compared to intrathecal application, and accordingly larger infusion volumes are required. Implanted pumps are not able to deliver these volumes or would require refilling too often. Epidural application is, therefore, usually delivered through an external pump connected either via a subcutaneous port or directly to the epidural catheter. Catheters should be tunneled subcutaneously to prevent infections along the catheter line. External pumps allow continuous infusion rates and also bolus injections for treatment of breakthrough pain and for dose titration with pain exacerbations. Long-term epidural therapy has been reported with treatment durations of several months. However, complications such as catheter dislocation, obstruction or infection are not rare with long-term therapy.

Epidural opioid therapy is indicated for intractable chronic cancer pain that is not relieved with systemic opioid therapy with adequate dosage and administration times, or with intolerable side effects preventing further dose increases. Epidural therapy with an external pump has the advantage that the dosage can easily be adapted with changing requirements in patients with progressive disease, and that even patient-controlled epidural anesthesia is possible. As the insertion of an epidural catheter is a standard skill for anesthesiologists, technical skills for epidural opioid application should be available in every hospital. Transient epidural opioid treatment may be useful to provide pain relief with pain exacerbations. Once adequate pain relief has been accomplished, changing back to oral or subcutaneous application is often possible.

### **Intraventricular**

Intracerebroventricular infusion of opioids has also been used for cancer pain management. In a review of



case series (Ballantyne et al. 1996), analgesic efficacy was comparable to intrathecal and better than epidural application. Transient side effects such as nausea or respiratory depression were more frequent with intracerebroventricular application, but persistent side effects such as nausea, urinary retention or pruritus were less frequent. Complications such as infections or catheter obstruction were reported only rarely. However, no controlled trial has compared this application route directly with other routes, and the technical skills for intracerebroventricular opioid therapy are often not available.

### Topical Administration

As opioid receptors are located in the spinal and supraspinal nervous system, topical application seems to have little use in pain management. However, recent studies have demonstrated that opioid receptors are expressed in peripheral tissues with ongoing inflammation. Intra-articular injections of morphine or buprenorphine have been used for postoperative pain after arthroscopy and for osteoarthritis pain with good effect (reviewed in Gupta et al. 2001). No reports have been published on intra-articular opioid application for cancer pain patients.

A mouthwash with morphine was used successfully for the treatment of mucositis following chemotherapy in patients with head and neck cancer (Cerchietti et al. 2002).

### Inhalation

Nebulized application of opioids such as morphine has been reported for the treatment of breathlessness (reviewed in Chandle 1999), but not for pain management. Opioid receptors are located throughout the respiratory tract, predominantly in the alveolar walls. The effect of opioids at these receptors is not known. The results of the clinical trials are not clear, and the use of nebulized opioids cannot be recommended at this stage, even if this application route can relieve breathlessness in selected patients.

### Change of Route

For patients with inadequate pain relief with opioid therapy in adequate doses and administration times, a switch to another opioid has been recommended. After switching, most patients report improved pain relief and fewer side effects, even if the dosage of the new opioid is lower than expected from accepted equianalgesic potency ratios (Pereira et al. 2001). A possible explanation for the effect is incomplete cross-tolerance between opioids (the preference of different opioid receptor populations by different opioids, and accordingly the development of tolerance only to specific subpopulations with each opioid). Opioid switching has become a standard in cancer pain management in recent years.

Switching of the route of administration has also been recommended to improve pain relief and reduce side effects (Cherny 2001). Changing from oral morphine to transdermal fentanyl or buprenorphine combines opioid switching with a change of the application route. However, only a few small trials have reported the effect of route switching, and larger trials are needed to establish the value of this method.

### References

1. Agency for Health Care Policy and Research, US Department of Health and Human Services (1994) Clinical Practice Guideline No. 9: Management of Cancer Pain. Washington, DC
2. Ballantyne JC, Carr DB, Berkey CS et al. (1996) Comparative Efficacy of Epidural, Subarachnoid, and Intracerebroventricular Opioids in Patients with Pain due to Cancer, *Reg Anesth* 21:542–556
3. Baxter AD, Laganier S, Samson B et al. (1994) A Comparison of Lumbar Epidural and Intravenous Fentanyl Infusions for Post-Thoracotomy Analgesia. *Can J Anaesth* 41:184–191
4. Camann WR, Denney RA, Holby ED et al. (1992) A Comparison of Intrathecal, Epidural, and Intravenous Sufentanil for Labor Analgesia. *Anesthesiology* 77:884–887
5. Cerchietti LC, Navigante AH, Bonomi MR et al. (2002) Effect of Topical Morphine for Mucositis-Associated Pain following Concomitant Chemoradiotherapy for Head and Neck Carcinoma. *Cancer* 95:2230–2236
6. Chandler S (1999) Nebulized Opioids to Treat Dyspnea *Am J Hosp Palliat Care* 16:418–422
7. Cherny N, Ripamonti C, Pereira J, Davis C, Fallon M, McQuay H, Mercadante S, Pasternak G, Ventafridda V (2001) Strategies to manage the adverse effects of oral morphine: an evidence-based report. *J Clin Oncol* 19(9):2542–54
8. Coluzzi PH, Schwartzberg L, Conroy JD et al. (2001) Breakthrough Cancer Pain: A Randomized Trial Comparing Oral Transmucosal Fentanyl Citrate (OTFC) and Morphine Sulfate Immediate Release (MSIR). *Pain* 91:123–130
9. Drexel H, Dzien A, Spiegel RW et al. (1989) Treatment of Severe Cancer Pain by Low-Dose Continuous Subcutaneous Morphine. *Pain* 36:169–176
10. Grass JA (1992) Fentanyl: Clinical Use as Postoperative Analgesic-Epidural/Intrathecal Route. *J Pain Symptom Manage* 7:419–430
11. Gupta A, Bodin L, Holmstrom B et al. (2001) A Systematic Review of the Peripheral Analgesic Effects of Intra-Articular Morphine. *Anesth Analg* 93:761–770
12. Hanks GW, deConno F, Cherny N et al. (2001) Morphine and Alternative Opioids in Cancer Pain: The EAPC Recommendations. *Brit J Cancer* 84:587–593
13. Miguel R, Barlow I, Morrell M et al. E (1994) A Prospective, Randomized, Double-Blind Comparison of Epidural and Intravenous Sufentanil Infusions. *Anesthesiology* 81:346–352; Discussion 25A–26A
14. Moulin DE, Kreeft JH, Murray-Parsons N et al. (1991) Comparison of Continuous Subcutaneous and Intravenous Hydro-morphine Infusions for Management of Cancer Pain. *Lancet* 337:465–468
15. Pereira J, Lawlor P, Vigano A et al. (2001) Equianalgesic Dose Ratios for Opioids. A Critical Review and Proposals for Long-Term Dosing. *J Pain Symptom Manage* 22:672–687
16. Ripamonti C, Bruera E (1991) Rectal, Buccal, and Sublingual Narcotics for the Management of Cancer Pain. *J Palliat Care* 7:30–35
17. Striebel HW, Koenigs D, Kramer J (1992) Postoperative Pain Management by Intranasal Demand-Adapted Fentanyl Titration. *Anesthesiology* 77:281–285
18. Vermeire A, Remon JP, Rosseel MT et al. (1998) Variability of Morphine Disposition during Long-Term Subcutaneous In-

fusion in Terminally Ill Cancer Patients. *Eur J Clin Pharmacol* 53:325–330

19. World Health Organization (1996) *Cancer Pain Relief: With a Guide to Opioid Availability*. World Health Organization, Geneva
20. Zech DF, Grond S, Lynch J et al. (1995) Validation of World Health Organization Guidelines for Cancer Pain Relief: A 10-Year Prospective Study. *Pain* 63:65–76

## Opioid Therapy in Cancer Patients with Substance Abuse Disorders, Management

STEVEN D. PASSIK, K. L. KIRSH  
Markey Cancer Center, University of Kentucky  
College of Medicine, Lexington, KY, USA  
spassik@uky.edu

### Characteristics

Nearly one-third of the United States population has used illicit drugs, and an estimated 6–15% has a substance use disorder of some type (Groerer and Brodsky 1992). While ► **substance abuse** and ► **addiction** are commonly believed to have lower base rates in cancer patients than in our society at large, these occurrences are highly problematic and worthy of attention. Also, the relatively low prevalence of substance abuse among cancer patients treated in tertiary care hospitals may reflect institutional biases or a tendency for patient under-reporting in these settings.

Consideration of substance abuse in the cancer population also highlights the need to diagnose and understand the less obvious aberrant drug-taking behaviors sometimes in evidence in the treatment of patients without formal psychiatric histories of substance use disorders. Such behaviors can be manifest, for example, when a patient with cancer and pain is escalating drug doses or using medications to treat other symptoms. Once these aberrant behaviors are identified, the clinician must decide on a course of action that is fair, appropriate, consistent with laws and regulations, and in the best interests of the patient.

With the pressure of regulatory scrutiny and the duty to treat pain but contain abuse or diversion, clinicians often feel that they must avoid being duped by those abusing prescription pain medications. However, the clinician attempting to diagnose the meaning of aberrant drug-related behaviors during pain management needs not be correct. The clinician has an obligation to be thorough, thoughtful, logically consistent and careful (not to mention humane and caring), but not necessarily right. Indeed, there are multiple possibilities in the differential diagnosis of aberrant drug-taking behaviors, with criminal intent and diversion being only one of the more remote possibilities.

Clinical management can be tailored to the multiple possibilities that might give rise to the behaviors noted in the assessment, and asserting control over prescriptions

can be accomplished without necessarily terminating the prescribing of controlled substances entirely. In the treatment of cancer pain, clinicians do not have the same latitude to not prescribe simply because of abuse concerns. The clinical and moral imperative to treat pain in these patients can create dilemmas if the patient (or someone around them) is abusing medications. These situations defy simple solutions.

### Concerns over Current Definitions

► **Tolerance** and ► **physical dependence** are not necessarily signs of addiction or abuse in cancer patients with pain. In fact, physical dependence is to be expected with chronic dosing of opioids, and the need for dose escalation to maintain effect is usually a sign of disease progression and worsening pain (and cannot be ascribed to tolerance) (Portenoy 1994).

The ability to categorize questionable behaviors (e.g. consuming a few extra doses of a prescribed opioid, or using an opioid prescribed for pain as a nighttime hypnotic) as outside the social or cultural norm also presupposes that there is certainty about the parameters of normative behavior. Less aberrant behaviors (such as aggressively complaining about the need for medications) are more likely to reflect untreated distress of some type, rather than addiction-related concerns. Conversely, more aberrant behaviors (such as injection of an oral formulation) are more likely to reflect true addiction. Although empirical studies are needed to validate this conceptualization, it may be a useful model when evaluating aberrant behaviors.

A more appropriate model definition of addiction notes that it is a chronic disorder characterized by “compulsive use of a substance resulting in physical, psychological or social harm to the user and continued use despite that harm” (Rinaldi et al. 1988). Although this definition was developed from addicted populations without medical illness, it appropriately emphasizes that addiction is a psychological and behavioral syndrome. Any appropriate definition of addiction must include the concepts of loss of control over drug use, compulsive use, and continued use despite harm.

### Clinical Management

Out-of-control aberrant drug-taking among patients with cancer pain represents a serious and complex clinical occurrence. The principles outlined herein help the clinician establish structure, control and monitoring so that they can prescribe freely and without prejudice.

First, a multidisciplinary team approach is recommended for the management of substance abuse in the palliative care setting. Mental health professionals with specialization in the addictions can be instrumental in helping palliative care team members develop strategies for management and treatment compliance. Second, the first member of the medical team (frequently a

nurse) to suspect problematic drug-taking or a history of drug abuse should alert the patient's palliative care team, thus beginning the assessment and management process (Lundberg and Passik 1997), which includes use of empathic and truthful communication. This approach entails starting the assessment interview with broad questions about the role of drugs (e.g. nicotine, caffeine) in the patient's life, and gradually becoming more specific in focus to include illicit drugs. Third, the development of clear treatment goals is essential for the management of drug abuse. The distress of coping with a life-threatening illness and the availability of prescription drugs for symptom control can make complete abstinence an unrealistic goal (Passik and Portenoy 1998). Rather, a harm reduction approach should be employed. A written agreement between the team and patient helps to provide structure to the treatment plan, establishes clear expectations, and outlines the consequences of aberrant drug-taking, and the inclusion of spot urine toxicology screens and pill counts in the agreement can be useful in maximizing compliance. Fourth, the team should consider using longer acting drugs (e.g. transdermal fentanyl patch or modified-release opioids). The longer duration and slow onset may help reduce aberrant drug-taking behaviors when compared to the rapid onset and increased frequency of dosage associated with short-acting drugs. Fifth, the team should make plans to reassess frequently the adequacy of pain and symptom control. Finally, the team should involve family members and friends in the treatment to help bolster social support and functioning. Becoming familiar with the family may help the team identify family members who are themselves drug abusers, and who may potentially divert the patient's medications and contribute to the patient's non-compliance.

Managing addiction problems in patients with cancer is labor intensive and time-consuming. Clinicians must recognize that virtually any centrally acting drug, and any route of administration, can potentially be abused. The problem does not lie in the drugs themselves. The effective management of patients with pain who engage in aberrant drug-taking behavior necessitates a comprehensive approach, and provides a practical means to manage risk, treat pain effectively and assure patient safety.

## References

- Groerer J, Brodsky M (1992) The Incidence of Illicit Drug Use in the United States, 1962–1989. *Brit J Addiction* 87:1345
- Lundberg JC, Passik SD (1997) Alcohol and Cancer: A Review for Psycho-Oncologists. *Psycho-Oncology* 6:253–266
- Passik SD, Portenoy RK (1998) Substance Abuse Issues in Palliative Care. In: Berger AM, Portenoy RK, Weissman DE (eds) *Principles and Practice of Supportive Oncology*. Lippincott Raven Publishers, Philadelphia, pp 513–530
- Portenoy RK (1994) Opioid Tolerance and Efficacy: Basic Research and Clinical Observations. In: Gebhardt G, Hammond D, Jensen T (eds) *Proceedings of the VII World Congress on Pain*. Progress in pain research and management, vol 2. IASP Press, Seattle, p 595
- Rinaldi RC, Steindler EM, Wilford BB et al. (1988) Clarification and Standardization of Substance Abuse Terminology. *JAMA* 259:555

## Opioid Tolerance

- ▶ Opioids, Clinical Opioid Tolerance

## Opioid Tolerance and Glutamate Homeostasis

- ▶ Glutamate Homeostasis and Opioid Tolerance

## Opioid Tone

### Definition

A hypothesis whereby endogenous opioid peptides are released in a tonic manner, in the absence of any evoking stimulus. The presumed effect of opioid tone would be to produce a constant state of analgesia, as the opioids bind to and activate opioid receptors. The sometimes observed hyperalgesic effect of the opioid antagonist, naloxone, has been attributed to opioid tone.

- ▶ Opioid Analgesia, Strain Differences

0

## Opioids and Bladder Pain/Function

DAGMAR WESTERLING, KARL-ERIK ANDERSSON  
Departments of Clinical Pharmacology, Anesthesiology and Intensive Care, Lund University Hospital, Lund, Sweden

Dagmar.westerling@skane.se,  
karl-erik.andersson@klinfarm.lu.se

### Definitions

Opioids are ligands (agonists and antagonists) at opioid receptors ( $\kappa$ ,  $\delta$  and  $\mu$ , or OR 1–3). Opioid receptors are mainly located on primary afferents in the dorsal horn and in several supraspinal centres of importance for micturition control, such as the periaqueductal grey. There are also opioid receptors on primary afferents in peripheral tissues, including the bladder.

Bladder pain may be evoked from distension, inflammation and/or physical damage (surgery, bladder stone, tumour growth etc). Bladder pain is a type of **▶ Visceral Nociception and Pain**. Opioid receptor agonists may be effective in the treatment of some types of bladder pain. Bladder function comprises collection, storage and emission of urine. The bladder and urethra constitute a

functional unit, which is under spinal and supraspinal nervous control.

Administration of analgesic doses of opioid agonists may cause pain relief but also urinary retention due to a dose dependent depression of micturition reflexes, by actions at local, spinal and/or supraspinal sites.

## Characteristics

### Bladder Function

#### Anatomy

The lower urinary tract consists of the ► **urinary bladder** and the urethra. The bladder can be divided into two main components: the bladder body, which is located above the ureteral orifices, and the base, consisting of the trigone, urethrovesical junction, deep detrusor and the anterior bladder wall (Fig. 1). The bladder is a hollow smooth muscle organ, lined by a mucous membrane, and covered on its outer aspect partly by peritoneal serosa and partly by fascia. Its muscular wall is formed of smooth muscle cells, which comprise the detrusor muscle. The detrusor is structurally and functionally different from e.g. trigonal and urethral smooth muscle. The urethra contains both smooth and striated muscles, the latter forming the external urethral sphincter (rhabdosphincter).

#### Innervation of the Urinary Bladder

The urinary bladder receives sympathetic, parasympathetic, sensory and somatic-motor innervation via the hypogastric, the pelvic and the pudendal nerves (Morrison et al. 2002) (Fig. 2) The smooth muscle layers of the bladder wall receive autonomic (mainly sympathetic but also parasympathetic fibres) and afferent innervation. The striated muscle of the external sphincter is under voluntary somato-motor control. There is a considerable overlap in the source of the innervation. Primary afferent nerves from the bladder have their cell bodies in

the dorsal root ganglia of the thoracolumbar and sacral spinal cord. From the dorsal root ganglia, sensory nerve cell bodies project both to the bladder, where information is received, and to the spinal cord, where the efferent pathways originate, and where the ► **primary afferents of the urinary bladder** connect to the spinothalamic tracts.

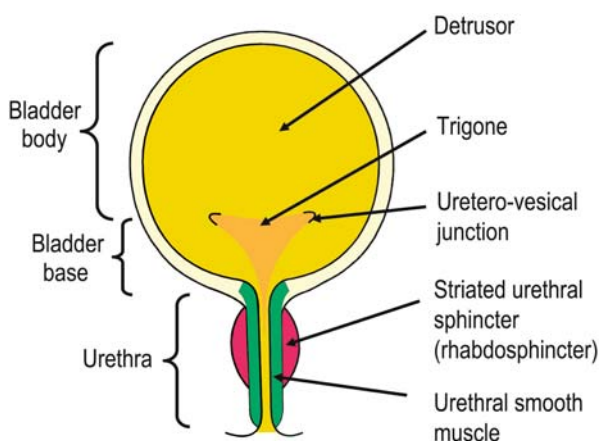
The primary afferents are myelinated ( $A\delta$ ) and thin unmyelinated (C) fibres, with nerve endings in the lamina propria and in the smooth muscle layers of the bladder and urethra. Retrograde tracing studies have shown that most of the sensory innervation of the bladder and urethra originates in the thoracolumbar region and travels via the pelvic nerve. In addition, some afferents originating in ganglia at the thoracolumbar level of the sympathetic outflow project via the hypogastric nerve. The sensory nerves of the striated muscle in the rhabdosphincter travel in the pudendal nerve to the sacral region of the spinal cord. Sacral sensory nerve terminals are uniformly distributed to all areas of the detrusor and urethra, whereas lumbar sensory nerve endings are most frequent in the trigone, and scarce in the bladder body. In the urinary bladder of both humans and animals, sensory nerves have been identified suburothelially as well as in the detrusor muscle. Suburothelially, they form a nerve plexus, which lies immediately beneath the epithelial lining. Some terminals may even be located within the basal parts of the urothelium. This suburothelial plexus is relatively sparse in the dome of the bladder, but becomes progressively denser near the bladder neck, and it is particularly prominent in the trigone.

The hypogastric and pelvic pathways are implicated, not only in the sensations associated with normal bladder filling, but also with bladder pain. The pelvic and pudendal pathways are also concerned with the sensation that micturition is imminent, and with thermal sensations from the urethra. The incoming information controls the activity in the parasympathetic, sympathetic and somatic efferent nerves to the lower urinary tract. Under normal conditions there is little ongoing activity in the primary afferent nerves corresponding to little or no conscious sensations from the empty and slowly filling urinary bladder.

#### Physiology, Initiation of Micturition

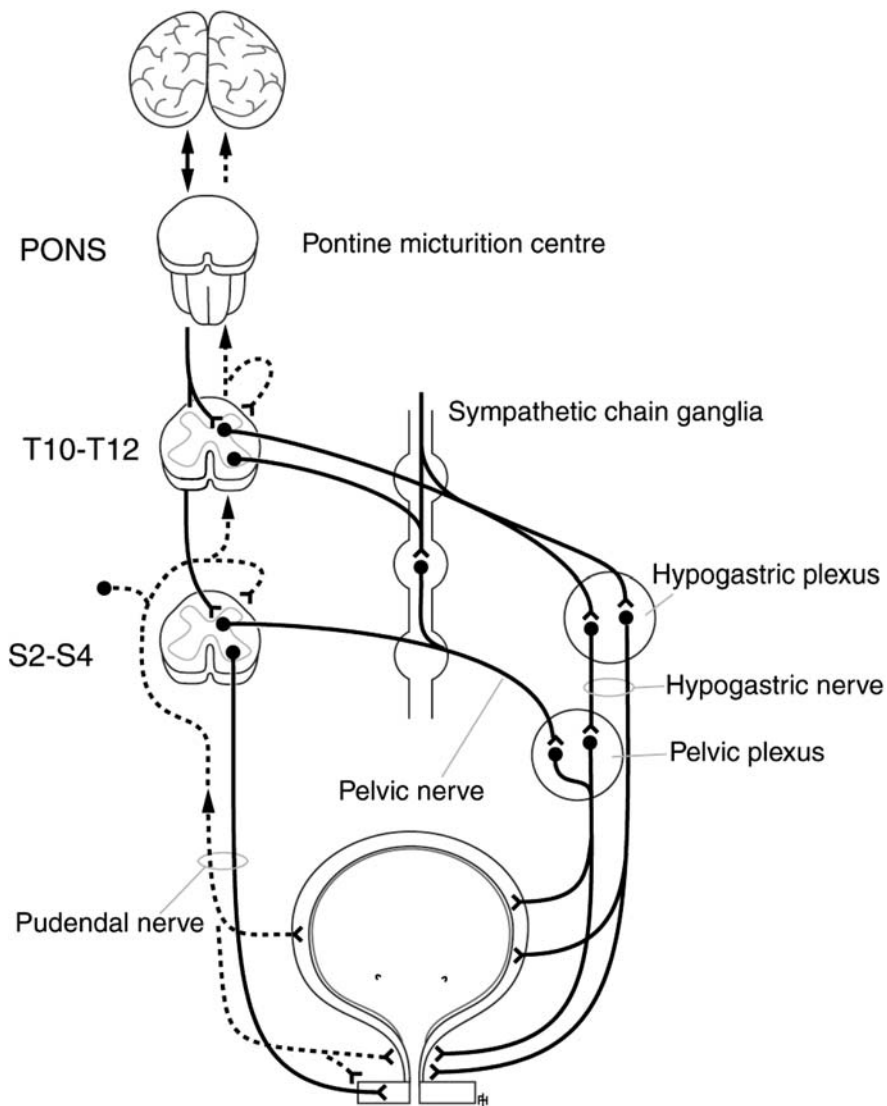
Bladder pressure increases very modestly during normal collection and storage of urine. When bladder pressure reaches an individual level of around 25–35 cm H<sub>2</sub>O, there is an urge to void. Under normal conditions this is a non-painful sensation. The smooth muscle of the detrusor contracts and urine is passed if the bladder neck, internal and external sphincters are relaxed at the same time. All of this requires a complex combination of nervous stimulation and inhibition (Fig. 3)

Myogenic activity, distension of the detrusor, and signals from the urothelium may initiate voiding (Ander-



**Opioids and Bladder Pain/Function, Figure 1** Anatomy of the urinary bladder. The bladder can be divided into two main components: the bladder body, which is located above the ureteral orifices, and the base, consisting of the trigone, urethrovesical junction, and the detrusor.



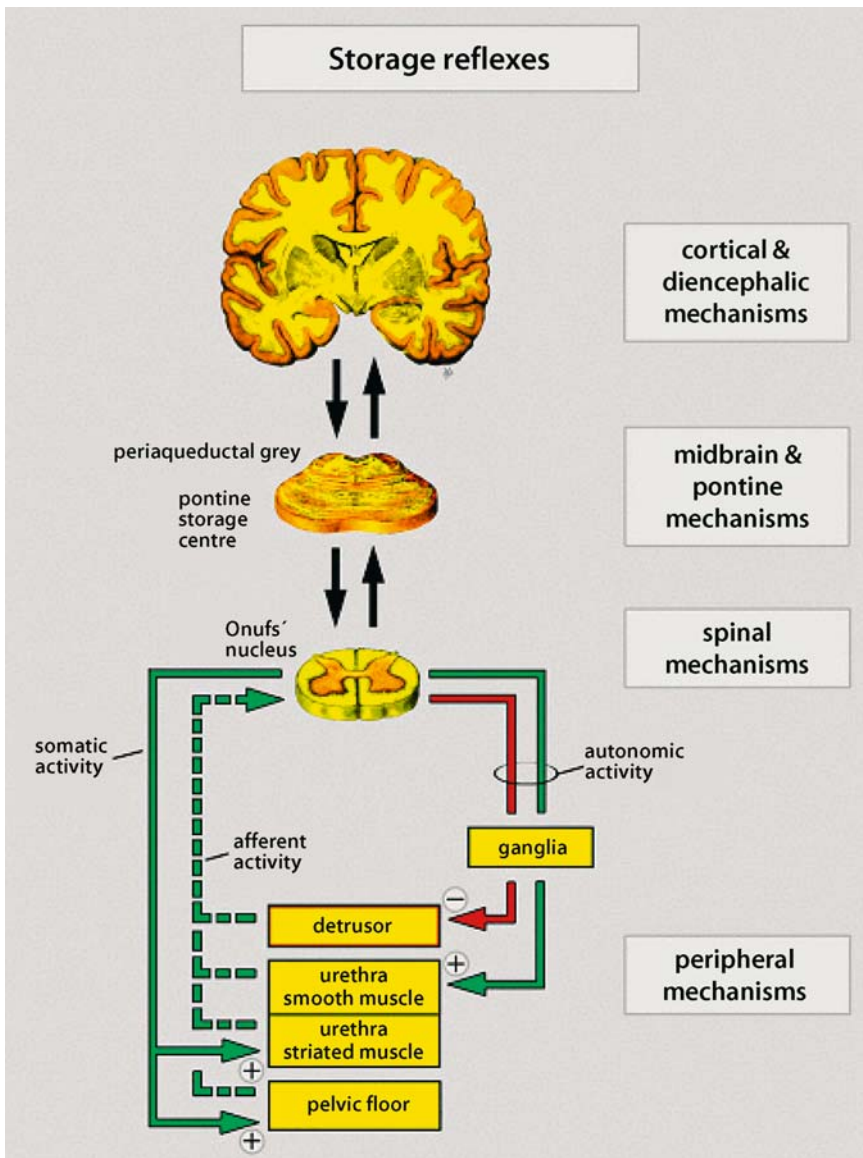


**Opioids and Bladder Pain/Function, Figure 2** Innervation of the urinary bladder. The urinary bladder receives efferent sympathetic (hypogastric nerve), parasympathetic (pelvic nerve), and somatic-motor (pudendal nerve) innervation. Afferent (sensory) information is conveyed via the hypogastric, pelvic and the pudendal nerves. In the figure, only afferent pathways in the pudendal nerve have been indicated (dotted line).

0

sson 2002). The normal stimulus for initiating micturition is distension of the bladder, activating mechanoreceptors in the bladder wall. A high level of activity can be recorded in small myelinated afferent nerves ( $A\delta$ ), which reach the lumbosacral spinal cord via the dorsal root ganglia. These  $A\delta$  afferents connect to a spinobulbospinal reflex consisting of an ascending limb from the lumbosacral spinal cord, an integration centre in the rostral brain stem, which is known as the pontine micturition centre (PMC), and a descending limb from the PMC back to the parasympathetic nucleus in the lumbosacral spinal cord. In the foetus and neonate, afferent information is conveyed by small unmyelinated (C-fibre) vesical afferents, which have a high mechanical threshold. Activity in these fibres is suppressed during development (“silent C-fibres”), but may be activated when the long reflex is damaged, as in spinal cord injuries, or by inflammation of the bladder mucosa, for example.

Extracellular adenosine triphosphate (ATP) has been found to mediate excitation of small-diameter sensory neurons via  $P2X_3$  receptors, and it has been shown that bladder distension causes release of ATP from the urothelium. In turn, ATP can activate  $P2X_3$  receptors on suburothelial afferent nerve terminals to evoke a neural discharge. However, it is not only ATP, but also a cascade of inhibitory and stimulatory transmitters/mediators that are most probably involved in the transduction mechanisms underlying the activation of afferent fibres during bladder filling. The urothelium may serve as a mechanosensor which, by producing NO, ATP and other mediators, can control the activity in afferent nerves, and thereby the initiation of the micturition reflex. The ► **firing of suburothelial afferent nerves**, and the threshold for bladder activation, may be modified by both inhibitory (e.g. NO) and stimulatory (e.g. ATP, tachykinins, prostanoids) mediators.



**Opioids and Bladder Pain/Function, Figure 3a** Normal function and physiology of the urinary bladder. During urine storage, there is continuous and increasing afferent activity (interrupted green line) from the bladder. There is no spinal parasympathetic outflow (red line -) that can contract the bladder. The sympathetic outflow to urethral smooth muscle, and the somatic outflow to urethral and pelvic floor striated muscles (continuous green lines +) keep the outflow region closed.

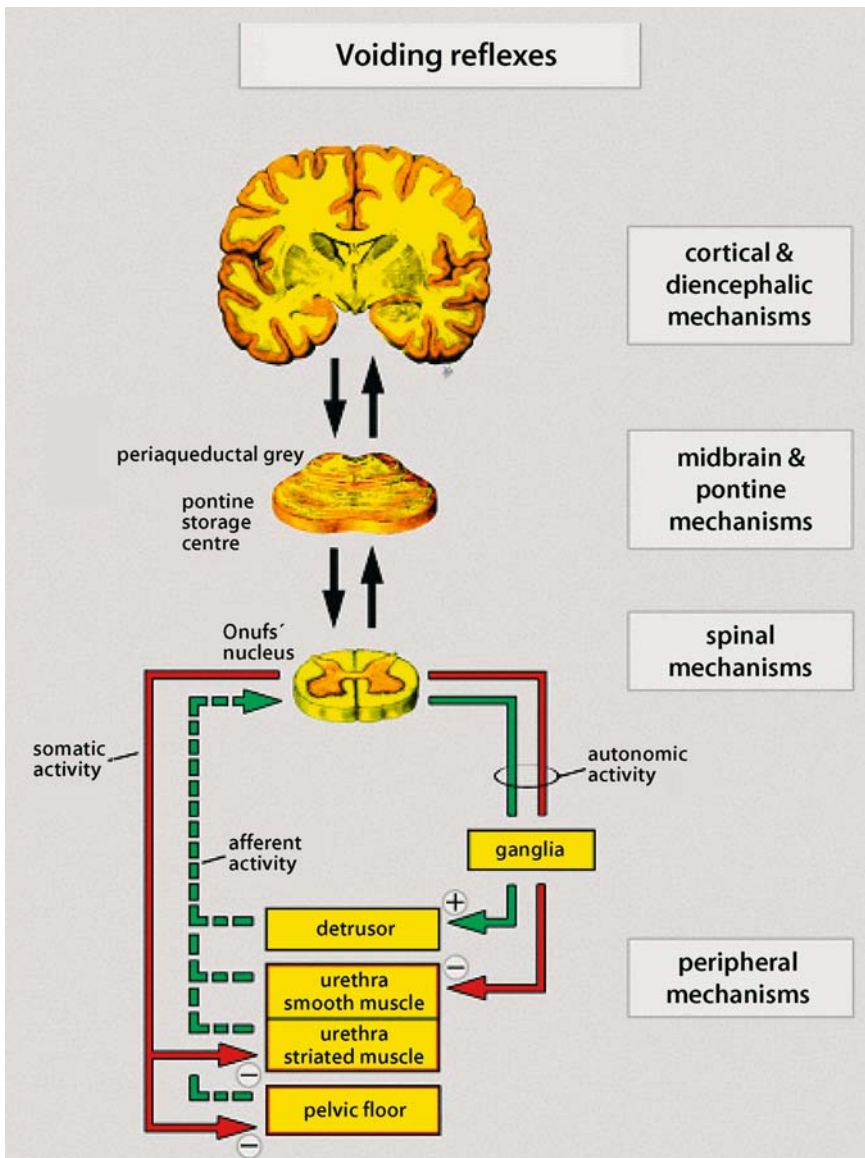
These mechanisms can be involved in the generation of bladder overactivity, causing urge, frequency and incontinence, but also in bladder pain.

#### Pathophysiology: Effect of Inflammation and Distension

If micturition is prevented and bladder pressure increases above 25–35 cm H<sub>2</sub>O, the sensation of bladder fullness becomes more and more unpleasant, and most subjects describe this as painful (Ness et al. 1998). The pressure in the bladder, although painful, is not even near pressure levels that potentially might be harmful to the tissues. Pain arising from the bladder is usually reported from the lower abdomen above the symphysis, but may also be referred to the inner thigh, groin and knees.

Inflammation of the bladder may be caused by infections (acute bacterial or viral cystitis) or there may be no identifiable causing agent (e.g. ► [interstitial cystitis](#)). Exposure to chemicals (poisoning, cytostatics etc) and radiation may also lead to inflammation. Bladder inflammation causes distress, severe pain and micturition disturbances with an increase in voiding frequency and a decrease in micturition volume. The bladder lamina propria is invaded by inflammatory cells, and there is edema and extravasation of plasma proteins.

Inflammation of the bladder causes increased firing in the afferent nerve fibres “silent” under normal conditions, which leads to increased sensitivity in the dorsal horn. This is due to activation of several receptors/systems, including N-Methyl D-Aspartate (NMDA) receptors, nitric oxide (NO), Nerve Growth



**Opioids and Bladder Pain/Function, Figure 3b** Normal function and physiology of the urinary bladder. Voiding reflexes involve supraspinal pathways, and are under voluntary control. During bladder emptying, the spinal parasympathetic outflow (continuous green line +) is activated, leading to bladder contraction. Simultaneously, the sympathetic outflow to urethral smooth muscle, and the somatic outflow to urethral and pelvic floor striated muscles (red line -) are turned off, and the outflow region relaxes. There is activity in afferent nerves (interrupted green line).

0

Factor (NGF) and substance P (SP). The increased sensitivity may be persistent, and the central nervous system (CNS) may continue to signal pain, even in the absence of ongoing stimuli from the urinary bladder. As the neurons in the spinothalamic tract receive painful stimuli from bladder afferents, there are also reports of pain from somatic structures at the same spinal level as the bladder (L4-S2). This phenomenon is defined as referred pain, and is due to the convergence of visceral primary afferents upon the neurons of the spinothalamic tract, where somatic afferent signalling is also projecting. Referred hyperalgesia with a lowering of pain thresholds in the areas of referred pain may also be detected (MacMahon et al. 1995), as well as referral of hyperalgesia to other visceral organs (viscero-visceral hyperalgesia) (Giamberardino 1998).

#### Bladder Pain: Animal Models

Instillation of e.g. capsaicin, prostaglandin E<sub>2</sub>, turpentine, or mustard oil into the bladder causes pain behaviour in rats. A widely used pain model is intraperitoneal injection of cyclophosphamide into rats and mice. Cyclophosphamide is metabolised to acrolein, which is excreted in urine and produces severe inflammation of the bladder (hemorrhagic cystitis). Cat models simulating interstitial cystitis in humans have been developed.

#### Bladder Pain: Clinical States

Pain from the bladder is often diffuse and poorly located. The pain may be felt in the midline above the symphysis. It may also be referred to the inner thighs, the groin or even to the knees. Pain may not be severe, but is rather

described as unpleasant and dull (Ness et al. 1998). Bladder pain may be accompanied by signs of activation of the autonomous nervous system, like sweating, nausea or dizziness. Pain may be continuous, with or without exacerbations, or appear in intervals, which may not be possible to anticipate. Typically, the contractions of an inflamed bladder causes severe, sudden, repeated cramping pain diffusely located to the midline in the lower abdomen. Bladder pain may be acute (acute infectious cystitis) or long lasting (chronic interstitial cystitis, malignancies, bladder stones etc). According to the International Association for the Study of Pain (IASP) nomenclature, a painful process lasting longer than six months is defined as chronic.

#### Bladder Function: Effects of Opioids

Morphine, given by various routes of administration to animals and humans, can increase bladder capacity or block bladder contractions. Furthermore, given intrathecally (i.t.) to anesthetised rats and intravenously (i.v.) to humans, the  $\mu$ -opioid receptor antagonist, naloxone, has been shown to stimulate micturition, suggesting that a tonic activation of  $\mu$ -opioid receptors has a depressant effect on the micturition reflex.

Morphine given i.t. was effective in patients with detrusor over-activity due to spinal cord lesions (Herman et al. 1988), but was associated with side-effects such as nausea and pruritus. Further side-effects of opioid receptor agonists include respiratory depression, constipation and abuse. Attempts have been made to reduce these side-effects by increasing selectivity towards one of the different opioid receptor types. Theoretically, selective receptor actions, or modifications of effects mediated by specific opioid receptors, may have useful therapeutic effects for micturition control.

Tramadol, a well-known analgesic, is a very weak  $\mu$  receptor agonist. Tramadol is metabolized to several different compounds, some of them almost as effective as morphine at the  $\mu$  receptor. However, the drug also inhibits serotonin (5-HT) and noradrenaline reuptake (Raffa and Friderichs 1996). This profile is of particular interest, since both  $\mu$ -receptor agonism and amine reuptake inhibition may be useful principles for the treatment of detrusor overactivity (Pandita et al. 2003). Central stimulation of  $\delta$ -opioid receptors in anaesthetized cats and rats inhibited micturition and parasympathetic neurotransmission in cat bladder gangliae. In humans, nalbuphine, a  $\mu$ -receptor antagonist and  $\kappa$ -receptor agonist, increased bladder capacity (Malinovsky et al. 1998). Buprenorphine (a partial  $\mu$ -receptor agonist and  $\kappa$ -receptor antagonist) decreased micturition pressure and increased bladder capacity more than morphine (Malinovsky et al. 1998). Animal studies have shown that nociceptin or orphanin FQ, the endogenous ligand of opioid-like receptors-1 (ORL1), may have an inhibitory effect on the micturition reflex in the rat (Lecci et al. 2000). In patients with neurogenic

detrusor overactivity, nociceptin/orphanin FQ given intravenously significantly increased bladder capacity and volume threshold for the appearance of detrusor overactivity (Lazzeri et al. 2003). Further exploration of these non  $\mu$ -opioid receptor mediated actions on micturition seems motivated.

#### Bladder Pain: Effect of Opioids

Clinically used opioid analgesics produce pain relief by activating opioid receptors. Most opioid analgesics are  $\mu$  agonists.  $\kappa$  and  $\delta$  receptors and other receptor systems (NMDA, monoaminergic transmission) may also be affected by some opioid analgesics, and may thus be of special interest in the treatment of bladder pain. By binding to opioid receptors, opioid analgesics provide pain relief through actions on GABA-interneurons. This causes activation of descending bulbospinal tracts. There is an increase in intracellular potassium, inhibition of some types of voltage gated calcium channels and of adenylyl cyclase, thereby decreasing the production of cAmp. Transmitter release is inhibited, neuronal firing rate is decreased and gene expression changes, all of which modulates the transmission of afferent pain signals from the bladder, as well as from other visceral and somatic structures.

Nociceptive pain is generally more sensitive to opioids than neuropathic pain. However, distension of the bladder produces nociceptive pain, although the low pressure-range of the bladder is not noxious. Painful bladder contractions are a type of incident pain, which may be difficult to treat due to its fast onset, as even the most fast-acting opioid analgesics have an onset time of at least 1–2 min after injection.

**Clinical Considerations. Routes of Administration of Opioids**

Opioid analgesics are indicated in opioid-sensitive bladder pain caused by e.g. operations, trauma or cancer (Guidelines on Pain Management 2003). Dull continuous pain from the urinary bladder may be reduced by opioid analgesics. In patients with bladder pain dominated by painful, frequent bladder contractions, opioid analgesics may provide dramatic pain relief.

Opioid treatment of chronic painful conditions like bladder pain in interstitial cystitis may provide pain relief and improve quality of life. However, there are no studies of conventional analgesics and interstitial cystitis (Guidelines on Chronic Pelvic Pain 2003). Before long-term opioid analgesic treatment of chronic benign conditions is initiated, careful consideration must be taken to inherent problems of tolerance, side-effects and the goals of the treatment. Drug (legal or illegal) dependence, in the past or present, constitutes a relative contraindication to long-term opioid treatment, and complicates any analgesic therapy.

Opioid sensitive pain from the bladder should be treated promptly with adequate doses using a suitable route of administration. The oral route of administration is the



preferred route for short and long-term therapy. Transdermal fentanyl patches may be a convenient alternative for special groups of patients.

Injections of opioids or patient controlled analgesia (PCA) may be more effective in patients who have difficulties in eating, are nauseated or in patients who suffer from severe, sudden incident pain caused by severe bladder contractions.

Spinal (epidural or i.t.) administration of opioids may be extremely effective, combined with local anaesthetics or clonidine for superior effect for postoperative pain relief, and for long-term use in patients with malignant disease. However, urinary retention is common after spinal administration of opioids. Bladder catheters may be necessary, but carry an increased risk of infection.

Intravesical administration of morphine has been recommended in children undergoing vesico-ureteral surgery (Duckett et al. 1997). The rationale for intravesical administration of comparatively low doses of morphine in opioid-naïve patients would be to activate peripheral opioid receptors with little or no side-effects. In a controlled randomised study of postoperative pain, however, no advantages of a continuous bladder infusion of morphine compared to placebo could be demonstrated (El-Ghoneimi et al. 2002).

Pain relief in a suffering subject is dependent on the qualities of the pain itself, qualities within the person, and of the particular opioid at hand depending on the route of administration. Acute and sub-acute side-effects, and long-term effects of the analgesic treatment, may ultimately determine the success or failure of therapy aimed at relief of bladder pain.

## References

- Andersson K-E (2002) Bladder Activation: Afferent Mechanisms. *Urology* 59:43–50
- Duckett JW, Cangiano T, Cubina M et al. (1997) Intravesical Morphine Analgesia after Bladder Surgery. *J Urol* 157:1407–1409
- El-Ghoneimi A, Deffarges C, Hankard R et al. (2002) Intravesical Morphine Analgesia is not Effective after Bladder Surgery in Children: Results of a Randomised Double-Blind Study. *J Urol* 168:694–697
- Giamberardino MA (1999) Recent and Forgotten Aspects of Visceral Pain. *Eur J Pain* 77–92
- Guidelines on Pain Management (2003) European Association of Urology, 2003
- Guidelines on Chronic Pelvic Pain (2003) European Association of Urology, 2003
- Herman RM, Wainberg MC, delGiudice PF et al. (1988) The Effect of a Low Dose of Intrathecal Morphine on Impaired Micturition Reflexes in Human Subjects with Spinal Cord Lesions. *Anesthesiology* 69:313–318
- Lazzeri M, Calo G, Spinelli M et al. (2003) Urodynamic Effects of Intravesical Nociceptin/Orphanin FQ in Neurogenic Detrusor Overactivity: A Randomized, Placebo-Controlled, Double-Blind Study. *Urology* 61:946–950
- Lecci A, Giuliani S, Meini S et al. (2000) Nociceptin and the Micturition Reflex. *Peptides* 21:1007–1021
- Malinovsky JM, Le Normand L, Lepage JY et al. (1998) The Urodynamic Effects of Intravenous Opioids and Ketoprofen in Humans. *Anesth Analg* 87:456–461
- McMahon SB, Dmitrieva N, Koltzenburg M (1995) Visceral Pain. *Br J Anaesth* 75:132–144
- Morrison J, Steers WD, Brading A et al. (2002) Neurophysiology and Neuropharmacology. In: Abrams P, Khoury S, Wein A (eds) *Incontinence, 2<sup>nd</sup> International Consultation on Incontinence*. Plymouth, Plymbridge Distributors Ltd, Plymouth, UK, pp 85–161
- Ness TJ, Richter HE, Varner RE et al. (1998) A Psychophysical Study of Discomfort Produced by Repeated Filling of the Urinary Bladder. *Pain* 76:61–69
- Pandita RK, Pehrson R, Christoph T et al. (2003) Actions of Tramadol on Micturition in Awake, Freely Moving Rats. *Br J Pharmacol* 139:741–748
- Raffa RB, Friderichs (1996) The Basic Science Aspect on Tramadol Hydrochloride. *Pain Rev* 3:249–271

## Opioids and Gene Therapy

DAVID J. FINK

Department of Neurology, University of Michigan and VA Ann Arbor Healthcare System, Ann Arbor, MI, USA

dfink@pitt.edu

### Synonyms

Therapeutic Gene Transfer; Viral Vectors; Gene Therapy and Opioids

### Definition

Gene therapy refers to the use of ► **vectors** to deliver genetic material in order to express a foreign gene (“► **transgene**”) *in vivo*. Gene delivery vectors are commonly constructed from viruses that have been modified to reduce their pathogenic potential, but that retain the ability of the native virus to deliver RNA or DNA (Table 1). Vector-mediated gene transfer of the genes coding for opioid peptides, and of genes coding for opiate receptors, has been used to achieve or enhance regional analgesic effects in animal models of chronic pain.

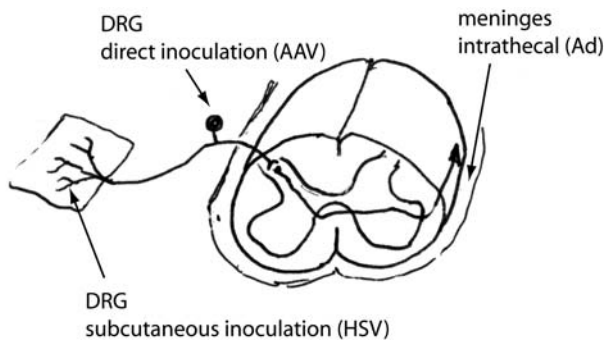
### Characteristics

Drugs acting at opioid receptors remain the most potent analgesic agents available, but their effective use in severe chronic pain is limited by three phenomena: (1) the widespread distribution of receptors within and outside the neuraxis results in side effects unrelated to analgesia that limit the maximum dose that may be administered; (2) continued use of opiate drugs results in tolerance; and (3) addiction and abuse are problematic. Three different gene therapy approaches to the treatment of chronic pain have been described (Fig. 1).

The first strategy uses injection of a gene transfer vector into CSF to transduce cells of the meninges in order to provide the continuous release of natural opioid peptides into the CSF. A replication deficient ► **adenoviral (Ad) vector** containing the coding sequence for human beta-endorphin injected into the subarachnoid space transduces cells of the pia mater, from which beta-endorphin is released into the cerebrospinal fluid. An analgesic effect

**Opioids and Gene Therapy, Table 1** Summary of the principal viral vectors used for gene transfer to the nervous system

Vector	Genome size (kb)	Genome type	Insert capacity (kb)	Integration	Characteristics
Retrovirus	8	ss-RNA	8	yes	Requires cell division for gene transfer. Can be used to transduce cells that are then transplanted back into host
Adenovirus	36	ds-DNA	8	no	Highly efficient gene transfer following direct injection into tissue or inoculation into CSF; immunogenicity limits applications
Adenoassociated virus	4.7	ss-DNA	4.7	yes	Non-immunogenic; prolonged transgene expression; limited insert capacity
Herpes simplex	152	ds-DNA	50	no	Effective transduction of DRG neurons from subcutaneous application; vector does not integrate into host genome
Lentivirus	9.4	ss-RNA	8	yes	Efficient gene transfer following direct inoculation; prolonged high level expression of transgenes



**Opioids and Gene Therapy, Figure 1** Three different approaches to gene transfer of opioid peptides or receptors have been described. Intrathecal inoculation of an Ad vector can be used to transduce cells of the meninges to release peptide into the CSF. Direct injection of an AAV vector into DRG can be used to overexpress opioid receptors in primary sensory neurons to increase opiate sensitivity. Subcutaneous inoculation of HSV vectors can be used to transduce primary sensory neurons in DRG; release of peptide from terminals in the spinal cord provides a regional analgesic effect.

could be demonstrated by attenuation of inflammatory hyperalgesia (Finegold et al. 1999). Indirect evidence suggests that the transgene product was acting a non- $\mu$ , non- $\delta$ , non- $\kappa 1$  site in the spinal cord.

The second approach involves direct injection of a gene transfer vector into the dorsal root ganglia (DRG) to transduce DRG neurons *in vivo*. A recombinant ► **adenoassociated viral (AAV) vector**, containing the cDNA coding for the  $\mu$ -opioid receptor (MOR), inoculated directly into the DRG, produces a persistent increase in MOR expression in DRG to enhance the efficacy of morphine, measured by a 50% reduction in ED<sub>50</sub> of morphine in both normal rats and rats with inflammatory pain (Xu et al. 2003). The major disadvantage of this strategy is “that direct injection of rAAV into the DRG could incur tissue damage and thus limits its application in gene therapy”.

Vectors constructed from recombinant ► **herpes simplex virus (HSV)** are particularly suitable to target transgene expression to DRG in an anatomically predictable man-

ner from peripheral inoculation. HSV is a neurotropic virus that naturally infects skin and mucous membranes. Following the initial epithelial infection, wild-type HSV is taken up by nerve terminals in the skin and carried by retrograde axonal transport to the DRG. Uptake and transport of the virion from the skin is an efficient process, mediated first by interactions between specific viral envelope glycoproteins and high-affinity receptors in the sensory nerve terminals in the skin, followed by specific interactions of capsid and tegument proteins with dynein molecules in the axon, to mediate the retrograde transport along microtubules to the cell body. Deletion of a single gene (e.g. HSV thymidine kinase, tk) from the viral genome impairs the ability of the recombinant to replicate in neurons. Deletion of one or more essential immediate early genes allows the construction of HSV-based vectors that are incapable of replicating and therefore appropriate for application to human gene therapy. A tk-deleted recombinant HSV vector containing the human proenkephalin (PE) gene under the control of the HSV latency associated promoter expresses PE RNA in DRG following subcutaneous inoculation in the skin, and increased levels of enkephalin in DRG (Antunes Bras et al. 1998). A similar tk-deleted recombinant HSV vector, delivered by subcutaneous inoculation into the dorsum of the foot, has been shown to reduce thermal hyperalgesia after sensitization with capsaicin or dimethyl sulfoxide, but does not alter baseline foot withdrawal responses to noxious radiant heat mediated by A $\delta$  and C fibers, (Wilson et al. 1999), a phenomenon that is reversed by naloxone. In a mouse model of polyarthritis, subcutaneous inoculation of the PE-expressing tk-deleted HSV vector into the foot reduces thermal hyperalgesia and improves locomotion in the treated animals (Braz et al. 2001). In the CFA polyarthritis model, vector-mediated enkephalin production not only reduces pain-related behaviors, but also significantly reduces the arthritic destruction of joint space and bone measured radiographically (Braz et al. 2001).

A replication-incompetent recombinant HSV vector, deleted for the essential immediate early HSV gene ICP4, has also been demonstrated to provide a pain-relieving effect in rodent models. Despite being unable to replicate in epithelial cells, the PE-expressing replication-incompetent HSV vector injected subcutaneously establishes a "latent" state in DRG (Goss et al. 2001), and reduces spontaneous pain behavior during the delayed phase in the formalin test of inflammatory pain (10 minutes to 1 hour after injection of formalin) without affecting the acute pain score. This effect is reversed by intrathecal administration of naltrexone (Goss et al. 2001). The analgesic effect was limited to the injected limb; formalin testing of the limb contralateral to the injection reveals no analgesic effect on that side (unpublished observation).

The vector-mediated analgesic effect of the PE-expressing vector persists for several weeks before waning. Animals tested four weeks after vector inoculation have shown no significant reduction in pain related behavior during the delayed phase of the formalin test (Goss et al. 2001), but animals re-inoculated with the vector four weeks after the initial inoculation, and then tested with formalin injection at 5 weeks, show a substantial and significant return of the antinociceptive effect (Goss et al. 2001).

In the spinal nerve ligation model of neuropathic pain, subcutaneous inoculation of the PE-expressing HSV vector into the foot one week after spinal nerve ligation produces an antiallodynic effect that lasts for several weeks before waning (Hao et al. 2003). Reinoculation of the vector 6 weeks after the initial inoculation re-establishes the antiallodynic effect; the magnitude of the effect produced by the reinoculation is at least as great as that produced by the initial injection, and persists for a longer time after the reinoculation than the effect produced by the initial inoculation. Intraperitoneal naloxone reverses the antiallodynic effect.

The effect of the PE-expressing HSV vector-mediated antiallodynic effect in neuropathic pain is continuous throughout the day. Animals tested repeatedly at different times through the day show a similar elevation in threshold at all times tested (Hao et al. 2003). Intraperitoneal morphine produces a greater antiallodynic effect than the vector alone, but inoculation of the maximum dose of morphine produces an antiallodynic effect that persists for only 1 to 2 hours before waning. The effect of vector-mediated enkephalin (acting predominantly at  $\delta$  opioid receptors) and morphine (acting predominantly at MOR) is additive. The ED<sub>50</sub> of morphine was shifted from 1.8  $\mu$ g/kg in animals with neuropathic pain from spinal nerve ligation, treated with PBS or inoculated with a control vector expressing *lacZ*, to 0.15  $\mu$ g/kg in animals injected with the PE-expressing vector one week after spinal nerve ligation. Twice daily inoculation of morphine (10 mg/kg IP) in spinal nerve ligated animals, results in the development of tolerance by one week; be-

yond that time, continued twice-daily administration of morphine has no antiallodynic effect. Animals inoculated with the PE-expressing vector one week after spinal nerve ligation continue to demonstrate the antiallodynic effect of the vector, despite the induction of tolerance to morphine (Hao et al. 2003).

In a rodent model of pain resulting from cancer in bone, created by implantation of NTCT 2472 cells into the distal femur, subcutaneous inoculation of the PE-expressing replication incompetent HSV vector into the plantar surface of the foot, one week after tumor injection, produces a significant reduction in ambulatory pain score compared to control vector-inoculated tumor-bearing animals. This effect is reversed by intrathecal naltrexone (Goss et al. 2002).

The experimental evidence demonstrates that replication incompetent HSV vectors can be used to target delivery of genes with analgesic potential to neurons of the DRG, resulting in the local spinal release of analgesic substances to produce focal analgesic effects. The efficacy of this intervention in different models, which recapitulate essential features of the several subtypes of chronic pain, sets the stage for further development in two directions. The same approach may be used to express other molecules that might be anticipated to have significant analgesic effects at the spinal level, such as other inhibitory neurotransmitters, anti-inflammatory cytokines, or neurotrophic factors that produce analgesic effects in specific types of chronic pain. The second direction will be to determine whether HSV-mediated gene transfer will prove effective in the treatment of pain in patients. Replication-incompetent HSV vectors are appropriate for human use, and a proposal for a phase I human trial to examine the safety and tolerability of subcutaneous inoculation of an HSV vector deleted for the IE genes ICP4, ICP22, ICP27 and ICP41, and expressing human PE under the control of the HCMV IEP, was presented to the Recombinant Advisory Committee at the NIH in June 2002, and is now under review by the U.S. Food and Drug Administration.

## References

1. Antunes Bras JM, Epstein AL, Bourgoin S, Hamon M, Cesselin F, Pohl M (1998) Herpes Simplex Virus 1-Mediated Transfer of Preproenkephalin A in Rat Dorsal Root Ganglia. *J Neurochem* 70:1299–1303
2. Braz J, Beaufour C, Coutaux A, Epstein AL, Cesselin F, Hamon M, Pohl M (2001) Therapeutic Efficacy in Experimental Polyarthritides of Viral-Driven Enkephalin Overproduction in Sensory Neurons. *J Neurosci* 21:7881–7888
3. DeLuca NA, McCarthy AM, Schaffer PA (1985) Isolation and Characterization of Deletion Mutants of Herpes Simplex Virus Type 1 in the Gene Encoding Immediate-Early Regulatory Protein ICP4. *J Virol* 56:558–570
4. Finegold AA, Mannes AJ, Iadarola MJ (1999) A Paracrine Paradigm for *In Vivo* Gene Therapy in the Central Nervous System: Treatment of Chronic Pain. *Hum Gene Ther* 10:1251–1257
5. Fink DJ, Glorioso JC (1997) Engineering Herpes Simplex Virus Vectors for Gene Transfer to Neurons. *Nat Med* 3:357–359
6. Goss JR, Harley CF, Mata M, O'Malley ME, Goins WF, Hu X-P, Glorioso JC, Fink DJ (2002) Herpes Vector-Mediated Expression

- of Proenkephalin Reduces Pain-Related Behavior in a Model of Bone Cancer Pain. *Ann Neurol* 52:662–665
7. Goss JR, Mata M, Goins WF, Wu HH, Glorioso JC, Fink DJ (2001) Antinociceptive Effect of a Genomic Herpes Simplex Virus-Based Vector Expressing Human Proenkephalin in Rat Dorsal Root Ganglion. *Gene Ther* 8:551–556
  8. Hao S, Mata M, Goins W, Glorioso JC, Fink DJ (2003) Transgene-Mediated Enkephalin Release Enhances the Effect of Morphine and Evades Tolerance to Produce a Sustained Antialloodynic Effect. *Pain* 102:135–142
  9. Kim SH, Chung JM (1992) An Experimental Model for Peripheral Neuropathy Produced by Segmental Spinal Nerve Ligation in the Rat. *Pain* 50:355–363
  10. Krisky DM, Wolfe D, Goins WF, Marconi PC, Ramakrishnan R, Mata M, Rouse RJ, Fink DJ, Glorioso JC (1998) Deletion of Multiple Immediate-Early Genes from Herpes Simplex Virus Reduces Cytotoxicity and Permits Long-Term Gene Expression in Neurons. *Gene Ther* 5:1593–1603
  11. Sah DW, Ossipo MH, Porreca F (2003) Neurotrophic Factors as Novel Therapeutics for Neuropathic Pain. *Nat Rev Drug Discov* 2:460–472
  12. Wilson SP, Yeomans DC, Bender MA, Lu Y, Goins WF, Glorioso JC (1999) Antihyperalgesic Effects of Infection with a Preproenkephalin-Encoding Herpes Virus. *Proc Natl Acad Sci USA* 96:3211–3216
  13. Wu N, Watkins SC, Schaffer PA, DeLuca NA (1996) Prolonged Gene Expression and Cell Survival after Infection by a Herpes Simplex Virus Mutant Defective in the Immediate-Early Genes Encoding ICP4, ICP27 and ICP22. *J Virol* 70:6358–6368
  14. Xu Y, Gu Y, Xu GY, Wu P, Li GW, Huang LY (2003) Adeno-Associated Viral Transfer of Opioid Receptor Gene to Primary Sensory Neurons: A Strategy to Increase Opioid Antinociception. *Proc Natl Acad Sci USA* 100:6204–6209

## Opioids and Inflammatory Pain

C. ZÖLLNER, M. SCHÄFER

Clinic for Anesthesiology and Operative Intensive Medicine, Charité-University Clinical Center Berlin, Campus Benjamin Franklin, Berlin, Germany  
zoellner@zop-admin.ukbf.fu-berlin.de,  
mischaefer@zop-admin.ukbf.fu-berlin.de

### Synonyms

Opioids and Opioid Receptor Function in Inflammation; Inflammatory Pain and Opioids

### Definition

In addition to the traditional belief that opioids elicit antinociception via opioid receptors within the central nervous system, recent research has shown that they also elicit antinociception via opioid receptors located on peripheral nerve terminals of sensory neurons. Such antinociceptive effects in the periphery are particularly prominent under painful inflammatory conditions.

### Characteristics

#### Peripheral Opioid Receptors and Inflammation

Pain can be relieved by systemic administration of opioids acting on specific opioid receptors (OR) within the central nervous system. However, substantial side-effects such as sedation, nausea, vomiting, respiratory

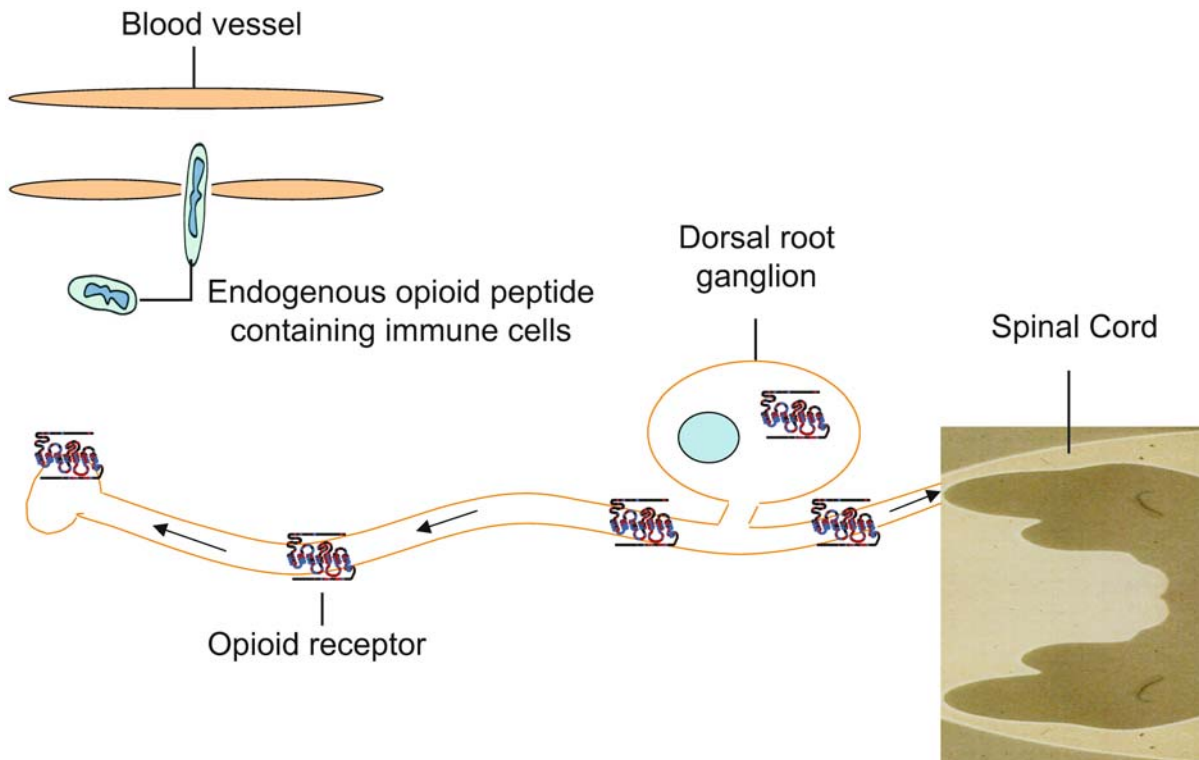
depression or respiratory arrest can occur following i.v. opioid administration. In animal experiments, it was shown that local application of  $\mu$ -opioid receptor (MOR) agonists into inflamed tissue elicited a pronounced antinociceptive effect (Stein et al. 1988). These results suggest that MOR agonists have a peripheral site of action within inflamed tissue. All three opioid receptor types ( $\mu$ ,  $\delta$  and  $\kappa$ ) are present on peripheral sensory neurons and are functionally involved in analgesia. As already known from the central side of action, peripheral OR increase potassium currents and decrease calcium currents in the cell bodies of sensory neurons. These effects can diminish the neuronal firing of peripheral sensory neurons (Woolf and Salter 2000). In addition, opioids can activate inhibitory G-proteins ( $G_{i/o}$ ) which lead to a decrease in the second messenger adenylate cyclase (cAMP) content. Saturation and competition experiments indicate that the pharmacological characteristics of these peripheral OR are very similar to those in the brain.

In primary sensory neurons, the neuronal cell body is located in the **dorsal root ganglion** (DRG) (Fig. 1). OR have been found on small-to-medium-diameter neuronal cell bodies within the DRG, and on central as well as peripheral nerve terminals of primary afferent neurons (Mousa et al. 2001). Peripheral analgesic effects of opioids are greatly enhanced within inflamed tissue. Following the induction of inflammation, MOR mRNA increases within the lumbar spinal cord (Maekawa et al. 1996). In addition, the **axonal transport** of MOR from DRG to the peripheral nerve terminals is increased (Hassan et al. 1993). This was demonstrated for various neuroreceptors, including MOR in peripheral nerves (Laduron and Castel 1990). This increase is reduced by ligation of the sciatic nerve, indicating that inflammation enhances the peripherally directed axonal transport of MOR (Hassan et al. 1993). In addition, the number of peripheral sensory nerve terminals is increased in inflamed tissue, a phenomenon known as sprouting (Stein 1995). It might be that inflammation can also disrupt the perineurium, which is a normally a rather impermeable barrier. This allows opioid agonists easier access to peripheral MOR. In conclusion, OR are present in the periphery and mediate potent analgesic effects after peripheral opioid application. An inflammatory process can result in a profound increase in the density of MOR in the DRG, an increase in the axonal transport of MOR to the periphery, and in the enhanced sprouting of MOR<sup>+</sup> peripheral sensory nerve terminals. This might explain why locally applied opioids are more effective within inflamed compared to non-inflamed tissue.

#### Inflammation and Exogenous Opioids

Quantification of MOR binding sites by ligand-binding experiments confirmed an increase in MOR within the DRG during inflammation. Together with immunohistochemistry experiments, it was shown that this increase





**Opioids and Inflammatory Pain, Figure 1** Primary afferent sensory neuron with its cell body (DRG). Opioid receptors are synthesized in the cell body of the DRG and transported towards its central (right) and peripheral (left) terminals. Under inflammatory conditions, immune cells migrate into the tissue. Exogenous (e.g. stressful stimuli) or endogenous (e.g. corticotropin-releasing-hormone, Interleukin 1) stimuli release opioid peptides from monocytic cells or lymphocytes. The endogenous ligands for opioid receptors reduce the excitability of the primary afferent neuron.

0

in MOR binding sites of DRG was due to an increase in both the number of MOR<sup>+</sup> neurons and the density of MOR<sup>+</sup> staining per neuron (Mousa et al. 2001). The affinity of certain opioid agonists (e.g. ► **DAMGO**, ► **Buprenorphine**) to MOR remained unchanged during inflammation. However, in a ► **G protein coupling** assay, it was shown that the alteration in the density of MOR in the DRG and the periphery during inflammation could lead to an increase in the number of ► **G proteins** activated (Zöllner et al. 2003). Interestingly, these changes did not occur either at spinal, supraspinal (e.g. hypothalamus) or at contralateral DRG regions. Subsequent to the MOR up-regulation in DRG, more OR are axonally transported towards the peripheral nerve endings. With a certain delay, an up-regulation in MOR can also be seen within inflamed subcutaneous tissue. In addition, neuronal OR in the inflamed paw might undergo changes owing to the specific milieu of inflamed tissue (e.g. low pH), which could contribute to an increase in opioid efficacy (Selley et al. 1993). These adaptive changes underscore the important differences in MOR binding and signalling between normal and inflamed tissue.

#### Inflammation and Endogenous Opioid Peptides

The natural ligands for OR are opioid peptides. So far, five different peptides have been described in

the neuroendocrine and central nervous system:  $\beta$ -endorphin ( $\beta$ END), enkephalin (ENK), dynorphin (DYN), ► **endomorphine 1** and **endomorphine 2**. The endogenous opioid peptides are released from vesicles in a calcium dependent way. In inflammatory conditions, opioid peptide-containing immune cells migrate from the circulation to the inflamed site (Fig. 1). Upon certain exogenous stressful stimuli (e.g. cold water swim stress or postoperative pain), these cells can locally release opioid peptides that subsequently bind to OR on sensory neurons, where they can increase the nociceptive thresholds of peripheral sensory neurons in inflamed tissue. The analgesic effects of endogenous opioid peptides can be blocked by antibodies against opioid peptides and by immunosuppression, suggesting involvement of the immune system in inflammatory pain control (Machelska et al. 2002). It has been shown that opioid-containing cells are predominantly granulocytes during early and monocytes or macrophages during later stages of inflammation (Rittner et al. 2001). The endogenous opioid-mediated analgesia increases in parallel with the ► **immune cell recruitment** and the degree of inflammation. Other endogenous stimuli have been identified to trigger opioid secretion from immune cells. For instance, Corticotropin-releasing hormone (CRH) stimulates the release of opioid peptides from immune cells that subsequently activate OR on sen-

sory nerve endings (Schäfer et al. 1997). These results indicate that the activation of the endogenous opioid production and release from immune cells might be a new approach to the development of peripherally acting analgesics.

### Peripheral Opioids and Clinical Implications

Since the first demonstration of the analgesic efficacy of ► **Intra-Articular Morphine** (Stein et al. 1991), many clinical studies have confirmed that application of peripheral opioids in patients with acute and chronic arthritic pain resulted in significant pain reduction. These effects were shown to be dose-dependent and reversible by naloxone, indicating a specific effect at OR. In addition, the intraarticular application of naloxone after knee arthroscopy increased pain in the presence of endogenous opioid peptides within synovial tissue. These studies in humans have shown that a stressful stimulus (e.g. surgery) leads to a tonic release of endogenous opioids to reduce inflammatory pain by activating intraarticular OR (Oliveira et al. 1999). These findings suggest that opioids are released from immune cells in inflamed tissue and can activate peripheral OR to attenuate clinically important pain. It was shown that these endogenous opioids do not interfere with exogenous morphine and do not produce ► **tolerance** to exogenous morphine at peripheral OR (Stein et al. 1996). In addition, local opioid analgesia was shown in patients with dental surgery (Likar et al. 1998) and acute visceral pain (Rorarius et al. 1999). In summary, peripheral opioids significantly reduce pain in patients with acute and chronic inflammatory diseases. In comparison to central acting opioids, the peripheral administration of morphine did not show any side-effects like respiratory depression, sedation or nausea.

### References

- Hassan AH, Ableitner A, Stein C et al. (1993) Inflammation of the Rat Paw Enhances Axonal Transport of Opioid Receptors in the Sciatic Nerve and Increases their Density in the Inflamed Tissue. *Neuroscience* 55:185–195
- Laduron PM, Castel MN (1990) Axonal Transport of Receptors. A Major Criterion for Presynaptic Localization. *Ann NY Acad Sci* 604:462–469
- Likar R, Sittl R, Gragger K et al. (1998) Peripheral Morphine Analgesia in Dental Surgery. *Pain* 76:145–150
- Machelska H, Mousa SA, Brack A et al. (2002) Opioid Control of Inflammatory Pain Regulated by Intercellular Adhesion Molecule-1. *J Neurosci* 22:5588–5596
- Maekawa K, Minami M, Masuda T et al. (1996) Expression of mu- and kappa-, but not delta-, Opioid Receptor mRNA is Enhanced in the Spinal Dorsal Horn of the Arthritic Rats. *Pain* 64:365–371
- Mousa SA, Zhang Q, Sitte N et al. (2001) Beta-Endorphin-Containing Memory Cells and  $\mu$ -Opioid Receptors Undergo Transport to Peripheral Inflamed Tissue. *J Neuroimmunol* 115:778
- Oliveira L, Paiva AC, Vriend G (1999) A Low Resolution Model for the Interaction of G Proteins with G Protein-Coupled Receptors. *Protein Eng* 12:1087–1095
- Rittner H, Brack A, Machelska H et al. (2001) Opioid Peptide-Expressing Leukocytes: Identification, Recruitment, and Simultaneously Increasing Inhibition of Inflammatory Pain. *Anesthesiology* 95:505–508
- Rorarius M, Suominen P, Baer G et al. (1999) Peripherally Administered Sufentanil Inhibits Pain Perception after Postpartum Tubal Ligation. *Pain* 79:83–88
- Schäfer M, Mousa SA, Stein C (1997) Corticotropin-Releasing Factor in Antinociception and Inflammation. *Eur J Pharmacol* 323:1–10
- Selley DE, Breivogel CS, Childers SR (1993) Modification of G Protein-Coupled Functions by Low-pH Pretreatment of Membranes from NG108-15 Cells: Increase in Opioid Agonist Efficacy by Decreased Inactivation of G Proteins. *Mol Pharmacol* 44:731–741
- Stein C (1995) The Control of Pain in Peripheral Tissue by Opioids. *N Engl J Med* 332:1685–1690
- Stein C, Comisel K, Haimerl E et al. (1991) Analgesic Effect of Intraarticular Morphine after Arthroscopic Knee Surgery. *N Engl J Med* 325:1123–1126
- Stein C, Millan MJ, Shippenberg TS et al. (1988) Peripheral Effect of Fentanyl upon Nociception in Inflamed Tissue of the Rat. *Neurosci Lett* 84:225–228
- Stein C, Pfluger M, Yassouridis A et al. (1996) No Tolerance to Peripheral Morphine Analgesia in Presence of Opioid Expression in Inflamed Synovia. *J Clin Invest* 98:793–799
- Woolf CJ, Salter MW (2000) Neuronal Plasticity: Increasing the Gain in Pain. *Science* 288:1765–1769
- Zöllner C, Shaqura M, Bopaiah CP et al. (2003) Painful Inflammation Induced Increase in  $\mu$ -Opioid Receptor Binding and G-Protein Coupling in Primary Afferent Neurons. *Mol Pharmacol* 64:202–210

## Opioids and Muscle Pain

KATHLEEN A. SLUKA

Physical Therapy and Rehabilitation Science Graduate Program, University of Iowa, Iowa City, IA, USA  
kathleen-sluka@uiowa.edu

### Synonyms

Musculoskeletal pain; Morphine and Muscle Pain

### Definition

Muscle pain is pain that originates in muscle tissue and results in an increased sensitivity of the muscle to noxious stimuli. This pain can be a result of tissue injury, inflammation, exercise, or ischemia. Opioids are a class of compounds utilized to treat pain that activate opioid receptors. There are 3 types of opioid receptors,  $\mu$ ,  $\delta$ , and  $\kappa$ , which are located peripherally and throughout the central nervous system.

### Characteristics

Muscle pain is characterized as a deep aching pain, and is associated with increased pain to deep pressure applied over the muscle, as well as ► **referred pain** to areas remote from the site of injury. Clinically, ► **fibromyalgia**, ► **myofascial pain**, ► **myositis** and ► **strain** are common forms of pain associated with tissue injury and/or pain in the muscle.

Animal models of muscle pain include inflammatory, induced by injection of carrageenan into the muscle

tissue, and non-inflammatory, induced by repeated injections of acid into the muscle (Kehl et al. 2000; Sluka et al. 2001). These models of muscle pain result in ► **secondary hyperalgesia** to mechanical (von Frey filaments) and heat stimuli. Further, ► **primary hyperalgesia**, as measured by a decrease in grip force, is present following carrageenan inflammation of the muscle (Kehl et al. 2000). The primary and secondary hyperalgesia associated with carrageenan muscle inflammation, is reversed by systemic administration of the opioid agonists morphine and levorphanol (Kehl et al. 2001; Radhakrishnan et al. 2003). In the non-inflammatory model of muscle pain, produced by repeated intramuscular acid injections, systemic morphine and intrathecal  $\mu$ - and  $\delta$ - opioid agonists reverse the secondary mechanical hyperalgesia (Sluka et al. 2002). Thus, these data show that animal models of muscle pain are responsive to  $\mu$ - and  $\delta$ - opioid activation at receptors that could be located peripherally, spinally or supraspinally.

In humans, muscle pain can be produced by infusion of hypertonic saline into the muscle, direct electrical stimulation of the muscle, or eccentric contraction of the muscle (► **DOMS**). The pain associated with intramuscular hypertonic saline infusion is reversed by epidural injection of the opioid agonist, fentanyl (50 or 100  $\mu$ g) (Eichenberger et al. 2003), suggesting a role for spinal opioid receptors in pain reduction. The pain associated with DOMS is reduced by activation of peripheral opioid receptors with morphine-6- $\beta$ -glucuronide (M6GI; a major metabolite of morphine that does not cross blood brain barrier) (Tegeder et al. 2003), but not by systemic administration of several opioid agonists (Barlas et al. 2000), suggesting a role for peripheral opioid receptors. The pain from electrical stimulation of the muscle is inhibited by the systemic administration of the opioid agonist, remifentanyl. Remifentanyl produces a greater inhibition of pain induced by electrical stimulation of the muscle when compared to the inhibition of pain from electrical stimulation of the skin, suggesting that muscle pain is more sensitive to opioids than cutaneous pain (Curatolo et al. 2000). Thus, there is evidence that in human subjects muscle pain is responsive to opioid agonists, and these effects could be as a result of activation of receptors located peripherally, spinally or supraspinally.

The use of opioids in the treatment of clinical muscle pain, either acute or chronic, is not common. However, there are a few studies, done predominately with patients with fibromyalgia or acute muscle sprain, which suggest treatment of muscle pain with opioids is effective. Mild to moderate pain resulting from acute muscle strain of the low back or soft tissue injury is effectively treated with a mild opioid (Tylenol with codeine), reducing pain by approximately 50% (Brown et al. 1986; Muncie et al. 1986). However, when compared to treatment with an anti-inflammatory, there

was an equivalent reduction and more side effects with the opioid (Brown et al. 1986). In patients with fibromyalgia, a more chronic pain condition, systemic administration of opioid agonists reduced spontaneous pain, as measured by a visual analogue scale (Biasi et al. 1998) and ► **temporal summation** (Price et al. 2002). Spinal administration (epidural) of opioid agonists also reduces spontaneous pain, tenderness, and lower limb fatigue (Bengtsson et al. 1989). Thus, clinically, the use of opioid treatment for muscle pain conditions is supported by results from basic science, experimental muscle pain models, and clinical studies using people with muscle sprain and fibromyalgia. However, a number of muscle pain conditions, such as myositis and myofascial pain, have not been investigated to date regarding the effectiveness of either short term or long-term opioid treatment.

## References

1. Barlas P, Craig JA, Robinson J, Walsh DM, Baxter GD, Allen JM (2000) Managing Delayed-Onset Muscle Soreness: Lack of Effect of Selected Oral Systemic Analgesics. *Arch Phys Med Rehabil* 81:966–972
2. Bengtsson M, Bengtsson A, Jorfeldt L (1989) Diagnostic Epidural Opioid Blockade in Primary Fibromyalgia at Rest and During Exercise. *Pain* 39:171–180
3. Biasi G, Manca S, Manganeli S, Marcolongo R (1998) Tramadol in the Fibromyalgia Syndrome: A Controlled Clinical Trial versus Placebo. *Int J Clin Pharmacol Res.* 18:13–19
4. Brown FL Jr, Bodison S, Dixon J, Davis W, Nowoslawski J (1986) Comparison of Diflunisal and Acetaminophen with Codeine in the Treatment of Initial or Recurrent Acute Low Back Strain. *Clin Ther* 9 Suppl C 52–58
5. Curatolo M, Petersen-Felix S, Gerber A, Arendt-Nielsen L (2000) Remifentanyl Inhibits Muscular more than Cutaneous Pain in Humans. *Br J Anaesthesia* 85:529–532
6. Eichenberger U, Giani C, Petersen-Felix S, Graven-Nielsen T, Arendt-Nielsen L, Curatolo M (2003) Lumbar Epidural Fentanyl: Segmental Spread and Effect on Temporal Summation and Muscle Pain. *Br J Anaesthesia* 90:467–473
7. Kehl LJ, Trempe TM, Hargreaves KM (2000) A New Animal Model for Assessing Mechanisms and Management of Muscle Hyperalgesia. *Pain* 85:333–343
8. Muncie HL Jr, King DE, DeForge B (1986) Treatment of Mild to Moderate Pain of Acute Soft Tissue Injury: Diflunisal vs. Acetaminophen with Codeine. *J Fam Pract* 23:125–127
9. Price DD, Staud R, Robinson ME, Mauderli AP, Cannon R, Vierck CJ (2002) Enhanced Temporal Summation of Second Pain and its Central Modulation in Fibromyalgia Patients. *Pain*. 99:49–59
10. Radhakrishnan R, Bement M, Skyba D, Kehl L, and Sluka K (2004) Models of muscle pain: Carrageenan model and acidic saline model. In: Enna SJ, Williams M, Ferkany J, Kenakin T, Porsolt R, and Sullivan J (eds) *Current Protocols in Pharmacology*. John Wiley & Sons, Hoboken, NJ, pp 5.35.1–5.35.28
11. Sluka KA, Kalra A, Moore SA (2001) Unilateral Intramuscular Injections of Acidic Saline Produce a Bilateral, Long-Lasting Hyperalgesia. *Muscle Nerve* 24:37–46
12. Sluka KA, Rohlwing JJ, Bussey RA, Eikenberry SA, Wilken JM (2002) Chronic Muscle Pain Induced by Repeated Acid Injection is Reversed by Spinally Administered  $\mu$  and  $\delta$ - but not  $\kappa$ , Opioid Receptor Agonists. *J Pharmacol Exp Ther* 302:1146–1150
13. Tegeder I, Meier S, Burian M, Schmidt H, Geisslinger G, Lotsch J (2003) Peripheral Opioid Analgesia in Experimental Human Pain Models. *Brain* 126:1092–1102

## Opioids and Nucleus Gracilis

- ▶ [Opioids in the Spinal Cord and Modulation of Ascending Pathways \(N. gracilis\)](#)

## Opioids and Opioid Receptor Function in Inflammation

- ▶ [Opioids and Inflammatory Pain](#)

## Opioids and Reflexes

CLAIRE D. ADVOKAT  
Department of Psychology, Louisiana State University,  
Baton Rouge, LA, USA  
cadvoka@lsu.edu

### Synonyms

Spinal nociceptive tail flick withdrawal reflex; Hindlimb Flexor Reflex; Reflexes and Opioids

### Definitions

The tail flick (TF) withdrawal reflex is a spinally mediated standard measure of pain sensitivity. In the most common procedure, a beam of high intensity light is focused on the tail, and the response time is automatically measured and defined as the interval between the onset of the thermal stimulus and the abrupt flick of the tail. Typically, several determinations are made, and the mean score is taken as the response latency. Increases in latency are interpreted to indicate an antinociceptive, i.e. analgesic, response. To reduce tissue damage, animals not responding after a predetermined cut-off score are assigned the maximum score.

The hindlimb flexor reflex is a spinally mediated withdrawal response of the hindlimb. Typically, flexor reflexes are elicited by electrical stimulation of the hindpaw. The reflex has 2 components; a short latency component that appears within 20 – 100 msec and is elicited by low threshold, non-nociceptive stimulation, and a longer latency component that appears at about 150 – 450 msec, in response to high threshold, nociceptive, C-fiber stimulation (>6.8 + 0.2 mA).

### Characteristics

Modern views of opiate action in the central nervous system (CNS) originated with the classic experiments of Wikler and colleagues, who demonstrated that systemically-administered opiates could suppress polysynaptic spinal nociceptive responses, such as the hindlimb flexor reflex and the tail withdrawal reflex, after ▶ [spinal transection](#) (Wikler 1950; Advokat and Burton 1987). While this showed that opiates could act

directly at the level of the spinal cord, the doses required in the spinal animal were larger than the doses needed in the intact animal, to produce the same effect. This observation led to the hypothesis that opiate analgesia was not only due to a direct action of the drug in the brain and the spinal cord, but was also mediated by an additional, indirect, effect of opiates in the brain, which increased descending supraspinal inhibition of spinal nociceptive reflexes (Advokat 1988).

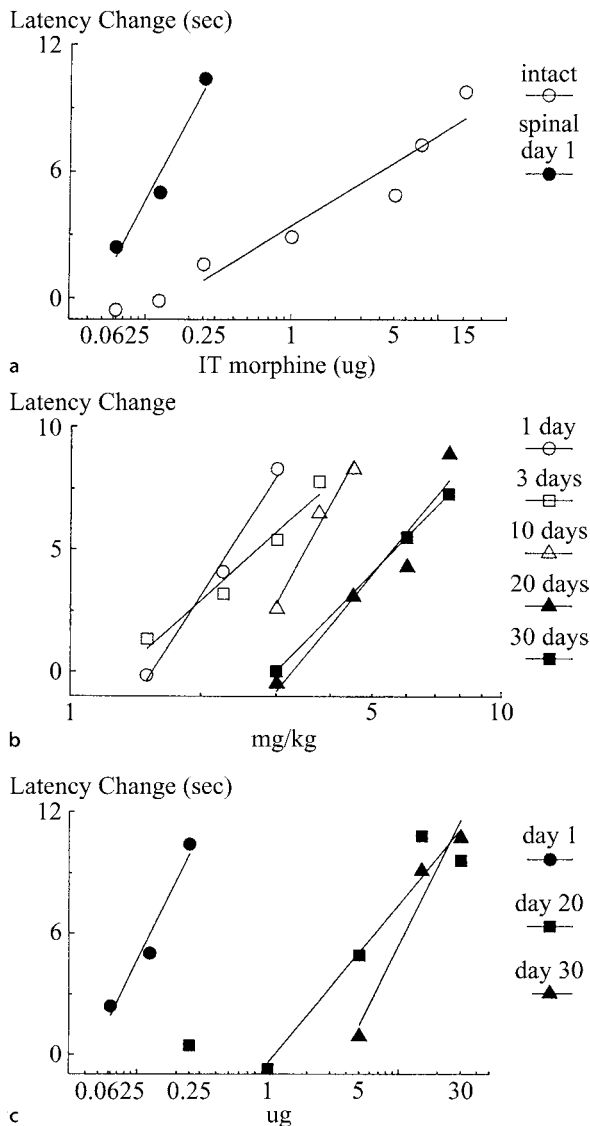
This view was supported by studies of the analgesic effect of morphine, administered concomitantly into the ▶ [intrathecal](#) space and the third cerebral ventricle (Yeung and Rudy 1980) or the ▶ [periaqueductal gray](#) (Siuciak and Advokat 1989a) of rats. Concurrent morphine administration to these sites had a ▶ [synergistic](#) effect on spinal antinociception, measured with the tail flick or ▶ [hot plate assay](#). The total amount of morphine concurrently administered to the brain and spinal cord, necessary to produce an ED<sub>50</sub> in these studies, was substantially less than the amount required separately at each site to produce the same effect. Furthermore, the total amount administered concomitantly to both sites was similar to the total concentration at these sites, which produced the same effect after systemic morphine administration (Advokat 1988). This confirmed that morphine-induced analgesia depended on a combined action at both spinal and supraspinal sites, but it did not indicate the nature of that interaction.

Some insight into this process was provided by studies in which morphine was administered intrathecally to the spinal cord of acute (1 day) spinally transected rats (Siuciak and Advokat 1989b). In this situation, the antinociceptive effect on spinal reflexes was considerably more potent than in the intact animal (Fig. 1a). These data demonstrated that the analgesic effect of spinal morphine at the spinal level was increased by either spinal transection or by supraspinally-administered morphine. The interpretation of this phenomenon was that spinal transection and intracerebral morphine administration produced the same effect on spinal opiate analgesia, because they eliminated (spinal transection) or suppressed (supraspinal morphine administration) an inhibitory action exerted by descending pathways on opiate-induced spinal antinociception.

The fact that systemically administered morphine was *less* potent in the acute spinal, compared to the intact animal, appeared to conflict with this hypothesis. However, it was subsequently shown that the amount of morphine reaching the spinal cord after acute spinalization was less than the concentration obtained at the same doses in intact rats (Advokat and Gulati 1991), demonstrating that the apparent decrease in potency of systemically-administered morphine might have been due to a disruption in the distribution of the drug to the CNS.

Several implications follow from these findings. First, they suggest that mechanisms responsible for descending control of spinal reflexes, *per se*, may be different





**Opioids and Reflexes, Figure 1** (a) Dose-response functions to intrathecal (IT) morphine in Intact (open circles) and Acute Spinal rats (filled circles) on the tail flick test. The data show that, 24 hours after spinal transection, the antinociceptive effect of spinally administered morphine is profoundly increased (Siuciak and Advokat 1989b). (b) Dose-response functions to subcutaneous morphine in Intact rats and in rats spinally transected for either 3, 10, 20 or 30 days. The data show a gradual decline in the antinociceptive effect of systemic morphine within a month after spinal transection (Advokat and Burton 1987). (c) Dose-response functions to intrathecal morphine in rats that were spinally transected either 1 day, 20 or 30 days previously. The data show a gradual decline in the antinociceptive effect of intrathecal morphine within a month after spinal transection (Siuciak and Advokat 1989b).

from those which mediate descending control of the effects of opiates on those same reflexes. A corollary of this proposition is that supraspinal mechanisms may also mediate the development of tolerance to opiate inhibition of spinal reflexes. That is, repeated administration of morphine may not only produce tolerance locally, at supraspinal and spinal sites, chronic opi-

ate exposure may also reduce the inhibitory effect of morphine acting through descending pathways. This hypothesis would be consistent with the observation that tolerance to systemic morphine administration does not necessarily confer tolerance to the effect of morphine at the level of the spinal cord (Siuciak and Advokat 1989a; Siuciak and Advokat 1989b; Advokat et al. 1987; Advokat 1989). Second, there is no reason to assume that opiates would be unique in producing effects at the spinal cord by a combination of direct and indirect mechanisms. The spinal action of other pharmacological agents, or endogenous neurotransmitters that are involved in the control of spinal reflex function, may also be supraspinally modulated (Advokat 1993). Such influences may be relevant to mechanisms responsible for **neuropathic pain** states that can occur after trauma or damage to the central nervous system (Wolf and Advokat 1995). Third, descending modulation may not only be inhibitory, but may also facilitate the effect of drugs on spinal reflexes. Fourth, supraspinal modulation may not be limited to nociceptive reflexes, but may also be exerted on a variety of other spinal reflexes. Finally, the effects observed after an acute spinal transection might not be permanent, and could conceivably change over time as a result of neurophysiological adaptations, such as neuronal degeneration or receptor alterations, following spinal transection.

The possibility that the effects of an acute spinal transection might be modified over time, led to the development of the chronic spinal preparation as a model of **spinal cord injury** (SCI). SCI, produced by trauma to, or disease of, the nervous system, frequently leads to both **spasticity** and chronic pain in a majority of patients. Although the spinalized rat does not 'perceive' the nociceptive stimulus applied below the lesion, the reflex withdrawal of both the tail and the hindlimb is preserved, providing a model for evaluating reflex function in chronic spinal animals.

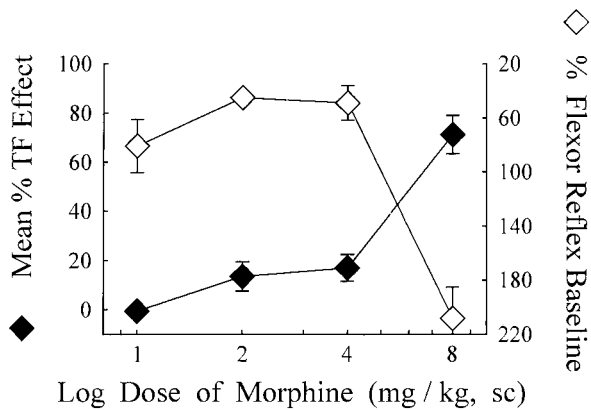
Initial studies of morphine-induced antinociception in this preparation, showed that during the first month following spinal transection, there was a gradual decrease in potency of the antinociceptive effect of morphine, whether administered systemically (Fig. 1b) (Advokat and Burton 1987) or directly onto the spinal cord (Fig. 1c) (Siuciak and Advokat 1989b). These results are consistent with other evidence from animal models and clinical observations, that the effect of opiate drugs is at least attenuated in neuropathic pain states produced by damage to the nervous system.

As with SCI in humans, a permanent and stable spastic response of the hindlimbs was also observed, developing in chronic spinal rats during the first few weeks following transection (Duke and Advokat 2000). This permitted the simultaneous assessment of the effect of antinociceptive and antispastic agents in the same, *in vivo*, unanesthetized animals. By concurrent elec-

trophysiological measurement of the hindlimb flexion response, and recording of the nociceptive tail flick reflex in the same animals, the antispastic, as well as antinociceptive effect, of morphine was evaluated in this model (Advokat and Duke 1999). The results (Fig. 2) showed first, that, while the analgesic effect of systemic morphine was reduced in chronic spinal rats, the same doses were still effective against hindlimb spasticity. The hyperreactive hindlimb flexion reflex was decreased by 50% at doses that produced no change in the nociceptive response of the tail to a noxious thermal stimulus, in the same animals. This demonstrated a separation between the dose-response functions of the two behaviors, indicating that the antispastic action occurs at a dose that does not produce an analgesic effect.

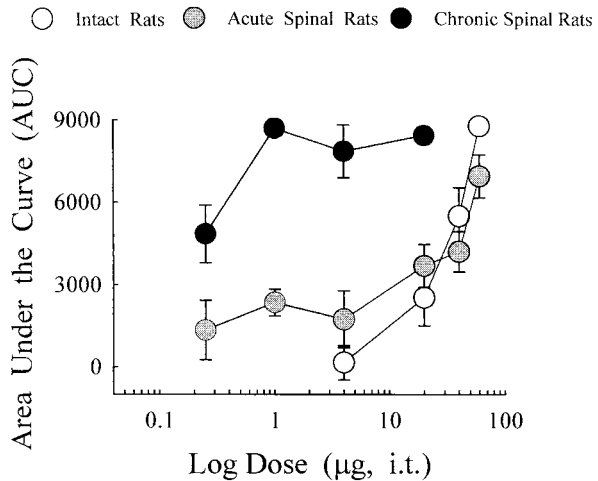
Second, the data in Figure 2 also show that, at the highest dose (8 mg/kg), there was a significant reversal of the effect of morphine on both behaviors. While this dose was large enough to produce an antinociceptive effect, it also *increased* the flexion response to more than 200% of baseline. That is, morphine simultaneously decreased the reaction to a normally painful stimulus, and increased the spastic response to a non-painful stimulus. This may be an example of the clinical phenomenon of “opioid-related” **myoclonus** that has been reported in cancer patients, which was “highly” associated with nerve dysfunction due to spinal cord lesions.

The observation that a single drug can modulate nociception and spasticity in the chronic spinal rat is not limited to morphine, but is relevant to the action of other pharmacological agents used in treating pain and

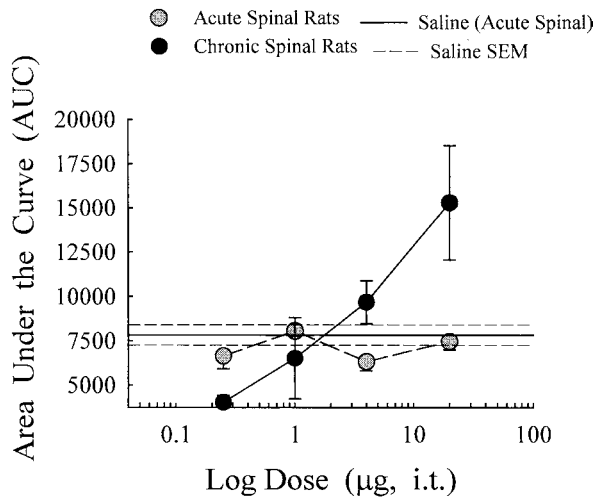


**Opioids and Reflexes, Figure 2** Dose-response functions for the effect of subcutaneous morphine on the tail flick withdrawal reflex (left axis, filled symbols) and the flexor withdrawal reflex (right axis, open symbols) of chronic spinal rats. Separate groups of spinally transected rats were tested at each dose; both tests were administered to each animal. The data show a separation in the effect of morphine on these two measures. At low doses of 1 to 4 mg/kg, there is minimal antinociception and a maximum antispastic effect. At the highest, 8 mg/kg dose, antinociception is maximum while the antispastic action is reversed, and a profound hyperreactive response is elicited (Advokat and Duke 1999).

spasticity in SCI. Studies with the antispastic agent baclofen have also shown a separation between the antinociceptive action of low doses and an antispastic, muscle-relaxant, effect of higher doses, in chronic spinal rats (Advokat et al. 1999). The usefulness of the chronic spinal rat has also been demonstrated in recent studies of the **Alpha( $\alpha$ ) 2-Adrenergic Agonist**, clonidine, on spinal reflex function (Advokat 2002).



**Opioids and Reflexes, Figure 3** Dose-response functions to intrathecal clonidine on the tail flick test, in Intact (open circles), Acute Spinal (shaded circles) and Chronic Spinal rats (solid circles). The data represent the mean  $\pm$  S.E.M. of the area under the time-effect curve (at 30, 60 and 90 minutes) for separate groups of rats (n = 3 to 6) tested after administration of the indicated doses of clonidine. There was a significant dose-dependent effect of clonidine within each of the three experimental conditions. Clonidine-induced antinociception in Intact rats was the same as that in Acute Spinal rats, but was greatly increased in Chronic Spinal rats (Advokat 2002).



**Opioids and Reflexes, Figure 4** Dose-response to intrathecal clonidine on the flexor reflex of Acute Spinal (shaded circles) and Chronic Spinal rats (solid circles). The data were obtained from the same animals whose tail flick test results are summarized in Fig. 3. There was no difference among the doses in Acute Spinal rats and no group differed from the saline condition. However, the same doses produced a significant dose-dependent effect in Chronic Spinal rats (Advokat 2002).

Acute spinalization did not change the antinociceptive effect of this drug on spinal reflexes (Fig. 3), nor did clonidine have any effect on the non-nociceptive flexor response in this situation (Fig. 4). However, one month after spinalization there was a significant increase in the antinociceptive effect of clonidine on the thermally elicited tail withdrawal reflex, as well as a dose-dependent response on the spastic hindlimb flexion reflex. These data provide behavioral evidence of ► **supersensitivity** to alpha<sub>2</sub>-adrenoceptor agonists in chronic spinal rats. Such results illustrate the insights provided by careful consideration of differential pharmacological modulation of spinal reflex function.

## References

1. Advokat C (1988) The Role of Descending Inhibition in Morphine-Induced Analgesia. *Trends Pharmacol Sci* 9:330–334
2. Advokat C (1989) Tolerance to the Antinociceptive Effect of Systemic Morphine in Spinally Transected Rats. *Behav Neurosci* 103:1091–1098
3. Advokat C (1993) Intrathecal Co-Administration of Serotonin (5HT) and Morphine Differentially Modulates the Tail Flick Reflex of Intact and Spinal Rats. *Pharmacol Biochem Behav* 45:871–879
4. Advokat C (2002) Spinal Transection Increases the Potency of Clonidine on the Tail Flick and Hindlimb Flexion Reflexes. *Eur J Pharmacol* 437:63–67
5. Advokat C, Burton P (1987) Antinociceptive Effect of Systemic and Intrathecal Morphine in Spinally Transected Rats. *Eur J Pharmacol* 139:335–343
6. Advokat C, Burton P, Tyler CB (1987) Investigation of Tolerance to Chronic Intrathecal Morphine Infusion in the Rat. *Physiol Behav* 39:161–168
7. Advokat C, Duke M (1999) Comparison of Morphine-Induced Effects on Thermal Nociception, Mechanoreception and Hindlimb Flexion in Chronic Spinal Rats. *Exp Clin Psychopharmacol* 7:219–225
8. Advokat C, Duke M, Zeringue R (1999) Dissociation of (-)Baclofen-Induced Effects on the Tail Withdrawal and Hindlimb Flexor Reflexes of Chronic Spinal Rats. *Pharmacol Biochem Behav* 63:527–534
9. Advokat C, Gulati A (1991) Spinal Transection Reduces both Spinal Antinociception and CNS Concentration of Systemically Administered Morphine in Rats. *Brain Res* 555:251–258
10. Duke M, Advokat C (2000) Pentobarbital-Induced Modulation of Flexor and H-Reflexes in Spinal Rats. *Brain Res* 881:217–221
11. Siuciak J, Advokat C (1989a) The Synergistic Effect of Concurrent Spinal and Supraspinal Opiate Agonists is Reduced by Both Nociceptive and Opiate Pretreatment. *Pharmacol Biochem Behav* 34:265–273
12. Siuciak J, Advokat C (1989b) Antinociceptive Effect of Intrathecal Morphine Injections in Tolerant and Non-Tolerant Spinal Rats. *Pharmacol Biochem Behav* 34:445–452
13. Wikler A (1950) Sites and Mechanisms of Action of Morphine and Related Drugs in the Central Nervous System. *Pharmacol Rev* 2:435–506
14. Wolf EA III, Advokat C (1995) The N-methyl-D-aspartate Antagonist Dextrorphan Acts Like Ketamine by Selectively Increasing Tail Flick Latencies in Spinally Transected, but not Intact Rats. *Analgesia* 1:161–170
15. Yeung JC, Rudy TA (1980) Multiplicative Interaction Between Narcotic Agonists Expressed at Spinal and Supraspinal Sites of Antinociceptive Action as Revealed by Concurrent Intrathecal and Intracerebroventricular Injections of Morphine. *J Pharmacol Exp Therap* 215:633–642

## Opioids, Clinical Opioid Tolerance

MISHA-MIROSLAV BACKONJA

Department of Neurology, University of Wisconsin-Madison, Madison, WI, USA

backonja@neurology.wisc.edu

### Synonyms

Analgesic Tolerance; Opioid Tolerance

### Definition

Tolerance is the term used to define the phenomenon in which an organism is less susceptible to the effect of a drug as a consequence of its prior administration (Foley 1993; Management of Cancer Pain Guideline Panel 1994).

### Characteristics

Though the definition of tolerance is relatively straightforward, tolerance to ► **opioids** is the need to increase dose requirements over time to maintain pain relief (Management of Cancer Pain Guideline Panel 1994). There are many clinical circumstances when opioid tolerance is suspected, and defining opioid analgesic tolerance in a clinical setting is much more subtle and certainly more challenging. This essay is a review of the issues and questions rather than a source of answers, and this is largely because the evidence based publications addressing this topic are lacking, and consensus statements related to opioids by experts and professional societies are thus far focused on regulatory issues of prescribing opioids. Unfortunately, basic science related to opioid analgesia, including tolerance, in spite of remarkable advances, has contributed very little to the opioid tolerance problems in the clinical setting. The primary reason for this shortcoming results from the fact that the majority of studies about opioid tolerance utilize models of acute tolerance, which is not a main issue in the clinical setting. Opioid analgesic tolerance during long-term therapy for chronic pain is the problem that first needs to be defined in its full complexity before it can be understood.

In most general terms, even in the clinic, there is a clear distinction between acute and chronic opioid tolerance. Acute tolerance is the term used to describe tolerance that develops very rapidly following either a single dose or a few doses given over a short period of time. Acute opioid tolerance is an everyday event for patients who are receiving opioids for peri-operative and post-operative analgesia, it is always anticipated, and with the introduction of post operative patient-controlled analgesia (PCA) pain relief is individualized, and in most cases successful in providing analgesia. In addition, post-operative acute pain as a rule dramatically improves as healing takes place over a short period of time and consequently tolerance is not an issue. For patients

who take opioids on a chronic basis (the commonly used term in this type of scenario is “opioid tolerant”) prior to operative procedures, the pre-operative dose has to be taken into account, and there are efforts to assist clinicians in this task (de Leon-Casasola 2002; Gordon and Ward 1995). In spite of these practical successes incidence of acute opioid analgesic tolerance and mechanisms of acute tolerance in clinical settings, peri-operative or otherwise, is not known.

Issues related to clinical opioid tolerance could be categorized as pharmacological, pathophysiological, psychological, social and societal, spanning from mechanisms to perceptions. Long-term treatment with opioids (a.k.a. chronic opioid therapy) for treatment of chronic pain presents a significant clinical problem. Incidence of opioid analgesic tolerance is not known and systematic studies on this issue are severely lacking.

Two ways of defining opioid analgesic tolerance in the case of the chronic opioid setting have emerged: first as a need to increase the dose of opioid analgesic to maintain the same level of pain relief, and the second as increasing intensity of pain at the same dose of medication. In either case, opioid analgesic tolerance is only not the result of pharmacological properties and effects of opioids, but it is also under the direct influence of underlying pain mechanisms.

The fact that underlying pain mechanisms are an important factor can be demonstrated in a case of neuropathic pain, which represents an example when pain mechanisms are the basis of labeling this type of pain as “opioid resistant” (Arner and Meyerson 1988), although this view was proven to be wrong when a number of clinical trials demonstrated evidence of analgesia for neuropathic pain (Dworkin et al. 2003). In practical terms, even neuropathic pain can be relieved with titration of the opioid analgesic until the therapeutic effect.

Another example related to underlying pain mechanisms is the natural course of the disease, which can make pain symptoms worsen as the disease progresses, such as in the case of progressive HIV neuropathy. This should be simply termed as worsening of pain due to progression of the disease. Another frequently cited clinical phenomenon is breakthrough pain, which refers to the underlying metastatic spread of neoplastic disease and associated mechanisms in cancer pain practice that require an increase in the dose to maintain the previous degree of pain relief. The most common scenario in the clinical setting of chronic noncancer pain treatment is flare-up of symptoms, which present natural fluctuations of chronic noncancer pain symptoms without any evidence of disease progression. Unfortunately, this spontaneous or activity precipitated fluctuation of pain symptoms is frequently erroneously termed as breakthrough pain, while in reality it is a fluctuation and flare-up of symptoms requiring flare-up management and not an increase in the dose of opioid ► [analgesics](#). It is difficult to determine which of the factors are at

play in each particular patient to cause more pain at the same dose of the opioid analgesics and it requires ongoing and very skillful clinical assessment.

There are numerous clinical scenarios when interpretations of the possibilities, which are not biological but rather due to psychosocial factors. A common scenario is undertreated pain, where a patient is asking for higher and higher doses, and many clinicians interpret this behavior as ► [addiction](#), although this is now a well-recognized phenomenon of pseudo-addiction. Further challenges stem from the assessment of severity of pain, which in many instances has a lot to do with the hidden meaning of pain rather than severity of any particular sensation (Williams 2000), which then introduces issues of psychosocial influences.

There are a couple of terms that confuse the lay public as well as uninformed clinicians when it comes to the use of opioids in clinical practice, and they are withdrawal symptoms and addiction and for many it is equated as tolerance. Only some patients who take opioids regularly at any dose and for any length of time and stop abruptly experience withdrawal symptoms, which include diarrhea, sweating, insomnia and goosebumps. Withdrawal symptoms are never the result of tolerance. Neither opioid tolerance nor withdrawal symptoms are inevitable, but should be anticipated and managed appropriately if they appear in patients who take opioids for pain control. The most bothersome ► [withdrawal symptom](#) in most patients with chronic pain who take opioids for pain relief is severe exacerbation of pain and associated anxiety. Opioid tolerance is one of the defining characteristics of opioid addiction, which is confusing and a serious concern to the lay public as much as to uninformed clinicians. The fundamental difference between chronic pain and addiction related to opioids is that, patients who have pain obtain and maintain clinically significant pain relief that allows them to maintain and improve their function, while patients with opioid addiction that take opioids as part of their addiction, experience and demonstrate a decline in function and well being. Additional and unfortunate confusion arises from the impression of language when opioids are termed as narcotics. It should be noted that narcotics is a regulatory term referring to substances of illegal and criminal trade, while opioid analgesics are pharmacological agents (drugs) used for pain relief, which when illegally used become narcotics.

Psychology studies of opioid use for pain relief led to the identification of associative and nonassociative tolerance. Associative tolerance is best expressed with low doses of drugs at long interdose intervals, and is readily modified by behavioral or environmental interventions. Nonassociative tolerance is best expressed with high doses of drugs at short interdose intervals, and is not modified by behavioral or environmental interventions. It is thought that associative tolerance results from the learning of drug-environment associations, whereas nonassociative tolerance and dependence can be viewed



simply as adaptive changes resulting from direct drug actions

Better understanding of clinical opioid tolerance has to address the complex interaction between the underlying mechanisms and psychosocial factors that ultimately lead to the prescribing and administering of opioids for the treatment of chronic pain. Unfortunately this issue has not been addressed in any publication or expert forum. In addition to this complexity, myths and confusion, not only in the lay public but among many clinicians, are further mired by frequent imprecision of language equating the use of opioids for pain relief with unavoidable development of tolerance and addiction, which then result in an unnecessary fear of opioids.

Opioid tolerance includes an additional range of clinical phenomena. In most general terms these phenomena can be viewed as tolerance to adverse events and this type of tolerance should be viewed as desirable, which is a contrast to tolerance to the analgesic effect, which is not desirable. Most significant tolerance to adverse events is tolerance to the respiratory depression effect, which develops relatively quickly after the initial exposure, especially in the presence of severe pain. In contrast, tolerance to gut effects, which leads to constipation, rarely develops.

Once other factors that can mimic opioid analgesic tolerance are excluded and managed, then clinical strategy for management, i.e. treatment of opioid analgesic tolerance, is ► [opioid rotation](#). This is possible because opioid cross-tolerance is incomplete. Opioid rotation is done on the basis of equianalgesic dose calculation.

In summary, although clinical opioid analgesic tolerance is much less frequent than is feared by the lay public and inexperienced clinicians, opioid tolerance is a very complex and dynamic process, under influence of many biological and psychosocial factors. In spite of its complexity, it is manageable by means of opioid rotation.

## References

- Arner S, Meyerson BA (1988) Lack of Analgesic Effect of Opioids on Neuropathic and Idiopathic Forms of Pain. *Pain* 33:11–23
- Dworkin RH, Backonja M, Rowbotham MC et al. (2003) Advances in Neuropathic Pain: Diagnosis, Mechanisms, and Treatment Recommendations. *Arch Neurol* 60:1524–1534
- Foley KM (1993) Changing Concepts of Tolerance to Opioids: What the Cancer Patient Has Taught Us. In: Chapman CR, Foley KM (eds) *Current and Emerging Issues in Cancer Pain: Research and Practice*. Lipincott-Raven, New York
- Gordon DB, Ward SE (1995) Correcting Patient Misconceptions about Pain. *AJN* 95:43–45
- Leon-Casasola OA de (2002) Cellular Mechanisms of Opioid Tolerance and the Clinical Approach to the Opioid Tolerant Patient in the Post-Operative Period. *Best Pract Res Clin Anaesthesiol* 16:521–525
- Management of Cancer Pain Guideline Panel (1994) *AHCP Clinical Practice Guideline: Management of Cancer Pain*. U.S. Department of Health and Human Services
- Williams ACD, Davies HT, Chadury Y (2000) Simple Pain Rating Scales Hide Complex Idiosyncratic Meanings. *Pain* 85:457–463

## Opioids, Effects of Systemic Morphine on Evoked Pain

CHARLES J. VIERCK JR

Department of Neuroscience and McKnight Brain Institute, University of Florida College of Medicine, Gainesville, FL, USA

vierck@mbi.ufl.edu

### Synonyms

Opioid Hypoalgesia; Systemic Morphine Effects on Evoked Pain; Evoked Pain and Morphine

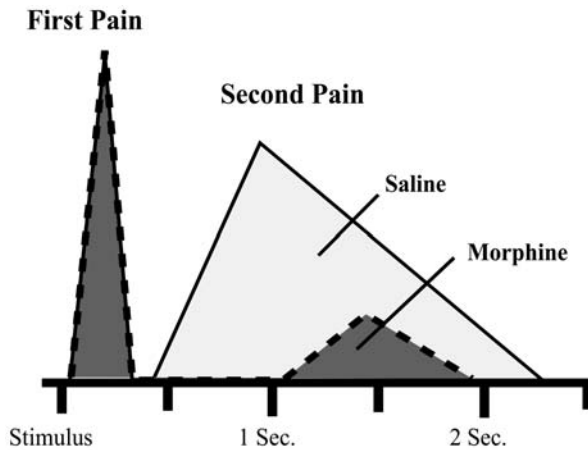
### Definition

Systemic morphine activates opiate receptors throughout the nervous system, attenuating a clinically important component of pain sensations and modulating a variety of pain reactions. Due to these effects, opiate agonists are the prototypical pharmacological treatment for many chronic pain conditions. Without addressing actions or relative potencies of opiate agonists acting at different receptors, effects of systemic administration of agonists will be outlined. These actions depend upon dosage, which is an important experimental and clinical consideration.

### Characteristics

Effects of systemic morphine on pain were first discovered in humans and were utilized clinically before experimental attempts to understand mechanisms of opioid ► [hypoalgesia](#) were initiated. A discrepancy between the substantial effects of morphine on clinical pain and meager attenuation of experimental pain in humans became apparent early (Beecher 1957). Potential explanations for results such as these were: 1) that there is a critical difference between chronic (clinical) pain and phasic (experimental) pain, or 2) that morphine reduces psychological suffering produced by pain with a lesser effect on the sensory component of pain. Subsequent research has revealed attenuation of a component of pain not assessed by early experimental methods, and also suppression of emotional and motivational reactions and associated physiological responses to pain.

Clinicians have noted that pain is rarely eliminated by systemic morphine. Chronic pain can be well controlled for a patient who is resting comfortably, but a procedure such as changing a dressing can produce intense pain. Observations such as this went unexplained until experimental studies asked subjects to separately rate early and late pain sensations that result from phasic activation of myelinated (A delta) and unmyelinated (C) ► [nociceptors](#). For example, when a preheated thermode briefly taps the skin, distinct early (► [first pain](#)) and late (► [second pain](#)) sensations are produced (Cooper et al.



**Opioids, Effects of Systemic Morphine on Evoked Pain, Figure 1** Average tracings of 6 subjects who followed the time-course and rated the magnitude of first and second pain elicited by 50-ms of electrocutaneous stimulation (1.28-mA/mm<sup>2</sup>; 0.5-ms pulses at 200-Hz) delivered to one lateral calf. Time course estimates utilized a finger-span device attached to a potentiometer, and the magnitudes of first and second pain were rated verbally, using ▶ [free magnitude estimation](#). Administration of 10-mg morphine sulphate 1-h before testing did not alter the magnitude of first pain. In contrast, second pain (dashed line) was delayed in onset and substantially reduced in magnitude and duration by morphine, relative to control measurements (solid line) (from Cooper et al. 1986).

1986). Prior i.m. injection of a therapeutic dose of morphine (approximately 0.1 mg/kg) dramatically reduces second pain, but has no detectable effect on first pain (Fig. 1). This differential result is also seen for brief mechanical stimulation of the skin that produces first and second pain. Similarly, chemical stimulation of C nociceptors by capsaicin produces a sensation of heat pain that is substantially attenuated by systemic morphine. These effects are specific to nociceptor input and do not apply to sensations of warmth that are subserved by activation of unmyelinated afferents (Cooper et al. 1986). Neurophysiological studies have shown that input from C nociceptors to spinal neurons is selectively reduced by systemic morphine (Jurna and Heinz 1979). This effect involves both presynaptic and postsynaptic inhibition (Zieglgänsberger and Bayerl 1976). Thus, pain reduction by opiate agonists (presumably including endogenous opiate agonists) ingeniously attenuates tonic pain from activation of C nociceptors by tissue injury, providing relief and facilitating sleep, but inappropriate activities (e.g. walking on a broken leg) are discouraged by preservation of phasic pain from activation of fast conducting A-delta nociceptors. Several implications of the inhibitory effects of morphine at the entry level of nociceptive processing are that: 1) spinal application of opiate agonists might be comparable to systemic administration, and 2) that the effects of morphine on pain can be modeled behaviorally by observing spinal reflexes. Neither of these suppositions is correct.

Reflex response latencies to heat or electrical stimulation and thresholds for mechanical stimulation can be increased by administration of opiate agonists. However, ▶ [intrathecal](#) application does not entirely account for systemic effects (Dickenson and Sullivan 1986), in part because opiate binding within the brain stem initiates descending modulation of spinal reflexes (Gebhart 1982). Despite these actions at brain stem and spinal levels, high doses of systemic morphine (minimally 3 mg/kg) are required to attenuate nociceptive reflexes. An important determinant of this relative insensitivity to systemic morphine is that nociceptive reflexes ordinarily function to withdraw a limb or tail from a tissue threatening stimulus in response to myelinated afferent input, well before input from C nociceptors reaches the spinal cord. However, cutaneous stimulation with a low level of nociceptive heat (e.g. 43–45°C) preferentially excites C nociceptors (Yeomans and Proudfit 1996), particularly for non-hairy skin. Prolonged stimulation at such temperatures can be used to evaluate whether reflex responses can appropriately reveal low dose modulation by morphine.

Stimulation of rodents' feet by nociceptive heat produces licking and guarding reflexes that are mediated by spinal-brain stem-spinal circuits, and do not require cerebral processing of nociception. These, and other responses (e.g. simple withdrawal, jumping, vocalizing), are preserved after decerebration (Woolfe and MacDonald 1944). However, ▶ [operant escape](#) from the same stimulus requires learning of a complex adaptive strategy within a specific environmental context, which involves multiple cerebral circuits for recognition of stimulus significance and for planning an appropriate motor sequence. After i.m. injection of 0.5 mg/kg morphine in rats, escape from 44°C stimulation is significantly decreased, as expected, but lick/guard responding is increased (Vierck et al. 2002). Similar to many experiments that have observed reflex responses to stimulation of myelinated afferents, lick/guard responding to low level nociceptive heat is not attenuated below a systemic dose of 3 mg/kg. A similar disparity between the sensitivity of reflex and operant escape behaviors to morphine has been reported for monkeys (Yeomans et al. 1995). Thus, in order to evaluate the effects of systemic morphine on nociceptive processing, it is important to utilize a behavioral response that requires cerebral processing and a stimulus that activates C nociceptors.

Diverse supraspinal actions of systemic morphine can be inferred from a widespread distribution of opiate receptors. In addition to effects on cerebral projection neurons at the spinal level by peripheral (Stein et al. 1989), spinal and descending modulation, opiate influences involve numerous systems of control over physiological and psychological reactions to nociceptive input. Considering first the brain stem, opiate agonists activate a variety of nuclei with descending

projections not only to the spinal dorsal horns, but also to the ventral and intermediolateral gray matter. Thus, opiate administration has direct sensory, motor and autonomic effects. For example, modulation of sympathetic outflow affects thermoregulation, which can influence nociceptive reactions to thermal stimulation (Tjolsen and Hole 1992). Parasympathetic modulation includes opiate actions within the vagal projection system of the brain stem (e.g. nucleus solitarius), and vagal activation can exert inhibitory influences on nociception (Ammons et al. 1983). Other brain stem effects involve modulation of defensive motor actions associated with nociception (e.g. fight or flight behaviors associated with rage or fear) (Braez 1994). Similarly, vocalizations related or unrelated to pain are suppressed via influences within the periaqueductal gray and associated structures (Cooper and Vierck 1986). In general, opiate influences on the brain stem are inhibitory for behavioral output and physiological reactions but excitation can result, depending on the dose and site of pharmacological application.

In addition to specific effects on nociceptive reactions, regulation of arousal by brain stem projection systems is susceptible to opiate modulation. Patterns of cortical EEG activity are modified by opiate actions within the brain stem and rostrally (Matejcek et al. 1988), and a generalized behavioral suppression results from therapeutic doses of morphine, particularly for primates (Vierck et al. 1984). Low doses of systemic morphine are sedative, promoting sleep and aiding recuperation from painful injuries. These effects on arousal can appear to represent analgesia by suppression of attention, particularly when high doses of morphine are administered.

Cerebral projection of nociception is susceptible to modulation via opiate agonist application to the thalamus and somatosensory cortex, and these effects are diverse (Wamsley 1983). For example, opiate receptor distribution in the medial thalamus is particularly high, and opiate receptors are present in cingulate, insular and prefrontal cortical regions. Opiate modulation at these sites is consistent with observations that systemic morphine reduces affective (emotional) and motivational responses to pain (Beecher 1957). Opiate actions within limbic projection systems (e.g. the septal area, amygdaloid nuclei and hypothalamus) are likely to be responsible for rewarding effects of opiates such as euphoria (Koob 1992). Also, nociceptive activation of the limbic system accesses brain stem systems of descending modulation, to influence autonomic and hormonal responses integral to diverse [▶ homeostatic adaptations](#) to nociceptive input. Systemic morphine actions on limbic system processing include influences on the hypothalamic-pituitary-adrenal axis, and modulation of hypothalamic output of numerous hormonal releasing factors and of pituitary hormonal secretion (Wood and Lyengar 1988). Relevance of these actions to a com-

prehensive regulation of behavioral and physiological reactions to pain is indicated by demonstrations of extensive nociceptive projections to the limbic system. The multiple actions of opiate agonists make apparent some important considerations concerning experimental evaluation of systemic morphine's effects relevant's to control over clinical pain. Reflex tests are relatively insensitive and do not reveal numerous cerebral actions of morphine on pain sensations and reactions. Also, observation of responses to phasic input from myelinated nociceptors is not useful. Evaluation of responses to C nociceptor input appears to be necessary, and is especially informative if [▶ temporal summation \(windup\)](#) of pain is produced. Attenuation of central sensitization produced by prolonged C nociceptor input is likely to be an important component of the clinical utility of systemic agonists (Price et al. 1985). Also, tests of responses to stimulation of inflamed tissue have revealed low-dose effects of systemic morphine on behavioral tests that are otherwise insensitive (Stein et al. 1989), indicating that peripheral actions constitute an important component of the effectiveness of systemic morphine for certain forms of clinical pain. In contrast, systemic morphine is relatively ineffective for control of chronic pain that can result from lesions within the central nervous system that interrupt nociceptive input to sites that contain opiate receptors (Arner and Meyerson 1988). Thus, morphine modulates nociceptive transmission to and within the central nervous system, but is less effective for attenuation of abnormal "spontaneous" activity that can result from deafferentation of pain transmission systems.

## References

1. Ammons W, Blair R, Foreman R (1983) Vagal Afferent Inhibition of Primate Thoracic Spinothalamic Neurons. *J Neurophysiol* 50:926–940
2. Arner S, Meyerson BA (1988) Lack of Analgesic Effect of Opioids on Neuropathic and Idiopathic Forms of Pain. *Pain* 33:11–23
3. Beecher HK (1957) Measurement of Pain; Prototype for the Quantitative Study of Subjective Sensations. *Pharmacoll Rev* 9:59–209
4. Braez J (1994) Neuroanatomy and Neurotransmitter Regulation of Defensive Behaviors and Related Emotions in Mammals. *Braz J Med Biol Res* 27:811–829
5. Cooper BY, Vierck CJ Jr (1986) Vocalizations as Measures of Pain in Monkeys. *Pain* 26:393–408
6. Cooper BY, Vierck CJ Jr, Yeomans DC (1986) Selective Reduction of Second Pain Sensations by Systemic Morphine in Humans. *Pain* 24:93–116
7. Dickenson AH, Sullivan AF (1986) Electrophysiological Studies on the Effects of Intrathecal Morphine on Nociceptive Neurones in the Rat Dorsal Horn. *Pain* 24:211–222
8. Gebhart G (1982) Opiate and Opioid Peptide Effects on Brain Stem Neurons: Relevance to Nociception and Antinociceptive Mechanisms. *Pain* 12:93–140
9. Jurna I, Heinz G (1979) Differential Effects of Morphine and Opioid Analgesics on A and C Fibre-Evoked Activity in Ascending Axons of the Rat Spinal Cord. *Brain Res* 171:573–576
10. Koob G (1992) Drugs of Abuse: Anatomy, Pharmacology and Function of Reward Pathways. *Trends Pharmacol Sci* 13:177–184

11. Matejcek M, Pokorny R, Ferber G et al. (1988) Effect of Morphine on the Electroencephalogram and other Physiological and Behavioral Parameters. *Neuropsychobiology* 19:202–211
12. Price DD, Von der Gruen A, Miller J et al. (1985) A Psychophysical Analysis of Morphine Analgesia. *Pain* 22:261–269
13. Stein C, Millan MJ, Shippenberg TS et al. (1989) Peripheral Opioid Receptors Mediating Antinociception in Inflammation. Evidence for Involvement of *Mu*, *Delta* and *Kappa* Receptors. *J Pharmacol Exp Therap* 248:1269–1275
14. Tjolsen A, Hole K (1992) The Effect of Morphine on Core and Skin Temperature in Rats. *Neuroreport* 3:512–514
15. Vierck CJ, Acosta-Rua A, Nelligan R et al. (2002) Low Dose Systemic Morphine Attenuates Operant Escape but Facilitates Innate Reflex Responses to Thermal Stimulation. *J Pain* 3:309–319
16. Vierck CJ Jr, Cooper BY, Cohen RH et al. (1984) Effects of Systemic Morphine on Monkeys and Man: Generalized Suppression of Behavior and Preferential Inhibition of Pain Elicited by Unmyelinated Nociceptors. In: von Euler C, Franzen O, Lindblom U et al. (eds) *Somatosensory Mechanisms*. MacMillan Press, London, pp 309–323
17. Wamsley J (1983) Opioid Receptors: Autoradiography. *Pharmacological Reviews* 35:69–83
18. Wood PL, Iyengar S (1988) Central actions of Opiates and Opioid Peptides. In: Pasternak GW (ed) *The Humana Press*, pp 307–356
19. Woolfe G, MacDonald AD (1944) The Evaluation of the Analgesic Action of Pethidine Hydrochloride (Demorol). *J Pharmacol Exp Ther* 80:300–307
20. Yeomans DC, Proudfit HK (1996) Nociceptive Responses to High and Low Rates of Noxious Cutaneous Heating are Mediated by Different Nociceptors in the Rat: electrophysiological. *Pain* 68:141–150
21. Yeomans DC, Cooper BY, Vierck CJ Jr (1995) Comparisons of Dose-Dependent Effects of Systemic Morphine on Flexion Reflex Components and Operant Avoidance Responses of Awake Non-Human Primates. *Brain Res* 670:297–302
22. Zieglgänsberger W, Bayerl H (1976) The Mechanism of Inhibition of Neuronal Activity by Opiates in the Spinal Cord of Cat. *Brain Res* 115:111–128

## Opioids in Geriatric Application

PERRY G. FINE

Pain Management and Research Center, University of Utah, Salt Lake City, UT, USA  
fine@aros.net

### Definition

By convention, geriatric patients are those 65 years of age and older. This age group represents the fastest growing segment of the total population of developed nations. Physiologically, older patients differ significantly from those in younger age groups in a variety of ways. The physiologic changes of aging, along with acute and chronic pathologic conditions and altered drug disposition frequently lead to increased pain-producing problems, this is in addition to changing sensory perception and the ability to communicate or cope with distress, and these normal and pathologic changes influence drug disposition. The rate of aging is influenced by genetic and environmental factors, so the trajectory of changes is different from person to person. Neverthe-

less, with the passage of time, senescence is inevitable, and aging is marked by several common traits:

Rates of gene transcription, lipofuscin and extracellular matrix cross-linking, and protein oxidation are altered, among other biochemical and tissue changes.

Physiologic capacity diminishes.

Adaptive processes to physiologic stress (e.g. increases in cardiac output; thermo-regulation; GI transit rate) are blunted.

Susceptibility and vulnerability to diseases are increased.

There is an accelerating rise in mortality with advancing age after maturation occurs.

These factors must be taken into account when assessing older patients with significant pain. Decisions about goals of therapy, when and how to prescribe opioid ► **analgesics**, and what effects to anticipate will be strongly influenced by these circumstances. They are oftentimes considerably different than the types of concerns relevant to younger patients;

### Characteristics

#### Pain Prevalence, Etiology and Features

Persistent and recurrent episodic pains are highly prevalent in older patients. About 5% of older Americans reportedly take prescription analgesics for most of a given year (Cooner and Amorosi 1997). Causes of pain in older patients are often from multiple etiologies. Most commonly, these include skeletal diseases such as osteoarthritis and degenerative spinal disorders, and ► **neuropathic pain** syndromes such as ► **post-herpetic neuralgia** and painful ► **diabetic polyneuropathy**. Also, pain-producing cardiovascular ailments and malignancies gain prevalence, adding to the overall burden of aging.

Surveys over the last several years have shown that serious pain is a frequent finding among both community dwelling and institutionalized older individuals, and it is largely under-treated in most settings except hospice, where comfort is a focus of care (Helme and Gibson 1999). Between 45–80% of nursing home residents are reported to have moderate to severe pain on a regular basis that is not adequately treated.

Although the adverse consequences of pain in older persons are not necessarily unique, they are oftentimes amplified, due to coexisting problems, including cognitive impairment, balance disturbances, deconditioning, sensory impairments, and other co-morbidities. As a result, the ill effects of pain, such as mood disorders (especially depression), social isolation, poor sleep, gait disturbance and inability to perform self-care and routine activities of daily living (ADLs) are compounded. The use of multiple medications for concurrent disease and symptom management creates an additional confound in the management of pain in geriatrics. Drug-drug and drug-disease interactions are, as a result, a far



more significant concern in this group of patients. The consequences of drug-related adverse effects, such as falls, confusion, or ► [obstipation](#) can have much graver consequences than in younger patients. Overall, however, as a pharmacological class, the risks associated with opioid analgesics are considerably less compared to other commonly prescribed drugs in older patients (Doucet et al. 1996).

### Aging and Opioid Pharmacology

Consistent with current theories of aging, the great individual variability observed in older persons is more likely to be the result of “tightly controlled but individually different cell and tissue-specific patterns of gene expression”, rather than age-specific genetic instability (Arking 2001). Each patient’s history, environmental exposure, and genetic makeup contributes to a unique pattern of organ function (or dysfunction) and subjective response to therapy (Barja 1998). Evidence suggests that sensitivity to drugs that act in the central nervous system, best demonstrated in studies of opioid analgesics, increases with age (Rooke et al. 2002). Age has long been known to be an independent predictor of response to opioids (Belleville et al. 1971). In decile groupings, after the age of forty, there appears to be a linear age-related increase in responsiveness to fixed morphine doses with regard to pain intensity differences in post-operative patients. This correlates with changes in drug absorption, distribution, metabolism and clearance, all of which are influenced by body composition changes (e.g. muscle:fat), reduced serum protein levels, cardiac output and organ perfusion (Fine 2004). Notwithstanding the multiple pharmacokinetic (► [pharmacokinetics](#)) alterations that influence opioid blood levels over time, the cause of increased sensitivity to opioids appears to be mostly a function of reduced central nervous system resilience (Guay et al. 2002). In addition, it has been postulated that increased sensitivity to the effects of opioids, both therapeutic and toxic, are related to the high prevalence of subclinical malnutrition in community and institutional dwelling geriatric patients. In the few studies that have specifically evaluated pharmacodynamic (► [pharmacodynamics](#)) effects of analgesic drugs in older patients, the rate of drug delivery, rather than the absolute dose of drug over time, influences both analgesia and adverse effects, including the most feared risk of life-threatening respiratory depression (Aburun et al. 2002). Opioids have been shown to affect immune system responses and neuro-endocrine function. A systematic review of the literature did not reveal any conclusive age-specific, or age-related, effects of pain or opioids on human immune functioning (Page 2003). However, this is an area that requires further study, since patients are being treated for more protracted periods of time with opioids, and overall life expectancy is increasing. The potential for chronic opioid therapy to

reduce testosterone levels in males requires ongoing assessment, in addition to a risk-benefit analysis, in terms of pain treatment, hormone depletion and hormone replacement.

### Indications and Guidelines

Opioid analgesics are most effectively used to achieve positive therapeutic goals when they are incorporated into a comprehensive non-pharmacologic, pharmacologic, behavioral and functional improvement (rehabilitative) pain management plan of care (Fine 2004) (see also ► [non-pharmacologic pain management](#)). The American Geriatrics Society has recently produced a clinical guideline based upon a systematic review of the literature, which outlines principles for analgesic use in older patients (Fine 2001). Key points with regard to opioids include:

- All older patients with functional impairment or diminished quality of life as a result of persistent pain are candidates for pharmacologic therapy.
- There is no role for ► [placebos](#) in the management of pain. Their use is unethical.
- The least toxic means of achieving pain relief should be used. When systemic medications are indicated, non-invasive routes should be considered first.
- Opioid analgesic drugs may help relieve moderate to severe pain, especially ► [nociceptive pain](#). (As an update, though, it should be noted that recent studies have demonstrated the efficacy of opioids in the management of various neuropathic pain conditions (Rowbotham et al. 2003).
- Opioids for episodic (non-continuous) pain should be prescribed as needed, rather than around the clock.
- Long-acting or sustained-release analgesic preparations should be used for continuous pain;
- ► [Breakthrough pain](#) should be identified and treated by the use of fast-onset, short-acting preparations.
- Constipation and opioid-related gastrointestinal symptoms should be prevented. Assessment of bowel function should be an initial and ongoing process during every follow-up visit for patients receiving analgesics.
- Non-opioid pain-modulating medications may be appropriate for some patients with neuropathic pain and some other chronic pain conditions.
- Patients taking analgesic medications should be monitored closely:
- Patients should be reevaluated frequently for drug efficacy and side effects during initiation, titration, or any change in dose of analgesic medications.
- Patients should be reevaluated regularly for drug efficacy and side effects throughout long-term analgesic drug maintenance.
- Patients on long-term opioid therapy should be evaluated periodically for inappropriate or dangerous drug-use patterns.

- Clinical endpoints should be decreased pain, increased function and improvements in mood and sleep, not decreased drug dose.

### Non Self-Reporting Patients

One of the more significant challenges in geriatric care is the management of symptoms in patients who are unable to provide an adequate history or narrative of their complaints. Most typically, these are patients suffering from severe cognitive impairments with associated verbal loss from advanced dementing illnesses (e.g. Alzheimers Disease, multi-infarct dementia). In these cases, it is incumbent upon practitioners to anticipate and appreciate the myriad co-existing conditions that typically cause pain in this population, and to develop the skills necessary to recognize symptoms, assess them, and sufficiently treat and monitor outcomes of therapy in patients who cannot self-report. Behavioral disturbances can be, and oftentimes are, mistaken as part and parcel of the dementing illness, rather than a manifestation of pain. Changes in usual behaviors, alterations in eating/sleeping/interpersonal response patterns, vocalizations, and various forms of agitation have been shown to be associated with pain perception that is modifiable by both pharmacologic and non-pharmacologic means. The decision to initiate and titrate opioid therapy must be based upon a high index of suspicion, combined with a failure to provide comfort through other means. An “N of 1” trial of opioid analgesics may be the best means of testing the hypothesis that a non self-reporting patient is experiencing pain. This approach has been shown to be effective at distinguishing analgesic- from non-analgesic-responsive behaviors, while significantly decreasing inappropriate use of psychotropic drugs that may only mask symptoms (Kovach et al. 1999). By sorting out causality in this way, and actively treating their pain, an important contribution to the maintenance of these vulnerable patients’ dignity, and basic humanistic care, can be made.

### References

1. Aburun F, Monsel S, Langeron O, Coriat P, Riou B (2002). Post-operative Titration of Intravenous Morphine in the Elderly Patient. *Anesthesiology* 96:17–23
2. AGS Panel on Persistent Pain in Older Persons (2002) The Management of Persistent Pain in Older Persons. *J Am Geriatr Soc* 50: S205–S224
3. Arking R (2001) The Biology of Aging: What Is It and When It Will Become Useful. *Infertility and Reproductive Medicine Clinics of North America* 12:469–487
4. Barja G (1998) Mitochondrial Free Radical Production and Aging in Mammals and Birds. *Ann NY Acad Sci* 854:224–238
5. Belleville JW, Forrest WH, Miller E et al. (1971) Influence of Age on Pain Relief from Analgesics: A Study of Postoperative Patients. *JAMA* 217:1835–1841
6. Cooner E, Amorosi S (1997) *The Study of Pain in Older Americans*. Louis Harris and Associates, New York
7. Doucet J, Chassagne P, Trivalle C et al. (1996) Drug-Drug Interactions Related to Hospital Admissions in Older Adults: A Prospective Study of 1000 Patients. *J Am Geriatr Soc* 44:944–948
8. Fine PG (2001) Opioid Analgesics in Older People. In: Ferrell BA (ed) *Clinics in Geriatric Medicine: Pain Management in the Elderly*. WB Saunders Company, Philadelphia, pp 479–485
9. Fine PG (2004) Pharmacological Management of Persistent Pain in Older Patients. *Clin J Pain* 20:220–226
10. Guay DRP, Lackner TE, Hanlon JT (2002) Pharmacologic Management. In: Weiner DK, Herr K, Rudy TE (eds) *Persistent Pain in Older Adults*. Springer, New York, pp 160–187
11. Helme RD, Gibson SJ (1999) Pain in Older People. In: Crombie IK, Croft PR, Linton SJ, et al. eds. *Epidemiology of Pain*. Seattle, IASP Press, pp 103–312
12. Kovach CR, Weissman DE, Griffie J et al. (1999). Assessment and Treatment of Discomfort for People with Late-Stage Dementia. *J Pain Symptom Manage* 18:412–419
13. Page GG (2003) The immune-suppressive effects of pain. *Adv Exp Med Biol* 521:117–25.
14. Rooke GA, Reeves JG, Rosow C (2002) Anesthesiology and Geriatric Medicine: Mutual Needs and Opportunities. *Anesthesiology* 96:2–4
15. Rowbotham MC, Twilling L, Davies MS, Reiser L, Taylor K, Mohr D (2003) Oral Opioid Therapy for Chronic Peripheral and Central Neuropathic Pain. *New Engl J Med* 348:1223–1232

## Opioids in Sympathetically Maintained Pain

- [Opioids in the Management of Complex Regional Pain Syndrome](#)

## Opioids in the Management of Complex Regional Pain Syndrome

SRINIVASA N. RAJA, SHEFALI AGARWAL  
Department of Anesthesiology and Critical Care  
Medicine, Johns Hopkins University School of  
Medicine, Baltimore, MD, USA  
sraja@jhmi.edu

### Synonyms

Opioids in Sympathetically Maintained Pain

### Definition

The role of opioids in the management of chronic non-cancer pain states has been a topic of considerable debate. Physicians’ concerns about the use of opioids for pain states other than that resulting from cancer, e.g. neuropathic pain, include the risk of addiction, tolerance to the opioid effect, and lack of efficacy. The belief that nociceptive pain responds to opioids, while neuropathic pain is resistant to opioids, stems from the report by Arner and Meyerson (1988). These investigators compared the effectiveness of infusions of opioid and placebo in a mixed group of forty eight patients with neuropathic, nociceptive and idiopathic pain. Twelve

patients in this group had neuropathic pain; four of these twelve patients had combined neuropathic and nociceptive pain. Only one of the eight patients with neuropathic pain alone, and one in the combined neuropathic/nociceptive group, responded positively to the opioid infusion test. These observations were in contrast with the reduction in pain in all of the 15 subjects with nociceptive pain after opioid infusions. This report has been controversial and criticized for an inherent selection bias in the study design (neuropathic pain patients were being treated with narcotics analgesics in moderately high doses prior to study) and for its small sample size. More recent clinical studies suggest that neuropathic pain is not resistant to opioids; however, the drug doses required to attenuate neuropathic pain may be higher than that required to relieve nociceptive pain.

## Characteristics

### Effect of Opioids in CRPS

A neuropathic pain state that is characterized by ongoing pain, allodynia (pain to normally innocuous stimuli), and significant limitation of function is Complex Regional Pain Syndrome (types I and II, formerly known as Reflex Sympathetic Dystrophy and Causalgia, respectively). The pathophysiology of this disease is uncertain, and hence therapies are aimed at symptomatic relief and functional rehabilitation. Opioids are often used in the management of patients with CRPS to alleviate the ongoing pain when more conservative therapies fail, and to help the patient participate in active physical therapy treatments.

Various therapeutic approaches have been proposed to alleviate the pain in patients with CRPS, but there is paucity of controlled clinical trials that have evaluated the beneficial effects of opioid therapies in patients with CRPS. Although the published literature is limited, growing clinical experience along with clinical re-evaluation of issues related to safety, efficacy and addiction or abuse, shows that some patients can achieve analgesia and improved function and quality of life without the occurrence of intolerable side effects. Since there are no controlled trials of opioid effects in a population of patients with CRPS, we will review the available data from studies of patients with neuropathic pain (a subset of patients in some of these studies have been diagnosed to have CRPS).

### Effects of Opioids in Other Neuropathic Pain States

Initial proof of the principle of the effectiveness of opioids on neuropathic pain was achieved using brief intravenous (I.V.) infusion studies (Rowbotham et al. 1991), comparing the effects of I.V. infusions of morphine, lidocaine and placebo in 19 patients with postherpetic neuralgia, using a double blind, crossover

design. A 33% decline in pain intensity was observed after morphine (0.3 mg/kg) infusion, compared to a 13% reduction with placebo. Pain relief ratings were also higher during the morphine sessions than lidocaine or placebo sessions.

Several subsequent studies have confirmed the beneficial role of opioids in the treatment of various neuropathic pain states. In a double blind crossover trial, the infusion of the opioid fentanyl was more effective in reducing the intensity of neuropathic pain, compared to the active placebo, diazepam, and the inert placebo, saline (DelleMijn and Vanneste 1997). Two recent additional randomized, controlled, crossover studies have reported beneficial effects of intravenous opioids on central pain and post-amputation pains (Attal et al. 2002, Wu et al. 2002). All four trials described above report a mean pain relief of 30–55% with opioids in the group of patients studied, but significant individual variations were observed. In contrast, the placebo response varied from an increase in pain of 5% to a 25% decrease in pain.

Infusion studies help demonstrate that opioids are likely to provide analgesia in patients with neuropathic pain. However, they may not predict whether therapy with oral opioids is likely to be similarly beneficial. A number of controlled trials published during the last five years have provided evidence for a beneficial effect of oral opioids in chronic neuropathic pain. In a crossover trial, the effects on pain of twice daily controlled release oxycodone treatment were studied in 50 patients with postherpetic neuralgia (Watson and Babul 1998). Subjects began with either placebo or 10 mg oxycodone twice a day and titrated to 60 mg per day. A significant decrease in overall pain intensity and pain relief was observed in the oxycodone treatment period as compared to the placebo period. Fifty eight percent of patients experienced at least moderate pain relief with oxycodone as compared to 18% with placebo. In addition, disability scores were lower during treatment with oxycodone. A similar decrease in pain and greater pain relief compared to placebo was observed in a multi-center, randomized, placebo-controlled trial in patients with distal symmetric diabetic neuropathy, treated with the weak opioid agonist tramadol (Harati et al. 1998, Raja et al. 2002), compared with the change in pain intensity and pain relief with opioids and tricyclic antidepressants in patients with postherpetic neuralgia. They observed similar reductions in pain intensity with both drugs, but patients reported greater satisfaction with the opioid therapy as compared to the therapy with tricyclic antidepressants (50% vs. 34%). Rowbotham et al. (2003) compared treatment with low (0.15 mg) – and high – strength (0.75 mg) capsules of levorphanol in a heterogeneous group of patients with peripheral or central neuropathic pain states. They reported a greater reduction in intensity with higher doses of opioids

than with lower doses. The mean dose of levorphanol in the high strength group was 8.9 mg/day, approximately equivalent to 135–270 mg of oral morphine and 90–135 mg of oxycodone. A double blind placebo controlled trial in neuropathic patients who were being treated with spinal cord stimulators, however, failed to demonstrate a significant effect of morphine on pain at lower doses, between 60 and 90 mg/day (Harke et al. 2001).

In summary, several studies have demonstrated that oral therapy with opioids can result in a reduction in neuropathic pain intensity. Studies also indicate that therapy with opioids can be associated with side effects, and the risk-benefit ratio needs to be evaluated carefully. More careful studies need to be conducted in future, to examine if patients with CRPS are likely to benefit from therapy with opioids similar to that observed in patients with other neuropathic pain states.

## References

1. Amer S, Meyerson BA (1988) Lack of Analgesic Effect of Opioids on Neuropathic and Idiopathic Forms of Pain. *Pain* 33:11–23
2. Attal N, Guirimand F, Brasseur L, Gaude V, Chauvin M, Bouhasira D (2002) Effects of IV Morphine in Central Pain – A Randomized Placebo-Controlled Study. *Neurology* 58:554–563
3. DelleMijn PL, Vanneste JA (1997) Randomised Double-Blind Active-Placebo-Controlled Crossover Trial of Intravenous Fentanyl in Neuropathic Pain. *Lancet* 349:753–758
4. Harati Y, Gooch C, Swenson M, Edelman S, Greene D, Raskin P, Donofrio P, Cornblath D, Sachdeo R, Siu CO, Kamin M (1998) Double-Blind Randomized Trial of Tramadol for the Treatment of the Pain of Diabetic Neuropathy. *Neurology* 50:1842–1846
5. Harke H, Gretenkort P, Ladleif HU, Rahman S, Harke O (2001) The Response of Neuropathic Pain and Pain in Complex Regional Pain Syndrome I to Carbamazepine and Sustained-Release Morphine in Patients Pretreated with Spinal Cord Stimulation: A Double-Blinded Randomized Study. *Anesth Analg* 92:488–495
6. Raja SN, Haythornthwaite JA, Pappagallo M, Clark MR, Travison TG, Sabeen S, Royall RM, Max MB (2002) Opioids versus Antidepressants in Postherpetic Neuralgia: A Randomized, Placebo-Controlled Trial. *Neurology* 59:1015–1021
7. Rowbotham MC, Reisner-Keller LA, Fields HL (1991) Both Intravenous Lidocaine and Morphine Reduce the Pain of Postherpetic Neuralgia. *Neurology* 41:1024–1028
8. Rowbotham MC, Twilling L, Davies PS, Reisner L, Taylor K, Mohr D (2003) Oral Opioid Therapy for Chronic Peripheral and Central Neuropathic Pain. *N Engl J Med* 348:1223–1232
9. Watson CP, Babul N (1998) Efficacy of Oxycodone in Neuropathic Pain: A Randomized Trial in Postherpetic Neuralgia. *Neurology* 50:1837–1841
10. Wu CL, Tella P, Staats PS, Vaslav R, Kazim DA, Wesselmann U, Raja SN (2002) Analgesic Effects of Intravenous Lidocaine and Morphine on Post-Amputation Pain: A Randomized Double-Blind, Active-Placebo-Controlled, Crossover Trial. *Anesthesiology* 96:841–848

## Opioids in the Modulation of Ascending Pathways

- ▶ [Opioids in the Spinal Cord and Modulation of Ascending Pathways \(N. gracilis\)](#)

## Opioids in the Periphery and Analgesia

CHRISTOPH STEIN

Department of Anaesthesiology and Intensive Care Medicine, Campus Benjamin Franklin, Charité University Medicine Berlin, Berlin, Germany  
christoph.stein@charite.de

### Synonyms

Peripheral Opioid Analgesia; Peripheral Mechanisms of Opioid Analgesia; Opioid Analgesic Actions Outside the Central Nervous System

### Definition

Opioid analgesia produced outside the central nervous system by interaction of endogenous or exogenous opioids with opioid receptors on peripheral sensory neurons.

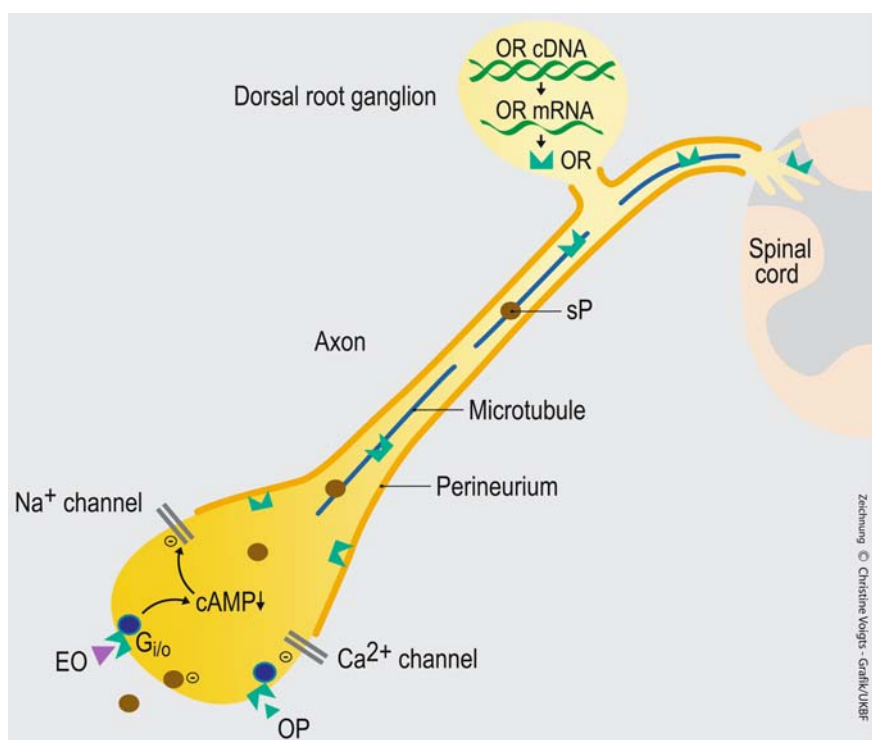
### Characteristics

Opioids can produce potent analgesia by activating opioid receptors outside the central nervous system, thus avoiding centrally mediated unwanted effects. Peripheral opioid receptors are localized on ▶ [primary afferent neurons](#). The cell bodies of these neurons in dorsal root ganglia express mu-, delta- and kappa-opioid receptor mRNAs and proteins (reviewed in Stein et al. 2001; Stein et al. 2003). ▶ [Opioid receptors](#) are intraaxonally transported into the neuronal processes (Hassan et al. 1993), and are detectable on peripheral sensory nerve terminals in animals (Stein et al. 1990) and in humans (Stein et al. 1996). Co-localization studies have confirmed the presence of opioid receptors on ▶ [C and A Fibers](#), on transient receptor potential vanilloid subtype-1 (TRPV-1) carrying visceral fibers, and on neurons expressing isolectin B4, ▶ [substance P](#) and/or ▶ [calcitonin-gene-related peptide](#), consistent with the phenotype of ▶ [nociceptors](#) (reviewed in Stein et al. 2003). Sympathetic neurons and immune cells can also express opioid receptors but their functional role in pain control is unclear (reviewed in Stein et al. 2001). The binding characteristics (affinity) of peripheral and central opioid receptors are similar (Hassan et al. 1993; Zöllner et al. 2003).

### Opioid Receptor Signaling in Primary Afferent Neurons

All three types of opioid receptors mediate the inhibition of high-voltage activated calcium currents in cultured primary afferent neurons. These effects are transduced by G-proteins (G<sub>i</sub> and/or G<sub>o</sub>). In addition, opioids – via inhibition of adenylyl cyclase – suppress tetrodotoxin-resistant sodium- and nonselective cation currents stimulated by inflammatory agents (Stein et al. 2001), which may account for the notable efficacy of peripheral opioids in inflammatory and ▶ [neuropathic pain](#) (Stein 1993; Stein et al. 2003). Consistent with their





**Opioids in the Periphery and Analgesia, Figure 1** Opioid receptor transport and signaling in primary afferent neurons. Opioid receptors (OR) and neuropeptides (e.g. substance P [sP]) are synthesized in the dorsal root ganglion, and transported along intraaxonal microtubules into central and peripheral processes of the primary afferent neuron. At the terminals OR are incorporated into the neuronal membrane and become functional receptors. Upon activation by exogenous (EO) or endogenous opioids (opioid peptides [OP]) OR couple to inhibitory G-proteins ( $G_{i/o}$ ). This leads to direct or indirect (via decrease of cyclic adenosine monophosphate [cAMP]), suppression (-) of  $Ca^{++}$  and/or  $Na^+$  currents, respectively, and to subsequent attenuation of sP release. The permeability of the perineurium is increased within inflamed tissue (from Stein et al. 2003).

0

effects on ion channels, opioids attenuate the excitability of peripheral nociceptor terminals, the propagation of action potentials, the release of excitatory proinflammatory neuropeptides (substance P, calcitonin gene-related peptide) from peripheral sensory nerve endings, and vasodilatation evoked by stimulation of C-fibers (Stein et al. 2001). All of these mechanisms result in analgesia and/or anti-inflammatory actions (Fig. 1).

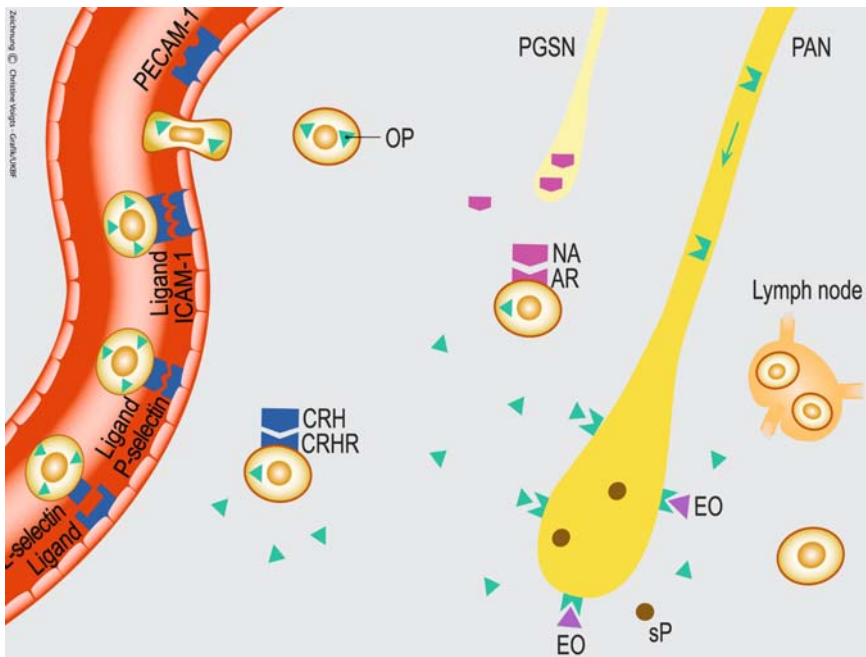
#### Peripheral Opioid Receptors and Tissue Injury

Peripheral opioid analgesic effects are augmented under conditions of tissue injury such as ► **inflammation**, neuropathy, or bone damage (Kalso et al. 2002; Stein 1993; Stein et al. 2001). One underlying mechanism is an increased number (“upregulation”) of peripheral opioid receptors. In dorsal root ganglia, the synthesis and expression of opioid receptors can be increased by peripheral tissue inflammation (Zöllner et al. 2003; Pühler et al. 2004). Subsequently, the axonal transport of opioid receptors is greatly enhanced (Hassan et al. 1993), leading to their upregulation and to enhanced agonist efficacy at peripheral nerve terminals. In addition, the specific milieu (low pH, prostanoid release) of inflamed tissue can increase opioid agonist efficacy by enhanced G-protein coupling and by increased neuronal cyclic adenosine monophosphate levels. Inflammation

also leads to an increase in the number of sensory nerve terminals (“sprouting”) and disrupts the perineurial barrier, thus facilitating the access of opioid agonists to their receptors (Stein et al. 2003). Clinical studies have indicated that the perineural application of opioid agonists along uninjured nerves (e.g. axillary plexus) does not reliably produce analgesic effects, supporting the notion that inflammation promotes accessibility and/or efficient coupling of opioid receptors in primary afferent neurons (Stein et al. 2003). The secretion of endogenous opioid ligands within inflamed tissue (Rittner et al. 2005; Mousa et al. 2004) may produce additive/synergistic interactions at peripheral opioid receptors. In some models, peripheral opioid analgesia is resistant to development of ► **tolerance**, and clinical studies suggest a lack of cross-tolerance between peripheral exogenous and endogenous opioids in synovial inflammation (Stein et al. 2003).

#### Endogenous Ligands of Peripheral Opioid Receptors

Three families of ► **opioid peptides** are well characterized, the endorphins, enkephalins and dynorphins. They bind to all three opioid receptors. Each family derives from a distinct gene and the respective precursors proopioidmelanocortin (POMC), proenkephalin and prodynorphin. The most extensively examined source



**Opioids in the Periphery and Analgesia, Figure 2** Migration of opioid-producing cells and opioid secretion within inflamed tissue. P-selectin, intercellular adhesion molecule-1 (ICAM-1) and platelet-endothelial cell adhesion molecule-1 (PECAM-1) are upregulated on vascular endothelium. L-selectin is coexpressed by immune cells producing opioid peptides (OP). L- and P-selectin mediate rolling of opioid-containing cells along the vessel wall. ICAM-1 mediates their firm adhesion and diapedesis. Adhesion molecules interact with their respective ligands. In response to stress or releasing agents (corticotropin-releasing hormone [CRH], sympathetic neuron-derived noradrenaline [NA], interleukin-1 $\beta$  [IL-1]), the cells secrete OP. CRH, NA and IL-1 elicit OP release by activating CRH receptors (CRHR), adrenergic receptors (AR) and IL-1 receptors (IL-1R), respectively. OP or exogenous opioids (EO) bind to opioid receptors on primary afferent neurons leading to analgesia (Fig. 1). Afterwards immune cells, depleted of the opioids, migrate to regional lymph nodes.

of opioids interacting with peripheral opioid receptors are immune cells (Rittner et al. 2005). Transcripts and peptides derived from POMC and proenkephalin, as well as the prohormone convertases PC1/3 and PC2, necessary for their posttranslational processing, were detected in such cells (Smith 2003; Mousa et al. 2004). The expression of immune-derived opioids is stimulated by viruses, endotoxins, cytokines, corticotropin releasing hormone (CRH) and adrenergic agonists (Smith 2003). POMC mRNA,  $\beta$ -endorphin, met-enkephalin and dynorphin are found in circulating cells and lymph nodes in conditions of painful inflammation. These peptides are upregulated in lymphocytes, monocytes/macrophages and granulocytes within injured tissue (Cabot et al. 1997; Rittner et al. 2005). Circulating opioid-containing leukocytes migrate to injured tissue directed by **Adhesion Molecules** and chemokines (Brack et al. 2004). In inflamed tissue,  $\beta$ -endorphin-containing leukocytes co-express L-selectin, and opioid cells, vascular P-selectin; ICAM-1 and PECAM-1 are simultaneously upregulated. Blocking selectins or ICAM-1 reduces the number of opioid cells and intrinsic analgesia (Machelska et al. 1998; Rittner et al. 2005) (Fig. 2).

The release of opioids from immunocytes can be stimulated by environmental stress, sympathetic neuron-

derived noradrenaline, interleukin-1 $\beta$  (IL-1) or CRH (Schäfer et al. 1994; Schäfer et al. 1996; Stein et al. 1993; Rittner et al. 2005) (Fig. 2). This release is receptor-specific and calcium-dependent, and it is mimicked by elevated extracellular potassium, consistent with a regulated secretory pathway, as in neurons and endocrine cells (Cabot et al. 1997). *In vivo*, the secreted opioid peptides bind to opioid receptors on sensory neurons and elicit analgesia within injured tissue (Stein et al. 1993; Schäfer et al. 1994; Schäfer et al. 1996). The efficacy of this pain inhibition is proportional to the number of opioid-producing immunocytes (Rittner et al. 2001). CRH-, IL-1 and stress-induced analgesia can be extinguished by immunosuppression (Schäfer et al. 1994; Stein et al. 1990), and by blocking the extravasation of opioid-containing leukocytes (Machelska et al. 1998). In patients undergoing knee surgery, opioid cells accumulate in the inflamed synovium and attenuate postoperative pain (Stein et al. 1993). Apparently, these immune-derived opioids do not induce cross-tolerance to locally administered morphine (Stein et al. 1996).

#### Preclinical Studies on Peripheral Opioid Analgesics

This basic research has stimulated the development of novel opioid ligands acting exclusively in the periph-

ery without central side-effects. A common approach is the use of hydrophilic compounds with minimal capability to cross the blood-brain-barrier. Among the first compounds were the mu-agonist loperamide (originally known as an antidiarrheal drug) and the kappa-agonist asimadoline. Peripheral restriction was also achieved with newly developed arylacetamide and peptidic kappa-agonists (Stein et al. 2003). While earlier attempts to demonstrate peripheral opioid analgesia in normal tissue failed, they were more successful in models of pathological pain (Stein 1993; Stein et al. 2003). In inflammation of the rat paw, the local injection of low, systemically inactive doses of mu-, delta- and kappa-agonists produced analgesia that was dose-dependent, stereospecific and reversible by selective antagonists. Some agonists produced both peripheral analgesic and anti-inflammatory effects (Stein et al. 2001). Possible underlying mechanisms of the latter include a reduced release of proinflammatory neuropeptides or cytokines, and a diminished expression of adhesion molecules. Potent antinociception was also shown in models of nerve damage and of visceral, thermal and bone pain (Stein et al. 2003).

#### Clinical Studies on Peripheral Opioid Analgesics

Controlled studies have demonstrated significant analgesic effects following the local application of opioids at sites of injury (Kalso et al. 2002; Stein et al. 2001). The intraarticular administration of the mu-agonist morphine is the best examined clinical application (Kalso et al. 2002). After knee surgery, it dose-dependently reduces pain scores and/or supplemental analgesic consumption by a peripheral mechanism of action and without side-effects (Kalso et al. 2002; Stein et al. 2001). Intraarticular morphine is active in the presence of opioid-containing inflammatory cells (Stein et al. 1996) and in chronic rheumatoid and osteoarthritis. Its effect is similar to a standard intraarticular local anesthetic or steroid injection and is long lasting (up to 7 days), possibly due to morphine's anti-inflammatory activity. Other trials showed efficacy of local opioid injections in bone pain, dental pain, corneal abrasions and visceral pain (Stein et al. 2003). Several studies found no peripheral effects of opioids. The majority of those trials examined the injection of agonists into the non-inflamed environment along nerve trunks (Stein et al. 2003). This suggests that intraaxonal opioid receptors may be „in transit“, and not available as functional receptors at the membrane. Novel peripherally restricted opioids have recently entered human trials, including a kappa-agonist that markedly reduced visceral pain in patients with chronic pancreatitis without severe side-effects (Stein et al. 2003). Beyond the absence of central side-effects, such novel compounds may offer advantages such as anti-inflammatory effects, lack of

tolerance, lack of constipation, lack of gastrointestinal, hepatic, renal and thromboembolic complications (typically associated with ► NSAIDs, Survey), and efficacy in neuropathic pain (Stein et al. 2003).

#### References

1. Brack A, Rittner HL, Machelska H et al. (2004) Control of inflammatory pain by chemokine-mediated recruitment of opioid-containing polymorphonuclear cells. *Pain* 112:229–238
2. Cabot PJ, Carter L, Gaiddon C et al. (1997) Immune Cell-Derived  $\beta$ -Endorphin: Production, Release and Control of Inflammatory Pain in Rats. *J Clin Invest* 100:142–148
3. Hassan AHS, Ableitner A, Stein C et al. (1993) Inflammation of the Rat Paw Enhances Axonal Transport of Opioid Receptors in the Sciatic Nerve and Increases their Density in the Inflamed Tissue. *Neuroscience* 55:185–195
4. Kalso E, Smith L, McQuay HJ et al. (2002) No Pain, No Gain: Clinical Excellence and Scientific Rigour – Lessons Learned from IA Morphine. *Pain* 98:269–275
5. Machelska H, Cabot PJ, Mousa SA et al. (1998) Pain Control in Inflammation Governed by Selectins. *Nat Med* 4:1425–1428
6. Mousa SA, Shakibaei M, Sitte N et al. (2004) Subcellular pathways of beta-endorphin synthesis, processing and release from immunocytes in inflammatory pain. *Endocrinology* 145:1331–1341
7. Pühler W, Zöllner C, Brack A et al. (2004) Rapid upregulation of mu opioid receptor mRNA in dorsal root ganglia in response to peripheral inflammation depends on neuronal conduction. *Neuroscience* 129:473–479
8. Rittner HL, Brack A, Machelska H et al. (2001) Opioid Peptide-Expressing Leukocytes: Identification, Recruitment, and Simultaneously Increasing Inhibition of Inflammatory Pain. *Anesthesiology* 95:500–508
9. Rittner HL, Machelska H, Stein C (2005) Leukocytes in the regulation of pain and analgesia. *J Leukoc Biol* 78:1215–1222
10. Schäfer M, Carter L, Stein C (1994) Interleukin-1 $\beta$  and Corticotropin-Releasing-Factor Inhibit Pain by Releasing Opioids from Immune Cells in Inflamed Tissue. *Proc Natl Acad Sci USA* 91:4219–4223
11. Schäfer M, Mousa SA, Zhang Q et al. (1996) Expression of Corticotropin-Releasing Factor in Inflamed Tissue is required for Intrinsic Peripheral Opioid Analgesia. *Proc Natl Acad Sci USA* 93:6096–6100
12. Smith EM (2003) Opioid Peptides in Immune Cells. *Adv Exp Med Biol* 521:51–68
13. Stein C (1993) Peripheral Mechanisms of Opioid Analgesia. *Anesth Analg* 76:182–191
14. Stein C, Hassan AHS, Lehrberger K et al. (1993) Local Analgesic Effect of Endogenous Opioid Peptides. *Lancet* 342:321–324
15. Stein C, Hassan AHS, Przewlocki R et al. (1990) Opioids from Immunocytes Interact with Receptors on Sensory Nerves to Inhibit Nociception in Inflammation. *Proc Natl Acad Sci USA* 87:5935–5939
16. Stein C, Machelska H, Schäfer M (2001) Peripheral Analgesic and Anti-Inflammatory Effects of Opioids. *Z Rheumatol* 60:416–424
17. Stein C, Pflüger M, Yassouridis A, Hoelzl J et al. (1996) No Tolerance to Peripheral Morphine Analgesia in Presence of Opioid Expression in Inflamed Synovia. *J Clin Invest* 98:793–799
18. Stein C, Schäfer M, Machelska H (2003) Attacking Pain at its Source: New Perspectives on Opioids. *Nat Med* 9:1003–1008
19. Zöllner C, Shaqura MA, Bopaiah CP et al. (2003) Painful Inflammation-Induced Increase in mu-Opioid Receptor Binding and G-Protein Coupling in Primary Afferent Neurons. *Mol Pharmacol* 64:202–210

## Opioids in the Spinal Cord and Central Sensitization

ANTHONY H. DICKENSON

Department of Pharmacology, University College  
London, London, UK

anthony.dickenson@ucl.ac.uk

### Definition

Activation of the N-methyl-D-aspartate (► **NMDA**) receptor causes a major excitatory drive in the dorsal horn of the spinal cord where ► **wind-up** and associated ► **central sensitization** is induced. Once the NMDA receptor is activated, inhibitory controls may be compromised, simply since greater levels of excitability will require greater inhibitory controls. Combinations of NMDA antagonists plus opioids therefore predictably synergise to produce marked inhibitory effects.

### Characteristics

Some of the very first studies on glutamate as a transmitter involved the spinal cord. The NMDA receptor has become an increasingly important target site for potential analgesics, as evidence accumulates for a role of the receptor in the enhancement of spinal processing of painful messages and in many long term events in the brain, including ► **long-term potentiation** and excitotoxic cell death. However, this important role of the receptor in a number of CNS functions can lead to problems in terms of side-effects.

There is now little doubt that glutamate seen in primary afferent terminals in laminae I, III and IV of the dorsal horn is a releasable transmitter. In the case of C-fibres, glutamate may coexist with peptides such as substance P and CGRP, which would make it highly likely that a noxious stimulus releases both peptides and excitatory amino-acids from the afferent nociceptive fibres (Battaglia and Rustioni 1988). Large A fibres, terminating in deeper laminae, have glutamate, yet do not normally contain peptides. Thus, glutamate is involved in the transmission of both high and low threshold information from afferents into the spinal cord. In addition to a key role in transmission from afferent fibres, there is further evidence that transmission, at least from trigemino- and spinothalamic tract cells, also involves glutamate (Dickenson 1997).

Although a number of studies have demonstrated that glutamate is released from both low and high threshold afferents, electrophysiological studies would indicate that, in general, only noxious events, at least under normal conditions, activate the NMDA receptor. It could be suggested that peptides may allow the differentiation between large A-fibre and C fibre inputs, since only C-fibre stimulation will elicit peptide release. Consequently, C-fibre induced release of excitatory peptides may provide the required depolarization to remove the

Mg<sup>++</sup> block of the receptor and allow NMDA receptor activation (Dickenson 1997).

### Wind-Up

Wind-up is the term given to a short-term increase in excitability of spinal neurones. When a constant C-fibre stimulus is delivered, the response of deep dorsal horn neurone increases rapidly after the first few stimuli, and then decays slowly after cessation of the stimulus. If a train of stimuli are given, at frequencies of about 0.5 Hz and above, the responses of the neurone to the first few stimuli remains constant. However, as the stimulus continues, there is a rapid incremental increase in firing of the neurone, and cumulative long slow depolarization such as those mediated by peptides including substance P seen with intracellular recordings, associated with increased action potentials. The neurone firing can increase by up to 20-fold the initial rate. Although wind-up is only induced by C-fibre stimulation, once the process has occurred, all responses of the neurones are enhanced and a post-discharge, firing following the C-fibre latency band, is evoked. Thus, noxious stimuli, applied at sufficient intensities, can enhance spinal excitatory events by mechanisms that are restricted to the spinal cord. Wind-up, in normal animals, is only produced by stimulation at C-fibre, and possibly also A-delta, stimulation, but not by low-intensity stimuli (Dickenson 1997). With regard to the functional significance of wind-up, it has been shown that high frequency C-fibre stimulation results in a marked and prolonged increase in the ► **flexion withdrawal reflex**, recorded from motoneurons in spinal rats. It is evident that a number of physiological inputs, causing repeated C-fibre activity, should activate the NMDA receptor, if the intensity and area of stimulus is sufficient. This has turned out to be the case, and there is evidence for involvement of the NMDA receptor in inflammatory pain, neuropathic pain, allodynia and ischaemic pain, and all processes in which the receptor alters the normal relationship between stimulus and response (Dickenson 1997; Price 1994). In these persistent pain states the NMDA receptor is vital both in establishing the augmented pain state, and in maintaining this state. Higher frequency stimulation of afferents can lead to NMDA-dependent ► **long-term potentiation** in the spinal cord, where the enhanced responses now last for hours (Ikeda et al. 2003; Rygh et al. 2000). This pivotal role of the NMDA receptor in the plasticity of the pain signalling system makes it an attractive target for development of new analgesics.

The NMDA receptor is of course not restricted to spinal pain pathways, and it is not surprising that NMDA receptor antagonists, such as the channel blocker ketamine and competitive antagonists, are associated with a range of adverse effects. In volunteers and patients, key roles of the receptor have been shown in states of capsaicin induced central hypersensitivity and after nerve injury re-



sponse (Dickenson 1997; Price 1994). The increased excitability leads not simply to increased pain ratings, but may well also increase the area of pain as has been seen in animal studies. However, the clinical use of NMDA receptor antagonists has been fraught by the simple fact that as therapeutic levels are attained, side-effects are on the verge of unacceptable. One possible approach to avoid the side-effects associated with global block of NMDA receptors is to target a particular receptor type by its subunit makeup. This was justified by animal studies that demonstrated that NR2B selective antagonists may have clinical utility for the treatment of pain conditions with a reduced side-effect profile compared to existing NMDA receptor antagonists (Boyce et al. 2001).

### NMDA Receptor Interactions with Opioids

Accumulating evidence indicates plasticity in opioid controls. The degree of effectiveness of morphine analgesia is subject to modulation by other transmitter systems in the spinal cord, and by pathological changes induced by peripheral nerve injury. In neuropathic pain states, a number of explanations can be given for this reduction in opioid actions. A potential marked loss of pre-synaptic opioid receptors as a result of nerve section can occur, although this appears not to be a factor in less severe nerve injuries. Possibly, more importantly, an up-regulation of the “anti-opioid peptide” ► **cholecystokinin**, after damage to peripheral nerve, could also contribute to the reduced morphine analgesia. In reality, a combination of factors is likely to be the cause of the particular problems that arise in the control of neuropathic pains with opioid drugs (Dickenson and Suzuki 2002). The CNS operates by a balance between excitation and inhibition. Thus, the profound excitations produced by NMDA receptor involvement in pain related responses of spinal cord neurones can further shift the balance in favour of excitation. The enhanced levels of firing will then lead to a reduced effectiveness of a given dose of an opioid. Reductions in opioid controls can be overcome by dose-escalation if excessive side-effects do not intervene, and one approach could be spinal delivery where high local levels can be achieved.

An approach that could be considered would be to use a combination of an NMDA antagonist with an opioid such as morphine. The dual actions of these pharmacological agents could be beneficial. The fact that NMDA receptor antagonists are effectively anti-hyperalgesic agents, reducing the hyperexcitability, means that the addition of an analgesic such as an opioid would enable the baseline response to also be inhibited. Interestingly, some opioids such as methadone, pethidine and ketobemidone appear to have both mu opioid receptor actions and weaker, but potentially functionally relevant, NMDA receptor blocking actions (Ebert et al. 1995). This additional action of these opioids, non-competitive NMDA antagonism, has been revealed by

both binding and electrophysiological approaches, but it remains unclear as to whether the non-opioid component of their actions contributes at all to their *in vivo* profile (Carpenter et al. 2000).

The spinal actions of opioids and their mechanisms of analgesia involve: 1) reduced transmitter release (e.g. glutamate and peptides) from nociceptive C-fibres (75 % of spinal opioid receptors are pre-synaptic) so that spinal neurones are less excited by incoming painful messages, and 2) post-synaptic inhibitions of neurones conveying information from the spinal cord to the brain (Dickenson and Suzuki 2002). From electrophysiological studies, a moderate dose of morphine, or indeed, any opioid, will initially profoundly inhibit neuronal activity evoked by C-fibre stimulation, delaying or abolishing activity indicative of pre-synaptic inhibition of transmitter release. However, as the stimulation continues, as wind-up is induced, the neuronal excitations produced by post-synaptic NMDA receptor activation breaks through the opioid inhibitions so that at moderate doses, opioids can only delay the onset of wind-up without inhibiting the process itself (Chapman and Dickenson 1992). Higher doses of opioid, presumably activating post-synaptic receptors as well, will abolish responses.

At supraspinal sites, opiate actions are becoming increasingly well understood but exact mechanisms are still elusive. Morphine can act to alter descending pathways from the brain to the cord which involve nor-adrenaline and serotonin, and these pathways then act to reduce spinal nociceptive activity. Actions of opioids on descending systems may be of particular relevance to pain states where supraspinal facilitatory pathways are superimposed on spinal hypersensitivity (Porreca et al. 2002; Suzuki et al. 2002).

Marked inhibitions can be produced through synergism between the combination of low threshold doses of morphine with low doses of NMDA receptor antagonists (Chapman and Dickenson 1992) using neuronal measures. In a model of neuropathic pain using behaviour against which morphine fails to be antinociceptive, the combined application of an NMDA antagonist, in this case MK-801, with morphine, restored the ability of morphine to inhibit the response (Yamamoto and Yaksh 1992). A human study on the flexion reflex in volunteers confirmed this idea, but indicated that the combination of ketamine and morphine had actions that rely on the type of afferent input (Bossard et al. 2002). These studies suggest that in the absence of NMDA receptor antagonists devoid of side-effects, the co-administration of a low dose of an NMDA antagonist with a low-dose of an opioid may deliver a good pain control with minor side-effects. However, there are some other important issues. Neurones in lamina I of the spinal cord have projections to ► **parabrachial/PAG** areas, whereas many deep cells project in the ► **spinothalamic tract** (Todd 2002). NMDA-dependent wind-up is clear and obvious

in deep cells and almost absent in lamina I cells, although both neuronal types support LTP when high-frequency stimuli are given (Dickenson 1997; Ikeda et al. 2003; Rygh et al. 2000). This suggests that in pain states other than those activated by very high frequency stimuli, spinothalamic inputs will be potentiated through wind-up like mechanisms, whereas inputs to emotional areas will not. This may then lead to dissociation between the emotional and sensory -discriminative aspects of pain. However, opioids have identical dose-response curves for ► **Laminae I and V Neurones** which would agree well with their ability to modulate both components of the sensation. As a consequence, the opioid-NMDA interaction will only be on lamina V activity, so that the sensory responses to pain could be expected to be altered more than the emotional aspects by a combination. However, an added complexity regarding lamina V, is that once LTP is induced morphine, at doses that completely suppress LTP, does not alter the underlying process. Thus, reversal of the opioid inhibition is only to the post-LTP response level (Rygh et al. 2000). Therefore, complex interactions of opioids with spinal mechanisms of hyperexcitability are likely, but further exploration of this area could lead to useful clinical advances.

## References

- Battaglia G, Rustioni A (1988) Coexistence of Glutamate and Substance P in Dorsal Root Ganglion Cells of the Rat and Monkey. *J Comp Neurol* 277:302–312
- Bossard AE, Guirimand F, Fletcher D et al. (2002) Interaction of a Combination of Morphine and Ketamine on the Nociceptive Flexion Reflex in Human Volunteers. *Pain* 98:47–57
- Boyce S, Wyatt A, Webb J et al. (1999) Selective NMDA NR2B Antagonists Induce Antinociception without Motor Dysfunction: Correlation with Restricted Localisation of NR2B Subunit in Dorsal Horn. *Neuropharmacology* 38:611–623
- Carpenter K, Chapman V, Dickenson AH (2000) Neuronal Inhibitory Effects of Methadone are Predominantly Opioid Receptor Mediated in the Rat Spinal Cord *In Vivo*. *Eur J Pain* 4:19–26
- Chapman V, Dickenson AH (1992) The Combination of NMDA Antagonism and Morphine Produces Profound Antinociception in the Rat Dorsal Horn. *Brain Res* 573:321–323
- Dickenson AH (1997) Mechanisms of Central Hypersensitivity: Excitatory Amino Acid Mechanisms and their Control. In: Dickenson AH, Besson JM (eds) *The Pharmacology of Pain*. Springer Berlin Heidelberg New York, pp 167–196
- Dickenson AH, Suzuki R (1999) Function and Dysfunction of Opioid Receptors in the Spinal Cord. In: Kalso E, McQuay HJ, Wiesenfeld-Hallén Z (eds) *Opioid Sensitivity of Chronic Non-cancer Pain*, Progress in Pain Research and Management, vol 14. IASP Press, Seattle, pp 1–28
- Ebert B, Andersen S, Krogsgaard-Larsen P (1995) Ketobemidone, Methadone and Pethidine are Non-Competitive N-methyl-D-aspartate Antagonists in the Rat Cortex and Spinal Cord. *Neurosci Lett* 187:165–168
- Ikeda H, Heinke B, Ruscheweyh R et al. (2003) Synaptic Plasticity in Spinal Lamina I Projection Neurons that Mediate Hyperalgesia. *Science* 299:1237–1240
- Price DD, Mao J, Mayer DJ (1994) Central Neural Mechanisms of Normal and Abnormal Pain States. In: Fields H et al. (eds) *Pharmacological Approaches to the Treatment of Chronic Pain: New Concepts and Critical Issues*. Progress in pain research and management, vol 1. IASP Press, Seattle, pp 61–84
- Porreca F, Ossipov M, Gebhart G (2002) Chronic Pain and Medullary Descending Facilitation. *Trends Neurosci* 25:319–325
- Rygh L, Green M, Athauda N et al. (2000) The Effect of Spinal Morphine following Long-Term Potentiation of Wide Dynamic Range Neurons in the Rat. *Anesthesiology* 92:140–146
- Suzuki R, Morcuende S, Webber S et al. (2002) Superficial NK1 Expressing Neurons Control Spinal Excitability through Activation of Descending Pathways. *Nat Neurosci* 5:1319–1326
- Todd AJ (2002) Anatomy of Primary Afferents and Projection Neurons in the Rat Spinal Dorsal Horn with Particular Emphasis on Substance P and the Neurokinin 1 Receptor. *Exp Physiol* 87:245–249
- Yamamoto T, Yaksh TL (1992) Studies on the Spinal Interaction of Morphine and the NMDA Antagonist MK-801 on the Hyperalgesia Observed in a Rat Model of Sciatic Mononeuropathy. *Neurosci Lett* 135:67–70

## Opioids in the Spinal Cord and Modulation of Ascending Pathways (N. gracilis)

RIE SUZUKI, ANTHONY H. DICKENSON  
Department of Pharmacology, University College  
London, London, UK  
uclrsu@ucl.ac.uk, anthony.dickenson@ucl.ac.uk

### Synonyms

Opioids in the Modulation of Ascending Pathways; Opioids and Nucleus Gracilis

### Definition

Spinally applied opioids have been shown to produce powerful ► **antinociception** behaviourally, both in acute pain models (tail flick, hot plate, von Frey) as well as in more chronic pain states (for review see Dickenson and Suzuki 1999). These actions are mediated through the activation of ► **opioid receptors**, which are found in abundance in the ► **superficial dorsal horn** of the spinal cord, the periphery and at various supraspinal sites, such as the nucleus gracilis (NG), parabrachial area (PB), periaqueductal gray (PAG), rostroventral medulla (RVM) and thalamus.

### Characteristics

The NG is an area in the brainstem that receives afferent input from direct projections of myelinated and unmyelinated primary afferent fibres, as well as second-order projections from ► **postsynaptic dorsal column (PSDC) neurones** of the spinal cord (lamina III–V) (Willis and Coggeshall 2004). A large proportion of NG neurones project to the contralateral thalamus via the medial lemniscus, although a smaller population has axons terminating within the ► **dorsal column nuclei**, and hence appear to be interneurons. Substantial evidence exists for a role of dorsal column nuclei in the processing of visceral nociceptive input (Willis et al. 1999). This structure is of particular interest since it has been involved in vari-

ous pathological conditions (Miki et al. 2000; Miki et al. 2002; Schwark and Ilyinsky 2001). The observation that ipsilateral lesions of the dorsal column or microinjection of lidocaine into the NG suppresses ► **tactile allodynia** (but not ► **thermal hyperalgesia**) (Sun et al. 2001), led studies to speculate that the NG may be implicated in mediating tactile hypersensitivity following peripheral nerve injury. In parallel with these findings, plasticity in NG neurones has been reported after tissue and nerve injury, which include electrophysiological and neurochemical alterations (Al-Chaer et al. 1997; Ma and Bisby 1998; Miki et al. 1998; Suzuki and Dickenson 2002). Clinically, a limited midline myelotomy at T8-10 level has been shown to relieve cancer pain in patients (for refs see Willis et al. 1999).

To study how activity in the NG can be modulated by spinal opioids, *in vivo* electrophysiological approaches were employed to record the responses of deep dorsal horn neurones after peripheral nerve injury. Spinal application of morphine was shown to selectively modulate noxious cutaneous input to the NG (Suzuki and Dickenson 2002). Morphine attenuated the noxious A $\delta$ - and C-fibre evoked responses of NG neurones, as well as responses evoked by mechanical punctate and heat stimuli. In contrast, the innocuous brush-evoked responses and A $\beta$ -fibre evoked activity remained relatively unaltered, in keeping with the proposed specific action of morphine on noxious inputs. Remarkably, responses evoked by mechanical punctate stimuli (von Freys of 2 and 9 grams) were dramatically attenuated by morphine administration in nerve injured animals, an effect that was not observed in sham control animals. These von Frey filaments are normally innocuous when applied to the rat hindpaw; however, after nerve injury, rats show aversive behaviours to the stimulus, a sign indicative of mechanical allodynia. The finding that neuronal responses evoked by normally innocuous stimuli are robustly inhibited by morphine after neuropathy is interesting, since this suggests an alteration in spinal opioid control, particularly on low threshold signalling systems. Whilst the efficacy of opioids in acute pain conditions is well established, the issue of opioid sensitivity in chronic neuropathic pain remains a much debated subject (Rowbotham 2001). Although previous behavioural studies have demonstrated a general lack of effect of intrathecally-administered morphine after neuropathy, morphine administered via the systemic route was shown to reverse tactile hypersensitivity (Bian et al. 1995; Lee et al. 1995), suggesting that these actions may be mediated through the supraspinal activation of opioid receptors, and subsequent activation of descending modulatory systems (Bian et al. 1995). Interestingly, the neuronal counterpart of this activity, as assessed by innocuous von Frey evoked activity recorded in NG neurones, is sensitive to intrathecal morphine treatment, and shows robust inhibition after nerve injury (Suzuki and Dickenson 2002).

The exact mechanism by which spinal morphine inhibits NG neuronal activity remains unclear; however several possibilities exist. One possibility is that spinal morphine, directly or indirectly, inhibits the PSDC pathway that originates from lamina III–V of the dorsal horn. The PSDC pathway projects via the dorsal funiculus and dorsolateral funiculus to the dorsal column nuclei, and the conduction velocities of their axons indicate they are small to medium-sized myelinated fibres (Willis and Coggeshall 2004). Dendrites of PSDC neurones have been shown to extend to lamina I and II, allowing them to receive monosynaptic input from small diameter fibres. Morphine applied spinally can, therefore, modulate the activity of PSDC neurones, through presynaptic inhibition of neurotransmitter release from nociceptive afferents. Alternatively, C-fibres can send collaterals through to the dorsal column from the lumbar segment. In this case, morphine may dampen excitability in these collateral fibres running to the GN via hyperpolarisation of the nerve terminals of small diameter fibres. The finding that low intensity mechanical evoked responses of NG neurones are selectively attenuated by spinal morphine after nerve injury, possibly suggests an acquired *de novo* opioid sensitivity of A $\beta$ -fibres (through a phenotypic switch).

Another electrophysiological study investigating the role of the PSDC pathway in visceral nociceptive processing demonstrated that morphine administration into the sacral cord robustly suppressed the responses of NG neurones to colorectal distension (CRD), but not to noxious cutaneous stimuli (Al-Chaer et al. 1996), suggesting that the latter responses are largely conveyed by the ascending collaterals of primary afferent fibres. Recordings were also made in PSDC neurones and morphine was similarly effective in reducing the responses of PSDC neurones to CRD and also to noxious cutaneous stimuli.

Thus, the NG represents an important area of the brainstem that is involved in the relay of nociceptive visceral and somatic inputs to the VPL nucleus of the thalamus. Input to the NG is mediated through direct projections of primary afferent fibres, and indirectly through the PSDC system which originates from laminae III–V of the spinal cord. Furthermore, these inputs are sensitive to spinally administered opioids and can be modulated by agents such as morphine. Since the NG has been implicated in tactile hypersensitivity that accompanies pathological conditions such as neuropathy, the fact that spinal morphine can modulate the activity of these neurones may have important clinical implications, particularly in the treatment of static allodynia.

## References

1. Al-Chaer E, Westlund K, Willis W (1997) Sensitization of Post-synaptic Dorsal Column Neuronal Responses by Colon Inflammation. *Neuroreport* 8:3267–3273
2. Al-Chaer E, Lawand N, Westlund K et al. (1996) Pelvic Visceral Input into the Nucleus Gracilis is Largely Mediated by the



- Postsynaptic Dorsal Column Pathway. *J Neurophysiol* 76:2675–2690
- Bian D, Nichols ML, Ossipov MH et al. (1995) Characterization of the Antiallodynic Efficacy of Morphine in a Model of Neuropathic Pain in Rats. *Neuroreport* 6:1981–1984
  - Dickenson A, Suzuki R (1999) Function and Dysfunction of Opioid Receptors in the Spinal Cord. In: Kalso E, McQuay H, Wiesenfeld-Hallin Z (eds) *Opioid Sensitivity of Chronic Non-cancer Pain*. Progress in Pain Research and Management. IASP Press, Seattle, pp 17–44
  - Lee YW, Chaplan SR, Yaksh TL (1995) Systemic and Supraspinal, but not Spinal, Opiates Suppress Allodynia in a Rat Neuropathic Pain Model. *Neurosci Lett* 199:111–114
  - Ma W, Bisby MA (1998) Partial and Complete Sciatic Nerve Injuries Induce Similar Increases of Neuropeptide Y and Vasoactive Intestinal Peptide Immunoreactivities in Primary Sensory Neurons and their Central Projections. *Neuroscience* 86:1217–1234
  - Miki K, Iwata K, Tsuboi Y et al. (1998) Responses of Dorsal Column Nuclei Neurons in Rats with Experimental Mononeuropathy. *Pain* 76:407–415
  - Miki K, Iwata K, Tsuboi Y et al. (2000) Dorsal Column Thalamic Pathway is Involved in Thalamic Hyperexcitability following Peripheral Nerve Injury: A Lesion Study in Rats with Experimental Mononeuropathy. *Pain* 85:263–271
  - Miki K, Zhou Q-Q, Guo W et al. (2002) Changes in Gene Expression and Neuronal Phenotype in Brain Stem Pain Modulatory Circuitry after Inflammation. *J Neurophysiol* 87:750–760
  - Rowbotham M (2001) Efficacy of Opioids in Neuropathic Pain. In: Hansson P, Fields H, Hill R et al. (eds) *Neuropathic Pain: Pathophysiology and Treatment*. IASP Press, Seattle, pp 203–213
  - Schwark H, Ilyinsky O (2001) Inflammatory Pain Reduces Correlated Activity in the Dorsal Column Nuclei. *Brain Res* 889:295–302
  - Sun H, Ren K, Zhong C et al. (2001) Nerve Injury-Induced Tactile Allodynia is Mediated via Ascending Spinal Dorsal Column Projections. *Pain* 90:105–111
  - Suzuki R, Dickenson A (2002) Nerve Injury-Induced Changes in Opioid Modulation of Wide Dynamic Range Dorsal Column Nuclei Neurons. *Neuroscience* 111:215–228
  - Willis W, Coggeshall R (2004) Sensory Pathways in the Dorsal Funiculus. In: Willis W and, Coggeshall R *Sensory Mechanisms of the Spinal Cord*. Kluwer Academics/Plenum Press, New York, pp 597–664
  - Willis W, Al-Chaer E, Quast M et al. (1999) A Visceral Pain Pathway in the Dorsal Column of the Spinal Cord. *Proc Natl Acad Sci USA* 96:7675–7679

## Opioids, Kappa Receptors and Visceral Pain

PIERRE J. M. RIVIÈRE  
Ferring Research Institute, San Diego, CA, USA  
pierre.riviere@fering.com

### Synonyms

$\kappa$ -opioid receptors; kappa receptors and visceral pain; kappa-opioid receptors; KOR

### Definitions

$\kappa$ - (kappa) opioid receptors are a subtype of opioid receptors. They are differentiated from other opioid receptor subtypes (mu and delta) by distinct gene, protein, tissue expression pattern, functional properties and side effect profile. Kappa-opioid receptor agonists are particularly effective analgesics in visceral pain models.

## Characteristics

### Kappa-Opioid Receptors, Pharmacological Subtypes and Cloned Receptor

Pharmacological studies have long established the existence of  $\kappa$ - (kappa) opioid receptors that are functionally differentiated from  $\mu$ - (mu) and  $\delta$ - (delta) opioid receptor subtypes (Martin et al. 1976). Radioligand studies have also provided evidence of heterogeneity of kappa binding sites in brain membrane preparations, characterizing two main binding sites termed  $\kappa_1$  and  $\kappa_2$ , each of them being further subdivided into high ( $\kappa_{1a-}$ ,  $\kappa_{2a-}$ ) and low affinity ( $\kappa_{1b-}$ ,  $\kappa_{2b-}$ ) binding sites (Rothman et al. 1990). However, only one kappa-opioid receptor (KOR1) has so far been cloned in human and rodents (Simonin et al. 1995). Its pharmacology is virtually identical to the previously characterized  $\kappa_1$ -receptor. KOR1 is a seven transmembrane domains (7TM) receptor, coupled to G-proteins (G-protein coupled receptors, GPCR) and negatively coupled to adenylate cyclase.

### Kappa-Agonists

Most of the kappa-agonists available so far have been optimized at the  $\kappa_1$ -binding site or the cloned KOR1. Thus, they are all  $\kappa_1$ -selective, with agonist potencies in the nanomolar range (typically 0.1 to 10 nM). Prototypic representatives of this class of compounds include both organic (U50,488, enadoline/CI-977, asimadoline/EMD61753, ADL 10-010, ADL 10-0116) and peptidic molecules (FE 200665 and FE 200666) (Binder et al. 2001; Rivière et al. 1999). U50,488 and enadoline are brain-penetrating compounds (Rivière et al. 1999), while the others have various degrees of peripheral selectivity, ranging from moderate (asimadoline) (Rivière et al. 1999), ADL 10-0101, ADL 10-0116 (Murphy et al. 2000) to high (FE 200665, FE 200666) (Rivière et al. 1999).

### Opioid Receptors and Pain Pathways

Opioid receptors are expressed on nerves involved in pain transmission (ascending sensory pathways) and modulation (descending inhibitory pathways) in the periphery, the spinal cord and the brain. Opioid receptors are mainly present on peptide-rich C-fibers of primary sensory afferents, where they prevent the activation and sensitization of these fibers and inhibit the release of pain transmitters. Upon activation by selective agonists, each opioid receptor subtype elicits different degrees of analgesia that varies greatly relative to the experimental conditions including: receptor subtype selectivity of the pharmacological agent, somatic vs. visceral pain, supra-spinal vs. spinal or peripheral site of action, and acute vs. inflammatory or chronic pain.

### Analgesic Effects of Kappa-Agonists in Visceral Pain Models

Kappa-agonists are particularly potent analgesics after systemic administration in a wide variety of visceral pain models (Burton and Gebhart 1998; Su et al. 2002).



The antinociceptive effects of kappa-agonists in visceral pain are consistent across a multitude of experimental conditions, irrespective of species (rats or mice), targeted visceral organs (duodenum, colon, bladder, vagina, uterus or peritoneum), nature of noxious stimuli (distension or chemical irritant), nature of measured endpoint (cardiovascular, visceromotor or electrophysiological responses, anesthetized or conscious animals, basal or inflammatory pain and chemical nature of kappa-agonists (organic molecules or peptides). Experimental visceral inflammation decreases pain thresholds, increases pain response and enhances the analgesic potency of kappa-agonists (Burton and Gebhart 1998; Langlois et al. 1994; Langlois et al. 1997; Sengupta et al. 1999). Peritoneal irritation-induced pain is also associated with gastrointestinal transit inhibition (Friese et al. 1997; Riviere et al. 1993; Riviere et al. 1994). In these conditions, blockade by kappa-agonists of peritoneal irritation-induced pain results in a reversal of intestinal ileus. The ability of kappa-agonists to reverse peritoneal irritation-induced ileus is correlated with their antinociceptive potency in this model (Friese et al. 1997). These data suggest that kappa-agonists might be appropriate to treat post operative pain associated with ileus.

#### **Involvement of Peripheral $\kappa_1$ -Receptors in Kappa-Agonists Induced Visceral Analgesia in Intact Animals**

In visceral pain models using intact animals, kappa-agonists are active at relatively low doses (typically 0.010 to 0.5 mg/kg, systemic route), and the rank order for analgesic potencies (Rivière et al. 1999; Burton and Gebhart 1998; Friese et al. 1997b) is consistent with that for agonist activity at the cloned KOR1. In these conditions, the analgesic effects of kappa-agonists are generally blocked by opioid antagonists (Burton and Gebhart 1998; Diop et al. 1994a; Diop et al. 1994b; Friese et al. 1997a; Langlois et al. 1994; Langlois et al. 1997), validating the involvement of opioid receptors, likely  $\kappa_1$ , considering the selectivity of the agonists for  $\kappa_1$ -receptors. Furthermore, in these models, the effects of kappa-agonists are generally blocked by peripherally restricted opioid antagonists, and/or peripherally restricted kappa-agonists are also equally effective compared to brain penetrating compounds in these models (Rivière et al. 1999; Burton and Gebhart 1998; Friese et al. 1997b; Sandner-Kiesling et al. 2002), suggesting that the  $\kappa_1$ -receptors involved in mediating kappa-agonist responses are located in the periphery.

#### **Involvement of Non-Opioid Blockade of Sodium Currents in Kappa-Agonists Direct Effects on Visceral Sensory Input**

Kappa-agonists have a direct inhibitory effect on visceral sensory input in the periphery. They inhibit the firing of decentralized pelvic afferents activated by colorectal distension (CRD) (Joshi et al. 2000; Sengupta et al. 1996; Sengupta et al. 1999; Su et al. 1997; Su et

al. 2002). These effects require higher doses than those needed in visceral pain models using intact animals (about 10-fold higher doses, typically 5 to 10 mg/kg, arterial administration) (Joshi et al. 2000; Sengupta et al. 1996; Sengupta et al. 1999; Su et al. 1997; Su et al. 2002). The inhibitory activity on pelvic afferents is not correlated with the rank order of potency at the cloned KOR1. The response to kappa-agonists cannot be completely antagonized by high doses of non-selective opioid antagonists or selective kappa antagonists (Sengupta et al. 1996; Su et al. 1997). KOR1 antisense oligodeoxynucleotide pretreatment does not alter the response to kappa-agonists (Joshi et al. 2000) and different enantiomers of U50,488, despite marked differences in agonist activity at  $\kappa_1$ -receptors; they are all equally potent and effective in inhibiting the firing of pelvic afferents (Su et al. 2002). Taken together, these data indicate the involvement of a non-opioid mechanism in the response to kappa-agonists in decentralized pelvic afferents. Whole cell patch-clamp experiments performed on rat colonic sensory neurons have established that organic, but not peptidic, kappa-agonists, when used at micromolar concentrations (i.e. about a 1,000-fold higher concentration than those for kappa-agonists activity), have non-opioid sodium channel blocking properties (Joshi et al. 2003).

#### **Clinical Data on Kappa-Agonists in Visceral Pain**

Very limited clinical information is available regarding kappa-agonists in visceral pain. Fedotozine was the first compound with kappa-agonist activity to be evaluated for visceral pain in a clinical setting. The compound was superior to placebo in reducing abdominal pain and bloating in non-ulcer dyspepsia (Fraitag et al. 1994) and irritable bowel syndrome (IBS) (Dapigny et al. 1995). It also increased pain perception thresholds to colonic distension in IBS patients (Delvaux et al. 1999). Fedotozine is an atypical kappa-agonist, being a mixed kappa/mu ligand (Allescher et al. 1991), with high affinity for the  $\kappa_{1a}$ -binding site (Lai et al. 1994), and relatively low affinity for the cloned KOR1 (Lai et al. 1994).

More recently, a pilot study reported that the kappa-agonist, ADL 10-0101, was effective in reducing pain in patients suffering from chronic pancreatitis (Eisenach et al. 2003). ADL 10-0101 is a classical  $\kappa_1$ /KOR<sup>1</sup>-selective agonist combined with peripheral selectivity. The analgesic response appeared to be robust and was not associated with the CNS side-effects of brain penetrating kappa-agonists, suggesting that the compound did not reach the brain, and therefore supporting the hypothesis that its effects were mediated in the periphery. The onset of analgesia was immediate, reaching a plateau within 60 min, and remaining at maximal levels for the duration of the monitoring period (4 hours). During this time interval, the plasma levels of the compound are estimated to have ranged from high nanomolar (first

hour, during and after administration) to intermediate/low nanomolar levels (~ 100 nM or less, 3<sup>rd</sup> and 4<sup>th</sup> hours). The plasma levels, at least during the last two hours of the study, when visceral analgesia was still maximal, were probably too low to elicit a non-specific sodium channel blockade, but were perfectly suitable to activate  $\kappa_1$ -receptors. Despite these preliminary and encouraging results, more definitive clinical proof of the concept for the therapeutic relevance of peripheral  $\kappa_1$ -receptors in visceral pain is still needed.

#### Side Effect Profile of Kappa-Agonists

The development and use of kappa-agonists has been limited by their side effects, which include primarily sedation and dysphoria (Rivière and Junien 2000). Unlike mu-agonists, kappa-agonists do not inhibit intestinal transit, induce euphoria, addiction or respiratory depression (Rivière and Junien 2000).

#### Kappa-Agonists, Targeted Clinical Profile for Visceral Pain

Since the unwanted side effects of kappa-agonists (sedation, dysphoria) are restricted to kappa receptors located in the CNS, i.e. beyond the blood brain barrier, and because the targeted kappa-receptors in visceral pain are located in the periphery, kappa-agonists with high peripheral selectivity are expected to be efficacious and safe for the treatment of visceral pain. Therapeutic indications for peripherally restricted kappa-agonists may include abdominal surgery associated with post-operative pain and ileus, pancreatitis pain, dysmenorrhea, labor pain and irritable bowel syndrome.

#### References

- Allescher HD, Ahmad S, Classen M, Daniel EE (1991) Interaction of Trimebutine and Jo-1196 (Fedotozine) with Opioid Receptors in the Canine Ileum. *J Pharmacol Exp Ther* 257:836–842
- Binder W, Machelska H, Mousa S, Schmitt T, Riviere PJ, Junien JL, Stein C, Schafer M (2001) Analgesic and Anti-Inflammatory Effects of Two Novel Kappa-Opioid Peptides. *Anesthesiology* 94:1034–1044
- Burton MB, Gebhart GF (1998) Effects of Kappa-Opioid Receptor Agonists on Responses to Colorectal Distension in Rats With and Without Acute Colonic Inflammation. *J Pharmacol Exp Ther* 285:707–715
- Dapoigny M, Abitbol JL, Fraitag B (1995) Efficacy of Peripheral Kappa Agonist Fedotozine versus Placebo in Treatment of Irritable Bowel Syndrome. A Multicenter Dose-Response Study. *Dig Dis Sci* 40:2244–2249
- Delvaux M, Louvel D, Lagier E, Scherrer B, Abitbol JL, Frexinos J (1999) The Kappa Agonist Fedotozine Relieves Hypersensitivity to Colonic Distention in Patients with Irritable Bowel Syndrome. *Gastroenterology* 116:38–45
- Diop L, Riviere PJ, Pascaud X, Dassaud M, Junien JL (1994a) Role of Vagal Afferents in the Antinociception Produced by Morphine and U-50,488H in the Colonic Pain Reflex in Rats. *Eur J Pharmacol* 257:181–187
- Diop L, Riviere PJ, Pascaud X, Junien JL (1994b) Peripheral Kappa-Opioid Receptors Mediate the Antinociceptive Effect of Fedotozine on the Duodenal Pain Reflex in Rat. *Eur J Pharmacol* 271:65–71
- Eisenach JC, Carpenter R, Curry R (2003). Analgesia from a Peripherally Active Kappa-Opioid Receptor Agonist in Patients with Chronic Pancreatitis. *Pain* 101:89–95
- Fraitag B, Homerin M, Hecketsweiler P (1994) Double-Blind Dose-Response Multicenter Comparison of Fedotozine and Placebo in Treatment of Nonulcer Dyspepsia. *Dig Dis Sci* 39:1072–1077
- Friese N, Diop L, Lambert C, Riviere PJ, Dahl SG (1997a) Antinociceptive Effects of Morphine and U-50,488H on Vaginal Distension in the Anesthetized Rat. *Life Sci* 61:1559–1570
- Friese N, Chevalier E, Angel F, Pascaud X, Junien JL, Dahl SG, Riviere PJ (1997b) Reversal by Kappa-Agonists of Peritoneal Irritation-Induced Ileus and Visceral Pain in Rats. *Life Sci* 60:625–634
- Joshi SK, Lamb K, Bielefeldt K, Gebhart GF (2003) Arylacetamide Kappa-Opioid Receptor Agonists Produce a Tonic- and Use-Dependent Block of Tetrodotoxin-Sensitive and -Resistant Sodium Currents in Colon Sensory Neurons. *J Pharmacol Exp Ther* 307:367–372
- Joshi SK, Su X, Porreca F, Gebhart GF (2000) Kappa-Opioid Receptor Agonists Modulate Visceral Nociception at a Novel, Peripheral Site of Action. *J Neurosci* 20:5874–5879
- Kamp EH, Jones RC, III, Tillman SR, Gebhart GF (2003) Quantitative Assessment and Characterization of Visceral Nociception and Hyperalgesia in Mice. *Am J Physiol Gastrointest Liver Physiol* 284:G434–G444
- Lai J, Ma SW, Zhu RH, Rothman RB, Lentz KU, Porreca F (1994) Pharmacological Characterization of the Cloned Kappa-Opioid Receptor as a Kappa 1b Subtype. *Neuroreport* 5:2161–2164
- Langlois A, Diop L, Friese N, Pascaud X, Junien JL, Dahl SG, Riviere PJ (1997) Fedotozine Blocks Hypersensitive Visceral Pain in Conscious Rats: Action at Peripheral Kappa-Opioid Receptors. *Eur J Pharmacol* 324:211–217
- Langlois A, Diop L, Riviere PJ, Pascaud X, Junien JL (1994) Effect of Fedotozine on the Cardiovascular Pain Reflex Induced by Distension of the Irritated Colon in the Anesthetized Rat. *Eur J Pharmacol* 271:245–251
- Martin WR, Eades CG, Thompson JA, Huppler RE, Gilbert PE (1976) The Effects of Morphine- and Nalorphine-Like Drugs in the Nondependent and Morphine-Dependent Chronic Spinal Dog. *J Pharmacol Exp Ther* 197:517–532
- Murphy DM, Koblisch M, Gauntner EK, Little PJ, Gottshall SL, Garver DD, DeHaven-Hudkins DL (2000) A Screening Process for *In Vivo* Assessment of Blood-Brain Barrier Penetration for Kappa (k) Opioid Receptor Agonists. *Drug Metabolism Reviews* 32[S2], 179, Abstract
- Rivière PJ, Junien JL (2000) Opioid Receptors, Targets for New Gastrointestinal Drug Development. In: Gaginnella TS, Guglietta A (eds) *Drug Development, Molecular Targets for GI Diseases*. Humana Press, Totowa, NJ, pp 203–238
- Rivière PJ, Pascaud X, Chevalier E, Le Gallou B, Junien JL (1993) Fedotozine Reverses Ileus Induced by Surgery or Peritonitis: Action at Peripheral Kappa-Opioid Receptors. *Gastroenterology* 104:724–731
- Rivière PJ, Pascaud X, Chevalier E, Junien JL (1994) Fedotozine Reversal of Peritoneal-Irritation-Induced Ileus in Rats: Possible Peripheral Action on Sensory Afferents. *J Pharmacol Exp Ther* 270:846–850
- Rivière PJ, Vanderah TW, Porreca F, Houghton R, Schteingart C, Trojnar J, Junien JL (1999) Novel Peripheral Peptidic Kappa-Agonists. *Acta Neurobiologiae Experimentalis* 59[3], 186, Abstract
- Rothman RB, Bykov V, De Costa BR, Jacobson AE, Rice KC, Brady LS (1990) Interaction of Endogenous Opioid Peptides and Other Drugs with Four Kappa-Opioid Binding Sites in Guinea Pig Brain. *Peptides* 11:311–331
- Sandner-Kiesling A, Pan HL, Chen SR, James RL, DeHaven-Hudkins DL, Dewan DM, Eisenach JC (2002) Effect of Kappa-Opioid Agonists on Visceral Nociception Induced by Uterine Cervical Distension in Rats. *Pain* 96:13–22
- Sengupta JN, Snider A, Su X, Gebhart GF (1999) Effects of Kappa-Opioids in the Inflamed Rat Colon. *Pain* 79:175–185

27. Sengupta JN, Su X, Gebhart GF (1996) Kappa, but not mu or delta, Opioids Attenuate Responses to Distention of Afferent Fibers Innervating the Rat Colon. *Gastroenterology* 111:968–980

28. Simonin F, Gaveriaux-Ruff C, Befort K, Matthes H, Lannes B, Micheletti G, Mattei MG, Charron G, Bloch B, Kieffer B (1995) Kappa-Opioid Receptor in Humans: cDNA and Genomic Cloning, Chromosomal Assignment, Functional Expression, Pharmacology, and Expression Pattern in the Central Nervous System. *Proc Natl Acad Sci USA* 92:7006–7010

29. Su X, Joshi SK, Kardos S, Gebhart GF (2002) Sodium Channel Blocking Actions of the Kappa-Opioid Receptor Agonist U50,488 Contribute to its Visceral Antinociceptive Effects. *J Neurophysiol* 87:1271–1279

30. Su X, Sengupta JN, Gebhart GF (1997) Effects of Opioids on Mechanosensitive Pelvic Nerve Afferent Fibers Innervating the Urinary Bladder of the Rat. *J Neurophysiol* 77:1566–1580

## Oral Opioids

KOK KHOR  
 Department of Pain Management, Prince of Wales Hospital, Randwick, NSW, Australia  
 kekhor@bigpond.com

### Synonyms

Narcotics, Major Analgesics

### Definition

Opioids are drugs chemically related to morphine. They are strong analgesics, used to relieve moderate to severe chronic pain when ► [paracetamol](#) and ► [NSAIDs, Surve](#)y (NSAIDs) are not effective or limited by adverse reactions.

### Characteristics

#### Historical Background

In the form of opium, opioids have been used for centuries to provide relief from pain. In the modern era, the active agents of opium have been isolated, and related compounds have been synthesised in an effort to produce drugs with different potencies and duration of action (Table 1).

#### Application

Opioids are routinely used to provide relief of pain during and immediately after surgical procedures. They are used to relieve persistent pain in patients with cancer.

They are used to provide relief of severe pain following acute injury. In these applications, there is little or no controversy. Indeed, the use of opioids for these conditions could be regarded as a hallmark of conventional medical practice.

More contentious is the use of opioids for ► [chronic pain](#) not caused by cancer, and for which there appears to be no other effective treatment. The vast majority of patients in this state suffer from musculoskeletal pain. In the 1950s, medical opinion considered that the risk of addiction far outweighed the benefits of long-term therapy with opioids, but in 1986 Portenoy and Foley (Portenoy and Foley 1986) reported that opioids could be used effectively and safely for non-cancer pain. Nevertheless, their use has remained controversial. Concerns persist about efficacy, adverse effects, development of tolerance, addiction, drug diversion, and scrutiny of provider prescription by governmental health agencies (Portenoy 1996; Fanciullo and Cobb 2001).

### Routes of Administration

Opioids can be administered by a variety of routes. Continuous or intermittent, subcutaneous, intramuscular, or intravenous injections are typically used for postoperative pain, or the pain of acute injury. Intrathecal or epidural routes can be used for postoperative pain and for cancer pain, or other chronic pain. Some preparations are available for rectal, sublingual, intranasal, and transdermal administration. Preparations for oral use are available for patients who are able to swallow, and who can obtain adequate analgesia by this route of administration.

### Adverse Effects

Common adverse effects leading to cessation of therapy include constipation, somnolence, confusion, nausea and dizziness (Roth et al. 2000; Caldwell et al. 1999; Peloso et al. 2000). Stable dosing of opioids without concurrent use of other centrally acting drugs generally does not lead to cognitive and psychomotor impairment. Good management of pain often leads to improvement in cognitive function (Fanciullo and Cobb 2001).

With chronic opioid dosing, physical dependence does develop, but patients are often stigmatised by being inaccurately labelled “addicted” (Portenoy 1996). Ad-



**Oral Opioids, Table 1** Opioids commonly used in Pain Medicine

Natural Opium Derivatives	Semisynthetic Derivatives	Synthetic Compounds
morphine	diacetylmorphine (heroin)	methadone
codeine	dihydromorphinone	meperidine (pethidine)
	dihydrohydroxymorphinone	fentanyl
	buprenorphine	
	oxycodone	

diction, however, is rare when opioids are used to treat pain, if patients have no prior history of opioid abuse (Portenoy 1996). Whereas addiction is characterised by drug-seeking behaviour, patients with chronic pain seek relief.

A confounding issue is that some individuals feign pain in order to obtain drugs that they subsequently sell-on to addicts. This is perhaps the leading problem currently concerning the use of opioids for chronic pain, for there is no reliable method for detecting fraudulent individuals who obtain opioids for diversion (Portenoy 1996). It is, therefore, imperative that physicians make a valid diagnosis before prescribing opioids, and be alert to potential abuse.

### Efficacy

For postoperative pain, cancer pain, and the pain of acute injury, the efficacy of opioids is not questioned. Their obvious and virtually universal effectiveness obviates the need for randomised controlled trials. The only issues in these arenas are securing an optimum dose, which may be very high in some cases, and combating side-effects that may arise.

In the context of chronic musculoskeletal pain, opioids have not been uniformly successful in relieving pain and improving function. Nevertheless, a subpopulation of patients is able to achieve sustained pain-relief without substantial toxicity, functional deterioration or aberrant behaviours (Portenoy 1996; Fanciullo and Cobb 2001; Graziotti and Goucke 1997). The opioid doses required are generally low, and stabilize during long-term administration, suggesting that tolerance is rarely the "driving force" for dose escalation or diminishing efficacy (Roth et al. 2000; Arkininstall et al. 1995; Jamison et al. 1998). A significant number of patients (30–50%) will cease therapy early because of intolerance to adverse events or ineffectiveness (Roth et al. 2000; Caldwell et al. 1999; Moulin et al. 1996). Some will achieve relief when different opioids are used.

### Osteoarthritis

Codeine and oxycodone are significantly more effective than placebo (Roth et al. 2000; Caldwell et al. 1999; Peloso et al. 2000) when used for osteoarthritis. Analgesia is accompanied by an improvement in physical function and sleep (Roth et al. 2000; Caldwell et al. 1999; Peloso et al. 2000; Fleischman et al. 1999). After an initial titration period, analgesia is maintained long-term (up to 18 months) (Roth et al. 2000). However, typical opioid related side-effects complicate treatment, and account for a number of patients ceasing therapy (Roth et al. 2000; Caldwell et al. 1999). Since they act by a different mechanism, opioids are synergistic with NSAIDs, and can be used to spare increases in NSAID

dose, and thereby avoid seriously adverse effects of NSAIDs (Caldwell et al. 1999).

### Low Back Pain

Two trials, although not a third, showed codeine, morphine, and methadone to be more effective than placebo for the relief of pain (Arkininstall et al. 1995; Moulin et al. 1996; Maier et al. 2002). Others have shown that opioids achieve significantly better relief of pain than usual care (Haythornthwaite et al. 1998) or NSAIDs (Jamison et al. 1998).

The degree of relief, however, was only modest. Opioids do not abolish pain. Furthermore, although some have found improvement in function and mood (Arkininstall et al. 1995), others found no improvement in these outcome measures (Moulin et al. 1996).

► **Multidisciplinary treatment** may be required to accomplish reductions in disability and suffering related to chronic pain (Haythornthwaite et al. 1998).

### Management Strategies

Numerous guidelines (Portenoy 1996; Fanciullo and Cobb 2001; Graziotti and Goucke 1997) are available for physicians to identify those patients who might benefit from the long-term use of opioids, to achieve optimal outcomes.

The patient should have objective evidence of organic pathology causing pain, and be psychologically stable, with appropriate mood and behaviour; be reliable; be in a stable social environment; have health-support systems and no prior history of substance abuse (Graziotti and Goucke 1997). Alerting features include unsanctioned dose escalations, continued use despite severe side-effects, manipulative behaviour to obtain more drugs (and from multiple prescribers), hoarding, and diversion of drugs (Portenoy 1996; Graziotti and Goucke 1997). An opioid contract can be used to inform the patient of risks of addiction, tolerance, dependence, and to set limits of opioid use and reasons for discontinuation of therapy (Portenoy 1996; Fanciullo and Cobb 2001).

Only one doctor who has an established therapeutic relationship with the patient should prescribe the opioid and assess the outcome of therapy. Failure to reach predetermined goals is an indication to cease prescribing (Graziotti and Goucke 1997).

Sustained release (morphine, oxycodone) or long acting (methadone) preparations are the drugs of choice because of single or twice-daily dosing and stable blood concentration. Immediate release preparations may be used for dose finding before commencement of sustained release agents, and are useful for breakthrough pain. Intramuscular pethidine is not suitable for chronic use because of its short half life, increased risk of dependence, and potential for central excitatory effects. Codeine is unsuitable because of its short duration of action (Graziotti and Goucke 1997).



A trial of oral opioids can be conducted over four to six weeks, with clearly defined goals and endpoints. A low dose of a sustained-release morphine or oxycodone is started twice-daily, with the outcome assessed after one to two weeks. Patients with fluctuating pain conditions require a variable dosing regimen, with immediate release morphine or oxycodone every 4 hours. Improvement in analgesia should be the minimal requirement, and patients should show improved function. Persistence with opioid therapy is contraindicated if the patient fails to achieve at least partial analgesia at a moderate dose, or if the dose rapidly escalates in opioid-naïve patients within a month of starting treatment. At the end of the trial period, if expected outcomes have not been achieved, the drug dose is tapered over a few days and ceased. Patients who are prescribed opioids on an ongoing basis should be reviewed monthly by the prescribing physician, with a detailed review by a pain management centre undertaken annually, at which analgesic efficacy, level of function, and aberrant behaviour, can be assessed (Graziotti and Goucke 1997).

### References

1. Arkinstall W, Sandler A, Goughnour B et al. (1995) Efficacy of Controlled-Release Codeine in Chronic Non-Malignant Pain: A Randomized, Placebo-Controlled Clinical Trial. *Pain* 62:169–178
2. Caldwell JR, Hale ME, Boyd RE et al. (1999) Treatment of Osteoarthritis Pain with Controlled Release Oxycodone or Fixed Combination Oxycodone Plus Acetaminophen Added to Non-Steroidal Anti-Inflammatory Drugs: A Double-Blind, Randomized, Multicenter, Placebo Controlled Trial. *J Rheumatol* 26:862–869
3. Fanciullo G, Cobb J (2001) The Use of Opioids for Chronic Non-Cancer Pain. *Int J Pain Med & Pall Care* 1:49–55
4. Fleischman RM, Kamin M, Olson WH et al. (1999) Safety and Efficacy of Tramadol for the Signs and Symptoms of Osteoarthritis. *Arthr Rheum* 42:S144
5. Graziotti PJ, Goucke CR (1997) The Use of Oral Opioids in Patients with Chronic Non-Cancer Pain. *MJA* 167:30–34
6. Haythornthwaite JA, Menefee LA, Quatrano-Piacentini BA et al. (1998) Outcome of Chronic Opioid Therapy for Non-Cancer Pain. *J Pain Symptom Manage* 15:185–194
7. Jamison RN, Raymond SA, Slawsby EA et al. (1998) Opioid Therapy for Chronic Non-Cancer Back Pain. *Spine* 23:2591–2600
8. Maier C, Hildebrandt J, Klinger R et al. (2002) Morphine Responsiveness, Efficacy and Tolerability in Patients with Chronic Non-Tumor Associated Pain - Results of a Double-Blind Placebo-Controlled Trial (MONTAS). *Pain* 97:223–233
9. Moulin DE, Lezzi A, Amireh R et al. (1996) Randomised Trial of Oral Morphine for Chronic Non-Cancer Pain. *Lancet* 347:143–147
10. Peloso PM, Bellamy N, Bensen W et al. (2000) Double-Blind Randomized Placebo Control Trial of Controlled Release Codeine in the Treatment of Osteoarthritis of the Hip or Knee. *J Rheumatol* 27:764–771
11. Portenoy RK (1996) Opioid Therapy for Chronic Non-Malignant Pain: A Review of the Critical Issues. *J Pain Symptom Manage* 11:203–217
12. Portenoy R, Foley K (1986) Chronic Use of Opioid Analgesics in Non-Malignant Pain: Report of 38 Cases. *Pain* 25:171–186
13. Roth SH, Fleishmann RM, Burch FX et al. (2000) Around-the-Clock, Controlled-Release Oxycodone Therapy for Osteoarthritis-Related Pain. *Arch Intern Med* 160:853–860

## Ordinary Cramp

### Definition

The term „ordinary“ usually includes conditions most frequently referred to as muscle cramps in normal or pathologic conditions, characterized by high-frequency, high-amplitude discharge of potentials on the EMG recordings.

► Muscular Cramps

## Ordinary Headache

► Headache, Episodic Tension Type

## Ordine<sup>®</sup>-morphine-hydrochloride

► Postoperative Pain, Morphine

0

## Organ or Body Part Dysfunction

► Impairment, Pain-Related

## Orofacial Pain, Movement Disorders

PETER SVENSSON

Department of Clinical Oral Physiology, University of Aarhus, Aarhus, Denmark  
psvensson@odont.au.dk

### Synonyms

Temporomandibular disorders; Mandibular Dysfunction; Muscle Hyperactivity; bruxism; Tremor; oral dystonia, dyskinesia

### Definition

Perturbations of normal jaw functions that are either likely to cause pain in orofacial tissues or are the consequences of pain, i.e. a broad and unspecific term that covers a variety of pathophysiological mechanisms and clinical conditions.

## Orofacial Pain

BARRY J. SESSLE<sup>1, 2</sup>,

JONATHAN O. DOSTROVSKY<sup>2</sup>

<sup>1</sup>Faculty of Dentistry, University of Toronto,  
Toronto, ON, Canada

<sup>2</sup>Department of Physiology, Faculty of Medicine,  
University of Toronto, Toronto, ON, Canada  
barry.sessle@utoronto.ca,  
j.dostrovsky@utoronto.ca

Although pain arising from the craniofacial region shares many features with the pain originating in other body regions, there are several pain conditions that are unique to this region. One of the best known and most prevalent is toothache, which results primarily from activation of nociceptors in the tooth pulp or dentine. A description of the clinical features, pathophysiology and management of dental pain is provided in the essay ► [dental pain, etiology, pathogenesis and management](#). Two other well-known conditions unique to the trigeminal system are trigeminal neuralgia and temporomandibular disorders (TMD) and these are described in the essays ► [trigeminal neuralgia, etiology, pathogenesis and management](#) ► [temporomandibular joint disorders](#) and ► [orofacial pain, movement disorders](#). Although postherpetic neuralgia can occur outside the orofacial region, facial tissues are often affected; its features are discussed in ► [postherpetic neuralgia, etiology, pathogenesis and management](#). In addition to these well-described pain states, there are several other conditions that are more difficult to classify, diagnose and manage. The best examples of these poorly defined conditions are atypical facial pain and burning mouth syndrome (BMS), which are described in the essay ► [atypical facial pain, etiology, pathogenesis and management](#). The problem of classification and taxonomy of orofacial pain is discussed in the essay ► [orofacial pain, taxonomy/classification](#). The relationships and interactions of pain with sleep and with oral movement disorders (e.g. tremor, dystonia and dyskinesia) and parafunctions such as bruxism are discussed in the essays ► [orofacial pain, sleep disturbance](#) and ► [orofacial pain, movement disorders](#). Headaches are of course also very common in the orofacial region and originate primarily as a result of activity in nociceptive afferents innervating the intracerebral vessels and meninges. The clinical features and underlying mechanisms of headaches are covered in ► [migraine, pathophysiology](#) and ► [non-migraine headaches](#).

### The Scope of Orofacial Pain

In addition to the wide range of pain conditions manifested in the orofacial area, epidemiological stud-

ies (e.g. LeResche 2001; Lipton et al. 1993) have revealed the very high prevalence of orofacial pain. Fortunately, some of the chronic conditions that are extremely painful or bothersome (e.g. trigeminal neuralgia, postherpetic neuralgia) are relatively uncommon (see ► [trigeminal neuralgia, etiology, pathogenesis and management](#) ► [postherpetic neuralgia, etiology, pathogenesis and management](#)). However, conditions such as TMD, BMS, headaches and toothaches are quite common and collectively have a prevalence of 10–15% or more in different populations (see ► [temporomandibular joint disorders](#) ► [atypical facial pain, etiology, pathogenesis and management](#) ► [dental pain, etiology, pathogenesis and management](#) ► [migraine, pathophysiology](#) and ► [non-migraine headaches](#)). Translated into worldwide figures, this means that at any one time TMD for example affects half a billion persons around the world! Studies in humans have drawn attention to the female predominance and to the importance of psychosocial influences as predisposing or modulating influences in many of these conditions, especially those that are chronic in nature and to the enormous economic as well as social costs of orofacial pain (Feinmann and Newton-John 2004; LeResche 2001; Sessle 2000). For example, changes in mental state (e.g. pain affect, depression) and sleep are frequent accompaniments of pain, as noted in the essays ► [orofacial pain, sleep disturbance](#) and ► [temporomandibular joint disorders](#) and there is evidence that in some situations pain may be the cause of these changes, in other cases the consequence. Also, the annual health care costs plus lost productivity, compensation, etc for pain are in the order of \$120B in the USA alone (see ► [Pain in the Workplace, Compensation and Disability Management](#)). By conservative estimates, orofacial pain including headache would represent a third of these costs and so the cost to the US economy of orofacial pain each year is approximately \$40B! Added to this economic burden is the personal suffering and disrupted quality of life of the orofacial pain patient and their interactions with family and friends. As pointed out in the various essays cited above, there have been some important advances in our knowledge of the clinical features and possible underlying mechanisms, although much remains to be learned and adequate therapy is still lacking in many cases.

### Aetiology and Pathogenesis of Orofacial Pain Conditions

The aetiology and underlying processes of most acute pain conditions occurring in the face and mouth are now reasonably well understood, although there are still several points requiring clarification, as outlined in ► [nociceptive processing in the brainstem](#). We now

know for example that trauma, dental caries or infection are the most common causes of acute pain from the tooth, as pointed out in ► [dental pain, etiology, pathogenesis and management](#), although the precise mechanisms and factors involved in the activation or sensitization of pulpal or dentinal afferents are not fully resolved (see ► [nociceptors in the dental pulp](#)). However, the biological processes giving rise to chronic orofacial pain are still poorly understood and it is clear from several essays on this topic that the aetiology of most of the chronic pain conditions expressed in the orofacial region is unclear and that their pathogenesis is still unresolved. This has impacted upon their diagnosis and management and even upon the classification schemes used to describe these conditions (see below and also ► [orofacial pain, taxonomy/classification](#)). The predisposing or risk factors related to each of these conditions are also poorly understood and this is exemplified by our limited ability to explain the female predominance in most of these chronic pain conditions. Nonetheless, with the recent emphasis on the need for a scientific underpinning and for an evidence basis for diagnostic and management approaches advocated for orofacial pain, some long-held beliefs are being laid to rest. For example, the past emphasis on occlusal factors, including sleep bruxism, as being of prime aetiological importance in TMD and related conditions, has not held up to scientific scrutiny, as the essays ► [temporomandibular joint disorders](#) and ► [orofacial pain, sleep disturbance](#), and recent systematic reviews (e.g. Forssell and Kalso 2004) have pointed out. But we clearly have a long way to go to identify the aetiological mechanisms and risk factors predisposing to most of the chronic orofacial pain states. There is in particular a need for longitudinal population based studies to help define the factors that have been implicated for most conditions (e.g. gender, genetic, age, comorbidity, trauma).

There is also a need for a greater emphasis on the development of animal models to help improve our understanding of the aetiology and pathogenesis of these conditions. Many of the current concepts on orofacial pain mechanisms draw largely upon findings from spinal models of chronic pain. Given the uniqueness of some of the orofacial pain conditions (e.g. trigeminal neuralgia, BMS), there is a need to apply and test these concepts within the framework of the trigeminal system by developing chronic orofacial pain models. Recent approaches that show much promise for improving our understanding of inflammatory or neuropathic orofacial pain conditions include the use of inflammatory irritants or complete Freund's adjuvant in inducing musculoskeletal pain (e.g. Dubner and Ren 2004; Henry 2004; Ren and Dubner 1999; Woda and Pionchon 2000) and of trigeminal nerve damage in evok-

ing nociceptive pain (Iwata et al. 2004; Woda and Pionchon 2000). From the limited trigeminal studies to date (see below) and from analogous studies in animal models of pain in the spinal system (see ► [animal models and experimental tests to study nociception and pain](#) and ► [peripheral neuropathic pain](#)), the mechanisms that appear to be involved in the pathogenesis of these chronic orofacial pain states include ectopic impulses generated in damaged afferent fibres, peripheral sensitization of afferent fibres, central sensitization of central nociceptive neurones, changes in segmental and descending inhibitory and facilitatory influences on nociceptive transmission and phenotypic changes in afferent fibres and central nociceptive neurones, including enhanced sympathetic modulation of afferent fibres and central sprouting of afferent fibres (see ► [nociceptive processing in the brainstem](#)). It has been suggested for instance that abnormal firing of trigeminal primary afferents leading to changes in central nociceptive pathways may be important in trigeminal neuralgia and neuropathic orofacial pain conditions (e.g. Devor et al. 2002; Iwata et al. 2004). Also, findings from inflammatory trigeminal models have led to suggestions (Hargreaves 2001; Sessle 1999; Sessle 2000) that both peripheral sensitization and central sensitization may explain the allodynia, hyperalgesia, diffuse and often referred pain and limitations of jaw movements that are characteristic of TMD (see ► [orofacial pain, movement disorders](#) and ► [temporomandibular joint disorders](#)) or several types of toothache including the "hot" tooth (see ► [dental pain, etiology, pathogenesis and management](#)). The animal models and correlated human studies also draw attention to the close interplay between pain and other CNS functions, such as sleep, anxiety and depression (see ► [orofacial pain, sleep disturbance](#)) and between sensory and motor systems in the expression of acute or chronic orofacial pain (see ► [orofacial pain, movement disorders](#)). While Svensson (see essay ► [orofacial pain, movement disorders](#)) also notes that a pain adaptation may apply in TMD, future research of this model needs to explain the cause of the pain and address the long-term motor consequences of chronic pain.

### Classification and Diagnostic Approaches and Issues

There is clearly a need for a practical, comprehensive and unified classification system for the variety of pain conditions that occur in the orofacial region. Zarkewska (2004) has noted that classification schemes need to be valid, reliable, comprehensive, flexible and generalizable, but this is certainly not the case for orofacial pain. As revealed in ► [orofacial pain, taxonomy/classification](#), several classification schemes for orofacial pain have been developed, but there is dis-

agreement or inconsistency between them on a number of points. There has recently been a move towards a mechanisms based classification, but application of such a scheme to orofacial pain or indeed pain elsewhere in the body is stymied by a lack of clear definition of the specific mechanisms applicable to the development and maintenance of each of these conditions, especially many of the neuropathic pain states (see ► [peripheral neuropathic pain](#) and ► [neuropathic pain of central origin](#)).

Also related to the classification issues are the difficulties associated with differential diagnosis of orofacial pain conditions. While some orofacial pain states are reasonably well defined and readily discernable (e.g. trigeminal neuralgia, postherpetic neuralgia see ► [trigeminal neuralgia, etiology, pathogenesis and management](#); ► [postherpetic neuralgia, etiology, pathogenesis and management](#)), many are complicated by vague or varying symptomatology, referral of pain, depression and concomitant pain elsewhere in the body (e.g. some toothaches, TMD; see ► [dental pain, etiology, pathogenesis and management](#) and ► [temporomandibular joint disorders](#)) or are diagnosed by exclusion (e.g. atypical facial pain, see ► [atypical facial pain, etiology, pathogenesis and management](#)). As a consequence of these features, it is not uncommon for a condition to be misdiagnosed and inappropriate therapy instituted (Truelove 2004; Vickers et al. 1998; also see below).

There are also available a multitude of diagnostic and assessment approaches that have been developed for orofacial pain (see ► [dental pain, etiology, pathogenesis and management](#) ► [atypical facial pain, etiology, pathogenesis and management](#) ► [temporomandibular joint disorders](#) ► [orofacial pain, movement disorders](#)). Clinical examination procedures, radiographic scans and common sensory assessment techniques (e.g. tooth pulp vitality tests) have long been mainstays of clinical diagnostic approaches. Over the past 2–3 decades, there have been substantive improvements in a number of these approaches that have been specifically developed for chronic as well as acute orofacial pains. While many of these particular approaches are not part of standard clinical practice, they have found extensive application in experimental or clinical studies of these conditions, and include pressure pain or tolerance thresholds, visual analogue scales, McGill pain questionnaire, quantitative sensory testing (QST), and magnetic resonance imaging (e.g. Bushnell 2001; Eliav et al. 2004; Essick 2004; Jaaskelainen 2004; Svensson et al. 2004). Although some of the orofacial pain states have reliable and validated diagnostic approaches, e.g. the research diagnostic criteria for TMD (see ► [temporomandibular joint disorders](#)), there are not yet any ‘gold standards’ for diagnosis of

most of the conditions (Eliav et al. 2004; Essick 2004; Goulet 2001; Jaaskelainen 2004; Svensson et al. 2004). Clearly there is room for further development and standardization and validation of assessment and diagnostic techniques for orofacial pain.

### Management Approaches and Issues

Some orofacial pain conditions, especially those that are chronic in nature, are often dealt with by medical specialists, but the dentist is the front line clinician for most orofacial pain conditions. Indeed dentists have been at the forefront in developing therapeutic procedures to control pain, a prime example being the introduction of gas anesthesia 160 years ago by dentists. Through these and subsequent developments, nearly all acute orofacial pain and procedural pain can be readily controlled and managed by general anesthetics, local anesthetics, analgesic drugs, etc. A case in point is the variety of management approaches available to the clinician for acute toothache (see ► [dental pain, etiology, pathogenesis and management](#)). Similarly, for the chronic orofacial pain conditions, a multitude of approaches are available and several so-called alternative medicine approaches (e.g. acupuncture, herbal remedies) have additionally become widely available over the past 2 decades. The essays on ► [temporomandibular joint disorders](#); ► [atypical facial pain, etiology, pathogenesis and management](#); ► [trigeminal neuralgia, etiology, pathogenesis and management](#); ► [postherpetic neuralgia, etiology, pathogenesis and management](#) as well as recent extensive reviews (e.g. Forssell and Kalso 2004; Stohler and Zarb 1999; Truelove 2004; Watson 2004; Widmer 2001) have noted that while some of these techniques have proven efficacy for certain orofacial pain conditions (e.g. trigeminal neuralgia, postherpetic neuralgia), the efficacy of most management approaches currently in use has not been validated or fully tested for their specificity and sensitivity. Indeed, several common management strategies have a limited scientific underpinning and so in a sense it could be argued that some conditions are often overtreated or have inappropriate treatment rendered. One example is the case of occlusal adjustments for TMD. Another is the not uncommon misdiagnosis of cases of atypical facial pain or trigeminal neuralgia where as a consequence the therapy instituted may be inappropriate and may be associated with an exacerbation of the pain and suffering of the patient (e.g. Truelove 2004; Vickers et al. 1998) (see ► [atypical facial pain, etiology, pathogenesis and management](#)).

Such considerations emphasize the need for well-designed cohort studies, randomized controlled trials (RCTs) etc to test the efficacy, validity, specificity, sensitivity and reliability of a number of management and



diagnostic strategies currently in use for pain in the face and mouth, as well as the need for an increased focus on enhancing pain educational programmes for health professionals and students who will be called upon to care for patients with orofacial pain (Attanasio 2002; Sessle 2003; Widmer 2001).

### Concluding Remarks

The challenges ahead in clarifying the mechanisms underlying the aetiology and pathogenesis of orofacial pain offer the reward of better diagnostic and management approaches than currently exist. Management approaches for many of these conditions are relatively ineffective or unproven (e.g. BMS) or are varied in view of the so-called multifactorial nature of the condition (e.g. TMD). Nonetheless, emerging technologies in imaging, sensory testing (e.g. QST), biological markers and molecular biology hold out promise of improved therapeutic approaches for these conditions.

#### ► Psychiatric Aspects of Pain and Dentistry

### References

1. Attanasio R (2002) The study of temporomandibular disorders and orofacial pain from the perspective of the predoctoral dental curriculum. *J Orofac Pain* 16:176–180
2. Bushnell MC (2001) Perception and behavioral modulation of pain. In: Lund JP, Lavigne GJ, Dubner R, Sessle BJ (eds) *Orofacial Pain. From Basic Science to Clinical Management*. Quintessence, Chicago, pp 107–114
3. Devor M, Amir R, Rappaport ZH (2002) Pathophysiology of trigeminal neuralgia: the ignition hypothesis. *Clin J Pain* 18:4–13
4. Dubner R, Ren K (2004) Brainstem mechanisms of persistent pain following injury. *J Orofac Pain* 18:299–305
5. Eliav E, Gracely RH, Nahlieli O, Benoliel R (2004) Quantitative sensory testing in trigeminal nerve damage assessment. *J Orofac Pain* 18:339–344
6. Essick GK (2004) Psychophysical assessment of patients with posttraumatic neuropathic trigeminal pain. *J Orofac Pain* 18:345–354
7. Feinmann C, Newton-John T (2004) Psychiatric and psychological management consideration associated with nerve damage and neuropathic trigeminal pain. *J Orofac Pain* 18:360–365
8. Forssell H, Kalso E (2004) Application of principles of evidence-based medicine to occlusal treatment for temporomandibular disorders: Are there lessons to be learned? *J Orofac Pain* 18:9–22
9. Goulet J-P (2001) The path to diagnosis. In: Lund JP, Lavigne GJ, Dubner R et al. (eds) *Orofacial Pain. From Basic Science to Clinical Management*. Quintessence, Chicago, pp 167–182
10. Hargreaves KM (2001) Neurochemical factors in injury and inflammation of orofacial tissues. In: Lund JP, Lavigne GJ, Dubner R et al. (eds) *Orofacial Pain. From Basic Science to Clinical Management*. Quintessence, Chicago, pp 59–66
11. Henry JL (2004) Future basic science directions into mechanisms of neuropathic pain. *J Orofac Pain* 18:306–310
12. Iwata K, Tsuboi Y, Shima A et al. (2004) Central neuronal changes after nerve injury: neuroplastic influences of injury and aging. *J Orofac Pain* 18:293–298
13. Jaaskelainen SK (2004) The utility of clinical neurophysiological and quantitative sensory testing for trigeminal neuropathy. *J Orofac Pain* 18:355–359
14. LeResche L (2001) Epidemiology of orofacial pain. In: Lund JP, Lavigne GJ, Dubner R et al. (eds) *Orofacial Pain. From Basic Science to Clinical Management*. Quintessence, Chicago, pp 15–25
15. Lipton JA, Ship JA, Larach-Robinson D (1993) Estimated prevalence and distribution of reported orofacial pain in the United States. *J Am Dent Assoc* 124:115–121
16. Ren K, Dubner R (1999) Central nervous system plasticity and persistent pain. *J Orofac Pain* 13:155–163
17. Sessle BJ (1999) The neural basis of temporomandibular joint and masticatory muscle pain. *J Orofac Pain* 13:238–245
18. Sessle BJ (2000) Acute and chronic craniofacial pain: brainstem mechanisms of nociceptive transmission and neuroplasticity, and their clinical correlates. *Crit Rev Oral Biol Med* 11:57–91
19. Sessle BJ (2003) Outgoing president's address: Issues and Initiatives in pain education, communication, and research. In: *Proceedings of the 10th World Congress on Pain*. IASP Press, Seattle, pp 3–12
20. Stohler CS, Zarb GA (1999) On the management of temporomandibular disorders: a plea for a low-tech, high-prudence therapeutic approach. *J Orofac Pain* 13:255–261
21. Svensson P, Baad-Hansen L, Thygesen T et al. (2004) Overview on tools and methods to assess neuropathic trigeminal pain. *J Orofac Pain* 18:332–338
22. Truelove E (2004) Management issues of neuropathic trigeminal pain from a dental perspective. *J Orofac Pain* 18:374–380
23. Vickers ER, Cousins MJ, Walker S et al. (1998) Analysis of 50 patients with atypical odontalgia. A preliminary report on pharmacological procedures for diagnosis and treatment. *Oral Surg Oral Med Oral Pathol Oral Radiol Endod* 85:24–32.
24. Watson CPN (2004) Management issues of neuropathic trigeminal pain from a medical perspective. *J Orofac Pain* 18:366–373
25. Widmer CG (2001) Current beliefs and educational guidelines. In: Lund JP, Lavigne GJ, Dubner R et al. (eds) *Orofacial Pain. From Basic Science to Clinical Management*. Quintessence, Chicago, pp 27–36
26. Woda A, Pionchon P (2000) A unified concept of idiopathic orofacial pain: pathophysiologic features. *J Orofac Pain* 14:196–212
27. Zakrzewska JM (2004) Classification issues related to neuropathic trigeminal pain. *J Orofac Pain* 18:325–331

### Characteristics

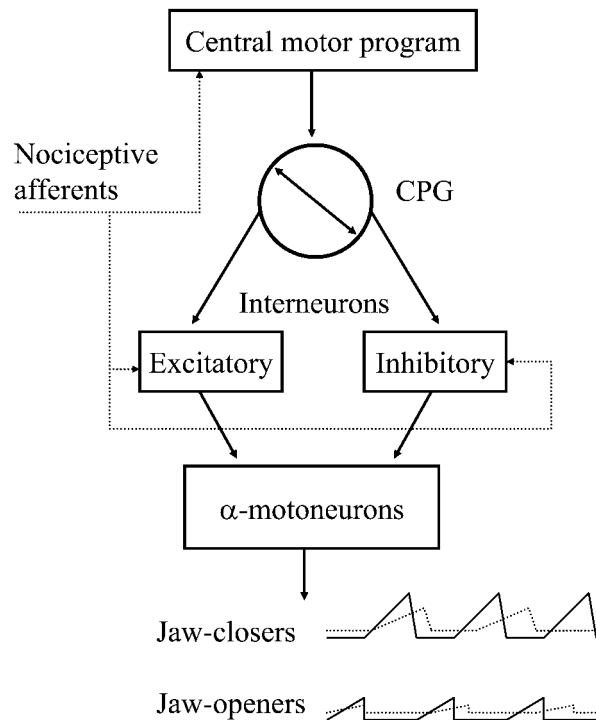
Normal jaw-motor functions involve fast, precise, highly coordinated and pain-free movement of the mandible during chewing, swallowing, speech, yawning etc. Deviation from normal jaw movements can be recognized as altered range of motion, irregular movements, postural changes and eventually noises such as clicking or grating sounds from the temporomandibular

joint (TMJ). There has been a longstanding “chicken or egg” debate in the dental community, whether changes in jaw-motor function will cause pain or pain will cause changes in jaw-motor function. However, syntheses of recent experimental and clinical studies have provided a better description of the relationship between different types of orofacial pain complaints and jaw-motor function.

### Temporomandibular Disorders (TMD)

TMD pains are considered a cluster of related pain conditions in the masticatory muscles, TMJ and associated structures, i.e. a form of orofacial musculoskeletal pain. The chewing pattern in patients with TMD pains differ in several characteristic ways compared to control subjects (Stohler 1999). For example, the movements of the mandible are smaller and tend to be more irregular, and the average and maximum opening velocity are slower. In accordance, it has been shown that TMD pain patients have a significantly longer duration of the chewing cycle. Furthermore, the jaw-closing muscles (masseter, temporalis) are significantly less activated during the agonist phase (jaw-closing), but significantly increased during the antagonist phase (jaw-opening) in TMD pain patients. The maximal voluntary **occlusal force** and electromyographic (EMG) activity are also reduced, and the endurance time at submaximal contractions is significantly shorter when compared with control subjects (Svensson and Graven-Nielsen 2001). With the mandible in its rest or **postural position** (normally 2–3 mm distance between the teeth), increased EMG activity, frequently referred to as muscle hyperactivity, has sometimes been reported in the jaw-closing muscles of TMD pain patients when compared to control subjects. However, firm conclusions have not been reached due to confounding factors in the studies, such as EMG cross-talk from facial muscles, inadequate control groups and prevalence of bruxism (see later). Recently, very small (1–2  $\mu\text{V}$ ) EMG increases have been found in well-controlled studies, although the diagnostic and pathophysiological significance of this finding remains unclear. It has also been reported that TMD pain patients may have abnormalities in mandibular kinaesthesia, which could influence the rest position of the mandible, and possibly underlie the common perception in TMD pain patients that the teeth do not fit together properly.

Traditionally, the interaction between pain and jaw-motor function has been explained by the vicious cycle concept, where muscle hyperactivity leads to pain and pain reinforces the muscle hyperactivity (Travell et al. 1942). The dental version of the vicious cycle was thought to be initiated by misalignment of the teeth (malocclusion), leading to changes in postural activity and chewing patterns. However, this stereotyped relation between pain and jaw-motor function was challenged in a series of critical papers (Lund et al. 1991). Furthermore, it was pointed out that comparable findings with slower movements and less EMG activity in the agonist phase, and more EMG activity in the antagonist phase, could also be observed during other dynamic motor tasks like gait and other repetitive movements in various musculoskeletal pain conditions (Graven-Nielsen et al. 2000). Analyses of the literature led to the formulation of the pain-adaptation model,



**Orofacial Pain, Movement Disorders, Figure 1** Highly schematic presentation of the pain-adaptation model modified after Lund et al. 1991. Thin nociceptive afferents (dotted lines) from orofacial tissues influence both the central motor program and the central pattern generator (CPG) and networks with excitatory and inhibitory interneurons in the brainstem. There is a shift in the normal drive to the alpha-motoneuron pool so that the jaw-closing muscles are less activated (dotted line) during pain in their agonist phase and more activated in their antagonist phase. The same is true for the jaw-opening muscles. The consequences of this reorganization of the motor function are slower and smaller jaw movements.

which strongly contrasts with the vicious cycle model (Lund et al. 1991) (Fig. 1). The pain-adaptation model predicts that the consequences of orofacial nociceptive inputs to premotoneurons in the brainstem during agonist function are a facilitation of inhibitory pathways to the alpha-motor neurons, and during antagonist function a facilitation of excitatory pathways. The essential prerequisite for the model is a collection of premotoneurons, constituting the **central pattern generator** in the brainstem and groups of inhibitory and excitatory interneurons. The pain-adaptation model explains many of the jaw-motor consequences of TMD pain, but does not provide any explanation for the origin of the pain. Nevertheless, the pain-adaptation model has made it clear that no causal link between changes in jaw-motor function (mandibular dysfunction) and pain can be derived from cross-sectional clinical studies, because pain in itself has a significant influence on jaw-motor function. Johansson and Sojka (1991) presented an alternative model to explain muscle tension and spread of muscle pain, which integrates the gamma-motoneuron system and, most recently the sympathetic nervous system in the pathophysiological mechanisms. Further

research will be necessary to test the hypotheses and pivotal parts of these different models.

Human experimental pain studies have nevertheless helped to clarify the interaction between orofacial pain and jaw-motor function. It has been shown that painful injections of e.g. hypertonic saline into the human masseter muscle, causes a reduction of the agonist EMG burst during empty open-close jaw-movements and during gum-chewing (Lund et al. 1991; Svensson et al. 1996). Experimental masseter pain also reduces the maximum displacement of the mandible in the lateral and vertical axes, and slows down the maximum velocity during jaw-opening and jaw-closing. Thus, experimental muscle pain studies have consistently shown a decrease in agonist EMG activity in the range of 10–15%, a small increase in the antagonist EMG activity and modest reductions in maximum displacements. These findings are in accordance with other experimental pain studies and recording of muscle activity during gait and repetitive shoulder movements in humans (Graven-Nielsen et al. 2000). In relation to the postural EMG activity, a small, but significant, increase in the EMG activity of the jaw-closing muscles, both during hypertonic saline-evoked pain and during the imagination of pain, has been demonstrated (Stohler 1999). Furthermore, ► [experimental jaw muscle pain](#) is associated with a short (<30–60 s) increase in EMG activity recorded with either intramuscular wire or surface EMG electrodes (Svensson and Graven-Nielsen 2001). Generally, the magnitude of these increases in human EMG activity is comparatively small in the jaw-closing muscles and relatively short-lived, which does not seem to justify the term muscle hyperactivity.

The experimental findings in humans are furthermore supported by observations in animal preparations of mastication. In decerebrated rabbits with cortically-driven mastication, noxious pressure applied to the zygoma or intramuscular injection of hypertonic saline causes a significant reduction in the agonist EMG burst, significant increases in the duration of the masticatory cycle, and significantly smaller amplitudes (Westberg et al. 1997). Thus, dynamic jaw-motor function seems to be reflexly changed by nociceptive activity. The relatively small EMG changes in the human jaw-closing muscles with the mandible at rest contrast with the significant EMG increases (300–400%) observed in animal studies using intramuscular EMG electrodes to record nocifensive reflex jaw responses following noxious stimulation of TMJ or muscle tissue (e.g. Hu et al. 1993; Cairns et al. 1998). The evidence of facilitation of EMG activity in both jaw-closing and jaw-opening muscles of rats and cats, following injection of various algescic substances into the deep craniofacial tissues, indicates that nociceptive afferents supplying these tissues activate excitatory pathways projecting to the alpha-motoneuron pools of the jaw-opening and jaw-closing muscles (Sessle 2000). The co-contraction of

the jaw-opening and jaw-closing muscles may serve as a “splinting” effect and reduce jaw movements (Sessle 2000), in accordance with the pain adaptation model (Lund et al. 1991), although the finding that noxious stimulation induces co-activation of these muscles at rest may not be entirely consistent with this model.

However, animal and human studies could differ in some aspects. For example, human pain studies are performed in conscious human beings, and the influence of higher-order brain centers cannot be excluded. The finding that chewing sometimes increases the perceived intensity of pain also suggests that higher-order brain centers could contribute to pain-induced changes in chewing. Furthermore, human studies are performed with a food bolus in the mouth, whereas many of the animal studies have usually involved empty open-close jaw-movements. The motor programs related to such different types of jaw-movements could also be differentially influenced by pain. Nevertheless, the human experimental and animal studies are in general agreement with each other, and in general, support the pain-adaptation model.

In summary, the sensory-motor integration in patients with TMD pain seems to apply to the pain-adaptation model. Several human experimental pain studies and animal trials substantiate this hypothesis. However, there are still important issues that will need to be explained. For example, the pain-adaptation model cannot explain the origin of pain. Moreover, the long-term consequences of an adapted jaw-motor function to a chronic painful input is unknown, and there might be conditions where the jaw muscles are not “allowed” to adapt, e.g. when the same load or work is required.

### **Bruxism and Oral Parafunctions**

Bruxism is considered an involuntary activity of the jaw muscles, which is characterized in subjects who are awake by jaw clenching and sometimes tooth gnashing and grinding (Lavigne et al. 2003). In sleep bruxism, both jaw clenching and tooth grinding are observed. The jaw muscle activity can be classified as either rhythmic (phasic), sustained (tonic) or a mixture of both types (Lavigne et al. 2003). It is estimated that about 8% of the adult population are sleep bruxers, but as many as 60% will demonstrate some form of rhythmic masticatory muscle activity. Thus, sleep bruxism can be viewed as an exaggerated normal behavior, which in some cases can be associated with significant destruction of the teeth. A point of discussion has been if sleep bruxism is related to TMD pain. About 20–30% of sleep bruxers report jaw muscle pain, which could either be due to a kind of localized post-exercise muscle soreness, or alternatively, a generalized muscle pain condition like fibromyalgia. However, several studies have now found that patients with the most jaw muscle EMG activity during sleep are actually those with the fewest muscle symptoms. One consideration is that protective

mechanisms in painful conditions will also prevent the overuse of muscles during sleep.

Human experimental studies have nevertheless clearly shown that sustained voluntary EMG activity (grinding or clenching) of a certain intensity and duration can lead to symptoms both in jaw muscles and TMJs (e.g. Arima et al. 1999); however, the level of pain is rather low and short-lived in accordance with the notion that jaw muscles are extremely fatigue-resistant. The current view is, therefore, that bruxism and other parafunctional jaw activities are only modest risk factors for the development or maintenance of TMD pain.

### Tremor, Orofacial Dystonia and Dyskinesia

The human mandible trembles at about 3–8 Hz when it is in its rest position with the jaw muscles relaxed, although the amplitude of this movement is too low to be detected visually (Jaberzadah et al. 2003). There is evidence that the mandible in the rest position is under a “pulsatile control”, where fluctuating activity in central neural pulse generators activate both the jaw-opening and jaw-closing alpha-motoneurons. Recently, it was shown that hypertonic saline-evoked pain in the masseter muscle caused a reduction in the power of the resting jaw tremor (Jaberzadah et al. 2003). This indicates that jaw muscle pain is capable of tonically modulating the amplitude of the outputs from the central “pulsatile control” generators that drive the alternating activation of antagonistic muscles, which produce jaw tremor at rest and during jaw movements.

For completeness, neurological conditions such as oral dyskinesia and dystonia will also be briefly mentioned, since they can be associated with orofacial pain complaints. Mandibular dyskinesia is involuntary, often continuous, repetitive movements of the tongue, lips, cheeks and jaw (Clark and Takeuchi 1995), and can be linked to withdrawal of neuroleptics (tardive dyskinesia). Orofacial dystonia is also involuntary, intermittent and momentarily sustained contraction of the orofacial or jaw muscles, which are normally only present during wakefulness. The pathophysiology may involve disorders of the central motor pathways and in particular the basal ganglia. Pain in these conditions is traditionally thought to be due to excessive muscle contractions.

In summary, movement disorders and orofacial pain covers a wide range of clinical conditions with different pathophysiological mechanisms and manifestations.

### References

- Arima T, Svensson P, Arendt-Nielsen L (1999) Experimental Grinding in Healthy Subjects: A Model for Post-Exercise Jaw Muscle Soreness. *J Orofac Pain* 13:104–114
- Cairns BE, Sessle BJ, Hu JW (1998) Evidence that Excitatory Amino Acid Receptors within the Temporomandibular Joint Region are Involved in the Reflex Activation of the Jaw Muscles. *J Neurosci* 18:8056–8064
- Clark GT, Takeuchi H (1995) Temporomandibular Dysfunction, Chronic Orofacial Pain and Oral Motor Disorders in the 21<sup>st</sup> Century. *Calif Dent Assoc J* 23:41–50
- Graven-Nielsen T, Svensson P, Arendt-Nielsen L (2000) Effect of Muscle Pain on Motor Control: A Human Experimental Approach. *Adv Physiother* 2:26–38
- Hu JW, Yu X-M, Vernon H, Sessle BJ (1993) Excitatory Effects on Neck and Jaw Muscle Activity of Inflammatory Irritant Applied to Cervical Paraspinal Tissues. *Pain* 55:243–250
- Jaberzadeh S, Svensson P, Nordstrom MA, Miles TS (2003) Differential Modulation of Tremor and Pulsatile Control of Human Jaw and Finger by Experimental Muscle Pain. *Exp Brain Res* 150:520–524
- Johansson H, Sojka P (1991) Pathophysiological Mechanisms Involved in Genesis and Spread of Muscular Tension in Occupational Muscle Pain. *Med Hypothes* 135:196–203
- Lavigne GJ, Kato T, Kolta A, Sessle BJ (2003) Neurobiological Mechanisms Involved in Sleep Bruxism. *Crit Rev Oral Biol Med* 14:30–46
- Lund JP, Donga R, Widmer CG, Stohler CS (1991) The Pain-Adaptation Model: A Discussion of the Relationship between Chronic Musculoskeletal Pain and Motor Activity. *Can J Physiol Pharmacol* 69:683–694
- Sessle BJ (2000) Acute and Chronic Craniofacial Pain: Brainstem Mechanisms of Nociceptive Transmission and Neuroplasticity, and their Clinical Correlates. *Crit Rev Oral Biol Med* 11:57–91
- Stohler CS (1999) Craniofacial Pain and Motor Function: Pathogenesis, Clinical Correlates, and Implications. *Crit Rev Oral Biol Med* 10:504–518
- Svensson P, Arendt-Nielsen L, Houe L (1996) Sensory-Motor Interactions of Human Experimental Unilateral Jaw Muscle Pain: A Quantitative Analysis. *Pain* 64:241–249
- Svensson P, Graven-Nielsen T (2001) Craniofacial Muscle Pain: Review of Mechanisms and Clinical Manifestations. *J Orofac Pain* 15:117–145
- Travell J Rinzler S Herman M (1942) Pain and Disability of the Shoulder and Arm. Treatment by Intramuscular Infiltration with Procaine Hydrochloride. *J Am Med Assoc* 120:417–422
- Westberg K-G, Clavelou P, Schwartz G, Lund JP (1997) Effects of Chemical Stimulation of Masseter Muscle Nociceptors on Trigeminal Motoneuron and Interneuron Activities during Fictive Mastication in the Rabbit. *Pain* 73:295–308

## Orofacial Pain, Sleep Disturbance

GILES J. LAVIGNE

Facultés de Médecine Dentaire et de Médecine,  
Université de Montréal, Montréal, QC, Canada  
gilles.lavigne@umontreal.ca

### Synonyms

Sleep Disturbance; Poor Sleep Quality

### Definition

Chronic pain is a major cause of ► [sleep disturbances](#) and complaints. Its major influence is to increase the magnitude and/or the frequency of arousal and ► [awakening](#) in sleep. A day with intense pain could be followed by sleep of poor quality, and poor sleep may be followed by more pain on the next day.

### Characteristics

Sleep is a physiological state usually characterized by isolation from the environment, except when an unpleasant, potentially harmful or life-threatening event occurs. During sleep, sensory perception is attenuated to prevent sleep disruption by non-relevant input in order to



promote sleep consolidation. The perception of pain in sleep should rather be termed nociception, since sleep is associated with an altered state of consciousness. The presence of pain during wakefulness, as well as the intrusion of pain in the sleeping period, are potentially associated with fatigue and lower sleep quality (e.g. complaints of non-restorative sleep), daytime sleepiness and risk of accidents, low memory performance, etc. Although the influence of chronic orofacial muscle and/or temporomandibular joint pain on sleep does not differ from that of pain in other parts of the body, the impact of trigeminal neuralgia or neuropathy on sleep is unknown.

### Epidemiology and Risk Factors

It is well known that  $\approx 2/3$  of chronic orofacial pain patients report poor sleep quality (Dao et al. 1994; Morin et al. 1998; Riley III et al. 2001; Yatani et al. 2002). The exacerbation of poor sleep in chronic pain patients could be associated with several risk factors:

1. Anxiety, catastrophising, depression, etc.
2. Alcohol, caffeine, nicotine and medications known to disturb sleep (e.g. cardio-active drugs, analgesics)
3. Sleep disorders such as insomnia, sleep apnea, periodic limb movement in sleep

Chronic pain patients frequently experience insomnia with an odds ratio of 1.5–2.0 (Moldofsky 2001). Risk factors in chronic orofacial muscle pain (e.g. myofascial pain alone or with temporomandibular arthralgia) include a history of trauma, jaw clenching habit, somatization and female gender (Huang et al. 2002). However, the link between orofacial pain and tooth grinding during sleep, termed sleep bruxism, is much less clear: only 1 sleep bruxism patient in 5 shows such a relation in the presence of objective sleep measures carried out in the laboratory. Sleep related headache and occasional temporomandibular joint lock or sounds are not uncommon. Sleep complaints with generalized pain sensitivity are not specific to the orofacial pain population, since they are found in the presence of other symptoms such as bowel complaints and frequent headaches that occur with chronic fatigue syndrome, fibromyalgia and temporomandibular disorders (Aaron et al. 2000; Moldofsky 2001).

### Interaction Between Pain and Sleep

In most cases, a new pain episode will precede complaints of poor sleep (Morin et al. 1998; Riley III et al. 2001). By contrast, when chronic pain sets in (e.g. burn pain after a few days, fibromyalgia) a vicious circle is reported: a day with high pain is followed by a night of poor sleep, and sleep of poor quality is followed by reports of higher pain the next day (Raymond et al. 2001). However, this interaction only explains a low percentage of the variability in pain and sleep complaints; other influences such as physical and/or psychological disabilities, fatigue, depression and the

risk factors mentioned above also have to be factored into the equation (Nicassio et al. 2002; McCracken and Iverson 2002).

### Sleep Architecture and Pain

A normal sleep period is characterized by alternated ► **sleep stages** (light St 1&2 to deep St 3&4 to Rapid Eye Movement (REM) sleep) that occur 3–5 times in a normal sleep period of 7–9 hours. We usually spend approximately 50–65% of a night in St 1&2, 20–25% in St 3&4, and 10–20% in REM sleep. The roles of sleep are to recover from fatigue, maintain cognitive function (e.g. memory consolidation and performance, concentration) and help overall biological regeneration. Sleep disruption (e.g. fragmentation) that interferes with sleep continuity is reported to induce some complaints of fatigue and poor cognitive performance the next day. Interestingly, recent findings have suggested that when sleep is restricted to 4 and 6 hours per day for 14 days, subjects showed deficits in cognitive performance (Van Dongen et al. 2003). The impact of chronic pain on cognitive function (e.g. memory, concentration, fatigue, driving ability) during wakefulness, and the benefit of a nap (e.g. <20 min with mainly light sleep vs. 60–90 min nap that allows the occurrence of deep and REM sleep) or pain medications, need to be investigated (Brousseau et al. 2003).

The duration of sleep stages in most chronic pain patients is normal, although some disruption in the microstructure of sleep has been found, e.g. sleep transition (termed sleep stage shift), frequent and long arousals termed awakenings (see Table 1). The quality of deep sleep (St 3&4) of chronic pain patients was initially described to be perturbed, due to the intrusion of so-called fast Alpha waves (as estimated on the electroencephalographic (► **EEG**) sleep traces; see also Glossary for definition), but this concept has been revisited. It is currently suggested that the sleep of chronic pain patients is under the influence of a EEG “protective” mechanism termed ► **cyclic alternating pattern** (CAP) (Moldofsky 2001). CAP is a natural rhythm in sleep in which every 20–60 seconds there is a brief arousal (named a ► **micro-arousal**), which allows the individual to adjust his/her body temperature, heart and respiratory rate to the environment. This physiological activity is like a “sentinel” that protects and/or prepares the body for a rapid awakening in the presence of a threatening situation. In the presence of sleep disruptive influences (e.g. sound, sleep apnea, periodic limb movement and pain), arousal or CAP rate per hour of sleep could be increased.

Sleep is also a state normally associated with a reduction in heart rate variability, due to a change in the balance of components of the autonomic nervous system. In light and deep sleep, a parasympathetic dominance “slows down” the cardiac activity, while during the awake or REM sleep state there is a cardiac-

**Orofacial Pain, Sleep Disturbance, Table 1**

Sleep changes that could be produced by pain (low to moderate level of evidence)
Lower sleep efficacy (% time asleep over total time in bed: usually >85%)
Longer duration of light sleep (stage 1)
Lower duration of deep sleep (Stages 3&4)
Lower density of slow wave EEG activity usually associated with un-refreshing sleep
Higher density of K complexes in EEG activity
More frequent sleep stage shift (transition from deep sleep to light sleep) and unstable deep sleep
Presence of more than 15 micro-arousals/hr (3–10 sec EEG changes with heart rate increase and possible rise in muscle tone) in young adults; more than 29/hr of sleep in older adults
In the presence of an usual number of micro-arousals/hr of sleep, a rise in sympathetic-cardiac activity, a high CAP rate and Alpha EEG intrusions in deep sleep (St 3&4)
High rate of awakening in sleep (e.g. >4/hr sleep)

sympathetic dominance, characterized by a higher cardiac activity/variability. The absence of a reduction in cardiac activity during light or deep sleep may cause un-refreshing or non-restorative sleep. This suggestion is supported by findings showing that fibromyalgia and insomniac patients maintain a high sympathetic cardiac activity (Martínez-Lavín et al. 1998; Moldofsky 2001; Brousseau et al. 2003). The specificity of this hypothesis to explain poor sleep in pain patients needs to be demonstrated in the absence of anxiety, which is highly prevalent in fibromyalgia and insomnia.

#### Experimental Pain and Sleep Fragmentation Models

During sleep, in comparison to the waking state, most sensory stimulation needs to be more intense to evoke a physiological response such as micro-arousal, awakening or a behavioural reaction during awakening. An auditory alarm needs to be over 65 dB to waken a sleeping subject, although sound in the range of 40 dB is known to cause sleep perturbations. In an experimental setting, sleep can be disrupted in two ways: ► **Sleep fragmentation** or deprivation. Sleep fragmentation is a brief intrusion in sleep that causes a transitional change in the sleep process (sleep stage shift, micro-arousal or awakening without a conscious response from the subject). Sleep deprivation is either a total prevention of sleep or is limited to a specific sleep stage (e.g. St 3&4). To be able to induce sleep deprivation, the subject has to be monitored with polysomnography recordings. When sleep onset becomes apparent (e.g. drowsiness to sleep St 1), a verbal command or a sensory stimulation is applied to maintain wakefulness. Both fragmentation and deprivation have potential consequences for functioning the next day (e.g. fatigue, sleepiness, boredom, irritability, poor memory performance) that could influence pain reports or clinician assessment of pain. For research purposes, the effects of three sensory pain modalities on sleep have been investigated: thermal (heat-cold thermode, laser heat),

mechanical (finger-joint pressure) and chemical (hypertonic saline or other algescic substance injection) (Drewes et al. 1997; Lavigne et al. 2000; Lavigne et al. 2004). Electric shock has also been used to test nociceptive - polysynaptic flexion reflex latency and amplitude (Sandrini et al. 2001). The use of these models, have confirmed that pain perception during sleep, similar to other sensory stimulations during sleep, is lower. However, it remains to be proven that the use of the three sensory modalities or the flexion reflex mimic clinical pain. It appears that the duration of the stimulation needs to be long enough (over 60 sec) to trigger a response that is similar to that observed in a situation associated with awakening in sleep, e.g.: “I was suddenly woken up by a toothache”. The validation of such models in the study of sleep and pain interaction is in progress.

#### Management

Sleep and pain interactions can be managed with classical approaches (see Table 2), (Brousseau et al. 2003). First, educate the patient about sleep “hygiene” to identify bad life habits that could exacerbate the problem (e.g. late day exercise, late meal, alcohol, poor sleep schedule, TV or computer in bedroom). In the presence of musculoskeletal pain-related problems, physical management (e.g. physical therapy, osteopathy, massage or fasciatherapy) could be beneficial. Light exercise is also recognized as being beneficial. However, an assessment needs to be made of the advantage and risk of a daytime nap; too long a nap could disrupt the circadian rhythm and induce prolonged sleep inertia/low cognitive functioning in the hours after the nap.

Second, if the presence of a sleep disorder is in doubt, it is strongly recommended that consultation with a sleep medicine physician be arranged, in order to rule out sleep disorders that create health risks (e.g. sleep apnea patients have a moderate to high risk of vehicle accident

**Orofacial Pain, Sleep Disturbance, Table 2**

Management guidelines for sleep and pain interaction (most have low level of evidence)
Sleep hygiene – life style
Bedroom should be an oasis, good mattress, etc
Avoid caffeine, nicotine and alcoholic products in evening
Relaxation (e. g. abdominal breathing, imagery, hot bath-hydrotherapy)
Use a regular sleep schedule as much as possible
Avoid heavy meals in the evening
Daytime nap should be in the afternoon and no more than 20 min
Light exercise program may be beneficial; avoid intense exercise late in the day
Physical therapy – massage
<b>Sleep disorders diagnosis</b>
Respiratory: sleep apnea & hypoapnea, upper airway resistance, snoring
Movement: periodic limb movement, sleep bruxism, abnormal swallowing, Parkinson-related activity, REM behaviour disorder, etc
Circadian – sleep cycle related: insomnia, hypersomnia, sleep-wake schedule shift, drug or alcohol abuse, narcolepsia, etc
<b>Medication</b>
Analgesics, AINS (Anti-inflammatory non-steroidal analgesics): morphine (risk of sleep disruption), gabapentin, pregabalin
Muscle relaxants: cyclobenzaprine (1/2 co) or clonazepam (low dose, not every evening) in early evening to prevent morning sleepiness and risk of vehicle accident
Sleep facilitators: zaleplon, (triazolam), temazepam, zopiclone, zolpidem and gabapentin at low dose (empirical basis so far)
Antidepressants: amitriptyline (low dose), trazodone, nefazodone and mirtazapine
Others: Valerian, Lavender, Kava, Cannabis: Additive effect possible (Consult: <a href="http://www.nccam.nih.gov">www.nccam.nih.gov</a> )

0

and hypertension with a shorter life expectancy) or exacerbate poor sleep (e.g. periodic limb movement, nightmare, upper airway resistance).

Third, some medication (analgesics, muscle relaxants, sleep facilitators) could be used on a short-term basis to improve sleep and reduce pain. Opioid effects on sleep need to be further characterized, since some evidence suggests a disruption of the so-called restorative deep sleep (also termed slow wave activity sleep). In the presence of a severe sleep and pain problem, antidepressants could improve sleep and assist in the management of concomitant psychological conditions (e.g. anxiety, depression), but caution is suggested, since there is limited evidence bearing on their use for this purpose. Psychological support may also be considered in some cases to improve relaxation, life style or manage concomitant conditions.

## References

- Aaron LA, Burke MM, Buchwald D (2000) Overlapping Conditions Among Patients with Chronic Fatigue Syndrome, Fibromyalgia, and Temporomandibular Disorder. *Arch Intern Med* 160:221–227
- Brousseau M, Manzini C, Thie NMR, Lavigne GJ (2003) Understanding and Managing the Interaction Between Sleep and Pain: An Update for the Dentist. *J Can Dent Assoc* 69:437–442
- Dao TTT, Lavigne GJ, Feine JS, Lund JP, Goulet J-P (1994) Quality of Life and Pain in Myofascial Pain Patients and Bruxers. *J Dent Res* 73:2047
- Drewes AM, Nielsen KM, Arendt-Nielsen L, Birket-Smith L, Hansen LM (1997) The Effect of Cutaneous and Deep Pain on the Electroencephalogram During Sleep - An Experimental Study. *Sleep* 20:623–640
- Huang GJ, Leresche L, Critchlow CW, Martin MD, Drangholt MT (2002) Risk Factors for Diagnostic Subgroups of Painful Temporomandibular Disorders (TMD). *J Dent Res* 81:284–288
- Lavigne GJ, Zucconi M, Castronovo C, Manzini C, Marchettini P, Smirne S (2000) Sleep Arousal Response to Experimental Thermal Stimulation During Sleep in Human Subjects Free of Pain and Sleep Problems. *Pain* 84:283–290
- Lavigne GJ, Brousseau M, Kato T, Mayer P, Manzini C, Guitard F, Montplaisir JY (2004) Experimental pain perception remains equally active over all sleep stages. *Pain* 110:646–655
- Martínez-Lavín M, Hermosillo AG, Rosas M, Soto M-E (1998) Circadian Studies of Autonomic Nervous Balance in Patients with Fibromyalgia: A Heart Rate Variability Analysis. *Arthri Rheum* 41:1966–1971
- McCracken LM, Iverson GL (2002) Disrupted Sleep Patterns and Daily Functioning in Patients with Chronic Pain. *Pain Res Manage* 7:75–79
- Moldofsky H (2001) Sleep and Pain: Clinical Review. *Sleep Med Rev* 5:387–398
- Morin CM, Gibson D, Wade J (1998) Self-Reported Sleep and Mood Disturbance in Chronic Pain Patients. *Clin J Pain* 14:311–314
- Nicassio PM, Moxham EG, Schuman CE, Gervirtz RN (2002) The Contribution of Pain, Reported Sleep Quality, and Depressive Symptoms to Fatigue in Fibromyalgia. *Pain* 100:271–279
- Raymond I, Nielsen TA, Lavigne GJ, Manzini C, Choinière M (2001) Quality of Sleep and its Daily Relationship to Pain Intensity in Hospitalized Adult Burn Patients. *Pain* 92:381–388
- Riley III JL, Benson MB, Gremillion HA, Myers CD, Robinson ME, Smith CL, Waxenberg LB (2001) Sleep Disturbances in

- Orofacial Pain Patients: Pain-Related or Emotional Distress? *J Craniomandib Pract* 19:106–113
15. Sandrini G, Milanov I, Rossi B, Murri L, Alfonsi E, Moglia A, Nappi G (2001) Effects of Sleep on Spinal Nociceptive Reflexes in Humans. *Sleep* 24:13–17
  16. Van Dongen HP, Maislin G, Mullington JM, Dinges DF (2003) The Cumulative Cost of Additional Wakefulness: Dose-Response Effects on Neurobehavioral Functions and Sleep Physiology from Chronic Sleep Restriction and Total Sleep Deprivation. *Sleep* 26:117–126
  17. Yatani H, Studts J, Cordova M, Carlson CR, Okeson JP (2002) Comparison of Sleep Quality and Clinical and Psychological Characteristics in Patients with Temporomandibular Disorders. *J Orofac Pain* 16:221–228

## Orofacial Pain, Taxonomy/Classification

ANTOON F. C. DE LAAT  
Department of Oral/Maxillofacial Surgery, Catholic University of Leuven, Leuven, Belgium  
antoon.delaat@med.kuleuven.ac.be

### Synonyms

Diagnostic subdivisions; Taxonomy, Orofacial Pain

### Definition

The development and establishment of widely accepted definitions, and a classification system for the different orofacial pain conditions.

### Characteristics

Composing and validating a classification is a continuously ongoing process, driven by new scientific data or better insights into pathophysiological processes. Ideally, a classification should be complete, and all the syndromes described should have clear exclusion and inclusion criteria. Unfortunately, this system of “complete truth” does not exist and will probably never be reached. Although this may sound frustrating, it provides, however, the necessary flexibility (also in regard of syndromes or definitions under debate) to convince as many users as possible to share a common language. One of the first classification schemes for orofacial pain was suggested in 1962, by the Ad Hoc Committee on Classification on Headache of the National Institute of Neurological Diseases and Blindness (Friedman et al. 1962). It was based on clinical symptoms and is not widely used.

An extraordinary effort by the International Headache Society (IHS) resulted in the classical “Classification and Diagnostic Criteria for Headache Disorders, Cranial ▶ **Neuralgias** and Facial Pain” (1988). It was the first time that sets of clear inclusion criteria for the different diagnoses were put together (Olesen 1988). The focus, however, was on headache, and many of the common sources for orofacial pain were grouped under its section 11: Headache or facial pain associated with

a disorder of ▶ **cranium**, neck, eyes, ears, nose, sinuses, teeth, mouth or other facial or cranial structures.

In order to incorporate the different subgroups of ▶ **temporomandibular disorders** (TMD) in the IHS-classification, the American Academy of Orofacial Pain (AAOP) provided specific inclusion and exclusion criteria (Okeson 1996). Even if clear descriptions of the different subgroups of TMD have been provided, the inclusion and exclusion criteria have been only partially operational. In the case of TMD, this has led an expert committee to focus on a subset of the most common temporomandibular disorders for which the Research Diagnostic Criteria (RDC) have been developed (Dworkin and LeResche 1992). A double axis system has been used: a somatic assessment based on primary signs and symptoms (pain and tenderness) allows classification into 3 groups (muscle problems, ▶ **disc displacement** and joint disorders), from which the first two are further subdivided with respect to the range of motion. In addition, a second axis examines and scores the pain severity, the psychological status of the patient and the related disability. The RDC-TMD allows for multiple diagnoses, has clear and testable inclusion and exclusion criteria, and has been operationally validated in several countries and languages.

The Task Force on Taxonomy of the IASP composed a second edition of the Classification of Chronic Pain in 1994 (Merskey and Bogduk 1994). In the section of “Relatively localised syndromes of the Head and the Neck”, each pain condition has been coded, defined, specified regarding location, system involved, main clinical and technical features and diagnostic criteria. In 1996, the AAOP expanded the original set of subdiagnoses of TMD to all conditions that could be associated with orofacial pain (Merskey and Bogduk 1994). Seven subgroups have been distinguished:

1. Intracranial pain disorders comprising tumors, hemorrhage, abscess, hematoma or edema. Due to their possible life-threatening character, they should always be ruled out expeditiously in the process of differential diagnosis.
2. The neurovascular disorders (Primary Headache disorders) include the variety of migraines, cluster headache, chronic paroxysmal hemicrania, the tension type-headaches, carotidynia and also temporal arteritis.
3. Neurogenic Pain Disorders find their etiology within the nervous system itself: the neurogenic pain may be paroxysmal (as in the typical neuralgias of the trigeminal, glossopharyngeal, nervus intermedius or superior laryngeal nerves), or continuous, comparable to deafferentation pain syndromes: peripheral neuritis, post-herpetic or posttraumatic neuralgias. The AAOP also includes in this category sympathetically maintained pain. The latter groups are characterized by their unremitting and mostly burning character.



4. Many tissues may be involved in intraoral pain: the ► [dental pulp](#), the periodontium as well as the mucogingival tissues and the tongue are sources for a variety of pain conditions.
5. The group of temporomandibular disorders has been subdivided in more detail by the AAOP into masticatory muscle disorders (myofascial pain, myositis, myospasm, unclassified local myalgia, myofibrotic contracture and neoplasia), and articular disorders (congenital and developmental disorders, disc derangement disorders, dislocation of the temporomandibular joint, inflammatory disorders, noninflammatory osteoarthritis, ankylosis and fractures). Other musculoskeletal pain may be of cervical origin and referred to the orofacial area.
6. Associated structures such as the ears, eyes, nose and paranasal sinuses, the throat, salivary glands and other soft tissues may be involved in pain felt in the orofacial region. Differential diagnosis is important here, and – as in many of the other categories – correct referral to the medical discipline mostly involved in the referring area is warranted.
7. In rare cases, mental disorders are the origin of orofacial pain, e.g. somatoform disorders and pain syndromes of psychogenic origin.

As for many other classification systems, a debate, also in the orofacial area, is still going on regarding pain syndromes without a clear definition or whose underlying pathophysiology is less well understood. “Atypical facial pain” was originally used as a “waste basket” for those orofacial pain syndromes that did not correspond to any of the suggested and defined diagnoses. More recently, this term – like “atypical odontalgia” and others – has been associated with a neuropathy-like pain, with attention drawn to their similarities regarding female predominance, clinical manifestation (but in different orofacial tissues) and lack of clear underlying pathophysiology. Indeed, based on these shared characteristics, a unified concept was recently proposed to group atypical facial pain, atypical odontalgia, glossodynia (stomatodynia) and atypical facial athromyalgia (the pain component in TMD) under the heading of idiopathic facial pain, which could be expressed in the jaws, the buccal mucosa, the teeth, the masticatory muscles or the TMJ (Woda and Pionchon 1999).

This kind of discussion and “regrouping” would probably take place more often if the principles of a “mechanism-based” classification (Woolf et al. 1998) were ever implemented. In a mechanism-based classification, the subdivisions are not driven by anatomical location but merely by the underlying pathophysiological process. Grouping pain syndromes in this way could allow more general and mechanism-oriented treatment approaches, and bridge the boundaries of specific med-

ical disciplines. At present, however, too little scientific data are available in this regard.

## References

1. Dworkin SF, LeResche L (1992) Research Diagnostic Criteria for Temporomandibular Disorders. *J Craniomandib Disord* 6:301–355
2. Friedman AP, Finlay KH, Graham JR et al. (1962) Classification of Headache. Special Report of the Ad Hoc Committee. *Arch Neurol* 6:173–176
3. Merskey H, Bogduk N (1994) Classification of Chronic Pain. Descriptions of Chronic Pain Syndromes and Definitions of Pain Terms. IASP Press, Seattle, pp 59–92
4. Okeson JP (1996) Orofacial Pain: Guidelines for Assessment, Diagnosis and Management. Quintessence, Chicago, pp 45–52
5. Olesen J (1988) Classification and Diagnostic Criteria for Headache Disorders, Cranial Neuralgias and Facial Pain. *Cephalalgia* 8
6. Woda A, Pionchon P (1999) A Unified Concept of Idiopathic Orofacial Pain: Clinical Features. *J Orofac Pain* 13:172–184
7. Woolf CJ, Bennett GJ, Doherty M et al. (1998) Towards a Mechanism-Based Classification of Pain? *Pain* 77:227–229

## Orphan G Protein-Coupled Receptor

### Definition

Orphan G Protein-Coupled Receptor is deduced from nucleic acid sequence to be a G protein-coupled receptor but of unknown ligand specificity.

► [Orphanin FQ](#)

0

## Orphanin FQ

DAVID K. GRANDY

Department of Physiology and Pharmacology, School of Medicine, Oregon Health and Science University, Portland, OR, USA  
grandyd@ohsu.edu

### Synonyms

OFQ; Nociceptin; NOC; OFQ/N; N/OFQ

### Definition

OrphaninFQ, discovered in 1995, is a naturally occurring, 17 amino acid long, kappa opioid-like peptide that is evolutionarily conserved among vertebrates. The name ‘orphanin’ was chosen because the peptide, isolated from pig hypothalamic extracts, was found to be a potent agonist of an ‘orphan’ opiate receptor-like G protein-coupled receptor (now referred to as ORL-1 and NOP1). The ‘FQ’ was added to reflect that this peptide’s N-terminal amino acid is phenylalanine (written as an ‘F’ in the single letter amino acid code), and its C-terminal amino acid is glutamine (Q). A peptide of identical sequence was simultaneously and independently discovered in rat brain extracts by another group of researchers, who named it ‘nociceptin’ based on its pronociceptive characteristics in stressed mice.

## Characteristics

The cloning of the mouse delta ( $\delta$ ) opiate receptor cDNA quickly led to the cloning of cDNAs and genes, from a variety of vertebrate species, that code for the mu ( $\mu$ ) $\Delta$ opiate receptor, the kappa ( $\kappa$ ) opiate receptor, and an opiate receptor-like **▶ orphan G protein-coupled receptor** (Darland et al. 1998). The latter is now referred to as both ORL-1 or NOP<sub>1</sub> (Mogil and Pasternak 2001). Based on the extensive amino acid sequence shared by ORL-1/NOP<sub>1</sub> and the 3 opiate receptor subtypes, it was predicted that this orphan opiate-like receptor would be activated by a peptide ligand resembling the opioid peptides  $\beta$ -endorphin, Met/Leu enkephalin and dynorphin. Furthermore, it was predicted that, when activated, this receptor would couple to second messenger systems similar, if not identical to, those modulated by the classic opiate receptors.

The search for ORL-1/NOP<sub>1</sub>'s endogenous agonist culminated with the co-discovery of a dynorphin-like heptadecapeptide (PheGlyGlyPheThrGlyAlaArgLysSerAlaArgLysLeuAlaAsnGln) from pig hypothalamic and rat brain extracts that was named **▶ orphanin FQ** (Reinscheid et al. 1995) and **▶ Nociceptin** (Meunier et al. 1995), respectively. At the cellular level, synthetic OFQ/N inhibits cAMP production *in vitro*, activates inwardly rectifying potassium channels, and inhibits a variety of voltage-dependent calcium channels including the L, P, and N types (Darland et al. 1998) in tissue slices, activities shared by the classic opiate receptors. In the low nanomolar to high picomolar range, OFQ/N is a potent and selective agonist of ORL-1/NOP<sub>1</sub> receptors; however, at concentrations in the high micromolar range, the peptide can activate  $\kappa \gg \mu = \delta$  opiate receptors expressed heterologously *in vitro* (Zhang et al. 1997).

In spite of the many physical and physiological similarities OFQ/N and ORL-1/NOP<sub>1</sub> share with the opioid peptides and their cognate receptors, respectively, the pair differ notably in that their interaction is insensitive to naloxone antagonism. Not surprisingly, this is the principle reason OFQ/N and its receptor are not generally accepted as bone fide members of the opioid peptide/opiate receptor family. Several relatively selective peptide and small molecule ORL-1/NOP<sub>1</sub> receptor antagonists have been developed recently (Mogil and Pasternak 2001), and are being used in efforts to clarify the functions of ORL-1/NOP<sub>1</sub>-mediated actions of OFQ/N *in vivo*.

Efforts to determine the biosynthetic origin of OFQ/N led to the identification and characterization of its precursor polypeptide prepro-orphaninFQ/nociceptin (ppOFQ/N) (Mollereau et al. 1996; Nothacker et al. 1996). In this precursor polypeptide the OFQ/N sequence is flanked by paired basic amino acids that are recognized and cleaved by trypsin-like endopeptidases. Further processing of OFQ/N by a carboxypeptidase may also be important *in vivo*, since OFQ/N-derived

peptides truncated by as many as 5 amino acid residues have been found to retain agonist activity, at least at ORL-1/NOP<sub>1</sub> receptors expressed *in vitro* (Butour et al. 1997; Reinscheid et al. 1996).

Analysis of ppOFQ/N amino acid sequences deduced from *mus*-, *rattus*-, and *homo*-derived cDNAs reveal ppOFQ/N, as is its receptor, to be evolutionarily conserved across species. Furthermore, the presence of numerous putative peptide domains flanked by endopeptidase cleavage recognition sites distributed throughout ppOFQ/N and the organization of its gene, recapitulate organizational schemes also present in the 3 opioid peptide precursors: proopiomelanocortin, preproenkephalin, and preprodynorphin (Darland et al. 1998). Taken together these features led to the prediction and eventual demonstration that ppOFQ/N codes for additional bioactive peptides; a result that suggests caution when interpreting outcomes of genetic manipulations that affect expression of the entire precursor.

Nucleic acid and antibody probes specific for ppOFQ/N and ORL-1/NOP<sub>1</sub> have been used to demonstrate the widespread, albeit unequal, distribution of both polypeptides throughout the central nervous system and periphery (Darland et al. 1998; Mogil and Pasternak 2001). Of particular note in the context of pain and nociception is the significant presence of both peptide and receptor in the periaqueductal gray (PAG), raphé nuclei, and the spinal cord (Darland et al. 1998; Mogil and Pasternak 2001).

As with the opioid peptides, early attempts to study the actions of OFQ/N *in vivo* were plagued by its sensitivity to proteolysis, membrane impermeability, and failure to cross the blood-brain barrier. Until recently, further complicating interpretation of *in vivo* studies was the lack of selective, small-molecule antagonists of the ORL1/NOP<sub>1</sub> receptor. In spite of these limitations the actions of OFQ/N in rodents and primates, have been documented.

When OFQ/N is administered intracerebroventricularly (icv), the most common observation is that it dose-dependently interferes with several opioid-mediated, naloxone-sensitive responses including antinociception. The literature also contains reports of the peptide producing hyperalgesia as well as analgesia (extensively reviewed in Mogil and Pasternak 2001). In contrast to its apparent antiopioid actions supraspinally, when administered intrathecally OFQ/N potentiates opioid analgesia, although the gender and physiological status of the subject (e.g. pregnancy) appear to influence the peptide's effects on nociceptive sensitivity (Dawson-Basoa and Gintzler 1997). To date there are few reports describing OFQ/N's effects on nociceptive processing when administered directly into brain tissue. Microinjection of OFQ/N into the midbrain PAG region of rats produces a mild hyperalgesia (Bytner et al. 2001) while blocking the antinociceptive effects of intra-PAG administered morphine (Morgan et al. 1997). In con-

trast, the focal application of OFQ/N into the rostral ventral medulla produced either no effect (two studies) or analgesia (one study) (Heinricher 2003).

Although the literature contains numerous contradictory reports regarding the effects of exogenous OFQ/N on various nociceptive behaviors, the consensus emerging from recent efforts to integrate these data is that the dynorphin-like peptide OFQ/N is not “anti-opioid” or “pronociceptive.” Rather, OFQ/N can be a modulator of opioid peptide/opiate alkaloid actions, exerting a potent, inhibitory effect on a wide range of cell types involved with nociceptive processing in the brain and spinal cord via the naloxone-insensitive activation of its cognate receptor. Therefore, the behavioral manifestations of exogenous OFQ/N are a reflection of the neuronal circuits present along the route of administration, as well as the species, strain, gender, and physiological status of the experimental subject (Harrison and Grandy 2000). What role, if any, endogenous OFQ/N plays in nociceptive processing remains to be established.

## References

1. Bytner B, Huang YH, Yu LC et al. (2001) Nociceptin/Orphanin FQ into the Rat Periaqueductal Gray Decreases the Withdrawal Latency to Heat and Loading, an Effect Reversed by (Nphe(1))nociceptin(1-13)NH(2). *Brain Res* 922:118–124
2. Butour JL, Moisan C, Mazarguil H et al. (1997) Recognition and Activation of the Opioid Receptor-Like ORL 1 Receptor by Nociceptin, Nociceptin Analogs and Opioids. *Eur J Pharmacol* 321:97–103
3. Darland T, Heinricher MM, Grandy DK (1998) Orphanin FQ/Nociceptin: A Role in Pain and Analgesia, But So Much More. *Trends Neurosci* 21:215–221
4. Dawson-Basoa M, Gintzler AR (1997) Nociceptin (Orphanin FQ) Abolishes Gestational and Ovarian Sex Steroid-Induced Antinociception and Induces Hyperalgesia. *Brain Res* 750:48–52
5. Harrison LM, Grandy DK (2000) Opiate Modulating Properties of Nociceptin/Orphanin FQ. *Peptides* 21:151–172
6. Heinricher MM (2003) Orphanin FQ/Nociceptin: From Neural Circuitry to Behavior. *Life Sci* 73:813–822
7. Meunier JC, Mollereau C, Toll L et al. (1995) Isolation and Structure of the Endogenous Agonist of Opioid Receptor-Like ORL1 Receptor. *Nature* 377:532–535
8. Mogil JS, Pasternak GW (2001) The Molecular and Behavioral Pharmacology of the Orphanin FQ/Nociceptin Peptide and Receptor Family. *Pharmacol Rev* 53:381–415
9. Mollereau C, Simons MJ, Soularue P et al. (1996) Structure, Tissue Distribution, and Chromosomal Localization of the Prepronociceptin Gene. *Proc Natl Acad Sci USA* 93:8666–8670
10. Morgan MM, Grisel JE, Robbins CS et al. (1997) Antinociception Mediated by the Periaqueductal Gray is Attenuated by Orphanin FQ. *Neuroreport* 8:3431–3434
11. Nothacker HP, Reinschei, RK, Mansour A et al. (1996) Primary Structure and Tissue Distribution of the Orphanin FQ Precursor. *Proc Natl Acad Sci USA* 93:8677–8682
12. Reinscheid RK, Nothacker HP, Boursion A et al. (1995) Orphanin FQ: A Neuropeptide that Activates an Opioid-Like G Protein-Coupled Receptor. *Science* 270:792–794
13. Reinscheid RK, Ardati A, Monsma FJ Jr et al. (1996) Structure-Activity Relationship Studies on the Novel Neuropeptide Orphanin FQ. *J Biol Chem* 271:14163–14168
14. Zhang G, Murray TF, Grandy DK (1997) Orphanin FQ has an Inhibitory Effect on the Guinea Pig Ileum and the Mouse vas Deferens. *Brain Res* 772:102–106

## Orthodromic Activation

### Definition

Electrical activity due to propagation of action potentials in the same direction to that observed when the neuron is naturally excited.

► [Corticothalamic and Thalamocortical Interactions](#)

## Orthologues

### Definition

A paralogue is an homologous member of a multigene family that may share some functional characteristics with the query sequence, whilst an orthologue is the closest relative of the query sequence in a different species, and is likely to share most or all functional characteristics with the protein encoded by the query sequence.

► [TRPV1 Receptor, Species Variability](#)

## Orthostatic Component of Pain

0

### Definition

Change of posture, or „intra-body“-pressure (coughing, sneezing, straining) can influence headaches due to low intracranial pressure.

► [Headache due to Low Cerebrospinal Fluid Pressure](#)

## Orthostatic Hypotension

### Definition

Orthostatic hypotension is a drop in blood pressure when standing up from a lying/sitting position.

► [Cancer Pain Management, Anesthesiologic Interventions, Neural Blockade](#)

## Oscillations (Neuronal)

### Definition

Oscillations are spike potentials that occur repeatedly at relatively fixed intervals.

► [Thalamus, Dynamics of Nociception](#)

## Osmolysis

### Definition

Osmolysis is the rupture of a cell membrane due to excessive accumulation of solvent (water), produced by an important decrease of concentration of ions inside the cell (hyposmolarity).

- ▶ [Post-Stroke Pain Model, Thalamic Pain \(Lesion\)](#)

## Osmosensitive

### Definition

Sensitive to changes in the osmolarity of the surrounding medium.

- ▶ [Mechanonociceptors](#)

## Osmotic

### Definition

A chemical used in prolotherapy solutions that acts by causing an osmotic shock to cells, leading to the release of proinflammatory substances. Osmotics include concentrated solutions of glucose, glycerine and zinc sulphate.

- ▶ [Pain Management](#)
- ▶ [Prolotherapy](#)
- ▶ [Prolotherapy Injection](#)

## Osteoarthritic Pain

### Definition

Osteoarthritic pain is caused by the irritation or degeneration of the joint cartilage. When cartilage becomes worn, exposed bones can rub together and the painful symptoms of osteoarthritis may appear. Chemical messenger substances that are associated with the disease process may cause the irritation.

- ▶ [Perireceptor Elements](#)

## Osteoarthritis

### Definition

Osteoarthritis is a painful condition in which there is breakdown of the articular cartilage (the cartilage on the ends of bones which assists the smooth movement of joints). Joints may become deformed and stiff. Inflammation is generally not marked but can be severe

in some patients. It has a prevalence of about 10% in western populations, and mainly afflicts elderly people.

- ▶ [NSAIDs and their Indications](#)

## Osteoarthritis Model

- ▶ [Arthritis Model, Osteoarthritis](#)

## Osteoblast

### Definition

Osteoblasts are specialized cells that lay down osseous matrix for bone formation.

- ▶ [Adjuvant Analgesics in Management of Cancer-Related Bone Pain](#)
- ▶ [NSAIDs, Adverse Effects](#)

## Osteoblastoma

### Definition

Osteoblastoma is a rare, benign, locally recurrent tumor of bone with a predilection for the spine.

- ▶ [Chronic Back Pain and Spinal Instability](#)

## Osteoclast

### Definition

A member of the macrophage-monocyte lineage of cells that is responsible for the absorption and removal of bone. Resorption is mediated by demineralization of bone by protons secreted by the osteoclast.

- ▶ [Adjuvant Analgesics in Management of Cancer-Related Bone Pain](#)
- ▶ [Cancer Pain, Animal Models](#)
- ▶ [NSAIDs, Adverse Effects](#)

## Osteolysis

### Definition

The process of bone resorption that occurs during normal bone homeostasis, but may become pathologic in



the presence of cancer cells.

► [Cancer Pain, Animal Models](#)

## Osteolytic Fibrosarcoma

### Definition

Osteolytic fibrosarcoma is a tumor of mesenchymal cell origin that may present as an osteolytic bone tumor. The primary tumor is comprised of malignant fibroblasts. NCTC 2472 sarcoma cells that produce osteolytic fibrosarcoma have been used to model cancer pain in mice. The clinical presentation of osteolytic fibrosarcoma features breakthrough pain as a prominent component.

► [Evoked and Movement-Related Neuropathic Pain](#)

## Osteopathy

► [Spinal Manipulation, Characteristics](#)

## Osteophyte

### Definition

A bony excrescence or osseous outgrowth.

► [Lumbar Traction](#)

## Oswestry Disability Index

OLE HAEGG

Department of Orthopedic Surgery, Sahlgren University Hospital, Goteborg, Sweden  
ollehagg@hotmail.com

### Synonyms

ODI; Oswestry Disability Questionnaire; Oswestry Low Back Pain Disability Questionnaire

### Definition

The Oswestry Disability Index (ODI) is a self-rating condition-specific outcome measure for evaluation of low back pain ► [disability](#). It was introduced in 1980 by Fairbank et al. (Fairbank et al. 1980), and consists of ten sections with six response alternatives describing functional impairment in a series of daily activities. There are two authorized versions, version 1.0 (Table 1) from 1980 and version 2.0 (Table 2) from 1989 (Pynsent

1993). The main difference between the versions is the construction of the section describing pain intensity.

### Scoring

For each section of six statements the total score is 5; if the first statement is marked the score = 0; if the last statement is marked the score = 5. Intervening statements are scored according to rank. If more than one box is marked in each section, take the highest score. If all ten sections are completed the score is calculated as follows: Example: 16 (total score) of 50 (total possible score)  $\times 100 = 32\%$ . If one section is missed (or not applicable) the score is calculated as follows: Example: 16 (total score)/45 (total possible score)  $\times 100 = 35.6\%$ . The final score may be summarized as: (total score)/(5  $\times$  number of questions answered ( $\times 100\%$ )). It is suggested that the total percentage is rounded to a whole number (Fairbank and Pynsent 2000). A low score = low degree of disability, a high score = high degree of disability.

### Versions in Non-English Languages

The ODI is available in five validated translations (Finnish, Greek, Norwegian, Spanish, and Japanese) and another five non-validated translations (Dutch, French, German, Danish, and Swedish).

### Characteristics

#### Validity

The ODI has been criticized for not being properly validated according to modern standards. This predicament is shared with many other outcome measures consisting of more than pure physical function, where external criteria by performance tests are available. There are no external criteria for benchmarking of outcome measures including more complex social/private activities such as personal care, sex life or social life. Validation of this type of measure is accomplished by assessing the behaviour of the outcome measure in conditions with generally accepted/established degrees of disability.

The ODI score was significantly associated with physical performance tests (Gronblad et al. 1993; Reneman et al. 2002). Radiculopathy patients had significantly greater scores than patients with low back pain (49 vs. 33) (Leclaire et al. 1997). "Normal" individuals scored lower (10) than chronic back pain (43), neurogenic claudication (37) and sciatica (45) (Fairbank and Pynsent 2000).

#### Reliability

Test-re-test ► [reliability](#) assessed with the Intraclass Correlation Coefficient (ICC) was 0.89 (one week,  $n = 32$ ) (Pratt et al. 2002), 0.94 (two weeks,  $n = 37$ ) (Holm et al. 2003), 0.84/0.92 (six weeks,  $n = 47/16$ ) (Davidson and Keating 2002), 0.83 (one week,  $n = 20$ ) (Gronblad et al. 1993).

**SECTION 1 - PAIN INTENSITY**

- I can tolerate the pain I have without having to use painkillers.
- The pain is bad but I manage without taking painkillers.
- Painkillers give complete relief from pain.
- Painkillers give moderate relief from pain.
- Painkillers give very little relief from pain.
- Painkillers have no effect on the pain and I do not use them.

**SECTION 2 - PERSONAL CARE (washing, dressing etc.)**

- I can look after myself normally, without causing extra pain.
- I can look after myself normally, but it causes extra pain.
- It is painful to look after myself and I am slow and careful.
- I need some help, but manage most of my personal care.
- I need help every day in most aspects of self-care.
- I do not get dressed, wash with difficulty and stay in bed.

**SECTION 3 - LIFTING**

- I can lift heavy weights without extra pain.
- I can lift heavy weights, but it gives extra pain.
- Pain prevents me from lifting heavy weights off the floor, but I can manage if they are conveniently positioned (e.g., on a table).
- Pain prevents me from lifting heavy weights but I can manage light to medium weights if they are conveniently positioned.
- I can lift only very light weights.
- I cannot lift or carry anything at all.

**SECTION 4 - WALKING**

- Pain does not prevent my walking any distance.
- Pain prevents me walking more than 1 mile.
- Pain prevents me walking more than ½ of mile.
- Pain prevents me walking more than ¼ mile.
- I can only walk using a stick or crutches.
- I am in bed most of the time and have to crawl to the toilet.

**SECTION 5 - SITTING**

- I can sit in any chair as long as I like.
- I can sit in my favourite chair as long as I like.
- Pain prevents me sitting more than 1 hour.
- Pain prevents me from sitting more than ½ an hour.
- Pain prevents me from sitting more than 10 minutes.
- Pain prevents me from sitting at all.

**Oswestry Disability Index, Figure 1** Oswestry Disability Index Version 1.0; Patient name: File...; Date:... This questionnaire has been designed to give the doctor information as to how your back pain has affected your ability to manage in everyday life. Please answer every section and mark in each section only the ONE box that applies to you. We realize you may consider that two of the statements in any one section relate to you, but please just mark the box, which most closely describes your problem.

**Responsiveness**

Score changes associated with different levels of patient perceived improvement/deterioration are summarized in Table 1.

**Effect Size**

Patient (or combined patient/clinician) perceived improvement was associated with effect size of 0.82–0.87 (n=970) (Walsh et al. 2003), 0.80 (n=81) (Beurskens et al. 1996), 0.52 (n=106) (Davidson and Keating 2002), 0.3–0.8 (n=318) (Taylor et al. 1999) and 0.86/1.87 (n=75/69) (Hagg et al. 2002).

**SECTION 6 - STANDING**

- I can stand as long as I want without extra pain.
- I can stand as long as I want but it gives me extra pain.
- Pain prevents me from standing for more than 1 hour.
- Pain prevents me from standing for more than 30 minutes.
- Pain prevents me from standing for more than 10 minutes.
- Pain prevents me from standing at all.

**SECTION 7 - SLEEPING**

- Pain does not prevent me from sleeping well.
- I can sleep well only by using tablets.
- Even when I take tablets, I have less than 6 hours sleep.
- Even when I take tablets, I have less than 4 hours sleep.
- Even when I take tablets, I have less than 2 hours sleep.
- Pain prevents me from sleeping at all.

**SECTION 8 - SEX LIFE (If applicable)**

- My sex life is normal and causes no extra pain.
- My sex life is normal but causes some extra pain.
- My sex life is nearly normal but is very painful.
- My sex life is severely restricted by pain.
- My sex life is nearly absent because of pain.
- Pain prevents any sex life at all.

**SECTION 9 - SOCIAL LIFE**

- My social life is normal and gives me no extra pain.
- My social life is normal, but increases the degree of pain.
- Pain has no significant effect on my social life apart from limiting my more energetic interests, e.g., dancing, etc.
- Pain has restricted my social life and I do not go out as often.
- Pain has restricted my social life to my home.
- I have no social life because of pain.

**SECTION 10 - TRAVELLING**

- I can travel anywhere without extra pain.
- I can travel anywhere but it gives extra pain.
- Pain is bad but I manage journeys over 2 hours.
- Pain restricts me to journeys of less than 1 hour.
- Pain restricts me to short necessary journeys under 30 minutes.
- Pain prevents travel except to the doctor or hospital.

**Receiver Operating Characteristics (ROC)**

The area below the ROC curve, as a measure of the ability to discriminate between subjects with and without back pain, was 0.76 (n=76) (Leclaire et al. 1997), 0.78 (n=99) (Davidson and Keating 2002), 0.78 (n=88) (Stratford et al. 1994) and 0.72 (n=970) (Walsh et al. 2003).

**Minimal Clinically Important Difference (MCID)**

Based on patient (or combined patient/clinician) perceived effect of treatment. For improvement the MCID was 10 (n=154) and for deterioration –6 (n=123) (Hagg et al. 2003).

**SECTION 1 - PAIN INTENSITY**

- I have no pain at the moment.  
 The pain is very mild at the moment.  
 The pain is moderate at the moment.  
 The pain is fairly severe at the moment.  
 The pain is very severe at the moment.  
 The pain is the worst imaginable at the moment.

**SECTION 2 - PERSONAL CARE (washing, dressing etc.)**

- I can look after myself normally, without causing extra pain.  
 I can look after myself normally, but it is very painful.  
 It is painful to look after myself and I am slow and careful.  
 I need some help, but manage most of my personal care.  
 I need help every day in most aspects of self-care.  
 I do not get dressed, wash with difficulty and stay in bed.

**SECTION 3 - LIFTING**

- I can lift heavy weights without extra pain.  
 I can lift heavy weights, but it gives extra pain.  
 Pain prevents me from lifting heavy weights off the floor, but I can manage if they are conveniently positioned (e.g., on a table).  
 Pain prevents me from lifting heavy weights but I can manage light to medium weights if they are conveniently positioned.  
 I can lift only very light weights.  
 I cannot lift or carry anything at all.

**SECTION 4 - WALKING**

- Pain does not prevent me walking any distance.  
 Pain prevents me walking more than 1 mile.  
 Pain prevents me walking more than ½ of mile.  
 Pain prevents me walking more than 100 yards.  
 I can only walk using a stick or crutches.  
 I am in bed most of the time and have to crawl to the toilet.

**SECTION 5 - SITTING**

- I can sit in any chair as long as I like.  
 I can sit in my favourite chair as long as I like.  
 Pain prevents me from sitting for more than 1 hour.  
 Pain prevents me from sitting more than ½ an hour.  
 Pain prevents me from sitting more than 10 minutes.  
 Pain prevents me from sitting at all.

**SECTION 6 - STANDING**

- I can stand as long as I want without extra pain.  
 I can stand as long as I want but it gives me extra pain.  
 Pain prevents me from standing for more than 1 hour.  
 Pain prevents me from standing for more than ½ an hour.  
 Pain prevents me from standing for more than 10 minutes.  
 Pain prevents me from standing at all.

**SECTION 7 - SLEEPING**

- My sleep is never disturbed by pain.  
 My sleep is occasionally disturbed by pain.  
 Because of pain, I have less than 6 hours of sleep.  
 Because of pain, I have less than 4 hours of sleep.  
 Because of pain, I have less than 2 hours of sleep.  
 Pain prevents me from sleeping at all.

**SECTION 8 - SEX LIFE (if applicable)**

- My sex life is normal and causes no extra pain.  
 My sex life is normal but causes some extra pain.  
 My sex life is nearly normal but is very painful.  
 My sex life is severely restricted by pain.  
 My sex life is nearly absent because of pain.  
 Pain prevents any sex life at all.

**SECTION 9 - SOCIAL LIFE**

- My social life is normal and causes me no extra pain.  
 My social life is normal, but increases the degree of pain.  
 Pain has no significant effect on my social life apart from limiting my more energetic interests, e.g., sports, etc.  
 Pain has restricted my social life and I do not go out as often.  
 Pain has restricted my social life to my home.  
 I have no social life because of pain.

**SECTION 10-TRAVELLING**

- I can travel anywhere without pain.  
 I can travel anywhere but it gives extra pain.  
 Pain is bad but I manage journeys over 2 hours.  
 Pain restricts me to journeys of less than 1 hour.  
 Pain restricts me to short necessary journeys under 30 minutes.  
 Pain prevents me from travelling except to receive treatment.

0

**Oswestry Disability Index, Figure 2** Oswestry Disability Index 2.0; Patient name: File...; Date:... Please read instructions: Could you please complete this questionnaire? It is designed to give us information as to how your back (or leg) trouble has affected your ability to manage in everyday life. Please answer every section. Mark one box only in each section that most closely describes you today.

**Error of Measurement**

The ► [error of measurement](#) at repeated measurements was, with 95% tolerance interval, 10 (n = 289) (Hagg et al. 2003), and with 90% tolerance interval 11/15 (n = 16/47) (Davidson and Keating 2002).

**References**

- Beurskens AJ, Vet HC de, Koke AJ (1996) Responsiveness of Functional Status in Low Back Pain: A Comparison of Different Instruments. *Pain* 65:71–76
- Davidson M, Keating JL (2002) A Comparison of Five Low Back Disability Questionnaires: Reliability and Responsiveness. *Phys Ther* 82:8–24
- Fairbank JC, Couper J, Davies JB et al. (1980) The Oswestry Low Back Pain Disability Questionnaire. *Physiotherapy* 66:271–273
- Fairbank JC, Pynsent PB (2000) The Oswestry Disability Index. *Spine* 25:2940–2952
- Gronblad M, Hupli M, Wennerstrand P et al. (1993) Intercorrelation and Test-Retest Reliability of the Pain Disability Index (PDI) and the Oswestry Disability Questionnaire (ODQ) and their Correlation with Pain Intensity in Low Back Pain Patients. *Clin J Pain* 9:189–195
- Hagg O, Fritzell P, Nordwall A (2003) The Clinical Importance of Changes in Outcome Scores after Treatment for Chronic Low Back Pain. *Eur Spine J* 12:12–21
- Hagg O, Fritzell P, Oden A et al. (2002) Simplifying Outcome Measurement: Evaluation of Instruments for Measuring Outcome after Fusion Surgery for Chronic Low Back Pain. *Spine* 27:1213–1222
- Holm I, Friis A, Storheim K et al. (2003) Measuring Self-Reported Functional Status and Pain in Patients with Chronic Low Back Pain by Postal Questionnaires: A Reliability Study. *Spine* 28:828–833

**Oswestry Disability Index, Table 1** Score changes related to different levels of patient (or combined patient/clinician) perceived treatment effect

Level of perceived effect	Reference study			
	(Beurskens et al. 1996) (n = 81)	(Davidson and Keating 2002) (n = 101)	(Taylor et al. 1999) (n = 225)	(Hagg et al. 2002) (n = 270)
Completely gone	n/a	33	n/a	n/a
Much better	n/a	16	n/a	28
Better/improved	12	9	18	10
Unchanged/non-improved	0	0	2	0
Worse	n/a	-6	-9	-6
Much worse	n/a	-4	n/a	n/a

n/a = not applicable

9. Leclaire R, Blier F, Fortin L et al. (1997) A Cross-Sectional Study Comparing the Oswestry and Roland-Morris Functional Disability Scales in Two Populations of Patients with Low Back Pain of Different Levels of Severity. *Spine* 22:68-71
10. Pratt RK, Fairbank JC, Virr A (2002) The Reliability of the Shuttle Walking Test, the Swiss Spinal Stenosis Questionnaire, the Oxford Spinal Stenosis Score, and the Oswestry Disability Index in the Assessment of Patients with Lumbar Spinal Stenosis. *Spine* 27:84-91
11. Pynsent P, Fairbank J, Carr A (1993) Outcome Measures in Orthopaedics. Butterworth-Heinemann, Oxford
12. Reneman MF, Jorritsma W, Schellekens JM et al. (2002) Concurrent Validity of Questionnaire and Performance-Based Disability Measurements in Patients with Chronic Nonspecific Low Back Pain. *J Occup Rehabil* 12:119-129
13. Stratford PW, Binkley J, Solomon P et al. (1994) Assessing Change Over Time in Patients with Low Back Pain. *Phys Ther* 74:528-533
14. Taylor SJ, Taylor AE, Foy MA et al. (1999) Responsiveness of Common Outcome Measures for Patients with Low Back Pain. *Spine* 24:1805-1812
15. Walsh TL, Hanscom B, Lurie JD et al. (2003) Is a Condition-Specific Instrument for Patients with Low Back Pain/Leg Symptoms Really Necessary? The Responsiveness of the Oswestry Disability Index, MODEMS, and the SF-36. *Spine* 28:607-615

## Oswestry Disability Questionnaire

- ▶ Oswestry Disability Index

## Oswestry Low Back Pain Disability Questionnaire

- ▶ Oswestry Disability Index

## Outcome Measures

VICTOR WILK  
Brighton Spinal Group, Brighton, VIC, Australia  
vicwil@tpg.com.au

### Synonyms

Outcome Questionnaires; Outcomes Assessment Tools; pain questionnaires; Measuring Tools

### Definition

An outcome measure is a feature of a patient's health status that can be quantified in order to assess the benefits of a treatment. Domains that are typically assessed include physical functioning, strength, range of movement, endurance, aerobic capacity, pain, disability, medication usage, work status, work capacity and quality of life. The term outcome measure is increasingly being used to refer to self-administered questionnaires, which seek to measure the change in status of the patient over time.

### Characteristics

#### Principles

Self-administered questionnaires have three broad purposes. They can discriminate between subjects; predict outcome; or evaluate change over time. The outcome measure should be: reliable, valid, responsive to change, simple to administer, quick to fill out (less than 5 minutes), quick and easy to score (less than 1 minute), and low in cost. In addition to the technical and scientific issues regarding the collating of outcome measures, there are also ethical and moral issues involved in the collection of data, interpretation of data and sharing of data with others. The main domains of assessment commonly measured are:

- Physical assessment by clinician
- Functional capacity
- Pain
- Disability
- Quality of life
- Psychological measures such as depression, anxiety, fear and various personality traits.
- Utilisation of services: medical visits, hospitalisation, drugs, allied health visits, and home help
- Employment status



## Applications

Traditional physical assessment, including noting the range of motion of the spine or joints, does not often correlate well with the level of pain and function. Pain, disability and quality of life measures assessed by self-administered questionnaires are best at predicting meaningful outcomes such as return to work.

Functional capacity is used increasingly in assessing fitness to return to work, and may involve measurement of aerobic capacity, standing and sitting tolerances, walking distance, walking speed, bending and lifting.

## Measuring Pain

The three dimensions of pain that may be assessed are: pain intensity, pain affect, and pain location. Pain intensity may be simply defined as “how much a person hurts”. Pain affect is more complex and relates to “the emotional feeling of pain”. Pain location is simply “where is the pain.”

### Pain intensity

Pain intensity is most commonly measured by rating scale methods including the verbal rating scales (Likert Scale), numerical pain scales (NRS), the visual analogue scale (VAS) and the more recently devised Visual Analogue Thermometer.

Verbal rating scales use descriptors such as none, slight, mild, moderate, severe, strong, intense, and extremely intense.

Numerical rating scales (NRS) involve rating pain on a scale of 0 to 10 (or 0 to 100) with no pain=0 and the worst pain imaginable = 10 (or 100). The 0 to 10 numerical scale is recommended for its ease of use and patient compliance.

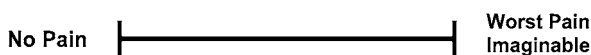
The Visual Analogue Scale (VAS) consists of a 10 cm line drawn on the page or administered by a slide rule, where the subject is asked to rate their pain from nil to worst imaginable (Fig. 1).

Visual analogue scales have the advantage of the subject not being able to recall their previous response, but are more difficult to score as the researcher needs to measure the mark on the line in millimetres each time; and they cannot be administered over the telephone like the NRS (Jensen and Karoly 1992).

Faces scales employ a series of caricatures (faces), expressing different degrees of happiness and/or distress and are used mainly with children, and have acceptable levels of correlation with other scales.

### Pain Affect

Pain Affect has been assessed using the ► **McGill Pain Questionnaire** (MPQ) (Melzack 1975) and others, where



**Outcome Measures, Figure 1** An example of a Visual Analogue Scale for pain.

patients are asked to choose words from a list to describe their pain; e.g. dull, sharp, stabbing. The use of emotive terms, such as agonising or cruel, signifies psychological distress.

### Pain Location

Pain Location is best assessed using pain drawings, where the patient is asked to mark their areas of discomfort. Recent studies have demonstrated some discriminating properties (Ohnmeiss et al. 2000) (Fig.2).

## Measures of Disability

Many disability scales are currently in use. The most common include the ► **Oswestry Disability Questionnaire** (ODQ), the Roland Morris Questionnaire (RMQ) for assessing low back pain, and the Neck Disability Index (NDI) for assessing neck problems. The ODQ has been the most studied questionnaire, having also been compared to a number of other measures, including the Pain Disability Index (PDI), the McGill Pain Questionnaire, and the Aberdeen Back Disability Questionnaire.

**The Oswestry Low Back Pain Disability Questionnaire (ODQ)** measures the extent to which a person's daily activities are restricted by back or leg pain (Fairbank et al. 1980). The first section rates the intensity of pain, and the remaining sections rate difficulties with personal care, lifting, walking, sitting, standing, sleeping, sex life, social life and travelling.

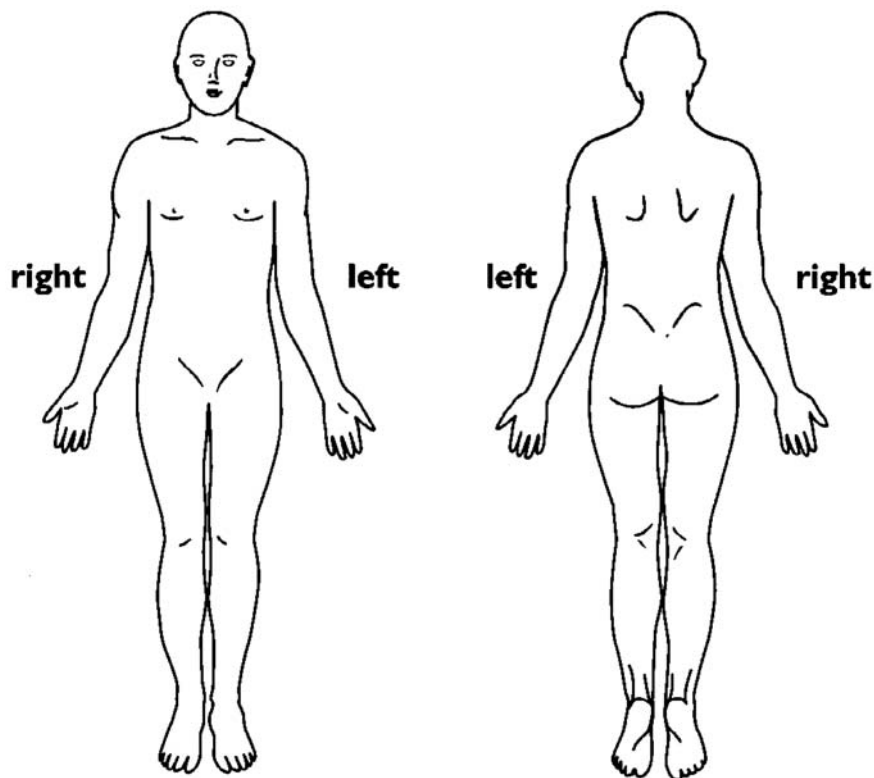
**The Roland Morris Questionnaire (RMQ)** was derived from the Sickness Impact Profile (SIP), reducing the items down from 136 to a more practical 24 (Roland and Morris 1983). The scale consists of yes/no responses to 24 items.

**The Neck Disability Index (NDI)** was first published in 1991, and was largely based on the Oswestry Disability Questionnaire (ODQ) for low back pain. Likewise, the Northwick Park Questionnaire is based on the Oswestry questionnaire with 9 questions using a 5–point scale, as well as a transitional question on the patients' global assessment.

Two questionnaires commonly in use to assess arthritis are the Lequesne (for osteoarthritis of hip and knee), and the Western Ontario and McMaster Universities Osteoarthritis Index (WOMAC).

**Function Specific questionnaires** ask the patient what particular activities they are limited in and then to rate that limitation over time. They are not useful in giving an overall measure of disability, but are very useful in assessing the usefulness of a treatment over time for a particular individual. They are reliable and valid for that subject and that condition, but it is difficult to compare the results with other subjects and other populations.

**The Fibromyalgia Impact Questionnaire (FIQ)** is a brief 10–item, self-administered instrument that measures physical functioning, work status, depression, anxiety, sleep, pain, stiffness, fatigue, and well being.



Outcome Measures, Figure 2 An example of a pain drawing

### Quality of Life

The best known of these are the Short Form 36 Questionnaire (SF-36) and the Sickness Impact Profile (SIP).

The SF-36 includes one multi-item scale that assesses eight health concepts: (1) physical activity limitation; (2) social activity limitation; (3) usual role activities limitation due to physical problems; (4) bodily pain; (5) general mental health; (6) role activities limitation due to emotional problems; (7) vitality; and (8) general health perceptions (McHornery et al. 1993). The SF-36 was developed for a normal population and scored between 0 and 100, the higher the score the better the health. A cut down version of 12 items has been developed called the SF-12.

The Sickness Impact Profile (SIP) underwent a long and rigorous development phase and was one of the first global health measures. However, as it contains 136 items covering 12 domains of health, it is not really practical, except in a clinical trial setting, and thus has not been used much recently. All of the items utilise binary scales with yes/no responses which contribute to its length.

### Psychological Measures

Pain, suffering, and disability each depend upon a range of cognitive and affective factors. A large number of instruments have been developed to assess patients' personalities, behaviours, attitudes, expectations, lev-

els of distress and coping strategies in dealing with chronic pain. However, researchers cannot agree which ones may be useful.

*Depression:* The measurement of depression is most commonly assessed by the Beck Depression Index (BDI) (Beck and Beamesderfer 1974) and Zung Depression Scale (Zung et al. 1965).

*Anxiety:* There are questions on anxiety in most psychological questionnaires. Despite this, a new, more specific questionnaire has recently been developed: The Pain Anxiety Symptom Scale (PASS). The Depression Anxiety Stress Scales (DASS) assesses both anxiety and depression.

*Willingness to change:* Pain Stages of Change Questionnaire (PSOCQ) assesses readiness for change. This questionnaire has been used as a screening tool when assessing patients for intake into a pain management program.

Other domains in the psychological sphere include coping strategies, catastrophising, abnormal illness behaviour/beliefs. A Fear-Avoidance Beliefs Questionnaire (FABQ) was developed by Waddell et al. (1993), based on theories of fear and avoidance behaviour, and focused specifically on patients' beliefs about how physical activity and work affected their low back pain. Another questionnaire, bridging the gap between physical and psychological impact of chronic pain, is the West Haven-Yale Multidimensional Pain Inventory (WHYMPI).

### Service Utilisation

This outcome measure requires no specific instruments. It catalogues the incidence and nature of medical consultations, hospitalization, use of drugs, allied health visits and home help assistance.

### Socio-Economic

Questions in this domain cover social, employment, financial, litigation and compensation issues.

### Patient Satisfaction

Deyo et al. found that the most important factor in patient satisfaction was receiving an adequate explanation for their symptoms (Deyo and Diehl 1986). Patient satisfaction may, therefore, be inappropriate as an outcome measure, as it may be rated high even if the patient may have been given a completely absurd explanation for their symptoms.

### Validity

An unresolved issue is what constitutes a meaningful degree of change with any outcome measure. Recent and ongoing research efforts have targeted precision and sensitivity to change of various outcome measures, and what constitutes a minimally effective change. These differ for different measures.

### References

1. Beck AT, Beamesderfer A (1974) Assessment of Depression: The Depression Inventory. *Mod Probl Pharmacopsychiatry* 7:151–169
2. Deyo RA, Diehl AK (1986) Patient Satisfaction with Medical Care for Low-Back Pain. *Spine* 11:28–30
3. Fairbank JC, Couper J, Davies JB, O'Brien JP (1980) The Oswestry Low Back Pain Disability Questionnaire. *Physiotherapy* 66:271–273
4. Jensen MP, Karoly P (1992) Self Reporting Scales and Procedures for Assessing Pain in Adults. In: Turk DC, Melzack R (eds) *Handbook of Pain Assessment*. The Guilford Press, New York, pp 135–151
5. McHorney CA, Ware JE, Raczek AE (1993) The MOS 36–Item Short-Form Health Survey (SF-36): II. Psychometric and Clinical Tests of Validity in Measuring Physical and Mental Health Constructs. *Medical Care* 31:247–263
6. Melzack R (1975) The McGill Pain Questionnaire: Major Properties and Scoring Methods. *Pain* 1:277–279
7. Ohnmeiss DD, Vanharanta H, Estlander AM, Jansen A (2000) The Relationship of Disability (Oswestry) and Pain Drawings to Functional Testing. *Eur Spine J* 9:208–212
8. Roland M, Morris R (1983) A Study of the Natural History of Back-Pain. Part 1: Development of a Reliable and Sensitive Measure of Disability in Low Back Pain. *Spine* 8:141–144
9. Waddell G, Newton M, Henderson I, Somerville D, Main CJ (1993) A Fear-Avoidance Beliefs Questionnaire (FABQ) and the Role of Fear-Avoidance Beliefs in Chronic Low Back Pain and Disability. *Pain* 52:157–168
10. Zung WW, Richards CB, Short MJ (1965) Self-Rating Depression Scale in an Outpatient Clinic. Further Validation of the SDS. *Arch Gen Psychiatry* 13:508–515

## Outcome Questionnaires

- ▶ Outcome Measures

## Outcomes Assessment Tools

- ▶ Outcome Measures

## Ovariectomy

### Definition

Surgical removal of both ovaries.

- ▶ Visceral Pain Models, Female Reproductive Organ Pain

## Over the Counter Analgesics

- ▶ Simple Analgesics

## Overalertness

- ▶ Hypervigilance and Attention to Pain

## Overlap Syndrome

### Definition

Overlap syndromes are a group of inflammatory myositis in association with other signs of a connective tissue disease. Myositis-associated autoantibodies are a characteristic.

- ▶ Myositis

## Oxidative Stress

### Definition

Oxidative stress occurs when the production of free radical species such as superoxide, hydrogen peroxide and nitric oxide exceeds the capacity of cells to remove them via their antioxidant defense mechanisms. The excess free radicals attach to proteins, lipids and nucleic acids and alter or disrupt the normal function of these cellular constituents. Oxidative stress has been implicated in normal aging and many pathologic processes, including diabetic neuropathy.

- ▶ Neuropathic Pain Model, Diabetic Neuropathy Mode

## Oxycodone

### Synonyms

Hydroxy-7.8-Dihydrocodeinone

**Definition**

Oxycodone (14-Hydroxy-7,8-Dihydrocodeinone) is a semi-synthetic derivative of the opium alkaloid thebaine, with mu and kappa activity.

► Postoperative Pain, Oxycodone

---

**Oxycodone and its Metabolites****Definition**

Oxycodone and its metabolites are excreted primarily by the kidney [ free oxycodone (19%); conjugated oxy-

codone (50%); conjugated oxymorphone (14%) and free and conjugated noroxycodone].

► Postoperative Pain, Oxycodone

---

**Oxycontin****Definition**

Oxycontin is a controlled release formulation of oxycodone that provides controlled release/delivery of oxycodone over 12 hours, with an onset of analgesia within 1 hour.

► Postoperative Pain, Oxycodone



## P/Q Type Calcium Channel

### Definition

Voltage-dependent  $\text{Ca}^{2+}$  channels not only mediate the entry of  $\text{Ca}^{2+}$  ions into excitable cells but are also involved in a variety of  $\text{Ca}^{2+}$ -dependent processes, including muscle contraction, hormone or neurotransmitter release, and gene expression. The alpha-1A isoform is abundantly expressed in neuronal tissue and corresponds to the P/Q  $\text{Ca}^{2+}$  channel type. The P/Q  $\text{Ca}^{2+}$  channel is responsible for presynaptic neurotransmitter release. Abnormalities in this channel could lead to abnormal neurotransmitter release. The affected CACNA1A gene encodes the pore-forming  $\alpha_{1A}$  subunit of the P/Q-type channel ( $\text{Ca}_v2.1$ ), a predominant mediator of voltage-gated  $\text{Ca}^{2+}$  entry and transmitter release at many synapses in the central nervous system. Alterations in synaptic signaling are of likely importance for cross-talk between an ascending pain transmission pathway and inhibition by a powerful descending modulatory system, interactions that ultimately govern the generation of headache pain.

- ▶ [Migraine, Childhood Syndromes](#)

## P1 Receptors

### Definition

P1 receptors are seven transmembrane, G protein-coupled receptors that are activated by adenosine.

- ▶ [Purine Receptor Targets in the Treatment of Neuropathic Pain](#)

## P2X Receptor

### Definition

Extracellular adenosine 5'-triphosphate (ATP) evokes cation currents in primary afferent neurons. P2X receptors are believed to be ligand-gated cation channels with two membrane spanning domains that are activated by the binding of extracellular ATP. P2X purinoceptors

have been cloned from different tissues and P2X1–7 cDNA have been identified. Among them, P2X3 subunits have been found to be important receptors that sense peripheral information.

- ▶ [ERK Regulation in Sensory Neurons during Inflammation](#)
- ▶ [Purine Receptor Targets in the Treatment of Neuropathic Pain](#)
- ▶ [TRPV1 Modulation by p2Y Receptors](#)

## P2X3 Receptor

### Definition

The P2X<sub>3</sub> receptor is a ligand-gated channel activated by adenosine triphosphate (ATP) and mediates fast excitatory transmission. The P2X<sub>3</sub> channel is selectively expressed by unmyelinated (C-fiber) nociceptors, and exists as either P2X<sub>3</sub> homomers or P2X<sub>2/3</sub> heteromers. P2X<sub>3</sub> receptor expression overlaps substantially with the IB4 positive population of small-diameter sensory neurons.

- ▶ [IB4-Positive Neurons, Role in Inflammatory Pain](#)
- ▶ [Nerve Growth Factor, Sensitizing Action on Nociceptors](#)

## P2Y Receptors

### Definition

P2Y Receptors are seven transmembrane, G protein-coupled receptors activated by ATP and other nucleotides.

- ▶ [Purine Receptor Targets in the Treatment of Neuropathic Pain](#)
- ▶ [TRPV1 Modulation by p2Y Receptors](#)

## p38 MAP Kinase

### Synonyms

P38 MAPK

### Definition

p38 mitogen activated protein kinase is involved in intracellular signaling pathways that control both: (a) the production of proinflammatory cytokines, and (b) cellular activation caused in response to proinflammatory cytokines binding to their receptors. p38 MAPK is activated by stress signals, such as inflammatory cytokines, heat shock and ischemia. Although an activity-dependent p38 activation occurs in neurons, the contribution of p38 MAPK to nociception and pain hypersensitivity is still under investigation. Peripheral inflammation induces p38 activation in small DRG neurons and contributes to the maintenance of inflammatory pain hypersensitivity.

- ▶ ERK Regulation in Sensory Neurons during Inflammation
- ▶ Proinflammatory Cytokines

## p75 Receptor

### Definition

P75 is the low-affinity nerve growth factor (NGF) receptor that binds and internalizes nerve growth factor (NGF), neurotrophin-3 (NT-3) and brain derived neurotrophic factor (BDNF). It is normally expressed in sensory neurones, mainly of small diameter, and on the terminals of sympathetic and small sensory neurones in peripheral tissues such as skin and vascular muscle. These target tissues produce neurotrophins, which are necessary for the maintenance of many sympathetic and sensory neurones. After peripheral nerve injury, p75 expression is reduced in neurones and upregulated on satellite glia in dorsal root ganglia.

- ▶ Nerve Growth Factor, Sensitizing Action on Nociceptors
- ▶ Satellite Cells and Inflammatory Pain
- ▶ Sympathetic and Sensory Neurons after Nerve Lesions, Structural Basis for Interactions

## PACAP

### Definition

PACAP (pituitary adenylate cyclase-activating polypeptide), a 38-amino acid peptide, was characterized from hypothalamic tissue as a potent stimulator of adenylyl cyclase. PACAP shows a high sequence homology with VIP. It has a wide distribution in the brain and spinal cord, as well as in sensory and autonomic ganglia and in inhibitory neurons of the enteric nervous system. PACAP in endings that innervate most endocrine glands and lymphatic tissue acts as an anti-inflammatory peptide. Immune cells also contain PACAP.

- ▶ Neuropeptide Release in the Skin

## Pachymeningeal Enhancement

### Definition

A distinct MRI picture that, in the setting of an orthostatic headache, is almost diagnostic of a CSF leak. After gadolinium there is diffuse enhancement limited to the pachymeninges without leptomeningeal involvement.

- ▶ New Daily Persistent Headache

## Pachymeningeal Enhancement in MRI with Gadolinium

### Definition

Typically linear, thick, and diffuse enhancement of the dura mater in MR images. Whereas the leptomeninges have blood brain barriers, the pachymeninges do not and therefore accumulate the contrast medium.

- ▶ Headache due to Low Cerebrospinal Fluid Pressure

## Paediatric Chronic Pain Management

- ▶ Complex Chronic Pain in Children, Interdisciplinary Treatment

## Paediatric Pain Measures

- ▶ Pain Assessment in Children

## Paediatric Pain Scales

- ▶ Pain Assessment in Children

## Paediatric Procedural Analgesia

- ▶ Pain and Sedation of Children in the Emergency Setting

## Paediatric Sedation

- ▶ Pain and Sedation of Children in the Emergency Setting

## PAG

- ▶ Periaqueductal Gray

## Paget's Disease

### Definition

Paget's disease is a malfunction in the normal process of bone remodeling.

- ▶ [Chronic Low Back Pain, Definitions and Diagnosis](#)

## Pain

### Definition

Pain is an unpleasant sensory and emotional experience associated with actual or potential tissue damage, or described in terms of such damage (Definition of the International Association for the Study of Pain, IASP). The inability to communicate verbally does not negate the possibility that an individual is experiencing pain and is in need of appropriate pain-relieving treatment. Pain is a symptom, not an impairment. A symptom, of itself, is neither exertional nor nonexertional. It is the nature of the limitations or restrictions caused by the symptom that are exertional or nonexertional. In a given individual, pain may cause exertional limitations and restrictions, nonexertional limitations and restrictions, or a combination of both.

- ▶ [Cancer Pain Management, Radiotherapy](#)
- ▶ [Disability Evaluation in the Social Security Administration](#)
- ▶ [Disability, Upper Extremity](#)
- ▶ [Ethics of Pain in the Newborn Human](#)
- ▶ [Lateral Thalamic Pain-Related Cells in Humans](#)
- ▶ [Multidimensional Scaling and Cluster Analysis Application for Assessment of Pain](#)
- ▶ [Pain Assessment in Neonates](#)
- ▶ [Pain Assessment in the Elderly](#)
- ▶ [Pain Treatment, Intracranial Ablative Procedures](#)
- ▶ [Physical Exercise](#)
- ▶ [Statistical Decision Theory Application in Pain Assessment](#)
- ▶ [Tourniquet Test](#)

## Pain Affect

- ▶ [Nociceptive Processing in the Cingulate Cortex, Behavioral Studies in Animals](#)

## Pain Amplification Disability Syndrome

- ▶ [Somatization and Pain Disorders in Children](#)

## Pain and Sedation of Children in the Emergency Setting

SUZAN SCHNEEWEISS

The Hospital for Sick Children and The University of Toronto, Toronto, ON, Canada

suzan.schneeweiss@sickkids.ca

### Synonyms

Paediatric Procedural Analgesia; Paediatric Sedation

### Definition

Procedural sedation is a technique of administering sedatives or dissociative agents with or without analgesics to induce a state that allows the patient to tolerate unpleasant procedures while maintaining cardiorespiratory function. Procedural sedation and analgesia are intended to result in a depressed level of consciousness while allowing the patient to maintain airway control independently and continuously. Specifically, the drug doses and techniques used are intended to maintain protective airway reflexes (American College of Emergency Physicians 1998).

### Characteristics

In recent years, there has been increasing recognition of the need to provide adequate analgesia and anxiolysis to children undergoing procedures in the Emergency Department (Kennedy and Luhmann 1999). Although children often report fear of a procedure to be the most anxiety provoking aspect of their emergency room visit, they often receive less analgesia than their adult counterparts in the emergency setting (Petrack et al. 1997). Fear of adverse events has often prevented the use of sedative and analgesic agents in children (Cote et al. 2000; Pena and Krauss 1999). Emergency physicians, skilled in the care of critically ill children as well as in the management of the paediatric airway, are increasingly providing children with better pain and anxiety control (Hoffman et al. 2002; Krauss and Green 2000). The Emergency Department provides a unique situation with regards to the patient population and the environment. Most children presenting with an acute illness or injury requiring an urgent or emergent procedure are healthy.

Although many procedures performed in the Emergency Department are not highly painful, such as an intravenous cannulation, they may provoke a high degree of anxiety in children and not only warrant pain relief, but also require some degree of anxiolysis. Even non-painful diagnostic imaging procedures such as CT scanning in which the child must lie motionless can provoke a high degree of anxiety. There are procedures, however, that are both highly painful and anxiety provoking, requiring both a higher degree of anxiolysis and analgesia (e.g. fracture reduction).

The therapeutic goals of procedural analgesia and anxiolysis are:

1. To ensure the patient's safety and welfare
2. To minimize physical discomfort or pain during a diagnostic or therapeutic procedure
3. To minimize the negative psychosocial responses to treatment
4. To enhance cooperativeness of the child
5. To return the patient to a state whereby safe discharge, as determined by recognized criteria, is possible.

#### Guidelines for Procedural Analgesia and Sedation

Guidelines are available from various sources regarding the general practice of procedural sedation and analgesia by non-anaesthetists in order to provide safe, consistent and appropriate sedation to children in the emergency setting undergoing invasive and non-invasive procedures (American College of Emergency Physicians 1998, 2004; American Academy of Pediatrics 1992, 2002; American Society of Anesthesiologists 2002; Innes et al. 1999). Central to these guidelines is the notion of a sedation continuum whereby any procedural sedative agent can result in a dose dependent alteration in a child's level of consciousness from ► **minimal sedation** progressing to ► **moderate sedation** and finally to ► **deep sedation** and general anaesthesia. In the emergency setting, the minimum amount of drug to achieve the desired depth of sedation is achieved by careful intravenous titration of the sedative and analgesic agents.

Agents used for moderate sedation require personnel skilled in management of potentially life threatening airway complications. These children require a thorough pre-procedural assessment including a focused history and physical examination including a detailed airway assessment for potential complications. Children deemed high risk should be referred to an anaesthetist for further assessment and management. Generally, children classified as ASA I or ASA II by the American Society of Anaesthesiologists, as shown in Table 1, can undergo moderate sedation by non-anaesthetist physicians. Skilled personnel must be available to deal

with potential complications. Children should be continuously monitored with frequent vital signs to detect early onset of reversible complications. Practice guidelines must be established in each individual emergency setting ensuring appropriate training of personnel to recognize potential adverse events and skills necessary to intervene and manage all potential complications. Suitable monitoring and emergency equipment should be available for children of all ages and sizes being treated. Emergency equipment including oxygen, suction, positive pressure bag-valve-mask and emergency resuscitation drugs should be immediately available and functional during sedation and recovery period. An assessment and documentation of food and fluid intake should be done prior to the procedure. Fasting guidelines and sound clinical judgment should be exercised by the physician in determining the appropriate time interval between the last oral intake and procedural sedation. In urgent, emergent or other situations where gastric emptying is impaired, the potential for aspiration of gastric contents must be considered in determining the timing of the intervention and the degree of sedation / analgesia. If possible, such patients may benefit from delaying the procedure. When proper fasting cannot be assured, the increased risks of sedation must be carefully weighed against its benefits and the lightest sedation should be used. Following the procedure, strict discharge criteria are required, as increased sedation may occur when the painful stimulus is discontinued or if there are prolonged sedative effects because of the pharmacodynamic or pharmacokinetic properties of the medication.

#### Non-pharmacological Management of Pain and Anxiety

Parents play a key role both in their response to their child's pain and in their care of the child in the Emergency Department. Increasingly, parental presence for procedures is encouraged as a source of comfort and support for their child (Merritt et al. 1998). Emergency personnel must be sensitive to parental needs while at the same time ensuring parents do not interfere with the procedure. Preparation of the family for the procedure is a key factor in reducing parental anxiety and

**Pain and Sedation of Children in the Emergency Setting, Table 1** Classification of the American Society of Anesthesiologists

CLASS	DESCRIPTION	SUITABILITY FOR SEDATION
1	Normally healthy patient	Excellent
2	A patient with mild systemic disease (no functional limitation)	Generally good
3	A patient with severe systemic disease (definite functional impairment)	Intermediate to poor; consider benefits relative to risks
4	A patient with severe systemic disease that is a constant threat to life	Poor, benefits rarely outweigh risks
5	A moribund patient who is not expected to survive without the operation	Extremely poor

Adapted from Krauss and Green (2000)



facilitating the procedure, including an explanation of the procedure to be performed as well as an accurate description of the sensations that children will probably experience. Emphasize the qualitative sensations that a child may experience such as cold, tingling, sharp, so that the child can focus on the sensation rather than only the expectation of hurting. Personnel should avoid using medical jargon when discussing the procedure with the family and explain when they need to attempt a procedure more than once. Age-appropriate distraction techniques are useful adjuncts. Child life specialists bring a wealth of distraction and relaxation techniques into the emergency setting (Aldock et al. 1985). Music, bubbles, puppetry, story and activity books may be very useful for younger children, while older children may benefit from music through headphones, directed breathing and calming self-instruction such as “I can do it” or “I am calm.” More sophisticated methods such as imagery and hypnosis requires skilled personnel and are particularly effective for children who require multiple procedures.

### Pharmacological Management of Pain and Anxiety

The practitioner must be familiar with the various pharmacological agents available and their side effect profiles as well as possible synergistic effects occurring when more than one agent is used (American College of Emergency Physicians 2004). Commonly used agents and drug dosages are listed in Table 2 and Table 3 respectively. Some agents such as ketamine provide both analgesia and anxiolysis while other agents may provide only analgesia (e.g. morphine) or anxiolysis (e.g. midazolam). Shorter acting opioid agents such as fentanyl are preferred to the traditional long acting morphine or meperidine because they have a faster onset of action and shorter duration of action and involve no histamine release. The dissociative agent, ketamine is commonly used because it is characterized by profound analgesia, sedation, amnesia and immobilization, while preserving upper-airway muscular tone and protective airway reflexes.

A key to minimizing complications of procedural sedation and analgesia is the slow titration of drugs to the

**Pain and Sedation of Children in the Emergency Setting, Table 2** Commonly used sedative and analgesic agents in the emergency department

AGENT / ROUTE OF ADMINISTRATION	CLINICAL EFFECT	PRECAUTIONS	INDICATIONS
<b>SEDATIVE-HYPNOTIC</b>			
MIDAZOLAM	Sedation Motion control Anxiolysis	No analgesia May not immobilize patient Paradoxical reactions Synergistic with opioid analgesic Reversible with flumazenil	Procedures requiring anxiolysis
PENTOBARBITAL	Sedation Motion control Anxiolysis	No analgesia Not reversible	Diagnostic Imaging
<b>ANALGESIC AGENTS</b>			
MORPHINE	Analgesia	Concomitant administration of other respiratory depressants, including benzodiazepines, increases the risk of respiratory depression and prolongs the period of sedation Reversible with naloxone	Procedures with moderate to severe pain
FENTANYL	Analgesia	Apnea, skeletal muscle rigidity, chest wall rigidity with higher doses Synergistic effect with benzodiazepines Reversible with naloxone	Procedures with moderate to severe pain
KETAMINE	Analgesia, Dissociation Amnesia Motion control	Not reversible Not for use if potential raised ICP, cardiovascular disorder, airway instability, active pulmonary infection or disease, procedures resulting in increased secretions, infants <3 months, psychiatric disorder, glaucoma	Procedures with moderate to severe pain, anxiety or requiring immobilization
NITROUS OXIDE	Anxiolysis Analgesia Sedation Amnesia	Avoid in pneumothorax, bowel obstruction, otitis media Deep sedation may occur if used in conjunction with opioids or other sedatives and may progress to a state of deep sedation / general anaesthesia	Procedures requiring mild sedation and analgesia
<b>REVERSAL AGENTS</b>			
FLUMAZENIL	Benzodiazepine reversal	May require repeated doses due to short duration of action	Benzodiazepine overdose
NALOXONE	Opioid reversal	May require repeated doses due to short duration of action	Opioid overdose

**Pain and Sedation of Children in the Emergency Setting, Table 3** Recommended drug dosages for paediatric procedural sedation

DRUG	ROUTE OF ADMINISTRATION	DOSAGE
<b>Sedatives</b>		
Midazolam	Oral Intranasal Intravenous	Wt. <20 kg: 0.5–0.75 mg/kg Wt. ≥20 kg 0.3–0.5 mg kg <sup>-1</sup> maximum 20 mg; Administer 20–45 min prior to procedure 0.1–0.2 mg/kg (maximum 5 mg) (0.5–5 years) initially 0.05–0.1 mg/kg, titrate to maximum of 0.15 mg/kg (maximum 10 mg)
Pentobarbital	Intravenous Intramuscular	2.5 mg/kg over 1 min, Wait 1 min then 1.25 mg/kg over 30 s Wait 1 min then 1.25 mg/kg over 30 s Wait 1 min., then if required give additional 1.0 mg/kg to a total dose of 4.0–6.0 mg/kg (maximum 200 mg), titrated to effect If no intravenous access: 6 mg/kg for children <15 kg 5 mg/kg for children ≥15 kg Administer 20–30 min prior to procedure (maximum 200 mg)
<b>Analgesics</b>		
Fentanyl	Intravenous	0.5–1 mcg kg <sup>-1</sup> , administered slowly in incremental doses every 1–2 min to desired effect, maximum 3 mcg kg <sup>-1</sup> ; maximum initial dose 100 mcg When used with midazolam, reduce dosages of both drugs
Morphine	Oral Intravenous	0.3 mg/kg; Administer 30–60 min prior to procedure 0.05–0.1 mg/kg over 1 min (maximum 15 mg) Dose may be repeated once at 15 min
Ketamine	Intravenous Intramuscular	0.5–1.5 mg/kg slowly over 1–2 min May repeat 0.5 mg/kg × 1 in 10 min (maximum 100 mg) 4 mg/kg; may repeat half the dose in 10 min (maximum 100 mg)
Nitrous Oxide	Inhalation	A self-administration of no more than 50% nitrous oxide in oxygen
<b>Reversal Agents</b>		
Naloxone	Intravenous Intramuscular Endotracheal	0.001 mg/kg, titrate to maximum of 0.01 mg/kg May repeat every 2 min as required maximum dose 1 mg / dose
Flumazenil	Intravenous	0.01 mg/kg over 15 s; repeated every 1–3 min to a maximum of 5 doses ≤20 kg: 0.05 mg/kg total dose >20 kg: 0.2 mg / dose; 1 mg total dose

Adapted from Kowalczyk (2004) Sedation and Analgesia Guidelines. The 2004–2005 Formulary of Drugs. The Hospital For Sick Children, 23<sup>rd</sup> edn. The Graphics Centre: The Hospital for Sick Children: Toronto;2

desired effect. Combination of drugs may accentuate the potential side effects of each drug individually. Each agent is administered individually in small incremental doses to the desired effect. Sufficient time must elapse between doses to allow the effect of each dose to be assessed before subsequent drug administration. The propensity for combinations of sedative and analgesic agents to potentiate respiratory depression emphasizes the need to appropriately reduce the dose of each component, as well as the need to continually monitor respiratory function. Specific benzodiazepine and opioid antagonists (reversal agents) are available

to reverse possible respiratory depression from over sedation, improving the safety of procedural sedation. Local and regional anaesthesia may be useful adjuncts to procedural analgesia. They have no systemic effects and do not result in compromises to the airway. Newer topical agents are now available and are particularly useful anaesthetics for wound closure and intravenous insertion (Bishai et al. 1999).

### References

1. Aldock DS, Feldman W, Goodman JT et al. (1985) Evaluation of child life intervention in emergency department suturing. *Pediatr Emerg Care* 1:111–115

2. American Academy of Pediatrics (1992) Guidelines for monitoring and management of pediatric patients during and after sedation for diagnostic and therapeutic procedures. *Pediatrics* 89:1110–1115
3. American Academy of Pediatrics (2002) Guidelines for monitoring and management of pediatric patients during and after sedation for diagnostic and therapeutic procedures: addendum. *Pediatrics* 110:836–838
4. American College of Emergency Physicians (2004) Clinical policy: Evidence-based approach to pharmacologic agents used in pediatric sedation and analgesia in the emergency department. *Ann Emerg Med* 44:4:342–377
5. American College of Emergency Physicians (1998) Clinical policy for procedural sedation and analgesia in the emergency department. *Ann Emerg Med* 31:663–677
6. American Society of Anesthesiologists Task Force on Sedation and Analgesia by Non-Anesthesiologists (2002) Practice guidelines for sedation and analgesia by non-anesthesiologists. *Anesthesiology* 96:1004–1017
7. Bishai R, Taddio A, Bar-Oz B et al. (1999) Relative efficacy of lignocaine-prilocaine cream and amethocaine gel for local analgesia before venipuncture in children. *Pediatrics* 104:e31
8. Cote CJ, Notterman DA, Karl HW et al. (2000) Adverse sedation events in pediatrics: a critical incident analysis of contributing factors. *Pediatrics* 105:805–814
9. Hoffman GM, Nowakowski R, Troshynski TJ et al. (2002) Risk reduction in pediatric procedural sedation by application of an American Academy of Pediatrics / American Society of Anesthesiologists. *Pediatrics* 109:236–243
10. Innes G, Murphy M, Nijssen-Jorden C et al. (1999) Procedural sedation and analgesia in the emergency department. Canadian consensus guidelines. *J Emerg Med* 17:145–156
11. Kennedy RM, Luhmann JD (1999) The ouchless emergency department. Getting closer: Advances in decreasing distress during painful procedures in the emergency department. *Pediatr Clin North Am* 46:1215–1247
12. Krauss B, Green SM (2000) Sedation and analgesia for procedures in children. *N Engl J Med* 342:938–945
13. Merritt KA, Sargent JR, Osborn LM (1998) Attitudes regarding parental presence during medical procedures. *AmJ Dis Child* 144:270–271
14. Pena BM, Krauss B (1999) Adverse events of procedural sedation and analgesia in pediatric emergency department. *Ann EmergMed* 34:4:483–491
15. Petrack EM, Christopher NC, Kriwinsky J (1997) Pain management in the emergency department: Patterns of analgesic utilization. *Pediatrics* 99:711–714

## Pain as a Cause of Psychiatric Illness

TIPU AAMIR, ROBERT G. LARGE  
The Auckland Regional Pain Service, Auckland  
Hospital, Auckland, New Zealand  
bobl@adhb.govt.nz

### Synonyms

Psychopathology caused by pain; Pain as a Stressor; Psychological Consequences of Pain; Psychiatric Illness

### Definition

The title suggests a linear model of causality from pain to psychiatric illness. Careful reading of the studies addressing this issue, however, suggests that it is not that simple.

Pain cannot be fully explained in terms of a pure sensory phenomenon. Wall and Melzack's (1965) gate control theory of pain proposed a balance between sensory and central inputs, with a tonic input to the gating systems in the spinal cord from higher centres. At around the same time, various explanations based on psychoanalytic principles started to dominate the literature. The assumption, underlying the psychoanalytic principles, is that pain is a defence against unconscious psychic conflict. Most of the literature was based on anecdotal accounts (Merskey and Spear 1967).

In the 1970s (Gamsa 1994), ► **behavioural therapies** and ► **cognitive** theories were employed to explain the relationship of psychological factors and pain. Fordyce looked at pain as a reflexive response to an antecedent stimulus (tissue damage). He also postulated that pain behaviours depend on contingent reinforcement and can be learned by observing 'pain models'. In this behavioural model, factors like emotional state and other psychosocial variables are not considered. Cognitive approaches to pain look at the meaning of pain to the patients themselves. This cognitive model also looks at the beliefs, self-efficacy, problem solving, and coping abilities of the person. In the last 25 years, both cognitive and behavioural approaches have been combined and used extensively in pain management programmes. This brief overview highlights the shift from a linear to a multicausal model. In a biopsychosocial model, psychological and emotional factors play an important role in the continual experience of pain. The fact that psychosocial factors are considered so important in maintaining pain, leads to the assumption that psychiatric illnesses will be more common in patients with pain.

### Characteristics

#### Relationship between Pain and Psychiatric Disorder

Studies of psychiatric diagnoses in pain populations have revealed a high incidence of ► **psychiatric disorder**. In one study, 94% of chronic pain patients suffered from a psychiatric disorder; 30% of these were diagnosed as suffering from depression (Large 1980). Polatin et al. (1996) showed that, after excluding ► **somatoform pain disorder**, 77% of patients met lifetime diagnostic criteria and 59% showed current symptoms for at least one psychiatric diagnosis. The most common diagnoses were of major depressive disorder, substance abuse, and anxiety disorders. 51% of patients in this study met criteria for at least one ► **personality disorder**. The prevalence rates were significantly higher compared to the rates in the general population. This study also showed that, out of the patients with a life time diagnosis of a psychiatric disorder, 54% with major depressive disorder, 94% with substance abuse disorder and 95% with anxiety disorder, had experienced the disorders before the onset of their back pain. Hotopf et al. (1998) showed a robust link between psychiatric disorder and

presence of physical symptoms. "Psychiatric disorder was associated with 2.9–6.9- fold increase in the odds of each physical symptom. Back pain, abdominal pain and chest pain were all associated with an increased likelihood of new onset psychiatric symptoms aged 43 years." The best estimate of 1-year prevalence of any psychiatric disorder between age group 18–54 years, diagnosed using DSM III R, is 21.0%. The rate of Major Depressive episode is 6.5%. Hence there is a definite association between psychiatric disorder and pain.

#### Proposed Model of Development of Psychopathology

Gatchel (1996) has proposed a model of the development of psychopathology in low back pain over a period of time. This model looks at pain in three stages. Stage 1 represents the initial psychological distress, which is associated with fear and anxiety. This is a natural emotional reaction. When the pain continues beyond the acute period (2–4 months), it leads into stage 2. This stage is associated with phenomena like depression, distress, anger, somatization and learned helplessness. Stage 3 is the acceptance of the "► sick role" and consolidation of "► abnormal illness behaviour".

Gatchel (1996) hypothesises that the specific nature of the psychological problems that develop in stage 2, depend on the individual's pre-morbid personality and psychological characteristics. They suggest that there is no specific "► pain prone personality". The patient who suffers from persistent emotional problems passes onto stage 3, where the "sick role" is established and the patient is excused from his/her duties. This reinforces the sick role. This situation can be further complicated by compensation issues, which can become critical in the persistence of disability.

Banks and Kerns (1996) proposed a ► **Diathesis-Stress** framework for the development of depression in patients suffering from chronic pain. Diathesis refers to constitutional, biological or psychological vulnerability. The stressors are any environmental or life event perceived by the individual as threatening to his or her physical or psychological well being, and exceeding his or her capacities to cope. This model hypothesizes that a constitutional vulnerability in the presence of ► **stress** can perpetuate chronic pain and trigger a depressive disorder.

#### Pain as a Stressor

Pain, unlike some other chronic conditions, for example hypertension, is symptomatic (Banks and Kerns 1996). This quality of pain makes it noxious and aversive. The experience of pain is closely associated with affective distress. This may range through anxiety, fear, anger and depression. Pain becomes an overriding and ever present part of a person's life.

At a psychological level, pain signifies danger. This is an instinctive phenomenon, which is ingrained in animals to propel them into self-preservation behaviour. This be-

haviour includes retraction from danger, reduced activity and rest. The fact that pain represents danger raises the level of anxiety. In the longer term, pain promotes ► **impairment** and ► **disability**.

Impairment and disability lead to the restriction of a person's ability to participate in day-to-day social activities. Over a period of time cumulative effects of ongoing impairment and disability lead to a series of events nominated as secondary losses (Banks and Kerns 1996).

Secondary loss refers to the effect of pain in various domains of daily life. These include loss of work and leisure activities, interference in and loss of intimate relationships, financial strife, unemployment and loss of self-esteem. Thus, it can be inferred that pain is not an isolated phenomenon; rather it affects a person globally.

A consideration of the models above, together with the fact that pain can act as a stressor in its own right, enables us to postulate a model in which all these factors can interrelate (Fig. 1). An individual can have underlying vulnerabilities. These vulnerabilities can be a biological predisposition to various psychiatric disorders or premorbid personality traits e.g. paranoid, antisocial, borderline, histrionic, narcissistic, dependent etc. People during their lifetime can pass through various life events e.g. physical/sexual abuses, deprivation, loss, financial difficulties etc. In an individual with premorbid vulnerability, any of these life events can become a precipitating factor for psychiatric disorder. When such a vulnerable individual suffers from pain, it can act as a strong stressor as described above, and can precipitate or magnify a mental disorder. Thus, pain acts as a magnifying lens. This relationship works both ways. Conditions like depression, anxiety and somatization can increase pain, which can lead to an increase in stress and further deterioration of mental state. The underlying mechanisms at work are both cognitive and behavioural.

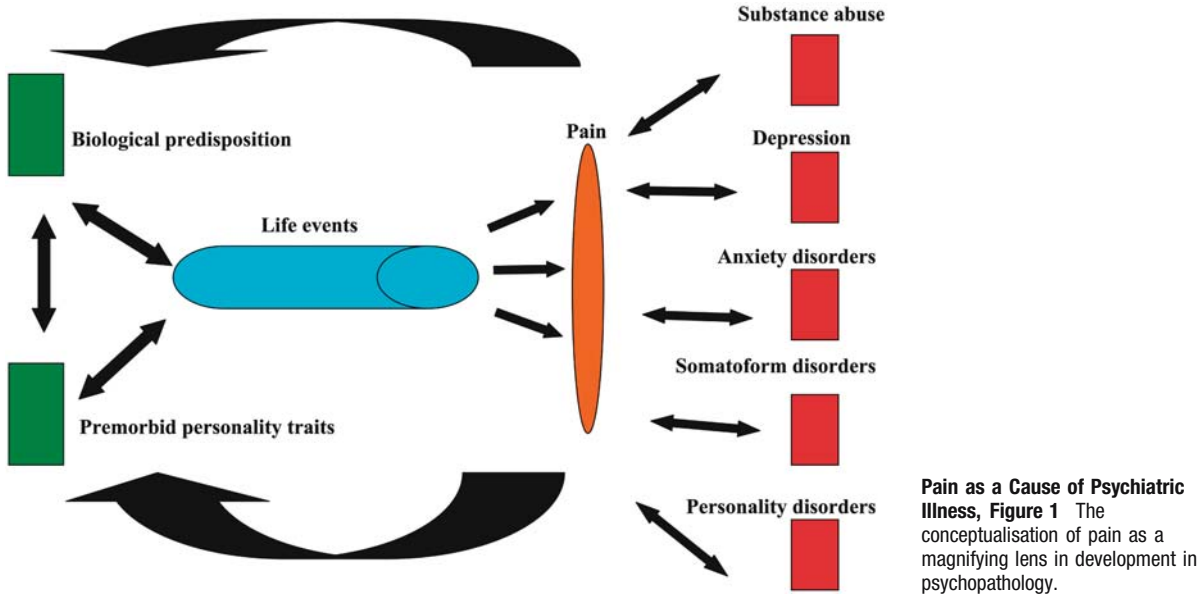
#### Relationship of Individual Psychiatric Disorders and Pain

##### Pain and Substance Related Disorders

The relationship between substance-related disorders and pain has been widely reported in the literature. The rate of current substance related disorders range between 15–28%, and the lifetime rate lies between 23–41%. Lifetime prevalence in the general population is 16.7% (Dersh et al. 2002). These disorders are more prevalent in males in both the pain sufferers and the general population.

Various pathways have been suggested to show the underlying interaction between the two conditions. Polatin et al. (1993) showed that 94% of chronic pain patients with lifetime substance related disorder had the onset of these disorders before the start of the pain disorder. This has been explained by an increased risk of accidents leading to chronic pain. Brown et al. (1996) have observed an increased risk for new substance related disorder 5 years after the onset of chronic pain. It can be due





to iatrogenic reasons. This risk is greater in individuals with a previous history of substance related disorder.

### Pain and Depressive Disorder

The relationship between pain and depression has generated quite a lot of interest, yet research on this subject is fraught with problems. These problems have arisen due to the different criteria used to define depression. Furthermore, DSM criteria of depression consist of a number of somatic features of depression e.g. sleep disturbance, sexual dysfunction etc. These features can also be symptomatic of organic illnesses (Dersh et al. 2002). However, despite these methodological difficulties, various hypotheses regarding the relationship between pain and depression have been studied.

Fishbain et al. (1997) conducted a literature review exploring the relationship between pain and depressive disorder. They considered the following hypotheses:

1. Antecedent: This hypothesis was very weakly supported by the literature
2. Consequence: This was very strongly supported by the literature.
3. Scar: This hypothesis suggested the episode of depression before the onset of pain predisposing to depression. Literature supporting this hypothesis was not consistent.
4. Cognitive-behavioural mediation model: This hypothesis presupposes the role of cognitive distortions mediating the relationship between depression and chronic pain. This model was supported by the literature.

Based on the currently available evidence, depression can be seen as a consequence of chronic pain in patients.

### Pain and Anxiety Disorder

Dersh et al. (2002) have highlighted the high rates of anxiety disorders in chronic pain patients. Rates between 16.5–28.8% have been observed. Factors leading to anxiety disorders can be premorbid vulnerability and anxiety in stage I (Gatchel 1996), Kinesophobia and operant conditioning (avoidance of feared situation reinforcing the disability) can maintain the disorder. Anxiety disorders can be explained on ► [diathesis-stress](#) model. Anxiety disorders have high rates in both acute and chronic pain states.

### Pain and Somatoform Disorders

Pain and somatoform disorders are closely related. Recently, literature has suggested an increased focus on internal stimuli. There has been no study published recently on this relationship using DSMIV. However, studies in the past suggested a rate of 73% (Dersh et al. 2002).

### Pain and Personality Disorder

The literature shows a high rate of personality disorders in chronic pain patients. The prevalence ranges from 31–81% (Dersh et al. 2002). However no specific personality disorder predicts chronicity. Research has shown that parameters on various personality assessments change from pre to post treatment in chronic pain subjects, with a reduction in personality disorder diagnoses being made post treatment. It may be that the stress of pain can exacerbate the patient's vulnerability, leading to the expression of psychopathology.

### Conclusion

The existing body of research shows that there is a definite association between psychiatric disorders and pain. The relationship between these conditions is complicated and efforts are being made to unravel the

complexities of their interaction. It is important for clinicians to be aware of this relationship, because failure to identify psychopathology can adversely affect the outcome of treatment and our patients' overall well being.

## References

1. Banks SM, Kerns RD (1996) Explaining High Rates of Depression Chronic Pain: A Diathesis-Stress Framework. *Psychol Bull* 119:95–110
2. Brown RL, Patterson JJ, Rounds LA, Papasouliotis O (1996) Substance use Among Patients with Chronic Back Pain. *J Family Practice* 43:152–160
3. Dersh J, Polatin PB, Gatchel RJ (2002) Chronic Pain and Psychopathology: Research Findings and Theoretical Considerations. *Psychosom Med* 64:773–786
4. Fishbain DA, Cutler R, Rosomoff HL, Rosomoff RS (1997) Chronic Pain-Associated Depression: Antecedent or Consequence of Chronic Pain? A review. *Clin J Pain* 13:116–137
5. Gamsa A (1994) The Role of Psychological Factors in Chronic Pain. I. A Half-Century of Study. *Pain* 57:5–15
6. Gatchel RJ (1996) Psychological Disorders and Chronic Pain: Cause-and-Effect Relationships. In: Gatchel RJ, Turk DC (eds) *Psychological Approaches to Pain Management: A Practitioner's Handbook*, chapter 2, pp 33–52
7. Hotopf M, Mayou R, Wadsworth M, Wessely S (1998) Temporal Relationships Between Physical Symptoms and Psychiatric Disorder. Results from a National Birth Cohort. *Br J Psychiatry* 173:255–61
8. Large RG (1980) The Psychiatrist and the Chronic Pain Patient: 172 anecdotes. *Pain* 9:253–263
9. Melzack R, Wall PD (1965) Pain Mechanisms: A New Theory. *Science* 150:971–979
10. Merskey H, Spear FG (1967) The Concept of Pain. *J Psychosom Res* 11:59–67
11. Polatin PB, Kinney PK, Gatchel RJ, Lillo E, Mayer TG (1993) Psychiatric Illness and Chronic Low-Back Pain. The Mind and the Spine - Which Goes First? *Spine* 18:66–71
12. Polatin PB, Mayer TG (1996) Occupational Disorders and the Management of Chronic Pain. *Orthop Clin North Am* 27:881–890

## Pain as a Stressor

- ▶ Pain as a Cause of Psychiatric Illness

## Pain Assessment

### Definition

Pain assessment is the systematic process of evaluating and making pain treatment decisions, obtained either through the use of self report or by proxy (a person other than the person experiencing pain, e.g. health care professional). The process incorporates the consistent use of standardized pain assessment tools to obtain a valid and reliable measure of pain and takes into consideration contextual, situational and familial factors. As it pertains to newborns, frequent assessment of pain and associated stress is required and especially relevant when newborns are on analgesics or sedatives.

- ▶ Pain Assessment in Children
- ▶ Pain Assessment in Neonates
- ▶ Pain Assessment in the Elderly

## Pain Assessment in Children

PATRICIA A. MCGRATH

Pain Research Center, The Hospital for Sick Children, University of Toronto, Toronto, ON, Canada  
patricia.mcgrath@sickkids.ca

### Synonyms

Paediatric Pain Measures; Paediatric Pain Scales

### Definition

Pain assessment is an integral component of pain management. At diagnosis, we need a reliable measure of a child's pain and an understanding of the factors that cause or contribute to pain and disability. Subsequent assessments of pain intensity enable us to determine when treatments are effective and to identify those children for whom they are most effective. Thus, pain assessment is a dynamic process that begins with a diagnostic examination and culminates with a clinical decision that a child's pain has improved sufficiently. Although the key aspects of assessment are the same throughout a treatment program, the assessment tools or specific measures differ depending on the treatment phase – diagnosis, routine clinical monitoring of treatment efficacy and evaluation at discharge to define whether a child has achieved the treatment objectives (McGrath and Koster 2001).

### Characteristics

The criteria for an accurate pain measure for children are similar to those required for any measuring instrument. A pain measure must be ▶ **valid**, in that it unequivocally measures a specific dimension of a child's pain so that changes in pain ratings reflect meaningful differences in a child's pain experience. The measure must be ▶ **reliable**, in that it provides consistent and trustworthy pain ratings regardless of the time of testing, the clinical setting or who is administering the measure. The measure must be relatively ▶ **free from bias** in that children should be able to use it similarly, regardless of differences in how they may wish to please adults. The pain measure should be practical and versatile for assessing different types of pain (e.g. disease-related, procedural pain) in many different children (according to age, cognitive level, cultural background) and for use in diverse clinical and home settings.

An extensive array of pain measures have been developed and validated for use with infants, children, and adolescents (Gaffney et al. 2003; McGrath and Gillespie 2001; RCN Institute 1999; Stevens et al. 2000). Children's pain measures are classified as

physiological (► [physiological pain measure](#)), behavioural (► [behavioral pain scale](#)) and psychological (► [psychological pain measures](#)) depending on what is monitored: physical parameters, such as heart or respiration rate, distress behaviours, such as crying or facial expression or children's own descriptions of what they are experiencing. Both physiological and behavioural measures provide indirect estimates of pain because the presence or strength of pain is inferred solely from the type and magnitude of responses to a noxious stimulus. In contrast, psychological measures can provide direct estimates for many different dimensions of pain (i.e. intensity, quality, affect, duration and frequency) and provide valuable information on the impact of pain.

### Behavioural Pain Scales

Most behavioural pain scales include checklists of the different distress behaviours (e.g. crying, grimacing, guarding) that children exhibit when they experience a certain type of pain (McGrath 1998; McGrath and Gillespie 2001; Stevens et al. 2000). Health care providers complete such pain scales by noting which of the listed behaviours they see and by ranking their intensity. Most behavioural scales were developed to measure acute procedural or post-operative pain in otherwise healthy children. More recently, attention is focusing on validating pain scales for children with developmental disabilities (Breau et al. 2002; Hadden and von Bayer 2002; Hunt et al. 1999; Oberlander and Craig 2003; Stallard et al. 2002; Terstegen et al. 2003).

### Physiological Pain Scales

Physiological parameters that have been monitored in infants and children as potential pain measures include heart rate, respiration rate, blood pressure, palmar sweating, cortisol and cortisone levels, O<sub>2</sub> levels, vagal tone and endorphin concentrations (Sweet and McGrath 1998). Although physiological responses can provide valuable information about a child's distress state, more research is required to develop a sensitive system for interpreting how these parameters reflect the quality or intensity of a child's pain. At present, physiological parameters do not constitute valid clinical pain measures for children.

### Psychological Pain Scales

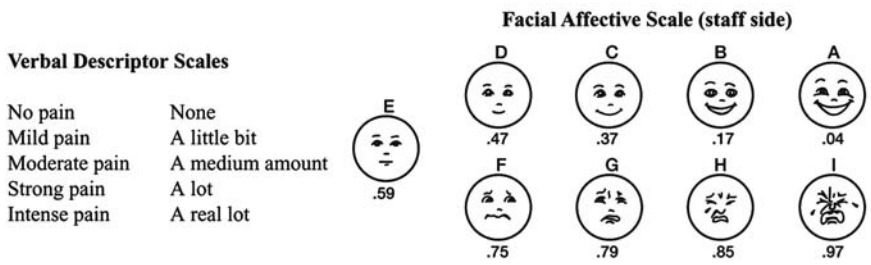
Psychological or self-report pain scales directly capture a child's subjective experience of pain. Interviews, questionnaires, adjective checklists and numerous pain intensity scales are available for children, each with some evidence of validity and reliability (Champion et al. 1998; McGrath and Gillespie 2001). These self-report measures can provide valuable diagnostic information about the causes and contributing factors for a child's pain, as well as provide practical tools for regularly assessing pain intensity to ensure that children receive adequate pain control.

When possible, health care providers should ask children directly about the location, quality, intensity, duration or frequency of pain using a semi-structured format (a few basic questions asked in a consistent manner with different follow-up questions depending on the child's responses). Clinical interviews are ideally suited for learning about the sensory characteristics of pain, the aversive component and contributing cognitive, behavioural and emotional factors. Interviews should also include a simple rating scale to document pain strength. Children can use many analogue, facial and verbal rating scales (samples shown in Fig. 1). Children select a level on the scale (i.e., a number, a mark on a visual analogue scale, a face from a series of faces varying in emotional expression or a particular word from an adjective list) to match the strength of their own pain. These scales are easy to administer, requiring only a few seconds once children understand how to use them. Table 1 lists some analogue scales developed for children, along with the type of pain used to initially develop the scale, the scale type, pain feature measured and the resulting pain score.

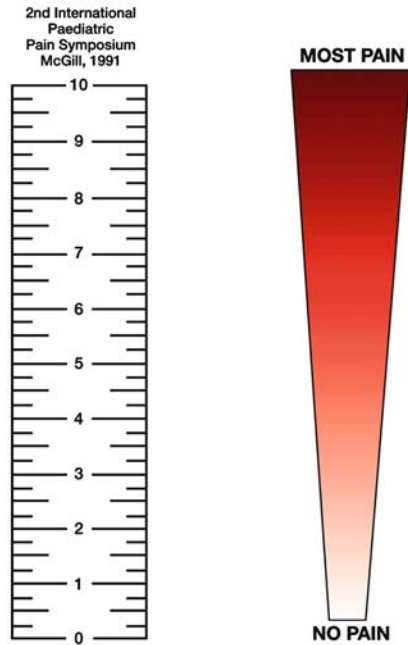
### Pain Ratings –What Do the Numbers Mean?

Although children can use many pain scales, the resulting pain scores from the different scales are not necessarily equivalent. Thus, it is important to know what the pain scores mean on different scales. Some scales simply use numbers to represent different pain intensity levels (e.g. no pain equals 0, mild pain equals 1, moderate pain equals 2 and strong pain equals 3). The numbers are often interpreted as if they represent absolute and accurate amounts of pain. But, unless an investigator studies the relationship between a child's pain level and the numbers he or she uses to rate – the psychometric properties – we only know that larger numbers mean stronger pain and we do not know how much stronger. As a result, when evaluating treatment effects, we cannot assume that a child who reports that a treatment lessened a pain from a score of 2 to 1 (moderate to mild) is equivalent to a reduction from 3 to 2 (strong to moderate) for another child. Similarly, when a child rates a pain as a 3, the pain level may not really be 3 × the strength of the pain he / she rates as a 1. Nevertheless, most pain scores are interpreted as if they represent numbers on equal interval or ratio scales.

The four types of measurement scales (nominal, as in the numbers designating players on a sports team, ordinal, as in the rank-ordering of children according to height, interval, as in the Fahrenheit temperature scale and ratio, as in a yardstick) refer to 4 different relationships between the properties of an event or perception (e.g. pain intensity score) and the number or metric system. Ratio scales have all the properties of the 3 other scales; they represent a set position or order between numbers, they show the magnitude of the difference between numbers and the numbers reflect true ratios of magnitude. Each



**Colored Analog Scale staff side (left) and child side (right)**



**Pain Assessment in Children, Figure 1** Three scales for assessing children's pain: word descriptor scale, facial affective scale and colored analog scale.

**Pain Assessment in Children, Table 1** Analog Pain Scales for Children

Name	Pain Type	Method	Pain Characteristic	Scale Type/Pain Score	Comments
Eland Colour Tool Eland and Anderson 1977	Post-operative	Projective rating scale on body outline	Intensity, location	Quantitative (probably interval)	Children select colours to represent 3 levels of pain and shade body outline
Poker Chip Tool Hester et al. 1990	Acute pain (immunization)	Object scale comprised of 4 poker chips	Intensity	Quantitative, interval scale pain scores 0-4	Children ages 4-7 yrs
Pain Thermometer Szyfelbein et al. 1985	Treatment (Burn dressing change)	Analogue scale, shaped like thermometer	Intensity	Quantitative, may be interval or ratio scale, pain scores 0-10	Children and adolescents, ages 8-17
Coloured Analogue Scale (CAS) McGrath et al. 1996	Acute trauma, postoperative, recurrent, chronic pain	Analogue scale, varying in length, hue, and area	Intensity	Quantitative, ratio scale properties, pain scores 0-10.0	Psychometric properties demonstrated Children ages 5 yrs and older, versatility demonstrated for clinical and home use
Multiple Size Poker Chip Tool (MSPCT) St. Laurent-Gagnon et al 1999	Procedural (immunization)	Object scale comprised of 4 poker chips, varying in size (2-3.8 cm)	Intensity	Quantitative, interval scale pain scores 0-4	Children ages 4-6 yrs



scale has a certain number of permissible mathematical calculations, so it is important to understand which type of scale one is using when measuring a child’s pain or evaluating analgesic efficacy.

**Guidelines for Selecting a Pain Scale for Children**

More than 50 pain scales have been developed for children. Yet, no one scale is appropriate for all children and for all situations in which they experience pain. The critical issue is how to select the most appropriate measure for the age and cognitive level of the child and one that satisfies your clinical objectives. Many simple, easy to use pain scales provide meaningful values that reflect a child’s pain intensity and are ideal measures for evaluating treatment effectiveness throughout a child’s treatment. But, they are not adequate for teaching us about the nature of a child’s pain or for identifying the primary and secondary situational factors that affect pain.

Health care providers must first consider the age and cognitive ability of a child when selecting a pain scale. Behavioural scales and physiological distress indices are required for infants and for children who are unable to communicate verbally. Although caution must always be used when interpreting children’s pain solely from their scores on these scales because children’s behaviours are not simply passive reflections of their pain intensity, these scales can provide valuable information. Because a child’s pain behaviours naturally vary in relation to the type of pain experienced, different behavioural scales are usually required for acute and chronic pain.

Most toddlers (approximately two years of age) first express the “hurting” aspect of pain using a few words learned from their parents to describe the sensations they feel when they hurt themselves. Gradually children learn to differentiate and describe three levels of pain intensity – “a little, some or medium and a lot” By the age of five, most children can differentiate a wide range of pain intensities and many children at this age can use simple quantitative scales to rate their pain intensity. These pain scales can provide meaningful values that reflect a child’s pain intensity and are ideal measures for evaluating treatment effectiveness throughout a child’s treatment.

But, pain intensity scales alone can not teach us about the nature of a child’s pain or enable us to identify the primary and secondary situational factors that affect pain (McGrath and Hillier 2003). Health care providers who treat a wide range of children’s pain problems need a flexible pain measurement inventory comprised of a more comprehensive assessment instrument and pain diaries, as well as simple pain intensity scales. Diaries are particularly useful for treating children with recurrent or chronic pain; children record prospectively the frequency, intensity, quality and duration of pain, as well as what they do to reduce the pain and its effectiveness. Diaries can be flexible instruments to fit the needs of the specific therapy program; health care providers may monitor school attendance, physical activity, peer activities, medication use and use of non-drug strategies using simple observation forms.

In summary, evaluating a child’s pain requires an integrated approach. Health care providers should always



**Pain Assessment in Children, Table 2** Primary components of pain assessment

<b>Sensory characteristics:</b>	<b>Cognitive factors:</b>
Onset Location Intensity Quality Duration Spread to other sites (consistent with neurological pattern) Temporal pattern Accompanying symptoms	Understanding of pain source Understanding of diagnosis, treatment, and prognosis Expectations Perceived control Relevance of disease or painful treatments Knowledge of pain control
<b>Medical/Surgical:</b>	<b>Behavioural factors:</b>
Investigations conducted Radiological and laboratory results Consult results Analgesic and adjuvant medications (type, dose, frequency, route)	General coping style Learned pain behaviours Overt distress level Parent’s behaviours Physical activities and limitations Social activities and limitations
<b>Clinical factors:</b>	<b>Emotional factors:</b>
Environmental features Roles of medical and associated health professionals Nature of interventions Documentation of pain Criteria for determining analgesic effectiveness	Frustration Anxiety Fear Denial Sadness Anger Depression

ask a child directly about his or her pain experience and evaluate the sensory characteristics to facilitate an accurate diagnosis. Pain onset, location, frequency (if recurring), quality, intensity, accompanying physical symptoms and pain related disability should be assessed as part of a child's clinical examination. Health care providers should also assess relevant situational factors in order to modify their pain-exacerbating impact, especially the factors listed in Table 2. Then, health care providers should assess pain intensity or pain behaviours regularly using brief quantitative scales to monitor the effectiveness of their therapy. Only previously validated pain scales should be used, unless clinicians are willing to conduct the rigorous research necessary to prove that a measure is valid and reliable and to determine its psychometric properties.

## References

- Breau LM, McGrath PJ, Camfield CS et al. (2002) Psychometric properties of the non-communicating children's pain checklist-revised. *Pain* 99:349–357
- Champion GD, Goodenough B, von Baeyer CL et al. (1998) Measurement of pain by self-report. In: Finley GA, McGrath PJ (eds) *Measurement of pain in infants and children*. Progress in Pain Research and Management. IASP Press, Seattle, pp 123–160
- Eland JM, Anderson JE (1977) The experience of pain in children. In: Jacox, AK (ed) *Pain: A source book for nurses and other health professionals*. Little, Brown, Boston, pp 453–471
- Gaffney A, McGrath PJ, Dick B (2003) Measuring pain in children: Developmental and instrument issues. In: Schechter NL, Berde CB, Yaster M (eds) *Pain in Infants, Children and Adolescents*, 2nd edn. Lippincott, Williams and Wilkins, Philadelphia, pp 128–141
- Hadden KL, von Baeyer CL (2002) Pain in children with cerebral palsy: common triggers and expressive behaviors. *Pain* 99:281–288
- Hester NO, Foster R, Kristensen K (1990) Measurement of Pain in Children: Generalizability and Validity of the Pain Ladder and the Poker Chip Tool. In: Tyler DC, Krane EJ (eds) *Pediatric Pain*. Raven Press, New York, pp 79–84
- Hunt AM, Goldman A, Seers K, Crichton N, Mastroyannopoulou K, et al. (2004) Clinical validation of the paediatric pain profile. *Dev Med Child Neurol* 46:9–18
- McGrath PJ (1998) Behavioral measures of pain. In: Finley GA, McGrath PJ (eds) *Measurement of pain in infants and children*. Progress in Pain Research and Management. IASP Press, Seattle, pp 83–102
- McGrath PA, Gillespie JM (2001) Pain Assessment in Children and Adolescents. In: Turk DC, Melzack R (eds) *Handbook of Pain Assessment*. Guilford Press, New York, pp 97–118
- McGrath PA, Hillier LM (2003) Modifying the psychological factors that intensify children's pain and prolong disability. In: Schechter NL, Berde CB, Yaster M (eds) *Pain in infants, children, and adolescents*. Lippincott Williams & Wilkins, Baltimore, pp 85–104
- McGrath PA, Koster AL (2001) Headache measures for children: a practical approach. In: McGrath PA, Hillier LM (eds) *The Child with Headache: Diagnosis and Treatment*. IASP Press, Seattle, pp 29–56
- McGrath PA, Seifert CE, Speechley KN et al. (1996) A new analogue scale for assessing children's pain: an initial validation study. *Pain* 64:435–443
- Oberlander TF, Craig KD (2003) Pain and children with developmental disabilities. In: Schechter NL, Berde CB, Yaster M (eds) *Pain in Infants, Children and Adolescents*, 2nd edn. Lippincott Williams & Wilkins, Philadelphia, pp 599–619
- RCN Institute (1999) *Clinical Guideline for the Recognition and Assessment of Acute Pain in Children: Recommendations*. RCN Publishing, London
- Szyfelbein SK, Osgood PF, Carr DB (1985) The assessment of pain and plasma beta-endorphin immunoactivity in burned children. *Pain* 22:173–82
- Stallard P, Williams L, Velleman R et al (2002) The development and evaluation of the pain indicator for communicatively impaired children (PICIC). *Pain* 98:145–149
- Stevens BJ, Johnston CC, Gibbins S (2000) Pain assessment in neonates. In: Anand KJS, Stevens BJ, McGrath PJ (eds) *Pain in Neonates*, 2nd edn. Elsevier, Amsterdam, pp 101–134
- St-Laurent-Gagnon T, Bernard-Bonnin AC, Villeneuve E (1999) Pain evaluation in preschool children and by their parents. *Acta Paediatr* 88:422–427
- Sweet S, McGrath PJ (1998) Physiological Measures of Pain. In: Finley GA, McGrath PJ (eds) *Measurement of pain in infants and children*. Progress in Pain Research and Management. IASP Press, Seattle, pp 59–82
- Terstegen C, Koot HM, de Boer JB et al. (2003) Measuring pain in children with cognitive impairment: pain response to surgical procedures. *Pain* 103:187–98

## Pain Assessment in Neonates

FAY WARNOCK

Children's and Women's Hospital and The University of British Columbia, Vancouver, BC, Canada  
warnock@nursing.ubc.ca

### Synonyms

Infant Composite Pain Measures; Infant Pain Instruments; Pain Evaluation

### Definition

► **Pain assessment** is the basis of all ► **pain management** for the rapidly developing ► **neonate**. Assessment is the evaluation of the presence, and if possible the severity, of a neonate's pain experience. Early and significant exposure to ► **pain** has far-reaching developmental and psychosocial implications for neonates and long term economic costs for society, especially if pain is not treated at critical epochs of infant development (Anand and Scalzo 2000). A neonate's expression of pain, and the ability of others to recognize and respond appropriately to those expressions, determines whether pain is treated (Craig 1998), and likely influences the future development or survival of that neonate. The assessment of pain during the newborn period is thus crucial, and is especially important for premature and full term newborns born at-risk (e.g. infants who have been prenatally exposed to illicit drugs (cocaine, alcohol). Such infants are at particular risk because prior exposure to stressors may make them more vulnerable to the harmful effects of subsequent stress and pain stimulation (which is often unavoidable owing to the medical needs of these babies) (Schneider 1998). Pain assessment enables health care providers to make judicious pain management decisions using reliable

and valid measures and to make use of relevant behavioral and environmental information about potential pain ► **modifying factors** for neonates. Yet, assessing pain and gauging the adequacy of pain treatment are particularly challenging in the newborn. For example, distinguishing newborns' responses to a noxious (painful) event, from their responses to a non-noxious but distress-inducing event (such as hunger) remains difficult due to lack of scientific data. In addition, healthcare provider attitude, lack of knowledge, and hospital organizational factors that hamper regular pain assessment as a part of care compound the difficulty of evaluating newborns who are still developing their ability to inhibit incoming sensory inputs and who cannot communicate their pain verbally.

Thus, while newborns are highly vulnerable to the negative developmental effects of pain stimulation, they are also entirely dependent upon their ► **caregivers**, and the process of pain assessment is a demanding and highly complex process. For these reasons we require ► **valid** and ► **reliable** measures of newborn pain in order to further theoretical understanding, and to help promote the development and practice of unbiased pain assessment approaches and best practice guidelines. We also need to be alert to the everyday factors that cause, intensify or prolong newborn pain in order to assess the newborn's pain comprehensively.

### Characteristics

The unbiased assessment of newborn pain requires pain assessment tools that meet universally acknowledged criteria pertinent to any measuring instrument. The pain tool must be reliable in that it is reproducible and stable under the different conditions in which it is likely to be used. A pain tool must also be valid in that it is rooted in theoretical understanding of the construct under study (e.g. newborns and their pain), it measures what it is intended to measure and it predicts what it is intended to predict. The tool must also have clinical utility, be ► **feasible** to use (if it is designed for clinical application), and it should allow quantification of both pain intensity and pain duration. In addition, the unbiased assessment of newborn pain requires that the act or process of assessment itself be ► **systematic** and based on ► **objective judgment** rather than ► **subjective judgment**.

At least 20 pain assessment tools have been developed for newborns (Mathew and Mathew 2003), including physiological, behavioral, and biochemical indicators (measures). These measures are categorized as ► **unidimensional** or ► **multidimensional** (composite) depending on the number of pain indicators included. At present, no biological measure of pain exists, so that these three pain indicators are 'indirect' estimates of newborn pain because we infer pain based on the type and frequency of responses made by the newborn to a noxious stimulus.

Heart rate is the most widely used physiological measure of newborn pain. Changes in heart rate can be assessed easily and continuously with an electrocardiograph. Other physical measures include blood pressure, respiratory rate, oxygen consumption, mean airway pressure, palmar sweat, flushing, pallor, intracranial pressure and cerebral blood volume. Behavioral measures include crying, grimacing, change in facial action (using the neonatal facial action coding system), body movement, infant state, and a lack of pain response (noted in premature infants). Some biochemical measures include increased secretion of cortisol, catecholamines, glucagons, growth hormone and decreased secretion of insulin. Behavioral measures provide the most direct information, because behavior enables the pre-verbal neonate to communicate their pain. Increase in heart rate and change in facial action are generally suggested to correlate with intensity of pain, with facial action being the most consistent (Craig 1998), and it has been found to be applicable for bedside application (Harrison et al. 2002). More recently, researchers investigating pain response in premature infants have added gestational age, prior pain experience and lack of response as important adjuncts to newborn pain assessment (Stevens et al. 1994). Of the tools published, the majority have been developed for research purposes rather than for direct clinical application.

### Application of Pain Assessment Tools for Research and for Clinical Purposes

P

The objective for using pain assessment tools in research is to correlate physiological, behavioral and/or biochemical indicators to identify the newborn pain response. The ability to quantify pain in this manner is fundamental for evaluating analgesic efficacy in clinical trials comparing different ► **pharmacological interventions** and/or ► **non-pharmacological interventions** for pain management. Quantification enables deductive inquiry, hypothesis testing and the development of valid pain assessment approaches and instruments. It also helps guide policy and the formation of professional standards of pain practice. Tools used to assess the composite indicators of newborn pain for clinical application have been developed from prior research. Most have also been designed to permit clinicians the ability to quantify their assessments of newborn pain response in order to determine the severity (level) of pain (please see next paragraph for further explanation). The direct application of these tools also helps promote a standardized approach to the clinical assessment of newborn pain, whereby clinicians are guided in knowing what to assess and how to interpret those assessments and to do so in a systematic and unbiased manner.

It is important to stress, however, that the process of pain assessment and pain care decision making must not rely solely on the use of any tool. The clinician must also judiciously consider additional factors that affect the new-

born's responses to pain, and to consider the ► **trajectory** of the newborn's expression of pain over time. Additionally, clinicians must observe how the newborn is interacting (or failing to interact) post pain event as this will provide important information on pain recovery. Interested readers can access several in-depth and critical reviews to examine the range of published tools on the topic (Mathew and Mathew 2003; Stevens and Franck 2001; Warnock and Lander 2004). Table 1 provides a brief listing of some of the published tools. Interested readers may also click on the following website to access detailed information about the validity and reliability measures of some of the tools listed in Table 1. <http://www.anna.org.au/docs/Painassessmenttools.pdf>

### How is Pain Assessment Applied for Research and for Clinical Purposes?

Pain assessment tools vary in the types of pain indicators they contain, but they all aim to assess the level of the newborn's immediate response to pain. The collection of pain data typically commences immediately after introduction of the pain stimulus, and involves scoring occurrences of the respective pain indicator(s) at specified intervals of a defined, but brief period of observation (e.g. every five seconds of a 20 second time block). Pain data collected for research purposes typically involve the use of a heart rate monitor and video cameras, which continuously record the physiological (heart rate) and behavioral (e.g. facial activity, motor movement, interaction) responses of the newborn as they undergo a pain event. The collected measures are then later examined and analyzed.

Similar data collection protocols are used to assess pain at the bedside. The clinician is required to score occur-

rences of listed ► **pain scale** items starting immediately after introduction of the pain event. In this case, however, measuring the level or severity of pain involves scoring of pain scales (e.g. 0 to 4, with 0 indicating no or minimal pain, 2 indicating some pain, 3 indicating moderate pain, and 4 indicating severe pain). The tool is usually one page in length and is composed of a brief listing of pain indicators which are defined. The clinician is asked to score and rank the items as they observe them to occur over a defined, but brief, period of observation (e.g. 30 s). Upon completion, the clinician tabulates a total pain score, which can presumably be interpreted to mean minimal or no pain, moderate pain, or severe pain. The total pain score serves as the basis for guiding pain care decision making. It is important for clinicians to understand that the pain assessment tool they are using may not have been originally designed to yield numerical differences in the magnitude of pain intensity. For this reason, it is important to examine the ► **level of the measurement scale** and the author's guide for interpreting the scale and the total score derived.

Given the extensive number of pain assessment instruments, there is a need to first distinguish pain assessment tools developed for research purposes from those developed for clinical application, and to then select those that are appropriate to the intended aims of the research or the clinical objective. While both forms provide meaningful information, research based tools are not appropriate for clinical use because they typically require extensive training and they are time consuming. It is also crucial that clinicians select pain assessment tools developed for clinical application and that have reported reliability and validity. Clinicians must also select tools that are developmentally appropriate and pertain to the

**Pain Assessment in Neonates, Table 1** A select listing of some pain assessment scales

Name	Acronym	Reported Applicability	Behavioral	Physiological
Comfort Scale* (Ambuel et al. 1992)	Comfort	Newborns Up to 3 years of age	✓	✓
Premature Infant Profile* (Stevens et al. 1996)	PIPP	Preterm Full-term Neonates	✓	✓
Crying, change in transcutaneous oxygen saturation, heart rate, blood pressure, facial expression and alteration in sleep pattern (Krechel and Bildner 1995)	CRIES	Full term	✓	✓
Scale for Use in Newborns (Blauer and Gerstmann 1998)	SUN	Not indicated	✓	✓
Neonatal Infant Pain Scale (Lawrence et al. 1993)	NIPS	Preterm Full-term Neonates	✓	
Échelle Douleur Inconfort Nouveau-Né, neonatal pain and discomfort scale (EDIN) (Debillon et al. 2001b)	EDIN	Prolonged pain in preterm infants	✓	✓

\* indicates tools with established reliability and validity



different types of pain experienced by the infant. For example, pain assessment tools developed for older infants and children may be unsuitable for use in neonates because of expected differences in pain reactivity, and tools designed to assess newborn ▶ **acute pain** will be unsuitable for assessing newborn ▶ **chronic pain**. Most available newborn pain assessment tools are reported to be appropriate for use in both premature and older infants and for acute forms of newborn pain. Some are also designed to assess the newborn's response to routine procedures.

### Current Issues in Pain Assessment

Given the relative beginning state of the newborn pain field, it is understandable that few psychometrically sound tools are available. It is also understandable, given the complexity of newborn pain, that different methodologies and models will still be needed in order to further pain assessment efforts. One area that will be likely to experience some change pertains to the process of data collection. As discussed, almost all pain assessment protocols require that pain data be collected starting immediately after introduction of the noxious stimulus, and that data be assessed intermittently over a very short period of observation. While this approach is necessary and has been extremely useful in that it has helped infer the occurrence of the newborn's immediate response to pain, it may have self-imposing limitations. For example, the approach is only capable of generating knowledge on the frequency rather than the duration of pain (Warnock and Lander 2004). Moreover, because the approach focuses on the newborn's immediate response to a noxious stimulus, it cannot be used by clinicians to assess chronic pain or to gauge the effects of pain treatment over time. New approaches that employ naturalistic designs (that go beyond the typical short data collection period) and that permit continuous coding of responses will enable the production of duration data, which in turn will enable insight into how long newborns actually spend in pain. The Eden scale provides an example of a tool currently being developed to assess chronic newborn and infant pain (Debillon et al. 2001a).

Another area that will likely experience change pertains to the analysis of pain assessment data. Currently, most pain studies seek to obtain correlations among the physiological, behavioral and hormonal indicators of newborn pain. However, these correlations (across situations or across studies) have frequently been found to be inconsistent and weak (Barr 1998). Similar "problems of dissociation" have also been noted in studies aimed at measuring infant stress (Gunner and Donzella 1999). While infant development likely underlies wide variation in newborn responses and subsequent measurement inconsistencies, researchers from the fields of infant stress suggest more research to understand how overt and covert stress-related processes interact to

regulate and modify each other, such as everyday environmental factors and caregiver presence. Inclusion and consideration of such factors is thought to strengthen theoretical understanding of infant reactivity and ultimately improve assessment. As it pertains to newborn pain, a similar aim would be to help identify internal and external factors underlying newborn pain reactivity, and to help identify real time patterning in the composite indicators of newborn pain. Little is currently known about the role that context and pain related caregiving have on newborn pain expression.

Another emerging area relevant to pain assessment concerns the development of pain assessment models that are aimed to facilitate the clinical assessment of pain and that emphasize the role of the external rater in observing, interpreting and making judgments within the context of patient-specific and method-specific factors (Snow 2004). While such investigations are more evident in adults and specifically the fields of gerontology and pain, they may provide useful information to the newborn pain field. Given the importance and complexity of assessing newborn pain, this is an important area for development.

In summary, the assessment of newborn pain is an important but complex process that demands the use of valid external measures, and the judicious consideration of numeric with modifying and familial information. The criteria for selecting a pain assessment tool from the array of existing tools should include choosing a valid and reliable tool that is designed for clinical use, and that includes assessment of the composite rather than a singular indicator of newborn pain. The tool that is chosen must also enable evaluation of the intensity, frequency and duration of pain. In addition to selecting and making use of sound pain assessment instruments, the process of pain assessment requires that health care providers do not rely on tools to guide their pain care decision making. It is also crucial that they consider the trajectory of the newborn's response to pain, and that they observe the impact of subtle changes in the external environment (including the impact of their own caregiving) that obviate important interaction opportunities for the newborn post-pain event. Tremendous progress has been made in our understanding of newborn pain since the mid 1980's, and it is clear that progression in pain assessment (and hence pain management) is evolving. An important component of that evolution involves the direct clinical application of credible pain assessment knowledge, and the joint efforts of clinicians and researchers to situate newborn pain assessment within the context of optimal nervous system development.

### References

1. Ambuel B, Debillon T, Zupan V et al. (1992) Assessing Distress in Pediatric Intensive Care Environments: The COMFORT Scale. *J Pediatr Psychol* 17:95–109

2. Anand KJ, Scalzo FM (2000) Can Adverse Neonatal Experiences Alter Brain Development and Subsequent Behavior? *Biol Neonate* 77:69–82
3. Barr RG (1998) Reflections on Measuring Pain in Infants: Dissociations in Responsive Systems and “Honest Signaling”. *Arch Dis Child Fetal Neonatal Ed* 76:152–156
4. Blauer T, Gerstmann DA (1998) Simultaneous Comparison of Three Neonatal Pain Scales during Common NICU Procedures. *Clin J Pain* 14:39–47
5. Craig KD (1998) The Facial Display of Pain. In Finley GA, McGrath PJ (eds) *Measurement of pain in infants and children*. International Association for the Study of Pain Press, Seattle, WA, pp 103–122
6. Debillon T, Zupan V, Ravault N et al. (2001a) Development and Initial Validation of the EDIN Scale, a New Tool for Assessing Prolonged Pain in Preterm Infants. *Arch Dis Child Fetal Neonatal Ed* 85:36–41
7. Debillon T, Zupan V, Ravault N et al. (2001b) Development and Initial Validation of the EDIN Scale, a New Tool for Assessing Prolonged Pain in Preterm Infants. *Arch Dis Child Fetal Neonatal Ed* 85:F34–41
8. Gunner MR, Donzella B (1999) Looking for the Rosetta stone: An Essay on Crying, Soothing and Stress. In: Lewis M, Ramsey D (eds) *Soothing and Stress*. Lawrence Erlbaum Associates, New Jersey, pp39–56
9. Harrison D, Evans C, Johnston L et al. (2002) Bedside Assessment of Heel Lance Pain in the Hospitalized Infant. *J Obstet Gynecol Neonatal Nurs* 31:551–557
10. Krechel SW, Bildner J (1995) CRIES: A New Neonatal Postoperative Pain Measurement Score. Initial Testing of Validity and Reliability. *Pediatr Anesth* 5:53–61
11. Lawrence J, Alcock D, McGrath P et al. (1993) The Development of a Tool to Assess Neonatal Pain. *Neonatal Netw* 12:59–66
12. Mathew PJ, Mathew JL (2003) Assessment and Management of Pain in Infants. *Postgrad Med J* 79:438–443
13. Schneider ML (1998) Prenatal Stress Alters Brain Biogenic Amine Levels in Primates. *Dev Psychopathol* 10:427–140
14. Snow AL, O’Malley KJ, Cody M et al. (2004) A Conceptual Model of Pain Assessment for Non-Communicative Persons with Dementia. *Gerontologist* 44:807–817
15. Stevens BJ, Franck LS (2001) Assessment and Management of Pain in Neonates. *Paediatr Drugs* 3:539–558
16. Stevens B, Johnston CC, Horton L (1994) Factors that Influence the Behavioral Response of Premature Infants. *Pain* 59:101
17. Stevens B, Johnston C, Petryshen P et al. (1996) Premature Infant Pain Profile: Development and Initial Validation. *Clin J Pain* 12:13–22
18. Warnock FF, Lander J (2004) Foundations of Knowledge about Neonatal Pain: Review Article. *J Pain Symptom Manage* 27:170–179

## Pain Assessment in the Elderly

ROBERT D. HELME, BARBARA WALKER  
Centre for Pain Management, St Vincent’s Hospital,  
Melbourne, VIC, Australia  
rhelme@bigpond.net.au

### Synonyms

Pain Measurement in the Elderly

### Definition

Pain assessment is undertaken in a number of different situations. Here I have made comment on epidemiologic, psychophysical and clinical studies in older people.

### Characteristics

The overriding theme of this essay is the need to carefully select validated measurement tools of ► [pain](#), ► [mood](#), ► [activity](#) and ► [cognitions](#). Some of these domains have yet to be properly explored.

### Epidemiologic Studies

One of the most quoted prevalence studies of pain, in which the effect of age was examined, is that by Crook et al. (1984). This was a telephone survey of a random sample obtained from a group general practitioner list. It demonstrated increased persistent pain complaints with increasing age, and highlighted the importance of pain for a large number of older people. There were very few participants over the age of 80, a problem common to most community based studies that seek to explore issues relevant to older people. The questions asked in this study regarding the temporal nature of pain did not follow the usual pattern of descriptions of acute and chronic pain.

However, other studies have not necessarily replicated these results (Gibson 2003). Collectively, the studies suggest a peak or plateau in the prevalence of chronic pain by the age of 65, and a decline in reported pain in those over 80 years of age. This is surprising, given an age related increase in pain associated disease, which continues into the ninth decade of life.

Many reasons can be put forward as to why reported prevalence figures for pain in older people vary so widely (Gibson 2003). They include methodological variations such as sample bias and choice of psychometric instruments, number of subjects, response rates, especially for the oldest old, and the unreliability of memory for pain. Perhaps the most likely reason for the variation in absolute prevalence figure is the nature of the questions asked; the pain time interval, the time in pain within this interval, the severity or interference of the pain in daily life, often recorded as whether the pain is ‘troubling’ or ‘bothersome’, and the effect of cueing (summation of pain at different sites).

A number of studies have examined pain at particular body sites and some consistent trends have emerged. A summary view is that age is associated with an increase in prevalence of chronic pain up to the age of 65, but not acute pain. Visceral pain is reduced amongst older people, and joint pain is increased.

### Reasons for Age Related Changes in Pain Prevalence

The overriding factor contributing to increased pain complaints with age is pathological load. Many acute and chronic illnesses increase in prevalence with advancing age, and the interplay of multiple diseases in an individual case is the hallmark of aged care medicine. Reasons for the relative decline in reported pain amongst older people are more numerous, but also more speculative (Gibson 2003). The report of pain by an older

individual may be suppressed by more significant life events such as death of a spouse, concern regarding loss of independence, fear that reporting of pain will lead to unwanted investigations, treatments, or the finding of serious pathology. There is a general perception that older persons are more stoic, cautious in attribution, and more likely to misattribute pain symptoms to the ageing process itself (Yong et al. 2001). They may not even use the term pain preferring discomfort, hurting or aching. The unpleasantness of pain in older people has never been examined.

### Pain Physiology

Psychophysical studies using physiologic stimuli have generally shown a progressive decrease in pain sensitivity with advancing age (Gibson 2003), especially if the duration of the stimulus is brief. Using differential nerve fibre blockade, Chakour and Gibson et al. (1996) showed that older persons rely on less well localised C fibre activation before reporting the presence of pain, whereas younger adults utilise the additional information from A delta nociceptive fibres. Moreover, when A delta fibre input was blocked in young adults, the observed age associated differences in pain threshold and subjective ratings of pain quality essentially disappeared. Age differences in the temporal summation of nociceptive input also vary as a function of nociceptive fibre type (Harkins et al. 1996) and rate of stimulation. Differential age effects on A delta and C fibre function may help explain some of the disparity in psychophysical findings. On the other hand, diminished physiologic reserve in descending inhibitory pathways may also lead to reduced pain tolerance in older people (Washington et al. 2000).

Studies of clinical pain states have also indicated that older persons may exhibit a relative absence of pain in the presentation of certain visceral disease states, such as ischemic heart pain and abdominal pain associated with acute infection (Gibson 2003). Unfortunately, most of the clinical studies are difficult to interpret, because the severity of pathology is seldom known, although controlled investigations of myocardial pain during exercise-induced ischemia generally support the view of a clinically significant decrease in ischemic pain perception with advancing age (Miller et al. 1990). In summary, evidence from physiological studies, psychophysical investigations, and age variations in disease presentation all suggest age related alterations in the function of peripheral and CNS nociceptive pathways. These changes are likely to influence the sensitivity to painful sensation and would be expected to contribute to a decline in pain reporting in persons of advanced age. However, most of the evidence of age differences in nociceptive function is indirect, and the clinical relevance of reduced pain sensitivity to experimental pain stimuli is still the subject of debate.

### Clinical Pain, Suffering and Disability

Older people can successfully complete validated self-report measures of pain, mood, activity, and pain and disease impact, as long as adequate time is allowed to complete the task and other factors such as visual impairment, hearing loss and physical disability of the hands are taken into account. Older persons are more likely to spend time deliberating over a question, rather than to respond in an impulsive manner, as often observed in younger individuals. However, visual analogue scales may be less likely to show age related effects than numerical scales and the ► [McGill Pain Questionnaire](#) (Gagliese and Katz 2003).

Behavioural indicators of pain include measures of medication use, number of different treatments, and, visits to physicians and other healthcare providers. These have rarely been utilised, as specificity is likely to be lower in older people with increased co-morbidity. Another category of behavioural measures includes motor activities, which indicate pain complaints such as moaning, limping, rubbing and facial expressions. These have been validated in older people with severe dementia who have language impairment (Hadjistavropoulos et al. 2000). Other measures include the use of walking aids, collars, and cushions. Functional measures such as sleep duration, up-time, mobility, self-care, and recreational activity are also relevant and can be reliably assessed in older people. There is a preference for behavioural indicators to be performance measures undertaken during direct observation, rather than self-report. Behavioural measures have been shown to be objective, sensitive to treatment effects and clinically relevant in Geriatric Medicine. However, such measures are often time consuming and are strongly influenced by social context. Inter- and intra-observer reliability for these measures is strong if observer training has been undertaken.

Due to the high incidence of physical disease in older persons, somatic markers are inappropriate for psychologic measures. There is also some evidence to suggest that older adults may under-report negative mood states, thereby emphasizing the need for age appropriate norms. A more comprehensive psychological assessment should include attention to the cognitive coping style of the older person, as well as assessment of pain beliefs and degree of somatic preoccupation. Unfortunately, standardized age specific instruments for monitoring these domains have yet to be developed.

### Management Outcomes

A careful evaluation of the individual is likely to identify the likely pathophysiological basis of chronic pain in the older person, whether nociceptive, neuropathic, psychogenic or mixed. This in turn leads to the selection of an appropriate management regimen and is helpful in determining prognosis. In clinical practice, most chronic pain in the elderly is related to nociceptive factors, in

particular degenerative musculoskeletal disease. However, clinical signs of ► [central sensitisation](#) need to be sought in all patients, and may well be different in older people. No studies have yet explored this hypothesis.

### Multidisciplinary Pain Management

The literature on treatment outcome reveals overwhelming support for multidisciplinary treatment of older chronic pain patients. However, no study has used appropriate control groups or randomisation procedures in the evaluation of treatment efficacy. There is a lack of standardised measurement tools for documenting disease and disability. It is not always clear whether the outcome measures have been validated for use with older people and the sample size in evaluation studies are often small. The goals for success, however, may not necessarily include reduced pain. Older people will often prefer to increase ambulation and socialisation rather than rest to decrease pain. Others will accept pain if it allows independence in their own home, rather than opting for less pain in the sedentary environment of an old age home. These factors need to be accounted for in the measurement tools.

### Dementia

The interaction between the pathology causing dementia and the perception of pain in these individuals has been reviewed (Farrell et al. 1996). A major clinical distinction lies between individuals who maintain communicative skills and those who have lost them, particularly in the advanced stages of Alzheimer's disease. Verbal patients, even with severe dementia, can report pain consistently using a variety of psychometric instruments, although simple word descriptors, such as the present pain intensity of the McGill Pain Questionnaire, appear to have greater clinical utility. Non-verbal patients may come to attention because of changes in behaviour, such as agitation, diminished physical activity or the appearance of distress. Apart from pain, altered behaviour may be due to related factors including urinary infection, constipation, decubitus ulcers, depression and reactions to medications.

### Conclusions

Pain is a common complaint of older people. It should be assessed and managed in the same way as for younger people, but with close attention to the impact of underlying diseases on the pain experience prior to and following treatment. There is evidence that the pain experience of older people is different, but this pertains more to the experimental laboratory than to the clinic.

### References

- Chakour MC, Gibson SJ, Bradbeer M et al. (1996) Effect of Age on A-Delta Fibre Modulation of Thermal Pain Perception. *Pain* 64:143–152
- Crook J, Rideout E, Browne G (1984) The Prevalence of Pain Complaints in a General Population. *Pain* 18:299–314
- Farrell MJ, Katz B, Helme RD (1996) The Impact of Dementia on the Pain Experience. *Pain* 67:7–15
- Gagliese L, Katz J (2003) Age Differences in Postoperative Pain are Scale Dependent: A Comparison of Measures of Pain Intensity and Quality in Younger and Older Surgical Patients *Pain* 103:11–20
- Gibson SJ (2003) Pain and Aging: The Pain Experience Over the Adult Life Span. In: Dostrovsky JO, Carr DB, Koltzenburg M (eds) *Proceedings of the 10<sup>th</sup> World Congress on Pain, Progress in Pain Research and Management*. IASP Press, Seattle 24:767–790
- Hadjistavropoulos T, LaChapelle DL, MacLeod FK et al. (2000) Measuring Movement Exacerbated Pain in Cognitively Impaired Frail Elders. *Clin J Pain* 16:54–63
- Harkins SW, Davis MD, Bush FM et al. (1996) Suppression of First Pain and Slow Temporal Summation of Second Pain in Relation to Age. *J Gerontol* 51 M260–M265
- Miller PF, Sheps DS, Bragdon EE et al. (1990) Age and Pain Perception in Ischemic Heart Disease. *Am Heart J* 120:22–30
- Washington LJ, Gibson SJ, Helme RD (2000) Age Related Differences in Endogenous Analgesia to Repeated Cold Water Immersion in Human Volunteers. *Pain* 89:89–96
- Yong H-H, Gibson SJ, Horne DJDeL et al. (2001) Development of a Pain Attitudes Questionnaire to Assess Stoicism and Cautiousness for Possible Age Differences. *J Gerontol* 56:P279–284

## Pain Associated with Traumatic Nerve Injury

### ► Neuroma Pain

## Pain Asymbolia

### Definition

Pain asymbolia is a neurological disorder characterized by damage to the limbic system in which patients are capable of perceiving the sensory qualities of pain, but fail to exhibit appropriate affective and motor reactions to noxious stimuli; 'pain without painfulness'; also considered a sensory-limbic disconnection syndrome.

### ► Thalamo-Amygdala Interactions and Pain

## Pain Attacks

### ► Pain Paroxysms

## Pain Behavior

### Definition

Pain behaviors refer to overt, observable, and measurable expressions and manifestations of pain and include distorted ambulation (i.e. use of a prosthesis, limping), facial/audible expressions of pain (e.g. verbal complaints of pain, grimacing), expressions of affective distress (e.g. sighing, crying), and seeking help (e.g. asking for assistance, taking pain medications).



- ▶ Assessment of Pain Behaviors
- ▶ Catastrophizing
- ▶ Interpersonal Pain Behaviour
- ▶ Multiaxial Assessment of Pain
- ▶ Multidisciplinary Pain Centers, Rehabilitation
- ▶ Spouse, Role in Chronic Pain

## Pain Belief

### Definition

Pain belief is a technical term for what psychologists see as patients' cognitions about the cause, duration, and likely outcomes of chronic pain. Cognition, as applied to catastrophizing, is usually understood to include an affective dimension.

- ▶ Ethics of Pain, Culture and Ethnicity

## Pain Catastrophizing

### Definition

Pain catastrophizing is an exaggerated negative orientation towards actual or anticipated pain experiences, consisting of negative pain-related cognitions.

- ▶ Catastrophizing
- ▶ Disability, Fear of Movement
- ▶ Fear and Pain
- ▶ Fear Reduction through Exposure In Vivo
- ▶ Hypervigilance and Attention to Pain
- ▶ Muscle Pain, Fear-Avoidance Model
- ▶ Psychology of Pain, Assessment of Cognitive Variables

## Pain Centralization

### Definition

The hypothesis that persistent intense pain can leave a durable pain inducing trace in the CNS, which is no longer amenable to relief by blocking afferent input from the periphery is known as pain centralization.

- ▶ Central Changes after Peripheral Nerve Injury

## Pain Chronification

- ▶ Transition from Acute to Chronic Pain

## Pain Cocktail

### Definition

A method of converting all opioids to an equivalent dose of methadone and delivering it with a masking vehicle. Pretreatment levels of medicine consumption are first determined and the programme is discussed with the patient. Subsequently, medicines are suspended in a thick, strong tasting liquid which camouflages the type and amount of pain killer. Thus, the patient does not know the exact content of the medicine being consumed. The dose is then systematically reduced over the period of treatment, always with the full knowledge of the patient.

- ▶ Multidisciplinary Pain Centers, Rehabilitation
- ▶ Operant Treatment of Chronic Pain

## Pain Control in Children with Burns

WALTER J. MEYER III<sup>1, 2</sup>, LEE WOODSON<sup>2, 3</sup>

<sup>1</sup>Department of Psychiatry and Behavioral Science, Galveston, TX, USA

<sup>2</sup>Shriners Hospitals for Children, Shriners Burns Hospital, Galveston, TX, USA

<sup>3</sup>Department of Anesthesiology, University of Texas Medical Branch, Galveston, TX, USA  
wmeyer@utmb.edu

P

### Synonyms

Treating Pediatric Burns; Recognizing Issues Contributing to Pain Secondary to Burn Injury and its Treatment; Pediatric Burns; Burn Pain Control in Children

### Definition

Burn pain encompasses wound pain and anxiety related to the cause of the injury as well as pain and anxiety related to the treatment of the burn wound. Late forms of burn pain include the intense itching of the healing skin and phantom limb pain when digits or limbs are lost with the burn injury.

Burn wounds are intensely painful and pain associated with wound care can be unbearable without the use of potent sedatives and analgesics. Appropriate sedation and analgesia for patients with major burn injuries not only reduces suffering but also shortens hospital stay and improves clinical outcome (Stoddard et al. 2002).

### Characteristics

The first 48 h after a burn injury are characterized by a decrease in blood flow to organs and tissues because of shock and extravasation of fluid into the burned tissue. During that period, intravenous pain and anxiety medications often do not reach the burned tissue and elim-

ination of those medications by the kidney and liver is impaired. Non-IV medications are not absorbed well and should not be used for children. There is delayed delivery to the desired site of action, delayed peak concentration and delayed effect, so short acting rapidly cleared medications are preferable to avoid overdosing children. For example, lorazepam is preferred to diazepam because it has a smaller volume of distribution and its metabolism is not affected by the liver.

By 72 h, a hypermetabolic state exists, characterized by increased oxygen consumption, hyperpyrexia, hypercortisolemia, increased sympathetic tone, tachycardia and increased blood flow to organs and tissues. Medications not cleared in the initial shock phase are now mobilized and their plasma concentration may rise rapidly into the overdose range. Intravascular proteins are extravasated into the wound with resultant edema and hypoalbuminemia; this leads to an increased free fraction of some drugs, such as benzodiazepines. In contrast, ► **acute phase proteins** like  $\alpha_1$ -acid glycoprotein may double in concentration after large burn injury. These proteins bind basic drugs (e.g. propranolol or imipramine). Since drug-binding proteins may respond in opposite ways to burn injury, changes in drug binding, response and clearance will depend on which protein binds the drug in question. The most important principle to remember is to monitor response and / or plasma levels, then titrate the drug doses appropriately.

Under-treated pain in burn patients not only results in unnecessary suffering but also enhances these hypermetabolic physiological changes with further rises in cortisol and catecholamines. Significant behavioral consequences are increased agitation and motor restlessness that can result in sheared grafts, dislodged vascular cannulas or endotracheal tubes.

### Pharmacological Treatment for Pediatric Inpatients

When mechanically ventilated children do not receive adequate sedation and analgesia, it is difficult to synchronize the child's respiratory effort with the ventilator. The child "fights" the ventilator and increases the risk of laryngeal injury, increased airway pressures, ► **barotrauma** and ► **ARDS**. Sedation and analgesia are preferred to muscle relaxation for ventilated children. Pharmacological relaxation makes it difficult to titrate analgesia and sedation since health care providers have difficulty evaluating children's responses. In addition, prolonged relaxation is associated with myopathy and children with burns already suffer debilitation due to motor weakness from muscle wasting.

In the longer term, inadequate sedation produces delirium, decreased pain tolerance, decreased cooperation with therapy, persistent anxiety and psychiatric disability (Stoddard et al. 2002). Treatment of burn pain in children is made more complex by problems with communication that make it difficult to assess pain. Pain

in pediatric patients is also difficult to separate from anxiety. When the child can communicate, a variety of assessment tools are available and each hospital should be consistent with whichever tool is used (Stoddard et al. 2002). When the patient is unable to communicate, then physiological variables (e.g. hypertension, tachycardia and agitation) must be used to assess the effectiveness of sedation and analgesia.

In most burn centers, standard therapy includes morphine and a benzodiazepine (Meyer et al. 2001; Stoddard et al. 2002). Some centers use acetaminophen successfully to treat pain of small burns and in small children in order to reduce narcotic requirements and avoid the possible respiratory depression and other problems caused by morphine (Meyer et al. 1996). Please see Table 1 for the starting doses used in the Shriners Hospitals for Children, Galveston, TX.

When morphine and a benzodiazepine do not control pain and anxiety adequately because of hyperalgesia associated with morphine tolerance or complications such as bowel obstruction, a change to methadone or to a different class of drugs may be necessary (Williams et al. 1998). Methadone has both pharmacokinetic and pharmacodynamic differences from morphine. The hyperalgesia associated with morphine may involve central ► **NMDA receptor** pathways and methadone's ability to antagonize NMDA receptors may contribute to its efficacy in pain no longer controlled with morphine (Callahan et al. 2004). In addition, methadone's longer half-

**Pain Control in Children with Burns, Table 1** Medications Used in Pediatric Burn Survivors for Pain and Anxiety

Medication	Dose
Background pain	
Acetaminophen	15 mg kg <sup>-1</sup> PO q 4 h
Morphine	0.03–0.05 mg kg <sup>-1</sup> IV q 4 h
Morphine	0.3 mg kg <sup>-1</sup> PO q 4 h
Methadone	0.1 mg kg <sup>-1</sup> orally q 6–12 h
Hydrocodone / Acetaminophen	0.2 mg hydrocodone kg <sup>-1</sup> / dose
Procedural pain	
Morphine	0.05–0.1 mg kg <sup>-1</sup> / dose IV
Fentanyl	10 µg kg <sup>-1</sup> / dose oral transmucosal
Ketamine	1–2 mg kg <sup>-1</sup> / dose IV
Anxiety	
Lorazepam	0.03–0.05 mg kg <sup>-1</sup> PO or IV q 4 h
Diazepam	0.1 mg kg <sup>-1</sup> PO q 8 h
Clonidine	3–5 µg kg <sup>-1</sup> PO q 8–12 h

life provides a smoother and more continuous control of background pain without wide swings in drug concentration and level of analgesia seen with the shorter acting morphine bolus doses.

Ketamine is another NMDA receptor antagonist that can be very useful in pediatric burn patients. Ketamine is unique in its ability to produce profound analgesia without depressing respiration or causing airway obstruction (Lin and Durieux 2005). Ketamine has been found to be safe for sedating children for painful procedures such as staple removal (Dimick et al. 1993) and is invaluable in the management of acute burn wounds in children. Since ketamine blocks NMDA receptors, infusion of low dose ketamine will often reduce opioid requirements in patients who have become tolerant (Kissin et al. 2000; Stoddard et al. 2002). Higher doses of ketamine alone have been infused for more than 3 weeks continuously with good effect in patients refractory to other drug regimens.

▶ **Alpha( $\alpha$ ) 2-Adrenergic Agonist** provide a relatively new class of sedative analgesic drugs and experience with these drugs in the ICU is rapidly increasing (Kamibayashi and Maze 2000). Like ketamine, these drugs possess the unique ability to provide sedation and analgesia with minimal respiratory depression; in addition, at lower doses patients can be aroused to cooperate with therapy. Clonidine, a partial alpha 2 adrenergic agonist (▶ **partial agonist**), has a relatively long duration of action, can be given orally and intravenously and is inexpensive. Dexmedetomidine, a full agonist, is only available as an injectable dosage form, has a shorter duration of action and is much more selective for alpha-2 adrenergic receptors than clonidine. Dexmedetomidine can be used as the sole sedative analgesic in mechanically ventilated patients or as a general anesthetic agent for surgical procedures. Administration of alpha 2 adrenergic agonists can dramatically reduce opioid requirements and case reports show effective analgesic action in burn patients tolerant to and poorly controlled with morphine (Lyons et al. 1996).

The use of propofol infusions in children has been limited by reports of metabolic acidosis and increased mortality (Wolf and Potter 2004). However, propofol infusions have been found safe and helpful for limited periods of time (less than 24 h) while other sedatives are weaned in preparation for extubation (Sheridan et al. 2003).

#### Non-pharmacological Treatment for Pediatric Inpatients

Psychological interventions include distractions, relaxation and active participation in burn dressing changes. These are often very helpful in reducing pain and anxiety in the patient who can co-operate. Hypnosis is very effective but no longer used because of the excessive personnel time used. A new form of distraction from the pain and anxiety associated with burn wound care is the use of immersive virtual reality. Immersive virtual reality in-

volves the use of sensory input from sight, sound and touch to give the participant a strong sense of being part of the computer generated environment. The few case reports published indicate that it is effective in reducing pain ratings (Hoffman et al. 2000).

Surgical approaches to managing pain emphasize covering the wound. For second-degree burns, synthetic dressings (e.g. ▶ **BiobraneRx**) have been very successful in relieving pain almost immediately while promoting healing. The donor sites used for grafts can also be quite painful.

#### Treatment for Pediatric Outpatients

The medications to be used in outpatient pain management should probably be initiated as an inpatient to assure a pain-free transition. As with inpatients, both background and procedural pain should be covered. Usually at this stage, in addition to pain and anxiety, itching has become a major issue. Pain and anxiety also go hand in hand. During rehabilitation, painful stretching of scar-contracted soft tissues such as muscle and tendon causes pain. Diazepam facilitates the muscle psychological relaxation needed for rehabilitation therapy.

Pain management as an outpatient can usually be managed with oral hydrocodone / acetaminophen combinations like Vicodin<sup>Rx</sup> or Lortab<sup>Rx</sup> dosed to provide 0.2 mg kg<sup>-1</sup> / q 4 h of hydrocodone and acetaminophen at no more than 20 mg kg<sup>-1</sup> / dose or 3000 mg day<sup>-1</sup>. These types of medication may require their extra-strength formulation when the amount of acetaminophen is too high. For the same reason they should not be given with Tylenol<sup>Rx</sup>. However ibuprofen (10 mg kg<sup>-1</sup>) PO can be given as an alternate, especially for muscle and bone pain associated with exercise or splints.

There are special outpatient situations that might require extra medication including wound cleaning.

▶ **Transmucosal fentanyl** (10  $\mu$ g kg<sup>-1</sup>) is often effective in reducing the pain (Robert 2003). If the procedure is very painful, such as staple removal, then ketamine will be needed to control pain effectively. Another adjunctive medication is the anesthetic gas mixture of 50% nitrous oxide and 50% oxygen, self-administered by patient-held mask during the wound debridement and dressing. Pain is usually effectively controlled but significant side effects have been reported including euphoria, nausea, vomiting, neurological changes, liver function abnormalities and anemia. Adequate gas scavenging equipment is essential to reduce chronic trace gas exposure to the caregivers.

#### Special Considerations for Children with Burns

##### Phantom Limb Pain

Many children with severe burns have to have amputations. About 1 / 3 will have significant phantom limb pain. This is usually controlled by amitriptyline (1–3 mg kg<sup>-1</sup>) (Thomas et al. 2003).

### Itching

Refractory itching is an unusual form of pain that does not respond to standard pain or anxiety medications. In fact, morphine sometimes makes it worse. A standard assessment instrument is recommended, just as it is for pain and anxiety. The attached figure provides such an instrument (► **ITCH MAN**) based on the drawing of one of our patients (Meyer 2001). Itching is treated with diphenhydramine HCl 1 mg kg<sup>-1</sup>, hydroxyzine 0.5 mg kg<sup>-1</sup> and / or cyproheptadine 0.1 mg kg<sup>-1</sup> alone or in combination when Itch Man scores are greater than 2 out of 4. Topical medications are also used; they include preparation H, benadryl cream, Eucerin cream, aquaphor and rarely pyridoxine cream 5%. In children pyridoxine cream is hazardous, since too much is absorbed. Some children do not respond well to any regimen and only receive significant relief after the scars mature in several years.

### Sleeping Difficulties

Sleep management in the outpatient is often very difficult. Children recovering from burn injury may be having pain at night due to lying in one position a long time or trying to sleep in special splints. They may be afraid of having nightmares or suffering from other manifestations of ► **acute stress disorder**. Or they may just be itching. Individual assessment must be done. If the child is afraid to go to sleep because of intrusive thoughts or nightmares, imipramine (1 mg kg<sup>-1</sup> q hs) or fluoxetine (0.3 mg kg<sup>-1</sup> q am) often provide relief (Tcheung et al. 2005).

### Summary

Children who suffer burn injury will have significant pain that requires aggressive treatment. Treating children's burn pain is an important part of their recovery, but is complicated by the major changes in children's metabolism associated with the burn injury. Unfortunately, the medications can also be associated with significant adverse effects including blood pressure changes, respiratory depression, bowel obstruction or physical dependence. Over-sedation can cause immobility that can slow rehabilitation and even lead to pressure sores. A large number of drugs in several drug classes are useful in providing sedation and analgesia for burn patients (Tobias 1999). The goal is to provide individualized drug therapy optimizing sedation and analgesia, while avoiding adverse effects. The treatment plan needs to follow the child throughout the rehabilitation phase of recovery.

### References

- Callahan RJ, Au JD, Paul M et al. (2004) Functional inhibition by methadone of N-methyl-D-aspartate receptors expressed in *Xenopus* oocytes: stereospecific and subunit effects. *Anesth Analg* 98:653–659

- Dimick P, Helvig E, Heimbach D et al. (1993) Anesthesia assisted procedures in a burn intensive care unit procedure room: benefits and complications. *J Burn Care Rehabil* 14:446–449
- Hoffman HG, Doctor JN, Patterson DR et al. (2000) Virtual reality as an adjunctive pain control during burn wound in adolescent patients. *Pain* 85:305–309
- Kamibayashi T, Maze M (2000) Clinical uses of  $\alpha$ 2-adrenergic agonists. *Anesthesiology* 93:1345–1349
- Kissin I, Bright CA, Bradley EL (2000) The effect of ketamine on opioid-induced acute tolerance: Can it explain reduction of opioid consumption with ketamine-opioid analgesic combinations? *Anesth Analg* 91:1483–1488
- Lin C, Durieux ME (2005) Ketamine and kids: an update. *Pediatr Anesth* 15:91–97
- Lyons B, Casey W, Doherty P et al. (1996) Pain relief with low-dose intravenous clonidine in a child with severe burns. *Intensive Care Med* 22:249–251
- Meyer WJ, Nichols R., Cortiella J et al. (1996) Acetaminophen in the management of background pain in children post burn. *J Pain Symptom Manage* 13:50–55
- Meyer WJ, Marvin JA, Patterson DR et al (2001) Management of pain and other discomforts in burned patients. In: Herndon DN (ed) *Total Burn Care*, 2nd edn. W.B. Saunders, London, pp 747–765
- Robert R, Brack A, Blakeney P et al. (2003) A Double-Blind Study of the Analgesic Efficacy of Oral Transmucosal Fentanyl Citrate and Oral Morphine in Pediatric Patients Undergoing Burn Dressing Change and Tubbing. *J Burn Care Rehabil* 24:351–355
- Sheridan RL, Keaney T, Stoddard F et al. (2003) Short-term propofol infusion as an adjunct to extubation in burned children. *J Burn Care Rehabil* 24:356–360
- Stoddard FJ, Sheridan RL, Saxe GN et al. (2002) Treatment of pain in acutely burned children. *J Burn Care Rehabil* 23:135–56
- Tcheung WJ, Robert R, Rosenberg L et al. (2005) early Treatment of Acute Stress Disorder in Children with Major Burn Injury. *Pediatric Critical Care Medicine* 6:676–681
- Thomas C, Brazeal B, Rosenberg L et al. (2003) Phantom Limb Pain in Pediatric Burn Survivors. *Burns* 29:139–142
- Tobias JD (1999) Sedation and analgesia in pediatric intensive care units: A guide to drug selection and use. *Paediatr Drugs* 1:109–126
- Williams PI, Sarginson RE, Ratcliffe JM (1998) Use of methadone in the morphine-tolerant burned paediatric patient. *Brit J Anaesth* 80:92–95
- Wolf AR, Potter F (2004) Propofol infusion in children: when does an anesthetic tool become an intensive care liability? *Pediatr Anesth* 14:435–438

## Pain Control in Children with Cancer

- **Cancer Pain, Palliative Care in Children**

## Pain Coping Skills

### Definition

Cognitive and behavioral strategies that children may use to assist in coping with pain. Such strategies are often categorized as active, approach oriented, or problem focused, as distinct from passive, avoidant oriented, or emotion focused coping. Active coping strategies include information seeking, specific question asking, problem solving, and social support. Avoidant, passive,



or emotion focused strategies include withdrawal, negative thinking, catastrophizing, passive adherence, and self-criticism.

- ▶ Experimental Pain in Children

## Pain Detection and Pain Tolerance Thresholds

### Definition

These are the levels at which the applied stimulus first feels painful to the subject (first pain, pricking pain, A-delta fiber pain), or the level at which the pain first becomes intolerable (second pain, burning pain, C-fiber pain).

- ▶ Quantitative Sensory Testing

## Pain Diaries

### Definition

Pain diaries are kept by patients to record their mood, activity, sleep, and pain on a daily basis, which provides an actual temporal relationship between psychosocial variables and pain.

- ▶ Pain Inventories

## Pain Disability

Pain Disability refers to any restriction or lack of ability, resulting from pain, to perform an activity in a manner or within the range that is considered normal.

- ▶ Fear Reduction through Exposure In Vivo

## Pain Disability Index

### Definition

The Pain Disability Index was developed to be a brief measure of the degree to which chronic pain interferes with normal role functioning. It includes 7 items that assess perceived disability in each of seven areas of normal role functioning.

- ▶ Pain Inventories

## Pain Disorder

- ▶ Pain, Psychiatry and Ethics

## Pain Disorder in Children

- ▶ Somatization and Pain Disorders in Children

## Pain Drawings

### Definition

Pain drawings consist of an outline of a human figure on which patients darken the areas where they are experiencing pain. These drawings can facilitate the assessment of the location and nature of the pain, and assist with the decisions for appropriate intervention.

- ▶ Pain Inventories

## Pain Due to Cancer

- ▶ Cancer Pain

## Pain Evaluation

- ▶ McGill Pain Questionnaire
- ▶ Pain Assessment in Neonates
- ▶ Pain Evaluation, Psychophysical Methods

## Pain Evaluation, Psychophysical Methods

LEON PLAGHKI  
Service de Médecine Physiques, Cliniques  
Universitaires St. Luc, Université Catholique de  
Louvain, Brussels, Belgium  
plaghki@read.ucl.ac.be

### Synonyms

Stimulus dependent method; Response Dependent Method

### Definition

Psychophysical methods for pain research are methods that allow the study of the relationship between intensity of physical stimuli and intensity of pain sensation.

## Characteristics

The fundamental question of classical psychophysics is stated in the following equation (Falmagne 1985):

$$P_{a,b} = F(u(a) - u(b)) \quad (1)$$

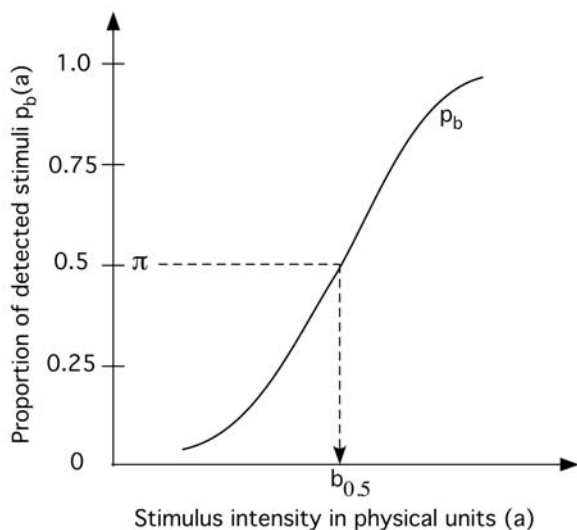
In words, if (a) and (b) are values denoting stimulus intensity on some physical scale (e.g. electrical current, temperature, pressure), the probability (P) of choosing stimulus intensity (a) over stimulus intensity (b) increases as a function (F) of the difference between these stimuli on the sensory scale (u), taken to be a measure of the intensity of sensation evoked by the stimuli. Such a function is traditionally referred to as a ► **psychometric function**.

The value of (b) can represent some fixed value or 'background noise', but it may also involve a different sensory modality. The fundamental equation can then be rewritten as follows:

$$P_b(a) = F(u(a) - u(b)) \quad (2)$$

In words, for a fixed stimulus of intensity (b) (the 'standard' or 'reference' stimulus),  $P_b(a)$  is the probability that stimulus intensity (a) (the 'comparison' stimulus) is judged as exceeding stimulus intensity (b) on the sensory scale (u), taken to be a measure of the intensity of sensation evoked by the stimuli. Typically,  $P_b(a)$  increases continuously as a function of value (a) in a characteristic ogival way (Fig. 1).

The fundamental question may be restated as follows: On a stimulus continuum (a), what is the smallest increment  $\Delta(a)$  such that  $a + \Delta(a)$  just noticeably exceeds (a)? This minimum increment of stimulus intensity is usually called the ► **just-noticeable-difference** (JND or 'difference threshold' or 'difference limen'). A variant, or particular case, of this question is: What is the minimum



**Pain Evaluation, Psychophysical Methods, Figure 1** Graph of an ideal psychometric function as specified by equation (2) (adapted from Falmagne 1985).

value of a stimulus that is "just detectable" by a subject? This value is called the 'absolute threshold'.

However, as biological systems are intrinsically variable in their reaction, the sequence of stimulus-response pairs must be regarded as a stochastic process (assumed to be stationary during the experiment). Consequently, whatever the stimulus intensity, when a subject is repeatedly presented with the same stimulus, he is likely to respond "yes" on some trials and "no" on other trials. Therefore,  $a + \Delta(a)$  cannot be defined as the stimulus value below which detection never occurs and above which detection always occurs. An empirical criterion ( $\pi$ ) has to be taken such that  $\Delta_\pi(a)$  represents a correct determination if a  $+ \Delta_\pi(a)$  is judged as exceeding (a) on a proportion ( $\pi$ ) of trials. Typically, criterion  $\pi$  is defined as the stimulus value which is detectable in 50% of the trials ( $\pi = 0.5$ ). The experimental procedures used to determine  $\Delta_\pi(a)$  are described and discussed in the following sections.

## Traditional Psychophysical Methods

It was Fechner (1860) who developed three methods of psychophysical measurement: the ► **method of limits**, the ► **method of constant stimuli** and the ► **method of adjustment** (Gescheider 1985).

### Method of Limits

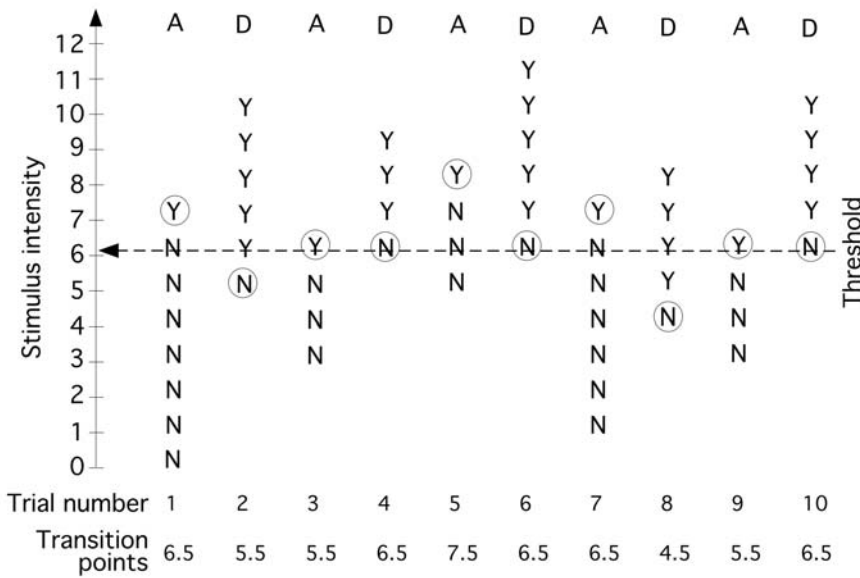
This method is the most frequently used. It is less precise than the other two methods but is also less time consuming, and yields satisfactory results if errors characteristic of the method are corrected.

### Absolute Threshold

To measure the absolute threshold, the experimenter starts with a stimulus well above or well below the threshold. On each successive trial, the threshold is approached by changing the stimulus intensity by a small amount until the boundary of sensation is reached. The stimuli are changed in either an ascending or descending series. Each transition point obtained from a number of ascending and descending series can be considered as reflecting threshold value. The threshold is thus estimated by averaging these values (Fig. 2). Subjects may show a tendency to repeat the same response within series (errors of habituation). This may falsely increase the threshold in ascending series, and decrease the threshold in descending series. A technique used to prevent such anticipation is to vary the starting point of each series.

### Difference Threshold

To measure the difference threshold, standard and comparison stimuli are presented in pairs. On each successive presentation, the comparison stimulus is changed by a small amount in the direction of the standard stimulus. During each series, whether ascending or descending, two transition points are obtained which are called the 'upper limen' (Lu) and 'lower limen' (Ll). Lu is the point on the physical dimension where "greater" responses change to "equal" responses, and



**Pain Evaluation, Psychophysical Methods, Figure 2** Determination of the absolute threshold by the method of limits.

A = ascending series of stimuli and D = descending series of stimuli

similarly LI is the point where the “lesser” responses change to “equal” responses. The range on the stimulus dimension on which a subject cannot perceive a difference between the comparison and the standard stimulus is called the interval of uncertainty (IU), and is computed by subtracting the average LI from the average Lu. The best estimate of the difference limen is taken as half the IU. The point of subjective equality (PSE) is given by  $(Lu + Li)/2$ .

**Method of Constant Stimuli**

This procedure consists of repeatedly presenting the same set of stimuli (between 5 and 9 different intensities, each presented a large number of times) in a random order throughout the experiment. Preliminary observations are needed for locating the approximate range of stimulus values.

**Absolute Threshold**

During the experiment, the number of “yes” responses for each stimulus intensity level is recorded. The proportion (p) for each stimulus intensity level is then computed, and a graph of the psychometric function is constructed as shown in the upper panel of Figure 3. The absolute threshold is usually defined as the stimulus intensity for which the proportion of trials resulting in a “yes” response is 0.50. A curve may be fitted to the data points, and the threshold may then be estimated by reading the stimulus intensity corresponding to  $p = 0.5$ . An ogival function has the property of becoming linear when the proportion of responses for each stimulus value is transformed by the following operation:  $\text{logit } p = \text{Ln}(p/(1-p))$  (Ashton 1972). The result of such transformation is illustrated in the lower panel of Figure 3. The threshold may then be estimated more precisely by determining

the best-fitting straight line. The straight line crosses the abscissa at threshold value. The steepness of the psychometric function depends on the subject’s capacity of discrimination, and may therefore be used as a measure of sensitivity.

**Difference Threshold**

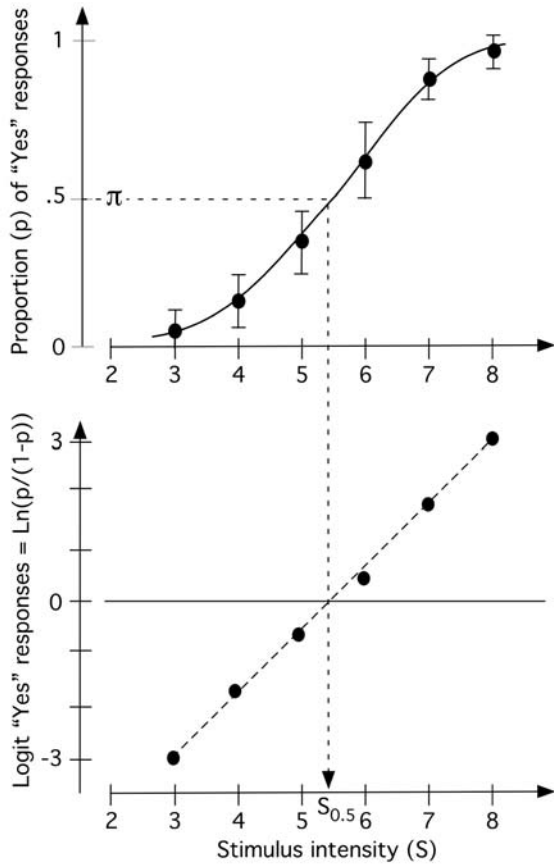
The method of constant stimuli can also be used to measure difference thresholds. The subject’s task is then to examine pairs of stimuli and to judge which stimulus produces a sensation of greater magnitude. One of the stimuli is assigned a fixed value (the ‘standard’ or ‘reference’ stimulus). The value of the other stimulus, called the ‘comparison’ stimulus, is changed from trial to trial. Usually 5 to 9 values of the comparison stimulus are given in random order. Spatial location or temporal order of stimulus pair presentations should be counterbalanced.

For each stimulus pair the proportion (p) of “greater” responses is computed, and a graph is constructed in a similar way as shown in Figure 3. When the subject cannot perceive any difference, we expect the proportions of “greater” and “lesser” responses to be approximately equal. This point on the psychometric function is called the ‘point of subjective equality’ (PSE). As for measuring absolute thresholds, the psychometric function for the difference threshold can be expressed in response proportions as well as in logit units, and the PSE can therefore be determined using the same methods of interpolation.

**Method of Adjustments**

This method resembles the method of limits, with the difference that it is the subject who adjusts the value of the ‘comparison’ stimulus and sets it to apparent equal-





**Pain Evaluation, Psychophysical Methods, Figure 3** Determination of the absolute threshold by the method of constant stimuli. Upper panel shows the psychometric function obtained in a fictitious experiment with 6 levels of stimulus intensity repeated *n* times. The dashed line points to the absolute threshold (value  $S_{0.5}$ ) defined as the stimulus intensity for which the proportion of trials resulting in a “yes” response is 0.5. The lower panel shows the result of the logit transformation performed to linearize the psychometric function. The straight line fitted to the data crosses the abscissa at the threshold value. The steepness of the psychometric function may be used as a measure of the subject’s sensitivity.

ity with the ‘reference’ stimulus. The adjustment can be made continuously by turning, for instance, a dial. Repeating this procedure allows computing an experimental distribution of values that is used to estimate the threshold or JND. One advantage of this method is the active participation of the subject, which may help prevent boredom and maintain high performance. As clearly stated by Falmagne (1958), the three traditional methods suffer from one or more of the following defects:

- there is no control over the criterion  $\pi$  (methods 1.1 and 1.3)
- the estimates may be systematically biased in several ways (methods 1.1 and 1.3)
- a large amount of data is often wasted (especially in method 1.2)

Some of these shortcomings can be overcome by using more sophisticated and computerized versions of these methods. Those will be succinctly described and discussed in the next section.

**Variations of the Traditional Methods: Adaptive Methods**

The originality of adaptive methods is that the course of the experiment is determined by data collected during the ongoing experiment: the stimulus presented on trial *n* depends on the subject’s response to one or more preceding trials.

Let the stimulus presented at trial *n* be denoted  $S_n$  and the subject’s response  $R_n$ , coded as 1 if the stimulus (*a*) is not judged as exceeding  $S_n$  and 0 if otherwise.

In the following adaptive methods, the succession of stimuli is governed by an equation of the form:

$$S_{n+1} = S_n + (\pi, n, R_n, R_{n-1}, S_{n-1}, \dots)(3)$$

In words, the value of the next stimulus is equal to the sum of the value of the present stimulus and another value, which may vary as a function of the probability  $\pi$  assigned to the target value ( $S_\pi$  i.e. absolute or difference threshold), the trial number *n*, the subject’s response to the present trial ( $R_n$ ), and eventually stimulus response pairs collected on earlier trials.

**Stochastic Approximation Method**

After choosing criterion  $\pi$ , the first stimulus ( $S_1$ ) is set somewhere in the neighborhood of the threshold ( $S_\pi$ ). Accuracy of the initial stimulus intensity is not critical. Stimulus  $S_1$  is then presented to the subject. Intensity of the second stimulus ( $S_2$ ) is determined by the following rule:

$$\text{if } R_1 = 0 S_2 = S_1 + c \cdot \pi$$

$$\text{else } S_2 = S_1 - c(1 - \pi)$$

where *c* is some constant > 0

Intensity of the following stimuli is determined by the rule:

$$S_{n+1} = S_n - c \cdot n^{-1} \cdot (R_n - \pi) (4)$$

where *n* is the trial number

By using the value *c/n*, accuracy of the estimation process is enhanced across successive stimuli, and is therefore only limited by the resolution of the stimulator. However, the counterpart to this resolution enhancement is a slowing down of the convergence process. This disadvantage can be overcome by changing the value of (*c*) as a function of subject’s responses on trials preceding trial *n*.

**The Simple Up-and-Down or Staircase Method**

In this method, the value of the stimulus on each trial is changed either positively or negatively by a fixed amount. The direction of the change is a function of equation (3). The fixed increment by which the stimulus is increased or decreased is referred to as a step, and a sequence of steps in the same direction is called a run.



An educated guess is made when choosing intensity of the initial stimulus ( $S_1$ ). The successive values ( $S_{n+1}$ ) are obtained by the following rule:

$$S_{n+1} = S_n + \delta (1 - 2R_n) \quad (5)$$

In words,  $\delta$  is the step size and  $S_{n+1}$ , the upcoming stimulus, is increased by  $\delta$  if  $R_n = 0$  and is decreased by  $\delta$  if  $R_n = 1$ .

The value of  $S_\pi$  (for  $\pi = 0.5$ ) is estimated by computing the mean of  $S_n$  values ( $n$  must be sufficiently large). A practical estimate of this value is obtained by averaging the peaks and troughs of all the runs. The choice of step size  $\delta$  is important. A frequently employed procedure is to start the first trials with a large step size, and then decrease the step size during the determinant portion of the data.

A source of difficulty is that subjects may become aware of the systematic character of the stimulus change. This may induce a strategy of anticipation which may bias responses. Such a bias can be prevented by 'interleaving' two or more staircase processes within each experimental session. In addition, convergence of staircases offers a complementary proof of the stationary character of the stochastic process ( $S_n, R_n$ ). As shown in Figure 4, the interleaved staircase processes may also involve different estimates.

### The Extended Up-and-Down or Staircase Method

As described in 2.2, the simple up-and-down procedure only permits the estimation of  $S_{0.5}$ . To extend this method to other values of  $\pi$  for  $S_\pi$  (e.g.  $\pi = 0.75$ ), the following rule has been proposed (Derman 1957):

$$S_{n+1} = S_n + \delta(1 - 2R_n Y_\pi) \quad (6)$$

where  $Y_\pi$  is a random variable taking value 1 with probability ( $\pi/2$ ), and value 0 with probability ( $1 - \pi/2$ ). By introducing this random variable, a possible strategy of anticipation is rendered even more difficult for the subject.

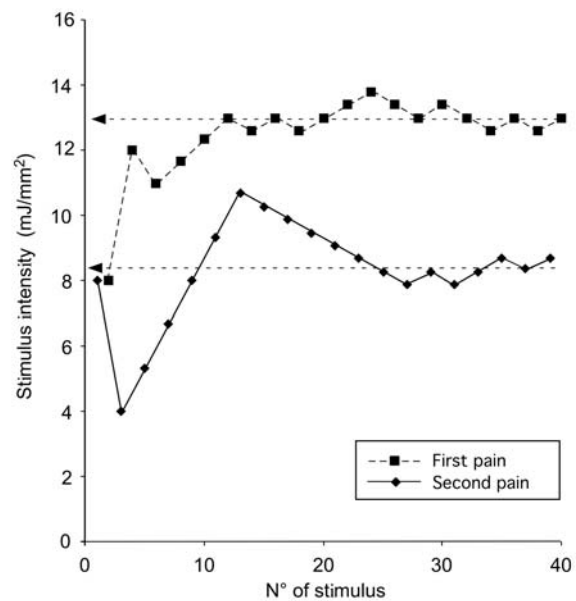
### Conclusions

As compared to conventional psychophysical methods, adaptive methods offer the following advantages:

- there is no need to model the psychometric function and to fit the data to that model,
- the total number of stimuli to deliver is significantly reduced,
- the number of painful and potentially harmful stimuli to deliver is reduced,
- interleaving several staircases allows a better control of possible psychological bias and gives the possibility of performing different estimates within the same experimental run (see example in Fig. 4).

### Response Dependent Methods

In the psychophysical methods described here above, stimulus intensity (or duration) is used as the dependent variable for a specific subjective magnitude of sensa-



**Pain Evaluation, Psychophysical Methods, Figure 4** Concurrent determination of the heat threshold for 'first' pain (i.e. pricking sensation and reaction times  $< 700$  ms) and for 'second' pain (i.e. burning sensation and reaction times  $\geq 700$  ms) by an interleaved adaptive accelerated stochastic procedure. Absence of reaction time and detections with reaction time  $> 1800$  ms are considered as trials without detection ( $R_n = 0$ ). Laser stimuli of 50 ms duration and 25 mm<sup>2</sup> surface areas were directed to the hand dorsum with a stimulus interval of 15 to 20 s. The procedure uses four steps. Step 1: Choose the parameters for the adaptive procedure (e.g.  $\pi = 0.75$ ,  $c = 2$ ,  $\delta = 0.4$  mJ/mm<sup>2</sup> and  $S_1 = S_2 = 8$  mJ/mm<sup>2</sup>). Step 2: The first staircase (composed of the odd trials) starts with stimulus  $S_1$  and reaction times of  $< 700$  ms. The second staircase (composed of the even trials) starts with  $S_2$  and reaction times of  $\geq 700$  ms. The rule of equation (4) is applied for the successive stimuli keeping  $c/n$  constant during a run of identical responses (i.e. the accelerated stochastic approximation). This rule is maintained until the maximum resolution of the laser stimulus is achieved. Step 3: Switch to the rule of equation (6) until convergence is achieved. Step 4: To estimate the threshold of 'first' and 'second' pain, compute the average of odd  $S_n$  trials and even  $S_n$  trials recorded during step 3. For the present subject, the threshold for 'first' and 'second' pain, defined as the energy density needed to detect the laser stimulus with a probability of 0.75, were 13.0 and 8.2 mJ/mm<sup>2</sup>, respectively.

tion. There is a second class of psychophysical methods that performs the reverse operation. It uses psychophysical judgments of magnitude of sensation as a dependent variable for specific stimulus intensities. These procedures present a large range of stimulus intensities, repeated several times in random fashion, and record a subjective estimate for each stimulus presented. The sensations produced may be scaled by different response methods, like visual analog scales, discrete numerical scales, cross-modality matches (e.g. handgrip force) or choosing among verbal descriptors quantified in preliminary experiments. These scaling methods use the mean response magnitude as a direct measure of perceptual magnitude. However, these measures may be susceptible to response bias, an effect in which a different response is used to describe the same sensation (Coppola

and Gracely 1983). To minimize bias effects, the direct scaling methods should rely on appropriate experimental designs (see ► [Multidimensional Scaling and Cluster Analysis Application for Assessment of Pain](#) for a thorough discussion).

### References

1. Ashton WD (1972) The Logit Transformation. Griffin, London
2. Coppola R, Gracely RH (1983) Where is the Noise in SDT Pain Assessment? *Pain* 17:257–266
3. Derman C (1957) Non-Parametric Up-and-Down Experimentation. *Ann Math Stat* 28:795–797
4. Falmagne JP (1985) Elements of Psychophysical Theory. Oxford University Press, New-York
5. Gescheider GA (1985) Psychophysics Method, Theory and Application, 2nd edn. Lawrence Erlbaum Ass, Hillsdale

## Pain-Facilitatory Systems

### Definition

Systems within the central nervous system whose normal function is to increase pain perception.

- [Descending Modulation of Nociceptive Processing](#)
- [Pain Modulatory Systems, History of Discovery](#)

## Pain Flares

### Definition

- [Breakthrough Pain](#)
- [Cancer Pain Management, Cancer-Related Breakthrough Pain, Therapy](#)
- [Evoked and Movement-Related Neuropathic Pain](#)
- [Incident Pain](#)

## Pain Generator

### Definition

The pain generator is an anatomic structure identified at the primary pathological focus of pain production.

- [Dorsal Root Ganglionectomy and Dorsal Rhizotomy](#)

## Pain History

### Definition

A pain history is an evaluation of the history of the current pain. This includes a careful description of the pain detailing the sensory characteristics, intensity, quality, location, duration, variability, predictability, exacerbating and alleviating factors, and impact of pain on daily life (e.g. sleeping, eating, school, social and physical activities, family and peer interactions).

- [Central Pain, Outcome Measures in Clinical Trials](#)

## Pain in Children with Cognitive Impairment

- [Pain in Children with Disabilities](#)

## Pain in Children with Disabilities

TIM F. OBERLANDER<sup>1</sup>, KENNETH D. CRAIG<sup>2</sup>  
<sup>1</sup>Division of Developmental Pediatrics, Centre for Community Child Health Research and The University of British Columbia, Vancouver, BC, Canada  
<sup>2</sup>Department of Psychology, University of British Columbia, Vancouver, BC, Canada  
 toberlander@cw.bc.ca, kcraig@psych.ubc.ca

### Synonyms

Pain in Children with Cognitive Impairment; Communication Limitations or Neurological Impairment

### Definition

The term “children with disabilities” encompasses diverse and overlapping conditions that are developmental (i.e. arising from genetic disorder) or acquired (ischemia, traumatic brain damage or infection) that lead to impaired cognitive, motor, social or communication capabilities. Some conditions are relatively prevalent (e.g. Down syndrome, autism, cerebral palsy, significant neurological impairment from traumatic brain injury) and others are relatively rare (e.g. genetic or metabolic disorders) (see Oberlander and Symons, 2006, for review of pain in individuals with neurological impairments).

### Characteristics

Pain is a frequent experience for children with disabilities, yet its presentation can be ambiguous and its recognition even by experienced caregivers highly subjective. Its presentation can be confounded by the child’s functional limitations and the underlying neurological condition itself. Even when pain-specific behaviours are thought to be present, they were regarded as altered and blunted or confused with other sources of generalized arousal (McGrath et al. 1998; Oberlander et al. 1999). This presents a tremendous challenge for clinicians and researchers alike. Until recently, pain in this setting received very little scientific attention and children with developmental disabilities were systematically excluded from research. Such neglect was in part based on erroneous beliefs that because the expression of pain was difficult, individuals with disabilities were indifferent, or worse insensitive, to pain. However, regardless of the degree of disability, pain has now been reported as a part of daily life and there are no reasons to believe that altered pain behaviours represent pain insensitivity or indifference (Oberlander and Craig 2003).

## Pain in Children

PATRICIA A. MCGRATH

Department of Anaesthesia, Divisional Centre of Pain Management and Research, The Hospital for Sick Children and Brain and Behavior Program, Research Institute at The Hospital for Sick Children and Department of Anaesthesia, University of Toronto, Toronto, ON, Canada  
patricia.mcgrath@sickkids.ca

### A Historical Perspective of a Dynamic Specialty Area

As in adults, a child's pain depends upon complex neural interactions, where impulses generated by tissue damage are modified by both ascending systems activated by innocuous stimuli and by descending pain suppressing systems activated by various situational and psychological factors. However, children are not 'little adults' with respect to how they perceive pain. The developing ► **nociceptive system** responds differently to injury (i.e. increased excitability and sensitization) when compared to the mature adult system. Moreover, a child's pain appears to have a greater degree of ► **plasticity** when compared to that of adults, more influenced by cognitive, behavioral and emotional factors.

Our knowledge of children's pain has advanced enormously during the past 30 years as a result of intensive research encompassing a "bench to bedside to community health research" perspective, covering a population from "*in utero* through adolescence" and including all types of acute and persistent pain (for review see McGrath 2005). Previously, clinical decisions about whether children were experiencing pain and, if so, about the particular pain therapies required were based primarily on clinicians' personal beliefs rather than on scientific evidence. Regrettably, common misbeliefs – that children did not feel pain in the same manner as adults and consequently did not require similar analgesics and pervasive fears – that children were at heightened risk of opioid addiction and should receive minimal analgesic doses caused many children to suffer needlessly.

In the late 1980s and early 1990s the first comprehensive books on childhood pain were written: three authored (McGrath 1990; McGrath and Unruh 1987; Ross and Ross 1988) and three edited (Bush and Harkins 1991; Pichard-Léandri and Gauvain-Piquard 1989; Tyler and Krane 1990) texts. These books heralding the beginning of the specialized field of pediatric pain continue to provide valuable insights about a child's perception, versatile assessment techniques and the management of common pain problems from a practical hands-on perspective. Today, thousands of ar-

ticles and nearly a hundred books on children's pain have been published. In striking contrast, 30 years ago near the founding of the International Association for the Study of Pain (1973–1975), only one book, "The Child with Abdominal Pains" (Apley 1975) and only 61 articles, ~20 articles per year, were published on children's pain. Similarly, during this period medical texts contained almost no information about the general topic of children's pain nor any reference to specific pain conditions. Only 26 pages referred to pain across 5 major pediatric texts, while 270 pages refer to children's pain in recent texts (McGrath 2005).

Today, most texts on pain include at least one chapter devoted to children's issues. Moreover, the pediatric field is enriched with recent comprehensive texts (Olsson and Jylli 2001; Schechter et al. 2003) and specialized texts on neonates (Anand et al. 2000), children's headache (McGrath and Hillier 2001), procedural related pain (Finley and McGrath 2001; Liozzi 2002) and biologic-social factors (McGrath and Finley 2003). The IASP core curriculum has recently been revised with expanded sections to encompass new findings in the fields of developmental neurobiology, pain assessment and evidence based pain management ([www.iasp-pain.org](http://www.iasp-pain.org)).

### The Developing Nociceptive System –Increased Sensitivity and Plasticity

Anand and colleagues dramatically highlighted the adverse impact of untreated postoperative pain in 1987, when they revealed that premature infants undergoing surgery without adequate analgesic medication had significantly increased post-surgical morbidity and mortality in comparison to a group who had received fentanyl (Anand et al. 1987). The ensuing publicity as people learned that minimal anesthesia and analgesia represented "the norm in pediatric postoperative management" – rather than the exception, sparked a revolution (for review see Schechter et al. 2003; see ► **evolution of pediatric pain treatment**). Ethical concerns and increasing publicity about the lack of analgesia for infants led to a dramatic upsurge in clinical research to document objectively how infants responded to surgical trauma and how analgesic administration affects post-surgical outcome. At the same time, basic scientific research focused on the developing ► **nociceptive system**, tracing the anatomical development of each component, starting from the primary sensory neurons innervating peripheral tissues to dorsal horn cells and spinal reflex connections, the pathways projecting to higher brain centers and the descending inhibitory pathways from the brain. Physiological studies detailed how the maturing pain system responded to different types of stimuli at different developmental periods.

Fitzgerald and colleagues initiated a series of elegant works to detail the development of the nociceptive system (for review see Fitzgerald and Howard 2003; see ► [infant pain mechanisms](#)). Considerable neuronal plasticity is evident throughout the developing system from the periphery to the brain. The basic nociceptive connections are formed before birth, but systems at birth are immature and exhibit increased responsiveness in comparison to the adult animal. The conduction velocity of afferent fibers, action potential shape, receptor transduction, firing frequencies and receptive field properties change substantially over the postnatal period. High threshold A $\delta$  mechanoreceptors (► [high threshold mechanoreceptor](#)) (which respond maximally to noxious mechanical stimuli) and low threshold A $\delta$  mechanoreceptors (which respond maximally to innocuous stimuli) respond with lower firing frequencies than those in the adult animal. The receptive fields of dorsal horn cells are larger in the newborn. The larger receptive fields and dominant ► [A-fiber](#) input increases the likelihood of central cells being excited by peripheral sensory stimulation and acts to increase the sensitivity of infant sensory reflexes. Some inhibitory mechanisms in the dorsal horn are immature at birth and ► [descending inhibition](#) is delayed. The lack of descending inhibition in the neonatal dorsal horn means that an important endogenous analgesic system that should attenuate noxious input as it enters the spinal cord is lacking and thus the effects of the input may be more profound than in the adult (Fitzgerald and Howard 2003).

Most studies in developmental neurobiology have been conducted on rat pups because they have comparable developmental timetables with respect to the anatomy, chemistry, and physiology of maturing human pain pathways. To study neural function in human infants, investigators have monitored behavioral and neurophysiologic responses and revealed comparable findings of plasticity and increased excitability in the developing nervous system (for review see ► [infant pain mechanisms](#); Andrews 2003; Johnston et al. 2003). In comparison to adults, young infants have exaggerated reflex responses (i.e. lower thresholds and longer lasting muscle contractions) in response to certain types of trauma, such as needle insertion. Repeated mechanical stimulation at strong (but not pain inducing) intensities can cause sensitization in very young infants, while repeated painful procedures such as those required during intensive care can profoundly affect sensory processing in infants. Infants after surgery can develop a striking hypersensitivity to touch, as well as to pain. While we do not know specifically how such injuries may affect the mature human pain system or influence adult pain perception, increasing attention is focused on the possible consequences of untreated pain, par-

ticularly in infants (Grunau 2000; see ► [long-term effects of pain in infants](#)). For example, circumcised newborn infants display a stronger pain response to subsequent routine immunizations at 4 and 6 months than uncircumcised infants, but application of lidocaine-prilocaine anesthetic cream at circumcision attenuates the pain response to the subsequent immunizations (Taddio et al. 1997). Studies of former premature infants who required intensive care have shown behavioral differences related to early pain experiences. The results of behavioral studies in infants, like those from neurobiological studies in animals indicate increased responsiveness to pain. Clinicians should appreciate that if an injury or medical procedure is noxious to adults, it will be noxious to infants (Porter et al. 1999).

### A Child's Pain Perception –Factors that Modify A Child's Pain

A child's pain perception can be regarded as plastic from a psychological, as well as biological perspective. Tissue damage initiates a sequence of neural events that may lead to pain, but many developmental, social and psychological factors can intervene to alter the sequence of nociceptive transmission and thereby modify a child's pain. Child characteristics, such as cognitive level, sex, gender, temperament, previous pain experience, family (► [impact of familial factors on children's chronic pain](#)) and cultural background shape generally how children interpret and cope with pain (Bennett-Branson and Craig 1993; Peterson et al. 1999; Schanberg et al. 1998).

In contrast, situational factors vary dynamically, depending on the specific circumstances in which a child experiences pain. For example, a child receiving treatment for cancer (► [Cancer Pain, Palliative Care in Children](#)) may have repeated injections, central venous port access and lumbar punctures, all of which can cause pain (depending on the analgesics, anesthetics or sedatives used). Even though the tissue damage from these procedures (► [acute pain in children, procedural](#)) is the same each time, the particular set of situational factors for each treatment is unique for a child. The expectations, behaviors and emotional state of the child, parent and health care provider all play a critical role. "What children and parents understand, what they (and health care staff) do and how children and parents feel" can profoundly impact a child's pain experience. Certain situational factors can intensify pain and distress, while others can eventually trigger pain episodes and prolong pain related disability or maintain the cycle of repeated pain episodes in recurrent pain syndrome (McGrath and Hillier 2001). Parents and health care providers can dramatically improve a child's pain experience and minimize their disability by modifying



children's understanding of a situation, their focus of attention, perceived control, expectations for obtaining eventual recovery and pain relief and the meaning or relevance of the pain.

Situational factors may affect children even more than adults. Adults typically have experienced a wide variety of pains (i.e. diverse etiology, intensity and quality) providing them with a broad base of knowledge and coping behaviors. When adults encounter new pains, they evaluate them primarily from the context of their cumulative life experience. In contrast, children with more limited pain experience must evaluate new pains primarily from the context of the immediate circumstances.

Children's understanding of pain, pain coping strategies and the impact of pain increase with age (Gaffney and Dunne 1987), but many questions remain about the interplay of maturation, cognitive development and experience in mediating a child's pain. Children's procedural pain (► [acute pain in children, procedural](#)) generally decreases with age (Goodenough et al. 1999; Lander and Fowler-Kerry 1991), but the effect of age probably varies depending on the type of pain and the nature of their previous pain experiences, that is, positive experiences with similar painful situations (Bijttebier and Vertommen 1998; Dahlquist et al. 1986).

Age, sex and psychosocial factors are now recognized as important factors in the development of persistent pain and pain related disability. Although the overall prevalence of pain increases with age, girls may be at greater risk than boys for developing certain types of persistent pain (Unruh and Campbell 1999). We do not yet know the specific prevalence of most types of chronic pain in children, but recent research is focusing on the epidemiology of childhood persistent pain (► [prevalence of chronic pain disorders in children](#)) to obtain age- and sex-related prevalence estimates, identify vulnerability and prognostic factors and determine the long term impact for children and their families.

### **Pain Measures for Infants and Children**

Pain assessment is an intrinsic component of pain management in infants and children. Clinicians need an objective measure of pain intensity and an understanding of the factors that cause or exacerbate pain for an individual child. More than 60 pain measures are now available for infants, children and adolescents (see ► [pain assessment in neonates](#); ► [pain assessment in children](#)) (Finley and McGrath 1998). While no single pain measure is appropriate for all children and for all situations in which they experience pain, we should be able to evaluate pain for almost every child.

Physiological parameters including heart rate, respiration rate, blood pressure, palmar sweating, cortisol

and cortisone levels, O<sub>2</sub> levels, vagal tone and endorphin concentrations have been studied as potential pain measures. However, they reflect a complex and generalized stress response, rather than correlate with a particular pain level. As such, they may have more relevance as distress indices within a broader behavioral pain scale. ► [Behavioral pain scales](#) record the type and amount of pain related behaviors children exhibit. Since a child's specific pain behaviors depend on the type of pain experienced, different scales are usually required for acute and persistent pain. Clinicians monitor children for a specified time period and then complete a checklist noting which distress behaviors (e.g. crying, grimacing, guarding) occur. Behavioral scales must be used for infants and children who are unable to communicate verbally. Recently, investigators are validating pain scales for children who are developmentally disabled. However, the resulting pain scores are indirect estimates of pain and do not always correlate with children's own pain ratings. Even though clinicians may use diaries rather than formal scales, prospective evaluation of a child's behavior is an essential component of pain management, providing information about medication use, compliance with treatment recommendations and the extent of pain-related disability (i.e. school attendance, physical activities and social activities with peers).

► [Psychological pain measures](#) or "self-report measures" include a broad spectrum of projective techniques, interviews, questionnaires, qualitative descriptive scales and quantitative rating scales designed to capture the subjective experience of a child's pain (see ► [pain assessment in children](#), Champion et al. 1998). By the age of five, most children can differentiate a wide range of pain intensities, and many can use simple ratio and interval pain scales (e.g. visual analog scales, numerical scales, faces, verbal descriptor scales) to rate their pain intensity. Many scales have excellent psychometric properties, are convenient to administer, easy for children to understand, adaptable to many clinical situations and help parents to monitor their children's pain at home. Interviews, usually conducted independently with a child and parents are the cornerstone of assessment for children with persistent pain, enabling clinicians to identify relevant child, family and situational factors that contribute to children's pain and disability problems.

### **Child-centered Pain Management**

Controlling a child's pain requires an integrated approach because many factors are responsible, no matter how seemingly clear cut the etiology. Adequate analgesic prescriptions, administered at regular dosing intervals, must be complemented by a practi-

cal cognitive-behavioral approach to ensure optimal pain relief. Pain control is achieved practically by adjusting both drug and nondrug therapies in a rational child oriented manner based on the assessment process (see ► [analgesic guidelines for infants and children](#)). ► [Analgesics](#) include acetaminophen, nonsteroidal anti-inflammatory drugs and opioids. ► [Adjuvant analgesics](#) include a variety of drugs with analgesic properties such as anticonvulsants and antidepressants that were initially developed to treat other health problems, but whose therapeutic uses have been expanded. The use of adjuvant analgesics has become a cornerstone of pain control for children with chronic pain, especially when pain has a neuropathic component. Children with severe pain may require progressively higher and more frequent opioid doses due to drug tolerance and should receive the doses they need to relieve their pain. The fear of opioid addiction in children has been greatly exaggerated. Neonates and infants require the same three categories of analgesic drugs as older children. However, premature and term newborns show reduced clearance of most opioids. The differences in pharmacokinetics and pharmacodynamics among neonates, preterm infants and full-term infants warrant special dosing considerations for infants and close monitoring when they receive opioids.

An extensive array of nondrug therapies is available to treat a child's pain including physical (► [chronic pain in children, physical medicine and rehabilitation](#)), psychological and complementary (► [Complementary Therapies](#)) and alternative (► [Alternative Therapies](#)) (► [CAM](#)) approaches. Counseling, attention and ► [distraction](#), guided imagery, ► [hypnosis](#), ► [relaxation training](#), ► [biofeedback](#) and behavioral management are used routinely to treat a child's procedural pain (► [acute pain in children, procedural](#)) and ► [chronic pain](#). Children seem more adept than adults at using psychological therapies, presumably because they are generally less biased than adults about their potential efficacy. Strong and consistent scientific evidence supports the efficacy of many psychological therapies for relieving children's procedural pain and for relieving childhood headache (► [chronic daily headache in children](#)), but few rigorous evaluations have been conducted on their efficacy for relieving other types of chronic pain, even though they are considered an essential component of many treatment programs. Pediatric research is just beginning on many of the therapies regarded as complementary to traditional medical approaches, such as acupuncture (Zeltzer et al. 2002).

Pain control is not merely "drug *versus* nondrug therapy", but rather an integrated approach to reduce or block nociceptive activity by attenuating responses in peripheral afferents and central pathways, activating

endogenous pain inhibitory systems and modifying situational factors that exacerbate pain (for specific types of problems in ► [Pain Management in Infants](#), see ► [pain and sedation of children in the emergency setting](#) ► [acute pain in children, post-operative](#) ► [CRPS-1 in children](#), ► [pain control in children with burns](#) ► [recurrent abdominal pain in children](#) ► [complex chronic pain in children, interdisciplinary treatment](#) ► [cancer pain and palliative care in children](#) ► [infant pain mechanisms](#) and ► [somatization and pain disorders in children](#).

### Future Challenges

As a result of extensive research, we have gained better insights about how the developing nociceptive system responds to tissue injury, how children perceive pain, how to assess pain in infants and children and which drug and nondrug therapies will alleviate their pain. The emphasis has shifted gradually from an almost exclusively disease-centered focus, detecting and treating the putative source of tissue damage—to a more child centered perspective, assessing the child with pain, identifying contributing psychological and contextual factors and then targeting interventions accordingly. However, serious challenges remain.

We have discovered much about the plasticity of the developing nociceptive system, but still have much to learn about how signals from painful stimuli are processed, especially at higher levels. Although we need further developmental research in neurobiology, neurophysiology and pharmacology, we now know that infants seem particularly vulnerable because of their heightened responsivity to tissue injury and we must devote particular attention to their pain management. We need to apply the existing knowledge about pain assessment and pain management more consistently within our clinical practice. Regrettably, many hospitals still do not require consistent documentation of children's pain, preventing us from ensuring that children's pain is adequately controlled. Hospital administrators or accreditation organizations should establish children's pain control as a priority. In spite of established analgesic dosing guidelines for infants and children, the undertreatment of postoperative (► [acute pain in children, post-operative](#)) and chronic pain (► [chronic pain in children, physical medicine and rehabilitation](#)) is a continuing problem in many centers. Moreover, increasing responsibility for evidence based practice dictates that health care providers adopt clear guidelines for determining when treatments are effective and for identifying children for whom they are most effective. We lack data from well-designed cohort studies and RCTs to support the efficacy of many interventions (both drug and nondrug thera-

pies) used extensively in clinical practice. Although cognitive-behavioral interventions are critical components of pain management programs for chronic pain, most of the data supporting their efficacy is derived from studies of childhood headache. As Eccleston and colleagues (2002) concluded, we urgently need well-designed studies of non-headache chronic pain in children and adolescents.

We critically need data on child centered treatment efficacy, that is, when interventions are selected for the individual child with pain, based on an assessment of the specific cognitive, behavioral and emotional factors contributing to their pain and disability. We need longitudinal studies to identify key risk factors that influence a child's vulnerability to chronic pain, in particular the apparent increased vulnerability in females. Future studies should use brain imaging technology and psychophysical measurement to evaluate the neural mechanisms underlying chronic pain and cognitive function in children. Our ultimate and continuing challenges are to better understand the experience of children's pain and to improve clinical practice, so that health care providers use the existing 'state of the art' pain scales, interpret children's pain scores to guide therapeutic decisions and document treatment effectiveness.

## References

- Anand KJ, Sippell WG, Aynsley-Green A (1987) Randomised trial of fentanyl anaesthesia in preterm babies undergoing surgery: effects on the stress response. *Lancet* 1:62–66
- Anand KJS, Stevens BJ, McGrath PJ (2000) *Pain in Neonates*. Elsevier, Amsterdam
- Andrews KA (2003) The Human Developmental Neurophysiology of Pain. In: Schechter NL, Berde CB, Yaster M (eds) *Pain in Infants, Children, and Adolescents*, 2nd edn. Lippincott Williams & Wilkins, Baltimore, pp 43–57
- Apley J (1975) *The child with abdominal pains*. Blackwell Scientific, Oxford
- Bennett-Branson SM, Craig KD (1993) Post-operative pain in children: Developmental and family influences on spontaneous coping strategies. *Can J Behav Sci* 25:355–383
- Bijttebier P, Vertommen H (1998) The impact of previous experience on children's reactions to venepunctures. *J Health Psychol* 3:39–46
- Bush JP, Harkins SW (1991) *Children in Pain: Clinical and Research Issues from a Developmental Perspective*. Springer-Verlag, New York
- Champion GD, Goodenough B, von Baeyer CL et al. (1998) Measurement of Pain by Self-Report. In: Finley GA, McGrath PA (eds) *Measurement of Pain in Infants and Children*. IASP Press, Seattle, pp 123–160
- Dahlquist LM, Gil KM, Armstrong FD et al. (1986) Preparing children for medical examinations: the importance of previous medical experience. *Health Psychol* 5: 249–259
- Eccleston C, Morley S, Williams A et al. (2002) Systematic review of randomised controlled trials of psychological therapy for chronic pain in children and adolescents, with a subset meta-analysis of pain relief. *Pain* 99:157–165
- Finley GA, McGrath PJ (1998) *Measurement of Pain in Infants and Children*. IASP Press, Seattle
- Finley GA, McGrath PJ (2001) *Acute and procedure pain in infants and children*. IASP Press, Seattle
- Fitzgerald M, Howard RF (2003) The Neurobiologic Basis of Pediatric Pain. In: Schechter NL, Berde CB, Yaster M (eds) *Pain in Infants, Children, and Adolescents*, 2nd edn. Lippincott Williams & Wilkins, 2003, Baltimore, pp 19–42
- Gaffney A, Dunne EA (1987) Children's understanding of the causality of pain. *Pain* 29:91–104
- Goodenough B, Thomas W, Champion GD et al. (1999) Unravelling age effects and sex differences in needle pain: Ratings of sensory intensity and unpleasantness of venipuncture pain by children and their parents. *Pain* 80:179–190
- Grunau RE (2000) Long-term consequences of pain in human neonates. In: Anand KLS, Stevens BJ, McGrath PJ (eds) *Pain in Neonates*, 2nd edn. Elsevier, Amsterdam, pp 55–76
- Johnston C, Stevens B, Boyer K et al. (2003) Development of Psychologic Responses to Pain and Assessment of Pain in Infants and Toddlers. In: Schechter NL, Berde CB, Yaster M (eds) *Pain in Infants, Children, and Adolescents*, 2nd edn. Lippincott Williams & Wilkins, 2003, Baltimore, pp 105–127
- Lander J, Fowler-Kerry S (1991) Age differences in children's pain. *Percept Mot Skills* 73:415–418
- Lioffi C (2002) *Procedure-related Cancer Pain in Children*. Radcliffe Medical Press Ltd, Oxford
- McGrath PA (1990) *Pain in Children: Nature, Assessment and Treatment*. Guilford Press, New York
- McGrath PA (2005) Children –Not Simply “Little Adults” In: Merskey H, Loeser J, Dubner R (eds) *The Paths of Pain 1975–2005*. IASP Press, Seattle
- McGrath PJ, Finley GA (2003) *Pediatric pain: biological and social context*. IASP Press, Seattle
- McGrath PA, Hillier LM (2001) *The Child with Headache: Diagnosis and Treatment*. IASP Press, Seattle
- McGrath PJ, Unruh AM (1987) *Pain in children and adolescents*. Elsevier, Amsterdam
- Olsson GL, Jylli L (2001) *Barn och Smärta*. Studentlitteratur, Lund
- Peterson L, Crowson J, Saldana L et al. (1999) Of needles and skinned knees: Children's coping with medical procedures and minor injuries for self and other. *Health Psychol* 18:197–200
- Pichard-Léandri E, Gauvain-Piquard A (1989) *La Douleur Chez L'Enfant*. Medsi / McGraw Hill, Paris
- Porter FL, Grunau RE, Anand KJ (1999) Long-term effects of pain in infants. *J Dev Behav Pediatr* 20:253–261
- Ross DM, Ross SA (1988) *Childhood pain: current issues, research, and management*. Urban & Schwarzenberg, Baltimore
- Schanberg LE, Keefe FJ, Lefebvre JC et al. (1998) Social context of pain in children with Juvenile Primary Fibromyalgia Syndrome: parental pain history and family environment. *Clin J Pain* 14:107–115
- Schechter NL, Berde CB, Yaster M (2003) *Pain in Infants, Children, and Adolescents*. Lippincott Williams & Wilkins, Baltimore
- Taddio A, Katz J, Ilersich AL et al. (1997) Effect of neonatal circumcision on pain response during subsequent routine vaccination. *Lancet* 349:599–603
- Tyler DC, Krane EJ (1990) *Advances in pain research and therapy*. Raven Press, New York
- Unruh AM, Campbell MA (1999) Gender variations in children's pain experiences. In: Finley GA, McGrath PJ (eds) *Chronic and recurrent pain in children and adolescents*. IASP Press, Seattle, pp 199–241
- Zeltzer LK, Tsao JC, Stelling C et al. (2002) A phase I study on the feasibility and acceptability of an acupuncture / hypnosis intervention for chronic pediatric pain. *J Pain Symptom Manage* 24:437–446

Recognition of the importance of pain in children with disabilities led to many questions about the nature, extent and functional impact of pain for the child and caregivers in the settings where these children live. To date, research in this field has been restricted by difficulties with the definition of pain itself and understanding how disabilities and pain intersect. Fortunately, the past 10 years has seen an exponential growth in research activity in this field, spanning exploration of pain in preterm infants, children with cognitive and communication impairments and children with developmental disabilities (McGrath et al. 1998; Oberlander and Craig 2003).

Lack of understanding of pain in this setting contributed to some of the difficulties in pursuing research in this field. The International Association for the Study of Pain (IASP) definition of pain as “an unpleasant sensory and emotional experience associated with actual or potential tissue damage or described in terms of such damage” (Merskey 1986) appears useful. Characterization of the experience of pain as an unpleasant sensory and emotional experience should be applicable to anyone regardless of a disability. However, an emphasis on self-report in the definition and the subjective experience of pain necessitated a capacity for effective verbal communication. This led Anand and Craig (1996) to argue that all features of the behavioural response to pain should be accepted as evidence of its presence and should not be discounted as a “surrogate measure” of pain (Anand and Craig 1996). IASP recently made a substantial change to this definition by adding a note indicating that “The inability to communicate verbally does not negate the possibility that an individual is experiencing pain and is in need of appropriate pain-relieving treatment.” (<http://www.iasp-pain.org/terms-p.html>). This broadening of research and clinical approaches to pain should contribute to better understanding of the thoughts, feelings and sensory features of pain in individuals with language and cognitive disabilities.

### Sources and Epidemiology

Reports on the epidemiology of pain suggest that pain in this setting is not uncommon (Engel et al. 2002). These children are at least as vulnerable to the usual sources of acute pain that afflict typical children, with cognitive, motor and communication impairment frequently leaving them more susceptible to environmental risk factors. While we have less of an understanding of the prevalence of chronic pain (e.g. headache, abdominal pain, musculoskeletal pain) in this setting, there is no reason to believe that anyone is spared the falls, burns, earaches or toothaches that are a common part of childhood. In addition to the usual sources of pain, the symptoms associated with specific conditions are often painful (e.g. spasticity and contractures, reflux oesophagitis, constipation) and are usually compounded by an increased exposure to painful medical procedures associated with their conditions (e.g. surgery for hydro-

cephalous shunts or motor spasticity). The likelihood of repeated pain contributes to the possibility that these children will be sensitized to pain and display adverse behavioural reactions. Compounding these painful experiences is the difficulty in communicating distress, thereby reducing the likelihood of early intervention or adequate care (Gilbert-Macleod et al. 2000) and conceivably increasing the exposure to and duration of pain.

### Assessment and Treatment

Recently, there have been considerable efforts to develop assessment instruments useful in home, clinical and research settings. Global proxy judgments of pain have been shown to underestimate pain and in response a number of empirical studies have yielded important inventories of behaviours considered by observers to be pain related among children with significant neurological impairments (Stallard et al. 2002). These multidimensional instruments are designed to assess pain in children and adults with communication and cognitive impairments and have demonstrated adequate psychometric features (i.e. reliability and validity) (Breau et al. 2002; Collignon and Giusiano 2001; Hadden and von Baeyer 2005; McGrath et al. 1998). Work to understand the clinical utility of these tools and the impact of developmental status is pending. Self-report tools can be useful for some with cognitive impairments (Fanurick et al. 1998). Research tools focusing upon sensitive and specific features of nonverbal pain display (e.g. facial expression, Nader et al. 2004) and biobehavioural reactivity (Oberlander et al. 1999) are becoming available. With refinement in instruments that document how children with disabilities express pain, we will increasingly better understand the nature of their experience of pain. Irrespective of the instruments used, it is clear that pain assessment should be routinely undertaken, regardless of the disability, particularly when extraordinary behaviour or context dictates the possibility that pain is present.

Studies of novel treatment strategies that recognize unique features of pain in this setting are still lacking. Both pharmacological and psychosocial interventions that focus on the sensitivity of pain to environmental, situational and emotional factors need to be explored in a multidisciplinary context. In particular, pain management should become an inherent part of the care of children with disabilities, especially where they are likely to encounter painful conditions (e.g. gastrointestinal pain, orthopaedic pain, pain due to respiratory infections) (Oberlander 2003, Taddio 2006). These interventions need to reflect the nature of the underlying condition and subsequent impairment, as well as individual differences in pain reactivity and abilities. It is important to recognize that the pharmacological treatment of conditions associated with developmental disabilities (i.e. anticonvulsants, medications used to treat gastrointestinal reflux etc) may alter pharmaco-



dynamics and pharmacokinetics of analgesics, thereby making pain management even more challenging.

### Functional Impact of Pain

Studies of pain in this setting typically focus on describing symptoms, duration and intensity of pain without accounting for the functional consequences of the symptom, even though chronic pain is likely to have a major impact on daily activities. If we are to fully understand pain in individuals with disabilities, we need an improved understanding of the physiological, psychological, behavioural, familial, social and occupational impact of pain on daily life.

There have been efforts to characterise functional disability associated with various childhood disabilities consistent with the five dimensions of the World Health Organization's system of pathophysiology, impairment, functional impairment, disability and societal limitations (WHO 1980). This schema provides a multidimensional framework for assessing the functional impact of pain in, for example, a youth with cerebral palsy. In this model, the pathophysiology of the disability would be the central lesions (presumably prenatal ischemic neurological injury). It also could include painful complaints such as chronic headache, which may or may not be related to factors associated with the disease (e.g. hydrocephalus / shunt malfunction or a concurrent migraine disorder). Here the disease and pain together receive consideration as potentially interrelated but separate pathophysiological entities. The impairment would include the neuromotor impairment (spasticity) and the frequency and intensity of the symptom (head pain), regardless of the aetiology. Compounding the impairment are the cognitive and communication limitations that are a concurrent consequence of the central impairment. The functional limitations that follow may be a consequence of motor, cognitive and communication limitations, as well as the impact the pain on activities of daily living (e.g. sleep, self-care, relationship with his mother, peer relationships). This individual's disability could be difficulty in carrying on life as an adolescent attending school or in age-appropriate social relationships. Finally, the societal limitations are those barriers placed by society, which limit participation even in a modified classroom setting, where teachers may have difficulty understanding, managing and coping with a student's pain. An individual may also be denied appropriate and timely pain management because caregivers may not accept that the pain is as "real" when the ability to communicate experiences with discrete words and motor movements is limited. The social contexts in which children with disabilities live, often dictate levels of care and support. Caregiver stress and burden can often be a limiting factor in the quality of care provided. This schema might be an oversimplification, but it begins to illustrate how pain and disability intersect.

Using this approach, one can appreciate how uncontrolled acute pain or chronic pain could play important roles as a determinant of well being in the context of a disability. There is considerable potential for a cascading spiral of compounding, disabling processes when pain becomes important in the life of a child with disability. It becomes obvious that one should consider not only the presence and severity of pain, but also its functional consequences and how these relate to any underlying neurological condition. This approach also encourages one to distinguish individuals who experience pain with little or no functional limitations from those that are more severely restricted in function. While the two may be separate in an aetiological sense, our assessment and management of pain in this setting is invariably influenced by the functional aspects of daily life (i.e. a limited capacity to communicate pain) associated with the neurological impairment. Understanding chronic pain and its impact on daily life is limited and much work is still needed to understand the deleterious impact of pain on child and family functioning in this setting.

### Conclusion

While pain in individuals with disability has received substantially increased attention over the past decade, numerous questions remain. At a very basic level, our understanding of relationships between altered neurological function and the pain system remains incomplete. Similarly, research needs to address questions about how social and cognitive impairments influence the expression of pain and the implications this might have for assessment and intervention strategies to reduce suffering where individuals experience repetitive painful events. Further, work needs to be directed towards understanding the impact of family and social influences, mental illness and culture have on the ongoing pain. Finally, we need to seek ways to translate research findings into meaningful clinical and public health policies that address pain in individuals with disabilities. Considerable work on recognition, assessment and management of pain in individuals with disabilities remains to be done.

### References

1. Anand KJS, Craig KD (1996) Editorial: New perspectives on the definition of pain. *Pain* 67:3–6
2. Breau LM, McGrath PJ, Camfield CS et al (2002) Psychometric properties of the non-communicating children's checklist-revised. *Pain* 99:349–357
3. Collignon P, Giusiano B (2001) Validation of a pain evaluation scale for patients with severe cerebral palsy. *Eur J Pain* 5:433–442
4. Engel JM, Kartin D, Jensen MP (2002) Pain treatment in persons with cerebral palsy: frequency and helpfulness. *Am J Phys Med Rehabil* 81:291–296
5. Fanurik D, Koh, JL, Harrison RD et al. (1998). Pain assessment in children with cognitive impairment: An exploration of self-report skills. *Clinical Nursing Research* 7:103–124
6. Gilbert-Macleod CA, Craig KD, Rocha EM et al. (2000) Everyday pain responses in children with and without developmental delays. *J Pediatr Psychol* 25:301–308

7. Hadden KL, von Baeyer CL (2005) Global and specific behavioural measures of pain in children with cerebral palsy. *Clin J Pain* 21:140–146
8. <http://www.iasp-pain.org/terms-p.html>. 2001
9. McGrath PJ, Rosmus C, Canfield C et al (1998) Behaviours caregivers use to determine pain in non-verbal, cognitively impaired individuals. *Developmental Medicine and Child Neurology* 40:340–343
10. Merskey H (1986) Classification of chronic pain: Descriptions of chronic pain syndromes and definitions of pain terms. *Pain* 3:51
11. Nader R, Oberlander TF, Chambers CT et al. (2004) The expression of pain in children with autism. *Clin J Pain* 20:88–97
12. Oberlander TF, Gilbert CA, Chambers CT et al. (1999) Biobehavioral responses to acute pain in adolescents with a significant neurological impairment. *Clin J Pain* 15:201–209
13. Oberlander TF, Craig KD (2003) Pain and children with developmental disabilities. In: Schechter NM, Berde CB, Yaster M (eds) *Pain in infants, children and adolescents*, 2nd edn. Williams & Wilkins, Baltimore, pp 599–619
14. Oberlander TF, Symons F (2006) Pain in Individuals with Developmental Disabilities. Paul H (ed) Brookes Publishing Inc., Baltimore, MD
15. Stallard P, Williams L, Velleman R et al. (2002) The development and evaluation of the pain indicator for communicatively impaired children (PICIC). *Pain* 98:145–149
16. Taddio A, Oberlander TF (2006) Pharmacological Management of pain in children and youth with significant neurological impairments. In: Oberlander TF, Symons F (eds) *Pain in Individuals with Developmental Disabilities*. Paul H Brookes Publishing Inc., Baltimore, MD
17. WHO (1980) International classification of impairments disabilities and handicaps. World Health Organization, Geneva

## Pain in Ganglionopathy

- ▶ Peripheral Neuropathic Pain

## Pain in HIV / AIDS

- ▶ Cancer Pain and Pain in HIV / AIDS

## Pain in Human Immunodeficiency Virus Infection and Acquired Immune Deficiency Syndrome

FRANCINE RAINONE, PETER SELWYN  
Montefiore Medical Center and Albert Einstein  
College of Medicine, Bronx, New York, NY, USA  
[frainone@montefiore.org](mailto:frainone@montefiore.org), [selwyn@aecom.yu.edu](mailto:selwyn@aecom.yu.edu)

### Synonyms

HIV-associated neuropathy; Neuropathy Due to HAART; Zidovudine (AZT)-Induced Headache; HIV and Pain; AIDS and Pain

### Definition

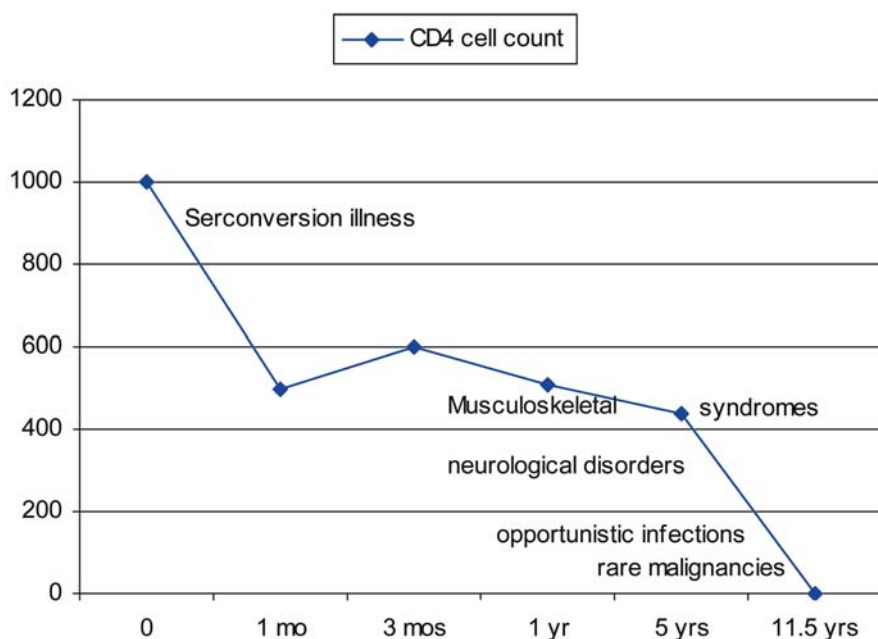
Neuropathic and nociceptive pain are common results of Human Immunodeficiency Virus (HIV) infection and its treatment. Despite the fact that pain is associated with psychological and functional morbidity, it remains under-treated in patients with HIV/Acquired Immune Deficiency Syndrome (AIDS) (Breitbart et al. 1996). Both patient and provider barriers contribute to this situation.

### Etiologies of Pain

As with cancer, pain in HIV/AIDS may be related to the disease itself, therapy or diagnostic procedures related to the disease, or may be independent of the disease or disease-related interventions. Also, like cancer, the severity, distribution and effect on quality of life all increase as the disease progresses (Singer et al. 1999). HIV infection is a progressive illness that results in severe immunodeficiency (declining CD4+ T-lymphocyte count), characterized by opportunistic infections and malignancies. The likelihood of developing particular pain problems is directly related to the CD4+ count of the patient, which reflects the likelihood of susceptibility to infections and complications of the disease (Fig. 1).

### Prevalence

Prevalence data on pain in patients with HIV/AIDS from the United States and other developed countries were primarily collected before the era (1996–present) of highly active antiretroviral therapy (HAART). Different populations were studied at varying stages of disease, and different methodologies of assessment were used. In addition, the prevalence data for children and adolescents with HIV/AIDS are sparse at best. As a result, it is difficult to interpret how well the data reflects current reality in either developed countries, where HAART is now widely available, or developing countries, where HAART has been largely inaccessible to date. Data on peripheral neuropathy and encephalopathy illustrate how different factors may be related to risk of pain and/or other HIV-related sequelae, in ways that are not always predictable. The incidence of peripheral neuropathy is increased in people with long-term infection, those with decreased CD4+ counts, and those with increased viral load. In countries where HAART is widely used, there is not only a decreasing incidence of both HIV-associated neurological disease and central nervous system (CNS) opportunistic infections, but also a trend towards increasing incidences of drug-induced peripheral neuropathy (Sacktor 2002). In contrast, a recent study reported that 14.9% of inpatients in Hospital Kuala Lumpur, who were seropositive for toxoplasmosis, had active toxoplasmic encephalitis (Nissapatorn et al. 2003). Additionally, there is evidence that pain prevalence differs in injection drug users (IDUs) and non-IDUs (Martin et al. 1999). A Swedish survey of outpatients infected with HIV found that in non-IDUs



**Pain in Human Immunodeficiency Virus Infection and Acquired Immune Deficiency Syndrome, Figure 1** The chronology of HIV-induced disease and related painful conditions (adapted from Stewart et al., 1997).

there was a strong correlation between disease state, CD4+ levels, mortality and pain. However, there was no significant correlation between these disease parameters and pain in IDUs. In those with symptomatic HIV disease, there was no difference between IDUs and non-IDUs in the prevalence of pain or number of pain sites. However, among those with asymptomatic HIV infection, IDUs reported both a significantly higher prevalence of pain and a significantly higher number of concurrent pain sites. If these data are borne out in further studies, they will provide clues to which populations are at risk for pain, and at which stage of illness.

Due to all of these factors, estimates of overall pain prevalence in HIV/AIDS have ranged widely, from 30% (Larue et al. 1997) to 88% (Frich and Borgbjerg 2000), depending on the population studied and the methodology employed. In one influential study, about 45% of pain was said to be directly related to the disease, about 15–30% was due to therapies or diagnostic procedures, and about 25–40% was attributed to unrelated conditions and treatments (Hewitt et al. 1997). Seventy-one percent of patients had somatic pain, 29% had visceral pain, 46% had neuropathic pain, and 46% experienced headache. These data must be interpreted as cautiously as all other prevalence data. A wide array of pain syndromes has been documented, in every major region and system of the body (O'Neill and Sherrard 1996).

### Characteristics

#### Types of Pain in HIV/AIDS

HIV/AIDS patients most commonly present with four major types of pain: headache, musculoskeletal pain,

visceral pain, and neuropathy. Secondary headache is generally due to infection (e.g. cryptococcal meningitis) or neoplasm (e.g. central nervous system lymphoma), though zidovudine (AZT) is known to induce headache in some patients. Interestingly, in one study primary migraine decreased in frequency over time, while primary tension-type headache increased in frequency, independent of antiretroviral treatment or CD4+ count (Evers et al. 2000).

Infectious agents, neoplasms, pharmaceuticals, diagnostic procedures and unrelated conditions may all cause pain in patients with HIV/AIDS. The most common pain-producing infectious agents are the HIV virus itself, cytomegalovirus (CMV), hepatitis B and C, candidiasis, toxoplasmosis, *mycobacterium avium* intracellulare (MAI), cryptococcosis, and cryptosporidiosis. Each of these diseases can cause pain in a variety of organ systems (See Table 1). The most common pain-producing neoplasms are lymphoma and Kaposi's sarcoma (KS). By direct invasion or metastasis, these neoplasms may cause pain almost anywhere in the body (Table 1). Some antivirals and antiretrovirals used to treat the HIV virus, as well as isoniazid (INH) used in the treatment of tuberculosis, may produce painful neuropathy (Table 2). Radiation and surgery used to treat neoplasms may also cause pain. Pre-existing conditions such as diabetic neuropathy, osteoarthritis and degenerative disc disease add to the possible etiologies.

#### Neuropathic Pain Syndromes

Symptomatic neuropathies are present in about 10% of patients with HIV/AIDS, although pathologic evidence is found in almost all end stage patients. The six major types of HIV-associated neuropathy are distal sensory

**Pain in Human Immunodeficiency Virus Infection and Acquired Immune Deficiency Syndrome, Table 1** Pain-producing infections and neoplasms

Pain Site/Type	Oropharynx	Eso-phagus	Ab-domen	HA	Chest	Biliary	Cuta-neous	Ano-rectal	Peripheral Neuropathy	Arthritis/Arthralgia	Myopathy/Polymyositis
<b>Infectious Etiology</b>											
HBV			X							X	
HSV	X	X					X	X			
HCV			X							X	
CMV	X	X	X			X			X		
HIV				X					X	X	X
EBV	X	X									
Toxoplasmosis				X							
Fungi, e.g. Candida	X	X									
Micro-Sporidiosis			X			X					X
MAI			X			X					
CryptoCoccus				X							
Cryptosporidiosis			X								
VZV							X				
Salmonella/Shigella/Campylobacter			X			X					
<b>Neoplastic Etiology</b>											
Kaposi's Sarcoma		X	X	X	X						
Lymphoma		X	X	X	X						

HBV, Hepatitis B virus; HPV, Human papilloma virus; HSV, Herpes simplex virus; HCV, Herpes C virus; CMV, Cytomegalovirus; HIV, Human immunodeficiency virus; EBV, Epstein Barr virus; MAI, Mycobacterium avium intracellulare; VZV, Varicella zoster virus

neuropathy (DSP), toxic neuropathy, acute and chronic inflammatory demyelinating polyradiculoneuropathy (AIDP and CIDP), progressive polyradiculopathy (PP), mononeuropathy multiplex (MM), and autonomic neuropathy (AN). Table 3 gives an overview of their clinical features (Verma 2001).

DSP is perhaps the most prevalent of the peripheral neuropathies. Treatment of DSP has been disappointing to date. Gabapentin and opioids may be useful in patients with less advanced disease, but generally fail in patients with end stage disease, when this condition is most prevalent. In a 48-week open-label study of recombinant nerve growth factor for 200 patients with DSP, there was a "significant trend" toward reduction in subjective report of pain. Clinically significant differences in function or Quantitative Sensory Testing, however, were absent (Schiffito et al. 2001). Antiretrovirals play a paradoxical role in DSP. On the one hand, decreasing viral load by directly treating HIV can alleviate peripheral neuropathic symptoms. On the other

hand, zalcitabine (ddC), didanosine (ddI) and stavudine (d4T) all cause a dose-dependent DSP in a significant minority of patients. This appears to be related to the spectrum of mitochondrial toxicity induced by these agents. Drug withdrawal does not always lead to symptom resolution, so early dose reduction or substitution of another anti-retroviral agent is recommended.

Immunomodulatory therapy is the mainstay of treatment for IDP. PP is usually caused by CMV infection: irreversible neurological deficits occur in the absence of rapid diagnosis and treatment with ganciclovir, foscarnet, cidofovir or valganciclovir. A four-week course is generally sufficient, though maintenance therapy may need to be taken if symptoms recur. MM is usually self-limited, and treatment is supportive. AN in its subclinical form is common. Symptomatic AN usually occurs in late stage disease. Symptoms depend on which components and levels of the autonomic system are involved. Additional HIV-induced neurological diseases include vacuolar myelopathy, which may involve both



**Pain in Human Immunodeficiency Virus Infection and Acquired Immune Deficiency Syndrome, Table 2** HIV-Related therapeutic agents that may cause pain\*

CLASS/AGENT	HEADACHE	PERIPHERAL NEUROPATHY	PANCREA-TITIS	ABDOMIN-AL PAIN	HEPA-TITIS	NEPHRO-LITHIASIS
NRTIs						
<i>AZT</i>	X			X	X	
<i>3TC</i>			X		X	
<i>DDI</i>		X	X	X		
<i>DDC</i>		X	X			
<i>D4T</i>		X	X			
<i>Abacavir</i>				X		
NTRTI						
<i>Tenofovir</i>				X		
NNRTI						
<i>Nevirapine</i>					X	
<i>Efavirenz</i>					X	
<i>Delavirdine</i>					X	
PI						
<i>Ritonavir</i>				X	X	
<i>Indinavir</i>				X		X
<i>Saquinavir</i>				X		
<i>Atazanavir</i>					X	
ANTI-MYCO-BACTERIAL						
<i>Isoniazid</i>		X				
ANTI-NEO-PLASTICS						
<i>Vincristine</i>		X				



NRTI, nucleoside reverse transcriptase inhibitor; AZT, zidovudine; 3TC, lamivudine; DDI, didanosine; DDC, zalcitabine; D4T, stavudine; NTRTI, nucleotide reverse transcriptase inhibitor; NNRTI, non-nucleoside reverse transcriptase inhibitor; PI, protease inhibitor  
 \*Xs indicate most commonly reported pain syndromes in association with different HIV-related therapeutic agents, although this may be seen with lesser frequency with agents not so indicated here  
 Symptoms may also occur with other protease inhibitors, but are most commonly reported for these PIs

sensory and motor loss, and may be associated with painful muscle spasms.

**Barriers to Treatment of Pain**

In developing countries where resources such as HAART, antibiotics and other agents are scarce or unavailable, lack of resources is the primary barrier to treatment. In a 1999 study in the United States, clinicians identified lack of knowledge, reluctance to prescribe opioids, inadequate access to pain specialists and issues related to drug addiction and abuse as the major barriers to providing better pain management to patients with HIV/AIDS (Breitbart et al. 1999). Additionally, the paucity of clinical trials evaluating the efficacy of pain

treatment in those with HIV/AIDS negatively impacts on clinician’s willingness to prescribe medication. There are limited studies of patient barriers to pain management. However, a 1998 report identified non-Caucasian racial status, fewer years of education, greater numbers of physical symptoms, and greater psychological distress as independent factors associated with barriers to adequate pain management in AIDS (Breitbart et al. 1998). Racial disparities in access to care, along with comorbid medical and psychiatric disorders, further complicate the management of pain in HIV/AIDS. Of note, people living in predominantly nonwhite neighborhoods in the United States have difficulties filling prescriptions for opioids (Morrison et al. 2000).

**Pain in Human Immunodeficiency Virus Infection and Acquired Immune Deficiency Syndrome, Table 3** HIV-Associated Neuropathies

Type	Stage of disease	Course/frequency	Symptoms
DSP	Mid to late	Indolent, protracted Common	Distal pain, paresthesias and numbness especially in feet.
Toxic	All	Common	Same
IDP: Acute Chronic	Any stage Mid to late stages	Rare Rare	Global limb weakness Global limb weakness
PP	Advanced	Rare, may show rapid progression	Cauda equina syndrome. Saddle anesthesia
MM	Early, late	Infrequent	Self-limited multifocal motor sensory, or mixed somatic or cranial neuropathy
AN	All	Common (subclinical)	Varied

DSP, distal sensory polyneuropathy; IDP, inflammatory demyelinating polyneuropathy; PP, progressive polyradiculopathy; MM, mononeuropathy multiplex; AN, autonomic neuropathy

### Conclusions

Despite the problems of determining actual prevalence, it is clear that pain is a common symptom in AIDS patients. Although there is often an identifiable etiology and treatment strategies exist, pain remains undertreated, and quality of life is adversely affected by lack of attention to this burdensome symptom. Issues of addiction and treating pain in patients with active or remote substance abuse need to be carefully addressed. As the goals of care shift from arresting the course of the disease to chronic disease management and palliation, the primary importance of pain management increases. The better a patient's pain is controlled, the more likely it is that he or she will adhere to other HIV-specific therapy and enjoy the highest quality of life possible.

### References

- Breitbart W, Kaim M, Rosenfeld B (1999) Clinicians' Perceptions of Barriers to Pain Management in AIDS. *J Pain Symptom Manage* 18:203-212
- Breitbart W, Passik S, McDonald MV et al. (1998) Patient-Related Barriers to Pain Management in Ambulatory AIDS Patients. *Pain* 76:9-16
- Breitbart W, Rosenfeld BD, Passik SD et al. (1996) The Undertreatment of Pain in Ambulatory AIDS Patients. *Pain* 65:243-249
- Evers S, Wibbeke B, Reichelt D et al. (2000) The Impact of HIV Infection on Primary Headache. Unexpected Findings from Retrospective, Cross-Sectional and Prospective Analyses. *Pain* 85:191-200
- Frich LM, Borgbjerg FM (2000) Pain and Pain Treatment in AIDS Patients: A Longitudinal Study. *J Pain Symptom Manage* 19:339-347
- Hewitt D, McDonald M, Portenoy R et al. (1997) Pain Syndromes and Etiologies in Ambulatory AIDS Patients. *Pain* 70:117-123
- Larue F, Fontaine A, Colleau SM (1997) Underestimation and Undertreatment of Pain in HIV Disease: Multicenter Study. *BMJ* 4:23-28
- Martin C, Pehrson P, Osterberg A et al. (1999) Pain in Ambulatory HIV-Infected Patients With and Without Intravenous Drug Use. *Eur J Pain* 3:157-164
- Morrison RS, Wallenstein S, Natale DK et al. (2000) "We Don't Carry That." Failure of Pharmacies in Predominantly Non-White Neighborhoods to Stock Opioids. *N Engl J Med* 342:1023-1036
- Nissapatorn V, Lee CK, Khairul AA (2003) Seroprevalence of Toxoplasmosis among AIDS Patients in Hospital Kuala Lumpur, 2001. *Singapore Medical J* 44:194-196
- O'Neill WM, Sherrard JS (1996) Pain in Human Immunodeficiency Virus Disease. A Review. *Pain* 68:323-328
- Sacktor N (2002) The Epidemiology of Human Immunodeficiency Virus-Associated Neurological Disease in the Era of Highly Active Antiretroviral Therapy. *J Neurovirol* 8S2:115-121
- Schiffito G, Yainoutsos C, Simpson DM et al. (2001) Long-Term Treatment with Recombinant Nerve Growth Factor for HIV-Associated Sensory Neuropathy. *Neurology* 57:1313-1316
- Singer EJ, Zorilla C, Fahy-Chandon B et al. (1999) Painful Symptoms Reported by Ambulatory HIV Infected Men in a Longitudinal Study. *Pain* 54:15-19
- Verma A (2001) Epidemiology and Clinical Features of HIV-1 Associated Neuropathies. *J Peripher Nerv Syst* 6:8-13

## Pain in Humans, EEG Documentation

ANDREW C. N. CHEN

Human Brain Mapping and Cortical Imaging Laboratory, Aalborg University, Aalborg, Denmark  
ac@smi.auc.dk

### Synonyms

EEG (electro-encephalography); MEG

### Definition

EEG (electro-encephalography) and its magnetic counter part of MEG (magneto-encephalography) is a web of spontaneous electrical oscillation in the cortex and the subcortical brain. A review is made of how it can be studied for understanding pain in the human brain.

## Neurophysiology of EEG

### Physiology

EEG has been classically decomposed into broad bands ( $\delta$ ,  $\theta$ ,  $\alpha$ ,  $\beta$ ,  $\gamma$ ) and some sub-bands for  $\alpha$  or  $\beta$ . The exact physiology for the simultaneous or separate genesis of these fundamental waves is not fully understood. Nevertheless, the physiology of EEG, and its relation to sleep-awake regulation, has been well documented. The cortical biophysics in EEG may encompass both focal transient events with the interaction of global wave oscillations (da Silva 1999).

### Functions

In addition to arousal and attention, increased interest is given to the functional aspects of EEG in memory, emotion, and cognitive processing. All of these functions are intimately involved in pain processing of the brain.

### Pain and Consciousness

#### Pain and Awareness in Multi-factors of EEG Measurement

Pain is primarily a somatic sensation of aversive quality in conscious awareness, as such; it may elicit, and can in turn be influenced by, emotional reactions (anxiety, fear, anger, depression). Both behaviors (bodily reflex, gesture, facial expression, motor act) and cognitive contingency (expectation, interpretation, copying) can also affect pain processing in the brain. The scientific and clinical interest lies on the neural representation of human pain in its sensory, perceptual, emotional, and cognitive dimensions (if they are really separable), using the advanced ► [EEG](#) / ► [MEG mapping](#) and advent of PET/fMRI neuroimaging (Chen 2001).

#### EEG Mapping

EEG is sensitive to various states from unconsciousness, sleep, and drug sedation to awareness and wakefulness. For drug induced EEG changes, the "bispectral index", using only frontal EEG measures, has gained special attention and wide-practice in neuro-anesthesia from wakefulness to sedation and from sedation to conscious awareness. Based on these measures, a Field Theory in neurophysics of consciousness has been proposed (John 2002). To clearly capture the brain states, recent work has been improved from clinical 19-ch EEG to high-resolution EEG of 128-ch, to increase spatial resolution and modeling of its underlying anatomical substrates. EEG, but less so in MEG, is highly dependent on the reference sites recorded as well as being sensitive to distortion by brain, CSF, skull, and scalp resistance. EEG mapping is influenced by the selected reference sites or averaged reference. Large individual differences in EEG activation should be considered, e.g. that some 10% of healthy subjects have little or no  $\alpha$  activity, and one subject may exhibit 20x fold the power of the other. Also, the majority of EEG records are often contaminated with various sorts of artifacts.

Thus, proper EEG acquisition, signal processing, data transformation, and statistical methods used can greatly influence the accuracy and reliability of the outcome of studies. Three major parameters in EEG measurements are band power, coherence, and current source density.

### Characteristics

#### EEG in Experimental Pain

Readers are reminded of the complexity of human pain in the brain, and the multifactors (technical, physical, physiological, and psychological conditions) determining the EEG/MEG measurements. To control these complexities, experimental human pain has been divided into three major categories of nociceptors: thermal, chemical, and mechanical stimuli. All of these stimuli can induce phasic changes in EEG, as well as tonic effects of EEG.

#### Phasic Pain

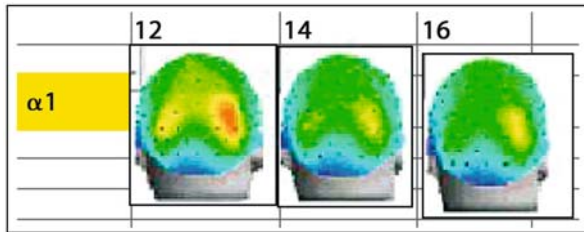
The micro-state of EEG changes in ms range can be examined by ► [frequency domain analysis](#) of averaged evoked potentials, such as the band-power density (Chen and Rappelsberger 1994), coherence of laser evoked potentials, wavelet analysis of galvanic evoked potentials (Chen and Hermann 2001) and cortical imaging (Babiloni et al. 2002) in somatosensory evoked potentials to median nerve stimulation. The meso-state of event-related synchronization (ERS) and event-related desynchronization (ERD) in 250 ms range can also be calculated by EEG power densities. The results indicated: (A) increased contralateral somatosensory and vertex coherence linkage and a web of centro-parietal and frontal instantaneous coherence in response to laser pain, (B) temporo-spatial dynamics, initiated at the contralateral hand area, then to the posterior parietal area, and terminated in the frontal area, by low to high gamma activation in response to painful median nerve stimulation.

#### Tonic Pain

To simulate the natural pain experience at the macro-state at a minute by minute level, methods of ► [thermal stimulation](#) often by cold-pressor test, chemical stimulation by capsaicin or hypertonic saline irritants, and ► [mechanical stimulation](#) by cuff-pressure test have been reported. These works were reviewed in a classic paper (Chen 1993) and have now been extended into spatio-temporal dynamics (Chen 2002; Chang 2004). For tonic pain and EEG, the results showed several general agreements (see review see Chang 2002): (A) increase of  $\delta$ -power, (B) increase in  $\theta$ -power, (C) reduction of  $\alpha$ -power, and (D) increase of  $\beta$ -power.

#### Topographic Spatial Effects

The effect of tonic pain (cuff-pressure test) on brain topographic mapping is shown in Fig. 1. The EEG of  $\alpha$ -power can be seen to be systematically reduced when be-



**Pain in Humans, EEG Documentation, Figure 1** Effect of tonic pain on brain topographic mapping.

tween non-pain (VAS intensity-2, I2) and pain (I4, slight pain and I6, moderate pain). The ► **posterior parietal alpha activity** has been modeled as sensorimotor activity of hand areas, and partly reflects reduction of parietal attention processing, largely in the right hemisphere, due to pain.

### EEG in Clinical Pain

Adding pathophysiology of the diseases and psychological alterations in patients, measurement of clinical pain by EEG can be very daunting. An early review (Chen 1993) reported (A) focal or generalized bursts of spikes, slow waves, or both in 61 % of the cases and (B) non-specific changes, diffused delta-theta without bursts in 35 % of the cases, through accumulated literature on headaches. The predominance of EEG abnormality differs with the type of headache (63.5 % in post-traumatic headache, 46.9 % in common migraine, 47.0 % in mixed headache, 45.5 % in childhood headache, 36.0 % in classic migraine, 17.5 % in cluster migraine, and 12.0 % in muscular headache), as compared to 10–15 % observed in non-headache controls. These EEG changes may be due to pathophysiology rather than pain in the patients per se. EEG changes in pain patients have been reported in cognitive disorders, headache, fibromyalgia, and chronic pain syndrome.

### Cognitive Disorders

When attention-memory mechanisms in the brain are deteriorated, such as in Alzheimer patients in pain stimulation (Benedetti et al. 1999). Patients with cognitive impairment who are insensitive to pain showed high  $\delta$  peak and low  $\alpha$  peak to galvanic and ischemic pain, indicating altered cognitive and affective factors. Likewise, patients of a psychiatric nature, with borderline personality disorders, also exhibited altered EEG activities between self-injury with reported pain experience, from those without reported pain experience in total EEG power. Further, there was a significant correlation between the theta activity, negatively with pain rating and positively with dissociative score (Russ et al. 1999).

### Headache

No specific EEG signals in migraine or headache pain have been characterized. One report suggested a general state of altered neuronal excitability, whilst another

showed a significant decrement of alpha rhythm power at the posterior areas of the brain during IPS at 20 c/sec. The diagnostic use of EEG was advocated in children suffering from migraine, with aura during the ictal phase, but not the interictal phase. Contradictory reports from a literature review did not support the effectiveness of EEG in headache. The quality of EEG data gathering, signal processing, study design, and data analyses of past research in this field may hamper a proper evaluation of EEG and headache pain.

### Fibromyalgia

EEG has been reported (Modolofsky 2002) to reflect disturbances in circadian sleep-wake rhythms: phasic (alpha-delta)/tonic alpha non-REM sleep disorders, the periodic K alpha cycling alternating pattern disorder in fibromyalgia patients. However, no drug has restored these EEG effects. The EEG characteristics include an increased EEG power density in the higher frequency band and a reduced EEG power density in the lower frequency bands, as well as  $\alpha$  K-complex as indicators of fragmented sleep. The fibromyalgia symptoms may relate to a non-restorative sleep disorder associated with the  $\alpha$ -EEG sleep anomalies. However, the specific etiology of sleep disorder in EEG, such as 'alpha-delta NREM sleep abnormality' in fibromyalgia and chronic fatigue syndrome, has been challenged.

### Chronic Pain

It is difficult to characterize EEG in chronic pain, largely due to the lack of specificity in defining chronic pain, as it is often associated with depression, disability, and dysfunctional illness behaviors. Nevertheless, the following reports may be consulted: EEG and injury model of neuropathic pain, EEG and chronic pain, chronic low back pain, irritable bowel syndrome.

### New Perspectives of EEG Measurement for Human Pain

#### Basic Sciences

EEG inherently has a large variance in genetic basis, contributing to individual characteristics of EEG patterns and may relate to individual sensitivity or tolerance to pain (Chen et al. 1989). The increased availability of the new generation of MEG (Kakigi et al. 2000) can be used more extensively, but there are hardly any reports of spontaneous MEG studies so far. There is also a new focus on how EEG can be related to other PET/fMRI neuroimaging modalities. Current EEG technology and software allow high-resolution scalp mapping (Chen 2002), cortical imaging and current source imaging (Fernandez-Bouzas et al. 2001) to define structure-function relations. Recently, exciting advances in frequency-domain source analysis of ongoing EEG has contributed to further understanding of brain dynamics in EEG. In principle, pain is a mental experience based on neural events and as such, should



be measurable by neurophysiological activation in the brain.

### Clinical Applications

In the near future, it will be questioned if advanced human brain mapping of EEG parameters and dynamics will provide (a) differential diagnosis of pain conditions, and (b) predictive values in prognosis of pain changes or modulation efficacies.

### Pain Treatment Efficacy and Mechanisms

Possibly to gain new understanding of EEG in altered states of consciousness, with focus on EEG patterns of some basic treatment efficacy and mechanisms of pain control in; (a) physical stimulation, such as transcranial magnetic stimulation or deep brain stimulation, transcutaneous electrical stimulation, or acupuncture, (b) psychological pain control, such as self-efficacy, expectation, placebo, relaxation, imagery, hypnosis, religious belief, and (c) various major categories of pharmacological treatments, such as NSAIDs, opiates, or tricyclic antidepressants, etc.

In conclusion, this review indicates some, but not enough, reporting on EEG and human pain to-date. Advances in EEG analyses will be likely to open a new era of research, and understanding of the natural state of spontaneous EEG dynamics, in acute and chronic pain in humans in the future.

### References

- Benedetti F, Vighetti S, Ricco C et al. (1999) Pain Threshold and Tolerance in Alzheimer's Disease. *Pain* 80:377–382
- Chang PF, Arendt-Nielsen L, Graven-Nielsen T et al. (2004) Comparative EEG Activation to Skin Pain and Muscle Pain Induced by Capsaicin Injection *Int J Psychophysiol* 51:117–126
- Chen, AC (1993) Human Brain Measures of Clinical Pain, A Review: I. Topographic mappings. *Pain* 54:115–132
- Chen AC (2001) New Perspectives in EEG/MEG Brain Mapping and PET/fMRI Neuroimaging of Human Pain. *Int J Psychophysiol* 42:147–159
- Chen AC (2002) EEG/MEG Brain Mapping of Human Pain: Recent advances. *Recent Advances in Human Brain Mapping*, 1232:5–16
- Chen AC, Dworkin SF, Hang J et al. (1989) Topographic Brain Measures of Human Pain and Pain Responsivity. *Pain* 37:129–141
- Chen AC, Herrmann CS (2001) Perception of Pain Coincides with the Spatial Expansion of Electroencephalographic Dynamics in Human Subjects. *Neurosci Lett* 297:183–186
- Chen AC, Rappelsberger P (1994) Brain and Human Pain: Topographic EEG Amplitude and Coherence Mapping. *Brain Topogr* 7:129–140
- Da Silva F (1999) Biophysical Aspects of EEG and Magnetoencephalogram Generation. In: Niedermeyer E, da Silva L (eds) *Electroencephalography: Principles, Clinical Applications, and Related Fields*, 4th edn. pp 76–92
- Fernandez-Bouzas A, Harmony T, Fernandez T et al. (2001) Cerebral Blood Flow and Sources of Abnormal EEG Activity (VARETA) in Neurocysticercosis. *Clin Neurophysiol* 112:2281–2287
- Ferracuti S, Seri S, Mattia D et al. (1944) Quantitative EEG Modifications during the Cold Water Pressor Test: Hemispheric and Hand Differences. *Int J Psychophysiol* 17:261–268
- John ER (2002) The Neurophysics of Consciousness. *Brain Res Rev.* 39:1–28
- Kakigi R, Hoshiyama M, Shimojo M et al. (2000) The Somatosensory Evoked Magnetic Fields. *Prog Neurobiol* 61:495–523
- Moldofsky H (2002) Management of Sleep Disorders in Fibromyalgia. *Rheum Dis Clin North Am* 28:353–365
- Russ MJ, Campbell SS, Kakuma T, Harrison K, Zanine E (1999) EEG Theta Activity and Pain Insensitivity in Self-Injurious Borderline Patients. *Psychiatry Res* 89:201–214

## Pain in Humans, Electrical Stimulation (Skin, Muscle and Viscera)

OLE K. ANDERSEN

Department of Health Science & Technology, Center for Sensory-Motor Interaction, Aalborg University, Aalborg, Denmark  
oka@hst.aau.dk

### Definition

Electrical stimulation initiates activity in nerve fibres directly without activating receptors. The stimulus intensity determines the size of the current field in the tissue and thereby the amount of fibres activated.

### Characteristics

Electrical stimulation leads to a depolarisation of the membrane of the nerves, and thereby action potentials are generated. Membrane depolarisation occurs at the negative electrode (the cathode). Unipolar, constant current pulses with a rectangular shape, are the most commonly used technique in pain research and treatment. The threshold for initiating an action potential is dependent on the diameter of the nerve fibre, with thick fibres having a lower **activation threshold** than thin fibres (Blair and Erlanger 1933). Hence, for a rectangular pulse applied to the skin (i.e. to nervous tissue underlying the skin), thick fibres mediating mechanoreceptive input are activated at the lowest stimulus intensities. Increasing the stimulus intensity leads to concurrent activation of thin myelinated fibres (A $\delta$  fibres), and eventually C fibres will also be activated at high intensities. Selective activation of nociceptive fibres using electrical stimulation is therefore not possible. The same fibre diameter-activation threshold relationship is also present in muscle tissue and in the viscera. The activation threshold is dependent on the duration of the stimulus, with higher currents needed for short pulses. Further, all fibres have a **blocking threshold**, meaning a current level at which action potentials are blocked due to positive potentials in the tissue at a distance from the cathode. These positive potentials enforce membrane polarisation and thereby action potential conduction is stopped (anodal blocking). The blocking threshold is dependent on nerve fibre diameter, with thick fibres having the lowest blocking threshold. Further, the distance between the electrode and the nerve is important, with higher currents needed for the blocking of distant

fibres. Selective activation of nociceptors using anodal blocking therefore only occurs in fibres close to the electrode and not for fibres that are further away, e.g. other fascicles of the nerve.

Theoretical and experimental studies have indicated that stimulus shapes with a slowly rising waveform may activate thin fibres prior to thick fibres when increasing the stimulus intensity (Grill and Mortimer 1995; Zimmermann 1968). The underlying mechanism is the ability of nerve fibres to accommodate to the stimuli, which is more prevalent in fibres with low excitation threshold (i.e. thick myelinated fibres). This also includes low frequency sinusoidal waveforms. However, these techniques are highly dependent on the distance from the electrode to the nerve, and are therefore difficult to use for assessing the integrity of nociceptors selectively.

Various thresholds may be assessed for electrical stimuli. The ► **detection threshold** is defined as the lowest current amplitude perceived by the subject, whereas the ► **pain threshold** is normally defined as the current amplitude that evokes pain in 50 % of stimuli. Different paradigms have been developed for estimating the thresholds, often involving some kind of ascending and descending staircases with varying intensity steps. The relationship between the detection threshold and the pain threshold depends on electrode configuration and stimulus site. Using small, invasive microelectrodes, the current density is high near the electrode, and the pain threshold is approximately five times higher than the detection threshold (Burke et al. 1975). The pain threshold is associated with activation of A $\delta$  fibres. Using surface electrodes on the volar forearm with a large area (28 mm<sup>2</sup>) the pain threshold is ten times higher than the detection threshold determined as 0.3 mA (Sang et al. 2003). In the latter study, both detection and pain thresholds were stable over both time and electrode position.

Electrical stimulation is used extensively for testing the sensitivity of the pain system in studies activating cutaneous structures (Andersen et al. 1994), muscular structures (Laursen et al. 1999), and in visceral structures (Arendt-Nielsen et al. 1997). In deep structures, repetitive stimulation by rectangular burst above the pain threshold evokes areas of referred pain. In the viscera it is difficult to determine the pain threshold to a single stimulus, whereas the pain threshold is easily determined if a train of stimuli is used. Further, the referred pain area gradually expands if stimulation is continued for 120 s (Arendt-Nielsen et al. 1997). Repetitive stimulation also allows quantification of central neuronal integration (Arendt-Nielsen et al. 2000). Hence, variation in stimulus burst frequency may be used for testing ► **temporal summation**, whereas stimulus intensity tests ► **spatial summation** as the current field in the tissue is enlarged for more intense stimuli, and thereby additional nerve fibres are activated concurrently. Electrical stimulation is widely used clinically for quantifying

various neuropathies (Krarup 2002), or for assessing detection and pain thresholds (Gracely et al. 1992).

Long-lasting electrical conditioning stimulation has been shown to enhance or reduce the sensitivity of the nociceptive system for several minutes, depending on stimulus parameters and electrode configuration. In the skin, the nerve-endings of nociceptors have the most superficial innervation. Using needle-like electrodes pressed against the skin, it is possible to activate A $\delta$  and C fibres over several minutes, at tolerable levels, via an array consisting of 16 of these electrodes in a 6 × 6 cm matrix. Continuous stimulation, by alternating between the electrodes in the array, result in inhibition of itch and reduced heat pain sensitivity (Nilsson et al. 2003). In another study, ► **long-term potentiation** in the sensitivity of the skin was induced experimentally by intense electrical stimulation via an array of 10 circular electrodes with a diameter of 200  $\mu$ m. The conditioning stimulus consisted of five trains of 100 ► **rectangular pulses** separated by 10 s. The stimulus intensity was up to 20 times the perception threshold. Enhanced pain sensitivity was observed for more than 60 min. after the conditioning (Klein et al. 2003).

Electrical stimulation may also be used for ‘transcutaneous electrical nerve stimulation’ (► **TENS**) for alleviating pain by robust activation of large myelinated fibres innervating mechanoreceptors. The underlying mechanism for the reduction in pain is the gate control theory proposed by Melzack and Wall. In TENS stimulation at frequencies up to 120 Hz, and normally using stimulus intensities below the pain threshold, it has been shown to relieve pain efficiently (Hansson and Lundberg 1999). Large electrodes (several cm<sup>2</sup>) are normally used in order to activate thick myelinated fibres in a large skin area, and treatment is continued for at least 30–45 minutes (Hansson and Lundberg 1999).

Electrical stimulation may also be used for evoking physiological correlates to pain, evoked potentials or ► **nociceptive withdrawal reflexes**. In fact, human nociceptive withdrawal reflexes are most efficiently elicited using electrical stimulation in an experimental setup. A train of five electrical stimuli over a period of 20 ms delivered to a sensory nerve, or directly to the skin on the foot, evoke an integrated withdrawal of the limb (Willer 1977, Andersen et al. 1994). For graded stimulus intensity, pain intensity and the size of the withdrawal reflex correlate under standardised experimental conditions (Chan and Dallaire 1989).

Continuous stimulation at the same site may lead to decreased responsiveness of the nerve fibres due to ► **fatigue** (Peng et al. 2003). Repetitive stimulation may also lead to a decrease in the evoked responses due to habituation, a central mechanism. Habituation is commonly seen following regular stimulation at low to medium pain intensities.

In conclusion, electrical stimulation is useful for testing the nociceptive system in experimental and clinical set-

tings. Electrical stimulation is not nociceptive specific, but different techniques (electrode configuration, stimulus waveform, stimulus intensity etc.) may enhance the selectivity.

## References

1. Andersen OK, Jensen LM, Brennum J et al. (1994) Evidence for Central Summation of C and A $\delta$  Nociceptive Activity in Man. *Pain* 59:273–280
2. Arendt-Nielsen L, Drewes AM, Hansen JB et al. (1997) Gut Pain Reactions in Man: An Experimental Investigation using Short and Long Duration Transmucosal Electrical Stimulation. *Pain* 69:255–262
3. Arendt-Nielsen L, Sonnenborg FA, Andersen OK (2000) Facilitation of the Withdrawal Reflex by Repeated Transcutaneous Electrical Stimulation: An Experimental Study on Central Integration in Humans. *Eur J Appl Physiol* 81:165–173
4. Blair EA, Erlanger J (1933) A Comparison of the Characteristics of Axons through their Individual Electrical Responses. *Am J Physiol* 6:524–564
5. Burke D, Mackenzie RA, Skuse NF et al. (1975) Cutaneous Afferent Activity in Median and Radial Nerve Fascicles: A Micro-electrode Study. *J Neurol Neurosurg Psychiatr* 38:855–864
6. Chan CWY, Dallaire M (1989) Subjective Pain Sensation is Linearly Correlated with the Flexion Reflex in Man. *Brain Res* 479:145–150
7. Gracely RH, Lynch SA, Bennett GJ (1992) Painful Neuropathy: Altered Central Processing Maintained Dynamically by Peripheral Input. *Pain* 51:175–194
8. Grill WM, Mortimer JT (1995) Stimulus Waveforms for Selective Neural Stimulation. *IEEE Engineering in Medicine and Biology*, pp 375–385
9. Hansson P, Lundberg T (1999) Transcutaneous Electrical Nerve Stimulation, Vibration and Acupuncture as Pain-Relieving Measures. In: Wall PD, Melzack R (eds) *Textbook of pain*. Churchill Livingstone, Edinburgh, pp 1341–1351
10. Klein T, Magerl W, Mantzka U et al. (2003) Perceptual Correlates of Long-Term Potentiation in the Spinal Cord. In: Dostrovsky J, Carr DB, Koltzenburg M (eds) *Proceedings of the 10th World Congress on Pain*. IASP Press, Seattle, pp 407–415
11. Krarup C (2002) Nerve Conduction Studies in Selected Peripheral Nerve Disorders. *Curr Opin Neurol*. 15:579–593
12. Laursen RJ, Graven-Nielsen T, Jensen TS et al. (1999) The Effect of Compression and Regional Anaesthetic Block on Referred Pain Intensity in Humans. *Pain* 80:257–263
13. Nilsson HJ, Psouni E, Schouenborg J (2003) Long Term Depression of Human Nociceptive Skin Senses Induced by Thin Fibre Stimulation. *Eur J Pain* 7:225–233
14. Peng YB, Ringkamp M, Meyer RA et al. (2003) Fatigue and Paradoxical Enhancement of Heat Response in C-Fiber Nociceptors from Cross-Modal Excitation. *J Neurosci* 23:4766–4774
15. Sang CN, Max MB, Gracely RH (2003) Stability and Reliability of Detection Thresholds for Human A-Beta and A-Delta Sensory Afferents Determined by Cutaneous Electrical Stimulation. *J Pain Symptom Manage* 25:64–73
16. Willer JC (1977) Comparative Study of Perceived Pain and Nociceptive Flexion Reflex in Man. *Pain* 3:69–80
17. Zimmermann M (1968) Selective Activation of C-Fibers. *Pflügers Arch* 301:329–333

## Pain in Humans, Psychophysical Law

DONALD D. PRICE

Department of Oral and Maxillofacial Surgery, Health Science Center, University of Florida, Gainesville, FL, USA  
dprice@dental.ufl.edu

## Synonyms

Psychophysical Law

## Definition

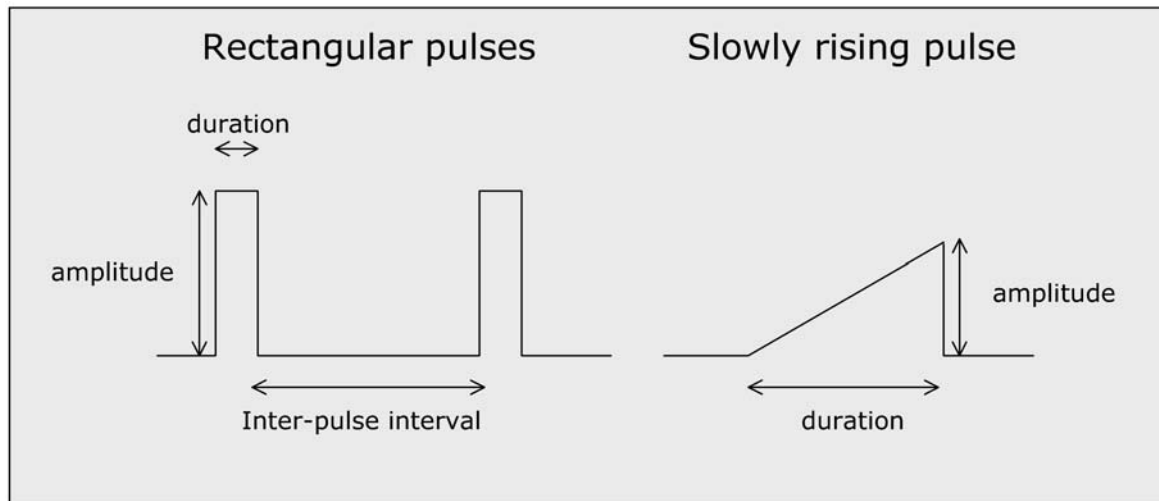
Similar to other ► [sensory modalities](#), experimentally induced pain has been shown to follow the power law, as formulated in ► [psychophysics](#) (Stevens 1975; Marks 1974). The ► [power law](#) implies a very simple and parsimonious concept “that equal stimulus ratios produce equal subjective ratios” (Stevens 1975). To the non-psychophysicist, this statement means that proportions of perceived stimulus intensities remain stable. For example, the perceived relations between the lighter or darker parts of a photograph are the same under bright or dim illumination. The power law can be expressed by the following simple equation:

$$\phi = k(S - S_0)^X,$$

where  $\phi$  = perceived magnitude,  $k$  is a constant,  $S_0$  is the stimulus magnitude at threshold (e.g. pain threshold) and  $X$  is an exponent for a given sense modality under a standard set of conditions. A power function whose exponent is 1.0 (i.e.  $\phi = k(S - S_0)^{1.0}$ ) predicts that two stimuli, whose ratio of measured intensities is 2:1, will result in two perceived intensities whose ratio is 2:1. Using this same stimulus ratio (2:1) in the case of a power function whose exponent is 2 (i.e.  $\phi = k(S - S_0)^{2.0}$ ), results in a ratio of perceived magnitudes that is 4:1. The relationship of perceived ratios to stimulus ratios would be the same for a given power function, regardless of the units of measurement of stimulus intensity or the stimulus magnitudes used to make up the stimulus intensity ratios. Different sense modalities have characteristic power function exponents. For example, that for visual intensity is about 0.7 (Stevens 1975; Marks 1974). This means that it bends slightly downward in linear coordinates. Perceived warmth has an exponent ranging from 0.5 to about 1.6, depending on the area of the stimulus (Marks 1974).

## Characteristics

Contact heat induced pain has been shown repeatedly to follow a positively accelerating (bending upward) power function (Price 1999; Price et al. 1996; Price et al. 1992), as illustrated in Figures 1 and 2. The exponent of the power function is consistently greater than 2.0, regardless of whether pain sensation intensity or unpleasantness (i.e. pain affect) is rated. Thus, for the data presented in Figure 2, the exponent for pain unpleasantness is significantly higher than that for pain sensation intensity, and both functions have exponents greater than 2.0 (Price et al. 1996). The functions were obtained using a ► [visual analogue scale](#) (VAS) and were very consistent across different groups of subjects, including both pain patients and pain free volunteer groups (Fig. 1). The power function exponent for contact heat-induced pain is also independent of area. Thus, the stimulus-response functions of contact heat-induced pain differ in this re-



**Pain in Humans, Electrical Stimulation (Skin, Muscle and Viscera), Figure 1** Rectangular shaped pulses are most often used for electrical stimulation. Other pulse shapes with slower current rise rates have been introduced for stimulation of thinner fibres without activation of thick myelinated fibres.

spect from those of warmth, whose power function exponents decrease systematically as a function of area. They decrease from 0.5 to 1.6 as the stimulus area increases (Marks 1974). However, the exponent for pain produced by radiant heat is close to 1.0 for different areas of stimulation (Adair et al. 1968; Price et al. 1975). Similar to radiant heat, cold pain also has an exponent close to 1.0 (Stevens 1975).

When subjects rate both the unpleasantness and the sensory intensity of contact induced heat pain, the power function exponent for unpleasantness is consistently higher than that pain sensation intensity (Price 1999; Price et al. 1996; Price et al. 1992). A higher exponent for pain affect compared with pain sensation, reflects the fact that unpleasantness ratings are systematically lower than sensory ratings, when both dimensions of pain are rated on the same length visual analogue scales (Price et al. 1996). This has the effect of increasing the slope when plotted in logarithmic coordinates. However, unpleasantness ratings are subject to a good deal of influence by psychological factors. The lower ratings in this case are due to the assurances made to the participants that the stimuli would be brief, would not produce tissue damage, and would remain within tolerable limits. Very different ratings would likely occur if subjects were made anxious about the pain stimuli.

These characteristics demonstrate that heat-induced pain is similar to other sensory modalities in that it follows a power function. This attribute helps to characterize heat-induced pain as a ► **somatosensory** submodality. In addition to larger exponents for contact heat-induced pain (>2.0) than for contact-induced warmth (e.g. .5–1.6), other major differences also exist between these sensory modalities. The perception of warmth intensity and the threshold for warmth are de-

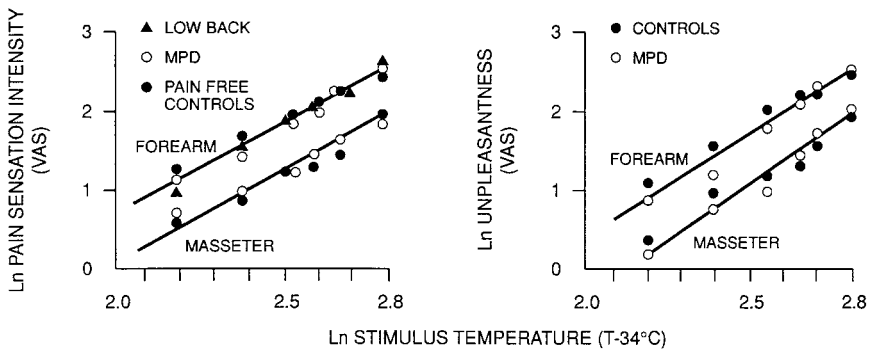
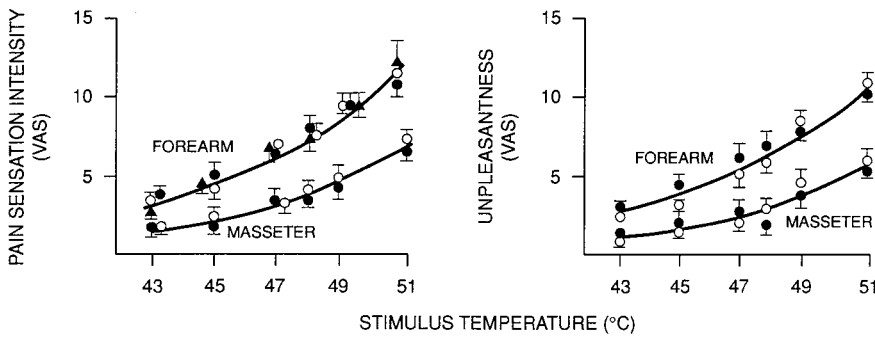
pendent on the rate of rise of skin temperature, whereas pain threshold and pain intensity are far less influenced by such factors (Price and Browe 1975; Kenshalo et al. 1967; Stevens and Marks 1971; Hardy et al. 1952). There are also differences in ► **spatial summation** attributes between pain and warmth (see below). These clear differences in psychophysical attributes indicate that heat-induced pain cannot be construed as a simple extension of warmth, and must be considered a separate sensory dimension. That warmth and pain are processed separately is also supported by considerable neurophysiological evidence, that separate neuronal populations process warmth and ► **nociception** (Price et al. 1992; Price and Browe 1975).

### Spatial Summation

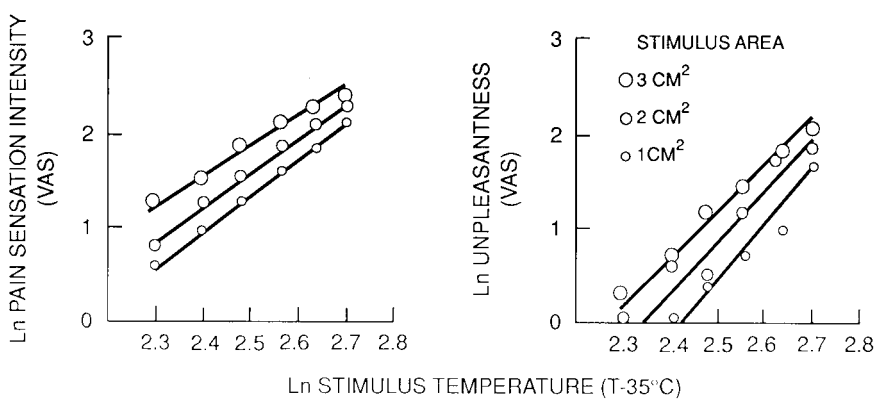
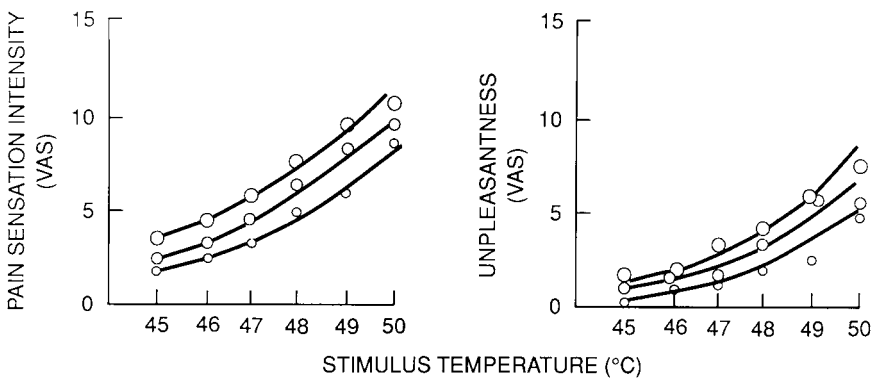
Both the power functions for heat induced pain and heat induced warmth are affected by spatial summation (Price 1999; Price et al. 1992; Kenshalo et al. 1967; Stevens and Marks 1971; Hardy et al. 1952) (Fig. 2). Summation of warmth takes place generously over large areas of the body surface, and as stimulus area increases, the overall perceived intensity of warmth increases. However, the slope of the stimulus response function, obtained when relating stimulus temperature to perceived warmth (in double logarithmic coordinates), decreases in magnitude with increasing stimulus area (Kenshalo et al. 1967; Stevens and Marks 1971). Therefore, the same change in temperature over a small area has a proportionately greater effect than that same change spread over a larger area. Furthermore, the perceived warmth intensity functions converge at a common point near pain threshold (Marks 1974).

In contrast to spatial summation of warmth, which decreases with increasing stimulus temperature, spatial summation of heat-induced pain increases with increas-





**Pain in Humans, Psychophysical Law, Figure 1** Stimulus-response functions for noxious temperature stimuli (5-sec duration) applied in random order to the ventral surface of the forearm and skin overlying the masseter area in normal volunteers and in pain patients. The upper graphs are the functions in linear coordinates and the lower graphs are the same functions expressed in double logarithmic coordinates (Price 1999).



**Pain in Humans, Psychophysical Law, Figure 2** Spatial summation of pain, showing sensory (left) and affective (right) VAS ratings of noxious temperatures. Functions are plotted in linear (top) and double logarithmic coordinates (Price et al. 1989).

ing stimulus temperature (Fig. 2). Thus, for intensely painful stimuli, stimulus area is a particularly critical factor in determining pain level. The pattern of spatial summation of pain occurs for small areas of skin (Douglass et al. 1992; Greene and Hardy 1958; Price et al. 1989), much larger areas that extent across several

▶ **dermatomes** (Arendt-Nielson et al. 1997), and even for multiple stimuli that are spatially separated by as much as 20 centimeters (Price et al. 1992). That the extent of spatial summation of pain is a function of both area and nociceptive stimulus intensity also has adaptive significance, because these features are consistent



with a mechanism that is sensitive to the total amount of biological threat to the integrity of body tissues. Given its potentially critical role in understanding the neural mechanisms of pain, as well as the obvious medical implications of this property of pain, it is astonishing that it is only within the last 15 years that direct scaling analyses have been applied to testing spatial summation of pain.

In the separate studies that used direct scaling methods, human observers made direct ratings of pain sensation intensity and/or pain unpleasantness in response to contact heat (Price et al. 1992; Douglass et al. 1992) or contact cold (Douglass et al. 1992). Considerable spatial summation occurred in both the intensity and unpleasantness dimensions of pain (Price et al. 1992; Douglass et al. 1992). Although spatial summation was evident throughout a wide range of temperatures, it was far larger at temperatures that were supra-threshold for pain ( $47^{\circ}$  to  $50^{\circ}\text{C}$ ) than at those near the pain threshold ( $43^{\circ}$  to  $46^{\circ}\text{C}$ ), and this result was consistent across multiple studies. The psychophysical features of spatial summation are consistent with a pain encoding mechanism that is heavily dependent on central neuronal recruitment.

The spatial summation of heat-induced pain is characterized by upward parallel displacement of the stimulus-response function in double logarithmic coordinates. A similar parallel displacement in double logarithmic coordinates is evident, regardless of whether the various sized stimulus areas are small, large, extend across several dermatomes, or are spatially separated. It also indicates that the power function exponent, the slope of the curve in double logarithmic coordinates, is stable across different areas and different spatial patterns of stimulation. This consistent power function exponent differs markedly from that of warmth, whose slope and power-function exponent decrease with increasing area. The minimal spatial summation near the pain threshold is consistent with previous studies, which concluded that spatial summation of pain threshold was minimal or non-existent (Hardy et al. 1952; Greene and Hardy 1958), and helps to explain why the property of spatial summation of pain has long eluded investigators. This spatial summation property of pain is very different from that of warmth, for which spatial summation occurs maximally near the threshold. This difference, in turn, may be related to the fact that the steepest portion of the stimulus response curve for warmth is near the warmth threshold, whereas that for heat induced pain is well above the pain threshold. There is also a possibility that central neural integrative mechanisms are quite different for pain and warmth. Spatial summation is undoubtedly a clinically important attribute of pain. Spatial summation is not a phenomenon confined to cutaneous pain, for there is evidence that considerable spatial summation takes place for visceral and muscular pain (Arendt-Nielson et al. 1997).

### Pain Intensity Discriminability

If one can detect the intensity of a noxious stimulus, one must also be able to detect differences in noxious intensities. What is surprising, however, is the sensitivity of this capability. It has been demonstrated that both humans and monkeys can detect temperature shifts of  $0.2^{\circ}$  to  $0.3^{\circ}\text{C}$  at nociceptive ( $>47^{\circ}\text{C}$ ) intensity levels (Dubner et al. 1986). This discriminative ability is even greater than that found for warmth. For example, temperature shifts of  $0.3^{\circ}$ – $0.5^{\circ}\text{C}$ , from a baseline of  $39^{\circ}\text{C}$ , are required for trained human observers to detect differences in warmth. The ability to detect very small differences of  $0.2^{\circ}$ – $0.3^{\circ}\text{C}$  within the nociceptive range ( $45^{\circ}$ – $51^{\circ}\text{C}$ ) is generally consistent with the presence of 21 levels of just-noticeable-differences obtained when studying radiant heat-induced pain (Hardy et al. 1952). Contrary to the notion that discrimination of different magnitudes of pain is poor and unlike other sensory modalities, discrimination of intensity and intensity differences within the nociceptive stimulus intensity range is extremely refined. Both psychophysical studies and studies of neurons at all levels within pain-related neural pathways, consistently demonstrate capacities of neurons and human observers to discriminate  $0.2^{\circ}$ – $0.3^{\circ}\text{C}$  differences (Price et al. 1992; Dubner et al. 1986).

### The Relationship of the Power Law to Validation of Pain Scales as Ratio Measurement Scales

The reliable power functions established for pain are interrelated with the validation of a specific type of pain scale as having ► ratio scale properties. An example of a pain scale that at least approximates a ratio scale level of measurement is the visual analogue scale (VAS). A critical test of whether VAS has ratio scale properties is to ask subjects to rate different noxious stimuli, and then to adjust different stimulus intensities to obtain separate judgments of ratios of intensity. Ratings of noxious stimuli and independent judgments of ratios should agree if the method represents a ratio scale. Price (1999) asked subjects to rate contact heat-induced temperatures, thereby producing a stimulus response curve like that shown in Fig 1. Subjects then received a standard test stimulus of  $47^{\circ}\text{C}$ , after which the temperature increased in intensity to a level judged to be twice as intense as this standard. According to the stimulus-response regression curve, they should have judged  $49.6^{\circ}\text{C}$  as twice as intense as the standard. The mean temperature chosen was  $49.8^{\circ}\text{C}$ , a value very close to that predicted. This test was replicated using other standard temperatures within the noxious range. Importantly, when this experiment was repeated using a numerical rating scale of 0-10, the predicted and observed judgments were significantly different, indicating that this scale does not have ratio scale properties. This negative finding is important, considering that the 0-10 numerical rating scale is the most common pain scale used by healthcare professionals.

At least some forms of experimentally induced pain follow the power law. Specific characteristics of their stimulus-response functions distinguish them as a sensory modality that is distinct from other somatosensory submodalities. These characteristics help explain some features of clinical pain, such as spatial summation, and help to establish the ability to measure pain in clinical contexts.

## References

1. Adair EE, Stevens JC, Marks LE (1968) Thermally Induced Pain: The Dol Scale and the Psychophysical Power Law. *Amer J Psych* 81:147–164
2. Arendt-Nielsen L, Graven-Nielsen T, Sventnson P, Jensen TS (1997) Temporal Summation in Muscles and Referred Pain Areas: An Experimental Human Study. *Muscle Nerve* 10:1311–1313
3. Douglass DK, Carstens E, Watkins LR (1992) Spatial Summation in Human Pain Perception: Comparison Within and Between Dermatomes. *Pain* 50:197–202
4. Dubner R, Bushnell MC, Duncan GH (1986) Sensory-Discriminative Capacities of Nociceptive Pathways and their Modulation by Behavior. In: Yaksh TL (ed) *Spinal Afferent Processing*. Plenum, New York, pp 321–331
5. Greene LC, Hardy JD (1958) Spatial Summation of Pain. *J Appl Physiol* 13:457–464
6. Hardy JD, Wolff HG, Goodell H (1952) Pain Sensations and Reactions. Williams and Wilkins, Baltimore
7. Kenshalo DR, Decker T, Hamilton A (1967) Spatial Summation on the Forehead, Forearm, and Back Produced by Radiant and Conducted Heat. *J Comp Physiol Psych* 63:510–515
8. Marks LW (1974) *Sensory Processes*. The New Psychophysics. Academic Press, New York
9. Price DD, Browe AC (1975) Responses of Spinal Cord Neurons to Graded Noxious and Non-Noxious Stimuli. *Exp Neurol* 48:201–221
10. Price DD, McHaffie JG, Larson MA (1989) Spatial Summation of Heat Induced Pain: Influence of Stimulus Area and Spatial Separation of Stimuli on Perceived Pain Sensation Intensity and Unpleasantness. *J Neurophysiol* 62:1270–1279
11. Price DD, McHaffie JG, Stein BE (1992) The Psychophysical Attributes of Heat-Induced Pain and their Relationships to Neural Mechanisms. *J Cogn Neurosci* 4:1–14
12. Price DD, Bush FM, Long S, Harkins SW (1996) A Comparison of Pain Measurement Characteristics of Mechanical Visual Analogue and Simple Numerical Rating Scales. *Pain* 56:217–226
13. Price DD (1999) *Psychological Mechanisms of Pain and Analgesia*. IASP Press, Seattle
14. Stevens JC, Marks LE (1971) Spatial Summation and the Dynamics of Warmth Sensation. *Perception Psychophysics* 9:291–298
15. Stevens SS (1975) *Psychophysics. Introduction to Its Perceptual, Neural, and Social Prospects*. John Wiley & Sons, New York

## Pain in Humans, Sensory-Discriminative Aspects

RICHARD H. GRACELY

Ann Arbor Veterans Administration Medical Center, Departments of Medicine-Rheumatology and Neurology and the Chronic Pain and Fatigue Research Center, University of Michigan Health System, Ann Arbor, MI, USA  
rgracely@umich.edu

## Synonyms

Sensory-discriminative aspects

## Definition

Pain is defined by the International Association for the Study of Pain (IASP) as “an unpleasant sensory and emotional experience associated with actual or potential tissue damage or described in terms of such damage” (Merskey and Bogduk 1994). The sensory aspect is essential, as the IASP definition elaborates: “Unpleasant abnormal experiences (dysesthesias) may also be pain but are not necessarily so because, subjectively, they may not have the usual sensory qualities of pain”, pain “is unquestionably a sensation in a part or parts of the body” (Merskey and Bogduk 1994).

## Characteristics

Somatosensory sensations such as pain can be described by four major dimensions, intensity, quality, location and duration. The intensity of pain sensation has been the primary outcome for a majority of basic and clinical pain studies. Pain intensity is intimately associated with pain quality, which can vary over a number of dimensions including mechanical, temporal, spatial and thermal. A pain sensation may be composed of only a single quality such as burning, with the pain intensity referring to the amount of burning. Alternatively, pain sensation may be multidimensional and described by a number of simultaneous qualities, each described in turn by a specific sensory intensity. In musical terms, pain can resemble a solo instrument with a specific loudness or an ensemble with a separate and varying loudness for each type of instrument. In this case, the ensemble can be described by an overall intensity and also separate intensities can be assigned to individual qualities.

In addition to intensity and quality, pain can vary in the location and extent of the sensation. The pain may be restricted to a small area or occupy a large region of the body. It may be superficial or deep. It may be accurately localized or be diffuse and poorly localized. Finally, pain can be brief or prolonged and can wax and wane. In the acute situation, the duration of an evoked pain may be increased during ► [central sensitization](#) or during loss of tonic inhibition. In chronic conditions, prolonged pain may be accompanied by neuroplastic changes, resulting in altered and new mechanisms that are not present during acute pain events.

Together, these features of intensity, quality, location and duration define a rich variety of painful experiences. These ► [sensory-discriminative](#) aspects of pain probably serve a number of important functions. They guide vermin detection (i.e. swat a mosquito) and guide conscious withdrawal behaviors. They provide predictions about the possibility of impending tissue damage (stepping barefoot onto hot rocks, continue or retreat?) and they provide information important for integration

with other systems. Examples include modification of gait associated with a sprained ankle, an interaction that may be further modified by other considerations (chasing prey, being chased by a predator).

#### Discriminating the Presence of Pain: The Pain Threshold

The simplest discrimination of pain is the determination of its presence. In the clinic, the presence of pain is often determined by the response to a standard stimulus. For example, metal objects at room temperature feel cool in the normal situation but evoke painful sensations in clinical conditions of cold allodynia. In the laboratory, the investigator is interested in the exact value of the lowest stimulus intensity needed to evoke pain or simply, the pain threshold.

In ► **sensory psychophysics**, the threshold describes a fundamental difference in sensory quality. As the magnitude of a stimulus is increased, the threshold marks the transition from the absence of sensation to the presence of sensation. This transition is not succinct. Subjects fail to report sensations to the same level of stimulus magnitude consistently and will report sensations when no stimulus is presented. Thus there is a band of stimulus intensities, extending down to zero, in which the presence of a sensation is uncertain. As stimulus intensity is increased, the uncertainty decreases until levels are reached at which the presence of sensation is certain and unmistakable. Mathematically, the probability of sensory detection increases as stimulus intensity is increased. The resulting function is usually described by an ogive (an accumulated normal Gaussian distribution); the probability of detection is near zero for a range of values, then the slope increases as stimulus intensity increases, reaching a peak slope and becoming nearly linear through the region of 50% probability. Further increases in stimulus intensity result in a reduced slope as 100% probability of detection is approached.

Since there is no single sensory detection threshold, the evaluation of such thresholds is based on determining a stimulus intensity that evokes a report of a sensation a certain percentage of the time, with 50% and sometimes 75% used as obvious rational standards.

These properties of the sensory detection threshold apply also to the determination of the pain threshold. However, there is a fundamental difference between determination of sensory thresholds and pain thresholds. In almost all cases, increasing stimulus intensity of a noxious stimulus does not lead to a transition from the absence of sensation to a pain sensation. In between there is a range of non-painful sensation. Heat stimuli become warm and hot before they begin to hurt. These pre-pain sensations present a measurement problem. In the psychophysical evaluation of sensory thresholds, the investigator can deliver a blank stimulus and be confident that the effect is the same as the effect of delivering a sub-threshold, unperceived

stimulus and also be confident that the blank stimulus will be confused with a real stimulus. The ability to present such blank trials provides the basis for robust methods such as sensory-decision-theory and two-alternative-forced-choice that provide relatively bias-free measures of sensory sensitivity. The pain investigator is hampered in this regard, because a true blank stimulus will rarely be confused with a painful stimulus.

#### Measurement of the Pain Threshold

Due to concerns about administering excessively painful stimulation, the pain threshold is usually approached from the bottom, by administering continuous stimulation increasing in intensity or an ascending series of discrete stimuli. These methods lack controls for psychophysical errors that are incorporated into more sophisticated psychophysical methods (Engen 1971). These measures are therefore vulnerable to a number of biases. Even more sophisticated methods cannot ensure that subjects follow instructions. The very multi-qualitative nature of pain sensation provides opportunities for irrelevant responses. As stimulus intensity increases, the evoked sensation may change in quality, may spread or may increase in time. There is nothing to prevent subjects from using any aspect of the stimulus-evoked sensations as their personal criterion for pain, and producing orderly responses by using this point as their pain threshold. In contrast, detection thresholds are immune to this problem, since there is no pre-pain sensation to use as an artefactual criterion. Subjects may be motivated to provide irrelevant responses. They may wish to minimize pain and discomfort, to be “tough” to an opposite gender experimenter (Levine and DeSimone 1991) or they may strive to give the “correct” answer. In the assessment of an analgesic, they may use perceived side effects as a clue that an active agent has been delivered and change their responses accordingly.

#### The Fundamental Problem of Pain Measurement

Sophisticated methods can control for many of the biases that influence simple threshold determinations. For example, clinical measures of the pressure pain threshold can be influenced significantly by psychological distress, while suprathreshold measures using random stimulation are independent of distress (Petzke et al. 2003). However, even the most sophisticated methods share a fundamental problem with simple threshold measures. Do differences in reports of pain intensity between individuals or within individuals over time represent altered experience or just altered labels used to describe the same experience? One attempt at solving this problem uses discrimination ability, essentially a behavioral measure of performance, as a correlate of pain sensitivity.



### Does Pain Discrimination Solve the Problem of Measuring Pain Intensity?

The psychophysical process can be broken down into two parts. One is discrimination sensitivity, the ability to distinguish between two different sensations. The other is the choice of labels used to describe these differences. All psychophysical judgments involve a “response criterion” which in the case of the pain threshold can be defined as the specific attributes of a stimulus-evoked sensation that result in the label “painful” This criterion can vary from highly expressive to stoical. Two fundamental problems in pain evaluation are the static case, e.g. “do differences in pain reports from different patients represent different sensory magnitudes or just different labels applied to similar sensory experiences?” and the dynamic case, e.g. “does a reduction in pain after a therapeutic treatment represent a reduction in pain sensation or a reduction only in the labels used to describe an essentially unchanged pain sensation?”

The role of the response criterion and the separate assessment of the criterion and sensory performance are explicitly addressed by the use of ► [signal detection](#) and ► [sensory decision theory](#) (SDT) (Swets 1964). Basically, SDT analytical procedures consider a threshold judgment in terms of whether the stimulus is present and whether it is reported as present. The two correct responses are a hit (a stimulus is reported present when it is present) and a correct rejection (stimulus reported absent when it is absent). The two errors are called a miss (stimulus reported absent when present) and a false alarm (stimulus reported present when absent). In statistical terms, SDT treats a threshold determination like a t-test. The measure of discrimination is directly analogous to the t statistic; it is the measure of difference in the means of two sensory distributions divided by their variability. It describes the overall sensitivity of the system. The response criterion parameter is directly related to the alpha level set by the experimenter. It is the probability of a Type I error, which is the same (and more meaningfully described) as a false alarm or false positive. As with the t-test, the setting of this criterion to minimize this error increases the other type of error, referred to as Type II or beta error (or as a miss or false negative). In the original application of SDT to wartime radar operators, the response criterion parameter was set by the operator and in this case determined by the demand characteristics. During wartime it is obviously beneficial to adapt a liberal criterion, to call anything remotely resembling an enemy plane an enemy plane. This vigilant strategy minimizes the misses at the expense of increased false alarms.

SDT has been applied in many studies of pain control interventions. The results of these studies were consistent with an interpretation of  $d'$  as pain sensitivity and the response criterion as response bias. Administration of placebo resulted in only a shift in the response criterion

without a change in  $d'$ , while the active interventions reduced  $d'$  with variable effects on the response criterion (Chapman 1977; Chapman et al. 1973; Clark and Yang 1974; Yang et al. 1979).

Proponents of SDT for pain assessment claimed that the fundamental problem in pain assessment, separating physiological pain sensitivity from labeling behavior, had been solved. Certainly, the separation of pain responses into these two parameters is a logical, appealing and good way of describing pain-rating behavior. However, this interpretation has not met with universal acceptance (Rollman 1977). Others note that the SDT measure of discrimination sensitivity is a statistic and using it to measure pain sensitivity is similar to using the t or F statistic or using the statistical p value to assess effect size. These statistics are related to the effects we want to measure, but this effect is divided by a measure of variance. In the case of pain, this variance can be in the physiological sensory system and also in the genitive system of choosing labels to describe the sensory experience (Coppola and Gracely 1983). Pain discrimination and experimental effects on pain discrimination can be measured by a number of robust methods, but the relationship of discrimination to “how much it hurts” is a clear topic for further investigation. As mentioned above, pain discrimination is not limited to discrimination of intensities. Discrimination applies also to qualities, duration and locus. Quality is assessed by well-known instruments such as the McGill Pain Questionnaire (Melzack 1975) or the short form of this questionnaire (Melzack 1987). Lenz et al. (1994) have developed a very rapid method for intra-operative brain stimulation and recording. The temporal and locus aspects of sensation are included in these instruments with qualities such as spreading or flickering. Spatial discrimination may also be assessed by methods such as two-point discrimination. This brief essay is confined to one aspect of psychophysical pain discrimination. From the classic review of Price and Dubner (1977) to the current state of the art, evidence for the mechanisms that mediate the sensory-discriminative aspects of pain processing form another large and growing story of the multiple systems that discriminate pain sensations and the plasticity of these systems when pain persists.

P

### References

1. Chapman CR (1977) Sensory decision theory methods in pain research: A reply to Rollman. *Pain* 3:295–305
2. Chapman CR, Murphy TM, Butler SH (1973) Analgesic strength of 33 percent nitrous oxide: A signal detection evaluation. *Science* 179:1246–1248
3. Clark WC, Yang JC (1974) Acupunctural analgesia? Evaluation by signal detection theory. *Science* 184:1096–1098
4. Coppola R, Gracely RH (1983) Where is the noise in SDT pain assessment? *Pain* 17:257–266
5. Engen T (1971) Psychophysics I. Discrimination and Detection. In: Kling JW, Riggs LA (eds) *Experimental Psychology*, 3rd edn. Holt, New York, pp 11–46

6. Lenz FA, Gracely RH, Hope EJ et al. (1994) The sensation of angina can be evoked by stimulation of the human thalamus. *Pain* 59:119–125
7. Levine FM, DeSimone LL (1991) The effects of experimenter gender on pain report in male and female subjects. *Pain* 44:69–72
8. Melzack R (1975) The McGill Pain Questionnaire: Major properties and scoring methods. *Pain* 1:277–299
9. Melzack R (1987) The short-form McGill pain questionnaire. *Pain* 30:191–197
10. Merskey H, Bogduk N (1994) Classification of Chronic Pain, Second Edition, IASP Task Force on Taxonomy. IASP Press, Seattle, pp 209–214
11. Petzke F, Gracely RH, Park KM et al. (2003) What do tender points measure? Influence of distress on 4 measures of tenderness. *J Rheumatol* 30:567–574
12. Price DD, Dubner R (1977) Neurons that subserve the sensory-discriminative aspects of pain. *Pain* 3:307–338
13. Rollman GB (1977) Signal detection theory measurement of pain: A review and critique. *Pain* 3:187–211
14. Swets JA (1964) Signal detection and recognition by human observers. Wiley, New York
15. Yang JC, Clark WC, Ngai SH et al. (1979) Analgesic action and pharmacokinetics of morphine and diazepam in man: an evaluation by sensory decision theory. *Anesthesiology* 51:495–502

## Pain in Humans, Sleep Disturbances

HARVEY MOLDOFSKY

Sleep Disorders Clinic of the Centre for Sleep and Chronobiology, Toronto, ON, Canada  
h.moldofsky@utoronto.ca

### Synonyms

Sleep disturbances

### Definition

This essay summarizes evidence on how an understanding of sleep and its disorders help in the assessment and management of common pain problems i.e., headache, migraine, backache and common rheumatic ailments such as osteoarthritis, rheumatoid arthritis and fibromyalgia. The pathophysiology of how pain and insomnia reinforce one another is described. Not only does pain have an adverse effect upon sleep, mood, cognitive functioning and behavior but disturbances to sleep also promote pain and fatigue as the result of exogenous physical or psychological noxious events or endogenous primary sleep disorders e.g. sleep apnea and ► [restless legs syndrome](#) (RLS). These sleep/wake-related issues are especially important in the evolution and management of headache, back pain and various articular and nonarticular rheumatic illnesses.

### Characteristics

#### The Interaction of Pain and Disordered Sleep

Pain and insomnia are among the most common complaints in our society so that the likelihood that the two conditions coincide in the same person should not be surprising. Our common experience is that any painful

condition will disturb sleep and if prolonged could have a negative effect upon mood, thinking, energy and behavior. In a recent Gallop Poll Survey, 56 million Americans complained that nighttime pain interfered with their falling asleep or promoted awakenings during the night or awakenings in the early morning. A Canadian population survey indicated that 44% of people with any painful disorder have sleep problems. This epidemiological study showed that the greater the severity of pain, the higher the likelihood of having insomnia or unrefreshing sleep (Moldofsky 2001). An experimental study employed to determine whether specific stages in electroencephalographic (EEG) sleep were affected by pain showed that all stages of sleep are disrupted by noxious stimulation of muscles and that quality of sleep was impaired (Lavigne et al. 2004).

While painful conditions may interfere with sleep, the corollary is also true. That is, healthy people who were exposed experimentally to several nights of noise-induced arousals from stages 3 and 4 (slow wave or deep) non rapid eye movement (non-REM) sleep caused them to experience unrefreshing sleep, nonspecific generalized muscle aching and fatigue (Moldofsky 2001; Moldofsky and Scarisbrick 1976; Moldofsky et al. 1975). These symptoms receded when they were allowed to sleep undisturbed. Localized effects on muscular function, i.e. jaw muscle activity, masseter pain and tenderness were not induced using a similar experimental design but without any changes in the duration of sleep time and EEG stages 1 and 2 sleep (Arima et al. 2001). Indeed, total sleep deprivation for 40 h as well as partial deprivation of slow wave sleep and rapid eye movement (REM) sleep increases pain sensitivity. Only the increase in slow wave sleep during recovery from sleep deprivation resulted in a decrease in pain sensitivity. Furthermore, sleep deprivation counteracts analgesic effects of drugs that affect opioidergic and serotonergic neural mechanisms (Kundermann et al. 2004). The sleep problems that occur with chronic pain may also stem from the depression and anxiety that occur as the result of physical, psychosocial, vocational and economic concerns. Patients' negative beliefs and attitudes about themselves and their chronic pain problems benefit from improvement in their sleep habits, cognitive behavioral therapy and a suitable aerobic fitness program. While traditional analgesic, anti-anxiety or antidepressant medications are often used empirically to address pain and mood symptoms, the potential adverse effects of such medications upon sleep and daytime functioning should be considered in the assessment and overall management programme (Moldofsky 2002).

#### Headache and Sleep

People who awaken from sleep with headache often have something wrong with their sleep (Goder et al. 2003). For example, heavy snorers and those with sleep apnea syndrome are more likely to awaken with morn-

ing headache than people in the general population. Successful treatment of the sleep apnea is helpful in controlling the frequency of such headaches. Furthermore, complaints of headache at awakening and during the day are three times more likely to occur among sufferers of restless legs syndrome (RLS). Similarly, patients with this sleep disorder experience improvement in their sleep and pain from successful treatment of RLS with gabapentin (Garcia-Borreguero et al. 2002). The physiology of sleep is intimately linked to migraine. Some people are awakened from rapid eye movement (REM) or dreaming sleep with migraine. Sleep deprivation or excessive sleep may trigger migraine attacks. Restful sleep may be associated with relief of migraine attacks, so that migraine sufferers who improve their sleep habits have reduced incidence and duration of their symptoms.

### Back Pain and Sleep

Low back pain is the most common of all musculoskeletal disorders in young adults, but most back strain injuries resolve within 3 months. Delay in falling asleep and higher overall sleep disturbance are found in chronic back pain sufferers who have degenerative spinal disease or post-laminectomy syndrome. These sleep problems are more likely to be the result of poor physical functioning, duration of pain and age rather than pain intensity and depressed mood.

Sleep physiological studies show that people with chronic low back pain have an arousal disturbance in EEG sleep that interferes with restful sleep (Moldofsky 2001). This alpha (7.5–11 Hz) non-REM EEG pattern during sleep might be caused by pain stimuli from injured muscles that intrude into sleep. When pain stimuli are applied to muscles, such EEG arousal patterns are seen in slow wave sleep. These differ from EEG sleep frequencies that are experimentally induced in joints and skin (Drewes et al. 1997). These sleep physiological disturbances interfere with the natural restorative properties of sleep, so that there is an adverse effect upon daytime functioning. Despite their engaging in a rehabilitation programme, those workers who had suffered a painful soft tissue strain or sprain injury and have persistent sleep disturbances have a poor prognosis for returning to work (Crook and Moldofsky 1996).

### Arthritic Disease and Sleep

About 75% of people with various painful rheumatic disorders report sleep problems. Fatigue, which is almost universal in people with rheumatic disorders, is largely explained by pain, sleep disturbance and depression.

### Osteoarthritis and Sleep

Light, restless sleep is common in patients with osteoarthritis or ankylosing spondylitis. While we can assume that proper management of osteoarthritic joint pain with pain remedies or anti-inflammatory drugs

would reduce the nocturnal restlessness, sleep disturbances may contribute to unrefreshing sleep, pain and fatigue symptoms. For example, restless legs and sleep-related involuntary leg movements can influence awakening in the morning with pain and stiffness that is not directly the result of the arthritis. Such people may benefit from treatment of their RLS with special medications for controlling their restlessness and periodic involuntary limb movements during sleep, so that they will awaken feeling refreshed and not troubled by the pain and stiffness.

### Rheumatoid Arthritis and Sleep

Sleep disturbances are important in patients with rheumatoid arthritis (Moldofsky 2001). Their fatigue is associated with poor sleep, functional disability, joint pain and depression. Along with increased weakness and diminished energy, there is an alpha EEG brain wave pattern riding in non-REM sleep that indicates an arousal disturbance during the sleep of acutely ill arthritic patients. Other primary sleep disorders, including periodic involuntary limb movements, RLS and sleep apnea also contribute to the pain and fatigue symptoms. In depressed rheumatoid patients, impaired sleep is associated with increased pain and increased human lymphocyte antigen DR T cell monoclonal antibodies that may perpetuate the disease (Cakirbay 2004).

### Fibromyalgia and Related Disorders and Sleep

People with fibromyalgia typically complain of generalized aching in their bodies, unrefreshing sleep, fatigue and cognitive and emotional difficulties that interfere with their day-to-day functioning. Such symptoms along with a hypersensitivity to various food, environmental and tactile noxious stimuli are also found in patients with other painful complaints including chronic headache, migraine, chronic fatigue syndrome, irritable bowel syndrome and temporomandibular joint disorder where unrefreshing sleep is common. The myalgia and multiple tender points in specific anatomic regions that are characteristic of fibromyalgia are related to the poor quality of sleep. The greater the number of tender points, the poorer the sleep in patients with fibromyalgia. This light unrefreshing sleep is associated with an alpha EEG brain wave pattern that is indicative of an arousal disturbance in sleep (Moldofsky 2003) or periodic arousals in the sleep EEG (Rizzi et al. 2004), which may be accompanied by sleep-related periodic limb movements, or respiratory disturbances. The finding of the alpha EEG sleep disorder in children with fibromyalgia and in their mothers who also have this disorder suggests the possibility of a familial or genetic influence for the disorder (Roizenblatt et al. 1997).

### References

1. Arima T, Svensson P, Rasmussen C et al. (2001) The relationship between selective sleep deprivation, nocturnal jaw-muscle activity and pain in healthy men. *J Oral Rehabil* 28:140–148

2. Cakirbay H, Bilici M, Kavakci O et al. (2004) Sleep quality and immune functions in rheumatoid arthritis patients with and without major depression. *Int J Neurosci* 114:245–256
3. Crook J, Moldofsky H (1996) The clinical course of musculoskeletal pain in empirically derived groupings of injured workers. *Pain* 67:427–433
4. Drewes AM, Nielsen KD, Arendt-Nielsen L et al. (1997) The effect of cutaneous and deep pain on the electroencephalogram during sleep: an experimental study. *Sleep* 20:632–640
5. Garcia-Borreguero D, Larrosa O, de la Llave Y et al. (2002) Treatment of restless legs syndrome with gabapentin: a double-blind, cross-over study. *Neurology* 59:1573–1579
6. Goder R, Friege L, Fritzer G et al. (2003) Morning headaches in patients with sleep disorders: a systematic polysomnographic study. *Sleep Med* 4:385–391
7. Kundermann B, Krieg JC, Schreiber W et al. (2004) The effect of sleep deprivation on pain. *Pain Res Manag* 9:25–32
8. Lavigne G, Brousseau M, Kato T et al. (2004) Experimental pain perception remains equally active over all sleep stages. *Pain* 110:646–655
9. Moldofsky H (2001) Sleep and Pain. *Sleep Med Rev* 5:387–398
10. Moldofsky H (2002) Management of sleep disorders in fibromyalgia. *Rheum Dis Clin North Am* 28:353–365
11. Moldofsky H (2003) Fibromyalgia and chronic fatigue syndrome: the role of sleep disturbances. In: Billiard M (ed) *Sleep Physiology, Investigations and Medicine*, Chapter 60. Kluwer Academic / Plenum Publishers
12. Moldofsky H, Scarisbrick P (1976) Induction of neurasthenic musculoskeletal pain syndrome by selective sleep stage deprivation. *Psychosom Med* 38:35–44
13. Moldofsky H, Scarisbrick P, England R et al. (1975) Musculoskeletal symptoms and non-REM sleep disturbance in patients with “fibrositis syndrome” and healthy subjects. *Psychosom Med* 37:341–351
14. Rizzi M, Sarzi-Puttini P, Atzeni F et al. (2004) Cyclic alternating pattern: a new marker of sleep alteration in patients with fibromyalgia? *J Rheumatol* 31:1193–1199
15. Roizenblatt S, Tufik S, Goldenberg J et al. (1997) Juvenile fibromyalgia Clinical and polysomnographic aspects. *J Rheumatol* 24:579–585

## Pain in Humans, Thermal Stimulation (Skin, Muscle, Viscera), Laser, Peltier, Cold (Cold Pressure), Radiant, Contact

LEON PLAGHKI

Cliniques Universitaires St. Luc, Brussels, Belgium  
plaghki@read.ucl.ac.be

### Synonyms

Thermal Stimulation (Skin, Muscle, Viscera); laser stimulation; Peltier; cold stimulation; cold pressure; Radiant Stimulation; contact

### Definition

► **Thermal stimulation** consists of transferring (adding or subtracting) calorific energy between the skin (mucosa, muscle, viscera) and its surroundings. There are three mechanisms by which calorific energy can be transferred: conduction, convection and radiation. These mechanisms can occur in isolation or in combination.

## Characteristics

### Some Fundamentals of Thermal Physics

Two systems are said to be in thermal equilibrium when they are at the same temperature. This equilibrium is dynamic (e.g. the body continuously radiates to the surroundings and continuously absorbs radiation from the surroundings). When a temperature gradient is created between two systems placed in thermal contact (i.e. such as to allow thermal transfer), changes in temperature initially occur in both systems. Eventually changes cease and both systems are then said to have regained thermal equilibrium. The temperature gradient determines the heat flow between systems through the property of thermal conductivity. The calorific energy added to (subtracted from) the system will raise (decrease) its temperature depending on the systems heat capacity. The transfer of radiation energy between systems is complicated by the properties of reflectivity, transparency and absorbance, which are, among other factors, a function of wavelength.

Thermal stimulation consists in creating a temperature gradient between the skin (mucosa, muscle, viscera) and its surroundings in such a way as to allow a net flow of calorific energy towards (heating) or from (cooling) the skin. The flow of energy occurs through three mechanisms, which may operate in isolation or in combination; conduction, convection and radiation. Both conduction and convection require the presence of matter. Conduction requires thermal motions to diffuse through the contact between bodies. Convection involves fluid movements around the skin. In contrast, radiation requires no intervening medium.

Depending on the main mechanism of heat transfer, different kinds of heat sources (or sinks) can be distinguished. Their advantages and disadvantages are based on the following essential features: specificity for the investigated modality, control precision of stimulus parameters such as intensity (power / duration / surface area), reproducibility, and safety (i.e. avoidance of tissue damage). These will be briefly presented.

### Stimulators Based on Heat Transfer by Conduction

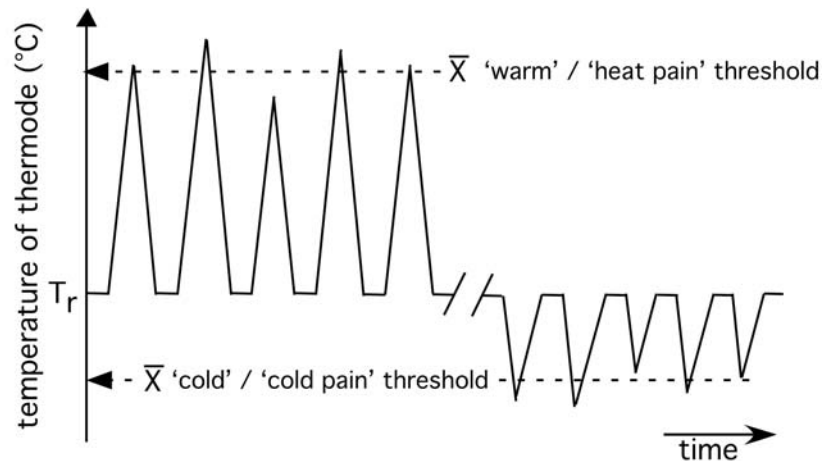
The most commonly used heat / cold ► **contact stimulators** rely on the Peltier principle (a thermoelectric effect in which passage of an electric current through a junction between two different solids causes heat to be produced or absorbed at that junction, according to the direction of the current) (Fig. 1). Advantages of such stimulators are numerous; the stimulus is natural, can be of long duration (seconds) and can cover large surface areas (several cm<sup>2</sup>). Cooling and heating rise times, as well as the baseline temperature of the device, can be very precisely controlled (Fruhstorfer et al. 1976).

Disadvantages of contact heat stimulators are; the mechanical activation of the skin, the variability of heat conductivity (which relies on the quality of the interface) and





Thermode



**Pain in Humans, Thermal Stimulation (Skin, Muscle, Viscera), Laser, Peltier, Cold (Cold Pressure), Radiant, Contact, Figure 1** Stimulators based on heat transfer by conduction. A thermode operating on the Peltier principle and positioned on the right thenar region is shown in the left panel. Starting at base skin temperature ( $T_r$ ), the temperature can be either increased or decreased. The subject's task consists of pressing a button when a given sensation (depending on the instructions received) is perceived. The button press reverses the temperature ramp to return to baseline skin temperature. Recordings of thermal perception thresholds for absolute warmth or heat pain thresholds (upwards) and cold or cold pain thresholds (downwards) are displayed in the right panel.

the slow rise time (around  $2^\circ\text{C}/\text{s}$  for most commercially available stimulators). The stimulator usually consists of a rigid surface, which does not always allow a good contact with the skin. The pressure applied against the skin may influence heat flow. Several recent and successful attempts have been made to improve some of these limitations such as increasing rise time (for a review see Arendt-Nielsen and Chen 2003).

#### Stimulators Based on Heat Transfer by Conduction and Convection

By immersing a limb (or part of a limb) in a stirred and thermostatically controlled water bath, depending on the temperature of the water, one can transfer calorific energy to or from the skin (Fig. 2).

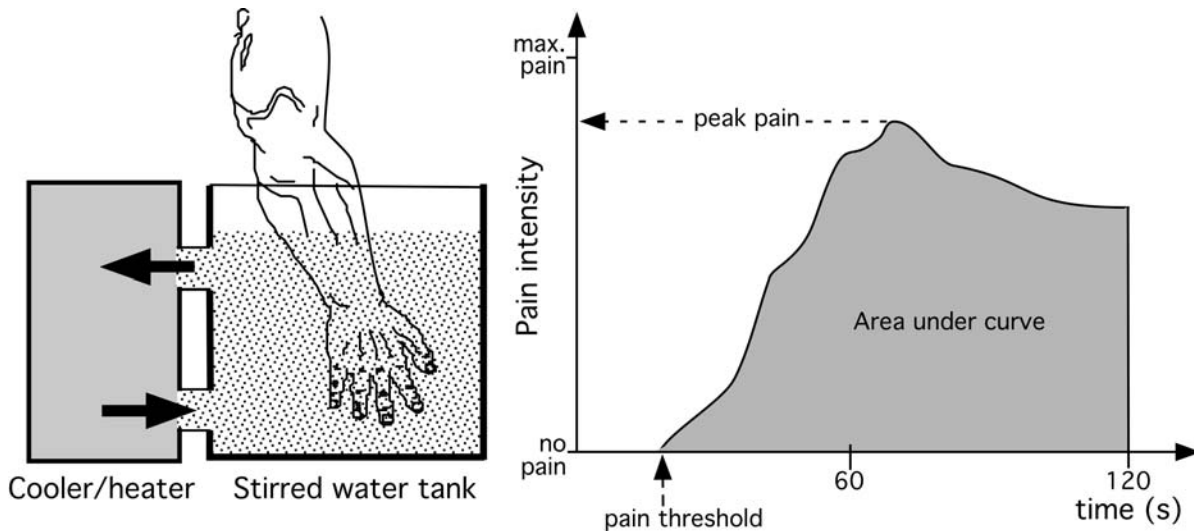
The ► **cold-pressor test** (CPT), a technique widely used in laboratory pain studies, consists in immersing a limb in very cold water (usually below  $5^\circ\text{C}$ ). It produces a severe pain that quickly increases towards a maximum, which, in most cases, is tolerated until the end of the test (a few minutes). If the test is prolonged, the pain usually declines. As the pain rises progressively, it is possible to rate pain intensity continuously using a device such as an electronic visual analogue scale interfaced to a computer. Collected data allows computing the pain threshold, the peak pain intensity, and the area under the pain intensity-time curve (Jones et al. 1988). However, results show that measurement of pain threshold, withdrawal (or tolerance) threshold and pain intensity are subject to great variability (Blasco and Bayes 1988).

#### Stimulators Based on Heat Transfer by Radiation

The first generation of radiant heat stimulators were based on focused light from a light bulb (Hardy et al.

1967). The key advantage of using radiant heat is the absence of contact and therefore the absence of concurrent mechanical activation of the skin. The disadvantage of these conventional sources is their low power. As long (seconds) exposure times are required, these stimulators do not allow the recording of time-locked responses such as reaction times or event-related potentials. An additional disadvantage is that these sources emit in the visible and near infrared spectral band. At these wavelengths, human skin energy absorption is poor while reflectivity is important and a function, among other factors, of skin pigmentation. This problem can be partly circumvented by blackening the skin (e.g. with India ink). More powerful devices have been constructed (e.g. xenon flash lamp) bypassing some of these limitations (Andersen et al. 1994).

In the mid-seventies Mor and Carmon (1975) introduced the laser in pain research. A laser (acronym for light amplification by stimulated emission of radiation) is a unique light source. In comparison to classical incandescent light sources, which emit their radiative energy in all spatial directions and in a large spectrum of wavelengths, the laser energy is confined to a narrow beam of nearly parallel monochromatic electromagnetic waves. This results in a high power density (radiation per unit area). The combination of these characteristics makes the laser a light source with a spectral energy density (radiation per unit wavelength) several orders of magnitude higher than any known light source. This is an essential characteristic if fast and high transfer of radiation energy is needed. To achieve a perfectly defined geometrical configuration of the laser beam, the laser is usually built to operate according to the fundamental mode TEM<sub>00</sub> (transverse electromagnetic mode). This



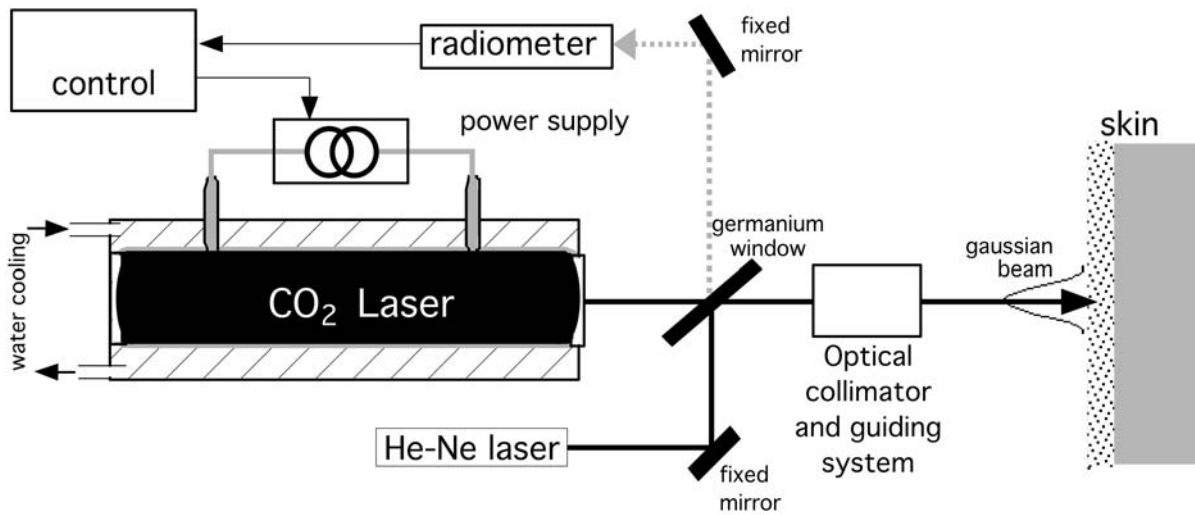
**Pain in Humans, Thermal Stimulation (Skin, Muscle, Viscera), Laser, Peltier, Cold (Cold Pressure), Radiant, Contact, Figure 2** Stimulators based on heat transfer by convection. Transfer of calorific energy to or from the skin is obtained by immersing part of a limb in a stirred and thermostatically controlled water bath. By using a device such as an electronic visual analogue scale interfaced to a computer, it is possible to rate pain intensity continuously as shown in the right panel. The collected data allow the determination of the pain threshold, the peak pain intensity and the area under the pain intensity-time curve.

mode exhibits the so-called Gaussian amplitude profile; the distribution of calorific power in a beam section perpendicular to the optical axis follows a Gaussian distribution centred on that axis. The irradiance profile and beam diameter are measured at the target (Fig. 3). Different laser emission sources have been developed for pain research (e.g. CO<sub>2</sub>, argon, thulium-YAG, and laser diodes) (see Arendt-Nielsen and Chen 2003). The CO<sub>2</sub> laser is currently the most commonly used source for both psychophysical and electrophysiological studies, as it is technically simple, provides high power, is relatively cheap and is easy to control. The light beam is outside the human visible spectrum. At the wavelength of 10.6  $\mu\text{m}$ , the skin acts as a black body (Hardy and Muschenheim 1934): reflectivity is negligible ( $< 1\%$ ), absorption is nearly complete and transparency is very low. For these reasons, the calorific energy remains confined to the upper skin layers (where transducer nerve terminals sensitive to thermal variations are located) and intracutaneous temperature profiles may be easily modelled (Haimi et al. 1983) in both time and space (Fig. 4). There is therefore no need for intracutaneous temperature measurements using invasive thermocouples, which are unreliable as the probes themselves modify the thermal field. The short and long term stability of the output power can be made very constant. The surface area of the stimulus can be easily adjusted (beam diameter 0.2–20 mm). For the purpose of skin stimulation, the radiant heat can be emitted continuously at low power or, more interestingly, as a pulse whose duration (tens of ms) is controlled by instantaneous power (e.g. 0.2–20 W (Meyer et al. 1976)). High power allows the production of very steep temperature

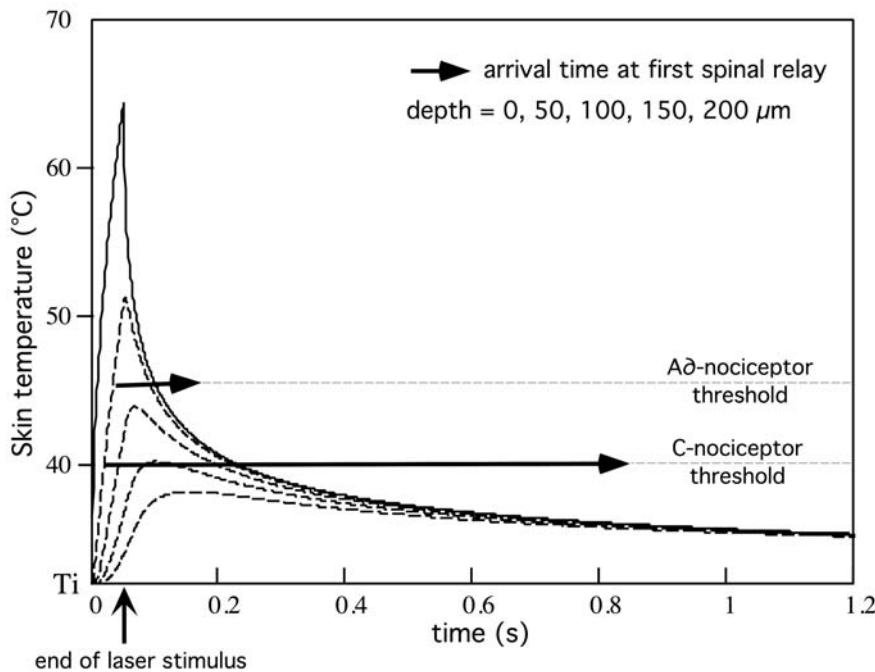
ramps (thousands  $^{\circ}\text{C} / \text{s}$ ). The result is a selective, very synchronized and quasi-simultaneous (Fig. 4) activation of A $\delta$  and C nociceptors (Bromm and Treede 1984), allowing the recording of time-locked neural responses such as laser evoked brain potentials. The versatility of laser stimulators allows exploitation of the differences between A $\delta$  and C fibre peripheral conduction velocities, nociceptor activation thresholds and nociceptor distribution density to study the respective effects of both afferents on central targets in isolation or in combination (Plaghki and Mouraux 2003).

#### Experimental Studies Using Thermal Stimulation

Heat stimulators are used for the determination of warmth and heat-pain detection thresholds. Using supraliminal stimuli, it is possible to characterize the gain of the sensory channel and such cutaneous hypersensitivity phenomena as hyperesthesia, hyperalgesia and allodynia. However, results are dependent on numerous factors such as anatomic site, age, sex and physiological condition (Dyck et al. 1993; Hilz and Neundörf 1990; Verdugo and Ochoa 1992). Variability of results may be explained by differences in stimulation devices (e.g. contact vs. radiant heat, rate of thermal change, stimulus surface area), testing environment (e.g. examiner, room temperature, quietness), testing algorithms (e.g. methods of limits vs. methods of levels), biophysical parameters (e.g. thickness of tissue overlying receptors, spatial distribution of receptors, skin base temperature and for radiative sources on skin reflectance, absorption and transparency) and psychological factors (e.g. motivation, affect, suggestion, attention, fatigue, learning). It is clear from this list that



**Pain in Humans, Thermal Stimulation (Skin, Muscle, Viscera), Laser, Peltier, Cold (Cold Pressure), Radiant, Contact, Figure 3** Stimulators based on heat transfer by radiation. Block diagram of a laser thermal stimulator. The infrared heat source is a CO<sub>2</sub> laser. A He-Ne laser beam is mixed with the IR beam to provide a visual image of the target skin area. The beam size is determined by an optical collimator and guided to the skin. Online control of the laser power output is obtained by reflecting a small fraction of the laser beam towards a radiometer.



**Pain in Humans, Thermal Stimulation (Skin, Muscle, Viscera), Laser, Peltier, Cold (Cold Pressure), Radiant, Contact, Figure 4** Simulation of skin temperature after exposing skin to a heat pulse produced by high power CO<sub>2</sub> laser stimulator. The graph displays skin temperature as a function of time for various skin depths. The parameters for the simulation were set as follows: power = 0.23 W / mm<sup>2</sup>, beam diameter = 10 mm, stimulus duration = 50 ms, distance from beam axis r = 0, initial skin temperature = 30°C. The horizontal arrows show the approximate arrival time of nociceptive information at the first spinal relay taking a peripheral nerve conduction distance of 1 m (e.g. stimulation of the right hand dorsum) and a nerve conduction velocity of 8 m/s for A $\delta$ -nociceptors and 1 m/s for C-nociceptors.

P

it is not recommended to extrapolate reference values obtained by one laboratory to another. There is a risk in comparing studies that are not rigidly controlled in methodology, examiner performance and testing format (Shy et al. 2003).

**Clinical Studies Using Thermal Stimulation**

Once thermal stimulators are used for the clinical assessments of sensory dysfunction in humans it is important to remember the recommendations made by the American Academy of Neurology (Shy et al. 2003). Briefly

stated, results of sensory testing with heat stimulators should not be used as sole criteria to diagnose peripheral or central structural neuropathies. Abnormalities must be interpreted in the context of a detailed clinical examination and other appropriate neurological testing procedures available to the clinician. Each laboratory engaged in sensory testing with heat stimuli should use standardized instructions to patients and allow only adequately trained personnel to perform the tests in a designated quiet room. They should be able to demonstrate reproducible results on normal and diseased subjects.

## References

1. Andersen OK, Jensen LM, Brennum J, Arendt-Nielsen L (1994) Evidence for central summation of C and A $\delta$  nociceptive activity in man. *Pain* 59:273–280
2. Arendt-Nielsen L, Chen A (2003) Lasers and other thermal stimulators of skin nociceptors in humans. *Neurophysiol Clin* 33:259–268
3. Blasco T, Bayes R (1988) Unreliability of the Cold Pressor Test Method in pain studies. *Methods Find Exp.Clin Pharmacol* 10:767–772
4. Bromm B, Treede RD (1984) Nerve fibre discharges, cerebral potentials and sensations induced by CO<sub>2</sub> laser stimulation. *Human Neurobiol* 3:33–40
5. Dyck PJ, Zimmerman I, Gillen DA et al. (1993) Cool, warm and heat-pain detection threshold: testing methods and interferences about anatomic distribution of receptors. *Neurology* 43:1500–1508
6. Frustorfer H, Lindblom U, Schmidt WG (1976) A method for quantitative estimation of thermal thresholds in patients. *J Neurosurg Neurosurg Psychiatry* 39:1071–1075
7. Haimi-Cohen R, Cohen A, Carmon A (1983) A model for the temperature distribution in skin noxiously stimulated by a brief pulse of CO<sub>2</sub> laser radiation. *J Neurosc Meth* 8:127–37
8. Hardy JD, Muschenheim C (1934) The emission, reflection and transmission of infra-red radiation by human skin. *J Clin Invest* 13:817–831
9. Hardy JD, Wolff HG, Goodell H (1967) Pain sensations and reactions. Hafner Publishing Company, New York
10. Hilz CD, Neundörfer B (1990) Thermal discrimination thresholds: a comparison of methods. *Acta Neurol Scand* 81:533–540
11. Jones SF, McQuay HJ, Moore RA et al. (1988) Morphine and ibuprofen compared using the cold pressor test. *Pain* 34:117–122
12. Meyer RA, Walker RE, Mountcastle VB (1976) A laser stimulator for the study of cutaneous thermal and pain sensations. *IEEE BME* 23:54–60
13. Mor J, Carmon A (1975) Laser emitted radiant heat for pain research. *Pain* 1:233–237
14. Plaghki L, Mouraux A (2003) How do we selectively activate skin nociceptors with a high power infrared laser? Physiology and biophysics of laser stimulation. *Neurophysiol Clin* 33:26277
15. Shy ME, Frohman EM, So Y et al. (2003) Quantitative sensory testing. Report of the Therapeutics and Technology Assessment Subcommittee of the American Academy of Neurology. *Neurology* 60:898–904
16. Verdugo R, Ochoa JL (1992) Quantitative somatosensory thermotest. A key method for functional evaluation of small caliber afferent channels. *Brain* 115:893–913

## Pain in Humans, Thresholds

JOEL D. GREENSPAN

Department of Biomedical Sciences, University of Maryland Dental School, Baltimore, MD, USA  
jgreenspan@umaryland.edu

### Synonyms

Pain thresholds; Tolerance Thresholds

### Definition

The earliest fundamental concept in ► **psychophysics** was that of threshold (Boring 1942). Simply stated, threshold is the minimal level of energy needed to evoke a sensation. Accordingly, thresholds are reported in terms of stimulus values, such as temperature levels (in °C) or mechanical forces (kg equivalent weight,

or Newtons). An alternative measure is the time it takes a constant, sustained stimulus to be perceived as painful, thus measuring pain threshold in terms of seconds. This simple idea of threshold served the field of psychophysics well for more than a century, until it was recognized that threshold was not a stationary phenomenon, nor solely based on a person's sensory apparatus. More specifically, psychophysically measured thresholds are dependent upon the neurophysiological signals evoked by a stimulus, and the person's evaluation of those signals (Gescheider 1985).

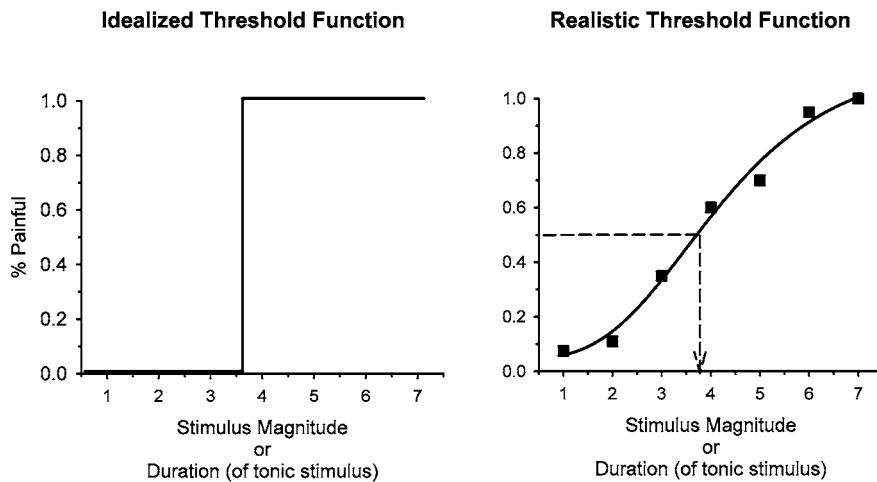
At the other end of the continuum of pain threshold is pain tolerance. Simply stated: pain tolerance is the maximum level of stimulation that a person will voluntarily endure. As with threshold, tolerance is expressed in terms of a stimulus value, or, alternatively, the time that a person tolerates a constant, sustained stimulus.

### Characteristics

The assessment of pain threshold is more complicated than other sensory thresholds because of the nature of pain and people's concept of it. In other sensory modalities, threshold is recognized by the "step" between no sensation and sensation. Thus, the subject is attempting to distinguish between sensing nothing and something. For pain thresholds, the subject is instead distinguishing between two types of sensation, one he considers painful and one non-painful. Thus, a critical element in pain threshold determination is the particular sensory experience an individual considers painful. This factor will be influenced by, among other things, the subject's pain experience history, and the instructions given by the experimenter. For instance, thresholds are likely to be different if a subject is instructed to indicate when he perceives "pain" versus when he perceives "a sharp or burning sensation" or "an uncomfortable sensation". It is also possible that a subject's criterion for judging what sensation is painful changes in the course of an evaluation session. Furthermore, the likelihood and extent of such changes can vary, depending upon the range and number of stimuli applied (Gracely and Naliboff 1996). Several other factors can influence pain threshold values, including features of the psychophysical protocol (the specific design, stimulation parameters, the threshold calculation procedure), which makes it dangerous to compare threshold values across studies that use different protocols.

Another important fact to recognize is that threshold is a statistical entity. While we are accustomed to representing thresholds as very precise values (i.e. heat pain thresholds expressed as temperature at a 0.1°C level of precision), it is not the case that weaker stimuli are necessarily painless, and stronger ones are always painful. Instead, there is a range of stimuli for which the lower values are less frequently painful, and the higher values are more frequently painful. The threshold value, in principle, is the midpoint of that range (Fig. 1). This concept





**Pain in Humans, Thresholds, Figure 1** Ideally, pain threshold can be envisioned as the stimulus level that divides non-painful from painful intensities of stimulation (left). In reality, however, there is a range of stimulus intensities that are sometimes perceived as painful and sometimes as non-painful. Thus, pain threshold is typically regarded as the stimulus intensity that is painful 50 % of the time (right).

applies whether one is considering a single person tested repeatedly, or a group of people.

Heat pain threshold has been found to be fairly consistent across many body sites (Hardy et al. 1952). However, heat pain thresholds are significantly higher on ► **glabrous skin** than on the hairy skin of the extremities (Taylor et al. 1993). This relative consistency across the body, allows one to assess regional pain threshold abnormalities by comparing thresholds between two body sites, when one of them is accepted as a reference. This approach is often used by comparing thresholds between homolateral body sites in the cases of unilateral sensory abnormalities (Kemler et al. 2000).

Pain tolerance is less frequently used than pain threshold in scientific studies, and it has some significant disadvantages:

1. For some forms of stimulation, pain tolerance cannot be reached without risking tissue injury
2. Pain tolerance generally shows greater variability than threshold, both within and across subjects
3. It is more widely altered by subject bias or past experience than threshold.

However, pain tolerance measures a qualitatively different aspect of the pain experience than pain threshold does. Arguably, pain tolerance is a measure more reflective of the affective and motivational aspects of the pain experience, while threshold is a measure of the discriminative aspect. One common form of this test is the ► **cold pressor test**, involving submersion of a body part in ice water (Hilgard et al. 1974, Chen et al. 1989), or the ischemic technique, using a pressure cuff on the subject's arm (Smith et al. 1972).

## References

1. Boring EG (1942) *Sensation and Perception in the History of Experimental Psychology*. Appleton-Century-Crofts, New York
2. Chen ACN, Dworkin SF, Haug et al. (1989) Human Pain Responsivity in a Tonic Pain Model: Psychological determinants. *Pain* 37:143–160

3. Gescheider GA (1985) *Psychophysics: Method, Theory and Application*. Lawrence Erlbaum Associates, Hillsdale, New Jersey
4. Gracely RH, Naliboff BD (1996) *Measurement of Pain Sensation*. In: Kruger L (ed) *Pain and Touch*. Academic Press, San Diego, CA, pp 243–313
5. Hardy JD, Wolff HG, Goodell H (1952) *Pain Sensations and Reactions*. The Williams & Wilkins Company, Baltimore
6. Hilgard ER, Ruch JC, Lange AF, Lenox JR, Morgan AH, Sachs LB (1974) *The Psychophysics of Cold Pressor Pain and its Modification Through Hypnotic Suggestion*. *Am J Psychol* 87:17–31
7. Kemler MA, Schouten HJA, Gracely RH (2000) *Diagnosing Sensory Abnormalities with Either Normal Values or Values from Contralateral Skin - Comparison of Two Approaches in Complex Regional Pain Syndrome I*. *Anesthesiol* 93:718–727
8. Smith GM, Lowenstein E, Hubbard JH et al. (1972) *Experimental Pain Produced by the Submaximum Effort Tourniquet Technique: Further Evidence of Validity*. *J Pharmacol Exp Ther* 163:468–474
9. Taylor DJ, McGillis SLB, Greenspan JD (1993) *Body Site Variation of Heat Pain Sensitivity*. *Somatosens Mot Res* 10:455–466

P

## Pain in Radiculopathy

- [Peripheral Neuropathic Pain](#)

## Pain in the Workplace

- [Pain in the Workplace, Compensation and Disability Management](#)
- [Pain in the Workplace, Risk Factors for Chronicity, Demographics](#)
- [Pain in the Workplace, Risk Factors for Chronicity, Job Demands](#)
- [Pain in the Workplace, Risk Factors for Chronicity, Psychosocial Factors](#)
- [Pain in the Workplace, Risk Factors for Chronicity, Workplace Factors](#)

## Pain in Superficial Tissues

HERMANN O. HANDWERKER  
 Department of Physiology and Pathophysiology,  
 University of Erlangen/Nürnberg, Erlangen,  
 Germany  
 handwerker@physiologie1.uni-erlangen.de

### Significance of Nociception in Superficial Tissues

Superficial tissues constitute an interface between the body and the outer world. They comprise the cornea and conjunctiva of the eye, the nasal mucosa, the oral mucosa (see ► [nociception in nose and oral mucosa](#)) the teeth and the mucosa of the external sexual organs (see ► [nociception in mucosa of sexual organs](#)). Of course, the most important of these organs is the skin, which constitutes by far the largest sensory organ of our body. All these tissues have in common that they guard and protect the body's interior against the environment. Obviously a protective, i.e. "nociceptive" neuronal system is mandatory for this aim. This becomes very evident in the rare cases of ► [congenital insensitivity to pain with anhidrosis](#), e.g. the CIPA syndrome, which is due to a mutation of the gene encoding for the trkA receptor, the high affinity receptor for the nerve growth factor (NGF). Children suffering from this syndrome are characterized by multiple unattended bruises, burns etc, due to pertinent maltreatment.

To fulfill the protective role the body surface is densely innervated and indeed most afferent nerve fibers providing input to the CNS come from it; far fewer nerves come from muscles and joints and comparatively little input has its origin in the interior organs of the body. The central nervous projections of the afferent input from the body surface are well organized in a specific thalamo-cortical system characterized by somatotopy of the neuronal populations receiving input from different sites on the body surface. However, pain processing in the CNS is obviously not confined to somatosensory projection regions. It has been shown by ► [functional imaging of cutaneous pain](#) that pain is processed in a network of multiple brain locations including those not somatotopically organized.

The largest "superficial tissue" of the body, the skin, fulfils a second task besides protecting the interior organs, namely the temperature exchange necessary to keep the internal temperature of homoeothermic animals at a more or less constant level. To this end the skin has a sophisticated vascular system controlled by sympathetic efferent nerves. Many cutaneous nociceptors release vasoactive neuropeptides, e.g. CGRP (calcitonin gene related peptide) that contribute to the regulation of blood flow, particularly in the superficial skin layers.

### Pain Theories

Not surprisingly, the skin was the first organ for which hypotheses were created to explain how nerve excitation leads to pain. In the late 19<sup>th</sup> century Goldscheider and Blix independently of each other discovered the "cold points" in the skin, defined spots where the touch of a small cold probe induces cold sensations, whereas only touch sensations are perceived from other skin sites. M.v. Frey extended these findings to "touch" and "pain" points and thus inaugurated the "specificity hypothesis" which postulates that separate sensory channels from the skin mediate the sensations of cold, warmth, touch and pain (von Frey 1896). This hypothesis replaced the older "intensity hypothesis" that assumed that strong excitation of a common, not further specified, cutaneous sensory system leads to pain. Sherrington coined the term "nociceptor" for the sensory endings of the nerve fibers mediating pain (Sherrington 1906). However, the term nociceptor remained a functionally, rather than a structurally, defined entity (Handwerker 2005).

With the advent of refined electrophysiological techniques in the middle of the 20<sup>th</sup> century, Erlanger and Gasser established three populations of cutaneous afferent nerve fibers, those with fast conducting and thick myelinated axons, labeled A $\alpha$ , $\beta$ , slower conducting, thin myelinated axons of the A $\delta$  class and the unmyelinated C-fibers. These three classes of nerve fibers are clearly distinguished by their different conduction velocities, in the range of 30–70 m/s for A $\alpha$ , $\beta$  fibers, 2–30 m/s for A $\delta$  and less than 2 m/s for the unmyelinated C-fibers. Erlanger and Gasser were able to establish that pain is only induced in normal skin when the slower conducting A $\delta$  and/or C-fibers are excited (Gasser 1935).

M.v. Frey had tried to correlate sensory structures in the skin with the different sensory modalities, albeit only with partial success. The myelinated nerve fibers connected to Merkel cells were soon identified as part of the "touch system" but an equally convincing association of the nerves at "pain points" with associated characteristic cells failed. The terminal endings in the skin of the thin nerve fibers are not generally endowed with corpuscular structures but were regarded as "naked nerve endings" However, not all "naked nerve endings" are nociceptors. Wedell and coworkers, studying the structure of nerve endings in the cornea, found that in this tissue only "naked nerve endings" are found (Wedell et al. 1959). On the other hand, from their psychophysical experiments they came to the conclusion that sensations of cooling, touch and pain can be induced from the cornea. This led them to rebuff the "specificity hypothesis" and to inaugurate a "pattern hypothesis" which flourished until single nerve fiber electrophysiology was established and electrophysiologists were unable

to find particular patterns of nerve fiber discharges characteristic for pain input. Nevertheless, this line of thinking survived somehow in form of the “► [gate control](#)” hypothesis of Melzack and Wall (Melzack and Wall 1965). According to this, pain is dependent on the ratio of input between myelinated “touch” and unmyelinated “pain” afferents through a presynaptic gate mechanism at the entrance to the spinal cord by which myelinated fibers close the door of a pain pathway whereas unmyelinated fibers open it. The gate control hypothesis thus postulated a “spatial” pattern instead of the temporal pattern of Wedell and coworkers.

During the last two decades the interest in the time honored debate on pain mechanisms declined. It is now quite clear that pain is initiated by a dedicated class of peripheral nerve fibers, the ► [nociceptors](#), at least when the tissues and the nervous system have not been altered before being affected by a painful stimulus. However, nociceptor excitation does not always lead to pain and not all kinds of pathological pain are mediated by nociceptors (see below). The term “nociceptor” itself has changed. Research is no longer focusing on specific morphological structures and not even much on thresholds to natural stimuli, but rather on biochemical and molecular features of neurons.

### Properties of Nociceptors

Cutaneous sensory receptors may roughly be subdivided into 4 categories:

1. Predominantly myelinated afferents that respond to gentle deformations of the skin. Many of the respective sensory nerve endings are connected to corpuscular structures. These afferents are referred to as low threshold mechanoreceptors (LTM) and provide information for touch and gentle pressure. Seen under the aspect of perceived objects, they deal with the shape and texture of objects coming in contact with the skin. The molecular mechanisms of their action are still unknown.
2. Afferents that are selectively sensitive to gentle or moderate cooling stimuli. These “cold fibers” mediate sensations of cold and are thinly myelinated or unmyelinated. Their terminals appear as “naked nerve endings” Recently, membrane structures have been described which might explain the cold sensitivity, i.e. certain cation channels of the trp-family that are cold and menthol sensitive (McKemy et al. 2002) and certain temperature sensitive potassium channels (Viana et al. 2002).
3. “Warm fibers” which are C-fibers that respond to mild heating stimuli and account for the sensation of warmth. They are usually capsaicin sensitive and therefore may be equipped with ► [VR1 receptors](#),

which also characterize many heat sensitive nociceptors.

4. A broad category of units with high threshold receptors for mechanical and thermal stimuli. Because these receptors respond most strongly to noxious mechanical and thermal stimuli and to chemical agents which either might damage the skin (e.g. acids) or are released as a consequence of skin damage (e.g. ► [inflammatory mediators](#)), they are labeled “nociceptors” using Sherrington’s term. These afferents may be thinly myelinated or unmyelinated and are thought to be responsible for the sensations of pain, itch and prickle.

Nociceptors were first discovered in the skin and their properties were described for the body surface. The first to record from nociceptive nerve fibers was Y. Zotterman (Zotterman 1939). Later A. Iggo achieved single unit recordings and used a ► [spike collision technique](#) to prove the nociceptive properties of individual C-fibers (Iggo 1958). Nociceptors are found among thinly myelinated (A $\delta$ ) and unmyelinated (C-) afferent nerve fibers, but the unmyelinated units are much more frequent than the faster conducting thinly myelinated units. Though the general properties of nociceptors are similar among mammals, there are species differences. This text refers mainly to the nociceptor populations in humans and in other primates.

Different criteria may be used to classify nociceptors:

1. Unmyelinated *versus* myelinated afferent nerve fibers.
2. Adequate stimuli
3. Type of response (for example rapidly adapting *versus* slowly adapting)
4. Immunocytochemistry (e.g. expression and secretion of neuropeptides or expression of receptors for nerve growth factors NGF and BDNF, IB4)

Identification of the adequate stimuli (i.e. the stimuli that most readily activate the respective unit) and determination of the conduction velocity serve most commonly as a basis for characterizing types of nociceptors. Superficial tissues provide an important advantage for studying nociceptor properties since they are readily accessible for psychophysical studies in humans and behavioral studies in animals. Therefore, in the case of cutaneous nociceptors a relationship can be established between sensations and stimulus magnitude (► [psychophysics](#)) and between discharge rates of individual fiber types and sensations (psychophysiology). A unique possibility of correlating sensations and nerve input into the CNS is provided by ► [microstimulation](#) (Ochoa and Torebjörk 1989; Torebjörk 1993) in the context of microneurography (► [microneurography and intraneural microstimulation](#)) experiments.

### CMHs and AMHs

One important distinction of nociceptor class is that between units of different conduction velocity. Generally, units conducting faster than 2 m/s are regarded as myelinated, whereas slower conducting units are unmyelinated. Since mechanical and heat stimuli were most often used to discriminate between cutaneous receptor classes, the names "AMH" for units with A-fibers which are mechanically and heat sensitive, and "CMH" for the respective C-fiber units, were introduced for the most common types of nociceptors. Since most of these units also respond to inflammatory mediators and other chemical stimuli, i.e. to algogenic substances, they were also labeled "polymodal" nociceptors.

CMHs in different types of skin respond similarly to heat and mechanical stimuli. The AMHs, however, respond in either of two distinct ways to heat. Type I AMHs, found in both hairy and glabrous skin (i.e. palmar and plantar skin of the extremities), have relatively high thresholds to heating stimuli, but become sensitized following a burning trauma or topical capsaicin application to the skin. After sensitization, their heat threshold drops by several degrees centigrade. Type II AMHs occur only in hairy skin and have lower heat thresholds (mean, 46°C) (Meyer et al. 1985). Type I AMHs are also termed high threshold mechanoreceptors in the literature (HTMs (Perl 1968)), since their initial unconditioned threshold to heating often exceeds the limitation of stimuli set to avoid skin damage or to exceed the tolerance of subjects in microneurography experiments. A comparable class of CM units has been described which do not respond to heating stimuli up to 50°C. It is unclear whether these units are in other respects different from the more common CMH units. Only rarely were nociceptors characterized according to their sensitivity to noxious cold. Many CM units, but also CMH and AMH units respond to cooling to temperatures lower than 20°C and may be essential for the initiation of cold pain. However, the thresholds vary over a wide range and constant cooling to temperatures close to 0°C blocks axonal conduction.

### Mechano-insensitive Nociceptors

An interesting class of cutaneous nociceptor has been described in the monkey (Cohen et al. 1990), and may be characteristic of primate (and perhaps pig) skin. These A- or C-units do not respond to strong mechanical stimuli and were called MIA (mechano-insensitive units). Similar mechano-insensitive C-fibers were characterized in microneurography experiments on human skin nerves and named ►  $CM_i$  units. These units become responsive to mechanical stimulation

when the skin is inflamed. Since sensitization "awakens" these units to mechanical responsiveness, they have been poetically called "sleeping nociceptors". One has to note, however, that many of these units are responsive to heating stimuli without preceding sensitization and most of them are excited by ► **capsaicin**, the specific ligand of the VR1 receptor. Therefore, they can also be regarded as heat- or chemo-nociceptors. In the region innervated by the superficial peroneal nerve of man, they comprise about 30% of the afferent C-fibers (Schmidt et al. 1995).

In man, these units generally have larger receptive fields and slower conduction velocities than the more common CMH units. Interestingly, the axons of  $CM_i$  units are characterized by postexcitatory subnormal and supranormal periods that are distinct from those of CMHs and CMs. This may indicate different voltage dependent membrane channels and/or pump mechanisms (see ► **mechano-insensitive c-fibres, biophysics**) (Weidner et al. 1999).

### Nociceptors and Pain

A painful stimulus affecting the skin with a fast rise time (e.g. a pin prick) often induces two pain phenomena. A sharp "first" pain is followed by a "second" pain of burning, aching or throbbing character. The "two pains" phenomenon is characteristic for stimuli applied to skin sites in the distal extremities at large conduction distances from the CNS. The "first pain" is generally attributed to AMHs, in particular AMH II units; the "second pain" may be mainly due to the conduction in C-fibers.

In psychophysical studies, the discharges of cutaneous nociceptors to controlled ramp-like or step-like stimuli in monkey or human skin were compared with the pain sensation in human volunteers. There is ample evidence in support of a role of CMHs in heat pain sensation, which includes:

- a) pain increases monotonically with stimulus intensities between 40 and 50°C (LaMotte and Campbell 1978; Meyer and Campbell 1981a). Since also the responses of CMHs increase monotonically over this temperature range, they are likely to be crucial for the transmission of heat pain;
- b) human judgments of pain in response to stimuli over the range 41-49°C correlate well with the activity of CMH nociceptors over this range;
- c) the ability of human subjects to discriminate between heating stimuli of different strengths correlates with the differences in discharge rates of CMHs (Gybels et al. 1979);
- d) selective A-fiber ischemic blocks indicate that C-fiber function is necessary and sufficient for heat pain perception (Torebjörk and Hallin 1973);



- e) stimulus interaction effects observed in psychophysical experiments (Adriaensen et al. 1980) are also observed in recordings from CMHs;
- f) the latency to pain sensation on glabrous skin following step temperature changes is long and therefore consistent with conduction in CMHs (Campbell and LaMotte 1983);
- g) in patients with congenital insensitivity to pain, microscopic examination of the peripheral nerves indicates the absence of C fibers (see ► [congenital insensitivity to pain with anhidrosis](#));
- h) the heat threshold for activation of CMHs recorded in conscious humans is just below the pain threshold (Gybels et al. 1979) (Van Hees and Gybels 1981);
- i) a linear relationship exists between responses of CMHs recorded in conscious humans and of pain over the temperature range 39-50 °C (Torebjörk et al. 1984);

AMH units also contribute to heat pain sensations. This has been demonstrated for long duration heating applied to the glabrous skin of the hand in human subjects, which evoked substantial pain for the duration of the stimulus. CMHs have a prominent discharge during the early phase of the stimulus, but this response adapts within seconds to a low level. In contrast, type I AMHs are initially unresponsive, but then discharge vigorously. Therefore, type I AMHs probably contribute to the pain during a sustained high intensity heat stimulus (Meyer and Campbell 1981b).

On the other hand, the “first pain” of a heat stimulus with fast onset is probably mediated by type II AMHs in the hairy skin and the absence of a “first pain” sensation to heat stimuli in the glabrous skin of the hand is paralleled by the absence of AMH II in this region (Campbell and LaMotte 1983).

In addition to these types of “conventional” nociceptors, mechano-insensitive CM<sub>i</sub> units also contribute to pain sensations.

- a) Long lasting tonic pressure stimuli applied to the skin induce slowly increasing pain. However, the discharges of CMHs adapt quickly after an initial burst of activity. In contrast, CM<sub>i</sub> units are unresponsive in the beginning and get slowly activated during the course of such a stimulus, in parallel with the pain sensations (Torebjörk et al. 1996);
- b) similarly, intracutaneous injection of a small bolus (0.1 µl of a 1% solution) of capsaicin induces an initial high frequency burst of discharges in CMHs and renders them mechano- and heat - insensitive thereafter. In contrast, CM<sub>i</sub> units are activated and show activity that waxes and wanes for many minutes in parallel with the burning sensations.

Since different types of nociceptors contribute to different types of pain sensations, it is of interest to know which types of sensation are induced by stimulation of just one receptor type. This aim can be achieved by intraneural microstimulation (Ochoa and Torebjörk 1983).

Stimuli employing this technique have shown that single impulses induced in CMHs often do not induce any sensation, indicating that a central nervous threshold that requires temporal and/or spatial summation has to be exceeded. Frequent electrical stimulation of presumed single CMHs induces pain, however, often burning in character (Torebjörk and Ochoa 1980). The sensations induced by A-delta fiber stimulation are more stinging in character. Whereas single electrical shocks cannot be resolved with C-fiber stimulation, this is easily possible when A-fibers are stimulated.

### Pain and Itch

In the early 20<sup>th</sup> century M.v. Frey who had discovered the “pain points” in the skin (see above) and thus had found evidence for a specific peripheral pain pathway, proposed an “intensity” hypothesis for explaining itch sensations. He came to this conclusion from the observation that weak stimulation of the “pain points” in the skin leads with a long latency to itching, but stronger stimulation to pain.

The intensity hypothesis was supported by the observation that ► [anterolateral cordotomy](#) abolished itch and pain likewise. The similarity of the neuronal apparatus for itch and pain was also demonstrated by the contemporary finding that itch and heat pain (but not the sensations of touch and of pinprick) are abolished in a skin patch desensitized with capsaicin. This led to the conclusion that both sensory modalities are mainly supported by unmyelinated, capsaicin sensitive primary afferents.

However, an “intensity” hypothesis cannot be brought in line with the well established phenomenon that itch is suppressed by simultaneously induced pain and with the differential effect of opioids which are known to suppress pain, but to enhance itching. Therefore alternative hypotheses had to be considered. An “occlusion” hypothesis postulated that a smaller population of chemosensitive primary afferents supports itch, whereas a larger population supports pain. Itch stimuli like histamine excite only the small population of primary afferents when brought into the superficial layers of human skin and thus induce itching. However, pain stimuli (e.g. heating, strong pressure or pinpricks) excite this small population of units sensitive to pruritogens and in addition a much larger population of nociceptors which are insensitive to pruritogens and this would induce pain and occlude itch by appropriate synaptic mechanisms in the CNS.

Some years ago, a class of slowly conducting C-fibers was described which were highly sensitive to histamine. Since the time course of the excitation of these units by pruritogenic agents strongly resembles the time course of itching induced by these agents, they were regarded as “itch units” (► [Itch/Itch Fibers](#)). These units belong to the mechano-insensitive C-units and are characterized by extremely slow conduction velocities and very large receptive fields (Schmelz et al. 1997). The notion of a specific “itch channel” in the PNS was supported by the finding of a corresponding specific central pathway in the cat by Craig and Andrew (Andrew and Craig 1999).

It has been shown above that not all sorts of pain can be explained by one single class of nociceptors. Likewise, not all forms of itching can be simply explained by the excitation of histamine sensitive CM<sub>i</sub> units which may, however, play an important role in physiological (like itching after insect bites) or pathological forms of itching (like itching from urticaria), which are sensitive to anti-histaminic drugs (H1 blockers). Other forms of itching, e.g. in atopic dermatitis, are insensitive to anti-histaminic therapy and in these patients itch can be induced by stimuli which do not excite CM<sub>i</sub> units. Itching then may be caused by “re-channeling” of impulses from nerve fibers normally mediating pain sensations. Even in experimental situations on normal subjects, itch induced by histamine iontophoresis can be rekindled by gently stroking the affected skin site and its environment with a soft brush, exciting only sensitive mechanoreceptor units (see ► [allodynia and ► alloknesis](#)). This clearly indicates that impulses from – presumably myelinated – mechanoreceptor units can be “gated” into the itch pathway in analogy to the gating of this kind of input into the pain pathway in allodynia.

### Hyperalgesias

Two basic forms of hyperalgesia have to be distinguished, ► [primary hyperalgesia](#) confined to the place of tissue injury and ► [secondary hyperalgesia](#) extending into the closer, or even the more distant, surroundings of a trauma. There has been a long-standing debate about the relative importance of peripheral and central neuronal mechanisms in generating hyperalgesia. Here again we have to distinguish between hyperalgesias due to inflammatory processes in the tissues and those due to alteration of the conductile membranes of peripheral nerves. Initially, the excitability increase of either peripheral or central neural pathways was favored. Recently, it has been suggested that peripheral and central mechanisms may contribute differentially depending on the type of tissue injury and sensory modality being tested (Kilo et al. 1994). This is particularly important for hyperalgesia affecting the skin, with its highly

differentiated innervation. Therefore, one has to distinguish again between hyperalgesia to heating, to different forms of mechanical stimulation and to cold.

- a) **Hyperalgesia to heating.** In several studies on human and monkey skin it has been shown that topical capsaicin treatment is able to lower the heat thresholds of CMH units by 5°C or more (Baumann et al. 1991; LaMotte et al. 1992). Similar changes were seen after burning lesions. Such sensitization of nociceptors may well explain primary hyperalgesia to heating. Probably CM and CM<sub>i</sub> units, by becoming sensitized to heating, contribute to spatial summation at central synapses. The increased impulse rate in sensitized C-units may lead to co-activation of neuropeptide (NK and CGRP) receptors and different types of glutamate receptors, including NMDA-receptors, thus enhancing synaptic efficacy in the pain pathway and inducing ► [primary heat hyperalgesia](#). Secondary heat hyperalgesia around a heating trauma or a capsaicin treated skin patch has not been found in most studies. If it exists, it is not very prominent.
- b) **Hyperalgesia to tonic blunt pressure.** Hyperalgesia to tonic blunt pressure was found only in the immediate area of a heating or freezing trauma or of capsaicin application and not in the surroundings (primary hyperalgesia) (Koltzenburg et al. 1992; Kilo et al. 1994). It is known to persist when the A-fibers are differentially blocked and it is diminished by cooling the skin, which reduces the activity in sensitized C fibers. However, the discharges of CMH units to blunt pressure stimulation are not increased after topical capsaicin (LaMotte et al. 1992). As in normal tissue, these units tend to adapt after an initial burst of activity. Therefore, the recruitment of sensitized CH and CM<sub>i</sub> units may be most important for this type of hyperalgesia. A-delta HTM units might also contribute to it.
- c) **Pinprick hyperalgesia.** Although hyperalgesia to punctuate stimuli with pins or hypodermic needles has rarely been studied in inflamed tissue (primary form), it clearly extends into the surroundings of a local trauma (secondary hyperalgesia). No clear signs of nociceptor sensitization to this form of stimulation were found in microneurography experiments. Therefore, it probably represents an example of ► [central sensitization](#) due to changes in responsiveness of centrally projecting units caused by the initial nociceptor impulse barrage, but it can be maintained for some time in the absence of such input (Kilo et al. 1994). It has been shown that the units mediating the secondary hyperalgesia to pinprick are myelinated (A-delta units) and not capsaicin sensitive (Magerl et al. 2002).

- d) **Touch evoked hyperalgesia.** This form of hyperalgesia is best evoked by gently stroking the skin, e.g. with a swap of cotton wool. It is often found in inflamed skin e.g. after sunburn (primary form), but also in the surroundings of a focal inflammation (secondary form). The latter has been clearly demonstrated in a wide area around a capsaicin injection site, though the area of touch-evoked hyperalgesia is smaller than that of pinprick hyperalgesia. Recordings from nociceptors around capsaicin injection sites in monkeys (Baumann et al. 1991) have not shown any evidence of peripheral sensitization to tactile stimuli. Instead, experiments with selective nerve blocks revealed that the tactile hyperalgesia was only detectable in the presence of intact conduction in large myelinated fibers and could be mimicked by intraneural electrical microstimulation of low threshold mechanoreceptive afferents that normally signal non-painful touch (Torebjörk et al. 1992). The notion that this form of hyperalgesia is mediated by myelinated sensitive mechanoreceptor units has led to the denomination of touch-evoked hyperalgesia as “► **allodynia** (i.e. pain induced by another form of sensory impact). This hypothesis is supported by the finding that neurons in the spinal cord of a monkey receiving nociceptor input displayed increased excitability to A-fiber input following capsaicin injections (Simone et al. 1991). It appears that ► **touch-evoked hyperalgesia** or ► **allodynia** is related to a sensitization of central neurons that is critically dependent on ongoing activity in nociceptive afferents and the hyperalgesia quickly disappears when such input is stopped. Thus, in microneurography experiments after the topical application of mustard oil, if the ongoing activity in sensitized nociceptors is stopped by cooling the skin, the touch-evoked hyperalgesia disappears. The linear relationship between background pain and touch-evoked hyperalgesia has also been observed in patients in whom touch-evoked hyperalgesia was a symptom of neuropathy (Koltzenburg et al. 1994). It is therefore independent of its underlying pathophysiology. From these observations, it appears that touch-evoked hyperalgesia is due to an ongoing nociceptor barrage gating the A-fiber impulses into the pain pathway. This nociceptive input does not need to be very strong, since the phenomenon of transient touch-evoked hyperalgesia can be demonstrated (Cervero et al. 1994).
- e) **Hyperalgesia to cold** is not apparent at inflamed skin sites. In contrast, cooling relieves the pain, due to suppression of ongoing and evoked C-fiber discharges. Cold pain is, however, often observed in neuropathic pain states (Wahren et al. 1991). The pathophysiology of cold hyperalgesia is still enigm-

- matic. A partial explanation is, however, provided by the following observations. The sensation of cooling the skin is mediated mainly by thin myelinated A-delta cold units. When these units are differentially blocked in a healthy subject leaving conduction in C-fibers intact, strong cold stimuli paradoxically induce a burning sensation (Yarnitsky and Ochoa 1990). This has been reported to be typical for patients suffering from cold hyperalgesia. In ► **quantitative sensory testing**, these patients often show elevated thresholds for cooling, thus combining cold **hypo**-esthesia with **hyper**-algesia. These observations suggest that cold hyperalgesia may be due to a central nervous disinhibition of the input from cold responsive nociceptive C-fibers.
- f) **Head zones.** Pain referred from inner organs to the skin is the classical example of a pain phenomenon caused by central nervous mechanisms. Henry Head made the observation that the skin sites to which the transfer occurs are typical for certain inner organs. Referred pain has been ascribed to convergent projections from inner organs and the respective skin sites to the same spinal and supraspinal projection neurons. Therefore hyperalgesia within aching Head zones is centrally mediated. One should therefore expect preferentially those forms of hyperalgesia that are caused by central nervous mechanisms in other pathophysiologicals. Unfortunately systematic studies are still lacking.

### Conclusion

The various forms and qualities of cutaneous pain cannot be explained by one single form of nociceptor input. One has to define exactly the stimulus conditions for physiological pain forms and the types of pathological changes for pathological pain. This applies even more strikingly to the different forms of hyperalgesia to which peripheral and central nervous processing contribute in different ways.

### References

1. Adriaensen H, Gybels J, Handwerker HO et al. (1980) Latencies of chemically evoked discharges in human cutaneous nociceptors and of the concurrent subjective sensations. *Neurosci Lett* 20:55–59
2. Andrew D, Craig AD (1999) Histamine-selective lamina I spinothalamic tract neurons. *Society of Neuroscience Abstract* 25:149
3. Baumann TK, Simone DA, Shain CN et al. (1991) Neurogenic hyperalgesia: the search for the primary cutaneous afferent fibers that contribute to capsaicin-induced pain and hyperalgesia. *J Neurophysiol* 66:212–227
4. Campbell JN, LaMotte RH (1983) Latency to detection of first pain. *Brain Res* 266:203–208
5. Cervero F, Meyer RA, Campbell JN (1994) A Psychophysical Study of Secondary Hyperalgesia - Evidence for Increased Pain to Input from Nociceptors. *Pain* 58:21–28

6. Cohen RH, Meyer RA, Davis KD et al. (1990) Mechanically insensitive afferents (MIAs) in cutaneous nerves of monkey. *Pain Suppl* 5:S105–S101
7. Gasser HS (1935) Conduction in nerves in relation to fiber types. *Res Publ Assoc Res Nerv Ment Dis* 15:35–59
8. Gybels J, Handwerker HO, Van Hees J (1979) A comparison between the discharges of human nociceptive nerve fibres and the subject's ratings of his sensations. *J Physiol* 292:193–206
9. Handwerker HO (2005) Nociceptors - Neurogenic Inflammation. In: Cervero F, Jensen TS (eds) *Pain*
10. Iggo A (1958) The electrophysiological identification of single nerve fibres, with particular reference to the slowest-conducting vagal afferent fibres in the cat. *J Physiol* 142:110–126
11. Kilo S, Schmelz M, Koltzenburg M et al. (1994) Different patterns of hyperalgesia induced by experimental inflammation in human skin. *Brain* 117:385–396
12. Koltzenburg M, Lundberg LER, Torebjörk HE (1992) Dynamic and static components of mechanical hyperalgesia in human hairy skin. *Pain* 51:207–219
13. Koltzenburg M, Kees S, Budweiser S et al. (1994) The properties of unmyelinated nociceptive afferents change in a painful chronic constriction neuropathy. In: Gebhart GF, Hammond DL, Jensen TS (eds) *Proceedings of the 7th World Congress on Pain*. IASP Press, Seattle, pp 511–522
14. LaMotte RH, Campbell JN (1978) Comparison of responses of warm and nociceptive C-fiber afferents in monkey with human judgments of thermal pain. *J Neurophysiol* 41:509–528
15. LaMotte RH, Lundberg LER, Torebjörk HE (1992) Pain, Hyperalgesia and Activity in Nociceptive-C Units in Humans After Intradermal Injection of Capsaicin. *J Physiol* 448:749–764
16. Magerl W, Fuchs P, Meyer RA et al. (2002) Roles of capsaicin-insensitive nociceptors in cutaneous pain and secondary hyperalgesia. *Brain* 124:1754–1764
17. McKemy DD, Neuhauss WM, Julius D (2002) Identification of a cold receptor reveals a general role for TRP channels in thermosensation. *Nature* 416:52–58
18. Melzack R, Wall PD (1965) Pain mechanisms: a new theory. *Science* 150:971–978
19. Meyer RA, Campbell JN (1981a) Evidence for two distinct classes of unmyelinated nociceptive afferents in monkey. *Brain Res* 224:149–152
20. Meyer RA, Campbell JN (1981b) Myelinated nociceptive afferents account for the hyperalgesia that follows a burn to the hand. *Science* 213:1527–1529
21. Meyer RA, Campbell JN, Raja SN (1985) Peripheral neural mechanisms of cutaneous hyperalgesia. In: Fields HL, Dubner R, Cervero F (eds) *Advances in pain research and therapy*, vol 9. Raven Press, New York, pp 53–71
22. Ochoa JL, Torebjörk HE (1983) Sensations evoked by intraneural microstimulation of single mechanoreceptor units innervating the human hand. *J Physiol* 342:633–654
23. Ochoa JL, Torebjörk HE (1989) Sensations evoked by intraneural microstimulation of C nociceptor fibres in human skin nerves. *J Physiol* 415:583–599
24. Perl ER (1968) Myelinated afferent fibers innervating the primate skin and their response to noxious stimuli. *J Physiol* 197:593–615
25. Schmelz M, Schmidt R, Bickel A et al. (1997) Specific C-receptors for itch in human skin. *Journal of Neuroscience* 17:8003–8008
26. Schmidt R, Schmelz M, Forster C et al. (1995) Novel classes of responsive and unresponsive C nociceptors in human skin. *J Neurosci* 15:333–341
27. Sherrington CS (1906) *The integrative action of the nervous system*. Yale University Press, New Haven
28. Simone DA, Sorkin LS, Oh U et al. (1991) Neurogenic hyperalgesia: central neural correlates in responses of spinothalamic tract neurons. *J Neurophysiol* 66:228–246
29. Torebjörk HE (1993) Human Microneurography and Intraneural Microstimulation in the Study of Neuropathic Pain. *Muscle Nerve* 16:1063–1065
30. Torebjörk HE, Hallin RG (1973) Perceptual changes accompanying controlled preferential blocking of A and C fibre responses in intact human skin nerves. *Exp Brain Res* 16:321–332
31. Torebjörk HE, Ochoa JL (1980) Specific sensations evoked by activity in single identified sensory units in man. *Acta Physiol Scand* 110:445–447
32. Torebjörk HE, LaMotte RH, Robinson CJ (1984) Peripheral neural correlates of magnitude of cutaneous pain and hyperalgesia: simultaneous recordings in humans of sensory judgments of pain and evoked responses in nociceptors with C-fibers. *J Neurophysiol* 51:325–339
33. Torebjörk HE, Lundberg LER, LaMotte RH (1992) Central changes in processing of mechanoreceptive input in capsaicin-induced secondary hyperalgesia in humans. *J Physiol* 448:765–780
34. Torebjörk HE, Schmelz M, Handwerker HO (1996) Functional properties of human cutaneous nociceptors and their role in pain and hyperalgesia. In: Belmonte C, Cervero F (eds) *Neurobiology of Nociceptors*. Oxford University Press, Oxford, pp 349–369
35. Van Hees J, Gybels J (1981) C nociceptor activity in human nerve during painful and non painful skin stimulation. *J Neurol Neurosurg Psychiat* 44:600–607
36. Viana F, de la Pena E, Belmonte C (2002) Specificity of cold thermotransduction is determined by differential ionic channel expression. *Nat Neurosci* 5:254–260
37. von Frey M (1896) *Untersuchungen über die Sinnesfunktionen der menschlichen Haut. Erste Abhandlung: Druckempfindung und Schmerz*. Abh mathem-phys Clas Kgl Sächs Ges Wiss 23:208–217, 239
38. Wahren LK, Torebjörk HE, Nystrom B (1991) Quantitative Sensory Testing Before and After Regional Guanethidine Block in Patients with Neuralgia in the Hand. *Pain* 46:23–30
39. Wedell G, Palmer E, Taylor D (1959) The significance of the peripheral anatomical arrangements of the nerves which subserve pain and itch. In: Wolstenholme GEW (ed) *Pain and Itch*. Churchill, London
40. Weidner C, Schmelz M, Schmidt R et al. (1999) Functional attributes discriminating mechano-insensitive and mechano-responsive C nociceptors in human skin. *J Neurosci* 19:10184–10190
41. Yarnitsky D, Ochoa JL (1990) Release of cold-induced burning pain by block of cold-specific afferent input. *Brain* 113:893–902
42. Zotterman Y (1939) Touch, pain and tickling. An electrophysiological investigation on cutaneous sensory nerve. *J Physiol* 95:1–28



## Pain in the Workplace, Compensation and Disability Management

PATRICK LOISEL

Disability Prevention Research and Training Centre,  
Université de Sherbrooke, Longueuil, QC, Canada  
patrick.loisel@usherbrooke.ca

### Definition

The prevalence of musculoskeletal pain at work and from work is high. The 1998 Quebec Health Survey found an 83% yearly prevalence of pain in one or more body parts in Quebec workers (37% having pain from time to time and 46% quite often or all the time). Interestingly, though, while 51% of these workers attributed their pain to their job, only 11% reported missing time from work because of their pain, and no more than 1.5% were absent for more than 3 months (Institut de la statistique du Québec 2001). This indicates that pain in the workplace is so frequent that it may appear as a “fact of life”, but that work absence from pain is fortunately infrequent. However, disability from musculoskeletal pain generates important costs. Studies have shown that workers absent from work for a long period of time because of musculoskeletal pain are responsible for the majority of workers’ compensation claim costs. In Canada, painful musculoskeletal disorders are associated with the highest morbidity cost due to long term disability (accounting for 39% of total long-term disability costs), and the third highest morbidity costs due to short-term disability (accounting for 10% of total short-term disability costs) (Health Canada 2002).

### Characteristics

#### Enlarged Vision of the Problem

Evidence shows that various non-medical factors may combine with the original painful musculoskeletal lesion to lead to long-term disability among workers. This has been confirmed by many studies, and highlights the need for a disability paradigm that is different from the usual medical disease paradigm (Loisel et al. 2001). In fact, it has been demonstrated that for many common work-related disorders, organic factors have little bearing on disability in comparison to personal, psychosocial, and environmental factors. Moreover, these factors are not only superimposed on the pain, but probably modulate the pain response through biological pain mechanisms. For example, ► **catastrophizing** and negative emotions and cognitions, some of them related to the worker’s perception of the job and the workplace, may facilitate pain centralization with the corresponding lowered threshold of spinal neural cells. Besides, evidence indicates that disability from musculoskeletal pain, which may lead to work exclusion and often reinforces the pain experience, is the result

of complex interactions occurring in the multipartite system involving several stakeholders (employer, insurer, health care providers) interacting with the patient in the pain/disability process (Frank et al. 1998). The workplace is a major player, involved from the beginning of the pain experience and influences both injury prevalence and outcomes once injuries occur.

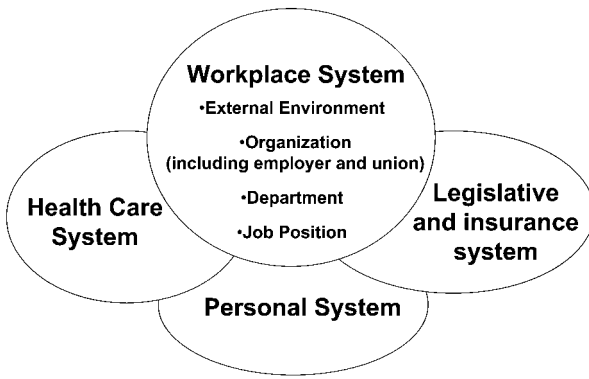
Whether or not workplace pain and disability stem from industrial accidents or diseases, they have a direct impact on the employers, since they greatly affect productivity, work organization and costs. In jurisdictions that have workers compensation boards (WCB), mainly in North America and Australia, employers generally pay for all WCB disbursements. In countries where work-related disorders are covered by the general healthcare system, employers generally have a high taxation level for hiring employees. Added to these direct costs, work absence leads to major indirect costs linked to work disorganization and production losses. The total cost to employers of disability, mainly due to musculoskeletal pain, has been estimated to be in a range of 8% to 15% of a company’s payroll (Salkever et al. 2000). This is large enough to adversely affect the ability of companies to compete in the global marketplace. Moreover, authors have recently introduced the new word “presenteeism”, meaning the productivity loss due to pain in the workplace impairing the normal productivity of the workers affected by health problems (Aronsson et al. 2000). In sum, employers have strong incentives to look for solutions to disabling musculoskeletal pain in the workplace, since they are significantly impacted by it.

Fortunately, recent findings have shed light on strategies that may lower the rates of musculoskeletal pain and disability.

#### Factors Related to the Workplace

Various workplace factors influencing the occurrence of musculoskeletal disorders and its subsequent disability have been identified. As presented in figure 1, these factors can be categorised into four hierarchical levels: the job position level, departmental level, organizational level, and external environmental level. Although various factors from other systems (health care, personal and legislative/insurance) can also influence disability from musculoskeletal pain (Fig. 1), this chapter will only focus on workplace factors.

At a job position level, work injury and disability rates vary with several physical and psychosocial factors. High physical workplace demands such as physical workload, repetitiveness, vibration, and awkward posture are significant risk factors (Malchaire et al. 2001). Employers, who make efforts to reduce this physical workload by appropriate ergonomic arrangements, may be rewarded by lower rates of absenteeism and fewer pain complaints, although this remains a controversial topic. Workplace-related psychosocial factors are more complex and may be related to different levels of the



**Pain in the Workplace, Compensation and Disability Management, Figure 1** Systems involved in the disability from musculoskeletal pain.

workplace system. At the job position level, job control, job dissatisfaction, stress, perceived ability to work, and emotional effort at work are among the psychosocial factors identified (Waddell and Main 2003).

At the department level, several factors may play a role. It has been shown that low social support from co-workers is an important risk factor. Also, the attitude of supervisors is a key issue. It is now well demonstrated that the duration of disability following a work injury is reduced if the supervisor communicates with the injured worker in a proactive, supportive manner, and if the worker expresses satisfaction with the supervisor. Specific supervisor training in this way seems to be a promising avenue (Pransky et al. 2001).

At the workplace organization (managerial) level, the workplace responsibility is even greater and also determines rules and attitudes at the above-mentioned levels. Studies accumulate to underline the importance of workplace organizational factors to reduce incidence and duration of disability claims. Main organizational topics include supportive disability management policies and procedures, people-oriented culture and collaboration between employer and union, and upper management “buy-in” of health and safety practices (Amick et al. 2000). Conversely, when employers appeal claims and express suspicion regarding the sincerity of workers’ reports, the result is often an increase in the prevalence of persistent pain and disability, as in a system with one winner and one loser; pain is the only chance for the worker to be the winner. Employer mistrust often has the effect of threatening the legitimacy or dignity of workers. Research has shown that these kinds of threats have a negative impact on return to work (Nordqvist et al. 2003).

Finally, at an external environmental level, mention has to be made of the socio-political environment that surrounds the workplace, as economic difficulties and unemployment that may lead to personnel lay-off could be associated with longer duration of work disability. This topic has to be explored in more depth in the future.

### Intervention in the Workplace

As employers’ responsibility in reducing workplace pain and subsequent disability becomes obvious, the point is how to make it happen. Some WCB jurisdictions have used financial incentives.

For example, the Quebec WCB (CSST) has developed a financial incentive policy, especially for larger workplaces, in which employers have lower workers’ compensation costs if they quickly bring injured employees back to work with modified duties, and higher costs (possibly x 4) for prolonged off-work time. Most employers respond to these incentives but sometimes in an inappropriate way, for example, by implementing inappropriate modified duties (too heavy or too light) or by appealing most cases. This is due to a lack of appropriate training of management regarding recent evidence in the field of disability prevention, and to a lack of dialogue among the stakeholders in the disability process: employer, union, insurer and healthcare provider.

Investigators have studied the effects of programs that allow collaboration with employers, and take into account the complex array of workplace environmental factors. For example, Yassi et al. (1995), in a teaching hospital in Manitoba, found that an early intervention in the workplace using modified/alternate work capacity, reduced costs for lost work time following injuries by 34% and decreased the incidence of lost-time from back pain by 43%. Krause et al. (1998), in a systematic review, also showed that modified work programs facilitated return to work, doubled the rate of return to work for injured workers, reduced by half the number of lost days, and were cost-effective. Loisel et al. (1997), in a randomized controlled trial on workers with low back pain, showed that the Sherbrooke Model consisting of the combination of an occupational intervention (on-site ergonomic intervention and occupational medicine) and a clinical intervention (functional restoration therapy and therapeutic return to work), helped workers return to work 2.41 times faster than usual care, and was cost-beneficial and cost-effective. Lemstra and Olynski (2003) showed that various strategies designed to change work-related stresses – including worker rotation schedules, reduced lifting loads, ergonomic redesign of tasks, and independent on-site management – resulted in lower injury claim incidence, duration and costs. In sum, there is evidence showing that workplace interventions, such as modified work and on-site ergonomics, have favourable effects on facilitating return to work among workers who are disabled because of musculoskeletal pain. Also, promoting an early return to work and involving the employer in the return to work process have positive effects on reducing disability.

### Conclusion

Work occupies a great deal of most people’s lives and defines a social role of considerable importance.

Pain at work, as pain in life, has a very high prevalence, but its consequences depend on a variety of factors, many of them being under the workplace control. Lowering physical workload and improving work organization (primary prevention) may have an important impact on the prevalence and intensity of musculoskeletal pain. Also, appropriate workplace disability management practices (secondary prevention) have been shown to lower the number of claims, and the duration of work absence. Most interestingly, recent studies have shown that primary and secondary prevention are not independent, but that appropriate actions in one of these sectors may positively impact the other, and that both may be viewed as a continuum of prevention of pain in the workplace and its consequences (Yassi et al. 2003). Reducing the prevalence of pain at work is an attainable goal and should be a target for the well informed manager. However, programs to reduce workplace pain and disability require an organizational and managerial culture that places high value on human resources and the creation of healthy workplaces.

As noted above, financial incentives may encourage employers to adopt effective disability prevention and disability management policies, but there is also a need for additional knowledge in the field of disability prevention and management, and for methods to transfer insights derived from research to the workplace. Training bodies (mainly universities) and healthcare providers have an important role to play in helping employers through the development of evidence-based disability management training programs, and positive collaboration with patients having work disability from pain in the workplace. Healthcare providers and employers should be trained to collaborate and to maintain an appropriate pain-free working situation for their patients/workers: it is a win-win strategy!

## References

- Amick BC, Habeck RV, Hunt A et al. (2000) Measuring the Impact of Organizational Behaviors on Work Disability Prevention and Management. *J Occup Rehabil* 10:21–38
- Aronsson G, Gustafsson K, Dallner M (2000) Sick but yet at Work. An Empirical Study of Sickness Presenteeism. *J Epidemiol Community Health* 54:502–509
- Frank J, Sinclair S, Hogg-Johnson S et al. (1998) Preventing Disability From Work-Related Low-Back Pain – New Evidence Gives New Hope – If We Can Just Get All the Players Onside. *CMJA* 158:1625–1631
- Health Canada (2002) Economic Burden of Illness in Canada. Health Canada, Ottawa, ON
- Institut de la statistique du Québec (2001) Enquête Sociale et de Santé 1998. Insitut de la statistique du Québec, Sainte-Foy, Qc
- Krause N, Dasinger LK, Neuhauser F (1998) Modified Work and Return to Work: A Review of the Literature. *J Occup Rehabil* 8:113–139
- Lemstra M, Olszynski WP (2003) The Effectiveness of Standard Care, Early Intervention, and Occupational Management in Worker's Compensation Claims. *Spine* 28:299–304
- Loisel P, Abenhaim L, Durand P et al. (1997) A Population-Based, Randomized Clinical Trial on Back Pain Management. *Spine* 22:2911–2918
- Loisel P, Durand MJ, Berthelette D et al. (2001) Disability Prevention – New Paradigm for the Management of Occupational Back Pain. *Dis Manage Health Outcomes* 9:351–360
- Malchaire J, Cock N, Vergracht S (2001) Review of the Factors Associated with Musculoskeletal Problems in Epidemiological Studies. *Int Arch Occup Environ Health* 74:79–90
- Nordqvist C, Holmqvist C, Alexanderson K (2003) Views of Laypersons on the Role Employers Play in Return to Work when Sick-Listed. *J Occup Rehabil* 13:11–20
- Pransky G, Shaw W, McLellan R (2001) Employer Attitudes, Training, and Return-to-Work Outcomes: A Pilot Study. *Assist Technol* 13:131–138
- Salkever DS, Shinogle J, Purushothaman M (2000) Employers' Disability Management Activities: Descriptors and an Exploratory Test of the Financial Incentives Hypothesis. *J Occup Rehabil* 10:199–214
- Waddell G, Burton AK, Main CJ (2003) Screening to Identify People at Risk of Long-Term Incapacity for Work. Royal Society of Medicine Press, London UK.
- Yassi A, Ostry A, Spiegel J (2003) Injury Prevention and Return to Work: Breaking Down the Solitudes. In: Sullivan T, Frank J (eds) Preventing and Managing Disability at Work. Taylor and Francis, London, ON
- Yassi A, Tate R, Cooper JE et al. (1995) Early Intervention For Back-Injured Nurses At a Large Canadian Tertiary Care Hospital – an Evaluation of the Effectiveness and Cost Benefits of a Two-Year Pilot Project. *Occup Med (Lond)* 45:209–214

## Pain in the Workplace, Risk Factors for Chronicity, Demographics

DENNIS C. TURK

Department of Anesthesiology, University of Washington, Seattle, WA, USA  
turkdc@u.washington.edu

P

## Synonyms

Age and Chronicity; Sex and Chronicity; Education and Chronicity; Household Income and Chronicity; Marital Status and Chronicity

## Definition

Statistical characteristics of populations (such as age, educational attainment or income) that predispose an individual or population to develop a problem, in this usage, the ► **probability** of developing chronic pain sufficiently intense to impede the ability to perform work-related activities.

## Characteristics

Identification of characteristics of individuals who have an increased ► **risk** of developing chronic pain is important, as it has the potential to: 1) guide research on the pathogenesis of chronic pain; 2) guide the design of interventions to prevent the transition from acute to chronic pain; and 3) permit delivery of interventions to those who are most in need of preventive efforts and subsequently to reductions in physical and occupational disability, emotional distress, and health care utilization.

The transition from acute to chronic pain has generated a great deal of interest, particularly in the area of work-related injuries and back pain in particular.

The interest in the transition from acute to chronic back pain has been fostered primarily by three factors: 1) the dramatic increases in disability associated with back injuries; 2) high costs of back injury in expenditures for medical treatment, indemnity costs, and lost productivity; and 3) the observation that, whereas up to 90% of individuals who sustained back injuries with accompanying pain returned to functioning within a brief interval (usually days or weeks), the remaining 10% developed long-term disabilities, often never returning to pre-injury levels of functioning. It is the observation that a relatively small percentage of patients with back injuries fail to return to functioning, thus consuming a disproportionate amount of healthcare resources and indemnity costs that has served, perhaps, as the greatest impetus towards the question of what factors predict – risk factors – for chronicity.

Although a number of ► **demographic** factors have been examined, the role of age, sex, marital status, and educational attainment has most frequently been considered as potential predictors of chronicity following a back injury.

#### **Age as a Predictor of Chronicity and Work Related Disability**

The most consistent finding across studies is that older workers have poorer outcomes, whether measured by number of compensation days or work status at follow-up (Turk 1997, Turner et al. 2000). However, one study found old age to predict poorer outcomes at six months (Gatchel et al. 1995a), but not at 1 year (Gatchel et al. 1995b). Only two population-based studies did not find the outcome to be worse in older workers. One found that workers aged 50 and over returned to work sooner and lost fewer days of work; however, age was not associated with work status three months after injury (Reid et al. 1997). There are a number of limitations to this study, including a low percentage of eligible people willing to participate and the small number of participants not working at the three-month follow-up. In the other study, age was not significantly associated with duration of wage replacement benefits among workers on benefits for at least 4 weeks (Hogg-Johnson et al. 1999). This study did not report results for workers on wage replacement for shorter periods of time. Another contradictory result for age was obtained, which found a trend toward earlier return to work in older patients (Lehmann et al. 1993), but again the sample was small and had limited statistical power and precision.

Specific to the issue of age, is the actual age of the sample of subjects included in the study, as the age of subjects included will define “older” and “younger.” For example, Weickgenant et al. (1994) reported that age was not a predictor of chronicity, but the sample of subjects in the study consisted of male Navy service men, the

majority of whom were under age 40. The definition of older varies substantially across studies, with some studies including subjects up to age 65. Participants over age 40 would be defined as older in the Weickgenant et al. (1994) study, but not necessarily in studies with samples of much older individuals.

Several factors may contribute to older workers’ poorer outcomes. Older workers may be less able to recover from injuries, and may be less likely to find different jobs if they are unable to return to the job they held at the time of injury. It is also possible that workers within a few years of retirement age may lack incentives for returning to work, and view workers’ compensation benefits as a bridge to social security disability or social security income.

#### **Sex as a Predictor of Chronicity and Work-Related Disability**

Even more than the case of age, the results for sex as a predictor of chronicity are quite inconsistent. Studies have reported that males are more likely to develop chronic back problems than females, that females are more likely to become disabled, and that sex did not predict disability at all (Turk 1997). To make things even more confusing, Crook and Moldofsky (1994) found that males were more likely to return to work; however, females had a higher probability of remaining at work once they returned. By contrast, Baldwin et al. (1996) reported that although women experienced shorter work absences, they were less likely to remain employed.

The majority of studies found no statistically significant association between outcome and worker sex, although several studies observed poorer outcomes for women (Turk 1997; Turner et al. 2000). In one study, sex did not predict work status at six months (Gatchel et al. 1995a), but women were less likely to be working at one year (Gatchel et al. 1995b). Rossignol et al. (1988) found that men had significantly more days of compensation than did women; however, when a logistic regression analysis that also included occupation was performed, this difference was no longer statistically significant. As a group, these results suggest that interactions or confounding of sex with other variables such as occupation and job physical demands or injury severity may be significant, and underscore the need for studies with large samples and multivariate statistical analyses.

#### **Marital Status as a Predictor of Chronicity and Work-Related Disability**

Intuitively, it might be expected that the presence of a spouse would provide social support, and thus should serve to buffer against the stresses associated with acute pain. Social support is a vague construct that can be measured in many ways, only one being the presence of a spouse. The simple presence of a spouse, however, does not indicate anything about the quality of the marital relationship. Moreover, a supportive spouse



may actually reinforce the sick role and unwittingly contribute to chronicity (Turk 1997; Turk et al. 1992). The results on marital status as a predictor of chronicity and work related disability have been inconsistent and contradictory. Several studies found no association between marital status and outcomes (Turk 1997; Turner et al. 2000); however, other studies found worse outcomes in workers who were single (Hazard et al. 1996; Lehmann et al. 1993), divorced (Cheadle et al. 1996; Hogg-Johnson et al. 1999), or married more than once (Hazard et al. 1996). Still other studies found interactions among marital status, sex, and number of children (Baldwin et al. 1996; Volinn et al. 1991) to be significant in predicting outcomes. It is possible that associations between family status and chronicity are due, at least in part, to differences in wage compensation rates for various family status categories. However, Volinn et al. (1991) found that although divorced and widowed workers with no children had the same wage replacement rates as did workers who had never married, they were over twice as likely to be chronically disabled. This suggests that being divorced or widowed with no children is indeed a risk factor for chronic disability. Two studies (Baldwin et al. 1996; Crook et al. 1998) demonstrated a potentially important interaction between sex and being single. They reported that being single predicted disability for men but not for women. Conversely, they found that being married was a predictor of disability for women but not for men.

#### **Educational Level as a Predictor of Chronicity and Work-Related Disability**

The education level of the individual with acute pain has also been examined to determine whether it predicted the development of chronicity. Yet again the results are equivocal. Almost an equal number of studies have suggested that educational attainment was either a significant predictor or failed to predict disability (Turk 1997). Two population-based studies found that less educated workers were at higher risk of chronic disability (Baldwin et al. 1996; Tate 1992), but the four non-population-based study articles reported no association between education and disability (Turner et al. 2000).

#### **Household Income as a Predictor of Chronicity and Work-Related Disability**

Several studies have considered the role of income in contributing to the transition from acute to chronic pain. Volinn et al. (1991) and Hasenbring et al. (1994) noted that lower income levels were a significant predictor, whereas, Murphy and Cornish (1984) and Weickgenant et al. (1994) failed to find that income predicted chronicity. Thus, no conclusions can be drawn regarding the role of pre-pain income. It is important to acknowledge that an increased level of income is likely to interact with education and job held. It is difficult to tease apart

these factors to determine whether any of them make an independent contribution to chronicity.

#### **Race/Ethnicity as a Predictor of Chronicity and Work-Related Disability**

Only one study reported the results of analyses of ethnic and racial groups as predictors. Among patients with acute back pain, non-Caucasians were less likely than Caucasians to be working at 6 months (Gatchel et al. 1995a) and 1 year (Gatchel et al. 1995b) later.

#### **Predictors of Recurrent Work Disability**

Very little is known about risk factors for recurrences of work disability in workers who do return to work. Only one study (Baldwin et al. 1996) presented data on the question of what happens to workers after they return to work. The documentation in this study of substantial disability recurrence rates in the first few years after an injured worker returns to work points to the need for research to identify predictors not only of length of initial disability, but also of whether or not a worker remains at work after returning. Such studies need to examine both recurrences of the original type of injury and new injuries.

#### **Conclusions**

Based on the review of demographic predictors, it is difficult to draw any firm conclusions regarding the role of these factors in the evolution of chronic pain following acute back pain. Variability in the statistical methods used across studies may also contribute to the discrepant findings reported. In addition to the methodological issues noted above, it is important to realize that demographic factors may interact. For example, age may be associated with income, and educational level may be highly correlated. Typically, demographic variables have been treated as independent predictors. Future research should consider the interaction among these variables when attempting to determine the best demographic set of predictors. An important caveat about the available research is that statistical associations found in analyses of large databases may or may not generalize to individual workers.

#### **References**

1. Baldwin ML, Johnson W, Butler RJ (1996) The Error of Using Returns-to-Work to Measure the Outcomes of Health Care. *Am J Ind Med* 29:632–641
2. Cheadle A, Franklin G, Wolfhagen C et al. (1994) Factors Influencing the Duration of Work-Related Disability: A Population-Based Study of Washington State Workers' Compensation. *Am J Public Health* 84:190–196
3. Crook J, Moldofsky H (1994) The Probability of Recovery and Return to Work from Work Disability as a Function of Time. *Qual Life Res* 3:S97–109
4. Crook J, Moldofsky H, Shannon H (1998) Determinants of Disability after a Work Related Musculoskeletal Injury. *J Rheumatol* 25:1570–1577
5. Gatchel R, Polatin P, Kinney R (1995a) Predicting Outcome of Chronic Back Pain using Clinical Predictors of Psychopathology: A Prospective Analysis. *Health Psychol* 14:415–420

6. Gatchel RJ, Polatin PB, Mayer TG (1995b) The Dominant Role of Psychosocial Risk Factors in the Development of Chronic Low Back Pain Disability. *Spine* 20:2702–2709
7. Hasenbring M, Marienfeld G, Kuhlendahl D et al. (1994) Risk Factors of Chronicity in Lumbar Disc Patients. *Spine* 19:2759–2765
8. Hazard RG, Haugh LD, Reid S et al. (1996) Early Prediction of Chronic Disability after Occupational Low Back Injury. *Spine* 21:945–951
9. Hogg-Johnson S, Cole DC, Group ECCD (1999) Early Prognostic Factors for Duration of Benefits among Workers with Compensated Occupational Soft Tissue Injuries. Toronto: Institute for Work and Health
10. Lehmann TR, Spratt KF, Lehmann KK (1993) Predicting Long-Term Disability in Low Back Injured Workers Presenting to a Spine Consultant. *Spine* 18:1103–1112
11. Murphy KA, Cornish RD (1984) Prediction of Chronicity in Acute Low Back Pain. *Arch Phys Med Rehabil* 65:334–337
12. Reid S, Haugh LD, Hazard RG (1997) Occupational Low Back Pain: Recovery Curves and Factors Associated with Disability. *J Occup Rehabil* 7:1–14
13. Rossignol M, Suissa S, Abenham L (1988) Working Disability due to Occupational Back Pain: Three-Year Follow-Up of 2,300 Compensated Workers in Quebec. *J Occup Med* 30:502–505
14. Tate DG (1992) Workers' Disability and Return to Work. *Am J Phys Med Rehabil* 71:92–96
15. Troup JDG, Martin JW, Lloyd DCEF (1981) Back Pain in Industry: A Prospective Study. *Spine* 6:61–69
16. Turk DC (1997) Transition from Acute to Chronic Pain: Role of Demographic and Psychosocial Factors. In: Jensen TS, Turner JA, Wiesenfeld-Hallin Z (eds) *Proceedings of the 8th World Congress on Pain, Progress in Pain Research and Management*. IASP Press, Seattle, pp 185–214
17. Turner JA, Franklin G, Turk DC (2000) Predictors of Long-Term Disability in Injured Workers: A Systematic Literature Synthesis. *Am J Indust Med* 38:707–722
18. Volinn E, Van Koeveering D, Loeser JD (1991) Back Sprain in Industry: The Role of Socioeconomic Factors in Chronicity. *Spine* 16:542–548
19. Weickgenant AL, Slater MA, Atkinson JH (1994, April) A Longitudinal Analysis of Coping and the Development of Chronic Low Back Pain. Abstract, 15th Scientific Sessions of the Society of Behavioral Medicine, Boston

## Pain in the Workplace, Risk Factors for Chronicity, Job Demands

GREG MCINTOSH  
Canadian Back Institute, Toronto, ON, Canada  
gmcintosh@cbi.ca

### Synonyms

Ergonomics; Occupational Pain; possible contributors; work duties; Risk Factors for Chronicity

### Definitions

Pain in the workplace refers to pain that occurs at a person's place of gainful employment. The pain may be limited to just the hours spent working or may be experienced at home too, even though the major exacerbating factors occur at work.

Risk factors are conditions, identified in healthy people, which are associated with an increased risk of developing pain; the outcome of interest is the onset of pain. Risk

factors and prognostic factors are often regarded as synonymous; however, prognostic factors are conditions, present in people already known to have pain, which are associated with an increased risk of recovery from an injury. The most common outcomes are pain reduction, functional improvement, and/or return to work.

Job demands refer to both the physical and psychosocial components people need to perform daily tasks at work. Supervisors, suppliers, competitors, co-workers, the company culture and the workers themselves all contribute to required job demands.

### Characteristics

#### Pain in the Workplace

The workplace provides us with financial status and security, defines who we are and our role in society in many cases. Unfortunately, the workplace can be associated with pain. In Canada and the U.S., for example, occupational back injuries account for approximately one third of all work related injuries that lead to protracted work disability (Cheadle et al. 1994). Of the 5% of American adults who experience a new episode of low back pain each year, 64% attribute their problem to an occupational injury (Frymoyer et al. 1987). Approximately 1% of all Americans are permanently disabled by back pain.

Over the last 40 years, low back pain prevalence in the general population has remained stable, but there has been a marked increase in disability rates. From 1960 to 1980, there was a 2,700% increase in back pain disability awards by the U.S. Social Security Administration (Bigos 1993). The disability rate increased at 14 times the rate of population growth between 1977 and 1981. Recent data indicates that the prevalence of work-related low back pain is no longer rising (Murphy and Volinn 1999), but it has stabilized at a very high level. For example, an estimated 22.4 million back pain cases are responsible for an estimated 149.1 million lost workdays per year (Guo et al. 1995), and an estimated 2.4 million Americans were disabled by back pain in 1990. This leads to a substantial socioeconomic impact in terms of medical costs and compensation; annual costs as of the mid-1980s were estimated at \$4.6 billion and \$16 billion, respectively, in the U.S. (Frymoyer et al. 1987).

Despite the staggering numbers, there is a lack of scientific evidence that working is physically harmful to the back. Back pain is work related to the extent that people of working age commonly get back pain and it has an impact on their work. However, ongoing symptoms and disability do not appear to be related to physical stress or occupational exposure. Hall et al. (1998) found that low back pain occurs without a precipitating event in two thirds of cases. They concluded that ► [spontaneous onset](#) is part of the natural history of back pain.

### Risk Factors

The study of risk factors has received a lot of attention. Research in occupational settings has revealed many risk

factors for developing low back pain including (NIOSH; Waddell 1998):

**Physical:**

- Heavy manual work
- Lifting and twisting
- Postural stress (sitting)
- Whole body vibration (driving)

**Psychosocial:**

- Monotonous work
- Lack of personal control
- Job dissatisfaction

**Physiologic:**

- Poor fitness
- Inadequate trunk strength

Unfortunately, the contribution of most of these factors is poorly understood in this multi-factorial condition (Deyo 1994). The literature regarding the ► [correlation](#) between physical demands and back pain is contradictory. While many cross-sectional studies have shown a relationship between heavy physical work load and the occurrence of back pain, other research (including ► [longitudinal studies](#)) have refuted this conclusion. While physical work may not cause the pain, it is certainly more difficult to continue a heavy job once back pain has occurred. The association between ► [sedentary work](#) and back pain occurrence is equally inconclusive; multiple studies present evidence for and against this association. Nachemson (1992) has stated that low back pain occurs with about the same frequency among those performing heavy labour and those with sedentary occupations.

There is some evidence, but mostly there is insufficient scientific data from quality studies, to establish strong associations between these risk factors and back pain occurrence. Such a diverse list implies that most workers will get back pain at some time in their life, which is true, but this does not mean that the condition will definitely lead to ► [chronic pain](#) and/or disability.

**Job Demands**

Pain involves both physical and emotional components. Addressing one and not the other often leads to treatment failure. There are important job demands and employment conditions to consider when planning for an injured worker to return to the workplace. Recognition of job demands that may become barriers to recovery can enhance recuperation. Addressing these circumstances soon after pain onset may: a) avoid costly and unnecessary medical investigation and treatment, b) avoid the frustration of trying to find medical answers for non-medical problems, and c) shift the focus towards altering the circumstances in an effort to prevent the development of chronicity and/or disability.

Feuerstein (1993) emphasized that as time away from the workforce due to injury increases, the number of factors contributing to the work disability also increases. Previous research has helped define seven barriers to recovery presented in this essay.

**1) Is there job security?**

The present economy may leave an injured worker with no job in which to return. This lack of a clear goal or endpoint to the rehabilitative process can negatively affect a person's desire for a timely recovery. Job availability must be determined early on, and monitored constantly throughout the rehabilitative process.

Key questions for the injured worker that help facilitate return to work and maintain employment:

1. When was the last time you spoke to your employer?
2. Is there a job to return to?
3. Does your employer know when you are planning to return?

**2) Is there worker motivation?**

Even when a job exists, an injured worker's motivation to return to the same employment must be determined. Poor working conditions, poor labour relations or strained relations with co-workers may negatively influence motivation to return to work and/or stay there. The association between job dissatisfaction and occupational back pain is weak; this probably reflects the fact that research on ► [job satisfaction](#) has been a crude measure that fails to ascertain accurately employees' attitudes about work. Often, the rehabilitation process becomes less effective as motivation to go back to the job decreases; however, it is rarely advisable to tell workers to stay off work, change their job, or give up work completely because of simple back pain (Waddell 1998).

Key questions:

1. Do you like your job, fellow workers, boss?
2. Does your company treat you well?

**3) Are there physical limitations?**

A workplace that requires function beyond the physical capabilities of an individual will produce pain, frustration and absenteeism. A person who does not have the physical ability to accomplish specific job demands, may not be eager to return to work. There are no quality studies to support the notion that a worker's back pain is job related, or that his/her job demands are bad for the spine. Nevertheless, injured workers must regain a certain functional ability in order to resume their job demands.

Key questions:

1. What are the physical requirements of your job?
2. Do you currently have those physical capabilities?
3. When will you be able to meet your job requirements?



#### 4) Is a graduated return to work acceptable?

An injured worker usually benefits from any workplace modifications, but these changes should be time limited, with the eventual goal of a return to full duties. The practice of placing ► [permanent restrictions](#) on an injured worker may have a negative effect on return to work, especially when employers prohibit anything other than a return to full duties. Ergonomic and work-style modification efforts may contribute to an increase in successful return to work, but this finding is not supported in the medical literature. Clinicians often tell workers that their pain is job related and they should stay off work until they are better. Pro-active return to work programs are effective because they allow workers gradually to re-enter the workplace and improve relationships between workers and employers; thus, good industrial relations make successful rehabilitation and return to work more likely.

Key questions:

1. Will your employer accommodate a graduated return to work in terms of progressive hours, progressive loads, and/or rotating positions?
2. What kind of cooperation is required?

#### 5) Is there unrecognised conflict?

Unrecognised or unresolved conflict between the injured worker and the employer (or others outside the work setting) presents a significant barrier to recovery. A worker's unhappiness with the employer or payor regarding the goals of rehabilitation may prolong recovery. Patients, clinicians, and payors each tend to have different definitions of success. Conflicting goals concerning the expected outcome will hinder return to work and may create disappointment, anxiety and anger when recovery does not proceed as planned. The goals of everyone involved must be identified and the objectives of the rehabilitation process clear to all. Litigation can also serve to heighten the conflict between the injured worker and the employer or payor. Unfortunately, our current ► [disability-litigation system](#) adds greatly to the epidemic of work related pain; and injured workers are often rewarded for non-function.

Key questions:

1. Do you have good relations with your family, employer, third party payor and/or fellow workers?
2. Do you agree with the goals of your rehabilitation?
3. Is there a lawyer involved?
4. Do you need your pain to get your settlement?

#### 6) Is there secondary gain?

Secondary gain is not ► [malingering](#). Workers with secondary gain issues have genuine symptoms but are not able to cope well, and may continue in the sick role to varying degrees. Secondary gain may result in a resistance to health that can affect recovery, and is not only

related to financial benefits but may include affection, control and escape.

**Financial.** People who believe that they are entitled to a financial reward because of an accident have little desire to recover quickly. Financial supplements for an injury may enable people to continue their current lifestyles. Unfortunately, this often removes the economic incentive to return to work (Frank 1995).

**Attention.** Families often spend more time with a family member who has incurred an injury. They pay more attention to and empathize more with the injured person in an effort to make him/her feel better. An extended duration of this adjusted family situation can eventually serve to reinforce the injured person's sickness behaviour. The secondary gain is love from a family that is only trying to help.

**Control.** The increased attention received by some injured workers can prompt an image of dependency that may give them a sense of control and manipulation over family, friends and peers. They may become accustomed to a life free of responsibilities, a life only possible when recovery remains unachievable.

**Escape.** Pain may allow a person to escape from the everyday pressures and responsibilities of life. Should the duration of this escape continue for too long and allow a worker to become too far removed from reality, the family's effort to help only reinforces the negative behaviour. Key questions

1. Is wage replacement sufficient to pay the bills?
2. How long will compensation last?

#### 7) Is there physician interference?

A physician must be part of an injured worker's treatment rather than part of the problem (Amadio 1988). A misinformed or overprotective doctor may prolong the rehabilitation effort unnecessarily. Returning to a normal lifestyle, including work, is a priority.

Key questions:

1. Is the person's pain sufficient to cancel returning to work?
2. Has return to work been delayed until the pain disappears?
3. Will returning to work result in increased harm?
4. How many doctors/specialists have been seen?

As this list of questions indicates, the job demands that may contribute to work disability range from obvious physical ones to subtle psychosocial and economic ones. Finding answers to these pertinent questions helps identify job demands and other factors that may act as barriers to recovery for an injured worker. Also, these answers will help enable clinicians to quantify their instincts, and injured workers to prepare for workplace re-integration. Resolution of possible barriers and rapid recovery allows the injured worker to return to a more normal lifestyle.



## References

1. Amadio P Jr, Cummings DM, Amadio PB (1988) A Framework for Management of Chronic Pain. *Am Fam Physician* 38:155–160
2. Bernard BP, Putz-Anderson V et al. (1997) Musculoskeletal Disorders and Workplace Factors: A Critical Review of Epidemiologic Evidence for Work-Related Musculoskeletal Disorders of the Neck, Upper Extremity, and Low Back. DHHS (NIOSH) publication, pp 97–141
3. Bigos SJ (1993) Primary Prevention for Incumbent Workers. Conference: The Sports Medicine Approach to Spinal Disorders in the Workplace
4. Cheadle A, Franklin G, Wolfhagen C, Savarino J, Liu PY, Salley C, Weaver M (1994) Factors Influencing the Duration of Work-Related Disability: A Population-Based Study of Washington State Workers' Compensation. *Am J Public Health* 84:190–196
5. Deyo RA (1994) Magnetic Resonance Imaging of the Lumbar Spine: Terrific Test or Tar Baby? *N Engl J Med* Editorial 331:115–116
6. Feuerstein M (1993) Musculoskeletal Injuries: Causes and Effects. *Rehab Management* Apr/May:30–36
7. Frank JW, Pulcins IR, Kerr MS, Shannos HS, Stansfeld SA (1995) Occupational Back Pain - An Unhelpful Polemic. *Scand J Work Environ Health* 21:3–14
8. Frank JW, Brooker AS, DeMaio SE, Kerr MS, Maetzel A, Shannon HS, Sullivan TJ, Norman RW, Wells RP (1996) Disability Resulting from Occupational Low Back Pain: Part II : What Do We Know About Secondary Prevention? A Review of the Scientific Evidence on Prevention after Disability Begins. *Spine* 21:2918–2929
9. Frank JW, Kerr MS, Brooker AS, DeMaio SE, Maetzel A, Shannon HS, Sullivan TJ, Norman RW, Wells RP (1996) Disability Resulting from Occupational Low Back Pain: Part I. What Do We Know About Primary Prevention? A Review of the Scientific Evidence on Prevention before Disability Begins. *Spine* 21 (24):2908–2917
10. Frymoyer JW, Cats-Baril W (1987) Predictors of Low Back Pain Disability. *Clin Orthop* 221:89–98
11. Guo HR, Tanaka S, Cameron LL, Seligman PJ, Behrens VJ, Ger J, Wild DK, Putz-Anderson V (1995) Back Pain among Workers in the United States: National Estimates and Workers at High Risk. *Am J Ind Med* 28:591–602
12. Hall H, McIntosh G, Wilson L, Melles T (1998) Spontaneous Onset of Back Pain. *Clin J Pain* 14:129–133
13. Murphy PL, Volinn E (1999) Is Occupational Low Back Pain on the Rise? *Spine* 24:691–697.
14. Nachemson A (1992) Newest Knowledge of Low Back Pain: A Critical Look. *Clin Orthop* 279:8–20
15. Sikorski JM (1985) A Rationalized Approach to Physiotherapy for Low Back Pain. *Spine* 10:571–579
16. Spengler DM, Bigos SJ, Martin NA, Zeh J, Fisher L, Nachemson A (1986) Back Injuries in Industry: A Retrospective Study. I. Overview and cost analysis. *Spine* 11:241–245
17. Waddell G (1998) *The Back Pain Revolution* Churchill Livingstone Edinburgh

## Pain in the Workplace, Risk Factors for Chronicity, Psychosocial Factors

DENNIS C. TURK

Department of Anesthesiology, University of Washington, Seattle, WA, USA  
turkdc@u.washington.edu

### Synonyms

Psychological factors; emotional factors; Personality

## Definition

Psychosocial factors, including individual differences (i.e. personality), premorbid psychological diagnoses, coping resources and strategies, cognitive (e.g. beliefs, attitudes, perceptions, expectancies), emotional (i.e. depression, ► **anxiety**), and behavioral (i.e. responses by significant others) variables, all have the potential to predispose one to, and to affect, chronicity following a work-related injury.

## Characteristics

As is so often the case in healthcare, when physical factors are insufficient to predict symptoms, psychological factors are considered. For example, Burton et al. (1995) demonstrated that, for acute back pain patients presenting in a primary care setting, conventional clinical information predicted outcome disability scores for only 10% of the cases, compared to psychosocial measures that accounted for 59% of the cases. The failure of injury severity to account for the majority of the variance in development of chronic disability following work-related injuries (Crook et al. 2002) has led some to postulate that a range of psychological variables may be relevant. Several investigators have evaluated the role of traditional psychological variables, namely, prior history of emotional problems, current history of psychological distress, personality factors, and alcohol and substance abuse, as well as patients' perceptions of ► **stress**, coping behaviors, attitudes and beliefs, health in general and their current symptoms (Turk 1997). Despite the suggestion that psychological variables may be important predictors of chronicity and work-related disability, few studies have actually systematically assessed psychosocial predictors. This is particularly surprising in light of the number of studies that have demonstrated the ability of these factors (e.g. ► **somatization**, **depression**, psychological distress, ► **fear-avoidance**) to predict long-term outcomes in patients with a variety of pain problems (e.g. Katz et al. 1998; MacFarlane et al. 1998). However, such measures are not collected routinely for administrative databases; moreover, the source of predictor data in many of the studies reviewed are difficult to obtain in large scale studies involving telephone interviews because of the length and personal nature of standard instruments. Prospective, longitudinal studies are needed to answer questions concerning the ability of psychosocial variables to predict subsequent work-related disability.

### Alcohol and Substance Abuse Predictors of Chronicity

History of alcohol and substance abuse have consistently been shown to be predictors of chronicity (Turk 1997). Gatchel et al. (1995a, 1995b), however, did not find that the presence of a substance abuse disorder predicted disability following a work-related injury. Overall, it does appear that prior or current use of alcohol or illicit drugs indicates a relatively poor prognosis for those who suf-

fer an acute episode of back pain, especially if the pain is attributed to a work related injury.

#### **Affective Distress as Predictor of Chronicity**

History of anxiety, depression, or psychological treatment has been identified as being involved in the transition from acute to chronic pain in several studies (Turk 1997). A number of studies, but not all (e.g. Gatchel et al. 1995a; Gatchel et al. 1995b; Lehman et al. 1993), have also demonstrated that levels of anxiety and depression at the time of acute pain predicted persistence of symptoms, time lost from work, and healthcare expenditures following work-related injuries (Crook 2002; Turk 1997).

Crook et al. (1998) reported that workers with greater psychological distress returned to work significantly later. Gatchel and colleagues found that higher baseline patient scores on the Hysteria scale of the MMPI predicted work disability (Gatchel et al. 1995a; Gatchel et al. 1995b). Diagnosis of a personality disorder predicted work disability at 6 months, but not at 1 year.

Less pervasive psychological distress described as lassitude, malaise, and loneliness when assessed during acute pain onset have been shown to predict the transition from acute to chronic pain (Turk 1997). These constructs appear to be measuring the emotional state of the individual at the time of assessment, and it is not clear whether they should be viewed as more pervasive characteristics rather than transient states. Diverse measures have been used to assess these states, and thus, one must be cautious in comparing and interpreting the results from different studies.

#### **Perceived Stress and Coping Responses as Predictors of Chronicity**

Perceptions of stress in ones life and the occurrence of a high number of stressful life events have been identified as present during the acute phase of an injury, along with inadequate or maladaptive coping, will affect the transition from the acute injury to chronic disability. It is important to acknowledge that the perception of stress and actual stresses may not be the same. Studies that have examined stress as a predictor of chronicity have usually relied on the individual's perceptions and appraisals.

#### **Health Perceptions as Predictors of Chronicity**

A number of investigators have attempted to assess patients' general somatic preoccupations and perceptions of their own health, as well as their beliefs about the severity of their current medical condition during periods of acute pain, to determine whether these perceptions and beliefs predicted subsequent chronic pain. Several studies have supported the role of these cognitive appraisals in predicting chronicity (Turk 1997). Two studies, however, failed to support the importance of the subject's appraisals (Murphy and Cornish 1984, Lehmann et al. 1993). The operationalizations of these

cognitive measures make comparisons across studies difficult. Since these psychological variables appear to have some predictive utility, additional research is needed to more carefully examine these factors.

#### **Conclusion**

If there is one factor that characterizes the results of the studies seeking to identify psychosocial predictors of the transition from acute to chronic pain, it is inconsistency. One explanation for the inconsistency is the predictor measures used, and that despite the fact that the variables and constructs included may appear comparable in different studies, they may be operationalized with different measures that have different characteristics (Crook et al. 2002, Turk 1997). It cannot be assumed that two scales designed to measure the same thing are actually comparable.

In addition to the factors described above, the design of the predictor studies can influence the outcomes. Cross-sectional and retrospective designs (e.g. Greenough and Fraser 1989) have numerous inherent problems. The inclusion of small samples of non-representative subjects will also influence the nature of the outcome. In addition, most of the studies on the transition from acute to chronic pain have treated the predictors as if they were independent, but many predictors are not independent. Many studies have demonstrated that psychosocial factors are better predictors of chronicity than are clinical or physical factors (Turk 1997; Turner et al. 2000). Clearly, chronicity is determined by a multitude of factors that interact in a reciprocal way over time. It appears that chronicity, especially accompanying work-related injuries, is a function of a complex interaction among demographic, physical, psychological, social and economic factors (Crook et al. 2002).

#### **References**

1. Burton AK, Tillotson KM, Main CJ et al. (1995) Psychosocial Predictors of Outcome in Acute and Subchronic Low Back Trouble. *Spine* 20:722-728
2. Crook J, Milner R, Schulz IZ et al. (2002) Determinants of Occupational Disability Following Low Back Pain: A Critical Review of the Literature. *J Occupat Rehabil* 12:277-295
3. Gatchel RJ, Polatin PB, Kinney RK (1995a) Predicting Outcome of Chronic Back Pain using Clinical Predictors of Psychopathology: A Prospective Analysis. *Health Psychol* 14:415-420
4. Gatchel RJ, Polatin PB, Mayer TG (1995) The Dominant Role of Psychosocial Risk Factors in the Development of Chronic Low Back Pain Disability. *Spine* 20:2702-2709
5. Greenough CG, Fraser RD (1989) The Effects of Compensation on Recovery from Low-Back Injury. *Spine* 14:947-955
6. Katz JN, Lew RA, Bessette L et al. (1998) Prevalence and Predictors of Long-term Work Disability due to Carpal Tunnel Syndrome. *Am J Ind Med* 3:543-550
7. Lehmann TR, Spratt KF, Lehmann KK (1993) Predicting Long-Term Disability in Low Back Injured Workers Presenting to a Spine Consultant. *Spine* 18:1103-1112
8. Macfarlane GJ, Hunt IM, Silman AJ (1998) Predictors of Chronic Shoulder Pain: A Population Based Prospective Study. *J Rheumatol* 25:1612-1615
9. Murphy KA, Cornish RD (1984) Prediction of Chronicity in Acute Low Back Pain. *Arch Phys Med Rehabil* 65:334-337

10. Turk DC (1997) Transition from Acute to Chronic Pain: Role of Demographic and Psychosocial Factors. In: Jensen TS, Turner JA, Wiesenfeld-Hallin Z (eds) *Proceedings of the 8th World Congress on Pain, Progress in Pain Research and Management*. IASP Press, Seattle, pp 185–214
11. Turner JA, Franklin G, Turk DC (2002) Predictors of Long-Term Disability in Injured Workers: A Systematic Literature Synthesis. *Am J Indust Med* 38:707–722

## Pain in the Workplace, Risk Factors for Chronicity, Workplace Factors

DENNIS C. TURK

Department of Anesthesiology, University of Washington, Seattle, WA, USA

turkdc@u.washington.edu

### Synonyms

Work environment; Socioeconomic Factors; workplace; Risk Factors for Chronicity; workplace factors

### Definition

In the context of a work-related injury, socioeconomic factors related to factors specific to the workplace (e.g. job satisfaction, control of work pace) and the economic environment (e.g. unemployment rate, extent of ► [wage replacement](#)) may influence time off work following a work-related injury.

### Characteristics

Identification of characteristics of individuals who have an increased risk for developing chronic pain is important as it has the potential to: (1) guide research on the pathogenesis of chronic pain; (2) guide the design of interventions to prevent the transition from acute to chronic pain; and (3) permit delivery of interventions to those who are most in need of preventive efforts and subsequently to reductions in physical and occupational disability, emotional distress, and health care utilization. A number of job characteristics and workplace factors have been examined to determine their role in the transition from acute to chronic pain and work-related disability.

The interest in the transition from acute to chronic pain has been fostered primarily by three factors: (1) the dramatic increase in disability associated with work-related injuries; (2) high costs of work-related injury in expenditures for medical treatment, ► [indemnity costs](#), and lost productivity; and (3) the observation that, whereas up to 90% of workers who sustained work-related injuries with accompanying pain return to functioning within a brief interval (usually days or weeks), the remaining 10% develop long-term disabilities, often never returning to pre-injury levels of functioning. It is the observation that a relatively small percentage of patients with back injuries fail to return to functioning,

consuming a disproportionate amount of health care resources and indemnity costs that has served, perhaps, as the greatest impetus toward the question of what factors – are risk factors – for chronicity.

### Company Size

Several studies found that workers in smaller companies had poorer outcomes; however, firm size did not predict cumulative compensated work absence in others (Turner et al. 2000). Larger firms may have greater resources for employing specialists in disability management, be more able to offer injured workers different jobs or job modifications to promote return to work, and have more incentive to shorten claims from their greater experience ratings in standard premium calculations.

### Job Accommodation

The availability of a modified job or workplace accommodation may be an important factor in facilitating return to work. In two studies, workers who had a modified job available to them returned to work significantly sooner (Crook et al. 1998; Hogg-Johnson et al. 1999). The latter study also found that when the employer did not offer accommodations for return to work, workers whose pain did not change, or worsened between baseline and four weeks, remained on benefits longer than did workers whose pain improved. When the employer did offer arrangements for return to work, the relationship between change in pain and time on benefits was much weaker. This suggests that job modifications may be particularly critical for workers whose pain is not improving.

### Availability of Wage Replacement

In many countries, people who experience work-related injuries are eligible for disability compensation. The wage replacement benefit is a ratio of the expected disability benefit to the preinjury wage. High benefit replacement rates are expected to provide greater incentives not to return to work. Some have suggested that the availability and high levels of wage replacement would serve as a disincentive for return to work and consequently reinforce disability (e.g. Hadler et al. 1995; Walsh and Dumitru 1988). Several studies have attempted to determine the validity of this assumption. The results are somewhat mixed; whereas some studies have supported the role of wage replacement in fostering chronicity, others have not (Turk 1997; Turner et al. 2000). To confuse matters even further, Ruser (1987) reported that wage replacement predicted chronicity for males, but Baldwin et al. (1996) found that it predicted only for females and not for males. The results on wage replacement illustrate the potential for interactions among predictor variables, in this case sex and levels of wage replacements.

Many authors have suggested that compensation paid to injured workers affects symptom complaints, reports of

disability, time to return to work, and response to treatment. At least regarding response to treatment, the results are inconsistent.

The role of ► [worker compensation](#) as a predictor of disability is a contentious topic that has generated much debate (e.g. Hadler et al. 1995; Walsh and Dumitru 1988). For example, Greenough and Fraser (1989) reported that patients who received compensation reported greater pain, disability, psychological disturbance, and unemployment at follow-up than patients who did not receive compensation. The authors concluded that the compensation acts directly and powerfully against the long-term interests of the patients (see also Hadler et al. 1995).

Dworkin (1990) suggested that the studies that have examined the role of compensation neglect to consider the fact that compensation may be a consequence of chronic pain. Dworkin suggests that the cause of compensation includes greater pain, greater disability, greater psychological disturbance, inability to work, and poorer response to treatment – the very same factors that have been associated in some studies, but that are almost invariably interpreted as consequences of compensation, rather than causes. Most likely, worker's compensation interacts with other variables described above.

It is important to acknowledge that the generic terms “compensation” and “wage replacement” are quite heterogeneous. Compensation may or may not be time limited. The funding may come from different sources. For example, in the United States disability compensation may be received from the Veterans Administration, Social Security Disability, or Worker Compensation depending upon a number of factors and the potential cause of pain onset. It would not be a surprise if such differences led to different outcomes, and the predictors of chronicity are likely to vary depending upon the type and source of compensation (e.g. Jamison et al. 1988). Studies on the role of compensation in chronicity have rarely made distinctions between the type or nature of compensation that patients received.

Despite limitations in the available studies, it does appear that compensation factors may contribute to delayed recovery and reinforce the sick role. It is important to consider not only whether compensation status affects disability, but under what conditions. A detailed review of the issues involved in compensation and litigation as predictors of disability are beyond the scope of this essay (see Turner et al. 2000).

## References

- Baldwin ML, Johnson WG, Butler RJ (1996) The Error of Using Returns-to-Work to Measure the Outcome of Health Care. *Am J Ind Med* 29:632–641
- Crook J, Milner R, Schulz IZ, Stringer B (2002) Determinants of Occupational Disability Following Low Back Pain: A Critical Review of the Literature. *J Occupat Rehabil* 12:277–295
- Crook J, Moldofsky H, Shannon H (1998) Determinants of Disability After a Work Related Musculoskeletal Injury. *J Rheumatol* 25:1570–1577
- Hazard RH (1990) Compensation in Chronic Pain Patients: Cause or Consequence? *Pain* 43:387–388
- Greenough CG, Fraser RD (1989) The Effects of Compensation on Recovery from Low-Back Injury. *Spine* 14:947–955
- Hadler NM, Carey TS, Garrett J, and the North Carolina Back Project (1995) The Influence of Indemnification by Workers' Compensation Insurance on Recovery from Acute Backache. *Spine* 20:2710–2715
- Hazard RG, Haugh LD, Reid S, Preble JB, MacDonald L (1996) Early Prediction of Chronic Disability after Occupational Low Back Injury. *Spine* 1:945–951
- Hogg-Johnson S, Cole DC, Group ECCD, Workgroup PM (1999) Early Prognostic Factors for Duration on Benefits among Workers with Compensated Occupational Soft Tissue Injuries. Institute for Work & Health, Toronto
- Infante-Rivard C, Lortie M (1996) Prognostic Factors for Return to Work After a First Compensated Episode of Back Pain. *Occup Environ Med* 53:488–494
- Jamison RN, Matt DA, Paris WCV (1988) Effects of Time-Limited vs. Unlimited Compensation on Pain Behavior and Treatment Outcome in Low Back Pain Patients. *J Psychosom Res* 32:277–283
- Lehmann TR, Spratt KF, Lehmann KK (1993). Predicting Long-Term Disability in Low Back Injured Workers Presenting to a Spine Consultant. *Spine* 18:1103–1112
- Ruser JW (1987) Workers' Compensation and Occupational Injuries and Illnesses. *J Labor Economics* 9:325–350
- Turk DC (1997) Transition from Acute to Chronic Pain: Role of Demographic and Psychosocial Factors. In: Jensen TS, Turner JA, Wiesenfeld-Hallin Z (eds) *Proceedings of the 8th World Congress on Pain, Progress in Pain Research and Management*. IASP Press, Seattle, pp 185–214
- Turner JA, Franklin G, Turk DC (2000) Predictors of Long-Term Disability in Injured Workers: A Systematic Literature Synthesis. *Am J Indust Med* 38:707–722
- Walsh NE, Dumitru D (1988) The Influence of Compensation on Recovery from Low Back Pain. *Occupat Med: State Art Rev* 109–121

## Pain-Inhibitory System

### Definition

Systems within the central nervous system whose normal function is the inhibition of pain.

- [Descending Modulation of Nociceptive Processing](#)
- [Pain Modulatory Systems, History of Discovery](#)
- [Stimulation-Produced Analgesia](#)

## Pain Inventories

MARC J. SHULMAN, ROBERT D. KERNS  
VA Connecticut Healthcare System, Yale University,  
New Haven, CT, USA  
marc.shulman@med.va.gov, robert.kerns@med.va.gov

### Synonyms

Pain measurement



## Definition

There are a variety of instruments that assess the direct physiological mechanisms of pain, as well as, affect, beliefs, coping styles, external influences, and psychosocial functioning associated with pain. These instruments are particularly valuable because the measurement of the intensity of pain, and determination of the extent to which pain affects an individual, can be quite difficult. There are no physiological indicators that allow for an objective measurement of the quantity of pain that an individual experiences, because pain is a complex, subjective, and multidimensional phenomenon. Consequently, by providing a holistic assessment of pain, ► [pain inventories](#) can serve as vital tools for understanding underlying pain mechanisms and for the development of techniques to control pain.

## Characteristics

### Self-Report Pain Measures

► [Self-Report Pain Measures](#) provide the most direct method for assessing aspects of pain such as pain intensity, pain affect, pain quality, and pain location, as well as constructs related to chronic pain. They can be particularly valuable for use in clinical and research settings because they produce standardized, reliable, and valid assessments. Additionally, they are cost and time efficient for administration and scoring, and are particularly sensitive to treatment related changes. Jensen and Karoly (2001) concluded that, although additional research is required to answer vital issues pertaining to the quality and measurement of the pain experience, most of the instruments that are now available have adequately demonstrated their excellent ► [reliability](#) and validity. They recommend that it is essential for clinicians and researchers to select instruments with a full understanding of their ► [psychometric](#) strengths and weaknesses, and to ensure that they are consistent with their conceptualization of pain.

### The Medical Outcomes Study 36-Item Short-Form Health Survey (SF-36)

The SF-36 was developed as a general measure of perceived health status (Ware and Sherbourne 1992) and is generally self-administered. The measure contains 36 items that are combined to form eight scales: Physical Functioning, Physical Role Functioning, Bodily Pain, General Health, Vitality, Social Functioning, Emotional Role Functioning, and Mental Health. Respondents use yes-no or 5 or 6 point scales to endorse the presence and degree of specific symptoms, problems and concerns. Scores on the scales range from 0–100, with higher scores indicating better health status and functioning. The measure takes about 10 to 15 minutes to complete. The SF-36 has been extensively validated with large samples from the general population and across several demographic subgroups, including samples of healthy

persons over 65 (Kazis et al. 1998). However, the SF-36 has only recently begun to be studied in ► [chronic pain](#) populations, including use as an outcome measure in pain intervention trials (Katz et al. 1992).

### West Haven-Yale Multidimensional Pain Inventory (WHYMPI)

The ► [West Haven-Yale Multidimensional Pain Inventory](#) (WHYMPI) (Kerns et al. 1985) is designed to measure psychosocial and behavioral aspects of chronic pain, and is useful across a variety of clinical populations. It is a multidimensional self-report instrument that consists of 52 questions, each scored on a 7-point ► [Likert scale](#) (0–6). There are three sections: 1) Pain Experience (five scales that measure perceived intensity and the impact of pain on several aspects of patients' lives), 2) Pain Relevant Significant Other Responses (three scales that measure patient's perceptions of the responses of significant others to their communication of pain), and 3) Daily Activities (four scales that measure performance of common activities). There is a version of the WHYMPI, where patients' significant others complete items that measure their responses to the patients' pain behaviors (Kerns and Rosenberg 1995). It takes approximately 10–15 minutes to complete the WHYMPI, and is written at a fifth grade reading level. The WHYMPI has demonstrated good reliability, and scores from the WHYMPI have been found to correlate with several other pain measures.

### Pain Disability Index (PDI)

The ► [Pain Disability Index](#) (Pollard 1984) was developed as a brief measure of the degree to which chronic pain interferes with normal role functioning. While most data come from patients with heterogeneous pain conditions, the PDI has been used to measure function/disability in a number of specific painful conditions. The PDI includes 7 items assessing perceived disability in each of seven areas of normal role functioning: family/home responsibilities, recreation, social activity, occupation, sexual behavior, self-care, and life-support activity. Each item is rated on a 10-point scale (0 – no disability to 10 - total disability), and the responses are summed. The PDI shows excellent reliability and ► [validity](#) as a brief measure of pain-related disability in younger individuals (Tait et al. 1990). There is minimal evidence for the psychometric properties of this scale for elderly individuals.

### Chronic Illness Problem Inventory (CIPI)

The ► [Chronic Illness Problem Inventory](#) (Kames et al. 1984) is a 65-item instrument developed to measure patient functioning in the areas of physical limitations, psychosocial functioning, healthcare behaviors, and marital adjustment. Each CIPI item describes a problem in functioning, and each patient rates the degree to which each item applies on a 5-point scale. Romano et al. (1992) concluded that its ease of administration and scoring, and its

preliminary psychometric properties, make this a useful instrument, but that its 18 scales can become unwieldy. Therefore, the CIPI demonstrates potential as an alternative measure of pain dysfunction, but should be used with caution and with additional measures of dysfunction, until further validation is achieved.

### Pain Drawings

► **Pain drawings** consist of an outline of a human figure on which patients darken the areas where they are experiencing pain. These drawings can facilitate the assessment of the location and nature of the pain, and assist with the decisions for appropriate intervention. Additionally, their visual representation enables clinicians to detect patterns of pain that may otherwise be overlooked. However, only very limited correlations have been found between the percentage of the body surface area with pain, and the measures of current psychological state and ► **premorbid functioning**. Therefore, firm conclusions about psychological illness cannot be reached based solely on the involvement of multiple areas of pain drawings (Ginzberg et al. 1988).

### Pain Diary

► **Pain diaries** can provide additional information beyond traditional assessment tools, which rely on recollections of the past and composite measures of critical variables. Jacob and Kerns (2001) point out that they provide an actual temporal relationship between psychosocial variables and pain, by having patients record their mood, activity, sleep, and pain on a daily basis, rather than relying on patients' global, retrospective self-reports. They also note that the reliability and validity of the pain diaries has been demonstrated across several studies and for a variety of pain-related difficulties.

### UAB Pain Behavior Scale

The ► **UAB Pain Behavior Scale** (Richards et al. 1982) consists of 10 target behaviors, each of which contributes equally to a total score. Therefore, there is a range of possible scores from 0 to 10. The 10 target behaviors were selected because they were judged to be the most relevant, frequently observed, and reliably measurable pain behaviors in a chronic pain population. Pain behavior is assessed by a trained clinician, who observes a series of behaviors demonstrated by the patient. Ratings are based on frequency estimates of pain behaviors: none (0), occasional (1/2) and frequent (1). Patients are asked to walk a short distance and stand for a few seconds. They are also asked to move from a sitting to a standing position and vice versa. Frequency of both verbal and non-verbal (i.e. moans, groans, etc.) pain behaviors is scored. The total process typically takes 5 minutes per patient. Although the UAB scale is a relatively basic instrument that can be administered rapidly by a variety of professionals, it has demonstrated good reliability and validity. However,

this tool must be viewed cautiously and used in combination with other measures, since additional research may be necessary to modify some of its pain behavior categories.

Given that these inventories assess different types of pain behaviors and experiences, and vary to the extent that they examine how individuals respond to pain, a comprehensive assessment may involve the use of a combination of several instruments, in order to achieve a valid and thorough understanding of the multidimensional nature of an individual's pain experience. For example, when forming an appropriate treatment plan for a patient with chronic pain, it may be useful for a clinician to administer the WHYMPI or CIPI to determine the extent that pain results in disability or interferes with daily functioning across multiple domains, while also encouraging the patient to keep a pain diary throughout treatment in order to track and monitor self-reported changes in pain behaviors and coping responses over time. However, in settings that require time-limited, brief screenings of pain, providers may choose instead to administer shorter measures such as the PDI, UAB Pain Behavior Scale, or Pain Drawings, or a combination of these tools, to inform strategies and goals for treatment. Individual inventories can be useful tools on their own in both clinical and research settings; what is critical is the implementation of ongoing assessment of pain, whether through self-report measures or behavioral tools, in order to evaluate short-term and long-term effectiveness of intervention methods and to improve treatment outcomes for patients with chronic pain.

### References

1. Ginzberg BM, Merskey H, Lau CL (1988) The Relationship between Pain Drawings and the Psychological State. *Pain* 35:141–146
2. Jacob MC, Kerns RD (2001) Assessment of the Psychosocial Context of the Experience of Chronic Pain. In: Turk DC, Melzack RM (eds) *Handbook of Pain Assessment*. Guilford Press, New York, pp 15–34
3. Jensen MP, Karoly P (2001) Self-Report Scales and Procedures for Assessing Pain in Adults. In: Turk DC, Melzack RM (eds) *Handbook of Pain Assessment*. Guilford Press, New York, pp 15–34
4. Kames LD, Naliboff BD, Heinrich RL et al. (1984) The Chronic Illness Problem Inventory: Problem-Oriented Psychosocial Assessment of Patients with Chronic Illness. *Int J Psychiatry Med* 14:65–75
5. Katz, JN, Harris TM, Larson MG et al. (1992) Predictors of Functional Outcomes after Arthroscopic Partial Meniscectomy. *J Rheumatol* 19:1938–1942
6. Kazis LE, Miller DR, Clark J et al. (1998) Health Related Quality of Life in Patients Served by the Department of Veterans Affairs: Results from the Veterans Health Study. *Arch Int Med* 158:626–632
7. Kerns RD, Rosenberg R (1995) Pain-Relevant Responses from Significant Others: Development of a Significant-Other Version of the WHYMPI Scales. *Pain* 61:245–249
8. Kerns RD, Turk DC, Rudy TE (1985) The West Haven-Yale Multidimensional Pain Inventory (WHYMPI). *Pain* 23:345–356
9. Pollard CA (1984) Preliminary Validity Study of Pain Disability Index. *Percept Mot Skills* 59:974

10. Richards JS, Nepomuceno C, Riles M et al. (1982) Assessing Pain Behavior: The UAB Pain Behavior Scale. *Pain* 14:93–98
11. Romano JM, Turner JA, Jensen MP (1992) The Chronic Illness Problem Inventory as a Measure of Dysfunction in Chronic Pain Patients. *Pain* 49(1):71–75
12. Tait RC, Chibnall JT, Krause S (1990) The Pain Disability Index: Psychometric Properties. *Pain* 40:171–182
13. Ware JE, Sherbourne CD (1992) The MOS 36-Item Short-Form Health Survey (SF-36), I: Conceptual Framework and Item Selection. *Med Care* 30:473–478

## Pain-Killers

- ▶ Simple Analgesics

## Pain Management

### Definition

Pain is managed most effectively by preventing, limiting, or avoiding its consequences. It is based on the systematic assessment of pain and associated stress, and includes the use of pharmacological and non-pharmacological interventions. Interested readers may click onto the following website for an official policy statement of the American Academy of Pediatrics on the Prevention and Management of Pain and Stress in the Neonate <<http://aappolicy.aappublications.org/cgi/content/full/pediatrics;105/2/454>>

- ▶ Pain Assessment in Neonates

## Pain Management in Infants

- ▶ Acute Pain Management in Infants

## Pain Management, Pharmacotherapy

- ▶ Bisphosphonates
- ▶ Muscle Relaxants
- ▶ Non Steroidal Anti-Inflammatory Drugs (NSAIDs)
- ▶ Oral Opioids
- ▶ Simple Analgesics
- ▶ Tricyclic Antidepressants

## Pain Management Programs

- ▶ Behavioral Therapies to Reduce Disability

## Pain Mapping

- ▶ Chronic Pelvic Pain, Laparoscopic Pain Mapping

## Pain Measurement

### Definition

A method for rating the intensity and subjective qualities of pain by means of questionnaires or behavioral assessment procedures. As pain is a personal experience, subjective report is the only way to assess it. Conventional pain measurement practice assumes that patients and research subjects can exercise introspection to gauge the magnitude of some features of pain, assign numbers accordingly, and report such numbers without bias.

- ▶ Consciousness and Pain
- ▶ McGill Pain Questionnaire
- ▶ Pain Inventories
- ▶ Pain Measurement by Questionnaires, Psychophysical Procedures and Multivariate Analysis

## Pain Measurement by Questionnaires, Psychophysical Procedures and Multivariate Analysis

W. CRAWFORD CLARK

College of Physicians and Surgeons, Columbia University, New York, NY, USA  
clarkcr@pi.cpmc.columbia.edu

### Synonyms

Pain measurement; Pain Questionnaire; pain threshold; ratio scaling; sensory decision theory; multidimensional scaling; Cluster Analysis

### Definition

If we are to diagnose and treat pain and suffering in a rational manner, we must measure them accurately. Quantification is extremely difficult because what is commonly labeled “pain” is a multidimensional experience that possesses a large number of qualities or dimensions and varies over a wide range of intensities. Measurement is concerned with the process and rationale involved in the construction of a measuring instrument and the properties that can be ascribed to it. Measurement provides the bridge between the empirical phenomena themselves and the laws and theories that interpret them. The increasing sophistication of data collection procedures and measurement models is the hallmark of the steady growth of psychology from speculative philosophy to a scientific discipline. Unfortunately, the application of new measurement models in the field of pain has lagged far behind their successful application elsewhere.

This chapter reviews the advantages of recently developed data collection and analytical methods used to quantify three major classes of pain measurement models.

1. Questionnaires and rating scales.
2. Psychophysical procedures, traditional thresholds, sensory or statistical decision theory and ratio scaling.
3. Multivariate procedures, including multidimensional scaling and cluster analysis.

These quantitative procedures yield numerical values; however, the arithmetical and hence statistical operations that can be performed on them differ according to the level of measurement that they meet, as follows. For nominal scales, the basic empirical operation is the determination of equality, e.g. a player is a member of team A or of team B, the number on the player's jacket is unrelated to any physical quantity. An example of an appropriate statistical test is  $\chi^2$ . For ordinal scales, the basic empirical operation is the determination of greater or lesser; the numbers represent order, but the distance between the numbers is unknown, e.g. hardness of minerals and rank order data on Likert scales. Examples of appropriate statistical tests include non-parametric measures such as the Wilcoxon ranked sum test and rank order correlations. For interval scales, the basic empirical operation is the equality of the interval or distance, between the numbers, e.g. Fahrenheit and centigrade scales and standard deviation scores on intelligence tests. Examples of appropriate statistical tests include the t-test and product-moment correlations. For **ratio scales**, the empirical operation is the determination of equality of ratios, e.g. 2 inches is to 4 inches as 40 inches is to 80 inches, that is 1/2; one can not make this statement for the commonly used temperature scales. Ratio scales require both equal interval distances and a true zero origin. Examples are degrees Kelvin, weight, length, watts and lumens. Appropriate statistical tests include, in addition to tests appropriate for the three levels of measurement already described, coefficient of variation and decibel transformations. All four levels of measurement have been used to study pain.

The clinician must rely on the patient's report because, unlike blood pressure, body temperature, etc., pain is a personal experience that cannot be physically observed. Although the patient's own descriptions of pain are important, questionnaires are needed to ensure that all aspects have been covered and to construct a defined body of data for clinical and research use. The patient's response to questionnaires is an important addition to physical information for a number of reasons, accurate differential diagnosis, e.g., whether a patient's back pain has a neurological or muscular origin and optimal choice of treatment strategies, including the choice of medications, dosage, radiation, psychological intervention, etc. The patient's responses are also used to measure treatment progress and its success or failure, as well as the outcome of clinical trials and the evaluation of the health of populations. The collection of quan-

titative data also serves to increase our understanding of neural mechanisms, as well as psychosocial, gender and ethnocultural differences. This basic knowledge leads to improved medications and treatment regimens.

## Characteristics

### Questionnaires and Rating Scales

The number of items on a pain test varies greatly. The long questionnaires may have over 100 questions or items, short questionnaires have 12 to 30 items, while a unidimensional rating scale has a single item. Each of these procedures has a role in pain assessment, depending upon the information needed and the time available. The advantage of unidimensional rating scales is that they are brief; however, they are typically used to evaluate only one of the many dimensions of pain, the pain intensity dimension. Short questionnaires take less time, but provide less information than the longer forms. The advantage of the longer questionnaires, which are simply a large set of rating scales, is that they assess many dimensions of pain, sensory qualities, negative and positive emotions, motivation, etc.; however they are too lengthy for frequent use.

### Unidimensional Scales

There are three types of unidimensional scales. Visual analogue (VAS) and numerical rating scales (NRS) are anchored by descriptors at each end, e.g. from "no pain" to "pain as bad as it could be". The patient responds to the VAS by marking a point on a line between the anchors, and to the NRS by choosing a number from 1 to 10. The particular descriptor chosen for the anchor does not appear to be critical. Seymour et al. (1985) compared a number of anchors, "troublesome", "miserable", "intense", "unbearable" and "worst pain imaginable" and found that the exact wording made little difference to the pain intensity ratings obtained. Furthermore, patients with less education, the aged and patients in some other cultures find the VAS confusing (Kremer et al. 1981). The accuracy of the VAS has been likened to a thermometer without numbers. The problem with the VAS and NRS scales is that one patient may feel that the proper location for "faint pain" is close to the "no pain" anchor while another may believe that it should be towards the middle of the scale. This problem is effectively resolved by the verbal category scale (VCS). To take an example from a threshold study of calibrated heat intensities, patients select a word from a set of descriptors ordered with respect to intensity, e.g. "no sensation", "warm", "moderate heat", "hot but not painful", "faint pain", "moderate pain", "severe pain", "withdraw". The facial expression category scale is mostly used with children and ranges from a smiling face and the statement "no hurt" through a frowning face, "hurts even more" to a crying face, "hurts worse." Scales with an even number of items are superior because the patient is forced to choose between the lower



or the upper half of the scale; an indifferent patient cannot avoid a difficult decision by picking the middle item.

A serious problem with all of the unidimensional pain intensity scales is that the patient's emotional state greatly influences the sensory pain intensity rating. Clark et al. (2002) studied postoperative pain in patients recovering from surgery who responded to both the 101 item MAPS, a multidimensional pain questionnaire and to a unidimensional pain numerical rating scale (PNRS). Multiple linear regression analysis revealed that scores on four of the eight subclusters in the MAPS emotional pain supercluster anxiety, depressed mood, fear and anger significantly predicted the patients' score on the pain rating scale. Even more surprisingly, none of the 17 subclusters in the somatosensory pain supercluster predicted scores on the PNRS. It was concluded that patient scores on unidimensional pain intensity scales reflect the emotional impact of pain much more than the sensory intensity of the pain. Obviously, such pain scales are poor indicators of the intensity of the patient's sensory pain and of the analgesic dosage required. These findings also suggest that the patient's anxiety and depression are poorly measured and hence inadequately treated. A treatment decision between increasing the dosage of an analgesic or instead adding a psychotropic drug cannot be made on the basis of a score on a pain intensity rating scale alone; clearly, as a minimum, the patient also should respond to unidimensional rating scales of negative emotions in addition to a pain scale. This was done by Knotkova et al. (2004), who found in a study of patients experiencing cancer related pain, that scores on a pain PNRS were significantly correlated with items in the MAPS somatosensory pain supercluster and that scores on the unidimensional anxiety and depression NRS were respectively correlated with the anxiety and depression items in the MAPS emotional pain supercluster. Thus, the MAPS questionnaire yielded much more information; the rating scales were sufficient to determine which of the patients with a high score on the pain intensity rating scale should have an increase in analgesic dosage and which should have an increase in psychotropic medication.

### Short Questionnaires

The clinical use of long questionnaires is limited by their length and the burden on incapacitated patients; however, attempts to circumvent this practical problem by resorting to a single pain rating scale fails to yield sufficient information for effective treatment strategies. Accordingly, a short questionnaire fills an important niche in clinical practice and research because it takes less time than the long form and provides much more information than a single rating scale.

Short questionnaires are usually constructed by reducing the number of items in an existing instrument (Coste et al. 1997). Shortening an existing instrument is prefer-

able to constructing a new one because it allows one to bypass the selection of items from a larger untested pool of items that must be defined anew. Typically, the longer form is shortened by a group of experts who select what they believe to be relevant items for inclusion. This is a dubious practice because experts have been found to disagree on two-thirds of the descriptors regarded as relevant to a particular patient population (Sonty et al. 2004). A separate problem is that most short questionnaires are considered to be applicable to any illness. This results in a serious loss of information in the short form because many of the descriptors are irrelevant for a particular disease. This loss is reflected in the small number of factors found with short forms. For example, studies with the long MPQ have yielded from four to as many as seven factors compared with one or two factors found with short forms of the MPQ (Wright et al. 2001). To be effective, the items on a short questionnaire should be tailored to contain items that are relevant to a specific patient population.

Instead of relying on the opinions of experts, item analysis should be used to shorten questionnaires. Item analysis is a superior way to construct a short questionnaire from a long version because an objective procedure determines the most relevant items. Furthermore, the patients themselves, not "experts," determine which items are relevant. Griswold and Clark (2005) used item analysis to examine the responses of 100 outpatients with cancer to the long 101 MAPS questionnaire. The item analysis procedure yields measures of inter-item consistency, the average of the degree to which the score on each item is correlated with the score on every other item and ► **discriminability**, how well each item contributes to the total score, that is to the desired construct. In addition, Cronbach's alpha demonstrated that the items within the 101 MAPS subclusters were homogeneous; thus, any item within a cluster is fairly representative of the entire cluster. To construct the 30 item short MAPS (SMAPS) questionnaire the item within each cluster that best met the item analysis criteria was selected. Representation of each of the 30 subclusters ensured that the structure of the MAPS dendrogram obtained by cluster analysis was maintained in the 30 item SMAPS.

### Psychophysical Procedures: Traditional Thresholds, Statistical or Sensory Decision Theory and Ratio Scaling

#### Traditional Thresholds

Grossberg and Grant (1978) provide an excellent, detailed examination of the topics presented in this section. The traditional methods of serial exploration and constant stimuli are two methods commonly used to determine the pain threshold or its inverse, sensitivity. In the method of serial exploration or limits, the subject responds "not painful" or "painful" to stimuli that are presented in serial order with respect to intensity. The pain detection threshold is the interpolated stimulus intensity between the last report of "not painful" and the

first report of “pain,” while the pain tolerance threshold lies between the highest intensity that yields a “severe pain” response and the intensity that causes a withdrawal response. Usually five or more thresholds are averaged to obtain a mean threshold value. The advantage of the method of limits is that it is quick and because the ascending series begins at a relatively low intensity, it avoids the shock to patients who might experience pain from a very low intensity stimulus (e.g. patients with causalgia).

In the method of constant stimuli, the subject responds “not painful” or “painful” to a set of about five different stimulus intensities, selected by the investigator, that are presented randomly with respect to intensity. The method of constant stimuli is clearly superior to the method of limits because it avoids the errors of anticipation (premature report of an expected perceptual change) and habituation (repetition of the previous report). Both the methods of limits and constant stimuli yield thresholds expressed in physical units (degree centigrade, watts, lumens, etc.) at the interval scale level of measurement. Although the methods of limits and constant stimuli may be useful in clinical practice, their use in research studies is indefensible because the traditional threshold obtained by these methods is an unresolvable mixture of neurosensory sensitivity and attitudinal or response bias, the tendency to favor a particular response over another. Thus, as Clark (2003c) emphasizes, it is impossible to determine whether a high threshold (few pain reports) is caused by sensory deficit or by a psychological attitude (e.g. stoicism).

### Sensory Decision Theory (SDT)

The statistical decision making or ► [sensory decision theory](#) model provides a quantitative solution to the problem of distinguishing sensory sensitivity  $P(A)$  or  $d'$ , from response bias  $B$  or  $Lx$ . These numerical values are at the interval scale level of measurement. The discrimination parameter,  $P(A)$  or  $d'$ , quantifies the observer’s ability to distinguish event A from event B, where the events may be higher and lower stimulus intensities, different physiological states, (e.g. present or absent gastric contractions), previously viewed or expressed words and new words (pain memory).  $P(A)$  is a non-parametric measure, while  $d'$  assumes normal distributions of noise and signal plus noise. In the instance of laboratory induced pain, the discriminability index,  $P(A)$  or  $d'$ , provides a pure measure of the functioning of the neural pathways mediating pain; for example, it has been found to be decreased by analgesics. The other SDT parameter is response bias,  $B$  or  $Lx$ , which quantifies the decision maker’s tendency to favor the reporting of one of the events over the other. It reflects the patient’s attitude concerning which stimulus intensities are to be called “painful” or “not painful;” it has been shown to be influenced by suggestion and by placebos described as analgesics. Differences in traditional thresholds between ethno-

cultural groups, between old and young subjects and between patients and normals have been demonstrated to be related to report bias,  $B$  or  $Lx$ . It is obvious that the commonly held belief that traditional thresholds are pure measures of sensory sensitivity uninfluenced by the subject’s attitude is patently false; the threshold is an unresolvable conglomerate of physiological and psychological variables (see review by Clark 2003a).

### Ratio Scaling

Baird and Noma (1978) provide an excellent review of ratio scaling. The most commonly used ratio scaling technique is magnitude estimation (Stevens 1975). Here the investigator presents a particular stimulus intensity and assigns it a numerical value (the modulus). The subject is then presented with stimuli of various intensities and after each presentation judges the intensity ratio between the stimulus and the modulus, e.g. three times greater, two times less. A plot of the ratio judgments averaged over a number of subjects (ordinate) against an arithmetic scale of the physical intensities (abscissa) yields an exponential function, termed a power function, that describes the increase along the response scale (R) that corresponds to an increase along the stimulus intensity scale (S). In brief, equal stimulus intensity ratios (S) produce equal subjective ratios (R).

The equation expressing this relationship is,

$$R = \lambda S^n$$

The constant  $\lambda$  is simply a way to change the unit of measurement; for example, we multiply by 100 to convert meters to centimeters.

When this equation is rewritten logarithmically, it yields the linear equation,

$$\log R = n \log S + \log \lambda$$

A plot of R against S on double logarithmic paper yields a best fitting straight line with a slope of  $n$ , the exponent, and an intercept  $\lambda$ . Some examples of sensitivity (slope) to various stimuli are electrical pain, 3.5, heaviness, 1.1, length of lines, 1.0 and brightness 0.3. The size of the pain exponent has been questioned; studies report slopes of 1.8 and 2.2. Stevens later predicted that, since pain is mediated by a separate neurosensory system, noxious stimulus intensities should yield a different equation and slope. A radically different approach to psychophysical scaling described below has been found to yield two different, but much smaller exponents, one for non-painful electrical stimuli, 0.69, and another, 0.26, for painful electrical stimuli.

### Contextual Effects

If the ratio scaling approach is valid, then the response scales, that is, the exponents and intercepts for each sensory modality should be relatively invariant. However, Baird and Noma (1978) review a number of studies in which the expected invariance is not found under a variety of conditions, including different instructions, changes in modulus intensity, whether judgments are

a multiple or a fraction of the modulus intensity and differences in the range of intensities of the comparison stimuli. The influence of these non-sensory variables is termed context effects. Even attitudinal differences can have an effect. Baird et al. (1972) demonstrated that giving different groups information about the experimenter's belief in the relation between line length and the number scale, caused the exponents to vary from 0.31 to 1.71. If the exponent is a pure measure of sensory sensitivity, it should not vary with induced changes in the subject's attitude. Contextual effects are probably responsible for the wide individual differences found among observers. This variability makes it necessary to average the responses of a large number of observers in order to obtain a stable exponent. Such average data are of no use in the clinic where treatment decisions must be tailored to each patient. It should be noted that the sensory decision theory yields a much purer measure of sensory function,  $P(A)$  or  $d'$ , because the context effects are segregated into the report bias parameter,  $B$  or  $Lx$ . The presence of context effects demonstrates that both the power law and its exponents are not pure measures of sensory function, at least when data are collected by standard ratio scaling procedures.

Context effects present a serious problem for ratio scaling methodology. Although in a formal sense as long as the scales fulfill the criterion that equal stimulus ratios produce equal response ratios, the definition of a ratio scale remains untouched. However, it may be asked, what good are the ratio scales if a different one is required for each measurement condition? As Baird and Noma (1978) point out, we would not be happy with a ruler whose scale values depended upon whether it was used to measure the length of a desk or the height of a chair. The ratio scales obtained from human observers lack the invariance that is found with physical units such as centimeters, watts, lumens, etc.

#### Multivariate Analysis (MVA): Multidimensional Scaling (MDS) and Cluster Analysis (CA)

MVA includes a variety of mathematical models and data collection procedures (Lattin et al. 2003). The MDS and CA models are of particular interest here. These models yield geometric representations that make it possible for an investigator to uncover the "hidden structure" of complex databases. Both MDS and CA analyze pairwise similarity judgments based on a 10-point scale from "not at all similar" to "extremely similar" or some other measure of association, e.g. correlations, to generate proximities among a set of ► **stimulus objects** as input. Stimulus objects may be words, physical stimuli or concepts. The response data are organized into a half-matrix in which rows and columns correspond to stimulus objects and the cells contain some measure of similarity such as ratings on a similarity scale. MVS has two advantages over presently used methods for questionnaire construction. First, the descriptors are grouped objectively by

MVS analysis of similarity judgments; thus an investigator does not make a priori judgments about which descriptors belong to which sensory, affective, etc. group of items. Secondly, the similarity judgments are made by lay people who may very well view the similarity and grouping of the descriptors in a different way from the "experts." This is important because it is lay people who will be responding to the pain questionnaire. That experts and lay people differ was demonstrated by Clark et al. (1995) who, using cluster analysis of similarity responses by college students found no evidence to support the homogeneous status claimed for descriptors in the MPQ major evaluative class; furthermore, many of the words assigned to each of the 22 subgroups of the MPQ were found to be dispersed among different clusters.

#### Multidimensional Scaling Models (MDS)

For the MDS models, analysis of the same similarity half-matrices described above yields the ► **group stimulus space**, a configuration of points (the stimulus objects) as on a map. The stimulus objects appear along specific dimensions, e.g. sensory, affective and motivational in continuous space at the interval level of measurement. A ► **dimension** is a characteristic that defines a point by its coordinates. Another advantage of some of these multidimensional models (e.g. individual difference scaling [INDSCAL]) is that they quantify individual differences by providing subject coordinates in the source or subject weight space. The coordinates locate each individual with respect to the dimensions in the group stimulus space. The location of the coordinates quantifies the ► **saliency** or relative importance of each dimension to each individual. The coordinates of each individual subject weight can be used to distinguish among subpopulations in the sample and can be correlated with individual scores on psychological, sensory or other measures.

INDSCAL has led to a novel approach to quantifying separately the neurosensory and the attitudinal components of the pain rating response to calibrated physical stimuli; the technique also can be used to construct verbal category scales at the interval scale level of measurement (Clark 2003b). First, subjects made 120 pairwise similarity judgments to all possible pairings of 8 electrical stimuli that ranged from non-noxious to noxious intensities and 8 related pain, somatosensory and affect descriptors. Analysis by INDSCAL yielded a one-dimensional solution with the physical and verbal stimulus objects interdigitated with respect to their subjective magnitude. These coordinate values (ordinate) were plotted against the scale of electrical intensities in milliwatts (mW). Two distinct log-log linear functions with different slopes and intercepts that confirmed Stevens's psychophysical power law were found. The lower intensity function with a slope of 0.69 ranged from the descriptor "slight sensation" and the 3 mW physical stimulus to "faint pain" and 63 mW, while the higher intensity function with a slope of 0.26 ranged from "upsetting"

and 88 mW to “severe pain” and 235 mW. The finding of two functions demonstrates the superiority of the INDSCAL approach over the magnitude estimation method, which was found to yield only a single function over a comparable set of electrical stimulus intensities. Since both the verbal and physical stimulus functions are at the interval scale level of measurement, it is possible to quantitate precisely the perceived intensities of the verbal descriptors at the interval scale level of measurement. The superiority of multidimensional scaling over magnitude estimation resides in differences between the judgment tasks. The judgment of similarity between two stimulus objects allows the participant, not the investigator, to determine the dimension(s) that s/he considers relevant. Furthermore, the task of judging the similarity between two stimulus objects that are simultaneously present is much more direct and simple than comparing the relative strength of a test stimulus to the remembered strength of a previously presented standard stimulus (modulus). It has been demonstrated that cancer patients find the somatosensory pain dimension to be more salient than do healthy controls. This and other applications of MDS using either pain descriptors or physical, electrical and thermal stimuli as stimulus objects to determine the number and characteristics of pain dimensions are reviewed elsewhere (Clark 2003a).

#### Cluster Analysis

The half-matrix obtained from pairwise similarity judgments just described for MDS can also be analyzed by one of the cluster analysis models. Indeed, the two models often provide complementary information and it is recommended that the same data set be analyzed both ways. Cluster models represent the structure of a set of stimulus objects (descriptors) and subsets of clusters in discrete space, where each cluster corresponds to a meaningful, homogeneous feature. Hierarchical agglomerative models (e.g. average linkage between groups) yield non-overlapping hierarchically organized, nested clusters, i.e. each cluster can be subsumed as a member of a larger, more inclusive, supraordinate cluster. A set of these hierarchically ordered clusters plotted along a relative similarity axis is termed a dendrogram. Clark et al. (1995) analyzed similarity judgments made to 270 descriptors of sensory pain, negative and positive emotions, motivations, physical illness, etc.; they found 50 subclusters subsumed under 18 primary clusters. Obviously, the objective cluster analysis approach to questionnaire construction is superior to the subjective, a priori approach of pain experts. In a subsequent study (Clark et al. 2003a), healthy male and female African-American, Euro-American and Puerto Rican subjects sorted 189 descriptors into similar piles (pile sort technique) and then sequentially merged their piles based on similarity judgments until only two piles remained (merge technique). After removing redundant descriptors and descriptors that had different meanings among

the six sex/ethnocultural groups, i.e. were located in different clusters, there remained a dendrogram containing 101 descriptors in 30 clusters subsumed within three superclusters, somatosensory pain, negative emotions and well-being. The 101-item multidimensional affect and pain survey (MAPS) is based on this dendrogram. Thus, unlike the other questionnaires, the MAPS is based on the structure of the empirically derived dendrogram that emerged from the participants' own views of their sensory-emotional pain space. Factor analysis has demonstrated the validity of MAPS and hence the advantage of the cluster analytic approach to test construction (Clark et al. 2003).

#### Conclusions

This review should make it clear that many procedures that have been demonstrated to be inadequate for the accurate assessment of pain and suffering are still in use, while procedures proven to be superior tend to be ignored. For example, long questionnaires are based on subjective, a priori judgments of the investigators rather than being constructed by cluster analysis of lay persons' similarity judgments; short questionnaires are based on the investigators' opinion, not objectively by item analysis of patients' ratings on long questionnaires; sensory sensitivity is still determined by the method of serial exploration, not by statistical or sensory decision theory; and, multidimensional scaling is seldom used to determine which pain dimension is most relevant to various patient groups.

#### Acknowledgments

This essay and much of the research by Clark and colleagues was supported by USPHS grants NINCDS-20248 and NICDR-12725, and by the Nathaniel Wharton Fund for Research and Teaching in Brain, Body and Behavior.

#### References

1. Baird JC, Noma E (1978) Fundamentals of scaling and psychophysics. Wiley, New York
2. Baird JC, Kriendler M, Jones K (1972) Generations of multiple ratio scales with a fixed stimulus attribute. *Percept Psychophys* 9:399–403
3. Clark WC (2003a) Pain, emotion, and drug-induced subjective states: applications of multivariate scaling. In: Adelman G, Smith B (eds) *Encyclopedia of Neuroscience*, 3rd edn (CD-ROM). Elsevier, Amsterdam, Netherlands
4. Clark WC (2003b) Do women actually experience more pain than men or do they merely report more? A multidimensional scaling approach. European Federation of the International Association for the Study of Pain, Prague, Czech Republic. *Book of Abstracts*, p 446
5. Clark WC (2003c) Comments on: Petzke et al. Increased pain sensitivity in fibromyalgia: effects of stimulus type and mode of presentation, *Pain* 105:403–413; and the related editorial: Hyperalgesia versus response bias in fibromyalgia, *Fillingim*. *Pain* 105:385–386
6. Clark WC, Fletcher JD, Janal MN (1995) Hierarchical clusters of 270 pain/emotion descriptors: toward a revision of the McGill Pain Questionnaire. In: Bromm B, Desmedt J (eds) *Pain and the*



- Brain: From Nociception to Sensation. Raven Press, New York, pp 319–330
7. Clark WC, Kuhl JP, Keohan ML et al. (2003) Factor analysis validates the cluster structure underlying the Multidimensional Affect and Pain Survey (MAPS), challenges the a priori classification of the descriptors in the McGill Pain Questionnaire (MPQ) and demonstrates sex differences in cancer patients. *Pain* 106:375–363
  8. Clark WC, Yang JC, Tsui SL et al. (2002) Unidimensional pain rating scales: a multidimensional affect and pain survey (MAPS) analysis of what they really measure. *Pain* 98:241–247
  9. Coste J, Guillemin F, Pouchot J et al. (1997) Methodological approaches to shortening composite measurement scales. *J Clin Epidemiol* 50:247–252
  10. Griswold GA, Clark, WC (2005) Item Analysis of cancer patient responses to the multidimensional affect and pain survey demonstrates high inter-item consistency and discriminability and determines the content of a short form. *J Pain* 6:67–74
  11. Grossberg JM, Grant BF (1978) Clinical psychophysics: applications of ratio scaling and signal detection methods to research on pain, fear, drug and medical decision making. *Psychol Bull* 85:1154–1176
  12. Knotkova H, Clark WC, Mokrejs P et al. (2004) What do ratings on unidimensional pain and emotion scales really mean? A Multidimensional Affect and Pain Survey (MAPS) analysis of responses by cancer patients. *J Pain Symptom Manage* 28:19–27
  13. Kremer E, Atkinson JH, Ignelzi RJ (1981) Measurement of pain: patient preference does not confound pain measurement. *Pain* 10:241–248
  14. Lattin JM, Carroll JD, Green PE (2003) *Analyzing Multivariate Data*. Duxbury Press, Belmont
  15. Seymour RA, Simpson Jm, Charlton JE, Phillips ME (1985) An evaluation of length and end-phrase of visual analogue scales in dental pain. *Pain* 21:177–185
  16. Sonty N, Chokhavatia S, Griswold GA et al (2004) Studies of patients with cancer, low back pain, and irritable bowel syndrome demonstrate that short forms of the Multidimensional Affect and Pain Survey (MAPS) and other questionnaires must be tailored to each patient group. American Pain Society, Vancouver
  17. Stevens SS (1975) *Psychophysics*. Wiley, New York
  18. Wright KD, Asmundson JG, McCreary DR (2001) Factorial validity of the short-form McGill pain questionnaire (SF-MPQ). *Eur J Pain* 5:279–284

## Pain Measurement in the Elderly

- ▶ Pain Assessment in the Elderly

## Pain Mechanisms Investigation in Human Infants

- ▶ Infant Pain Mechanisms

## Pain Memory

STEPHEN MORLEY  
Academic Unit of Psychiatry and Behavioral Sciences,  
University of Leeds, Leeds, UK  
s.j.morley@leeds.ac.uk

### Synonyms

Recall; recognition; recollection

## Definition

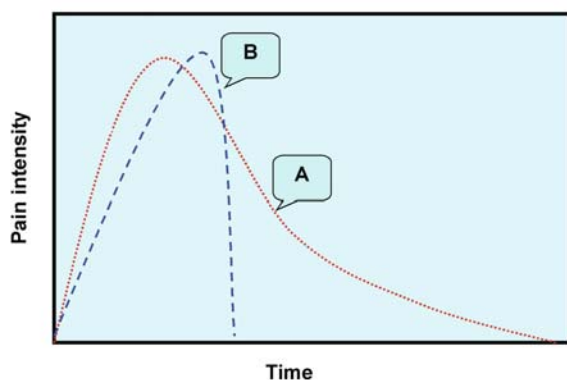
Human memory is an extensive and complex system. Memories are influenced by a variety of processes occurring at the time of encoding, the period of storage and the context of retrieval. Many memories are consciously accessible through language, and it is accepted that memories are reconstructed and influenced by the characteristics of the to-be-remembered material, and the conditions at the time of recall. There is extensive evidence for the influence of implicit memories (material of which the person is unaware) on behaviour and experience.

## Characteristics

Memory for pain has not been extensively or systematically studied, and it is only recently that studies of memory for pain have begun to appear. Many studies have been stimulated by important practical questions, concerning the ▶ **accuracy and reliability** of retrospective clinical judgements of pain and improvement as a result of treatment, but have lacked a strong theoretical rationale. Other relevant questions concern the influence of memory for pain on health behaviour e.g. willingness to attend dental investigations, or other potentially painful medical screening or diagnostic procedures. This essay considers factors that influence memory for discrete events in which pain is a defining characteristic, memory of persistent (chronic) pain, and memories that are characterised by the somatosensory re-experiencing of pain.

Contrary to earlier speculation, there is good evidence that people have ready access to ▶ **autobiographical memories** in which the experience of pain is a central feature – an *event memory* e.g. Morley (1993). Studies requesting participants to retrieve vivid memories of events report that up to 20% of such memories concern accidents or personal injury. When vivid memories are not specified, between 6%–12% of memories retrieved to neutral (non-pain-related) cues are of painful experiences. The presentation of pain-related cues, e.g. body parts, enhances recall of pain-related events by a factor of 2 to 3. Available data indicate that retrieval of pain-related memories in these studies is not influenced by the presence of current pain. Participants recall pain events ranging from trivial injury to more major trauma e.g. road traffic accidents. The accounts are often rich in information concerning the contextual setting in which the event occurred, and participants are frequently able to make judgments about the sensory-intensity and affective dimensions of the pain *experience memory*. In marked contrast to this, participants in these studies do not typically report the subjective recollection of the event; that is, they do not re-experience the sensory and affective qualities of the original event – a *somatosensory memory*. The biopsychological advantages of retrieving the event and its context but not the experience are readily apparent.

Due to the retrospective nature of most autobiographical studies i.e., there are no data on the original experience, it is not possible to determine which aspects of the original event influence the recalled experience of pain. Where these data are available, it has been possible to begin to answer this question. In Fig. 1 – curve A shows an idealised time course of a single event in which pain is experienced. There are three general models of how this experience may be processed and encapsulated in memory (Fredrickson and Kahneman 1993). The additive model proposes that the intensity of each moment of pain is summated: extending the experience with a series of low-intensity moments will therefore increase the total painfulness, and result in the recall of a greater pain experience. The simple averaging model averages the moments of pain giving each moment unit weight. This model predicts that the extension of the pain experience by a series of low-intensity moments will reduce the average pain experienced, and predicts that recalled pain will be reduced. Under this model, a short high-intensity pain is predicted to be recalled as less aversive than a longer low-intensity pain. A weighted averaging model allocates weights to different moments (the sum of the weights is constrained to 1). Empirical studies indicate that the peak and end of the experience are strongly predictive of recalled experience (Redelmeier and Kahneman 1996). The model, therefore, weights these two features of the experience and assigns zero, or very small weight, to other moments. It implies the phenomenon of *duration neglect*, i.e. that the duration of the painful event is relatively unimportant in determining recalled experience. Thus, in Fig. 1, the experience represented by curve B will be recalled as more painful than that represented by curve A, although B represents less total pain. The model predicts that interventions to reduce the amount of recalled pain and suffering should be targeted at reducing the peak-experience and ensuring that the end of the event is characterised by a slow decline, rather than an abrupt cessation of pain, and rather than by a premature attempt to eliminate pain completely. Appli-



**Pain Memory, Figure 1** Time course of two pain events - plotting pain intensity against time. See the text for an explanation.

cations of this model are pertinent where painful procedures cannot be avoided. Managing the individual's pain experience to conform to the peak-end requirements is predicted to reduce recalled suffering, and to enhance later compliance to similar painful procedures. For example, Redelmeier et al. (2003) showed that extending the duration of colonoscopy at low pain intensity reduced the patients recalled less total pain. There is evidence that chronic pain patients also discount pain free periods when asked to recall their usual level of pain over the past week. As a consequence, the recalled usual pain overestimates the average experienced pain (Stone et al. 2004), indicating that retrospective estimates of pain are poorly suited to evaluating treatments where intermittent pain relief might be expected.

A person's expectation of a painful event is also consistently associated with variation in recall accuracy. Evidence from clinical observational studies indicates an individual's expectation of pain experience is frequently more strongly correlated with recalled pain, than is the actual experience. In clinical studies this relationship may be moderated by the individual's characteristics. For example, the presence of high anxiety in the relationship between expectation and recall is marked, but low anxiety attenuates or eliminates the relationship (Erskine et al. 1990). Expectation has also been established as a significant influence on recall in experimental studies. Price et al. (1999) elegantly demonstrated that placebo effects, based on remembered pain, were significantly (3–4 times in this study) greater than the concurrently estimated effect, and the recalled placebo effects were strongly related to an individual's expected pain levels.

The person's state, both at the time of the to-be-remembered experience and at the time of recall, have an influence on recalled pain. Several studies of chronic pain patients report that at the time of recall, if patients' pain levels are lower than at the period about which they are asked to make a memory judgement, then the recalled pain level is less than that reported. Similarly, a relatively raised level of pain at the time of recall is associated with an overestimation of the original pain. Eich et al. (1985) called this an assimilation effect. Experimental studies in which pain levels at the time of recall have been manipulated confirm the effect, and also indicate that the bias is present when other concurrent aspects of the pain experience are assessed, such as affect and drug use. In chronic pain patients, the relative importance of pain at the time of recall appears to increase, as the time since the original event increases (Haas et al. 2002), i.e. the original state becomes less important. For acute pain, however, there is evidence that negative emotions at the time of the to-be-remembered event are the stronger mediator of recall as time increases (Gedney and Logan 2004). These complex findings require further theoretical development, but may be partly understood in the context

of how an individual combines their implicit theory of events (expectations of pain experience over time) and information about their current state, relative to their implicit theory to reconstruct the original event (Ross 1989).

Somatosensory memory has not been extensively investigated, but there are sufficient observations to confirm the existence of such memories. Vivid recollection of previously experienced pain, complete with the accompanying affect, can be evoked by direct brain stimulation (Lenz et al. 1997). Somatosensory memories have also been reported by patients with phantom limbs (Katz and Melzack 1990) and in PTSD sufferers (Salomons et al. 2003). Under normal circumstances, the somatosensory memory would appear to be ‘inhibited’ and not accessible via verbal recall (c.f.) (Brewin et al. 1996). Compromised neurobiological integrity or altered states of consciousness appear to be prerequisites for the experience of somatosensory memories. The phenomenon is not well understood.

► **Statistical Decision Theory Application in Pain Assessment**

## References

1. Brewin CR, Dalgleish T, Joseph S (1996) A Dual Representation Theory of Posttraumatic Stress Disorder. *Psychol Rev* 103:670–686
2. Eich E, Reeves JL, Jaeger B, Graff-Radford SB (1985) Memory for Pain: Relation between Past and Present Pain Intensity. *Pain* 23: 375–380
3. Erskine A, Morley S, Pearce S (1990) Memory for Pain: A Review. *Pain* 41: 255–265
4. Fredrickson BL, Kahneman D (1993) Duration Neglect in Retrospective Evaluations of Affective Episodes. *J Pers Soc Psychol* 65:45–55
5. Gedney JJ, Logan H (2004) Memory for Stress Associated Acute Pain. *Journal of Pain* 5: 83–91
6. Haas M, Nyiendo J, Aickin M (2002) One-Year Trend in Pain and Disability Relief Recall in Acute and Chronic Ambulatory Low Back Pain Patients. *Pain* 95: 83–91
7. Katz J, Melzack R (1990) Pain ‘Memories’ in Phantom Limbs: Review and Clinical Observations. *Pain* 43:319–336
8. Lenz FA, Gracely RH, Zirh AT, Romanoski AJ, Dougherty PM (1997) The Sensory-Limbic Model of Pain Memory. *Pain Forum* 6: 22–31
9. Morley S (1993) Vivid Memory for ‘Everyday’ Pains. *Pain* 55: 55–62
10. Price DD, Milling LS, Kirsch I, Duff A, Montgomery GH, Nicholls SS (1999) An Analysis of Factors that Contribute to the Magnitude of Placebo Analgesia in an Experimental Paradigm. *Pain* 83: 147–156
11. Redelmeier DA, Kahneman D (1996) Patients’ Memories of Painful Medical Treatments: Real-Time and Retrospective Evaluations of Two Minimally Invasive Procedures. *Pain* 66: 3–8
12. Redelmeier DA, Katz J, Kahneman D (2003) Memories of Colonoscopy: A Randomized Trial. *Pain* 104:187–194
13. Ross M (1989) Relation of Implicit Theories to the Construction of Personal Histories. *Psychol Rev* 96:341–357
14. Salomons TV, Osterman JE, Gagliese L, Katz J (2003) Pain Flashbacks in Posttraumatic Stress Disorder. *Clin J Pain* 20:83–87
15. Stone AA, Broderick JE, Shiffman SS, Schwartz JE (2004) Understanding Recall of Weekly Pain from a Momentary Assessment Perspective: Absolute Agreement, Between- and Within-Person Consistency, and Judged Change in Weekly Pain. *Pain* 107:61–69

## Pain Modulation

► **Descending Modulation of Nociceptive Processing**

## Pain Modulatory Circuitry and Endogenous Pain Control

► **Descending Circuitry, Molecular Mechanisms of Activity-Dependent Plasticity**

## Pain Modulatory Pathways

► **Descending Circuitry, Opioids**

## Pain Modulatory Systems, History of Discovery

GREGORY W. TERMAN

Department of Anesthesiology and the Graduate Program in Neurobiology and Behavior, University of Washington, Seattle, WA, USA  
gwt@u.washington.edu

### Synonyms

Pain-Inhibitory Systems; Pain-Facilitatory Systems

### Definition

Activation of nociceptive pathways by tissue damage promotes the important ability of an organism to perceive pain and make a subsequent adaptive response. More surprising, teleologically, is the existence of endogenous pain modulatory systems that function to inhibit or facilitate nociception, and thus alter the fidelity of pain perception. Nonetheless, since early in the 1970s, much evidence has accumulated to support the existence of such pain modulatory systems. Moreover, activation of ► **pain-inhibitory systems** has been demonstrated to subserve the analgesic effects of several new and age old therapies, and ► **pain-facilitatory systems** have been found to mediate pain in a number of animal models of clinical pain.

### Characteristics

The concept of descending pain modulation goes back to Sherrington in the early 1900s, and was an important part of Melzack and Wall’s gate control theory of pain in 1965 (Melzack and Wall 1965). However, there was little direct evidence for dedicated pain modulatory systems until Reynolds, in 1969, reported that electrical stimulation of the midbrain ► **periaqueductal gray**

(PAG) resulted in sufficient analgesia to perform laparotomy in rats. Liebeskind and his colleagues replicated this phenomenon and labeled it “stimulation-produced analgesia” (SPA) (see ▶ [Stimulation-produced analgesia](#)). Moreover, in a series of studies spanning two decades they identified the anatomical, electrophysiological and neurochemical substrates of at least one neural system descending from brain to spinal cord, whose normal function was the inhibition of pain. Many laboratories have since studied this endogenous pain-inhibitory system and have found it to be potent, specific for pain, dependent on pathways from PAG through rostral ventral medulla down the dorsolateral funiculus of the spinal cord, and effective in inhibiting pain transmission as early as the first nociceptive synapse between primary afferent and spinal dorsal horn (Basbaum and Fields 1978; Mayer and Price 1976).

Another important characteristic of endogenous pain-inhibitory systems, found in early studies, was that these systems, activated by SPA, might also subserve analgesia from opiate drugs (Mayer and Price 1976). The same brain regions from which SPA can be elicited are rich in opiate receptors, and can produce analgesia when microinjected with opiates. Like opiate analgesia, tolerance develops to the analgesic effects of repeated brain stimulation, and cross-tolerance develops between opiate analgesia and SPA suggesting a common underlying mechanism. Finally, opiate antagonists such as naloxone can antagonize SPA (although this finding was not universal). The commonality between opiate and endogenous pain inhibition encouraged the search and eventual identification of the endogenous opioid peptides (Hughes et al. 1975). Additional neurochemicals implicated in mediating endogenous pain inhibition include serotonin, norepinephrine, acetylcholine acting at nicotinic receptors and the endogenous cannabinoids. Each of these has been studied as potential new analgesic therapeutics, although thus far the clinical utility has been hampered by low efficacy or toxic side effects. Of more apparent clinical utility was the success of SPA in inhibiting pain in some patients. Unfortunately, there are still no long-term placebo controlled studies demonstrating success of this invasive and complicated therapy in alleviating pain in humans.

One alternative approach to identifying clinical applications of our knowledge of endogenous pain-inhibitory systems is to identify less invasive approaches to activating these systems. Given the importance of nociception for survival, it has been widely assumed that pain-inhibitory systems would be most active during times of life threatening stress. Enduring pain in order to escape a predator, for example, might provide an adaptive advantage to animals that could inhibit nociception at least temporarily. The missionary, David Livingstone, wrote of his mauling by a lion that he had a feeling “of dreaminess in which there was no sense of pain”. Moreover, numerous battlefield stories of seriously

wounded soldiers without apparent pain exist. Tissue damage is not required to activate pain-inhibitory systems, however, and animal models of these phenomena have been labeled “▶ [stress-induced analgesia](#)” (Akil et al. 1976). Electric shock, restraint, rotation, forced swim, and intruder threat can all produce analgesia in laboratory animals without producing identifiable tissue damage (Hayes et al. 1978). Like SPA, early studies of SIA differed in the reported involvement of opioid peptides. Timing, severity and location of a single stressor were all eventually reported to differentially produce opioid and nonopioid SIA (Terman et al. 1984). Moreover, opioid SIA itself proved not to be a unitary phenomenon, although lesion and cross-tolerance studies have demonstrated an anatomical and neurochemical overlap (including overlap with opioid SPA). Some forms of opioid SIA, although depending on descending pain-inhibitory pathways, appear to be activated entirely by the physical properties of the stressor, and can be elicited even in the surgically anesthetized animal (Terman et al. 1984). On the other hand, other forms of opioid SIA depend on learning mechanisms and can be blocked by decerebration, muscarinic antagonists, amygdala lesions, and pentobarbital anesthesia. Placing rats in a cage where footshock was previously received, but is not currently administered, can also elicit analgesia (“▶ [conditioned analgesia](#)”). Evidently, animals cannot only activate their intrinsic pain-inhibitory systems in the presence of stress, but they can also learn to activate them in anticipation of such stimuli. Unconditioned expectations also appear capable of activating opioid descending pain-inhibitory substrates. The scent of an animal’s natural predator, for instance, can induce analgesia. In man, ▶ [placebo analgesia](#) is also dependent on expectation and conditioning, and is mediated by endogenous opiates and associated with activity in brainstem regions which support SPA (Benedetti and Amanzio 1997). A specific example of learned opiate SIA is the phenomenon of “learned helplessness”. Inescapable stress in the laboratory, on the battlefield or, as in Livingstone’s case, in the jungle, can eventually lead to exhaustion of all escape behaviors. Maier and colleagues demonstrated that rats actually learn to stop attempting escape from prolonged electric shock (termed “▶ [learned helplessness](#)”), and that they become analgesic in these conditions (Maier et al. 1983). This form of opioid SIA may be similarly activated by other intense forms of physical activity. Indeed, some hypothesize that this form of opioid SIA may occur in long distance runners world-wide, and motivate them to continue running even long after the lions have stopped chasing them.

Do studies of stress-induced analgesia have any other human applications? In addition to exercise, there are a number of pain-inhibitory phenomena in man provoked by procedures that might be considered stressful, including electric shock, acupuncture, moxibustion,



transcutaneous electrical nerve stimulation, and even sexual activity. Elucidating the neural basis of SIA might one day lead to the development of new approaches to pain management. Perhaps the greatest promise for such an advance lies in determining the neurochemistry of ► **nonopioid analgesia**. The similar efficacy of opioid and nonopioid SIA, bodes well for development of a novel nonopioid analgesic that does not show tolerance or cross-tolerance to mu opiates like morphine. The neurochemistry of “nonopioid” SIA, however, is still poorly understood despite considerable study. Probably the most convincing results have demonstrated ► **Kappa( $\kappa$ ) Opiate/Opioid Receptors** (not technically “nonopiate”) and/or ► **NMDA glutamate receptors** to be important in mediating such phenomena. It should be noted that NMDA receptors can also be pro-nociceptive, and thus reduction of SIA by NMDA antagonists could work by decreasing nociceptive input necessary for producing SIA. That is, they could have their effects on the afferent (activating) rather than the efferent side of a nonopiate pain inhibitory system. Le Bars et al, in a series of electrophysiological studies, reported just such a phenomenon termed, ► **Diffuse Noxious Inhibitory Controls** (DNIC), in the anesthetized rat (Villanueva and Le Bars 1995). Dorsal horn neuronal nociceptive responses are inhibited by noxious stimulation applied outside the neuron’s receptive field, but not if given in the presence of low doses of morphine, presumably because morphine inhibits the very nociceptive input that elicits DNIC. Thus, discriminating between a drug’s effects on ascending and descending mechanisms underlying SIA is important; particularly if one hopes to activate descending nociception inhibitory pathways without activating ascending nociceptive pathways, as would be clinically desirable. Moreover, the NMDA receptor story is a prime example of a change in emphasis in the pain modulation field, beginning in the 1990s, shifting away from studying pain-inhibitory systems and towards studying pain-facilitatory systems. Until the late 1980’s, virtually all small animal studies of nociceptive processes involved threshold changes in responses to some nociceptive stimulus (usually heat). This approach is likely to have grown out of a pre-conception that the central nervous system, in general, and nociceptive transmission circuitry, specifically, normally underwent little change during an organism’s adult life and was essentially hard-wired. Since that time an explosion of neuroscience research has demonstrated the amazing plasticity of the adult brain and spinal cord. Correspondingly, and perhaps in response to the studies of pain-inhibitory systems described above, pre-clinical pain researchers have developed and investigated numerous innovative pain tests and animal models of pain demonstrating that basic nociception is under complex modulatory influences. Much of this research has attempted to mimic clinically relevant pain states, such as inflammation

or nerve injury. Studies of such models have shown that the mechanisms underlying ► **inflammatory** and ► **neuropathic pain** differ considerably, and that both differ from more acute or “transient” pains represented by threshold studies in previously untreated animals. This has served to focus attention more than ever on pain modulation systems, due to overwhelming evidence that pain responses elicited by noxious stimuli are integrally dependent on the prior nociceptive experiences of an animal.

Following inflammation, a host of neurochemical changes take place in primary afferents that make them more responsive to noxious stimuli (► **hyperalgesia**), or produce a nociceptive response to normally non-noxious stimuli (► **allodynia**). These changes are termed ► **peripheral sensitization**. Changes also take place within the nervous system post-synaptic to the primary afferent, and these changes can also produce facilitations in nociceptive responses – termed “► **central sensitization**”.

Although Hardy in 1950 suggested that hyperalgesia following tissue injury or inflammation was due to changes in the spinal cord dorsal horn (secondary hyperalgesia), it was the work of Woolf and colleagues more than 30 years later that dramatically consolidated this concept. In 1983, Woolf reported that tissue injury caused an increase in responses (measured by motoneuron responses) that persisted even after local anesthetic blockade of the damaged tissue, suggesting central mediation of this sensitivity (Woolf 1983). Central sensitization has now been demonstrated in a number of laboratories using a variety of response endpoints (threshold stimuli, response frequency, and receptor field size), eliciting stimuli (thermal, chemical, acute joint inflammation and C-fiber electrical stimulation), and a number of inflammatory and neuropathic pain models.

Descending serotonergic influences are now clearly implicated in both facilitatory and inhibitory forms of pain modulation, with the facilitatory or inhibitory effects being due primarily to differential effects of different serotonergic receptor subtypes (of which there are many) or, instead, from differences in circuitry. Serotonin, for example, can activate both excitatory and inhibitory neural transmission in the spinal cord. Stimulation of serotonin-rich regions of the RVM can have excitatory or inhibitory effects on dorsal horn nociception at virtually overlapping stimulation sites dependent on the glutamate dose or electrical stimulation intensity administered, emphasizing the intermingling of nociceptive inhibitory and facilitatory cells in the brainstem as described by Fields. Like serotonin, norepinephrine may also have opposite effects on nociception, depending on the specific receptor subtypes and the neural circuitry activated. Microinjection of alpha2-adrenergic agonists into the RVM can inhibit the tail-flick response and produce a long-lasting decrease in ► **on-cell firing rate**; however, alpha1 no-

radrenergic receptor agonists excite RVM on-cells suggesting pain-facilitatory effects. Indeed, lesions of some noradrenergic inputs to RVM have been found to both potentiate morphine analgesia and inhibit sensitization, suggesting pro-nociceptive effects of norepinephrine. Other neurochemicals implicated in descending nociceptive facilitation include substance P, thyrotropin releasing hormone (TRH) and ► [cholecystokinin \(CCK\)](#). Descending nociceptive facilitatory systems may also work by potentiating or disinhibiting spinal cord facilitatory mechanisms including glutamate and/or nitric oxide. Indeed, CCKB receptors are coupled to the production of arachidonic acid and presumably its cyclooxygenase and lipoxygenase metabolites that modulate nociception in the spinal cord. Glial activation and cytokine release have also been implicated in descending nociceptive facilitation (Watkins et al. 1995).

In this essay we have described what is known about specific pain-inhibitory and facilitatory systems that descend from the brain to modulate nociception in the spinal cord. It is likely that similar modulation takes place at every rostral stop of the nociceptive message on its way to consciousness – though perhaps by different mechanisms. The pain patient's knowledge of descending pain modulation provides a psychological double-edged sword. The existence of inhibitory systems can provide hope for overcoming debilitating nociception. Descending facilitatory systems, however, provide fodder for fears of patients (or their doctors) that their pain is “all in their heads.” Such psychological dilemmas (and their treatment) are outside the scope of this essay but are integral to a full understanding of pain and its modulation.

## References

- Akil H, Madden J et al. (1976) Stress-Induced Increases in Endogenous Opioid Peptides: Concurrent Analgesia and its Partial Reversal by Naloxone. In: Kosterlitz HW (ed) *Opiates and Endogenous Opioid-Peptides*. Elsevier, Amsterdam, pp 63–70
- Basbaum AI, Fields HL (1978) Endogenous Pain Control Mechanisms: Review and Hypothesis. *Ann Neurol* 4:451–462
- Benedetti F, Amanzio M (1997) The Neurobiology of Placebo Analgesia: From Endogenous Opioids to Cholecystokinin. *Prog Neurobiol* 52:109–125
- Hayes RL, Bennett GJ, Newlon PG, Mayer DJ (1978) Behavioral and Physiological Studies of Non-Narcotic Analgesia in the Rat Elicited by Certain Environmental Stimuli. *Brain Res* 155:69–90
- Hughes J, Smith TW, Kosterlitz HW, Fothergill LA, Morgan BA, Morris HR (1975) Identification of Two Related Pentapeptides from the Brain with Potent Opiate Agonist Activity. *Nature* 258:577–580
- Maier SF, Sherman JE, Lewis JW, Terman GW, Liebeskind JC (1983) The Opioid/Nonopioid Nature of Stress-Induced Analgesia and Learned Helplessness. *J Exp Psychol Anim Behav Process* 9:80–90
- Mayer DJ, Price DD (1976) Central Nervous System Mechanisms of Analgesia. *Pain* 2:379–404
- Melzack R, Wall PD (1965) Pain Mechanisms: A New Theory. *Science* 150:971–979
- Terman GW, Shavit Y, Lewis JW, Cannon JT, Liebeskind JC (1984) Intrinsic Mechanisms of Pain Inhibition: Activation by Stress. *Science* 226:1270–1277
- Villanueva L, Le Bars D (1995) The Activation of Bulbo-Spinal Controls by Peripheral Nociceptive Inputs: Diffuse Noxious Inhibitory Controls. *Biol Res* 28:113–125
- Watkins LR, Maier SF, Goehler LE (1995) Immune Activation: The Role of Pro-Inflammatory Cytokines in Inflammation, Illness Responses and Pathological Pain States. *Pain* 63:289–302
- Woolf CJ (1983) Evidence for a Central Component of Post-Injury Pain Hypersensitivity. *Nature* 306:686–688

## Pain Nurse(s)

### Definition

A pain nurse is specially trained to work in an acute pain team, take care of patients, teach ward nurses and instruct patients in pain relieving methods.

► [Postoperative Pain, Acute Pain Team](#)

## Pain of Recent Origin

► [Acute Pain, Subacute Pain and Chronic Pain](#)

## Pain Ombudsman-Nurses

### Definition

Pain ombudsman nurses are specially trained to make sure that patients receive adequate pain relief in the ward they are responsible for.

► [Postoperative Pain, Acute Pain Team](#)

## Pain Paroxysms

RON AMIR<sup>1</sup>, Z. HARRY RAPPAPORT<sup>2</sup>, MARSHALL DEVOR<sup>1</sup>

<sup>1</sup>Institute of Life Sciences and Center for Research on Pain, Hebrew University of Jerusalem, Jerusalem, Israel

<sup>2</sup>Department of Neurosurgery, Rabin Medical Center, Tel-Aviv University, Petah Tikva, Israel  
ronamir@pob.huji.ac.il

### Synonyms

Pain attacks; lightning pain; lancinating pain; fit of pain

### Definition

A pain paroxysm is a sudden-onset, excruciating and usually brief and well-localized pain that can occur spontaneously with no obvious precipitating event or in response to a trigger stimulus. The term “paroxysm” derives from the Greek – “*paroxunein*”, to irritate, provoke or excite (literally to sharpen excessively).

## Characteristics

### Clinical Manifestation

Pain paroxysms are part of the clinical picture in a variety of neurological conditions, but especially in painful neuropathies. ▶ **Trigeminal neuralgia** is the prototypical neuropathic pain diagnosis that features pain paroxysms. Extremely intense, rapid onset, brief, well localized pain attacks cause the patient to wince, hence an alternative name for the condition, *tic douloureux* (French for painful wincing). Paroxysmal pain is also reported in other cranial nerve neuralgias, such as glossopharyngeal neuralgia, and is common in most chronic neuropathic pain states including traumatic neuropathies, postherpetic neuralgia, diabetic neuropathy and a variety of painful mono- and poly-neuropathies associated with metabolic disorders, toxins, radiation and genetic mutations (Otto et al. 2003; Scadding 1999; Zakrzewska 1999). Painful paroxysms are sometimes listed as a definitive diagnostic criterion for neuropathic pain, although this relationship should not be exaggerated. Painful neuropathies may present as intense burning pain without paroxysms, for example, and paroxysms can be present in conditions that are not neuropathic.

Pain paroxysms are also a characteristic of specific types of headaches, for example paroxysmal hemicrania, cluster headache, SUNCT (short-lasting, unilateral, neuralgiform headache attacks with conjunctival injection and tearing) and idiopathic stabbing headache (Pareja et al. 1996; Sharav 1999). In these conditions the paroxysms tend to be of slower onset, and of longer duration than in neuropathy. Finally, normal (nociceptive) and inflammatory pain can be paroxysmal in nature if a sudden, brief pain-provoking stimulus is applied, such as a sharp rap over the ulnar nerve at the elbow or an untoward movement in a patient with low back pain.

### Sensory Characteristics

There are no formal criteria for the suddenness of onset, intensity and brevity of a pain that would properly be called paroxysmal. In common usage, these parameters vary among painful conditions. Descriptions such as “shooting”, “electric-shock like”, “lancinating” and “lightning” reflect very rapid rise-time of the pain, less than a second. Terms such as boring and throbbing indicate slower onset times, perhaps of several seconds. Pain duration is typically a few seconds to a few minutes, although an attack may last much longer. Furthermore, attacks may repeat at frequent intervals or appear as exacerbations on top of a steady burning or cramping pain. In trigeminal neuralgia, for example, pain attacks sometimes repeat so frequently that one pain runs into the next, with the patient having the impression of a continuous, uninterrupted pain. It is more usual, however, for there to be hours, days or even months between attacks.

Pain paroxysms may be spontaneous or evoked. In the case of cluster headache, for example, there is no obvious trigger for individual paroxysms, although a number of environmental factors may increase the likelihood of a series (i.e. a cluster) of attacks. Likewise, in trigeminal neuralgia, lightning attacks may arise spontaneously. However, in this condition it is usually possible to identify a “trigger point” at which very light touch consistently evokes a painful paroxysm (Kugelberg and Lindblom 1959). The pain is usually felt at the point of stimulation, although it often radiates beyond. Sometimes the touch needs to be repeated several times in order to evoke an attack, and the pain may follow the evoking stimulus by several seconds. In patients in whom the trigger spot is in a location that is subject to repeated unintended stimulation, such as within the oral cavity during chewing or swallowing, evoked paroxysms may appear to be spontaneous.

When a painful paroxysm is evoked from a trigger point, the pain almost always outlasts the stimulus by at least a second or two and fills an area larger than that stimulated. The mismatch in time and space indicates that an intrinsic pain source is kindled. Triggering is not simply amplification, as when light touch to tender skin evokes a sensation of pain (tactile allodynia). Indeed, in the region of the trigger point in trigeminal neuralgia, the skin tends to show reduced sensitivity to touch. Finally, evoked pain paroxysms tend to be followed by a “refractory period” that lasts for several seconds or minutes after an evoked attack. During the course of the refractory period, intentional stimulation of the trigger point fails to evoke a second attack (Kugelberg and Lindblom 1959).

### Mechanism

The pathophysiological substrate(s) of pain paroxysms is not known with much certainty. However, the striking characteristics of the sensation: sudden, intense, brief and localized, constrain the likely possibilities. Sensory experience in a conscious brain reflects corresponding impulse activity. Accordingly, a pain paroxysm presumably reflects a brief, rapid onset and intense barrage of impulse activity in a large, localized population of neurons. In the case of pain paroxysms evoked by a sudden intense noxious stimulus applied to intact and inflamed tissue, there is little mystery. The challenge is to understand spontaneous paroxysms, and painful paroxysms evoked by weak, non-noxious stimuli. Naturally, speculation on this subject tends to revolve around the mechanism(s) of pain in trigeminal neuralgia.

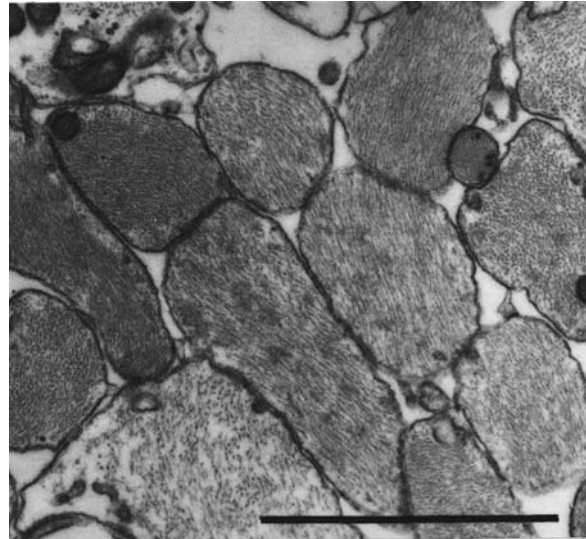
It has long been believed that the intense focal activity underlying lightning pains in trigeminal neuralgia originates in the central nervous system (CNS), presumably in the trigeminal brainstem (Fromm and Sessle 1991). According to this CNS theory, a process akin to a focal epileptic seizure accounts for the pain attack. The analogy between pain paroxysms and epileptic seizures accounts for the classic observation that the anticon-



vulsants diphenylhydantoin (phenytoin, Dilantin) and carbamazepine (Tegretol) are highly effective at controlling pain paroxysms in tic. However, the evidence for a primary CNS etiology doesn't go much beyond that. Idiopathic trigeminal neuralgia is not associated with focal lesions in the trigeminal brainstem, or with electrographic signs of seizure foci in this area, although in rare cases demyelinating plaques in multiple sclerosis (MS), and space occupying tumors constitute a likely focal pathology. Moreover, trigeminal neuralgia is not responsive to a variety of anticonvulsants that are effective in epilepsy, for example barbiturates and benzodiazepines.

The weight of evidence shifted to theories based on peripheral nervous system (PNS) pathophysiology, perhaps with a secondarily evoked CNS component (► [central sensitization](#)), with two key discoveries (Devor et al 2002). The first was the accumulation of data that in most cases of trigeminal neuralgia there is a specific, focal demyelinating lesion in the trigeminal root a few millimeters distal to its point of entry into the pons. Pathology in the trigeminal root ganglion (TRG) has also been documented. Focal demyelination of the trigeminal root is caused by compression of the root by a small impinging artery. Surgical separation of the offending vessel from the compressed root by ► [microvascular decompression](#) (MVD) frequently provides definitive, long-term relief from pain attacks. The second major discovery favoring PNS pathophysiology was that phenytoin, carbamazepine and other anticonvulsant drugs effective in trigeminal neuralgia reduce abnormal hyperexcitability of injured primary sensory neurons, in addition to their CNS actions. This “membrane stabilizing” effect is due to pharmacological block of voltage sensitive  $\text{Na}^+$  channels, proteins that play a key role in neuronal excitability in both PNS and CNS (Catterall 1987). In contrast, the anticonvulsant drugs that are not effective in trigeminal neuralgia (e.g. pentobarbital) tend to act synaptically by enhancing GABAergic neurotransmission. There are no GABAergic (or other) synapses along the trigeminal root or in the TRG.

In 1994 Rappaport and Devor proposed the “TRG ► [ignition hypothesis](#)”, a PNS-based model that integrates the tissue pathology known to be present in trigeminal neuralgia, the pathophysiology of injured hyperexcitable primary afferent neurons and the pharmacology of peripherally acting membrane stabilizing drugs. The ignition hypothesis proposes that pain paroxysms result from synchronous recruitment of ectopic firing in a large population of hyperexcitable TRG neurons that innervate the territory in which the pain is felt. The ectopic hyperexcitability of these neurons is due to axonopathy caused by microvascular compression or, less frequently, to direct root or TRG pathology or to intracerebral damage to trigeminal root axons (e.g. due to a tumor, or MS). Synchronous recruitment results



**Pain Paroxysms, Figure 1** EM of close axonal apposition (human IX). Fascicular demyelination in a biopsy specimen removed from a patient with glossopharyngeal neuralgia. In contrast to healthy cranial nerve roots, large numbers of non-myelinated and demyelinated axons are in close apposition to one another without an intervening glial process. This anatomical arrangement is a potential substrate for functional cross-excitation among the axons. Scale bar: 1  $\mu\text{m}$ .

from non-synaptic coupling mechanisms characteristic of injured PNS neurons: chemically mediated cross-excitation and/or ephaptic crosstalk. In cross-excitation, neurotransmitter molecules, and probably also  $\text{K}^+$  ions, are released into the extracellular space from active neurons. These diffuse towards neighboring neurons and excite them. In ephaptic crosstalk, excitatory electrical current passes directly from the active neuron to closely apposed passive neighbors (Amir and Devor 1996). According to the ignition hypothesis, paroxysms begin with discharge in a small cluster of trigeminal neurons, presumably low threshold afferents, that begin to fire in response to cutaneous trigger-point stimulation or spontaneously. Cross-excitation and ► [ephaptic coupling](#) in the injured trigeminal root or ganglion then ‘ignites’ activity in passive neighboring neurons, including nociceptors (Amir and Devor 1996, 2000). This augmented activity ignites additional passive neighbors and these ignite still more. The resulting positive-feedback chain-reaction builds up rapidly into an intense, explosive crescendo. Although triggered by peripheral afferent input, the actual ectopic impulse activity underlying the pain is generated within the injured trigeminal root axons or TRG, and can persist for some time after the end of the stimulus itself (“afterdischarge”). Since afferent neurons of all types become active simultaneously, something that otherwise occurs only with electrical stimulation, the felt sensation is electric shock-like. After a few seconds of massive firing, activity-evoked after-suppression develops (Amir and Devor 1997), damping the afterdischarge paroxysm and establishing



a period of refractoriness. Like CNS seizure activity, the ignition mechanism is expected to be sensitive to membrane stabilizing drugs such as anticonvulsants. Drug action, however, is supposed to be in the PNS rather than the CNS.

### Segmental Paroxysms and Hyperpathia

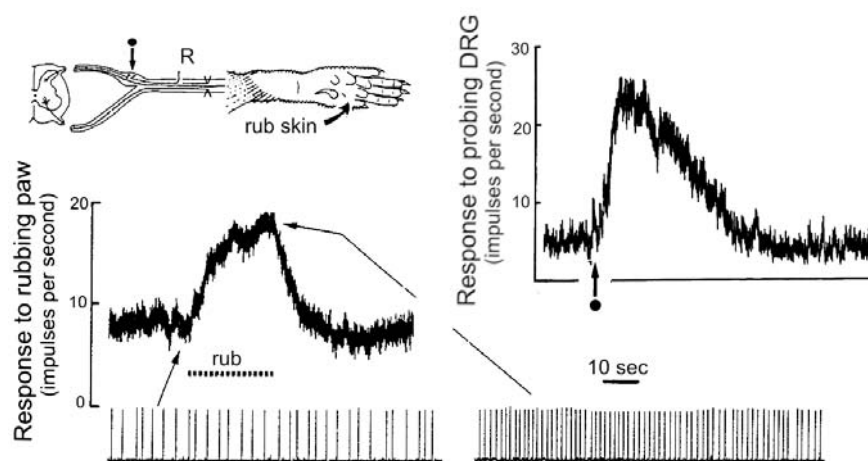
It is important to note that although the ignition hypothesis was developed with trigeminal neuralgia in mind, it applies equally to other cranial nerve neuralgias, and also to pain paroxysms felt at spinal segmental levels (Devor 2005). Particularly at spinal levels, paroxysmal afterdischarge bursts may be triggered by factors other than afferent impulses. Such activity may be triggered by mechanical forces applied to the DRG or site of axonal injury (Fig. 2). Examples are nerve traction during straight leg lifting or nerve compression as articulating vertebrae move against one another in the presence of tissue swelling or intervertebral disc herniation. Afterdischarge and the spread of activity from neuron to neuron due to cross-excitation and ephaptic crosstalk are expected to give rise to additional symptoms in neuropathy, not just pain. For example, they are expected to cause the abnormal sensation to persist after the end of the triggering stimulus, resulting in after-sensation and to spread in space from the point of stimulation. Afterdischarge and cross-excitation are also a potential basis for “windup” of sensation on repeated stimulation. Specifically, with each stroke of the skin, activated neurons in the injured nerve and DRG release an additional amount of neurotransmitter into the extracellular space. As the neurotransmitter accumulates, its excitation of neighboring neurons increases. The three phenomena of spread of sensation within the limb away from the point

of stimulation, after-sensation and windup are typical characteristics of hyperpathic sensory abnormalities in neuropathy (Noordenbos 1959).

### Treatment

Pain paroxysms in trigeminal neuralgia respond to specific anticonvulsant medications, notably carbamazepine and gabapentin, and to a lesser extent phenytoin. Tricyclic antidepressants and systemically applied local anesthetic agents, including the antiarrhythmic mexiletine, are also effective. These same drugs reduce pain paroxysms in a wide range of other neuropathic pain conditions (Scadding 1999; Zakrzewska 1999), supporting the contention that all, or most, instances of lightning pain are due to the same underlying mechanism. Barbiturates and benzodiazepines, although effective anticonvulsants, do not relieve pain paroxysms, presumably because they act synaptically rather than as **membrane stabilizers**.

The effectiveness of drug therapy in trigeminal neuralgia frequently declines over time perhaps because of progression of the neuronal injury with resulting increase in ectopic neuronal hyperexcitability. In these patients interventional approaches are used. These fall into two categories. The first involves percutaneous partial damage to the trigeminal root and ganglion using radiofrequency coagulation, retro-gasserian glycerol injection, balloon compression or, more recently, focal irradiation (gamma-knife). These procedures, which cause various degrees of facial hypoesthesia, probably work by reducing the critical mass of electrical activity available for pain ignition. The second approach is to reverse the pathology that caused abnormal hyperexcitability and neuronal coupling in the first place. In



**Pain Paroxysms, Figure 2** Electrophysiology: mechanical afterdischarge. Paroxysmal afterdischarge due to direct mechanical stimulation of a DRG and to DRG cross-excitation. In this series of experiments, carried out in rats, the sciatic nerve was partially injured and some days later electrophysiological recordings were made of impulse activity arising ectopically from the DRG (axonal recordings made from electrode R in the sketch). A weak, momentary mechanical probe applied to the surface of the exposed DRG (< 1 sec, arrow) triggered 30 sec of accelerated impulse activity (mechanical afterdischarge). Similarly, gentle rubbing of the skin of the hind paw evoked a crossed afterdischarge burst. The recorded neuron did not respond directly to the skin stimulus as its axon had been cut across before placement on the recording electrode (R). However, neighboring neurons in the DRG with intact axons were directly activated and their activity cross-excited the recorded neuron.

trigeminal neuralgia, this can be accomplished with MVD surgery. This eliminates the source of continuous nerve irritation and permits remyelination.

The corresponding approaches are also available for treatment of pain paroxysms in segmental neuropathic pain. Membrane stabilizers are the first line of medical treatment. Interventional approaches include radiofrequency partial thermocoagulation of paraspinal nerves or DRGs, mobilization of neuromas to sites where they are less likely to be triggered by mechanical forces and surgical release of entrapped nerves.

► **Tic and Cranial Neuralgias**

## References

1. Amir R, Devor M (1996) Chemically-mediated cross-excitation in rat dorsal root ganglia. *J Neurosci* 16:4733–4741
2. Amir R, Devor M (1997) Spike-evoked suppression and burst patterning in dorsal root ganglion neurons of the rat. *J Physiol* 501:183–196
3. Amir R, Devor M (2000) Functional cross-excitation between afferent A- and C-neurons in dorsal root ganglia. *Neuroscience* 95:189–195
4. Catterall WA (1987) Common modes of drug action on Na<sup>+</sup> channels: local anaesthetics, antiarrhythmics and anticonvulsants. *Trends Pharmacol Sci* 8:57–65
5. Devor M (2005) Response of nerves to injury in relation to neuropathic pain. In: McMahon S L, Klotzenburg M (eds) *Wall and Melzack's Textbook of Pain*, 5th edn. Churchill Livingstone, London, pp 905–927
6. Devor M, Amir R, Rappaport ZH (2002) Pathophysiology of trigeminal neuralgia: the ignition hypothesis. *Clin J Pain* 18:4–13
7. Kugelberg E, Lindblom U (1959) The mechanism of the pain in trigeminal neuralgia. *J Neurol Neurosurg Psychiatr* 22:36–43
8. Fromm G, Sessle B (1991) Trigeminal neuralgia: current concepts regarding pathogenesis and treatment. *Butterworth-Heinemann*, Boston, pp 1–230
9. Noordenbos W (1959) *Pain*. Elsevier, Amsterdam
10. Otto M, Bak S, Bach FW et al. (2003) Pain phenomena and possible mechanisms in patients with painful polyneuropathy. *Pain* 101:187–192
11. Pareja JA, Ruiz J, de Isla C et al. (1996) Idiopathic stabbing headache (jabs and jolts syndrome). *Cephalalgia* 16:93–96
12. Rappaport ZH, Devor M (1994) Trigeminal neuralgia: the role of self-sustaining discharge in the trigeminal ganglion. *Pain* 56:127–138
13. Scadding JW (1999) Peripheral neuropathies. In: Wall PD, Melzack R (eds) *Textbook of pain*, 4th edn. Churchill Livingstone, Edinburgh, pp 815–834
14. Sharav, Y (1999) Orofacial pain. In: Wall PD, Melzack R (eds) *Textbook of pain*, 4th edn. Churchill Livingstone, Edinburgh, pp 711–737
15. Zakrzewska JM (1999) Trigeminal, eye and ear pain. In: Wall PD, Melzack R (eds) *Textbook of pain*, 4th edn. Churchill Livingstone, Edinburgh, pp 739–759

## Pain Pathway

### Definition

A conceptualization of pain mechanisms, which suggests that a dedicated interconnected set of CNS loci exist whose activation gives rise to the experience of pain; compare with dynamic ensemble.

► **Gynecological Pain, Neural Mechanisms**

## Pain Prevention

► **Pre-Emptive or Preventive Analgesia and Central Sensitisation in Postoperative Pain**

## Pain Processing in the Cingulate Cortex, Behavioral Studies in Humans

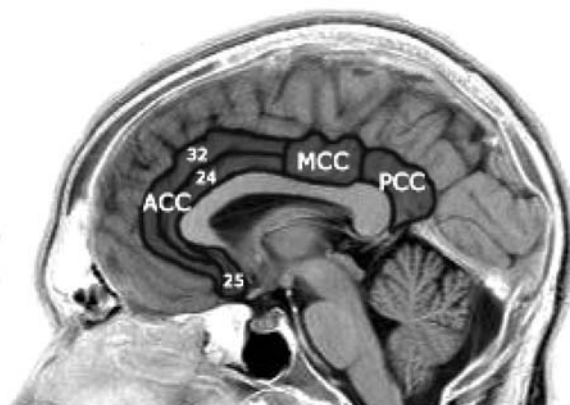
SERGE MARCHAND, PHILIPPE GOFFAUX  
Faculty of Medicine, Neurochirurgie, University of Sherbrooke, Sherbrooke, QC, Canada  
serge.marchand@usherbrooke.ca  
philippe.goffaux@chus.qc.ca

### Synonyms

Cingulate Cortex, Effect on Pain-Related Behavior in Humans; Nociceptive Processing in the Cingulate Cortex, Behavioral Studies in Human

### Definition

The cingulate cortex (CC) is a cortical structure located in the medial portion of the cerebral hemispheres immediately above the ► **corpus callosum** (Fig. 1). The CC can be functionally divided into an anterior (ACC) and a posterior part (PCC) with an intermediate or medial part (MCC); all play specific roles in pain perception, anticipation and response (Vogt 2003). The function of the CC in pain has been studied in humans using different approaches, ranging from single cell recordings during surgery to psychophysical and brain imaging studies. This key structure is also believed to play a critical role in a wide variety of regulatory human behaviors, including attention processing, emotional processing, anti-



**Pain Processing in the Cingulate Cortex, Behavioral Studies in Humans, Figure 1** MRI scan highlighting the anterior cingulate cortex (ACC), midcingulate cortex (MCC) and posterior cingulate cortex (PCC). Also shown is a non-exhaustive subdivision of the ACC including Brodmann areas 32 (dorsal ACC), 24 (ventral ACC) and 25 (subgenual ACC).

pation of pain, monitoring of performance and reward, self-awareness and regulation of ► **autonomic functions** (Allman et al. 2001).

### Characteristics

Pain perception is supported by multiple brain regions including regions that play a major role in the sensory component of pain (intensity, localization, duration) and in the affective component of pain (fear, attention, unpleasantness). Brain regions believed to play a primary role in subsuming sensory-discriminative dimensions of pain include the primary and secondary somatosensory cortices (SI, SII). On the other hand, the affective component of pain is thought to involve the insular and cingulate cortices. Most of the brain imaging or electrophysiological studies published to date consistently obtain increased activity in the CC following the administration of painful stimuli. However, painting a unified portrait of the different functions subsumed by the CC has not yet been accomplished and may, in fact, prove difficult, partly because the cingulate cortex is not a homogeneous structure. From a ► **cytoarchitectural** point of view, the cingulate cortex is composed of a number of different “areas” each involved in producing different behavioral outputs, be they pain-related or not. Given the results obtained when measuring the cortical activity underlying pain and non-pain related functions, it appears clear that the different regions of the cingulate cortex are activated along with other brain structures to produce a distributed pattern of cortical activity (Garcia-Larrea et al. 2003). Nowhere is this more evident than when looking at the distributed representation underlying nociceptive processing. The matrix of cortical activity observed when noxious stimuli are given suggests that there is no central pain structure in the human brain, but rather a pain-related network involving thalamic, somatosensory and fronto-limbic structures. Furthermore, of all the different subsections of the CC, it is the ACC that most consistently co-activates when pain is experienced (Porro et al. 1998). Our review will, therefore, include the entire CC, but we will pay particular attention to the role of the ACC in nociceptive processing and pain perception.

### ACC-PCC Coactivation

Using brain activity recording techniques that have a good temporal resolution (electrical brain source analysis with current reconstruction imaging), Bromm (2004) showed that when applying a phasic nociceptive stimulus (i.e. rapid onset and short duration), the PCC is activated first and plays a role in the evaluation of sensory-discriminative aspects of the stimuli, while the ACC is activated later with a role for the motivational-affective aspect of pain. Bromm argues that the early, sensory-discriminative role played by the PCC is largely missed by most neuroimaging studies because these studies use imaging techniques that

have poor temporal resolution (e.g. PET and fMRI) and so cannot dissociate early and late CC activation (see ► **PET scan** (Positron Emission Tomography) and ► **fMRI** (functional Magnetic Resonance Imaging)). This methodological constraint prevents the measurement of fast, transient PCC activity tied to the onset of nociceptive stimuli.

### ACC Activity: Pain Perception or Cognitive Control?

Early on, lesion studies suggested a link between ACC activity and the processing of pain affect. In particular, it appeared that cingulotomies helped reduce emotional responses to pain (decreased distress, bother and worry) rather than the perception of pain intensity *per se* (Boukoms 1994) (see ► **cingulotomy**). However, even if the emotional role played by the ACC is important, recent studies have demonstrated that the ACC is more complex than we previously thought. In fact, lesions of the ACC appear to affect both sensory and motivational aspects of pain (Talbot et al. 1995). These findings shed light on Bromm’s (2004) conclusions regarding the importance of the PCC during sensory-discriminative pain processing and argue against the idea that specific CC structures are exclusively involved in response to nociceptive afferents. In other words, a given CC structure may be particularly sensitive in mediating a specific dimension of pain, but it is unlikely to be uniquely involved.

Direct recordings of the ACC by either microelectrodes (Hutchinson et al. 1999) or subdural electrodes (Lenz et al. 1998) do however suggest a functional dissociation between the processing of nociceptive and non-nociceptive afferents. These electrode recordings show a clear implication of the ACC during and in anticipation of noxious stimuli. However, no activity is recorded following the administration of non-noxious stimuli. Interestingly, stimulation of these same ACC neurons fails to provoke any pain, while intense sensations of either fear or pleasure have been reported after ACC stimulation (Allman et al. 2001). Together, these results lend credence to the idea that the ACC plays a major role in pain perception and that pain is the end-result of an integrated pattern of cortical firing rather than the by-product of a single cortical region’s activity.

It is also possible to draw a parallel between the signal obtained through modern imaging techniques and the subjective experience of pain. The results obtained by the very few studies that have done this appear, at first glance, to be equivocal. While some authors find that activity in the ACC covaries with pain unpleasantness (Rainville et al. 1997), others find that ACC activity is related to accompanying pain-triggered attentional/anticipatory factors (Lorenz et al. 2003). A closer look at these studies suggests, however, that their results may not be so contradictory. Studies which indicate that the ACC plays a key role in processing pain-affect

primarily show activity in the ventral section of the ACC (► [Brodmann area 24](#)) while those that argue that the ACC processes pain-related anticipation and attention primarily show activity in the dorsal section of the ACC (Brodmann area 32). Dissociating the neural mechanisms underlying pain-related cognitive factors from those underlying affect-related factors will constitute the next challenge in this field.

#### ACC and Endogenous Pain Modulation Systems

Pain is not solely the result of the activation of brain structures by nociceptive afferences, but the integration of different endogenous pain modulation systems at different levels of the central nervous system. Descending inhibitory systems from brainstem structures, including the periaqueductal gray (PAG), play a major role in pain modulation (Fields and Basbaum 1999). Connectivity between the PAG and the CC has been demonstrated, suggesting influence between CC and PAG (An et al. 1998). Recent brain imaging studies have shown that distraction induced pain inhibition activates both the CC and the PAG, suggesting a possible role for the CC in the descending modulation of nociception by the PAG (Valet et al. 2004).

#### ACC as Context-Driven Integrator

It has recently been suggested that, since the ACC harbors neuronal connections with brain regions that are also involved in action, attention, executive control, speech and affect, it should not be surprising that this structure plays an integral role in regulating and modulating human behavior as a function of what is contextually appropriate (Paus 2001). With respect to pain processing, the ACC may serve to integrate intensity signals with the subjective meaning attributed to (or expected from) these signals so as to produce appropriate pain-related reactions. These reactions certainly include escape behaviors and overt manifestations of displeasure but may also include covert responses such as endogenous changes in the regulation of autonomic function and pain modulation. As reported above, anatomical data support such a role for the ACC, as this structure sends projections to brainstem regions involved in endogenous pain modulation (An et al. 1998) and autonomic activity (Vilensky and Hoesen 1981). These projections would also explain why exposure to a tonic noxious stimulus leads to a rise in heart rate and to the concurrent activation of descending pain control mechanisms (Willer et al. 1989).

Of the different cortical structures involved in pain perception, the CC plays a very complex role encompassing the anticipation and modulation of pain. Its role in the motivational-affective component of pain and in the emotionally driven responses to potential or actual danger for the organism makes it a key cortical structure in the complex and subjective experience of pain.

#### References

1. Allman JM, Hakeem A, Erwin JM et al. (2001) The anterior cingulate cortex, the evolution of an interface between emotion and cognition. *Ann New York Acad Sci* 935:107–117
2. An X, Bandler R, Ongur D et al. (1998) Prefrontal cortical projections to longitudinal columns in the midbrain periaqueductal gray in macaque monkeys. *J Comp Neurol* 401:455–479
3. Bouckoms AJ (1994) Limbic surgery for pain. In: Wall PD, Melzack R (eds) *Textbook of pain*, 3rd edn. Churchill Livingstone, Edinburgh, pp 1171–1187
4. Bromm B (2004) The involvement of the posterior cingulate gyrus in phasic pain processing of humans. *Neurosci Lett* 361:245–249
5. Fields H, Basbaum A (1999) Central nervous system mechanisms of pain modulation. In: Wall PD, Melzack R (eds) *Textbook of pain*. Churchill Livingstone, Edinburgh, pp 309–329
6. Garcia-Larrea L, Frot M, Valeriani M (2003) Brain generators of laser-evoked potentials: from dipoles to functional significance. *Neurophysiol Clin* 33:279–292
7. Hutchison WD, Lozano AM, Kiss ZHT et al. (1999) Pain-related neurons in human cingulate cortex. *Nat Neurosci* 2:403–405
8. Lenz FA, Rios M, Zirh A et al. (1998) Painful stimuli evoke potentials recorded over the human anterior cingulate gyrus. *J Neurophysiol* 79:2231–2234
9. Lorenz J, Cross DJ, Minoshima S et al. (2003) Keeping pain out of mind: the role of the dorsolateral prefrontal cortex in pain modulation. *Brain* 126:1079–1091
10. Paus T (2001) Primate anterior cingulate cortex: Where motor control, drive and cognition interface. *Nat Rev Neurosci* 2:417–424
11. Porro CA, Cettolo V, Pia Francescato M et al. (1998) Temporal and intensity coding of pain in the human cortex. *J Neurophysiol* 80:3312–3320
12. Rainville P, Duncan GH, Price DD et al. (1997) Pain affect coded in human anterior cingulate but not somatosensory cortex. *Science* 227:968–971
13. Talbot JD, Villemure JG, Bushnell MC et al. (1995) Evaluation of pain perception after anterior capsulotomy: a case report. *Somatosens Mot Res* 12:115–126
14. Valet M, Sprenger T, Boecker H et al. (2004) Distraction modulates connectivity of the cingulo-frontal cortex and the midbrain during pain—an fMRI analysis. *Pain* 109:399–408
15. Vilensky JA, van Hoesen GW (1981) Corticopontine projections from the cingulate cortex in the rhesus monkey. *Brain Res* 205:391–395
16. Vogt BA, Berger GR, Derbyshire SW (2003) Structural and functional dichotomy of human midcingulate cortex. *Eur J Neurosci* 18:3134–3144
17. Willer JC, De Broucker T, Le Bars D (1989) Encoding of nociceptive thermal stimuli by diffuse noxious inhibitory controls in humans *J Neurophysiol* 62:1028–1038

## Pain Progression

### ► Transition from Acute to Chronic Pain

## Pain Prone Patients

ROLF H. ADLER  
Prof. em. Medicine, Kehrsatz, Switzerland

### Characteristics

Clinical observation reveals that there are people who seem to experience pain with unusual intensity and fre-



quency. With peripheral lesions they seem to suffer more pain than most people do, but often they suffer pain without any peripheral process. Among such patients, the presence or absence of a peripheral disorder is not well correlated with the presence or absence of pain. Indeed we often find that the discovery of the lesion and its removal or cure does not alleviate the pain, which may persist or even recur at a later date. In other words, there are certain individuals, called “pain prone“, among whom psychic factors play the primary role in the genesis of pain, in the absence as well as in the presence of peripheral lesions.

Clinical psychological studies of many pain prone persons have by now provided a fairly good understanding of the determinants of this susceptibility to suffer pain (Szasz 1957; Engel 1951, 1959, 1970; Rangell 1953; Kolb 1954; Hart 1957). The key comes through understanding how pain may yield pleasure. It is pleasure in a relative sense, which is in place of something even more distressing. Beginning from a primitive protective system, pain evolves into a complex psychic mechanism, part of the system whereby man maintains himself in his environment. Both as a warning system and as a mechanism of defence, pain helps to avoid or ward off even more unpleasant feeling states or experiences and may even offer the means whereby certain gratifications can be achieved, albeit at a price. If this adaptive role of pain in the psychic economy can be understood, it can be comprehended how it is that certain persons actually seek pain, even to the extent of creating it as a purely psychic experience if no peripheral stimulus is available to evoke it.

“Pain prone patients repeatedly or chronically suffer from one or another painful disability, sometimes with and sometimes without any recognizable peripheral change. In their choice of pain as the symptom, a long-term background of guilt and/or a guilt-provoking situation precipitating pain can be expected. Some of these individuals are chronically depressive, pessimistic and gloomy people whose guilty, self-deprecating attitudes are readily apparent. Some seem to have suffered the most extraordinary number and variety of defeats, humiliations and unpleasant experiences. They drift into situations or submit to relationships in which they are hurt, beaten, defeated, humiliated and seem not to learn from experience; . . . they conspicuously fail to exploit situations which should lead to successes. . . . Even though they complain of pain, for them the pain is almost a comfort or an old friend. It is an adjustment, a way of adaptation, acquired through psychic experience” (Adler et al. 1989; see also Adler 1976; Adler et al. 1997).

Patients who “need to suffer pain” to maintain their mental equilibrium have certain characteristics and modes of behavior that can be detected in a single conversation. The best results are obtained with a history taking technique that allows the patient to tell his story in

his own words, but nevertheless to be guided into areas which seem important. Once the “need to suffer pain” has been diagnosed, time can be saved and the patient can be spared unnecessary, costly and sometimes hazardous investigations and surgery with its serious consequences. Of course one must not forget that a patient who “needs to suffer pain” may also have a painful organic disease.

It is believed that with this type of patient, pain plays an important part in early childhood in controlling the mental equilibrium (see also Engel’s, 1959, hypothesis of pain prone patients having lived through a distinct pattern of developmental psychosocial experiences). Consequently, therapy that is aimed at eliminating “pain” is a threat to the patient’s mental stability. This results in a breakdown in the doctor-patient relationship or in exacerbation of the pain with the subsequent tragic chain reaction of investigations and operations. The aim of the doctor-patient relationship should be for the doctor to give support to the patient in his pain. Only after months or years of patiently building up a working relationship should one work on the background to the patient’s complaints. In some cases, the doctor has to be content with protecting the patient from surgery. He has to realize that some of these patients are so ill that to aim to cure them would be roughly comparable to an internist expecting a diabetic patient’s pancreas to start producing insulin again when treatment is progressing satisfactorily (for further literature on the relationship between childhood experiences and pain in adulthood see Adler et al. 1989; Egle et al. 1991; Raphael et al. 2001).

The validity of the assumption of a meaningful correlation between certain childhood experiences and pain proneness in adulthood is based on the following prerequisites. The samples must be homogenous, e.g. pelvic pain, psychogenic pain, multiple personality disorder based on DSM-III, etc. fulfill this request. The psychosocial factors (childhood traumata) must be present more frequently in the samples than in the control groups. These factors must antedate the studied disease, which is the case in the cited studies. The findings should be confirmed by other researchers, which many studies in different countries do. The correlation must prevail after statistical control of confounding factors, a requirement fulfilled by many of the above-mentioned studies. A dosage-effect relation should exist. The studied factors should be specific for the disease. Relative specificity exists, since other diseases such as depression, substance abuse etc are also related to childhood traumatic experiences. The correlation should be biologically plausible. This seems to be the case, e.g. same location of pain in sick parents and the child and later patient. In summary, Engel’s 1959 paper on “psychogenic pain and the pain prone patient” is justifiably called seminal. A physician’s knowledge about the correlation between traumatic childhood experiences and ensuing proneness to suffer repeatedly

from pain to which psychosocial factors contribute heavily, goes a long way with regard to diagnosis and therapy.

## References

1. Adler RH (1976) The need to suffer pain. CIBA review 7
2. Adler RH, Zlot IS, Humy Ch et al (1989) Engel's psychogenic pain and the pain prone patient: a controlled retrospective clinical study. *Psychosom Med* 51:87–101
3. Adler HR, Zamboni P, Hofer T et al (1997) How not to miss a somatic needle in the hay stack of chronic pain. *J Psychosom Res* 42:499–506
4. Egle UT, Kissinger D, Schwab R (1991) Parent-child relations as a predisposition for psychogenic pain syndrome in adulthood. A controlled retrospective study in relation to GL Engel's "pain proneness" *Psychother Psychosom Med Psychol* 41:247–256
5. Engel GL (1951) Primary atypical facial neuralgia. A hysterical conversion symptom. *Psychosom Med* 13:375–396
6. Engel GL (1959) "Psychogenic" Pain and the Pain prone Patient. *Am J Med* 26:899–918
7. Engel GL (1970) Conversion symptoms. In: Mac Bryde CM, Blacklow RS (eds) *Signs and Symptoms: Applied Physiology and Clinical Interpretation* chap. 30, 5th edn. Lippincott, Philadelphia
8. Hart H (1957) Displacement, guilt and pain: *Psychoanalyt Rev* 34
9. Kolb LC (1954) *The Painful Phantom. Psychology, Physiology, and Treatment.* American lecture Series. Charles C. Thomas, Springfield 111
10. Rangel L (1953) Psychiatric aspects of pain. *Psychosom Med* 15
11. Raphael KG, Wisdom CS, Lange G (2001) Childhood victimization and pain in adulthood: a prospective investigation. *Pain* 92:283–93
12. Szasz T (1957) *Pain and Pleasure.* New York, Basic Books

## Pain Prone Personality

### Definition

An hypothesized personality constellation, which is thought to render the individual more prone to the development of a pain disorder.

- ▶ Pain as a Cause of Psychiatric Illness
- ▶ Pain Prone Patients

## Pain, Psychiatry and Ethics

MARK D. SULLIVAN  
Psychiatry and Behavioral Sciences, University of Washington, Seattle, WA, USA  
sullimar@u.washington.edu

### Synonyms

Psychogenic pain; Pain Disorder; Mental Pain; somatization

### Definition

Pain Disorder associated with psychological factors now officially exists as a subtype of the psychiatric diagnosis of Pain Disorder in the American Psychiatric Association's

Diagnostic and Statistical Manual, Fourth Edition, (DSM IV) (1994). This diagnosis requires that: a) Pain in one or more anatomical sites is of sufficient severity to warrant clinical attention, b) Pain causes clinically significant distress or impairment in social, occupational, or other important areas of functioning, c) Psychological factors are judged to have an important role in the onset, severity, exacerbation, or maintenance of the pain, d) The symptom of pain is not intentionally produced or feigned (as in Factitious Disorder or Malingering), and e) The pain is not better accounted for by a Mood, Anxiety, or Psychotic Disorder and does not meet criteria for Dyspareunia.

### Characteristics

In many common pain syndromes (e.g. low back pain, headache, fibromyalgia), it is difficult to identify the tissue pathology giving rise to symptoms. When a somatic cause for pain cannot be identified, many clinicians begin to seek psychological causes. The identification of what has classically been called "psychogenic pain" is a difficult, and perhaps impossible, task. "Pain Disorder" is the current psychiatric diagnosis that most closely corresponds to the concept of psychogenic pain.

We are drawn to the concept of psychogenic pain because it fills the gaps left when our attempts to explain clinical pain exclusively in terms of tissue pathology, fails. Positive criteria for the identification of psychogenic pain, mechanisms for the production of psychogenic pain, and specific therapies for psychogenic pain are lacking. Psychiatric diagnosis of many disorders, such as depression, can be very helpful to the clinician and patient by pointing toward specific effective therapies. However, the diagnosis of psychogenic pain too often only serves to stigmatize further the patient who experiences chronic pain. The recent history of the psychiatric diagnosis of "psychogenic pain" is instructive. In 1980, DSM-III introduced a new diagnostic category for pain problems, "Psychogenic Pain Disorder" (American Psychiatric Association 1980). To qualify, a patient needed to have: severe and prolonged pain inconsistent with neuroanatomical distribution of pain receptors or without detectable organic etiology or pathophysiologic mechanism. Related organic pathology was allowed, but the pain had to be "grossly in excess" of what was expected on the basis of physical exam. Difficulties in establishing that pain was psychogenic led to changes in the diagnosis for DSM-III-R (American Psychiatric Association 1987). In DSM-III-R, the diagnosis was renamed "Somatoform Pain Disorder" and three major changes were made in the diagnostic criteria. The requirements for etiologic psychological factors and lack of other contributing mental disorders were eliminated, and a requirement for "preoccupation with pain for at least six months" was added (Stoudemire and Sandu 1987). In DSM-III-R, therefore, Somatoform Pain Disorder becomes purely a diagnosis of exclusion. The diagnosis is

made when medical disorders are excluded in a patient “preoccupied” with pain.

The DSM-IV subcommittee on pain disorders found that, despite these changes, “Somatoform Pain Disorder” was rarely used in research projects or clinical practice. They identified a number of reasons for this: 1) the meaning of “preoccupation with pain” is unclear, 2) whether pain exceeds that which is expected is difficult to determine, 3) the diagnosis does not apply to many patients disabled by pain where a medical condition is contributory, 4) the term “somatoform pain disorder” implies that this pain is somehow different from organic pain, and 5) acute pain of less than 6 months duration was excluded (King and Strain 1992).

The DSM-IV subcommittee has tried to devise a broader diagnostic grouping encompassing both acute and chronic pain problems. They wanted to have all the factors relevant to the onset or maintenance of the pain delineated, and also to have a diagnostic category that does not require more training than the majority of DSM-IV users would be expected to have. These two requirements may not be compatible. Furthermore, no guidance is given in determining when psychological factors have a major role in pain or are considered important enough in the presence of a painful medical disorder to be coded as a separate mental disorder. Given the high rates of mood and anxiety disorders among disabled chronic pain patients, many patients most appropriate for the diagnosis would be excluded. Although depression and anxiety diagnoses point toward specific proven therapies, this is not true for Pain Disorder. The diagnosis thus continues covertly as a diagnosis of exclusion, with neither clear inclusion criteria nor implications for therapy.

Prospective studies have demonstrated a strong association between medically unexplained symptoms (pain and non-pain) and depressive and anxiety disorders (Gureje et al. 2001). Patients with chronic pain will often dismiss a depression diagnosis, stating that their depression is a “direct reaction” to their pain problem. Psychiatry has long debated the value of distinguishing a “reactive” form of depression caused by adverse life events, and an endogenous form of depression caused by biological and genetic factors (Frank et al. 1994). Life events are important in many depressive episodes, though they play a less important role in recurrent and very severe or melancholic or psychotic depressions (Fishbain et al. 1997). Currently, the only life event that will exclude someone from a depression diagnosis, who otherwise qualifies, is bereavement. Determining whether a depression is a “reasonable response” to life’s stress may be very important to patients seeking to decrease the stigma of a depression diagnosis, and has been of interest to pain investigators. It is not, however, important in deciding that treatment is necessary and appropriate. Indeed, there is no clarity in assessment to be gained from debating whether the depression caused

the pain or the pain caused the depression. If patients meet the criteria for a depressive disorder, it is likely that they can benefit from appropriate treatment.

Psychiatric diagnosis and treatment of these depressive and anxiety disorders can add an essential and often neglected component to the conceptualization and treatment of chronic pain problems (Sullivan and Turk 2000). However, it is absolutely critical to avoid a dualistic model, which postulates that pain is either physical or mental in origin. This model alienates patients who feel blamed for their pain. It also is inconsistent with modern models of pain causation. Since the gate control theory of pain, multiple lines of evidence suggest that pain is a product of efferent as well as afferent activity in the nervous system. Tissue damage and nociception are neither necessary nor sufficient for pain (Sullivan 1998). Indeed, it is now widely recognized that the relationship between pain and nociception is highly complex, and must be understood in terms of the situation of the organism as a whole. Attribution of pain to solely psychological causes is ethically suspect, because it is often used as justification for denial of medical treatment to persons suffering from such pain.

We are only beginning to understand the complexities of the relationship between pain and suffering. Pain usually, but not always, produces suffering. Suffering can, through somatization, produce pain (Katon et al. 2001). We have traditionally understood this suffering, as we have understood nociception, as arising from a form of pathology intrinsic to the sufferer. Hence, the traditional view that pain is due to either tissue pathology (nociception) or psychopathology (suffering). An alternative model that allows us to escape this dualism is to think of pain as having causes outside as well as inside the body (Sullivan 2001). For humans, social pathology can be as painful as tissue pathology (Eisenberger 2003). Psychological trauma as well as physical trauma appears to contribute to many chronic pain problems. Insurance carriers and medical practitioners who exclude psychological trauma from coverage or treatment may deny patients resources essential for recovery.

Psychologic care for patients with chronic pain should occur within the medical treatment setting whenever possible. This is the most effective way to reassure patients that the somatic elements of their problems are not neglected. It also allows integration of somatic and psychological treatments in the most effective manner.

## References

1. American Psychiatric Association (1980) *Diagnostic and Statistical Manual of Mental Disorders*, 3<sup>rd</sup> edn. American Psychiatric Association Press, Washington DC
2. American Psychiatric Association (1987) *Diagnostic and Statistical Manual of Mental Disorders*, 3<sup>rd</sup> edn, Revised. American Psychiatric Association Press, Washington DC

3. American Psychiatric Association (1994) Diagnostic and Statistical Manual of Mental Disorders, 4<sup>th</sup> edn. American Psychiatric Association Press, Washington DC
4. Eisenberger EI, Lieberman MD, Williams KD (2003) Does rejection hurt? An fMRI study of social exclusion. *Science* 302:290–2
5. Fishbain DA, Cutler R, Rosomoff HL et al. (1997) Chronic Pain-Associated Depression: Antecedent or Consequence of Chronic Pain? A review. *Clin J Pain* 13:116–137
6. Frank E, Anderson B, Reynolds CF et al. (1994) Life Events and the Research Diagnostic Criteria Endogenous Subtype. *Arch Gen Psychiat* 51:519–524
7. Gureje O, Simon GE, Von Korff M (2001) A Cross-National Study of the Course of Persistent Pain in Primary Care. *Pain* 92:195–200
8. Katon WJ, Sullivan MD, Walker EA (2001) Medical Symptoms without Identified Pathology: Relationship to Psychiatric Disorders, Childhood and Adult Trauma, Personality Traits. *Ann Intern Med* 134:917–925
9. King SA, Strain JJ (1992) Revising the Category of Somatoform Pain Disorder. *Hosp Comm Psychiat* 43:217–219
10. Stoudemire A, Sandu J (1987) Psychogenic/Idiopathic Pain Syndromes. *Gen Hosp Psychiat* 9:79–86
11. Sullivan M (1998) The Problem of Pain in the Clinico-Pathological Method. *Clin J Pain* 14:196–201
12. Sullivan MD (2001) Finding Pain Between Minds and Bodies. *Clin J Pain* 17:146–156
13. Sullivan MD, Turk DC (2000) Psychiatric Disorders and Psychogenic Pain. In: Loeser JD, Butler S, Turk DC (eds) *Bonica's Management of Pain*, 3<sup>rd</sup> edn. Williams and Wilkins, Philadelphia, pp 483–500

## Pain Questionnaire

- ▶ Multidimensional Scaling and Cluster Analysis Application for Assessment of Pain
- ▶ Outcome Measures
- ▶ Pain Measurement by Questionnaires, Psychophysical Procedures and Multivariate Analysis

## Pain Rehabilitation

### Definition

A rehabilitation program aimed at improving activity and participation of individuals with chronic non-malignant pain.

- ▶ [Physical Medicine and Rehabilitation, Team-Oriented Approach](#)

## Pain-Related Anxiety

- ▶ [Fear and Pain](#)

## Pain-Related Disability

- ▶ [Complex Chronic Pain in Children, Interdisciplinary Treatment](#)

## Pain-Related Fear

### Definition

Pain-related fear is a general term used to describe several forms of fear with respect to pain, such as fear of injury, fear of movement, and fear of physical activities that usually increase pain.

- ▶ [Disability, Fear of Movement](#)
- ▶ [Fear and Pain](#)
- ▶ [Fear Reduction through Exposure In Vivo](#)
- ▶ [Hypervigilance and Attention to Pain](#)
- ▶ [Muscle Pain, Fear-Avoidance Model](#)

## Pain-Related Impairment

- ▶ [Impairment, Pain-Related](#)

## Pain-Relevant Communication

### Definition

Pain-relevant communication refers to verbal and non-verbal exchanges in the context of a person's expressions of pain.

- ▶ [Spouse, Role in Chronic Pain](#)

## Pain Scale

### Definition

A pain scale is a system of rating the level, magnitude or intensity of pain in order to quantify the individual's pain experience. This may include categorical items such as cartoon faces, simple classifications, and the assignment of numbers to the categories that rank in magnitude with the category descriptors. Depending on their levels of measurement and how they have been developed, category scale items (and summary scores derived from them) may only provide a measure of the grade of pain, rather than an absolute and accurate measure of differences in the magnitude of pain (scores at the interval or ratio level).

- ▶ [Pain Assessment in Neonates](#)

## Pain Schema

### Definition

An organized cognitive structure containing information about a particular domain of experience related to pain. Pain schema are said to vary in terms of their level of activation. Once activated by a particular stimulus



situation, pain schema will contribute to the preferential processing of pain-related information.

- ▶ Psychology of Pain, Assessment of Cognitive Variables

## Pain Schools

- ▶ Information and Psychoeducation in the Early Management of Persistent Pain

## Pain System

- ▶ Lateral Thalamic Pain-Related Cells in Humans

## Pain Tension Cycle

### Definition

Pain tension cycle refers to the observation that pain leads to reflexive increases in tension that will again increase pain levels. This process may lead to a vicious cycle.

## Pain Therapy, Biofeedback in the Treatment of Pain

- ▶ Biofeedback in the Treatment of Pain

## Pain Threshold

### Definition

Pain threshold is defined as the lowest stimulus intensity that reliably elicits the perception of pain. Attention as well as motivational and emotional factors are known to influence the pain threshold that can be measured in the laboratory. There are three methods that are typically used to determine an individual's pain threshold: (1) Method of limits: Stimulus intensity is continuously increased until the subject perceives the stimulus as painful. Typically, several ascending and descending series of stimuli are used in order to reduce confounding influences due to expectation or habituation. (2) Method of adjustment: The subject adjusts stimulus intensity until the subjective pain threshold is reached. (3) Method of constant stimuli: A set of stimuli of fixed intensities are presented several times. Pain threshold is defined as the stimulus intensity that evokes a pain report in 50 percent of the trials.

- ▶ Hyperaesthesia
- ▶ Hyperpathia, Assessment

- ▶ Hypervigilance and Attention to Pain
- ▶ Hypoesthesia, Assessment
- ▶ Modeling, Social Learning in Pain
- ▶ Pain in Humans, Electrical Stimulation (Skin, Muscle and Viscera)
- ▶ Pain in Humans, Thresholds
- ▶ Pain Measurement by Questionnaires, Psychophysical Procedures and Multivariate Analysis
- ▶ Psychology of Pain, Self-Efficacy
- ▶ Somatic Pain
- ▶ Tourniquet Test

## Pain Tolerance

### Definition

Pain tolerance is defined as the maximum stimulus intensity, or the maximum time of continuous painful stimulation that a subject is willing to endure.

- ▶ Hyperaesthesia
- ▶ Hypervigilance and Attention to Pain
- ▶ Hypoesthesia, Assessment
- ▶ Modeling, Social Learning in Pain
- ▶ Psychology of Pain, Self-Efficacy
- ▶ Tourniquet Test

## Pain Treatment, Implantable Pumps for Drug Delivery

P

KHAN W. LI, FREDERICK A. LENZ  
Department of Neurosurgery, Johns Hopkins Hospital,  
Baltimore, MD, USA  
flenzi@jhmi.edu

### Synonyms

Subdural Drug Pumps; Intrathecal Drug Pumps; Intraventricular Drug Pumps; Intracerebroventricular Drug Pumps; Epidural Drug Pumps

### Definition

Mechanical system that delivers substances to the central nervous system in a controlled fashion for treatment of pain or spasticity.

### Characteristics

Recent technological advances have made it possible to deliver drugs directly to the central nervous system via implanted pumps. This method is currently utilized when other medical or surgical therapies have failed, or have been associated with the production of significant side effects (Smith et al. 2002). Patients with cancer have been studied most frequently, although this technique is often used in patients with non- ▶ **malignant pain syndromes**. The most common analgesic used is

morphine, which has been shown to be both safe and efficacious (Wang et al. 1979; Smith et al. 2002). The main advantage of ► **intrathecal** or ► **intraventricular** administration is the decrease in systemic side effects due to decreased blood levels, as compared to the levels required for pain control when morphine is given orally or intravenously (Smith et al. 2002).

Before the availability of implantable pumps, opioids were directly infused in a single bolus injection via lumbar puncture or via an Ommaya reservoir with a catheter in the lumbar CSF space. This method was time-consuming and fraught with potential complications. Repeated lumbar punctures or reservoir injections led to an increased risk of meningitis and cerebrospinal fluid leak. In addition, bolus injections were associated with respiratory depression (Simpson 2003). With the introduction of implantable pumps for infusion of morphine, the delivery system was completely internalized allowing for continuous infusion of analgesics, which is both safer and more effective in obtaining pain relief (Simpson 2003; Penn 2003; Levy and Salzman 1997; Smith et al. 2002).

#### Routes of Administration

Implantable pumps can be used for intraspinal (intrathecal/subdural or epidural) or intraventricular drug delivery. Intrathecal or intraventricular administration is generally thought to be superior to the ► **epidural** route. Epidural administration utilizes higher doses, which increases the risk of adverse systemic effects, such as respiratory depression, and which increases the frequency with which the drug reservoir must be refilled. In addition, there is the risk of catheter misplacement or migration into the subdural space. With the increased opioid dosages used with epidural pumps, this complication could lead to over-dosage and life-threatening respiratory depression. On the other hand, misplacement of an intrathecal catheter or migration into the epidural space would produce only inadequate pain relief or symptoms of withdrawal, which can both be treated with oral opioids (Simpson 2003).

Intraventricular delivery is believed to be as efficacious as intrathecal delivery but more invasive. Thus, it is usually reserved for cases that fail to respond to intraspinal delivery or in cases of refractory craniofacial pain. Several studies have investigated the safety and efficacy of intraventricular drug delivery. With daily morphine injections via an ommaya reservoir, Karavelis et al. were able to achieve adequate pain relief in a large series of 90 patients. Only 10% of their patients reported less than 50% relief of pain. There were two cases of iatrogenic intracerebral hematomas and two cases of infection. Permanent sequelae were not reported. Overall, only three of the 90 intraventricular catheters failed (Karavelis et al. 1996). A number of studies that examined the issue of intraventricular vs. intraspinal morphine delivery have been reviewed by Ballantyne et al. They found that 75%

of patients with intraventricular morphine drug delivery achieved excellent pain control, versus 58% in patients with intrathecal morphine (difference not statistically significant) (Ballantyne et al. 1996). There was also a trend towards fewer technical problems with intraventricular therapy, although adverse effects of sedation and confusion were more common (Ballantyne et al. 1996). The most commonly used avenue of analgesic delivery via implantable pumps, however, remains the intrathecal route. The technique of pump implantation has been well described previously (Levy and Salzman 1997). First, a lumbar puncture is performed between L2 and L5 to avoid the caudal end to the spinal cord, which lies at L1 or above. A catheter is then threaded through the needle in a rostral direction. Catheter placement in the mid or lower thoracic region is then confirmed with fluoroscopy. Placement of the catheter into the cervical region has been performed, but increases the risk of respiratory depression. Attention is then turned to creating a subcutaneous pocket for the implantable pump. The site of this pocket must be accessible for refilling of the pump's reservoir and for possible re-programming. Once an adequate pocket is made, the pump is implanted and the intrathecal catheter is tunneled subcutaneously, connected to the pump and secured to prevent catheter migration.

#### Complications

Infection with resulting meningitis remains the most common complication, usually necessitating pump removal and long-term intravenous antibiotics. Cerebrospinal fluid leaks can usually be treated with flat bed rest or placement of an injection of the patient's blood into the epidural space, i.e. epidural blood patch. In some cases, re-exploration of the site of dural penetration is necessary. Catheter migration, disconnection, obstruction or kinking along with battery failure are all common occurrences that require replacement of the catheter or pump. In the setting of strong magnetic fields, such as an MRI scan, pumps should be turned off or the reservoirs emptied.

A rare, but clinically significant complication of long-term intrathecal catheter use is the development of space-occupying inflammatory lesions at the distal catheter tip. Recently, a series of 41 reported cases was reviewed in the literature, all after infusion of morphine (Coffey and Burchiel et al. 2002). Fourteen of these patients presented with complete spinal cord injuries. It is theorized that intraspinal morphine infusion is more responsible than the catheter itself, since these lesions have not been reported with intrathecal baclofen or with lumboperitoneal shunt catheters (Coffey and Burchiel et al. 2002). The incidence of this potentially devastating complication is low, but clinicians must be aware of it and must warn patients of its potential.

Medical complications from opioid administration include respiratory depression, which can be fatal. Tran-

sient respiratory depression is particularly associated with intraventricular delivery (Ballantyne et al. 1996). Symptoms of withdrawal may also occur when the pump malfunctions or the reservoir is depleted. In most cases, oral opioids can be administered until the pump is replaced. A troublesome but poorly understood side effect is painful myoclonus (Penn 2003). Other adverse effects are similar to those experienced with systemic opioid administration: pruritis, hypotension, constipation, confusion, drowsiness and urinary retention.

### Pump Designs

A simple continuous infusion pump is the most commonly used, which is both effective and inexpensive. The rate of opioid infusion is adjusted by replacing the contents of the reservoir with differing drug concentrations. There are also pumps activated by placing pressure over a switch on the subcutaneous (patient-controlled) pump, which can then deliver bolus infusions or adjust the continuous rate. Programmable pumps can be re-programmed with an external device to adjust the rate of infusion at pre-set times. While programmable and patient controlled pumps may initially appear to be superior to simple continuous infusion pumps, they do have some disadvantages. They are much more costly and utilize more battery power, which leads to more frequent pump changes. The programmable and patient-controlled pumps, in general, should be reserved for patients with non-malignant pain who do not have a short life expectancy (Simpson et al. 2003).

### Implantable Pumps in the Future

There are two obvious potential areas of advancement for implantable pain pumps. The first is the design of cheaper and more versatile pumps. Antibiotic coated pumps and catheters may someday help lower infection rates, and longer battery lives will reduce the frequency of pump changes. The second is the use of different drugs, including those that are given systemically but have not traditionally been used intrathecally. In addition, pumps may be used to deliver drugs designed specifically for intrathecal or intraventricular administration. Of the former, some drug classes currently under investigation include sodium channel antagonists, calcium channel antagonists, NMDA antagonists, GABA agonists, alpha-2 adrenergic agonists, acetylcholinesterase inhibitors, adenosine agonists and somatostatin analogues (Dougherty and Staats 1999; Lorenz et al. 2002; Middleton et al. 1996). Recent studies have also looked at combination therapy using such drugs as clonidine, benzodiazepines, and bupivacaine in addition to morphine (Rainov et al. 2001). Other novel approaches include the implantation of spheres containing cells, or the transplantation of cells that elaborate particular **neurotransmitters**, and so function as biologic drug pumps. Trials have already been performed with human chromaffin cells transplanted

into the subarachnoid space of patients with refractory cancer pain (Pappas et al. 1997).

### References

1. Ballantyne JC, Carr DB, Berkey CS, Chalmers TC, Mosteller F (1996) Comparative Efficacy of Epidural, Subarachnoid, and Intracerebroventricular Opioids in Patients with Pain due to Cancer. *Reg Anesth* 21:542–56
2. Coffey RJ, Burchiel K (2002) Inflammatory Mass Lesions Associated with Intrathecal Drug Infusion Catheters: Report and Observations on 41 Patients. *Neurosurgery* 50:78–87
3. Dougherty PM, Staats PS (1999) Intrathecal Drug Therapy for Chronic Pain. *Anesthesiology* 91:1891–1918
4. Karavelis A, Foroglou G, Selviaridis P, Fountzilias G (1996) Intraventricular Administration of Morphine for Control of Intractable Cancer Pain in 90 Patients. *Neurosurgery* 39:57–62
5. Levy RM, Salzman D (1997) Implanted Drug Delivery Systems for Control of Chronic Pain. In: North RB, Levy RM (eds) *Neurosurgical Management of Pain*. Springer-Verlag, New York, pp 302–324
6. Lorenz M, Hussein S, Verner L (2002) Continuous Intraventricular Clonidine Infusion in Controlled Morphine Withdrawal – Case Report. *Pain* 98:335–338
7. Middleton JW, Siddall PJ, Walker S, Molloy AR, Rutkowski SB (1996) Intrathecal Clonidine and Baclofen in the Management of Spasticity and Neuropathic Pain Following Spinal Cord Injury: A Case Study. *Arch Phys Med Rehabil* 77:824–826
8. Pappas GD, Lazorthes Y, Bes JC, Tafani M, Winnie AP (1997) Relief of Intractable Cancer Pain by Human Chromaffin Cell Transplants: Experience at Two Medical Centers. *Neurol Res* 19:71–77
9. Penn RD (2003) Intrathecal Medication Delivery. *Neurosurg Clin N Am* 14:381–387
10. Rainov NG, Heidecke V, Burkert W (2001) Long-Term Intrathecal Infusion of Drug Combinations for Chronic Back and Leg Pain. *J Pain Symptom Manage* 22:862–871
11. Simpson R (2003) Mechanisms of Action of Intrathecal Medications. *Neurosurg Clin N Am* 14:353–364
12. Smith TJ, Staats PS, Deer T, Stearns LJ, Rauck RL, Boortz-Marx RL, Buchser E, Catala E, Bryce DA, Coyne PJ, Pool GE; Implantable Drug Delivery Systems Study Group (2002) Randomized Clinical Trial of an Implantable Drug Delivery System Compared with Comprehensive Medical Management for Refractory Cancer Pain: Impact on Pain, Drug-Related Toxicity and Survival. *J Clin Oncol* 20:4040–4049
13. Wang JK, Nauss LE, Thomas JE (1979) Pain Relief by Intrathecally Applied Morphine in Man. *Anesthesiology* 50:149–151

P

## Pain Treatment, Intracranial Ablative Procedures

PHILIP L. GILDENBERG

Baylor Medical College, Houston, TX, USA  
hsc@stereotactic.net

### Synonyms

Thalamotomy; Mesencephalotomy; Mesencephalic Tractotomy; Cingulotomy; Pain; Cancer pain; Stereotactic; Intracranial Ablative Procedures

### Definition

Interruption, within the brain or brain stem, of pathways or structures concerned with pain intensity, unpleasantness, or suffering for relief of subacute or **chronic pain**.

## Characteristics

In the early part of the twentieth century, the spinothalamic tract was interrupted at several sites where it lies close to the surface of the brain stem (White and Sweet 1969; Gybels and Sweet 1989). The descending tract of the trigeminal nucleus, which concerns pain perception specifically, was interrupted in the dorsolateral medulla to treat head, neck, and face pain. The spinothalamic pathway lies just below the pial surface, at the lateral edge of the tectum of the midbrain, and presented a target for ► **ablation**. The localization of the tracts on visualization of the surface of the brain stem, however, is uncertain, so there was a high incidence of unsuccessful analgesia or pain relief, and a high incidence of unwanted neurological side effects.

When human stereotactic surgery was invented in 1947 (Spiegel et al. 1947), it became possible to insert an electrode accurately into any desired cerebral anatomic structure. This structure could then be ablated by application of a coagulating current or injection of a toxic substance, such as alcohol. One goal of such surgery was to treat persistent pain. The safety and effectiveness of these procedures was dramatically improved with the introduction of modern imaging techniques, such as computerized tomography or magnetic resonance imaging.

Selection of the proper patient is an important factor in whether ► **intracranial** ablative procedures might successfully relieve pain. Pain that involves the body or extremities may be treated by a procedure involving the peripheral nerves or spinal cord. Intracranial procedures are more likely to be used in patients with pain involving the head and/or neck, the upper part of the body, such as the brachial plexus, or pain that is widespread throughout the body. The etiology of the pain must be clearly defined, and the severity of the pain is consistent with the etiology (Gildenberg 1996; Gildenberg and DeVaul 1985). Ordinarily, such surgery is reserved for persistent pain accompanying serious conditions, such as involvement of the head or neck with cancer, cancer that is widespread throughout the body, or pain that may persist after severe nerve injury, especially involving the face. Pain may recur months or years after an initially successful procedure. Consequently, ablative intracranial surgery is used to treat ► **cancer pain** more often than persistent pain of other etiologies. Patients should not be considered for ablative procedures unless significant psychological factors are ruled out or controlled. It seemed logical that pain would disappear if the primary pain pathway, the spinothalamic tract, were interrupted in the spinal cord or brain stem (Gildenberg 1973). When it was first interrupted stereotactically in the midbrain, a procedure called mesencephalotomy, hemisensory loss of pain sensation or analgesia could be achieved throughout the entire contralateral body, face and head, often with good but temporary relief of pain.

A high risk of postoperative central pain was observed. It was observed, that if the mesencephalic central grey were also interrupted, pain relief was more certain and persisted longer (Nashold et al. 1969). Even if only the gray matter is interrupted, it may be possible to achieve pain relief without loss of pin stick pain sensation or analgesia (Shieff and Nashold 1990).

Ablation of targets in the thalamus has also been used for the management of persistent pain. Much of the spinothalamic tract terminates in the brainstem, in structures that may project to the thalamus, but its influence projects to many areas of the thalamus. The spinoreticulothalamic pathways may project to the more medial thalamic nuclei, including the intralaminar and centromedian nuclei. High success rates for treatment of a broad range of conditions have been reported by ► **lesions** of these nuclei and posteriorly adjacent nuclei (Jeanmonod et al. 1994), although these high success rates have not been duplicated (Gybels and Sweet 1989). Ablative lesions in those parts of the thalamus may successfully relieve persistent pain, especially such cancer pain as Pancoast syndrome, from infiltration of the brachial plexus by lung cancer, or diffuse cancer pain (Spiegel et al. 1964). It is sometimes observed that patients who have successful pain relief from lesions in the intralaminar or centromedian nuclei may abruptly withdraw their narcotics with a minimum of withdrawal symptoms (Gildenberg and DeVaul 1982).

Intracranial procedures ablating parts of the ► **limbic system** are sometimes used to treat such psychiatric conditions as obsessive-compulsive disorder or ► **intractable** depression, if they cannot be managed with medications. A common target for such psychosurgery is the anterior portion of the cingulate bundle, as it wraps around the anterior end of the corpus callosum. Ablation of that same area has been successful in alleviating severe persistent pain, particularly that of cancer, and particularly if the cancer has caused severe emotional distress (Hassenbusch 1998).

## References

1. Gildenberg PL (1973) Percutaneous Cervical Cordotomy. *Clin Neurosurg* 21:246–256
2. Gildenberg PL (1996) General and Psychological Assessment of the Pain Patient. In: Tindall GT, Cooper PR, Barrow DL (eds) *The Practice of Neurosurgery*. Williams and Wilkins, Baltimore, pp 2987–2996
3. Gildenberg PL, DeVaul RA (1982) Management of Chronic Pain Refractory to Specific Therapy. In: Youmans JR (ed) *Neurological Surgery*. W.B.Saunders, Philadelphia, pp 3749–3768
4. Gildenberg PL, DeVaul RA (1985) *The Chronic Pain Patient. Evaluation and Management*. Karger, Basel
5. Gybels JM, Sweet WH (1989) *Neurosurgical Treatment of Persistent Pain. Physiological and Pathological Mechanisms of Human Pain*. Karger, Basel
6. Hassenbusch SJ (1998) Cingulotomy for Cancer Pain. In: Gildenberg PL, Tasker RR (eds) *Stereotactic and Functional Neurosurgery*. McGraw-Hill, New York, pp 1447–1451
7. Jeanmonod D, Magnin M, Morel A (1994) Chronic neurogenic pain and the medial thalamotomy. *Schweiz Rundsch Med Prax* 83:702–707



8. Nashold BS, Wilson WP, Slaughter DG (1969) Stereotaxic Mid-brain Lesions for Central Dysesthesia and Phantom Pain. Preliminary report. *J Neurosurg* 30:116–126
9. Shieff C, Nashold BSJ (1990) Stereotactic Mesencephalotomy. *Neurosurg Clin N Am* 1:825–839
10. Spiegel EA, Wycis HT, Marks M, Lee AS (1947) Stereotaxic Apparatus for Operations on the Human Brain. *Science* 106:349–350
11. Spiegel EA, Wycis HT, Szekely EG, Gildenberg PL, Zanes C (1964) Combined Dorsomedial, Intralaminar and Basal Thalamotomy for Relief of So-Called Intractable Pain. *J Internat Coll Surg* 42:160–168
12. White JC, Sweet WH (1969) Pain and the Neurosurgeon. A Forty Year Experience. Charles C Thomas, Springfield

## Pain Treatment, Motor Cortex Stimulation

JEFFREY A. BROWN

Department of Neurological Surgery, Wayne State University, School of Medicine and Neurological Surgery, Detroit, NY, USA  
jbrown@neurosurgery.wayne.edu

### Synonyms

Cortical Stimulation for Relief of Pain; motor cortex stimulation

### Definition

A technique for relief of neuropathic pain, involving stimulation of the somatotopically appropriate area of ► **motor cortex** through electrodes implanted in the epidural space (see ► **cortex and pain**).

### Characteristics

Epidural motor cortex stimulation is a form of neuromodulation used to treat central and neuropathic pain syndromes, including pain from post-stroke ► **central pain** syndromes, trigeminal nerve injury, post herpetic neuralgia, brachial plexus injury, spinal cord (► **spinal cord stimulation**) injury and phantom limb pain.

In order to develop a treatment for thalamic pain syndrome more effective than chronic stimulation of the thalamic relay nucleus with deep brain electrodes (► **deep brain stimulation**), Hirayama et al. investigated the effects of stimulation of various brain regions (Hirayama et al. 1990). They described complete, long-term inhibition of the burst hyperactivity recorded in thalamic neurons in cats after antero-lateral cordotomy. Tsubekawa et al. then applied the technique clinically in seven patients with chronic, intractable, neuropathic pain, and reported success of the technique in all patients studied (Tsubokawa et al. 1991). Tsubokawa then reviewed a series of 11 patients with central pain after putaminal or thalamic hemorrhage, treated with motor cortex stimulation for two years. There was greater than 80% pain relief maintained in five of the 11 patients (Tsubokawa et al. 1993). Two years later, Meyerson et al. 1993, successfully relieved greater than 50% of pain in all five patients in his

series who had trigeminal neuropathic pain. Allodynia, dysesthesia and hyperaesthesia diminished during stimulation (Meyerson et al. 1993). Katayama et al. treated four patients with lateral medullary infarctions, whose pain relief from ventral posterior thalamic nuclear stimulation had ceased to be effective. These patients were then treated by motor cortex stimulation and reported 40–60% pain relief (Katayama et al. 1994).

### Patient Screening

Yamamoto et al. noted that successful pain relief by motor cortex stimulation could be predicted, if patients responded by at least 40% pain relief to incremental infusions of intravenous thiamylol to a maximum dose of 250 mg, but not to morphine in doses of up to 18 mg given over five hours (Yamamoto et al. 1997). Katayama et al. have observed that satisfactory pain relief can be obtained in 73% of patients when they have no motor weakness. If weakness is moderate to severe, then only 15% of patients will benefit from stimulation. In addition, if motor responses cannot be induced by stimulation, then only 8% of patients will obtain pain relief (Katayama et al. 1998). The conclusion to be drawn is that motor cortex stimulation requires an intact motor system to be effective, but not an intact somatosensory system.

### Mechanism of Effect

Positron emission tomography, performed by Garcia-Larrea et al. in patients being treated by motor cortex stimulation, show elevations in cerebral blood flow in the ipsilateral thalamus, cingulate gyrus, orbitofrontal cortex and midbrain (see ► **thalamus and pain**). The degree of pain relief correlates with increased blood flow in the cingulate gyrus. Nociceptive spinal reflexes are also attenuated by stimulation. In general terms, the cingulate gyrus is believed to be involved in the affective dimension of ► **chronic pain** (Garcia-Larrea et al. 1999; Garcia-Larrea et al. 2000).

### Morbidity

Several series have reported seizures occurring, usually during implantation of the stimulator. The effect of motor cortex stimulation in primates has been studied by Bezard et al. However, although stimulation could cause reversible seizures, neither epilepsy nor a reduced threshold for kindling of seizure occurred (Bezard et al. 1999). Epidural hematomas have been associated with the surgery, but without neurological injury. Stimulator pocket infections and electrode wire fractures have occurred, which are known complications of the implantation of neuro-stimulators.

### Facial Pain

Nguyen et al. reviewed a series of 12 patients with neuropathic ► **facial pain**, of whom 75% achieved good to excellent pain relief. This is due to the cortical representation of the face being large and accessible over the convexity. Therefore, it is easier to treat facial pain when

the electrodes are placed somatotopically over the correlating representational region of the pain on the motor cortex (Nguyen et al. 2000).

### Central Pain Syndromes

In a recent series of patients with central pain syndromes, it was reported that 10 out of 14 patients (77%) achieved substantial pain relief (Nguyen et al. 2000).

### Motor Effects

Motor cortex stimulation has been observed to improve motor function independent of pain control. Improved thalamic hand syndrome, spasticity, action tremor, intention myoclonus, advanced Parkinson's symptoms and recovery after stroke have been reported to occur with stimulation.

### Surgical Technique

The surgical technique has been refined since the initial report of Tsubokawa. Treatment planning begins with an MRI or CT scan that is integrated into a neuro-navigational system. The target is selected on the primary motor cortex, based on anatomic landmarks. These were first established by Nguyen et al. in 2000. Most often, the target for facial pain, for example, is selected anterior to the central sulcus, at the level of the inferior frontal sulcus, as seen on the sagittal MRI or CT. Patients are induced with general endotracheal anesthesia, and need not be awakened for evaluation of pain relief during surgery. The central sulcus, at the level of hand function, may be identified using median nerve somatosensory evoked potentials and determination of N20 P20 phase shift. Electromyographic recordings during cortical stimulation of the target muscles in the region of pain are done to determine the site of maximal electromyographic response to stimulation. A four-plate electrode paddle array is sutured to the dura, parallel to the central sulcus, overlying the primary motor cortex. Often patients are found to have substantial pain relief from the intraoperative stimulation. Several days of trial stimulation is performed, after which the pulse generator is implanted, when pain relief is greater than 50%. Subthreshold stimulation relieves pain. Stimulation is done at low frequency (40 Hz), usually low pulse width (90 msec) and low amplitudes (2–10 volts). More difficult to treat pain syndromes (such as anesthesia dolorosa) will require higher energy delivery.

### Conclusions

Motor cortex stimulation represents a paradigm change in the treatment of central and neuropathic pain syndromes, and potentially the treatment of movement disorders and paresis associated with stroke (Brown 2003). The morbidity is low and pain relief significant in patients who are otherwise not amenable to medical or surgical treatment. Clinical trials, published after the introduction of the technique a dozen years ago,

continue to show favorable pain relief in this difficult to treat population of patients.

### References

1. Bezaud E, Boraud T, Nguyen JP, Velasco F, Keravel Y, Gross C (1999) Cortical Stimulation and Epileptic Seizure: A Study of the Potential Risk in Primates. *Neurosurgery* 45:346–350
2. Brown J (2003) Guest Editorial. *Neurological Research* 25:115–117
3. Garcia-Larrea L, Peyron R, Mertens P, Gregoire MC, Lavenne F, Le Bars D et al. (1999) Electrical Stimulation of Motor Cortex for Pain Control: A Combined PET-Scan and Electrophysiological Study. *Pain* 83:259–273
4. Garcia-Larrea L, Peyron R, Mertens P, Laurent B, Mauguiere F, Sindou M (2000) Functional Imaging and Neurophysiological Assessment of Spinal and Brain Therapeutic Modulation in Humans. *Arch Med Res* 31:248–257
5. Hirayama T, Tsubokawa T, Katayama Y et al. (1990) Chronic Change in Activity of Thalamic Relay Neurons Following Spinothalamic Tractotomy in Cat: Effect of Motor Cortex Stimulation. *Pain* 5:273
6. Katayama Y, Fukaya C, Yamamoto T (1998) Post-Stroke Pain Control by Chronic Motor Cortex Stimulation: Neurological Characteristics Predicting a Favorable Response. *J Neurosurg* 89:585–591
7. Katayama Y, Tsubokawa T, Yamamoto T (1994) Chronic Motor Cortex Stimulation for Central Deafferentation Pain: Experience with Bulbar Pain Secondary to Wallenberg Syndrome. *Stereotact Funct Neurosurg* 62:295–299
8. Meyerson BA, Lindblom U, Linderöth B, Lind G, Herregodts P (1993) Motor Cortex Stimulation as Treatment of Trigeminal Neuropathic Pain. *Acta Neurochir Suppl (Wien)* 58:150–153
9. Nguyen JP, Lefaucher JP, Le Guerin C, Eizenbaum JF, Nakano N, Carpentier A et al. (2000) Motor Cortex Stimulation in the Treatment of Central and Neuropathic Pain. *Arch Med Res* 31:263–265
10. Nguyen JP, Lefaucher JP, Le Guerin C, Fontaine D, Nakano N, Sakka L et al. (2000) Treatment of Central and Neuropathic Facial Pain by Chronic Stimulation of the Motor Cortex: Value of Neuronavigation Guidance Systems for the Localization of the Motor Cortex. *Neurochirurgie* 46:483–491
11. Tsubokawa T, Katayama Y, Yamamoto T, Hirayama T, Koyama S (1991) Treatment of Thalamic Pain by Chronic Motor Cortex Stimulation. *Pacing Clin Electrophysiol* 14:131–134
12. Tsubokawa T, Katayama Y, Yamamoto T, Hirayama T, Koyama S (1993) Chronic Motor Cortex Stimulation in Patients with Thalamic Pain. *J Neurosurg* 78:393–401
13. Yamamoto T, Katayama Y, Hirayama T, Tsubokawa T (1997) Pharmacological Classification of Central Post-Stroke Pain: Comparison with the Results of Chronic Motor Cortex Stimulation Therapy. *Pain* 72:5–12

## Pain Treatment, Spinal Cord Stimulation

BJÖRN A. MEYERSON

Department of Clinical Neuroscience, Section of Neurosurgery, Karolinska Institute/University Hospital, Stockholm, Sweden  
bjorn.meyerson@karolinska.se

### Synonyms

Dorsal column stimulation (DCS); Epidural Spinal Electrical Stimulation; Spinal cord stimulation

## Definition

Activation of the spinal ► **dorsal columns** by electrical stimuli, delivered via an implanted spinal electrode and pulse generator. This technique is applied as treatment of neuropathic pain, preferably of peripheral origin, of ► **angina pectoris** and of ischemic extremity pain. Stimulation evokes paresthesias that must cover the area of pain to be effective, and it may also induce peripheral vasodilatation.

## Characteristics

Spinal cord stimulation (SCS) evolved as a direct clinical application of the ► **gate-control theory** with the idea to produce inhibition of nociception at the first spinal relay by antidromic activation of the low threshold dorsal column fibers. The general conceptualisation of the theory may still be valid as a base for the understanding of the mode of action of SSC, but it does not account for the fact that only neuropathic pain conditions may respond to this treatment; relief of ischemic pain is presumably secondary to other effects of the stimulation. Experimental studies, on rat models of neuropathic pain, have provided some insight into the mechanisms involved in the pain relief (Meyerson and Linderoth 2003). SCS applied in such animals may suppress mechanical hypersensitivity (“allodynia”) and neuronal hyperexcitability in the spinal dorsal horn. These effects are associated with increased release of gamma-amino butyric acid (GABA) in the dorsal horn, while the release of excitatory amino acids (glutamate, aspartate) is decreased. The crucial role of GABA is further evidenced by the finding that the SCS effects on allodynia may be enhanced and counteracted by the administration of GABA<sub>B</sub> agonists and antagonists, respectively. There is also evidence that adenosine-related mechanisms are involved. These data suggest that segmental spinal mechanisms are crucial but some recent findings support the notion that part of the pain inhibiting effect of SCS is more dependent on the involvement of supraspinal loops (El-Koury et al. 2002).

There is no convincing evidence that SCS directly influences nociceptive forms of pain. The beneficial effect on ischemic extremity pain is assumed to result from the reduction of ischemia, due to a vasodilatation (Linderoth and Foreman 1999). This can be produced by an antidromic activation of primary afferents or be sympathetically mediated. Experimental data indicate that the former mechanism is associated with a peripheral release of ► **calcitonin gene related peptide (CGRP)** (Croom et al. 1997).

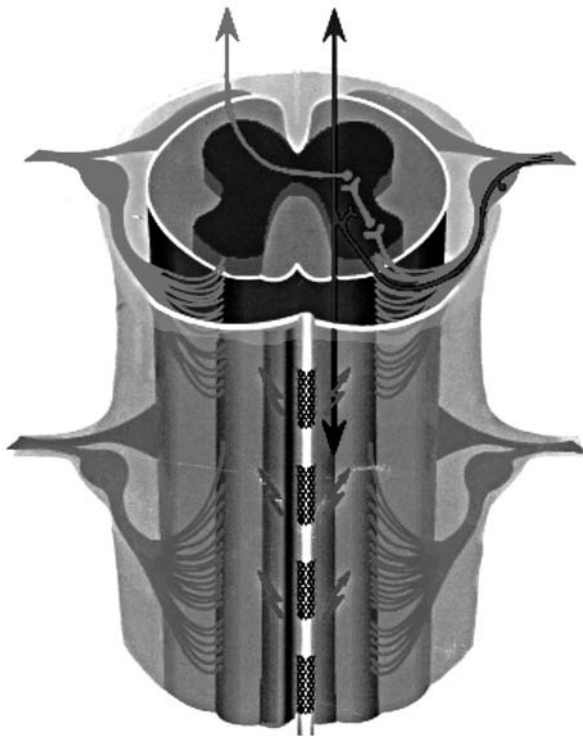
In myocardial ischemia, the antianginal effect of SCS is probably due to a restoration of the oxygen/supply balance. It has been experimentally demonstrated that the time taken for the onset of angina during exercise or heart pacing can be significantly increased by SCS, and the de-

pression of the ST segment in the electrocardiogram is counteracted (Mannheimer et al. 1993). It has also been shown that during controlled exercise SCS causes a reversion of myocardial lactate production to extraction. Increased or redistributed coronary blood flow, reduced myocardial oxygen demand and depression of cardiac sympathetic activity have all been suggested as underlying mechanisms (Jessurun et al. 1996; Foreman et al. 2000).

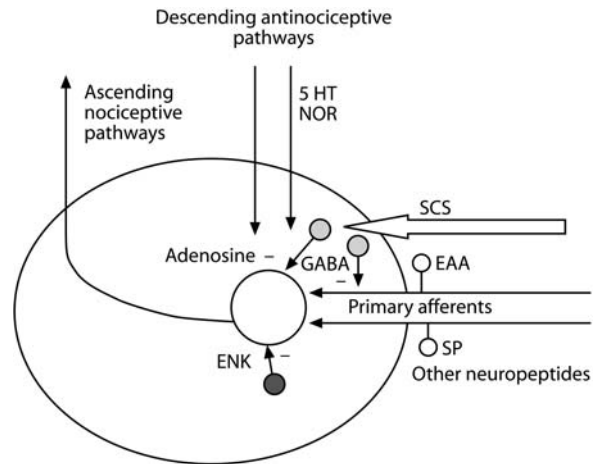
SCS applied for either neuropathic, peripheral ischemic or cardiac (angina pectoris) pain is indicated only when pharmacotherapy or surgical treatment options have been exhausted. Good treatment compliance is required, as the patient externally controls the pulse generator. There are very few randomised, prospective SCS studies, and placebo-controlled trials are not possible due to the presence of paresthesias. There are a large number of case studies of SCS applied for various forms of neuropathic pain, comprising relatively large patient cohorts with long-term follow-up, and the reported outcomes are highly concordant. In general, good results, defined as >50% pain reduction, supplemented by assessment of analgesic medication and global satisfaction, are reported in 60–70% of the patients (Meyerson and Linderoth 2000; Simpson et al. 2005). It is notable that the analgesic effect often remains for many years, and there is no tendency towards tolerance and fatigue. The most common SCS indication is lumbo-sacral rhizopathy, a diagnosis that often represents a mixed, complex pain condition, which also comprises nociceptive pain components located in the lumbar region. This “low back pain” is less likely to respond to SCS, although it has been claimed that it can also be ameliorated by using special types of multipolar electrodes and dual channel pulse generators (North et al. 2005); others maintain that it is preferably the “radiating leg pain” that is amenable to SCS (North et al. 1993). The second common indication is pain following peripheral nerve injury or disease. Such pain may occur as a result of surgery or trauma, and is often associated with abnormalities of cutaneous sensibility, which may give rise to evoked pain. The injury may comprise a major nerve or small, peripheral nerve branches (sometimes presenting as “scar pain”). Of the many forms of neuropathy due to metabolic disease, diabetic polyneuropathy is the most common and is likely to respond to SCS. Pain due to peripheral nerve injury sometimes presents as Complex Regional Pain Syndrome (CPRS type 2) and this condition, as well as CPRS type 1, are also considered to be good indications (Kumar et al. 1997). Good evidence for the efficacy of SCS for CRPS has been provided in a recent randomised, controlled study (Kemler et al. 2004). Pain associated with complete deafferentation, and pain located in the axial parts of the trunk are less likely to respond, and the same applies to central pain (Barolat 1995).

SCS for the management of ischemic pain in the extremities (arteriosclerosis and vasospastic disorders)

is, to date, practiced in relatively few centres. Provided the treatment is applied only with stringent selection criteria, the overall outcome is favourable, with 60–70% of the patients enjoying substantial pain relief (Ubbink and Vermeulen 2004). There is also a marked amelioration of claudication and an increased walking distance. Further, SCS may facilitate the healing of small ulcers and there may be some limb salvage effect. Intractable angina pectoris has emerged as an important indication for SCS, since successful outcomes are reported in up to 85% of patients (Ten Vaarwerk et al. 1999). Outcome is defined in terms of daily number of anginal attacks, consumption of nitrates, visits to the emergency room and quality of life. There is one randomised study that has compared the outcome of stimulation to controls with inactive SCS, confirming the remarkably favourable outcome of the treatment (Hautvast et al. 1998). There has been much concern about the risk that SCS might conceal critical coronary ischemia leading to infarction. Several studies, however, have provided evidence that the warning pain signal under these circumstances is not influenced by SCS.



**Pain Treatment, Spinal Cord Stimulation, Figure 1** Schematic illustration of how a percutaneously introduced quadripolar electrode in the epidural space may activate the spinal dorsal columns. The electrode is connected to a subcutaneously implanted pulse-generator, “neuropace-maker”, supplying electrical pulses which are set by an external remote control. The stimulation-induced paresthesias must cover the painful region in order to produce pain relief. It is believed that the suppression of pain takes place at the first synaptic relay in the dorsal horn and/or by the activation of pain inhibiting supraspinal loops.



**Pain Treatment, Spinal Cord Stimulation, Figure 2** Illustration of putative, and partly demonstrated, transmitter mechanisms involved in the effect of SCS on the synaptic dorsal horn pain relay. SP, substance P; EAA, excitatory amino acids (glutamate, aspartate).

SCS is a well-established, minimally invasive treatment that is well tolerated and may offer effective management of pain conditions for which there are often no alternative treatments available. It has also been shown, in a number of studies, to be cost-effective.

## References

- Barolat G (1995) Current Status of Epidural Spinal Cord Stimulation. *Neurosurg Quarterly* 5:98–124
- Croom JE, Foreman RD, Chandler MJ, Barron KW (1997) Cutaneous Vasodilatation during Dorsal Column Stimulation is Mediated by Dorsal Roots and CGRP. *Am J Physiol* 272: 950–957
- El-Khoury C, Hawwa M, Baliki SF, Atweh SF, Jabbur SV, Saadé NE (2002) Attenuation of Neuropathic Pain by Segmental and Supraspinal Activation of the Dorsal Column System in Awake Rats. *Neuroscience* 112:541–553
- Foreman RD, Linderth B, Ardell JL, Barron KW, Dejongste MJL, Hull SS, Chandler MJ, TerHhorst GJ, Armour JA (2000) Modulation of Intrinsic, Cardiac Neuronal Activity by Spinal Cord Stimulation (SCS) in the Dog: Implications for the Use of SCS in Angina Pectoris. *Cardiovasc Res* 47:367–375
- Hautvast RW, DeJongste MJ, Staal MJ, van Gilst WH, Lie KI (1998) Spinal Cord Stimulation in Chronic Intractable Angina Pectoris: A Randomized, Controlled Efficacy Study. *Am Heart J* 136:1114–1120
- Jessurun GAJ, DeJongste MJL, Blanksma PK (1996) Current Views on Neurostimulation in the Treatment of Cardiac Ischemic Syndromes. *Pain* 66:109–116
- Kemler MA, De Vet HC, Barandse GA, Van Den Wildenberg FA, Van Kleef M (2004) The effect of spinal cord stimulation in patients with chronic reflex sympathetic dystrophy: two years' follow-up of the randomized controlled trial. *Ann Neurol* 55:13–8
- Kumar K, Nath RK, Toth C (1997) Spinal Cord Stimulation is Effective in the Management of Reflex Sympathetic Dystrophy. *Neurosurgery* 40:503–508
- Linderth B, Foreman RD (1999) Physiology of Spinal Cord Stimulation: Review and Update. *Neuromodulation* 2:150–164
- Mannheimer C, Eliasson T, Andersson B et al. (1993) Effects of Spinal Cord Stimulation in Angina Pectoris Induced by Pacing and Possible Mechanisms of Action. *BMJ* 307:477–480
- Meyerson BA and Linderth B (2000) Spinal Cord Stimulation. In: Loeser JD (ed) *Bonica's Management of Pain*, 3rd edn. Lippincott Williams & Wilkins, Philadelphia, pp 1857–1987



12. Meyerson BA, Linderoth B (2003) Spinal Cord Stimulation - Mechanisms of Action in Neuropathic and Ischemic Pain, In: Simpson B (ed) *Electrical Stimulation and the Relief of Pain*. Elsevier, pp 161–182
13. Nachbur G, Gersbach P, Hasdemir M (1994) Spinal Cord Stimulation for Unreconstructable Chronic Limb Ischaemia, *Eur J Vasc Surg* 8:383–388
14. North RB, Kidd DH, Zahurak M et al. (1993) Spinal Cord Stimulation for Chronic, Intractable Pain: Experience Over Two Decades. *Neurosurgery* 32:384–395
15. Nort RB, Kidd DH, Olin J et al. (2005) Spinal cord stimulation for axial low back pain: a prospective, controlled trial comparing dual with single percutaneous electrodes. *Spine* 15:1412–8
16. Simpson BA, Meyerson BA, Linderoth B (2005) Spinal cord and brain stimulation. In: McMahon SB, Koltzenburg M (eds) *Textbook of Pain*, 5th edn. Elsevier, pp 563–582
17. TenVaarwerk IA, Jessurun GA, DeJongste MJ, Andersen C, Mannheimer C, Eliasson T, Tadema W, Staal MJ (1999) Clinical Outcome of Patients Treated with Spinal Cord Stimulation for Therapeutically Refractory Angina Pectoris. *The Working Group on Neurocardiology. Heart* 82:82–88
18. Ubbink DT, Vermeulen H (2003) Spinal cord stimulation for non-reconstructable chronic critical leg ischaemia (Cochrane Review). *The Cochrane Library*. Issue 3

## Pain Treatment, Spinal Nerve Blocks

RICHARD B. NORTH

Neurosurgery, Johns Hopkins University School of Medicine, Baltimore, MD, USA

RNorth@jhmi.edu

### Synonyms

Diagnostic block; Prognostic Block; Therapeutic block; Spinal Nerve Block

### Definition

Spinal injections of ► **local anesthetic agents** are used (Boas 1991) as an aid to diagnosis, as prognostic tests for ablative procedures and (Mooney 1991) as therapy. They may be administered within, or adjacent to, the spinal column.

### Characteristics

Temporary nerve blocks using local anesthetic are often employed in the diagnostic evaluation of spinal pain syndromes - for example, in establishing lumbar radiculopathy (Boas 1991; Bonica and Buckley 1990; Mooney 1991; Steindler and Luck 1938) or lumbar facet disease (Carette 1991; North 1994; Schwarzer et al. 1994) as a cause of low back and sciatic pain. Temporary relief of pain by reversible local anesthetic blocks, however, does not reliably predict the long-term results of permanent ablative or anatomic procedures.

The spinal nerves arise from anterior (motor) and posterior (sensory) rootlets shortly after they exit the spinal cord. They traverse the subdural space (filled with spinal fluid) enclosed by the dura and fuse prior to exiting this space. As they exit the spinal canal through the foramina between the pedicles of adjacent vertebrae, the sensory

axons proceed into their cell bodies, which are located in the dorsal root ganglion (DRG). Thereafter, a branch is sent to the ► **anterior primary ramus**, which provides the nerve supply to the extremities (e. g., the brachial plexus) and the chest wall. A second branch is the ► **posterior primary ramus**, which supplies branches to the paraspinal joints, ligaments, discs and skin. Commonly used spinal nerve block targets include the nerve root (at the level of the DRG) (Boas 1991), and the medial branch of the posterior primary ramus, (Bonica and Buckley 1990). “Facet” blocks, are also commonly performed at multiple adjacent levels. ► **Referred pain** due to spinal pathology, e.g., sciatica due to nerve root involvement, often responds not only to blockade of these spinal structures, but also to peripheral nerve blockade in the distribution of the pain, viz. (Mooney 1991) sciatic nerve block at the medial border of the sciatic notch in the buttock. A lumbar subcutaneous control injection (superficial to lumbosacral fascia and superficial to any „trigger point“ is seldom effective (Steindler and Luck 1938).

We have reported previously that, in patients whose sciatica is relieved completely by monoradicular lumbosacral blocks, ablating the primary afferent neurons by dorsal root ganglionectomy does not provide long-term pain relief (North et al. 1991). This is consistent with prior studies of dorsal rhizotomy, whose long-term results were predicted poorly by temporary diagnostic or prognostic blocks (Loeser 1972). Likewise, using lumbar medial branch posterior primary ramus blocks to screen patients for radiofrequency denervations, we have observed that the results of the former predict the long-term results of the latter imperfectly (North et al. 1994). The temporary clinical effects of reversible blocks are not maintained by permanent ablative procedures for chronic pain. Furthermore, diagnostic or prognostic blocks have failed to predict the outcome of anatomic procedures, such as lumbar fusion or decompression, in patients responding to facet joint or nerve root blocks (Dooley et al. 1988; Esses et al. 1993).

Pain may be relieved by temporary blocks directed to areas of pain referral, as opposed to areas of underlying pathology. In one series of patients with a chief complaint of sciatica attributable in all cases to radiculopathy, not only paraspinal lumbosacral root blocks and medial branch posterior primary ramus blocks (at or proximal to the pathology) but also sciatic nerve blocks (distal or collateral to the pathology) produced temporary relief in a majority of patients; the specificity of diagnostic blocks was as low as 24% (North et al. 1996).

Nonspecific relief of segmental pain by reversible blockade may be explained anatomically by branching of primary afferents and/or by convergence upon second-order neurons in the spinal cord of primary afferents, from the regions of injury and of referred pain (Roberts et al. 1989). As reflected by single unit recordings from centrally projecting wide dynamic range neurons, nociceptive as well as non-painful sensory inputs have

excitatory effects upon the same central pain-signaling neurons (Gillette et al. 1993). Pain relief may reflect blockade of tonic, normally non-painful input to central neurons, which is necessary to maintain their ability to signal pain (Owens et al. 1992; Willis 1993).

Double blocks, using anesthetic agents with different durations of action, have been advocated as a method to isolate physiologic, as opposed to functional or placebo responses, to identify a putative pain generator (Schwarzer et al. 1994). Longer-lasting relief with a longer-acting agent is interpreted as a specific response, indicating that the pain generator has been identified. Segmental physiologic effects may vary, however, with duration of drug action, confounding diagnosis by double blocks.

Lack of specificity may in fact be advantageous in therapeutic applications of local anesthetic blockade: blocking an area of pain referral may afford relief even in the absence of local pathology.

There are nonspecific effects not only in the spatial domain but also in the time domain: prolonged relief of pain may occur after local anesthetic blocks, substantially exceeding their pharmacologic duration of action (Arn et al. 1990).

## References

1. Arn S, Lindblom U, Myerson BA, Molander C (1990) Prolonged Relief of Neuralgia after Regional Anesthetic Blocks. A Call for Further Experimental and Systematic Clinical Studies. *Pain* 43:287–297
2. Boas RA (1991) Nerve Blocks in the Diagnosis of Low Back Pain. In: Loeser JD (ed) *Low Back Pain, Neurosurgery Clinics of North America*. W. B. Saunders, Philadelphia, pp 807–816
3. Bonica JJ, Buckley FP (1990) Regional Analgesia with Local Anesthetics. In: Bonica JJ (ed) *The Management of Pain*. Lea & Fibiger, Philadelphia, pp 1883–1966
4. Carette S, Marcoux S, Truchon R, Grondin C, Gagnon J, Allard Y, Latulippe MA (1991) Controlled Trial of Corticosteroid Injections into Facet Joints for Chronic Low Back Pain. *N Engl J Med* 325:1002–1007
5. Dooley JF, McBroom RJ, Taguchi T, Macnab I (1988) Nerve Root Infiltration in the Diagnosis of Radicular Pain. *Spine* 13:79–83
6. Esses SI, Moro JK (1993) The Value of Facet Joint Blocks in Patient Selection for Lumbar Fusion. *Spine* 18:185–190
7. Gillette RG, Kramis RC, Roberts WJ (1993) Characterization of Spinal Somatosensory Neurons having Receptive Fields in Lumbar Tissues of Cats. *Pain* 54:85–98
8. Loeser JD (1972) Dorsal Rhizotomy for the Relief of Chronic Pain. *J Neurosurg* 36:745–754
9. Mooney V (1991) Injection Studies: Role in Pain Definition. In: Frymoyer JW, Ducker TB, Hadler NM, Kostuik JP, Weinstein JN, Whitecloud TS (eds) *The Adult Spine: Principles and Practice*. Raven Press, New York, pp 527–540
10. North RB, Kidd DH, Campbell JN, Long DM (1991) Dorsal Root Ganglionectomy for Failed Back Surgery Syndrome: A Five Year Follow-Up Study. *J Neurosurg* 74:236–242
11. North RB, Kidd DH, Zahurak M, Piantadosi S (1996) Specificity of Diagnostic Nerve Blocks: A Prospective, Randomized Study of Sciatica due to Lumbosacral Spine Disease. *Pain* 65:77–85
12. North RB, Han M, Zahurak M, Kidd DH (1994) Radiofrequency Lumbar Facet Denervation: Analysis of prognostic factors. *Pain* 57:77–83
13. Owens CM, Zhang D, Willis WD (1992) Changes in the Response State of Primate Spinothalamic Cells Caused by Mechanical Damage or Activation of Descending Controls. *J Neurophysiol* 67:1509–1527
14. Roberts WJ, Gillette RG, Kramis RC (1989) Somatosensory Input from Lumbar Paraspinous Tissues: Anatomical Terminations and Neuronal Responses to Mechanical and Sympathetic Stimuli. *Soc Neurosci Abstr* 15:755
15. Schwarzer AC, Aprill CN, Derby R, Fortin J, Kine G, Bogduk N (1994) The False-Positive Rate of Uncontrolled Diagnostic Blocks of the Lumbar Zygapophysial Joints. *Pain* 58:195–200
16. Steindler A, Luck JV (1938) Differential Diagnosis of Pain in the Low Back: Allocation of the Source of Pain by Procaine Hydrochloride Method. *JAMA* 110:106–113
17. Willis WD (1993) Mechanical Allodynia: A Role for Sensitized Nociceptive Tract Cells with Convergent Input from Mechanoreceptors and Nociceptors? *APS Journal* 2:23–33

## Painful Channelopathies

STEPHEN G. WAXMAN

Department of Neurology, Yale School of Medicine, New Haven, CT, USA and VA Medical Center, West Haven, CT, USA

stephen.waxman@yale.edu

### Definition

Channelopathies are disorders in which aberrant function of ► **ion channels**, or lack of function of ion channels, produces clinical signs and symptoms. Acquired transcriptional ► **channelopathies** are the result of dysregulated production of channel proteins, due to changes in transcription of their respective genes; although the ion channel proteins are in themselves normal, deployment of abnormal ensembles of channel proteins distorts the function of neurons. Genetic channelopathies, on the other hand, are the result of mutations in ion channel genes, which result in the absence of channels, channels that fail to function, or channels that function abnormally. Painful channelopathies are those in which patients experience clinically significant pain.

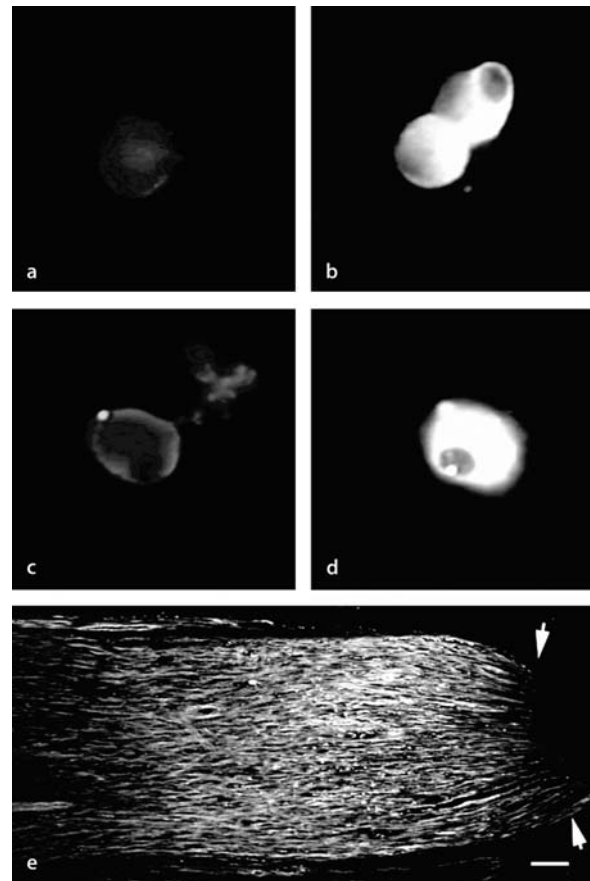
### Characteristics

Given the crucial role of voltage-gated ion channels in the generation and propagation of action potentials, it is not surprising that channelopathies (acquired, in which there are abnormal patterns of expression of normal ion channel genes; and genetic, in which mutant genes produce abnormal channels) can produce pain syndromes. However, it has only been over the past decade that, with the advent of contemporary molecular techniques of analyses, it has been possible to identify voltage-gated ion channels as major contributors to pain syndromes and, in fact, to provide precise molecular identification of the channel isoforms that are involved.

The prototype of acquired painful channelopathy involves the up-regulation of the Na<sub>v</sub>1.3 sodium channel following nerve injury. Waxman et al. 1994) demonstrated that, following transection of the axons of ► **dorsal root ganglion** (DRG) neurons, there is a marked up-regulation of mRNA for the Na<sub>v</sub>1.3 sodium channel. This was subsequently shown to be due, at least

in part, to interruption of access to peripheral pools of neurotrophins, including ► [nerve growth factor](#) (NGF) and glial cell line derived neurotrophic factor (GDNF) (Black et al. (1997; Dib-Hajj et al. 1998; Boucher et al. 2000). Using immunocytochemistry, Black et al. (1999) demonstrated that, following axonal transection; there is an up-regulation of  $\text{Na}_v1.3$  protein as well as mRNA, with deposition of abnormal aggregations of  $\text{Na}_v1.3$  within the injured axonal tips within experimental neuromas. ► [Patch-clamp](#) studies demonstrated that, concomitant with the up-regulation of  $\text{Na}_v1.3$ , a new TTX-sensitive sodium current, characterized by rapid recovery from inactivation (rapid repriming), emerges within axotomized DRG neurons; the rapid recovery from inactivation would be expected to poise these neurons to fire at inappropriately high frequencies (Cummins and Waxman 1997). Evidence for production of the rapidly-repriming current by  $\text{Na}_v1.3$  was initially inferential, based on the concurrent time courses of up-regulation of  $\text{Na}_v1.3$  and the rapidly-repriming current. However, subsequent studies, in which  $\text{Na}_v1.3$  was heterologously expressed in HEK cells, and within DRG neurons, provided definitive evidence that the  $\text{Na}_v1.3$  channel produces a rapidly-repriming current. More recent studies have demonstrated that, following injury to peripheral nerves,  $\text{Na}_v1.3$  is expressed not only within DRG neurons, but also within secondary (and possible tertiary) nociceptive neurons in superficial laminae within the dorsal horn (Hains et al. 2004). Concomitant with expression of  $\text{Na}_v1.3$  within these dorsal horn nociceptive neurons, they become hyper-responsive, firing spontaneously and at higher-than-normal frequencies in response to stimulation. Importantly,  $\text{Na}_v1.3$  antisense oligonucleotides, which penetrate the dorsal horn but not DRG, reverse the up-regulation of  $\text{Na}_v1.3$  within dorsal horn neurons, attenuate their abnormal hyper-responsive firing, and ameliorate the pain-related behavior that occurs in this experimental model (Hains et al. 2004). Thus, it appears that up-regulated expression of  $\text{Na}_v1.3$  within secondary and possibly third-order neurons within the CNS, as well as within primary sensory neurons within DRG, contributes to neuropathic pain after nerve injury. Hains et al. (2003) have also demonstrated a similar up-regulation of  $\text{Na}_v1.3$  within DRG and dorsal horn nociceptive neurons following contusive spinal cord injury. This up-regulation of  $\text{Na}_v1.3$  is accompanied by pain-related behaviors. As with peripheral nerve injury, introduction of  $\text{Na}_v1.3$  antisense, which attenuates the expression of  $\text{Na}_v1.3$  within dorsal horn neurons, blunts their hyperexcitability and ameliorates the pain-related behaviors.

$\text{Na}^+$  channel  $\alpha$  subunits are the most salient of the neuronal membrane channels, whose expression in primary sensory neurons is regulated in the event of nerve injury. However, a number of other ion channels that may affect electrical excitability in afferent neurons are

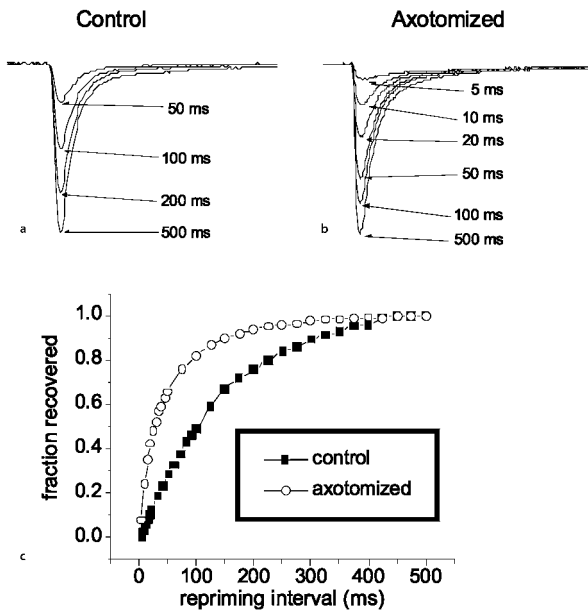


**Painful Channelopathies, Figure 1**  $\text{Na}_v1.3$  sodium channel immunostaining in control (a, c) and axotomized (b, d) DRG neurons *in vitro*. Control DRG neurons exhibit low levels of or nondetectable  $\text{Na}_v1.3$  immunostaining, while somata of peripherally axotomized small DRG neurons display robust  $\text{Na}_v1.3$  immunoreactivity. (e)  $\text{Na}_v1.3$  sodium channel immunostaining in ligated and transected sciatic nerve. Note the increased  $\text{Na}_v1.3$  immunostaining immediately proximal to the ligature constricting the sciatic nerve. Control sciatic nerve (not shown) does not exhibit  $\text{Na}_v1.3$  immunoreactivity. Scale bar: 100  $\mu\text{m}$ . Modified from Black et al. (1999).

known to be regulated by axotomy. These include the  $\text{Na}^+$  channel  $\beta 2$  and  $\beta 3$  subunits and a variety of voltage sensitive  $\text{K}^+$  channels (including  $\text{Kv}1.1, 1.2, 1.3, 1.4, 2.1, 4.3, 9.3$ , the  $\alpha 2 \delta$  subunit of L-type  $\text{Ca}^{2+}$  channel, and the hyperpolarization-activated, cyclic nucleotide-modulated (HCN) “pacemaker” channel (Ishikawa et al. 1999; Xiao 2002; Wang et al. 2002; Chaplan et al. 2003; Yang et al. 2004).

Recent studies on erythromelgia (a rare autosomal dominant disease characterized by intermittent burning pain, associated with warmth and redness in the distal extremities, also termed erythromelalgia), provide the first example of a genetic painful channelopathy in which the physiological basis for pain is understood. Yang et al. (2004) have demonstrated, in two families with erythromelgia, two mutations in the  $\text{Na}_v1.7$  channel. This channel is known to be selectively expressed within DRG neurons and is present within their neurites,





**Painful Channelopathies, Figure 2** Recovery from inactivation for TTX-sensitive currents are faster in DRG neurons following transection of their peripheral axons, due at least in part to up-regulation of  $Na_v1.3$ . (a) and (b): family of TTX-sensitive current traces from control (a) and axotomized (b) DRG cells showing the rate of recovery from inactivation at  $-80$  mV. Cells are prepulsed to  $-20$  mV for 20 ms to inactivate all of the current, then returned to  $-80$  mV for increasing recovery durations before the test pulse of  $-20$  mV. Maximum pulse rate was 0.5 Hz. (c) Time course for recovery from inactivation at  $-80$  mV for the currents shown in (a) and (b). Recovery is much faster in the axotomized neuron. Single exponential functions fitted to the data yield time constants of 160 ms for the control neuron and 41 ms for the axotomized neurons. Modified from Black et al. (1999).

including the axon tips (Toledo-Aral 1997). Cummins et al. (1998) demonstrated that the  $Na_v1.7$  channel exhibits slow closed-state inactivation, a biophysical characteristic that endows it with responsiveness to slow, small depolarizations. Thus, the  $Na_v1.7$  channel appears to be deployed close to sensory terminals, and is tuned in a manner that poises it to amplify depolarizing stimuli such as generator potentials. Yang et al. (2004) reported two mutations in  $Na_v1.7$  in erythralgia, one located in the II/S5 segment (L858H), and the other in the loop region between II/S4 and II/S5 (I848T). Importantly, the leucine and isoleucine at these two sites are highly conserved within most voltage-gated sodium channels, and a mutation similar to the I848T mutation in  $Na_v1.7$  has previously been reported in familial paramyotonia. The physiological effects of the I848T and L858H  $Na_v1.7$  mutations in erythralgia have been studied by Cummins et al. (2004) who observed that they produce a negative shift in the voltage-dependence of activation, slowed deactivation, and an enhanced response to small depolarizing inputs similar to generator potentials; these changes in functional characteristics of the mutant channels confer hyperexcitability on DRG neurons in erythralgia.

Since these initial discoveries, several additional mutations in  $Na_v1.7$  have been found and characterized in other families with erythralgia; these mutations increase the excitability of nociceptive DRG neurons (Waxman and Dib-Hajj 2005).

A second example of a genetic painful channelopathy is familial hemiplegic migraine (FHM). FHM is a rare autosomal dominant subtype of migraine with aura. Missense mutations in the human chromosome 19 *CACNA1A* gene, which codes for the p/q-type calcium channel  $Ca_v2.1$ , have been found in some affected families (Kors et al. 2002). The detailed relation between the gene mutation and the pain phenotype FHM is not yet fully understood. Understanding of the physiological effects of these mutations will almost certainly contribute substantially to our understanding of the associated pain syndromes.

## References

- Black JA, Cummins TR, Plumpton C, Chen YH, Hormuzdiar W, Clare JJ, Waxman SG (1999) Upregulation of a Silent Sodium Channel after Peripheral, but not Central, Nerve Injury in DRG Neurons. *J Neurophysiol* 82:2776–2785
- Black JA, Langworthy K, Hinson AW, Dib-Hajj SD, Waxman SG (1997) NGF has Opposing Effects on  $Na^+$  Channel III and SNS Gene Expression in Spinal Sensory Neurons. *NeuroReport* 8:2331–2335
- Boucher TJ, Okuse K, Bennett DL, Munson JB, Wood JN, McMahon SB (2000) Potent Analgesic Effects of GDNF in Neuropathic Pain States. *Science* 290:124–127
- Chaplan SR, Guo H-Q, Lee DH, Luo L, Liu C, Kuei C, Velumian AA, Butler MP, Bown SM, Dubin AE (2003) Neuronal Hyperpolarization-Activated Pacemaker Channels Drive Neuropathic Pain. *J Neurosci* 23:1169–1178
- Cummins TR, Dib-Hajj SD, Waxman SG (2004) Electrophysiological properties of mutant  $Nav1.7$  sodium channels in a painful inherited neuropathy. *J Neurosci* 24:8232–8236
- Cummins TR, Howe JR, Waxman SG (1998) Slow Closed-State Inactivation: A Novel Mechanism Underlying Ramp Currents in Cells Expressing the hNE/PN1 Sodium Channel. *J Neurosci* 18:9606–9619
- Cummins TR, Waxman SG (1997) Down-Regulation of Tetrodotoxin-Resistant Sodium Currents and Up-Regulation of a Rapidly Repriming Tetrodotoxin-Sensitive Sodium Current in Small Spinal Sensory Neurons Following Nerve Injury. *J Neurosci* 17:3503–3514
- Dib-Hajj SD, Black JA, Cummins TR, Kenney AM, Kocsis JD, Waxman SG (1998) Rescue of  $\alpha$ -SNS Sodium Channel Expression in Small Dorsal Root Ganglion Neurons after Axotomy by Nerve Growth Factor In Vivo. *J Neurophysiol* 79:2668–2676
- Hains BC, Klein JP, Saab, C Y, Craner M J, Black JA, Waxman SG (2003) Upregulation of Sodium Channel  $Nav1.3$  and Functional Involvement in Neuronal Hyperexcitability Associated with Central Neuropathic Pain after Spinal Cord Injury. *J Neurosci* 23:8881–8892
- Hains BC, Saab CY, Klein JP, Craner MJ, Waxman SG (2004) Altered Sodium Channel Expression in Second-Order Spinal Sensory Neurons Contributes to Pain after Peripheral Nerve Injury. *J Neurosci* 24:4832–4840
- Ishikawa K, Tanaka M, Black J, Waxman S (1999) Changes in Expression of Voltage-Gated Potassium Channels in Dorsal Root Ganglion Neurons Following Axotomy. *Muscle Nerve* 22:502–507
- Kors EE, van den Maagdenberg AM, Plomp JJ, Frants RR, Ferrari MD (2002) Calcium Channel Mutations and Migraine. *Curr Opin Neurol* 15:311–316



13. Toledo-Aral JJ, Moss BL, He Z-J, Koszowski AG, Whisenand T, Levinson SR, Wolf JJ, Silos-Santiago I, Halegoua S, Mandel G (1997) Identification of PN1, a Predominant Voltage-Dependent Sodium Channel Expressed Principally in Peripheral Neurons. *Proc Natl Acad Sci USA* 94:1527–1532
14. Wang H, Sun H, Della Penna K, Benz R, Xu J, Gerhold D, Holder D, Koblan K (2002) Chronic Neuropathic Pain is Accompanied by Global Changes in Gene Expression and Shares Pathobiology with Neurodegenerative Diseases. *Neuroscience* 114:529–546
15. Waxman SG, Dib-Hajj SD (2005) Erythralgia: Molecular Basis for an Inherited Pain Syndrome. *Trends in Molec Medicine* (in press)
16. Waxman SG, Kocsis JD, Black JA (1994) Type III Sodium Channel mRNA is Expressed in Embryonic but not Adult Spinal Sensory Neurons, and is Re-Expressed Following Axotomy. *J Neurophysiol* 72:466–471
17. Xiao H, Huang Q, Zhang F, Bao L, Lu Y, Guo C, Yang L, Huang W, Fu G, Xu S, Cheng X, Yan Q, Zhu Z, Zhang X, Chen Z, Han Z, Zhang X (2002) Identification of Gene Expression Profile of Dorsal Root Ganglion in the Rat Peripheral Axotomy Model of Neuropathic Pain. *Proc Natl Acad Sci USA* 99:8360–8365
18. Yang EK, Takimoto K, Hayashi Y, de Groat WC, Yoshimura N (2004) Altered Expression of Potassium Channel Subunit mRNA and Alpha-Dendrotoxin Sensitivity of Potassium Currents in Rat Dorsal Root Ganglion Neurons after Axotomy. *Neuroscience* 123:867–874
19. Yang J, Wang Y, Li S, Xu Z, Li H, Ma L, Fan J, Bu D, Liu B, Fan Z, Wu G, Jin J, Ding B, Zhu X, Shen Y (2004) Mutations in SCN9A, Encoding a Sodium Channel Alpha Subunit, in Patients with Primary Erythralgia. *J Mod Genet* 41:171–174

## Painful Disc Syndrome

### ► Chronic Back Pain and Spinal Instability

## Painful Scars

A. Lee Dellon  
Johns Hopkins University, Baltimore, MD, USA  
aldellon@erols.com

### Synonyms

Cutaneous neuroma; neuroma; collateral sprouting

### Definition

A scar results whenever the skin is cut. Since all normal skin is innervated, cutting the skin results in the division of at least small intra-epithelial nerve endings. Usually, the cut extends deeper than just the skin, going to some depth either as required by the surgeon or as a result of trauma, and this places actual nerve fibers in cutaneous nerves in harms way. When a scar becomes painful, it is due to injury to either the nerve endings within the skin or in the immediate, subjacent tissues. The pain may be due to a true neuroma, to entrapment of the nerve within the scar, to inflammatory mediators stimulating the nerve. The treatment of the painful scar is related to non-operative attempts to disengage the nerve from the scar, treat the inflammatory mediators, and desensitize the skin or operative attempts to relocate the injured nerve away from the scar.

## Characteristics

Whenever an incision is made into the skin, there is the risk of having a painful scar. Normal skin is innervated by both large and small fibers, which are both quickly- and slowly-adapting. The nerve endings are related either directly to the skin itself, as is the case of the C-fibers, or to dermal appendages, like hair follicles, as is the case of the A-beta fibers, or end in encapsulated structures like the Meissner or Pacinian Corpuscle (Dellon 1981). Injury to the skin itself can create entrapment of these small nerve endings within the scar. Injury that extends to the deeper tissues can create entrapment of the cutaneous nerves that supply that skin territory. Subsequent stimulation of the scar will stimulate the injured nerves, sending neural impulses interpreted as pain.

The management of the painful scar must include mechanical and chemical means to manipulate the wound healing process, with the goal of disentangling the nerve endings or the cutaneous nerve from the scar. The initial approach is to have the patient apply a topical cream to the scar and massage the scar. A cream is preferred over an ointment, as the cream becomes absorbed. Vitamin E cream is traditional. Use of a cortisone-containing cream is preferred as it decreases inflammation, which in itself, may be contributing to the perceived pain through mediators like the cytokines (Devor et al 1985). If the scar remains painful after 6 weeks of topical medication and massage, then ultrasound with steroid iontophoresis, available at most physical therapy centers, is recommended. The ultrasound transmits heat energy deeply into the tissues, where it may render the collagen more likely to respond to the massage and stretching of the therapist. The steroid is carried transdermally by this technique (iontophoresis). If the scar remains painful, direct injection of the scar and subdermal region with a steroid compound is recommended, accompanied by massage. A water soluble steroid is preferred, since if injected directly into the nerve it will not induce further nerve injury (Mackinnon et al 1982). Topical xylocaine anesthetic patches (Lidoderm patches or EMLA cream) can be effective in controlling the painful scar. In physical therapy, direct attempts to desensitize the skin can be introduced, such as fluidotherapy, which bombards the painful skin surface with small pellets driven by air, or the use of transcutaneous nerve stimulators, which overdrive the sensory stimuli to the spinal cord, can be tried (Mackinnon and Dellon 1988). ► **Desensitization** is a form of sensory re-education applied for the treatment of pain, and is successful by inducing a re-organization of the cortical maps (Dellon 1997).

If a scar remains painful after 6 months of attempts to desensitize it, then operative approaches can be considered. If just the scar itself is sensitive, suggesting that the mechanism for the pain is related just to the scar, and not to an underlying cutaneous nerve, then the scar can

be excised and the skin sutured again, re-initiating the wound healing process.

If the scar is painful, and there is a trigger spot in the scar that causes a distal tingling into the skin, but the distal skin has not lost sensation, then a cutaneous nerve is adherent to the scar, but a true neuroma of that nerve may not be present. In this situation, a scar excision and a neurolysis of the cutaneous nerve is the best operative approach.

If the scar is painful, and there is an area of numbness or dysesthesia distal to the scar, and there is a trigger point for the pain that generates a perception of tingling along the course of a known cutaneous nerve, then the surgical approach must include the concept of dealing with a true neuroma of the cutaneous nerve. It has been demonstrated that such a neuroma is mechanosensitive and is the origin of spontaneous neural impulses (Meyer et al 1985). The neuroma must therefore be excised. The problem then becomes what to do with the proximal end of the nerve, so that it does not create another painful neuroma. It has been demonstrated that when a sensory nerve is implanted into a normal muscle, that this alteration in the microenvironment of the sensory nerve permits axonal sprouting, but that, in the absence of nerve growth factor in the immediate tissues about the spouts, and in the absence of tension, a classic end-bulb neuroma does not form (Mackinnon et al. 1985). This approach has been utilized for both upper and lower extremity painful scars.

In the upper extremity, the most common painful scar is related to injury to the palmar cutaneous branch of the median nerve. The appropriate surgical strategy is to interrupt function of this cutaneous neuroma and implantation of the proximal end of the palmar cutaneous nerve into the pronator quadratus muscle. This muscle is proximal to the wrist joint and has a limited excursion (Evans and Dellon 1994). A similar problem has been described for the painful scar related to ► [tarsal tunnel decompression](#). This pain in the proximal scar is due to a neuroma of the saphenous nerve, which must be resected and the nerve implanted into the soleus muscle (Kim and Dellon 2001a). This pain in the distal scar is due to a neuroma of a calcaneal nerve, which must be resected and the nerve implanted into the flexor hallucis longus muscle (Kim and Dellon 2001b).

In the clinical situation, where more than one nerve may innervate the painful scar, nerve blocks are essential to identify whether one or more than one cutaneous nerve is involved in the pain mechanism. The most common site for this confusion is a painful scar over the dorsal radial aspect of the wrist. In this location scars occur not only from trauma, but from elective surgery in which a cyst from the dorsal wrist capsule, a ganglion, is excised or tendonitis of the first dorsal extensor compartment is treated by tendon sheath incision. In 1985, the source of the failure to treat painful scars in this region was related to the presence of overlap between the radial sen-

sory nerve and the lateral antebrachial cutaneous nerve in 75 % of people (Mackinnon and Dellon 1985). The nerve block must first be done over the anterolateral forearm, to block the lateral antebrachial cutaneous nerve, as a more distal block will affect both of the nerves. The surgical approach is to resect both of the involved nerves and implant them into the brachioradialis muscle (Mackinnon and Dellon 1987). This is done with the elbow in extension, so that subsequent elbow extension will not pull on the nerves implanted into the muscle.

The concept of placing the proximal end of the peripheral nerve in a “quiet” area is the reason that thoracotomy incisions are often more painful than abdominal incisions; with every breath, the ribs go through a range of motion, causing movement of the intercostal nerves and stimulating a painful neural impulse.

In the lower extremity, the most common location of a painful scar is over the dorsum of the foot. This area exemplifies all the problems related to treatment of the painful scar. Foot wear, such as shoes or even sandals, will press upon the scar. There is no subcutaneous padding over the dorsum of the foot. The extensor tendons create movement, and the ankle range of motion will put tension on the cutaneous nerve. There is overlap of the saphenous nerve, superficial peroneal nerve, deep peroneal nerves and the sural nerves in virtually all the dorsal skin. Initial nerve blocks are essential to identifying the source(s) of the painful inputs from the scar. Scars can be either from trauma, or elective incisions designed for ankle fusion, capsular reconstruction, tendon surgery, tumor excision, treatment of the ► [Morton’s neuroma](#), or bunion surgery. Pain related to an interdigital nerve in the foot has been mistakenly termed a neuroma, whereas it is actually chronic nerve compression, and should be treated by neurolysis instead of nerve resection (Dellon 1992). After identification of the involved nerve, its function can be interrupted by surgery planned for the leg, rather than the foot or the ankle. The deep and superficial peroneal nerves can be interrupted in the anterolateral leg, translocating the proximal nerve away from tension and into a motor environment (Dellon and Aszmann 1998).

► [Collateral sprouting](#) can be a source of pain related to the painful scar. When a cutaneous nerve is divided, the distal axon degenerates but the Schwann cell lives. The Schwann cell upregulates and produces nerve growth factor. The nerve growth factor, instead of acting as a guide for the original nerve to regenerate to its target organ, stimulates normal axons in the adjacent skin. The original nerve cannot respond, as it is either stuck in the original scar, or has been relocated to a new site. The sprouting of normal nerve fibers, in response to nerve growth factor, can create the perception of pain as this new pattern of neural impulses reaches the post-central gyrus. Previously documented only in amphibian models for the C- and A-delta fiber populations, collateral sprouting has now been documented

in the human in relationship to A-beta fibers, with the use of the ► **Pressure-Specified Sensory Device**™ in patients with lower extremity nerve injury (Inbal et al 1987; Dellon et al 1996). Treatment of pain due to collateral sprouting requires the same desensitization approach as for the painful scar itself (Dellon 1997). For the lower extremity, the most successful and practical approach is simply to walk in a swimming pool for 15 to 20 minutes, three or four times per week, allowing the water to provide the sensory stimuli to the skin.

## References

1. Dellon AL (1981) Evaluation of Sensibility and Re-Education of Sensation in the Hand, Williams & Wilkins, Baltimore, pp 27–46
2. Dellon AL (1992) Treatment of Morton's Neuroma as a Nerve Compression: The Role for Neurolysis. *J Amer Pod Med Assn* 82:399–402
3. Dellon AL (1997) Somatosensory Testing and Rehabilitation. Amer Occupational Therapy Association, Bethesda, MD
4. Dellon AL, Aszmann OC, Muse V (1996) Collateral Sprouting Documentation using the PSSD. *Ann Plast Surg* 37:520–525
5. Dellon AL, Aszmann OC (1998) Treatment of Dorsal Foot Neuromas by Translocation of Nerves into Anterolateral Compartment. *Foot and Ankle* 19:300–303
6. Devor M, Govrin-Lippmann R, Raber P (1985) Corticosteroids Suppress Ectopic Neural Discharge Originating in Experimental Neuromas. *Pain* 22:127–137
7. Evans GRD, Dellon AL (1994) Implantation of the Palmar Cutaneous Branch of the Median Nerve into the Pronator Quadratus for Treatment of Painful Neuroma. *J Hand Surg* 19A:203–206
8. Inbal R, Rousso M, Ashur H, Wall PD, Devor M (1987) Collateral Sprouting in Skin and Sensory Recovery after Nerve Injury in Man. *Pain* 28:141–154
9. Kim J, Dellon AL (2001a) Tarsal Tunnel Incisional Pain due to Neuroma of the Posterior Branch of Saphenous Nerve. *J Amer Pod Med Assn* 91:109–113
10. Kim J, Dellon AL (2001b) Calcaneal Neuroma: Diagnosis and Treatment. *Foot Ankle Internat* 22:890–894
11. Mackinnon SE, Dellon AL, Hudson AR et al (1985) Alteration of Neuroma Formation Produced by Manipulation of Neural Environment in Primates *Plast Reconstr Surg* 76:345–352
12. Mackinnon SE, Dellon AL (1985) The Overlap Pattern of the Lateral Antebrachial Cutaneous Nerve and the Superficial Branch of the Radial Nerve *J Hand Surg* 10A:522–526
13. Mackinnon SE, Dellon AL (1987) The Results of Treatment of Recurrent Dorsal Radial Wrist Neuromas *Ann Plast Surg* 19:54–61
14. Mackinnon SE, Dellon AL (1988) *Surgery of the Peripheral Nerve*, Thieme, New York, pp 455–491
15. Mackinnon SE, Hudson AR, Gentili F et al. (1982) Peripheral Nerve Injection Study with Steroid Agents, *Plast Reconstr Surg* 69: 482–490
16. Meyer RA, Raja SN, Campbell JN et al. (1985) Neural Activity Originating from a Neuroma in the Baboon Brain *Res* 325:255–260

## Painful Tonic Seizure

### Definition

Paroxysmal painful sensations irradiating from the spinal cord into the extremities.

► **Central Pain in Multiple Sclerosis**

## Painless Neuropathies

MARCO LACERENZA, PAOLO MARCHETTINI  
Scientific Institute San Raffaele, Pain Medicine Center,  
Milano, Italy  
marchettini.paolo@hsr.it

### Definition

Any disorder affecting any part of the peripheral nervous system not associated with pain.

### Characteristics

Peripheral neuropathies are abnormalities in structure and function of motor, sensory and autonomic neurons and/or their axons. In spite of the variety of injuries (compressive, genetic, infective, inflammatory, ischemic, metabolic, traumatic, toxic or associated with neoplasm), the peripheral nervous system reactions are limited to four major pathologies: ► **Wallerian degeneration**, axonal degeneration, neuronopathy and ► **segmental demyelination**. However, according to the specific agent causing the neuropathy such standardized pathologic manifestations take place in different époques. Therefore, considering the neuropathy as a time frame, where symptoms are due to an evolving biochemical and morphological reaction to an injury, it can be stated that most neuropathies are painless within a defined time frame. For example, a traumatic nerve injury is usually extremely painful in the first days, while in the later, chronic phase it is painful in only 2.5 – 5% of patients (Kline and Hudson 1995). In the case of painful diabetic neuropathy there are reports of patients in whom severe neuropathic pain lasting months wore off to be followed by hypoesthesia and ► **paraesthesiae** (Brown et al. 1976; Yuen et al. 2001). Most mild neuropathies remain undiagnosed just because they are painless. Such is the case of mild genetic neuropathies, painless traumatic and iatrogenic neuropathies or subclinical metabolic neuropathies. Therefore, although many may not share this view, painless neuropathies are likely to outnumber the painful ones. Most of the time, pain in peripheral neuropathy is a positive sensory symptom arising from diseased primary afferent units. An exception is the nerve trunk pain due to the physiological activation of nervi nervorum nociceptors. This may be the cause of part of the complaints of patients with carpal tunnel syndromes, Guillain-Barré syndrome, ► **radiculopathies** or vasculitis.

Through the technique of ► **microneurography and intraneural microstimulation** on humans subjects, it has been demonstrated that excitation of nociceptors elicits either a dull burning pain (C nociceptors), or a sharp pricking pain (A delta nociceptors), while paraesthesias arise from ► **ectopic nerve impulses** generated in dysfunctional large myelinated fibers (Ochoa and Torebjörk 1980; Torebjörk and Ochoa 1980; Ochoa

and Torebjörk 1989). Therefore, extrapolating from the experimental information to clinical practice, it may be expected that neuropathies affecting only motor neurons or large myelinated primary afferent neurons are painless, apart from neuropathies associated with nerve trunk pain.

For example, most of the time, Bell's palsy involving the facial nerve is painless as well as the neuropathies of the spinal accessory nerve (causing weakness and wasting of the trapezius and sternocleidomastoid muscles), and the neuropathies of the hypoglossal, XII cranial nerve. Less clear is the pathophysiology of idiopathic trigeminal sensory neuropathy, in which sensory loss can be transient or permanent, localized mainly in the II and III nerve divisions, sometimes with paraesthesias, but painless (Blau et al. 1969).

Isolated neuropathies of motor branches of the brachial plexus can be painless. Painless infraspinatus atrophy due to suprascapular nerve entrapment is described in subjects overexerting the upper extremity, like, for example, volleyball players (Tengan et al. 1993).

Damage of the long thoracic nerve causes weakness and wasting of the serratus anterior muscle and winging of the scapula. Among the most frequent causes of this neuropathy are: closed trauma, sporting activities, iatrogenic procedures, viral infections, idiopathic conditions and metabolic disorders. Most of the time the neuropathy is painless, and the shoulder pain described by some patients is due to the dislocation of the scapula during movements of the upper limb. In many other cases the condition is completely symptom free and its recognition accidental.

The comprehensive group of motor neuronopathies is painless with the exception of poliomyelitis in the acute phase and postpolio syndrome (Bendz 1954; Klein et al. 2004). In both of the above conditions pain is not related to the motor-neuronopathy, albeit to myelitis and musculo-skeletal complications, respectively. Cramps may indeed be relevant in up to 50% of patients with motor neuronopathy, and represent a nociceptive pain. This also includes the different sporadic and genetic forms of amyotrophic lateral sclerosis (ALS), bulbar motor neuron syndromes, spinal muscular atrophy, focal motor neuron disease and paraneoplastic lower motor neuron syndrome.

Diffuse motor neuropathies can be predominantly demyelinating or axonal, and the differential diagnosis of ALS or other untreatable conditions is crucial since some are treatable. Among the treatable conditions, multifocal motor neuropathy (MMN) is the most representative. MMN is more common in males and has an estimated prevalence of 1 per 100,000; it is primarily a disease of young adults and is initially characterized by progressive asymmetrical limb weakness, and later by muscular atrophy. The diagnostic clue is the electrophysiological demonstration of persistent localized motor conduction blocks, with normal or near-normal motor and

sensory conduction velocities. MMN is painless apart from cramps, fasciculations and (rarely) paraesthesias, which may be part of the clinical picture. Evidence for an autoimmune mechanism is substantial, and the disease is treatable with intravenous immunoglobulin (IVIg) and/or cyclophosphamide (Biessels et al. 1997). Acute axonal motor neuropathy is more common in Japan, China and 3<sup>rd</sup> world countries than in the West. It is often anticipated by diarrhea, gastrointestinal or upper respiratory symptoms as a landmark of *Campylobacter jejuni* or *Haemophilus influenzae* infections. Weakness of distal rather than proximal muscles is prominent between the 6<sup>th</sup> and the 12<sup>th</sup> days from the onset. Sensory symptoms are absent. The electrophysiology points to a predominantly axonal dysfunction and IgG vs. GM1 ganglioside can be found in 40–50% of cases, with the treatment of choice being IVIg. Moreover, there is a slowly progressive form of painless motor neuropathy with axonal electrophysiological features, involving asymmetrically distal arms more commonly than legs, without symptoms or signs of sensory involvement. The condition may be treatable with IVIg or prednisone suggesting an immune-mediated aetiology (Katz et al. 2002).

Predominantly myelinated afferent and efferent fibers can be affected simultaneously in sporadic and genetic forms of neuropathy in painless clinical pictures. For example, in the group of neuropathies associated with monoclonal gammopathy of undetermined significance (MGUS), pain is an uncommon symptom. The illness has a male preponderance and begins insidiously around the 5<sup>th</sup>–6<sup>th</sup> decade of life with a distal symmetrical sensorimotor polyneuropathy. The lower limbs and the sensory fibers are affected earlier, and electrophysiological studies reveal demyelination (mostly in IgM MGUS patients) or mixed demyelinating and axonal damage. More than 50% of IgM MGUS neuropathy patients show a monoclonal protein with reactivity against myelin-associated glycoprotein (MAG), and have a favorable prognosis even after several years of illness. Aggressive immune interventions are limited to patients with progressive disabling neuropathy (Suarez and Kelly 1993; Nobile–Orazio et al. 2000).

In the last decade, rapid advances in the description of several new genes implicated in hereditary neuropathies have shed light on the pathophysiology of nerve demyelination and axonal degeneration. Charcot-Marie-Tooth (CMT), also called hereditary motor and sensory neuropathy (HMSN), is the most common type of hereditary neuropathy, and comprises a family of clinically and genetically heterogeneous inherited neuropathies linked to approximately 26 loci. The clinical pictures differ from one another for the age of onset, mode of transmission, severity of the illness and electrophysiological and nerve biopsy features pointing to a predominantly demyelinating or axonal damage. Disturbing sensory symptoms are uncom-



mon in CMT1 patients and pain, not accountable by skeletal abnormalities, is rare. Traditional clinical judgment based on correspondence between localization of positive and negative sensory phenomena, commonly associated with neuropathic pain and the descriptive characteristics of pain quality, considers neuropathic pain in CMT an unlikely phenomenon, the most common pain by far being of the musculo-skeletal type. A recent paper in disagreement with this view (Carter et al. 1998), reported a high prevalence of neuropathic pain localized mainly in the low back, knees, and ankles in CMT patients. The authors themselves properly caution that the finding is exclusively based on the wording of the neuropathic questionnaire.

Hereditary neuropathy with liability to pressure palsies (HNPP) is an autosomal dominant disorder, characterized by recurrent sensorimotor painless neuropathies associated with nerve conduction abnormalities typically localized to segments of nerves liable to pressure palsies. The disorder is pathologically characterized by focal myelin thickening, named tomacula, which was

the hallmark of HNPP when the genetic test was not available. The genetic abnormality is a 1.5 Mb deletion on chromosome 17p11.2, and the clinical picture can vary from recurrent invalidating transient mononeuropathies and/or brachial plexopathy, to benign forms with only some paraesthesias and subclinical electrophysiological abnormalities (Harding 1995, Berciano and Combarros 2003).

In the group of hereditary sensory and autonomic neuropathies (HSAN) there are rare forms of painless neuropathies. For example, HSAN IV is an autosomal recessive disorder (gene locus: chromosome 1q21–22) where congenital insensitivity to pain, anhidrosis, abnormal temperature control, and mild mental retardation are the clinical presentation. Selective loss of small myelinated and unmyelinated fibers is associated with normal tendon reflexes and sensory nerve conduction velocities (Nagasako et al. 2003).

In the realm of diabetic neuropathies it is possible to find very different clinical pictures related to multifactorial pathogenetic mechanisms. A few of them are

**Painless Neuropathies, Table 1** Neuropathies/neuronopathies in which pain due to nerve damage is absent or uncommon

Motor Nerve Mononeuropathies	
	Spinal accessory nerve
	Hypoglossal nerve
	Facial nerve (predominantly motor)
	Motor branches of the brachial plexus
Motor Neuropathies	
	Sporadic
	Hereditary
	Diffuse
	Focal
	Paraneoplastic
Large Fiber Neuropathies	
Predominantly Motor	Demyelinating: Multifocal motor neuropathy
	Axonal: Acute form; Chronic form
Sensory- Motor	Demyelinating: MGUS related polyneuropathy
	Large fiber diabetic neuropathy
Hereditary Large Fiber Neuropathy	
	Demyelinating: HNPP; CMT
	Axonal: CMT
Hereditary Small Fiber Neuropathy	
	HSAN IV

MGUS, monoclonal gammopathy of undetermined significance; HNPP, hereditary neuropathy with liability to pressure palsies; CMT, Charcot-Marie-Tooth disease; HSAN, hereditary sensory and autonomic neuropathy

painless neuropathies or relatively painless conditions for at least part of the natural history. For example, some patients affected by distal symmetrical polyneuropathy do not complain of positive sensory symptoms or pain, and may even present recurrent painless neurotrophic foot ulcers. The rare condition named diabetic pseudotabes is a large fiber symmetric polyneuropathy associated with sensory ataxia but rarely with pain. Although the cause of pain in diabetic neuropathies is still unknown, it appears that the absence of vascular or nerve inflammation, the sparing of small myelinated and unmyelinated fibers, a sort of inhibition of the later phase of myelinated fiber regeneration, and the absence of axonal atrophy may be the ingredients making a diabetic neuropathy virtually painless (Brown et al. 1976; Stephen et al 1990).

### References

- Berciano J, Combarros O (2003) Hereditary Neuropathies. *Curr Opin Neurol* 16:613–622
- Bendz P (1954) Pain Associated with Acute Poliomyelitis; Neurologic and Therapeutic Considerations. *AMA Am J Dis Child* 88:141–147
- Biessels GJ., Franssen HH, van den erg LH, Gibson A, Kappelle LJ, Venables GS, Wokke JHJ (1997) Multifocal Motor Neuropathy. *J Neurol* 244:143–152
- Blau JN, Harris M, Kennet S (1969) Trigeminal Sensory Neuropathy. *N Engl J Med* 281:873–876
- Britland ST, Young RJ, Sharma AK, Clarke F (1990) Association of Painful and Painless Diabetic Polyneuropathy with Different Patterns of Nerve Fiber Degeneration and Regeneration. *Diabetes* 39:898–908
- Brown MJ, Martin JR, Asbury AK (1976) Painful Diabetic Neuropathy. *Arch Neurol* 33:164–171
- Carter GT, Jensen MP, Galer BS, Kraft GH, Crabtree LD, Beardsley RM, Abresch RT, Bird TD (1998) Neuropathic Pain in Charcot-Marie-Tooth Disease. *Arch Phys Med Rehabil* 79:1560–1564
- Harding AE (1995) From the Syndrome of Charcot, Marie and Tooth to Disorder of Peripheral Myelin Proteins. *Brain* 118:809–818
- Katz JS, Barohn RJ, Kojan S, Wolfe GI, Nations SP, Saperstein DS, Amato AA (2002) Axonal Multifocal Motor Neuropathy without Conduction Block or Other Features of Demyelination. *Neurology* 58:615–620
- Klein MG, Keenan MA, Esquenazi A, Costello R, Polansky M (2004) Musculoskeletal Pain in Polio Survivors and Strength-Matched Controls. *Arch Phys Med Rehabil* 85:1679–1683
- Kline DG, Hudson AR (1995) *Nerve Injuries*. WB Saunders Company, Philadelphia
- Nagasako EM, Oaklander AL, Dworkin RH (2003) Congenital Insensitivity to Pain: An Update. *Pain* 101:213–219
- Nobile-Orazio E, Meucci N, Baldini L, Di Troia A, Scarlato G (2000) Long-Term Prognosis of Neuropathy Associated with Anti-MAG IgM M-Proteins and its Relationship to Immune Therapies. *Brain* 123:710–717
- Ochoa J, Torebjörk HE (1980) Paraesthesiae from Ectopic Impulse Generation in Human Sensory Nerves. *Brain* 103:835–853
- Ochoa JL, Torebjörk HE (1989) Sensation Evoked by Intraneural Microstimulation of C Nociceptor Fibres in Human Skin Nerves. *J Physiol* 415:583–599
- Suarez GA, Kelly JJ Jr (1993) Polyneuropathy Associated with Monoclonal Gammopathy of Undetermined Significance: Further Evidence that IgM-MGUS Neuropathies are Different than IgG-MGUS. *Neurology* 43:1304–1308
- Tengan CH, Oliveira AS, Kiyamoto BH, Morita MP, De Medeiros JL, Gabbai AA (1993) Isolated and Painless Infraspinal Atrophy in Top Level Volleyball Players. Report of Two Cases and Review of the Literature. *Arq. Neuropsiquiatr* 51:125–129
- Torebjörk HE, Ochoa J (1980) Specific Sensation Evoked by Activity in Single Identified Sensory Units in Man. *Acta Physiol Scand* 110:445–447
- Yuen KCJ, Day JL, Flannagan DW, Rayman G (2001) Diabetic Neuropathic Cachexia and Acute Bilateral Cataract Formation following Rapid Glycaemic Control in a Newly Diagnosed type 1 Diabetic Patient. *Diabetes UK. Diabetic Medicine* 18:854–857

## Paleospinothalamic Tract

### Synonyms

Anterior Spinothalamic Tract

### Definition

The paleospinothalamic tract is the medial and phylogenetically older component of the spinothalamic tract. It is comprised of the axons of nociceptive-specific and wide dynamic range neurons. It projects to the medial thalamus and is responsible for the autonomic and emotional aspects of pain. Sometimes called anterior spinothalamic tract.

- ▶ [Acute Pain Mechanisms](#)
- ▶ [Parafascicular Nucleus, Pain Modulation](#)
- ▶ [Somatic Pain](#)

## Palliative Care

### Definition

Palliative Care refers to care of the patient with active, progressive, far-advanced disease in a multidisciplinary approach, for which the focus of the care is to optimize quality of life.

- ▶ [Cancer Pain, Palliative Care in Children](#)

## Palliative Care and Cancer Pain Management

- ▶ [Cancer Pain Management, Interface between Cancer Pain Management and Palliative Care](#)

## Palliative Care in Children

- ▶ [Cancer Pain, Palliative Care in Children](#)

## Palliative Medicine

### Definition

Palliative medicine refers to the study and management of patients with progressive life-threatening illness. It represents the physician or specialist medical contribution to the multidisciplinary palliative care team.

- [Cancer Pain Management, Interface Between Cancer Pain Management and Palliative Care](#)

## Palliative Radiotherapy

### Definition

Palliative radiotherapy affords relief, but is not a cure.

- [Cancer Pain Management, Radiotherapy](#)

## Palliative Surgery in Cancer Pain Management

ANNE M. HEFFERNAN<sup>1</sup>, KEVIN C. CONLON<sup>2</sup>

<sup>1</sup>The Adelaide and Meath Hospital incorporating The National Children's Hospital, Dublin, Ireland

<sup>2</sup>Trinity College Dublin, University of Dublin and The Adelaide and Meath Hospital incorporating The National Children's Hospital, Dublin, Ireland  
[profsurg@tcd.ie](mailto:profsurg@tcd.ie)

### Synonyms

Cancer Pain Management, Palliation of Upper GI Cancer

### Definition

The primary aim of any palliative procedure is the relief of symptoms with resultant preservation or improvement in the patient's quality of life. Although palliative surgery in cancer management may, in its broadest sense, refer to any surgery that is non-curative, it is generally considered to encompass surgical intervention that is aimed primarily at the treatment of symptoms or complications of a tumor in patients in whom a curative option is not available. The decision to proceed with a palliative procedure is complex and includes recognition of the general medical condition of the patient, the extent and prognosis of the disease, knowledge of the natural history of the symptoms, potential durability of the proposed intervention and its impact on the expectancy and quality of life, potential alternative non-surgical options, and the patient's wishes (Miner and Karpeh 2004). The following section focuses on gastrointestinal malignancies to explore the issues further.

## Characteristics

### Clinical Features

Despite recent advances in the diagnosis, screening and multidisciplinary management of malignant disease, approximately 560,000 patients in the United States will die each year of cancer (Jemal et al. 2004). Gastrointestinal (GI) cancers such as gastric, pancreatic and colonic account for 25% of the total deaths. For these patients, the end of life is often spent dealing with symptoms and complications requiring palliative surgical intervention, such as abdominal or pelvic pain, sepsis, gastrointestinal obstruction, biliary obstruction, haemorrhage, intestinal perforation and ascites.

Pain is experienced by 20–50% of cancer patients at diagnosis (depending on the primary site), and by up to 75% of patients with advanced cancer (Kane et al. 1984). Pain is a particularly distressing symptom for patients with GI malignancies and is generally indicative of local and perineural invasion. Table 1 details the prevalence of pain in common advanced GI cancers (Bonica 1986; Moran et al. 1987).

The goal of effective pain management is to enable patients to have a good quality of life, attain a reasonable performance status, tolerate diagnostic and therapeutic procedures, and to die relatively free of pain while maintaining freedom of choice and minimizing side effects. Successful pain therapy begins with a comprehensive pain assessment, taking into account the individual patient's goals and priorities and their definition of pain and suffering. A treatment plan is formulated which should be a dynamic process, changing in response to the underlying progressive disease and perhaps involving multiple treatment interventions over time.

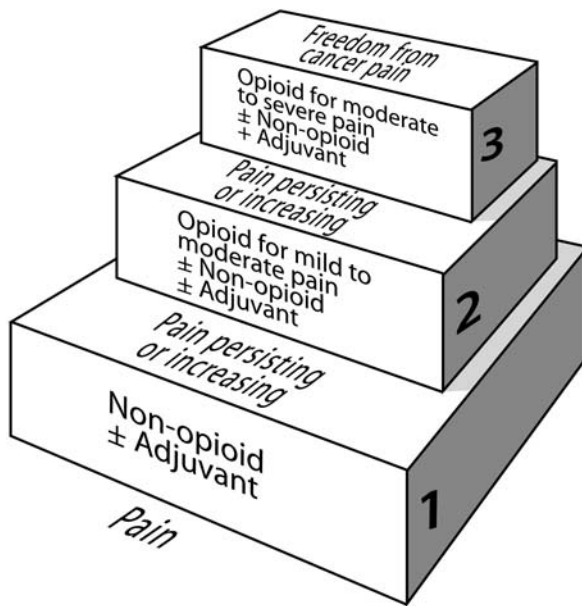
Guidelines originally formulated by the World Health Organisation (WHO) in 1982, and updated in 1996, have become the internationally accepted standard for the principles governing treatment of cancer pain. These guidelines focus on oral analgesic use as the mainstay of therapy (World Health Organization 1996; Schug et al. 1992).

The analgesic ladder is utilized (Fig. 1). Inadequate pain relief at one level results in a step up to the next level

P

**Palliative Surgery in Cancer Pain Management, Table 1** Prevalence of pain in advanced or terminal cancer of the upper gastrointestinal tract (4, 5)

Primary site of cancer	Patients with pain (%)	
	Mean	Range
Oesophagus	87	80–93
Pancreas	81	72–100
Liver/biliary	79	65–100
Stomach	78	67–93
Rectal	25	12–30



**Palliative Surgery in Cancer Pain Management, Figure 1** The WHO analgesic ladder (from World Health Organization, 1996, with permission).

instead of changing to a drug on the same level. Non-opioids are used for pain of mild to moderate intensity. They exhibit a ceiling effect, whereby a further increase in dose beyond an established maximum effective dose will not result in improved analgesia. If pain is not controlled, the addition of a so-called “weak” opioid to the non-opioid is reasonable. When the combination fails despite the use of appropriate doses, the opioid may be replaced by a stronger opioid. Any further increase in pain is then treated by an increase in the opioid dose. Obviously, patients presenting with moderate or severe pain should be started on step 2 or even step 3 immediately, rather than working slowly up the ladder.

All steps of the analgesic ladder may be complemented by the use of co-analgesic drugs. These provide an alternative for patients who cannot be treated with conventional analgesics alone without encountering unacceptable morbidity. For example, drugs such as the tricyclic antidepressants (e.g. amitriptyline or imipramine) and anticonvulsants (e.g. carbamazepine or gabapentin) have been used successfully for neuropathic pain. Corticosteroids may enhance analgesia in a variety of situations, including pain related to nerve compression or bony metastases. They may also improve mood, appetite and general strength. When a pharmacological approach fails to relieve pain, interventional approaches to treatment are available, aimed at interrupting, destroying or stimulating pain pathways. In addition to surgery, these interventional strategies include many types of neural blockade, neuraxial infusion, and other therapies.

Celiac sympathetic plexus blockade is an example of one such interventional approach. This can be achieved either by intra-operative open or laparoscopic chemical

splanchnicectomy, percutaneous or endoscopically directed celiac blockade, or thoracoscopic splanchnicectomy. Chemical splanchnicectomy typically involves the injection of 20 ml of 50% alcohol around the base of the celiac artery, and has been demonstrated in patients with unresectable pancreatic cancer to achieve adequate pain relief in up to 80% of cases, with duration of relief lasting up to six months (Lillemoe et al. 1993).

Complementary therapies may also have a role in achieving pain relief and are becoming increasingly popular with the general public. Massage, acupuncture, and aromatherapy have shown promise for the palliation of symptoms but more rigorous examination is required before they can be considered an integral part of conventional pain management.

Visceral pain may be secondary to gastrointestinal obstruction, which is not infrequent in patients with advanced disease. Dysphagia is the predominant symptom in 75% of patients with esophageal carcinoma. For these patients, the choice of palliative therapy depends on tumor size, location, patient performance, status, and the experience available. In general, non-operative approaches such as endoscopic dilation and/or stent placement, or laser ablation using the neodymium:yttrium-aluminum-garnet (Nd:YAG) laser are more commonly utilized than surgical procedures such as palliative resection, substernal bypass or feeding enterostomy. While incomplete surgical resection may relieve dysphagia in 70–80% of cases, median survival is short (7–9 months) and morbidity high (40–50%) (Nash and Gerdes 2002).

The role of palliative resection as a palliative intervention is controversial in other GI sites as well. A recent retrospective review from Memorial Sloan-Kettering Cancer Center examined 307 patients who underwent a non-curative gastric resection (Miner et al. 2004). A palliative resection with residual gross disease was performed in 48% of cases, specifically to relieve specific symptoms, control pain, or improve quality of life. Median survival was significantly reduced in this cohort compared to the non-palliative group (8.3 months vs. 13.5 months,  $P < 0.001$ ). Only 24% of patients required an additional palliative procedure during their remaining lifetime. However, many of these interventions were performed to treat new symptoms that arose after the initial palliative resection. The same group has subsequently attempted to better define the group of patients who would benefit from an aggressive surgical approach (Miner and Karpeh 2004). By using a partitioned survival analysis, they defined three clinical health states: time with subjective toxic effects of treatment (TOX), time without symptoms requiring additional palliative procedures (TWiST), and time required in hospital for additional palliative procedures (REL). Patients with multiple sites of metastatic disease had decreased time in the TWiST state, suggesting that palliative resection may not be beneficial in this group.



For patients with adenocarcinoma of the pancreas in whom the primary tumor cannot be resected with negative margins, improvements in peri-operative morbidity following pancreaticoduodenectomy have led some authors to propose an aggressive surgical approach (Lillemoe et al. 1996). Survival appears to be somewhat improved compared to palliative bypass. However, prospective data are lacking and this strategy is considered controversial.

Improvements in endoscopic techniques, coupled with the increasing use of laparoscopy to stage pancreatic cancer, have led many to question the role of surgery for the majority of patients who present with advanced pancreatic malignancies. Proponents of laparoscopic staging have argued that, due to the poor prognosis in patients with unresectable disease, avoidance of a laparotomy is beneficial with reduced hospital stay, and less time for administration of adjuvant treatment. However, critics have argued that the procedure is of minimal benefit, as patients with unresectable disease will require a subsequent bypass procedure for biliary and/or gastric outlet obstruction. Historically, prophylactic bypasses have been supported by reports of the development of obstructive jaundice in as many as 70% of patients, and gastric outlet obstruction in up to 25% of patients with unresectable pancreatic cancer. Although endoscopic techniques for the relief of obstructive jaundice have replaced surgery, the utility of surgery to palliate gastric and duodenal obstruction remains controversial.

A recent study examined the role of prophylactic gastric bypass in this disease, randomizing 87 patients who were thought to lack a significant risk for duodenal obstruction to receive either a retrocolic gastrojejunostomy or no gastrojejunostomy (Lillemoe et al. 1999). Late gastric outlet obstruction requiring intervention developed in 8 of 43 patients (18.6%) who did not receive a gastrojejunostomy at a median of 2 months from initial exploration, suggesting that prophylactic bypass is indicated in a significant proportion of patients. Similar data were recently published from Europe (Van Heek et al. 2003). However, a non-randomized but prospective study from Memorial Sloan-Kettering appears to differ from the previously cited work (Espat et al. 1999). In this study, the outcome of 155 patients with laparoscopically staged, unresectable pancreatic cancer who did not undergo open enteric or biliary bypass at the time of initial laparoscopic staging was analyzed. A subsequent surgical bypass was only required in 3% of patients, leading the authors to suggest that gastroenterostomy should be reserved for those who develop documented gastric outlet obstruction. These contrasting data indicate that further studies are required to determine the place of surgical palliation for this patient population.

In contrast to the controversy that exists in upper gastrointestinal cancer, surgical palliation is considered

appropriate for both advanced colon and rectal cancer. Options include resection with restoration of intestinal continuity, abdominoperineal resection, or creation of a diverting colostomy, depending on the symptoms and clinical status of the patient. Each patient should be approached individually. Palliative resection may be indicated in a patient with minimal residual disease. However, in the patient with significant comorbidities, carcinomatosis or extensive hepatic disease, a fecal diversion or no intervention may be more appropriate. In summary, the role for surgical palliation for gastrointestinal cancer continues to evolve. Unfortunately, specific indications for palliative resection, surgical bypass or endoscopic palliation remain unclear as well-designed prospective randomized trials are lacking. However, there is no doubt that selected patients do benefit from aggressive surgical intervention with improved symptomatic palliation and quality of life. Further prospective studies are required to identify the patient subgroups that would benefit from such an approach.

## References

1. Bonica JJ (1986) Cancer Pain: Current Status and Future Needs. In: Bonica JJ (ed) *The Management of Pain*. Lea & Febiger, Philadelphia, PA, pp 400–455
2. Espat NJ, Brennan MF, Conlon KC (1999) Patients with Laparoscopically Staged Unresectable Pancreatic Adenocarcinoma do not Require Subsequent Surgical Biliary or Gastric Bypass. *J Am Coll Surg* 188:649–655
3. Jemal A, Tiwari RC, Murray T et al. (2004) Cancer Statistics 2004. *Ca Cancer J Clin* 54:8–29
4. Kane RL, Wales J, Bernstein L (1984) A Randomised Controlled Trial of Hospice Care. *Lancet* 1:890–894
5. Lillemoe KD, Cameron JL, Hardacre JM et al. (1999) Is Prophylactic Gastrojejunostomy Indicated for Unresectable Periampullary Cancer? A Prospective Randomized Trial. *Ann Surg* 230:322–328
6. Lillemoe KD, Cameron JL, Kaufman HS et al. (1993) Chemical Splanchnicectomy in Patients with Unresectable Pancreatic Cancer: A Prospective Randomized Trial. *Ann Surg* 217:447–455
7. Lillemoe KD, Cameron JL, Yeo CJ et al. (1996) Pancreaticoduodenectomy: Does It Have a Role in Palliation of Pancreatic Cancer? *Ann Surg* 223:718–725
8. Miner TJ, Jaques DP, Karpeh MS et al. (2004) Defining Palliative Surgery in Patients Receiving Noncurative Resections for Gastric Cancer. *J Am Coll Surg* 198:1013–1021
9. Miner TJ, Karpeh MS (2004) Gastrectomy for Gastric Cancer: Defining Critical Elements of Patient Selection and Outcome Assessment. *Surg Oncol Clin N Am* 13:455–466
10. Moran MR, Rothenberger DA, Lahr CJ et al. (1987) Palliation for Rectal Cancer. *Arch Surg* 122:640–643
11. Nash CL, Gerdes H (2002) Methods of Palliation of Esophageal and Gastric Cancer. *Surg Oncol Clin N Am* 11:459–483
12. Schug SA, Zech D, Grond S (1992) A Long-Term Survey of Morphine in Cancer Pain Patients. *J Pain Symptom Manage* 7:259–266
13. Van Heek NT, De Castro SM, van Eijck CH et al. (2003) The Need for a Prophylactic Gastrojejunostomy for Unresectable Periampullary Cancer: A Prospective Randomized Multicenter Trial with Special Focus on Assessment of Quality of Life. *Ann Surg* 238:894–902
14. World Health Organization (1996) *Cancer Pain Relief and Palliative Care*. Report of a WHO Expert Committee, 3<sup>rd</sup> edn. World Health Organization, Geneva

## Pancreas

### Definition

The pancreas is a roughly triangular, glandular organ in the retroperitoneal area of the upper abdomen. An exocrine division secretes powerful digestive enzymes, such as amylase and lipase, while the endocrine division secretes insulin and glucagons.

- ▶ [Animal Models and Experimental Tests to Study Nociception and Pain](#)
- ▶ [Visceral Pain Model, Pancreatic Pain](#)

## Pancreatalgia

### Definition

Pancreatalgia is pain arising from the pancreas or felt in or near the region of the pancreas.

- ▶ [Animal Models and Experimental Tests to Study Nociception and Pain](#)
- ▶ [Visceral Pain Model, Pancreatic Pain](#)

## Pancreatitis

### Definition

Pancreatitis is inflammation of the pancreas. Clinically, pancreatitis is defined by sudden severe abdominal pain, nausea, fever, and leukocytosis. Persistent pancreatitis is typically characterized by fatty necrosis and may be accompanied by unremitting pain. The pain may arise with biliary ductal blockage or chronic alcohol abuse.

- ▶ [Animal Models and Experimental Tests to Study Nociception and Pain](#)
- ▶ [Visceral Pain Model, Pancreatic Pain](#)

## Pancreatitis Pain

### Definition

Pain arising from the pancreas is referred to the upper right quadrant radiating to the back.

- ▶ [Animal Models and Experimental Tests to Study Nociception and Pain](#)
- ▶ [Visceral Pain Model, Pancreatic Pain](#)

## Panic Attacks

### Definition

These consist of repeated, unpredictable attacks of intense fear accompanied by severe anxiety symptoms in the body that may last from minutes to hours.

- ▶ [Psychiatric Aspects of Visceral Pain](#)

## Pannus

Hyperplastic synovium resulting from arthritis can be extremely destructive to the joints, particularly in rheumatoid arthritis. Pannus can erode both articular cartilage and subchondral bone once cartilage is damaged. Profound hard tissue damage in the joint may lead to joint deformity, instability and ankylosis.

- ▶ [Arthritis Model, Adjuvant-Induced Arthritis](#)

## PAOD

- ▶ [Peripheral Arterial Occlusive Disease](#)

## Papillae

### Definition

Fungiform, foliate, and filiform papillae of the tongue, where a high concentration of nociceptive nerve endings can be found; they also host gustatory receptors.

- ▶ [Nociception in Nose and Oral Mucosa](#)

## Papilloedema

### Definition

Swelling of the papilla of the optic nerve, due to high intracranial pressure.

- ▶ [Headache due to Low Cerebrospinal Fluid Pressure](#)

## PAR

- ▶ [Proteinase-Activated Receptors](#)

## Parabrachial Hypothalamic and Amygdaloid Projections

JEAN-FRANÇOIS BERNARD  
 Institut National de la Santé et de la Recherche  
 Médicale, INSERM U-677, Paris, France  
 jfbernar@ext.jussieu.fr

### Synonyms

The brachium conjunctivum (bc) (Fig. 1 light gray) is also named superior cerebellar peduncle (scp). It is a large tract that links the cerebellum with the mesencephalon and the thalamus.

### Definition

The parabrachial (PB) area is a group of neurons that surround the brachium conjunctivum. As shown in Figure 1, the PB area is located in a dorsal and lateral region of the brainstem, at the level of junction between the pons (below the cerebellum) and the mesencephalon (below the inferior colliculus). Due to the PB localization, the coronal plane located at the level where the inferior colliculus (mesencephalic) merges with the pons, may be used as a plane of reference (Pr) (indicated with a dotted line in Fig. 1a). Thus, it is possible to identify a mesencephalic (mPB) and a pontine (pPB) portion, rostral and

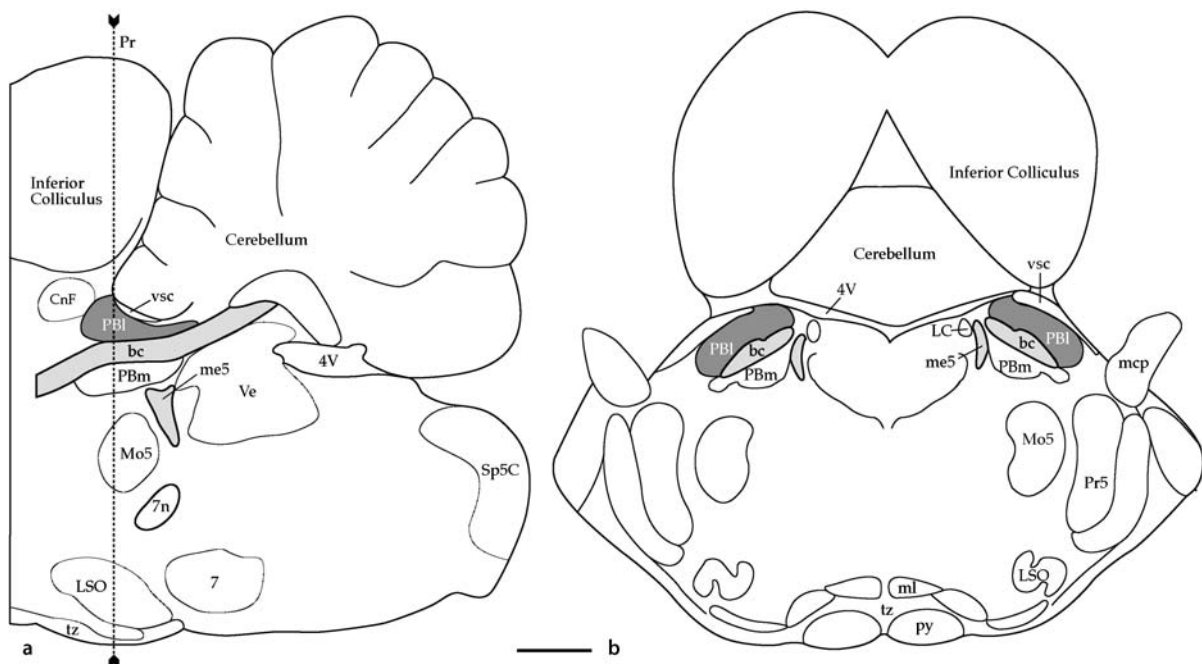
caudal to the Pr, respectively. From the Pr, mPB and pPB extend respectively  $\approx 400 \mu\text{m}$  in a rostral direction and  $\approx 800 \mu\text{m}$  in a caudal direction.

The PB is a complicated area, since in addition to the rostro-caudal division it includes at least ten subnuclei (Fig. 3a). However, it is important to consider only two major divisions: 1) the parabrachial lateral (PBL) (Fig. 1, dark gray) is dorsal and lateral to the bc. It is chiefly the nociceptive/visceral region that is presented here, 2) the parabrachial medial (PBM) (Fig. 1, white) is ventral and medial to the bc. It is chiefly a gustatory area, although even a small portion is linked functionally to the PBL.

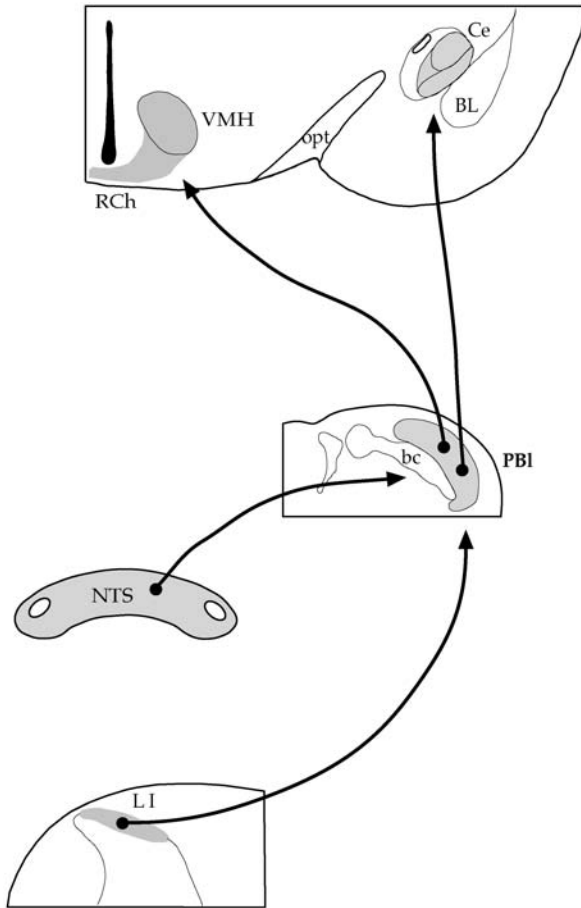
### Characteristics

#### Lamina I Afferent Projection to PB

Anatomical ► retrograde and ► anterograde axonal tracers have demonstrated that the PBL specifically receives a very extensive projection arising from the ► lamina I neurons of the trigeminal and spinal dorsal horn (Fig. 2) (Cechetto et al. 1985; Bernard et al. 1995). Lamina I neurons make up a key primary relay for nociceptive messages conveyed by A $\delta$  and C fibers from periphery. Most of lamina I–PB neurons are nociceptive responsive, and a substantial proportion of them respond only to noxious stimuli (Bester et al. 2000). Smaller populations of lamina I neurons are sensitive to innocuous thermal stimuli (see ► Spino-Parabrachial



**Parabrachial Hypothalamic and Amygdaloid Projections, Figure 1** Diagrams indicating the location of the parabrachial area, lateral division (PBL). (a) Sagittal section of the brainstem of the rat (1.9 mm lateral). (b) Coronal section of the brainstem of the rat ( $-0.30$  mm interaural) which corresponds to the level of the dotted line in (a). In both drawings, the PBL is in dark gray, the brachium conjunctivum (bc) and the mesencephalic trigeminal tract (me5) are in light gray. Scale bar, 1 mm (a and b). Abbreviations: 4V, 4<sup>th</sup> ventricle; 7, facial nucleus; 7n, facial nerve; CnF, cuneiformis nucleus; LC, locus coeruleus; LSO, lateral superior olive; mcp, medial cerebellar peduncle; ml, medial lemniscus; Mo5, motor trigeminal nucleus; PBM, parabrachial medial area; Pr, coronal plan of reference; Pr5, principal sensory trigeminal nucleus; py, pyramidal tract; Sp5C, spinal trigeminal nucleus, caudal; tz, trapezoid body; Ve, vestibular nuclei; vsc, ventral spinocerebellar tract.



**Parabrachial Hypothalamic and Amygdaloid Projections, Figure 2** Summary diagram of the parabrachio-amygdaloid and -hypothalamic pathways, with indication of the two primary inputs of the parabrachial lateral division (PBI). In gray: regions processing nociceptive and/or visceral messages. Abbreviations: bc, brachium conjunctivum; BL, basolateral amygdaloid nucleus; Ce, central nucleus of the amygdala; LI, lamina I of the dorsal horn of the spinal cord; NTS, nucleus of tract solitary; opt, optic tract; RCh, retrochiasmatic area; VMH, ventromedial nucleus of the hypothalamus.

Tract). The PBI area also receives projections from spinal laminae IV, V, VIII and the lateral spinal nucleus (see ► [Spino-Parabrachial Tract](#)). However, this latter projection chiefly targets the medial most portion of the PBI (e.g. the internal lateral subnucleus), which does not project to the ► [amygdala](#) and the ► [hypothalamus](#), and is thus not included in this report.

#### Solitary Afferent Projection to PB

The PBI receives a second very extensive projection arising from the nucleus of the solitary tract (Fig. 2) (Herbert et al. 1990). Although, not so directly involved in nociceptive processing as lamina I neurons, this input conveys, via the vagal nerve, visceral nociceptive and homeostatic (blood pressure, blood CO<sub>2</sub>/pH, concentration of lipid and amino acid in duodenum etc) messages to the PBI.

#### Properties of PB-Ce & PB-Hypothalamic Neurons

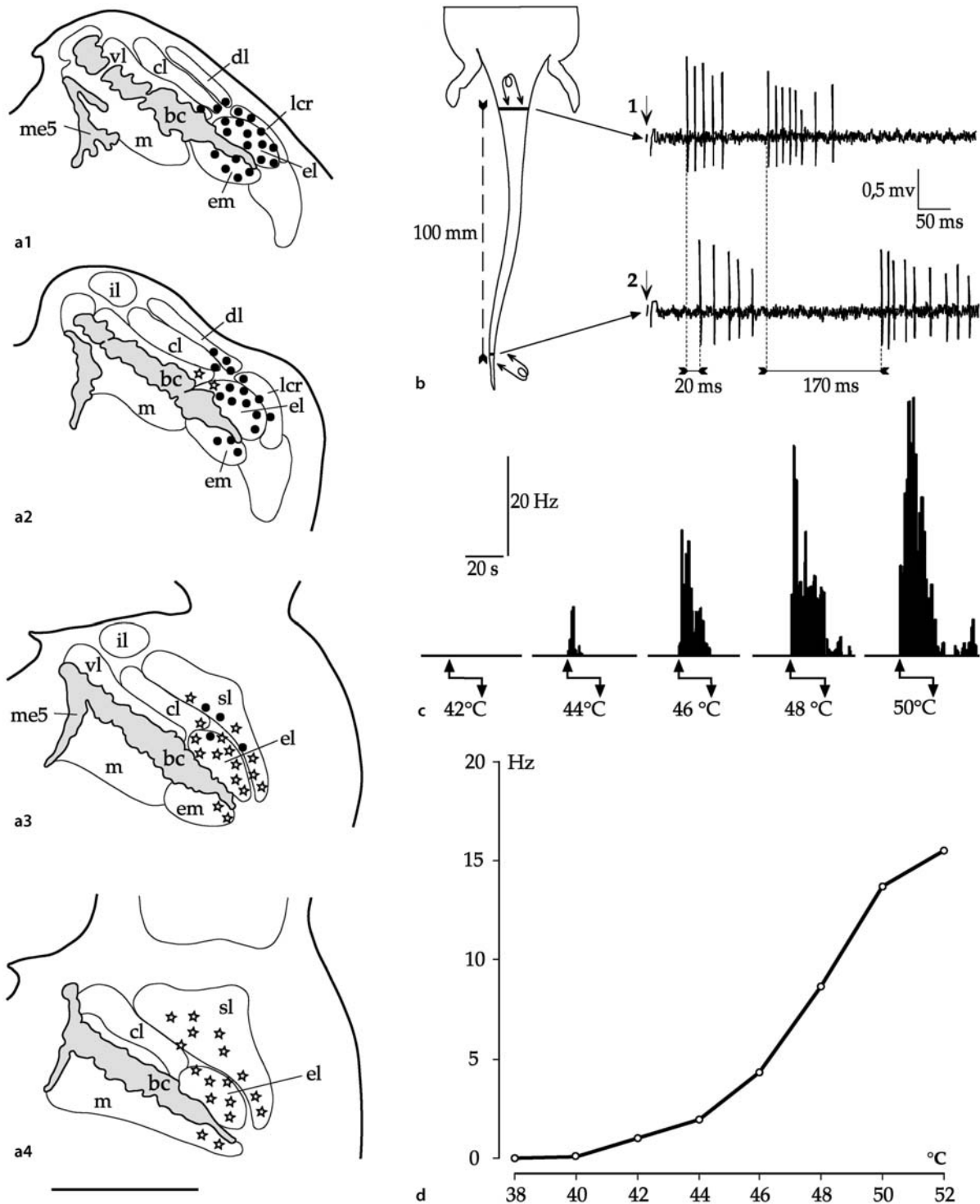
The two primary projections of the PBI (with the exception of the internal lateral subnucleus) are the central nucleus of the amygdala (Ce), the ventromedial (VMH) and retrochiasmatic (RCh) hypothalamic nuclei (Fig. 2). An extensive electrophysiological study has recorded numerous PBI neurons in rats under halothane anaesthesia (0.5%) in a nitrous oxide/oxygen mixture (Bernard and Besson 1990; Bester et al. 1995). These PB neurons were identified by ► [antidromic](#) electrical stimulation, applied within the Ce or the VMH/RCh. In agreement with anatomical studies, the locations of parabrachial neurons projecting to the Ce (PB-Ce) or to the VMH/RCh nuclei (PB-VMH) are clearly distinct. As shown in Figure 3a, the PB-Ce neurons (black points) are located in the caudal “pontine” portion of the PBI (pPBI), whereas the PB-VMH neurons (stars) are located in the rostral “mesencephalic” portion of the PBI (mPBI).

A high proportion of PB-Ce (70%) and PB-VMH (50%) neurons are nociceptive specific (NS), the remainder being unresponsive. These NS neurons are strongly excited by noxious electrical ( $\geq 1$  mA), mechanical (pinch, squeeze) and thermal ( $\geq 44^\circ\text{C}$ ) cutaneous stimuli, whereas electrical ( $< 1$  mA), tactile, innocuous pressure and thermal ( $< 44^\circ\text{C}$ ) somatic stimuli are weakly or totally ineffective. The cutaneous receptive fields of these neurons are generally large including several areas of the body (tail, paws, hemiface, or tongue), although a stronger activation is obtained from stimuli applied to one part of the body (often contralateral). The receptive field of one third of the neurons is relatively small (restricted to one part of the body). Noxious stimuli applied outside the excitatory receptive field inhibit the responses of NS neurons.

The ongoing discharge of PB-Ce and PB-VMH neurons is very low. These neurons respond to intense noxious transcutaneous electrical stimuli (2 ms, 3 – 30 mA) with two peaks of activation (Fig. 3b). In the individual example of Figure 3b, the increased latency (20 ms = 0.02 s) of the first peak, with 100 mm (0.1 m) increased distance of electrical stimulus, corresponds to a nerve conduction velocity of  $0.1/0.02 = 5$  m/s. The increased latency of the second peak (170 ms = 0.17 s) corresponds to a nerve conduction velocity of  $0.1/0.17 = 0.59$  m/s. On average, the early and the late peak were triggered by the activation of peripheral fibers with conduction velocities in 8 – 20 m/s and 0.5 – 0.8 m/s range, e.g. an activation of A $\delta$  and C-fibers, respectively. Furthermore, the response due to C-fibers exhibits a wind-up phenomenon during repetitive stimulation (0.66 Hz).

PB-Ce and PB-VMH neurons respond to mechanical and/or thermal noxious stimuli with a strong and sustained but decreasing activation. These neurons exhibit a clear capacity to encode thermal stimuli in the noxious range. Figure 3C shows a PB neuron with-





**Parabrachial Hypothalamic and Amygdaloid Projections, Figure 3** (a) Location of nociceptive specific neurons antidromically driven from the central nucleus of the amygdala (black points) or from the ventromedial hypothalamic nucleus (stars). Drawings of coronal sections of parabrachial region are presented from caudal to rostral, 300  $\mu$ m apart. (a 1, 2) pontine division of the PB area. (a 3, 4) mesencephalic division of the parabrachial area. Brachium conjunctivum (bc) and mesencephalic trigeminal tract (me5) are in light gray. (b) Single sweep recording of the early and late peak of spike firing evoked by transcutaneous electrical stimulation of the base (1) and the tip (2) of the tail. Note the 20 ms and 170 ms increased latency of first and second discharge peak when the electrical stimulus is moved 100 mm apart from the base to the tip of tail. (c) Encoding properties of a nociceptive specific parabrachio-amygdaloid neuron to thermal stimulation applied to the contralateral forelimb. (d) Mean stimulus-response curve of parabrachial neurons (discharge during 20 s) as a function of temperature applied on skin. Scale bar, 1 mm (a). Abbreviations: cl, central lateral; dl, dorsal lateral; el, external lateral; em, external medial; il, internal lateral; lcr, lateral crescent; m, medial; sl, superior lateral; vl, ventral lateral subnuclei of the parabrachial area.

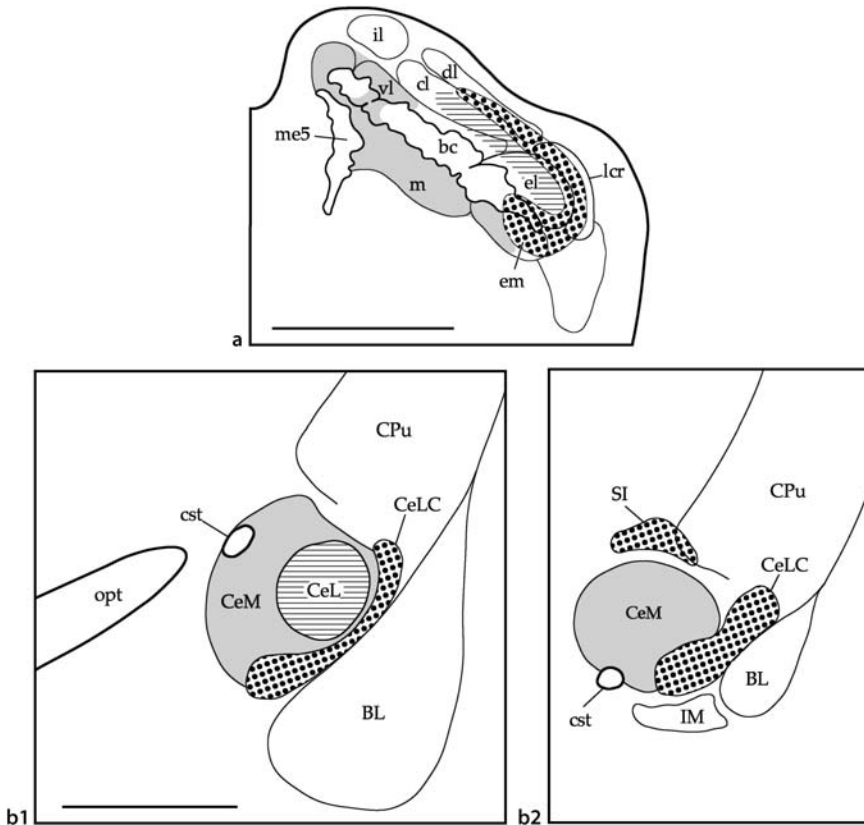
out ongoing activity, which does not respond to 42°C applied to contralateral forepaw. On the other hand, the response appears at 44°C and increases in parallel with temperature within the noxious range. The mean stimulus-response curve (discharge as a function of nociceptive temperature) increases progressively from a mean threshold around 44°C up to a maximum of around 50/52°C (Fig. 4D). The main change in the mean curve (steepest portion of the slope) is in 46–50°C range (e.g. when the painful sensation becomes unbearable). Intravenous morphine induced a strong depression of the response elicited by noxious thermal stimuli in a dose related and naloxone reversible fashion, with an ED<sub>50</sub> = 1.8 mg/kg (Huang et al. 1993). PB neurons are also affected by visceral noxious stimuli (intraperitoneal injection of bradykinine and/or colorectal distension with mean threshold of 56 ± 24 mmHg) almost exclusively in the noxious range (Bernard et al. 1994). An additional small population of PB neurons responds specifically to cold. They encode linearly cold tempera-

tures from an innocuous range (25 to 15°C) up to a very low (–10°C) and noxious cold (Menendez et al. 1996).

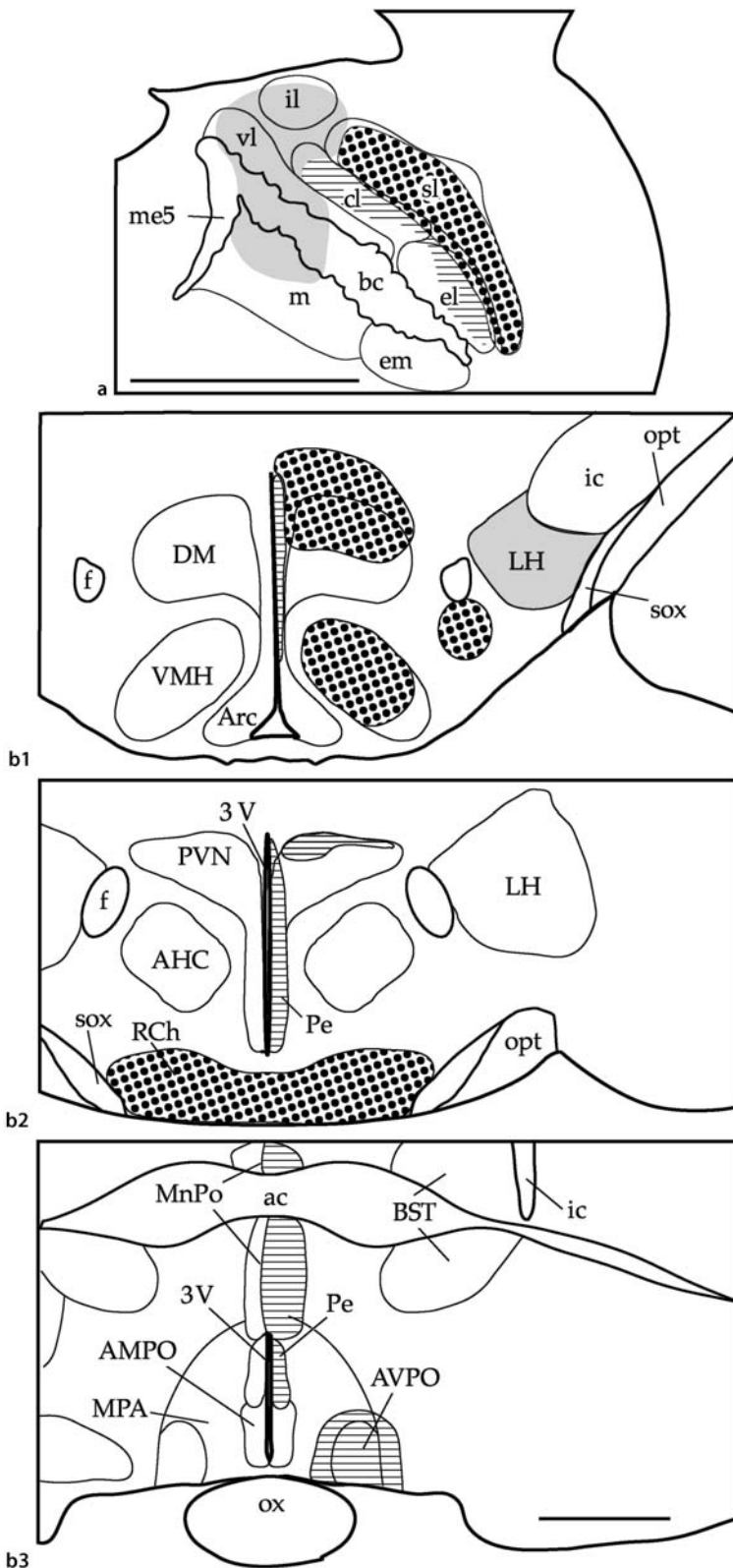
#### Projections upon the Amygdala

These projections were studied with retrograde (► WGA-HRP) (Moga et al. 1990) and anterograde axonal tracer (► PHA-L) (Bernard et al. 1993). PB projections to the amygdala originate almost exclusively from the pPB and target chiefly the ipsilateral Ce.

1. The pPB nociceptive & visceral areas centered on the external lateral subnucleus and including adjacent areas + the external medial subnucleus (in ventrolateral position), project primarily to the lateral capsular portion of the Ce (CeLC), the lateral portion to the Ce (CeL) and to a lesser extent to the SI (Fig. 4, large dots and hatching areas). Note that the PB hatched areas also project to the lateral dorsal portion of the ► **bed nucleus of the stria terminalis**, which is considered a functional extension of the Ce (not illustrated)



**Parabrachial Hypothalamic and Amygdaloid Projections, Figure 4** Summary diagram illustrating, in coronal sections, the projection pattern from the pontine parabrachial (pPB) area (a) to the caudal (b1) and rostral (b2) levels of the central nucleus of the amygdala (Ce). The pPB "nociceptive area" (large dots) projects upon the CeLC and the SI (large dots). pPB "nociceptive + visceral" area (horizontal hatching) projects upon the CeL (horizontal hatching). The pPB "gustatory" area (gray) projects upon the CeM (gray). Scale bars, 1 mm (a and b). Abbreviations: BL, basolateral amygdaloid nucleus; CeL, lateral subdivision of Ce; CeLC, lateral capsular subdivision of Ce; CeM, medial subdivision of Ce; cl, central lateral PB subnucleus; CPu, caudate-putamen; cst, commissural stria terminalis; dl, dorsal lateral PB subnucleus; el, external lateral PB subnucleus; em, external medial PB subnucleus; il, internal lateral PB subnucleus; IM, intercalated main amygdaloid nucleus; lcr, lateral crescent PB subnucleus; m, medial PB subnucleus; me5, mesencephalic trigeminal tract; opt, optic tract; PB, parabrachial area; SI, substantia innominata; sl, superior lateral PB subnucleus; vl, ventral lateral PB subnucleus.



**Parabrachial Hypothalamic and Amygdaloid Projections, Figure 5** Summary diagram illustrating, in coronal sections, the projection pattern from the mesencephalic parabrachial (mPB) area (a) to the hypothalamus (caudal to rostral) (b, 1–3). The mPB “nociceptive” area (large dots) projects upon the VMH, RCh, DM and subfornical hypothalamic nuclei (large dots). The mPB “nociceptive + visceral” area (horizontal hatching) projects upon the Pe, PVN dorsal, MnPo and AVPO hypothalamic nuclei (horizontal hatching). The mPB “gustatory” (gray) + pPB “gustatory” (see Fig. 4a, in gray) areas project upon the caudal portion of the lateral hypothalamus (gray). Scale bars, 1 mm (a and b). Abbreviations: 3V, third ventricle; ac, anterior commissure; AHC, anterior hypothalamic area central; AMPO, anterior medial preoptic nucleus; Arc, arcuate nucleus; AVPO, anteroventral preoptic nucleus; BST, bed nucleus of stria terminalis; cl, central lateral PB subnucleus; dl, dorsal lateral PB subnucleus; DM, dorsal medial nucleus; el, external lateral PB subnucleus; em, external medial PB subnucleus; f, fornix; ic, internal capsule; il, internal lateral PB subnucleus; lcr, lateral crescent PB subnucleus; LH, lateral hypothalamus; m, medial PB subnucleus; me5, mesencephalic trigeminal tract; MnPO, median preoptic nucleus; MPA, medial preoptic area; opt, optic tract; ox, optic chiasm; PB, parabrachial area; Pe, periventricular nucleus; pPB, pontine parabrachial area; RCh, retrochiasmatic area; sl, superior lateral PB subnucleus; sox, supraoptic decussation; vl, ventral lateral PB subnucleus; VMH, ventromedial hypothalamic nucleus.

P

2. The caudal pPBm gustatory area is centered on the medial subnucleus and includes the adjacent area in the bc. It projects primarily to the medial portion of the Ce (CeM). Additional projections were also found in the basolateral, basomedian and cortical nuclei of the amygdala (Fig. 4, gray areas).

An electrophysiological study of the Ce, in anesthetized rats, has shown that CeLC and SId neurons are strongly excited by noxious stimuli, whereas neurons in CeL and CeM are unresponsive or inhibited by noxious stimuli (Bernard et al. 1992).

Considering the role of Ce in such aversive emotions as fear and autonomic controls (Aggleton 1992), the PB-amygdaloid nociceptive pathway could be involved in the affective-emotional (fear, memory of aggression) and ► **autonomic** (pupil dilatation, cardiorespiratory, adrenocortical responses, and micturition) reactions to noxious events. The pPB-CeLC pathway would be mainly implicated in ► **emotional/autonomic responses** to cutaneous pain, whereas the pPB-CeL pathway would be mainly implicated in emotional/autonomic responses to visceral pain and/or digestive & chemosensitive disorders. In contrast, the pPB-CeM pathway would be implicated in learning taste aversion and autonomic responses to feeding.

#### Projections upon the Hypothalamus

These projections were studied with retrograde (WGA-HRP) (Moga et al. 1990) and anterograde axonal tracer (PHA-L) (Bester et al. 1997). PB projections to the hypothalamus originate chiefly from the mPB.

1. The mPBI nociceptive & visceral region, centered on the superior lateral subnucleus including the adjacent portion of the external lateral and central lateral subnucleus, projects extensively to ventromedial (VMH), the median preoptic (MnPo) and the retrochiasmatic (RCh) hypothalamic nuclei. This mPBI area also projects, but with a lower density to the periventricular (Pe), the anteroventral preoptic (AVPO), the dorsal medial (DM) and the dorsal portion of paraventricular (PVN) hypothalamic nuclei (Fig. 5, large dots and horizontal hatching).
2. Almost all of the PB subnuclei project diffusely to the posterior portion of the lateral hypothalamus (pLH) (Fig. 5b), the more consistent projection originating from the medial mPB (Fig. 5a gray) and the pPBm “gustatory” region (Fig. 4a gray).

Considering the role of each of the hypothalamic targets (Swanson 1987): aggression, defense, feeding, thermogenesis (VMH, RCh, DM), chemical and body fluid regulation (MnPo, Pe), thermoregulation and regulation of vigilance/sleep states (AVPO) neuroendocrine secretions of CRH (PVN dorsal), the PB-hypothalamic pathway would be involved in numerous motivational behaviors (see ► **motivational reactions**) (aggression/defense,

flight, feeding, drinking, awakening) as well as in autonomic and neuroendocrine responses to noxious events. The pPBm-pLH pathway could be a link between taste and feeding behaviors.

#### References

1. Aggleton JP (1992) *The Amygdala, Neurobiological Aspects of Emotion, Memory, and Mental Dysfunction*. Wiley-Liss, New York
2. Bernard JF, Aldén M, Besson JM (1993) The Organization of the Efferent Projections from the Pontine Parabrachial Area to the Amygdaloid Complex: A Phaseolus Vulgaris leucoagglutinin (PHA-L) Study in the Rat. *J Comp Neurol* 329:201–229
3. Bernard JF, Besson JM (1990) The Spino (Trigemino)-Ponto-amygdaloid Pathway: Electrophysiological Evidence for an Involvement in Pain Processes. *J Neurophysiol* 63:473–490
4. Bernard JF, Dallel R, Raboisson P, Villanueva L, Le Bars D (1995) Organization of the Efferent Projections from the Spinal Cervical Enlargement to the Parabrachial Area and Periaqueductal Grey: A PHA-L Study in the Rat. *J Comp Neurol* 353:480–505
5. Bernard JF, Huang GF, Besson JM (1992) The Nucleus Centralis of the Amygdala and the Globus Pallidus Ventralis: Electrophysiological Evidence for an Involvement in Pain Processes. *J Neurophysiol* 68:551–569
6. Bernard JF, Huang GF, Besson JM (1994) The Parabrachial Area: Electrophysiological Evidence for an Involvement in Visceral Nociceptive Processes. *J Neurophysiol* 71:1646–1660
7. Bester H, Besson JM, Bernard JF (1997) Organization of Efferent Projections from the Parabrachial Area to the Hypothalamus: A Phaseolus Vulgaris-Leucoagglutinin Study in the Rat. *J Comp Neurol* 383:245–281
8. Bester H, Chapman V, Besson JM, Bernard JF (2000) Physiological Properties of the Lamina I Spinoparabrachial Neurons in the Rat. *J Neurophysiol* 83:2239–2259
9. Bester H, Menendez L, Besson JM, Bernard JF (1995) Spino (Trigemino) Parabrachiohypothalamic Pathway: Electrophysiological Evidence for an Involvement in Pain Processes. *J Neurophysiol* 73:568–585
10. Cechetto DF, Standaert DG, Saper CB (1985) Spinal and Trigeminal Dorsal Horn Projections to the Parabrachial Nucleus in the Rat. *J Comp Neurol* 240:153–160
11. Herbert H, Moga M, Saper CB (1990) Connections of the Parabrachial Nucleus with the Nucleus of the Solitary Tract and Medullary Reticular Formation in the Rat. *J Comp Neurol* 293:540–580
12. Huang GF, Besson JM, Bernard JF (1993) Morphine Depresses the Transmission of Noxious Messages in the Spino (Trigemino)-Ponto-Amygdaloid Pathway. *Eur J Pharmacol* 230:279–284
13. Menendez L, Bester H, Besson JM, Bernard JF (1996) Parabrachial Area: Electrophysiological Evidence for an Involvement in Cold Nociception. *J Neurophysiol* 75:2099–2116
14. Moga MM, Herbert H, Hurlley KM, Yasui Y, Gray TS, Saper CB (1990) Organization of Cortical, Basal Forebrain, and Hypothalamic Afferents to the Parabrachial Nucleus in the Rat. *J Comp Neurol* 295:624–661
15. Swanson LW (1987) *The Hypothalamus*. In: Hökfelt, Swanson LW (eds) *Handbook of Chemical Neuroanatomy, vol 5, Integrated Systems of the CNS, Part I*. Elsevier, Amsterdam, Oxford, pp1–124

## Parabrachial/PAG

### Definition

Areas of the midbrain with important projections from lamina I of the spinal cord, which are thought to link to



emotional aspects of pain and descending pathways back to the spinal cord.

- ▶ [Opioids in the Spinal Cord and Central Sensitization](#)

## Paracetamol

### Synonyms

Acetaminophen

### Definition

An analgesic drug that causes pain relief in the CNS and in the peripheral tissues by unknown mechanisms. Its pharmacological actions are considered to be primarily in the brain. It also has antipyretic actions, lowering feverish body temperatures. Paracetamol is often classified as a non-steroidal anti-inflammatory drug, whereas in fact it is only weakly anti-inflammatory. It differs from acidic NSAIDs such as aspirin or diclofenac, because it easily crosses the blood brain barrier and enters the central nervous system.

- ▶ [Cyclooxygenases in Biology and Disease](#)
- ▶ [Postoperative Pain, Acute Pain Management, Principles](#)
- ▶ [Simple Analgesics](#)

## Paracetamol in Postoperative Pain

- ▶ [Postoperative Pain, Paracetamol](#)

## Paracrine

### Definition

A type of function in which a substance is synthesized in and released from endocrine cells to act locally on nearby cells of a different type and affects their function.

- ▶ [Diencephalic Mast Cells](#)

## Paradoxical Cold Sensation

### Definition

A large proportion of cold thermoreceptors can be excited by increments in temperature (usually  $>45^{\circ}\text{C}$ ). The sensory correlate of this excitation is the „paradoxical cold sensation“ that can be evoked by strong heat stimulation of a cold spot on the skin, a term coined by Max von Frey in 1895 to describe the phenomenon. The co-localization of TRPV1 (heat-activated) and TRPM8 (cold-activated) receptors on single sensory neurons may be the molecular basis for the paradoxical cold sensation.

- ▶ [Nociceptors, Cold Thermotransduction](#)

## Paradoxical Heat

### Definition

Paradoxical heat is a heat sensation (sometimes painful) that results from temperature decreases. Such an experience can occur when cool stimuli are mixed with heat stimuli, or in cases of neuropathy.

- ▶ [Threshold Determination Protocols](#)

## Paraesthesia

- ▶ [Paresthesia](#)

## Parafascicular Nucleus (PF)

### Definition

The parafascicular nucleus is part of the caudal group of intralaminar nuclei, which projects heavily to the striatum, but also lightly to the cerebral cortex.

- ▶ [Brainstem Subnucleus Reticularis Dorsalis Neuron](#)
- ▶ [Spinothalamic Projections to Ventromedial and Parafascicular Nuclei](#)

P

## Parafascicular Nucleus, Pain Modulation

ERIK ASKENASY, NACHUM DAFNY

Health Science Center at Houston, Neurobiology and Anatomy, University of Texas, Houston, TX, USA  
nachum.dafny@uth.tmc.edu

### Synonyms

Intralaminar nuclei in pain; CM-PF Complex

### Definition

The parafascicular nucleus (PF) and center-median nucleus (CM) along with other intralaminar nuclei are considered to be higher integrative centers and major relay stations for nociception in humans. These nuclei have been largely overlooked, for a variety of reasons including their location deep within the brain making surgical manipulations both difficult and dangerous. Recently however, renewed interest concerning their role in pain modulation resurfaced, in part because of the expansion of stereotactic neurosurgery together with deep brain stimulation.

## Characteristics

### Anatomy

The internal medullary lamina separates the medial from the ► **lateral thalamic nuclei**. The intralaminar nuclei can be divided into anterior (rostral) and posterior (caudal) groups. The caudal group consists of the PF and the CM and together with the central lateral nucleus (a rostral nucleus) comprises a majority of the intralaminar nuclei (Weigel and Krauss 2004). Posteriorly the CM-PF complex is separated from the pretectum by a thin lamina. Medially the CM merges with the PF, which lies just lateral to the anterior periaqueductal gray (Weigel and Krauss 2004). Nociceptive impulses reach the medially located intralaminar nuclei *via* the spinal cord by means of the diffusely projecting ► **paleo-spinothalamic tract**. It is likely that the affective and ► **motivational components of pain** (such as the desire to end, reduce or escape from the noxious stimuli) are modulated in part by the effect of the intralaminar nuclei on the anterior cingulate cortex and other higher systems (Taber et al. 2001). Conversely the ► **neo-spinothalamic tract** projects to the lateral somatosensory thalamus (ventral posterior lateralis (VPL) and ventral posterior medialis (VPM)). These nuclei are involved in the ► **sensory and discriminative aspects of pain** and have projections to the primary somatosensory cortex (Young et al. 1995).

### Inputs and Projections

The main efferent projection from the PF is to the striatum, namely the ► **caudate nucleus**. However, additional studies have disclosed many projections to other areas such as the prefrontal cortex, premotor cortex, and anterior cingulate cortex (Weigel and Krauss 2004). When projections from the medial thalamus (a region encompassing nuclei including the PF and CM) are included, projections include to the basolateral amygdaloid complex, nucleus accumbens, subthalamic nucleus and olfactory tubercle, as well as to the primary somatosensory cortex, frontal cortex, parahippocampus and hippocampus (Berendse and Groenewegen 1991). Like efferent projections, afferent inputs to the intralaminar nuclei are numerous and include the ► **paleo and archispinothalamic tracts and trigeminal lemniscus** (Boivie 1979), the periaqueductal gray (Hamilton 1973), midbrain and brainstem reticular formation, superior colliculus, locus ceruleus, dorsal raphe nucleus, pretectum, cerebellum, pulvinar and prefrontal cortex.

### Types of Neurons

There are three groups of neurons within the PF, which can be differentiated by their baseline electrical firing patterns (Liu et al. 1993). The first pattern is characterized by a slow firing rate and comprises approximately 60-70% of the total neuronal population. The second pattern is characterized by spontaneous burst firing and comprises approximately 10-20% of the neuronal

population. The third pattern is characterized by a fast firing rate and comprises approximately 15-20% of the total PF recorded neuronal population. These three types of neurons are distributed randomly throughout the PF (Liu et al. 1993).

Another way of grouping PF neurons is based on their response to noxious stimuli. When painful stimuli, such as tail pinch, sciatic nerve stimulation or tail immersion, were administered to rats, type I and II neurons showed a change in baseline discharge patterns as opposed to type III neurons, which did not show a change from baseline activity (See Table 1) (Liu et al. 1993, Reyes-Vazquez et al. 1986). Thus, type I and type II neurons are nociceptive reactive and can be classified as either ‘nociceptive-on’ or ‘nociceptive-off’ depending on whether an elevated or depressed response to noxious stimuli occurs. Type III neurons are ‘non-nociceptive’ as they do not respond to noxious stimuli. Further studies have indicated that ‘nociceptive-on’ neurons comprise a majority of cells within the PF while ‘non-nociceptive’ cells comprise the minority (See Table 2) (Liu et al. 1993, Reyes-Vazquez et al. 1986). This percentage correlates well with various studies which show that the majority of cells within the PF respond to noxious stimuli (Dong et al. 1978).

### Effect of Stimulation

Intraoperative stimulation of the CM-PF complex in patients undergoing surgery for intractable pain has provided valuable information. It is notably difficult to confirm electrode placement in the intralaminar nuclei, as they have no ‘signature’ response to stimulation. Be that as it may, stimulation of the CM-PF complex results in unpleasant sensations such as a diffuse burning (Sano et al. 1966) or warmth (Ray and Burton 1980) of the contralateral body and a signal all over the body as if “I was going to explode” (Mark et al. 1963). Pulling of both sides of the face and shoulder (Rinaldi et al. 1991), intense and painful cramping in the head, neck and contralateral arm and a marked increase in the pain of which patients were initially complaining were also seen (Sano et al. 1966). In animals, stimulation of the CM-PF complex results in aversive pain-like responses (Kaelber and Mitchell 1967). It was postulated that stimulation might cause both a diffuse unpleasant sensation and a state of awareness. Coupled, this sensation may be a motivating force to avoid the inciting stimulus (Kaelber and Mitchell 1967).

### Stimulation of Other Nuclei

In animals, electrical stimulation of various nuclei within the brain can also modify activity in the PF. Stimulation of the locus ceruleus (LC) has antinociceptive properties as it produces a decrease in noxious evoked impulses recorded from the PF (Han et al. 2002). Responses from other nuclei are more complex. Excitation of the dorsal raphe nucleus or the cerebellar lateral nucleus results in an intensity-dependent suppression

**Parafascicular Nucleus, Pain Modulation, Table 1** Neuronal Subpopulations within the PF (based on baseline activity)

Type	Percent	Description	Noxious stimuli
I	60–70%	0.2–10 spikes/sec (slow firing rate)	Respond
II	10–20%	2–6 spikes/burst (bursting activity)	Respond
III	15–20%	10–45 spikes/sec (fast firing group)	No Response

**Parafascicular Nucleus, Pain Modulation, Table 2** Neuronal Subpopulations within the PF

Type	Percent	Change From Baseline	Duration of change
'on'*	50–70%	260–500% Increase	30–150 sec
'off'*	20–30%	60–80% Decrease	10–150 sec
'non'*	10–20%	No Change	NA

\*'on' indicates nociceptive-on neurons; 'off' indicates nociceptive-off neurons; 'non' indicates non-nociceptive neurons

of impulses from 'off' cells. Low intensity dorsal raphe or cerebellar lateral nucleus stimulation inhibits 'on' cells, while high intensity stimulation was found to activate 'on' cells (Liu et al. 1993).

#### Effects of Deep Brain Stimulation (DBS)/Lesioning

DBS for pain relief targeting the CM-PF complex shows good results (Table 3). Medial thalamotomies have also been employed as a tool for chronic, severe, intractable pain and far more studies have been conducted using this treatment modality compared to DBS of the CM-PF. Initially pain relief was experienced by 50–75% of these patients (Tasker 1990). However, ablative lesions are becoming less frequent, possibly due to the high rate of recurrence of pain. Gamma knife has also been employed to perform medial thalamotomies. Results using radiofrequency ablation are similar to those seen using electrocautery.

#### Effect of Drugs

Animal studies have investigated the effects of numerous drugs on PF activity. Examples of a few substances that appear to have antinociceptive properties include morphine, gamma-amino butyric acid (GABA) and acetylcholine. Morphine inhibits the increased activation of the PF in response to noxious stimuli and naloxone antagonized morphine's effects. Similarly, microinjections of GABA or GABA agonists into the

PF also resulted in antinociception. Administration of a GABA antagonist prevented these inhibitory effects on PF activity (Reyes-Vazquez et al. 1986). Carbachol, a nonspecific acetylcholine agonist, likewise has antinociceptive properties. This property is inhibited by atropine, indicating that the antinociceptive action is probably muscarinic (Harte et al. 2004).

Other substances such as neuropeptide FF and norepinephrine have more complex actions. When given intrathecally, neuropeptide FF has antinociceptive properties, as opposed to when it is microinjected into the PF where it inhibits morphine's effects. Stimulation of the LC also has antinociceptive properties presumably *via* an adrenergic mediated descending pathway that inhibits the nociceptive response of dorsal horn neurons (Han et al. 2002, Zhang et al. 1997).

#### Summary

In summary, the PF appears to be involved in the affective and ► **motivational components of the pain** response. The main afferent projections to the PF include the spinothalamic tracts, superior colliculi and several brainstem nuclei. In turn, the PF sends significant projections to the caudate nucleus and the prefrontal and premotor cortices. Within the PF, three electrophysiological neuronal subpopulations can be classified. The 'nociceptive-on' neurons comprise a majority of neu-

P

**Parafascicular Nucleus, Pain Modulation, Table 3** Effect of CM-PF Deep Brain Stimulation (DBS)

Study	DBS	Result	Follow Up
Andy 1980	CM-PF	Alleviation of pain and dyskinesias in 3/3 pts.	—
Hariz & Bergenheim 1995	CM	Alleviation of pain in 2/4 pts.	Mean 16 mo.
Krauss et al. 2002	CM-PF	CM-PF DBS superior to VPL/VPM in 11 pts.	—
Ray and Burton 1980	CM-PF	Excellent-Good results in 21/28 pts.*	Mean 14 mo.

\* Excellent-Good results are those with >50% relief of pain

rons and hence the overall response of the PF to noxious stimuli is activation. When the PF is stimulated intraoperatively, a variable response ranging from contractures and clonus to a diffuse unpleasantness is seen. In animals, stimulation of the PF results in activation of the PAG, which is intimately involved in the gate control theory of descending pain control. Hence, a circuit can be theorized whereby painful stimuli transmitted to the PF *via* the spinothalamic tracts produce activation of the descending pain control pathway. Additionally, in animals stimulation of the locus ceruleus and substantia nigra decreases the response of the PF to noxious stimuli and may provide an explanation for the antinociceptive properties seen with norepinephrine and dopamine. It is unclear why intraoperative stimulation produces seemingly opposite responses compared to DBS or thalamotomy. In fact, intuitively one would postulate that DBS and thalamotomy themselves would yield opposite results on nociception. However, this is not the case. Both thalamotomy *via* electrocautery or gamma knife and DBS result in significant pain relief for a majority of patients. Unfortunately this effect appears to be transient for ablative lesions. Long-term studies using DBS of the CM-PF are lacking and preclude any conclusion concerning its effectiveness in alleviating pain in the long run.

Clearly the role of the PF in ascending and descending pain modulation is complex and it is likely that dividing pain systems into the medial thalamus paleospinothalamic system (affective and motivational) *versus* the lateral thalamus neospinothalamic system (sensory and discriminatory) is an oversimplification (Weigel and Krauss 2004). Additionally, the PF has been postulated to play a role in attentional orienting to behaviorally significant events and seizure control.

## References

- Berendse HW, Groenewegen HJ (1991) Restricted cortical termination fields of the midline and intralaminar nuclei in the rat. *Neuroscience* 42:73–102
- Boivie J (1979) An anatomical reinvestigation of the termination of the spinothalamic tract in the monkey. *J Comp Neurol* 186:343–369
- Dong WK, Ryu H, Wagman IH (1978) Nociceptive responses of neurons in medial thalamus and their relationship to spinothalamic pathways. *J Neurophys* 41:1592–1613
- Hamilton BL (1973) Projections of the nuclei of the periaqueductal grey matter in the cat. *J Comp Neurol* 152:45–58
- Han BF, Zhang C, Qi JS et al. (2002) ATP-sensitive potassium channels and endogenous adenosine are involved in spinal antinociception produced by locus coeruleus stimulation. *Sheng Li Xue Bao* 54:139–144
- Harte SE, Hoot MR, Borszcz GS (2004) Involvement of the intralaminar parafascicular nucleus in muscarinic-induced antinociception in rats. *Brain Res* 1019:152–161
- Kaelber WW, Mitchell CL (1967) The centrum medianum-central tegmental fasciculus complex. A stimulation, lesion and degeneration study in the cat. *Brain* 90:83–100
- Liu FY, Qiao JT, Dafny N (1993) Cerebellar stimulation modulates thalamic noxious-evoked responses. *Brain Res Bull* 30:529–534
- Mark VH, Ervin FR, Yakovlev PI (1963) Stereotactic thalamotomy: III. The verification of anatomical lesion sites in the human thalamus. *Arch Neurol Chicago* 8:528–538
- Ray CD, Burton CV (1980) Deep brain stimulation for severe, chronic pain. *ACTA Neurochir Suppl* 30:289–293
- Reyes-Vazquez C, Enna SJ, Dafny N (1986) The parafascicular thalami as a site for mediating the antinociceptive response to GABAergic drugs. *Brain Res* 383:177–184
- Rinaldi PC, Young RF, Albe-Fessard D et al. (1991) Spontaneous neuronal hyperactivity in the medial and intralaminar thalamic nuclei of patients with deafferentation pain. *J Neurosurg* 74:415–421
- Sano K, Yoshioka M, Ogashiwa M et al. (1966) Thalamotomy. A new operation for relief of intractable pain. *Confin Neurol* 27:63–66
- Taber KH, Rashid A, Hurley RA (2001) Functional Anatomy of Central Pain. *J Neuropsychiatry Clin Neurosci* 13:437–440
- Tasker RR (1990) Thalamotomy. *Neurosurg Clin N Am* 1:841–864
- Weigel R, Krauss JK (2004) Center median-parafascicular complex and pain control. *Stereotact Funct Neurosurg* 82:115–126
- Young RF, Jacques DS, Rand RW et al. (1995) Technique of stereotactic medial thalamotomy with the Leksell gamma knife for treatment of chronic pain. *Neurol Res* 17:59–65
- Zhang C, Yang S, Guo Y et al. (1997) Locus coeruleus stimulation modulates the nociceptive response in parafascicular neurons: an analysis of descending and ascending pathways. *Brain Res Bull* 42:273–278

## Parahippocampal Region

### Definition

The parahippocampal region is situated next to the hippocampal formation in the brain. Various parcellations of this region have been proposed. Here, we adhere to the definition used by Squire and colleagues: the perirhinal cortex, the entorhinal cortex and the parahippocampal cortex comprise the parahippocampal region. The parahippocampal cortex, which forms part of the region, is not to be confused with the parahippocampal region itself.

► [Hippocampus and Entorhinal Complex, Functional Imaging](#)

## Parahippocampal Region, Neuroimaging

► [Hippocampus and Entorhinal Complex, Functional Imaging](#)

## Parallel Pain Processing

### Definition

Parallel pain processing is the theoretical model of a dual pain system, in which the sensory-discriminative and affective-motivational dimensions of pain are simultaneously processed in two anatomically distinct



neural circuits, termed the lateral pain system and the medial pain system, respectively.

- ▶ [Thalamo-Amygdala Interactions and Pain](#)

## Parameters Indicative of Skeletal Muscle Contraction

### Definition

Parameters indicative of skeletal muscle contraction are: (A) Decreased I band length/sarcomere length ratio (ultrastructural contraction index); (B) increased muscle cell membrane fluidity; (C) increased sarcoplasmic reticulum (SR)  $\text{Ca}^{2+}$ -uptake capacity, measured as  $\text{Ca}^{2+}$ -ATPase activity (correlated linearly to the number of ureteral "crises"), and (D) decreased SR- $\text{Ca}^{2+}$  release capacity, measured as ryanodine binding.

The presence of a state of contraction in the hyperalgesic muscle, whose extent correlates with the algogenic activity of the ureteral stone, is an event that could contribute to the generation of the hyperalgesia via sensitization of muscle nociceptors in the ureteral calculus model.

- ▶ [Visceral Pain Model, Kidney Stone Pain](#)

## Paraneoplastic Syndrome

### Definition

Paraneoplastic Syndromes are disorders that can be painful, which occur with increased frequency in patients with cancer with etiologies that are incompletely understood. Paraneoplastic syndromes may precede the diagnosis of cancer and allow its earlier identification.

- ▶ [Cancer Pain Management, Orthopedic Surgery](#)
- ▶ [Cancer Pain Management, Overall Strategy](#)

## Paraphysiological Cramps

### Definition

Characterized by the occurrence in healthy subjects during particular conditions such as pregnancy or exercising. Occasional cramps are those cramps that occasionally occur in healthy subjects, in the absence of exercising or pregnancy. In this case, a strong muscular contraction or a sustained abnormal posture may lead to Muscle Cramps.

- ▶ [Muscular Cramps](#)

## Paraproteinemic Neuropathies

- ▶ [Metabolic and Nutritional Neuropathies](#)

## Paraspinal

### Definition

On the side of the spinal area.

- ▶ [Lower Back Pain, Physical Examination](#)

## Parasylyian

### Definition

In the vicinity of the Sylvian fissure.

- ▶ [Secondary Somatosensory Cortex \(S2\) and Insula, Effect on Pain Related Behavior in Animals and Humans](#)

## Parasympathetic Component

### Definition

A group of visceral responses driven by the parasympathetic nervous system. This motor autonomic system is one of the two antagonistic visceral controls (the other being sympathetic). It includes schematically a first pre-ganglionic neuron (cholinergic) located in the medulla oblongata (ambiguus nucleus, dorsal motor nucleus of vagus) or in the sacral spinal cord. Parasympathetic axons of the first neurons travel within cranial nerves (X, IX, VII, VIIbis and III) and the pelvic nerve. The second neuron (cholinergic) is located in nervous ganglia close to the viscera. It innervates the smooth muscles of viscera and blood vessels, the heart and the glandular tissues. For example, within the cardiovascular sphere, this system triggers a bradycardia and a decrease of blood pressure.

- ▶ [Hypothalamus and Nociceptive Pathways](#)

P

## Paravertebral Muscle

- ▶ [Lower Back Pain, Physical Examination](#)

## Parental Response

- ▶ [Impact of Familial Factors on Children's Chronic Pain](#)

## Paresthesia

TURO J. NURMIKKO

Department of Neurological Science and Pain Research Institute, University of Liverpool, Liverpool, UK  
tjn@liv.ac.uk

### Synonyms

Paraesthesia

### Definition

An abnormal sensation, perceived in the skin, pleasant or unpleasant and often described as if the skin is alive (pins and needles, tingling).

IASP definition: An abnormal sensation, whether spontaneous or evoked (Merskey and Bogduk 1994).

### Characteristics

Paresthesia is a tingling or prickling sensation, often compounded by numbness, perceived in the skin or mucosa. It is described variably as pins and needles, skin crawling, electricity or a limb going dead and is familiar to most people who have sat too long with their legs crossed or fallen asleep with their arm crooked under their head. In healthy people paresthesias are usually transient, disappear quickly when the cause has been removed and cause limited discomfort. In diseases affecting the nervous system, the symptoms usually persist and may become very annoying.

Existing pain nomenclature defines paresthesia as an abnormal cutaneous sensation, which is not painful or unpleasant (Merskey and Bogduk 1994). Painful or unpleasant sensation is referred to as dysesthesia. This dichotomy is artificial and many hold it too puristic. In common clinical communication, the term “paresthesia” is used to describe all abnormal sensations in the skin whether unpleasant or not. The mechanisms that are responsible for the generation of paresthesia or dysesthesia are not likely to be very different.

Even in the healthy, paresthesia occurs commonly. Experiments using a tight cuff around one’s arm for 20 min or more demonstrate that most people develop tingling during this time. They also experience tingling after the cuff is released, but it is then sharper and more intense, and may become painful. Prolonged deep breathing (hyperventilation) also causes tingling in the hands, feet and face in many people. Experiments using recordings in single nerves (► [microneurography](#)) show increased activity in afferent nerve fibers supplying the area of the hand in which tingling is perceived (Mogyoros et al. 2000). Paresthesia and dysesthesia are therefore produced in the nerve, whether the cause is interruption of its blood supply, change in its chemical milieu or some other disturbance. When a gentle electrical current is applied to the skin, e.g. by using a TENS machine, paresthesias are felt because of nerve ending activation.

Warmth applied to the fingers and toes that have long been exposed to cold causes profuse tingling by the same mechanism.

Osteopaths and acupuncturists are familiar with tender spots or trigger points in muscles, which when pressed or massaged cause a tingling sensation usually referred away from the point. The most famous of such points is Ho-Ku, the classic acupuncture point in the webbing between the thumb and the index finger. Needling of the point causes tingling and numbing sensation, brought about by activation of nerve cells responsible for the sensation of wider areas than just the Ho-Ku point.

Permanent paresthesias may be a sign of a neurological disease. Practically any neurological condition affecting sensory tracts in the nervous system is capable of provoking paresthesia. Classical peripheral nervous system diseases include carpal tunnel syndrome, polyneuropathy, nerve injury and shingles. The central nervous system may also be the origin of various paresthesias – they are frequently reported by patients with stroke, MS and migraine. Intentional provocation of paresthesia is the cornerstone of several clinical tests, such as the ► [Tinel signs](#) and Phalen signs in ► [carpal tunnel syndrome](#), and ► [Lhermitte’s sign](#) used in conjunction with MS. The location and quality of paresthesia tell little of the underlying cause, which can only be determined by neurological investigations.

What causes paresthesia and dysesthesia? Evidence from microneurography – single nerve cell recordings in man from a pure sensory nerve of the arm or leg points strongly to increased excitability of sensory axons and formation of ectopic impulses (Campero et al. 1998; Mogyoros et al. 2000). These come in abrupt onset, high frequency bursts of action potentials in myelinated fibers (Campero 1988). The quality of paresthesia depends on which fibers are mostly active. Individual fibers when stimulated using weak currents give rise to specific sensations, such as pressure, vibration and touch (Ochoa and Torebjork 1983; Vallbo et al. 1984). In an injured nerve, mechanical and electrical stimuli cause prolonged firing. Once filtered through the central nervous system, these impulse patterns are then interpreted as tingling by the brain. In the healthy nerve, the bursts originate at the site of nerve compression. In chronic neurological cases, bursts originate at the sites of ► [demyelination](#) and remyelination and regenerating nerve sprouts and in the dorsal root ganglion (Campero et al. 1998; Devor and Seltzer 1999; Mogyoros et al. 2000). A crucial ingredient for such alteration is accumulation of ► [sodium channels](#) (see neuropathic pain). It is likely that many other factors contribute to this, either permanently or temporarily, including tissue ischemia, changes in blood gases and ion concentrations and many substances released into the tissues during injury such as peptides, neurotrophins, histamine, bradykinin, prostaglandins, cytokines and a host of other inflammatory mediators.

The ► **axons** in the central nervous system have also been shown to be capable of similar excessive discharge. Alterations in central myelin occur in MS, rendering surviving axons excitable. In spinal cord injury, increased burst activity is seen in the ► **thalamus** while microstimulation of specific thalamic nuclei can give rise to different types of paresthesia (Ohara et al. 2004). Stimulation of the somatosensory cortex induces paresthesia in the corresponding part of the body as Penfield showed in his classical experiments during brain surgery for epilepsy. In migraine, moving paresthesia is associated with a wave of short-lasting excitation of the cortex, which precedes the better-known reduction of cortical activity (Leão's spreading cortical depression) (Spierings 2003).

There are no established guidelines for the treatment of paresthesia or dysesthesia. Intuitively, neurologists and pain specialists have used similar medication to that found useful in neuropathic pain, as well as simple stimulation therapies and distraction. If chronic hyperventilation is the cause, training in proper breathing and relaxation programs is helpful. Whenever the underlying disease can be treated, e.g. release of a trapped nerve, most patients may expect amelioration of their paresthesia. In cases for which no curative treatment exists, annoying paresthesia may be controlled with antiepileptic and antidepressant medication. Interestingly, successful treatment of pain with ► **spinal cord stimulation** may be effective in controlling dysesthesia as well as ongoing pain, although in itself it produces clearly perceived tingling over the painful area. It is very unusual for patients in these circumstances to feel paresthesia as unpleasant.

- **Cancer Pain Management, Neurosurgical Interventions**
- **Cervical Transforaminal Injection of Steroids**
- **Guillain-Barré Syndrome**
- **Metabolic and Nutritional Neuropathies**
- **Painless Neuropathies**
- **Thalamic Plasticity and Chronic Pain**
- **Threshold Determination Protocols**

## References

1. Campero M, Serra J, Marchettini P et al. (1998) Ectopic impulse generation and autoexcitation in single afferent myelinated fibers in patients with peripheral neuropathic and positive symptoms. *Muscle Nerve* 21:1661–1667
2. Devor M, Seltzer Z (1999) Pathophysiology of damaged nerves in relation to chronic pain. In: Wall PD, Melzack R (eds) *Textbook of pain*, 4th edn. Churchill Livingstone, Edinburgh, pp 129–162
3. Merskey H, Bogduk N (1994) *Classification of Chronic Pain*. IASP Press, Seattle
4. Mogyoros I, Bostock H, Burke D (2000) Mechanisms of paresthesias arising from healthy axons. *Muscle Nerve* 310–320
5. Ochoa J and Torebjork E (1983) Sensations evoked by intraneural stimulation of single mechanoreceptor units innervating the human hand. *J Physiol* 342:633–654
6. Spierings E (2003) Pathogenesis of migraine attack. *Clin J Pain* 19:255–262
7. Vallbo AB, Olsson KA, Westberg KG et al. (1983) Microstimulation of single tactile afferents from the human hand. *Brain* 107:727–729

## Parietal Cortex, PET and fMRI Imaging

- **PET and fMRI Imaging in Parietal Cortex (SI, SII, Inferior Parietal Cortex BA40)**

## Parity

### Definition

Until a woman has delivered her first baby she is said to be nulliparous or primiparous. When she has delivered she then becomes multiparous and the number of her completed pregnancies describes her parity.

- **Postpartum Pain**

## Parkinson's Disease

### Definition

A disease characterized by muscle tremor and difficulty in initiating and sustaining locomotion. The disease results from degeneration of dopamine-releasing neurons of the midbrain.

- **Central Pain, Outcome Measures in Clinical Trials**

**P**

## Paroxysmal

### Definition

Repeatedly occurring suddenly. It also implies brevity, which may not always be the case.

- **Trigeminal Neuralgia, Diagnosis and Treatment**

## Paroxysmal Hemicrania

MARGARITA SANCHEZ DEL RIO  
Neurology Department, Hospital Ruber Internacional,  
Madrid, Spain  
msanchezdelrio@ruberinternacional.es

### Synonyms

Sjaastad's Syndrome

## Definition

Attacks of strictly unilateral pain usually in the orbital, supraorbital and / or temporal region, with similar characteristics of pain and associated symptoms to those seen in ► **cluster headache**, but shorter-lasting (5–20 min) and more frequent ( $\geq 5$  per 24 h). Occur more commonly in females and respond absolutely to indomethacin. See below for the IHS diagnostic criteria.

### Paroxysmal (I.H.S. 3.2) Hemicrania Diagnostic Criteria

- A At least 20 attacks fulfilling criteria B-D
- B Attacks of severe unilateral orbital, supraorbital or temporal pain lasting 2–30 min
- C Headache is accompanied by at least one of the following:
  1. ipsilateral conjunctival injection and / or lacrimation
  2. ipsilateral nasal congestion and / or rhinorrhoea
  3. ipsilateral eyelid oedema
  4. ipsilateral forehead and facial sweating
  5. ipsilateral miosis and / or ptosis
- D Attacks have a frequency above 5 per day for more than half of the time, although periods with lower frequency may occur
- E Attacks are prevented completely by therapeutic doses of indomethacin<sup>1</sup>
- F Not attributed to another disorder<sup>2</sup>

#### Notes:

1. In order to rule out incomplete response, indomethacin should be used in a dose of  $\geq 150$  mg daily orally or rectally, or  $\geq 100$  mg by injection, but for maintenance smaller doses are often sufficient.
2. History and physical and neurological examinations do not suggest any of the disorders listed in groups 5–12, or history and/or physical and/or neurological examinations do suggest such a disorder but it is ruled out by appropriate investigations or such a disorder is present but attacks do not occur for the first time in close temporal relation to the disorder.

### Episodic and Chronic Paroxysmal Hemicrania Diagnostic Criteria

#### Episodic Paroxysmal Hemicrania

- A Fulfils criteria for 3.2 paroxysmal hemicrania
- B At least two attack periods lasting 7–365 days and separated by pain-free remission periods of  $\geq 1$  month

#### Chronic Paroxysmal Hemicrania (CPH)

- A Fulfils criteria for 3.2 paroxysmal hemicrania
- B Attacks recur over >1 year without remission periods or with remission periods lasting <1 month

#### Probable Paroxysmal Hemicrania

- A Attacks fulfilling all but one of criteria A-E for 3.2 paroxysmal hemicrania
- B Not attributed to another disorder

## Characteristics

### Chronic Paroxysmal Hemicrania

► **Chronic paroxysmal hemicrania** (CPH) was first described by Sjaastad and Dale in 1974. It is a distinctive clinical syndrome that is part of a family of headache disorders referred to as the trigeminal autonomic cephalgias.

In contrast to cluster headache, in CPH there is a preponderance among women (3:1 female to male ratio). Onset is usually in adulthood with a mean age of 33 years, although childhood cases are reported. There is no family history of chronic paroxysmal headache, although migraine may occur in families. Pain is strictly unilateral and without side shift, although recently it has been reported to alternate sides in 15% of patients (Boes and Dodick 2002). Maximum pain intensity is located in ocular, temporal, maxilla or frontal regions. Occasionally pain may involve the nuchal, occipital and retro-orbital areas. Pain is typically described as throbbing, pulsatile or sharp, ranging from moderate to severe intensity. Although typically patients prefer to lie still, some prefer to pace as in cluster headache. The frequency of attacks is variable, ranging from 2–40  $\times$  a day; the duration of most attacks ranges from 2–45 min. Patients may have soreness or tenderness in the interval between attacks, especially if the attacks are frequent. Attacks may also occur at night awakening patients from sleep.

Associated symptoms during episodes of headache are ipsilateral lacrimation, conjunctival injection, nasal congestion and rhinorrhoea. Less frequently there may be ipsilateral eyelid oedema, mild miosis, photophobia or nausea. There has been one reported case of dissociation between associated symptoms and pain (Pareja 1995). In a recent report, migrainous features were reported in 87% of patients (Boes and Dodick 2002). There may be precipitating events such as mechanical stimulation, particularly with bending or rotating the head, pressure over the ipsilateral greater occipital nerve, or alcohol ingestion (Sjaastad et al. 1982; Sjaastad et al. 1984). The pathophysiology is unknown and any presumption is based on the similarities with cluster headache.

The association of ► **paroxysmal hemicrania** with co-existent ► **trigeminal neuralgia** (CPH-tic syndrome) has recently been described (Caminero et al. 1998; Hannerz 1993). The importance of this observation is that both conditions require treatment. The pathophysiological significance of the association is not yet clear.

### Episodic Paroxysmal Hemicrania

► **Episodic paroxysmal hemicrania** (EPH) was first described by Kudrow et al. (1987). Today there is sufficient clinical evidence to consider EPH as a subtype of paroxysmal hemicrania, based on the presence of symptomatic periods lasting from weeks to months separated by remission periods lasting more than 1 month. A sea-



sonal pattern has been described (Veloso et al. 2001). While in CPH there is a female preponderance, EPH affects men and women practically equally (1:1.3 male to female ratio). EPH may be confused with episodic cluster headache but may be distinguished by the higher frequency and shorter duration of attacks.

### Imaging

MRI studies of patients with CPH have been normal. Most cases are primary but there have been cases secondary to gangliocytoma of the sella turcica, collagen vascular disease, cerebrovascular disease, Pancoast tumour, frontal lobe tumour, cavernous sinus meningioma, acoustic neurinoma, intracranial hypertension or increased CSF pressure. Based on these findings, a complete work up should initially include blood count, ESR, vasculitic investigations and brain imaging.

### Differential Diagnosis

The differential diagnoses of paroxysmal hemicrania include cluster headache, ► [hemicrania continua](#), trigeminal neuralgia and ► [SUNCT](#).

### Treatment

Indomethacin is the treatment of choice and a *sine qua non* criterion for diagnosis. The therapy should be initiated at 25 mg / 8 h; if after 1 week there is no benefit, it should be increased to 50 mg / 8 h. Complete resolution of the attack usually occurs within 1–2 days of initiating the effective dose. In order to rule out incomplete response, indomethacin should be used in a dose of  $\geq 150$  mg daily orally or rectally or  $\geq 100$  mg by injection, but for maintenance, smaller doses are often sufficient (Antonaci et al. 1998; Pareja et al. 2001). In CPH, long-term treatment is usually necessary, although long-lasting remissions have been reported following cessation of indomethacin (Sjaastad and Antonaci 1987). In EPH, indomethacin should be given for slightly longer than the typical headache phase and then gradually tapered. If there is not a complete response to indomethacin, the diagnosis should be reconsidered. Other agents that have demonstrated partial success in anecdotal cases are acetylsalicylic acid, verapamil, steroids, acetazolamide, piroxicam and rofecoxib.

### References

- Antonaci F, Pareja JA, Caminero AB et al. (1998) Chronic paroxysmal hemicrania and hemicrania continua. Parenteral indomethacin: the 'indotest'. *Headache* 38:122–128
- Boes CJ, Dodick DW (2002) Refining the clinical spectrum of Chronic paroxysmal Hemicrania: A review of 74 patients. *Headache* 42:699–708
- Caminero AB, Pareja JA, Dobato JL (1998) Chronic paroxysmal hemicrania-tic syndrome. *Cephalalgia* 18:159–161
- Hannerz J (1993) Trigeminal neuralgia with chronic paroxysmal hemicrania: the CPH-tic syndrome. *Cephalalgia* 13:361–364
- Kudrow L, Esperanza P, Vijayan N (1987) Episodic paroxysmal hemicrania? *Cephalalgia* 7:197–201
- Pareja JA (1995) Chronic paroxysmal hemicrania: dissociation of the pain and autonomic features. *Headache* 35:111–113
- Pareja JA, Caminero AB, Franco E et al. (2001) Dose, efficacy and tolerability of long-term indomethacin treatment of chronic paroxysmal hemicrania and hemicrania continua. *Cephalalgia* 21:906–910
- Sjaastad O, Dale I (1974) Evidence for a new (?) treatable headache entity. *Headache* 14:105–108
- Sjaastad O, Antonaci F (1987) Chronic paroxysmal hemicrania: a case report. Long-lasting remission in the chronic stage. *Cephalalgia* 7:203
- Sjaastad O, Russell D, Saunte C et al. (1982) Chronic paroxysmal hemicrania. VI. Precipitation of attacks. Further studies on the precipitation mechanism. *Cephalalgia* 2:211–214
- Sjaastad O, Saunte C, Graham JR (1984) Chronic paroxysmal hemicrania. Mechanical precipitation of attacks: new cases and localization of trigger points. *Cephalalgia* 4: 113–118
- Veloso GC, Kaup AO, Peres MFP et al. (2001) Episodic paroxysmal hemicrania with seasonal variation. *Arq Neuropsiquiatr* 59:944–947

## Paroxysmal Hypertension

### Definition

This is a sudden acute rise in blood pressure of at least 25% of the diastolic value.

► [Headache Due to Hypertension](#)

## Paroxysmal Hypertensive Headaches

### Definition

These are severe generalized headaches caused by sudden severe rises in blood pressure to diastolic values of at least 25% above normal/usual.

► [Headache Due to Hypertension](#)

## Partial Agonist

### Definition

A partial agonist is a drug that binds to receptors, but is only partially effective.

► [Pain Control in Children with Burns](#)

## Partial Sciatic Nerve Ligation

### Synonyms

PSL Model

### Definition

Partial Sciatic Nerve Ligation (PSL Model) is a rodent model of peripheral nerve injury. In this model of neuropathic pain, the mid-thigh section of the sciatic nerve is surgically isolated and 33–50% of the nerve thickness is tightly ligated with silk sutures.

► [Neuropathic Pain Model](#)

## Participation

### Definition

Is described as involvement in a life situation. It represents the societal perspective of functioning. Problems an individual may experience in involvement in life situations are participation restrictions. Limitations and restrictions are assessed against a generally accepted population standard; they reflect the discordance between the observed and the expected performance.

- ▶ [Disability and Impairment Definitions](#)
- ▶ [Physical Medicine and Rehabilitation, Team-Oriented Approach](#)

## Participation Restrictions

### Definition

Participation restrictions are problems an individual may experience in involvement in life situations.

- ▶ [Physical Medicine and Rehabilitation, Team-Oriented Approach](#)

## Parvalbumin

### Definition

Parvalbumin is a member of the EF-hand family calcium binding proteins expressed in fast-firing neurons. They are small proteins and have three EF-hand domains, with two of them having calcium binding capacity. Parvalbumin often exhibits a complementary distribution pattern with that of calbindin D-28k in central neurons. In the monkey thalamus, antibodies against parvalbumin selectively label the rod domain of the medial ventro-posterior nucleus of the thalamus, which is related to trigeminothalamic projection from the principal sensory nucleus of the trigeminal nerve.

- ▶ [Spinothalamic Terminations, Core and Matrix](#)
- ▶ [Thalamus, Receptive Fields, Projected Fields, Human](#)
- ▶ [Trigeminothalamic Tract Projections](#)

## Parvocellular Neurons

### Definition

Neurons with soma of a small size located in the paraventricular hypothalamic nucleus. These neurons synthesize a number of releasing hormones that influence the secretion of pituitary anterior lobe hormones. These releasing hormones are transported from the hypothalamus to the pituitary gland via the venous hypophysial portal system.

lamus to the pituitary gland via the venous hypophysial portal system.

- ▶ [Hypothalamus and Nociceptive Pathways](#)

## Parvocellular VP

### Synonyms

VPpc

### Definition

Parvocellular VP (VPpc) is the medial-most portion of VP<sub>p</sub>, which includes the gustatory region of the thalamus.

- ▶ [Thalamus, Visceral Representation](#)

## Passive

### Definition

This refers to movement of a body part without using power generated from one's own muscle action.

- ▶ [Cancer Pain Management, Orthopedic Surgery](#)

## Passive Avoidance

### Definition

Passive Avoidance is a behavioral test of the response of an experimental animal to a noxious stimulus. The animal is signaled when a stimulus is about to occur, and is allowed to avoid the stimulus by an action taken prior to the onset of the stimulus.

- ▶ [Visceral Pain Model, Lower Gastrointestinal Tract Pain](#)

## Passive Relaxation

- ▶ [Relaxation in the Treatment of Pain](#)

## Passive Spinal Mobilisation

ROBERT GASSIN

Musculoskeletal Medicine Clinic, Frankston, VIC, Australia

rgassin@pen.hotkey.net.au

### Synonyms

Mobilisation; Maitland Mobilisation; Manipulation Without Impulse; Manipulation Without Thrust, Oscillatory Mobilisation

## Definition

Passive spinal mobilisation is a form of spinal manual therapy. It refers to the application of a rhythmic, oscillatory force to the spine with the aim of moving one or more spinal joints, and increasing its range of motion. The procedure can be further qualified by specifying the region of the spine being mobilised, i.e. 'lumbar' and 'cervical' instead of 'spinal'.

## Characteristics

### Mechanism

The mechanism of action of passive spinal mobilisation remains unknown. Several theories have been proposed to explain pain relief following the procedure. These include: reduction of disc bulging or prolapse; correction of posterior joint dysfunction, breaking down or stretching adhesions in the zygapophysial joint capsules, freeing of an entrapped meniscoid in a zygapophysial joint; correction of spinal misalignment; muscle relaxation; stretching of the vertebral ligaments; normalisation of local or regional reflex activity; activation of a central control mechanism; and placebo effect. None of these theories is strongly supported by scientific evidence.

### Applications

The indications for the use of passive spinal mobilisation depend on the individual practitioner's paradigm. Passive spinal mobilisation is generally considered a means of improving the range of movement of a hypomobile spinal segment or region, and of achieving pain relief. Passive spinal mobilisation is used as an isolated treatment or as part of a multimodal management strategy, for the management of many musculoskeletal conditions.

### Efficacy

Quality research on the efficacy of passive spinal mobilisation is sparse. Interpretation of outcomes of trials is often difficult, as passive spinal mobilisation is often used in conjunction with spinal manipulation, or as part of a multimodal management approach. In the case of systematic reviews and meta-analyses, trials of spinal manipulation and passive spinal mobilisation are often combined, making interpretation of results difficult.

### Low Back Pain

There is little data on the efficacy of passive mobilisation in the management of low back pain. Passive mobilisation of the sacroiliac joint has been compared to flexion exercises, resulting in better function at 3 and 5 days (Delitto et al. 1992); and to massage, resulting in decreased sick-leave and analgesic consumption, but not pain, at 3 weeks (Wreje et al. 1992). In a recent randomised controlled trial, randomly selected passive spinal mobilisation techniques were found to be as

effective as therapist-selected ones for the treatment of low back pain (Chiradejnant et al. 2003).

### Neck Pain

There have been several reviews describing studies on passive cervical spinal mobilisation (Koes et al. 1991; Aker et al. 1996; Hurwitz et al. 1996; Kjellman et al. 1999, Harms-Ringdahl and Nachemson 2000, Gross et al. 2002a, Gross et al. 2002b).

For the treatment of neck pain, most studies have combined passive spinal mobilisation with other treatment modalities. Consequently, it is not possible to determine the contribution of individual treatment modalities to the overall outcome. In the most recent review, passive spinal mobilisation alone was found to have similar effects to placebo, wait period, or control group, and appeared similar in benefit for pain relief to spinal manipulation. Multimodal care, including some combination of mobilisations and exercise, was found to be superior to control, other physical medicine methods, and rest (Gross et al. 2002a). The latter conclusion is supported by at least one other review (Harms-Ringdahl and Nachemson 2000).

In a recent randomised controlled trial (Hoving et al. 2002), passive cervical mobilisation was compared to exercise therapy and general practitioner care, in patients with at least 2 weeks of non-specific neck pain. Treatment was provided over 6 weeks and outcomes measured at 7 weeks. Passive cervical mobilisation scored consistently better than general practitioner care on most outcome measures, but was not consistently and significantly better than exercise therapy.

Another trial compared the effectiveness of cervical spinal manipulation and passive cervical mobilisation (Hurwitz et al. 2002). Mean reductions in pain and disability were similar in the manipulation and mobilisation groups over 6 months. The authors concluded that cervical spinal manipulation and passive cervical mobilisation yielded comparable clinical outcomes.

There is no evidence for the effectiveness of passive spinal mobilisation as an isolated treatment in the management of whiplash. However, there are a number of studies that have demonstrated its effectiveness in combination with other treatment modalities (Mealy et al. 1986, McKinney et al. 1989, Provinciale et al. 1996). When compared with rest, analgesia, and a soft collar, mobilisation combined with exercises, local heat and analgesia provided statistically significant improvements in pain scores, and range of movement at 4 and 8 weeks (Mealy et al. 1986). Mobilisation combined with other interventions was more effective than rest and analgesia at 1 and 2 months after treatment, but not more effective than a program of home exercises (McKinney et al. 1989). At one year follow-up, significantly more patients who had been treated with home exercises were free of pain. Multimodal therapy, involving mobilisation and a variety

of other interventions, was more effective than TENS, pulsed electromagnetic therapy, ultrasound, and calcic iontophoresis (Provinciale et al. 1996).

### Headache of Cervical Origin

A small study found that a combination of oscillatory passive spinal mobilisation and muscle energy technique was more effective than application of cold packs, for the treatment of post-traumatic headache. Differences in outcome were statistically significant at 2 weeks, but not at 5 weeks post-treatment (Jensen et al. 1990).

A large study (Jull et al. 2002) found that mobilisation therapy was more effective than general practitioner care in reducing the frequency and intensity of headaches of cervical origin, but was not more effective than exercise therapy or exercise therapy combined with mobilisation therapy. Benefits achieved by either mobilisation or exercise were sustained for 12 months.

### Contraindications

Controversy exists regarding the contraindications to passive spinal mobilisation. Nevertheless, it is generally agreed, that in the presence of certain conditions, passive spinal mobilisation should only be performed with extreme care, if at all. Listed below are such conditions (Gassin and Masters 2001):

Conditions in which passive spinal mobilisation should be performed with extreme care or is contraindicated:

- Neoplasia (benign or malignant)
- Active infection
- Active inflammation
- Cauda equina syndrome
- Instability following trauma
- Active spondylolysis/spondylolithesis
- Vertebral or rib fracture
- Osteoporosis
- Bleeding disorders
- Anticoagulation (warfarin therapy)
- Radicular pain
- Radiculopathy
- Vertebro-basilar insufficiency (cervical spine)
- Upper cervical spine in rheumatoid arthritis
- Abnormal spinal anatomy (e.g. upper cervical spine in Downs syndrome)
- Severe pain
- Severe distress
- Anxious patient
- Past adverse effect from passive spinal mobilisation

### Adverse Effects

Passive spinal mobilisation is a safe procedure when performed by a qualified practitioner aware of high-risk situations. Most adverse effects following passive spinal mobilisation are benign and of short duration. The most common is local discomfort. Seriously adverse effects have seldom been reported, and are considered

exceedingly rare. A report of a cerebrovascular accident following passive cervical mobilisation is cited in a review of the risks and benefits of spinal manipulation (Di Fabio 1999).

### References

1. Chiradejnant A, Maher CG, Latimer J, Stepkovitch N (2003) Efficacy of "Therapist-Selected" versus "Randomly Selected" Mobilisation Techniques for the Treatment of Low Back Pain: A Randomised Controlled Trial. *Aust J Physiother* 49:233–241
2. Delitto A, Cibulka MT, Erhard RE, Bowling RW, Tenhula JH (1992) Evidence for Use of an Extension-Mobilisation Category in Acute Low Back Syndrome: A Prescriptive Validation Pilot Study. *Phys Ther* 73:216–223
3. Di Fabio RP (1999) Manipulation of the Cervical Spine: Risks and Benefits. *Phys Ther* 79:50–65
4. Gassin R and Masters S (2001) Spinal Manual Therapy – The Evidence. *Australasian Musculoskeletal Medicine* 6:26–31
5. Gross AR, Kay T, Hondras M, Goldsmith C, Haines T, Peloso P, Kennedy C, Hoving J (2002a) Manual Therapy for Mechanical Neck Disorders: A Systematic Review. *Manual Therapy* 7:131–149
6. Harms-Ringdahl K, Nachemson A (2000) Acute and Subacute Neck Pain: Nonsurgical Treatment. In: Nachemson A, Jonsson E (eds) *Neck and Back Pain: The Scientific Evidence of Causes, Diagnosis, and Treatment*. Lippincott Williams and Wilkins, Philadelphia, pp 327–338
7. Hoving JL, Koes BW, de Vet HC, van der Windt DA, Assendelft WJ, van Mameren H, Deville WL, Pool JJ, Scholten RJ, Bouter LM (2002). Manual Therapy, Physical Therapy, or Continued Care by a General Practitioner for Patients with Neck Pain. A Randomized, Controlled Trial. *Ann Intern Med* 136:713–722
8. Hurwitz EL, Morgenstern H, Harber P, Kominski GF, Yu F, and Adams AH (2002) A Randomized Trial of Chiropractic Manipulation and Mobilisation for Patients with Neck Pain: Clinical Outcomes from the UCLA Neck-Pain Study. *Am J Public Health* 92:1634–1641
9. Jensen OK, Nielsen FF, Vosmar L (1990) An Open Study Comparing Manual Therapy with the Use of Cold Packs in the Treatment of Post-Traumatic Headache. *Cephalalgia* 10:241–250
10. Jull G, Trott P, Potter H, Zito G, Niere K, Shirley D, Emberson J, Marschner I, Richardson C (2002) A Randomized Controlled Trial of Exercise and Manipulative Therapy for Cervicogenic Headache. *Spine* 27:1835–1843
11. McKinney LA, Dornan JO, Ryan M (1989) The Role of Physiotherapy in the Management of Acute Neck Sprains following Road-Traffic Accidents. *Arch Emergency Med* 6:27–33
12. Mealy K, Brennan H, Fenelon GC (1986) Early Mobilisation of Acute Whiplash Injuries. *Br Med J* 292:656–657
13. Provinciali L, Baroni M, Illuminati L, Ceravolo G (1996) Multimodal Treatment to Prevent the Late Whiplash Syndrome. *Scand J Rehab Med* 28:105–111
14. Wreje U, Nordgen B, Aberg H (1992) Treatment of Pelvic Joint Dysfunction in Primary Care: A Controlled Study. *Scand J Prim Care* 10:310–315

## Patch-Clamp

### Definition

An electrophysiological method that makes it possible to record the electrical currents produced by specific ion channels.

► [Painful Channelopathies](#)



## Pathogen

An agent that causes disease, especially a living microorganism such as a bacterium or fungus.

- ▶ [Animal Models of Inflammatory Bowel Disease](#)

## Pathological Fracture

### Definition

A fracture due to weakening of the bone structure by pathological processes, such as tumors, infections, or other abnormal process.

- ▶ [Cancer Pain Management, Orthopedic Surgery](#)
- ▶ [Cancer Pain Management, Radiotherapy](#)
- ▶ [Chronic Low Back Pain, Definitions and Diagnosis](#)

## Pathophysiological Pain

### Definition

Pathophysiological pain is that form of pain that results from abnormal processing within the peripheral or central nervous system, such as during hyperalgesia and/or allodynia that results from nervous system disease.

## Patient Assisted Laparoscopy

- ▶ [Chronic Pelvic Pain, Laparoscopic Pain Mapping](#)

## Patient-Centered

### Definition

A way of approaching patient-therapist interactions where the goals, thoughts, and feelings of the patient are of primary importance.

- ▶ [Chronic Pain, Patient-Therapist Interaction](#)

## Patient Controlled Analgesia

### Synonyms

PCA

### Definition

A method of analgesia that allows the patient to self-administer small incremental doses of an analgesic to treat pain under a controlled regimen. Nurse administered intermittent opioid injection requires good staffing levels to minimize the delay between need and injection. Patient controlled analgesia overcomes these logistical problems. The patient presses a button and receives a pre-set dose of opioid, from a microprocessor-controlled syringe pump or a disposable device connected to an intravenous or subcutaneous cannula. Safety is increased by the use of a lock-out interval, namely the time from the end of the delivery of one dose until the device will respond to another patient demand. Patient-controlled analgesia produces a modest improvement in postoperative pain relief over a 24-hour period compared with conventional analgesia. It is preferred by patients, and is not associated with additional side effects. Patient-controlled epidural analgesia (PCEA) is a relatively new method of maintaining labor analgesia. There have been many studies performed that have compared the efficacy of PCEA with continuous epidural infusion (CEI). Patients who receive PCEA are less likely to require anesthetic interventions, require lower doses of local anesthetic and have less motor block than those who receive CEI.

- ▶ [Acute Pain in Children, Post-Operative](#)
- ▶ [Alpha\( \$\alpha\$ \) 2-Adrenergic Agonists in Pain Treatment](#)
- ▶ [Analgesic Guidelines for Infants and Children](#)
- ▶ [Epidural Infusions in Acute Pain](#)
- ▶ [Postoperative Pain, Acute Pain Management, Principles](#)
- ▶ [Postoperative Pain, Acute Pain Team](#)
- ▶ [Postoperative Pain, Appropriate Management](#)
- ▶ [Postoperative Pain, Data Gathering and Auditing](#)
- ▶ [Postoperative Pain, Preoperative Education](#)
- ▶ [Rest and Movement Pain](#)

## Patient Controlled Epidural Analgesia

### Definition

A technique used to provide continuous epidural analgesia. After an epidural catheter is placed, the patient is connected to a machine that continuously delivers medication and allows the patient to self administer medication to supplement the analgesia. There is greater patient satisfaction with this technique because it allows the patient to be in control of their doses. It is a safe technique because the physician sets limits on the machine to prevent over dosage.

- ▶ [Analgesia During Labor and Delivery](#)
- ▶ [Postoperative Pain, Patient Controlled Analgesia Devices, Epidural](#)

## Patient Controlled Intravenous Analgesia

- Postoperative Pain, Patient Controlled Analgesia Devices, Parenteral

### Patient Education

GEOFFREY HARDING  
Sandgate, QLD, Australia  
geoffharding@uq.net.au

#### Definition

Patient education is the provision to patients of information, in the form of booklets, pamphlets or videotapes, on the biological basis for their pain, its effects, and how it can be treated, especially in terms of what the patient can do.

#### Characteristics

##### Rationale

Patient education was developed as a tool in the management of pain in the belief that patients who did not understand their condition responded less well to treatment. It was expected, therefore, that providing information that explained their condition would help them understand, and would allay fears that they might have. Furthermore, patient education serves to inform patients of how they could contribute to their own rehabilitation instead of relying totally on interventions from others.

##### Instruments

Information can be delivered individually to patients (one-on-one) or in patient-groups (one-on-many, or many-on-many). It can also be delivered to spouses or "significant others". Educative efforts can be directed at the general public in the form of community campaigns. The latter might involve the use of television, press and radio.

Most of the educational material will be given in the form of informal drawings and diagrams, pamphlets, booklets, audiotapes, videotapes and CD-ROM. These have been assigned the collective term "bibliotherapy" (Jones 2002).

##### Efficacy

Patient education seems to be of value for patients with arthritis. A meta-analysis (Superior-Cabuslay et al. 1996) found that: patient education provides additional benefits that are 20–30 % as great as the effects of NSAID treatment for pain relief in osteoarthritis and rheumatoid arthritis, 40 % as great as NSAID treatment for improvement in functional ability in rheumatoid arthritis, and 60–80 % as great as NSAID treatment in reduction in tender joint counts. Others, however,

contend that education is not of demonstrable benefit for patients with osteoarthritis of the knee (Lord et al. 1999), even though all practice guidelines for osteoarthritis recommend it (Pencharz et al. 2002).

For neck pain, a Cochrane Review (Gross et al. 2000) found only three studies that assessed patient education. It concluded that patient education was not shown to be beneficial in reducing pain.

For low back pain, trials have found patient education not to be effective, either in reducing pain or improving function (Roberts et al. 2002; Gilbert et al. 1985; Roland and Dixon 1989; Cherkin et al. 1996). An education booklet was no less effective for acute low back pain than chiropractic manipulation or McKenzie therapy (Cherkin et al. 1998). However, although not effective for pain once established, education does have a modest effect in reducing absenteeism, when used as a preventative measure (Symonds et al. 1995).

More encouraging have been the results of mass-media campaigns. A media campaign (Television commercials, aired in prime-time slots; radio and printed advertisements; outdoor billboards, posters, seminars; workplace visits and publicity articles), featuring medical experts and sporting and media personalities, was conducted in the State of Victoria, in Australia, over a two-year period (Buchbinder et al. 2001). The campaign was backed up by the widespread distribution of "The Back Book" (Burton et al. 1996). Evaluation of the campaign showed a significant change in public attitudes to back pain.

Importantly, the major change was the de-medicalising of the problem. Fewer patients felt that they needed to see a doctor. In addition, there were significant decreases in the number of compensable claims and the number of days on compensation during the period of the campaign, when compared with a "control" State (New South Wales) where no similar campaign was conducted. The change in attitude of the public was accompanied by a change in the attitude of doctors, a significant proportion of whom changed their beliefs from relying on passive interventions, to encouraging activation and self-help.

##### Indications

Despite the popularity of patient education amongst promoters of practice guidelines, there is little evidence to support the use of this intervention by individual practitioners. Although it may be of some benefit to patients with rheumatoid arthritis, its benefit in osteoarthritis is disputed. It has not been shown to be beneficial for reducing neck or back pain, but it may be of value as a preventative measure in reducing concerns about back pain and resultant absenteeism.

If education is to be of benefit, it seems more effective to conduct media campaigns that address the public as a whole, for this there is evidence (Buchbinder et al. 2001). The prospect is not only one of changing public attitudes,

but also that the public will drive changes in the attitudes of those who treat them.

► [Psychological Treatment of Pain in Older Populations](#)

## References

1. Buchbinder R, Jolley D, Wyatt M (2001) Breaking the Back of Back Pain. Public Policy Initiatives Directed Towards Managing the Disability of Back Pain can be Highly Successful. Editorial. *Med J Aust* 175:456–457
2. Burton AK, Waddell G, Burt R, Blair S (1996) Patient Educational Material in the Management of Low Back Pain in Primary Care. *Bull Hosp Joint Dis* 55:138–141
3. Cherkin DC, Deyo RA, Battie M, Street J, Barlow W (1998) A Comparison of Physical Therapy, Chiropractic Manipulation, and Provision of an Educational Booklet for the Treatment of Patients with Low Back Pain. *New Engl J Med* 339:1021–1029
4. Cherkin DC, Deyo RA, Street JH, Hunt M, Barlow W (1996) Pitfalls of Patient Education. Limited Success of a Program for Back Pain in Primary Care. *Spine* 21:345–355
5. Gilbert JR, Taylor DW, Hildebrand A, Evans C (1985) Clinical Trial of Common Treatments for Low Back Pain in Family Practice. *Brit Med J* 291:791–794
6. Gross AR, Aker PD, Goldsmith CH, Peloso P (2000) Patient Education for Mechanical Neck Disorders. *Cochrane Database Syst Rev*: CD000962
7. Jones FA (2002) The Role of Bibliotherapy in Health Anxiety: An Experimental Study. *Br J Community Nurs* 7:498–504
8. Lord J, Victor C, Littlejohn P, Ross FM, Axford JS (1999) Economic Evaluation of a Primary Care-Based Education Programme for Patients with Osteoarthritis of the Knee. *Health Technol Assess* 3:1–55
9. Pencharz JN, Grigoriadis E, Jansz GF, Bombardier C (2002) A Critical Appraisal of Clinical Practice Guidelines for the Treatment of Lower-Limb Osteoarthritis. *Arthritis Res* 4:36–44
10. Roland M, Dixon M (1989) Randomized Controlled Trial of an Educational Booklet for Patients Presenting with Back Pain in General Practice. *J Roy Coll Gen Pract* 39:244–246
11. Roberts L, Little P, Chapman J, Cantrell T, Pickering R, Langridge J (2002) General Practitioner-Supported Leaflets may Change Back Pain Behaviour. *Spine* 27(17):1821–1828
12. Superior-Cabuslay E, Ward MM, Lorig KR (1996) Patient Education Interventions in Osteoarthritis and Rheumatoid Arthritis: A Meta-Analytic Comparison with Non-Steroidal Anti-Inflammatory Drug Treatment. *Arthritis Care Res* 9:292–301
13. Symonds TL, Burton AK, Tilotson KM, Main CJ (1995) Absence Resulting from Low Back Trouble can be Reduced by Psychosocial Intervention at the Work Place. *Spine* 20:2738–2745

## Patient Information

- [Information and Psychoeducation in the Early Management of Persistent Pain](#)

## Patient-Therapist Interaction

### Definition

The verbal and nonverbal interactions between health care providers and their patients or clients. These interactions may include, but are not necessarily limited to, communication and negotiations concerning patient history, diagnosis, and clinical care.

- [Chronic Pain, Patient-Therapist Interaction](#)

## Pavlovian Conditioning

### Synonyms

Classical conditioning

### Definition

Pavlovian conditioning occurs if pairs of stimuli are presented together; a neutral stimulus by itself elicits the same response as the unconditioned stimulus. Other terms used are respondent conditioning and Type-S conditioning.

- [Classical Conditioning](#)  
 ► [Fear Reduction through Exposure In Vivo](#)  
 ► [Respondent Conditioning of Chronic Pain](#)

## Paw Pressure Test

### Definition

Application of constant pressure, through a blunt probe, on the dorsal aspect of the hind leg of a restrained rat, with the time for withdrawal of the leg corresponding to the latency of the test. This method is used to measure the threshold for mechanonociception.

- [Thalamotomy, Pain Behavior in Animals](#)

## PCA

Patient Controlled Analgesia in which the patient controls the frequency of delivery of analgesic agents within lockout periods and safe dose limits determined by the health provider.

- [Patient Controlled Analgesia](#)  
 ► [Postoperative Pain, Data Gathering and Auditing](#)  
 ► [Postoperative Pain, Patient Controlled Analgesia Devices, Parenteral](#)

## PCA Pump

### Definition

Small, microprocessor-driven, programmable infusion devices for intravenous or epidural delivery of analgesics.

- [Acute Pain in Children, Post-Operative](#)  
 ► [Postoperative Pain, Patient Controlled Analgesia Devices, Parenteral](#)

## PCEA

- [Postoperative Pain, Patient Controlled Analgesia Devices, Epidural](#)

## PCM

- ▶ Protein-Calorie Malnutrition

## PDPH

- ▶ Post Dural Puncture Headache

## Pediatric Burns

- ▶ Pain Control in Children with Burns

## Pediatric Dosing Guidelines

- ▶ Analgesic Guidelines for Infants and Children

## Pediatric Integrated Care for Painful Procedures

- ▶ Acute Pain in Children, Procedural

## Pediatric Migraine

- ▶ Migraine, Childhood Syndromes

## Pediatric Pain Management

- ▶ Psychological Treatment of Pain in Children

## Pediatric Pain Treatment, Evolution

- ▶ Evolution of Pediatric Pain Treatment

## Pediatric Pharmacological Interventions

- ▶ Acute Pain in Children, Procedural

## Pediatric Physical Therapy

- ▶ Chronic Pain in Children, Physical Medicine and Rehabilitation

## Pediatric Physiotherapy

- ▶ Chronic Pain in Children, Physical Medicine and Rehabilitation

## Pediatric Post-Surgical Pain

- ▶ Acute Pain in Children, Post-Operative

## Pediatric Psychological Interventions

- ▶ Acute Pain in Children, Procedural

## Peltier

- ▶ Pain in Humans, Thermal Stimulation (Skin, Muscle, Viscera), Laser, Peltier, Cold (Cold Pressure), Radiant, Contact

## Pelvic Inflammatory Disease

### Definition

Pelvic inflammatory disease is a general term that refers to infection and inflammation of the upper genital tract in women. Chlamydia, gonorrhea and other bacteria are the primary cause, usually via ascending infection through the uterine cervix. Following an under-treated acute episode, chronic pelvic inflammatory disease can result where infection persists in devitalized tissues, resulting in chronic pain and repeated recurrence of infective manifestations such as pyrexia and rigors. Tubal damage can result in infertility.

- ▶ Chronic Gynaecological Pain, Doctor-Patient Interaction
- ▶ Chronic Pelvic Pain, Pelvic Inflammatory Disease and Adhesions
- ▶ Gynecological Pain, Neural Mechanisms

## Pelvic Neurectomy

### Definition

Surgical resection of the pelvic nerves.

- ▶ Visceral Pain Models, Female Reproductive Organ Pain

## Pelvic Pain Syndrome

- ▶ Epidemiology of Chronic Pelvic Pain



## Pelvic Pain Syndrome of Bladder Origin

- ▶ Interstitial Cystitis and Chronic Pelvic Pain

## Penile Block

### Definition

Blockade of the paired dorsal penile nerves by subcutaneous infiltration with local anesthetic at the base of the penis; by subpubic injection of local anesthetic bilaterally beneath Scarpa's fascia or by injection of local anesthetic at the 10:30 and 1:30 positions beneath Bucks' fascia at the base of the penis.

- ▶ Acute Pain in Children, Post-Operative

## PENS

- ▶ Percutaneous Electrical Nerve Stimulation

## Peptides in Neuropathic Pain States

TODD W. VANDERAH<sup>1</sup>, CARL-OLAV STILLER<sup>2</sup>,  
FRANK PORRECA<sup>1</sup>

<sup>1</sup>University of Arizona, Department of Pharmacology,  
College of Medicine, Tucson, AZ, USA

<sup>2</sup>Division of Clinical Pharmacology, Department of  
Medicine, Karolinska University Hospital, Stockholm,  
Sweden

vanderah@u.arizona.edu, carl-olav.stiller@ki.se,  
frankp@u.arizona.edu

### Synonyms

Neuropeptides in Neuropathic Pain States

### Definition

Several endogenous peptides have been implicated in neuropathic pain states. This section will address recent reports that suggest how some peptides may play a role in establishing and maintaining neuropathic pain. Studies have demonstrated that peptides and often their corresponding receptors are either up-regulated or down-regulated after damage to peripheral nerves. Here, we focus on a few selected neuropeptides which are up-regulated during states of peripheral nerve injury and which may promote pain. All peptides mentioned are found within the somatosensory system but are not limited to this system.

### Characteristics

#### Vasoactive Intestinal Peptide (VIP) and Pituitary Adenylate Cyclase Activating Peptide (PACAP)

VIP is a 28 amino acid polypeptide. PACAP occurs in two variants, a 38 amino acid polypeptide and the C-terminally truncated form (PACAP-27). VIP and PACAP share 68% amino acid homology and act at similar receptors and hence their roles in neuropathic pain will be summarized together.

The mRNA for PACAP in the L5 DRG dramatically increases within 2 days after ▶ **chronic constriction injury** (CCI) of the sciatic nerve and slowly reverses to basal levels within 1 to 2 weeks post-injury, whereas the mRNA for VIP in the L5 DRG dramatically increases within 1 to 2 weeks and remains elevated for long periods of time (42 days) post-injury (Nahin et al. 1994; Noguchi et al. 1989). In a rat model of diabetic neuropathy using streptozocin, the VIP content in the sciatic nerve was decreased; however no change in VIP content was seen in the spinal cord as compared to control animals (Noda et al. 1990).

In the CCI model, VPAC<sub>2</sub> receptor mRNA increases dramatically whereas VPAC<sub>1</sub> receptor mRNA in laminae III and IV decreases. The level of mRNA for PAC<sub>1</sub> receptors does not change significantly (Inagaki et al. 1994; Dickinson et al. 1999). PACAP knockout mice do not develop allodynia or hyperalgesia after L5 spinal nerve lesion (Mabuchi et al. 2004).

Pharmacological studies *in vivo* have demonstrated an excitatory action of VIP and PACAP in either naïve or nerve injured animals; however antagonism at VPAC<sub>1</sub>, VPAC<sub>2</sub> and PAC<sub>1</sub> receptors in nerve injured animals showed negligible effects when applied to sustained brush evoked activity of dorsal horn neurons ipsilateral to the injury. The VPAC<sub>1</sub> and PAC<sub>1</sub> antagonists significantly inhibited cold allodynia in the CCI animal. Antagonists for all three receptors inhibited mustard oil evoked thermal hypersensitivity (Dickinson et al. 1999). PACAP and VIP may play a role in establishing a state of neuropathy and VIP may be important in maintaining an ongoing pain state.

### Dynorphin

Elevated levels of spinal prodynorphin, a large precursor protein thought to be active as a 17 amino acid polypeptide, serve to maintain enhanced pain states following nerve injury. Thus far, the binding site for ▶ **dynorphin** as an excitatory peptide has not been elucidated, although studies have shown an indirect pathway for modulating function at the NMDA receptor channel (Koetzner et al. 2004).

Peripheral nerve injury has been consistently associated with increased levels of immunoreactivity for dynorphin or mRNA for prodynorphin in neurons of the dorsal horn of the spinal cord (Malan et al. 2000). Peripheral nerve injury results in significant ipsilateral increases in im-

munoreactivity for dynorphin in laminae I–II and V–VII of the dorsal horn within 5 days of injury with peak elevations at day 10 (Malan et al. 2000). The time course of dynorphin up-regulation after nerve injury was found to be consistent with the maintenance phase of neuropathic pain.

Mice not expressing spinal dynorphin (prodynorphin knockout mice) develop tactile and thermal hypersensitivities immediately after nerve injury, but these signs resolve spontaneously over the following 4–6 days, whereas wild type mice expressing dynorphin up-regulation after nerve injury maintain behavioral signs of neuropathic pain throughout the observation sessions (Gardell et al. 2004; Wang et al. 2001). Dynorphin is thought to promote ► [spinal sensitization](#) by directly or indirectly enhancing PGE<sub>2</sub> release, which may subsequently enhance release of excitatory transmitters from primary afferent terminals (Koetzner et al. 2004).

Dynorphin fragments not binding to kappa opioid receptors with high affinity, such as dynorphin 2-17 and 2-13 elicit effects similar to those of dynorphin in rats (Vanderah et al. 1996), yet this dynorphin-binding site has not been identified. Currently it is thought that dynorphin plays a role in maintaining neuropathic pain.

#### **Cholecystokinin (CCK)**

CCK was first isolated from porcine intestine as a 33 amino acid polypeptide; however a shorter form of CCK (CCK-8) appears to act as a neurotransmitter in the central nervous system. In naive animals, CCK is not found in the DRG or terminals of primary afferents of non-primates, but is detected in the superficial laminae of the spinal cord. Immunoreactivity for CCK is seen in CNS structures known to modulate nociception including the periaqueductal gray (PAG), raphe nuclei and the medullary reticular formation. CCK acts at two identified receptors, CCK<sub>1</sub> and CCK<sub>2</sub>, with distribution in spinal and supraspinal regions, including regions of pain modulation. The ► [axotomy](#) model of neuropathic pain results in a slight increase in CCK in medium diameter DRG neurons and a significant increase in mRNA for CCK in 30% of all neurons of the DRG (see Hökfelt et al. 1994). Following complete section of the sciatic nerve, potassium evoked release of CCK in the dorsal horn is slightly elevated 3 and 7 days after axotomy. The potassium evoked CCK release in the cingulate cortex is markedly enhanced (4–6-fold) following axotomy of the sciatic nerve (Gustafsson et al. 2000). Recent studies using microdialysis in the rostral ventromedial medulla (RVM) have demonstrated a significant 3-fold increase in CCK-LI in L5/L6 spinal nerve ligated (► [Spinal Nerve Ligation Model SNL](#)) rats compared to sham-operated rats (Vanderah, unpublished observations). In addition, nerve injury results in a significant increase in mRNA for the CCK<sub>2</sub> receptor in medium to large diameter sensory fibers (Wank et al. 1992).

The microinjection of CCK into the RVM of normal rats resulted in time dependent behavioral signs of pain, including an increased sensitivity to normally non-noxious mechanical stimuli and noxious thermal hyperalgesia. RVM administration of L365,260, a CCK<sub>2</sub> receptor antagonist, produced a reversible block of SNL-induced pain (Xie et al. 2005). CCK acts to promote nociception, since numerous studies have shown that CCK antagonists enhance morphine and/or endogenous opioid analgesia to mechanical or thermal stimuli. CCK is thought to play a role in maintaining neuropathic pain at the level of the spinal cord as well as at supraspinal regions, by driving descending facilitatory pathways (Xie et al. 2005).

#### **Neuropeptide Y (NPY)**

NPY, a 36 amino acid polypeptide, has been implicated in modulating nociception. The pharmacological administration of NPY has resulted in both antinociception and nociception. Studies in animals with experimental neuropathies have shown a marked increase in NPY in large diameter neurons (Zhang et al. 1993; Ossipov et al. 2002; Wakisaka et al. 1991).

Axotomy results in a significant increase in NPY expression in laminae III and IV suggesting a role for medium and large DRG cells (Wakisaka et al. 1991). Following axotomy or spinal nerve ligation, NPY immunoreactivity increases significantly in fibers in the ► [nucleus gracilis](#) (Zhang et al. 1993; Ossipov et al. 2002). SNL results in a significant increase in NPY expression in the ipsilateral L5 and L6 DRG, in the nerve on the side proximal to the DRG and in the ipsilateral side of the nucleus gracilis (Ossipov et al. 2002).

Microinjection studies of an NPY receptor antagonist into the nucleus gracilis, as well as NPY antiserum, resulted in a reversal of SNL mechanical hypersensitivities (Ossipov et al. 2002). Thus far using dose selective antagonists, the NPY<sub>1</sub>, but not the NPY<sub>2</sub>, receptor has been identified in the nucleus gracilis as the receptor that NPY uses to promote mechanical hypersensitivity after peripheral nerve injury (Ossipov et al. 2002), although due to a lack of a highly selective antagonist, other NPY receptors (Y<sub>3</sub>, Y<sub>4</sub> and Y<sub>5</sub>) can not be ruled out. NPY has been shown to produce antinociception in chemical and thermal-induced pain when given into either the spinal cord, nucleus raphe magnus or ► [periaqueductal grey](#).

#### **References**

1. Dickinson T, Mitchell R, Robberecht P et al. (1999) The role of VIP/PACAP receptor subtypes in spinal somatosensory processing in rats with an experimental peripheral mononeuropathy. *Neuropharmacology* 38:167–180
2. Gardell LR, Ibrahim M, Wang R et al. (2004) Mouse strains that lack spinal dynorphin upregulation after peripheral nerve injury do not develop neuropathic pain. *Neuroscience* 123:43–52

3. Gibbs J, Flores CM, Hargreaves KM (2004) Neuropeptide Y inhibits capsaicin-sensitive nociceptors via a Y<sup>1</sup>-receptor-mediated mechanism. *Neuroscience*. 125(3):703–9
4. Gustafsson H, Stiller CO, Brodin E (2000) Peripheral axotomy increases cholecystokinin release in the rat anterior cingulate cortex. *Neuroreport* 11:3345–3348
5. Hökfelt T, Morino P, Verge V et al. (1994) CCK in cerebral cortex and at the spinal level. *Ann N York Acad Sci* 713:157–163
6. Inagaki N, Yoshida H, Mizuta M et al. (1994) Cloning and functional characterization of a third pituitary adenylate cyclase-activating polypeptide receptor subtype expressed in insulin-secreting cells. *Proc Natl Acad Sci USA* 91:2679–2683
7. Koetzner L, Hua XY, Lai J et al. (2004) Nonopioid actions of intrathecal dynorphin evoke spinal excitatory amino acid and prostaglandin E2 release mediated by cyclooxygenase-1 and -2. *J Neurosci* 24:1451–1458
8. Mabuchi T, Shintani N, Matsumura S et al. (2004) Pituitary adenylate cyclase-activating polypeptide is required for the development of spinal sensitization and induction of neuropathic pain. *J Neurosci* 24:7283–7291
9. Malan TP, Ossipov MH, Gardell LR et al. (2000) Extraterritorial neuropathic pain correlates with multisegmental elevation of spinal dynorphin in nerve-injured rats. *Pain* 86:185–194
10. Nahin RL, Ren K, De Leon M, Ruda M (1994) Primary sensory neurons exhibit altered gene expression in a rat model of neuropathic pain. *Pain* 58:95–108
11. Naveilhan P, Hassani H, Lucas G et al. (2001) Reduced antinociception and plasma extravasation in mice lacking a neuropeptide Y receptor. *Nature* 409:513–7
12. Noda K, Umeda F, Ono H et al. (1990) Decreased VIP content in peripheral nerve from streptozocin-induced diabetic rats. *Diabetes* 39:608–612
13. Noguchi K, Senba E, Morita Y et al. (1989) Prepro-VIP and preprotachykinin mRNAs in the rat dorsal root ganglion cells following peripheral axotomy. *Brain Res Mol Brain Res* 6:327–330
14. Noguchi K, Senba E, Morita Y et al. (1990) Alpha-CGRP and beta-CGRP mRNAs are differentially regulated in the rat spinal cord and dorsal root ganglion. *Brain Res Mol Brain Res* 7:299–304
15. Ossipov MH, Zhang ET, Carvajal C et al. (2002) Selective mediation of nerve injury-induced tactile hypersensitivity by neuropeptide Y. *J Neurosci* 22:9858–9867
16. Vanderah TW, Laughlin T, Lashbrook JM et al. (1996) Single intrathecal injections of dynorphin A or des-Tyr-dynorphins produce long-lasting allodynia in rats: blockade by MK-801 but not naloxone. *Pain* 68:275–281
17. Wakisaka S, Kajander KC, Bennett GJ (1991) Increased neuropeptide Y (NPY)-like immunoreactivity in rat sensory neurons following peripheral axotomy. *Neurosci Letters* 124:200–203
18. Wang Z, Gardell LR, Ossipov MH et al. (2001) Pronociceptive actions of dynorphin maintain chronic neuropathic pain. *J Neurosci* 21:1779–1786
19. Wang JZ, Lundberg T, Yu L (2000) Antinociceptive effects induced by intra-periaqueductal grey administration of neuropeptide Y in rats. *Brain Res* 859:361–3
20. Wank SA, Harkins R, Jensen RT, Shapira H, de Weerth A, Slattery T (1992) Purification, molecular cloning, and functional expression of the cholecystokinin receptor from rat pancreas. *Proc Natl Acad Sci USA* 89:3125–3129
21. Xie YY, Herman DS, Stiller C-O et al. (2005) Mediation of Opioid-induced Paradoxical Pain and Antinociceptive Tolerance by Cholecystokinin in the Rostral Ventromedial Medulla. *J Neurosci* 25:409–416
22. Zhang X, Meister B, Elde R et al. (1993) Large caliber primary afferent neurons projecting to the gracile nucleus express neuropeptide Y after sciatic nerve lesions: an immunohistochemical and in situ hybridization study in rats. *Eur J Neurosci* 5:1510–1519
23. Zhang Y, Lundberg T, Yu L (2000) Involvement of neuropeptide Y and Y1 receptor in antinociception in nucleus raphe magnus of rats. *Regulatory Peptides* 95:109–13

## Per Capita Morphine Consumption

### Definition

National per capita kilogram consumption of morphine has become the benchmark index for monitoring the status of pain control internationally. Since the 1970's, the consumption of morphine has increased more than three-fold internationally. Much of this is attributed to the long term use of oral morphine in many countries for the treatment of cancer pain. The 10 countries that consumed 57% of all morphine in 1991 have ranked highest in morphine consumption for many years. They include: Australia, Canada, Denmark, Iceland, Ireland, New Zealand, Norway, Sweden, the United Kingdom, and the United States. The remaining 14% of morphine was consumed by approximately 100 other countries, the majority of the world's population. The report of the International Narcotics Control Board in 1995 demonstrated an 80.19 mg per capita consumption of morphine for Denmark, in comparison with a consumption of less than 0.1 mg for many developing nations.

► [Cancer Pain Management, Undertreatment and Clinician-Related Barriers](#)

## Percutaneous Cordotomy

RONALD R. TASKER

University of Toronto, Toronto Western Hospital, Toronto, ON, Canada

P

### Synonyms

Anterolateral cordotomy

### Definition

The use of a needle to make radiofrequency lesions in the spinal cord, to sever the antero-lateral quadrant of the spinal cord which contains the ► [spinothalamic tract](#).

### Characteristics

Initially, after Spiller's discovery of a pain pathway in the spinal cord, cordotomy was done by open means (Spiller and Martin 1912), usually bilaterally at T1 and T2, particularly for pain caused by cancer. Mullan and his colleagues' introduction of percutaneous cervical cordotomy under local anesthesia (Mullan et al. 1965) spared sick patients the risks of open operation, and facilitated physiological corroboration of the target. Although percutaneous cordotomy can be done by the high dorsal approach, usually in the C1-C2 interspace using a frame, the low anterior cervical approach, usually at C5-6 or the high lateral cervical approach at C1-2 or occiput C1, the latter has been widely adopted.

Percutaneous cordotomy should be considered for the relief of pain, depending upon transmission of signals

in the spinothalamic tract from below the level of intervention, especially in the leg and especially caused by cancer. It is not helpful for the steady burning element of ► **neuropathic pain**. It may, however, be useful for the relief of ► **allodynia**, hyperpathia and neuralgic pain associated with neuropathic syndromes (Tasker et al. 1992, Tasker and Dostrovsky 1989). It is usually unsuccessful, if done in the lower cervical area, in relieving pain above the C5 dermatome.

The major contraindication to cordotomy is the risk of loss of unconscious breathing (► **Ondine's curse**) through concomitant lesioning of the ipsilaterally distributed reticulospinal tract that lies among the cervical fibers of the spinothalamic tract. In the author's series, indications for cordotomy were pain from cancer of the cervix, 22%, cancer of the rectum, 16%, cancer of the colon, 10%, cancer of the lung, 7%, cancer of the breast, 4%, cancer of other sites, 29% and spinal cord ► **central pain**, 7% (Tasker et al. 1974).

The technique of percutaneous cordotomy has been refined over many years. Percutaneous cordotomy usually requires neuroleptanalgesia, and myelography with the image intensifier to identify cord and the location of spinothalamic tract (Onofrio 1971); intradural impedance monitoring tracks penetration of the cord (Gildenberg et al. 1969), macro-stimulation identifies cord structures (Tasker et al. 1974) while ► **radio frequency current lesion making** completes the procedure (Rosomoff et al. 1965). The percutaneous procedure can also be done under general anesthesia in an uncooperative patient, sacrificing only the patient's description of the effects of stimulation.

A sharpened stainless steel electrode insulated with shrink-fit Teflon tubing leaving a 2 mm bare tip is introduced through a #19 thin wall lumbar puncture needle at the C1-2 interspace, to penetrate the spinal cord at the level of the dentate ligament as illustrated by positive contrast myelography and impedance monitoring. The latter measures 400 ohms in spinal fluid and up to 1200 ohms in cord. Recently, computed tomographic (CT) guidance has been used, rather than myelography, to provide anatomic guidance during cordotomy (Kanpolat et al. 1995).

When the electrode is in the spinothalamic tract and stimulated at 2 Hz, muscle contractions in time with the stimulation appear in the ipsilateral trapezius or shoulder girdle and sometimes the upper limb, but not in the lower limb and contralateral analgesia beginning at 35 mA and 60–75 degrees centigrade, and enlarged in 10 mA steps to a maximum of 50 mA and a temperature of 90 degrees centigrade.

Published data suggests a 63–77% range of complete, and 68–96% significant contralateral pain relief. Complete pain relief in 90% of patients immediately post-operatively, 84% after three months, 61% at one year, 43% between one and five years and 37% between 5 and 10 years (Tasker 1988).

The complications of cordotomy are related to damage to nearby structures. The chief complication is respiratory failure, as mentioned above, with death in 0–5% after unilateral cordotomy, significant reversible respiratory complications in up to 10% and significant persistent paresis or ataxia in up to 10% as well as significant worsening of micturition control in up to 15%; post-cordotomy dysaesthesia affects less than 10%. Ipsilateral ptosis from sympathetic tract damage is seen frequently, although transiently, as well as reduced respiratory excursion ipsilaterally, and often paresis of the ipsilateral lower limb; in our experience any patient who can still elevate the limb off the table, however weakly, just after the lesion is made, will recover and not suffer significant disability.

### Bilateral Cordotomy

It is rare for cancer pain to be unilateral so that the bilateral procedure must sometimes be considered. The two procedures are best separated by at least one week. If the expected rate of immediate significant pain relief with unilateral cordotomy is 80%, after bilateral surgery it is 80% × 80% or 64%. If the first procedure interfered with automatic respiration ipsilaterally, it is unwise to proceed on the other side. Although it is usual to have urological complications after unilateral cordotomy, these are very common after the bilateral procedure, since the bladder pathways are so close to the ideal cordotomy lesion.

### References

1. Gildenberg PL, Zanes C, Flitter M et al. (1969) Impedance Measuring Device for Detection of Penetration of the Spinal Cord in Anterior Percutaneous Cervical Cordotomy. Technical note. *J Neurosurg* 30:87–92
2. Kanpolat Y, Akyar S, Caglar S (1995) Diametral Measurements of the Upper Spinal Cord for Stereotactic Pain Procedures: Experimental and Clinical Study. *Surg Neurol* 43:478–482
3. Mullan S, Hekmatpanah J, Dobben G et al. (1965) Percutaneous, Intramedullary Cordotomy Utilizing the Unipolar Anodal Electrolytic Lesion. *J Neurosurg* 22:548–553
4. Onofrio BM (1971) Cervical Spinal Cord and Dentate Delineation in Percutaneous Radiofrequency Cordotomy at the Level of the First to Second Cervical Vertebrae. *Surg Gynecol Obstet* 133:30–34
5. Rosomoff HL, Brown CJ, Sheptak P (1965) Percutaneous Radiofrequency Cervical Cordotomy: Technique. *J Neurosurg* 23:639–644
6. Spiller WG, Martin E (1912) The Treatment of Persistent Pain of Organic Origin in the Lower Part of the Body by Division of the Anterolateral Column of the Spinal Cord. *JAMA* 58:1489
7. Tasker RR (1988) Percutaneous Cordotomy: The Lateral High Cervical Technique. In: Schmidek HH, Sweet WH (eds) *Operative Neurosurgical Techniques Indications, Methods, and Results*. Saunders, W.B., Philadelphia, pp 1191–1205
8. Tasker RR, DeCarvalho GT, Dolan EJ (1992) Intractable Pain of Spinal Cord Origin: Clinical Features and Implications for Surgery. *J Neurosurg* 77:373–378
9. Tasker RR, Dostrovsky JO (1989) Deafferentation and Central Pain. In: Wall PD, Melzack R (eds) *Textbook of Pain*. Churchill Livingstone, Edinburgh London Melbourne and New York, pp 154–180



10. Tasker RR, Organ LW, Smith KC (1974) Physiological Guidelines for the Localization of Lesions by Percutaneous Cordotomy. *Acta Neurochir (Wien.) Suppl* 21:111–117

## Percutaneous Electrical Nerve Stimulation

- ▶ Transcutaneous Electrical Nerve Stimulation Outcomes
- ▶ Transcutaneous Electrical Nerve Stimulation (TENS) in Treatment of Muscle Pain

## Performance

What an individual does in his or her current environment.

- ▶ Disability, Functional Capacity Evaluations

## Periaqueductal Gray

### Synonyms

PAG

### Definition

The Periaqueductal Gray is an area of gray matter surrounding the aqueduct of Sylvius in the midbrain and upper thalamus between the third and fourth ventricles, which is part of the descending pain pathway that relays in the nucleus raphe magnus. Stimulation in the PAG in experimental animals results in analgesia.

- ▶ Deep Brain Stimulation
- ▶ Descending Circuits in the Forebrain, Imaging
- ▶ Forebrain Modulation of the Periaqueductal Gray
- ▶ GABA Mechanisms and Descending Inhibitory Mechanisms
- ▶ Nitrous Oxide Antinociception and Opioid Receptors
- ▶ Nociceptive Processing in the Nucleus Accumbens, Neurophysiology and Behavioral Studies
- ▶ Opioids and Reflexes
- ▶ Opioid Electrophysiology in PAG
- ▶ Peptides in Neuropathic Pain States
- ▶ Psychiatric Aspects of Visceral Pain
- ▶ Spinomesencephalic Tract
- ▶ Spinothalamic Tract Neurons, Descending Control by Brainstem Neurons
- ▶ Spinothalamocortical Projections from SM
- ▶ Stimulation-Produced Analgesia

## Pericranial Muscles

### Definition

The pericranial muscles, with importance in tension-type headache, are the neck muscles, chewing muscles, mimetic facial muscles and muscles in the inner ear (tensor tympani, stapedius).

- ▶ Headache, Episodic Tension Type

## Peridural Infusions

- ▶ Epidural Infusions in Acute Pain

## Perikarya

- ▶ Soma

## Perineural Catheters

### Definition

Plastic catheters placed near a peripheral nerve for application of numbing drug solutions.

- ▶ Cancer Pain Management, Anesthesiologic Interventions, Neural Blockade

P

## Perineural Injection

### Definition

Local anesthetic injection around the nerve or into the sheath containing the nerve(s) either under direct surgical visualization or percutaneously.

- ▶ Acute Pain in Children, Post-Operative

## Perineuronal Basket

### Definition

Following major peripheral nerve injuries with limited regeneration, some large diameter sensory neurones within dorsal root ganglia that contain transected axons, become surrounded by varicose nerve terminals of collateral branches of sympathetic and peptidergic sensory neurones. These terminals branch amongst the multiple layers of perisomatic glia that develop around these neurones. There is limited evidence of synaptic contact with neurone somata or functional responses to activation of small diameter neurones.

- ▶ Satellite Cells and Inflammatory Pain
- ▶ Sympathetic and Sensory Neurons after Nerve Lesions, Structural Basis for Interactions

## Perineuronal Cells

- ▶ Satellite Cells and Inflammatory Pain

## Perineuronal Terminals

- ▶ Sympathetic and Sensory Neurons after Nerve Lesions, Structural Basis for Interactions

## Periodic Disorders of Childhood that are Precursors to Migraine

- ▶ Migraine, Childhood Syndromes

## Peripheral Arterial Occlusive Disease

### Synonyms

PAOD

### Definition

A condition caused by atherosclerotic narrowing of limb arteries, associated with activity dependent pain and trophic disturbances.

- ▶ Vascular Neuropathies

## Peripheral Glutamate Receptors, Role in Inflammation

- ▶ Inflammation, Role of Peripheral Glutamate Receptors

## Peripheral Mechanisms of Opioid Analgesia

- ▶ Opioids in the Periphery and Analgesia

## Peripheral Modulation of Nociceptors

- ▶ Perireceptor Elements

## Peripheral Nerve Blocks

JOHN ROBINSON

Pain Management Clinic, Burwood Hospital,  
Christchurch, New Zealand

jon.r@xtra.co.nz

### Synonyms

Diagnostic Blocks; therapeutic blocks

### Definition

Peripheral nerve blocks are procedures in which local anaesthetic is injected onto a nerve in order to block conduction of nociceptive information along it, and thereby temporarily relieve pain. Different types of block are distinguished by their purpose.

For ▶ **diagnostic blocks** the purpose is to obtain diagnostic information (Bogduk 2002). The objective of ▶ **therapeutic blocks** is to treat the pain. Prophylactic blocks are used to anaesthetise a part of the body, so that other treatment can be applied to that part without aggravating the patient's pain. ▶ **Prognostic Block** are used to predict the relief of pain, and any side-effects, that might be expected from a treatment procedure in which the nerve will be destroyed.

### Characteristics

#### Diagnostic Blocks

#### Principles

Diagnostic blocks are used to establish if a patient has a peripheral source of nociception and its location. If a patient's pain is not relieved by a block, a source of pain in the distribution of the target nerve is excluded. If the block relieves the pain, the inference is that the nerve is responsible for mediating the patient's pain, and the source probably lies somewhere in the territory innervated by the nerve.

#### Applications

In patients with ▶ **neuropathic pain**, diagnostic blocks can be used to determine if a patient's pain, or other symptoms, are generated or sustained by activity in a peripheral nerve. Perhaps most critically, if peripheral nerve blocks do not relieve the patient's pain, a peripheral mechanism is excluded, whereupon a diagnosis of ▶ **central pain** becomes more likely. On the other hand, if a block relieves the pain, a peripheral contribution can be inferred. For example, if anaesthetising a neuroma relieves pain, then ectopic impulse generation from the neuroma can be deduced to be the basis of that pain.

An important caveat applies to patients in whom disinhibition is a mechanism of symptom production. In such patients, pain, ▶ **hyperalgesia**, and ▶ **allodynia** may arise, not because of nociceptive activity in damaged peripheral nerves, but because of disinhibition of

central connections of otherwise intact, normal nerves, whose receptive fields overlap into the territory of a damaged nerve. Under these conditions, relief of pain by blocking the overlapping nerves does indicate that they are responsible for mediating the patient's symptoms, but does not constitute evidence that the cause of pain lies in their territory.

In patients with ► **somatic pain**, diagnostic blocks can be used to identify sources of pain that cannot be detected by other means, such as medical imaging. If blocking a nerve completely relieves the patient's pain, a source somewhere in the territory of the nerve can be inferred. For defining the source of pain, such blocks become more accurate the more distally along a nerve they are applied, for under those conditions the number of possible sources is progressively less.

Diagnostic blocks can be applied in a similar manner for patients with ► **Visceral Nociception and Pain**, but the number of accessible sites for blocks is small. Typically, they entail ► **sympathetic blocks** in which the coeliac plexus or splanchnic nerves are anaesthetised, in order to establish that the source of pain lies somewhere amongst the viscera of the upper abdomen.

#### Validity

For diagnostic blocks to be valid, they should be both target-specific and controlled.

Target-specificity means that the block must accurately anaesthetize the target nerve, and not unintentionally anaesthetize some other structures that may be the cause of the patient's pain. For superficial and readily accessible nerves, target-specificity can be achieved by limiting the injection of local anaesthetic to the immediate vicinity of the target nerve. For deeper structures, which cannot be palpated, target-specificity is achieved by using fluoroscopic guidance.

Controls are critical to the validity of diagnostic blocks (Bogduk 2002). Patients with pain may report relief for reasons other than the action of the local anaesthetic administered. These constitute false-positive responses. Controls involve administering, on a separate occasion, an agent with an action different from that of the local anaesthetic normally used for the block. This agent may be an inactive one, in which case the control is a ► **placebo**; or the agent may be another local anaesthetic agent with a different duration of action (Bogduk 2002). The latter type is referred to as a comparative local anaesthetic block. In either instance, the blocks should be conducted under double-blind conditions, so that neither the patient nor the physician knows what the expected effect is.

If placebo blocks are used, the criteria for a true-positive response would be complete relief of pain when the local anaesthetic agent is administered, but no relief of pain when the placebo is administered. If the patient obtains relief when the placebo is administered, the response to the block cannot be considered positive.

For comparative blocks, typical agents are lignocaine, which has a short duration of action (1–4 hours), and bupivacaine, which has a long duration of action (4–8 hours). A true-positive response would be one in which the patient obtains complete relief of pain each time that the nerve is blocked, but reports longer-lasting relief when the long-acting agent is used, and short-lasting relief when the short-acting agent is used.

#### Utility

Peripheral nerve blocks are commonly practised for the assessment of neuropathic pain. In this context, they are typically assumed to be valid. No studies have tested their validity by using controls (Bogduk 2002).

For the diagnosis of somatic pain, any nerve can be the target, depending on the site of the patient's pain (Buckley 2001). Controls have not typically been advocated for blocks of the trigeminal nerve, intercostal, abdominal nerves, or other major peripheral nerves. They are assumed to be valid, but this may not be correct (Bogduk 2002).

Only in the context of spinal pain have diagnostic blocks been tested and shown to have validity (Bogduk 2002). Diagnostic blocks of the medial branches of the dorsal rami, both in the cervical spine and in the lumbar spine, have target-specificity, provided that needles are placed correctly under fluoroscopic control (Bogduk 2002; Barnsley and Bogduk 1993; Dreyfuss et al. 1997; Kaplan et al. 1998); they are diagnostically valid if performed under controlled conditions (Bogduk 2002; Barnsley et al. 1993; Lord et al. 1995; Schwarzer et al. 1994); and they are used to pinpoint the zygapophysial joints as the source of a patient's pain (see ► **cervical medial branch blocks**, ► **lumbar medial branch blocks**).

#### Therapeutic Blocks

Single or repeated peripheral nerve blocks are sometimes undertaken as a treatment for neuropathic pain. The expectation is that once nociceptive activity has been suppressed by the block it may not return, or may take some time to return after the local anaesthetic has worn off. Although anecdotally such blocks are reputed to work for some patients (Arner et al. 1990), there is no formal evidence that they do work by more than a ► **placebo effect**.

There is no evidence that repeated blocks for somatic pain are an effective and useful treatment. Once the local anaesthetic wears off, pain recurs.

#### Prophylactic Blocks

Prophylactic blocks are typically used in the treatment of patients with ► **Complex Regional Pain Syndromes, General Aspects**. These patients may not be able to tolerate the affected body part to be touched, due to hyperaesthesia, hyperalgesia, or allodynia. In order to permit physical therapy to be applied, peripheral nerve blocks can be used to anaesthetise the affected part. A com-

mon example is the use of brachial plexus blocks or axillary blocks to anaesthetise the upper limb. Although promoted as an adjunct in the management of complex regional pain syndromes, the efficacy of such blocks has not been vindicated by controlled trials (Azad et al. 2000; Lamacraft et al. 1997).

### Prognostic Blocks

Prognostic blocks were classically applied as a test for surgical neurectomy. It was believed that, if blocking a nerve would relieve the patient's pain temporarily, cutting or avulsing that nerve should secure permanent relief. Clinical experience showed that this was not the case. Despite nerves having been cut, pain recurred in many, if not most patients. Consequently, surgical neurectomy has been all but abandoned as a treatment for pain; and prognostic blocks are no longer used for this purpose.

One explanation for the failure of neurectomy in the past may be that physicians did not understand and recognise the potential for patients with central pain to have apparently positive responses to diagnostic blocks. If symptoms are relieved because blocks anaesthetise overlapping, but normal nerves, neurectomy will not achieve lasting relief, for the mechanism of pain lies not in the cut nerve, but in the central nervous system. Indeed, under such conditions, neurectomy is likely to worsen the patient's condition by increasing the number of damaged nerves, without at all addressing the mechanism of pain. Prognostic blocks, however, have been vindicated as a predictive test for radiofrequency ► [lumbar medial branch neurotomy](#) and ► [cervical medial branch neurotomy](#). If patients obtain complete relief following ► [Medial Branch Block](#), they can expect to obtain complete and lasting relief if the same nerve is coagulated (Lord et al. 1996; McDonald et al. 1999; Dreyfuss et al. 2000).

► [Postoperative Pain, Regional Blocks](#)

### References

- Arner S, Lindblom U, Meyerson BA, Molander C (1990) Prolonged Relief of Neuralgia after Regional Anaesthetic Blocks. A Call for Further Experimental and Systematic Clinical Studies. *Pain* 43:287–297
- Azad SC, Beyer A, Romer AW, Galle-Rod A, Peter K, Schops P (2000) Continuous Axillary Brachial Plexus Analgesia with Low Dose Morphine in Patients with Complex Regional Pain Syndromes. *Eur J Anaesth* 17:185–188
- Barnsley L, Bogduk N (1993) Medial Branch Blocks are Specific for the Diagnosis of Cervical Zygapophysial Joint Pain. *Reg Anesth* 18:343–350
- Barnsley L, Lord S, Bogduk N (1993) Comparative Local Anaesthetic Blocks in the Diagnosis of Cervical Zygapophysial Joints Pain. *Pain* 55:99–106
- Bogduk N (2002) Diagnostic Nerve Blocks in Chronic Pain. *Best Pract Res Clin Anaesthesiol* 16:565–578
- Buckley FP (2001) Regional Anesthesia with Local Anesthetics. In: Loeser JD (ed) *Bonica's Management of Pain*, 3<sup>rd</sup> edn. Lippincott Williams & Wilkins, Philadelphia, pp 1893–1952
- Dreyfuss P, Halbrook B, Pauza K, Joshi A, McLarty J, Bogduk N (2000) Efficacy and Validity of Radiofrequency Neurotomy for Chronic Lumbar Zygapophysial Joint Pain. *Spine* 25:1270–1277
- Dreyfuss P, Schwarzer AC, Lau P, Bogduk N (1997) Specificity of Lumbar Medial Branch and L5 Dorsal Ramus Blocks: A Computed Tomographic Study. *Spine* 22:895–902
- Kaplan M, Dreyfuss P, Halbrook B, Bogduk N (1998) The Ability of Lumbar Medial Branch Blocks to Anesthetize the Zygapophysial Joint. *Spine* 23:1847–1852
- Lamacraft G, Molloy AR, Cousins MJ (1997) Peripheral Nerve Blockade and Chronic Pain Management. *Pain Rev* 4:122–47
- Lord SM, Barnsley L, Bogduk N (1995) The Utility of Comparative Local Anaesthetic Blocks versus Placebo-Controlled Blocks for the Diagnosis of Cervical Zygapophysial Joint Pain. *Clin J Pain* 11:208–213
- Lord SM, Barnsley L, Wallis BJ, McDonald GJ, Bogduk N (1996) Percutaneous Radio-Frequency Neurotomy for Chronic Cervical Zygapophysial-Joint Pain. *N Engl J Med* 335:1721–1726
- McDonald G, Lord SM, Bogduk N (1999) Long-Term Follow-Up of Cervical Radiofrequency Neurotomy for Chronic Neck Pain. *Neurosurgery* 45:61–68
- Schwarzer AC, Aprill CN, Derby R, Fortin J, Kine G, Bogduk N (1994) The False-Positive Rate of Uncontrolled Diagnostic Blocks of the Lumbar Zygapophysial Joints. *Pain* 58:195–200

## Peripheral Neuralgia

► [Peripheral Neuropathic Pain](#)

## Peripheral Neurogenic Pain

► [Peripheral Neuropathic Pain](#)

## Peripheral Neuropathies

### Definition

Peripheral neuropathies refer to neurological disorders that affect the sensory, motor and/or autonomic nerves. Peripheral neuropathy is caused by abnormal nerve functioning (i.e. the failure of nerves to carry information to and from the brain and spinal cord) due to various etiologies. These disorders can originate from causes such as diabetes, alcoholism, HIV, toxin exposure, metabolic abnormalities, vitamin deficiency, or adverse effects of certain drugs. The resultant symptoms include pain, loss of sensation, and inability to control muscles.

► [Cancer Pain, Assessment in the Cognitively Impaired](#)  
 ► [Experimental Pain in Children](#)

## Peripheral Opioid Analgesia

► [Opioids in the Periphery and Analgesia](#)



## Peripheral Neuropathic Pain

MARSHALL DEVOR

Department of Cell and Animal Biology, Institute of Life Sciences and Center for Research on Pain, Hebrew University of Jerusalem, Jerusalem, Israel  
marshlu@vms.huji.ac.il

### Synonyms

Nerve Pain; Peripheral Neuralgia; Peripheral Neurogenic Pain; Pain in Radiculopathy; Pain in Ganglionopathy

### Definition

“Neuropathic pain” is defined by the International Association for the Study of Pain (IASP) as pain initiated by a primary lesion or dysfunction in the nervous system (Merskey and Bogduk 1994). This section deals with disorders of the peripheral nervous system. Central (neuropathic) pain is reviewed elsewhere (► [central pain](#)). Neuropathic pain needs to be distinguished from normal (or “nociceptive”) pain and from pain due to inflammation of innervated tissue. In nociceptive and inflammatory pain, the neural impulses that signal pain arise from sensory endings as part of the normal functioning of the pain detection system. Neuropathic pain results from abnormal neural discharge arising in a pain system that has been damaged.

### Characteristics

#### Precipitating Events

Peripheral neuropathic pain may result from any type of neural damage or disease, physical, chemical or metabolic, that has the effect of inducing pathology in a peripheral nerve (neuropathy), sensory or autonomic ganglion (ganglionopathy) or dorsal root (radiculopathy). If damage occurs suddenly, the initial impact may evoke pain sensation due to ► [injury discharge](#). In general, however, peripheral neuropathic pain is not an immediate effect of the traumatic event, but results from secondary pathophysiological changes that develop over time in the peripheral and central nervous systems (PNS, CNS). Damage or disease affecting peripheral nerves induces two main types of pathological change, often in combination. 1) Various degrees of injury to the myelin sheath that surrounds many axons (dysmyelination and demyelination) (see ► [demyelination](#)). Disruption of the Schwann cell sheath that surrounds small diameter non-myelinated axons might also be of importance. 2) Various degrees of injury to axons, from minor axonopathy to frank transection (axotomy) (see ► [wallerian degeneration](#)). More subtle disruptions may also occur, such as in the endoneurial matrix; but

these ultimately cause pain by affecting nerve fibers and their glial sheath. While it is obvious why damage or disease that disrupts the ability of axons to propagate nerve impulses from peripheral tissues into the CNS may cause “negative” sensory (and motor) abnormalities such as hypoesthesia and numbness (or weakness/ataxia), it is not obvious why neural pathology causes “positive” sensory abnormalities such as dysesthesias and pain (Devor 2006).

The neural pathology that brings about pain is usually due to one of the following precipitating events: trauma, infection, inflammation, metabolic abnormalities, malnutrition, vascular abnormalities, neurotoxins, radiation, inherited mutations or autoimmune attack. Some typical examples of each are listed in Table 1 and most are discussed in more detail in focused essays in this volume. Sometimes neuropathy arises spontaneously without an identified cause. This is “idiopathic” neuropathy.

#### Individual Variability

Pain in neuropathy is notoriously variable from patient to patient even when the precipitating injuries or diseases are essentially identical. This variability is determined by a combination of environmental factors and genetic predisposition (Mogil 2004). Environmental factors include upbringing and cultural norms, activity, use of prosthetics, drugs and even diet. Little is currently known about genetic polymorphisms that affect susceptibility to pain given a fixed neural pathology (“pain susceptibility genes”). In contrast, progress is being made in the very different effort of defining mutations and polymorphisms that predispose to acquiring particular types of nerve pathology that may be painful (“disease susceptibility genes”) (► [painful channelopathies](#); ► [hereditary neuropathies](#); ► [congenital insensitivity to pain with anhidrosis \(CIPA\)](#)).

The mismatch between the degree of nerve injury and the amount of pain is sometimes extreme (► [painless neuropathies](#)). For example, amputation of an arm may yield a pain-free stump and a painless phantom while accidental puncture of a small cutaneous nerve branch with a fine sterile needle during insertion of a venous catheter occasionally cascades into catastrophic chronic neuropathic pain. The precipitating event may be so minor as to go unrecognized. Many experts consider chronic regional pain syndrome type I (CRPS1, formerly known as reflex sympathetic dystrophy (RSD)) as a neuropathic pain syndrome, and new evidence from skin histology supports this idea (► [CRPS, evidence based treatment](#) ► [complex regional pain syndrome](#) ► [Complex Regional Pain Syndromes, General Aspects](#)). However, by definition, evidence of frank nerve injury is absent in CRPS1

**Peripheral Neuropathic Pain, Table 1** Categories of neuropathy often associated with chronic pain

Crossreferences to other essays	Precipitating event	Examples
<ul style="list-style-type: none"> <li>▶ Brachial Plexus Avulsion and Dorsal Root Entry Zone</li> <li>▶ Plexus Injuries and Deafferentation Pain</li> <li>▶ Neuroma Pain</li> <li>▶ Painful Scars</li> </ul>	nerve trauma	stump pain, phantom limb, CRPS2 (causalgia), bone fractures, penetrating injuries.
<ul style="list-style-type: none"> <li>▶ Painful Scars</li> <li>▶ Iatrogenic Causes of Neuropathy</li> </ul>	iatrogenic nerve injury (e.g. surgery, radiotherapy, chemotherapy)	scar pain, post-thoracotomy pain, post-mastectomy pain, accidental intraneural injection, vincristine neuropathy
<ul style="list-style-type: none"> <li>▶ Thoracic Outlet Syndrome</li> <li>▶ Entrapment Neuropathies: Carpal Tunnel Syndrome</li> </ul>	nerve compression due to entrapment	carpal tunnel, ulnar n. entrapment, foraminal (lateral) stenosis
<ul style="list-style-type: none"> <li>▶ Radiculopathies</li> <li>▶ Tic and Cranial Neuralgias</li> <li>▶ Cancer Pain, Animal Models</li> <li>▶ Sciatica</li> </ul>	nerve compression by: tumor, artery, edema, herniated intervertebral disc	many cancer pains, sciatica, trigeminal neuralgia
<ul style="list-style-type: none"> <li>▶ Viral Neuropathies</li> <li>▶ Hansen's Disease</li> </ul>	parasitic, bacterial or viral infection	nerve abscess, Hanson's disease (leprosy), tabes dorsalis, postherpetic neuralgia, HIV/AIDS neuropathy
<ul style="list-style-type: none"> <li>▶ Inflammatory Neuritis</li> </ul>	inflammation (sterile)	acute and chronic demyelinating neuropathy, dorsal root ganglionitis, tumor infiltration of nerves or innervated tissues
<ul style="list-style-type: none"> <li>▶ Small Fiber Neuropathies</li> <li>▶ Vascular Neuropathies</li> <li>▶ Diabetic Neuropathies</li> <li>▶ Metabolic and Nutritional Neuropathies</li> </ul>	metabolic/ nutritional/ ischemic	diabetic neuropathy, sickle cell anemia, occlusive/ ischemic angiopathy, alcoholic neuropathy, vitamin deficiency
<ul style="list-style-type: none"> <li>▶ Toxic Neuropathies</li> </ul>	toxic	lead, mercury, ethanol, vincristine neuropathy (and other chemotherapeutics)
<ul style="list-style-type: none"> <li>▶ Iatrogenic Causes of Neuropathy</li> </ul>	ionizing radiation	radiation burns, radiation therapy for cancer
<ul style="list-style-type: none"> <li>▶ Painful Channelopathies</li> <li>▶ Hereditary Neuropathies</li> </ul>	hereditary neuropathies	some Marie-Charcot-Tooth neuropathies, Fabry's disease
<ul style="list-style-type: none"> <li>▶ Small Fiber Neuropathies</li> <li>▶ Ganglionopathies</li> <li>▶ Guillain-Barré Syndrome</li> </ul>	autoimmune, idiopathic	Guillain-Barré, small fiber neuropathies, paraproteinemia, Sjögren syndrome

(Merskey and Bogduk 1994). Others conclude that CRPS1 must reflect an abnormality of signal processing in the brain, or even a functional (i.e. psychiatric) problem (Verdugo et al. 2004). Unfortunately, it is difficult to rule out minor pathology or rearrangements at the molecular level, which may be enough for severe pain. Diagnostic electromyography and nerve conduction studies are insensitive to subtle damage, especially in small diameter, slow conducting axons and even nerve and skin punch biopsy are not likely show up the molecular changes that are currently believed to be responsible for altering neural excitability and causing pain (below). One should therefore keep an open mind about the possibility of chronic pains of uncertain origin, including those in deep somatic tissues or viscera (Freeman 2005), being neuropathic (▶ [restless legs syndrome](#) ▶ [small fiber neuropathies](#) ▶ [fibromyalgia, mechanisms and treatment](#)).

### Symptoms and Signs

Positive sensory changes, such as spontaneous or stimulus evoked parestheses (tingling, pins and needles), dysesthesias (odd unpleasant sensations, not frankly painful) and frank ongoing or stimulus evoked pain are unexpected *a priori* and represent the main burden of neuropathy both for the patient and for the investigator seeking theoretical understanding and improved avenues for treatment. Ongoing pain (a positive symptom) may be present even when the limb is completely numb (a negative symptom). Three categories of pain need to be distinguished.

1. **Spontaneous pain** (ongoing pain) is present at rest when no (intentional) stimulus is applied. Ongoing neuropathic pain can be truly independent of any stimulus or associated with internal factors such as

blood chemistry, autonomic nervous system activity or hormones. It is a bad habit to say “pain” when “spontaneous pain” is meant.

2. **Evoked pain** occurs on stimulation of the skin or other accessible tissues such as the oral or nasal mucosa. By current IASP usage (Merskey and Bogduk 1994), pain evoked by stimuli that are normally painless (touch, warm, cool, dilute chemicals) is called “allodynia” (tactile allodynia, heat allodynia etc.). When a normally painful stimulus evokes more intense pain than expected, this is “hyperalgesia”. Allodynia and hyperalgesia arise in inflammatory conditions and also in neuropathy. In circles where the term allodynia has not been adopted, hyperalgesia continues to mean excess pain from all types of stimuli, weak or strong. In the animal research literature, reduced threshold to mechanical stimulation is almost universally and correctly called tactile allodynia, while reduced threshold to cutaneous heating is widely called heat hyperalgesia, in violation of the IASP definition. Reduced threshold, hence pain in response to normally non-painful heating, is heat allodynia.
3. **Pain on movement** occurs especially on weight bearing (e.g. walking, bending) or deep palpation of muscles, tendons, nerve trunks or viscera (tender spots, “trigger points”, ► [tinel sign](#)) (see also essay ► [tinel sign](#)). This might simply be mechanical allodynia of the deep tissues, perhaps due to inflammation. Alternatively, it may reflect a very different process, ectopic mechanosensitivity at sites at which damage has occurred along the course of a nerve branch (neuroma in continuity, ► [microneuroma](#)). There is ambiguity here because the source of pain is not at the surface and hence difficult to analyze.

### The Sensory Quality of Neuropathic Pain

Some of the words that people with neural damage or disease use to describe their sensory experience are generic, but some are characteristic of neuropathy in general or even of particular neuropathic pain syndromes (Bouhassira et al. 2004). Burning pain is very common in neuropathy, in traumatic nerve injuries, for example “causalgia” is now called CRPS2 (caustic = burning) (► [causalgia, assessment](#)) and in postherpetic neuralgia (► [viral neuropathies](#); ► [postherpetic neuralgia, etiology, pathogenesis and management](#); ► [postherpetic neuralgia, pharmacological and non-pharmacological treatment options](#)). But it also results from acute burns. The feeling of intense, bone chilling cold and cold allodynia is more indicative of neuropathy and descriptions such as tingling, pins and needles or electric shock-like paroxysms are uncommon in healthy people and are strong indicators of nerve in-

volvement (► [paresthesia](#)). Sometimes horrible sensations are reported that defy description, even by articulate patients, pain unlike anything we normally experience. For lack of words, such sensations are put in the grab bag of “dysesthesia”.

A constellation of pain descriptors particular to neuropathic pain conditions is “► [hyperpathia](#)”. Hyperpathia refers to sensations with odd variations in time and space. For example, a gentle tap on the back of the hand may feel dull, as if felt through a boxing glove. However, with repeated tapping (say, once or twice a second for 10–20 seconds) the sensation “winds up”, becoming stronger and stronger until it reaches a painful crescendo. Hyperpathic sensations also spread in space, for example a localized touch on the hand causing a stinging sensation that spreads up into the arm. Hyperpathia is different from “► [referred pain](#)”, where stimulation at one point is felt somewhere else (► [hyperpathia](#)).

### Anesthesia Dolorosa and Phantom Limb Pain

Special mention should be made of neuropathic pain felt in parts of the body that are completely numb, e.g. due to brachial plexus avulsion (► [anesthesia dolorosa](#)) or that no longer exist following amputation (phantom limb pain) (► [anesthesia dolorosa model, autotomy](#)). Such pains can have all of the characteristics of other neuropathic pains (burning, cramping, electric shocks, steady or waxing and waning) and may be exacerbated by factors such as palpation of the stump, urination, emotional upset or cold weather. Phantom limb pain should not be confused with stump pain, which is (post-surgical) inflammatory or neuropathic pain felt in the stump (► [brachial plexus avulsion and dorsal root entry zone](#)).

### Neuropathic Pain Mechanisms

Neuropathic pain is fundamentally a paradox. Like cutting a telephone cable, injuring a nerve ought to make the line go dead (negative symptoms). Why, then, does neuropathy trigger paresthesias, dysesthesias and pain (positive symptoms)? A related issue concerns diversity. Different neuropathic pain diagnoses are triggered by different precipitating events and present with different clinical pictures and natural histories. Does each have its own pain mechanism or is “peripheral neuropathic pain” a single disease with a variety of manifestations? Both dilemmas are rooted in the misconception that nerves are like copper telephone cables. Axons are not wires but live, protoplasmic extensions of specialized cells, neurons. We need to understand how these cells respond to demyelination and axonopathy and how they interact with their PNS and CNS neighbors.

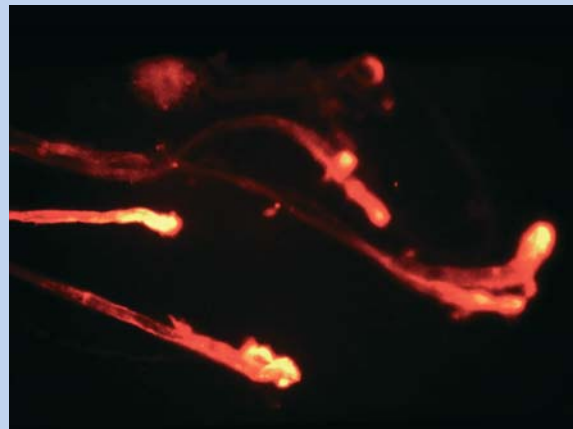
### Injury and Disease Alter Neuronal Phenotype

Depending on severity, the axon distal to the site of injury including its sensory ending may die back from the tissue it innervates, or even undergo (Wallerian) degeneration. But the proximal part of the axon, the DRG cell body, and connections with the CNS usually survive (Tandrup et al. 2000), and these can become a source of pain. Signaling in the injured neuron is drastically altered, however. Neural signaling takes two forms, rapid electrical impulse traffic (measured in meters/second), and relatively slow axoplasmic transport of molecules (measured in centimeters/day). Electrical impulses convey moment-to-moment sensory signals. Transported molecules affect impulse traffic in the longer term and may also signal independently of spikes. Transported molecules fill a variety of roles, structural (e.g. cytoskeletal elements, membranes), response (e.g. transducer molecules, receptors), transmission (e.g. ion channels and other “molecules of excitability”, the exocytosis complex, neurotransmitters) and trophic regulation (e.g. neurotrophins, nerve cell adhesion molecules (NCAMs)). Nerve injury affects both forms of signaling, resulting in numerous changes in nerve cell functioning (i.e. in neuronal “phenotype”) (► [retrograde cellular changes after nerve injury](#)). The most important is the emergence of electrical hyperexcitability and consequent abnormal impulse discharge, the basis for paresthesias, dysesthesias and pain. Nerve injury also triggers a variety of changes in spinal processing of afferent nerve signals, many of which result in abnormal CNS amplification (“► [central sensitization](#)”). In the presence of central sensitization, impulses carried by low threshold A $\beta$  touch afferents can yield a sensation of pain (tactile allodynia, “A $\beta$  pain”). In this way, both injured and nearby non-injured sensory neurons contribute to neuropathic pain sensation (Campbell et al. 1988; Torebjork et al. 1992).

The cascade of events that lead to neuropathic pain begins with the injured primary sensory neuron. Axonal transection blocks the normal flow of neurotrophic signaling molecules between the periphery and the sensory cell body. This triggers a change in the quantity of various of the proteins synthesized (“expressed”) by the cell body and exported to both peripheral and central axon endings (Boucher and McMahon 2001). Some molecules start to be expressed in excess (“up-regulation of gene expression”) while the synthesis of others is reduced (“down-regulation”) (Costigan et al. 2002; Xiao et al. 2002). Altogether, many hundreds, and perhaps thousands of genes are regulated in this way, significantly altering neuronal function. Among these changes, the up-regulation of the Nav1.3 Na $^+$  channel and the down-regulation of certain K $^+$  channels are suspected to be of particular impor-

tance (Boucher and McMahon 2001; Kocsis and Devor 2000).

In addition to changes in gene expression, the delivery (“► [trafficking](#)”) of transported molecules is disrupted (► [trafficking and localization of ion channels](#)). Most significant is the accumulation or depletion of molecules of excitability at sites of axonal injury, including zones of demyelination, swollen terminal endbulbs at the cut axon end, retraction bulbs (e.g. in axons that are dying back) and outgrowing sprouts (Fig. 1). The best-documented example is the accumulation of Na $^+$  channels in neuroma endings (Devor et al. 1993). As for demyelination, while it is not clear whether this alters gene expression, it does affect channel trafficking. In intact axons, Na $^+$  channels are largely excluded from the axonal membrane under myelin. When myelin is stripped off the axon, Na $^+$  channels accumulate locally. The ectopic accumulation of Na $^+$  channels in neuroma endings and patches of demyelination gives rise to a local hyperexcitability and ectopic impulse discharge (Devor 2006).



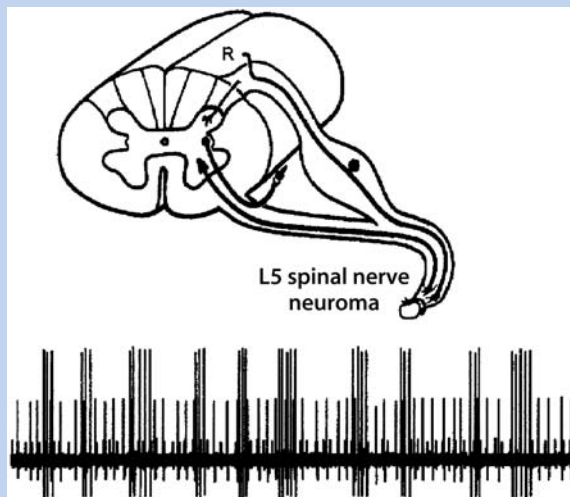
**Peripheral Neuropathic Pain, Figure 1** Immunolabeling shows the accumulation of Na $^+$  channels at the chronic cut end of injured axons (for details see (Devor et al. 1989).

Finally, neuropathy may induce electrical hyperexcitability by changing the current carrying ability of ion channels, and their kinetics. Proinflammatory mediators such as prostaglandins, cytokines and trophic factors can affect channel kinetics in this way, usually by activating protein kinases (PKA, PKC; Gold et al. 1996; Li et al. 1992). Thus, inflammatory mediators might enhance neuropathic discharge in two ways, by exciting (depolarizing) injured neurons and by increasing their fundamental excitability (► [inflammatory neuritis](#)).



### Spontaneous Ectopic Discharge

Altered expression, trafficking and kinetics of ion channels renders many afferents prone to excess generation of electrical impulses, either spontaneously or in response to physical, thermal or chemical stimuli (Fig. 2). Neurons that previously generated impulses only at their peripheral sensory ending in response to an adequate stimulus (touch, pinch etc.), now begin to generate impulses spontaneously at ectopic pacemaker sites, primarily where the nerve injury took place and within the sensory ganglion (Devor 2006). Ectopically generated impulses are conveyed along the dorsal roots into the CNS where they drive central pain signaling neurons. A broad variety of evidence from studies in animals and humans indicates that this spontaneous ectopic discharge gives rise to spontaneous paresthesias, dysesthesias and pain in neuropathy, including anesthesia dolorosa and phantom limb sensation (Devor 2006; Nordin et al. 1984; Tessler and Kleiman 1994) (► [ectopia, spontaneous](#)).



**Peripheral Neuropathic Pain, Figure 2** Recordings (R) from afferent axons associated with an injured nerve frequently show abnormal ongoing tonic and burst discharge that originates ectopically at the nerve injury site and associated DRGs.

It is natural to presume that the sensory quality evoked by spontaneous ectopic discharge bears a relation to the type of afferent involved. For example, thermal sensitivity to heat and cold stimuli is normally due to the activation of thermosensitive C and A $\delta$  afferents. Spontaneous burning pain in neuropathy would thus be due to spontaneous ectopic activity in injured thermal nociceptors. This inference could be wrong, however, given the major distortion wrought by central sensitization on the relation between afferent fiber type and resulting sensation (note A $\beta$  pain). In principle, CNS pathways that signal hot, and are normally activated by thermal

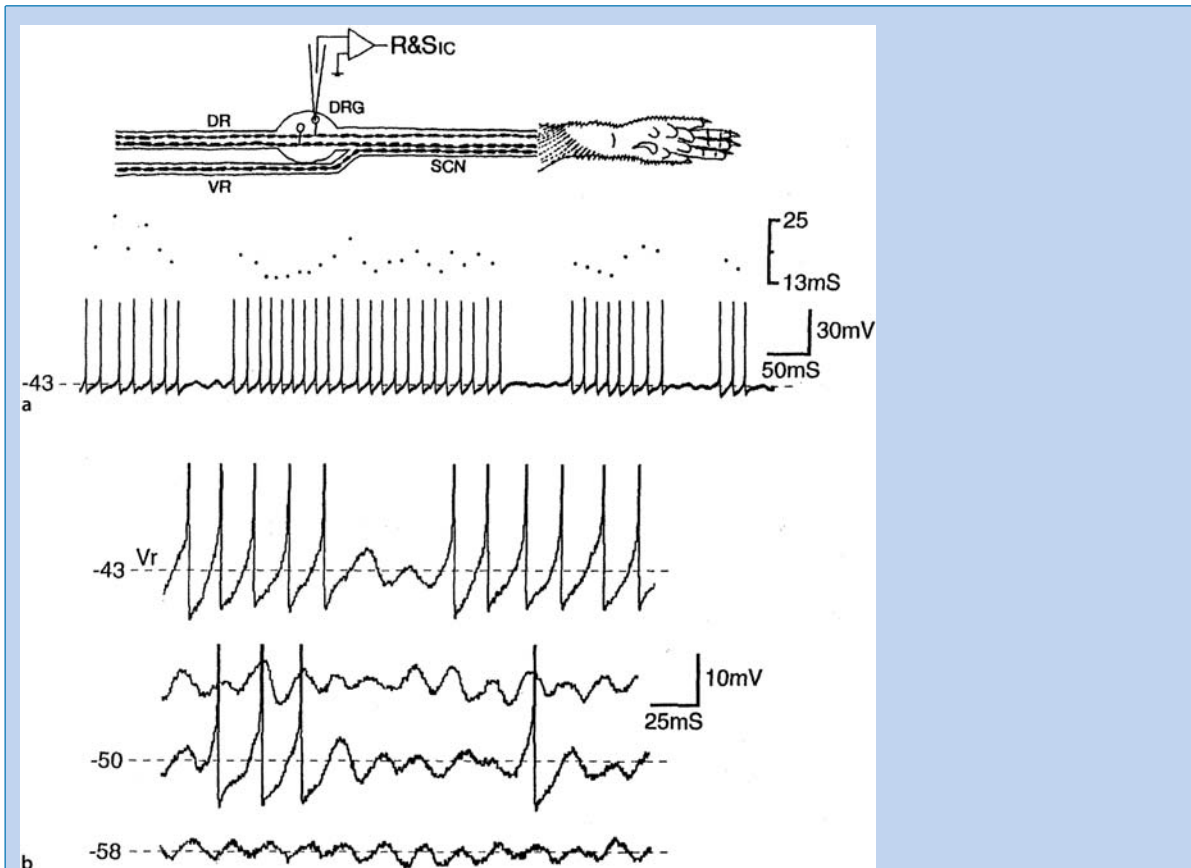
nociceptors, might now be driven by ectopic activity in non-thermal afferents at normal body temperature. Bizarre dysesthetic sensation presumably results from atypical mixtures of afferent drive. Electric shocks, for example, activate all afferent types in a nerve simultaneously. This is probably the type of ectopic activity that underlies electric shock-like paroxysms in neuropathy (Devor et al. 2002) (► [pain paroxysms](#)).

Injury evoked ectopic hyperexcitability is not simply a matter of lowered threshold for repetitive impulse discharge. Rather, it reflects a qualitative change in neuronal phenotype. Most intact sensory neurons are *incapable* of generating sustained impulse discharge in mid-nerve or within sensory ganglia, even in the presence of strong sustained depolarizing stimuli. They are designed to fire exclusively in response to stimuli applied to sensory endings in skin, muscle etc. Neuropathic alterations in gene expression and protein trafficking actually create repetitive firing capability *de novo* at ectopic locations. Repetitive firing capability (“pacemaker capability”) is a result of electrical resonance that emerges in the cell membrane of the injured afferent neurons, and subthreshold oscillations that develop as a result (Amir et al. 1999). Affected neurons become responsive to slow onset and sustained depolarizing stimuli, which previously did not evoke discharge (Fig. 3). Some begin to fire spontaneously at resting membrane potential.

### Pain on Movement and Deep Palpation

Gentle percussion over sites of nerve injury, areas of entrapment or neuromas for example, typically evokes an intense stabbing or electric shock-like sensation. This is the Tinel sign. In the event of injuries that leave the nerve in continuity (e.g. a crush or freeze lesion) a second Tinel may be evoked further distally, at the farthest position reached by regenerating sprouts. This sensory abnormality is due to ectopic mechanosensitivity that develops at sites of nerve injury and demyelination. When pathology is disseminated along a nerve due to dying back and/or sprouting, odd sensations may be evoked by tapping along the entire course of major nerves (e.g. in diabetic neuropathy) (► [tinel sign](#)).

Ectopic mechanosensitivity is also a feature of spinal roots entrapped by stenosis in the spinal canal, the root foramina (“lateral stenosis”) and by herniation of intervertebral disks (► [sciatica](#) ► [thoracic outlet syndrome](#)). This is a major factor in pain evoked on movement, straight leg lifting and deep palpation in a variety of chronic musculoskeletal disorders. For example Kuslich et al. (Kuslich et al. 1991) exposed deep paraspinal tissues in patients with radiculopathy and sciatica pain using local anesthetics applied sequentially to exposed surgical planes. Gentle palpation



**Peripheral Neuropathic Pain, Figure 3** Ectopic burst discharge in neuropathy is driven by subthreshold membrane potential oscillations. (a) shows the experimental setup for intracellular recording from rat DRG and an example of burst discharge with the associated distribution of interspike intervals. (b) illustrates a neuron in which subthreshold oscillations were present at resting membrane potential (-58 mV), but with no spiking. When the cell was gradually depolarized, peaks of oscillatory sinusoids began to trigger ectopic burst discharge.

of exposed nerve root and ganglion sheaths reproduced the patients' usual sciatica pain. Stimulation of other tissues such as muscles, tendons and the annulus fibrosus of intervertebral discs did not do so. Interestingly, momentary mechanical probing of ectopic pacemaker sites frequently evokes discharge that long outlasts the stimulus itself. Such "afterdischarge" is the likely explanation of aftersensations and trigger point pain. Ectopic mechanosensitivity is likely to develop at locations where small nerve branches cross through fascial planes, under tendons or are otherwise at risk of being locally pinched (► [neuropathic pain, joint and muscle origin](#)).

#### Abnormal Response to Other Stimuli

In addition to mechanical force, injured neurons also develop abnormal sensitivity to other depolarizing stimuli. Notable among these are ectopic responses to circulating catecholamines and noradrenalin released from nearby (injured) postganglionic sympathetic axons. Ectopic adenosensitivity of sensory neurons yields sympathetic-sensory coupling, an impor-

tant substrate of sympathetically maintained chronic pain states (SMP). Afferent response to inflammatory mediators such as  $\text{TNF}\alpha$ , IL-1 and prostaglandins is a second example of ectopic chemosensitivity (Watkins and Maier 1999). Abnormal discharge may also arise from temperature changes, ischemia, hypoxia, hypoglycemia and other conditions capable of locally depolarizing afferent neurons at sites at which they have developed local resonance and ectopic pacemaker capability (Devor 2006).

#### Allodynia

Along with spontaneous pain, tactile allodynia is the most irksome sensory abnormality in neuropathy. The simplest explanation is reduced response threshold in nociceptive afferents, the "excitable nociceptor hypothesis". However, there is precious little evidence that fibers that were originally mechano-nociceptors ever come to respond to the very weak tactile stimuli that typically evoke allodynia in animals or patients (see references in Banik and Brennan 2004). Rather, tactile allodynia appears to be an abnormal

sensory response to impulse activity in low threshold mechanosensitive A $\beta$  afferents. A $\beta$  afferents normally signal touch and vibration sense, but in neuropathy (and inflammation) they can evoke A $\beta$  pain (Campbell et al. 1988; Torebjork et al. 1992) due to central sensitization. We must assume that central sensitization also causes ► **ectopic** spontaneous and evoked activity in A $\beta$  fibers to be amplified in the CNS and felt as painful (► **central changes after peripheral nerve injury**).

### Hyperpathia

Although the causes of hyperpathic sensory peculiarities are not known for certain they are probably a result of pathophysiological cross-excitation among injured sensory neurons, coupled with central sensitization. Injured sensory neurons communicate with one another through ► **ephaptic (electrical) coupling** and through a novel non-synaptic, neurotransmitter mediated (paracrine) mechanism, axonal and DRG “cross excitation” (Amir and Devor 1996; Lisney and Devor 1987). Neuron to neuron crosstalk of this sort could account for windup (incremental buildup of the paracrine mediator on repeated stimulation), for hyperpathic spread of sensation from the site of stimulation and for pain paroxysms (Devor et al. 2002) (► **hyperpathia** ► **pain paroxysms**).

### The Relation of PNS Injury to Central Sensitization

Some authors limit use of the term “central sensitization” to functional changes that are dependent on ongoing nociceptive afferent activity and that reverse rapidly when the impulse activity is blocked (Ji et al. 2003). The best-known mechanism of this sort involves the recruitment of NMDA-type glutamate receptors on postsynaptic neurons in the dorsal horn. Other investigators use a broader definition that encompasses all of the many CNS changes that tend to increase spinal gain (amplification), whether or not they are labile or closely linked to impulse traffic. Numerous such changes have been reported, including altered expression and release of neuromodulatory peptides from primary afferent terminals, spinal disinhibition due to loss of inhibitory interneurons containing GABA, glycine, taurine and/or endogenous opiates, altered gene expression and consequent hyperexcitability of intrinsic spinal neurons, denervation supersensitivity, afferent terminal sprouting, release by “activated” microglia and astrocytes of proinflammatory cytokines, up-regulation of postsynaptic transcription factors and transmembrane signaling molecules (e.g. pERK, CREB, MAPK), suppression of brainstem descending inhibition and augmentation of brainstem descending facilitation and others ► **central changes after peripheral nerve injury**; ► **cord glial activation**).

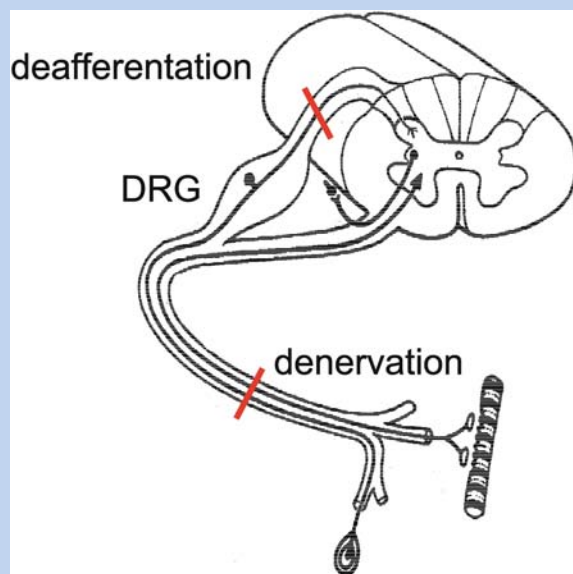
All of these changes are triggered by nerve injury (and some by peripheral inflammation), although in most instances little or nothing is known about the mechanism whereby the injury triggers the central change. There are three fundamental possibilities, 1) depolarization of postsynaptic neurons due to impulse traffic *per se*, 2) other actions of neuroactive substances released within the spinal cord by impulse traffic (e.g. changes in postsynaptic receptors or metabotropic signaling) and 3) trophic interactions between primary afferents and dorsal horn neurons, linked to impulse activity or independent of it.

In healthy animals and people, when central sensitization is induced by acute noxious stimuli, the neuroactive substances responsible for the CNS change are present in and released from nociceptive C fibers (and perhaps A $\delta$  fibers) and are surely specific to these afferent types. Activity in A $\beta$  afferents, no matter how intense, does not normally induce central sensitization or trigger pain. However, at least in the early stages of neuropathic pain in animal models, almost all of the ectopic firing present is in A $\beta$  afferents (Liu et al. 2000). How, then, does the neuropathy induce central sensitization? One explanation that has been proposed is that central sensitization in neuropathy is a result of ectopic spontaneous discharge that emerges, albeit at extremely low firing rates, in C fibers that have not been injured directly, but that share peripheral nerve trunks and peripheral tissues with the damaged and degenerating injured afferents (Wu et al. 2001). Another source of nociceptor input is the small number of injured C- (and A $\delta$ ) fibers that do develop ectopia soon after transection. Finally, it is possible that, in the presence of chronic inflammation and neuropathy, A $\beta$  afferents *acquire* the ability to trigger central sensitization even though they are not normally able to do so. Specifically, this might occur when inflamed or axotomized A $\beta$  afferents begin to synthesize and release neuroactive substances (e.g. substance P, NPY, BDNF) that are normally present only in nociceptors. These are the very mediators that are thought to trigger central sensitization upon C-fiber activation (Devor 2006; Malcangio et al. 2000; Molander et al. 1994). If so, ectopic activity in A $\beta$  afferents could play two roles in neuropathic pain, 1) triggering and maintaining a central hyperexcitability state and 2) providing normal and ectopic input for central amplification.

### Deafferentation Pain

In the context of PNS-triggered CNS changes, it is important to compare the frequently confused terms “neurectomy” and “► **deafferentation**” Nerve injury denervates peripheral tissue, but in adults most DRG cell somata survive for quite a long time (Tandrup et al. 2000) and impulses generated in the nerve end and

DRG continue to be able to activate the CNS (Wall and Devor 1981) and to evoke sensory experience (Tinel sign). Deafferentation (by dorsal rhizotomy or ganglionectomy), in contrast, causes the degeneration of central terminals of sensory neurons so that electrical stimulation of corresponding nerves no longer activates dorsal horn neurons (Fig. 4). A distinctive darkening of central terminals visible in electron micrographs of nerve injured animals, inappropriately termed “degeneration atrophy” (Knyihar-Csillik et al. 1989), has led some observers to presume that peripheral axotomy is equivalent to deafferentation by rhizotomy. This is clearly incorrect (Bailey and Ribeiro-Da-Silva 2006).



**Peripheral Neuropathic Pain, Figure 4** The distinction between “deafferentation” and “denervation”. Dorsal rhizotomy prevents all peripheral impulse traffic from entering the spinal cord along the affected spinal segment. The cord has been deafferented. Transecting peripheral nerves disconnects the spinal cord from peripherally innervated tissues, but it does not prevent impulses that originate ectopically at the nerve injury site or the associated DRGs from entering the cord.

Both neurectomy and deafferentation can trigger neuropathic pain, but while minor nerve injury sometimes produces devastating pain, modest or diffuse deafferentation does not. C2 dorsal root ganglionectomy, for example, is frequently performed for the relief of severe headache without provoking deafferentation pain and multi-segmental partial dorsal rhizotomy is routinely performed for relief of painful spasticity in children with cerebral palsy (Sindou et al. 1986; White and Sweet 1969). Since nerve injury does not normally cause massive retrograde cell death, deafferentation probably does not contribute substantially to pain in most peripheral neuropathies. Possible exceptions are late stage postherpetic neuralgia and tabes dorsalis.

Like central pain, the mechanism(s) of deafferentation pain is almost entirely unknown. Commonly offered explanations are “denervation supersensitivity” and release from inhibition, both processes that fit under the umbrella of central sensitization (► [brachial plexus avulsion and dorsal root entry zone](#)).

### Treatment Modalities

Impressive progress in understanding peripheral neuropathic pain mechanisms has not yet been translated into improved therapeutic agents. The problem is not a dearth of drug targets but the massive investment required to vet each one. However, we do have a better idea as to why certain empirically effective treatment modalities work.

### Systemic Drugs

The first line analgesics with proven efficacy in the relief of neuropathic pain include (certain) anticonvulsants, tricyclic antidepressants, (systemic) local anesthetics and (certain) antiarrhythmics (McQuay and Moore 1998). As the names imply these drugs are “adjuvants”, not developed as pain relievers. On the face of it they appear to fit into highly diverse drug families, but there is a common denominator. All of these drugs are “membrane stabilizers”; they reduce membrane excitability and hence suppress ectopic neural discharge (Catterall 1987). Not all anticonvulsants are effective. The ones that are, e.g. carbamazepine, lamotrigine and gabapentin, act on ion channels and suppress ectopia. In contrast, anticonvulsants that act by synaptic modulation (e.g. barbiturates and benzodiazepines) are ineffective. Likewise for antidepressants. Tricyclics, which are powerful  $\text{Na}^+$  channel blockers in addition to affecting catecholamine reuptake, are effective. SSRIs (selective serotonin reuptake inhibitors), in contrast, are ineffective. Corticosteroids are also membrane stabilizers. Suppression of ectopia originating in the PNS reduces abnormal afferent drive as well as reversing central sensitization and hence tactile allodynia. It kills two birds with one stone. The efficacy of each of these drugs in a broad range of neuropathic pain diagnoses is a strong argument that, despite clinical diversity, these conditions share a common neural mechanism, ectopic hyperexcitability.

Unfortunately, the effectiveness of the adjuvant drugs is usually limited by the presence of intolerable side effects, sedation, vertigo and nausea. Just as they suppress the firing properties of afferent neurons, they also alter firing patterns of neurons in the brain. Indeed, a component of their very efficacy as analgesics could be due to suppression of discharge in CNS pain transmission neurons (Woolf and Wiesenfeld-Hallin 1985). But assuming that much of the desired analgesic action is in the PNS and the unwanted side effects are



due to CNS actions, the dose limiting side effect profile might be overcome. Potential approaches include targeted delivery *via* indwelling catheters, molecular targeting to PNS specific receptors or reduction of permeation through the blood-brain barrier while preserving PNS activity.

Attempts are also being made to develop drugs that suppress central sensitization directly. A popular drug target is the NMDA-type glutamate receptor. Unfortunately, these centrally acting drugs also tend to have unwanted central side effects. But since their primary site of action is in the CNS, novel approaches will be needed to obtain selectivity. Opioid analgesics, which act within the CNS by suppressing already amplified pain signals, are no longer viewed as ineffective in neuropathy (Rowbotham et al. 2003). However, in addition to their well-known liabilities, many experienced clinicians still believe that, dose for dose, they are less effective for neuropathic pain than for nociceptive or inflammatory pain of equivalent intensity. The same holds true for simple pain relievers such as aspirin and other NSAIDs, acetaminophen (paracetamol) and COX2 inhibitors.

Cutaneous allodynia requires responsive A $\beta$  afferents. In addition, during the early stages of dying back, part of the afferent drive that maintains central sensitization may derive from nociceptor endings that are still in the skin. Therefore, topical application of local anesthetics or of drugs that desensitize nociceptor endings (notably capsaicin) can be effective. Nerve and plexus conduction blocks are also effective, as is spinal (foraminal, epidural or intrathecal) block using a variety of agents including local anesthetics, opiates, Ca<sup>2+</sup> channel blockers, adrenergic agents and partial neurolysis. These interventional approaches are technically demanding and carry risk, however, and sustaining the block over time is difficult. In practice, these methods are mostly used *in extremis*. Physical modalities such as TENS (transcutaneous electrical nerve stimulation) and spinal cord stimulation (SCS) are often used with the intent of recruiting endogenous pain control mechanisms. To the extent that these modalities work, the effect is paradoxical. TENS and SCS preferentially activate A $\beta$  fibers. In patients with tactile allodynia, this ought to provoke pain, not relieve it! Finally, surgical procedures may sometimes be used to reduce neural irritation and promote recovery. Examples are the release of a nerve from entrapping connective tissue (e.g. at the carpal tunnel) ([► ulceration, prevention by nerve decompression](#)) or by microvascular decompression in trigeminal neuralgia ([► tic and cranial neuralgias](#)). Surgery in selected patients can also reduce mechanical stimulation of ectopic pacemaker sites, for example, mobilization of a stump neuroma to a location less likely to be subject to mechan-

ical compression during weight bearing ([► neuroma pain](#)).

### Transition to Chronicity

There is a long held belief that unrelieved pain can “burn” itself into the CNS (pain “centralization”) just as over eons a torrential river can gouge a canyon in solid rock. The presumption is that persistent pain, *per se*, induces a change in biological pain mechanisms rendering treatment by conventional analgesic modalities ineffective (Kalso 1997). This belief probably arose from anecdotes related by amputees of pains felt in the limb prior to amputation persisting in the phantom. More recently the idea of centralization has become associated with pain in CRPS1 (RSD) on the grounds that patients with chronic CRPS1 are so difficult to treat.

As laid out above, neural trauma and disease can induce permanent CNS changes that contribute to chronic pain. However, the concept that pain alone can do the same thing, in the absence of nerve pathology, should be regarded with skepticism for several reasons. First, amputees relate similar anecdotes concerning the continued presence of rings, bunions and other non-painful features of the limb prior to amputation. Dysesthesias resulting from nerve injury induced ectopia can be misinterpreted as persisting sensory experience. Second, centralization is not evident in situations where an obvious peripheral source of pain is present, for example labor pain or pain from a kidney stone or an arthritic hip. These pains vanish without a trace when the peripheral noxious source is ultimately removed by delivery, passage of the stone or joint replacement. Where pain, *per se*, can cause permanent mischief is by inducing a downward spiral of psychosocial deterioration and financial distress in the chronic pain sufferer.

### Perspective

Chronic neuropathic pain constitutes a significant burden for the sufferer, his/her family, carers, employers and society at large. Whereas a generation ago very little was known about its underlying causes, this is no longer the case. A biological basis is now in place for understanding the problem at the systems, cellular and molecular levels. The new knowledge has not yet been translated into more effective treatment modalities. However, numerous promising targets and strategies have been identified in recent years and they will inevitably pay off in the form of better therapeutic options in the future.

### References

1. Amir R, Devor M (1996) Chemically-mediated cross-excitation in rat dorsal root ganglia. *J Neurosci* 16:4733–4741

2. Amir R, Michaelis M, Devor M (1999) Membrane potential oscillations in dorsal root ganglion neurons: role in normal electrogenesis and in neuropathic pain. *J Neurosci* 19:8589–8596
3. Bailey AL, Ribeiro-Da-Silva A (2006) Transient loss of terminals from non-peptidergic nociceptive fibers in the substantia gelatinosa of spinal cord following chronic constriction injury of the sciatic nerve. *Neuroscience* 138:675–690
4. Banik RK, Brennan TJ (2004) Spontaneous discharge and increased heat sensitivity of rat C-fiber nociceptors are present in vitro after plantar incision. *Pain* 112:204–13
5. Boucher TJ, McMahon SB (2001) Neurotrophic factors and neuropathic pain. *Curr Opin Pharmacol* 1:66–72
6. Bouhassira D, Attal N, Fermanian J et al. (2004) Development and validation of the Neuropathic Pain Symptom Inventory. *Pain* 108:248–57
7. Campbell JN, Raja SN, Meyer RA et al. (1988) Myelinated afferents signal the hyperalgesia associated with nerve injury. *Pain* 32:89–94
8. Catterall WA (1987) Common modes of drug action on Na<sup>+</sup> channels: local anaesthetics, antiarrhythmics and anticonvulsants. *Trends Pharmacol Sci* 8:57–65
9. Costigan M, Befort K, Karchewski L et al. (2002) Replicate high-density rat genome oligonucleotide microarrays reveal hundreds of regulated genes in the dorsal root ganglion after peripheral nerve injury. *BMC Neurosci* 3:16–28
10. Devor M (2005) Response of nerves to injury in relation to neuropathic pain. In: McMahon SL, Koltzenburg M (eds) *Wall and Melzack's Textbook of Pain*, 5th edn. Churchill Livingstone, London
11. Devor M, Keller CH, Deerinck T et al. (1989) Na<sup>+</sup> channel accumulation on axolemma of afferents in nerve end neuromas in *Apterionotus*. *Neurosci Lett* 102:149–154
12. Devor M, Govrin-Lippmann R, Angelides K (1993) Na<sup>+</sup> channel immuno-localization in peripheral mammalian axons and changes following nerve injury and neuroma formation. *J Neurosci* 13:1976–1992
13. Devor M, Amir R, Rappaport ZH (2002) Pathophysiology of trigeminal neuralgia: the ignition hypothesis. *Clin J Pain* 18:413
14. Freeman R (2005) Autonomic peripheral neuropathy. *Lancet* 365:1259–70
15. Gold MS, Reichling DB, Shuster MJ et al. (1996) Hyperalgesic agents increase a tetrodotoxin-resistant Na<sup>+</sup> current in nociceptors. *Proc Natl Acad Sci* 93:1108–1112
16. Ji RR, Kohno T, Moore KA et al. (2003) Central sensitization and LTP: do pain and memory share similar mechanisms? *Trends Neurosci* 26:696–705
17. Kalso E (1997) Prevention of chronicity. In: Jensen TS, Turner JA, Wiesenfeld-Hallin ZA (eds) *Proceedings of the 8th World Congress on Pain*. Progress in Pain Research and Management, vol 8. IASP Press, Seattle, pp 215–230
18. Knyihar-Csillik E, Rakic P, Csillik B (1989) Transneuronal degeneration atrophy in the Rolando substance of the primate spinal cord evoked by axotomy-induced transganglionic degenerative atrophy of central primary sensory terminals. *Cell Tissue Res* 258:515–525
19. Kocsis JD, Devor M (2000) Altered excitability of large diameter cutaneous afferents following nerve injury: consequences for chronic pain. In: Devor M, Rowbotham MC, Wiesenfeld-Hallin ZA (eds) *Proceedings of the 9th World Congress on Pain*. Progress in Pain Research and Management, vol 16. IASP Press, Seattle
20. Kuslich S, Ulstro C, Michael C (1991) The tissue origin of low back pain and sciatica. *Orth Clin North Amer* 22:181–187
21. Li M, West JW, Lai Y et al. (1992) Functional modulation of brain sodium channels by cAMP-dependent phosphorylation. *Neuron* 8:1151–1159
22. Lisney SJW, Devor M (1987) Afterdischarge and interactions among fibers in damaged peripheral nerve in the rat. *Brain Res* 415:122–136
23. Liu X, Eschenfelder S, Blenk K-H et al. (2000) Spontaneous activity of axotomized afferent neurons after L5 spinal nerve injury in rats. *Pain* 84:309–318
24. Malcangio M, Ramer MS, Jones MG et al. (2000) Abnormal substance P release from the spinal cord following injury to primary sensory neurons. *Eur J Neurosci* 12:397–9
25. McQuay M, Moore (1998) *An Evidence-based Resource for Pain Relief*. Oxford University Press, Oxford, p 264
26. Merskey H, Bogduk N (1994) *Classification of Chronic Pain. Descriptions of Chronic Pain Syndromes and Definitions of Pain Terms*. IASP Press, Seattle, pp 40–43
27. Mogil JS (2004) *The Genetics of Pain*. Progress in Pain Research and Management, vol 28. IASP Press, Seattle, p 349
28. Molander C, Hongpaisan J, Persson JK (1994) Distribution of c-fos expressing dorsal horn neurons after electrical stimulation of low threshold sensory fibers in the chronically injured sciatic nerve. *Brain Res* 644:74–82
29. Nordin M, Nystrom B, Wallin U et al. (1984) Ectopic sensory discharges and paresthesiae in patients with disorders of peripheral nerves, dorsal roots and dorsal columns. *Pain* 20:231–245
30. Rowbotham MC, Twilling L, Davies PS et al. (2003) Oral opioid therapy for chronic peripheral and central neuropathic pain. *N Engl J Med* 348:1223–32
31. Sindou M, Mifsud JJ, Boisson D et al. (1986) Selective posterior rhizotomy in the dorsal root entry zone for treatment of hyperspasticity and pain in the hemiplegic upper limb. *Neurosurgery* 18:587–95
32. Tandrup T, Woolf CJ, Coggeshall RE (2000) Delayed loss of small dorsal root ganglion cells after transection of the rat sciatic nerve. *J Comp Neurol* 422:172–180
33. Tessler MJ, Kleiman SJ (1994) Spinal anaesthesia for patients with previous lower limb amputations. *Anaesthesia* 49:439–441
34. Torebjork H, Lundberg L, LaMotte R (1992) Central changes in processing of mechanoreceptive input in capsaicin-induced secondary hyperalgesia in humans. *J Physiol (Lond)* 448:765–780
35. Verdugo RJ, Bell LA, Campero M et al. (2004) Spectrum of cutaneous hyperalgesias/allodynia in neuropathic pain patients. *Acta Neurol Scand* 110:368–76
36. Wall P, Devor M (1981) The effect of peripheral nerve injury on dorsal root potentials and on the transmission of afferent signals into the spinal cord. *Brain Res* 209:95–111
37. Watkins LR, Maier SF (1999) *Cytokines and Pain*. Springer-Verlag Telos
38. White J, Sweet W (1969) *Pain and the Neurosurgeon*. Thomas, Springfield, pp 123–256, p 93
39. Woolf CJ, Wiesenfeld-Hallin Z (1985) The systemic administration of local anaesthetics produces a selective depression of C-afferent fibre evoked activity in the spinal cord. *Pain* 23:361–374
40. Wu G, Ringkamp M, Hartke TV et al. (2001) Early onset of spontaneous activity in uninjured C-fiber nociceptors after injury to neighboring nerve fibers. *J Neurosci* 21:RC140 1–5
41. Xiao HS, Huang QH, Zhang FX et al. (2002) Identification of gene expression profile of dorsal root ganglion in the rat peripheral axotomy model of neuropathic pain. *Proc Natl Acad Sci USA* 99:8360–8365

## Peripheral Opioid Receptors (OR)

### Definition

In addition to the central nervous system, three types of opioid receptors ( $\mu$  and  $\kappa$ ) are expressed in peripheral sensory neurons. Their activation by locally applied opioid agonists results in appropriate signal transduction and subsequent inhibition of the generation and transmission of painful stimuli. Thus, they are all functionally involved in opioid analgesia.

- ▶ Opioids and Inflammatory Pain

## Peripheral Sensitization

### Definition

Inflammatory mediators, intense, repeated, or prolonged noxious stimulation, or both, can increase the excitability of nociceptors. The sensitized nociceptors exhibit a lowered threshold for activation, increased responsiveness to a given stimulus, enlargement of the receptive fields and an increased rate of firing. Sleeping or silent nociceptors, usually not responsive to any stimulus or only responsive to stimuli with a very intense strength, get responsive and react like polymodal nociceptors. Many different mediators, including histamine or bradykinin as well as agents not traditionally considered to be mediators but released during inflammation (like  $H^+$  ions), can cause sensitization of nociceptors.

- ▶ Arthritis Model, Kaolin-Carrageenan Induced Arthritis (Knee)
- ▶ Cancer Pain, Animal Models
- ▶ Cytokines, Effects on Nociceptors
- ▶ Metabotropic Glutamate Receptors in Spinal Nociceptive Processing
- ▶ Nick Model of Cutaneous Pain and Hyperalgesia
- ▶ Spinothalamic Tract Neurons, Role of Nitric Oxide

## Peripheral Sensitization in Muscle and Joint

- ▶ Sensitization of Muscular and Articular Nociceptors

## Peripheral Vascular Disease

### Definition

A clinical syndrome of ischemia of the extremities leading to spontaneous or exercise related pain in the extremities, often treated by bypass surgery and rarely by spinal cord stimulation.

- ▶ Pain Treatment, Spinal Cord Stimulation
- ▶ Sciatica

## Periphery of the Ventral Posterior Complex (VPP)

### Definition

A region surrounding VPL and VPM. Neurons in this region are small, and many respond to noxious stimuli. The region includes VPI.

- ▶ Thalamus, Nociceptive Cells in VPI, Cat and Rat

## Perireceptor Elements

ANA GOMIS

Instituto de Neurociencias de Alicante, Universidad Miguel Hernandez-CSIC, San Juan de Alicante, Spain  
agomis@umh.es

### Synonyms

Perireceptor Events; Peripheral Modulation of Nociceptors; Nociceptors, Perireceptor Elements

### Definition

Elements or events interposed between the stimulus and the sensor element involved in the stimulus- ▶ [sensory receptor](#) coupling process. These structures may act as filters for the stimulating energy, modulating the transmission of mechanical forces or the accessibility of chemicals to the transducing area of the receptor membrane.

### Characteristics

▶ [Sensory transduction](#) takes place in specialized portions of sensory receptor cells that differ from each other in their ability to respond preferentially to a particular form of energy. The primary transducer or detector is the place where transformation of the stimulus into an electrical signal begins and corresponds to a molecular entity, located in the cell membrane that is modified by the stimulus. These include receptor molecules for chemicals, mechanosensitive transduction channels, and transduction molecules for thermal energy, etc. The detector is usually linked to perireceptor structures that convey the stimulus to the detector, and/or modify some of its characteristics.

A classical example of the participation of perireceptor elements in chemical transduction is provided by the mucus surrounding chemoreceptor cells in the olfactory system. There, chemical signals, ▶ [odorant](#) or ▶ [pheromones](#), are perceived by highly specialized sensory cells, the olfactory receptor cells. In contrast to aquatic animals that smell water-soluble odorants, terrestrial animals smell small volatile lipophilic

molecules; these molecules must pass through an aqueous medium (mucus, sensillum lymph) in order to reach the chemosensory membrane of the receptor neurons. Rheological properties of the mucus, i.e. diffusion parameters, viscosity, mucociliary transport, are major determinants of odorant access. Moreover, the mucus contains several different kinds of odorant-binding proteins that probably assist in the delivery of some odorants to the receptor proteins, or in their subsequent removal. After diffusion through the mucus, the odors bind to one of a large family of odorant receptor proteins (Buck and Axel 1991).

In mechanoreceptor cells, receptor molecules located in the transducing region of the membrane are sensitive to mechanical forces. Mammals have several types of morphologically distinct cells that sense mechanical signals, such as hair cells of the ► [cochlea](#) or mechanosensory neurons in ► [sensory ganglia](#). Some of these cells may have structures around the transducing area that play an essential role in modulating the receptor response. This is the case in accessory cells in the ► [Merkel receptor](#), ► [Ruffini receptor](#), ► [Meissner receptor](#) or Pacinian receptor endings. For example, in the Pacinian corpuscle, the nerve ending is surrounded by a gelatinous structure formed from plasma membrane, wrapped round and round the nerve much like the layers of an onion. Pressure applied to the corpuscle pushes on the layers of this structure and is ultimately detected by the membrane of the nerve, located deep within. The many layers of membrane wrapped around the nerve act as a viscoelastic filter, so that sustained pressure is transmitted to the transducing membrane as brief and transient deformation at the onset and the end of the stimulus.

Additionally, many mechanosensory cells have distinctive cytoskeletal structures including microtubules, cilia or actin-based filament bundles (Sukharev and Corey 2004), as well as extracellular features associated with the supposed sites of transduction. Evidence from genetics and electrophysiological studies has suggested that mechanotransduction takes place in a mechanosensory complex, formed by an ion channel coupled to extracellular and cytoskeletal proteins, and with modulating proteins (Du H et al. 1996; Walker et al. 2000). Thus, proteins in the mechanosensory complex transferring mechanical energy to the ion channel also act, in some extent, as perireceptor elements.

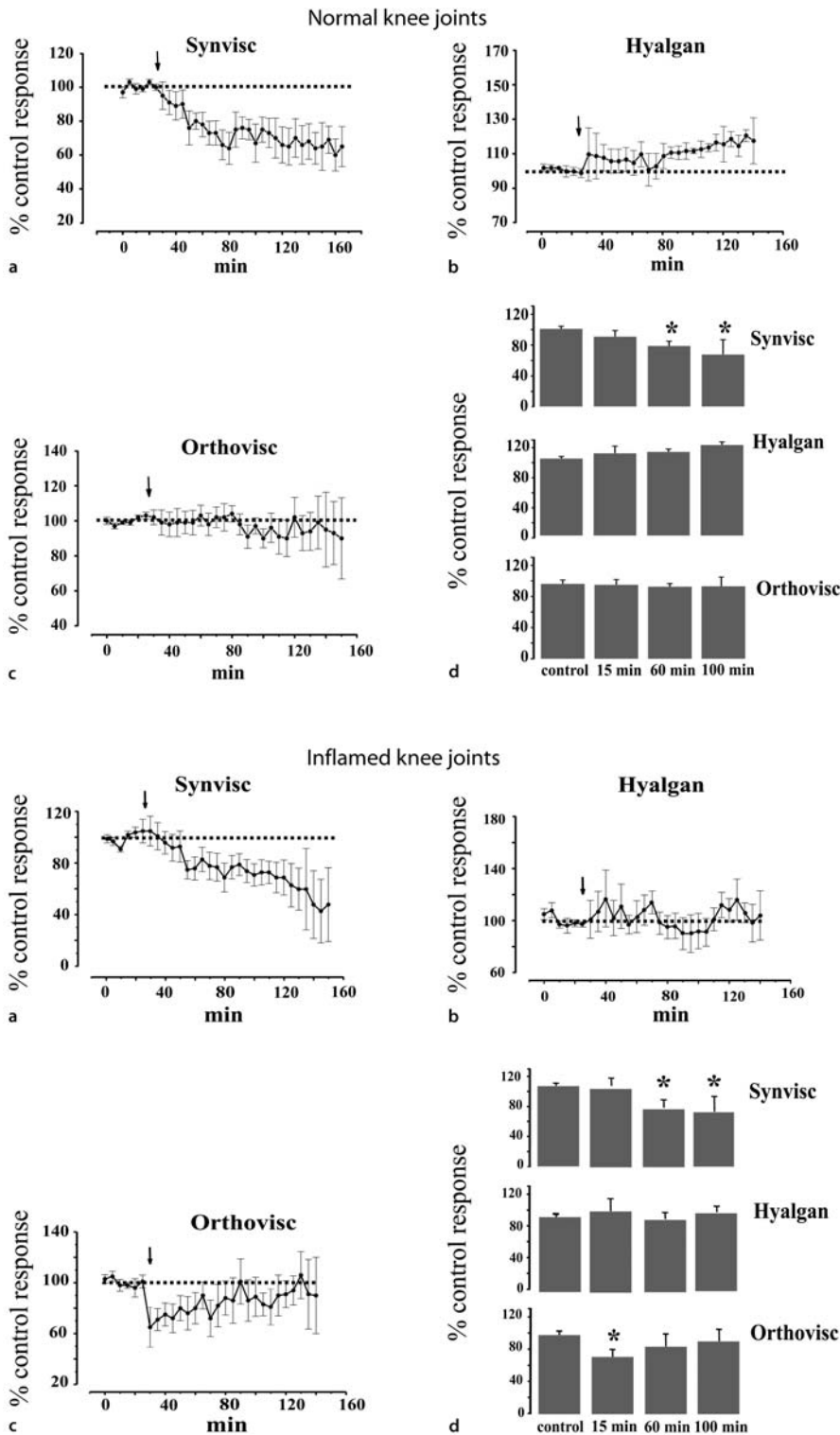
In nociceptive endings, the influence of perireceptor events in the transmission and modulation of the stimulus is largely ignored. Nociceptors are naked nerve terminals embedded in an intercellular matrix that contains collagen fibrils and proteoglycans. In contrast with low threshold mechanoreceptors, they are devoid of specialized structures that would act as filters for the transmission of mechanical forces to the receptive sites (Zelena 1994). Receptor sites in nociceptive terminals appear to be discontinuous patches of bare ► [axolemma](#), which are separated from the adjacent tissue only by the

► [basal lamina](#) of the nerve fibre. Thus, the receptive plasma membrane seems to be particularly exposed to the direct action of stimuli. However, the role played by collagenous fibrils and viscous intercellular matrix surrounding nociceptive nerve endings, and by proteins of the mechanosensory apparatus in the modulation of noxious stimuli, is still undefined. Genetics screens for mutations in *Drosophila* revealed *painless*, a member of the TRPA (ankyrin-repeat transient ► [receptor potential](#)) subfamily of TRP channels. *Painless* is required for both thermal and mechanical nociception, but not for sensing light touch (Tracey et al. 2003). Indeed, the closest vertebrate homolog of *painless*, ANKTM1 (also known as TRPA1), is expressed in a subset of pain sensing neurons of the mouse (Story et al. 2003). These channels and associated proteins could be candidates for pain transduction molecules.

As mentioned above, it has been speculated that ► [viscoelastic elements](#) in the extracellular compartment and in the cytoskeletal domain of the receptor membrane play a role in the transmission of force, the determination of sensitivity, and the adaptation properties of mechanosensory channels (Hamill and McBride 1996). Therefore, the possibility exists that the viscoelastic characteristics of the extracellular matrix influence the functional behaviour of mechanosensory channels in nociceptors. Another relevant property of nociceptor terminals, i.e. their sensitivity to exogenous and endogenous chemical agents, may be equally influenced by pericellular mechanisms that are also incompletely known. As was the case for the transmission of mechanical forces, the extracellular matrix located around nociceptive endings may modify the effect of chemicals by interfering with the diffusion and/or the accessibility of molecules to the membrane surface.

Joint nociceptors are an example of the modulation of impulse activity by extracellular perireceptor elements. In joints, hyaluronic acid, a ► [glycosaminoglycan](#) that fills the intercellular space between the collagen fibrillar network surrounding the cells, vessels, and neural elements of the solid tissues of the joint, has been proposed to act as an elastoviscous buffer, reducing the transmission of mechanical stretch to the transducing membrane of nerve endings (Balazs 1982). In favour of this possibility is the observation that spontaneous and movement-evoked nerve impulse activity of joint nociceptors decreases in normal and inflamed joints after intra-articular injection of an elastoviscous solution of sodium hyaluronan (Pozo et al. 1997). The same inhibition was obtained with this substance in osteoarthritic pain in humans (Balazs and Denlinger 1984). In contrast, injection of non-elastoviscous solutions of low-molecular mass hyaluronan did not cause a decrease of joint nociceptor activity in the cat or of joint pain in humans (Pozo et al. 1997). Moreover, high molecular weight hyaluronan solutions were more effective than lower molecular weight hyaluronan so-



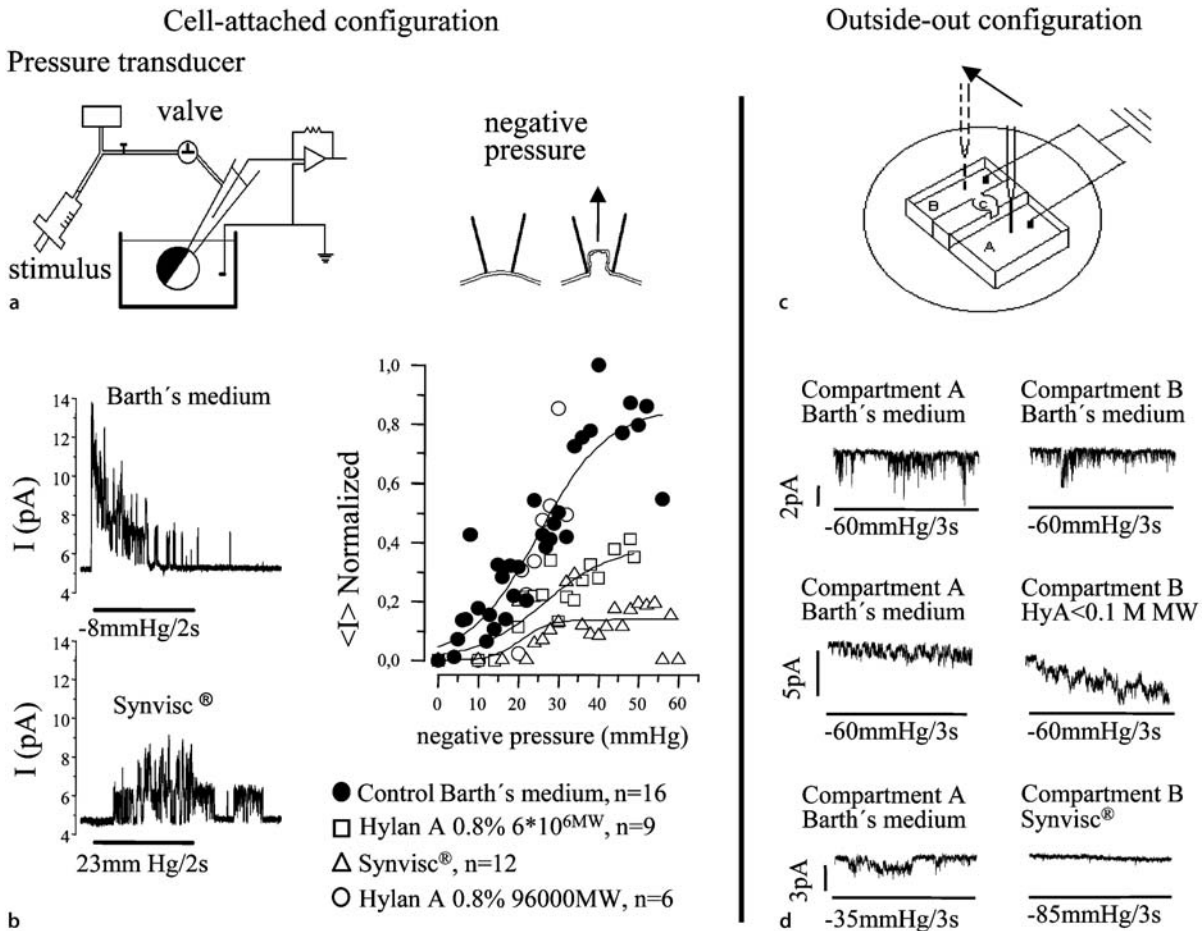


**Perireceptor Elements, Figure 1** Effects of the elastoviscous solutions (as indicated on the graphs) on the movement-evoked impulse activity of fine primary afferents innervating normal and inflamed knee joints. The graphs in (a, b, c) display the averaged total number of evoked impulses of primary afferent units over the period of time shown on the abscissa and expressed as the mean  $\pm$  SEM percent of the average control responses. The arrows indicate the time when the test substance was injected into the knee joint. (d) Mean evoked impulse activity under control conditions and at different times after the injection of the test substances is expressed as percentages of the control response, which was taken as 100%. Each column is the average of three consecutive recordings taken before the designated times. \*Indicates significance at  $P < 0.05$ ; vertical bars are SEM.

P

lutions in reducing the mean impulse frequency of movement-evoked discharges in pain nerve fibres, in both intact and acutely inflamed (arthritic) knee joints of the rat (Gomis et al. 2004) (Fig. 1). Hyaluronan acts as an elastoviscous filter for the transmission of force

to mechanosensory channels in the cell membrane of *Xenopus Laevis* oocytes “*in vitro*”. There, elastoviscous solutions of high molecular weight reduced the response to membrane stretch of native mechanosensory channels in whole oocytes (cell-attached recording) and



**Perireceptor Elements, Figure 2** (a) Cell attached configuration. A whole oocyte immersed in the solution. (b) Left panel, one example of currents recorded in control conditions and in presence of Synvisc. Right panel, Normalized averaged current against negative pressure applied in different conditions. (c) Recording chamber for excised patches. (d) Examples of currents from excised patches exposed to control solution or hylans with different elastoviscosity.

in isolated membrane patches (outside out), while non-elastoviscous solutions were without effect (de la Peña et al. 2002) (Fig. 2).

Thus, it is possible that hyaluronan, normally present in the surroundings of nociceptive nerve terminals, acts as a perireceptor element for the modulation of the tension transmitted to mechanosensory channels in nociceptor endings of the joints and perhaps also in other tissues. Additionally, glycosaminoglycans and proteoglycans that are bound to the plasma membrane of nerve terminals and extend into the extracellular space may modify the surface charge, and limit, by electrostatic binding, the diffusion of molecules such as ► **inflammatory mediators** to nociceptive nerve endings. Moreover, because their ability to bind significant amounts of  $\text{Ca}^{2+}$ , glycosaminoglycans may also act as an ionic buffer for this ion (Fukami 1986). Recent work (Gomis et al. 2005) has shown in the median articular nerve of guinea pig knee that the enhanced nerve impulse activity observed 24 hours and seven days after surgical partial meniscectomy, plus the transection of the lateral cruciate liga-

ment, was significantly reduced by highly elastoviscous sodium hyaluronan but also by its degraded, low molecular form, suggesting that this molecule acted not only as a mechanical filter, but also as a chemical buffer for inflammatory mediators. Still, the nature and the influence of perireceptor mechanisms in the modulation of sensory transduction in peripheral nociceptors remain to be defined.

## References

- Balazs EA (1982) The Physical Properties of Synovial Fluid and the Special Role of Hyaluronic Acid. In: Helfet AJ (ed) Disorders of the Knee. Lippincott Co, Philadelphia, pp 61–74
- Balazs EA, Denlinger JL (1984) The Role of Hyaluronic Acid in Arthritis and its Therapeutic Use. In: Peyron JC (ed) Osteoarthritis: Current Clinical and Fundamental Problems. Ciba Geigy, Paris, pp 165–174
- Buck L, Axel R (1991) A Novel Multigene Family May Encode Odorant Receptors: A Molecular Basis for Odor Recognition. *Cell* 65:175–187
- De la Peña E, Sala S, Rovira JC et al. (2002) Elastoviscous Substances with Analgesic Effects on Joint Pain Reduce Stretch-Activated Ion Channels Activity *In Vitro*. *Pain* 99:501–508

5. Du H, Gu G, William CM et al. (1996) Extracellular Proteins Needed for *C. Elegans* Mechanosensation. *Neuron* 16:183–94
6. Fukami Y (1986) Studies of Capsule and Capsular Space of Cat Muscle Spindles. *J Physiol* 376:281–297
7. Gomis A, Pawlak M, Balazs EA et al. (2004) Effects of different molecular weight elastoviscous hyaluronan solutions on articular nociceptive afferents. *Arthritis Rheum* 50:314–326
8. Hamill OP, McBride DW Jr (1996) A Supramolecular Complex Underlying Touch Sensitivity. *Trends Neurosci* 19:258–261
9. Pozo MA, Balazs EA, Belmonte C (1997) Reduction of Sensory Responses to Passive Movements of Inflamed Knee Joints by Hylan, a Hyaluronan Derivative. *Exp Brain Res* 116:3–9
10. Story GM, Peier AM, Reeve AJ et al. (2003) ANKTM1, a TRP-Like Channel Expressed in Nociceptive Neurons, is Activated by Cold Temperatures. *Cell* 112:819–829
11. Sukharev S, Corey DP (2004) Mechanosensitive Channels: Multiplicity of Families and Gating Paradigms. *Sci STKE* 219:re4
12. Tracey WD Jr, Wilson RI, Laurent G et al. (2003) Painless, a *Drosophila* Gene Essential for Nociception. *Cell* 113:261–273
13. Walker RG, Willingham AT, Zuker CS (2000) *Drosophila* Mechanosensory Transduction Channel. *Science* 287:2229–2234
14. Zelena J (1994) Nerves and Mechanoreceptors. Chapman & Hall, London

## Perireceptor Events

- ▶ Perireceptor Elements

## Perispinal Infusions

- ▶ Epidural Infusions in Acute Pain

## Periventricular Gray

### Definition

A gray matter structure at the most medial and posterior and inferior aspect of the wall of the third ventricle, just anterior to the iter of the aqueduct.

- ▶ Deep Brain Stimulation

## Permanent Partial Disability

- ▶ Impairment Rating, Ambiguity
- ▶ Impairment Rating, Ambiguity, IAIABC System

## Permanent Partial Impairment

- ▶ Impairment Rating, Ambiguity
- ▶ Impairment Rating, Ambiguity, IAIABC System

## Permanent Restrictions

### Definition

Activities or job tasks that an injured worker should never perform again.

- ▶ Pain in the Workplace, Risk Factors for Chronicity, Job Demands

## Persistent Acute Pain

- ▶ Postoperative Pain, Acute-Recurrent Pain

## Persistent Pain and Descending Modulation

- ▶ Descending Modulation and Persistent Pain

## Persisting Pain

- ▶ Acute Pain, Subacute Pain and Chronic Pain

P

## Person

### Definition

A person is any human being with the possibility of self-awareness, which does not necessarily have to be actual, but can even be potential, as in the case of premature babies and severely ill patients.

- ▶ Ethics of Pain in the Newborn Human

## Personal Characteristics

### Definition

A client's internal context that influences work productivity. Examples are: coping style and coping behavior related to workmates and managers, self-reliance related to occupational performance, perception of self-efficacy, orientation to life and internal strength, work interests, attitudes to being at work or not, working life and life in general, fear and avoidance of performing occupations due to pain, state of depressive symptoms.

- ▶ Vocational Counselling

## Personal Factors

### Definition

Personal factors are the particular background of an individual's life and living, and comprise features of the individual that are not part of a health condition or health states.

► [Disability and Impairment Definitions](#)

## Personality

► [Pain in the Workplace, Risk Factors for Chronicity, Psychosocial Factors](#)

## Personality and Pain

JENNIFER A. HAYTHORNTHWAITE  
Johns Hopkins University, Baltimore, MD, USA  
jhaytho1@jhmi.edu

### Synonyms

Trait; Temperament; individual difference; Disposition

### Definition

A dynamic system of behavioral, cognitive, emotional, and/or interpersonal processes that interact with situational characteristics and show consistency over time and situations.

### Characteristics

Individuals come to the experience of pain, either acute or chronic, with personality characteristics – habitual styles of interpreting and responding to internal and external experiences – that influence the response to pain and adaptation when pain becomes chronic. Early work in the study of pain proposed a “pain-prone personality,” the idea that certain personality traits caused pain and pain-related disability. With increasing knowledge of the factors that are involved in the experience of pain, this early premise has grown in complexity and subtlety, and evolved to conceptualize certain personality characteristics as vulnerabilities to respond to pain with certain affective, behavioral, cognitive and interpersonal processes that promote the chronicity of pain or pain-related disability. One of the most useful conceptual models for understanding the role of personality in pain is the “diathesis-stress” model (Dersh et al. 2002). In this model, certain personality dimensions are “diatheses” – risk factors or vulnerabilities – that influence how the individual responds to the “stress” of pain. For example, an individual who experiences distress in the form of somatic symptoms – headaches

or stomach aches – may respond to the stress of pain with hypervigilance and preoccupation with the pain. Such a response may inhibit certain coping strategies such as distraction, leading to prolonged pain and increased risk of disability. Alternatively, an individual prone to experience negative moods, and prone to perceived threats, may respond to the stress of pain with ► [catastrophizing](#) thoughts about its meaning and impact (Goubert et al. 2004).

Modern personality theory attempts to synthesize *dispositional* approaches, which focus on fixed, stable traits that have broad impact across situations, with *process* approaches, which focus on cognitive/emotional/behavioral/social processes that are activated by situations (Mischel and Shoda 1998). These newer approaches to personality, referred to as a cognitive-affective processing system, focus on mental experiences that are characteristically activated in distinctive patterns by specific internal and external experiences. This model nicely complements the diathesis-stress model, providing a framework for integrating the extensive information available about cognitive processes involved in the experience of pain and pain-related disability. For example, recent work identifying personality dimensions that activate cognitive processes in response to pain, (Goubert et al. 2004) is consistent with this newer work on personality that emphasizes *stable if. . . then* behavioral responses to situations (Mischel and Shoda 1998).

Although an explicit assumption of this model is that personality precedes the experience of pain, most studies measure personality after the individual has already experienced pain. Since extensive work with the Minnesota Multiphasic Personality Inventory (MMPI) indicates that the experience of pain can influence the measurement of personality (Vendrig 2000), caution is warranted in interpreting many of the studies of personality factors and pain. Examples of important personality risk factors for pain include somatization, neuroticism or negative affectivity, and anxiety sensitivity, each of which is reviewed below. These personality dimensions are to be distinguished from personality disorders such as psychopathology, which are reviewed separately.

### Hypochondriasis and Somatization

Hypochondriasis is a personality dimension characterized by preoccupation with the fear that one has a serious illness, despite medical reassurance. Somatization is a personality dimension characterized by preoccupation with bodily sensations as expressions of distress, which is often expressed as illness behavior in the form of interrupting daily activities because of symptoms, or seeking treatment for these symptoms. Both hypochondriasis and somatization are characterized by preoccupation with symptoms that are typically minor, and both involve somatic amplification – sensitivity to or magnification of everyday



somatic experiences. Somatization, which is more frequently studied in chronic pain, increases risk of developing chronic pain (Dersh et al. 2002), contributes to the chronicity of low back pain (Pincus et al. 2002), in part explains the high rates of psychological distress and depression that occur when people develop chronic pain (McBeth et al. 2002), and influences healthcare use and outcome following treatment (Dersh et al. 2002).

### Neuroticism or Negative Affectivity

Neuroticism is a personality dimension characterized by the propensity to experience negative emotions such as anxiety, depression and irritability. Individuals high on neuroticism are hypervigilant to threatening internal and external cues, and report greater negative mood, greater distress in response to stressful experiences, more somatic complaints, and poorer health. Some data indicate a correlation between neuroticism and reports of pain, although a detailed analysis of this relationship suggests that neuroticism is related to ratings of pain unpleasantness, more so than pain intensity (Wade et al. 1992). In the context of chronic pain, neuroticism as a personality diathesis influences cognitive appraisals of pain and coping with pain, as well as reports of mood (Affleck et al. 1992). In particular, neuroticism activates catastrophizing and fearful concerns about injury, thereby lowering the threshold for perceiving pain as threatening (Goubert et al. 2004).

### Anxiety Sensitivity

Anxiety sensitivity is a personality dimension characterized by the fear that anxiety symptoms – e.g. rapid heart rate – signal danger or illness – e.g. an impending heart attack (i.e. fear of fear). The role of anxiety in determining adaptation to pain, both acute and chronic, has stimulated interest in understanding personality vulnerabilities that increase risk for pain-related anxiety, fear of pain, and the resulting escape and avoidance responses often observed in highly fearful individuals. Anxiety sensitivity is a personality diathesis that predisposes individuals to experience pain-related anxiety and fear of pain (Asmundson et al. 1999), and negative mood more generally (Hadjistavropoulos et al. 2004). Individuals high in anxiety sensitivity also report greater pain in both laboratory and clinical settings, and greater avoidance of pain-inducing activities and disability (Vlaeyen and Linton 2000).

### Personality Disorders and Psychopathology

#### Personality Disorders

Personality disorders, including paranoid, obsessive-compulsive, borderline, avoidant, and passive-aggressive personality, are more common in patients with chronic pain than in the general population or in other medical populations (Dersh et al. 2002). Given that much of the research on this topic measures individuals who

are seeking treatment for chronic pain that has not responded to multiple treatments, the known higher rates of psychiatric co-morbidity among patients seeking care for chronic painful conditions suggests caution in interpreting any causal relationship between personality disorder and the development of chronic pain. Although personality disorders are inconsistently related to outcome of treatment, the presence of a personality disorder does predict other important outcomes, such as return to work following an acute back pain episode (Gatchel et al. 1995). The presence of a personality disorder, particularly borderline disorder, can complicate treatment and may require special intervention (Weisberg 2000).

### MMPI

Early work with the MMPI attempted to distinguish between organic and psychogenic pain, an effort that has not been pursued in recent years as a result of increased knowledge of the complexities of emotional, cognitive, behavioral, and social factors that influence the expression of pain. The MMPI has been used to predict various outcomes, ranging from which personality type will develop pain to which type will respond, or not respond, to treatment, primarily in back pain (Vendrig 2000). Although no consistent scale profile predicts outcome of multidisciplinary treatment, scores on hypochondriasis (scale 1) predict outcome of surgery, and scores on hysteria (scale 3), indicating naiveté and general malaise, predict the development of back pain or disability following back pain. While these findings are informative on an epidemiological level, the MMPI remains most useful as a clinical tool to understand the individual's personality in a clinical setting in which such information will aid in planning treatment (Vendrig 2000), such as when patients are referred for psychological evaluation prior to back surgery (Epker and Block 2001).

### Summary

Individuals arrive at the experience of pain with important differences in temperament, chronic mood, and skills which activate cognitive, affective, behavioral, and interpersonal responses to pain. These processes in turn influence the experience of pain, and can contribute to the persistence of pain and pain-related disability. Newer approaches to personality also integrate newer approaches to information processing that integrate affective tone (Mischel and Shoda 1998), and extensive work on information processing in people with chronic pain demonstrates a complex interplay between cognitive predispositions that are activated by environmental stimuli (Pincus and Morley 2001).

### References

1. Affleck G, Tennen H, Urrows S, Higgins P (1992) Neuroticism and the Pain-Mood Relation in Rheumatoid Arthritis: Insights from a Perspective Daily Study. *J Consult Clin Psychol* 60:119–126

2. Asmundson GJ, Norton PJ, Veloso F (1999) Anxiety Sensitivity and Fear of Pain in Patients with Recurring Headaches. *Behav Res Ther* 37:703–713
3. Dersh J, Polatin PB, Gatchel RJ (2002) Chronic Pain and Psychopathology: Research Findings and Theoretical Considerations. *Psychosom Med* 64:773–786
4. Epker J, Block AR (2001) Presurgical Psychological Screening in Back Pain Patients: A Review. *Clin J Pain* 17:200–205
5. Gatchel RJ, Polatin PB, Kinney RK (1995) Predicting Outcome of Chronic Back Pain Using Clinical Predictors of Psychopathology: A Prospective Analysis. *Health Psychol* 14:415–420
6. Goubert L, Crombez G, Van Damme S (2004) The Role of Neuroticism, Pain Catastrophizing and Pain-Related Fear in Vigilance to Pain: A Structural Equations Approach. *Pain* 107:234–241
7. Hadjistavropoulos HD, Asmundson GJ, Kowalyk KM (2004) Measures of Anxiety: Is There a Difference in their Ability to Predict Functioning at Three-Month Follow-Up Among Pain Patients? *Eur J Pain* 8:1–11
8. McBeth J, Macfarlane GJ, Silman AJ (2002) Does Chronic Pain Predict Future Psychological Distress? *Pain* 96:239–245
9. Mischel W, Shoda Y (1998) Reconciling Processing Dynamics and Personality Dispositions. *Annu Rev Psychol* 49:229–58
10. Pincus T, Burton AK, Vogel S, Field AP (2002) A Systematic Review of Psychological Factors as Predictors of Chronicity/Disability in Prospective Cohorts of Low Back Pain. *Spine* 27:E109–E120
11. Pincus T, Morley S (2001) Cognitive-Processing Bias in Chronic Pain: A Review and Integration. *Psychol Bull* 127: 599–617
12. Vendrig AA (2000) The Minnesota Multiphasic Personality Inventory and Chronic Pain: A Conceptual Analysis of a Long-Standing but Complicated Relationship. *Clin Psychol Rev* 20:533–559
13. Vlaeyen JW, Linton SJ (2000) Fear-Avoidance and its Consequences in Chronic Musculoskeletal Pain: A State of the Art. *Pain* 85:317–332
14. Wade JB, Dougherty LM, Hart RP, Rafii A, Price DD (1992) A Canonical Correlation Analysis of the Influence of Neuroticism and Extraversion on Chronic Pain, Suffering, and Pain Behavior. *Pain* 51:67–73
15. Weisberg JN (2000) Personality and Personality Disorders in Chronic Pain. *Curr Rev Pain* 4:60–70

## Personality Disorder

### Definition

A pervasive well-established pattern of thinking and behavior that leads to distress for the individual and/or dysfunctional interpersonal relationships.

► [Pain as a Cause of Psychiatric Illness](#)

## Personality Disorders and Pain

MICHAEL R. BOND

University of Glasgow, Glasgow, UK  
m.bond@admin.gla.ac.uk

### Synonym

Psychosocial Maladjustment and Pain

### Definition

1. Personality disorder is characterised by personality traits that are pervasive, inflexible and maladaptive.

They cause significant functional impairment and/or subjective distress.

2. Personality disorder is an enduring pattern of inner experience and behaviour that deviates from the expectations of the individual's culture.
3. The onset of personality disorder occurs in adolescence or early adult life. The disorders are stable over time.
4. There are ten types of personality disorder, each of which has specific diagnostic criteria (DSM-IV-TR, 2000). Examples include paranoid, schizoid, antisocial, borderline, histrionic, dependent and narcissistic.

### Characteristics

A study of 200 individuals with chronic low back pain by Polatin et al. (1993) revealed that at some time in their lives, 54% of the subjects had suffered from a major depressive disorder, 94% had a history of substance abuse and 95% a history of anxiety disorder. At the time of assessment, 59% had at least one psychiatric disorder, most often depression, but also substance abuse and/or an anxiety disorder. The criteria for a personality disorder were met by 51% of the population studied, a surprisingly high figure. However, recent studies have not detected particular combinations of abnormal personality characteristics that give rise to greater vulnerability to chronic pain and disability. Fyer et al. (1988) reported that the presence of antisocial, borderline and paranoid personality disorders as co-diagnoses in pain patients was associated with a poorer prognosis for recovery and a higher relapse rate than amongst individuals in pain but without personality disorders. Weisburg and Keefe (1997) reported that the presence of pathological personality traits is associated with reduced ability to cope with pain, a longer period in pain for any given condition, interference with treatment and a poorer prognosis. It is clear, therefore, that both personality disorders and major psychiatric illnesses increase vulnerability to major stresses and are associated with greater levels of pain and disability, a longer duration of symptoms and a poorer response to treatment. Finally, the presence of pain, especially chronic pain, intensifies the severity of pre-existing personality traits.

### References

1. American Psychiatric Association (2000) *Diagnostic and Statistical Manual of Mental Disorders, 4th Revision. DSM-IV-TR*. American Psychiatric Association, Washington DC
2. Fyer MR, Francis AJ, Sullivan T et al. (1988) Comorbidity of Borderline Personality Disorder. *Arch Gen Psychiatry* 45:348–352
3. Polatin PB, Kinney RK, Gatchel RA et al. (1993) Psychiatric Illness and Chronic Low Back Pain. *Spine* 18:66–71
4. Weisburg JN, Keefe FJ (1997) Personality Disorders in the Chronic Pain Population: Basic Concepts, Empirical Findings and Clinical Implications. *Pain Forum* 6:1–9

## Personally-Relevant Stressful Situations

### Definition

These are stress situations that are personally unique and meaningful compared to general stressors such as painful stimulation or mental arithmetic.

- ▶ Respondent Conditioning of Chronic Pain

## Persuasion

### Definition

The use of techniques such as information provision or argument in order to influence an individual's standing on a particular issue.

- ▶ Psychology of Pain, Self-Efficacy

## PES

- ▶ TENS, Mechanisms of Action

## PET

- ▶ Positron Emission Tomography

## PET and fMRI Imaging in Parietal Cortex (SI, SII, Inferior Parietal Cortex BA40)

MARIE-CLAIRE ALBANESE<sup>1</sup>, GARY DUNCAN<sup>2</sup>

<sup>1</sup>Department of Psychology, McGill University, Montreal, QC, Canada

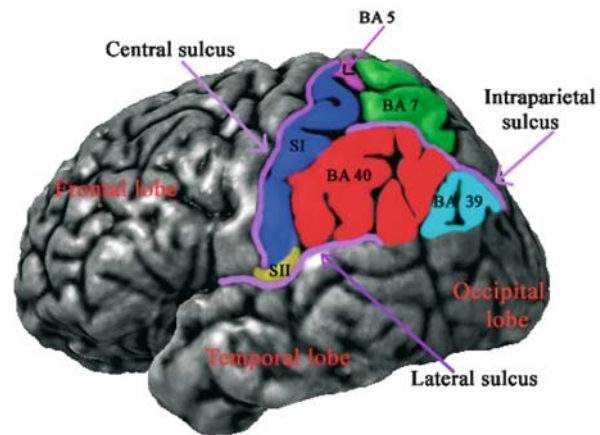
<sup>2</sup>Département de Stomatologie, Médecine dentaire et Centre de recherche en sciences neurologiques, Université of Montreal, Montreal, QC, Canada  
mclaire@bic.mni.mcgill.ca,  
gary.duncan@umontreal.ca

### Synonyms

Parietal Cortex, PET and fMRI Imaging; fMRI Imaging and PET in Parietal Cortex

### Definition

Parietal cortex approximates the superior middle third of the ▶ [cerebral cortex](#), occupying a portion of the two



**PET and fMRI Imaging in Parietal Cortex (SI, SII, Inferior Parietal Cortex BA40), Figure 1** Schematic depiction of the lateral surface of the [left] cerebral hemisphere, which is subdivided into four lobes: frontal, parietal, temporal and occipital. The central sulcus forms the anterior border of the parietal lobe, and the lateral sulcus makes the delineation between the parietal and temporal lobes. The parietal lobe is comprised of several anatomical areas, namely the primary somatosensory cortex (SI), the secondary somatosensory cortex (SII), the superior lobule (Brodmann areas (BA) 5 and 7), and the inferior parietal lobule (BA 39 and 40).

▶ [hemispheres](#) situated below the crown of the head. The parietal cortex is positioned in front of the occipital lobe and behind the frontal lobe. The human parietal cortex can be subdivided into the postcentral and posterior parietal regions; the postcentral gyrus contains the primary ▶ [somatosensory](#) cortex or SI (Brodmann areas 3, 1 and 2), while the posterior parietal region is made up of the superior (Brodmann areas 5 and 7) and inferior parietal lobules (Brodmann areas 39 and 40), which are separated by the intraparietal sulcus (Fig. 1). Medial and underneath the parietal cortex, in the superior bank of the lateral sulcus, lies the parietal operculum, defined functionally as the secondary somatosensory cortex or SII.

### Characteristics

Brain imaging studies, using positron emission tomography (PET) or functional magnetic resonance imaging (fMRI), have consistently revealed activation in the parietal cortex following the presentation of noxious stimuli. A number of well-controlled studies now indicate that this parietal activity is directly associated with the human perception of acute experimental pain, regardless of the stimulus modality. For example, painful cutaneous thermal stimuli (Chen et al. 2002; Coghill et al. 2001; Coghill et al. 2003; Strigo et al. 2003; Talbot et al. 1991), visceral stimuli (Strigo et al. 2003; Verne et al. 2003) and transcutaneous electrical nerve stimuli (Downar et al. 2003) reliably activate a common network of brain areas in the parietal lobe ▶ [contralateral](#) to the side of the stimulation. These parietal cortex regions (SI, SII and inferior parietal lobule) appear to be preferentially related to the sensory-discriminative aspects of painful stimuli, such as quality, intensity, spatial and temporal charac-

teristics, rather than to affective aspects of pain such as pain unpleasantness (Hofbauer et al. 2001; Rainville et al. 1997) or empathy for pain (Singer et al. 2004). Additional evidence for the importance of the parietal cortex in the processing of the intensity and location of painful stimuli comes from the case report of a patient who suffered an ischemic lesion to the right SI and SII; consequent to this lesion, this patient was unable to perceive the intensity of painful heat stimuli applied to the left hand, but complained that the stimuli were “clearly unpleasant” (Ploner et al. 1999).

In addition to the generally observed pain-related parietal activity contralateral to the area of the skin receiving the noxious stimulation, Coghill et al. (2001) recently demonstrated that the right inferior parietal cortex (Brodmann area 40) was activated following cutaneous thermal pain, regardless of which arm received the noxious stimulation. This kind of functional lateralization in the right posterior parietal cortex is also important for the influence of attention on somatosensory processing. In fact, unilateral neglect, in which patients are not aware of the left side of their body or somatosensory stimuli applied to it, results only from a lesion in this area of the right hemisphere; a lesion of the homologous area of the left parietal lobe never results in unilateral neglect of either side of the body.

A similar network of cortical regions appears to be involved in the conscious experience of abnormal pain sensitivity, such as mechanical **▶ allodynia** – a symptom of **▶ neuropathic pain**. Experimental mechanical allodynia can be elicited in healthy human subjects by gently stroking with a soft brush an area of skin that has been pretreated with topical or **▶ intradermal** injection of **▶ capsaicin**. Using such models, brush-evoked allodynia has been associated with activation in contralateral SI, SII and Brodmann area 40 of the inferior parietal cortex (Maihöfner et al. 2004), as well as ipsilateral SII (Iadarola et al. 1998; Maihöfner et al. 2004) and ipsilateral inferior parietal cortex (Iadarola et al. 1998).

Patients who suffer from chronic pain conditions, such as fibromyalgia and chronic low back pain (CLBP), show more extensive patterns of activation in the parietal cortex. For example, Giesecke et al. (2004) showed, in a recent fMRI study of experimental pressure pain, that fibromyalgia and CLBP patients exhibited a more elevated level of activation in contralateral SI and bilateral SII concomitant with a higher level of reported pain, compared to that observed in the control group of healthy subjects. It also appears that post-stroke central chronic pain is associated with decreased binding sites for endogenous opioids in contralateral SII and inferior parietal cortices (Willoch et al. 2004), which is consistent with the hypothesis that endogenous opioids take part in the inhibition of neural circuits subserving pain perception. Therefore, this lowered number of opioid binding sites in regions of the parietal cortex, which are directly involved in the sensory-discriminative aspects of

pain, may contribute to sustained levels of pain associated with stroke.

In conclusion, functional neuroimaging data acquired with either **▶ PET** or **▶ fMRI** demonstrate that regions within the parietal cortex take part in processing the sensory-discriminative aspects of painful stimuli. Converging evidence from studies of healthy subjects involving either experimental pain or experimental models of chronic pain, as well as studies of chronic pain patients, suggests that activation in contralateral SI, SII and inferior parietal cortices plays a large role in the conscious experience of pain.

## References

1. Bushnell MC, Duncan GH, Hofbauer RK et al. (1999) Pain perception: is there a role for primary somatosensory cortex? *Proc Natl Acad Sci USA* 96:7705–7709
2. Chen JI, Ha B, Bushnell MC et al. (2002) Differentiating noxious- and innocuous-related activation of human somatosensory cortices using temporal analysis of fMRI. *J Neurophysiol* 88:464–474
3. Coghill RC, Gilron I, Iadarola MJ (2001) Hemispheric lateralization of somatosensory processing. *J Neurophysiol* 85:2602–2612
4. Coghill RC, McHaffie JG, Yen YF (2003) Neural correlates of interindividual differences in the subjective experience of pain. *Proc Natl Acad Sci USA* 100:8538–8542
5. Downar J, Mikulis DJ, Davis KD (2003) Neural correlates of the prolonged salience of painful stimulation. *Neuroimage* 20:1540–1551
6. Giesecke T, Gracely RH, Grant MA et al. (2004) Evidence of augmented central pain processing in idiopathic chronic low back pain. *Arthritis Rheum* 50:613–623
7. Hofbauer RK, Rainville P, Duncan GH et al. (2001) Cortical representation of the sensory dimension of pain. *J Neurophysiol* 86: 402–411
8. Iadarola MJ, Berman KF, Zeffiro TA et al. (1998) Neural activation during acute capsaicin-evoked pain and allodynia assessed with PET. *Brain* 121:931–947
9. Maihöfner C, Schmelz M, Forster C et al. (2004) Neural activation during experimental allodynia: a functional magnetic resonance imaging study. *Eur J Neurosci* 19:3211–3218
10. Ploner M, Freund HJ, Schnitzler A (1999) Pain affect without pain sensation in a patient with a postcentral lesion. *Pain* 81:211–214
11. Rainville P, Duncan GH, Price DD et al. (1997) Pain affect encoded in human anterior cingulate but not somatosensory cortex. *Science* 277:968–971
12. Singer T, Seymour B, O’Doherty J et al. (2004) Empathy for pain involves the affective but not sensory components of pain. *Science* 303:1157–1162
13. Strigo IA, Duncan GH, Boivin M, Bushnell MC (2003) Differentiation of visceral and cutaneous pain in the human brain. *J Neurophysiol* 89:3294–3303
14. Talbot JD, Marrett S, Evans AC et al. (1991) Multiple representations of pain in human cerebral cortex. *Science* 251:1355–1358
15. Verne GN, Himes NC, Robinson ME et al. (2003) Central representation of visceral and cutaneous hypersensitivity in the irritable bowel syndrome. *Pain* 103:99–110
16. Willoch F, Schindler F, Wester HJ et al. (2004) Central poststroke pain and reduced opioid receptor binding within pain processing circuitries: a [<sup>11</sup>C]diprenorphine PET study. *Pain* 108:213–220

## Petrissage

### ▶ Massage and Pain Relief Prospects



## PGE2

### Definition

PGE<sub>2</sub> is one of many lipid mediators that are formed both by neurons and pro-inflammatory cells following activation of PLA2. Prostaglandins activate a number of G-protein coupled receptors. Subsequent phosphorylation of ligand and voltage gated channels leads to enhanced nociceptor excitability.

- ▶ [Nociceptors in the Orofacial Region \(Skin/Mucosa\)](#)

## PGHS

- ▶ [COX-1 and COX-2 in Pain](#)
- ▶ [NSAIDs, Mode of Action](#)

## PGH-Synthase

- ▶ [NSAIDs, COX-Independent Actions](#)

## PHA-L

### Definition

Phaseolus vulgaris leucoagglutinin. A protein of the lectin group extracted from the red bean, which has a high affinity for the soma of neurons and migrates in an axonal anterograde (orthodromic) direction. It produces Golgi-like labeling of the axonal projections

- ▶ [Parabrachial Hypothalamic and Amygdaloid Projections](#)

## Phantom Limb Pain, Treatment

HERTA FLOR<sup>1</sup>, RALF BARON<sup>2</sup>

<sup>1</sup>Department of Clinical and Cognitive Neuroscience at the University of Heidelberg, Central Institute of Mental Health, Mannheim, Germany

<sup>2</sup>Department of Neurological Pain Research and Therapy, Neurological Clinic, Christian Albrechts University Kiel, Kiel, Germany

flor@as200.zi-mannheim.de,

r.baron@neurologie.uni-kiel.de

### Synonyms

Treatment of Phantom Pain; Treatment of Neuropathic Pain

### Definition

▶ [Phantom limb pain](#) or phantom pain is defined as pain in a body part that is no longer present. It may be related to a certain position or movement of the phantom, and may be elicited or exacerbated by a range of physical (e.g. changes in weather or pressure on the residual limb) and psychological factors (e.g. emotional stress). It seems to be more intense in the distal portions of the phantom, and may have a number of different qualities such as stabbing, throbbing, burning, or cramping. Phantom limb pain is often confused with pain in the area adjacent to the amputated body part. This phenomenon is referred to as ▶ [residual limb pain](#) or stump pain and is usually positively correlated with phantom limb pain. In addition, ▶ [postamputation pain](#) at the site of the wound must be distinguished from pain in the residual limb and phantom limb pain, which may all co-occur in the early phase after amputation. Finally, it may be useful to assess acute and chronic ▶ [preamputation pain](#), which was found to be related to the incidence, type and severity of phantom limb pain in the phase following amputation. Phantom limb pain is commonly classified as neuropathic pain, and is assumed to be related to damage of peripheral neurons. Although phantom limb pain is more common after the amputation of an arm or leg, it may also occur after the surgical removal of other body parts such as a breast, the rectum, the penis, the testicles, an eye, the tongue or the teeth. Both peripheral and central factors have been discussed as determinants of phantom limb pain. Psychological factors do not seem to contribute to the aetiology of the problem, but may rather affect the course and the severity of the pain. The general view today is that of multiple changes along the neuraxis contributing to the experience of phantom limb pain.

### Characteristics

Several studies, including large surveys of amputees, have shown that most treatments for phantom limb pain are ineffective and fail to consider the mechanisms underlying the production of the pain (Flor 2002; Sherman 1997; Sindrup and Jensen 1999). Most studies are uncontrolled short-term assessments of small samples of phantom limb pain patients. The maximum benefit reported from a host of treatments such as local anaesthesia, sympathectomy, dorsal root entry zone lesions, cordotomy and rhizotomy, neuro-stimulation methods, or pharmacological interventions such as anticonvulsants, barbiturates, antidepressants, neuroleptics and muscle relaxants seems to be around 30% (Sherman 1997). This does not exceed the placebo effect reported in other studies. Table 1 summarizes treatments currently available for phantom limb pain, and indicates to what extent controlled studies have been performed.

Pharmacological interventions include a host of agents, and although tricyclic antidepressants and sodium chan-

**Phantom Limb Pain, Treatment, Table 1** Commonly employed treatments for phantom limb pain (+ denotes that at least one controlled study with a positive effect of phantom limb pain is available, - denotes that a controlled study with no effect on phantom pain is available)

Pharmacological	Surgical	Anesthesiological	Psychological	Other
Conventional Analgesics	Stump revision	Nerve blocks	EMG biofeedback	TENS+
Opioids+	Neurectomy	Epidural blockade	Temperature biofeedback	Acupuncture
Calcitonin+	Sympathectomy	Sympathetic block	Cognitive-behavioural pain management	Physical therapy
Beta-blockers	Rhizotomy	Local anaesthesia	Sensory discrimination training +	Ultrasound
Neuroleptics	Cordotomy	Lidocaine +	Hypnosis	Manipulation
Anticonvulsives:	Tractotomy		Mirror training	Prosthesis training
Gabapentin +	Dorsal column stimulation			
NMDA-receptor antagonists:	Deep brain stimulation			
- ketamine +				
- dextromethorphan +				
- memantine -				
Antidepressants:				
Amitriptyline -				
Barbiturates				
Muscle relaxants				

nel blockers have been indicated as treatments of choice for neuropathic pain (Sindrup and Jensen 1999), there is only one controlled study for phantom limb pain regarding antidepressants. The study involved patients with phantom limb and residual limb pain and found no support for the efficacy of amitriptyline (Robinson et al. 2002). Controlled studies have also been performed for opioids (Huse et al. 2001; Wu et al. 2002), calcitonin (Jaeger and Maier 1992), ketamine (Nikolajsen et al. 1996), dextromethorphan (Abraham et al. 2003) and gabapentin (Bone et al. 2002), all of which were found to effectively reduce phantom limb pain. Memantine, also an NMDA receptor antagonist like ketamine was, however, not effective (e.g. Maier et al. 2003), although animal studies suggest that ► [cortical reorganization](#) can be prevented and reversed by the use of NMDA receptor antagonists or GABA agonists. In one controlled study, ► [transcutaneous electrical nerve stimulation](#) (TENS) yielded a small effect on phantom limb pain (Katz and Melzack 1991).

Mechanism-based treatments are rare but have been shown to be effective in a few small but mostly uncontrolled studies. Lidocaine was found to reduce the phantom limb pain of patients with neuromas in two controlled studies (e.g. Chabal et al. 1992). ► [Biofeedback](#) (see also ► [biofeedback in the treatment of pain](#)) treatments resulting in vasodilatation of the residual limb, or decreased muscle tension in the residual limb, helped to reduce phantom limb pain and seemed promising in patients where peripheral factors contributed to the pain (Sherman 1997). Based on the findings from neuroelectric and neuromagnetic source imaging, changes in cortical reorganization might influence phantom limb pain. Animal work on stimulation-induced plasticity would suggest that extensive behaviourally relevant (but not passive) stimulation of a body part leads to an expansion of its representation zone. Thus, the use of a myoelectric prosthesis might be one method to

influence phantom limb pain. It was shown that intensive use of a myoelectric prosthesis was positively correlated with both reduced phantom limb pain and reduced cortical reorganization (Lotze et al. 1999). When cortical reorganization was partialled out, the relationship between prosthesis use and reduced phantom limb pain was no longer significant suggesting that cortical reorganization mediates this relationship. An alternative approach in patients where prosthesis use is not viable is the application of behaviourally relevant stimulation. A two-week training that consisted of a ► [sensory discrimination](#) training of electric stimuli to the stump for two hours per day led to significant improvements in phantom limb pain and a significant reversal of cortical reorganization (e.g. Flor et al. 2001). A control group of patients who received standard medical treatment and general psychological counselling in this time period did not show similar changes in cortical reorganization and phantom limb pain. The basic idea of the treatment was to provide input into the amputation zone, and thus undo the reorganizational changes that occurred subsequent to the amputation. Ramachandran et al. (1996), who employed a virtual reality box to train patients to move the phantom limb and reduce phantom limb pain, described another behaviourally oriented approach. A mirror was placed in a box and the patients inserted both his or her intact arm and the phantom. The patient was then asked to look at the mirror image of the intact arm, which is perceived as an intact hand where the phantom used to be. The patients are then asked to make symmetric movements with both hands, thus suggesting real movement from the lost arm to the brain. This procedure seems to re-establish control over the phantom and to reduce phantom limb pain in some patients, although controlled data for phantom limb pain are lacking. In summary, controlled trials of effective treatment of phantom limb pain are rare.

Treatments that have been shown to be effective in controlled trials include opioids, calcitonin, ketamine, dextromethorphan, gabapentin, TENS and sensory discrimination training. Uncontrolled studies have reported the reduction of phantom limb pain by the use of lidocaine, biofeedback, prosthesis training, as well as motor cortex stimulation. Due to the paucity of controlled studies, it seems reasonable to base the treatment of phantom pain on recommendations for neuropathic pain in general, such as antidepressant medication other than tricyclics and calcium channel modulators including gabapentin. In addition, opioids, calcitonin, ketamine, dextromethorphan, TENS or sensory discrimination training might be applied.

### Prevention of Phantom Limb Pain

Katz and Melzack (1990) emphasized that there are somatosensory pain memories that may be revived after an amputation and lead to phantom limb pain. They have also noted that implicit and explicit memory components can be differentiated, both of which contribute to the experience of phantom limbs and phantom limb pain. They therefore suggested that both memory components needed to be targeted in pre-emptive analgesic trials destined to prevent the onset of phantom limb pain, i.e. that both general and spinal anaesthesia were needed.

Pre-emptive analgesia refers to the attempt to prevent chronic pain by early intervention before acute pain occurs, e.g. before and during surgery. Based on the data on sensitisation of spinal neurons by afferent barrage, it has been suggested that general anaesthesia should be complemented by peripheral anaesthesia, thus preventing peripheral nociceptive input from reaching the spinal cord and higher centres. However, pre-emptive analgesia that included both general and spinal anaesthesia has not consistently been efficacious in preventing the onset of phantom limb pain (for a review see Jensen and Nikolajsen 1999). Whereas several studies reported a reduction of the incidence of phantom limb pain when additional epidural anaesthesia was used in the pre- and perioperative stage, one well-controlled study failed to find a beneficial effect on phantom limb pain (Nikolajsen et al. 1997). A pre-existing pain memory that has already led to central and especially cortical changes would not necessarily be affected by a short-term elimination of afferent barrage. Thus, it is possible that peripheral analgesia would eliminate new but not pre-existing central changes in the perioperative phase. Here, NMDA-antagonists as well as GABA agonists might be beneficial to prevent both central reorganisation and phantom limb pain. A placebo-controlled double-blind randomized study (Wiech et al. 2001) that used the NMDA receptor antagonist memantine, in addition to brachial plexus anaesthesia in patients undergoing traumatic amputations of individual fingers or a hand, found that the active drug significantly reduced

the incidence of phantom limb pain one year after the surgery from 72% to 20%, whereas placebo failed to show a similar effect.

The development of more powerful treatments for phantom limb pain needs controlled treatment outcome, prospective and double blind placebo controlled outcome research. Only then will effective evidence-based interventions be available.

- ▶ [Cancer Pain, Assessment in Children](#)
- ▶ [DREZ Procedures](#)
- ▶ [Magnetoencephalography in Assessment of Pain in Humans](#)

### References

1. Abraham RB, Marouani N, Weinbroum AA (2003) Dextromethorphan Mitigates Phantom Pain in Cancer Amputees. *Ann Surg Oncol* 10:268–274
2. Bone M, Critchley P, Buggy DJ (2002) Gabapentin in Postamputation Phantom Limb Pain: A Randomized, Double-Blind, Placebo-Controlled, Cross-Over Study. *Reg Anesth Pain Med* 27:481–486
3. Chabal C, Jacobson L, Russell LC et al. (1992) Pain Response to Perineuronal Injection of Normal Saline, Epinephrine, and Lidocaine in Humans. *Pain* 49:9–12
4. Flor H (2002) Phantom-Limb Pain: Characteristics, Causes, and Treatment. *Lancet Neurol* 1:182–189
5. Flor H, Denke C, Schaefer M et al. (2001) Sensory Discrimination Training Alters both Cortical Reorganization and Phantom Limb Pain. *Lancet* 357:1763–1764
6. Huse E, Larbig W, Flor H et al. (2001) The Effects of Opioids on Phantom-Limb Pain and Cortical Reorganization. *Pain* 90:47–55
7. Jaeger H, Maier C (1992) Calcitonin in Phantom Limb Pain: A Double-Blind Study. *Pain* 48:21–27
8. Jensen TS, Krebs B, Nielsen J et al. (1985) Immediate and Long-Term Phantom Limb Pain in Amputees: Incidence, Clinical Characteristics and Relationship to Pre-Amputation Pain. *Pain* 21:267–278
9. Jensen TS, Nikolajsen L (1999) Phantom Pain and other Phenomena after Amputation. In: Wall PD, Melzack RA (eds) *Textbook of Pain*. Churchill Livingstone, Edinburgh, pp 799–814
10. Katz J, Melzack RA (1990) Pain 'Memories' in Phantom Limbs: Review and Clinical Observations. *Pain* 43:319–336
11. Katz J, Melzack RA (1991) Auricular Transcutaneous Electrical Nerve Stimulation (TENS) Reduces Phantom Limb Pain. *J Pain Symp Manage* 6:77–83
12. Lotze M, Grodd W, Birbaumer N et al. (1999) Does Use of a Myoelectric Prosthesis Reduce Cortical Reorganization and Phantom Limb Pain? *Nat Neurosci* 2:501–502
13. Maier C, Dertwinkel R, Mansourian N et al. (2003) Efficacy of the NMDA-Receptor Antagonist Memantine in Patients with Chronic Phantom Limb Pain – Results of a Randomised Double-Blinded, Placebo-Controlled Trial. *Pain* 103:277–283
14. Nikolajsen L, Gottrup H, Kristensen AGD et al. (2000) Memantine (a N-methyl D-aspartate Receptor Antagonist) in the Treatment of Neuropathic Pain following Amputation or Surgery – A Randomised, Double-Blind, Cross-Over Study. *Anesth Analg* 91:960–966
15. Nikolajsen L, Hansen CL, Nielsen J (1996) The Effect of Ketamine on Phantom Limb Pain: A Central Neuropathic Disorder Maintained by Peripheral Input. *Pain* 67:69–77
16. Nikolajsen L, Ilkjaer S, Christensen JH et al. (1997) Randomised Trials of Epidural Bupivacaine and Morphine in Prevention of Stump and Phantom Pain in Lower-Limb Amputation. *Lancet* 350:1353–1357
17. Ramachandran VS, Rogers-Ramachandran D (1996) Synaesthesia in Phantom Limbs Induced with Mirrors. *Proc R Soc Lond B Biol Sci* 263:377–386

18. Robinson LR, Czerniecki JM, Ehde DM et al. (2004) Trial of Amitriptyline for Relief of Pain in Amputees: Results of a Randomized Controlled Study. *Arch Phys Med Rehabil* 85:1–6
19. Sherman RA, Devor M, Jones DEC et al. (1997) Phantom Limb Pain-Plenum Series in Behavioral Psychophysiology and Medicine. Plenum Press, New York
20. Sindrup SH, Jensen TS (1999) Efficacy of Pharmacological Treatments of Neuropathic Pain: An Update and Effect Related to Mechanism of Drug Action. *Pain* 83:389–400
21. Wiech K et al. (2001) Prevention of Phantom Limb Pain and Cortical Reorganization in the Early Phase after Amputation in Humans. *Soc Neurosci Abstr* 28:163–169
22. Wu CL, Tella P, Staats PS et al. (2002) Analgesic Effects of Intravenous Lidocaine and Morphine on Postamputation Pain. *Anesthesiology* 96:841–848

---

## Phantom Sensation

### Definition

Phantom sensation is a normal phenomenon after limb amputation and is experienced by virtually all amputees. The patient feels that the amputated limb is still present and he/she may have vivid sensations in the missing limb, including feelings of movement and posture.

- ▶ [Postoperative Pain, Postamputation Pain, Treatment and Prevention](#)

---

## Phantom Tooth Pain

- ▶ [Atypical Facial Pain, Etiology, Pathogenesis and Management](#)

---

## Pharmacodynamics

### Definition

Pharmacodynamics refers to the end-organ effects of drugs, i.e. “what the drug does to the body”.

- ▶ [Opioids in Geriatric Application](#)

---

## Pharmacogenetics

### Definition

The study of the genetic factors influencing variable drug response, due to either variable pharmacodynamic or pharmacokinetic factors. The genetically variable *CYP* genes, producing P450 enzymes involved in drug metabolism, are the best known examples. This concept is also referred to as *pharmacogenomics*, with the latter term suggesting the simultaneous consideration of more than one gene.

- ▶ [Heritability of Inflammatory Nociception](#)
- ▶ [Opioid Analgesia, Strain Differences](#)

---

## Pharmacogenetics of NSAIDs

- ▶ [NSAIDs, Pharmacogenetics](#)

---

## Pharmacokinetic Profile of Fentanyl

### Definition

Pharmacokinetic profile of fentanyl is best described by a three compartment model.

- ▶ [Postoperative Pain, Fentanyl](#)

---

## Pharmacokinetics

### Definition

Pharmacokinetics refers to the effects of physiological processes of the body on drugs, including absorption, distribution, metabolism and excretion (elimination, clearance), i.e. “what the body does to the drug”.

- ▶ [Opioids in Geriatric Application](#)

---

## Pharmacokinetics of the NSAIDs

- ▶ [NSAIDs, Pharmacokinetics](#)

---

## Pharmacological Interventions

### Definition

Used to prevent and manage pain and distress in infants. May include, but is not limited to, the use of opioids (e.g. morphine, fentanyl), oral analgesics (acetaminophen) and sedation (benzodiazepines, chloral hydrate), local anesthetics (lidocaine), and systemic anesthetics (ketamine). The decision to prescribe analgesia and sedation should be based on the drug, the clinical situation and setting, the person administering the drug, the physiological stability of the newborn, invasiveness of the procedure, the expected duration of drug effect and the observed duration of pain. Subsequent doses should be modified based on multiple factors, including the cause of the pain, previous response, clinical condition, concomitant drug use, and the known properties of the sedative and analgesic drugs administered.

- ▶ [Pain Assessment in Neonates](#)



## Pharmacotherapy

### Definition

Pharmacotherapy refers to the treatment of disease by means of drugs.

- ▶ Migraine, Preventive Therapy

## Phase–1 Reactions

### Definition

Phase–1 Reactions are the reactions of biotransformation, where the drug molecule is transformed by oxidation, reduction or hydrolysis.

- ▶ NSAIDs, Pharmacokinetics

## Phase–2 Reactions

### Definition

Phase–2 Reactions are the reactions of biotransformation where the drug molecule is conjugated with different molecules, such as activated glucuronic acid, sulfate, amino acids, oligopeptides, acetic acid, etc.

- ▶ NSAIDs, Pharmacokinetics

## Phenadone

- ▶ Postoperative Pain, Methadone

## Phenotype

### Definition

The phenotype describes the actual appearance of an individual, which depends on the interaction between the different alleles of genes and between the genotype and the environment.

- ▶ NSAIDs, Pharmacogenetics

## Phentolamine Test

### Definition

The Phentolamine Test is a test for SMP, in which phentolamine or placebo is administered systemically in a double blinded fashion and a positive result is a decrease in pain.

- ▶ Complex Regional Pain Syndrome and the Sympathetic Nervous System
- ▶ Sympathetically maintained Pain

## Pheromones

### Definition

A chemical secreted by an animal, especially an insect, that influences the behavior or development of others of the same species, often functioning as an attractant of the opposite sex.

- ▶ Perireceptor Elements

## Phonophobia

### Definition

Hypersensitivity to sound.

- ▶ Clinical Migraine with Aura
- ▶ Headache, Episodic Tension Type
- ▶ Hemicrania Continua

## Photochemical Model

- ▶ Spinal Cord Injury Pain Model, Ischemia Model

## Photophobia

### Definition

Hypersensitivity to light.

- ▶ Clinical Migraine with Aura
- ▶ Headache, Episodic Tension Type
- ▶ Hemicrania Continua

## Photosensitivity

### Definition

Photosensitivity of the skin: typical symptom of systemic lupus erythematosus (SLE).

- ▶ Headache Due to Arteritis

## Physeptone

- ▶ Postoperative Pain, Methadone

## Physical Abuse

### Definition

Hitting, shaking, throwing, poisoning, burning or scalding, drowning, suffocating, or otherwise causing physical harm to another person.

- ▶ [Chronic Pelvic Pain, Physical and Sexual Abuse](#)

## Physical Activity

### Definition

Defined here as all spontaneous or regular everyday physical activity that consumes energy, including walking or cycling to work, working in the garden and so on (Caspersen C, Christenson G (1985) Physical Activity, Exercise, and Physical Fitness. Public Health Rep 100:125-131).

- ▶ [Physical Exercise](#)

## Physical Agent

### Definition

A physical agent is a form of acoustic, aqueous, electrical, mechanical, thermal, or light energy, which is applied to tissues in a systematic way to alter physiologic processes for therapeutic purposes.

The goal of use may include heating (hot packs, the diathermies), cooling (ice therapy), healing (e.g. low intensity laser therapy), muscle stimulation (electrical stimulation), and pain control (e.g. TENS) as well as the introduction of pharmaceutical agents through the skin (iontophoresis). Many agents are thought to produce more than one effect (such as pain relief and the promotion of healing). Although the thermal properties of the heating and cooling agents are well established, these agents may also have non-thermal effects.

- ▶ [Chronic Pain in Children, Physical Medicine and Rehabilitation](#)
- ▶ [Therapeutic Heat, Microwaves and Cold](#)

## Physical Capacity Evaluation

- ▶ [Disability, Functional Capacity Evaluations](#)

## Physical Conditioning Programs

EVA SCHONSTEIN

School of Physiotherapy, Faculty of Health Science, The University of Sydney, Lidcombe, Sydney, NSW, Australia

e.schonstein@fhs.usyd.edu.au

### Synonyms

Physical conditioning programs (PCP) are also called work conditioning, work hardening, functional restoration, exercise programs, physical reconditioning, dynamic back strength exercises, exercise therapy/program, intensive dynamic back care exercise program, graded activity program, multidisciplinary rehabilitation programs and intensive training program.

### Definition

Physical conditioning programs are defined (Schonstein et al. 2003a; Schonstein et al. 2003b) as any exercise program designed specifically for people with work related disability, aimed at increasing strength, endurance, flexibility, and cardiovascular fitness with an intended improvement of work and/or functional status, which either simulates or duplicates work and/or functional tasks in a safe, supervised environment. PCP differ from most physiotherapy programs in that firstly, they are directly related to or simulate an injured person's job demands, and secondly, workers' work capacities and performances can be carefully monitored and documented. Under such supervision, injured workers can learn appropriate job performance skills, in addition to improving their physical condition. The aim of these programs is for a return-to-work, improvement in work status (for workers performing modified duties) and/or the achievement of a higher level of function.

Physical conditioning programs differ in their goals from other programs, such as patient care management; multidisciplinary treatments incorporating behavioural interventions; pain clinics; and standard medical care or physiotherapy, in that these latter interventions aim to reduce symptoms, pain intensity, use of medications and healthcare providers, and to increase global improvement and quality of life (Guzman et al. 2003), physiological outcomes, such as range of motion and spinal flexibility (van Tulder 2003a), or behavioural outcomes such as anxiety, depression, and cognition (van Tulder 2003b), whereas PCPs focus principally on reducing disability associated with work related back pain. In other words, PCPs are distinguished from other programs by their principal outcome measure, which is time between injury and return to permanent, full-time duties.

## Characteristics

A systematic review of the literature (Schonstein et al. 2003b) highlighted the wide variation in the content and duration of interventions that are currently labelled as physical conditioning, work conditioning, work hardening or functional restoration or exercise programs, and the variations in the types of assessment of outcomes used in clinical trials investigating the effectiveness of these interventions. These variations limited the degree to which the results of trials could be compared and/or pooled. In addition, variations in the timing of the outcome assessments, subjects studied, overall poor methodological quality, inadequate reporting of results and small sample sizes limited the conclusions that could be drawn regarding the efficacy of physical conditioning programs.

### Effectiveness of Physical Conditioning Programs

There is evidence that physical conditioning (functional restoration/work conditioning/hardening) programs, which include a cognitive-behavioural approach, can reduce the number of sick days lost for workers with chronic back pain. Trials that showed positive results for chronic patients had significant cognitive-behavioural components combined with intensive physical training (specific to the job or not), which included aerobic capacity, muscle strength and endurance and coordination; and were all in some way work-related and given to groups supervised by a physiotherapist or a multidisciplinary team (Schonstein et al. 2003b). Research evidence is unclear about which is more effective: intensive physical training, cognitive behavioural therapy or a combination of the two. There is conflicting or no evidence about the effectiveness of exercise therapy alone compared with inactive treatments for chronic low back pain (Schonstein et al. 2003b; van Tulder et al. 2003a), although behavioural treatment seems to be an effective treatment for chronic low back pain patients (van Tulder et al. 2003b). It could be hypothesized, therefore, that work oriented intensive physical training therapy can be an effective way of delivering cognitive behavioural therapy.

All subjects included in trials that showed a treatment effect were either off work or on suitable duties, with an explicit capacity to return to their pre-injury jobs because their employers expected them to return to work (Schonstein et al. 2003b). The main aim of any cognitive behavioural intervention, following the identification of psychosocial risk factors, is to help patients assume responsibility for self-management of their condition, and therefore, recommendations for management of chronic back pain should include both physical and psychosocial strategies (Turk and Okifuji 2002). Further available evidence supports the efficacy of multidisciplinary physical conditioning programs in reducing the risk for chronicity in workers with back pain (Morley et

al. 1999), as well as being cost effective (Turk and Okifuji 2002).

### Characteristics of Study Population

Most trials studied included patients with chronic symptoms (defined as more than four weeks duration of symptoms), with only a few including participants with acute pain only. Most studies included both males and females (with more males than females). Most trials included subjects who were either working or not, with some studies only including subjects who were off work. The majority of trials excluded subjects with prior back and/or neck surgery; however, a few included subjects with prior surgery (Schonstein et al. 2003b).

### Characteristics of Physical Conditioning Programs

The duration of interventions varied from only one session to one hour per week for one and a half years during work hours. Two studies included in-patient programs of three-week duration; however, the majority were outpatient interventions of between three and twelve-week duration. Supervision of subjects in intervention programs was mostly the responsibility of physiotherapists, with some studies indicating that supervision was provided by multidisciplinary teams. Many interventions included cognitive behavioural/psychological components, whose principal aim was to draw subjects' attention away from pain and disability, and focus them on returning to function. An analysis of PCPs that have been shown to be effective in reducing time off work shows that they typically include the following components: a physical training program (graded activity program that is quota based rather than pain based), a pain management/patient education (back school) program, and a workplace visit with a participatory ergonomic evaluation of the workplace. There is no evidence of effectiveness of one of these components over another.

### Psychosocial Factors

Cognitive behavioural approach addresses psychosocial factors that are known to delay the return to full function (including work), and deals with issues such as meaning, fears and beliefs relating to pain, beliefs about how to deal with the pain, coping skills and strategies and expectations of treatment (Waddell 2000). The term psychosocial factors, in the context of workers compensation for disability due to simple (idiopathic, non-specific) back pain, refers to the interaction between disabled workers and their environment including family members, friends, people at work, employers, the compensation system and health professionals (Kendall et al. 1997). These factors have been described as specifically including psychological factors such as catastrophising, fear avoidance, anxiety, depression and distress, a passive attitude towards rehabilitation, and self-perceived poor health, social

factors such as issues relating to family and social support, and work factors such as job satisfaction and security (Linton 2000; Pincus et al. 2002) and have all been implicated in facilitating a transition from acute to chronic disability in people complaining of back pain. The key psychosocial factors that appear to favour chronicity are beliefs that back pain is due to progressive pathology, that it is harmful or severely disabling, that avoidance of activity will help recovery and that passive rather than active self-management treatments will help (Main and Williams 2002). The collective term of Yellow Flags has been attached to these factors, and it is usually contrasted to the Red Flags that indicate specific, organic pathology. There is currently an international consensus, as reflected by an analysis of international guidelines, for the management of back pain, that psychosocial factors (Yellow Flags) are risk factors for chronicity (Koes et al. 2001).

Identification of psychosocial factors is, therefore, an important first step towards prevention of chronicity in disability related to back pain symptoms. General practitioners are considered the most appropriate health professionals for the initial assessment of both Red Flags [i.e. any serious spinal pathology (such as nerve root pain, cauda equina and inflammatory disorders)] and risk of chronicity (Yellow Flags) during the initial consultation. These tasks can apparently be achieved in no more than about 9 minutes (Mulholland 2002; Samanta et al. 2003). Failure of the primary carer (usually doctors) to provide immediate and effective care, which includes appropriate advice, can promote progression to chronic pain (Main and Williams 2002). The identification of risk factors for chronicity in back pain does not in itself lead to the reduction of such a risk, indeed we do not as yet know if (and which) interventions available are the most effective and for whom (Borkan et al. 2002). Nevertheless, identification of workers' pre-treatment beliefs and tailoring interventions, such as physical conditioning programs to increase acceptance of evidence based self-management treatment, can improve the disability outcome for workers with back pain (Turk and Okifuji 2002). It follows, therefore, that if psychosocial factors have been identified by medical practitioners for a worker with chronic disability due to back pain, based on current best evidence, he/she would refer that worker for a physical conditioning program that includes the above mentioned components, and this is likely to speed up the process of return to permanent full-time duties. Medical practitioners, who practice evidence based medicine, would not only be referring workers at risk of chronicity for such programs, but would also monitor content and outcomes through initiating effective communication between all stake holders.

Psychosocial factors, therefore, seem to be a definite risk factor for progression towards chronicity for workers with back pain, and the evidence seems to indicate that their identification and management could remove

some of the most important barriers to return to work following an episode of back pain disability.

## References

1. Borkan J, Van Tulder M, Reis S et al. (2002) Advances in the Field of Low Back Pain in Primary Care: A Report from the Fourth International Forum. *Spine* 27:128–132
2. Guzman J, Esmail R, Karjalainen K et al. (2003) Multidisciplinary Bio-Psycho-Social Rehabilitation for Chronic Low Back Pain. *Cochrane Database Syst Rev* (1)
3. Kendall NAS, Linton SJ, Main CJ (1997) Guide to assessing psychosocial yellow flags in acute low back pain: Risk factors for long-term disability and work loss. Accident rehabilitation & compensation insurance corporation of New Zealand and the National Health Committee, Wellington
4. Koes BW, Tulder MW van, Ostelo R et al. (2001) Clinical guidelines for the management of low back pain in primary care: An international comparison. *Spine* 26:2504–2513
5. Linton SJ (2000) A review of psychological risk factors in back and neck pain. *Spine* 25:1148–1156
6. Main CJ, Williams AC (2002) Musculoskeletal Pain. *BMJ* 325:534–537
7. Morley S, Eccleston C, Williams A (1999) Systematic Review and Meta-Analysis of Randomized Controlled Trials of Cognitive Behaviour Therapy and Behaviour Therapy for Chronic Pain in Adults, Excluding Headache. *Pain* 80:1–13
8. Mulholland R (2002) Why Back Pain Triage? *JBJS* 84 Suppl 2:147
9. Pincus T, Vlaeyen JW, Kendall NAS et al. (2002) Cognitive-Behavioral Therapy and Psychosocial Factors in Low Back Pain: Directions for the Future. *Spine* 27:133–138
10. Samanta J, Kendall J, Samanta A (2003) 10-min Consultation: Chronic Low Back Pain. *BMJ* 326:535
11. Schonstein E, Kenny D, Keating J et al. (2003a) Physical Conditioning Programs for Workers with Back and Neck Pain: A Cochrane Systematic Review. *Spine* 28:391–395
12. Schonstein E, Kenny DT, Keating J et al. (2003b) Work Conditioning, Work Hardening and Functional Restoration for Workers with Back and Neck Pain. *Cochrane Database Syst Rev* (1)
13. Turk DC, Okifuji A (2002) Psychological Factors in Chronic Pain: Evolution and Revolution. *J Consult Clin Psychol* 70:678–690
14. van Tulder MW, Malmivaara A, Esmail R et al. (2003a) Exercise Therapy for Low Back Pain. *Cochrane Database Syst Rev* (1)
15. van Tulder MW, Ostelo R, Vlaeyen JWS (2003b) Behavioural Treatment for Chronic Low Back Pain. *Cochrane Database Syst Rev* (1)

---

## Physical Deconditioning

### Definition

Physical Deconditioning refers to the reduction in flexibility, strength and endurance resulting from the restriction of muscular activity.

► [Cognitive-Behavioral Perspective of Pain](#)

---

## Physical Dependence

### Definition

Physical dependence is an adaptive state characterized by intense physical disturbances (withdrawal or abstinence syndrome characteristic of the particular drug, i.e.



diarrhea, sweating, restlessness, etc. after opioid cessation) when repeated drug administration is suspended.

- ▶ [Opiates During Development](#)
- ▶ [Opioid Therapy in Cancer Patients with Substance Abuse Disorders, Management](#)
- ▶ [Psychiatric Aspects of the Management of Cancer Pain](#)

## Physical Exercise

KAISA MANNERKORPI

Department of Rheumatology and Inflammation Research, Sahlgrenska Academy, Göteborg University, Göteborg, Sweden

kaisa.mannerkorpi@rheuma.gu.se

### Synonyms

Physical Performance Capacity; functioning; Fitness Training

### Definition

▶ **Physical activity** is defined here as all spontaneous or regular everyday physical activity that consumes energy, including walking or cycling to work, working in the garden etc.

▶ **Physical exercise** is planned physical activity that consumes energy and increases the breathing rate and perspiration.

### Characteristics

Many patients with ▶ **chronic pain** (IASP 1994) have reduced physical performance capacity, which may be associated with their primary impairment and pathological processes but also with a reduced overall physical activity level. A person with ▶ **pain** disorder may refrain from physical activity due to the anticipation of the aggravation of pain, which in turn will reduce his / her cardiovascular and muscle function, with a subsequent negative impact on the impairments, functional limitations and other aspects of health. Multiple personal and environmental factors can contribute to a reduced level of activity; they include distress, reduced confidence in the ability to manage the disease and disrupted relations with social fields that previously provided an opportunity for regular physical activity.

A growing body of evidence indicates that a sedentary lifestyle and a low level of physical activity are associated not only with poor fitness but also with the risk of coronary diseases, osteoporosis, diabetes mellitus and so on. Exercise as a form of treatment for patients with chronic pain disorders can therefore have various goals. Specific exercises can be designed to restore identified dysfunction in the musculoskeletal system, such as muscle weakness, while general whole body exercise or aerobic exercise can aim to improve overall function, health

and mood or prevent secondary impairments and diseases associated with inactivity.

This essay will focus on the effects of exercise evaluated in randomised controlled trials (RCT). The results of the studies are discussed separately in patients with chronic low back pain (CLBP), rheumatoid arthritis (RA) and ▶ **fibromyalgia (FM)**.

### Chronic Low Back Pain (CLBP)

During the course of life, 70–85% of individuals will experience low back pain, but most of them recover within a few weeks. Low back pain is considered to be chronic when it has lasted for more than 3 months. Active treatments are being increasingly advocated and recent research indicates that exercise plays an important role in the management of CLBP.

A RCT compared 0.5 h sessions of individual physiotherapy, 1 h sessions of muscle reconditioning on training devices and 1 h sessions of group low impact aerobic exercise (Mannion et al. 2001). All the three patient groups reported a reduction in pain intensity, pain frequency and disability after the 3 month treatment period, with no differences between them. The reduction in pain intensity and frequency was maintained in all three groups during the 1 year follow-up, while the reduction in disability was maintained in the strength training and aerobic exercise groups but not in those receiving individual physiotherapy (Mannion et al. 2001).

Moreover, a recently published review (Liddle et al. 2004) comprising 16 RCTs of exercise, published between 1990 and 2001, found that exercise was beneficial for patients with CLBP, regardless of the chosen exercise. In this review, strengthening exercise was found to be the most common type of exercise, followed by flexibility, aerobic exercise and multimodal programmes. The strengthening exercises focused predominantly on the muscles in the lumbar spine, followed by the muscles in the abdomen and legs. Most of the studies had evaluated the effects on back-specific function and work disability and improvements were found when comparing the intervention group with an untreated control group or a group receiving the advice of a physician, but not when comparing an exercise programme with another type of programme (Liddle et al. 2004). To summarise, exercise appears to be beneficial for patients with CLBP, regardless of the type of exercise that is chosen.

### Exercise in Rheumatoid Arthritis (RA)

Rheumatoid arthritis (RA) is a chronic systemic inflammatory disease. The clinical picture of RA is dominated by pain, stiffness, fatigue, reduced range of motion and muscle weakness. A reduction in muscle strength and aerobic capacity has been documented in several studies and exercise has therefore been regarded as an important part of the rehabilitation of patients with RA. Several studies have indicated that patients with RA can engage

in physical exercise without exacerbating their symptoms or increasing the inflammatory process. Furthermore, a recent 2 year study revealed that long-term, high intensity exercise does not contribute to the progress of joint destruction in RA (de Jong et al. 2004).

A recent review, comprising 15 RCTs of exercise in RA, published between 1989 and 2000, found evidence that exercise improves aerobic capacity (6 of the total of 9 studies incorporating aerobic exercise) and muscle strength (8 of the total of 14 studies incorporating strengthening exercises) in patients with RA (Stenström and Minor 2003). Pain intensity was found to have decreased in three studies. Based on the results of this review, the authors suggest that both aerobic exercise and strengthening exercise for RA patients should be of moderate to hard intensity, which means 60–85% of maximum heart rate in aerobic exercise *versus* 50–80% of a maximum voluntary contraction in strength training.

### Exercise in Fibromyalgia (FM)

Fibromyalgia (FM) is characterised by long-lasting, widespread pain (► [chronic widespread pain](#)) and generalised tenderness (Wolfe et al. 1990), often accompanied by fatigue and other symptoms. Most patients with FM report activity limitations in daily life and reduced physical performance capacity has been reported in several studies. Most researchers in the field suggest that aberrant physiological pain processing mechanisms, together with multiple psychological and environmental factors, interact in the development of FM.

A recent systematic review (Mannerkorpi and Iversen 2003) comprising 27 RCTs of physical exercise for patients with FM and related syndromes, published between 1988 and 2002, concluded that exercise was beneficial for patients with FM and related syndromes. Moderate to high intensity aerobic exercise twice a week was found to improve aerobic capacity and reduce muscle tenderness (McGain et al. 1988), but these outcomes were not found in all the reviewed studies (Mannerkorpi and Iversen 2003). The reasons for these inconsistent results may be related to the differences in the exercise programmes and / or the patients' baseline physical capacity. For example, a study aiming to evaluate the effects of high intensity aerobic exercise found that the patients that had been recruited to the study were not able to manage the planned level of exercise (van Santen et al. 2002). However, a meta-analysis of efficacy comprising four exercise programmes performed at 55–90% of the predicted maximum heart capacity at least twice a week for a minimum of 20 min found a 17% improvement in aerobic performance and a 28% improvement in tender point pain threshold (Busch et al. 2002), indicating that this type of exercise improves aerobic capacity and diminishes tenderness in patients with FM who manage this intensity of exercise.

Walking is aerobic exercise that can be performed at varying intensities and it appears to be an alternative for those patients with FM who are unable to participate in exercise programmes of higher intensity. Studies of walking have indicated improvements in functioning, symptoms and mood in sedentary people with FM (Mannerkorpi and Iversen 2003), something that was also reported in a recent study comprising sedentary women with FM who participated in a supervised walking programme three times a week for 20 weeks (Valim et al. 2003).

Exercise in a temperate pool can be another alternative for sedentary patients with chronic pain, as physical properties such as buoyancy and temperature facilitate training in water and alleviate pain and stiffness, while viscosity provides the resistance required in aerobic and strengthening exercise. Pool exercise programmes evaluated in patients with FM have been of varying length, ranging from 6 weeks to 6 months and of varying intensity, ranging from low to moderate to high intensity of exercise (Mannerkorpi and Iversen 2003). Improvements have been observed in physical performance capacity and distress in several studies of pool exercise.

Learning how to modify the exercises to their own limitations may be important for patients with chronic pain, disabilities and distress. This approach was applied in a study evaluating the effects of a 6 month pool exercise programme combined with a six session educational programme in patients with FM (Mannerkorpi et al. 2000). The exercise programme included aerobic, endurance, flexibility, relaxation and body awareness exercises and during the first weeks the exercises focused on teaching patients how to perform the exercises properly and how to modify the exercises to match their threshold of pain and fatigue. The treatment group improved in terms of physical performance capacity (6 min walking test) and ratings of FM symptoms and distress, when compared with the control group. A long term follow up found that improvements in walking capacity and pain ratings lasted for 2 years (Mannerkorpi et al. 2002), probably because the patients had continued to exercise after completing the trial.

Few studies have independently evaluated the effects of strength training in FM. It appears that patients with FM can manage strength training when it is started at low loads and progresses individually. In one study, the intervention group exercised twice a week, starting at 40–60% of their one repetition maximum voluntary contraction and gradually increased the intensity to 60–80% of their maximum (Häkkinen et al. 2001). Improvements were found in muscle strength, mood and muscle firing patterns.

To summarise, most patients with FM are able to manage low intensity exercise, while it is suggested that high intensity exercise should be undertaken with care. Due to the large variability in functioning and symptom sever-

ity in patients with FM, it is recommended that exercise prescriptions should be individualised.

### Exercise, Pain and Mood

The primary goal of exercise as a treatment for chronic pain patients is to improve or maintain physical function and reduce disability. Most exercise studies have documented improvements in function following exercise and this result is probably easiest to attain in sedentary patients with a low baseline level of functioning. Although pain reduction is desirable in patients with chronic pain, only a few studies have reported improvements in pain following exercise. Improvements in pain intensity and frequency have been reported in CLBP patients (Mannion et al. 2001), while an increase in the pain threshold has been found in studies of patients with FM participating in aerobic exercise (MacGain et al. 1988). Improvements in mood have, however, been found in several studies evaluating the effects of exercise in distressed patients (Häkkinen et al. 2001; Mannerkorpi et al. 2000; Valim et al. 2003).

### Compliance

Motivating patients with chronic pain to start and continue regular physical activity and exercise is crucial in order to improve function and maintain the gains. Adherence to exercise appears to improve by informing the patients about the risks and benefits of exercise and by adjusting the exercise to match individual limitations. Education and collaborative discussions about the patient's preferences and obstacles that prevent him/her from exercising might enhance adherence to planned exercise programmes. Furthermore, many patients with chronic pain appreciate exercising in a supervised group, which also provides the social support that is frequently needed for regular exercise.

### References

1. Busch A, Schacter C, Peloso P et al. (2002) Exercise for treating fibromyalgia syndrome. *Cochrane Database of systematic Reviews*
2. de Jong Z, Munneke M, Zwiderman A et al. (2004) Long term high intensity exercise and damage of small joints in rheumatoid arthritis. *Ann Rheum Dis* 63:1399–1405
3. Häkkinen A, Häkkinen K, Hannonen P et al. (2001) Strength training induced adaptations in neuromuscular function of premenopausal women with fibromyalgia: comparison with healthy women. *Ann Rheum Dis* 60:21–26
4. IASP (1994) Classification of chronic pain. International Association for the Study of Pain, Seattle
5. Liddle S, Baxter G, Gracey J (2004) Exercise and chronic low back pain: what works? *Pain* 107:176–190
6. McGain G, Bell D, Mai F et al. (1988) A controlled study of the effects of a supervised cardiovascular fitness training program on the manifestations of primary fibromyalgia. *Arthritis Rheum* 31:1135–1141
7. Mannerkorpi K, Iversen M (2003) Physical exercise in fibromyalgia and related syndromes. *Best Pract Res Clin Rheumatol* 17:629–647
8. Mannerkorpi K, Nyberg B, Ahlmén M et al. (2000) Pool exercise combined with an education program for patients with fibromyalgia syndrome. *J Rheumatol* 27:2473–2481
9. Mannerkorpi K, Ekdahl C, Ahlmen M (2002) Six- and 24-month follow-up of pool exercise therapy and education for patients with fibromyalgia. *Scand J Rheumatol* 31:306–310
10. Mannion A, Muntener M, Taimela S et al. (2001) Comparison of three active therapies for chronic low back pain: results of a randomized clinical trial with one-year follow-up. *Rheumatology* 40:772–778
11. Stenström C, Minor M (2003) Evidence for the benefit of aerobic and strengthening exercise in rheumatoid arthritis. *Arthritis Rheum* 49:428–434
12. Valim V, Oliveira L, Suda A et al. (2003) Aerobic fitness effects in fibromyalgia. *J Rheumatol* 30:2473–2481
13. van Santen M, Bolwijn P, Verstappen F et al. (2002) A randomized clinical trial comparing fitness and biofeedback training versus basic treatment in patients with fibromyalgia. *J Rheumatol* 29:575–581
14. Wolfe F, Smythe H, Yunus M et al. (1990) The American College of Rheumatology 1990 criteria for the classification of fibromyalgia. Report of the Multicenter Criteria Committee. *Arthritis Rheum* 33:160–172

## Physical Medicine and Rehabilitation, Team-Oriented Approach

BENGT H. SJÖLUND

Rehabilitation and Research Centre for Torture Victims, South Danish University, Copenhagen, Denmark  
bsj@rct.dk

### Synonyms

Team Approach; Group-Oriented Practice; multidisciplinary; multiprofessional; interdisciplinary; interprofessional approach

### Definition

The team-oriented approach is carried out by a group of healthcare professionals from different disciplines who share common values and objectives and provide a disabled person with holistic and comprehensive medical care, using the combined expertise of multiple caregivers. The team is the cardinal working unit in modern rehabilitation medicine, the medical specialty that primarily works with patients with ► **impairments**, ► **activity limitations** and ► **participation restrictions** (ICF 2001).

### Characteristics

In the rehabilitation process, the objective is to support the patient to reach the fullest possible physical, psychological, social, educational, vocational and recreational goals that are consistent with existing impairments, contextual limitations and life plans. The patient and his/her significant other work together with the rehabilitation team to develop realistic and multidimensional goals for the rehabilitation process and agree upon a ► **rehabilitation plan** to achieve these goals and to improve life satisfaction / quality of life (cf. Loisel et al. 2003).

P

## Physical Medicine and Rehabilitation

BENGT H. SJÖLUND

Rehabilitation and Research Centre for Torture Victims, South Danish University, Copenhagen, Denmark  
bsj@rct.dk

### Introduction

Physical medicine has ancient roots in the medical field, being part of the more than 3000-year-old traditional Chinese medicine as well as being known to have been utilized by the Romans. It is an umbrella notion containing diagnostic and above all diverse therapeutic procedures of non-surgical and non-pharmacological character. Examples are the manual (mechanical) manipulation of musculoskeletal structures and the delivery of heat, cold, massage, dry needling and, since the 19<sup>th</sup> century, application of electric currents or electromagnetic radiation to soft tissue, muscles, tendons or joints. Furthermore, so-called balneology, i.e. the use of baths or irrigation of parts of the body with water, sometimes with specific mineral or other (e.g. iodine or sulfur) content is traditionally included in physical medicine. These treatments were originally given in specific, “health-promoting” environments, such as the ► *spa* (Latin: *salus per aqua* – health through water) or “Kurort” organizations, a custom that has lingered on in several middle European countries but is nowadays mostly found outside medical practice. The main indications for physical medicine treatments were usually the relief of chronic illness or symptoms such as aches or pain.

Rehabilitation medicine, on the other hand, originated in British experiences of patients with spinal cord injuries during the second world war, where Dr Ludwig (later Sir Ludwig) Guttmann in Stoke Mandeville, UK pioneered in developing reliable rehabilitation programs for persons with paraplegia and tetraplegia (Bedbrook 1981). Rehabilitation literally means “redressing” (Latin *habitat* – dress). Apart from crisis intervention, these programs put strong emphasis on conservative treatment of the spinal fractures, on prophylactic treatment to avoid pressure sores, on care to empty the urinary bladder at regular intervals and on how to train adequate techniques for breathing and coughing in high injuries. Further, they teach effective means to develop techniques of independently taking care of personal hygiene as well as transferring between beds, chairs and wheel chairs, including the effective handling of transport vehicles. Special efforts are made to counter autonomic dysfunction and metabolic deregulation and to make sexual relations as well as paternity or maternity possible.

After the post-acute rehabilitation, a life long follow up ensues. The result is that the remaining number of life years has increased from 1–2 years after the injury even in young persons, to today’s normal life span for a paraplegic, usually at an independent level and a moderately reduced life span for the tetraplegic, as a rule partly dependent.

To fulfill the many needs of persons in rehabilitation, it was recognized early on that many different health professions as well as the physician and the nurse were necessary in the daily work. This led to the development of rehabilitation teams, supervised by the physician and consisting also of nurses, physiotherapists, occupational therapists, social workers, psychologists and sometimes vocational specialists and speech therapists. Somatic rehabilitation has gradually been expanded to include patients with disabilities from stroke, from neurological disease, from traumatic brain injury, from multi-trauma, from musculoskeletal conditions including amputations and from chronic pain. Generally speaking, rehabilitation can be considered as a re-adaptive process, where the disabled person adapts his / her set of values to a different, more restricted life situation (Dijk 2001).

In the mid-twentieth century, the two medical areas merged in the medical specialty physical medicine and rehabilitation (now usually physical and rehabilitation medicine; PRM), “concerned with the promotion of physical and cognitive functioning, activities (including behavior), participation (including quality of life) and modifying personal and environmental factors” as presently defined (UEMS 2003) by the PRM Section of the Union Européenne Medecin Specialistes (UEMS). An important part of the work in PRM is therefore disability assessment, usually performed with the ► *Team Approach* where health professionals jointly assess the patients. These assessments were greatly aided by the publication of the International Classification of Impairments, Disabilities and Handicaps (ICIDH) by the World Health Organization in 1980. This classification distinguished between dysfunction at the organ level (impairment), the person level (disability) and the life situation level (handicap) rather than focusing on the underlying pathology and on the diagnosis of a disease. Through further international development, the ICIDH was recently replaced by the context sensitive International Classification of Functioning, Disability and Health (ICF; WHO 2001). Established in the ICF, contextual (environmental and personal) factors in addition to the impairments are crucial in assessing the functioning on the person level (activities) as well as on the life situation level (participation).

Even if patients in chronic pain have been treated at length with physical medicine approaches in rehabilitation centers since the 1920s in the Western world, it



was only with the pioneering cooperation in the 1960s between professionals from the anesthesiology department and from the rehabilitation medicine department in the world's first pain clinic at the University of Washington, Seattle, USA (Bonica 1990; Fordyce 1976) that the multidisciplinary team approach from PRM was introduced into the work with patients in chronic pain. For assessment, special instruments or questionnaires have been adapted and developed to help the team assess not only the pain but also the person and his or her perceived disability. The Minnesota multiphasic personality inventory (MMPI) (Cox et al. 1978), the McGill multidimensional pain questionnaire (MMPQ) (Melzack 1975), the disability rating index (Salén et al. 1994), the Oswestry low back pain disability questionnaire (Fairbank et al. 1980), the multidimensional pain inventory (MPI) (Rudy et al. 1995) and various life satisfaction and health related quality of life questionnaires (e.g. SF-36 and Lisat-11) (Melin et al. 2003) are among the most commonly used to provide supplementary information.

As regards a closer analysis of the mechanisms of chronic pain, which should be considered as a sensory impairment (Sjölund 2003) causing activity limitations and participation restrictions according to the ICF, this area still suffers the same shortcomings as in many other sectors of pain management; i.e. the exact mechanism of chronic musculoskeletal pain is usually not known. For example, whereas 1 / 3 of a large Western adult population reports chronic pain from the musculoskeletal system (Bergman et al. 2001), only 0.5% fulfill the criteria of rheumatoid arthritis (Simonsson et al. 1999) and another 1.3% those of fibromyalgia (Lindell et al. 2000). Most people on sick leave with back pain do not show signs of columnar disease or injury (Uden 1994). Additionally, it has been amply demonstrated that most disc herniations that can be demonstrated with MRT are asymptomatic (Savage and Roberts 1997; Stadnik et al. 1998). Instead, it may well be that many of these persons have pain due to a disturbed function in the sensory part of the central nervous system (dysfunctional pain; Johansen et al. 1999; Sjölund 1994, 2004).

### Role of PRM in Pain Management

Three important roles for PRM can be discerned in modern pain management. First, even if the origin of pain is often uncertain, the PRM physician is trained to evaluate impairments, whether they are motor, cognitive or, as is the case with longstanding pain, sensory in nature. In addition, he / she will assess if the patient is medically suitable for rehabilitation, as well as the rehabilitation potential of the patient. Further, he / she is trained to communicate a disabling condition and its prognosis to the patient and the significant other.

Second, some of the physical medicine modalities have been found to withstand the test of evidence based medicine for the alleviation of various pain conditions, mostly those referred to the musculoskeletal system. Such techniques as well as pharmacological agents, singly or in combination, are commonly used by the PRM specialist to administer symptomatic impairment therapy.

Third, the PRM physician coordinates and facilitates the activities of the multi- or inter-disciplinary team in the multi-professional pain rehabilitation programs. This is carried through not only by mastering adequate rehabilitation strategies, but also by promoting encouragement, motivation and confidence during the rehabilitation process and by taking full medical responsibility for the team actions.

### Physical Medicine Modalities

Some forms of ► **Spinal Manipulation, Characteristics** techniques, as well as ► **ultrasound** for some painful conditions and injections, usually of steroids (► **steroid injections**) and local anesthetics or mixtures thereof show a beneficial effect in chronic musculoskeletal pain, but only short to intermediate term, as does ► **dry needling**, i.e. the use of an injection (or similar) needle for mechanical stimulation of deep tissue. Mechanical elongation of musculoskeletal tissues by force application, such as ► **Lumbar Traction** and ► **stretching**, has less convincing effects. The same seems to be true for different forms of short wave and microwave therapy (► **Therapeutic Heat, Microwaves and Cold**) as well as for the delivery of heat, cold, ► **Massage and Pain Relief Prospects** and low level ► **laser** therapy. In general, the multitude of methods of single therapist performed ► **physiotherapy** can be questioned for anything but very short lasting effects in chronic pain. On the other hand, ► **physical exercise** programs have recently been shown to have a beneficial effect, even in fibromyalgia. Likewise, needle ► **acupuncture**, where the ► **acupuncture mechanisms** have become increasingly clarified during the last decades, has been found to have demonstrable positive long term outcomes, e.g. in low back pain, even if there is a need for further randomized controlled studies. For ► **transcutaneous electrical nerve stimulation (TENS)**, the classical hypothesis of induced activity in large mechanoreceptive fibers closing a spinal gate is insufficient to explain the clinical observations of hour long after effects, but new data on its mechanisms indicate a combination of spinal and supraspinal actions. There are systematic reviews indicating positive outcomes in chronic pain, but the picture is less clear regarding many other forms of pain. Here too, new studies are badly needed. An interesting new somatic stimulation technique, ► **cutaneous field stimulation (CFS)**,

holds promising results in cases where TENS is not effective.

Generally speaking, however, randomized controlled studies that include reasonably large homogenous patient groups ( $n > 60$ ) are hitherto rarely available for physical treatment modalities, no doubt due both to the difficulties of blinding and to the almost impossible task of financing studies of sufficient size without the support of large organizations like the pharmaceutical industry. Therefore, many of the current recommendations for such therapeutic modalities are still based on best practice consensus or on single authorities rather than on large randomized controlled trials. It is a vital need in this field to develop more adequate test paradigms for physical modalities, especially for long-term evaluation in patients with chronic pain.

### Team Oriented Rehabilitation

When it comes to multiprofessional rehabilitation programs, ► **interdisciplinary pain rehabilitation** has emerged as a successful integrated therapy, well supported by a number of RCTs as well as by systematic reviews (Flor et al. 1992; Morley et al. 1999). However, the exact characterization of what is being treated is still lacking, and has been denoted pain behaviors (Fordyce 1976), pain disorder (DSM-IV) (Aigner and Bach 1999), “chronic pain syndrome” (Black 1975) or dysfunctional MPI profile (Turk and Rudy 1988) as well as fear avoidance (Crombez et al. 1999). As pointed out previously (Sjölund 2003), the activity limitations and participation restrictions caused by chronic pain considered as a sensory impairment in conjunction with individual contextual factors in ICF terms, probably describe these conditions most clearly at present.

The program should be based on behavioral-cognitive psychology to be effective, but should also contain activity related components, such as ► **training by quota**, ► **body awareness therapies** and ► **relaxation training**, usually led by physiotherapists and / or occupational therapists. Education / information on the nature of chronic pain and on principles for the management of chronic as opposed to acute pain, has been found to be an essential program component and should be given by the physician in charge. (► **Information and Psychoeducation in the Early Management of Persistent Pain**) ► **Coordination exercises** may be of help in whiplash-associated disorders and ► **ergonomic counseling** is usually relevant in all forms of spinal and upper extremity pain conditions.

Most importantly, interdisciplinary pain rehabilitation should be accompanied by ► **vocational counseling** to support a re-entry into all aspects of active life. Furthermore, it is probably an advantage to combine evidence based treatment modalities, both phys-

ical and pharmacological, with the multiprofessional cognitive-behavioral programs (Fig. 1), since pain is a strong negative reinforcer and minimizing such a signal would diminish the learning of further pain behaviors.



**Physical Medicine and Rehabilitation, Figure 1** PRM-related management of chronic pain.

### References

1. Aigner M, Bach M (1999) Clinical utility of DSM-IV pain disorder. *Compr Psychiatry* 40:353–357
2. Bedbrook G (1981) *The Care and Management of Spinal Cord Injuries*. Springer Verlag, New York
3. Bergman S, Herrstrom P, Hogstrom K et al. (2001) Chronic musculoskeletal pain, prevalence rates, and sociodemographic associations in a Swedish population study. *J Rheumatol* 28:1369–1377
4. Black RG (1975) The Chronic Pain Syndrome. *Surg Clin North Am* 55:4
5. Bonica J (1990) *The Management of Pain*, 2nd edn. Lea & Fabiger, Philadelphia, pp I–II
6. Cox G, Chapman CR, Black RG (1978) The MMPI in chronic pain. *J Behav Med* 1:437–444
7. Crombez G, Vlaeyen JW, Heuts PH et al. (1999) Pain-related fear is more disabling than pain itself: evidence on the role of pain-related fear in chronic back pain disability. *Pain* 80:329–339
8. Dijk AJ van (2001) *On Rehabilitation Medicine. A theory-oriented contribution to assessment of functioning and individual experience*. Eburon Publishers, Delft, pp 1–280
9. Fairbank J, Couper, J, Davies, JB et al. (1980) The Oswestry Low Back Pain Disability Questionnaire. *Physiotherapy* 66:271–273
10. Flor H, Fydrich T, Turk DC (1992) Efficacy of multidisciplinary pain treatment centers: a meta-analytic review. *Pain* 49:221–230
11. Fordyce WB (1976) *Behavioural Methods in Chronic Pain and Illness*. CV Mosby, Co, St Louis, USA
12. Johansen M, Graven-Nielsen T, Olesen AS, et al (1999) Generalised muscular hyperalgesia in chronic whiplash syndrome. *Pain* 83:229–234
13. Lindell L, Bergman S, Petersson IF et al. (2000) Prevalence of fibromyalgia and chronic widespread pain. *Scand J Prim Health Care* 18:149–153
14. Melin R, Fugl-Meyer KS, Fugl-Meyer AR (2003) Life satisfaction in 18–64-year old Swedes in relation to education, employment situation, health and physical activity. *J Rehabil Med* 35:84–87

15. Melzack R (1975) The McGill Pain Questionnaire: Major properties and scoring methods. *Pain* 1:275–299
16. Morley S, Eccleston C, Williams A (1999) Systematic review and meta-analysis of randomized controlled trials of cognitive behaviour therapy and behaviour therapy for chronic pain in adults, excluding headache. *Pain* 80:1–13
17. Rudy T, Turk D, Kubinski JA et al. (1995) Differential treatment responses of TMD patients as a function of psychological characteristics. *Pain* 61:103–112
18. Salén BA Spangfort, E, Nygren ÅL et al. (1994) The Disability Rating Index: An instrument for the assessment of disability in clinical settings. *J Clinical Epidemiol* 47:1423–1435
19. Savage RA WG, Roberts N (1997) The relationship between the magnetic resonance imaging appearance of the lumbar spine and low back pain, age and occupation in males. *Eur Spine J* 6:106–114
20. Simonsson M, Bergman S, Jacobsson LT et al. (1999) The prevalence of rheumatoid arthritis in Sweden. *Scand J Rheumatol* 28:340–343
21. Sjölund B (1994) Chronic pain in society – a case for chronic pain as a dysfunctional state? *Quality of Life Research* 3:5–9
22. Sjölund BH (2003) Current and Future Treatment Strategies for Chronic Pain. In: Ring H, Soroker N (ed) *Advances in Physical and Rehabilitation Medicine*. Monduzzi Editore, Bologna, pp 307–313
23. Sjölund BH (2006) Dysfunctional pain. In: Schmidt RF, Willis W (ed) *The Encyclopaedia of Pain*. Springer Verlag, this volume
24. Stadnik T, Lee R, Coen H et al. (1998) Annular tears and disk herniation: prevalence and contrast enhancement on MR images in the absence of low back pain or sciatica. *Radiology* 205:49–55
25. Turk DC, Rudy T (1988) Toward an empirically devised taxonomy of chronic pain patients: Integration of psychology assessment data. *J Consult Clinical Psychol* 56:233–238
26. Uden A (1994) Specified diagnosis in 532 cases of back pain. *Qual Life Res* 3:33–34
27. UEMS (2003) Definition of PRM. In: [www.euro-prm.org](http://www.euro-prm.org)
28. WHO (2001) *International Classification of Functioning, Disability and Health*. World Health Organization, Geneva, pp 1–299

The medical specialist supervising and carrying the responsibility for the rehabilitation process is the physical and rehabilitation medicine physician who has 3–5 years of residency training in this and related fields, focusing on conducting an effective team approach as well as on stabilizing and expanding the medical platform for the rehabilitation efforts, i.e. minimizing the impairment or dysfunction of (usually) the nervous and / or the musculoskeletal organ systems. In this context it should be remembered that persistent pain can be considered as a sensory impairment (Sjölund 2003), necessitating in depth knowledge of pain analysis and management by the team physician in a ► [pain rehabilitation](#) team. He / she should further have a broad knowledge of the various rehabilitation treatments and strategies available, as well as of the profile and skills of the different allied health professions in pain rehabilitation (Table 1). Consultations in traditional health care usually work according to the medical model, where a physician attends to the patient's needs. If another discipline is considered necessary to assess or treat the patient, that professional is consulted by the attending physician, either generally or more specifically. The consultant physician or allied health professional would usually discuss possible additional needs with the attending physician before major new diagnostic or therapeutic measures are undertaken. The medical model provides a clear chain of responsibility but may result in multiple professionals performing multiple tasks with little or no coordination (King et al. 1998). It should be remembered, however, that a prescription of specific training exercises or activity training can be as specific as a prescription of drugs and should never be changed in a major way without consulting the attending physician.

The ► [multidisciplinary](#) team model implies that organized interactions occur between the patient and

not only the attending physician but also with other physicians and / or allied health care professionals, usually but not always from the same unit. It retains the medical approach in that the team is attending physician controlled and most of the communication is vertical, i.e. between the attending physician and the other professionals. Assessments and treatments by different professionals in the team are usually independent of each other and a common strategy need not be shared, unless by the authority of the attending physician. Team conferences are usually conducted to report assessment results and progress from the various professionals to the attending physician. Coordination may suffer (Rothberg 1981).

The ► [interdisciplinary](#) team model differs from the previous two approaches in that the expected principle is group decision making in assessment, rehabilitation planning and treatment. The patient is considered the most important member of the team, both in planning and in decision making. Common strategies of rehabilitation are used, where the different professionals contribute important components. The group shares the responsibility for the rehabilitation carried out and the team conference, led by any of the team members, is the important forum for lateral communication and for decision making. This concept allows a free exchange of ideas and may benefit from group synergies in problem solving but can be time-consuming. The team members need training in the team process, which is rarely given during undergraduate studies. Coordination is facilitated. However, in a medical setting the medico-legal responsibility is still carried by the attending physician. Upcoming conflicts between different views should be resolved in team meetings. This is helped by communication ability and commitments by the different team members (Given and Simmons 1977).

**Physical Medicine and Rehabilitation, Team-Oriented Approach, Table 1** Main allied health professions for pain rehabilitation, given in order of importance

Profession	Profile	Typical services
Psychologist	Cognitive-behavioral  Conduct psycho-educational group sessions on the following subjects: cognitive restructuring coping self-statements relaxation assertiveness training communication training maintenance of gains coping with flare-ups	Assess personality style, coping and problem-solving skills
Physical Therapist	Restoration of motor function and awareness Administer pain relief	Offer various physical modalities such as TENS, acupuncture, heat, traction Teach functional employment skills.
Occupational Therapist	Activity training	Assess activity limitations Train self-care to independence Train home management skills. Teach adaptive and ergonomic techniques to compensate for functional deficits Evaluate environmental barriers Explore and train vocational and recreational activities Educate the family to maintain patient independence
Vocational Counselor	Attain realistic vocational goals	Evaluate vocational interests and skills Counsel on return to work, sometimes with adjustment of work environment Organize job-related activities Act as liaison and as mentor Provide support to employer
Social Worker	Interact with family and insurers	Evaluate total living situation including family, finances and employment history Coordinate funding resources Assess vocational barriers Facilitate discharge planning Provide emotional support
Rehabilitation Nurse	Medical support	Nursing if gross physical impairment Case management when appropriate

The transdisciplinary team model is going a step further in that the various team members cross into each other's professional areas, in assessment, planning or treatment (Hoffman 1990). This model has been said to originate from cost reduction efforts or from lack of health professionals in under-financed health care or social care and occurs so far mostly in educational and vocational rehabilitation settings. The exchange of information between different professionals as well as the consistency of information to patients have been reported to be highly valued in this approach, even if the therapy given has a lower quality. It is very doubtful whether this model can develop in medically oriented rehabilitation programs where the different professionals act upon highly specialized competences under government regulated licensing qualifications. If the physician is not a co-therapist, such teams may cross

medico-legal borders with unfortunate consequences (King et al. 1998).

One difficulty is inherent in the notion "disciplinary", which indicates either different medical disciplines (e. g. orthopedic surgery, psychiatry, neurology) or various professions (physician, ► [physiotherapist](#), psychologist, ► [occupational therapist](#) etc). It is in fact more appropriate to reserve the notion multi / inter / disciplinary for teams containing disciplines within a profession and to use multi / inter / professional for teams containing several professions (cf. UEMS PRM Section).

What then, characterizes an effective team? There are many suggestions and statements, especially from the management literature (e. g. Leigh and Maynard 1995) but in fact little research has been performed in this field. However, there is consensus that a coordinated team care



approach seems more effective than fragmentary care for patients with long term illness or pain (Flor et al. 1992; Keith 1991; Loisel et al. 2003). Among organization theorists, McGregor's 11 characteristics are often used to denote an effective work team (Characteristics of an effective team, McGregor 1960). In particular, a common objective is an exceedingly important factor, in pain rehabilitation consisting of a common strategy to assess and resolve the ► [activity limitations](#) and ► [participation restrictions](#) of a certain individual.

#### Characteristics of an Effective Team (Modified from McGregor 1960)

1. Informal and comfortable atmosphere
2. Focused discussions where all participate
3. The objective is well understood and accepted by all members of the group.
4. The members listen to each other and feel free to voice even unorthodox but creative ideas.
5. There may be disagreement but the group seeks to resolve rather than suppress it. Dominance by the majority or by the minority is avoided. A genuine disagreement may be taken up for reconsideration at a later moment.
6. Most decisions are reached by a consensus but there is a minimum of formal voting.
7. Criticism is frequent, frank and constructive.
8. Team members are free to express their feelings and their ideas. There are few hidden agendas.
9. When action is decided, clear assignments are made and accepted.
10. The chairman of the group does not dominate it and the leadership shifts from time to time.
11. The group is self-conscious about its operations and regularly examines how well it performs.

In practice, the various team members combine their skills to achieve these goals and to produce a reasonable and efficient rehabilitation plan in cooperation with the patient and his / her significant other. This plan should be a written document, where overriding goals should be broken down into stepwise attainable smaller goals, with time frames, measures to be undertaken and therapist involvement clearly stated. In particular, the role of the team physician is to perform an adequate sensory impairment analysis, to communicate the results in clear layman language to the patient, to treat the pain symptomatically, bearing in mind the long term efficacy of the modality chosen and to facilitate the rehabilitation process by educating the patient and supporting the actions of the other team members.

As for the patient, he / she is expected to make a transition from the passive observer role common in acute medical care to a more active participatory role in the team, emphasizing both autonomy and responsibility for his / her own rehabilitation. This requires not only information

but also education of the patient and family by the health professionals.

#### References

1. Flor H, Fydrich T, Turk DC (1992) Efficacy of multidisciplinary pain treatment centers: a meta-analytic review. *Pain* 49:221–230
2. Given B, Simmons S (1977) The interdisciplinary health care team: fact or fiction? *Nurs Forum* 16:165–183
3. Hoffman LP (1990) Transdisciplinary team model: an alternative for speech language pathologists. *Texas J Audiol Speech Pathol* 16:3–6
4. ICF (International Classification of Functioning, Disability and Health) (2001) 1st edn. World Health Organization. Geneva, pp 1–299
5. Keith RA (1991) The comprehensive treatment team in rehabilitation. *Arch Phys Med Rehabil* 72:269–274
6. King JC, Nelson TR, Heye ML et al. (1998) Prescriptions, referrals, order writing and the rehabilitation team function. In: DeLisa, JA, Gans BM (eds) *Rehabilitation Medicine. Principle and Practice*, 3rd edn. Lippincott Raven, Philadelphia, New York, pp 269–285
7. Leigh A, Maynard M (1995) *Leading your team –how to involve and inspire teams*. Nicholas Brealey Publishing Ltd, Great Britain, pp 1–217
8. Loisel P, Durand MJ, Diallo B et al. (2003) From evidence to community practice in work rehabilitation: the Quebec experience. *Clin J Pain* 19:105–113
9. McGregor D (1960) *The human side of enterprise*. McGraw Hill, New York pp 232–235
10. Rothberg JS (1981) The rehabilitation team: future direction. *Arch Phys Med Rehabil* 62:407–410
11. Sjölund BH (2003) Current and future strategies for chronic pain. In: Soroker N, Ring H (eds) *Advances in Physical and Rehabilitation Medicine*. Monduzzi Editore, Bologna pp 307–313
12. UEMS (Union Européenne Médecins Spécialistes) Physical & Rehabilitation Medicine Section web page; <http://www.euro-prm.org/>

P

## Physical Performance Capacity

- [Physical Exercise](#)

## Physical Stressors

- [Stress and Pain](#)

## Physical Therapy

- [Exercise](#)

## Physiological Pain Measure

### Definition

Indirect measure of pain in which we infer presence or intensity of pain by noting changes from baseline levels for physiological parameters such as heart rate or respiration rate.

- [Pain Assessment in Children](#)

## Physiological Pathways

### ► Stress and Pain

## Physiotherapist

### Definition

A Physiotherapist is an allied healthcare professional working with motor control & musculoskeletal function.

### ► Physical Medicine and Rehabilitation, Team-Oriented Approach

## Physiotherapy

CHRISTOPH GUTENBRUNNER

Department of Physical Medicine and Rehabilitation,  
Hanover Medical School, Hanover, Germany  
gutenbrunner.christoph@mh-hannover.de

### Definition

Physiotherapy includes a wide range of therapeutic exercises carried out by physiotherapists, including active and passive movements as well as complex therapy concepts, aiming at the improvement of disturbed functions and recovery from diseases. Many physiotherapeutic techniques can be used for rehabilitation and prevention. Physiotherapy includes diagnostic measures but does not aim at the diagnosis of a disease, rather at the use of physiotherapeutic techniques and the follow-up of the therapy.

### Characteristics

#### Methods

Basic techniques of physiotherapy are:

- passive movements of joints and rest techniques aiming at the prevention of contractures or the improvement of the mobility of the joint in question. Other passive techniques are extensions and tractions. In manual therapy, special translatory passive movements are used in order to remove articular blocs
- active movements of joints or functional units of the locomotor system in order to facilitate the respective movements. Active resisted movements are used for training purposes too, e.g. to train muscles or to improve the mechanical properties of ligaments, tendons and bones
- complex movements to initiate or practice complex locomotor functions and to improve coordinative capabilities. In order to use the facilitation effects of the buoyancy and the resistance caused by the viscosity,

complex movements are often carried out in water pools

- practicing special activities such as transferring oneself, walking, climbing stairs etc. In this field there are some overlaps with occupational therapy which is, however, more oriented to everyday activities
- cardiovascular training including endurance training of the cardio-pulmonary system and training techniques aiming at an improvement in the peripheral blood flow
- breathing exercises aiming at an improvement of respiratory functions or at the prevention of pulmonary complications of longer lasting immobilization phases
- other mechanical stimuli such as pressure or mechanical stimulation (e.g. deep friction) aiming at reactions of the tissue (e.g. stimulation of muscle blood flow) or at reflex responses (e.g. stimulation of tendon receptors)
- use of technical equipment in order to relieve affected joints or to support functions or activities (e.g. walking aids) and to stimulate sensorimotor functions (Pezzi ball etc.) as well as for the training of muscles and the cardio-pulmonary system (so-called medical training)
- relaxation therapies, e.g. using the mechanism of post-isometric muscle relaxation or respiration techniques.

In addition, the personal interaction between therapist and patient is obviously a relevant factor in physiotherapy.

Beside these techniques in physiotherapy, many complex concepts and schools exist, most of them based on special theories of the function of the locomotor system and the effects of special techniques. These concepts and schools are mostly described by a single therapist or physician and many of them lack scientific evaluation. Some of them are only in use in single countries or regions. A system of the concepts and schools in physiotherapy has been produced by (Gutenbrunner and Weimann 2004), differentiating between

- Organ-specific exercise concepts (e.g. respiration therapy, scoliosis therapy (Lehnert and Schroth), functional spine therapy (Laabs))
- Training therapies (isokinetic muscle training, medical training therapy)
- Manual medicine (chiropractic, manual medicine (Maitland concept), osteopathy)
- Neuro-physiological concepts (developmental neurobiological based concept (Bobath), developmental kinesiology (Vojta), senso-motoric facilitation (Janda), proprioceptive neuromuscular facilitation (Kabat and others))
- Concepts based on special techniques (hippotherapy, functional movements (Klein-Vogelbach), aquatic exercise, loop (sling) table therapy)

- f) Relaxation therapy and body orientated psychotherapies (progressive muscle relaxation (Jacobson), functional integration (Feldenkrais), perceptive-cognitive therapy model (Affolter))

The concepts mentioned are of course only examples. The list of concepts is not complete nor are the concepts mentioned especially recommended.

### Mechanisms

The application of physiotherapeutic techniques can induce a variety of reactions, most of which are therapeutically relevant. The main principles of these reactions refer to a system of adaptive capabilities of the organism (Gutenbrunner 2004):

- a) Relief of strain or protection is a principle enabling the organism's healing and recovery processes. Physiologically speaking, immobilization leads to de-adaptation (muscle atrophy, calcium loss from bone etc.). Therefore only partial immobilization should be carried out. This can be effective, e.g. if muscle tenseness is caused by an increased afferent input from receptors of tendons or joint capsules. In physiotherapy, tractions aiming mainly at a relief of pressure on the joints and special rest techniques aiming at the prevention of contractures are of relevance.
- b) Inhibition and facilitation are mechanisms that influence the proprioceptors of muscles and joint structures in order to facilitate or to reduce pathological muscle activity. The interneurons are located in the spinal cord. Inhibition and facilitation mechanisms are of relevance mostly in neurological conditions.
- c) Habituation, on the contrary, describes a mechanism controlled by the formatio reticularis. Habituation reduces (within minutes) autonomous reactions to different stimuli (increase of blood pressure or heart rate). Probably pain perception can also be influenced by habituation.
- d) Senso-motoric adaptation describes repetitive exercises of specific movements that can induce coordinative capabilities. Probably peripheral (functional changes in the synapses of the motor cells), sprouting and central (activation of sleeping synapses, neuroplasticity) mechanisms are involved. Recently it has been shown that neuroplasticity can be induced by physiotherapeutic techniques (for an overview see Rolnik 2004). Beside physical exercises, mental exercises can also improve coordinative performance.
- e) Functional adaptation is a process that can be induced by repeated dynamic exercises; however, its development needs several weeks of time. It is triggered by hormonal mechanisms (pituitary-adrenocortical axis). It may lead to normalization of different autonomic functions (positive cross-adaptations) and can be of some significance in the treatment of chronic

pain, because pain perception is closely related to autonomic arousal.

- f) Trophic and plastic adaptation describes the possibility of inducing growth of cells or intracellular organelles by repeated application of strain, e.g. muscle training, increase in the resistance of ligaments or structural adaptations of the bones after repeated mechanical stress. Such processes are triggered by specific hormone systems (growth hormone, erythropoietin etc). The therapeutic significance is obvious in all states of weakness of structures of the locomotor system. Its relevance has been proven in several painful diseases such as low back pain or osteoporosis (for an overview see Gutenbrunner 2004).
- g) Changes of behavior and psychic adjustments can be interpreted as cortical adaptations. There is no doubt that movements can influence central nervous functions, e.g. strenuous work reduces pain perception, probably triggered by hormonal (opioid-like peptides as well as serotonin, adrenalin and noradrenalin) or neural mechanisms. It has been proven that serial dynamic exercise may reduce depression and anxiety, which certainly is relevant in chronic pain syndromes. Physiotherapy can additionally play an important role in behavioral therapy concepts.

### Effects in Pain Syndromes

In pain syndromes physiotherapy can be useful because of the following principles:

- a) diminished dysfunction of affected organs (joints, muscles etc.)
- b) inhibiting pain perception by stimulation of sensory afferents according to the gate-control theory
- c) avoiding painful movements by an improvement of the quality of movement, e.g. by muscular training or improvement of coordinative skills
- d) normalization of autonomic nervous functions and reduction of depression by use of functional adaptive processes

For these reasons physiotherapy is indicated in all pain syndromes in which dysfunction of the locomotor system is involved. The active therapy should start as early as possible. Other indications justified by the reduction of depression and normalization of autonomic functions are other chronic pain syndromes with co-morbidities and a marked reduction of quality of life. In most cases, physiotherapy is applied in combination with other treatments, such as analgesic drugs, other physical therapies, psychotherapy and educational programmes.

These indications are supported by clinical experience. However, the evidence in controlled clinical trials is weak. One reason for this is that there are only a few controlled studies using pain as the main outcome parameter. Secondly, many studies use the (recommended) strategy with a polypragmatic (rehabilitative)

approach. Nevertheless – looking into the literature of the last few years (Medline 2001–2003) – there are some studies confirming the effectiveness of physiotherapy in many painful syndromes, e.g. low back pain (Pengel et al. 2002), cervical spine syndromes (Persson and Lilja 2001), cervicogenic headache (Jull et al. 2002), femoro-patellar pain syndromes (Cowan et al. 2003; Crossley et al. 2002), shoulder pain (Hay et al. 2003) and cranio-mandibular dysfunction (Oh et al. 2002). Complex regimens were proven to have positive results in low back pain (Moseley 2002; Schonstein et al. 2003) and fibromyalgia (Gustafsson et al. 2002). For some techniques, controlled trials have shown negative results (Hemmila et al. 2002; Smidt et al. 2002) and some meta-analyses also show weak or missing evidence (Brosseau et al. 2002; Goodyear-Smith and Arroll 2001). Summarizing the evidence from an expert point of view, it can be stated that implementing physiotherapy in pain therapy and rehabilitation programmes is useful, although the scientific evidence is still weak. Therefore further prospective controlled studies are needed.

## References

- Brosseau L, Casimiro L, Milne S et al. (2002) Deep transverse friction massage for treating tendinitis. *Cochrane-Database-Syst-Rev* 4:CD003528
- Cowan SM, Bennell KL, Hodges PW et al. (2003) Simultaneous feedforward recruitment of the vasti in untrained postural tasks can be restored by physical therapy. *J Orthop Res* 21:553–558
- Crossley K, Bennell K, Green S et al. (2002) Physical therapy for patellofemoral pain: a randomized, double-blinded, placebo-controlled trial. *Am J Sports Med* 30:857–865
- Goodyear-Smith F, Arroll B (2001) Rehabilitation after arthroscopic meniscectomy: a critical review of the clinical trials. *Int Orthop* 24:350–363
- Gustafsson M, Ekholm J, Broman L (2002): Effects of a multiprofessional rehabilitation programme for patients with fibromyalgia syndrome. *J Rehabil Med* 34:119–127
- Gutenbrunner C, Weimann G (2004) *Krankengymnastische Methoden und Konzepte*. Springer, Berlin Heidelberg New York
- Gutenbrunner C (2004) Therapieprinzipien. In: Gutenbrunner C, Weimann G (eds) *Krankengymnastische Methoden und Konzepte*. Springer, Berlin Heidelberg New York, pp 10–24
- Hay EM, Thomas E, Paterson SM et al. (2003): A pragmatic randomised controlled trial of local corticosteroid injection and physiotherapy for the treatment of new episodes of unilateral shoulder pain in primary care. *Ann Rheum Dis* 62:394–399
- Hemmila HM, Keinänen-Kiukaanniemi SM, Levoska S et al. (2002) Long-term effectiveness of bone-setting, light exercise therapy, and physiotherapy for prolonged back pain: a randomized controlled trial. *J Manipulative Physiol Ther* 25:99–104
- Jull G, Trott P, Potter H et al. (2002) A randomized controlled trial of exercise and manipulative therapy for cervicogenic headache. *Spine* 27:1835–1843
- Moseley L (2002) Combined physiotherapy and education is efficacious for chronic low back pain. *Aust J Physiother* 48:297–302
- Oh DW, Kim KS, Lee GW (2002) The effect of physiotherapy on post-temporomandibular joint surgery patients. *J Oral Rehabil* 29:441–446
- Pengel HM, Maher CG, Refshauge KM (2002) Systematic review of conservative interventions for subacute low back pain. *Clin Rehabil* 16:811–820
- Persson LC, Lilja A (2001) Pain, coping, emotional state and physical function in patients with chronic radicular neck pain. A comparison between patients treated with surgery, physiotherapy or neck collar—a blinded, prospective randomized study. *Disabil Rehabil* 23:325–335
- Rolnik JD (2004) Nervensystem. In: Gutenbrunner C, Weimann G (eds) *Krankengymnastische Methoden und Konzepte*. Springer, Berlin Heidelberg New York, pp 54–55
- Schonstein E, Kenny DT, Keating J et al. (2003) Work conditioning, work hardening and functional restoration for workers with back and neck pain. *Cochrane-Database-Syst-Rev* 2003:CD001822
- Smidt N, van der Windt DA, Assendelft WJ et al. (2002) Corticosteroid injections, physiotherapy, or a wait-and-see policy for lateral epicondylitis: a randomised controlled trial. *Lancet* 359:657–662

## Picrotoxin

- ▶ [Post-Stroke Pain Model, Cortical Pain \(Injection of Picrotoxin\)](#)

## Pin-Prick Pain

- ▶ [First and Second Pain Assessment \(First Pain, Pricking Pain, Pin-Prick Pain, Second Pain, Burning Pain\)](#)

## PIRFT

### Definition

Percutaneous intradiscal radiofrequency thermocoagulation – where a radiofrequency lesion is made in the nucleus pulposus, causing thermal fibrosis, which reduces nociceptive input from a painful intervertebral disc.

- ▶ [Discogenic Back Pain](#)

## Piriformis

### Definition

One of the groin muscles involved in hip movement.

- ▶ [Sacroiliac Joint Pain](#)

## Pituitary Adenylate Cyclase Activating Peptide

### Definition

A polypeptide present in the pituitary and areas of the nervous system that modulates pain sensation as well as other neuronal processes.

- ▶ [Peptides in Neuropathic Pain States](#)



## Pituitary Adenylate Cyclase-Activating Polypeptide

- ▶ PACAP

## Pituitary Gland

### Definition

The pituitary gland (hypophysis) is a neuroglandular organ located in the sella turcica just below the base of the brain (the hypothalamus). It includes two portions: 1) the anterior hypophysis (adenohypophysis) that is glandular and includes three parts – the anterior, intermedialis and tuberalis, 2) the posterior hypophysis (neurohypophysis) that is directly linked up to the hypothalamus via the pituitary stem which contains the axons of the hypothalamic magnocellular neurons.

- ▶ Hypothalamus and Nociceptive Pathways

## PKA

- ▶ Protein Kinase A

## PKC

- ▶ Protein Kinase C
- ▶ TRPV1 Modulation by PKC

## Placebo

SCOTT MASTERS  
Caloundra Spinal and Sports Medicine Centre,  
Caloundra, QLD, Australia  
scottyl@ozemail.com.au

### Synonyms

Dummy; Sham; Inactive Agent; Inert Agent

### Definition

Finding an adequate definition of ▶ placebo has proved a challenge. All definitions deal with the paradox of an intervention producing a beneficial effect when it is not supposed to do so. The paradox arises when an intervention has some effects that are due to a known physiological mechanism, and others whose mechanism is unknown. Respectively, these are referred to as the specific and non-specific effects of a treatment. The paradox is resolved if and once the mechanisms of the non-specific effects become known. However, while so long

as its mechanism remains unknown, any affect that is not due to the specific, intended effects of a treatment, is referred to as a ▶ placebo effect. Any beneficial effect that cannot be attributed to the specific, intended effects is referred to as a placebo response.

In its purist form, a placebo is an agent with no (known) therapeutic effect, or “an intervention designed to simulate medical therapy” (Brody 2000), but which has no specific therapeutic effect.

The opposite of a placebo-effect is a ▶ nocebo effect, in which harm occurs for no apparent reason (see ▶ nocebo).

### Characteristics

The term placebo (from the Latin: “I shall please”) was first used medically in the late 1700’s. It described medicines adapted more to please patients rather than cure them. The use of placebos was widespread well into the first half of the 20<sup>th</sup> century. In a 1981 hospital study, physicians and nurses admitted to using placebo administration in up to 80% of patient contacts, mainly for analgesia (Gray and Flynn 1981).

The placebo-effect is a specific phenomenon that needs to be distinguished from others with which it has been confused. It is not natural history, spontaneous recovery, regression to the mean, or the “Hawthorne effect”.

The natural history of some conditions is that recovery occurs in due time, because of healing or resolution of the original problem that caused pain. The relief that occurs is a property of the disorder itself, and neither implies nor requires a placebo-effect. The two are distinguished by comparing the outcomes of a group treated with placebo and a group having no treatment.

Regression to the mean is a statistical phenomenon that occurs when measurements are taken. It refers to the tendency of measurements to be inflated at the commencement of an experiment, but to return to average levels as the experiment continues. Patients with chronic pain are more likely to present to a doctor, or to enrol in studies, when their pain is worse than usual. In time, that pain settles to lesser, and more typical, average levels, regardless of the treatment implemented. The observed improvement is not due to a placebo-effect; it is a reflection of normal fluctuations in reported levels of pain.

The “Hawthorne effect” is a phenomenon in which a subject’s performance changes because they recognise that they are being studied. The change occurs consciously or subconsciously as the subject tries to guess and produce the behaviour that they believe the investigator is looking for. The essential feature is that the subject believes that they are being judged in some way. A “Hawthorne effect” may contaminate a placebo-effect, if the patient believes their role is to please the investigator. However, the essence of the placebo-effect is that it is a response that the subject reports as due to an intervention, under open conditions, with no hidden agendas.

### Mechanism

Four main theories are used to explain the placebo-effect (Brody 2000; Peck and Coleman 1991)

According to *classic conditioning theory*, the placebo-response is a conditioned response to features of the treatment setting (doctor's attire and equipment, pills, etc.). Relief occurs because going to doctors in the past has been associated with relief.

The *response expectancy theory* maintains that patients respond favourably to treatment because they expect that treatment will relieve their pain.

The *meaning model* suggests three factors are important to maximise the placebo response. Firstly, the patient must feel listened to and must receive a valid coherent explanation for their illness. Secondly, the patient needs to feel care and compassion from their treatment environment. Lastly, the patient should feel empowered. The meaning model implies that patients amplify their pain because of fears about what is causing it, and its implications. When these fears are eliminated, the pain is reduced to tolerable or trivial levels, and emerges as a therapeutic effect.

*Cognitive dissonance theory* states that the holding of two or more beliefs, which are psychologically inconsistent, creates tension in the individual's psyche. This motivates the individual to reduce this inconsistency. For placebo treatments, the knowledge that a treatment has been administered, that the healer has said the treatment would work, and that only very ill people don't improve, creates a dissonance if the patient doesn't improve. To reduce the likelihood of this anxiety-provoking dissonance, the patient alters their perception of their symptoms and their illness.

### Biochemical Mediators

Modern research has demonstrated that placebo responses are not a psychological phenomenon or a sign of aberrant behaviour. There is compelling evidence that endogenous opioids are involved in the placebo response to analgesia (Benedetti and Amanzio 1997; Ter Riet et al. 1998; Amanzio and Benedetti 1999; Amanzio et al. 2001). The placebo-effect is reversible by naloxone; blockade of cholecystokinin receptors potentiates placebo analgesia; and placebo analgesia can mimic the respiratory depression side effect of morphine, and this side-effect is reversible by naloxone. Catecholamines and cortisol have also been implicated as important mediators of the placebo-effect (Brody 2000).

### Response Rate

A figure of 35% is often quoted as if it is a standard measure of the incidence of placebo response rates, but it is inaccurate and misleading. It is no more than the average incidence of placebo responses in the 15 papers that Beecher reviewed in his 1955 article: "The Powerful Placebo" (Beecher 1955). It is more realistic to recognise that the incidence of placebo responses can vary

from 0% to 100%, depending on the disease, the setting, the administrator of the placebo, and numerous other factors (Voudouris et al. 1989).

Contrary to popular opinion, it is not the psychologically weak or the malingerer who responds to placebo; and there is no such entity as a "placebo-responder". It has been shown that, under different circumstances, the same individual can be both a responder and a non-responder (Peck and Coleman 1991; Voudouris et al. 1989).

### Clinical Application

Brody has suggested that practice style and clinician behaviour can be modified to potentiate the placebo-effect in an ethical manner (Brody 2000). Areas for modification include:

#### Sustained Partnership

Developing a relationship with patients is often what separates primary practice from tertiary care. Six elements have been linked to superior health outcomes (Fig. 1).

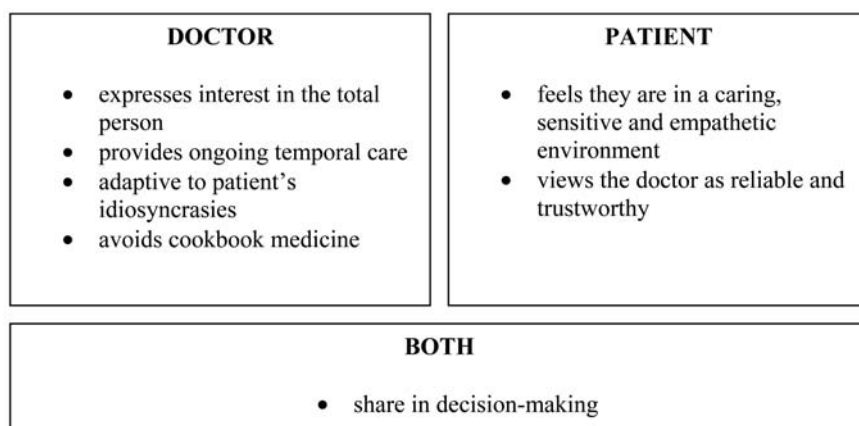
#### Mastery

Empowering patients is an important part of the recovery process. Mastery encourages the patient to change from a passive instrument, who is totally dependant on the "healer", to a person ready to take control of their health issues by regaining control. The patient is encouraged to express their desires about management, and verbalise their hidden thoughts about the reason for their problem and possible solutions.

#### Story

Many presentations to primary care are undifferentiated, and remain so despite a barrage of investigations. Patients can feel abandoned if they are dismissed after a fruitless search for meaningful pathology. This is a common experience for people with chronic pain. If their pain story can be reconstructed in a way they can understand, other management issues (e.g. physical therapy, vocational training, and medication use) are simpler to implement.

Similarly for acute pain, patients do much better if they are expressly told that they are receiving a strong painkiller, than if their treatment is covert (whereby they have no chance of a story). An elegant study on post-operative patients illustrates this difference (Voudouris et al. 1989). Patients were given buprenorphine on demand for three consecutive days along with a basal infusion of saline. Three different stories were told about the saline infusion. The first group was told nothing (natural history); the second was told that the saline could be either a powerful analgesic or a placebo (double-blind); and the third group were all told it was a potent analgesic (deceptive administration). The reduction in buprenorphine use in the double-blind group



**Placebo, Figure 1** Ethical attitudes and behaviours that serve to enhance placebo responses.

was 20% compared with the natural history group, and 33% for the deceptive administration group.

These results are consistent with other hidden-injection studies (Amanzio et al. 2001). Patients unaware that they are receiving pain-killing injections get significantly less analgesic response than those who are made aware. This reinforces the importance of making certain that patients understand what their analgesics are for, how to use them properly, and to comprehend on their level how the analgesics will work in their body.

Importantly, the above scenarios involve complementing the use of active medication with placebo. Placebo used solely as therapy is not innocuous. It can delay patients seeking more effective treatments, it can reduce the response to active therapy in the future, it can add to the cost of treatment; and may result in a nocebo effect. Also, by being a constant reminder of illness, it may prevent people from functioning to their otherwise full capacity.

### Summary

Placebo treatment is not the same as no treatment. Normal treatment is the sum of natural history, placebo-effect, and medical treatment. In pain medicine, it has been clearly shown that utilising the placebo response can decrease the amount of analgesic needed and improve response to analgesics. Health workers would be well served to familiarise themselves with the ethical ways of harnessing the placebo-effect.

- ▶ Amygdala, Pain Processing and Behavior in Animals
- ▶ Descending Circuits in the Forebrain, Imaging
- ▶ Functional Imaging of Cutaneous Pain
- ▶ Lumbar Traction
- ▶ Opioids in Geriatric Application

### References

1. Amanzio M, Benedetti F (1999) Neuropharmacological Dissection of Placebo Analgesia: Expectation-Activated Opioid Systems versus Conditioning Activated Specific Subsystems. *J Neurosci* 19:484–494
2. Amanzio M, Pollo A, Maggi G, Benedetti F (2001) Response Variability to Analgesics: A Role for Non-Specific Activation of Endogenous Opioids. *Pain* 90:205–215

3. Beecher HK (1955) The Powerful Placebo. *JAMA* 159:1602–06
4. Benedetti F, Amanzio M (1997) The Neurobiology of Placebo Analgesia: From Endogenous Opioids to Cholecystekinin. *Prog Neurobiol* 52:109–125
5. Botsche PC (1994) Is there Logic in the Placebo? *Lancet* 344:925–926
6. Brody H (2000) The Placebo Response. *J Fam Pract* 2000; 49:649–654
7. Gray G, Flynn P (1981) A Survey of Placebo use in a General Hospital. *Gen Hosp Psychiatry* 3:199–203
8. Peck C, Coleman G (1991) Implications of Placebo Theory for Clinical Research and Practice in Pain Management. *Theoretical Medicine* 12:247–270
9. Ter Riet G, De Craen A J M, De Boer A, Kessels AG (1998). Is Placebo Analgesia Mediated by Endogenous Opioids? A Systematic Review. *Pain* 6:273–75
10. Voudouris NJ, Peck CL, Coleman G (1989) Conditioned Response Models of Placebo Phenomena: Further Support. *Pain* 38:109–116

P

## Placebo Analgesia

### Definition

Placebo analgesia is pain reduction that results from a subject's perception of a therapeutic intervention, regardless of whether the intervention is an active or inert agent.

- ▶ Hypnotic Analgesia
- ▶ Pain Modulatory Systems, History of Discovery
- ▶ Placebo
- ▶ Placebo Analgesia and Descending Opioid Modulation

## Placebo Analgesia and Descending Opioid Modulation

FABRIZIO BENEDETTI

Department of Neuroscience, Clinical and Applied Physiology Program, University of Turin Medical School, Turin, Italy

fabrizio.benedetti@unito.it

## Synonyms

Placebo Analgesic Effect; Placebo Analgesic Response

## Definition

Placebo analgesia is the reduction or the disappearance of pain, when an inert treatment (the placebo) is administered to a subject who is told that it is a painkiller. The placebo effect, so far considered a nuisance in clinical research when a new analgesic treatment has to be tested, has now become a target of scientific investigation, to better understand the physiological and neurobiological mechanisms that link a complex mental activity to different functions of the body. Usually, in clinical research, the term placebo effect refers to any improvement in the condition of a group of subjects that has received a placebo treatment. Conversely, the term placebo response refers to the change in an individual caused by a placebo manipulation. However, these two terms are sometimes used interchangeably.

## Characteristics

### Methodological Aspects

The identification of a placebo analgesic effect is not easy and its study is full of pitfalls. In fact, the effect, which follows the administration of a placebo, can be due to many factors, such as spontaneous remission (► [natural history](#)), ► [regression to the mean](#), symptom detection ambiguity and biases. All these phenomena need to be ruled out by means of control groups. Spontaneous remission can be ruled out by means of a no-treatment group, regression to the mean can be controlled by using an experimental pain model in healthy volunteers, symptom detection ambiguity and biases can be avoided by using objective physiological measurements. It is also necessary to rule out the possible effects of co-interventions. For example, the mechanical insertion of a needle by itself may induce analgesia, thus leading to erroneous interpretations. Therefore, the choice of the experimental model is crucial.

When the correct methodological approach is used, striking placebo effects can be detected, which are mediated by psychophysiological mechanisms worthy of scientific inquiry. In fact, this psychological component represents the real placebo effect. Therefore, the psychological causal relationship, which links the administration of a placebo to the observed effect, is the interesting aspect to be investigated.

### Mechanisms

The placebo effect is basically a context effect, where the context (e. g. the doctor's words, the sight of a syringe, and other sensory inputs) around the medical intervention plays a crucial role. Today, we know that the context may produce a therapeutic effect through at least two mechanisms: conscious anticipatory processes and unconscious ► [conditioning](#) mechanisms. In the

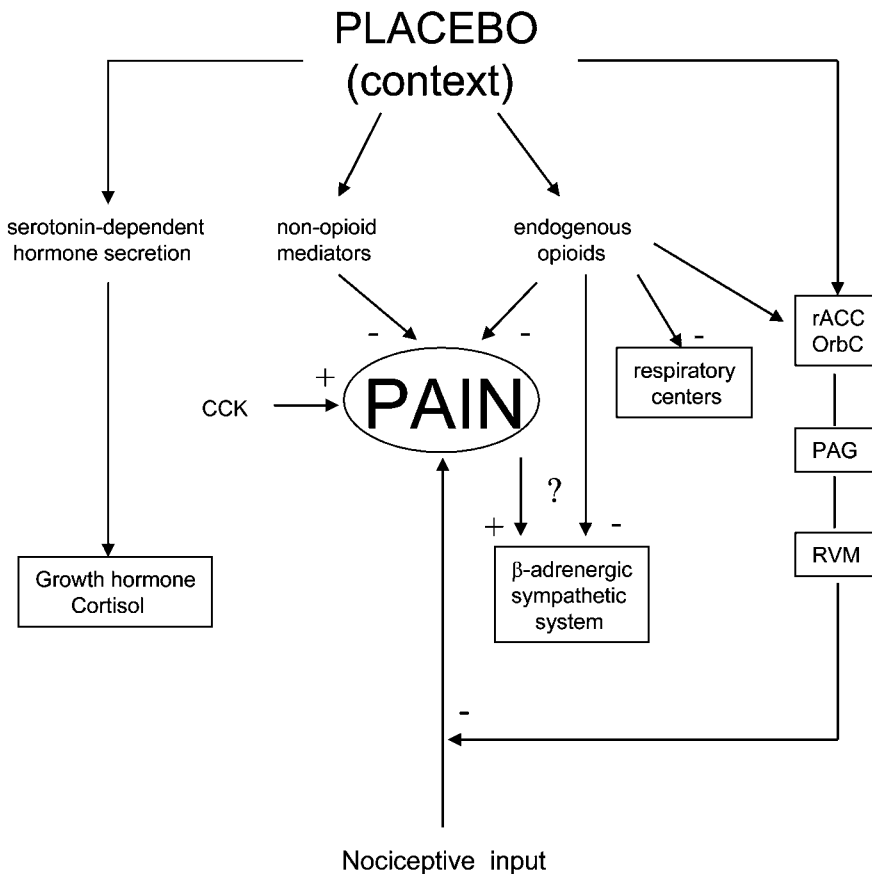
first case, ► [expectation](#) and anticipation of analgesia has been shown to induce an analgesic effect. In the second case, contextual cues (e. g. color and shape of a pill) may act as a conditioned stimulus that, after repeated associations with an unconditioned stimulus (the painkiller contained in the pill), are alone capable of inducing analgesia. In the case of pain, it has been shown that cognition plays a crucial role, even though a conditioning procedure is performed (Benedetti et al. 2003). Therefore, a conditioning procedure, in which repeated associations between contextual cues and analgesia are performed, acts through the increase of expectations, inducing placebo analgesic responses with positive expectations, as well as nocebo hyperalgesic responses when negative expectations are present (Benedetti et al. 2003). The nocebo effect is a phenomenon that is opposite to the placebo effect.

The neural mechanisms underlying placebo analgesia are only partially understood. However, in the studies performed so far, there is a general agreement that the endogenous opioid systems play an important role in some circumstances. In fact, there are several lines of evidence indicating that placebo analgesia is mediated by a descending pain modulating circuit, which uses ► [endogenous opioids](#) as ► [neuromodulators](#). This experimental evidence comes from a combination of both imaging and pharmacological studies (see Fig. 1).

By using ► [positron emission tomography](#) (PET), it was found that the very same brain regions in the cerebral cortex and in the brainstem were affected by both a placebo and the rapidly acting opioid agonist remifentanyl, thus indicating a related mechanism in placebo-induced and opioid-induced analgesia (Petrovic et al. 2002). In particular, the administration of a placebo induced the activation of the rostral anterior cingulate cortex (rACC), the orbitofrontal cortex (OrbC) and the brainstem. Moreover, there was a significant covariation in activity between the rACC and the lower pons/medulla at the level of the rostral ventromedial medulla (RVM), and a subsignificant covariation between the rACC and the periaqueductal gray (PAG), thus suggesting that the descending rACC/PAG/RVM pain-modulating circuit is involved in placebo analgesia. There is a striking overlap between this placebo-activated circuit and the pain modulating descending network, rich of opioid receptors, described by Fields and Basbaum (Fields HL and Basbaum 1999; Price 1999). It has also been found that the activity of rACC is different in placebo responders and non-responders (Petrovic et al. 2002), thus indicating a strong correlation between brain activity and the occurrence of placebo analgesia.

The study with PET (Petrovic et al. 2002) tells us that placebo analgesia and opioid analgesia share a common neural mechanism, but it does not allow us to conclude that the placebo-activated descending network is an opioid network. In support of the involvement of endogenous opioids in this descending circuit,





**Placebo Analgesia and Descending Opioid Modulation, Figure 1** Cascade of events that may occur during a placebo procedure. Pain is inhibited by a descending inhibitory network involving the rostral anterior cingulate cortex (rACC), the orbitofrontal cortex (OrbC), the periaqueductal gray (PAG) and the rostral ventromedial medulla (RVM). Endogenous opioids inhibit pain through this descending network and/or other mechanisms. The respiratory centers may be inhibited by opioid mechanisms as well. The  $\beta$ -adrenergic sympathetic system is also inhibited during placebo analgesia, although the underlying mechanism is not known (reduction of the pain itself and/or direct action of endogenous opioids). Non-opioid mechanisms are also involved. Cholecystokinin (CCK) counteracts the effects of the endogenous opioids, thus antagonizing placebo analgesia. Placebos may also affect serotonin-dependent hormone secretion, like growth hormone and cortisol.



there are several pharmacological studies, which show that placebo analgesia is antagonized by the opioid antagonist naloxone (Levine et al. 1978; Grevert et al. 1983; Levine JD and Gordon 1984; Amanzio and Benedetti 1999). In addition, it has been shown that the endogenous opioid systems have a somatotopic organization, since local placebo analgesic responses in different parts of the body can be blocked selectively by naloxone (Benedetti et al. 1999a).

The placebo-activated endogenous opioids do not only act on pain transmission, but on the ► **respiratory centers** as well, since a naloxone-reversible placebo respiratory depressant effect has been described (Benedetti et al. 1999b). Likewise, a reduction of  $\beta$ -adrenergic sympathetic activity, which is blocked by naloxone, has been found during placebo analgesia (Pollo et al. 2003). However, it is not known whether the  $\beta$ -sympathetic reduction is due to the reduction of pain, or a direct action of the endogenous opioids on the  $\beta$ -adrenergic sympathetic system. These findings clearly indicate that the placebo-activated opioid systems have a broad range of actions, influencing pain, respiration and the autonomic nervous system, though it is not known whether they only act through a descending modulating network.

The placebo-activated endogenous opioids have also been shown to interact with endogenous substances that

are involved in pain transmission. In fact, based on the anti-opioid action of ► **cholecystokinin (CCK)**, CCK-antagonists have been shown to enhance placebo analgesia, thus suggesting that the placebo-activated opioid systems are counteracted by CCK during a placebo procedure (Benedetti et al. 1995, Benedetti 1996).

It is important to point out, that some types of placebo analgesia appear to be insensitive to naloxone, thus suggesting that neuromodulators other than opioids can be involved in some circumstances (Amanzio and Benedetti 1999; Gracely et al. 1983). For example, if a placebo is given after repeated administrations (pre-conditioning) of the non-opioid painkiller ketorolac, the placebo analgesic response is not blocked by naloxone (Amanzio and Benedetti 1999). A placebo-induced activation of ► **growth hormone** and inhibition of ► **cortisol** have been described after pre-conditioning with the analgesic drug sumatriptan, an agonist of serotonin 5-HT<sub>1B/1D</sub> receptors, thus suggesting that placebos may also act on serotonin-dependent mechanisms (Benedetti et al. 2003).

The findings obtained in the field of pain, indicate that placebo analgesia is one of the best models to unravel the intricate mechanisms of the placebo effect further. However, it is worth remembering, that placebo-activated endogenous substances have also been described in other

pathological conditions (de la Fuente-Fernandez et al. 2001).

## References

1. Amanzio M, Benedetti F (1999) Neuropharmacological Dissection of Placebo Analgesia: Expectation-Activated Opioid Systems Versus Conditioning-Activated Specific Sub-Systems. *J Neurosci* 19:484–494
2. Benedetti F, Amanzio M, Maggi G (1995) Potentiation of Placebo Analgesia by Proglumide. *Lancet* 346:1231
3. Benedetti F (1996) The Opposite Effects of the Opiate Antagonist Naloxone and the Cholecystokinin Antagonist Proglumide on Placebo Analgesia. *Pain* 64:535–543
4. Benedetti F, Arduino C, Amanzio M (1999a) Somatotopic Activation of Opioid Systems by Target-Directed Expectations of Analgesia. *J Neurosci* 19:3639–3648
5. Benedetti F, Amanzio M, Baldi S et al. (1999b) Inducing Placebo Respiratory Depressant Responses in Humans via Opioid Receptors. *Eur J Neurosci* 11:625–631
6. Benedetti F, Pollo A, Lopiano L et al. (2003) Conscious Expectation and Unconscious Conditioning in Analgesic, Motor and Hormonal Placebo/Nocebo Responses. *J Neurosci* 23:4315–4323
7. de la Fuente-Fernandez R, Ruth TJ et al. (2001) Expectation and Dopamine Release: Mechanism of the Placebo Effect in Parkinson's Disease. *Science* 293:1164–1166
8. Fields HL, Basbaum AI (1999) Central Nervous System Mechanisms of Pain Modulation. In: Wall PD, Melzack R (eds) *Textbook of pain*. Churchill Livingstone, Edinburgh, pp 309–329
9. Gracely RH, Dubner R, Wolske PJ et al. (1983) Placebo and Naloxone can Alter Postsurgical Pain by Separate Mechanisms. *Nature* 306:264–265
10. Grevert P, Albert LH, Goldstein A (1983) Partial Antagonism of Placebo Analgesia by Naloxone. *Pain* 16:129–143
11. Levine JD, Gordon NC, Fields HL (1978) The Mechanisms of Placebo Analgesia. *Lancet* 2:654–657
12. Levine JD, Gordon NC (1984) Influence of the Method of Drug Administration on Analgesic Response. *Nature* 312:755–756
13. Petrovic P, Kalso E, Petersson KM et al. (2002) Placebo and Opioid Analgesia – Imaging a Shared Neuronal Network. *Science* 295:1737–1740
14. Pollo A, Rainero I, Vighetti S et al. (2003) Placebo Analgesia and the Heart. *Pain* 102:125–133
15. Price DD (1999) *Psychological Mechanisms of Pain and Analgesia*. IASP Press, Seattle, WA

## Placebo Analgesic Effect

- Placebo Analgesia and Descending Opioid Modulation

## Placebo Analgesic Response

- Placebo Analgesia and Descending Opioid Modulation

## Placebo Effect

### Definition

The difference in outcome between a placebo treated group and an untreated group in an unbiased experiment.

- Placebo

## Plain Radiography

PETER LAU

Department of Clinical Research, Royal Newcastle Hospital, University of Newcastle, Newcastle, NSW, Australia  
petercplau@hotmail.com

### Synonyms

Plain X-Ray; Radiography; Computed Radiography; Digital Radiography

### Definition

Plain radiography is a means of obtaining a picture of internal structures by passing X-rays through them, and recording the shadows cast by these structures.

### Characteristics

X-rays are a form of electromagnetic radiation that has the property of being able to pass through biological tissues. However, different tissues absorb the radiation to different extents and not all the X-rays beamed at a body will emerge. Effectively, the tissues in the body cast shadows. If these shadows are recorded, an image can be developed of the tissues through which the X-rays have been beamed.

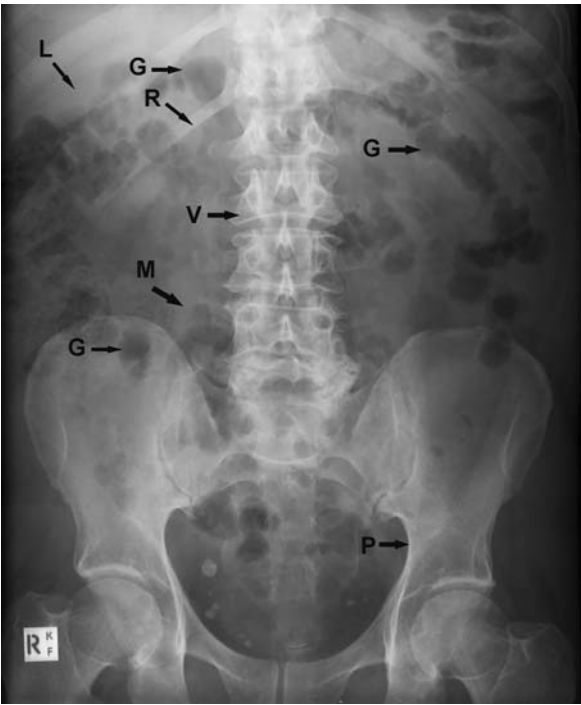
The classical means of obtaining an image has been to record the shadows of X-rays on a photographic film. The image is obtained by placing the film in a cassette on the opposite side of the body from that which the X-rays enter.

Modern techniques use electronic recording instead of photographic film. A detector placed behind the body records the density of radiation emerging. The captured information is stored in digital form (digital radiography), which can be processed by a computer in order to generate a photographic image (computed radiography). Apart from producing better quality images, digital radiography also allows data to be archived and distributed electronically.

Irrespective of how the images are obtained, plain radiographs are based on a single principle. Different tissues absorb X-rays to different extents and cast shadows of different densities.

Bones, or other tissues that contain calcium, absorb X-rays greatly and cast dense shadows. Photographically, they appear white, because the photographic emulsion in line with bones is relatively unexposed to radiation and remains chemically unaltered. Gas does not absorb X-rays and casts no shadows. Photographically it appears black (Fig. 1).

Tissues containing water or protein absorb X-rays to various, but small, extents. They appear as various shades of gray. In standard radiography, using film-based images, these tissues are poorly resolved.



**Plain Radiography, Figure 1** A plain radiograph of the abdomen, illustrating the different radiographic densities of various tissues. The bones of the ribs (R), vertebrae (V) and pelvis (P) appear white. Gas (G) in the intestinal tract appears black. The liver (L) and the muscles (M) of the posterior abdominal wall appear grey.

Plain radiography produces an incomplete image of internal structures. It produces a two-dimensional representation, or shadow, of a three dimensional object. The image, therefore, needs to be carefully interpreted.

The advantage of plain radiography is that it is inexpensive and available almost everywhere. However, in the context of pain medicine, plain radiography has limited utility.

#### Contrast Media

Hollow organs, tubular structures and spaces, which are normally invisible to X-rays, can be rendered visible by injecting into them a radiographic dye. The dyes contain iodine or barium, which absorb X-rays and cast a dense radiographic shadow. When injected into a cavity, the dye changes the contrast of the cavity by changing it from invisible to visible. For this reason, they are referred to as contrast media.

#### Utility

The cardinal utility of plain radiography is to demonstrate the status of bones. Radiographs can show the location, shape, internal architecture and density of bones. When focused on joints, X-rays can demonstrate the proximity and relative position of the bones forming the joint and the shape of the ends of these bones (Fig. 2).

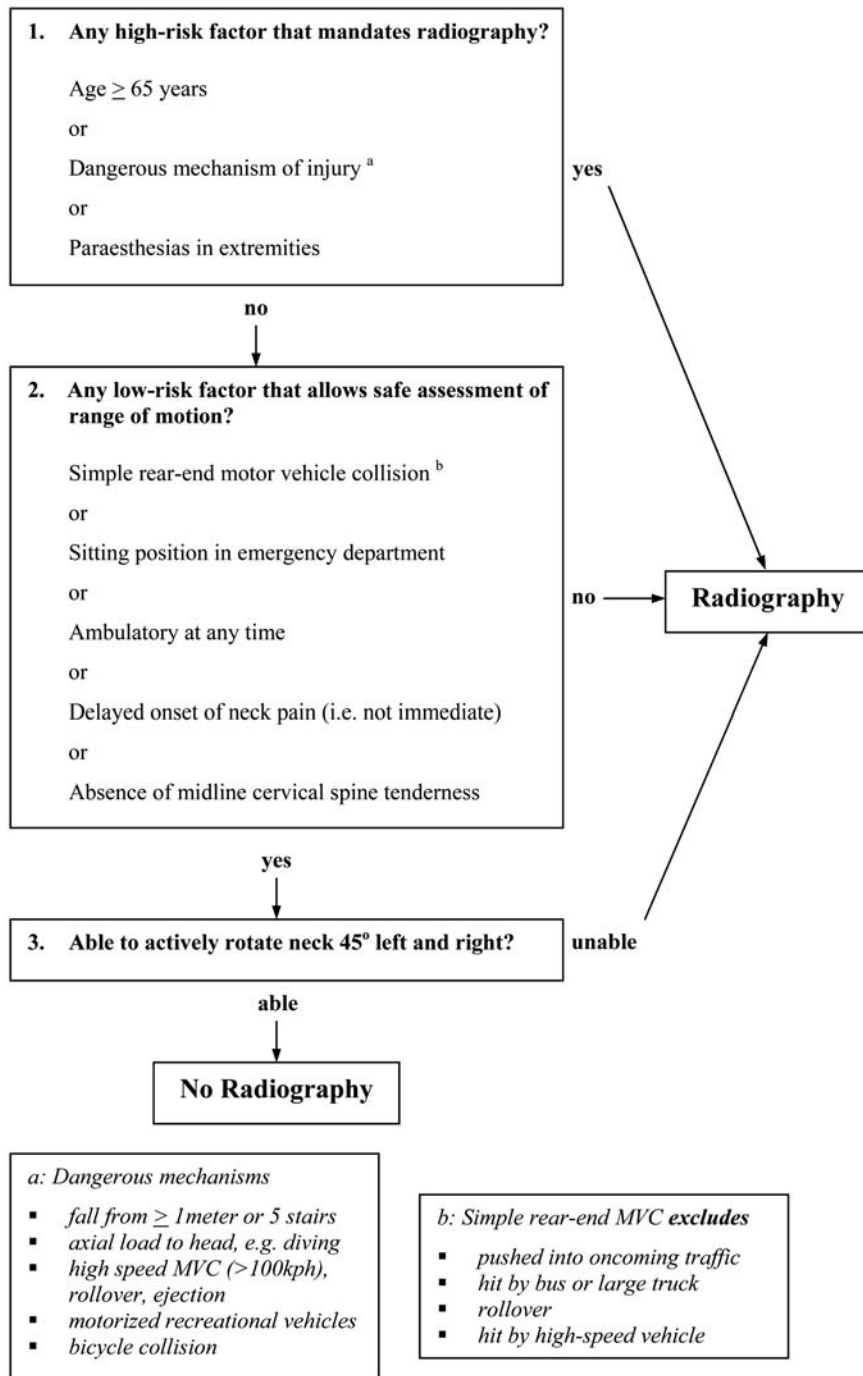
#### Fractures

The foremost application of plain radiography is in the detection of fractures. It is, therefore, critical in the inves-

P



**Plain Radiography, Figure 2** A plain radiograph of a pair of hands, illustrating how the structure of bones and joints can be demonstrated. For example, the proximal phalanx (pp) and the metacarpal bone of the third finger are labelled and the arrow points to the metacarpophalangeal joint.



**Plain Radiography, Figure 3** The Canadian C-Spine Rule (Stiell et al. 2001).

tigation of acute pain following trauma. In cases of major trauma, where fracture is clinically obvious or highly likely, the utility of plain radiography is unquestioned. However, when the trauma is not major or when fractures are unlikely to be the cause of pain, there has been a tendency for physicians to over-use radiographs. Radiographs are taken out of habit, just in case or to protect physicians from accusations of negligence – so-called defensive medicine.

Fractures are rarely the cause of acute low back pain. Contemporary guidelines deny the utility of plain radiography for the investigation of patients with back pain (Australian Acute Musculoskeletal Pain Guidelines Group 2003; Bogduk and McGuirk 2002). They recommend plain radiography only in patients with risk factors for fracture, such as major trauma or minor trauma in elderly patients, osteoporosis, use of corticosteroids or the possibility of a pathological fracture.



**Plain Radiography, Table 1** The Ottawa (Stiell et al. 1997) and Pittsburgh (Seaberg et al. 1998; Seaberg and Jackson 1994) knee rules, listing the indications for plain radiography of the knee and the Ottawa (Lawrence et al. 1996) ankle rules, listing the indications for plain radiography of the ankle

OTTAWA KNEE RULE	PITTSBURGH KNEE RULE	OTTAWA ANKLE RULE
Age 55 or more	Age less than 11	Pain in the zone of either malleolus, and any of: tenderness at: the posterior edge of the lateral malleolus the posterior edge of the medial malleolus the base of the fifth metatarsal the navicular bone or inability to walk four steps
Isolated tenderness of patella	Age greater than 51	
tenderness at head of fibula	Cannot walk four steps	
Unable to flex 90°		
Unable to transfer weight twice onto each lower limb, regardless of limping		

Otherwise, guidelines recommend medical imaging only if there are clinical indicators of a possible serious cause for the pain; but even so, magnetic resonance imaging, rather than plain radiography, is the modality of choice (Australian Acute Musculoskeletal Pain Guidelines Group 2003; Bogduk and McGuirk 2002). In patients with idiopathic neck pain, the chances of fracture being the cause are essentially nil (Bogduk 1999; Heller et al. 1983; Johnson and Lucas 1997). Even in patients with neck pain after trauma, the prevalence of fractures is only about 3% (Bogduk 1999). In order to minimize the use of plain radiographs in the pursuit of cervical fractures the Canadian C-spine rule has been formulated and validated (Stiell et al. 2001) (Fig. 3). Similarly, in patients presenting with ankle pain or knee pain, the over-use of plain radiographs can be safely reduced by following the Ottawa ankle rule (Stiell et al. 1995) and the Ottawa (Stiell et al. 1997) or Pittsburgh (Seaberg and Jackson 1994; Seaberg et al. 1998) knee rules (Table 1).

### Infection and Tumours

Infections and tumours of bone may manifest with different forms of periosteal reaction or by erosion of bone. These can be detected by plain radiography, but tend to occur late in the development of bone disease. Their early stages are better detected by computerized tomography (CT) or ► [magnetic resonance imaging](#) (MRI). These modalities also provide better resolution of later stages of tumours and infection.

### Arthropathy

Although plain radiography can produce images of joints, these are rarely diagnostic. Joint infections or inflammatory monoarthropathies are diagnosed by aspiration and laboratory testing of the aspirate. Polyarthropathies, such as rheumatoid arthritis and the various spondylarthropathies, are diagnosed from their clinical features. The utility of plain radiography is

limited to confirming the joint pathology and grading its severity in terms of erosions and loss of joint space.

### Degenerative Joint Disease

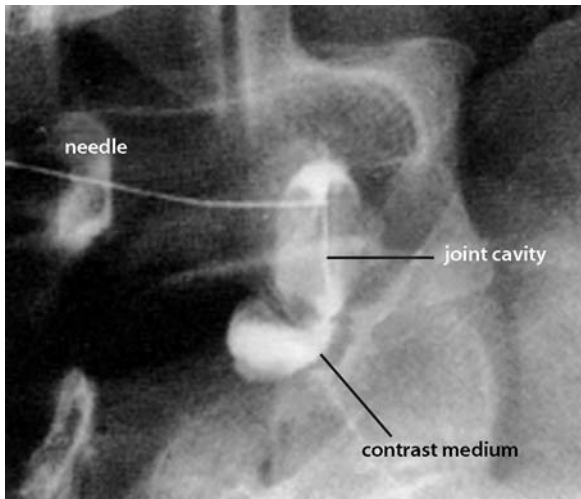
Plain radiography has, perhaps, been most over-used and wrongly interpreted in the context of so-called degenerative joint disease or osteoarthritis. Although radiography can reveal abnormalities, such as loss of joint space, subchondral sclerosis, subchondral cysts and osteophytes, these bear an inconsistent, and sometimes negative, relationship to pain. They are normal age changes rather than a disease that causes pain.

Most patients with joint pain have minimal or no radiographic changes in their joints (Lawrence et al. 1996). Conversely, not all patients with radiographic osteoarthritis have pain (Lawrence et al. 1996). Only some 60–80% of patients with severe radiographic changes in the hip or knee complain of pain. This figure drops to 30% in patients with radiographic changes in the hands. Under these conditions, plain radiography does not allow a diagnosis of the cause of pain to be made.

Spondylosis is very common in patients who do not have back pain. Consequently, there is only a marginal association between the presence of pain and the presence of degenerative changes in the lumbar spine (van Tulder et al. 1997). The association is too weak to allow degenerative joint disease to be the diagnosis of back pain. Similarly, an association between spondylosis and neck pain is all but lacking (Australian Acute Musculoskeletal Pain Guidelines Group 2003; Bogduk 1999; Heller et al. 1983) Consequently, neck pain cannot be attributed to degenerative joint disease.

### Structural Abnormalities

It had been the fashion to attribute low back pain to conditions such as spondylolysis and spondylolisthesis. However, epidemiological surveys have shown that these conditions, in adults, are just as common in



**Plain Radiography, Figure 4** An arthrogram of a right L5-S1 zygapophysial joint. A needle has been inserted into the joint. Contrast medium has been injected and appears white. It outlines the joint cavity and fills the subcapsular recesses above and below the joint.

patients with no pain as in patients with low back pain (van Tulder et al. 1997). They are incidental findings and cannot be regarded as the cause of pain.

#### Implications

Physicians have typically misused, and over-used plain radiography in the pursuit of a cause of pain. The utility of plain radiography is essentially limited to the identification of fractures, which are uncommon, or even rare, causes of pain, other than in patients with severe trauma. Plain radiographs have no diagnostic utility for the pur-

suit of degenerative joint disease because this cannot be held to be the cause of pain, even when evident.

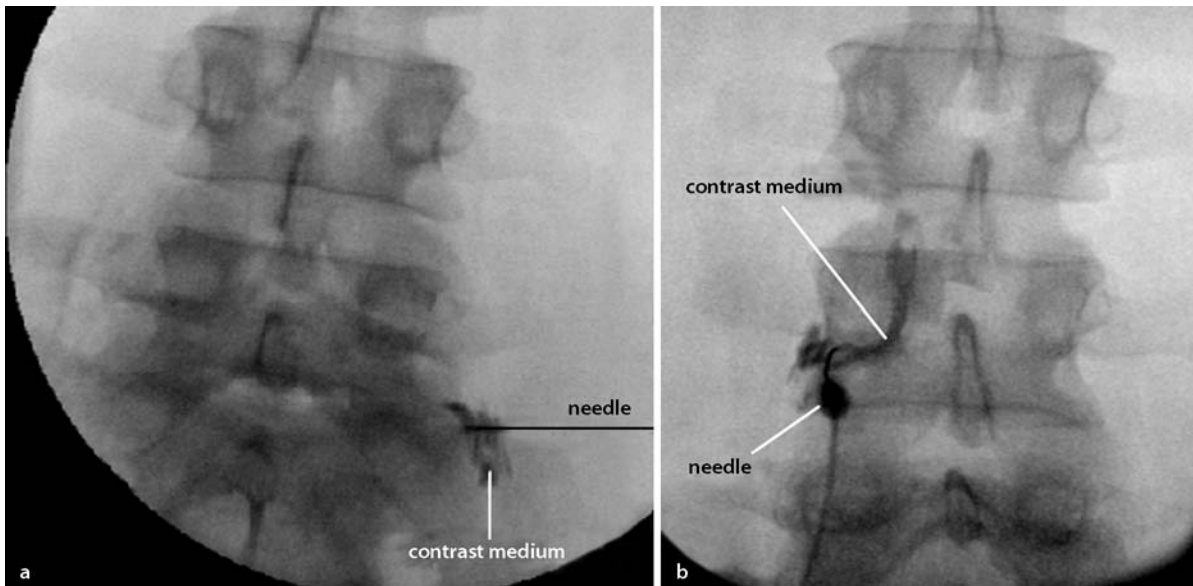
#### Fluoroscopy

Fluoroscopy is an adaptation of plain radiography. It involves capturing continuous images on a television screen as X-rays are continuously transmitted through the body. Continuous screening allows movements and events occurring within the body to be monitored and recorded. In radiology at large, fluoroscopy has been used to study the flow of contrast medium through blood vessels and through the urinary, genital and gastrointestinal tracts. In pain medicine, the greatest utility of fluoroscopy is to guide injections into deep structures. Prior to injecting a diagnostic or therapeutic agent, contrast medium can be injected in order to demonstrate where the injectate will flow. For intra-articular injections, contrast medium can be injected into the cavity of the target joint (Fig. 4). For nerve blocks, contrast medium can be injected onto the target site where the nerve lies, in order to ensure that the injectate covers the target but also does not flow to affect other structures (Fig. 5).

In this regard, fluoroscopy itself is not a diagnostic procedure. It is a tool that uses modified, plain radiography to ensure the accuracy and safety of other diagnostic and therapeutic procedures.

#### References

1. Australian Acute Musculoskeletal Pain Guidelines Group (2003) Evidence-Based Management of Acute Musculoskeletal Pain. Australian Academic Press, Brisbane. Online. Available at <http://www.nhmrc.gov.au> accessed 21.09.2004



**Plain Radiography, Figure 5** Examples of contrast medium used to ensure the accuracy of nerve blocks. (a) Right L5 medial branch block. The contrast medium remains in the correct target region for the nerve. (b) Left L4 spinal nerve block. The contrast medium outlines the course of the nerve and its roots.

2. Bogduk N (1999) The neck. *Bailliere's Clinical Rheumatology* 13:261–285
3. Bogduk N, McGuirk B (2002) *Medical Management of Acute and Chronic Low Back Pain. An Evidence-Based Approach*. Elsevier, Amsterdam
4. Heller CA, Stanley P, Lewis-Jones B et al. (1983) Value of x ray examinations of the cervical spine. *Brit Med J* 287:1276–1278
5. Johnson MJ, Lucas GL (1997) Value of cervical spine radiographs as a screening tool. *Clin Orthop* 340:102–108
6. Lawrence JS, Bremner JM, Bier F (1996) Osteo-arthritis: prevalence in the population and relationship between symptoms and X-ray changes. *Ann Rheum Dis* 25:1–24
7. Stiell I, Wells G, Laupacis A et al. (1995) Multicentre trial to introduce the Ottawa ankle rules for use of radiography in acute ankle injuries. *BMJ* 311:594–597
8. Stiell IG, Wells GA, Hoag RH et al. (1997) Implementation of the Ottawa Knee Rule for the use of radiography in acute knee injuries *JAMA* 278:2075–2079
9. Stiell IG, Wells GA, Vandemheen KL et al. (2001) The Canadian C-spine rule for radiography in alert and stable trauma patients. *JAMA* 286:1841–1848
10. Seaberg DC, Jackson R (1994) Clinical decision rule for knee radiographs. *Am J Emerg Med* 12:541–543
11. Seaberg DC, Yealy DM, Lukens T et al. (1998) Multicenter comparison of two clinical decision rules for the use of radiography in acute, high-risk knee injuries. *Ann Emerg Med* 32:8–13
12. van Tulder MW, Assendelft WJJ, Koes BW et al. (1997) Spinal radiographic findings and nonspecific low back pain. A systematic review of observational studies. *Spine* 22:427–434

## Plain X-Ray

- ▶ Plain Radiography

## Plantar Incision Model

- ▶ Nick Model of Cutaneous Pain and Hyperalgesia

## Plantar Test

- ▶ Thermal Nociception Test

## Plasma Concentration Versus Time Profiles

- ▶ NSAIDs, Pharmacokinetics

## Plasma Extravasation

### Definition

The leakage of plasma from blood vessels during acute inflammation associated with tissue injury. Pro-inflammatory mediators (PGE<sub>2</sub>, histamine, bradykinin, SP, CGRP) act on vasculature to induce vasodilation and

increase endothelial cell gaps. This permits the movement of plasma into the extravascular space to form regions of edema (swelling) that surround wounds. Plasma extravasation is partly mediated by antidromic activation of primary afferent C-fibers which produce neurogenic inflammation.

- ▶ Formalin Test
- ▶ Inflammation, Modulation by Peripheral Cannabinoid Receptors
- ▶ Neurogenic Inflammation and Sympathetic Nervous
- ▶ Nociceptors in the Orofacial Region (Skin/Mucosa)
- ▶ System

## Plasticity

### Definition

Plasticity is the ability of central nervous system tissue to change due to a variety of causes, including psychological factors. Changes can be in connectivity, inputs and/or response properties of neurons.

- ▶ Cancer Pain, Palliative Care in Children
- ▶ Sensitization of Visceral Nociceptors
- ▶ Thalamic Plasticity and Chronic Pain
- ▶ Thalamus, Receptive Fields, Projected Fields, Human

P

## Pleomorphic Vesicles

### Definition

Pleomorphic vesicles are contained in axon terminals a mixture of round, oval and flattened synaptic vesicles.

- ▶ Trigeminal Brainstem Nuclear Complex, Anatomy

## Plexopathy

### Definition

Radiation plexopathy is injury to a nerve plexus caused by radiation, usually intended as a treatment for cancer and to be therapeutic. It may present anywhere from six months to up to twenty years after radiation treatment. It is not usually a painful condition, but at times can be extremely painful. Pain typically involves the shoulder, lateral arm, and thumb and fore finger, because of the primary involvement of the upper trunk of the brachial plexus. Lumbar plexopathy is extremely uncommon.

- ▶ Cancer Pain Management, Neurosurgical Interventions
- ▶ Cancer Pain Management, Overall Strategy
- ▶ Plexus Injuries and Deafferentation Pain

## Plexus Injuries and Deafferentation Pain

PRAVEEN ANAND

Peripheral Neuropathy Unit, Imperial College London,  
Hammersmith Hospital, London, UK  
p.anand@imperial.ac.uk

### Synonyms

Brachial Plexus Avulsion Injury; plexopathy; deafferentation; Anesthesia Dolorosa Due to Plexus Avulsion; Obstetric Brachial Palsy; OBP

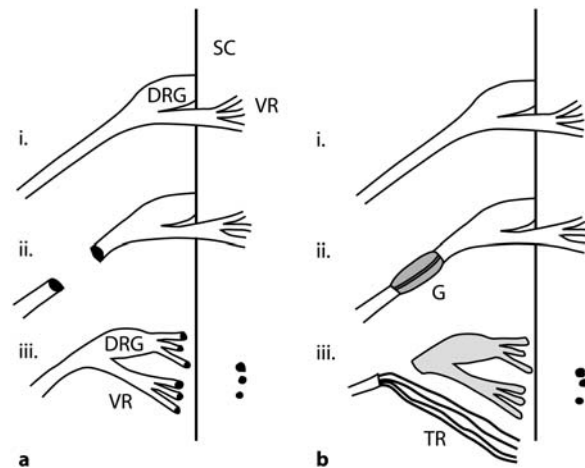
### Definition

Plexopathy refers to any lesion of the brachial or lumbosacral nerve plexus including trauma, infection, inflammation, ischemia, infiltration by or pressure from tumors, and post-radiation injury. Such lesions lead to pain syndromes that share the frequency and characteristics of other nerve lesions. Traction injuries, particularly of the ► **brachial plexus**, may result in ► **avulsion** of dorsal and ventral spinal roots from the spinal cord, which is frequently associated with severe, persistent pain due to ► **deafferentation** (“deafferentation pain”), and in some cases also because of injury to the dorsal spinal cord. The brachial plexus is the region of peripheral nervous system where the lowest four cervical and first thoracic spinal nerve roots (C5 – T1) unite and branch, in the lower part of the neck and behind the clavicle. Nerve fibers in the plexus, as they proceed distally, form the main nerves to the upper limb – the median, ulnar, musculocutaneous, radial and circumflex nerves. The lumbosacral plexus is formed by the union of lumbar and sacral spinal nerve roots (mainly L2 – S3) as they traverse the posterior wall of the abdomen and pelvis. The main tributary branches emerge as the femoral, obturator, sciatic and pudendal nerves.

### Characteristics

#### Background and Anatomy

There are distinctive aspects of plexus injuries, which may involve both central and distal axons of sensory neurons at different spinal root levels (Fig. 1). Chronic pain has been estimated to occur in about 5% of patients with peripheral nerve injury (Sunderland 1993), and this also applies to patients with plexus injuries where the lesion lies within the plexus, distal to the dorsal root ganglion. However, the majority of patients with spinal root avulsion injury, i.e. injury proximal to the dorsal root ganglion, report severe chronic pain at some point in the course of their condition (Wynn-Parry 1980; Birch et al. 1998). The degree of pain is related to the number of avulsed roots (Berman et al. 1998). Pain may occur from the time of injury, or within days, and is often intractable, lasting from months to years, or even decades. In brachial plexus avulsion injury there is intradural rupture of the spinal roots, which leads to degeneration of



**Plexus Injuries and Deafferentation Pain, Figure 1** Schematic representation of brachial plexus injuries. DRG, dorsal root ganglion; VR, ventral root; SC, spinal cord; G, graft; TR, transfer. (a) Before repair: (i) intact root, (ii) rupture, (iii) avulsion. (b) After repair: (i) intact root, (ii) rupture repaired by grafting, (iii) avulsion repaired by nerve transfer (from Berman et al. 1998).

somatic efferent and pre-ganglionic autonomic efferent fibers, and central processes of sensory fibers; however, the distal axons of somatic afferents remain intact. The latter are electrophysiologically “functional”, and continue to mediate cutaneous axon-reflex vasodilatation (Bonney and Gilliatt 1958). The transition from central to peripheral nervous system structures takes place in the transitional region, near to where the rootlets enter the spinal cord. CNS cells extrude into the rootlets in a cone shaped arrangement: thus “each transitional region can be subdivided into an axial central nervous system compartment and a surrounding peripheral nervous system compartment” (Berthold et al. 1993). The axons traverse this region; the blood vessels that serve the nerve fibers do not. In traction lesions of the adult brachial plexus, the rupture is usually peripheral to the transitional zone. However, some avulsion injuries cause damage central to the transitional zone, which may result in a spinal cord lesion and “central pain”. The pain following spinal root avulsion injuries is more severe and persistent than injuries distal to the dorsal root ganglion, in accordance with its central origin. The avulsion injury related pain is characteristically constant, described as crushing or burning, usually felt in the hand of patients with brachial plexus injury, with intermittent excruciating paroxysms of pain shooting down the arm. In complete brachial plexus avulsion injury (i.e. avulsions of C5 – T1) the painful limb is insensate – hence this pain is termed anesthesia dolorosa. As the pain after avulsion injury is related to the number of roots avulsed, the pain may be mild or even absent when there is only one root injured, particularly if it is an intra-dural injury of a dorsal root with no direct lesion of the spinal cord. This may explain why surgical



dorsal rhizotomy has been practiced to produce pain relief, usually for a short duration such as in severe tumor-related pain. In approximately 30% of patients with avulsion injuries there is allodynia to mechanical and thermal stimuli between the injured and intact dermatomes (i.e. border-zone), prior to any surgical nerve repair, but this is usually clinically mild and often not noticed by the patient, and may require quantitative sensory testing to reveal it. A few patients may demonstrate more severe allodynia and hyperalgesia after spontaneous or post-surgical sensory recovery, with features similar to partial nerve injury.

### Pain Mechanisms

It is now well established that peripheral nerve injury leads to a number of peripheral and central changes. Distinct mechanisms are involved in pain following spinal cord root avulsion. There is evidence that pain experienced after brachial plexus avulsion injury parallels the generation of abnormal activity within the dorsal horn of the spinal cord. Following dorsal rhizotomy in cats, increased burst activity is seen in dorsal horn cells in as early as 14 days (Loeser and Ward 1967). Continuous high frequency activity has also been reported in the cat dorsal horn and, significantly, this type of firing is characteristic when the denervation is due to avulsion rather than rhizotomy (Ovelmen-Levitt 1988), in accordance with clinical observations. Ischemic or hemorrhagic damage to the spinal cord, and death of inhibitory interneurons, may contribute. A high proportion of root avulsion patients report at least transient pain relief following dorsal root entry zone (DREZ) lesioning (Nashold et al. 1983), implicating this region in avulsion pain.

The usual current practice for repairing spinal cord root avulsion injuries is by transferring an intact neighboring nerve to the distal stump of the damaged nerve, in an effort to facilitate axonal regeneration and restore some motor and sensory function (Fig. 1). Clinical observations have indicated that successful surgical repair is associated with relief of avulsion pain, even in patients where repair was delayed for years and there was no prospect of motor recovery (Berman et al. 1996). In a prospective study, a correlation and close temporal relationship was observed between reduction in pain and functional recovery (Berman et al. 1998). It was concluded that nerve repair can reduce pain from spinal root avulsions, and that the mechanism involves successful regeneration with restoration of peripheral inputs (e.g. from muscle), or central connections.

The findings are different after brachial plexus injuries in neonates (Anand and Birch 2002). Results of repair in the obstetric brachial plexus lesion are often disappointing for motor function, presumably related to the relative delay of surgery and consequent retrograde degeneration of motor neurons, a process which proceeds much more rapidly in neonates than in adults. Results of sensory re-

covery are very much better, demonstrated by quantitative sensory testing. While recovery of function after spinal root avulsion was demonstrably related to surgery, there were remarkable differences from adults, including excellent restoration of sensory function in children, and evidence of exquisite CNS plasticity, i.e. perfect localization of restored sensation in avulsed spinal root dermatomes, now presumably routed via nerves that had been transferred from a distant spinal region. Sensory recovery exceeded motor or cholinergic sympathetic recovery. Remarkably, there was no evidence of long-term chronic pain or other neuropathic syndromes, although pain was reported normally to external stimuli in unaffected regions. We proposed that differences in neonates that account for their lack of long-term chronic pain after spinal root avulsion injury are related to later maturation of injured fibers, and greater CNS plasticity (e.g. sprouting or maturation of descending inhibitory tracts).

### Treatment

The clinician must always bear in mind that the sooner the distal axonal segment is reconnected to the proximal segment and cell body, the better the result will be, both for regeneration and preventing the development of chronic pain. The general treatment options are similar to other traumatic neuropathies, but pain may be more intractable after brachial plexus avulsion injury. There are few randomized placebo-controlled double-blind clinical trials of pain relief in patients with brachial plexus injury alone (Berman et al. 2004). Tricyclic antidepressants and anticonvulsants are widely used, in combination with opioids, cannabinoids, and other treatments. The latter include transcutaneous electrical nerve stimulation (TENS), ► [acupuncture](#), spinal cord stimulation, nerve transfers (e.g. intercostal to ulnar nerve), ► [DREZ lesions](#), and behavioral therapies.

### References

1. Anand P, Birch R (2002) Restoration of Sensory Function and Lack of Long-Term Chronic Pain Syndromes after Brachial Plexus Injury in Human Neonates. *Brain* 125:113–122
2. Berman JS, Birch R, Anand P (1998) Pain following Human Brachial Plexus Injury with Spinal Cord Root Avulsion and the Effect of Surgery. *Pain* 75:199–207
3. Berman, JS, Symonds C, Birch R (2004) Efficacy of Two Cannabis Based Medicinal Extracts for Relief of Central Neuropathic Pain from Brachial Plexus Avulsion: Results of a Randomised Controlled Trial. *Pain* 112:299–306
4. Berman J, Taggart M, Anand P, Birch R (1996) Late Intercostal Nerve Transfer Relieves the Pain of Pre-Ganglionic Injury to the Brachial Plexus. *J Bone Joint Surg* 78:759–760
5. Berthold CH, Carlstedt T, Corneliussen O (1993) Anatomy of the Mature Transitional Zone. In: Dyck PJ, Thomas PK, Griffin JW, Low PA, Poduslo JF (eds) *Peripheral Neuropathy*, 3<sup>rd</sup> edn. WB Saunders, Philadelphia, pp 75–80
6. Birch R, Bonney G, Wynn Parry CB (1998) *Surgical Disorders of the Peripheral Nerves*. Churchill Livingstone, London, pp 467–490
7. Bonney G, Gilliatt RW (1958) Sensory Nerve Conduction after Traction Lesion of the Brachial Plexus. *Proc R Soc Med* 51:365–367

8. Loeser JD, Ward AA (1967) Some Effects of Deafferentation on Neurons of the Cat Spinal Cord. *Arch Neurol* 17:629–636
9. Nashold BS, Ost Dahl RH, Bullitt E, Friedman A, Brophy B (1983) Dorsal Root Entry Zone Lesions: A New Neurosurgical Therapy for Deafferentation Pain. In: JJ Bonica (ed) *Adv Pain Res Ther* 5:739–750
10. Ovelmen-Levitt J (1988) Abnormal Physiology of the Dorsal Horn as Related to the Deafferentation Syndrome. *Appl. Neurophysiol* 51:104–116
11. Sunderland S (1993) *Nerves and Nerve Injuries*. Churchill Livingstone, London
12. Wynn-Parry CB (1980) Pain in Avulsion Lesions of the Brachial Plexus. *Pain* 9:41–53

## PLIF

### Definition

Posterior lumbar interbody fusion – graft/cages placed between the vertebral bodies from posterior approach, retracting the thecal side to one side.

- ▶ [Spinal Fusion for Chronic Back Pain](#)

## PMS

- ▶ [Premenstrual Syndrome](#)

## Pneumothorax

### Definition

An accumulation of air in the pleural space.

- ▶ [Postoperative Pain, Regional Blocks](#)

## Point Acupuncture

- ▶ [Acupuncture](#)

## Point Prevalence

### Definition

Point prevalence refers to the rates of a specific disorder at a single point in time.

- ▶ [Depression and Pain](#)
- ▶ [Prevalence of Chronic Pain Disorders in Children](#)

## Polyarteritis Enterica

- ▶ [Reiter's Syndrome](#)

## Polyarthritis

### Definition

Polyarthritis involves joints in the back, hip, knee and ankle, and can produce such widespread pain that even though pain is localized to joints, patients will describe it as “leg pain” and even draw their pain pattern as leg pain rather than separate joint pain.

- ▶ [Sciatica](#)

## Polymodal Nociceptor(s)

### Definition

Sensory receptors in the skin with thinly myelinated (A $\delta$ ) or unmyelinated (C) afferent nerve fibers, which are activated by noxious stimuli of different modalities such as noxious (painful) mechanical stimuli, heat, lowering of pH or different chemical mediators, typically appearing in lesioned or inflamed tissues (e.g. bradykinin, prostaglandins, histamine and others). Many cutaneous nociceptors are multimodal and respond to two of three stimulus energies. Polymodal nociceptors are connected to the spinal cord's dorsal $\delta$  or C) afferent nerve fibers.

- ▶ [Mechano-Insensitive C-Fibres, Biophysics](#)
- ▶ [Nick Model of Cutaneous Pain and Hyperalgesia](#)
- ▶ [Nociceptors in the Orofacial Region \(Meningeal/Cerebrovascular\)](#)
- ▶ [Polymodal Nociceptors, Heat Transduction](#)
- ▶ [Sensitization of Visceral Nociceptors](#)
- ▶ [Spinothalamocortical Projections to Ventromedial and Parafascicular Nuclei](#)

## Polymodal Nociceptors, Heat Transduction

CAROLINA ROZA

Institute of Neuroscience, University Miguel Hernández-CSIC, Alicante, Spain

croza@umh.es

### Synonyms

Thermal Transduction; Mechanoheat Nociceptor; polymodal nociceptors; capsaicin receptors; A Delta( $\delta$ )-mechanoheat receptor; C-Mechanoheat Receptor; C-Heat Receptor

### Definition

Sensory process by which noxious heat is transduced into propagated nerve impulses at the peripheral endings of nociceptive afferents. The impulse activity in these fibers may lead to the generation of subjective sensations of pain in humans.

## Characteristics

Transduction of noxious heat takes place in two types of slowly conducting primary afferents: C- and A $\delta$ -fibers. Although a group of C-fibers in human skin has been described that presented only responses to noxious heat (Schmelz et al. 2000b), studies in animals have demonstrated that both types of fibers also typically respond to mechanical forces of noxious intensity, and hence have been categorized as mechano-heat nociceptors (CMH and AMH respectively) (Campbell and Meyer 1996). In addition, when explored, these fibers usually also respond to various chemicals (Davis et al. 1993), and in particular to capsaicin, which also excites heat-sensitive fibers of viscera, muscle, and the cornea of the eye (Belmonte and Gallar 1996; Cervero 1994; Mense 1996). Therefore, it is likely that CMHs and AMHs belong to the group of polymodal nociceptors.

### CMHs

They are present with similar heat thresholds in hairy and glabrous skin. CMHs respond both to heat and mechanical stimuli. Their heat threshold is over 38°C, but below 50°C. After reaching their threshold, their response increases monotonically with the stimulus intensity, and this is in parallel with the heat sensation threshold and the intensity-response curve of pain evoked by heat in humans (LaMotte and Campbell 1978). With repeated stimulation, their response decreases showing ► *fatigue*. In addition, they are activated only briefly after capsaicin application (Campbell and Meyer 1996).

### CHs

In human skin, 45% of the C units are mechano-heat afferents; however, a small percentage (4%) responds exclusively to heating, with thresholds between 45°C and 48°C. In contrast with CMH, CH exhibit prolonged bursting discharges for minutes ( $\geq 10$ ) following injection of capsaicin. It is likely that this bursting discharge pattern induces the waxing and waning pain characteristic of capsaicin injections. It has been proposed that CH fibers are responsible for the development of ► *Flare* and ► *hyperalgesia* after exposure to noxious heat (Schmelz et al. 2000a).

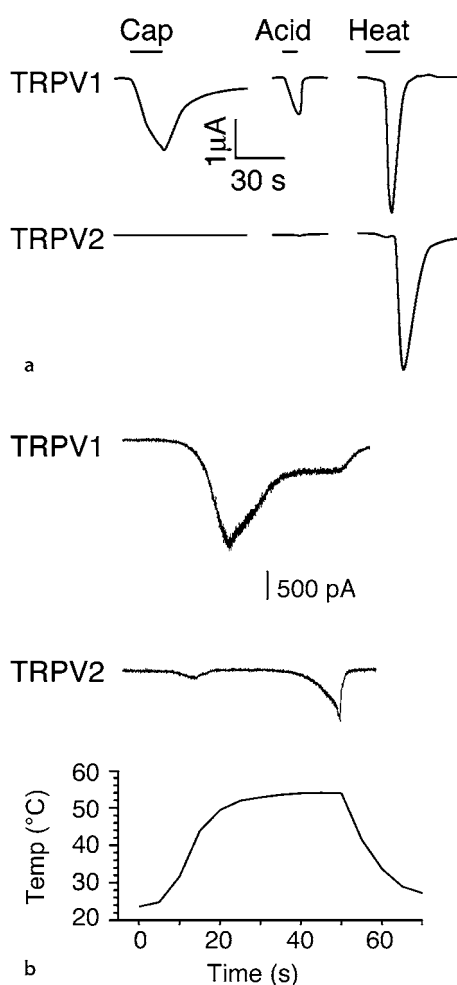
### AMHs

According to their response to heat, fibers within this group have been divided into two subpopulations, Type I AMH (or AMHI) and Type II AMH (or AMHII) (Treede et al. 1995). Type II AMH fibers are only present in hairy skin; they have a heat threshold of ~46°C; the peak response is reached early after the stimulus, and adaptation occurs over the next seconds. They show desensitization after a burn injury. With regard to their heat response, these fibers behave like CMH, but with higher heat pain thresholds.

Type I AMHs are present in both hairy and glabrous skin and have heat thresholds over 53°C; their response

to heating winds up with time, reaching a peak late in the stimulus. They become sensitized after a burn injury. Type I AMH have been proposed to be the high threshold mechanonociceptors (or HTHM) described by others, that also have the ability of transducing intense, noxious heat. These fibers probably contribute to heat pain evoked by a sustained, high-intensity heat stimulus (Campbell and Meyer 1996).

Most AMH units described in human hairy skin are similar to AMH type II, but some data suggest that AMH I units also exist in the glabrous skin of the human hand. A- $\delta$  fibers are less abundant than C-fibers in human skin nerves. ► *Microneurography* experiments additionally indicate that in human hairy skin, the proportion of heat sensitive elements is smaller in the A- $\delta$  fibers group than among C-fibers. In humans, heat thresholds of



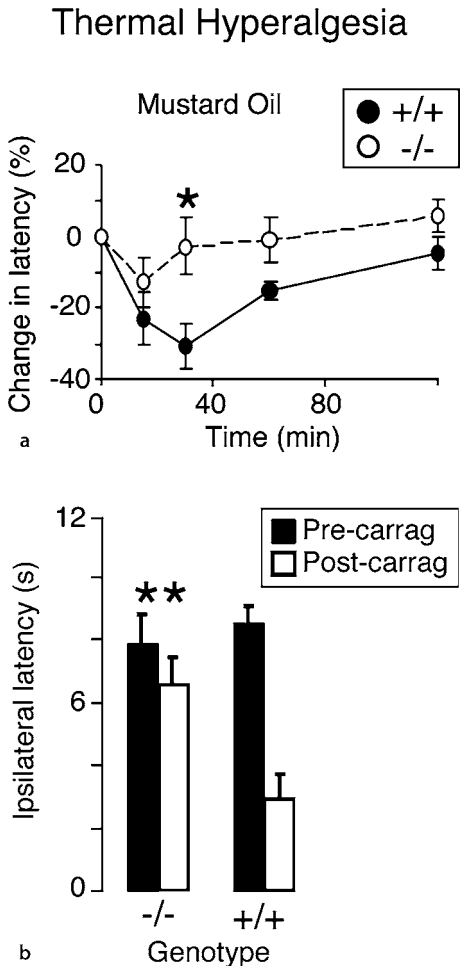
**Polymodal Nociceptors, Heat Transduction, Figure 1** (a) Responses of the cloned TRPV1 and TRPV2 expressed in *Xenopus* oocytes to capsaicin (1  $\mu$ M), protons (pH 4) and noxious heat (from 23°C to 55°C in 15 s). Whereas cells expressing TRPV1 responded to all pain-producing stimuli, those expressing TRPV2 exhibited responses only to noxious heat. (b) TRPV1 and TRPV2 expressed in HEK293 cells showed different heat response thresholds (~42°C and ~53°C respectively; final temperature 54°C). Adapted from (Caterina et al. 1999).

AMH type II and CHM units were in the same range of 36–49°C.

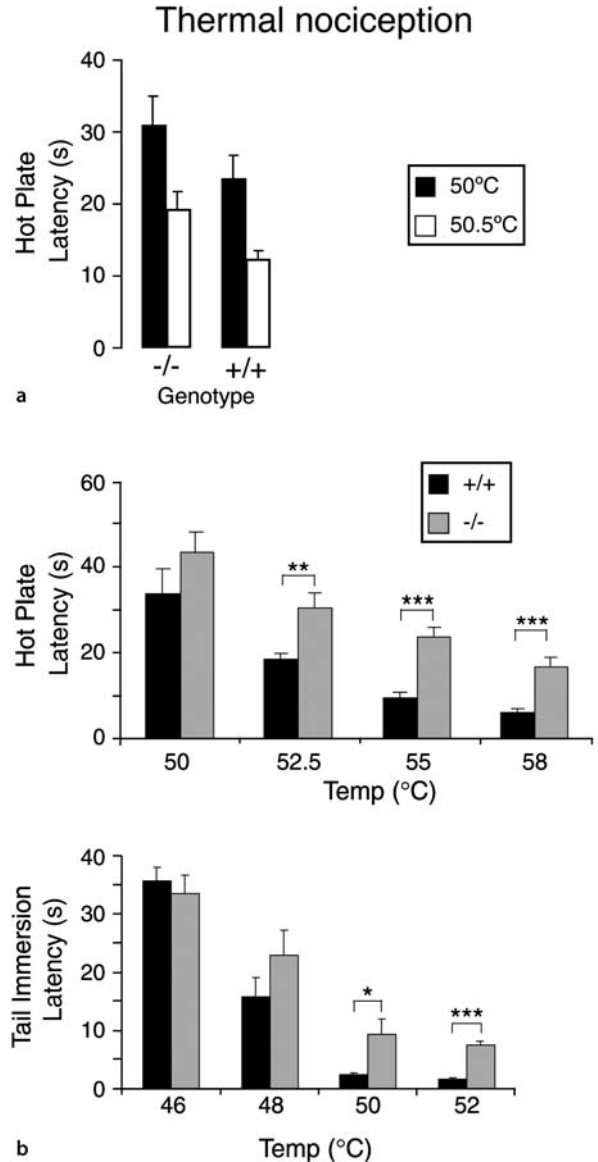
**Cellular and Molecular Mechanisms**

The transducer elements for mechanical forces and heat in A-δ and C polymodal afferents appear to be located in the same receptor ending (Treede et al. 1990), but are represented by separate molecular entities. This is because exposure of single nerve endings to capsaicin inactivates their responsiveness to heat and acid, but not to mechanical forces (Belmonte et al. 1991). Cesare and McNaughton (1996) first showed that heating over 42°C evoked an inward current in the soma of a subpopulation of DRG neurons. The cloning of two members of the TRP (“transient receptor potential”) cation channel family has settled the molecular basis underlying the transduction of noxious heat in the population of heat-

sensitive neurons (Fig. 1) (Caterina et al. 1997 1999). TRPV1 is a channel protein with a heat threshold of 43°C that also responds to capsaicin and to protons, all pain-producing stimuli (Tominaga et al. 1998). The most compelling evidence that TRPV1 was the primary heat-responsive channel was obtained in dissociated neurons from TRPV1<sup>-/-</sup> sensory ganglia of mice, where heat currents were absent or greatly attenuated (Caterina



**Polymodal Nociceptors, Heat Transduction, Figure 2** TRPV1<sup>-/-</sup> mice showed reduced thermal hyperalgesia induced by inflammation evoked by (a) mustard oil (10%) painted at the planter hindpaw and (b) by subplantar injection of carrageen (0.025 mls, 2%). These results demonstrate a role for TRPV1 in the development of inflammation induced heat hyperalgesia. Adapted from (Caterina et al. 2000) and (Davis et al. 2000), respectively.



**Polymodal Nociceptors, Heat Transduction, Figure 3** Two different assays were used to analyze the withdrawal responses to noxious heat in two different TRPV1 mutant mice strains. (a) In the TRPV1 mutant mice constructed by Davis and co-workers, there were not significant differences between both genotypes in the hot plate test at the two temperatures tested. (b) In the mice constructed by Caterina and co-workers, TRPV1<sup>-/-</sup> mice showed impaired responses to heat stimulation, but only when noxious heat reached intensities far above TRPV1 threshold (~43°C), as seen in both the hot plate and tail immersion tests. Adapted from (Davis et al. 2000) and (Caterina et al. 2000).



et al. 2000; Davis et al. 2000). TRPV1 is expressed by both peptidergic and non-peptidergic primary afferents with small diameter cell bodies, and has been proposed as the molecular substrate for the primary heat response of CMH fibers. CMH and Type II AMH fire at the same heat threshold that gates isolated TRPV1 channels. However, in contrast with the behavior of the channel, CMH and Type II AMH fibers do not sensitize to heat. Thus, the contribution of TRPV1 to heat responses in this type of fiber is not clearly defined, because the absence of TRPV1 abolished the inflammation-induced thermal hyperalgesia possibly mediated by CH and Type I AMH fibers (Fig. 2) (Caterina et al. 2000; Davis et al. 2000).

TRPV2 has 49% identity with TRPV1, is not gated by capsaicin and is expressed in primary afferents with cell bodies of all diameters, as well as in motoneurons and in a number of non-neural tissues (Caterina et al. 1999). Due to its high heat threshold, (~52°C) this channel may be the molecular substrate of the response of Type I AMH fibers to strong heat, and of the residual sensitivity to heat of TRPV1<sup>-/-</sup> mice (Fig. 3) (Caterina et al. 2000).

In spite of these advances in knowledge, the available information only partially explains the cellular and molecular basis of heat transduction. For instance, it has recently been described that nociceptors lacking TRPV1 and TRPV2 have normal heat responses (Woodbury et al. 2004), implying the existence of an additional and still ignored heat transduction mechanism. This may contribute to the variable responses to heat of the different classes of nociceptors.

## References

- Belmonte C, Gallar J (1996) In: Belmonte C, Cervero F (eds) *Neurobiology of Nociceptors*. Oxford University Press, Oxford, pp 147–183
- Belmonte C, Gallar J, Pozo MA et al. (1991) Excitation by Irritant Chemical Substances of Sensory Afferent Units in the Cat's Cornea. *J Physiol* 437:709–725
- Campbell JN, Meyer RA (1996) Cutaneous Nociceptors. In: Belmonte C, Cervero F (eds) *Neurobiology of Nociceptors*. Oxford University Press, Oxford, pp 117–145
- Caterina MJ, Leffler A, Malmberg AB et al. (2000) Impaired Nociception and Pain Sensation in Mice Lacking the Capsaicin Receptor. *Science* 288:306–313
- Caterina MJ, Rosen TA, Tominaga M et al. (1999) A Capsaicin-Receptor Homologue with a High Threshold for Noxious Heat. *Nature* 398:436–441
- Caterina MJ, Schumacher MA, Tominaga M et al. (1997) The Capsaicin Receptor: A Heat-Activated Ion Channel in the Pain Pathway. *Nature* 389:816–824
- Cervero F (1994) Sensory Innervation of the Viscera: Peripheral Basis of Visceral Pain. *Physiol Rev* 74:95–138
- Cesare P, McNaughton P (1996) A Novel Heat-Activated Current in Nociceptive Neurons and its Sensitization by Bradykinin. *Proc Natl Acad Sci USA* 93:15435–15439
- Davis JB, Gray J, Gunthorpe MJ et al. (2000) Vanilloid Receptor-1 is Essential for Inflammatory Thermal Hyperalgesia. *Nature* 405:183–187
- Davis KD, Meyer RA, Campbell JN (1993) Chemosensitivity and Sensitization of Nociceptive Afferents that Innervate the Hairy Skin of Monkey. *J Neurophysiol* 69:1071–1081
- LaMotte RH, Campbell JN (1978) Comparison of Responses of Warm and Nociceptive C-Fiber Afferents in Monkey with Human Judgments of Thermal Pain. *J Neurophysiol* 41:509–528
- Mense S (1996) Nociceptors in Skeletal Muscle and their reaction to Pathological Tissue Changes. In: Belmonte C, Cervero F (eds) *Neurobiology of Nociceptors*. Oxford University Press, Oxford, pp 184–201
- Schmelz M, Michael K, Weidner C et al. (2000a) Which Nerve Fibers Mediate the Axon Reflex Flare in Human Skin? *Neuroreport* 11:645–648
- Schmelz M, Schmid R, Handwerker HO (2000b) Encoding of Burning Pain from Capsaicin-Treated Human Skin in Two Categories of Unmyelinated Nerve Fibres. *Brain* 123:560–71
- Tominaga M, Caterina MJ, Malmberg AB et al. (1998) The Cloned Capsaicin Receptor Integrates Multiple Pain-Producing Stimuli. *Neuron* 21:531–543
- Treede RD, Meyer RA, Campbell JN (1990) Comparison of Heat and Mechanical Receptive Fields of Cutaneous C-Fiber Nociceptors in Monkey. *J Neurophysiol* 64:1502–1513
- Treede RD, Meyer RA, Raja SN (1995) Evidence for Two Different Heat Transduction Mechanisms in Nociceptive Primary Afferents Innervating Monkey Skin. *J Physiol* 483:747–758
- Woodbury CJ, Zwick M, Wang S et al. (2004) Nociceptors Lacking TRPV1 and TRPV2 have Normal Heat Responses. *J Neurosci* 24:6410–6415

## Polymodal Sensory Neurones

### Definition

Polymodal sensory neurones are primary afferent neurones that are activated by thermal, chemical and mechanical stimuli, s. also Polymodal Nociceptor.

► TRPV1 Receptor, Species Variability

P

## Polymodality

### Definition

Polymodality is the capacity to respond to more than one type of stimulus: mechanical, thermal or chemical.

► Mechanonociceptors

## Polymorphism

### Definition

A polymorphism is a genetic variant that appears in at least 1% of a population.

► Capsaicin Receptor

► Thalamus, Clinical Pain, Human Imaging

## Polymyalgia Rheumatica

### Definition

Polymyalgia rheumatica is a suspected autoimmune disease occurring in patients over the age of 50 with symp-

toms of muscle pain, most often in the shoulder and neck region, but also in muscles of the trunk and pelvic girdle, and signs of inflammation in blood tests: Elevated ESR and CRP.

- ▶ [Cancer Pain, Assessment in the Cognitively Impaired](#)
- ▶ [Muscle Pain in Systemic Inflammation \(Polymyalgia Rheumatica, Giant Cell Arteritis, Rheumatoid Arthritis\)](#)

## Polymyositis

### Definition

Polymyositis is an inflammatory muscle disease that only affects muscles. The development of symptoms is subacute, always starting in proximal muscles. Muscle wasting is prominent in chronic forms. Muscle pain sometimes occurs. Muscle biopsy is diagnostic.

- ▶ [Myositis](#)

## Polyol Pathway

### Definition

The metabolism of glucose to sorbitol by the enzyme aldose reductase and subsequent metabolism of sorbitol to fructose by sorbitol dehydrogenase. The enzymes of the polyol pathway are found in tissues that develop disorders during diabetes, and metabolism of excess glucose by the polyol pathway is considered to be an early etiologic mechanism in many diabetic complications. Inhibitors of aldose reductase have been extensively studied as a potential treatment for diabetic neuropathy and other complications. However, while these aldose reductase inhibitors have protective effects in many animal models of diabetic neuropathy, their clinical efficacy remains to be proven.

- ▶ [Neuropathic Pain Model, Diabetic Neuropathy Model](#)

## Polyps

### Definition

Placebo-controlled trials have been performed in patients with colorectal adenomas to assess if selective COX-2 inhibitors have any beneficial effect in this condition.

- ▶ [Cyclooxygenases in Biology and Disease](#)

## Polyradiculopathy

### Definition

Polyradiculopathy refers to pathologic involvement of the nerve roots.

- ▶ [Viral Neuropathies](#)

## Polysomnography

### Definition

The study of sleep patterns by the simultaneous recording of the electroencephalogram [EEG] and video monitoring of the patient, together with the recording of other biological data.

- ▶ [Hypnic Headache](#)

## P0m

- ▶ [Medial Part of the Posterior Complex](#)

## Pons

### Definition

Typically means bridge in Latin, but this reference is to the area of the brainstem where the trigeminal nerve exits.

- ▶ [Trigeminal Neuralgia, Diagnosis and Treatment](#)

## Poor Sleep Quality

- ▶ [Orofacial Pain, Sleep Disturbance](#)

## Population Survey

- ▶ [Prevalence of Chronic Pain Disorders in Children](#)

## Portacatheters

### Definition

Portacatheters are surgically placed ports that are most often connected to a catheter placed in the internal jugular vein. These ports enable the medical team to easily administer repeat medications.

- ▶ [Analgesic Guidelines for Infants and Children](#)

## Positioning

### Definition

Containment through positioning and blanket rolls to provide the infant with physical boundaries and help in maintaining a flexed position.

- ▶ Acute Pain Management in Infants

## Positive Reinforcement

### Definition

An event that increases the likelihood that the behavior that preceded it will be repeated. Often, but not always, positive reinforcement is perceived as pleasurable.

- ▶ Impact of Familial Factors on Children's Chronic Pain
- ▶ Motivational Aspects of Pain
- ▶ Operant Perspective of Pain

## Positive Sensory Phenomenon

### Definition

Positive sensory phenomenon is a clinical sign that is interpreted by the patient as less than when compared to normal bodily function and experiences.

- ▶ Hypoalgesia, Assessment
- ▶ Hypoesthesia, Assessment

## Positron Emission Tomography

### Synonyms

PET

### Definition

Positron emission tomography (PET) is an imaging technique that uses radiolabeled compounds to study physiologic processes *in vivo*. In cerebral activation studies, <sup>15</sup>O-water is used to study regional cerebral blood flow. Cerebral regional increases in positron emissions during a condition of interest compared to baseline reflect increases in regional blood flow, which is a marker of neuronal activation. PET is often used to measure changes in regions of activity within the brain during an experimental task, thus implicating functional involvement of these areas in task performance. PET is also heavily used in clinical oncology (for medical imaging of tumors and to search for metastases).

- ▶ Amygdala, Functional Imaging
- ▶ Amygdala, Pain Processing and Behavior in Animals
- ▶ Cingulate Cortex, Functional Imaging
- ▶ Descending Circuits in the Forebrain, Imaging

- ▶ Human Thalamic Response to Experimental Pain (Neuroimaging)
- ▶ Nociceptive Processing in the Cingulate Cortex, Behavioral Studies in Humans
- ▶ Pain Processing in the Cingulate Cortex, Behavioral Studies in Humans
- ▶ PET and fMRI Imaging in Parietal Cortex (SI, SII, Inferior Parietal Cortex BA40)
- ▶ Thalamus and Visceral Pain Processing (Human Imaging)
- ▶ Thalamus, Clinical Pain, Human Imaging
- ▶ Thalamus, Clinical Visceral Pain, Human Imaging

## Post Dural Puncture Headache

### Synonyms

PDPH

### Definition

A headache that occurs following spinal anesthesia. The etiology of the headache is secondary to a decrease in cerebrospinal (CSF) fluid leading to reduced support for intracranial structures. Traction on meningeal vessels and nerves, in the sitting or standing position, leads to the classic postural headache. Additionally, because of the loss of CSF, there is compensatory dilation of intracranial blood vessels that also cause headache.

- ▶ Analgesia During Labor and Delivery

P

## Post Stroke Central Pain

### Definition

A neurological condition caused by damage to the central nervous system that results in persistent pain. Usually as a result of neurological injury along the path of the spinothalamic pathway.

- ▶ Thalamic Plasticity and Chronic Pain

## Post Surgical Nerve Injury

- ▶ Iatrogenic Causes of Neuropathy

## Postamputation Pain

### Definition

Postamputation pain refers to pain at the site of the wound related to the amputation and must be distinguished from pain in the residual limb and phantom limb pain that may all co-occur in the early phase after amputation.

- ▶ Phantom Limb Pain, Treatment
- ▶ Postoperative Pain, Postamputation Pain, Treatment and Prevention

## Posterior Intervertebral Joint

- ▶ Zygapophyseal Joint

## Posterior Nucleus

### Synonyms

PO

### Definition

A transitional diencephalic zone of the thalamus consisting of complex and varied cells lying caudal to the ventral posterolateral nucleus, medial to the rostral part of the pulvinar, and dorsal to the medial geniculate body. It starts at the dorsolateral aspect of the supragenulate nucleus and expands laterally to the medial geniculate complex, and anteriorly ventral to VPL, and becomes continuous with VPI.

- ▶ Spinothalamic Terminations, Core and Matrix
- ▶ Thalamic Nuclei Involved in Pain, Human and Monkey
- ▶ Thalamus, Visceral Representation

## Posterior Part of the Ventromedial Nucleus

### Synonyms

Vmpo

### Definition

The posterior part of the Ventromedial Nucleus (VMpo) is a region that is claimed to be the main spinothalamic termination site for lamina I neurons, especially in the monkey and human.

- ▶ Human Thalamic Response to Experimental Pain (Neuroimaging)

## Posterior Primary Ramus

### Definition

Posterior branch of a spinal nerve that supplies branches to the paraspinal joints, ligaments, discs and skin.

- ▶ Pain Treatment, Spinal Nerve Blocks

## Post-Excitatory Effects of C-Fibres

- ▶ Mechano-Insensitive C-Fibres, Biophysics

## Post-Firing Excitability Changes in Different Nociceptor Populations

- ▶ Nociceptors, Action Potentials and Post-Firing Excitability Changes

## Postherpetic Neuralgia

### Definition

Postherpetic neuralgia is the paroxysmal pain extending along the course of one or more nerves following herpes zoster (acute shingles). Definitions of this are arbitrary but include pain at one, three or six months.

- ▶ Cancer Pain, Assessment in the Cognitively Impaired
- ▶ Neuralgia, Assessment
- ▶ Opioids in Geriatric Application
- ▶ Postherpetic Neuralgia, Etiology, Pathogenesis and Management
- ▶ Postherpetic Neuralgia, Pharmacological and Non-Pharmacological Treatment Options

## Postherpetic Neuralgia, Etiology, Pathogenesis and Management

PETER N. WATSON

University of Toronto, Toronto, ON, Canada

peter.watson@utoronto.ca

### Synonyms

Shingles Pain; Herpes Zoster Pain; Zoster-associated pain

### Definition

▶ **Postherpetic neuralgia** (PHN), as very generally defined, is pain along the course of a nerve following the characteristic acute segmental rash of ▶ **herpes zoster** (HZ). A more specific definition is pain persisting after the rash has healed (usually 1 month). Some investigators studying therapeutic approaches have chosen longer periods of 2, 3, or even 6 months after the disease onset. ▶ **Zoster-associated pain** (ZAP) is a recent term originating with studies of antiviral agents, which includes all pain beginning before, at onset, and after the rash, and does not discriminate between the acute pain of HZ and the chronic pain of PHN. It is more useful for the study of antiviral agents.



## Characteristics

### Incidence, Natural History and Demographics

HZ is the most common neurological illness (Kurtzke 1984), and PHN its most frequent complication. The incidence of PHN (defined as pain persisting for more than 1 month) has been variously estimated from 9% to 14% (Watson et al. 1991). Gradual improvement occurs in some patients after that time (Watson et al. 1991). The incidence of PHN is directly related to age. About 50% at age 60 years and nearly 75% at age 70 years with HZ have PHN 1 month or more following the rash (Watson et al. 1991). The dermatomes most commonly affected are the ophthalmic division of the fifth cranial nerve and the midthoracic segments.

### Pathology and Pathogenesis

There is evidence from pathological studies of both peripheral and central abnormalities in PHN (Watson et al. 1988). The pathogenesis of PHN remains unknown. Ectopic generators of abnormal discharges may occur at different locations along a damaged sensory nerve, from the regenerating sprout to the dorsal root ganglion. The discovery of pathologic change in the dorsal horn (Watson et al. 1988) in some patients with PHN supports the concept of a possible derangement with hypersensitive neurons in the central nervous system.

### Clinical Features

When the acute rash has healed, the affected skin often exhibits a reddish, purple, or brownish hue. As this subsides, pale scarring often remains. The scarred areas are usually at least hypoesthetic, and yet the skin often exhibits marked skin pain on tactile stimulation (▶ **allodynia**), or increased pain to noxious stimulation (▶ **hyperalgesia**), or an increased sensitivity to touch (▶ **hyperesthesia**). A steady burning or aching may occur and also a paroxysmal, lancinating pain. The examination of the affected, scarred skin often reveals a loss of sensation to pinprick, temperature, and touch over a wider area than the scars and an even wider area of sensitive or painful skin. The sensitive skin may paradoxically include the anesthetic areas, where it is elicited by stroking or skin traction between thumb and forefinger, an effect that may be caused by summation on hypersensitive central neurons with expanded receptive fields.

### Prevention

It is not known whether vaccination of older adults will attenuate or prevent herpes zoster. Clinical trials are currently underway, but the results will not be known for some years. The other preventive avenue is to treat herpes zoster early and aggressively. It is important that antiviral therapy with valacyclovir or famciclovir be initiated within 72 hours of the onset of pain or rash in order to inhibit viral replication. It appears that there is a modest reduction in ZAP and PHN with this approach.

Another measure that should be considered is the early, aggressive use of analgesics including opioids to prevent the development of sensitization of the nervous system. It is possible that regional anesthesia of the painful area may help to resolve acute pain and prevent PHN, although this is not scientifically proven. It has been suggested that early antidepressant therapy, at the stage of herpes zoster, may help to prevent persistent pain (Bowsher 1996).

### The Treatment of Established Postherpetic Neuralgia

Due to space constraints, complete references for this section are not given, but may be obtained from the author (CPNW) or a recent review book chapter (Watson and Gershon 2001). Randomized, controlled trials (RCTs) have repeatedly shown that the antidepressant amitriptyline relieves PHN (Watson and Gershon 2001). These studies have demonstrated that most patients are not depressed, and pain relief occurs without a change in depression ratings. This analgesia occurred at lower doses than usually used to treat depression (median 75 mg). Amitriptyline has severe limitations in the long-term because of side effects, and the fact that good relief occurs in only about one half of the patients. One of the effects of this drug is to potentiate both serotonin and noradrenaline in the central nervous system. Experience with serotonergic agents (clomipramine, trazodone, nefasodone, fluoxetine, zimeldine) in PHN has been disappointing. Desipramine, a more selective norepinephrine reuptake inhibitor, has been shown to be more effective than placebo in PHN, and pain relief with this drug as well was found not to be mediated by mood elevation (Watson and Gershon 2001). An RCT comparing maprotiline (noradrenergic) with amitriptyline found that, although both were effective, amitriptyline was more so (Watson and Gershon 2001). A comparison of nortriptyline (more noradrenergic) with amitriptyline showed about equal efficacy for both drugs, with less severe side effects with nortriptyline (Watson and Gershon 2001).

The anticonvulsant gabapentin has been proven superior to placebo in PHN, with 43% of the patients reporting at least moderate improvement (versus 12% with placebo), (Watson and Gershon 2001). As it appears to have fewer side effects than antidepressants, it has been suggested as a first-line treatment for this condition. A dose of 3500 mg/day was aimed for in the trial above and many patients achieved that. A recent study reports favorable results with pregabalin (Dworkin et al. 2003). The efficacy of this drug seems comparable to gabapentin (see Table 1).

An RCT of the opioid compound sustained release oxycodone has shown that 58% of the subjects experienced at least moderate improvement in pain versus 18% on placebo (Watson and Gershon 2001). An RCT has shown that although opioids and antidepressants (nortriptyline, desipramine) relieve PHN, opioids may be more effective.

**Postherpetic Neuralgia, Etiology, Pathogenesis and Management, Table 1** Number needed to treat (NNT) data in some neuropathic pain conditions

DRUG	CONDITION				COMMENTS
	Postherpetic Neuralgia	Diabetic Neuropathy	Painful Neuropathy	Central Pain	
<b>ANTIDEPRESSANTS</b>					
McQuay et al. 1996	2.3	3.0		1.7	systematic review
Sindrup and Jensen 1999	2.3	2.4		1.7	review
Collins et al. 2000	2.1	3.4			systematic review
IMIPRAMINE			2.7		RCT
VENLAFAXINE			5.2		RCT
Sindrup et al. 2003					
<b>GABAPENTIN</b>					
Sindrup and Jensen 1999	3.2	3.7			systematic review
<b>PREGABALIN</b>					
Dworkin et al. 2003	3.4				RCT
<b>OXYCODONE</b>					
Watson et al. 1998	2.5				RCT
Watson et al. 2003 (Pain in press)		2.6			RCT
<b>TRAMADOL</b>					
Sindrup and Jensen 1999			3.4		systematic review
Boureau et al. 2003	4.76				RCT

tive (Raja et al. 2002). Tramadol was more effective than placebo in a recent RCT (Boureau et al. 2003).

Although there is a long tradition of combining an antidepressant with a neuroleptic for PHN and other neuropathic pain, clinical experience has indicated no additional analgesic effects and an RCT now supports no benefit (Graff-Radford et al. 2000).

Topical therapies for PHN fall into 3 categories: capsaicin preparations, aspirin/nonsteroidal, anti-inflammatory preparations and local anesthetics.

Capsaicin remains the most controversial of the topical agents. Several hundred patients have now participated in controlled and uncontrolled clinical trials, and the two concentrations have been commercially available and in widespread use for several years. Yet, even in larger-scale studies, there is a wide divergence in reported results, with some investigators reporting no benefit in well-designed, controlled studies. Others have reported success rates for capsaicin that seem extraordinarily high for a condition long thought to be among the most intractable of chronic pain syndromes. Crushed aspirin in either chloroform or ethyl ether is internationally available but awkward to use. Lidocaine has been formulated into adhesive patches (Lidoderm<sup>®</sup>) with a soft,

woven backing that can be applied to cover the area of pain. A randomized, placebo-controlled trial has demonstrated the benefit of these patches (Watson and Gershon 2001).

Kotani et al. (2000) reported the results of an RCT of an intrathecal corticosteroid (methylprednisolone), given with lidocaine, in patients with PHN. More than 90% of the patients who received this reported excellent or good pain relief at 4 weeks and at 1 and 2 years, as compared with only approximately 6% of those who received only lidocaine, and approximately 4% of those who received no treatment. During the 2 years of this trial, no critical adverse effects, such as arachnoiditis or neurotoxic effects from the methylprednisolone, were noted. Use of this technique in larger numbers of patients, and observation during longer follow-up periods, will be important to identify any occurrences of these potentially severe side effects.

Surgical procedures are not useful for most patients with PHN (Watson and Gershon 2001).

#### How Effective are Pharmacological Agents in Clinical Practice?

The ► **number needed to treat (NNT)** has been suggested to convey the clinical meaningfulness of a trial

(Table 1). This evaluation is a description of an arbitrary therapeutic effect for a desired outcome of 50% improvement or more. It describes the difference between an intervention such as a drug and a control treatment. It is expressed as the number of patients required to be treated for a favourable response. Antidepressants and oxycodone may have an advantage in relieving pain; according to NNT data; however, their side-effect profile may make them less satisfactory to patients. Caution is required in comparing NNT figures, because of differences in study numbers and data analysis, as Dworkin has suggested (Dworkin et al. 2003).

#### A Summary of Practical Guidelines for the Treatment of Postherpetic Neuralgia

For established PHN (neuropathic pain persisting more than 3 months after HZ), the most consistently effective agents appear to be the older antidepressant drugs, and several RCTs in PHN support this approach. These indicate that pain may be taken from moderate or severe to mild in about one-half to two-thirds of the patients. Therapy may commence with nortriptyline (less severe side effects than amitriptyline) in a dose of 10 mg before bed in those over 65 years and with 25 mg in those 65 or under. The dose is increased by similar increments in a single bedtime dose every 7 to 10 days, until relief is obtained or intolerable side effects supervene. If these fail, then amitriptyline and then another noradrenergic agent, such as desipramine, are reasonable choices. Occasional patients failing these may benefit from a serotonergic drug, such as an SSRI, but no RCT has been done in PHN and these agents are not useful for many individuals.

An alternative approach, which may also be regarded as first-line, is gabapentin increased slowly to as much as 3600 mg/day (1200x3). A trial-and-error approach in refractory patients may also include the anticonvulsants carbamazepine, oxycarbazepine, phenytoin, clonazepam, lamotrigine, topiramate, or valproate. Resistant cases may require opioids on an as needed and/or round the clock basis. A variety of long-acting opioids are available. The dose can be increased to satisfactory relief or unacceptable side effects. A lidocaine patch has been shown to be useful by RCT.

► **Transcutaneous electrical nerve stimulation (TENS)** may be worth trying. Electrode placement, frequency, intensity, and duration of stimulation is a matter of trial and error. Some patients may benefit from nerve blocks that, if efficacious, may be repeated at appropriate intervals. “Scientifically based data regarding the efficacy of nerve blocks for either prevention or long-term treatment of PHN are not available” to quote from Perry Fine’s superb review (Watson and Gershon 2001), and the interested reader is referred there for a comprehensive review of this subject. At least 30% of our patients remain totally refractory or unsatisfactorily relieved and our approach with those is to see them

regularly, and try any new or older approach that seems reasonable and safe. Approximately 50% of patients, including even those with pain of long duration, will improve over the years with one-half of these being on no treatment (Watson et al. 1991).

#### References

1. Bowsher D (1996) Postherpetic neuralgia and its treatment: a retrospective survey of 191 patients. *J Pain Symptom Manage* 12:327–331
2. Kurtzke JR (1984) Neuroepidemiology. *Ann Neurol* 16:265–277
3. Watson CPN, Watt VR, Chipman M et al. (1991) The prognosis with postherpetic neuralgia. *Pain* 46:195–199
4. Watson CPN et al. (1988) Postherpetic neuralgia: postmortem analysis of a case. *Pain* 35:129–138
5. Watson CPN, Gershon AA (2001) Herpes Zoster and Postherpetic Neuralgia. *Pain Research and Management*, vol 11, 2<sup>nd</sup> edn. Elsevier Science BV
6. Dworkin RH, Dworkin RH, Corbin AE et al. (2003) Pregabalin for the treatment of postherpetic neuralgia: a randomized, placebo-controlled trial. *Neurology* 60:1274–1283
7. Raja SN, Haythornthwaite JA, Pappagallo M et al. (2002) Opioids versus antidepressants in postherpetic neuralgia: a randomized placebo-controlled trial. *Neurology* 59:1015–1021
8. Boureau F, Legallicier P, Kabir-Ahmadi M et al. (2003) Tramadol in postherpetic neuralgia: a randomized, double-blind, placebo-controlled trial. *Pain* 104:323–331
9. Graff-Radford SB, Shaw LR, Naliboff BN (2000) Amitriptyline and fluphenazine in postherpetic neuralgia. *Clin J Pain* 16:188–192
10. Kotani N, Kushikata T, Hashimoto H et al. (2000) Intrathecal methylprednisolone for intractable postherpetic neuralgia. *NEngl J Med* 343:1515–1519
11. McQuay et al. (1996) A systematic review of antidepressants in neuropathic pain. *Pain* 68:217–227
12. Sindrup SH, Jensen TS (1999) Efficacy of pharmacological treatment of neuropathic pain: an update and effect related to mechanism of drug action. *Pain* 83:389–400
13. Collins SL (2000) Antidepressants and anticonvulsants for diabetic neuropathy and postherpetic neuralgia: a quantitative systematic review. *J Pain Symptom Manage* 20:449–458
14. Sindrup SH, Bach FW, Madsen E et al. (2003) Venlafaxine versus imipramine in painful polyneuropathy. *Neurology* 60:1284–1289
15. Watson CPN et al. (1998) Oxycodone relieves neuropathic pain: a randomized controlled trial in postherpetic neuralgia. *Neurology* 50:1837–1841

P

## Postherpetic Neuralgia, Pharmacological and Non-Pharmacological Treatment Options

ANNE KØRSVIK BERTELSEN<sup>1</sup>, MILES BELGRADE<sup>2</sup>

<sup>1</sup>Department of Neurology, Haukeland University Hospital, Bergen, Norway

<sup>2</sup>Department of Neurology, University of Minnesota Medical School, Minneapolis, MN, USA

anne.kjorsvik@biomed.uib.no, mbelgral@fairview.org

#### Definition

► **Postherpetic neuralgia** is pain that persists following acute ► **herpes zoster**, or shingles. The time point at which acute herpes zoster pain becomes postherpetic neuralgia has been the focus of disagreement in the

medical literature. Nonetheless, one definition is pain persisting for more than three months after the crusting of skin lesions following an acute attack of herpes zoster (Bowsher 1997; Desmond et al. 2002).

### Characteristics

Postherpetic neuralgia (PHN), which affects up to 70% of elderly persons with herpes zoster (HZ), is difficult to treat and is the most common and feared complication following HZ.

Herpes zoster is caused by reactivation of the varicella-zoster virus (VZV), which can lay dormant in the dorsal root ganglia of the cranial or spinal nerves after chickenpox in childhood. PHN may arise from abnormal activity in damaged or dysfunctional peripheral sensory neurons caused by the herpes zoster infection (Rowbotham et al. 1998). The pain in PHN is typically described as constant burning, throbbing or aching or intermittent stabbing or shooting paroxysms, and may extend beyond the margins of the original rash. Cutaneous **▶ allodynia** is a characteristic feature of PHN that occurs in the affected skin dermatomes. Even the lightest touch, such as contact of clothing with the skin in the affected area, may provoke intense pain. Others may have paresthesias and **▶ dysesthesias** in the affected dermatome. Some patients may also have areas of sensory loss that lack responses to thermal, tactile, pinprick, or vibratory stimuli. This lack of sensation is termed negative symptoms in contrast to the positive sensory symptoms of spontaneous pain and allodynia. One important mechanism causing PHN is thought to be the accumulation of voltage-gated sodium channels along the damaged peripheral sensory neurons. This will result in lower activation threshold, more intense response to stimuli and spontaneous **▶ ectopic discharges** along the axons. These peripheral changes subsequently lead to hyperexcitability of central neurons in the dorsal horn, a state called **▶ central sensitization**. Clinical symptoms with marked allodynia and spontaneous pain may, therefore, be explained by augmented and spontaneous activation of damaged **▶ nociceptive neurons** (C and A-delta fibers), providing continuous input into the spinal cord and thereby maintaining central sensitization. Other peripheral mechanisms accounting for spontaneous pain, **▶ hyperalgesia** and allodynia in PHN may include sensitization of peripheral **▶ nociceptors**, increased adrenergic activation of C fibers, regeneration of damaged axons leading to neuromas or abnormal sprouting, and collateral innervation of denervated areas by neighboring axons.

### Pharmacological Management of Postherpetic Neuralgia

(The most common pharmacological treatment options are listed in Table 1).

Postherpetic neuralgia is unresponsive to common analgesics like non-steroidal anti-inflammatory drugs. To date, no single treatment guarantees good efficacy in all

patients. Currently, the antiepileptic drugs gabapentin and pregabalin, as well as the topical lidocaine patch 5% and capsaicin cream, have been approved by the US Food and Drug Administration (FDA) for the treatment of PHN, and should therefore be used as first-choice treatments. However, when these treatments fail or yield inadequate pain relief, other agents beneficial in relieving PHN should be tried. Different treatment options are discussed below.

### Anticonvulsant Agents

Gabapentin (Neurontin) has been shown to be effective in the treatment of PHN, and was approved by the US FDA in May 2002 for this indication. Structurally, gabapentin is an analogue of gamma-aminobutyric acid, GABA, but pharmacologically gabapentin appears to have no direct effect on GABA uptake or metabolism. Its mechanism of action appears to involve binding to the  $\alpha_2\delta$  subunit of voltage-dependent calcium channels (Backonja 2000), by inhibiting calcium influx with subsequent reduced release of excitatory neurotransmitters from presynaptic terminals, and thus reduced nociceptive transmission. Gabapentin seems to be most effective at or above doses of 1800 and up to 3600 mg per day (Backonja and Glanzman 2003; Stacy et al. 2003). Lower doses (<900 mg per day) have shown limited effect in the treatment of postherpetic neuralgia. However, the initial daily dose should not be higher than 900 mg divided into three doses, and doses should be reduced and the dosing interval increased in patients with renal failure. Gabapentin is usually well tolerated, but dizziness, somnolence, and mental clouding may occur.

Pregabalin (Lyrica), another analogue of GABA, was approved by the US FDA in September 2004 for the management of PHN. Pregabalin, which also binds to the  $\alpha_2\delta$  subunit of voltage-dependent calcium channels, has a more linear bioavailability than gabapentin and lower doses are therefore needed to achieve pain relief. This increases its therapeutic index with respect to gabapentin and should lead to fewer dose-related side effects. The therapeutic dose-range for pregabalin is between 150–600 mg per day, divided into two or three doses (Dworkin et al. 2003). The initial daily dose should be 150 mg divided into two doses.

### Antidepressants

Tricyclic antidepressants (e.g. amitriptyline, desipramine and nortriptyline) are the most commonly used drugs in the treatment of PHN, and, interestingly, they are found to be strong sodium channel modulators (Pancrazio et al. 1998), in addition to their well-known effect on reuptake of serotonin and noradrenaline. The sodium channel-blocking effect is presumed to be the pain-relieving mechanism of these drugs in the case of **▶ neuropathic pain**. The cumulative efficacy reported from trials suggests that about one third of patients



**Postherpetic Neuralgia, Pharmacological and Non-Pharmacological Treatment Options, Table 1** Most common pharmacological treatment options of postherpetic neuralgia

Drug	Daily dose	Most significant and common side effects	Comments
Pregabalin (Lyrica)	150–600 mg divided in two doses	Dizziness, somnolence	Well tolerated and few drug interactions. Higher bioavailability than gabapentin.
Gabapentin (Neurontin)	900–3600 mg divided in three doses	Dizziness, somnolence	Well tolerated when slow dose titration. Few drug interactions.
Lidocaine patch 5% (Xylocaine)	Up to three or four patches	Local irritation with oedema	Can only be applied to intact skin. Avoid if severe hepatic disease.
Capsaicin cream (0.025–0.075%) (Zostrix)	Three or four applications	Initial unpleasant burning sensation before analgesia	Can only be applied to intact skin. Hands should be washed thoroughly after application.
Amitriptyline (Elavil)	10–75 mg given as a single bed-time dose	Arrhythmia, orthostatic hypotension, sedation, confusion	Should be avoided in elderly and in those with heart disease.
Nortriptyline (Aventyl, Pamelor)	25–75 mg given as a single bed-time dose		Should be avoided in elderly and in those with heart disease.
Oxycodone	20 mg	Sedation, dizziness, constipation	Addiction and withdrawal symptoms

will achieve a 50% reduction in neuropathic pain, and their analgesic effect appears to be independent of their antidepressant effect. However, the benefits are often outweighed by intolerable side effects, especially among the elderly. These drugs should be given in appropriate doses and several should be tried before concluding that there is no response. The effect will often be delayed for up to four weeks. It is recommended to use desipramine or nortriptyline in the elderly to avoid the more frequent side effects (anticholinergic and orthostatic hypotension) reported with the use of amitriptyline.

**Antipsychotic (Neuroleptic)**

Many patients who do not obtain relief with tricyclics alone may benefit from the addition of a phenothiazine, for instance fluphenazine (1 mg three or four times a day) together with amitriptyline (50–75 mg per day). If the pain is severe, and all other methods fail, immediate pain relief may be obtained in hospitalized patients with a short course of high-dose chlorprothixene (50 mg every 6 hours for 5 days). However, this treatment requires hospitalization, is associated with adverse effects, and allows the return of symptoms within few weeks or months.

**Opioid Analgesics**

Although opioids are considered a last resort for chronic pain control, there are moderate data suggesting efficacy and tolerability of oxycodone and other opioids for this condition (Watson 2003).

**Topical Analgetics**

Lidocaine patch (xylocaine) has been shown in several trials to significantly reduce pain intensity, allodynia

and heat and cold sensitivity in patients suffering from PHN (Galer et al. 1999; Rowbotham et al.1995). The most common adverse reactions are localized erythema or edema. Systemic reactions are rare, but CNS excitation and/or depression have been reported, as well as such cardiovascular symptoms as bradycardia and hypotension. Lidocaine should be applied to intact skin only.

Capsaicin cream (Zostrix), the active component in hot chili peppers, applied topically four to five times a day for 4 weeks is effective in PHN treatment and is approved by the US Food and Drug Administration (FDA) for this indication (Kost and Straus 1996). Initial burning of the skin upon application is an unpleasant side effect that leads to discontinuation of treatment in more than 30% of patients. Capsaicin is thought to affect pain transmission by depleting the neural stores of substance P, a pain-modulating substance, in nociceptive fibers and/or promoting localized, temporary denervation of the epidermis. The capsaicin cream contains 0.025% to 0.075% capsaicin and should be applied to intact skin only. Patients should wash their hands thoroughly after applying capsaicin cream in order to prevent inadvertent contact with other areas.

**Local Injection of Anesthetics and Steroids**

The dull-ache component of the PHN is often the most resistant to therapy. If that component of pain persists, the scar can be infiltrated with the local anesthetic lidocaine. In one controlled trial (Kotani et al. 2000), repeated intrathecal administration of methylprednisolone acetate resulted in sustained pain relief in 90% of patients with PHN. The treatment was well tolerated; however, these encouraging preliminary results require confirmation.



### Sensory Nerve Block

Nerve root involvement is a frequent characteristic of PHN, but the pain-relieving effect of sensory nerve blocks is limited. There are some reports of success with this pain therapy in the early stage of the disease, although coincidental spontaneous resolution cannot be excluded.

### Sympathetic Nerve Block

Sympathetic blocks are sometimes helpful in alleviating pain, although results are often temporary and may only be obtainable in patients with neuralgia of less than 2 months' duration (Wu et al. 2000). Sympathetic blocks of the stellate ganglion and trigeminal branch blocks are often used to treat trigeminal zoster.

### Central Blocks

Epidural corticosteroid administration has been successful in treating various lumbosacral conditions. However, for patients with PHN, the pain relief is only temporary, and is therefore not indicated for these patients.

### Neurolytic Blocks

Neurolytic blocks may be considered in patients with PHN when other blocks have not given the patient significant relief. They should only be done after a prognostic block has shown that an effective block of the appropriate area can be achieved. Neurolytic agents are used in cases of prolonged destruction of the nerves.

These blocks include ethyl alcohol 50% in aqueous solution, absolute alcohol 95% in aqueous solution, and phenol 6%. Ethyl alcohol causes a higher incidence of neuritis than phenol. The duration of effects may vary from days to years, but usually ranges from 2 to 6 months. Ammonium compounds can also be used for peripheral nerve blockade. Pain relief follows selective destruction of unmyelinated C fibers by the ammonium ion: e.g. a solution of ammonium sulphate 10%, in lidocaine 1%, or ammonium chloride 15%. The duration of action ranges from 4 to 24 weeks. Cryoanalgesia has also been used as a means of producing long-term blocks with unpredictable results.

Complications that may result from any nerve block procedure include pain, local hemorrhage, infection, needle soreness and numbness.

### Other Non-Pharmacological Therapies

**The following techniques are used when all others fail; ice and other cold therapies.**

Ice is applied to the skin for 2 to 3 minutes several times a day, starting with the least sensitive skin area and approaching the most sensitive area. Ethyl chloride, or other cold spray, can also be used. Fluid is then sprayed twice over the entire painful area, and the evaporation cools the area. This treatment may relieve pain for varying lengths of time. As soon as the pain returns

to near its former intensity the treatment is repeated. Two to three sets of spray per day are often necessary to relieve the pain in responsive patients.

### Nerve Stimulation Therapies

▶ **Transcutaneous electrical nerve stimulation (TENS)** has been used in an attempt to relieve intractable pain of PHN. Although the success rate is low, relief can be sufficient to permit a return to normal activities without analgesic therapy.

### Acupuncture

Significant pain relief has been obtained in patients with PHN using acupuncture.

### Consultation and Psychological Treatments

In patients suffering from PHN, emotional stability is almost always affected. Therefore, it is especially important to treat the whole patient and not just an area of the skin. Severe depression is seen in more than 50% of these patients, and suicide is commonly considered in those with long-term intractable pain. Consultation by a psychologist or clinical social worker who is experienced in pain management is a valuable adjunct to drug therapy.

Training the patient in stress management and relaxation techniques is important. Anxiety and stress can exacerbate and prolong the pain. By practicing these techniques, some patients are able to control pain to some degree. In some patients, the pain-tension-anxiety cycle can convert acute pain symptoms into a chronic condition. Often, no matter what is done to treat these patients, the pain is not relieved unless the stress factors are also removed.

### Surgery and Neurosurgery

Surgery is the last resort for the treatment of severe intractable postherpetic neuralgia.

▶ **Cordotomy** is often initially very effective in relieving pain; however, in most cases the pain eventually returns. Early return has been blamed on failure to ablate all the nerves in the pathways, which resume function after the swelling has decreased.

Stereotactic ablation of the conduction paths in the thalamus, and mesencephalon and frontal lobotomy may be a treatment option in patients with short life expectancies who have not had success with any other methods.

▶ **Dorsal column stimulators** with an implanted electrode placed over the dorsal columns of the spinal cord, have been used with some success.

▶ **Deep brain stimulators**, which are patient-activated, have been applied to the mesencephalic medial lemniscus to block the pain-conducting systems and stimulate endorphin secretion, which then produces analgesia through an agonist action at opioid receptors. Good pain relief has been achieved in many patients with this therapy.

## References

1. Backonja MM (2000) Anticonvulsants (Antineuropathics) for Neuropathic Pain Syndrome. *Clin J Pain* 16:67–72
2. Backonja M, Glanzman RL (2003) Gabapentin Dosing for Neuropathic Pain: Evidence from Randomized, Placebo-Controlled Clinical Trials. *Clin Ther* 25:81–104
3. Bowsher D (1997) The Management of Postherpetic Neuralgia. *Postgrad Med J* 73:623–629
4. Desmond RA, Weiss HL, Arani RB et al. (2002) Clinical Applications for Change-Point Analysis of Herpes Zoster Pain. *J Pain Symptom Manage* 23:510–516
5. Dworkin RH, Corbin AE, Young JP Jr et al. (2003) Pregabalin for the Treatment of Postherpetic Neuralgia: A Randomized, Placebo-Controlled Trial. *Neurology* 60:1274–1283
6. Galer BS, Rowbotham MC, Perander J et al. (1999) Topical Lidocaine Patch Relieves Postherpetic Neuralgia More Effectively than a Vehicle Topical Patch: Results of an Enriched Enrollment Study. *Pain* 80:533–538
7. Kost RG, Straus SE (1996) Postherpetic Neuralgia-Pathogenesis, Treatment, and Prevention. *N Engl J Med* 335:32–42
8. Kotani N, Kushikata T, Hashimoto H et al. (2000) Intrathecal Methylprednisolone for Intractable Postherpetic Neuralgia. *N Engl J Med* 343:1514–1519
9. Pancrazio JJ, Kamatchi GL, Roscoe AK (1998) Lynch C 3rd. Inhibition of Neuronal Na<sup>+</sup> Channels by Antidepressant Drugs. *J Pharmacol Exp Ther* 284:208–214
10. Rowbotham MC, Davies PS, Fields HL (1995) Topical Lidocaine Gel Relieves Postherpetic Neuralgia. *Ann Neurol* 37:246–253
11. Rowbotham M, Harden N, Stacey B et al. (1998) Gabapentin for the Treatment of Postherpetic Neuralgia: A Randomized Controlled Trial. *JAMA* 280:1837–1842
12. Stacey BR, Glanzman RL (2003). Use of Gabapentin for Postherpetic Neuralgia: Results of Two Randomized, Placebo-Controlled Studies. *Clin Ther* 25:2597–2608
13. Watson CPN (2003) Postherpetic Neuralgia. In: Rice AS, Warfield CA, Justins D et al. (eds) *Clinical Pain Management – Chronic Pain*. Arnold Press, London, p 453
14. Wu CL, Marsh A, Dworkin RH (2000). The Role of Sympathetic Nerve Blocks in Herpes Zoster and Postherpetic Neuralgia. *Pain* 87:121–129

## Post-Hypnotic Suggestion

### Definition

These are suggestions given within the hypnotic session, which then take effect outside of formal hypnosis. The suggestions may be diffuse and general, simply to encourage a sense of well-being or self-control; or may be highly specific and linked to a post-hypnotic cue. The cue may be a word, image or action which when exhibited elicits the post-hypnotic response. For example, a subject may be taught to look at a hand in a particular way, which then induces the return.

- ▶ [Therapy of Pain, Hypnosis](#)

## Postictal Headache

- ▶ [Post-Seizure Headache](#)

## Post-Infarction Sclerodactyly

- ▶ [Complex Regional Pain Syndromes, General Aspects](#)

## Post-Lumbar Puncture Headache

- ▶ [Headache Due to Low Cerebrospinal Fluid Pressure](#)

## Postoperative Pain, Acute Neuropathic Pain

PHILIP SIDDALL, MICHAEL COUSINS  
Pain Management Research Institute, University of Sydney, Royal North Shore Hospital, Sydney, NSW, Australia  
phils@med.usyd.edu.au,  
mccousins@nscchahs.health.nsw.gov.au

### Definition

Neuropathic pain is defined as pain initiated or caused by a primary lesion or dysfunction in the nervous system (Merskey and Bogduk 1994). In the context of postoperative pain, it refers to pain that occurs in the acute postoperative setting following trauma to the peripheral or central nervous system.

### Characteristics

#### Prevalence

It has been reported that 1–3 % of patients experience neuropathic pain in the acute postoperative period (Hayes et al. 2002). In the long term, it has been reported that approximately 15–25 % of people may experience persistent neuropathic pain following procedures such as inguinal hernia repair (Callesen et al. 1999) and mastectomy (Jung et al. 2003). For surgery involving damage to major nerve trunks such as limb amputation, the prevalence is even higher (Nikolajsen and Jensen 2001). People with nervous system trauma such as brachial plexus avulsion (Parry 1980) or spinal cord injury (Siddall et al. 1999) also have a high incidence of acute neuropathic pain postoperatively. Failure to recognize acute postoperative neuropathic pain may result in inappropriate treatment and poorly controlled pain, with a subsequent adverse effect on postoperative outcomes (Hayes and Molloy 1997). It has also been suggested that unrecognized or inadequately treated acute neuropathic pain may be associated with an increased likelihood of persistent neuropathic pain (Callesen et al. 1999).

### Diagnosis

Neuropathic pain can usually be identified on the basis of history and clinical examination. Surgery or trauma that is known to result in damage to major nerve trunks, such as amputation or brachial plexus avulsion, should lead to a high index of suspicion for the presence of postoperative neuropathic pain. It is usually stated that descriptors such as shooting, stabbing, electric and burning are suggestive of neuropathic pain. However, these descriptors are not exclusive and a diagnosis based on pain descriptors alone is often difficult. Diagnosis is therefore assisted by other symptoms of nerve involvement, such as paraesthesiae and numbness in the region corresponding to or adjacent to the site of pain. The pain may also be paroxysmal and, in contrast to nociceptive pain, may be spontaneous with no relation to position or movement. However, shooting electric sensations in a radicular pattern, which are aggravated by movement, may also be suggestive of nerve root impingement or irritation.

Clinical examination is also helpful. Once again, it is often stated that increased responsiveness to either thermal or mechanical stimuli (► [allodynia](#) and ► [hyperalgesia](#)) in a region is indicative of neuropathic pain. However, these features are often present with nociceptive pain, particularly where there is ► [central sensitization](#) following tissue trauma. Therefore, these signs are not diagnostic for neuropathic pain. A diagnosis of neuropathic pain is more likely in the presence of signs of reduced sensory function. This loss of sensation may be indicative of nervous system damage, which is a prerequisite for the diagnosis of neuropathic pain. The presence of vasomotor and sudomotor changes, in addition to the features described above, is indicative of a ► [complex regional pain syndrome](#) (Wasner et al. 2003).

Imaging may also be appropriate in some acute postoperative settings to assist with the diagnosis of neuropathic pain. For example, a person with radicular pain following spinal trauma may require magnetic resonance imaging to determine whether there is impingement of a nerve root that may require surgical treatment.

### Mechanisms

Surgery is often carried out in those with trauma to the nervous system. This trauma may give rise to postoperative neuropathic pain. Surgery itself inevitably results in damage to small nerves and some procedures, such as amputation, deliberately sever or lesion larger nerves. Poor positioning during anaesthesia may also result in damage to vulnerable nerves or the brachial plexus. Compromise in blood supply to the spinal cord may lead to ischaemic damage. Any of these situations may lead to complete or partial deafferentation, leading to the development of neuropathic pain. The mechanisms of neuropathic pain are dealt with elsewhere, but include:

1. Generation of ectopic impulses (Devor et al. 1992). Although generally too early for neuroma forma-

tion, acute nerve injury may be associated with the generation of ectopic impulses in primary afferents. These may arise from compression on the dorsal root ganglion following trauma, and occur through an increased activation of sodium channels.

2. Increased excitation of central neurons. An afferent barrage following acute nerve injury may induce a central neuronal hyperexcitability due to increased glutamate release and activation of N-methyl D-aspartate (NMDA), non-NMDA and metabotropic glutamate receptors with subsequent ► [central sensitisation](#).
3. Decreased inhibition of central neurons. A reduction in local or descending inhibitory processes involving  $\gamma$  aminobutyric acid (GABA), glycine, opioids, serotonin and noradrenaline may occur, either as a result of direct damage or secondary changes. This loss of inhibition will again lead to an increased excitability of central neurons.
4. Altered sympathetic function. The mechanisms of complex regional pain syndromes are poorly understood, but broadly, there is a central hyperreflexic state affecting somatosensory, vasomotor, sudomotor and somatomotor responses (Wasner et al. 2003). Whether this hyperreflexia is due to increased peripheral inputs or loss of inhibition, and to what extent it is determined by contributions from peripheral, spinal and supraspinal levels is unclear.

### Treatment

It has been suggested that pre-emptive analgesia may be useful in reducing the incidence of neuropathic pain postoperatively. Several agents and approaches have been used. These include the systemic administration of opioids and NMDA antagonists and epidural administration of opioids, local anaesthetics and clonidine (Power and Barratt 1999). Peripheral nerve block may also be beneficial. Although there is theoretical support for the use of pre-emptive analgesia, there is still no clear evidence for an improvement in long term outcomes (Moiniche et al. 2002).

There are few studies that specifically examine the effectiveness of treatments of acute postoperative neuropathic pain. It is traditionally stated that opioids are relatively ineffective for the treatment of neuropathic pain. However, there is increasing evidence that they may be effective if an appropriate dose is used. Several randomized controlled studies, using intravenous administration of opioids for the treatment of a number of neuropathic pain states, demonstrate the efficacy of intravenous opioids in the treatment of neuropathic pain when compared with placebo (Attal et al. 2003). Tramadol may also be an option, because of its serotonergic and noradrenergic effects, which may provide an advantage in the treatment of neuropathic pain.

Local anaesthetics such as lidocaine (lignocaine) are also widely used for the treatment of acute postoperative



neuropathic pain. One of the actions of local anaesthetics is to produce sodium channel blockade. This reduces the amount of ectopic impulses generated by activity at these receptors. Relatively low concentrations of local anaesthetic are required to reduce ectopic neural activity in damaged nerves (Tanelian and MacIver 1991). Systemic administration of local anaesthetic provides a dose that does not block normal nerve conduction, but leads to a reduction in ectopic impulse generation. Therefore, local anaesthetics are administered systemically by intravenous or subcutaneous infusion. Topical application is also possible, although it is not clear whether adequate doses can be obtained rapidly to provide pain relief in this situation.

As mentioned above, nerve injury may lead to an afferent barrage with release of glutamate and activation of NMDA receptors resulting in central neuronal hyperexcitability. NMDA receptor antagonists such as ketamine have been used widely as treatment for acute postoperative neuropathic pain (Stubhaug and Breivik 1995). Administration is generally an infusion via the intravenous or subcutaneous route. One of the main problems with the use of ketamine is the occurrence of disturbing side effects such as hallucinations, although benzodiazepines may help reduce these symptoms. Careful monitoring can help to minimize the rate of occurrence of these side effects. However, they can be distressing to the person when they do occur.

Although systemic intravenous and subcutaneous administration of drugs such as opioids, lidocaine and ketamine is feasible in the inpatient setting, oral administration of a number of drugs is also possible and may be preferred. Unfortunately, most studies suggest that these oral agents are less effective than drugs used systemically. Most of the evidence for the effectiveness of opioids for the treatment of neuropathic pain comes from studies using acute intravenous administration. Local anaesthetics are not available in oral form, and the local anaesthetic congener mexiletine does not appear to be as effective as lidocaine in reducing neuropathic pain. Similarly, ketamine is difficult to administer orally, and other NMDA antagonists available for administration via the oral route, such as dextromethorphan, are also not as effective.

Several agents that are widely used for the treatment of persistent neuropathic pain are not available for systemic administration, but are available in the oral form. These include the tricyclic antidepressants such as amitriptyline, prothiaden and nortriptyline, and anticonvulsants such as carbamazepine, valproate, lamotrigine and gabapentin. Although the effectiveness of these agents has been demonstrated for a number of persistent neuropathic pain states, there is little evidence for their effectiveness in the acute postoperative setting. In principle, as most of the mechanisms for acute neuropathic pains are shared with chronic pain, there is good reason to believe that they should be effective in

the acute setting. However, restrictions on oral intake may limit the use of this mode of administration in the early postoperative period. The time required for dose titration also presents a problem. Side effects of tricyclic antidepressants such as sedation, postural hypotension, paralytic ileus and urinary retention are also of concern postoperatively. Most evidence suggests that systemic administration of agents such as lidocaine is just as effective, if not more effective, than tricyclic antidepressants and anticonvulsants for the treatment of neuropathic pain. Therefore, unless there is a reason to avoid systemic administration, it may be preferable to use this route, at least initially, to obtain satisfactory symptomatic relief.

Epidural administration of agents such as morphine, clonidine and local anaesthetics may be useful for the control of acute neuropathic pain. This approach has the advantage of more specific targeting of changes, such as spinal cord sensitisation and abnormal activity in primary afferents.

Complex regional pain syndromes are treated with a number of approaches including intravenous regional administration of agents such as guanethidine, sympathetic ganglion blockade, epidural administration of clonidine and exercise of the affected limb. Unfortunately, there is little evidence for the effectiveness of any of these agents, and systematic review of the effectiveness of guanethidine found it was no different from placebo (McQuay et al. 1996).

## References

1. Attal N, Guirimand F, Brasseur L et al. (2002) Effects of IV Morphine in Central Pain - A Randomized Placebo-Controlled Study. *Neurology* 58:554–563
2. Callesen T, Bech K, Kehlet H (1999) Prospective Study of Chronic Pain after Groin Hernia Repair. *Br J Surg* 86:1528–1531
3. Devor M, Wall PD, Catalan N (1992) Systemic Lidocaine Silences Ectopic Neuroma and DRG Discharge without Blocking Nerve Conduction. *Pain* 48:261–268
4. Hayes C, Browne S, Lantry G et al. (2002) Neuropathic Pain in the Acute Pain Service: A Prospective Survey. *Acute Pain* 4:45–48
5. Hayes C, Molloy AR (1997) Neuropathic Pain in the Perioperative Period. *International Anesthesiology Clinics* 35:67–81
6. Jung BF, Ahrendt GM, Oaklander AL et al. (2003) Neuropathic Pain Following Breast Cancer Surgery: Proposed Classification and Research Update. *Pain* 104:1–13
7. Merskey H, Bogduk N (1994) Classification of Chronic Pain: Descriptions of Chronic Pain Syndromes and Definitions of Pain Terms. IASP Press, Seattle
8. Moiniche S, Kehlet H, Dahl JB (2002) A Qualitative and Quantitative Systematic Review of Pre-Emptive Analgesia for Postoperative Pain Relief – The Role of Timing of Analgesia. *Anesthesiology* 96:725–741
9. Nikolajsen L, Jensen TS (2001) Phantom Limb Pain. *Br J Anaesth* 87:107–116
10. Parry C (1980) Pain in Avulsion Lesions of the Brachial Plexus. *Pain* 9:41–53
11. Power I, Barratt S (1999) Analgesic Agents for the Postoperative Period. *Nonopioids*. *Surg Clin North Am* 79:275–295
12. Siddall PJ, Taylor DA, McClelland JM et al. (1999) Pain Report and the Relationship of Pain to Physical Factors in the First Six Months Following Spinal Cord Injury. *Pain* 81:187–197

13. Stubhaug A, Breivik H (1995) Post-Operative Analgesic Trials: Some Important Issues. *Bailliere's Clin Anaesthesiol* 9:554–582
14. Tanelian DI, MacIver MB (1991) Analgesic Concentrations of Lidocaine Suppress Tonic A-delta and C Fiber Discharges Produced by Acute Injury. *Anesthesiology* 74:934–936
15. Wasner G, Schattschneider J, Binder A et al. (2003) Complex Regional Pain Syndrome-Diagnostic, Mechanisms, CNS Involvement and Therapy. *Spinal Cord* 41:61–75

## Postoperative Pain, Acute Pain Management Principles

HARALD BREIVIK

Rikshospitalet University Hospital, Oslo, Norway  
harald.breivik@medisin.uio.no

### Definitions

The principles of acute pain management are to fully exploit ► **paracetamol** (acetaminophen), to add a nonsteroidal anti-inflammatory analgesic drug (NSAID) or a ► **glucocorticosteroid**, and for more severe pain, administer an ► **opioid** in addition to paracetamol (with or without an NSAID). After surgery of the thorax, upper abdomen, and after orthopedic surgery close to joints and on weight bearing parts of the skeleton, severe pains provoked by movement are best relieved by ► **nerve blocks**, epidural, or ► **spinal analgesia**. Relieving such ► **dynamic pain** facilitates coughing and mobilization and reduces cardio - respiratory complications after surgery. An ► **acute pain team** (APT) with dedicated nurse(s) will facilitate education of ward nurses, doctors and patients, making implementation of improved pain relieving methods possible, as well as ongoing audit and continuous quality improvement of postoperative pain management.

### Characteristics

Acute postoperative pain management should always start with one ► **nonopioid analgesic drug**, the addition of another non-opioid analgesic, before adding a ► **potent opioid analgesic** for more severe pain. Local and regional analgesic techniques are needed for severe movement-associated pain:

First, fully exploit paracetamol (acetaminophen) as the nonopioid drug with the least adverse effects, when used in appropriate doses orally, rectally, or by I.V. infusion (for review and detailed descriptions of optimal dosing of paracetamol to children and adult patients, see Breivik 2002). Paracetamol is too often under-dosed in amount and dosing interval (Breivik 2002; Breivik 2000; Korpela and Olkkola 1999).

Then take advantage of the additive analgesic effect of a ► **nonsteroidal anti-inflammatory analgesic drug** (NSAID) co-administered with paracetamol (in those

patients who tolerate the NSAID drugs) (Breivik et al. 1999). NSAIDs are contraindicated when patients have:

- Actual or potential bleeding problems
- History of gastrointestinal ulceration
- Aspirin-sensitive asthma
- Renal impairment
- Hypovolemia
- Hyperkalemia
- Diuretic medication
- Pre-clampsia
- Severe liver dysfunction
- Circulatory failure

NSAIDs should be used with caution in:

- Elderly patients (above 65–70 years), who often have significant renal impairment,
- Diabetic patients (renal impairment likely)
- Patients with widespread vascular disease
- Patients on ► **ACE-inhibitors**, **beta-blockers**, ► **cytospirin**, **methotrexate**

Except for bleeding and gastrointestinal ulcer disease, these are likely contraindications for the specific COX2-inhibiting drugs (coxibs), as much as for the traditional mixed ► **COX1-inhibiting** and ► **COX2-inhibiting** NSAIDs. More research is needed to establish the renal and cardiovascular safety of coxibs in postoperative patients.

Glucocorticosteroid drugs have analgesic effects with minimal risk of adverse effects (Romundstad et al. 2004), and seem to reduce postoperative nausea and fatigue (Holte and Kehlet 2002; Aasboe et al. 1998).

Weak ► **opioid analgesic** drugs, such as codeine and tramadol, are often added to the nonopioid analgesics with some increased pain relief, but with significantly increased prevalence of adverse effects such as nausea, dizziness and sedation.

A potent opioid is often required in addition to paracetamol (with or without an NSAID or a coxib) for more severe pain. A potent opioid like ► **morphine**, or ► **oxycodone**, is then administered either by mouth, rectally, or by injection. The administration of the opioid analgesic is usually under the control of a nurse who is guided by standing orders on dosing and monitoring of effects (Breivik 2002).

► **Patient-Controlled-Analgesia** (PCA), i.e. the administration of a potent opioid in small bolus doses intravenously, controlled by the patient who is allowed to push a bolus-release button on a PCA-pump. An alternative to an I.V. PCA pump is to let the patient self-administer a limited number of tablets of a potent opioid (after day case surgery) (Breivik 2002). The basis for PCA is that the pain is subjective, and only the patient can know how much pain relieving medication is needed, how much subjective pain relief and adverse effects result from an analgesic drug dose.

PCA-devices must be constructed so that no patient can have an accidental overdose (Breivik 2002).

### Local Anesthetics, Nerve Blocks and Neuraxial Analgesia

Most severe pain occurs on movement after major surgery of the thorax, upper abdomen and after orthopedic surgery close to joints and on weight bearing parts of the skeleton ("dynamic pain"). Whereas pain at rest may be controlled by increasing the potency of pharmacologic analgesia stepwise, pain provoked by deep breathing, coughing, moving a limb or getting out of bed and walking around, is not well relieved by analgesic drugs. Such ► **incident pain** or break through pain, is best relieved by local anesthetic drugs given as a peripheral nerve block, epidural or spinal (subarachnoidal) infusion of a local anesthetic combined with an opioid and an adrenergic drug (Breivik 2002; Breivik 2000; Kehlet 1998; Capdevila 1999; Niemi and Breivik 2003; Breivik 2002).

### Acute Pain Team (APT)

For management of acute postoperative pain to be optimal, an acute pain team (APT) or ► **acute pain service** (APS) is necessary: An APT is organized in a hospital to prevent and treat acute pain after surgery, trauma, acute pain caused by medical conditions, and even labor pain. An APT is most often based in a department of anesthesiology, the pain clinic of the hospital, or one of the clinical departments having many patients with acute pain problems. Basic to any acute pain team is a staff of well-trained and dedicated nurse(s), active during daytime working hours, or up to full 24 hours 7 days per week (Breivik 2002). The pain nurse(s) must have an ► **anesthesiologist** attached to the APT on a part- or full-time basis, with night and week-end assistance with epidural catheter and PCA-pump problems from the on-call anesthesia residents, or from a dedicated 24-h pain team in some major hospitals. Surgeons and other clinical specialists are associated with the pain team in various ways, again depending on the type of patients and pain conditions taken care of by the APT (Breivik 2002). A successful postoperative pain management program will ensure that:

- all patients are at least offered optimal pharmacological pain relief with appropriate combinations of paracetamol and NSAIDs, when tolerated
- ward nurses have standing orders to administer potent opioids by intramuscular or intravenous injections
- patients at increased risk of developing postoperative respiratory and cardiac complications, due to unrelieved dynamic pain after major thoracic or abdominal surgery, are offered optimal ► **thoracic epidural analgesia** (Niemi and Breivik 2003)
- a dedicated acute pain team is established for effective and safe management of pain in all surgical patients. Continuous day-time coverage with

- anesthesiologist-backed pain nurse(s) is a minimum
- there is an ongoing educational program for ward nurses, surgeons, anesthesiologists and patients
- monitoring of pain, pain-relief, and any side effects (► **respiratory depression** whenever opioids are administered) is continuous and results recorded at least every 4 hours. This will "make pain visible" focus attention on inadequate pain relief, and is a powerful tool in ongoing audit and continuous quality-improvement of pain relief (Breivik 2002)
- there is a high index of suspicion for early signs of intraspinal bleeding or infection, vigilant monitoring of leg-weakness and any new back-ache, coupled with high levels of preparation for rapid verification of diagnosis (MRI-scan or CT-scan with contrast) and surgical removal of a blood clot or abscess, preventing permanent neurological damage, should any of these very rare complications to ► **epidural analgesia** happen (Breivik 2002)
- the risks are minimized and benefits are maximized for patients in terms of more comfort, less pain and more gain in improved rehabilitation and outcome after surgery (Breivik 2002; Breivik 2002).

### References

1. Aasboe V, Rder JC, Grøgaard B (1998) Betamethasone Reduces Postoperative Pain and Nausea after Ambulatory Surgery. *Anesth Analg* 87:319–323
2. Breivik H (2000) High-Tech Versus Low-Tech Approaches to Postoperative Pain Management. In: Devor M, Robotham MC, Wiesenfeld-Hallin Z (eds) *Proceedings of the 9<sup>th</sup> World Congress on Pain*. IASP Press, Seattle
3. Breivik H (2002) How to Implement an Acute Pain Service. *Best Pract Res Clin Anaesthesiol* 16:527–547
4. Breivik H (2002) Epidural Analgesia. In: Breivik H, Campbell W and Eccleston C (eds) *Clinical Pain Management. Practical Applications and Procedures*. Arnold, London, pp 409–416
5. Breivik EK, Barkvoll P, Skovlund E (1999) Combining Diclofenac with Acetaminophen or Acetaminophen-Codeine after Oral Surgery: A Randomized, Double-Blind Single-Dose Study. *Clin Pharmacol Ther* 66:625–635
6. Capdevila X, Barthelet Y, Biboulet P et al. (1999) Effects of Perioperative Analgesic Technique on the Surgical Outcome and Duration of Rehabilitation after Major Knee Surgery. *Anesthesiology* 91:8–15
7. Holte K, Kehlet H (2002) Perioperative Single-Dose Glucocorticoid Administration: Pathophysiologic Effects and Clinical Implications. *J Am Coll Surg* 195:694–712
8. Kehlet H (1998) Modification of Responses to Surgery by Neural Blockade: Clinical Implications. In: Cousins MJ, Bridenbough PO (eds) *Neural Blockade in Clinical Anesthesia and Management of Pain*, 3<sup>rd</sup> edn. Lippincott-Raven Publ, Philadelphia, pp 129–175
9. Korpela R, Olkkola KT (1999) Paracetamol – Misused Good Old Drug? *Acta Anaesthesiol Scand* 43:245–247
10. Niemi G, Breivik H (2003) The Optimal Concentration of Adrenaline in a Low-Dose Thoracic Epidural Infusion of Bupivacaine and Fentanyl after Major Surgery. A Randomised, Double-Blind Dose-Finding Study. *Acta Anaesthesiol Scand* 47:439–450
11. Romundstad L, Breivik H, Niemi G et al. (2004) Methylprednisolone intravenously 1 day after surgery has sustained analgesic and opioid-sparing effects. *Acta Anaesthesiol Scand* 48:1223–1231

## Postoperative Pain, Acute Pain Team

HARALD BREIVIK

Rikshospitalet University Hospital, Rikshospitalet,  
Norway

harald.breivik@klinmed.uio.no

### Definitions

An ► **acute pain team** (APT) is organized in a hospital to prevent and treat acute pain after surgery, trauma, acute pain caused by medical conditions, and labor pain. An APT is based in a department of anesthesiology, the pain clinic of the hospital, or one of the clinical departments that has patients with acute pain problems. For optimal management of acute postoperative pain, an APT is necessary for facilitating education of nurses, doctors and patients, for implementation of improved pain relieving methods, audit and continuous quality improvement.

### Characteristics

An acute pain team must have a staff of well trained and dedicated nurses, varying from one to several, covering only daytime hours, or up to full 24 hour coverage 7 days per week. The ► **pain nurse(s)** must have an ► **anesthesiologist** attached to the APT on a part- or full-time base, depending on the size of the hospital. Surgeons and other clinical specialists are associated with the pain team in various ways, again depending on the type of patients and pain conditions taken care of by the APT (Breivik 2002)

### Why an Acute Pain Team is Necessary

Epidural anesthesia had a renaissance about 30 years ago, and it was obvious that prolonging ► **epidural analgesia** into the immediate postoperative period, and beyond, could more effectively control ► **dynamic pain** after major surgery than parenteral opioids. It also soon became apparent that ► **thoracic epidural analgesia** with local anesthetic infusions had beneficial effects on postoperative complications such as ► **thromboembolism**, gastrointestinal immobility and negative nitrogen balance (for review, see Breivik 2002). Episodes of hypotension, pronounced ► **local anesthetic motor blockade** causing leg weakness, and inability to spontaneously empty the urinary bladder, were all frequent adverse effects of bolus injections or continuous epidural infusions of relatively high concentrations of local anesthetic. When ► **neuraxial morphine** administration entered epidural analgesia practice, respiratory depression, nausea and pruritus were potentially dangerous and often quite bothersome adverse effects (Stenseth et al. 1985).

These adverse effects, and dramatic case reports on ► **delayed severe respiratory depression** when opioids were administered epidurally, caused restrictions on where and how epidural analgesia could be used for

postoperative pain. This effective technique was reserved for ► **high dependency or intensive care units**. Attempts to move patients to the surgical wards with these epidural analgesia techniques were aborted when such complications occurred. It was, of course, not possible to keep many patients in the recovery ward or in the high-dependency unit solely for the purpose of giving pain relief with epidural analgesia techniques. Thus, fear of side-effects and complications, and the practice of limiting epidural analgesia to high-dependency nursing units, caused lack of confidence, skepticism and mistrust among surgeons and ward nurses. When we started to plan major improvements in postoperative pain relief for most patients after major surgery, by offering to implement epidural analgesia and patient controlled parenteral opioid analgesia on surgical wards, it was evident that we first needed to overcome these obstacles to wider use of the most effective pain-relieving methods available.

It was quite obvious to us that, in order to harvest the many potential benefits from optimal and prolonged epidural analgesia, we had to have a system that would enable nurses to care for patients with epidural analgesia on the surgical wards. Our early experience soon led to the conclusion that an acute pain organization was needed.

An acute pain team of well trained nurses and dedicated anesthesiologist(s) who are able spend enough time and dedication to:

- Fine tune an optimal thoracic epidural analgesia regimen
- Implement safe patient controlled intravenous opioid analgesia (PCA)
- spend enough time with ward nurses to make them confident in monitoring and handling pain pumps, in monitoring effects and observe and treat any adverse effects
- Teach anesthesiologists in the operating room to place epidural catheters at optimal segmental spinal cord level
- Teach and motivate on-call anesthesiologists to help solve epidural catheter and pain pump problems during nights and week-ends
- Up-grade ► **traditional pharmacological pain relief** with non-opioid and opioid analgesics in order to improve postoperative pain relief for all surgical patients

### How to Implement an Acute Pain Team

Ward nurses, surgeons, anesthesiologists, and hospital administrators must be motivated; they must realize that traditional postoperative pain management can be improved, and that this is important for patients' well being, satisfaction with the hospital, and also that the outcome of surgery can be improved by optimal postoperative pain management.



Initially, one full-time pain nurse and an anesthesiologist, able to spend most of his working day on the APT, will establish procedures and regimens for epidural analgesia and patient controlled analgesia (PCA) in the recovery room area. Gradually, they spread knowledge and practice of these basic techniques to more wards, one ward at a time.

Initially, the anesthesiologist and the pain nurse closely follow every patient, but with intensive education and training of the ward nurses, they gradually take responsibility for monitoring and titration of epidural analgesia as well as PCA. Soon nurses on the surgical wards, as well as surgeons, realize that a well tailored epidural analgesia can make the patient much more comfortable and satisfied with the postoperative pain relief. Nursing and mobilization of the patients becomes easier. Enthusiasm for the services of the APT grows.

The first reports of acute pain service teams came from the United States, and Ready et al. reported on the development of independent anesthesiology-based postoperative pain management service in 1988 (Breivik 1993). European models have been based on APT-nurses, with focus on education and organization of regimens based on "► pain ombudsman-nurses" in each ward, and on help from the responsible operating room anesthesiologists (Rawal and Berggren 1994; Breivik et al. 1995; Breivik 1995).

The ultimate goal of an APT is to reduce unnecessary suffering from unrelieved pain in all surgical patients, and to exploit potential benefits of optimal pain relief on postoperative complications and outcome of surgery (Breivik 2000; Breivik 2002; Rawal 1999).

#### Important Success-Factors for Implementing an Effective Acute Postoperative Pain Team

- Well trained and dedicated pain nurse(s) supervised by an anesthesiologist
- Anesthesiologist able to spend much of the working day with the APT
- APT is available continuously during working day-time
- Ongoing educational program for all health personnel involved in the care of surgical patients
- Information to patients (also in writing) before and after surgery
- Optimal epidural analgesia for severe dynamic pain, prolonged for 3–7 days after major surgery (Breivik 2002)
- Offer selected peripheral nerve blocks with continuous catheter techniques
- Use up-graded, optimal pharmacological pain relief in all patients with paracetamol plus an NSAID (or COX2-inhibitor) as base, plus I.M., I.V., or oral opioid when needed (Breivik 2000).
- Robust routine for monitoring pain-relieving effect, adverse effects, early symptoms of possible catastrophic complications from respiratory depression,

infection or bleeding in spinal canal (Breivik et al. 1995) (Breivik 1995).

- Highly prepared for handling potentially dangerous complications from bleeding or infection in the spinal canal (Breivik 2002)
- Ongoing audit and continuous quality improvement of postoperative pain management (Breivik et al. 1995; Breivik 2000; Rawal 1999)

#### References

1. Breivik H (1993) Recommendations for Foundation of a Hospital-Wide Postoperative Pain Service – A European View. *Pain Digest* 3:27–30
2. Breivik H (1995) Benefits, Risks and Economics of Post-Operative Pain Management Programmes. *Bailliere's Clinical Anaesthesiology* 9:403–422
3. Breivik H (2000) High-Tech versus Low-Tech Approaches to Postoperative Pain Management. In Devor M, Robotham MC, Wiesenfeld-Hallin Z (eds) *Proceedings of the 9<sup>th</sup> World Congress on Pain*. *Progr in Pain Research and Management* 16:787–807
4. Breivik H (2002) Epidural Analgesia. In: Breivik H, Campbell W and Eccleston C (eds) *Clinical Pain Management. Practical Applications and Procedures*. Arnold, London, pp 409–416
5. Breivik H (2002) How to Implement an Acute Pain Service. *Best Pract Res Clin Anaesthesiol* 16:527–547
6. Breivik H, Höglström H, Niemi G et al. (1995) Safe and Effective Post-Operative Pain-Relief: Introduction and Continuous Quality-Improvement of Comprehensive Post-Operative Pain Management Programmes. *Bailliere's Clinical Anaesthesiology* 9:423–460
7. Rawal N (1999) 10 Years of Acute Pain Services – Achievements and Challenges. *Reg Anesth Pain Med* 24:68–73
8. Rawal N, Berggren L (1994) Organization of Acute Pain Service: A Low Cost Model. *Pain* 57:117–123
9. Ready LB, Oden R, Chadwick HS et al. (1988) Development of an Anaesthesiology-Based Postoperative Pain Management Service. *Anesthesiology* 68:100–106
10. Stenseth R, Sellevold O, Breivik H (1985) Epidural Morphine for Postoperative Pain: Experience with 1085 Patients. *Acta Anaesthesiol Scand* 29:146–156

P

## Postoperative Pain, Acute Presentation of Complex Regional Pain Syndrome

SUELLEN M. WALKER

University of Sydney Pain Management and Research Centre, Royal North Shore Hospital, St Leonards, NSW, Australia

swalker@anatomy.usyd.edu.au,

suellen.walker@ucl.ac.uk

#### Synonyms

CRPS Type I: reflex sympathetic dystrophy, Sudeck's atrophy, algodystrophy, shoulder-hand syndrome, post-traumatic pain syndrome

CRPS Type II: causalgia

#### Definition

► **Complex Regional Pain Syndrome (CRPS) Type I** has the following features (Stanton-Hicks et al. 1995):

1. CRPS is usually preceded by a noxious event. This is not an essential diagnostic feature, as a precipitating injury cannot be identified in approximately 10 % of cases (Cepeda et al. 2002).
2. Spontaneous pain or allodynia/hyperalgesia occur in a regional distribution, not limited to a single nerve territory, and the degree of pain is disproportionate in severity to the inciting event.
3. There is, or has been, evidence of oedema, changes in skin blood flow, or abnormality of sudomotor activity in the region of the pain.
4. Other reasons for the symptoms and differential diagnoses have been excluded.

The criteria for CRPS Type II are the same as Type I, but the syndrome develops in association with a definable major nerve lesion.

### Characteristics

CRPS is a variable constellation of symptoms and signs, which may include pain and sensory changes, autonomic dysfunction, trophic changes, motor impairment, and psychological changes. CRPS most commonly follows injuries involving the limbs, but may also develop in association with visceral diseases and central nervous system lesions. Recurrent episodes of CRPS occur in 10 to 30 % of patients, and migratory symptoms involving multiple extremities have also been reported (Walker and Cousins 1997).

### Pain

Pain is an essential criterion for CRPS, and is disproportionate in duration, severity and distribution to the expected clinical course of the inciting event. Pain is often described as deep and diffuse in distribution; tearing, burning or stinging in character; and may be exacerbated by movement or position (e.g. when the limb is dependent). Sensory symptoms are common, particularly hyperalgesia and allodynia to light touch, thermal stimulation, deep pressure or joint movement (Birklein et al. 2000).

### Autonomic Dysfunction

Abnormalities of skin blood flow lead to changes in skin temperature and colour, ranging from warm and red to cold, pale and cyanotic. Oedema and increased or decreased sweating may occur, with side-to-side asymmetry between affected and non-affected limbs.

### Trophic Changes

Trophic changes such as muscle wasting, thin shiny skin, coarse hair and thickened nails, are not invariably present. Joint stiffness may occur due to functional motor disturbances and/or trophic changes in joints and tendons. Periarticular osteoporosis occurs in a small percentage of cases.

### Motor Impairment

Disturbances of motor function including weakness, tremor, decreased range of movement and dystonia are common (Birklein et al. 2000), but were not included in the original criteria for CRPS. Voluntary guarding may be seen as patients attempt to protect their hyperalgesic limb, with range of movement limited by pain.

### Psychological Issues

Psychological factors play a role in all forms of pain and dysfunction, as they influence patients' beliefs, expectations, incentive for recovery, coping mechanisms and stress tolerance. Behavioural responses are particularly important in patients with CRPS, as immobilisation and overprotection of the affected limb may produce or exacerbate demineralisation, vasomotor changes, oedema and trophic changes. There is no evidence from current series that a particular psychological profile predisposes to CRPS, or is specific to the diagnosis of CRPS, when compared to other patients with chronic pain. Therefore, most authors conclude that behavioural and emotional changes are a result of chronic pain rather than a cause of CRPS (Cepeda et al. 2002).

### Diagnostic Criteria

Revision of the taxonomy and introduction of the term CRPS by an IASP Taskforce aimed to establish a non-mechanistic description with uniform terminology and diagnostic criteria (Stanton-Hicks et al. 1995). The diagnosis is based on clinical symptoms and signs. However, it has been suggested that the original criteria have high sensitivity, but low specificity, resulting in overdiagnosis of CRPS (Bruehl et al. 1999; Galer et al. 1998). Improved differentiation between neuropathic pain and CRPS has been achieved by inclusion of motor neglect signs (Galer et al. 1998), or by an algorithm that requires at least two sign categories and four symptom categories (Bruehl et al. 1999). These expanded criteria have not been extensively evaluated or validated (Cepeda et al. 2002). The lack of uniform diagnostic criteria in clinical studies limits our ability to assess the prevalence of the condition or the efficacy of different treatments. Unfortunately, even since the introduction of the IASP criteria, clinical studies still lack homogeneity, with diagnostic features being vaguely or inaccurately applied (Reinders et al. 2002).

### Acute Presentation: Stages versus Severity

Three stages of "RSD" were traditionally described: an early phase with acute pain and prominent sympathetic changes; a dystrophic stage with ongoing pain and motor/trophic changes; and finally, a late atrophic stage. Prospective studies following fracture or hand injury, show gradual resolution of symptoms in the majority of patients, with relatively few experiencing increasingly problematic stages (Field and Atkins 1997; Bruehl et al. 2002). Progressive stages of symptoms and signs could

not be demonstrated by a retrospective patient questionnaire (Galer et al. 2000) or by physicians' evaluation (Bruehl et al. 2002). Therefore, it has been suggested that different subtypes of severity, rather than stages, of CRPS exist: (1) a relatively limited syndrome with vasomotor signs predominating, (2) a relatively limited syndrome with neuropathic pain/sensory abnormalities predominating, and (3) a florid CRPS syndrome similar to "classic RSD" descriptions (Bruehl et al. 2002). However, all patients in this series were retrospectively assessed and had symptoms for an average of 24 months. Different subtypes of acute presentation have not been prospectively confirmed.

Pain (100 % of patients) and oedema (78–88 %) are prominent features in the acute presentation of CRPS (Schurmann et al. 1999; Birklein et al. 2000). Other features include: tremor (45 %); changes in skin colour (71 %); and increased sweating (29 %) (Schurmann et al. 1999). In prospective studies, objective differences in skin temperature occur in 28 % to 44 % of patients, and an increase rather than a decrease in skin temperature is more likely early in the disease (Birklein et al. 1998, Birklein et al. 2000, Schurmann et al. 1999). The reverse has been reported in a retrospective survey, with a greater proportion of patients reporting cold skin early in the disease (Galer et al. 2000), but may be influenced by the patients' memory of symptoms months to years later.

#### Differentiating Acute CRPS from Trauma

Identification of CRPS in patients with acute injury can be difficult, as many of the clinical diagnostic features of CRPS occur with trauma and inflammation. In prospective studies following Colles' fracture, symptoms and signs attributable to CRPS (pain, swelling, stiffness and colour change) can be identified in 24 % of patients, with a further 28 % having borderline symptoms (Field and Atkins 1997). Although differences may be apparent between groups of patients, clear differentiating features may be difficult to distinguish in individual patients (Schurmann et al. 1999). As a result, it may be several weeks before symptoms can no longer be explained by the severity of the initial injury, leading to some inherent delay in diagnosis. A high index of suspicion is required to identify CRPS if symptoms are not typical or severe. Comparison of patients with early CRPS and those with uncomplicated trauma or surgery of the upper limb (Birklein et al. 2001; Schurmann et al. 1999) found that pain, hyperalgesia, and oedema were present in both groups. Increases in skin temperature, confirmed by ► **thermography**, were also present in approximately one-third of patients following either trauma or CRPS. Although different mechanisms for the increase in blood flow are likely (release of vasodilatory mediators from peripheral nerve endings and inflammatory cells following trauma, and inhibition of sympathetically mediated vasoconstriction in CRPS) (Birklein et al. 2001), the presence or absence of skin

temperature changes does not aid differentiation between the two groups. However, the presence of motor signs and increased sweating was specific to patients with CRPS. Tests of sympathetic reactivity showing impairment of sympathetic vasoconstrictor reflexes and/or hyperhidrosis (Birklein et al. 2001; Schurmann et al. 1999) have also been suggested as aids in the early differentiation of uncomplicated trauma and CRPS.

#### Investigations and Sympathetic Function Tests

The diagnostic criteria for CRPS are based on clinical symptoms and signs, and there is no "gold standard" diagnostic test. Radiological investigations, ► **quantitative sensory testing**, tests of ► **sudomotor function** and measurement of skin temperature and regional blood flow have all been utilised to support, but do not confirm, the diagnosis of CRPS (Cepeda et al. 2002; Walker and Cousins 1997). Physician diagnosis of oedema, skin temperature changes and restricted movement is in strong agreement with objective measures of hand volume, infrared readings of skin temperature, and measurement of joint range of motion with a goniometer (Oerlemans et al. 1999). Therefore, the main role of objective tests may be in research settings, or to more precisely evaluate the severity of signs and response to treatment. Patients experiencing pain relief following a sympathetic block are said to have a component of ► **sympathetically maintained pain** (SMP). However, the proportion of SMP can vary with time and between individuals, and there is no data about the specificity or sensitivity of ► **sympathetic blockade** as a diagnostic tool for CRPS (Cepeda et al. 2002).

#### Treatment

Early recognition and treatment are commonly believed to give the best chance of a successful outcome in patients with CRPS. However, identification of specific CRPS symptoms may be difficult early in the course of injury, and a delay of several months before diagnosis is still common. Prospective studies report some natural resolution of CRPS symptoms in the 3 to 12 months following Colles' fracture (Field and Atkins 1997), but the ability of treatment to hasten resolution has not been evaluated in prospective controlled trials.

Despite a diverse range of treatment options, there is limited scientific evidence to support many treatments currently used for CRPS (Cepeda et al. 2002; Kingery et al. 1997). Despite introduction of the IASP criteria, clinical trials lack homogeneity in inclusion criteria and outcome evaluation. Relatively few blinded placebo controlled trials have been conducted, and interpretation of the results is often hampered by small sample sizes, which increases the likelihood of a false positive result (Cepeda et al. 2002).

Clinical consensus supports facilitating mobilisation and activity with physical therapy to preserve and recover limb function and minimise secondary effects

due to disuse, but no controlled trials have evaluated the impact of physical therapy on the natural history of CRPS (Cepeda et al. 2002). Controlled trials support the use of bisphosphonates, oral corticosteroids and epidural clonidine, but the small sample size makes it difficult to evaluate precisely the extent of the treatment effect. Antidepressant and anticonvulsant drugs have been shown to be effective in patients with neuropathic pain, but trials have not specifically evaluated effects in CRPS patients. Beneficial effects of gabapentin are currently reported only in uncontrolled case series. Several studies have failed to identify a beneficial effect following intravenous regional block with guanethidine (Cepeda et al. 2002; Kingery et al. 1997).

A systematic review of local anaesthetic sympathetic blockade in CRPS has recently been conducted (Cepeda et al. 2002). Only three randomised controlled trials enrolling more than 10 patients were identified, and the majority of reports were case series of poor quality. Of the 1144 patients included in 29 studies, 29% achieved a full response (decrease of pain intensity to below 25% of preblock value or response described as 'great', 'dramatic', 'complete', 'absolute' or 'excellent'), 41% obtained a partial response, and in 32% there was either no or only a minimal response. The authors noted that heterogeneity in the studies limited the interpretation of the results, but concluded "soft evidence supports the therapeutic role of sympathetic blockade" (Cepeda et al. 2002). Further well-designed controlled trials are required.

## References

- Birklein F, Kunzel W, Sieweke N (2001) Despite Clinical Similarities there are Significant Differences between Acute Limb Trauma and Complex Regional Pain Syndrome I (CRPS I). *Pain* 93:165–171
- Birklein F, Riedl B, Claus D et al. (1998) Pattern of Autonomic Dysfunction in Time Course of Complex Regional Pain Syndrome. *Clin Auton Res* 8:79–85
- Birklein F, Riedl B, Sieweke N et al. (2000) Neurological Findings in Complex Regional Pain Syndromes - Analysis of 145 Cases. *Acta Neurol Scand* 101:262–269
- Bruhl S, Harden RN, Galer BS et al. (1999) External Validation of IASP Diagnostic Criteria for Complex Regional Pain Syndrome and Proposed Research Diagnostic Criteria. *International Association for the Study of Pain* 81:147–154
- Bruhl S, Harden RN, Galer BS et al. (2002) Complex Regional Pain Syndrome: Are there Distinct Subtypes and Sequential Stages of the Syndrome? *Pain* 95:119–124
- Cepeda MS, Lau J, Carr DB (2002) Defining the Therapeutic Role of Local Anesthetic Sympathetic Blockade in Complex Regional Pain Syndrome: A Narrative and Systematic Review. *Clin J Pain* 18:216–233
- Field J, Atkins RM (1997) Algodystrophy is an Early Complication of Colles' Fracture. What are the Implications? *J Hand Surg (Br)* 22:178–182
- Galer BS, Bruhl S, Harden RN (1998) IASP Diagnostic Criteria for Complex Regional Pain Syndrome: A Preliminary Empirical Validation Study. *International Association for the Study of Pain*. *Clin J Pain* 14:48–54
- Galer BS, Henderson J, Perander J et al. (2000) Course of Symptoms and Quality of Life Measurement in Complex Regional Pain Syndrome: A Pilot Survey. *J Pain Symptom Manage* 20:286–292
- Kingery WS (1997) A Critical Review of Controlled Clinical Trials for Peripheral Neuropathic Pain and Complex Regional Pain Syndromes. *Pain* 73:123–139
- Oerlemans HM, Oostendorp RA, de Boo T et al. (1999) Signs and Symptoms in Complex Regional Pain Syndrome Type I/reflex Sympathetic Dystrophy: Judgment of the Physician Versus Objective Measurement. *Clin J Pain* 15:224–232
- Reinders MF, Geertzen JH, Dijkstra PU (2002) Complex Regional Pain Syndrome Type I: Use of the International Association for the Study of Pain Diagnostic Criteria Defined in 1994. *Clin J Pain* 18:207–215
- Schurmann M, Grادل G, Andress HJ et al. (1999) Assessment of Peripheral Sympathetic Nervous Function for Diagnosing Early Post-Traumatic Complex Regional Pain Syndrome type I. *Pain* 80:149–159
- Stanton-Hicks M, Janig W, Hassenbusch S et al. (1995) Reflex Sympathetic Dystrophy: Changing Concepts and Taxonomy. *Pain* 63:127–133
- Walker SM, Cousins MJ (1997) Complex Regional Pain Syndromes: Including "Reflex Sympathetic Dystrophy" and "Causalgia" *Anaesth Intensive Care* 25:113–125

## Postoperative Pain, Acute-Recurrent Pain

W. A. WILLIAMS, STEPHAN A. SCHUG  
Royal Perth Hospital and University of Western  
Australia, Perth, WA, Australia  
schug@cyllene.uwa.edu.au

### Synonyms

Prolonged Acute Pain; Long-Lasting Acute Pain; Persistent Acute Pain; Acute-Recurrent Pain

### Definition

Pain is defined by the International Association for the Study of Pain as "an unpleasant sensory and emotional experience associated with actual or potential tissue damage, or described in terms of such damage" (Merskey and Bogduk 1994). Acute pain begins with the onset of tissue damage and may persist until tissue healing has occurred. Pain experienced beyond this point is usually described as persistent or chronic. In situations in which the healing time cannot be defined, an arbitrary time point of three months is often used. Acute pain which persists for many months or even years differs from chronic pain, in that a degree of tissue pathology is considered to exist.

### Characteristics

Traditionally, we have tended to view acute pain as a temporary state. More recently, we have come to regard acute pain as the initiation phase of a persistent nociceptive and behavioural cascade, triggered by tissue damage (Siddall and Cousins 2004). This cascade has the potential to span orders of magnitude, space and time.

### Pathophysiology

Nociceptive pain occurs with the activation of nociceptors by noxious stimuli (e.g. trauma from a surgical



incision). This pain can be considered a protective response to an adverse stimulus and will subside with the removal of the stimulus. However, tissue damage may lead to a phase of persistent acute pain, maintained by the cellular and neuronal release of inflammatory mediators, such as prostaglandins. A prolonged phase of tissue damage may sensitize nociceptors. This in turn may lead to reduced pain thresholds or an increase in the frequency of neuronal firing, producing hyperalgesia. Therefore, acute pain, in particular if persistent, can lead to the development of chronic pain states as described in 'Transition from Acute to Chronic Pain' (Perkins and Kehlet 2000).

### Causes of Persistent Acute Pain

Persistent acute pain can be due to persistent nociception, caused by processes such as inflammation, chronic infection, tumour persistence and recurrence. Other important causes are neuropathic pain states, due, for example, to nerve compression or entrapment.

### References

1. Merskey H, Bogduk N (1994) Classification of Chronic Pain. IASP Press, Seattle
2. Perkins FM, Kehlet H (2000) Chronic Pain as an Outcome of Surgery. A Review of Predictive Factors. *Anesthesiology* 93:1123–1133
3. Siddall PJ, Cousins MJ (2004) Persistent Pain as a Disease Entity: Implications for Clinical Management. *Anesth Analg* 99:510–520

## Postoperative Pain, Adverse Events (Associated with Acute Pain Management)

SARAH J. HARPER, STEPHAN A. SCHUG  
Royal Perth Hospital and University of Western  
Australia, Crawley, WA, Australia  
schug@cylene.uwa.edu.au

### Synonyms

Medical Mishaps; Medical Misadventures; complications; Side Effects

### Definition

A medical adverse event is defined by the Food and Drug Administration of the USA (FDA) as any undesirable experience by a patient associated with a medical intervention. Such an adverse event is defined as a serious adverse event (SAE) when the patient outcome is either death or disability, the event is life-threatening or potentially life-threatening, or its sequelae require hospitalization or prolongation of hospital stay or lead to disability, congenital abnormality or requires intervention to prevent permanent impairment or damage.

### Characteristics

In the early days of Acute Pain Services (APS) (Ready et al. 1988) there was underlying concern amongst those involved in the care of the perioperative patient, that the benefits of such an approach must be balanced by additional risks associated with newer pain management techniques (Rowbotham 1992; Spittal 1992). Several large studies of morbidity and mortality associated with acute pain management techniques have been able to quantify this risk, demonstrating the excellent safety profiles of these techniques for use on the general surgical ward, (e.g. Schug and Torrie 1993; Flisberg et al. 2003); these two large studies, examining a combined total of more than 5500 surgical patients under the care of an APS, reported only one serious complication resulting in morbidity and there was no mortality related to pain management techniques.

### Respiratory Depression

Opioid administration is always linked to the risk of respiratory depression, but this risk is often overestimated. Continuous morphine infusion has the highest rate of respiratory depression of around 1.65 % (Schug and Torrie 1993). This technique lacks the inherent safety of patient feedback provided by PCA, and is thus only recommended for use in specific circumstances such as palliative care, and patients requiring intravenous opiates who are unable to use any type of PCA device. There are new innovative PCA devices on the market, which do not require manual dexterity to operate e.g. breath or voice activated devices, and this should widen the spectrum of patients able to use an analgesic technique with a 'feedback' component.

PCA techniques without background infusions carry an extremely small risk of respiratory depression of between 0.1 and 0.8 % (Macintyre 2001). PCA devices used with an added background infusion have a respiratory depression rate almost as high as that of continuous opioid infusions (1.1–3.9 %), and are only recommended in specific circumstances such as patients with pre-operative morphine requirements (Hansen et al. 1991). In a large audit of PCA use, of the 6% of patients who experienced hypoxaemia and the 2 % who experienced respiratory depression, virtually all had one of three risk factors: bolus dose greater than 1 mg morphine, age greater than 65 years and intra-abdominal surgery (Sidebotham et al. 1997). A further risk factor is activation of the PCA device other than by the patient (parents, other visitors); the device should be clearly labelled for patient use only (Macintyre 2001). Epidural opioids also carry a risk of respiratory depression due to systemic or CSF absorption of the agent. The incidence of respiratory depression has been reported in numerous studies involving data collection from the APS, and lies between 0.24 % and 1.6 % (Wheatley et al. 2001). It is a dose-dependent effect and less common

with more lipophilic opioids such as fentanyl. Respiratory depression is often associated with sedation.

#### **Nausea and Vomiting**

The incidence of nausea amongst patients with PCA techniques is highest on day 1 at 28 %, and declines over the following two days to 14.3 % and then 4.7 % (Sidebotham et al. 1997). A large audit of 6000 patients receiving PCA analgesia revealed that only 5 patients discontinued their PCA device because of nausea (Sidebotham et al. 1997). Nausea should be screened for amongst these patients and treated aggressively, as nausea and vomiting are one of the adverse effects most disliked by patients.

Nausea and vomiting in the patient receiving an epidural infusion may be due to drug effects e.g. opioid-local anaesthetic mixtures, or to hypotension secondary to sympathectomy. The overall frequency is similar to that associated with PCA techniques.

#### **Sedation**

This occurs in up to 30 % of patients on PCA infusions. Many patients dislike this adverse effect and underuse their PCA for this reason, choosing to remain alert in preference to becoming completely pain-free, but sedated (Sidebotham et al. 1997).

#### **Addiction and Inappropriate Opioid Self-Administration**

There is no evidence that this is a problem in any of the large surveys performed. Previous and current drug users have been safely managed using both regional and intravenous pain management techniques. It is important to remember that background opiate requirements will need to be continued over the perioperative period to avoid acute withdrawal states (Chapman and Hill 1989).

#### **Drug and Programming Errors**

These are a rare cause of adverse events when using pain management techniques. Premixed bags of epidural solutions and PCA syringes reduce the risk of drug error. Epidural hubs should be incompatible with ordinary syringes and giving sets. The programmed device should be routinely double checked before being connected to a patient.

#### **Neurological Injury after Regional Analgesia**

The insertion of catheters near to neural structures carries a potential risk of neurological trauma. Several large published series of patients receiving epidural catheters have revealed a reassuring safety record. The rarity of the event makes it difficult to quantify it exactly, but the best available evidence points to an incidence of serious neurological sequelae between of 0.006 % and 0.005 % (Kane 1981; Aromaa et al. 1997). The onset of neurological injury related to the use of epidural analgesia or anaesthesia is not always a causal relationship; there are multiple reports in the literature of neurological disorder being wrongly blamed on the use of epidural tech-

niques (Wheatley et al. 2001; Lovstad et al. 1999). Regional nerve catheter techniques also have an excellent safety record in this respect (Schug and Torrie 1993).

#### **Local Anaesthetic Toxicity during Regional Analgesia**

The risk of local anaesthetic toxicity from regional or peripheral nerve blocks is related to inadvertent misplacement of the catheter intravenously, or subsequent migration of the catheter into a vascular space. Other potential causes are drug or programming errors, as discussed above, and the use of bolus doses of local anaesthetic resulting in higher peak plasma levels than similar dosages given by infusion. The incidence of toxicity from racemic bupivacaine, notably convulsions, as a result of high peak plasma levels is 0.01–0.12 % (Brown et al. 1995). Overall, the newer enantiomer specific local anaesthetics ropivacaine and levobupivacaine exhibit less cardiotoxicity than racemic bupivacaine, and are preferable from a safety point of view (Stewart and Kellett 2003).

#### **Hypotension Associated with Epidural Analgesia**

Orthostatic hypotension occurs in about 0.7–3 % of patients receiving epidural analgesia (Wheatley et al. 2001). It is important to exclude intrathecal catheter migration as a cause of this by aspirating before administering a bolus dose of local anaesthetic (Flisberg et al. 2003). The more stable block levels achieved by using a continuous infusion technique are probably advantageous in this regard.

#### **Inadvertent Dural Puncture during Epidural Catheter Insertion**

Dural puncture occurs in 0.32–1.23 % of epidural insertions and can result in a disabling Post Dural Puncture Headache (PDPH) (Wheatley et al. 2001).

#### **Epidural Space Infection after Epidural Analgesia**

Short-term catheter insertion is rarely associated with infection (Schug and Torrie 1993). A meta-analysis of 915 case reports of epidural abscesses identified that the majority was spontaneous, and only 5.5 % were related to epidural anaesthesia and analgesia (Reihsaus et al. 2000). The overall incidence is estimated at somewhere between 1 in 2,000 and 1 in 7,000 (Wheatley et al. 2001). Associations include longer period of catheterisation, immunocompromised patients and perioperative anticoagulant therapy. Full aseptic precautions, including the use of gown and face-mask, are strongly recommended during insertion.

#### **Epidural Haematoma after Epidural Analgesia**

This is another very rare complication defying accurate assessment of risk; nevertheless, the consequences can be catastrophic as a spinal haematoma not detected and treated early results in irreversible paraplegia. The best estimate of neurological dysfunction after haematoma formation associated with epidural anaesthesia is 1 in 150,000 cases (Flisberg et al. 2003). The risk is clearly

related to coagulopathies and, more relevant, the use of anticoagulation.

### Inadequate Pain Management

Inadequate treatment effects are an adverse effect in itself. Its occurrence necessitating dose-adjustments has been shown to be more common in patients receiving epidural analgesia than PCA techniques (Flisberg et al. 2003).

### References

1. Aromaa U, Lahdensuu M, Cozantits DA (1997) Severe Complications Associated with Epidural and Spinal Anaesthesia in Finland 1987–1993. A Study Based on Patient Insurance Claims. *Acta Anaesthesiol Scand* 41:445–452
2. Brown DL, Ransom DM, Hall JA et al. (1995) Regional Anesthesia and Local Anesthetic-Induced Systemic Toxicity: Seizure Frequency and Accompanying Cardiovascular Changes. *Anesth Analg* 81:321–328
3. Chapman CR, Hill HF (1989) Prolonged Morphine Self-Administration and Addiction Liability. Evaluation of Two Theories in a Bone Marrow Transplant Unit. *Cancer* 63:1636–1644
4. Flisberg P, Rudin A, Linner R et al. (2003) Pain Relief and Safety after Major Surgery. A Prospective Study of Epidural and Intravenous Analgesia in 2696 Patients. *Acta Anaesthesiol Scand* 47:457–465
5. Hansen LA, Noyes MA, Lehman ME (1991) Evaluation of Patient-Controlled Analgesia (PCA) versus PCA Plus Continuous Infusion in Postoperative Cancer Patients. *J Pain Symptom Manage* 6:4–14
6. Kane RE (1981) Neurologic Deficits following Epidural or Spinal Anesthesia. *Anesth Analg* 60:150–161
7. Lovstad RZ, Steen PA, Forsman M (1999) Paraplegia after Thoracotomy - Not Caused by the Epidural Catheter. *Acta Anaesthesiol Scand* 43:230–232
8. Macintyre PE (2001) Safety and Efficacy of Patient-Controlled Analgesia. *Br J Anaesth* 87:36–46
9. Ready LB, Oden R, Chadwick HS et al. (1988) Development of an Anesthesiology-Based Postoperative Pain Management Service. *Anesthesiology* 68:100–106
10. Reihnsaus E, Waldbaur H, Seeling W (2000) Spinal Epidural Abscess: A Meta-Analysis of 915 Patients. *Neurosurg Rev* 23:175–204
11. Rowbotham DJ (1992) The Development and Safe Use of Patient-Controlled Analgesia *Br J Anaesth* 68:331–332
12. Schug SA, Torrie JJ (1993) Safety Assessment of Postoperative Pain Management by an Acute Pain Service. *Pain* 55:387–391
13. Sidebotham D, Dijkhuizen MR, Schug SA (1997) The Safety and Utilization of Patient-Controlled Analgesia. *J Pain Symptom Manage* 14:202–209
14. Spittal MJ (1992) Epidural Morphine in a Small Community Hospital: A False Sense of Security. *Anesth Analg* 74:468–470
15. Stewart J, Kellelt N (2003) The Central Nervous System and Cardiovascular Effects of Levobupivacaine and Ropivacaine in Healthy Volunteers. *Anesth Analg* 97:412–416
16. Wheatley RG, Schug SA, Watson D (2001) Safety and Efficacy of Postoperative Epidural Analgesia. *Br J Anaesth* 87:47–61

## Postoperative Pain, Anti-Convulsant Medications

ROSS MACPHERSON

Department of Anesthesia and Pain Management,  
University of Sydney, Sydney, NSW, Australia  
rmacpher@nscchahs.health.nsw.gov.au

### Synonym

Anti-epileptic agents; anti-convulsant medication

### Characteristics

A number of different anti-convulsant medications have found a place in the management of neuropathic pain states. Despite being a somewhat heterogeneous group, their targets of action often share similarities with those involved in pain transmission.

Anti-convulsants generally act at three main sites – the sodium or calcium channels or the GABA (A) receptor. Other agents, such as vigabatrin promote GABAminergic transmission by attenuating the rate of GABA breakdown by transaminases.

At the sodium channel, they attenuate neuronal conduction by maintaining the sodium channel in the inactivated state. This is similar to the mode of action of local anaesthetic agents.

Another important target is the GABA receptor. As well as being an important site to suppress epileptic activity in the brain, it has been implicated in modulating the pain pathway at a number of sites (Wilcox 1999). Presynaptic GABA (B) receptors, through coupling to Ca channels have an important inhibitory role, while postsynaptically, GABA (A) receptors that act as chloride sensitive ligand gated ion channels can hyperpolarize dorsal horn neurones.

Although it has been known for some time that anti-convulsants are useful in the management of neuropathic pain, their role was initially limited to some degree by their side effect profile (Gourlay 1999). For example, McQuay (1995) found that while agents such as carbamazepine and phenytoin were effective in the management of a range of pain states, the NNT (number needed to treat) to achieve pain relief and the appearance of minor adverse effects were very similar. In the case of diabetic neuropathy, for example, NNT's were 2.5 and 3.1 respectively; trigeminal neuralgia 2.6 and 3.4 and migraine prophylaxis 1.6 and 2.4

The implication from these data was that effective doses for pain management often brought significant CNS side effects, which many patients found particularly unpleasant, which has limited the usefulness of these agents.

In examining the use of anti-convulsant agents in pain management, it is perhaps easiest to look at the drugs from a temporal viewpoint. Carbamazepine and phenytoin are older agents that have been available for over twenty years, while newer anti-epileptic agents that have been successfully used in pain management include lamotrigine and gabapentin. There is also a group of very new anti-epileptic agents such as topiramate, oxcarbazepine and levetiracetam that have yet to be fully evaluated with regard to their application in the management of neuropathic pain states (Perucca 2001; Smith 2001).

Carbamazepine was one of the earliest drugs used for neuropathic pain and has been widely studied, although many of these studies suffer from either small numbers or lack of appropriate controls (Rowbotham 2002). Nevertheless, it has been shown to be effective, especially in trigeminal neuralgia and diabetic neuropathy (Campbell et al. 1966; Rull et al. 1969).

As mentioned above, associated CNS effects are both-ersome, and include sedation, visual disturbances and ataxia. In addition to these effects, carbamazepine is well known to cause a range of other serious, although rare adverse effects such as leukopenia, aplastic anaemia and hepatic failure. Furthermore, the enzyme inducing effect of carbamazepine is considerable, resulting in a long list of possible drug interactions.

However, newer agents such as lamotrigine and gabapentin now provide at least equal efficacy when compared with earlier agents, and with a superior side effect profile.

In pain management, the anti-convulsants cannot be considered a homogeneous group. They have different mechanisms of action and demonstrate varying efficacies in the management of different neuropathic pain states.

## References

1. Campbell FG, Graham JG, Zilkha KL (1966) Clinical Trials of Carbamazepine in Trigeminal Neuralgia. *J Neurol Neurosurg Psychiatry* 29:265–267
2. Gurlay GK (1999) Clinical Pharmacology of the Treatment of Chronic Non-Cancer Pain. In: Devor M (ed) Pain – an Updated Review. Refresher Course Syllabus 9<sup>th</sup> World Congress on Pain, pp 433–442
3. McQuay HJ, Carroll D, Jadad AR et al. (1995). Anti-Convulsant Drugs for the Management of Pain: A Systematic Review. *BMJ* 311:1074–1052
4. Perucca E (2001) Clinical Pharmacology and Therapeutic Use of New Antiepileptic Drugs. *Fund Clin Pharmacol* 15:405–417
5. Rowbotham MC (2002) Neuropathic Pain: From Basic Science to Evidence Based Treatment. In: Dostrovsky J (ed) Pain – an Updated Review. Refresher Course Syllabus 10<sup>th</sup> World Congress on Pain, pp 165–176
6. Rull JA, Quibrera R et al. (1969) Symptomatic Treatment of Peripheral Diabetic Neuropathy with Carbamazepine: A Double-Blind Crossover Trial. *Diabetologia* 5:215–218
7. Smith PE (2001) Clinical Recommendations for Oxcarbazepine. *Seizure* 91:87–91
8. Wilcox GL (1999) Pharmacology of Pain and Analgesia. In: Devor M (ed) Pain – an Updated Review. Refresher Course Syllabus 9<sup>th</sup> World Congress on Pain, pp 573–591

## Postoperative Pain, Anti-Depressants

ROSS MACPHERSON

Department of Anesthesia and Pain Management,  
University of Sydney, Sydney, NSW, Australia  
rmacpher@nscchahs.health.nsw.gov.au

## Synonyms

Anti-depressant drugs

## Characteristics

It was recognised that anti-depressant drugs, specifically the tricyclic anti-depressants, also had analgesic effects, more than twenty years ago (Watson et al. 1982). These were quite distinct from their mood altering properties. For example, when it came to the use of anti-depressants in pain management, the dose needed was much smaller than that needed to treat depression, and the time to onset of therapeutic effect was faster (Sindrup 1992).

The principle mode of action of the tricyclics, at least in the treatment of depression, is inhibition of reuptake of either noradrenaline or serotonin (or both) at the neuronal synapse. This is also clearly important in the drugs analgesic effect, as such an action will facilitate descending inhibitory pathways terminating at the spinal cord. Specifically, their action is probably via the  $\alpha_2$  receptor site (Gray et al. 1999). However, as Rowbotham points out in his excellent review (Rowbotham 2002), this may be far from the whole story. Tricyclic antidepressants have also been shown to have significant activity at the sodium channel (Gerner et al. 2001), a property that they have in common with the anti-epileptic agents (q. v.), and they may also have antagonistic effects at the NMDA receptor. Some workers have proposed that the anti-depressants may have activity at the opioid receptor (Pick et al. 1992), although the importance of this mechanism is unclear.

Much has been written of the role of anti-depressants in neuropathic pain, and these agents certainly have their supporters, but it is perhaps true to say that their role in neuropathic pain management has been slightly eclipsed by the anti-epileptic agents.

Rowbotham questions the logic behind this, as he points out that the majority of clinical trials carried out have found them to be efficacious. The limiting factor, of course, has been the development of annoying side effects, which can range from just being a simple nuisance, such as dry mouth to hypotension – a response that can be associated with significant morbidity. Many of these adverse effects are as a result of the drugs' anti-cholinergic properties, a fact that must be borne in mind when prescribing the drug to patients with prostatism, glaucoma or cardiac arrhythmias.

Where the agents involved have significant sedative properties, it is usually prescribed as a single night time dose to take advantage of this effect. In the small doses used in pain management (e.g. amitriptyline 25–75 mg), the effect is usually transient.

However, not all populations have been equally responsive, as some studies involving TCA's in patients with either cancer pain (Anon 2002; Mercadante et al. 2002), spinal cord injury induced pain (Cardenas et al. 2002), or fibromyalgia (Heymann et al. 2001) have not produced such positive results.

Furthermore, some studies have demonstrated that other medication, such as anti-epileptics, can often



be effective in cases where TCA's have failed (Anon 2002; Dallochio et al. 2000). Occasional trials have examined the effectiveness of combinations of the two agents i.e. TCA's and anti-epileptic agents (Heughan and Sawynok 2002).

In contradistinction to the anti-epileptic agents, the newer anti-depressants, such as the selective serotonin reuptake inhibitors, have not provided any great advance. In fact, most studies have shown agents such as fluoxetine, paroxetine and sertraline have generally been found to be either little better than placebo, or inferior to amitriptyline.

If it is decided to use TCA's for the management of neuropathic pain states, Rowbotham suggests a number of guidelines. Firstly, he suggests that if a TCA fails to produce pain relief having given an effective dose, other agents are unlikely to succeed; however, if a TCA proves effective, but side effects are a barrier, another anti-depressant should be tried. Despite the fact that evidence for the effectiveness of the newer non-tricyclics is less than encouraging (Watson and Evans 1985; Max et al. 1992; Gourlay 1999), he also suggests commencing treatment with the newer anti-depressant agents, even though solid evidence for this is lacking.

Mcquay (1996) has examined the evidence for the use of anti-depressant medications using diabetic neuropathy as the study condition, the NNT for pain relief and minor side effects (for all anti-depressants) were 3 and 2.8 respectively. For patients with post-herpetic neuralgia the data were 2.3 and 6, and for atypical and central pain 2.8 and 1.7.

In summary, there is a strong body of evidence to suggest that in many cases antidepressant medications are at least as useful as other groups in the treatment of neuropathic pain states. However, should such an approach fail, then other drug groups should certainly be used.

## References

1. Anonymous (2002) Gabapentin: New Indication. In: Postherpetic Neuralgia when Amitriptyline Fails. *Prescrire International* 11:111–112
2. Cardenas DD, Warms CA, Turner JA et al. (2002) Efficacy of Amitriptyline for Relief of Pain in Spinal Cord Injury: Results of a Randomized Controlled Trial. *Pain* 96:365–373
3. Dallochio C, Buffa C, Mazzarello P et al. (2000) Gabapentin vs. Amitriptyline in Painful Diabetic Neuropathy: An Open-Label Pilot Study. *J Pain Symptom Manage* 20:280–285
4. Gerner P, Mujtaba M, Sinnott CJ et al. (2001) Amitriptyline Versus Bupivacaine in Rat Sciatic Nerve Blockade. *Anesthesiology* 94:661–667
5. Gourlay G (1999) Clinical Pharmacology of the Treatment of Chronic Non-Cancer Pain. In: Devor M (ed) *Pain – an Updated Review. Refresher Course Syllabus 9<sup>th</sup> World Congress on Pain*, pp 433–442
6. Gray AM, Pache DM, Sewell RD (1999) Do Alpha2-Adrenoceptors Play an Integral Role in the Antinociceptive Mechanism of Action of Antidepressant Compounds? *Eur J Pharmacol* 378:161–168
7. Heughan CE, Sawynok J (2002) The Interaction between Gabapentin and Amitriptyline in the Rat Formalin Test after Systemic Administration. *Anesth Analg* 94:975–980
8. Heymann RE, Helfenstein M, Feldman D (2001) A Double-Blind, Randomized, Controlled Study of Amitriptyline, Nortriptyline and Placebo in Patients with Fibromyalgia. An Analysis of Outcome Measures. *Clin Exp Rheumatol* 19:697–702
9. Max MB, Lynch SA, Muir J et al. (1992) Effects of Desipramine, Amitriptyline and Fluoxetine on Pain in Diabetic Neuropathy. *N Engl J Med* 326:1250–1256
10. McQuay HJ, Tramer M, Nye BA et al. (1996) A Systematic Review of Antidepressants in Neuropathic Pain. *Pain* 68:217–227
11. Mercadante S, Arcuri E, Tirelli W et al. (2002) Amitriptyline in Neuropathic Cancer Pain in Patients on Morphine Therapy: A Randomized Placebo-Controlled, Double-Blind Crossover Study. *Tumori* 88:239–242
12. Pick CG, Paul D, Eison MS et al. (1992) Potentiation of Opioid Analgesia by the Antidepressant Nefazodone. *Eur J Pharmacol* 211:375–381
13. Rowbotham MC (2002). Neuropathic Pain: From Basic Science to Evidence Based Treatment. In: Dostrovsky J (ed) *Pain – An Updated Review. Refresher Course Syllabus 10<sup>th</sup> World Congress on Pain*, pp 165–176
14. Sindrup SH, Brosen K, Gram LF (1992) Antidepressants in Pain Treatment: Antidepressant or Analgesic Effect? *Clin Neuropharmacol* 15:636A–637A
15. Watson CP, Evans RJ, Reed K et al. (1982) Amitriptyline Versus Placebo in Post-Herpetic Neuralgia. *Neurology* 32:671–673

## Postoperative Pain, Appropriate Management

PAUL M. MURPHY

Department of Anaesthesia and Pain Management,  
Royal North Shore Hospital, St Leonard's, NSW,  
Australia  
drpmurphy@hotmail.com

P

### Synonyms

Management of Postoperative Pain

### Definition

Even minor surgery is associated with tissue damage and the potential for significant pain in the postoperative period. Pain experienced in this setting is typically ► **nociceptive** in nature, however 1–3% of referrals to an acute postoperative pain service have been reported as being neuropathic in nature (see ► **neuropathic pain**) (Hayes et al. 2002).

### Characteristics

#### Assessment

Pain is undoubtedly a personal and subjective experience. Individuals undergoing a similar operative procedure may experience vastly different levels of pain. This may be dependent upon a number of factors including previous experiences, cultural factors, coping strategies, age and gender. Importantly, greater than expected pain reported in the postoperative setting must always be considered as a potential indicator of surgical complications such as infection, compartment syndrome or haematoma formation. Similarly an alteration in the character of the pain may indicate an underlying complication (Breivik 1993). It is well established that a poor correlation exists

between patient and staff estimations of pain intensity (Coulling 2005). A self-report pain-rating tool is therefore an essential component of adequate postoperative pain management.

1. Categorical rating scale: verbal descriptors are utilized to rate the patients' pain e.g. mild, moderate, severe, worst etc.
2. Verbal numeric rating scale: the patient rates their pain from "none" (0) to "worst" (10)
3. Visual analogue scale (VAS): an unnumbered 10 cm line ranges from "no pain" to "worst pain". Numbering is avoided in order to prevent cueing of the patients' response. The distance marked along the line from the "no pain" (0) point is the VAS score.

Good correlation exists between VNRS and VAS; however once a scoring system is established for an individual patient it should be maintained in order to monitor progress (Averbuch and Katzer 2004). In addition to monitoring the patient's pain score, it is also important to assess adequately and monitor any potential side effects including sedation, nausea and vomiting, respiratory depression and ► **pruritus**. Special care must be taken to use appropriate assessment tools in groups with special needs or communication difficulties such as children, the cognitively impaired and ethnic groups unable to speak the dominant language (Morrison and Siu 2000).

#### Pharmacological Management of Postoperative Pain

A number of pharmacological agents may be utilized either in isolation or in a multimodal manner to achieve good postoperative pain control.

1. Opioids. In the majority of cases, opioid analgesics form the cornerstone of effective pain control. In the initial postoperative period potent  $\mu$  ► **receptor** ► **Adrenergic Agonist** such as meperidine, morphine or fentanyl may administered *via* the parenteral route (SC/IM/IV) (Jensen et al. 2004). ► **Patient controlled analgesia (PCA)** systems are also frequently utilized. These systems allow the patient to self-administer a predetermined dose of analgesic agent (opioid). A "lock-out" period (commonly 5–6 minutes) is utilised in order to reduce the potential for overdose. Certain systems allow a continuous or intermittent background infusion in addition to the patient controlled boluses. There is ongoing conflict as to whether PCA systems result in improved pain control and reduced opioid consumption relative to "by the clock" or "on demand" administration; however it is widely accepted that PCA systems are associated with a high degree of patient satisfaction (Ballantyne et al. 1993). Opioids have been administered peri-operatively *via* the ► **intrathecal** and ► **epidural** routes in obstetric and orthopaedic settings, with good analgesic benefit demonstrated for 24 hours postoperatively (Murphy et al. 2003).

2. Non-steroidal anti-inflammatory drugs (NSAIDs) are useful in the management of mild to moderate pain, particularly if there is an inflammatory component. They may also be utilised as adjuncts to opioids where they display ► **synergistic** analgesic properties. These agents are available in oral, rectal, intramuscular (IM) and intravenous (IV) formulations (Miranda et al. 2004).
3. Paracetamol is an important agent in the management of postoperative pain. It may be used alone in the management of mild to moderate pain or as an adjunct to opioids in the management of severe pain (Remy et al. 2005). It may be administered *via* the oral, rectal or more recently IV route as proparacetamol.

#### Neuroaxial Blockade

Intrathecal and epidural analgesic techniques have been used with great success in the acute postoperative period (Rodgers et al. 2000). Techniques such as this significantly reduce the patients' requirement for systemic opioid administration and thus the potential for opioid associated side effects. These techniques should be practised and managed by an anaesthesiologist. The route of administration (intrathecal *versus* epidural), location (thoracic *versus* lumbar) and the agents utilised must be decided on an individual basis considering the procedure to be performed, the medical status of the patient and the "risk-benefit" ratio associated with the procedure. ► **Neuroaxial** analgesic techniques have the potential for serious adverse complications and therefore it is important that a stringent management plan including close observation of the patient is maintained in the postoperative period. The main agents administered *via* this route are local anaesthetics and opioids. These agents display synergistic properties when administered *via* the neuroaxial route. Recently interest has developed in other potentially useful agents that may be administered by these routes including ► **clonidine** and ► **midazolam** (Tucker et al. 2004).

#### Regional Analgesic Techniques

A number of peripheral nerve blocks and local anaesthetic infusions may be utilised to provide postoperative analgesia and to reduce systemic opioid requirements. Many of these techniques may incorporate a limited PCA function, which can be particularly useful in the management of "incident" pain in the rehabilitation setting. Commonly utilised techniques include continuous brachial plexus local anaesthetic infusion and continuous femoral nerve analgesia (Illfeld et al. 2005).

#### Additional Techniques

Other techniques that have been demonstrated to be of benefit in the management of acute and postoperative pain include cognitive behavioural techniques, relaxation therapy, ► **TENS** and physical therapies including

hot and cold packs and deep breathing exercises (Rakel and Frantz 2003).

## References

1. Averbuch M, Katzper M (2004) Assessment of Visual Analog versus Categorical Scale for Measurement of Osteoarthritis Pain. *J Clin Pharmacol* 44:368–72
2. Ballantyne JC, Carr DB, Chalmers TC et al. (1993) Postoperative patient controlled analgesia: meta-analysis of initial randomized controlled trials. *J Clin Anesth* 5:182–93
3. Breivik H (1993) Recommendations for foundation of a hospital-wide post-operative pain service – a European view. *Pain Digest* 3:27–30
4. Coulling S (2005) Nurses' and doctors' knowledge of pain after surgery. *Nurs Stand* 19:41–9
5. Hayes C, Browne S, Lantry G et al. (2002) Neuropathic pain in the acute pain service: a prospective survey. *Acute Pain* 4:45–48
6. Ilfeld BM, Morey TE, Thannikary LJ et al. (2005) Clonidine added to a continuous interscalene ropivacaine perineural infusion to improve postoperative analgesia: a randomized, double-blind, controlled study. *Anesth Analg* 100:1172–8
7. Jensen MP, Mendoza T, Hanna DB (2004) The analgesic effects that underlie patient satisfaction with treatment. *Pain* 110:480–7
8. Miranda HF, Silva E, Pinaridi G (2004) Synergy between the anti-nociceptive effects of morphine and NSAIDs. *Can J Physiol Pharmacol* 82:331–8
9. Morrison RS, Siu AL (2000) A comparison of pain and its treatment in advanced dementia and cognitively intact patients with hip fracture. *J Pain Symptom Manage* 19:240–8
10. Murphy PM, Stack D, Kinirons B et al. (2003) Optimizing the dose of intrathecal morphine in older patients undergoing hip arthroplasty. *Anesth Analg* 97:1709–15
11. Rakel B, Frantz R (2003) Effectiveness of transcutaneous electrical nerve stimulation on postoperative pain with movement. *J Pain* 4:455–64
12. Remy C, Marret E, Bonnet F (2005) Effects of acetaminophen on morphine side-effects and consumption after major surgery: meta-analysis of randomized controlled trials. *Br J Anaesth* 94:505–13
13. Rodgers A, Walker N, Schug S et al. (2000) Reduction of post operative mortality and morbidity with epidural or spinal anaesthesia: results from overview of randomized trials. *BMJ* 321:1493–1497
14. Tucker AP, Mezzatesta J, Nadeson R et al. (2004) Intrathecal midazolam II: combination with intrathecal fentanyl for labor pain. *Anesth Analg* 98:1521–7

## Postoperative Pain, Compartment Syndrome

E. L. BRANDON, STEPHAN A. SCHUG  
Royal Perth Hospital and University of Western  
Australia, Crawley, WA, Australia  
schug@cyllene.uwa.edu.au

### Synonyms

Compartmental Syndrome

### Definition

Compartment syndrome is a condition in which an increase in the pressure within a closed, non-expansile muscle compartment reduces the level of capillary perfusion to less than that required for the viability of tissues. The resultant ischaemia can have permanent

and disabling sequelae; it is a limb and potentially life threatening syndrome, which will lead to muscle necrosis with permanent functional impairment and renal failure if not treated. It was first described in 1872 by the German surgeon R. von Volkmann, whose name is associated with this condition (Volkmann 1882).

### Characteristics

Compartment syndromes are characteristically seen following trauma to, or arterial reconstruction of, an extremity (Mubarak and Hargens 1983). However, they have also been described following the use of a tourniquet, surgical procedures requiring lithotomy, and as a result of drug abuse or medication injection (Franc-Law 2000), but can even occur with simple physical activity. In most cases of compartment syndrome it is clear which factors led to the compromise of local blood flow, for example, a fracture of the lower third of the tibia, peripheral vascular disease or a tight plaster cast. The factors that compromise local blood flow in the lithotomy position are not so obvious, and the term well leg compartment syndrome (WLCS) has recently been advocated for this situation (Heppenstall and Tan 1999). The possibilities include arterial hypo-perfusion, venous obstruction, or an increase in compartment pressure resulting from the weight of the limb in the stirrups.

Regardless of the aetiology, pathological elevation of intracompartmental pressures impedes capillary perfusion and may rapidly progress to muscle ischaemia, metabolic acidosis and rhabdomyolysis with subsequent release of metabolic toxins. Myoglobinuric renal failure, multi-organ failure and possible death may ensue. Amputation of the limb is occasionally required and there is also the risk of long-term neuromuscular deficit of the limb and altered gait due to long-term ischaemic contracture or nerve injury secondary to ischaemia.

### Pathophysiology

Possible explanations regarding the pathophysiology of compartment syndrome have developed with time, from Rowland's theory in 1910 of a direct plasma leak after ischaemia to current concepts focusing on the ischaemia-reperfusion theory of cellular injury (Rowlands 1910). Ischaemia leads to the depletion of intracellular energy stores, causing cellular swelling, oedema and an increase in venular pressure due to venous outflow obstruction with a resultant increase in capillary pressure. Intracompartmental pressure eventually equals capillary pressure, stopping nutrient blood flow and leading to tissue infarction.

### Diagnosis

The diagnosis of compartment syndrome requires a high index of clinical suspicion, and the typical postoperative presentation includes leg pain out of proportion

to clinical findings. The earliest signs are often subtle and most often neurological because the tissues most sensitive to hypoxia are nonmyelinated type C sensory fibres. There may be swelling of the affected limb, pain with passive stretch of the muscles within the compartment, paraesthesias and pulselessness may also be present. However, because compartment syndrome occurs at interstitial pressures below systolic arterial pressure, the presence of a pulse does not exclude the presence of a compartment syndrome. The condition may be misdiagnosed as a deep vein thrombosis or neurapraxia.

Compartment pressures may be measured invasively. However, there is still no universal agreement at what intracompartmental pressure one should consider fasciotomy. It has been argued that intracompartmental pressure monitoring should only be used to confirm clinical findings.

#### Management of Compartment Syndrome

Treatment involves correction of metabolic acidosis, treatment of renal failure and decompressive fasciotomies of each compartment. If fasciotomy is not performed within 12 hrs of ischaemia, there is little recovery of neuromuscular function.

#### Analgesia and Compartment Syndrome

Providing good intra- and postoperative analgesia is the goal of every anaesthetist. However, much controversy exists about the most suitable analgesia for patients undergoing orthopaedic/vascular extremity surgery, or surgery requiring a prolonged lithotomy position; that is those patients at risk of developing a compartment syndrome postoperatively.

The use of epidural analgesia has provoked the most concern. This relates to two main issues; the role of epidural analgesia in contributing to compartment syndrome, and the risk of epidural analgesia masking the symptoms of compartment syndrome. It has been suggested that sympathetic blockade induced by the use of epidural local anaesthetics causes increased blood flow to a limb, and that this may contribute to a rise in intracompartmental pressure (Price et al. 1996). In contrast, epidurally administered opioids do not abolish the normal vasoconstrictor response, but may reduce afferent nociceptor input to the sympathetic nervous system by a direct effect on the peripheral vasculature, thereby potentially increasing blood flow to an extremity (Cousins and Glynn 1980).

The use of epidural analgesia for postoperative pain produces a sensory block of the lower limb. There is much debate about whether this masks the signs of compartment syndrome. Strecker et al. reported a case of compartment syndrome after osteocutaneous free fibula transfer, in which postoperative pain was managed with 0.125 % epidural bupivacaine for 4 days (Strecker et al. 1986). After discontinuation of the epidural, the

patient complained of dull pain, but no treatment was considered for a further 3 days.

Morrow et al. (1994) described a patient who underwent bilateral closed intramedullary femoral rodding for femoral shaft fractures, and received continuous epidural bupivacaine and fentanyl postoperatively. Thirteen hours after surgery, it was noted that the patient had numbness and paresis of the leg. Tibial pressures were elevated and decompressive fasciotomies were undertaken.

Tang and Chiu (2000) described a case of compartment syndrome following a total knee replacement, in which they claim continuous epidural analgesia masked the pain (Tang and Chiu 2000).

However, there have been many cases of compartment syndrome diagnosed successfully during epidural blockade (Dunwoody et al. 1997, Beerle and Rose 1993, Turnbull and Mills 2001): Beerle and Rose administered bupivacaine and fentanyl via the epidural route, which did not mask the signs of compartment syndrome due to the lithotomy position (Beerle and Rose 1993). Turnbull and Turnbull described 3 cases in which compartment syndrome developed after surgery in the Lloyd-Davies position, in which all 3 patients reported severe bilateral calf pain in the recovery room despite functioning thoracic epidurals (Turnbull and Mills 2001).

Epidural local anaesthetics act by blocking nerve transmission in the somatic and sympathetic fibres as they pass through the epidural space. The degree of neural blockade is dose and concentration dependent, with the lowest concentration causing sympathetic blockade and increasing concentrations producing analgesia, cutaneous anaesthesia and finally motor blockade. Epidural opioids exert their analgesic effect by binding to opioid receptors in the dorsal horn of the spinal cord and selectively blocking nociceptive stimulation, thereby producing analgesia. Unlike local anaesthetics, they do not produce cutaneous anaesthesia or motor blockade. It is common practise to combine low dose local anaesthetics and opioids in order to reduce the side effects of each agent.

In the light of these differences, several authors have advocated omitting the local anaesthetic component, and just delivering epidural opioids on their own with the aim of maintaining the sensation of skin and deep tissues, and thereby making a compartment syndrome easier to diagnose. However, the use of fentanyl as the sole agent in an epidural has been shown to mask a compartment syndrome in a patient undergoing bilateral corrective osteotomies (Price et al. 1996).

In summary, epidural analgesia is unlikely to mask the signs of complete compartment syndrome, although it may delay the diagnosis in patients with early compartment syndrome. However, quality and frequency of monitoring are important factors in preventing the syndrome being masked by epidural analgesia.



Postoperative epidural analgesia is not the only suspect when considering the association between analgesia and delayed diagnosis of compartment syndrome. Harrington et al. report the case of a 53 year old male who underwent intramedullary nailing of a tibial fracture who subsequently developed compartment syndrome (Harrington et al. 2000). This went unrecognised until the patient went back to theatre for wound inspection 36 hours later. Initial postoperative pain relief was managed with a morphine patient-controlled analgesia (PCA) device. The authors concluded that nursing staff were not alerted to the increasing morphine consumption because use of the PCA reduces nurse-patient contact. They suggest the use of more sophisticated PCA pumps, which allows a specified 4 hour maximum dose to be set. In this way, the patient with increasing analgesic requirements would be forced to seek nursing attention earlier, and this would allow earlier appropriate management. Other methods of postoperative analgesia have also been implicated in a delay in diagnosing compartment syndrome, including peripheral nerve blocks and spinals.

A recent survey of a group of orthopaedic surgeons and anaesthetists in the UK showed that significant differences exist regarding the preferred choice of postoperative analgesia in clinical situations, which have previously been shown to be associated with a high risk of compartment syndrome (Raghuram et al. 2004). Both surgeons and anaesthetists favoured the use of the PCA, but a higher proportion of anaesthetists preferred the use of epidurals and nerve block compared to the orthopaedic surgeons. The authors propose that management of postoperative pain in patients at risk of compartment syndrome should be along the lines of traditional on-demand intramuscular morphine, so that increasing analgesic requirements must be reviewed by the nursing staff prior to administration of the next dose. They also suggest that the use of local and regional nerve blocks, without intracompartmental pressure monitoring, should be contraindicated in these high-risk patients. However, these views are not widely supported by the evidence available.

### Conclusion

Whatever mode of analgesia is used in patients at high risk of developing compartment syndrome, a high index of clinical suspicion, careful detailed examination and compartmental pressure monitoring remain the cornerstone for diagnosis and treatment. Pain management should be multi-disciplinary, and close liaison is necessary between surgeons and anaesthetists when planning a postoperative analgesic regimen.

### References

1. Beerle BJ, Rose RJ (1993) Lower Extremity Compartment Syndrome from Prolonged Lithotomy Position not Masked by Epidural Bupivacaine and Fentanyl. *Reg Anesth* 18:189–190

2. Cousins MJ, Glynn CJ (1980) New Horizons. In: Cousins MJ, Bridenbough PO (eds) *Neural Blockade in Clinical Anaesthesia and Management of Pain*. JB Lippincott, Philadelphia, pp 699–719
3. Dunwoody JM, Reichert CC, Brown KL (1997) Compartment Syndrome Associated with Bupivacaine and Fentanyl Epidural Analgesia in Pediatric Orthopaedics. *J Pediatr Orthop* 17:285–288
4. Franc-Law JM (2000) Poisoning Induced Acute Atraumatic Compartment Syndrome. *American J Emerg Med* 18:616–621
5. Harrington P et al. (2000) Acute Compartment Syndrome Masked by Intravenous Morphine from a Patient Controlled Analgesia Pump. *Injury* 31:387–389
6. Heppenstall B, Tan V (1999) Well Leg Compartment Syndrome. *Lancet* 354:970
7. Volkmann R (1882) *Krankheiten der Bewegungsorgane*. In: von Pitha F, Billroth Th (eds) *Handbuch der Allgemeinen und Speziellen Chirurgie*, vol 2. Enke, Stuttgart, pp 234–920
8. Morrow BC, Mawhinney IN, Elliott JR (1994) Tibial Compartment Syndrome Complicating Closed Femoral Nailing: Diagnosis Delayed by an Epidural Analgesic Technique – Case Report. *J Trauma* 37:867–868
9. Mubarak SJ, Hargens AR (1983) Acute Compartment Syndromes. *Surg Clin North Am* 63:539–565
10. Price C, Ribeiro J, Kinnebrew T (1996) Compartment Syndromes Associated with Postoperative Epidural Analgesia. A Case Report. *J Bone Joint Surg Am* 78:597–599
11. Raghuram T et al. (2004) Differences in Attitudes to Analgesia in Postoperative Limb Surgery put Patients at Risk of Compartment Syndrome. *Injury* 35:290–295
12. Rowlands RP (1910) Volkmann's Contracture. *Guys Hosp Gaz* 24:87
13. Strecker WB, Wood MB, Bieber EJ. (1986) Compartment Syndrome Masked by Epidural Anaesthesia for Postoperative Pain. Report of a Case. *J Bone Joint Surg Am* 68:447–448
14. Tang WM, Chiu KY (2000) Silent Compartment Syndrome Complicating Total Knee Arthroplasty: Continuous Epidural Anaesthesia Masked the Pain. *J Arthroplasty* 15:241–243
15. Turnbull D, Mills GH (2001) Compartment Syndrome Associated with the Lloyd Davies Position: Three Case Reports and Review of the Literature. *Anaesthesia* 56:980–982

P

## Postoperative Pain, COX-2 Inhibitors

LESLEY A. COLVIN<sup>1</sup>, IAN POWER<sup>2</sup>

<sup>1</sup>Department of Anaesthesia, Critical Care and Pain Medicine, Western General Hospital, Edinburgh, UK

<sup>2</sup>Anaesthesia, Critical Care and Pain Medicine, The University of Edinburgh, Edinburgh, UK

ian.power@ed.ac.uk

### Synonyms

Cyclooxygenase 2 inhibitors; Coxibs; COX-2 inhibitors

### Definition

COX-2 inhibitors are anti-inflammatory analgesics that act by specific inhibition of one of the isoenzymes involved in prostaglandin synthesis, cyclooxygenase 2 (COX-2). These drugs were developed as an alternative to traditional ► [NSAIDs](#), [Survey](#) (NSAIDs), with the aim of maintaining or improving efficacy and reducing adverse effects.

## Characteristics

### Mechanism of Action

The COX enzymes, of which there are several variants, are involved in prostaglandin production from ► **arachadonic acid** (see Fig. 1). Standard NSAIDs act by inhibiting activity of cyclooxygenase-1 and -2 enzymes (COX-1 and COX-2); otherwise known as prostaglandin endoperoxide synthases (PGHS). There is about 60% homology of the amino acid sequence between COX-1 and COX-2, with both enzymes having very similar active sites and catalytic properties, although COX-2 has a larger potential binding site due to a secondary internal pocket. COX-2 is degraded more rapidly and has a shorter half-life than COX-1.

COX-1 is expressed constitutively in a wide range of tissues, and is thought to be involved in many physiologic "housekeeping" functions. The prostanoids produced by COX-1 are functionally active in many areas, including the gastro-intestinal tract, kidney, lung and cardiovascular systems. In contrast, the functional COX-2 enzyme is normally only found in a few restricted tissues such as the brain, renal cortex and tracheal epithelium, although COX2 mRNA is widely distributed. In response to specific stimuli, the expression of the COX-2 isoenzyme is induced or up-regulated. The prostaglandins subsequently produced play a key role in inflammatory processes and pain. Prostaglandin E<sub>2</sub>, in particular, plays an important role in ► **inflammation**, pyresis and ► **hyperalgesia**. The role of COX-2 in pyrexia may depend on the aetiology of the pyrexia. COX-2 may be involved in lipopolysaccharide-induced pyrexia, although COX-1 may be more important in fever occurring without infection. A variety of other stimuli found in the peri-operative period have been shown to

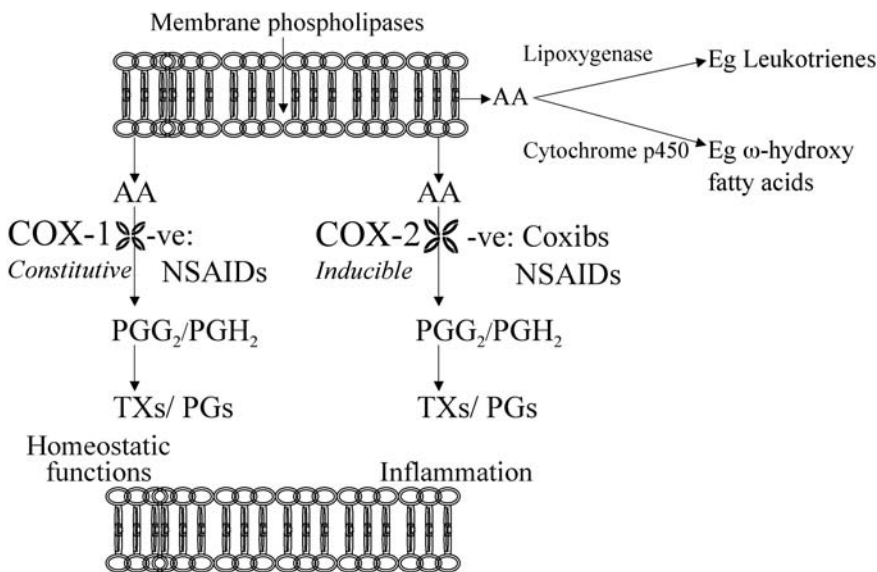
induce COX-2, including cytokines and growth factors (Masferrer et al. 1999).

Although COX-2 inhibitors act mainly on COX-2, they may have variable activity on the COX-1 enzyme. A range of assays, including *in vitro* whole blood assays, have been used to give an indication of the selectivity of different agents acting on the COX1 and COX2 enzymes (see Table 1) (Baigent and Patrono 2003)). These may not be clinically relevant, as there can be significant variability in individual plasma levels with the same dose, as well as variability in actual enzyme inhibition.

### Efficacy

There is a large body of evidence of the efficacy of traditional NSAIDs in the treatment of both acute and chronic pain. Used alone, they are effective in mild to moderate post-operative pain, and have an opioid sparing effect when used as part of a ► **balanced analgesic regime** in the treatment of moderate to severe post-operative pain. Although there is evidence of clinical efficacy and safety, not all COX-2 inhibitors are licensed for the treatment of acute post-operative pain (rofecoxib and parecoxib are licensed). Ideally, any new agent would have to demonstrate efficacy similar to that of conventional ► **NSAIDs** but with reduced adverse effects, in particular, on the gastro-intestinal tract and platelet function.

There is level one evidence (systematic reviews/ meta-analyses) of the efficacy of COX-2 inhibitors for chronic pain conditions, such as rheumatoid arthritis and osteoarthritis, compared to both placebo or active comparator (usually a standard NSAID) (Deeks et al. 2002). There have also been studies demonstrating efficacy in dysmenorrhoea and acute gout.



**Postoperative Pain, COX-2 Inhibitors, Figure 1** Free arachadonic acid (AA) is produced from membrane bound phospholipids and may be metabolised by several different pathways into a variety of substances. The enzymes involved include lipoxygenase, cytochrome p450 and cyclooxygenases-1 and -2 (COX-1 and COX-2). COX-1 is involved in the production of a wide range of prostaglandins and thromboxanes that are essential for many homeostatic processes. COX-2 is induced by a variety of mediators, such as cytokines and growth factors, which are central to inflammatory processes. Non-steroidal anti-inflammatory drugs (NSAIDs) inhibit both enzymes whereas COX-2 inhibitors are selective for COX-2.

**Postoperative Pain, COX-2 Inhibitors, Table 1** Relative selectivity of a range of anti-inflammatory agents for COX-1 and -2 enzymes, as measured using human whole blood assays *in vitro* using platelet COX-1 and monocyte COX-2. IC<sub>50</sub> ratio = 50 % inhibitory concentration (modified from Baigent and Patrono 2003).

Inhibitor	COX-1:COX-2 (IC <sub>50</sub> ratio)
Rofecoxib	267
Celecoxib	30
Diclofenac	29
Meloxicam	18
Indomethacin	1.9
Acetaminophen	1.6
Naproxen	0.7
Ibuprofen	0.5

There is now an increasing amount of evidence that COX-2 inhibitors are at least as effective as standard NSAIDs in the treatment of post-operative pain. Clinical studies have looked at dental pain, orthopaedic procedures including major spinal and joint replacement surgery, gynaecological and cardiac surgery. To date there are several systematic reviews that demonstrate efficacy of specific COX-2 inhibitors in the acute post-operative setting (Barden et al. 2004c; Barden et al. 2004b; and Barden et al. 2004a). These have been summarised in Table 2, along with some other agents for comparison. The ► [number-needed-to-treat](#) (NNT) is defined as the number of patients needed to receive the active agent (e.g. COX-2 inhibitor) for one patient to achieve a 50 % reduction in the level of their pain com-

pared with placebo over a 4–6 hour period. The NNTs for currently available COX-2 inhibitors is similar to that for diclofenac and better than that for tramadol or morphine.

More recently produced agents, such as valdecoxib and etoricoxib, may have an improved analgesic effect compared to older agents, with a good safety profile. New developments include agents that can be given both parenterally and orally, with obvious benefits for the peri-operative management of pain. Some of these agents have very fast onset and a long duration of action.

### Safety

Despite the considerable evidence for analgesic efficacy of standard NSAIDs, for post-operative use there is also considerable evidence regarding their potential for harm (Tramer et al. 2000). NSAIDs have been found to cause more deaths than asthma, multiple myeloma, cervical cancer and Hodgkin's disease. As selective COX-2 inhibitors should not interfere with the physiological functions of COX-1 produced prostanoids, there should be an improved safety profile with these agents.

Most of the studies have looked at adverse events in the chronic pain setting with prolonged use of the agents, but generally at lower doses than those used for acute pain. The systematic reviews of COX-2 inhibitors for efficacy in treating acute pain (see Table 2) have generally found no significant increase in adverse events compared to placebo, but information is limited and further study is required.

### Gastro-Intestinal

One of the commonest side effects with NSAIDs is gastrointestinal toxicity. Approximately 1 in 1200 pa-

P

**Postoperative Pain, COX-2 Inhibitors, Table 2** Relative efficacy of different COX-2 Inhibitors (Compiled from The Cochrane Library of Systemic Reviews/ Bandolier) (Barden et al. 2004a; Barden et al. 2004b)

Drug used	No of trials in systematic review	Type of surgery	Number of patients receiving active treatment	Number-needed-to-treat (NNT) (95% CI)
Valdecoxib 20–40 mg	4	Dental	380	20 mg: 1.7 (1.4–2.0) 40 mg: 1.6 (1.4–1.8)
Celecoxib 400 mg	4	Dental; orthopaedic	704	1.9 (1.6–2.3)
Etoricoxib 60–180 mg	3	Dental	824	60 mg: 2.0 (1.6–2.8) 120 mg 1.5 (1.3–1.7)
Rofecoxib 50 mg	7	Dental; orthopaedic	667	2.2 (1.9–2.4)
Diclofenac 100 mg	7		618	2.3 (2.0–2.7)
Ibuprofen 400 mg	52		6358	2.4 (2.3–2.6)
Morphine 10 mg (intramuscular)	20		696	2.9 (2.6–3.6)
Paracetamol 1000 mg	46		2530	3.8 (3.4–4.4)
Tramadol 100 mg	18		1486	4.6 (3.4–4.4)

tients on chronic NSAID treatment (> two months) will die from related gastroduodenal complications (Tramer et al. 2000). The COX-1 isoenzyme is the predominant cyclooxygenase found in the gastric mucosa. The prostanoids produced here help to protect the gastric mucosa by reducing acid secretion, stimulating mucous secretion, increasing production of mucosal phospholipids and bicarbonate and regulating mucosal blood flow. As COX-2 inhibitors do not interfere with these processes, a reduction in gastro-intestinal complications compared to standard NSAIDs would be expected.

A reduction in morbidity and mortality from upper GI complications has been shown in several large studies of chronic pain populations as well as healthy volunteers. Studies have looked at several parameters including faecal red blood cell loss, endoscopic studies and incidence of upper gastrointestinal clinical events. The majority of these studies demonstrated a significant reduction in GI bleeds, perforation and peptic ulcer disease found in comparison to NSAIDs (Rostom et al. 2004). Using the strictest criteria of endoscopically proven ulcer, combining data from 3 large scale trials (Simon et al. 1999; Laine et al. 1999; Hawkey et al. 2000), no significant difference in incidence rate was found after 12 weeks of treatment between placebo and all doses of coxibs (~6%), compared to conventional NSAIDs with a significantly higher incidence rate (28%).

Peri-operatively, the use of higher doses than those used for chronic pain, combined with risk factors such as frail, elderly or dehydrated patients may increase the risk of acute GI events, although there is no evidence of this to date. Studies in the acute setting have mainly focussed on efficacy as a primary outcome measure, but none of these studies found any severe adverse GI events. There have been several studies using injectable parecoxib (a pro-drug of valdecoxib), looking specifically at acute upper GI complications that found no endoscopically proven ulcers, compared to up to 23% of patients receiving ketorolac (Stoltz et al. 2002).

### Cardiovascular

Some of the large-scale studies of use of COX-2 inhibitors in chronic conditions have found an increased risk of cardiovascular events, mainly an increased risk of myocardial infarction (NHS Centre for Reviews and Dissemination 2004). The VIGOR study in particular, where patients on low dose aspirin were excluded, found an increased risk of MI for those patients on rofecoxib compared to naproxen (Bombardier et al. 2002). Several explanations have been postulated including a protective effective of NSAIDs in reducing platelet aggregation, similar to low dose aspirin. Alternatively, there may be an alteration in endothelial prostaglandin balance by COX-2 selective inhibition with increased thromboxane A<sub>2</sub> production relative to prostacyclin.

In acute post-operative pain, one study found adverse effects of COX-2 inhibitors, when parecoxib followed by valdecoxib was used in patients undergoing CABG surgery for up to 2 weeks afterwards. An increase in cerebrovascular accidents, renal dysfunction and sternal wound problems was found (Ott et al. 2003). Several studies have found an increase in thrombotic events resulting in the withdrawal of some of these agents. The risks and benefits of COX-2 selective agents remain the subject of considerable debate (Garner et al. 2005; Jones et al. 2005).

### Renal

COX-2 is normally found in the renal cortex and is therefore inhibited by both conventional NSAIDs and COX-2 inhibitors. There is the potential for peripheral oedema and hypertension, as well as direct effects on renal excretory function with oliguria and decreased creatinine clearance. Although this has so far not been clinically significant in trials on COX-2 inhibitors, it may become so in patients with a range of co-morbidities that would have been excluded from clinical trials. Studies have not found any greater risk for these problems with COX-2 inhibitors compared to standard NSAIDs.

### Haematological

Thromboxane production, requiring COX-1 activity, is important in the platelet aggregation necessary for haemostasis. With standard NSAIDs, there is the possibility of increased bleeding risk due to inhibition of platelet cyclooxygenase, which is mainly COX-1. This is of relevance, both in terms of surgical complications but also in the use of central regional techniques, such as epidural blocks. COX-2 inhibitors seem to have little effect on platelet activity or bleeding time, which may be beneficial in the peri-operative situation.

### Other

Respiratory problems have been reported, and as COX-2 is expressed in respiratory epithelium, their safety in susceptible asthmatics is not clear. Other reported side effects include nausea, constipation, dental infection and congestive cardiac failure.

### Conclusion

COX-2 inhibitors have been shown to be effective in the treatment of post-operative pain, with particular advantages in terms of improved GI safety compared to standard NSAIDs. As the evidence base for their clinical use increases, it appears that some of the newer agents may be more effective than previously available NSAIDs. COX-2 inhibitors provide a valuable addition to balanced postoperative pain management, with fast onset and long duration of action. Associated thrombotic events have restricted the critical use of COX-2 inhibition.



## References

1. Baigent C, Patrono C (2003) Selective Cyclooxygenase 2 Inhibitors, Aspirin and Cardiovascular Disease. *Arthritis Rheum* 48:12–20
2. Barden J, Edwards J, Moore R et al. (2004a) Single Dose Oral Rofecoxib for Postoperative Pain. *Cochrane Database of Systematic Reviews* 1
3. Barden J, Edwards J, McQuay H et al. (2004b) Single Dose Oral Celecoxib for Postoperative Pain. *Cochrane Database of Systematic Reviews* 1
4. Barden J, Edwards J, Moore R et al. (2004c) Single Dose Oral Etoricoxib for Postoperative Pain. *Cochrane Database of Systematic Reviews* 1
5. Bombardier C, Laine L, Reicin A et al. (2002) Comparison of Upper Gastrointestinal Toxicity of Rofecoxib and Naproxen in Patients with Rheumatoid Arthritis. VIGOR Study Group. *N Engl J Med* 343:1520–1528
6. Deeks JJ, Smith LA, Bradley MD (2002) Efficacy, Tolerability, and Upper Gastrointestinal Safety of Celecoxib for Treatment of Osteoarthritis and Rheumatoid Arthritis: Systematic Review of Randomised Controlled Trials. *BMJ* 325:619
7. Garner S, Fodan D, Frankish R, Maxwell L (2005) Rofecoxib for osteoarthritis. *Cochrane Database of Systematic Reviews* 1
8. Hawkey C, Laine L, Simon T et al. (2000) Comparison of the Effect of Rofecoxib (A Cyclooxygenase 2 Inhibitor), Ibuprofen, and Placebo on the Gastroduodenal Mucosa of Patients with Osteoarthritis: A randomized, Double-Blind, Placebo-Controlled Trial. The Rofecoxib Osteoarthritis Endoscopy Multinational Study Group. *Arthritis Rheum* 43:370–377
9. Jones SF, Power I (2005) Editorial I: postoperativ NSAIDs and COX-2 inhibitors: cardiovascular risks and benefits. *Br J Anaesth* 95:281–284
10. Laine L, Harper S, Simon T et al. (1999) A Randomized Trial Comparing the Effect of Rofecoxib, a Cyclooxygenase 2-Specific Inhibitor, with that of Ibuprofen on the Gastroduodenal Mucosa of Patients with Osteoarthritis. Rofecoxib Osteoarthritis Endoscopy Study Group. *Gastroenterology* 117:776–783
11. Masferrer JL, Koki A, Seibert K (1999) COX-2 Inhibitors. A New Class of Antiangiogenic Agents. *Ann N Y Acad Sci* 889:84–86
12. NHS Centre for Reviews and Dissemination (2004) Risk of Cardiovascular Events Associated with Selective COX-2 Inhibitors. *Database of Abstracts of Reviews of Effectiveness Issue* 1
13. Ott E, Nussmeier NA, Duke PC et al. (2003) Efficacy and Safety of the Cyclooxygenase 2 Inhibitors Parecoxib and Valdecoxib in Patients Undergoing Coronary Artery Bypass Surgery. *J Thorac Cardiovasc Surg* 125:1481–1492
14. Rostom A, Dube C, Boucher M et al. (2004) Adverse Gastrointestinal Effects of COX-2 Inhibitors for Inflammatory Diseases. *Cochrane Database of Systematic Reviews* 1
15. Simon LS, Weaver AL, Graham DY et al. (1999) Anti-Inflammatory and Upper Gastrointestinal Effects of Celecoxib in Rheumatoid Arthritis - A Randomized Controlled Trial. *JAMA* 282:1921–1928
16. Stoltz RR, Harris SI, Kuss ME et al. (2002) Upper GI Mucosal Effects of Parecoxib Sodium in Healthy Elderly Subjects. *Am J Gastroenterol* 97:65–71
17. Tramer MR, Moore RA, Reynolds DJM et al. (2000) Quantitative Estimation of Rare Adverse Events which Follow a Biological Progression: A New Model Applied to Chronic NSAID Use. *Pain* 85:169–182

## Postoperative Pain, Data Gathering and Auditing

KERSI TARAPOREWALLA

Royal Brisbane and Womens' Hospital, University of Queensland, Brisbane, QLD, Australia  
Kersi\_taraporewalla@health.qld.gov.au

## Synonyms

Data collection; Data management; Acute Pain Database; Audit; Data Auditing/Collection/Gathering/Management/Security; Data gathering

## Definition

► Data gathering consists of information collected by acute pain services, or their equivalents, in the day to day running of the service for purposes of patient care, improvement, auditing, comparison, or cost benefit analysis.

## Characteristics

### Introduction

A database is more than a collection of information or data. It is a tool to perform useful functions for its users. Rather than merely store data, database management requires three vital components, each of which requires a critical question to be answered when a database is set up (Allen 2002):

- It needs to be a representation of a portion of the real world it is created from. The critical question is how much data needs to be collected to produce a clear picture of the portion of the world it represents.
- The information stored needs to be set out in a logically coherent manner, with inherent meaning. This element needs careful planning and forethought as to how different pieces of the data will be linked to present a realistic set, rather than a distorted view.
- Specific purposes need to be addressed in creation of the database. The critical question is to what use is the information retrieved required, and what sorts of information will need to be collected to allow this to happen.

The purposes determine how the data needs to be analysed and manipulated. This could vary from a simple count of one field or element, to complex queries and reports across fields with Boolean operators.

Common purposes reported for the postoperative pain database (POPDB) have been auditing and quality assurance activities. Early databases, using paper records, tended to be simple and flat, partly due to the limitations of data retrieval. Improvement in computer technology has seen the development of relational databases, run by single operators. While the present databases represent a significant advance in retrieval, they have limitations due to the purposes intended. Significant advances in database technology can now be introduced including the use of wireless area network technology, computerised record keeping and online analytic processing to allow for improved clinical decision making at point of treatment. This also requires the use of data warehouses for the sharing of data from multiple institutions, and the pooling of data to allow for creation of standards of care, and to improve audit comparisons.

For a database to have the power to improve performance, several issues need to be considered.

#### Culture of Data Collection

The clinical work of optimising postoperative analgesia with minimal or no adverse effects is viewed as the primary aim of postoperative pain management units (such as acute pain services APS). The extra effort required in collecting data, requires a culture that recognises quality assurance of clinical routines and also improves postoperative pain management (Elmasri and Mavathe 2000). Numerous reasons have been put forward for failure to collect data by APS units. These include:

- Cost of collection and management of a database given limited budgets
- Lack of personnel resources and support to collect and enter data
- Lack of institutional or departmental support
- Lack of expertise in database management or computer technology
- Previous failures at attempts in collecting data
- Issues of confidentiality of data and its security
- Medicolegal problems arising from deficiencies in management identified by the database
- Lack of equipment

These limitations have been partly addressed by the development of commercial databases for acute pain management; however, most have failed in being unable to generate adequate reporting support.

While all of the above reasons have a genuine origin, they can be overcome to produce databases with significant power to improve APS units and reduce patient discomfort.

#### Purposes of Data Collection

Data that are collected and stored but not used are costly and wasteful. The purposes that the POPDB is to be used for needs to be clarified at the design stage, so as to identify the types of data that need to be collected. The following uses of POPDB have been reported:

- Quantifying efficacy and safety of APS (Hammond et al. 2000)
- Providing evidence of quality of care (Kuwahara et al. 2000)
- Monitoring performance of APS
- Assessing the effects of training in postoperative pain care
- Allowing decision systems in the creation of protocols

Once data fields have been determined, consideration needs to be addressed as to how the data will be represented, entered, validated and retrieved.

#### Methods of Data Collection

Early methods of data collection consisted of separate paper record forms derived from ward notes (McLeod 2002). Paper records have numerous drawbacks. They

are retrospective, tedious, require repetitive data entry, and make statistics difficult. Systems using this form have reported achieving only 60 % completion (Sanders and Michel 2002). However, there are advantages to paper based POPDB. They are easy to administer and tend not to need a large amount of capital outlay.

The development of relational databases has considerably added power to the POPDB. Data can now be categorised and stored with appropriate prompts for the user. Statistic manipulations become easier, and the total amount of data that can be stored is considerably greater. The types of tables that can be created include modalities used, equipment used, personnel involved, and patient demographics. The data tables can be generated to make intrinsic sense as a stand-alone portion of the total database. The development of smaller sized computers, as well as hand held devices such as personal digital assistants, allow for data to be entered at point of care delivery (Stomberg et al. 2003). This has a significant advantage in having data prospectively collected and analysed, and may also increase the chances of having data that are complete, consistent and accurate.

#### Who Collects the Data

Past experience has shown that enthusiasts are most likely to collect data in a consistent manner, partly due to factors discussed in the culture of data collection. The advent of the pain nurse provides an ideal opportunity to perform regular audits by data entry (Tan and Wong 2003). However, as APS units grow in size, it becomes vital that all members be involved in data entry. This has significant implications for training of staff involved in the management of postoperative pain.

#### Data Needed to be Collected

Enthusiasm for data collection tends to lead to collection of as much data as possible, in case the data might be needed in the future or become important, and the perception that it is better to collect data prospectively. There are a significant number of problems in collecting everything. These include increasing the time required to collect the data, staff annoyance at extra work for no return leading to poor data entry in fields not being analysed, large databases slowing down computer performance, increased likelihood of data entry errors, and increased chance of confusion in queries setup for reporting. As a general principle, the purpose of the POPDB should dictate the data collected.

Authors reporting on quality assurance and workload activities have collected the following types of data:

- Patient demographics – name, age, sex, ASA status etc
- APS techniques and drugs used – ► PCA, epidural, regional blocks etc
- Adverse effects of techniques and drugs – nausea and vomiting, sedation, respiratory depression, motor weakness

- Assessment of pain
- Personnel involved
- Equipment used
- Duration of treatment – time involved in care

There are two factors that have impaired how retrieved information is used by the wider community. There is no agreement as to what constitutes the minimal data set that POPDB should collect so as to gain meaningful comparisons from reports generated (Elmasri and Mavathe 2000; Turner and Halliwell 1999). Further, there is no uniform set of definitions and scoring systems e.g. sedation, nausea and pain intensity, making comparisons and standard setting difficult. These are urgently required for future developments and advances in postoperative pain care, as well as POPDB functions.

Data stored in POPDB should be in fixed coded systems rather than free text format. Free text formats create difficulties in analysing due to spelling errors, abbreviations used, loose terminology and the lack of clear definitions. Coded or fixed entry formats have the advantages of retrieval and checks for data quality, but need careful attention in the planning stage to allow for all possible values that may arise.

#### Quality of Data

The value of reports generated from a POPDB is dependent on the quality of data stored in it. This quality can be appreciated in terms of completeness, validation, error handling and audit trails.

Incomplete forms and tables stored in the POPDB represent lost values that cannot be analysed. Data entry rates reported at 60% significantly impair the meaning that can be generated, and introduce biases to interpretations made from reports produced. Staff averse to the ideas of data collection are more likely to be incomplete in their data entry. Data need to be checked for completeness at time of entry, and periodically thereafter. The former can be performed by a software approach that checks for the minimal fields that need to be completed before the form can be closed and stored in the database. Periodic checking of data quality requires a database manager to be employed to check fields for completeness and correction of errors of omission from the patient notes. Changes made to the database after initial entry need to have an automatically generated timestamp to allow for audit trails.

Validity of data implies that data entered have sufficient meaning to be interpretable. Hence a name field should not contain numbers, and a low pulse rate needs to have a range (e.g. < 45) defined. Validation of data entries can be significantly improved if the user is given a pick list of fixed entries that can be used. This list needs to be complete and of limited size so as to be able to group and categorise the data in meaningful ways. Thus, a rare complication can be stored as "other complication" with an associated text entry field, and a drug list of local anaes-

thetic agents can be generated from the limited number of drugs regularly used by the unit. Pick lists can become more useful when data entry can be generated by simple means such as pointers, touch screen or using the first few letters of the choices. Validation can also be improved by incorporation of a software check at time of entry. It is important to realise that such validation does not check the truth of the data entered; rather, it eliminates nonsense entries into fields by accident.

Validity also implies consistency of what information is collected. A report from one institution produced a correlation coefficient of 0.4 for pain scores and 0.02 for sedation scores between ward nurses and APS staff (Wigfull and Welchew 1999). This suggests that audits need to validate their data prior to generating reports.

How the POPDB handles errors is of significant importance. Errors of omission can be checked for and corrected. The time of correction needs to be registered. Online correction of omission needs to be handled with diplomacy so as not to irritate the human user. Errors of commission are more difficult to manage. Some advances can be made in checking for logical errors, such as entering local anaesthetic or sensory levels when PCA is used, or the entry of inappropriate infusion rates for continuous epidural infusions.

The use of default values in data fields has advantages and problems. Default values speed data entry and reduce the workload on the user. Care needs to be taken as to the values chosen for default, e.g. a pain score ► **default value** of 99 can be used to check that data have not been entered rather than a default value of 0. Default values that are also possible data entries can lead to errors at the time of retrieval, because of the interpretation ascribed to the collected results for the data field. Default values can also be used to check for errors of omission.

An audit trail is an important part of any database. It needs to be automatically generated and allow for validation, data entry checking and can explain differences in reports produced at different times. Database entries should not be used to generate patient notes; rather, data entries should be created simultaneously with patient notes. The patient notes could be produced as a report from the database. However, if the data fields are altered after patient records are generated, all reports should show the data trail of when the data was altered.

#### Data Security

There are two opposing factors at play. Data need to be stored in an easily accessible format for retrieval and transfer to other databases to become part of a larger set. However, sensitive patient information needs to be handled for confidentiality. Security of information in electronic form remains a problem for the computer industry, and ingenious solutions, such as encryption, have been formulated. The backwash of this problem is the lack of trust in providing information for storage by physi-

cians. As a principle, shared information regarding patients should not be able to identify individual patients. This can be managed by creating appropriate tables that can be shared using numerous security limits for the sensitive data.

### Audit Reports

The author has seen numerous proposed POPDB put for commercial use, with many failing to generate reports that can be produced by the user on an ad hoc basis. Most force reports perceived by the creators of the software as being important for an APS, rather than letting the APS users determine what information is of value. No POPDB should be used unless the reports that can be generated are credible and serve the purpose the POPDB was set up to do.

Audits of activities of APS can be expressed in terms of:

- Efficiency – e.g. time to achieve satisfactory pain relief, number of pumps idle
- Effectiveness – in terms of no. of patients with satisfactory pain relief, complication rates, costs incurred in providing the service, early discharge rate
- Resource utilisation – costs, drugs used, equipment used and needed
- Quality of service – as compared with standards set, other institutions or nationally accepted rates.

Certain points need to be addressed in reports generated by audits. When prevalence or incidences of events are reported, they need to be expressed in terms of incidence per 100 or 1000 cases. Thus, both the numerator and denominator in terms of sample size need to be stated.

Interpretation needs to be provided in context for results obtained. Thus, a low complication rate for epidural analgesic techniques may be due to low rate of use, intense monitoring or choice of drugs etc. Explanations generated by members of the APS who understand the constructs of the figures are more likely to reflect reality. The purpose of this form of activity is to enable suitable comparisons. The adoption of national audits, which produce a national average as well as a range for quality measures, such as epidural failure rates, allow for realistic achievable targets to be set for improvement activities (Wigfull and Welchew 1999).

### Future of Data Collection

Considerable advances can be gained in postoperative patient care, in terms of research and evidence based practice, on the basis of an individual unit's data collection activity. With pooling of data from multiple time periods and institutions, clinical decision making of the appropriate choice of drug or technique for an individual can be enhanced. This sets the stage for improved care. The POPDB of the future is likely to be organised so as to produce continuous performance indicators of the quality of care (Kuwahara et al. 2000).

However, a culture that encourages data collection and incorporation of technological advances in computing will be required before it can be established.

### References

1. Allen H (2002) Using Personal Digital Assistants for Pain Management. *Tech Reg Anesth Pain Manage* 6:158–164
2. Elmasri R, Mavathe S (2000) Chap 1: Databases and Database Users. In: *Fundamentals of Database Systems*, 3rd edn. Addison-Wesley, pp 3–21
3. Hammond EJ, Veltman M, Turner G et al. (2000) The Development of a Performance Indicator to Objectively Monitor the Quality of Care Provided by an Acute Pain Team. *Anaesth Intensive Care* 28:293–299
4. Kuwahara B, Klassen K, Goresky G et al. (2000) The Acute Pain Service at the Alberta Children's Hospital. *Clin Ped Anesth* 6:105–115
5. McLeod G (2002) The Use of Audit in Acute Pain Services: A UK Perspective. *Acute Pain* 4:57–64
6. Sanders MK, Michel MZM (2002) Acute Pain Services – How Effective Are We? *Anaesthesia* 57:27
7. Stomberg MW, Loerentzen P, Joelsson H et al. (2003) Postoperative Pain Management on Surgical Wards – Impact of Database Documentation of Anesthesia Organized Services. *Pain Manage Nurs* 4:155–164
8. Tan CH, Wong WSH A (2003) Baseline Audit of the Efficacy and Safety of an Acute Pain Service (APS) for Caesarean Section Patients. *Acute Pain* 4:99–104
9. Turner G, Halliwell R (1999) Data Collection by Acute Pain Services in Australia and New Zealand. *Anaesth Intensive Care* 27:632–635
10. Wigfull J, Welchew EA (1999) Acute Pain Service Audit. *Anaesthesia* 54:299

## Postoperative Pain, Epidural Infusions

EDWARD A. SHIPTON

Department of Anaesthesia, Christchurch School of Medicine, University of Otago, Christchurch, New Zealand

shiptonea@xtra.co.nz

### Synonyms

Extradural Infusions

### Definition

The epidural route of drug delivery has achieved widespread use for surgical and obstetrical analgesia (Shang and Gan 2003). Epidural blockade is usually performed in the thoracic and lumbar regions, or caudally to involve the sacral nerve distributions. Continuous epidural infusion of local anaesthetics can reduce the stress response to surgery (Holte and Kehlet 2002) and allow rapid mobilization after major surgical procedures.

### Characteristics

Recommended multimodal mixtures for epidural infusions consist of low concentrations of a local anaesthetic (e.g. bupivacaine 1 mg/ml, ropivacaine 1–1.5 mg/ml, levobupivacaine 1 mg/ml), a lipophilic opioid (e.g. fentanyl 2 µg/ml, sufentanil 0.5 µg/ml) and an adrenergic



agonist adrenaline (2 µg/ml) (Breivik 2002). Loading doses are usually given at the start of the infusion and the infusion rate titrated. Multimodal mixtures result in overall risks being lower for adverse effects. After major abdominal and thoracic surgery, pain during coughing is mild when the three components are used together (Breivik 2002).

Subanaesthetic doses of local anaesthetic inhibit excitatory synaptic mechanisms in the dorsal horn. The addition of opioids improves the quality of postoperative epidural analgesia, acting on the pre- and post-synaptic opioid receptors. Adrenaline acts on the pre- and post-synaptic alpha-2 receptors and has an analgesic effect of its own (dose-related), although it does not improve epidural analgesia at the lumbar level. It does not impair blood flow to the spinal cord, reduces systemic absorption and adverse effects of opioids (e.g. decreases pruritus) and local anaesthetics. The minimally effective concentration of adrenaline to maintain relief of dynamic pain is approximately 1.5 µg/ml (Niemi and Breivik 2003).

Other additions to an epidural infusion include clonidine (10-20 µg/h in adults, or 0.08-0.12 µg/kg/h in children), or a dose of the S+ enantiomer of ketamine (0.5 mg/kg) to reduce opioid consumption and improve analgesia (Cucchiari et al. 2003; Ivani et al. 2003).

When compared to intravenous ► **patient-controlled analgesia**, epidural analgesia results in better analgesia and reduced opioid requirement. When compared to continuous epidural infusion only, PCEA (patient controlled epidural analgesia) with background epidural infusion results in equivalent analgesia with lower local anaesthetic doses and plasma levels, lower opioids dosage, no motor effects, less sedation, self-adjustment by the patient and higher patient satisfaction (Standl et al. 2003).

The magnitude of pain relief must be weighed against the frequency of adverse events. The incidence of serious complications is low (Ng and Goh 2002). Patients can be nursed on the wards with appropriately trained staff. There is a high incidence of minor adverse effects, especially during the first 48 hours. Local anaesthetic may result in hypotension, motor blockade and urinary retention, if the catheter is in the low thoracic or thoracolumbar area (Breivik 2002). Opioids may result in respiratory depression, gastrointestinal immotility, nausea and pruritus. Small doses, or a continuous infusion of naloxone (0.25 µg/kg/h) or nalmefene (15-25 µg), are effective in reducing opioid-related adverse effects and also paradoxically reduce postoperative opioid requirements (Shang and Gan 2003). In children, continuous epidural infusion for postoperative pain is satisfactory. No major adverse effects occurred in children nursed on regular wards (Kampe et al. 2003). Robust monitoring is, however, important during the early postoperative period as well as the involvement of the Acute Pain Service in the management of side effects, especially inadequate

analgesia (e.g. catheter displacement, unilateral block, and tachyphylaxis).

Severe neurological injury is rare. The insertion of epidural needles or catheters should generally be avoided in patients with coagulation disorders, or in those who are fully anticoagulated. Similarly the use of low molecular weight heparin for deep vein thrombosis prophylaxis may be associated with a higher risk of epidural haematoma, particularly in the higher dose ranges.

A thoracic epidural with local anaesthetic is more beneficial for patients at high risk of cardiac or pulmonary complications after thoracic or abdominal surgery (Breivik 2002). It dilates stenotic coronary arteries, increases myocardial oxygen supply, decreases myocardial oxygen consumption, decreases myocardial ischemic events and postoperative myocardial infarction, improves lung function and oxygenation, and improves gastro-intestinal motility. Whereas lumbar epidural analgesia with local anaesthetic dilates the arteries of the lower part of the body, constricts the coronary arteries, decreases myocardial oxygen supply, causes leg weakness, and urinary retention, and does not improve gastro-intestinal function (Breivik 2002). Continuous epidural analgesia is associated with a lower incidence of perioperative adverse cardiac events (Matot et al. 2003). To derive the full protective cardiac effect from a perioperative epidural technique, the catheter must be inserted in the high thoracic region.

Beneficial effects on pulmonary outcome occur by promoting the postoperative recovery of diaphragmatic contractility, which returns the functional residual capacity/closing capacity to normal. This has direct implications on the length of postoperative mechanical ventilation (de Leon-Casasola 2003). The addition of enforced early mobilisation may represent a further means of improving pulmonary outcome.

The addition of an epidural local anaesthetic to an opioid shortens the time of intestinal paralysis after surgery. Continuous epidural analgesia significantly lowers the risk of thromboembolic complications after lower body procedures, while no effect is seen after major abdominal surgery (Holte and Kehlet 2002).

The role of postoperative epidural analgesia on postoperative morbidity is controversial. There appear to be contradictory findings in the results of recent large-scale outcome studies compared with those obtained by meta-analysis. This is due to confusion over the definition of a perioperative epidural technique (de Leon-Casasola 2003). Nevertheless, a substantial evidence base now exists to show that neuraxial blockade reduces postoperative morbidity and mortality in high-risk patients. The local anaesthetic must be administered both during and after surgery in a continuous fashion for at least 72 hours (de Leon-Casasola 2003), or 4-7 days after major thoracic or abdominal surgery (Breivik 2002).

Evidence is mounting that continuous epidural analgesia has a positive influence on protein and glucose metabolism, leading to preservation of muscle protein, a decrease in whole body protein catabolism, an improved nutritional substrate and amelioration of insulin sensitivity (Carli et al. 2002). Epidural analgesia in a multimodal analgesic regimen results in significantly less deterioration in postoperative functional status (lower pain and fatigue scores, earlier mobilization and return of gastro-intestinal function) and health related quality of life at six-week follow-up (Wu and Rajah 2002).

## References

- Breivik H (2002) Postoperative Pain: Toward Optimal Pharmacological and Epidural Analgesia. In: Giamberardino MA (ed) *Pain 2002 – An Updated Review*. IASP Press, Seattle, pp 337–349
- Carli F, Mayo N, Klubien K et al. (2002) Epidural Analgesia Enhances Functional Exercise Capacity and Health-Related Quality of Life after Colonic Surgery: Results of a Randomized Trial. *Anesthesiology* 97:540–549
- Cucchiari G, Dagher C, Baujard C et al. (2003) Side-Effects of Postoperative Epidural Analgesia in Children: A Randomized Study Comparing Morphine and Clonidine. *Paediatr Anaesth* 13:318–323
- de Leon-Casasola OA (2003) When it Comes to Outcome, we Need to Define what a Perioperative Epidural Technique Is. *Anesth Analg* 96:315–318
- Holte K, Kehlet H (2002) Effect of Postoperative Epidural Analgesia on Surgical Outcome. *Minerva Anesthesiol* 68:157–161
- Ivani G, Vercellino C, Tonetti F (2003) Ketamine: A New Look to an Old Drug. *Minerva Anesthesiol* 69:468–471
- Kampe S, Kiencke P, Delis A et al. (2003) The Continuous Epidural Infusion of Ropivacaine 0.1 % with 0.5 microg x mL(-1) Sufentanil Provides Effective Postoperative Analgesia after Total Hip Replacement: A Pilot Study. *Can J Anaesth* 50:580–585
- Matot I, Oppenheim-Eden A, Ratrot R et al. (2003) Preoperative Cardiac Events in Elderly Patients with Hip Fracture Randomized to Epidural or Conventional Analgesia. *Anesthesiology* 98:156–163
- Ng JM, Goh MH (2002) Problems Related to Epidural Analgesia for Postoperative Pain Control. *Ann Acad Med Singapore* 31:509–515
- Niemi G, Breivik H (2003) The Minimally Effective Concentration of Adrenaline in a Low-Concentration Thoracic Epidural Analgesic Infusion of Bupivacaine, Fentanyl and Adrenaline after Major Surgery. A Randomized, Double-Blind, Dose-Finding Study. *Acta Anaesthesiol Scand* 47:439–450
- Shang AB, Gan TJ (2003) Optimising Postoperative Pain Management in the Ambulatory Patient. *Drugs* 63:855–867
- Standl T, Burmeister MA, Ohnesorge H et al. (2003) Patient-Controlled Epidural Analgesia Reduces Analgesic Requirements Compared to Continuous Epidural Infusion after Major Abdominal Surgery. *Can J Anaesth* 50:258–264
- Wu CL, Raja SN (2002) Optimising Postoperative Analgesia. *Anesthesiology* 97:533–534

## Postoperative Pain, Fentanyl

PETER C. A. KAM

Department of Anaesthesia, St. George Hospital, University of New South Wales, Kogarah, NSW, Australia  
p.kam@unsw.edu.au

## Synonym

Fentanyl; Sublimaze®; Durogesic® – transdermal patch; Actiq® Oral transmucosal fentanyl citrate; Chemical name: N-Phenyl-N-(1-(2-phenylethyl)-4-piperidinyl)-procaïnamide

## Definition

► Fentanyl is a potent and rapid onset synthetic opioid that is a phenylpiperidine derivative.

## Characteristics

Fentanyl is a derivative of 4-anilinoperidine and is structurally related to pethidine. It is commercially formulated as a citrate, a white crystalline solid that is readily soluble in acidic aqueous solutions. It has a pK<sub>a</sub> of 8.4 and each ml of aqueous solution contains 0.05 mg fentanyl base (0.0785 mg of the citrate). It is a highly lipophilic drug and produces analgesia, respiratory depression, vagal effects, emesis, constipation and physical dependence.

## Pharmacology

Fentanyl is an opioid analgesic that binds predominantly to mu (μ) receptors. Its primary therapeutic actions are analgesia and sedation. Mood alterations, euphoria and dysphoria are common. Fentanyl also depresses the respiration, cough and may cause nausea and vomiting directly by stimulating the chemoreceptor trigger zone. A dose of fentanyl 100 microgram is equivalent in analgesic activity to morphine 10 mg. Fentanyl appears to cause less vomiting than either morphine or pethidine.

## Pharmacodynamics

### Analgesia

Minimum effective analgesia serum concentrations of fentanyl in opioid naïve patients range from 0.3–1.5 ng/ml, and adverse effects increase in frequency at serum concentrations above 2 ng/ml. Loss of consciousness occurs at mean serum concentrations of approximately 34 ng/ml.

Clinically significant histamine release rarely occurs with fentanyl. Fentanyl preserves cardiac stability and attenuates stress related endocrine changes at higher doses. Decreased sensitivity to CO<sub>2</sub> stimulation follows fentanyl administrations and the duration and degree of respiratory depression is dose-related. The peak respiratory depressant effect of a single intravenous fentanyl dose occurs 5–15 minutes following injection.

## Pharmacokinetics

The Pharmacokinetics of fentanyl is described by a three-compartment model, with a distribution half-life of 1.7 min, a redistribution half-life of 13 min. and an elimination half-life of 219 min (McLain and Hug 1980; Duthie et al. 1986). The volume of distribution of fentanyl is 4 l/kg and clearance is 57 l/h.

The onset of action is almost immediate, but maximal analgesic effects occur after several minutes. The average duration of action following a single intravenous dose of 100 microgram is 30–60 minutes.

At physiological pH, 80 % fentanyl is protein bound, up to a concentration of 500 µg/ml. Fentanyl accumulates in skeletal muscle and fat, and is slowly released into the blood. Fentanyl is metabolised in the liver by cytochrome CYP3A4 isoenzyme. It has a high first pass clearance (N-dealkylation), and about 75 % of an intravenous dose is excreted in the urine primarily as metabolites, nor fentanyl, and OH-prop-nor fentanyl, and less than 10 % as unchanged drug.

After a single bolus dose of fentanyl (2 µg/kg), the duration of effective analgesia is relatively short because of drug redistribution. With constant steady-state infusion of fentanyl, the fentanyl has a long steady half-time, which is the result of the large conductance ratio associated with the slow compartment of the steady state model. In a simulated pharmacokinetics mode of steady-state fentanyl infusion, the context-sensitive half-time of fentanyl was approximately 20 min. after 1 hour infusion, and this increased to approximately 180 min. after 4 hours infusion and 280 min. after 8 hours infusion (Hughes et al. 1992). Intravenous fentanyl has been used for patient controlled analgesia with a bolus dose of 1–2 µg/kg, and lock out interval of 5 min. (Nikkola et al. 1997).

Epidural and intrathecal administration of fentanyl, in combination with local anaesthetics, is widely used for postoperative analgesia and obstetric analgesia. Most studies indicate that combination therapy reduces dose requirements of local anaesthetics when they are administered as single drugs. This dose reduction is associated with reduced local anaesthetic related side effects (hypotension and motor block), and little (sedation) or no (vomiting or pruritus) reduction in opioid related adverse effects (Walker et al. 2002). Epidural fentanyl (25–50 µg) produces a consistent and intense analgesia, but the duration is short, although this can be overcome by administering it as a continuous infusion. It is common practice to combine low concentrations of fentanyl (2 µg/ml) with a local anaesthetic solution. Addition of fentanyl to spinal anaesthetics produces synergistic analgesia for somatic and visceral pain. Doses added to spinal anaesthetic range from 10–20 µg. There is very little risk of early respiratory depression and urinary retention, although the incidence of pruritus is increased.

#### Transmucosal Fentanyl Formulation

It is also available as a lollipop preparation (transmucosal preparation), which has been successfully used in children (Feld et al. 1989) The use of oral ► [transmucosal fentanyl](#) citrate in the management of acute and postoperative pain has not been adequately evaluated, and it is currently not recommended for anal-

gesia in this setting. It has been used for breakthrough analgesia in opioid tolerant patients with cancer. A formulation of transmucosal fentanyl system (► [Actiq®](#)) produced more significant pain relief at 15, 30, 45, and 60 minutes following administration (over a recommended 15 minutes) in opioid tolerant cancer patients. It is contraindicated in acute and postoperative patients, because life threatening respiratory depression can occur at any dose in patients not taking chronic opiates (Payne et al. 2001).

#### Transdermal Fentanyl

Transdermal fentanyl (► [Durogesic®](#)) is a transdermal patch system that continuously delivers fentanyl for 72 hours. It is a transparent unit that comprises of a protective liner and 4 functional layers. These layers include a backing of clear polyester film, a drug reservoir of fentanyl and alcohol gelled with hydroxy ethyl cellulose; a ethylene–vinylacetate co-polymer membrane that controls the rate of delivery of fentanyl and a layer of silicone adhesive. The approximate analgesic potency ratio of transdermally administered fentanyl to parenteral morphine ranges from 1:20 to 1:30 in opioid naïve patients in acute pain.

Release of fentanyl from the patch is determined by the co-polymer release membrane, and the diffusion of fentanyl delivered to the systemic circulation across average skin (25, 50, 75 or 100 µg/h fentanyl). The small amount of alcohol in the patch enhances dry through the co-polymer release membrane and increases the permeability of the skin for diffusion of fentanyl. After initial application of a fentanyl patch, serum fentanyl concentrations increase gradually and peak serum fentanyl concentrations occur between 24 and 72 hours. After repeated 72 hour applications, serum concentrations reach a steady state that is maintained during subsequent applications of similar dose patches. Since elderly cachectic or debilitated patients have altered pharmacokinetics due to poor fat stores, muscle wasting and altered clearance, they should not be started on doses greater than 25 µg/l, unless they have previously been taking another opioid equivalent or greater than 135 µg oral morphine per day. The terminal half-life after removal of the patch is 13–25 hours. These properties make it unsuitable for acute pain (8h can be). Clinically significant doses of fentanyl can be administered transdermally by iontophoresis (currents 1–2 mA) for delivery periods of 2 hours, but more research is required.

#### Adverse Reactions

The major adverse reactions associated with fentanyl are respiratory depression, apnoea, muscle rigidity and bradycardia. Respiratory depression is more common if an intravenous dose is given rapidly and can be immediately reversed by naloxone. Muscle rigidity can be associated with reduced thoracic or chest wall compliance and/or apnoea. Bradycardia is caused by

stimulation of the nucleus ambiguus and can be controlled by atropine. Itching and spasm of the sphincter of Oddi are other adverse effects.

### Uses

Fentanyl can be used as an analgesic (2–10 µg/kg) or anaesthetic (20–100 µg/kg) and can be administered intravenously, intramuscularly, epidurally, intrathecally, via mucous membranes or transdermally. Transdermal fentanyl is extremely useful for chronic cancer pain when the oral route cannot be used.

### References

1. Duthie DJ, McLaren AD, Nimmo WS (1986) Pharmacokinetics of Fentanyl during Constant Rate IV Infusion for the Relief of Pain after Surgery. *Br J Anaesth* 58:950–956
2. Feld LH, Champeau MW, Van Steemis CA et al. (1989) Pre-anaesthetic Medication in Children: A Comparison of Oral Transmucosal Fentanyl Citrate Versus Placebo. *Anesthesiology* 71:374–377
3. Hughes MA, Glass PSA, Jacobs JR (1992) Context-Sensitive Half-Time in Multi-Compartment Pharmacokinetic Models for Intravenous Anaesthetic Drugs. *Anesthesiology* 76:334–341
4. Jeal W, Benfield P (1997) Transdermal Fentanyl: A Review of its Pharmacological Properties and Therapeutic Efficacy in Pain Control. *Drugs* 53:109–138
5. McLain DA, Hug CC (1980) Intravenous Fentanyl Pharmacokinetics. *Clin Pharmacol Ther* 28:106–114
6. Nikkola EM, Ekblad UU, Kero PO et al. (1997) Intravenous Fentanyl PCA during Labour. *Can J Anaesth* 44:1248–1255
7. Payne R, Coluzzi P, Hart L et al. (2001) Long-Term Safety of Oral Transmucosal Fentanyl Citrate for Breakthrough Cancer Pain. *J Pain Symptom Manage* 22:575–583
8. Walker SM, Goudas LC, Cousins MJ et al. (2002) Combination Spinal Analgesic Chemotherapy: A Systematic Review. *Anesth Analg* 95:674–715

## Postoperative Pain, Gabapentin

ROSS MACPHERSON

Department of Anesthesia and Pain Management,  
University of Sydney, Sydney, NSW, Australia  
rmappher@nscchahs.health.nsw.gov.au

### Synonym

Aminomethyl-Cyclohexane-Acetic Acid; Anti-epileptic; Gabapentin

### Characteristics

Gabapentin, a structural analogue of GABA, was initially synthesised in the late 1970's, and developed during the following decade as an anti-convulsant (Gilron 2002). Since then, it has been in trials for a wide variety of uses including psychiatric illness (Malek-Ahmadi 2003), post-menopausal flushes (Guttuso et al. 2003) chemotherapy induced nausea (Guttuso et al. 2003b) and a number of different pain states. This summary will concentrate only on its use in pain medicine. Despite the structural similarity between these two moi-

eties, it has been constantly shown that gabapentin has no direct GABAergic action, nor does it affect GABA uptake or metabolism (Backonja 2002). Its action may be through an effect on glutamate function, or alternatively, through alpha 2-delta calcium channel binding (Taylor et al. 1998).

Two large trials have confirmed the effectiveness of gabapentin in the treatment of diabetic neuropathy (Backonja et al. 1998), neuropathic pain states (Serpell 2002) and post-herpetic neuralgia (Rowbotham et al. 1998). The drug appeared to be well tolerated, although transient dizziness and somnolence were reported through the various studies. Dosing with gabapentin needs to be increased gradually and titrated to effect. Backonja and Glanzman (2003), in reviewing a number of studies, have suggested that dosage should be gradually stepped up to 900 mg/day and thereafter increased up to 1,800 mg/day. This should be sufficient for most patients, although some may need further titration to 3,600 mg/day.

In a recent interesting study, Dirks et al. (2002) gave patients undergoing mastectomy a single oral dose of gabapentin (1,200 mg) orally one hour prior to surgery. They found that this simple strategy resulted in a substantial reduction in post-operative morphine consumption and in movement related pain, confirming the results of previous work (Eckhardt et al. 2000).

Lamotrigine, another of the newer anti-epileptic agents, is a phenyltriazine derivative. While it has been in trials in the treatment of a number of pain states including HIV-associated neuropathy (Simpson et al. 2000), trigeminal neuralgia (Zakrzewska et al. 1997) spinal cord injury pain (Finnerup et al. 2002) and neuropathic pain states (Sandner-Kiesling 2002; McCleane 1999), results have been conflicting. In at least one of these studies there was a range of significantly adverse effects reported including ataxia, constipation, somnolence and diplopia. However, this has not been a consistent finding (Sandner-Kiesling 2002).

Anticonvulsants continue to be used for a wide range of neuropathic and chronic pain states, despite the fact that in many cases, convincing evidence is lacking. While controlled trials have been conducted into diabetic neuropathy and trigeminal neuralgia, large scale studies of the effectiveness of anticonvulsants in the management of other pain states are lacking (Backonja 2002). However, a number of small trials examining the role of gabapentin in conditions such as pain associated with spinal cord injury, phantom limb pain (Bone et al. 2002) and central pain syndromes (Putzke et al. 2002; To et al. 2002; Tai et al. 2002) have been performed with encouraging results.

### References

1. Backonja MM (2002) Use of Anticonvulsants for the Treatment of Neuropathic Pain. *Neurology* 59:S14–S17



2. Backonja M, Beydoun A, Edwards KR et al. (1998) Gabapentin for the Symptomatic Treatment of Painful Neuropathy in Patients with Diabetes Mellitus: A Randomized Controlled Trial. *JAMA* 280:1831–1836
3. Backonja M, Glanzman RL (2003) Gabapentin Dosing for Neuropathic Pain: Evidence from Randomized, Placebo-Controlled Clinical Trials. *Clin Ther* 25:81–104
4. Bone M, Critchley P, Buggy DJ (2002) Gabapentin in Postamputation Phantom Limb Pain: A Randomized, Double-Blind, Placebo-Controlled, Cross-Over Study. *Reg Anesth Pain Med* 27:481–486
5. Dirks J, Fredensbor B, Domspaar J (2002) A Randomized Study of the Effects of Single-dose Gabapentin Versus Placebo on Postoperative Pain and Morphine Consumption after Mastectomy. *Anesthesiology* 97:560–564
6. Eckhardt K, Ammon S, Hofmann U et al. (2003) Gabapentin Enhances the Analgesic Effect of Morphine in Healthy Volunteers. *Anesth Analg* 91:185–191
7. Finnerup NB, Sindrup SH, Bach FW et al. (2002) Lamotrigine in Spinal Cord Injury Pain: A Randomized Controlled Trial. *Pain* 96:375–383
8. Gilron IM (2002) Is Gabapentin a “Broad-spectrum” Analgesic? *Anesthesiology* 97:537–539
9. Guttuso T Jr, Kurlan R, McDermott MP et al. (2003) Gabapentin’s Effects on Hot Flashes in Postmenopausal women: A Randomized Controlled Trial. *Obstet Gynecol* 101:337–345
10. Guttuso T Jr, Roscoe J, Griggs J (2003) Effect of Gabapentin on Nausea Induced Chemotherapy in Patients with Breast Cancer. *Lancet* 361:1703–1705
11. Malek-Ahmadi P (2003) Gabapentin and Posttraumatic Stress Disorder. *Ann Pharmacother* 37:664–666
12. McCleane G (1999) 200 mg daily of Lamotrigine has no Analgesic Effect in Neuropathic Pain: A Randomized, Double-Blind Placebo Controlled Trial. *Pain* 83:105–107
13. Putzke JD, Richards JS, Kezar L et al. (2002) Long-Term Use of Gabapentin for Treatment of Pain after Traumatic Spinal Cord Injury. *Clin J Pain* 18:116–121
14. Rowbotham M, Harden N, Stacey B et al. (1998) Gabapentin for the Treatment of Postherpetic Neuralgia: A Randomized Controlled Trial. *JAMA* 280:1837–1842
15. Sandner-Kiesling A, Rumpold Seitzlin G, Dorn C et al. (2002) Lamotrigine Monotherapy for Control of Neuralgia after Nerve Section. *Acta Anaesthesiol Scand* 46:1261–1264
16. Serpell MG, Neuropathic Pain Study Group (2002) Gabapentin in Neuropathic Pain Syndromes: A Randomised, Double-Blind, Placebo-Controlled Trial. *Pain* 99:557–566
17. Simpson DM, Onley R, McArthur JC et al. (2000) A Placebo-Controlled Trial of Lamotrigine for Painful HIV-Associated Neuropathy. *Neurology* 54:2115–2119
18. Tai Q, Kirshblum S, Chen B et al. (2002) Gabapentin in the Treatment of Neuropathic Pain after Spinal Cord Injury: A Prospective, Randomized, Double-Blind, Crossover Trial. *J Spinal Cord Med* 25:100–105
19. Taylor CP, Gee NS, Su TZ et al. (1998) A Summary of Mechanistic Hypotheses of Gabapentin Pharmacology. *Epilepsy Res* 29:233–249
20. To TP, Lim TC, Hill ST et al. (2002) Gabapentin for Neuropathic Pain Following Spinal Cord Injury. *Spinal Cord* 40:282–285
21. Zakrzewska J, Chardhry Z, Nurmikko TJ et al. (1997) Lamotrigine (Lamictal) in Refractory Trigeminal Neuralgia: Results from a Double-Blind Placebo-Controlled Crossover Trial. *Pain* 73:223–230

## Postoperative Pain, Hydromorphone

ROSS MACPHERSON

Department of Anesthesia and Pain Management,  
University of Sydney, Sydney, NSW, Australia  
rmacpher@nscchahs.health.nsw.gov.au

### Synonyms

Dihydromorphinone; Dilaudid; Hydromorphone

### Definition

A hydrogenated ketone derivative of morphine.

### Characteristics

Hydromorphone has had something of a dual life. First synthesised in the early part of last century, it was introduced into clinical practice by Krehl in 1926, and gained immediate popularity as a potent analgesic and an alternative to morphine. Interest in hydromorphone continued for the next fifty years (Hanna et al. 1962) after which its popularity started to wane.

It remained more of a second line agent, often prescribed for the treatment of chronic non-productive cough, until the last ten years or so, during which time the drug has undergone a type of renaissance. There are a number of reasons for this.

The development of Pain Medicine as a speciality probably initiated a re-examination of many older drugs, to try to evaluate whether they had a place in modern therapy. This was made timelier by the discovery of the concept of ► **opioid rotation** – where the substitution of one opioid for another, especially in patients with chronic pain states, often resulted in a relative reduction in both dosage and side effects (Mercadante 1999).

On a milligram for milligram basis, hydromorphone is clearly more potent than morphine, although there is some variation. Most studies have found the hydromorphone:morphine equianalgesic dose ratio to be in the range of 5:1 to 7:1, although some studies have found the ratio to be in the order of 10:1 (Jain et al. 1989).

Quigley and Wiffen (2003) have recently reviewed the studies looking at hydromorphone in both acute and chronic pain states. They make the point that only forty three studies had actually been conducted between 1966 and 2000, and that many of these were poorly controlled and had very small patient numbers. Their overall assessment of the data available was that there was little difference between hydromorphone and other opioids with regard to analgesic efficacy and side-effect profile. Some studies have suggested that troublesome pruritus, so often a complication of morphine use, may be less with hydromorphone (Katcher and Walsh 1999; Chaplan et al. 1992; Goodarzi 1999).

Despite this, hydromorphone does have some interesting pharmacological features that set it apart to some degree from other agents. Its potency and favourable solubility – it is about 8 times more soluble in water than morphine and 15 times more soluble than fentanyl – have made it a popular agent for use in implanted intrathecal or epidural pumps, and many studies have concentrated on this aspect of its use (Chaplan 1992; Drakeford 1991; Gaeta 1995).

The drug has variable bioavailability (35–80 %) and a short half life which, when given orally, usually necessitates multiple daily dosing. However, a new sustained-release dosage form, incorporating an osmotic pump system, provides the promise of sustained analgesia following a single oral dose (Angst et al. 2001).

Metabolism of hydromorphone does not result in the production of any metabolites with analgesic efficacy. However, a number of metabolites are produced, at least one of which has been implicated in the precipitation of adverse effects.

The neuroexcitatory effects of opioids have been well described (Bruera and Neumann 1999). Although any member of the opioid group can precipitate a neurotoxic response, morphine and hydromorphone have been particularly implicated. These responses are thought to be due, at least in part, to accumulation of excitatory metabolites – in this case morphine-3-glucuronide or hydromorphone-3-glucuronide respectively (Wright et al. 2001, Armstrong and Cozza 2003). Despite having a more polar structure than the parent molecule, they can cross the blood-brain barrier and exert significant effects (Smith 2000).

Lastly, some researchers are looking at novel routes of hydromorphone administration. At least one series has been conducted looking at the absorption of intra-nasal hydromorphone with encouraging results (Coda et al. 2003). In this study, following the administration of a single intra-nasal dose of either 1 or 2 mg of hydromorphone, the authors found that absorption was rapid, and overall bioavailability was in the order of 50%. The drug has also been administered by inhalation (Sarhill et al. 2000).

In summary, hydromorphone has established itself as a useful addition to the analgesic repertoire. It is most useful in opioid rotation and in intrathecal use.

## References

1. Angst M, Drover D, Lotsch J et al. (2001) Pharmacodynamics of Orally Administered Sustained-release Hydromorphone in Humans. *Anesthesiology* 94:63–73
2. Armstrong SC, Cozza KL (2003) Pharmacokinetic Drug Interactions of Morphine, Codeine, and their Derivatives: Theory and Clinical Reality, part I. *Psychosomatics* 44:167–171
3. Bruera E, Neumann CM (1999). Cancer Pain. In: Devor M (ed) Pain – An Updated Review. Refresher Course Syllabus 9<sup>th</sup> World Congress on Pain, pp 25–35
4. Chaplan S et al. (1992) Morphine and Hydromorphone Epidural Analgesia. *Anesthesiology* 77:1090–1094
5. Coda BA, Rudy AC, Archer SM et al. (2003) Pharmacokinetics and Bioavailability of Single-Dose Intranasal Hydromorphone Hydrochloride in Healthy Volunteers. *Anesthesia and Analgesia* 97:117–123
6. Drakeford MK, Pettine KA, Brookshire L et al. (1991) Spinal Narcotics for Postoperative Analgesia in Total Joint Arthroplasty. *J bone Joint Surg* 73:424–428
7. Gaeta RR, Marcario A, Brodsky JB et al. (1995) Pain Outcomes after Thoracotomy: Lumbar Epidural Hydromorphone Versus Intrathecal Bupivacaine. *J Cardio-thor Vasc Anesth* 9:534–537
8. Goodarzi M, (1999) Comparison of Epidural Morphine, Hydromorphone and Fentanyl for Postoperative Pain Control in Children Undergoing Orthopaedic Surgery. *Paediatric Anaesthesia* 9:419–422
9. Hanna C, Mazuzan J, Abajian J (1962) An Evaluation of Dihydromorphinone in Treating Postoperative Pain. *Anesthesia and Analgesia* 11:39–44
10. Jain AK, McMahon FG, Reder R et al. (1989) A Placebo-Controlled Study of an Oral Solution of 5 and 10 mg of Hydromorphone Hydrochloride in Postoperative Pain. *Clin Pharmacol Ther* 45:175
11. Katcher J, Walsh D (1999) Opioid-Induced Itching: Morphine Sulfate and Hydromorphone Hydrochloride. *Journal of Pain and Symptom Management* 17:70–72
12. Krehl L (1926) Aertzliche Erfahrungen mit Dilaudid (Medical Experiences with Dilaudid). *Munchen med Wchnschr* 73:596
13. Mercadante S (1999) Opioid Rotation for Cancer Pain: Rationale and Clinical Aspects. *Cancer* 86:1856–1866
14. Quigley C, Wiffen P (2003) A Systematic Review of Hydromorphone in Acute and Chronic Pain. *J Pain Symptom Manage* 25:169–178
15. Sarhill N, Walsh D, Khawam E et al. (2000) Nebulized Hydromorphone for Dyspnea in Hospice Care of Advanced Cancer. *American Journal of Hospice & Palliative Care* 17:389–391
16. Smith MT (2000) Neuroexcitatory Effects of Morphine and Hydromorphone: Evidence Implicating the 3-Glucuronide Metabolites. *Clin Exp Pharmacol Physiol* 27:524–528
17. Wright AW, Mather LE, Smith MT (2001) Hydromorphone-3-glucuronide: A More Potent Neuro-Excitant than its Structural Analogue, Morphine-3-glucuronide. *Life Sciences* 69:409–420

## Postoperative Pain, Importance of Mobilisation

PETER C. A. KAM

University of New South Wales at St. George Hospital, Kogarah, NSW, Australia  
p.kam@unsw.edu.au

### Synonym

Enforced Mobilisation; Fast Track Surgery; Accelerated Recovery Programs; Mobilisation Following Surgery

### Definition

There is no formal definition of early mobilisation following surgery. However, it may be defined as early resumption of "normal" physical activity of the patient following a surgical procedure. The term "normal physical activity" usually refers to normal "activities of daily living", such as getting out of bed, walking (initially with support), sitting, and personal toilet care (Harwood and Ebrahim 2002).

### Characteristics

Traditionally, postoperative hospitalisation of patients is undertaken so that they can be observed and treated for surgical or anaesthetic complications that may arise, and that they recover to an adequate level of self-care before discharge. Traditional postoperative care includes bed rest, which is undesirable because it predisposes to weakness and loss of muscle tissue, thromboem-

bolic and pulmonary complications, and orthostatic circulatory disturbances (Harper and Lyles 1988).

There is no scientific basis for restrictions of ► **activities of daily living** in the postoperative period. (Kehlet and Wilmore 2002) All efforts should be undertaken to enforce postoperative mobilisation, which is possible with effective pain relief, education and nutritional support. Therefore, new approaches are directed towards evaluating new perioperative therapies to reduce postoperative morbidity, shorten convalescence, decrease the length of hospital stay and resources, and reduce economic hospital costs.

The methods used to facilitate early postoperative mobilisation include potential improvements in the preoperative preparation of patient, intraoperative strategies and revising postoperative care regimens.

### Preoperative Period

Patient education of the postoperative care plan can modify the patient's response to the operative experience. Effective postoperative analgesia can be achieved by good preoperative instruction of patients on the various methods of providing postoperative analgesia (Egbert et al. 1964). Informed patients experience significantly less pain and require less analgesia in the postoperative period. ► **Preoperative education** also aids coping, reduces preoperative anxiety and can enhance post-surgical recovery (Daltroy et al. 1988, Klufta and Roizer 1966). Enhanced recovery derived from early mobilisation can be facilitated by preoperative nutritional support. In severely malnourished patients who suffer >15 % weight loss, ► **preoperative nutritional support** for 7–10 days effectively reduces postoperative complications (Veteran's Affairs Total Parenteral Nutrition Study Group 1991). Micronutrient (vitamin and minerals) deficiencies are common in elderly patients. Evaluation and preoperative nutritional supplementation may be beneficial in selected patients, by reducing fatigue and improving wound healing.

Postoperative confusional states delay postoperative recovery. Patients who abuse alcohol, even in the absence of alcohol-related organ dysfunction, experience higher morbidity and prolonged recovery after surgery (Tonnesen and Kehlet 1999). Patients who use recreational drugs or substances should be weaned off these agents to avoid withdrawal symptoms. In smokers, nicotine patches applied postoperatively reduce nicotine withdrawal in the postoperative period, which may cause postoperative confusional states.

### Intraoperative Period

Multimodal analgesia and anaesthesia regimens that include regional anaesthesia appear to facilitate early mobilisation of surgical patients. The concept of ► **multimodal** or ► **balanced analgesia** takes advantage of additive or synergistic effects of the combination of

multiple drugs and techniques. This results in lower doses of the individual drugs and will enable a concomitant reduction in the side effects. The reduced side effects experienced by the patient may be brought about by the differences in the side effect profile of the drugs (Kehlet 1997).

Intraoperative infiltration of local anaesthesia into the surgical field can allow early discharge and mobilisation following inguinal hernia surgery with minimal side-effects. Urinary retention is eliminated with pronounced economic benefits. (Callesen et al. 1998) Similar results have been reported with paravertebral block anaesthesia for surgery on the breast for cancer. (Coveney et al. 1998) The use of simple and safe local anaesthetic infiltration techniques in minor operations should be encouraged (Moiniche et al. 1998).

Regional anaesthesia, utilising local anaesthetics, is the most effective method to attenuate metabolic response (increased cortisol, catecholamine, glucagon levels, insulin resistance and negative nitrogen balance) to surgery (Liu et al. 1995). These inhibitory effects on the catabolic responses are most pronounced when regional anaesthesia is employed as continuous epidural analgesia for 24–48 hours postoperatively. Total afferent neural blockade is achieved by spinal or epidural anaesthesia in lower body procedures. However, the inflammatory responses (e. g. increased acute phase proteins, IL-6) are not attenuated by central neural blockade. Postoperative ileus, which is associated with intra-abdominal procedures, is shortened by several days by continuous thoracic epidural analgesia with local anaesthetic (+ small doses of opioids). This is not achieved after lumbar epidural local anaesthetic or opioid techniques. A meta-analysis demonstrated significant reduction in pulmonary complications (-30 %), pulmonary embolism (50 %) myocardial infarction (30 %), ileus (2 days) and blood loss (~30 %) in patients after upper and lower abdominal procedures who received continuous epidural local anaesthetic analgesia (Ballantyne et al. 1998).

The use of minimal invasive abdominal surgical techniques can also facilitate early mobilisation and discharge following surgery. Inflammatory and immune mediators are reduced by minimally invasive surgical techniques. Most studies report less pain, shorter hospital stay and reduced morbidity after laparoscopic surgery.

The use of modern anaesthetic agents that cause less nausea and vomiting may aid in the implementation of early mobilisation programs. Propofol and total intravenous anaesthesia techniques can facilitate more rapid recovery after anaesthesia and early mobilisation of patients in the postoperative period.

### Postoperative Care

Postoperative recovery or convalescence depends on several factors of which pain, fatigue, rehabilitation,



and specific surgical factors are most important. Early postoperative fatigue may arise from sleep deprivation resulting from noise in hospitals, drugs (opioids, benzodiazepines), and inflammatory response (IL-6). Late fatigue may occur several weeks after surgery, and this may be related to loss of weight and muscle mass and associated weakness.

### Effective Analgesia

Effective treatment of postoperative analgesia allows early mobilisation. This can be achieved by multimodal or balanced analgesia. Multimodal analgesia takes advantage of additive or synergistic effects, by combining agents that act at different mechanisms and/or sites. There is concomitant reduction of side effects, because of the reduced doses of the individual drugs, and differences between drugs in side effect profiles. The concomitant administration of paracetamol and nonsteroidal analgesic drugs with opioids can reduce total opioid consumption. This can decrease the adverse effects of the opioids such as constipation, to facilitate early feeding and recovery of metabolic function of the patient.

► **Early mobilisation** after major procedures can only be effectively achieved by using epidural or local anaesthetic techniques. The use of systemic analgesics (such as opioids or NSAIDs) alone does not reliably facilitate early mobilisation. The use of simple and safe local anaesthetic infiltration techniques in minor operations aids early mobilisation by providing good analgesia (Moiniche et al. 1998). Continuous epidural techniques are more effective for more severe pain. In a randomised trial where patients who underwent elective colonic resection received either ► **patient controlled analgesia** with morphine or thoracic epidural analgesia with bupivacaine and fentanyl, the patients in the epidural group had lower postoperative pain and fatigue scores, which allowed them to mobilise to a greater extent and eat more. The superior quality of analgesia provided by thoracic epidural analgesia had a positive impact on out-of-bed mobilisation, recovery of bowel function, and intake of food, with long-lasting effects on functional exercise capacity and health related quality of life after colonic surgery (Carli et al. 2002). ► **Effective analgesia** during continuous passive motion after major knee surgery, achieved with continuous epidural infusion and continuous femoral block, improved early postoperative rehabilitation and hastened convalescence (Capdevila et al. 1999).

### Early Enteral Feeding

Early enteral (oral) feeding reduces catabolism and limits loss of muscle function and postoperative fatigue. Epidural analgesia and more effective treatment of nausea and vomiting and postoperative ileus can facilitate early enteral feeding and early mobilisation in the postoperative period (Silk and Green 1998).

### Postoperative Hypoxaemia

Early postoperative hypoxaemia is a result of anaesthesia related causes. Late postoperative hypoxaemia can occur as an episodic event (related to REM-sleep disturbances) or as a persistent phenomenon (due to pulmonary complications and the supine position). Postoperative sleep disturbances and episodic hypoxaemia can be reduced by the use of regional local anaesthetic techniques and reduced use of opioids. Postoperative pulmonary function is most effectively improved by continuous epidural analgesia with local anaesthetics.

A multimodal interventional approach is therefore essential for an effective postoperative rehabilitation program. Therefore, early mobilisation of the postsurgical patient requires organization to successfully interface between the patient, the surgeon, the anaesthetist, the surgical nurse and the physiotherapist. Such programs require nurse specialization, specialized wards or units, optimal use of regional anaesthetic techniques and multimodal analgesia, opioid free or opioid reduced analgesia, and comprehensive revision of traditional concepts of postoperative surgical care.

### References

- Ballantyne JC, Carr DB, De Ferranti S (1998) The Comparative Effects of Postoperative Analgesic Therapies on Pulmonary Outcome: Cumulative Meta-analysis of Randomised Controlled Trials. *Anesth Analg* 86:598–612
- Callesen T, Bech K, Kehlet H (1998) The Feasibility, Safety and Cost of Infiltration Anaesthesia for Hernia Repair. *Anaesthesia* 53:31–35
- Carli F, Mayo N, Klubien K et al. (2002) Epidural Analgesia Enhances Functional Exercise Capacity and Health Related Quality of Life after Colonic Surgery. *Anesthesiol* 97:540–549
- Capdevila X, Barthelet Y, Biboulet P et al. (1999) Effects of Perioperative Analgesic Technique on the Surgical Outcome and Duration of Rehabilitation after Major Knee Surgery. *Anesthesiol* 91:8–15
- Coveney E, Wetz CR, Greengass R et al. (1998) Use of Paravertebral Block Anaesthesia in the Surgical Management of Breast Cancer: Experience in 156 Cases. *Ann Surg* 227:496–501
- Daltroy LH, Morlino CI, Eaton HM et al. (1988) Preoperative Education for Total Hip and Knee Replacement Patients. *Arthritis Care Res* 11:469–478
- Egbert LD, Bart GE, Welch CE et al. (1964) Reduction of Postoperative Pain by Encouragement and Instruction of Patients. *N Engl J Med* 207:824–827
- Harper CM, Lyles YM (1988) Physiology and Complications of Bed Rest. *J Am Geriatr Soc* 36:1047–1054
- Harwood RH, Ebrahim S (2002) The Validity, Reliability and Responsiveness of the Nottingham Extended Activities of Daily Living Scale in Patients Undergoing Total Hip Replacement. *Disability and Rehabilitation* 24:371–377
- Kehlet H (1997) Multimodal Approach to Control Postoperative Pathophysiology and Rehabilitation. *Br J Anaesth* 78:606–617
- Kehlet H, Wilmore DW (2002) Multimodal Strategies to Improve Surgical Outcome. *The Am J Surg* 183:630–641
- Klafta JM, Roizer MF (1966) Current Understanding of Patients Attitudes Toward and Preparation for Anaesthetic: A Review. *Anesth Analg* 83:1314–1321
- Liu SS, Carpenter RL, Neal JM (1995) Epidural Anaesthesia and Analgesia, Their Role in Postoperative Outcome. *Anesthesiol* 82:1474–1506
- Moiniche S, Mikkelsen S, Wettersev J et al. (1998) A Qualitative Systematic Review of Incisional Local Anaesthesia for Postop-



erative Pain Relief after Abdominal Operations. *Br J Anaesth* 81:377–383

15. Silk BBA, Green CJ (1998) Perioperative Nutrition: Parenteral Versus Enteral. *Current Opin Clin Nutr Metab Care* 1:21–27
16. Tonnesen H, Kehlet H (1999) Preoperative Alcoholism and Postoperative Morbidity. *Br J Surg* 86:867–874
17. Veteran's Affairs Total Parenteral Nutrition Study Group. (1991) Perioperative Total Parenteral Nutrition in Surgical Patients. *N Engl J Med* 325:525–532

## Postoperative Pain, Intrathecal Drug Administration

EDWARD A. SHIPTON

Department of Anaesthesia, University of Otago,  
Christchurch, New Zealand  
shiptonea@xtra.co.nz

### Synonyms

Subarachnoid Drug Administration

### Definition

Deep to the ► **arachnoid membrane** is the subarachnoid or ► **intrathecal space**, containing cerebrospinal fluid, brain, spinal cord above the level of L1-2 and the cauda equina (the lumbar and sacral nerve roots) below L1-2. The dural sac ends at S2. For the management of postoperative pain, multimodal combinations of drugs (usually local anaesthetics and opioids) are inserted into the intrathecal space. The intrathecal route has the advantages of simplicity, reliability, and low dose requirements. It is characterized by rapid onset and offset, easy administration, minimal expense, and minimal adverse effects or complications (Shipton 1999). The use of intrathecal opioids has profoundly changed the quality of spinal anaesthesia, with improved analgesia, a reduction in local anaesthetic requirements and shorter duration of motor blockade.

### Characteristics

#### Local Anaesthetics

Local anaesthetics have been placed in the intrathecal space for approximately 100 years. Different characteristics of patients and local anaesthetic formulations will influence the spread of spinal anaesthesia. The height (level) and the duration of sensory analgesia are important clinically. The important characteristics of intrathecal local anaesthetics in determining this are the density, the dose, the concentration and the volume of local anaesthetic injected (Shipton 1999). The predictability of the spread of spinal anaesthesia can be improved, by adjusting both ► **baricity** of the solution and the position of the patient during the intrathecal local anaesthetic injection.

Lignocaine (5% in 7.5% dextrose) provides a short- to intermediate-acting intrathecal drug. Tetracaine (0.5%

in 5% dextrose) and bupivacaine (0.75% or 0.5% in 8.5% dextrose) provide intermediate- to long-duration neural blockade. Increasingly, the clinical isobaric forms of bupivacaine (0.5% and 0.75%) are being used. Ropivacaine (0.5% and 0.75%) is as effective as bupivacaine, but with a more rapid postoperative recovery of sensory and motor functions (McNamee et al. 2002). There are many possible choices of local anaesthetics for outpatient spinal anaesthesia including procaine, mepivacaine, prilocaine and small doses of lignocaine (20–25 mg) or bupivacaine (5 mg) combined with an intrathecal opioid (fentanyl 20 µg).

Since its introduction in 1948, hyperbaric 5% lignocaine (lidocaine), with its predictable onset and limited duration of action, has been used for millions of spinal anaesthetics. Concern about the use of spinal lignocaine began in 1991 with published reports of cauda equina syndrome after continuous spinal anaesthesia. Large concentrations of local anaesthetics administered intrathecally increased glutamate concentrations in the cerebrospinal fluid (Yamashita et al 2003). The margin of safety may be smallest with lignocaine.

### Morphine

There is convincing evidence that preservative-free morphine, in doses from 100–500 µg, provides excellent postoperative analgesia for 8–20 hours (Shipton 1999). Following gynaecological surgery, intrathecal morphine (200 µg) gives optimal analgesia. Increasing the dose shows no more analgesic efficacy but increases the number of pruritic patients requiring treatment. Intrathecal morphine (150 µg) when added to intrathecal isobaric ropivacaine (0.5%, 15 mg), provides sufficient postoperative analgesia for Caesarean delivery with shorter duration of motor block (Ogun et al 2003).

### Lipophilic Opioids

Lipophilic opioids are more rapid in onset, have a shorter duration of action and have a more segmental spread and analgesic effect. The adverse effect profiles of intrathecal lipophilic opioids are now well characterized and appear less troublesome than intrathecal morphine. Lipophilic opioid/local anaesthetic combinations permit more rapid motor recovery (Shipton 1999). Intrathecal fentanyl and sufentanil allow clinicians to use smaller doses of spinal local anaesthetic, yet still provide excellent anaesthesia for surgical procedures without producing significant adverse effects.

The addition of intrathecal fentanyl (15 µg) to hyperbaric bupivacaine (0.5%) in parturients undergoing caesarean section improves the quality of anaesthesia. The combination of the intrathecal and intravenous routes (with fentanyl) provides better haemodynamic stability and a less pronounced stress response, as reflected by 24-h urinary cortisol excretion. Sufentanil (5 µg) in combination with mepivacaine provided more complete and

prolonged analgesia than mepivacaine alone after Caesarean section (Meininger et al 2003).

Meperidine (pethidine) has local anaesthetic properties in addition to its opioid properties. It has been used as the sole intrathecal agent for anaesthesia but has no real advantages over lignocaine (Urmey 2003).

#### Other Opioids

For Caesarean section, the Effective Dose<sub>95</sub> for intrathecal diamorphine is 0.4 mg (Saravanan et al 2003). Combining intrathecal diamorphine with hyperbaric bupivacaine gives superior analgesia than bupivacaine alone. Hydromorphone is a potent analgesic, with dose-related clinical effects, and an adverse effect profile similar to that of other mu opioid receptor agonists (Quigley 2002).

#### Adrenaline

Adrenaline acts on the pre- and post-synaptic alpha-2 adrenergic receptors, has an analgesic effect of its own (dose-related), does not impair blood flow to the spinal cord, reduces systemic absorption and reduces adverse effects of opioids (e.g. pruritus) and local anaesthetics. In the lumbar intrathecal space, adrenaline (epinephrine) has no effect on the pharmacokinetics of alfentanil, fentanyl, or sufentanil, but it increases the area under the concentration-time curve of morphine and decreases its elimination half-life (Bernards et al 2003).

#### Clonidine

In inguinal hernia repairs, the addition of clonidine (15 µg) to hyperbaric bupivacaine (6 mg) increases the spread of analgesia, prolongs the time to first analgesic request, and decreases postoperative pain, as compared to bupivacaine alone. In total knee replacement surgery, intrathecal clonidine (25 µg or 75 µg) combined with intrathecal morphine (250 µg) provides superior analgesia as compared to intrathecal morphine alone (Sites et al 2003). Clonidine (1 µg/kg) combined with intrathecal morphine (4 µg/kg) provides effective analgesia after coronary artery bypass graft surgery and allows earlier extubation.

#### Neostigmine

In post-gynaecological surgery, the addition of low-dose intrathecal neostigmine (1.5 µg) to intrathecal morphine (100 µg) doubles the duration to the first rescue analgesic and decreases the analgesic consumption in 24 h, without increasing the incidence of adverse effects (Almeida et al 2003). After knee replacement surgery, intrathecal neostigmine (50 µg) gives postoperative analgesia lasting about seven hours, with fewer adverse effects and better satisfaction ratings as compared to intrathecal morphine (300 µg).

#### Non-Steroidals

Spinal prostaglandin synthesis has been implicated in acute pain processes and in the generation and maintenance of ► [central sensitization](#). The intrathecal injection

of cyclo-oxygenase inhibitors produces antinociception and reduces hypersensitivity in animals. The intrathecal injection of the cyclo-oxygenase inhibitor, ketorolac (0.25–2 mg) in healthy volunteers has shown no serious adverse effects (Eisenach et al 2002).

#### Others

Intrathecal adenosine (0.25–2 mg) provides analgesia without affecting blood pressure, heart rate, end-tidal carbon dioxide, or neurological function. Minor effects such as headache and back pain, however, have been reported. The addition of preservative-free intrathecal midazolam (2 mg) to lignocaine (5%) gives more effective analgesia following Caesarean section than does lignocaine alone. Sameridine (25 mg) is a new compound with both local anaesthetic and opioid properties for intrathecal administration. It has recently been tested to provide anaesthesia for surgery and extended postoperative analgesia (Modalen et al 2003)

#### Obstetrics

A small dose of opioid delivered into the cerebrospinal fluid provides almost immediate relief from labour pain without motor block or significant haemodynamic perturbation, and with minimal risks to the mother and foetus (De Balli P et al 2003). Considerable research has focused on the optimum dose of opioids when delivered intrathecally, with or without adjuncts. Fentanyl and sufentanil have emerged as the most useful. Bupivacaine is added to provide anaesthesia and prolong the duration of analgesia, although this tends to increase the likelihood of motor blockade of the lower extremities. The combined spinal-epidural (CSE) technique has been developed to counteract the short duration of effect (90–180 min) of intrathecal opioids for labour analgesia.

#### Children

The use of spinal anaesthesia in children has been primarily limited to situations in which general anaesthesia was considered to pose an excessive risk. Intrathecal bupivacaine is used in high-risk infants, as analgesia persists for several hours after the return of motor function. The ex-premature infant and the neurologically impaired child account for the majority of spinal anaesthetics used today (Lederhaas 2003). After spinal fusion in children, low-dose intrathecal morphine (2–5 µg/kg) supplemented by intravenous ► [patient controlled analgesia](#) (PCA) morphine provides better analgesia than PCA or morphine alone.

#### Adverse Effects

Too high a dose of local anaesthetic may result in hypotension, motor blockade and urinary retention (Ship-ton 1999). With high sympathetic blockade, sudden bradycardia and cardiac arrest may occur. Mepivacaine and lignocaine have each been associated with transient neurological symptoms (TNS) following intrathecal

administration. This has stimulated development of alternative agents and combinations of local anaesthetics and opioids (Urmeý 2003).

Adverse effects of opioids include pruritus, nausea and vomiting, urinary retention, and respiratory depression. Nausea and vomiting remain the main adverse effects of intrathecal morphine (Rawal 1999). Most adverse effects are dose-dependent and may be more common if the opioid is administered intrathecally. Although rare, respiratory depression continues to be a major problem of intrathecal opioids (Rawal 1999). None of the currently available opioids is completely safe; however, extensive international experience has shown that patients receiving spinal opioids for postoperative analgesia can be safely nursed on regular wards, provided that trained personnel and appropriate guidelines are available. Following non-injurious intervals of spinal ischaemia, intrathecal morphine is found to potentiate motor dysfunction.

The rapid onset of analgesia with intrathecally-administered agents must be balanced against the added risks of dural puncture. Development of small-gauge, pencil-point needles are responsible for the success of outpatient spinal anaesthesia with acceptable rates (0–2%) of ► **postdural puncture headache** (PDPH) (Urmeý 2003). In high-risk patients (e.g. age < 50 years, post-partum, large-gauge-needle puncture), patients should be offered an early epidural blood patch (within 24–48 h of dural puncture).

Prophylactic intravenous ondansetron is effective in the prevention of pruritus after intrathecal fentanyl administration (Gurkan and Toker 2003). Nalbuphine is superior to propofol for the treatment of intrathecal morphine-induced pruritus after caesarean delivery.

Of major concern is the development of intrathecal and epidural bleeding producing spinal cord or cauda equina compression and paresis (Shipton 1999). Coagulopathies or anticoagulant therapies form the predominant risk factors, whereas low-dose heparin thromboprophylaxis, non-steroidal anti-inflammatory drugs and low dose aspirin are rarely associated with spinal bleeding complications. The use of higher doses of low molecular weight heparin for thromboprophylaxis may be associated with a higher risk of epidural haematoma.

## References

- Almeida RA, Lauretti GR, Mattos AL (2003) Antinociceptive Effect of Low-Dose Intrathecal Neostigmine Combined with Intrathecal Morphine following Gynecologic Surgery. *Anesthesiology* 98:495–498
- Bernards CM, Shen DD, Sterling ES et al. (2003) Epidural, Cerebrospinal Fluid, and Plasma Pharmacokinetics of Epidural Opioids (Part 2): Effect of Epinephrine. *Anesthesiology* 99:466–475
- Eisenach JC, Curry R, Hood DD et al. (2002) Phase I Safety Assessment of Intrathecal Ketorolac. *Pain* 99:599–604
- Lederhaas G (2003) Spinal Anaesthesia in Paediatrics. *Best Pract Res Clin Anaesthesiol* 17:365–376
- McNamee DA, McClelland AM, Scott S et al. (2002) Spinal Anaesthesia: Comparison of Plain Ropivacaine 5 mg ml<sup>-1</sup> with Bupivacaine 5 mg ml<sup>-1</sup> for Major Orthopaedic Surgery. *Br J Anaesth* 89:702–706
- Meininger D, Byhahn C, Kessler P et al. (2003) Intrathecal Fentanyl, Sufentanil, or Placebo Combined with Hyperbaric Mepivacaine 2% for Parturients Undergoing Elective Cesarean Delivery. *Anesth Analg* 96:852–858
- Modalen AO, Westman L, Arlander E et al. (2003) Hypercarbic and Hypoxic Ventilatory Responses after Intrathecal Administration of Bupivacaine and Sameridine. *Anesth Analg* 96:570–575
- Ogun CO, Kirgiz EN, Duman A et al. (2003) Comparison of Intrathecal Isobaric Bupivacaine-Morphine and Ropivacaine-Morphine for Cesarean Delivery. *Br J Anaesth* 90:659–664
- Quigley C (2002) Hydromorphone for Acute and Chronic Pain. *Cochrane Database Syst Rev* 1:CD003447
- Rawal N (1999) Epidural and Spinal Agents for Postoperative Analgesia. *Surg Clin North Am* 79:313–344
- Saravanan S, Robinson AP, Qayoum Dar A et al. (2003) Minimum Dose of Intrathecal Diamorphine Required to Prevent Intraoperative Supplementation of Spinal Anaesthesia for Caesarean Section. *Br J Anaesth* 91:368–372
- Shipton EA (1999) Central Neural Blockade. In: Shipton EA (ed) *Pain – Acute and Chronic*. Arnold, London, pp 177–209
- Sites BD, Beach M, Biggs R et al. (2003) Intrathecal Clonidine Added to a Bupivacaine-Morphine Spinal Anesthetic Improves Postoperative Analgesia for Total Knee Arthroplasty. *Anesth Analg* 96:1083–1088
- Urmeý WF (2003) Spinal Anaesthesia for Outpatient Surgery. *Best Pract Res Clin Anaesthesiol* 17:335–346
- Yamashita A, Matsumoto M, Matsumoto S et al. (2003) A Comparison of the Neurotoxic Effects on the Spinal Cord of Tetracaine, Lidocaine, Bupivacaine, and Ropivacaine Administered Intrathecally in Rabbits. *Anesth Analg* 97:512–519

## Postoperative Pain, Ketamine

P

ROSS MACPHERSON

Department of Anesthesia and Pain Management,  
University of Sydney, Sydney, NSW, Australia  
rmacpher@nscchahs.health.nsw.gov.au

### Synonyms

Ketamine; Chloro-phenyl-2-methylaminocyclohexanone-hydrochloride; Ketalar

### Definition

General anaesthetic and analgesic agent. Novel structure unrelated to other classes of anaesthetic agent. Phencyclidine derivative.

### Characteristics

#### Activity

Ketamine has wide ranging activities at a number of discrete sites within the CNS (Krystal et al. 1994). From an anaesthetic viewpoint, its main site of action is most likely the NMDA receptors that are most densely localised in the cerebral cortex and hippocampus. The NMDA receptor comprises of an ion channel, which when blocked attenuates the capacity of excitatory amino acids, notably glutamate, from opening the ion channel and increasing calcium permeability. Ketamine binds to the receptor in a non-competitive manner.

Other receptors at which ketamine is known to have activity include mu and sigma opioid receptors, as well as nicotinic muscarinic and cholinergic receptors within the CNS and PNS. In addition to all these effects at receptor sites, ketamine has also been shown to inhibit re-uptake of a range of neurotransmitters including noradrenaline, dopamine and serotonin. It is also a weak inhibitor of acetylcholinesterase.

#### **Ketamine as an Anaesthetic Agent**

Since ketamine was originally intended to be used as a general anaesthetic agent, it is important to review this aspect of the drug's pharmacological profile. Administered in a dose of 1–2 mg/kg I.V., it provides a period of unconsciousness of up to 15 minutes, although this can be prolonged by administration as a continuous I. V. infusion (15–30 micrograms/kg/min). The state of unconsciousness produced by ketamine has been designated “dissociative anaesthesia”, which differs from that produced by other anaesthetic agents, inasmuch as many reflexes such as breathing and upper airway protective reflexes are maintained.

#### **Ketamine as an Analgesic Agent**

Ketamine's analgesic properties were recognised soon after the drug's release. This again was unusual, as most anaesthetic induction agents have either no analgesic properties or are mildly analgesic. Yet it took almost twenty years before this aspect of ketamine's pharmacological profile was specifically exploited. In a comprehensive review of the literature, Schmid et al. (1999) suggested that there are three dosage ranges that must be considered with regard to ketamine. The first is the dose employed when the drug is used as an anaesthetic agent, outlined above. The second is the dose needed for ketamine to have analgesic or anti-hyperalgesic effects in its own right – so called “low dose ketamine”, usually in the range of an I.V. or epidural bolus of 1 mg/kg, or continuous I.V. administration in the order of 20 micrograms/kg/min or less. Lastly, the authors suggest we need to consider even lower doses than this, where ketamine has no analgesic effects on its own, but may act synergistically with other agents such as opioids.

#### **Ketamine as a Local Anaesthetic Agent**

As ketamine gained popularity as an analgesic, studies were undertaken to investigate its efficacy when administered by routes of administration other than the parenteral routes.

Laboratory investigations have confirmed that ketamine possesses significant sodium channel blocking properties, sufficient to explain the “local anaesthetic” effect of the drug when given intrathecally (Reckziegel et al. 2002; Haesler et al. 2003). Indeed, animal studies of intrathecal ketamine have demonstrated promising results, although there are still some concerns that ei-

ther ketamine itself, or some of the additives found in the non-preservative free product, may result in spinal cord damage. Others have reported use of ketamine (or its enantiomers) without adverse effects (Sator-Katzenschlager et al. 2001), claiming that its use is without sequelae.

Studies where ketamine has been administered as the sole agent by the epidural route have failed to demonstrate any significant analgesic effects (Peat et al. 1989; Wong et al. 1997), although when combined with morphine it does exert an opioid sparing effect with improved analgesia (Chia et al. 1998). Similar results have been seen when epidural morphine has been given in combination with intravenous ketamine (Aida et al. 2000).

#### **Post-Operative Pain**

There have been a large number of reports of low-dose ketamine used in a variety of different surgical procedures. Results have generally shown a morphine-sparing effect (Menigaux et al. 2001; Weinbrom 2003), but this has not been a consistent finding (Reeves et al. 2001). There have also been some trials looking at the pre-emptive effects of ketamine. Since the whole subject of the efficacy of pre-emptive analgesia is under question, it is no surprise that again results have been conflicting (Holthusen et al. 2002, White 2002).

#### **Novel Routes of Administration**

Since ketamine is often “snorted” by drug abusers, this suggested that the drug has appreciable absorption when administered by the intra-nasal route, and studies are currently being undertaken to assess the suitability of this method of administration. The oral route of administration has also been reported to have been successful in some individual case reports (Kannan et al. 2002), having been used successfully in the management of cancer related neuropathic pain.

There are also a number of trials currently being conducted on the efficacy of ketamine in a topical formulation (of between 0.25 and 1.5 %) in the treatment of complex regional pain syndrome Type I (Ushida et al. 2002), and early results are encouraging.

#### **Adverse Effects**

The adverse effects of ketamine when used as a general anaesthetic have been well described. While the drug has effects on most physiological systems, it is the cardiovascular and psychological effects that have received the most attention. Pronounced cardiovascular stimulation, brought about through either central sympathetic stimulation or inhibition of re-uptake of peripheral catecholamines, results in an increase in mean blood pressure, heart rate and cardiac index. This may be beneficial in the anaesthetic management of critically ill patients in whom hypotension is to be avoided.

The psychological effects of the drug are also well known, and indeed have probably limited the use of the



drug in anaesthetic practice. Adults, much more so than children, are prone to a range of disturbing and bizarre dreams following ketamine use, which may become recurring. Numerous strategies have been employed to try and limit these effects, including pre-treatment with either benzodiazepines or droperidol, and allowing patients to emerge from ketamine anaesthesia without undue stimulation. It is during emergence that many of these effects are particularly prominent, including auditory and visual hallucinations, disorientation, restlessness and confusion.

There are two important features relating to the psychomimetic effects of ketamine. The first is that they are dose-dependent. The second is that they are thought to be induced to a much greater extent by the R(-) isomer of ketamine.

There have been a number of studies specifically investigating the risks of psychomimetic events in patients receiving low-dose ketamine for analgesia. In his review of these reports, Schmid (1999) summarised the results as suggesting that I.V. low dose ketamine (at a dose of < 2.5 micrograms/kg leading to a blood level of < 50 nanograms/ml) does not cause hallucinations or impairment of cognitive function. However, at higher levels, even using dosages that might be said to be in the "low-dose" range, psychologically adverse effects can be demonstrated (Krystal et al. 1994); however, blood levels, where measured, are usually in the region of 200 nanograms/ml.

#### Abuse Potential

It is important for clinicians to be aware of the abuse potential of ketamine. Despite having been relatively freely available for over 40 years, it is only recently that the drug has been utilised for non-therapeutic uses. Due to the drugs extensive use in veterinary anaesthetic practice, its ease of availability probably led to its illicit use; however, with awareness of the drug's abuse potential, authorities in most countries have restricted its availability, which has made supply through hospitals and other medical facilities more difficult. This is important, as diversion of ketamine from legitimate sources was the main source of illicit supply, since the drug is difficult to manufacture from other products (Smith et al. 2002).

#### References

- Aida S, Yakamura T, Baba H et al. (2000) Preemptive Analgesia by Intravenous Low-dose Ketamine and Epidural Morphine in Gastrectomy: A Randomized Double-Blind Study. *Anesthesiol* 92:1624–1630
- Chia Y Y, Liu K, Liu Y C et al. (1998) Adding Ketamine in a Multimodal Patient-Controlled Epidural Regimen Reduces Postoperative Pain and Analgesic Consumption. *Anesth Analg* 86:1245–1249
- Haeseler G, Tetzlaff D, Bfler J et al. (2003) Blockage of Voltage-Operated Neuronal and Skeletal Muscle Sodium Channels by S(+) and R(-)-Ketamine. *Anesth Analg* 96:1019–1026
- Holthusen H, Backhaus P, Boeminghaus F et al. (2002) Preemptive Analgesia: No Relevant Advantage of Preoperative Compared with Postoperative Intravenous Administration of Morphine, Ketamine, and Clonidine in Patients Undergoing Transperitoneal Tumour Nephrectomy. *Reg Anesth Pain Med* 27:249–253
- Kannan TR, Saxena A, Bhatnagar S et al. (2002) Oral Ketamine as an Adjuvant to Oral Morphine for Neuropathic Pain in Cancer Patients. *J Pain Symptom Manage* 23:60–65
- Krystal J, Karper L, Seibyl J et al. (1994) Subanaesthetic Effects of the Noncompetitive NMDA Antagonist, Ketamine, in Humans: Psychotomimetic, Perceptual, Cognitive, and Neuroendocrine Responses. *Archives of General Psychiatry* 51:199–214
- Reeves M, Lindholm DE, Myles P (2001) Adding Ketamine to Morphine for Patient-Controlled Analgesia after Major Abdominal Surgery: A Double-Blinded, Randomized Controlled Trial. *Anesth Analg* 93:116–120
- Menigaux C, Guignard ,Fletcher D et al. (2001) Intraoperative Small-Dose Ketamine Enhances Analgesia after Outpatient Knee Arthroscopy. *Anesth Analg* 93:606–612
- Peat S J, Bras P, Hanna M H (1989) A Double-Blind Comparison of Epidural Ketamine and Diamorphine for Postoperative Analgesia. *Anaesthesia* 44:555–558
- Reckziegel G, Friederich P, Urban B (2002) Ketamine Effects on Human Neuronal Na<sup>+</sup> channels. *Eur J Anaesthesiol* 19:634–640
- Reeves M, Lindholm D, Myles P et al. (2001) Adding Ketamine to Morphine for Patient-Controlled Analgesia After Major Abdominal Surgery: A Double-Blinded, Randomized Controlled Trial. *Anesth Analg* 93:116–120
- Sator-Katzenschlager S, Deusch E, Maier P et al. (2001) The Long-Term Antinociceptive Effect of Intrathecal S(+)-Ketamine in a Patient with Established Morphine Tolerance. *Anesth Analg* 93:1032–1034
- Schmid R, Sandler A, Katz J (1999) Use and Efficacy of Low-Dose Ketamine in the Management of Acute Postoperative Pain: A Review of Current Techniques and Outcomes. *Pain* 82:111–125
- Smith K M, Larive L L, Romanelli F (2002) Club Drugs: Methylene-dioxy-methamphetamine, Flunitrazepam, Ketamine Hydrochloride, and [Gamma]-Hydroxybutyrate. *Am J Health-System Pharmacy* 59:1067–1076
- Ushida T, Tani T, Kanbara T et al. (2002) Analgesic Effects of Ketamine Ointment in Patients with Complex Regional Pain Syndrome Type 1. *Reg Anesth Pain Med* 27:524–528
- Weinbroum A (2003) A Single Small Dose of Postoperative Ketamine Provides Rapid and Sustained Improvement in Morphine Analgesia in the Presence of Morphine-Resistant Pain. *Anesth Analg* 96:789–795
- White P (2002) The Role of Non-Opioid Analgesic Techniques in the Management of Pain After Ambulatory Surgery. *Anesth Analg* 94:577–585
- Wong C S, Lu C C, Chergn C H et al. (1997) Pre-Emptive Analgesia with Ketamine Morphine and Epidural Lidocaine Prior to Total Knee Replacement. *Can J Anaesth* 44:31–37

## Postoperative Pain, Lignocaine

ROSS MACPHERSON

Department of Anesthesia and Pain Management,  
University of Sydney, St. Leonards, NSW, Australia  
rmacpher@nscchahs.health.nsw.gov.au

#### Synonym

Lidocaine

#### Definition

Local anaesthetic of the amide type; membrane stabilising drug

## Characteristics

Lignocaine has a number of uses in anaesthesia and pain medicine. It is perhaps most commonly used as a local anaesthetic agent either in local or regional anaesthesia, or in epidural or spinal blockade. However, it is also given parenterally in the management of neuropathic pain states.

The first reports of the use of parenteral lignocaine for analgesic purposes was in 1961 (Bartlett and Hutaserani 1961), although it was not until about 20 years later that it began to be seriously investigated for this purpose (Mao and Chen 2000).

Since then lignocaine has been extensively employed both as a diagnostic and a therapeutic tool in the management of neuropathic pain by a variety of means (Bath et al. 1990). Although it has mainly been administered by the intravenous or subcutaneous routes, impressive results have also been achieved when the drug has been used by the topical route.

Where lignocaine is used parenterally, in most studies the drug was administered by the intravenous route (Kastrup 1987), but the subcutaneous route has also been employed (Devulder et al. 1993). The route of administration does not seem to be important, so long as a plasma concentration of between 2–5 micrograms/ml is achieved (Rowbotham et al. 1995), and onset of relief of symptoms, if it is to occur, generally starts within 60 minutes.

In the many studies reported, lignocaine was administered either as a bolus or as a bolus followed by a continuous infusion. Bolus doses have been in the range of 1.5–5 mg/kg and infusions 2 mg/kg/hr. As dosage increases, so naturally does the incidence of adverse effects. Serial measurements of plasma lignocaine levels are important, if treatment is to be continued over any period of time.

Lignocaine therapy has been employed in the treatment of a wide variety of pain states, including central and peripheral neuropathic pain states, post-herpetic neuralgia and neuropathic cancer pain. While there have been good results in many of these studies, it does appear that systemic lignocaine is most effective in treating pain resulting from peripheral nerve injury (Galer et al. 1993). More recently, lignocaine in high concentration (5 %) in a topical patch product has been used to control local pain from conditions such as post-herpetic neuralgia (Galer 2002). While this approach does not produce plasma levels comparable to those achieved with parenteral administration, the results are encouraging. In another study (Devers and Galer 2002), the authors were able to demonstrate significant pain relief using the lignocaine patch, in a group of patients whose pain had hitherto been unrelieved by all standard analgesic agents. Clearly, the use of parenteral lignocaine will be limited to the hospital population. However, the response of patients to lignocaine infusion has been used as a diagnos-

tic tool, in an effort to identify those patients whose pain state is likely to respond to other membrane stabilising agents. Patients are usually administered a single dose of between 2–5 mg/kg of lignocaine intravenously (with or without control placebo), and the response to the infusion recorded (Galer et al. 1996).

While many workers use the so called “lignocaine test” to predict response to other agents, Mao and Chen (2000) have pointed out that data supporting the use of the test is somewhat anecdotal. More studies need to be carried out to truly identify its validity.

## References

1. Bartlett EE, Hutaserani O (1961) Xylocaine for the Relief of Postoperative Pain. *Anesth Analg* 40:296–304
2. Bath FW, Jensen TS, Kastrup J et al. (1990) The Effect of Intravenous Lidocaine on Nociceptive Processing in Diabetic Neuropathy. *Pain* 40:29–34
3. Devers A, Galer BS (2000) Topical Lidocaine Patch Relieves a Variety of Neuropathic Pain Conditions: An Open-Label Study. *Clin J Pain* 16:205–208
4. Devulder JE, Ghys L, Dhondt W et al. (1993) Neuropathic Pain in a Cancer Patient Responding to Subcutaneously Administered Lignocaine. *Clin J Pain* 9:220–223
5. Galer BS, Harle J, Rowbotham MC (1996) Responsive to Intravenous Lidocaine Infusion Predicts Subsequent Response to Oral Mexiletine: A Prospective Study. *J Pain Symptom Manage* 12:161–167
6. Galer BS, Jensen MP, Ma T et al. (2002) The Lidocaine Patch 5 % Effectively Treats all Neuropathic Pain Qualities: Results of a Randomized, Double-Blind, Vehicle-Controlled, 3-Week Efficacy Study with use of the Neuropathic Pain Scale. *Clin J Pain* 18:297–301
7. Galer BS, Miller KV, Rowbotham MC (1993) Responses to Intravenous Lidocaine Infusion Differs Based on Clinical Diagnosis and Site of Nervous System Injury. *Neurology* 43:1233–1235
8. Kastrup J, Petersen P, Dejgard A et al. (1987) Intravenous Lidocaine Infusion – A New Treatment of Chronic Painful Diabetic Neuropathy. *Pain* 28:75
9. Mao J, Chen L (2000) Systemic Lidocaine for Neuropathic Pain Relief. *Pain* 87:7–17
10. Rowbotham MC, Davies PS, Fields HL (1995) Topical Lidocaine Gel Relieves Postherpetic Neuralgia. *Ann Neurol* 37:246–253

## Postoperative Pain, Local Anaesthetics

LAURENCE E. MATHER

Department of Anaesthesia and Pain Management,  
University of Sydney at Royal North Shore Hospital,  
Sydney, NSW, Australia  
lmather@med.usyd.edu.au

### Synonyms

Local analgesics

### Definitions

A local anaesthetic is a chemical substance that, when applied in the region of a neuronal structure in sufficient concentration, produces reversible blockade of axonal conduction without depolarisation, and loss of sensation in the region innervated. These drugs produce ► **Neural Blockade**, local anaesthesia, regional anaesthesia, or

conduction anaesthesia (or analgesia, depending on how they are used). A local anaesthetic should be capable of producing a differential neural blockade, i.e. sensory without significant motor neural blockade, and have an acceptable difference between beneficial and toxic doses. The latter clause is important because of its contemporary significance: achieving greater safety in local anaesthetics, especially of the long-acting variety, has been *the* major driving-force in the medicinal chemistry and pharmacology of these drugs for many decades. Although many drugs have local anaesthetic properties, only a few satisfy these requirements and are used clinically for that purpose. Conversely, local anaesthetics have a variety of pharmacological actions, some of which are exploited therapeutically, and others of which are avoided assiduously.

Some substances, and/or formulations of some substances, have been introduced/used that produced, either intentionally or unintentionally, irreversible local anaesthesia. Such agents are neurolytic and, if intentionally neurolytic, still may have a small amount of use in the management of chronic pain.

Local anaesthetics may be applied with great precision to the neuraxis to produce neurally selective central blockade of a range of spinal nerves, or peripherally to produce blockade of a plexus or defined nerves, or they may be infiltrated to produce generalized blockade of nerve endings and axons in a more diffuse region. They may also be applied topically to produce surface anaesthesia in the mucous membranes or the skin.

### Characteristics

Local anaesthetics work primarily by sodium channel blockade of axonal membranes, thereby preventing action potentials from being propagated – a fairly recent concept – however, local anaesthesia for attenuating pain from surgical and other physical procedures, is a very old concept (Liljestrand 1971). Three main methods have been used:

1. Refrigeration. Avicenna (980-1030) used snow or ice for refrigeration to alleviate pain, a forerunner of present day ethyl chloride spray that was introduced in the early 20<sup>th</sup> C.
2. Pressure. Nerve compression is an ancient method of alleviating pain, especially for amputations. Paré (1510-1590), a military surgeon, recorded the use of pressure for amputations, and found that it produced a better surgical field, haemostasis, and diminished pain. Esmarch (1823-1909), also a military surgeon, followed this idea by using a rubber tube as a compression bandage above the site of operation to produce haemostasis, a technique that was subsequently adopted to reduce the systemic absorption of local anaesthetics.
3. True local anaesthetics as we now know them. The leaves of the Coca bush spring from ancient Peru.

Although the extraction and preparation of the pure alkaloid cocaine from Coca leaves derives from a 19<sup>th</sup>C golden age of European chemistry, cocaine was originally identified as a stimulant, like caffeine, and not identified with anaesthesia. Its use as a possible local anaesthetic came from an observation of von Anrep in 1880, who, after personally observing its anaesthetizing properties on cutaneous nerves, tongue and pupil, recommended such a use. The story of Koller in 1884, trying it as an anaesthetic for ophthalmic surgery, is illustrious in anaesthesia history; its subsequent use for anaesthesia of other mucous membranes followed rapidly. Alongside these experiments were those with its use for producing conduction block. Such experiments then enabled great progress to be made in neurophysiology, and have continued to do so through use of chemical variants of the local anaesthetics to act as probes. From a clinical perspective, the administration of cocaine represents a somewhat dramatic watershed in the history of anaesthesia, because it enabled a new realm of surgery to be performed on conscious patients having anaesthesia only of the required part of the body, at a time when operating conditions were still fairly primitive, general anaesthetic agents were still in their infancy, and muscle relaxants had not been discovered (Brown and Fink 1998).

Final elucidation of the chemical structure of cocaine did not occur until 1924 but, by then, a host of synthetic substitutes had already been prepared and tried, based upon the anaesthetic portion (“anaesthesiophore”) of the cocaine molecule. “Ester caines”: the introduction of procaine (Novocaine) by Einhorn (1905) heralded the next generation of local anaesthetics having greater safety than cocaine and, importantly, lacking its addictive/psychostimulant properties. As the cocaine anaesthesiophore contained an aromatic group, an amine and an ester linking group, the ensuing generation of synthetic local anaesthetics, such as procaine, were also aromatic amines and contained an ester group (usually as p-aminobenzoic acid esters). “Amide caines”: apart from cinchocaine (dibucaine, introduced in 1924), which contains a carbamoyl (reversed amide) linkage, the next and present generation of synthetic amino local anaesthetics evolved in the mid 1940s, with an amide linkage in place of the isosteric ester from the prototype lidocaine (lignocaine, Xylocaine, which remains in widespread clinical use). These have a major advantage of chemical stability to hydrolysis compared to esters, and have largely replaced them. Moreover, allergic reactions derive from chemical structure specificity, and the preponderance of clinical allergic reactions, estimated to be 1% of all local anaesthetic adverse reactions, were provoked by “ester caines” probably mediated through their p-aminobenzoic acid metabolites. “Chiral caines”: cocaine is a chiral substance;

being an enzymically synthesized natural product it is enantiopure. Further evolution of the “amide caines” took place during the 1990s: driven by attempts to reduce the systemic toxicity of the long-acting synthetic local anaesthetic, racemic bupivacaine, when the enantiopure agents, ropivacaine and levobupivacaine, were introduced as substitutes.

Contemporary local anaesthetics (Table 1) work as expected – they produce local anaesthesia limited, mainly, by the skill of the anaesthetist in placing the dose of drug in the right place. They act by reversibly blocking neural sodium channels to prevent depolarization but, overall, they are not highly receptor selective and thus also block other ► **ion channels** (Strichartz 1998). They enter axoplasm as the base, but their conjugate acid is required for receptor block. To some extent, they also expand membrane volumes, thereby disrupting ion channels, and this is thought to augment ion channel blockade. Thus, as pointed out below, their physicochemical properties are very important, and their  $pK_a$  regulates their degree of ionization. A Modulated Receptor Hypothesis has been developed to account for the fact that these substances inhibit depolarization of stimulated channels (phasic block) more than resting channels (tonic block).

Like all drugs, the pathway to clinical acceptance of local anaesthetics is dominated by toxicity testing. They first have to survive laboratory testing for tissue toxicity – a primary screen – a local anaesthetic that causes leakiness of cell membranes is of no value. Next, they have to have no unexpected or disproportionately high systemic toxicity – and this is critical. Although administered locally for local effects, these agents will be absorbed systemically with a time course that closely relates to the vascularity of the administration

site, and any manoeuvres made to reduce their rate of systemic absorption, such as use of physical or chemical haemostasis with vasoconstrictors (Tucker and Mather 1998). Both tissue and systemic toxicity are determined by the physicochemical properties of the molecule (see Table 1). Two properties predominate: extent of ionization as determined by the  $pK_a$  of the amine group and lipophilicity of its various substituents, especially of the amino group (although two local anaesthetics, benzocaine and butamben, have survived from early days without having an ionizable amine group). The clinically useful local anaesthetics have a  $pK_a$  value within a reasonably narrow range: those for the surviving “ester caines” (around 9) are higher than for “amide caines” (around 8). The extent of ionization is important, because it bears an inverse relationship to the speed of onset of effect. Lipophilicity, usually measured as the distribution coefficient for an organic solvent (typically *n*-octanol) to pH 7.4 buffer, is related to the extent of ionization, and is important because it bears a direct relationship to the duration of effect.

Prolonging the duration of action of local anaesthetics has had an interesting history (Liljestrand 1971; Brown and Fink 1998). Amongst the early investigations, Corning, in 1885, found that effect duration of cocaine injected subcutaneously could be prolonged by a tourniquet applied above the site of injection; Braun, in 1903, found that the addition of “suprarenal extract” could delay the absorption of procaine and thus he founded the first “chemical tourniquet” – a practice that survives today, usually with adrenaline as the vasoconstrictor (so that the commercial products are generally offered as “plain” or “with adrenaline”); Hoffman and Kochmann, in 1912, found that the procaine effect on isolated frog nerves could be prolonged by potassium

**Postoperative Pain, Local Anaesthetics, Table 1** Physicochemical Properties of Local Anaesthetics (Tucker and Mather 1998)

Agent	Mol. wt	$pK_a$ (25 °C)	<i>n</i> -octanol; pH 7.4; 25 °C Distribution Coefficient*	Plasma Protein binding (%)	Aqueous solubility (mg HCl/ml; pH 7.37, 37 °C)
<i>Esters</i>					
Procaine	236	9.0	1.7	5.8	–
Chloroprocaine	271	9.3	9.0	–	–
Amethocaine	264	8.6	221	76	1.4
<i>Amides</i>					
Prilocaine	220	8.0	25	55	–
Lignocaine	234	7.8	43	64	24
Mepivacaine	246	7.9	21	77	15
Ropivacaine	274	8.2	115	90	–
Bupivacaine	288	8.2	346	95	0.83
Etidocaine	276	7.9	800	94	–



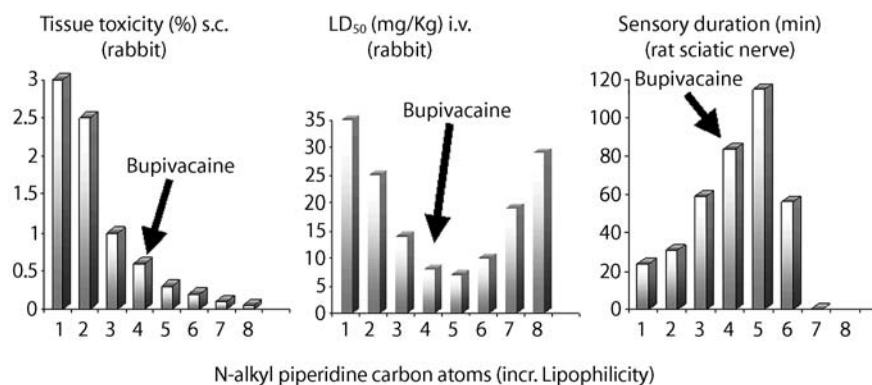
phosphate – the precursor of knowledge about the importance of  $K^+$  and  $Na^+$  flux in axonal transmission; in 1928, Yeomans et al, used procaine in oil, and Pitkin used a procaine-alcohol-mucilage (“spinocaine”) – the neurolytic properties of oil and alcohol would certainly have prolonged the block! Chemical modifications (and concurrent physicochemical properties), such as through simple substituents, converted procaine into amethocaine (tetracaine), and through homologous series converted mepivacaine into bupivacaine, thereby prolonging duration, and increasing toxicity! Unfortunately, overall, the same molecular changes increase both activity and toxicity.

In the 1950s, the quest for new local anaesthetics produced a family of N-alkyl piperidine 2,6-xylydides, which helped to reveal the significance of the physicochemical properties (Åberg et al. 1977). It was found that increasing their N-*n*-alkyl carbon chain gave increased lipophilicity as expected, along with increased tissue toxicity, and a bell-shaped relationship with both duration of neural blockade and systemic toxicity: this is interpreted in terms of extracellular – intracellular membrane permeability having an optimal value for axons, vital organs, notably heart and brain, and for causing direct effects. In both latter cases, the relevant maxima occurred at C4 or C5 alkyl chain length (see Fig. 1). From this family, the N-methyl homologue, mepivacaine, was selected for clinical development on the basis of its favourable local anaesthetic activity, combined with relatively low tissue and systemic toxicity, in animals. The others were deemed unsuitable because of local tissue or systemic toxicity. However, it was soon realised that when the doses were scaled to equi-toxicity in animal tests, a relatively longer duration neural blockade could be obtained; the N-*n*-butyl derivative, bupivacaine, was tested in the 1960s and soon found acceptance in clinical anaesthesiology. Since then, despite a variety of new conventional amino amide type local anaesthetics e.g. etidocaine, or new molecular forms, e.g. biotoxins and cyclizing lignocaine analogues, being tested and/or introduced for producing

long duration of action, bupivacaine has become the de facto standard long-acting local anaesthetic.

Many other properties correlate with lipophilicity. Indeed, classification by lipophilicity is as functionally relevant as classifying these molecules by chemical structures, although the classification would range only between moderately (e.g. lidocaine, mepivacaine) and highly lipophilic (e.g. ropivacaine, bupivacaine). Importantly, binding to plasma and tissue proteins also correlates directly: these properties are significant in drug distribution effects and are believed to play a role, for example, in ameliorating the trans-placental distribution when these drugs are used for obstetric anaesthesia and/or analgesia.

Although of long-standing concern, the modern day appreciation of local anaesthetic systemic toxicity and the subsequent quest for safer long-acting local anaesthetics arose from a brief report in 1979, of sudden onset of convulsions and ventricular fibrillation from etidocaine used for caudal anaesthesia in a 31 y.o. healthy fit male (Prentiss 1979). This report was followed the same year by an editorial containing a small case report series in which bupivacaine used epidurally, brachial plexus blocks, intravenous regional anaesthesia (Bier’s block) or caudal block, was believed to be causative in patients undergoing “sudden cardiovascular collapse” from which resuscitation was “difficult” (Albright 1979). A variety of other reports followed implicating bupivacaine and its then-competitor, etidocaine, as having disproportionately high cardiotoxicity compared to shorter-acting agents. It had been known from the early days that local anaesthetics caused CNS toxicity (frank seizures), and that local anaesthetics could cause myocardial depression, but the heart was thought to be more resistant to conduction toxicity from clinical doses. Through preclinical non-human and human studies, with intravenous doses of possible replacement drugs, it was learned that all local anaesthetics caused similar CNS toxicity in parallel to local anaesthetic potency. The symptomatology in humans could be graded through prodromal features



**Postoperative Pain, Local Anaesthetics, Figure 1** Relationships between tissue toxicity, systemic toxicity and duration of neural blockade for a homologous series of racemic N-alkyl piperidine 2,6-xylydides (data from erg et al. 1977).

including circumoral numbness (a local sensory effect), light-headedness, tinnitus, visual disturbances, slurring of speech, irrational conversation, muscle irritability; more serious effects such as seizures, coma, apnoea, respiratory arrest, and finally myocardial failure have been studied in experimental animals. Moreover, cardiac studies with *in vitro* and *in vivo* models in animals have shown that all local anaesthetics are myocardial depressants, again with dose-related potency that parallels local anaesthetic potency and with doses that apparently cause no CNS effects. A progression to fatality has been found with decreased left ventricular  $dP/dt_{max}$ , increased left ventricular end diastolic pressure, increased pulmonary artery pressure, progressing to cardiac failure, with hypotension, and abrupt onset malignant arrhythmias. In all of this, the role of CNS and sympathetic nervous system stimulation seems paramount; the onset of seizures causes a reversal of the myocardial depressant effects but predisposes towards malignant arrhythmias (Mather and Chang 2001).

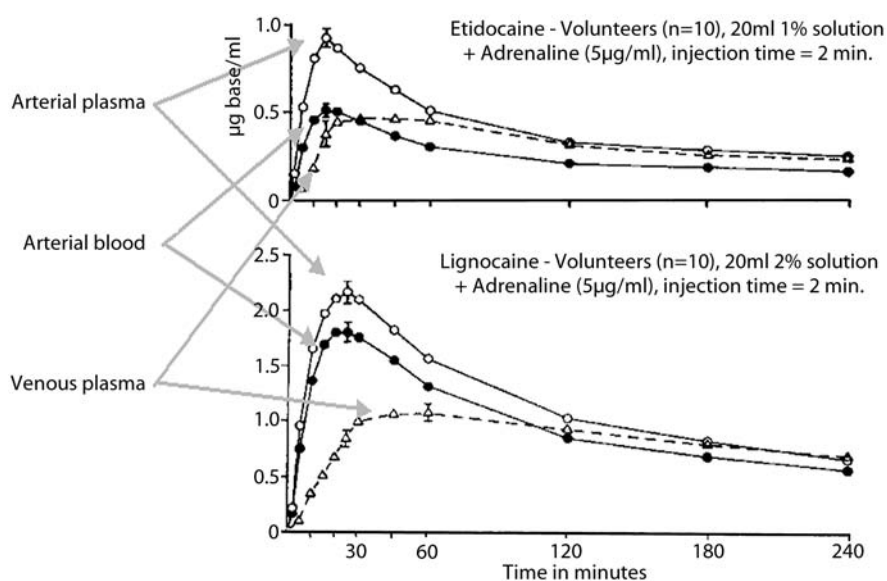
Ropivacaine and levobupivacaine, the drugs intended as replacements for bupivacaine, are enantiopure: both are of the S-configuration. Enantioselectivity in CNS models indicates a greater toxicity of the R-enantiomers. In electrophysiological and cardiac contractile function models, it has been found that, with cell channel blockade, e.g. firing frequency, R > S enantioselectivity is modest at Na<sup>+</sup> channels, high at certain K<sup>+</sup> channels, and moderate at Ca<sup>2+</sup> channels. In isolated heart muscle, e.g. papillary muscle, R > S enantioselectivity occurs with faster and more potent block of inactivated channels. Other models do not show significant enantioselectivity, e.g. disturbances of membrane Na<sup>+</sup>/Ca<sup>2+</sup> pump, inhibition of c-AMP production; disturbances of mitochondrial energy transduction (Mather and Chang 2001; Groban 2003). Whole body toxicity studies have consistently found that the S-enantiomers of these drugs produce the same toxicity as either the racemic or R-enantiomers, but require greater doses to do so. As they have essentially the same anaesthetic potency, the S-enantiomers thus have a greater margin of safety, and this is the rationale for their introduction into clinical practice (Mather and Chang 2001). It should be noted that, of the commonly used drugs, lidocaine and procaine are not chiral local anaesthetics. Local anaesthetics present the reverse side of conventional ► **pharmacokinetics**: drug absorption is bad, and minimal systemic bioavailability is good (Strichartz 1998, Tucker and Mather 1979). Blood-borne drugs will be delivered to all parts of the body in proportion to the distribution of cardiac output such that, in clinical use, systemic toxicity is well related to drug plasma concentrations, as far as these mirror drug concentrations in well-perfused vital organs. Toxicity occurs because of overdose, unexpectedly rapid absorption, or inadvertent intravascular injection. The role of dose

in toxicity is clear, but dosing guidelines are usually couched in terms of dose/body weight. However, while a small person probably should receive a smaller dose than a large person, the use of weight as a linearizing factor is questionable. Absorption rate is related to vascularity and the surface area of the administration site. All local anaesthetics are vasodilators at the concentrations used for neural blockade, hence the use of vasoconstrictors, in general, reduces the rate of absorption from the administration site, thereby prolonging the duration and reducing the risk of systemic toxicity. The S-enantiomers vasodilate relatively less than the R-enantiomers, so there is, usually, less gain in their being used with adrenaline.

The pharmacokinetics associated with drug systemic absorption from neural blockade can be broadly generalized by several points. 1. A systemically absorbed drug has a similar blood concentration profile to that after intramuscular injection. Biphasic absorption is the rule. This can be interpreted as a "portion" of the dose being absorbed reasonably rapidly with a half life of around 5–10 minutes, generating the "peak" arterial blood concentration at around 10 minutes after injection. The remaining "portion", presumably that distributed into fatty tissues, is absorbed more slowly with a half life measured in many 10s of minutes, thereby sustaining the blood drug concentrations compared to intravenous drug administration. 2. Most pharmacokinetic studies are based upon venous (typically antecubital fossa) blood sampling, and these find peak venous blood concentrations at around 30–60 minutes after administration. The discrepancy occurs because of drug equilibration in the tissues being drained. However, due to circulatory readjustments to central neural blockade, concomitant medications, etc., venous profiles can vary markedly. 3. The magnitude of the peak drug concentration in arterial blood is usually considerable greater than in venous blood. 4. Due to binding to plasma proteins, plasma drug concentrations are usually greater than blood concentrations, with the discrepancy being greater for the more lipophilic agents. Toxicity, should it occur, will usually occur close to the time of maximum arterial blood drug concentrations. If the drug is administered repeatedly or by infusion, the late onset toxicity becomes a concern. Toxicity will then take longer to recede, because the body burden of drug is high (see Fig. 2).

The most sinister outcome of neural blockade is that of rapid intravascular injection (Mather, Copeland and Ladd 2005). In this case, the body is presented with the highest plasma drug concentrations almost immediately after injection, so that the probability of CNS and/or cardiac toxicity is greatest. Thus, the effects are likely to be particularly severe; however they are likely to be short lived.

Local anaesthetics are amongst the most versatile of drugs for the management of pain. Many of their appli-



**Postoperative Pain, Local Anaesthetics, Figure 2** Drug concentrations after epidural administration in healthy volunteer subjects, showing the time courses in arterial and venous blood samples. Data from Tucker and Mather (1979).

cations, however, require the skill, if not artistry, of an experienced anaesthetist to place them where they can provide anaesthesia with or without motor blockade, or analgesia with or without anaesthesia. Good local anaesthesia can be wonderful, bad local anaesthesia can be lethal.

## References

1. Åberg G, Dhuner K-G, Sydnes G (1977) Studies on the Duration of Local Anaesthesia: Structure/Activity Relationships in a Series of Homologous Local Anaesthetics. *Acta Pharmacol Toxicol* 41:432-443
2. Albright GA (1979) Cardiac Arrest following Regional Anesthesia with Etidocaine or Bupivacaine (editorial). *Anesthesiology* 51:285-287
3. Brown DL, Fink BR (1998) The History of Neural Blockade and Pain Management. In: Cousins MJ, Bridenbaugh PO (eds) *Neural Blockade*, 3rd edn. Lippincott, Philadelphia, pp 3-27
4. Groban L (2003) Central Nervous System and Cardiac Effects from Long-Acting Amide Local Anesthetic Toxicity in the Intact Animal Model. *Reg Anesth Pain Med* 28:3-11
5. Liljestrand G (1971) The Historical Development of Local Anesthesia. In: Lechat P (ed) *Local Anesthetics* vol 1, International Encyclopedia of Pharmacology and Therapeutics. Pergamon Press, New York, pp1-38
6. Mather LE, Chang D-HT (2001) Cardiotoxicity of Local Anaesthetics. *Drugs* 61:333-343
7. Mather LE, Copeland SE, Ladd LA (2005) Acute Toxicity of Local Anesthetics: Underlying Pharmacokinetic and Pharmacodynamic Concepts. *Reg Anesth Pain Med* 30:553-566
8. Prentiss JE (1979) Cardiac Arrest following Caudal Anesthesia. *Anesthesiology* 50:51-53
9. Strichartz GR (1998) Neural Physiology and Local Anesthetic Action. In: Cousins MJ, Bridenbaugh PO (eds) *Neural Blockade*, 3rd edn. Lippincott, Philadelphia, pp 35-54
10. Tucker GT, Mather LE (1979) Clinical Pharmacokinetics of Local Anaesthetic Agents. *Clin Pharmacokin* 4:241-278
11. Tucker GT, Mather LE (1998) Properties, Absorption and Disposition of Local Anesthetics. In: Cousins MJ, Bridenbaugh PO (eds) *Neural Blockade*, 3rd edn. Lippincott, Philadelphia, pp 55-95

## Postoperative Pain Management

### Definition

Postoperative Pain, Thoracic and Cardiac Surgery; Acute Postoperative Pain Therapy

► Postoperative Pain, Thoracic and Cardiac Surgery

P

## Postoperative Pain, Membrane Stabilising Agents

ROSS MACPHERSON

Department of Anesthesia and Pain Management, University of Sydney, Sydney, NSW, Australia  
rmacpher@nscchahs.health.nsw.gov.au

### Synonyms

Membrane Stabilising Agents

### Definition

The term membrane stabilisation refers to the suppression or attenuation of the transmission of neuronal impulses, usually via a reduction in ionic fluxes through sodium channels (Khodorova et al. 2001). The most common membrane stabilising drugs are lignocaine, mexiletine and flecainide.

### Characteristics

Membrane stabilising agents have multiple pharmacological functions. All have significant anti-arrhythmic activity and are primarily used for this purpose, while their utility as analgesics has been a relatively late discovery (Mao and Chen 2000).

At a cellular level, much research has been carried out examining the different sub-groups of sodium channels involved in the development of neuropathic pain (Strichartz et al. 2002). Divided into ► **tetrodotoxin**-sensitive and tetrodotoxin-resistant channels, it is the latter group that seem to be involved in the generation and conduction of nociceptive neuronal discharges (Brau et al. 2001). Recent studies have identified further sub-groups within each of these divisions (Porreca et al. 1999).

Lignocaine has multiple uses. While it is most widely used as a local anaesthetic agent, its membrane stabilising properties can be exploited through its administration systemically, either by the subcutaneous or intravenous routes. When used in this way, the lignocaine infusion can be used in both the diagnosis and treatment of neuropathic pain. Flecanide and mexiletine can be administered orally.

### References

1. Bau ME, Dreimann M, Olschewski A et al. (2001) Effect of Drugs Used for Neuropathic Pain Management on Tetrodotoxin-resistant  $\text{Na}^+$  currents in Rat Sensory Neurons. *Anesthesiol* 94:137–144
2. Khodorova A, Meissner K, Leeson S et al. (2001) Lidocaine Electively Blocks Abnormal Impulses Arising from Noninactivating Na Channels. *Muscle Nerve* 24:634–637
3. Porreca F, Lai J, Bian D et al. (1999) Comparison of the Potential Role of the Tetrodotoxin-Insensitive Sodium Channels, PN3/SNS and NaN/SNS2, in Rat Models of Chronic Pain. *Proc Natl Acad Sci USA* 96:7640–7644
4. Strichartz GR, Zhou Z, Sinnott C et al. (2002) Therapeutic Concentrations of Local Anaesthetics Unveil the Potential Role of Sodium Channels in Neuropathic Pain. *Novartis Foundation Symposium* 241:189–201

## Postoperative Pain, Methadone

ROSS MACPHERSON

Department of Anesthesia and Pain Management,  
University of Sydney, Sydney, NSW, Australia  
rmapher@nscchs.health.nsw.gov.au

### Synonyms

Amidine; Amidine hydrochloride; Physeptone; Phenadone; (+/-)-6-Dimethylamino-4,4-diphenylheptane-3-one-hydrochloride; Methadone

### Definition

Synthetic opioid of the diphenylpropylamine class.

### Characteristics

Methadone has a unique place amongst opioid analgesics, by virtue of its somewhat unusual pharmacokinetic profile and its range of clinical applications, and its role in acute pain management is undergoing an expansion. Methadone is a truly synthetic opioid, its

usefulness as an analgesic first being noted by German chemists during the 1940's as a result of the systematic investigation of compounds possessing pethidine-like structures.

In terms of its pharmacological profile, while it shares many of the attributes common to members of the opioid group, in general there are some important differences (Garrido and Troconiz 1999). The first is its impressive oral bioavailability. Most opioids are well known for their poor and erratic absorption following oral dosing, yet methadone has a bioavailability variously quoted as being from 66 to 100% (Kristensen et al. 1996)]. It can be detected in the plasma within 30 minutes after oral dosing, with peak plasma levels generally achieved within 4–6 hours. Secondly, is its variable and prolonged duration of action, which has been measured at anything from between 12 to 150 hours following a single dose.

This has important clinical applications. For one thing, these data suggest significant inter-subject variation in dosage requirements, stressing the importance of individualising drug regimes. Many reasons for this variability have been suggested, with variations in both cytochrome P450 3A (CYP3A) activity and binding to alpha 1 lycoprotein being cited as critical (Boulton et al. 2001). Such variability means that the time required to reach steady state levels can be as long as a week, or as short as a day, implying that methadone is not always a suitable choice for the first line treatment of acute pain states. Likewise, the prescriber must be alert for the development of delayed toxicity, which can present even after cessation of treatment because of drug accumulation and deposition in extravascular sites.

The interesting pharmacokinetic profile of methadone also allows it to be administered on a once daily basis for the management of abstinence syndrome in opioid dependent patients (Mattick et al. 2002). It is also particularly useful in ► **opioid rotation** programs, because it seems that only partial tolerance occurs between methadone and other full opioid agonists.

The activity of methadone extends beyond that at the mu opioid receptor, as it has been shown to also possess antagonist action at NMDA receptor sites. Although this has been known for some time (Ebert et al. 1998), it is still a matter of debate as to the degree to which this activity contributes to its analgesic effect (Chizh et al. 2000). Since drugs with NMDA antagonist properties have a clear role in the management of neuropathic pain, it is not surprising that there have been reports of methadone being successfully used to treat such conditions (Bruera and Sweeney 2002).

The majority of literature dealing with the analgesic properties of methadone is concerned with its application in either chronic pain or cancer pain states (Ripamonti and Bianchi 2002; Bidlack et al. 2000). However, there is increasing interest in its use in acute pain states (Shir et al. 2001), especially where there



may be an element of neuropathic pain, or of tolerance to other opioids such as morphine. Indeed, despite the somewhat unfavourable pharmacokinetic parameters outlined above, intravenous methadone by either bolus or ► **P.C.A.** has been used in difficult cases to assist in the management of intractable pain states (Sabatowski et al. 2001; Fitzgibbon and Ready 1997). Although results have been favourable, methadone used by this route may result in high plasma levels, which is not without risk, as cases of serious cardiac arrhythmias have been reported in some patients (Krantz et al. 2002). Other research has focussed on the administration of methadone via the epidural route in the management of acute post-operative pain. In one study (Prieto-Alvarez et al. 2002), methadone was administered epidurally either as a continuous infusion or as an intermittent bolus. Due to the long half-life of the drug, bolus administration is needed only every eight hours. Results were favourable with good pain relief in both groups of patients who had undergone either abdominal or lower limb surgery.

As with many other commonly used analgesics such as ketamine, methadone is currently presented as a racemic mixture, with individual enantiomers displaying significant differences. The levorotatory enantiomer (R-methadone) displays greater mu receptor affinity and subsequently has enhanced analgesic potency, assessed as between 8 to 50 times more when compared to S-methadone. However, both enantiomers bind to the NMDA receptors. Likewise the desired therapeutic effects of the drug, such as analgesia and suppression of withdrawal syndrome, lie almost entirely with the R-isomer (Olsen et al. 1976). Again, as with ketamine, researchers have recently succeeded in producing preparations of the active isomer, which may herald an expanded role for methadone in the future.

In summary, methadone is a potent opioid agonist with a favourable pharmacokinetic profile that allows for oral administration on a once or twice daily basis. It also has antagonist activity at NMDA receptor which might contribute to its analgesic activity, especially in neuropathic pain states. Due to limited cross-tolerance between methadone and other opioids, it can be of use in the management of nociceptive pain states where patients have become tolerant to other opioids.

## References

- Bidlack JM, McLaughlin JP, Wentland MP (2000) Partial Opioids. Medications for the Treatment of Pain and Drug Abuse. *Annals of the New York Academy of Sciences* 909:1–11
- Boulton DW, Arnaud P and DeVane CL (2001) Pharmacokinetics and Pharmacodynamics of Methadone Enantiomers after a Single Oral Dose of Racemate. *Clin Pharmacol and Therap* 70:48–57
- Bruera E, Sweeney C (2002) Methadone use in Cancer Patients with Pain: A Review. *J Palliat Med* 5:127–138
- Chizh BA, Schults H, Scheede M et al. (2000) The N-methyl-D-aspartate Antagonistic and Opioid Components of d-Methadone Antinociception in the Rat Spinal Cord. *Neurosci Letters* 296:117–120
- Ebert B, Thorkildsen C, Anderson S et al. (1998) Opioid Analgesics as Noncompetitive N-methyl-D-aspartate (NMDA) Antagonists. *Biochemi Pharmacol* 56:553–559
- Fitzgibbon DR, Ready LB (1997) Intravenous High-Dose Methadone Administered by Patient Controlled Analgesia and Continuous Infusion for the Treatment of Cancer Pain Refractory to High-Dose Morphine. *Pain* 73:259–261
- Garrido MJ, Troconiz IF (1999) Methadone: A Review of its Pharmacokinetic/Pharmacodynamic Properties. *J Pharmacol Toxicol Methods* 42:61–66
- Krantz MJ, Lewkowicz L, Hays H et al. (2002) Torsade de Pointes Associated with Very High Dose Methadone. *Ann Int Med* 137:501–504
- Kristensen K, Blemmer T, Angelo HR et al. (1996) Stereoselective Pharmacokinetics of Methadone in Chronic Pain Patients. *Therapeutic Drug Monitoring* 18:221–227
- Makin MK, Ellershaw JE (1998) Substitution of another Opioid for Morphine: Methadone can be used to Manage Neuropathic Pain Related to Cancer. *Br Med J* 317:81
- Mattick, R, P et al. (2002) Methadone Maintenance Therapy versus no Opioid Replacement Therapy for Opioid Dependence. *Cochrane Database of Systematic Reviews* (4):CD002209
- Prieto-Alvarez P, Tello-Galindo I, Cuenca-Pena J et al. (2002) Continuous Epidural Infusions of Racemic Methadone Results in Effective Postoperative Analgesia and Low Plasma Concentrations. *Can J Anesthes* 49:25–31
- Ripamonti C, Bianchi M (2002) The Use of Methadone for Cancer Pain. *Hematology – Oncology Clinics of North America* 16:543–555
- Sabatowski R, Kasper SM, Radbruch L (2002) Patient-Controlled Analgesia with Intravenous L-Methadone in a Child with Cancer Pain Refractory to High-Dose Morphine. *J Pain Symptom Manag* 23:3–5
- Sartain JB, Mitchell SJ (2002) Successful Use of Oral Methadone after Failure of Intravenous Morphine and Ketamine. *Anaesthesia and Intensive Care* 30:487–489
- Shir Y, Rosen G, Zelden A et al. (2001) Methadone is Safe for Treating Hospitalized Patients with Severe Pain. *Can J Anaesthes* 48:1109–1113

## Postoperative Pain, Mexiletine

ROSS MACPHERSON

Department of Anesthesia and Pain Management,  
University of Sydney, Sydney, Australia  
rmacpher@nscchahs.health.nsw.gov.au

### Synonym

Methyl-2-(2,6-Xylyloxy)-Ethylamine-Hydrochloride;  
Mexitil; Mexiletine/Mexitil

### Definition

Membrane stabilising and anti-arrhythmic agent (Class IB).

### Characteristics

Mexiletine, an anti-arrhythmic agent structurally related to lignocaine, has been the most commonly used oral agent of the membrane-stabilising group, although still generally much less popular than anti-depressant and anti-convulsant agents. As a result, the number of studies involving mexiletine are small, and the evidence supporting its use is somewhat less impressive than drugs in other categories.

Furthermore, these studies have produced mixed results, with some favouring the drugs use (Dejard et al. 1988; Lindstrom and Lindblom 1987), but others suggesting that even in high doses, it has minimal effectiveness (Wallace et al. 2000; Ando et al. 2000). The main concerns are with side effects, both cardiac and non-cardiac, which can be common (Chabal et al. 1992; Jarvis and Coukell 1998; Kreeger and Hammill 1987). Patients in whom the use of mexiletine is proposed need to undergo cardiological assessment and have serial ECG examinations performed prior to commencement of therapy (Portenoy 1999), and any symptom suggestive of being related to cardiac abnormality needs to be investigated. Non-cardiac adverse effects include upper gastrointestinal discomfort, which is common and often limits treatment, (Rowbotham 2002) and tremor.

## References

1. Ando K, Wallace M, Braun J et al. (2000) Effect of Oral Mexiletine on Capsaicin-Induced Allodynia and Hyperalgesia: A Double-Blind, Placebo-Controlled, Crossover Study. *Regional Anesthesia and Pain Medicine* 25:1–2
2. Chabal C, Jacobson L, Mariano A et al. (1992) The Use of Oral Mexiletine for the Treatment of Pain after Peripheral Nerve Injury. *Anesthesiol* 76:513–517
3. Chiou-Tan FY, Tuel SM, Johnson JC et al. (1996) Effect of Mexiletine on Spinal Cord Injury Dysesthetic Pain. *Am J Phys Med Rehab* 75:84–87
4. Dejgard A, Petersen P, Kastrup J (1988) Mexiletine for Treatment of Chronic Painful Diabetic Neuropathy. *Lancet* 1:9–11
5. Jarvis B, Coukell AJ (1998) Mexiletine: A Review of its Therapeutic Use in Painful Diabetic Neuropathy. *Drugs* 56:691–707
6. Kreeger W, Hammill SC (1987) New Antiarrhythmic Drugs: Tocainide, Mexiletine, Flecainide, Encainide, and Amiodarone. *Mayo Clin Proc* 62:1033–1050
7. Lindstrom P, Lindblom U (1987) The Analgesic Effect of Tocainide in Trigeminal Neuralgia. *Pain* 28:45–50
8. Portenoy (1999) Opioid and Adjuvant Analgesics. In: M Devor (ed) *Pain – an Updated Review. Refresher Course Syllabus 9<sup>th</sup> World Congress on Pain*, pp 1–18
9. Rowbotham MC (2002). Neuropathic Pain: From Basic Science to Evidence Based Treatment. In: Dostrovsky J (ed) *Pain – an Updated Review. Refresher Course Syllabus 10<sup>th</sup> World Congress on Pain*, pp 165–176
10. Wallace M, Magnuson S, Ridgeway B (2000) Efficacy of Oral Mexiletine for Neuropathic Pain with Allodynia: A Double-Blind, Placebo-Controlled, Crossover Study. *Reg Anesth Pain Med* 25:459–467

## Postoperative Pain Model

► Nick Model of Cutaneous Pain and Hyperalgesia

## Postoperative Pain, Morphine

PETER C. A. KAM  
Department of Anaesthesia, St George Hospital,  
University of New South Wales, Kogarah, NSW,  
Australia  
p.kam@unsw.edu.au

## Synonym

Morphine Sulphate; Morphine; Ordine<sup>®</sup>-morphine-hydrochloride; MS Contin<sup>®</sup> Controlled (Slow) Release Morphine Sulphate; Kapanol<sup>®</sup> controlled release pellets within a capsule

## Definition

A strong (potent) naturally occurring opiate.

## Characteristics

► **Morphine** is the most commonly used strong opioid of choice for acute pain. Other strong opioids are used mainly when morphine is not readily available, or when the patient experiences intolerable adverse effects with morphine.

## Chemistry

Morphine is a naturally occurring phenanthrene derivative. It is poorly lipid soluble due to the 2 hydroxyl moieties. The OH group at C3 enhances van der Waal forces that bind the aromatic phenol ring to the opioid receptor. Morphine is formulated as tablets, suspensions and as slow release capsules and granules in a wide range of strengths. The parenteral preparation may be given subcutaneously, intramuscularly and intravenously. Morphine is the principal alkaloid of opium, and constitutes 9–17% of opium.

## Pharmacodynamics

Morphine is a  $\mu$ -agonist, binding to receptors in the brain, spinal cord and other tissues. Following its binding to  $\mu$ -receptors in the brain (periaqueductal grey, hippocampus) and the spinal cord (lamina 1), morphine produces analgesia – particularly effective for visceral pain. Sedation and drowsiness are frequently observed with therapeutic doses. In the absence of pain, morphine sometimes produces dysphoria (unpleasant sensation of fear and anxiety). Nausea and vomiting occur via stimulation of serotonin and dopamine receptors in the chemoreceptor trigger zone by morphine. Morphine may induce mild bradycardia due to vagal stimulation, and hypotension secondary to histamine release and a decrease in sympathetic tone. Morphine constricts the sphincters of the gastrointestinal tract, resulting in constipation. Pruritis, most marked following epidural or intrathecal administration, does not appear to be associated with histamine release. Morphine inhibits the release of ACTH, prolactin and gonadotrophic hormones. ADH secretion is increased. The tone of bladder detrusor and sphincter of the bladder is increased and this precipitates urinary retention.

## Pharmacokinetics

Morphine is a weak base ( $pK_a$  – 8.0). When administered orally, morphine is ionised in the acidic gastric contents, and absorption only occurs when it becomes un-

ionised in the alkaline environment of the small bowel. It undergoes extensive first pass metabolism, and its oral bioavailability is 25–30%. Its peak effects occur after 10 and 30 minutes following intravenous and intramuscular injection respectively, lasting 3–4 hours. Unlike most other opioids, morphine is relatively water soluble.

Morphine undergoes extensive hepatic biotransformation by phase II reactions to morphine-3-glucuronide (70%) and morphine-6-glucuronide (5–10%), and the remainder undergoes sulphation. Morphine-3-glucuronide has no analgesic effects and is possibly a  $\mu$ -antagonist. Morphine-6-glucuronide is pharmacologically active and is 13 times more potent than morphine. The plasma concentration of morphine-6-glucuronide exceeds that of the parent drug (by a factor of 9) after 30 min. of intravenous administration. It crosses the blood-brain barrier and contributes to the analgesic effects of morphine. Both metabolites are excreted renally and accumulate in renal failure.

There are 2 slow-release formulations, ► **Kapanol**<sup>®</sup> and **MS-Contin**<sup>®</sup>. Kapanol is a formulation of morphine prepared as polymer coated sustained release pellets contained in a capsule. Following oral administration, the rate of absorption of morphine is slower. A single 50 mg oral dose of kapanol results in a mean peak plasma concentration of 8.1 ng/ml at 8.5 hrs. A steady state is achieved within 2 days when Kapanol is given on a fixed dosing regimen. Kapanol<sup>®</sup>, when given on a 12 hourly dosing regime, results in a lower mean peak plasma morphine concentration, and higher mean trough plasma morphine concentration than the same total dose of morphine solution given at 4 hourly dosing schedules. The reduced fluctuation in plasma morphine concentration may reduce the incidence of breakthrough pain and adverse effects.

► **MS Contin** is a controlled (slow) release tablet formulation of morphine. MS Contin tablets produce peak morphine concentrations 4–5 hours post dose, and therapeutic concentrations persist for about 12 hours.

### Clinical Efficacy

A systematic review of a single IM dose of morphine 10 mg for moderate to severe postoperative pain reported ► **numbers needed to treat** (NNT) of 2.9. This means that one out of every three patients treated, achieved more than 50% pain relief with Morphine. Increasing the dose of morphine would lower the NNT. Therefore, the key to morphine use is to titrate the dose to analgesic effect in individual patients.

Morphine is given by intramuscular or subcutaneous injection in doses of 0.1 to 0.2 mg/kg body weight every three to six hours. Lower doses are used in children and elderly patients and should be titrated to effect. When a rapid onset of action is desirable, morphine can be administered intravenously with caution in a dose of 0.05–1.0 mg/kg over 5–15 minutes with close monitor-

ing. Morphine can also be administered by continuous intravenous infusion using a controlled rate infusion pump or a syringe driver. The dose of morphine should be titrated according to the patient's analgesic requirements and previous opioid usage. Most adult patients, with no previous exposure to opioid usage, will require a morphine infusion at a rate of 0.5 to 2.0 mg/h after adequate analgesia has been achieved with a loading dose. In children, an infusion at a rate of 0.01–0.05 mg/kg/h provides adequate analgesia.

► **Patient controlled analgesia** using morphine as the agent to provide postoperative pain relief is a common method used for postoperative analgesia. This allows the patient to titrate the amount of morphine they require for adequate pain relief against sedation or other side effects. For most opioid naïve adult's demands, doses of 0.5–2.0 mg, with a lockout interval of 5 minutes, is adequate via PCA. In some patients, a background continuous infusion at a basal rate (usually 1 mg/hr) may be required to provide adequate analgesia, but this is associated with a higher incidence of adverse effects, and therefore requires close monitoring.

When morphine is administered to patients with chronic pain associated with cancer, the dose of morphine must be individualised according to the response and tolerance of patient. The dose of morphine should be reduced in poor risk patients, in very old or very young patients, and in patients receiving other depressants. Oral morphine should be used in preference to parenteral morphine whenever it is possible to achieve analgesia by this route. When patients are converted from parenteral morphine to oral morphine, the dose of oral morphine should be increased, because about 60% of oral morphine is metabolised in the liver by the first pass effect.

### Conversion of the slow release formulation.

Based on single dose studies, parenteral morphine 10 mg is equipotent to oral morphine 60 mg. In chronic use this ratio does not apply, and the ratio of parenteral morphine 10 mg to oral morphine 30 mg may be more appropriate. However, it is best to assume that the parenteral to oral potency ratio is high when converting from a slow release morphine (e.g. Kapanol) to parenteral morphine, and estimate the parenteral morphine based on 1 : 6 ratio. The total daily oral morphine dose is estimated, and should then be divided into two Kapanol or MS Contin doses given every 12 hours. Kapanol is not bioequivalent to other controlled release morphine formulations, and has reduced fluctuation in dosed adjusted plasma morphine levels.

Opioid analgesic agents do not relieve dysaesthetic pain, postherpetic neuralgia and some forms of headache. Morphine may have a prolonged and cumulative effect in patients with impaired renal function. In these patients, the active metabolite morphine-6-glucuronide can accumulate so that analgesia may last for 6–8 hours.

## References

1. Dahlstrom B, Tamsen A, Paalzow L et al. (1982) Patient-Controlled Analgesic Therapy, Part IV: Pharmacokinetics and Plasma Concentrations of Morphine. *Clin Pharmacokin* 7:266–279
2. Aitkenhead AR, Vater M, Achola K et al. (1984) Pharmacokinetics of Single Dose IV Morphine in Normal Volunteers and Patients with End Stage Renal Failure. *Br J Anaesth* 56:813–819
3. Hull CJ (1991) Pharmacokinetics for Anaesthesia. Butterworth-Heinemann Oxford:290–295
4. Gourlay GK (1998) Sustained Relief of Chronic Pain. Pharmacokinetics of Sustained Release Morphine. *Clin Pharmacokin* 35:173–190
5. Gourlay GK, Cherry DA, Onley MM et al. (1997) Pharmacokinetics and Pharmacodynamics of Twenty-Four Hourly Kapanol Compared to Twelve Hourly MS Contin in the Treatment of Severe Cancer Pain. *Pain* 69:295–302
6. McQuay HJ, Moore A (1998) An Evidence-Based Resource of Pain Relief. Oxford University Press, Oxford
7. McQuay H (1999) Opioids in Pain Management. *Lancet* 353:2229–2232
8. Moore RA, McQuay H (1998) Peak Plasma Concentrations after Oral Morphine – A Systematic Review. *J Pain Symptom Manage* 16:388–402
9. Kalso E, Heiskanen H, Rantio M et al. (1996). Epidural and Subcutaneous Morphine in the Management of Cancer Pain: A Double Cross Over Study. *Pain* 67:443–449

## Postoperative Pain, Non Steroidal Anti-Inflammatory Drugs

IAN POWER<sup>1</sup>, LESLEY A. COLVIN<sup>2</sup>

<sup>1</sup>Anaesthesia Critical Care and Pain Medicine, The University of Edinburgh, Edinburgh, UK

<sup>2</sup>Department of Anaesthesia, Critical Care and Pain Medicine, Western General Hospital, Edinburgh, UK  
ian.power@ed.ac.uk

### Synonyms

NSAID; Cyclooxygenase Inhibitors

### Definition

In the 20<sup>th</sup> century many chemical substances, now known as the ► NSAIDs, Survey or NSAIDs, were developed with the same anti-inflammatory, analgesic and antipyretic effects of aspirin. The introduction a few years ago of injectable preparations of the NSAID ketorolac, diclofenac, ketoprofen and tenoxicam delivered peri-operative analgesia free from opioid disadvantages of respiratory depression, sedation, nausea and vomiting, gastrointestinal stasis or abuse potential. Extensive clinical investigation and use of NSAIDs has confirmed that they are effective post-operative analgesics, although significant contraindications and adverse effects limit this use.

### Characteristics

#### General

NSAIDs have a spectrum of analgesic, anti-inflammatory and antipyretic effects, but those used for peri-operative

pain relief produce marked analgesia with little anti-inflammatory action.

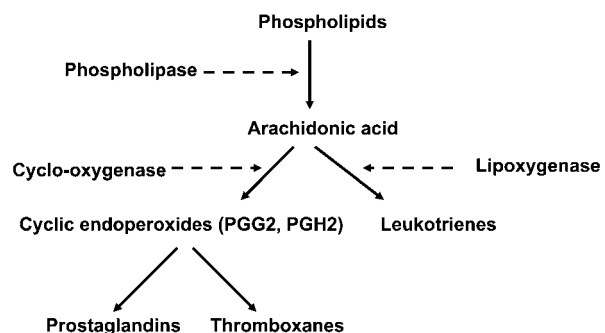
NSAID absorption is rapid by all routes of administration, whether enteral or by injection. NSAIDs are highly protein bound, have low volumes of distribution of the order of 0.1 litres/kg, and the unbound fraction is active. Consequently, NSAIDs can potentiate the effects of other highly protein bound drugs by displacing them from protein-binding sites (oral anticoagulants, oral hypoglycaemics, sulphonamides, and anticonvulsants).

### Mechanism of Action

Many NSAID and aspirin, effects can be explained by inhibition of prostaglandin synthesis in peripheral tissues, nerves, and the central nervous system. However, the NSAIDs and aspirin may have other mechanisms of action independent of any effect on prostaglandins, including effects on basic cellular and neuronal processes (McCormack 1994).

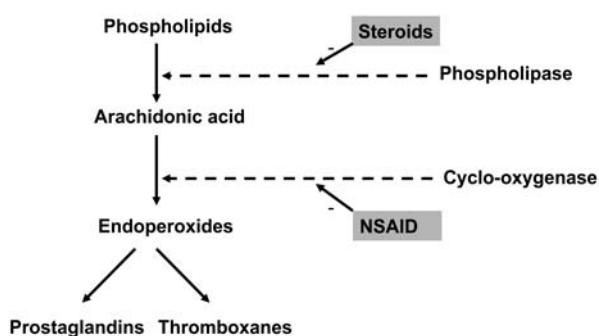
Von Euler first described ‘prostaglandins’ as locally active tissue agents that produce smooth muscle contraction. Many prostaglandins are now recognized, and they are all based on a 20-carbon chain molecule. Hence, they are one family of the ‘eicosanoids’ (from ‘eicos’ Greek for ‘twenty’), oxygenated metabolites of arachidonic acid and other polyunsaturated fatty acids that include leukotrienes. The basal rate of prostaglandin production is low, and is regulated by tissue stimuli or trauma that activates phospholipases to release arachidonic acid. Prostaglandins are then produced by the enzyme prostaglandin endoperoxide (PGH) synthase, which has both cyclo-oxygenase and hydroperoxidase sites. Two subtypes of cyclo-oxygenase enzyme have been identified: the ‘constitutional’ COX-1 and the ‘inducible’ COX-2 (see Fig. 1).

Prostaglandins have many physiological functions including: gastric mucosal protection; renal tubular function and vasodilation; bronchodilation; endothelial prostacyclin produces vasodilation and prevents platelet adhesion; platelet thromboxane produces aggregation and vessel spasm. Such physiological roles are mainly regulated by COX-1, and are the basis for many of



Postoperative Pain, Non Steroidal Anti-Inflammatory Drugs, Figure 1 Eicosanoid production.





Postoperative Pain, Non Steroidal Anti-Inflammatory Drugs, Figure 2 NSAID mechanism of action.

the adverse effects associated with NSAID use. Tissue damage induces COX-2 production with the production of prostaglandins that produce pain and inflammation. COX-2 may be 'constitutive' in some tissues, including the kidney.

NSAIDs, like aspirin, are 'non-selective' cyclo-oxygenase inhibitors that inhibit both COX-1 and COX-2, unlike the newer 'COX-2 inhibitors' that have been developed to inhibit selectively the inducible form. Paracetamol may work by inhibiting a further sub-type 'COX-3' in the central nervous system (see Fig. 2).

Non-selective COX-1 and COX-2 inhibition confers both the analgesic and the adverse effect (peptic ulceration, renal impairment, bleeding and aspirin induced asthma) profile of NSAIDs.

### Efficacy

The efficacy of single dose NSAIDs as postoperative analgesics has been examined and confirmed by many studies. Using the concept of ► **number needed to treat** (NNT), obtained from meta-analyses of well designed studies of postoperative analgesia, McQuay and Moore from Oxford University have enabled comparison of the efficacy of NSAIDs with other types of analgesics for acute pain relief after surgery ([www.jr2.ox.ac.uk/bandolier/booth/painpag/](http://www.jr2.ox.ac.uk/bandolier/booth/painpag/)). From such work, the NNT of ketorolac 10 mg is 2.6, diclofenac 50 mg 2.3, and ibuprofen 400 mg 2.4. For comparison, the NNT of morphine 10 mg intramuscularly is 2.9, and codeine 60 mg 16.7.

Individual studies have confirmed that NSAIDs, such as ketorolac, for example, are effective postoperative analgesics (Power et al. 1990; NHMRC 1999). When given in combination with opioids, NSAIDs produce better analgesia and reduce opioid consumption by 25 to 50%. Of the NSAIDs available, most experience has been gained in surgical patients with ketorolac, which has proven to be an effective postoperative analgesic (Gillis and Brogden 1997). To improve safety, ketorolac doses were revised in the United Kingdom after the drug was launched, and the current recommended dose in adults younger than 65 years is 10 mg every four to six

hours, with a maximum daily dose of 40 mg. In adults over 65 years of age, the recommended dose is still 10 mg, but the dosing interval is lengthened to six to eight hours, with a daily maximum of 30 mg. NSAIDs are insufficient for sole use for the relief of very severe pain immediately after major surgery, although they are very useful analgesic adjuncts, improving pain relief whilst reducing opioid requirements. They are of considerable value in day case surgery, where they can be given by injection at the time of surgery and then continued in tablet form when the patient is discharged from hospital, often avoiding the need for any opioid therapy.

### Safety

NSAIDs possess undesirable effects, because of their mechanism of action, as prostaglandins are local tissue hormones regulating function, and interference with their synthesis can produce problems. NSAID side effects are more common with long-term use, but in the perioperative period the main concerns are the potential of producing peptic ulceration, interference with platelets, renal impairment and bronchospasm in individuals who have aspirin induced asthma. In general, the risk and severity of NSAID associated side effects is increased in the elderly population.

### Platelet Function

Platelet cyclo-oxygenase is essential for the production of the cyclic endoperoxides and thromboxane A<sub>2</sub>, which mediate the primary haemostatic response to vessel injury by producing vasoconstriction and platelet aggregation. Unlike aspirin, which acetylates cyclo-oxygenase irreversibly, NSAIDs inhibit platelet cyclo-oxygenase in a reversible fashion. Studies have confirmed that single doses of NSAID, such as ketorolac and diclofenac, do inhibit platelet function (prolong skin bleeding time and inhibit platelet function *in vitro*) (Power et al. 1998), but do not tend to increase surgical blood loss in normal patients (Moiniche et al. 2003). However, the presence of a bleeding diathesis or administration of anticoagulants may increase the risk of significant surgical blood loss upon NSAID administration.

### Renal Function

In the kidney prostaglandins have many physiological roles, including the maintenance of renal blood flow and glomerular filtration rate in the presence of circulating vasoconstrictors, regulation of tubular electrolyte handling and modulation of the actions of renal hormones. The adverse renal effects of chronic NSAID use are common and well recognised. In some clinical conditions high circulating concentrations of the vasoconstrictors renin, angiotensin, norepinephrine, and vasopressin increase production of intrarenal vasodilators including prostacyclin, and renal function can be sensitive to NSAIDs. Diclofenac has been shown to

affect renal function in the immediate postoperative period after major surgery (Power et al. 1992), and administration of other potential nephrotoxins, such as gentamicin, increased the renal effect of ketorolac (Jaquenod et al. 1998). However, in clinical practice, with careful patient selection and monitoring, the incidence of NSAID induced renal impairment is low in the perioperative period (Lee 2004).

#### Aspirin Induced Asthma

Precipitation of bronchospasm is a recognised phenomenon in individuals with asthma, chronic rhinitis and nasal polyps. Such 'aspirin induced asthma' affects 10 to 15% of asthmatics, can be severe, and there is a cross sensitivity with NSAIDs (Szczeklik and Stevenson 2003). A history of aspirin-induced asthma is a contraindication to NSAID use after surgery, although there is no reason to avoid NSAIDs in other asthmatics. The mechanism of this is unclear, but the reaction increases with the potency of a drug as a cyclo-oxygenase inhibitor. One hypothesis is that cyclo-oxygenase inhibition increases arachidonic acid availability for production of inflammatory leukotrienes by lipo-oxygenase pathways. The syndrome is less common in children and the susceptibility may be revealed in adult life by a viral illness.

#### Peptic Ulceration

The gastric and duodenal epithelia have various protective mechanisms against acid and enzyme attack, and many of these involve prostaglandin production. Chronic NSAID use is associated with peptic ulceration and bleeding (Henry et al. 1996), and the latter may be exacerbated by the anti-platelet effect. One meta-analysis has estimated the risk associated with NSAIDs of perforations, ulcers and bleeds, finding that the pooled relative risk from nine cohort studies, comprising over 750,000 person-years of exposure, was 2.7 (95% CI: 2.1, 3.5) (Ofman et al. 2002). Acute gastroduodenal damage and bleeding can occur with short term NSAID use in the perioperative period. One post marketing surveillance study of ketorolac found that the risk of gastrointestinal haemorrhage was small, but larger and more clinically important when ketorolac was used in higher doses, in older subjects, and for more than five days (Strom et al. 1996).

#### Other

Prostaglandin production has been shown to be important in animal models of bone healing, but there is little research evidence that any inhibitory effect of NSAIDs is important clinically (Harder and An 2003).

#### Contraindications

The presence, in patients, of a bleeding diathesis, peptic ulceration, significant renal impairment, peptic ulceration and aspirin induced asthma should be respected as contraindications to NSAID administration

#### Conclusion

NSAIDs are powerful analgesics that can be used to relieve postoperative pain effectively and minimise opioid requirements. NSAIDs can be recommended as an integral component of multimodal analgesia in combination with paracetamol and opioids, but contraindications effectively prevent their use in many surgical patients (NHMRC 1999).

#### References

- Gillis JC, Brogden RN (1997) Ketorolac. A Reappraisal of its Pharmacodynamic and Pharmacokinetic Properties and Therapeutic use in Pain Management. *Drugs* 53:139–188
- Harder AT, An YHH (2003) The Mechanisms of the Inhibitory Effects of Nonsteroidal Anti-Inflammatory Drugs on Bone Healing: A Concise Review. *J Clin Pharmacol* 43:807–815
- Henry D, Lim LL et al. (1996) Variability in Risk of Gastrointestinal Complications with Individual Non-Steroidal Anti-Inflammatory Drugs – Results of a Collaborative Meta-Analysis. *BMJ* 312:1563–1566
- Jaquenod M, Ronnedh C et al. (1998) Factors Influencing Ketorolac-Associated Perioperative Renal Dysfunction. *Anesth Analg* 86:1090–1097
- Lee ACM, Craig JC, Knight JF et al. (2004) Effects of Nonsteroidal Anti-Inflammatory Drugs on Post-Operative Renal Function in Normal Adults (Cochrane Review). In: *The Cochrane Library*. John Wiley & Sons, Chichester, UK
- McCormack K (1994) Non-Steroidal Anti-Inflammatory Drugs and Spinal Nociceptive Processing. *Pain* 59:9–43
- Moiniche S, Romsing J et al. (2003) Nonsteroidal Anti-Inflammatory Drugs and the Risk of Operative Site Bleeding after Tonsillectomy: A Quantitative Systematic Review. *Anesth Analg* 96:68–77
- NHMRC (1999) *Acute Pain Management: Scientific Evidence*. Australian National Health and Medical Research Council, Canberra
- Ofman JJ, MacLean CH et al. (2002) A Meta-Analysis of Severe Upper Gastrointestinal Complications of Nonsteroidal Anti-Inflammatory Drugs. *J Rheumatol* 29:804–812
- Power I, Cumming AD et al. (1992) Effect of Diclofenac on Renal Function and Prostacyclin Generation after Surgery. *Br J Anaesth* 69:451–456
- Power I, Noble W et al. (1990) Comparison of I.M. Ketorolac Trometamol and Morphine Sulphate for Pain Relief after Cholecystectomy. *Br J Anaesth* 65:448–455
- Power I, Noble W et al. (1998) Effects of Ketorolac and Dextran-70 Alone and In Combination on Haemostasis. *Acta Anaesthesiologica Scandinavica* 42:982–986
- Strom BL, Berlin JA et al. (1996) Parenteral Ketorolac and Risk of Gastrointestinal and Operative Site Bleeding. A Postmarketing Surveillance Study. *JAMA* 275:376–382
- Szczeklik A, Stevenson DD (2003) Aspirin-Induced Asthma: Advances in Pathogenesis, Diagnosis, and Management. *J Allergy Clin Immunol* 111:913–921

## Postoperative Pain, Opioids

PETER C. A. KAM  
University of New South Wales, St George Hospital,  
Kogarah, NSW, Australia  
p.kam@unsw.edu.au

#### Synonym

Opioid; Opiate

**Definition**

An ► **opioid** is any compound (endogenous or exogenous – naturally occurring or synthetic) that has pharmacological activity at an ► **opioid receptor**. The term “► **opiate**” describes a substance that is a naturally occurring opioid.

**Characteristics**

**Opioid Receptor**

In 1976, Martin and Colleagues first classified the opioid receptors as Mu ( $\mu$ ), Kappa ( $\kappa$ ) and Sigma ( $\sigma$ ), based on the specificity of 3 agents acting at these receptors, i.e. morphine, ketocyclazone, and SKF 10047, respectively. Two further opioid receptors were described, delta ( $\delta$ ) and epsilon ( $\epsilon$ ) receptors, based on their responses to enkephalins and epsilon  $\beta$  endorphins, respectively. However, later studies demonstrated conclusively that sigma and epsilon receptors were not opioid receptors (Shook et al. 1988). From the 1980s, only 3 opioid receptors,  $\mu$ ,  $\delta$  and  $\kappa$ , were established. The opioid receptors were cloned in the 1990s (Thompson et al. 1993 and Yasuda et al. 1993).

In 1996, the International Union of Pharmacology (IUPHAR) recommended that the greek alphabets,  $\mu$ ,  $\delta$  and  $\kappa$  should be replaced by OP<sub>3</sub>; OP<sub>1</sub> and OP<sub>2</sub>, respectively (numbered in the order in which they were cloned) (Dhawan et al. 1996). In 1994, the ► **nociceptin/orphanin FQ receptor** was discovered. This accidentally cloned new opioid receptor was called orphan receptor because no ligand was known at that time. An endogenous opioid called orphanin F/Q or nociceptin was discovered. Nociceptin F/Q is a heptadecapeptide and shows similarity to dynorphin A (Calo et al. 2000).

Latest guidelines from ► **IUPHAR** show that the opioid receptors should be called ► **MOR**, ► **DOR**, ► **KOR** or ► **NOR** (see table 1).

**Location of Opioid Receptors**

Opioid receptors synthesized in sensory neuron cell bodies are found throughout the central nervous system. Mu and kappa receptors are located in the cerebral cortex, amygdala, hippocampus, thalamus, mesencephalon, pons, medulla and spinal cord. Kappa receptors are also present in the hypothalamus, whilst the delta receptors are present in the telencephalon and the spinal cord.

**Postoperative Pain, Opioids, Table 1** Classification of Opioid Receptors

Conventional Nomenclature	Previous Nomenclature	Proposed Nomenclature
Delta	OP1	DOR
Kappa	OP2	KOR
Mu	OP3	MOR
Orphan	ORL1	NOR

In the spinal cord, opioid receptors are found at the terminal zones of C-fibres, primarily in lamina I. OP<sub>3</sub> (Mu) receptors predominate in the spinal cord ( $\mu$  = 70%,  $\delta$  = 24%,  $\kappa$  = 6% in the rat).

Peripherally, opioid receptors have been identified in peripheral tissue. They are silent until activated by inflammatory mediators (Stein 1993). Opioid receptors have also been identified on the surface of immune cells such as  $\tau$  and  $\beta$  lymphocytes, monocytes and macrophages. Stimulation of presynaptic OP<sub>1</sub> ( $\delta$ ) and OP<sub>3</sub> ( $\mu$ ) receptors results in hyperpolarization of the nerve terminal with reduced excitatory neurotransmitter release, mediated by inhibition of voltage – gated calcium channels. Activation of postsynaptic opioid receptors activate potassium channels, enhancing the outward flow of potassium, thereby hyperpolarizing the membrane and inhibiting the response of the post synaptic membrane to neurotransmitters. The action of morphine on opioid receptors is mediated by inhibitory G protein, coupled to adenylyl cyclase, thus reducing cAMP formation.

**Classification of Opioid Drugs**

Traditionally, opioids have been classified as weak, intermediate and strong. Codeine is considered a “weak” opioid; partial  $\mu$  agonists or mixed agonist – antagonists as “intermediate” and pure agonists (e.g. morphine) as “strong” opioids. Opioids can also be classified according to their chemical structures: Morphinans (e.g. morphine, codeine); phenylpiperidines (meperidine, fentanyl); diphenylpropylamine (e.g. methadone, dextropropoxyphene) and esters (e.g. remifentanyl). The best way of classifying opioids is by utilizing a functional approach; pure agonists (e.g. morphine, fentanyl); partial agonists (e.g. buprenorphine); agonist-antagonists (e.g. pentazocine) and mixed action (e.g. meperidine - opioid agonist with anti-cholinergic and membrane stabilizing properties; tramadol - weak  $\mu$  agonist; and inhibition of reuptake of norepinephrine and 5 HT) (see table 2).

**Pharmacodynamics**

The opioid effects on the central nervous system include analgesia, sedation, respiratory depression, miosis, nausea and vomiting.

**Postoperative Pain, Opioids, Table 2** Bioavailability of Commonly Used Opioids

OPIOID	BIOAVAILABILITY (%)
Morphine	25
Meriperidine	52
Codeine	50
Oxycodone	60
Hydromorphone	25
Methadone	80



### Analgesia

There are 2 distinct anatomical sites, supraspinal and spinal, which are responsible for opioid mediated analgesia. Systemically administered opioids produce both spinal and supraspinal analgesia. Activation of supraspinal opioid receptors, mainly  $\mu$  receptors, transmit descending impulses that inhibit spinal nociceptive neurons and reflexes to produce analgesia. The periaqueductal grey is a major site for supraspinal opioid analgesia. The neurotransmitters in the spinal cord that mediate the effects of descending inhibitory pathways are norepinephrine and 5HT. All three types of opioid receptor are present on the peripheral terminals of sensory nerves, but their activation requires an inflammatory reaction. Euphoria often occurs, and dysphoria is associated with  $\kappa$  agonists. Muscle rigidity appears to be associated with central activation of the  $\mu$  receptor, whereas supraspinal  $\delta$  and  $\kappa$  receptors may attenuate this effect. Rigidity involving the thoracic and abdominal muscles can interfere with breathing. It may be related to opioid-mediated inhibition of dopamine release in the striatum. Involuntary movements (catatonic) of the limbs are frequently observed in patients receiving high doses of opioids.

### Gastrointestinal Tract

Significant concentrations of  $\mu$  opioid receptors are present in the gastrointestinal tract. Opioids increase intestinal tone, decrease peristalsis and delay gastric emptying resulting in ileus or constipation. Opioids also cause spasm of the sphincter of Oddi and increase bile duct tone, resulting in increased common bile duct pressure and decreased bile production and flow. Nausea and vomiting is mediated by stimulation of opioid receptors within the chemoreceptor trigger zone in the area postrema of the medulla.

### Respiratory System

Opioids depress both the central (medullary) and peripheral chemoreceptors. The  $\text{CO}_2$  response curve is shifted to the right and the slope decreased, with a shift of the apnoeic threshold. The effect on the medullary chemoreceptor involves inhibition of acetyl choline release. The hypoxic drive is also depressed by opioids. Pain may counteract the depressant effects of opioids.

### Tolerance and Dependence

► **Tolerance** can be defined as a reduction in response to the same dose of drug after repeated administration. The exact mechanism underlying tolerance is not known but several mechanisms appear to be involved. Acute (desensitisation) and chronic tolerance may involve the uncoupling of the receptor from the G-protein-adenyl cyclase cascade. Chronic receptor activation may cause compensatory increase in adenylyl cyclase activity and increased cellular cAMP concentration, which induces cAMP phosphodiesterase and increased cAMP degra-

ation. The stimulatory effects of the opioids may activate phosphokinase C and desensitise the  $\text{K}^+$  channels normally opened by opioids.

► **Dependence** is a state in which an abstinence syndrome may occur following abrupt withdrawal, dose reduction or administration of an antagonist. ► **Addiction** is a behavioural state characterised by compulsive self-administration of a drug, continuously or periodically, in order to experience its psychic effects and sometimes to avoid the discomfort of its absence, often obtaining supply by deceptive or illegal means. Addiction rarely develops in patients receiving opioids for severe pain. The fear of addiction is a common cause of under-prescription and under-use of strong opioid analgesics, and this is unfounded and unnecessary.

### Opioid Hyperexcitability and Rotation

In patients who experience ► **opioid hyperexcitability** (whole body hyperalgesia and allodynia, abdominal muscle spasms and symmetrical jerking of legs), methadone is preferred. The exact mechanism of opioid hyperexcitability is not known, but it has been suggested that metabolites such as morphine-3-glucuronide, normorphine and hydromorphone-3-glucuronide may be involved. When opioid related side effects occur before satisfactory analgesia is achieved, the first opioid is ceased and a new opioid is introduced. This treatment strategy is known as “► **opioid rotation**”, and the change to an alternative drug can yield a better balance between analgesia and side effects.

### Pharmacokinetics of Opioids

The bioavailability of commonly used opioids tends to be poor and variable. The bioavailability of methadone, however, is 80%, but it is not suitable for the use of acute pain because of its prolonged half-life.

The pharmacokinetics of the opioids are summarised in the following table 3.

### Routes of Administration

Oral, sublingual, rectal, parenteral and spinal (epidural and intrathecal) routes of administration of opioids are employed.

For acute pain the parenteral route is usually used, where as the oral route is the norm for cancer patients who can swallow.

### Sublingual Route

Buprenorphine is given sublingually because of considerable increase in bioavailability compared to the oral route (55% vs. 15% after oral administration).

### Rectal Route

Rectal administration of opioids bypasses the portal circulation to a variable extent, according to the amount absorbed into the middle and inferior rectal veins (systemic circulation), compared with the superior rectal vein (por-



Postoperative Pain, Opioids, Table 3 Table 3

Drug	Volume of Distribution L/kg	Clearance ml/min/kg	Elimination Half-life (h)
Morphine	3.5	15	3
Neriperidine	4	12	4
Codeine	2.6	11	3
Oxycodone	2.6	10	3.7
Hydromorphone	4.1	22	3.1
Fentanyl	4.0	13	3.5
Remifentanyl	0.4	40	0.1
Alfentanil	0.8	6	1.6
Methadone	3.8	1.4	35
Buprenorphine	7	70	2.5

tal circulation), resulting in variable rectal bioavailability ranging from 70–120%

#### Transdermal Route

Passive diffusion of highly lipid soluble opioids like fentanyl is possible. Fentanyl is delivered via patches that contain a drug reservoir and a rate controlling membrane. The system is convenient and comfortable but does not permit rapid titration of dose. Therefore, the transdermal route is not suitable for acute pain, but is useful for patients with stable pain who cannot take oral medications.

#### Parenteral Routes

Opioids can be administered parenterally by subcutaneous, intramuscular and intravenous routes, either via continuous infusions or intermittent injections. Traditionally, IM opioids are prescribed 4 hourly PRN, but a reluctance to give opioids more frequently is a major factor for the lack of efficacy of IM regimen. Although the subcutaneous route is often used for opioid administration for cancer pain management, it is also used for acute pain management. Morphine is the opioid commonly used for intermittent SC injection.

Continuous and intermittent intravenous opioid administration is also used in acute pain management. Intermittent intravenous administration of opioids results in large variations in blood concentrations of the drug, and is therefore not an effective way to achieve good analgesia. If sustained analgesia is to be achieved without side effects, smaller doses more often produce less variability in blood concentrations of the drug with better analgesia.

To avoid the peaks and troughs in the blood concentrations of opioids, constant intravenous infusions of opioid are used. However, a loading dose is required. There is considerable delay in matching the amount of opioid delivered to the amount of opioid actually needed. There is a risk that blood levels of the drug or

its active metabolite may continue to rise after analgesia is achieved. As such, ► [patient controlled analgesia \(PCA\)](#) is frequently used. PCA has been associated with better pain relief and greater intermittent opioid injection. Smaller and frequent intravenous bolus doses that are received whenever pain becomes uncomfortable, enables individual titration of analgesia and maintenance of opioid blood concentrations within the analgesic range. This overcomes inter-patient variability in opioid requirements. As acute pain intensity is rarely constant, PCA enables the amount of opioid delivered to be rapidly titrated to effect and against dose-related side effects.

P

#### Spinal Opioids

The epidural and intrathecal routes of administration of opioids allow smaller doses, prolonged duration of action and minimal side effects. The main aim is to achieve selective spinal analgesia. Intrathecal opioids can provide prolonged analgesia. In cardiac surgical patients, analgesia for about 36 hours was achieved with lumbar intrathecal 2–4 mg morphine.

Highly lipid soluble opioids are less effective or potent when administered intrathecally because of the diffusion of the opioid from the subarachnoid space, and their sites of action in the dorsal horn. A method of converting from conventional parenteral routes to intrathecal administration is to use 1% of the former total daily dose. Lower doses should be used if the opioid is combined with a local anaesthetic. Delayed respiratory depression may occur with the non-lipophilic opioids.

#### References

1. Calo G, Guerrini R, Rizzi A et al. (2000) Pharmacology of Nociceptin and its Receptor: A Novel Therapeutic Target. *Br J Pharmacol* 129:1261–1283
2. Dhawan BN, Celsselin F, Raghbir R (1996) International Union of Pharmacology. Classification of opioid receptors. *Pharmacol Rev* 12:567–592

- Shook JE, Kazmierski W, Wire WS et al. (1988) Opioid Receptor Selectivity of  $\beta$ -Endorphin *In Vitro* and *In Vivo*:  $\mu$ ,  $\delta$  and  $\epsilon$  Receptors. *J Pharmacol Exp Ther* 246:1018–1025
- Stein C (1993) Peripheral Mechanisms of Opioid Analgesia. *Anesth Analg* 76:182–191
- Thompson RC, Mansour A, Akil A et al. (1993) Cloning and Pharmacological Characterisation of a Rat  $\mu$ -opioid Receptor. *Neuron* 11:903–911
- Yasuda K, Raynor K, Kong et al. (1993) Cloning and Functional Comparison of Kappa Opioid and Delta Opioid Receptors from Mouse Brain. *Proc Natl Acad Sci USA* 90:6736–6740

## Postoperative Pain, Oxycodone

PETER C. A. KAM

Department of Anaesthesia, St George Hospital,  
University of New South Wales, Kogarah, NSW,  
Australia  
p.kam@unsw.edu.au

### Synonyms

Oxycodone; Endone<sup>®</sup>; Oxynorm<sup>®</sup>; Roxicodone<sup>®</sup>

### Definition

► **Oxycodone** is a semi-synthetic opioid full agonist with  $\mu$  and  $\kappa$  activity.

### Characteristics

► **Oxycodone** (14-hydroxy-7,8-dihydrocodeinone) is a semi-synthetic derivative of the opium alkaloid thebaine. It is a full opioid agonist, acting on OP<sub>3</sub> ( $\mu$ ) and OP<sub>2</sub> ( $\kappa$ ) receptors.

### Pharmacodynamics

The analgesic effect of oxycodone is mediated by the parent compound and not by oxymorphone, a potent minor metabolite (Kaiko 1997). The affinity of oxycodone for the  $\mu$  receptor is 1 : 10 to 1 : 40 that of morphine, and four times that of meperidine (pethidine). Oxycodone also binds the OP<sub>2</sub> or kappa receptor, which contributes to its analgesic, dysphoric and sedative effects (Poyhoa et al. 1993).

### Pharmacokinetics

Oxycodone has an elimination half-life of 2.6–3.2 hours, a volume of distribution at steady state of 2.6 l/kg and plasma protein binding of 38–45%. The plasma clearance of oxycodone is 0.8 l/min. The ► **oral bioavailability** of oxycodone is approximately 60%, which is almost double that of morphine (Leow et al. 1992). Maximal plasma concentrations are achieved at 1–1.5 hours after an oral dose of oxycodone. Oral oxycodone undergoes ► **low first pass metabolism** and is among those opioids possessing a short ► **elimination half-life**. These properties make it possible for oral oxycodone to provide for both a relatively short time to steady state pain control, as well as less variation in bioavailability and drug effects.

### Metabolism

Oxycodone is extensively metabolised in the liver by demethylation to noroxycodone, oxymorphone and then these are conjugated to glucuronides. The major circulating metabolite is noroxycodone, with an AUC ratio of 0.6 relative to that of oxycodone. Noroxycodone is a considerably weaker analgesic than oxycodone. Oxymorphone is present in only low concentrations in the plasma, although it is a potent analgesic. Therefore, the ► **analgesic effect of oxycodone** is mainly mediated by the parent compound. The formation of oxymorphone is mediated by CYP2D6.

### Excretion

► **Oxycodone and its metabolites** are excreted primarily by the kidney. The excretory products of oxycodone in the urine include free oxycodone (19%); conjugated oxycodone (50%); conjugated oxymorphone (14%) and free and conjugated noroxycodone. The plasma concentrations of oxycodone are 15% greater in elderly patients compared with young subjects. Female subjects have higher plasma concentration (~25%) than males.

In patients with impaired renal functions (~ creatinine clearance < 60 ml/min) peak plasma oxycodone and noroxycodone are 50% and 20% higher than in normal subjects, respectively. This is associated with increased sedation. The T<sub>1/2</sub>  $\beta$  oxycodone in patients with renal impairment increases by 1 hour. In patients with mild to moderate hepatic dysfunction, peak plasma oxycodone and noroxycodone concentrations are 50% and 20% higher, respectively, than in normal subjects, and the T<sub>1/2</sub>  $\beta$  of oxycodone is increased by 2–3 hours.

### Oxycontin-Controlled Released Formulation

Although immediately – released oxycodone has a high oral bioavailability and a short elimination half-life, it has to be administered frequently to maintain plasma concentrations within the therapeutic range. This may be convenient in patients with persistent pain conditions.

► **Oxycontin** is a controlled release formulation of oxycodone that provides controlled release/delivery of oxycodone over 12 hours, with an onset of analgesia within 1 hour. Convenient oral dosing of oxycodone every 12 hours to provide sustained analgesia can therefore be achieved.

A ► **dual matrix (Agro Contin System)** that uses 2 different types of retarding polymers is utilised to achieve measured/controlled release of the active drug. Two hydrophobic molecules are used containing an acrylic polymer. Gastrointestinal fluids dissolve the oxycodone tablet surface and expose the hydrophobic-acrylic matrix, releasing initial quantities of oxycodone. The active oxycodone then diffuses through the hydrophobic/acrylic matrix, becoming available for prolonged absorption. This formulation enables a biphasic absorption pattern to be achieved; an initial rapid absorption

with an onset of action of 1 hour, followed by a slow release and absorption phase that assures effective blood concentrations of oxycodone over 12 hours.

### Pharmacokinetics of Oxycontin

Oxycontin has 2 half-lives of absorption consistent with a biphasic absorption pattern. The absorption of oxycodone from oxycontin follows a biexponential process, with a rapid phase of  $T_{1/2}$  absorption = 37 min, and a slow phase of  $T_{1/2}$  absorption component accounting for 38% of the available dose, and the slow phase accounting for 63% of the available dose.

Studies comparing the pharmacokinetic profile of oxycontin with that of immediate release oxycodone show that the bioavailability was comparable for the 2 preparations, and oxycontin yielded about half the  $C_{max}$ , with about twice the time to  $T_{max}$ . Steady state plasma oxycodone concentrations were achieved after 24–36 hours of dosing with q12h oxycontin tablets (Kaiko et al. 1996).

### Clinical Efficacy

Oxycodone has been widely used in many countries to treat moderate to severe postoperative pain (Kalso et al. 1991), as well as for chronic cancer and non-cancer pain by oral, rectal and subcutaneous routes. In a randomised double blind study, Kalso et al. compared the efficacy of IV oxycodone with that of IV morphine in patients after abdominal surgery following opioid free inhalational anaesthesia. Pain relief was achieved faster (28 min vs. 46 min), and lasted longer (39 min vs. 27 min) with oxycodone than morphine. Morphine caused more sedation than oxycodone.

A controlled release formulation of oxycodone in patients undergoing anterior cruciate ligament repair on an ambulatory basis provided significant analgesic benefit, with less side effects compared with fixed dose or as needed oxycodone regimens (Reuben et al. 1999). Kalso and Vainio also demonstrated that both oxycodone and morphine effectively relieved cancer pain with both IV and oral administration in a double-blind cross over trial. A higher bioavailability for oxycodone was demonstrated by the mean daily consumption of the opioids: Oxycodone 150 mg orally; vs. morphine 204 mg orally. Morphine caused more nausea and hallucinations compared with oxycodone. A multicenter randomised double-blind parallel-group study of patients with chronic cancer pain compared the effectiveness and safety of controlled-release oxycodone tablets with immediate-release oxycodone. There were no significant differences in effective analgesia and the incidence of adverse events. The Study showed that controlled release oxycodone administered every 12 hours could provide equally effective analgesia as immediate release oxycodone administered 4 times at the same total daily dose, and in addition, offered the benefit of twice daily dosing (Parris et al. 1998).

Dose titration can be accomplished as readily with oral controlled release oxycodone as with immediate release oxycodone, in patients with chronic malignant or non-malignant pain of moderate to severe intensity (Saltzman et al. 1999).

Systematic reviews indicate that the  $\blacktriangleright$  NNT of oxycodone 15 mg is 2.3. The effect of oxycodone in the treatment of postherpetic neuralgia has been evaluated in a long term trial. Oxycodone relieved steady pain, brief pain and allodynia.

The NNT of oxycodone for postherpetic neuralgia was 2.5 (Watson and Babul 1998).

### Adverse Effects

The adverse effects of oxycodone are typical of opioid agonists. The most common adverse drug reactions during oxycodone therapy are constipation, nausea, dizziness, headache, dry mouth, confusion, sweating and drowsiness.

### References

1. Kaiko RF (1997) Pharmacokinetics and Pharmacodynamics of Controlled Release Opioids. *Acta Anaesthesiol Scand* 41:166–174
2. Kaiko RF, Benziger DP, Fitzmartin RD et al. (1996) Pharmacodynamic-Pharmacokinetic Relationships of Controlled Release Oxycodone. *Clin Pharmacol Ther* 59:52–61
3. Kalso E, Poyhia R, Annala P et al. (1991) Intravenous Morphine and Oxycodone for Pain after Abdominal Surgery. *Acta Anesth Scand* 35:642–646
4. Leow KP, Smith MT, Williams B et al. (1992) Single Dose and Steady State of Oxycodone in Patients with Cancer. *Clin Pharmacol Ther* 52:487–495
5. Parris WCV, Johnson BW, Croghan MK et al. (1998) The Use of Controlled – Release Oxycodone for the Treatment of Chronic Cancer Pain: A Randomised, Double Blind Study. *J Pain Symptom Manage* 16:205–211
6. Poyhoa R, Vainio A, Kalso E (1993) A Review of Oxycodone's Clinical Pharmacokinetics and Pharmacodynamics. *J Pain Symptom Manage* 8:63–67
7. Reuben SS, Connelly NR, Maciolek H (1999) Post Operative Analgesia with Controlled Release Oxycodone for Outpatient Anterior Cruciate Ligament Surgery. *Anesth Analg* 88:1286–1291
8. Saltzman RT, Roberts MS, Wild J et al. (1999) Can a Controlled Release Oral Dose Form of Oxycodone be Used as Readily as an Immediate Release Form for the Purpose of Titrating to Stable Pain Control? *J Pain Manage* 18:271–279
9. Watson CPN, Babul N (1998) Efficacy of Oxycodone in Neuropathic Pain: A Randomised Trial in Postherpetic Neuralgia. *Neurology* 50:1837–1841

P

## Postoperative Pain, Paracetamol

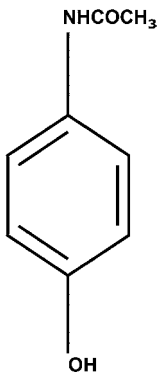
IAN POWER<sup>1</sup>, LESLEY A. COLVIN<sup>2</sup>

<sup>1</sup>Anaesthesia Critical Care and Pain Medicine, University of Edinburgh, Edinburgh, UK

<sup>2</sup>Department of Anaesthesia, Critical Care and Pain Medicine, Western General Hospital, Edinburgh, UK  
ian.power@ed.ac.uk, lesley.colvin@ed.ac.uk

### Synonyms

Acetaminophen; Paracetamol in Postoperative Pain



Postoperative Pain, Paracetamol, Figure 1 Paracetamol.

### Definition

Paracetamol is the remaining para-aminophenol used in clinical practice for analgesia, being the active metabolite of the earlier, more toxic, drugs acetanilide and phenacetin. Paracetamol can be given orally, rectally or parentally, has little anti-inflammatory activity and is an effective analgesic and antipyretic.

### Characteristics

#### General

Paracetamol is absorbed rapidly from the small intestine after oral administration, can be given rectally and parenteral preparations have recently been introduced into clinical practice (Bannwarth and Pehourcq 2003). Paracetamol has lower protein binding (hence less potential drug interactions) than NSAIDs and a higher volume of distribution than NSAIDs. The recommended paracetamol dose in adults is 0.5–1 g oral or rectal, every 3–6 h when necessary; maximum of 6 g a day in divided doses for acute use and 4 g a day for chronic use.

#### Mechanism of Action

The mechanism of action of paracetamol is not well understood, but it may act by inhibiting prostaglandin synthesis in the central nervous system, with little peripheral nervous system effect. Unlike morphine, paracetamol has no known endogenous binding sites and unlike the NSAIDs apparently does not inhibit peripheral cyclo-oxygenase activity. There is growing evidence of a central antinociceptive effect of paracetamol. Possible mechanisms include central COX-2 inhibition, the existence of a cyclo-oxygenase, COX-3, that is selectively susceptible to paracetamol and modulation of descending serotonergic pathways that suppress spinal cord nociceptive transmission (Bonfont et al. 2003; Botting 2003; Warner and Mitchell 2002). Paracetamol has also been shown to prevent prostaglandin production at the cellular transcriptional level, independent of cyclo-oxygenase activity (Mancini et al. 2003). A new potent nitric oxide releasing version of paracetamol (Moore and Marshall

2003) (nitroxyparacetamol, or nitroacetaminophen) has anti-inflammatory and analgesic properties, with a described mechanism of action in the spinal cord, which may differ from that of paracetamol (Moore and Marshall 2003; Romero-Sandoval et al. 2003).

### Efficacy

The efficacy of single dose paracetamol as a postoperative analgesic has been examined and confirmed by many studies. Using the concept of number needed to treat (NNT), obtained from meta-analyses of well designed studies of postoperative analgesia, McQuay and Moore from Oxford University have enabled comparison of the efficacy of paracetamol with other types of analgesics for acute pain relief after surgery ([www.jr2.ox.ac.uk/bandolier/booth/painpag/](http://www.jr2.ox.ac.uk/bandolier/booth/painpag/)). From such work, the NNT of paracetamol is 3.8 (3.4–4.4) (Barden 2004). For comparison, the NNT of morphine 10 mg intramuscularly is 2.9, ibuprofen 400 mg 2.4 and codeine 60 mg 16.7. The combination of paracetamol 1000 mg plus codeine 60 mg has a NNT of 2.2. Paracetamol is therefore an effective postoperative analgesic, with a potency slightly less than that of a standard dose of morphine or of the nonsteroidal anti-inflammatory drugs (Barden 2004).

Paracetamol is an effective adjunct to opioid analgesia, requirements for the latter typically being reduced by 20–30% when combined with a regular regime of oral or rectal paracetamol (Romsing et al. 2002). One study has demonstrated that the use of oral paracetamol in addition to PCA morphine lowered pain scores, shortened the duration of PCA use and improved patient satisfaction (Schug et al. 1998). However, recent work has questioned whether the usual dose of rectal paracetamol, 1 g six hourly, is too low for maximal opioid sparing benefit as this produces a sub-optimal plasma paracetamol concentration (Kvalsvik et al. 2003). The addition of an NSAID to paracetamol also improves efficacy (Hyllested et al. 2002; Romsing et al. 2002). Paracetamol can be recommended an integral component of multimodal analgesia in combination with NSAIDs and opioids.

Intravenous paracetamol is an effective analgesic after surgery (Hernandez-Palazon et al. 2001), is as effective as morphine and better tolerated after dental surgery (Van Aken et al. 2004), although there is some evidence of a ceiling effect (Hahn et al. 2003).

### Safety

In general, ► **acetaminophen** has fewer side effects than the NSAIDs, and can be used when the latter are contraindicated (e.g. asthma, peptic ulcers).

### Hepatic

A small amount of ingested paracetamol undergoes cytochrome P450 –mediated hydroxylation producing a reactive toxic metabolite that is normally rendered harm-



less by conjugation with liver glutathione and renal excretion as mercapturic derivatives. With larger doses, the rate of formation of the reactive metabolite exceeds that of glutathione conjugation and the reactive metabolite combines with hepatocellular macromolecules, resulting in cell death. The clinical picture is of centrilobular hepatocellular necrosis, occasionally with acute renal tubular necrosis. Doses of more than 150 mg/kg taken within 24 h may result in severe liver damage, hypoglycaemia and acute tubular necrosis. Individuals taking enzyme-inducing agents are more likely to develop hepatotoxicity. Early signs include nausea and vomiting, followed by right subcostal pain and tenderness the next day. Hepatic damage is maximal 3 to 4 days after ingestion and may lead to death. Treatment consists of gastric emptying and the specific antidotes methionine and acetylcysteine, which offer effective protection up to 10–12 h after ingestion. Acetylcysteine is effective to 24 h and perhaps beyond. The plasma paracetamol concentration related to time from ingestion indicates the risk of liver damage (acetylcysteine is given if the plasma paracetamol concentration is greater than 200 mg/litre at 4 h and 6.25 mg/litre at 24 h after ingestion). The molecular mechanisms of paracetamol hepatotoxicity are being researched actively, in the hope that advances will make it possible to prevent liver failure (Prescott 2003).

Care is required to avoid inadvertent overdoses in children where the dose changes with age (e.g. 6–12 years 250–500 mg 6-hourly) and when combination preparations containing paracetamol are given in error together with the parent drug to excess. There is encouraging evidence that nitroxyparacetamol may have less hepatic toxicity than paracetamol (Futter et al. 2001).

### Conclusion

Paracetamol is an effective postoperative analgesic that should be used as a fundamental component of multimodal analgesia (NHMRC 1999). In normal doses paracetamol is safe, but with overdose, liver toxicity may be severe. In the perioperative period when oral intake is not possible, the introduction of parenteral preparations may expedite the use of paracetamol.

### References

- Bannwarth B, Pehourcq F (2003) Pharmacological rationale for the clinical use of paracetamol: Pharmacokinetic and pharmacodynamic issues. *Drugs* 63:5–13
- Barden JEJ, Moore A, McQuay H (2004) Single dose oral paracetamol (acetaminophen) for postoperative pain (Cochrane Review). *The Cochrane Library*. John Wiley & Sons, Chichester
- Bonnefont J, Courade JP, Allouie A et al. (2003) Mechanism of the antinociceptive effect of paracetamol. *Drugs* 63:1–4
- Botting R (2003) COX-1 and COX-3 inhibitors. *Thromb Res* 110:269–272
- Futter LE, al-Swayeh OA, Moore PK (2001) A comparison of the effect of nitroparacetamol and paracetamol on liver injury. *Br J Pharmacol* 132:10–12
- Hahn TW, Mogensen T, Lund C et al. (2003) Analgesic effect of i.v. paracetamol: possible ceiling effect of paracetamol in postoperative pain. *Acta Anaesthesiol Scand* 47:138–145
- Hernandez-Palazon J, Tortosa JA, Martinez-Lage JF et al. (2001) Intravenous administration of propacetamol reduces morphine consumption after spinal fusion surgery. *Anesth Analg* 92:1473–1476
- Hyllested M, Jones S, Pedersen JL et al. (2002) Comparative effect of paracetamol, NSAIDs or their combination in postoperative pain management: a qualitative review. *Br J Anaesth* 88:199–214
- Kvalsvik O, Borchgrevink PC, Hagen L et al. (2003) Randomized, double-blind, placebo-controlled study of the effect of rectal paracetamol on morphine consumption after abdominal hysterectomy. *Acta Anaesthesiol Scand* 47:451–456
- Mancini F, Landolfi C, Muzio M et al. (2003) Acetaminophen down-regulates interleukin-1 beta-induced nuclear factor-kappa B nuclear translocation in a human astrocytic cell line. *Neurosci Lett* 353:79–82
- Moore PK, Marshall M (2003) Nitric oxide releasing acetaminophen (nitroacetaminophen). *Dig Liver Dis* 35:49–60
- NHMRC (1999) Acute pain management: scientific evidence. National Health and Medical Research Council, Canberra, Australia
- Prescott LF (2003) Future perspectives with paracetamol. *Drugs* 63:51–56
- Romero-Sandoval EA, Del Soldato P, Herrero JF (2003) The effects of sham and full spinalization on the antinociceptive effects of NCX-701 (nitroparacetamol) in monoarthritic rats. *Neuropharmacology* 45:412–419
- Romsing J, Moiniche S, Dahl JB (2002) Rectal and parenteral paracetamol, and paracetamol in combination with NSAIDs, for postoperative analgesia. *Br J Anaesth* 88:215–226
- Schug SA, Sidebotham DA, McGuinety M et al. (1998) Acetaminophen as an adjunct to morphine by patient-controlled analgesia in the management of acute postoperative pain. *Anesth Analg* 87:368–372
- Van Aken H, Thys L, Veekman L et al. (2004) Assessing analgesia in single and repeated administrations of propacetamol for postoperative pain: Comparison with morphine after dental surgery. *Anesth Analg* 98:159–165
- Warner TD, Mitchell JA (2002) Cyclooxygenase-3 (COX-3): Filling in the gaps toward a COX continuum? *Proc Natl Acad Sci USA* 99:13371–13373

P

## Postoperative Pain, Pathophysiological Changes in Cardiovascular Function in Response to Acute Pain

Z. KARIM, STEPHAN A. SCHUG  
Royal Perth Hospital and University of Western  
Australia, Crawley, WA, Australia  
schug@cyllene.uwa.edu.au

### Synonyms

Cardiac Stress Response; Reactive Tachycardia

### Definition

Cardiovascular responses are part of the manifestations of the acute stress response exhibited by an organism in response to injury, surgery and acute pain; acute pain is typically associated with a neuroendocrine stress response that is proportional to the pain intensity. The sympathetic activation increases efferent sympathetic

tone to all viscera and releases catecholamines from the adrenal medulla. This hormonal response results from increased sympathetic tone and hypothalamically mediated reflexes (Aantaa and Scheinin 1993).

The major catecholamines involved are epinephrine and norepinephrine (Desborough 2000). The primary precursor for both of these hormones is tyrosine, which is available from both the diet and from the synthesis of phenylalanine (Desborough 2000). Epinephrine is the methylated product of norepinephrine (Aantaa and Scheinin 1993).

### Characteristics

The cardiovascular effects of the acute trauma and pain process are often very prominent and include hypertension, tachycardia, enhanced myocardial irritability, and increased systemic vascular resistance (Desborough 2000).

Cardiac output increases in most people, but in people with compromised left ventricular function, the cardiac output may decrease. The increase in cardiac output will result in an increase in myocardial oxygen demand, precipitating myocardial ischaemia in those with coronary artery disease.

Sympathetic fibres are widely distributed throughout the heart. The cardiac sympathetic fibres originate in the thoracic spinal cord (T1–T4) and travel to the heart, initially through the cervical ganglia (stellate), then as cardiac nerves (Aantaa and Scheinin 1993).

Norepinephrine release causes positive chronotropic, dromotropic, and inotropic effects, primarily through activation of the beta-1 adrenergic receptors. Beta-2 adrenergic receptors are fewer in number and are mainly found in the atria; activation increases the heart rate and, to a lesser extent, contractility. Alpha-1 adrenergic receptors have a positive inotropic effect (Millar 2000). Parasympathetic fibres primarily innervate the atria and conducting tissues. Acetylcholine acts on specific cardiac muscarinic receptors (M2) to produce negative chronotropic, dromotropic, and inotropic effects (Morgan et al. 2002).

Cardiac autonomic innervation has an apparent sidedness, as the right sympathetic and right vagus nerves primarily affect the sino-atrial node, while the left sympathetic and vagus principally affect the atria-ventricular node. Vagal effects frequently have a rapid onset and resolution, while sympathetic influences generally have a gradual onset and dissipation.

### Effects on Heart Rate

Cardiac output is generally proportional to heart rate. Heart rate is an intrinsic function of the sinoatrial node, but is modified by autonomic, humoral, and local factors. Enhanced vagal activity slows the heart rate via stimulation of M2 cholinergic receptors, while enhanced sympathetic activity increases the heart rate, mainly by activation of beta-1 adrenergic receptors and, to a lesser

extent, beta-2 adrenergic receptors. The beta-1 adrenergic receptor responds to the circulating catecholamine release as part of the stress response.

Direct stimulation of beta-1 receptors by epinephrine raises the cardiac output and oxygen demand by increasing the contractility and heart rate, (increased rate of spontaneous phase 4 depolarisation), and systolic blood pressure, although beta-2 mediated vasodilatation in skeletal muscle may lower diastolic blood pressure.

### Effects on Stroke Volume

Three major factors, preload, afterload, and contractility normally determine stroke volume.

Preload is the muscle fibre length prior to contraction, while afterload is the resistance against which the ventricle must contract. Contractility is an intrinsic property of the cardiac muscle that is related to the force of contraction, but is independent of both the preload and afterload (Morgan et al. 2002). Heterometric autoregulation results in an increase in stretch of a muscle myocyte, thereby producing an increase in the tension developed, and hence influencing the ventricular function (Millar 2000). This is part of Starling's Law of the Heart (Millar 2000).

Experimentally, maximally developed tension in cardiac myocytes occurs at a resting sarcomere length of 2.0 to 2.3 micrometers, which allows optimum cross-bridge formation between the contractile proteins that make up the thick and thin filaments (Millar 2000). Clinically, this translates to peak ventricular output occurring at filling pressures of 10 to 12 millimetres Hg.

Beta receptor occupancy predominantly activates adenylyl cyclase within the cardiac myocytes, to increase the conversion of adenosine triphosphate to cyclic adenosine monophosphate (cAMP). The cAMP facilitates the intracellular shift of calcium which increases inositol phosphate (IP3 and IP4). This in turn has positive chronotropic (increased heart rate), dromotropic (increased conduction) and inotropic (increased contractility) effects.

### Effects on Systemic Vascular Resistance

Arteriolar tone is the principal determination of the systemic vascular resistance. Although both the sympathetic and parasympathetic systems can exert important influences on the circulation, autonomic control of the vasculature is primarily sympathetic. Sympathetic outflow to the circulation passes out of the spinal cord at all thoracic and the first two lumbar segments (Ganong 2001). These fibres reach the blood vessels via specific autonomic nerves, or by travelling along the spinal nerves. Sympathetic fibres innervate all parts of the vasculature except for the capillaries. Their principal function is to regulate the vascular tone. Variation of arterial vascular tone serves to regulate the blood pressure and the distribution of blood flow to the various

organs, while variations in venous tone alter venous return to the heart.

The vasculature has sympathetic vasoconstrictors and vasodilator fibres, but the former are more important physiologically in most tissue beds. Sympathetically induced vasoconstriction (via alpha-1 adrenergic receptors) can be potent in skeletal muscles, kidneys, gut, and skin; it is the least active in the brain and heart (Ganong 2001).

The vasomotor centre in the reticular formation of the medulla and the lower pons controls vascular tone and autonomic influences on the heart. Distinct vasoconstrictor and vasodilator centres have been identified. The anterolateral column mediates vasoconstriction. The vasomotor centre is also responsible for the adrenal secretion of the catecholamines, as well as the enhancement of cardiac automaticity and contractility. Vasodilatory centres, which are located in the lower medulla, are also adrenergic, but function by projecting inhibitory fibres upwards to the vasoconstrictor areas (Ganong 2001).

Overall, the effects of stress due to injury, surgery and acute pain on cardiovascular function are potentially harmful, in particular to patients at high risk such as those with coronary heart disease. Providing a blockade to this stress response and acute pain stimuli has the potential to reduce postoperative cardiovascular complications.

## References

1. Aantaa R, Scheinin M (1993) Alpha-Adrenergic Agents in Anaesthesia. *Acta Anaesthesiol Scand* 37:1–16
2. Desborough JP (2000) The Stress Response to Trauma and Surgery. *Br J Anaesth* 85:109–117
3. Ganong WF (2001) *Review of Medical Physiology*. 20<sup>th</sup> edn. McGraw Hill, New York
4. Millar RD (2000) *Anaesthesia*. 5<sup>th</sup> edn. Churchill Livingstone, Edinburgh
5. Morgan GE, Mikhail MS, Murray MJ, Larson CP (2002) *Clinical Anesthesiology* 3<sup>rd</sup> edn. McGraw Hill, New York

## Postoperative Pain, Pathophysiological Changes in Metabolism in Response to Acute Pain

Z. KARIM, STEPHAN A. SCHUG  
Royal Perth Hospital and University of Western  
Australia, Crawley, Perth, WA, Australia  
schug@cyllene.uwa.edu.au

### Synonyms

Stress Metabolism; Catabolism, Destructive Metabolism

### Definition

Acute pain, trauma and surgery are typically associated with a neuroendocrine stress response that is propor-

tional to the severity of the injury and the pain intensity. Sympathetic activation increases efferent sympathetic tone to all viscera and releases catecholamines from the adrenal medulla.

The hormonal response results from increased sympathetic tone and hypothalamically mediated reflexes (Desborough 2000), increases in catabolic hormones (catecholamines, cortisol, and glucagon) and a decrease in anabolic hormones (insulin and testosterone). The net effect is a negative nitrogen balance, carbohydrate intolerance and increased lipolysis. The increase in cortisol, renin, aldosterone, angiotensin, and antidiuretic hormone results in sodium retention, water retention, and a secondary expansion of the extracellular space (UKPD Group 1998).

## Characteristics

### Carbohydrate Metabolism

Blood glucose concentration increases as part of the response to stress and pain stimulus. Cortisol and catecholamines facilitate glucose production as a result of increased hepatic glycogenolysis and gluconeogenesis (Bent et al. 1978). In addition, insulin resistance develops with a reduction in the peripheral utilisation of glucose (Bent et al. 1978).

Therefore, processes of normal glucose maintenance and homeostasis are ineffective in the perioperative period. Hyperglycaemia persists because catabolic hormones promote glucose production and there is a relative lack of insulin, together with a peripheral insulin resistance (Cuthbertson 1932).

### Protein Metabolism

Protein catabolism is stimulated by an increased cortisol concentration (Desborough and Hall 1993). Muscle proteins, as well as visceral proteins, are catabolised to release constituent amino acids. These amino acids are either catabolised for energy or utilised in the liver to form new proteins, in particular so called 'acute phase' proteins (Colley et al. 1983). Constituent amino acids are also metabolised by the liver to other substrates such as glucose, fatty acids and ketone bodies (Bent et al. 1978). Urinary nitrogen can be measured as an indirect measure of protein catabolism.

This catabolism results in marked weight loss and, even more relevant, muscle wasting in patients after major surgery and burns, thus impairing rehabilitation.

### Fat Metabolism

Lipolysis converts the triglycerides in the fat stores of the body into glycerol and fatty acids. This process is stimulated by catecholamines, growth hormone and cortisol; insulin on the other hand inhibits this process. The free fatty acids are utilised for the process of gluconeogenesis in the liver (Bent et al. 1978).

### Water and Electrolyte Balance

Preservation of adequate body fluid volume is also influenced by the numerous hormonal changes. Arginine vasopressin, released by the posterior pituitary gland, results in water retention and this, as a consequence, results in the production of both concentrated urine and a relative oliguria (Desborough and Hall 1993).

The sympathetic stimulation also increases the production of renin from the cell of the juxtaglomerular apparatus, which in turn stimulates the production of angiotensin 2 (Desborough 2000). Angiotensin 2 promotes the release of aldosterone leading to reabsorption of sodium and water, further promoting the retention of water.

Overall, the catabolic changes of the metabolism and the disturbance of the water and electrolyte balance impair postoperative recovery and cause postoperative complications. Provision of multimodal analgesia and a multidisciplinary rehabilitative approach to the postoperative period aim to reduce these detrimental changes (Kehlet 1997).

### References

1. Bent JM, Paterson JL, Mashiter K et al. (1978) Effects of high Dose Fentanyl Anaesthesia on the Established Metabolic and Endocrine Response to Surgery. *Anaesthesia* 39:19–23
2. Colley CM, Fleck A, Goode AW et al. (1983) Early Time Course of the Acute Phase Protein Response in Man. *J Clin Pathol* 36:203–207
3. Cuthbertson DP (1932) Observation on the Disturbance of Metabolism Produced by Injury to the Limb. *Q J Med* 1:233–246
4. Desborough JP (2000) The Stress Response to Trauma and Surgery. *Br J Anaesth* 85:109–117
5. Desborough JP, Hall GM (1993) Endocrine Responses to Surgery. In: Kaufman L (ed) *Anaesthesia Review*, vol 10, Churchill Livingstone, Edinburgh, pp 131–148
6. Ganong WF (2001) *Textbook of Medical Physiology*, 20<sup>th</sup> edn. McGraw Hill, New York
7. Kehlet H (1997) Multimodal Approach to Control Postoperative Pathophysiology and Rehabilitation. *Br J of Anaesth* 78:606–617
8. UKPD Group (1998) Effect of Intensive Glucose Control with Sulphonylureas or Insulin Compared with Conventional Treatment and Risk of Complication in Patients with Type 2 Diabetes Mellitus. *Lancet* 352:837–853

## Postoperative Pain, Pathophysiological Changes in Neuro-Endocrine Function in Response to Acute Pain

Z. KARIM, STEPHAN A. SCHUG  
Royal Perth Hospital and University of Western  
Australia, Perth, WA, Australia  
schug@cyllene.uwa.edu.au

### Synonyms

Stress response; General Adaptation Syndrome; hypothalamic-pituitary-adrenal axis response

### Definition

The neuro-endocrine response is part of the stress response that is mediated as a reaction to acute pain. The response is mediated via the afferents from the site of primary noxious stimulation, and relies primarily on the hypothalamic-pituitary-adrenal axis. This response has a role in the preservation of an organism in the face of an acute injury.

### Characteristics

Acute pain is characterised by the increased secretion of pituitary hormones and the activation of the sympathetic nervous system (Desborough 2000). Hypothalamic activation of the autonomic nervous system results in increased secretion of catecholamines, epinephrine and norepinephrine from the adrenal medulla.

This increased sympathetic activity also results in the cardiovascular effects of tachycardia and hypertension (Desborough 2000).

The following relevant changes in hormone secretion occur in response to acute pain and surgery (Desborough 2000; Millar 2000; Ganong 2001; Desborough and Hall 1989). The hypothalamus releases stimulating factors, which in turn stimulate the anterior pituitary gland to synthesize the corticotrophins. Therefore, the release of adrenocorticotrophic hormone (ACTH), thyroid stimulating hormone (TSH), growth hormone and prolactin increases. Arginine vasopressin (AVP) is the major hormone produced by the posterior pituitary gland; it is a major antidiuretic hormone that influences water balance in the kidneys.

ACTH then stimulates the adrenal cortex to produce increased levels of glucocorticoids, resulting in increased levels of cortisol. Cortisol has a role in carbohydrate metabolism and promotes protein breakdown.

Growth hormone has a major role in growth regulation, and has some of its action mediated through the insulin like growth factors. Growth hormone also promotes protein breakdown, promotes lipolysis, and has an anti-insulin like effect. Plasma levels of growth hormone also influence glycogenolysis.

The pancreas often decreases insulin production, while increased amounts of glucagon are released. Insulin is the major anabolic hormone. It is a polypeptide, with two chains linked by two disulphide bridges. Insulin is synthesised and secreted by the beta cells of the pancreas. Insulin in normal situations is secreted after food intake, when the blood glucose and amino acid concentration increases. Insulin, as part of its action, promotes the uptake of glucose into muscles and adipose tissues, and facilitates the conversion of glucose into glycogen and triglycerides. Insulin also stimulates the formation of glycogen from glucose in the liver and inhibits protein catabolism and lipolysis.

Acute pain and surgery causes a reduction in the production of insulin, which in turn results in the failure of



the secretion to match the catabolic and hyperglycaemic response. The normal insulin responsive cells also fail to respond appropriately to the reduced levels of insulin, resulting in the “insulin resistance” that occurs in the perioperative period.

Glucagon production in the alpha cells of the pancreas increase and this promotes hepatic glycogenolysis. Hepatic gluconeogenesis also increases, but this response is not a major contributor to the hyperglycaemic state seen in the perioperative period.

TSH, released from the anterior pituitary, stimulates the thyroid gland to synthesize and release thyroxine (T4) and triiodothyronine (T3) into the circulation. Triiodothyronine is three to five times more metabolically active than thyroxine

These hormones are bound extensively to their binding proteins, albumin, thyroxine binding prealbumin and thyroid binding globulin. The free thyroid hormones in the plasma are metabolically active, and the very low concentration of the free T3 and T4 that are present in the circulation are in equilibrium with the bound hormones in the plasma and tissues. Thyroid hormones increase the oxygen consumption of most of the metabolically active tissues of the body. The brain tissues and the spleen cells are not under the influence of the thyroid hormones. The metabolic rate and heat production are also increased as a direct influence of the thyroid hormones. The other actions of the thyroid hormones include an increase in carbohydrate absorption from the gut, stimulation of the central and peripheral nervous system and its influence on growth and development.

Like the thyroid hormones, the catecholamines also increase the metabolic rate and stimulate the nervous system. The thyroid hormones increase the number and affinity of the beta-adrenoreceptors in the heart, and also increase the sensitivity of the heart to the actions of the catecholamines.

Last, but not least, beta endorphin and prolactin levels are also increased during acute pain and surgery. Beta-endorphin is an endogenous opioid peptide and has a role in the perception of pain.

Follicle stimulating hormone (FSH) and luteinizing hormone (LH) do not change markedly during surgery and acute pain. The gonadotrophin secretion and release may be reduced in situations of acute pain, but their significance in this situation remains undetermined.

## References

1. Desborough JP (2000) The Stress Response to Trauma and Surgery. *BJA* 85:109–117
2. Desborough JP, Hall GM (1989) Modification of the Hormonal and Metabolic Response to Surgery by Narcotics and General Anaesthesia; *Clinical Anaesthesiology* 3:317–334
3. Ganong WF (2001) Review of Medical Physiology. 20<sup>th</sup> edn. McGraw Hill, New York
4. Millar RD (2000) Textbook of Anaesthesia. 5<sup>th</sup> edn. Churchill Livingstone, Edinburgh

## Postoperative Pain, Patient Controlled Analgesia Devices, Epidural

PER FLISBERG, STEPHAN A. SCHUG  
Royal Perth Hospital and University of Western  
Australia, Perth, WA, Australia  
schug@cyllene.uwa.edu.au

### Synonyms

Patient controlled epidural analgesia; PCEA; On-Demand Epidural Analgesia

### Definition

► **Patient controlled epidural analgesia** (PCEA) is an analgesic technique which transfers the concept of classical PCA (parenteral) to the provision of epidural analgesia. It allows the individual patient to adjust the epidural block height and density by self-administering the analgesic medications via a pump into the epidural space. The pump is usually an electronic or mechanical, reusable or disposable device, delivering a metered dose of drug in response to the patient trigger. The device can be programmed in a variety of ways to provide only on-demand doses or to also administer a continuous background infusion. Pumps need a mechanism that ensures that the selected dose cannot be given too frequently; thus a lock-out time interval can be programmed.

### Characteristics

Epidural analgesia in general offers improved analgesia compared to intramuscular analgesia and intravenous patient controlled analgesia (Dolin et al. 2002). Since epidural analgesia is not a single entity, there are difficulties when interpreting the available data on the efficacy of PCEA. PCEA can be provided with a variety of medications, each on its own and in combination. The catheter can be inserted at different levels of the epidural space and the technique can be provided for a large variety of different operations.

The introduction of PCEA technique has individualised and improved the patients' epidural analgesia, by giving patients control over their own quality of analgesia. Studies have shown that patient controlled epidural analgesia leads to reductions in pain intensity, less consumption of drugs, and superior patient satisfaction (Lubenow et al. 1994; Liu et al. 1998; Silvasti and Pitkanen 2001).

### The Issue of Background Infusions

The best regimen for PCEA after major surgery has not yet been fully clarified; however, data support the use of an additional background infusion, in contrast to parenteral PCA.

The addition of a background infusion when using a local anaesthetic-opioid combination epidurally was found

to be superior compared to PCEA alone in patients undergoing gastrectomy (Komatsu et al. 1998). The same investigators have also shown that a night-time infusion added to PCEA following gastrectomy decreases the incidence of postoperative pain associated with coughing during the night, and improves sleep compared with PCEA alone (Komatsu et al. 2001). In addition, a large prospective study in patients undergoing major abdominal surgery, found that PCEA combined with background infusion was superior regarding dynamic postoperative pain scores compared with intravenous PCA (Flisberg et al. 2003).

#### PCEA for Labour Pain

In labour analgesia, the PCEA concept became a widely accepted technique early on. PCEA in labour analgesia offers several advantages over conventional techniques of pain relief including reduced drug consumption, improved analgesia, and thereby superior patient satisfaction, and has been proven to be safe (Ferrante et al. 1994; Gambling et al. 1988; Paech 1991). In a recent study it was shown that even ultra-low doses of an opioid combined with a local anaesthetic administered via PCEA reduced the dose required, compared with continuous epidural infusion (Ledin et al. 2003).

A meta-analysis compared PCEA with continuous infusion in labour analgesia; it confirmed that patients having PCEA are less likely to require analgesic interventions, and have less disturbance of motor function than those receiving continuous epidural infusion (Van der Vyver et al. 2002).

#### Economic Aspects of PCEA

No randomised-controlled trial has so far been published comparing the cost of PCEA versus intravenous PCA. Recently, a retrospective study examined the costs involved with the use of postoperative PCEA. It concluded that the treatment length was the main cost driver, both for drugs and for staff costs (Schuster et al. 2004). A comparison of the cost effectiveness of PCEA versus intrathecal morphine has also been performed (Vercauteren et al. 2002); it found that PCEA resulted in better pain relief and caused less nausea and vomiting, but was more expensive to provide than intrathecal morphine.

#### Safety Aspects of PCEA

In order to achieve effective and safe analgesia with PCEA, the patient needs some introductory education about the technique and has to understand the basic principle. This has become evident in a study where several patients had difficulties in operating the PCEA device (Silvasti and Pitkanen 2001). However, if used correctly, PCEA results in improved mental status in elderly patients (Mann et al. 2000), compared with parenteral PCA.

A number of large surveys have shown that PCEA can be provided safely on general hospital wards, as long as certain safety requirements are maintained and supervision by an anaesthesia-based pain service is offered (Filsber et al. 2003; Liu 1998).

#### References

1. Dolin SJ, Cashman JN, Bland JM (2002) Effectiveness of Acute Postoperative Pain Management: I Evidence from published data. *Br J Anaesthesia* 89:409–423
2. Ferrante FM, Rosinia FA, Gordon C et al. (1994) The Role of Continuous Background Infusions in Patient-Controlled Epidural Analgesia for Labor and Delivery. *Anesth Analg* 79:80–84
3. Flisberg P, Rudin A, Linner R et al. (2003) Pain Relief and Safety after Major Surgery. A Prospective Study of Epidural and Intravenous Analgesia in 2696 Patients. *Acta Anaesthesiol Scand* 47:457–465
4. Gambling DR, Yu P, Cole C et al. (1988) A Comparative Study of Patient Controlled Epidural Analgesia (PCEA) and Continuous Infusion Epidural Analgesia (CIEA) during Labour. *Can J Anaesth* 35:249–254
5. Komatsu H, Matsumoto S, Mitsuhashi H et al. (1998) Comparison of Patient-Controlled Epidural Analgesia with and without Background Infusion after Gastrectomy. *Anesth Analg* 87:907–910
6. Komatsu H, Matsumoto S, Mitsuhashi H (2001) Comparison of Patient-Controlled Epidural Analgesia with and without Night-Time Infusion following Gastrectomy. *Br J Anaesthesia* 87:633–635
7. Ledin Eriksson S, Gentile C, Olofsson CH (2003) PCEA Compared to Continuous Epidural Infusion in an Ultra-Low-Dose Regimen for Labor Pain Relief: A Randomized Study. *Acta Anaesthesiol Scand* 47:1085–1090
8. Liu SS, Allen HW, Olsson GL (1998) Patient-Controlled Epidural Analgesia with Bupivacaine and Fentanyl on Hospital Wards: Prospective Experience with 1,030 Surgical Patients. *Anesthesiology* 92:433–441
9. Lubenow TR, Tanck EN, Hopkins EM et al. (1994) Comparison of Patient-Assisted Epidural Analgesia with Continuous-infusion Epidural Analgesia for Postoperative Patients. *Reg Anesth* 19:206–221
10. Mann C, Pouzeratte Y, Boccara G et al. (2000) Comparison of Intravenous or Epidural Patient-Controlled Analgesia in Elderly after Major Abdominal Surgery. *Anesthesiology* 92:433–441
11. Paech MJ (1991) Epidural Analgesia in Labour: Constant Infusion Plus Patient – Controlled Boluses. *Anaesth Intens Care* 19:32–39
12. Schuster M, Gottschalk A, Freitag M et al. (2004) Cost Drivers in Patient-Controlled Epidural Analgesia for Postoperative Pain Management after Major Surgery. *Anesth Analg* 98:708–713
13. Silvasti M, Pitkanen M (2001) Patient-Controlled Epidural Analgesia versus Continuous Epidural Analgesia after Total Knee Arthroplasty. *Acta Anaesthesiol Scand* 45:472–476
14. Van der Vyver M, Halpern S, Joseph G (2002) Patient-Controlled Epidural Analgesia versus Continuous Infusion for Labour Analgesia: A Meta-Analysis. *Br J Anaesth* 89:459–645
15. Vercauteren M, Vereecken K, Malfá M et al. (2002) Cost-Effectiveness of Analgesia after Caesarean Section. A Comparison of Intrathecal Morphine and Epidural PCA. *Acta Anaesthesiol Scand* 46:85–89

## Postoperative Pain, Patient Controlled Analgesia Devices, Parenteral

K. M. POLLOCK, STEPHAN A. SCHUG  
Royal Perth Hospital and University of Western  
Australia, Crawley, WA, Australia  
schug@cyllene.uwa.edu.au

## Synonyms

PCA; Patient Controlled Intravenous Analgesia; on-demand analgesia; On-Demand Analgesia Computer

## Definition

A PCA device is usually an electronic or mechanical pump, which delivers a metered dose or volume of drug in response to a patient trigger. It is most often given to patients who undergo moderate or major surgery, and are expected to be in moderate to severe pain post-operatively. The patient can therefore determine when and how much analgesia they receive within the prescribed and programmed limits of the device. Historically, the devices were used only in the postoperative setting, using intravenous opioid. Increasingly they are used in other clinical settings, via other parenteral routes and with non-opioid drugs.

## Characteristics

► **Patient controlled analgesia** is a concept of pain relief, which takes the subjective nature of pain and the wide interindividual variability of opioid requirements into consideration. The concept was first used by Sechzer to measure pain in 1968 (Sechzer 1968).

PCA devices have been used since the 1980's, primarily using intravenous opioids. Most of the evidence on efficacy, adverse effects, education and safety is based on opioid usage.

Devices can be separated into two types of pumps. An electronic pump allows the operator to set bolus volume, lockout period, time-dose limit, and background infusions. Mechanical pumps are simple devices that allow a fixed volume of liquid drug to be delivered, the empty chamber filling up over a period of 5–6 minutes, effectively producing a mechanical lockout period.

## PCA versus Conventional Analgesia

In 1993, Ballantyne et al. performed a meta-analysis of the randomised controlled trials comparing outcomes of PCA and intramuscular (i.m.) analgesia (Ballantyne et al. 1993). Significantly greater analgesic efficacy was seen using PCA, though the magnitude of the pain score reduction was small. More recent studies comparing PCA with traditional methods of opioid analgesia have produced contradictory results. Some show significantly improved analgesia with PCA, while others show no difference. In a later review, Macintyre suggested that at least some of the trials showing no difference involved patients who had a higher level of post-operative nursing care than a general ward setting, and possibly fast access to conventional analgesia (Macintyre 2001). A later meta-analysis of 32 trials in 2001 concluded that opioid via PCA provided better efficacy than conventional opioid analgesia, with no real difference in the amount of opioids consumed (Walder et al. 2001).

PCA has also been used effectively in settings other than the post-operative, i.e. in bone marrow transplantation, burns, and cancer pain. Many trials comparing the effectiveness of new drugs also use PCAs to measure the drug's analgesic ability to decrease PCA opioid requirements, 'the opioid-sparing effect'.

## Dose

The PCA delivers its bolus dose in response to a patient trigger. This is usually pressing a button or lever, but can be by blowing into a mouthpiece. The optimal amount of bolus dose has been investigated. Owen et al. found that the optimal dose for morphine is 1 mg, with lower doses associated with ineffective analgesia, and higher doses with increased incidence of respiratory depression (Owen et al. 1989). To increase safety, many hospitals have a policy of keeping the concentration of drug used in the device fixed. Variable bolus PCA devices have been investigated, but did not offer any increased patient satisfaction, or lead to decreased complications (Love et al. 1996). There seems to be no advantage in setting hourly or 4-hourly dose limits on the electronic devices (Sidebotham et al. 1997). There is wide variation in patients' opioid requirements, and there have been several reports of respiratory depression at doses well inside the standard set limits.

## Lockout Interval

This is the time between a bolus delivery and the next valid delivery request. Within this latent period, a patient is 'locked out' from further access to the drug regardless of the number of times the request button is pressed. Electronic pumps may allow a variable lockout period. Ideally, the time period would reflect the time it would take to achieve full effect from the drug delivered. In practice, for most intravenous opioids, the lockout period is set to 5–10 minutes (Badner et al. 1996).

## Continuous Infusions

Most electronic PCA devices can deliver continuous (background) infusions on top of the demand doses. However, studies in both adults and children have been unable to show improved pain relief, and have shown an increased incidence of respiratory depression (Badner et al. 1996). Prescribing a background infusion may also increase programming errors. However, it may be suitable for opioid tolerant patients (on long-term opioids for cancer or chronic pain or on maintenance programs), or those who report waking up in severe pain.

## Drug

There seems little evidence to suggest major differences in efficacy or side effects between the most commonly used PCA opioids (Woodhouse et al. 1999). However, patients who experience particular side effects from one drug, may benefit from switching to another at an equipotent dose, (► **opioid rotation**). Pethidine use in PCAs

should be avoided because of the complications associated with accumulation of the metabolite, norpethidine. Side effects ranging from anxiety to seizure activity have been reported. This may occur within the first 24 hours of commencing the PCA, even in the absence of renal impairment.

#### Patient Factors

Patients from 4 years old to over 90 have used PCA effectively. Since successful use requires reasonable cognitive function, it may be an unsuitable analgesic plan for patients who are confused or who have dementia. Opioid requirements can be reduced in the elderly, and reduction of the bolus dose may be required. In opioid-tolerant patients, a background infusion and higher bolus dose may be indicated. In all cases, appropriate patient selection and education is essential to improve compliance, satisfaction and safety. Psychological factors also influence usage (Perry et al. 1994).

#### Patient Outcome

Patient satisfaction scores are often higher in those using PCA compared with conventional analgesia (Ballantyne et al. 1993). This is attributed to improved feelings of autonomy, less anxiety, and lower post-operative pain scores. However, in a more recent study, PCA was shown to be valued as a way to avoid the difficulty of disclosing pain or securing pain relief within the usual nurse-patient relationship (Taylor et al. 1996).

#### Adverse Effects

Respiratory depression is the most concerning potential side effect. Several audits have reported an incidence of 0.1 to 0.8%, although with a background infusion, this rises to between 1.1 and 3.9% (Macintyre 2001). Respiratory rate seems to correlate poorly with opioid related respiratory depression; the best marker seems to be sedation score. However, some studies have suggested that respiratory depression associated with i. m. analgesia is even more common. This is probably associated with higher plasma concentrations as the initial bolus is absorbed.

There have been several case reports of malfunction of both electronic and mechanical pumps (Baird and Schug 1996). Manufacturers have since altered much of the associated hardware and software. Anti-reflux valves are now recommended for use with all pumps. Triggering by patients, relatives, or other staff has also been reported. Operator error in the programming of pumps or in preparation of content and concentration of syringes has been a reasonably common safety issue. Hospital protocol and staff education on the use of PCA should decrease these incidences.

Several cases have been reported where the PCA device was thought to be 'masking' the signs of myocardial infarction, pulmonary embolus, urinary retention and compartment syndrome. Concern has been expressed

that a patient with pain from a new medical or surgical problem could control the pain with PCA so effectively, that the cause may remain undiagnosed. However, most PCA treatment prescriptions incorporate regular clinical assessments of pain scores and amount of drug used. These are done on up to an hourly basis. An unexpected change in the rate of analgesic use, nature of pain, or its intensity should trigger careful monitoring and investigation.

#### Other Routes and Drugs

PCA has been used successfully via the intranasal (Striebel et al. 1996), subcutaneous and oral route. An interesting new concept is the transdermal electrotransport of fentanyl via a patient-controlled transdermal system using iontophoresis (Chelly et al. 2004); this might become commercially available in the near future. Overall PCA is a very effective and relatively safe method of post-operative analgesia, and compares well to conventional analgesia. Having a standard protocol, and then tailoring it to suit the individual patient by a single specialist team, will increase efficacy and safety.

#### References

1. Badner NH, Doyle JA, Smith MH et al. (1996) Effect of Varying Intravenous Patient-Controlled Analgesia Dose and Lockout Interval while Maintaining a Constant Hourly Maximum Dose. *J Clin Anesth* 8:382-385
2. Baird MB, Schug SA (1996) Safety Aspects of Postoperative Pain Relief. *Pain Digest* 6:219-225
3. Ballantyne JC, Carr DB, Chalmers TC et al. (1993) Post-Operative Patient-Controlled Analgesia: Meta-Analysis of Initial Randomised Controlled Trials. *J Clin Anesth* 5:182-193
4. Chelly JE, Grass J, Houseman TW et al. (2004) The Safety and Efficacy of a Fentanyl Patient-Controlled Transdermal System for Acute Postoperative Analgesia: A Multicenter, Placebo-Controlled Trial. *Anesth Analg* 98:427-433
5. Love DR, Owen H, Ilsley AH et al. (1996) A Comparison of Variable-Dose Patient-Controlled Analgesia. *Anesth Analg* 83:1060-1045
6. Macintyre PE (2001) Safety and Efficacy of Patient-Controlled Analgesia. *Br J Anaesth* 87:36-46
7. Owen H, Plummer JL, Armstrong I et al. (1989) Variables of Patient-Controlled Analgesia. 1. Bolus Size. *Anaesthesia* 44:401-406
8. Perry F, Parker RK, White PF et al. (1994) Role of Psychological Factors in Postoperative Pain Control and Recovery with Patient-Controlled Analgesia. *Clin J Pain* 10:57-63
9. Sechzer PH (1968) Objective Measurement of Pain. *Anesthesiology* 29:209-213
10. Sidebotham D, Dijkhuizen MR, Schug SA (1997) The Safety and Utilization of Patient-Controlled Analgesia. *J Pain Symptom Manage* 14:202-209
11. Taylor N, Hall GM, Salmon P (1996) Is Patient-Controlled Analgesia Controlled by the Patient? *Soc Sci Med* 43:1137-1143
12. Walder B, Schafer M, Henzi I et al. (2001) Efficacy and Safety of Patient-Controlled Opioid Analgesia for Acute Postoperative Pain. A Quantitative Systematic Review. *Acta Anaesthesiol Scand* 45:795-804
13. Woodhouse A, Ward M, Mather L (1999) Inter-Subject Variability in Post-Operative Patient-Controlled Analgesia (PCA): Is the Patient Equally Satisfied with Morphine, Pethidine and Fentanyl? *Pain* 80:545-553



## Postoperative Pain, Persistent Acute Pain

EDWARD A. SHIPTON

Department of Anaesthesia, University of Otago,  
Christchurch, Otago, New Zealand  
shiptonea@xtra.co.nz

### Synonyms

Subacute Pain; chronic pain

### Definition

Persistent acute postoperative pain is pain in the location of the surgery that persists beyond the usual course of an acute injury (surgery), and is different from that suffered pre-operatively. Postoperatively, if it persists beyond three months, it is known as chronic pain.

### Characteristics

The duration of severe postoperative pain rarely exceeds 72 hours. Mobilization does increase pain intensity after abdominal, thoracic and orthopaedic surgery. In some patients, the hyperphenomena (primary and secondary ► [hyperalgesia](#), mechanical ► [allodynia](#)) that are normal in the first days or weeks after surgery, do not regress but persist (Breivik 2002b). Peripheral nerve fibres mediate the spread of secondary hyperalgesia, but when secondary hyperalgesia has fully developed, it becomes less dependent on or even independent of peripheral neural activity originating from the injured site. Patients with ongoing pain display significantly elevated Interleukin-6 levels and an attenuated elevation of cortisol secretion after awakening. The severity of postoperative pain appears to be related to levels of beta-endorphin immunoreactive material in plasma before surgery (Matejec et al. 2003).

Pain experience is individualized. However, the relative importance of different nociceptive mechanisms for the intensity, duration, and character of postoperative pain is not well established. Peripheral neuronal barrage from tissue injury produces central nervous system changes that contribute to the maintenance of postoperative pain. Clinical and experimental evidence shows that noxious stimuli may sensitise central neural structures involved in pain perception. Activation of the ► [N-methyl-D-aspartate \(NMDA\) receptors](#) sets in motion this series of events (Shipton 1999). This is illustrated by the development of sensitisation, wind-up, or expansion of receptive fields of central nervous system neurones, as well as by the enhancement of flexion reflexes and the hyperalgesia and persistence of pain after surgery.

### Psychological Profile

In the transition from subacute to chronic pain, functional disability and psychological distress play a more

important role than pain intensity. Pain is a multifactorial dynamic experience, not just a sensation. Emotion, perception and past experience all affect an individual's response to noxious stimuli. Patient attitudes and concerns about postoperative pain need to be understood. After orthognathic surgery, an abnormal psychological profile was the most significant factor associated with the presence and persistence of pain (Aghabeigi et al. 2001). There is some evidence (level 3) that chronic depression plays a role in the development of new pain locations (although not for low back pain); that prior nervousness and past negative life events predict work disability; and that depression, anxiety, and a sense that control rests outside of one's own self may predict slower recovery from pain and disability (Kuch 2001). Children with behavioural problems or other somatic symptoms are at increased risk, at least in the short term, of developing chronic widespread pain (Jones et al. 2003).

### Prevalence

Surgery contributes to persistent acute pain in about 22% of patients, and is particularly associated with the development of abdominal, anal, perineal and genital pain. Trauma was a cause of persistent acute pain in about 19% of patients (Crombie et al. 1998). Post-traumatic ► [neuropathic pain](#) is a major contributor to persistent pain. As many as two thirds of patients have discomfort and pain around the scar area 12 months after surgery. Persistent pain occurs after laparoscopic cholecystectomy (13%), inguinal hernia repair (54%), post-thoracotomy (62%), amputation (70%), post-cardiac surgery pain (39%) and mastectomy (30%) (Breivik 2002a; Bruce et al. 2003).

### Risk Factors

There is increasing evidence that the site and extent of the surgery are the most important factors determining the intensity and duration of acute postoperative pain. Thoracic, major limb amputation and spinal surgeries are the most painful procedures. Abdominal, urological and major orthopaedic surgery leads to severe postoperative pain. Similar to acute musculoskeletal injury, there is limited evidence (level 3) that the location and extent of injury predict reports of pain and poor functional activity outcomes (Hunter 2001).

A recent survey showed that nearly 80% of patients experience pain after surgery. Of these patients, 86% had moderate, severe, or extreme pain (Apfelbaum et al. 2003). Severe levels of pain following discharge from hospital remained a concern for 21% of patients. Unrelieved acute postoperative pain is a risk factor in developing persistent pain (Breivik 2002a). Patients who have the most severe pain, or who have consumed the most analgesics during the week after surgery, have a higher risk of having persistent pain after many months (Breivik 2002a). In hernia repairs, preoperative pain and high pain scores in the first week after

surgery are risk factors for the development of chronic pain.

Another risk factor may be the presence of preoperative pain. In cardiac surgery, patients with preoperative angina or who were overweight (body mass index  $\geq 25$ ) at the time of surgery were more likely to report chronic pain (Bruce et al. 2003). In phantom-limb pain, a major role is assigned to pain occurring before the amputation and to the central and peripheral neural changes related to it (Flor 2002).

### Modern Approaches

Advances in surgical technique, such as key-hole surgery and the microsurgical approach using operating microscopes, has led to 'fast track' surgery with minimal hospital stay and reduced convalescence (Kehlet and Wilmore 2002). About 60% of surgery is now performed in an ambulatory setting. In spinal surgery, microdiscectomy patients, for example, have greater reduction in pain and disability than do fusion patients. Following inguinal hernia repair, chronic pain is reported less often after laparoscopic and mesh repairs. In thoracic surgery, intracostal sutures seem less painful than pericostal sutures (Cerfolio et al. 2003). Developments and improvements of multimodal interventions within the context of 'fast track' surgery programmes represent a major change in achieving a pain (and risk) free perioperative course.

New approaches in pain control include the optimal use of regional anaesthetic techniques and multimodal (or balanced) analgesia. The recent home use of interscalene perineural catheters for three days significantly decreased postoperative pain after shoulder surgery (Hfeld et al. 2003). After moderately painful orthopaedic surgery of the lower extremity, the use of an infusion of ropivacaine with a portable mechanical pump and a popliteal sciatic perineural catheter at home decreased pain, opioid use and related side effects.

### Prevention

The single best approach to persistent acute postoperative pain is to prevent it. Communication with patients is vital in the delivery of optimal perioperative pain care. A thorough explanation of the operation and the expected outcome should be given to the patient. The patient and family should be provided with a written workable, effective and safe pain management programme for use at home. This is particularly important for parents of infants and children undergoing operative procedures on a day surgery basis.

The next challenge is to identify the operative procedures associated with the development of pain so that preventive measures can be implemented. The expected severity and duration of each specific type of surgery needs to be reviewed. Are measures that are normally used to control pain after this particular type of surgery failing to provide relief?

The least painful surgical approach with acceptable exposure should be chosen, and tissue trauma during surgery minimised. Optimal acute perioperative pain control can be achieved with the use of basic multimodal pharmacological analgesia, which will improve the relief of post-operative pain for most surgical patients (Breivik 2002b). More advanced approaches, such as well-tailored epidural ► [multimodal analgesia](#), are needed to relieve severe dynamic pain (e.g. when coughing). Early ambulation should also be aimed for. The technique of ► [pre-emptive analgesia](#), an evolving clinical concept, implies the introduction of an analgesic regimen before the onset of noxious stimuli, with the goal of preventing sensitisation of the nervous system to subsequent stimuli that could amplify pain. It has been widely assumed that pre-emptive analgesia may reduce the risk of developing persistent acute pain. Yet a recent systematic review has not found any beneficial effect of pre-emptive analgesia on postoperative pain, due to poor trial designs and confusion over terminology and definition (Moiniche et al. 2002).

### Future

Preoperative assessment of experimental pain perception by ► [quantitative sensory tests](#) can predict the level of post-Caesarean section pain. The use of quantitative sensory testing should enable more mechanism-based and improved approaches to surgical analgesia management in the future (Wilder-Smith 2003). In addition, by identifying the type of pain (nociceptive, neuropathic, visceral), the provider can more efficiently treat pain by selecting the most appropriate intervention. The use of secondary analgesics in acute postoperative pain is still in its infancy. Gabapentin reduces pain on movement after breast surgery for cancer (Fassoulaki et al. 2002). Secondary analgesics may be useful in reducing persistent acute pain. Early interventions for patients at risk may beneficially influence long-term outcomes.

Better acute pain relief may reduce persistent acute pain after surgery. Can continuous perioperative neuraxial blockade (up to 5–7 days following major abdominal or thoracic surgery) reduce persistent postoperative pain? Future evaluation of the effects of epidural analgesia on postoperative outcome also requires integration of epidural analgesia within a multimodal rehabilitation programme. Additional measures that reverse or prevent the formation of ► [central sensitisation](#) processes might be more effective. Postoperative pain is mediated centrally by the NMDA receptors. Oral dextromethorphan, an NMDA antagonist, reduces immediate and late postoperative pain in patients undergoing soft tissue and bone surgery. Whether or not their use can reliably prevent persistent pain syndromes (after thoracotomy, mastectomy, and amputation) is still unknown. A prospective study is needed, to compare the incidence and severity of persistent pain after post surgical neuropathic pain in patients with and without a small dose

of an NMDA antagonist. Research into the long-term effects of optimal neuraxial analgesia and drugs that dampen glutamatergic hyperphenomena (hyperalgesia/allodynia) are urgently needed, to verify whether these approaches can reduce the problem of acute persistent post-operative pain (Breivik 2002b).

Neither sex nor age is a determining factor for the intensity of postoperative pain, but do express different risks for severity of injury and disease (Hunter 2001). After sternotomy for cardiac surgery, the prevalence of persistent pain decreased with age, from 55% in those aged less than 60 years to 34% in patients over 70 years. Future identification of predictors of acute persistent pain should include control for age and gender.

There needs to be an ongoing educational programme for patients and all health personnel involved in the care of surgical patients (Breivik 2002b). More support, more information and more suitable analgesic protocols are needed to manage patients' pain effectively, whilst in hospital and also following discharge at home. In the rheumatoid arthritis model, pain coping and social support, assessed very early in the disease process, affected pain and long-term functional disability. The patient should be followed-up at home. Pain management should be within the capability of the patient, significant others, and other home resources.

Accurate evaluation of the frequency of persistent post-operative pain will require standardization of definition and methods of assessment. Prospective studies are required to define the role of risk factors identified in this review.

## References

1. Aghabeigi B, Hiranaka D, Keith DA et al. (2001) Effect of Orthognathic Surgery on the Temporomandibular Joint in Patients with Anterior Open Bite. *Int J Adult Orthodon Orthognath Surg* 16:153–160
2. Apfelbaum JL, Chen C, Mehta SS et al. (2003) Postoperative Pain Experience: Results from a National Survey Suggest Postoperative Pain Continues to be Undermanaged. *Anesth Analg* 97:534–540
3. Breivik H (2002a) Postoperative Pain: Toward Optimal Pharmacological and Epidural Analgesia. In: Giamberardino MA (ed) *Pain 2002 – An Updated Review*. IASP Press, Seattle, pp 337–349
4. Breivik H (2002b) How to Implement an Acute Pain Service. *Best Pract Res Clin Anaesthesiol* 16:527–547
5. Bruce J, Drury N, Poobalan AS et al. (2003) The Prevalence of Chronic Chest and Leg Pain Following Cardiac Surgery: A Historical Cohort Study. *Pain* 104:265–273
6. Crombie IK, Davies HT, Macrae WA (1998) Cut and Thrust: Antecedent Surgery and Trauma among Patients Attending a Chronic Pain Clinic. *Pain* 76:167–171
7. Fassoulaki A, Patris K, Sarantopoulos C et al. (2002) The Analgesic Effect of Gabapentin and Mexiletine after Breast Surgery for Cancer. *Anesth Analg* 95:985–991
8. Hunter J. Demographic Variables and Chronic Pain (2001) *Clin J Pain* 17(Suppl):S14–S19
9. Ilfeld BM, Morey TE, Wright TW et al. (2003) Continuous Interscalene Brachial Plexus Block for Postoperative Pain Control at Home: A Randomized, Double-Blinded, Placebo-Controlled Study. *Anesth Analg* 96:1089–1095
10. Kehlet H, Wilmore DW (2002) Multimodal Strategies to Improve Surgical Outcome. *Am J Surg* 183:630–641
11. Kuch K (2001) Psychological Factors and the Development of Chronic Pain. *Clin J Pain* 17(Suppl):S33–S38
12. Matejec R, Ruwoldt R, Bodeker RH et al. (2003) Release of Beta-Endorphin Immunoreactive Material under Perioperative Conditions into Blood or Cerebrospinal Fluid: Significance for Postoperative Pain? *Anesth Analg* 96:481–486
13. Moiniche S, Kehlet H, Dahl JB (2002) A Qualitative and Quantitative Systematic Review of Preemptive Analgesia for Postoperative Pain Relief: The Role of Timing of Analgesia. *Anesthesiology* 96:725–741
14. Shipton EA (1999) Central Neural Blockade. In: Shipton EA (ed) *Pain – Acute and Chronic*, Arnold, London, pp 1–36
15. Wilder-Smith OH, Tassonyi E, Crul BJ, Arendt-Nielsen L (2003). Quantitative Sensory Testing and Human Surgery: Effects of Analgesic Management on Postoperative Neuroplasticity. *Anesthesiology* 98:1214–1222

## Postoperative Pain, Postamputation Pain, Treatment and Prevention

LONE NIKOLAJSSEN

Department of Anaesthesiology, Aarhus University Hospital, Aarhus, Denmark  
nikolajsen@dadlnet.dk

### Synonyms

Postamputation pain

### Definition

Phantom pain may occur following amputation of other body parts than limbs, but the present essay will focus on clinical characteristics, mechanisms, treatment, and possible preventive measures of ► **phantom pain** after limb amputation.

The phantom complex includes three elements:

- Phantom pain: painful sensations referred to the missing limb
- ► **Phantom sensation**: any sensation of the missing limb, except pain
- Stump pain: pain localized to the amputation stump

There is an overlap between these elements, and in the same individual, phantom pain, phantom sensations and ► **stump pain** often coexist.

### Characteristics

#### Clinical Characteristics Including Mechanisms

60–80% of patients experience phantom pain following limb amputation. The incidence does not seem to be influenced by age in adults, gender, side, level of amputation or cause (civilian versus traumatic) of amputation. Phantom pain is less frequent in young children and congenital amputees (Melzack et al. 1997). Prospective studies in patients amputated mainly because of peripheral vascular disease have shown that the onset of phantom pain is usually within the first week after amputation, but case reports have suggested that the onset may be delayed for months or even years. The number of patients

with severe phantom pain is probably in the range of 5–10%. Pain is intermittent in most amputees; only few are in constant pain. Episodes of pain attacks are most often reported to occur daily, or at daily or weekly intervals. Phantom pain is primarily localized to the distal parts of the missing limb. In upper limb amputees, pain is normally felt in the fingers and palm of the hand, and in lower limb amputees pain is generally experienced in the toes, foot or ankle. The reason for this clear and vivid phantom experience of distal limb parts is not clear, but may be explained by the larger cortical representation by the hand and foot, as opposed to the lesser representation of the more proximal parts of the limb. It is not possible to give exact descriptions of the time course of phantom pain as no prospective studies with long-term (many years) follow-up exist. Prospective studies with a maximum follow-up period of 2 years suggest that phantom pain may diminish with time, and in a retrospective survey of 526 veterans, phantom pain had disappeared in 16%, decreased markedly in 37%, remained similar in 44%, and increased in 3% of the respondents reporting phantom pain (Wartan et al. 1997).

Experimental and clinical studies indicate that a series of mechanisms are involved in generating phantom pains, and that these include elements in the periphery, the spinal cord, brainstem, thalamus and cerebral cortex. It is likely that the first events occur in the periphery, which subsequently generates a cascade of events that sweep more centrally, finally recruiting cortical brain structures. The latter may be responsible for the complex and vivid sensation that characterizes certain phantom pain sensations (for review on clinical characteristics and mechanisms, see Nikolajsen and Jensen 2004).

### Treatment

Phantom pain may be very difficult to treat, and – despite much research in the area – there is little evidence from randomized trials to guide clinicians with treatment. A systematic literature search (Medline 1966-99) was performed recently in order to determine the optimal management of phantom pain. The authors identified 186 articles, but after exclusion of letters, reviews, descriptive trials without intervention, case reports and trials with major methodological errors, only 12 articles were left for review (Halbert et al. 2002). Since then a few well-designed studies have been published. Until more clinical data become available, guidelines in analogy with treatment regimens used for other ► [neuropathic pain](#) conditions are probably the best approximation.

A large number of randomised controlled trials have shown a beneficial effect of ► [tricyclic antidepressants](#) and ► [sodium channel blockers](#) in different neuropathic pain conditions. No controlled data are available for phantom pain, but the drugs are generally believed to be effective, – at least in some patients. The effect of ► [gabapentin](#) was examined in a well-designed

cross-over study including 19 patients with phantom pain. After 6 weeks of treatment, gabapentin at a daily dose of 2400 mg was better than placebo in reducing phantom pain (Bone et al. 2002). A similar effect of gabapentin was described in an open study. Permanent phantom pain should not be accepted until ► [opioids](#) have been tried. Opioids can probably be used safely for several years with a limited risk of dependence. In a randomised, double-blind, cross-study with active placebo, 31 amputees received a 40 min. infusion of lidocaine, morphine or diphenhydramine. Compared with placebo, morphine reduced both stump and phantom pain, whereas lidocaine only decreased stump pain (Wu et al. 2002). In another placebo-controlled, cross-over study including 12 patients, a significant reduction in phantom pain was found during treatment with oral morphine (Huse et al. 2001). Case reports have suggested that methadone may reduce phantom pain. The effect of ► [NMDA receptor antagonists](#) have been examined in different studies. Ketamine administered intravenously reduced pain in amputees with stump and phantom pain (Nikolajsen et al. 1996). However, two other well-designed studies found no effect of memantine, an NMDA receptor antagonist available for oral use, at doses of 20 and 30 mg, respectively. In both studies, memantine was administered in a blinded, placebo-controlled cross-over fashion to patients with stump and phantom pain (Nikolajsen et al. 2000; Maier et al. 2003). Dextromethorphan, another NMDA receptor antagonist, has been suggested to be effective in reducing phantom pain. Calcitonin significantly reduced phantom pain when used intravenously in the early postoperative phase. A large number of other treatments, for example beta-blockers, mexiletine (the oral congener of lidocaine), topical application of capsaicin, intrathecal opioids, various anaesthetic blocks and injection of botulinum toxin have been claimed to be effective in phantom pain, but none of them have proven to be effective in well-controlled trials with a sufficient number of patients.

Physical therapy involving massage, manipulation and passive movements may prevent trophic changes and vascular congestion in the stump. Other treatments such as transcutaneous electrical nerve stimulation (TENS), acupuncture, ultrasound and hypnosis may, in some cases, have a beneficial effect on stump and phantom pain. At least 3 studies have examined the effect of TENS on phantom pain, but the results are not consistent. Others have used visual feedback with a mirror to eliminate painful phantom limb spasms (Ramachandran and Rogers-Ramachandran 2000). It has also been demonstrated that sensory discrimination training, obtained by applying stimuli at the stump, reduced pain in 5 upper limb amputees (Flor et al. 2001). The advantage of most of the above mentioned non-medical treatments is the absence of side-effects and complications, and the fact that the treatment can be easily repeated.



However, most of these studies are uncontrolled observations.

Surgery on amputation neuromas and more extensive amputation have previously played important roles in the treatment of stump and phantom pain. Today stump revision is probably only performed in cases of obvious stump pathology, and in properly healed stumps there is almost never any indication for proximal extension of the amputation because of pain. The results of other invasive techniques such as, for example, ► [dorsal root entry zone lesions \(DREZ\)](#), sympathetomy, and ► [cordotomy](#) have generally been unfavourable and most of them have been abandoned today. Surgery may produce short-term pain relief but pain often reappears.

### Prevention

Some early studies showed that preamputation increases the risk of subsequent phantom pain, and that phantom pains in some cases are a replicate of pain experienced before the amputation.

The above observations led to the theory that preamputation pain creates an imprint in memorizing structures of the central nervous system, and that such an imprint could be responsible for persistent pain after amputation. Inspired by this, Bach et al. (1988) carried out the first study on the ► [prevention of phantom pain](#): 25 patients were allocated by means of the year of their birth to either epidural pain treatment 72 h before the amputation (B: 11 patients) or conventional analgesics (C: 14 patients). All patients had spinal or epidural analgesia for the amputation, and both groups received conventional analgesics to treat postoperative pain. Blinding was not described. After 6 months the incidence of phantom pain was lower among patients who had received the preoperative epidural blockade. Since then a few trials have examined the short-term and long-term impact of regional analgesia (epidural and nerve blocks) on phantom pain. Some of the studies, – but not all, have confirmed that regional analgesia may be effective in reducing postamputation pain. Unfortunately, some of the trials are of very poor methodological quality (see Nikolajsen and Jensen 2004 for details). Nikolajsen et al. (1997) carried out a randomized, double-blind and placebo-controlled study, in which 60 patients scheduled for lower ► [limb amputation](#) were randomly assigned into one of two groups: a blockade group that received epidural bupivacaine and morphine before the amputation and during the operation (29 patients) and a control group that received epidural saline and oral/intramuscular morphine (31 patients). Both groups had general anaesthesia for the amputation and all patients received epidural analgesics for postoperative pain management. Patients were interviewed about preamputation pain on the day before the amputation and about stump and phantom pain after 1 week, 3, 6 and 12 months. Median duration of preoperative epidural blockade (blockade group

was 18 hours. After 1 week the percentage of patients with phantom pain was 51.9 in the blockade group and 55.6 in the control group. Subsequently, the figures were (blockade/control): at 3 months, 82.4/50; at 6 months, 81.3/55 and at 12 months, 75/68.8. Intensity of stump and phantom pain and consumption of opioids were also similar in both groups, at all four postoperative interviews. So according to this study, it is not possible to prevent phantom pain by a ► [preoperative epidural blockade](#). The aim of pre-emptive treatment is to avert spinal sensitization by blocking, in advance, the cascade of intraneuronal responses that take place after peripheral nerve injury. A true pre-emptive approach is probably not possible in patients scheduled for amputation. Many have suffered from ischaemic pain for months or years, and are likely to present with pre-existing neuronal hyperexcitability. It cannot be excluded that a preoperative epidural blockade for a longer period (weeks?) would prevent phantom pain from developing. However, this would be very inconvenient from a practical point of view, as the decision to amputate is often not taken until the day before or even on the same day as surgery.

In conclusion, epidural blockade is effective in the treatment of preoperative ischaemic pain and postoperative stump pain, but at present no studies of sufficient methodological quality have provided evidence that preoperative epidural blockade has any beneficial effect in preventing phantom pain. It cannot be excluded that other approaches may be effective.

### References

1. Bach S, Noreng MF, Tjélliden NU (1988) Phantom Limb Pain in Amputees during the First 12 Months following Limb Amputation after Preoperative Lumbar Epidural Blockade. *Pain* 33:297–301
2. Bone M, Critchley P, Buggy DJ (2002) Gabapentin in Postamputation Phantom Limb Pain: A Randomized, Double-Blind, Placebo Controlled, Cross-Over Study. *Regional Anesthesia and Pain Medicine* 27:481–486
3. Flor H, Denke C, Schaefer M et al. (2001) Effect of Sensory Discrimination Training on Cortical Reorganisation and Phantom Limb Pain. *The Lancet* 357:1763–1764
4. Halbert J, Crotty M, Cameron ID (2002) Evidence for the Optimal Management of Acute and Chronic Phantom Pain: A Systematic Review. *Clin J Pain* 18:84–92
5. Huse E, Larbig W, Flor H et al. (2001) The Effect of Opioids on Phantom Limb Pain and Cortical Reorganization. *Pain* 90:47–55
6. Maier C, Dertwinkel R, Mansourian N et al. (2003) Efficacy of the NMDA-Receptor Antagonist Memantine in Patients with Chronic Phantom Limb Pain - Results of a Randomized Double-Blinded, Placebo-Controlled Trial. *Pain* 103:277–283
7. Melzack R, Israel R, Lacroix R et al. (1997) Phantom Limbs in People with Congenital Limb Deficiency or Amputation in Early Childhood. *Brain* 120:1603–1620
8. Nikolajsen L, Gottrup H, Kristensen AGD et al. (2000) Memantine (a N-methyl D-aspartate Receptor Antagonist) in the Treatment of Neuropathic Pain following Amputation or Surgery: A Randomised, Double-Blind, Cross-Over Study. *Anesth Analg* 91:960–966
9. Nikolajsen L, Hansen CL, Nielsen J et al. (1996) The Effect of Ketamine on Phantom Pain: A Central Neuropathic Disorder Maintained by Peripheral Input. *Pain* 67:69–77

10. Nikolajsen L, Ilkjr S, Krøner K et al. (1997) Randomised Trial of Epidural Bupivacaine and Morphine in Prevention of Stump and Phantom Pain in Lower-Limb Amputation. *Lancet* 350:1353–1357
11. Nikolajsen L, Jensen TS (2005) Phantom Limb. In: Mchahon S, Koltzenburg M (eds) *Wall & Melzack's Textbook of Pain*, 5<sup>th</sup> edn. Churchill-Livingstone, London, pp 961–71
12. Ramachandran VS, Rogers-Ramachandran D (2000) Phantom Limbs and Neural Plasticity. *Arch Neurol* 57:317–320
13. Wartan SW, Hamann W, Wedley JR et al. (1997) Phantom Pain and Sensation among British Veteran Amputees. *Br J Anaesth* 78:652–659
14. Wu CL, Tella P, Staats PS et al. (2002) Analgesic Effects of Intravenous Lidocaine and Morphine on Postamputation Pain. *Anesthesiology* 96:841–848

## Postoperative Pain, Pre-Emptive or Preventive Analgesia

JØRGEN B. DAHL

Department of Anaesthesiology, Glostrup University Hospital, Herlev, Denmark  
jbdahl@dadlnet.dk

### Synonyms

Preventive Analgesia; Protective Analgesia; Prevention of Postoperative Pain

### Definition

“► **Pre-emptive analgesia**” is a treatment that starts before surgery, in order to prevent or reduce the establishment of ► **sensitization** of dorsal horn neurons caused by tissue injury. Sensitization of dorsal horn neurons is supposed to amplify postoperative pain.

### Characteristics

The idea of pre-emptive analgesia was addressed by Crile in 1913 (Crile 1913) and further elaborated by Patrick Wall in 1988 (Wall 1988). The concept was originally based on experimental observations demonstrating that a short barrage of nociceptor afferent input to the dorsal horn neurons results in an activity dependent hyperexcitability, which may outlast the stimulus – a phenomenon now termed “heterosynaptic ► **central sensitization**” (Woolf and Salter 2006). Wall suggested, that it might be preferable (and more efficacious) to prevent pain and the consequences of a ► **noxious** input to the CNS (i.e. dorsal horn sensitization), rather than to treat pain when this sensitization is already established (Wall 1988).

### Central Sensitization and “Pain Memory”

Central sensitization includes an altered processing of both nociceptive signals and ► **Innocuous Input/Stimulus**, tactile impulses from myelinated afferents, leading to painful sensations when these afferents are activated. As suggested by Woolf and Salter, central sensitization manifests itself in the clinic as ► **clinical**

**pain**, with hyperalgesia, allodynia, spread of sensitization and persistent pain (Woolf and Salter 2006). The neurophysiological and biochemical mechanisms of these alterations are complex and not fully understood (Woolf and Salter 2006), but include an increase in synaptic efficacy mediated by neurokinin and N-methyl-D-aspartic acid (NMDA) receptor mechanisms (Woolf and Salter 2006). Since central sensitization may outlast the stimuli that triggered the alterations in the first place, it may be considered as a “pain memory”

### Clinical Studies

The idea of “prevention of postoperative pain”, published by Wall in 1988 (Wall 1988), resulted in substantial clinical interest. The interpretation and clinical implementation of the concept however has varied and provoked substantial controversy (Kissin 2005). The basic assumption is that the surgical injury leads to sensitization and hyperexcitability of dorsal horn neurons in the spinal cord, which in turn amplify postoperative pain. “Pre-emptive analgesia” aims at preventing the central alterations since experimental studies have demonstrated that this may be possible with pre-injury measures, whereas the same measures applied post-injury are less effective.

As pointed out by Kissin, at least two approaches have been used to reveal pre-emptive analgesia (Kissin 2005). One has been to compare the pain relieving effect of identical analgesic regimens administered before *versus* after the surgical incision or procedure. The other has been to compare the effect of a pre-surgical administered analgesic with no treatment and subsequently to evaluate the analgesic effect beyond the expected presence of the drug in the biophase (Kissin 2005). Outcome measures of these trials have varied. In most studies, pain intensity and/or requirements for supplemental analgesics have been the primary outcomes, whereas in other studies allodynia and hyperalgesia surrounding the surgical wound have been the major focus of interest.

### Evidence from Controlled Clinical Trials of Identical Analgesic Treatments, Initiated Before Versus After the Surgical Incision or Procedure

Recently, two systematic reviews of the clinical literature have examined the effects of identical analgesic treatments initiated before *versus* after surgical incision, with contrasting results (Møiniche et al. 2002; Ong et al. 2005). In a review of 80 controlled trials with different analgesic regimens, Møiniche et al. were not able to demonstrate any substantial clinical benefits of pre-emptive analgesia with NSAIDs, iv-opioids, iv-ketamine, dextromethorphan, peripheral local anesthetics or epidural or caudal analgesia (Møiniche et al. 2002).

In the most recent metaanalysis, Ong et al. investigated the effect of five types of analgesic interventions (epidu-

ral analgesia, local anesthetic wound infiltration, systemic NMDA receptor antagonists, systemic NSAIDs and systemic opioids) on three outcome variables, postoperative pain scores, analgesic consumption and time to first rescue analgesia, in 66 clinical studies (Ong et al. 2005). The overall conclusion from this latter metaanalysis was that pre-emptive epidural analgesia resulted in consistent improvements in all three outcome variables, whereas pre-emptive local anesthetic wound infiltration and NSAID administration reduced analgesic consumption and increased time to first rescue analgesia, without effect on postoperative pain scores. The least proof of efficacy was found with systemic NMDA antagonist and opioid administration (Ong et al. 2005). Reasons for the contrasting results between these metaanalyses were discussed by Ong et al. (2005). These reasons may include differences in methodology and included data, as well as differences in included studies.

#### Evidence from Controlled Clinical Trials of Pre-surgical Versus No Treatment

It has been argued that not only the surgical incision, but also other noxious intraoperative and postoperative stimuli may trigger central sensitization (Dierking et al. 1992). As a result, both pre- and postoperative administration of analgesics may reduce central sensitization and thus decrease postoperative pain intensity (McCartney et al. 2004). Consequently, it may not be possible to demonstrate pre-emptive analgesic effects with studies of identical analgesic treatments, initiated before *versus* after surgery (McCartney et al. 2004). A different approach is to study effects of an analgesic treatment initiated before surgical incision on pain and/or analgesic consumption beyond the expected pharmacological duration of action relative to an untreated or placebo control ("preventive analgesia") (McCartney et al. 2004). McCartney et al. conducted a systematic review of the clinical literature to determine the extent to which NMDA antagonists have yielded analgesic effects beyond five half-lives when given during the perioperative period (McCartney et al. 2004). The results of this metaanalysis demonstrated that ketamine and dextromethorphan produced a significant preventive analgesic benefit in 14 of 24 and in 8 of 12 studies respectively, whereas none of 4 studies examining magnesium demonstrated a preventive analgesic benefit (McCartney et al. 2004).

#### Effects of Pre-emptive Analgesia on the Development of Chronic Pain

It has been assumed that pre-emptive analgesia may reduce the risk of developing chronic postoperative pain, including phantom limb pain. This assumption may be supported by data suggesting that patients with high intensity acute postoperative pain scores also have a higher risk of developing a chronic pain state (Perkins and Kehlet 2000). One trial has investigated the effect

of identical pre- *versus* post-incisional treatment on long-term pain (Obata et al. 1999). Results showed that the percentage of patients with pain at 6 months postoperatively was significantly reduced (Obata et al. 1999). Unfortunately, the preliminary promising results with pre-emptive analgesia in patients undergoing limb amputation were not confirmed by a recent metaanalysis (Halbert et al. 2002).

#### Other Approaches to Reduce Central Sensitization

Anti-hyperalgesics such as ketamine and dextromethorphan reduce the injury-induced hyperexcitability of the central nervous system, but have no effect on the nociceptive input *per se*. Ketamine and dextromethorphan are both NMDA-receptor antagonists. The effect of ketamine on postoperative pain has been examined in a number of recent metaanalyses (Elia and Tramer 2005; Bell et al. 2005).

The overall conclusions from these reviews are that ketamine has a modest opioid sparing effect after surgery (Elia and Tramer 2005; Bell et al. 2005). Adverse effects are mild or absent with low dose regimens and ketamine may reduce opioid related side effects such as nausea and vomiting (Bell et al. 2005). The data should however be interpreted with caution, since published original studies with ketamine are very heterogeneous and the results of the different metaanalyses cannot be translated into any specific administration regimen with ketamine (Elia and Tramer 2005; Bell et al. 2005).

In a systematic review examining the effects of dextromethorphan in postoperative pain, results showed that dextromethorphan did not reduce the postoperative pain score with a clinical significant magnitude. Time to first analgesic request was significantly prolonged in most comparisons, and significant, albeit modest, reductions in supplemental opioid consumption were observed in a majority of studies with parenteral administration and in about half of the studies with oral administration (Duedahl et al. 2006).

The anticonvulsant gabapentin is widely used for treatment of chronic pain and experimental studies have demonstrated anti-hyperalgesic effects of gabapentin in models involving central neuronal sensitization, without affecting acute pain transmission. A substantial number of clinical studies investigating the effect of gabapentin on postoperative pain have recently been published (Dahl et al. 2004). The results of these studies have demonstrated promising effects on both postoperative pain and opioid requirements. So far, side effects have been few and not disturbing (Dahl et al. 2004), but further studies are obviously needed.

In summary, ► **timing** of analgesia *per se* may have some effect on postoperative pain, but results are conflicting. One metaanalysis has demonstrated analgesic effects of NMDA antagonists beyond five half-lives when administered during the perioperative period, which may point to a pre-emptive effect. Antihyperalgesics such

as ketamine and dextromethorphan have been demonstrated to have moderate effects on postoperative opioid requirements. Gabapentin has demonstrated promising effects in postoperative pain treatment. In future studies, attention should be directed towards protective analgesia (Møiniche et al. 2002; Dahl et al. 2004) aimed at the prevention of pain hypersensitivity through intensive and prolonged, multimodal analgesic ("protective") interventions. Furthermore, anti-hyperalgesic drugs and methods should be further developed and evaluated in clinical trials of postoperative pain.

## References

1. Bell RF, Dahl JB, Moore A et al. (2005) Peri-operative ketamine for acute post-operative pain: a quantitative and qualitative systematic review. *Acta Anaesthesiol Scand* 49:1405–28
2. Crile GW (1913) The kinetic theory of shock and its prevention through association. *Lancet* 185:7–16
3. Dahl JB, Mathiesen O, Møiniche S (2004) 'Protective premedication': an option with gabapentin and related drugs? *Acta Anaesthesiol Scand* 48:1130–6
4. Dierking G, Dahl JB, Kanstrup J et al. (1992) The effect of pre-versus postoperative inguinal field block on postoperative pain following herniorrhaphy. *Br J Anaesthesia* 68:344–348
5. Duedahl TH, Rømsing J, Møiniche S et al. (2006) A qualitative systematic review of dextromethorphan in postoperative pain. *Acta Anaesthesiol Scand* 50:1–13
6. Elia N, Tramer MR (2005) Ketamine and postoperative pain: a quantitative systematic review of randomised trials. *Pain* 113:61–70
7. Halbert J, Crotty M, Cameron ID (2002) Evidence for the optimal management of acute and chronic phantom pain: a systematic review. *Clin J Pain* 18:84–92
8. Kissin I (2005) Preemptive analgesia at the Crossroad. *Anesthesia Analgesia* 100:754–756
9. McCartney CJ, Sinha A, Katz J (2004) A qualitative systematic review of the role of N-methyl-D-aspartate receptor antagonists in preventive analgesia. *Anesth Analg* 98:1385–1400
10. Møiniche S, Kehlet H, Dahl JB (2002) A qualitative and quantitative systematic review of preemptive analgesia for postoperative pain relief – the role of timing of analgesia. *Anesthesiology* 96:725–741
11. Obata H, Saito S, Fujita N et al. (1999) Epidural block with mepivacaine before surgery reduces long-term post-thoracotomy pain. *Canadian J Anaesth* 46:1127–1132
12. Ong CK-S, Lirk P, Seymour RA et al. (2005) The Efficacy of Preemptive Analgesia for Acute Postoperative Pain Management: A Meta-Analysis. *Anesth Analg* 100:757–773
13. Perkins F, Kehlet H (2000) Chronic pain as an outcome of surgery. A review of predictive factors. *Anesthesiology* 93:1123–1133
14. Wall PD (1988) The prevention of postoperative pain. *Pain* 33:289–290
15. Woolf CJ, Salter MW (2006) Postoperative pain and its management. In: McMahon SB, Koltzenburg M (eds) *Wall and Melzack's Textbook of Pain*. Churchill Livingstone, Edinburgh New York, pp 91–105

## Postoperative Pain, Preoperative Education

EDWARD A. SHIPTON  
Department of Anaesthesia, University of Otago,  
Otago, New Zealand  
shiptonea@xtra.co.nz

## Synonyms

Preoperative Teaching; Preoperative Patient Education

## Definition

Pain is a sensory and emotional experience that is influenced by physiologic, sensory, affective, cognitive, socio-cultural, and behavioural factors. Research in postoperative pain management indicates room for improvement, especially in the area of patient education (Chung 1999). Patients who undergo surgery experience acute psychological distress in the preoperative period. It is essential to ensure patients are adequately assessed, well educated and prepared both clinically and psychologically for the event. Since the 1960s, many primary studies and several ► [meta-analyses](#) have been conducted to assess the effectiveness of education for patients undergoing surgery. Many have demonstrated the beneficial impact that preoperative education exerts on the postoperative recovery of patients (Mordiffi et al. 2003). These studies are often in discreet patient cohorts with little attention paid to generalising the results (Hobbs 2002). The delivery is often based on the healthcare providers' view of what information should be included. It is also clear that patients' coping behaviour varies considerably and strongly influences the usefulness of providing detailed preoperative information.

## Characteristics

The amount of care the patient will need, who will care for them, and the pain management strategies needed are important issues to address before surgery. Establishing a seamless preoperative process that anticipates all of the patient's clinical needs helps achieve programme goals and outcomes, reduces costly delays and improves patient and family satisfaction.

Preoperative instruction has been demonstrated to have benefit with regard to patient anxiety, postoperative pain, postoperative complications and length of hospitalisation. A recent meta-analysis of 20 studies assessing variation in length of hospital stay and pain outcomes in relation to age, ethnicity, gender, and education confirmed the positive moderate effects of preoperative teaching on these outcomes (Guruge and Sidani 2002). After preoperative education, a group of hysterectomy patients ambulated significantly earlier than those without teaching (Oetker-Black et al. 2003). Patients taught to assess their pain will have more control over the dose and delivery of analgesic drugs, regardless of the analgesic technique used (Macintyre and Ready 2002). Also, being able to introduce an effective smoking intervention programme 6–8 weeks before surgery will reduce postoperative morbidity. Other advantages of patient education include good patient rapport and communication, which is associated with a lower incidence of malpractice litigation. A preoperative teaching interview guide, explor-



ing five dimensions of preoperative information (situational/procedural information, sensation/discomfort information, patient role information, psychosocial support, and skills training), found a correlation between the amount of preoperative teaching received and the value thereof (Bernier et al. 2003).

### Preadmission

► **Preadmission clinics** offer an excellent means for patient education. The overall goal of preadmission testing programmes is to ensure patient preparedness, while increasing quality healthcare and overall customer satisfaction. An effective preadmission program is a major investment in a patient's recovery. Patients begin to formulate their expectations of the postoperative hospitalisation during the preadmission program. The challenge is to better understand the factors patients consider important when formulating judgments about the quality of preadmission education. The preadmission clinic gives an opportunity to educate patients about pain control (including patient controlled analgesia), adverse effects (such as nausea and vomiting), and answer any questions they might have.

### Anxiety

Independent risk factors for preoperative anxiety include history of cancer and smoking, psychiatric disorders, negative future perception, moderate to intense depressive symptoms, high trait-anxiety, moderate to intense pain, medium level surgery, female gender, ► **American Society of Anesthesiologists' Status Category III**, and having received more than 12 years of education (Caumo et al. 2001). Preoperative anxiety correlates with high postoperative anxiety, increased postoperative pain and analgesic requirements, decreased patient satisfaction and prolonged hospital stay. Female patients have higher preoperative anxiety than males.

Patient education decreases preoperative anxiety and pain (Giraudet-Le Quintrec et al. 2003). However, for patients with high anxiety levels and poor coping skills, excessive information can exacerbate anxiety and pain. The question remains as to what type of preprocedural preparation works best to reduce anxiety. Patient's socio-demographic and psychological characteristics and type of surgery need to be considered when identifying patients at risk of experiencing high anxiety both before and after surgery, so that psychological support and clinical management can be tailored to alleviate their anxiety.

### Fears

The most requested information from patients is related to anxiety-creating factors such as pain and postoperative symptoms after surgery. Many patients fear and expect postoperative pain. This can affect pain perception and analgesic requirements. Patients place

more emphasis on the duration of surgery, with less priority being given to questions relating to complications of anaesthesia (Moore and Pace 2003). However, fears of brain damage, death and ► **intraoperative awareness** associated with general anaesthesia remain prevalent, suggesting that preoperative education of patients should also address these. Education can further decrease the proportion of surgical patients who fear addiction to pain medication.

### Method

Patient information should include procedural information (current and reflect best practice), sensory information (what the patient can expect), and physiological coping information. In addition to pain and mobility information, patient education should reflect knowledge of what can be expected at three months after surgery, including expected and potential improvements in mobility, pain, and ambulation and in non-physical dimensions, such as sleep, home management, and social interaction.

What are the optimal methods for educating patients? Increasing multi-culturalism and diversity of the surgical population challenges the ability of the preoperative educator to convey information effectively. There is often a lack of patient focus when delivering such information and it needs repetition. The information should be realistic. Education should include treatment goals, options available for monitoring and treating acute pain, the need to communicate inadequate analgesia and adverse effects, and addressing fears of opioid addiction (Macintyre and Ready 2002). When warranted, education should include the use of ► **patient-controlled analgesia** (either intravenously, subcutaneously or epidurally) and regional anaesthesia catheters.

A preadmission educational booklet for coronary bypass surgery patients resulted in fewer concerns about asking for help and taking analgesia (Watt-Watson et al. 2001). Patients' ability to recall potential risks is significantly increased by an educational intervention using printed material (Chan et al. 2002). Overall, patients prefer direct information from their healthcare professional, rather than via the mail. The use of video teaching gives better reported pain control and satisfaction after invasive procedures (Duhalde et al. 2002). For example, using videotapes decreased anxiety and stress, measured in terms of urinary cortisol excretion and intraoperative systolic blood pressure increase, in patients undergoing hip replacement surgery, and prepared them to cope better with postoperative pain. Cognitive interventions such as distraction and reappraisal have been used to improve the care of women having an elective hysterectomy (Cheung et al. 2003).

Which group of patients would most likely benefit from more information is an important question that remains relatively untouched. Whether the preoperative contact,

supplemented by videotape or in-hospital, on-demand television programming, or computer networks, such as the World Wide Web or home television, are the most effective and practical means for this education, remains to be seen.

### Measures

A variety of tools can be used to assess the effectiveness of preoperative education. These include the ► [SF 36 Health Status Questionnaire](#) and the General Well-Being questionnaire, which emphasise the outcome of medical care as the patient sees it, the State-Trait Anxiety Inventory, the Hospital Anxiety and Depression Scale and the Montgomery-Asberg Depression Rating Scale to measure anxiety and depression, as well as pain measurement tools such as the visual analogue pain scale and the McGill Pain Questionnaire Short Form.

### Children

Preoperatively, parents are more anxious when their child is less than one year of age or when it is the child's first surgery. Postoperative pain is negatively related to parents' provision of surgery-relevant information during the preoperative period. With patient controlled analgesia, preoperative education on its use provides children and parents with invaluable information, alleviating their concerns about getting 'hooked on drugs,' overdosing, adverse effects, and being able to get pain relief when needed (Kotzer et al. 1998). In adolescents, cognitive-behavioural interventions, designed to prepare them for surgery, should be tailored to individual factors and developmental needs, especially the adolescents' preoperative anxiety level and age. Preoperative education (information plus coping skills) is effective in reducing postoperative anxiety in adolescents with high preoperative anxiety (LaMontagne et al. 2003).

### Future

Surgical services should be re-engineered to include preadmission assessment, education and care after discharge. Preoperative education should be individually tailored and include individualized discharge analgesic packages (Chung 1999). Adequate training in preoperative education and communication skills should be given to preoperative assessment teams. Future research could examine the influence of demographic characteristics, particularly education and ethnicity, on the outcomes of preoperative teaching. An ongoing programme of education and support might, in the future, use alternative methods such as CD-ROM or the Internet.

### References

1. Bernier MJ, Sanares DC, Owen SV et al. (2003) Preoperative Teaching Received and Valued in a Day Surgery Setting. *AORN* 77:563–572

2. Caumo W, Schmidt AP, Schneider CN et al. (2001) Risk Factors for Preoperative Anxiety in Adults. *Acta Anaesthesiol Scand* 45:298–307
3. Chan Y, Irish JC, Wood SJ et al. (2002) Patient Education and Informed Consent in Head and Neck Surgery. *Arch Otolaryngol Head Neck Surg* 128:1269–1274
4. Cheung LH, Callaghan P, Chang AM (2003) A Controlled Trial of Psycho-Educational Interventions in Preparing Chinese Women for Elective Hysterectomy. *Int J Nurs Stud* 40:207–216
5. Chung F (1999) Postoperative Pain Control in Ambulatory Surgery. *Surg Clin North Am* 79:401–430
6. Duhalde A, Boucheny D, Dougados M (2002) Effects of Video Information on Preoperative Anxiety Level and Tolerability of Joint Lavage in Knee Osteoarthritis. *Arthritis Rheum* 47:380–382
7. Giraudet-Le Quintrec JS, Coste J, Vastel L et al. (2003) Positive Effect of Patient Education for Hip Surgery: A Randomized Trial. *Clin Orthop* 414:112–120
8. Guruge S, Sidani S (2002) Effects of Demographic Characteristics on Preoperative Teaching Outcomes: A Meta-Analysis. *Can J Nurs Res* 34:25–33
9. Hobbs FDR (2002) Does Pre-Operative Education of Patients Improve Outcomes? The Impact of Pre-Operative Education on Recovery following Coronary Bypass Surgery: A Randomised Controlled Trial. *Eur Heart J* 23:600–601
10. Kotzer AM, Coy J, LeClaire AD (1998) The Effectiveness of a Standardized Educational Program for Children using Patient-Controlled Analgesia. *J Soc Pediatr Nurs* 3:117–126
11. LaMontagne LL, Hepworth JT, Cohen F et al. (2003) Cognitive-Behavioral Intervention Effects on Adolescents' Anxiety and Pain following Spinal Fusion Surgery. *Nurs Res* 52:183–190
12. Macintyre PE, Ready LB (2002) *Acute Pain Management*, 2<sup>nd</sup> edn. WB Saunders, London, pp 225–231
13. Moores A, Pace NA (2003) The Information Requested by Patients Prior to Giving Consent to Anaesthesia. *Anaesthesia* 58:703–706
14. Mordiffi SZ, Tan SP, Wong MK (2003) Information Provided to Surgical Patients versus Information Needed. *AORN J* 77:546–549
15. Watt-Watson J, Stevens B, Costello J et al. (2000) Impact of Preoperative Education on Pain Management Outcomes after Coronary Artery Bypass Graft Surgery: A Pilot. *Can J Nurs Res* 31:41–56

## Postoperative Pain, Regional Blocks

ANDREW J. FARACI, SPENCER S. LIU  
Virginia Mason Medical Center, Seattle, WA, USA  
anesssl@vmmc.org

### Synonyms

Regional anesthesia; Peripheral nerve blocks; Regional Blocks

### Definition

The chemical blockade of inputs in response to noxious mechanical stimuli originating from various anatomical groupings of afferent nerve fibers and their distal innervations. The goal of the regional blockade is to provide analgesia and rapid functional recovery to patients during the perioperative period, whilst simultaneously taking steps to utilize correct technique and local anesthetic agents so as to reduce potential side effects associated with these blocks.

## Characteristics

The numerous regional blocks available to treat postoperative pain can best be understood by classifying each into anatomical subheadings, and addressing the different afferent innervations they are designed to suppress. Each block will be described with respect to the most typical indications, complications, and technique associated with their use, with appropriate local anesthetic agent selection and overall contraindication from regional blocks to follow.

## The Upper Extremity

### Brachial Plexus

Indications for ► **brachial plexus** blockade are procedures involving the shoulder or upper extremity. Examples of these types of surgeries include acromioplasty rotator cuff repair, humeral, hand, and forearm procedures. Common techniques available for brachial plexus blockade are the ► **interscalene** approach, and the axillary approach.

### Interscalene Approach

Often utilized for open shoulder surgeries and surgeries of the proximal upper extremity, the interscalene approach can be used for the placement of continuous interscalene catheters or single shot local anesthetic dosing. Continuous interscalene analgesia has been shown to reduce patient requirements for postoperative opioids, provide better analgesia, reduce opioid-related side effects, and give better patient satisfaction for at least the first 48 hours following surgery, when compared with IV ► **patient controlled analgesia** in prospective, randomized, controlled trials (Liu and Salinas 2003; Ifeld et al. 2003).

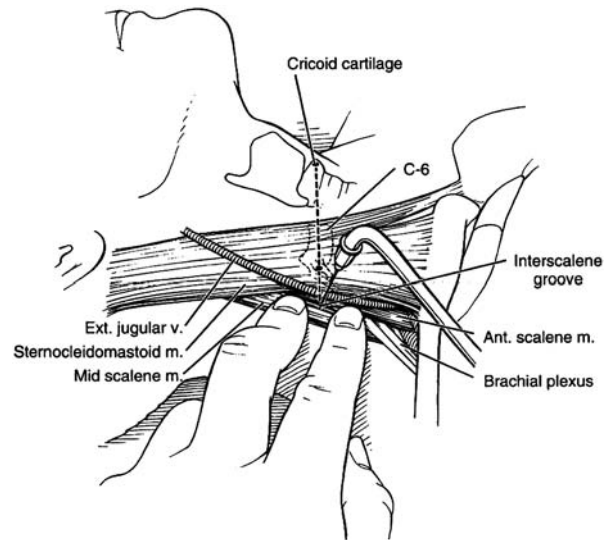
Potential complications to the interscalene approach include inadvertent injection into the vertebral artery, epidural and subarachnoid space, phrenic and recurrent laryngeal nerve block, block of the ipsilateral sympathetic chain, and ► **pneumothorax** (Liu and Salinas 2003).

Technique involves needle entry in the interscalene groove, typically utilizing a needle capable of electrical peripheral nerve stimulation for localization of the brachial plexus via muscle twitch, and either a single shot injection of a local anesthetic agent or the insertion of catheters 5–10 cm into the brachial plexus sheath for continuous anesthetic infusion (Mulroy 2002) (Fig. 1).

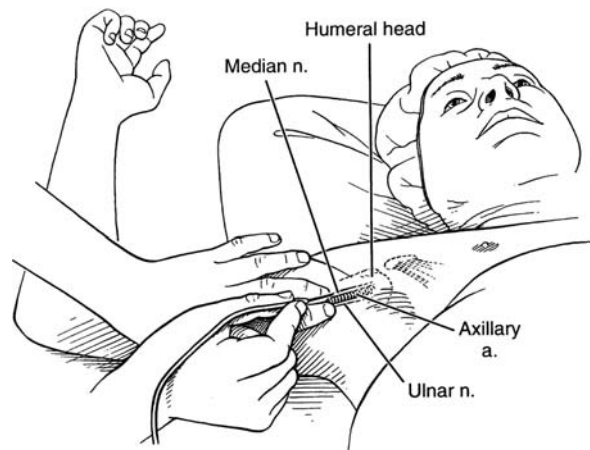
### Axillary Approach

Often employed for more distal upper extremity procedures involving the hand and forearm, the benefit of using continuous axillary brachial plexus block over PCA has not been established as for continuous interscalene analgesia (Liu and Salinas 2003).

A complication unique to this technique is axillary artery hematoma.



**Postoperative Pain, Regional Blocks, Figure 1** Interscalene block. Ant., anterior; Ext., external; m., muscle; v., vein. From Urmey WF. Upper extremity blocks and lower extremity blocks, in Brown DL: Regional Anesthesia and Analgesia, Philadelphia, W. B. Saunders Co., 1996. By permission of Mayo Foundation for Medical Education and Research.



**Postoperative Pain, Regional Blocks, Figure 2** Illustration of anesthesiologist and patient for axillary block. Patient's arm bent at 90 degrees. Anesthesiologist's fingers straddle artery (a.); humeral head is shown and facilitates plexus fixation. n., nerve. From Urmey WF. Upper extremity blocks and lower extremity blocks, in Brown DL: Regional Anesthesia and Analgesia, Philadelphia, W. B. Saunders Co., 1996. By permission of Mayo Foundation for Medical Education and Research.

Techniques for the axillary approach are numerous, and involve a peri-arterial single shot injection of local anesthetics or continuous catheter placement via the use of nerve stimulators, fluoroscopic, and ultrasound guided needle placement (Mulroy 2002) (Fig. 2).

## The Thorax and Abdomen

### Intercostal Approach

Indicated for abdominal and chest-wall procedures, this block can offer an alternative to spinal or epidural anesthesia. Bilateral blockade of the 6<sup>th</sup> through to the



12<sup>th</sup> intercostal nerves provides sensory anesthesia for the thoracic and abdominal wall in these respective dermatomes, i.e., from the xiphoid to the pubis, and have been shown to be weakly associated with improved pulmonary outcome measures in postoperative recovery studies (Mulroy 2002; Ballantyne et al. 1998). Complications include pneumothorax, airway obstruction secondary to sedation in the prone position during placement, systemic toxicity, and hypotension. Technique is typically the posterior approach. The classic posterior approach inserts the needle at the inferior portion of the body of the rib and walking the needle tip inferiorly off the body of the rib. A continuous technique has been described, inserting a catheter into the ► [intercostal space](#) to provide analgesia to several levels via spread of injected solutions (Mulroy 2002).

### Paravertebral Approach

Indicated for blocking peripheral nerves as they exit from the intervertebral foramina along the thoracic and lumbar vertebrae. Particularly useful for blocking lumbar roots, which do not have a convenient rib to mark their peripheral course, this block may be employed for procedures involving the chest (i.e. breast procedures) or abdominal wall as well as lower abdominal and upper leg procedures, (i.e. inguinal hernia repair). Paravertebral blocks provide ipsilateral somatic and sympathetic nerve blockade in multiple contiguous thoracic dermatomes above and below the site of injection, and are effective in treating acute and chronic pain of unilateral origin from the chest and abdomen (Karmakar 2001). Useful as an alternative to epidural or intercostal anesthesia, this method has a decreased accuracy of placement associated with its use, with a 10% failure rate reported in several series (Mulroy 2002).

Complications include pneumothorax, subarachnoid injection, and systemic toxicity.

Technique for placement involves introducing a 3–4 in needle 3–4 cm lateral to the midline, until the transverse process of the desired nerve root is contacted. Walking to the inferior border of the transverse process, the needle is advanced 2 cm below the inferior border and anesthetic solution is then injected (Mulroy 2002). The thoracic paravertebral technique is similar to the lumbar approach, with the nerve tending to lie more superiorly under its transverse process.

### The Lower Extremity

#### Lumbar Plexus

Indications for ► [lumbar plexus](#) blockade are procedures involving anatomical structures of the pelvic girdle, knee, and proximal tibia. Examples of these types of surgeries are total hip replacement (THR), knee arthroscopy, knee replacement, ACL repair, and repair of tibia plateau fracture. Common techniques available for lumbar plexus blockade include the femoral

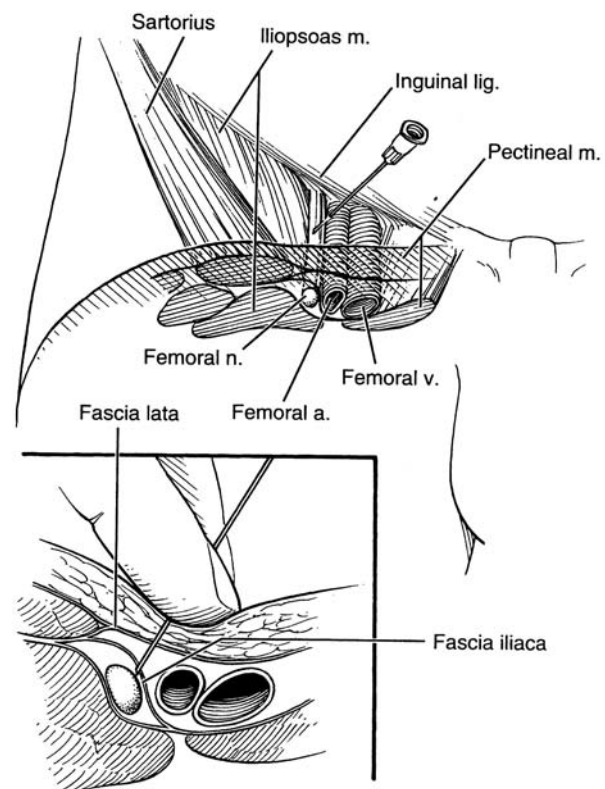
nerve sheath approach and the ► [psoas compartment](#) approach.

### Femoral Nerve Sheath Approach

Indicated in a majority of open knee procedures, continuous femoral analgesia for total knee replacement has been shown to provide comparable or improved analgesia, with fewer side effects, for at least the first 48 hours following surgery, faster short-term functional recovery of knee flexion, accelerated physical rehab, and reduction in hospital stay and total rehab when compared to IV PCA in prospective clinical trials. Data also supports continuous femoral analgesia after total hip replacement, with significant morphine sparing effects resulting in decreased incidence of nausea, vomiting, pruritus and sedation versus IV PCA (Liu and Salinas 2002).

Complications arising from femoral nerve sheath blocks include inadvertent injection of the femoral vein/artery, femoral nerve injury, and infection.

The technique most commonly employed in the placement of femoral nerve sheath single shot injections of local anesthetics or continuous catheter infusions,



**Postoperative Pain, Regional Blocks, Figure 3** Anteroposterior (a) and cross-sectional (b) views of the femoral nerve (n.), which lies between the fascia lata and the iliac fascia, lateral to the femoral artery (a.) and vein (v.). lig., ligament; m, muscle. From Urmev WF. Upper extremity blocks and lower extremity blocks. , in Brown DL: Regional Anesthesia and Analgesia, Philadelphia, W. B. Saunders Co., 1996. By permission of Mayo Foundation for Medical Education and Research.



involves perivascular isolation of femoral nerve twitch with nerve stimulators. Catheters are typically inserted 10–15 cm into the femoral sheath to maximize cephalad proximity to the lumbar plexus (Liu and Salinas 2002) (Fig. 3).

### Psoas Compartment Approach

Indicated for procedures that require a more reliable block of the obturator nerve (e.g. total hip replacement (THR)), continuous psoas compartment analgesia has been shown to provide improved analgesia and patient satisfaction in THR/ hip fracture patients when compared to IV PCA (Liu and Salinas 2002).

Complications are similar to FIC and femoral nerve sheath blocks with infection, neurologic, and vascular injuries being the most common.

The technique of psoas compartment block involves placing the patient in the lateral decubitus position with the operative extremity up. The needle insertion point is 3 cm caudal and 5 cm lateral to the L4 spinous process. A 15 cm stimulating needle is advanced perpendicular to the skin, and directed slightly midline until the L5 transverse process is encountered. The needle is then redirected slightly cephalad, sliding past the superior aspect of the L5 transverse process and advanced until stimulation of the quadriceps muscle is elicited (Mulroy 2002).

### Sciatic Nerve

Indications for sciatic nerve block primarily involve open procedures of the foot and distal lower extremity. When compared to IV PCA, continuous sciatic nerve block has been shown to provide superior analgesia with significantly reduced incidence of nausea/vomiting, urinary retention, and sedation. After moderately painful orthopedic surgery of the lower extremity, ropivacaine infusion using a portable mechanical pump and a popliteal sciatic perineural catheter at home also decreased pain, opioid use and related side effects, sleep disturbances and improved overall satisfaction (Ilfeld et al. 2002).

The incidence of complications associated with sciatic nerve block is very low and similar to those listed for lumbar plexus blocks with infectious, vascular and neurologic injury having the highest frequency.

There are two techniques available in blocking the sciatic nerve, the posterior popliteal approach, and the lateral approach. The posterior popliteal approach is performed with the patient in the prone position, with the benefits over PCA as described above. This approach is often associated with decreased catheter durability and function, given its close proximity to the knee joint. The lateral approach can be performed in a supine patient, a position that has been anecdotally shown to be advantageous in allowing a more secure placement of the catheter between the vastus lateralis and biceps femoris, away from the mobile knee joint. There have been no clinical tri-

als, however, to determine which approach is optimal for catheter placement (Liu and Salinas 2002).

### Drugs for Continuous Perineural Anesthesia

Lidocaine, bupivacaine, and ropivacaine have all been used in conjunction with continuous infusions, PCA, or a combination of background infusions and PCA boluses, for prolonged plexus analgesia. The longer acting amino-amides bupivacaine, levobupivacaine and ropivacaine, being the most commonly used agents, are frequently mixed with adjuvants such as epinephrine, clonidine, and opioids, offering the ability to spare local anesthetic volume, reduce motor and sensory blocks, and improve the quality of analgesia. In specific agent selection, there is insufficient data to determine an optimal analgesic solution. Both levobupivacaine and ropivacaine, however, have less CNS and cardiovascular toxicity than bupivacaine and may be safer (Ladd et al. 2002).

### Contraindications

Common contraindications include infection at the block site and allergy to analgesics. Peripheral nerve blocks have generally been considered safe in the anticoagulated patient. However, compressive neuropathies have been described in anticoagulated patients, secondary to post block perineural hematoma formation. Placement of peripheral nerve catheters during a central neuraxial or general anesthesia to improve patient comfort, although not contraindicated, may lead to potential neurologic injury due to inadvertent intraneural injection. Use of a nerve stimulator does not guarantee avoidance of this type of neurologic injury (Liu and Salinas 2002).

### References

1. Ballantyne JC, Carr DB, deFerranti S et al. (1998) The Comparative Effects of Postoperative Analgesic Therapies on Pulmonary Outcome: Cumulative Meta-Analyses of Randomized, Controlled Trials. *Anesth Analg* 86:598–612
2. diBenedetto P, Casati A, Bertini L et al. (2002) Postoperative Analgesia with Continuous Sciatic Nerve Block After Foot Surgery: A Prospective, Randomized Comparison Between the Popliteal and Subgluteal Approaches. *Anesth Analg* 94:996–1000
3. Ilfeld BM, Morey TE, Wang RD et al. (2002) Continuous Popliteal Sciatic Nerve Block for Postoperative Pain Control at Home: A Randomized, Double-Blinded, Placebo-Controlled Study. *Anesthesiology* 97:959–965
4. Ilfeld BM, Morey TE, Wright TW et al. (2003) Continuous Interscalene Brachial Plexus Block for Postoperative Pain Control at Home: A Randomized, Double-Blinded, Placebo-Controlled Study. *Anesth Analg* 96:1089–1095
5. Karmakar M (2001) Thoracic Paravertebral Block. *Anesthesiology* 95:771–780
6. Ladd L, Chang D, Wilson KA et al. (2002) Effects of CNS Site-Directed Carotid Arterial infusions of Bupivacaine, Levobupivacaine, and Ropivacaine in Sheep. *Anesthesiology* 97:418–428
7. Liu S, Salinas F (2003) Continuous Plexus and Peripheral Nerve Blocks for Postoperative Analgesia. *Anesth Analg* 96:262–272
8. Mulroy M (2002) Regional Anesthesia: An Illustrated Procedural Guide, 3rd edn. Lippincott Williams & Wilkins, Philadelphia

9. Neal J, McDonald S, Larkin K et al. (2003) Suprascapular Nerve Block Prolongs Analgesia After Nonarthroscopic Shoulder Surgery but Does Not Improve Outcome. *Anesth Analg* 96:982–986

## Postoperative Pain, Thoracic and Cardiac Surgery

ELMAR BERENDES<sup>1</sup>, HUGO VAN AKEN<sup>1</sup>,  
THOMAS HACHENBERG<sup>2</sup>

<sup>1</sup>Clinic and Policlinic for Anaesthesiology and operative Intensive Medicine, University Hospital Münster, Münster, Germany

<sup>2</sup>Clinic for Anaesthesiology and Intensive Therapy, Otto-von-Guericke University, Magdeburg, Germany  
berendes@klinikum-krefeld.de

### Synonyms

Postoperative pain management; acute postoperative pain therapy; thoracic surgery; cardiac surgery; thoracic epidural anesthesia; high thoracic epidural anesthesia

### Definition

Pain influences patients' morbidity and mortality postoperatively after cardiac and thoracic surgical procedures. Adequate perioperative analgesia is essential to avoid pulmonary and cardiac complications. ► **Postoperative pain management** must be aggressive to relieve severe dynamic pain, e.g. when the patient is coughing, and needs robust routines that will discover early symptoms and signs of potentially serious complications. ► **Thoracic epidural anesthesia** provides excellent analgesia, improves left ventricular function and reduces perioperative pulmonary complications and myocardial ischemia. Thus, optimal use of pharmacological analgesia, combined with a well-tailored perioperative thoracic epidural anesthesia, can markedly reduce complications in patients at high risk of developing postoperative respiratory infections and cardiac ischemic events.

### Characteristics

#### Pulmonary and Cardiac Function after Thoracic and Cardiac Surgery

Sternotomy, and in particular lateral thoracotomy, result in postoperative pain and impair respiratory mechanics and coughing. Both affect the retraction forces of the chest wall. After sternotomy, thoracic compliance decreases whilst compliance of the lungs increases. These mechanisms may enhance the development of atelectasis, even if tidal volume and airway pressure remain unchanged during mechanical ventilation. The opened pleura, further increases the compliance of the respiratory system. The chest wall and pleura compartment of-

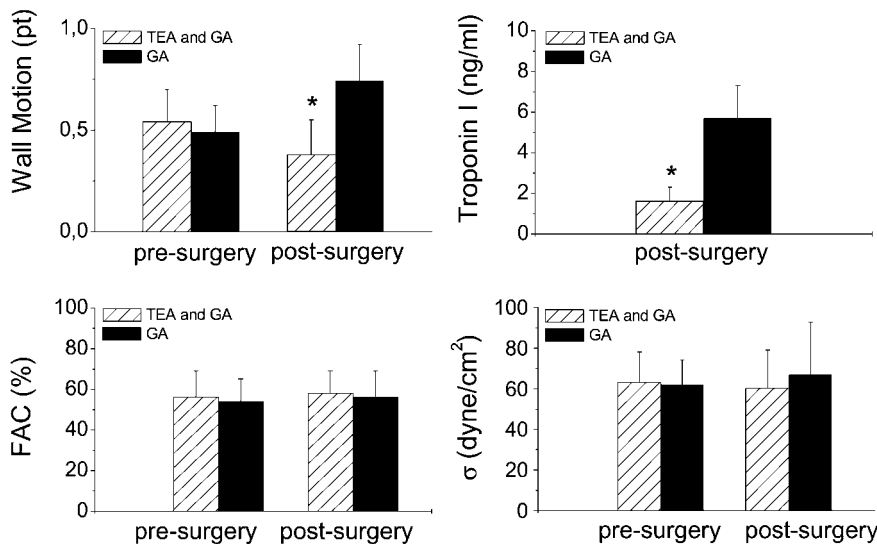
fer significant impedance to lung expansion after sternotomy and rib extraction, unless the pleura is opened (Hachenberg and Pfeiffer 1999; Barnas et al. 1996). The deflation of the lung during one lung ventilation invariably results in an increased shunt, impaired oxygenation and carbon dioxide elimination. After thoracic surgical procedures, the following major problems result in an impaired pulmonary function: 1. Decreased lung volume (e.g. atelectasis, resection of lung tissue, pleural effusion, and thoracic restriction); 2. Impaired ventilation (decreased functional residual capacity, dysfunction of diaphragm, dysfunction of intercostal muscles, increased airway resistance); and 3. Impaired gas exchange (atelectasis, lung oedema, decreased cardiac output and decreased minute ventilation).

Cardiac and thoracic surgical procedures are further associated with exaggerated perioperative adrenergic stimulation, resulting in hormonal response and systemic inflammation. These pathophysiological changes can lead to perioperative myocardial ischemia or other life-threatening cardiac events. The incidence of perioperative myocardial infarction is 0.2% in patients without, and 4.0% in patients with pre-existing coronary artery disease (Ashton et al. 1993). Severe myocardial ischemia appears most frequently during the first 48 hours after major surgery (Metzler et al. 1997). Thus, perioperative pain management should focus on effective perioperative pain relief and a reduction of pulmonary and cardiac complications.

#### Effects of Thoracic Epidural Anesthesia on Pulmonary and Myocardial Function

The effects of thoracic epidural anesthesia on lung volume, respiratory mechanics and pulmonary gas exchange depend on the extent of segmental regional blockade and sympathicolysis. Theoretically, thoracic epidural anesthesia may lead to an alteration of intrathoracic blood volume, lung volume and pulmonary vasotone by sympathicolysis, paralysis of intercostal muscles, decreased volume of thoracic cavity and increased thoracic and abdominal compliance. However, the results of prospective, randomized clinical trials postulate beneficial effects of thoracic epidural anesthesia, and no study has reported a deterioration of pulmonary function by thoracic epidural anesthesia during and after ► **thoracic surgery** (Hachenberg and Pfeiffer 1999). The excellent analgesia after thoracic surgery, by contrast, results in lower incidence of respiratory morbidity (Ballantyne et al. 1998).

An activation of myocardial sympathetic nerves in ► **cardiac surgery** can result in myocardial ischemia, especially in patients with coronary artery disease (Nabel et al. 1988). Consequently, a reversible cardiac sympathectomy by ► **high thoracic epidural anesthesia** has anti-ischemic effects owing to the blockade of efferent sympathetic fibers (Olausson et al. 1997). Clinical studies of high thoracic epidural anesthesia



**Postoperative Pain, Thoracic and Cardiac Surgery, Figure 1** Patients' Global and Regional Left Ventricular Function and Afterload. Pre- and postoperative values of (a) global left ventricular wall motion index, (c) left ventricular fractional area change (FAC), and (d) left ventricular end systolic meridional wall stress ( $\sigma$ ) as well as (b) postoperative concentrations of cardiac troponin I in patients receiving general anesthesia (GA) or general anesthesia and high thoracic epidural anesthesia (TEA). Mean  $\pm$  SD, \*  $P < .05$  (Berendes et al. 2003).

imply beneficial effects for the perioperative management of patients who underwent coronary artery bypass grafting. The sympathetic blockade by high thoracic epidural anesthesia results in depression of the endocrine perioperative stress response (Loick et al. 1998), an improvement of global systolic and diastolic left ventricular function (Schmidt et al. 2000), and a reduction of new wall motion abnormalities (Berendes et al. 2003) during and after coronary artery bypass grafting. These effects of high thoracic epidural anesthesia may improve the long-term outcome after myocardial revascularisation. Figure 1 shows the effects of high thoracic epidural anesthesia on postoperative and global left ventricular function, cardiac troponin I concentrations and afterload after coronary artery bypass grafting.

#### Specific Problems of High Thoracic Epidural Anesthesia for Coronary Artery Bypass Grafting

Several studies have reported the advantages of an additional high thoracic epidural anesthesia such as earlier weaning from mechanical ventilation, decreased catecholamine response, reduction of perioperative myocardial ischemia, improved renal and pulmonary outcome and better pain control. However, there are some problems limiting the routine use of high thoracic epidural anesthesia for coronary artery bypass grafting. Since the neurological risk of high thoracic epidural anesthesia for this procedure remains inadequately defined, placement of the epidural catheter one day prior to surgery is mandatory to minimize the risk of epidural hematoma because of intra-operative systemic anticoagulation. Moreover, in many cases, pain control may be not effective for chest tubes and venous graft preparation. Thus, an additional systemic analgesia with opioids and/or non-opioid analgesics is routinely necessary.

#### Clinical Implications of Thoracic Epidural Anesthesia for Thoracic and Cardiac Surgery

In thoracic, and especially cardiac, surgical procedures an effective cardiomyocyte functional protection during a perioperative insult stress requires a balanced preservation vs. blunting of  $\beta$ -adrenergic signaling. Adrenergic sensitization optimizes post-ischemic functional recovery, while desensitization protects against intra-operative oxygen supply/demand imbalance. The deleterious effects of adrenergic stimulation on  $\beta$ -adrenergic receptor density and  $\beta$ -adrenergic receptor coupling, and the positive effects of thoracic epidural anesthesia have been well documented (Lefkowitz et al. 2000). Thus, attenuation of the stress response via-blockade and/or selective anesthetic regimens, i.e. thoracic epidural anesthesia, has the potential to prevent adverse events. Consequently, a multimodal approach to reduce patients' stress response and improve recovery, consisting of intra-operative general anesthesia, thoracic epidural anesthesia, postoperative patient-controlled epidural anesthesia, early extubation, early oral nutrition and enforced mobilization is the most appropriate regimen, particularly for patients undergoing thoracic and cardiac surgical procedures (Brodner et al. 2001). Other local anesthetic techniques such as intercostal nerve block, intrapleural local anesthesia or wound infiltration are less effective than thoracic epidural anesthesia, and have not been introduced in clinical practice for routine use (Ballantyne et al. 1998).

#### Systemic Analgesia after Thoracic and Cardiac Surgery

Systemic postoperative pain management after thoracic and cardiac surgery is mainly based on intravenous opioids when thoracic epidural anesthesia is not possible. Opioids are potent analgesics; their use, however, may cause a variety of adverse effects, such as excessive

sedation, respiratory depression, biliary spasm, depression of gastrointestinal motility, and postoperative nausea and vomiting. Some systemic side effects can be blunted by adequately tailored opioid analgesia, given in time and not on demand, combined with a non-opioid analgesic like propacetamol or metamizol (Hyllested et al. 2001). Non-steroidal anti-inflammatory drugs effectively reduce opioid consumption after thoracic surgery (Pertunnen et al. 1999); however, the fear of potentially serious side effects, such as predisposition to increased postoperative bleeding and deterioration of renal function, means that these drugs are not widely used, especially after cardiac surgical procedures performed with cardiopulmonary bypass. Thus, recent studies have focused on the reduction of opioid consumption by paracetamol or propacetamol (Lathinen et al. 2002, Avellanda et al. 2000) showing different results. In the study of Lathinen et al. (2002), an adjunctive therapy with propacetamol neither decreased cumulative opioid consumption nor reduced adverse effects after coronary bypass grafting, while Avellanda et al. (2000) found that pain scores were significantly decreased with a single additional propacetamol infusion after cardiac surgery. The combination of non-steroidal anti-inflammatory drugs and paracetamol may confer additional analgesic efficacy compared with paracetamol alone, and the published data suggest that paracetamol may enhance analgesia when added to a non-steroidal anti-inflammatory drug, compared with non-steroidal anti-inflammatory drugs alone (Hyllested et al. 2001).

A good interdisciplinary acute pain service and/or well designed algorithm for postoperative pain therapy implemented in routine postoperative care is essential, especially for thoracic and cardiac surgical procedures

## References

- Ashton CM, Petersen NJ, Wray NP et al. (1993) The Incidence of Perioperative Myocardial Infarction in Men Undergoing Non-Cardiac Surgery. *Ann Intern Med* 118:504–510
- Avellanda C, Gómez A, Martos F et al. (2000) The Effect of a Single Intravenous Dose of Metamizol (2 g), Ketorolac (30 mg) and Propacetamol (1 g) on Hemodynamic Parameters and Postoperative Pain after Heart Surgery. *Eur J Anaesth* 17:85–89
- Badner NH, Knill RL, Brown JE et al. (1998) Myocardial Infarction after Non-Cardiac Surgery. *Anesthesiology* 88:572–578
- Ballantyne JC, Carr DB, de Ferranti D et al. (1998) The Comparative Effects of Postoperative Analgesic Therapies on Pulmonary Outcome: Cumulative Meta-Analyses of Randomised, Controlled Trials. *Anesth Analg* 86:598–612
- Barnas GM, Gilbert TB, Watson RJ et al. (1996) Respiratory Mechanics in the Open Chest: Effects of Parietal Pleurae. *Respiratory Physiology* 104:63–70
- Berendes E, Schmidt C, Van Aken H et al. (2003) Reversible Cardiac Sympathectomy by High Thoracic Epidural Anesthesia Improves Regional Left Ventricular Function in Patients Undergoing Coronary Artery Bypass Grafting. *Arch Surg* 138:1283–1290
- Brodner G, Van Aken H, Hertle L et al. (2001) Multimodal Perioperative Management – Combining Thoracic Epidural Analgesia, Forced Mobilization, and Oral Nutrition – Reduces Hormonal and Metabolic Stress and Improves Convalescence after Major Urologic Surgery. *Anesth Analg* 92:1594–1600
- Hachenberg T, Pfeiffer B (1999) Use of Thoracic Epidural Anaesthesia for Thoracic Surgery and its Effect on Pulmonary Function. *Baillière's Clinical Anaesthesiology* 13:57–72
- Hyllested M, Jones S, Pedersen JL et al. (2002) Comparative Effect of Paracetamol, NSAIDs, or their Combination in Postoperative Pain Management: A Qualitative Review. *Br J Anaesth* 88:199–214
- Lahtinen P, Kokki H, Hendolin H et al. (2002) Propacetamol as Adjunctive Treatment for Postoperative Pain after Cardiac Surgery. *Anesth Analg* 95:813–819
- Lefkowitz RJ, Rockman HA, Koch WJ (2000) Catecholamines, Cardiac  $\beta$ -adrenergic Receptors, and Heart Failure. *Circulation* 101:1634–1637
- Loick HM, Schmidt C, Van Aken H et al. (1999) Modulation of Immune and Stress Response by High Thoracic Epidural Anesthesia or Clonidine in Patients Undergoing Cardiopulmonary Bypass Grafting. *Anesth Analg* 88:701–709
- Nabel EG, Ganz P, Gordon JB et al. (1988) Dilation of Normal and Constriction of Atherosclerotic Coronary Arteries Caused by the Cold Pressure Test. *Circulation* 77:43–52
- Olausson K, Magnusdottir H, Lurje L et al. (1997) Anti-Ischemic Effects and Anti-Anginal Effects of Thoracic Epidural Anesthesia versus Those of Conventional Therapy in the Treatment of Severe Refractory Unstable Angina Pectoris. *Circulation* 96:2178–2182
- Pertunnen K, Nilsson E, Kalso E (1999) I. V. Diclofenac and Ketorolac for Pain after Thoracoscopic Surgery. *Br. J Anaesth* 82:221–227
- Schmidt C, Wirtz S, Van Aken H et al. (2000) Effect of High Thoracic Epidural Anesthesia on Global Left Ventricular Function in Patients with Coronary Artery Disease. *Anesthesiology* 93:A 656

## Postoperative Pain, Tramadol

PETER C. A. KAM

University of New South Wales at St George Hospital,  
Kogarah, NSW, Australia  
p.kam@unsw.edu.au

### Synonym

Tramal<sup>®</sup>

### Definition

► **Tramadol** is a synthetic, centrally acting analgesic agent that is structurally related to codeine and morphine. It has a methyl substitution on the phenol moiety, and this accounts for its affinity for opioid receptors. It is a racemic mixture and the 2 enantiomers function in a complementary manner to enhance analgesic actions.

### Characteristics

#### Pharmacodynamic Properties

The overall mechanisms of the analgesic actions of tramadol are mediated by modulation of opioid and monoamine descending inhibitory pathways mediated by the raphe nucleus, periaqueductal grey, locus coeruleus and reticulospinal projections (Lee et al. 1993). Tramadol acts as an opioid agonist and inhibits the reuptake of norepinephrine and serotonin. The (+)-enantiomer of tramadol has selective mu ( $\mu$ ) ag-



onist actions. The affinity of the (+)-enantiomer for the  $\mu$ -receptor is ~ 6000 times less than that of morphine, and 10 times less than codeine. It binds weakly to kappa and delta receptors. O-desmethyl (MI) tramadol metabolite formed during extensive hepatic metabolism of tramadol is pharmacologically active, with a ~ 200 fold higher affinity for the  $\mu$ -receptor compared with racemic tramadol. The (+)-enantiomer is also a potent inhibitor of 5-HT reuptake. 30% of the analgesic actions of tramadol are antagonised by naloxone.

The non-opioid analgesic actions of tramadol are mediated by its actions on monoamine systems, where it inhibits the reuptake of norepinephrine and serotonin. The (-) enantiomer is a more effective inhibitor of 5-HT reuptake and also increases its release by autoactivation (Bamigbade and Langford 1998). O-Desmethyl tramadol (MI) metabolite may have an important role in mediating the analgesic actions of tramadol. As it is metabolised by liver cytochrome P450 (CYP) 2D6 sparteine oxygenase, tramadol may have reduced analgesic effects in patients deficient in CYP 2D6 enzyme (~ 8% Caucasian population).

In double-blind controlled studies, the analgesic effects of oral tramadol (100 mg) peaked at 1–2 hrs and lasted for 3–6 hours after drug administration. ► **Intravenous tramadol** (2 mg/kg) provided similar anti-nociceptive effects to that of pethidine (1 mg/kg). The minimum effective serum concentration (MEC) of tramadol is 20.2 to 986.3  $\mu\text{g/l}$  (median 287.7  $\mu\text{g/l}$ ), with the MEC for the MI metabolite being 0.9–190.5  $\mu\text{g/l}$  (median 36.2  $\mu\text{g/l}$ )

### Respiratory Effects

In clinical studies in postoperative patients using equianalgesic dose (potency ratio 10 : 1 for tramadol: morphine), tramadol had less effect on the respiratory centre compared with morphine.

### Gastrointestinal Motility

Unlike opioids, which impair gastrointestinal motility, tramadol generally has no significant effect on gastrointestinal function. Tramadol does not prolong gastric emptying. In volunteers receiving oral tramadol, median oro-caecal transit times were similar to those receiving a placebo, although there was a trend towards an increase in total colonic transit time.

### Central Nervous System

Tramadol has been shown to cause idiopathic seizures in clinical use with an incidence of < 10%. Significant dose related activation of EEG variables (spectral edge, median power frequency, delta power and alpha/delta ratio) is produced by tramadol (Vaughan et al. 2000). However, tramadol has no effects on the depth of anaesthesia, as measured by auditory-evoked response, when it is used for intra-operative analgesia during surgery.

### Pharmacokinetics

Tramadol is rapidly absorbed with an ► **oral bioavailability** of 70% after a single dose administration, and ~ 90% after multiple doses (due to saturated first-pass hepatic metabolism). A  $C_{\text{max}}$  of 308  $\mu\text{g/l}$  is reached in 1–6 hours after a single oral 100 mg dose. Multiple doses result in higher  $C_{\text{max}}$  values for tramadol and its MI metabolite. Tramadol has a large volume of distribution (~ 260 l) indicating high tissue affinity of the drug. It is ~ 20% bound to plasma proteins. Tramadol crosses the placental barrier with a foetal maternal ratio of 0.8.

Tramadol undergoes first-pass hepatic metabolism via 2 metabolic pathways, mainly involving isoenzyme CDYP2D6 and to a lesser extent CYP3A. Tramadol is metabolised by CYP2D6 to O-desmethyl tramadol (MI), which is active (binds to  $\mu$ -receptor). In patients who are deficient in CYP2D6 isoenzyme, inactive N-desmethyl tramadol is produced. The O- and N-desmethylated compounds are conjugated (sulphation or glucuronidation).

The elimination kinetics of tramadol follows a 2 compartmental model, with a terminal elimination half life of ~ 5.5 hours. The  $T_{1/2\beta}$  of its MI metabolite is approximately 6.6–6.9 hours. Tramadol and its metabolites are excreted primarily via the kidneys (90%), with the remaining (10%) eliminated in the faeces. Therefore, the  $T_{1/2\beta}$  is prolonged in patients with impaired renal and hepatic function (10.8 and 13.3 hours respectively).

### Clinical Efficacy

Earlier studies on the anaesthetic efficacy of oral or parenteral tramadol in acute post-operative pain management showed that intravenous tramadol 50 to 150 mg was equivalent in analgesic efficacy to morphine 5 to 15 mg in the treatment of moderate, but not in severe, pain. The peak analgesic effect of intramuscular tramadol occurred within 1–2 hours and lasted for 5–6 hours. In a meta-analysis of 3453 postoperative patients, it was found that the analgesic efficacy of tramadol 75–100 mg was similar to that of codeine 60 mg, and combinations of aspirin 650 mg plus codeine 60 mg, and paracetamol 650 mg plus dextropropoxyphene 100 mg (Moore and McQuay 1997). The NNT of tramadol 50 mg is 8.3; that of tramadol 100 mg is 4.8 and that of tramadol 150 mg is 2.4, indicating a dose dependent response.

Tramadol (dose titrated to response) reduced severe postoperative pain associated with abdominal, orthopaedic and cardiac surgery by 46–57% after 4–6 hours, compared with a 69% reduction with morphine (Gritti et al. 1998, Lanzetta et al. 1998, Bloch et al. 2002).

With nurse controlled analgesia, the overall analgesic efficacy with tramadol was comparable to that of equipotent doses of parenteral morphine. Comparative studies, comparing the analgesic efficacy of tramadol with the NSAIDs, suggest that tramadol is a more effective anal-

gesic for pain following orthopaedic surgery compared with ketorolac. Investigators reported that the analgesic efficacy of tramadol was excellent in 79% patients, compared with 58% in patients receiving ketorolac. (Lanzetta 1998) Tramadol provided longer mean pain-free intervals between doses than that achieved with ketorolac.

Two double-blind comparative studies reported that continuous intravenous infusions of tramadol (12 mg/h), achieved analgesic efficacy similar to that obtained with intermittent boluses of tramadol 50 mg (Hartjen et al. 1996). However, there was an increased consumption of tramadol with continuous infusion compared with intermittent bolus doses (223.5 vs. 176.6 mg after 6–8 hrs; and 449 vs. 201 mg after 24 hours), although this was not associated with increased side effects.

#### Patient Controlled Analgesia (PCA)

Comparative studies have shown that tramadol provides effective analgesia over 24–48 hours period using PCA for moderate to severe postoperative pain. The analgesic efficacy of tramadol was similar to that achieved with morphine PCA (Pang et al. 1999, Stamer et al. 1997). In these studies, a loading dose (100 to 150 mg or 3 mg/kg) followed by a bolus dose (16–30 mg, or 0.3 mg/kg) were used.

A randomised double-blind controlled study comparing the analgesic efficacy of tramadol infusion with epidural morphine for post-thoracotomy pain, showed that IV tramadol (150 mg bolus followed by continuous infusion 450 mg/24h) was as effective as epidural morphine (2 mg loading dose, followed by infusion 0.2 mg/h). This technique utilizing tramadol avoids the necessity of placement of a thoracic epidural catheter (Bloch et al. 2002).

#### Paediatric Use

Oral tramadol 1.5 mg/kg combined with oral midazolam (0.5 mg/kg; maximum dose 7.5 mg) provided effective postoperative analgesia in children undergoing extraction of 6 or more teeth, without delay in recovery (Roelofse and Payne 1999).

Two recent studies investigated the analgesic effects of caudal tramadol in children undergoing hypospadias surgery. In one study involving 90 children, it was concluded that the caudal tramadol (2 mg/kg), or its concomitant use with caudal bupivacaine, did not provide additional analgesia. In the children who received caudal tramadol, pain scores at 3 hrs postoperative were significantly higher.

#### Intraoperative Analgesia

Intraoperative tramadol provided analgesia similar to that of equipotent doses of morphine, potency ratio morphine to tramadol = 1 : 11.23.

There were early concerns that tramadol may predispose to intraoperative awareness, because of its stimulatory

effects on EEG of patients receiving tramadol. However recent studies using tramadol in combination with potent volatile or intravenous anaesthetics have not shown any increase in intraoperative awareness in patients undergoing surgery (Coetzee et al. 1996).

#### Day Surgery

Its lack of sedative and respiratory depressant effects make tramadol an attractive analgesic agent. Studies have reported that perioperative tramadol provided better analgesia than fentanyl in combination with codeine/paracetamol or ketorolac. In a large multicentre study, oral tramadol (100 mg) after discharge, in combination with intravenous tramadol (100 mg pre, intra or postoperative doses), provided better analgesia than a combination of intravenous fentanyl (100 µg) and postoperative codeine (16 mg)/paracetamol (1 Gm) tablets (Bamigkade et al. 1998).

#### Neuropathic Pain

The treatment of pain in polyneuropathy is often difficult. The tricyclic antidepressants and anticonvulsants are the main drugs used in the treatment of pain in polyneuropathy, with NNT of 2.6 for tricyclic antidepressants, 2.5 for anticonvulsant sodium channel blockers, 4.1 for gabapentin. However, tramadol has been shown to be effective for pain in polyneuropathy with an NNT of 2.4.

#### Side Effects

The most common side effects of tramadol in clinical and postmarketing surveillance studies of oral or parenteral doses of tramadol were nausea (6.1%), dizziness (4.6%) drowsiness (2.4%), sweating (1.9%), vomiting (1.7%) and dry mouth (1.6%).

There are no differences in the incidence of nausea and vomiting in patients receiving tramadol compared with other opioids. In a randomised double-blind parallel group study involving patients undergoing laparoscopic surgery who received intraoperative intravenous tramadol 100 mg or morphine 10 mg, the incidence of vomiting (30%) and nausea (15–16%) was similar in both groups. The incidence of seizures is estimated to be < 1%. The risk of epilepsy is increased in patients receiving pro-convulsant drugs, neuroleptic agents, monoamine oxidase inhibitors, or patients with epilepsy.

#### Drug Interactions

Drugs acting on hepatic CYP3A and CYP2D6 isoenzymes can affect the pharmacokinetics of tramadol. Carbamazepine induces hepatic enzymes. Concomitant administration of tramadol with carbamazepine results in a 50% decrease in  $T_{1/2\beta}$  of tramadol as a result of induction of the metabolism of tramadol. Cimetidine, a potent inhibitor of cytochrome P450 isoenzymes, prolongs the  $T_{1/2\beta}$  of tramadol and its  $M_1$  metabolite.

Ondansetron is a 5HT<sub>3</sub> receptor antagonist and an anti-emetic agent commonly used for post anaesthetic nausea and vomiting. When administered to a patient receiving tramadol for analgesia, ondansetron reduced the overall analgesic effect of tramadol by approximately 25 %, probably by blocking spinal 5HT<sub>3</sub> receptors (Arcioni et al. 2002).

There have been case reports of enhanced effects of warfarin in a patient receiving concomitant warfarin and tramadol. Tramadol is not recommended in patients who are receiving monoamine oxidase inhibitors, or the serotonin reuptake inhibitors or within 2 weeks of their withdrawal. Administration of tramadol and these antidepressant drugs predispose to the serotonin syndrome.

Recommended dosage of oral or parenteral tramadol in adults < 75 yrs is 50–100 mg every 4–6 hours with a maximum of 400–600 mg/day.

## References

1. Arcioni R, della Rocca M, Romano S et al. (2002) Ondansetron Inhibits the Analgesic Effects of Tramadol: A Possible 5HT<sub>3</sub> Spinal Involvement in Acute Pain in Humans. *Anesth Analg* 94:1553–1557
2. Bamigbade TA, Langford RM (1998) Tramadol Hydrochloride: An Overview of Current Use. *Hosp Med* 59:373–376
3. Bamigbade TA, Langford RM, Blower AL et al. (1998) Pain Control in Day Surgery: Tramadol vs. Standard Analgesia. *Br J Anaesthesia* 80:558–559
4. Bloch MB, Dyer RA, Heijke SA et al. (2002) Tramadol Infusion for Post-Thoracotomy Pain Relief: A Placebo Controlled Comparison with Epidural Morphine. *Anesth Analg* 94:523–528
5. Coetzee JF, Maritz JS, du TJC (1996) Effect of Tramadol on Depth of Anaesthesia. *Br J Anaesth* 76:415–418
6. Gritti G, Verri M, Launo C et al. (1998) Multi Centre Trial Comparing Tramadol and Morphine for Pain after Abdominal Surgery. *Drugs Exp Clin Res* 24:9–16
7. Hartjen K, Fisher MV, Mewes R et al. (1996) Preventive Tramadol Infusion in Comparison with Bolus Application on Demand during the Early Postoperative Period. *Anaesthetist* 45:538–544
8. Lanzetta A, Vizzardi M, Letzia G et al. (1998) Intramuscular Tramadol versus Ketorolac in Patients with Orthopaedic and Traumatologic Postoperative Pain: A Comparative Multicenter trial. *Curr Ther Res Clin Exp* 59:39–47
9. Lee CR, McTavish D, Sorkin EM (1993) Tramadol a Preliminary Review of its Pharmacodynamic and Pharmacokinetic Properties, and Therapeutic Potential in Acute and Chronic Pain States. *Drugs* 46:313–340
10. Moore RA, McQuay HJ (1997) Single-Patient Data Meta-analysis of 3453 Postoperative Patients: Oral Tramadol versus Placebo, Codeine and Combination Analgesics. *Pain* 69:287–294
11. Pang WW, Mok MS, Lin CH et al. (1999) Comparison of Patient-Controlled Analgesia (PCA) with Tramadol or Morphine. *Can J Anaesth* 46:1030–1035
12. Roelofse JA, Payne KA (1999) Oral Tramadol Analgesic Efficacy in Children following Multiple Dental Extractions. *Eur J Anaesthesiol* 16:441–447
13. Sindrup SH, Jensen TS (2000) Pharmacologic Treatment of Pain in Polyneuropathy. *Neurology* 55:915–920
14. Stamer VM, Maier C, Grond S et al. (1997) Tramadol in the Management of Postoperative Pain: A Double-blind, Placebo- and Active Drug-Controlled Study. *Eur J Anaesthesiol* 14:646–654
15. Vaughan DJ, Shinner G, Thornton C et al. (2000) Effect of Tramadol on Electroencephalographic and Auditory Evoked Variables during Light Anaesthesia. *Br J Anaesth* 85:705–707

## Postoperative Pain, Transition from Parenteral to Oral Drugs

RICHARD BURSTAL

John Hunter Royal Hospital, Newcastle, NSW, Australia

richard.burstal@hnehealth.nsw.gov.au

### Synonyms

Transition from Parenteral to Oral Analgesic Drugs  
The term “analgesic gap” has been used to describe the increase in pain levels during this period when management is inadequate.

### Definition

The change from intravenous or intramuscular administration of analgesic drugs to the oral route.

### Characteristics

Oral analgesia is the route of choice for all patients where the gastrointestinal tract is intact, motility is adequate, and the patient is not being starved (NHMRC 1998). In acute postoperative pain these conditions are frequently not met, and for severe pain the delay between administration and onset of effect make the oral route less appealing. None the less, it is still the commonest route for drug administration, and the mainstay for ambulant patients.

In those patients where parenteral routes of administration have been chosen in the first instance, the issue of transition to oral medication is quite complex, and must be planned with some idea of the natural history of the pain in mind.

A UK Audit Commission report in 1997 highlighted some deficiencies in postoperative analgesia (Audit Commission 1997). The Commission commented in particular on the period between immediate postoperative care, usually co-ordinated by an Acute Pain Service, and discharge on simple oral analgesia. Smith and Power (Smith and Power 1998) coined the term “analgesic gap” to describe increased pain in this period, and pointed out that responsibility for covering the gap was usually delegated to the junior surgical team. They also referred to the lack of research effort in this area, which remains a problem.

The benefits of ► [multimodal analgesia](#) have been known since around 1990 (Kehlet and Dahl 1993). The use of combinations of local anaesthesia, NSAIDs, paracetamol, other non-opioid drugs and opioids to improve pain relief and reduce side-effect intensity is widespread amongst Acute Pain Services. One interpretation of the Audit Commission report is that this practice is not continued appropriately once the initial severe pain has been controlled. Possible reasons for this include the presence of contraindications to the use of NSAID, and reluctance to use oral opioids after

parenteral treatment is ceased. Although oral opioids are often said to be difficult to use for the immediate treatment of postoperative pain because of impaired gastric emptying due to both drug and surgical factors, there are reports of success as well as failure in this setting (Derbyshire et al. 1985, Pearl et al. 2002) Once GIT function has begun to return to normal, however, there is no evidence to suggest that parenteral routes offer any advantage. A neuropathic basis should be considered for pain that is poorly responsive to opioids, and appropriate adjunctive agents either substituted or added to the regimen.

Three groups of patients will be considered:

1. Those where the pain intensity is expected to decline rapidly
2. Those where the decline in pain intensity will occur over days to a week
3. Those where pain is thought to be stable but ongoing for longer periods of time

#### **Patients where Pain Intensity is expected to Decline Rapidly**

Examples of such patients include those undergoing laparoscopic surgery, minor orthopaedics, or superficial surgery of other types. Treatment for such patients should be based on simple analgesics (NSAIDs, paracetamol (NHMRC 1998), but provision should be made for opioid supplementation with a rapidly acting formulation if required. As gastric emptying is usually rapidly re-established in such patients, the oral route is to be preferred, as fear of needles is a known cause of poor analgesia in prn regimens.

#### **Patients where the Decline in Pain Intensity will occur Over Days to a Week**

These patients are probably the highest risk group for experiencing the analgesic gap. Again multimodal analgesia should be the key to ongoing therapy, with regular oral NSAID/paracetamol forming the cornerstone. Despite this there will be a number of patients where pain relief will deteriorate if parenteral opioids are simply ceased (Ng et al. 2000). The requirement for strong opioids can be judged from the pattern and amount of opioid use prior to cessation of parenteral therapy. This is easiest if the parenteral modality has been PCA, but may still be ascertained for infusions, by examination of rate variation and bolus requirement in response to various manoeuvres such as dressing changes etc. Patients requiring more than 2 doses per hour may be assumed to have a need for ongoing opioids. In such patients, this can be achieved by the method described by Smith and Power (Smith and Power 1998), using a baseline of slow release opioid, with fast acting oral opioid available on demand. As they point out, this regimen provides a background level of analgesia well below the threshold for respiratory depression, but adequate for control of rest pain,

with the demand doses available for control of dynamic pain.

The use of controlled release oxycodone following PCA for major abdominal, gynaecological, or orthopaedic surgery has been studied by Ginsberg (Ginsberg et al. 2003). The authors suggest the use of a conversion factor of 1.2X the IV morphine daily dose to predict the daily dose of controlled release oxycodone. As the tablets are only available in certain sizes, doses were usually adjusted down to the nearest tablet strength available. Note the contrast with the conversion factor of 3 that is usually quoted.

The length of time that slow release opioids are required will vary with the severity of the pain, but may be quite extended after painful surgery such as thoracotomy and orthopaedics. In the study of Ginsberg et al. (Ginsberg et al. 2003), the average duration of oral opioid therapy was 4 days for abdominal and gynaecological surgery, and 5 days for orthopaedics; however, one third of the 189 patients remained on opioids at the conclusion of the seven day study period. Pain control was maintained at 4 or less on an 11-point numerical scale throughout the 12-hour dose period, but most patients required supplemental doses of rapidly acting oxycodone (62% on day 1 and 38% on day 7).

The safety of the technique was also evaluated. Most patients were commenced on oral controlled release treatment on the first postoperative day, and the incidence of paralytic ileus was reported as 2.1% (4/189). There were also 4 patients with low oxygen saturations, 3 of whom had low baseline readings.

Alternatively, the dose of slow release drug may also be estimated from the daily dose of fast acting drug, where this is prescribed alone in the first instance. Whichever method is used, the kinetics of the slow release drug must be respected, and adequate time allowed to reach steady state. Where PCA is being used, the controlled release drugs may be safely commenced the night before it is planned to cease PCA.

#### **Patients where Pain is thought to be Stable but Ongoing for Longer Periods of Time**

Examples of such patients include burns patients, multi-trauma patients, and some painful medical problems such as calciphylaxis. Typical patterns of pain would include a stable background component present throughout the whole day, with possible periods of increased intensity associated with dressings or other clinical activities. In this group, conversion from parenteral to oral using the conversion factors usually quoted for chronic pain may be more appropriate. Fast acting agents may be required to cover breakthrough pain, and can also be used to estimate dosage changes, either as a result of tolerance or increases in pain intensity.

A conversion chart such as Table 1 (NHMRC 1998) should be used to guide dosage adjustment, but care must be exercised when changing drugs, because cross-



**Postoperative Pain, Transition from Parenteral to Oral, Table 1** Transition from Parenteral to Oral

Agonists	Approximate Equi-analgesic dose	
	Parenteral	Oral
Morphine	10 mg	30 mg
Oxycodone	15 mg	20–30 mg
Fentanyl	100 mcg	N/A
Hydromorphone	1.5 mg	7.5 mg
Methadone	10 mg	20 mg
Codeine	130 mg	200 mg
Dextropropoxyphene		130 mg
Tramadol	100 mg	????
Partial Agonists		
Buprenorphine	0.4 mg	0.4–0.8 mg (sublingual)

tolerance is often incomplete, and doses lower than the equi-analgesic dose are recommended, with dosage titrated to clinical effect. As mentioned above, it is usual practice to adjust doses down to the nearest appropriate tablet size.

### Choice of Drugs

There is little evidence on which to base the decision as to which oral drug is best to use. The 4 commonest options, morphine, oxycodone, methadone and tramadol, will be considered.

### Morphine

Morphine has a long history of use via the oral route, and is probably still the commonest oral opioid. It is available in several controlled release preparations designed for once or twice daily dosing. The exact kinetics of these varies, and should be considered in prescribing and interpreting responses to doses. It is also available in rapidly acting syrup formulation, which provides capacity for treatment of those with problems swallowing tablets, and for supplemental dosing. Care should be exercised, particularly in those with impaired renal function, because of accumulation of the ► [glucuronide metabolites](#), both of which are pharmacologically active. Morphine-3-glucuronide may be responsible for central excitation seen with chronic dosing, whilst morphine-6-glucuronide may produce respiratory depression. Both have half-lives significantly longer than the parent drug.

### Oxycodone

Oxycodone (Davis et al. 2003) has recently become available in a variety of dosages in controlled release form. Rapidly acting tablets are available for supplemental doses. It has a 60% oral bioavailability, and the rapid onset and sustained duration of effect make

it a viable alternative to morphine. The main metabolite, noroxycodone, is inactive, although 10% of the dose is converted to oxymorphone, which has 14X the analgesic potency of oxycodone. Since both are renally excreted, doses should be reduced in renal failure. It also has more activity at ► [kappa opioid receptors](#), which may offer some advantage where there is felt to be a neuropathic component to the pain, but may mean that there is a lower conversion ratio for patients converting from oxycodone to morphine than those switching from morphine to oxycodone.

### Methadone

Methadone (Mancini et al. 2000) is not available in controlled release formulation, and both absorption and elimination are highly variable. In its favour it is cheap, has a high lipid solubility and bioavailability, and can usually be dosed twice daily for pain management. It has no active metabolites and does not accumulate in chronic renal failure. It is active at both mu and ► [delta opioid receptors](#). It would probably have a very limited role because of its variable kinetics were it not for its ► [NMDA antagonist](#) properties, which give it a potential advantage over the other opioids for the treatment of ► [neuropathic pain](#). Care must be taken to avoid toxicity due to increasing duration of effect with chronic dosing.

### Tramadol

Tramadol (Scott and Perry 2000, Shipton 2000) also has unusual characteristics. Only 30% of its analgesic activity is attributed to ► [Mu\(μ\)-Opioid Receptor](#) agonism, the remainder being due to enhancement of ► [noradrenergic and serotonergic inhibitory pathways](#). This results in analgesia associated with low risk of respiratory depression and generally with low levels of sedation. Unfortunately, this is balanced by a strong emetic effect. Care must also be taken to avoid drug interactions with other drugs producing raised serotonin levels and those reducing the seizure threshold (particularly SSRIs and MAOI's). It is available in both controlled release and immediate onset capsules. Dose reduction is required in renal failure. Due to its alternative mechanism of action, tramadol may be the drug of choice where low mu activity is particularly desirable e.g. patients where sedation and reduced GIT motility are problematic, although high doses may be required to produce sufficient analgesia in severe pain.

### References

1. Audit Commission (1997) Anaesthesia Under Examination. In: Audit Commission, London
2. Davis MP, Varga J, Dickerson D et al. (2003) Normal-Release and Controlled-Release Oxycodone: Pharmacokinetics, Pharmacodynamics, and Controversy. Support Care Cancer 11:84–92
3. Derbyshire DR, Bell A, Parry PA et al. (1985) Morphine Sulphate Slow Release. Comparison with I.M. Morphine for Postoperative Analgesia. Br J Anaesth 57:858–865

4. Ginsberg B, Sinatra RS, Adler LJ et al. (2003) Conversion to Oral Controlled-Release Oxycodone from Intravenous Opioid Analgesic in the Postoperative Setting. *Pain Med* 4:31–38
5. Kehlet H, Dahl JB (1993) The Value of “Multimodal” or “Balanced Analgesia” in Postoperative Pain Treatment. *Anesth Analg* 77:1048–1056
6. Mancini I, Lossignol DA, Body JJ (2000) Opioid Switch to Oral Methadone in Cancer Pain. *Curr Opin Oncol* 12:308–313
7. Ng A, Hall F, Atkinson A, Kong K et al. (2000) Bridging the Analgesic Gap. *Acute Pain* 3:172–180
8. NHMRC (1998) *Acute Pain Management: Scientific Evidence*. AusInfo, Canberra
9. Pearl ML, McCauley DL, Thompson J et al. (2002) A Randomized Controlled Trial of Early Oral Analgesia in Gynecologic Oncology Patients Undergoing Intra-Abdominal Surgery. *Obstet Gynecol* 99:704–708
10. Scott LJ, Perry CM (2000) Tramadol: A Review of its Use in Perioperative Pain. *Drugs* 60:139–176
11. Shipton EA (2000) Tramadol – Present and Future. *Anaesth Intensive Care* 28:363–374
12. Smith G, Power I (1998) Audit and Bridging the Analgesic Gap. *Anaesthesia* 53:521–522

## Postoperative Pain, Venous Thromboembolism

O. J. TWEEDIE, STEPHAN A. SCHUG  
Royal Perth Hospital and University of Western  
Australia, Crawley, WA, Australia  
schug@cyllene.uwa.edu.au

### Synonyms

Vein Thrombosis; deep vein thrombosis (DVT); Red Thrombi; Embolism; Pulmonary Embolism (PE)

### Definition

Venous thrombi (red thrombi) are blood clots in a vein, principally erythrocytes trapped in a fine fibrin mesh with few platelets. The less common arterial/or white thrombi are large aggregates of platelets trapped in fibrin strands with very few erythrocytes. Unregulated activation of the haemostatic system may cause thrombosis. Certain patients can be identified as at-high-risk; these may have acquired or inherited factors. A venous thrombus may be friable and dislodge as an embolus, which may obstruct blood flow to critical organs such as the lung (pulmonary embolism).

### Characteristics

#### Causation

The triad of thrombogenesis, first described by R. Virchow in 1858 (Virchow’s triad), identified three factors causal of venous thrombosis: stasis of blood, endothelial injury and hypercoagulability.

In the postoperative setting bed rest, immobilisation and inactivity due to postoperative pain may cause stasis of blood flow, and protect activated procoagulants from circulating inhibitors and fibrinolysins and liver clearance. In addition, postoperative plasma concentrations

of clotting factors rise. Vessel wall damage can be due to direct trauma, catheters, infection, or external compression. This tissue damage evokes a stress hormone response leading to activation of cytokines, adhesion molecules and coagulation factors.

The final result of these processes is a hypercoagulable state, which contributes to the multifactorial pathogenesis of venous thromboembolism. Once initiated, coagulation is the dominant process and produces retrograde and prograde thrombosis. Thrombosis may be friable and therefore dislodge, and thus embolise. Such embolisation leads to occlusion of blood flow to critical organs, in particular the lungs in the form of pulmonary embolism (PE).

However, the presence of deep vein thrombosis (DVT) does not reliably predict the sequelae of PE, death or post-thrombotic complications (Handoll 2003). The outcome of the DVT may be complete resolution without ill effects or, in the worst case, cause pulmonary embolism and thereby even death. DVT prevalence in the community is 0.2%, but rises to 30–40% after surgery for hip fractures; 0.9% of deaths in hospital are due to PE.

### Methods of Reduction

The incidence of postoperative venous thromboembolism can be reduced by preventative measures. These can be mechanical devices such as thromboembolic deterrent stockings (TEDS), which are either elastic compression stockings (ECS) or graduated compression stockings (GCS), as well as pneumatic leg compression devices (muscle pumps). Furthermore, there are pharmacological methods including low-dose aspirin, warfarin, heparin (unfractionated (UFH) or low-molecular weight (LMWH) heparin) and dextran.

Effective pain-relief can modify the surgical stress response and enable mobilisation, thus reducing the predisposition to the hypercoagulable state. Techniques of neuraxial blockade (epidural or spinal anesthesia) have also been shown to be very effective in reducing venous thromboembolism in some situations.

The efficacy of these methods has been assessed in detail. Graduated compression stockings significantly reduce the occurrence of deep vein thrombosis in hospitalised moderate and high-risk postoperative patients of all specialities (DVT incidence: 13% in treatment group, 27% in control group) (Amaragiri 2003). The data suggest that GCS are most effective when combined with another method of thromboprophylaxis (sequential compression + dextran 70 + subcutaneous heparin: DVT incidence: 2% in treatment group, 15% in control group) (Amaragiri 2003).

Following surgery for hip fractures, physical methods of pneumatic compression showed a significant decrease in DVT and PE incidence. However, current data are insufficient to determine their effect on fatal PE or mortality. Physical methods can be as effective as injectable anti-

coagulants in this patient group, but compliance remains a problem (Handoll 2003).

In colorectal surgery, a combination of GCS and low dose heparin was found to be more effective than the heparin alone for DVT prevention (Wille-Jørgensen 2003). Low dose aspirin shows favourable results in surgery for hip fractures (Handoll 2003), although evidence indicates little effect on the venous side of the circulation (Amaragiri 2003). Recent guidelines propose physical methods and/or aspirin for thromboprophylaxis in post surgery hip fracture patients (Handoll 2003). It is suggested that injectable anticoagulation be reserved for high risk patients, and those with contraindications to physical methods post surgery for hip fractures (Handoll 2003).

Unfractionated heparin greatly reduces the incidence of DVT and appears to reduce the mortality from PE in general and orthopaedic surgery (Handoll 2003). In lower limb joint replacement, low molecular weight heparin is more effective than both unfractionated heparin and warfarin (Choi 2003).

Both unfractionated and low molecular weight heparin can be used as effective thromboprophylaxis after colorectal surgery (Wille-Jørgensen 2003).

Data on prevention of fatal PE is inadequate to make conclusions on treatment with heparin (Handoll 2003).

#### Effects of Neuroaxial Blockade on Venous Thrombembolism

There are several physiological effects of neuroaxial blockade that provide a rationale for an expected reduction in venothrombotic sequelae (Steele 1991). As described above, hypercoagulability manifested by increased fibrinogen and platelet activity has been implicated in the cause of post-operative venous thrombosis (Tuman 1991). Neural blockade attenuates this response by its effect on afferent and efferent neural transmission, and by local anaesthetic drug effects (Kehlet 1998).

The effect on post-operative neuroendocrine response partially explains the difference in platelet function between general anaesthesia and continuous epidural blockade, as neuraxial blockade substantially reduces the surgical stress response (Steele 1991; Tuman 1991; Kehlet 1998). Other favourable physiological changes also occur. The sympathetic blockade increases blood flow to lower extremities (Steele 1991; Kehlet 1998), in particular in atherosclerotic patients (Tuman 1991). Furthermore, the venous emptying rate and venous capacity are increased (Tuman 1991).

Both local anaesthetic solutions alone, and local anaesthetic in combination with epidural opiates, are more effective than epidural opioids alone at reducing the hypercoagulable state (Kehlet 1998). Local anaesthetic causes an inhibition of platelet aggregation *in vitro*, and this effect may also occur *in vivo* (Steele 1991). It is also thought that local anaesthetic may block leucocyte locomotion, and by preventing these cells from adhering to

or invading venous walls, preserving endothelial structure (Kehlet 1998). Neuronal blockade may inhibit the increase in platelet aggregation seen post-operatively; thromboelastography demonstrates an increased coagulation inhibition in continuous epidural blockade (Tuman 1991; Kehlet 1998).

Most clinical trials into the effect of neuroaxial blockade have been too small to detect a significant effect on mortality and major life threatening events. This is mostly due to the low incidence of such events, and the lack of screening for complications. Most evidence comes from systematic reviews of the relevant randomised trials, although single studies in orthopaedic surgery demonstrate a reduced incidence in deep venous thrombosis (e.g. Jørgensen 1991). In a systematic review, an overall reduction in mortality was found in postoperative patients treated with neuraxial blockade; one less death per hundred patients was seen in the 30 days post-operatively if treated with a neuroaxial blockade (Rodgers 2000). This might be partially due to the effect of neuraxial blockade on thrombotic complications, as the incidence of deep venous thrombosis and pulmonary embolism is reduced by 50% (Rodgers 2000).

#### Conclusion

Good postoperative pain relief is essential to enable ambulation and physiotherapy, but on its own is not sufficient to reduce the incidence of venous thromboembolism as it is often a result of multiple causative factors. Thus, the approach to prophylaxis needs to be multimodal and appropriate to the individual risk, and may include, beside good analgesia, use of neuraxial blockade as well as mechanical and pharmacological measures.

#### References

1. Amaragiri SV LT (2003) Elastic Compression Stockings for Prevention of Deep Vein Thrombosis (Cochrane Review). The Cochrane Library
2. Choi PT BM, Scott J, Douketis J (2003) Epidural Analgesia for Pain Relief following Hip or Knee Replacement (Cochrane Review). The Cochrane Library
3. Handoll HH, G FM, McBirnie J, Tytherleigh-Strong G et al. (2003) Heparin, Low Molecular Weight Heparin and Physical Methods for Preventing Deep Vein Thrombosis and Pulmonary Embolism following Surgery for Hip Fractures (Cochrane Review). The Cochrane Library
4. Jørgensen LN, Rasmussen LS, Nielsen PT, Leffers A, Albrecht-Beste E (1991) Antithrombotic Efficacy of Continuous Extradural Analgesia after Knee Replacement. *Br J Anaesth* 66:8–12
5. Kehlet H (1998) Modification of Responses to Surgery by Neural Blockade. In: Cousins MJ BP (ed) *Neural Blockade in Clinical Anaesthesia and Management of Pain*. Lippincott-Raven, Philadelphia, pp 145–146, 158–159
6. Rodgers A, Walker N, Schug S, McKee A, Kehlet H, van Zundert A, Sage D, Futter M, Saville G, Clark T, MacMahon S (2000) Reduction of Postoperative Mortality and Morbidity with Epidural or Spinal Anaesthesia: Results from Overview of Randomised Trials. *Br Med J* 321:1–12
7. Steele SM, Slaughter TF, Greenberg CS, Reves JG (1991) Epidural Anesthesia and Analgesia: Implications for Perioperative Coagulability. *Anesth Analg* 73:683–685

8. Tuman KJ, McCarthy RJ, March RJ, DeLaria GA, Patel RV, Ivankovich AD (1991) Effects of Epidural Anesthesia and Analgesia on Coagulation and Outcome after Major Vascular Surgery. *Anesth Analg* 73:696–704
9. Wille-Jørgensen P RM, Andersen BR, Borly L (2003) Heparins and Mechanical Methods for Thromboprophylaxis in Colorectal Surgery (Cochrane Review). The Cochrane Library

## Postpartum Pain

ANITA HOLDCROFT  
Imperial College London, London, UK  
aholdcro@imperial.ac.uk

### Synonyms

After-Pains, Postnatal Pain

### Definition

The postpartum period starts immediately following childbirth, but the length of the period is not well defined, except the ► **puerperium**. Major physiological events as well as important psychological and social changes have occurred during childbirth. The changes continue after delivery and pain is an important accompanying feature. Childbirth is associated with labour pain from expulsive uterine contractions but after delivery uterine contractions become tonic. Women frequently report pains after delivery in many sites of the body. The incidence and severity of postpartum pains are influenced by ► **parity**.

### Characteristics

#### The Size of the Problem

In 1997 a United Kingdom government-led survey of 3570 women (with a 67% response rate), up to 10 days after delivery, found that the majority of women reported pains in various parts of their body (Audit Commission 1997). The types of pain included headache, genital tract trauma, pelvic girdle pain, surgical incision, uterine contractions, backache, constipation, haemorrhoids and breast pain. These pains continued for over a month in most women, and in a few women persisted for years. For example, backache was present in 35% of women at 10 days and continued in 27% for 3 months. Similar long-term pain symptoms after delivery were reported a decade earlier and the comment made that ‘this (morbidity after pregnancy) is hardly recognised by professionals let alone recorded in official statistics’ (Drife 1995).

Anaesthetic techniques during labour and delivery may contribute to some of these symptoms. Epidural analgesia has been excluded as a risk factor for backache in a large randomised controlled trial (Loughnan et al. 2002). However, for headaches, in a prospective study following 65348 anaesthetic interventions, the incidence of headache lasting for more than 4 hours

and not relieved by mild analgesics was about 2%, but increased to 11% for women receiving multiple regional anaesthetics (Chan et al. 2002).

Other interventions, such as episiotomy, increase the incidence and severity of pain on the first day and up to a week after delivery. This pain results in a significant reduction in mobility and time taken to bond with the baby (Karacam and Eroglu 2003). Perineal care and pain relief have recently been reviewed (Calvert and Fleming 2000), and prolonged recovery was the general outcome for different types of vaginal delivery in all the questionnaire studies cited. In Dublin, a more active approach has been taken through an obstetric perineal clinic whose results have been reported. Up to a tenth of women referred to the clinic have pain for about a year after delivery (Fitzpatrick et al. 2002). These patients must represent only part of a group of women suffering long-term pain morbidity after childbirth.

### Physiological Factors Modulating Pain after Delivery

One of the most dramatic physiological events that occur in women after placental expulsion is the decrease in the concentrations of sex steroid hormones. Once the placental unit no longer functions, the levels of progesterone and estradiol decrease to pre-pregnant values over three days. Sex steroid hormones, as well as peptides such as beta-endorphin and prolactin, modulate pain during parturition. These altered responses are considered to be part of a protective system to reduce pain during delivery. After delivery, however, the rapid decrease in the levels of hormones that have been maintaining analgesia during pregnancy may, in effect, be similar to a withdrawal state, and pain thresholds have been demonstrated to decrease rapidly after delivery (Jarvis et al. 1997).

Further hormonal effects are generated during the establishment of lactation immediately post partum. Basal serum prolactin levels decrease and it is the prolactin secretion by the anterior pituitary that initiates lactation. The continued secretion of prolactin for the production of breast milk is maintained by suckling. The maternal pituitary during suckling and in response to neonatal cries also produces oxytocin. This hormone generates the uterine tonicity that mothers report as so-called abdominal ‘after pains’ during breast-feeding (Rhodes 1966).

Breast-feeding pain, abdominal pain and headaches in the post delivery period have been selected for more detailed analysis.

### Postpartum Abdominal Pain

The potential causes of acute and prolonged lower abdominal pain after delivery include uterine involution and contraction (see below), constipation and pelvic joint pain especially ► **symphysis pubis dysfunction** (Snow and Neubert 1997, Owens et al. 2002).



**Postpartum Pain, Table 1** Pathological Causes of Postpartum Lower Abdominal Pain (\*indicates a disorder relevant to the development of chronic pain)

Gastrointestinal tract	Constipation*
	Bowel obstruction
	Infections e. g. appendicitis
Urinary tract	Over-distended bladder
	Infection
Genital tract	Haematoma
	Infection e. g. local abscess, parametritis*
	'After pains' from uterus
Musculoskeletal	Symphysis pubis dysfunction

Contribution of uterine involution to pain modulation after delivery:

- Prolonged contractions
- During breast feeding, contractions more frequent in multiparous women
- Associated hormonal changes e. g. oxytocin release
- Inflammatory sensitisation

Less common causes include urinary retention, haematoma, infection and abscess formation in the abdominal cavity as a rare consequence, for example, of Caesarean section (Table 1).

During labour, women often experience severe abdominal pain from cervical dilation and periodic uterine contractions, for whose pain relief strong opioids or regional nerve block are used. After childbirth, the uterine muscle continues to contract under the influence of oxytocin, either endogenously generated by the hypothalamic-pituitary axis or exogenously administered for control of excessive bleeding. The induced contractions are tonic and last longer than those during labour in order to reduce haemorrhage. For many decades it has been recognised that these pains increase with parity and may be more severe than during labour (Rhodes 1966), but the extent of the pain problem was not defined until recently. In a prospective study of 100 primiparous and 100 multiparous women, lower abdominal pains were reported to occur in 50% of primiparous women but increased to 86% in multiparous women (Murray and Holdcroft 1989). In the multiparous compared with the primiparous group, a statistically significant increase was measured not only in the incidence of pain but also in its severity. Scores, using a verbal rating scale, measured moderate and severe pain occurring in 30% and 58% of primiparous and multiparous women respectively. In addition, the McGill Pain Questionnaire total pain rating index score measured values of over 20 (i. e. comparable with labour pain intensity (Melzack 1993)) in 9% of primiparous

women, compared with 25% of multiparous women. This intensity of pain at a time when tiredness and psychosocial changes are unavoidable requires adequate analgesia and supportive treatment to be available.

### Headaches after Delivery and Anaesthetic Intervention

Headache of any duration or severity is common after delivery, occurring in a quarter of women without anaesthetic interventions. After epidural nerve blockade in labour, post **dural puncture** headache is recognised to occur in 1 in 100 women. Not all dural punctures by needle or catheter result in headaches but about half are recognised in relation to this, and in the others the diagnosis depends on the presenting symptoms, with the assumption that the dural puncture was missed e. g. the catheter eroded into the cerebrospinal fluid space without being observed. This type of headache is less common after spinal anaesthesia because fine bore needles are used, so that leak of cerebrospinal fluid as the cause of the low pressure headache is minimised. The incidence of headache after dural puncture increases in relation to pregnancy when compared with the non-pregnant state, and with the increasing use of regional anaesthetic techniques (spinal, epidural and combined spinal epidural techniques) for labour analgesia or delivery by Caesarean section. One of the proposed mechanisms for the high frequency of postdural puncture headaches in pregnancy is that a woman's brain changes size. Ventricular volume increases and brain size reversibly decreases, so that meningeal structures may be more vulnerable to pressure effects of low cerebrospinal fluid volumes complicating dural puncture (Oatridge et al. 2002).

A large prospective postpartum multicentre study has determined the clinical presentation and management of post delivery headaches as diagnosed by the reporting clinician. The study focussed on headaches of clinical significance i.e. more than 4 hours duration and not responding to mild analgesics. They were classified as either related to a dural puncture (based on diagnosis not actual observation of dural puncture) or not. The study confirmed in almost 1000 women that postdural puncture headache was severe in half the women in whom it was diagnosed and restricted their daily activity (Chan et al. 2002). This disability occurs at a time when women are trying to care for their baby and be mobile for breast-feeding. The diagnosis of postdural puncture headache was based on features of pain severity, incapacity, a postural component, and bilateral site of origin. It was accompanied by symptoms such as neck and/or shoulder stiffness, photophobia, nausea and vomiting (Table 2). The severe nature of the headache and the high level of disability at this time of recovery from delivery and bonding to the baby would suggest that pain management should be rapid and effective. In practice, strong pain relief was usually not given, and treatment by blood patch occurred not on the first day,

**Postpartum Pain, Table 2** Headache after childbirth and its associated features (Chan et al. 2002)

Feature	Post dural puncture n=404	Non-Post dural puncture n=571
Restriction of activity (all types of activity)	87%	36%
Postural	81%	12%
Neck and shoulder stiffness or pain	54%	13%
Pain severity		
Severe	50%	6%
Moderate	33%	31%
Mild	12%	55%
Not known	5%	8%
Nausea and Vomiting	15%	7%
Photophobia	17%	4%

but most frequently on the second day after delivery, with delays of many days also being recorded.

### Breast Feeding and Pain

After delivery, the establishment of lactation may influence a mother's pain state. First, there are circulating hormones that alter neurochemicals involved in pain sensations. Second, the frequency of breast-feeding may alter sleep patterns; and third, the position of women during breast-feeding can influence musculoskeletal pains. These combined factors may modulate pain sensations during feeds.

In a prospective questionnaire study of pain during breastfeeding coupled with measurements of uterine activity, three groups of women, one primiparous, one of low parity and the other of high parity (3 or more births) reported that the intensity of pain during breast feeding significantly increased with parity, together with the number of pain sites, particularly in the lower abdomen and back (Holdcroft et al. 2003). Most women (96%) described deep pain during breast-feeding at one or more sites: lower back, abdomen and/or breasts. Tenderness at the site was a common feature in 62% of women. The associated uterine contractions significantly increased in number and duration with parity, and contractions of longer duration were correlated with higher pain intensity. Thus, these results demonstrated an increasing effect on pain symptoms with parity.

The proposed mechanisms for these effects may be directly or indirectly related to dynamic activity in pain modulation. Indirectly for example, milk production differs in primiparous and multiparous women, and the role of prolactin in this pain response needs further investigation. In addition, the contribution of uterine contractions may be contributory. Structural and anatomical changes in the uterus are recognised, but of more relevance is the role of central sensitisation in multiparous women, and further research is needed to investigate this possibility.

However, recognition and treatment of the severe pains in multiparous women during lactation may encourage more women to continue breast-feeding after the initial postpartum period.

### References

1. Audit Commission (1997): *First Class Delivery: Improving Maternity Services in England and Wales*, London
2. Calvert S, Fleming V (2000) *Journal of Advanced Nursing* 32:407–415
3. Chan TML, Ahmed E, Yentis SM, Holdcroft A (2003) Postpartum Headaches: Summary Report of the National Obstetric Anaesthetic Database (NOAD) 1999. *Int J Obstet Anaesth* 12:107–112
4. Drife JO (1995) Assessing the Consequences of Changing Childbirth. *BMJ* 310:144
5. Fitzpatrick M, Cassidy M, O'Connell PR, O'Herlihy C (2002) Experience with an Obstetric Perineal Clinic. *Eur J Obstet Gynecol Reprod Biol* 100:199–203
6. Holdcroft A, Snidvongs S, Cason A, Doré C, Berkely KJ (2003) Pain and Uterine Contractions During Breast Feeding in the Immediate Post-Partum Period Increase with Parity. *Pain* 104:589–596
7. Jarvis S, McLean KA, Chirnside J, Deans LA, Calvert SK, Molony V, Lawrence AB (1997) Opioid-Mediated Changes in Nociceptive Threshold During Pregnancy and Parturition in the Sow. *Pain* 72:153–159
8. Karacam Z, Eroglu K (2003) Effects of Episiotomy on Bonding and Mothers' Health. *J Adv Nursing* 43:384–394
9. Loughnan BA, Carli F, Romney M, Dore CJ, Gordon H (2002) Epidural Analgesia and Backache: A Randomized Controlled Comparison with Intramuscular Meperidine for Analgesia During Labour. *Br J Anaesth* 89:466–72
10. Melzack R (1993) Labour Pain as a Model of Acute Pain. *Pain* 53:117–120
11. Murray A, Holdcroft A (1989) Incidence and Intensity of Postpartum Lower Abdominal Pain. *BMJ* 298:1619
12. Oatridge A, Holdcroft A, Saeed N, Hajnal JV, Puri BK, Fusi L, Bydder GM (2002) Change in Brain Size During and After Pregnancy: A Study of Normal and Pre-Eclamptic Women. *Am J Neuroradiol* 23:19–26
13. Owens K, Pearson A, Mason G. (2002) Symphysis Pubis Dysfunction – A Cause of Significant Obstetric Morbidity. *Eur J Obstet Gynecol Reprod Biol* 105:143–146
14. Rhodes P (1966) Lactation and After-Pains. *The Practitioner* 196:279–280

15. Snow RE, Neubert AG (1997) Peripartum Pubic Symphysis Separation: A Case Series and Review of the Literature. *Obstet Gynecol Surv* 52:438–443

## Post-Radiation Plexopathy

### ► Plexopathy

## Post-Seizure Headache

TOBIAS LENIGER, HANS CHRISTOPH DIENER  
Department of Neurology, University Essen, Essen,  
Germany  
tobias.leniger@uni-essen.de, h.diener@uni-essen.de

### Synonyms

Postictal headache; seizure associated headache

### Definition

Headache, which begins after the seizure. The temporal relationship between seizure and headache is not clearly defined. A time interval of 1 h has recently been suggested (Leniger et al. 2001).

### Characteristics

#### Epidemiology and Clinical Features

The incidence of post-seizure headache (PSH) varies between 34 and 43% (Förderreuther et al. 2002; Leniger et al. 2001). Higher PSH frequencies of up to 51% reported by Schon and Blau (1987) cannot be compared because the IHS criteria were not applied in that study. Of patients with PSH, 60–66% experienced seizures, always combined with headache (Förderreuther et al. 2002; Leniger et al. 2001). In 62.5% of 47 patients with PSH the headache lasted longer than 4 h (Förderreuther et al. 2002). Leniger et al. (2001) reported an average of 18.6 h duration and an average pain intensity of 6.1 on the visual analogue scale in 115 patients with PSH. Thus, PSH is a frequent, long-lasting, and severe symptom accompanying epileptic seizures. Phonophobia, photophobia, hemicrania, throbbing pain quality, and nausea are typical symptoms observed in 41–72% of patients with PSH (Leniger et al. 2001).

#### Subtypes of PSH

According to the IHS criteria, PSH could be predominantly classified as a migraine-like headache in 34–56% of patients, followed by tension-type headache in 34–37% of patients (Förderreuther et al. 2002; Leniger et al. 2001). PSH could not be classified in 8–21% of patients (Förderreuther et al. 2002; Leniger et al. 2001). The PSH subtypes were not significantly associated with a certain seizure type or an epilepsy syndrome (focal versus generalized epilepsy syndrome) (Leniger et al. 2001).

### Migraine-Like PSH

A history of migraine was significantly associated with the occurrence of migraine-like PSH (Förderreuther et al. 2002; Leniger et al. 2001). So far, the linkage of migraine headache and epileptic seizures has not been fully understood. It may be unspecific or based on the pathophysiological mechanism of ► **spreading depression**. Next to the predominance of migraine-like headache in PSH, epidemiological data revealed an increased prevalence of (seizure independent) migraine in patients with epilepsy and vice versa (Andermann and Andermann 1987; Leniger and Diener 1999; Ottman and Lipton 1994). If spreading depression plays a pivotal role in these comorbid conditions, migraine with aura may be over represented. However, only a minority of patients with migraine-like PSH (16%) complained about a migraine headache with aura symptoms (Leniger et al. 2001). In contrast, patients with migraine attacks occurring independently of epileptic seizures were found to have significantly more migraine with aura as compared to patients with migraine alone (Leniger et al. 2003). The latter finding supports the hypothesis of spreading depression as an underlying substrate in comorbid conditions. It can be speculated that in patients with migraine-like PSH the seizure itself represents or covers the aura symptoms, so that a decreased frequency of migraine-like PSH with aura symptoms can be observed (Leniger et al. 2003). Thus, the predominance of migraine-like PSH is not associated with a specific epilepsy syndrome or seizure type, but the linkage of migraine and epilepsy may be based on spreading depression as an expression of altered brain state with ► **neuronal hyperexcitability** (Leniger et al. 2003).

### Therapy

There are no recommendations for the treatment of PSH. Förderreuther et al. (2002) reported a self-medication with acetylsalicylic acid and nonsteroidal antirheumatics in 30% of their patients with PSH. Triptans may have good efficacy in migraine-like PSH (Förderreuther et al. 2002; Jacob et al. 1996; Ogunyemi and Adams 1993). A number of ► **Anticonvulsant (Agent)** (e.g. valproate, gabapentin, and topiramate) have demonstrated some efficacy in migraine prophylaxis (Freitag et al. 2002; Hering and Kuritzky 1992; Klapper et al. 1997; Lensen et al. 1994; Mathew et al. 1995; Mathew et al. 2001; Mathew et al. 2002; Von Seggern et al. 2002). However, there are no data showing that these anticonvulsants are also effective in the treatment of migraine-like PSH.

### References

1. Andermann E, Andermann F (1987) Migraine-Epilepsy Relationships: Epidemiological and Genetic Aspects. In: Andermann F, Lugaresi E (eds) *Migraine and Epilepsy*. Butterworths, Boston, pp 281–291

2. Förderreuther S, Henkel A, Noachtar S et al. (2002) Headache Associated with Epileptic Seizures: Epidemiology and Clinical Characteristics. *Headache* 42:649–655
3. Freitag FG, Collins SD, Carlson HA et al. (2002) A Randomized Trial of Divalproex Sodium Extended-Release Tablets in Migraine Prophylaxis. *Neurology* 58:1652–1659
4. Hering R, Kuritzky A (1992) Sodium Valproate in the Prophylactic Treatment of Migraine: A Double-Blind Study versus Placebo. *Cephalalgia* 12:81–84
5. Jacob J, Goadsby PJ, Duncan JS (1996) Use of Sumatriptan in Post-Ictal Migraine Headache. *Neurology* 47:1104
6. Jensen R, Brinck T, Olesen J (1994) Sodium Valproate has a Prophylactic Effect in Migraine without Aura: A Triple-Blind, Placebo-Crossover Study. *Neurology* 44:647–651
7. Klapper J, on behalf of the Divalproex Sodium in Migraine Prophylaxis Study Group (1997) Divalproex Sodium in Migraine Prophylaxis: A Dose-Controlled Study. *Cephalalgia* 17:103–108
8. Leniger T, Diener HC (1999) Migräne und Epilepsie – ein Zusammenhang? *Akt Neurol* 26:116–120
9. Leniger T, Isbruch K, von den Driesch S et al. (2001) Seizure-Associated Headache in Epilepsy. *Epilepsia* 42:1176–1179
10. Leniger T, von den Driesch S, Isbruch K et al. (2003) Clinical Characteristics of Patients with Comorbidity of Migraine and Epilepsy. *Headache* 43:672–677
11. Leniger T, Diener HC, Hufnagel A (2003) Erhöhte cerebrale Erregbarkeit und Spreading depression – Ursachen für eine Komorbidität von Epilepsie und Migräne? *Nervenarzt* 74:869–874
12. Mathew NT, Kailasam J, Meadors L (2002) Prophylaxis of Migraine, Transformed Migraine, and Cluster Headache with Topiramate. *Headache* 42:796–803
13. Mathew NT, Rapoport A, Saper J et al. (2001) Efficacy of Gabapentin in Migraine Prophylaxis. *Headache* 41:119–128
14. Mathew NT, Saper JR, Silberstein SD et al. (1995) Migraine Prophylaxis with Divalproex. *Arch Neurol* 52:281–286
15. Ogunyemi A, Adams D (1993) Migraine-Like Symptoms Triggered by Occipital Lone Seizures: Response to Sumatriptan. *Can J Neurol Sci* 25:151–153
16. Ottmann R, Lipton RB (1994) Comorbidity of Migraine and Epilepsy. *Neurology* 44:2105–2110
17. Schon F, Blau NJ (1987) Post-Epileptic Headache and Migraine. *J Neurol Neurosurg Psych* 50:1148–1152
18. Von Seggern RL, Mannix LK, Adelman JU (2002) Efficacy of Topiramate in Migraine Prophylaxis: A Retrospective Chart Analysis. *Headache* 42:804–809

## Post-Stroke Pain Model, Cortical Pain (Injection of Picrotoxin)

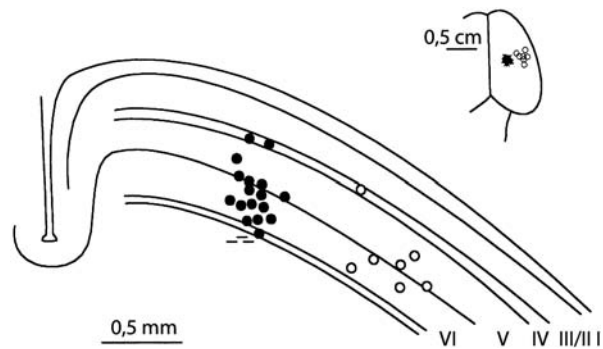
JEAN-LOUIS OLIVÉRAS  
JACQUELINE MONTAGNE-CLAVEL  
Inserm, Paris, France  
jean-louis.oliveras@tolbiac.inserm.fr

### Definition

Producing “pain-like” behavioral reactions in animals in which the cortical GABAergic control, a powerful inhibitory process potentially disturbed in various post-stroke situations including epilepsy, is removed.

### Characteristics

After microinjection of picrotoxin (2 µg/0.2 µl/3 min) at somato-motor (SmI) cortical level in the rat (rear paw region) (Fig. 1), remarkable reproducible and specific behavioral reactions do occur, for at least one hour, together



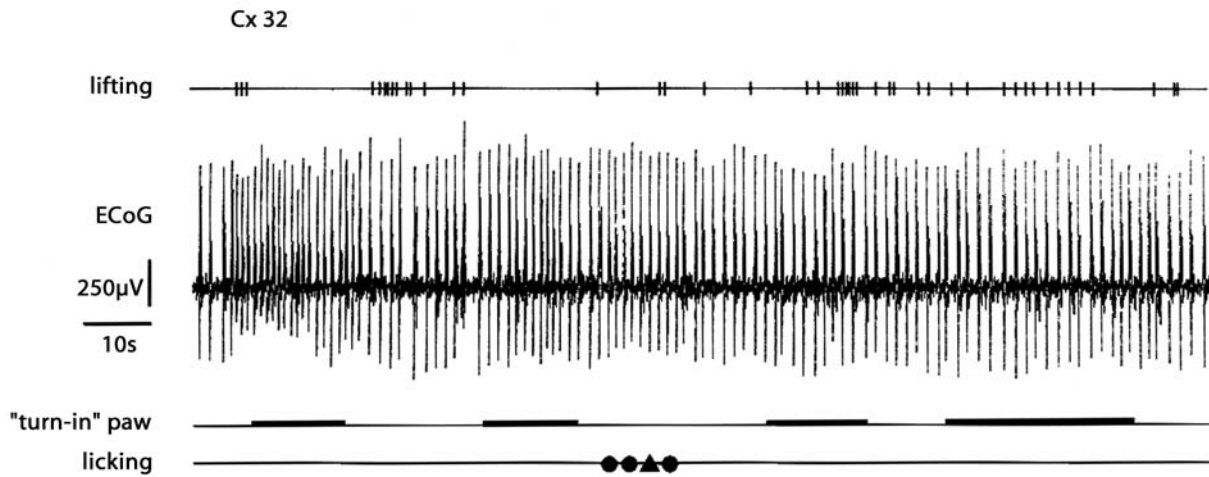
**Post-Stroke Pain Model, Cortical Pain (Injection of Picrotoxin), Figure 1** Cortical localization of the effective “pain-like” reactions producing sites in the rat after picrotoxin microinjection. Relative to the vibrissae region (open circles), which provoke minor effects, black circles, mainly located to layer VI, indicate “pain-like” reactions restricted to the hind paw.

with cortical events, such as electrocorticogram (ECoG) continuous high amplitude spike-and-waves complexes, and less frequent and irregular long duration bursts. These “pain-like” manifestations, observed contralaterally to the microinjection site, are not in phase with the ECoG spikes and bursts (Fig. 2), except the “tremor” reaction (see below), and consist of:

1. Lifting off the floor, fast withdrawal of the paw towards the abdomen, followed by placing the paw onto the floor, after a variable time from very fast to several seconds, in which the paw stays retracted.
2. Licking the paw, palm and digits, varying from very briefly to a few seconds, sometimes ending with biting the tip of the digits.
3. “Turn-in-paw,” which consists of turning the foot in a supine position on the floor or against the flank, frequently grasping the digits inside the palm, and staying in this posture for a while.
4. Tremor, probably another manifestation of seizure, as very fast trembling of the paw or the whole limb, sometimes associated with lifting, and particularly noticeable in the digits. This response can be prolonged for as long as several seconds.

In addition to these primary reactions, there are other manifestations, such as “limping” and “shaking”, which are invariably associated with lifting or tremor. Episodes of “neglected paw” are frequently noted, as the animal suddenly loses its paw and limb placement reflexes, or is unable to use them for walking properly; or lying on the ipsilateral side with the “paw on the tail,” or intense rearing and urination. Vocalizations are rarely noted. These “pain-like” manifestations resemble those observed after formalin administration into the paw (Abbott et al. 1995; Olivéras and Montagne-Clavel 1996), and are not apparently due to indirect “peripheral effect” (Montagne-Clavel 1996), i.e. as possible cramps provoked by excessive cortical centrifugal motor excitation (for example see Richardson 1987). Except the tremor,





**Post-Stroke Pain Model, Cortical Pain (Injection of Picrotoxin), Figure 2** ECoG isolated spikes and behavioral manifestations after microinjection of picrotoxin into Sml. From this example without any burst (see text), it is clear that the behavioral reactions are not in phase with the ECoG, even for the “lifting.” The triangle indicates biting of the tip of the digits (the symbol “Cx 32” designates the animal number).

all these reactions can be quantitatively modulated by pharmacological agents directly administered into the rat SmI cortex, such as naloxone, a specific opiate antagonist (Richardson 1987) or cholinergic antagonists (Montagne-Clavel and Olivéras 1997).

All these observations serve as a simple “model” for post-stroke central pain, especially in the case of seizure, “possibly painful” (Kryzhanovski et al. 1992; Lenz et al. 1989; Mauguière and Gurgeon 1987; Nair et al. 2001; Scholtz et al. 1999; Wilkinson 1973; Yamashiro et al. 1991), strongly emphasize potent common deficit mechanisms between central pain and epilepsy, such as a loss of somato-sensory and somato-motor cortical GABA control (Dykes et al. 1984, Li and Prince 2002). Technically, this model requires simple procedures, such as classical microinjection technique and ECoG chronic recordings in awakened animals, and a good sense of observation (see details in Olivéras and Montagne-Clavel 1996).

## References

- Abbott FV, Franklin KBJ, Westbrook RF (1995) The Formalin Test: Scoring Properties of the First and Second Phases of the Pain Responses in Rats. *Pain* 60:91–102
- Olivéras J-L, Montagne-Clavel J (1996) Picrotoxin Produces a Central Pain-Like Syndrome when Microinjected into the Somato-Motor Cortex of the Rat. *Physio Behav* 60:1425–1434
- Richardson DE (1987) Does Epileptic Pain Really Exist? *Appl Neurophysiol* 50:365–368
- Montagne-Clavel J, Olivéras J-L (1997) Cholinergic Modulation of the Picrotoxin-Induced “Pain-Like” Symptoms at Somato-Motor Cortical Level in the Rat. *Exp Brain Res* 117:362–368
- Kryzhanovski GN, Reshetnyak VK, Igonkina SI, Zinkevich VA (1992) Epileptiform Activity in the Somato-Sensory Cortex of Rats with Trigeminal Neuralgia. *Pathol Physiol Gen Pathol* 114:126–128
- Lenz FA, Kwan HC, Dostrovsky JO, Tasker RR (1989) Characteristics of the Bursting Pattern of Action that Occurs in the Thalamus of Patients with Central Pain. *Brain Res* 496:357–360
- Mauguière F, Gurgeon J (1978) Somato-Sensory Epilepsy: A Review of 127 Cases. *Brain* 101:307–332
- Nair DR, Najm I, Bulacio J, Luders H (2001) Painful Auras in Focal Epilepsy. *Neurology* 57:700–702
- Scholtz J, Viergegge P, Moser A (1999) Central Pain as a Manifestation of Partial Epileptic Seizures. *Pain* 80:445–450
- Wilkinson HA (1973) Epileptic Pain. An Uncommon Manifestation with Localizing Value. *Neurology* 23:518
- Yamashiro K, Iwayama K, Kurihara M, Mori K, Tasker RR, Albe-fessard D (1991) Neurons with Epileptiform Discharge in the Central Nervous System and Chronic Pain. *Acta Neurochir Suppl (Wien)* 52:130–132
- Dykes RW, Landry P, Metherate R, Hicks TP (1984) Functional Role of GABA in the Cat Primary Somato-Sensory Cortex: Shaping Receptive Fields of Cortical Neurons. *J Neurophysiol* 52:1066–1093
- Li H, Prince DA (2002) Synaptic Activity in Chronically Injured, Epileptogenic Sensory-Motor Neocortex. *J Neurophysiol* 88:2–12
- Zilles K (1985) *The Cortex of the Rat: A Stereotaxic Atlas*. Springer-Verlag, Berlin

## Post-Stroke Pain Model, Thalamic Pain (Lesion)

NAYEF E. SAADÉ, SUHAYL J. JABBUR  
Neuroscience Program, Faculty of Medicine, American University of Beirut, Beirut, Lebanon  
nesaade@aub.edu.lb

### Definition

Blockage of the blood supply to a brain center, as with other organs, often leads to cell death in the area due to asphyxia. This pathology in the brain is commonly known as stroke. Patients suffering from strokes involving parts of the thalamus may complain from motor and sensory disturbances referred, in general, to the opposite side of the body (Tasker et al. 1991). The most frequent and paradoxical manifestations are spontaneous pain, ► **allodynia** (painful sensation induced by innocuous or nonpainful stimulation) and ► **hyperalgesia**. This

pathology was first referred to as the “thalamic syndrome” (Dejerine and Roussy 1906). This syndrome was later shown to be one aspect of a pathological entity known as ► **central pain**, resulting from injuries or trauma at various levels of the central nervous system (Bowsher 1996). Several observations based on clinical and/or animal experimentation shed more light on the origin of this syndrome.

### Characteristics

Roussy (1907) was among the first to attempt to reproduce the thalamic syndrome pathology in experimental animals, including monkeys, dogs and cats. He defined two main approaches, the open, bloody method (*méthode sanglante*) and the blind method (*méthode aveugle*) (Roussy 1907). The first was based on a surgical approach to produce lesions in the posterior thalamus through the roof of the third ventricle of the brain. The second (blind) was based on an electrical lesion through electrodes placed in the brain as illustrated (Fig. 1).

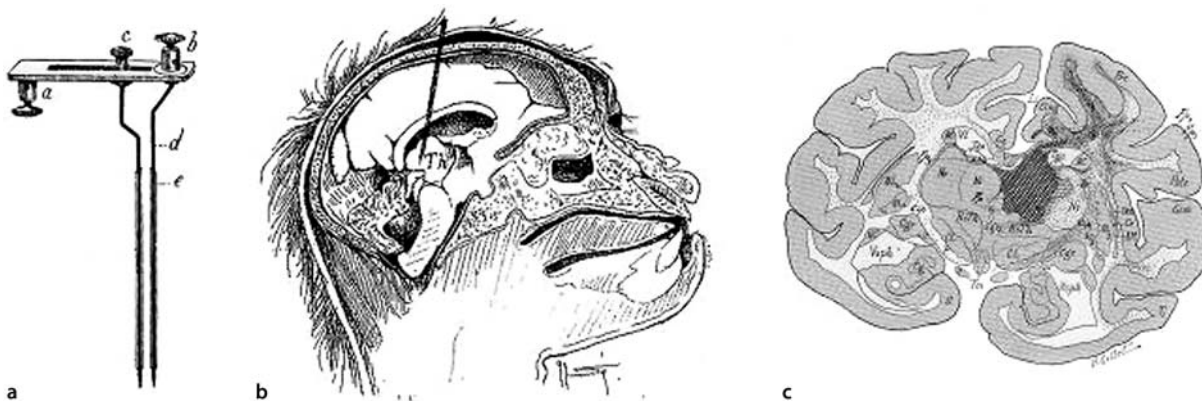
About a century after the studies of Roussy, modern techniques for placement of controlled lesions in the thalamus still use the blind method, but with more refined tools. Based on the established three dimensional (stereotaxic, see ► **stereotaxy**) coordinates of an animal’s brain and the use of the Horsley-Clark apparatus (► **Horsley-Clark apparatus or stereotaxic frame**), punctuate and size controlled lesions can be placed in different parts of the thalamus as in other areas of the brain.

Figure 2a represents the penetration points on the dorsal aspect of the skull to reach the different nuclear groups of the rat thalamus, based on data extracted from the Paxinos and Watson atlas (Paxinos and Watson 1986). Lesions can be placed either in the lateral (posterior to bregma -2 to -4 mm, lateral 2.5–3.5 mm, vertical 5.25–6.25 mm) or the medial (posterior to bregma -1.5 to -4 mm, lateral 0.2–0.75 mm, vertical 5.25–6.25 mm)

thalamic nuclear groups by using either electrical current or chemical substances (Fig. 2b and c). For this purpose, the head of the anesthetized rat is placed in the stereotaxic frame, the bony skull is exposed by skin incision and small holes are drilled in the bone to allow the penetration of electrodes or pipettes (Fig. 2).

For the electrolytic lesion, coaxial bipolar metal electrodes, insulated except for about 50  $\mu\text{m}$  from their tips (intertip distance 0.1–0.2 mm) and fixed on a micromanipulator are introduced stereotaxically into a nucleus of the thalamus. Constant current (20–30  $\mu\text{A}$ ) is injected for a period of 20–50 seconds. This current has been shown to produce cellular death by ► **electrolysis**. The volume and extent of the lesion depend on the duration and the intensity of the injected current. For lesions that involve the rostrocaudal extent of a thalamic nuclear group, more than one penetration and current injection are needed (Saadé et al. 1999). This technique can produce graded lesions in different parts of the thalamus and allow for the observation of their effects on the general sensorimotor behavior of the animal. However, it presents the inconvenience of non-selective destruction of local neurons in addition to passing fibers in the area that are not necessarily involved in the activities of the lesioned center.

A more selective local lesion, restricted to neuronal cell bodies, is based on the injection of excitatory amino acids such as kainic or ibotenic acids. Excitotoxic lesion of neuronal cell bodies is attributed to the excessive activation of neurons leading to the accumulation of calcium ions inside the cells (the mitochondria, in particular) that leads to ► **osmolysis** (Schinder et al. 1996; Wall et al. 1988). Solutions of ibotenic (0.03 M) or kainic acid (0.01 M) are injected through a micropipette (tip diameter 50–75  $\mu\text{m}$ ) or a Hamilton syringe (5  $\mu\text{l}$ ) fixed to a microinjector and placed stereotaxically in a thalamic nucleus. The injection is performed slowly over a period of 2–3 min using a manual or motorized microinjector. The size and the extent of the lesion



**Post-Stroke Pain Model, Thalamic Pain (Lesion), Figure 1** Blind lesion from the original drawings by Roussy (1907). These show the bipolar platinum electrodes (a), their presumed trajectory in the brain (b) and a transverse brain section illustrating the extent of the lesion (c).



**Post-Stroke Pain Model, Thalamic Pain (Lesion), Figure 2** Stereotaxic placement of lesions in the thalamus. (a) shows a dorsal view of the exposed surface of the skull illustrating the penetration points used to produce lesions in the thalamus. These points correspond to the coordinates taken from Paxinos and Watson's Atlas (Paxinos and Watson 1986). (b) represents a transverse section of the rat's brain illustrating a lesion in the lateral thalamus induced by kainic acid injection. Panel (c) shows another section in a different rat illustrating an electrolytic lesion placed in the medial thalamus. Both lesions are indicated by arrows.

depend on the injected volume (0.25–0.75  $\mu$ l) and the location and number of injections in a part (lateral or medial) of the thalamus.

The initial excitatory effects of the injections are not, in general, observed, since they occur during a short period following the injection when the animal is under deep anesthesia. In both types (electrolytic or chemical) of lesions, however, the stable effects are observed 2–3 days after the recovery of the animal from anesthesia and the acute effects of surgery. These effects can be assessed by observing the variations in the thresholds of the acute phasic pain tests (paw pressure, paw withdrawal, tail flick, hot plate, etc.) or the temporal evolution of the formalin test considered as a model for acute tonic pain (Saadé et al. 1999; Saadé et al. 1997). The effects of either lateral or medial thalamic lesions in a rat model of mononeuropathy are also under investigation. Finally, it is worth noting that other techniques such as surgical ablation or embolization of the arterial supply to the thalamus are still practiced in experimental animals. The extent of the resulting lesion, however, is not as well circumscribed as those of localized electrolytic or chemical lesions.

## References

1. Bowsher D (1996) Central pain: Clinical and physiological characteristics. *J Neurol Neurosurg Psychiatr* 61:69
2. Dejerine J, Roussy G (1906) Le syndrome thalamique. *Rev Neurol* 14:521–532
3. Paxinos G, Watson C (1986) The rat brain in stereotaxic coordinates. Academic Press, London
4. Roussy G (1907) La Couche Optique. Le syndrome thalamique. Steinheil, Paris
5. Saadé NE, Atweh SF, Bahuth N et al. (1997) Augmentation of nociceptive reflexes and chronic deafferentation pain by chemical lesions of either striatal dopaminergic terminals or midbrain dopaminergic neurons. *Brain Res* 751:1–12
6. Saadé NE, Kafrouni AI, Saab CY et al. (1999) Chronic thalamotomy increases pain-related behavior in rats. *Pain* 83:401–409
7. Schinder AF, Olson EC, Spitzer NC et al. (1996) Mitochondrial dysfunction is a primary event in glutamate neurotoxicity. *J Neurosci* 16:6125–6133
8. Tasker RR, Decarvalho G, Dostrovsky JO (1991) The history of central pain syndromes, with observations concerning pathophysiology and treatment. In: Casey K L (ed) *Pain and Central*

*Nervous System Disease: The Central Pain Syndromes*. Raven Press, New York, pp 31–58

9. Wall PD, Bery J, Saadé NE (1988) Effects of lesion to rat spinal cord lamina cell projection pathways on reactions to acute and chronic noxious stimuli. *Pain* 35:327–339

## Post-Sympathectomy Neuralgia

### Definition

Postsympathectomy neuralgia is a pain syndrome associated with a lesion at the sympathetic nervous system.

► [Neuralgia, Assessment](#)

P

## Postsynaptic Dorsal Column Neurons

### Synonyms

PSDC

### Definition

Postsynaptic dorsal column neurons are cells that are found predominantly in lamina III–V of the spinal cord, projecting to the dorsal column nuclei. Whilst cells in the lumbosacral enlargement project to the gracile nucleus (GN), those in the cervical enlargement project to the cuneate nucleus. PSDC neurones receive convergent inputs from high threshold muscle, skin and joint afferents, as well as low-threshold muscle and cutaneous afferents. Some receive visceral input.

- [Nociceptive Circuitry in the Spinal Cord](#)
- [Opioids in the Spinal Cord and Modulation of Ascending Pathways \(N. gracilis\)](#)
- [Postsynaptic Dorsal Column Projection, Functional Characteristics](#)
- [Spinal Ascending Pathways, Colon, Urinary Bladder and Uterus](#)
- [Spinal Dorsal Horn Pathways, Dorsal Column \(Visceral\)](#)



## Postsynaptic Dorsal Column Neurons, Responses to Visceral Input

ELIE D. AL-CHAER

Center for Pain Research (CPR), and University of Arkansas for Medical Sciences, Little Rock, AR, USA  
ealchaer@uams.edu

### Synonyms

Dorsal horn neurons; second order neurons; posterior column neurons; visceral nociceptive tracts

### Definition

A postsynaptic dorsal column neuron is a spinal cord neuron whose cell body and dendrites are located in the dorsal horn or central gray matter of the spinal cord, and whose axon projects in the dorsal column to terminate in the dorsal column nuclei of the medulla oblongata, usually on the side ipsilateral to the cell body. The axons of some postsynaptic dorsal column neurons convey visceral nociceptive information through the dorsal column to the dorsal column nuclei. Postsynaptic dorsal column neurons can be identified electrophysiologically by antidromic stimulation of the dorsal column or the dorsal column nuclei, or histologically by injecting a retrograde tracer into the dorsal column nuclei.

### Characteristics

Postsynaptic dorsal column neurons are a class of sensory projection neurons. They form the postsynaptic component of the dorsal column, one of several different sensory pathways that transmit signals of touch, ► **kinesthesia** and two-point discrimination from the level of the spinal cord to the brain. Evolving clinical and experimental evidence has confirmed a role of the dorsal column in visceral pain that involves largely postsynaptic dorsal column neurons (Al-Chaer et al. 1996a; Al-Chaer et al. 1996b; Hirshberg et al. 1996; Al-Chaer et al. 1999). The nociceptive signals depend on input to the spinal cord from peripheral nociceptors in the viscera. The signals are processed in the spinal cord and are then transmitted to the ipsilateral dorsal column nuclei (Al-Chaer et al. 1996b; Al-Chaer et al. 1997a) and, after a synaptic relay, to the contralateral ventrobasal complex of the thalamus (Al-Chaer et al. 1996a; Al-Chaer et al. 1998). Clinical observations have shown that a ► **midline myelotomy**, severing axons in the human posterior columns, can help attenuate otherwise intractable visceral pain (Hirshberg et al. 1996), whereas stimulation of the posterior columns in patients with severe ► **irritable bowel syndrome** produces immediate increased intensity of abdominal pain (Malcolm et al. 2001). These observations concur with experimental data obtained in animals, which show that severing the axons of the dorsal columns in rats or monkeys reduces the responses to ► **colorectal distension** (CRD)

of neurons in the ventral posterolateral nucleus of the thalamus, and of neurons in the dorsal column nuclei, particularly in nucleus gracilis (Al-Chaer et al. 1996a; Al-Chaer et al. 1996b; Al-Chaer et al. 1997a; Al-Chaer et al. 1998).

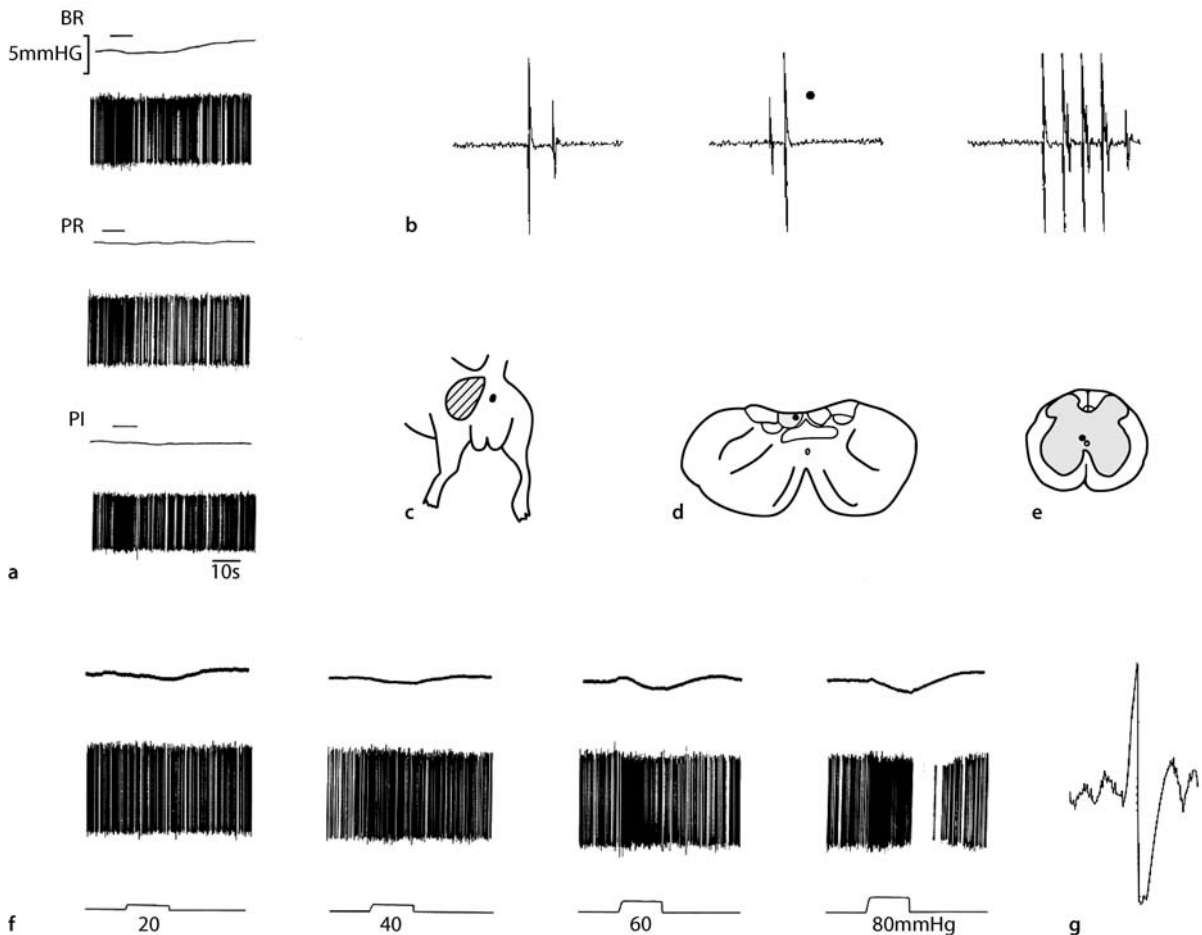
The dorsal column nuclei are known to receive both a direct sensory input from primary afferent fibers (Kuo and De Groat 1985; Giuffrida and Rustioni 1992), and an indirect input from a large number of postsynaptic dorsal column neurons located in the ipsilateral dorsal horn and the central gray matter of the spinal cord. The cells of origin of the postsynaptic dorsal column pathway were mapped at different levels of the spinal cord using retrograde (Giesler et al. 1984), anterograde (Cliffer and Giesler 1989) and degeneration tracing techniques (Rustioni A 1973). The projections are somatotopic; the cuneate nucleus receives more projections from the thoracic and cervical segments of the cord and the gracile nucleus receives more projections from the lumbar and sacral segments (Campbell et al. 1974). Iontophoretic injections of an anterograde tracer (*Phaseolus vulgaris* leucoagglutinin, PHA-L) in the rat's sacral cord, label dorsal column fibers near the midline terminating within the most medial part of the ipsilateral nucleus gracilis (Cliffer and Giesler 1989), whereas injections in the mid-thoracic spinal cord label fibers near the dorsal intermediate septum, and that terminate in the border area between the nucleus gracilis and the nucleus cuneatus (Wang et al. 1999). Investigation of viscerosensitive postsynaptic dorsal column neurons in rats and monkeys, using retrograde labeling and ► **Fos** protein expression in response to visceral stimulation, showed them to be located mainly in the gray matter near the central canal (Lamina X) (Hirshberg et al. 1996). These observations concurred with the location of postsynaptic dorsal column neurons isolated electrophysiologically using antidromic activation.

The role of the postsynaptic dorsal column pathway in somatosensory processing is not clear, but evidence shows that postsynaptic dorsal column neurons receive nociceptive input from the viscera, and relay signals of visceral nociception to the dorsal column nuclei.

Microdialysis administration of morphine or of a non-N-methyl-D-aspartate antagonist (CNQX) into the sacral spinal cord, after restricting the afferent input from the colon onto the sacral cord to the pelvic nerves by sectioning the hypogastric nerves, can block visceral nociceptive responses recorded from neurons of the nucleus gracilis. The ability of morphine or CNQX to block the visceral responses in the nucleus gracilis is consistent with a synaptic action, presumably at synapses of viscerosensory afferents onto postsynaptic dorsal column neurons (Al-Chaer et al. 1996b).

Recordings from individual antidromically-identified postsynaptic dorsal column neurons in rats showed them to be activated by graded intensities of colorectal





**Postsynaptic Dorsal Column Neurons, Responses to Visceral Input, Figure 1** In (a) are shown the responses of a PSDC cell to cutaneous stimuli as well as the blood pressure traces obtained during stimulation. The cell was located in the dorsal commissural region at S1 (e), was antidromically activated from the nucleus gracilis (d) and had a cutaneous receptive field over the rump area (c). (b) shows traces of antidromic activation (left), collision (middle trace; dot indicates expected time of antidromic spike) and high frequency following (right). (f) shows the responses of the cells to CRD and the corresponding changes in blood pressure (top traces). (g) shows a trace of the cellular spike.

distension spanning the innocuous and noxious range (Fig. 1), and confirmed that their responses to visceral stimuli could in fact be blocked by microdialysis of morphine or CNQX (Fig. 2). Furthermore, viscerosensitive postsynaptic dorsal column neurons in the sacral cord receive convergent somatic input from the skin over the hindpaws, the hindlegs, the rump and the perineal area and respond mainly to innocuous cutaneous stimuli, but also mildly to noxious cutaneous pinch (Al-Chaer et al. 1996b).

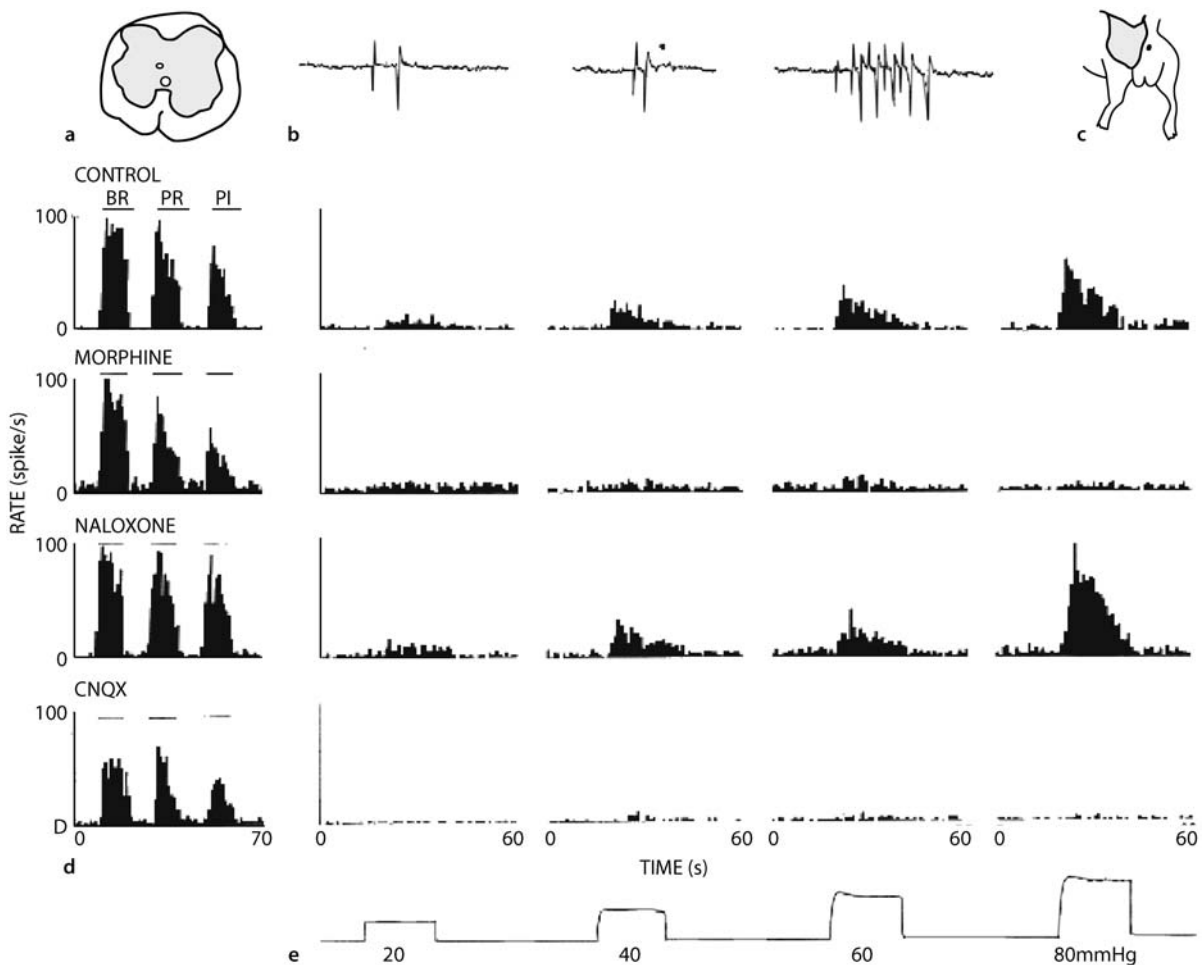
Responses of viscerosensitive postsynaptic dorsal column neurons to CRD sensitize following colon inflammation with mustard oil. The sensitization is characterized by a decrease in threshold and an increase in firing rate in response to CRD and an attenuation of the responses to cutaneous stimuli (Al-Chaer et al. 1997b).

## References

1. Al-Chaer ED, Lawand NB, Westlund KN, Willis WD (1996a)

Visceral Nociceptive Input into the Ventral Posterolateral Nucleus of the Thalamus: A New Function of the Dorsal Column. *J Neurophysiol* 76:2661–2674

2. Al-Chaer ED, Lawand NB, Westlund KN, Willis WD (1996b) Pelvic Visceral Input into the Nucleus Gracilis is Largely Mediated by the Postsynaptic Dorsal Column Pathway. *J Neurophysiol* 76:2675–2690
3. Al-Chaer ED, Westlund KN, Willis WD (1997a) The Nucleus Gracilis: An Integrator for Visceral and Somatic Information. *J Neurophysiol* 78:521–527
4. Al-Chaer ED, Westlund KN, Willis WD (1997b) Effects of Colon Inflammation on the Responses of Postsynaptic Dorsal Column Cells to Visceral and Cutaneous Stimulation. *NeuroReport* 8:3267–3273
5. Al-Chaer ED, Feng Y, Willis WD (1998) A Role for the Dorsal Column in Nociceptive Visceral Input into the Thalamus of Primates. *J Neurophysiol* 79:3143–3150
6. Al-Chaer ED, Feng Y, Willis WD (1999) A Comparative Study of Viscerosomatic Input onto Postsynaptic Dorsal Column and Spinothalamic Tract Neurons in the Primate. *J Neurophysiol* 82:1876–1882
7. Campbell SK, Parker TD, Welker W (1974) Somatotopic Organization of the External Cuneate Nucleus in Albino Rats. *Brain Res* 77:1–23



**Postsynaptic Dorsal Column Neurons, Responses to Visceral Input, Figure 2** (a) Location of PSDC cell in the dorsal commissural gray at S1. (b) Traces of antidromic activation of the cell from the cervical FG as well as of collision of the antidromic spike with orthodromic action potential (middle trace, the dot indicates the expected time of the antidromic spike). (c) Receptive field of the cell extending from perineal area to base of tail and upper aspect of hindlimb. (d) and (e) Responses of the cell to cutaneous stimuli (d) and to graded CRD (e) before and after morphine, after naloxone and after CNQX.

8. Cliffer KD, Giesler GJ (1989) Postsynaptic Dorsal Column Pathway of the Rat. III. Distribution of Ascending Afferent Fibers. *J Neurosci* 9:3146–3168
9. Giesler GJ, Nahin RL, Madsen AM (1984) Postsynaptic Dorsal Column Pathway of the Rat. I. Anatomical studies. *J Neurophysiol* 51:260–275
10. Giuffrida R, Rustioni A (1992) Dorsal Root Ganglion Neurons Projecting to the Dorsal Column Nuclei of Rats. *J Comp Neurol* 316:206–220
11. Hirshberg RM, Al-Chaer ED, Lawand NB, Westlund KN, Willis WD (1996) Is there a Pathway in the Dorsal Funiculus that Signals Visceral Pain? *Pain* 67:291–305
12. Kuo DC, De Groat WC (1985) Primary Afferent Projections of the Major Splanchnic Nerve to the Spinal Cord and the Nucleus Gracilis of the Cat. *J Comp Neurol* 231:421–434
13. Malcolm A, Phillips SF, Kellow JE, Cousins MJ (2001) Direct Clinical Evidence for Spinal Hyperalgesia in a Patient with Irritable Bowel Syndrome. *Am J Gastroenterol* 96: 2427–2431
14. Rustioni A (1973) Non-Primary Afferents to the Nucleus Gracilis from the Lumbar Cord of the Cat. *Brain Res.* 51:81–95
15. Wang CC, Willis WD, Westlund KN (1999) Ascending Projections from the Area of the Spinal Cord around the Central Canal: A *Phaseolus Vulgaris* Leucoagglutinin Study in Rats. *J Comp Neurol.* 415:341–367

## Postsynaptic Dorsal Column Projection, Anatomical Organization

KARIN N. WESTLUND

Department of Neurosciences and Cell Biology,  
University of Texas Medical Branch, Galveston, TX,  
USA

kwhigh@utmb.edu

### Synonyms

Cutaneous mechanical sensation; Visceral Pain Pathway; second order sensory relay; PSDC Projection

### Definition

Postsynaptic dorsal column (PSDC) cells are second order ► [sensory relay neurons](#) in the spinal cord. The PSDC cells receive cutaneous mechanical and/or noxious visceral information received from the periphery by

primary afferents. The information is relayed by PSDC axons ascending through the dorsal column to innervate the ► **dorsal column nuclei** in the dorsal midline of the caudal medulla. The largest numbers of PSDC cells are located in laminae III and IV, primarily transmitting information about innocuous cutaneous mechanical input. The PSDC cells located in lamina X transmit information about noxious stimulation received from afferent fibers innervating inflamed visceral organs.

**Characteristics**

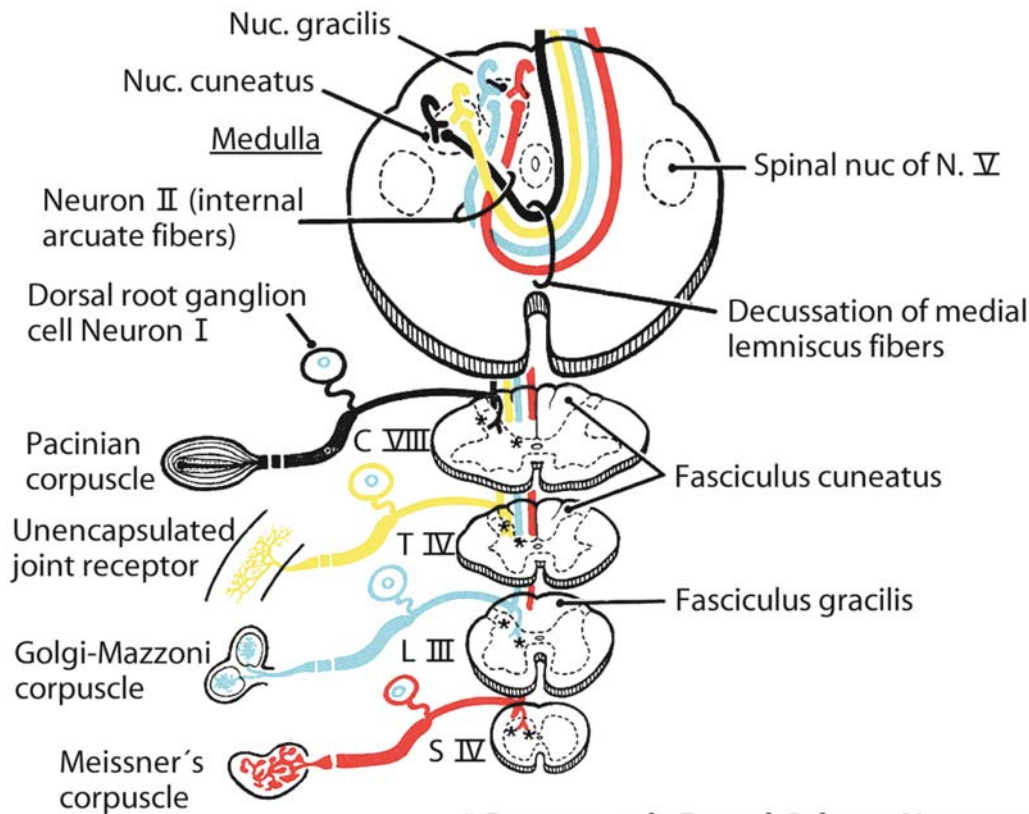
The traditional view of the dorsal column as solely a direct pathway for primary afferent fiber transmission of discriminative cutaneous and deep sensory stimuli has been expanded in the light of the many studies describing postsynaptic input transmitted to the dorsal column nuclei. In addition to ► **myelinated** and ► **unmyelinated** ► **primary afferent nerve fibers**, the dorsal column is

composed of second order fibers arising from neurons in the spinal gray matter (Fig. 1). The long, ascending tracts in the dorsal column terminate in the dorsal column nuclei. The uncrossed dorsal column fibers are ► **topographically** arranged in both human and other animals. Second order fibers arising from PSDC cells in lumbosacral levels of the spinal cord travel uncrossed, medially in the ► **fasciculus gracilis** to the ► **gracile nucleus**. Those arising from cervicothoracic levels of the spinal cord travel in the ► **fasciculus cuneatus** to terminate in the ► **cuneate nucleus**.

**Postsynaptic Dorsal Column Projection in Animals**

The existence of ascending non-primary afferent fibers in the dorsal columns was first demonstrated in cats (Petit 1973; Rustioni 1973) and has been well studied in several species. The cells of origin of the second order pathway terminating in the dorsal column nucleus are referred to

**Primary Afferent and Postsynaptic Dorsal Column Projections in the Dorsal Column**



**Postsynaptic Dorsal Column Projection, Anatomical Organization, Figure 1** Sensory information is transduced by specialized receptor endings in the periphery. The information is relayed by primary afferent nerves (1) directly to the dorsal column nuclei in the dorsal midline of the caudal medulla or (2) to the spinal cord gray matter. The cutaneous mechanical information is sent through ascending projections in the dorsal column from postsynaptic dorsal column cells (stars) in lamina III and IV. Information about noxious input in visceral structures is also relayed through the dorsal column in projection fibers arising from postsynaptic neurons in lamina X. Dorsal column projections are ► **somatotopically** arranged with information from the lower body situated medially in the dorsal column while the upper body is represented in the lateral portions of the dorsal column. (Modified from *Human Neuroanatomy*, R.C. Truex and M.B. Carpenter, 6<sup>th</sup> edition, Williams and Wilkins, Baltimore, 1969).

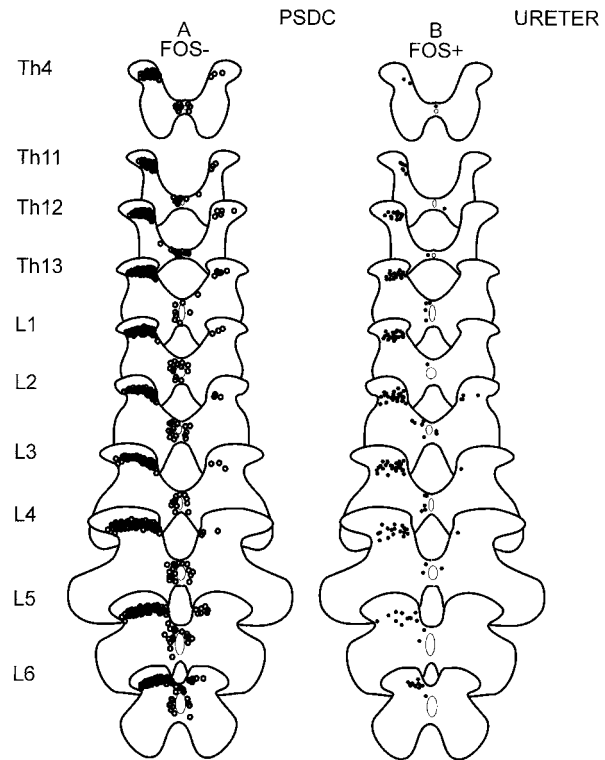
as postsynaptic dorsal column neurons. These neurons have been described as being primarily localized in laminae III and IV of the spinal gray matter (Giesler et al. 1984). However, a column of postsynaptic dorsal column cells is also located around the central canal primarily in lamina X (Giesler et al. 1984; Hirshberg et al. 1996).

#### Laminae III and IV Postsynaptic Dorsal Column Neurons

Post-synaptic dorsal column neurons are scattered throughout the length of the spinal cord but the laminae III-IV PSDC cells are localized in highest density in the cervical and lumbar enlargements. Response properties of PSDC neurons have been characterized by Brown and colleagues (Brown et al. 1983). The PSDC cells have resting discharges characterized as single impulses, or bursts of impulses at short intervals separated by longer, irregular periods. Receptive fields were identified as being either excitatory, with clearly defined zones of high and low thresholds which were sometimes discontinuous, or they were inhibitory (40%). Inhibitory fields were either small if adjacent to an excitatory field, or were large and separated from an excitatory field. Almost all of the PSDC cells received convergent inputs from low and/or high threshold cutaneous and subcutaneous mechanoreceptors (▶ [cutaneous mechanoreception](#), ▶ [subcutaneous mechanoreception](#)) from regions tested, which included both hairy and glabrous skin. Axons of PSDC cells send this information through the dorsal column with conduction velocities of  $38.3 \text{ ms}^{-1}$  on average (range  $22\text{--}61 \text{ ms}^{-1}$ ). Noxious somatic mechanical stimulation can induce Fos expression in the laminae III and IV postsynaptic dorsal column neurons. However, transmission of noxious information is not believed to be the major function of the post-synaptic dorsal column pathway (Giesler and Cliffer, 1985). For example, in an unanesthetized, ▶ [decerebrated](#), spinalized rat preparation, 64% of PSDC cells responded only to innocuous mechanical stimuli, while only 36% responded to noxious pinch.

#### Lamina X Postsynaptic Dorsal Column Neurons

Other postsynaptic dorsal column neurons are identified in lamina X that relay noxious visceral input to the dorsal column nuclei (Al-Chaer et al. 1996; Honda 1985; Honda and Lee 1985). Both somatic and visceral inputs have been shown to converge on lamina X PSDC neurons and are then relayed to the dorsal column nuclei (Honda 1985; Honda and Lee 1985). Visceral nociceptive responses are recorded in 50% of the cells of the dorsal column nuclei as a consequence (Rustioni 1973). The PSDC cells in lamina X have been shown to receive terminals of primary afferent fibers containing ▶ [vasoactive intestinal polypeptide](#), a peptide found in abundance in visceral afferent fibers (Honda and Lee 1985). While visceral afferent fibers typically remain silent upon stimulation, responses to



**Postsynaptic Dorsal Column Projection, Anatomical Organization, Figure 2** Distribution of PSDC neurons (a) retrogradely labeled from the dorsal column nuclei with fluorescent-labeled dextran tracers. (b) Fos expression was evident in some of the PSDC cells after distention of the ureter. The retrogradely labeled PSDC neurons were found in laminae III-IV and in the vicinity of the central canal. (Modified from Palecek et al. Pain 104:249, 2003)

intense noxious visceral input can be evoked in lamina X PSDC neurons. A state of sensitization induced by inflammation of the visceral organ produces a sustained increase in background firing and increased responsiveness in a greater number of PSDC cells. For example, inflammation of the colon with mustard oil or of the pancreas with bradykinin, have been shown to lower the threshold of PSDC cells and increase the responses of visceroreceptive (▶ [visceroreception](#)) lamina X neurons (Al-Chaer et al. 1997; Willis et al. 1999). Both excitatory and inhibitory responses can be recorded in PSDC cells in response to noxious visceral input.

#### Postsynaptic Dorsal Column Projection in Humans

Clinical reports primarily in the 1970's have reported hundreds of neurosurgical cases in which unexpected and immediate postoperative relief of pain, primarily intractable cancer pain, was relieved after lesions in the central spinal cord. These lesions, designed to cut the crossing fibers of the spinothalamic tract segmentally, were created by passing a fine instrument longitudinally along the midline. The results were in most cases quite successful in providing widespread alleviation of pain with only a girdle of cutaneous ▶ [analgesia](#) and tempera-



ture loss, without the complications seen with anterolateral lesion of the spinothalamic tract or dorsal root section. It was never previously understood why this type of lesion removed cancer pain in regions below the lesion as well as segmentally. Thus, the practice has been mostly abandoned. Further refinement of neurosurgical technique revealed the puzzling finding that a punctuate lesion had similarly positive effects for pain relief below the level of the lesion (Hitchcock 1970; Gildenberg and Hirshberg 1984; Nauta et al. 1997). The anatomical basis for pain relief in patients after dorsal column lesion can now be speculated on, based on animal studies reporting that visceral nociceptive information is transmitted by axons in the dorsal columns arising from PSDC cells around the central canal.

The existence of an ascending pathway located at the base of the dorsal columns was also speculated on, since this region contains the only ascending fibers remaining after segmental isolation and in addition, surgical lesions not deep enough to sever the spinothalamic tract crossing in the gray matter were also successful. Basic studies were initiated revealing the postsynaptic dorsal column projections transmitting information about visceral pain (Hirshberg et al. 1996; Wang et al. 1999; Willis et al. 1999). Surgical incisions in the spinal cord midline aimed either at crossing spinothalamic tract axons or the proposed pathway in the base of the dorsal column would necessarily pass through and sever ascending postsynaptic dorsal column axons located dorsally in the midline (Wang et al. 1999). Also coincidentally, the route taken by the fibers of lamina X postsynaptic neurons as they leave the gray matter in rats is to align themselves at the base of the dorsal columns, traveling for several segments in the position predicted by earlier neurosurgical successes in patients with intractable pain. As they travel rostrally, the fibers are elevated dorsally by the addition of other postsynaptic dorsal column fibers entering the dorsal column at each successive spinal segment. The second order PSDC axons from PSDC cells receiving information about viscera in the lower body (pelvic) are pushed to the midline. The PSDC axons carrying information about the viscera in the upper body travel along the intermediate septum between the gracile and cuneate fasciculi.

Kim and Kwon (2000) report a series of high thoracic level lesions of which one was particularly successful. This lesion placed at the lateral edge of the gracile fasciculus at the dorsal root entry zone eliminated stomach cancer pain, while midline lesions were less effective in eliminating visceral pain arising from thoracic levels. Additional surgical studies are needed to clarify the effectiveness of a lesion placed off midline between the gracile and cuneate nuclei, perhaps at the C7 segment where the septum is oriented vertically or at the dorsal root entry zone at the C8-T1 border. However, the clinical reports imply that human spinal cord is organized similarly to that reported in animal studies, i.e. carrying

visceral nociceptive information to the brain as a component of the postsynaptic dorsal column system.

## References

1. Al-Chaer ED, Lawand NB, Westlund KN et al. (1996) Pelvic visceral input into the nucleus gracilis is largely mediated by the postsynaptic dorsal column pathway. *J Neurophysiol* 76:2675–2690
2. Brown AG, Brown PB, Fyffe RE et al. (1983) Receptive field organization and response properties of spinal neurones with axons ascending the dorsal columns in the cat. *J Physiol* 337:575–588
3. Giesler GJ Jr, Nahin RL, Madsen AM (1984) Postsynaptic dorsal column pathway of the rat. I. Anatomical studies. *J Neurophysiol* 51:260–275
4. Giesler GJ Jr, Cliffer KD (1985) Postsynaptic dorsal column pathway of the rat. II. Evidence against an important role in nociception. *Brain Res* 326:347–356
5. Gildenberg PL, Hirshberg RM (1984) Limited myelotomy for the treatment of intractable cancer pain. *J Neurol. Neurosurg. Psychiatry* 47:94–96
6. Hirshberg RM, Al-Chaer ED, Lawand NB et al. (1996) Is there a pathway in the posterior funiculus that signals visceral pain? *Pain* 67:291–305
7. Hitchcock E (1970) Stereotactic cervical myelotomy. *J Neurosurg. Phschiat* 33:224–230
8. Honda CN (1985) Visceral and somatic afferent convergence onto neurons near the central canal in the sacral spinal cord of the cat. *J Neurophysiol* 53:1059–1078
9. Honda CN, Lee CL (1985) Immunohistochemistry of synaptic input and functional characterizations of neurons near the spinal central canal. *Brain Res* 343:120–128
10. Kim YS, Kwon SJ (2000) High thoracic midline dorsal column myelotomy for severe visceral pain due to advanced stomach cancer. *Neurosurgery* 46:85–90
11. Nauta HJ, Hewitt E, Westlund KN et al. (1997) Surgical interruption of a midline dorsal column visceral pain pathway. Case report and review of the literature. *J Neurosurg* 86:538–542
12. Petit D (1972) Postsynaptic fibres in the dorsal columns and their relay in the nucleus gracilis. *Brain Res* 48:380–384
13. Rustioni A (1973) Non-primary afferents to the nucleus gracilis from the lumbar cord of the cat. *Brain Res* 51:81–95
14. Wang CC, Willis WD, Westlund KN (1999) Ascending projections from the area around the spinal cord central canal: A Phaseolus vulgaris leucoagglutinin study in rats. *J Comp Neurol.* 415:341–367
15. Willis WD, Al-Chaer ED, Quast MJ et al. (1999) A visceral pain pathway in the dorsal column of the spinal cord. *Proc Natl. Acad Sci U.S.A* 96:7675–7679

P

## Postsynaptic Dorsal Column Projection, Functional Characteristics

KARIN N. WESTLUND

Department of Neurosciences and Cell Biology,  
University of Texas Medical Branch, Galveston, TX,  
USA

kwhigh@utmb.edu

### Synonyms

Second order cutaneous mechanical input; dorsal horn; Visceral Pain Pathway

### Definition

Second order neurons in the deep layers of the spinal cord dorsal horn receive ► [cutaneous mechanical](#) and/or

visceral information that is relayed through the ► **dorsal column** to the ► **dorsal column nuclei** in the medulla. The ascending axons of these second order neurons are referred to as the postsynaptic dorsal column projection. The ► **postsynaptic dorsal column** (PSDC) cells located in laminae III and IV primarily transmit noxious cutaneous mechanical input, while the PSDC cells in laminae VII, X and perhaps III transmit noxious visceral pain input.

### Characteristics

The dorsal column has previously been known solely as a direct pathway for primary afferent fiber transmission of ► **epicritic** information, e.g. discriminative responses to cutaneous and deep sensory stimuli. The functional characteristics of the dorsal column pathway have been expanded in the light of the many studies describing postsynaptic dorsal column input to the dorsal column nuclei. The dorsal column is composed of both direct primary afferent fibers and axons of second order postsynaptic dorsal column cells distributed as a column through the length of the spinal cord. The direct input is discriminative information about light touch, vibration and limb position in space. This ► **epicritic** information is carried by large, heavily myelinated fibers. In contrast, the second order axons of post-synaptic dorsal column neurons are medium-sized myelinated axons, based on conduction velocities in rats (Giesler and Cliffer 1985).

### Laminae III and IV Postsynaptic Dorsal Column Neurons

Laminae III-IV PSDC cells are responsive to mechanical input following cutaneous stimulation (Giesler and Cliffer 1985), but are not believed to be important in transmission of noxious cutaneous input in rats. In other mammals including monkeys and humans, these cells are primarily found medially, primarily in laminae III-VI at cervical levels and more laterally in lumbar levels (Rustioni et al. 1979). Background discharge in PSDC neurons consists of short high-frequency bursts separated by longer intervals. In unanesthetized, decerebrated animals, 64% of the PSDC cells responded only to innocuous cutaneous input, while the remainder responded best to strong mechanical stimuli. Input can be received from more than one afferent fiber and can include more than one modality (Uddenberg 1968). For example, a neuron may respond to hair movement, pressure and/or pinch stimulation of the skin (not to pinch in rat). The neuronal responses to the different types of input vary in their discharge pattern in agreement with input type, i.e. hair movement produces rapidly adapting responses whereas maintained tactile contact produced slowly adapting (Angaut-Petit 1975). Inhibition of post-synaptic dorsal column neuron responses to peripheral input can be achieved by stimulation of other peripheral nerves, demonstrating complex interactions within this system (Brown et al. 1983).

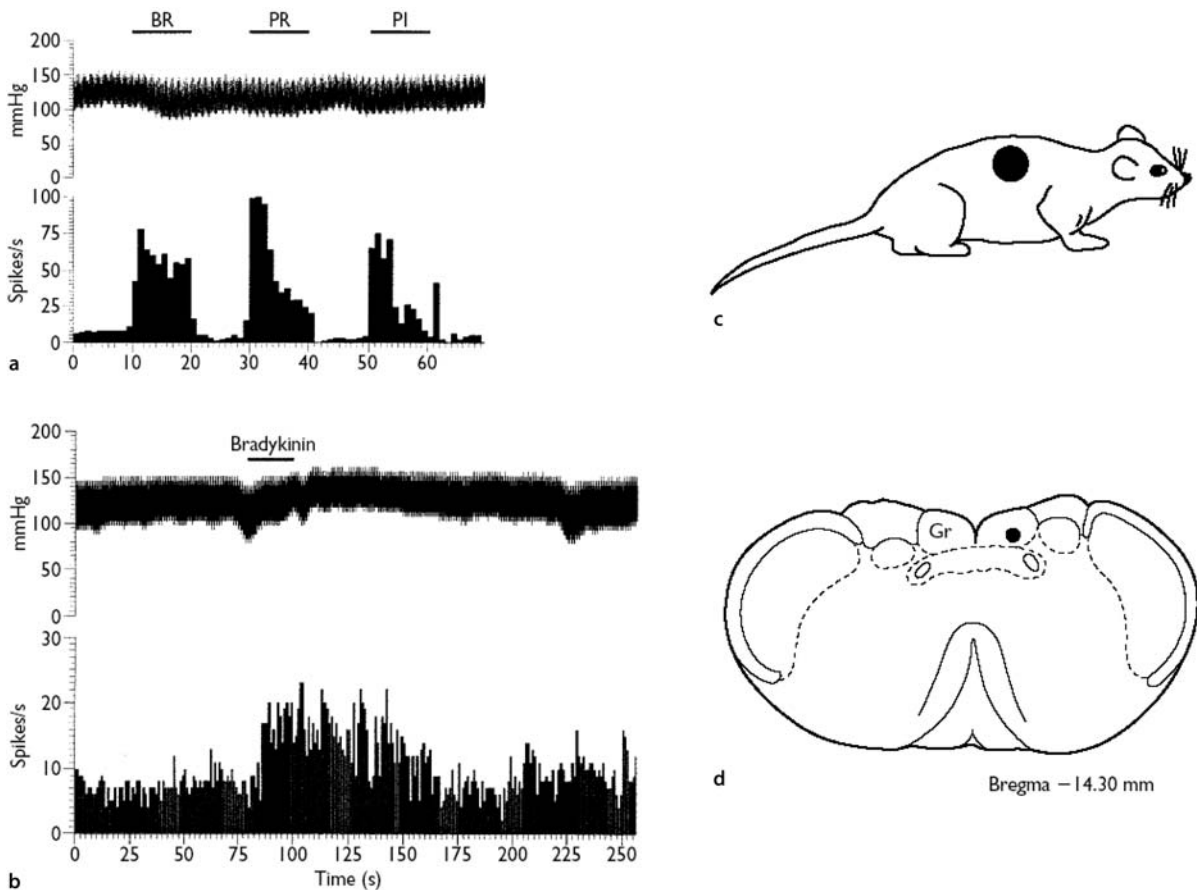
### Lamina X Postsynaptic Dorsal Column Neurons

Both somatic and visceral inputs have been shown to converge onto the majority of the lamina X PSDC neurons (Honda 1985; Honda and Perl 1985). Those excited by noxious input are sometimes inhibited by innocuous inputs and *vice versa*. In addition to direct input from ► **mechanosensitive** visceral afferents, convergent somatic and visceral inputs received by PSDC neurons in laminae X are relayed by the dorsal columns. Visceral nociceptive responses are recorded in up to 50% of cells in the dorsal column nuclei (Rustioni 1973; Angaut-Petit 1975; Cliffer and Giesler 1989; Berkeley and Hubscher 1995). While responses to intense noxious visceral input can be evoked in lamina X PSDC neurons (Honda 1985), a state of sensitization induced by inflammation of visceral organs produces a sustained increase in background firing and increased responsiveness in a greater number of cells (Al-Chaer et al. 1996; Ness and Gebhart 1987; Feng et al. 1998; Wang et al. 1999) Both excitatory and inhibitory responses are recorded in PSDC cells in response to visceral input.

The PSDC cells in lamina X have been shown to receive vasoactive intestinal polypeptide afferent fibers, as well as fibers containing somatostatin, substance P, leu-enkephalin and serotonin (Honda and Lee 1985).

### References

1. Al-Chaer ED, Lawand NB, Westlund KN et al. (1996) Pelvic visceral input into the nucleus gracilis is largely mediated by the postsynaptic dorsal column pathway. *J Neurophysiol* 76:2675–2690
2. Angaut-Petit D (1975) The dorsal column system: I. Existence of long ascending postsynaptic fibres in the cat's fasciculus gracilis. *Exp Brain Res* 22:457–470
3. Berkeley KJ, Hubscher CH (1995) Are there separate central nervous system pathways for touch and pain? *Nat Med* 1:766–773.
4. Brown AG, Brown PB, Fyffe RE et al. (1983) Receptive field organization and response properties of spinal neurones with axons ascending the dorsal columns in the cat. *J Physiol* 337:575–588
5. Cliffer KD, Giesler GJ Jr (1989) Postsynaptic dorsal column pathway of the rat. III. Distribution of ascending afferent fibers. *J Neurosci* 9:3146–3168
6. Feng Y, Cui M, Al-Chaer ED, Willis WD (1998) Epigastric antinociception by cervical dorsal column lesions in rats. *Anesthesiol* 89:411–420
7. Giesler GJ Jr, Cliffer KD (1985) Postsynaptic dorsal column pathway of the rat. II. Evidence against an important role in nociception. *Brain Res* 326:347–356
8. Honda CN (1985) Visceral and somatic afferent convergence onto neurons near the central canal in the sacral spinal cord of the cat. *J Neurophysiol* 53:1059–1078
9. Honda CN, Lee CL (1985) Immunohistochemistry of synaptic input and functional characterizations of neurons near the spinal central canal. *Brain Res* 343:120–128
10. Honda CN, Perl ER (1985) Functional and morphological features of neurons in the midline region of the caudal spinal cord of the cat. *Brain Res* 340:285–295
11. Ness TJ, Gebhardt GF (1987) Characterization of neuronal responses to noxious visceral and somatic stimuli in the medial lumbosacral spinal cord of the rat. *J Neurophysiol* 57:1867–1892
12. Rustioni, A (1973) Non-primary afferents to the nucleus gracilis from the lumbar cord of the cat. *Brain Res* 51:81–95
13. Rustioni A, Hayes NL, O'Neill S (1979) Dorsal column nuclei and ascending spinal afferents in macaques. *Brain* 102:95–125



**Postsynaptic Dorsal Column Projection, Functional Characteristics, Figure 1** Responses of a cell in the dorsal column nucleus to (a) cutaneous stimuli (brush, BR; press, PR; pinch, PI) and (b) bradykinin applied to pancreatic afferent fibers. The accompanying change in blood pressure (mmHg) is also shown. (c) This cell had a cutaneous receptive over the back of the thorax. (d) The cell was located at the lateral edge of the gracile nucleus (GR). Reprinted from Wang and Westlund (2001) *NeuroReport* 12:2527–2530.

P

14. Uddenberg N (1968) Functional organization of long, second-order afferents in the dorsal funiculus. *Experientia* 15:441–442
15. Wang CC, Westlund KN (2001) Responses of rat dorsal column neurons to pancreatic nociceptive stimulation. *NeuroReport* 12:2527–2530
16. Wang CC, Willis WD, Westlund KN (1999) Ascending projections from the area around the spinal cord central canal: A PHA-L study in rats. *J Comp Neurol* 415:341–367

## Postsynaptic Inhibition

### Definition

Postsynaptic inhibition is a form of synaptic inhibition in which the responses of a postsynaptic neuron are reduced. Mechanisms of postsynaptic inhibition include the opening of potassium or chloride channels, resulting in an increased membrane conductance and often a hyperpolarization.

- ▶ [GABA Mechanisms and Descending Inhibitory Mechanisms](#)

## Postsynaptic Opioid Receptors

- ▶ [Opioid Receptors at Postsynaptic Sites](#)

## Post-Traumatic Headache

- ▶ [Headache, Acute Post-Traumatic](#)

## Post-Traumatic Neuralgia

### Definition

Pain syndrome that occurs after a traumatic nerve injury.

- ▶ [Neuralgia, Assessment](#)

## Posttraumatic Subdural Hemorrhage

- ▶ [Headache Due to Intracranial Bleeding](#)

## Postural Position

### Synonyms

Rest Position

### Definition

Postural or rest positions are habitual mandibular positions that are assumed when the person is relaxed, with no voluntary activation of the jaw-closing muscles. They determined in part by the viscoelasticity of the muscles and by the contractile elements.

- ▶ Orofacial Pain, Movement Disorders

## Posture

### Definition

Posture refers to the position of a joint or complex of joints in the body, which is maintained for a specific unit of time. A posture is always associated with static loading.

- ▶ Ergonomic Counseling

## Potassium Sensitivity Testing

### Definition

Intravesical infusion of a potassium solution that often elicits pain in IC patients.

- ▶ Interstitial Cystitis and Chronic Pelvic Pain

## Potent Opioid Analgesic

### Definition

Morphine-like painkiller that can relieve very intense pain by administering appropriate doses intravenously, epidurally or directly into the cerebrospinal fluid around the spinal cord.

- ▶ Postoperative Pain, Acute Pain Management, Principles

## Pourpre Myelotomy

- ▶ Midline Myelotomy

## Power Law

### Definition

Power law refers to a stimulus-response function wherein equal stimulus ratios result in equal response ratios. In psychophysics the law is expressed as  $\psi = k(S - S_0)^X$ .

- ▶ Pain in Humans, Psychophysical Law
- ▶ Spinothalamic Tract Neurons, in Deep Dorsal Horn

## Power of Ultrasound

### Definition

The power is total energy per unit time.

- ▶ Ultrasound Therapy of Pain from the Musculoskeletal System

## PPI

- ▶ Present Pain Intensity Subscale

## Preadmission Clinics

### Definition

Preadmission clinics are used to carry out a preanesthetic evaluation. Goals include creating a doctor-patient relationship, identifying the present surgical problem and the medical conditions that co-exist, mounting a management strategy for perioperative anesthetic care, and obtaining informed consent for the anesthetic plan. The consultation is recorded in the patient's records. Anesthetic options with their risks and benefits are discussed. The preadmission clinic corrects conditions as far as possible to diminish patient anxiety and decrease perioperative morbidity and mortality.

- ▶ Postoperative Pain, Preoperative Education

## Preamputation Pain

### Definition

Preamputation pain refers to pain prior to the amputation that is often related to later phantom limb pain.

- ▶ Phantom Limb Pain, Treatment



## Precontemplation

### Definition

A readiness to change stage in which a person sees no need and has no intention of changing a behavior that others (not the person) might see as problematic (e.g. problem drinking, smoking, avoiding exercise).

- ▶ [Motivational Aspects of Pain](#)

## Predentin

### Definition

The deepest thin layer of dentin that is not mineralized.

- ▶ [Nociceptors in the Dental Pulp](#)

## Prednisone

The treatment of choice in all vasculitides in combination with immunosuppressants; as sole therapy in cranial arteritis; starting dose is 60 to 80 mg/day.

- ▶ [Headache Due to Arteritis](#)

## Pre-Emptive Analgesia

### Definition

Pre-emptive analgesia is a treatment that is initiated before and is operational during the tissue injury (for example, a surgical procedure), in order to reduce the physiological consequences of nociceptive transmission provoked by the procedure. The hypothesis behind this is that the transmission of noxious afferent input from the periphery to the spinal cord during the induction of a tissue injury induces a prolonged state of ▶ [central sensitization](#), which amplifies subsequent input from the injury and leads to heightened pain. By interrupting the transmission of noxious inputs to the spinal cord during the injury, a pre-emptive approach is suggested to prevent the establishment of central sensitization, resulting in reduced pain intensity and lower analgesic requirements, even after the analgesic effects of the (pre-emptive) agents have worn off.

- ▶ [Formalin Test](#)
- ▶ [Nick Model of Cutaneous Pain and Hyperalgesia](#)
- ▶ [Pre-Emptive or Preventive Analgesia and Central Sensitisation in Postoperative Pain](#)

## Pre-Emptive or Preventive Analgesia and Central Sensitisation in Postoperative Pain

EMMA L. BRANDON, STEPHAN A. SCHUG  
Royal Perth Hospital and University of Western  
Australia, Perth, WA, Australia  
schug@cyllene.uwa.edu.au

### Synonyms

Prophylactic Pain Treatment; Pain Prevention

### Definitions

#### Pre-emptive Analgesia

This term was used for the first time by P. Wall in an editorial in *Pain* in 1988. He wrote “that we should consider . . . the possibility that pre-emptive preoperative analgesia has prolonged effects which long outlast the presence of the drugs” (Wall 1988). Pre-emptive analgesia is now commonly defined as a pre-operative analgesic treatment that is more effective than the identical treatment administered after incision or surgery (as evidenced by reduced pain or analgesic consumption or both). The only difference is the timing of administration.

#### Preventive Analgesia

In contrast, the definition of preventive analgesia focuses on duration of effect. Postoperative pain and/or analgesic consumption is reduced relative to another treatment, to a placebo treatment or to no treatment, as long as the effect is observed at a point in time that exceeds the expected duration of action of the target agent. The intervention may or may not be initiated before surgery. For example, a preventive effect is present if postoperative administration of a target analgesic agent but not a placebo results in reduced postoperative pain or analgesic consumption after the effects of the target agent have worn off (Nguyen et al. 2001; Reuben et al. 2001).

#### Characteristics

Although the concept that pain is more difficult to treat late rather than early in its course is not new, the scientific basis of this phenomenon was not realised until Woolf and others elucidated mechanisms for the effect in the spinal cord in the early 1980s (Woolf 1983). The demonstration of pre-emptive analgesia in animals (Woolf 1983) and the unravelling of spinal cord mechanisms by scientists led to the hypothesis that analgesia prior to surgery may enhance post-operative pain management (Wall 1988).

However, randomised controlled trials and their meta-analysis have failed to show clinically useful benefits of timing of analgesia when comparing pre-incisional

and post-incisional interventions (Moiniche et al. 2002; Eisenach 2000). Reasons for this include problems with definitions, the design of the studies or no clinical benefit of pre-emptive analgesia.

The almost exclusive focus on the narrow definition of pre-emptive analgesia had the unintended effect of diverting attention away from certain clinically significant findings because they did not conform to what had become the accepted definition. The concept of pre-emptive analgesia has now evolved and has led to progress in our understanding of the mechanisms that contribute to acute postoperative pain.

In addition to skin incision, central and peripheral sensitisation is now believed to be triggered by other factors including preoperative noxious inputs and pain, the extent of intra-operative tissue injury and postoperative inflammation and ectopic neural activity in the case of post-surgical nerve injury. Hence the focus has shifted from the timing of a single intervention to the concept of 'preventive' analgesia (Kissin 1994). Each of the aforementioned factors is a potential target for a preventive approach.

A systematic review of 27 studies identified evidence for a benefit of preventive analgesia, with 60% of studies finding reduced pain or analgesic consumption beyond the clinical duration of action of the analgesic intervention (Katz and McCartney 2002). Of the six preventive studies that examined the use of NMDA antagonists, four found positive preventive effects. Similarly in a most recent other systematic review of NMDA antagonists, fourteen of twenty-four ketamine studies and eight of twelve dextromethorphan studies report a preventive analgesic effect (McCartney et al. 2004). This may reflect their role in reducing central sensitisation by their actions at the NMDA receptor-ion channel complex or by reducing acute opioid tolerance (Mao et al. 1995). Preventive analgesic effects have also been shown with clonidine, gabapentin, local anaesthetic, NSAIDs and morphine (Katz and McCartney 2002).

Preventive analgesia may even reduce the risk of developing chronic postoperative pain states; while studies investigating the role of neural blockade in pre-emptive analgesia have found no effect, use of a local anaesthetic regime throughout the perioperative period has been shown to provide effective and prolonged analgesia (e.g. Reuben et al. 2001; Fischer et al. 2000; Gottschalk et al. 1998; Obata et al. 1999; Senturk et al. 2002). Reuben et al. demonstrated a significant reduction in pain 24 hours after post-incisional administration of 5 mg morphine injected intramuscularly or infiltrated directly into the exposed cancellous bone and bone marrow cavity in patients undergoing iliac bone harvest (Reuben et al. 2001). Remarkably, the incidence of pain one year later was significantly lower in the iliac infiltration group (5%) than in the intramuscular injection group (37%). Several studies have shown an effect of perioperative epidural analgesia for thoracotomies with a significant

reduction of pain at 6 months postoperatively (Obata et al. 1999, Senturk et al. 2002). Similarly, Gottschalk et al. found prolonged benefit (up to 9.5 weeks) after pre- and intra-operative epidural analgesia for radical prostatectomy (Gottschalk et al. 1998). More trials are required to confirm this hypothesis.

In conclusion, the previous concept of pre-empting nociception by providing analgesia before surgical incision should be broadened to the concept of pre-empting central excitatory changes by providing effective analgesia, specific antagonists to the excitatory process and/or complete neural blockade throughout the various stages of injury, i.e. by providing preventive analgesia.

## References

1. Abdi S, Lee DH, Park SK et al. (2000) Lack of pre-emptive analgesic effects of local anaesthetics on neuropathic pain. *Br J Anaes* 85:620–623
2. Eisenach JC (2000) Pre-emptive hyperalgesia, not analgesia? *Anesthesiology* 92:308–309
3. Fischer S, Troidi H, MacLean et al. (2000) Prospective double blind randomised study of a new regimen of pre-emptive analgesia for inguinal hernia repair: evaluation of postoperative pain course. *Eur J Surg* 166:545–551
4. Gottschalk A, Smith DS, Jobes DR et al. (1998) Pre-emptive epidural analgesia and recovery from radical prostatectomy. A randomised controlled trial. *JAMA* 279:1076–1082
5. Katz J, McCartney CJ (2002) Current status of pre-emptive analgesia. *Curr Opin Anaesthesiol* 15:435–441
6. Kissin I (1994) Pre-emptive analgesia: terminology and clinical relevance. *Anesth Analg* 79:809–10
7. Mao J, Price DD, Mayer DJ (1995) Mechanisms of hyperalgesia and morphine tolerance: a current review of their possible interactions. *Pain* 62:259–274
8. McCartney CJL, Sinha A, Katz J (2004) A qualitative systematic review of the role of n-methyl-d-aspartate receptor antagonists in preventive analgesia. *Anesth Analg* 98:1385–1400
9. Moiniche S, Kehlet H, Dahl JB (2002) A qualitative and quantitative systematic review of pre-emptive analgesia for post-operative pain relief: the role of timing of analgesia. *Anesthesiology* 96:725–741
10. Nguyen A, Girard F, Boudreault D et al. (2001) Scalp nerve blocks decrease the severity of pain after craniotomy. *Anesth Analg* 93:1272–1276
11. Obata H, Saito S, Fujita N et al. (1999) Epidural block with mepivacaine before surgery reduces long-term post-thoracotomy pain. *Can J Anaesth* 46:1127–32
12. Reuben SS, Vieira P, Faruqi S et al. (2001) Local administration of morphine for analgesia after iliac bone graft harvest. *Anesthesiology* 95:390–394
13. Senturk M, Ozcan PE, Talu GK et al. (2002) The effects of three different analgesia techniques on long-term postthoracotomy pain. *Anesth Analg* 94:11–15
14. Wall PD (1988) The prevention of post-operative pain. *Pain* 33:289–90
15. Woolf CJ (1983) Evidence for a central component of post-injury pain hypersensitivity. *Nature* 308:686–688

## Preferential Processing

### Definition

A systematic bias for the processing of information related to a specific domain of experience.

- ▶ Psychology of Pain, Assessment of Cognitive Variables

## Prefrontal Cortex

### Definition

The prefrontal cortex is a neocortical structure of the frontal lobe located in the rostral region of the frontal cortex, just anterior to the premotor areas that is farthest developed in humans. It is important for higher cortical functions that characterize the flexibility of human behavior, the ability to control attention and the richness of intellectual and emotional competence.

- ▶ Descending Circuits in the Forebrain, Imaging
- ▶ Functional Imaging of Cutaneous Pain

## Prefrontal Cortex, Effects on Pain-Related Behavior

JÜREGEN LORENZ

Hamburg University of Applied Sciences, Hamburg, Germany

juergen.lorenz@rzbd.haw-hamburg.de

### Definition

The prefrontal cortex (PFC) is a ▶ **neocortical** brain region of the frontal lobe that is farthest developed in humans. As indicated by human functional brain imaging, it plays a major role in cognitive, attentional and emotional processing of painful stimuli and recruitment of endogenous pain control.

### Characteristics

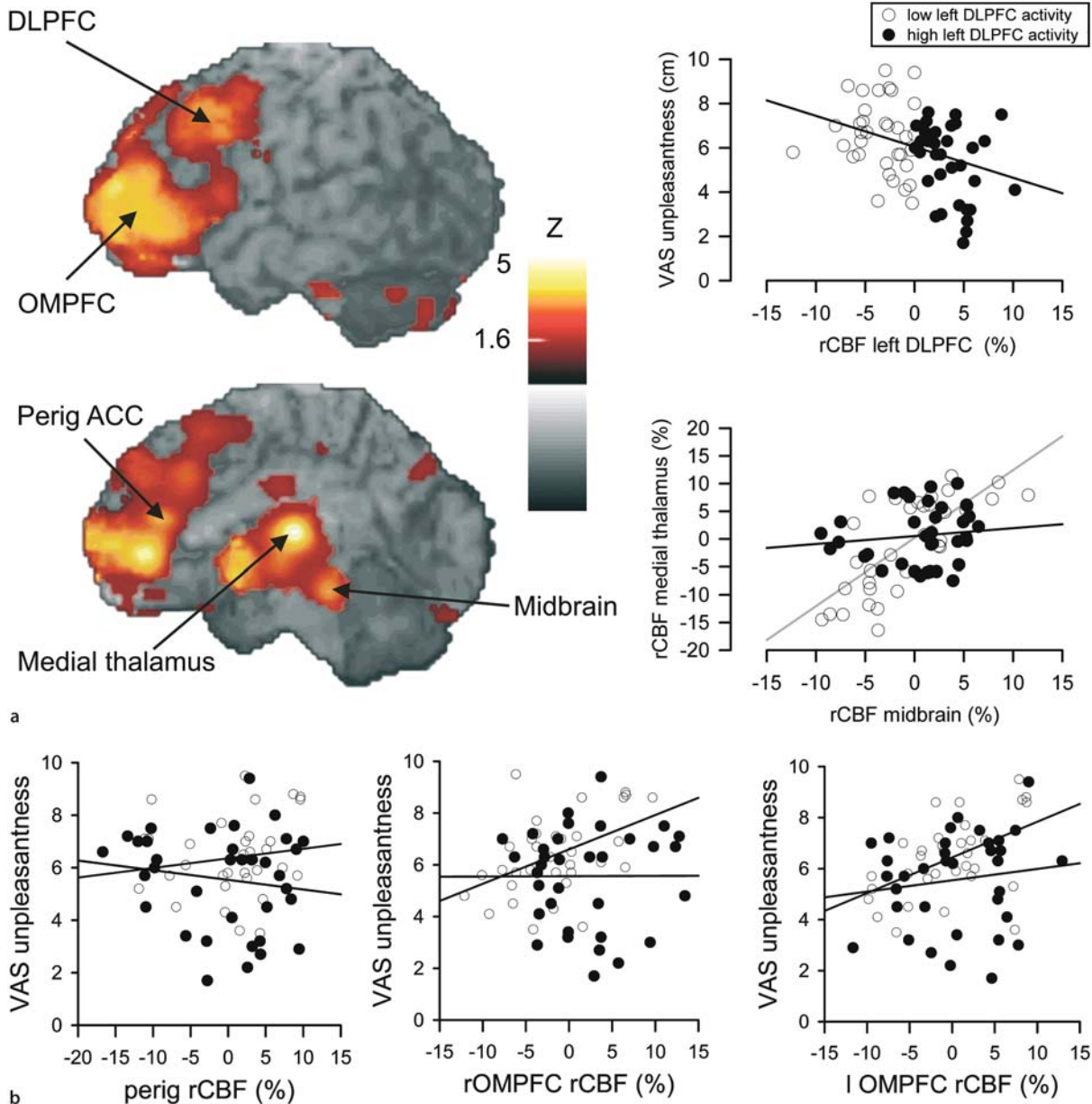
The PFC is considered to be important for higher cortical functions that characterize the flexibility of human behavior, the ability to control attention and the richness of intellectual and emotional competence. PFC comprises orbital and medial (Brodman areas 10, 11, 13, 14), ventrolateral (Brodman areas 12, 45), dorsolateral (Brodman area 46), and mid-dorsal (Brodman area 9) regions of the frontal lobe and has manifold, mostly reciprocal, connections to visual, auditory, somatosensory, olfactory, gustatory, visceral and motor cortical areas. As part of neuronal circuits, the PFC is linked to subcortical structures such as the basal ganglia (important for motivation and initiation of movement) and ▶ **thalamus**, and limbic structures (important for emotional behavior) such as ▶ **cingulate cortex**, ▶ **amygdala**, hypothalamus and brainstem.

The PFC is activated in several, yet not all functional imaging studies using experimental painful stimuli or clinical pain states. It typically fails to show a clear pain-related stimulus-response function (Coghill et al.

1999), which led to the assumption that PFC activity mainly relates to the engagement of attention during pain processing (Peyron et al. 1999). On the other hand, it has long been assumed that higher cortical functions represented by the PFC participate in endogenous pain control. The biological significance of endogenous pain control, primarily governed by endorphins (the body's own morphine-like substances), is generally seen in the context of behavioral conflicts in which the subject needs to disengage from pain in order to fight or escape at the presence of body injury. Analogous human life situations are sporting competition or combat, during which a subject may fail to be aware of even severe tissue damage, which becomes painful when the victim releases engagement in these activities.

A particular part of the PFC, the dorsolateral prefrontal cortex (DLPFC), is important for continuous monitoring of the external world, maintenance of information in short-term memory, and governing efficient performance control in the presence of distracting or conflicting stimuli (Bunge et al. 2001; Sakai et al. 2002). In turn, orbital and medial portions of the prefrontal cortex (OMPFC) are known to be important for mood and emotional behavior, e.g. when guided by cues of reward or punishment, as well as for visceral and autonomic homeostasis related to eating and drinking behavior (Price et al. 1996). Lorenz et al. (2002; 2003) confirmed differential responses of DLPFC and OMPFC during pain. They used O<sup>15</sup>-water injections in healthy volunteers, to scan cerebral blood flow responses by ▶ **positron emission tomography** (PET), following contact heat stimuli applied upon normal and capsaicin-treated skins of the volar forearm. They found strong activation of the bilateral DLPFC and OMPFC during capsaicin-induced heat allodynia (Fig. 1). Whereas DLPFC exhibited a negative, OMPFC yielded a positive relationship to the unpleasantness of perceived pain. Furthermore, the interregional correlation of activity between midbrain and medial thalamus was significantly reduced dependent on the amount of DLPFC activity, which could indicate a top-down mode of inhibition of effective synaptic connectivity between brainstem and medial thalamus, causing reduced pain unpleasantness. Consistent with this view, the perigenual cingulate cortex (perig ACC), as well as the bilateral OMPFC which receive strong input from the medial thalamus, exhibited a clear reduction of positive relationship to pain unpleasantness during scans of high compared to low DLPFC activity.

The interaction of DLPFC with critical nodes of the descending inhibitory pathways such as the perigenual ACC and the midbrain, both brain regions that are richly provided with opioid receptors, may therefore be particularly important for disengagement from the prepotent pain behavior to pursue other behavioral goals. This is consistent with the notion that lateral PFC exerts cognitive control during the processing of emotionally



**Prefrontal Cortex, Effects on Pain-Related Behavior, Figure 1** Surface-rendered and sagittal views of statistical (Z-score) maps of  $O^{15}$ -water positron emission tomography (PET) scans from 14 volunteers during contact heat stimulation of their left volar forearm which was sensitized by a topical solution of capsaicin. The maps illustrate significant activation of the dorsolateral prefrontal cortex (DLPFC), the orbital and medial prefrontal cortex (OMPFC), the perigenual anterior cingulate cortex (perig ACC), medial thalamus, and the dorsomedial midbrain. DLPFC activity showed a negative correlation with the visual analogue score of unpleasantsness (upper right diagram). When dividing scans according to a median-half-split of left DLPFC activity, scans during low DLPFC activity (open circles) yielded significantly greater correlations than scans with high left DLPFC (filled circles) activity between midbrain and medial thalamic activations. This result suggests a modulation of synaptic connectivity within the afferent medial thalamic pathway by which the affective reaction to the painful stimulation is diminished.

salient stimuli (Goel and Dolan 2003), especially when the emotional content of task stimuli is task-irrelevant and distracting (Bishop et al. 2004). Lorenz and Bromm (1997) found that the ability to maintain performance accuracy in a short-term memory task during experimental painful muscle ischemia positively correlates with frontal lobe activity measured by event-related

brain potentials of the electroencephalogram elicited by the memory stimuli. Goel and Dolan (2003) argued that the reciprocity of neural responses within lateral and ventral medial PFC cortex reflects the degree to which decision making is guided by respective rational or emotional reasoning. During acute pain inflicting the intact body, such as when touching a hot plate, imme-



diate withdrawal is of pivotal importance, resulting in activation of brain areas like the premotor and motor cortex, dorsal basal ganglia and cerebellum (Casey et al. 2001) which allow rapid and spatially coordinated motor reactions. Thus, whereas acute pain orchestrates a habitual pain behavior, ongoing pain states caused by tissue damage requires executive attentional and behavioural control governed by the DLPFC.

Recent clinical studies lend further support to the association of the DLPFC with pain suppression. Apkarian et al. (2004) observed a reduction of the gray matter density, determined by morphometry of magnetic resonance scans in bilateral DLPFC and right thalamus in chronic back pain patients, which was strongly related to pain characteristics. In agreement with the suggested role of DLPFC in pain control, high-frequency transcranial magnetic stimulation (rTMS) over left DLPFC was able to ameliorate chronic migraine (Brighina et al. 2004). This is consistent with earlier studies in animals where electrical stimulation of fiber connections of the prefrontal cortex to the midbrain mediated antinociceptive effects in rodents (Hardy and Haigler 1985). In summary, collective evidence suggests that the PFC represents a brain substrate for the human ability to actively cope with pain.

## References

1. Apkarian AV, Sosa Y, Sonty S et al. (2004) Chronic Back Pain is Associated with Decreased Prefrontal and Thalamic Gray Matter Density. *J Neurosci* 24:10410–10415
2. Bishop S, Duncan J, Brett M et al. (2004) Prefrontal Cortical Function and Anxiety: Controlling Attention to Threat-Related Stimuli. *Nat Neurosci* 7:184–188
3. Brighina F, Piazza A, Vitello G et al. (2004) rTMS of the Prefrontal Cortex in the Treatment of Chronic Migraine: A Pilot Study. *J Neurol Sci* 227:67–71
4. Bunge SA, Ochsner KN, Desmond JE et al. (2001) Prefrontal Regions Involved in Keeping Information In and Out of Mind. *Brain* 124: 2074–2086
5. Casey KL, Morrow TJ, Lorenz J et al. (2001) Temporal and Spatial Dynamics of Human Forebrain Activity during Heat Pain: Analysis by Positron Emission Tomography. *J Neurophysiol* 85:951–959
6. Coghill RC, Sang CN, Maisog JM et al. (1999) Pain Intensity Processing within the Human Brain: A Bilateral, Distributed Mechanism. *J Neurophysiol* 82:1934–1943
7. Goel V, Dolan RJ (2003) Reciprocal Neural Response within Lateral and Ventral Medial Prefrontal Cortex during Hot and Cold Reasoning. *Neuroimage* 20:2314–2321
8. Hardy SGP, Haigler HJ (1985) Prefrontal Influences upon the Midbrain: A Possible Route for Pain Modulation. *Brain Res* 339:285–293
9. Lorenz J, Bromm B (1997) Event-Related Potential Correlates of Interference between Cognitive Performance and Tonic Experimental Pain. *Psychophysiology* 34:436–445
10. Lorenz J, Cross DJ, Minoshima S et al. (2002) A Unique Representation of Heat Allodynia in the Human Brain. *Neuron* 35:383–393
11. Lorenz J, Cross DJ, Minoshima S et al. (2003) Keeping Pain Out of Mind: The Role of the Dorsolateral Prefrontal Cortex in Pain Modulation. *Brain* 126:1079–1091
12. Peyron R, Garcia-Larrea L, Groeogire M-C et al. (1999) Haemodynamic Brain Responses to Acute Pain in Humans. Sensory and Attentional Networks. *Brain* 122:1765–1780
13. Price JL, Carmichael ST, Drevets WC et al. (1996) Networks Related to the Orbital and Medial Prefrontal Cortex; A Substrate for Emotional Behavior. In: Holstege G, Bandler R, Saper CB (eds) *Progress in Brain Research*, vol 107. Elsevier, Amsterdam; pp 523–536
14. Sakai K, Rowe JB, Pasingham RE (2002) Active Maintenance in Prefrontal Area 46 Creates Distractor-Resistant Memory. *Nat Neurosci* 5:479–484

## Premenstrual Dysphoric Disorder

### ► Premenstrual Syndrome

## Premenstrual Syndrome

ANDREA J. RAPKIN, JUDITH A. MIKACICH  
Department of Obstetrics and Gynecology, University of California, Los Angeles Medical Center, Los Angeles, CA, USA  
arapkin@mednet.ucla.edu,  
jmikacich@mednet.ucla.edu

### Synonyms

Premenstrual Tension; Premenstrual Dysphoric Disorder; PMS

### Definition

Premenstrual syndrome (PMS) is defined as the presence of disabling physical and psychological symptomatology during the premenstrual period, with relief soon after the onset of menses. Formal diagnosis of PMS is made when one or more physical symptoms and at least one psychological symptom are present for up to 2 weeks prior to menses, with remission by the cessation of menstrual flow (ACOG 2000). Predominant physical complaints include bloating, mastalgia and increased appetite. Psychological symptoms include irritability, anxiety, mood swings and depression. Cognitive changes, including confusion and poor concentration, are also reported. Behaviorally, social withdrawal and increased arguing are typically seen. The symptoms of PMS begin after ovulation and may persist through the first 4 days of the ► **follicular phase** of the menstrual cycle. Symptoms should be documented prospectively for at least two consecutive menstrual cycles, restricted to the ► **luteal phase** and no more than the first 5 days of the follicular phase of the menstrual cycle and result in functional impairment. Other medical or psychological diagnoses that might also explain the symptoms must be excluded. The affective and somatic symptoms used as diagnostic criteria for PMS by the American College of Obstetrics and Gynecology (ACOG) are listed in Table 1 (ACOG 2000). Premenstrual dysphoric disorder (PMDD) is a more severe premenstrual disorder

**Premenstrual Syndrome, Table 1** Diagnostic Criteria for Premenstrual Syndrome (PMS). PMS is diagnosed when the patient prospectively documents at least one of the following affective and somatic symptoms during the 5 days before menses for three menstrual cycles. Symptoms are of sufficient severity to impact social or economic performance. Symptoms abate during the first 5 days of the menstrual cycle and do not recur until that would explain the symptoms. There is no concomitant pharmacological therapy, hormone ingestion or drug or alcohol abuse

American College of Obstetricians and Gynecologists	
Affective Symptoms	Somatic Symptoms
Depression	Breast Tenderness
Angry outbursts	Abdominal bloating
Irritability	Headache
Anxiety	Swelling of extremities
Confusion	
Social Withdrawal	

Adapted from ACOG Practice Bulletin 2000; 15:1-9

focused on the psychological symptoms and is defined in Table 2 (APA 1994). To meet criteria for PMDD, women must experience one or more moderately severe to disabling mood symptoms during the premenstrual phase of most of the preceding 12 cycles.

**Characteristics**

An estimated 50-80% of menstruating women experience some physical and/or psychological symptomatology during the premenstrual period.

In approximately 3-5% of cases, symptoms are of sufficient severity to disrupt social or psychological functioning. A recent study noted a 6.3% prevalence of PMDD among a community-based sample of American women; other estimates have suggested a prevalence of 3-8% of women (Soares et al. 2001).

A clinical diagnosis of PMS or PMDD relies on the patient's daily recording of symptoms for at least two successive menstrual cycles. Cyclical symptoms confined to the latter half of each menstrual cycle and resolving by day five of menses, as well as a clearly symptom-free interval from menses until ovulation, are critical to the diagnosis of PMS/PMDD. Consistent post-menstrual timing of symptoms suggests an underlying affective or anxiety disorder, as does the presence of physical symptoms relating only to appetite, energy and sleep and not including breast tenderness and/or bloating. A complete history and physical examination should be performed, in order to exclude other diagnoses. The differential diagnosis of PMS includes various conditions subject to menstrual magnification or premenstrual exacerbation, including depressive disorders, generalized anxiety disorder, panic disorder, hypothyroidism, irritable bowel syndrome, endometriosis, anemia, chronic fatigue syndrome, fibromyalgia, systemic lupus erythematosus, perimenopause, drug or alcohol abuse and domestic violence. In women with PMS or PMDD, the lifetime prevalence of major depression varies between 30% and 76%.

**Premenstrual Syndrome, Table 2** DSM-IV Criteria for Premenstrual Dysphoric Disorder (PMDD), American Psychiatric Association

DSM-IV Criteria for Premenstrual Dysphoric Disorder (PMDD) American Psychiatric Association PMDD is diagnosed when, for most of the preceding twelve cycles, the patient meets the following criteria:	
1.	<b>Experiences five or more symptoms, including at least one core symptom</b>  Markedly depressed mood, hopelessness, self-deprecating thoughts* Marked anxiety, tension* Marked affective lability* Persistent and marked anger or irritability* Decreased interest in usual activities Subjective sense of difficulty in concentrating Subjective sense of being out of control Lethargy, easy fatigability Marked change in appetite Hypersomnia or insomnia Other physical symptoms, such as breast tenderness, headache, bloating
2.	Reports symptoms during the last week of the luteal phase, with remission within a few days of onset of menses.
3.	Documents absence of symptoms during the week following menses
4.	Demonstrates marked interference of symptoms with work, school or usual social activities and relationships
5.	Symptoms are not an exacerbation of another disorder
6.	Prospective daily ratings confirm three of the above criteria during at least two consecutive symptomatic menstrual cycles.

\*core symptom

Adapted from the Diagnostic and Statistical Manual of Mental Disorders, 4th edn. Washington, D.C.: American Psychiatric Association; 1994:715-718

Two potential etiological explanations for the occurrence of PMS symptoms include dysregulation of serotonergic activity and/or of gamma-aminobutyric acid subunit A (GABA<sub>A</sub>) receptor function. Decreased serotonin transmission in the brain is thought to contribute to depressed mood, irritability, anger and aggression, poor impulse control and increased carbohydrate craving. Most, but not all, serotonergic parameters that have been evaluated are altered only during the symptomatic luteal phase in women with PMS (Rapkin and Mikacich 2001). Furthermore, serotonergic, but not noradrenergic, antidepressants are effective in PMS/PMDD. The neurotransmitter GABA<sub>A</sub> is considered a primary regulator of cognitive function and affect. Its pharmacological effect is modulated by various factors that bind to and/or alter the subunit configuration of the GABA<sub>A</sub> receptor. Allopregnanolone is a neuroactive steroid produced by the ovary, the adrenal gland and *de novo* in the brain, as a metabolite of both cholesterol and progesterone. Similar to benzodiazepines and barbiturates, allopregnanolone binds to the chloride channel of the GABA<sub>A</sub> receptor and thus has anxiolytic and anticonvulsant effects. Rodent studies of exposure to and withdrawal from progesterone after metabolism to allopregnanolone reveal decreased sensitivity of GABA<sub>A</sub> receptors to GABA agonists, resulting in insensitivity to endogenous anxiolytic ► **neurosteroids** or to benzodiazepines. The finding of decreased sensitivity was attributed to alterations in GABA<sub>A</sub> receptor subunit composition (Smith et al. 1998). Women with PMS/PMDD may also be less sensitive to the anxiolytic, sedating effects of neurosteroids during the luteal phase (Sundstrom et al. 2003). Diminished levels of, or sensitivity to, allopregnanolone and/or altered GABAergic transmission could contribute to symptoms of anxiety, irritability and depression in women with PMS/PMDD (Rapkin et al. 1997). Additionally, in women with premenstrual mood disorders, an appropriate increase in neuroactive steroid levels in response to stress may not occur (Girdler et al. 2001). Fluoxetine and paroxetine, two selective serotonin reuptake inhibitors (SSRIs), increase brain allopregnanolone content in rats and possibly in individuals with depression. The increase in allopregnanolone concentrations in the brain acting via GABA receptors may contribute to the rapid anxiolytic and antidepressant clinical action of this class of drugs. The consistent finding of diminished serotonergic activity, for the most part limited to the luteal phase, in women with PMS/PMDD, as well as the rapid therapeutic response to the administration of selective serotonin reuptake inhibitors and the proposed alteration in neurosteroid concentration or reactivity suggest that the interaction between ovarian sex steroids, the GABA<sub>A</sub> receptor and/or the central serotonergic system differ in women with PMS/PMDD compared with asymptomatic women or individuals with an affective or anxiety disorder.

Selective serotonin reuptake inhibitors (SSRIs) are considered the treatment of choice in PMS/PMDD. Response is usually seen within the first few days of exposure. Intermittent treatment with SSRIs during the luteal phase only has also proven effective for about 60% of woman with PMDD (Halbreich et al. 2002). More recently, weekly luteal phase dosing with enteric-coated fluoxetine in 90 mg doses (two doses) was shown to be efficacious and well tolerated (Miner et al. 2002). In addition to improvement in mood, other aspects of PMS/PMDD are relieved by treatment with SSRIs. SSRIs may reduce the most common physical symptoms, such as bloating and breast tenderness, associated with PMS (Steiner et al. 1995). In a recently published study, intermittent luteal phase dosing of sertraline failed to demonstrate significant improvement in physical symptoms, but did reduce complaints of premenstrual cognitive disturbance, increased appetite, increased sleep and lethargy (Halbreich et al. 2002). Historically, oral contraceptive pills (OCPs) have not proven uniformly beneficial in PMS/PMDD. However, a newer OCP containing the progestin drospirenone, a spironolactone derivative with antiandrogenic and antiminerlocorticoid effects and with a shorter pill-free interval, has shown promise in the treatment of PMDD in at least one study (Freeman et al. 2001; Yonkers et al. 2005). The same OCP was found to improve health related quality of life and general well-being, as well as to relieve several physical premenstrual symptoms, in women with PMS (Borenstein et al. 2003). Continuous OCPs, without the placebo week off, are also under investigation for the treatment of PMS.

The use of a gonadotropin releasing hormone (GnRH) agonist to suppress ovarian sex steroids provides symptomatic relief in a majority of women with PMS (Muse et al. 1984). Bone density and cardiovascular and vaginal health can theoretically be maintained and vasomotor symptoms prevented with add back therapy; however, long-term studies are lacking. Bilateral oophorectomy with hormone add back is also effective for severe PMS/PMDD, but should be reserved for extreme cases in whom other methods have failed; preliminary treatment with a GnRH agonist with add back has been successful and reproduction is completed.

Several complementary and alternative medicine approaches have demonstrated some efficacy in premenstrual disorders, although studies were not well controlled. These include light therapy, certain herbal and nutritional supplements including calcium and the use of exercise and mind-body approaches, such as ► **Cognitive-Behavioral Therapy** (CBT) (Girman et al. 2003).

## References

1. American College of Obstetricians and Gynecologists (2000) ACOG Practice Bulletin: Premenstrual Syndrome. Compendium of Selected Publications 15:1–9

2. American Psychiatric Association (1994) Diagnostic and statistical manual of mental disorder-IV, 4th edn. Washington, DC
3. Borenstein J, Yu HT, Wade S et al. (2003) The effect of an oral contraceptive containing ethinyl estradiol and drospirenone (Yasmin) on premenstrual symptomatology and health-related quality of life. *J Reprod Med* 48:79–85
4. Freeman EW, Kroll R, Rapkin A et al. for the PMS/PMDD research group (2001) Evaluation of a unique oral contraceptive in the treatment of Premenstrual
5. Dysphoric Disorder. *J Women's Health Gen Based Med* 20:561–596
6. Girdler SS, Straneva PA, Light KC et al. (2001) Allopregnanolone levels and reactivity to mental stress in premenstrual dysphoric disorder. *Biological Psychiatry* 49:788–797
7. Girman A, Lee R, Kligler B (2003) An integrative medicine approach to premenstrual syndrome. *Am J Obstet Gynecol* 188:S56–65
8. Halbreich U, Bergeron R, Yonkers KA et al. (2002) Efficacy of intermittent, luteal phase sertraline treatment of premenstrual dysphoric disorder. *Obstet Gynecol* 100:1219–1229
9. Miner C, Brown E, McCray S et al. (2002) Weekly luteal-phase dosing with enteric-coated fluoxetine 90 mg in premenstrual dysphoric disorder: a randomized, double-blind, placebo-controlled clinical trial. *Clin Ther* 24:417–433
10. Muse KN, Cetel NS, Futterman LA et al. (1984) The premenstrual syndrome – Effects of “medical ovariectomy.” *N Engl J Med* 311:1345–1349
11. Rapkin AJ, Mikacich JA (2001) Premenstrual Syndrome: Gynaecology or Psychiatry? *Repr Med Rev* 9:223–239
12. Rapkin AJ, Morgan M, Goldman L et al. (1997) Progesterone metabolite allopregnanolone in women with premenstrual syndrome. *Obstet Gynecol* 90:709–714
13. Smith SS, Gong QH, Hsu FC et al. (1998) GABA<sub>A</sub> receptor alpha-4 subunit suppression prevents withdrawal properties of an endogenous steroid. *Nature* 392:926–929
14. Soares CN, Cohen LS, Otto MW et al. (2001) Characteristics of Women with Premenstrual Dysphoric Disorder (PMDD) Who Did or Did Not Report History of Depression: A Preliminary Report from the Harvard Study of Moods and Cycles. *J Women's Health Gender-Based Med* 10:873–878
15. Steiner M, Steinberg S, Stewart D et al. (1995) Fluoxetine in the treatment of premenstrual dysphoria. *N Engl J Med* 332:1529–1534
16. Sundstrom Poromaa I, Smith S et al. (2003) GABA receptors, progesterone and premenstrual dysphoric disorder. *Arch Womens Ment Health* 6:23–41
17. Yonkers KA, Brown C, Pearlstein TB (2005) Efficacy of a New Low-Dose Oral Contraceptive With Drospirenone in Premenstrual Dysphoric Disorder. *Obstet Gynecol* 106:492–501

---

## Premenstrual Tension

- ▶ Premenstrual Syndrome

---

## Premorbid Functioning

### Definition

Premorbid functioning refers to the state of existence before the occurrence of physical disease or emotional illness.

- ▶ Pain Inventories

---

## Preoperative Education

### Definition

Preoperative education includes instructions concerning techniques of postoperative analgesia, mobilization, and respiratory care (coughing and other physiotherapy maneuvers). This aids coping and reduces perioperative anxiety.

- ▶ Postoperative Pain, Importance of Mobilisation

---

## Preoperative Epidural Blockade

### Definition

Preoperative epidural blockade (infusion of local anesthetic agents and sometimes also opioids in the epidural space via an epidural catheter) is very effective in reducing preamputation ischemic pain and postamputation stump pain, but is most likely not to prevent phantom pain.

- ▶ Postoperative Pain, Postamputation Pain, Treatment and Prevention

---

## Preoperative Nutritional Support

### Definition

Preoperative nutritional support refers to preoperative enteral or parenteral nutritional supplementation of carbohydrates, proteins, vitamins and minerals to improve the nutritional state of the patient.

- ▶ Postoperative Pain, Importance of Mobilisation

---

## Preoperative Patient Education

- ▶ Postoperative Pain, Preoperative Education

---

## Preoperative Teaching

- ▶ Postoperative Pain, Preoperative Education

---

## Pre-Paid Care

### Definition

A fee paid by an employer and/or employee each month to cover all anticipated health care costs

- ▶ Disability Management in Managed Care System



## Preparation

### Definition

A readiness to change stage in which a person states an intention to change soon, and in fact may be making initial steps towards changing behavior.

- ▶ [Motivational Aspects of Pain](#)

## Preparation Programs

- ▶ [Psychological Treatment of Pain in Children](#)

## Prepuce Clitoris

### Definition

This is the hood of the clitoris, comparable to the male foreskin, which may completely or incompletely cover the glans.

- ▶ [Clitoral Pain](#)

## Present Pain Intensity Subscale

### Synonyms

PPI

### Definition

Zero to five scale, with word anchors for the subjective measurement of pain intensity.

- ▶ [Cancer Pain, Assessment in the Cognitively Impaired](#)

## Pressing/Tightening

### Definition

Pain of a constant quality often compared to an iron band around the head.

- ▶ [Headache, Episodic Tension Type](#)

## Pressure Algometer

### Definition

A pressure algometer is a device to measure the detection threshold or tolerance threshold of pressure induced pain.

- ▶ [Headache, Episodic Tension Type](#)

## Pressure-Specified Sensory Device

### Definition

This is a computer-linked device to measure the cutaneous pressure threshold for both one-point and two-point moving-touch and static-touch (quickly- and slowly-adapting large fiber nerve populations). The first measurement to become abnormal in a large fiber neuropathy, such as that with symmetrical diffuse diabetic polyneuropathy or chemotherapy-induced neuropathy, is the pressure required to discriminate one- from two-point static stimuli, while the distance between the two stimuli remains within normal limits. This device can also measure and document the stage of neuropathy and neural regeneration.

- ▶ [Painful Scars](#)
- ▶ [Ulceration, Prevention by Nerve Decompression](#)

## Presynaptic

### Definition

Events occurring in the axonal terminal before the neurotransmitter crosses into the synapse.

- ▶ [Amygdala, Pain Processing and Behavior in Animals](#)

P

## Presynaptic Inhibition

### Definition

Presynaptic inhibition is a form of synaptic inhibition in which the release of a transmitter, in response to the invasion of the action potential into the synaptic terminals, is reduced by the activation of an axo-axonic gabaergic synapse. In such cases, this is the result of a depolarization of primary afferent terminals by activation of GABA<sub>A</sub> receptors. In other cases, transmitter release is reduced because of a reduction in the Ca<sup>++</sup> influx required for transmitter release. An example is the presynaptic inhibition produced by GABA action on GABA<sub>B</sub> receptors on presynaptic endings. Presynaptic inhibition is known to occur on primary afferent terminals that drive spinal cord projection neurons.

- ▶ [Central Changes after Peripheral Nerve Injury](#)
- ▶ [GABA and Glycine in Spinal Nociceptive Processing](#)
- ▶ [GABA Mechanisms and Descending Inhibitory Mechanisms](#)

## Presynaptic Reuptake

### Definition

Pumping of neurotransmitter from synaptic cleft back into the presynaptic neurone.

- ▶ [Antidepressants in Neuropathic Pain](#)

## Prevalence

### Definition

The number of events in a given population at a designated time, e.g. the proportion of individuals in the population with a disease at a particular time. Prevalence is determined by the average incidence and average duration of disease.

- ▶ [Low Back Pain, Epidemiology](#)
- ▶ [Migraine Epidemiology](#)
- ▶ [Pain in the Workplace, Risk Factors for Chronicity, Job Demands](#)
- ▶ [Prevalence of Chronic Pain Disorders in Children](#)
- ▶ [Psychiatric Aspects of the Epidemiology of Pain](#)
- ▶ [Psychological Aspects of Pain in Women](#)

## Prevalence of Chronic Pain Disorders in Children

ELIZABETH VAN DEN KERKHOFF<sup>1</sup>, ADAM VAN DIJK<sup>2</sup>  
<sup>1</sup>Department of Community Health and Epidemiology, Queen's University, Kingston, ON, Canada

<sup>2</sup>Department of Anesthesiology, Queen's University, Kingston General Hospital, Kingston, ON, Canada  
 ev5@post.queensu.ca, 2anv1@qlink.queensu.ca

### Synonyms

Period prevalence; point prevalence; epidemiology; Population Survey; Chronic Pain Disorder Prevalence in Children

### Definition

▶ **Prevalence** is the number of instances that a given disease / condition is present in a given population at a designated time point or over a specified period (typically 3 months or 1 year). ▶ **Lifetime prevalence** is the total number of persons known to have had the disease or attribute for at least part of their life. The different types of pain included in this review include pain related to disease and trauma, nonspecific pain and pain associated with emotional distress. ▶ **Chronic pain** is defined as any prolonged pain that lasts a minimum of 3 months or any recurrent pain that occurs throughout a minimum period of 3 months.

### Background

Knowledge about special pain problems in infants, children and adolescents has increased since the 1980s; however little is still known about the ▶ **epidemiology** of pain in children in the general population. A 1999 review concluded that the understanding of the epidemiology of chronic pain in children was limited (McGrath 1999). The purpose of this paper is to summarize the current knowledge about the prevalence of chronic pain in children by updating the literature from 1998 to present.

### Characteristics

Sixteen prevalence studies of childhood pain in the general population were published between 1998 and 2004. Most studies were based upon European school children and no studies were found based on North American children. Disease definition was based on self-reports with no follow up to ascertain whether the condition was diagnosed. Two studies included reports from both parents and children. Sample size ranged from 164 to 62,677; however most studies were based on sample sizes of less than a 1000. The majority of studies reported 3 months to 1 year period prevalences and five studies reported lifetime prevalence. Age of participants ranged from less than 1 year to 18 years. Prevalence estimates ranged from 3.7% (Groholt et al. 2003) for back pain to 97% (Bandell-Hoekstra et al. 2001) for non-migraine headache. Most estimates were stratified by sex and four studies were stratified by age.

### Prevalence Estimates (1998–2004)

As in the past, the recent literature is restricted to measuring pain intensity in a few common pain sites (e.g. headache, back, musculoskeletal and abdominal). Using the following key words, pain, survey, children, prevalence, pain experience interview, adolescence, chronic pain, scales, Canadian, European, paper survey, headache, back pain and abdominal pain and searching Medline, Embase, CINAHL and AMED resulted in approximately 20 studies being identified. Table 1 provides an overview of studies published since 1998. Prevalence estimates for abdominal pain ranged from 6.1% (lifetime) in males (Groholt et al. 2003) to 52% (period) in females (Huang et al. 2000). Lifetime prevalence estimates for back pain ranged from 3.7% (Groholt et al. 2003) in males to 43% in females (Jones et al. 2003). Prevalence for headache ranged from a 1 year period prevalence of 7.9% in males to a lifetime prevalence of 97% in both sexes (Bandell-Hoekstra et al. 2001); while prevalence of migraine ranged from 6.1% in females (Ayatollahi et al. 2002) to 14% in males (Shivpuri et al. 2003). Limb pain estimates ranged from 22% (Perquin et al. 2000) to 32% (Smedbraten et al. 1998) and neck and / or shoulder pain prevalence ranged from 12% in males (Smedbraten et al. 1998) to 24% in females (Hakala et al. 2002). In all studies stratified by sex or age, females generally reported more pain

**Prevalence of Chronic Pain Disorders in Children, Table 1** Summary of prevalence studies published between 1996 and 2004

Pain Sites	Sample Size Range	Number and Type of Prevalence Estimates	Age Range (years)	Range of Prevalence (%)	Year Range
Abdominal pain	164–6,230	1 point; 3 period; 2 lifetime;	0–18	Female = 11–52 Male = 6.1–35 All = 8.3–43	1998–2003
Back	538–62,677	3 period; 3 lifetime	3–18	Female = 5.6–43 Male = 3.7–38 All = 4.7–40	1998–2004
Headache (non-migraine)	460–5,424	7 period; 5 lifetime; 1 unspecified	0–18	Female = 12–95 Male = 7.9–92 All = 9.8–97	1998–2004
Headache (migraine)	1,305–6,230	1 period; 1 lifetime; 1 unspecified	7–18	Female = 6.1–14 Male = 9.0–9.8 All = 11	2002–2004
Limb	569–5,424	2 period; 1 lifetime	0–18	Female = 29 Male = 32 All = 22–30	1998–2003
Neck and shoulder	569–62,677	1 period; 1 lifetime	14–18	Female = 23–24 Male = 12 All = 17	1998–2002
Overall or general pain	571–1,030	1 point; 1 period	3–18	Female = 24–36 Male = 23–30 All = 24–80	2001–2003

\*Based on 16 studies conducted between 1998–2004 (manuscript in preparation – page restrictions preclude citations for all survey studies, so please contact author for source material)

than males and younger ages tended to report more pain than older ages. Parents reported similar (Antoniuk et al. 1998) or higher (Al et al. 2002) prevalence of pain in children than the children themselves.

#### Incidence of Pain in Children

Few longitudinal studies have been conducted following pain-free children to assess the ► **incidence** of pain in children. Stahl studied pain-free adolescents and reported more frequent neck pain in girls and with increasing age. At 1 year the occurrence of neck pain in the past month was 21% and in the past week 6.3%, while at 4 years the incidence was 43% in the past month and 19% in the past week (Stahl et al. 2004). In a 13 year follow up, cumulative incidence of pain rose from 31 to 43% (Brattberg 2004). A 5 year ► **longitudinal study** on the history of low back pain in 11 year old children found that annual incidence rose from 12% at age 12 to 22% at age 15+ (Burton et al. 1996).

#### Pain and its Impact on a Child's Health

Few longitudinal studies have also been conducted to assess the impact of chronic pain in childhood on future years. Brattberg found that children reporting back pain, headache and nervousness were more likely to report pain problems and that respondents who reported pain later in life also had higher levels of dissatisfaction with their quality of life, finances, leisure activities and sex life as young adults (Brattberg 2004). Other studies have

concluded that some musculoskeletal symptoms that develop at an early age such as headaches and back pain can lead to chronic pain and depression in adulthood. These have both economic and societal implications that underscore the importance of early prevention (Mikkelsen et al. 1997; Rethelyi et al. 2004). Perquin et al. followed a ► **cohort** of 987 children aged 0–18 for 2 years and found that one-third who had benign pain at baseline still had pain at the 2 year follow-up and pain often did not diminish over time. They reported that pain impacted on health status, school absence, health care use and medication use and interfered in daily activities (Perquin et al. 2003).

#### Conclusion

There are varying estimates of the prevalence of pain in children. The most frequently studied pain sites are the abdomen, head and back. Females reported more pain than males and younger ages tended to report more pain than older ages. Children who report pain are more likely to experience pain in follow up. In order to provide adequate prevention and treatment strategies for children, more longitudinal studies are required to offer further insight into the natural history, ► **risk factors** or prognostic indicators for pain and the impact of pain on the lives of children and their families. In 1999, McGrath concluded that four themes emerged from the review of the literature on children's pain

(McGrath 1999) and the themes continue to be relevant. First, there were relatively few major epidemiological studies of chronic pain in children. Second, the available studies yielded widely varying results due to differences in pain definitions, methods for identifying children, age and gender of study populations, country of origin and presentation and analysis of data. Third, specific disease or pain definitions were lacking for most types of chronic pain in children, so there are few uniform, consistent, and standard diagnostic criteria and many definitions and diagnostic criteria for children are based on clinical findings in adults. Fourth, longitudinal, case-control and cohort studies (► [case control study](#) ► [cohort study](#)) have not been conducted for most types of pain in children; therefore a paucity of data is available about the natural history, risk factors or prognostic indicators for pain or the impact of pain on the lives of children and their families.

## References

- Al JM, Awada A, Al AS (2002) Headache syndromes amongst schoolchildren in Riyadh, Saudi Arabia. *Headache* 42:281–286
- Antoniuk S, Kozak MF, Michelon L et al. (1998) Prevalence of headache in children of a school from Curitiba, Brazil, comparing data obtained from children and parents. *Arq Neuropsiquiatr* 56:726–733
- Ayatollahi SM, Moradi F, Ayatollahi SA (2002) Prevalences of migraine and tension-type headache in adolescent girls of Shiraz (southern Iran). *Headache* 42:287–290
- Bandell-Hoekstra IE, bu-Saad HH, Passchier J et al. (2001) Prevalence and characteristics of headache in Dutch schoolchildren. *Eur J Pain* 5:145–153
- Brattberg G (2004) Do pain problems in young school children persist into early adulthood? A 13-year follow-up. *Eur J Pain* 8:187–199
- Burton AK, Clarke RD, McClune TD et al. (1996) The natural history of low back pain in adolescents. *Spine* 21:2323–2328
- Groholt EK, Stigum H, Nordhagen R et al. (2003) Recurrent pain in children, socio-economic factors and accumulation in families. *Eur J Epidemiol* 18:965–975
- Hakala P, Rimpela A, Salminen JJ et al. (2002) Back, neck, and shoulder pain in Finnish adolescents: national cross sectional surveys. *BMJ* 325:743
- Huang RC, Palmer LJ, Forbes DA (2000) Prevalence and pattern of childhood abdominal pain in an Australian general practice. *J Paediatr Child Health* 36:349–353
- Jones GT, Silman AJ, Macfarlane GJ (2003) Predicting the onset of widespread body pain among children. *Arthritis Rheum* 48:2615–2621
- McGrath PA (1999) Chronic pain in children. In: Crombie IK (ed) *Epidemiology of Pain*, C.P.L.S.L.L.V.M. IASP Press, Seattle, pp 81–101
- Mikkelsen M, Salminen JJ, Kautiainen H (1997) Non-specific musculoskeletal pain in preadolescents. Prevalence and 1-year persistence. *Pain* 73:29–35
- Perquin CW, Hazebroek-Kampschreur AA, Hunfeld JA et al. (2000) Chronic pain among children and adolescents: physician consultation and medication use. *Clin J Pain* 16:229–235
- Perquin CW, Hunfeld JA, Hazebroek-Kampschreur AA et al. (2003) The natural course of chronic benign pain in childhood and adolescence: a two-year population-based follow-up study. *Eur J Pain* 7:551–559
- Rethelyi JM, Berghammer R, Ittzes A et al. (2004) Comorbidity of pain problems and depressive symptoms in young women: results from a cross-sectional survey among women aged 15–24 in Hungary. *Eur J Pain* 8:63–69
- Shivpuri D, Rajesh MS, Jain D (2003) Prevalence and characteristics of migraine among adolescents: a questionnaire survey. *Indian Pediatr* 40:665–669
- Smedbraten BK, Natvig B, Rutle O et al. (1998) Self-reported bodily pain in schoolchildren. *Scand J Rheumatol* 27:273–276
- Stahl M, Mikkelsen M, Kautiainen H et al. (2004) Neck pain in adolescence. A 4-year follow-up of pain-free preadolescents. *Pain* 110:427–431

## Prevention of Phantom Pain

### Definition

Several studies have been carried out to examine if phantom pain (pain localized to the missing limb and experienced by 60–80% of amputees after amputation) can be prevented. Most studies have examined the effect of pre- or perioperative epidural or perineural blockade. However, prevention of phantom pain may not be possible. Postoperative Pain, Postamputation Pain, Treatment and Prevention

## Prevention of Postoperative Pain

- [Postoperative Pain, Pre-Emptive or Preventive Analgesia](#)

## Preventive Analgesia

- [Postoperative Pain, Pre-Emptive or Preventive Analgesia](#)

## Preventive Therapy

### Definition

Designed to reduce headache attack frequency and severity.

- [Migraine, Preventive Therapy](#)

## Pricking Pain

- [First and Second Pain Assessment \(First Pain, Pricking Pain, Pin-Prick Pain, Second Pain, Burning Pain\)](#)



## Primary Afferents/Neurons

### Definition

Primary afferents are sensory neurons (axons or nerve fibers) in the peripheral nervous system that transduce information about mechanical, thermal, and chemical states of the body and transmit it to sites in the central nervous system. Those that innervate the trunk and limbs have their cell bodies in dorsal root ganglia. The cell body gives rise to a peripheral process, which terminates in tissue (e.g. skin, muscle etc), and a central process that enters the spinal cord. Primary afferents are highly specialized such that separate populations transmit information about different types of innocuous mechanical, innocuous thermal, and noxious information. At the first synapse of the afferent pathway, afferent input and temporal and spatial processing of the afferent input takes place. Enhanced sensitivity of the central processing of afferent input can contribute to inflammatory hyperalgesia (central sensitization).

- ▶ Encoding of Noxious Information in the Spinal Cord
- ▶ Mechanonociceptors
- ▶ Neutrophils in Inflammatory Pain
- ▶ NGF, Regulation during Inflammation
- ▶ Nociceptive Circuitry in the Spinal Cord
- ▶ Nociceptor(s)
- ▶ Opioids in the Periphery and Analgesia
- ▶ Postsynaptic Dorsal Column Projection, Anatomical Organization
- ▶ Primary Afferents/Neurons
- ▶ Prostaglandins, Spinal Effects
- ▶ Vagal Input and Descending Modulation

## Primary Afferents of the Urinary Bladder

### Definition

Myelinated (A $\delta$ ) and thin unmyelinated (C) fibers with nerve endings in the lamina propria and in the smooth muscle layers of the bladder and urethra.

- ▶ Opioids and Bladder Pain/Function

## Primary and Secondary Hyperalgesia

### Definition

Hyperalgesia is increased sensitivity to pain or enhanced intensity of pain sensation with stimulation. Primary hyperalgesia is the area of increased pain sensitivity to both mechanical and thermal stimuli around a wound that is due to local tissue damage (inflammation resulting in peripheral nociceptor sensitization). Secondary hyperalgesia lies outside the damaged area. It is thus a larger

area of increased pain sensitivity, but only to mechanical stimuli, which is due to central nervous mechanisms (central or spinal sensitization).

- ▶ Quantitative Sensory Testing
- ▶ Spinothalamic Neuron

## Primary and Secondary Zones

### Definition

The primary zone describes the area of skin directly affected by the inflammatory injury. The secondary zone is the area surrounding the primary zone which, as a consequence of the injury at the primary zone, has altered sensory properties. Sensory changes in the primary zone may be due to ▶ peripheral sensitization or ▶ central sensitization. Sensory changes in the secondary zone are generally accepted to be exclusively caused by ▶ central sensitization.

- ▶ Quantitative Thermal Sensory Testing of Inflamed Skin

## Primary Anorgasmia

### Definition

This means that the individual has never been able to achieve an orgasm

- ▶ Clitoral Pain

P

## Primary Cells (RVM)

### Definition

Primary cells are a class of RVM neurons defined *in vitro* by lack of response to mu-opioid agonists. Primary cells presumably correspond to off-cells and neutral cells defined *in vivo*.

- ▶ Opiates, Rostral Ventromedial Medulla and Descending Control

## Primary Cough Headache

JAMES W. LANCE

Institute of Neurological Sciences, Prince of Wales Hospital and University of New South Wales, Sydney, NSW, Australia  
jimlance@bigpond.com

### Synonym

Benign Cough Headache; Valsalva Manoeuvre Headache

## Definition

Headache precipitated by coughing in the absence of any intracranial disorder.

## Characteristics

The headache starts suddenly as a sharp pain on coughing, straining or other forms of ► **Valsalva maneuver** and not at other times. It usually lasts less than 1 min but may sometimes persist for 30 min or longer.

Organic causes of cough headache, such as intermittent obstruction of the cerebrospinal pathway, internal carotid or ► **vertebro-basilar arterial disease** and cerebral ► **aneurysms** must be excluded by imaging.

Primary cough headache mainly affects patients older than 40 years of age, is usually bilateral and is responsive to indomethacin.

## Clinical Reports

In 1932, Tinel described four patients with severe head pain on coughing and various Valsalva-like manoeuvres (Ekbohm 1986). Sir Charles Symonds reported 21 patients with cough headache in whom no intracranial disease became apparent, together with 6 patients whose headaches resulted from basilar impression caused by Paget's disease or space-occupying lesions in the posterior fossa (Symonds 1956). He concluded that there was a syndrome of benign cough headache as it improved or disappeared in 15 patients during the follow-up period of 18 months to 12 years. Ages ranged from 37 to 77 years (mean 55 years). Of the 21 patients, 18 were men.

Rooke (1968) reported cough headache as a form of exertional headache in presenting the histories of 103 patients, whose headaches were precipitated by running, bending, coughing, sneezing, lifting or straining. During the follow-up period of 3 years or more structural lesions such as platybasia, ► **Chiari type I malformation**, subdural haematoma, and cerebral or cerebellar tumours came to light in 10 patients. The remaining 93 patients fell into the primary cough or exertional headache category. Thirty were free of headache in 5 years and 73 were improved or free of headache after 10 years. Men were affected more than women in the ratio 4:1. Some patients reported that their cough headache followed a respiratory infection. Like Symonds (1956), Rooke noted that some patients improved after the removal of abscessed teeth.

Cough headache is best considered as an entity separate from exertional headache. Pascual et al. (1996) reported that the average age of their patients with cough headache was 43 years older than their patients with exertional headache. They analyzed their experience with 72 patients whose headaches were precipitated by coughing (30), physical exercise (28) or sexual activity (14). Of the patients with cough headache, 17 were secondary to Chiari type I malformations. The remaining

13 patients, 10 men and 3 women, were diagnosed as "benign cough headaches". Their ages ranged between 44 and 81 years (mean  $67 \pm 11$  years). Headache was also brought on by a sudden Valsalva manoeuvre in 4 subjects but never by physical exertion. Headache was bilateral in 12 cases and unilateral in one. Doppler ultrasound showed no evidence of carotid disease in this case. Indomethacin 75 mg daily was effective in the 6 patients for whom it was prescribed but not for patients with Chiari type I malformation. The tendency to benign cough headache persisted for 2 months to 2 years.

An atypical cough headache in a 57 year old man was unilateral and recurred in bouts of 30–60 days reminiscent of episodic cluster headache (Perini and Toso 1998). The headaches involved one supraorbital region, were very severe and lasted for 1–10 min without any autonomic features. The pain was eased by a non-steroidal anti-inflammatory agent, nimesulide.

## Symptomatic Cases

The most common secondary cough headaches are those caused by Chiari type I malformation in which a tongue of cerebellum projects through the foramen magnum and provides a valve-like obstruction to the flow of cerebrospinal fluid (CSF) on coughing. Patients with this Chiari type I malformation are significantly younger than patients with primary cough headache. Pascual et al. (1996) found that the age of onset in the secondary cases varied from 15–64 years (mean  $39 \pm 14$  years). His patients complained of occipital and sub-occipital pain precipitated by laughing, weight lifting or sudden changes in posture as well as by coughing. All patients later developed posterior fossa symptoms or signs. Eight patients underwent operation with improvement of headache in seven. Ertsey and Jelencsik (2000) reported a 48 year old woman with Chiari type I malformation whose cough headaches were suppressed in 3–4 days by indomethacin 25 mg but this does not reflect the general experience.

Cough headache was the presenting feature of a cerebral aneurysm in a report by Smith and Messing (1993). Their patient described a severe right temporal ache on coughing or bending lasting 1–5 min, not relieved by indomethacin. After 24 days the pain became continuous and a right third cranial nerve palsy developed. She was found to have a posterior communicating artery aneurysm. Her headache settled post-operatively. Cough headache has also been reported as the presenting symptom of carotid stenosis persisting for 1 year before other neurological symptoms appeared (Britton and Guiloff 1988). The headache disappeared after the artery occluded, causing a hemiparetic stroke.

## Pathophysiology of Cough Headache

Williams (1976) studied the relationship between CSF pressure in the cisterna magna and lumbar sac during

coughing. At first, lumbar pressure was greater than cisternal pressure, then the pressure gradient reversed. He postulated that any obstruction that interfered with the downward rebound pulsation at the foramen magnum could cause cough headache. He later reported two patients whose cerebellar tonsils extended below the foramen magnum who presented with cough headache (Williams 1980). During a Valsalva manoeuvre he recorded a marked craniospinal pressure differential in the rebound phase. After the cerebellar tonsils were decompressed, the steep pressure gradient on coughing was eliminated and the cough headache disappeared.

Whether this explanation accounts for primary cough headache is uncertain. Coughing increases intrathoracic and intra-abdominal pressure, which is transmitted to the epidural veins, causing a pressure wave to move rostrally in the CSF. Temporary impaction of the cerebellar tonsils during the relaxation phase after coughing even in the absence of a Chiari type I malformation remains the most plausible mechanism of primary cough headache.

The possibility of venous distension being sufficient in itself to cause headache seems unlikely. Lance (1991) described a man with a large goitre whose face became purple when he lifted his arms above his head. As the veins in his neck distended, he developed a sudden headache. The headache vanished after the goitre was removed. This circumstance is exceptional.

The Valsalva manoeuvre does not usually initiate headache and some source of venous sensitisation would have to be proposed to account for primary cough headache of venous origin. "Benign Valsalva manoeuvre-related headache" has been put forward as a more inclusive descriptive term (Calandre et al. 1996) but "benign" or "primary cough headache" is more succinct and will be hard to displace.

### Treatment

Mathew (1981) reported two patients who improved with indomethacin 50 mg 3 × daily, one of whom had not responded to propranolol or methysergide. Raskin (1995) followed 30 patients with primary cough headache for 3 years or more. Out of 16 patients treated with indomethacin 50–20 mg daily, 10 lost their headache completely, 4 were moderately improved and 2 did not respond.

A separate group of 14 patients were subjected to lumbar puncture with 40 ml of CSF being removed. Six patients improved immediately and 3 improved gradually but the procedure was ineffective in 8 patients, 6 of whom later responded to indomethacin. Raskin commented that indomethacin and lumbar puncture may both be effective by lowering intracranial pressure.

Boes et al. (2002) stated that they usually combined indomethacin with a protein pump inhibitor for long-term

use. They mentioned that some patients have improved with acetazolamide and methysergide.

### Summary

The International Headache Society Diagnostic Criteria for the diagnosis of primary cough headache are as follows:

- a) Headache of sudden onset, lasts from 1 second to 30 min.
- b) Headache brought on by coughing, straining and / or Valsalva manoeuvre.
- c) The same headache does not occur without coughing or straining.
- d) Not attributed to any other disorder.

The condition appears to be caused by a pulse of increased intra-cranial pressure and relieved by treatments that reduce CSF pressure. It is imperative to exclude cough headache caused by structural lesions, such as Chiari type I malformation, by MRI before the diagnosis is made. The syndrome has been the subject of a comprehensive review by Boes et al. (2002). Primary cough headache is best regarded as an entity separate from primary exertional headache, which affects a younger age group. The prognosis is for gradual improvement over a period of 2 months to 12 years. The symptom is usually controlled, at least partially, by indomethacin.

### References

1. Boes CJ, Matharu MS, Goadsby PJ (2002) Benign cough headache. *Cephalalgia* 22:772–779
2. Britton TC, Guiloff RJ (1988) Carotid artery disease presenting as cough headache. *Lancet* 1:1406–1407
3. Calandre L, Hernandez-Lain A, Lopez-Valdes E (1996) Benign Valsalva's manoeuvre-related headache: an MRI study of six cases. *Headache* 36:251–253
4. Ekblom K (1986) Cough headache. In: Rose FC (ed) *Headache. Handbook of Clinical Neurology*, vol 4. Elsevier, Amsterdam, pp 367–376
5. Ertsey C, Jelencsik I (2000) Cough headache associated with Chiari type I malformation: responsiveness to indomethacin. *Cephalalgia* 20:518–520
6. Lance W (1991) Solved and unsolved headache problems. *Headache* 31:439–445
7. Mathew NT (1981) Indomethacin responsive headache syndrome. *Headache* 21:147–150
8. Pascual P, Iglesias F, Oterino A et al. (1996) Cough, exertional and sexual headache. *Neurology* 4:1520–1524
9. Perini F, Toso V (1998) Benign cough "cluster" headache. *Cephalalgia* 18:493–494
10. Raskin NH (1995) The cough headache syndrome: treatment. *Neurology* 45:1784
11. Rooke E (1968) Benign exertional headache. *Med Clin North Am* 52:801–808
12. Smith WS, Messing RO (1993) Cerebral aneurysm presenting as cough headache. *Headache* 33:203–204
13. Symonds C (1956) Cough Headache. *Brain* 79:557–568
14. Williams B (1976) Cerebrospinal fluid pressure changes in response to coughing. *Brain* 99:331–346
15. Williams B (1980) Cough headache due to craniospinal pressure dissociation. *Arch Neurol* 37:226–230

## Primary Dysmenorrhea

### Definition

Primary dysmenorrhea is menstrual pain, beginning at or shortly after onset of menstrual bleeding and lasting up to 72 hours, without pelvic pathology. It usually appears within 1–2 years of menarche and primarily affects ovulatory women.

► [Dyspareunia and Vaginismus](#)

## Primary Exertional Headache

ANDREAS STRAUBE

Department of Neurology, Ludwig Maximilians University, Munich, Germany  
astraube@nefo.med.uni-muenchen.de

### Synonyms

Weight-Lifter's Headache; Diver's Headache; Effort Headache

### Definition

The headache is precipitated by any form of exercise. Recognized sub-varieties include "weight-lifter's headache, diver's headache, effort headache, etc."

### Characteristics

Since a patient with primary exertional headache (pEH) seldom goes to the doctor, there are very few epidemiological studies or reports on treatment options for pEH. The new classification of the International Headache Society (IHS) provides the following description and diagnostic criteria for pEH.

### Diagnostic Criteria

1. Pain is bilateral, throbbing on onset, and short or long-lasting (5 min–48 h)
2. It specifically occurs during or immediately after physical exercise requiring exertion.
3. There is a close temporal relationship between pain and physical exercise, particularly in hot weather or at high altitude.
4. The headache is prevented by avoiding excessive exertion.
5. It cannot be attributed to any other disorder.

When acute onset of this headache type first occurs, the possibility of a subarachnoid hemorrhage must be excluded. Some patients prevent pEH by ingesting ergotamine tartrate. Indomethacin is also reported to be effective in the majority of such cases. Exercise-induced migraine is classified under migraine.

### Epidemiology

According to the Vågå, Norway, study of headache, 12.3% of all individually interviewed inhabitants of this community (ages 18 to 65 years old) reported having had pEH. There was a slight preponderance of females (F / M: 1.38) and the age of onset usually occurred before the 3<sup>rd</sup> decade. This is supported by Pascual et al. (1996), who noted that onset of pEH occurs at an earlier age than cough headache. In a population of college students, about 35% reported about experience with sport- and exercise-related headache (Williams and Nukada 1994). Exertional headache is thought to be experienced by nearly 4% of weight lifters. However, since a ► [Valsalva maneuver](#) is often performed during weight lifting, it is not clear if this is really the case (Powell 1982; Rooke 1968). Older studies reported a definite relationship between benign ► [sexual activity headache](#) and pEH. A study on 45 patients with sexual activity headache reported that 60% had also experienced pEH and 47% also had a personal history of migraine (Silbert et al. 1991). Contrary to benign sexual activity headache, which is seldom a persisting problem, two-thirds of 93 patients with pEH still complained of it 5 years after their first experience with it (Rooke 1968).

### Clinical Characteristics

Most authors describe pEH as an abrupt, bilateral, severe headache that lasts for minutes to hours. Sometimes it has a pulsating character that later becomes dull. Some patients also have vomiting. Only one study analyzed the headache duration and intensity in more detail (Sjaastad and Bakketeig 2002). The headache was found to last minimally 5 min and maximally 24 h and had a mild to moderate intensity in the majority of the patients. The same study also reported that brief and long-lasting attacks occurred equally often, and that the longer lasting attacks had more migraine-like features. Both patient groups frequently complained of ► [jab-like and jolt-like headaches](#) (Sjaastad and Bakketeig 2003).

### Differential Diagnosis

The more limited form of pEH must be differentiated from the sudden onset headache due to a closed glottis, which elevates the intrathoracic and intracranial pressure. Increased intracranial pressure is more related to the cough headache. Other forms of exertional headache are caused by stimulation of cold-sensitive trigeminal afferences (ice cream headache) or are due to pressure (e.g. goggle headache in divers; Cheshire and Ott 2001). Especially in cases of sudden onset headache, other causes of symptomatic forms have to be excluded, such as subarachnoid hemorrhage, mass lesions, ► [spontaneous CSF leaks](#) or an anomaly of the posterior fossa (Buzzi et al. 2003; Green 2001;



Mokri 2002). The IHS also recognizes sexual activity headache as a distinct diagnosis, although it is still not clear if this more slowly developing headache shares some common features with pEH. The activation of a migraine by exertion also has to be differentiated from those forms of headaches that are elicited by exertion. In recent years, there have been several reports on patients who experienced an acute headache after vigorous exercise and then relief after rest. In the end, a myocardial ischemia was identified as the cause (Lance and Lambros 1998; Lipton et al. 1997).

### Pathophysiology

There is no generally accepted pathophysiological explanation for exertional headache. The acute-onset exertional headache seen in weight lifters seems to be related to an acute increase in intrathoracic pressure. This increased pressure in turn causes an increase of pressure in the cranial veins, which results in the increased intracranial pressure regularly seen during the monitoring of patients with brain edema. However, it is still unclear why the Valsalva maneuver does not elicit headache in normal subjects. A second explanation is that exertion causes an inappropriate reaction of the cerebral vasculature in some patients (Lane and Gulevich 2002). Using stress transcranial Doppler to evaluate the myogenic mechanism of the cerebral vessels, Heckmann et al. (1997) detected signs in two patients that cerebral vascular autoregulation is disturbed during ergometer stress; no constriction occurs during systemic blood pressure increase. Another mechanism under discussion is the retention of carbon dioxide. Especially in divers, this causes a relaxation of the cerebrovascular smooth muscles (Cheshire and Ott 2001). The finding of an asymmetric bifrontal hypoperfusion in one subject with a post exercise-provoked headache is hard to explain (Basoglu et al. 1996). However, it is possible that this only reflects an oligemia during a migraine attack. A single report on one patient who had sexual activity headache as well as exertional headache identified cerebral **arterial spasms** during angiography of the patient (Silbert et al. 1989). This finding is completely unspecific and can be a result of the angiography itself.

In view of the few published papers on the pathophysiology of exertional headache, it is impossible to draw final conclusions. Nevertheless, it is highly probable that the disturbed **autoregulation of the cerebral vessels** that results in relaxation under stress best explains the mechanisms underlying the headache. The migraine-like features point to a secondary activation of the trigeminovascular system. Secondary forms of the exertional headache (e.g. cardiac exertional headache) may be caused by co-activation of the autonomic systems and secondary relaxation of the cerebral vessels.

### Treatment

Controlled studies on the treatment of pEH are not available. Most reviews as well as case reports draw attention to the therapeutic benefit of indomethacin, a strong COX 1 and COX 2 inhibitor. Indomethacin reduces the intracranial pressure in pseudotumor cerebri (Förderreuther and Straube 2000), probably by having a vasoconstrictory effect on the cerebral vessels. In general, initial doses of 25 mg p.o. twice daily are recommended, but some patients require higher dosages (up to 75–100 mg p.o. twice daily). Another infrequently used alternative is DHE, which is limited to subcutaneous administration. Since propranolol may also be helpful for sexual activity headache, trials with the beta-blocker are called for.

### References

1. Basoglu T, Ozbenli T, Bernay I et al. (1996) Demonstration of frontal hypoperfusion in benign exertional headache by Technetium-99m-HMPAO SPECT. *J Nucl Med* 37:1172–1174
2. Buzzi MG, Formisano R, Colonnese C et al. (2003) Chiari-associated exertional, cough, and sneeze headache responsive to medical therapy. *Headache* 43:404–406
3. Cheshire WP, Ott MC (2001) Headache in Divers. *Headache* 41:235–247
4. Förderreuther S, Straube A (2000) Indomethacin reduces CSF pressure in pseudotumor cerebri. *Neurology* 55:1043–1045
5. Green MW (2001) A spectrum of exertional headaches. *Med Clin North Am* 85:1085–1092
6. Heckmann JG, Hilz MJ, Muck-Weymann M et al. (1997) Benign exertional headache / benign sexual headache: a disorder of myogenic cerebrovascular autoregulation? *Headache* 37:597–598
7. Lance JW, Lambros J (1998) Unilateral exertional headache as a symptom of cardiac ischemia. *Headache* 38:315–316
8. Lane JC, Gulevich S (2002) Exertional, cough, and sexual headaches. *Curr Treat Options Neurol* 4:375–381
9. Lipton RB, Lowenkopf T, Bajwa ZH et al. (1997) Cardiac cephalgia: a treatable form of exertional headache. *Neurology* 49:813–816
10. Mokri B (2002) Spontaneous CSF leaks mimicking benign exertional headaches. *Cephalalgia* 22:780–783
11. Pascual J, Iglesias F, Oterino A et al. (1996) Cough, exertional, and sexual headaches: an analysis of 72 benign and symptomatic cases. *Neurology* 46:1520–1524
12. Powell B (1982) Weight lifter's cephalgia. *Ann Emerg Med* 11:449–451
13. Rooke ED (1968) Benign exertional headache. *Med Clinics North Am* 52:801–808
14. Silbert PL, Hankey GJ, Prentice DA et al. (1989) Angiographically demonstrated arterial spasm in case of benign sexual headache and benign exertional headache. *Aust N Z J Med* 19:466–468
15. Silbert PL, Edis RH, Stewart-Wynne EG et al. (1991) Benign vascular sexual headache and exertional headache: interrelationships and long term prognosis. *J Neurol Neurosurg Psychiatr* 54:417–421
16. Sjaastad O, Bakketeig LS (2002) Exertional headache. I. Vågå study of headache epidemiology. *Cephalalgia* 22:784–790
17. Sjaastad O, Bakketeig LS (2003) Prolonged benign exertional headache. The Vågå study of headache epidemiology. *Headache* 43:611–615
18. Williams SJ, Nukada H (1994) Sport and exercise headache: Part 1. Prevalence among university students. *Br J Sp Med* 28:90–95

## Primary Hyperalgesia

### Definition

An increased response to a stimulus that is normally painful, at the site of injury or inflammation. This would include pain from noxious stimulation of the muscle. Primary hyperalgesia usually occurs to both thermal and mechanical stimuli, and is caused (at least in part) by primary afferent nociceptor sensitization. Primary hyperalgesia results from the direct effects of injury to skin and nerve tissue, whereas secondary hyperalgesia involves the increased pain sensitivity of the surrounding tissue.

- ▶ Autologous Thrombocyte Injection as a Model of Cutaneous Pain
- ▶ Descending Modulation and Persistent Pain
- ▶ Hyperalgesia
- ▶ Muscle Pain Model, Inflammatory Agents-Induced
- ▶ Nick Model of Cutaneous Pain and Hyperalgesia
- ▶ Nocifensive Behaviors (Muscle and Joint)
- ▶ Opioids and Muscle Pain
- ▶ Spinothalamic Neuron
- ▶ UV-Induced Erythema

## Primary Motor Cortex

### Sensory

M1

### Definition

A part of the frontal lobe cerebral cortex, confined to the gyrus in front of the central sulcus (Brodmann's area 4). This area has a lower threshold of excitability to induce muscle movement compared with other motor areas, and contributes a large number of fibers to the corticospinal and corticobulbar tracts. It is the only cortical area to contain the large Betz's neurons.

- ▶ Motor Cortex, Effect on Pain-Related Behavior

## Primary Somatosensory Cortex (S1), Effect on Pain-Related Behavior in Humans

MARKUS PLONER, ALFONS SCHNITZLER  
Department of Neurology, Heinrich-Heine-University,  
Düsseldorf, Germany  
ploner@neurologie.uni-duesseldorf.de

### Definition

The primary somatosensory cortex (S1) is a functionally defined part of the somatosensory and ▶ nociceptive

system. Anatomically, S1 occupies the postcentral cortex and consists of four architectonic fields each containing a somatotopic representation of the contralateral body half. Afferent projections to S1 originate mainly from the ventroposterior nucleus of the thalamus. Physiological, functional imaging and lesion studies provide converging evidence for an association between S1 and the ▶ sensory-discriminative aspect of pain perception.

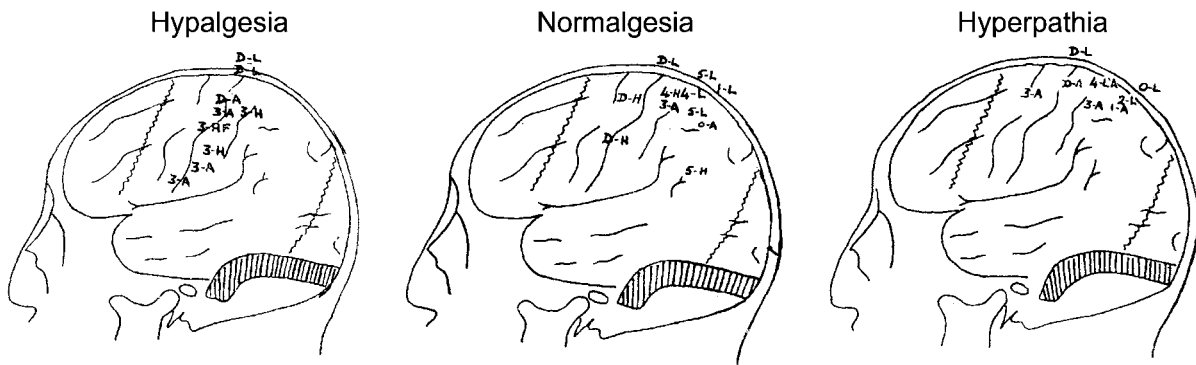
### Characteristics

The behavioral effects of cortical lesions determined early concepts of the relevance of the cerebral cortex for the perception of pain. In the first half of the 20<sup>th</sup> century the view that pain has "little, if any, true cortical representation" predominated (Penfield and Boldrey 1937). This notion was mainly based on Henry Head's observation that "pure cortical lesions cause no increase or decrease of sensibility to measured painful stimuli" (Head and Holmes 1911, p 154) and on the fact that electrical stimulations of S1 only rarely elicited painful sensations (Penfield and Boldrey 1937). In the second half of the 20<sup>th</sup> century an opposing view emerged. Various lesion studies contradicted Head's findings by clearly demonstrating alterations of pain perception due to lesions of the S1 region (reviewed in Kenshalo and Willis 1991; Sweet 1982).

Russell (1945) and Marshall (1951) presented two seminal studies in patients with traumatic head injury involving the postcentral cortex. Both authors observed patients with a loss of all forms of somatosensory sensations including a loss of pain perception. In these patients, lesions were located in the more anterior parts of the postcentral cortex (the left panel of Fig. 1 shows the lesion documentation of Russell (1945) in this type of patient). By contrast, more extended lesions located in the posterior parts of the postcentral cortex yielded deficits in position sense and two-point-discrimination but no deficits in pain perception (Fig. 1, middle panel). Additionally, in a few cases of both series, hyperpathia was observed (Fig. 1, right panel). Thus, Marshall and Russell both concluded that the postcentral cortex comprising S1 is concerned with the appreciation of pain but that the effects of postcentral lesions on pain perception are largely inconsistent.

This side by side hypo-, norm- and hyper-algesia after postcentral lesions may partly reflect that S1 not only participates in the mediation but also in the modulation of pain perception (Bushnell et al. 1999). Accordingly, surgical excision of S1 has at least transiently been successful in alleviating phantom limb and central pain conditions (White and Sweet 1969).

However, the inconsistency of the observed effects of S1 lesions might also be due to methodological reasons. Despite the very good clinical documentation of the perceptual lesion effects, information about lesion extent or presence of additional lesions was often scant



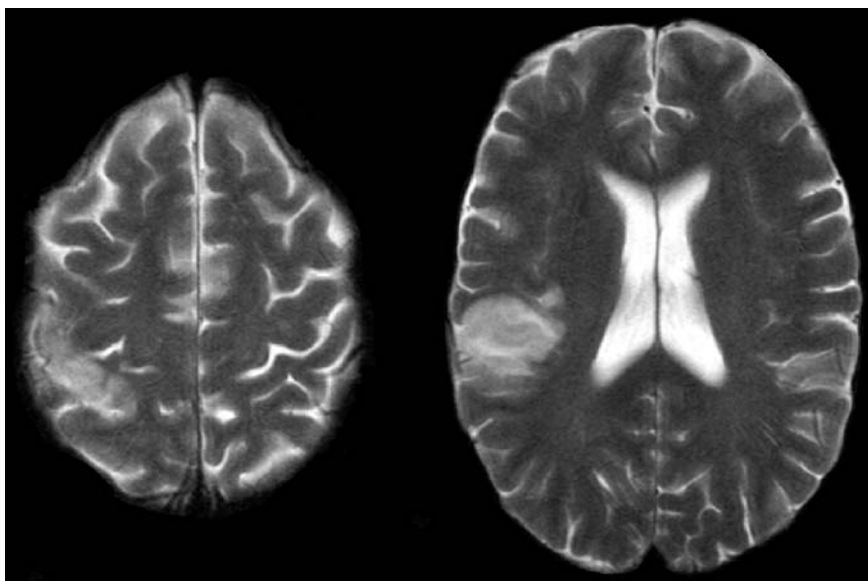
**Primary Somatosensory Cortex (S1), Effect on Pain-Related Behavior in Humans, Figure 1** Locations of lesions causing permanent deficits in all forms of somatosensory sensation including pain (left), in discriminative sensations excluding pain (middle) and of lesions causing hyperpathia (right). Figures, depth of wounds in centimeters; D, depressed fracture without dural tear; L, leg; A, arm; H, hand; F, face. From Russell 1945.

before high-resolution structural brain imaging became available. Furthermore, clinical examination of pain perception was carried out with non-selective painful stimuli that yield a coactivation of nociceptive and tactile afferents and result in an interference between touch and pain perception. Moreover, the complex and multidimensional nature of pain may have not been sufficiently appreciated, so that the different sensory, **► cognitive aspects of pain** and **► affective aspects of pain** perception could not be disentangled.

Conceptual and methodological advances now allow more subtle investigations of lesion effects on pain perception. Recently, the case of a patient with an ischemic lesion of the postcentral cortex was reported (Ploner et al. 1999) (Fig. 2). This patient suffered from a complete loss of tactile and thermal sensation on the contralateral hand. However, application of selective pain stimuli to the affected hand yielded a clearly unpleasant feeling emerging from an ill-localized and extended area some-

where between fingertips and shoulder, that he wanted to avoid. The fully eloquent patient was completely unable to further describe quality, localization and intensity of the perceived stimulus nor did he choose the given description “pain” for the perceived sensation. This pattern of deficits sheds light on some basic functional aspects of the role of S1 in pain perception. The postcentral lesion has resulted in a dissociation between different aspects of pain perception with a loss of sensory-discriminative capabilities, while sparing pain affect. This indicates a crucial role of S1 for the sensory-discriminative aspect of pain perception, which is in accordance with anatomical, neurophysiological and functional imaging data from the past decades (reviewed in Duncan and Albanese 2003; Schnitzler and Ploner 2000). In addition, the fact of a perceptual dissociation of pain perception strongly suggests that the different aspects of pain perception are organized in parallel.

P



**Primary Somatosensory Cortex (S1), Effect on Pain-Related Behavior in Humans, Figure 2** Magnetic resonance images of an ischemic lesion of the right postcentral cortex causing a loss of pain sensation with preservation of pain affect. From Ploner et al. 1999.

In conclusion, lesion studies indicate that S1 constitutes an essential part of a parallel-organized cortical network of pain perception. Within this network, S1 is particularly associated with sensory-discriminative capabilities of pain perception and may also be involved in the modulation of pain perception.

## References

1. Bushnell MC, Duncan GH, Hofbauer RK et al. (1999) Pain perception: Is there a role for primary somatosensory cortex? *Proc Natl Acad Sci USA* 96:7705–7709
2. Duncan GH, Albanese MC (2003) Is there a role for the parietal lobes in the perception of pain? *Adv Neurol* 93:69–86
3. Head H, Holmes G (1911) Sensory disturbances from cerebral lesions. *Brain* 34:102–254
4. Kenshalo DR, Willis WD (1991) The role of the cerebral cortex in pain sensation. In: Peters A, Jones EG (eds) *Cerebral Cortex*, vol 9. Plenum Press, New York, pp 153–212
5. Marshall J (1951) Sensory disturbances in cortical wounds with special reference to pain. *J Neurol Neurosurg Psychiatry* 14:187–204
6. Penfield W, Boldrey E (1937) Somatic motor and sensory representation in the cerebral cortex of man as studied by electrical stimulation. *Brain* 60:389–443
7. Ploner M, Freund HJ, Schnitzler A (1999) Pain affect without pain sensation in a patient with a postcentral lesion. *Pain* 81:211–214
8. Russell WR (1945) Transient disturbances following gunshot wounds of the head. *Brain* 68:79–97
9. Schnitzler A, Ploner M (2000) Neurophysiology and functional neuroanatomy of pain perception. *J Clin Neurophysiol* 17:592–603
10. Sweet WH (1982) Cerebral localization of pain. In: Thompson RA, Green J (eds) *New perspectives in cerebral localization*. Raven Press, New York, pp 205–242
11. White JC, Sweet WH (1969) Pain and the neurosurgeon. A forty-year experience. Charles C Thomas, Springfield, Illinois

## Primary Somatosensory Cortex (SI)

### Definition

The majority of neurons originating in the ventroposterior nucleus of the thalamus project to the primary somatosensory cortex (SI), while the remaining fibers project to the secondary somatosensory cortex (SII) in the posterior parietal lobe.

- ▶ [Opioid Receptor Localization](#)
- ▶ [Spinothalamic Input, Cells of Origin \(Monkey\)](#)

## Primary Stabbing Headache

JAMES W. LANCE

Institute of Neurological Sciences, Prince of Wales Hospital and University of New South Wales, Sydney, NSW, Australia  
jimlance@bigpond.com

### Synonym

Ice-pick pains; Jabs and Jolts Syndrome; Ophthalmodynia Periodica; Idiopathic Stabbing Headache

### Definition

Localised stabs of pain in the head that occur spontaneously in the absence of organic disease of underlying structures or of the cranial nerves.

### Characteristics

Primary stabbing headaches (PSH) are pains occurring as a single stab or series of stabs confined to the head, predominantly in the orbit, temple or parietal area. Each stab lasts from a fraction of a second to 3 seconds and pains recur irregularly, from a single stab occasionally to many each day. There are no accompanying symptoms or signs. Such pains are more common in patients subject to migraine, cluster or tension headache than in the headache-free population.

The briefest of stabs, previously known as ▶ [ice-pick pains](#), usually respond to indomethacin. The more prolonged stabs, previously called the “jabs and jolts syndrome” are less responsive to medication. Ophthalmodynia periodica is a stabbing pain limited to one eye.

### Clinical Reports

Sharp stabbing pains in the head resembling a jab from a nail or a needle were described by Raskin and Schwartz (1980) as “ice-pick” pains. They found that 42 out of 100 migraine patients had experienced this symptom, compared with only 3 out of 100 headache-free control subjects.

The most common sites affected were the orbits or temples. The pains were often associated with the times of recurrence of migraine headache. They commented that similar pains could occur with temporal arteritis.

Drummond and Lance (1984) obtained a history of ice-pick pains in 200 out of 530 patients with recurrent migraine and tension headache. In the 92 patients in whom the site of ice-pick pains had been recorded, it coincided with the site affected by the patient’s customary headaches in 37, 19 unilateral and 18 bilateral. Stabbing pains have also been reported in conjunction with cluster headaches (Ekbom 1975). Sudden stabbing pains in one eye are termed “ophthalmodynia periodica”. Over 60% of patients with this syndrome are migraine sufferers (Lansche 1964).

The “jabs and jolts syndrome” was first described by Sjaastad et al. (1979). These are sharp knife-like pains lasting less than 1 min in patients with migraine, tension and cluster headache as well as in chronic paroxysmal hemicrania (▶ [CPH](#)). They were called “jabs and jolts” to distinguish them from episodes of CPH which last more than 3 min (Sjaastad 1992). Pareja et al. (1999) considered the differential diagnosis of idiopathic (primary) stabbing headache from ▶ [trigeminal neuralgia](#) affecting the first division and ▶ [SUNCT](#) (short-lasting unilateral neuralgiform headache attacks with conjunctival injection and tearing) syndrome. SUNCT is confined to one periocular area and is associated with autonomic features not present in PSH, which is multifocal



and variable in location. SUNCT lasts more than 5 seconds and commonly continues for 1 minute or more. It affects men more than women in contrast to PSH, which mainly affects women.

Sjaastad et al. (2001) conducted a large-scale study of headache epidemiology in 1838 adults living in Vågå, Norway and found that 35.2% claimed to have experienced primary stabbing headaches, a much higher proportion than found in previous studies. The female:male ratio was about 1.5, whereas it was 6.6 in an earlier report by Pareja et al. (1996). The mean age of onset was 28 in the Norwegian series and 47 in the Spanish series. The primary stabbing headaches were associated with another form of headache in half of the patients reported by Pareja et al. (1996). Contrary to the experience in adults, PSH in children is not usually accompanied by other forms of headache (Soriani et al. 1996). Martins et al. (1995) reported recurrent stabbing pains in bouts they termed “status”, outside the area innervated by the trigeminal nerve in the retro-auricular, parietal and occipital regions in 6 patients. Attacks were daily, recurred every minute and subsided after 1 week. None were associated with migraine. A recent publication from the Vågå study (Sjaastad et al. 2003) also pointed out that stabbing pains were not necessarily confined to the head. They were reported throughout the body in 4 patients, in the face in 3 and in the neck in 12.

### Pathophysiology

The stabbing quality of these pains suggests a paroxysmal neuronal discharge comparable with trigeminal neuralgia. The localisation of pains to the habitual site of migraine or cluster headache suggests the possibility of a defect in the brain's ► [endogenous pain control pathway](#) that permits the spontaneous synchronous discharge of neurones receiving impulses from the area to which the head pain is referred.

### Treatment

Matthew (1981) reported the response of 5 patients to indomethacin 50 mg three times daily, but not to aspirin or placebo. Twenty patients in whom PSH accompanied atypical headaches responded well to indomethacin (Medina and Diamond 1981), which has remained the treatment of choice. The bout of frequent stabs (“status”) described by Martins et al. (1995) also settled promptly with indomethacin. Provesan et al. (2002) described PSH developing after a stroke in 3 patients, all of whom improved with the COX-2 inhibitor celecoxib. Sjaastad (1992) reported that the “jabs and jolts syndrome” responded only partially to indomethacin or not at all.

### Summary

It remains to be determined whether brief, stabbing ice-pick pains have the same pathophysiology as the longer-lasting “jabs and jolts syndrome” and form part of a spec-

trum linking up with SUNCT and CPH although devoid of their autonomic features. The frequent response to indomethacin in ice-pick pains and CPH is a striking clinical difference from “jabs and jolts” and SUNCT, which respond poorly if at all.

In view of the gross discrepancy in the reported prevalence of PSH in different communities, further studies are required to clarify this and to determine whether the reported association of PSH with other headaches is greater than could be accounted for by chance.

► [Hemicrania Continua](#)

### References

1. Drummond PD, Lance JW (1984) Neurovascular disturbances in headache patients. *Clin Exp Neurol* 20:93–99
2. Ekblom K (1975) Some observations on pain in cluster headache. *Headache* 14:219–225
3. Lansche RK (1964) Ophthalmodynia periodica. *Headache* 4:247–249
4. Martins IP, Parreira B, Costa I (1995) Extratrigeminal ice-pick status. *Headache* 35:107–110
5. Mathew NT (1981) Indomethacin responsive headache syndrome. *Headache* 21:147–150
6. Medina JL, Diamond S (1981) Cluster headache variant: spectrum of a new headache syndrome. *Arch Neurol* 38:705–709
7. Pareja JA, Ruiz J, de Isla C et al (1996) Idiopathic stabbing headache (jabs and jolts syndrome). *Cephalalgia* 16:93–96
8. Pareja JA, Kruszewski P, Caminero AB (1999) SUNCT syndrome versus idiopathic stabbing headache (jabs and jolts syndrome). *Cephalalgia* 19 (Suppl 25):46–48
9. Provesan EJ, Zukerman E, Kowacs PA et al. (2002) COX-2 inhibitor for the treatment of idiopathic stabbing headache secondary to cerebrovascular diseases. *Cephalalgia* 22:197–200
10. Raskin NH, Schwartz RK (1980) Icepick-like pain. *Neurology* 30:203–205
11. Sjaastad, O (1992) Cluster headache syndrome. WB Saunders, London, pp 310–312
12. Sjaastad O, Egge K, Hørven I et al. (1979) Chronic paroxysmal hemicrania V. Mechanical precipitation of attacks. *Headache* 19:31–36
13. Sjaastad O, Pettersen H, Bakketeig LS (2001) The Vågå study; epidemiology of headache. *Cephalalgia* 21:207–215
14. Sjaastad O, Pettersen H, Bakketeig LS (2003) Extracerebral jabs / idiopathic stabs. Vågå study of headache epidemiology. *Cephalalgia* 23:50–54
15. Soriani G, Battistella PA, Arnaldi C et al. (1996) Juvenile idiopathic stabbing headache. *Headache* 36:565–567

P

## Primary Vulvar Vestibulitis

### Definition

Dyspareunia from the first attempt of sexual intercourse.

► [Vulvodinia](#)

## PRM Specialist

### Definition

PRM Specialist is a physician with 3–5 years of postgraduate training in Physical & Rehabilitation

Medicine, carrying final medical responsibility for team actions.

- ▶ [Physical Medicine and Rehabilitation, Team-Oriented Approach](#)

---

## PRN

- ▶ [Pro Re Nata](#)

---

## Pro Re Nata

### Synonyms

PRN

### Definition

According to circumstances; as necessary.

- ▶ [Assessment of Pain Behaviors](#)
- ▶ [Operant Treatment of Chronic Pain](#)
- ▶ [Psychology of Pain and Psychological Treatment](#)

---

## Probability

### Definition

The chance or likelihood that a given event will occur.

- ▶ [Pain in the Workplace, Risk Factors for Chronicity, Demographics](#)

---

## Probable Cause

### Definition

A reasonable ground for supposing that something will predispose toward a particular outcome.

- ▶ [Pain in the Workplace, Risk Factors for Chronicity, Demographics](#)

---

## Procedural Distress

### Definition

The aggregate of pain and anxiety that induce a stress response to an invasive procedure.

- ▶ [Cancer Pain, Assessment in Children](#)

---

## Prognosis

### Definition

The prognosis is a measure of the probability of a favorable or unfavorable outcome of a given condition.

- ▶ [Psychiatric Aspects of the Epidemiology of Pain](#)

---

## Prognostic Block

- ▶ [Pain Treatment, Spinal Nerve Blocks](#)

---

## Programmed Cell Death

- ▶ [Apoptosis](#)

---

## Progressive Adjustive

- ▶ [Lumbar Traction](#)

---

## Progressive Muscle Relaxation

### Definition

Progressive muscle relaxation is a relaxation technique in which patients are trained to systematically tense and relax specific muscle groups. Benefits are achieved as individuals become more aware of the presence of muscle tension in their bodies and as they learn to reduce this tension.

- ▶ [Coping and Pain](#)
- ▶ [Pain](#)
- ▶ [Psychological Treatment in Acute](#)
- ▶ [Relaxation in the Treatment of Pain](#)

---

## Proinflammatory Cytokines

LINDA R. WATKINS, STEVEN F. MAIER  
Department of Psychology and the Center for Neuroscience, University of Colorado at Boulder, Boulder, CO, USA  
lwatkins@psych.colorado.edu

### Definition

A family of proteins, including tumor necrosis factor (TNF), interleukin-1 (IL1), and (often but not always) IL6. "Pro-inflammatory" refers to their classical function in the peripheral immune system, where they en-

hance inflammation by orchestrating the early immune response to damage and infection.

### Characteristics

#### Peripheral Tissues

Proinflammatory cytokines are released by activated immune cells at sites of infection, inflammation, and damage. Their release can enhance nociceptive signaling in skin, muscle, and joints. A wide array of cell types at these sites can release proinflammatory cytokines including macrophages, neutrophils, fibroblasts, chondrocytes, keratinocytes, and endothelial cells. In addition, mast cells can contribute to pain signaling by cytokines, as they can release enzymes that cleave extracellular pools of inactive proinflammatory cytokines to their active forms (for review see Watkins et al. 1999). Given that dorsal root ganglion neurons express mRNAs for proinflammatory cytokine receptors, it is likely that appropriate receptors are expressed at sensory nerve terminals of these DRG neurons (for review see Watkins and Maier 2002).

In addition to activating nociceptive neurons that project directly to the spinal cord, peripheral proinflammatory cytokines can also enhance pain as a natural consequence of immune-to-brain communication (for review see Maier and Watkins 98; Watkins and Maier 2000). Immune-to-brain communication refers to a pathway activated by localized (such as at sites of infection or inflammation) or blood-borne proinflammatory cytokines. These activate sensory neurons (e.g. vagal afferents) and/or ► [circumventricular brain structures](#) (e.g. area postrema), respectively (for review, see Watkins et al. 1995). This communication pathway relays to the brain that a peripheral immune challenge has occurred. Subsequently, specific brain and brain-to-spinal cord pathways become activated, causing ► [glial activation](#) and proinflammatory cytokine release. This, in turn, results in the expression of well-characterized sickness responses. Sickness responses refer to a brain-orchestrated constellation of changes aimed at enhancing the survival of the host. These include a wide array of symptoms such as fever, increases in sleep, decreases in food and water intake, and decreases in social behavior, as well as increases in pain to formerly innocuous stimuli (sickness-induced hyperalgesia) (for review see Maier and Watkins 1998; Watkins and Maier 2000). Whether hyperalgesia continues throughout sickness, versus being replaced by hypoalgesia at later timepoints, is a subject of debate.

#### Peripheral Nerves

While sensory neurons are classically believed to be activated by stimuli in their terminal receptive fields, there is growing evidence that immune cells can exert excitatory influences over sensory neuronal function at mid-axonal sites as well. Cells resident within periph-

eral nerves that can produce proinflammatory cytokines include dendritic cells, endothelial cells, fibroblasts, macrophages, mast cells, and Schwann cells. In addition, under inflammatory, infectious or traumatic conditions, the blood-nerve barrier breaks down. This allows immune cells (predominantly macrophages and neutrophils) to be recruited out of the bloodstream and into the nerve, where they contribute to local proinflammatory cytokine production (for review see Watkins and Maier 2002).

Involvement of immune cells in pain from nerve trauma has been studied predominantly in 2 animal models: *Aplysia* and rats. In the simpler nervous system of *Aplysia*, it is known that activated immunocytes (immune-like cells of *Aplysia*) release TNF-like and IL<sup>1</sup>-like proinflammatory cytokines. These alter ion channels in *Aplysia* neurons, causing hyperexcitability. Hyperexcitability of injured *Aplysia* nerves is greater in the presence of activated immunocytes, an effect mimicked by application of IL1 (for review see Clatworthy 1999). Similarly in rats, neuropathy is linked to the activity of macrophages recruited to the site of injury. Notably, simply delaying the recruitment of macrophages to the injury site delays the development of neuropathic pain, while attracting activated immune cells to the injury site enhances the development of neuropathic pain (for review see Myers et al. 1999). Indeed, simply attracting and activating immune cells to an otherwise healthy sciatic nerve induces pain facilitation. Of the various neuroactive substances released by activated immune cells, TNF, IL1 and IL6 have received the most experimental support for their involvement in neuropathic pain of both traumatic and inflammatory origin. Blockade of TNF, IL1 or IL6 reduces neuropathic pain. TNF injected into the sciatic nerve induces pain facilitation, and TNF applied topically to the sciatic nerve evokes ► [ectopic activity](#) in single primary afferent nociceptive fibers (for review see Watkins and Maier 2002).

Although it is clear that proinflammatory cytokines can induce pain, how they do this from mid-axonal sites is controversial (for review see Watkins and Maier 2002). Proinflammatory cytokine receptors are expressed by dorsal root ganglia neuronal cell bodies, but whether or not functional receptors are expressed along the course of the peripheral nerves is unknown. Of the proinflammatory cytokines, TNF has been the most intensively studied as regards its effects on neuroexcitability. It rapidly alters peripheral nerve activity, suggesting that it may exert direct effects on axonal function. Membrane modeling studies suggest that TNF can dimerize and insert through cell membranes, forming a pore-like structure. Formation of TNF “pores” is facilitated under the acidic conditions that occur at inflammation sites. Intriguingly, the TNF “pores” have been reported to form voltage-dependent sodium channels. Other lines of evidence suggest that TNF enhances nerve ex-

citability by increasing the membrane conductance of endogenous sodium and calcium channels. Like TNF, IL1 also rapidly increases neuronal excitation and produces long-lasting increases in conductance of sodium and calcium channels. Thus, multiple mechanisms may account for proinflammatory cytokine actions on peripheral nerves.

In addition to direct effects on axonal excitability, proinflammatory cytokines may serve as retrogradely transported signals which influence gene activation in intact dorsal root ganglia somas. TNF and IL6 have each been reported to be retrogradely transported from the site of peripheral nerve injury to the dorsal root ganglia. Intriguingly, the transport of TNF after nerve trauma appears to be bidirectional. That is, after nerve injury, medium and large dorsal root ganglion neurons produce TNF and anterogradely transport it to the injury site (Schafers et al. 2002).

### Dorsal Root Ganglia

Proinflammatory cytokines can be produced by a variety of cell types in dorsal root ganglia, including glially derived ► **satellite cells**, macrophages, endothelial cells, and neurons. Under conditions of neuropathy, immune cells migrate from the systemic circulation into the dorsal root ganglia. In response to peripheral nerve injury, satellite cells (and presumably other immune cells) are activated and release proinflammatory cytokines in the dorsal root ganglia.

Dorsal root ganglia neurons can also be affected by proinflammatory cytokines produced by herniated discs. Herniated discs spontaneously produce TNF, IL1 and IL6, among other inflammatory products. In addition, exposure of nerve roots to herniated disc substances (nucleus pulposus) induces elevations in dorsal root ganglion expression of proinflammatory cytokine mRNAs, as well as pain facilitation. Topical application of TNF to dorsal root ganglia and proximal roots induces spontaneous activity, possibly via binding to TNF receptors expressed by neuronal somata. Applying TNF to nerve roots causes activation of Schwann cells, local production of TNF, and recruitment of macrophages, just as does application of nucleus pulposus. Moreover, blocking TNF activity delays the development of pain facilitation in response to applied nucleus pulposus (for review see Watkins and Maier 2002).

### Spinal Cord

Spinal proinflammatory cytokines have been attracting increasing interest (for review see DeLeo and Yezierski 2001; DeLeo et al. 2004; Watkins and Maier 2003; Watkins et al. 2001). While TNF transport from dorsal root ganglia to spinal cord has been reported after peripheral nerve injury (Shubayev and Myers 2002), it is as yet unknown whether this TNF can be released so as to affect spinal cord function. If this were true, it would be a novel source of spinal cord neuroexcitation by proinflamma-

tory cytokines. What is clear is that the reverse is true; namely, that proinflammatory cytokines in spinal cord CSF can be retrogradely transported to dorsal root ganglia where they affect gene expression of sensory neurons.

The predominant view is that proinflammatory cytokines, likely of glial origin, are important in the induction and maintenance of pain facilitation. In some models, recruitment of immune cells to spinal cord may also contribute to alterations in pain responsiveness (for review see DeLeo and Yezierski 2001; DeLeo et al. 2004). Intrathecal delivery of IL1 and IL6 has each been reported to enhance pain responsiveness. Rapid glial activation and rapid elevations of proinflammatory cytokines have been observed in spinal cord and surrounding CSF, the latter observation implying cytokine release. Blockade of spinal TNF, IL1 and IL6 have each been reported to prevent and/or reverse pain facilitation induced by inflammation of peripheral tissues, inflammation and trauma to either peripheral nerves or spinal nerves, and spinal cord glial activation in response to viral gp120. Importantly, glial involvement in pain facilitation is not restricted to the time of injury. Rather, recent data from several laboratories point to prolonged glial activation, lasting many weeks. For example, intrathecal blockade of IL1, even 2 months after traumatic neuropathy, still rapidly and completely reverses neuropathic pain (Watkins and Maier 2003). Prolonged upregulation of proinflammatory cytokines for many weeks after tissue or nerve injury have also been reported. Such observations are striking in that they imply that spinal cord glial activation and proinflammatory cytokines may be important contributors to perseverative pain states.

It is not yet clear whether glial activation and proinflammatory cytokine release is linked to spinal cord neurodegeneration. Several laboratories have now reported neurodegeneration in spinal cord dorsal horn following peripheral nerve injury. It is intriguing that available evidence suggests that a positive feedback cycle may exist wherein neural excitation triggers glial activation, which leads to the release of neuroexcitatory (and potentially neurotoxic) substances from glia, which leads to further neuroexcitation. If this cycle is sufficiently potent or prolonged, neuronal death could occur. Indeed, a number of substances released from activated glia (including proinflammatory cytokines) have been linked to neurodegeneration in a variety of diseases, such as Alzheimer's, Parkinson's, prion disease, multiple sclerosis, and AIDS dementia. If glia contribute to neurodegeneration in spinal cord, this could in turn further activate glia. This is because neurons normally keep glia in an unactivated state via contact inhibition. Dying and dead neurons can induce a state of perseverative hyperexcitability in nearby glia. While obviously speculative for spinal cord, the implications are intriguing.



## Brain

There is growing literature implicating brain proinflammatory cytokines in pain modulation. Several laboratories have now reported that ► [intracerebroventricular](#) administration of TNF, IL1, and IL6 induces pain facilitation, and intracerebroventricular IL1 enhances nociceptive neuronal responses in trigeminal nucleus caudalis (Oka and Hori 1999). A complex dose response function has been reported for intracerebroventricular IL1, wherein low doses (picograms) induce hyperalgesia and high doses (nanograms) induce hypoalgesia. Likewise, intracerebroventricular antagonists of TNF and IL1 block pain facilitation induced by intraperitoneal inflammation.

Microinjections of proinflammatory cytokines into discrete brain regions reveal marked heterogeneity of effects. For example, IL1 microinjection into the preoptic area produces pain facilitation. In contrast, IL1 microinjections into the ventromedial hypothalamus, centromedial thalamus and gelatinosus nucleus of the thalamus produce hypoalgesia. Such differential effects of proinflammatory cytokines in diverse brain regions may, at least in part, explain the complex dose response function reported after intraventricular administration.

Lastly, there is a small but growing literature suggesting that proinflammatory cytokine levels increase in brain following manipulations that induce pain facilitation. Increases in IL1 in glial cells of the hypothalamus have been reported following subcutaneous formalin. Following peripheral neuropathy, neuronal TNF increases in hippocampus and in the region of the locus coeruleus, and blockade of hippocampal TNF blocks the development of neuropathic pain. Very recently, subcutaneous complete Freund's adjuvant was found to produce non-homogenous increases in glial activation markers in brain, with greater activation in midbrain, thalamus and cerebral cortex, compared to pons or medulla (Rhaghavendra et al. 2004). Notably, mRNA for TNF, IL1, and IL6 were all increased in each of these brain regions (Rhaghavendra et al. 2004).

Thus, while little is yet known about supraspinal actions of proinflammatory cytokine in pain modulation, these initial studies clearly suggest that proinflammatory cytokine regulation of pain within the central nervous system includes supraspinal as well as spinal sites of action.

### Implications for Pain Control

The animal data are clear that immune- and glially-derived products can dramatically amplify pain. It is no longer a question of whether they do, at least in laboratory animals. It is now a matter of how to focus drug discovery to take advantage of this knowledge so to test whether clinical pain, that is resistant to currently available drugs, may be resolved by using compounds that target immune and/or glial cells.

One issue that immediately arises is whether systemic drug delivery is desirable. One issue with systemic de-

livery is that drugs that will control immune/glial contributions to pain would also be expected to be generally immunosuppressive. A second issue with systemic delivery is that, unless the blood-nerve barrier is disrupted, it may be difficult for many compounds to reach therapeutic levels in nerve. A third issue is that by the time drugs are administered, damage to peripheral nerves has already occurred. While treatment may prevent further immune-derived damage, the damage already present may be sufficient to maintain the pain. The last issue is that blood brain barrier permeability is a double-edged sword for immune/glial active compounds. If a drug does not cross the blood-brain barrier, it cannot directly control glial activation that is driving pain facilitation. On the other hand, if a drug does cross the blood-brain barrier, it would disrupt glial function in brain as well as spinal cord. As glia are now implicated as regulators of wide ranging phenomena, such as learning and memory, hormone regulation, thermoregulation, and so forth, pervasive alterations in glial function need to be carefully considered.

One alternative approach would be to specifically target glia within the spinal cord, via direct administration to the cerebrospinal fluid space surrounding the spinal cord. As glia normally serve very important functions, one simply wants to control their activation rather than to aim to destroy these cells. From studies of animal models, a variety of compounds have now been identified which can prevent and/or reverse exaggerated pain states of diverse etiologies. These include drugs that disrupt glial activation (e.g. minocycline), proinflammatory cytokine antagonists (e.g. infliximab, etanercept, anakinra), drugs that disrupt proinflammatory cytokine synthesis (e.g. propentofylline, thaliomide and congeners), or disrupt both proinflammatory cytokine signaling and synthesis (e.g. leflunomide, methotrexate, ► [p38 MAP kinase](#) inhibitors, the anti-inflammatory cytokine interleukin-10). For detailed discussion of these compounds as regards pain control, readers are referred to the review by Watkins and Maier (2003).

### Conclusions

Over the past decade, an increasing and convincing literature has linked proinflammatory cytokines with pain. Both peripheral immune-generated proinflammatory cytokines and central (primarily) glially-generated proinflammatory cytokines are involved. Peripherally, proinflammatory cytokines increase excitability at peripheral nerve terminals as well as mid-axonally along nerve bundles. They signal the brain both via sensory neuron-to-spinal cord and immune-to-brain circuitries. Centrally, to date, most evidence of glially driven pain facilitation has accrued in spinal cord. While the study of glial activation in brain is still in its infancy, it is clear that an intriguing story will emerge there as well.

► [Cord Glial Activation](#)

► [Cytokines, Regulation in Inflammation](#)

## References

1. Clatworthy AL (1999) Evolutionary Perspectives of Cytokines in Pain. In: Watkins LR, Maier SF (eds) Cytokines and Pain. Birkhäuser, Basel, pp 21–38
2. DeLeo JA, Tanga FY, Tawfik VL (2004) Neuroimmune Activation and Neuroinflammation in Chronic Pain and Opioid Tolerance/Hyperalgesia. *Neuroscientist* 10:40–52
3. DeLeo JA, Yezierski RP (2001) The Role of Neuroinflammation and Neuroimmune Activation in Persistent Pain. *Pain* 2001:1–6
4. Maier SF, Watkins LR (1998) Cytokines for Psychologists: Implications of Bi-Directional Immune-to-Brain Communication for Understanding Behavior, Mood, and Cognition. *Psych Rev* 105:83–107
5. Myers RR, Wagner R, Sorkin LS (1999) Hyperalgesic Actions of Cytokines on Peripheral Nerves. In: Watkins LR, Maier SF (eds) Cytokines and Pain. Birkhäuser, Basel, pp 133–158
6. Oka T, Hori T (1999) Brain Cytokines and Pain. In: Watkins LR, Maier SF (eds) Cytokines and Pain. Birkhäuser, Basel, pp 183–204
7. Rhaghavendra V, Tanga FY, DeLeo JA (2004) Complete Freund's Adjuvant-Induced Peripheral Inflammation Evokes Glial Activation and Proinflammatory Cytokine Expression in the CNS. *Eur J Neurosci* 20:467–473
8. Schafers M, Geis C, Brors D et al. (2002) Anterograde Transport of Tumor Necrosis Factor-Alpha in the Intact and Injured Rat Sciatic Nerve. *J Neurosci* 22:536–545
9. Shubayev VI, Myers RR (2002) Anterograde TNF Alpha Transport from Rat Dorsal Root Ganglion to Spinal Cord and Injured Sciatic Nerve. *Neurosci Lett* 320:99–101
10. Watkins LR, Hansen MK, Nguyen KT et al. (1999) Dynamic Regulation of the Proinflammatory Cytokine, Interleukin-1beta: Molecular Biology for Non-Molecular Biologists. *Life Sci* 65:449–481
11. Watkins LR, Maier SF (2000) The Pain of Being Sick: Implications of Immune-to-Brain Communication for Understanding Pain. *Ann Rev Psych* 2000:29–57
12. Watkins LR, Maier SF (2002) Beyond Neurons: Evidence that Immune and Glial Cells Contribute to Pathological Pain States. *Physiol Rev* 82:981–1011
13. Watkins LR, Maier SF (2003) Glia: A Novel Drug Discovery Target for Clinical Pain. *Nat Rev Drug Discov* 2:973–985
14. Watkins LR, Maier SF, Goehler LE (1995) Cytokine-to-Brain Communication: A Review and Analysis of Alternative Mechanisms. *Life Sci* 57:1011–1026
15. Watkins LR, Milligan ED, Maier SF (2001) Glial Activation: A Driving Force for Pathological Pain. *Trends Neurosci* 24:450–455

## Projection Neurons

### Definition

Projection neurons of the spinal cord are those with axons that travel rostrally to reach the brain.

- ▶ [Nociceptive Circuitry in the Spinal Cord](#)
- ▶ [Opioid Receptors at Postsynaptic Sites](#)

## Projective Field (PF)

### Definition

A projective field is an area of the body in which a sensation is provoked due to stimulation of a neuron.

- ▶ [Central Pain, Human Studies of Physiology](#)
- ▶ [Thalamus, Receptive Fields, Projected Fields, Human](#)

## Prolactin

### Definition

Prolactin is one of the gonadotrophic hormones secreted by the anterior pituitary that stimulates the gonads to release hormones, thereby regulating sexual and reproductive function. Other gonadotrophic hormones include luteinizing hormone and follicle stimulating hormone.

- ▶ [Cancer Pain Management, Opioid Side Effects, Endocrine Changes and Sexual Dysfunction](#)

## Proliferant

### Definition

An injection solution used in prolotherapy that aims to induce inflammation, the release of tissue growth factors and the subsequent deposition of collagen fibers.

- ▶ [Prolotherapy](#)

## Prolonged Acute Pain

- ▶ [Postoperative Pain, Acute-Recurrent Pain](#)

## Prolotherapy

MICHAEL YELLAND

School of Medicine, Griffith University, Logan, QLD, Australia

myelland@bigpond.com

### Synonyms

Sclerotherapy; reconstructive therapy

### Definition

The term ▶ [prolotherapy](#) derives from the Latin word: 'proles' meaning 'growth' or 'offspring'. It refers to a treatment that involves the injection of chemicals designed to strengthen weakened ligaments, based on the premise that these ligaments are a source of instability and chronic pain.

### Characteristics

#### Mechanism

Prolotherapy is based on the premise that much chronic musculoskeletal pain and disability is the result of ligamentous laxity or weakness, and that the correction of this laxity will result in a reduction in pain and disability. The evidence for a direct link between ligamentous laxity and pain/disability is weak. Other mechanisms of action, such as central modulation of pain perception and

denervation of painful structures by the phenol component of prolotherapy solutions (Klein et al. 1993), are just two other possibilities.

The purported mechanism is that '► proliferant' solutions strengthen weakened ligaments and tendinous attachments (entheses) by inducing inflammation, the release of tissue growth factors, and the subsequent deposition of collagen fibres. In osteoarthritis, proliferant solutions are believed to stimulate cartilage growth and repair. There is some evidence from animal and human studies, that the proliferant solutions can induce thickening of ligaments, and increase chondrocyte activity in cartilage (Hackett et al. 1993; Reeves and Hassanein 2000a; Klein et al. 1989).

There are three major classes of proliferants – the ► irritants (phenol, guaiacol and tannic acid), the ► chemotactics (sodium morrhuate), and the ► osmotics (glucose, glycerine and zinc sulphate) (Banks 1991). There is some overlap in their actions. Irritants act by triggering cellular trauma and by attracting macrophages, which ingest them and secrete polypeptide growth factors. Chemotactics attract inflammatory cells. The osmotics cause an osmotic shock to cells, leading to the release of proinflammatory substances. In knee osteoarthritis, it has been proposed that hypertonic glucose acts by stimulating chondrogenesis with enlargement of articular cartilage and repair of full thickness joint cartilage defects (Reeves and Hassanein 2000a).

#### Technique

Injections into ligaments are performed through an anaesthetised wheal of skin over each site, after first contacting bone to confirm their position. Approximately 0.5 – 3 ml of solution is infiltrated at each site, depending on the size of the structures treated. Intravenous analgesia and sedation is often given with more extensive injection regimens. For joint pain and osteoarthritis, the joint cavity is injected along with the tender ligaments, although in some protocols, the joint cavity alone is injected (Reeves and Hassanein 2000a). Analgesics, heat and general activity are recommended for post-injection pain and stiffness, but anti-inflammatory medications are prescribed in order to avoid negating the inflammatory effect of the injections.

#### Applications

Prolotherapists treat patients with pain of mechanical origin, where an assumption is made that the pain is of ligamentous or tenoperiosteal in origin. This is based on a history, which excludes non-mechanical causes, and an examination, which finds tenderness in ligaments consistent with the distribution of the pain. Maps relating the putative structures to the distribution of pain have been drawn by Hackett (Hackett et al. 1993), and are based on observations of pain responses to needling of ligaments and entheses in hundreds of patients.

Treatments are commonly given at 1–2 week intervals, but intervals of up to 2 months have been described. Improvement in symptoms can occur with as little as one treatment, but more typically it occurs slowly over several treatments. Typically, six treatments are given for low back pain, five to six for the knee, hip and shoulder, four to five for the neck or upper back pain, and three for thumb and finger joints.

Vitamin and mineral supplements (including vitamin C, zinc and manganese) are given in some protocols, in the hope that they will facilitate ligament healing (Dhillon 1997; Yelland et al. 2002). Exercises may also be added to improve healing. Some protocols emphasise the importance of resuming activities that had been reduced or ceased due to pain (Klein et al. 1993; Ongley et al. 1987).

#### Efficacy

##### Low back pain

Four trials of prolotherapy for non-specific chronic low back pain have been performed (Table 1). The first three used a glucose/glycerine/phenol/lignocaine proliferant (Klein et al. 1993; Ongley et al. 1987; Dechow et al. 1999). The fourth used a simpler glucose/lignocaine proliferant (Yelland et al. 2004). All trials included only patients with pain for longer than six months, which had failed prior treatments.

In the first trial (Ongley et al. 1987), the proliferant group had an initial manipulation under local anaesthesia, while the saline controls had a sham manipulation under a lower dose of local anaesthesia. All participants had six injection treatments and did exercises for six months. The proportion of participants with greater than 50% reductions in pain/disability scores at six months was significantly higher in the proliferant group (0.88) than in the saline controls (0.39). These results, however, have been construed as evidence of efficacy of manipulation rather than prolotherapy (van Tulder et al. 1997), and as the cumulative neurolytic effect of phenol on treated ligaments (Klein et al. 1993). The second trial compared proliferant solution with lignocaine controls (Klein et al. 1993). Both groups showed improvements in mean pain or disability scores at six months, but the differences between groups did not quite reach statistical significance. However, the proportion with greater than 50% reductions in pain or disability scores at six months was significantly higher in the proliferant group (0.77) than in the lignocaine controls (0.53).

The third trial (Dechow et al. 1999) gave only three injection treatments, with much lower volumes of solution than in the other trials. It used a lignocaine control group. No change in mean pain or disability occurred in either group over six months.

In the fourth trial (Yelland et al. 2004), the proportion of patients with greater than 50% reduction in pain at six

**Prolotherapy, Table 1** Comparison of efficacy data for the four prolotherapy trials on the treatment of chronic low back pain. Note that pain and disability scales for each study have different ranges that are outlined in footnotes to the table

	Ongley et al.		Klein et al.		Dechow et al.		Yelland et al.	
	Proliferant (n=40)	Control (n=41)	Proliferant (n=39)	Control (n=40)	Proliferant (n=36)	Control (n=38)	Proliferant (n=54)	Control (n=56)
>50% reduction in pain/disability at 6 months	88% (disability scores)	39% (disability scores)	77%	53%	Not reported	Not reported	50% (pain) 49% (disability)	46% (pain) 32% (disability)
Mean pain (CI) at inception	3.8 (3.4–4.2)	4.0 (3.6–4.4)	4.9 (4.5–5.3)	4.6 (4.2–4.9)	5.4 (3.8–7.0)	5.3 (3.7–6.9)	5.2 (4.7–5.7)	5.5 (4.9–6.1)
Mean pain (CI) at 6 months	1.5 (1.1–1.9)	3.1 (2.5–3.7)	2.3 (1.8–2.8)	2.9 (2.3–3.4)	5.2 (3.4–7.0)	4.4 (2.6–6.2)	3.1 (2.4–3.8)	3.4 (2.7–4.1)
Mean pain (CI) at 12 months	-	-	-	-	-	-	3.3 (2.5–4.1)	3.7 (2.9–4.4)
Mean disability (CI) at inception	11.5 (9.7–14.1)	11.8 (10.0–13.6)	9.4 (8.3–10.5)	8.3 (7.2–9.3)	35 (17–53)	34 (16–52)	13.7 (12.3–15.0)	14.3 (13.1–15.5)
Mean disability (CI) at 6 months	3.4 (2.0–4.9)	8.3 (6.1–10.5)	4.0 (2.9–5.2)	4.4 (3.1–5.6)	36 (18–54)	35 (17–53)	7.9 (6.0–10.0)	9.3 (7.7–10.9)
Mean disability (CI) at 12 months	-	-	-	-	-	-	8.0 (6.0–10.0)	9.8 (8.1–11.5)
Reduction in pain means at 6 months	60%	23%	53%	38%	4%	17%	39%	38%
Reduction in disability means at 6 months	70%	30%	57%	47%	3%	-3%	42%	35%
Reduction in pain means at 12 months	-	-	-	-	-	-	36%	35%
Reduction in disability means at 12 months	-	-	-	-	-	-	42%	31%

a: VAS pain scale, range 0–8 cm; b: VAS pain scale, range 0–7.5 cm; c: VAS pain scale, range 0–10 cm; d: Combination of Roland–Morris and Waddell's disability questionnaires, range 0–33; e: Oswestry disability scale, range 0–50; f: Modified Roland–Morris questionnaire, range 0–23

months was 0.50, compared with 0.46 for saline controls. The proportions for greater than 50% reduction in disability were 0.46 and 0.32, respectively. Neither of these differed significantly. Responses at 6 months were maintained to 24 months. This trial also showed no additive benefit from lumbar flexion-extension exercises.

### Osteoarthritis of the Knee

There has been only one small trial of prolotherapy for chronic osteoarthritis of the knee (Reeves 2000a). It compared 2-monthly intra-articular injections of glucose-lignocaine with lignocaine alone. Both groups showed significant improvements in pain, subjective swelling and goniometric knee measures at six months. However, only the glucose-lignocaine groups showed a reduction in the number of knee-buckling episodes. A superior response in the glucose-lignocaine group only came to light by combining measures in a multivariate analysis ( $p=0.015$ ). The improvements in pain were

similar to those seen with medications such as NSAIDs, but improvements in flexion range were greater.

### Osteoarthritis of the Hand

A small trial ligament prolotherapy for chronic osteoarthritis of the hand found that pain at rest and with grip, improved more in the glucose-lignocaine group than in the lignocaine group, at 6 months, but not by a significant margin. Improvement in pain with movement of fingers and the finger flexion range improved more significantly in the glucose-lignocaine group (Reeves and Hassanein 2000b).

### Safety

In the trials of prolotherapy for chronic low back pain, transient post-injection soreness and stiffness occurred in the majority of patients. Significant post-injection headache, suggestive of lumbar puncture, occurred in 2–4%. There were no long-term sequelae in any



of these trials. The phenol component of the glucose/glycerine/phenol/lignocaine solution raises the most concern because of its potential neurotoxic effect. At the recommended concentration of 1.25%, phenol is unlikely to damage nerves, but significant complications have been reported due to an error in its concentration in other settings (Reeves and Baker 1992).

Adverse events in knee and hand prolotherapy include temporary discomfort and stiffness, a flare in pain requiring corticosteroid injection; and, in the fingers, a transient restriction of venous return due to pressure effects (Reeves and Hassanein 2000a, Reeves and Hassanein 2000b).

Pneumothorax and non-life threatening allergic reactions have also been reported following prolotherapy (Dorman 1993).

### Indications

Advocates of prolotherapy recommend its use for patients with chronic pain that been unresponsive to other treatments, and for which a ligament source is suspected. It is not indicated for ► **radicular pain** or ► **neuropathic pain**.

The scientific evidence has not shown a superiority of prolotherapy over sham treatments. The effect of the other components of treatment, including the doctor-patient relationship, skin wheals, the physical trauma caused by the needles themselves, and the vitamin and mineral supplements used, have still to be studied. Nevertheless, substantial proportions of patients with chronic musculoskeletal pain do benefit. Although contentious, prolotherapy may, therefore, constitute a viable alternative for patients not responsive to other interventions.

### References

1. Klein RG, Eek BC, DeLong WB, Mooney V (1993) A Randomized Double-Blind Trial of Dextrose-Glycerine-Phenol Injections for Chronic, Low Back Pain. *J Spinal Disord* 6:23–33
2. Hackett GS, Hemwall GA, Montgomery GA (1993) Ligament and Tendon Relaxation Treated by Prolotherapy, 5th edn. Hemwall, Oak Park, Illinois, pp 94–100
3. Reeves KD, Hassanein K (2000a) Randomized Prospective Double-Blind Placebo-Controlled Study of Dextrose Prolotherapy for Knee Osteoarthritis with or without ACL Laxity. *Altern Ther Health Med* 6:68–70, 72–74, 77–80
4. Klein RG, Dorman TA, Johnson CE (1989) Proliferant Injections for Low Back Pain: Histologic Changes of Injected Ligaments and Objective Measurements of Lumbar Spine Mobility Before and After Treatment. *J Neurol Orthop Med Surg* 10:123–126
5. Banks AR (1991) A Rationale for Prolotherapy. *J Orthop Med* 13:54–59
6. Dhillon GS (1997) Prolotherapy in Lumbo-Pelvic Pain. *Australian Musculoskeletal Medicine* 2:17–19
7. Yelland MJ, Glasziou PP, Bogduk N, Schluter P, McKernon M (2004) Prolotherapy Injections, Saline Injections and Exercises for Chronic Low-Back Pain: A Randomized Trial. *Spine* 29:9–16
8. Ongley MJ, Klein RG, Dorman TA, Eek BC, Hubert LJ (1987) A New Approach to the Treatment of Chronic Low Back Pain. *Lancet* 2:143–6
9. Dechow E, Davies RK, Carr AJ, Thompson PW (1999) A Randomized, Double-Blind, Placebo-Controlled Trial of Sclerosing Injections in Patients with Chronic Low Back Pain. *Rheumatology* 38:1255–1259
10. van Tulder MW, Koes BW, Bouter LM (1997) Conservative Treatment of Acute and Chronic Non-Specific Low Back Pain. A Systematic Review of Randomized Controlled Trials of the Most Common Interventions. *Spine* 22:2128–2156
11. Klein RG, Eek BCJ (1997) Prolotherapy: An Alternative Approach to Managing Low Back Pain. *J Musculoskeletal Med* 14:45–49
12. Reeves KD, Hassanein K (2000b) Randomized, Prospective, Placebo-Controlled Double-Blind Study of Dextrose Prolotherapy for Osteoarthritic Thumb and Finger (DIP, PIP, and Trapeziometacarpal) Joints: Evidence of Clinical Efficacy. *J Altern Complement Med* 6:311–20
13. Reeves KD, Baker A (1992) Mixed Somatic Peripheral Phenol Nerve Block for Painful or Intractable Spasticity: A Review of 30 Years of Use. *Am J Pain Manage* 2:205–210
14. Dorman T (1993) Prolotherapy: A Survey. *J Orthop Med* 15:49

## Promoter

### Definition

A region of DNA, upstream from the transcription start site, which contains binding sites for RNA polymerase and a number of proteins that regulate the rate of transcription of the adjacent gene.

► **NSAIDs and Cancer**

## Prophylactic Pain Treatment

► **Pre-Emptive or Preventive Analgesia and Central Sensitisation in Postoperative Pain**

## Prophylactic Therapy

► **Preventive Therapy**

## Propofol

### Definition

Propofol is an intravenous anesthetic acting, at least partly, via GABA<sub>A</sub> receptors.

► **GABA and Glycine in Spinal Nociceptive Processing**

## Propranolol

### Definition

A beta-blocker.

► **Migraine, Preventive Therapy**

## Proprioception

### Definition

Sensory information from the muscles, tendons or joints that give information about limb position, movement and position of that area of the body to the brain.

- ▶ Cordotomy Effects on Humans and Animal Models
- ▶ Trigeminal Brainstem Nuclear Complex, Anatomy
- ▶ Trigeminal Neuralgia, Diagnosis and Treatment

## Propriospinal Neurons

### Definition

Neurons with cell bodies in the spinal cord and axonal projections with sites of termination in other spinal cord sites.

- ▶ Spinal Ascending Pathways, Colon, Urinary Bladder and Uterus

## Prospective Observational Cohort Study

### Definition

A study that starts with the present condition of a population of individuals and observes them into the future.

- ▶ Low Back Pain, Epidemiology

## Prostacyclin

### Definition

Prostacyclin is a prostaglandin-like material that is synthesized mainly by a COX-2-dependent process in cells lining blood vessels and in smooth muscle. Prostacyclin causes vasodilation and decreases the aggregation of platelets, thereby inhibiting the clotting of blood.

- ▶ NSAIDs and their Indications

## Prostodynia

### Definition

Perineal pain, often felt in the region of the prostate when sitting, typical of prostatitis-induced pain, but without infection, often caused by myofascial trigger points in the pelvic floor musculature.

- ▶ Chronic Pelvic Pain, Musculoskeletal Syndromes

## Prostaglandin E2

- ▶ PGE2

## Prostaglandin Endoperoxide Synthase

- ▶ COX-1 and COX-2 in Pain
- ▶ Cyclooxygenases in Biology and Disease

## Prostaglandin H Synthase

- ▶ COX-1 and COX-2 in Pain
- ▶ NSAIDs, COX-Independent Actions
- ▶ NSAIDs, Mode of Action

## Prostaglandins

### Definition

Prostaglandins are endogenous mediators that are synthesized from arachidonic acid. These hormone-like, lipid-soluble regulatory molecules have a variety of effects in the body, including potentiation of the effects of painful mediators, the production of fever, smooth muscle contraction and relaxation, kidney regulation, neuronal activity and reproduction. Prostaglandins are also involved in the processes of inflammation.

- ▶ Cancer Pain, Animal Models
- ▶ COX-1 and COX-2 in Pain
- ▶ NSAIDs and their Indications
- ▶ Prostaglandins, Spinal Effects

## Prostaglandins in Inflammatory Nociceptor Sensitisation

- ▶ Inflammatory Nociceptor Sensitisation, Prostaglandins and Leukotrienes

## Prostaglandins, Spinal Effects

HORACIO VANEGAS<sup>1</sup>, HANS-GEORG SCHAIBLE<sup>2</sup>

<sup>1</sup>Instituto Venezolano de Investigaciones Científicas (IVIC), Caracas, Venezuela

<sup>2</sup>Institute for Physiology, Friedrich Schiller University, Jena, Germany

hvanegas@ivic.ve,

hans-georg.schaible@mti.uni-jena.de

## Synonyms

Spinal cord; dorsal horn; dorsal root ganglion; primary afferent; prostanoids; eicosanoids; Autacoids; Spinal Effects of Prostaglandins

## Definition

Prostaglandins (PGs) are derivatives of arachidonic acid, a 20-carbon fatty acid that generally originates from cell membranes by the action of the phospholipase A<sub>2</sub> enzyme family. Arachidonic acid is acted upon by enzymes commonly called ► [cyclooxygenases](#) (COX-1 and COX-2) to yield PGH<sub>2</sub>, which is subsequently transformed into PGD<sub>2</sub>, PGE<sub>2</sub>, PGF<sub>2α</sub> and PGI<sub>2</sub> (prostaglandin). Spinal PGs are key players in the processing and transmission of pain signals, particularly during inflammation of peripheral tissues.

## Characteristics

### Introduction

In the spinal cord, PGs may be synthesized and released by the incoming primary afferents as well as by intrinsic spinal neurons, glial cells and vascular cells. Primary afferents and intrinsic spinal cells are in turn a target for PG actions. Therefore, the effects of spinal PGs have been studied on primary afferent neurons in the ► [dorsal root ganglion](#) (DRG) as well as on the spinal cord itself (for recent reviews see Svensson and Yaksh 2002; Vanegas and Schaible 2001).

Under basal conditions, both COX-1 mRNA and COX-2 mRNA are present in DRG neurons of small to medium size, a class which includes the nociceptive afferents. In the spinal cord, COX-1 and -2 mRNA as well as COX-1 and -2 proteins are expressed during basal conditions. In particular, COX-2 has been found in neurons of all laminae and in white matter glial cells. Basal release of PGD<sub>2</sub>, PGE<sub>2</sub>, PGF<sub>2α</sub> and PGI<sub>2</sub> occurs in DRGs and spinal cord. In addition, COX-2 is an inducible enzyme. Acute and chronic peripheral inflammation, spinal cord injury, and the spinal action of glutamatergic agonists, dynorphin, interleukins or nuclear factor kappa B, significantly increase the expression of COX-2 and the release of PGE<sub>2</sub> and PGI<sub>2</sub> (Ghilardi et al. 2004; Koetzner et al. 2004; Lee et al. 2004; Maihöfner et al. 2000; Samad et al. 2001; Svensson and Yaksh 2002; Tegeder et al. 2001; Vanegas and Schaible 2001; Yaksh et al. 2001). These PGs may arise from both primary afferents and from spinal intrinsic neurons and glial cells.

Once released into the intercellular space, PGs bind to specific membrane receptors on primary afferent fibers and intrinsic spinal cells (Vanegas and Schaible 2001). The receptors for PGD, PGE, PGF and PGI are called DP, EP, FP and IP receptors, respectively. There are four types of EP receptors (EP<sup>1</sup>-EP<sup>4</sup>) as well as some EP3 subtypes. All PG receptors are G-protein-coupled molecules with seven transmembrane domains. Their activation triggers intracellular signals which lead to

increases of intracellular calcium (EP1 and an EP3 subtype), increases of cAMP (EP2, EP4, IP and an EP3 subtype), and increases of inositol phosphates (FP, IP and an EP3 subtype). These actions lead to cellular activation. In contrast, the EP3α receptor subtype mediates a decrease in cAMP and, consequently, cellular inhibition.

Induction of COX-2 expression and the subsequent increase in PG synthesis and release are critical factors in the development of spinal cord hyperexcitability (► [central sensitization](#)) that results from peripheral inflammation and trauma, and significantly contributes to the resulting hyperalgesia. This is supported, in general, by the following findings (Vanegas and Schaible 2001): a) induction of COX-2 in primary afferents and spinal cord has been found in models of inflammation and trauma; b) PGs are released in the spinal cord in models of inflammation and trauma; c) PGs induce neuronal hyperexcitability and the release of neuroactive compounds in DRG cells and spinal cord; d) application of PGs to the spinal cord in freely moving animals induces hyperalgesia and allodynia, which are typical of central sensitization; e) there is close correlation between manipulations that induce spinal release of PGs and manipulations that induce hyperalgesia and allodynia; and f) spinal administration of COX inhibitors (see ► [COX-1 and COX-2 in Pain](#) and ► [Cyclooxygenases in Biology and Disease](#)) reduces manifestations of central sensitization in various experimental models and in humans.

### Ionic Currents, Release of Mediators and Synaptic Transmission

PGs can have a direct effect upon neurons, and also facilitate the effect of other mediators. Primary nociceptive afferents express both TTX-sensitive and TTX-resistant sodium currents, in addition to other voltage-dependent ion currents. PGE<sub>2</sub> enhances TTX-resistant sodium currents, and PGE<sub>2</sub> and PGI<sub>2</sub> diminish potassium currents. As a consequence, primary nociceptive afferents show a decreased threshold and an increased firing rate. These effects are mediated by the cAMP-protein kinase A (PKA) cascade. PGs also facilitate a voltage-gated calcium (inward) current (Vanegas and Schaible 2001). The PG-induced increase in primary afferent excitability, firing rate and calcium entry may be the reason why PGs increase release of glutamate, aspartate, substance P, CGRP and nitric oxide in the spinal cord. Additionally, PGE<sub>2</sub> increases the expression of substance P's NK1 receptor in primary afferent neurons, also by way of the cAMP-PKA cascade (Segond von Banchet et al. 2003). As a consequence, a larger proportion of these neurons show an increase in intracellular calcium when exposed to substance P. In neurons of laminae II-III, where nociceptive afferents abundantly terminate, PGE<sub>2</sub> application induces an increase in glutamatergic miniature excitatory postsynaptic currents (EPSCs),

which indicates an enhancement of spontaneous glutamate release from presynaptic terminals (Minami et al. 1999). PGE<sub>2</sub>, and to some extent PGF<sub>2</sub> α, also induces an increase in the glutamate-dependent EPSCs evoked by electrical stimulation of presynaptic axons, which indicates a sensitization of pre- and/or postsynaptic elements. In agreement with behavioral experiments (see below), neonatal treatment with capsaicin, which destroys nociceptive primary afferents, reduces the sensitizing effect of PGE<sub>2</sub> upon evoked EPSCs. All these effects of PGs upon primary afferents certainly contribute to the enhancement of spinal excitability, and the resulting hyperalgesia during peripheral inflammation and trauma.

PGs also have direct effects upon spinal postsynaptic neurons. The EP2 receptor has been located in laminae IV–VI of the dorsal horn (Vanegas and Schaible 2001) and, through this receptor, PGE<sub>2</sub> excites neurons located here because it induces an inward sodium current (Baba et al. 2001). Furthermore, PGE<sub>2</sub> reduces glycinergic synaptic inhibition in the dorsal horn (Reinold et al. 2005), also via the EP2 receptor. Both the increase in excitation and the decrease in inhibition must, of course, contribute to hyperalgesia.

In addition, several PGs may facilitate the action of other neuroactive substances (Vanegas and Schaible 2001). For example, PGs facilitate bradykinin-induced release of substance P and CGRP. This is not surprising since activation of PKA is a common factor in the effect of PGs and bradykinin, and since induction of substance P and CGRP release by bradykinin is at least partly mediated by PG synthesis. PGs also facilitate capsaicin-induced calcium inflow, also via PKA. This is probably why PGs facilitate capsaicin-induced release of substance P and CGRP in the spinal cord, a phenomenon that may lead to nociceptive behavior in freely moving animals and is exacerbated during peripheral inflammation.

All these effects of PGs lead to an enhanced elicitation of pain signals and an increase in their synaptic transfer in the spinal cord.

#### Neuronal Responses to Natural Stimuli

Action potential discharges by spinal nociceptive neurons constitute the drive for segmental and suprasegmental nociceptive reflexes, as well as for the thalamocortical transmission of pain signals. A study of such discharges is therefore essential for understanding the influence of PGs upon the mechanisms of pain and hyperalgesia. PGE<sub>2</sub> induces an increase in the responses of spinal nociceptive neurons to innocuous and noxious stimulation of, for example, the knee joint (Vasquez et al. 2001). This mimics inflammation-induced spinal hyperexcitability (Schaible and Grubb 1993) and fits in with the proposed role of PGs in central sensitization (see above). The facilitatory influence of PGs, however, is subject to plasticity, and seems only to

be important for the initiation of spinal sensitization. Once the inflammation of a peripheral tissue is fully developed, PGE<sub>2</sub> application to the spinal cord has negligible effects upon the enhanced neuronal discharges to innocuous or noxious stimulation. This may in part be related to down-regulation of PG receptors. Indeed PGE<sub>2</sub> binding to membranes obtained from the spinal cord of animals with inflammation is 30% reduced, and exposing DRG neurons to PGE<sub>2</sub> for 72 h decreases PGE<sub>2</sub> binding. However, peripheral inflammation actually brings about a change in the relative role of the various PG receptor types. Before inflammation, spinal application of EP1, EP2 and EP4 agonists increases spinal neuronal firing to innocuous and noxious stimulation, whereas EP3α receptor agonists have no effect (Bär et al. 2004). However, when the inflammation is fully developed EP2 and EP4 agonists have no effect, like PGE<sub>2</sub>, and EP3 agonists now exert an inhibitory effect upon hyperalgesia. This means that the actions of COX, PGs and COX inhibitors prior to inflammation may be significantly changed during inflammation, a fact that has considerable importance for the treatment of inflammatory pain.

#### Behavioral Effects of Direct Spinal Application of PGs

In general, intrathecal PG administration to normal and freely moving rats or mice has elicited an increase in the responses to noxious stimuli (hyperalgesia), as well as aversive and/or aggressive responses to touch (allodynia) (Vanegas and Schaible 2001). This fits in with the effects of PGs upon nociceptive afferents and spinal neurons (see above). Somatic hyperalgesia was evidenced, for example, as a decrease in the time it takes for an animal to withdraw from contact with a hot object. Visceral hyperalgesia was evidenced, for example, as an increase in the number of contractions of the abdominal wall (writhing) elicited by intraperitoneal injection of acetic acid.

Intrathecal PGE<sub>2</sub> and PGD<sub>2</sub> elicit hyperalgesia and allodynia, and both phenomena are strongly attenuated in animals that have been neonatally injected with capsaicin. Therefore, the effects of PGE<sub>2</sub> and PGD<sub>2</sub> might totally or partially be exerted upon nociceptive afferents, except that no DP receptors have been found in primary afferents. EP1 and EP3 receptors in these afferents, and EP2 receptors in spinal neurons, might be involved in these effects. Glutamate, substance P, nitric oxide, cGMP and catecholamines are also involved in the behavioral effects of PGE<sub>2</sub> (Vanegas and Schaible 2001).

#### Concluding Remarks

Given their role in hyperalgesia, particularly during inflammation, the effects of PGs in the spinal cord have been intensively investigated, as have the spinal actions of COX inhibitors. Although the specificity of PG effects has been difficult to evaluate, because good ago-



nists and antagonists are still lacking, there is general agreement that PGs significantly contribute to the increase in spinal neuronal excitability caused by inflammation and trauma, and that this in turn is a fundamental cause of pain and hyperalgesia. To what extent the glial cells are involved in this hyperexcitability is presently unclear. It is clear, however, that the effects of spinal PGs during induction of hyperexcitability may radically change once this process is fully established, and that this must have important consequences for the interpretation and treatment of hyperalgesia.

## References

1. Baba H, Kohno T, Moore KA et al. (2001) Direct Activation of Rat Spinal Dorsal Horn Neurons by Prostaglandin E<sub>2</sub>. *J Neurosci* 21:1750–1756
2. Bär K-J, Natura G, Telleria-Diaz A et al. (2004) Changes in the Effect of Spinal Prostaglandin E<sub>2</sub> during Inflammation: Prostaglandin E (EP<sup>1</sup>-EP<sup>4</sup>) Receptors in Spinal Nociceptive Processing of Input from the Normal or Inflamed Knee Joint. *J Neurosci* 24:642–651
3. Ghilardi JR, Svensson CI, Rogers SD et al. (2004) Constitutive Spinal Cyclooxygenase-2 Participates in the Initiation of Tissue Injury-Induced Hyperalgesia. *J Neurosci* 24:2727–2732
4. Koetzner L, Hua X-Y, Lai J et al. (2004) Nonopioid Actions of Intrathecal Dynorphin Evoke Spinal Excitatory Amino Acid and Prostaglandin E<sub>2</sub> Release Mediated by Cyclooxygenase-1 and -2. *J Neurosci* 24:1451–1458
5. Lee K-M, Kang B-S, Lee H-L et al. (2004) Spinal NF-κB Activation Induces COX-2 Upregulation and Contributes to Inflammatory Pain Hypersensitivity. *Eur J Neurosci* 19:3375–3381
6. Maihöfner C, Tegeder I, Euchenhofer C et al. (2000) Localization and Regulation of Cyclo-Oxygenase-1 and -2 and Neuronal Nitric Oxide Synthase in Mouse Spinal Cord. *Neuroscience* 101:1093–1108
7. Minami T, Okuda-Ashitaka E, Hori Y et al. (1999) Involvement of Primary Afferent C-Fibres in Touch-Evoked Pain (Allodynia) Induced by Prostaglandin E<sub>2</sub>. *Eur J Neurosci* 11:1849–1856
8. Reinold H, Ahmadi S, Depner UB et al. (2005) Spinal Inflammatory Hyperalgesia is Mediated by Prostaglandin E Receptors of the EP<sub>2</sub> Type. *J Clin Invest* 115:673–679
9. Samad T, Moore KA, Sapirstein A et al. (2001) Interleukin-1β-Mediated Induction of COX-2 in the CNS Contributes to Inflammatory Pain Hypersensitivity. *Nature* 410:471–475
10. Schaible H-G, Grubb BD (1993) Afferent and Spinal Mechanisms of Joint Pain. *Pain* 55:5–54
11. Segond von Banchet G, Scholze A, Schaible H-G (2003) Prostaglandin E<sub>2</sub> Increases the Expression of the Neurokinin<sub>1</sub> Receptor in Adult Sensory Neurons in Culture: A Novel Role for Prostaglandins. *Br. J Pharmacol* 139:672–680
12. Svensson CI, Yaksh TL (2002) The Spinal Phospholipase-Prostanoid Cascade in Nociceptive Processing. *Annu Rev Pharmacol Toxicol* 42:553–583
13. Tegeder I, Niederberger E, Vetter G et al. (2001) Effects of Selective COX-1 and -2 Inhibition on Formalin-Evoked Nociceptive Behavior and Prostaglandin E<sub>2</sub> Release in the Spinal Cord. *J Biochem* 79:777–786
14. Vanegas H, Schaible H-G (2001) Prostaglandins and Cyclooxygenases in the Spinal Cord. *Prog Neurobiol* 64:327–363
15. Vasquez E, Bär K-J, Ebersberger A et al. (2001) Spinal Prostaglandins are Involved in the Development but not the Maintenance of Inflammation-Induced Spinal Hyperexcitability. *J Neurosci* 21:9001–9008
16. Yaksh TL, Dirig DM, Conway CM et al. (2001) The Acute Antihyperalgesic Action of Nonsteroidal, Antiinflammatory Drugs and Release of Spinal Prostaglandin E<sub>2</sub> is Mediated by the Inhibition of Constitutive Spinal Cyclooxygenase-2 (COX-2) but not COX-1. *J Neurosci* 21:5847–5853

## Prostanoids

### Definition

Prostanoids are generated from arachidonic acid in response to a wide range of different stimuli. Once arachidonic acid has been liberated, cyclooxygenases catalyze the formation of the cyclic endoperoxides, prostaglandin (PG)G<sub>2</sub> and PGH<sub>2</sub>, by oxygenation and subsequent cyclization of arachidonic acid. The type of prostanoid that is produced from PGH<sub>2</sub> is largely dependent on the enzymes present in the individual cells. The term prostanoid encompasses related compounds such as the prostaglandins (PGD<sub>2</sub>, PGE<sub>2</sub>, PGF<sub>2</sub>α), thromboxane A<sub>2</sub> (TXA<sub>2</sub>), and prostacyclin (PGI<sub>2</sub>).

- ▶ COX-1 and COX-2 in Pain
- ▶ Neutrophils in Inflammatory Pain
- ▶ Prostaglandins, Spinal Effects

## Protective Analgesia

- ▶ Postoperative Pain, Pre-Emptive or Preventive Analgesia

## Protein Kinase A

P

### Synonyms

PKA

### Definition

Cyclic AMP (cAMP), which is generated by adenylate cyclase (AC) activation, activates the Protein Kinase A (PKA) by binding to the regulatory subunits. PKA has been implicated in persistent pain mechanisms both in the peripheral and central nervous system. The sensitization of primary afferent neurons that occurs in the setting of inflammation has been shown to involve cAMP- and PKA-dependent mechanisms.

- ▶ ERK Regulation in Sensory Neurons during Inflammation

## Protein Kinase C

### Synonyms

PKC

### Definition

Protein Kinase C (PKC) is activated by the intracellular lipid second messengers phosphatidylserine and di-

acylglycerol (DAG), and to some extent by  $\text{Ca}^{2+}$ . There is substantial evidence supporting a role for PKC expressed in dorsal horn neurons in regulating pain hypersensitivity in a number of different pain models. The  $\epsilon$  isoform of PKC plays a major role in peripheral sensitization of the peripheral terminals of nociceptors.

- ▶ ERK Regulation in Sensory Neurons during Inflammation
- ▶ TRPV1 Modulation by p2Y Receptors
- ▶ TRPV1 Modulation by PKC

## Proteinase-Activated Receptors

### Synonyms

PAR

### Definition

Proteinase-activated receptors (PAR) are seven-transmembrane-spanning receptors coupled to G-proteins. Proteinases hydrolyze, at a specific cleavage site, the extracellular N-terminus of the receptor, whereby a new N terminus is exposed that acts as a tethered ligand, which binds intramolecularly to initiate cellular signals. Four PARs have been cloned, of which PAR-1 and PAR-2 are localized on peptidergic afferents. Activation of PAR-2 by trypsin or mast-cell tryptase is an important mechanism to stimulate and sensitize nociceptive afferents.

- ▶ Neuropeptide Release in the Skin

## Protein-Calorie Malnutrition

### Definition

PCM stems from the inadequate intake of carbohydrate, protein, and fat to meet metabolic requirements and/or the reduced absorption of macronutrients. PCM in cancer results from multiple factors most often associated with anorexia, cachexia, and the early satiety sensation frequently experienced. These factors range from altered tastes to a physical inability to ingest or digest food, leading to reduced nutrient intake.

- ▶ Cancer Pain, Evaluation of Relevant Comorbidities and Impact

## Proteoglycan

### Definition

A protein containing one or more covalently linked and usually sulfated polysaccharides called glycosaminoglycans.

- ▶ Diencephalic Mast Cells

## Provocation Discogram

- ▶ Cervical Discography
- ▶ Lumbar Discography

## Provocative

### Definition

Discography: injection of a vertebral disc leading to reproducible pain.

- ▶ Cervical Discography
- ▶ Chronic Low Back Pain, Definitions and Diagnosis
- ▶ Lumbar Discography

## Provocative Maneuver

- ▶ Lower Back Pain, Physical Examination

## Proximal Diabetic Neuropathy

- ▶ Diabetic Neuropathies

## Pruriception

### Definition

The sensory modality of itch or behavior related to itch (from the Latin word *prurire*, to itch).

- ▶ Allodynia and Alloknosis

## Pruriceptive

### Definition

Related to the sensation of itch or itch behavior. A pruriceptive stimulus elicits itch and scratching behavior. A pruriceptive neuron mediates the sensation of itch (from the Latin word *prurire*, to itch).

- ▶ Allodynia and Alloknosis

## Pruritic Stimulus

### Definition

A stimulus that produces a sensation of itch.

- ▶ Spinothalamic Tract Neurons, Central Sensitization

## Pruritus

### Definition

Pruritus refers to itching, taken from the Latin word *prurire*, to itch.

- ▶ Cutaneous Field Stimulation
- ▶ Itch
- ▶ Itch/Itch Fibers
- ▶ Postoperative Pain, Appropriate Management

## PSDC

- ▶ Postsynaptic Dorsal Column Neurones

## PSDC Projection

- ▶ Postsynaptic Dorsal Column Projection, Anatomical Organization

## Pseudoaffective Response

### Definition

An alternative spelling is „pseudoaffective.“ A term coined by Sherrington in 1890’s referring to reflex responses suggestive of emotional responses to painful stimuli. Initially characterized in decerebrate cats they included cardiovascular reflexes, visceromotor reflexes, flexion-withdrawal reflexes and vocalization. Examples include changes in heart rate, blood pressure, respiratory rate, and activation of sweat glands.

- ▶ Nocifensive Behaviors, Gastrointestinal Tract
- ▶ Nocifensive Behaviors of the Urinary Bladder
- ▶ Visceral Pain Model, Urinary Bladder Pain (Irritants or Distension)

## Pseudoaddiction

### Definition

Pseudoaddiction is a term coined for such patients who seek the drug [usually opiates or analgesics] in the presence of inadequate pain relief, and who show no such preoccupation once the dose is escalated and comfort has been reached. May accompany an addictive disorder.

- ▶ Cancer Pain, Evaluation of Relevant Comorbidities and Impact
- ▶ Psychiatric Aspects of the Management of Cancer Pain

- ▶ Visceral Pain Model, Lower Gastrointestinal Tract Pain

## Pseudoptosis

### Definition

Pseudoptosis refers to decreased palpebral width that is not paretic in nature.

- ▶ Sunct Syndrome

## Pseudotumor Cerebri

### Definition

Pseudotumor Cerebri is a neurologic manifestation of Behçet’s disease.

- ▶ Headache Due to Arteritis

## PSL Model

- ▶ Neuropathic Pain Model, Partial Sciatic Nerve Ligation Model
- ▶ Partial Sciatic Nerve Ligation

## Psoas Compartment

### Definition

The Psoas Compartment is a potential space in the psoas muscle through which the lumbar plexus travels.

- ▶ Postoperative Pain, Regional Blocks

## Psoriatic Arthritis

### Definition

Psoriatic arthritis is an inflammatory arthritis that develops in about 5 to 8 percent of patients with psoriasis, a disease that is characterized by sharply demarcated inflammatory plaques on the skin.

- ▶ NSAIDs and their Indications
- ▶ Sacroiliac Joint Pain

## Psychiatric Aspects of Litigation and Pain

GEORGE MENDELSON

Department of Psychological Medicine, Monash University and Caulfield Pain Management & Research Centre, Caulfield General Medical Centre, Caulfield, VIC, Australia  
george.mendelson@med.monash.edu.au

### Definition

#### The Concept of "Compensation Neurosis"

The concept of "neurosis" has been traditionally invoked with reference to personal injury litigants who complain of physical symptoms for which there is no objectively demonstrable organic basis. Very frequently, such symptoms include the complaint of persistent pain. Terms such as "compensation neurosis" and "accident neurosis" were introduced to refer to this type of clinical presentation, with the expectation that all the symptoms complained of will resolve following the finalization of litigation or cessation of compensation payments. However, there is no empirical support for either the view that there is a specific diagnosis of "compensation neurosis", or that after litigation is finalized the individual will return to his or her pre-accident level of functioning and resume work (Mendelson 1995).

#### The Relationship between Compensation Status and Persistent Pain

There are three approaches that can be used to examine the possible relationship between compensation and chronic pain, and these will be briefly reviewed:

- a) comparison of the described pain experience of litigants (or those receiving compensation payments) with that of pain patients with similar complaints who are not involved in litigation and/or not receiving compensation benefits;
- b) comparison of treatment response between groups of pain patient with similar clinical syndromes, where members of one group are involved in litigation or receive compensation, and the others do not;
- c) examination of the presentation and duration of chronic pain complaints under different systems of compensation or access to common law litigation.

#### Compensation Status and Pain Description

Studies of the impact of compensation benefits on the described characteristics of pain have generally compared patients with chronic pain receiving compensation and those who had no such claims; the two groups are compared on pain measures such as duration, intensity, locus of pain, pain description, and the quality of pain. Most results of such comparisons have not shown significant differences between the compensation and non-

compensation groups on any clinical characteristic of pain (Mendelson 1984; Melzack et al. 1985).

A minority of studies, however, have found that involvement in litigation does influence pain reports. In one study comparing patients with "whiplash" involved in litigation with similar patients whose litigation had been finalized, the authors concluded that "the rather robust effect of litigation status on pain reports" could be attributed "to the potential mediational role of the stress of litigation".

Similar comparisons of patients with chronic pain have been undertaken on measures of illness behaviour, using the Illness Behaviour Questionnaire (IBQ). No differences between compensation and no-compensation groups were found in the mean group scores on the scales of the IBQ, or on the Conscious Exaggeration scale of the IBQ which, it had been asserted, can detect deception with the object of financial gain among chronic pain patients involved in litigation (Mendelson 1987).

#### The Effect of Compensation on Pain Treatment Outcome

Studies of the effect of compensation on treatment outcome of chronic pain have been reviewed elsewhere (Mendelson 1983), and were in general agreement that patients in receipt of compensation and/or involved in litigation, had a worse prognosis than those with similar complaints who were neither in receipt of such payments nor involved in litigation. It is also generally considered that litigants and those receiving compensation payments show reduced motivation for effective treatment.

In one study, those injured at work who were receiving pain-contingent benefits, were away from work for a mean of 14.2 months, as compared with 4.9 months for those with similar complaints not in receipt of compensation payments. The authors concluded that "the financial rewards of compensation" were responsible for the prolonged work absence of those injured at work. Comparisons of workers' compensation and non-workers' compensation patients, who had undergone surgery, showed that residual symptoms were significantly more common in those receiving compensation benefits. Several studies have also found that there was no relationship between physical status and work disability status following surgery, and it was postulated that receipt of compensation was the cause of failure to return to work.

In a population-based epidemiological study, Blyth et al. (2003) found that a significant proportion of patients with chronic pain were able to work, indicating that complete relief of pain may not be an essential therapeutic target. The authors also found that litigation, mainly work-related, for chronic pain was strongly associated with higher levels of pain-related disability, even after taking into account other factors associated with poor functional outcomes.



Although most published studies have reported that the receipt of compensation has a negative effect on treatment outcome and prolongs work disability, it has been demonstrated that specific treatment programmes can reduce the likelihood of progression to pain chronicity following work injuries. It has been shown that a treatment programme for low back pain, which incorporates behavioural methods, is more effective than traditional management. Thus, the adverse effect of compensation on the outcome of treatment for acute pain following work injuries, can be modified by specific programmes that stress early mobilization and return to the work-place, appropriate activity and exercises, and avoidance of other factors that might promote “learned pain behaviour” (Tyrer 1986).

### The Compensation System and Chronic Pain

Several studies have compared the impact of compensation on chronic pain complaints by examining data from New Zealand, where in 1974 both the traditional workers’ compensation scheme and the right to sue in civil courts at common law for personal injuries were abolished, and comparing the New Zealand experience with the traditional common law systems and workers’ compensation schemes in the United States and Australia. In the US and Australia, personal injury claims can be litigated in court, with the plaintiff seeking damages from the wrongdoer, and similarly allow an injured worker to sue the employer if negligence can be established as having caused or contributed to the injury.

These studies showed that in New Zealand a significantly smaller proportion of those injured in accidents had chronic pain, and similarly, the period of work incapacity was significantly shorter in the New Zealand sample.

The relationship between societal expectations concerning illness and illness behaviour was explored by Balla (1982) in an analysis of the “late whiplash syndrome”, as manifested in Australia and in Singapore. A prospective study of Singapore patients with an acute whiplash injury, whose “original acute complaints of pain in the head and neck region were the same as seen in Australia”, showed that the symptoms resolved and that the patients did not develop chronic neck pain.

On the basis of these findings, Balla postulated that the “late whiplash syndrome” is a “culturally constructed illness behaviour based on indigenous categories and social structural determinants.” He also noted that in Australia such a condition had been accepted as compensable by the courts, and that this provided a positive reinforcement for “illness behaviour” following the acute phase of “whiplash”.

### Characteristics

#### Chronic Pain, Litigation, and Psychiatric Diagnosis

When litigants, and/or compensation recipients, complain of chronic pain or disability that cannot be ex-

plained on the basis of objectively demonstrable organic abnormality, they are often referred for a psychiatric assessment. The question is then posed as to whether the individual is suffering from a mental disorder that could “explain” the complaint of persistent pain and the alleged resultant disability.

The “classification of chronic pain” published by the International Association for the Study of Pain (Merskey and Bogduk 1994) recognises “pain of psychological origin” (Code I-16) among the group of “relatively generalized syndromes”. “Pain of psychological origin” is further classified as arising through four different mechanisms: through muscle tension; delusional or hallucinatory pain; hysterical, conversion, or hypochondriacal pain; and pain associated with depression.

If the patient has pain associated with a clinically significant psychiatric illness, such as major depression or psychosis, then specific treatment of the mental disorder is required; with appropriate treatment, the mental illness and pain should resolve. More commonly, the patient with chronic pain might have some symptoms that overlap those found in mental disorders, such as sleep disturbance or dysphoria, but the nature of the psychiatric symptoms elicited and findings on mental state examination do not warrant the formal diagnosis of a specific mental disorder such as a depressive illness, a generalized anxiety disorder, or a psychotic condition.

In the absence of a specific mental disorder that could explain the presence of pain not attributable to an objectively demonstrable organic lesion, or pain that is disproportionate to the extent of any objectively demonstrable pathology or evidence of continuing physical injury, clinicians sometimes use a variety of terms such as psychogenic pain disorder, somatoform pain disorder, pain disorder (American Psychiatric Association (2000) or learned pain behaviour (Tyrer 1986).

The most recent edition of the Diagnostic and Statistical Manual of Mental Disorders (American Psychiatric Association 2000) includes the diagnosis of “Pain Disorder”, with three subtypes: “Pain Disorder Associated With Psychological Factors”, “Pain Disorder Associated With Both Psychological Factors and a General Medical Condition”, and “Pain Disorder Associated With a General Medical Condition”. The latter “*is not considered a mental disorder and is coded on Axis III*. It is listed in this section to facilitate differential diagnosis” (italics in original).

The diagnosis of “Pain Disorder Associated With Psychological Factors” requires that “psychological factors are judged to have the major role in the onset, severity, exacerbation, or maintenance of the pain. (If a general medical condition is present, it does not have a major role in the onset, severity, exacerbation, or maintenance of the pain.) This type of Pain Disorder is not diagnosed if criteria are also met for Somatization Disorder.”

The diagnosis of “Pain Disorder Associated With Both Psychological Factors and a General Medical Con-

dition” is made if “both psychological factors and a general medical condition are judged to have important roles in the onset, severity, exacerbation, or maintenance of the pain”. The relevant general medical condition or anatomical site of the pain is to be coded on Axis III.

In the assessment of personal injury litigants or compensation recipients with chronic pain, it is uncommon for such a patient to acknowledge the presence of any pre-injury emotional problems or psychological conflict that could “explain” the persistence of disproportionate pain and resultant disability following the injury. In the absence of any understandable intrapsychic basis for the “psychogenesis” of chronic pain in such patients, it is usually postulated that the pain persists beyond the usual duration of healing because of environmental factors that reinforce the pain complaints and pain behaviour.

In the context of the evaluation of a patient with chronic pain – where the pain cannot be attributed to a physical lesion – in a medico-legal setting, it is inaccurate to make the diagnosis of Pain Disorder, which is a mental disorder, unless there is some specific evidence of pre-existing intrapsychic conflict or psychological disturbance. In such a situation, the presentation of a somatic complaint (i.e. pain) allows the individual to avoid acknowledging and dealing with the conflict, and thus also avoid the experience of anxiety that this would evoke (primary gain).

For that reason, the term “learned pain behaviour” (Tyrer 1986) might provide a more accurate description of the psychological mechanisms that lead to the persistence of pain following an injury in compensable circumstances.

Tyrer has described factors that promote pain complaints and pain behaviour, such as sympathetic attention from those of importance to the individual, or permission to avoid unpleasant activities. Block et al. (1980) have demonstrated empirically that patients with “sympathetic spouses” showed more marked pain behaviour when they were told that the spouse was observing the interview through a one-way mirror.

In general, environmental factors that might reinforce pain behaviour include the availability of medications prescribed on a “pain contingent” basis as well as, in some cases, availability or entitlement to “pain contingent” compensation benefits. Such factors, which tend to promote pain complaints and pain behaviour, have been termed “secondary gains.”

Finally, “tertiary gain”, which might also perpetuate pain complaints, is that which is obtained by others in the patient’s environment who obtain some form of benefit from the patient’s continuing sick role. Tertiary gain may accrue to spouses, children and relatives of the patient, as well as to that individual’s medical and paramedical attendants and lawyers. It has been commented that a family that is “fearful, suspicious or highly competitive” might undermine a rehabilitation programme, and the same authors have emphasised the need to identify

such families and design intervention strategies, which will minimise the risk that such a family may adversely affect the patient’s progress towards recovery.

Bayer (1985) has provided an illuminating discussion of the mechanisms of self deception in patients with pain of non-organic origin, discussing patterns of abnormal illness behaviour shown by such patients in relation to cognitive dissonance theory. This approach also helps to explain the mental processes which lead to disproportionate disability among individuals who have minimal, or no, discernible physical basis for the complaint of pain.

Fibromyalgia following trauma might be considered a special example of Pain Disorder Associated With Both Psychological Factors and a General Medical Condition. In an editorial, Wolfe (2000) described the case vignette of a patient who had been diagnosed with fibromyalgia by two “of the best fibromyalgia experts in the US (well known authors and clinicians)”. Subsequent surveillance and a “detailed review of medical and nonmedical records” caused the clinicians to re-view their diagnosis and to conclude “that the patient was malingering”. Wolfe wrote that “observations such as this call into question the validity and reliability of the fibromyalgia evaluations in the medico-legal setting”.

Iatrogenic factors have also been implicated in contributing to the entrenchment of pain complaints in the absence of an organic disorder, in particular where the diagnosis of fibromyalgia had been made.

In the area of psychiatric evaluation of chronic pain patients in receipt of, or seeking, compensation also lies the question frequently asked of the psychiatrist by solicitors or insurance agents, namely “does this person have real pain or is he/she malingering.” The recent introduction of technological equipment in an attempt to assess physical impairment “objectively” has given rise to claims that such equipment can be used to “catch malingerers.” This is discussed in the next section.

#### **Alleged Malingering of Chronic Pain**

Complaints of chronic pain in the setting of personal injury litigation not infrequently give rise to the allegation that the plaintiff is either exaggerating the severity of the pain and the resultant alleged disability, or is malingering. It needs to be emphasised that malingering is neither a medical nor a psychiatric diagnosis. Malingering is fraud within a medical context, and thus it is an act that is properly assessed by a tribunal or a court of law. The range of contemporary clinical settings in which malingering may need to be considered has been illustrated in the current edition of the Diagnostic and Statistical Manual of Mental Disorders (DSM-IV-TR) (American Psychiatric Association 2000), which describes malingering as: the intentional production of false or grossly exaggerated physical or psychological symptoms, motivated by external incentives such as

avoiding military duty, avoiding work, obtaining financial compensation, evading criminal prosecution, or obtaining drugs.

It must be noted that DSM-IV-TR does not include malingering among the other diagnosable mental disorders, but rather places it among various “conditions” that might be “a focus of clinical attention.” In DSM-IV-TR, malingering is given the code V65.2.

In the current tenth edition of the International Classification of Diseases (ICD-10), malingering similarly is not included among the diagnosable mental and behavioural disorders, but is listed among “factors influencing health status and contact with health services.” In ICD-10, malingering (conscious simulation) is given the code Z76.5, and includes “persons feigning illness with obvious motivation.”

A number of studies have reported the views of clinicians about the rate of malingering. There has been no study that has reported the incidence of malingering based on legal findings. Some authors have noted that the views of examiners are influenced by whether the medicolegal assessment is requested on behalf of the plaintiff or the defendant. In reading such articles, it is important to keep in mind that, despite their titles, they are not studies of the frequency and characteristics of pain malingering as determined by the “triers of fact” (i.e. the courts), but only surveys of views (and possibly prejudices) about malingering.

A variety of methods have been suggested to identify putative malingerers complaining of persistent pain. These can be conveniently grouped into four main types, namely questionnaires, clinical examination, facial expression and testing with mechanical devices. Other attempts to detect malingering have included differential spinal blocks, thermography, and the par-enteral administration of agents such as Amytal and Pentothal.

There have been a number of published studies describing questionnaires that purport to be able to detect malingered pain. Such questionnaires are usually constructed by asking volunteers or patients to simulate and pretend that they have pain, or to exaggerate the pain that they do experience. Some authors have claimed that a subset of pain descriptors is able to differentiate between volunteers and back pain patients instructed to exaggerate the severity of the pain they experienced.

The research paradigm used in such studies has been criticized, and described as the “paradox in asking subjects to *comply* to instructions to *fake* in order to study subjects who *fake* when ordered to *comply*”.

The introduction of spinal dynamometry, which allows measurement of the range of motion and strength of exertion, led to it being called “a spinal lie detector”. However, Jayson (1992) has shown that, in relation to low back pain, dynamometric techniques that may indicate that a submaximal effort has been made cannot be used as “the final arbiter” of malingering.

Similar considerations apply to the use of the Jamar dynamometer to measure grip strength, and to the use of other mechanical devices as indicators of alleged malingering.

It has also been suggested that nondermatomal sensory deficits (“glove and stocking” anaesthesia) in association with chronic pain are indicative of malingering (or, as an alternative, that the pain does not have an organic basis). Others have argued, however, that nondermatomal somatosensory deficits might have a central basis.

### Conclusions

Although it is often alleged that compensation and litigation invariably cause exaggeration of pain complaints and prolong disability, the available empirical evidence does not support such a simplistic view. While there are studies that support the view that compensation and litigation often have an adverse effect on treatment response in chronic pain, this effect can be modified by work and by the provision of specific treatment programmes.

The view that financial considerations are the main determinants of behaviour by injured workers ignores the extensive research that has shown the importance of occupational and other psychosocial factors.

The prevalence of chronic pain complaints among personal injury litigants is positively correlated with compensation systems that provide pain contingent benefits and allow litigation at common law, but there is no consistent evidence to support the view that – as a group – chronic pain patients involved in litigation or receiving compensation describe their pain as more severe or more distressing than similar patients with pain which is not compensable.

There is some evidence that the rate and duration of claims are influenced by the level of compensation payments, but the research in this area is meagre and does not allow for any firm conclusions.

There is no support for the view that litigants and/or compensation recipients with chronic pain suffer from or have a specific psychiatric “condition” such as “compensation neurosis” or “accident neurosis”. There is also no support for the view that litigants with chronic pain are significantly more psychologically disturbed than similar patients not claiming compensation (Mendelson 1984). These findings contradict the view that patients involved in litigation develop the putative psychiatric condition termed “accident neurosis” or “compensation neurosis”, as these patients could not be distinguished on psychometric testing from those not seeking compensation. Some authors have specifically commented on the deleterious effect of using such labels, which have no clinical validity.

It needs to be emphasized to clinicians and lawyers alike that malingering is not a diagnosis, and that there is no valid clinical methodology that can detect purported “malingering” of pain. Malingering is an act, and it

is fraud in relation to one's health status, that is, in a medical context. Whether or not a person is malingering should, therefore, be determined by the trier of fact, be it a judge, a jury, or a tribunal.

Numerous studies have demonstrated that the assessment of chronic pain patients needs to take into consideration societal expectations, and that attitudes to illness and illness behaviour must also be considered. The impact of the compensation system and of litigation on the process of becoming a chronic pain patient has important social policy implications that thus far have been generally neglected by governments and by policy-makers.

The various findings reviewed above suggest that the effect of compensation on chronic pain complaints and disability can best be conceptualized as occurring at an unconscious rather than a conscious level, as do other secondary gains that tend to perpetuate psychogenic symptoms. These include personality, cultural factors, interpersonal dynamics, occupational and societal factors (see List Below). For that reason, the simplistic notion of "compensation neurosis" as a specific clinical condition that is reversible once the claim is finalized is invalid. Emotional factors that promote psychogenic symptoms also lead to other changes in the individual's level of functioning which, once established, perpetuate the symptoms after litigation has been finalized.

Factors that influence outcome of compensable injuries, including chronic pain:

- Personality:
  - Childhood emotional deprivation
  - Hypochondriacal traits
  - Unmet dependency needs
- Demographic factors:
  - Age
  - Education level
- Cultural factors:
  - Illness behaviour
  - Folk belief concerning illness
- Interpersonal dynamics:
  - Within the family
  - Social milieu
- Occupational factors:
  - Job dissatisfaction
  - Work stress
  - Type of work performed
  - Employer/supervisor attitude
- Psychological reaction:
  - Alteration in self-concept and body image
  - Personality disorganization
  - Regression
  - Development of a mental disorder
- Physical factors:
  - Presence and nature of physical injury or disease
  - Extent of residual organic impairment
- Economic factors:
  - Compensation payments
  - Job security/level of unemployment
  - Litigation
  - Level of wages
- Societal factors:
  - Acceptance of complaint as work or injury related
  - Expectations concerning prognosis
  - Availability of rehabilitation
- Therapeutic variables:
  - Appropriate early pain management
  - Treatment of specific mental disorder if present
  - Early intervention to develop a vocational rehabilitation plan

This emphasizes the need to carefully evaluate each litigant with chronic pain to assess the relative importance of compensation and other factors, and to avoid stereotyping or labelling litigants as universally motivated by potential financial gains.

In the diagnostic evaluation of patients with chronic pain seeking compensation, in the absence of an objectively demonstrable organic lesion or evidence of continuing physical injury that could explain the persistence of pain, diagnoses such as "psychogenic pain disorder" are problematic.

This issue has also caused difficulty for courts that have to make decisions concerning entitlement to benefits, and contradictory judgments have been reported.

A legal solution to this dilemma had been adopted by the Ontario Workers' Compensation Appeals Tribunal (1987). In a lengthy decision on a pension application by a worker who had sustained some injuries when a wall collapsed, but whose subsequent chronic pain complaints were described as predominantly psychogenic, the Tribunal held, in effect, that if pain that was considered to be psychogenic persisted following a documented physical injury that had resolved, the claimant would be entitled to benefits. It was noted that in the Tribunal's view "a non-organic element in



the chronic condition is compensable,” and that “the Tribunal determined that the injuries resulting from the fall were a significant contributing factor in the development of both the organic and the non-organic components of the worker’s chronic pain condition”.

## References

1. American Psychiatric Association (2000) Diagnostic and Statistical Manual of Mental Disorders, 4<sup>th</sup> edn, Text Revision. APA, Washington, DC
2. Balla JI (1982) The Late Whiplash Syndrome: A Study of an Illness in Australia and Singapore. *Culture Medicine Psychiatry* 6:191–210
3. Bayer TL (1985) Weaving a Tangled Web: The Psychology of Deception and Self Deception in Psychogenic Pain. *Soc Sci Med* 20:517–527
4. Block AR, Kremer EF, Gaylor M (1980) Behavioral Treatment of Chronic Pain: The Spouse as a Discriminative Cue for Pain Behaviour. *Pain* 9:243–252
5. Blyth FM, March LM, Nicholas MK, Cousins, MJ (2003) Chronic Pain, Work Performance and Litigation. *Pain* 103:41–47
6. Jayson MIV (1992) Trauma, Back Pain, Malingering, and Compensation. *BMJ* 305:7–8
7. Melzack R, Katz J, Jeans ME (1985) The Role of Compensation in Chronic Pain: Analysis Using a New Method of Scoring the McGill Pain Questionnaire. *Pain* 23:101–112
8. Mendelson G (1983) The Effect of Compensation and Litigation on Disability following Compensable Injuries. *American Journal of Forensic Psychiatry* 4:97–112
9. Mendelson G (1984) Compensation, Pain Complaints, and Psychological Disturbance. *Pain* 20:169–177
10. Mendelson G (1987) Measurement of Conscious Symptom Exaggeration by Questionnaire: A Clinical Study. *J Psychosom Res* 31:703–711
11. Mendelson G (1995) “Compensation Neurosis” Revisited: Outcome Studies of the Effects of Litigation. *J Psychosom Res* 39:695–706
12. Merskey H, Bogduk N (1994) Classification of Chronic Pain: Descriptions of Chronic Pain Syndromes and Definitions of Pain Terms, 2<sup>nd</sup> edn. IASP Press, Seattle
13. Ontario Workers’ Compensation Appeals Tribunal (1987) Decision no. 915. Research Publications Department, WCAT, Toronto
14. Tyrer SP (1986) Learned Pain Behaviour. *BMJ* 292:1–2
15. Wolfe F (2000) For Example in Not Evidence: Fibromyalgia and the Law. *J Rheumatol* 27:1115–1116

## Psychiatric Aspects of Multimodal Treatment for Pain

- Multimodal Rehabilitation Treatment and Psychiatric Aspects of Multimodal Treatment for Pain

## Psychiatric Aspects of Pain and Dentistry

CHARLOTTE FEINMANN  
Eastman Dental Institute and Department of Psychiatry and Behavioural Sciences, University College London, London, UK  
rejuce@ucl.ac.uk

### Synonyms

Chronic pain; orofacial pain; temporomandibular joint

## Definition

There are four recognisable symptom complexes of chronic orofacial pains, which may, however, coexist: temporomandibular disorder (TMD, myofascial face pain); chronic facial pain (atypical facial neuralgia); chronic odontalgia (atypical and phantom tooth pain); and burning mouth syndrome (oral dysaesthesia)

## Characteristics

Chronic orofacial pain is an ill-understood group of conditions, which may affect the whole of the mouth and face. Unfortunately, descriptions of disorders and treatment tend to be influenced by the background of the specialist assessing the patient. Thus, patients who see Maxillofacial Surgeons have symptoms described in terms of clicking, sticking and locking of the temporomandibular joint (TMJ), and pain in the associated musculature. ENT surgeons may retain Costen’s outdated notion that the pain is due to missing molar teeth, and may refer on to the Maxillofacial Surgeons or restorative dental specialists. Despite advice from the National Institute of Health that “there is no evidence linking occlusal abnormalities with pain”, patients’ continue to have pain treated by occlusal adjustment by ill-informed practitioners, often leading to more problems for patients (NIH 1996). Macfarlane et al. (2002) have found that 26% of a UK population complained of orofacial pain, but only 46% of those sought help. An obvious explanation for why some individuals choose to consult while others do not is the severity of their symptoms. Sadly, epidemiological studies of facial pain have tended to ignore intensity and frequency of symptoms, and recorded only their presence or absence.

Patients may complain of pain, clicking or locking in the temporomandibular joint and surrounding muscles. TMJ pain is often associated with disorders of function; the patients may complain of locking of the joint, clicking and sticking. Eating and other oral activities such as kissing may be difficult, and on examination the jaw may deviate to one side.

Traditional signs of temporomandibular disorders (► TMD) have included temporomandibular joint sounds; mandibular motility and pain elicited on palpation of the joint and associated musculature. The prevalence of joint sounds and the wide range of mandibular motility in healthy populations, together with the subjectivity of mobility assessment and pain report on palpation, mean that these signs must be interpreted with considerable caution. Also, joint sounds may remain unchanged, despite perceived improvement of TMD after treatment. There is growing support for a distinction between muscle-related (‘myogenous’) TMD and joint-related (‘arthrogenous’) TMD and hence, pain on palpation may be the most useful clinical measure. The publication of Research Diagnostic Criteria for TMD (RDC/TMD) has provided an opportunity for

standardised evaluation of TMD2. Whilst the distinction between myogenous and arthrogenous complaint may be valid, the inclusion of non-pain signs such as joint sounds and jaw opening, as suggested in the RDC/TMD, appears inappropriate, and self-reported disability factors may be more relevant.

Current diagnoses include tension headache, migraine, neckache, temporomandibular disorder (temporomandibular joint pain dysfunction syndrome, facial arthromyalgia) and chronic facial pain or ► **atypical facial pain**. These pains appear to arise from blood vessels, muscles and joint capsules rather than sensory nerve branches, as in trigeminal neuralgia. Artificial distinctions in clinical presentation lead patients to different specialists providing different treatments, including dentists, neurologists, otorhinologists, osteopaths, chiropractors and psychiatrists, with little collaboration between the specialties.

There are additional important problems concerning the recognition and definition of underlying psychiatric disturbances. Emotional disturbance, when present, is often mild and of brief duration, and psychiatric classification has proved an inadequate measure to capture the problem.

Atypical facial pain is no longer included in the International Association for the Study of Pain's 'Classification of Chronic Pain'. The term originated in order to distinguish the condition from 'typical' trigeminal neuralgia, since the pain neither follows the distribution of the peripheral nerve, nor responds to anti-epileptic agents. However, the categorisation of individuals with similar pain histories into a diagnostic pigeon-hole labelled 'atypical' is self-contradictory, and the definition of a condition by what it isn't, rather than what is, is unsatisfactory. A better term might be 'Chronic Facial Pain' (CFP), since the defining characteristics are longevity and site, as distinct from TMD, which affects the jaw rather than the (mid-) face and intra-oral pains.

The pain is usually a continuous dull ache with intermittent severe episodes, primarily affecting areas of the face other than joints and muscles of mastication, such as the zygomatic maxilla. Pain may be bilateral and will often have been present for several years. Analgesics are ineffective.

Chronic (atypical) odontalgia (CO) has a similar character, but is localised to one or more premolar or molar teeth, stimulating pulpitis. There may be a history of inappropriate dental treatment including extraction and subsequent recurrence of symptoms, apparently from another tooth. Dentists must resist the temptation to over investigate and repeat tests carried out by others. The term 'chronic' is used in preference to 'atypical' for reasons described above.

Positron emission tomography has demonstrated an increased contralateral cingulate cortex activity (and decreased prefrontal cortex activity), in response to both heat and nociceptive stimuli, in CAFP patients relative

to controls. This is suggestive of an exaggerated perception of pain in response to peripheral stimuli (Sarlain and Greenspan 2002).

Patients may complain of a burning tongue, occasionally the gingivae and lips are also involved, or the denture-bearing areas of the hard palate and lower alveolus, making the wearing of a denture impossible.

The patient is often middle-aged and female, but can be any age or sex. The picture is invariably one of a burning sensation that gradually increases in severity and frequency, until the patient suffers it for the greater part of every day. It is not present on waking but very quickly builds up to its maximum intensity for that day. It may be unilateral or bilateral. The most striking feature of the condition is that it is usually relieved by eating or drinking, and patients may chew gum or other food in order to seek relief. Organic pains of the tongue are made worse by eating and drinking, and this distinction may be crucial in making the diagnosis.

Denture intolerance due to discomfort or pain in the absence of any mucosal or bony lesion is a comparable problem. The diagnosis can be made on the many sets of dentures carried by the patient.

A common presentation is with posturing of the jaw, and bizarre complaints such as an inability to speak clearly. A full history and appropriate investigations should eliminate any deficiencies or serum iron, vitamins B12, B1, B2 and B6 and folate. A localised diabetic neuropathy can be excluded by blood and urine glucose estimations.

The persistent 'nasty' taste (dysgeusia), usually with an obsessional concern of having halitosis, and the dry mouth sensation may occur separately or together with a burning tongue. This patient may also complain of dysphagia. Examination invariably reveals no gross oral, pharyngeal or antral sepsis. Where the complaint is principally that of a dry mouth, there may be adequate or overtly reduced salivary flow. However, sialography and salivary gland biopsies and stimulated flow rates to exclude Sjogren's syndrome are normal. Further, concern in patients over halitosis is not uncommon. Variations include an illusion of sand in saliva, excess saliva, or excess mucus, which cannot be objectively substantiated.

These complaints are often a manifestation of stress. Recognisable causes are professional worries, bereavement, loneliness and, curiously enough, in women, the premature retirement of a successful husband (perhaps a symbolic bereavement). The patient may also show symptoms of agitation, early waking, loss of appetite and libido. There is occasionally a firmly held delusional explanation such as amalgam fillings, 'hyperacidity' or impaired pancreatic or hepatic function, which may require referral to a psychologist.

The phantom bite (Marbach 1978): patients complain of continuous discomfort because their teeth do not meet correctly.

They are often intensively involved with, and superficially knowledgeable about, details of dental anatomy, physiology and restorative dentistry. At consultation they frequently present numerous radiographs of the teeth, casts, splints, old crowns and pictures of themselves when perfect. A careful history will reveal a long succession of attempted treatment plans by a variety of dentists who have not been successful. The spouse may be involved in the delusion (a folie-a-deux). Dentists must be cautious in trying to provide any treatment for these patients.

It is possible that the problem is a disturbance in kinaesthesia (position sense), particularly as this can be produced experimentally when vibration is applied to muscle tendons. Prolonged dental treatment, especially occlusal equilibration and the replacement of natural tooth contour may have a similar effect in obsessional individuals. Continued attempts to 'equilibrate' the occlusion do not help.

If there is no clinical evidence of an iatrogenic grossly deranged occlusion, the condition should be considered to be an obsessional or ► **psychotic** problem. If this is not recognised, the patient will eventually be rendered cusplless, then edentulous, incapable of tolerating false dentures and invariably acquiring other intractable syndromes.

#### Initiation and Diagnosis

Many chronic facial pain patients specifically relate the onset of their symptoms to dental treatment itself. Other frequently reported precipitating factors include infections, toxins and stress, such as following bereavement. However, once initiated, the patient may inadvertently exacerbate, and thereby maintain, the pain problem through his or her own actions. For example, a proportion of patients completely avoid movement of the jaw, which eventually results in muscular atrophy and greater joint stiffness. Others compulsively stretch and hyperextend the jaw numerous times each day, provoking local irritation. Frequent prodding and touching the painful areas of the face, teeth or gums is also common in facial pain patients, and is also likely to irritate already sensitive muscles and nerves. The role of fear-avoidance tendency to avoid fear painful activity is useful for patients to understand. Sarlais and Greenspan (2003) have described a generalised hyperexcitability in the central processing of the nociceptive cortex as the pathophysiological basis of the TMJ pain.

Underpinning these behaviours is the patient's mood state. High levels of anxiety – related to concerns such as will the pain worsen, is there an undetected malignant cause increase the perception of pain, as does significantly depressed mood.

#### Associated Symptoms: Physical

It is crucial for an understanding of these patients to realise that headache and facial pain are not the patient's

exclusive problems. Nor are these symptoms mutually exclusive, as they may occur sequentially or simultaneously in any patient. Eighty percent of patients will complain, if prompted, of other recurrent symptoms such as chronic neck and low back pain, migraine, pruritic skin disturbances, irritable bowel or dysfunctional uterine bleeding. The prevalence of these symptoms is much higher than in the general population, indicating that facial pain and headache are features of a more generalised somatisation disorder. Specialists unfamiliar with the variety of the disorders, however, may not elicit the range of symptoms. There does seem to be an adequate muscular correlate to account for the pain of tension headache or chronic facial pain, and there is no satisfactory explanation about the aetiology of facial pain. The combination of a number of disorders has been termed a 'vulnerable neurochemistry' or a pain-prone patient, however, appreciation of ► **central sensitisation** and the phenomenon of ► **wind up** has improved our understanding of the pathophysiology of pain.

#### Chronic Symptoms

Chronic symptoms and syndromes pose a major challenge to medicine: they are common, frequently persistent, and are associated with significant distress, disability and unnecessary expenditure of medical resources. In UK primary care, somatic symptoms and syndromes account for 20% of consultations. Among medical outpatients, somatic complaints accounted for 35% of new referrals in a UK study. Even among medical inpatients, a substantial proportion has complaints that are found to be functional. The prevalence of emotional distress and disorder in patients who attend hospital with unexplained syndromes (such as irritable bowel syndrome), is higher than in patients with comparable medical conditions (such as inflammatory bowel disease), and many such patients are severely disabled.

Wessely et al. (1999) suggest that each medical specialty has defined its own syndrome or syndromes in terms of symptoms that relate to their organ or interest (see Table 1).

Patients seek help from doctors for symptoms, and doctors diagnose diseases to explain them. Symptoms are the patient's subjective experience of changes in his or her body; diseases are objectively observable abnormalities in the body. Difficulties arise when the doctor can find no objective changes to explain the patient's subjective experience. The symptoms are then referred to as medically unexplained or functional.

Wessely and colleagues postulate that: "the existence of specific somatic syndromes is largely an artefact of medical specialisation. That is to say, the differentiation of specific syndromes reflects the tendency of specialists to focus on only those symptoms pertinent to their specialty, rather than any real differences between patients". Treating the symptoms in terms of severity, number of

**Psychiatric Aspects of Pain and Dentistry, Table 1** Chronic Syndromes by Specialty

Gastroenterology	Irritable bowel syndrome, non-ulcer dyspepsia
Gynaecology	Premenstrual syndrome, chronic pelvic pain
Rheumatology	Fibromyalgia
Cardiology	Atypical or non-cardiac chest pain
Respiratory medicine	Hyperventilation syndrome
Infectious disease	Chronic (postviral) fatigue syndrome
Neurology	Tension headache
Dentistry	Temporomandibular joint dysfunction, atypical facial pain
Ear, nose and throat	Globus syndrome
Allergy	Multiple chemistry sensitivity

Table reproduced by permission

symptoms, associated psychological distress, and functional disturbance will in the future prevent harm done to patients by idiosyncratic isolated specialists.

A '► diathesis-stress' framework has been proposed to explain the high comorbidity between chronic pain and depression. This approach encourages identification of vulnerability factors in the individual as well as investigation into the nature of the stressor, and may be a useful theoretical basis from which to advance the study of depression in chronic facial pain.

### Management

The treatment offered to a chronic facial pain sufferer will be determined by the specialist understanding of the clinician to whom he/she is referred. A specialist must eliminate possible dental causes with clinical and radiographic investigation, but extensive investigation can lead to patients being off-loaded from specialist to specialist in search of a diagnosis, and feeling ill understood, over-investigated and dissatisfied. Evidence suggests that it may be more helpful to assess patients in terms of disability and coping strategies, rather than pain intensity *per se* (Feinmann and Madland 2001). It is crucial that physicians and patients reach an agreement about how to manage the pain. The mainstays of treatment are counselling and antidepressant medication.

It is important to acknowledge the genuine anger that patients may have about previous treatment, and to attempt to explain the interaction between peripheral and central perception of pain before attempting treatment. The evidence-based treatments are antidepressants, cognitive therapy, hypnosis and relaxation (see Table 2).

Pain relief with tricyclic agents appears to be independent of the antidepressant effect of the drugs. These drugs are considered to act by altering the sensory

**Psychiatric Aspects of Pain and Dentistry, Table 2**

Evidence-based treatment
Antidepressants
Cognitive Behaviour Therapy
Relaxation
Hypnotherapy
Reattribution

discrimination component of pain. The possibility of interference with serotonin reuptake in the brainstem has been proposed. A study of 181 (Harrison et al. 1999) patients treated with either Fluoxetine or cognitive behaviour therapy, especially targeted at facial pain, found that Fluoxetine reduced pain at three months compared to placebo, and these improvements were maintained when the drug ceased. Dworkin (2002) has also confirmed the effectiveness of CBT in facial pain. The decision as to whether a tricyclic or an SSRI is needed is really dependent on which side effects, such as sedation profile, the patient requires, and general treatment needs to be continued for at least six months and may be for as long as three years to maintain improvement. Antidepressants are used independently of their antidepressant effect and probably have a central pain relieving effect.

Both relaxation treatment and hypnosis have been shown to be effective in the management of facial pain. Patients who respond least well to treatment are non-anxious somatisers, those who insist on a physical cause for pain, those with odd dysfunctional health beliefs, lots of unsuccessful surgery and no life event before onset of pain. There is some evidence that these patients respond to intensive psychotherapy or extended CBT. The physical and psychological functioning of patients with chronic disabling TMJ pain is substantially associated with the patient's beliefs; in particular, stopping patients catastrophising about disability was shown to be crucial for pain relief (Dworkin et al. 2002)

### Counselling and Changing the Agenda

Antidepressants should not be used in isolation. A pragmatic treatment approach must be adopted, in which the diagnosis is first established by a careful history that identifies other idiopathic pains and seeks out stressful life events. Many patients will respond to reattribution or 'change of agenda' of their physical symptoms to an emotional cause by an explanation of amplifying normal bodily sensations.

### Summary of Management

1. For successful management it is important to: Identify not only the features of the joint pain but also chronic



pain disorders elsewhere, for example the head, neck, back, abdomen and pelvis

2. Identify predisposing adverse life events or a history of an emotional or psychiatric disturbance
3. Emphasise to the patient that the pain is real rather than imaginary, arising in 'cramped' muscles and dilated blood vessels as a response to emotional stress, and that drug therapy is not being used to treat depression but has a direct effect in relieving the painful muscles and blood vessels
4. Tricyclic antidepressants such as Nortriptyline 10–100 mg, TCAs or Selective Serotonin Reuptake Inhibitors (SSRIs) such as Fluoxetine 20 mg daily, Venlafaxine 37.5 mg bd should be prescribed at night in gradually increasing doses, combined with regular reviews at 3–6 week intervals to provide reassurance and to achieve drug compliance. Little or no response at 12 weeks indicates a need for further investigation
5. Dental treatment should be confined to essential problems such as sensitive carious cavities, pulpal inflammation or marked occlusal disturbances, usually where there is a gross deficiency of functional teeth
6. Only when conservative treatments have been exhausted should an alternative orthoscopic or surgical opinion be sought.

## References

1. Dworkin S, LeResche (1998) A Research Classification for TMJ Disorders. *Pain* 36:281–5
2. Dworkin S, Turner J, Mand L (2002) A Randomised Clinical Trial of CBT. *J Orofac Pain* 16 14:259–276
3. Feinmann C (1983) – Long Term Outcome of Facial Pain Treatment. *J Psychiatr Res* 37:381–387
4. Feinmann C and Madland G (2001) Chronic Facial Pain – A Multidisciplinary Problem. *J Neurol Neurosurg Psychiatry* 6:7126–7129
5. Harrison S, Glover, Feinmann C (1999). A Comparison of Antidepressant Medication Alone and in Combination with Cognitive Behaviour Therapy for Chronic Idiopathic Facial Pain. In: Jensen T and Turner I (eds) *Proceedings of the 8<sup>th</sup> World Congress on Pain. Progress in Pain Research and Management, vol. 8.* IASP Press, Seattle
6. Hotopf MM, Mayou R, Wadsworth M et al. (1999) Childhood Risk for Adults with Medically Unexplained Symptoms: Results from a National Cohort Study. *Am J Psychiatr* 156:1796–1800
7. LeResche L (1997). *The Aetiology of Temporomandibular Joint Pain.* IASP Press, Seattle
8. Marblach J (1978) Phantom Bite Syndrome. *Am J Psychiatr* 135–4:476–479
9. Marcfarlane T, Blinkhour A, Davies R et al. (2002) Orofacial Pain in the Community. Prevalence and Associated Impact. *Community dentists and Oral Epidemiology* 30:50–60
10. NIH (1996). *Technology Assessment Statement Management of Temporomandibular Disorders.* Washington DC National Institute of Health
11. Sarlain E, Greenspain (2003) Evidence for Generalised Hyperalgesia in Temporomandibular Disorders. *Pain* 102:221–226
12. Von Knorff M, Dworkin S, LeResche L et al. (1998). An Epidemiologic Comparison of Pain Complaints. *Pain* 32:193–197
13. Wessley S, Nimnuan C and Sharpe M (1999) Functional Somatic Syndromes: One or Many. *Lancet* 354:966–939

## Psychiatric Aspects of the Epidemiology of Pain

ELDON TUNKS, JOAN CROOK, ROBIN WEIR  
Hamilton Health Sciences Corporation, Hamilton,  
ON, Canada  
tunks@hhsc.ca

### Synonyms

Chronic pain, persistent pain; (may include; chronic low back pain, whiplash-associated disorder, chronic fibromyalgia, chronic headache, temporomandibular joint pain)

Chronic fibromyalgia; widespread pain; fibrositis  
Chronic pain disorder (DSM-IV); somatoform pain disorder (DSM-III R and ICD-10); psychalgia (ICD-10)  
Psychiatric morbidity; maladjustment; psychological disorders; psychiatric syndromes

Co-morbidity; dual diagnoses; for example, “double depression”, or “pain disorder associated with psychological factors and medical conditions”

Mood disorder; for example, depression, dysthymia  
Anxiety disorder

### Definitions

► **Prevalence:** the frequency at one point in time of a condition in a population.

► **Risk:** a measure of the probability that a given condition will arise.

► **Prognosis:** a measure of the probability of a favorable or unfavorable outcome of a given condition.

In ► **epidemiology**, the units of observation are generally samples of people drawn from populations of interest to the research. Epidemiology is concerned with comparing one sample with another, and inferring relevance to the larger population from which the sample is drawn. Although classically epidemiology has been understood to be the study of the characteristics of larger populations, such as in a census or transcultural studies, epidemiological methods are applied to a great variety of scientific inquiry, including the study of natural history of illnesses, the comparison of clinical or social policy interventions or natural events that affect health outcomes, studies of risk factors predicting new illnesses, factors affecting prognosis, and other applications, most of which is beyond the scope of this brief discussion.

### Characteristics

In epidemiological methods, procedures are established to detect “cases” of interest. The operational definitions used will have a significant effect on the characteristics of the “cases” studied, and on the results. For example, some definitions in the earliest epidemiological studies of “chronic pain” used selection criteria that were specific for constant and prolonged pain, while others used criteria that detected constant and prolonged pain but

also intermittent pain, and hence the prevalence reports varied with the definitions used in the methodology. (The estimates of chronic pain prevalence, using various methodologies, have ranged from 10% to 55%). Recently, with the development of standardized diagnostic criteria and instruments, some epidemiological studies have assessed the prevalence of specific subgroups of pain disorders such as migraine, chronic fibromyalgia, temporomandibular joint pain, or chronic low back pain. In reading any epidemiological studies, it is essential to look first at the methods section and the sampling methods, before reading the results.

We have confined ourselves here to studies of various populations that either have had, or who were at risk for, both psychological (psychiatric) and chronic pain problems. The hypotheses underlying many of these studies were the following three:

1. Chronic pain is a symptom of psychological maladjustment; for example a form of somatization.
2. Chronic pain causes ► **depression** (or anxiety), or depression (or anxiety) causes pain.
3. Pain and depression (or anxiety) are separate phenomena that may be associated for various reasons, including common risk factors, selection factors that bring them to clinical attention, or common constitutional predispositions.

There is no reason to believe that these hypotheses must be mutually exclusive, but our brief review is concerned with the second and third hypothesis.

Epidemiologists have studied these hypotheses through the following questions:

- a) What is the prevalence of chronic pain associated with psychiatric ► **co-morbidity**?
- b) How does co-morbidity affect the prognosis and/or the clinical course of chronic pain or depression?
- c) How does pain influence the risk of developing psychiatric conditions?
- d) How do psychiatric conditions influence the risk of developing pain disorders?

A few such studies and their findings are presented here for illustration.

#### **What is the Prevalence of Chronic Pain Associated with Psychiatric Co-Morbidity?**

Crook et al. (1986) conducted a standardized telephone survey of adults in 393 randomly selected households registered with a group family practice, and separately 62 files representing all patients who had attended a university outpatient pain clinic within the previous six months. "Persistent pain" was defined as having both "pain always or usually present" and "noteworthy pain within the previous two weeks" Psychological and psychosocial problems were assessed by standardized interview questions identifying physical function, pain on activities, emotional status, attitude, pain-related

behavior, and social consequences of long-term pain. In both community and specialty clinic samples, similar ranges of problems were found of pain in the neck, upper or lower back, upper or lower limbs, or headache, and demographic variables were similar across the two samples. Significant differences were found between groups, however, with regard to a higher prevalence of work-related accidents, more constant pain and greater reported disability, greater psychosocial difficulties and distress, in the specialty pain clinic group. Patients referred to tertiary-level specialty pain clinics are not necessarily characteristic of patients in the community. Patients are more likely to be selected for referral if there are significant psychosocial or functional problems.

Breslau and Davis (1992) used standardized structured interview schedules to identify cases with lifetime diagnoses of migraine and/or major depression or anxiety disorders, in a random sample of 1200 drawn from young adults in a large HMO. At baseline, 12.9% of the sample met the criteria for migraine at any point in their lives. Those with migraine were found to have a three-fold to six-fold increased prevalence of anxiety or mood disorders, compared to those who did not have migraine.

Ohayon and Schatzberg (2003) conducted a cross-section telephone survey of a random sample of 18,980 subjects, representative of the general populations of the UK, Germany, Italy, Portugal, and Spain. The prevalence of persistent pain (more than six months duration), of non-painful physical conditions, and the relationship with "major depression" were determined. The prevalence of at least one chronic pain condition was 17.1%, and of at least one depressive symptom was 16.5%. Chronic pain occurred 4 times more often in those with "major depression". There was an even stronger association with "major depression" if both chronic pain and another medical condition coexisted. Constant pain increased the probability of having "major depression" (► **Adjusted Odds Ratio** 1.6).

Based on the above studies, one can conclude that chronic pain disorders in general, and specific chronically painful physical conditions, are associated with increased prevalence of psychiatric diagnoses. This prevalence of psychological co-morbidity is further increased by ► **selection factors** operative in the referral of chronic pain patients to tertiary specialty pain clinics.

#### **Does Chronic Pain and Psychological Co-Morbidity Affect the Prognosis and/or the Clinical Course of Chronic Pain or Depression?**

Crook et al. (1989) followed up the community and specialty pain clinic patients studied in their initial survey, using the same definitions and methods. 77% were re-interviewed. After two years, it was found that 13% of the persistent pain sufferers from the specialty pain clinic, and 36% of the persistent pain sufferers from the community family practice group no longer reported that pain was a problem. Of those who suffered ongo-

ing pain, on average they reported that their pain had become more intermittent, that psychological distress factors improved, and that their use of health services decreased. However, the emotional factors that distinguished the pain clinic group from family practice group were still an important distinguishing factor, and likely played an important role in the chronic morbidity and worse overall prognosis of these patients. A standardized and validated inventory of “coping” was employed in the same follow-up study (Crook et al. 1988). Multiple regression analysis found that “adversarialness” explains some of the variance in patients’ adjustment to chronic pain. The more that patients were adversarial as a way of coping, the more depressed and anxious they tended to be, the more they assessed their pain as serious, and felt a lack of ability to control, prevent, or lessen their pain. The “ability to mobilize environmental resources” explained a small amount of variance with regard to sexual relations and social consequences of the pain.

Weir et al. (1992) conducted an historical cohort survey of 571 patients referred to the specialty pain clinic, through chart review and mailed questionnaire, which was followed up by a standardized telephone interview including demographic and economic and utilization variables and validated measures (assessing meaning of illness, social support, and psychosocial adjustment to illness). 81% of the sample were “fair to poorly adjusted psychosocially”, and 56% of these fell in the “poorly adjusted” range. Compared with other specialty clinic samples, the prevalence of those who were poorly adjusted was greater among pain service patients. It was found that individuals who lacked intimate and caring social relationships, and whose pain problem had a high impact on their lives, and were low in perceived resilience, were unemployed, and in constant pain, and perceived the burden of the pain as affecting all aspects of their lives, were the individuals who were most likely to be poorly adjusted. On the positive side, it was found that patients who had used specialty pain clinic services generated proportionately less costs in the use of other health services, when compared with those who had not used the specialty pain clinic services: this provides evidence for the efficacy and social benefits of multidisciplinary services for these patients with co-morbid chronic pain and psychological problems.

Livingston et al. (2000), in a survey of elderly patients with physical disability and psychiatric morbidity, found that those who developed depression became more likely to consult with their doctors. It appeared that elderly subjects with physical limitations who had become depressed were more likely to complain to their doctors about an illness, but only two subjects in their sample reported consultation because of depression, suggesting that depression may be under-reported or unnoticed in this group of patients with co-morbid pain, physical limitation, and depression.

MacFarlane et al. (1996) reported assessment of 141 subjects initially defined with “chronic widespread pain” “regional pain” or “no pain” after a follow-up period of a median of 27 months. Of those with chronic widespread pain initially, 35% still had chronic widespread pain at follow-up, 50% had regional pain, and 15% no pain at follow-up. Of those initially with regional pain, 65% still had regional pain, 19% chronic widespread pain, and 16% no pain at follow-up. They were more likely to have widespread pain at follow-up if at original assessment they had any of the following: 11 or more tender points on examination, a high score on a measure of psychological distress and fatigue, or if they had problems with sleep, micturition, abdominal pain or headache. Any of the above symptoms increased the odds of non-improvement by at least three-fold, although because of sample size only the increased odds associated with sleep problems were statistically significant.

Wells et al. (1992) surveyed the course of depression over a two-year period in 626 adult outpatients suffering with major depressive disorders or depressive symptoms. The course of depression was assessed over the two follow-up years using a validated structured telephone interview. Initial functional impairment was greater in those with ▶ **dysthymia** or “double depression”. By two years, the initial level of functional impairment and the initial depression severity both accounted for much of the variance in final depression outcomes. Impaired functional status and well-being, associated with bodily pain, made a significant contribution to depressive symptoms at the end of the second follow-up year. This indicates that co-morbid dysthymia and pain confer a guarded prognosis. Note also that other epidemiology studies have shown that in chronic pain populations, dysthymia is more prevalent than expected.

Magni et al. (1994) studied, at an eight-year interval, a sample of 2324 non-institutionalized adults, who were interviewed for presence or absence of musculoskeletal pain and depression. For those who had chronic pain at baseline, there were no socio-demographic variables that significantly predicted the persistence of pain at eight years of follow-up. For patients who were depressed at baseline, the only significant predictive variable for persistent depression at eight years was unemployment.

These findings are important in several respects. With regard to prognosis, co-morbid chronic pain and psychological factors confer more guarded outcomes, both with respect to psychiatric outcomes as well as with respect to pain and functional outcomes. Given that patients with co-morbid psychological and chronic pain disorders are more likely to be referred to tertiary specialty chronic pain centers, it is important that chronic pain management teams be equipped with the necessary resources to deal with psychological and psychosocial complications and functional impairments, and not just with pain

relief techniques. Finally, general community rehabilitation clinics dealing with chronic pain need also to be alert to those patients with higher loading on psychosocial factors, in order to identify and provide timely multidisciplinary care to these individuals with a potentially worse prognosis.

#### **Does Chronic Pain Influence the Risk of Developing Psychiatric Conditions?**

Livingston et al. (2000) conducted a community survey of psychiatric morbidity in people 65 years old or more, and selected those for follow-up who needed significant daily help with ADL due to physical ill health, but who did not initially have a psychiatric disorder (depression, anxiety, or dementia). After three years, 77 of the initial 141 subjects were able to be re-interviewed. 10% became seriously depressed, and a total of 24% became mildly, moderately, or severely depressed. Frequency of pain was significantly associated with onset of depression. Consultation for chronic illness was not significantly associated with development of depression.

Patten (2001) studied data from a Canadian national population health survey, with follow-up two years later. "Major Depression" was assessed using a standardized interview for depression, and self reported long-term medical diagnoses (providing that the diagnosis was made by a health professional and the condition was expected to last more than six months). The diagnoses surveyed included migraine, arthritis or rheumatism, back problems, and other painful or non-painful medical conditions. After adjusting for age and gender, the association between any long-term medical condition and developing "major depression" was highly significant. With increasing age, long-term medical conditions became less influential in predicting new onset "major depression". Female gender was another factor predictive of new onset "major depression".

#### **Do Psychiatric Conditions Influence the Risk of Developing Pain Disorders?**

Croft et al. (1995) studied a sample drawn from 4501 adults registered in two family practices. A standardized postal questionnaire was used to define psychological distress (depression and anxiety). New episodes of low back pain were identified by monitoring primary care attendances and by the second postal survey after 12 months. The odds of developing low back pain among those with the highest scores on the psychological measure were 2.4 times greater than the odds of low back pain in those with the lowest psychological scores, taking into account age and gender.

#### **Bidirectional Influence of Pain and Psychological Problems as Risk Factors**

Breslau et al. (1994) followed a random sample of 1007 young adults (median age 26 years) over a

follow-up of 3.5 years. Those who initially had migraine but not major depression had a Relative Risk for developing "major depression" of 3.2, compared to individuals with no migraine or depression at baseline. Those who initially had a diagnosis of "major depression" but not migraine, on follow-up at 3.5 years had Relative Risk for developing migraine of 3.1, compared to individuals with no migraine or depression at baseline.

Gureje et al. (2001) reported on results of the WHO Study of Psychological Problems in General Health Care, involving 15 centers and 14 countries. Primary care patients aged 18 to 65 were sampled, and stratified according to scores on the General Health Questionnaire. Interviews were conducted most commonly in patients' homes, and diagnoses were made according to ICD-10 criteria. The disability was rated according to an occupational disability schedule, and treating physicians completed ratings of medical illness severity. Patients with significant psychological or somatic symptoms, and a random sample of the remainder, were followed up at 12 months (a total of 3197). The only demographic factor significantly associated with non-recovery was greater age (over 40), while the presence of anxiety or depression at baseline was a marginally significant predictor of non-recovery. Non-recovery was also associated with low back pain (78.3%), headache (72.3%), joint pain (71.3%), limb pain (63.9%), chest pain (59.2%), abdominal pain (53.5%), and other pains (34.1%). With regard to new onset of pain during the study period, the age of greater than 40 was the only demographic factor significantly associated, and the clinical factors predicting the onset were anxiety or depression, interviewer-rated occupational role disability, and fair or poor self-rated health. After adjusting for other variables, occupational role disability at baseline was a significant predictor of onset of persistent pain (► **Odds Ratio** of 3.63), with baseline anxiety or depression contributing further risk (Odds Ratio 2.18). After adjusting for other variables, occupational role disability at baseline was a significant predictor of psychological disorder (Odds Ratio 3.23), and the effect of baseline pain disorder contributed a further risk of psychological disorder (Odds Ratio 2.33). This demonstrates that there was a bidirectional influence of risk factors between psychological disorder and pain disorder, but with occupational role disability at baseline conferring greater variance for the risk of either chronic pain or psychiatric disorder.

Hotopf et al. (1998), in a population-based birth cohort study, at 36 and 43 years follow-up, found that psychiatric disorder at 36 years increased the odds of reporting physical symptoms seven years later, by three-fold to seven-fold, and likewise physical symptoms at 36 years predicted psychological symptoms seven years later.



Magni et al. (1994) studied, at an eight-year interval, a sample of 2324 non-institutionalized adults, who were interviewed for presence or absence of musculoskeletal pain and depression, using standardized measures. Among those who were free of pain at baseline, depressive symptoms significantly predicted the development of chronic musculoskeletal pain at eight years, with an Odds Ratio of 2.14, although depression accounted for only a small percentage of the variance. Among those who were free of depression at baseline, chronic pain predicted the onset of depression at eight years, with an Odds Ratio of 2.85. Other predictive factors for depression included lower education, coming from rural or small urban locations, unemployment, and female gender.

#### What Psychological/Psychiatric Conditions Affect the Course and Prognosis of Chronic Pain?

Tunks et al. (2000) reported a review of the extensive epidemiological literature concerning the course and prognosis of chronic pain resulting from musculoskeletal injury. Several prospective studies have demonstrated that there is a higher level of persistent pain and functional disability than previously assumed. Initial return to work after injury marks a return to stable employment for less than half of injured workers. The majority of the workers who initially return to work incur periods of further work absence related to the original injury. The probability of eventual successful return to work decreases with the number of months off the job.

In long-term follow-up of low back patients who have completed pain clinic treatment, only a minority have completely favorable outcomes on all adjustment measures at 5 years, and for most the outcomes are variable, and are not consistent over time, with a large percentage never presenting a completely successful picture at any time.

Work factors associated with a higher prevalence of back pain include heavy, unpleasant, and dangerous work, higher age and lower wage, and especially previous pain sick-listings. Some of the factors associated with prolonged work absence include difficult working conditions, physical limitations experienced while performing work, and job dissatisfaction. Some factors improving occupational prognosis include the possibility of changing occupations, and the ability to modify the job or make a better fit between the worker's capacity and the job requirements. The number of times a worker attempts work re-entry increases the likelihood of eventual success. In one study, those who were not working at the time of treatment onset had poorer outcomes than those who still worked.

Significant pain factors influencing prognosis include the number of painful sites, pain intensity and the number of disability days, fatigue, and pain behavior.

Significant psychological factors affecting prognosis include co-morbid depression, anxiety, or dysthymia,

and psychosocial maladjustment. There is no test which prospectively identifies individuals who will have an unfavorable outcome, but on average, those with higher levels of impairment tend to have the highest number of painful sites, the highest number of reported functional limitations, and the greatest pain behavior. On average, similar individuals during follow-up tend to demonstrate greater interference in occupational, social, and family roles, and higher levels of subjective distress including pain, insomnia, and fatigue.

#### References

1. Breslau N, Davis GC (1992) Migraine, Major Depression and Panic Disorder: A Prospective Epidemiologic Study of Young Adults. *Cephalalgia* 12:85-90
2. Breslau N, Davis GC, Schultz LR, Peterson EL (1994) Migraine and Major Depression: A Longitudinal Study. *Headache* 34:387-393
3. Croft PR, Papageorgiou AC, Ferry S, Thomas E, Jayson MI, Silman AJ (1995) Psychologic Distress and Low Back Pain. Evidence from a Prospective Study in the General Population. *Spine* 20:2731-7
4. Crook J, Tunks E, Rideout E, and Browne G (1986) Epidemiologic Comparison of Persistent Pain Sufferers in a Specialty Clinic and in the Community. *Arch Phys Med Rehabil* 67:451-455
5. Crook J, Tunks E, Kalaher S, Roberts J (1988) Coping with Persistent Pain: A Comparison of Persistent Pain Sufferers in a Specialty Pain Clinic and in a Family Practice Clinic. *Pain* 34:175-184
6. Crook J, Weir R, Tunks E (1989) An Epidemiological Follow-Up Survey of Persistent Pain Sufferers in a Group Family Practice and Specialty Pain Clinic. *Pain* 36:49-61
7. Gureje O, Simon GE, Von Korff M (2001) A Cross-National Study of the Course of Persistent Pain in Primary Care. *Pain* 92:195-200
8. Hotopf M, Mayou R, Wadsworth M, Wessely S (1998) Temporal Relationship between Physical Symptoms and Psychiatric Disorder. Results from a National Birth Cohort. *Br J Psychiatry* 173:255-261
9. Livingston G, Watkin V, Milne B, Manela MV, Katona C (2000) Who Becomes Depressed? The Islington Community Study of Older People. *J Affective Disorders* 58:125-133
10. Macfarlane GJ, Thomas E, Papageorgiou AC, Schollum J, Croft PR, Silman AJ (1996) The Natural History of Chronic Pain in the Community: A Better Prognosis than in the Clinic? *J Rheumatol* 23:1617-1620
11. Magni G, Moreschi C, Rigatti-Luchini S, Merskey H (1994) Prospective Study on the Relationship between Depressive Symptoms and Chronic Musculoskeletal Pain. *Pain* 56:289-297
12. Ohayon MM, Schatzberg AF (2003) Using Chronic Pain to Predict Depressive Morbidity in the General Population. *Arch Gen Psychiat* 60:39-47
13. Patten SB (2001) Long-Term Medical Conditions and Major Depression in a Canadian Population Study at Waves 1 and 2. *J Affective Disorders* 63:35-41
14. Tunks E, Crook J, Crook M (2000) The Natural History and Effective Treatment of Chronic Pain from Musculoskeletal Injury. In: Sullivan T (ed) *Injury and the New World of Work*. UBC Press, Vancouver, p 219-245
15. Weir R, Browne GB, Tunks E, Gafni A, Roberts J (1992) A Profile of Users of Specialty Pain Clinic Services: Predictors of Use and Cost Estimates. *J Clin Epidemiol* 45:1399-1415
16. Wells KB, Burnam MA, Rogers W, Hays R, Camp P (1992) The Course of Depression in Adult Outpatients. *Arch Gen Psychiat* 49:788-794

## Psychiatric Aspects of the Management of Cancer Pain

SANTOSH K. CHATURVEDI

National Institute of Mental Health & Neurosciences,  
Bangalore, India

chatur@nimhans.kar.nic.in

### Synonyms

Psychiatric Management of Cancer Pain; Psychological Management of Cancer Pain; Psychosocial Management of Cancer Pain

### Definition

► **Cancer pain** has been described as a somatopsychic experience, with its intensity depending both on the extent of tissue damage and on the patient's psychological state. In patients with cancer, the pain will be exacerbated by associated physical symptoms and by ► **psychological factors** like mood disturbances, and social factors like responses of partners and caregivers (Sutton et al. 2002). Psychiatric management of pain is the use of psychiatric methods in the assessment and relief of cancer pain.

### Characteristics

The management of cancer pain depends on a comprehensive assessment that characterizes the symptom in terms of phenomenology and pathogenesis, assesses the relation between the pain and the disease, and clarifies the impact of the pain and comorbid conditions on the patient's ► **quality of life**. This assessment requires an approach that explores the many dimensions of pain and other features of cancer (Portenoy and Lesage 1999). In this context, the psychiatric aspect of cancer pain assessment and management need to be addressed.

### Psychiatric Management of Cancer Pain

In order to address the issues related to psychiatric aspects of cancer pain, it is important to understand the different causes and varieties of pain syndromes in cancer patients. According to Twycross (1997) about three quarters of patients with advanced cancer experience pain. Most of these have multiple pains. Causes of pain fall into four broad categories: the cancer itself, related to the cancer with or without debility, related to treatment, concurrent disorder. From a neuropathological perspective, pain is either nociceptive or neuropathic. Whatever the cause, pain is a "somatopsychic" experience (Twycross 1997). In addition, there are patients with pain from cancer, with a history of drug ► **addiction**, and dying patients with cancer related pain. Pain in cancer patients is associated with many psychological antecedents, and reactions that not only aggravate pain due to progressive disease or its treatment, but also cause ► **psychogenic pain**

in a cancer patient. Though cancer pain purely due to psychological factors may be rare, there can be a ► **somatoform pain disorder** or atypical somatoform disorder presenting as cancer pain, or an ► **abnormal illness behavior** aggravating the cancer pain, and interfering in its relief (Chaturvedi and Maguire 1998). Turk and colleagues (1998) documented greater perceived disability and lower activity among cancer patients with pain, compared to non-cancer chronic pain patients, with comparable pain severity.

### Psychological Factors and Psychological Symptoms in Cancer Pain Patients

Psychological factors play an important part in chronic cancer-related pain patients. The sense of hopelessness, and fear of impending death may add to and exaggerate the pain, which in turn contributes to the overall suffering of the patient. The chronicity of cancer pain is associated with a series of psychological signs, i.e. disturbances in sleep, reduction in appetite, impaired concentration, irritability, and with signs of depressive disorder. Higher levels of pain intensity in cancer patients have been found to be associated with mood disturbances like ► **depression**, frustration, anger, exhaustion, maladaptive behavioral coping responses, beliefs that pain is related to cancer progression, greater life stress, feelings of helplessness and hopelessness (Spiegel et al. 1994; Poulos et al. 2001; Sela et al. 2002; Okana et al. 2001). A recent critical review of the literature by Zaza and Baine (2002), examined the evidence for an association between chronic cancer pain and psychological distress, social support, and coping, and found that, based on several criteria, the reviewed studies confirmed that the evidence was strong for psychological distress, moderate for social support and inconclusive for coping. This review, thus, emphasized that chronic pain assessment should include routine screening for psychological distress.

Most patients with cancer who experience chronic pain also develop other physical and psychological symptoms. Studies have shown that pain, fatigue, and psychological distress are the most common symptoms in patients with cancer (Portenoy et al. 1994). A broad psychiatric assessment of symptoms is an essential part of the management of cancer patients. Fear of pain is one of the most common and dreaded fears among cancer patients, and is an important factor in causing depression in cancer patients. Patients with pain related emotional states (including anger and frustration) and negative moods reported higher levels of cancer pain (Sela et al. 2002; Greenwood et al. 2003).

### Addiction and Fear of Addiction

Many health care workers are concerned that there is a significant risk of addiction when using opioids for cancer pain. Most surveys have shown that patients or physicians, except when there is a worsening of pain, usually

do not escalate pain medication. It has also been shown that tolerance to pain relief does not occur as frequently as it occurs for the other side effects of opiates. Secondly, tolerance or ► **physical dependence** alone should not be criteria for dependence or 'addiction'. Addiction should only be considered if there is a psychological and behavioral syndrome characterized by craving, compulsive use, aberrant drug seeking behavior (such as reuse or falsification of prescriptions, use of street drugs), use of the drug for other effects, unsupervised escalation of drugs and contact with several doctors for the same and relapses after withdrawal. Cancer patients should also be evaluated for pain relief, as patients with inadequate pain relief may also show 'undue preoccupation' about the drug. '► **Pseudo addiction**' is a term coined for such patients who seek the drug in the presence of inadequate pain relief, and who show no such preoccupation once the dose is escalated and comfort reached (Weissman and Haddox 1989).

#### Issues related to psychiatric management

The psychiatric management of cancer pain would consist of elicitation of features of depression, ► **anxiety**, somatic focusing, hypochondriasis and abnormal illness behavior and treating them by appropriate methods.

#### Treatment of Psychiatric Disorders in Cancer Patients with Pain

The cancer patient with pain has an enhanced risk of developing the common psychiatric disorders in cancer. In terms of frequency, depression, anxiety or mixed symptoms of anxiety and depression are the most common problems. These need to be evaluated for their severity and persistence, and treated appropriately with a combination of psychopharmacological and psychosocial methods.

#### Use of Psychotropics for Cancer Pain Management

The response of cancer pain to tricyclic anti-depressants (TCAs) is usually good (Pannerai et al. 1991). Relatively low dosages of tricyclic anti-depressants given at night are often effective and benefit in reducing pain, normal sleep is restored, fatigue is diminished and the patient is able to engage more energetically in daily activities. The exact mechanism of antidepressant effects in cancer pain is not fully understood. The antinociceptive action of these agents seems to be independent of any beneficial effect on depression or mood. Although the co-administration of TCAs may increase plasma morphine concentrations, any potentiation of morphine analgesia is thought not to be due to an increased bioavailability of the opiate, but to an intrinsic analgesic effect of antidepressants. On this basis, the use of antidepressants in combination with opioids for the treatment of cancer pain is suitable when a component of deafferentation is present, or when there is concomitant depressive illness (Panerai et al. 1991). The interaction between the

cognitive component (perception of nociceptive stimuli) and the affective component of pain is reflected in the overlap between the actions of antinociceptive agents (analgesics) and mood altering drugs (► **psychotropics**). Anxiety, depression, fear and sleeplessness may all respond to psychotropic drugs, and this may result in reduction in pain or a greater ability to cope with it. Selective Serotonin Reuptake Inhibitors (SSRI's) may also be useful in the management of cancer pain, without significant adverse drug reactions. It is thought that these agents might be more analgesic than other antidepressants, because serotonergic neurons are involved in the response to noxious stimulation through pathways in the midbrain. However, clinical trials have not convincingly confirmed their superiority in pain relief. Phenoazines and butyrophenones in low doses also act as adjuncts in cancer pain relief. Psychotropics are also known to potentiate narcotic analgesia.

#### Psychological Treatments, Communication, Counseling

A number of psychological treatment approaches are available for cancer pain patients depending upon the presence of contributing factors. Family counseling, marital counseling, individual psychotherapy, cognitive therapy, and supportive therapy may be advised wherever necessary. ► **Psychoeducational interventions** on pain in adults with cancer were found to be beneficial in a meta-analysis (Devine 2003). These are not a substitute for analgesics, but they may serve as adjuvant therapy. The intervention must be acceptable to the patients, and not too burdensome for cancer patients in pain to use (Devine 2003).

#### Behavioral Intervention for Cancer Pain

► **Behavior therapies** are also found to be useful. Relaxation exercises, yoga, meditation and biofeedback may help in pain relief in cancer patients. Pharmacological and behavioral therapies may be combined for some patients. Multidisciplinary pain clinics can provide a vast range of treatments for cancer pain patients. Reasonably strong evidence exists documenting beneficial effects of relaxation-based cognitive-behavioral interventions, education about analgesic usage, and supportive counseling (Devine 2003).

#### Maintaining Quality of Life

Suffering due to cancer pain can be an important reason for poor quality of life. Psychological symptoms and psychiatric morbidity can aggravate the suffering from cancer pain, and lead to poor quality of life. Pain relief is therefore very important for enhancing the quality of life. Multidisciplinary approaches, with due attention to psychological and psychiatric factors, prove to be most effective. Where most approaches have failed, it is important to encourage and motivate the patient in the process of teaching him to 'live with pain'.

## References

1. Chaturvedi SK, Maguire P (1998) Persistent Somatization in Cancer: A Follow Up Study. *J Psychosom Res* 45:249–256
2. Devine EC (2003) Meta-Analysis of the Effect of Psycho Educational Interventions on Pain in Adults with Cancer. *Oncol Nurs Forum* 30:75–89
3. Greenwood KA, Thurston R, Rumble M, Waters SJ, Keefe FJ (2003) Anger and Persistent Pain: Current Status and Future Directions. *Pain* 103:1–5
4. Keefe FJ, Ahles TA, Porter LS, Sutton LM, McBride CM, Pope MS, McKinstry ET, Furstenberg CP, Dalton J, Baucom DH (2003) The Self-Efficacy of Family Caregivers for Helping Cancer Patients Manage Pain at End of Life. *Pain* 103:157–162
5. Okano Y, Okamura H, Watanabe T, Narabayashi M, Katsumata N, Ando M, Adachi I, Kazuma K, Akechi T, Uchitomi Y (2001) Mental Adjustment to First Recurrence and Correlated Factors in Patients with Breast Cancer. *Breast Cancer Res Treat* 67:255–262
6. Panerai AE, Bianchi M, Sacerdote P, Ripamonti C, Ventafridda V, De Conno F (1991) Antidepressants in Cancer Pain. *J Palliat Care* 7:42–44
7. Poulas AR, Gertz MA, Pankratz VS, Post-White J (2001) Pain, Mood Disturbance, and Quality of Life in Patients with Multiple Myeloma. *Onco Nurs Forum* 28:1163–1171
8. Portenoy RK, Thaler HT, Kornblith AB, Lepore JM, Friedlander-Klar H, Coyle N, Smart-Curley T, Kemeny N, Norton L, Hoskins W et al. (1994) Symptom Prevalence, Characteristics and Distress in Cancer Population. *Qual Life Res* 3:183–189
9. Portenoy RK, Lesage P (1999) Management of Cancer Pain. *The Lancet* 353:1695–1700
10. Sela R, Bruera L, Conner-Spady B, Cumming C, Wallen C (2002) Sensory and Affective Dimensions of Advanced Cancer Pain. *Psycho Oncology* 11:23–34
11. Spiegel D, Sands S, Koopman D (1994). Pain and Depression in Patients with Cancer. *Cancer* 74:2570–2578
12. Sutton LM, Porter LS, Keefe FJ (2002) Cancer Pain at the End of Life: A Biopsychosocial Perspective. *Pain* 99:5–10
13. Turk DC, Sist TC, Okifuji A, Miner MF, Florio G, Harrison P, Massey J, Lema ML, Zevon MA (1998). Adaptation to Metastatic Cancer Pain, Regional, Local Cancer Pain, and Non-Cancer Pain: Role of Psychological and Behavioural Factors. *Pain* 74:247–256
14. Weissman DE, Haddox JD (1989) Opioid Pseudo-Addiction – An Iatrogenic Syndrome. *Pain* 36:363–366
15. Zaza C, Baine N (2002) Cancer Pain and Psychosocial Factors: Critical Review of the Literature. *J Pain Symptom Manage* 24:526–542

## Psychiatric Aspects of Visceral Pain

STEPHEN P. TYRER<sup>1</sup>, ANN WIGHAM<sup>2</sup>

<sup>1</sup>Royal Victoria Infirmary, University of Newcastle upon Tyne, Newcastle-on-Tyne, UK

<sup>2</sup>McCoull Clinic, Prudhoe Hospital, Northumberland, UK

s.p.tyrer@ncl.ac.uk, ann\_wigham@hotmail.com

### Synonyms

Functional Aspects of Visceral Pain; non-organic aspects of visceral pain

### Definition

The internal organs of the body, closely related to or contained within the pleural, pericardial or peritoneal cavities, are termed the viscera. Visceral pain is pain that is caused by activation of pain receptors from infiltration,

compression, extension or stretching of the thoracic, abdominal or pelvic viscera. Psychiatric, in the context of this chapter, refers to the effects of the mind and illnesses affecting the mind, on the perception of pain arising from the viscera. The word, functional, refers to symptoms or disorders which, after appropriate medical assessment, cannot be explained by a defined medical disease.

### Characteristics

The general characteristics of pain due to visceral pathology are that it is:

- a) Diffuse and poorly localised with referral to somatic structures.
- b) Referred to the somatic structures in the body wall.
- c) Often accompanied by ► **autonomic** and motor reflexes.
- d) Not necessarily associated with injury (Cervero and Laird 1999).

Pain is not evoked from all viscera, as many solid viscera are not innervated by ‘sensory’ receptors. However, pains from the lining membranes of hollow organs such as the colon are very sensitive. The combined inputs from somatic and visceral afferent fibres from these structures converge onto spinal cord neurons enhancing their excitability. Visceral ► **hyperalgesia** results through the process of what is known as ► **central sensitisation** (Roza et al. 1998). Although visceral pain is referred to ► **cutaneous** areas, subjects are able to distinguish pain arising from a cutaneous or visceral origin, with visceral pain being perceived as more unpleasant (Strigo et al. 2002).

Stimuli that induce visceral pain are distension, ischaemia and inflammation. However, unlike somatic pain, the severity of the pain experienced does not always correlate with the seriousness of the condition leading to the pain.

### Neuroanatomy of Visceral Pain

It is only recently, with the development of functional neuroimaging methods, that the anatomical correlates of visceral pain have been able to be investigated in human subjects. There are two distinct classes of nociceptive sensory receptors that innervate internal organs. The first respond to mechanical stimuli that are perceived as unpleasant, so-called high-threshold receptors. The second class, low-threshold receptors, respond to a wide range of stimuli from innocuous to noxious (Sengupta et al. 1994).

The cell bodies of visceral afferent neurons are situated in the dorsal root ganglia of the thoracic and lumbar nerves, the afferent fibres from which are conveyed in the sympathetic trunk and then to the viscera by the cardiac, pulmonary and splanchnic nerves. The majority of these fibres terminate in the ► **substantia gelatinosa**. From here the connections ascend to the inferior solitary nucleus, the midbrain, the medial forebrain bundle, the



hypothalamus, via the limbic system to the thalamus, and then to the cerebral cortex to evaluate and localise the pain. In addition, the ► **periaqueductal gray matter** (PAG) in the midbrain transmits descending opiate-mediated pain inhibitory messages back to the spinal cord by way of the brain stem raphe nuclei, as well as conveying information rostrally to the amygdala.

Experimentally applied visceral pain to normal subjects has been shown to activate the anterior cingulate cortex (ACC) (Strigo et al. 2003), part of the limbic lobe that comprises a high density of opiate receptors. The ACC has extensive connections with PAG, a region that is involved with diminishment of pain. There is some evidence that this descending antinociceptive system is defective in visceral pain (Naliboff et al. 2001). The known relationship between intense emotional feelings and visceral sensations, such as nausea and feelings of chest discomfort, can be explained on the basis of these pathways.

#### Association with Functional Somatic Symptoms

Reports of patients with abdominal pain in the absence of organic findings were described 120 years ago. The conditions from which these individuals suffered were described as the visceral neuroses. The aetiology of these illnesses included (Ryle 1939):

- peripheral or central irritation from a previous injury
  - “inborn sensitivity” traits
  - apprehension that the symptoms are due to organic disease
  - hereditary predisposition
  - lack of manifestation of organic disease under congenial conditions, but which become apparent under stress.
- The beliefs of these early authors have been borne out by subsequent work. Inflammation of the oesophagus reduces the threshold of viscerosomatic spinal neurons to noxious stimuli in cats (Garrison et al. 1992) and in healthy volunteers (Sarkar et al. 2000). In this second study, volunteers exposed to acid infusion into the lower oesophagus subsequently had a lower pain threshold in the upper oesophagus after signs of inflammation had resolved. Furthermore, patients with non-cardiac chest pain in the same investigation had a lower resting oesophageal pain threshold than healthy controls, and this threshold fell further and for longer than the controls following acid infusion. This study illustrates both hypersensitivity of these visceral neurones and secondary ► **allodynia** in the distribution of the same nerves, independently of the site of the stimulus, the phenomenon of ► **central sensitisation** (Roza et al. 1998).

The genetic contribution to these disorders has only been investigated in detail in IBS. Studies have shown that this syndrome is twice as common in monozygotic twins as in dizygotic pairs (Levy et al. 2001). These authors posit evidence showing that these disorders are related to both inborn factors and social learning. It has been proposed that the symptoms described in functional somatic disorders are not greatly different from each other (Wessely

et al. 1999), and that the manifestation of one disorder rather than another results from excessive attention to one symptom dependent on familial experience (Levy et al. 2001).

The ► **hypochondriacal** fears of patients who have functional somatic disorders may be related to the distress that these disorders cause (Wessely et al. 1999).

#### Relationship of Psychiatric Issues in Disorders Leading to Visceral Pain

Depression and anxiety are the illnesses most frequently found in patients with chronic pain attending Pain Clinics (Tyrer et al. 1989; Fishbain et al. 1998). Anxiety has been found to decrease pain threshold and tolerance (Cornwall and Donderi 1988), and depression is also associated with poorer treatment outcomes. ► **Panic attacks** are particularly associated with subjective reports of symptoms referable to the viscera. The symptoms occurring during panic attacks are similar to those occurring in animals during fearful response to conditioned stimuli. ► **Functional imaging** has demonstrated activation of the same anatomical structures in the limbic system, in particular the amygdala, during panic attacks as those occurring during visceral pain (Gorman et al. 2000). Autonomic activation is found in both conditions.

Disorders that give rise to visceral pain in which there is lack of evidence of organic findings are now considered under the rubric of somatoform disorders. These cover a wide variety of disorders in which there is repeated presentation of physical symptoms together with persistent requests for medical investigations, in spite of negative findings and reassurance by doctors that the symptoms have no physical basis. The condition that is most often found in patients with visceral pain is somatoform autonomic dysfunction (F45.3 in the ICD-10 classification). Such autonomic symptoms are unsurprising in view of the fact that autonomic nerves innervate the viscera. Details of the most common conditions that fall under this category are given below.

#### Non-Cardiac Chest Pain

Pain in the upper chest region is common. In a comprehensive population-based birth cohort study, chest pain was reported in 17% of respondents at the age of 36, with a prevalence of exertional chest pain of 1% (Hotopf et al. 1999). There was a significant relationship between psychiatric disorder and the presence of chest pain, and this was particularly high for exertional chest pain. Furthermore, with increasing severity of the psychiatric disorder, the odds of reporting chest pain increased. The exertional chest pain reported was not due to cardiac disease; only one subject who reported exertional chest pain had evidence of cardiac illness. As in most studies involving medical conditions, the most prominent psychiatric diagnoses were anxiety and depression. This study suggests that if a child has relatives with physical ill-

nesses or suffers from fatigue, this primes the person to attend to normal physiological sensations in a different way.

The relationship between chest pain, psychiatric morbidity and the presence of coronary disease in older patients shows a lesser trend for an increase in psychiatric morbidity in those with non-organic findings. Evidence of psychiatric illness is higher in this group. A large study did not reveal any difference in psychiatric morbidity in those with positive angiographic findings than in those without, but 25% of subjects showed evidence of a psychiatric disorder (Valkamo et al. 2001).

### Irritable Bowel Syndrome

The symptoms of irritable bowel syndrome consist of pain or discomfort for twelve weeks of the previous twelve months associated with relief with defecation and abnormal frequency of defecation. The prevalence of this disorder varies from 3% to 22% according to the criteria used (Talley and Spiller 2002). Children with persistent abdominal pain are more likely to suffer from psychiatric disorders in adulthood, but there is debate about whether they are especially prone to physical symptoms once the psychiatric disorder is controlled (Hotopf et al. 1998; Blanchard and Scarff 2002). As with most of the functional somatic disorders there is female predominance. It is widely thought that psychological distress is a major factor in the use of health care by adults with irritable bowel syndrome and patients attending medical clinics have high levels of generalised anxiety, depression and hypochondriasis. However, studies have found that those with similar symptoms who do not seek health care for their symptoms are indistinguishable from controls without the disorder (Drossman et al. 1988). There is a relationship between severity of pain as opposed to other symptoms and referral to health care (Koloski et al. 2001). Although acute stress probably aggravates the disorder, more important chronic sustained stresses such as separation and bereavement are likely to be important in contributing to persistence of symptoms.

Treatment options are centred on the principle that the patient is largely responsible for care. Tricyclic antidepressants, ► [cognitive behaviour therapy](#) and hypnotherapy have all been reported to be superior to standard care in patients.

### Uterine and Pelvic Pain

Nociceptive stimulation of the uterine cervix by balloon dilation leads to pain in the hypogastric and low back regions, in the same areas in which pain is experienced during labour and menstruation (Bajaj et al. 2002). The gynaecological symptom that is associated with the highest frequency of psychiatric disorder is abdominal or pelvic pain (Bixo et al. 2001). Patients with these symptoms had a more than three-fold increased risk of having an anxiety disorder. Although it has been proposed that women with

chronic pelvic pain have a higher incidence of sexual abuse in the past and/or sexual or relationship difficulties at the time of presentation, a recent comprehensive study using a cohort design in over a thousand patients showed that physically and sexually abused individuals were not at risk for increased pain symptoms (Raphael et al. 2001). Previous positive findings in this area are likely to have been related to selection bias.

### Conclusion

The prevalence of psychiatric disorders in patients with visceral pain is greater than with other forms of somatic or neuropathic pains. The involvement of the anterior cingulate cortex in the limbic system in visceral pain states helps to explain this. The increased distress that these symptoms cause may also reflect the hyperalgesia resulting from central sensitisation. The autonomic accompaniments of visceral pain, which occur in anxiety-provoking situations, further reinforce the feeling of threat that arises. Cognitive behavioural therapy is an advantage in visceral pain conditions, but less attention has been paid to this form of treatment than in other painful conditions. Explanation and education about visceral pain mechanisms should be more widely employed.

### References

1. Bajaj P, Drewes AM, Gregersen H et al. (2002) Controlled Dilation of the Uterine Cervix – An Experimental Visceral Pain Model. *Pain* 99:433–442
2. Bixo M, Sundstrom-Poromaa I, Bjorn I, Astrom M (2001) Patients with Psychiatric Disorders in Gynecological Practice. *Am J Obstet Gynecol* 185:396–402
3. Blanchard E, Scharff L (2002) Psychosocial Aspects of Assessment and Treatment of Irritable Bowel Syndrome in Adults and Recurrent Abdominal Pain in Children. *J Consult Clin Psychol* 70:725–738
4. Cervero F, Laird JM (1999) Visceral Pain. *Lancet* 353:2145–2148
5. Cornwall A, Donderi DC (1988) The Effect of Experimental Induced Anxiety on the Experience of Pressure Pain. *Pain* 35:105–113
6. Drossman D, McKee DC, Sandler RS et al. (1988) Psychosocial Factors in the Irritable Bowel Syndrome. A Multivariate Study of Patients and Nonpatients with Irritable Bowel Syndrome. *Gastroenterology* 95:701–708
7. Fishbain DA, Cutler R, Rosomoff H (1998) Comorbid Psychiatric Disorders in Chronic Pain Patients. *Pain Clin* 11:79–87
8. Garrison D, Chandler MJ, Foreman RD (1992) Viscerosomatic Convergence onto Feline Spinal Neurons from Esophagus, Heart and Somatic Fields: Effects of Inflammation. *Pain* 49:373–382
9. Gorman JM, Kent JM, Sullivan GM et al. (2000) Neuroanatomical Hypothesis of Panic Disorder, Revised. *Am J Psychiatry* 157:493–505
10. Hotopf M, Carr S, Mayou R et al. (1998) Why Do Children Have Chronic Abdominal Pain, and What Happens to Them When They Grow Up? Population Based Cohort Study. *BMJ* 316:1196–1200
11. Hotopf M, Mayou R, Wadsworth M (1999) Psychosocial and Developmental Antecedents of Chest Pain in Young Adults. *Psychosom Med* 61:861–867
12. Koloski N, Talley NJ, Boyce PM et al. (2001) Predictors of Health Care Seeking for Irritable Bowel Syndrome and Nonulcer Dyspepsia: A Critical Review of the Literature on Symptom and Psychosocial Factors. *Am J Gastroenterol* 96:1340–1349

13. Levy R, Jones KR, Whitehead WE et al. (2001) Irritable Bowel Syndrome in Twins: Heredity and Social Learning Both Contribute to Etiology. *Gastroenterology* 121:799–804
14. Naliboff BD, Derbyshire SW, Munakata J et al. (2001) Cerebral Activation in Patients with Irritable Bowel Syndrome and Control Subjects during Rectosigmoid Stimulation. *Psychosom Med* 63:365–375
15. Raphael K, Widom CS, Lange G (2001) Childhood Victimization and Pain in Adulthood: A prospective investigation. *Pain* 92:283–293
16. Roza C, Laird JMA, Cervero F (1998) Spinal Mechanisms Underlying Persistent Pain and Referred Hyperalgesia in Rats with an Experimental Ureteric Stone. *J Neurophysiol* 79:1603–1612
17. Ryle JA (1939) Visceral Neuroses. *Lancet* II: 297–301
18. Sarkar S, Aziz Q, Woolf CJ et al. (2000) Contribution of Central Sensitisation to the Development of Non-Cardiac Chest Pain. *Lancet* 356:1154–1159
19. Sengupta JN, Gebhart GF (1994) Characterization of Mechanosensitive Pelvic Nerve Afferent Fibres Innervating the Colon of the Rat. *J Neurophysiol* 71:2046–2060
20. Strigo IA, Bushnell MC, Boivin M et al. (2002) Psychophysical Analysis of Visceral and Cutaneous Pain in Human Subjects. *Pain* 97:235–246
21. Strigo IA, Duncan G, Boivin M et al. (2003) Differentiation of Visceral and Cutaneous Pain in the Human Brain. *J Neurophysiol* 89:3294–3303
22. Talley N, Spiller R (2002) Irritable Bowel Syndrome: A Little Understood Organic Bowel Disease? *Lancet* 360:555–564
23. Tyrer SP, Capon N, Peterson DN, Charlton JE, Thompson JW (1989) The Detection of Psychiatric Illness and Psychological Handicaps in a British Pain Clinic Population. *Pain* 36:63–74
24. Valkamo M, Hintikka J, Niskanen L et al. (2001) Psychiatric Morbidity and the Presence and Absence of Angiographic Coronary Disease in Patients with Chest Pain. *Acta Psychiatr Scand* 104:391–396
25. Wessely S, Nimnuan C, Sharpe M (1999) Functional Somatic Symptoms: One or Many? *Lancet* 354:936–939

## Psychiatric Disorder

### Definition

Psychiatric disorder is a term usually reserved for conditions that have met defined diagnostic criteria in a system of psychiatric classification.

- ▶ Pain as a Cause of Psychiatric Illness

## Psychiatric Evaluation

- ▶ Disability Assessment, Psychological / Psychiatric Evaluation

## Psychiatric Illness

- ▶ Pain as a Cause of Psychiatric Illness

## Psychiatric Management of Cancer Pain

- ▶ Psychiatric Aspects of the Management of Cancer Pain

## Psychiatric Physiotherapy

- ▶ Psychosomatic and Psychiatric Physiotherapy

## Psychobiological Model

- ▶ Diathesis-Stress Model of Chronic Pain

## Psychoeducation

- ▶ Information and Psychoeducation in the Early Management of Persistent Pain

## Psychoeducational Intervention

### Definition

A technique that uses a didactic approach, including lectures and discussions, to teach coping skills to the individual.

- ▶ Psychiatric Aspects of the Management of Cancer Pain

## Psychogenic

### Definition

Having an emotional or psychological origin.

- ▶ Chronic Back Pain and Spinal Instability

## Psychogenic Headache

- ▶ Headache, Episodic Tension Type

## Psychogenic Pain

### Definition

Pain arising out of psychological, emotional or psychosocial factors. It is caused by psychological stress, and tends to be aggravated or relieved in relation to the stress.

- ▶ Pain, Psychiatry and Ethics
- ▶ Psychiatric Aspects of the Management of Cancer Pain

## Psychogenic Pain Disorder

- ▶ Somatization and Pain Disorders in Children

## Psychiatry and Pain Management

MICHAEL R. BOND

University of Glasgow, Glasgow, UK  
m.bond@admin.gla.ac.uk

The use of psychiatric diagnoses is one aspect of the multimodal system used for the assessment of individuals in pain and especially those in chronic pain. This system represents a movement away from a single, linear or 'cause and effect' model of pain to the use of a biopsychosocial model, which has been one of the most important developments in the field of pain research and management in the past 30 years. Psychiatric diagnoses provide a structured framework for emotional and physical symptoms, taking into account social factors and they serve as a basis for the treatment and prognosis of several pain disorders.

The use of psychiatric diagnoses is in accordance with the definition of pain developed in 1979 by the taxonomy committee of the International Association for the Study of Pain (IASP) led by the psychiatrist, Professor Harold Merskey, who is a contributor to this section. The definition states that pain is 'an unpleasant, sensory, and emotional experience associated with actual or potential tissue damage or described in terms of such damage'. Pain is a subjective experience and the use of the term and behaviour associated with it is learned in childhood, but shaped throughout life by additional experiences and the social contexts in which it occurs. Several hypotheses have been proposed to explain why certain emotional changes take place as an aspect of pain experiences and all involve psychological mechanisms which have been the subject of extensive research in the past 3 decades and which are discussed elsewhere in this volume. Examples of such models are considered by Muhammed and Large in this section and the reader might also refer to the publication by Price and Bushnell (2004) which seeks to explain the link between noxious stimulation and the short and long term changes in emotion and behaviour produced *via* intermediary cognitive processes. These mechanisms do not explain, however, why different psychiatric disorders develop in different individuals.

People experience mood changes that occur in all painful disorders, but their intensity and duration is often relatively minor and falls short of a formal psychiatric condition. Suffering undoubtedly occurs however and in these circumstances its relief is a necessary part of management. Acute pain gives rise to feelings of both anxiety and depression, but primarily of anxiety, whereas those in chronic pain develop more complex changes, which include feelings of depression and anxiety, which may proceed to become a psychiatric disorder.

To enable sense to be made of such changes, clinicians need a frame of reference, a systematic diagnostic index and the one most often used in pain research and management is the diagnostic and statistical manual of the American Psychiatric Association in its fourth and revised version (2002).

DSM IV-TR diagnoses have five axes. The first axis is for the primary diagnosis, for example, a major depressive disorder and the second axis for any personality disorder detected. The third axis allows reporting of current general medical conditions that are relevant, the fourth enables a description of psychosocial and environmental problems and the fifth an overall global assessment of function. The first three axes are particularly important, but quite often consideration of personality disorder is neglected, even though a high rate of such a disorder exists in chronic pain patients. Although this has relevance to the development and management of the primary condition, none of the personality disorders predict specifically the development of chronicity of pain. For further information about mood and anxiety disorders, the reader is referred to Gallagher and Verma (2004).

Considerable effort has been put into identifying the extent to which psychiatric disorders occur as comorbidity in populations of pain patients. There is a wide variation in the levels of incidence and prevalence described in the literature and this is reviewed by Eldon Tunks in this section, who in addition, reviews the relationship between certain aspects of mental disorder and pain. Further consideration of epidemiology is given in the contribution from Muhammed and Large. Despite the variations that occur, it is clear that there is a definite increase in the number of individuals who develop psychiatric disorders when physically ill, compared with a healthy population and that the number increases further when pain, especially chronic pain is present. The effect of pain itself, fear of pain and the nature of the condition are important in the generation of psychiatric disorders and this is mentioned in essays on cancer pain by Chaturvedi, on visceral pain by Tyrer and Wigham and on facial pain by Feinmann.

Mood disorders during painful illness or post-injury are associated with increased levels of pain and lowered tolerance for it. In turn that may be associated with an increased need for analgesic drugs. Mood changes make rehabilitation more difficult and prolong recovery time. For these reasons the detection and treatment of mood disorders is important. Psychiatric disorders that occur include major depressive disorder, general anxiety disorder, post-traumatic stress disorder and adjustment disorder – a condition that develops when a patient does not adapt emotionally and socially to a chronic physical disorder, including those that are painful. It is important to be aware that depressive ill-



nesses and certain forms of anxiety disorder have pain as a symptom, for example pain is present in approximately half of all patients who develop depressive disorders.

A wide range of factors needs to be taken into account in an analysis of pain disorders and their management. This is illustrated in the contribution of Hapidou who deals with psychological aspects of pain in women. She indicates that differences in pain experiences, including mood changes, behaviour and responses to treatment do exist between women and men.

The social consequences of chronic pain have emotional effects and this is a further relatively neglected issue. Writing about social dislocation and chronic pain, Roy draws attention to the fact that loss of ability to work, loss of income, loss of status within and outside the family and forced role changes are all factors that tend to promote or exacerbate mood change and other psychiatric disorders. Social aspects of the biopsychosocial model are significant and they have implications for the management of pain problems and, in particular, the processes of rehabilitation and return to work.

It is readily appreciated that painful conditions result in changes of mood. Equally, we are aware that individuals with anxieties in daily life may develop pain, for example headache or backache, although there is no known underlying tissue injury. This is a normal psychological process known as somatisation and it is almost always transient and treatable. In a more powerful form, it is the basis for a group of psychiatric disorders known as the somatoform disorders, some of which include pain as a symptom. In these conditions, anxiety is focused somatically by an unconscious process and therefore, there will be evidence of background emotional problems or distress not linked by the patient to his or her physical complaints and disability, both of which will be out of proportion to any physical pathology if present. It is a matter for a doctor or other health professional to decide the extent to which a discrepancy exists, whether it can be dealt with simply by advice and reassurance or whether it constitutes one of the somatoform group disorders and needs more specialist attention. The two somatoform disorders in which pain features prominently and most often are hypochondriasis and pain disorder, A third condition, somatisation disorder is less common.

The concept of the sick role is fundamental to the understanding of somatoform disorders. The behaviour shown in the sick role is known as illness behaviour and it is important when assessing a person with a somatisation disorder. At times it is significantly out of keeping with the level of physical abnormality demonstrated and is associated with a level of disability far greater than would be expected. These issues are ad-

ressed briefly by Pilowsky who deals with hypochondriasis. In this condition the key features are an increase in somatic focusing and the sufferer's fears or beliefs that they have a serious disease as a cause for pain, for example cancer or heart disease. In some, hypochondriasis is a personality trait and the individual is well aware that their fears may be groundless but nevertheless seeks reassurance. At other times the beliefs are held with greater conviction and may even reach delusional proportions. Care must be taken with patients who have marked hypochondriasis, because on occasions, this is a manifestation of a major depressive disorder.

An unconscious link between the concerns or anxieties of everyday life and the presence of pain is characteristic of the condition of pain disorder. The diagnosis is made only when co-morbid anxiety or depression are absent. Most often the condition comes to light after exhaustive clinical investigations have failed to reveal a physical cause for pain and after the patient has been labelled 'psychiatric'. The difficulties in making the diagnosis, other than by exclusion are described by Sullivan. The fact that the definition of this condition has changed three times in the DSM series since 1980 underlies his comments. He makes the important point that the route the patient is taken down by doctors and the labelling that takes place during that process frustrates and angers the sufferer, who usually rejects attempts to involve the use of psychological terms, which to them implies that their pain is not 'genuine'. This raises difficulties in management once the diagnosis has been made, although the development of multimodal clinics and management programmes has eased the problem.

Fishbain's essay on multimodal treatment outlines clearly why such facilities are needed for the treatment of complex pain problems and the role within them of psychiatric methods. The reasons for an integrated approach are evident and such programmes have been found to be superior to the use of single therapies. Fishbain comments, however, that the reason why such packages work is not fully understood. From the patient's perspective, the multimodal approach is often much more acceptable than single therapy, especially if that is psychologically based, because for obvious reasons, blending physical, psychological and social techniques allows the therapy team to present to the patient what seems a more reasonable and acceptable set of explanations and reasons for therapies needed. The role of non-psychiatrists in a multimodal treatment programme has been described elsewhere. Psychiatrists share techniques based on cognitive and behavioural concepts with psychologists and in addition, have the vital role of directing the use of psychotropic drugs and in particular, those of the antidepressant

group for the treatment of psychiatric disorders and pain. Originally developed to combat depressive disorders, the antidepressants of the tricyclic group were noted as long ago as the 1960s to have an independent analgesic effect at doses lower than those used in the treatment of depression. The value of tricyclics as analgesics and in particular, nortriptyline, amitriptyline and imipramine has been established for some years. Wilson and Merskey comment on their use in a range of painful disorders, concluding that there is little evidence of potency in the treatment of acute pain, but some suggestion that amitriptyline may be of value in rheumatic disorders. The greatest success is gained in the treatment of pains due to nerve injury or neuropathic pain. The tricyclic drugs and amitriptyline and imipramine, which act as both neuroadrenergic and serotonergic agents (mixed n and s agents) are more effective than single noradrenergic agents. They appear to equal in effect the anticonvulsant drug, gabapentin, widely used currently in the treatment of neuropathic pain. Decisions about the selection of individual drugs are based upon their effectiveness and also, taking into consideration adverse effects they may cause.

The pain specialist, most often an anaesthetist, but perhaps a psychologist or occasionally a psychiatrist may be asked to act as an expert witness in cases of post-injury litigation. The complexities of such problems are described in the essay by Mendelson and can be demanding of witnesses, who require extensive knowledge of this field and the ability to express opinions clearly. Many claimants have a history of a painful injury with persistent post-injury pain and disability with, in a significant number, marked changes in emotions. Key questions put to medical experts, first in reports and perhaps later in court by lawyers for the insurer will at some point focus upon the extent to which the accident has caused the level of pain and disability of which the litigant complains and any emotional and social difficulties that have developed. At times it is im-

plied that the claimant's evidence is a fabrication and a means of gaining financially. In these circumstances, the term malingering may be used by lawyers but, as Mendelson points out, this is not a medical or psychiatric diagnosis, but a word used to describe a fraud within a medical context. As such it is for lawyers to determine whether or not it is present. Lawyers tend to seek definitive psychiatric diagnoses when emotional factors form a major part of the litigant's problem. Some, but not all do have specific disorders, for example a major depressive disorder or post-traumatic stress disorder, due to the effects of the accident or injury, but the terms accident neurosis or compensation neurosis should not be used, because they do not have clinical validity. Finally, although there is no clear evidence that the severity of pain amongst litigants is any greater than in non-litigants, the often stressful process of seeking compensation may well contribute to the chronicity of the condition, albeit at an unconscious rather than a conscious level. Moreover, once established over a period of several years, symptoms, including pain, often continue after litigation has been settled and, as such are difficult to treat.

To conclude, the essays in this section reveal that the discipline of psychiatry has an important role in the evaluation and management of pain, both when determined by physical causes and when it is a symptom of a mental disorder.

### References

1. American Psychiatric Association (2002) *Diagnosis and Statistical Manual of Mental Disorders (Fourth Revision) DSM IV-TR*. American Psychiatric Association, Washington DC
2. Gallagher RN, Verma S (2004) Mood and anxiety disorders in chronic pain. In: Dworkin RH, Breitbart WS (eds) *Psychosocial Aspects of Pain: A Handbook for Health Care Providers*. IASP Press, Seattle
3. Price DD, Bushnell MC (2004) Overview of pain dimensions and their psychological modulation. In: Price DD, Bushnell DC (eds) *Psychological Methods of Pain Control: Basic Science and Clinical Perspectives Progress in Pain Research and Management*, vol 29. IASP Press, Seattle

## Psychogenic Rheumatism

### ► Fibromyalgia

## Psychological Aspects of Pain in Women

ELENI G. HAPIDOU

Department of Psychiatry and Behavioural Neurosciences, McMaster University and Hamilton Health Sciences, Hamilton, ON, Canada  
hapidou@hhsc.ca

### Definition

Considerable evidence from ► [epidemiology](#), the clinic and the laboratory suggests that women experience pain differently than do men (Berkley and Holcroft 1999; Fillingim et al. 2003; Riley et al. 1998; Rollman 2003; Unruh 1996). Women are more sensitive to both exogenous and endogenous painful stimulation, report greater clinical pain with the same pathology or tissue injury as men, have a wider pain distribution, a greater likelihood to develop chronic pain after trauma and use analgesics more than do men (Berkley and Holcroft 1999; Unruh 1996; Fillingim et al. 2003). Moreover, women's pain as part of reproductive life is unparalleled to anything in men. Be-

cause of documented differences between women and men, the National Institute of Health has recently mandated ► [sex](#) / ► [gender](#) differential designs and analyses in behavioral and biomedical research (Rollman 2003).

## Characteristics

### Epidemiology of Pain in Women

Women have a higher ► [prevalence](#) of migraine, trigeminal neuralgia, causalgia, neuralgia, neck, shoulder, knee and abdominal pain, pain from osteoporosis, ► [irritable bowel syndrome](#) (IBS), interstitial cystitis, rheumatoid arthritis ► [fibromyalgia](#), carpal tunnel syndrome and ► [temporomandibular disorder](#) (TMD) (Fillingim et al. 2003; Unruh 1996; Yunus 2002). Prevalence patterns vary according to condition and across the lifespan.

### Clinical Pain

There is an even higher female predominance of several clinical pain syndromes. Prevalence rates for TMD, IBS, migraine and fibromyalgia are 2-9 times higher in women than men (Yunus 2002). Some studies also show that women report more chronic back pain, pain causing activity limitations, osteoarthritis, rheumatoid arthritis, pain from multiple sclerosis, colonoscopy, oral surgery, dental pain and orthopedic surgery, but findings for chronic pain severity are less consistent (Fillingim 2002).

### Pain Sensitivity in the Laboratory

Laboratory pain in women has been widely investigated in the context of sex/gender differences and the menstrual cycle in both pain-free women and in women with clinical pain syndromes. Studies using a variety of ► [noxious stimuli](#) (e.g. mechanical, ischemic, the ► [cold pressor task](#) (CPT) and measuring a variety of responses (pain threshold, tolerance, pain ratings) in different body systems (cardiovascular, neuromuscular, cerebral, autonomic nervous system) show increased pain responsiveness in women (Fillingim 2002). The magnitude of gender differences varies across pain induction methods, with effects being relatively consistent and robust with pressure and cold pressor pains but rather contradictory with thermal and electrical pains (Fillingim 2002; Riley et al. 1998). Discrepancies in ► [effect sizes](#) are also evident between experimental and clinical studies with the latter obtaining smaller or minimal ones (Myers et al. 2003).

### Factors Mediating Gender Differences / Proposed Mechanisms

Biological, psychological and sociocultural factors have all been implicated to explain women's differential sensitivity to pain. Specific mechanisms include body size, gonadal hormones, brain function, anxiety, cardiovascular reactivity / blood pressure, cortisol, gender role expectancies (► [gender role theories in pain](#)), self-efficacy and learning history regarding pain behavior (Derbyshire et al. 2002; Fillingim et al. 2003; Riley

et al. 1998). Only some of the main factors mentioned are reviewed here.

### The Influence of the Menstrual Cycle / Reproductive Hormone Status

Gonadal hormones can alter ► [nociception](#) both peripherally and centrally (Aloisi 2003). Although not consistent for all types of noxious stimuli, on average, pain threshold and tolerance are highest in the follicular and lowest in the luteal phase of the menstrual cycle (Riley et al. 1999). Effect size across all stimulus modalities is about 0.40. The fact that certain pain syndromes such as TMD, migraine, myofascial pain, autoimmune diseases and irritable bowel syndrome (IBS) are more prevalent in women during their reproductive years suggests the role of gonadal hormones in the development and pathogenesis of these problems.

### Central Processing

Neuroimaging findings from positron emission tomography (PET) suggest that women are different from men in terms of brain activation patterns in response to noxious heat (Derbyshire et al. 2002; Paulson et al. 1998). Greater cerebral flow was shown in the anterior insula, thalamus and prefrontal left hemisphere (Paulson et al. 1998) and the perigenual cingulate cortex (Derbyshire et al. 2002) in women. These structures are also implicated in affective processing (Derbyshire et al. 2002). Women with IBS are also different from men in response to a visceral stressor. They showed greater activation in the ventromedial prefrontal cortex, right anterior cingulate cortex and left amygdala (Naliboff et al. 2003).

### Gender Roles / Expectations

Women differ from men in terms of their expectations of the typical male and female response to pain (Robinson et al. 2001). When the effect of gender role expectations on laboratory pain was assessed with the ► [gender role expectation of pain \(GREP\) scale](#) in a large number of university students, women were rated as more willing to report pain, as more sensitive to pain and as less enduring of pain than men. Men rated their own endurance as higher than that of the typical man. Willingness to report pain accounted for 46% of the variance, 1.8 standard deviations above the mean. Self-efficacy beliefs are another factor that could account for the lower tolerance and the higher pain intensity ratings by women in the CPT (Jackson et al. 2002). Women, who were told that men do better in tolerating ischemic pain, had the lowest systolic blood pressure reactivity and reported lower perceived ability to tolerate the painful task (Fillingim et al. 2002).

### Emotional Factors

Women tend to be more worried and irritated about pain (Unruh 1996) and have more negative cognitions and emotions, such as ► [catastrophizing](#) about pain than men (Keefe et al. 2000). They show a much higher prevalence

of somatic depression (appetite, sleep disturbance and fatigue), but not of pure depression, than men and this is also associated with high rates of pain (Silverstein 2002). Anxiety plays a role in women's increased sensitivity to laboratory pain as compared to men, in reporting clinical pain and symptoms and in predicting poorer outcome of pain relief procedures (blocks and injections) for chronic pain (Edwards et al. 2003). Pre-operative anxiety and depression in women undergoing radical mastectomy is associated with higher post-operative pain and analgesic requirements (Ozalp et al. 2003). Pregnant parous and nulliparous women tolerated less pain in the CPT and experienced more severe pain if they feared pain of labor (Saisto et al. 2001). In a population study in Sweden, older women's (60–74 yrs) higher risk for migraine was associated with a history of major depression, higher levels of susceptibility to stress and somatic trait anxiety (Mattsson and Ekselius 2002).

Depression and anxiety are more common in women with TMD and fibromyalgia (Yunus 2002). Women with chronic pain differ from men in terms of anger management style and hostility (Burns et al. 1996). Women who express hostile anger characterized by cynicism and resentment may suffer greater pain than women with less hostile anger. Women who express non-hostile anger report the best adjustment to chronic pain (lowest pain, highest activity).

Women responded more positively than men to pleasant odors in terms of reducing their perceived pain intensity and unpleasantness of thermal stimuli (Marchand and Arsenault 2002). Odor related brain activity was also higher in women than men in functional magnetic resonance imaging (fMRI) (Yousem et al. 1999). That pleasant odors may reduce pain perception could have implications for alternative therapies, such as the use of aromatherapy in pain management.

### Trauma / Abuse and Pain

A trauma history that includes physical and sexual abuse has been associated with poor health status, the development of chronic pain such as pelvic pain in women, other heterogeneous pain problems, catastrophizing, psychological distress, functional disability and lifetime surgeries (Seville et al. 2003). Women with a history of trauma from non-clinical or primary care samples are no different from men in terms of pain and distress, but emotional distress occurs more in traumatized men with chronic pain.

### Coping Styles

Pain coping instructions have different effects on women and men in the experimental setting. When instructed to focus on the sensory aspects of pain in the CPT, pain-free women reported more negative pain responses - lower pain threshold and tolerance and higher sensory pain ratings than did men (Keogh and Henderfeldt 2002). When instructed to focus on the emotional aspects of

pain, they reported higher affective pain ratings. In dealing with clinical pain, women tend to use a greater range of pain coping strategies than men, including alternative pain therapies (Berkley and Holcroft 1999). Women with osteoarthritis and rheumatoid arthritis tend to use emotion-focused strategies (venting emotions, redefinition, seeking spiritual comfort and emotional support) more than problem-focused strategies (attempting pain reduction, relaxation and distraction), which are more often used by men (Affleck et al. 1999). Women with chronic pain who view themselves as responsible for their health status tend to use more adaptive coping strategies than those who rely more on medical professionals (Buckelew et al. 1990).

### Clinicians' Responses to Women's Symptoms and Pain

Gender biases and expectations seem to influence health care professionals' responses to pain. Male and female physicians treat chronic neck pain differently in women and men (Hamberg et al. 2002). Three times more women than men are referred to a mind/body clinic (Nakao et al. 2001) and this approximates normative patterns for women. Women with TMD are treated surgically more often than men (Marbach et al. 1997). Physicians seem to prescribe opioids to men with affective distress and to women with functional disability (Fillingim et al. 2003).

### Treatment Outcome

Improved long-term behavioral medicine rehabilitation outcomes (less chance of obtaining early retirement and better quality of life) were found for women with chronic pain as compared to untreated controls (Jensen et al. 2001). However, there is a paucity of research on differential treatment outcome for chronic pain based on gender. Most research exists with respect to pharmacological outcome.

### Analgesic Responses

Pharmacological interventions act differentially on women in both clinical and experimental pain conditions but the pattern of results is not consistent across drugs or testing methods (Fillingim 2002). Also, the practical implications are not yet known. Results are more consistent for opioids, which produce greater analgesia for women (Craft 2003). Women respond better to mixed  $\mu$ - and  $\kappa$ -opioids such as pentazocine, nalbuphine and butorphanol, experience longer analgesia than men with higher doses of nalbuphine and have greater morphine analgesia than men (Craft 2003). Morphine, meperidine and hydromorphone, all  $\mu$ -agonists, produced equipotent analgesia in women for pressure pain, but greater analgesia for women in the CPT (Zacny 2002). There are also gender differences in anesthetic drug effects (Pley et al. 2003). Whereas animal studies on sex differences in opioid analgesia typically show opposite results from studies in humans,



it was recently reported that the melanocortin-1 receptor (Mc1r) gene (in humans expressed in red hair and fair skin) is responsible for altered kappa-opioid analgesia in both humans and animals (Mogil et al. 2003). Women with two variant MC1R alleles had a greater analgesic response to pentazocine than did men and non-redhead women and “this represents an example of a direct translation of a pharmacogenetic finding from mouse to human.” (p. 4867). Mechanisms suggested to account for sex differences in opioid analgesia include drug metabolism, genotype, density of receptors, gonadal steroids and psychosocial factors such as anxiety and expectancies (Craft 2003; Fillingim 2002). Sex differences in opioid analgesia need to be examined in models of acute inflammatory and chronic pain, as well in long-acting opioids (Craft 2003). Other analgesics such as anti-inflammatories need to be examined as well (Fillingim 2002).

## References

- Affleck G, Tennen H, Keefe FJ et al. (1999) Everyday life with osteoarthritis or rheumatoid arthritis: independent effects of disease and gender on daily pain, mood, and coping. *Pain* 83:601–609
- Aloisi AM (2003) Gonadal hormones and sex differences in pain reactivity. *Clin J Pain* 19:168–174
- Berkley KJ, Holcroft A (1999). Sex and gender differences in pain. In: Wall P, Melzack R (eds) *Textbook of Pain*, 4th edn. Churchill Livingstone, London, pp 95<sup>1</sup>–965
- Buckelew SP, Shutty MS Jr, Hewett J et al. (1990) Health locus of control, gender differences and adjustment to persistent pain. *Pain* 42:287–294
- Burns JB, Johnson BJ, Mahoney N et al. (1996) Anger management style, hostility and spouse responses: gender differences in predictors of adjustment among chronic pain patients. *Pain* 64:445–453
- Craft RM (2003) Sex differences in opioid analgesia: “From mouse to man”. *Clin J Pain* 19:175–186
- Derbyshire SW, Nichols TE, Firestone L et al. (2002) Gender differences in patterns of cerebral activation during equal experience of painful laser stimulation. *J Pain* 3:401–411
- Edwards R, Augustson E, Fillingim R (2003) Differential relationships between anxiety and treatment-associated pain reduction among male and female chronic pain patients. *Clin J Pain* 19:208–216
- Fillingim RB, Browning AD, Powell T et al. (2002) Sex differences in perceptual and cardiovascular responses to pain: The influence of a perceived ability manipulation. *Pain* 3:439–445
- Fillingim RB, Doleys DM, Edwards RR et al. (2003) Clinical characteristics of chronic back pain as a function of gender and oral opioid use. *Spine* 28:143–150
- Fillingim RB (2002) Sex differences in analgesic responses: evidence from experimental pain models. *Eur J Anesthesiol* 19 (Suppl 26):16–24
- Hamberg K, Risberg G, Johansson EE et al. (2002) Gender bias in physician’s management of neck pain: a study of the answers in a Swedish national examination. *J Women’s Health Gend Based Med* 11:653–666
- Jackson T, Iezzi T, Gunderson J et al. (2002). Gender differences in pain perception: The mediating role of self-efficacy beliefs. *Sex Roles* 47:561–568
- Jensen IB, Bergstrom G, Ljungquist T et al. (2001) A randomized controlled component analysis of a behavioral medicine rehabilitation program for chronic spinal pain: are the effects dependent on gender? *Pain* 91:65–78
- Keefe FJ, Lefebvre JC, Egert JR et al. (2000) The relationship of gender to pain, pain behavior and disability in osteoarthritis patients: the role of catastrophizing. *Pain* 87:325–334
- Keogh E, Henderfeldt M (2002) Gender, coping and the perception of pain. *Pain* 97:195–201
- Marbach JJ, Ballard GT, Frankel MR et al. (1997) Patterns of TMJ surgery: evidence of sex differences. *J Am Dent Assoc* 128:609–614
- Marchand S, Arsenault P (2002) Odors modulate pain perception. A gender-specific effect. *Physiol Behav* 76:251–256
- Mattsson P, Ekselius L (2002) Migraine, major depression, panic disorder, and personality traits in women aged 40–74 years: a population-based study. *Cephalalgia* 22:543–551
- Mogil JS, Wilson SG, Chesler EJ et al. (2003) The melanocortin-1 receptor gene mediates female-specific mechanisms of analgesia in mice and humans. *Neuroscience* 100:4867–4872
- Myers CD, Riley, JL 3rd, Robinson ME (2003) Psychosocial contributions to sex-correlated differences in pain. *Clin J Pain* 19:225–232
- Nakao M, Fricchione G, Zuttermeister PC et al. (2001) Effects of gender and marital status on somatic symptoms of patients attending a mind/body medicine clinic. *Behav Med* 26:159–168
- Naliboff BD, Berman S, Chang L et al. (2003) Sex-related differences in IBS patients: central processing of visceral stimuli. *Gastroenterology* 124:1975–1977
- Ozalp G, Sarioglu R, Tuncel G et al. (2003) Preoperative emotional states in patients with breast cancer and postoperative pain. *Acta Anaesthesiol Scand* 47:26–29
- Paulson PE, Minoshima S, Morrow TJ, Casey KL (1998) Gender differences in pain perception and patterns of cerebral activation during noxious heat stimulation in humans. *Pain* 76:223–9
- Pley H, Spigset O, Kharasch ED et al. (2003) Gender differences in drug effects: implications for anesthesiologists. *Acta Anaesthesiol Scand* 47:241–259
- Riley III JL, Robinson ME, Wise EA et al. (1998) Sex differences in the perception of noxious experimental stimuli: A meta-analysis. *Pain* 74:181–187
- Riley III JL, Robinson ME, Wise EA et al. (1999) A meta-analytic review of pain perception across the menstrual cycle. *Pain* 81:225–235
- Robinson ME, Riley JL, Myers C et al. (2001) Gender role expectations of pain: Relationship to sex differences in pain. *Pain* 2:251–257
- Rollman GB (2003) Sex makes a difference: Experimental and clinical pain responses. *Clinical J Pain* 19:204–207
- Saisto T, Kaaja R, Ylikorkala O et al. (2001) Reduced pain tolerance during and after pregnancy in women suffering from fear of labor. *Pain* 93:123–127
- Seville JL, Ahles TA, Wasson JH et al. (2003) Ongoing distress from emotional trauma is related to pain, mood, and physical function in a primary care population. *J Pain Symptom Manage* 25:256–263
- Silverstein B (2002) Gender differences in the prevalence of somatic versus pure depression: A replication. *Am J Psychiatry* 159:1051–1052
- Unruh AM (1996) Gender variations in clinical pain experience. *Pain* 65:123–167
- Yousem DM, Maldjian JA, Siddiqi F et al. (1999) Gender effects on odor-stimulated functional magnetic resonance imaging. *Brain Res* 818:480–487
- Yunus MB (2002) Gender differences in fibromyalgia and other related syndromes. *J Gend Specif Med* 5:42–47
- Zacny JP (2002) Gender differences in opioid analgesia in human volunteers: cold pressor and mechanical pain (CPDD abstract). NIDA Research Monograph 182:22–23

## Psychological Assessment of Pain

DENNIS C. TURK

Department of Anesthesiology, University of Washington, Seattle, WA, USA

turkdc@u.washington.edu

## Synonyms

Evaluation; assessment; screening

## Definition

A thorough psychological assessment will typically involve an interview with the patient (and ► **significant others**), observation of the patient's (and significant other's) behaviors, and completion of a standardized set of self-report questionnaires. The overall objectives of assessment are to determine the extent to which cognitive (► **cognitive factors**), emotional, or behavioral factors are exacerbating the pain experience, interfering with functioning, or impeding rehabilitation. The information obtained should assist in treatment planning, specifically the matching of treatment (► **Treatment matching**) components to the needs of individual patients, and modification of the treatment plan as needed.

## Characteristics

In some settings, such as hospitals, health professionals are asked to conduct bedside pain evaluations or provide a pain consultation service for physicians treating patients with complicated symptoms or on rehabilitation units. Under these circumstances, a brief psychological ► **screening** may be all that is feasible. In those instances, patients are routinely queried as to pain severity, location, and characteristics. In addition, when feasible, patients should be asked about the impact of pain on their activities (e.g. socializing, eating, ambulating), current and past treatments for pain, and patients' expectations for pain relief. In addition, behavioral manifestations of pain should be observed (e.g. limping, protective body postures, moaning), and changes in these should be noted. Regular reassessment of patients attends to alterations (improvement or deterioration) in symptom severity, physical functioning, emotional functioning, and social functioning (Turk et al. 2002; Turk et al. 2004).

A thorough psychological evaluation will reveal aspects of the patient's history that are relevant to the current situation. For example, the psychologist will gather information about psychological disorders, substance abuse or dependence, vocational difficulties, and family role models for chronic illness. In terms of current status, topics covered include recent life stresses, vocational, social and physical functioning, sleep patterns, and emotional functioning. The purpose of the evaluation is to examine whether historical or current factors are influencing the way the patient perceives and copes with pain.

A central component of a psychological evaluation is the interview. A number of topics, roughly fitting within ten general areas, are covered in the interviews:

### Experience of Pain and Related Symptoms

Location and description of pain (e.g. "sharp", "burning")

Onset and progression

Perception of cause (e.g. trauma, virus, stress)

What have they been told about their symptoms and condition? Do they believe that what they have been told is accurate?

Exacerbating and relieving factors (e.g. exercise, relaxation, stress, massage). "What makes your pain worse?" "What makes your pain better?"

Pattern of symptoms (e.g. symptoms worse certain times of day or following activity or stress)

Sleep habits (e.g. difficulty falling asleep or maintaining sleep, sleep hygiene)

Thoughts, feelings, and behaviors that precede, accompany, and follow fluctuations in symptoms

### Treatments Received and Currently Receiving

Medication (prescribed and over-the-counter). How helpful have these been?

Pattern of medication use (as needed or time-contingent), changes in quantity or schedule

Physical modalities (e.g. physical therapy). How helpful have these been?

Exercise (e.g. Do they participate in a regular exercise routine? Is there evidence of deactivation and avoidance of activity due to fear of pain or exacerbation of injury?). Has the pattern changed (increased, decreased)?

Complementary and alternative (e.g. chiropractic manipulation, relaxation training). How helpful have these been?

Which treatments have they found the most helpful?

Compliance/adherence with recommendations of health care providers.

Attitudes towards previous health care providers

### Compensation/Litigation

Current disability status (e.g. receiving or seeking disability, amount, percentage of former job income, expected duration of support)

Current or planned litigation (e.g. "Have you hired an attorney")

### Activity

Typical daily routine ("How much time do you spend sitting, standing, lying down?")

Changes in activities and responsibilities (both positive and obligatory) due to symptoms ("What activities did you use to engage in prior to your symptoms?" "How has this changed since your symptoms began?")

Changes in significant other's activities and responsibilities due to patient's symptoms

What does the patient do when pain is not bothering him or her (uptime activities)?

Activities that patient avoids because of symptoms

Activities continued despite symptoms.

### Responses by Patient and Significant Others

Patient's behavior when pain increases or flares up ("What do you do when your pain is bothering you?")

“Can others tell when your pain is bothering you?”  
 “How do they know?”)

Significant others’ responses to behavioral expressions of pain (“How can significant others tell when your pain is bad?” “What do your significant others do when they can tell your pain is bothering you?” “Are you satisfied with their responses?”)

Significant other’s response when patient is active (“How does your significant other respond to your engaging in activities?”)

Impact of symptoms on interpersonal, family, marital, and sexual relations (e.g. changes in desire, frequency, or enjoyment)

Pattern of activity and pacing of activity (can use activity diaries that ask patients to record their pattern of daily activities [time spent sitting, standing, walking, and reclining] for several days or weeks)

### Coping

How does the patient try to cope with his or her symptoms? (e.g. “What do you do when your pain worsens?” “How helpful are these efforts?”). Does patient view himself or herself as having any role in symptom management? “What role?”

Current life stresses

Pleasant activities (“What do you enjoy doing?”)

### Educational and Vocational History

Level of education completed (any special training)

Work history

How long at most recent job?

How satisfied with most recent job and supervisor?

What like least about most recent job?

Would they like to return to most recent job? If not, what type of work would they like?

Current work status (including homemaking activities)

Vocational and avocational plans

### Social History

Relationships with family or origin

History of pain or disability in family members

History of substance abuse in family members

History of or current physical, emotional, and sexual abuse. Was the patient a witness to abuse of someone else?

Marital history and current status?

Quality of current marital and family relations.

### Alcohol and Substance Use

Current and history of alcohol use (quantity, frequency)

History and current use of illicit psychoactive drugs

History and current use of prescribed psychoactive medications

Consider the CAGE questions as a quick screen for alcohol dependence (Mayfield et al. 1987). Depending on response, consider other instruments for alcohol and substance abuse (Allen and Litten 1998).

### Psychological Dysfunction

Current psychological symptoms/diagnosis (depression including suicidal ideation, anxiety disorders, somatization, post-traumatic stress disorder). Depending on responses, consider conducting formal structured clinical interview for DSM (SCID) (American Psychiatric Association 1997).

Is the patient currently receiving treatment for psychological symptoms? If yes, what treatments (e.g. psychotherapy or psychiatric medications). How helpful?

History of psychiatric disorders and treatment including family counseling

Family history of psychiatric disorders

### Concerns and Expectations

Patient concerns/fears (e.g. Does the patient believe he/she has serious physical problems that have not been identified? Or that symptoms will become progressively worse and patient will become more disabled and more dependent? Does the patient worry that he/she will be told the symptoms are all psychological?)

► **Explanatory models** (“What have you been told is the cause of your symptoms?” “Does this explanation make sense?” “What do you think is the cause of your pain now?”)

Expectations regarding the future and regarding treatment (will get better, worse, never change)

Attitude towards rehabilitation versus “cure.”

Treatment goals

Psychologists are interested in how patients experience their pain, what types of things exacerbate or alleviate the symptoms and what thoughts and feelings they have about their pain.

In addition to asking about the severity of pain, patients are asked about the location and changing (spreading) of pain, the characteristics of pain (e.g. burning, aching), the effect of pain on activities, and what they do when their pain is particularly severe as well as how they typically control their pain. Patients are asked about their sleep, specifically if they have any difficulty initiating or maintaining sleep? They may be asked about what treatments they have tried in the past and are using presently, how effective these have been.

The patient’s social history is important. The psychologist inquires about the patient’s background including family structure, marital (social) status, socioeconomic status, educational background, health history, and presence of anyone in the family with a history of chronic pain.

When patients with persistent pain seek compensation for lost wages or are involved in litigation, these processes can add an additional layer of distress. Psychologists attempt to determine whether compensation or litigation statuses might inadvertently be contributing to and maintaining the patients’ symptoms.

Antecedents and consequences of pain symptoms and associated behaviors (► [Antecedents and consequences of behaviour](#)) can potentially shape future experiences and behaviors (Fordyce 1976). Pain psychologists use information to formulate hypotheses about what behavioral factors in a person's life may serve to maintain or exacerbate the pain experience. It is helpful to gather this information through interviews with patients and significant others, together as well as separately. During conjoint interviews, the psychologist observes interactions between the significant others, and responses by significant others to patients' expressions of pain and suffering. Symptoms of chronic pain are extremely distressing and many times there is no cure or treatment capable of substantially reducing all symptoms (Boothby et al. 1999). At the present time, rehabilitation, including improvement in emotional functioning, physical functioning, and quality of life, is the goal. Rehabilitation in spite of pain is a daunting task even for patients with ample ► [coping](#) skills.

People who feel that they have a number of successful methods for coping with pain may suffer less than those who behave and feel helpless, hopeless, and demoralized. Thus, assessments focus on identifying factors that *exacerbate* and *ameliorate* the pain experience. The psychologist not only focuses on deficits and weaknesses in coping efforts and coping repertoire, but also strengths (DeGood and Tait 2001).

Characteristics of jobs are important in chronic pain. The psychologist inquires about the patient's current and previous work history, the nature of the work, physical demands required, how the patient gets along with co-workers, supervisors, and employees, and whether the patient believes that he or she will be able to return to their previous occupation. Questions about whether the patient liked his or her previous job and wishes to return to the same or a related job are discussed along with other plans they have for the future.

History of and current alcohol and substance use are important topics to be addressed during a psychological assessment. Moreover, a significant percentage of people with chronic pain are prescribed one or more analgesic medications, with a substantial percentage receiving prescriptions for opioid medication (Clark 2002). A psychologist may use a structured interview such as the SCID (American Psychiatric Association 1997) to determine if the patient meets the criteria for substance abuse or dependence. In addition, a psychological assessment will include determination of whether patients have a prior history of psychiatric illness, and whether they are currently being treated for psychological problems. The SCID-I and SCID-II (1997) can be used to determine whether the patient suffers from any Axis I [primary psychiatric diagnosis] or Axis II [personality disorder] DSM-IV diagnoses (American Psychiatric Association 1994). In addition to the use of interviews, psychologists may make use of a number of self-report mea-

asures to assess psychological status and emotional distress (Bradley et al. 2001).

Patients should be asked about their beliefs and expectations about the future of their pain problem (DeGood and Tait 2001). Are they convinced that they will not be "fixed" unless they have a surgery? What would they do if their pain were eliminated? These questions are meant not only to assess the patient's thoughts (beliefs, expectations, attitudes) surrounding their pain problem, but also to assess whether the patient has considered that rehabilitation is possible. To what extent have they internalized the disability role? Are they expecting to improve?

Observation of patients' behaviors (ambulation, body postures, facial expressions) can occur while they are being escorted to interview, during the interview, and when exiting interview (observation checklists are available to assist in assessing pain behaviors, Keefe et al. 2001). Observation of significant others' responses to patients can occur at the same time.

A large number of psychological instruments have been used to assess domains relevant to patients with chronic pain (Turk and Melzack 2002). Data gathered from measures not specifically developed or standardized (normed) on a chronic pain sample should be interpreted with caution, as their medical condition may influence some of the responses (Turk et al. 2004). Still, standardized assessment measures can provide an alternate source of information about areas that appear to be influencing patients' adaptation to their pain and their response to treatment.

Once areas of concern are identified from the evaluation, it is important to develop a plan for how to assess progress. Health care providers should look for signs that the patients' psychosocial, physical, and behavioral functioning have improved or declined. Patients may be asked to complete diaries in which they report (daily, several times a day) the activities they performed (e.g. number of hours sitting, standing, walking), their mood (e.g. fear, anxiety, depression), medication usage, thoughts, use of coping strategies, and sleep quality.

The high levels of emotional distress, disability, and reduced quality of life noted in many chronic pain patients suggests that psychological screening is essential; in the majority of cases, a thorough psychological evaluation is desirable. Psychosocial assessment allows health care professionals to tailor treatment to meet individual needs and preferences (Turk 1990). A comprehensive assessment is a complex task, involving an exploration of a broad range of areas. The importance of psychologists in the assessment and treatment of chronic pain has been accepted by a number of agencies and governmental bodies in the United States, Canada, and England (e.g. United States Veterans Administration; U.S. Social Security Administration, Ontario Workplace Safety and Insurance Board). In fact, for multidisciplinary treatment programs to be certified, the Commission on the Accreditation of Rehabilitation



Facilities in the United States requires involvement of psychologists in the treatment.

## References

1. American Psychiatric Association (1994) Diagnostic and Statistical Manual of Mental Disorders, 4<sup>th</sup> edn. American Psychiatric Association Press, Washington, DC
2. American Psychiatric Association (1997) User's Guide for the Structured Clinical Interview for DSM-IV Axis I disorders SCID-1: Clinician Version. American Psychiatric Press, Washington, DC
3. Bradley LA, McKendree-Smith NL (2001) Assessment of Psychological Status Using Interviews. In: Turk DC, and Melzack R (eds) Handbook of Pain Assessment, 2<sup>nd</sup> edn. Guilford Press, New York, pp 292–319
4. Clark JD (2002) Chronic pain prevalence and analgesic prescribing in a general medical population. *J Pain Symptom Manage* 23:131–137
5. DeGood DE, Tait RC (2001) Assessment of Pain Beliefs and Pain Coping. In: Turk DC, & Melzack R (eds) Handbook of Pain Assessment, 2<sup>nd</sup> edn. Guilford Press, New York, pp 320–345
6. Fordyce WE (1976) Behavioral Methods for Chronic Pain and Illness. Mosby, St. Louis
7. Keefe FJ, Williams DA, Smith SJ (2001) Assessment of Pain Behaviors. In: Turk DC, Melzack R (eds) Handbook of Pain Assessment, 2<sup>nd</sup> edn. Guilford Press, New York, pp 170–190
8. Turk DC (1990) Customizing Treatment for Chronic Patients Who, What, and Why. *Clin J Pain* 6:255–270
9. Turk DC, Melzack R (2001) Handbook of Pain Assessment, 2<sup>nd</sup> edn. Guilford Press, New York
10. Turk DC, Monarch ES, Williams AD (2002) Psychological Evaluation of Patients Diagnosed with Fibromyalgia Syndrome: Comprehensive Approach. *Rheumatic Disease Clinics of North America* 28:219–233
11. Turk DC, Monarch ES, Williams AR (2004) Pain Assessment. In: Hadjistavropoulos T, Craig KD (2004) Pain: Psychological Perspectives. Erlbaum, Mahwah, NJ, pp 209–244

## Psychological Consequences of Pain

- Pain as a Cause of Psychiatric Illness

## Psychological Evaluation

- Disability Assessment, Psychological / Psychiatric Evaluation

## Psychological Factors

### Definition

Factors related to life events, stress, emotions, behaviors and other events in the environment that have an impact on the individual's state of mind.

- Pain in the Workplace, Risk Factors for Chronicity, Psychosocial Factors
- Psychiatric Aspects of the Management of Cancer Pain

## Psychological Management of Cancer Pain

- Psychiatric Aspects of the Management of Cancer Pain

## Psychological Pain Measures

### Definition

Direct measure of pain in which individuals describe the intensity, location, and quality of their pain experience using a broad array of subjective rating scales such as visual analog scales, adjective checklists and numerical scales.

## Psychological Predictors of Chronicity

MICHAEL K. NICHOLAS

Pain Management and Research Centre, Royal North Shore Hospital, University of Sydney, St. Leonards, NSW, Australia

miken@med.usyd.edu.au

### Synonyms

Psychological Risk Factors; Psychosocial Predictors or Risk Factors

### Definition

Beliefs, responses, mood states, personality characteristics and environmental interactions that increase the likelihood that pain will persist beyond the acute stage and that pain will be more disabling.

### Characteristics

Early attempts to predict the development of chronic pain and associated ► **disability** based on psychological factors focussed mainly on personality theories, traumatic childhood experiences or pre-existing psychopathology (for reviews see Asghari and Nicholas 1999; Gamsa 1994; Roy 1985; Weisberg and Keefe 1999). However, these propositions are unproven, and the support that is available is mostly derived from retrospective or cross-sectional analyses. In recent years researchers have employed stronger research methods, especially prospective research designs, but methodological problems still persist. These are mostly related to differences between studies over variables such as sample composition and size, relevant outcomes, measures employed, and time covered (e.g. Linton 2000; Pincus et al. 2002).

At least four systematic reviews of prospective studies have been published to date. Overall, despite their differences, they provide consistent evidence that psychological factors contribute to the progression from acute pain to chronic, disabling pain.

Linton (2000) analysed 26 prospective studies that examined the development of back and neck pain. He found a consistent relationship between some psychological factors and the onset of pain, the transition from acute to chronic pain and the development of associated disability. These factors included stress, distress and anxiety, as well as measures of depressed mood. Linton also found that certain beliefs, including ► [fear-avoidance](#) beliefs and catastrophic (overly alarmist) beliefs, were strongly associated with the development of disability following onset of pain. Linton's review also found evidence that passive coping strategies, such as waiting for someone else to help or resting, were associated with poorer outcomes, and that pain behaviours, coupled with disability, were a risk factor for future back pain problems. Overall, Linton's findings are consistent with the model described most coherently by Vlaeyen et al. (1995). Specifically, this model suggested that when people experience acute back pain, those who are highly fearful of pain are likely to focus more on the pain and interpret it as harmful, leading them to avoid activities they believe could aggravate their pain. If these responses were maintained, they could lead to chronic disability. Conversely, Vlaeyen et al. argued that those who responded to their acute back pain by not avoiding normal activities, but by gradually resuming them, were more likely to regain normal functional lifestyles.

More recently, Pincus et al. (2002) reported a systematic review of 6 studies that met specified quality criteria, and examined the relationship between psychological factors and chronicity/disability in people with low back pain. This review found that there was an increased risk of chronicity (persisting pain and/or disability) when psychological distress/depressive mood, and to a lesser extent, somatization, were present at onset. Importantly, the finding that distress was a significant predictor of poor outcomes was independent of pain and function at baseline. Pincus et al. reported a moderate effect size that was similar across studies ( $d \sim 0.4$  and odds ratios  $\sim 3.0$ ) for distress. This was greater than the effect sizes found for what they termed 'physical clinical' factors measured in the same study populations. Interestingly, other factors that had been reported by others to be predictors did not appear to be independent in these analyses. These included: the hysteria subscale of the MMPI; praying/hoping/ ► [catastrophizing](#) or passive coping strategies; and fear avoidance beliefs. In part, this finding was due to a lack of relevant studies of acceptable quality relating to some of these psychological constructs.

In occupational settings, Linton (2001) described an analysis of 21 prospective studies that examined the

possible role of psychological work-place factors in disability due to back pain up to 1-year later. This review revealed a strong relationship ( $>75\%$  studies agree, with 3 or more prospective studies) between the development of future back pain problems, and psychological factors present at initial onset of back pain. These psychological factors included job satisfaction, monotonous work, workplace relations, self-rated work demands, self-reported stress, and perceived ability to work. There was moderate evidence ( $>50\%$  studies agree, with 2 or more prospective studies) that work pace, sense of control, perceived emotional effort at work and belief that work is dangerous were also predictive of future back pain and associated disability.

Truchon et al. (2000) examined biopsychosocial risk factors for disability from occupational low back pain and reported that preoccupation with own health, negative attitudes/outlook, and passive coping strategies were predictive of future back pain and disability problems. Like Linton's (2000) review, Truchon et al.'s review also found that when psychological variables were studied in combination with medical or clinical variables (e.g. severity of diagnosis and clinical tests, like straight leg raising), the psychological variables were more powerful predictors of future low back pain and disability problems. Even so, the medical variables still account for a proportion of the variance in future pain problems.

Although each of these reviews studied similar questions and only examined prospective studies, there was relatively little overlap in studies between the reviews. In part, this is probably related to their use of different inclusion criteria and different populations. Nevertheless, as a whole, these reviews provide strong evidence that a number of psychological and social (i.e. environmental) variables play a significant role in the progression of pain experience from acute to chronic, and the associated development of disability. There is also evidence that when both psychosocial and medical/clinical variables are measured, the psychosocial variables are stronger predictors of future pain and disability problems.

While the study of psychosocial risk factors has provided important information, it remains the case that, even when exposed to many of these risk factors a large proportion of people with acute or sub-acute pain do not develop chronic pain and associated disability. As Linton (2002) has pointed out, these psychosocial factors should be termed 'risk factors' rather than 'predictors', as they only increase the risk of a person developing chronic, disabling pain. Some have argued that this observation may be explained by the concept of variance in vulnerability or predisposition to respond to certain stressors, also known as a stress-diathesis model (see ► [Diathesis-Stress Model of Chronic Pain](#)) (e.g. Turk 2002). Other explanations have suggested that the impact of a persisting pain depends on dynamic processes, such as learning, which would include the person's

interactions with their pain, injury and environment (e.g. Linton 2002).

Turk's (2002) description of a diathesis-stress model incorporated potential predisposing psychological factors such as ► **Anxiety Sensitivity**, general fearful appraisals of bodily sensations, and previous experiences with pain. He argued that a person with heightened anxiety sensitivity, fearful appraisals of bodily sensations and previous troublesome experiences with pain might be more likely to respond to the onset of a new pain with fear, overly alarmist thought processes (► **catastrophizing**), and low confidence in their ability to cope with the pain (low self-efficacy beliefs), which could lead to their engaging in avoidance or escape behaviours (from the pain or expected pain). These responses, in turn, could result in greater disability than would be the case if these responses had been different. Recent studies of personality in relation to pain have taken a similar perspective, with personality characteristics acting as a modulator of a person's responses to pain, rather than a causal influence (for reviews see Asghari and Nicholas 1999; Weisberg and Keefe 1999). Linton (2002) explored the possible role of processes, like learning (conditioning), within the context of an evolving interplay of psychological risk factors, somatic (e.g. nature of the injury), and environmental factors (e.g. work demands) that could lead to the development of chronic pain and disability over an extended period. Some of these factors, like small lifestyle changes to minimize pain, might seem quite innocuous at the time, but over an extended period they could have important ramifications for adjustment, especially given the recurrent nature of musculoskeletal pain and the associated opportunities for learning. Linton argued that at the level of the individual person, many aspects of the development of chronic pain and disability were likely to involve events that were salient or critical to the individual at a certain time, but not at all times, and not necessarily across all injured people in a regular or linear manner. Identifying these risk factors at the individual level is likely to require careful assessment (and time), but a short (self-report) screening instrument developed by Linton and Halldén (1998) has proved to be useful in this context (e.g. Boersma and Linton 2002).

Overall, the evidence that psychological factors can contribute to the development of chronic pain and associated disability is strong. There is also good evidence that other somatic and environmental factors can also play a role in this process. Rather than see these factors as predictors of chronic pain and disability, it may be more accurate and useful to view them as risk factors for future pain-related problems. The strength of the findings in relation to psychological and environmental interactions has potentially significant implications for the treatment/management of acute/sub-acute back and neck pain particularly, as well as the prevention of their

progression to chronic pain and associated disability. For example, as many of the psychological and environmental risk factors (e.g. fears, beliefs, responses, and work demands) are amenable to change, it suggests that interventions aimed at modifying these factors could greatly limit the progression and impact of chronic pain.

## References

1. Asghari A, Nicholas MK (1999) Personality and Adjustment to Pain. *Pain Rev* 6:85–97
2. Boersma K, Linton SJ (2002) Early Assessment of Psychological Factors: The Orebro Screening Questionnaire for Pain. In: Linton SJ (ed) *New Avenues for the Prevention of Chronic Musculoskeletal Pain and Disability, Pain Research and Clinical Management*, vol 12. Elsevier, Amsterdam, pp 205–213
3. Gamsa A (1994) The Role of Psychological Factors in Chronic Pain. Part I. A Half Century of Study. *Pain* 57:5–15
4. Linton SJ (2000) A Review of Psychological Risk Factors in Back and Neck Pain. *Spine* 25:1148–1156
5. Linton SJ (2001) Occupational Psychological Factors Increase the Risk for Back Pain: A Systematic Review. *J Occup Rehab* 11:53–66
6. Linton SJ (2002) Why Does Chronic Pain Develop? A Behavioural Approach. In: Linton SJ (ed) *New Avenues for the Prevention of Chronic Musculoskeletal Pain and Disability, Pain Research and Clinical Management*, vol 12. Elsevier, Amsterdam, pp 67–82
7. Linton SJ, Halldén K (1998) Can we Screen for Problematic Back Pain? A Screening Questionnaire for Predicting Outcome in Acute and Subacute Back Pain. *Clin J Pain* 14:209–215
8. Pincus T, Burton AK, Vogel S et al. (2002) A Systematic Review of Psychological Factors as Predictors of Chronicity/Disability in Prospective Cohorts of Low Back Pain. *Spine* 27:109–120
9. Roy R (1985) Engel's Pain-Prone Disorder Patients: 25 Years After. *Psychother Psychosom* 43:126–135
10. Truchon M, Fillion L (2000) Biopsychosocial Determinants of Chronic Disability and Low-Back Pain: A Review. *J Occup Rehab* 10:117–142
11. Turk DC (2002) A Diathesis-Stress Model of Chronic Pain and Disability following Traumatic Injury. *Pain Res Manag* 7:9–19
12. Vlaeyen JW, Kole-Snijders AM, Boeren RG et al. (1995) Fear of Movement/(Re)Injury in Chronic Low Back Pain and its Relation to Behavioral Performance. *Pain* 62: 363–372
13. Weisberg JN, Keefe FJ (1999) Personality, Individual Differences, and Psychopathology in Chronic Pain. In: Gatchel RJ, Turk DC (eds) *Psychosocial Factors in Pain: Critical Perspectives*. Guilford Press, New York, pp 56–73

P

## Psychological Risk Factors

- **Psychological Predictors of Chronicity**

## Psychological Strategies

### Definition

Strategies relating to the modification of emotion, cognition, or behavior of the individual.

- **Acute Pain in Children, Procedural**

## Psychological Treatment

- ▶ Psychological Treatment in Acute Pain
- ▶ Psychological Treatment of Chronic Pain, Prediction of Outcome

## Psychological Treatment in Acute Pain

ROBERT R. EDWARDS  
Department of Psychiatry and Behavioral Sciences,  
Johns Hopkins University School of Medicine,  
Baltimore, MD, USA  
redwar10@jhmi.edu

### Synonyms

Relaxation; hypnosis; distraction; Sensory Focusing; cognitive; behavioral

### Definition

Psychological treatments encompass all non-pharmacological, non-surgical interventions in which the patient actively participates to alter his behavior, cognitions, or affect.

### Characteristics

Psychological factors are influential contributors to the experience of pain. However, practitioners are not always aware of studies validating psychological treatments, with the result that acute pain experiences are often not optimally managed. Multiple cognitive, affective, and behavioral approaches for coping with acute pain have been developed, though in general, these treatments overlap substantially with one another.

### Education and Preparation

A common intervention for acute pain related to trauma or medical procedures involves providing patients with information about the cause and likely course of pain. These easily-implemented interventions reduce fear and uncertainty and set realistic expectations. Educational approaches are helpful in a variety of settings. For example, providing information together with strategies to increase perceptions of control reduces children's pain during common medical procedures. Similarly, for adults with acute low back pain, providing an educational booklet prospectively reduced maladaptive beliefs about pain and pain-related disability (Burton et al. 1999).

### Relaxation

An extensive literature attests to the benefits of relaxation in reducing acute and chronic pain. The ▶ [psychophysiological model of pain](#) suggests that muscle tension may exacerbate pain at an injury site; a primary goal of relaxation training is to prevent this ex-

acerbation. Common methods for inducing relaxation include deep breathing, relaxing individual muscle groups (i.e. ▶ [progressive muscle relaxation](#)), or visualizing pleasant scenes (i.e. ▶ [guided imagery](#)). In general, no specific relaxation technique is consistently superior to any other, though preferences and effectiveness may vary across individuals. Tape recordings are as effective as clinician-directed interventions, and may offer substantial time savings. Relaxation has been rated as one of the most effective intervention techniques and is used by most pediatric hospitals across the United States (O'Byrne et al. 1997).

### Hypnosis

▶ [Hypnosis](#) generally involves 2 components: focused attention and suggestion. An initial induction phase involves fixation of attention and dissociation, followed by a phase in which suggestions for analgesia are offered. Hypnosis has been most widely studied in the context of cancer pain. Prior studies of children have suggested that hypnosis is more effective than supportive counseling for managing pain and distress (Chen et al. 2000), and a recent meta-analysis strongly supported its effectiveness as an adjunct to surgery. Specifically, 89% of surgical patients benefited from hypnosis in the following ways: reduced pain, reduced distress, reduced hospital stay, and reduced physiological disruption (Montgomery et al. 2002). Unfortunately, hypnosis requires substantial time and expertise to perform properly, making it difficult to implement in some settings.

### Distraction

Distraction techniques are conceptually simple and easily implemented. Paying attention to painful stimuli reliably increases reports of pain; logically, then, diverting attention away from the source of pain should be an effective pain-reducing tool. Many approaches to distraction have been systematically studied: they range from providing toys to children to playing enjoyable music. For example, recent findings suggest that adding pleasant music to standard nursing care reduces anxiety and pain for patients undergoing flexible sigmoidoscopy (Chlan et al. 2000).

### Sensory Focusing

In contrast to distraction, sensory focusing techniques postulate that paying close attention to somatic sensations such as pain may reduce distress, by discouraging an individual from interpreting the meaning of the sensations, by providing self-regulatory information, and by increasing perceptions of control. In a study of burn patients, those trained in sensory focusing reported greater pain relief compared to a music distraction control group, and remembered less pain than a usual care comparison group (Haythornthwaite et al. 2001). Since distraction has proven effective in reducing acute pain of milder intensity in other contexts, healthcare providers



may wish to reserve sensory focusing interventions for moderate to severe pain; moreover, matching the intervention to the patients' preferences (i.e. focusing on pain vs. ignoring pain) may increase the impact of these interventions.

### Cognitive Restructuring

Cognitive restructuring focuses on the role of thoughts, attitudes, and beliefs in determining responses to pain. Cognitive interventions challenge negative and maladaptive patterns of self-talk, such as ► **catastrophizing** (e.g. "I can't stand the pain"). These are replaced with more balanced cognitions that emphasize control, reduce negative emotions, and encourage adaptive coping. Specific skills include monitoring thoughts, thought-stopping, and generating accurate cognitions. Cognitive interventions have demonstrated positive effects in the reduction of pain and distress due to invasive medical procedures, as well as in the management of intermittent pain from conditions such as sickle cell disease (Yaster et al. 2000).

### Social Support

Much research suggests that positive social support is beneficial in enhancing the quality of life in individuals coping with chronic pain, but recent findings also underscore its usefulness in acute pain conditions. The simple presence of another person is associated with increased tolerance and decreased pain ratings during a laboratory pain task (Brown et al. 2003). In addition, a recent randomized, controlled trial of a social-support intervention found that, compared to a standard care control group, patients who were provided with a brief, supportive social encounter before undergoing invasive medical procedures reported reduced procedure-related pain and physiologic instability (Lang et al. 2000).

### Memory-Influencing Strategies

Memory is an active process, prone to multiple biases. In situations in which acutely painful experiences are likely to be repeated (e.g. dressing changes for burns); it may be useful to promote as minimally unpleasant a memory as possible for the event. Among children undergoing aversive medical procedures, a brief post-procedure discussion session reduced anticipatory distress and discomfort during subsequent procedures (Chen et al. 1999). Among adults, adding a brief period of minimally painful stimulation to the end of a painful procedure can be used to take advantage of the fact that the most recent events are best remembered (i.e. the recency effect). Adults undergoing colonoscopy who were exposed to several additional minutes of mild stimulation (i.e. the tip of the colonoscope was left just barely inserted) reported less unpleasantness, remembered less pain, and were more likely to return for a repeat scope than individuals undergoing a standard procedure, during which greater pain was reported

during the last several minutes of the colonoscopy (Redelmeier et al. 2003).

### Humor and Positive Mood Induction

Studies of laboratory-induced pain report that induction of positive mood using humorous films or pleasant images reliably increases pain tolerance and decreases pain ratings (for a review see Martin 2001). Though it has generally not been systematically studied as a clinical intervention, many practitioners engage in lighthearted or humorous banter before or during procedures that produce discomfort; such interventions may warrant further investigation in a variety of clinical settings.

### Positive Reinforcement

This strategy is used primarily with children undergoing painful procedures; it entails providing children with tangible rewards for any positive behavior and any adaptive coping efforts during the procedure. Rewards should be given immediately after the procedure has been completed. This technique is designed to facilitate interpretation of pain as a challenge rather than a punishment (Chen et al. 2000); it is easy to implement and is often effectively combined with other coping skills training (e.g. a child is trained in relaxation and then rewarded for using relaxation during a procedure).

### Treatment Combinations

Most psychological interventions are delivered as treatment packages. At present, little is known about which combinations are optimal for reducing acute pain. However, accumulating evidence does suggest that a variety of psychological interventions are potent adjuncts to pharmacological pain management. For example, a large study of surgery patients reported that groups receiving relaxation training, music distraction, or both, in addition to patient-controlled opioid analgesics (PCA) did not differ in post-surgical pain. However, all 3 groups reported less pain than the PCA-alone group (Good et al. 2002). Some research has also directly compared pharmacological and psychological interventions. During bone marrow aspiration, an intervention including relaxation, distraction, cognitive restructuring, and positive reinforcement was equivalent to general anesthesia on the outcomes of pain, reported fear, and pulse rates in pediatric oncology patients (Jay et al. 1995). In general, though, such trials are the exception rather than the rule; the effectiveness of psychological interventions is most often studied over and above the effects of standard pharmacological pain management.

### Summary

Many behavioral and cognitive techniques are efficacious for reducing acute pain, which is the most consistent risk factor for the development of chronic pain and disability. Psychological approaches have proven efficacious as both primary and adjunctive treatments

in this reduction of acute pain. A review concluded that pharmacotherapy and CBT-based interventions are equally effective, that each has distinct benefits and disadvantages, and that the greatest effects are likely to come from individualized interventions matched to important patient characteristics (Kuppenheimer and Brown 2002). Future studies of psychological treatments for acute pain will benefit from considering cost-effectiveness and from evaluating individual difference variables that can help practitioners to most effectively match patients to interventions.

## References

1. Brown JL, Sheffield D, Leary MR et al. (2003) Social Support and Experimental Pain. *Psychosom Med* 65:276–283
2. Burton AK, Waddell G, Tillotson KM et al. (1999) Information and Advice to Patients with Back Pain can have a Positive Effect. A Randomized Controlled Trial of a Novel Educational Booklet in Primary Care. *Spine* 24:2484–2491
3. Chen E, Joseph MH, Zeltzer LK (2000) Behavioral and Cognitive Interventions in the Treatment of Pain in Children. *Pediatr Clin North Am* 47:513–525
4. Chen E, Zeltzer LK, Craske MG et al. (1999) Alteration of Memory in the Reduction of Children's Distress during Repeated Aversive Medical Procedures. *J Consult Clin Psychol* 67:481–490
5. Chlan L, Evans D, Greenleaf M et al. (2000) Effects of a Single Music Therapy Intervention on Anxiety, Discomfort, Satisfaction, and Compliance with Screening Guidelines in Outpatients Undergoing Flexible Sigmoidoscopy. *Gastroenterol Nurs* 23:148–156
6. Good M, Anderson GC, Stanton-Hicks M et al. (2002) Relaxation and Music Reduce Pain after Gynecologic Surgery. *Pain Manag Nurs* 3:61–70
7. Haythornthwaite JA, Lawrence JW, Fauerbach JA (2001) Brief Cognitive Interventions for Burn Pain. *Ann Behav Med* 23:42–49
8. Jay S, Elliott CH, Fitzgibbons I et al. (1995) A Comparative Study of Cognitive Behavior Therapy versus General Anesthesia for Painful Medical Procedures in Children. *Pain* 62:3–9
9. Kuppenheimer WG, Brown RT (2002) Painful Procedures in Pediatric Cancer. A Comparison of Interventions. *Clin Psychol Rev* 22:753–786
10. Lang EV, Benotsch EG, Fick LJ et al. (2000) Adjunctive Non-Pharmacological Analgesia for Invasive Medical Procedures: A Randomised Trial. *Lancet* 355:1486–1490
11. Martin RA (2001) Humor, Laughter, and Physical Health: Methodological Issues and Research Findings. *Psychol Bull* 127:504–519
12. Montgomery GH, David D, Winkel G et al. (2002) The Effectiveness of Adjunctive Hypnosis with Surgical Patients: A Meta-Analysis. *Anesth Analg* 94:1639–1645
13. O'Byrne KK, Peterson L, Saldana L (1997) Survey of Pediatric Hospitals' Preparation Programs: Evidence of the Impact of Health Psychology Research. *Health Psychol* 16:147–154
14. Redelmeier DA, Katz J, Kahneman D (2003) Memories of Colonoscopy: A Randomized Trial. *Pain* 104:187–194
15. Yaster M, Kost-Byerly S, Maxwell LG (2000) The Management of Pain in Sickle Cell Disease. *Pediatr Clin North Am* 47:699–710

## Psychological Treatment of Chronic Pain, Prediction of Outcome

ROBERT J. GATCHEL

Department of Psychology, College of Science,  
University of Texas at Arlington, Arlington, TX, USA  
gatchel@uta.edu

## Synonyms

Biopsychosocial model; chronic pain; Treatment Outcome; Psychological Treatment

## Definition

The biopsychosocial model of pain has greatly increased our ability to evaluate more comprehensively the intricate interaction among biological, psychological and social factors that all contribute to the unique individual experience of pain. Adhering to such a model, in turn, leads to a better method of predicting pain treatment outcomes.

## Characteristics

Current efforts to study pain conditions have broadened from antiquated, unidimensional biomedical reductionist models to more heuristic, multidimensional models of pain that take into account physiological, psychological and social variables. This ► [biopsychosocial perspective](#) has greatly increased our ability to evaluate more comprehensively factors that can contribute to a better method of predicting treatment outcomes. Of course, when reviewing this area, it is important to keep in mind that treatment response predictors will vary from one form of pain syndrome to another. To date, the following pain conditions have received the greatest amount of empirical attention: chronic low back pain, headache, irritable bowel syndrome, rheumatoid arthritis, upper-extremity disorders and temporomandibular joint disorders. Each of these disorders will be discussed below. A more comprehensive discussion of many of these pain conditions can be found in Turk and Gatchel (2002).

## Chronic Low Back Pain

There have been a number of studies linking psychosocial factors to treatment outcome. Elkayam et al. (1996) found that the presence of personality disorders was highly correlated with poor outcome after a ► [multidisciplinary treatment program](#), as were psychosocial stressors such as divorced marital status and unemployment. Hildebrandt et al. (1997) found that the most important variable in predicting a successful treatment outcome after a ► [functional restoration](#) and behavioral support program was the reduction in the patient's subjective feelings of disability. Rainville and colleagues (Rainville et al. 1997) found that compensation involvement had an adverse effect on self-reported pain and disability, both before and after a spine rehabilitation program. Such compensation issues have been indicated in numerous other studies with chronic pain patients. Finally, Harkapaa et al. (1996) reported that a patient's optimistic expectations and locus of control beliefs significantly predicted increased functional capacity in a group of patients who underwent an intensive multidisciplinary treatment program. Thus,

taken as a whole, the following psychosocial variables appear to be predictors of response to treatment: presence of personality disorders, psychosocial stressors such as divorced marital status and employment status, objective feelings of disability, optimistic expectations and locus of control beliefs and compensation status.

### Headache

Gatchel and colleagues (1985) found that scores on the Millon Behavioral Health Inventory (MBHI) significantly predicted response to a multidisciplinary treatment program for chronic headache patients. Response to treatment was measured by number of daily headaches, duration of headaches, intensity of headaches and all medications taken. Of all the scales on the MBHI, the emotional vulnerability scale was found to be consistently related to outcome on all four longitudinal treatment measures. In another study, Osterhaus et al. (1993) evaluated the outcome of a combined behavioral treatment consisting of relaxation training and temperature biofeedback, as well as cognitive training in school children suffering from migraine headaches. Predictors of positive outcome were found to be gender, headache history, age and psychosomatic complaints before training.

### Irritable Bowel Syndrome (IBS)

Blanchard and colleagues have conducted the most extensive biopsychosocial research with IBS patients. In an early study, Blanchard et al. (1988) found three potentially important predictors of biobehavioral treatment outcome: trait anxiety, frequency of symptom-free days at baseline and gender. More specifically, having lower initial levels of trait anxiety, being male and having more episodic symptoms (i.e., more symptom-free days) were associated with successful outcomes. However, subsequently, Blanchard et al. (1992) found that neither trait anxiety, gender nor baseline symptom-free days predicted outcome. The only variable that significantly predicted outcome was the presence or absence of an Axis I disorder as measured by the Anxiety Disorders Interview Schedule-Revised. They found that the absence of an Axis I disorder predicted more than twice the likelihood of successful outcome from treatment. Thus, results in this area are still somewhat equivocal.

### Rheumatoid Arthritis

There is currently a paucity of research evaluating which patients are most likely to have a positive response to treatment. In one study, Young (1992) reported no clear delineation of patient demographic characteristics associated with better outcomes of patients undergoing cognitive-behavioral treatment. Radojevik et al. (1992), in contrast, reported that spousal participation in treatment tended to enhance outcome. Finally, Sinclair and Wallston (2001) found that, in a cohort of women with rheumatoid arthritis who received brief cognitive-

behavioral intervention, personal coping resources and maladaptive and adaptive pain coping behaviors were predictors of improvement. Obviously, additional clinical research in this area is greatly needed.

### Upper Extremity Disorders

Work-related upper extremity musculoskeletal disorders have become more prevalent during the last decade. A prospective cohort study investigating the effects of psychosocial factors in long-term employment status of a sample of such chronic patients who completed an interdisciplinary functional restoration program was conducted by Burton et al. (1997). Overall, the results revealed that patients who were older, Caucasian, had a current diagnosis of an anxiety disorder and whose perceptions of their disability deteriorated from pre- to post-treatment evaluations were significantly less likely to have returned to work at 1 year follow-up. Thus again, psychosocial variables influence the successful rehabilitation of these pain patients.

### Temporomandibular Joint Disorder

There have been few studies evaluating those psychosocial variables that serve to predict response to treatment. Schwartz et al. (1979) found that those patients who responded less positively to conservative treatment, relative to those who responded well, had greater elevations on several scales of the MMPI (hypochondriasis, depression, hysteria, psychopathic deviation, psychoasthenia and schizophrenia). Such elevations subsequently were interpreted to suggest a tendency towards excessive pain sensitivity and agitated depression in TMD patients unresponsive to treatment (Block 1996). A study by Friction and Olsen (1996) evaluated chronic TMD patients prior to entering a multidisciplinary treatment program. Overall, these authors concluded that symptoms of depression were the best predictors of response to treatment.

Rudy and colleagues (1995) were the first to utilize the Multidimensional Pain Inventory (MPI) to classify TMD patients within three psychosocial-based coping subgroups and then evaluate their differential response to treatment. Findings indicated that as an overall group, patients improved significantly, but comparisons across subgroups revealed differential patterns of response to treatment. The most notable changes occurred with the subgroup characterized by the greatest amount of psychological distress (dysfunctional copers). This subgroup demonstrated significantly greater improvements on measures of pain intensity, perceived impact of TMD symptoms on their lives, depression and negative thoughts, compared with subgroups characterized by greater personal problems (interpersonally distressed copers) and those patients who appeared to be less disabled by TMD (adaptive copers). This was interpreted as an "initial levels" effect because the dysfunctional patients had a greater range to improve. Subsequently,

Kight (1999) evaluated multiple psychosocial variables in an attempt to predict response to treatment in a group of TMD patients treated with cognitive therapy, biofeedback or a combination of both. The most robust predictor of poor response to treatment was coping ability as measured by the MPI. Those subjects who were categorized as either dysfunctional or interpersonally distressed copers displayed significantly poorer response to treatment. These findings were somewhat different from those reported above by Rudy and colleagues (1995). The most likely reason was the different treatment protocols used in the two studies. This highlights the fact that there may be different predictors of outcome success for the same disorder, depending upon the treatment program administered.

### Summary and Conclusions

As a whole, various studies have delineated variables that appear to hold promise for differentiating between those patients who respond and those who do not respond to a particular treatment program. For the cognitive-behavioral treatment of chronic pain in general, McCracken and Turk (2002) found that decreased negative emotional responses to pain, decreased perceptions of disability and increased orientation toward self-management during the course of treatment predicted a favorable treatment outcome. It should also be kept in mind that, even for the same pain condition, there may be a different array of predictor variables, depending upon the specific type of treatment program administered. Such response specificity should always be remembered when comparing results across studies. Also, one must be aware of the “pain homogeneity” myth. That is to say, not all pain conditions respond similarly to a particular treatment program. This was especially highlighted in the studies evaluating the different coping subgroups identified by the MPI. As Turk and Gatchel (1999) have pointed out, future research should be directed at “...not whether a treatment is effective but rather what treatment components delivered in what way, and when, produce the most successful outcomes for individual pain sufferers with what set of characteristics.” (p. 490).

### References

- Blanchard EB, Schwarz SP, Neff DF (1988) Two-year follow-up of behavioral treatment of irritable bowel syndrome. *Behav Ther* 19:67–73
- Blanchard EB, Schwartz SP, Suls JM et al. (1992) Two controlled evaluations of multicomponent psychological treatment of irritable bowel syndrome. *Behav Res Ther* 30:175–189
- Block AR (1996) Presurgical Psychological Screening in Chronic Pain Syndromes. Erlbaum, Hillsdale
- Burton K, Polatin PB, Gatchel RJ (1997) Psychosocial factors and the rehabilitation of patients with chronic work-related upper extremity disorders. *J Occup Rehab* 7:139–153
- Elkayam O, Ben Itzhak S, Avrahami E et al. (1996) Multidisciplinary approach to chronic back pain: Prognostic elements of the outcome. *Clin Exp Rheumatol* 14:281–288
- Fricton JR, Olsen T (1996) Predictors of outcome for treatment of temporomandibular disorders. *J Orofac Pain* 10:54–65
- Gatchel RJ, Deckel AW, Weinberg N et al. (1985) The utility of the Millon Behavioral Health Inventory in the study of chronic headaches. *Headache* 25:49–54
- Harkapaa K, Jarvikoski A, Estlander AM (1996) Health optimism and control beliefs as predictors for treatment outcome of a multimodal back treatment program. *Psychol Health* 12:123–134
- Hildebrandt J, Pflingsten M, Saur P et al. (1997) Prediction of success from a multidisciplinary treatment program for chronic low back pain. *Spine* 22:990–1001
- Kight M, Gatchel RJ, Wesley L (1999) Temporomandibular disorders: An example of the interface between psychological and physical diagnoses. *Health Psychol* 18:177–182
- McCracken LM, Turk DC (2002) Behavioral and cognitive-behavioral treatment for chronic pain. *Spine* 27:2564–2573
- Osterhaus SO, Passchier J, van der Helm-Hylkema H et al. (1993) Effects of behavioral psychophysiological treatment on schoolchildren with migraine in a nonclinical setting: predictors and process variables. *J Pediatr Psychol* 18:697–715
- Radojevik V, Nicassio PM, Weisman MH (1992) Behavioral intervention with and without family support for rheumatoid arthritis. *Behav Ther* 23:13–20
- Rainville J, Sobel J, Hartigan C et al. (1997) The effect of compensation involvement of the reporting of pain and disability by patients referred for rehabilitation of chronic low back pain. *Spine* 22:2016–2024
- Rudy TE, Turk DC, Kubinski JA et al. (1995) Differential treatment response of TMD patients as a function of psychological characteristics. *Pain* 61:103–112
- Schwartz RA, Greene CS, Laskin DM (1979) Personality characteristics of patients with myofascial pain-dysfunction (MPD) syndrome unresponsive to conventional therapy. *J Dental Res* 58:1435–1439
- Sinclair VG, Wallston KA (2001) Predictors of improvement in a cognitive-behavioral intervention for women with rheumatoid arthritis. *Ann Behav Med* 23:291–297
- Turk DC, Gatchel RJ (1999) Psychosocial factors and pain: Revolution and evolution. In: Gatchel RJ, Turk DC (eds) *Psychosocial Factors in Pain: Critical Perspectives*. Guilford, New York
- Turk DC, Gatchel RJ (2002) *Psychological Approaches to Pain Management: A Practitioner’s Handbook*. Guilford, New York
- Young LD (1992) Psychological factors in rheumatoid arthritis. *J Consult Clin Psychol* 60:619–627

## Psychological Treatment of Headache

BEVERLY E. THORN<sup>1</sup>, FRANK ANDRASIK<sup>2</sup>  
<sup>1</sup>University of Alabama, Tuscaloosa, AL, USA  
<sup>2</sup>University of West Florida, Pensacola, FL, USA  
 bthorn@bama.ua.edu, fandrasi@uwf.edu

### Synonyms

Cognitive-behavioral treatment; Behavioral Treatment; biofeedback; relaxation; Stress Management; non-pharmacological treatment; Non-Drug Treatment; psychosocial interventions

### Definition

Psychological therapies are ► **psychosocial interventions** applied to the management of headache as adjunctive or alternative procedures to medication. Psychological headache therapies with demonstrated efficacy



are categorized under the general rubric of cognitive-behavioral therapy (CBT). These therapies commonly include behavioral treatments, cognitive treatments, or, most frequently, combinations of cognitive and behavioral therapies. Relaxation, ► [biofeedback](#) and behavioral pacing strategies are most often categorized as behavioral components of CBT, with the greatest bulk of the headache treatment outcome research having utilized relaxation and biofeedback. The two major cognitive components of CBT are ► [cognitive restructuring](#) and cognitive coping skills training. Cognitive restructuring includes the identification and modification of dysfunctional thinking. When applied to the treatment of pain, cognitive restructuring typically focuses on identifying and decreasing dysfunctional pain-related cognitions. ► [Cognitive coping training](#) for pain includes, but is not limited to, attention diversion strategies, reinterpreting pain sensations, calming self-statements, and imagery techniques. Treatment outcome research indicates that cognitive-behavioral therapies effectively decrease headache frequency and intensity, as well as decrease psychological distress and dysfunction, and increase adaptive coping responses and sense of personal control over headaches (Blanchard and Andrasik 1985). Neither generic psychotherapy (e.g. insight-oriented therapy) nor hypnotherapy has been shown to be more effective than control or placebo conditions for the management of headache (Holroyd 2002; Holroyd and Lipchik 1999).

## Characteristics

### Efficacy

CBT is an empirically supported treatment that has become the common standard of psychosocial intervention for pain. CBT has proven effective in reducing the occurrence of headaches by approximately 40–50% (Penzien et al. 2002), and these psychological approaches have been effectively extended beyond typical adult patients, to pediatric as well as elderly populations (Blanchard and Diamond 1996). These interventions not only reduce pain, but also increase adaptive coping responses, self-efficacy, and physical functioning, and decrease dysfunctional cognitions (Holroyd 2002). Additionally, psychological treatment of headache is cost-effective relative to biomedical approaches. In addition to cost, measures of patient acceptance of psychological treatment, patient attrition, and long-term maintenance issues add support to the efficacy of psychological treatment for headache. In particular, long-term maintenance of psychological headache treatment appears to be much better (5 years and longer) than with drug treatment. It is hypothesized that psychological treatments teach patients certain coping skills that they can subsequently utilize following treatment, whereas drug treatments do not introduce such skills acquisition (Blanchard and Diamond 1996).

The efficacy of psychological treatments are often evaluated by comparing those receiving the treatment to participants who monitor their symptoms while waiting for treatment (wait-list comparison groups), or to participants who receive credible attention placebo treatment (often educational information regarding headaches or supportive psychotherapy). A common methodological difficulty associated with the extant treatment outcome research is small sample size, which limits the statistical power necessary to identify subtle but important treatment effects. Nonetheless, meta-analyses, and several studies using adequate sample sizes (i.e. over 30 subjects per cell) allow certain generalizations to be made. First, combinations of electromyographic (EMG) biofeedback and relaxation instruction have been shown to be superior to placebo treatment for tension headaches. Second, including cognitive therapy with relaxation or relaxation plus EMG biofeedback for tension headaches adds incremental utility to treatment gains. Third, for pure migraine headache, thermal biofeedback to induce hand warming and relaxation instruction are superior to placebo. Findings regarding the incremental advantage of adding a cognitive component to treatment for migraine have been mixed, although the U.S. Headache Consortium Guidelines conclude that relaxation, thermal biofeedback plus relaxation, and cognitive-behavioral therapy are all appropriate treatments for the prevention of migraine (Silberstein and Rosenberg 2000). As many headache patients experiencing migraine also experience tension headaches, a combination of relaxation, biofeedback, and cognitive interventions is likely to be efficacious for most headache patients.

### Therapeutic Mechanisms

A crucial issue in all intervention research is identifying the mechanisms responsible for treatment success. Most of the CBT-pain treatment comparison studies have compared “behavioral” components with “cognitive” components.

An examination of the specific mechanisms associated with certain headache treatments, has led to a reexamination of the commonly accepted pathophysiological models for tension headache (prolonged pericranial muscle contraction) and migraine headache (vasospasm of cranial blood vessels). In examinations of the mechanisms associated with electromyographic biofeedback (EMG-BF) for tension headache, it has been reliably demonstrated that the actual change in EMG level is not associated with treatment success. Rather, patients’ belief in the success of the training, and subsequent increases in patient self-efficacy and internal ► [locus of control](#) do predict improvements following EMG-BF. In similar studies examining the mechanisms associated with temperature biofeedback (TBF) for migraine, success performance feedback, independent of actual success in hand-warming, predicted

improvements in following TBF (Holroyd 2002). Additionally, patients who attribute improvements following therapy to their own efforts demonstrate better long-term outcome than patients who attribute improvement to the interventions of health care providers (Spinoven et al. 1992). Such findings have led to a competing cognitive-attributional model as the mechanism for treatment success. The most recent research regarding psychophysiological mechanisms of headache (as well as other pain disorders) points to a likely central nervous system dysfunction, i.e. ► **central sensitization**, maintaining both types of headache (Holroyd 2002). Finally, recent research with functional MRI has shown that distraction, a common component of CBT, leads to significant activation within the periaqueductal gray region, a site recognized for higher cortical control of pain (Tracey et al. 2002). Thus, these treatments may be impacting central mechanisms of headache as well.

### Areas of Ongoing Research

#### Difficult to Treat Headache Types

The discussion above pertains primarily to typical forms of headache. As research progresses, certain forms of headache have been shown to be particularly difficult to treat. These include patients experiencing medication-overuse headache, cluster headache, post-traumatic headache, or headaches accompanied by comorbid conditions. For these headache types, intensive, comprehensive, multidisciplinary treatments may be needed. Although menstrual migraine is common, the limited number of available studies has produced equivocal findings. Further research is also warranted here (Andrasik 2004).

#### Cognitive-Attributional Emphases

It is possible that certain patient characteristics contribute to the determination of the relative success of psychological treatment for headache. One patient characteristic with particular relevance is dysfunctional thinking. In the pain literature, dysfunctional thinking has often been referred to as ► **catastrophizing**. Headache sufferers have been shown to have higher levels of catastrophizing than pain-free controls, and pain-related catastrophizing is a robust predictor of treatment outcome (Hassinger et al. 1999; Ukestad and Wittrock 1996). Treatments specifically targeted at reducing catastrophizing are being developed, examined, and promulgated (Thorn et al. 2002; Thorn 2004).

#### Application in Primary Practice Settings

Although the evidence clearly supports the efficacy of CBT for headache management, the effectiveness of such interventions applied in primary practice settings and/or neurology clinics needs to be established. Promising evidence for the effectiveness of home-based and/or limited contact therapies for self-management of headache may provide a practical vehicle through which

the implementation of CBT procedures in medical practice settings can be generalized. Novel public health interventions within the school system or communities at large or via internet-based therapies are presently in their infancy with regards to exploring their treatment utility and applicability (Andrasik 2004; Holroyd 2002; Penzien et al. 2002).

#### Integration with Drug Therapy

Clinical trials that include direct comparisons of drug treatment vs. psychological treatment for headache are few in number. The most extensive investigation to date showed a quicker response to medication, with the behavioral treatment achieving a similar level of benefit over time for individuals experiencing chronic tension-type headache. Combining both treatments revealed the greatest effect (Holroyd et al. 2001). CBT investigations aimed directly at increasing the integration of ► **behavioral self-management** skills into everyday life (Hoodin et al. 2000), as well as increasing adherence to proper medication scheduling or for medication withdrawal (Andrasik 2004; Blanchard and Diamond 1996; Holroyd 2002; Penzien et al. 2002), will be useful for the future.

### References

1. Andrasik F (2004) Behavioral Treatment of Migraine: Current Status and Future Directions. *Expert Rev Neurother* 4:89–99
2. Blanchard EB, Andrasik F (1985) Management of Chronic Headaches: A Psychological Approach. Pergamon, New York
3. Blanchard EB, Diamond S (1996) Psychological Treatment of Benign Headache Disorders. *Professional Psychology: Res Pract* 27:541–547
4. Hassinger HJ, Semenchuk EM, O'Brien WH (1999) Appraisal and Coping Responses to Pain and Stress in Migraine Headache Sufferers. *J Behav Med* 22:327–340
5. Holroyd KA (2002) Assessment and Psychological Management of Recurrent Headache Disorders. *J Consult Clin Psychol* 70:656–677
6. Holroyd KA, Lipchik GL (1999) Psychological Management of Recurrent Headache Disorders: Progress and Prospects. In Gatchel RJ, Turk DC (eds) *Psychosocial Factors in Pain: Critical Perspectives*. Guilford Press, New York, pp 193–212
7. Holroyd KA, O'Donnell FJ, Stensland M et al. (2001) Management of Chronic Tension-Type Headache with Tricyclic Antidepressant Medication, Stress Management Therapy, and their Combination: A Randomized Controlled Trial. *JAMA* 285:2208–2215
8. Hoodin F, Brines BJ, Lake AE et al. (2000) Behavioral Self-Management in an Inpatient Headache Treatment Unit: Increasing Adherence and Relationship to Changes in Affective Distress. *Headache* 40:377–383
9. Penzien DB, Rains JC, Andrasik F (2002) Behavioral Management of Recurrent Headache: Three Decades of Experience and Empiricism. *Appl Psychophysiol Biofeedback* 27:163–181
10. Silberstein SD, Rosenberg J (2000) Multispecialty Consensus on Diagnosis and Treatment of Headache. *Neurology* 54:1553–1554
11. Spinoven P, Lensen AC, Van Dyck R et al. (1997) Autogenic Training and Self-Hypnosis in the Control of Tension Headache. *Gen Hosp Psychiatry* 14:408–415
12. Thorn BE (2004) *Cognitive Therapy for Chronic Pain: A Step-by-Step Guide*. Guilford Publications Inc, New York
13. Thorn BE, Boothby JL, Sullivan MJL (2002) Targeted Treatment of Catastrophizing for the Management of Chronic Pain. *Cogn Behav Pract* 9:127–138

14. Tracey I, Ploghaus A, Gati JS et al. (2002) Imaging Attentional Modulation of Pain in the Periaqueductal Gray in Humans. *J Neurosci* 22:2748–2752
15. Ukestad LK, Wittrock DA (1996) Pain Perception and Coping in Female Tension Headache Sufferers and Headache-Free Controls. *Health Psychol* 15:65–68

## Psychological Treatment of Pain in Children

CHRISTIANE HERMANN

Department of Clinical and Cognitive Neuroscience at the University of Heidelberg, Central Institute of Mental Health, Mannheim, Germany  
chermann@zi-mannheim.de

### Synonyms

Pediatric Pain Management; Preparation Programs; cognitive-behavioral therapy; relaxation; biofeedback; Operant Treatment

### Definition

Children and adolescents experience pain from a number of different sources. Pediatric pain problems that have been the target of psychological interventions are procedure-related acute pains (e.g. lumbar puncture), disease-related chronic pain (e.g. rheumatoid arthritis, cancer, sickle cell disease) and chronic pain of benign or unknown origin (e.g. migraine, tension-type headache, abdominal pain, widespread musculoskeletal pain such as fibromyalgia). Since the 1980s, a variety of psychological treatments for pediatric pain have been developed using well-established psychological interventions for adults as a model. These include cognitive-behavioral interventions that focus on improving pain and stress coping skills, relaxation techniques such as progressive muscle relaxation or autogenic training, biofeedback and operant treatment approaches with the aim of reducing pain behavior.

### Characteristics

Psychological treatments for pediatric pain can be subdivided into two broad categories: (a) interventions for acute procedure-related pain and (b) interventions for recurrent or chronic pain, regardless of its origin. Although both types of interventions rely on cognitive and behavioral techniques, they differ with regard to design, goal, treatment delivery and the target population.

### Procedure-Related Pain

In the early 1980s, due to the demonstrated success of surgery preparation programs, efforts were made to develop programs that would specifically help children to prepare for and cope with painful medical procedures. Many hospitalized children are repeatedly confronted with invasive and painful medical procedures

such as lumbar punctures, bone marrow aspirations and venipunctures. Moreover, routine painful medical procedures (e.g. vaccination) are known to induce considerable distress in healthy children.

Virtually all programs to reduce procedure-related pain rely on cognitive-behavioral therapy (CBT). Across studies there is a great deal of consistency in the type of interventions included in these treatment packages (for how to implement such programs see Duff 2003). The central components are breathing exercises (e.g. blowing a party blower; pretending to be a tire) and other distraction techniques (e.g. playing with toys, solving puzzles, counting). A second component are cognitive coping strategies such as imagery (e.g. imagining the favorite hero or a pleasant scene) and positive self-statements. A third component is modeling. Films telling the story of a peer model coping well with the procedure are often used. A fourth component are reinforcement (e.g. praising) and incentives (e.g. small rewards) for using coping skills and for holding still. Finally, role-play is often included for desensitization and as a means for behavioral rehearsal. For example, the child first learns about the procedure and then performs the procedure using a doll, while being encouraged to apply the learned coping skills prior to the actual procedure. Most treatment protocols also include active coaching (i.e. prompting the child to use coping skills) either by the parent, a nurse or a psychologist during the actual medical procedure.

Preparation programs are brief and, due to the specific situational demands, involve only 1–2 up to 4 sessions, which are delivered within a short period of time (0–2 days) prior to the procedure. The majority of programs has been designed for children between 3 and 7 years who suffer from leukemia. Due to their developmental stage, young children rely more on primary coping (i.e. attempts to alter the situation) and use less secondary coping strategies (i.e. attempts to adjust oneself to the situation). CBT protocols train the child in using simple secondary coping strategies such as breathing or other externally oriented distraction techniques. Since young children cannot be expected to remember and initiate the use of coping skills, active coaching is important. Many preparation programs train the parent to assume a primary role. There is good evidence for strong correlations between parental anxiety and the child's procedural distress. Even though parents may be aware of this, most of them prefer to be present during the procedure. Also, almost all children perceive the presence of parents as most helpful. Training the parent is not only beneficial because it facilitates active coaching, but it also reduces parents' own distress and can promote the transfer of the learned skills to subsequent procedure sessions (e.g. Kazak et al. 1998).

Based on a comprehensive literature review, Powers (1999) concluded that CBT for procedure-related pain can be regarded as well established when the criteria

for empirically supported treatments as defined by the ► [Task Force on Promotion and Dissemination of Psychological Procedures](#) (Chambless and Ollendick 2001) are applied. In fact, CBT protocols have been shown to be superior to standard hospital routines, attention control and tranquilizers. While distress during the procedure is lower under general anesthesia, CBT is associated with less adjustment problems during the 24 h after the procedure. More recently, the integration of psychological and adequate pharmacological interventions has become of interest. Clearly, merely adding a sedative drug has not proven to enhance the effectiveness of CBT. The combination of CBT and adequate pharmacological intervention (analgesics, anesthetics and sedatives) appears to be somewhat more effective in reducing child and parent distress than pharmacological intervention alone (Kazak et al. 1998). While CBT is effective in reducing distress during an actual procedure, little is known about the maintenance and generalization of treatment gains. Initial findings in healthy children undergoing routine vaccination suggest that distraction may be particularly effective in preventing the formation of pain-related aversive memories, even if being equivalent to topical anesthetics in reducing actual pain and anxiety during the procedure (Cohen et al. 2001). Since there is increasing evidence that even in neonates, the experience of acute (procedure-related) pain subsequently leads to anticipatory distress; basic psychological interventions have begun to be evaluated in this population. Skin-to-skin holding, or kangaroo care, has recently been demonstrated to significantly lower the level of pain in preterm and full-term neonates during heel-lancing procedures (e.g. Johnston et al. 2003).

### Chronic Pain

A substantial number of children and adolescents suffer from persistent or recurrent chronic pain of 3 months or longer. Despite the obviously common occurrence of pediatric chronic pain, conclusions with regard to its severity and to pediatric pain as a health problem are difficult to draw. Many children cope quite well and never seek treatment. Yet, recurrent or chronic pain during childhood may also increase the risk of a lifetime of chronic pain, at least in a subgroup of children. While reducing acute distress is the main goal of interventions for procedure-related pain, treatments for chronic pediatric pain are aimed at decreasing the frequency and intensity of pain, and reducing pain-related disability by improving the child's coping skills, thus reducing the impact of chronic pain on the child's personal growth and development. Even though data are lacking at present, such interventions may also be important as a preventive measure in reducing the risk of developing a life-long pain problem.

Progressive muscle relaxation (PMR) is one of the most frequently used interventions for pediatric pain

either alone or as part of CBT. Typically, PMR is administered by a therapist on an individual basis or in groups. CBT packages for chronic pediatric pain are highly similar to adult programs and usually comprise 4 major components: (1) education about the pain; (2) learning of cognitive and behavioral pain coping skills such as imagery, distraction, and relaxation; (3) stress management, i.e. identifying and coping with stressful situations using thought stopping, cognitive restructuring, assertiveness and problem solving; and (4) relapse prevention. CBT for pediatric pain has been provided individually or in groups. For pediatric migraine, a self-help booklet is available (McGrath et al. 1990). Skin temperature or thermal ► [biofeedback](#) (BFB) (i.e. volitional hand-warming) and EMG-BFB from the m. frontalis have been used most frequently in the treatment of childhood headache. For migraine, additional forms of BFB such as vasoconstriction training, i.e. learned voluntary constriction of extracranial blood vessels, and a specific form of EEG-BFB, i.e. BFB of the ► [contingent negative variation](#) (CNV), a slow cortical potential that is enhanced in migraine have also been evaluated (Hermann and Blanchard 2002). Operant treatment is yet to be evaluated systematically in children with chronic pain. The operant model of chronic pain postulates that chronic pain is maintained by operant reinforcement of pain behaviors such as verbal and nonverbal expressions of pain, guarding, resting and reduced activity. In children, interventions to modify (pain) behavior based on the operant model have been used as an additive to CBT or BFB protocols. Typically, brief parent training (1–3 sessions) is provided that comprises the principles of contingency management with the aim of minimizing positively (e.g. paying attention) or negatively reinforcing (e.g. excuse from daily chores) parental responses to the child's pain. Moreover, parents are taught to encourage their children to practice and use pain coping skills and maintain normal daily activities during pain episodes. Most recently and for the first time, an interdisciplinary CBT program involving physical, occupational and cognitive therapy and education has been evaluated, with good success in adolescents with chronic pain (Eccleston et al. 2003a).

Psychological programs typically address children and adolescents between the ages of 8 and 18 years, with very few attempts to treat children as young as 6 years of age. All available psychological treatments for chronic pediatric pain require the child to engage in active coping and self-initiate coping attempts, thus not being a promising approach in very young children. Empirical evaluations of psychological interventions have mostly focused on childhood headaches. According to several systematic reviews (Eccleston et al. 2003b; Hermann et al. 1995; Hermann and Blanchard 2002; Holden et al. 1999), relaxation meets criteria for a well-established intervention for childhood headache. Thermal BFB



alone is probably efficacious for pediatric migraine, while EMG-BFB appears to be promising for tension-type headache. CBT alone or combined with BFB meets criteria for a probably efficacious intervention for childhood HA, recurrent abdominal pain (see Janicke and Finney 1999) and sickle cell pain (Chen et al. 2004). Unfortunately, there is insufficient data on the effectiveness of psychological interventions for children with other painful conditions such as fibromyalgia, rheumatoid arthritis or cancer, even though the available literature suggests that CBT may be helpful (Walco et al. 1999). Interestingly, and unlike for adults, efforts have been made early on to develop cost-effective treatments for pediatric headache involving minimal therapist contact. For example, relaxation and CBT have been administered as self-help treatments, and both thermal BFB and CBT have been provided in a home-based format involving a minimum number of clinic sessions. Evidence for their effectiveness has been mixed. At present, it is unknown for which children such a treatment format may be a suitable alternative to a clinic-based treatment. Conclusions with regard to the effectiveness of psychological interventions are limited, since direct comparisons between treatments are rare, and few data on the long-term outcome (> 6 months) are available. Changes in pain activity have often been used as the primary and sole outcome measure, with little attention being paid to disability and other psychosocial aspects. With greater availability of adequate assessment instruments, this is likely to change. Overall, psychological interventions are a promising approach to the management of chronic pediatric pain. Aside from determining what works best for which type of pediatric pain problem, at what age and for whom, it will be the greatest challenge to make such treatments available for those who need it.

## References

1. Chambless DL, Ollendick TH (2001) Empirically Supported Psychological Interventions: Controversies and Evidence. *Annu Rev Psychol* 52:685–716
2. Chen E, Cole SW, Kato PM (2004) A Review of Empirically Supported Psychosocial Interventions for Pain and Adherence Outcomes in Sickle Cell Disease. *J Pediatr Psychol* 29:197–209
3. Cohen LL (2001) Children's Expectations and Memories of Acute Distress: Short- and Long-Term Efficacy of Pain Management Interventions. *J Pediatr Psychol* 26:367–374
4. Duff AJ (2003) Incorporating Psychological Approaches into Routine Pediatric Venipuncture. *Arch Dis Child* 88:931–937
5. Eccleston C, Malleson PN, Clinch J et al. (2003a) Chronic Pain in Adolescents: Evaluation of a Programme of Interdisciplinary Cognitive Behaviour Therapy. *Arch Dis Child* 88:881–885
6. Eccleston C, Yorke L, Morley S et al. (2003b) Psychological Therapies for the Management of Chronic and Recurrent Pain in Children and Adolescents. *Cochrane Database Syst Rev* CD003968
7. Hermann C, Kim M, Blanchard EB (1995) Behavioral and Prophylactic Pharmacological Intervention Studies of Pediatric Migraine: An Exploratory Meta-Analysis. *Pain* 60:239–256
8. Hermann C, Blanchard EB (2002) Biofeedback in the Treatment of Headache and Other Childhood Pain. *Appl Psychophysiol Biofeedback* 27:143–162
9. Holden EW, Deichmann MM, Levy JD (1999) Empirically Supported Treatments in Pediatric Psychology: Recurrent Pediatric Headache. *J Pediatr Psychol* 24:91–109
10. Janicke DM, Finney JW (1999) Empirically Supported Treatments in Pediatric Psychology: Recurrent Abdominal Pain. *J Pediatr Psychol* 24:115–127
11. Johnston CC, Stevens B, Pinelli J et al. (2003) Kangaroo Care is Effective in Diminishing Pain Response in Preterm Neonates. *Arch Pediatr Adolesc Med* 157:1084–1088
12. Kazak AE, Penati B, Brophy P et al. (1998) Pharmacologic and Psychologic Interventions for Procedural Pain. *Pediatrics* 102:59–66
13. McGrath PJ, Cunningham SJ, Lascelles MA et al. (1990) Help Yourself – A Treatment for Migraine Headaches. University of Ottawa Press, Ottawa
14. Powers SW (1999) Empirically Supported Treatments in Pediatric Psychology: Procedure-related pain. *J Pediatr Psychol* 24:131–145
15. Walco GA, Sterling CM, Conte PM et al. (1999) Empirically Supported Treatments in Pediatric Psychology: Disease-Related Pain. *J Pediatr Psychol* 24:155–167

## Psychological Treatment of Pain in Older Populations

HEINZ-DIETER BASLER

Institute of Medical Psychology, University of Marburg, Marburg, Germany  
basler@med.uni-marburg.de

### Synonyms

Psychological Treatment of Pain in the Elderly; Psychotherapy of Older Pain Patients

### Definition

The elderly are the fastest growing segment of the population in the industrialized countries, a phenomenon that has spurred the development of gerontology and ▶ **geriatric medicine**, dedicated to the study of aging processes and the treatment of age-related disorders. Older populations are far from being a homogeneous group. The chronological age does not correspond very strictly with the biological age, and with the physical and mental function of a person. The area of competence in geriatric medicine is better described by the performance of an individual than by the date on the birth certificate.

The prevalence of chronic pain in the elderly is estimated to range between 25% and 50% in community-based samples both in the United States and in European countries. Differences are due to varying criteria with regard to the definition of chronicity, and also to inclusion of different age groups in different studies. Musculoskeletal disorders constitute a predominant cause of pain in the elderly, especially osteoarthritis. Some pain related diagnoses are more frequent in the elderly like zoster, temporal arteriitis, polymyalgia rheumatica, arteriosclerotic peripheral vascular disease or injuries from fractured bones. Cancer of almost

every type is more common in old age, and most of those affected suffer significant pain. Moreover, patients are more likely to complain about pain at multiple sites of the body, and to receive more than one pain related diagnosis. On the other hand, there is a decline in the prevalence of headache, dental pain and abdominal pain with increasing age. Nonetheless, in comparison with younger age groups, the overall number of pain diagnoses is more frequent in the elderly, with the exception of the oldest. This may be due to the fact that only the healthiest survive until that age (Farrell et al. 1996).

Epidemiological studies often fail to incorporate ► **nursing home residents**. Studies especially designed to address that population found considerably higher numbers of chronic pain reports with a range of between 45 and 80% (Harkins and Price 1992). Uncontrollable pain and its behavioral consequences are a major cause of loss of independence and, finally, of admission to a nursing home.

### Characteristics

Geriatricians are confronted with special challenges often amplified by an additional pain diagnosis. In a study at geriatric clinics with chronic pain patients, we found on average five additional medical diagnoses, indicating the high frequency of comorbidity in this population (Basler et al. 2003). Comorbidity corresponded with reduced functional status and impaired mood. The most challenging issue in the medical care of the elderly is the pain related decline in functional status and resultant dependency on care givers.

There is a consensus in the literature that pain in the elderly is underreported, underdiagnosed and undertreated. Helme et al. (1997) blame ageist attitudes which probably deny most elderly patients the opportunity to have their suffering minimized. However, it is not solely the fault of the physician; it is often the elderly themselves who consider pain a normal part of aging and fail to report it. Kamel et al. (2001) demonstrated that the simple question "Do you have pain?" helped to detect a pain condition more often than the spontaneous report of the patient. An even higher number of pain reports resulted from the application of standardized pain scales. ► **Underreporting of pain** may also be explained by the fear that bringing pain to the clinician's attention may prompt the initiation of further diagnostic tests and treatments, some of which may cause even more discomfort. Moreover, the patient may fear that pain means worsening disease, a threat to his or her independence, or even impending death. On the part of the physician, there is sometimes the misconception that increases in the sensory threshold of the elderly found in laboratory studies are directly related to reduced suffering from clinical pain conditions. Harkins and Price (1992), after a review of the literature, came to the conclusion that findings in the laboratory should

not be transferred to clinical practice in an uncritical way: "Age is not an analgesic!"

Assessing pain may also be complicated by sensory and cognitive impairments that are common in older adults. Due to the varying degrees of pathology in these disorders and the wide range of individual differences, it is important to carefully assess and consider a patient's cognitive abilities and functioning before setting up a treatment plan. Filling in a pain questionnaire may be an excessive demand for an impaired individual, and should be replaced by semistructured interviews (Basler et al. 2001). A special challenge is the assessment of pain in individuals diagnosed with dementia. Although most cognitively impaired patients appear to be able to reliably report pain at the moment, a diagnosis of dementia requires behavioral observation under inclusion of breathing, negative vocalization, facial expression, body language, and consolability (Warden et al. 2003).

### Treatment Goals

The main priority for elderly and frequently comorbid patients is the maintenance of functional independence within a community setting. In old age, the risk of losing self-reliance as a consequence of pain is much higher than in younger individuals. Pain reduction is often more difficult to achieve, partly due to the long duration of the pain condition. Consequently, complete relief of pain is not a realistic goal. The emphasis may be rather on achieving a level of pain control that allows the patient to be mobile and socially interactive (Kerns et al. 2001).

### Age Effects of Treatment

Some early publications about the treatment, especially of headache disorders, in the 1980's seemed to support the assumption that psychological treatment procedures are less effective in the elderly. Meanwhile, the body of research has gradually increased and become more comprehensive, although the available evidence about possible age effects of psychological procedures is far from being satisfactory (Ersek et al. 2003). Nevertheless, there seems to be a consensus that the similarities of treatment and effect sizes between the old and the young outweigh the differences. Data indicate that the elderly are underrepresented in multidisciplinary treatment programs, despite the conviction that multidisciplinary management is a key to the successful practice of geriatric medicine (Gibson et al. 1996; Kee et al. 1998).

### Treatment Recommendations

In 2002, the American Geriatric Society published a consensus report about the management of persistent pain in older persons based on the available evidence (AGS Panel 2002). They discriminate between three levels of evidence; level 1 providing evidence from at least one properly randomized, controlled trial, level II supplying evidence from at least one well-designed clinical trial without randomization or from cohort

or case-controlled studies, and level III referring to evidence based on clinical expertise. Regarding non-pharmacological treatment, the panel suggests the following treatment modalities, all based on level I evidence:

1. A physical activity program should be considered for all older persons.
2. Any physical activity program for older patients should include exercises that improve flexibility, strength, and endurance.
3. Patient education programs should be integral components of the management of persistent pain syndromes.
4. Formal cognitive-behavioral therapies are helpful for many older adults with persistent pain.

Other modalities (e.g. heat, cold, massage, liniments, chiropractic, acupuncture and transcutaneous electrical nerve stimulation) are recommended at level III evidence (expert opinion). They often offer temporary relief and can be used as adjunctive therapies.

The authors emphasize that learning cognitive and behavioral pain coping strategies is an important part of pain management for all elderly patients with persistent pain. Cognitive coping strategies are designed to modify factors such as helplessness, low self-efficacy and catastrophizing that have been shown to increase pain and disability. Recent results indicate the significance of ► **fear avoidance beliefs** (Vlaeyen and Linton 2000). Many, not only elderly, patients have the perception that physical activity contributed to the initiation of the pain, and that the pain will be triggered and reinforced by resuming physical activity. Others are afraid of having a fall with attendant bone fractures. These misconceptions have to be addressed and replaced by the conviction that physical activity has the potential to recondition the musculature and to control pain in the long run. Behavioral strategies can help elderly patients to control pain by pacing their activities, increasing their involvement in pleasurable activities, and using relaxation methods. Cognitive strategies are typically combined with behavioral strategies, and together they are known as cognitive-behavioral therapy.

Systematic reviews and randomized controlled trials provide strong evidence that participation in regular physical activity reduces pain and enhances the functional capacity of older adults with persistent pain (O'Grady et al. 2000). In addition, increasing physical activity may improve psychological health, and regular participation in physical activities may lessen the clinical impact of age-related biological changes and of chronic illness.

► **Patient education** has shown to considerably improve overall pain management, especially when associated with actual practice of self-management and coping strategies. The content should include information about self-help techniques, the known causes of pain,

the goals of treatment, treatment options, expectations of pain management, and analgesic use.

### Treatment Modification

Some authors recommend modifications in the treatment protocol for the elderly to take sensory and cognitive restrictions into account. They suggest, for example, extending the sessions in order to ensure comprehension of instructions, facilitating home practice by provision of audio tapes and written material, and remaining with the patient throughout the feedback training sessions, thus facilitating positive verbal feedback and encouragement. Exercise programs have to establish quotas with a very gradual increase in the demands made on the patient. Moreover, emphasis should be placed on the incorporation of care givers into the treatment plan (Keefe et al. 1996). It appears crucial to individualize the treatment, because cognitively unimpaired elderly patients may be insulted by a protocol that underestimates their capacities.

### References

1. AGS Panel on Persistent Pain in Older Persons (2002) The Management of Persistent Pain in Older Persons. *JAGS* 50:205–224
2. Basler HD, Bloem R, Casser HR et al. (2001) A Structured Pain Interview for Geriatric Patients. *Schmerz* 15:164–171
3. Basler HD, Hesselbarth S, Kaluza G et al. (2003). Comorbidity, Multiple Medication and Well-Being of Elderly Patients with Chronic Pain. *Schmerz* 17:252–260
4. Ersek M, Turner J, McCurry SM et al. (2003) Efficacy of a Self-Management Group Intervention for Elderly Persons with Chronic Pain. *Clin J Pain* 19:156–167
5. Farrell MJ, Gibson SJ, Helme RD (1996) Chronic Nonmalignant Pain in Older People. In: Ferrell BR, Farrell BA (eds) *Pain in the Elderly*. IASP-Press, Seattle, pp 81–89
6. Gibson SJ, Farrell MJ, Katz B et al. (1996) Multidisciplinary Management of Chronic Nonmalignant Pain in Older Adults. In: Ferrell BR, Farrell BA (eds) *Pain in the Elderly*. IASP Press, Seattle, pp 91–100
7. Harkins SW, Price DD (1992) Assessment of Pain in the Elderly. In: Turk DC, Melzack R (eds) *Handbook of Pain Assessment*. Guilford Press, New York, pp 315–331
8. Helme RD, Bradbeer M, Katz B et al. (1997) Management of Chronic, Nonmalignant Pain in the Elderly: Experience in an Outpatient Setting. In: Mostofski DI, Lomranz J (eds) *Handbook of pain and aging*. Plenum Press, New York, pp 241–266
9. Kamel HK, Phlavan M, Malekgoudarzi B et al. (2001). Utilizing Pain Assessment Scales Increases the Frequency of Diagnosing Pain among Elderly Nursing Home Residents. *J Pain Symptom Managem* 21:450–455
10. Kee WG, Middaugh S, Redpath S et al. (1998) Age as a Factor in Admission to Chronic Pain Rehabilitation. *Clin J Pain* 14:121–128
11. Keefe FJ, Caldwell DS, Baucom D et al. (1996) Spouse-Assisted Coping Skills Training in the Management of Osteoarthritic Knee Pain. *Arthrit Care Res* 9:279–291
12. Kerns RD, Otis JD, Stein MK (2001) Cognitive-Behavioral Therapy for Chronic Pain in the Elderly. *Clin Geriatr Med* 17:503–522
13. O'Grady M, Fletcher J, Ortiz S (2000) Therapeutic and Physical Fitness Exercise Prescriptions for Older Adults with Joint Disease: An Evidence Based Approach. *Rheum Dis Clin North Am* 26:617–646
14. Vlaeyen JWS, Linton SJ (2000) Fear-Avoidance and its Consequences in Chronic Musculoskeletal Pain: A State of the Art. *Pain* 85:317–332

15. Warden V, Hurley AC, Volicer L (2003). Development and Psychometric Evaluation of the Pain Assessment in Advanced Dementia (PAINAD) Scale. *J Am Med Dir Assoc* 4:9–15
16. Widner S, Zeichner A (1993) Psychologic Interventions for the Elderly Chronic Pain Patients. *Clin Gerontol* 13:3–18

## Psychological Treatment of Pain in the Elderly

### ► Psychological Treatment of Pain in Older Populations

## Psychology of Pain, Assessment of Cognitive Variables

MICHAEL J. L. SULLIVAN  
 Department of Psychology, University of Montreal,  
 Montreal, QC, Canada  
 michael.jl.sullivan@umontreal.ca

### Synonyms

Evaluation of Pain-Related Thought, Psychological Aspects of Pain; Cognitive Assessment

### Definition

Cognitive Assessment refers to a variety of procedures designed to elucidate the thought content or thought processes implicated in the pain experience. Cognitive assessment in pain research may address stable internal factors such as beliefs, or may address situationally determined or transient factors such as automatic thoughts, ► **expectancies**, or ► **coping** strategies. Assessments that make use of self-report questionnaires are typically aimed at assessing thought content (e.g. whether or not an individual endorses a specific pain-related belief). Assessments that involve performance of ► **cognitive tasks** are typically aimed at the analysis of the thought process (e.g. vigilance, bias, accessibility).

### Characteristics

#### Background

The writings of Beecher (1956) first drew attention to the important role of cognitive factors in the pain experience. Working as a military physician, Beecher was struck by the wide range of soldiers' responses to injury and pain. Beecher (1956) provided vivid descriptions of soldiers who had sustained severe wounds in combat, yet did not request narcotics to alleviate their pain. He suggested that for many soldiers, the wounds may have represented their 'ticket to safety', and that their pain experience may have been lessened by this positive reinterpretation. As clinicians and researchers became more aware of the important role of psychological factors as determinants of pain experience, the challenge facing them was to devise means of reliably and validly assessing pain-related

► **cognitions**. A variety of self-report questionnaires have been developed to assess cognitions associated with pain. The advantage of questionnaires is they are relatively easy to administer and score, thus facilitating their inclusion in research protocols. Self-report instruments have been used extensively to assess coping, ► **appraisal**, expectancies, and beliefs about pain. One limitation of self-report questionnaires is that they can only assess cognitions of which individuals are aware, thus restricting their application to the study of consciously accessible thought content. Self-report questionnaires are also susceptible to wilful distortion, which can be a significant drawback if the questionnaires are administered under conditions where there might be incentives (e.g. compensation) for certain forms of self-presentation (e.g. disability).

A number of cognitive performance paradigms have been developed in order to more directly assess pain-related thought processes (Pincus and Morley 2001, Keogh et al. 2001). Paradigms that assess the amount of time required to make decisions about different aspects of pain stimuli, the interpretation of ambiguous pain-related stimuli, memory of pain stimuli, and cognitive interference due to pain have been useful in the study of cognitive dimensions such as vigilance, accessibility and ► **preferential processing** (Pincus and Morley 2001).

Due to the multitude of assessment instruments and procedures that have been developed, it is not possible to provide a comprehensive review of these within the space limitations of this essay. The review below is selective by necessity, and focuses on areas of high research activity and current theoretical relevance.

### Cognitive Assessment of Pain-Related Thought Content

#### Coping

The assessment of coping dominated much of the research on the psychology of pain in the 1980s. This work emerged from the view that pain symptoms could be viewed as a physical and psychological stressor, and that the manner in which individuals coped with their pain would have implications for physical and emotional outcomes. Numerous investigations have used the Coping Strategies Questionnaire (CSQ, Rosenstiel and Keefe 1983) to assess coping strategies for pain. The CSQ consists of 7 coping subscales, coping self-statements, praying or hoping, ignoring pain sensations, reinterpreting pain sensations, increasing behavioural activities, and catastrophizing. Subscale scores have been used to examine the correlates of coping in research, as well as in clinical practice as a means of identifying targets of intervention.

A different approach to the assessment of coping and adaptation is reflected in the Multidimensional Pain Inventory developed by Kerns and his colleagues (Kerns et al. 1985). This instrument is based on Turk and Rudy's Multiaxial Assessment of Pain, which integrates med-



## Psychology of Pain and Psychological Treatment

HERTA FLOR<sup>1</sup>, NIELS BIRBAUMER<sup>2</sup>

<sup>1</sup>Department of Neuropsychology at the University of Heidelberg, Central Institute of Mental Health, Mannheim, Germany

<sup>2</sup>Institute of Medical Psychology and Behavioral Neurobiology, University of Tübingen, Tübingen, Germany

flor@zi-mannheim.de,

niels.birbaumer@uni-tuebingen.de

Pain has for a long time been viewed as a purely sensory phenomenon or an epiphenomenon of a medical disorder in the medical sciences and as a result of a disordered personality (see also ► [personality and pain](#)) in psychology. Both views have changed over the past 40 years and it has been recognized that pain is a psychobiological experience, with emotional aspects and learning aspects rather than personality characteristics being important determinants of pain. Thus nociception, the physiological process of a noxious signal being transmitted from the periphery to the brain, has been differentiated from the experience of pain, which encompasses all aspects including psychological, social and cultural factors. The International Classification of Diseases (ICD10) (World Health Organization 1992) as well as the Diagnostic and Statistical Manual for Mental Disorders (DSMIV-TR) (American Psychological Association 2000) still adhere to the distinction psychogenic – somatogenic or physical *versus* somatoform pain, which must be viewed as obsolete given the large number of research findings emphasizing the importance of psychological factors in any type of pain, acute or chronic (cf. Gatchel and Turk 1999). The biopsychosocial or ► [diathesis stress](#) (see also ► [diathesis-stress model of chronic pain](#)) model of pain views pain as a complex response that can be described on the verbal-subjective, the motor-behavioral and physiological levels. It can be based on nociceptive input but nociception (the transmission of noxious input from the periphery to the highest levels of the CNS) is not a prerequisite for the experience of pain, which can be an exclusively central phenomenon, but always has physiological antecedents and consequences (Flor and Turk 2006; Flor et al. 1990).

### The Role of Learning in Chronic Pain

Both associative and nonassociative learning (see also ► [modeling, social learning in pain](#)) processes as well as social learning have been found to be of fundamental significance in the development of chronic pain. The repeated application of painful stimuli leads to reduced responsiveness, i.e. ► [habituation](#) to the painful stimula-

tion. In many states of chronic pain, ► [sensitization](#) (see also ► [psychology of pain, sensitisation, habituation and pain](#)) rather than habituation occurs due to changes at both the level of the receptor and the central nervous system (Woolf and Mannion 1999). Sensory information accelerates habituation and reduces activation caused by surprise, insecurity and threat. This mechanism may underlie the effects reported in a large number of studies that support the positive results of preparatory information prior to acutely painful procedures, such as surgery or bone marrow aspiration. The most influential model of psychological factors in chronic pain was W. E. Fordyce's assumption that chronic pain can develop and be maintained due to ► [operant conditioning](#) (see also ► [operant treatment of chronic pain; ► operant perspective of pain](#)) of pain behaviors, i.e. overt expressions of pain. Fordyce (1976) postulated that acute pain behaviors such as limping or moaning may come under the control of external contingencies of reinforcement and thus develop into a chronic pain problem. Positive reinforcement of pain behaviors (see also ► [motivational aspects of pain](#)) (e.g. by attention and the expression of sympathy), negative reinforcement of pain behaviors (see also ► [motivational aspects of pain](#)) (e.g. the reduction of pain through the intake of medication or by the cessation of activity) as well as a lack of reinforcement of healthy behaviors (see also ► [motivational aspects of pain](#)) could provoke chronicity in the absence of nociceptive input. Thus ► [pain behaviors](#) (see also ► [motivational aspects of pain](#))—originally elicited by nociceptive input may, over time, occur in response to environmental contingencies. This model has generated much research that has not only confirmed the original assumptions made by Fordyce, but has also shown that in addition to pain behaviors, the subjective experience of pain as well as physiological responses related to pain are subject to reinforcement learning. A special role has been assigned to significant others of chronic pain patients, who have high reinforcement potential. When solicitous, i.e. pain-reinforcing spouses were present, several studies found that the patients were more pain sensitive during acute pain tests than when the spouses were absent. The patients with non-solicitous spouses did not differ in the spouse present or absent conditions. These studies suggest that spouses can serve as discriminative stimuli for the display of pain behaviors by chronic pain patients, including their reports of pain intensity (e.g. Flor et al. 1995a). Health care providers may also become discriminative cues influencing patients' responses. Solicitous responses by significant others can also lead to increased physiological pain responses in the patients, whereas focusing on healthy behaviors by significant others can have positive effects on the pain experience.

Of equal importance is the operant conditioning related to the intake of pain medication. Patients are often told by their physicians or by well-meaning family members that they should not continue to take analgesic medication unless the pain increases to a point where it becomes intolerable (referred to ▶ *prn* from the Latin "take as needed"). When pain medication is taken at that stage, both pharmacological and behavioral factors can contribute to the development of misuse of medication and in severe cases even drug dependence. If analgesic medication is taken only at peak pain levels, the effect of the medication is less potent and patients cycle between high and low levels of medication, which facilitates the development of dependence. In addition, medication intake is negatively reinforcing, since the intake of medication ends an aversive state (pain). Subsequently, the pain reducing behavior (use of analgesics) increases in frequency. Thus, both pharmacotherapists and behavioral psychologists recommend that analgesic medication should not be taken on a pain contingent but rather in a time contingent fashion adapted to the specific pain level of the patient and the half-life of the drug.

The negative reinforcement of activity levels is an important process in the development of disability. A specific activity, for example walking, is performed until pain sets in, at which point the activity is interrupted and replaced by rest. Subsequently, the pain will be reduced. This reduction of an aversive state – pain – negatively reinforces the cessation of activity. As was the case with the intake of analgesic medication, the cessation of activity has to be made dependent on amount of activity achieved – quota based (e.g. number of stairs climbed, distance walked), rather than on the amount of pain. Thus, the pain reinforcing quality of rest is eliminated. This formulation supports the strategy of encouraging patients to perform activities to meet a specific quota and not until pain is perceived as overwhelming.

The respondent conditioning (see also ▶ *respondent conditioning of chronic pain*) model postulates that numerous formerly neutral cues can be associated with the experience of pain and can – over time – themselves elicit responses that lead to an increased pain response and create the experience of pain in the absence of nociceptive input. To illustrate the proposed process from a respondent conditioning perspective, the patient may have learnt to associate increases in muscle tension with all kinds of stimuli that were originally associated with nociceptive stimulation. Thus, sitting, walking, bending or even thoughts about these movements may elicit anticipatory ▶ *anxiety* (see also ▶ *depression and pain*; ▶ *fear and pain*) and increases in muscle tension. This fear of movement or "▶ *kinesiophobia*" (see also ▶ *fear and pain*) has been discussed as an important

factor in the maintenance and exacerbation of chronic pain (e.g. Vlaeyen and Linton 2000). Subsequently, patients may display maladaptive responses to any number of stimuli and reduce the frequency of performance of many activities other than those that initially reduced pain. Thus, although the original association between injury and pain results in anxiety regarding movement, over time the anxiety may lead to increased muscle tension and pain even if the nociceptive stimuli are no longer present. In addition, stress situations can increase muscle tension levels and cause sympathetic activation and may thus reinforce the process. Many patients have reported that an acute pain problem evolved into chronic pain at a time where personal stressors co-occurred with the pain. ▶ *Stress* (see also ▶ *stress and pain*) situations may serve as additional US and also as CS for muscle tension increases, increased sympathetic activation and subsequently pain. Wunsch et al. (2003) have shown that pain perception can be increased or decreased by classically conditioning positive or negative stimuli to pain.

Non-occurrence of pain is a powerful reinforcer for reduction of movement. Thus, the original respondent conditioning may be complemented by an ▶ *operant process*, (see also ▶ *operant treatment of chronic pain*; ▶ *operant perspective of pain*) whereby the nociceptive stimuli need no longer be present for the avoidance behavior to occur. People who suffer from acute back pain, regardless of the cause, may adopt specific behaviors (e.g. limping) to avoid pain and they may never obtain "corrective feedback" because they fail to perform more natural movements and learn that they may not induce pain. Reduction in physical activity may subsequently result in muscle atrophy and increased disability. In this manner, the physical abnormalities proposed by biomechanical models of pain may actually be secondary to changes in behavior initiated through learning. Chronic pain patients tend to focus their attention on impending pain and subsequently avoid many types of activity, thus fostering the development of disability and depression. The release of endogenous opioids – the body's own analgesic system – may also be influenced by respondent conditioning (cf. Flor et al. 2002) as well as brain responses related to the experience of pain (cf. Schneider et al. 2004). Moreover, fear of pain and subsequent avoidance of activity is one of the best predictors (see also ▶ *psychological predictors of chronicity*) of subsequent chronicity (see also ▶ *psychological predictors of chronicity*) (Asmundson et al. 1999).

Response acquisition through the observation of others or ▶ *social learning* (see also ▶ *modeling, social learning in pain*) is an essential mechanism of learning new patterns of behavior. Children acquire attitudes about health and health care, the perception and interpreta-

tion of symptoms and physiological processes from their parents and social environment. They also learn appropriate responses to injury and disease and thus may be more or less likely to ignore or over-respond to normal bodily sensations they experience. The culturally acquired perception and interpretation of symptoms determines how people deal with illness. The observation of others in pain is an event that captivates attention. This attention may have survival value, may help to avoid experiencing more pain and may help to learn what to do about acute pain.

Modeling (see also ► [modeling, social learning in pain](#)) probably plays a part in the phenomenon of “pain-prone families” families with a significantly elevated occurrence of pain problems (Whitehead et al. 1994). It was, for example reported that children show the same pain syndromes as their parents currently have, rather than the pain problems their parents had in their own childhood. reported an increased occurrence of pain syndromes in spouses and relatives of pain patients. The large cultural variations in pain expression are also important. In common clinical practice, the acquisition or extinction of pain related behavior by means of modeling has received little attention. However, there are occasional indications for the role of modeling in treating pain problems in children on burn units and in the treatment of post-operative pain.

Despite the great deal of data available on the modification of experimentally induced pain behavior by means of modeling in normal (healthy) subjects, there are few experimental results concerning chronic pain patients. Nor are there any longitudinal studies of the development of pain syndromes in “pain-prone families.” Further investigation of modeling as a factor in the development of chronic pain disorders is necessary.

### Cognitive Factors and Pain

Cognitive-behavioral models of chronic pain emphasize that the evaluation of the pain experience by the patient greatly determines that amount of pain that is experienced as well as its negative consequences (Flor and Turk 2006; Turk et al. 1983). General assumptions that characterize the cognitive-behavioral perspective are (1) people are active processors of information and not passive reactors, (2) thoughts (e.g. appraisals, expectancies) can elicit or modulate mood, affect physiological processes, influence the environment and serve as an impetus for behavior (conversely, mood, physiology, environmental factors and behavior can influence thought processes), (3) behavior is reciprocally determined by the person and environmental factors, (4) people can learn more adaptive ways of thinking, feeling and behaving and (5) people are capable and should be involved as active agents in change of maladaptive thoughts, feelings and behaviors.

From the cognitive-behavioral perspective (see also ► [cognitive-behavioral perspective of pain](#)), people suffering from chronic pain are viewed as having negative expectations about their own ability to control certain motor skills, such as performing specific physical activities (e.g. climbing stairs, lifting objects) that are attributed to one overwhelming factor, namely a chronic pain syndrome. Moreover, chronic pain patients tend to believe that they have a limited ability to exert any control over their pain. Such negative, maladaptive appraisals of the situation and personal efficacy may reinforce the experience of demoralization, inactivity and overreaction to nociceptive stimulation. Specifically, too much attention to pain may be associated with a state of hypervigilance (see ► [hypervigilance and attention to pain](#)) that increases the impact of pain and leads to unnecessary suffering (Vlaeyen and Linton 2000).

A great deal of research has been directed toward identifying cognitive (thinking) factors that contribute to pain and disability. Numerous studies have been conducted to examine the importance of cognitive components of the pain. These have consistently demonstrated that patients’ attitudes, beliefs, expectancies about their plight, their coping resources and the health care system affect their reports of pain, activity, disability and response to treatment (e.g. Keefe et al. 2004). Pain, when interpreted as signifying ongoing tissue damage or a progressive disease seems to produce considerably more suffering and behavioral dysfunction than if it is viewed as being the result of a stable problem that is expected to improve. A number of studies have used experimental pain stimuli and demonstrated that the conviction of personal control (see also ► [psychological treatment of headache](#)) can ameliorate the experience of experimentally induced nociception. Moreover, the type of thoughts employed during exposure to painful stimulation has been related to pain tolerance and pain intensity ratings. ► [Catastrophizing](#) (see also essay ► [catastrophizing](#)) thoughts have been associated with lower pain tolerance and higher ratings of pain intensity. In contrast, coping thoughts have been related to higher pain tolerance and lower pain intensity ratings.

Certain beliefs may lead to maladaptive ► [coping](#) (see also ► [coping and pain](#); ► [motivational aspects of pain](#)), increased suffering and greater disability. Patients who believe their pain is likely to persist may be passive in their coping efforts and fail to make use of available strategies, even when in their repertoire, to cope with pain. Patients who consider their pain to be an “unexplainable mystery”, may negatively evaluate their own abilities to control or decrease pain and are less likely to rate their coping strategies as effective in controlling and decreasing pain.

Once beliefs and expectancies (cognitive schemata) about a disease are formed they become stable and are very difficult to modify. Patients tend to avoid experiences that could invalidate their beliefs and they guide their behavior in accordance with these beliefs, even in a situation where the belief is no longer valid (no corrective feedback is received to discredit this belief). For example, feeling some muscular pain following activity may be caused by lack of muscle strength and general deconditioning and not by additional tissue damage. Self-regulation of pain and its impact depends upon the person's specific ways of dealing with pain, adjusting to pain and reducing or minimizing pain and distress caused by pain—their coping strategies. Coping is assumed to be manifested by spontaneously employed purposeful and intentional acts and it can be assessed in terms of overt and covert behaviors. Overt, behavioral coping strategies include rest, medication and use of relaxation. Covert coping strategies include various means of distracting oneself from pain, reassuring oneself that the pain will diminish, seeking information and problem solving. Studies have found active coping strategies (efforts to function in spite of pain or to distract oneself from pain such as activity, ignoring pain) to be associated with adaptive functioning and passive coping strategies (depending on others for help in pain control and restricted activities) to be related to greater pain and depression. However, beyond this, there is no evidence supporting the greater effectiveness of one active coping strategy compared to any other (Fernandez and Turk 1989). Specific coping strategies need not always be adaptive or maladaptive. It seems more likely that different strategies will be more effective than others for some people at some times, but not necessarily for all people all of the time or even the same person at different times. One of the most important factors for improved coping with pain as well as the success of psychological treatment seems to be a sense of mastery over the goals one seeks to accomplish in the sense of increased self-efficacy (Keefe et al. 2004).

### **Pain and Affect**

The affective factors associated with pain include many different emotions, but they are primarily negative in quality. ▶ [Anxiety](#) (see also ▶ [depression and pain](#); ▶ [fear and pain](#)) and ▶ [depression](#) (see also ▶ [depression and pain](#); ▶ [fear and pain](#)) have received the greatest amount of attention in chronic pain patients; however anger has recently received considerable interest as an important emotion in chronic pain patients. Research suggests that from 40–50% of chronic pain patients suffer from depression (Romano and Turner 1985). There have been extensive and fruitless debates concerning the causal relationship between depression and pain. In the majority of cases,

depression appears to be the patients' reaction to their plight. The presence of depression is closely related to the feelings of loss of control and helplessness often associated with pain.

Several investigators have also found a close association between fear of pain and dysfunctional coping. In addition, high comorbidity between anxiety disorders and pain seems to be present. Muscular hyperreactivity to stress seems to be closely associated with fear of pain (see also ▶ [fear and pain](#)) (e.g. Geisser et al. 2004) and exposure therapy (see also ▶ [fear reduction through exposure in vivo](#)) has been suggested as a new treatment option (Keefe et al. 2003).

Anger (see also ▶ [anger and pain](#)) has been widely observed in individuals with chronic pain (e.g. Greenwood et al. 2003). The internalization of angry feelings seems to be strongly related to measures of pain intensity, perceived interference and reported frequency of pain behaviors. Anger and hostility are closely associated with pain in persons with spinal cord problems. Frustrations related to persistence of symptoms, limited information on etiology and repeated treatment failures, along with anger toward employers, the insurance, the health care system, family members and themselves, also contribute to the general dysphoric mood of these patients. The impact of anger and frustration on exacerbation of pain and treatment acceptance has not received adequate attention. It would be reasonable to expect that the presence of anger may serve as an aggravating factor, associated with increasing autonomic arousal and blocking of motivation and acceptance of treatments oriented toward rehabilitation and disability management rather than cure, which are often the only treatments available for chronic pain.

### **Biobehavioral Perspective**

A biobehavioral or a ▶ [diathesis stress](#) (see also ▶ [diathesis-stress model of chronic pain](#)) model of chronic pain needs to consider the factors discussed above and their mutual interrelationships in the explanation of chronic pain. The existence of a physiological disposition or diathesis is one important component. This predisposition is related to a reduced threshold for noxious stimulation and can be determined by genetic factors or acquired through early learning experiences. For example, Mogil (1999) showed that large genetic variations in individual pain sensitivity exist. Very impressive evidence for the role of early traumatic experience comes from the work of Anand et al. (1999) who showed that minor noxious experience in neonate rats leads to dramatic alterations (sensitization) in nociceptive processing in the adult organism. A further component of the biobehavioral model is a response stereotypy of a particular bodily system, such as exaggerated muscular responses of the lower back muscle



to stress and pain that is based both on the diathesis and on aversive experiences present at the time of the development of the response. These aversive stimuli may include personal or work stress or problematic occupational conditions and will lead not only to painful responses, but also to avoidance behaviors and associated maladaptive cognitive and affective processes. The cognitive evaluation of these external or internal stimuli is of great importance in the pain response as discussed above.

### Memory for Pain

An important maintaining factor in this chronicity process is the development of pain memories (see also ► [fear and pain](#)). These pain related memories may be explicit or implicit and may subsequently guide the patient's experience and behaviors (Erskine et al. 1990). For example, pain patients have a tendency to remember preferentially negative and pain related life events and show a deficit in the retrieval of positive memories. The experience of chronic pain also leads to the development of somatosensory pain memories, for example, an expanded representation of the affected body part in primary somatosensory cortex. This expanded cortical representation is accompanied by increased sensitivity to both painful and nonpainful stimuli and may be further enhanced by learning processes or attention to painful stimulation. An even more dramatic example of a learned memory for pain has been found in phantom limb pain patients (Flor et al. 1995b). In upper extremity amputees, the magnitude of the phantom limb pain was found to be proportional to the amount of reorganization in primary somatosensory cortex, namely, the shift of the cortical mouth representation into the area where the amputated limb was formerly represented. The brain obviously maintains a memory of the former input to the deafferented area and subsequently stimulation stemming from areas adjacent to the deafferented zone elicits sensations and pain in the now absent limb. Phantom sensations and cortical reorganization are absent in congenital amputees. The focus of the biobehavioral perspective is thus on the patient and not just on the symptoms or the underlying pathology and this focus also requires that the treatment of the patients be tailored not only to medical factors, but incorporate psychosocial variables that may often be predominant in states of chronic pain.

### Psychological Assessment of Pain and its Consequences

As noted above, pain is viewed as a complex response with verbal-subjective, motor-behavioral and physiological components that need to be assessed in a multifactorial model (Turk and Melzack 2001). A comprehensive psychological assessment

(see also ► [psychophysiological assessment of pain](#) ► [psychological assessment of pain](#) ► [psychology of pain, assessment of cognitive variables](#)) of pain includes the measurement of the intensity and quality of pain, as well as its consequences in many areas of life and a thorough analysis of pain eliciting and pain maintaining factors. Pain coping strategies and pain related cognitions give important information about how patients deal with pain and how this may lead to chronicity. In view of the high comorbidity of pain and depression, the assessment of depression is important in addition to the measurement of anger and anxiety related to pain. Pain behaviors are important for the analysis of pain reinforcing factors and can be assessed by observation checklists or video recordings with subsequent behavioral analyses. The amount of disability should also be determined as well as the patients' general activity levels. Psychophysiological assessments (► [psychophysiological assessment of pain](#) ► [assessment of pain behaviors](#)) become more common as the cost of equipment as well as the complexity of the assessments are decreasing due to new technical developments. General measures of arousal such as heart rate and skin conductances as well as more specific pain related variables such as muscle tension levels or responses to stress have been assessed. Turk and Rudy (1988) proposed a multiaxial pain assessment based on the multidimensional pain inventory (Kerns et al. 1985) that includes patients' estimates of and responses to pain, significant other responses to pain behaviors and activity levels. Cluster analyses were used to identify various patient subgroups that were similar across different diagnoses and that reflected psychosocial patient characteristics.

### Psychological Treatment of Chronic Pain

#### Biofeedback and Relaxation

► [Biofeedback](#) (see also ► [biofeedback in the treatment of pain](#)) refers to the modification of a bodily process (e.g. skin temperature, muscle tension) that normally does not reach consciousness (see ► [consciousness and pain](#)) by making the bodily process perceptible to the patient. The physiological signal is measured and amplified and fed back to the patients by the use of a computer that translates variations in bodily processes into visual or auditory or tactile signals. Seeing or hearing their blood pressure or muscle tension enables persons to self-regulate it. The most common type of biofeedback for chronic pain is muscle tension or electromyographic (EMG) biofeedback, which was found to be effective for several chronic musculoskeletal pain syndromes (e.g. Flor et al. 1992). For migraine headache (see ► [psychological treatment of headache](#)), temperature, blood flow in the temporal

artery or slow cortical potentials have been fed back with good results (Penzien et al. 2002). Similar good results are available for Raynaud's disease with respect to temperature feedback (e.g. Kranitz and Lehrer 2004). Other respondent methods are various types of relaxation training (see also ► [relaxation in the treatment of pain](#)), among which progressive muscle relaxation seems to be especially suited for the treatment of chronic musculoskeletal pain (e.g. Ostelo et al. 2005).

#### **Operant Behavioral Treatment**

Patients who show high levels of pain behaviors and are very incapacitated by their pain should profit from ► [operant behavioral treatment](#) (see also ► [cognitive-behavioral treatment of pain](#)). The goals of this treatment are increases in activity levels and healthy behaviors related to work, leisure time and the family, as well as medication reduction and change in the behavior of significant others (cf., Fordyce 1976). The overall goal is to reduce disability by reducing pain and increasing healthy behaviors. This approach has been found to be effective with patients with chronic back pain as well as other pain syndromes.

#### **Cognitive-behavioral Treatment of Chronic Pain**

The cognitive behavioral (see ► [cognitive-behavioral treatment of pain](#) ► [cognitive-behavioral perspective of pain](#)) model of chronic pain emphasizes the role of cognitive, affective and behavioral factors on the development and maintenance of chronic pain. The cognitive behavioral perspective that focuses on the important role of assigning more responsibility to the patients can be applied to any type of treatment. The central tenet of cognitive-behavioral treatment is to reduce feelings of helplessness and uncontrollability and to establish a sense of control over pain in the patients. This is achieved by the modification of pain eliciting and maintaining behaviors, cognitions and emotions. The CB approach teaches patients various techniques to deal effectively with episodes of pain. Pain related cognitions are changes produced by cognitive restructuring and pain coping strategies, such as attention diversion, self-hypnosis (see also ► [therapy of pain, hypnosis](#)), use of imagery or relaxation that increase self-efficacy (see also ► [psychology of pain, self-efficacy](#)). Several studies have examined the efficacy (see ► [psychology of pain, efficacy](#)) of cognitive-behavioral pain management, which must be considered as a very effective treatment of chronic pain (e.g. Turk and Okifuji 2002).

#### **Important Aspects of Psychological Treatment of Chronic Pain**

Psychological treatment of chronic pain is usually performed in an interdisciplinary setting (see

► [motivational aspects of pain](#)) that includes medical interventions, physiotherapy and social measures that are often combined in a multimodal approach. The problem with multimodal approaches is that some parts of the treatments may counteract each other and that it is difficult to assess the contribution of the individual components. Rather than combining an array of diverse intervention strategies, it might be more fruitful to aim for a differential indication of various treatment components based on the pain related characteristics of the patients. For example, Turk et al. (1998) found that persons characterized by high levels of dysfunction responded better to an interdisciplinary pain treatment program for fibromyalgia than those who were interpersonally distressed. The prediction of outcome (see ► [psychological treatment of chronic pain, prediction of outcome](#)) in psychological pain treatment would greatly benefit from such an indication-based approach.

Another important aspect of psychological pain management is the motivation (see ► [motivational aspects of pain](#)) of the patients for a psychological approach. This is often difficult since they may be concerned that the referral to a mental health professional implies that their pain is "not real," they are exaggerating, the pain they feel is really "all in their head" or their pain is a psychological and therefore not a physical problem. Furthermore, many pain sufferers fear that a referral for psychological intervention implies that they can no longer be helped by the traditional health care system and that they are being abandoned as "hopeless cases." They may view the referral as requiring that they prove that they do have legitimate reasons for their reported symptoms. These people usually believe that psychological assessment is not relevant to their problem, when they know that there must be a known physical basis for their symptoms. The patient may believe that cure of the disease or elimination of the symptoms or physical limitations is all that is required or ask why they are being referred to a psychologist or psychiatrist. This requires a motivational phase prior to treatment that familiarizes the patients with the multidimensional view of chronic pain and motivates them to view a psychological approach as a chance to alter their attitude toward their pain and a first step toward improvement as well as an optimal patient therapist interaction (see ► [chronic pain, patient-therapist interaction](#)) that is characterized by an emphasis of the self-management skills of the patient. Psychological pain treatments are also effective in children (see ► [psychological treatment of pain in children](#)) (Eccleston et al. 2003) and older populations (see ► [psychological treatment of pain in older populations](#)) (Weiner et al. 2002) and can be used throughout the life span. To what extent spouses (see ► [spouse,](#)

role in chronic pain) or significant others should be included in psychological pain treatment is a matter of controversy; the literature is not consistent on this point (Lankveld et al. 2004). Moreover, gender (see ► [gender and pain](#)) aspects have been addressed with respect to pain sensitivity, but are virtually unexplored with respect to the efficacy of psychological pain treatment. Psychological treatment methods have also been successfully applied to the treatment of acute pain (see ► [psychological treatment in acute pain](#)) states (e.g. Luebbert et al. 2001), where they can be employed to prevent chronicity (see ► [chronicity, prevention](#)) and the development of persistent pain memories (e.g. Linton et al. 2005).

## References

- Anand KJ, Coskun V, Thirivikraman KV et al. (1999) Long-term behavioral effects of repetitive pain in neonatal rat pups. *Physiol Behav* 66:627–637
- Asmundson GJ, Norton PJ, Norton GR (1999) Beyond pain: The role of fear and avoidance in chronicity. *Clin Psychol Rev* 19:97–119
- American Psychiatric Association (2000) *Diagnostic and Statistical Manual of Mental Disorders – Trial Version*. American Psychiatric Association, Washington, DC
- Eccleston C, Yorke L, Morley S et al. (2003) Psychological therapies for the management of chronic and recurrent pain in children and adolescents. *Cochrane Database Syst Rev* 1:CD003968
- Erskine A, Morley S, Pearce S (1990) Memory for pain: a review. *Pain* 41:255–265
- Fernandez E, Turk DC (1989) The utility of cognitive coping strategies for altering pain perception: a meta-analysis. *Pain* 38:123–135
- Flor H, Turk DC (2006) Learning processes and cognitive factors. In: McMahon S, Koltzenburg M (eds) *Wall & Melzack's Textbook of Pain*, 5th edn. Elsevier, London (in press)
- Flor H, Birbaumer N, Turk DC (1990) The psychobiology of chronic pain. *Advances in Behaviour Research and Therapy* 12:47–84
- Flor H, Fydrich T, Turk DC (1992) Efficacy of multidisciplinary pain treatment centers: a meta-analytic review. *Pain* 49:221–230
- Flor H, Breitenstein C, Birbaumer N et al. (1995a) A psychophysiological analysis of spouse solicitude towards pain behaviors, spouse interaction, and pain perception. *Behav Ther* 26:255–272
- Flor H, Elbert T, Knecht S et al. (1995b) Phantom Limb Pain as a Perceptual Correlate of Cortical Reorganization. *Nature* 357:482–484
- Flor H, Birbaumer N, Schulz R et al. (2002) Pavlovian conditioning of opioid and nonopioid pain inhibitory mechanisms in humans. *Eur J Pain* 6:395–402
- Fordyce WE (1976) *Behavioral methods in chronic pain and illness*. Mosby, St. Louis
- Gatchel RJ, Turk DC (1999) *Psychosocial factors in pain: Critical perspectives*. Guilford Press, New York
- Geisser ME, Haig AJ, Wallbom AS et al. (2004) Pain-related fear, lumbar flexion, and dynamic EMG among persons with chronic musculoskeletal low back pain. *Clin J Pain* 20:61–69
- Greenwood KA, Thurston R, Rumble M et al. (2003) Anger and persistent pain: current status and future directions. *Pain* 103:1–5
- Keefe FJ, Rumble ME, Scipio CD et al. (2004) Aspects of persistent pain: current state of the science. *J Pain* 5:195–211
- Kerns RD, Turk C, Rudy TE (1985) The West Haven–Yale Multidimensional Pain Inventory (WHYMPI). *Pain* 23:345–356
- Kranitz L, Lehrer P (2004) Biofeedback applications in the treatment of cardiovascular diseases. *Cardiol Rev* 12:177–181
- Lankveld W van, Helmond T van, Naring G et al. (2004) Partner participation in cognitive-behavioral self-management group treatment for patients with rheumatoid arthritis. *J Rheumatol* 31:1738–1745
- Linton SJ, Boersma K, Jansson M et al. (2005) The effects of cognitive-behavioral and physical therapy preventive interventions on pain-related sick leave: a randomized controlled trial. *Clin J Pain* 21:109–19
- Luebbert K, Dahme B, Hasenbring M (2001) The effectiveness of relaxation training in reducing treatment-related symptoms and improving emotional adjustment in acute non-surgical cancer treatment: a meta-analytical review. *Psychooncology* 10:490–502
- Mogil JS (1999) The genetic mediation of individual differences in sensitivity to pain and its inhibition. *Proc Natl Acad Sci USA* 96:7744–7751
- Ostelo RW, Tulder MW van, Vlaeyen JW et al. (2005) Behavioural treatment for chronic low-back pain. *Cochrane Database Syst Rev* CD002014
- Penzien DB, Rains JC, Andrasik F (2002) Behavioral management of recurrent headache: three decades of experience and empiricism. *Appl Psychophysiol Biofeedback* 27:163–181
- Romano JM, Turner JA (1985) Chronic pain and depression: does the evidence support a relationship? *Psychol Bull* 97:18–34
- Schneider C, Palomba D, Flor H (2004) Pavlovian conditioning of muscular responses in chronic pain patients: central and peripheral correlates. *Pain* 112:239–247
- Turk DC, Okifuji A (2002) Psychological factors in chronic pain: evolution and revolution. *J Consult Clin Psychol* 70:678–690
- Turk DC, Meichenbaum DH, Genest M (1983) *Pain and behavioral medicine: A cognitive-behavioral approach*. Guilford, New York
- Turk DC, Okifuji A, Sinclair JD et al. (1998) Interdisciplinary treatment for fibromyalgia syndrome: clinical and statistical significance. *Arthritis Care Res* 11:186–195
- Turk DC, Rudy TE (1988) Toward an empirically derived taxonomy of chronic pain patients: Intergration of psychological assessment data. *Journal of Consulting and Clinical Psychology* 56:233–238
- Vlaeyen JW, Linton SJ (2000) Fear-avoidance and its consequences in chronic musculoskeletal pain: a state of the art. *Pain* 85:317–332
- Weiner D, Herr K, Rhudy TE (2002) *Persistent pain in older adults*. Springer, New York
- Whitehead WE, Crowell MD, Heller BR et al. (1994) Modeling and reinforcement of the sick role during childhood predicts adult illness behavior. *Psychosom Med* 56:541–550
- Woolf CJ, Mannion RJ (1999) Neuropathic pain: Aetiology, symptoms, mechanisms, and management. *Lancet* 353:1959–1967
- World Health Organization (1992) *The International Statistical Classification of Diseases and Related Health Problems, 10th rev, vol 1*. World Health Organization, Geneva
- Wunsch A, Philippot P, Plaghi L (2003) Affective associative learning modifies the sensory perception of nociceptive stimuli without participant's awareness. *Pain* 102:27–38

ical, psychosocial and behavioural data. The MPI addresses coping and adaptation in relation to an empirically derived typology, where individuals are classified as 1) adaptive copers, 2) interpersonally distressed, or 3) dysfunctional. The MPI has been used as a tool to predict health outcomes in patients with persistent pain conditions, and to match patients with appropriate interventions (Turk and Rudy 1990).

### Self-Efficacy

In pain research, ► **self-efficacy** has been described as an individuals' confidence in their ability, to control or manage various aspects of health conditions associated with pain (Lorig et al. 1989). A number of scales have been developed to assess self-efficacy for dealing with pain and illness-related symptoms. The Arthritis Self-Efficacy Scale (Lorig et al. 1989) has been used in numerous studies to assess individuals' confidence in their ability to perform various behaviours aimed at controlling pain and arthritis symptoms. This instrument yields three subscales; assessing pain management, physical function and other arthritis symptoms. Several single item scales have been developed to assess self-efficacy in relation to specific aspects of experimental paradigms. A two item subscale of the Coping Strategies Questionnaire (Rosenstiel and Keefe 1983) has often been used to assess coping efficacy in relation to pain.

### Pain Catastrophizing

A variety of assessment instruments have been developed to assess catastrophic thinking associated with pain. The catastrophizing subscale of the CSQ (Rosenstiel and Keefe 1983) and the ► **Pain Catastrophizing Scale** (Sullivan et al. 1995) have been used extensively. On these questionnaires, individuals are asked to indicate the frequency with which they experience different catastrophic thoughts in relation to their pain (i.e. "It's terrible and it's never going to get any better"). In recent years, pain catastrophizing has emerged as one of the most robust psychological predictors of pain-related outcomes (Sullivan et al. 2001a).

### Pain/Health Beliefs

Health Beliefs have been discussed as a construct central to successful adjustment to persistent pain conditions. Numerous investigations have addressed the role of control beliefs with the Multidimensional Health Locus of Control Scale (MHLC; Wallston et al. 1978). The MHLC yields three subscales; assessing the degree to which individuals believe that their health outcomes are under their own control, under the control of health professionals, or determined by chance. Another frequently used measure of pain beliefs is the Survey of Pain Attitudes (SOPA; Jensen et al. 1994). The SOPA assesses 7 beliefs hypothesized to be important to pain outcomes; belief in one's control over pain, belief in oneself as dis-

abled by pain, belief that pain is a signal for harm, belief that emotions influence pain, belief in a medical cure for pain, belief that others should attend to one's pain display, and belief in the use of medication to manage pain. One and two-item measures of pain beliefs have recently been developed in order to facilitate their inclusion in clinical and research protocols (Jensen et al. 2003).

### Expectancies

Expectancies for pain have been discussed as a significant determinant of pain experience (Kirsch 1985). Manipulations of pain expectancies can lead to significant increases or decreases in pain experience. It has been suggested that many psychological interventions for pain management may exert their effects through their influence on pain expectancies (Sullivan et al. 2001b). Typically, single item measures are used to assess an individual's expectancies for pain in relation to specific clinical or experimental procedures.

### Cognitive Assessment of Pain-Related Thought Process

A modified Stroop procedure has been used in a number of studies to assess the selective processing of pain-related stimuli. In this procedure, participants are presented with words printed in different colours, and their task is to state the colour of the word as quickly as possible. Certain words will tend to 'grab the attention' of the participant such that colour naming latency will be increased. It has been suggested that chronic pain patients might possess '► **pain schema**' that will draw their attention to pain-related stimuli, and consequently will have longer colour naming reaction times for pain words (Pincus and Morley 2001).

The Dot Probe procedure has also been used to address questions concerning pain patient's processing of pain-related information. In this task, two words are presented on a screen, and one is then replaced by a dot. The participant's task is to identify as quickly as possible the location of the dot. If the word that remains on the screen is a word that is attention grabbing, latency to identify the location of the dot will be increased. There are indications that chronic pain patients with high levels of fear of pain have difficulty disengaging their attention from pain-related words (Keogh et al. 2001).

Primary task paradigms and ► **thought suppression** procedures have been used to address the degree of attentional control individuals have over pain-related information (Crombez et al. 1999, Sullivan et al. 2001a). Preferential processing of pain-related information has been addressed with procedures assessing differential memory for pain and non-pain information, and the interpretation of ambiguous words (Pincus and Morley 2001).

### References

1. Beecher HK (1956) Relationship of Significance of Wound to Pain Experienced. *JAMA* 161:1609–1613



2. Crombez G, Eccleston C, Baeyens F et al. (1997) When Somatic Information Threatens, Catastrophic Thinking Enhances Attentional Interference. *Pain* 74:230–237
3. Jensen MP, Keefe FJ, Lefebvre JC et al. (2003) One- and Two-Item Measures of Pain Beliefs and Coping Strategies. *Pain* 104:453–469
4. Jensen MP, Romano JM, Turner JA et al. (1994) Relationship of Pain-Specific Beliefs to Chronic Pain Adjustment. *Pain* 57:301–309
5. Keogh E, Ellery D, Hunt C et al. (2001) Selective Attentional Bias for Pain-Related Stimuli amongst Pain Fearful Individuals. *Pain* 91:91–100
6. Kerns RD, Turk DC, Rudy TE (1985) The West Haven Yale Multidimensional Pain Inventory (WHYMPI). *Pain* 23:345–356
7. Kirsch I (1985) Response Expectancy as a Determinant of Experience and Behavior. *Am Psychol* 40:1189–1202
8. Lorig K, Chastain R, Ung E et al. (1989) Development and Evaluation of a Scale to Measure Perceived Self-Efficacy in People with Arthritis. *Arthritis Rheum* 32:37–44
9. Pincus T, Morley S (2001) Cognitive Processing Bias in Chronic Pain: A Review and Integration. *Psychol Bull* 127:599–617
10. Rosenstiel AK, Keefe FJ (1983) The Use of Coping Strategies in Chronic Low Back Pain Patients: Relationship to Patient Characteristics and Current Adjustment. *Pain* 17:33–44
11. Sullivan MJL, Bishop S, Pivik J (1995) The Pain Catastrophizing Scale: Development and Validation. *Psychol Assess* 7:524–532
12. Sullivan MJL, Thorn B, Haythornthwaite JA et al. (2001a) Theoretical Perspectives on the Relation between Catastrophizing and Pain. *Clin J Pain* 17:52–64
13. Sullivan MJL, Rodgers WM, Kirsch I (2001b) Catastrophizing, Depression and Expectancies for Pain and Emotional Distress. *Pain* 91:147–154
14. Turk DC, Rudy TE (1990) The Robustness of an Empirically Derived Taxonomy of Chronic Pain Patients. *Pain* 43:27–35
15. Wallston KA, Wallston BS, DeVellis R (1978) Development of the Multidimensional Locus of Control (MHLC) scales. *Health Educ Monogr* 6:161–170

## Psychology of Pain, Efficacy

STEPHEN MORLEY

Academic Unit of Psychiatry and Behavioral Sciences,  
University of Leeds, Leeds, UK  
s.j.morley@leeds.ac.uk

### Synonyms

Treatment Outcome Research

### Definition

Efficacy of psychological treatments (mainly ► **Cognitive-Behavioral Therapy**) is established through randomized controlled trials. Absolute efficacy – comparison of treated groups with untreated groups – has been established. There is some evidence of relative ► **efficacy**, i.e. that cognitive behavioral treatments are relatively more efficacious than a range of other treatments. Little is known about the efficacy of specific treatment components.

### Characteristics

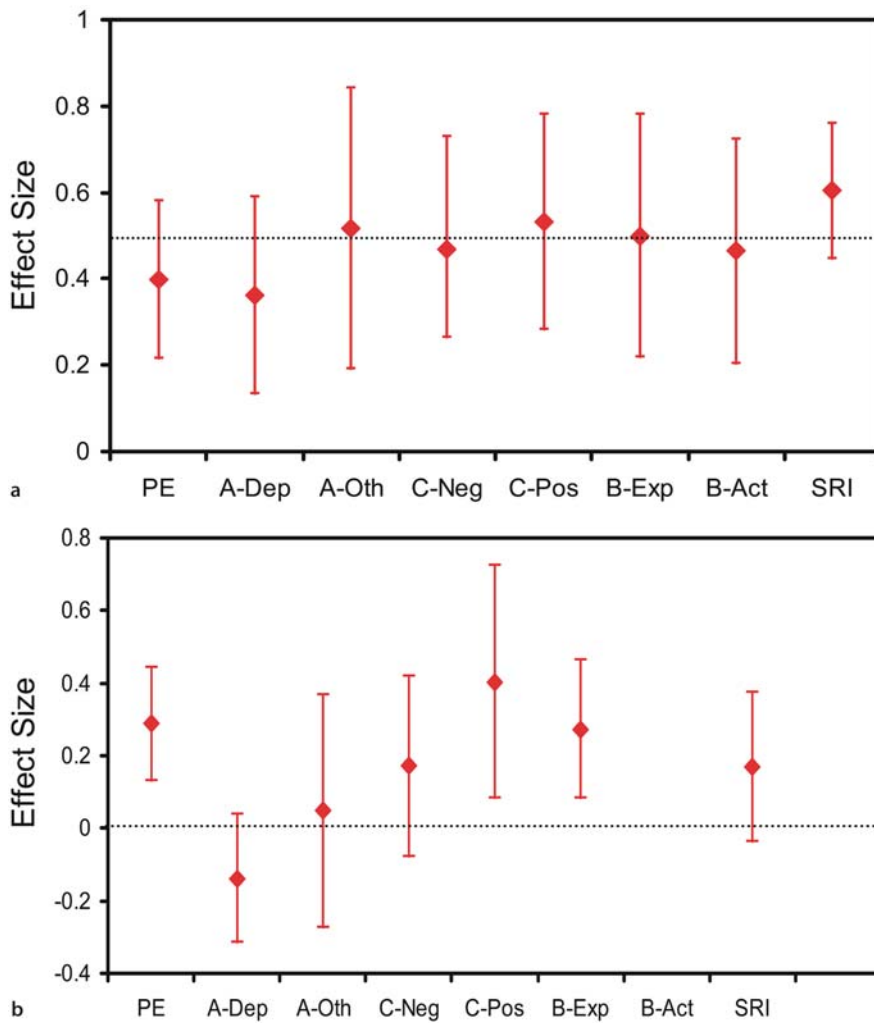
Psychological treatments for pain are broadly cognitive-behavioral in orientation. They contain multiple components and have been designed to address the problem

of chronic pain rather than acute pain. The cognitive-behavioral analysis of chronic pain has generally eschewed differences between various medically defined diagnostic groups, and focused on the common psychological consequences of the experience of chronic pain *per se*. Consequently, there is a significant shared set of treatment components across many studies. Treatments may include procedures developed from ► **operant** analyses of pain, which focus on alteration of observable behavior (Fordyce 1976), procedures such as ► **relaxation** and ► **biofeedback**, and a range of cognitive procedures for which the central focus of therapy are changes in a person's appraisal, and increases in self-management of pain and its associated consequences (Morley and Williams 2002; Turk 2002). Treatments typically comprise strategies to educate and develop collaborative and active participation by the patient; graded behavioral activities; the development of cognitive strategies to modify attention to, and appraisal of, pain; strategies to manage adverse mood states; strategies to modify social contingencies (including family and spouse) that may reinforce undesirable pain-related behaviors. These treatments are often delivered to patients in groups (Keefe et al. 2002) by multidisciplinary teams e.g. psychologist, physical therapist, nurse; anesthesiologist. The intended therapeutic outcomes are changes in behavioral activity, effective use of coping strategies, improved mood, and reduction in inappropriate medication and health costs. The definitions of the broad outcome domains are given in Table 1.

The absolute efficacy of treatment programs has been established through randomized controlled trials of comparing treatment with no-treatment (waiting list) control groups (Wampold 2001). Figure 1a shows the mean ► **effect-sizes** and their confidence intervals for a range of outcomes grouped by domains of measurement. The effect-sizes were computed by comparing post treatment scores of treated and untreated groups. The median effect-size across all domains of measurement is 0.5 units. Similarly, Fig. 1b shows the available data for comparisons between cognitive-behavioral treatments and a range of alternative control conditions e.g. standard medical treatment, structured education, bibliotherapy. The comparison tests the relative efficacy of cognitive-behavioral treatments against other presumed active treatments. The figure suggests that for all domains of measurement, cognitive-behavioral treatments are at least as effective as other treatments, and perhaps more effective in modifying measures of 'pain experience', 'positive cognitive appraisal and coping' and 'behavioral expression' – for the definitions see Table 1. The data in Fig. 1 are taken from a ► **meta-analysis** of studies published to the end of 1996 (Morley et al. 1999), and more recent publications have continued to support the absolute effectiveness of cognitive-behavioral treatments for chronic pain.

**Psychology of Pain, Efficacy, Table 1** Measurement domains used in the evaluation of psychological treatments for chronic pain conditions – after Morley et al. 1999

Domain	Definition
Pain experience	Measures of subjective pain experience captured by ratings of intensity, sensation and unpleasantness.
Mood and affect	Measures of mood and affective state (but not trait predispositions): these measures were divided into measures of depression and measures of other states – predominantly anxiety.
Cognitive coping and appraisal	Measure of coping strategies and appraisals used in attempts to manage pain: these measures were divided into measures of negative coping, i.e. variables known to be correlated with poor adjustment (catastrophizing), and measures of positive coping ,i.e. associated with good adjustment.
Pain Behavior	Observable behavior associated with pain: behavioral expression concerns behavior that signals the presence of pain e.g. guarding, whereas behavior activity indicates behavioral activation. It is assumed that effective treatment results in the decrease of behavioral expression and increase of behavioral activity.
Social role interference	These measures assess the impact of pain on the ability of the sufferer to function in a variety of social roles ranging from simple self care to more complex family, work and social activities. Effective treatment should result in the increase in social role activity – decreased interference.
Biological and fitness	Assessments of biological functioning and physical fitness.
Use of health care	Use of a variety of health care facilities ranging from medication to clinic visits.
Miscellaneous	This category contains a wide range of measures not otherwise accommodated in the above definitions. It included pain drawings and a variety of personality diagnostics and idiographic measures.

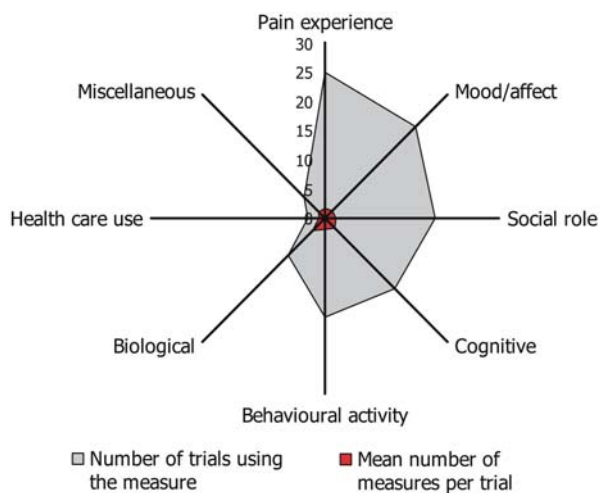


**Psychology of Pain, Efficacy, Figure 1** These figures show the mean effect-sizes and their confidence intervals for measures from several outcome domains for a set of randomized controlled trials reviewed by Morley et al. (1999). The domains are briefly defined in Table 1 and the abbreviations for the two figures are: PE, Pain experience; A-Dep, Affect-Depression; A-Oth, Affect- Other measures; C-Neg, Cognitive coping and appraisal-negative thoughts; C-Pos, Cognitive coping and appraisal- positive; B-Exp, Behavior – Expression; B-Act, Behavior – Activity; SRI, Social Role Interference. (a) shows the absolute efficacy (treatment Vs. no treatment) – the dotted line shows the median (unweighted) effect-size across all domains. (b) shows the relative efficacy in comparison with a group of other treatments. The dotted line at ES = 0 shows the expected ES when the treatments are equivalent. Note there were no observations in the B-Act domain.

Cognitive behavioral treatments have also been applied to children with pain, but absolute efficacy has only been established for children with headache, as there are insufficient trials for other causes of pain (Eccleston et al. 2002).

Despite considerable progress in establishing the efficacy of psychological treatments for chronic pain, there are still several issues that require further research.

1. **Trial Design.** The adoption of the randomized controlled trial is not without difficulty, especially with regard to the selection of appropriate control groups (Schwartz et al. 1997). The nature of psychological treatment is such that it can neither be delivered nor received 'blindly', and many key outcomes in pain research cannot be measured by independent observers. The influences of treatment credibility and expectation of therapeutic gain require careful design of control groups to ensure equivalence with the treated groups, or control through statistical methods for non-equivalent groups should be instigated.
2. **Outcome Measures.** The selection of outcome measures and their evaluation requires further consideration. Figure 2 provides a graphical representation of the relative frequency of measurement from the set of trials considered by Morley et al. (1999) for each of the outcome domains shown in Table 1. The figure suggests that some domains are under represented. Health care use and behavioural activity require a more substantial evaluation, especially as these domains capture outcomes that might be considered as critical for health care purchasers, employers and other stakeholders including patients and their families. These critical outcomes need further development



**Psychology of Pain, Efficacy, Figure 2** The relative frequency of measures in each outcome domain (see Table 1) for 25 outcome trials (Morley et al. 1999) is shown in the outer display. There is a marked bias in the number of measures across domains. The inner display shows the average number of measures in each domain used within each trial. Many trials use more than one measure within each domain. This may not be necessary.

and evaluation in future trials. For example, studies on psychological treatments as a secondary prevention strategy have evaluated absence from work as an outcome (Linton and Andersson 2000).

3. **Evaluation Strategy.** The majority of trials have evaluated efficacy using inferential statistical comparisons of treatment and control distributions on continuous variables. This evaluation criterion does not address the clinical meaningfulness of change of between group differences. Future trials will need to address this issue, and to develop clinically meaningful outcome criteria for the critical domains using strategies such as those discussed by Jacobson (Jacobson et al. 1999).

Thus far, it has not been possible to establish the efficacy of specific cognitive behavioral treatments for chronic pain, i.e. whether the processes invoked by the treatment rationale are necessary for therapeutic change, or whether changes are due to other processes not invoked by cognitive behavioral theory. This is a considerable challenge within the general arena of evaluating psychological therapies (Wampold 2001), and the complex, multi-componential, nature of contemporary psychological therapy for pain suggests this will be a substantial task. Resolving this issue might be enhanced by the development of more precisely articulated formulations of chronic pain. The consideration of possible subgroups of patients defined by psychological principles, rather than medical diagnoses, such as the fear-avoidance model (Vlaeyen et al. 2001; Vlaeyen and Linton 2000), is a recent development that may encourage a further generation of well designed trials to determine the absolute, relative and specific efficacy of psychological treatments for pain.

## References

1. Eccleston C, Morley S, Williams AC de C, Yorke L, Mastroyannopoulou K (2002) Systematic Review and Meta-Analysis of Randomised Controlled Trials of Psychological Therapy for Chronic Pain in Children and Adolescents. *Pain* 99:157-165
2. Fordyce WE (1976) Behavioral Methods for Chronic Pain and Illness. Mosby, St Louis
3. Jacobson NS, Roberts LJ, Berns SB, McGlinchey JB (1999) Methods for Defining and Determining the Clinical Significance of Treatment Effects: Description, Application, and Alternatives. *J Consult Clin Psychol* 67:300-307
4. Keefe FJ, Beaupré PM, Gil KM, Rumble ME, Aspnes AK (2002) Group Therapy with Patients with Chronic Pain. In: Turk DC, Gatchel RJ (eds) *Psychological Approaches to Pain Management: A Practitioner's Handbook*, 2nd edn. Guilford Press, New York, pp 234-255
5. Linton SJ, Andersson T (2000) Can Chronic Disability be Prevented? A Randomized Trial of a Cognitive-Behavior Intervention and Two Forms of Information for Patients with Spinal Pain. *Spine* 25:2825-2831
6. Morley S, Eccleston C, Williams AC de C (1999) Systematic Review and Meta-Analysis of Randomized Controlled Trials of Cognitive Behaviour Therapy and Behaviour Therapy for Chronic Pain in Adults, Excluding Headache. *Pain* 80:1-13
7. Morley S, Williams AC de C (2002) Conducting and Evaluating Treatment Outcome Studies. In: Gatchel RJ, Turk DC (eds) *Psy-*

- chosocial Factors in Pain, 2nd edn. Guilford Press, New York, pp 52–68
8. Schwartz CE, Chesney MA, Irvine J, Keefe FJ (1997) The Control Group Dilemma in Clinical Research: Applications for Psychosocial and Behavioral Medicine Trials. *Psychosom Med* 59:362–371
  9. Turk DC (2002) A Cognitive-Behavioral Perspective on Treatment of Chronic Pain Patients. In: Gatchel RJ, Turk DC (eds) *Psychosocial Factors in Pain*, 2nd edn. Guilford Press, New York, pp 138–158
  10. Vlaeyen JWS, de Jong J, Geilen M, Heuts P, van Breukelen G (2001) Graded Exposure *In Vivo* in the Treatment of Pain-Related Fear: A Replicated Single-Case Experimental Design in Four Patients with Chronic Low Back Pain. *Behav Res Ther* 39:151–166
  11. Vlaeyen JWS, Linton SJ (2000) Fear-Avoidance and its Consequences in Chronic Musculoskeletal Pain: A State of the Art. *Pain* 85:317–332
  12. Wampold BE (2001) *The Great Psychotherapy Debate: Models, Methods, and Findings*. Lawrence Erlbaum Associates, Mahwah, NJ

## Psychology of Pain, Self-Efficacy

MICHAEL J. L. SULLIVAN  
 Department of Psychology, University of Montreal,  
 Montreal, QC, Canada  
 michael.jl.sullivan@umontreal.ca

### Synonyms

Outcome expectancies; Confidence in Coping Abilities; self-efficacy

### Definition

► **Self-Efficacy** was originally defined as ‘belief in one’s capabilities to organize and execute the course of action required to produce given attainments’ (Bandura 1977). In research addressing the role of self-efficacy in the context of pain-related outcomes, self-efficacy has been described as an individuals’ confidence in their ability to control or manage various aspects of health conditions associated with pain, such as pain symptoms, fatigue, distress and disability (Lorig et al. 1989). In pain research, self-efficacy has been operationally defined in terms of one’s *overall* confidence in the ability to deal with symptoms, stresses or limitations associated with a pain condition (e.g. Anderson et al. 1995; Lorig et al. 1989), or in terms of the ability to manage, control or decrease *specific* components of symptoms or disability (e.g. ability to decrease pain, ability to complete certain activities in spite of pain) (Keefe et al. 1997).

### Characteristics

#### Self-Efficacy and Pain-Related Outcomes

Self-efficacy has been shown to be associated with a number of pain-related outcomes such as pain intensity, disability and depression (Arnstein et al. 1999; Lorig et al. 1989). A relation between self-efficacy and pain-related outcomes has been reported in patients with

acute pain symptoms (Kaplan et al. 1996), chronic pain (Arnstein et al. 1999) and in response to experimentally induced pain (Bandura et al. 1987). Considerable research has addressed the relation between self-efficacy and pain-related outcomes in patients with arthritic conditions (e.g. rheumatoid arthritis, osteoarthritis, fibromyalgia). For example, Beckham et al. (1994) reported that low self-efficacy was associated with increased psychological distress and poorer physical functioning in patients with rheumatoid arthritis.

#### Theoretical Perspectives on Self-Efficacy

Self-efficacy is a particular form of expectancy, that is, a probabilistic judgment about the future occurrence of a specific outcome. Bandura (1977) distinguishes between two forms of expectancies related to behavioral outcomes: outcome expectancies and efficacy expectancies. Outcome expectancies refer to individuals’ estimates that a given behavior will result in a given outcome. Efficacy expectancies refer to the confidence individuals’ have that they possess the ability to successfully execute the behavior required to yield a given outcome. Under conditions where individuals possess the necessary skills for execution of a particular behavior, and when adequate incentives are in place, efficacy expectancies are said to be a major determinant of individuals’ activity choices, and the effort they will expend to attain desired outcomes (Bandura 1977).

According to Bandura, self-efficacy expectancies develop as a result of a number of experiential and ► **social learning** factors. Past experience with success or failure in producing specific outcomes will influence individuals’ confidence to produce such outcomes in the future. ► **Vicarious experience**, exposure to information and the attributions made for outcomes can also influence the development of self-efficacy expectancies (Bandura 1977).

As discussed by Bandura (1977), self-efficacy acts a mediator of various health outcomes. Within this conceptualization, self-efficacy can be viewed as a final common pathway of a variety of psychological influences on behavior. In pain research, considerable attention has been given to the role of coping strategies in the development of self-efficacy expectancies. Keefe et al. (1997) reported that certain pain coping strategies were associated with varying levels of self-efficacy. For example, ignoring pain sensations and coping self-statements were associated with higher levels of self-efficacy. High levels of pain catastrophizing have been associated with lower levels of self-efficacy (Sullivan et al. 2001). Self-efficacy also appears to be influenced by transient variations in mood and pain. Lefebvre et al. (1999) found that daily fluctuations in pain, arthritis symptoms, positive and negative mood, and coping all contributed to a significant variance in the prospective prediction of self-efficacy. These findings suggest self-efficacy may be one



of the mechanisms through which coping strategies improve pain-related outcomes.

A number of investigations have shown a close association between self-efficacy expectancies and pain catastrophizing (Keefe et al. 1997). For example, scale items that assess self-efficacy for coping with pain, have frequently loaded on the same factor as scale items that assess catastrophic thinking (Sullivan et al. 2001). Albeit a close association, the two constructs do not appear to be redundant. One investigation revealed that self-efficacy prospectively predicted pain behavior and activity avoidance, even when controlling for pain catastrophizing (Asghari and Nicholas 2001).

Bandura (1977) suggests that while self-efficacy may ► **mediate** various health outcomes, as a function of dynamic feedback processes self-efficacy can also influence its cognitive and motivational antecedents. High levels of self-efficacy may increase individuals' investment in their coping efforts, thereby increasing the probability of positive outcome, and in turn, contributing to the maintenance or enhancement of self-efficacy.

#### Mechanisms of Action: Self-Efficacy and Pain

A study by Bandura et al. (1987) provided evidence of a link between self-efficacy and endogenous opiates. In this study, subjects were taught a variety of cognitive strategies to control pain prior to participation in an experimental pain procedure (i.e. ► **cold pressor test**). Subjects were asked to rate their confidence in their ability to control pain. Training in the use of cognitive pain control strategies enhanced self-efficacy, which in turn increased ► **pain tolerance**. However, the administration of naloxone (i.e. an opioid antagonist) interfered with the pain tolerance enhancing the influence of increased self-efficacy.

#### Mechanism of Action: Self-Efficacy and Disability

According to Bandura (1977), efficacy expectancies determine how much effort people will expend, and how long they will persist in the face of obstacles and aversive experiences (p 194). The proposed influence of self-efficacy on behavioral persistence suggests a possible relation between self-efficacy and pain-related disability. Consistent with this account, there is growing evidence that self-efficacy expectancies contribute to the severity of disability associated with chronic pain (Arnstein et al. 1999; Kaplan et al. 1996; Lackner et al. 1996).

The term functional self-efficacy has been used to describe pain patients' confidence in their ability to carry out specific physical maneuvers that might be associated with pain (Lackner et al. 1996). Lower levels of functional self-efficacy are thought to impact on disability by limiting the range of activities the patient will undertake, or by reducing the effort invested in activity. Rejeski et al. (2001) found that low levels of functional self-efficacy predicted declining levels of physical function over a 30 month period in older adults with knee pain.

#### Assessment

Self-efficacy judgments are considered to be most predictive of proximal behavior (Bandura 1977). As such, the bulk of research on self-efficacy and behavioral outcomes has made use of single item scales, worded in a fashion directly relevant to the behavior of interest. In pain research, several single item scales have been developed that are designed to assess self-efficacy in relation to specific aspects of experimental paradigms. A two item subscale of the Coping Strategies Questionnaire (Rosenstiel and Keefe 1983) has often been used to assess coping efficacy in relation to pain.

A number of scales have also been developed to assess a 'generalized' self-efficacy orientation to dealing with pain and illness-related symptoms. The Arthritis Self-Efficacy Scale (Lorig et al. 1989) has been used in numerous studies, to assess individuals' confidence in their ability to perform various behaviors, aimed at controlling pain and arthritis symptoms. This instrument yields three subscales assessing pain management, physical function and other arthritis symptoms. A similar measure was developed to assess self-efficacy beliefs in chronic pain patients not restricted to arthritis (Anderson et al. 1995) The Chronic Pain Self-Efficacy Scale is a 22 item questionnaire that generates scores on three subscales: pain management, coping, and physical function. A measure of functional self-efficacy was developed by Barry et al. (2003). On this scale, respondents are asked to rate their confidence in their ability to carry out ten different activities of daily living.

#### Treatment

There are no intervention programs that have been designed to specifically target self-efficacy expectancies. However, several components of pain management programs are considered to be conducive to the enhancement of self-efficacy (Nicholas et al. 1992).

Strategies considered to enhance self-efficacy include ► **mastery experience**, ► **role modeling**, ► **persuasion**, and reinterpretation of physiological and affective states (Bandura 1977). These strategies, either alone or in combination, have been incorporated in several interventions aimed at assisting individuals in managing distress and disability associated with persistent pain conditions (Nicholas et al. 1992). There are indications that the increases in self-efficacy observed following participation in cognitive-behavioral interventions may be one of the mechanisms through which positive treatment outcomes are achieved (Anderson et al. 1995).

#### References

1. Anderson KO, Dowds BN, Pelletz RE, Edwards WT (1995) Development and Initial Validation of a Scale to Measure Self-Efficacy Beliefs in Patients with Chronic Pain. *Pain* 63:77-84
2. Arnstein P, Caudill M, Mandle CL, Norris A, Beasley R (1999) Self-Efficacy as a Mediator of the Relationship between Pain

- Intensity, Disability and Depression in Chronic Pain Patients. *Pain* 80:483–491
3. Asghari A, Nicholas MK (2001) Pain Self-Efficacy Beliefs and Pain Behavior: A Prospective Study. *Pain* 94:85–100
  4. Bandura A (1977) *Self-Efficacy: The Exercise of Control*. Freeman, New York
  5. Bandura A, O'Leary A, Taylor CB, Gauthier J et al. (1987) Perceived Self-Efficacy and Pain Control: Opioid and Non-Opioid Mechanism. *J Pers Soc Psychol* 53:563–571
  6. Barry LC, Guo Z, Kerns RD, Duong BD, Reid MC (2003) Functional Self-Efficacy and Pain-Related Disability among Older Veterans with Chronic Pain in a Primary Care Setting. *Pain* 104:131–137
  7. Beckham JC, Rice JR, Talton SL (1994) Relationship of Cognitive Constructs to Adjustment in Rheumatoid Arthritis Patients. *Cog Ther Res* 18:479–498
  8. Kaplan GW, Wurtele SK, Gillis D (1996) Maximal Effort during Functional Capacities Evaluations: An Evaluation of Psychological Factors. *Arch Phys Med Rehab* 77:161–174
  9. Keefe FJ, Kashikar-Zuck S, Robinson E, Salley A, Beaupre P, Caldwell D, Baucom D, Haythornthwaite J (1997b) Pain Coping Strategies that Predict Patients' and Spouses' Ratings of Patients' Self-Efficacy. *Pain* 73:191–199
  10. Lackner JM, Carosella A, Feuerstein M (1996) Pain Expectancies, Pain and Functional Self-Efficacy Expectancies as Determinants of Disability in Patients with Chronic Low Back Pain Disorders. *J Consult Clin Psychol* 64:212–220
  11. Lefebvre JC, Keefe FJ, Affleck G, Raezer LB, Starr K, Caldwell DS, Tennen H (1999) The Relationship of Arthritis Self-Efficacy to Daily Pain, Daily Mood, and Daily Pain Coping in Rheumatoid Arthritis Patients. *Pain* 80:425–435
  12. Lorig K, Chastain R, Ung E, Shoor S, Holman HR (1989) Development and Evaluation of a Scale to Measure Perceived Self-Efficacy in People with Arthritis. *Arthritis Rheum* 32:37–44
  13. Nicholas MK, Wilson PH, Goyen J (1992) Comparison of a Cognitive Behavioural Group Treatment and an Alternative Non-Psychological Treatment for Chronic Low Back Pain Patients. *Pain* 4:339–347
  14. Rejeski WJ, Miller ME, Foy C, Messier S, Rapp S (2001) Self-Efficacy and the Progression of Functional Limitations and Self-Reported Disability in Older Adults with Knee Pain. *J Gerontol* 56:S261–S265
  15. Sullivan MJL, Thorn B, Haythornthwaite JA, Keefe FJ, Martin M, Bradley LA, Lefebvre JC (2001) Theoretical Perspectives on the Relation between Catastrophizing and Pain. *Clin J Pain* 17:52–64

## Psychology of Pain, Sensitisation, Habituation and Pain

MICHAEL K. NICHOLAS

Pain Management and Research Centre, Royal North Shore Hospital, University of Sydney, St. Leonards, NSW, Australia

miken@med.usyd.edu.au

### Synonyms

Hyperalgesia; hypersensitivity; desensitization; sensitization; habituation

### Definition

Sensitisation in relation to ► **pain** occurs when a person's threshold for responding to a stimulus as noxious (painful) is reduced. This is analogous to allodynia (experiencing a normally non-noxious stimulus as painful)

or ► **hyperalgesia** (raised pain report to a previously experienced noxious stimulus). Habituation or desensitisation in relation to pain may be seen when greater tolerance for persisting pain (of normal severity for that person) is reported, or the person reports their pain as not as troubling as it had been. Habituation should be evident in the presence of the pain and not when pain is absent. Thus, when a pain relieving intervention has been administered, habituation cannot be assessed until the pain severity has returned to previous levels.

### Characteristics

While there is evidence that certain chemicals and nerve injuries can induce hyperalgesia and allodynia phenomena (e.g. Hood et al. 2003), and there is evidence that central (CNS) changes or mechanisms appear to underlie these phenomena when they persist, there is growing evidence that the psychological processes associated with learning and attentional mechanisms may also contribute to these common phenomena of chronic pain. This evidence is particularly important for its potential treatment implications.

The principle learning processes that have been considered in relation to sensitization phenomena are operant (or instrumental) learning and classical (or Pavlovian) conditioning.

Birbaumer et al. (1995) reviewed evidence supporting the presence of learning processes in the development and maintenance of chronic pain. This included evidence of both classical and instrumental (operant) learning responses, reflected in stereotypy of certain muscle groups to personally-relevant stressful situations relative to control conditions, as well as conditioning of muscle and pain responses to previously neutral tones and slides in healthy subjects. Birbaumer et al. also cited evidence of learned facilitation for pain-related information by the primary cortical projection areas in chronic pain patients.

More recently, Flor et al. (2002) demonstrated that operant learning of both increased and decreased pain responses could be demonstrated under controlled conditions, and was also associated with measurable cortical responses. This study showed slower extinction rates of learned cortical responses among chronic back pain patients than normal controls.

Vlaeyen and Linton (2002) described evidence supporting a role for fear of pain contributing to the development of avoidance responses and ultimately, disability, in many people with persisting pain. They reported evidence that negative appraisals of internal and external stimuli, negative affectivity and ► **anxiety** sensitivity could contribute to the development of pain-related fear, and how that, in turn, could lead to escape and avoidance behaviours, as well as ► **hypervigilance** to internal and external illness information, muscular reactivity, as well as physical disuse and behavioural changes. From another perspective, while the repeated

► **exposure** to a stimulus (e.g. pain) might be expected to lead to ► **habituation** (to that stimulus), these findings might also suggest that this is less likely in those people who develop pain-related fear, escape and avoidance responses, as well as hypervigilance to such internal stimuli. Laboratory evidence of habituation to a repeated experience of (experimentally-induced) pain suggests that it does happen to some extent, but not completely (Crombez et al. 1997), and it is unstable, being readily reversed in the presence of a stressor or when the pain becomes unpredictable.

Predisposing personality attributes have been proposed to explain why some individuals and not others develop fear of pain and subsequent difficulties. Turk and Okifuji (2002) have referred to these constructs within the rubric of a diathesis–stress model, whereby a person’s predisposing attributes only emerge under certain conditions of stress (e.g. the presence of pain). For example, Asmundson (1999) suggested that anxiety sensitivity might predispose individuals to developing a fear of pain, and indirectly predict ► **fear/avoidance** behaviour. Similar arguments have been posited for the personality construct of neuroticism.

Drawing an analogy between chronic pain and anxiety disorders, Aldrich et al. (2000) argued that hypervigilance to bodily sensations is more likely in those chronic pain patients who are more anxious. This view draws on the perspective that one of the crucial functions of anxiety is concerned with prioritising the selection and processing of information. By logical extension, it might be expected that people in chronic pain who are also anxious may attend to pain-related information at the expense of other, less personally-relevant information. There is certainly some evidence that chronic pain patients exhibit selective attention to pain information, relative to other, non-pain, information (see review by Pincus and Morley 2001). However, methodological limitations in studies to date restrict the conclusions that can be drawn about the role of selective attention in chronic pain.

Eccleston and Crombez (1999) reviewed studies that investigated the thesis that attention was an active process and was the primary mechanism by which nociception accesses awareness and disrupts current activity. In support of this thesis, Eccleston and Crombez described a number of studies of ways in which attention in relation to pain had been modified. These included increased awareness of bodily information (high somatic awareness and high pain intensity in chronic pain patients), as well as heightened catastrophic thinking.

The evidence summarised here suggests that the psychological processes associated with learning and attention in relation to pain can account for many of the typical features of pain sensitization phenomena. This evidence has a number of possible treatment implications for people in distressing or disabling persisting pain. For example, if pain-related fear is a potential

driver of escape and avoidance behaviour, then interventions such as graded exposure to the feared stimulus, that have proven successful in people with other fears (like phobias for certain places), ought to be useful for people with pain-related fears and associated disability. To date, there is preliminary evidence that encouraging chronic low back pain patients with high levels of fear of pain to engage in activities they would normally avoid, such as falling (onto a foam rubber mattress), can help to reduce such fears, catastrophic beliefs, and pain-related disability. In the context of pain patients who are highly sensitised or hypervigilant to the experience of pain, this intervention could be described as a form of desensitisation or habituation. These findings suggest that if pain patients can have their fears or distressing beliefs about their pain desensitised by direct experience, as opposed to attempts to reassure them, they might more easily limit the intrusive or activity limiting effects of their pain.

In addition to graded behavioural exposure tasks, recent anxiety research would also suggest that pain patients could be desensitised or habituated to their pain by encouraging their repeated (for prolonged periods), deliberate experiencing of their pain, as opposed to their trying to avoid or escape from it by attention–distraction or behavioural change (e.g. Forsyth and Eifert 1998). These have been called acceptance-based strategies, but to date no controlled trials have been reported in the pain literature.

## References

1. Aldrich S, Eccleston C, Crombez G (2000) Worrying About Chronic Pain: Vigilance to Threat and Misdirected Problem Solving. *Behav Res Ther* 38:457–70
2. Asmundson GJG (1999) Anxiety Sensitivity and Chronic Pain: Empirical Findings, Clinical Implications, and Future Directions. In: Taylor S (ed) *Anxiety Sensitivity: Theory, Research, and Treatment of the Fear of Anxiety*. L. Erlbaum associates, Mahwah, NJ, pp 269–285
3. Birbaumer N, Flor H, Lutzenberger W, Elbert T (1995) The Corticalization of Chronic Pain. In: Burkhart Bromm, Desmedt JE (eds) *Pain and the Brain: From Nociception to Cognition*. Advances in Pain Research and Therapy, vol 22. Raven Press, New York, pp 331–343
4. Crombez G, Eccleston C, Baeyens F, Eelen P (1997) Habituation and the Interference of Pain with Task Performance. *Pain* 70:149–154
5. Eccleston C, Crombez G (1999) Pain Demands Attention: A Cognitive-Affective Model of the Interruptive Function of Pain. *Psychol Bull* 125:356–366
6. Flor H, Knost B, Birbaumer N (2002) The Role of Operant Conditioning in Chronic Pain: An Experimental Investigation. *Pain* 95:111–118
7. Forsyth JP, Eifert GH (1998) Phobic Anxiety and Panic: An Integrative Behavioural Account of their Origin and Treatment. In: Plaud JJ, Eifert GH (eds) *From Behavior Theory to Behavior Therapy*. Allyn and Bacon, MA, pp 40–67
8. Hood DD, Curry R, Eisenach JC (2003) Intravenous Remifentanyl Produces Withdrawal Hyperalgesia in Volunteers with Capsaicin-Induced Hyperalgesia. *Anaesth Analg* 97:810–815
9. Pincus T, Morley S (2001) Cognitive-Processing Bias in Chronic Pain: A Review and Integration. *Psychol Bull* 127:599–617

10. Turk DC (2002) A Diathesis-Stress Model of Chronic Pain and Disability following Traumatic Injury. *Pain Res Manag* 7:9–20
11. Vlaeyen, JWS, Linton SJ (2002) Pain-Related Fear and its Consequences in Chronic Musculoskeletal Pain. In: Linton SJ (ed) *New Avenues for the Prevention of Chronic Musculoskeletal Pain and Disability, Pain Research and Clinical Management*, vol 12. Elsevier, Amsterdam, pp 83–103

## Psychometric Function

### Definition

A psychometric function describes the relationship between the probability  $P_b(a)$  that a stimulus 'a' is judged as exceeding a fixed standard stimulus 'b', from the viewpoint of some sensory attribute in a discrimination experiment. This term is also used in a detection experiment, when it describes the probability  $P_b(a)$  of detecting a stimulus 'a' embedded in some "background noise" denoted by 'b'. When a psychometric function is graphed (i.e.  $P_b(a)$  as a function of stimulus intensity 'a') it typically exhibits an S-shaped curve.

- ▶ Pain Evaluation, Psychophysical Methods

## Psychometrics

### Definition

Psychometrics is the branch of psychology that deals with the design, administration, and interpretation of quantitative tests for the measurement of psychological variables.

- ▶ Pain Inventories

## Psychomotor Physiotherapy

### Definition

A branch within physiotherapy that focuses on the body-mind relationship, originally developed in Norway in the late 1940s. Through body awareness techniques, the aim is to improve and normalize the muscular control and help the patient to become aware of how the mind and body interact. Different techniques, ranging from stimulating massage to active exercise, are part of the therapy sessions. Common for all approaches is to teach the patient to register tension, and to notice the difference between contracted and relaxed muscles. Furthermore, the therapy also focuses on how respiration can influence muscle tension and guarded movements.

- ▶ Body Awareness Therapies

## Psychomyogenic Headache

- ▶ Headache, Episodic Tension Type

## Psychopathology

### Definition

A broad term to describe abnormal psychological functioning leading to emotional suffering for the individual and/or dysfunctional interpersonal relationships.

- ▶ Pain as a Cause of Psychiatric Illness

## Psychophysical Law

- ▶ Pain in Humans, Psychophysical Law

## Psychophysical Testing

- ▶ Quantitative Sensory Testing

## Psychophysics

### Definition

Psychophysics is the branch of psychology concerned with the relationships of physical stimuli to sensory processes of organisms, including detection, discriminability, sensations, perceptions, and hedonic judgments. It describes the relationship between physical stimuli and the perceptions they evoke.

- ▶ Pain in Humans, Psychophysical Law
- ▶ Pain in Humans, Thresholds
- ▶ Quantitative Thermal Sensory Testing of Inflamed Skin
- ▶ Secondary Somatosensory Cortex (S2) and Insula, Effect on Pain Related Behavior in Animals and Humans
- ▶ Spinothalamic Tract Neurons, in Deep Dorsal Horn

## Psychophysiological Model of Pain

### Definition

A model in which pain is conceptualized as part of a stress response, which includes muscle tensing or activation of other physiologic mechanisms that contribute to the onset or exacerbation of pain. The model postulates a series of positive-feedback loops such that pain results in increased muscle tension, which exacerbates pain, etc.

- ▶ Coping and Pain
- ▶ Psychological Treatment in Acute Pain



## Psychophysiological Assessment

### Definition

A procedure designed to identify the specific physiological dysfunction relevant to a particular pain condition in order to guide treatment efforts and gauge treatment progress.

- ▶ [Biofeedback in the Treatment of Pain](#)
- ▶ [Psychophysiological Assessment of Pain](#)

## Psychophysiological Assessment of Pain

FRANK ANDRASIK<sup>1</sup>, BEVERLY E. THORN<sup>2</sup>,  
HERTA FLOR<sup>3</sup>

<sup>1</sup>Institute for Human and Machine Cognition,  
University of West Florida, Pensacola, FL, USA

<sup>2</sup>Department of Psychology, University of Alabama,  
Tuscaloosa, AL, USA

<sup>3</sup>Central Institute of Mental Health, Department of  
Neuropsychology, Ruprecht Karls University of  
Heidelberg, Mannheim, Germany  
fandrasik@ihmc.us, bthorn@bama.ua.edu,  
flor@as200.zi-mannheim.de

### Synonym

Stress Profile; Psychophysiological Stress Profile

### Definition

▶ **Psychophysiological assessment** is designed to identify the physiological dysfunction or response modalities assumed to be relevant to the pain condition, and to do so under varied stimulus conditions, psychological and physical, that mimic work and rest (reclining, bending, stooping, lifting, working a keyboard, simulated stressors, etc.) in order to guide treatment efforts and gauge progress. Our comments are restricted to peripheral measures, particularly muscle tension, as these have garnered the greatest attention by researchers and clinicians. Readers seeking more extended discussion of peripheral, and the less commonly utilized central measures of physiology, are referred to Flor 2001, Cacioppo et al. 2000, Peek 2003, and Stern et al. 2001.

### Common Measures Used In Pain Assessment

#### Electromyography (EMG)

The EMG signal arises from the electrochemical changes that occur when a muscle contracts, and it is monitored by placing a series of electrodes along the muscle fibers (to assess the muscle action potentials associated with the ion exchange across the membrane of the muscles). Various factors affect this signal, including sensor composition, size and placement; distance between sensors; adiposity; and bandpass or recording

range. Sensors are typically placed either along the forehead (when measures of general tension are of interest) or at specific sites of interest (e.g. frontal-posterior neck placement for tension-type headache, Hudzyski and Lawrence 1988, masseter and temporalis muscles for temporomandibular pain, Crider and Glaros 1999).

### Other Measures of Interest

Other measures may be of interest for conditions that arise from vascular problems (e.g. migraine or Raynaud's disease) or dysfunction of the sympathetic nervous system (e.g. complex regional pain syndromes, phantom pain). Measures used include: blood flow/volume, skin temperature, heart rate, blood pressure, and skin conductance.

Work with phantom limb pain illustrates the value of matching the psychophysiological response to pain type (Sherman 1997). Pain described as burning, throbbing, and tingling is associated with decreased temperature in the stump, while pain described as cramping is preceded by and associated with EMG changes. Targeting feedback accordingly leads to the greatest outcome.

### Characteristics

Flor (2001) identified the six functions, utility, and advantages of psychophysiological data collection as it is commonly performed:

1. demonstrate the role of psychological factors in maladaptive physiological functioning
2. provide a necessary prerequisite or justification for the use of biofeedback and related psychophysiological therapies
3. facilitate tailoring treatments to individual patients
4. make it possible for therapists and researchers to document efficacy, generalization, and transfer of treatment objectively
5. identify predictors of treatment response
6. serve as a source of motivation (e.g. as patients realize they are able to influence bodily processes by their own thoughts, emotions, and actions their feelings of helplessness decrease and they become more open to trying psychological approaches)

The key components of a psychophysiological assessment are reviewed below (and are discussed more fully in Flor (2001) and Arena and Schwartz (2003), among others).

### Adaptation

An ▶ **adaptation phase** is included for three chief reasons:

1. to allow patients to become familiar with the setting and recording procedure
2. to minimize pre-session effects (rushing to the appointment, temperature and humidity differences between office and outdoors)

3. to permit habituation of the orienting response and response stability to occur.

Although the importance of completing a pre-baseline period is widely acknowledged, little research has been conducted to help identify key parameters of adaptation or the amount of time needed to achieve stability. Most, but not all, individuals will achieve stability within 5–20 minutes (some individuals, though, are not fully adapted even after a 60-minute session). Practitioners are encouraged to extend this period until some stability is achieved for the key responses of interest (defined as minimal to no fluctuation within a specified time period). Patients are instructed merely to sit quietly during this period and to refrain from any conscious efforts to relax or alter their physiology.

### Baseline

Once adaptation has occurred, the clinician will need to collect some type of baseline data. The baseline data serve as the basis of comparison for subsequent assessment phases, and as the basis for gauging progress within and across future treatment sessions. Again, there are no definitive data to document the optimal approach (should eyes be open or closed? should the patient be fully reclined or sitting upright? should conditions be neutral or designed to promote relaxation?) or the desired duration of baseline data collection. In practice, the ► **baseline phase** typically ranges from 1–5 minutes, which should be adequate for providing a representative sample of the patient's typical responses during resting states.

Clinicians (and researchers) often collect a second type of baseline, which is intended to assess preexisting abilities to regulate physiology. When the goal of biofeedback is generalized relaxation, it is useful to collect a second baseline during which the patient is instructed in a manner similar to this: "I would now like to see what happens when you try to relax as deeply as you can. Use whatever means you believe will be helpful. Please let me know when you are as relaxed as possible."

It was once thought that elevated resting levels of muscle tension might be a unique characteristic of patients experiencing chronic pain. A review of 60 psychophysiological investigations conducted with headache, back, and TMD patients, found minimal support for this notion (Flor and Turk 1989). Research on this topic, however, is compounded by questions about measurement reliability/stability (Flor 2001; Arena and Schwartz 2003).

### Reactivity

The third component examines psychophysiological activity in response to simulated or clinician- or experimenter- induced stressors, which are designed to be personally relevant, or to approximate conditions that rival real world events that are associated with pain onset, exacerbation, or perpetuation. Again, there

is no standard empirically-validated approach. Some examples of commonly used stimulus conditions are:

- negative imagery, wherein a patient concentrates on a personally relevant unpleasant situation (the details of which have been obtained during the intake interview, such as a stressful encounter with a coworker or boss)
- cold exposure (e.g. Raynaud's) or cold pressor test (as a general physical stressor)
- movement, such as sitting, rising, bending, stooping, or walking
- load bearing, such as lifting or carrying an object
- operation of a keyboard

Although baseline differences for EMG have not been found to be reliable in characterizing pain disorders, symptom-specific responses to stimuli have been found for certain pain conditions on a more consistent basis (see Flor 2001 for review).

### Recovery

Another component involves ► **recovery** or return to baseline. If multiple stressful stimuli are presented to a patient, then a post-stress recovery period is recommended after each stimulus presentation. This phase continues until the patient's physiology returns to a value close to that observed prior to stimulus presentation (often responses do not fully return to their starting values).

The above components constitute the basic approach to psychophysiological assessment. The final components mentioned here are less common in practice (but they are gaining in acceptance) and may be very useful as well.

### Muscle Scanning

Cram (1990) developed a procedure for quickly sampling EMG activity from multiple sites, in a manner that does not require multiple separate recording channels (only 2 channels are needed). This approach is made possible by the use of 2 hand held "post" electrodes, which are used to obtain brief (around 2 seconds per site) sequential bilateral recordings while the patient is sitting or moving. A normative database helps the therapist determine if any readings are abnormally high or low and if any asymmetries (right versus left side differences) exist, as these may be suggestive of bracing or favoring of a position or posture. The goal of biofeedback is to return the aberrant readings to a more normal state. Although this type of approach seems straightforward at first blush, in actuality it is more complex. A number of factors can influence the readings obtained, including the angle and force by which the sensors are applied, the amount of adipose tissue present (fat acts as an insulator and dampens the signal), and the degree to which the sensors are placed in a similar location to that used for the norming sample (plus other variables that affect EMG in general).

### Muscle Discrimination

Some have speculated that an inability to perceive bodily states accurately may be a factor in maintaining chronic pain. Flor and colleagues found that patients with chronic pain were unable to perceive muscle tension levels accurately, both in the affected and nonaffected muscles and that, when exposed to tasks requiring production of muscle tension, these patients overestimated physical symptoms, rated the task as more aversive, and reported greater pain (Flor et al. 1999). These findings point to a heightened sensitivity.

Flor (2001) describes a procedure that can be easily used to assess muscle discrimination abilities in a clinical setting:

- present the patient with a bar of varying height on a monitor
- instruct the patient to tense a muscle to the level reflected in the height of the bar
- vary the bar height from low to high
- correlate the EMG readings obtained with the actual heights of the bars
- define as “good” discrimination abilities correlation coefficients  $\geq .80$
- define as “bad” or poor discrimination abilities correlation coefficients  $\leq .50$

### Trigger Points

Some researchers have turned their attention to the psychophysiological model of Travell and Simons (1983), who postulated that a large percentage of chronic muscle pain resulted from trigger points. Hubbard (1996) provides the rationale for this approach below:

- muscle tension and pain are sympathetically mediated hyperactivity of the muscle stretch receptors, or the muscle spindles
- muscle spindles, which are scattered throughout the muscle belly (hundreds within the trapezius muscle), are encapsulated organs that contain their own muscle fibers
- although traditionally viewed as a stretch sensor, the muscle spindle is now recognized to be a pain and pressure sensor, and an organ that can be activated by sympathetic stimulation; thus, the pain associated with trigger points arises in the spindle capsule

Support for this model comes from studies where careful needle electrode placements have detected high levels of EMG activity in the trigger point itself, but data collected from adjacent non-tender sites just 1 cm away are relatively silent (Hubbard 1993). Further, when exposed to a stressful stimulus, EMG activity increases at the trigger point but not at the adjacent site (McNulty et al. 1994). This work provides further evidence of the link between behavioral and emotional factors and mechanisms of muscle pain.

### Summary

Flor (2001) has listed a number of recommendations for conducting psychophysiological assessment with pain patients, which serves as a good summary:

- Use multiaxial classification of patients, to identify specific somatic and psychosocial characteristics of the patients.
- If possible, use normative data from controls.
- Control for pain status (i.e. test in a pain-free and a painful state, if possible).
- Control for medication (i.e. make sure patient has not taken analgesic or psychotropic medication for several days, if possible).
- Use sites both proximal and distal to the painful site.
- Make sure that the measures selected are relevant for the specific type of pain being studied (e.g. temperature recordings for Raynaud’s syndrome, rather than EMG levels).
- Use ecologically valid methods of stress induction (i.e. use self-selected stressors; test stressfulness by assessing subjective stress rating, heart rate, or skin conductance levels).
- Use sufficiently long adaptation phases and baselines.
- Use a syndrome-specific and a general autonomic measure.

### References

1. Arena JG, Schwartz MS (2003) Psychophysiological Assessment and Biofeedback Baselines for the Front-Line Clinician: A Primer. In: Schwartz MS, Andrasik F (eds) Biofeedback: A practitioner’s guide, 3<sup>rd</sup> edn. Guilford Press, New York, pp 128–158
2. Cacioppo JT, Tassinary LG, Bernston GG (2000) Handbook of Psychophysiology, 2<sup>nd</sup> edn. Cambridge University Press, Cambridge
3. Cram JR (1990) EMG Muscle Scanning and Diagnostic Manual for Surface Recordings. In: Cram JR and Associates (eds) Clinical EMG for Surface Recordings, vol 2. Clinical Resources, Nevada City, CA, pp 1–141
4. Crider AB, Glaros AG (1999) A Meta-Analysis of EMG Biofeedback Treatment of Temporomandibular Disorders. *J Orofacial Pain* 13:29–37
5. Flor H (2001) Psychophysiological Assessment of the Patient with Chronic Pain. In: Turk DC, Melzack R (eds) Handbook of Pain Assessment, 2<sup>nd</sup> edn. Guilford, New York, pp 76–96
6. Flor H, Fürst M, Birbaumer N (1999) Deficient Discrimination of EMG Levels and Overestimation of Perceived Tension in Chronic Pain Patients. *Appl Psychophysiol Biofeedback* 24:55–66
7. Flor H, Turk DC (1989) Psychophysiology of Chronic Pain: Do Chronic Pain Patients Exhibit Symptom-Specific Psychophysiological Responses? *Psychol Bull* 105:219–259
8. Hubbard D, Berkoff G (1993) Myofascial Trigger Points Show Spontaneous EMG Activity. *Spine* 18:1803–1807
9. Hubbard D (1996) Chronic and Recurrent Muscle Pain: Pathophysiology and Treatment, and Review of Pharmacologic Studies. *J Musculoskeletal Pain* 4:123–143
10. Hudzynski LG, Lawrence GS (1988) Significance of EMG Surface Electrode Placement Models and Headache Findings. *Headache* 28:30–35
11. McNulty E, Gevirtz R, Hubbard D, Berkoff G (1994) Needle Electromyographic Evaluation of Trigger Point Response to a Psychological Stressor. *Psychophysiology* 31:313–316

12. Peek, CJ (2003) A Primer of Biofeedback Instrumentation. In: Schwartz MS, Andrasik F (eds) Biofeedback: A Practitioner's Guide, 3<sup>rd</sup> edn. Guilford Press, New York, pp 43–87
13. Sherman R (1997) Phantom Pain. Plenum Press, New York
14. Stern RM, Ray WJ, Quigley KS (2001) Psychophysiological Recording, 2<sup>nd</sup> edn. Oxford University Press, Oxford
15. Travell J, Simons D (1983) Myofascial Pain and Dysfunction: The Trigger Point Manual. Williams & Wilkins, New York

## Psychophysiological Reactivity

### Definition

Reactivity of psychophysiological systems (for instance muscle tone, heart rate, sweating) in reaction to fear-eliciting situations, such as certain physical activities in case of chronic low back pain patients with fear of movement/(re)injury.

- ▶ Disability, Fear of Movement

## Psychophysiological Stress Profile

- ▶ Psychophysiological Assessment of Pain

## Psychosocial Factors

### Definition

Thoughts, emotions, and contextual factors that may have an influence on behavior and physiological reactivity.

- ▶ Impact of Familial Factors on Children's Chronic Pain
- ▶ Multiaxial Assessment of Pain
- ▶ Stress and Pain

## Psychosocial Interventions

### Definition

Psychosocial interventions are non-pharmacological treatments that, while recognizing biological contributions to pain, focus on individual psychological factors (e.g. cognitions, beliefs) as well as social contextual factors (e.g. family system).

- ▶ Psychological Treatment of Headache

## Psychosocial Maladjustment and Pain

- ▶ Personality Disorders and Pain

## Psychosocial Management of Cancer Pain

- ▶ Psychiatric Aspects of the Management of Cancer Pain

## Psychosocial Obstacles to Recovery

- ▶ Yellow Flags

## Psychosocial Predictors or Risk Factors

- ▶ Psychological Predictors of Chronicity
- ▶ Yellow Flags

## Psychosocial Treatments for Pain

### Definition

Psychosocial treatments for pain include interventions that target maladaptive thoughts and behaviors that contribute to the maintenance and exacerbation of pain symptoms. Cognitive-behavioral therapy (CBT) involves questioning negative thought patterns using a Socratic approach (e.g. what is the evidence that one's pain will never end?), as well as direct behavioral modifications (e.g. pacing oneself during pain-free periods to avoid over-exertion). In children, psychosocial treatments for pain often involve the parent(s) or the larger family unit.

- ▶ Experimental Pain in Children

## Psychosocioeconomic

### Definition

The combination of psychological, sociological, and economic factors affecting an individuals surrounding environment.

- ▶ Lower Back Pain, Physical Examination

## Psychosocioeconomic Syndrome

- ▶ Lower Back Pain, Physical Examination



## Psychosomatic and Psychiatric Physiotherapy

### Definition

A licensed physiotherapy direction that includes Psychomotor Physiotherapy, among a range of body-mind approaches. The education program only exists in Norway, and since 1994 physiotherapists must take 2 years of additional education at post-graduate level in order to qualify for this license. The program includes education in many body-awareness techniques, which is also applicable for patients with long-lasting pain.

- ▶ Body Awareness Therapies

## Psychotherapy

### Definition

Psychotherapy refers to the treatment of psychological, emotional, or behavior disorders through interpersonal communications between the patient and a trained counselor or therapist.

- ▶ Complex Chronic Pain in Children, Interdisciplinary Treatment

## Psychotherapy of Older Pain Patients

- ▶ Psychological Treatment of Pain in Older Populations

## Psychotic

### Definition

A morbid belief out of keeping with the patients background.

- ▶ Psychiatric Aspects of Pain and Dentistry

## Psychotropics

### Definition

Drugs that affect psychological or emotional states, behavior or experience.

- ▶ Psychiatric Aspects of the Management of Cancer Pain

## Ptosis

### Definition

Ptosis refers to drooping of the upper eyelid. During acute bouts of cluster headache and during exacerbations of hemicrania continua, the eyelid on the side of the pain often droops.

- ▶ Hemicrania Continua

## Pudendal Nerve

### Definition

The pudendal nerve arises from three sacral roots (S–2 to S–4), and leaves the pelvis through the greater sciatic foramen to reach the deep gluteal region and bend around the sacrospinous ligament. After entering Alcock's canal through the lesser sciatic foramen, the nerve courses within a duplication of the muscle fascia along the obturator internus muscle and divides into several branches supplying the anal and urethral sphincters, the pelvic floor muscles, and anal, perineal, and genital sensitivity.

- ▶ Pudendal Neuralgia in Women

## Pudendal Neuralgia

P

### Definition

Pudendal nerve entrapment may be diagnosed clinically. Computed tomography-guided steroid nerve blocks may provide temporary or long term relief. A prolonged pudendal nerve distal motor latency on electrodiagnostic testing may confirm the diagnosis. Surgery frequently finds the pudendal nerve flattened at the ischial spine level, or in the pudendal canal of Alcock in contact with the sharp inferior border of the sacrospinous ligament. After surgical decompression significant relief of pain is frequently obtained. Pudendal nerve entrapment should be considered in the differential diagnosis of chronic urogenital or anorectal pain, particularly if the pain is aggravated by sitting or if there is a history of bicycle riding.

- ▶ Clitoral Pain
- ▶ Pudendal Neuralgia in Women

## Pudendal Neuralgia in Women

MAURICE F. BENSIGNOR<sup>1</sup>, JEAN-JACQUES LABAT<sup>2</sup>, ROGER ROBERT<sup>3</sup>, MICHEL GUERINEAU<sup>3</sup>

<sup>1</sup>Centre Catherine de Sienne, Reze, France

<sup>2</sup>Neurology and Rehabilitation, Clinique Urologique, Nantes Cedex 1, France

<sup>3</sup>Neurosurgery, Hotel Dieu, Nantes Cedex 1, France  
dr.ben@wanadoo.fr

### Synonyms

Women with chronic perineal pain have often been suffering for years. Various specialists generally propose a diagnosis according to their own specialty like vulvodynia, levator ani syndrome or interstitial cystitis. No evidence of any lesion was found by imaging, thus psychological distress is concluded. Careful assessment helps in locating the initial pain, which may tend to extend with time as a consequence of sensitization and plastic changes in the central nervous system. Perineal pain extending anteriorly to the vulva, vagina or bladder or posteriorly to the anorectal region, particularly when unilateral and worsened in a sitting position evokes an involvement of pudendal nerves (Turner 1991). These neuropathic etiologies have been recognized with the development of electrophysiological explorations besides urological, gynecological, colorectal and musculoskeletal disorders, thus leading to therapeutic advances with steroid blocks and surgery.

### Definition

#### Neuroanatomical Basis for Perineal Pain

A significant part of the nociceptive stimuli initiator in the perineal area follow the pudendal nerve to the sacral segments S2, S3, S4. Visceral fibers of the pelvic plexus run through the sympathetic system. Different types of pain may be involved and eventually associated: nociception in nerves and visceral structures; focal muscle spasm resulting in anoxia and build-up of noxious metabolites; lost afferents through trauma or disease, which may result in increased spontaneous activity from dorsal horn cells involved in the transmission of pain; selective loss of inhibitory inputs from the larger myelinated somatic afferents, which may lead to enhanced spinal pain transmission; peripheral afferents becoming sensitized and in turn creating more muscle spasm, re-enforcing pain and creating a vicious cycle (Wesselmann 1997).

### Characteristics

The variety of possible causes for chronic pain in the perineum makes a careful clinical assessment crucial. The location of initial pain is essential to determine the involved dermatomal territory. ► **Pudendal neuralgia** may be initially described as paresthesias, dysesthesias or an unpleasant sensation of numbness; the pain progressively evolves to burning and / or pinching without neuralgic shocks. Allodynia and hyperalgesia may be present. The description of symptoms is remarkably constant from one patient to another and over months or years for a single patient. No relief is generally obtained from peripheral or central analgesics nor from NSAIDs. The pain is located in the perineum uni- or bi-laterally

with anterior (vulvar, vaginal, urethral) or posterior (anorectal) irradiations. It is described as burning, often associated with an annoying sensation of weight or foreign body, worsened in the sitting position except on the toilet and relieved by standing up or after prolonged decubitus, thus not affecting sleep. Neurological examination of the perineum is normal. Gentle pressure on the ischial spine, sacrospinous ligament or the lateral wall of the ischioanal fossa reveals tenderness. Pelvic examination may reveal spasm of levator ani muscles, which are felt to be tense and tender along the pelvic sidewalls. Pain deep in the buttock is frequently associated; tenderness is found on the trigger points of piriformis and / or obturator muscles. Sympathetic activation may result in inappropriate peripheral catecholamine outflow and sensitization of nociceptors and mechanoreceptors. Allodynia and hyperalgesia may be associated and occasionally skin vasoconstriction or abnormal sweating. This mechanism could also account for long lasting pain after colorectal, urological or gynecological surgery or infection.

Electrophysiology helps the diagnosis when physical examination fails to identify a lesion (Labat 1990). Electromyography of bulbospongiosus muscle and sphincter ani may show signs of peripheral neuropathy, impoverishment of impulse activity on tracing, polyphasic action potentials and spontaneous denervation activity. Stimulating and recording methods are used to measure sacral reflex latency (S2, S3, S4) and distal motor latency of pudendal nerves. Cortical evoked potentials have poor diagnostic value. Sacral reflex latency can be measured by stimulating sensory afferents with external electrodes (dorsal nerve of the clitoris) and recording in an effector muscle of the perineum like the bulbospongiosus. It is a polysynaptic reflex involving somatic pathways. Normal latency is under 44 ms. Increased sacral latency indicates a proximal rather than a peripheral lesion. Pudendal nerve distal motor latency is obtained by intrarectal stimulation using a special electrode (Dantec St Mark's Hospital) applied on the ischial spine and recording through a needle in the bulbospongiosus muscle. Normal values are less than 4 ms for the perineal branch. A long history of straining at stool, antecedent obstetrical trauma or perineal descent may lead to perineal stretch neuropathy, which results in increased distal latency on pudendal nerves. Electrophysiological exploration may give an objective confirmation for a suspected nerve involvement in perineal pain syndromes.

### Medical Treatment

Antidepressant and anticonvulsant drugs are often proposed to treat neuropathic pain. They may be worth a try but are often disappointing in the long term. When present, the myofascial component requires specific treatment. When a nerve ligament conflict is suspected, therapeutic blocks are worth a try. The injections must

be made in the ligament, close to the entrapment site, avoiding intraneural injections (Bensignor 1989). Local anesthetic blocks can also be performed for diagnostic purposes. They may provide information on the nociceptive afferent pathways, provided that they are located accurately; deep perineal nerve blocks should be performed with fluoroscopy or CT scan. Local anesthetic solutions should be injected in small volumes (2–4 ml), possibly with a contrast dye added to visualize spread. If the pain predominates on one side, a unilateral block is performed. Pain relief is likely to be obtained in 10 minutes. If the pain is then localized on the other side, a contralateral block is proposed. Reaching pudendal nerves through a perineal approach is difficult, uncomfortable for the patient and the operator and enhances the risks for poor location or secondary infection. A transgluteal approach should be preferred.

#### Block at the Ischial Spine

The patient is placed in prone position with a pillow under the hip joint of the side to be blocked under fluoroscopy, hip and knee in slight flexion. The X-rays are centered on the ischial spine medially to the coxofemoral joint. After skin preparation with an antiseptic, the subcutaneous tissues are infiltrated with 2 ml 1% lidocaine. A 22 G 3.5' spinal needle is then inserted vertically until it impinges the tip of the ischial spine (Fig. 1). It is then slightly withdrawn and re-inserted medially in the sacrospinous ligament. Paresthesias referred to the cli-

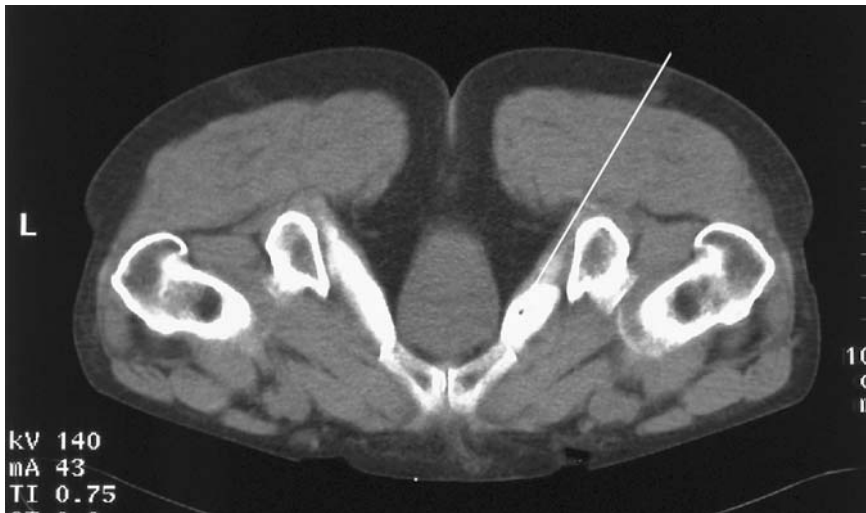
toris, labia, vagina or anus may be elicited. After aspiration test, 4 ml 1% lidocaine are injected. The diagnostic block can be complemented by therapeutic injection of methylprednisolone acetate 40–80 mg.

#### Block in the Alcock's Canal

Alcock's canal can be located accurately with computer tomography, which enables rectal perforation to be avoided. The patient is prone; after a scout view, a scan is performed through the middle of the obturator foramen. The ideal positioning of the needle(s) is simulated on the screen between the obturator muscle and its inner fascia, medially to the ischium. This line is extended to the buttock skin; depth and distance from the inserting point to the midline are recorded. After local anesthesia of the skin and subcutaneous tissues a 22 G 5' needle is inserted as previously drawn on the screen. A contrast dye is injected and its diffusion between the obturator muscle and its inner fascia checked on a scan (Fig. 2). The needle may have to be re-positioned until a proper diffusion of the dye is obtained. Diagnostic and therapeutic blocks can then be performed as described above. Steroid blocks' efficiency is probably linked to a reversal of local edema and possibly to an atrophy of thickened ligaments. In our experience, they provide significant improvement in two thirds of the patients with 2–3 blocks each, over a period of 6 months. We find it appropriate to perform the blocks at minimum intervals of 6–8 weeks and to limit the number of blocks to 2–4.



**Pudendal Neuralgia in Women,**  
**Figure 1** Ischial spine block  
(fluoroscopy).



**Pudendal Neuralgia in Women,**  
**Figure 2** Alcock's canal block (CT scan).

### Pudendal Nerve Surgery

It seemed logical to propose surgical decompression when patients were only transiently improved by medical treatments, as in carpal canal syndromes or ulnar entrapment at the elbow. The transluteal approach described (Robert 1989), following G. Amarenco's hypothesis (Amarenco 1988), allows all possible entrapments to be corrected through a single incision. Two main entrapment locations, possibly occurring together were found, pinched between the sacrospinous and sacrotuberous ligaments near the ischial spine or in Alcock's canal due to the falciform process of the sacrotuberous ligament and / or fascia of the obturator internus muscle (Robert 1998). A gluteal incision is made; the gluteus maximus muscle fibers are dissected and dissociated from the sacrotuberous ligament, which is then resected. If the fascia of the obturator is thick or the falciform process is threatening the nerve, these can be incised. The sacrospinous ligament is cut and the nerve can then be transposed frontally to the ischial spine. This minor surgery does not harm vital functions. The sacrifice of the two ligaments has no morbid consequences for the sacroiliac joint. Surgical decompression of the pudendal nerve in intractable pudendal neuralgias may be effective for patients in whom medical treatment, physical therapy and nerve blocks have failed. A success rate of 10 / 14 was obtained at 1 year in a prospective randomized study on 32 patients, confirming the results of a previous retrospective assessment of 158 operated patients (Robert 1994). The surgical procedure is therefore validated and can reasonably be proposed for such patients.

### Conclusion

Perineal pain is a rather common cause of discomfort and disability, especially among women. Psychotherapy, analgesic and tranquilizing drugs are far from being the only available resource when no evidence of a

usual lesion can be found. Clear understanding of possible contributing, perhaps associated factors, careful assessment and comprehensive physical examination are essential. A multidisciplinary approach is often useful to make a differential diagnosis. Much more work remains to be done for a clearer understanding of pain mechanisms and to demonstrate the validity of various therapeutic possibilities. Patients' best interests will be better served by a step wise conservative approach offering psychological evaluation and intervention as a reasonable but not exclusive part, using electrophysiology, imaging, nerve blocks, rehabilitation and possibly surgery when indicated.

### References

1. Amarenco G, Lanoe Y, Ghnassia RT et al. (1988) Syndrome du canal d'Alcock et névralgie périnéale. *Rev Neurol* 144:523–526
2. Besignor-Le Henaff M, Labat JJ, Robert R et al. (1993) Douleur périnéale et souffrance des nerfs honteux internes. *Cah Anesth* 41:111–114
3. Labat JJ, Robert R, Besignor M et al. (1990) Les névralgies du nerf pudendal (honteux interne). Considérations anatomocliniques et perspectives thérapeutiques. *J Urol* 96:239–244
4. Robert R, Brunet C, Faure A et al. (1994) La chirurgie du nerf pudendal lors de certaines algies périnéales: évolution et résultats. *Chirurgie* 119:535–539
5. Robert R, Prat-Pradal D, Labat JJ et al. (1998) Anatomic basis of chronic perineal pain: role of the pudendal nerve. *Surg Radiol Anat* 20:93–98
6. Turner ML, Marinoff SC (1991) Pudendal neuralgia. *Am J Obstet Gynecol* 165:1233–1234
7. Wesselmann U, Burnett AL, Heinberg LJ (1997) The urogenital and rectal pain syndromes. *Pain* 73:269–294

## Puerperium

### Definition

The term puerperium refers to the first six weeks after delivery. It is during this time that the reproductive organs



are returning to their non-pregnant condition following labor and delivery.

- ▶ Postpartum Pain

## PUF Scale

### Definition

Pelvic Pain, Urgency, and Frequency Patient Symptom Scale, utilized for quantifying the degree of symptoms associated with interstitial cystitis.

- ▶ Interstitial Cystitis and Chronic Pelvic Pain

## Pulmonary Embolism (PE)

- ▶ Postoperative Pain, Venous Thromboembolism

## Pulpal Nociceptors

- ▶ Nociceptors in the Dental Pulp

## Pulpalgia

- ▶ Dental Pain, Etiology, Pathogenesis and Management

## Pulpitis

### Definition

This is a state of inflammation of the dental pulp. In its acute stage it is associated with severe attacks of paroxysmal pain, and is exacerbated by cold or hot foods. Most cases are due to penetration of a carious lesion into the pulp chamber.

- ▶ Atypical Facial Pain, Etiology, Pathogenesis and Management
- ▶ Dental Pain, Etiology, Pathogenesis and Management
- ▶ Substance P Regulation in Inflammation

## Pulsed Electromagnetic Therapy

- ▶ Modalities

## Punch Skin Biopsies

### Definition

A newer, minimally invasive method of observing and quantitating small sensory axons in which small skin punches (typically 3 mm in diameter) are removed, sectioned, and immunolabeled. The procedure can be performed at various locations on the body, and repeated to monitor disease progress or the effectiveness of treatment. The method does not provide information about motor or large myelinated axons, demyelination, or vasculitis. Serious complications are nil.

- ▶ Diabetic Neuropathies

## Punctate Hyperalgesia

### Definition

Punctate hyperalgesia is the increase in pain above normal levels perceived to mechanical stimulation produced by a small contact diameter probe such as a von Frey hair.

- ▶ Quantitative Thermal Sensory Testing of Inflamed Skin

## Punctate Midline Myelotomy

- ▶ Midline Myelotomy

## Punctuate Allodynia

### Definition

Punctuate stimuli such as a pinprick evokes pain.

- ▶ Hyperpathia, Assessment

## Punishment

### Definition

Punishment has no useful role to play in contingency management and should be avoided.

- ▶ Training by Quotas

## Purine Receptor Targets in the Treatment of Neuropathic Pain

LUCY VULCHANOVA

Department of Veterinary and Biomedical Sciences,  
University of Minnesota, St. Paul, MN, USA  
lucy@med.umn.edu

### Synonyms

Purinergic receptors; Nucleotide Receptors

### Definition

The purine nucleotide ► **adenosine 5′ triphosphate** (ATP) and some of its metabolites such as adenosine have been recognized as ubiquitous intercellular messengers. Based on their preferred ligands and functional characteristics, purine receptors are classified as follows: (i) ► **P1 receptors** – activated by adenosine, seven transmembrane, G protein-coupled; (ii) ► **P2X receptors** – activated by ATP, cation channels; (iii) ► **P2Y receptors** – activated by ATP and in some cases uridine 5′ triphosphate (UTP), seven transmembrane, G protein-coupled. Therapeutic approaches that lead to activation of adenosine receptors in the spinal cord, and inhibition of P2X receptors in sensory neurons and spinal cord, are under development as potential treatments of neuropathic pain.

### Characteristics

#### Modulation of Adenosine Signaling for the Treatment of Neuropathic Pain

Four subtypes of P1 receptors have been identified: A<sub>1</sub>, A<sub>2A</sub>, A<sub>2B</sub> and A<sub>3</sub> (for review see Ribeiro et al. 2003). In general, A<sub>1</sub> and A<sub>3</sub> have inhibitory actions, whereas A<sub>2A</sub> and A<sub>2B</sub> have stimulatory actions. In the central nervous system (CNS), high levels of A<sub>1</sub> are present in the cortex, cerebellum, hippocampus and dorsal horn of spinal cord. The expression of A<sub>2A</sub> is prominent in the basal ganglia. Modulation of adenosine signaling at A<sub>1</sub> and A<sub>2A</sub> in the CNS has therapeutic potential for the treatment of a number of disorders including Alzheimer's disease, Parkinson's disease and chronic pain. Activation of peripheral adenosine receptors is associated with effects such as hypotension, bradycardia, hypothermia, and bronchial constriction, which limit the systemic use of adenosine agonists.

In different experimental paradigms, spinal, peripheral and systemic modulation of adenosine signaling has shown potential for the treatment of neuropathic pain (for review see Ribeiro et al. 2003). The analgesic effects of adenosine appear to be mediated predominantly by A<sub>1</sub> receptors in the dorsal horn of the spinal cord. One of the strategies developed to exploit adenosine analgesia has been the design of A<sub>1</sub> allosteric modulators, which can enhance the effects of endogenous adenosine without producing side-effects in its absence. Intrathecal

and systemic administration of the allosteric modulator T62 was able to reduce mechanical hypersensitivity in the spinal nerve ligation model of neuropathic pain, but its chronic use was associated with the development of ► **tolerance**. These findings, together with the modest anti-allodynic effect of intrathecal adenosine (20% reversal of hypersensitivity), suggest that modulation of the adenosine system may be a more promising adjuvant strategy, rather than a sole therapy for neuropathic pain.

#### P2X Receptors and Neuropathic Pain

P2X receptors are cation channels activated by ATP (for review see North 2002). The seven cloned subunits (P2X<sub>1-7</sub>) each have two transmembrane domains with intracellular amino- and carboxy-termini and a large extracellular loop. Studies on their stoichiometry suggest that individual channels are comprised of three subunits. When expressed in ► **transfected cells**, all subunits but P2X<sub>6</sub> can form functional ► **homomeric channels**. Co-expression of different subunits has also suggested the existence of ► **heteromeric channels** (P2X<sub>2/3</sub>, P2X<sub>1/5</sub>, P2X<sub>2/6</sub>, P2X<sub>4/6</sub>). P2X receptors are widely expressed in the CNS, where they mediate fast excitatory transmission in response to synaptically released ATP. The most abundant CNS subunits are P2X<sub>2</sub>, P2X<sub>4</sub> and P2X<sub>6</sub>. P2X receptors are also present in autonomic and sensory ganglia of the peripheral nervous system, as well as in non-neuronal tissues such as smooth muscle.

#### P2X Receptors in Sensory Neurons as Targets for Neuropathic Pain

Six (P2X<sub>1-6</sub>) of the seven cloned P2X receptor subunits are expressed in sensory neurons at varying levels, P2X<sub>3</sub> being the most abundant (for example see Collo et al. 1996). Application of ATP to dissociated dorsal root ganglion (DRG) neurons activates three types of inward currents: 1) transient, rapidly desensitizing; 2) sustained, slowly desensitizing; and 3) a combination of transient and sustained. It is believed that the transient, rapidly desensitizing currents are mediated by homomeric P2X<sub>3</sub> channels, whereas some of the sustained currents are mediated by heteromeric P2X<sub>2/3</sub> channels (North 2002; Tsuzuki et al. 2003). Cells that respond to ATP with a combination of transient and sustained currents are thought to express both homo- and heteromeric channels composed of P2X<sub>2</sub> and P2X<sub>3</sub>. Other homo- or heteromeric channel configurations are also likely to contribute to sustained currents in DRG neurons (North 2002; Tsuzuki et al. 2003).

Considerable research effort has been directed at the P2X<sub>3</sub> subunit, whose expression is largely restricted to sensory neurons. Immunohistochemical studies have demonstrated that in DRG, P2X<sub>3</sub> is predominantly present in small, neuropeptide-poor neurons, many of which also express other channels known to play a role in nociception and chronic pain, such as the capsaicin

receptor VR1/TRPV1 (reviewed in North 2003). Following nerve injury, P2X<sub>3</sub> expression is differentially modulated in injured and uninjured primary afferent neurons. Although the pattern of changes is different depending on the neuropathic pain model used, the modulation of P2X<sub>3</sub> levels is consistent with a role of P2X<sub>3</sub> in nerve injury-induced hypersensitivity.

The ability of ATP agonists to excite nociceptive nerve fibers, and the high levels of P2X<sub>3</sub> expression in presumed nociceptors, have led to the identification of the P2X<sub>3</sub> receptor subunit as a pronociceptive molecule whose inhibition may reduce pain (reviewed in North 2003). Knockdown of P2X<sub>3</sub> expression by ► [antisense oligonucleotide](#) (ASO) treatment has been instrumental in the functional validation of P2X<sub>3</sub> as a therapeutic target for neuropathic pain. ASO inhibited nerve injury-induced mechanical hypersensitivity in two different rodent models of neuropathic pain. In the ► [spinal nerve ligation model](#), there was approximately 50% inhibition of mechanical ► [allodynia](#) after ASO treatment. In the partial nerve ligation model (see ► [Neuropathic Pain Model, Partial Sciatic Nerve Ligation Model](#)), ASO treatment resulted in approximately 30% reversal of mechanical ► [hyperalgesia](#), but was ineffective in inhibiting mechanical allodynia. In both studies, the expression of P2X<sub>3</sub> was inhibited by approximately 50%.

Knockdown of P2X<sub>3</sub> has also been achieved using a novel alternative approach to targeted inhibition of gene expression, which employs ► [siRNA](#) (Dorn et al. 2004; Hemmings-Mieszczyk et al. 2003). ASO and siRNA work through different mechanisms, and *in vitro* studies have suggested that siRNA are more potent and have longer lasting effects. In the partial nerve ligation model, siRNA was slightly more effective than ASO in attenuating nerve injury-induced mechanical allodynia and hyperalgesia (Dorn et al. 2004). However, the reduction in P2X<sub>3</sub> protein expression by siRNA treatment was comparable to that achieved by ASO treatment. Interestingly, in transfected cells, simultaneous targeting of two different regions of the P2X<sub>3</sub> mRNA by ASO and siRNA resulted in greater inhibition of P2X<sub>3</sub> expression than either of the two treatments alone (Hemmings-Mieszczyk et al. 2003), suggesting that a siRNA- and ASO-based combinatorial approach to P2X<sub>3</sub> knockdown may have an enhanced analgesic effect. A systematic comparison of the two technologies *in vivo* will substantially aid their evaluation and optimization for basic research and clinical use as novel therapeutic agents (Holmlund 2003).

The therapeutic potential of P2X<sub>3</sub> inhibition has led to efforts towards development of selective P2X<sub>3</sub> antagonists. A newly developed drug from Abbott, A-317491, was reported to be a selective blocker of P2X<sub>3</sub> and P2X<sub>2/3</sub> channels (reviewed in North 2003). Administered intrathecally, the drug was effective in inhibiting mechanical hypersensitivity in two rodent models of

neuropathic pain – spinal nerve ligation and ► [chronic constriction injury](#).

The relative contribution of P2X<sub>3</sub> homomeric and P2X<sub>2/3</sub> heteromeric channels to neuropathic pain is poorly understood, because the P2X<sub>3</sub> antagonist A-317491, as well as ASO and siRNA, affect both types of channels. It has been suggested that heteromeric P2X<sub>2/3</sub> channels mediate mechanical allodynia following intraplantar injection of the ATP analog  $\alpha\beta$ meATP (Tsuda et al. 2000). Therefore, it is possible that the mechanical hypersensitivity in neuropathic pain depends on heteromeric channels rather than homomeric P2X<sub>3</sub>. The relative contribution of heteromeric channels is particularly relevant to ASO or siRNA approaches that target P2X<sub>3</sub>. For example, if P2X<sub>3</sub> is required for assembly and/or trafficking of the heteromeric channels, P2X<sub>3</sub> knockdown would result in functional inactivation of both homomeric and heteromeric channels. Conversely, in the absence of P2X<sub>3</sub>, P2X<sub>2</sub> may form aberrant homomeric or heteromeric channels. In this case, simultaneous targeting of both subunits may be more effective in attenuating nerve injury-induced mechanical hypersensitivity.

#### **P2X Receptors in Non-Neuronal Cells as Targets for Neuropathic Pain**

Nerve injury is associated with a robust activation of microglia in the dorsal horn of the spinal cord ipsilateral to the injury. Tsuda and colleagues have demonstrated that the expression of P2X<sub>4</sub> receptors is upregulated in activated microglia, with a time course that parallels the development of mechanical hypersensitivity (Tsuda et al. 2003). Using a combination of antagonist treatments, the authors deduced that inhibition of P2X<sub>4</sub> receptors has an anti-allodynic effect. Treatment with an ASO targeting the P2X<sub>4</sub> receptor also attenuated mechanical allodynia, whereas intrathecal injection of ATP-primed activated microglia induced allodynia in a P2X<sub>4</sub>-dependent manner. Taken together, these results indicate that the P2X<sub>4</sub> receptor in microglia is sufficient for the development, and necessary for the maintenance, of mechanical hypersensitivity.

Finally, recent evidence suggests that the non-neuronal P2X<sub>7</sub> receptor subunit may participate in the neuro-immune signaling cascade, which summons immune cells to the site of nerve injury (Shamash et al. 2002). Pro-inflammatory cytokines released during this process are believed to modulate protein expression in sensory neurons, and thus contribute to the development of neuropathic pain. Activation of P2X<sub>7</sub> channels by ATP has been shown to stimulate secretion of pro-inflammatory cytokines from cultured Schwann cells (Colomar et al. 2003). Therefore, ATP released from damaged cells at the site of nerve injury may activate P2X<sub>7</sub> channels on Schwann cells and, acting in concert with other mediators, may contribute to cytokine secretion. Consistent with this scenario is the recent report of

that mice lacking the P2X<sub>7</sub> receptor fail to develop neuropathic pain (presented at the Spring Pain Research Conference 2004).

### P2Y Receptors in Sensory Neurons

Eight mammalian P2Y receptor subtypes have been identified. The agonist preferences of these receptors vary between different subtypes as well as between different species homologs of the same subtype (for review see von Kugelgen and Wetter 2000). In addition to ATP, some P2Y receptors are activated by adenosine diphosphate (ADP) or by uridine di- or triphosphate (UTP or UDP). P2Y receptor activation generally has stimulatory effects through Ca<sup>2+</sup> release from intracellular stores, although some P2Y receptors have also been shown to couple to inhibitory pathways. P2Y receptors are widely expressed throughout the periphery, whereas P2Y<sub>1</sub> appears to be the predominant CNS subtype. Sensory neurons express high levels of P2Y<sub>1</sub> and P2Y<sub>2</sub> receptors. There is evidence that P2Y<sub>2</sub> is present in nociceptors and its activation in peripheral terminals results in action potential firing (Stucky et al. 2004). In addition, P2Y<sub>2</sub> may mediate activation of transcription factors in sensory neurons (Molliver et al. 2002). Although the role of P2Y receptors in neuropathic pain has not been explored directly, these findings suggest that P2Y<sub>2</sub> may play a role in nociceptive signaling, as well as in sensory neuron plasticity underlying chronic pain states.

### References

- Collo G, North RA, Kawashima E et al. (1996) Cloning of P2X5 and P2X6 Receptors and the Distribution and Properties of an Extended Family of ATP-Gated Ion Channels. *J Neurosci* 16:2495–2507
- Colomar A, Marty V, Medina C et al. (2003) Maturation and Release of Interleukin-1beta by Lipopolysaccharide-Primed Mouse Schwann Cells Require the Stimulation of P2X7 Receptors. *J Biol Chem* 278:30732–30740
- Dorn G, Patel S, Wotherspoon G et al. (2004) siRNA Relieves Chronic Neuropathic Pain. *Nucleic Acids Res* 32:e49
- Hemmings-Mieszczyk M, Dorn G, Natt FJ et al. (2003) Independent Combinatorial Effect of Antisense Oligonucleotides and RNAi-Mediated Specific Inhibition of the Recombinant Rat P2X3 Receptor. *Nucleic Acids Res* 31:2117–2126
- Holmlund JT (2003) Applying Antisense Technology: Affinity and Other Antisense Oligonucleotides in Clinical Development. *Ann NY Acad Sci* 1002:244–251
- Molliver DC, Cook SP, Carlsten JA et al. (2002) ATP and UTP Excite Sensory Neurons and Induce CREB Phosphorylation through the Metabotropic Receptor, P2Y<sub>2</sub>. *Eur J Neurosci* 16:1850–1860
- North RA (2002) Molecular Physiology of P2X Receptors. *Physiol Rev* 82:1013–1067
- North RA (2003) P2X3 Receptors and Peripheral Pain Mechanisms. *J Physiol* 554:301–308
- Ribeiro JA, Sebastiao AM, Mendonca A de (2003) Adenosine Receptors in the Nervous System: Pathophysiological Implications. *Prog Neurobiol* 68:377–392
- Shamash S, Reichert F, Rotshenker S (2002) The Cytokine Network of Wallerian Degeneration: Tumor Necrosis Factor-Alpha, Interleukin-1alpha, and Interleukin-1beta. *J Neurosci* 22:3052–3060
- Stucky CL, Medler KA, Molliver DC (2004) The P2Y Agonist UTP Activates Cutaneous Afferent Fibers. *Pain* 109:36–44
- Tsuda M, Koizumi S, Kita A et al. (2000) Mechanical Allodynia Caused by Intraplantar Injection of P2X Receptor Agonist in Rats: Involvement of Heteromeric P2X2/3 Receptor Signaling in Capsaicin-Insensitive Primary Afferent Neurons. *J Neurosci* 20:RC90
- Tsuda M, Shigemoto-Mogami Y, Koizumi S et al. (2003) P2X4 Receptors Induced in Spinal Microglia Gate Tactile Allodynia after Nerve Injury. *Nature* 424:778–783
- Tsuzuki K, Ase A, Seguela P et al. (2003) TNP-ATP-Resistant P2X Ionic Current on the Central Terminals and Somata of Rat Primary Sensory Neurons. *J Neurophysiol* 89:3235–3242
- Kugelgen I von, Wetter A (2000) Molecular Pharmacology of P2Y-Receptors. *Naunyn Schmiedebergs Arch Pharmacol* 362:310–323

## Purinergic Receptors

### Definition

Purinergic receptor molecules bind adenosine triphosphate (ATP) and its metabolites. They are grouped in two large classes with many subgroups, namely P2X receptors that control ion channels, and P2Y receptors that are coupled to a G protein and induce changes in the intracellular cascade of second messengers. The P2X3 receptor is assumed to be specific for nociceptive endings.

- ▶ [Muscle Pain Model, Ischemia-Induced and Hypertonic Saline-Induced](#)
- ▶ [Nociceptors in the Orofacial Region \(Skin/Mucosa\)](#)
- ▶ [Purine Receptor Targets in the Treatment of Neuropathic Pain](#)

## Putamen

### Definition

Part of the striatum, a component of the basal ganglia, which receives afferents from motor and somatosensory cortical areas, substantia nigra, and the centromedian thalamic nucleus. It projects efferents to the globus pallidus, which in turn projects to the thalamus and to cortical motor areas.

- ▶ [Nociceptive Processing in the Nucleus Accumbens, Neurophysiology and Behavioral Studies](#)

## Pyeloplasty

### Definition

A surgical operation to relieve an obstruction at the junction of the pelvis of the kidney and the ureter, often involving a re-fashioning of the junction. Such an obstruction in infants is often diagnosed prenatally by the presence of hydronephrosis (accumulation of fluid in the kidney) observed by routine ultrasound scan during pregnancy.

- ▶ [Infant Pain Mechanisms](#)



---

## Pyramidal Cells

### Definition

The pyramidal cells are the major neuronal type in the hippocampus. The pyramidal cells of field CA1 have basal dendrites that extend into stratum oriens and apical dendrites that extend to the stratum lacunosum-moleculare. The axons of CA1 pyramidal cells project in a topographic fashion to the adjacent subiculum and to other cortical and sub-cortical areas including the pre- and infralimbic cortex, the lateral septal area, and the amygdala.

- ▶ [Nociceptive Processing in the Hippocampus and Entorhinal Cortex, Neurophysiology and Pharmacology](#)

---

## Pyramidal Neuron

### Definition

A pyramidal neuron is a specific type of cortical cell that sends its axon to other brain areas.

- ▶ [Corticothalamic and Thalamocortical Interactions](#)



## QOL

- ▶ Quality of Life

## QST

- ▶ Quantitative Sensory Tests
- ▶ Quantitative Sensory Testing

## QTL Mapping

- ▶ Quantitative Trait Locus Mapping

## Quadratus Lumborum

### Definition

Quadratus lumborum is the muscle involved in hip flexion and balancing postural distortion.

- ▶ Sacroiliac Joint Pain

## Quality of Life

### Synonyms

QOL

### Definition

Quality of life (QOL) is defined as an individual's perception of their position in life, in the context of the culture and value systems in which they live and in relation to their goals, expectations, standards and concerns. It is a broad concept, incorporating the person's physical health, level of independence, social relationships, personal beliefs and their relationship to salient features of the environment in a complex way. QOL includes both positive and negative dimensions embedded in socio-cultural and environmental contexts.

It has also been defined as „the subjective satisfaction expressed or experienced by an individual in his physical, mental and social situation“, „the capacity of an individual to realize his life plans“, and „the difference at a particular period in time between the hopes and expectations of the individual's present experience“.

- ▶ Cancer Pain Management, Interface Between Cancer Pain Management and Palliative Care
- ▶ Central Pain, Outcome Measures in Clinical Trials
- ▶ Psychiatric Aspects of the Management of Cancer Pain

## Quantal Release Probability

### Definition

Quantal release probability refers to the likelihood of vesicular release events of quanta of neurotransmitter occurring in a population of nerve terminals or a single nerve terminal, usually during invasion of an action potential. Drugs that have presynaptic actions on nerve terminals either increase or decrease quantal release probability.

- ▶ Opioid Electrophysiology in PAG

## Quantitative Sensory Testing

OLIVER H. G. WILDER-SMITH

Pain and Nociception Research Group, Pain Centre, Department of Anaesthesiology, Radboud University Nijmegen Medical Centre, Nijmegen, The Netherlands  
o.wildersmith@anes.umcn.nl

### Synonyms

Psychophysical Testing; QST

### Definition

In the context of human pain, quantitative sensory testing (QST) is generally taken to involve the application of a variety of nociceptive stimuli to the body, and the elicitation of voluntary verbal or non-verbal responses defining the subject's experience of the stimulus (Zaslansky and Yarnitsky 1998; Kosek and Ordeberg 2000; Wilder-Smith 2000a; Greenspan 2001; Graven-Nielsen

and Arendt-Nielsen 2002). The responses to a given test stimulation depend on the entire neuraxis, thereby limiting its localising value. QST should be distinguished from other forms of formal sensory testing entailing the direct measure (e.g. via electrical or magnetic signals) of involuntary responses to stimulation (e.g. nociceptive flexion reflexes, evoked or event-related potentials) (Dotson 1997).

The historical origin of this method lies in the field of neurology and clinical neurophysiology, where it has been extensively used clinically since the 1980s. In this framework, QST has been used for the study and diagnosis of many types of disorders of the nervous system, with a particular emphasis on the sensory assessment of small fibre function in the context of neuropathies (for reviews see Zaslansky and Yarnitsky 1998; Siao and Cros 2003). The use of QST in the field of pain medicine – on which this contribution will concentrate – is more recent, and experience less extensive, than in the context of neurology.

QST explores nervous system sensory processing under standardised conditions in an intact organism. The methodology can be either stimulus dependent (e.g. threshold determination) or response dependent (e.g. generating a stimulus-response curve using pain intensity visual analogue scoring).

## Characteristics

### Assessment and Induction Techniques

Two major types of responses (or endpoints) are typically used in QST. The first (stimulus dependence) entails the determination of thresholds (e.g. ► [pain detection or pain tolerance threshold](#)), while the second (response dependence) involves rating the magnitude of the pain (e.g. by ► [visual analogue scale](#)) produced by the given stimulus. The use of thresholds has the advantage of providing an easily defined – and thus generally reliable and reproducible – endpoint for the subject. Pain magnitude rating, while more difficult to teach and thus potentially less reliable, has the advantage that ► [suprathreshold stimuli](#) can be used. These are important for studying true nociceptive processing, frequently not reliably or well-reflected using threshold or subthreshold stimuli. For optimal results, subjects must undergo some preliminary QST training in order to be able to detect or rate painful stimuli consistently and reliably, and the stimuli must be applied under standardised conditions (Zaslansky and Yarnitsky 1998; Rommel et al. 2001; Graven-Nielsen and Arendt-Nielsen 2002; Wilder-Smith et al. 2003). Under such conditions, QST results can be expected to remain relatively stable over days or weeks in normal subjects (Siao and Cros 2003). It must, however, be remembered that many factors influence QST results, including the technical characteristics of the devices and the testing algorithms (protocols) used.

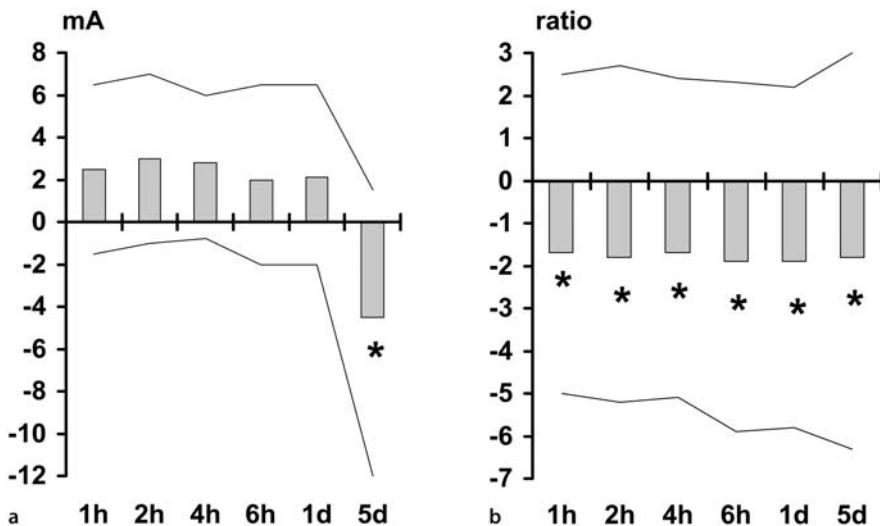
As for all neurophysiological measures, QST is subject to large interindividual variability, which may in part be genetically determined (Flores and Mogil 2001). This, combined with the present lack of large normal value databases, may make it difficult to reliably determine whether a given QST measurement is "normal" or "abnormal". As a result, methods using a given individual to provide his own normal measures are preferred for the analysis of QST. Examples of such methods include the determination of baseline values before predictable nociceptive events such as surgery, or comparison of affected limbs (or sides) with their normal opposite (Wilder-Smith et al. 2003).

Choice of the type, characteristics and location of the defined QST stimulus are important, as the options thus provided open the possibility of testing many different aspects of nociceptive processing. Stimulation using physiological stimuli (e.g. pressure, temperature, chemical) generally provides a means of including peripheral nociceptors in the analysis of nervous system processing. In contrast, electrical stimulation is considered to more or less bypass peripheral nociceptors, and may thus be more indicative of central aspects of nociceptive processing (Zaslansky and Yarnitsky 1998). Dermatome stimulation stimulates the most terminal fine nerve fibres (► [A-delta or C fibres](#)), a part of the nervous system bypassed if direct stimulation of larger sensory nerves (e.g. sural nerve) is used.

Basic QST usually involves simple stimulation, but stimuli summated either in time or space may provide more information on aspects of nociceptive processing relevant to clinical pain states such as postoperative pain or chronic pain diseases (e.g. ► [windup](#), ► [central sensitisation](#)) (Arendt-Nielsen et al. 1994; Arendt-Nielsen et al. 1997). A further development in this direction is the investigation of changes in QST induced by a variety of nociceptive conditioning stimuli (e.g. ► [ice water bucket test](#)), thus permitting insight into how the system defends itself against nociceptive challenge – and how vulnerable it may be to such a challenge.

The topography of changes in nervous system processing can also provide useful information on underlying processes. Thus, QST measurements performed at different sites may, e.g. provide the basis for differentiating between generalised (e.g. supraspinal) and segmental (e.g. spinal) changes in sensory processing (Wilder-Smith et al. 1996), or to differentiate changes in referred pain areas from those in the primary painful site (Kosek and Hansson 2003). A further example of topographical differences reflecting differing mechanisms is the differences in QST results in areas of ► [primary and secondary hyperalgesia](#) associated with a surgical wound, where the former reflects mainly local and peripheral nociceptive mechanisms and the latter, central mechanisms (Brennan 1999). The most frequently stimulated tissue for QST is the skin, a superficial somatic structure, due to its easy accessibility. However, stimulation of other





**Quantitative Sensory Testing, Figure 1** (a) Generalised neuroplasticity after back surgery: Time course of change in pain tolerance thresholds to transcutaneous electrical stimulation (mA, change is vs. preoperative baseline value) at site distant to surgery. (b) Segmental neuroplasticity after back surgery: Time course of change in normalised thresholds to transcutaneous electrical stimulation (ratio; i.e. threshold close to surgery divided by threshold distant to surgery, change is vs. preoperative baseline value). Bar values are means, thin lines are standard deviations. X-axis gives time after end of surgery in hours (h) or days (d). \* =  $P < 0.05$  vs. preoperative baseline value. (Figure adapted from Wilder-Smith et al.1996).

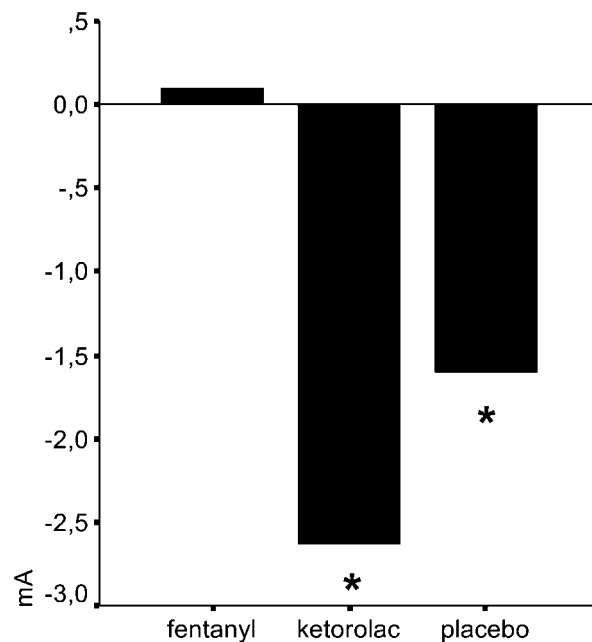
tissues, such as visceral (e.g. oesophagus) or deep (e.g. muscle) structures, provides further different but fundamentally important types of topographical information.

#### Use of QST in Practice

QST can be used in three major ways in the field of human pain and nociception:

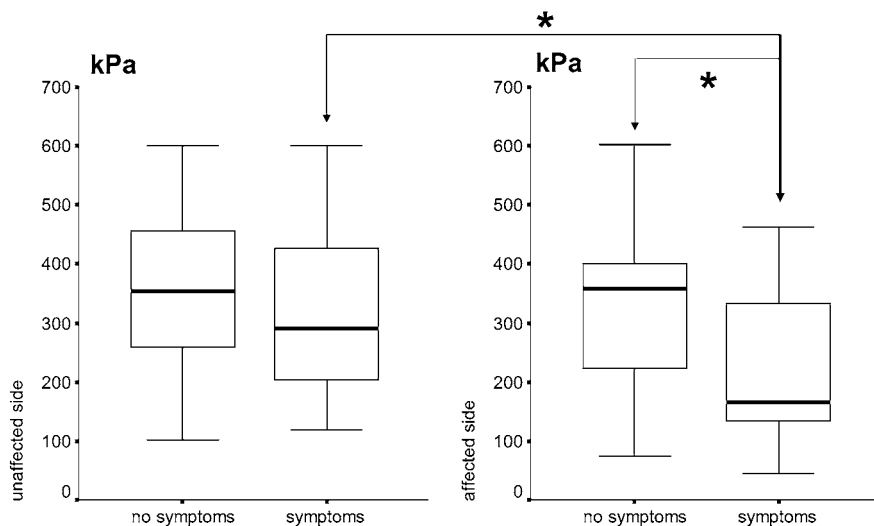
1. To study the baseline processing of nociceptive stimuli by the (healthy) nervous system and how the nervous system defends itself against nociceptive input
2. To study how processing of nociceptive stimuli by the nervous system is altered by nociceptive processes or pain diseases (► [nociceptive neuroplasticity](#))
3. To study how pharmacological or therapeutic interventions affect nociceptive processing in health and disease

In the field of pain, QST is used for both research and clinical purposes. Typical research applications include the experimental exploration of nociceptive processing in health, the investigation of pain mechanisms in disease, and the study of how therapeutic interventions (particularly pharmaceutical agents) affect nociceptive processing. On the clinical side, QST provides information for diagnostic, prognostic and therapeutic purposes. In pain diagnostics, the insight QST provides into nociceptive mechanisms makes it a basis for ► [mechanism-based approaches to pain and nociception](#). Understanding the baseline sensitivity of the nervous system to nociception, and how vigorously it can defend itself, may provide clues as to the vulnerability of the person to future nociceptive challenge (e.g. surgery, trauma). On the pain therapeutic side,



**Quantitative Sensory Testing, Figure 2** Change at five days postoperatively vs. preoperative baseline value of pain tolerance threshold to transcutaneous electrical stimulation at site distant to surgery for patients undergoing back surgery and receiving placebo (saline i.v.), ketorolac (30 mg i.v.) or fentanyl (3 µg/kg i.v.) supplementation for isoflurane/nitrous oxide/oxygen general anaesthesia. Bar values (mA) are means, standard deviations omitted for clarity. \* =  $P < 0.05$  vs. preoperative baseline value. (Figure adapted from Wilder-Smith et al.2003).

using QST to make nociceptive neuroplasticity visible can help achieve a mechanism-based choice of treatment method (e.g. drugs, physical stimulation), as well as being suitable for the documentation and study of treatment effects.



**Quantitative Sensory Testing, Figure 3** Pressure pain thresholds (in kPa) in patients having been diagnosed as having CRPS type 1 of a single upper extremity 8 to 9 years ago. In the graphs, the values for the affected and unaffected upper extremity are shown for patients presently exhibiting symptoms of active CRPS type 1 or not. Boxplot: medians with interquartile ranges and ranges. Statistically significant differences ( $* = P < 0.05$ ) are indicated by the arrows. (Figure based on Vaneker M 2005).

### Examples

In the context of acute perioperative pain, QST has proven particularly valuable in providing insight into postoperative nociceptive neuroplasticity, its mechanisms and the impact of various analgesic or antinociceptive therapeutic interventions (Wilder-Smith et al. 1996; Wilder-Smith 2000b; Wilder-Smith et al. 2003). For example, using change in electric pain tolerance thresholds compared to preoperative baseline, it has been shown that surgery under "non-analgesic" anaesthesia (un-supplemented isoflurane/nitrous oxide) is followed by long-lasting spinal sensitisation, manifesting as generalised hyperalgesia five days after surgery (see Fig. 1). Another study has demonstrated that pre-emptive analgesia, with a single dose of fentanyl before back surgery lasting less than an hour, is able to prevent the appearance of such generalised hyperalgesia (central sensitisation) five days postoperatively, while the similar application of ketorolac is not (Wilder-Smith et al. 2003) (see Fig. 2).

QST is now also starting to prove valuable in understanding the pathological neuroplasticity associated with chronic pain conditions (Kosek and Ordeberg 2000; Rommel et al. 2001). An example of such use is given here in the context of CRPS type 1, where patients suffering from active, symptomatic disease had significantly lower pressure pain thresholds in the affected upper extremity as compared to the unaffected one, while there was no difference between the two extremities in patients with inactive, asymptomatic disease (see Fig. 3).

### References

- Arendt-Nielsen L, Brennum J, Sindrup S et al. (1994) Electrophysiological and Psychophysical Quantification of Temporal Summation in the Human Nociceptive System. *Eur J Appl Physiol Occup Physiol* 68:266–273
- Arendt-Nielsen L, Graven-Nielsen T, Svensson P et al. (1997) Temporal Summation in Muscles and Referred Pain Areas: An Experimental Human Study. *Muscle Nerve* 20:1311–1313
- Brennan TJ (1999) Postoperative Models of Nociception. *ILAR J* 40:129–136
- Dotson RM (1997) Clinical Neurophysiology Laboratory Tests to Assess the Nociceptive System in Humans. *J Clin Neurophysiol* 14:32–45
- Flores CM, Mogil JS (2001) The Pharmacogenetics of Analgesia: Toward a Genetically-Based Approach to Pain Management. *Pharmacogenomics* 2:177–194
- Graven-Nielsen T, Arendt-Nielsen L (2002) Peripheral and Central Sensitization in Musculoskeletal Pain Disorders: An Experimental Approach. *Curr Rheumatol Rep* 4:313–321
- Greenspan JD (2001) Quantitative Assessment of Neuropathic Pain. *Curr Pain Headache Rep* 5:107–113
- Kosek E, Hansson P (2003) Perceptual Integration of Intramuscular Electrical Stimulation in the Focal and the Referred Pain Area in Healthy Humans. *Pain* 105:125–131
- Kosek E, Ordeberg G (2000) Abnormalities of Somatosensory Perception in Patients with Painful Osteoarthritis Normalize Following Successful Treatment. *Eur J Pain* 4:229–238
- Rommel O, Malin JP, Zenz M, Janig W (2001) Quantitative Sensory Testing, Neurophysiological and Psychological Examination in Patients with Complex Regional Pain Syndrome and Hemisensory Deficits. *Pain* 93:279–293
- Siao P, Cros DP (2003) Quantitative Sensory Testing. *Phys Med Rehabil Clin N Am* 14:261–286
- Vaneker M, Wilder-Smith OH, et al. (2005) Patients initially diagnosed as 'warm' or 'cold' CRPS 1 show differences in central sensory processing some eight years after diagnosis: a quantitative sensory testing study. *Pain* 115:204–211
- Wilder-Smith OH (2000a) Changes in Sensory Processing after Surgical Nociception. *Curr Rev Pain* 4:234–241
- Wilder-Smith OH (2000b) Pre-Emptive Analgesia and Surgical Pain. *Prog Brain Res* 129:505–524
- Wilder-Smith OH, Tassonyi E, Cruil BJ et al. (2003) Quantitative Sensory Testing and Human Surgery: Effects of Analgesic Management on Postoperative Neuroplasticity. *Anesthesiology* 98:1214–1222
- Wilder-Smith OH, Tassonyi E, Senly C et al. (1996) Surgical Pain is Followed not only by Spinal Sensitization but also by Supraspinal Antinociception. *Br J Anaesth* 76:816–821
- Zaslansky R, Yarnitsky D (1998) Clinical Applications of Quantitative Sensory Testing (QST). *J Neurol Sci* 153:215–238

## Quantitative Sensory Tests

### Synonyms

QST

### Definition

Quantitative sensory tests (QST) are techniques employed to measure the intensity of stimuli needed to produce specific sensory perceptions. They quantify nervous system input-response relations, allowing detection and quantification of nociceptive neuroplasticity. Quantitative sensory tests provide insight into nociceptive mechanisms, with the potential to provide the diagnostics for mechanism-based approaches to perioperative nociception and pain management. Quantitative sensory tests are used to evaluate a sensory detection threshold or other sensory responses from supra-threshold stimulation. The common physical stimuli are: (i) touch-pressure, (ii) vibration, and (iii) coolness, warmth, cold pain, and heat pain. Thermal somatosensory testing allows the clinician to test small nerve fibers. In this technique, thresholds for warmth, cold, heat-induced pain and cold-induced pain are quantitatively measured and then compared to age-matched normal population values. A deviation from the normal range can indicate the existence of peripheral nerve disease. Vibratory sensory testing enables the clinician to test large nerve fibers and is useful as an aid in early diagnosis, follow-up, and therapy assessment. It measures sensory thresholds for vibration. These thresholds deviate from the normal range in diabetic neuropathy and peripheral nerve diseases. In QST, the subject must be able to comprehend what is being asked by the test, be alert and not taking mind-altering medications, and not biased to a certain test outcome.

- ▶ [Diagnosis and Assessment of Clinical Characteristics of Central Pain](#)
- ▶ [Postoperative Pain, Acute Presentation of Complex Regional Pain Syndrome](#)
- ▶ [Postoperative Pain, Persistent Acute Pain](#)

## Quantitative Thermal Sensory Testing of Inflamed Skin

LOUISE HARDING  
Hospitals NHS Foundation Trust, University College  
London, London, UK  
louise.harding@uclh.org

### Definition

Psychophysical tests using hot and cold stimuli (or heat) to investigate inflammation evoked changes in small fibre pathways.

### Characteristics

Quantitative thermal sensory testing gives an indirect measurement of the ► [somatosensory pathways](#) involved in communicating thermal signals. Thermal stimuli are detected and transduced by A $\delta$  and C ► [primary afferent fibres](#). A $\delta$  cool fibres transmit the sensation of cold and A $\delta$  nociceptors relay fast sharp thermal pain. Warm C fibres convey innocuous warming signals and C nociceptors mediate burning sensations. Through studying the temperature-sensation relationship of both innocuous and noxious thermal sensations, sensory testing can be used to investigate changes in activity of these small fibre pathways in experimental and clinical conditions.

The methods used to investigate thermal sensation have changed over the years, as more and more sophisticated assessment tools have evolved. Many investigators use electronically controlled contact thermodes, which are held against the skin and programmed to heat or cool following specific operator set parameters. Alternatively, if only a heat stimulus is required, xenon lamps, argon or CO<sub>2</sub> lasers can be used (Arendt-Nielson and Bjerring 1988; Sumikura et al. 2003). These radiant heat methods cannot be manipulated and controlled as readily as contact thermodes, but as they do not touch the skin, they have the advantage of giving heat without also activating mechanosensitive fibres. The subject uses feedback systems, rating scales and questionnaires to report thermal sensation information. By manipulating the rate, amplitude and duration of thermal stimulus, a wealth of information about thermal sensibility can be recorded.

Inflamed skin, as anyone who has tried to take a hot shower with sunburn will know, is much more sensitive to heat. Using human models of inflammatory pain, quantitative thermal sensory testing can be used to characterise this heat hypersensitivity. The most prominent change in thermal sensitivity that develops in inflamed skin, is a decrease in the heat pain threshold, i.e. the temperature at which a hot stimulus produces a sensation of pain. Heat pain thresholds can be reduced by as much as 8°C in inflamed skin, from an average heat pain threshold of 43°C to a normally luke warm 36°C. This reduction in heat pain threshold can be readily assessed using contact thermodes and a testing algorithm called the Method of Limits (Yarnitsky and Ochoa 1990). The essence of the test is as follows, the thermode is held against the skin at a neutral temperature, and warmed at an operator-controlled rate. Subjects are requested to press a button the instance they feel the thermode stimulus change from 'hot' to 'pain'. When the button is pressed a feedback system switches off the heating, and the arresting temperature is recorded as the heat pain threshold. The method is quick and simple with high repeatability. Decreases in threshold, which have been shown in a number of different experimental models of inflammatory pain, are shown in Table 1. The method

Q

**Quantitative Thermal Sensory Testing of Inflamed Skin, Table 1** Heat Pain Thresholds in Human Models of Experimental Inflammation

Model	Heat pain threshold (°C)				
	Burn <sup>a</sup>	Capsaicin <sup>b</sup>	UV <sup>c</sup>	Freeze <sup>b</sup>	mustard oil <sup>d</sup>
Baseline	44.5	42.5	44.5	42.5	42.1
Inflamed skin	39.7	33.7	36.7	37.1	36.5
change in threshold	-4.8	-8.8	-7.8	-5.4	-5.6

a: Pedersen and Kehlet 1998b; b: Kilo et al. 1994; c: Benrath et al. 2001; d: Schmeltz et al. 1996

used to evoke inflammation will affect the change in threshold. For instance, ► **capsaicin**, which directly sensitises the heat responsive ion channels, tends to produce a bigger decrease in heat pain threshold than tissue damage models where ► **sensitisation** is indirect, evoked by injury released endogenous ► **inflammatory mediators** sensitising heat responsive ion channels.

The development of heat pain sensitisation appears to follow a similar time frame to the development of other features of inflammation such as pain and erythema. This has been shown in the burn and capsaicin models, where decreased heat pain thresholds are evident within 5 minutes of application of the inflammatory stimulus. Heat pain thresholds can remain reduced for the duration of the inflammatory response, and generally return to pre-inflammation levels with the resolution of skin reddening. Some drop in heat pain threshold may, however, still be evident for many hours after blood flow has returned to normal (Benrath et al. 2001).

Inflammation produces changes in thermal sensitivity not only within the inflamed area but also in surrounding skin, in an area termed the secondary zone. Absolute heat pain thresholds are not changed in this area, but there is an increase in the perceived intensity of supra-pain threshold heat stimuli (Pedersen and Kehlet 1998a; Yucel et al. 2002). This change in perceived intensity can again be characterised with simple quantitative thermal sensory testing. Typically, a contact thermode or radiant heat source is programmed to give a supra-heat pain threshold stimulus, and the subject is instructed to rate the pain intensity of the stimulus using simple visual analogue scales (VAS) or 0–10 ordinal pain intensity scales. This type of assessment method is relatively crude, and consequently only large changes in sensation intensity tend to be detected. Integrated electronic VAS systems, which capture intensity scores every tenth of a second, are currently available with many commercial contact thermode assessment machines. These greatly increase the sensitivity of the test, such that subtle changes in stimulus intensity can be identified. Electronic intensity scales also allow real time intensity measures with changing temperature, thus enabling precise elucidation of stimulus response function of human perception of thermal stimuli.

Whilst decreased heat pain thresholds are generally accepted as a peripheral event, heat hyperalgesia in skin surrounding the inflamed area is thought, by many, to be a central phenomena. Pharmacological studies showing differential modulation of sensory changes in the ► **primary and secondary zones** have helped clarify differences in mechanisms (Ilkjaer et al. 1997; Warner et al. 2001), although drug studies of secondary heat hyperalgesia are currently lacking. It has been suggested that heat hyperalgesia and secondary ► **punctate hyperalgesia** share common mechanisms. Like heat hyperalgesia, punctate hyperalgesia is characterised by an increase in the sharp pricking pain quality, and is also thought to be predominantly A $\delta$  mediated (Ziegler et al. 1999). Further research is required before full characterisation of increased heat sensitivity in inflamed skin is complete.

## References

1. Arendt-Nielsen L, Bjerring P (1988) Reaction Times to Painless and Painful CO<sub>2</sub> and Argon Laser Stimulation. *Eur J Appl Physiol Occup Physiol* 58:266–273
2. Benrath J, Gillardon F, Zimmermann M (2001) Differential Time Courses of Skin Blood Flow and Hyperalgesia in the Human Sunburn Reaction Following Ultraviolet Irradiation of the Skin. *Eur J Pain* 5:155–167
3. Ilkjaer S, Dirks J, Brennum J, Wernberg M, Dahl JB (1997) Effect of Systemic N-Methyl-D-Aspartate Receptor Antagonist Dextromethorphan on Primary and Secondary Hyperalgesia in Humans. *Br J Anaesth* 79:600–605
4. Kilo S, Schmeltz M, Koltzenburg M (1994) Handwerker HO. Different Patterns of Hyperalgesia Induced by Experimental Inflammation in Human Skin. *Brain* 117:385–396
5. Pedersen JL, Kehlet H (1998) Secondary Hyperalgesia to Heat Stimuli after Burn Injury in Man. *Pain* 76:377–384
6. Pedersen JL, Kehlet H (1998b) Hyperalgesia in a Human Model of Acute Inflammatory Pain: A Methodological Study. *Pain* 74:139–151
7. Schmeltz M, Schmidt R, Ringkamp M, Forster C, Handwerker HO, Torebjörk HE (1996) Limitation of Sensitization to Injured Parts of Receptive Fields in Human Skin C-Nociceptors. *Exp Brain Res* 109:141–147
8. Sumikura H, Andersen OK, Drewes AM, Arendt-Nielsen L (2003) Spatial and Temporal Profiles of Flare and Hyperalgesia after Intradermal Capsaicin. *Pain* 105:285–291
9. Werner MU, Perkins FM, Holte K, Pedersen JL, Kehlet H (2001) Effects of Gabapentin in Acute Inflammatory Pain in Humans. *Reg Anesth Pain Med* 26:322–328
10. Yarnitsky D, Ochoa JL (1990) Studies of Heat Pain Sensation in Man: Perception Thresholds, Rate of Stimulus Rise and Reaction Time. *Pain* 40:85–91



11. Yucel A, Andersen OK, Nielsen J, Arendt Nielsen L (2002) Heat Hyperalgesia in Humans: Assessed by Different Stimulus Temperature Profiles. *Eur J Pain* 6:357–364
12. Ziegler EA, Magerl W, Meyer RA, Treede RD (1999) Secondary Hyperalgesia to Punctate Mechanical Stimuli. Central Sensitization to A-Fibre Nociceptor Input. *Brain* 122:2245–2257

## Quantitative Trait Locus Mapping

### Synonyms

QTL

### Definition

Genetic linkage mapping as applied to quantitatively varying traits. In QTL mapping, a genetically segregating population (e.g. an *F2 intercross* or backcross) is

„phenotyped“ at a trait of interest, and then „genotyped“ at polymorphic DNA markers (e.g. microsatellites or single-nucleotide polymorphisms) of known genomic location. Statistical evidence of co-inheritance between phenotypic values and genotype at a marker or series of markers is sought, called *genetic linkage*. Once genetic linkage between the phenotype and marker genotype is established, one can infer the presence of a controlling gene or genes in the genomic vicinity of the marker.

- ▶ Heritability of Inflammatory Nociception
- ▶ Opioid Analgesia, Strain Differences
- ▶ Single-Nucleotide Polymorphisms

## Quotas

- ▶ Training by Quotas



## Radial Arm Maze

### Definition

A behavioral test used to measure spatial and working memory.

- ▶ Nociceptive Processing in the Cingulate Cortex, Behavioral Studies in Animals

## Radiant Heat

### Definition

In the Tail-Flick Test the nociceptive stimulus is often a light beam focused on the tip of the tail.

- ▶ Tail-Flick Test

## Radiant Heat Test

- ▶ Thermal Nociception Test

## Radiant Stimulation

- ▶ Pain in Humans, Thermal Stimulation (Skin, Muscle, Viscera), Laser, Peltier, Cold (Cold Pressure), Radiant, Contact

## Radiculalgia

- ▶ Radicular Pain, Diagnosis

## Radicular Leg Pain

- ▶ Sciatica

## Radicular Nerve Root Pain

### Definition

Pain radiating from the back (usually from a slipped disk) to a distal part of the leg (or arm).

- ▶ Cancer Pain Management, Anesthesiologic Interventions, Neural Blockade

## Radicular Pain

### Definition

Pain in a dermatomal distribution (the distribution of referred symptoms caused by spinal nerve root irritation), which may resemble the distribution of classic dermatomal maps for cervical nerve roots, but is not infrequently provoked outside of the distribution of these classic dermatomal maps.

- ▶ Cervical Transforaminal Injection of Steroids
- ▶ Radicular Pain, Diagnosis

## Radicular Pain, Diagnosis

JAYANTILAL GOVIND

Department of Anaesthesia, Pain Clinic, University of New South Wales, Liverpool Hospital, Sydney, NSW, Australia

jaygovind@bigpond.com

### Synonyms

Radiculalgia; sciatica; Brachialgia

### Definition

Radicular pain is a form of pain caused by irritation of the sensory root or the dorsal root ganglion (DRG) of a spinal nerve.

Radicular pain is not nociceptive pain, for the neural activity arises from the dorsal root, and not from stimulation of peripheral nerve endings. Therefore, it is not synonymous with ▶ somatic pain or ▶ somatic referred pain, and needs to be distinguished from them.

Nor is radicular pain synonymous with radiculopathy. Whereas radicular pain is caused by the generation of ectopic impulses, radiculopathy is caused by the blocking of conduction along sensory and motor axons, and is characterised by loss of nerve function (Merskey and Bogduk 1994).

## Characteristics

### Pathophysiology

The introduction of computerised tomography (CT) and ► **magnetic resonance imaging** (MRI) has brought into question the belief that a simple mass effect adequately accounts for the mechanism of lumbar radicular pain. Studies have shown that in patients whose symptoms of sciatica had resolved, still showed the same mass effect on serial CTs, whilst conversely, disc herniations evident on CT or MRI may not be associated with either low back or lumbar radicular pain (Bogduk and Govind 1999). In animal studies, compression of a normal nerve root causes only a momentary discharge, too brief to account for radicular pain (Howe et al. 1977).

Ectopic impulses evoked by the compression of an uninjured DRG produce a train of sustained discharges mediated via the A- $\delta$ , C and the A- $\beta$  fibres (Howe et al. 1977), which may account for the distinctive quality of radicular pain – its shooting or electric nature. Hence a mechanical basis for radicular pain can be accommodated, provided that the dorsal root ganglion is regarded as the source of pain.

However, experiments in laboratory animals (Howe et al. 1977) and in post-surgical patients (Smith and Wright 1959; Kuslich et al. 1991) have shown that radicular pain can be generated from nerve roots, provided that they have been previously damaged. Thus, for lumbar radicular pain, it is feasible that two distinctive but not mutually exclusive mechanisms prevail.

On the one hand, nerve roots that are chronically compressed may become sensitised to mechanical stimulation. Whilst the exact mechanism is not known, the pathogenesis might include partial damage to the axon, neuroma-in-continuity, or focal demyelination, intraneural oedema, and impaired microcirculation, each of which is capable of generating ectopic impulses from the affected nerve (Devor 1996).

The second explanation invokes a chemically mediated non-cellular inflammatory process – a type of “chemical radiculitis”. Studies have shown the nucleus pulposus to be inflammotogenic and leukotactic (Olmarker et al. 1995); that injecting phospholipase A<sub>2</sub> (PLA<sub>2</sub>) into rat sciatic nerve produces demyelination, axonal injuries and increased macrophage phagocytic activity, and that the resulting mechanical hyperalgesia correlates with PLA<sub>2</sub> immunoreactivity (Kawakami et al. 1996). In the absence of nerve compression, applying nucleus pulposus in the epidural space causes a delay in the nerve conduction velocity of nerve roots, and methyl

prednisolone injected intravenously within twenty hours, prevents this reduction in conduction velocity (Olmarker et al. 1994).

The evidence would suggest that, unlike the DRG, for the dorsal nerve root to be a source of radicular pain due to disc herniation, an injury either mechanically or chemically induced is a pre-requisite.

With respect to cervical radicular pain, there are no equivalent experimental data. One study showed that applying a sufficiently strong stimulus to a normal dorsal nerve root is always followed by a peripheral radiation of pain; but gentle stimulation of dorsal roots previously affected by compressive lesions, evoked a sensation of pain or paraesthesia (Fryckholm 1951). Herniated cervical intervertebral discs have been shown to produce nitric oxide, metalloproteinases, interleukin-6 and prostaglandin E<sub>2</sub> (Kang et al. 1995), but their role as possible mediators of nerve root inflammation has not been fully ascertained.

### Clinical Features

Radicular pain has certain distinctive qualitative features. It is not dull or achy in quality. Where radicular pain has been produced experimentally, in all instances it has been perceived as a shooting or lancinating pain (Smith and Wright 1959; Kuslich et al. 1991) and unlike somatic pain, radicular pain has both a cutaneous and deep quality. Radicular pain can be episodic, recurrent or paroxysmal.

In the case of lumbar and sacral radicular pain, the pain is felt in the lower limb when L4, L5, S1, or S2 nerve roots are involved. Pain is typically felt along the back of the thigh, into the leg and into the foot. Pain does not follow the corresponding dermatome. Lumbar radicular pain travels through the lower limb along a narrow band usually not more than 5–8 cm wide (Smith and Wright 1959). Whilst it may be felt throughout the entire length of the lower limb, it is more commonly experienced below the knee than above the knee.

With respect to the cervical spine, typical patterns of radicular pain have been mapped (Slipman et al. 1998), but cervical radicular pain and cervical somatic referred pain have similar distributions. Hence the pattern of pain cannot be used to determine its cause or mechanism. Pain over the shoulder girdle and upper arm can be either somatic referred pain or radicular pain, but pain in the forearm and hand is unlikely to be somatic referred pain, and is more likely to be radicular in nature (Bogduk 1999). Pain that radiates into the upper limb, and is shooting electric in quality, is bound to be radicular in origin.

### Aetiology

A large number of lesions have been reported to cause radicular pain (Bogduk and Govind 1999; Bogduk 1999). Systematically, any abnormality of the vertebral column, or any space-occupying lesion of spinal tissues,



that impinges on a spinal nerve or its roots may cause radicular pain. These include: osteophytes, cysts, and tumours of the vertebral column; cysts and tumours of the spinal cord, nerve roots, and their dural sheaths; tumours of epidural fat and blood vessels; and infections, infestations, or metastatic deposits in the vertebral column or vertebral canal. However, herniation of an intervertebral disc is the single most common cause, followed by foraminal stenosis due to osteoarthritis of the zygapophysial joints.

The differential diagnosis includes intrinsic disorders of the dorsal root or its axons, such as diabetic neuropathy, postherpetic neuralgia, and various, rare dorsal root ganglionopathies.

### Diagnosis

Radicular pain must be distinguished from somatic referred pain. Although not an absolute distinction, radicular pain is sharp, shooting or lancinating in quality, and topographically it must involve a region beyond the spine. Imaging studies, including computerised tomography and magnetic resonance imaging, may assist in determining both the putative cause and the segmental level. Features of radiculopathy including absent reflexes, weakness, numbness or muscle wasting may be evident clinically. Electrophysiological tests for the investigation of patients with acute radicular pain are generally not helpful (Bogduk and Govind 1999; Bogduk 1999).

### Treatment

Physicians often prescribe what is commonly referred to as “conservative therapy” for radicular pain. Typically, this consists of exercises, traction, analgesics, and other measures, such as collars for cervical radicular pain. Multiple studies have shown that these interventions confer no benefit greater than that of the natural history of the condition (Bogduk and Govind 1999; Bogduk 1999).

Traditionally, the mainstay for treatment of radicular pain has been surgery, in the form of laminectomy and microdiscectomy for lumbar radicular pain, and foraminotomy for cervical radicular pain. Studies have shown that surgery does not achieve better long-term outcomes than conservative therapy, but surgery has the distinct advantage of providing prompt relief when used for patients with severe pain that does not respond to other measures (Bogduk and Govind 1999; Bogduk 1999).

Other interventions that have been advocated and tested for radicular pain include ► [epidural injection of steroids](#), and ► [Transforaminal Injection of Steroids](#).

### References

1. Bogduk N (1999) Medical Management of Acute Cervical Radicular Pain: An Evidence-Based Approach. Newcastle Bone and Joint Institute, Newcastle

2. Bogduk N, Govind J (1999) Medical Management of Acute Lumbar Radicular Pain: An Evidence-Based Approach. Newcastle Bone and Joint Institute, Newcastle
3. Devor M (1996) Pain Arising from Nerve Root and Dorsal Root Ganglion. In: Weinstein JN, Gordon SL (eds) Low Back Pain: A Scientific and Clinical Overview. American Academy of Orthopaedic Surgeons Rosemont, Illinois, pp 187–208
4. Fryckholm R (1951) Cervical Nerve Root Compression Resulting from Disc Degeneration and Root-Sleeve Fibrosis: A Clinical Investigation. *Acta Chirurgica Scandinav Supp* 160:10149
5. Howe JF, Loeser JD, Calvin WH (1977) Mechanosensitivity of Dorsal Root Ganglia and Chronically Injured Axons: A Physiological Basis for the Radicular Pain of Nerve Root Compression. *Pain* 3:25–41
6. Kang JD, Georgescu HI, McIntyre-Larkin L, Stanovic-Racic M, Evans CH (1995) Herniated Cervical Intervertebral Discs Spontaneously Produce Matrix Metalloproteinases, Nitric Oxide, Interleukin-6 and Prostaglandin E<sub>2</sub>. *Spine* 22:2373–2378
7. Kawakami M, Tamaki T, Weinstein JN, Hashizume H, Nishi I, Meller ST (1996) Pathomechanism of Pain-Related Behaviour Produced by Allografts of the Intervertebral Disc in the Rat. *Spine* 21:2101–2107
8. Kuslich SD, Ulstrom CL, Michael CJ (1991) The Tissue Origin of Low Back Pain and Sciatica: A Report of Pain Response to Tissue Stimulation during Operations on the Lumbar Spine using Local Anaesthesia. *Ortho Clinic North Amer* 22:181–187
9. Merskey H, Bogduk N (eds) (1994) Classification of Chronic Pain. Description of Chronic Pain Syndromes and Definitions of Pain Terms, 2<sup>nd</sup> edn. IASP Press, Seattle 1994
10. Olmarker K, Blomquist J, Stromberg J, Nanmark U, Thomsen P, Rydevik B (1995) Inflammotogenic Properties of Nucleus Pulposus. *Spine* 20:665–669
11. Olmarker K, Byrod G, Cornefjord M, Nordberg B, Rydevik B (1994) Effects of Methyl Prednisolone on Nucleus Pulposus Induced Nerve Root Injury. *Spine* 19:1803–1808
12. Slipman CW, Plataras CT, Palmitier RA, Huston CW, Sterenfeld EB (1998) Symptom Provocation of Fluoroscopically Guided Cervical Nerve Root Stimulation: Are Dynatomal Maps Identical to Dermatomal Maps? *Spine* 23:2235–2242
13. Smith MJ, Wright V (1959) Sciatica and the Intervertebral Disc. An Experimental Study. *J Bone Joint Surg* 40A:1401–1418

R

## Radiculopathies

PAOLO MARCHETTINI

Pain Medicine Center, Scientific Institute San Raffaele, Milano, Italy  
marchettini.paolo@hsr.it

### Synonyms

Root disease; sciatica; lumbago; cauda equina; neck pain; back pain

### Definition

► **Radiculopathy** is a pathological condition affecting the spinal roots of peripheral nerves (see ► [spinal root disease](#)). The term has no implication for the mechanism causing damage to the root, which may be mechanical compression / ischemia, inflammation or primary or metastatic tumour. Spondyloarthritis is by far the most common cause of radiculopathy. Radiculopathy, independent of the cause, is, in the majority of cases, a painful

medical condition. Besides pain, root injury may also cause weakness and sensory disorder. Weakness is obvious in the limbs, while abnormal sensation may also be detected in the chest and abdomen. Patients with radiculopathy tend to seek the opinion of a specialist in orthopaedic surgery, neurology or neurosurgery or, when pain prevails, of a pain specialist or an anaesthesiologist.

## Characteristics

### Clinical Features

Pain and related sensory motor symptoms in radiculopathy may appear suddenly (acute) or develop slowly with progressive increase, followed by improvement and relapse (chronic). Acute radiculopathy is almost exclusively caused by sudden compression of a root by a herniated intervertebral disk. In some cases the root is squeezed inside the radicular pocket by a disk fragment herniated into the foramina. The compressed root undergoes ischemia and also swelling that worsens the ischemia. Pain is usually reported to be very intense, interfering with common simple daily activities and sleep.

Pain is both nociceptive, originating from the ruptured ligament, the perineural sheath and the meninges, and neuropathic, originating from ectopic impulses generated by mechanical compression and ischemia of nociceptive afferents (small myelinated and myelinated). The nociceptive pain originates at root level and spreads above or below along the spine. The neuropathic pain radiates into the innervation territory of the root. Quite often nociceptive pain in lumbosacral radiculopathy is worsened by manoeuvres that increase spinal fluid pressure, such as sneezing, coughing and voiding. Such manoeuvres more rarely increase neck and upper limb pain in cervical radiculopathy. Transient mechanical compression of the cord causes sensations of an “electric shower” known as the *Lehrmitte* sign. *Lehrmitte*’s sign, which is usually not painful, may be provoked by forced extension or flexion of the neck. Lateral rotation of the head in the opposing direction of an elevated arm may cause root stretching in cervical radiculopathy (*Spurling* sign). Elevation of a lower limb in the supine position causes lumbosacral root stretching (*Lasègue* sign). *Spurling* and *Lasègue* signs are commonly painful, evoking both local pain (in the neck or back) and radicular pain. The single root stimulated by such manoeuvres may be readily identified by the selective anatomical distribution of the radicular dysesthesias. Neuropathic sensory symptoms and neuropathic pain are projected into the root’s anatomical territory. This anatomical territory consists of the cutaneous and also the bone and muscle structures innervated by that root (territory of positive sensation). It is a territory wider than the area of cutaneous hypoesthesia that may ensue following complete root section (territory of negative sensation) (Marchettini

1993; Marchettini and Ochoa 1994). Many patients are good “witnesses” and clearly perceive and describe the difference between the pain originating from ligaments (purely nociceptive) and the pain originating from root compression (nociceptive and neuropathic).

The typical medical history of radiculopathy in disk herniation is of preceding neck or back pain for many days or even months, which over time becomes very intense and more focal. The back pain suddenly disappears and is followed within hours by the radicular pain. Radicular pain combines nociceptive neck or back pain of various qualities, with neuropathic pain projected into the limb. The ► **neck pain**, which is due to meningeal and cervical root compression, radiates over a wide area in the neck, and is often referred into the scapular area. The equivalent back pain radiates into the buttocks. The neuropathic radicular pain combines large fibre positive symptoms (tingling and numbness) and small fibre positive symptoms (pins and needles from small myelinated fibres, burning, deep soreness, squeezing and cramp-like from unmyelinated fibres). Axonal degeneration is not confined to the site of root compression, but extends to the primary sensory neurons within the dorsal root ganglion as a result of the axon reaction. Therefore sensory loss may be long lasting even after root decompression.

When the disk pinches the root, any movement elongating it worsens the pain. This leads to reflex paraspinal muscle contraction to avoid movement and to the search for a comfortable position reducing radicular stretching. This position is usually neck and back hyperextension and limb flexion, particularly the lower limb. To further avoid radicular stretching, patients tend to sleep on their side. In the ► **cauda equina** syndrome, short distance walking evokes symptoms of neuropathic pain and paresthesias in the legs and buttocks. Curiously, biking or walking, or any lower limb activity practiced while bending forward, may be symptom-free. Probably this happens because tilting forward reduces intraspinal pressure and interferes less with radicular blood flow. Rare alternative mechanical causes of single segment radiculopathy or cauda equina syndrome are epidural varices (Genevay et al. 2002), synovial cysts (Yarde et al. 1994) or even perineural cysts filled with cerebrospinal fluid (Tarlov 1938). Primary root tumours are Schwannomas and neurinomas. Spinal roots may also be compressed by bone metastasis or, more rarely, invaded by leptomeningeal metastasis. The latter event is becoming more common because of spinal fluid sequestration of metastatic cells in patients surviving systemic chemotherapy.

### History

Until the mid part of the last century, intervertebral disc herniation, which is the most common cause of radiculopathy, was hard to distinguish among the multiple other nerve root diseases caused by tuberculosis, syphilis and cancer. Radiculopathy caused by disk com-

pression was often recognised late when it reached the paralysing state and thus carried a poor general prognosis. Nevertheless, in the late 1940's Guillain and Barré polyradiculoneuropathy, which is a rare condition, was considered the most common "reversible" or "curable" root disease (Henri Roger quoted by Bénard 1966). Historical note, Cotugno, a master of the Salernitan School, is classically credited with having been the first to describe the characteristic distribution of radicular pain in the leg that in 1764 he named "► sciatica" (ischias postica, or morbus ischiaticus). However it is not until 1934 that Mixter and Barr (quoted by Parisien and Ball 1998) established a relationship between rupture of the intervertebral disc and lumbosacral radiculopathy, an observation that took about two additional decades to gain wider recognition. This knowledge led to enthusiastic, aggressive root decompression through surgical laminectomy that consequently produced a new iatrogenic entity, the "failed back surgery syndrome". The second most common cause of radiculopathy in spondyloarthritis, the intermittent claudication of the cauda equina, was recognised later by Blau and Logue in 1961.

### Anatomy

Nerve roots are made of 4–5 voluminous fascicles that ramify distally and give rise to the peripheral nerve plexus and peripheral nerves. Radicular fascicles already possess anatomical segregation, each one hosting fibres of well defined peripheral territories. Thus, partial root compression affecting one or two fascicles may mimic a peripheral nerve injury. Radicular fascicles are separated by epineural septa and embedded in the connective tissue of the perineurium. From the radicular pocket inward into the spinal canal, the perineurium fuses with the dura mater and is surrounded by the arachnoid that keeps the nerve root bathed in cerebrospinal fluid. Meninges and perineurium are sensitive structures, innervated by nociceptive nerve endings. As a consequence, inflammation and trauma of nerve roots always causes pain of mixed quality with irritation of the meninges and perineurium (nociceptive pain) and of radicular axons (neuropathic pain). Cervical and thoracic roots cross the intervertebral foramen corresponding to their anatomical level, while the lumbar and sacral roots show a progressive downward shift, due to the termination of the conus medullaris approximately at the first lumbar vertebral body. As a consequence, the cauda equina's lumbar and sacral roots first travel downwards within the vertebral canal and then reach the intervertebral foramen by taking off sideways with a variable angle (mean 40° for the lumbar and 23° for the sacral roots). Because of this they are more exposed to ischemia than thoracic or cervical roots. At the L4–L5 intervertebral level the L5 root is situated anterolaterally, displacing the S1 root laterally, while the lower sacral roots are positioned dorsally. Therefore the most

common disk protrusion, the L4–L5, may hit the L5 or S1 root depending on the median or lateral side of its bulging or herniation. Nerve roots receive a vascular supply from peripheral and central sources. However they are not served by a regional segmental supply. In the case of the cauda equina, ischemia is a considerable risk because the majority of the arteries are "end" arteries without effective anastomotic connections. The neural structure of the cauda equina occupies about half (44 %) of the cross sectional area of the spinal space. Constriction of the spinal canal increases the spinal fluid pressure on the roots by about 50 mm Hg for each 3<sup>rd</sup> reduction from normal. As a consequence, narrowing of the spinal canal severely affects the blood supply to the cauda equina.

### Diagnostic Work-up

Plain radiographs have been the traditional first-choice imaging technique and many clinicians still routinely prescribe them in back pain patients. It is well recognised, however, that particularly in the early stages of disc disease or other vertebral diseases, they have a low yield (McNally et al. 2001). Plain radiographs may show indirect signs of disc degeneration through reduction of the intervertebral space and osteoarthritic changes. However, such signs appear only in the advanced stages of spondyloarthritis. Their main utility is to rule out more worrisome causes of back pain and radiculopathy such as infection or metastasis. A loss of about 80 % of vertebral bone may be required before a destructive lesion can be visualised with this method. In addition plain radiographs cannot define the cause of nerve root compression. CT scanning allows proper examination of horizontal planes and explores roots and disks that are best visualised when degenerative changes from gas formation and calcification begin to appear. The gas, also known as vacuum phenomenon, was first observed by Fick in 1910; in 1942 Knutsson described its radiographic characteristics and it was first analysed by Ford and co-workers (1977), who reported that the gas was 90–95% nitrogen. CT scans, however, may completely miss early disk pathology. MRI, eventually with limited timesaving protocols, is becoming the method of first choice to explore radiculopathy.

One has to be aware that imaging techniques cannot predict clinical outcome. In the case of CT scans, for example, it has been shown that none of the features of disk herniation has any significant correlation with the pain prognosis. On the contrary, larger herniation or the presence of free disk fragments may be more common in patients who go on to have good outcomes (Beauvais et al. 2003). The same probably applies to MRI.

Another prognostic approach, electromyography, does not reveal all structural or clinical radiculopathy. However, its sensitivity may reach 92 % (Dillingham and Dasher 2000). In lumbosacral radiculopathy, electromyographic screening of 4 to 5 leg and paraspinal

muscles may provide valuable information in 89 % of cases of root disease. Electromyography is indicated when differential diagnosis is considered. The most common examples are polyradiculoneuropathy (Guillain-Barré), plexopathy, multineuropathy and the overall assessment of the patient to examine peripheral nerve function when systemic diseases such as severe diabetes or uraemia coexist. Electromyography is also recommended as a pre-surgical assessment before performing laminectomy, particularly in the presence of muscle weakness.

### Therapy

The majority of patients heal spontaneously without needing invasive procedures. Pain control is the only medical need in most cases. However, the clinical course in radiculopathy is quite variable. Although symptoms usually improve within 2 weeks, in a conspicuous minority of patients pain continues for months and at times years. In the first 2 months about 60 % of the patients have a marked improvement in back and leg pain. By 1 year, one third are still complaining of back or leg pain. Surgery is usually decided upon within the first year. Large and migrated disk herniations decrease spontaneously more than disk protrusions or small-contained herniations. Morphologic changes (reduction in protrusion or even hernia re-entry) may be observed; however they usually follow rather than anticipate the clinical improvement.

In addition, clinical improvement may be quite remarkable in the absence of morphological improvement. New minimally invasive percutaneous techniques have been proposed to reduce the risk of chronic arachnoiditis following back surgery. However, there are no clinical trials of percutaneous discectomy technique to provide definite evidence supporting the efficacy or advantages of the procedure. The success rate is 41 % for percutaneous discectomy *versus* 40 % for the conventional open method (Haines et al. 2002). There is controversy regarding the use of epidural steroids. The only agreement regarding its efficacy is in decreasing the symptoms of the acute phase (Boswell et al. 2005). There is no clear evidence that epidural steroids alter the natural history of radiculopathy or the morphology of herniation.

- ▶ Cervical Transforaminal Injection of Steroids
- ▶ Pain Treatment, Spinal Cord Stimulation
- ▶ Whiplash

### References

1. Beauvais C, Wybier M, Chazeraïn P et al. (2003) Prognostic value of early computed tomography in radiculopathy due to lumbar intervertebral disk herniation. A prospective study. *Joint Bone Spine* 70:134–139
2. Bénard H (1966) Eulogy of Henri Roger (1860–1946) *Bull Acad Natl Med* 150: 651–656
3. Blau JN, Logue V (1961) Intermittent claudication of the cauda equina: an unusual syndrome resulting from central protrusion of a lumbar intervertebral disc. *Lancet* 277:1081–1086
4. Boswell MV, Shah RV, Everett CR et al. (2005) Interventional techniques in the management of chronic spinal pain: Evidence-based practice guidelines. *Pain Physician* 8:1–47
5. Dillingham TR, Dasher KJ (2002) The lumbosacral electromyographic screen: Revisiting a classic paper. *Clin Neurophysiol* 111:2219–2222
6. Fick R (1910) *Handbuch der Anatomie und Mechanik der Gelenke unter Berücksichtigung der bewegenden Muskeln*, vol 2. G Fischer, Jena
7. Ford LT, Gilula LA, Murphy WA, Gado M (1977) Analysis of gas in vacuum lumbar disc. *Am J Roentgenol* 128:1056–1057
8. Genevay S, Palazzo E, Hutten D et al. (2002) Lumboradiculopathy due to epidural varices: Two case reports and a review of the literature. *Joint Bone Spine* 69:214–217
9. Haines SJ, Jordan N, Boen JR et al. (2002) Discectomy strategies for lumbar disc herniation: Results of the LAPDOG trial. *J Clin Neurosci* 9:411–417
10. Knutsson F (1942) The vacuum phenomenon in the intervertebral discs. *Acta Radiol* 23:173–9
11. Marchettini P (1993) Muscle pain: animal and human experimental and clinical studies. *Muscle Nerve* 16:1033–1039
12. Marchettini P, Ochoa JL (1994) The clinical implications of referred muscle pain sensation. *Am Pain Soc J* 3:10–12
13. McNally EG, Wilson DJ, Ostlere SJ (2001) Limited magnetic resonance imaging in low back pain instead of plain radiographs: experience with first 1000 cases. *Clin Radiol* 56:922–925
14. Orendacova J, Cizkova D, Kafka J et al. (2001) Cauda equina syndrome. *Prog Neurobiol* 64:613–637
15. Parisien RC, Ball PA (1998) William Jason Mixter (1880–1958). Ushering in the “dynasty of the disc” *Spine* 23:2363–2366
16. Tarlov IM (1938) Perineural cysts of the spinal root. *Arch Neurol Psych* 40:1067–1074
17. Yarde WL, Arnold PM, Kepes JJ et al. (1995) Synovial cysts of the lumbar spine: Diagnosis, surgical management, and pathogenesis report of eight cases. *Surg Neurol* 43:459–465

## Radiofrequency

### Definition

An electric current oscillating at high frequencies, usually > 400,000 cycles per second.

- ▶ Facet Joint Pain

## Radiofrequency Ablation

### Definition

The use of heat delivered via a high-frequency current to destroy tissue.

- ▶ Cancer Pain Management, Neurosurgical Interventions
- ▶ Facet Joint Procedures for Chronic Back Pain

## Radiofrequency Denervation

### Definition

Procedure by which a nerve is coagulated by heating the tip of an electrode to 80°C, with consequent loss of nociceptive transmission.

- ▶ Whiplash



## Radiofrequency Lesion

- ▶ Radiofrequency Neurotomy, Electrophysiological Principles

## Radiofrequency Neurotomy, Electrophysiological Principles

JAYANTILAL GOVIND

Department of Anaesthesia, Pain Clinic, Liverpool Hospital, University of New South Wales, Sydney, NSW, Australia  
jaygovind@bigpond.com

### Synonyms

RF; Thermo-coagulation; Radiofrequency Lesion; Heat Lesion; Thermal Neuroablation

### Definition

Radiofrequency (RF) neurotomy is a means of treating pain, by which the nerves from a source of pain are coagulated using an electrode, through which a high-frequency electrical current is passed, in order to heat the tissues immediately surrounding the tip of the electrode.

### Characteristics

RF neurotomy is not electrocautery. It is the creation of a targeted, therapeutic, thermal lesion achieved by passing a low energy, high frequency, alternating current (100,000 – 500,000 Hz) between the small surface area on the uninsulated tip of an (active) electrode, and the large surface area of a ground plate (the dispersive electrode) that is applied to a remote area of the body. The concentration of current in tissues around the active electrode achieves sufficient density to denature those tissues by heating them.

In Pain Medicine, RF neurotomy is used to coagulate peripheral nerves, in order to block nociceptive information from a source that is responsible for a patient's pain. Similar techniques are used to produce lesions in the central nervous system for the relief of ▶ [central pain](#).

### Electrophysiological Principles

Figure 1 illustrates the pattern of the electric current lines in the body between the active and dispersive electrode. The current leaving the large area of the dispersive plate is concentrated onto the small area of the exposed tip of the electrode.

The alternating current produced by the generator passes through the body, and agitates charged molecules in the tissues, thereby heating them. Where the current converges and concentrates towards the active tip of the electrode, current density is greater and heating is greater.

Heating occurs as a result of agitation of charged molecules in the tissues and the resultant friction between them. Thus, the tissue adjacent to the electrode becomes the source of heat, not the electrode itself. In proportion to the current density, temperatures are higher closer to the electrode. Accordingly, around the tip of the electrode, isotherms can be depicted (Fig. 2). If tissues are heated sufficiently they coagulate. The volume of coagulated tissue assumes the shape of a "prolate spheroid" (Organ 1976), whose long axis is formed along the uninsulated tip of the electrode (Fig. 3)

### Creation and Size of Lesion

The principal factors that govern temperature equilibrium between the electrode and the heated tissue are distance from the tip ( $r$ ), current intensity ( $I$ ), and duration ( $t$ ) of application (Lord and Bogduk 2002). Tissue heating ( $T$ ) varies with the square of the current intensity ( $I^2$ ); it decreases rapidly away from the tip by a factor of  $1/r^4$ ; and increases with the duration of application. Mathematically the relationship is (Lord and Bogduk 2002):

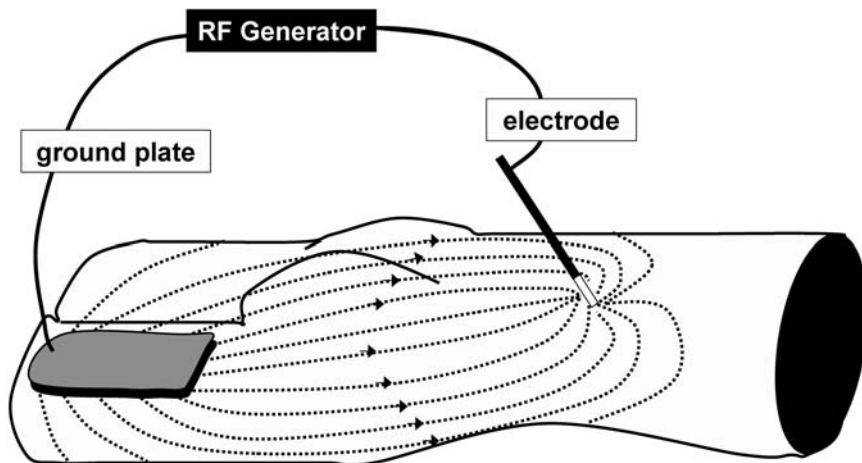
$$T \propto \left[ \frac{I^2}{r^4} \right] \times \log(Kt)$$

where  $K$  is a constant.

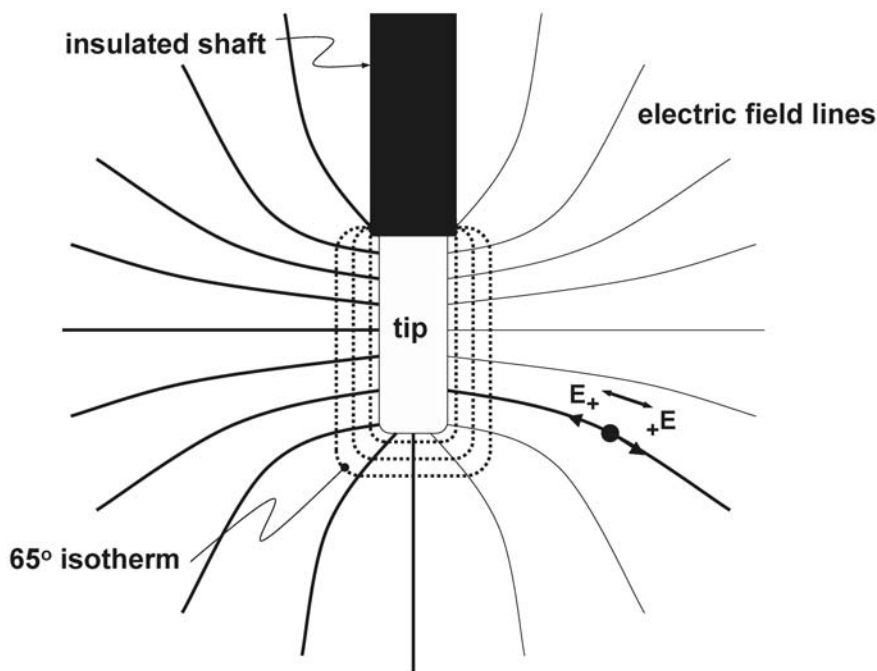
Sufficient time must be allowed for some of the heat to be transmitted to the periphery of the lesion volume. Optimal current should generate a lesion of a maximum volume for the size of the electrode tip. The rapid application of high current, however, may result in solidification and char formation, which in turn will impede current flow and heating. Due to the increased resistance, lesion-size becomes submaximal.

As the temperature of the electrode reaches 60°C, coagulation commences on the surface of the electrode tip (Lord and Bogduk 2002, Lord et al. 1988, Bogduk et al. 1987). The volume of coagulated tissue expands as the temperature reaches 80°C. At this temperature, the lesion is initially about 60% of maximal achievable size. If temperature is maintained at 80°C for thirty seconds, the lesion increases to 85% size. After sixty seconds, it reaches 94% maximal size. The growth of the lesion asymptotes at 90 seconds. Maintaining the current for longer than this does not achieve appreciable increases in the size of the lesion (Bogduk et al. 1987). Accordingly, the optimal duration for the maximal coagulation lies between sixty and ninety seconds.

Temperature monitoring is critical to safety. During coagulation the temperature should be increased slowly from body temperature to 80°C. A rate of 1°C per second is recommended. This slow increase allows patients to report any untoward sensations, and allows the operator to abort the lesion before any appreciable damage is done. Maintaining the temperature under 85°C not only



**Radiofrequency Neurotomy, Electrophysiological Principles, Figure 1** The electric field produced by a radiofrequency (RF) generator, between a ground plate on the body surface and an electrode introduced into the body. The field lines converge on the tip of the electrode.



**Radiofrequency Neurotomy, Electrophysiological Principles, Figure 2** The isotherms of a radiofrequency current. As the electric field ( $E$ ) oscillates, tissues are heated in proportion to the density of the field lines. Around the tip of the electrode, a temperature gradient is established, with temperatures highest at the surface of the electrode, but progressively less away from the electrode. The isotherms represent regions with the same temperature. The 65° isotherm is labelled.

ensures creating a lesion of maximal volume, but also avoids the risk of boiling, charring, and gas or steam formation, which can occur when higher temperatures are applied, and which compromise both the safety and the efficacy of the lesion made.

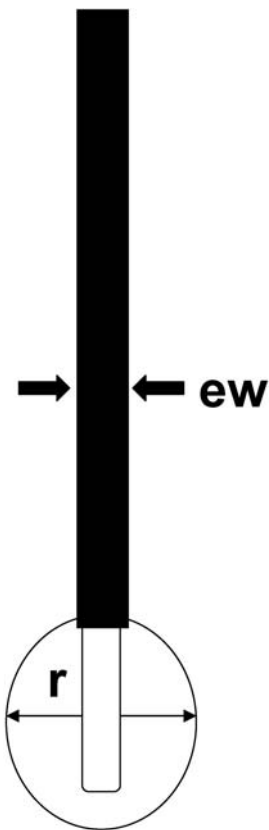
During coagulation, impedance should remain reasonably constant as power and temperature are increased. Erratic behaviour of the impedance and fluctuation of temperature indicates either faulty equipment or connections, or dissipation of heat into tissues such as blood or other fluids.

Electrodes with larger exposed tips produce larger lesions. Longer exposed tips produce elongated, elliptical lesions (Organ 1976; Alberts et al. 1966). Coagulation occurs principally in a radial direction perpendicular to the long axis of the electrode, i.e. sideways (Lord and Bogduk 2002; Lord et al. 1988; Bogduk et al. 1987).

Depending on the shape of the point of the electrode, relatively less coagulation occurs distal to the point.

The dimensions of lesions generated are proportional to the size of the electrode used, and can be normalised and expressed in terms of electrode-widths (Lord et al. 1988). In a radial direction, large diameter (1.6 mm) electrodes coagulate tissues up to  $1.6 \pm 0.3$  (mean  $\pm$  sd) electrode-widths away from the surface of the electrode. Distally, tissues up to  $0.4 \pm 0.2$  electrode-widths from the tip of the electrode are coagulated. With electrodes of smaller diameter (0.7 mm), the radial range is  $2.3 \pm 0.4$  electrode-widths, and the distal range is  $1.4 \pm 0.4$  electrode-widths.

These figures indicate that electrodes must be placed accurately, i.e. very close to the target nerve, in order to ensure that it is coagulated. Since the electrode-width of smaller electrodes is less than 1 mm, the electrode will,

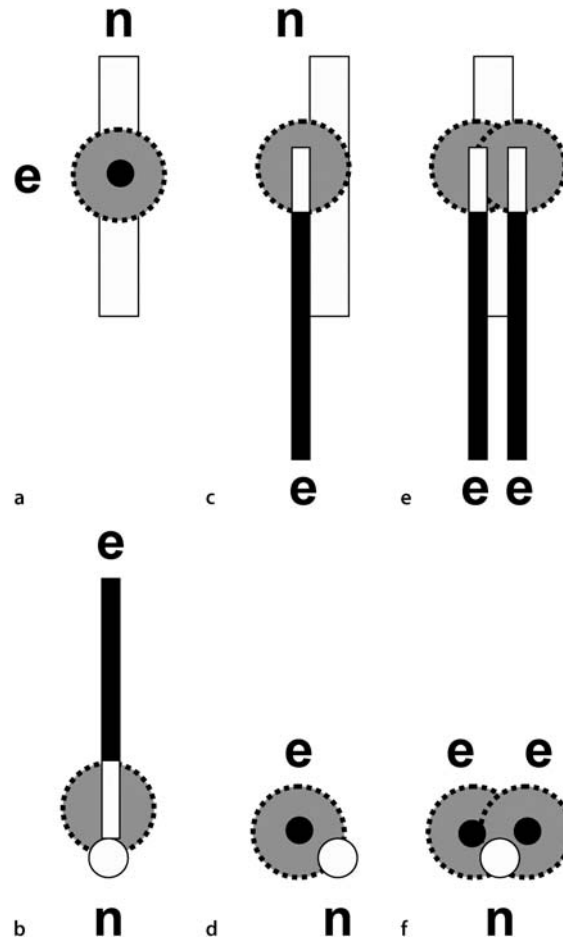


**Radiofrequency Neurotomy, Electrophysiological Principles, Figure 3** The shape of a radiofrequency lesion. Tissues are heated in a more radial direction from the tip of the electrode than in a distal direction. On average, the effective radius ( $r$ ) of the lesion is about twice the diameter, or less, of the electrode's width ( $ew$ ).

on average, coagulate nerves within 2 mm of its surface. However, there is a 17.5% chance of failing to coagulate the nerve, if it is not within 1.3 mm (mean size of lesion minus one sd) of the electrode. Larger electrodes coagulate tissues within 2.6 mm from their surface, with a one standard deviation lower limit of 2 mm. Electrodes placed perpendicular to the target nerve may miss coagulating the nerve completely (Fig. 4a). For optimal coagulation, the electrode must be placed parallel to the nerve (Lord and Bogduk 2002; Lord et al. 1988; Bogduk et al. 1987). Creating multiple, parallel lesions compensates for possible inaccuracies in placing the electrode exactly on the target nerve. However, to be effective those lesions must be centred no further than one electrode-width from another. At greater displacements, nerves may escape coagulation because of the circular, cross-sectional shape of the lesions generated (Fig. 4b).

#### Physiology

By coagulating neural tissue, RF neurotomy creates a mechanical barrier to the transmission of nociceptive traffic. The denatured proteins in the nerve are incapable



**Radiofrequency Neurotomy, Electrophysiological Principles, Figure 4** The problems of matching a radiofrequency electrode ( $e$ ) and its lesion to the target nerve ( $n$ ). (a) top view; (b) transverse view; of an electrode placed perpendicularly onto a nerve. Although the electrode rests on the nerve, the lesion it makes is largely proximal to the nerve, for little lesion is produced distal to its tip. As a result the nerve may escape complete coagulation. (c) top view; (d) transverse view; of electrodes placed parallel to the target nerve. Since the electrodes coagulate transversely, the nerve is more likely to be incorporated into the lesion. (e) top view; (f) transverse view; of an electrode placed in two positions on a target nerve. If the two placements are not more than two electrode widths apart, their lesions overlap, and maximise the likelihood of the nerve being coagulated thoroughly.

R

of transmitting action potentials across the denatured zone.

Earlier views, that radiofrequency neurotomy selectively destroys A $\delta$  and C fibres (Letcher and Goldring 1968), have not been corroborated. Experiments have established that radiofrequency neurotomy results in indiscriminate destruction of small unmyelinated, small myelinated and large myelinated fibres (Smith et al. 1981), including alpha motor neurones (Dreyfuss et al. 2000).

Recovery from RF neurotomy is not a simple matter of nerve regeneration. Before regeneration can occur, the coagulated proteins have to be removed and replaced,

and the affected segment of nerve reconstituted. This takes considerably longer time than conventional regeneration of a nerve after it has been cut.

### Indications

The classical indication for RF neurotomy is ► [trigeminal neuralgia](#). Otherwise, RF neurotomy can, in principle, be applied to any peripheral nerve that has been shown to be responsible for mediating a patient's pain. However, the procedure has only been validated in the context of certain forms of spinal pain.

Pain arising from the lumbar or cervical zygapophysial joints can be treated by performing RF neurotomy of the nerves that innervate those joints. The cardinal indication for this therapy is complete relief of pain following controlled, ► [lumbar medial branch blocks](#) or ► [cervical medial branch blocks](#), respectively.

Experimental applications include lumbar discogenic pain and certain forms of sacroiliac joint pain (Lord and Bogduk 2002).

### Side Effects and Complications

In principle, the side effects of RF neurotomy are due to the loss of function of the nerve that is coagulated. If the nerve has a cutaneous distribution, numbness will occur in that distribution. Hyperaesthesia may complicate this denervation. If the nerve has a major proprioceptive function, impaired proprioception should be expected. When motor fibres are coagulated, muscle denervation will occur.

The generic complications that may occur are those associated with any percutaneous procedure: infection, haematoma, allergy, and unintended damage to structures adjacent to the target nerve. Potential complications specific to RF neurotomy are electrical in nature, and include burns resulting from damaged insulation of the electrode, or from incorrect application of the dispersive plate. In particular, alternatives to plate electrodes, such as spinal needles, should not be used as the ground electrode. In that event, current concentrates around the needle and will cause burns along its entire length.

### Efficacy

To be consistent with the rationale for the procedure, complete relief of pain should be the standard outcome. If diagnostic blocks produce complete relief, so should RF. If complete relief is not achieved, either the patient was incorrectly selected or the procedure may have been technically imperfect.

Specific data, from observational studies and from controlled studies, are available for ► [cervical medial branch neurotomy](#), for ► [lumbar medial branch neurotomy](#) and for trigeminal neurotomy. Early data are available for sacroiliac neurotomy. These are provided in the sections dealing with these procedures. For other

applications of RF neurotomy, comparable data are not available.

### References

1. Alberts WW, Wright EW, Feinstein B, von Bonin G (1966) Experimental Radiofrequency Brain Lesion Size as a Function of Physical Parameters. *J Neurosurg* 25:421–423
2. Bogduk N, MacIntosh J, Marsland A (1987) Technical Limitations to the Efficacy of Radiofrequency Neurotomy for Spinal Pain. *Pain* 20:529–535
3. Dreyfuss P, Halbrook B, Pauza K, Joshi A, McLarty J, Bogduk N (2000) Efficacy and Validity of Radiofrequency Neurotomy for Chronic Lumbar Zygapophysial Joint Pain. *Spine* 25:1270–1277
4. Letcher FS, Goldring S (1968) The Effect of Radiofrequency Current and Heat on Peripheral Nerve Action Potential in the Cat. *J Neurosurg Sci* 29:42–47
5. Lord SM, Bogduk N (2002) Radiofrequency Procedures in Chronic Pain. *Best Practice and Research. Clin Anaesthesiol* 16:597–617
6. Lord SM, McDonald GJ, Bogduk N (1988) Percutaneous Radiofrequency Neurotomy of the Cervical Medial Branches: A Validated Treatment for Cervical Zygapophysial Joint Pain. *Neurosurgery Quarterly* 8:288–308
7. Organ LW (1976) Electrophysiologic Principles of Radiofrequency Lesion Making. *Appl Neurophysio* 39:69–76
8. Smith HP, McWhorter JM, Challa VR (1981) Radiofrequency Neurolysis in a Clinical Model: Neuropathological Correlation. *J Neurosurg* 55:246–253

## Radiofrequency Rhizotomy

### Definition

Treatment of TN by an injury produced by a radiofrequency current, applied through a needle placed in the space around the sensory (Gasserian) ganglion containing the cell bodies of the sensory fibers in the trigeminal nerve.

- [Trigeminal, Glossopharyngeal, and Geniculate Neuralgias](#)

## Radiography

- [Plain Radiography](#)

## Radioisotope

### Definition

An isotope that is radioactive, i.e. one having an unstable nucleus, which gives it the property of decay by one or more of several processes.

- [Cancer Pain Management, Radiotherapy](#)



## Radio-Ligand Binding

### Definition

A method for detecting the distribution of receptors in tissue sections, based on the use of radio-labeled compounds that bind specifically to the receptor. These can then be revealed with autoradiography.

- ▶ [Opioid Receptors at Postsynaptic Sites](#)

## Radiopharmaceuticals

### Definition

Radioisotopic medications that emit radiation for diagnostic or therapeutic purposes including bone cancer pain management.

- ▶ [Adjuvant Analgesics in Management of Cancer-Related Bone Pain](#)

## Radiosurgical Rhizotomy

### Definition

Treatment of TN by a mild injury produced by irradiation of the intracranial portion of the trigeminal nerve using focused, MRI guided radiation, using either cobalt (gamma ray) or a linear accelerator as a source.

- ▶ [Trigeminal, Glossopharyngeal, and Geniculate Neuralgias](#)

## Radiotherapy

### Definition

Treatment of disease by ionizing radiation.

- ▶ [Adjuvant Analgesics in Management of Cancer-Related Bone Pain](#)

## Raeder's Paratrigeminal Syndrome

### Definition

A combination of pain, ipsilateral oculosympathetic defect and ipsilateral trigeminal dysfunction.

- ▶ [Headache due to Dissection](#)

## Ramus

### Definition

Ramus refers to a branch; a projecting part.

- ▶ [Facet Joint Pain](#)

## Randall-Selitto Paw Pressure Test

VALERIE KAYSER

NeuroPsychoPharmacologie Médecine, INSERM U677, Faculté de Médecine Pitié-Salpêtrière, Paris, France

kayser@ext.jussieu.fr

### Definition

Rat-appropriate mechanical assay based on the use of short-duration stimuli (in the order of seconds). In the course of this pain test, a pressure of increasing intensity is applied to a punctiform area on the hind paw, or far less commonly, on the tail. The monitored reactions range from paw withdrawal reflexes (the rat withdraws its paw) to more complex organized unlearned behaviors (escape or vocalization). The measured parameter is the threshold (weight in grams) for the appearance of a given behavior. Tests using constant pressure have been abandoned progressively for those applying gradually increasing pressures.

### Characteristics

The Randall-Selitto paw pressure test (Randall and Selitto 1957) is a sensitive assay, able to show effects for the different classes of antinociceptive agents, at doses comparable to those used for analgesics in humans (refs. in Guilbaud et al. 1999). Its predictability is strong related to situations in which one is trying to understand the basic mechanisms underlying pain, and in terms of identifying analgesic molecules. Results obtained with this assay are reproducible not only within the same laboratory but also between different laboratories. Its advantage is a precise stimulus application (e.g. right vs. left paw). Further, the test allows simultaneous analysis of the ▶ [threshold](#) of response to noxious stimulation of a spinal reflex (▶ [withdrawal](#) of the limb) on the one hand, and a centrally processed reaction (▶ [vocalization](#)) on the other (Kayser and Christensen 2000). The method has been helpful especially for assessing mechanical hypersensitivity under varied experimental conditions, such as during different phases in localized inflammation (Kayser and Guilbaud 1987; Kayser et al. 1998). It requires, however, restraining of the rat by hand. Thus, the animals cannot control the intensity or duration of the stimulus. From a physiological point of view, it seems essential that three parameters in this test can be controlled with some precision by the experimenter: the intensity, the duration, and the surface area of stimulation. These three parameters determine the global quantity of nociceptive information that will be carried to the central nervous system by the peripheral nervous system. In healthy rats, this type of mechanical stimulation has a certain number of disadvantages. Firstly, repetition of the stimulus can produce a diminution, or conversely

an increase, in the sensitivity of the stimulated part of the body; in the latter case this carries the risk that the tissues may be altered by inflammatory reactions that could call into question the validity of repeated tests. Secondly, there is the necessity of applying relatively high pressures. Lastly, there is a non-negligible level of variability of the responses. With the aim of improving the sensitivity of the test, Randall and Selitto (1957) proposed comparing the thresholds observed with a healthy paw and with an inflamed paw, based on the principle that inflammation increases the sensitivity to pain, and that this increased sensitivity is susceptible to modification by analgesics. The inflammation was induced beforehand by a subcutaneous injection into the area to be stimulated of substances such as croton oil, beer yeast, or carrageenin, the last of these being the most commonly used today. Even though it was found that the sensitivity of the method was improved it was to the detriment of its specificity, because two different pharmacological effects, analgesic and anti-inflammatory, could be confused. However, a comparison in the same animal of responses triggered from a healthy and an inflamed paw allows this problem to be overcome: nonsteroidal anti-inflammatory drugs are inactive on the former, but do increase the lowered vocalization threshold when pressure is applied to the latter (Winter and Flataker 1965). The mechanical stimulation used differs notably from the application of von Frey filaments, often almost revered by neurologists, but which has the disadvantage of activating low-threshold mechanoreceptors as well as nociceptors. There are also technical difficulties in applying mechanical stimuli in freely moving rats.

In practice, as illustrated in Figure 1, the paw or tail (Kayser et al. 1996) is jammed between a plane surface, and a blunt point mounted on top of a system of



**Randall-Selitto Paw Pressure Test, Figure 1** Mechanical stimulation is made using the procedure of Randall and Selitto (1957), with an Ugo Basile analgesimeter: a linearly increasing force is applied via a dome shaped plastic tip ( $\varnothing = 1$  mm) onto the surface of the hindpaw. The force causing paw withdrawal is quoted, as well as that inducing vocalization (audible squeak).

cogwheels with a cursor that can be displaced along the length of a graduated beam. These devices permit the application of constantly increasing pressure and the interruption of the assay when the threshold is reached. When the pressure increases, one can see successively the reflex withdrawal of the paw, a more complex movement whereby the animal tries to release its trapped limb, then a sort of struggle (animal tries to escape, not always observed), and thereafter vocalization (an audible squeak) (Winter and Flataker 1965). The stimulus intensity necessary to elicit paw withdrawal from mechanical stimulation, struggle reaction or vocal response from the animal is determined. If the first of these monitored reactions is undoubtedly a proper spinal reflex, although under influence of descending supra-spinal inputs, the last two clearly involve supra-spinal structures (Winter and Flataker 1965). It was firmly established in experiments in which the effect of interruption of the anterolateral quadrant of the rat cervical spinal cord, as well as partial lesion of the lateral ventrobasal complex of the thalamus has been determined, using paw withdrawal and vocalization threshold to paw pressure as the endpoints. Both lesions led to a large enhancement of the vocalization threshold to paw pressure, but did not alter the paw withdrawal threshold (Kayser et al. 1985). Other studies have shown that systemic low doses of morphine, that strongly depressed neuronal thalamic but not spinal responses to noxious stimuli in the rat, produced marked effects in the first but not in the second of these two tests (Kayser and Guilbaud 1990; Kayser 1994).

In our laboratory, a mechanical stimulus was applied using the Ugo Basile analgesimeter (Apelex). This instrument, controlled by a pedal, generates a linearly increasing pressure applied through a dome-shaped plastic tip (1mm diameter) onto the dorsal surface of the paw. The rat is gently held by the trunk, leaving the head and limbs freely exposed. Testing sessions are conducted in a quiet room. Rats are randomly assigned to groups of five or six for a given series of tests, and are not acclimatized to the test situation beforehand. Force is applied until the rat withdraws its limb (withdrawal threshold to paw pressure) and/or squeaks (vocalization threshold to paw pressure). The withdrawal reflex that occurs before vocalization is prevented by smoothly holding the rat's hind paw in position under the pusher until vocalization. The two paws are tested consecutively in each rat. The sequence of sides is alternated between the animals to prevent 'order' effects. For each rat, a control threshold (mean of two consecutive stable thresholds expressed in grams) is determined before injecting the drug. After drug administration, nociceptive pressure thresholds are measured every 5 or 10 min, until they have returned to the level of the control values. Thus, each rat is its own control. Results are then expressed in grams or as a percentage of the control values. Based on the principle that the

application of the stimulus must not produce lesions, one often defines a limit for how long the animal should be exposed to the stimulus (the cut-off level; around 600g, Fletcher et al. 1997). This limit is absolutely necessary when the intensity of the stimulus is increasing, for the prevention of skin damage. In some cases, the threshold of another reaction, ► **struggle**, is noted, but this response, although considered by some authors as reliable (see discussion in Winter and Flataker 1965) is difficult to assess and therefore, appears unsuitable for pharmacological studies.

In the paw withdrawal threshold test, the pressure for a brisk motor response is used as the endpoint. This simple reflex measure permits the animal to have control over stimulus magnitude, and thus ensures that the animal can control the level of pain. Reflex responses, however, suffer from a number of limitations as measures of pain behavior. They are a measure of reflex activity and not pain sensation. Changes in reflex activity can result from alterations in motor as well as sensory processing. In addition, drugs that affect motoneuron or muscle function will alter reflex latencies in a manner similar to analgesic drugs. Vocalization is another commonly used reaction to painful stimuli. Using the vocalization threshold to paw pressure test, antinociceptive effects of analgesic compounds have been elicited using low doses, devoid of obvious side effects such as drowsiness or locomotor deficit (Christensen et al. 1998). Thus, the test may be useful when assessing the activity of newly designed analgesic substances (Kayser et al. 2003). This approach also appears to be a good tool to determine the optimal use of peripheral versus systemic administration of analgesic compounds (refs in Kayser and Guilbaud 1994; Guilbaud et al. 1999). Finally, the effects of compounds on the two nociceptive thresholds can be systematically compared, in order to explore the relative contribution of spinal versus supra-spinal mechanisms to their antinociceptive effects (Kayser and Christensen 2000; Aubel et al. 2004).

## References

- Aubel B, Kayser V, Mauborgne A, Farre A, Hamon M, Bourgoïn S (2004) Antihyperalgesic effects of cizolirtine in diabetic rats: behavioral and biochemical studies. *Pain* 110:22–32
- Christensen D, Idänpään-Heikkilä JJ, Guilbaud G, Kayser V (1998) The Antinociceptive Effect of Combined Systemic Administration of Morphine and the Glycine/NMDA Receptor Antagonist, (+)-HA966 in a Rat Model of Peripheral Neuropathy. *Br J Pharmacol* 125:1641–1650
- Fletcher D, Kayser V, Guilbaud G (1997) The Influence of the Timing of Bupivacaine Infiltration Induced by Two Carrageenin Injections Seven Days Apart. *Pain* 69:303–309
- Guilbaud G, Kayser V, Perrot S, Keita H (1999) Antinociceptive Effect of Opioid Substances in Different Models of Inflammatory Pain. In: Kalso E, McQuay H and Wiesenfeld-Hallin Z, (eds) Opioid Sensitivity of Chronic Noncancer Pain, *Progress in Pain Research and Management*, vol 14. IASP Press, Seattle, pp 201–223
- Kayser V (1994) Endogenous Opioid Systems Involved in the Modulation of Pain: Behavioural Studies in Rat Models of Persistent Hyperalgesia. In: Gebhart GF, Hammond DL and Jensen TS (eds) *Progress in Pain Research and Management, Proceedings of the 7<sup>th</sup> World Congress on Pain*, vol II. IASP Press, Seattle, pp 553–568
- Kayser V, Berkley KJ, Keita H, Gautron M, Guilbaud G (1996) Estrous and Sex Variations in Vocalization Thresholds to Hindpaw and Tail Pressure Stimulation in the Rat. *Brain Research* 742:352–354
- Kayser V, Christensen D (2000) Antinociceptive Effect of Systemic Gabapentin in Mononeuropathic Rats, Depends on Stimulus Characteristics and Level of Test Integration. *Pain* 88:53–60
- Kayser V, Farré A, Hamon M, Bourgoïn S (2003) Effects of the Novel Analgesic, Cizolirtine, in a Rat Model of Neuropathic Pain. *Pain* 104:169–177
- Kayser V, Guilbaud G (1987) Local and Remote Modifications of Nociceptive Sensitivity during Carrageenin-Induced Inflammation in the Rat. *Pain* 28:99–108
- Kayser V, Guilbaud G (1990) Differential effects of Various Doses of Morphine and Naloxone on Two Nociceptive Test Thresholds in Arthritic and Normal Rats. *Pain* 41:353–363
- Kayser V, Guilbaud G (1994) Peripheral Aspects of Opioid Activity: Studies in Animals. In: Besson JM, Guilbaud G and Ollat H (eds) *Peripheral Neurons in Nociception: Physiopharmacological Aspects*. John Libbey Eurotext, Paris, pp 137–156
- Kayser V, Idänpään-Heikkilä JJ, Guilbaud G (1998) Sensitization of the Nervous System, Induced by Two Successive Hindpaw Inflammations, is suppressed by a Local Anesthetic. *Brain Research* 794:19–27
- Kayser V, Peschanski M, Guilbaud G (1985) Neuronal Loss in the Ventrobasal Complex of the Rat Thalamus alters Behavioural Responses to Noxious Stimulation. In: Field MJ (ed) *Advances in Pain Research and Therapy*, vol 9. Raven Press, New York, pp 277–284
- Randall LO, Selitto JJ (1957) A Method for Measurement of Analgesic Activity on Inflamed Tissue. *Arch Int Pharmacodyn* CXI:409–419
- Winter CA, Flataker L (1965) Reaction Thresholds to Pressure in Edematous Hindpaws of Rats and Responses to Analgesic Drugs. *The Journal of Pharmacology and Experimental Therapeutics* 150:165–171

R

## Randomized

### Definition

Randomized allocation to treatment, which requires the use of a list of random numbers usually generated by a computer program, so that each successive subject has an equal chance of being assigned to each treatment or treatment sequence.

- **Antidepressants in Neuropathic Pain**
- **Central Pain, Pharmacological Treatments**

## Randomized Controlled Trial

### Synonyms

RCT

### Definition

An epidemiologic experiment in which subjects in a population are randomly allocated into groups to receive an experimental intervention or not.

- **Lumbar Traction**

## RAP

- ▶ Recurrent Abdominal Pain
- ▶ Recurrent Abdominal Pain in Children

## Raphe Nuclei

### Definition

The major source of serotonin production in the brainstem. Neurons in these midline nuclei have descending projections to spinal cord as well as ascending projections.

- ▶ Molecular Contributions to the Mechanism of Central Pain

## Rapid Eye Movement Sleep

### Synonyms

REM Sleep

### Definition

The rapid eye movement (REM) phase of sleep is associated with dreaming, nocturnal emissions, enuresis and the onset of some headaches that may awaken the subject.

- ▶ Hypnic Headache

## Rapidly Adapting Responses

### Definition

Rapidly adapting responses refers to the fast acclimation of peripheral afferents to incoming information about peripheral stimuli that are responsible for the perception of localized movement along the skin, for example. The stimulus usually produces only a short lasting response.

- ▶ Postsynaptic Dorsal Column Projection, Functional Characteristics

## Rating Impairment Due to Pain in a Workers' Compensation System

HENRY STOCKBRIDGE

University of Washington School of Public Health and Community Medicine, Seattle, WA, USA  
stoh235@lni.wa.gov

### Synonyms

Impairment Rating; Disability Rating; Evaluation of Permanent Impairment; Impairment Due to Pain; Impact on Activities of Daily Living; workers' compensation

## Characteristics

### Introduction

Workers' compensation systems around the world have many similarities and even more differences. In the U.S., each state has its own laws governing many aspects of workers' compensation, ranging from broad, overarching principles to minute details affecting day-to-day operations, including calculation of the monetary award for impairment due to pain (Barth and Niss 1999; Cocchiarella and Lord 2002, personal communication 2003). A key function of workers' compensation systems is the provision of a monetary award, to compensate injured workers for any permanent impairment resulting from work-related conditions. Healthcare providers are often given the responsibility of quantifying the impairment, so that adjudicators can calculate the appropriate monetary payment. In many cases quantifying impairment is easy. For example, an uncomplicated amputation of a digit can be straightforward. However, quantifying impairment can also be highly complex. When pain contributes to impairment, the process of quantifying impairment can require special knowledge and skills.

The distinction between the two terms "disability" and "impairment" is important for an understanding of the differences among workers' compensation systems, especially with respect to the issue of impairment due to pain. The terms are defined slightly differently in different workers' compensation systems, but "disability" generally refers to the inability to perform a specific task or job, while impairment is the loss of function of an organ or part of the body (Medical Examiners' Handbook 2000).

For example, if a classical pianist and a truck driver both lose a finger both would have the same impairment and receive the same award, if the law is written to compensate impairment. However, their disabilities would be different, because the truck driver would be able to continue in his or her job, and the pianist would not. If the law is written to compensate disability rather than impairment, the pianist would receive a significantly higher monetary award.

Although disability and impairment can be distinguished conceptually, the distinctions between them become ambiguous in certain types of disorders, such as mental illnesses. Also, workers' compensation systems often contribute to the ambiguities surrounding the terms by using them interchangeably.

This essay will illustrate the range of approaches to the problem of rating impairment/disability associated with pain by describing two very different systems: the workers' compensation systems of California and Washington State.

### California Workers' Compensation System

In the current system in California, monetary awards for permanent residuals from work-related injuries



are based on disability rather than impairment. The role of pain in the rating process is understood more easily in light of this legal underpinning. In 1917, California's Workers' Compensation Insurance and Safety Act added a provision that, when rating permanent disability, "consideration be given to the diminished ability of such an injured employee to compete in the open labor market." In 1951, the California State Senate decided that this language "imposed the obligation to make . . . due allowance for such disabling subjective factors as, for example, pain, discomfort, and psychiatric or mental disturbances, provided, of course, the subjective factor or factors be considered to be of a permanent nature" (Physician's Guide 2001, Personal communication 2003).

In fact, the California Constitution (Article XIV, Section 4) states that a complete system of workers' compensation must include ". . . adequate provisions for the comfort, health and safety and general welfare of any and all workers . . . to the extent relieving from the consequences of any injury or death incurred or sustained by workers in the course of their employment . . ."

Instructions for healthcare providers on this issue are presented in the Physician's Guide: Medical Practice in the California Workers' Compensation System (Physician's Guide 2001). The Physician's Guide is explicit in stating that pain should be considered in the rating process. It says, "Some impairments can be defined in purely medical terms and can be objectively measured. . . . Impairment also applies to less easily measured functions such as emotional stability, loss of concentration, or pain that causes a handicap in performing activities of work or daily living."

The Physician's Guide goes further, actually to require consideration of pain. It says: "There are four categories of information, called factors of disability, that must be covered in a disability evaluation: objective factors; subjective factors; work restrictions; loss of pre-injury capacity." It also states: "Although a genuine human experience, pain is not readily measurable or objectively validated. Consequently the evaluation, management, and disability evaluation of pain disorders depend on the assessment of an individual's verbal and non-verbal pain behavior. This presumes a reasonable degree of expertise and competence in the field. . . . Although fraud and malingering are uncommon, over-elaboration, symptom magnification, and embellishment often characterize pain complaints. The credibility of the injured worker must be assessed. . . . The disability rating of pain should address . . . the extent to which the pain interferes with the performance of work related tasks. . . . Subjective factors can be the only ratable factor for an injured worker. . . ."

The Physician's Guide instructs the doctor to list subjective complaints in one section of the medical-legal report using the worker's own words. The doctor then

describes subjective disability in a separate section, to express the doctor's judgment as to the intensity and frequency of pain. This judgment is based on complaints, diagnosis, physical exam findings, test results, history, credibility assessment etc. An example of a complete description of subjective factors is: "Occasional minimal pain at rest, increasing to intermittent slight to moderate pain on repetitive fingering activities, such as key-stroking continuously for over 30 minutes." The doctor's role is to provide a narrative description, which is translated by a state disability evaluator into a numerical rating using defined techniques.

The bottom line for the injured worker is the monetary award, which is based on the worker's percentage of permanent disability. For example, in California, a worker with 100% permanent total disability may receive \$602 per week for life. The California system permits even 100% disability awards to be made essentially, entirely on the basis of subjective disability (although this is rare). An example is a 100% disability award for constant, severe back pain.

#### Washington State Workers' Compensation System

In contrast to California, Washington State law requires that monetary awards for permanent residuals from work-related injuries be based on impairment rather than disability (although the two terms often seem to be used interchangeably in Washington workers' compensation). Impairment is rated using primarily two systems: the Washington State Category Rating System (CRS) and the American Medical Association Guides to the Evaluation of Permanent Impairment (the Guides) (American Medical Association Guides to the Evaluation of Permanent Impairment 2001). The latter is generally used for conditions of the upper and lower extremities, hearing loss and loss of vision. The former is used for most other conditions (disorders of the spine, digestive tract, respiratory tract, and so forth). The process and method of rating impairment is described in some detail in a publication of the Washington State Department of Labor and Industries, the Medical Examiners' Handbook (Medical Examiners' Handbook 2000).

Until 2001, neither of these two systems provided a method for quantifying impairment due solely to pain in the absence of objective findings. Each of these systems included consideration of pain within the context of individual organ systems, such as with peripheral neuropathies. However, they did not provide a method for quantifying pain in excess of what was already included in those organ systems.

In 2001, the American Medical Association published the Fifth Edition of the Guides, which included an entire chapter, Chapter 18, providing a method for rating impairment associated with pain.

When the Fifth Edition was published, it was necessary to determine whether the new method in Chapter 18 con-

flicted with existing laws contained in the Washington State Industrial Insurance Act.

In particular, in Washington State there is a strong emphasis on objective findings to support medical opinions and adjudicative decisions. Since pain is by definition subjective, it was necessary to determine if Chapter 18 conflicted with this and other aspects of the legal foundation of the system.

After considerable legal analysis, it was determined that Chapter 18 of the Fifth Edition of the AMA's Guides to the Evaluation of Permanent Impairment could not be used to calculate awards for permanent impairment under Washington's Industrial Insurance Act. The decision was published in Provider Bulletin 02-12, "Rating Permanent Impairment," ("Rating Permanent Impairment" 2002), which includes the rationale saying, in part:

"This rule is in response to a new chapter in the AMA's Guides to the Evaluation of Permanent Impairment, Chapter 18, which proposes to rate pain in excess of what is already considered in other chapters of that document. Chapter 18 fails to segregate a worker's subjective areas of pain already taken into consideration in the Category rating system . . . and in the organ and body systems of the AMA's Guides to the Evaluation of Permanent Impairment. This will result in overlapping PPD awards, a double recovery, for the same impairment. Further, there have been no studies performed demonstrating that the methods outlined in the new chapter are valid or reliable. The American Medical Association itself has issued two subsequent publications highlighting the confusion and lack of clarity surrounding Chapter 18. In addition, Chapter 18 of the Guides conflicts with existing law, and may result in similarly situated injured workers receiving different PPD awards for the same degree of impairment . . . The amount of the permanent partial disability award is not dependent upon or influenced by the economic impact of the occupational injury or disease on an individual worker. Rather, Washington's Industrial Insurance Act requires that permanent partial disability be established primarily by objective physical or clinical findings establishing a loss of function . . . The impairment caused by the worker's pain complaints is already taken into consideration in the categories and in the organ and body system ratings in the AMA Guides . . . Chapter 18 of the 5<sup>th</sup> Edition of AMA Guides to the Evaluation of Permanent Impairment cannot be used to calculate awards for permanent partial disability under Washington's Industrial Insurance Act."

### Summary

The California and Washington workers' compensation systems have developed very different approaches to the problem of rating impairment associated with pain. In California, providers are required to evaluate subjective factors such as pain, and subjective factors can be the only ratable factor for an injured worker.

While California does provide a method for characterizing pain, any such characterization is necessarily a product of judgment, rather than objective measurement, and that judgment is inherently imprecise, affected by predisposition, perspective, prior experience, and other factors. Also, the Physician's Guide states that the credibility of the injured worker must be assessed, which can pose a number of challenges for many providers. While rare, the California system even permits 100% disability awards to be made essentially entirely on the basis of subjective reports of a worker. In contrast, in Washington State there is a strong emphasis on objective findings to support medical opinions and adjudicative decisions. The positions reached by the two states regarding the rating of pain reflects differences in the overall legal frameworks that the states have developed for workers' compensation. For example, California law stipulates that permanent awards for an injured worker should take into account his or her ability to work (i.e. disability), whereas Washington State compensation law indicates (though with some ambiguity) that awards should be made on the basis of impairment. Systems developed to address this issue will most likely continue to change as interest in this topic grows and further research is conducted.

### References

1. American Medical Association Guides to the Evaluation of Permanent Impairment (2001) AMA Press, Chicago
2. Barth PS, Niss M (1999) Permanent Partial Disability Benefit: Interstate Differences. Workers Compensation Research Institute. WC-99-2. September
3. Cocchiarella L, Lord SJ (2002) Master the AMA Guides Fifth. AMA Press, Chicago Physician's Guide (2001) Medical Practice in the California Workers' Compensation System. State of California, Department of Industrial Relations, Industrial Medical Council. 3<sup>rd</sup> edn.
4. Medical Examiners' Handbook (2000) Washington State Department of Labor and Industries, Olympia, WA, September
5. Personal communication (2003) State of California, Department of Industrial Relations
6. Personal communication (2003) International Association of Industrial Accident Boards and Commissions (IAIABC), Madison, WI
7. "Rating Permanent Impairment." (2002) Washington State Department of Labor and Industries. Provider Bulletin 02-12

## Ratio Scale

### Definition

Ratio scale is a scale that yields an accurate measurement of true ratios or proportions of magnitude and has a true zero point.

- ▶ [Pain in Humans, Psychophysical Law](#)
- ▶ [Pain Measurement by Questionnaires, Psychophysical Procedures and Multivariate Analysis](#)

## Raynaud's Syndrome

### Definition

Raynaud's syndrome refers to a set of symptoms characteristic of peripheral vascular disease, caused by an inappropriate response of the peripheral arteries in reaction to environmental stimuli (i.e. usually to the cold). Common symptoms of Raynaud's in the affected parts (e.g. toes, fingers) include the color change of first white, then blue/red and icy cold hands and feet.

- ▶ [Experimental Pain in Children](#)

## Raynaud's Vibration White Finger Syndrome

### Definition

This disorder is characterized by blanching of the fingers and pain when exposed to cold. It can be naturally occurring or as a result of prolonged exposure to hand-arm vibration, particularly noted in colder environments.

- ▶ [Ergonomics Essay](#)
- ▶ [Raynaud's Syndrome](#)

## RCT

- ▶ [Randomized Controlled Trial](#)

## Reactive Arthritis

- ▶ [Reiter's Syndrome](#)

## Reactive Hypertension

- ▶ [Postoperative Pain, Pathophysiological Changes in Cardiovascular Function in Response to Acute Pain](#)

## Reactive Tachycardia

- ▶ [Postoperative Pain, Pathophysiological Changes in Cardiovascular Function in Response to Acute Pain](#)

## Reactivity

### Definition

A measure of psychophysiological response to a stressful stimulus.

- ▶ [Psychophysiological Assessment of Pain](#)

## Real Time PCR

### Definition

Real time polymerase chain reaction assays allow fluorescent detection and quantification of nucleic acid sequences as they accumulate in a PCR reaction with time.

- ▶ [Nerve Growth Factor Overexpressing Mice as Models of Inflammatory Pain](#)

## Reassurance and Activation

- ▶ [Activation/Reassurance](#)

## Recall

### Definition

A procedure in which the person remembering generates a report of a memory either in response to a cue (cued recall), or in response to a general instruction to recall remembered events (free recall).

- ▶ [Pain Memory](#)
- ▶ [Recognition](#)

## Receiver Operating Characteristics

### Synonyms

ROC

### Definition

A graphic method for assessing the ability of a test to discriminate between disease and health. The size of the area under the curve is a measure of this ability.

- ▶ [Oswestry Disability Index](#)

## Receptive Field (RF)

### Definition

The receptive field of a somatosensory neuron is the body region where a stimulus of a given type elicits a change in the firing of that neuron. For example, excitatory receptive fields are body regions where application of a stimulus produces increases in discharge frequencies of neurons, while inhibitory receptive fields are regions where stimuli produce decreases in discharge frequencies of neurons. Some types of neurons may have separate receptive fields for noxious and innocuous information, and portions of these receptive fields may be both excitatory and inhibitory. Some cells have both somatic and

visceral receptive fields. Receptive fields vary in size according to cell type and stage of development. The size of dorsal horn cell peripheral cutaneous receptive fields has been shown to be larger in the newborn rat, but decreases with age.

- ▶ Allodynia (Clinical, Experimental)
- ▶ Amygdala, Pain Processing and Behavior in Animals
- ▶ Central Pain, Human Studies of Physiology
- ▶ Encoding of Noxious Information in the Spinal Cord
- ▶ Exogenous Muscle Pain
- ▶ Hyperalgesia
- ▶ Infant Pain Mechanisms
- ▶ Insular Cortex, Neurophysiology and Functional Imaging of Nociceptive Processing
- ▶ Mechano-Insensitive C-Fibres, Biophysics
- ▶ Mechanonociceptors
- ▶ Nick Model of Cutaneous Pain and Hyperalgesia
- ▶ Nociceptive Processing in the Secondary Somatosensory Cortex
- ▶ Opiates During Development
- ▶ Opioid Modulation of Nociceptive Afferents In Vivo
- ▶ Referred Muscle Pain, Assessment
- ▶ Second Somatosensory Cortex
- ▶ Spinothalamic Tract Neurons, Central Sensitization
- ▶ Thalamic Bursting Activity, Chronic Pain
- ▶ Thalamic Plasticity and Chronic Pain
- ▶ Thalamus, Nociceptive Cells in VPI, Cat and Rat
- ▶ Thalamus, Receptive Fields, Projected Fields, Human

---

## Receptor

### Definition

Specialized proteins located in their neuronal membrane that bind neurotransmitters, neuropeptides and drugs. Binding of a transmitter or neuropeptide to its receptor induces a response in the neuron or target cell associated with the receptor. Also used to refer to cells or nerve endings specialized in sensory transduction.

- ▶ Descending Circuitry, Transmitters and Receptors
- ▶ Mechanonociceptors

---

## Receptor Affinity

### Definition

Receptor affinity refers to the ability of a ligand to bind a receptor. The affinity of the various non-radioactive compounds is evaluated by displacement curves for the binding of a radioactive-ligand endowed with high affinity for the receptor. It is expressed as the inhibition constant ( $K_i$ ) of the binding of the radioactive-selective ligand calculated from the concentration of peptide required to displace 50% of the labeled ligand ( $IC_{50}$ ), by means of the equation  $K_i = IC_{50} / [(2L/L_0) + (L/K_D) - 1]$ ,

where  $L$  is the free radioligand concentration in equilibrium with  $IC_{50}$  of unlabeled ligand,  $L_0$  is the free radioligand concentration in the absence of competing ligand, and  $K_D$  is the equilibrium dissociation constant of the radioligand.

- ▶ Opioid Peptides from the Amphibian Skin

---

## Receptor Potential

### Definition

The membrane potential change elicited in receptor neurons during sensory transduction.

- ▶ Nociceptor Generator Potential
- ▶ Perireceptor Elements

---

## Receptor Selectivity

### Definition

Receptor selectivity refers to the ratio between the affinities for two different receptor types. For example, the  $\mu/\delta$  selectivity of a compound is the ratio between the  $\mu$  opioid receptor affinity and the  $\delta$  opioid receptor affinity of such a compound.

- ▶ Opioid Peptides from the Amphibian Skin

---

## Receptors in the Descending Circuitry

- ▶ Descending Circuitry, Transmitters and Receptors

---

## Recist

### Definition

Recist is an acronym for the Response Evaluation Criteria in Solid Tumors, the evidence based validating assessment of treatment effects of reducing tumor volume.

- ▶ Cancer Pain Management, Chemotherapy

---

## Recognition

### Definition

A procedure in which the person remembering reports whether an event (stimulus) that is currently presented to them has occurred in the past. Under most conditions recognition memory produces more remembered material than memory retrieved under recall conditions.

- ▶ Pain Memory
- ▶ Recall



## Recognizing Issues Contributing to Pain Secondary to Burn Injury and its Treatment

- ▶ Pain Control in Children with Burns

## Recollection

### Definition

Recollective memory occurs when an individual recalls a specific episode from their past experience. A defining feature of recollective memory is that in addition to remembering that an event occurred, the rememberer has some phenomenal experience of the remembered event. This is often in the form of a visual or auditory image or some affective experience.

- ▶ Pain Memory

## Recording of Pain Behavior

- ▶ Assessment of Pain Behaviors

## Recovery

### Definition

A period designed to allow physiological responses to a return to a normal or near normal state.

- ▶ Psychophysiological Assessment of Pain

## Recruitment to an Injury Site

### Definition

In the case of immune cells, this refers to attracting immune cells out of the blood stream and into the tissue at a site of injury. Immune cell recruitment occurs in response to chemical signals generated at the injury site, which attracts and activates immune cells to respond.

- ▶ Proinflammatory Cytokines

## Rectangular Pulses

### Definition

Rectangular electrical pulses are current pulses with a square shape. They are characterized by the amplitude and their duration.

- ▶ Pain in Humans, Electrical Stimulation (Skin, Muscle and Viscera)

## Recurrent Abdominal Pain

### Synonyms

RAP

### Definition

Recurrent abdominal Pain (RAP) was initially defined as three or more bouts of pain, severe enough to affect activities over a period of at least three months. Subsequently, this definition of RAP has been expanded to include any child with recurrent abdominal pain of any etiology, including inflammatory bowel disease, metabolic disorders, and irritable bowel syndrome, as examples.

- ▶ Experimental Pain in Children
- ▶ Recurrent Abdominal Pain in Children

## Recurrent Abdominal Pain in Children

DAVID S. JONES, LYNN S. WALKER  
Division of Adolescent Medicine and Behavioral Sciences, Vanderbilt University Medical Center, Nashville, TN, USA  
david.s.jones@vanderbilt.edu,  
lynn.walker@vanderbilt.edu

### Synonyms

Chronic Abdominal Pain of Childhood; RAP

### Definition

Recurrent abdominal pain (RAP) is a term used to describe commonly encountered abdominal pain and associated gastrointestinal (GI) symptoms in a heterogeneous group of school-age children. Apley and Naish pioneered the definition of RAP as three or more episodes of abdominal pain severe enough to interfere with a child's activities and occurring during a period longer than 3 months (Apley and Naish 1958). This definition encompasses pain that occurs in the presence or absence of organic disease.

### Characteristics

RAP, also termed chronic abdominal pain of childhood, is common in the pediatric population, usually affecting children between 5–15 years of age. Females appear to be affected slightly more frequently than males. It is estimated that 10–15% of school-age children experience abdominal pain episodes of sufficient duration and intensity to interfere with normal activity and thus meet Apley's criteria for RAP. It is likely, however, that a greater percentage of children have recurrent abdominal pain episodes without disrupting normal activities and do not come to the attention of a medical provider (Boyle 2000). In those children who receive a medical evaluation, most have no evidence of organic

R

abnormalities (inflammatory, infectious, anatomic, neoplastic or metabolic disease) as a cause of their pain and therefore are classified as having functional abdominal pain. Given that RAP is usually ► **functional** (i.e. without identifiable organic disease), several authors use the terms “recurrent abdominal pain” and “functional abdominal pain” interchangeably.

Gastrointestinal symptoms experienced by children with RAP often change in severity, frequency or location over time. RAP symptoms can include diffuse or localized abdominal pain that can be dull or sharp in nature, ► **dyspepsia** symptoms or pain associated with a change in bowel habits. In addition to GI symptoms, children with RAP frequently describe vague somatic pain or sensory complaints such as headache, limb pain, dizziness or tingling sensations that may occur during or between abdominal pain episodes. The presence of certain clinical signs and symptoms such as involuntary weight loss, deceleration of linear growth, gastrointestinal bleeding, unexplained fever, or unexplained physical findings are not typical for functional bowel disorders and should alert the clinician to the possibility of underlying pathology (Hyams et al. 2005).

Recently, GI symptom-based diagnostic criteria known as the Rome criteria have been established to classify sub-groups of children with functional gastrointestinal disorders. The criteria were formed in order to facilitate investigative, diagnostic and treatment strategies. The Rome II criteria for pediatric functional gastrointestinal disorders are outlined in Table 1 (Rasquin-Weber et al.

1999). The majority of children with RAP can be classified into one or more subtypes of functional GI disorders with the estimated prevalence of each subtype (Walker et al. 2004), also shown in Table 1. Children with RAP most commonly have irritable bowel syndrome (IBS) or functional dyspepsia. It is not yet known whether the different clinical presentations of RAP identified by the Rome criteria represent distinct disorders or variable expressions of the same disorder, as some children meet the diagnostic criteria for more than one Rome sub-group. High rates of disability including school and work absenteeism, social dysfunction and healthcare utilization are common in children with RAP. It is estimated that nearly one-third of pediatric patients with RAP will continue to experience elevated gastrointestinal symptoms, disability and health service utilization into adulthood (Walker et al. 1998).

### Pathogenesis of RAP

The pathogenesis of RAP in children is still not well understood, but is best appreciated within a biopsychosocial framework. According to this framework, biological, psychological, social and environmental factors interact in the etiology, exacerbation and maintenance of abdominal pain episodes. Proposed biological factors have included altered gastrointestinal motility and ► **visceral** ► **hypersensitivity**. Motility studies have failed to identify consistent and reproducible motility disturbances across or within RAP sub-groups (Zeiter and Hyams 2002). Recent studies

**Recurrent Abdominal Pain in Children, Table 1** Rome II criteria and estimated incidence within sub-groups (in parentheses) of functional abdominal pain disorders in children. All criteria include duration of at least 12 weeks of symptoms, which need not be continuous, in the previous 12 months unless otherwise noted

<b>Irritable bowel syndrome</b> (44.9%)	<ol style="list-style-type: none"> <li>1. Abdominal discomfort or pain with 2/3 features:               <ol style="list-style-type: none"> <li>a) Relieved with defecation</li> <li>b) Onset associated with change in stool frequency</li> <li>c) Onset associated with change in stool form/appearance</li> </ol> </li> <li>2. No structural or metabolic abnormalities to explain symptoms</li> </ol>
<b>Functional dyspepsia</b> (15.9%)	<ol style="list-style-type: none"> <li>1. Persistent or recurrent pain or discomfort centered in the upper abdomen</li> <li>2. No evidence that organic disease is likely to explain symptoms</li> <li>3. No evidence that dyspepsia is relieved by defecation or associated with change in stool frequency/form</li> <li>4. May be characterized by abdominal fullness, bloating, nausea, early satiety</li> </ol>
<b>Functional abdominal pain syndrome</b> (7.5%)	<ol style="list-style-type: none"> <li>1. Continuous or nearly continuous abdominal pain in school-age child or adolescent</li> <li>2. No or only occasional relation of pain to physiological events (e.g., eating)</li> <li>3. Some loss of daily functioning</li> <li>4. The pain is not malingering or feigned</li> <li>5. Insufficient criteria for other functional GI disorders that would explain pain</li> <li>6. No structural, inflammatory or metabolic abnormalities to explain symptoms</li> </ol>
<b>Abdominal migraine</b> (4.7%)	<ol style="list-style-type: none"> <li>1. Three or more episodes, in preceding 12 months, of midline abdominal pain lasting several hours to days, paroxysmal in nature</li> <li>2. No evidence of metabolic, structural or CNS disease</li> <li>3. Two of following features:               <ol style="list-style-type: none"> <li>a) Headache during episodes</li> <li>b) Photophobia during episodes</li> <li>c) Family history of migraines</li> <li>d) Headache confined to one side of head</li> <li>e) Sensory, visual or motor aura preceding episodes</li> </ol> </li> </ol>

suggest that visceral hypersensitivity is a major factor contributing to functional abdominal pain in both children and adults. It is now believed that children with RAP have abnormal bowel reactivity to physiological, noxious or psychological stressful stimuli (Van Ginkel et al. 2001). Children with RAP, in comparison to controls, have been shown to report increased abdominal pain in response to visceral stimulation and distention such as water drinking to satiety (Walker et al. 2005). Similarly, adults with IBS have lower pain thresholds in response to abdominal visceral distention along with an altered appraisal and interpretation of physiological or painful abdominal stimuli that occurs within the central nervous system (Mertz et al. 2000).

The cause of such hypersensitivity is likely to be altered sensory thresholds or modulation of sensorial input within both the enteric nervous system (ENS) and the central nervous system (CNS). The ENS is comprised of a highly complex and intricately connected group of motor and sensory neurons within the wall of the intestines. The ENS sensory neurons are appropriately activated by ► **serotonergic** stimulation in response to luminal abnormalities such as excess distention, toxins, infections or other inflammation. The ENS provides direct sensorial input to the CNS and the CNS can modulate the activity of ENS components in order to maintain normal gut function. The inter-relationship between the ENS and CNS is often described as the “► **brain-gut axis**”. It is thought that in children with RAP, sensory neurons within the ENS or CNS may become over-sensitized for a number of reasons including infection, inflammation or psychological stress. This sensitization manifests as excess sensory input to the CNS and pain perception during normal physiologic processes (i.e. distention after meals), exposure to exacerbating foods, illness or stress. Genetic factors may partially account for a predisposition to hypersensitivity or altered pain perception after a stressor, as RAP children have been shown to have higher numbers of family members who report chronic GI complaints.

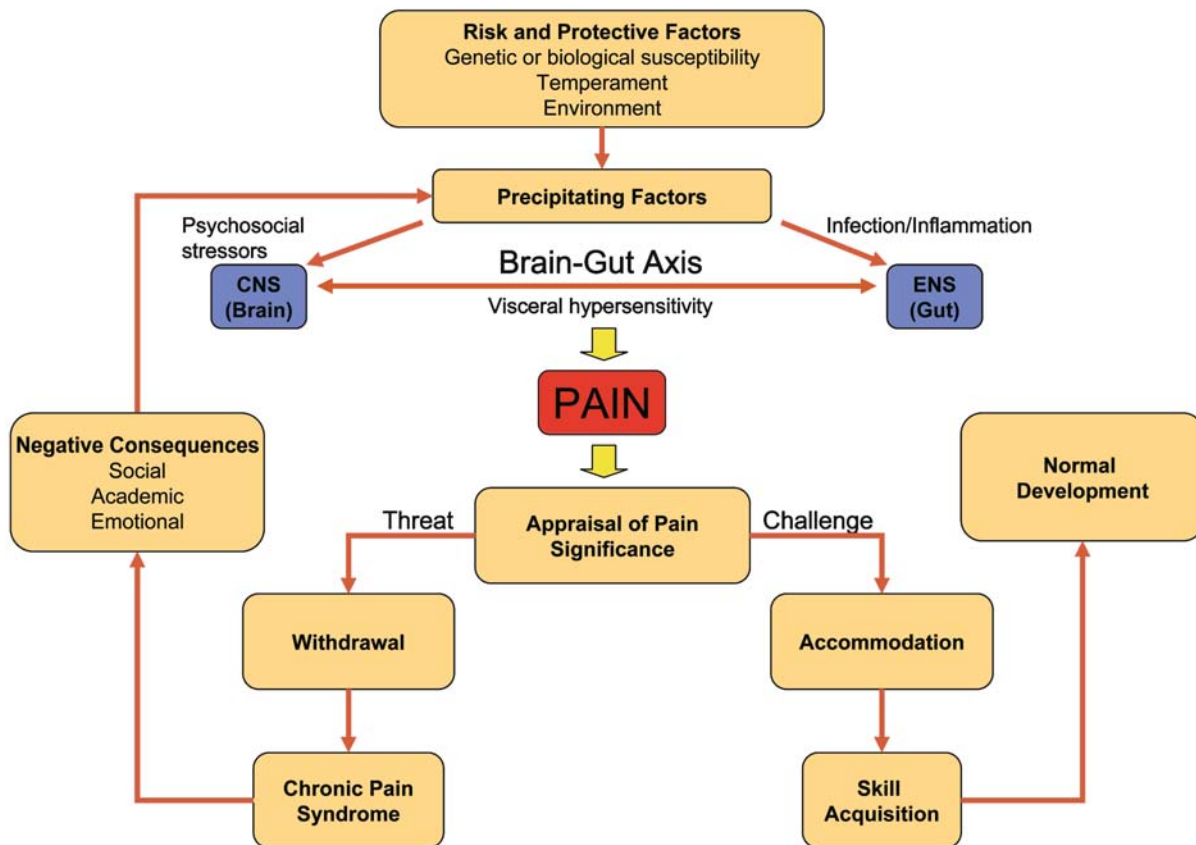
Psychological and emotional factors may contribute to the development and maintenance of RAP, emergence of disability and extent of health care utilization. Children with RAP have significantly higher levels of anxious, depressive and ► **somatization** symptoms than well children and many meet established criteria for an anxiety or depressive psychiatric disorder (Walker and Greene 1989). Furthermore, the severity of underlying anxious and depressive symptoms correlates positively with the risk for continued episodes of pain and somatic symptoms. Mothers of RAP patients more often have underlying anxiety or depressive symptoms or disorders, indicating that psychological factors may also be influenced by an underlying genetic susceptibility. Psychological characteristics such as negative affectivity, perceived low social and academic competence and passive coping with pain are also more prevalent in some RAP

patients (Walker et al. 2001) and may be associated with greater illness severity and duration. The presence or absence of psychological symptoms in the child or family does not reliably distinguish between abdominal pains resulting from functional or organic disease.

Environmental and social factors also play a vital role in the pathogenesis of RAP. Children with RAP and their families report higher levels of daily life stressors and negative life events. Exposure to social stressors such as peer interactions, familial disturbances, school demands and physical or emotional abuse may contribute to the onset, frequency, severity and duration of pain episodes in RAP patients. Modeling and reinforcement of symptoms and disability by the parents can influence children’s responses to their own pain, creating situations where children are rewarded for pain episodes by parental attention, removed from stressful social circumstances (e.g. school demands) or experience other secondary gain (Walker 1999). Thus, within the specialized CNS and GI tract, several biological, psychological and social factors interact to produce abdominal pain. Each system may influence the other given the “brain-gut axis”. Children’s appraisal and reactivity to abdominal pain are also influenced by the above factors. Some children appraise their pain as a challenge and accommodate pain episodes into their daily routines, maintaining a normal course of psychosocial development. Other children appraise their pain as a significant threat and withdraw from their daily routines, adopting a chronic sick role that has negative social, academic and emotional consequences. These interactions are described in detail elsewhere (Walker 1999) and schematically represented in Fig. 1.

### Diagnosis and Treatment

RAP in childhood is not a clinical diagnosis nor is it a diagnosis of exclusion. The classification of functional abdominal pain can generally be made on the basis of a careful history, thorough physical examination and minimal laboratory testing. RAP is highly suggested by the presence of chronic and recurrent abdominal symptoms in the context of normal growth, development and physical examination (including examination for blood in stool) and normal laboratory evaluation. Serum and stool samples are often evaluated to rule out a potential occult infectious or inflammatory process. Further testing such as upper gastrointestinal endoscopy or radiological imaging may be performed at the discretion of the medical provider in order to reassure about the lack of organic disease, but with the realization that further medical testing with consistent negative results may increase patient and family anxiety regarding the presence of undetected organic disease. An expectation that the child may have functional abdominal pain should be discussed with the patient and the family at the outset, with efforts made to identify contributing life stressors and psychological factors. Once a medical



**Recurrent Abdominal Pain in Children, Figure 1** Impact of biological, psychological and social factors in RAP onset and outcomes.

evaluation has ruled out organic disease, the patient and family should be educated on the nature of RAP with extensive communication outlining the goals of therapy. These patients can be therapeutically challenging and need to recognize that the goal of treatment might not be complete pain elimination, but an improvement in the frequency or severity of the pain with improved function and decreased disability.

The child with RAP is best treated recognizing the multifactorial pathogenesis, utilizing treatments aimed at the underlying biological as well as psychological and social factors. The mainstays of biological therapy are dietary modification and medication. A short trial away from identified exacerbating foods or increasing fiber intake in IBS is safe and occasionally effective. The medications currently utilized to decrease biological hypersensitivity have had inconsistent results in childhood studies (Weydert et al 2003) and should be used sparingly in the short-term in an attempt to relieve individual symptoms and alleviate disability. These medications include anti-spasmodics, smooth muscle relaxants, antacids, non-stimulating laxatives and newer serotonergic agonists or antagonists. Patients with or without identified underlying psychiatric disorders will often respond to serotonin-selective reuptake

inhibitors (SSRIs) or tricyclic antidepressants (TCAs). Psychosocial interventions, typically ► **cognitive behavior therapy**, encourage active coping with pain, identification of stressors, stress reduction and resumption of normal activities. In addition, family members are encouraged to avoid unintentionally rewarding the child with special attention for pain behavior.

## References

1. Apley J, Naish N (1958) Recurrent abdominal pain: a field survey of 1,000 school children. *Arch Dis Childhood* 33:165–170
2. Boyle JT (2000) Abdominal pain. In: Walker W, Durie P, Hamilton J et al. (eds) *Pediatric Gastrointestinal Disease*, 3rd edn. BC Decker, Ontario, pp 135–149
3. Hyams JS, Boyle JT, Colletti R et al. (2005) Chronic abdominal pain in children: a policy statement by the chronic abdominal pain subcommittee of the American Academy of Pediatrics and the North American Society for Pediatric Gastroenterology, Hepatology and Nutrition. *J Pediatric Gastroenterology and Nutrition* (in press)
4. Mertz H, Morgan V, Tanner G et al. (2000) Regional cerebral activation in irritable bowel syndrome and control subjects with painful and nonpainful rectal distention. *Gastroenterology* 118:842–848
5. Rasquin-Weber A, Hyman PE, Cucchiara S et al. (1999) Childhood functional gastrointestinal disorders. *Gut* 45:60–68
6. Van Ginkel R, Voskuil WP, Benninga MA et al. (2001) Alterations in rectal sensitivity and motility in childhood irritable bowel syndrome. *Gastroenterology* 120:31–38



7. Walker LS, Greene JW (1989) Children with recurrent abdominal pain and their parents: more somatic complaints, anxiety, and depression than other patient families. *J Pediatr Psychol* 14:231–243
8. Walker LS, Guite JW, Duke M et al. (1998) Recurrent abdominal pain: a potential precursor of irritable bowel syndrome in adolescents and young adults. *J Pediatr* 132:1010–1015
9. Walker LS (1999) The evolution of research on recurrent abdominal pain: history, assumptions, and a conceptual model. In: McGrath P, Finley A (eds) *Chronic and Recurrent Pain in Children and Adolescents, progress in pain research and management*, vol 13. IASP Press, Seattle, pp 141–172
10. Walker LS, Lipani TA, Greene JW et al. (2004) Recurrent abdominal pain: symptom subtypes based on the Rome II criteria for pediatric functional gastrointestinal disorders. *J Pediatr Gastroenterol Nutr* 38:187–191
11. Walker LS, Garber J, Smith CA et al. (2001) The relation of daily stressors to somatic and emotional symptoms in children with and without recurrent abdominal pain. *J Consult Clin Psychol* 69:85–91
12. Walker LS, Williams SE, Smith CA et al. (2005) Validation of a symptom provocation test for laboratory studies of abdominal pain and discomfort in children and adolescents. *J Pediatric Psychology* (in press)
13. Weydert JA, Ball TM, Davis MF (2003) Systematic review of treatments for recurrent abdominal pain. *Pediatrics* 111:1–11
14. Zeiter DK, Hyams JS (2002) Recurrent abdominal pain in children. *Pediatr Clin North Am* 49:53–71

## Recurrent Pelvic Pain

- ▶ [Epidemiology of Chronic Pelvic Pain](#)

## Red Flags

### Definition

Red Flags are presenting signs and symptoms considered indicative of possible spinal pathology or of the need for an urgent surgical evaluation. These “risk factors” for serious pathology or disease became incorporated into screening tools, recommended for use in primary care by clinicians to identify those patients in whom an urgent specialist opinion was indicated. Assessment of these risk factors was included within a new set of clinical guidelines for the management of acute low back pain, reviewed in Waddell (1998). Increasingly, however, the problem of low back disability has become recognized as a biopsychosocial phenomenon, and research reviews have demonstrated the powerful influence of psychological factors (Linton, 2000), and social factors (Waddell et al. 2002) as predictors of disability.

- ▶ [Yellow Flags](#)

## Red Thrombi

- ▶ [Postoperative Pain, Venous Thromboembolism](#)

## Re-Entrant Excitation

### Definition

Excitation due to a positive feedback signal.

- ▶ [Corticothalamic and Thalamocortical Interactions](#)

## Referred Hyperalgesia

### Definition

Hyperalgesia of the somatic body wall tissues in an area of referred pain, i.e. an area other than that in which the noxious stimulation takes place (Head, 1983, *Brain* 16:1). Referred hyperalgesia from viscera may involve both superficial (skin, subcutis) and deep tissues (muscle), but is most often confined to the muscle.

In humans with colics from calculosis of one upper urinary tract, hyperalgesia of the oblique musculature of the ipsilateral lumbar region is revealed by a significant decrease in the pain threshold to pressure and electrical muscle stimulation with respect to the contralateral side and normal control values (Vecchiet et al. 1989).

- ▶ [Gynecological Pain, Neural Mechanisms](#)
- ▶ [Visceral Pain Model, Kidney Stone Pain](#)

## Referred Muscle Pain

### Definition

Referred pain from one muscle to another is related to the ▶ [central sensitization](#) of nociceptive sensory neurons in the spinal cord. The pattern is similar to the “meridian connections” of acupuncture points.

- ▶ [Dry Needling](#)
- ▶ [Muscle Pain, Referred Pain](#)
- ▶ [Referred Muscle Pain, Assessment](#)

## Referred Muscle Pain, Assessment

THOMAS GRAVEN-NIELSEN

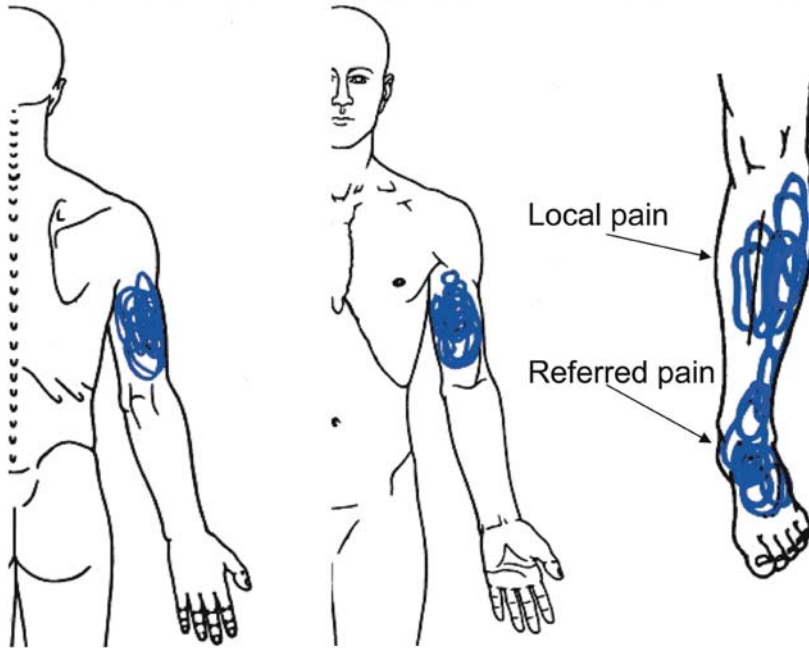
Laboratory for Experimental Pain Research, Center for Sensory-Motor Interaction (SMI), Aalborg University, Aalborg, Denmark  
tgn@hst.aau.dk

### Definition

Pain perceived at a site adjacent to or at a distance from the site of origin (local pain, see Fig. 1). To distinguish between ‘referred pain’ and ‘spread of pain’, referred pain is typically restricted to areas outside the local pain area.

R

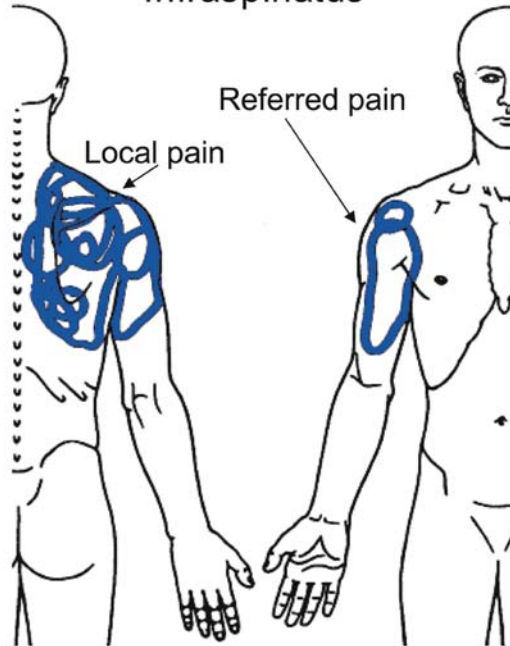
Triceps Brachii    Biceps Brachii    Tibialis anterior



Trapezius



Infraspinatus



**Referred Muscle Pain, Assessment, Figure 1** Distribution of experimentally induced local and referred pain. Hypertonic saline (0.5 to 1 ml, 5.8 %) was injected into musculus triceps brachii, biceps brachii, tibialis anterior, trapezius and infraspinatus. The subjects (n = 9–15) outlined the area of pain. Saline-induced pain in tibialis anterior and infraspinatus showed distinct referred pain areas (not included in the local pain area), whereas the other muscles showed more localized pain around the injection site.

**Characteristics**

Referred pain has been known and described for more than a century and has been used extensively as a diagnostic tool in the clinic. Mainly musculoskeletal and visceral pain conditions are accompanied by local and/or referred pain. Originally, the term ‘referred tenderness and pain’ was used.

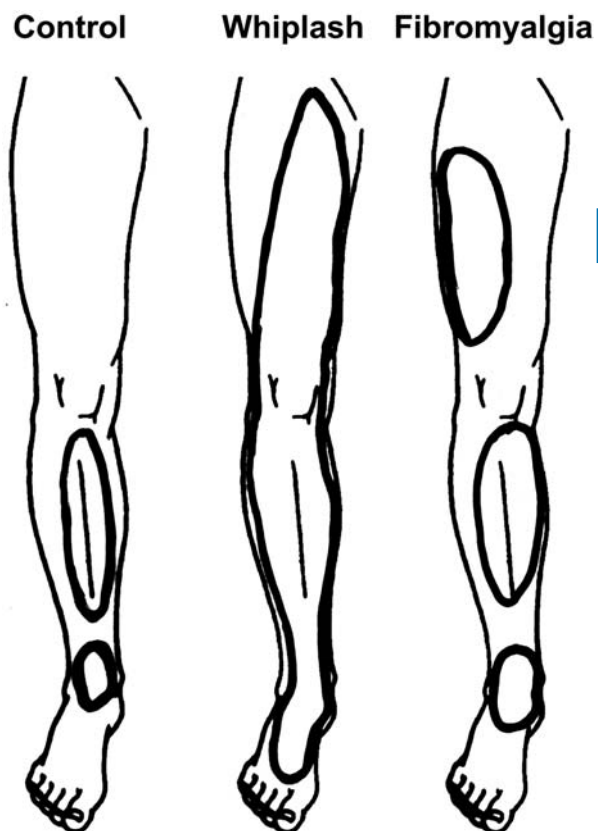
In contrast to the sharp and localized characteristics of cutaneous pain, muscle pain is described as aching with diffuse and referred localization. Kellgren (1938) was one of the pioneers to study experimentally the characteristics of muscle pain, and the actual locations of referred pain to selective stimulation of specific muscle groups. Several theories regarding the appear-

ance of referred pain have been suggested, but no firm neurophysiologic-based explanations for referred pain exist. It has been shown that ► **wide dynamic range neurons**, as well as nociceptive specific neurons in the spinal cord and in the brain stem, receive convergent afferent input from the skin, muscles, joints, and viscera. This may cause misinterpretation of the afferent information coming from muscle afferents when reaching higher levels in the central nervous system, and hence be one reason for the diffuse and referred characteristics.

Referred pain is probably a combination of central processing and peripheral input, as it is possible to induce referred pain to limbs with complete sensory loss due to an anesthetic block (Kellgren 1938). However, the involvement of peripheral input from the referred pain area is not clear, as anesthetizing this area shows inhibitory or no effects on the referred pain intensity. ► **Central sensitization** may be involved in the generation of referred pain. A complex network of extensive collateral synaptic connections for each muscle afferent fiber onto multiple dorsal horn neurons is assumed (Mense and Simons 2001). Under normal conditions, afferent fibers have fully functional synaptic connections with dorsal horn neurons, as well as latent synaptic connections to other neurons within the same region of the spinal cord. Following ongoing strong ► **noxious** input, latent synaptic connections become operational, thereby allowing for convergence of input from more than one source. Animal studies show a development of new and/or expansion of existing ► **receptive fields** by a noxious muscle stimulus. Recordings from a dorsal horn neuron, with a receptive field located in the biceps femoris muscle, show new receptive fields in the tibialis anterior muscle and at the foot after i. m. injection of bradykinin into the tibialis anterior muscle (Hoheisel et al. 1993). In the context of referred pain, the unmasking of new receptive fields due to central sensitization could mediate referred pain. A number of studies have found that the area of the referred pain correlated with the intensity of the muscle pain (Laursen et al. 1997). Moreover, the appearance of referred pain is delayed (20–40 s) compared to the local muscle pain (Graven-Nielsen et al. 1997; Laursen et al. 1997), indicating that a time dependent process, like the unmasking of new synaptic connections, is involved in the neural mediation of referred pain. Referred pain has been suggested to be the phenomenon of ► **secondary hyperalgesia** in deep tissue.

Substantial clinical knowledge exists on the patterns of referred muscle pain from various skeletal muscles, and after activation of ► **trigger points** in myofascial pain patients. Similarly, the pattern of referred pain evoked by exogenous muscle pain has been thoroughly mapped, initially by Kellgren (1938) and later by others (Fig. 1). Referral of muscle pain is typically described as a sensation from deep structures (Graven-Nielsen et al. 2002), in contrast to visceral referred pain that is both superficially and deeply located. The pattern and

size of referral seems to be changed in chronic musculoskeletal pain conditions; e.g. fibromyalgia patients experience stronger pain and larger referred areas after exogenous muscle pain (hypertonic saline) compared to matched controls (Sørensen et al. 1998). Interestingly, these manifestations were present in lower limb muscles where the patients typically do not experience ongoing pain. Normally, pain from the tibialis anterior is projected distally to the ankle and only rarely proximally (Fig. 1). In the fibromyalgia patients, substantial proximal spread of the experimentally-induced referred pain areas was found (Fig. 2). This corresponds to basic neurophysiological experiments in rats, where muscle nociception caused a proximal sensitization of dorsal horn neurons (Mense and Simons 2001). Enlarged referred pain areas in pain patients suggest that the efficacy of central processing is increased (central sensitization). Moreover, the expanded referred pain areas in fibromyalgia patients were partly inhibited by ketamine (an N-methyl-D-aspartate receptor antagonist) targeting central sensitization (Graven-Nielsen et al. 2000). Extended referred pain areas from the tibialis anterior muscle has also been shown in patients suf-



**Referred Muscle Pain, Assessment, Figure 2** Typical distribution of experimentally induced local and referred pain in healthy subjects and musculoskeletal pain patients (fibromyalgia and whiplash). Hypertonic saline was injected into musculus tibialis anterior. Expanded pain referrals were characteristically seen in the musculoskeletal pain patients.

fering from chronic whiplash pain; the extended areas of referred pain were also found in the neck/shoulder region (Johansen et al. 1999). Similarly, in patients with temporomandibular pain disorders, enlarged pain areas were found after experimental masseter muscle pain (Svensson et al. 2001). In patients suffering from chronic osteoarthritic knee pain, extended areas of saline-induced referred pain have been found (Bajaj et al. 2001). This shows that noxious joint input to the central nervous system facilitates the mechanisms of referred pain from muscle, possibly due to central sensitization.

### Referred Hyperalgesia

Central sensitization facilitates the mechanism for referred pain. Likewise, central sensitization might be involved in hyperalgesia at sites distant from the pain locus, as referred or widespread hyperalgesia. Referred hyperalgesia can be present in areas with or without referred pain. In referred pain areas, Kellgren (1938) found tenderness to pressure, but some of the later studies have been unable to reproduce this finding. Skin sensitivity in the referred pain area has reportedly depended on the stimulus modality tested (Graven-Nielsen et al. 1997; Leffler et al. 2000). Increased sensitivity to electrical cutaneous stimulation, and decreased sensitivity to radiant heat or pinprick stimulation, has been reported in referred pain areas (Graven-Nielsen et al. 1997; Leffler et al. 2000). Moreover, hyperalgesia to pressure was found distal to the referred pain area, produced by experimental pain induced in the tibialis anterior muscle (Graven-Nielsen et al. 2002). This suggests involvement of summation between muscle afferents and the somatosensory afferents from the hyperalgesic area, eventually facilitated by central sensitization. In clinical studies, a modality-specific and tissue-specific change of the somatosensory function in referred pain areas has been reported (Leffler et al. 2003), in line with the experimental findings.

Central sensitization of dorsal horn or brain stem neurons, initiated by nociceptive activity from muscles, may explain the expansion of pain with referral to other areas and probably hyperalgesia in these areas. However, facilitated neurons cannot account for the decreased sensation to certain sensory stimuli in the referred area. Descending inhibitory control of the dorsal horn neurons may explain the decreased response to additional noxious stimuli in the referred pain area, and therefore mask any eventual increase in somatosensory sensitivity in referred pain areas (Graven-Nielsen et al. 2002).

### References

1. Bajaj P, Graven-Nielsen T, Arendt-Nielsen L (2001) Osteoarthritis and its Association with Muscle Hyperalgesia: An Experimental Controlled Study. *Pain* 93:107–114
2. Graven-Nielsen T, Arendt-Nielsen L, Svensson P et al. (1997) Stimulus-Response Functions in Areas with Experimentally In-

duced Referred Muscle Pain – A Psychophysical Study. *Brain Res* 744:121–128

3. Graven-Nielsen T, Aspegren KS, Henriksson KG et al. (2000) Ketamine Reduces Muscle Pain, Temporal Summation, and Referred Pain in Fibromyalgia Patients. *Pain* 85:483–491
4. Graven-Nielsen T, Gibson SJ, Laursen RJ, Svensson P, Arendt-Nielsen L (2002) Opioid-Insensitive Hypoalgesia to Mechanical Stimuli at Sites Ipsilateral and Contralateral to Experimental Muscle Pain in Human Volunteers. *Exp Brain Res* 146:213–222
5. Hoheisel U, Mense S, Simons DG et al. (1993) Appearance of New Receptive Fields in Rat Dorsal Horn Neurons Following Noxious Stimulation of Skeletal Muscle: A Model for Referral of Muscle Pain? *Neurosci Lett* 153:9–12
6. Johansen MK, Graven-Nielsen T, Schou OA et al. (1999) Generalised Muscular Hyperalgesia in Chronic Whiplash Syndrome. *Pain* 83:229–234
7. Kellgren JH (1938) Observations on Referred Pain Arising from Muscle. *Clin.Sci* 3:175–190
8. Laursen RJ, Graven-Nielsen T, Jensen TS et al. (1997) Quantification of Local and Referred Pain in Humans Induced by Intramuscular Electrical Stimulation. *Eur J Pain* 1:105–113
9. Leffler AS, Kosek E, Hansson P (2000) Injection of Hypertonic Saline into Musculus Infraspinatus Resulted in Referred Pain and Sensory Disturbances in the Ipsilateral Upper Arm. *Eur J Pain* 4:73–82
10. Leffler AS, Hansson P, Kosek E (2003) Somatosensory Perception in Patients Suffering from Long-Term Trapezius Myalgia at the Site Overlying the Most Painful Part of the Muscle and in an Area of Pain Referral. *Eur J Pain* 7:267–276
11. Mense S, Simons DG (2001) Muscle pain. Understanding its Nature, Diagnosis, and Treatment. Lippincott Williams & Wilkins, Philadelphia
12. Sörensen J, Graven-Nielsen T, Henriksson KG et al. (1998) Hyperexcitability in Fibromyalgia. *J Rheumatol* 25:152–155
13. Svensson P, List T, Hector G (2001) Analysis of Stimulus-Evoked Pain in Patients with Myofascial Temporomandibular Pain Disorders. *Pain* 92:399–409

## Referred Pain

### Definition

Referred pain is a sensation of pain arising from a body region remote from the site of the noxious event and afferent activation, most frequently appearing as pain or hyperalgesia in muscle or skin as a result of visceral nociceptive activation. Referred pain is usually explained by convergent afferent input to central pain processing neurones from visceral organs and the corresponding myotome or dermatome. Common examples of referred pain include pain down the left arm when a person is having a heart attack, or pain down the leg with low back pain. Referred pain has been known and described for more than a century, and has been used extensively as a diagnostic tool in the clinic.

- ▶ [Cancer Pain](#)
- ▶ [Cancer Pain, Goals of a Comprehensive Assessment](#)
- ▶ [Exogenous Muscle Pain](#)
- ▶ [Nociceptors in the Orofacial Region \(Meningeal/Cerebrovascular\)](#)
- ▶ [Opioids and Muscle Pain](#)
- ▶ [Pain Treatment, Spinal Nerve Blocks](#)
- ▶ [Peripheral Neuropathic Pain](#)



- ▶ Referred Hyperalgesia
- ▶ Somatic Referred Pain
- ▶ Spinothalamic Tract Neurons, Visceral Input
- ▶ Thalamus, Visceral Representation
- ▶ Visceral Nociception and Pain
- ▶ Visceral Pain and Nociception
- ▶ Visceral Referred Pain

## Reflective Listening

### Definition

Reflective listening involves making statements that are meant to clarify and restate what the other person is saying. The usual intent of reflective listening is to build rapport and allow the other person to explore his or her thoughts and feelings about the issue being discussed in further depth.

- ▶ Chronic Pain, Patient-Therapist Interaction

## Reflex Sympathetic Dystrophy

- ▶ Complex Regional Pain Syndrome and the Sympathetic Nervous System
- ▶ Complex Regional Pain Syndromes, General Aspects
- ▶ CRPS-I in Children
- ▶ Neuropathic Pain Models, CRPS-I Neuropathy Model
- ▶ Sympathetically Maintained Pain in CRPS I, Human Experimentation

## Reflexes and Opioids

- ▶ Opioids and Reflexes

## Refractory Period

### Definition

The period of time following the end of a painful attack during which no stimulus, however strong, precipitates a further attack. In cells, it refers to the time during which an excitable membrane does not respond to a stimulus that normally generates a response.

- ▶ Molecular Contributions to the Mechanism of Central Pain
- ▶ SUNCT Syndrome

## Regional Anesthesia

### Definition

Various regional anesthetic techniques exist to promote postoperative pain relief. Regional anesthesia techniques can block or reduce pain anywhere in the body for several hours to several days, depending on the technique used. Techniques used include neuraxial local anesthetic techniques, peripheral nerve blocks and regional plexus blocks with local anesthetic, and wound infiltration with local anesthetics. The infiltration of wounds with local anesthetics, besides providing analgesia, appears to reduce the local inflammatory response to trauma or surgery. Local infiltration may help reduce the up-regulation of peripheral nociceptors that manifests as hypersensitivity to stimuli. Local anesthetic can also be administered intra-articularly (knee and shoulder), or on bone wounds (iliac crest graft sites). Catheter techniques can be used to prolong the duration of peripheral nerve blocks, and are either infused continuously or boluses can be administered with patient-controlled pumps. With the advent of disposable infusion pumps, home discharge with a catheter and pump in place is possible. Advantages include better postoperative pain control, reduced blood loss and decreased rates of deep venous thrombosis. If given as the sole anesthetic technique intra-operatively, it allows patient involvement and avoids the common adverse effects of general anesthesia.

- ▶ Cancer Pain Management, Anesthesiologic Interventions, Neural Blockade
- ▶ Multimodal Analgesia in Postoperative Pain
- ▶ Postoperative Pain, Regional Blocks

R

## Regional Blocks

- ▶ Postoperative Pain, Regional Blocks

## Regional Heterogeneity

### Definition

Regional heterogeneity, as it applies to glia, refers to the fact that glia in various CNS sites are not the same. These cells express receptors dependent on their specific microenvironments. Regional heterogeneity exists in the spinal cord, as glia within the dorsal horn exhibit higher glutamate transporter expression and higher fractalkine receptor expression than other regions of spinal cord.

- ▶ Cord Glial Activation

## Regional Infusion

- ▶ Intravenous Infusions, Regional and Systemic

## Regression to the Mean

### Definition

A statistical phenomenon that assumes that individuals tend to receive their initial pain assessment when pain is near its greatest intensity, and that their pain level is likely to be lower when they return for a second assessment.

- ▶ [Placebo Analgesia and Descending Opioid Modulation](#)

## Rehabilitation

### Definition

Therapy that centers on active efforts by a patient to overcome deficits that are brought on by disease or injury, and are not completely correctable by medical or surgical therapies. Physical conditioning and learning new adaptive strategies for managing diseases are fundamental to rehabilitation.

- ▶ [Compensation, Disability and Pain in the Workplace](#)
- ▶ [Disability, Effect of Physician Communication](#)

## Rehabilitation Plan

### Definition

A rehabilitation plan is a written document specifying stepwise goals to improve functions, activities and participation in disabled persons including necessary contextual modifications.

- ▶ [Physical Medicine and Rehabilitation, Team-Oriented Approach](#)

## Reinforcers

### Definition

Reinforcers are defined in a circular fashion. If a consequence systematically following an operant leads to strengthening that operant, it is, by definition, a reinforcer. If it fails to have such an effect when observed over time, it is not a reinforcer for that activity, for that person, in that context.

- ▶ [Malingering, Primary and Secondary Gain](#)
- ▶ [Training by Quotas](#)

## Reiter's Syndrome

### Synonyms

Arthritis urethritica; Venereal arthritis; Reactive arthritis; Polyarteritis enterica

### Definition

Reiter's syndrome, an autoimmune disorder, is the combination of three seemingly unlinked symptoms; inflammatory arthritis of large joints, inflammation of the eyes (conjunctivitis and uveitis), and urethritis. It is named after Hans Reiter, a German military physician, who in 1916 described the disease in a World War I soldier who had recovered from a bout of diarrhea. It is also known as arthritis urethritica, venereal arthritis, reactive arthritis and polyarteritis enterica.

- ▶ [Chronic Low Back Pain, Definitions and Diagnosis](#)
- ▶ [Sacroiliac Joint Pain](#)

## Relationship

- ▶ [Chronic Pain, Patient-Therapist Interaction](#)

## Relative Potency

### Definition

Relative potency is determined by comparing graded dose-response curves for two drugs (A and B). From these curves the dose required to produce fifty percent of the maximum response can be estimated, and the ratio of the dose of A/B that produces an equivalent response is found.

- ▶ [Opioid Rotation](#)

## Relaxation

### Definition

A group of therapeutic procedures that aim to teach individuals how to induce a state of reduced musculoskeletal activity. The induction of relaxation is accompanied by quiescence in visceral activity and brain states associated with mental calmness and a positive mood, s. also Relaxation Therapy.

- ▶ [Psychological Treatment in Acute Pain](#)
- ▶ [Psychological Treatment of Headache](#)
- ▶ [Psychological Treatment of Pain in Children](#)
- ▶ [Psychology of Pain, Efficacy](#)
- ▶ [Therapy of Pain, Hypnosis](#)

## Relaxation in the Treatment of Pain

BEVERLY E. THORN<sup>1</sup>, FRANK ANDRASIK<sup>2</sup>

<sup>1</sup>University of Alabama, Tuscaloosa, AL, USA

<sup>2</sup>University of West Florida, Pensacola, FL, USA  
bthorn@bama.ua.edu, fandrasi@uwf.edu

### Synonyms

Progressive muscle relaxation; autogenic training; guided imagery; Passive Relaxation; meditation; Hypnotic Relaxation; diaphragmatic breathing

### Definition

► **Relaxation interventions** are categorized as psychological therapies, psychophysiological therapies, and/or behavioral therapies. Relaxation therapies involve a systematic process of teaching patients to become aware of their physiological responses, and to gain a sense of physiological and cognitive/emotional calm or serenity. Successful relaxation is thought to decrease overall sympathetic nervous system arousal, which is associated with physiological concomitants (e.g. reductions in muscle tension, heart rate, blood pressure, and respiration) as well as cognitive/affective components (e.g. a sense of tranquility, reduced anxiety and distress). Relaxation can be achieved through a variety of means, including specific muscle relaxation or breathing exercises, biofeedback-assisted relaxation, ► **Hypnotic Relaxation**, ► **meditation**, or mental imagery. Relaxation therapies are often used in conjunction with other psychological interventions, such as cognitive stress coping therapy, and other cognitive-behavioral approaches. Relaxation interventions are widely utilized with both acute and chronic pain management, and there is a well-established evidence base for their use (Andrasik 1986; Andrasik 2004; Arena and Blanchard 1996).

### Characteristics

#### Types of Relaxation Therapy

The most frequently used form of relaxation therapy is ► **progressive muscle relaxation** (PMR), whereby patients are taught to discriminate between tense and relaxed muscles by volitionally tensing, and then relaxing, a prescribed set of muscle groups throughout the body (Bernstein and Borkovec 1973; Bernstein and Carlson 1993; Jacobsen 1938; Lehrer 1982). This form of relaxation is often used as the sole relaxation intervention, or as a first component of a multi-session relaxation protocol. PMR is thought to help patients discriminate between tensed and relaxed muscles, thus facilitating the process of learning to achieve reductions in muscle tension. Patients with previous injuries, pain, or strain in any particular muscle group, are instructed to omit that group of muscles from the tension-relaxation protocol.

Another common form of relaxation therapy is ► **guided mental imagery**, whereby a patient is taught to create a mental “image” of a relaxing setting (the image may include auditory, olfactory, tactile, and even gustatory imagery, as well as visual imagery). The most commonly employed guided imagery involves asking the patient to imagine a peaceful and pleasant scene or place in great detail. Patients are encouraged to include in their image as many of the sensory aspects of the scene as possible; although visual imagery is most predominant, supplementing the visual image with the other senses (e.g. auditory or tactile imagery) is thought to enhance the depth of the experience.

A third form of relaxation therapy involves ► **autogenic training**, whereby various verbal cues associated with physiological aspects of the relaxation response (e.g. “my hands are heavy and warm”) are repeated slowly by the participant (Schultz and Luthe 1969). Autogenic relaxation training is also called cue-assisted relaxation, since it involves self-verbalized cues associated with decreased sympathetic nervous system arousal. Cue-assisted relaxation can also involve a simpler format, in which a verbal cue (e.g. “relax”) is repeated in the mind of the patient as they continue to relax and breathe slowly and deeply.

Virtually all forms of relaxation include instruction in the use of ► **diaphragmatic breathing**. Diaphragmatic breathing involves teaching the patient to draw air more deeply into the lungs by moving the diaphragm downward toward the umbilicus, and thus causing a notable expansion of the abdomen upon inspiration. In addition to coupling diaphragmatic breathing with other forms of relaxation during periods of practice, patients are often instructed to use diaphragmatic breathing as a brief intervention tool in response to stressors as they arise during their daily routine. In addition to slow diaphragmatic breathing, the following are also helpful techniques for patients: paced respiration, breath meditation, breath mindfulness, and pursed-lip breathing. When breathing is the sole or main focus, certain instruments may be useful to quantify and shape breathing more precisely (e.g. nasal airflow temperature gauge, strain gauge, EMG from accessory breathing muscles, capnometer and oximeter methods, spirometry, arterial blood oxyhemoglobin saturation, etc.) (Gevirtz and Schwartz 2003).

Many relaxation protocols, especially when they involve more than a single training session, utilize deepening strategies to help patients increase their depth of relaxation. Deepening strategies often involve counting slowly, each number representing a deeper level of relaxation. In some cases, the patient is instructed to visualize descending a very secure staircase, and each step represents a deeper level of relaxation. These deepening strategies share similarities with hypnosis, although they may or may not be labeled hypnosis. At this point, it is not known whether self-hypnosis,

meditation, or more “traditional” relaxation procedures are quantitatively distinguishable from one another in terms of their outcome. Although qualitatively somewhat different, they also share many similarities, and are thus grouped together as relaxation strategies for the purposes of this essay.

An example of a multi-session relaxation instruction regimen is taken from Andrasik (1986), and is briefly summarized here. Following an education phase where the client is informed about relaxation procedures, instruction begins with progressive muscle relaxation in which the patient tenses, then relaxes, a relatively large number of muscle groups (e.g. 18 specific muscle groups), followed by a deepening strategy. A second session incorporates imagery training into the protocol. Subsequent sessions include discrimination training, where patients are taught various gradations of tension and relaxation in order to understand that the state of muscle tension or relaxation is a continuous process, rather than a dichotomous, either-or state. Later sessions decrease the number of muscle groups that are contracted and then relaxed, which shortens the procedure and makes it more easily “portable,” and relaxation by recall is introduced, where the patient attempts relaxation without going through the tension-relaxation cycles, but rather by focusing on the process of relaxation, and recalling the previous instruction. Final sessions incorporate cue-assisted relaxation (using diaphragmatic breathing and often using a word cue to signal relaxation, such as “relax”).

Although relaxation treatments most commonly lead to positive outcomes, a small number of individuals can experience initial negative outcomes (muscle cramps, disturbing sensory, cognitive, or emotional reactions) and/or encounter other problems that impact adherence and practice. Schwartz, Schwartz, and Monastera (2003) provide a detailed discussion of these potential problems, along with solutions for addressing them.

### Efficacy

The efficacy of relaxation treatments have most frequently been evaluated by comparing one form of relaxation training to another, or comparing relaxation training to other forms of credible treatment. For example, in a study comparing progressive muscle relaxation to autogenic relaxation training in low back pain patients, both forms of relaxation were found to increase feelings of relaxation (Rohrmann et al. 2001). Other efficacy investigations have compared individuals receiving relaxation instruction, to waiting list control comparison groups, or to participants who receive credible attention placebo treatment (often education information regarding pain or supportive psychotherapy). For example, in a study comparing relaxation and guided imagery for individuals in rehabilitation for anterior cruciate ligament reconstruction, patients were compared to controls (no treatment) or placebo

treatment groups (attention, encouragement, and support). In this study, those patients receiving guided imagery/relaxation training reported significantly less pain and re-injury anxiety at 24-weeks post-surgery than patients in the placebo group or the no treatment condition (Cupal and Brewer 2001).

Another example of a well-controlled efficacy study of relaxation assessed self-reported pain of bone marrow transplant patients after one of four treatments: relaxation/imagery training alone, combined cognitive-behavioral treatment (CBT) with imagery/relaxation training, medical treatment as usual, or therapist support (Syrjala et al. 1995). In this clinical trial, relaxation/imagery training alone or combined relaxation/imagery/CBT resulted in lower pain reports compared to the treatment as usual or therapist support groups, although the addition of CBT did not add incremental value.

### Therapeutic Mechanism

The specific mechanism responsible for the success of relaxation in pain management is not known. There is no evidence that clearly demonstrates the superiority of one type of relaxation training over other types, even for specific pain disorders. It is, however, widely observed that relaxation instruction elicits general reductions in muscle tension.

Flor and colleagues (1999) have shown that patients with chronic pain are unable to perceive muscle tension levels accurately (in either affected or nonaffected muscles) and, further, when exposed to tasks requiring production of muscle tension, they overestimate physical symptoms, rate the task as more aversive, and report greater pain. Their findings indicate a heightened sensitivity, and suggest that relaxation strategies may lead to increased discrimination accuracy with a concomitant reduction in sensitivity.

Additionally, it is commonly observed that relaxation is associated with reductions in heart rate and respiratory activity, physiological responses thought to moderate ► [sympathetic nervous system arousal](#) (Good et al. 1999). Thus, the success of the various forms of relaxation instruction may be more related to an overall reduction in levels of sympathetic nervous system arousal, and perhaps a reduction in the cognitive and affective factors that exacerbate pain.

### References

1. Andrasik F (1986) Relaxation and Biofeedback for Chronic Headaches. In: Holzman AD, Turk DC (eds) *Pain Management: A Handbook of Treatment Approaches*. Pergamon Press, NY, pp 213–239
2. Andrasik F (2004) The Essence of Biofeedback, Relaxation, and Hypnosis. In: Dworkin RH, Breitbart WS (eds) *Psychosocial Aspects of Pain: A Handbook for Health Care Providers*. IASP Press, Seattle, pp 285–305
3. Arena JG, Blanchard EB (1996) Biofeedback and Relaxation Therapy for Chronic Pain Disorders. In: Gatchel RJ, Turk DC (eds) *Psychological Approaches to Pain Manage-*



- ment: A Practitioner's Handbook. Guilford Press, New York, pp 179–230
4. Bernstein DA, Borkovec TD (1973) Progressive Relaxation Training. Research Press, Champaign, IL
  5. Bernstein DA, Carlson CR (1993) Progressive Relaxation: Abbreviated Methods. In: Lehrer PM, Woolfolk RL (eds) Principles and Practice of Stress Management, 2<sup>nd</sup> edn. Guilford Press, NY
  6. Cupal DD, Brewer BW (2001) Effects of Relaxation and Guided Imagery on Knee Strength, Reinjury Anxiety, and Pain following Anterior Cruciate Ligament Reconstruction. *Rehab Psychol* 46:28–43
  7. Flor H, Fürst M, Birbaumer N (1999) Deficient Discrimination of EMG Levels and Overestimation of Perceived Tension in Chronic Pain Patients. *Appl Psychophysiol Biofeedback* 24:55–66
  8. Gevirtz RN, Schwartz MS (2003) The Respiratory System in Applied Psychophysiology. In: Schwartz MS, Andrasik F (eds) *Biofeedback: A Practitioner's Guide*, 3<sup>rd</sup> edn. Guilford Press, NY, pp 212–244
  9. Good M, Stanton-Hicks M, Grass JA, Anderson G, Choi C, Schoolmeesters L, Salman A (1999) Relief of Postoperative Pain with Jaw Relaxation, Music, and their Combination. *Pain* 81:163–172
  10. Jacobsen E (1938) *Progressive Relaxation*. University of Chicago Press, Chicago
  11. Lehrer PM (1982) How to Relax and How Not to Relax: A Reevaluation of the Work of Edmund Jacobson–I. *Behav Res Ther* 20:417–428
  12. Rorhmann S, Hopf M, Hennig J, Netter P (2001) Psychobiological Effects of Autogenic Training and Progressive Muscle Relaxation in Patient with Back Pain, Multiple Sclerosis (MS) and Healthy Individuals. *Zeitschrift fuer Klinische Psychologie, Psychiatrie und Psychotherapie* 49:373–387
  13. Schultz JH, Luthe W (1969) *Autogenic Training*, vol 1. Grune and Stratton, New York
  14. Schwartz MS, Schwartz NM, Monastra VJ (2003) Problems with Relaxation and Biofeedback-Assisted Relaxation and Guidelines for Management. In: Schwartz MS, Andrasik F (eds) *Biofeedback: A Practitioner's Guide*, 3<sup>rd</sup> edn. Guilford Press, NY, pp 251–264
  15. Syrjala KL, Donaldson GW, Davis MW, Kippes ME et al. (1995) Relaxation and Imagery and Cognitive-Behavioral Training Reduce Pain during Cancer Treatment: A Controlled Clinical Trial. *Pain* 63:189–198

## Relaxation Interventions

### Definition

A systematic process of teaching patients to become aware of their physiological responses and to gain a sense of physiological and cognitive/emotional calm or serenity.

- ▶ [Psychological Treatment of Headache](#)

## Relaxation-Induced Anxiety

### Definition

A sudden increase in anxiety during deep relaxation that can range from mild to moderate intensity and that can approach the level of a minor panic episode.

- ▶ [Biofeedback in the Treatment of Pain](#)
- ▶ [Relaxation in the Treatment of Pain](#)

## Relaxation Therapy

### Definition

Standardized instructions or meditative techniques used to elicit a relaxation response, characterized by a generalized decrease in the sympathetic nervous system and metabolic activity and an altered state of consciousness, described as a subjective experience of well-being. The techniques include autogenic training, transcendental meditation, yoga and Jacobson's method of progressive relaxation.

- ▶ [Biofeedback in the Treatment of Pain](#)
- ▶ [Body Awareness Therapies](#)
- ▶ [Complex Chronic Pain in Children, Interdisciplinary Treatment](#)
- ▶ [Migraine, Preventive Therapy](#)
- ▶ [Relaxation](#)
- ▶ [Relaxation in the Treatment of Pain](#)
- ▶ [Relaxation Training](#)

## Relaxation Training

BENGT H. SJÖLUND

Rehabilitation and Research Centre for Torture Victims, South Danish University, Copenhagen, Denmark  
bsj@rct.dk

### Synonyms

Autogenic training; Stress Management

### Definition

A relaxation procedure, taught to patients during a number of individual or group sessions, from which a psychophysiological determined relaxation response should preferably be elicited. It is often used as one component of a pain rehabilitation program (e.g. Turner-Stokes 2003).

### Characteristics

Systematic training in relaxation techniques for continued self-use has been reported to have beneficial results in patients with chronic temporomandibular disorder, both on pain severity and life interference from pain (Carlson et al. 2001), immediately after intervention and at a 26-week follow-up. There were also significant decreases in affective distress, somatization, obsessive-compulsive symptoms, tender point sensitivity, awareness of tooth contact and sleep dysfunction. Similarly, in an evaluation of the effectiveness of a meditation based stress reduction program on fibromyalgia, seventy seven patients meeting the 1990 criteria of the American College of Rheumatology for fibromyalgia took part in a 10-week group outpatient program with a

carefully defined treatment approach. The mean scores of all the patients completing the program showed improvement, but 51% showed moderate to marked improvement and were considered as responders, indicating that a meditation based stress reduction program is indeed effective for patients with fibromyalgia (Kaplan et al. 1993).

In a study of the relative effectiveness of EMG biofeedback, applied relaxation training and a combined procedure *versus* a wait list control for the management of chronic, upper extremity cumulative trauma disorder, patients in all three treatment conditions showed significant short-term reductions in pain and psychopathology in comparison to the wait list group (Spence et al. 1995). There was some relapse on measures of depression, anxiety and pain beliefs for treated patients during a 6-month follow-up period, although the measures remained significantly below pre-treatment levels for most outcome indices and self-monitored pain continued to decrease. Interestingly, the greatest short-term treatment benefits on measures of pain, distress, interference in daily living, depression and anxiety were shown by patients receiving applied relaxation training (cf. Stuckey et al. 1986), whereas by the follow-up, the differences between the treatment groups were no longer evident. In children with chronic tension type headache, a controlled study has shown that headache activity in the children treated with relaxation training was significantly more reduced than among those in the no treatment control group at post-treatment as well as the 6-month follow-up. At these evaluations, 69% and 73% respectively of the pupils treated with relaxation had achieved a clinically significant headache improvement (at least a 50% improvement) as compared to 8% and 27% respectively of the pupils in the no treatment control group (Larsson and Carlsson 1996). In adults, stress management therapy consisting of relaxation training and cognitive coping has been found to produce larger (but modest) reductions in tension type headache activity, analgesic medication use and headache related disability than placebo, but antidepressant medication yielded more rapid improvements in headache activity (Holroyd et al. 2001). Combined therapy was, however, found more likely to produce clinically significant reductions in headache index scores than monotherapy. In a recent systematic review, positive effects (medium range) of autogenic training and of autogenic training *versus* control in a meta-analysis of at least 3 studies were found for tension headache/migraine, somatoform pain disorder (unspecified type), anxiety disorders, mild to moderate depression/dysthymia and functional sleep disorders (Stetter and Kupper 2002), demonstrating that this technique can be of considerable value as part of a multidisciplinary pain rehabilitation program. In a recent Cochrane review on behavioural treatment of chronic low back pain (Ostelo et al. 2004), moderate evidence (2 trials, 39 people) was found in favour of

progressive relaxation for a large positive effect on pain and behavioural outcomes, but only short-term.

## References

1. Carlson CR, Bertrand PM, Ehrlich AD et al. (2001) Physical self-regulation training for the management of temporomandibular disorders. *J Orofac Pain* 15:47–55
2. Holroyd KA, O'Donnell FJ, Stensland M et al. (2001) Management of chronic tension-type headache with tricyclic antidepressant medication, stress management therapy, and their combination: a randomized controlled trial. *JAMA* 285:2208–2215
3. Kaplan KH, Goldenberg DL, Galvin-Nadeau M (1993) The impact of a meditation-based stress reduction program on fibromyalgia. *Gen Hosp Psychiatry* 15:284–289
4. Larsson B, Carlsson J (1996) A school-based, nurse-administered relaxation training for children with chronic tension-type headache. *J Pediatr Psychol* 21:603–614
5. Ostelo RWJG, Tulder MW van, Vlaeyen JWS et al. (2004) Behavioural treatment for chronic low-back pain. *The Cochrane Database of Systematic Reviews* 2004, Issue 3. Art. No. CD002014. DOI: 10.1002/14651858.CD002014.pub2
6. Spence SH, Sharpe L, Newton-John T et al. (1995) Effect of EMG biofeedback compared to applied relaxation training with chronic, upper extremity cumulative trauma disorders. *Pain* 63:199–206
7. Stetter F, Kupper S (2002) Autogenic training: a meta-analysis of clinical outcome studies. *Appl Psychophysiol Biofeedback* 27:45–98
8. Stuckey SJ, Jacobs A, Goldfarb J (1986) EMG biofeedback training, relaxation training, and placebo for the relief of chronic back pain. *Percept Mot Skills* 63:1023–1036
9. Turner-Stokes L, Erkeller-Yuksel F, Miles A et al. (2003) Out-patient cognitive behavioral pain management programs: a randomized comparison of a group-based multidisciplinary versus an individual therapy model. *Arch Phys Med Rehabil* 84:781–788

## Reliability

DAVID VIVIAN  
Metro Spinal Clinic, Caulfield, VIC, Australia  
dvivian@metrospinal.com.au

### Definition

► **Reliability** is the extent to which two observers obtain the same results, when using the same diagnostic test, on the same sample of patients.

### Characteristics

Reliability is determined by having two observers independently apply the test on the same patients, and recording the results in a contingency table (Table 1).

**Reliability, Table 1** A contingency table from which the reliability of a diagnostic test can be derived.

Observer One	Observer Two	
	Positive	Negative
Positive	a	b
Negative	c	d

In such a table, the total number (N) of patients in the sample is a+b+c+d; 'a' constitutes the number of patients in whom both observers found that the test was positive; 'd' is the number of patients in whom both observers found that the test was negative; 'b' is the number of patients in whom observer one found the test to be positive, but observer two found it to be negative; and 'c' is the number of patients in whom observer one found the test to be negative, but observer two found it to be positive. Such a table shows that the observers agreed that the test was positive in 'a' cases, and agreed that the test was negative in 'd' cases. Their apparent rate of agreement is  $[(a+d) / N] \times 100\%$ .

The apparent rate of agreement, however, is not an accurate measure of how good the test is, for it incorporates agreement that might have occurred by chance alone. The true agreement is provided by discounting the apparent agreement for agreement by chance. This is illustrated in Figure 1.

This figure illustrates that if there is not complete agreement in all cases, the observed agreement (Po) is less than complete agreement by the extent to which there is disagreement. The figure also illustrates that complete agreement consists of two, hypothetical parts: the agreement expected by chance alone (Pe), and the range available for possible agreement beyond chance alone (1-Pe). Meanwhile, the observed agreement (Po) also consists of one portion due to agreement by chance alone (Pe), and another portion that is the agreement beyond chance alone (Po-Pe). In determining the reliability of the test, credit is not given to the observers for that agreement which they achieved by chance alone. Their true skill, and the strength of the test, is determined by how well they agreed beyond chance alone.

That is established by measuring how far their observed agreement extends into the range of agreement available beyond chance alone, and is expressed by a statistic called kappa, where:

$$\text{kappa} = (Po - Pe) / (1 - Pe).$$

In words, kappa is the extent to which the observed agreement (discounted for chance) fills the range of possible agreement available (also discounted for chance).

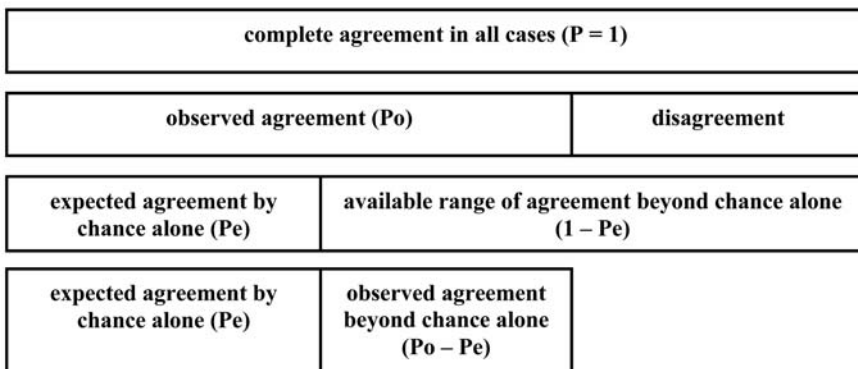
**Reliability, Table 2** A contingency table from which agreement can be derived.

	Observer Two		Totals
	Positive	Negative	
Observer One Positive	a	b	a+b
Observer One Negative	c	d	c+d
Totals	a+c	b+d	N = a+b+c+d

An example to help understand this concept is a multiple choice examination. If there are 100 questions each with four choices, a candidate could, on average, answer one in four questions correctly simply by guessing. By chance alone they could score 25%. A candidate, who scores 65%, has not demonstrated a proficiency of 65%, for 25 of those 65 marks could have been gained by chance alone. Their true skill is demonstrated by how well they performed beyond chance alone. Accordingly their raw score (65) is discounted by the number of questions that they could have answered correctly by chance alone (25), which yields 40. Similarly, the total number of questions (100) is discounted by the number of questions that might have been answered correctly by chance alone (25), to yield the available number of questions that might have been answered correctly beyond chance alone (75). The true skill of the candidate is then the proportion of the available number of questions (75) that the candidate correctly answered (40), i.e.  $40/75 = 53\%$ . The true skill of the candidate, discounted for chance, is 53%, not the raw score of 65%.

Not obvious in the determination of reliability is how the expected agreement by chance alone should be estimated. This is based on what the two observers find, on average, which is shown by the sums of the columns and rows of the contingency table (Table 2).

This table shows that, overall, observer one recorded positive findings in (a+b) cases. On average, therefore, this observer would record positive findings in (a+b)/N of all cases presented to him. Meanwhile, observer two



**Reliability, Figure 1** The distinction between observed agreement and agreement beyond chance.

found (a+c) cases presented to him to be positive. If these cases were presented to observer one, the number that observer one would be expected to record as positive, by chance alone, would be  $(a+c) \times [(a+b) / N]$ . Similarly the proportion of cases that observer one recorded as negative is  $(c+d) / N$ . The number of cases that observer two found to be negative is (b+d). If these cases were presented to observer one, the number that would be expected to be recorded as negative, by chance alone, would be  $(b+d) \times [(c+d) / N]$ .

These derived numbers provide an estimate of the agreement expected by chance alone (Pe), i.e.

$$Pe = [(a+c)(a+b)/N + (b+d)(c+d)/N] / N$$

This is different from the observed agreement (Po), viz.  $Po = (a+d)/N$ .

From these equations, Po, Pe, (Po-Pe), and (1-Pe) can be calculated, and hence, kappa can be calculated. Readers interested in further reading about kappa, can consult the original literature (Cohen 1960) or various other educational resources (Sackett et al. 1991, Bogduk 1998). For practical purposes, however, readers should understand that once calculated kappa can range in value from 0 to 1, or from 0 to -1. Negative values of kappa indicate abject disagreement, which occurs only for very unreliable tests. For most tests, the values are positive. A value of 0 indicates no agreement beyond chance alone. A value of 1 indicates complete, i.e. perfect, agreement.

Values between 0 and 1 can be accorded a range of verbal descriptors (Table 3). The kappa values indicate quantitatively, and the descriptors indicate qualitatively, just how reliable the diagnostic test is.

If practitioners use diagnostic tests with high kappa scores, they can be confident that the reliability of the test is good. However, if the kappa score is low, practitioners should realize that the diagnostic test does not work well; that someone else using the same test on the same patient is not likely to obtain the same result. Consequently, they have grounds to question or doubt the result that they have obtained.

The kappa score does not, and cannot, determine which of two observers is correct. It measures only how consistent any two observers are, or might expect to be. However, if consistency is lacking, the test or how it is used is defective. In essence, diagnostic tests with low kappa

scores just do not work well enough to be reliable. Their results are little better than guessing, and do not reflect professional proficiency.

- ▶ [Multiaxial Assessment of Pain](#)
- ▶ [Oswestry Disability Index](#)
- ▶ [Pain Assessment in Children](#)
- ▶ [Pain Assessment in Neonates](#)
- ▶ [Pain Behaviors](#)
- ▶ [Pain Inventories Assessment](#)

## References

1. Bogduk N (1998) Truth in Musculoskeletal Medicine II. Truth in Diagnosis: Reliability. *Australasian Musculoskeletal Medicine* 3:21-23
2. Cohen J (1960) A Coefficient of Agreement for Nominal Scales. *Educ Psych Meas* 20:37-46
3. Sackett DL, Haynes RB, Guyatt GH, Tugwell P (1991) *Clinical Epidemiology. A Basic Science for Clinical Medicine*, 2nd edn. Little, Brown & Co, Boston, pp 119-139

## REM Sleep

- ▶ [Rapid Eye Movement Sleep](#)

## Renin

### Definition

Renin is a proteolytic enzyme secreted by specific kidney cells. It catalyzes the formation of angiotensin and thus affects blood pressure.

- ▶ [NSAIDs, Adverse Effects](#)

## Repetitive Strain Injuries

### Synonyms

RSI

### Definition

A descriptive term used to label pain associated with repetitive activities.

- ▶ [Disability, Upper Extremity](#)

## Repetitive Transcranial Magnetic Stimulation

### Synonyms

rTMS

**Reliability, Table 3** Verbal translations of kappa scores.

Kappa Value	Descriptor
0.8-1.0	Very good
0.6-0.8	good
0.4-0.6	moderate
0.2-0.4	slight
0.0-0.2	Poor



**Definition**

This form of stimulation uses a rapidly and repetitive changing magnetic field to stimulate the nervous system. Repetitive Transcranial Magnetic Stimulation (rTMS) can modulate cortical excitability and function of the stimulated cortical areas. It has been proposed as a noninvasive treatment modality for movement and psychiatric disorders.

- ▶ Stimulation Treatments of Central Pain

**Repetitiveness of Movement****Definition**

This term is used for repetitive movements with a cycle time of at least 1 per 30 seconds.

- ▶ Ergonomic Counseling

**Repriming****Definition**

Repriming refers to the resetting of the electrical status of a discharged neuron that permits re-firing.

- ▶ Molecular Contributions to the Mechanism of Central Pain

**Rescue Analgesic****Definition**

Rescue analgesic agents are medications prescribed in addition to regularly scheduled analgesic medications, which are intended to be taken during episodes of pain not controlled by a patient's scheduled analgesic regimen.

- ▶ Evoked and Movement-Related Neuropathic Pain

**Residual Functional Capacity****Synonyms**

RFC

**Definition**

A person's remaining capacity to perform work-related physical and mental activities. The assessment of RFC is a determination reserved for the Commissioner of Social Security.

- ▶ Disability Evaluation in the Social Security Administration

**Residual Limb Pain****Definition**

Also called phantom limb pain, refers to pain in the portion of the body adjacent to the amputation line. Residual limb pain and phantom limb pain are often correlated.

- ▶ Pain Assessment in Children
- ▶ Phantom Limb Pain, Treatment

**Resiniferatoxin****Synonyms**

RTX

**Definition**

An investigational drug for the treatment of IC; appears to desensitize urothelial nerve fibers.

- ▶ Interstitial Cystitis and Chronic Pelvic Pain

**Resistance****Definition**

Patient behaviors (such as arguing, changing the subject, interrupting, denying a problem) that indicate the patient is not interested in changing his or her behavior.

- ▶ Chronic Pain, Patient-Therapist Interaction

**Respiratory Centers****Definition**

Brainstem centers that specifically regulate ventilation.

- ▶ Placebo Analgesia and Descending Opioid Modulation

**Respiratory Depression****Definition**

Severe slowing or arrest of spontaneous breathing caused by morphine and morphine-like drugs.

- ▶ Postoperative Pain, Acute Pain Management, Principles

**Respondent Conditioning**

- ▶ Classical Conditioning

## Respondent Conditioning of Chronic Pain

HERTA FLOR

Department of Clinical and Cognitive Neuroscience  
at the University of Heidelberg, Central Institute of  
Mental Health, Mannheim, Germany  
flor@zi-mannheim.de

### Synonyms

Classical conditioning; Pavlovian conditioning

### Definition

Classical conditioning refers to a type of learning, where a neutral or conditioned stimulus (CS) is repeatedly paired with a biologically significant or unconditioned stimulus (US) and comes to elicit a conditioned response (CR) that is often, but not always, similar to the original response to the US, the unconditioned response (UR).

### Characteristics

Gentry and Bernal (1977) were the first to describe a respondent model of the development of chronic pain. They suggested that acute pain (the unconditioned stimulus, US) that is associated with sympathetic activation and increased generalized [▶ muscle tension](#) (the unconditioned response, UR) may evolve into a chronic pain problem through a process of classical conditioning. In their model, the frequent association of innocuous stimuli (conditioned stimuli, CS) such as a certain environment or a certain body position with acute pain states may elicit [▶ fear of pain](#) (see also [▶ fear and pain](#)), sympathetic activation and increased muscle tension (the conditioned response, CR) to these previously neutral stimuli. Gentry and Bernal further suggested that this process of conditioning might lead to a [▶ pain-tension cycle](#), which may maintain the chronic pain problem independent of the original tissue damage. Thus, the pain resulting from this process may be a purely [▶ musculoskeletal type of pain](#) completely unrelated to the original cause of pain.

Linton et al. (1985) have further elaborated on the respondent conditioning perspective of chronic pain, and have emphasized that there is a wide range of stimuli that may serve as CSs and USs. They point out that both direct and indirect noxious stimuli (e.g. pain originating from a herniated disk, carrying something heavy with a problem back) may be important USs. Whereas the US may be related to an injury, the UR usually manifests itself as activation of the sympathetic nervous system, anxiety and muscle tension increases. The CS related to the US and the CR is not pain initially, but can be pain-provoking over time. Linton et al. (1985) state that there is no evidence of classical conditioning of neurological pain, but only of anxiety and related physiological activation. This elevated anxiety may

then lead to heightened sensitivity to noxious stimuli (Asmundson et al. 1999; Vlaeyen and Linton 2000). Whether muscle tension produced by muscle contraction leads to pain is dependent on: (1) the amount of muscle contraction; (2) the duration of the contraction; and (3) the individual vulnerability (predispositional factors such as prior injury or personality characteristics). The pain produced by muscle tension may thus not be the same as the original pain; however, patients (and physicians) may not be able to discriminate between the two.

There is evidence on the role of respondent conditioning in chronic pain patients. For example, patients who suffered from upper back pain and healthy controls received unconditioned stimuli (painful electric stimulation) to the forearm, and a picture of a dead body (thought to have a high belongingness with pain) served as the CS+ (followed by shock most of the time), and picture of a rabbit (positive cue unrelated to pain) served as the CS- (never followed by shock). The chronic back pain patients already showed anticipatory high muscle tension in the arm during the preconditioning phase, when the dead body was never followed by pain. In the learning phase they displayed an increase of the muscular response in the arm close to where the painful stimulus was applied and, in addition, had conditioned responses in the trapezius muscle (Schneider et al. 2004, see also Vlaeyen et al. 1999). These results suggest that a conditioning process may already have taken place in chronic pain patients, and that the often observed heightened stress reactivity in these patients (Flor et al. 1992, Moulton and Spence 1992) may be a result of classical conditioning that is quite specific to the site of pain. These data lend credence to the assumption that classically conditioned pain responses may not only be a consequence of the occurrence of an acute pain episode, but may also play a role in the evolution of chronic pain states. The role of high levels of muscle tension in the development of pain has also been substantiated by stress induction studies in chronic pain patients. For example, syndrome-specific (i.e. lower back and facial pain) alterations in muscle tension in response to stress were observed in patients with chronic low back pain or [▶ temporomandibular pain](#) and dysfunction. Subjects who suffered from chronic temporomandibular pain showed increases in masseter muscle tension when exposed to personally relevant stress episodes; in contrast, subjects who suffered from chronic back pain selectively tensed their lumbar erector spinae muscles. Healthy controls showed high cardiovascular responses but not elevated muscular reactivity to stress. Skin conductance levels were equally elevated in all groups when stress or pain, as compared to neutral imagery, was employed. The observation that patients respond selectively to [▶ personally-relevant stressful situations](#) but not to general stressors, suggests the presence of classically

conditioned responses rather than unconditioned responses in these patients (see Flor et al. 1991; Flor et al. 1992; Moulton and Spence 1992). The specificity of the response to the situation from the patients' lives support the learning (see also ► [modeling, social learning in pain](#)) view.

To illustrate the proposed process, from a respondent conditioning perspective, the patient may have learned to associate increases in muscle tension with all kinds of stimuli that were originally associated with nociceptive stimulation. Thus, sitting, walking, bending, or even thoughts about these movements may elicit ► [anticipatory anxiety](#) (see also ► [depression and pain](#); ► [fear and pain](#)) and increases in muscle tension. This fear of movement or "► [kinesiophobia](#)" (see also ► [fear and pain](#)) has been discussed as an important factor in the maintenance and exacerbation of chronic pain (e.g. Asmundson et al. 1997; Vlaeyen et al. 1999). Subsequently, patients may display maladaptive responses to any number of stimuli, and reduce the frequency of performance of many activities other than those that initially reduced pain. This process is referred to as stimulus generalization. The anticipatory anxiety related to movement may act as a conditioned stimulus for muscle tension (conditioned response) that may be maintained after the original unconditioned stimulus (e.g. injury) and unconditioned response (pain and muscle tension) have subsided. Thus, although the original association between injury and pain results in anxiety regarding movement, over time the anxiety may lead to increased muscle tension and pain, even if the nociceptive stimuli are no longer present. In addition, stress situations can increase muscle tension levels and cause sympathetic activation and may, thus, reinforce this process. Many of our patients have reported that an acute pain problem evolved into chronic pain at a time where personal stressors co-occurred with the pain. Stress situations may serve as additional US and also as CS for muscle tension increases, increased sympathetic activation, and subsequently pain.

Non-occurrence of pain is a powerful reinforcer for the reduction of movement. Thus, the original respondent conditioning may be complemented by an ► [operant process](#) (see also ► [operant treatment of chronic pain](#); ► [operant perspective of pain](#)), whereby the nociceptive stimuli need no longer be present for the avoidance behaviour to occur. People who suffer from acute back pain, regardless of the cause, may adopt specific behaviours (e.g. limping) to avoid pain, and they may never obtain "corrective feedback" because they fail to perform more natural movements and fail to learn that they may not induce pain (Vlaeyen et al. 1995). Reduction in physical activity may subsequently result in muscle atrophy and increased disability. In this manner, the physical abnormalities proposed by biomechanical models of pain (cf. Dolce and Racynski 1985) may actually be secondary to changes in behaviour initiated

through learning. Similarly, Lethem et al. (1983) have emphasized that chronic pain patients tend to focus their attention on impending pain and subsequently avoid many types of activity, thus fostering the development of disability and depression.

As the pain symptoms persist, more and more situations may elicit anxiety and anticipation of pain. Depression, pain, and dependence on medication may follow, further intensifying the pain-tension cycle. Thus, psychological expectations may lead to modified behaviour that, in turn, produces physical changes leading to still further physical deconditioning. In the case of chronic pain, the anticipation of, or prevention of, pain may be sufficient for the long-term maintenance of the avoidance behaviours. These observations add support to the importance of active physical therapy, with patients progressively increasing their activity levels despite fear of injury and discomfort associated with renewed use of deconditioned muscles. Disconfirmation of the expected and feared outcomes by exposure may help to desensitize patients, and will serve to reinforce performance of additional activities that had previously been feared and avoided. The importance of operant learning factors will be further discussed in the following section. The role of fear of pain and movement is described in another essay. In addition to the anticipation of pain and to associated physiological processes, the subjective evaluation of pain may also be modified by its association with affective variables such as positive, negative or neutral emotional states. Wunsch et al. (2003) showed that aversive slides paired with a painful stimulus lead to higher pain intensity ratings of the same painful stimulus than when appetitive or neutral slides preceded the painful stimulus. They demonstrated that the conditioning changed the evaluation of the painful stimulus without the participants' awareness, and concluded that pain is the result of complex cognitive-emotional interactions that need to be considered when the experience of pain is evaluated. In a study in healthy controls, Diesch and Flor (2005) showed that the use of pain as an unconditioned stimulus, and non-painful tactile stimuli as conditioned stimuli, leads to a fast acquisition of conditioned muscle tension increases, as well as an expansion of the representation of the CS that signals pain in primary somatosensory cortex. In addition, the presence of pain, no matter if the CS was paired with the US or not, lead to a more aversive evaluation of the non-painful tactile sensation that served as CS. These data suggest that the mere presence of pain leads to a more aversive evaluation of any type of non-painful bodily sensation. This might explain why chronic pain patients frequently complain about a host of physical symptoms, and are often classified as suffering from ► [somatization](#) disorder.

Finally, several animal studies and studies in humans have shown that pain-inhibiting descending systems, both opioid and non-opioid mediated, can be classically

conditioned and thus be influenced by learning (e.g. Flor et al. 2002). For example, the tick-tock of a clock (CS) was systematically combined with the application of stress (mental arithmetic and noise, US), which leads to a stress-induced ► [hypoalgesia](#). After several pairings of the CS and the US, the tick tock of the clock alone elicited a hypoalgesic response that could be partially reversed by naloxone, an opiate antagonist. This suggests that biochemical variables involved in the transmission of nociception as well as ► [antinociception](#) are also influenced by learning. These learning processes could be used to enhance analgesic processes in states of chronic pain.

These results support the contribution of respondent factors in the maintenance and exacerbation of chronic pain syndromes. They also suggest that interventions designed to alter high levels of muscle tension, and specifically stress reactivity as well as the cognitive and emotional evaluation of pain, might be of great value in the treatment of chronic pain patients.

## References

- Asmundson GJ, Norton GR, Allardings MD (1997) Fear and Avoidance in Dysfunctional Chronic Back Pain Patients. *Pain* 69:231–236
- Asmundson GJ, Norton PJ, Norton GR (1999) Beyond Pain: The Role of Fear and Avoidance in Chronicity. *Clin Psychol Rev* 19:97–119
- Diesch E, Flor H (2005) Reorganization of Primary Somatosensory Cortex Related to Differential Aversive Pavlovian Delay Conditioning. (submitted)
- Dolce JJ, Raczynski JM (1985) Neuromuscular Activity and Electromyography in Painful Backs: Psychological and Biomechanical Models in Assessment and Treatment. *Psychol Bull* 97:502–520
- Flor H, Birbaumer N, Schugens MM et al. (1992) Symptom-Specific Psychophysiological Responses in Chronic Pain Patients. *Psychophysiology* 29:452–460
- Flor H, Birbaumer N, Schulte W et al. (1991) Stress-Related EMG Responses in Patients with Chronic Temporomandibular Pain. *Pain* 46:145–152
- Flor H, Birbaumer N, Schulz R et al. (2002) Pavlovian Conditioning of Opioid and Nonopioid Pain Inhibitory Mechanisms in Humans. *Eur J Pain* 6:395–402
- Gentry WD, Bernal GAA (1977) Chronic Pain. In: Williams R, Gentry WD (eds) *Behavioral Approaches to Medical Treatment*. Ballinger, Cambridge, MA, pp 173–182
- Lethem J, Slade PO, Troup JPG et al. (1983) Outline of a Fear-Avoidance Model of Exaggerated Pain Perception. *Behav Res Ther* 21:401–408
- Linton SJ, Melin L, Götestam KG (1985) Behavioral Analysis of Chronic Pain and its Management. In: Hersen M, Bellack A, Eisler M (eds.) *Progress in Behavior Modification*. Academic Press, New York, pp 1–42
- Moulton B, Spence SH (1992) Site-Specific Muscle Hyper-Reactivity in Musicians with Occupational Upper Limb Pain. *Behav Res Ther* 30:375–386
- Schneider C, Palomba D, Flor H (2004) Pavlovian Conditioning of Muscular Responses in Chronic Pain Patients: Central and Peripheral Correlates. *Pain* 112:239–247
- Vlaeyen J W, Linton SJ (2000) Fear-Avoidance and its Consequences in Chronic Musculoskeletal Pain: A State of the Art. *Pain* 85:317–332
- Vlaeyen JWS, Seelen HAM, Peters M et al. (1999) Fear of Movement/(Re)injury and Muscular Reactivity in Chronic Low Back Pain Patients: An Experimental Investigation. *Pain* 82:297–304
- Wunsch A, Philippot P, Plaghki L (2003) Affective Associative Learning Modifies the Sensory Perception of Nociceptive Stimuli without Participant's Awareness. *Pain* 102:27–38

## Respondents

### Definition

Body activity elicited by antecedent stimuli to which they reflexly respond, hence the term „respondent“. The light of a room suddenly brightens, eliciting a reflexive pupillary response. Sight of food to a hungry person reflexly elicits salivation. Those are autonomically-mediated events.

Operants are sensitive to consequences. Respondents are usually little influenced by contingent reinforcement. Repetition of an operant leading to reinforcing consequences tends to strengthen or increase it. Conversely, removing a reinforcing consequence leads to a reduction in the rate of occurrence or strength of the operant. Ultimately, without reinforcement an operant extinguishes or fades from the repertoire.

Punishment of an operant usually leads to its delay until another occasion and does virtually nothing to diminish its future strength or probability of occurrence. The methods described here relate to operants, not respondents; i.e. exercise and activity, not attitudes, motivation, personality traits, and the like.

► [Training by Quotas](#)

## Response Dependent Method

► [Pain Evaluation, Psychophysical Methods](#)

## Response Prevention

### Definition

Response prevention consists of gradually refraining from safety behaviors (checking body parts, escape from and avoiding pain increasing activities) that lead to a temporary reduction of fear.

► [Fear Reduction through Exposure In Vivo](#)

## Response to Analgesics

### Definition

Different pains respond in different ways to analgesics. Inflammatory pain is thought to be most sensitive to opioids. Neuropathic pain is less sensitive to opioids, although some opioids like methadone, levorphanol and fentanyl may have more effect than morphine. Bone pain



is less sensitive to opioids, but the effect of opioids increases after administration of NSAIDs. Muscle cramp may be insensitive to opioids or may even be exacerbated by it. Analyzing complex pain histories, and responses to different analgesics should be investigated. The effect of analgesics should always be seen in the context of the adverse effects.

► [Cancer Pain](#)

## Responsive Neurostimulation

### Definition

A treatment of epilepsy in which stimulation is delivered to the brain in response to a detected event which predicts the onset of a seizure in that patient.

► [Pain Treatment, Spinal Cord Stimulation](#)

## Responsiveness

### Definition

Responsiveness refers to a measure of the ability of an outcome instrument used to detect a score change.

► [Oswestry Disability Index](#)

## Rest and Movement Pain

PAUL M. MURPHY

Department of Anaesthesia and Pain Management,  
Royal North Shore Hospital, St Leonard's, NSW,  
Australia  
drpmurphy@hotmail.com

### Definition

In a 1990 study of ► [breakthrough pain](#) in cancer sufferers, Portenoy and Hagen proposed a standard definition of breakthrough pain. It was defined as a transient increase in the intensity of moderate or severe pain, occurring in the presence of well-established baseline pain. Breakthrough pain was further characterized as being of rapid in onset (typically less than 3 minutes) and of short duration (median 30 minutes) (Portenoy and Hagen 1990). This paper paved the way for the systematic study of breakthrough pain, resulting in the 2002 definition of breakthrough pain by the American Pain Society as:

“Intermittent exacerbations of pain that can occur spontaneously or in relation to specific activity; pain that increases above the level of pain addressed by the ongoing analgesic; includes incident pain and end-of-dose failure.”

### Characteristics

In the acute setting breakthrough pain is predominantly somatic but may also be visceral or occasionally neuropathic (see ► [Visceral Nociception and Pain](#), ► [neuropathic pain](#), ► [somatic pain](#)).

### Potential Aetiology

1. Breakthrough pain due to voluntary or involuntary movement is referred to as ► [incident pain](#)
2. End of dose failure
3. Idiopathic (Caraceni et al. 1999; McQuay and Jadad 1994; Portenoy et al. 1999)

### Management of Movement Associated or Incident Pain

In order to achieve the optimal balance between adequate analgesia and side effect profile, so-called rescue medication for breakthrough pain should be individualised and carefully titrated (Patt and Ellison 1998).

1. Breakthrough pain is typically managed with short acting oral immediate release opioids, given as required. In many institutions it is standard practice to use the same opioid for the treatment of baseline and breakthrough pain, but in different formulations, such as long acting morphine for baseline pain and short acting morphine for breakthrough pain. Some sources recommend the use of different opioids for the management of baseline and breakthrough pain, suggesting that as it allows for the administration of lower doses of each agent, dose dependent side effects may be minimised. Unfortunately many of the opioids used in the management of postoperative incident/breakthrough pain, such as morphine, hydromorphone and oxycodone, are not very ► [lipophilic](#) and thus oral formulations of these agents are relatively poorly absorbed. The poor absorption kinetics of such agents may render them less than perfect in managing breakthrough pain because of the delayed onset of analgesia (Simmonds 1999).
2. Another strategy that may be implemented is the prophylactic treatment of breakthrough pain using higher dosages of baseline opioids. The sometimes significantly higher opioid doses utilised in these strategies may be associated with an increased risk of adverse effects (Bruera 1999).
3. ► [Patient controlled analgesia \(PCA\)](#) systems provide the patient with a considerable degree of autonomy in meeting their analgesic needs. Protocols typically allow the patient to self-administer a pre-determined dose of analgesic agent (morphine, fentanyl) once a “lock-out” period (commonly 5–6 minutes) has elapsed. More advanced protocols allow for background drug infusions to run in parallel with bolus administration, thus providing baseline analgesic control. A potential benefit of a background infusion is that it prevents exacerbations

in pain following a period of sleep, during which time the patient has not administered drug boluses. Evidence in this regard is contradictory, with some authors suggesting that this type of protocol does not improve analgesic outcome but simply increases the administered drug dose. Typically it has been suggested that PCA systems are associated with both improved pain control and reduced opioid consumption relative to “on demand” IM or IV administration by nursing staff, although recent evidence is controversial. Irrespective of the conflicting data with regard to pain control and drug utilization, it is widely accepted that PCA systems are associated with significantly enhanced patient satisfaction in the management of both rest and movement/incident pain (Upton et al. 1997).

### References

1. Bruera E (1999) Management of breakthrough pain due to cancer – The Simmonds article reviewed. *Oncology* 13:1110–1113
2. Caraceni A, Portenoy RK (1999) An international survey of cancer pain characteristics and syndromes. *Pain* 82:263–274
3. McQuay HJ, Jadad AR (1994) Incident pain. *Cancer Surv* 21:17–24
4. Patt RB, Ellison NM (1998) Breakthrough pain in cancer patients: Characteristics, prevalence and treatment. *Oncology* 12:1035–1052
5. Portenoy RK, Hagen NA (1990) Breakthrough pain: definition, prevalence and characteristics. *Pain* 41:273–81
6. Portenoy RK, Payne D, Jacobsen P (1999) Breakthrough pain: characteristics and impact in patients with cancer pain. *Pain* 81:129–134
7. Simmonds MA (1999) Management of breakthrough pain due to cancer. *Oncology* 13:1103–1114
8. Upton RM, Semple TJ, Macintyre PE (1997) Pharmacokinetic optimisation of opioid treatment in acute pain therapy. *Clin Pharmacokinet* 33:225–44

## Rest Position

- ▶ Postural Position

## Resting State Network

### Definition

PET and fMRI studies have suggested that the resting brain has a default mode of internal (possibly conceptual) processing. The activation of the areas involved in the resting state network during baseline recording in functional imaging, may mask out the activation of these areas in a task-baseline comparison. That the default-mode network includes the hippocampus suggests that episodic memory may be incorporated in default-mode cognitive processing.

- ▶ Hippocampus and Entorhinal Complex, Functional Imaging

## Restless Legs Syndrome

MICHAEL POLYDEFKIS

Department of Neurology, Johns Hopkins University School of Medicine, Baltimore, MD, USA  
mpolyde@jhmi.edu

### Synonyms

RLS

### Definition

Restless legs syndrome (RLS) is characterized by a desire to move the limbs, usually associated with unpleasant sensations in lower extremities, less often in the arms.

### Characteristics

RLS symptoms are worse or exclusively present during periods of rest in the evening or night time with at least partial or temporary relief by activity (Allen et al. 2003). RLS interferes with sleep quality leading to marked day time fatigue and impaired quality of life. Though scientific interest in RLS has recently dramatically increased, the etiology and pathophysiology remain unknown. While RLS generally falls within the domain of movement disorders, there is increasing evidence for investigators to view RLS from a neuropathic pain perspective.

RLS was originally described in 1945 by Karl Ekbom (Ekbom 1945) who reported two forms of the syndrome: one characterized by ▶ **dysesthesias**, ‘asthenia crurum paresthetica’ and one by pain, ‘asthenia crurum dolorosa’. Adjectives used by Ekbom to describe patient symptoms included many neuropathic descriptors such as burning, tingling, or nerve vibrations. In part, this has prompted speculation of a causal association with peripheral neuropathy. Indeed there is a loose correlation between painful neuropathies and RLS in terms of evening/night time worsening of symptoms, sleep interference and body topography. Several prominent causes of painful neuropathy including diabetes (O’Hare et al. 1994), cryoglobulinemia (Gemignani et al. 1997), uremia and amyloid (Salvi et al. 1990) have all been associated with RLS, supporting such a link. While the incidence of RLS among patients with neuropathy has been reported as similar to the general population at 5.2% (Rutkove et al. 1996), this investigation did not include evaluation of small caliber unmyelinated nerve fibers. This distinction may be important, as RLS is observed in many patients with small fiber neuropathy (Polydefkis et al. 1999), and has prompted some to perceive RLS among the spectrum of painful symptoms experienced by these patients. Furthermore, many patients with primary RLS have subclinical small fiber abnormalities, suggesting that abnormal peripheral sensation may play a role

in RLS pathophysiology (Polydefkis et al. 2000). In addition, other forms of peripheral nerve injury such as radiculopathy (Walters et al. 1996) and spinal stenosis (LaBan et al. 1990) have also been associated with RLS.

RLS and painful neuropathies also share many similarities in treatment options. Opiates, antiepileptic agents and the  $\alpha$ 2-agonists all have well accepted efficacy for both conditions. The diurnal pattern of RLS was noted to have an inverse relationship to endogenous dopamine levels, and a clinical response to dopaminergic agents emerged as a hallmark for RLS. Interestingly, dopamine also plays a role in pain processing, with high levels of dopaminergic activity in the striatum reducing neuronal encephalin content, leading to a compensatory rise in  $\mu$ -opioid receptor expression. A role for dopamine as an inhibitor of pain perception is supported by its efficacy in relieving the pain associated with breast cancer and bone metastases, herpes zoster (Kernbaum and Hauchecorne 1981), painful Parkinson's disease (Quinn et al. 1986) and diabetic neuropathy.

Recent studies have suggested that ► **central sensitization** may exist in RLS (Stiasny-Kolster et al. 2004). Enhanced spinal reflexes are a feature of central sensitization in both animal models and human subjects, and have also been documented to occur in RLS (Bara-Jimenez et al. 2000). The presence of profound static ► **mechanical hyperalgesia**, a hallmark of central sensitization, in RLS patients (Stiasny-Kolster et al. 2004) provides further evidence. Sensitization of dorsal horn neurons to mechanical stimuli by conditioning stimulation of nociceptive C fiber afferents is well described (Simone et al. 1991) and could explain the association between peripheral nerve abnormalities, particularly painful neuropathies and RLS. In contrast to typical neuropathic pain syndromes, the absence of ► **dynamic mechanical hyperalgesia** (allodynia) (Stiasny-Kolster et al. 2004) in RLS may explain why central sensitization of the nociceptive system in RLS has been underappreciated.

Viewing RLS from a neuropathic pain perspective has the opportunity to foster new treatment strategies. Glutamate and substance P are important in the induction of central sensitization, and imply that NMDA antagonists and NK1 receptor antagonists may have a future as RLS treatments. In support of this is the report of the NMDA receptor antagonist amantadine improving RLS symptoms. Furthermore, incorporating central sensitization into the pathophysiology of RLS can explain why antinociceptive agents such as epilepsy medications are efficacious in RLS.

In summary, pain as a symptom of RLS has been underappreciated. There is compelling clinical evidence that the two share many common features. Approaching RLS from such a viewpoint offers the potential to improve our pathophysiologic understanding of the disease, as well as offer novel treatment strategies.

## References

- Allen RP, Kushida CA, Atkinson MJ et al. (2003) Factor Analysis of the International Restless Legs Syndrome Study Group's Scale for Restless Legs Severity. *Sleep Med* 4:133–135
- Bara-Jimenez W, Aksu M, Graham B et al. (2000) Periodic Limb Movements in Sleep: State-Dependent Excitability of the Spinal Flexor Reflex. *Neurology* 54:1609–1616
- Ekbom K (1945) Restless Legs. *Acta Med Scand* 158:1–123
- Gemignani F, Marbini A, Di Giovanni G et al. (1997) Cryoglobulinaemic Neuropathy Manifesting with Restless Legs Syndrome. *J Neurol Sci* 152:218–223
- Kernbaum S, Hauchecorne J (1981) Administration of Levodopa for Relief of Herpes Zoster Pain. *Jama* 246:132–134
- LaBan MM, Viola SL, Femminineo AF et al. (1990) Restless Legs Syndrome Associated with Diminished Cardiopulmonary Compliance and Lumbar Spinal Stenosis – A Motor Concomitant of “Vesper's Curse” *Arch Phys Med Rehabil* 71:384–388
- O'Hare JA, Abuaisa F, Geoghegan M (1994) Prevalence and Forms of Neuropathic Morbidity in 800 Diabetics. *Ir J Med Sci* 163:132–135
- Polydefkis M, Allen RP, Hauer P et al. (2000). Subclinical Sensory Neuropathy in Late-Onset Restless Legs Syndrome. *Neurology* 55:1115–1121
- Polydefkis M, Hauer P et al. (1999) Small Fiber Sensory Neuropathy in Restless Legs Syndrome. *Neurology* 52 (Suppl 2):A411
- Quinn N.P, Koller WC, Lang AE et al. (1986) Painful Parkinson's Disease. *Lancet* 1:1366–1369
- Rutkove SB, Matheson JK, Logigian EL (1996) Restless Legs Syndrome in Patients with Polyneuropathy. *Muscle Nerve* 19: 670–672
- Salvi F, Montagna P, Plasmati R et al. (1990) Restless Legs Syndrome and Nocturnal Myoclonus: Initial Clinical Manifestation of Familial Amyloid Polyneuropathy. *J Neurol Neurosurg Psychiatry* 53:522–525
- Simone DA, Sorkin LS, Oh U et al. (1991) Neurogenic Hyperalgesia: Central Neural Correlates in Responses of Spinothalamic Tract Neurons. *J Neurophysiol* 66:228–246
- Stiasny-Kolster K, Magerl W, Oertel WH et al. (2004) Static Mechanical Hyperalgesia without Dynamic Tactile Allodynia in Patients with Restless Legs Syndrome. *Brain* 127:773–782
- Walters A S, Wagner M, Hening WA (1996) Periodic Limb Movements as the Initial Manifestation of Restless Legs Syndrome Triggered by Lumbosacral Radiculopathy. *Sleep* 19:825–826

R

## Reticular Activating System

### Definition

The system of cells of the reticular formation of the medulla oblongata that receive collaterals from the ascending sensory pathways and project to higher centers; they control the overall degree of central nervous system activity, including wakefulness, attentiveness, and sleep; abbreviated RAS.

► **Somatic Pain**

## Reticular Formation

### Definition

Reticular formation is the central core within the brain stem, consisting of a short diffusely projecting web of neurons located in the brainstem, receiving many inputs

and projecting widely throughout the central nervous system.

- ▶ Pain Treatment, Intracranial Ablative Procedures
- ▶ Spinothalamic Projections to Ventromedial and Parafascicular Nuclei

## Reticular Nucleus Inputs from Cortex

- ▶ Cortical Projections
- ▶ Corticothalamic and Thalamocortical Interactions

## Retinal Slip

### Definition

Movements of images across the retina. Retinal slip is considered to be an error-signal necessary for vestibular compensation. The error signal is brought on by a combination of visual fixation and head movements. The brain tries to minimize the error signal by increasing the gain of the vestibulo-ocular reflexes.

- ▶ Coordination Exercises in the Treatment of Cervical Dizziness

## Retrograde

### Definition

Signals and transport of molecules from the periphery (axonal nerve endings) along the axoplasm towards the cell body.

- ▶ Retrograde Cellular Changes after Nerve Injury
- ▶ Substance P Regulation in Inflammation

## Retrograde Axonal Tracer

### Definition

A substance (protein, enzyme) that is injected at the level of axonal endings. It is incorporated within the endings, then conveyed in a retrograde (antidromic) direction within the axon back to the soma. The tracer is generally colored by a histochemical reaction, with or without an earlier immune amplification reaction, s. also Retrograde Tracing Technique.

- ▶ Parabrachial Hypothalamic and Amygdaloid Projections

## Retrograde Cellular Changes after Nerve Injury

TOMAS HÖKFELT<sup>1</sup>, PABLO BRUMOVSKY<sup>1, 2</sup>, MARCELO VILLAR<sup>2</sup>

<sup>1</sup>Department of Neuroscience, Karolinska Institutet, Stockholm, Sweden

<sup>2</sup>Neuroscience Laboratory, Austral University, Buenos Aires, Argentina

tomas.hokfelt@neuro.ki.se

### Synonyms

Nerve Injury; axotomy; Nerve Ligation

Other types of nerve injury: Seltzer model; Bennett Model; Chung model; Gazelius Model

### Definition

▶ **Retrograde** changes refer to the alteration in expression of various molecules in the parent dorsal root ganglion (sensory) neurons after any type of lesion of the peripheral axon (branch). This occurs in humans after various types of lesions and is mimicked in experimental animal models, mainly in attempts to understand mechanisms underlying ▶ **neuropathic pain**.

### Characteristics

#### Nerve Injury and Neuropathic Pain

Nerve injury, such as transection of a nerve (axotomy), occurs under a wide variety of circumstances in real life, ranging from a simple accidental cut during cooking to more or less complicated surgical procedures in hospitals, amputation of a limb being the extreme. Early work on experimental animals by Wall, Devor and colleagues showed that such a transection has profound consequences as recorded by electrophysiological methods, including massive and persistent spontaneous discharges in lumbar dorsal rootlets, possibly contributing to chronic neuropathic pain

Dramatic and robust chemical changes have also more recently been found to occur in ▶ **DRGs** after peripheral nerve injury, in fact, leading to a completely new neuron phenotype, encompassing hundreds of regulatory molecules, including inter- and intracellular messengers, as shown in recent global ▶ **gene array** studies comparing lesioned and non-lesioned DRGs (Costigan et al. 2002; Xiao et al. 2002). The purpose and consequences of these changes are beginning to be understood, with not only upregulated and/or *de novo* synthesized molecules possibly contributing to the survival and regeneration of the damaged neuron, but also the generation (pronociceptive) and/or attenuation (antinociceptive) of pain. It is, however, clear that changes not only affect neurons but also satellite and other non-neuronal cells in the DRGs and around the lesion site. Moreover,



the effect is not limited to the DRGs, but also includes neurons and glia in subsequent relay stations, primarily the dorsal horn of the spinal cord (Yang et al. 2004). Interestingly, similar chemical changes have been observed in a number of nerve injury models not involving a complete transection of the nerve. Moreover, the changes described in this chapter have essentially been seen only after damage to the peripheral branch of sensory neurons, and not after transection of the dorsal roots, that is the central, afferent branches of the DRG neurons terminating in the dorsal horn.

#### Do DRG Neurons Die after Peripheral Nerve Injury?

This issue has been much debated, but recent studies based on unbiased ► **stereological techniques** have shown that in the rat no significant loss of neurons occurs up until four weeks after the ‘standard’ lesion (transection of the sciatic nerve at mid-thigh level) (Tandrup et al. 2000). In contrast, after mid-thigh axotomy in the mouse, there is already a significant loss of neurons after one week (Shi et al. 2001), possibly due to the short distance between lesion and cell bodies in this small animal.

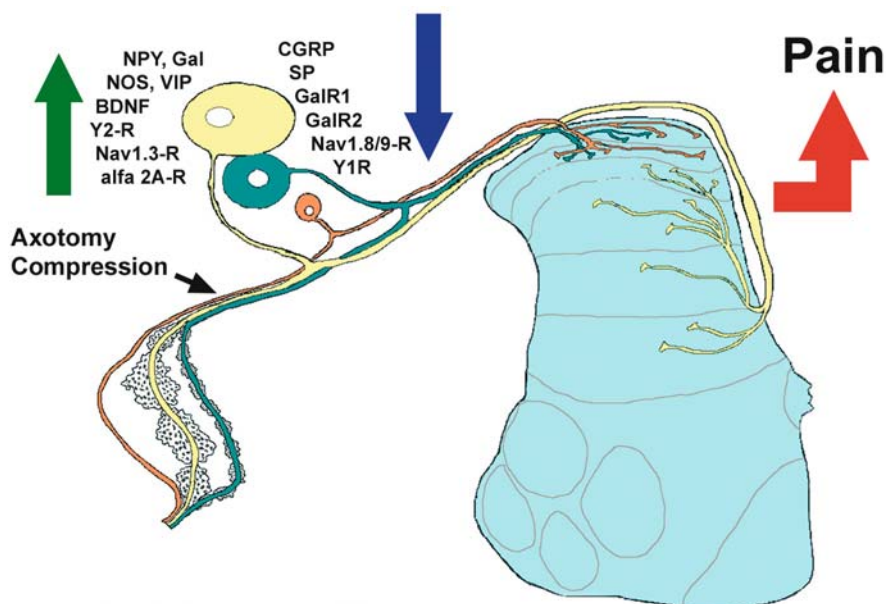
#### Transmitters/Neuropeptides in DRG Neurons

Today we know that the main and principal (classic) transmitter in most DRG neurons is glutamate, acting on pre- and postsynaptic glutamate receptors of various classes in the dorsal horn (and periph-

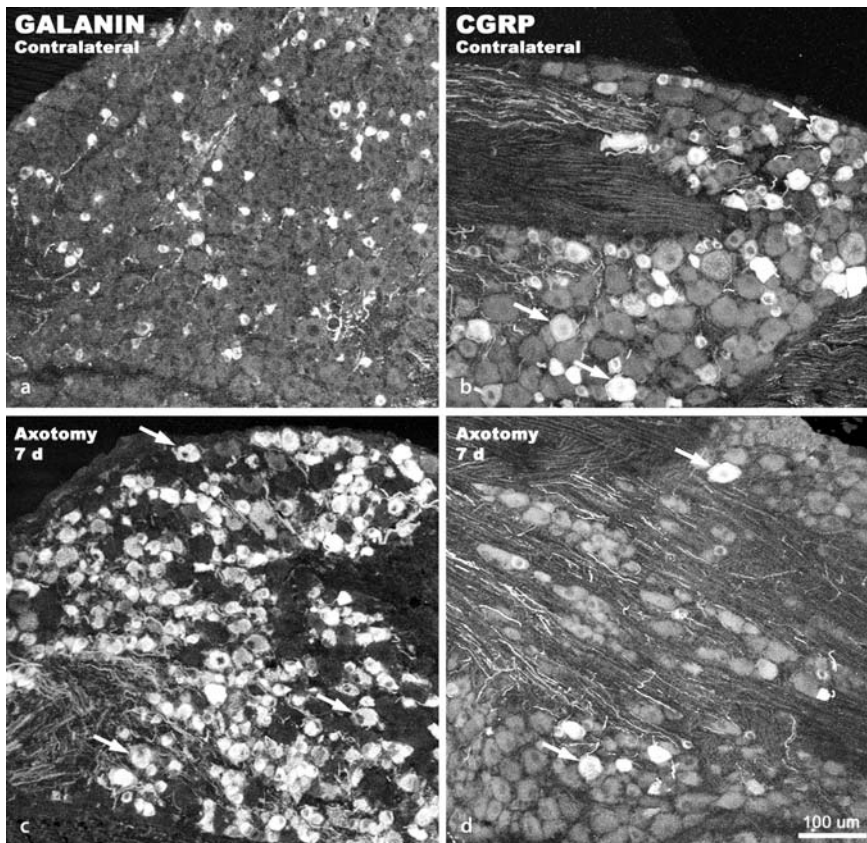
ery) including both ligand-gated ion channels and 7-transmembrane, G-protein-coupled (metabotropic) receptors (GPCRs). Other transmitter candidates are the nucleotide adenosine-triphosphate (ATP) and the ‘gaseous’ transmitter nitric oxide, as well as a number of neuropeptides such as ► **substance P**, ► **calcitonin gene-related peptide (CGRP)**, ► **somatostatin** and pituitary adenylate cyclase-activating peptide (PACAP) (Hökfelt et al. 1997). There is a second population of small DRG neurons many of which apparently lack most of these neuropeptides, and they are characterized by expression of components of the receptor for the glial-derived neuro ► **trophic factor (GDNF)**, and the isolectin B4 (IB4) from *Griffonia simplicifolia* I, which is a marker for many of these cells (McMahon and Priestley 2005).

#### Expression of Regulatory Molecules after Axotomy

Substance P and CGRP are downregulated in the DRG neurons after peripheral axotomy, whereas vasoactive intestinal polypeptide (VIP), ► **neuropeptide Y (NPY)**, ► **galanin**, PACAP and the enzyme ► **nitric oxide synthase** are upregulated (Hökfelt et al. 1997) (Figs. 1, 2). Receptors for peptides (e.g. the cholecystokinin B receptor) and classic transmitters (e.g. the  $\alpha_{2A}$ -adrenoceptor) are also regulated (Fig. 1). Many of these changes are long-lasting and remain, if regeneration is efficiently prevented. A similar effect is also seen in several neuropathic pain models, that is, without a com-



**Retrograde Cellular Changes after Nerve Injury, Figure 1** Schematic drawing showing changes in the expression of different neurotransmitters, receptors and channels in DRGs and spinal cord of rat after axotomy or constriction of a peripheral nerve. Normally, small and medium-sized neurons produce detectable levels of, e.g. CGRP, substance P (SP) and GalR2 and Y1R receptors, while larger neurons express GalR1 and Y2R receptors and some CGRP. Axotomy of the sciatic nerve induces dramatic changes in the expression of these molecules, some being upregulated (e.g. NPY, galanin (Gal), Nav 1.3R, Y2R) and others downregulated (CGRP, substance P, Y1R). In contrast, the expression of peptides and receptors in dorsal horn neurons largely seems to be unaffected by axotomy. Moreover, myelin basic protein shows degeneration distal to the sciatic nerve lesion.



**Retrograde Cellular Changes after Nerve Injury, Figure 2** Fluorescence micrographs showing mouse DRG sections after incubation with galanin (a, c) or CGRP (b, d) antisera, contralateral (a, b) and ipsilateral (c, d) to a 7-day-axotomy of the sciatic nerve at the midhigh level. Several galanin-immunoreactive small neurons are seen in contralateral DRGs (a) and many CGRP-IR neurons, ranging from small to large (arrows in b) in size. A dramatic upregulation of galanin is observed ipsilateral to the nerve lesion, in many small and some large DRG neurons (arrow in c). In contrast, the expression of CGRP is strongly downregulated, and only some large CGRP-IR neurons are still observed (arrows in d). Note that all figures have the same magnification.

plete transection of the axons (Nahin et al. 1994). In the non-peptide DRG neurons several markers, including certain vanilloid receptors and purinoreceptors as well as some sodium channels, are upregulated and other molecules are downregulated (McMahon and Priestley 2005) (Fig. 1). For information on other GPCRs, ligand-gated receptors, and ion channels see below and McMahon and Priestley (2004).

#### Classic Growth Factors

► **Nerve growth factor (NGF)**, brain-derived neurotrophic factor (BDNF) and neurotrophin 3 (NT3) are the main members of the classic growth factor family and are in general target-derived, acting on neuronal tyrosine kinase (trk) receptors (► *trkA*, *trkB* and *trkC*). However, BDNF is, in fact, constitutively expressed in neurons, mainly in small, *trkA* positive (NGF-sensitive) ones, packaged in large dense core vesicles (the same vesicles that store neuropeptides), transported into the dorsal horn of the spinal cord and released, acting in a transmitter-like fashion (McMahon and Priestley 2005). BDNF is mainly upregulated in medium-sized and large diameter (*trkB*- and *trkC*-positive) neurons after axotomy. Also, members of the fibroblast growth factor (FGF) family and their receptors are present in DRG neurons and regulated by nerve injury (Grothe et al. 2001)

#### Voltage-Gated Sodium Channels

Much attention is presently focused on voltage-gated sodium channels in DRG neurons and their role in chronic pain. Many subtypes are expressed in DRG neurons and are of ► **tetrodotoxin (TTX)-sensitive** or TTX-resistant subtypes. The former, especially  $Na_v1.3$ , are involved in the generation of ectopic discharges after injury and in maintaining neuropathic pain. Also, some subtypes are upregulated, while others are downregulated after nerve injury (McMahon and Priestley 2005).

#### Global Gene Expression Studies

Global gene expression analyses have shown that hundreds of different types of genes change, and are down- or upregulated in sensory ganglia after nerve injury (Costigan et al. 2002; Xiao et al. 2002). Thus, Xiao et al. (2002) examined 7523 genes and expressed sequence tags (ESTs) of which, respectively, 122 and 51 were strongly changed after axotomy. Costigan et al. (2002) categorized such genes into “ion channels”, “neurotransmission”, “vesicle trafficking”, “apoptosis”, “cytoskeleton”, “immunologically related genes” and “unknown genes”, the latter reflecting identification of many ‘novel’ DRGs genes. These changes are bidirectional in several categories.

### Species Differences

Most studies of this type have been carried out on rats, and recently also on mice, without many qualitative differences. In monkey (*Macaca mulatta*), the upregulation of galanin is strong and NPY weak, and guinea pigs show the reverse situation (Hökfelt et al. 1997). Human ganglia have been analysed only to a limited degree, nevertheless showing that substance P, CGRP and galanin are expressed in DRG neurons in proportions similar to those found in the monkey (Landry et al. 2003).

### Mechanisms Underlying Injury-Induced Phenotypic Changes

The various molecules seem to be regulated by 'individual' mechanisms. The down-regulation of the two excitatory peptides substance P and CGRP is a consequence of interrupted supply of NGF from peripheral tissues, since it can be reversed by exogenous NGF (McMahon and Priestley 2005). The dramatic axotomy-induced upregulation of galanin is strongly influenced by the cytokine leukaemia inhibitory factor (LIF) (Rao et al. 1993), with GDNF also being involved (Gardell et al. 2003). Other groups have shown that the upregulation of VIP is dependent on the ciliary neurotrophic factor (CNTF), just as LIF a member of the neuropoietic cytokine family, and that NPY upregulation involves both NGF and BDNF. Interestingly, GDNF and related molecules have been shown to partially or completely reverse many of the nerve injury-induced morphological and neurochemical changes described above, as well as to block the associated neuropathic pain state (Gardell et al. 2003), opening up new venues for understanding mechanisms underlying neuropathic pain, and possibly its treatment.

### Functional Consequences of Altered Gene Expression in the DRG

The regulation of molecules in DRG neurons could, among others, promote survival and regeneration, and/or affect various sensory modalities, in particular pain. Based on studies of the nociceptive flexor reflex and other functional models, it has been concluded that the downregulation of excitatory CGRP and substance P attenuates pain transmission in the dorsal horn. In contrast, the increased galanin levels may serve to reduce the nociceptive input after nerve injury (Xu et al. 2000), and may be important for regeneration (Wynick et al. 2001). Also, upregulated NPY could both enhance regeneration and control pain threshold.

An interesting aspect of axotomy-induced regulation concerns the so called 'sprouting paradigm', proposed to underlie neuropathic pain. Using the cholera toxin- $\beta$  subunit (CTB) as a selective retrograde tracer for large DRG neurons, large myelinated, non-nociceptive primary afferents seem to sprout from deeper laminae into spinal laminae I and II, where nociceptive afferents normally terminate, and this could lead to neuropathic pain. However, several groups have now shown that af-

ter peripheral nerve injury, small DRG neurons also take up CTB, presumably due to upregulation of the monoganglioside GM1, the receptor for CTB, and that no or only little sprouting seems to occur (Bao et al. 2002).

### Nerve Injury-Induced Cell Loss in the Dorsal Horn

Peripheral nerve injury also causes cell loss and apoptotic cell death in the dorsal horn, which can be blocked by treatment with an NMDA receptor antagonist (MK-801) (Azkue et al. 1998). Coggeshall et al. (2001) have shown that it is the release of glutamate from myelinated afferents (A-fibres) that is responsible for this cell death, possibly affecting inhibitory GABAergic mechanisms.

### Changes in Spinal Glia after Peripheral Nerve Injury

It has become increasingly clear that spinal glia are also activated by peripheral nerve injury, especially if there is an inflammatory component, and this activation is associated with pain-related behaviour. Here pro-inflammatory cytokines and other molecules play important roles (Watkins et al. 2001).

### Concluding Remarks

Peripheral nerve injury induces many changes in DRGs and the spinal cord, as impressively shown in recent global gene expression analyses. We could here only deal with a limited number of the molecules involved. These changes may play a role in nociception and be important for survival/regeneration, and may lead to novel therapeutic strategies.

Importantly, and in contrast, in inflammatory pain substance P and CGRP are upregulated in DRG neurons, without distinct effects on galanin, VIP or NPY in these neurons. Instead, inflammation, but not peripheral axotomy, activates opioid and other peptides in local dorsal horn neurons (Dubner and Ruda 1992). Thus, the nerve injury-induced changes are clearly different from the regulatory events seen after peripheral inflammation, suggesting existence of separate defence systems for inflammatory and neuropathic pain, associated with, respectively, dorsal horn and DRG neurons (Hökfelt et al. 1997).

### Acknowledgements

This work was supported by The Swedish Research Council, The Marianne and Marcus Wallenberg Foundation, The Knut and Alice Wallenberg Foundation and an Unrestricted Bristol-Myers Squibb Neuroscience Grant. We thank Drs. Zsuzsanna Wiesenfeld-Hallin, Xiao-Jun Xu and Zhang Xu for valuable support.

### References

1. Azkue JJ, Zimmermann M, Hsieh TF et al. (1998) Peripheral Nerve Insult Induces NMDA Receptor-Mediated, Delayed Degeneration in Spinal Neurons. *Eur J Neurosci* 10:2204–2206
2. Bao L, Wang HF, Cai HJ et al. (2002) Peripheral Axotomy Induces Only Very Limited Sprouting of Coarse Myelinated Afferents into Inner Lamina II of Rat Spinal Cord. *Eur J Neurosci* 16:175–185



3. Coggeshall RE, Lekan HA, White FA et al. (2001) A-Fiber Sensory Input Induces Neuronal Cell Death in the Dorsal Horn of the Adult Rat Spinal Cord. *J Comp Neurol* 435:276–282
4. Costigan M, Befort K, Karchewski L et al. (2002) Replicate High-Density Rat Genome Oligonucleotide Microarrays Reveal Hundreds of Regulated Genes in the Dorsal Root Ganglion after Peripheral Nerve Injury. *BMC Neurosci* 3:16
5. Dubner R, Ruda MA (1992) Activity-Dependent Neuronal Plasticity following Tissue Injury and Inflammation. *Trends Neurosci* 15:96–103
6. Gardell LR, Wang R, Ehrenfels C et al. (2003) Multiple Actions of Systemic Artemin in Experimental Neuropathy. *Nat Med* 9:1383–1389
7. Grothe C, Meisinger C, Claus P (2001) *In Vivo* Expression and Localization of the Fibroblast Growth Factor System in the Intact and Lesioned Rat Peripheral Nerve and Spinal Ganglia. *J Comp Neurol* 434:342–357
8. Hökfelt T, Zhang X, Xu Z-Q et al. (1997) Cellular and Synaptic Mechanisms in Transition of Pain from Acute to Chronic. In: Jensen TS, Turner JA, Wiesenfeld-Hallin Z (eds) *Proc 8<sup>th</sup> World Congr Pain, Prog Pain Res Management*, vol 8. IASP Press, Seattle, pp 133–153
9. Landry M, Aman K, Dostrovsky J et al. (2003) Galanin Expression in Adult Human Dorsal Root Ganglion Neurons. *Neuroscience* 117:795–809
10. McMahon SB, Priestley JV (2004) Nociceptor Plasticity. In: Hunt SP, Koltzenburg M (eds) *The Neurobiology of Pain*. OUP, Oxford, pp 35–64
11. Nahin RL, Marino De León KR, Ruda M (1994) Primary Sensory Neurons Exhibit Altered Gene Expression in a Rat Model of Neuropathic Pain. *Pain* 58:95–108
12. Rao MS, Sun Y, Escary JL et al. (1993) Leukemia Inhibitory Factor Mediates an Injury Response but not a Target-Directed Developmental Transmitter Switch in Sympathetic Neurons. *Neuron* 11:1175–1185
13. Shi TJ, Tandrup T, Bergman E et al. (2001) Effect of Peripheral Nerve Injury on Dorsal Root Ganglion Neurons in the C57 BL/6J Mouse: Marked Changes Both in Cell Numbers and Neuropeptide Expression. *Neuroscience* 105:249–263
14. Tandrup T, Woolf CJ, Coggeshall RE (2000) Delayed Loss of Small Dorsal Root Ganglion Cells after Transection of the Rat Sciatic Nerve. *J Comp Neurol* 422:172–180
15. Wynick D, Thompson SW, McMahon SB (2001) The Role of Galanin as a Multi-Functional Neuropeptide in the Nervous System. *Curr Opin Pharmacol* 1:73–77
16. Xiao HS, Huang QH, Zhang FX et al. (2002) Identification of Gene Expression Profile of Dorsal Root Ganglion in the Rat Peripheral Axotomy Model of Neuropathic Pain. *Proc Natl Acad Sci USA* 99:8360–8365
17. Xu XJ, Hökfelt T, Bartfai T et al. (2000) Galanin and Spinal Nociceptive Mechanisms: Recent Advances and Therapeutic Implications. *Neuropeptides* 34:137–147
18. Yang L, Zhang FX, Huang F et al. (2004) Peripheral Nerve Injury Induces Trans-Synaptic Modification of Channels, Receptors and Signal Pathways in Rat Dorsal Spinal Cord. *Eur J Neurosci* 19:871–883

---

## Retrograde Labeling

- ▶ [Retrograde Tracing Technique](#)

---

## Retrograde Tracing Technique

### Synonyms

Retrograde Labeling

### Definition

Retrograde tracing (retrograde labeling) is a neuroanatomical method used to determine the location of the cells of origin of a nervous system pathway. A tracer substance that will be taken up by synaptic terminals (and sometimes by axons) is injected into a region of interest, such as a central nervous system nucleus. The tracer is then conveyed retrogradely by axonal transport to the cell bodies, and often just the proximal dendrites of the neurons that give rise to the projection being labeled. After a suitable time has passed to allow for the uptake and transport of the tracer, the nervous tissue is fixed, sectioned and the retrograde tracer located microscopically. In some cases, histological processing is required to visualize the tracer. In other cases, the tracer is fluorescent and can be identified using suitable optics without special processing.

- ▶ [Spinothalamic Tract, Anatomical Organization and Response Properties](#)
- ▶ [Spinothalamic Input, Cells of Origin \(Monkey\)](#)
- ▶ [Spinothalamic Neuron](#)
- ▶ [Trigeminal Brainstem Nuclear Complex, Anatomy](#)

---

## Retrograde Transport

### Definition

Movement of proteins towards the cell body.

- ▶ [Opioid Receptor Trafficking in Pain States](#)

---

## Retroperitoneal

### Definition

Visceral pain is referred to the somatic structures outside the lining of the abdominal cavity.

- ▶ [Animal Models and Experimental Tests to Study Nociception and Pain](#)
- ▶ [Visceral Pain Model, Pancreatic Pain](#)

---

## Retrospective

### Definition

Looking back at events that have already taken place.

- ▶ [Facet Joint Pain](#)

---

## Reversal Reaction

- ▶ [Type-1 Reaction \(Leprosy\)](#)



## Reversible Posterior Leucoencephalopathy Syndrome

- ▶ Headache Due to Hypertension

## Rexed's Lamina II

- ▶ Substantia Gelatinosa

## Rexed's Laminae

### Definition

Rexed's Laminae is an architectural classification of the structure of the spinal cord, based on the cytological features of the neurons in different regions of the grey substance described by the Swedish Anatomist B. Rexed. It consists of nine laminae (I–IX) that extend throughout the cord, roughly paralleling the dorsal and ventral columns of the grey substance, and a tenth region (lamina X) that surrounds the central canal and consists of the dorsal and ventral commissures and the central gelatinous substance. Laminae I and II are often referred to as the superficial part of the dorsal horn.

- ▶ DREZ Procedures
- ▶ Opioid Receptors at Postsynaptic Sites
- ▶ Spinothalamic Neuron
- ▶ Spinothalamic Tract Neurons, Glutamatergic Input
- ▶ Visceral Nociception and Pain
- ▶ Visceral Pain and Nociception

## RFC

- ▶ Residual Functional Capacity

## Rheumatoid Arthritis

### Definition

Rheumatoid arthritis is a variable autoimmune disease in which peripheral joints are inflamed. The principal characteristics are pain, swelling and redness (due to increased blood flow) of joints. There is also overgrowth of the synovial tissue. Marked destruction of cartilage and bone may occur resulting in deformities of joints. The disease affects about 1 percent of the population. Pathologic processes may also be present outside joints.

- ▶ Muscle Pain in Systemic Inflammation (Polymyalgia Rheumatica, Giant Cell Arteritis, Rheumatoid Arthritis)
- ▶ NSAIDs and their Indications

## Rhinorrhea

### Definition

Rhinorrhea refers to running of the nose. During acute bouts of cluster headache and during exacerbations of hemicrania continua, the nostril on the side of the pain often runs.

- ▶ Hemicrania Continua

## Rhizotomy

### Definition

Destruction of the nerve root within the bony canal. This refers to the anatomical location of purposeful nerve injury. For example, in dorsal rhizotomy dorsal roots are severed.

- ▶ Anesthesia Dolorosa Model, Autotomy
- ▶ Thalamic Plasticity and Chronic Pain

## Risk

### Definition

Risk is the likelihood, probability, or degree of probability of loss or injury.

- ▶ Pain in the Workplace, Risk Factors for Chronicity, Demographics
- ▶ Psychiatric Aspects of the Epidemiology of Pain

R

## Risk Factor

### Definition

A behavior, environmental exposure, or inherent human characteristics that is associated with an increased probability of a particular health-related outcome (Oleckno, 2002).

- ▶ Prevalence of Chronic Pain Disorders in Children

## Risk Factors for Chronicity

- ▶ Pain in the Workplace, Risk Factors for Chronicity, Job Demands
- ▶ Pain in the Workplace, Risk Factors for Chronicity, Workplace Factors

## Risk for Development of a WMSD

### Definition

A risk is determined by three factors: 1) the degree of exposure to the risk factors; 2) the likelihood that a ► [work-related musculoskeletal disorder](#) (WMSD) will develop on exposure to the risk factors; 3) the severity of the damage.

Consequently, the longer a person is exposed to the risk factors, the higher the risk. The same also applies if the relation between the risk factors and the development of a WMSD is more likely. Finally, a risk is defined as higher if a more severe form of WMSD develops.

- [Ergonomic Counseling](#)

## RLS

- [Restless Legs Syndrome](#)

## ROC

- [Receiver Operating Characteristics](#)

## Rolandic Sulcus

- [Central Sulcus](#)

## Role Modeling

### Definition

An instructional strategy involving the actual demonstration of a particular behavior.

- [Psychology of Pain, Self-Efficacy](#)

## Role Plays

### Definition

Role plays refer to practice situations in pain treatment, where desirable behaviors are practiced with the help of the therapist or group members.

- [Operant Treatment of Chronic Pain](#)

## Root Canal Therapy

### Definition

Root canal therapy is a procedure carried out by dentists in which the dental pulp is removed from the tooth (usually under local anesthesia) and replaced with an inert filling material.

- [Dental Pain, Etiology, Pathogenesis and Management](#)

## Root Disease

- [Radiculopathies](#)

## Rostral Ventral Medulla

### Definition

The rostral ventral medulla is a region of the brainstem near the pontomedullary junction, and includes the nucleus raphe magnus and the adjacent magnocellular reticular formation. Many neurons in the rostral ventral medulla project serotonergic axons to the spinal cord. Other neurotransmitters, including peptides, can also be contained in axons of neurons in this region.

- [Nociceptive Processing in the Nucleus Accumbens, Neurophysiology and Behavioral Studies](#)
- [Pain Modulatory Systems, History of Discovery](#)
- [Spinothalamic Tract Neurons, Descending Control by Brainstem Neurons](#)
- [Stimulation-Produced Analgesia](#)

## Rostral Ventromedial Medulla

PEGGY MASON

Department of Neurobiology, Pharmacology and Physiology, University of Chicago, Chicago, IL, USA  
p-mason@uchicago.edu

### Synonyms

RVM

Ventromedial medulla (VMM), raphe magnus (RM) and the adjacent reticular nucleus which is termed reticularis magnocellularis in human, sheep, cat and rat, but is often termed reticularis gigantocellularis pars alpha in rat.

## Definition

Rostral ventromedial medulla (RVM) contains serotonergic and non-serotonergic cells in the caudal raphe and the adjacent medullary reticular formation. RVM cells receive input from rostral sites such as the hypothalamus and its caudal extension the periaqueductal gray, which are important in modulating nociception as well as other physiological processes. RVM cells project to the spinal cord, particularly the superficial dorsal horn, the intermediolateral cell column that contains preganglionic sympathetic neurons, and the central canal region. Through these connections, RVM cells form one of the primary descending pathways involved in the modulation of nociceptive transmission and other spinal processes. RVM has been strongly implicated in contributing to opioid analgesia, and to the hyperalgesia associated with some forms of chronic pain.

## Characteristics

Neurons in RVM receive a strong direct projection from sites in the midbrain ► **periaqueductal gray (PAG)**, especially the caudal ventrolateral portion of PAG. A monosynaptic, glutamatergic connection from PAG to RVM is critical to the antinociception evoked by PAG stimulation (Aimone and Gebhart 1986). RVM neurons also receive inputs from nuclei in the hypothalamus and from the amygdala. While such inputs are likely to activate nociceptive modulatory circuits in RVM under stressful conditions, little is known about how these circuits are engaged in the normal, uninjured animal. Electrical stimulation throughout the RVM region mainly blocks withdrawals from noxious stimuli, and greatly reduces the responses of dorsal horn cells to noxious stimuli (reviewed in Basbaum and Fields 1984). Microinjection of glutamate, an agonist at the most common excitatory receptor in the CNS, into the breadth of RVM produces similar antinociceptive effects. Thus, there exists within the RVM a neural element that when excited will produce antinociception. Further, the similarity of effects upon activation of cells in both the medial and lateral portions of RVM (Sandkuhler and Gebhart 1984), may be due to the large dendritic fields of the non-serotonergic component neurons that extend mediolaterally throughout the region (Potrebic and Mason 1993). The functional and anatomical continuity within the RVM suggest that the entire region is a functional unit, albeit highly heterogeneous. For example, while the antinociceptive effects of stimulation in the midline and lateral regions of the RVM are phenomenologically similar, they are pharmacologically distinguishable (Barbaro et al. 1985). Microinjection of a mu opioid receptor agonist into RVM has similar effects as does glutamate microinjection, suggesting that the antinociceptive output cell of RVM is excited by mu opioid receptor agonists. This is likely to occur through a disinhibitory mechanism,

with mu opioid receptor agonists inhibiting a tonically active GABAergic input to the antinociceptive output cell (reviewed in Fields et al. 1991). Endogenously, local neurons provide at least one of the major sources of opioid input to the RVM.

Inactivation of RVM greatly attenuates the antinociception evoked by either electrical stimulation of the PAG or opioid microinjection into the PAG. Thus, the descending antinociceptive pathway from PAG requires excitation of a RVM cell type. Neurons that are indirectly excited by mu opioid receptor agonists are thought to be the antinociceptive output cells of the RVM. Inactivation of RVM also blocks the hyperalgesia associated with naloxone-precipitated withdrawal from morphine, leading to the idea that RVM modulates nociceptive transmission positively, as well as negatively (Kaplan and Fields 1991). Bidirectional modulation is accomplished by two populations of RVM neurons, one that suppresses pain transmission and one that facilitates it. The latter group is comprised of neurons that are directly inhibited by morphine. Recently, Porreca and co-workers have greatly extended our understanding of RVM-mediated nociceptive facilitation. They demonstrated that ablation of opioid-binding neurons in RVM blocks the allodynia and hyperalgesia associated with neuropathic pain (Porreca et al. 2001). Thus, RVM's facilitation of nociception may contribute to behaviors associated with persistent pain.

Most RVM cells project caudally into the spinal cord (Skagerberg and Bjorklund 1985). Rostrally-projecting RVM cells are few, and are concentrated in the pontine portion of raphe magnus. Within the spinal cord, RVM axons travel primarily in the dorsolateral funiculus and target the superficial and deep dorsal horn, the intermediolateral cell column, and the central canal. The oligosynaptic projection from RVM neurons to most sympathetic targets suggests that RVM cells contribute to the control of many homeostatic functions, as well as to sensory modulation. Indeed, evidence supports a role for RVM neurons in thermoregulation (Nakamura et al. 2004).

All of the serotonin in the spinal cord arises from the medulla. Most of the serotonin in the intermediate and dorsal gray comes from RVM as opposed to other caudal serotonergic cells in the cat; this has not been confirmed in the rat (Oliveras et al. 1977). While all or most of the serotonin in the dorsal horn arises from RVM neurons, only a minority of cells in RVM, about 15–25%, contains serotonin. These serotonergic cells are anatomically, pharmacologically, and physiologically distinct from their non-serotonergic neighbors. Most of the serotonergic RVM cells project to the spinal cord, principally through thin unmyelinated fibers that descend in the dorsolateral funiculus. Although antinociception is sensitive to serotonin receptor antagonists, serotonergic cells are not activated and serotonin release is not increased by antinociceptive manipulations (Gao et

al. 1998; Matos et al. 1992). It therefore appears that the sensitivity of antinociception to manipulations of serotonin, stems from influences on the effects of other neurotransmitters released from non-serotonergic RVM cells.

- ▶ [Descending Modulation and Persistent Pain](#)
- ▶ [Forebrain Modulation of the Periaqueductal Gray](#)
- ▶ [Opiates, Rostral Ventromedial Medulla and Descending Control](#)

## References

1. Aिमone LD, Gebhart GF (1986) Stimulation-Produced Spinal Inhibition from the Midbrain in the Rat is Mediated by an Excitatory Amino Acid Neurotransmitter in the Medial Medulla. *J Neurosci* 6:1803–1813
2. Barbaro NM, Hammond DL, Fields HL (1985) Effects of Intrathecally Administered Methysergide and Yohimbine on Microstimulation-Produced Antinociception in the Rat. *Brain Res* 343:223–229.
3. Basbaum AI, Fields HL (1984) Endogenous Pain Control Systems: Brainstem Spinal Pathways and Endorphin Circuitry. *Ann Rev Neurosci* 7:309–338
4. Fields HL, Heinricher MM, Mason P (1991) Neurotransmitters in Nociceptive Modulatory Circuits. *Ann Rev Neurosci* 14:219–245
5. Gao K, Chen DO, Genzen JR et al. (1998) Activation of Serotonergic Neurons in the Raphe Magnus is Not Necessary for Morphine Antinociception. *J Neurosci* 18:1860–1868
6. Kaplan H, Fields HL (1991) Hyperalgesia during Acute Opioid Abstinence: Evidence for a Nociceptive Facilitating Function of the Rostral Ventromedial Medulla. *J Neurosci* 11:1433–1439
7. Matos FF, Rollema H, Brown JL et al. (1992) Do Opioids Evoke the Release of Serotonin in the Spinal Cord? An *In Vivo* Microdialysis Study of the Regulation of Extracellular Serotonin in the Rat. *Pain* 48:439–447
8. Nakamura K, Matsumura K, Hubschle T et al. (2004) Identification of Sympathetic Premotor Neurons in Medullary Raphe Regions Mediating Fever and Other Thermoregulatory Functions. *J Neurosci* 24:5370–5380
9. Oliveras JL, Bourgoin S, Hery F et al. (1977) The Topographical Distribution of Serotonergic Terminals in the Spinal Cord of the Cat: Biochemical Mapping by the Combined Use of Microdissection and Microassay Procedures. *Brain Res* 138:393–406
10. Porreca F, Burgess SE, Gardell LR et al. (2001) Inhibition of Neuropathic Pain by Selective Ablation of Brainstem Medullary Cells Expressing the Mu-Opioid Receptor. *J Neurosci* 21:5281–5288
11. Potrebic SB, Mason P (1993) Three-Dimensional Analysis of the Dendritic Domains of On- and Off-Cells in the Rostral Ventromedial Medulla. *J Comp Neurol* 337:83–93
12. Sandkuhler J, Gebhart GF (1984) Characterization of Inhibition of a Spinal Nociceptive Reflex by Stimulation Medially and Laterally in the Midbrain and Medulla in the Pentobarbital-Anesthetized Rat. *Brain Res* 305:67–76
13. Skagerberg G, Bjorklund A (1985) Topographic Principles in the Spinal Projections of Serotonergic and Non-Serotonergic Brainstem Neurons in the Rat. *Neuroscience* 15:445–480

## Rostral Ventromedial Medulla Cell Types

PEGGY MASON

Department of Neurobiology, Pharmacology and Physiology, University of Chicago, Chicago, IL, USA  
p-mason@uchicago.edu

## Synonyms

RVM cell types

## Definition

Rostral ventral medulla (RVM) cells have been classified as on, off, neutral and serotonergic. RVM contains both serotonergic and non-serotonergic cell types. In addition to the obvious neurochemical difference between these two cell types, there are anatomical, physiological and functional differences.

## Characteristics

Serotonergic cells comprise about 15 % of the cells in RVM. They have relatively few (3–5) mediolaterally-oriented dendrites, which typically extend for less than 750  $\mu\text{m}$  (Gao and Mason 1997). Most serotonergic RVM cells send unmyelinated axons through the dorso-lateral funiculus into the spinal cord. The axons travel through and collateralize heavily in the ventrolateral medulla, a region that contains neurons involved in cardiovascular and respiratory control. Serotonergic cells are heterogeneous in neurochemistry, anatomy and physiology. Most serotonergic cells contain at least one, and often several, co-transmitters, including excitatory and inhibitory amino acids and a plethora of neuropeptides (Bowker et al. 1982). The functional implications of serotonergic cell heterogeneity are unclear and represent a challenge for the future. Since decreasing the availability of serotonin or antagonizing the activation of serotonergic receptors strongly attenuates antinociception, serotonergic RVM cells were originally thought to be the antinociceptive output cell of the RVM. However, serotonergic RVM cells are not activated by midbrain periaqueductal gray stimulation or opioid administration that evokes antinociception. Further, supraspinal opioid administration that causes analgesia does not consistently evoke serotonin release in the spinal cord. Serotonergic cells in RVM discharge slowly (<5 Hz) and steadily, never bursting or pausing for long periods of time (Auerbach et al. 1985). Serotonergic RVM cells fire at their highest rates when an animal is active and moving about, fire progressively more slowly as an animal proceeds from drowsy to slow wave sleep, and are silent during rapid eye movement sleep. The discharge of serotonergic RVM cells in anesthetized animals resembles that of animals in a quiet waking state. Thus, the antagonism of RVM-induced antinociception by manipulations that decrease serotonin transmission is likely to be due to antagonism of the actions of tonically released serotonin. Within the dorsal horn, serotonin is likely to primarily function by presynaptically modulating the release of glutamate and other transmitters (Li and Zhuo 1998).

In 1983, Fields and colleagues introduced a physiological classification scheme for 3 classes of non-serotonergic RVM cells (Fields et al. 1983). This classification system, based on data from anesthetized rats, has proved heuristic and has greatly stimulated the pain



modulation field. In essence, the classification system's utility stems from the ability to predict a cell's response to analgesic doses of opioids by its response to noxious cutaneous heat (Barbaro et al. 1986). 'On' cells are excited by noxious cutaneous stimuli and inhibited by opiates and are thought to facilitate nociceptive transmission. 'Off' cells are inhibited by noxious cutaneous stimuli, excited by opiates and are thought to inhibit nociceptive transmission. On and Off cell discharge is correlated with increases and decreases, respectively, in cutaneous nociceptive sensitivity evoked by opioid receptor mediated manipulations, including morphine administration and withdrawal from the same. These findings have implicated On and Off cells in the bidirectional opioid modulation of cutaneous heat-evoked nociceptive responses. Thus, RM neurons integrate brainstem and forebrain input to modulate dorsal horn circuitry, with On cells' facilitating and Off cells' inhibiting nociceptive transmission.

A third class of cells was originally termed neutral, because they failed to respond to noxious heating of the rat tail. These cells also failed to respond to analgesic doses, leading to great uncertainty as to the role, if any, of neutral cells in pain modulation. The picture has recently been complicated by clear findings by several investigators that neutral cells respond to noxious stimulation of other modalities and at other sites (Ellrich et al. 2000; Miki et al. 2002).

In the anaesthetized rat, there are non-serotonergic cells that are excited or inhibited by noxious stimulation, and thus resemble On and Off cells (Leung and Mason 1999; Oliveras et al. 1989). These cells respond similarly to a number of non-noxious stimuli, such as brush and even non-somatic stimuli such as clap. Thus, non-serotonergic RVM cells appear to respond to unexpected external stimulation, regardless of modality, and may therefore function to modify sensory processing at times of danger. Additionally, On and Off cells are active preferentially during waking and sleep, respectively. This pattern may contribute to the lack of responsiveness during sleep to noxious stimulation that is experienced as moderate pain during waking. There is an increase in On and Off cell activity after hindpaw inflammation (Miki et al. 2002). In addition, some Neutral cells change their response profile to that of On or Off cells after hindpaw inflammation that persists for 10–24 h.

To date, the Fields' cell classification system explains far more of the existing data than any other. Yet, there are problems that need to be addressed. For instance, cells that are excited by noxious stimulation are not inhibited by morphine in the awake animal (Martin et al. 1992). Finally, as discussed above, RVM neurons have been implicated in a number of processes in addition to pain modulation. Yet the role of On and Off cells in these other processes is either unknown or controversial. As an example of the latter,

two groups have investigated RVM cell responses to a thermoregulatory cold challenge. One group found that On cells were activated and the other that Off cells were activated (Rathner et al. 2001; Young and Dawson 1987). Understanding if and how individual RVM neurons contribute to multiple modulatory functions presents an exciting challenge for the future.

## References

1. Auerbach S, Fornal C, Jacobs BL (1985) Response of Serotonin-Containing Neurons in Nucleus Raphe Magnus to Morphine, Noxious Stimuli, and Periaqueductal Gray Stimulation in Freely Moving Cats. *Exp Neurol* 88:609–628
2. Barbaro NM, Heinricher MM, Fields HL (1986) Putative Pain Modulating Neurons in the Rostral Ventral Medulla: Reflex-Related Activity Predicts Effects of Morphine. *Brain Res* 366:203–210
3. Bowker Lund KN, Sullivan MC, Wilber JF et al. (1982) Transmitters of the Raphe-Spinal Complex: Immunocytochemical Studies. *Peptides* 3:291–298
4. Ellrich J, Ulucan C, Schnell C (2000) Are 'Neutral Cells' in the Rostral Ventro-Medial Medulla Subtypes of On- and Off-Cells? *Neurosci Res* 38:419–423
5. Fields HL, Bry J, Hentall I (1983) The Activity of Neurons in the Rostral Medulla of the Rat during Withdrawal from Noxious Heat. *J Neurosci* 3:2545–2552
6. Gao K, Mason P (1997) Somatodendritic Morphology and Axonal Anatomy of Intracellularly Labeled Serotonergic Neurons in the Rat Medulla. *J Comp Neurol* 389:309–328
7. Leung CG, Mason P (1999) Physiological Properties of Medullary Raphe Neurons during Sleep and Waking. *J Neurophysiol* 81:584–595.
8. Li P, Zhuo M (1998) Silent Glutamatergic Synapses and Nociception in Mammalian Spinal Cord. *Nature* 393:695–698
9. Martin G, Montagne CJ, Oliveras JL (1992) Involvement of Ventromedial Medulla "Multimodal, Multireceptive" Neurons in Opiate Spinal Descending Control System: A Single-Unit Study of the Effect of Morphine in the Awake, Freely Moving Rat. *J Neurosci* 12:1511–1522
10. Miki K, Zhou QQ, Guo W et al. (2002) Changes in Gene Expression and Neuronal Phenotype in Brain Stem Pain Modulatory Circuitry after Inflammation. *J Neurophysiol* 87:750–760
11. Oliveras JL, Vos B, Martin G et al. (1989) Electrophysiological Properties of Ventromedial Medulla Neurons in Response to Noxious and Non-Noxious Stimuli in the Awake, Freely Moving Rat: A Single-Unit Study. *Brain Res* 486:1–14
12. Rathner JA, Owens NC, McAllen RM (2001) Cold-Activated Raphe-Spinal Neurons in Rats. *J Physiol* 535:841–854
13. Young AA, Dawson NJ (1987) Static and Dynamic Response Characteristics, Receptive Fields, and Interaction with Noxious Input of Midline Medullary Thermoresponsive Neurons in the Rat. *J Neurophysiol* 57:1925–1936

R

## Roxicodone®

► Postoperative Pain, Oxycodone

## RSD

► CRPS-1 in Children

---

**RSI**

- ▶ Disability, Upper Extremity
- ▶ Repetitive Strain Injuries

---

**rTMS**

- ▶ Repetitive Transcranial Magnetic Stimulation

---

**RTX**

- ▶ Resiniferatoxin

---

**Ruffini Receptor****Definition**

Encapsulated cutaneous mechanosensory receptors. Ruffini receptors transmit information about the direction and intensity of shear forces within the skin and between skin and underlying tissues. They belong to the slowly adapting detectors.

- ▶ Perireceptor Elements

---

**Rumination****Definition**

A tendency to fix attention on a particular symptom, situation or outcome.

- ▶ Catastrophizing

## S/N Ratio

- ▶ Signal-to-Noise Ratio

## Sacral Hiatus

### Definition

A normally occurring gap at the lower end of the sacrum. It is closed by the sacrococcygeal ligament, and provides access to the sacral epidural space for administration of anesthetics.

- ▶ Epidural Infusions in Acute Pain

## Sacroiliac Injury

- ▶ Sacroiliac Joint Pain

## Sacroiliac Joint

### Definition

The sacroiliac joint lies next to the spine and connects the sacrum (the triangular bone at the bottom of the spine) with the pelvis (iliac crest).

- ▶ Chronic Low Back Pain, Definitions and Diagnosis
- ▶ Lower Back Pain, Physical Examination

## Sacroiliac Joint Blocks

ANTHONY C. SCHWARZER  
Faculty of Medicine and Health Sciences, The University of Newcastle, Newcastle, NSW, Australia  
msi5@ozemail.com.au

### Synonyms

Sacroiliac Joint Injection; intra-articular sacroiliac joint injection; Intra-Articular Sacroiliac Joint Block

### Definition

Intra-articular injection of local anaesthetic into the sacroiliac joint (SIJ) under controlled conditions, is a diagnostic test that is used to confirm or deny that the SIJ is the source of a patient's pain.

### Characteristics

#### Principles

The explicit purpose of a SIJ block is to test if a patient's pain is relieved by anaesthetizing the joint targeted. The block tests the hypothesis that perhaps the pain arises from the SIJ. If pain is not relieved, the target joint cannot be regarded as mediating the patient's pain, whereupon, a new hypothesis about the source of pain is required. If pain is relieved, the response constitutes *prima facie* evidence that the targeted joint is the source of the patient's pain; but steps need to be taken to ensure that the observed response is not false-positive. A positive response occurs when there is complete relief of a defined region of pain. The block need not relieve every area of pain, for a diagnosis of SIJ pain does not preclude other sources giving rise to pain in other areas. Remaining areas of pain may be targeted separately, using other investigations.

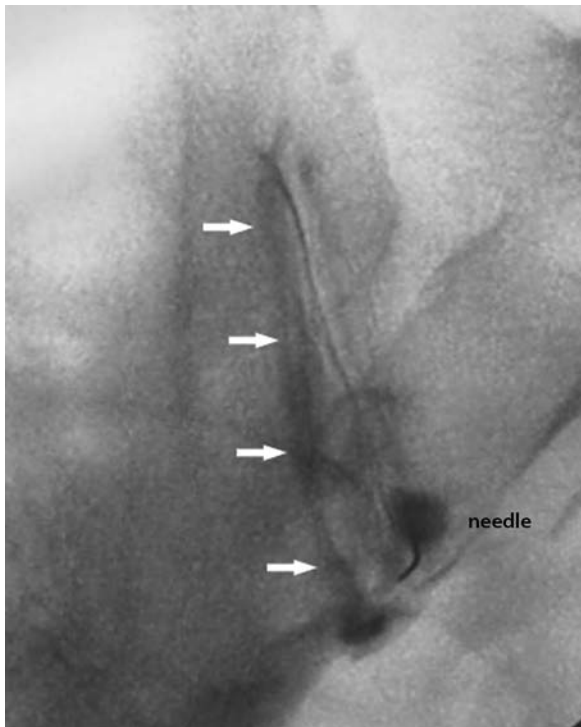
#### Setting

The procedure is conducted using a C-arm fluoroscope, with the patient lying face down on a radiolucent table. No sedation is required. Needle placement and spread of contrast medium is documented with hard-copy films or an image on specialized paper.

#### Technique

The procedure is performed using a strict aseptic technique, with the physician using sterile gloves. The skin of the back is cleansed using an iodine-based solution, chlorhexidine, or an alcohol-based antiseptic. A 90 mm 25 gauge spinal needle is optimal. Local anaesthetic agents, typically bupivacaine 0.5% or lignocaine 2%, are injected. Contrast medium is required to verify intra-articular placement of the needle.

The target point lies along the inferior, posterior aspect of the joint, approximately 1–2 cm cephalad of its most inferior end. The C-arm of the fluoroscope is rotated until the medial cortical line of the medial silhouette of the SIJ



**Sacroiliac Joint Blocks, Figure 1** An AP radiograph of a sacroiliac joint arthrogram. The needle lies in the inferior end of the joint cavity. The arrows indicate contrast medium that has spread throughout the joint cavity.

is maximally crisp. Once the inferior, posterior margin of the joint has been isolated radiographically, the target point is selected. The puncture point directly overlies the target (Dreyfuss et al. 1994, Schwarzer et al. 1995).

The needle is directed through the puncture point towards the target point, but aiming initially at the sacrum. The needle is then withdrawn slightly and redirected towards the joint space a few millimetres cranial to its lower end. Once the needle has entered the joint space, intra-articular placement must be confirmed with an injection of a small volume (0.3 – 0.5 ml) of contrast medium. If the needle has been correctly placed, upon injection the contrast medium will outline the joint space (Fig. 1). Local anaesthetic is then injected and continued until there is a firm resistive endpoint. No more than 1.5 ml of local anaesthetic is used.

### Complications

Like any invasive procedure, SIJ blocks carry the nominal risk of infection, bleeding and allergic reaction.

### Evaluation

After completion of the procedure, the response is evaluated. A validated pain measure such as the visual analogue pain scale is used. Information is obtained at half hourly to hourly intervals for at least four hours after the procedure. An independent assessor also records the re-

sponse before, and half an hour after, the procedure. A response is considered positive if there is greater than 75%, and ideally greater than 90%, relief from the injection. The duration of relief must be consistent with the known duration of action of the local anaesthetic used. If the patient has a positive response then a second, or confirmatory, block is performed on a different day.

### Application

SIJ blocks are used in patients with low back pain that is maximal below the topographic level of the L5 vertebra. The patient may or may not have somatic referred pain in the lower limb. The pain must have failed to resolve with conservative means and with the passage of time.

### Validity

Intra-articular SIJ blocks have face validity. An injection of contrast medium followed by up to 1.5 ml of local anaesthetic will remain within the joint and not anaesthetise any other structure. A volume exceeding 2.5 ml will leak through the joint capsule, thereby anaesthetising structures posteriorly and/or anteriorly (Fortin et al. 1994, Fortin and Tolchin 1993). If an injection of local anaesthetic into the joint results in complete relief of the patient's usual pain, then there is evidence to suggest that the pain stems from the SIJ. However, this does not constitute proof that the SIJ is the source of pain. There is the risk of false-positive responses. Patients may report relief of pain for reasons other than the action of the agent injected. In order to avoid or to reduce false-positive diagnoses based on the results of SIJ blocks, these blocks should be subjected to some form of control.

A compelling form of control is the injection of a placebo agent such as normal saline, but this would require informed consent, and patients might object to undergoing a sham procedure. An alternative form of control is to anaesthetise the joint on separate occasions using agents with different durations of action. This form of control, known as comparative local anaesthetic blocks, has been validated in the context of peripheral nerve blocks, but it has not been validated in the context of intra-articular blocks (Barnsley et al. 1993, Lord et al. 1995). It is not known whether local anaesthetic agents exhibit the same duration of action when injected intra-articularly, as they do when injected into or onto more superficial tissues. Nevertheless, comparative blocks have some degree of concept validity and strict content validity. Their critical utility arises when repeat blocks fail to relieve the patient's pain. In that event, they demonstrate that the first response was false-positive, and thereby reduce false-positive diagnoses based on single blocks.

An alternative idiom is the use of anatomical controls. A positive response to a SIJ block is more compelling if the patient has previously had negative responses to zygapophysial joint blocks, and/or lumbar discography (Schwarzer et al. 1995). Such patterns of response



do not absolutely rule out the chance of a placebo-response, but the fact that the patient has not exhibited a placebo-response during earlier investigations, intuitively increases the credibility of their response.

Using anatomical controls, Schwarzer et al. (1995) estimated that in patients with chronic low back pain, the source of pain could be traced to the SIJ in 13% of cases (95% confidence interval: 6% to 20%). Maigne et al. (1996) used controlled diagnostic blocks, and found a prevalence of 19% (95% CI: 9% to 29%).

In the absence of any other valid, diagnostic tests, controlled SIJ blocks constitute the only available means of establishing a diagnosis of SIJ pain. There have been no studies of the validity of pain radiographs using controlled diagnostic blocks as the criterion standard. CT analysis of the SIJ has limited value as judged against diagnostic intra-articular SIJ injections due to poor sensitivity and specificity (Elgafy et al. 2001). There are no studies of the diagnostic validity of MRI imaging for SIJ pain. Bone scintigraphy demonstrated a specificity of 90–100%, but poor sensitivity (Slipman et al. 1996; Maigne et al. 1998). No specific features on history or physical examination features have been validated scientifically, which accurately identify a painful SIJ (Schwarzer et al. 1995). None of the commonly used items of history, or physical examination tests that are purported to diagnose SIJ pain have been validated. (Dreyfuss et al. 1994; Dreyfuss et al. 1996). Patterns of referred pain are not diagnostic of SIJ pain (Schwarzer et al. 1995). However, it has been established by several investigators that, in patients with SIJ pain, pain is always maximal below L5 (Schwarzer et al. 1995; Fortin et al. 1994; Fortin et al. 1994). Pain maximal above L5 is highly unlikely to be of SIJ origin.

### Utility

SIJ blocks have diagnostic utility, in that if and once positive, they identify the source of pain. SIJ blocks have limited therapeutic utility. There is no proven treatment for SIJ pain if and once it is diagnosed.

Injections of corticosteroids into the SIJ have been shown to be efficacious in the treatment of sacroiliitis, due to various spondyloarthropathies in most, but not all, controlled and observational outcome studies. These studies imply a therapeutic role for intra-articular SIJ corticosteroid injections when the diagnosis of true sacroiliitis has been established (Maugars et al. 1992; Maugars et al. 1996). One retrospective, uncontrolled case series on the use of IA corticosteroids exists for those with documented idiopathic SIJ pain with promising results (Slipman et al. 2001). Uncontrolled, observational reports suggest some benefit from the use of extra-articular corticosteroids for presumed SIJ pain.

### Indications

The cardinal indication for SIJ blocks is the need to know if a patient's pain is arising from a SIJ or not. SIJ blocks

may be performed in the course of the systematic investigation of low back pain, or when there is, *a priori*, a high index of suspicion that the joint is painful.

### References

1. Barnsley L, Lord S, Bogduk N (1993) Comparative Local Anaesthetic Blocks in the Diagnosis of Cervical Zygapophysial Joints Pain. *Pain* 55:99–106
2. Dreyfuss P, Dreyer S, Griffin J, Hoffman J, Walsh N (1994) Positive Sacroiliac Joint Screening Tests in Asymptomatic Adults. *Spine* 19:1138–1143
3. Dreyfuss P, Michaelsen M, Pauza K, McLarty J, Bogduk N (1996) The Value of History and Physical Examination in Diagnosing Sacroiliac Joint Pain. *Spine* 21:2594–2602
4. Elgafy H, Semaan HB, Ebraheim NA, Coombs RJ (2001) Computed Tomography Findings in Patients with Sacroiliac Pain. *Clin Orthop* 382:112–8
5. Fortin JD, Aprill CN, Ponthieux B et al. (1994) Sacroiliac Joint: Pain Referral Maps Upon Applying a New Injection/Arthrography Technique Part II: Clinical Evaluation. *Spine* 19:1483–1489
6. Fortin JD, Dwyer AD, West S, Pier J (1994) Sacroiliac Joint: Pain Referral Maps Upon Applying a New Injection/Arthrography Technique. Part I: Asymptomatic Volunteers. *Spine* 19:1475–1482
7. Fortin JD, Tolchin RB (1993) Sacroiliac Provocation and Arthrography. *Arch Phys Med Rehabil* 74:125–129
8. Lord SM, Barnsley L, Bogduk N (1995) The Utility of Comparative Local Anaesthetic Blocks versus Placebo-Controlled Blocks for the Diagnosis of Cervical Zygapophysial Joint Pain. *Clin J Pain* 11:208–213
9. Maigne JY, Aivaliklis A, Pfefer F (1996) Results of Sacroiliac Joint Double Block and Value of Sacroiliac Pain Provocation Tests in 54 Patients with Low Back Pain. *Spine* 21:1889–1892
10. Maigne JY, Boulahdour H, Chatellier G (1998) Value of Quantitative Radionuclide Bone Scanning in the Diagnosis of Sacroiliac Joint Syndrome in 32 Patients with Low Back Pain. *Eur Spine J* 7:328–331
11. Maugars Y, Mathis C, Berthelot J (1996) Assessment of the Efficacy of Sacroiliac Corticosteroid Injections in Spondyloarthropathies: A Double-Blind Study. *Br J Rheum* 35:767–770
12. Maugars Y, Mathis C, Vilon P, Prost A (1992) Corticosteroid Injection of the Sacroiliac Joint in Patients with Seronegative Spondyloarthropathy. *Arthritis and Rheumatism* 35:564–568
13. Schwarzer AC, Aprill CN, Bogduk N (1995) The Sacroiliac Joint in Chronic Low Back Pain. *Spine* 20:31–37
14. Slipman CW, Lipetz JS, Plastaras CT, Jackson HB (2001) Vresilovic EJ, Lenrow DA, Braverman DL. Fluoroscopically Guided Therapeutic Sacroiliac Joint Injections for Sacroiliac Joint Syndrome. *Am J Phys Med Rehabil* 80:425–32
15. Slipman CW, Sterenfeld Eb, Chou LH, Herzog R, Vresilovic E (1996) The Value of Radionuclide Imaging in the Diagnosis of Sacroiliac Joint Syndrome. *Spine* 21:2251–2254

S

## Sacroiliac Joint Denervation

- ▶ Sacroiliac Joint Radiofrequency Denervation

## Sacroiliac Joint Injection

- ▶ Sacroiliac Joint Blocks

## Sacroiliac Joint Neurotomy

### ► Sacroiliac Joint Radiofrequency Denervation

## Sacroiliac Joint Pain

RICARDO J. KOMOTAR, J. MOCCO,  
CHRISTOPHER J. WINFREE  
Department of Neurological Surgery, Neurological  
Institute, Columbia University, New York, NY, USA  
cjlw12@columbia.edu

### Synonyms

Sacroiliitis; Sacroiliac Injury; Lower back pain

### Definition

Sacroiliac (SI) joint pain is defined as back discomfort in the area of the SI joint, where the spine and pelvis meet (Tanner 1997). This pain may be the result of an underlying condition or trauma leading to nerve damage and bone ► [necrosis](#).

### Characteristics

#### Background

Sacroiliac joint syndrome (SIJS) was a common diagnosis for low back pain in the early 1900's (Tanner 1997). In 1932, however, the discovery of vertebral disc herniation altered the diagnosis and management of back pain. Currently, SIJS is difficult to distinguish from other types of low back pain and, as a result, is often overlooked. Nevertheless, SIJS remains an important contributor to disability, accounting for nearly 20% of chronic low back pain cases (Maigne et al. 1996).

#### Anatomy

The SI joints exist bilaterally and hinge the lower half of the skeleton by connecting the ► [sacrum](#) to the ► [ilium](#) (Bogduk 1995). Their ► [articular](#) surfaces are integrated and covered by a combination of ► [hyaline cartilage](#) and ► [fibrocartilage](#). Not designed for motion, these joints commonly fuse with age and are difficult to examine. Although the SI joints typically move only two to three millimeters during exertion, they may be mobilized by certain therapeutic positional exercises. Limited movement enables the SI joints to absorb shock and act as ► [fulcrums](#) during ambulation (Bowen and Cassidy 1981).

#### Medical History

The most classic presentation of SIJS is medial buttock discomfort, with sacral sulcus pain nearly always being present (Fortin et al. 1994). A distinguishing feature for this syndrome is a lack of pain above the L-5 level (Fukui and Nosaka 2002). Patients may also complain of referred pain to the hip, groin, abdomen, thigh, or calf.

### Physical Exam

Physicians need to rule-out other potential causes of lower back pain, including disk disease, ► [spinal stenosis](#), degenerative hip joint disease, and posterior facet syndrome (Bogduk 2004). With SIJS, full lumbar spine and hip range of motion are expected. Furthermore, neurological examination is usually normal, with negative nerve-root tension signs. ► [Gluteus medius](#) weakness may be found and is often combined with tightness in the ► [piriformis](#) muscle and ► [quadratus lumborum](#) (Calvillo et al. 2000).

### Diagnostic Testing

No single test accurately identifies SIJS. Diagnostic examination aims to detect abnormal movement in the SI joint and elicit pain by stressing adjacent structures, such as the lumbar spine, hip joint, and femoral or sciatic nerves (Cibulka and Koldehoff 1999). Of note, the thigh thrust and Gaenslen's sign have the greatest predictive value and should be used in combination. Other diagnostic tests that may be implemented during physical exam include the Distraction test, Sacroiliac shear test, Patrick's test, and Compression test.

### Radiology

Conventional X-ray and computed tomography (CT) are rarely useful in evaluating possible SIJS. Bone scans, despite their high ► [specificity](#), are not recommended for the diagnostic workup of SIJS due to their low ► [sensitivity](#) (Esdaile and Rosenthal 1983). Similarly, MRI has a high sensitivity and allows visualization of soft-tissue anatomy, yet is of limited value due to its low specificity (Bigot et al. 1999). With this in mind, the gold standard for the diagnosis of SIJS is provocative injection under fluoroscopic guidance (Prather 2003). More specifically, this technique confirms the diagnosis of SIJS by inducing pain upon injection, followed by symptom relief with an anesthetic block. This is the most reliable method for establishing the diagnosis of SIJS and allows immediate radiographic interpretation. It is an invasive procedure, however, and should be used once less complicated and invasive therapeutic measures are exhausted.

### Differential Diagnosis

Numerous conditions may mimic SIJS (Miller 1973). For instance, sacral stress fractures should be considered in athletes with chronic pain in this region. ► [Spondyloarthropathies](#) often begin with symptoms of sacroiliitis (Khan and van der Linden 1990). ► [Ankylosing spondylitis](#) and spondyloarthritis associated with inflammatory bowel disease may also produce findings consistent with SIJS. In addition, ► [Psoriatic arthritis](#), ► [Reiter's syndrome](#), ► [Myofascial pain](#), and Osteitis condensans ilii are other potentially confounding diagnoses that may present with sacroiliitis.

## Treatment Options

First line treatment for sacroiliac joint disease should consist of conservative therapy. To begin with, patients should avoid any activities, including athletic endeavors, which aggravate symptoms. In addition, patients should be advised to take anti-inflammatory medications for pain relief. Irrespective of their analgesic effects, these medications are beneficial in reducing regional inflammatory processes that may cause symptoms. Therefore, patients should continue on these medications as long as they are efficacious.

Physical therapy is another key component of conservative treatment, as strengthening the musculature surrounding the SI joint may help increase flexibility and protect from further injury. Rehabilitation must address functional biomechanical deficits with exercise regimens that stabilize the SI joints against large shear stresses (Prather 2003). These targeted exercises may be used in combination with therapeutic joint mobilization to counter muscle disability or abnormal shear forces. Abnormal posture or leg-length discrepancy must also be treated, as this condition is associated with detrimental positioning of the sacrum. If leg-length discrepancy is detected on the physical exam, orthoses and heel lifts can help correct this deformity.

If conservative treatments fail, ► [Corticosteroid Injections](#) may be effective. This procedure delivers concentrated anti-inflammatory medication directly into the sacroiliac joint for prolonged pain relief. As the SI joint lies deep within the pelvis, these injections are usually given under X-Ray guidance in a hospital setting (Bellaiche 1995).

## Conclusion

SIJS remains a diagnostic challenge. After ruling out other potential sources of pain, a combination of provocative maneuvers and diagnostic injections has proven reliable in the evaluation of SIJS. If conservative management consisting of physical therapy does not foster recovery, fluoroscopically guided injection of analgesics into the SIJ should be considered for both diagnostic confirmation of the pain source and symptomatic improvement.

## References

- Bellaiche L (1995) Cortisone Injection into the Sacroiliac Joint. *Ann Radiol* 38:192–195
- Bigot J, Loeuille D, Chary-Valckenaere I et al. (1999) Determination of the Best Diagnostic Criteria of Sacroiliitis with MRI. *J Radiol* 80:1649–1657
- Bogduk N (1995) The Anatomical Basis for Spinal Pain Syndromes. *J Manipulative Physiol Ther* 18:603–605
- Bogduk N (2004) Management of Chronic Low Back Pain. *Med J Aust* 180:79–83
- Bowen V, Cassidy JD (1981) Macroscopic and Microscopic Anatomy of the Sacroiliac Joint from Embryonic Life until the Eighth Decade. *Spine* 6:620–628
- Calvillo O, Skaribas I, Turnipseed J (2000) Anatomy and Pathophysiology of the Sacroiliac Joint. *Curr Rev Pain* 4:356–361
- Cibulka MT, Koldehoff R (1999) Clinical Usefulness of a Cluster of Sacroiliac Joint Tests in Patients with and without Low Back Pain. *J Orthop Sports Phys Ther* 29:83–89; discussion 90–82
- Esdaile J, Rosenthal L (1983) Radionuclide Joint Imaging. *Compr Ther* 9:54–63
- Fortin J D, Aprill C N, Ponthieux B et al. (1994) Sacroiliac Joint: Pain Referral Maps upon Applying a New Injection/Arthrography Technique. Part II: Clinical Evaluation. *Spine* 19:1483–1489
- Fukui S, Nosaka S (2002) Pain Patterns Originating from the Sacroiliac Joints. *J Anesth* 16:245–247
- Khan MA, Linden SM van der (1990) A Wider Spectrum of Spondyloarthropathies. *Semin Arthritis Rheum* 20:107–113
- Maigne J Y, Aivaliklis A, Pfefer F (1996) Results of Sacroiliac Joint Double Block and Value of Sacroiliac Pain Provocation Tests in 54 Patients with Low Back Pain. *Spine* 21:1889–1892
- Miller DS (1973) Low back pain. Differential Diagnosis Determines Treatment: Hospitalization Enables more Efficient Treatment. *Med Trial Tech Q* 20:1–41
- Prather H (2003) Sacroiliac Joint Pain: Practical Management. *Clin J Sport Med* 13:252–255
- Tanner J (1997) Sacroiliac Joint Pain. *Spine* 22:1673–1674

## Sacroiliac Joint Radiofrequency Denervation

WAY YIN

Department of Anesthesiology, University of Washington, Seattle, WA, USA  
wyin@nospinepain.com

## Synonyms

Sacroiliac Joint Neurotomy; Sacroiliac Joint Denervation; Sacroiliac joint radiofrequency; Sensory Stimulation-Guided Radiofrequency Neurotomy; Stereotactic Sacroiliac Joint Denervation

## Definition

Sacroiliac joint radiofrequency denervation is a treatment for low back pain originating from the sacroiliac joint complex (SIJC). Radiofrequency (RF) current is channeled through percutaneous electrodes to coagulate sensory nerves from the SIJC. Coagulation of these sensory nerves disrupts the transmission of nociceptive signals from the SIJC, thereby relieving pain.

## Characteristics

### Mechanism

► [Radiofrequency neurotomy](#) achieves relief of pain by coagulating sensory nerves that are conducting nociceptive information from a painful structure (see ► [Radiofrequency Neurotomy, Electrophysiological Principles](#)).

### Indications

Sacroiliac joint radiofrequency denervation is a structure-specific therapeutic intervention, specifically for the treatment of chronic back pain arising from the sacroiliac joint complex. SIJC RF should only be considered in patients who have demonstrable pain arising

from the sacroiliac joint, and in whom other structural sources of low back pain have been eliminated (e.g. zygapophysial joints, intervertebral discs).

Demonstration of SIJC pain requires the patient to experience complete or near complete relief of pain following controlled local anesthetic blocks of the SIJC. Response to a single anesthetic injection of the SIJC is insufficient to justify proceeding with denervation, as the rate of false-positive responses to single anesthetic injections may exceed 35% (Barnsley et al. 1993; Schwarzer et al. 1994). SIJC RF should only be considered in the absence of specific contraindications to therapeutic intervention.

### Technique

Any attempt to denervate the SIJC requires a detailed understanding of relevant sensory neuroanatomy. The primary sensory neuroanatomy of the SIJC is currently felt to arise from the dorsal rami of L5–S3 (Grob et al. 1995; Fortin et al. 1999; Willard et al. 1998). Numerous lateral branches of the segmental dorsal rami form a lateral dorsal sacral plexus, and branches from this plexus travel laterally in a complex and highly variable three dimensional topography, to ultimately supply sensation to the deep interosseous ligaments and the sacroiliac joint proper. These nerves constitute the target for denervation of the SIJC.

Several techniques for denervation of the SIJC by radiofrequency neurotomy have been described (Gevargez et al. 2002; Kline 1992; Lennard 2000; Ferrante et al. 2001; Yin et al. 2003), all of which utilize fluoroscopic (Lennard 2000; Ferrante et al. 2001; Kline et al. 1992; Yin et al. 2003) or CT guidance (Gevargez et al. 2002).

The first technique described to denervate the SIJC is attributed to Kline (Kline 1992). He performed serial bipolar radiofrequency lesions along the medial aspect of the posterior ilium on the dorsal sacral plate (Fig. 1). Other techniques have used single lesions along the medial sacral ala and lateral aspect of the first dorsal

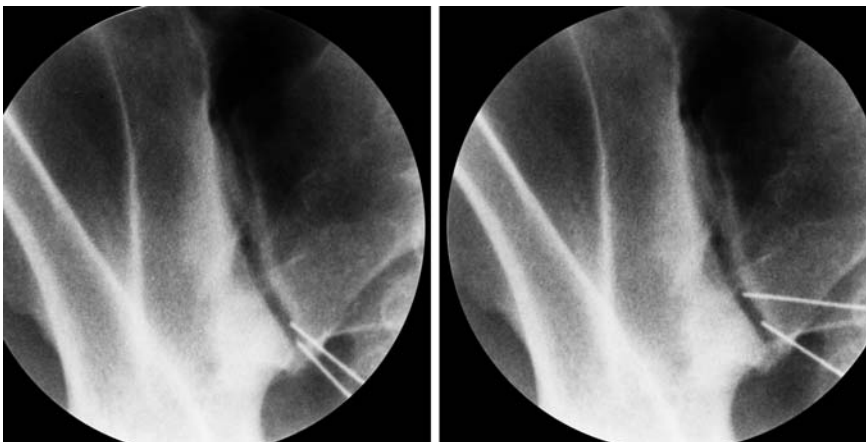
sacral foramen (Gevargez et al. 2002), or along the lateral margins of the S1–S3 dorsal sacral foramina (Lennard 2000).

A technique based on the neuroanatomy of the dorsal sacral plexus, and incorporating patient-blinded, sensory stimulation to select symptom-bearing lateral branch nerves has recently been described (Yin et al. 2003). This sensory stimulation guided (SSG) technique is based on the known neuroanatomy of the dorsal sacral plexus, and has produced the most favorable outcomes of all techniques to date (Yin et al. 2003). The SSG technique involves inserting a needle electrode into the vicinity of each of the lateral branches of the sacral dorsal that may be mediating the patient's pain (Yin et al. 2003). A stimulating current is passed through the electrode, in an effort to reproduce the patient's pain. The patient is asked to report any responses to stimulation, and must be able to discriminate between reproduction of concordant pain and non-painful paresthesiae. Reproduction of the patient's pain indicates that a nerve that mediates the pain has been located. Wherever a symptomatic nerve is identified with reproducible low voltage sensory stimulation, it is thermocoagulated with the electrode.

Sensory mapping is undertaken systematically across the medial sacral ala and the lateral aspects of the dorsal sacral foramina, in order to find all nerves that may be involved (Fig. 2A-D). Symptomatic nerves are nearly always identified from L5 and S1, with progressively fewer nerves being found from S2 and S3 (Yin et al. 2003). Patients with referred pain in the lower extremity or groin associated with SIJC pain will typically experience relief of their referred pain following successful SIJC denervation, especially if concordant symptoms are elicited on lateral branch sensory mapping.

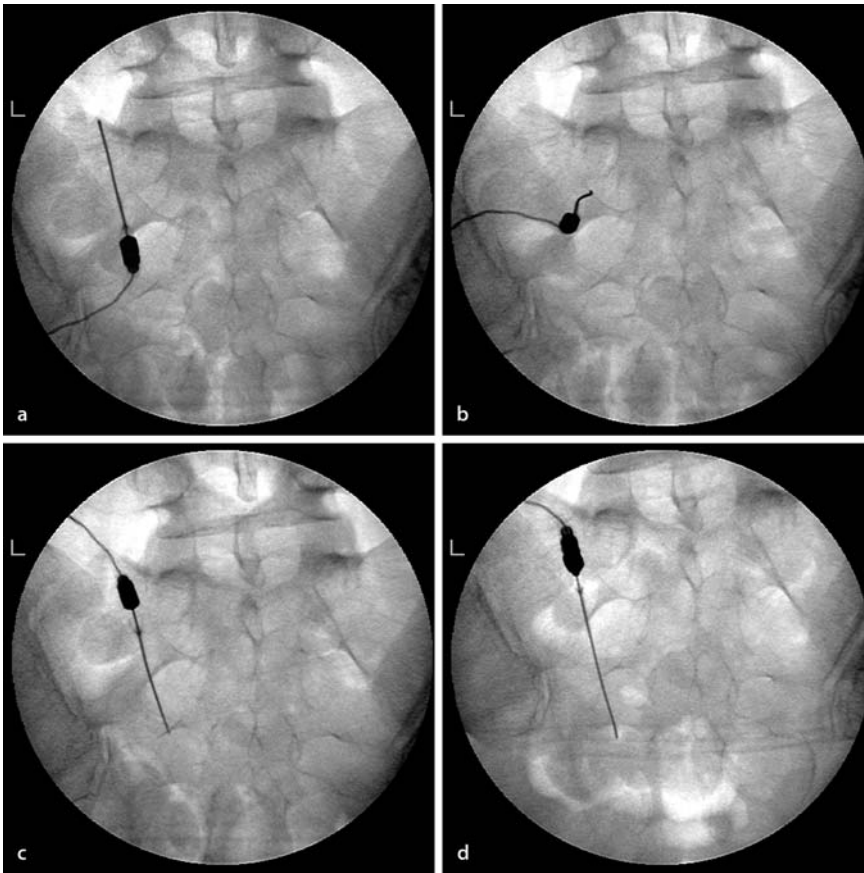
### Efficacy

To date, the efficacy of SIJC RF is based on non-controlled prospective (Gevargez et al. 2002) and retrospec-



**Sacroiliac Joint Radiofrequency Denervation, Figure 1** Sacro-Iliac Joint Radiofrequency Denervation, bipolar technique (courtesy Kline MT).





**Sacroiliac Joint Radiofrequency Denervation, Figure 2** Sacro-iliac Joint Radiofrequency Denervation, sensory stimulation guided technique, typical electrode placement. A. L5 lateral branch, B. S1 lateral branch, C. S2 lateral branch; D. S3 lateral branch.

tive case series (Ferrante et al. 2001; Yin et al. 2003). No controlled or long-term (i.e. greater than 1 year) efficacy studies have been published to date.

If patients are properly selected, the duration of properly performed SIJC RF exceeds that of local anesthetic and steroid injections into the SIJC, and as published reports to date suggest, may provide efficacy beyond that provided by conservative, non-interventional means (Gevargez et al. 2002; Yin et al. 2003). Published efficacy ranges from a low of 36.4% of patients experiencing greater than 50% reduction in pain for more than 6 months (Ferrante et al. 2001), to a high of 64% of patients experiencing greater than 60% relief for more than 6 months using the SSG technique (Yin et al. 2003). Some 36% of patients experienced complete relief for more than 6 months (Yin et al. 2003).

Although controlled trials have still to be conducted, radiofrequency neurotomy is the only procedure for sacroiliac joint pain that has a documented efficacy. No other procedure has been shown to provide lasting relief, and none has been found to produce complete relief of pain.

#### Complications

Reported complications following SIJC RF by any technique are rare, and no mortality has been reported.

Patients most commonly experience a period of post-operative discomfort that is self-limited. Patients will occasionally experience moderate term localized dysesthesia or hypoesthesia in the skin of the ipsilateral buttock following SIJC RF denervation.

S

#### References

1. Barnsley L, Lord S, Wallis B, Bogduk N (1993) False-Positive Rates of Cervical Zygapophysial Joint Blocks. *Clin J Pain* 9:124–30
2. Ferrante FM, King LF, Roche EA et al. (2001) Radiofrequency Sacroiliac Joint Denervation for Sacroiliac Syndrome. *Reg Anesth Pain Med* 26:137–42
3. Fortin J, Kissling R, O'Connor B et al. (1999) Sacroiliac Joint Innervation and Pain. *Am J Orthop* 1999; 28:687–90
4. Gevargez A, Groenemeyer D, Schirp S et al. (2002) CT-Guided Percutaneous Radiofrequency Denervation of the Sacroiliac Joint. *Eur Radiol* 12:1360–5
5. Grob K, Neuhuber W, Kissling R (1995) Innervation of the Sacroiliac Joint of the Human. *Z Rheumatol* 54:117–22
6. Kline MT (1992) Stereotactic Radiofrequency Lesions as Part of the Management of Chronic Pain. Paul M Deutsch, Orlando, Florida
7. Lennard TE (2000) *Pain Procedures in Clinical Practice*, 2nd edn. Hanley & Belfus, Inc, Philadelphia
8. Schwarzer AC, Aprill CN, Derby R, Bogduk N (1994). The False-Positive Rate of Uncontrolled Diagnostic Blocks of the Lumbar Zygapophysial Joints. *Pain* 58:195–200
9. Willard F, Carreiro J, Manko W (1998) The Long Posterior Interosseous Ligament and the Sacrococcygeal Plexus. Third Interdisciplinary World Congress on Low Back and Pelvic Pain

10. Yin W, Willard F, Carreiro J et al. (2003) Sensory Stimulation-Guided Sacroiliac Joint Radiofrequency Neurotomy: Technique Based on Neuroanatomy of the Dorsal Sacral Plexus. *Spine* 28:2419–25

## Sacroiliitis

- ▶ Sacroiliac Joint Pain

## Sacrum

### Definition

The sacrum is the wedge-shaped bone consisting of five fused vertebrae forming the posterior part of the pelvis.

- ▶ Sacroiliac Joint Pain

## Saliency

### Definition

Saliency quantifies the relative importance of each dimension to an individual.

- ▶ [Multidimensional Scaling and Cluster Analysis Application for Assessment of Pain](#)
- ▶ [Pain Measurement by Questionnaires, Psychophysical Procedures and Multivariate Analysis](#)

## Salpingitis-Oophoritis-Peritonitis

- ▶ [Chronic Pelvic Pain, Pelvic Inflammatory Disease and Adhesions](#)

## Sarcomere

### Definition

A sarcomere is the basic contractile unit of striated muscle. Sarcomeres are attached to each other end-to-end at the Z line, where the actin molecules are anchored and where the myosin is anchored by titan. The sarcomere is essentially a constant-volume structure that can change length by a factor of nearly two in most muscles. Localized microscopic abnormal shortening of sarcomeres appears to be characteristic of myofascial trigger points.

- ▶ [Myofascial Trigger Points](#)

## Satellite Cells

### Definition

Satellite cells are glial cells of the dorsal root ganglia. Each neuron within the dorsal root ganglia is encircled by a layer of satellite cells in close apposition. Satellite cells become activated in response to injury of „their“ neuron’s peripheral axon.

- ▶ [Proinflammatory Cytokines](#)
- ▶ [Satellite Cells and Inflammatory Pain](#)

## Satellite Cells and Inflammatory Pain

REGINALD J. DOCHERTY

Wolfson Centre for Age-Related Diseases, King’s College London, London, UK  
reginald.docherty@kcl.ac.uk

### Synonyms

Satellite cells; Fibroblast-Like Satellite Cells; Perineuronal Cells; Satellite Glial Cells; Neuroglial Cells

### Definition

Satellite cell (SC) is a general term that refers to the non-neuronal cells that surround neurones. In sensory ganglia, the term usually refers to the particular cells that surround and encapsulate the cell bodies of the neurones and form a sheath around the cell body region.

### Characteristics

Several key features of the behaviour of the SCs that encapsulate the cell bodies of sensory ganglia make them interesting in the context of pain, including pain associated with inflammation, and have led to the suggestion that they may act as nociceptors (Heblich et al. 2001). Firstly, the SCs form an intimate anatomical association with dorsal root ganglion (DRG) neuronal cell bodies and are well placed to influence their activity (Pannese 1981). Secondly, the SCs display a range of responses when remote tissue damage occurs at the axon or processes of the host neurone (Li and Zhou 2001, Hanani et al. 2002, Elson et al. 2004). Thirdly, they are sensitive to the inflammatory mediator ▶ [bradykinin](#) (England et al. 2001) and the somatic response of the host sensory neurones to bradykinin is dependent, at least partly, on their association with the SCs (Heblich et al. 2001).

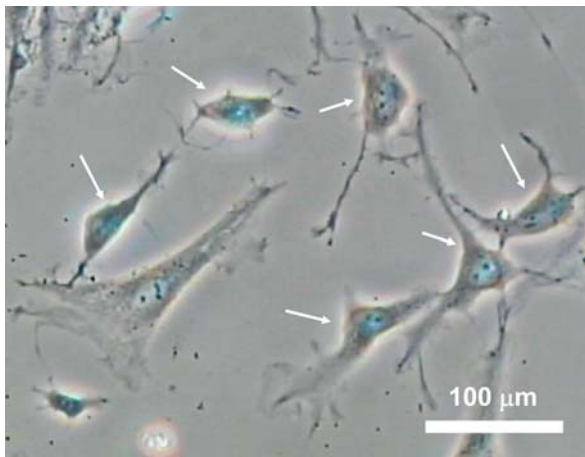
### Anatomical Characteristics

In dorsal root ganglia the cell body of each sensory neurone is plastered with SCs, which make a sheath that creates a physical barrier between the somatic region of the host neurone and its neighbours. The morphology and ultrastructure of the somatic SCs and their physical relationship to their host neurones has been reviewed in

detail (Pannese 1981). The SC sheath can be as thin as 50 nm or as thick as 5  $\mu\text{m}$ , whilst the number of SCs that contribute to the sheath can be as few as two or as many as ten, depending on the size of the neuronal cell body that is encapsulated (Leda et al. 2004). The SCs are difficult to identify with a conventional light microscope in fresh tissue, but become obvious when a histological stain is used that highlights their nuclei (Leda et al. 2004). They are also clearly distinguishable in electron micrographs (Pannese 1981).

The physical relationship between the SCs and their host neurones is intimate. In electron micrographs, host neurones can be seen to extend fine finger-like processes that occupy invaginations of the SC membrane and maximise the surface area of contact (Pannese 1981; Pannese 2002), but the function of these interesting structures is not known. The community of SCs around a host neurone communicate with each other via gap junctions (Hanani et al. 2002), which suggests that together they form a functional unit around their host.

When DRG are freshly dissociated (e.g. using collagenase enzymes), the isolated neuronal somata have a 'lumpy' appearance due to the SCs that are stuck to them. When the cells are grown in tissue culture, the SCs migrate from the host neurones on to the flat surrounding matrix (e.g. polyornithine coated plastic), where they adopt a polygonal morphology that resembles that of small fibroblasts, macrophages or ► **Schwann cell precursors** (Fig. 1). The SCs share several surface markers with Schwann cells, which distinguish them from fibroblasts, e.g. the ► **p75 neurotrophin receptor**. They can also be distinguished from immune cells in that they do not express CD45 (Leda et al. 2004); however, no unique markers for the SCs have been identified. The paucity of objective criteria that can be used to identify the cells is a particular problem for experiments per-



**Satellite Cells and Inflammatory Pain, Figure 1** The figure shows a phase contrast photomicrograph of a group of fibroblast like satellite cells (indicated by arrows) isolated from the dorsal root ganglion of a 1-day-old rat pup and grown in tissue culture.

formed in tissue culture, and makes the comparison of the somatic SCs with other non-neuronal cells difficult, e.g. those associated with the nerve terminal region. On balance, it seems likely that the SCs are closely related to Schwann cells, but a more definitive description of their lineage or relationship to other cells is not possible at this time.

### Physiological and Pathophysiological Characteristics

SCs in DRG are often considered as passive cells whose role is to provide structural and metabolic support for the sensory neurones with which they are associated. However, the view that the SCs have a passive role in sensory function is undermined by observations of SCs that display active responses to nerve trauma and local inflammation. Observations of this type go back to the work of Cajal (1928), quoted by Elson et al. (2004), who showed that the SCs proliferate following transplantation of ganglia. Since then several authors have shown that transection or damage to central or peripheral processes of sensory nerves initiates proliferation of the SCs in the ganglion (Pannese 1981; Lu and Richardson 1991; Hanani et al. 2002). Mild skin abrasions that traumatise nerve terminals and cause inflammation provoke a proliferative response (Elson et al. 2004). Local inflammation within the ganglion induces proliferation of SCs (Lu and Richardson 1991), but evidence for proliferative responses to remote inflammatory stimuli (in the absence of nerve damage) is not available. The SCs are somehow involved in the formation of ► **perineuronal 'basket' structures** that form, especially around large 'A' type cell bodies of cutaneous neurones in DRG, following peripheral nerve injury (Ramer et al. 1999; Li and Zhou 2001; Hu and McLachlan 2003). A basket is made up of a lattice of fine processes that invade the SC sheath. The processes sprout from sympathetic fibres that invade the ganglion or from damaged sensory neurones within the ganglion. This basket appears as a 'ring' structure in a section through the tissue. It is conceivable that the SCs provide guidance signals for the invading neuronal processes, or collaborate with host neurones to anchor invading processes in the vicinity of the cell body (Ramer et al. 1999). Following nerve injury the number of gap junctions between the SCs increases, and the SC envelope around one neurone makes gap junction connections with the envelope around neighbouring neurones. This important observation has inspired the suggestion that the SCs may provide a conduit for communication between neighbouring neurones in the ganglion (Hanani et al. 2002). Such a mechanism may underlie the cross-talk between neighbouring neurones in the ganglion that has been observed by Amir and Devor (2000). Clearly, cross-talk between neurones in the DRG could increase the size of their receptive field and/or respecify their sensory modality. Thus, proliferation and remodelling of the SC envelope could contribute to the

generation of pain states such as ► **hyperalgesia** and ► **allodynia**, and perhaps other sensory ► **dysthesias** too.

The SCs are not electrically excitable. In culture, they have a resting membrane potential of about -60 mV and exhibit voltage-gated potassium channel activity (England et al. 2001), but they do not appear to express other voltage-gated conductances, such as voltage-gated sodium and calcium channels. In this respect, the SCs differ from Schwann cells which express at least voltage-gated calcium channels in addition to potassium channels. The SCs express calcium-activated chloride channels, and these are activated when the intracellular concentration of calcium rises (see below).

### Pharmacological Characteristics

Pannese (1981) has reviewed the effects of various substances, including metal ions, on the anatomical appearance and structural properties of sensory neurone SCs, but there have been surprisingly few studies of other pharmacological properties. Recently, it has been shown that SCs respond to bradykinin (England et al. 2001), ATP via P2Y receptors (Weick et al. 2003) and ► **nitric oxide** (Thippeswamy and Morris 2002).

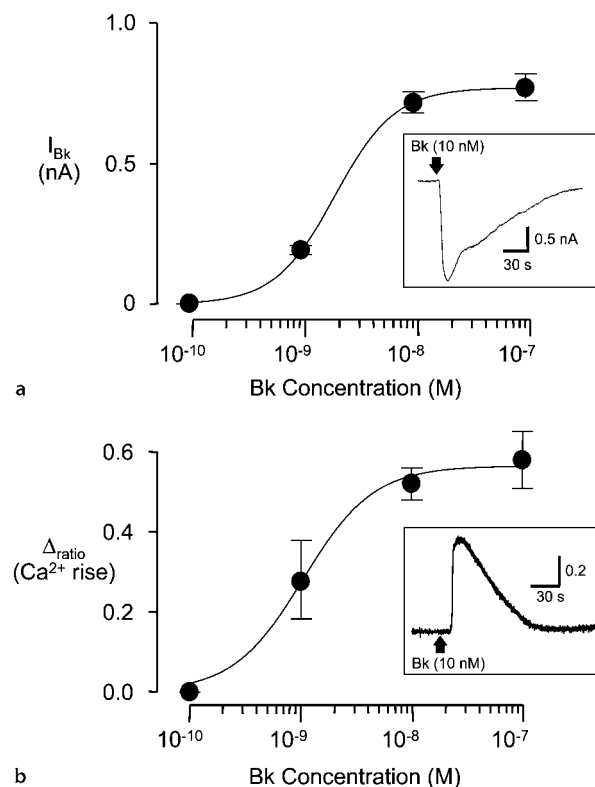
### Nitric Oxide (NO) Signalling

Small diameter sensory neurones can make and release (NO), and this causes an increase in the levels of cGMP in their SCs. In mature, intact neurones this function is inhibited by target derived ► **nerve growth factor** (NGF). Loss of target derived NGF, e.g. following nerve transection, leads to upregulation of NOS at the neuronal cell body and release of NO. The NO may promote NGF production in the SCs, which then become an alternative source of NGF. In this way, and perhaps also by other mechanisms, the SCs are neuroprotective. Thus, following peripheral nerve transection (but not in intact neurones), inhibitors of neuronal nitric oxide synthase (nNOS) or of cGMP production in SCs cause neuronal cell death, presumably by depriving the neurones of the alternative source of NGF. Details of the mechanisms concerned remain to be established firmly, but the case presented for a neuroprotective role for the SCs is strong (Thippeswamy and Morris 2002). This mechanism would also be consistent with a role for NGF as a guidance signal for the invading neuronal processes that form perineuronal baskets (see above). There is no strong evidence that neurone to SC signalling by NO contributes to inflammatory pain, but the existence of this mechanism highlights a potential danger in the use of non-specific inhibitors of NOS as anti-inflammatory agents where the inflammation is associated with nerve damage.

### Bradykinin (Bk)

Bk is an important mediator of pain and inflammation, which is released from blood borne high molecular

weight kininogens by the action of proteolytic kallikrein enzymes. A closely related peptide, Lys-Bk (kallidin), is produced in the tissues from low molecular weight kininogen. Bk provokes a response in DRG SCs that is mediated by constitutive B2 Bk receptors, and involves an increase in the intracellular  $\text{Ca}^{2+}$  concentration and activation of a  $\text{Ca}^{2+}$ -activated  $\text{Cl}^-$  conductance (England et al. 2001). The importance of this result is that it establishes the presence of B2 receptors on the SCs, and demonstrates their responsiveness to an inflammatory mediator (Fig. 2). The functional relevance of the increase in intracellular  $\text{Ca}^{2+}$  concentration, and the activation of a  $\text{Ca}^{2+}$ -activated  $\text{Cl}^-$  conductance, is not known. The host neurones, like the SCs, express B2 receptors, but their response to Bk is complex, involving sensitisation of ► **TRPV1** channels as well as activation of a  $\text{Na}^+$ -dependent conductance, which mediates a slowly activating depolarising current ( $I_{\text{Bk}}$ ). The sensitisation of TRPV1 channels is probably due to a direct effect of Bk on the neurones, but there is evidence that activation of  $I_{\text{Bk}}$  depends on the presence of SCs and may be secondary to activation of SCs (Heblich et al. 2001). Thus SCs could have the ability to pass signals to



**Satellite Cells and Inflammatory Pain, Figure 2** Concentration-response data for the response of neonatal rat dorsal root ganglion satellite cells to Bk. (a) An inward  $\text{Ca}^{2+}$ -activated  $\text{Cl}^-$  current measured using whole cell voltage clamp at -60 mV. (b) A rise in intracellular  $\text{Ca}^{2+}$  measured by indo-1 fluorescence (modified from Fig. 2, England et al. 2001). Insets are examples of responses of each type.



their host neurones to provoke a response. The nature of the signals that pass from SCs to neurones is not known, but the potential importance of this mechanism cannot be overemphasised - SCs that 'pick up' signals from 'A' cells, and transmit them to 'C' cells in the ganglion, could play a key role in the pathology of neuropathic and/or inflammatory pain.

In summary, the somatic SCs of sensory neurones are active participants in sensory processes, including nociception. The SCs are activated by nerve damaging and inflammatory stimuli, probably exchange signals with their host neurones, and may mediate cross-talk between neurones at the level of the sensory ganglion. The concept that this cellular collaboration occurs and is involved in sensory function is relatively new, but has considerable potential for improving our understanding of sensory dysfunction.

## References

1. Amir R, Devor M (2000) Functional Cross-Excitation Between Afferent A-and C-Neurons in Dorsal Root Ganglia. *Neuroscience* 95:189–195
2. Cajal SRY (1928) *Degeneration and Regeneration in the Nervous System*. London: Oxford University Press
3. Elson K, Simmons A, Speck P (2004) Satellite Cell Proliferation in Murine Sensory Ganglia in Response to Scarification of the Skin. *Glia* 45:105–109
4. England S, Hebllich F, James IF, Robbins J, Docherty RJ (2001) Bradykinin Evokes a Calcium-Activated Chloride Current in Non-Neuronal Cells Isolated from Neonatal Rat Dorsal Root Ganglia. *J Physiol* 530:395–403
5. Hanani M, Huang TY, Cherkas PS, Ledda M, Pannese E (2002) Glial Cell Plasticity in Sensory Ganglia Induced by Nerve Damage. *Neuroscience* 114:279–283
6. Hebllich F, England S, Docherty RJ (2001) Indirect Actions of Bradykinin on Neonatal Rat Dorsal Root Ganglion Neurones: A Role for Non-Neuronal Cells as Nociceptors. *J Physiol* 536:111–121
7. Hu P, McLachlan EM (2003) Selective Reactions of Cutaneous and Muscle Afferent Neurons to Peripheral Nerve Transection in Rats. *J Neuroscience* 23:10559–10567
8. Ledda M, De Palo S, Pannese E (2004) Ratios Between Number of Neuroglial Cells and Number and Volume of Nerve Cells in the Spinal Ganglia of Two Species of Reptiles and Three Species of Mammals. *Tissue and Cell* 36:55–62
9. Li L, Zhou X-F (2001) Pericellular *Griffonia simplicifolia* I Isolectin B4-Binding Ring Structures in the Dorsal Root Ganglia Following Peripheral Nerve Injury in Rats. *J Comp Neurol* 439:259–274
10. Lu X, Richardson M (1991) Inflammation Near the Nerve Cell Body Enhances Axonal Regeneration. *J Neuroscience* 11:972–978
11. Pannese E (1981) The Satellite Cells of the Sensory Ganglia. *Advances in Anatomy, Embryology and Cell Biology* 65:1–111
12. Pannese E (2002) Perikaryal Surface Specializations of Neurons in Sensory Ganglia. *Int Rev Cytol* 220:1–34
13. Ramer MS, Thompson SWN, McMahon SB (1999) Causes and Consequences of Sympathetic Basket Formation in Dorsal Root Ganglia. *Pain* 82:S111–S120
14. Thippeswamy T, Morris R (2002) The Roles of Nitric Oxide in Dorsal Root Ganglion Neurons. *Ann N Y Acad Sci* 962:103–110
15. Weick M, Cherkas PS, Hartig W, Pannicke T, Uckermann O, Bringmann A, Tal M, Reichenbach A, Hanani M (2003) P2 Receptors in Satellite Glial Cells in Trigeminal Ganglia of Mice. *Neuroscience* 120:969–77

## Satellite Glial Cells

- ▶ Satellite Cells and Inflammatory Pain

## Scalenus Anticus Syndrome

- ▶ Thoracic Outlet Syndrome

## Scanning

### Definition

A high and fast rate of switching attention to different stimuli/locations, in order to facilitate the detection of information.

- ▶ Hypervigilance and Attention to Pain

## SCC

- ▶ Spinal Cord Compression

## Scheduling Reinforcement

### Definition

Initially, reinforcing of the occurrences of the behavior should be increased as often as possible. When the behavior has come to occur with some frequency, the frequency of reinforcement should be faded to a diminishing ratio (e.g. 1:1 to 1:5, 1:10, etc.). As the rate of occurrence of the target behavior reaches the desired levels, the reinforcement should be faded further. Naturally occurring consequences in the environment to the patient's normal activities will tend to take over to sustain activity level; a form of generalization.

- ▶ Training by Quotas

## Schema

### Definition

A schema is a perceptual hypothesis that serves as the fundamental unit for constructing awareness.

- ▶ Consciousness and Pain

## Schema Activation

### Definition

The hypothesized engagement of an organized knowledge structure (i.e. pain schema), which leads to the preferential processing of schema-relevant information.

- ▶ Catastrophizing

## Schemata

### Definition

Schemata are fuzzy, preconscious and dynamical patterns, roughly related to dynamically stable patterns in neural networks.

- ▶ Consciousness and Pain

## Schrober's Test

- ▶ Lower Back Pain, Physical Examination

## Schwann Cell

### Definition

These cells form the sheath around axons in the peripheral nervous system; the sheath and axon together are called a nerve fiber. The fibers are either myelinated or unmyelinated. Myelinated fibers have Schwann cells wrapped around the axon as a spiral. The spiral (the myelin) consists of the membrane of a single Schwann cell from which the cytoplasm has been removed during the wrapping process. The Schwann cells of a single nerve fiber are separated from each other by nodes of Ranvier. Note that unmyelinated nerve fibers also have a sheath of Schwann cells. However, in this case the Schwann cell is not wrapped around the axon.

- ▶ Hansen's Disease
- ▶ Hereditary Neuropathies
- ▶ Satellite Cells and Inflammatory Pain
- ▶ Sensitization of Muscular and Articular Nociceptors
- ▶ Toxic Neuropathies
- ▶ Wallerian Degeneration

## Sciatic Inflammatory Neuritis

### Synonyms

SIN

### Definition

The animal model, Sciatic Inflammatory Neuritis, produces a local inflammation around one sciatic nerve that leads to enhanced responses to low threshold mechanical stimuli.

- ▶ Neuropathic Pain Model, Neuritis/Inflammatory Neuropathy

## Sciatic Inflammatory Neuropathy

- ▶ Neuropathic Pain Model, Neuritis/Inflammatory Neuropathy

## Sciatic Neuralgia

- ▶ Sciatica

## Sciatic Neuropathy

- ▶ Sciatica

## Sciatic Notch

- ▶ Lower Back Pain, Physical Examination

## Sciatica

GABOR B. RACZ, CARL E. NOE  
Baylor University Medical Center, Texas Tech  
University Health Science Center, Lubbock, TX, USA  
gabor.racz@ttuhsc.edu

### Synonyms

Cotunnus Disease; Lumbosacral Radiculitis; sciatic neuropathy; sciatic neuralgia; Radicular Leg Pain

### Definition

Sciatica is pain in the distribution of the sciatic nerve (buttocks, posterior thigh and/or lower limb)

### Characteristics

Sciatica is a clinical diagnosis, one made by history and physical examination as opposed to a radiographic diag-

nosis made by a test such as a magnetic resonance imaging (MRI) study. Pain with sciatica is within the territory of the sciatic nerve. The sciatic nerve is the largest peripheral nerve in humans, and is formed by several branches of nerve roots passing out of the lower lumbar spine and sacrum. The sciatic nerve travels through the buttocks and into the backside of the thigh. Branches of the sciatic nerve continue into the lower leg and foot. Physical examination findings include a positive straight leg raising test (Lasegue's sign).

Classically, the patient reclines and the examiner lifts the foot while the leg remains unbent at the knee. This has the effect of stretching the nerve fibers that comprise the sciatic nerve. Normally, there is enough slack in the system to prevent any symptoms, but if nerve root irritation is present, pain is exacerbated.

### Acute Sciatica

Acute sciatica refers to sciatic pain of recent onset. Chronic sciatica is used to describe pain persisting beyond six months duration. Some patients have recurrent episodes of sciatica, sometimes associated with recurrent injuries and subsequent resolution.

Acute sciatica can be caused by a number of diagnoses which are more specific than the general clinical diagnosis of sciatica. Sudden onset of sciatica commonly occurs with an acute lumbar disk herniation. In this circumstance, the lumbar disk protrudes out of its normal position and irritates a nerve root, usually the fifth lumbar or first sacral, or another nerve root(s) which forms the sciatic nerve. As a result, the nerve root discharges, sending nerve impulses to the brain, which is experienced as pain from the body region where the irritated nerve fibers have receptors. Often the natural history of acute sciatica is favorable, resolving with time and analgesics. Oral or injected corticosteroids are common treatments. A minority of patients with acute sciatica progress to have surgery to decompress nerve roots. In addition to pain, patients with sciatica may experience loss of sensation, weakness or loss of bladder and bowel function. These symptoms may push patients toward surgical treatment. Other spinal causes of acute sciatica include spondylolisthesis and spinal stenosis. Spondylolisthesis is a shifting of one vertebra out of normal alignment. Spondylolisthesis can be traumatic or degenerative. This can result in a narrowing of spaces within the spine where nerve roots pass. Spinal stenosis is a narrowing of canals inside the spine where nerves pass. Spinal stenosis is usually degenerative and caused by bone spurs and thickening of ligaments. These diagnoses are confirmed by x-rays or other imaging tests. Patients with these diagnoses are frequently treated with surgery.

Rare but important causes of acute sciatica include acute epidural abscess, epidural hematoma and spinal cord infarction and conus medullaris syndrome.

Other causes of sciatica of more gradual onset include piriformis syndrome and peripheral neuropathy. Piriformis syndrome results from the sciatic nerve being compressed by the piriformis muscle. This muscle is a part of the musculature of the buttocks, near the point where the sciatic nerve passes out of the pelvis into the leg. Piriformis syndrome is frequently treated with exercises to stretch the piriformis muscle.

Peripheral neuropathy is commonly associated with diabetes and may also be a result of trauma to the sciatic nerve. Diabetic peripheral neuropathy is frequently treated with medications for neuropathic pain.

Tumors are less common causes of sciatica but can occur at any location along the nerve pathway involving the sciatic nerve.

Diseases and conditions in the pelvis can produce symptoms of sciatica, since the nerve roots form a plexus that lies in the pelvis.

### Chronic Sciatica

Chronic sciatica can result from failed back surgery syndrome, arachnoiditis and chronic lumbosacral radiculopathy. Failed back surgery syndrome is a non-specific term used to classify patients who have persistent or recurrent symptoms, even after having back surgery. Sometimes patients have a definitive cause for symptoms, but often patients have pain that cannot be explained by conventional medical tests. Epidural adhesions may be associated with chronic sciatica. Epidurography is a newer test that is used to identify epidural adhesions, and ► [lysis of adhesions](#) is a newer procedure used to treat this problem.

Following lysis of adhesions, an exercise program, including the technique of "neural flossing", is recommended.

Arachnoiditis is inflammation of a lining of the nerve roots. This can result in scarring around nerve roots and permanent nerve damage.

Patients with chronic sciatica may benefit from rehabilitation treatment to improve physical and psychosocial function. Medications for neuropathic pain, opioids, antidepressants and anti-convulsants, are also commonly used for symptomatic relief. Spinal cord stimulation is also used (Dubuisson 2003).

### Differential Diagnosis

Conditions that mimic sciatica include referred pain from the sacroiliac and zygochypophyseal (facet) joints (Wiener 1993). Referred pain is pain which is localized away from the area of pathology. Patients with coronary artery disease sometimes report left arm pain when their problem is a lack of blood flow to their heart. The innervation of the internal organs is less specific than the innervation of the face or hand, and sometimes the localization of the problem is inaccurate. Sacroiliitis and lumbar spondylosis (degenerative arthritis of the zygochypophyseal joints) are sometimes associated with

referred pain into the back of the leg, and mistakenly diagnosed as sciatica. Hip arthritis can produce referred pain to the knee as well.

▶ **Trochanteric Bursitis** is an inflammation of the bursa near the greater trochanter of the hip. This condition can produce pain in the thigh.

▶ **Meralgia paresthetica** is a pain syndrome involving the lateral femoral cutaneous nerve which results in pain in the lateral thigh.

▶ **Herpes Virus** can infect nerve roots, including the nerve roots of the sciatic nerve. In the case of shingles (Herpes zoster), a rash is usually present along the course of the infected nerve root.

▶ **Polyarthritis** involving joints in the back, hip, knee and ankle can produce such widespread pain, that even though pain is localized to joints, patients will describe it as “leg pain”, and even draw their pain pattern as leg pain rather than separate joint pain.

▶ **Hamstring Muscle Strain** produces pain in the biceps femoris muscles in the back of the thigh. Stretching the muscle can produce pain as is found with a straight leg raising maneuver.

Multiple sclerosis (see ▶ **Central Pain in Multiple Sclerosis**) sometimes manifests as radiating pain in a distribution similar to that of the sciatic nerve.

▶ **Peripheral vascular disease** can be a cause of leg pain at rest or with walking.

▶ **Deep venous thrombosis** (blood clot) commonly affects the lower leg, and can present as a pain syndrome mimicking sciatica with primarily distal extremity pain. Phantom pain may occur in the distribution of the sciatic nerve following amputation or congenital lower limb absence. Patients may experience pain described as shooting, spasms or cramps. Patients may also experience the sensation of the limb being twisted or unusually positioned. The end of the nerve may form a neuroma which may be treated by excision or neuromodulation.

▶ **Ergonomics Essay**

▶ **Facet Joint Pain**

▶ **Guillain-Barré Syndrome**

▶ **Radicular Pain, Diagnosis**

▶ **Radiculopathies**

## References

1. Dubuisson D (2003) Nerve Root Disorders and Arachnoiditis. In: Melzack R, Wall P (eds) Handbook of Pain Management- A Clinical Companion to Wall and Melzack's Textbook of Pain. Elsevier, London, pp 289–304
2. Wiener S (1993) Acute Unilateral Upper and Lower Leg Pain. In: Wiener S Differential Diagnosis of Acute Pain by Body Region. McGraw-Hill, New York, pp 559–565

## SCI-Pain

▶ **Spinal Cord Injury Pain**

## Sclerosant

- ▶ **Proliferant**
- ▶ **Prolotherapy**

## Sclerotherapy

- ▶ **Prolotherapy**

## Scotoma

### Definition

Scotoma refers to a blind spot, area of visual loss.

- ▶ **Clinical Migraine with Aura**

## Screening

### Definition

Screening refers to an initial assessment that serves as the basis for more in-depth and comprehensive evaluation.

- ▶ **Psychological Assessment of Pain**

## Second Messenger Cascades

### Definition

Second messenger cascades are intracellular signaling pathways that depend on one or more second messengers, and that lead to the activation of a protein kinase. The protein kinase can then alter protein function by protein phosphorylation.

- ▶ **Spinothalamic Tract Neurons, Role of Nitric Oxide**

## Second Order Neurons

### Definition

There are three orders of neurons. The first-order neurons carry signals from the periphery to the spinal cord; the second-order neurons carry signals from the spinal cord to the thalamus; and the third-order neurons carry signals from the thalamus to the primary sensory cortex. Second order neuron is generally located in the spinal cord or brainstem. The neuron receives information from first order neurons (usually from several or even many) and transmits information to the other neuronal centers.



- ▶ Postsynaptic Dorsal Column Neurons, Responses to Visceral Input
- ▶ Postsynaptic Dorsal Column Projection, Functional Characteristics

## Second Pain

### Definition

Second pain is a slow onset, dull, throbbing, aching sensation associated with the activation of slowly conducting, unmyelinated (C) nociceptors. When a noxious stimulus is sufficient to activate both A $\delta$  and C nociceptors, second pain is perceived one to two seconds after first pain due to differences in nerve conduction velocity.

- ▶ Encoding of Noxious Information in the Spinal Cord
- ▶ Opioids, Effects of Systemic Morphine on Evoked Pain

## Second Pain Assessment

- ▶ First and Second Pain Assessment (First Pain, Pricking Pain, Pin-Prick Pain, Second Pain, Burning Pain)

## Second Somatosensory Cortex

### Synonyms

SII

### Definition

The second somatosensory cortex (SII) is located at the upper bank of the Sylvian fissure, and is considered to play a role in pain perception. It receives thalamic input from the VPL and VPM nuclei and has a somatotopic organization. Its presence in humans has been confirmed by MEG.

- ▶ Magnetoencephalography in Assessment of Pain in Humans
- ▶ Nociceptive Processing in the Secondary Somatosensory Cortex
- ▶ Secondary Somatosensory Cortex (S2) and Insula, Effect on Pain Related Behavior in Animals and Humans
- ▶ Spinothalamic Input, Cells of Origin (Monkey)

## Secondary Cells (RVM)

### Definition

Secondary cells are a class of RVM neurons defined *in vitro* by response to mu-opioid agonists. These neurons were originally proposed to be unresponsive to

kappa agonists, but this characteristic has since been questioned. Secondary cells presumably correspond to on-cells recorded *in vivo*.

- ▶ Opiates, Rostral Ventromedial Medulla and Descending Control

## Secondary Dysmenorrhea

### Definition

Menstrual pain arising in association with underlying pathology, such as leiomyomata, adenomyosis, or endometriosis. It usually occurs years after menarche and may occur in anovulatory cycles.

- ▶ Dyspareunia and Vaginismus

## Secondary Hyperalgesia

### Definition

Secondary hyperalgesia is a centrally-mediated condition that may occur due to injury or disease in an area of the body. Secondary hyperalgesia is defined as an increase in pain sensitivity when a noxious stimulus is delivered to a region surrounding, but not including, the zone of injury (increased pain sensitivity outside of the area of injury or inflammation). Secondary hyperalgesia is due to central neuron sensitization and requires continuous nociceptor input from the zone of primary hyperalgesia for its maintenance. Secondary hyperalgesia implies only mechanical hyperalgesia, i.e. "allodynia" and "pin prick". Thermal hyperalgesia does not occur in the secondary zone.

- ▶ Allodynia
- ▶ Descending Circuits in the Forebrain, Imaging
- ▶ Descending Modulation and Persistent Pain
- ▶ Hyperalgesia
- ▶ Muscle Pain Model, Inflammatory Agents-Induced
- ▶ Nick Model of Cutaneous Pain and Hyperalgesia
- ▶ Nociceptors, Action Potentials and Post-Firing Excitability Changes
- ▶ Opioids and Muscle Pain
- ▶ Referred Muscle Pain, Assessment
- ▶ Spinothalamic Tract Neurons, Glutamatergic Input
- ▶ Spinothalamic Tract Neurons, Peptidergic Input
- ▶ UV-Induced Erythema

S

## Secondary Losses

### Definition

Losses that can occur from being a patient or being disabled.

- ▶ Malingering, Primary and Secondary Gain

## Secondary Mechanical Allodynia

### Definition

Secondary mechanical allodynia is pain in response to stimulation that is usually non-painful, applied in an area surrounding a site of damage or inflammation, s. also Secondary Hyperalgesia.

- ▶ Spinothalamic Neuron
- ▶ Spinothalamic Tract Neurons, Role of Nitric Oxide

## Secondary Prevention

- ▶ Chronicity, Prevention
- ▶ Disability, Effect of Physician Communication
- ▶ Disability Prevention

## Secondary Somatosensory Cortex

- ▶ Nociceptive Processing in the Secondary Somatosensory Cortex

## Secondary Somatosensory Cortex (S2) and Insula, Effect on Pain Related Behavior in Animals and Humans

ERIC A. MOULTON<sup>1</sup>, JOEL D. GREENSPAN<sup>2</sup>

<sup>1</sup>Program in Neuroscience, University of Maryland, Baltimore, MD, USA

<sup>2</sup>Program in Neuroscience and Dept. of Biomedical Sciences, Dental School, University of Maryland, Baltimore, MD, USA

emoulton@mclean.harvard.edu,

jgreenspan@umaryland.edu

### Definition

The functions of the secondary somatosensory cortex (S2) and ▶ *insula* can be inferred by evaluating the perceptual or behavioral consequences of lesions (disruptions) or direct stimulation of these anatomical sites.

### Characteristics

#### Lesions

In the current context, a lesion is a disruption of a brain region that adversely affects its function, most often by way of tissue injury. In animal studies, lesions are intentionally produced in a brain area of interest, while lesions in humans are “accidents of nature”, most often resulting from pathologies such as strokes or tumors. Functional deficits associated with lesions are determined through behavioral and psychophysical evaluations. The study of

the effects of lesions relies on the concept of functional modularity, which assumes that a biological process can be localized to a particular area in the brain. The drawbacks of using lesions to assess function are 1) that they may damage the passage of transmitting neural tracts along with the neural integration regions at the site of injury, thus altering neural function of a site remote from the physical disruption, 2) functional processes may be distributed, such that damage to a functionally relevant area may be compensated for by other involved regions and 3) other parts of the cortex may change their function to adopt the functional properties of the damaged area, an example of neural plasticity.

Early studies on patient populations reported that ▶ *parasyylvian* lesions could result in decreased pain and temperature sensation on the side of the body contralateral to the lesion (Biernacki 1956; Davison and Schick 1935). Lesions in this area could also selectively mitigate the affective reaction to painful stimuli, without significantly altering thresholds for pain sensation (Berthier et al. 1988). ▶ *Central pain* sometimes accompanied deficits in pain and temperature discrimination associated with parasyylvian lesions. More recent studies have attempted to determine whether the precise location of a lesion within the parasyylvian cortex was correlated with specific functional deficits. Lesions to the posterior insula and adjacent parietal operculum (including S2) were associated with impaired pain and temperature detection, while lesions to the anterior insula did not show such sensory effects (Cereda et al. 2002; Greenspan and Winfield 1992; Greenspan et al. 1999; Schmähmann and Leifer 1992). In one study (Greenspan and Winfield 1992), the sensory deficits were alleviated after the subject underwent surgery to extract a temporal lobe tumor that compressed posterior insula and S2. Though discrete lesions of posterior insula vs. S2 are rare in clinical cases, a group analysis indicated that lesions to S2 alter pain thresholds while posterior insular lesions do not (Greenspan et al. 1999). Instead, posterior insular lesions were associated with increased pain tolerance. These results suggest that S2 has a ▶ *sensory-discriminative* role in pain processing, while the neighboring insula is more related to ▶ *affective-motivational* processing.

The involvement of these parasyylvian areas in pain processing is also supported by a primate study evaluating the effects of an accidentally induced cerebral compression of a portion of the posterior parietal cortex, including S2 and insula (Dong et al. 1996). The investigators found that escape behavior to noxious temperatures was nearly eliminated, while detection of temperature changes remained intact.

### Stimulation

Stimulation refers to the direct electrical and/or pharmacological stimulation of a particular cortical area to determine its functional relevance. An invasive proce-

dure, cortical stimulation is commonly performed in animals, though it can also be performed on people with implanted electrodes or while undergoing certain neurosurgical procedures. The function of an area is inferred from evoked animal behavior or human subject report following the stimulation.

Electrical stimulation of the insula in monkeys does not elicit apparent ► [nocifensive](#) responses, though such studies were performed with the animals under anesthesia (Hoffman and Rasmussen 1953; Kaada et al. 1949). Instead, stimulation of the insula elicited autonomic reactions, including changes in blood pressure, heart rate and respiration. Cardiovascular responses to insular stimulation have also been reported in humans (Oppenheimer et al. 1992).

Though early work in patients suggested that stimulation of the insula would not evoke pain (Penfield and Faulk 1955), a more recent study has reported that electrical insular stimulation can elicit painful sensations and reactions in humans (Ostrowsky et al. 2002). Using intracranial electrodes for stimulation, they found that stimulation of the posterior insula in 14 out of 43 patients elicited pain ranging from mild to intolerable. The quality of the evoked pain was described as burning, stinging, shocking and / or disabling. Stimulation of the right posterior insula more frequently evoked pain (n = 12) than the left (n = 3).

Studies that have stimulated in the vicinity of S2 in humans have not evoked pain (Ostrowsky et al. 2002; Penfield and Jasper 1954). Interestingly, some evidence suggests that S2 stimulation can produce ► [antinociception](#) (Kuroda et al. 2001). Using a formalin model for chronic pain in unanesthetized rats, this group found that electrical stimulation of S2 along with inhibition of neuronal nitric oxide synthase could synergistically suppress spinal nociceptive neurons as well as behavioral reactions (Kuroda et al. 2001).

### Overview

There are few pain-related studies involving lesions or direct stimulation of S2 or insula. Lesion study interpretations are limited by the location specificity of lesions in patients, and the potential for remote effects. The available evidence suggests that the posterior insula and parietal operculum including adjacent S2 are necessary for normal pain sensation. The posterior insula may have a more direct role in pain perception, particularly suprathreshold pain perception, than S2 but this distinction is only tentatively supported at this point. More work is needed to better elaborate the pain-related functionality of these brain regions.

### References

- Berthier M, Starkstein S, Leiguarda R (1988) Asymbolia for pain: a sensory-limbic disconnection syndrome. *Ann Neurol* 24:41–49
- Biamond A (1956) The conduction of pain above the level of the thalamus opticus. *Arch Neurol Psychiatry* 75:231–244

- Cereda C, Ghika J, Maeder P et al. (2002) Strokes restricted to the insular cortex. *Neurology* 59:1950–1955
- Davison C, Schick W (1935) Spontaneous pain and other subjective sensory disturbances. *Arch Neurol Psychiatry* 34:1204–1237
- Dong W, Hayashi T, Roberts V et al. (1996) Behavioral outcome of posterior parietal cortex injury in the monkey. *Pain* 64:579–587
- Greenspan J, Winfield J (1992) Reversible pain and tactile deficits associated with a cerebral tumor compressing the posterior insula and parietal operculum. *Pain* 50:29–39
- Greenspan J, Lee R, Lenz F (1999) Pain sensitivity alterations as a function of lesion location in the parasyllian cortex. *Pain* 81:273–282
- Hoffman B, Rasmussen T (1953) Stimulation studies of insular cortex of *Macaca mulatta*. *J Neurophysiol* 14:343
- Kaada B, Pribam K, Epstein J (1949) Respiratory and vascular responses in monkeys from temporal pole, insula, orbital surface and cingulate gyrus. *J Neurophysiol* 12:347–356
- Kuroda R, Kawao N, Yoshimura H et al. (2001) Secondary somatosensory cortex stimulation facilitates the antinociceptive effect of the NO synthase inhibitor through suppression of spinal nociceptive neurons in the rat. *Brain Res* 903:110–116
- Oppenheimer S, Gelb A, Girvin J (1992) Cardiovascular effects of human insular cortex stimulation. *Neurology* 42:1727–1732
- Ostrowsky K, Magnin M, Ryvlin P et al. (2002) Representation of pain and somatic sensation in the human insula: a study of responses to direct electrical cortical stimulation. *Cereb Cortex* 12:376–385
- Penfield W, Jasper H (1954) *Epilepsy and the functional anatomy of the human brain*. Little Brown, Boston
- Penfield W, Faulk M (1955) The insula: Further observations on its function. *Brain* 78:445–470
- Schmahmann J, Leifer D (1992) Parietal pseudothalamic pain syndrome. Clinical features and anatomic correlates. *Arch Neurol* 49:1032–1037

## Secondary Trigeminal Neuralgia

- [Trigeminal Neuralgia, Etiology, Pathogenesis and Management](#)

S

## Secondary Vulvar Vestibulitis

### Definition

Dyspareunia after a period of pain-free sexual intercourse

- [Vulvodinia](#)

## Sedentary Work

### Definition

Work performed primarily in the seated position without exposure to vibration.

- [Pain in the Workplace, Risk Factors for Chronicity, Job Demands](#)

## Segmental Analgesia

### Definition

Analgesic effect within the stimulated segment.

- ▶ [Transcutaneous Electrical Nerve Stimulation Outcomes](#)

## Segmental Anti-Nociceptive Mechanisms

### Definition

Neural circuitry that is located within the spinal cord that, when active, prevents the onward transmission of noxious information en route to higher centers in the brain.

- ▶ [Transcutaneous Electrical Nerve Stimulation \(TENS\) in Treatment of Muscle Pain](#)

## Segmental Demyelination

### Definition

Segmental Demyelination is the loss of myelin with sparing of axonal continuity; can be the result of injury of either the myelin sheath or Schwann cells. Demyelination can also be related to alterations in axonal caliber (secondary demyelination). Both axonal atrophy and swelling may cause myelin alterations over many consecutive internodes of individual fibers.

- ▶ [Demyelination](#)
- ▶ [Painless Neuropathies](#)

## Seizure-Associated Headache

### Definition

Headache which occurs before, during, or after seizure

- ▶ [Post-Seizure Headache](#)

## Seizures

### Definition

Frequent symptom in cerebral vasculitis; manifestation of systemic vasculitides and the isolated angiitis of the central nervous system .

- ▶ [Headache Due to Arteritis](#)

## Selectins

### Definition

Selectins are a family of transmembrane molecules, expressed on the surface of leukocytes and activated endothelial cells. The selectin family members, L-Selectin, P-Selectin, and E-Selectin, are involved in the adhesion of leukocytes to activated endothelium.

- ▶ [Cytokine Modulation of Opioid Action](#)

## Selection Factors

### Definition

Selection factors are characteristics that increase the probability that the patient will be referred for treatment, or that increase the probability that a subject will be chosen for an experiment.

- ▶ [Psychiatric Aspects of the Epidemiology of Pain](#)

## Selective Anesthesia

### Definition

Selective anesthesia is a technique sometimes used to localize a source of pain. Small areas or individual teeth are anesthetized sequentially until the pain disappears.

- ▶ [Dental Pain, Etiology, Pathogenesis and Management](#)

## Selective Nerve Root Block

### Definition

A Pain Management technique for selectively anesthetizing a single nerve root.

- ▶ [Epidural Steroid Injections for Chronic Back Pain](#)
- ▶ [Spinal Cord Injury Pain](#)

## Selective Nerve Root Injection

### Definition

This term is often used to refer to a local anesthetic block placed outside of the neuroforamen, and some practitioners have advocated for its use as a diagnostic tool for identifying the level of pain-producing pathology. However, placing even a small volume of injectate along the course of the spinal nerve within or near the neural foramen can result in epidural spread, and analgesia at more than one spinal level. Placebo responses are also com-



mon. Thus the usefulness of selective nerve root injection as a diagnostic tool is uncertain.

- ▶ Cervical Transforaminal Injection of Steroids
- ▶ Epidural Steroid Injections for Chronic Back Pain

## Selective Serotonin Reuptake Inhibitors

- ▶ Antidepressant Analgesics in Pain Management

## Self-Constructs

### Definition

A term used in Personal Construct Theory, which focuses on the constructs developed by individuals to explain and deal with their social world. Established chronic pain is often associated with self-constructs of being physically ill or impaired, with diminished control.

- ▶ Therapy of Pain, Hypnosis

## Self-Efficacy

### Definition

Self-efficacy is a person's appraisal of his or her ability to engage in specific behaviors, ability to cope with a specific situation, or ability to cope with pain symptoms or stress in general.

- ▶ Assessment of Pain Behaviors
- ▶ Motivational Aspects of Pain
- ▶ Psychology of Pain, Assessment of Cognitive Variables
- ▶ Psychology of Pain, Self-Efficacy
- ▶ Therapy of Pain, Hypnosis

## Self-Management

### Definition

Self-Management is an individual's willingness and motivation to exert effort on their own behalf to maximize their health or to minimize symptoms and disability. Self-management involves active efforts to control life and symptoms in contrast to passive dependency on others to provide treatment and assistance at all levels.

- ▶ Cognitive-Behavioral Perspective of Pain

## Self-Organization

### Definition

Self-organization is a process whereby a pattern at the global level of a system emerges solely from interactions among lower-level components of the system.

- ▶ Consciousness and Pain

## Self-Regulation

- ▶ Biofeedback in the Treatment of Pain

## Self-Reinforcement

### Definition

Reinforcement that is not provided by others but the patient him- or herself.

- ▶ Operant Treatment of Chronic Pain

## Self-Report Pain Measures

### Definition

Self-report pain measures are instruments that rely on the patient's assessments of their pain intensity, pain affect, pain quality, and pain location, as well as constructs related to chronic pain.

- ▶ Pain Inventories

## Seltzer Model

- ▶ Neuropathic Pain Model, Partial Sciatic Nerve Ligation Model

## Sense of Control

### Definition

The belief that one is able to exert some control on life, problems, symptoms, and health. Perceptions of low levels of control contribute to passivity, dependency, low levels of persistence in the face of adversity, and ultimately a feeling of helplessness, emotional distress, and demoralization.

- ▶ Cognitive-Behavioral Perspective of Pain

## Sensitive Locus

### Synonyms

LTR Locus; Local-Twitch-Response Locus

### Definition

The sensory component of an MTrP locus is the sensitive locus, or local-twitch-response locus (LTR locus), which consists of sensitized receptors. From this locus, referred pain and LTR can be elicited by mechanical stimulation with a needle.

- ▶ Dry Needling

## Sensitivity

### Definition

Sensitivity is a statistical decision theory term equivalent to hit rate. It defines the probability that the test is positive when given to a group of patients with the disease.

- ▶ Sacroiliac Joint Pain
- ▶ Statistical Decision Theory Application in Pain Assessment

## Sensitization

### Definition

In the periphery, it describes the process by which the peripheral endings of nociceptive sensory neurones become more easily activated by stimuli. An increase in the excitability of the terminal membrane of peripheral nociceptive fibers reduces the amount of depolarization required to initiate an action potential discharge. Sensitization of a nociceptor is not caused by an unspecific lesion of the nociceptor, but by binding of sensitizing substances to specific receptor molecules in the membrane of the nociceptor. Typical sensitizing substances are prostaglandin E2 and bradykinin. In the CNS, it is a process by which nociceptive neurons become more responsive to peripheral stimulation. This process requires a series of steps that include release of certain neurotransmitters, activation of signal transduction pathways in the neurons that become sensitized, and phosphorylation of excitatory surface membrane receptors, such as glutamate receptors, on the affected central neurons.

- ▶ Allodynia (Clinical, Experimental)
- ▶ Clinical Migraine without Aura
- ▶ Deafferentation Pain
- ▶ Hyperalgesia
- ▶ Infant Pain Mechanisms
- ▶ Inflammation, Modulation by Peripheral Cannabinoid Receptors

- ▶ Nociceptive Processing in the Amygdala, Neurophysiology and Neuropharmacology
- ▶ NSAIDs, Mode of Action
- ▶ Postoperative Pain, Pre-Emptive or Preventive Analgesia
- ▶ Postsynaptic Dorsal Column Projection, Functional Characteristics
- ▶ Quantitative Thermal Sensory Testing of Inflamed Skin
- ▶ Sensitization of Muscular and Articular Nociceptors
- ▶ Spinothalamic Tract Neurons, Glutamatergic Input
- ▶ Thalamus, Dynamics of Nociception

## Sensitization of Muscular and Articular Nociceptors

SIEGFRIED MENSE<sup>1</sup>, HANS-GEORG SCHAIBLE<sup>2</sup>

<sup>1</sup>Department of Anatomy and Cell Biology, University of Heidelberg, Heidelberg, Germany

<sup>2</sup>Department of Physiology, Friedrich-Schiller-University of Jena, Jena, Germany

mense@urz.uni-heidelberg.de,  
hans-georg.schaible@mti.uni-jena.de

### Synonyms

Peripheral Sensitization in Muscle and Joint; increased resting activity and hyperexcitability of muscular and articular nociceptors; Muscular Nociceptors, Sensitization; Articular Nociceptors, Sensitization

### Definition

In normal tissue, nociceptors have no resting activity and exhibit a high threshold to mechanical stimuli. In addition, a nociceptor is supposed to encode the intensity of stimuli within the noxious range. During pathological processes in muscle and joint, nociceptive primary afferent neurons supplying these tissues are rendered active and hyperexcitable to mechanical stimuli. This process of sensitization of deep tissue afferents contributes to the dysesthesia and mechanical hyperalgesia observed after various forms of deep tissue injury.

### Characteristics

#### Ongoing Pain/Dysesthesias and Mechanical Hyperalgesia During Diseases or Overuse of Muscle and Joint

A number of different conditions can cause painful sensations from muscle, including overuse during strenuous exercise, trauma (blow to a muscle or muscle tear), ischemic contractions, myofascial trigger points and acute myositis. All these conditions are accompanied by the release of agents from muscle tissue that sensitize nociceptors (Mense 1993; Mense 2003). Generally, muscle lesions first cause tenderness (▶ allodynia, i.e. there is no

spontaneous pain, but light mechanical stimuli or movements are painful) and later spontaneous pain develops in addition to the tenderness.

Joint inflammation is characterized by hyperalgesia and persistent pain at rest, which is usually dull and poorly localized. Noxious stimuli cause greater pain than normal and pain is even evoked by mechanical stimuli whose intensity does not normally elicit pain (i.e. movements in the working range and gentle pressure, e.g. during palpation) (Schaible and Grubb 1993; Schaible 2005).

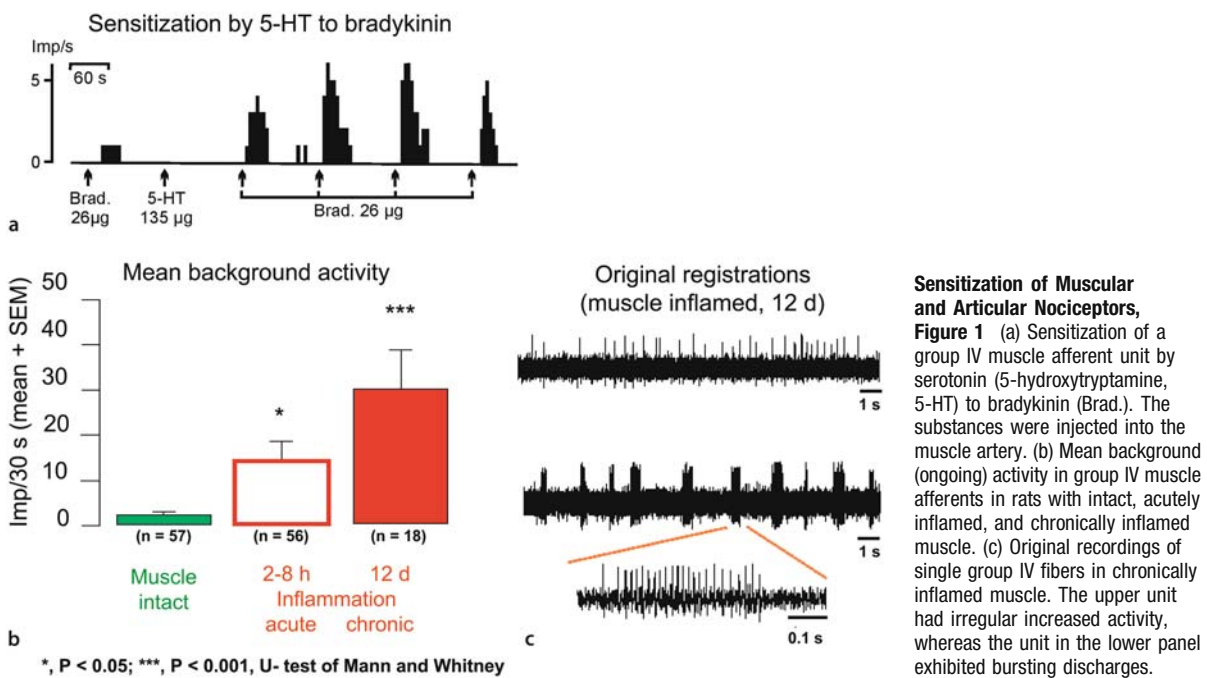
### Mechanosensitivity Changes in Muscle Afferents During Pathophysiological Conditions

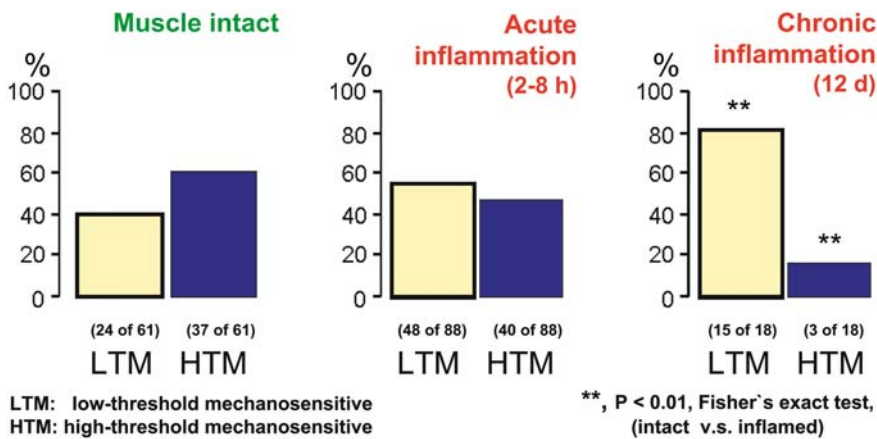
If a muscle contracts under ischemic conditions, severe pain develops within 1 or 2 minutes. During ischemia, a subpopulation of group IV units responds strongly to contractions, whereas these units are not or are only minimally excited by contractions when the blood supply is intact (Mense and Stahnke 1983). This increase in mechanosensitivity may be due to compounds that are released by ischemia such as bradykinin, prostaglandins and protons.

Experimental muscle inflammation is the typical example of chemical sensitization of nociceptors by pro-inflammatory agents released from muscle tissue. One effect of the sensitization is an increased discharge rate of group III and IV fibers. The activity increases gradually from intact to acute (carrageenan induced) and chronic (Freund's adjuvant induced) myositis (Fig. 1b). The discharges of group IV units in inflamed muscle are often intermittent, with bursts separated by periods of complete silence (Berberich et al. 1988) (Fig. 1c, lower panel). The bursting pattern of activity is known

to be particularly effective at central synapses. Moreover, in inflamed muscle, the mechanical threshold of muscle nociceptors drops markedly. This change expresses itself by a shift in the mechanosensitivity from high to low thresholds (Fig. 2). In normal, uninfamed muscle, high threshold mechanosensitive (HTM) units are generally assumed to be nociceptive, whereas low threshold mechanosensitive (LTM) units may inform higher centers about the degree of muscle activity, i.e. they fulfill ergoreceptive or proprioceptive functions. In inflamed muscle, no functional classification based on threshold can be made; an LTM unit may be a sensitized nociceptor or an originally non-nociceptive ending. The sensitization of nociceptors is assumed to be the peripheral neuronal mechanism of tenderness of an inflamed or otherwise lesioned muscle (in addition to central nervous sensitization).

Data from group IV units in normal muscle show that low concentrations of inflammatory agents such as serotonin and PGE<sub>2</sub> sensitize these unencapsulated nerve endings without exciting them (Fig. 1a), whereas high concentrations are excitatory (Mense 1981). Therefore, when a muscle lesion develops and the concentrations of inflammatory substances rise, nociceptors are likely to be first sensitized and then activated. In patients, a similar temporal sequence can often be observed; first there is tenderness (due to sensitization of nociceptors) followed by spontaneous pain (due to ongoing nociceptor activity). There are also cases where tenderness does not develop into spontaneous pain; a prominent example is delayed onset muscle soreness after unaccustomed exercise. In this case, the patients experience tenderness to pressure and pain during movements, but no pain during rest.





**Sensitization of Muscular and Articular Nociceptors, Figure 2** Changes in mechanical thresholds of group IV muscle afferents following muscle inflammation. Left panel, data from intact muscle; middle panel, data from rats with acute myositis (duration 2-8 h); right panel, data from chronic myositis (duration 12 d). The bars show the proportion of units with low (open bars) and high mechanical threshold (filled bars).

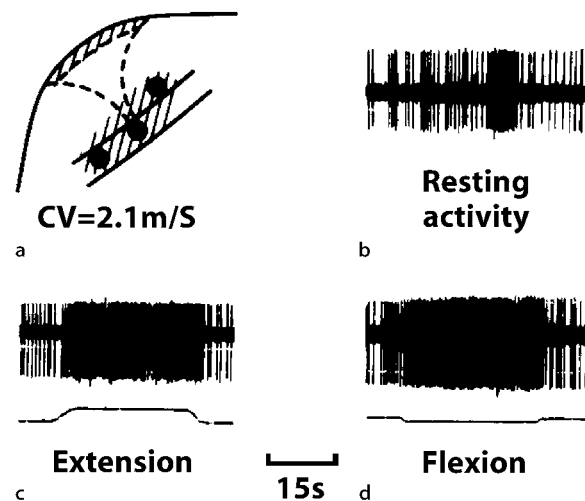
### Mechanosensitivity Changes in Articular Afferent Fibers During Joint Inflammation

An important mechanism for heightened pain sensitivity in a joint is an increase in mechanosensitivity in joint afferents. Changes in the discharge properties have been studied in models of acute and chronic joint inflammation. As an acute model of inflammation, the kaolin/carrageenan model has been used. After injection of kaolin and carrageenan into the joint, inflammation with swelling and cellular infiltration develops within 1-3 hours. This time course permits recording from neurons before and importantly during development of inflammation, so changes in excitability can be observed directly. As a model of chronic inflammation, Freund's adjuvant induced inflammation of the joint has been used.

During development of acute inflammation, the discharge properties of articular afferents (see ► [articular nociceptors](#)) are significantly altered (Coggeshall et al. 1983; Schaible and Schmidt 1985; Schaible and Schmidt 1988). First, some low threshold group II fibers with rapidly conducting axons and corpuscular sensory endings show transiently increased responses to innocuous and noxious joint movements in the initial hours of inflammation. These fibers do not develop ongoing discharges. Secondly, many low threshold group III and IV fibers with unencapsulated nerve endings that do not respond to movements within the working range in the normal joint exhibit increased responses to these movements. Thirdly, a large proportion of articular afferents in the normal joint that are only weakly activated by innocuous movements are sensitized, as well as high threshold afferents that do not normally respond to innocuous movements. After sensitization, they show pronounced responses to movements in the working range of the inflamed joint and enhanced responses to noxious movements. Fourth, neurons that have a receptive field but do not respond to movements of the normal joint develop responses to joint movements. Fifth, numerous initially mechanoinsensitive afferents (silent

nociceptors) are sensitized and become mechanosensitive. Under normal conditions, these silent nociceptors do not show mechanosensitive receptive fields and they do not respond to innocuous or noxious joint movement. However, during the inflammatory process a receptive field becomes detectable, and the fibers start to respond to movements of the joint (Grigg et al. 1986; Schaible and Schmidt 1988). In addition, many units develop ongoing discharges in the resting position.

Figure 3 shows discharges of a group IV fiber from the inflamed knee joint of the cat. The dots in Fig. 3a mark the most sensitive spots at which the fiber was activated by pressure to the medial collateral ligament and to the capsule. The fiber was also activated by pressure to the



**Sensitization of Muscular and Articular Nociceptors, Figure 3** Discharges of a group IV fiber from the acutely inflamed knee joint of a cat. Inflammation was evoked by kaolin/carrageenan several hours before the recordings. (a) Receptive fields in the knee joint. Dots show most sensitive spots in the medial collateral ligament and the fibrous capsule. Shaded areas show sensitive areas in the medial and anterior aspect of the knee. (b) Resting discharges in the absence of mechanical stimulation. (c) Response to extension within the working range. (d) Response to flexion within the working range.



shaded areas. Under normal conditions, nociceptive articular afferents are only activated from tiny spots. This fiber had substantial resting discharges (Fig. 3b) and was strongly activated by extension (Fig. 3c) and flexion (Fig. 3d) within the working range of the joint. Increased mechanosensitivity has also been found during chronic Freund's complete adjuvant induced arthritis, suggesting that mechanical sensitization is an important neuronal basis for chronic persistent hyperalgesia of the inflamed joint (Guilbaud et al. 1985).

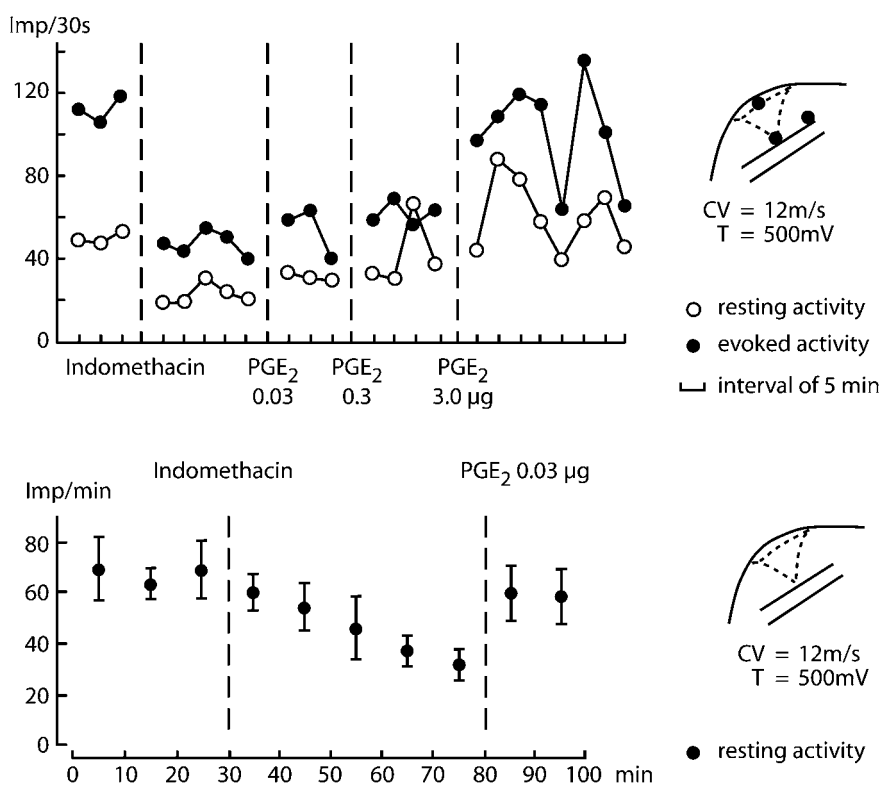
### Mechanisms of Sensitization of Muscular Nociceptors

As was to be expected, there is a marked interaction between the many substances released during a muscle lesion. A sensitizing action of serotonin and PGE<sub>2</sub> on the responses of group IV units to bradykinin has been described above. Conversely, acetylsalicylic acid, a blocker of cyclooxygenase mediated prostaglandin synthesis reduced responses to bradykinin, indicating that bradykinin releases PGs from muscle tissue and thus potentiates its own action (Mense 1982). In inflamed tissue, a neuroplastic change takes place in the bradykinin receptor. In normal tissue, bradykinin acts by binding to the B2 receptor, whereas in inflamed tissue, a new receptor molecule for bradykinin (the B1 receptor) is synthesized by the dorsal root ganglion cell and mediates the effect of bradykinin. Recently, novel agents that are released in a pathologically altered muscle (protons, ATP, interleukin-6 (IL-6), tumor

necrosis factor- $\alpha$  (TNF- $\alpha$ ), brain derived neurotrophic factor (BDNF) and nerve growth factor (NGF)) have been tested for their excitatory and sensitizing action on single muscle group IV endings (Hoheisel et al 2004). NGF had an excitatory effect on muscle nociceptors, but there was no acute sensitization to mechanical stimuli. This is no contradiction to other reports describing NGF induced hyperalgesia, because the subjective hyperalgesia occurs after several hours and is centrally mediated. The NGF induced activation of the endings as well as immunohistochemical data show that muscle group IV units express the TrkA receptor for NGF. Surprisingly, TNF- $\alpha$  and BDNF desensitized the endings for several minutes. This suggests that in the periphery, sensitizing and desensitizing processes are active simultaneously.

### Mechanisms of Mechanical Sensitization of Articular Afferents

The key to the changes in the mechanosensitivity of sensory group III and IV fibers is their chemosensitivity. A large proportion of these fibers express receptors for endogenous compounds that are produced and released during pathophysiological conditions. Mediators such as bradykinin, prostaglandins, serotonin and others are able to excite and/or sensitize primary afferent neurons to mechanical and chemical stimuli (see ► [Articular nociceptors](#)). The application of these mediators can partly mimic the inflammation-evoked sensitization (see [Articular nociceptors](#)).



**Sensitization of Muscular and Articular Nociceptors, Figure 4** Effects of indomethacin and subsequent PGE<sub>2</sub> on the discharges of articular afferents from inflamed cat knee joint. (a) Group III unit with three receptive fields in the inflamed knee. The initial three dots show the responses to flexion of the inflamed knee, the circles the resting discharges in the 30 s before flexion. Both responses to flexion and resting discharges were significantly reduced approximately 60 min after indomethacin. The intra-arterial injection of PGE<sub>2</sub> at increasing doses into the knee joint reversed the effect of indomethacin on resting discharges and flexion movements. (b) Group IV unit with a receptive field in the patellar ligament of the inflamed knee. The symbols show average resting discharges in three 10 min periods before indomethacin, a reduction in the resting discharges after indomethacin and the reversal of the effect by intra-arterial injection of PGE<sub>2</sub> into the knee joint. CV: conduction velocity, T: threshold in electrical stimulation of joint nerve (From Heppelmann et al. 1986).

Limited knowledge is available about the potential of antagonists to reduce inflammation-evoked resting discharges and mechanical sensitization. Recordings of articular afferents have documented effects of nonsteroidal anti-inflammatory drugs (NSAIDs) in articular afferents. Both PGE<sub>2</sub> and PGI<sub>2</sub> cause ongoing discharges and/or sensitization to mechanical stimulation of the joint (cf Schaible 2005). Conversely, NSAIDs such as aspirin and indomethacin reduce spontaneous discharges from acutely and chronically inflamed joints and attenuate the responses to mechanical stimulation (Heppelmann et al. 1986). Figure 4 shows the effects of systemic indomethacin on the discharges of a group III fiber (Fig. 4a) and a group IV fiber (Fig. 4b) from the inflamed knee joint. Indomethacin reduced both the movement-evoked responses and the resting discharges (note that there is an interval of about 1 hour between the initial testing and the testing after indomethacin in Fig. 4a). The effect of indomethacin was reversed by subsequent intra-arterial application of PGE<sub>2</sub> into the joint.

As has been shown for muscle afferents, PGs sensitize joint afferents to the effects of bradykinin whether or not they have an excitatory effect. After the administration of PGE<sub>2</sub>, the fibers show more pronounced responses to bradykinin. These data show the importance of prostaglandins in the process of peripheral sensitization.

## References

- Berberich P, Hoheisel U, Mense S (1988) Effects of a carrageenan-induced myositis on the discharge properties of Group III and IV muscle receptors in the cat. *J Neurophysiol* 59: 1395–1409
- Grigg P, Schaible H-G, Schmidt RF (1986) Mechanical sensitivity of group III and IV afferents from posterior articular nerve in normal and inflamed cat knee. *J Neurophysiol* 55:635–643
- Guilbaud G, Iggo A, Tegner R (1985) Sensory receptors in ankle joint capsules of normal and arthritic rats. *Exp Brain Res* 58:29–40
- Heppelmann B, Pfeffer H-G, Schaible H-G et al (1986) Effects of acetylsalicylic acid and indomethacin on single groups III and IV sensory units from acutely inflamed joints. *Pain* 26:337–351
- Hoheisel U, Reinöhl J, Unger T et al (2004) Acidic pH and capsaicin activate mechanosensitive group IV muscle receptors in the rat. *Pain* 110:149–157
- Mense S (1981) Sensitization of group IV muscle receptors to bradykinin by 5-hydroxytryptamine and prostaglandin E<sub>2</sub>. *Brain Res* 225: 95–105
- Mense S (1982) Reduction of the bradykinin-induced activation of feline group III and IV muscle receptors by acetylsalicylic acid. *J Physiol* 326: 269–283
- Mense S (1993) Nociception from skeletal muscle in relation to clinical muscle pain. *Pain* 54:241–289
- Mense S (2003) The pathogenesis of muscle pain. *Curr Pain Headache Rep* 7: 419–425
- Mense S, Stahnke M (1983) Responses in muscle afferent fibres of slow conduction velocity to contractions and ischaemia in the cat. *J Physiol* 342: 383–397
- Schaible H-G (2005) Basic mechanisms of deep somatic pain. In: McMahon SB, Koltzenburg M (eds) *Textbook of Pain*. In Press
- Schaible H-G, Grubb BD (1993) Afferent and spinal mechanisms of joint pain. *Pain* 55:5–54
- Schaible H-G, Schmidt RF (1985) Effects of an experimental arthritis on the sensory properties of fine articular afferent units. *J Neurophysiol* 54:1109–1122
- Schaible H-G, Schmidt RF (1988) Time course of mechanosensitivity changes in articular afferents during a developing experimental arthritis. *J Neurophysiol* 60:2180–2195

## Sensitization of the Nociceptive System

### Definition

A process that leads to a decrease of the threshold of a certain stimulus (e.g. heat, pressure) that activates nociceptive neurons and elicits pain. Sensitization manifests in ► **hyperalgesia**, which is an increased response to nociceptive stimuli and ► **allodynia**, which is a sensation of pain caused by normally non-painful stimuli such as touch and cold.

► **COX-1 and COX-2 in Pain**

## Sensitization of Visceral Nociceptors

GERALD F. GEBHART

Department of Pharmacology, University of Iowa,  
Iowa City, IA, USA

gf-gebhart@uiowa.edu

### Synonyms

Excitability; hyperalgesia; hypersensitivity; plasticity; Visceral Nociceptors, Sensitization

### Definition

Among all categories of cutaneous receptors (i.e. mechanoreceptors, thermoreceptors and nociceptors), only nociceptors sensitize. Bessou and Perl (see Perl 1996 for review) described an enhancement of responsiveness of C-fiber ► **polymodal nociceptors** after exposure to noxious intensities of skin heating. This sensitization was manifest by an increase in discharge for a given stimulus intensity, associated with a lowering of the response threshold to heat stimulation. Visceral ► **mechanonociceptors** exhibit the same ability as cutaneous nociceptors to sensitize, but with significant differences. Like some cutaneous nociceptors, most, if not all visceral mechanonociceptors are polymodal. That is, they respond to mechanical, chemical and/or thermal stimuli. Unlike low threshold cutaneous receptors, both low- and high-threshold visceral mechanoreceptors sensitize, suggesting that most mechanosensitive visceral receptors can function as, or contribute to, nociception.

## Characteristics

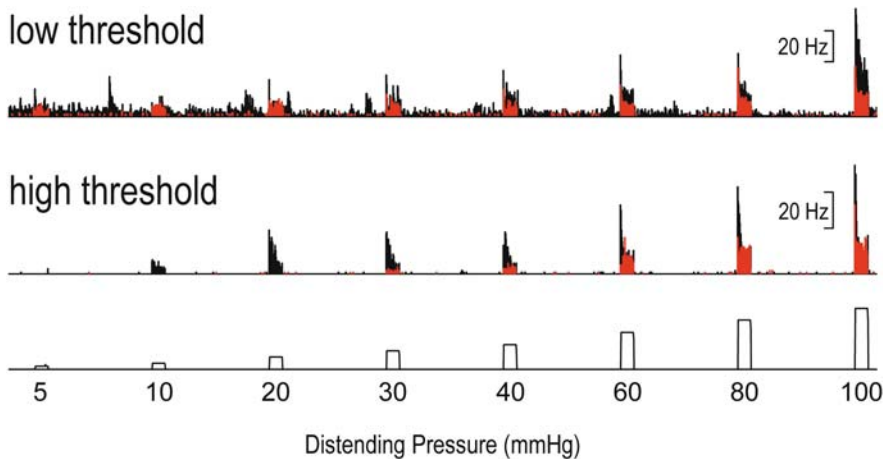
Stimuli adequate for activation of visceral nociceptors include distension of hollow organs, traction on the mesentery, ischemia and chemicals typically associated with organ inflammation. As experimental hollow organ distension (e.g. with a balloon) reproduces in human subjects the quality and localization of pathophysiological visceral disorders (see Ness and Gebhart 1990 for review), hollow organ distension and other mechanical stimuli (e.g. probing, stretch) have been most widely employed to examine the characteristics of visceral nociceptors.

Virtually all visceral afferent fibers are thinly myelinated A $\delta$ -fibers or unmyelinated C-fibers. Little is known about the structure of their peripheral terminals, and it is assumed that most peripheral visceral afferent terminals (i.e. receptors) are unencapsulated or “free” nerve endings. As conventional techniques have not been successful in morphological characterization of these nerve terminals, the assumption about their being unencapsulated is without direct experimental support. Two mechanoreceptive endings in the viscera have been identified, and both appear to be associated with activation by low intensity stimulation. These endings, intraganglionic laminar endings (IGLEs) and intramuscular arrays (IMAs), may represent a subset of mechanosensitive visceral receptors with functions that do not include nociception, although this is unknown at present. IGLEs have been found to lie parallel to muscle layers situated, as their name implies, at the surface of myenteric ganglia of the intrinsic innervation of the organ. IGLEs have been best characterized on vagal afferent terminals that innervate the upper gastrointestinal tract. IMAs differ in morphology and distribution from IGLEs and, presumably, also in stimuli adequate for their activation. IMAs are long terminal arrays associated either with circular or longitudinal layers of organ muscles; their distribution is more restricted than is the distribution of IGLEs. Due to their different morphologies and distributions, it has been suggested that IGLEs respond to muscle tension and detect rhythmic motor activity; IMAs are believed to respond to stretch (Powley and Phillips 2002). Their distribution in the proximal and distal gastrointestinal tract, and their association with sphincters, suggests roles other than nociception, but this remains to be established.

Visceral mechanonociceptors in hollow organs are assumed to be associated with muscle layers, and to respond to tension developed in muscle produced by, for example, distension or stretch. The functional properties of visceral mechanoreceptive nociceptors ([▶ mechanoreceptive/mechanosensitive visceral receptors](#)) have been characterized using both *in vivo* and *in vitro* preparations, to record activity from both axons and cell soma of neurons innervating various organs. Two populations

of mechanosensitive afferent fibers have been characterized *in vivo*: those with low thresholds for activation and those with high thresholds for activation, which likely fulfill the role of providing information about acute visceral nociception. Approximately 75–80% of visceral mechanosensitive afferent fibers recorded in a variety of animal species, and innervating a variety of organs (e.g. stomach, gall bladder, urinary bladder, colon, uterus), have low thresholds for response within what is considered the physiological range (i.e. < 5 mmHg). The remaining 20–25% have thresholds for response in the noxious range (i.e.  $\geq$  30 mmHg), an intensity of organ distension typically associated with [▶ nocifensive behaviors](#) when applied in behaving animals ([▶ Nocifensive Behaviors, Gastrointestinal Tract](#)). Both low- and high-threshold mechanosensitive visceral afferents are slowly adapting and respond to organ distension, and both encode stimulus intensity into the noxious range. Thus, unlike cutaneous low-threshold mechanoreceptors, which do not respond to noxious intensities of mechanical stimulation of the skin, low-threshold visceral mechanoreceptors continue to encode into the noxious range (e.g. see Sengupta and Gebhart 1995 for review). To further distinguish low-threshold mechanosensitive visceral receptors from low-threshold cutaneous mechanoreceptors, low-threshold visceral mechanoreceptors sensitize after experimental organ insult. Accordingly, because 1) both low- and high-threshold visceral mechanoreceptors encode into the noxious range, and 2) both low- and high-threshold visceral mechanoreceptors sensitize, they are functionally distinct from low- and high-threshold mechanoreceptors in the cutaneous realm, and are likely to contribute to nociception after organ insult. Figure 1 illustrates responses of a low- and of a high-threshold colon mechanoreceptor before and after organ irritation. The low-threshold pelvic nerve fiber exhibits a clear increase in response magnitude, particularly at distending pressures  $\geq$  30 mmHg, and an increase in spontaneous activity. The high-threshold pelvic nerve fiber exhibits a similar increase in response magnitude, as well as a decrease in response threshold from 30 to 10 mmHg.

Mechanically insensitive, silent receptors have also been reported as innervating the viscera. Mechanically insensitive afferent fibers are unresponsive to intensities of organ distension of 80–100 mmHg, but acquire spontaneous activity and mechanosensitivity after organ insult. As unbiased electrical search stimulation has not been widely used in such experiments, it is difficult to discriminate between afferent endings that might be chemo-selective, and thus not responsive to a mechanical search stimulus, and those which are truly mechanically insensitive. Accordingly, the proportion of silent receptors among the visceral innervation is unknown, and has been estimated at between 30% and more than 80%.



**Sensitization of Visceral Nociceptors, Figure 1** Pelvic nerve afferent fiber responses to colon distension in the rat (distending pressures illustrated bottom-most). Representative responses of a low threshold and of a high threshold fiber are illustrated before (colored histograms) and 30 minutes after (black histograms) intracolonic instillation of 2.5% acetic acid. Both of these mechanosensitive pelvic nerve afferent fibers innervating the rat colon clearly sensitize following experimental organ insult.

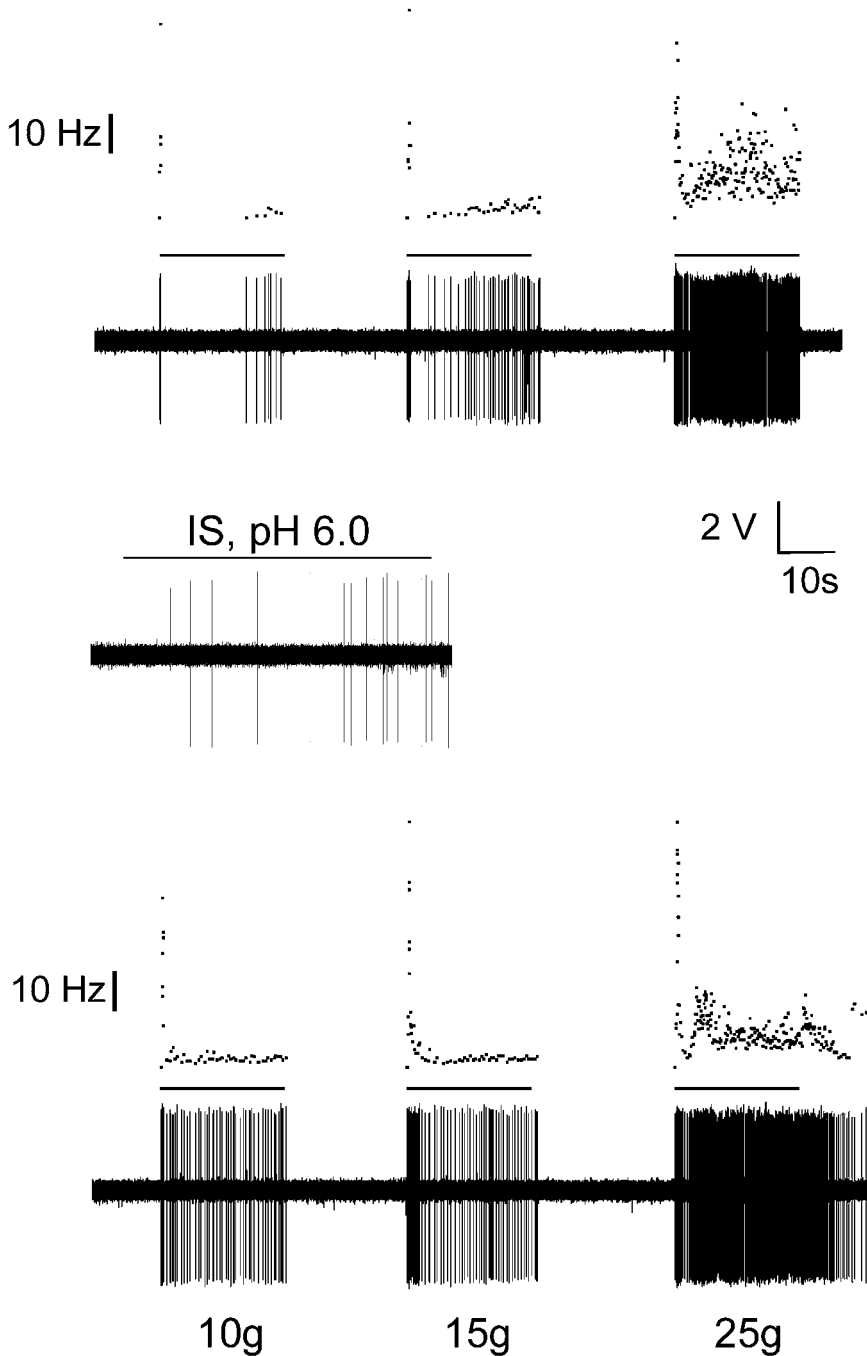
*In vitro* organ-nerve preparations have led to broader functional characterization of mechanosensitive endings in the viscera. In all organs studied to date, including the esophagus, stomach, urinary bladder and colon, three receptors – mucosal, tension (muscular) and serosal – have been characterized, based on responses to application of different mechanical stimuli. In addition, receptive endings that respond to both mucosal stimulation and stretch (muscular-mucosal receptors) have been found in the stomach, colon and urinary bladder, and mesenteric receptors have been identified in the lumbar splanchnic innervation of the colon (Brierly et al. 2004). The nature of these *in vitro* organ-nerve preparations allows for localization of receptive endings in the organ, which is not easily achieved using *in vivo* preparations, and also permits direct application of putative sensitizing mediators to the receptive ending in the organ. Receptive fields *in vitro* are typically 1–4 mm<sup>2</sup> in area; multiple receptive endings are occasionally found. Figure 2 illustrates responses to stretch of a muscular mechanosensitive ending in the urinary bladder of the mouse, and its activation by and sensitization following application of an inflammatory soup directly to the receptive ending in the urinary bladder.

Sensitization represents a process by which neuron excitability is increased initially by events in the local environment of the nociceptive ending and, later, by transcriptional events in the cell soma. Local events associated with sensitization include release of, synthesis of, or attraction of, chemical mediators and modulators to the site of organ insult. The list of putative mediators/modulators of nociceptor sensitization is long, and includes amines such as histamine and serotonin, peptides such as substance P, products of arachidonic acid metabolism, protons, cytokines, ATP, etc. The lumen of hollow organs also contains at various times secreted peptides, protons, serotonin derived from enterochromaffin cells, potassium ions in the urinary bladder, bile salts, etc. Two points of emphasis are important. First,

many so-called functional visceral disorders such as non-ulcer dyspepsia, irritable bowel syndrome, and in some cases, interstitial cystitis, exist in the absence of biochemical or morphological evidence of tissue inflammation or pathology. Second, many if not all of the chemicals identified above are normally present, either within the lumen of hollow organs or released into the lumen as part of normal organ function. Accordingly, pain and discomfort associated with functional disorders can arise by an increase in excitability of mechanoreceptor endings in organ tissue layers in the absence of frank organ insult.

An increase in excitability is associated with alterations in voltage-gated and/or ligand-gated ion channels present in visceral sensory neurons, which has been studied by whole cell patch clamp techniques. Voltage-sensitive ion channels underlie both the generation of action potentials and repolarization/hyperpolarization of sensory neurons. After experimental organ insult (e.g. stomach inflammation or ulceration), excitability is increased (Fig. 3). The increase in excitability (sensitization) is accompanied by changes in voltage-sensitive ion currents: the whole cell inward sodium current recovers more rapidly from inactivation and is significantly increased, principally contributed to by an increase in the tetrodotoxin-resistant sodium current (Bielefeldt et al 2002 a, b), and current density of a slowly inactivating outward A-type potassium current is significantly reduced (Dang et al. 2004). These changes in sodium and potassium currents after organ insult are wholly consistent with an increase in excitability that underlies the process of sensitization. Ligand-gated ion channels can similarly play a role in the process of sensitization, although direct evidence at present is limited. Several such channels/receptors are candidates as modulators of sensory neuron excitability: acid-sensing ion channels (ASICs), transient receptor potential vanilloid 1 (TRPV1) receptors, purinergic P2X channels and proteinase-activated receptors (PARs), to name but a few. In conjunction with whole cell patch clamp



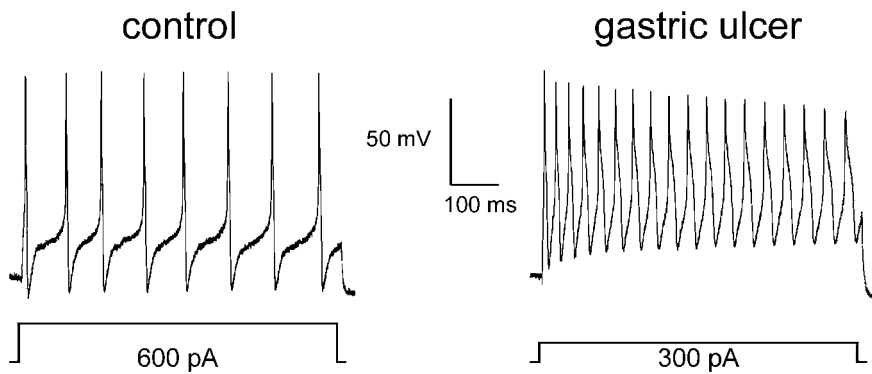


**Sensitization of Visceral Nociceptors, Figure 2** Recording of a pelvic nerve afferent fiber innervating the urinary bladder of the mouse. The top-most set of records illustrate action potentials and instantaneous firing frequency (above) during stretch of 10, 15 and 25 g applied to the receptive field of the afferent fiber. An inflammatory soup (IS) containing histamine, serotonin, prostaglandin  $E_2$  and bradykinin, all at 5 mM in Krebs' solution at pH 6.0, is shown to activate this afferent fiber, after which responses to stretch are significantly increased (bottom row of records).

S

recordings of identified visceral sensory neurons (e.g. Sugiura 2005), the use of receptor-selective agonists and antagonists, antisense oligonucleotides, and knock-out or knockdown strategies have further established roles for these channels/receptors in either or both basal visceral nociceptive sensitivity or the process of sensitization. For example, ATP is released from bladder urothelium during stretch or distension and activates pelvic nerve afferent fibers (Rong et al. 2002), P2X2 and P2X3 receptors are increased in the urothelium of

interstitial cystitis patients (Tempest et al. 2004), and P2X3 deficient mice exhibit reduced pain behaviors in general and urinary bladder hyporeflexia (Cockayne et al. 2000). Similarly, TRPV1 is expressed in visceral organs and bladder function is significantly altered in TRPV1 deficient mice (Birder et al. 2001; Birder et al. 2002). Accordingly, as new information is acquired, it is likely that these and other ligand-gated receptors will be established as contributing to the modulation of visceral nociceptor sensitization.



**Sensitization of Visceral Nociceptors, Figure 3** Whole cell patch clamp recordings (current clamp mode) of thoracic dorsal root ganglion cells innervating the rat stomach. In contrast to the control circumstance (left), the number of action potentials produced by current injection is significantly greater at a lower intensity of current in a neuron taken from a rat one week after gastric ulceration.

## References

- Bielefeldt K, Ozaki N, Gebhart GF (2002a) Experimental Ulcers Alter Voltage-Sensitive Sodium Currents in Rat Gastric Sensory Neurons. *Gastroenterol* 122:394–405
- Bielefeldt K, Ozaki N, Gebhart GF (2002b) Mild Gastritis Alters Voltage-Sensitive Sodium Currents in Gastric Sensory Neurons. *Gastroenterol* 122:752–761
- Birder LA, Kanai AJ, de Groat WC et al. (2001) Vanilloid Receptor Expression Suggests a Sensory Role for Urinary Bladder Epithelial Cells. *Proc Natl Acad Sci USA* 98:13396–13401
- Birder LA, Nakamura Y, Kiss S et al. (2002) Altered Urinary Bladder Function in Mice Lacking the Vanilloid Receptor TRPV1. *Nature Neurosci* 5:856–860
- Brierley SM, Jones RCW 3rd, Gebhart GF et al. (2004) Splanchnic and Pelvic Mechanosensory Afferents Signal Different Qualities of Colonic Stimuli in Mice. *Gastroenterol* 127:166–178
- Cockayne DA, Hamilton SG, Zhu QM et al. (2000) Urinary Bladder Hyporeflexia and Reduced Pain-Related Behaviour in P2X<sub>3</sub>-Deficient Mice. *Nature* 407:1011–1015
- Dang K, Bielefeldt K, Gebhart GF (2004) Gastric Ulcers Reduce A-Type Potassium Currents in Rat Gastric Sensory Ganglion Neurons. *Am J Physiol* 286:G606–612
- Ness TJ, Gebhart GF (1990) Visceral Pain: A Review of Experimental Studies. *Pain* 41:167–234
- Perl ER (1996) Cutaneous Polymodal Receptors: Characteristics and Plasticity. In: Kumazawa T, Kruger L, Mizumura K (eds) *Progress in Brain Research*, vol 113. The Polymodal Receptor: A Gateway to Pathological Pain. Elsevier, Amsterdam, pp 21–37
- Powley TL, Phillips RJ (2002) Musings on the Wanderer: What's New in our Understanding of Vago-Vagal Reflexes? I. Morphology and Topography of Vagal Afferents Innervating the GI Tract. *Am J Physiol Gastrointest Liver Physiol* 283:G1217–G1225
- Rong W, Spyer KM, Burnstock G (2002) Activation and Sensitisation of Low and High Threshold Afferent Fibres Mediated by P2X Receptors in the Mouse Urinary Bladder. *J Physiol* 541:591–600
- Sengupta JN, Gebhart GF (1995) Mechanosensitive Afferent Fibers in the Gastrointestinal and Lower Urinary Tracts. In: *Progress in Pain Research and Management*, vol 5. Visceral Pain. IASP Press, Seattle, pp 75–98
- Sugiura T, Dang K, Lamb K et al. (2005) Acid Sensing Properties in Rat Gastric Sensory Neurons from Normal and Ulcerated Stomach. *J Neurosci* 25:2617–2627
- Tempest HV, Dixon AK, Turner WH et al. (2004) P2X and P2X Receptor Expression in Human Bladder Urothelium and Changes in Interstitial Cystitis. *BJU Int* 93:1344–1348

## Sensorimotor Integration

Sensorimotor integration by hippocampus (and associated structures) is proposed to involve, in part, modu-

lation of (voluntary) motor control regions by the hippocampus in response to sensory information entering the region. In addition, the hippocampus is proposed to integrate information regarding ongoing motor activity, with sensory information and feedback to the motor regions.

► [Nociceptive Processing in the Hippocampus and Entorhinal Cortex, Neurophysiology and Pharmacology](#)

## Sensory Decision Theory

Sensory decision theory refers to the application of statistical decision theory to judgments concerning two above-threshold sensory stimuli of different intensities.

- [Pain Measurement by Questionnaires, Psychophysical Procedures and Multivariate Analysis](#)
- [Statistical Decision Theory Application in Pain Assessment](#)

## Sensory Dimension of Pain

### Definition

Dimension of pain characterized by the quality of the experience (e.g. burning, aching, stinging), its spatial location, its temporal dynamics, and its subjective intensity.

- [Cingulate Cortex, Functional Imaging](#)
- [Nociceptive Processing in the Cingulate Cortex, Behavioral Studies in Humans](#)

## Sensory Discrimination

### Definition

The ability to experience and recognize changes in the quality, duration, location, and intensity of stimuli.

- [Pain in Humans, Sensory-Discriminative Aspects](#)
- [Spinothalamic Tract, Anatomical Organization and Response Properties](#)
- [Spinothalamic Neuron](#)

## Sensory-Discriminative Aspect of Pain

### Definition

Certain aspects of pain sensation can be discriminated with accuracy. These include pain quality, location, intensity and duration. Sensory discrimination of painful stimuli is thought to depend on the processing of nociceptive information by the part of the spinothalamic tract that synapses in the ventral posterior lateral nucleus, and by that nucleus and the cortical areas to which it projects, including SI and SII.

- ▶ Amygdala, Pain Processing and Behavior in Animals
- ▶ Hypnotic Analgesia
- ▶ Pain in Humans, Sensory-Discriminative Aspects
- ▶ Parafascicular Nucleus, Pain Modulation
- ▶ Secondary Somatosensory Cortex (S2) and Insula, Effect on Pain Related Behavior in Animals and Humans
- ▶ Spinothalamic Input, Cells of Origin (Monkey)
- ▶ Thalamic Nuclei Involved in Pain, Cat and Rat
- ▶ Thalamo-Amygdala Interactions and Pain
- ▶ Thalamus, Nociceptive Cells in VPI, Cat and Rat

## Sensory Endings in Joint Tissues

- ▶ Articular Afferents, Morphology

## Sensory Focusing

- ▶ Psychological Treatment in Acute Pain

## Sensory Ganglia

### Definition

Cluster of neurons in the somatic peripheral nervous system that contain the cell bodies of sensory nerve axons. Sensory ganglia also have non-neuronal supporting cells.

- ▶ Perireceptor Elements

## Sensory Ganglionectomy

- ▶ Dorsal Root Ganglionectomy and Dorsal Rhizotomy

## Sensory Ganglionitis

- ▶ Ganglionopathies

## Sensory Impairment

- ▶ Dysfunctional Pain and the International Classification of Function

## Sensory Modalities

### Definition

Sensory modalities are the basic types of sensory phenomena, such as vision, audition, somatosensation, smell, and taste.

- ▶ Pain in Humans, Psychophysical Law

## Sensory Neuropathy

- ▶ Ganglionopathies

## Sensory Receptor

### Definition

An organ having nerve endings (e.g. the skin, viscera, eye, nose, mouth) that respond to stimulation.

- ▶ Perireceptor Elements

## Sensory Relay Neurons

### Definition

Sensory Relay Neurons are projection neurons located between the spinal cord and the cerebral cortex relaying nociceptive messages to higher brain centers.

- ▶ Postsynaptic Dorsal Column Projection, Anatomical Organization

## Sensory Rhizotomy

- ▶ Dorsal Root Ganglionectomy and Dorsal Rhizotomy

## Sensory Saturation

### Definition

Sensory Saturation is a maneuver for non-pharmacologic analgesia. It implies administering oral sugar, massaging the baby, attracting its attention by speaking.

- ▶ Ethics of Pain in the Newborn Human

## Sensory Stimulation-Guided Radiofrequency Neurotomy

- ▶ Sacroiliac Joint Radiofrequency Denervation

## Sensory Transduction

### Definition

Process by which energy in the environment is converted into electrical signals by sensory receptors.

- ▶ [Perireceptor Elements](#)

## SEPs

- ▶ Somatosensory Evoked Potentials

## Sequential Relay

### Definition

A sequential relay has been proposed that consists of: (a) perforant path fibers of the entorhinal cortex that innervate dentate granule cells, (b) mossy fibers of dentate granule cells that innervate CA3 pyramidal cells, and (c) Schaffer-collaterals of CA3 pyramidal cells that innervate CA1 pyramidal cells. Stimulation of perforant path fibers can lead to sequential activation of the other members of the relay.

- ▶ [Nociceptive Processing in the Hippocampus and Entorhinal Cortex, Neurophysiology and Pharmacology](#)

## Serotonergic

### Definition

Related to the action of the serotonin, a biochemical neurotransmitter found primarily in the central nervous system, gastrointestinal tract and platelets.

- ▶ [Recurrent Abdominal Pain in Children](#)
- ▶ [Stimulation-Produced Analgesia](#)

## Serotonin

### Synonyms

5-hydroxytryptamine; 5-HT

### Definition

Serotonin is a monoamine neurotransmitter synthesized in serotonergic neurons in the central nervous system and enterochromaffin cells in the gastrointestinal tract. In the central nervous system, serotonin is involved in the regulation of mood, sleep, emesis, sexuality and appetite. It is thought to be significant in the biochemistry of depression, migraine, bipolar disorder and anxiety. Serotonin is contained in brainstem (medulla and midbrain) neurons with descending projections to the spinal cord or ascending projections in the forebrain. Projections to spinothalamic and spinomesencephalic tract neurons are believed to have inhibitory and/or facilitatory influences on these projection neurons. It is also released by platelets and mast cells during the inflammatory response.

- ▶ [Autologous Thrombocyte Injection as a Model of Cutaneous Pain](#)
- ▶ [Cancer Pain Management, Gastrointestinal Dysfunction as Opioid Side Effects](#)
- ▶ [Descending Circuitry, Transmitters and Receptors](#)
- ▶ [Fibromyalgia](#)
- ▶ [Molecular Contributions to the Mechanism of Central Pain](#)
- ▶ [Spinomesencephalic Tract](#)
- ▶ [Thalamic Neurotransmitters and Neuromodulators](#)

## Serotonin Antagonist

### Definition

A substance that blocks the action of serotonin.

- ▶ [Migraine, Preventive Therapy](#)

## Serotonin Blockers

### Definition

Type 3 serotonin (5-hydroxytryptamine [5-HT<sub>3</sub>]) receptor blocker, class of antiemetic agents; e.g. dolasetron, granisetron, ondansetron, and tropisetron.

- ▶ [Cancer Pain Management: Chemotherapy](#)

## Serotonin Norepinephrine Reuptake Inhibitors

- ▶ [Antidepressant Analgesics in Pain Management](#)

## Serous Meningitis

- ▶ [Headache in Aseptic Meningitis](#)



## Sex

### Definition

Sex is the classification of living things, generally as male or female according to their reproductive organs and functions assigned by the chromosomal complement. In essence, sex refers to the biological component of being male or female.

- ▶ Gender and Pain
- ▶ Psychological Aspects of Pain in Women

## Sex and Chronicity

- ▶ Pain in the Workplace, Risk Factors for Chronicity, Demographics

## Sex Differences in Descending Pain Modulatory Pathways

ANNE Z. MURPHY, DAYNA R. LOYD  
Center for Behavioral Neuroscience, Georgia State University, Atlanta, USA  
amurphy@gsu.edu

### Synonyms

Descending Pain Modulatory Pathways, Sex Differences

### Definition

The midbrain ▶ **periaqueductal gray** (PAG), and its descending connections with the ▶ **rostral ventromedial medulla** (RVM) and ▶ **dorsal horn** of the ▶ **spinal cord**, have long been recognized as the key neural circuit in the endogenous descending pain modulatory system. Recent anatomical and behavioral studies in the rat indicate that this PAG-RVM circuit is sexually dimorphic in its anatomical organization, and in its activation during acute or chronic inflammatory pain states. In particular, quantitative differences were noted in the distribution of PAG-RVM output neurons for males and females. This dimorphic organization was most evident within the caudal PAG, where twice as many PAG-RVM neurons were present in females versus males. Interestingly, while females have significantly more PAG neurons projecting to the RVM, very few (<12 %) of these cells are engaged during acute or chronic inflammatory pain states. By contrast, over 25 % of PAG-RVM neurons were activated by acute or chronic inflammatory pain in males. Sex differences in the PAG-RVM-spinal cord circuit may contribute to sex-dependent sensory thresholds and opioid responsiveness.

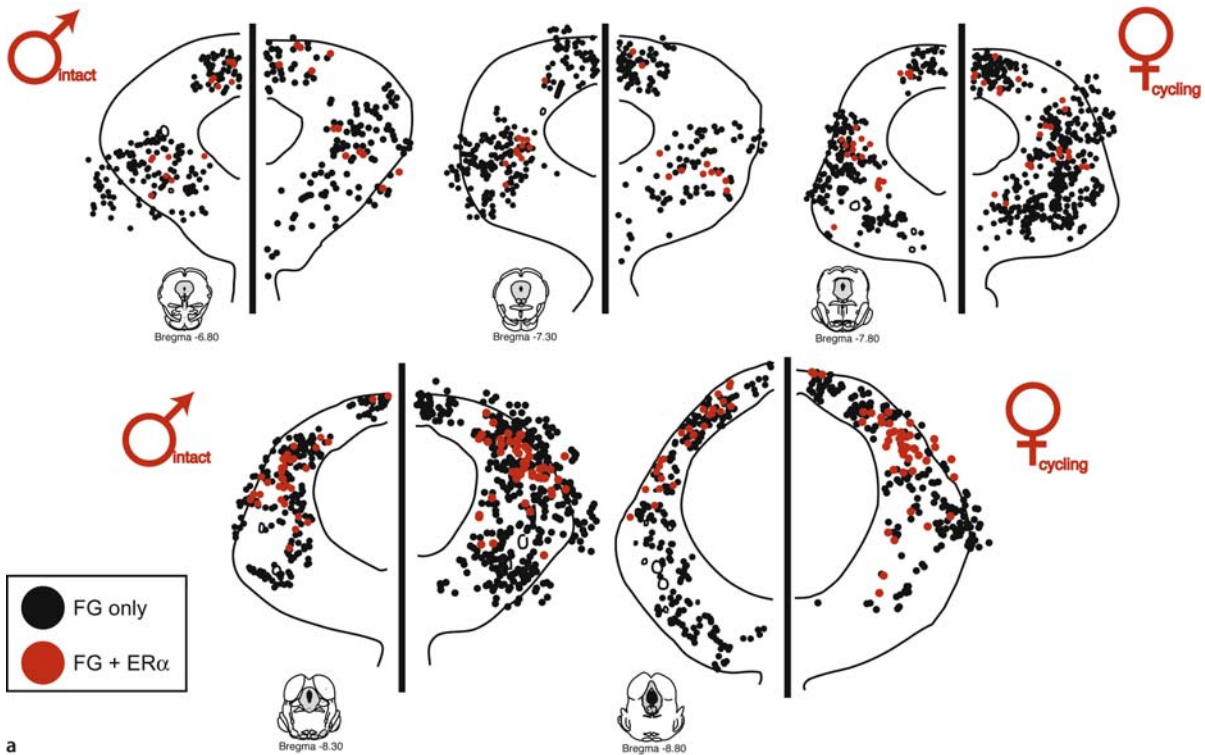
### Characteristics

The midbrain periaqueductal gray has been identified as a key neural structure in the endogenous descending analgesia circuit (Basbaum and Fields 1984). Electrical or chemical stimulation of the PAG inhibits both spinal and supraspinal nociceptive withdrawal reflexes, as well as dorsal horn neuronal responses to noxious peripheral stimulation (Reynolds 1969, Carstens et al. 1979). In addition to ▶ **stimulation-produced analgesia**, the PAG is also a crucial neural substrate for ▶ **opioid analgesia**. Administration of ▶ **morphine**, or other mu opioid receptor agonists, into the PAG produces potent analgesia, which is blocked by central or systemic administration of the opioid antagonist naloxone (Jensen and Yaksh 1986). There are no direct projections from the PAG to the dorsal horn of the spinal cord. Rather, the PAG provides direct and extensive input to the rostral ventromedial medulla (RVM). Bulbosplinal fibers from the RVM descend within the dorsolateral funiculus, and terminate in the dorsal horn of the spinal cord at all rostrocaudal levels (Basbaum et al. 1978). Similar to the PAG, stimulation of the RVM produces a powerful analgesic response, and the RVM is a critical site for morphine-induced analgesia (Le Bars et al. 1980). Lesions of the RVM or dorsolateral funiculus completely abolish PAG stimulation- or opiate-induced analgesia, indicating that this PAG-RVM-spinal cord circuit is a critical neural pathway for stimulation-produced, or opiate-induced analgesia.

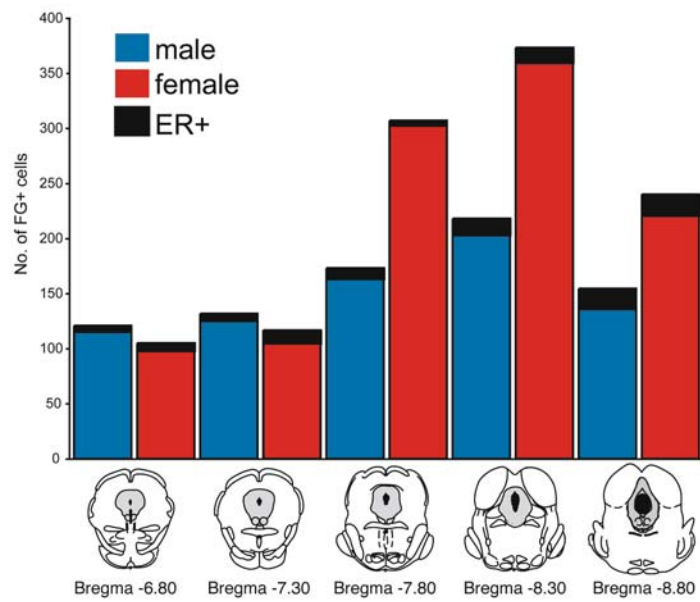
It is becoming increasingly clear that males and females differ in both their sensitivities to pain (Fillingham 2000), as well as in the ability of opioids and other analgesic compounds to alleviate it (Craft 2003). For example, Krzanowska and Bodnar (1999) reported intra-PAG morphine ED<sub>50</sub> values of 1.2 μg for male rats in comparison to >50 μg in estrus female rats. Similarly, in a model of chronic inflammatory pain, ED<sub>50</sub> values for systemic morphine in male rats were 5.9 mg/kg, versus 9.4 mg/kg in cycling female rats (Murphy 2002). As the PAG-RVM circuit is an essential pathway by which morphine produces an analgesic response, sex differences in the anatomical organization and/or steroid regulation of the PAG-RVM pathway may account for sex-dependent pain thresholds or opioid analgesia.

### Anatomical Organization of the PAG-RVM Circuit

Previous studies examining the anatomical and physiological characteristics of the PAG-RVM circuit have been conducted exclusively on males (Behbehani and Fields 1979; Basbaum and Fields 1979); thus, how this circuit is arranged in females was not previously known. Studies in our laboratory have used a variety of anatomical techniques to delineate the organization of the PAG-RVM circuit in males and females (Murphy 2001; Loyd and Murphy 2004). Injection of FG into the RVM results in dense retrograde labeling throughout the rostrocaudal



a



b

**Sex Differences in Descending Pain Modulatory Pathways, Figure 1** (a) Distribution of cells retrogradely labeled following Fluorogold injection into the rostral ventromedial medulla for five rostrocaudal levels of the periaqueductal gray. Left, intact males; Right, cycling females. (b) Number of Fluorogold positive cells for males and females for five rostrocaudal levels of the periaqueductal gray. Black bars on top indicate the number of retrogradely labeled cells that also contained ER $\alpha$ .

axis of PAG in both males and females. The distribution of PAG cells retrogradely labeled from the RVM for males (left) and females (right) is plotted in Figure 1a for five rostrocaudal levels of PAG. As shown in Fig-

ure 1, there are significant sex differences in the number of retrogradely labeled neurons; this difference is dependent on the rostral-caudal axis of PAG. In the rostral PAG (Bregma -6.80 to -7.30), retrogradely labeled

neurons are localized within the dorsomedial and lateral columns of PAG. Both the distribution and number of retrogradely labeled neurons is comparable for males and females (Fig. 1b). At mid-levels of PAG (Bregma -7.80), the distribution of PAG-RVM neurons within the lateral region of PAG extends ventrally into the ventrolateral column in both males and females. In addition, a large number of retrogradely labeled cells are present within the dorsomedial region of PAG. As shown in Figure 1B, at this PAG level, there are almost twice as many PAG-RVM output neurons present in females in comparison to males. This sex difference in retrograde labeling is not restricted to one region of PAG, but rather is present within the dorsomedial, lateral and ventrolateral sites. Moving caudally through the PAG (Bregma -8.30), sex differences in the number and distribution of PAG-RVM output neurons becomes even more evident, with females again having almost twice as many PAG-RVM output neurons as males. In females, PAG neurons retrogradely labeled from the RVM extend from the dorsomedial to the ventrolateral regions of PAG; by contrast, in males, PAG-RVM output neurons are primarily localized within the lateral region of PAG, with only a few retrogradely labeled neurons present within the ventrolateral region. In the most caudal pole of PAG (Bregma -8.80), the sex difference in the number of PAG-RVM neurons becomes less evident, with comparable numbers of retrogradely labeled cells present within the dorsal half of PAG. However, in males, a very large population of PAG-RVM cells is present within the ventrolateral PAG that is not present in females.

#### Steroid Modulation of the PAG-RVM Circuit

The PAG contains a large population of both estrogen (ER $\alpha$ ) and androgen (AR) receptor containing neurons (Murphy and Hoffman 2000, Murphy and Hoffman 1999). Indeed, this region contains the largest population of steroid receptors outside of the hypothalamus. ER $\alpha$  immunoreactive neurons are localized primarily within the dorsomedial and lateral regions of PAG, and are highly co-distributed among PAG-RVM output neurons. For both males and females, the percentage of PAG neurons retrogradely labeled from the RVM that contained ER $\alpha$  ranged between 6–20 %, with no significant differences noted in either the distribution or number of dual labeled cells (Fig. 1b). For both males and females, the largest percentage of PAG-RVM output neurons that also contained ER $\alpha$  was within the caudal PAG primarily within the dorsal half (Fig. 1a).

#### Activation of the PAG-RVM Circuit

In addition to the sexually dimorphic anatomical organization of the PAG, the activation of this circuit during either acute (formalin) or chronic (intraplantar complete Freund's adjuvant; CFA) inflammatory pain is similarly dimorphic (Murphy 2001; Loyd and Murphy 2004). Figure 2a shows the distribution of PAG-RVM

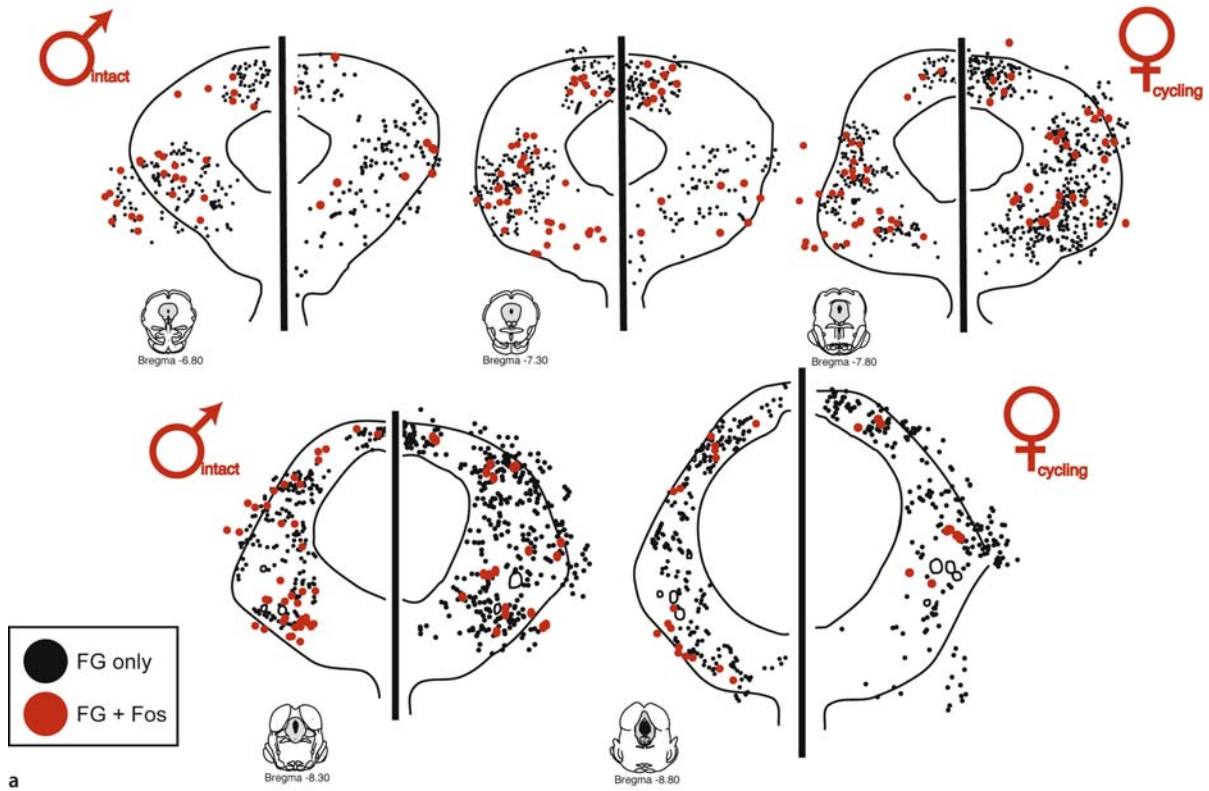
output neurons that also contained the **Fos protein**, a marker for neural activation, following formalin injection into the hindpaw. Similar results were obtained following CFA administration. Inflammatory pain, induced by either acute or chronic methods, resulted in extensive Fos induction throughout the rostrocaudal axis of PAG. No significant differences were noted in either the distribution or number of Fos+ cells for males in comparison to females. Interestingly, while there are a greater number of PAG-RVM output neurons present in females versus males, very few of these PAG neurons retrogradely labeled from the RVM were activated during inflammatory pain. Indeed, in females, overall less than 10 % of PAG-RVM neurons contain Fos following formalin injection; by contrast, in males, over 40 % of PAG-RVM neurons expressed Fos following either acute or chronic inflammatory pain. Sex differences in the activation of the PAG-RVM circuit were most prevalent within the lateral and ventrolateral regions of PAG. These regions are the critical PAG sites for either stimulation-produced or opioid-induced analgesia.

#### Summary

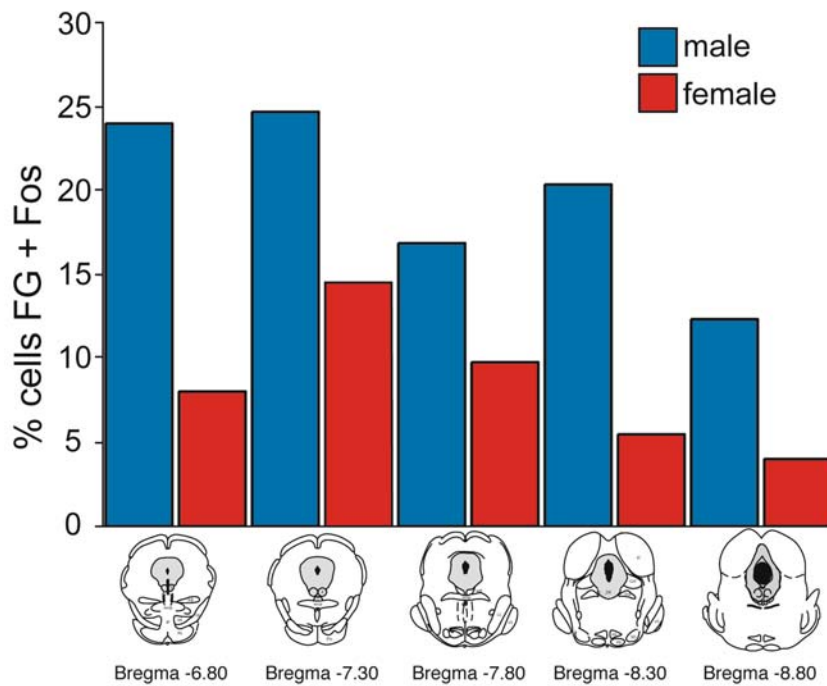
The anatomical organization of the PAG-RVM pathway is different for males and females. Within the caudal half of PAG, there are almost twice as many PAG-RVM output neurons present in females in comparison to males. There are also regional differences in the distribution of PAG neurons retrogradely labeled from the RVM for males and females. Up to 20 % of PAG-RVM neurons contain receptors for the gonadal steroid estrogen, suggesting that steroid modulation of the PAG-RVM circuit may contribute to the sex differences noted in sensory thresholds and opioid responsiveness. There are also significant sex differences in how this circuit is engaged during acute or chronic inflammatory pain states. Together, these data suggest that sex differences, in both the anatomical and functional organization of the PAG-RVM circuit, may contribute to sexually dimorphic pain thresholds and opioid responsiveness.

#### References

1. Basbaum AI, Clanton CH, Fields HL (1978) Three Bulbospinal Pathways from the Rostral Medulla of the Cat: An Autoradiographic Study of Pain Modulating Systems. *J Comp Neurol* 178:209–224
2. Basbaum AI, Fields HL (1979) The Origin of Descending Pathways in the Dorsolateral Funiculus of the Spinal Cord of the Cat and Rat: Further Studies on the Anatomy of Pain Modulation. *J Comp Neurol* 187:513–531
3. Basbaum AI, Fields HL (1984) Endogenous Pain Control Systems: Brainstem Spinal Pathways and Endorphin Circuitry. *Annu Rev Neurosci* 7:309–338
4. Behbehani MM (1995) Functional Characteristics of the Midbrain Periaqueductal Gray. *Prog Neurobiol* 46:575–605
5. Behbehani MM, Fields HL (1979) Evidence that an Excitatory Connection Between the Periaqueductal Gray and Nucleus Raphe Magnus Mediates Stimulation Produced Analgesia. *Brain Res* 170:85–93
6. Carstens E, Yokota T, Zimmermann M (1979) Inhibition of Spinal Neuronal Responses to Noxious Skin Heating by Stimulation of



a



b

**Sex Differences in Descending Pain Modulatory Pathways, Figure 2** (a) Distribution of cells retrogradely labeled from the rostral ventromedial medulla that co-expressed formalin induced Fos for five rostrocaudal levels of the periaqueductal gray. Left, intact males; Right, cycling females. (b) Percentage of Fluorogold positive cells that were also Fos+ for males and females for five rostrocaudal levels of the periaqueductal gray.



- Mesencephalic Periaqueductal Gray in the Cat. *J Neurophysiol* 42:558–568
7. Craft RM (2003) Sex Differences in Opioid Analgesia: “From Mouse to Man” *Clin J Pain* 19:175–186
  8. Fillingim R (2000) Sex, Gender, and Pain: Women and Men Really are Different. *Curr Rev Pain* 4:24–30
  9. Jensen TS, Yaksh TL (1986) III. Comparison of the Antinociceptive Action of Mu and Delta Opioid Receptor Ligands in the Periaqueductal Gray Matter, Medial and Paramedial Ventral Medulla in the Rat as Studied by Microinjection Technique. *Brain Res* 372:301–312
  10. Krzanowska EK, Bodnar RJ (1999) Morphine Antinociception Elicited from the Ventrolateral Periaqueductal Gray is Sensitive to Sex and Gonadectomy Differences in Rats. *Brain Res* 821:224–230
  11. Le Bars D, Dickenson AH, Besson JM. (1980) Microinjection of Morphine Within Nucleus Raphe Magnus and Dorsal Horn Neurone Activities Related to Nociception in the Rat. *Brain Res* 189:467–481
  12. Loyd D, Murphy AZ (2004) Sex Differences of Organization and Activation of the Midbrain Periaqueductal Gray – Nucleus Raphe Magnus Pathway. *Soc Neurosci Abstr*
  13. Murphy AZ (2002) Systemic Morphine Administration Produces a Greater Degree of Analgesia in Males Versus Females in a Persistent Inflammatory Pain Model. *Soc Neurosci* 654.11
  14. Murphy AZ (2001). Sexually Dimorphic Innervation of the Nucleus Raphe Magnus: A Potential Mechanism to Account for Sex Based Differences in Pain Sensitivities. *Soc Neurosci Abstr* 508.9
  15. Murphy AZ, Hoffman GE (1999) Distribution of Androgen and Estrogen Receptor Containing Neurons in the Male Rat Periaqueductal Gray. *Horm Beh* 36:98–108
  16. Reynolds DV (1969) Surgery in the Rat During Electrical Analgesia Induced by Focal Brain Stimulation. *Science* 164:444–445

## Sex Differences in Opioid Analgesia

REBECCA M. CRAFT  
Washington State University, Pullman, WA, USA  
craft@wsu.edu

### Synonyms

Gender Differences in Opioid Analgesia; Opioid Analgesia and Sex Differences

### Definition

Opioid analgesia that differs in potency, efficacy, time course or some other variable, between males and females (defined anatomically or via sex chromosome).

### Characteristics

Recent reviews of epidemiological, clinical and experimental studies indicate that women suffer disproportionately more pain than men. A majority of experimental studies in humans report that women have lower pain thresholds and lower pain tolerance than men, for many, though not all, types of noxious stimuli (Berkley 1997). Women also report more endogenous pains, and a number of painful clinical syndromes, such as migraine, temporomandibular disorder, rheumatoid arthritis, fibromyalgia, and irritable bowel syndrome, are more prevalent in women than in

men (Berkley 1997; Unruh 1996; Fillingim 2000). The existence of sex differences in pain, and the fact that the developmental profile of some types of pain clearly parallels reproductive function, strongly suggest that gonadal steroid hormones significantly influence pain (Fillingim 2000; Riley et al. 1999; Craft et al. 2004). Given the significant roles of endogenous opioids and opioid receptors in pain and analgesia, it is not surprising that sex differences in opioid analgesia have been observed. Greater opioid analgesia in women than men was initially reported in a series of studies conducted in dental pain patients (e.g. Gear et al. 1996; Gear et al. 2000). In these studies, the mixed-action opioid agonists pentazocine, nalbuphine and butorphanol were found to be longer-acting and/or more efficacious in women than in men. Due to the paucity of studies, it is still too early to draw firm conclusions regarding the reliability of sex differences in opioid analgesia in humans. In contrast, there are now sufficient studies in rats and mice from which some generalizations can be made. Mu opioid agonists such as morphine are often found to be more potent, and in some cases more efficacious, in male rodents than in females (Craft 2003a). Although a fair number of studies report no sex differences in opioid analgesia in rodents, almost none report greater opioid analgesia in females compared to males. Sex differences in mu opioid analgesia appear to extend to opioids with mixed actions or selective kappa opioid agonist activity, whereas there is less evidence for sex differences in analgesia produced by selective delta opioid agonists (Craft 2003a). Sex differences in opioid analgesia do not appear to depend on the type of acute noxious stimulus used in the pain test (thermal, mechanical, electrical, chemical), although they may depend on the intensity of the noxious stimulus (particularly when lower efficacy agonists are examined), and the hormonal state of subjects at the time of testing (Craft 2003a). For example, females in vaginal estrus (or ovariectomized females replaced with estradiol) appear to be the least sensitive to morphine analgesia (Craft et al. 2004).

Mechanisms underlying sex differences in opioid analgesia are not yet well understood. Gonadal steroid hormones such as estradiol and testosterone have been shown to act both organizationally (during development) and activationally (in the adult) to influence sensitivity to opioid analgesia in male and female rats (Craft et al. 2004). Gonadal steroids may influence opioid analgesia by modulating opioid pharmacokinetics and/or pharmacodynamics. In rodents, gonadal hormones have been shown to influence opioid disposition and metabolism, as well as opioid receptor density and signal transduction, at least in some brain areas (Craft et al. 2004, Craft 2003a). In humans, there is little evidence for sex differences in opioid pharmacokinetics, but one group has demonstrated that brain mu opioid receptor binding potential differs between men and women exposed to a painful stimulus (Zubieta

et al. 2002), suggesting that opioid receptor density or endogenous opioid release differs between men and women.

The clinical impact of these findings is not yet known. Few preclinical studies have employed assays that closely mimic the clinical pain situations in which opioids are most often used, and sex difference studies in humans and non-human primates are still relatively rare. Thus, it is not known whether men and women are likely to respond differently to opioids under conditions of injury- or disease-induced hyperalgesia or allodynia, for example. Furthermore, two groups have demonstrated that rodent genotype is a significant moderating factor in sex difference studies (Mogil et al. 2000; Mogil et al. 2003; Cook et al. 2000), and this appears also to be the case in humans (Mogil et al. 2003). Of further potential clinical relevance, some rodent studies suggest that opioid tolerance may develop differentially in males and females, and that “side-effects” such as respiratory depression, sedation and euphoria may also differ between the sexes (Craft 2003a). As opioids are usually administered repeatedly, and side-effects may limit their therapeutic use, these are important issues to be resolved in determining whether opioid analgesics should be used according to “sex-specific guidelines” in the future (Craft et al. 2004; Craft 2003b).

## References

- Berkley KJ (1997) Sex Differences in Pain. *Behav Brain Sci* 20:371–380
- Craft RM (2003a) Sex Differences in Opioid Analgesia: “from Mouse to Man.” *Clin J Pain* 19:175–186.
- Craft RM (2003b) Sex Differences in Drug- and Non-Drug-Induced Analgesia. *Life Sci* 72:2675–2688
- Craft RM, Mogil JS, Aloisi AM (2004) Sex Differences in Pain and Analgesia: The Role of Gonadal Hormones. *Eur J Pain* 8:397–411
- Cook CD, Barrett AC, Roach EL, Bowman JR, Picker MJ (2000) Sex-Related Differences in the Antinociceptive Effects of Opioids: Importance of Rat Genotype, Nociceptive Stimulus Intensity, and Efficacy at the mu Opioid Receptor. *Psychopharmacology* 150:430–442
- Fillingim RB (2000) Sex, Gender, and Pain. IASP Press, Seattle
- Gear RW, Miaskowski C, Gordon NC, Paul SM, Heller PH, Levine JD (1996) Kappa-Opioids Produce Significantly Greater Analgesia in Women than in Men. *Nat Med* 2:1248–1250
- Gear RW, Miaskowski C, Gordon NC, Paul SM, Heller PH, Levine JD (2000) Action of Naloxone on Gender-Dependent Analgesic and Antianalgesic Effects of Nalbuphine in Humans. *J Pain* 1:122–127
- Mogil JS, Chesler EJ, Wilson SG, Juraska JM, Sternberg WF (2000) Sex Differences in Thermal Nociception and Morphine Antinociception in Rodents Depend on Genotype. *Neurosci Biobehav Rev* 24:375–389
- Mogil JS, Wilson SG, Chesler EJ, Rankin AL, Nemmani KVS, Lariviere WR, Groce MK, Wallace MR, Kaplan L, Staud R, Ness TJ, Glover TL, Stankova M, Mayorov A, Hraby VJ, Grisel JE, Fillingim RB (2003) The melanocortin-1 Receptor Gene Mediates Female-Specific Mechanisms of Analgesia in Mice and Humans. *Proc Natl Acad Sci USA* 100:4867–4872
- Riley JL, Robinson ME, Wise EA, Price DD (1999) A Meta-Analytic Review of Pain Perception Across the Menstrual Cycle. *Pain* 81:225–235
- Unruh AM (1996) Gender Variations in Clinical Pain Experience. *Pain* 65:123–167
- Zubieta J-K, Smith YR, Bueller JA, Xu Y, Kilbourn MR, Jewett DM, Meyer CR, Koeppe RA, Stohler CS (2002) Mu-Opioid Receptor-Mediated Antinociceptive Responses Differ in Men and Women. *J Neurosci* 22:5100–5107

## Sexual Abuse

### Definition

Forcing or enticing another person to take part in sexual activities, whether or not they are aware of what is happening. The activities may involve physical contact, including penetrative (e.g. rape or buggery) and non-penetrative acts. They may include non-contact activities, such as involving another person in looking at, or in the production of, pornographic material or watching sexual activities or encouraging another person to behave in sexually inappropriate ways.

▶ [Chronic Pelvic Pain, Physical and Sexual Abuse](#)

## Sexual Activity Headache

### Definition

Headache occurring during sexual intercourse.

▶ [Primary Exertional Headache](#)

## Sexual Dysfunctions

▶ [Gynecological Pain and Sexual Functioning](#)

## Sexual Pain Disorder

▶ [Dyspareunia and Vaginismus](#)

## Sexual Response

### Definition

There are four phases involved in the sexual response: desire, excitement, orgasm, and resolution. Desire is also referred to as libido. Excitement is a state of arousal that often occurs as a result of physical contact or emotional readiness. During excitement the body responds by increasing the heart rate, blood pressure, and respiratory rate. Blood flow increases to the genitals in both men and women. In women, this creates a state of engorgement in the labia and surrounding structures, as well as lubrication of the vagina. In men, this results in an erection. The third phase, orgasm, is also called climax, where muscles in the genitalia and pelvic region contract. In males

this is accompanied by ejaculation. Finally, resolution is the return of the body to its original state.

- ▶ Cancer Pain Management, Opioid Side Effects, Endocrine Changes and Sexual Dysfunction

## SF-36 Health Status Questionnaire

### Definition

The SF-36 is a multi-purpose, short-form health survey with 36 questions. It consists of an 8-scale profile of functional health and well-being scores, psychometrically-based physical and mental health summary measures and a preference-based health utility index. It is a generic measure, in contrast to one that targets a specific age, disease, or treatment group. The SF-36 has been used in surveys of general and specific populations, comparing the relative burden of diseases, and in differentiating the health benefits produced by a wide range of different treatments.

- ▶ Postoperative Pain, Preoperative Education

## SFEMG

- ▶ Single Fiber Electromyography

## SF-MPQ

### Definition

Short-Form McGill Pain Questionnaire.

- ▶ McGill Pain Questionnaire

## Sham

- ▶ Placebo

## Shear Stress

### Definition

Shear stress is applied to vascular endothelial cells by the force of laminar blood flow along their surface. This induces COX-2 in the cells, which supplies endoperoxides for the synthesis of prostacyclin (PGI<sub>2</sub>).

- ▶ Cyclooxygenases in Biology and Disease

## Shingles Pain

- ▶ Postherpetic Neuralgia, Etiology, Pathogenesis and Management

## Short-Lasting Unilateral Neuralgiform Headache Attacks with Conjunctival Injection and Tearing

- ▶ SUNCT Syndrome

## Shortwave Diathermy

- ▶ Modalities

## Shoulder Pain

### Definition

Non-specific shoulder pain is a prominent feature of polymyalgia rheumatica.

- ▶ Muscle Pain in Systemic Inflammation (Polymyalgia Rheumatica, Giant Cell Arteritis, Rheumatoid Arthritis)

## Shoulder-Hand Syndrome

- ▶ Complex Regional Pain Syndromes, General Aspects

## SI

- ▶ Primary Somatosensory Cortex (SI)

S

## SII

- ▶ Nociceptive Processing in the Secondary Somatosensory Cortex
- ▶ Secondary Somatosensory Cortex

## SII/PV

- ▶ Nociceptive Processing in the Secondary Somatosensory Cortex

## SIA

### Definition

Stress-Induced Analgesia.

- ▶ Acupuncture Mechanisms

## Sicca-Syndrome

### Definition

Dryness of the mouth and eyes may be a sign of Sjögren's syndrome, in which salivary glands are the main target for the autoimmune disease.

- ▶ [Muscle Pain in Systemic Inflammation \(Polymyalgia Rheumatica, Giant Cell Arteritis, Rheumatoid Arthritis\)](#)

## Sick Role

### Definition

A role legitimized by medical sanction, which by its "special status" relieves the patient of the usual demands and obligations and takes priority over other social roles (e.g. occupation, familial). In children, these behaviors may be learned or reinforced by parental or family responses.

- ▶ [Impact of Familial Factors on Children's Chronic Pain](#)
- ▶ [Malingering, Primary and Secondary Gain](#)
- ▶ [Pain as a Cause of Psychiatric Illness](#)

## Sickle Cell Disease

### Definition

Sickle Cell disease is an inherited, chronic condition in which the red blood cells, which are normally disc-shaped, become crescent shaped. As a result, the red blood cells function abnormally and cause small blood clots. These clots give rise to recurrent painful episodes called "sickle cell pain crises" Sickle cell disease occurs most commonly in African Americans or in people of Mediterranean descent. Its severity can range from mild to life threatening.

- ▶ [Experimental Pain in Children](#)

## Side Effects

- ▶ [Cancer Pain Management, Opioid Side Effects, Uncommon Side Effects](#)
- ▶ [Postoperative Pain, Adverse Events \(Associated with Acute Pain Management\)](#)

## Sign of Formication

- ▶ [Tinel Sign](#)

## Signal Detection Analysis/Theory

### Definition

Signal detection analysis is used to explain how decisions are made in uncertain or ambiguous situations, e.g. judgments concerning the presence or absence of a stimulus at threshold intensity. Psychophysics, i.e. the characterization of the relationship between a physical stimulus and its subjective perception, represents an important area of application for signal detection analyses. Signal detection theory assumes that a person's response to stimulation is influenced both by the ability to discriminate between stimuli and by a response bias, i.e. subjective criteria used to label a stimulus, for example, as painful versus not painful. Signal detection analysis provides methods on how to estimate these two response components based on the person's response pattern across trials.

- ▶ [Modeling, Social Learning in Pain](#)
- ▶ [Statistical Decision Theory Application in Pain Assessment](#)

## Signaling

### Definition

The process of conditioning an infant to anticipate the occurrence of a painful event based on the repeated pairing of a stimulus with the painful event.

- ▶ [Acute Pain Management in Infants](#)

## Signaling Molecules of Thalamic Regions

- ▶ [Thalamic Neurotransmitters and Neuromodulators](#)

## Signal-to-Noise Ratio

### Synonyms

S/N Ratio

### Definition

After some kind of stimulation, both real signals and background noises are recorded. This is the ratio between them. If its value is high, it means a good recording.

- ▶ [Magnetoencephalography in Assessment of Pain in Humans](#)



## Significant Others

### Definition

Significant others are important persons in the social environment and most often include spouses or living partners, family members, neighbors, close friends and even a health care provider.

- ▶ Psychological Assessment of Pain
- ▶ Spouse, Role in Chronic Pain

## Significant Others' Responses to Pain

### Definition

It has been shown that the responses of significant others such as the spouse play an important role in the development of chronic pain.

- ▶ Operant Treatment of Chronic Pain

## Sildenafil

### Synonyms

Viagra

### Definition

Sildenafil (Viagra) is indicated for the treatment of erectile dysfunction. Erection is mediated by the release of nitric oxide in the corpus cavernosum of the penis. Nitric oxide stimulates the enzyme guanylate cyclase, which increases levels of cGMP; it is this response that creates smooth muscle relaxation and blood flow. A substance called phosphodiesterase type 5 (PDE5) leads to the degradation of cGMP. Sildenafil increases the availability of cGMP. Randomized controlled clinical trials demonstrate improved sexual performance as measured by firmness of erection, ability to maintain erection after penetration, as well as satisfaction and enjoyment with intercourse. The usual recommended dose is 50 mg administered 30-60 minutes prior to intercourse, with maximum recommended dosing frequency once per day. Clinical trials regarding the use of sildenafil to treat opioid-induced sexual dysfunction, in men or women, have not been conducted.

- ▶ Cancer Pain Management, Opioid Side Effects, Endocrine Changes and Sexual Dysfunction

## Silent Myocardial Ischemia

### Definition

Myocardial ischemia is the term for inadequate oxygen supply (from inadequate blood flow) to the heart muscle

(myocardium). In silent myocardial ischemia, patients have myocardial ischemia as indicated by the marked ST segment changes of the electrocardiogram (ECG) without experiencing angina (chest discomfort).

- ▶ Thalamus and Visceral Pain Processing (Human Imaging)
- ▶ Thalamus, Clinical Visceral Pain, Human Imaging
- ▶ Visceral Pain Model, Angina Pain

## Silent Nociceptor

ROBERT F. SCHMIDT

Institute of Physiology, University of Würzburg,  
Würzburg, Germany  
rfs@mail.uni-wuerzburg.de

### Synonyms

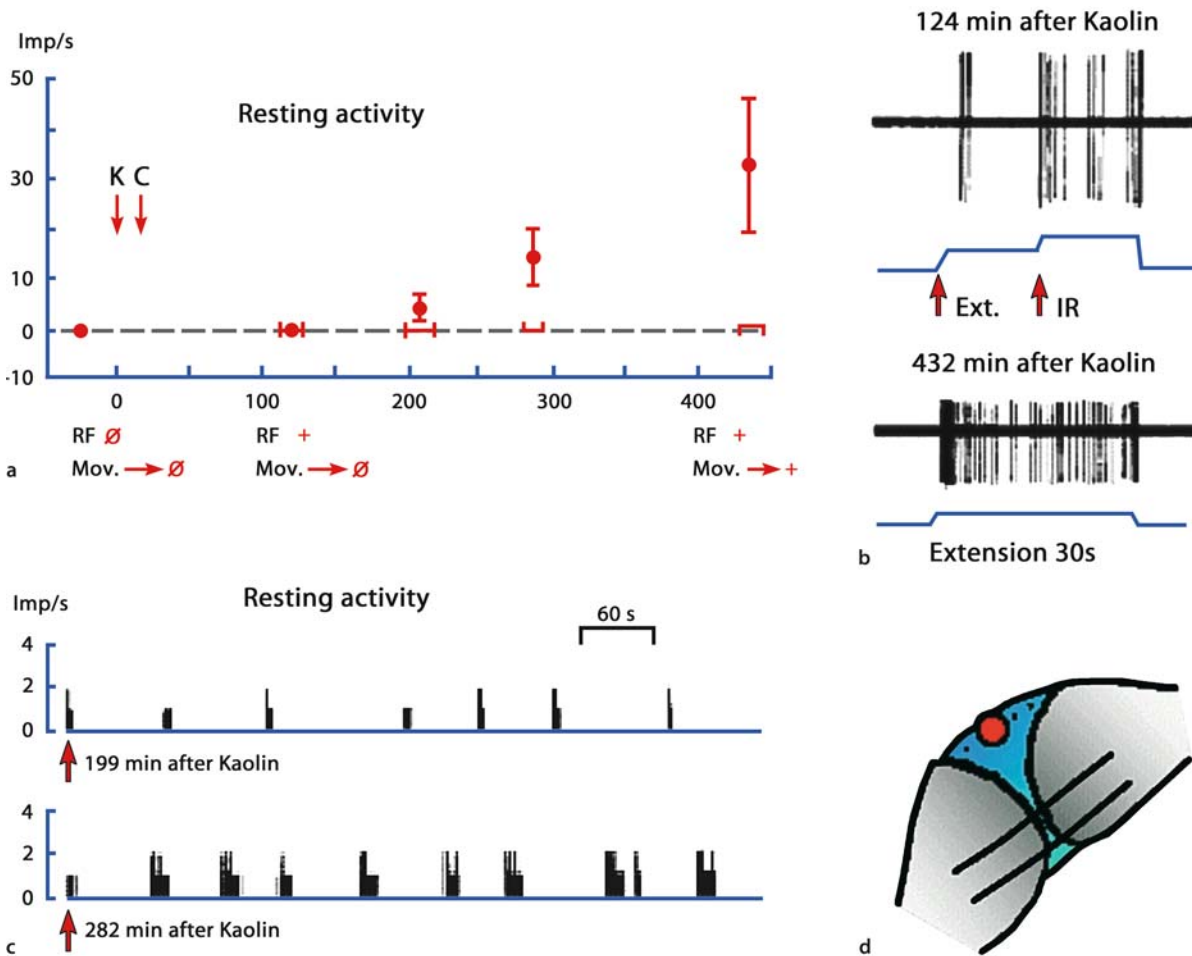
Mechanoinsensitive nociceptor; sleeping nociceptor

### Definition

▶ **Nociceptors** that are normally insensitive to even very intense mechanical stimuli but that become sensitized in the course of pathophysiological processes in the tissue to become responsive to (formerly) nonnoxious mechanical stimuli. Silent nociceptors form a widespread, if not a universal, component of the somatovisceral afferent system in mammals.

### Characteristics

Investigations of single primary afferent units in sensory nerves or in dorsal roots usually reveal a certain proportion of afferent fibers that despite their electrical identification cannot be excited by adequate natural mechanical stimulation. Except for the ambiguity with respect to unmyelinated afferents (▶ **C Fiber**) in peripheral nerves (some 50% of which are preganglionic autonomic efferents), the lack of responsiveness of such units is usually attributed to failure to find the peripheral receptive field of the unit or to inadequate or sub-threshold natural stimulation. Usually such units are not even mentioned in reports of such studies, except perhaps indirectly in the data on the total number of units isolated. The concept of silent nociceptors first emerged in a series of studies that explored the responses of fine articular primary afferent units to passive movements of the cat's knee joint (Coggeshall et al. 1983; Schaible and Schmidt 1983a; Schaible and Schmidt 1983b; Schaible and Schmidt 1985; Grigg et al. 1986). It was firmly established in experiments in which silent articular nociceptors were first identified and then afterwards exposed to an experimental arthritis. As illustrated in Fig. 1, this inflammation sensitized the silent nociceptors to the point where many of them developed resting activity, as well as vigorous responses to movements in the working range



**Silent Nociceptor, Figure 1** Effects of an experimental arthritis on a silent ("sleeping") Group IV (C-fiber) unit. The unit had no receptive field and no resting activity in the beginning of the recording session. (a) Time course of the development of resting discharges. Mean and standard deviation of resting discharges quantified during the indicated times (bars). The first spontaneous activity was recorded about 2 h after the intraarticular injection of kaolin (K and red arrow) and carrageenan (C) and second red arrow in (a). The receptive field (RF in (a)) shown in (d) (red dot near the patella) appeared about 100 min after the onset of inflammation. (b) and (c) Response to movements (b) and resting activity (c) in the inflamed state at the indicated times after the kaolin application; Ext., extension; IR, pronation. Modified from Schaible and Schmidt 1988a.

of the joint (Schaible and Schmidt 1988a, Schaible and Schmidt 1988b).

While the concept of mechanoinsensitive, i.e. silent nociceptors, in the articular nerves of the cat's knee joint emerged from the experiments quoted above, it became obvious that there is most probably a range of mechanical thresholds for articular fine afferents under both physiological and pathophysiological conditions. Under physiological conditions, the spectrum of mechanical thresholds is rather evenly distributed, whereas under pathophysiological conditions, such as in experimental arthritis, all units become sensitized and the spectrum of thresholds is skewed, i.e. most units can now be activated by stimulation which under normal conditions is completely ineffective (for details see Schmidt and Schaible 1994).

Following the description of silent nociceptors in the nerves to the cat's knee joint, an ever increasing number

of research reports have provided evidence that silent afferent units are widespread in mammalian somatic and visceral peripheral nerves, including nerves of primates and humans (for reviews see Schmidt et al. 1994, Schaible and Schmidt 1996, Schmidt 1996). Thus, silent primary afferent units may be a universal feature of the somatovisceral afferent system of mammals and presumably of other vertebrates. They seem to form a substantial subpopulation of the fine afferent fibers in the ► A-delta (Group III) and ► C fiber (Group IV) range with particularly slow conduction velocities. Many details of the functional characteristics and the possible afferent and efferent functions of silent nociceptors have still to be elucidated. For instance, many of the mechanoinsensitive units can be activated by chemical stimulation, particularly by algescic substances such as ► bradykinin, but whether such stimuli have any physiological significance under normal conditions is open

for discussion. Furthermore, no evidence is available yet as to whether silent afferents have more prominent efferent functions than other fine afferent units. There is, however, little doubt that they form a special population of fine afferent units, which only come into play under pathophysiological conditions, thus providing a special alarm system to inform the organism about particularly threatening noxious stimuli.

- ▶ [Arthritis Model, Kaolin-Carrageenan Induced Arthritis \(Knee\)](#)
- ▶ [Articular Nociceptors](#)
- ▶ [Nick Model of Cutaneous Pain and Hyperalgesia](#)

## References

1. Coggeshall RE, Hong KA, Langford LA et al. (1983) Discharge characteristics of fine medial articular afferents at rest and during passive movements of inflamed knee joints. *Brain Res* 272:185–188
2. Grigg P, Schaible H-G, Schmidt RF (1986) Mechanical sensitivity of group III and IV afferents from posterior articular nerve in normal and inflamed cat knee. *J Neurophysiol* 55:635–643
3. Schaible H-G, Schmidt RF (1983a) Activation of groups III and IV sensory units in medial articular nerve by local mechanical stimulation of knee joint. *J Neurophysiol* 49:35–44
4. Schaible H-G, Schmidt RF (1983b) Responses of fine medial articular nerve afferents to passive movements of knee joints. *J Neurophysiol* 49:1118–1126
5. Schaible H-G, Schmidt RF (1985) Effects of an experimental arthritis on the sensory properties of fine articular afferent units. *J Neurophysiol* 54:1109–1122
6. Schaible H-G, Schmidt RF (1988a) Direct observation of the sensitization of articular afferents during an experimental arthritis. In: Dubner R, Gebhardt GF, Bond MR (eds) *Pain Research and Clinical Management Series, Proceedings of the 5<sup>th</sup> World Congress on Pain, vol III*. Elsevier Science Publisher, Amsterdam, pp 44–50
7. Schaible H-G, Schmidt RF (1988b) Time course of mechanosensitivity changes in articular afferents during a developing experimental arthritis. *J Neurophysiol* 60:2180–2195
8. Schaible H-G, Schmidt RF (1996) Neurobiology of Articular Nociceptors. In: Belmonte C, Cervero F (eds) *Neurobiology of Nociceptors*. Oxford University Press, Oxford, pp 202–219
9. Schmidt RF (1996) The articular polymodal nociceptor in health and disease. In: Kumazawa T, Kruger L, Mizumura K (eds) *The Polymodal Receptor: A Gateway to Pathological Pain*. *Progr Br Res* 113:53–81
10. Schmidt RF, Schaible H-G (1994) Silent Primary Afferents. NATO ASI. In: Urban L (ed) *Cellular Mechanisms of Sensory Processing. The Somatosensory System. Series: Cell Biology, vol H 79:289–296*, Springer-Verlag, Berlin
11. Schmidt RF, Schaible H-G, MeSSLinger K et al. (1994) Silent and Active Nociceptors: Structure, Functions, and Clinical Implications. In: Gebhart GF, Hammond DL, Jensen TS (eds) *Proc. of the 7th World Congress on Pain, Progress in Pain Research and Management, vol 2*. IASP Press, Seattle, pp213–250

## Simple Analgesics

NIKOLAI BOGDUK

Department of Clinical Research, Royal Newcastle Hospital Newcastle, University of Newcastle, Newcastle, NSW, Australia  
 nik.bogduk@newcastle.edu.au

## Synonyms

Paracetamol; acetaminophen; pain-killers; over the counter analgesics

## Definition

The term – simple analgesics, is used to imply a class of drugs, designed to relieve pain, but which are less potent and safer than ▶ [opioids](#), and which are not ▶ [NSAIDs, Survey](#) (NSAIDs). In effect, the class of drugs is now represented only by paracetamol, known also as acetaminophen.

## Characteristics

Paracetamol was first introduced in 1893, and became commercially available during the 1950s (Prescott 2000). It has become the most widely available and most widely used analgesic. Much of its attraction stems from its relative safety. Although in large doses, either acutely or cumulatively, it can be toxic, paracetamol is substantially free of adverse effects when used in recommended doses. For this reason, it rapidly became available to the public as “over-the-counter” medication, i.e. not requiring a prescription.

In its pure form, paracetamol is a relatively weak analgesic, substantially less potent than opioids. In order to provide greater analgesia, preparations are available, called compound analgesics, in which small but various doses of opioids such as codeine or dextro-propoxyphene, are combined with paracetamol.

## Mechanism

The mechanism by which paracetamol exerts its analgesic effects remains largely a mystery. When it is used, the excretion of prostaglandin metabolites is decreased, but paracetamol does not reduce the synthesis of prostaglandins. It has only a weak inhibitory effect on cyclo-oxygenase 1 and cyclo-oxygenase 2. It is suspected to have an effect on cyclo-oxygenase 3 or a variant of cyclo-oxygenase 2 (Botting 2000).

## Application

Paracetamol is suitable for any and all forms of mild to moderate pain and is used widely for such pain. Its application is limited only by its modest efficacy. It is perhaps most widely used for short-term management of acute but self-limiting pain, or intermittent pain; but it has also become the drug of first choice for persistent or chronic pain.

## Efficacy

For a drug so widely used, and with such a long history of use, there is surprisingly little literature explicitly on the efficacy of paracetamol. Rather, paracetamol has most often been studied as the benchmark, or comparison, drug against which other and newer analgesics have been tested. Nevertheless, in recent years data on the efficacy of paracetamol have emerged.

Paracetamol is effective for the relief of postoperative pain. For a 50% reduction in pain, it has an NNT (see ► [number needed to treat](#) (NNT)) of 4 (Barden et al. 2004). For the postoperative pain of dental extraction, it is more effective than placebo, and as effective as diclofenac (Kubitze et al. 2003).

For the relief of pain due to dysmenorrhoea, paracetamol is more effective than placebo and no less effective than ► [NSAIDs](#) (Majoribanks et al. 2003). It has fewer side-effects than NSAIDs.

For the relief of tension-type headache, paracetamol is more effective than placebo, and more effective than naproxen (Prior et al. 2002). For the relief of acute attacks of migraine, it is as effective, or slightly less effective, than various triptans (Diener and Limmroth 2001).

Paracetamol has not been tested for the relief of spinal pain. There is conflicting evidence as to whether it is less effective than NSAIDs or not (Van Tulder et al. 2003). It can be used for rheumatoid arthritis, but surveys show that both patients and physicians prefer to use NSAIDs for this condition (Wienecke and Gotzsche 2004). For the treatment of pain due to osteoarthritis, the division is less clear. For this condition, paracetamol is more effective than placebo but less effective than NSAIDs for the relief of pain (Towheed et al. 2003; Zhang et al. 2004), although equally effective to NSAIDs for improving function (Towheed et al. 2003). NSAIDs, however, carry a greater risk of gastrointestinal side-effects (Towheed et al. 2003; Zhang et al. 2004). For this reason, paracetamol is recommended as a first-line drug for osteoarthritis (Towheed et al. 2003; Zhang et al. 2004).

Although compound analgesics were developed with the prospect of providing greater analgesia and, therefore, greater patient satisfaction, than paracetamol alone, the outcome data are disappointing. A meta-analysis of the literature on oral surgery and post-operative pain showed that codeine added only a 5% increase in pain relief to that afforded by paracetamol alone (de Craen et al. 1996); but the addition of codeine significantly increased the risk of side-effects, particularly with repeated use. Another meta-analysis found that, for 50% relief of postoperative pain, the NNT of paracetamol 650 mg compounded with codeine 60 mg was 4: a value neither substantially nor statistically better than that of the NNT of paracetamol alone (4–5) (Moore et al. 2000). Compared to paracetamol alone, paracetamol compounded with codeine had an NNT of 7.7 (Moore et al. 2000). Paracetamol compounded with dextropropoxyphene has an NNT of 4.4 (Collins et al. 2000). For the relief of back pain, compound analgesics containing codeine are not more effective than NSAIDs, but produce more side-effects (Bogduk 2004). Compound analgesics containing dextropropoxyphene are no more effective than paracetamol with caffeine, or paracetamol alone (Bogduk 2004).

► [Cancer Pain Management, Principles of Opioid Therapy, Drug Selection](#)

## References

1. Barden J, Edwards J, Moore A et al. (2004) Single Dose Oral Paracetamol (Acetaminophen) for Postoperative Pain. *Cochrane Database Syst Rev*: CD004602
2. Bogduk N (2004) Pharmacological Alternatives for the Alleviation of Back Pain. *Expert Opin Pharmacother* 5:2091–2098
3. Botting RM (2000) Mechanism of Action of Acetaminophen: Is there a Cyclooxygenase 3? *Clin Infect Dis* 31:202–210
4. Collins SL, Edwards JE, Moore RA et al. (2000) Single Dose Dextropropoxyphene, Alone and with Paracetamol (Acetaminophen), for Postoperative Pain. *Cochrane Database Syst Rev*:CD001440
5. Craen AJM de, Di Giulio G, Lampe-Schoenmaeckers AJEM et al. (1996) Analgesic Efficacy and Safety of Paracetamol-Codeine Combinations versus Paracetamol Alone: A Systematic Review. *Brit Med J* 313:321–325
6. Diener HC, Limmroth V (2001) Analgesics. *Curr Med Res Opin* 17:13–16
7. Kubitze F, Ziegler G, Gold MS et al. (2003) Analgesic Efficacy of Low-Dose Diclofenac versus Paracetamol and Placebo in Postoperative Dental Pain. *J Orofac Pain* 17:237–244
8. Majoribanks J, Proctor ML, Farquhar C (2003) Nonsteroidal Anti-Inflammatory Drugs for Primary Dysmenorrhoea. *Cochrane Database Syst Rev*: CD001751
9. Moore A, Collins S, Carroll D et al. (2000) Single Dose Paracetamol (Acetaminophen), With and Without Codeine, for Postoperative Pain. *Cochrane Database Syst Rev*:CD001547
10. Prescott LF (2000) Paracetamol: Past, Present, and Future. *Am J Ther*:143–147
11. Prior MJ, Cooper KM, May LG et al. (2002) Efficacy and Safety of Acetaminophen and Naproxen in the Treatment of Tension-Type Headache. A Randomized, Double-Blind, Placebo-Controlled Trial. *Cephalalgia* 22:740–748
12. Towheed TE, Judd MJ, Hochberg MC et al. (2003) Acetaminophen for Osteoarthritis. *Cochrane Database Syst Rev*:CD004257
13. Van Tulder MW, Scholten RJPM, Koes BW et al. (2003) Non Steroidal Anti-Inflammatory Drugs for Low Back Pain (Cochrane Review). In *Cochrane Library*, Issue 3. Update software, Oxford
14. Wienecke T, Gotzsche PC (2004) Paracetamol versus Nonsteroidal Anti-Inflammatory Drugs for Rheumatoid Arthritis. *Cochrane Database Syst Rev*:CD003789
15. Zhang W, Jones A, Doherty M (2004) Does Paracetamol (Acetaminophen) Reduce the Pain of Osteoarthritis? A Meta-Analysis of Randomised Controlled Trials. *Ann Rheum Dis* 63:901–917

## Simple Nerve Blocks

### Definition

Numbing of a single peripheral nerve.

► [Cancer Pain Management, Anesthesiologic Interventions, Neural Blockade](#)

## Simple Synapse

### Definition

Synapse is composed of a complex of the axon terminal, dendrite or dendritic spine, and is often seen on presynaptic axons.

► [Morphology, Intraspinal Organization of Visceral Afferents](#)



## Simulated Job Tasks

### Definition

Simulated job tasks are in contrast to real work tasks. These are performed in job-related environments that imitate the clients' regular occupation without producing products or services. The Revised Handbook for Analyzing Jobs is a useful starting point in designing simulated job tasks.

- ▶ Vocational Counselling

## SIN

- ▶ Neuropathic Pain Model, Neuritis/Inflammatory Neuropathy
- ▶ Sciatic Inflammatory Neuritis

## Single Fiber Electromyography

### Synonyms

SFEMG

### Definition

SFEMG uses dedicated intramuscular electrodes to record action potentials from individual muscle fibers. SFEMG is the most sensitive *in vivo* method to detect dysfunctions of neuromuscular transmission. It is part of the diagnostic work-up of neuromuscular disorders, in particular myasthenia.

- ▶ Clinical Migraine without Aura

## Single Interval Procedure

### Definition

A single interval procedure is a statistical decision method in which a sensory decision is made after each stimulus presentation.

- ▶ Statistical Decision Theory Application in Pain Assessment

## Single Nucleotide Polymorphisms

### Synonyms

SNP

### Definition

Substitution of one nucleotide for another somewhere in the genome of different individuals. These are the most common type of DNA variant, occurring on average once in every 1,000 base pairs. Single Nucleotide Polymorphisms (SNPs) are being catalogued and mapped in the genomes of various species, and are useful for both QTL mapping and association studies.

- ▶ Association Study
- ▶ Heritability of Inflammatory Nociception
- ▶ NSAIDs, Pharmacogenetics
- ▶ Opioid Analgesia, Strain Differences
- ▶ Quantitative Trait Locus Mapping
- ▶ TRPV1 Receptor, Species Variability

## Single or Straight Form of Terminal Branches

### Definition

Terminal branches form several patterns depending on the function of the afferent fiber. Somatic afferents from skin make complicated, concentrated nest-like terminations different from visceral afferents, which have single or straight terminal branches.

- ▶ Morphology, Intraspinous Organization of Visceral Afferents

## Single Photon Emission Computed Tomography

PETER LAU

Department of Clinical Research, Royal Newcastle Hospital, University of Newcastle, Newcastle, NSW, Australia

petercplau@hotmail.com

S

### Synonyms

SPECT

### Definition

Single photon emission computed tomography is a means of obtaining images of the internal structure of the body by combining the technology of nuclear medicine with that of computerized tomography (CT). Virtual images of the body are synthesized by a computer, based on the radiation emitted from a radioactive chemical administered intravenously to the patient.

### Characteristics

According to their metabolic activities and blood flow, different healthy and diseased tissues absorb radionuclides (radioactive isotopes) at different rates. When injected into the body, these radionuclides accumulate in

different tissues to different extents. From those tissues, radioactive emissions will emerge, in proportion to the concentration of radionuclide absorbed by them. By detecting those emissions across various diameters of the body, an image can be synthesized on the basis of the size and location of the inferred source of radiation. Images can be displayed in sagittal, axial or coronal planes.

SPECT scanning does not demonstrate tissues directly. Rather, it detects areas of increased metabolic activity or increased blood flow. The site of these abnormalities, however, can be deduced from a knowledge of the anatomy of the region being studied.

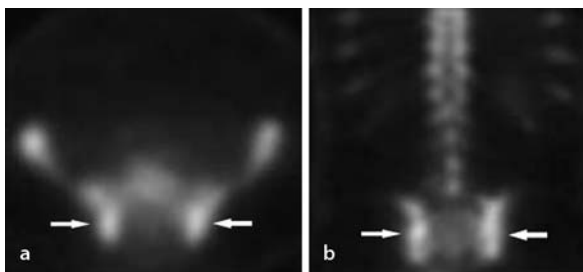
SPECT is a major advance on conventional nuclear medicine imaging because it provides high-resolution images of the region being studied. It converts the normally flat, two-dimensional image of a bone scan into multiple, axial, sagittal and coronal slices. This allows any source of radiation to be localized accurately to specific structures present the plane being studied (Murray 1994).

### Applications

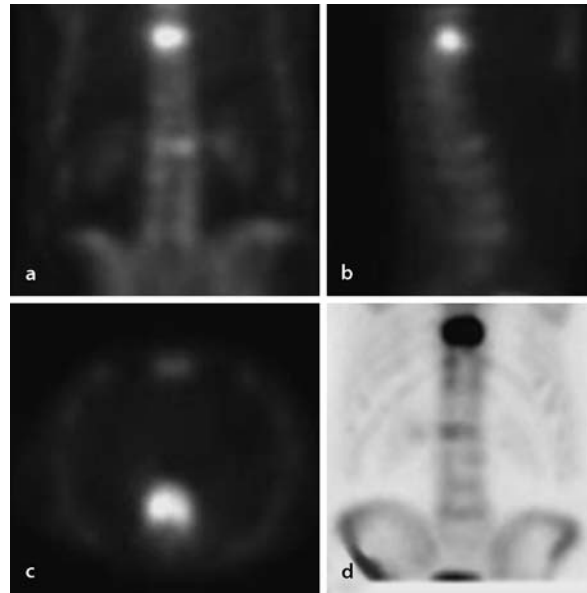
The application of SPECT in pain medicine is limited to those conditions that might be associated with pain and which themselves are characterized by increased blood flow.

Amongst musculoskeletal disorders, those that are associated with increased blood flow are stress reactions in bone (Fig. 1), acute fractures (Fig. 2), pseudoarthroses and certain bone tumours. However, although several descriptive studies extol what SPECT can show, few studies have demonstrated the validity of SPECT quantitatively.

In the context of low back pain, a review of the literature (Littenberg et al. 1995) found 13 reports on the accuracy of SPECT. Only three studies provided a reasonable reference standard and allowed the calculation of sensitivity and specificity. The review concluded that SPECT is useful in detecting pseudoarthrosis after failed spinal fusion, evaluating young patients with back pain and distinguishing benign from malignant lesions in cancer patients.



**Single Photon Emission Computed Tomography, Figure 1** A SPECT scan showing stress reaction in the sacro-iliac joints after lumbar spinal fusion. Both joints show intense uptake of radionuclides (arrows). (a) Axial view. (b) Coronal view. Images provided by courtesy of Dr John Booker of Hunter Imaging Group and Sonic Health, Newcastle, Australia.

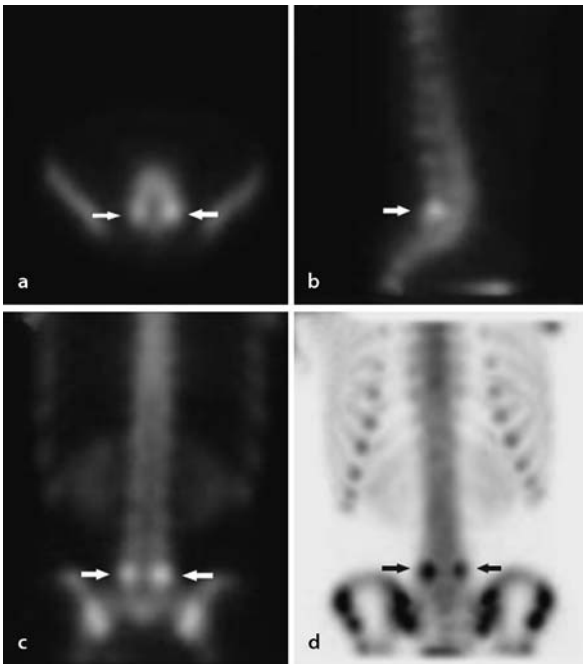


**Single Photon Emission Computed Tomography, Figure 2** A SPECT scan of a vertebral compression fracture in the lower thoracic spine. (a) Coronal view. (b) Lateral view. (c) Axial view. (d) The accompanying bone scan. Images provided by courtesy of Dr John Booker of Hunter Imaging Group and Sonic Health, Newcastle, Australia.

Although pseudoarthrosis can be detected, there is no evidence as yet, either that this abnormality is a cause of pain or that detecting it makes a difference to management. In young athletes with back pain, SPECT is far more sensitive than plain radiography for the detection of pars fractures. However, because SPECT shows increased blood flow, rather than the fracture itself, it lacks specificity. SPECT will be positive not only in patients with actual fractures but also in patients with stress reactions and incipient fractures. Supplementary CT is required to demonstrate the morphology of the abnormality detected by SPECT (Fig. 3).

Osteoid osteoma accounts for approximately 10% of benign bone tumours and frequently affects young adults in the second decade. Although more commonly found in the proximal femur and tibia, it can also affect the posterior elements of the spine. SPECT allows for localisation of the uptake to the posterior element of the spine rather than the anterior body or the pedicles, which are sites of malignant primary and metastatic neoplasm. Therefore with solitary lesions, metastatic malignant disease should be suspected when the area of increased uptake extends from the vertebral body into the pedicle, whereas simultaneous involvement of the vertebral body and a portion of the posterior arch is most often caused by benign conditions. For other lesions associated with back pain, SPECT has not been sufficiently evaluated for either validity or cost-effectiveness.

In the evaluation of hip pain, SPECT can be used to distinguish activity from overlying or underlying tissues that otherwise obscures structures at the depth of inter-



**Single Photon Emission Computed Tomography, Figure 3** A SPECT scan of a bilateral pars stress fracture. The arrows point to the areas of increased uptake in the pars interarticularis. (a) Axial view. (b) Lateral view. (c) Coronal view. (d) The accompanying bone scan. Images provided by courtesy of Dr John Booker of Hunter Imaging Group and Sonic Health, Newcastle, Australia.

est. Thus, the hyperaemia of the overlying soft tissues and the underlying acetabulum can be differentiated by SPECT from the abnormal activity of the femoral head in avascular necrosis.

Some practitioners have used SPECT to demonstrate the juxta-articular hyperaemia that occurs in some patients with complex regional pain syndromes. While perhaps satisfying, this is a superfluous diagnostic investigation. The diagnosis of complex regional pain syndrome is entirely clinical and does not require SPECT for confirmation.

For certain neurological disorders associated with pain, SPECT has potential, but still not proven, applications. To date, it has been used in an exploratory manner in experimental settings. In patients with migraine, SPECT has been used to demonstrate neurogenic inflammation of the meninges (Pappagallo 1999). During migraine, antidromic activity in trigeminal afferents and orthodromic parasympathetic vasodilatory activity increase the permeability of vessels in the meninges to molecules such as albumin. SPECT is able to detect this exudation. In this regard, however, SPECT is not diagnostic. Migraine is diagnosed by its clinical features. Rather, SPECT is a potential tool by which to explore the mechanisms involved in this condition.

SPECT has been used to explore possible neurological correlates with somatisation disorders. A small, initial study has suggested that somatisation disorders may be

associated with hypoperfusion of certain areas of the brain (Garcia-Campayo et al. 2001). It remains to be established, however, that these changes are specific to and biologically meaningful as the basis of somatisation disorders.

## References

1. Garcia-Campayo J, Sanz-Carrilo C, Baringo T et al. (2001) SPECT scan in somatization disorder patients: an exploratory study of eleven cases: *Aust NZ J Psych* 35:359–363
2. Littenberg B, Siegel A, Tosteson AN et al. (1995) Clinical efficacy of SPECT bone imaging for low back pain. *J Nucl Med* 36:1707–1713
3. Murray IPC (1994) Bone Scintigraphy: The Procedure and Interpretation. In: Murray IPC, Lell PJ (eds). *Nuclear Medicine in Clinical Diagnosis and Treatment*, vol 2. Churchill Livingstone, Edinburgh, pp 925–931
4. Pappagallo M (1999) The pain in migraine is not mainly in the brain. In: *Johns Hopkins Physicians Update* 11:2

## Single Unit Activity

### Synonyms

SUA

### Definition

A microelectrode in the extracellular space records action potentials that constitute the output signal of neurons. The active zone of a tungsten microelectrode has a length of a few  $\mu\text{m}$  tapered to a tip of  $< 1 \mu\text{m}$ , giving an impedance around  $0.5 \text{ M}\Omega$ . The signal is filtered from 300 Hz to 3000 Hz. On the basis of their size and shape, the action potentials are assigned to individual putative neurons.

► [Thalamotomy for Human Pain Relief](#)

S

## Single-Unit Recording

### Definition

Single-unit recording is a neurophysiological recording of a single neuron using a micro-electrode.

► [Insular Cortex, Neurophysiology and Functional Imaging of Nociceptive Processing](#)

## Sinus Thrombosis

### Definition

Sinus Thrombosis is a neurologic manifestation of Behçet's disease.

► [Headache Due to Arteritis](#)

## siRNA

### Definition

siRNA (small interfering RNA) are double-stranded RNA sequences, approximately 20 nucleotides in length, with characteristic 2–3 nucleotide 3' overhangs. Introduction of siRNA into cells activates a posttranscriptional gene silencing mechanism known as RNA interference (RNAi). siRNA are a relatively novel tool for inhibition of the synthesis of a protein of interest.

- ▶ [Purine Receptor Targets in the Treatment of Neuro-pathic Pain](#)

## Situational Assessment

### Synonyms

Job Site Evaluation

### Definition

Situational assessment is undertaken in the ordinary work environment during a visit to the client's ordinary workplace. It consists of systematic observation for assessing work-related behavior and occupational capabilities during the client's performance of ordinary work tasks. The observations are video-recorded and used for ergonomic and/or job analyses.

- ▶ [Vocational Counselling](#)

## Situational Factors

### Definition

Situational factors are a multiplicity of cognitive, behavioral and emotional factors whose interplay with the patient will greatly affect a child, whether to increase or decrease the child's pain, distress or disability.

- ▶ [Cancer Pain, Palliative Care in Children](#)

## Situational Pain Questionnaire

### Definition

Situational pain questionnaire refers to the application of statistical decision theory to the construction of, and the analysis of, responses to a pain questionnaire.

- ▶ [Statistical Decision Theory Application in Pain Assessment](#)

## Sjögren's Syndrome

### Definition

Sjögren's Syndrome is characterized by keratoconjunctivitis sicca and symptomatic xerostomia (the sicca-syndrome), and associated with the detection of anti-Ro (SSA – 97%) and anti-La (SSB – 78%) autoantibodies. It is the most frequent of the autoimmune diseases characterized by sicca syndrome, and is often combined with rheumatoid arthritis.

- ▶ [Headache Due to Arteritis](#)
- ▶ [Muscle Pain in Systemic Inflammation \(Polymyalgia Rheumatica, Giant Cell Arteritis, Rheumatoid Arthritis\)](#)

## Sjaastad's Syndrome

- ▶ [Paroxysmal Hemicrania](#)

## Skin Conductance-Assisted Relaxation

### Definition

A form of biofeedback that employs information about sweat gland activity in order to facilitate overall relaxation.

- ▶ [Biofeedback in the Treatment of Pain](#)

## Skin-Nerve Preparation

### Definition

The skin-nerve preparation is an *in vitro* preparation consisting of a patch of skin and its nerve supply. It is very useful for establishing the receptive field properties of individual neurons.

- ▶ [Nerve Growth Factor, Sensitizing Action on Nociceptors](#)

## Skin Nociception, Species Differences

- ▶ [Species Differences in Skin Nociception](#)

## Skin-to-Skin Contact

### Definition

Also known as kangaroo care: an infant is placed on his/her mother's bare chest during a painful procedure or for soothing after a painful procedure.

- ▶ [Acute Pain Management in Infants](#)



## SLE

- ▶ Systemic Lupus Erythematosus

## SLEA

- ▶ Sublenticular Extended Amygdala

## Sleep

### Definition

A physiological state usually characterized by isolation from the environment, except when an unpleasant or potentially harmful or life-threatening event is present.

- ▶ Orofacial Pain, Sleep Disturbance

## Sleep Disturbance

- ▶ Orofacial Pain, Sleep Disturbance
- ▶ Pain in Humans, Sleep Disturbances

## Sleep Fragmentation

### Definition

Interruption of any sleep stage by isolated or repetitive events such as sleep stage shifts (deeper to lighter), micro-arousal or awakening, short duration of deep St 3 & 4 sleep, or Alpha EEG wave intrusion. As a result, EEG frequency is in the fast range, heart rate is increased, muscle tone higher with occasional body movements. As a consequence, sleep continuity may be impaired and sleep complaints are frequent (e.g. un-refreshing).

- ▶ Orofacial Pain, Sleep Disturbance

## Sleep Stage

### Definition

A division of specific sleep period into sleep stages (St): light sleep (St 1 or 2), deep sleep (St 3 & 4) or Rapid Eye Movement (REM). Each sleep stage has its own EEG characteristics (frequency change or large amplitude signal such as K Complex in stage 2), heart rate and muscle tone, best demonstrated by polygraphic recording, which allows sleep stage scoring.

- ▶ Orofacial Pain, Sleep Disturbance

## Sleeping Nociceptor

- ▶ Silent Nociceptor

## Small-Caliber Afferent Fibers

- ▶ Spinal Dorsal Horn Pathways, Muscle and Joint

## Small Fiber Neuropathies

JOHN W. GRIFFIN

Department of Neurology, Departments of Neuroscience and Pathology, Johns Hopkins University School of Medicine, Johns Hopkins Hospital, Baltimore, MD, USA  
jgriffi@jhmi.edu

### Definition

The small fiber neuropathies are a group of disorders of diverse etiologies that have predominant involvement of A $\delta$  and C-fibers, with consequent impairment of nociception, variable degrees of autonomic dysfunction, and frequently neuropathic pain.

### Characteristics

The “small fibers” of the PNS include the A $\delta$  and C sensory fibers, the  $\gamma$  efferent fibers, and the preganglionic parasympathetic and postganglionic sympathetic C-fibers. In contrast, the large fibers of the PNS include the A $\beta$  afferents from skin, muscle, and the internal organs, as well as the  $\alpha$  motor neurons. Most disorders of the PNS are characterized by distally predominant loss of axons, a process often referred to as distal axonal degeneration or “dying back.” Distal axonal degeneration affects long fibers before shorter ones, with the distal-most regions of the long axons underlying pathologic changes that closely resemble Wallerian degeneration following axonal injury. With time, the process moves proximally up the long fibers, and shorter fibers become affected. This process can affect large caliber fibers, producing numbness in the toes, loss of the tendon reflexes at the ankle, and weakness in the toes and ankles. When distal axonal degeneration affects small fibers predominantly, there can initially be a loss of protective and nociceptive sensibility in the toes and feet, autonomic features such as orthostatic hypotension, and often spontaneous stimulus-independent neuropathic pain.

### Causes of Small Fiber Neuropathies

Neuropathies that can prominently or predominantly involve small fibers include diabetic polyneuropathy (Dyck and Dyck 1999); amyloid neuropathy, either heritable or associated with monoclonal gammopathies; the sensory neuropathy of AIDS; occasional patients with sarcoidosis; Fabry's disease, a sex-linked recessive disorder; some other types of inherited sensory neuropathy; and idiopathic painful polyneuropathy, a frequent problem that especially affects elderly individuals (Holland et al. 1998; Periquet et al. 1999).

The understanding of the relationship of SFN to diabetes is evolving. Symptomatic diabetic neuropathy usually occurs in the setting of longstanding, well-documented diabetes. However, recent studies have found that loss of small sensory fibers and autonomic dysfunction can occur early in the course of diabetes. Presentation with neuropathic pain can occur at the stage of impaired glucose tolerance, before frank diabetes supervenes (Singleton et al. 2001; Sumner et al. 2003).

### Clinical Manifestations

The term "small fiber neuropathy" implies the triad of loss of protective sensibility, presence of spontaneous neuropathic pain, and autonomic dysfunction. The portion of the "small fiber" spectrum that an individual physician sees is defined by his or her specialty and patient population. To neurologists, the most frequent cause of presentation is neuropathic pain. To generalists and diabetologists, presenting problems may reflect painless injuries or autonomic dysfunction alone. Examples include diabetic patients who develop painless ulcers or foot fractures without other neurologic symptoms, or diabetics who present with complaints of impotence in the absence of other symptoms.

Irrespective of the initial complaint, most patients will develop elevated pin and thermal thresholds in the feet and some elements of autonomic dysfunction. The feature that distinguishes small fiber neuropathies from large or mixed neuropathies is the absence of loss of tendon reflexes at the ankle, of joint position sensibility in the toes, or of strength in the intrinsic muscles of the feet and in the ankle dorsiflexors and everters.

The neuropathic pain is usually greatest in the feet, and with time may affect the fingers. Various adjectives are used to describe the pain, with "burning" among the most frequent. There are often superimposed lightning pains, sudden "stabbing" or "electric" pains in one limb that last for seconds to a minute or so. Patients frequently complain that the pain is worse at night, presumably reflecting the lack of distracting stimuli. The affected extremities may have hypalgesia to touch and temperature, hyperalgesia or allodynia to these modalities, or any variation.

Occasional patients have widespread small fiber loss and pain, involving the face, trunk, and arms as well as the legs (Holland et al. 1998). Such patients may well

have a sensory ganglionopathy or neuronopathy (see ► [ganglionopathies](#)), rather than a length-dependent process as the explanation for the widespread distribution of their involvement.

### Laboratory Tests for SFN

Several autonomic function tests that have been extensively used have well-established norms for the whole age range. They are limited by the fact that they are not widely available. Measures of cardiac and blood pressure regulation are most widely available. These tests include heart period variability (sinus arrhythmia) with standardized breathing, the Valsalva response, and measures of blood pressure changes in going from lying to standing or on a tilt table (Diem et al. 2003).

Sudomotor (sweat) testing is useful (Diem et al. 2003; Kennedy 2002; Low 1990). This approach allows assessment of regional differences in the body, including testing of the distal leg, the first region affected in most nerve diseases. Qualitative testing with dyes that change color with moisture, such as quinazarin and starch/iodine, can be done anywhere, but benefit from a controlled temperature/humidity room. Sweat production can be quantitated by silastic molds or by the quantitative sudomotor axon reflex test (QSART) (Low 1990). QSART is a measure of sudomotor function and requires specialized machinery. This test has been extensively validated, but is not widely available.

As a test of small fiber sensory function, quantitative thermal testing has been validated for a variety of instruments, but also has limited availability.

Skin biopsies can be used to study cutaneous nerve fibers, using selective immunocytochemical stains for specific C-fiber types (Herrmann et al. 1999; Holland et al. 1998; Kennedy and Wendelschafer-Crabb 1994). The technique is most highly developed for assessment of epidermal fibers. Most of these fibers are nociceptors. This technique offers the promise of being able to examine the same patient at multiple sites and at multiple times, creating a spatial and temporal picture of the degree of small fiber sensory loss. The use of punch skin biopsies with local anesthesia is well tolerated by patients. Normative data has been published, and the reproducibility and interobserver reliability are excellent (McArthur et al. 1998). Abnormalities on skin biopsy and QSART have a high degree of concordance, suggesting that small fiber involvement typically affects both somatic sensory and autonomic postganglionic C-fibers, although there can be specificity of involvement by fiber population.

Nerve biopsy can also be used to assess small fibers (Herrmann et al. 1999), and has the advantage that large fibers can be assessed on the same specimen. However, there are several limitations. Only a few nerves, such as the sural, superficial peroneal, and some cutaneous nerves of the forearm are suitable for biopsy. Assessment of C-fibers requires electron microscopy, and the quantitation

by EM morphometry is laborious. Only one site in time and space can be biopsied.

### Pathogenesis

It is widely accepted that neuropathic pain can be initiated by sensitization, hyperexcitability, and/or spontaneous discharge in primary afferent neurons, leading to “► **central sensitization**” or facilitation. When neuropathic pain of peripheral origin occurs in small fiber neuropathies, are spontaneous discharges in the degenerating small fibers driving the process? Or are the responsible nerve fibers their intact neighbors? Where in the afferent neuron does the spontaneous discharge arise, in the perikaryon, the degenerating terminal, or in intact terminals? The mechanisms by which degeneration of small sensory fibers including nociceptors generate neuropathic pain is not understood. An attractive hypothesis is that a new population of ion channels is inserted into the excitable membranes of the responsible neurons. Evidence that this mechanism can apply in man comes from erythromelalgia, a disorder characterized by marked heat hyperalgesia. Microneurographic studies identified a decrease in conduction velocity and an increase in activity-dependent slowing in C-fibers (Orstavik et al. 2003). In addition, C-fibers that would normally be classified as mechanically-insensitive afferents, based on their conduction properties, had mechanosensitivity, suggesting that sensitization of nociceptors may play a role in this disease. Recently, mutations in the Na channel Na(v)1.7 have been identified (Yang et al. 2004).

### Treatment

When possible, the treatment of the underlying disease should be treated. If there is loss of protective sensibility, protection from painless injury should be undertaken, as described in ► **Diabetic Neuropathy Treatment**. Education regarding the nature of neuropathic pain is often helpful; patients interpret the spontaneous pain as evidence of ongoing tissue damage. Understanding the pain as dysfunctional nerve fibers can be reassuring.

The first line medications of the neuropathic pain associated with SFN are anticonvulsants, and gabapentin is most widely used (Sindrup and Jensen 2000). An analog, pregabalin, has had reported efficacy in neuropathic pain. No head-to-head comparison with gabapentin is available. Carbamazepine and dilantin are alternatives for which some evidence of efficacy is available, and there are limited data surrounding lamotrigine (Sindrup and Jensen 2000).

There is increasing attention to serotonin-norepinephrine reuptake inhibitors, including duloxetine and venlafaxine. In older populations they are expected to provide a better safety profile compared to tricyclic antidepressants such as nortriptyline and amitriptyline.

Tramadol, an analgesic that acts through both opiate and non-opioid receptors, is a second line medication. In pa-

tients with severe pain not responsive to other modalities opiates, may be required. Opiates can be effective in neuropathic pain states (Raja et al. 2002).

### References

1. Diem P, Laederach-Hofmann K, Navarro X, Mueller B, Kennedy WR, Robertson RP (2003) Diagnosis of Diabetic Autonomic Neuropathy: A Multivariate Approach. *Eur J Clin Invest* 33:693–697
2. Dyck PJB and Dyck PJ (1999) Diabetic Polyneuropathy. In: Dyck PJ, Thomas PK (eds) *Diabetic neuropathy*. W.B.Saunders Company, Philadelphia, pp 255–278
3. Herrmann DN, Griffin JW, Hauer P, Cornblath DR, McArthur JC (1999) Epidermal Nerve Fiber Density and Sural Nerve Morphometry in Peripheral Neuropathies. *Neurology* 53:1634–1640
4. Holland NR, Crawford TO, Hauer P, Cornblath DR, Griffin JW, McArthur JC (1998) Small-Fiber Sensory Neuropathies: Clinical Course and Neuropathology of Idiopathic Cases. *Ann Neurol* 44:47
5. Kennedy WR (2002) Usefulness of the Silicon Impression Mold Technique to Evaluate Sweating. *Clin Auton Res* 12:9–10
6. Kennedy WR, Wendelschafer-Crabb G (1994). Quantification of Nerve in Skin Biopsies from Control and Diabetic Subjects. *Neurology* 44:A275
7. Low PA (1990) The Effect of Aging on Cardiac Autonomic and Post Ganglionic Sudomotor Function. *Muscle Nerve* 13:152–157.
8. McArthur JC, Stocks A, Hauer P, Cornblath DR, Griffin JW (1998) Epidermal Nerve Fiber Density: Normative Reference Range and Diagnostic Efficiency. *Arch Neurol* 55:1513–1520
9. Orstavik K, Weidner C, Schmidt R, Schmelz M, Hilliges M, Jorum E, Handwerker H, Torebjork E (2003) Pathological C-Fibres in Patients with a Chronic Painful Condition. *Brain* 126:567–578
10. Periquet MI, Novak V, Collins MP, Nagaraja HN, Erdem S, Nash SM, Freimer ML, Sahenk Z, Kissel JT, Mendell JR (1999) Painful Sensory Neuropathy: Prospective Evaluation Using Skin Biopsy. *Neurology* 53:1641–1647
11. Raja SN, Haythornthwaite JA, Pappagallo M, Clark MR, Trivison TG, Sabeen S, Royall RM, Max MB (2002) Opioids versus Antidepressants in Postherpetic Neuralgia: A Randomized, Placebo-Controlled Trial. *Neurology* 59:1015–1021
12. Sindrup SH, Jensen TS (2000) Pharmacologic Treatment of Pain in Polyneuropathy. *Neurology* 55:915–920
13. Singleton JR, Smith AG, Bromberg MB (2001) Painful Sensory Polyneuropathy Associated with Impaired Glucose Tolerance. *Muscle Nerve* 24:1225–1228
14. Sumner CJ, Sheth S, Griffin JW, Cornblath DR, Polydefkis M (2003) The Spectrum of Neuropathy in Diabetes and Impaired Glucose Tolerance. *Neurology* 60:1081–1111
15. Yang Y, Wang Y, Li S, Xu Z, Li H, Ma L, Fan J, Bu D, Liu B, Fan Z, Wu G, Jin J, Ding B, Zhu X, Shen Y (2004) Mutations in SCN9A, Encoding a Sodium Channel Alpha Subunit, in Patients with Primary Erythromelalgia. *J Med Genet* 41:171–174

S

## Small Fiber Neuropathy/Polyneuropathy

### Definition

Peripheral nerve disorders mainly affecting thin myelinated (A-delta) and unmyelinated (C-) fibers (small fibers).

- **Diabetic Neuropathy, Treatment**
- **Toxic Neuropathies**

## Small Fibers

### Definition

A collective term for small myelinated axons, unmyelinated axons, and small-diameter axons.

- ▶ Toxic Neuropathies

## SMP

- ▶ Sympathetically Maintained Pain
- ▶ Sympathetically Maintained Pain, Clinical Pharmacological Tests
- ▶ Sympathetically Maintained Pain in CRPS I, Human Experimentation

## SMT

- ▶ Spinomesencephalic Tract

## SNI Model

- ▶ Neuropathic Pain Model, Spared Nerve Injury

## SNL

- ▶ Spinal Nerve Ligation Model

## SNL Model

- ▶ Neuropathic Pain Model, Spinal Nerve Ligation Model

## SNP

- ▶ Single Nucleotide Polymorphisms

## Social Dislocation and the Chronic Pain Patient

RANJAN ROY  
Faculty of Social Work and Department of Clinical Health Psychology, Faculty of Medicine, University of Manitoba, Winnipeg, MB, Canada  
roy@cc.umanitoba.ca

### Synonyms

Disruption; Displacement

### Definition

Dislocation and loss of social roles associated with chronic pain are legion. They occur mainly in three areas, namely, work, family relations and social life.

### Characteristics

The magnitude of social upheaval caused by chronic pain disorders is significant for many patients. Generally, a pain patient seen at a pain clinic has failed to respond to the ministrations of modern medicine. She/he has lived with the pain for many months or even years by the time the patient arrives at a pain clinic. The descent of a person into chronic patienthood, and the new reality of this world, constitutes the central feature of this chapter. Many patients lose most of their valued roles, and the chronic sick role tends to loom large in their lives.

### The World of Work

There can be little debate about the beneficial outcome of pain management programs, even in terms of patients returning to work following treatment. On the other hand, many patients do not. This job loss has profound consequences. At its simplest, it calls for a redefinition of self. A person's sense of whom and what she/he is tends to be closely tied to what one does. "What do you do?" is probably one of the most oft asked questions in social situations. Work is often at the center of one's self-image, and constitutes the core identity. Hence, the loss of that identity for many patients poses an emotional and intellectual challenge of a magnitude that becomes the source of much grief and even depression. This process of redefinition of self, inevitably in the negative direction, and the associated sense of loss are the two binding themes of this chapter.

Loss of work, for many patients and their families, translates into loss of income, loss of social standing, loss of friends and mates, and social isolation is not an unknown outcome. For many patients there is no greater insult than their inability to earn a living. Work for many is not a means to an end, but an end in itself. Job loss for health reasons that cannot always be medically substantiated, and challenged by employers, insurance companies and workers compensation board, creates an untenable situation for the patient. Anger combined with humiliation and grief is not an uncommon presentation for these patients. Loss of the occupational role is extraordinarily undesirable, and has consequences for every aspect of a person's life. However, the impact of unemployment that results from chronic pain has received scanty attention from researchers.

When unemployment is caused by accidents and health problems, then it carries additional burdens of coping with poor health as well as unemployment. Both chronic pain and unemployment are known to produce similar negative consequences. Both generate family conflict, depression, ▶ [somatization](#) disorders, social isolation



and loss of roles. Unemployment also contributes to family violence, family crisis, health problems, and suicide (Roy 2001). A major Canadian study involving 14,313 subjects revealed the far reaching consequences of unemployment (D'Arcy and Siddique 1987). Significant health differences emerged between the employed and the unemployed: the unemployed showing a higher level of distress, short and long-term disabilities, numerous health problems, and proportionately greater utilisation of health services. Interaction effects of socioeconomic status and demographic variables showed an association of employment status and emotional health. The blue-collar workers were more prone to physical illness in contrast to white-collar workers, who seemed more prone to emotional distress. Low-income unemployed, who were the principal wage earners, were the most psychologically distressed. An inescapable truth is that the pain clinic population is well-represented by this last group. It serves as a double-edged sword, because insufficient education is a known barrier to returning to work among individuals suffering from arthritis and musculoskeletal disorders. Fear of lay-off and unemployment is common in workers with low-back strain injuries, resulting in lost time.

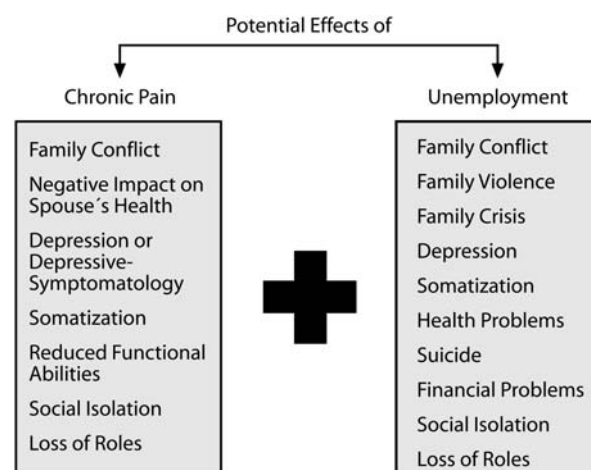
A high rate of unemployment among chronic pain patients was reported in a comparative study of headache and back pain patients that was designed to grade the severity of chronic pain (Stang et al. 1998). The sample consisted of 662 headache and 1024 backache subjects. Over the study period of three years, 13% of headache subjects and 18% of back pain subjects were unable to obtain or keep full-time work due to their pain conditions. Among the employable, 12% head and back pain subjects, respectively, were unemployed. Grading of chronic pain emerged as a significant factor in predicting disability, and the highest grade of chronic pain predictably showed the highest levels of affective distress. Unemployment was strongly associated with pain grade, which has great significance for the population attending pain clinics, whose pain levels are generally very high.

Studies investigating the consequences of the added burden of unemployment in the chronic pain population are few and far between. Jackson and associates (Jackson et al. 1998) investigated the complex nature of the effects of unemployment in a group of 83 chronic pain subjects and 88 healthy controls. After controlling for length of current unemployment and number of pain sites, several psychosocial measures, such as structured and purposeful time-use, perceived financial security, and social support from formal sources, were the most powerful predictors of emotional distress. Structured and purposeful time-use emerged as the most significant predictor of emotional distress for both groups. This study addressed in a most comprehensive way some of the consequences of chronic pain and unemployment and their power to predict emotional distress.

► **Depression**, or at least many depressive symptoms, is ubiquitous in the chronic pain population. As previously noted, unemployment, on the basis of limited data, is high in this population. Averill and associates (Averill et al. 1996) investigated the impact of unemployment on depression in 300 patients randomly selected from 1000 patients referred to a pain clinic. A remarkable 67% of the subjects were unemployed. A statistically significant association was found between work-related variables and Beck Depression Inventory (BDI). Unequivocal support was found for an association between unemployment and increased depressive symptomatology. A Swedish study reported higher levels of depression in a group of unemployed women compared to an employed group (Hall and Johnson 1998). Their results showed that even after controlling for social support, stressful life-events, and marital status, depression on the basis of BDI was higher in the unemployed group. Pervasive feelings of social isolation, embarrassment, mild depression, and a generally low life-satisfaction were reported in an investigation of 73 unemployed workers over the age of 50 (Rife and First 1989). Shame appears to be a common response to unemployment, associated with guilt, poorer mental health and not infrequently, clinical depression (Eales 1998).

A Norwegian investigation of the effects of long-term unemployment in a group of 270 subjects reported the prevalence of depression, anxiety, and somatic illness was 4–20 times higher than a control group of employed persons at baseline (Classen et al. 1993). A striking finding was that the chances of reemployment were reduced by 70% among those with a psychiatric diagnosis. This study is of special relevance to the chronic pain population, many of whom fall into the long-term unemployment category, and many of whom have major and minor psychiatric diagnoses.

S



**Social Dislocation and the Chronic Pain Patient, Figure 1** Potential effects of Chronic Pain and Unemployment.

The double jeopardy of chronic pain and unemployment often creates an untenable situation for pain patients. Chronic pain and unemployment often create the same problems. Both give rise to family conflicts; depression and somatization; social isolation; financial difficulties; and loss of roles. Unemployment is associated with a rise in family violence and suicide. The level of vulnerability for chronic pain patients is significantly worsened by the problem of unemployment (see Fig. 1).

### Family Relations

Family disruption caused by chronic and debilitating illness including chronic pain is considerable. Research into this important topic is extensive, all pointing in the direction that many and varied aspects of family functioning is placed under jeopardy by chronic pain in a family member. Research in one critical area, namely, what may constitute healthy functioning for a family with a chronic pain patient in its midst, is non-existent. Should this resemble "normal" families as proposed by family researchers? Do these families learn to function effectively without necessarily emulating normal families?

The research literature reveals the diversity and complexity of family problems encountered by the chronic pain families. Findings are contradictory, and to-date there is no adequate way of judging what may be construed as optimum functioning for families with chronic patients in their midst. Family system-based studies have yielded very contradictory findings. Two family functioning scales, Family Environment Scale (FES) and Family Adaptability and Cohesion Evaluation Scale (FACES) are the most common measures of family functioning in the chronic pain literature. Studies vary widely in the specifics of what precise family function may be adversely affected by chronic pain. Findings based on both these scales, on the one hand, show extensive family dysfunction in almost every aspect of family life and, on the other hand, virtually normal family functioning (Roy 2001).

Prima facie, a review of the literature leads to a predictable conclusion, that no aspect of family functioning remains unaffected by chronic pain. Family roles, communication, capacity for expression of positive feelings, family cohesion, family's capacity for adapting to a person with chronic illness, family organization and family cohesion all fall prey to chronic pain.

The following three studies investigated family functioning from a broad perspective and reported similar findings. One of earlier qualitative studies investigated family functioning of 12 back pain and 20 headache patients and their families (Roy 1989). The study was based on the author's personal knowledge of these patients and their families. Roy's assessment of these families was based on the McMaster Model of Family Functioning (MMFF). MMFF assesses the following dimensions of family functioning: 1) problem solving,

2) communication, 3) roles, 4) affective responsiveness, 5) affective involvement, and 6) behavior control.

The capacity to solve problems was compromised for 75% of back pain families and 100% of headache families; communication was at the pathological end of the continuum for 50% of back pain and 75% of the headache families. Direct and clear communication was supplanted by unsatisfactory communication patterns. Another incidental finding was the actual amount of communication between the family members and the patient declined.

Problems related to role functioning was pervasive. Nurture and support related roles were ineffective for 75% of back pain and 100% of headache families. Children were the main victims of the failure of this critical aspect of family life. Marital and sexual gratification declined for 75% of back pain and 60% of headache families. Occupational and household roles were compromised for 50% of the back pain group, but the headache group remained unaffected.

These families' capacity to express a wide range of emotions or their affective responsiveness was seriously compromised. Nearly 65% of both groups expressed difficulties in this area. Not only did they fail to express the whole range of emotions, they were inclined to show their negative emotions more readily than positive feelings. Their capacity for empathic involvement was also hampered, and 83% of back pain families and 60% of headache families were found wanting. Finally, in the area of behavior-control, which deals with family rules, 83% and 80% of back and head pain families, respectively, were encountering difficulties. This particular aspect of family life has special implications for families with children.

This was a qualitative study and the findings were based on extensive family interviews. The interviews were anchored to the MMFF. No specific family functioning instruments were used. The objective of this study was to develop a comprehensive picture of how families were affected in their day-to-day functioning when an adult, usually a parent, was afflicted with a chronic pain disorder.

One American study employed the survey method to assess the social and personal impact of headache in a community sample of headache sufferers in Kentucky (Kryst and Scherl 1994). A total of 647 persons were assessed for serious headache. The 12-month period of prevalence for all serious headaches was 13.4%. A vast majority of these patients, 73.6%, reported that headache had adversely affected at least one aspect of their lifestyle. Of these 20% of men and 62% of women reported negative effects on their family relations. In addition, efficiency at work, attending social events, capacity for planning ahead, relations with friends, and self-image suffered for a significant proportion of this population. It is reasonable to assume that given the global impact virtually in every aspect of living

for these patients, that many dimensions of family life would have been disrupted.

In a nationwide survey of 4000 persons, Smith (Smith 1998) identified 350 migraine sufferers of whom 269 were female and 81 males. This is an important study exploring many aspects of family life. Sixty-one percent reported that their headache had a significant impact on their families. Most families were either sympathetic or understanding of the member with headache. Nevertheless, headache delayed or postponed household duties for nearly 79% of the respondents, and another 64% reported that activities with children and spouses were adversely affected.

The household activities delayed or postponed included 81% delaying or postponing house cleaning and yard-work, 79% laundry and shopping, 76% cooking, 69% activities with spouse, 62% activities with children, and 18% stayed in bed.

Social activities were either cancelled or postponed, albeit by a smaller number of patients. One striking finding was that 61% of the subjects had to give up parental care for children under 12. This included 61% canceling plans for playing, helping with homework or spending time together. Sixty-six percent of the children kept quiet, 25% of the children became confused and another 17% were hostile. This is an impressive catalogue of problems that affected younger children.

For the older children between the ages of 12 and 17, 87% stopped playing music or engaged in any noisy activities, 61% stopped asking questions or for help with homework, 42% stopped inviting friends home and 34% stopped visiting friends. However, children over 12 showed more understanding (87%) and 42% were helpful. Finally, 25% of the migraine sufferers reported that their headaches had a negative effect on their relationship with their spouse or partner. For a full 24% of the respondents, frequency and/or quality of sexual relations fell. However, only 5% reported divorce and another 5% cited headache as a cause for separation from a spouse or partner.

This study, painted with a broad brush, leaves little room for doubt that migraine produces significant problems for the families, and that role related activities are seriously compromised. By extension, an argument can be made that the affective aspects of family life were also adversely affected. The author concluded that ‘... the patients’ family should not be ignored when treating the individual patient and that appropriate involvement of the family may be indicated.’

These three studies taken together show the extent of the damage that chronic pain inflicts on families. Family roles, communication, marital relations, relations with children are all affected by parental chronic pain. One central issue that needs to be addressed is how to determine effective family functioning in families with chronic pain patients. These survey type studies present a more comprehensive picture of the problems encoun-

**Social Dislocation and the Chronic Pain Patient, Table 1** Distribution of family problems in a group of chronic pain patients (Roy 1989) Subjects: n = 12 with chronic back pain, n = 20 with chronic headache

Family Problems Reported	Back pain	Headache
Problem Solving	75%	100%
Communication	50%	75%
Role Function (Marital/Sexual)	75%	100%
Household Roles	50%	Nil
Affective Responsiveness	65%	65%
Absence of Empathic Involvement	83%	60%

**Social Dislocation and the Chronic Pain Patient, Table 2** Distribution of family problems in a community sample of headache sufferers (Kryst and Scherl 1994)n = 647

At least one aspect of lifestyle affected:	73.6%
Family relations adversely affected: Men	20%
Family relations adversely affected: Women	62%

In addition

- Efficiency at work
  - Attending social events
  - Capacity for planning ahead
  - Relations with friends
- were issues for a majority of patients

**Social Dislocation and the Chronic Pain Patient, Table 3** Distribution of family problems in a community sample of migraine sufferers (Smith 1998)n = 350, female = 269, male = 81

Negative Impact on family	61%
Postponed Household Duties	79%
Postponed Housecleaning and Yard-work	81%
Postponed laundry and shopping	79%
Postponed cooking	76%
Postponed activities with spouse	69%
Postponed activities with children	62%
Stayed in bed	18%
Given up parental care on children under12	61%
Negative impact on partner relationship	25%
Decline in sexual relations	24%

tered by chronic pain families. The other point of note is the high level of agreement between the studies about the pervasiveness of family problems. The findings of these three studies are presented in the following tables (see Table 1, 2, 3).

**Social Disruption**

The loss of a support system for chronic pain patients, especially those seen in pain clinics, is sadly a common



tale. Common sense dictates that persistent and severe pain narrows or eliminates social interaction. When job loss is added, the sense of isolation for some patients becomes almost as intolerable as the pain itself.

As a starting point, the nature of interaction between an individual and the social support system is explored. It is convenient to visualize the support system as informal, semiformal and formal. Within the confines of the informal system, it is usual to have partners, close relatives, children, parents, grandparents, and perhaps close friends. The semi-formal system represents work, church, stores, voluntary associations, family physicians and so on. The formal systems consist of medical services, workers compensation board, unemployment insurance, Canada Pension, courts, police, and so on. Close listening to the patients reveals an interesting pattern in relation to the social system network. As their interaction with informal and semiformal systems shrink, their involvement with the formal systems tends to rise.

### Social Support and Headache

The literature on the role of social support and headache is a collection of studies without benefit of a central theme, such as testing the buffering role of social support. The literature is more concerned with the lack of social support or the need for its availability. Martin and Theunissen (Martin and Theunissen 1993) compared 28 subjects with chronic headaches with two individually matched control groups in terms of life-events, stress, coping skills, and social support. The headache group scored significantly lower on social support compared to the control groups. No differences were found on life-events, stress or coping between the groups. The authors suggested that clinicians should make some effort to mobilize social support, and that effective social support should be considered a desirable treatment goal. Lack or ineffective use of social support was noted in a study of 87 undergraduates with recurrent tension headaches, compared to 177 healthy subjects in a matched control group (Holm et al. 1986). Headache subjects relied on ineffective coping strategies of avoidance and self-blame, and made less use of social support than did normal controls. In another study involving Australian and American undergraduate students, a major finding was that the prevalence of headache was three to four times higher among American students than their Australian counterparts (Martin and Nathan 1987). A greater incidence of stressors and a deficient social support system accounted for much of the difference between the two groups. A study involving 62 adult chronic headache sufferers and 64 non-headache controls (Martin and Soon 1993) found that it was not just the ineffective use of social support that was problematic, but a lack of satisfaction with the available support. However, support measures did not reveal any linear relationship with chronicity of headache. They made a plea for greater attention from clinicians and re-

searchers to the social dimension of headache. Another study noted poorer social support in 24 female patients with cluster headache compared to randomly selected and age-matched migraine sufferers (Blomkvist et al. 1997). However, cluster headache patients were found to be significantly more positive as to their anticipated activities in the future compared to migraine patients. The consequences for the lack of social support were not addressed.

These studies on the whole failed to make a compelling case for the value of social support, and relied on the proposition of the intrinsic merit of such support. Nevertheless, a couple of these studies made a strong plea that the social dimensions of headaches, including social support, should be an integral part of a clinical investigation.

### Chronic Low Back Pain (CLBP) and Social Support

A handful of studies investigated the influence of social support on CLBP. These studies generally confirmed the value of social support in coping with CLBP. Social support appears to have the capacity to enable CLBP patients to gain good pain control. That was one of the findings of a study involving 95 African-American CLBP patients (Klapow et al. 1995). Twenty-five subjects, categorized with chronic pain syndrome, reported greater life adversity, more reliance on passive-avoidant coping strategies, and a less satisfactory network. In contrast, subjects reporting good pain control reported less adversity, less reliance on passive-avoidant coping strategies, and a more satisfactory social support network. A third group comprised of 24 subjects presented a mixed picture, to the extent that they reported less life adversity, but more reliance on passive-avoidant coping strategies and more satisfactory social support network. Their adaptation to pain was positive. Two points are noteworthy: Firstly, a social support network was only one of the psychosocial factors predicting good pain control; and second, the concept of a social support network was not distinguished from intimate social support.

A Swedish study that looked beyond intimate social support and involved a non-clinical population of 90 registered nurses found that social support from co-workers, in addition to psychological demands, authority over decisions, and skill utilization, had a significant effect on the symptoms of low-back pain (Ahlberg-Hulten and Theorell 1995). However, neck and shoulder pain were only related to support at work. The latter finding was telling in terms of the role of social support in mitigating shoulder and neck pain. However, from a theoretical or clinical perspective, the reasons for social support being more effective with one kind of pain than another remain unclear.

In another Swedish study, involving 22,180 employees, 31% reported neck pain and 39% reported back pain (Linton 1990). Lifting, monotonous work tasks, vibration, and uncomfortable work postures were the



most important ergonomic factors. Work content and social support were the critical psychosocial factors. The combination of a poor psychosocial work environment and exposure to one of the ergonomic variables produced the highest risk factors. In other words, inadequate social support emerged as a very critical factor in predicting high risk for back pain.

Trief and colleagues (Trief et al. 1995) investigated the role of social support in the mitigation of depression in 70 patients with CLBP. The depressed patients differed from the non-depressed patients in their perceived social support and family environment. A noteworthy finding was that depression did not appear to have any association with rehabilitation outcomes. Clearly, susceptibility to depression in CLBP patients is related to the availability of social support, and to that extent, this study furnishes further evidence for the stress-buffer model for social support.

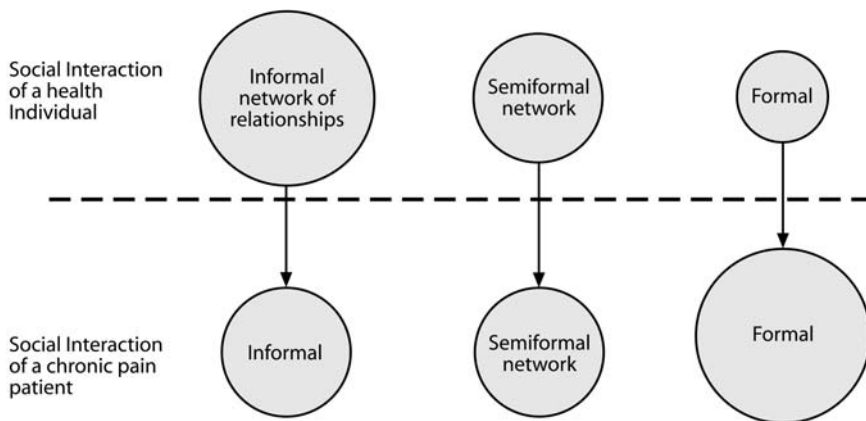
It is virtually impossible to draw any general conclusions on the basis of a handful of rather varied studies on social support and CLBP. While these studies confirm the usefulness of social support in preventing depression or coping more effectively with pain, they vary widely in scope and methodology. From a clinical perspective, they lend further credence to the necessity of careful assessment of the patient's social support system. Yet, a common clinical observation that the social network for chronic pain patients tends to shrink over time has yet to be empirically confirmed (see Fig 2).

**Conclusion**

Significant losses of valued social roles demanding a re-definition of one's sense of self or identity underpin the

struggle for chronic pain patients. A patient's familiar assumptive world is turned upside down. This chapter is a conscious attempt to emphasize the "social" in the biopsychosocial perspective of chronic pain. There is truly no debate about the significance of social factors in complicating medical disorders, and yet as a focus of research, the social aspects of chronic pain disorders still remains the least investigated. Not a single study is to be found on the global consequences of chronic pain. Job loss, disruption to family relationships, reduced physical capacity, increased social isolation for the patient combined with decline in spousal health, and disruptive behavior in children is not as exaggerated a scenario as one might be inclined to think. For many chronic pain patients, if pain was the only problem they had to deal with, life for them would be a great deal more tolerable. Unfortunately, chronic pain disorders have a way of imposing related and yet unforeseen problems that tend to make coping with pain much more onerous. A simple fact that depression and chronic pain together predict a poor outcome illustrates this point. Not infrequently, the root cause for depression is to be found in the altered circumstances of the patients.

Deliberate and well-planned social interventions to address specific problems needs to be incorporated into the overall management and treatment of our patients. Great strides have been made in relation to psychological treatment of chronic pain, but that cannot be said for social interventions. While at a common sense level clinicians of every stripe fully appreciate the importance of the patient's environment, for reasons that remain unclear, their social problems are seldom addressed. On



**Examples of support systems**

Informal systems	Semiformal systems	Formal systems
Spouses/partners Children Parents Friends/relatives Close friends Neighbours	Workplace Church Volunteer organization Family physicians	Medical services WCB Insurance companies Legal systems Canada pension

**Social Dislocation and the Chronic Pain Patient, Figure 2** Representation of social network.

the other hand, when the social problems are assessed alongside the medical and psychological ones, patients become the main beneficiaries of such a comprehensive approach. Research is rather silent on this topic. There is no empirical evidence to suggest that recognition and treatment of social problems alongside medical and psychological improves outcome. While researchers may want to sort that out, at a clinical level, the patients' need for help with social problems cannot and should not be ignored.

The way ahead is to pay heed to the social environment of the patient. Pain clinics must incorporate routine social assessment of each patient alongside medical and psychological. Finally, a case is presented that captures the essence of social dislocation.

Mr. Albert, in his mid30's was involved in a work-related accident, which had profound impact on every aspect of his life. He was married man with a baby daughter. He was in the construction business and had a reputation for his knowledge of commercial constructions. His wife worked, and together they generated a substantial income. He enjoyed a very close relationship with his parents. He was a churchgoer, had an extensive network of friends, and belonged to a number of social organizations.

The accident, which occurred at a construction site, was initially not thought be serious. While lifting heavy material, he slipped and fell, sustaining bruises on his buttocks and back. He was off work for a few days, seemingly made a complete recovery and returned to his job. He soon discovered that he was experiencing severe back pain, especially while lifting. He persisted until his pain worsened to the point that he had to take time off work. His employer remained very sympathetic to Mr. Albert's situation. That was about to change.

Mr. Albert sought medical treatment, and after extensive radiological, orthopedic and neurological investigations, he was pronounced fit. He was incredulous as his pain continued to worsen. He filed for worker's compensation, which was denied. As a starting point, he was left with no income and a very painful lower back. He was in the early stages of conflict with three key systems, medical, employer and the worker's compensation board. His problems were just beginning. An immediate consequence of the action of these three organizations was a precipitous drop in his income. Thus began his struggle on the domestic front as well as the world outside.

Regarding his trials and tribulations on the domestic front, a great reversal of fortune occurred along with an equally measurable change in his roles and attitudes. Sexual activities came to a halt. Mr. Albert assumed the role, albeit grudgingly, of a homemaker and babysitter, since they could no longer afford daycare. This family had no savings and they were forced into finding cheaper accommodation. All this time, Mr. Albert was not so gradually sinking into a chronic sick role. Level

of tension between him and his wife became palpable, and his pain continued unabated.

Mr. Albert's search for a medical cure gained momentum. He saw several specialists and sub-specialists including a psychiatrist, but all the findings were negative. In the meantime, strained finances created serious tensions in family relationships. Social outings, family get-togethers, even church and social activities were abandoned. All this happened in a matter of six months. His pain continued to be a mystery. Hopelessness and helplessness were the overpowering emotions he experienced, at the basis of which was a terrific loss of self-esteem as man, a father, a partner and a provider. This is a summary of the information obtained during a routine psychosocial assessment at the point of Mr. Albert's admission to a pain clinic. His story is not unique among chronic pain sufferers.

## References

- Ahlberg-Hulten G, Theorell T (1995) Social Support, Job Strain and Musculo-Skeletal Pain among Female Health Care Personnel. *Scand J Work Environ Health* 21:435-439
- Averill P, Novy D, Nelson D et al. (1996) Correlates of Depression in Chronic Pain Patients: A Comprehensive Examination. *Pain* 65:93-100
- Blomkvist V, Hannerz J, Orth-Gomer K et al. (1997) Coping Styles and Social Support in Women Suffering from Cluster Headaches or Migraine. *Psychother Psychosom* 66:150-154
- Classen B, Bjorndal A, Hjort P (1993) Health and Re-Employment in a Two-Year Follow-Up of Long-Term Unemployed. *J Epidemiol Community Health* 47:14-18
- D'Arcy C, Siddique C (1987) Unemployment and Health: An Analysis of Canada Health Survey@ Data. *Inter. Int J Health Serv* 15:609-635
- Eales M (1998) Depression and Anxiety in Unemployed Men. *Psychol Med* 18:935-945
- Hall E, Johnson J (1998) Depression in Unemployed Swedish Women. *Soc Sci Med* 27:134-135
- Holm J, Holroyd V, Hursey K et al. (1986) The Role of Stress in Recurrent Tension Headache. *Headache* 26:160-167
- Jackson T, Lezzi A, Lafreniere K et al. (1998) Relations of Employment Status to Emotional Distress among Chronic Pain Patients: A Path Analysis. *Clinical Journal of Pain* 14:55-60
- Klapow J, Slater M, Patterson T et al. (1995) Psychosocial Factors Discriminate Multidimensional Clinical Groups of Chronic Low-Back Patients. *Pain* 62:349-355
- Kryst S, Scherl E (1994) A Population Based Survey of the Social and Personal Impact of Headache. *Headache* 34:344-350
- Linton S (1990) Risk-Factors for Neck and Back Pain in a Working Population in Sweden. *Work and Stress* 4:41-49
- Martin P, Nathan P (1987) Differential Prevalence Ratio for Headaches: A Function of Stress and Social Support. *Headache* 27:292-333
- Martin P, Soon K (1993) The Relationship between Perceived Stress, Social Support and Chronic Headache. *Headache* 33:307-314
- Martin P, Theunissen C (1993) The Role of Life-Event Stress, Coping and Social Support in Chronic Headache. *Headache* 33:301-306
- Rife J, First R (1989) Discouraged Older Workers: An Exploration Study. *Int J Aging Hum Dev* 29:195-203
- Roy R (1989) *Chronic Pain and the Family: A Problem Centered Perspective*. Human Sciences Press, New York
- Roy R (2001) *Social Relations and Chronic Pain*. Kluwer Academic/Plenum Publishers, New York
- Smith R (1998) Impact of Migraine on the Family. *Headache* 38:424-426

20. Stang P, Von Korff M, Galer BS (1998) Reduced Labor Force Participation among Primary Care Patients with Headache. *J Gen Intern Med* 13:296–302
21. Trief P, Carnrike C, Drudge O (1995) Chronic Pain and Depression: Is Social Support Relevant? *Psychol Rep* 76:27–236

## Social Learning

### Definition

The process by which individuals acquire knowledge about different aspects of their social environment. This may include experience, behavioral consequences (e.g. reward vs. punishment) or observation. In short, it is a term used to describe the process by which new behaviors are learned through observation.

- ▶ Behavioral Therapies to Reduce Disability
- ▶ Psychology of Pain, Self-Efficacy

## Social Learning Theory

### Definition

A psychological theory, proposed by Albert Bandura, in which the importance of observing and modeling the behaviors, attitudes, and emotional reactions of others is emphasized.

- ▶ Impact of Familial Factors on Children's Chronic Pain

## Social Security Disability Insurance

### Synonyms

SSDI

### Definition

The Social Security Disability Insurance (SSDI) is a national program administered by the Social Security Administration that provides disability benefits to disabled workers insured under the Social Security Act, children of insured workers who become disabled before age 22, and disabled widows or widowers and certain surviving divorced spouses of insured workers.

- ▶ Disability Evaluation in the Social Security Administration

## Social Stressors

- ▶ Stress and Pain

## Social Support

### Definition

Social support generally refers to the availability or provision of instrumental and/or emotional assistance from significant others.

- ▶ Spouse, Role in Chronic Pain

## Socioeconomic Factors

- ▶ Pain in the Workplace, Risk Factors for Chronicity, Workplace Factors

## Sodium Channel

### Definition

A large transmembrane protein found in excitable cells that selectively allows sodium ions to cross the cell membrane in response to membrane depolarization. In axons, the influx of sodium ions initiates and restores the action potential.

- ▶ Demyelination

## Sodium Channel Blockers

### Definition

A chemical substance that will selectively block the movement of ions through a particular ion channel, e.g. TTX blocks some voltage-gated sodium channels. Sodium channel blockers are drugs used for epilepsy; however, the drugs are also effective in various neuropathic pain conditions, as for example trigeminal neuralgia, and may also be effective in phantom pain.

- ▶ Postoperative Pain, Postamputation Pain, Treatment and Prevention

## Sodium Pump

### Definition

The sodium-potassium ATP-ase. Specialized membrane protein that utilizes metabolic energy (ATP) to move sodium ions out of the cell in exchange for slightly fewer potassium ions.

- ▶ Nociceptors, Action Potentials and Post-Firing Excitability Changes

## Soft Tissue Manipulation

- ▶ [Massage and Pain Relief Prospects](#)

## Soft Tissue Pain Syndromes

### Synonyms

STP Syndromes

### Definition

A generic term used to include painful medical conditions, such as bursitis, tendinitis, complex regional pain syndrome (CRPS), myofascial pain syndrome (MPS), and fibromyalgia syndrome (FMS), which substantially contribute to morbidity and physical dysfunction in the general population.

- ▶ [Muscle Pain, Fibromyalgia Syndrome \(Primary, Secondary\)](#)

## Soft Tissue Rheumatism

- ▶ [Myofascial Pain](#)

## Softener

### Definition

A softener is a laxative drug whose principal mode of action is to make the bowel movement softer and therefore easier to pass.

- ▶ [Cancer Pain Management, Gastrointestinal Dysfunction as Opioid Side Effects](#)

## Solicitous

### Definition

Manifesting or expressing attentive care and protectiveness that is full of concern or fear.

- ▶ [Assessment of Pain Behaviors](#)

## Solicitous Responses

### Definition

Solicitous responses are defined as a set of positive responses (e.g. expressions of sympathy, taking over duties and responsibilities) delivered by significant others, including the spouse or family members, contingent on display of pain behaviors.

- ▶ [Spouse, Role in Chronic Pain](#)

## Solicitousness

- ▶ [Spouse, Role in Chronic Pain](#)

## Soma

### Synonyms

Perikarya

### Definition

Soma refers to the cell body of the neurone, which accommodates its nucleus and the main part of its synthesis machinery such as the endoplasmic reticulum, ribosomes, Golgi complex and mitochondria.

- ▶ [Nociceptors, Action Potentials and Post-Firing Excitability Changes](#)
- ▶ [Spinothalamic Tract Neurons, Morphology](#)

## Somatic Dysfunction

### Definition

Somatic dysfunction is the impairment or altered functioning of the related elements of the musculoskeletal system. This is characterized by asymmetry of bony landmarks, altered articular mobility and tissue texture abnormality.

- ▶ [Chronic Pelvic Pain, Physical Therapy Approaches and Myofascial Abnormalities](#)

## Somatic Pain

PAUL M. MURPHY

Department of Anaesthesia and Pain Management,  
Royal North Shore Hospital, St Leonard's, NSW,  
Australia  
drpmurphy@hotmail.com

### Definition

This term is derived from the Greek *σῶμα*, meaning body. In principle, somatic pain is pain evoked by nociceptive information arising from any of the tissues that constitute the structure of the body. These would include the bones, muscles, joints, ligaments, and tendons of the spine, the trunk, and the limbs; but technically they would include also the skull, the pachymeningeal coverings of the brain and spinal cord, and the teeth. More explicitly, somatic pain, is used to distinguish pain that does not arise from the viscera, i.e. internal organs, of the body. Pain from those structures is referred to as ▶ [Visceral Nociception and Pain](#). Similarly, pain from the head or skull is referred to as ▶ [headache](#), and pain



from the teeth is ► **dental pain**. Consequently, somatic pain is effectively restricted to refer to pain arising from musculoskeletal structures, the limbs, the spine, the chest wall, and the abdominal wall.

Somatic Pain is typically described as aching or stabbing. It is localized to the area of tissue injury or stimulation, and may follow the distribution of a nerve root or peripheral nerve. A pivotal feature of somatic pain is that it is caused by the stimulation of the nerve endings of the peripheral nerves that innervate the tissues that are the source of pain. This feature distinguishes somatic pain from ► **neuropathic pain**, ► **neuralgia**, and ► **radicular pain**, in which the source of nociception lies in axons of the affected nerve. In this respect, somatic pain and visceral pain do not differ. Both are evoked by the stimulation of free nerve endings. In mechanism and clinical features both are quite similar. They differ only with respect to the classification of the tissues from which they arise. Both somatic pain and visceral pain can be referred to remote sites. Although the mechanism of referral is similar, the clinical features of each differ (see ► **Somatic Referred Pain** and ► **Visceral Referred Pain**).

## Characteristics

### Background

► **Specificity theory** suggests that the ► **somatosensory** system processes sensory modalities by means of specific receptors and neuroanatomical pathways, although this view is less rigid than previously thought. As early as 1906 it was proposed that cutaneous receptors responding to noxious stimuli should be termed nociceptors (Sherrington 1906).

### Nociceptors

Nociceptors in the skin and other deeper somatic tissues such as the periosteum are morphologically free nerve endings or simple receptor structures. A noxious stimulus activates the nociceptor, depolarising the membrane *via* a variety of stimulus specific ► **transduction** mechanisms. C polymodal nociceptors are the most numerous of somatic nociceptors and respond to a full range of mechanical, chemical and thermal noxious stimuli (see ► **noxious stimulus**). These nociceptors are coupled to unmyelinated C fibres. Electrophysiological activity in these slow conduction C fibres is characteristically perceived as dull, burning pain. Faster conducting A $\delta$  fibres are coupled to more selective thermal and mechanothermal receptors considered to be responsible for the perception of sharp or “stabbing” pain (Julius and Basbaum 2001).

### Spinal Cord Integration

The majority of somatic nociceptive neurons enter the dorsal horn spinal cord at their segmental level. A proportion of fibres pass either rostrally or caudally in ► **Lissauer’s tract**. Somatic primary afferent fibres

terminate predominantly in laminae I (marginal zone) and II (► **substantia gelatinosa**) of the ► **dorsal horn**, where they synapse with projection neurons and excitatory/inhibitory ► **interneurons**. Some A $\delta$  fibres penetrate more deeply into lamina V (Parent 1996).

Projection neurons are classified as:

1. Nociceptive specific (NS):
  - respond exclusively to noxious stimuli
  - small receptive field
  - predominate in lamina I
  - also in laminae II and V
2. Low threshold neurons (LT):
  - respond to innocuous stimuli only
  - laminae III, IV
3. Wide dynamic range neurons (WDR):
  - input from wide range of sensory afferents
  - large receptive field
  - predominate in lamina V (also in I)

The amino acids ► **glutamate** and ► **aspartate** are the primary ► **neurotransmitters** involved in spinal excitatory transmission. Fast post-synaptic potentials generated *via* the action of glutamate on AMPA receptors are primarily involved in nociceptive transmission. Prolonged C fibre activation facilitates glutamate-mediated activation of ► **NMDA receptors** and subsequent “► **wind-up**”. The peptidergic neurotransmitters ► **substance P** and calcitonin G related peptide (CGRP) are co-produced in glutamatergic neurons and released with afferent stimulation. These transmitters appear to play a neuromodulatory role facilitating the action of excitatory amino acids. A number of other molecules including glycine, ► **GABA**, somatostatin, endogenous opioids and endocannabinoids play modulatory roles in spinal nociceptive transmission (Fürst 1999).

S

### Supraspinal Somatic Pain Pathways

Nociceptive somatic input is relayed to higher cerebral centres *via* three main ascending pathways (Basbaum and Jessel 2000).

1. Spinothalamic path:
  - originates in laminae I and V–VII
  - composed of NS and WDR neuron axons
  - projects to thalamus *via* lateral tracts (► **neospinothalamic tract**) and medial tracts (► **paleospinothalamic tract**)
  - lateral tract passes to ventral posterior lateral (VDL) nucleus and subserves discriminative components of pain
  - medial tract is responsible for autonomic and emotional components

- additional fibres pass to ► [reticular activating system](#) (arousal response) and the periaqueductal grey matter (PAG) (► [descending modulation](#))
2. Spinoreticular pathway:
    - originates in laminae VII and VIII
    - terminates predominantly on the medial medullary reticular formation
  3. Spinomesencephalic pathway:
    - originates in laminae I and V
    - terminates in midbrain
    - projects to mesencephalic PAG
    - not essential for pain perception but appears to modulate afferent input

### Cortical Representation of Somatic Pain

Multiple cortical areas are activated by nociceptive afferent input including the primary and secondary somatosensory cortex, the insula, the anterior cingulate cortex and the prefrontal cortex. Pain is a multidimensional experience with sensory-discriminative and affective-motivational components. Advances in functional brain imaging have allowed further understanding of the putative role of cortical structures in the pain experience. The primary and secondary somatosensory cortices and the insula predominantly subserved pain intensity. The prefrontal cortex, right posterior cingulate cortex and the brainstem/periventricular grey matter play important roles in interpreting pain intensity. The affective unpleasant sensation of pain appears to be subserved by the left anterior cingulate cortex, while the right anterior cingulate cortex, left thalamus and frontal inferior cortex play important roles in somatic

- [pain threshold](#) (Treede et al. 1999).
- [Cancer Pain Management, Overall Strategy](#)
- [Cancer Pain Management, Treatment of Neuropathic Components](#)
- [Chronic Pelvic Pain, Musculoskeletal Syndromes](#)
- [Diagnosis of Pain, Epidural Blocks](#)
- [Rest and Movement Pain](#)
- [Taxonomy](#)

### References

1. Basbaum AI, Jessel TM (2000) The perception of pain. In: Kandel ER, Schwartz JH, Jessel TM (eds) *Principles of Neural Science*. McGraw-Hill, New York, pp 472–91
2. Fürst S (1999) Transmitters involved in antinociception in the spinal cord. *Brain Res Bull* 48:129–41
3. Julius D, Basbaum AI (2001) Molecular mechanisms of nociception. *Nature* 413:203–7
4. Parent A (1996) *Carpenter's Human Neuroanatomy*. Williams & Wilkins, Baltimore MD
5. Sherrington CS (1906) *The Integrative Action of the Nervous System*. Scribner, New York
6. Smullen DH, Skilling SR, Larson AA (1990) Interactions between Substance P, calcitonin gene related peptide, taurine and excitatory amino acids in the spinal cord. *Pain* 42:93–101
7. Treede R-D, Kenshalo DR, Gracely RH et al. (1999) The cortical representation of pain. *Pain* 79:105–11

## Somatic Referred Pain

DAVID ROSELT

Aberdovy Clinic, Bundaberg, QLD, Australia  
droselet@aberdovy.com.au

### Synonyms

Referred pain

### Definition

Referred pain is pain perceived in a region innervated by nerves other than those innervating the source of the pain (Bogduk 1987; Merskey 1994). Somatic referred pain is explicitly somatic pain that becomes referred. The term is used to distinguish referred pain that arises from the musculoskeletal tissues of the body from ► [visceral referred pain](#).

### Characteristics

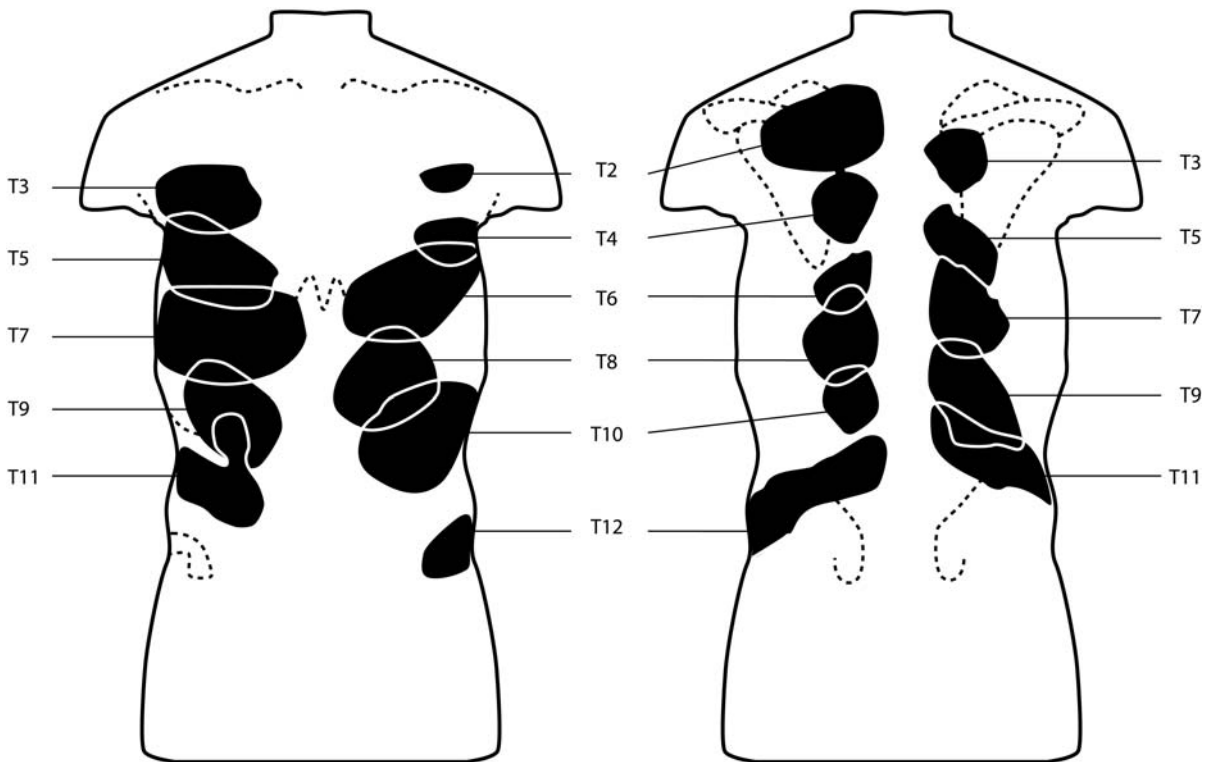
The physiological basis of referred pain is convergence. Common neurons in the spinal cord and thalamus receive sensory input from different peripheral sites, and relay this onto higher centres. Under those conditions, and in the absence of additional sensory input to clarify the situation, the brain is unable to identify the source of the pain accurately, and attributes it erroneously to the entire area subtended by the common neurons (Bogduk 1987). Somatic referred pain typically occurs when the source of pain lies in a deep musculoskeletal structure, from which the brain is unaccustomed to receiving nociceptive input. Ambiguity as to the source of information arises, either or both, because the painful structure is not densely innervated, and the central pathways along which the information is relayed are not highly organized somatotopically. In essence, the ambiguity is “built in” to the nervous system.

### Nature

Much of our understanding of referred pain arose from clinical experiments by Kellgren in the late 1930s (Bogduk 2002; Kellgren 1938; Kellgren 1939). He showed that noxious stimulation of muscle using injections of hypertonic saline, produced local and referred pain that was diffuse and often perceived as being removed from the site of stimulation. In the limbs, muscle pain tended to be referred towards the joint upon which the muscle acted (Kellgren 1938).

When investigating spinal referred pain by injecting interspinous ligaments with hypertonic saline, Kellgren (1939) found that stimulation of thoracic segments produced referred pain in the posterior and anterior chest wall (Fig. 1). Injection into the cervical and lumbar segments produced referred pain in the upper and lower limbs, respectively (Fig. 2 and 3).

These experiments showed that spinal pain could arise from noxious stimulation of intrinsic structures of the



**Somatic Referred Pain, Figure 1** Patterns of referred pain produced by noxious stimulation of the thoracic interspinous ligaments at the segments indicated. Based on Kellgren (1939).

vertebral column, and produce pain referred to the trunk and limbs. This was in the face of the prevailing wisdom and contemporary assumptions (that persist today) that referred pain from the spine could only be caused by nerve root compression (Bogduk 2002).

Nerve root compression may cause ► **radiculopathy**, which is conduction block resulting in numbness and or weakness. It may cause ► **radicular pain**, which is pain arising from irritation of a spinal nerve or its roots. This pain has a different quality and distribution from somatic referred pain, and is due to ectopic activation of the nerve root axons or dorsal root ganglia, rather than stimulation of peripheral nociceptors (Bogduk 1987; Merskey 1994).

Somatic referred pain occurs in a segmental distribution, and such stimulation of successively lower spinal segments produces pain in successively more caudal regions of the trunk or limbs (Fig. 1, 2, and 3). This segmental pattern, however, does not correspond to dermatomes. Kellgren's work was subsequently reproduced by others (Feinstein et al. 1954) who produced maps of referred pain similar to those of Kellgren. The patterns of distribution of pain from a given segment are not identical between studies, and differ between individuals. Nevertheless, all studies showed a segmental pattern.

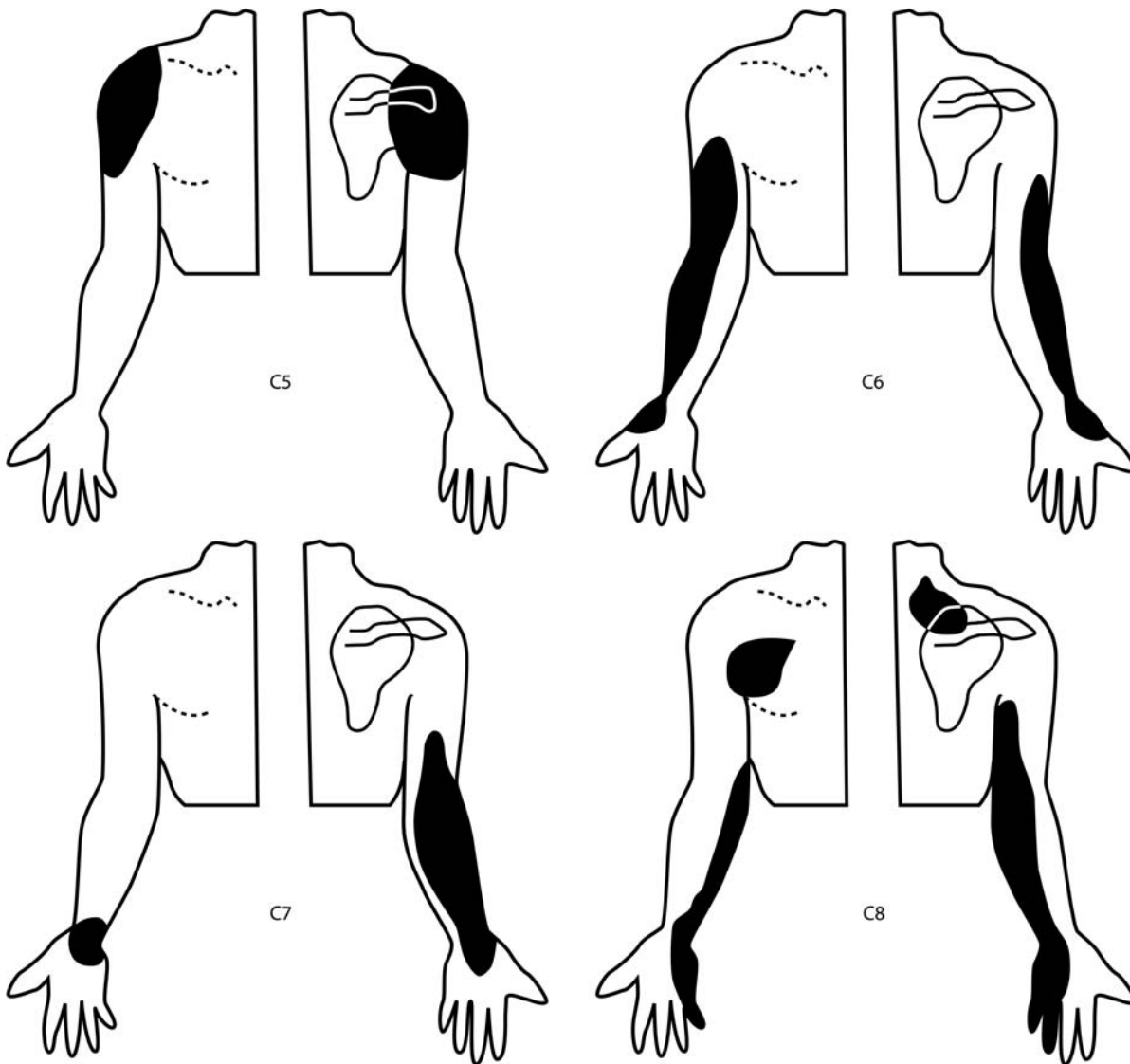
Inman and Saunders (1944) published an influential paper that firmly introduced the concept of sclerotomes. They proposed that sclerotomes represented the seg-

mental pattern of innervation of skeletal tissues, and were different from dermatomes and myotomes. However, although conceptually attractive, this concept is poorly founded.

Dermatomes are the areas of skin supplied by individual spinal nerves. They were first mapped by studying the zones of eruption of vesicles in herpes zoster, which provide a physical tracer of segmental nerves. Subsequently, they were corroborated by studies of the zones of sensory loss following dorsal rhizotomy (Bogduk 2002). In this regard, dermatomes have a tangible, anatomical substrate.

Myotomes are the groups of muscles supplied by a given spinal nerve. They were derived from mapping zones of weakness after segmental nerve injury, and reinforced by mapping EMG activity in response to electric stimulation of segmental nerves (Bogduk 2002). Therefore, they too, have an anatomical substrate.

In contrast, no anatomical substrate for sclerotomes has been established. No one has traced the segmental innervation of skeletal tissues. Sclerotomes were only inferred to exist simply because pain from deep, skeletal tissues, seemed to follow a segmental pattern. The maps published by Inman and Saunders (1944) were idealized and not based on published quantitative data (Bogduk 2002). They did not take into account the variance between individuals and between studies, in the patterns of somatic referred pain. This variance suggests that the



**Somatic Referred Pain, Figure 2** Patterns of referred pain produced by noxious stimulation of the cervical interspinous ligaments at the segments indicated. Based on Kellgren (1939).

purported pattern of segmental innervation of deep tissues is not consistent. Alternatively, and furthermore, pattern referral may be more due to differences in central connections of deep somatic afferents, than to patterns of peripheral innervation.

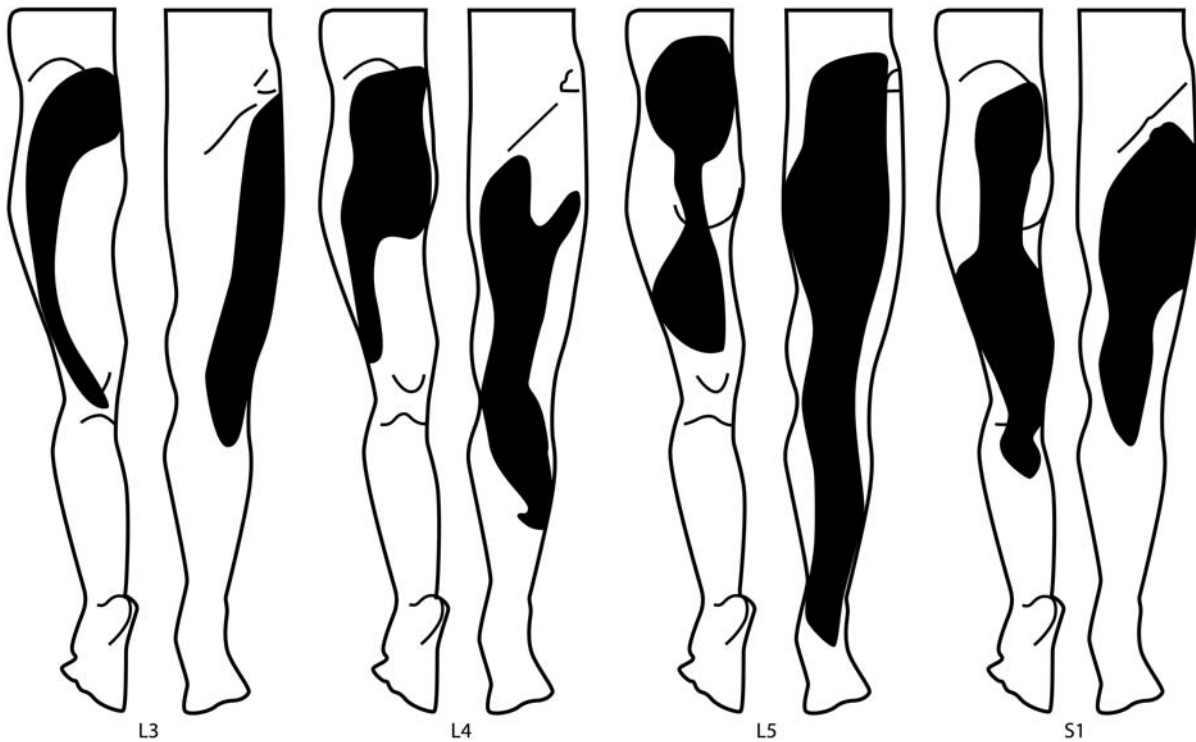
Kellgren's work was extended, when researchers from the mid-1970s onwards investigated patterns of referred pain from structures more likely to be clinically relevant than the interspinous ligaments.

Mooney and Robertson (1976) injected hypertonic saline into the lower lumbar zygapophysial joints in normal volunteers, and produced low back pain with referral to the lower limbs. This knowledge was then applied to relieve similar clinical pain, by injecting local anaesthetic and steroid into patient's lumbar zygapophysial joints.

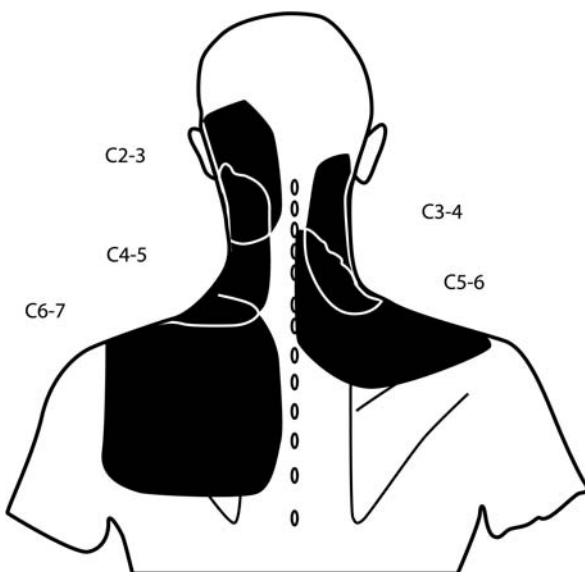
Others have reproduced or emulated this study, using intra-articular injections and electrical stimulation, to confirm that the lumbar zygapophysial joints can be a source of referred pain into the buttock and lower limb (Bogduk and McGuirk 2001). Studies have also shown that noxious stimulation of lumbar intervertebral discs (O'Neill et al. 2002) and the sacroiliac joint (Fortin et al. 1994) can produce referred pain into the lower limb. The patterns of pain from lumbar structures, however, are too variable to be used to infer the segmental location of the source of pain.

In contrast, noxious stimulation of the zygapophysial joints of the cervical spine causes pain in distinctive patterns, which can be reliably used to pinpoint the segmental source of pain (Bogduk 2003) (Fig. 4). According to their segmental location, these joints refer pain





**Somatic Referred Pain, Figure 3** Patterns of referred pain produced by noxious stimulation of the lumbar interspinous ligaments at the segments indicated. Based on Kellgren (1939).



**Somatic Referred Pain, Figure 4** Patterns of referred pain produced by noxious stimulation of the cervical zygapophysial joint or the cervical intervertebral discs.

to the shoulder girdle or into the head (Bogduk 2003; Bogduk 2004). The same segmental patterns apply to cervical intervertebral discs (Grubb and Kelly 2000). Somatic referred pain can be associated with muscle spasm in the areas of referred pain. Mooney and Robert-

son (1976) found that referred pain from the lumbar zygapophysial joints was associated with involuntary activity in the hamstring muscles, and demonstrated this with EMG. This phenomenon was explored by Bogduk (1980), who replicated Kellgren's experiments. Referred pain produced by injecting the lower lumbar interspinous ligaments with hypertonic saline was associated with involuntary muscle activity in the multifidi, tensor fasciae latae, and gluteus medius muscles. This activity started shortly after the onset of pain, and disappeared as the pain passed over the next few minutes (Bogduk 1980).

#### Clinical Features

All the experimental studies on somatic referred pain have consistently shown that it has a characteristic quality. It is felt deeply, and is aching in quality, or like an expanding pressure. It expands to encompass a broad area. Once established, its location remains constant. Subjects or patients are aware of its distribution in a general sense; they can clearly identify the centroid of the distribution; but its boundaries are hard to define.

These features distinguish somatic referred pain from radicular pain and **neuropathic pain**, which differ in quality. Radicular pain is typically shooting or lancinating in quality and extends along a narrow band. Neuropathic pain is usually burning in quality and is associated with sensory disturbances. Somatic referred pain is not associated with neurological abnormalities.

Making the distinction between somatic referred pain and radicular or neuropathic pain is crucial, for the investigation and subsequent treatment of these different types of pain are distinctly different. Confusing or misrepresenting one for the other becomes a recipe for failure and misadventure.

### References

1. Bogduk N (1980) Lumbar Dorsal Ramus Syndrome. *Med J Aust* 2:537–541
2. Bogduk N (1987) *Clinical Anatomy of the Lumbar Spine and Sacrum*, 3rd edn. Churchill Livingstone, Edinburgh, pp 187–213
3. Bogduk N (2002) The Physiology of Deep Somatic Pain. *Australasian Musculoskeletal Medicine* 7:6–15
4. Bogduk N (2003) The Anatomy and Pathophysiology of Neck Pain. *Phys Med Rehabil Clin N Am* 14:455–472
5. Bogduk N (2004) The Neck and Headaches. *Neurol Clin N Am* 22:151–171
6. Bogduk N, McGuirk B (2001) *Medical Management of Acute and Chronic Low Back Pain. An Evidence-Based Approach*. Elsevier, Amsterdam, pp 9–10
7. Feinstein B, Langton JNK, Jameson RM (1954) Experiments on Pain Referred from Deep Somatic Tissues. *J Bone Joint Surg* 35A:981–987
8. Fortin JD, Dwyer AP, West S (1994) Sacroiliac Joint: Pain Referral Maps Upon Applying a New Injection/Arthrography Technique: Part 1: Asymptomatic Volunteers. *Spine* 19:1475–1482
9. Grubb SA, Kelly CK (2000) Cervical Discography: Clinical Implications from 12 Years of Experience. *Spine* 25:1382–1389
10. Inman VT, Saunders JBD (1944) Referred Pain from Skeletal Structures. *J Nerv Ment Dis* 99: 660–667
11. Kellgren JH (1938) Observations on Referred Pain Arising from Muscle. *Clin Sci* 3:175–190
12. Kellgren JH (1939) On the Distribution of Pain Arising from Deep Somatic Structures with Charts of Segmental Pain Areas. *Clin Sci* 4:35–46
13. Merskey H, Bogduk N (1994) Classification of Chronic Pain. Descriptions of Chronic Pain Syndromes and Definitions of Pain Terms, 2nd edn. IASP Press, Seattle, pp 11–16
14. Mooney V, Robertson J (1976) The Facet Syndrome. *Clin Orthop* 115:149–156
15. O'Neill C, Kurgansky M., Derby R et al. (2002) Disc Stimulation and Patterns of Referred Pain. *Spine* 27:2776–2781

## Somatic Sensory and Intralaminar Nuclei of Thalamus

### Definition

Nuclei that transmit input from the dorsal column nuclei and STT to the cortex.

- ▶ [Deep Brain Stimulation](#)

## Somatic Sensory Nucleus of Human Thalamus

### Definition

Relevant to the discussion of plasticity is the principle somatic sensory nucleus of the thalamus (ventral posterior-VP, also known as ventral caudal - Vc).

- ▶ [Thalamus, Receptive Fields, Projected Fields, Human](#)

## Somatization

### Definition

The tendency to use numerous physical symptoms to express emotional distress.

- ▶ [Pain in the Workplace, Risk Factors for Chronicity, Psychosocial Factors](#)
- ▶ [Pain, Psychiatry and Ethics](#)
- ▶ [Recurrent Abdominal Pain in Children](#)

## Somatization and Pain Disorders in Children

JANET W. M. ELLIS

Department of Anaesthesia, Divisional Centre for Pain Management and Pain Research, The Hospital for Sick Children, Toronto, ON, Canada  
joostjanet@rogers.com

### Synonyms

Somatoform disorder; somatoform pain disorder; Pain Amplification Disability Syndrome; Psychogenic Pain Disorder; conversion disorder; Somatization Disorder; Pain Disorder in Children; Body Dysmorphic Disorder; hypochondriasis

### Definition

Somatization and Pain Disorders are types of psychiatric disorders in children defined within the major diagnostic category of Somatoform Disorders, Diagnostic and Statistical Manual of Mental Disorders, 4<sup>th</sup> edn (American Psychiatric Association 2000). The essential feature of Somatization Disorder is a pattern of recurring, multiple, clinically significant somatic complaints. A complaint is considered clinically significant when the individual seeks medical treatment or has impaired social or physical functioning. The somatic complaints begin before 30 years of age and cannot be fully explained by any known general medical condition or the direct effects of a substance. The essential feature of Pain Disorder is pain in one or more anatomic sites, causing significant distress or impairment, and psychological factors are thought to be important in the genesis, exacerbation and maintenance of the condition. In these ▶ [somatoform disorders](#), children express their emotional distress through physical distress and symptoms. Although children experience somatic distress and symptoms that are not caused by pathological findings, they attribute those symptoms to physical illness and seek medical help.

### Classifications

The specific DSM IV criteria for classifying Somatoform Disorders are listed below. If an individual with Somatoform Disorder also has a medical condition,

**Somatization and Pain Disorders in Children, Table 1** Comparison of Somatoform Disorders

	Somatization Disorder	Conversion	Pain Disorder		Body Dysmorphic Disorder
Main features	Recurrent, multiple, chronic, somatic complaints not accounted for by medical findings	Symptoms affecting voluntary motor or sensory systems, suggesting neurological disorder, preceded by stress	Pain is the predominant focus of treatment, psychological factors affect onset, severity, exacerbation, and maintenance	Fear of, or belief that one has a serious illness despite adequate medical evaluation and reassurance, NOT DELUSIONAL	Imagined ugliness, NOT DELUSIONAL INTENSITY
Age of onset	<30	10–35	Any age	Early adulthood	Adolescence
Associated features	Repeated work-ups, multiple physicians, inconsistent history, chaotic lives	La belle indifference, suggestible symptoms do not conform to anatomical pathways	Disability, social isolation, search for the cure	Repeated work-ups, doctor shopping, childhood illness	Frequent checking, avoidance, feeling mocked by others; surgery makes it worse
Co-morbid	+/-	+/-	Common	Infrequent	No
Medical illness					
Epidemiology	0.2–2% women, 0.2% men	25% of medical out-patients	?	4–9% medical out-patients	?
Gender	Women > men	2:1–10:1 women > men	Equal	Equal	Equal
Course	Chronic	Usually self-limited, 25% recur in one year	Variable, often Chronic	Chronic, waxes and wanes	Chronic
Secondary gain	+/-	+/-	+	+/-	-
Family history	Somatization disorder, antisocial, substance abuse	Conversion disorder	Depression alcohol abuse, pain disorder	Illness in family member when a child	
Co-morbid psychiatric illness	Major depression, panic, substance abuse, personality disorder	Dissociative disorder, PTSD, depression	Substance abuse, depression, anxiety	Anxiety, depression	Depression, delusional disorder, social phobia, OCD, suicide
Treatment	Regular appointments, maintain vs. cure	Suggest cure, examine stress, no need to confront	Avoid iatrogenesis, multi-modal treatment, care not cure	? Selective serotonin reuptake inhibitors	Prevent iatrogenesis, SSRI, ?antipsychotics

Reproduced with permission from: Brusco C, Geringer E (2004) Somatoform Disorders. In: Stern TA, Herman JB (eds) Massachusetts General Hospital Psychiatry Update and Board Preparation, McGraw-Hill, p138

that condition does not fully account for the functional impairment (Fritz et al. 1997). Although adolescents with complex chronic pain may exhibit many features of Somatoform Disorders, a formal diagnosis of many somatoform disorders is rare for children with pain because of a lack of developmentally appropriate diagnostic criteria. For example, only postpubertal and/or sexually active patients would satisfy the sexual criterion for Somatization Disorder, as shown in Table 1.

Diagnostic criteria for 300.81 Somatization Disorder (Reproduced with permission from: Diagnostic and Statistical Manual of Mental Disorders 4<sup>th</sup> edn (2000), American Psychiatric Association, pp 490

- a) A history of many physical complaints beginning before age 30 years that occur over a period of several years and result in treatment being sought or significant impairment in social, occupational, or other important areas of functioning.
- b) Each of the following criteria must have been met, with individual symptoms occurring at any time during the course of the disturbance:
  1. four pain symptoms: a history of pain related to at least four different sites or functions (e.g. head, abdomen, back, joints, extremities, chest, rectum, during menstruation, during sexual intercourse, or during urination)

2. two gastrointestinal symptoms: a history of at least two gastrointestinal symptoms other than pain (e.g. nausea, bloating, vomiting other than during pregnancy, diarrhea, or intolerance of several different foods)
  3. one sexual symptom: a history of at least one sexual or reproductive symptom other than pain (e.g. sexual indifference, erectile or ejaculatory dysfunction, irregular menses, excessive menstrual bleeding, vomiting throughout pregnancy)
  4. one pseudoneurological symptom: a history of at least one symptom or deficit suggesting a neurological condition not limited to pain (conversion symptoms such as impaired coordination or balance, paralysis or localized weakness, difficulty swallowing or lump in throat, aphonia, urinary retention, hallucinations, loss of touch or pain sensation, double vision, blindness, deafness, seizures; dissociative symptoms such as amnesia; or loss of consciousness other than fainting)
- c) Either (1) or (2):
1. after appropriate investigation, each of the symptoms in Criterion B cannot be fully explained by a known general medical condition or the direct effects of a substance (e.g. a drug of abuse, a medication)
  2. when there is a related general medical condition, the physical complaints or resulting social or occupational impairment are in excess of what would be expected from the history, physical examination, or laboratory findings.
- d) The symptoms are not intentionally produced or feigned (as in Factitious Disorder or Malingering).

### Prevalence

While 25–44% of children report recent histories of somatic complaints such as headaches (Taylor et al. 1996), these symptoms are transient and do not cause significant distress. Campo et al. (1999) reported that almost 3% of 11–15 year olds attending a pediatric service had frequent complaints of pain and frequent pain-related doctor visits, while 10–30% of school age and adolescent children experience weekly symptoms. However, only a few studies have applied DSM-III criteria, and none DSM-IV criteria, for diagnosing specific disorders, so that the number of cases that meet the diagnostic criteria for somatoform disorder is much smaller. Offord and colleagues (1987) found recurrent distressing somatic symptoms in 10.7% of girls, and 4.5% of boys aged 12–16. In a small sample, Garber and colleagues (1991) reported that about 1% of children had sufficient somatization symptoms to qualify for somatization disorder. Up to puberty, there is no difference between girls and boys, but after puberty, ratios of between 3:1 and 6:1 have been reported (Campo et al. 1999).

### Characteristics

#### Developmental Considerations

Some degree of somatization is normal in young children (Fritz et al. 1997). Preschool children may express their pain, depression, fear, and anxiety behaviorally (Sifford 2003). Children who are anxious about attending school may express their anxiety through headaches, stomachaches or other physical symptoms (Garralda 1999), while adolescents are more likely to experience chronic daily headaches.

#### Contributing Factors

Many factors influence the development of the pain experience and expression of the somatization or pain: previous pain experience, physiologic, sensory, cognitive, emotional, behavioral, affective, sociocultural, developmental, familial factors, as well as any comorbid psychiatric condition (usually depression or anxiety). The circumstances surrounding the physical symptom or pain may also invest it with meaning. For example, illness and injury may lead to normal fear, anxiety and sadness, and fear of death, but can also lead to an increasing experience of distress along the continuum.

#### Assessing the Child with Somatoform Disorder

At specialized pain clinics, team members typically assess the extent to which behavioral and psychological factors are influencing children's pain and disability. After reviewing the child's pain history, medical diagnostic tests, and completing a physical examination, the team notes a major (or sometimes subtle) discrepancy between the child's somatic complaints and physical findings that may account for those complaints. In further discussion with children and parents, the team explores the potential impact of emotional factors, such as parental anxiety, school related stress, or children's extremely high standards for achievement. Typically, families believe that any emotional stress is a direct effect of the pain and ensuing disability, rather than a causative or contributing factor.

Pain teams will generally encourage children to resume activities, using appropriate analgesics for pain relief. However, teams should also introduce the concept of chronic pain as a complex bio-psycho-social problem that requires psychological or psychiatric assistance, as well as medical and physical. Other diagnoses that should be considered for children with continuing chronic pain and increasing disability in the absence of physical findings are malingering and **► Munchausen's by Proxy**. Children with possible psychiatric disorders should be referred for a formal psychiatric diagnosis, with a treatment plan coordinated between the pain team and psychiatrist.

Comorbid psychiatric conditions often complicate the presentation and the management of Somatoform Disorders. Children may have a co-existing depressive, anxiety or obsessive compulsive disorder. Conversely, soma-



tization may represent the common presentation of other psychiatric disorders in the primary care setting (Campo and Fritsch 1994).

The lack of definitive data on the prevalence of somatoform disorders in children and adolescents makes it difficult to determine the extent to which children with pain and psychiatric disorders are identified and appropriately managed. This is important, as pain management in the context of somatization requires a thorough understanding of the patterns and processes involved in order to manage it effectively. Similarly, a pain team may have a patient with a pain disorder and significant psychiatric disorder, but may not have the expertise necessary to treat the psychiatric disorder. Two important solutions include the presence of a psychiatrist on the Pain Team, and diligent communication between all healthcare specialists and the primary care physician.

Children with psychiatric disorders and pain problems may be at special risk for continuing pain and increasing disability. Failure to recognize the emotional source for pain and clearly communicate the diagnosis to parents, will lead to continued health care visits as parents seek an explanation and treatment for their child's physical symptoms. Moreover, parents may ignore the factors contributing to children's emotional distress so that they persist and often intensify. Ultimately, a cycle of doctor shopping, increased disability, heightened risk of iatrogenic illness, persistent suffering, and burgeoning health care costs begins and may continue for years. The child often misses many months or even years of school and one parent may give up work to stay at home and attend appointments.

#### Life Events

Several life events may be particularly relevant for children with pain and psychiatric disorders. Pediatric patients often experience family crises including divorce, discord, birth of a sibling, and recent death of a close relative. The child may present with a mixed picture of depressive features of an **► Adjustment disorder**, and also with a Somatization disorder.

A history of physical or sexual abuse seems to be another specific predictor. Haugaard (2004) reported that somatization and other somatoform disorders are likely to occur more frequently in children and adolescents who have been severely maltreated than in others. Adult somatization has been linked to physical, emotional and especially sexual abuse in childhood (Walker et al. 1992).

#### Family Factors

Minuchin et al. (1975) identified family risk factors for Somatization: enmeshment, overprotectiveness, rigidity, and lack of conflict resolution. Family intervention in this case involves challenging the family, re-labeling of symptoms, and supporting increased independence in the patient. Somatoform disorders are often a huge

burden to parent-child relationships and disrupt family functioning, hence the importance of the family therapy and guidance (Garraida 1999).

#### Treatment and Management

Few studies have evaluated the available treatments for children with somatoform disorders. Outcome Studies are needed for certain best practice. The ideal Pain Team reflects the multifactorial etiology and consists of a pain specialist, nursing specialist, physiotherapy, occupational therapy, psychology, psychiatry, social services, child life and pastoral care, as well as optimal communication with the primary care physician and any other physicians involved in the patient's care. Medications used for pain relief include analgesics, anti-inflammatories, and off-label low dose use of antidepressants such as Amitriptyline, and anticonvulsants such as Gabapentin.

Shapiro and Rosenfeld (1987) suggested a two step treatment approach for Somatization Disorders: 1) achieve symptom reduction by cognitive behavioral therapy, biofeedback, hypnosis or supportive psychotherapy, and 2) provide more explorative psychotherapy to understand the underlying processes. In cognitive behavioral therapy, the treatment involves promoting changes in the reinforcement that a child receives for reporting symptoms, and helping the child develop strategies for coping with his/her symptoms and other distress (Campo and Reich 1999). The therapist encourages the family and school to give frequent praise for maintaining normal activity while minimizing any discussion of the pain. Supportive psychotherapy, for example, may be helpful in a bereavement situation. Psychodynamic therapy, with the assumption that the somatic symptom is a conscious expression representing an unconscious conflict, may be appropriate, for example, when the suspected source of pain is a conflict such as guilt feelings over having been sexually abused (King 2003).

#### Future Challenges

In order to effectively recognize children and adolescents with somatization and pain disorders, we need more developmentally appropriate diagnostic categories for these psychiatric conditions. We require valid data about specific risk factors, best practice management, and longitudinal outcome studies.

Optimal child-centered care requires a continuum of health care delivery, interdisciplinary cooperation, and continued communication among primary care providers, psychiatry and pain specialists. A cohesive approach should prevent children from being referred to multiple specialists and receiving unnecessary, costly investigations. Families are usually significantly disrupted and distressed, thereby increasing the risk of iatrogenic injury, continued personal suffering, and economic impact to society. Thus, pain and somatization disorders in children warrant greater research attention.

## References

1. American Psychiatric Association (2000) *Diagnostic and Statistical Manual of Mental Disorders*, 4<sup>th</sup> edn. American Psychiatric Association, Washington DC
2. Brusco C, Geringer E (2004) Somatoform Disorders. In: Stern TA, Herman JB (eds) *Massachusetts General Hospital Psychiatry Update and Board Preparation*. McGraw-Hill, New York
3. Campo JV, Fritsch SL (1994) Somatization in Children and Adolescents. *J Am Acad Child Adolesc Psychiatry* 33:1223–1225
4. Campo JV, Jansen-McWilliams L, Comer D et al. (1999) Somatization in Pediatric Primary Care: Association with Psychopathology, Functional Impairment, and Use of Services. *Journal J Am Acad Child Adolesc Psychiatry* 38:1093–1101
5. Campo JV, Reich M (1999) Somatoform Disorders In: Netherton S, Holmes D, Walker C (eds) *Child and Adolescent Psychological Disorders*. Oxford University Press, NY, pp 320–343
6. Fritz GK, Fritsch S, Hagino O (1997) Somatoform Disorders in Children and Adolescents: A Review of the Past 10 Years. *J Am Acad Child Adolesc Psychiatry* 36:1329–1338
7. Garralda ME (1999), Practitioner Review: Assessment and Management of Somatization in Childhood and Adolescence: A Practical Perspective. *J Child Psychol Psychiatry* 40:1159–1167
8. Haugaard JJ (2004) Recognizing and Treating Uncommon Behavioral and Emotional Disorders in Children and Adolescents who have been Severely Maltreated: Somatization and Other Somatoform Disorders. *Child Maltreatment* 9:169–176
9. King SR (2003) Assessment and Management of Somatoform Pain Disorders. In: Schechter NL, Berde CB, Yaster M (eds) *Pain in Infants, Children and Adolescents*, Lippincott Williams & Wilkins, Philadelphia, pp 293–302
10. Minuchin S, Baker L, Rosman BL et al. (1975) A Conceptual Model of Psychosomatic Illness in Children. *Family Organization and Family Therapy*. *Arch Gen Psychiatry* 32:1031–1038
11. Offord DR, Boyle MH, Szatmari P et al. (1987) Ontario Child Health Study, II: Six-Month Prevalence of Disorder and Rates of Service Utilization. *Arch Gen Psychiatry* 44:832–836
12. Shapiro E, Rosenfeld AA (1987) *The Somatizing Child: Diagnosis and Treatment of Conversion and Somatization Disorders*. Springer-Verlag, New York
13. Sifford LU (2003) Psychiatric Assessment and Management of Pediatric Pain. In: Schechter NL, Berde CB, Yaster M (eds) *Pain in Infants, Children and Adolescents*, Lippincott Williams & Wilkins, Philadelphia, pp 265–292
14. Taylor DC, Szatmari P, Boyle MH et al. (1996) Somatization and the Vocabulary of Everyday Bodily Experiences and Concerns: A Community Study of Adolescents. *J Am Acad Child Adolesc Psychiatry* 35:491–499
15. Walker LS, Garber J, Greene JW (1991), Somatization Symptoms in Pediatric Abdominal Pain Patients: Relation to Chronicity of Abdominal Pain and Parent Somatization. *J Abnorm Child Psychol* 19:379–94

## Somatization Disorder

- ▶ [Somatization and Pain Disorders in Children](#)

## Somatoform Disorders

### Definition

A category of psychiatric disorders in which individuals have physical symptoms that suggest a general medical condition, but they are not fully explained by a general medical condition, by the direct effects of a substance, or

by another mental disorder. The symptoms must cause clinically significant distress or impairment in social, occupational, or other areas of functioning.

- ▶ [Hypochondriasis, Somatoform Disorders and Abnormal Illness Behaviour](#)
- ▶ [Somatization and Pain Disorders in Children](#)

## Somatoform Pain Disorder

### Definition

A term used in the DSM III of the American Psychiatric Association to describe a preoccupation with pain causing distress and disability, which is presumed to be generated by psychological factors.

- ▶ [Pain as a Cause of Psychiatric Illness](#)
- ▶ [Psychiatric Aspects of the Management of Cancer Pain](#)
- ▶ [Somatization and Pain Disorders in Children](#)

## Somatosensory

### Definition

Derived from the Greek word for “body,” somatosensory input refers to sensory signals from all tissues of the body including skin, viscera, muscles, and joints. Somatic usually refers to input from body tissue other than viscera.

- ▶ [Acute Pain Mechanisms](#)
- ▶ [Infant Pain Mechanisms](#)
- ▶ [Pain in Humans, Psychophysical Law](#)
- ▶ [PET and fMRI Imaging in Parietal Cortex \(SI, SII, Inferior Parietal Cortex BA40\)](#)
- ▶ [Somatic Pain](#)

## Somatosensory Evoked Potentials

### Synonyms

SEPs

### Definition

These are electrical signals generated by the nervous system following surface excitation (until now almost always using electrical stimuli) of mixed afferent fibers in peripheral nerves. These afferent signals can be recorded over the peripheral nerve, spinal cord, or over the somatosensory cortex using scalp electrodes, with various surface recording montages (electrode locations) in humans.

- ▶ [Diagnosis and Assessment of Clinical Characteristics of Central Pain](#)
- ▶ [Infant Pain Mechanisms](#)
- ▶ [Metabolic and Nutritional Neuropathies](#)

## Somatosensory Nervous System

### Definition

The somatosensory nervous system is part of nervous system that conveys sensations from the body, such as touch, position, pain and temperature.

- ▶ Hypoalgesia, Assessment
- ▶ Hypoesthesia, Assessment

## Somatosensory Pain Memories

### Definition

Somatosensory pain memories refer to memory processes related to painful somatosensory stimulation. These can occur already at the level of the spinal cord, but also involve the brain stem, the thalamus and cortical as well as subcortical regions.

- ▶ Diathesis-stress Model of Chronic Pain

## Somatosensory Pathways

### Definition

The neuronal pathway that brings sensory information from the periphery (skin and internal organs) to the brain. Each pathway has a number of levels of neural integration where sensory information may be processed.

- ▶ Quantitative Thermal Sensory Testing of Inflamed Skin

## Somatostatin

### Synonyms

Somatotropin

### Definition

Somatostatin, also called somatotropin, releases an inhibiting hormone, and is a cyclic peptide of 14 amino acids. It was originally isolated from the hypothalamus, but occurs in a variety of neurons and endocrine cells. Its main action is inhibition of release of other mediators.

- ▶ Cancer Pain Management, Adjuvant Analgesics in Management of Pain Due To Bowel Obstruction
- ▶ Neuropeptide Release in the Skin
- ▶ Opioid Modulation of Nociceptive Afferents In Vivo

## Somatotopic

### Definition

The correspondence of information transmitted from receptors in regions of the body through respective nerve fibers to specific integrative functional regions and the cerebral cortex.

- ▶ Postsynaptic Dorsal Column Projection, Anatomical Organization

## Somatotopic Organization

### Definition

A central nervous system structure is said to have a somatopic organization, when there is a systematic spatial correspondence between the locations of neurons receiving somatosensory information from given parts of the body and particular parts of the nervous system structure. For example, the lateral part of the ventral posterior nucleus of the thalamus receives somatosensory information from the hindlimb and the trunk below the midthoracic level, whereas the medial part of this nucleus receives input from the forelimb and upper trunk.

- ▶ Spinothalamic Input, Cells of Origin (Monkey)
- ▶ Spinothalamic Tract Neurons, in Deep Dorsal Horn
- ▶ Trigeminal Brainstem Nuclear Complex, Anatomy

## Somatotopical Location

### Definition

Both the motor and somatosensory cortices receive, and give rise to, projections in an ordered fashion that mirrors the body.

- ▶ Motor Cortex, Effect on Pain-Related Behavior

## Somatotopy

### Definition

Relationship between particular brain and body regions. Neuronal activation in a brain region that is related to a specific sensory pathway is referred to as somatotopically organized.

- ▶ Trigeminothalamic Tract Projections

## Somatotropin

- ▶ Somatostatin

## Somatovisceral Convergence

### Definition

The phenomenon or functional property, which shows both somatic and visceral input converging on the same neurons in the dorsal horn. Stimuli in viscera often evoke the somatic pain, that is, shoulder or back pain. That is called referred pain, which is relevant to the somatovisceral convergent cells.

- ▶ Morphology, Intraspinial Organization of Visceral Afferents

## Sonography

- ▶ Ultrasound

## Soul Pain

### Definition

Deeper pain or anguish relating to spiritual or existential distress.

- ▶ Cancer Pain Management, Interface Between Cancer Pain Management and Palliative Care

## Source Analysis

- ▶ Magnetoencephalography in Assessment of Pain in Humans

## SP1 and SP2 Silent Periods

- ▶ Jaw-Muscle Silent Periods (Exteroceptive Suppression)
- ▶ Masseter Inhibitory Reflex

## Spa

### Definition

The term is derived from the Walloon word “espa” meaning fountain.

- ▶ Spa Treatment

## Spa Therapy

- ▶ Spa Treatment

## Spa Treatment

DAN BUSKILA

Rheumatic Disease Unit, Faculty of Health Sciences, Soroka Medical Center, Ben Gurion University, Beer Sheva, Israel

dbuskila@bgumail.bgu.ac.il

### Synonyms

Spa Therapy; balneotherapy; Medical Hydrology; Thermal Therapy; thalassotherapy

### Definition

Different modalities of treatment at a ▶ spa include balneotherapy (bathing in mineral water), ▶ mud therapy (heated mud packs applied to the body), ▶ hydrotherapy (immersion of the body in thermal water), ▶ thalassotherapy (bathing in the sea), ▶ heliotherapy (exposure to sun) and more (Sukenic et al. 1999).

The term balneotherapy comes from the Latin *balneum* (bath). This form of treatment was used since the Roman era but became popular for the management of arthritis and pain in Europe during the eighteenth century. Spa therapy or balneotherapy has been frequently and widely used in classical medicine in the management of various musculoskeletal conditions (Verhagen et al. 1997).

### Characteristics

During the years we have conducted several studies on the effect of balneotherapy in the ▶ Dead Sea area of Israel. The Dead Sea region is the major spa area in Israel for patients with arthritis. The unique climatic conditions in this area and the balneological therapy which is based primarily on mud packs and bathing in ▶ sulfur baths and Dead Sea water combine to alleviate the symptoms of pain and arthritis (Sukenic et al. 1990). The patients are treated, usually once a day, with salt baths heated to 35–37°C for 20 min and mud packs heated to 40–42°C are applied to the body for 20 min. Similar studies from other parts of the world have used water at a temperature around 34°C (Verhagen et al. 1997).

The mechanisms by which spa therapy alleviates pain and arthritis in musculoskeletal disorders are not fully understood. However thermal, chemical and mechanical effects have been suggested. Mud therapy has been shown to influence chondrocyte activity in osteoarthritic patients by modulating the production of serum cytokines (interleukin 1) and by increasing insulin growth factor 1 and decreasing tumor necrosis factor alpha in the serum after 12 days of mud pack application (Bellometti et al. 1997). Beta-endorphin and stress hormones decreased significantly in patients with osteoarthritis undergoing thermal mud therapy (Pizzoferrato et al. 2000).



It has been suggested that thermal treatment reduces pain by reducing inflammation and therefore diminishes the cause of stress. Mud bath therapy has been shown to influence nitric oxide, myeloperoxidase and glutathione peroxidase serum levels in arthritic patients (Bellometti et al. 2000). Recently it was shown that sulfur bath therapy could cause a reduction in oxidative stress, alterations in superoxide dismutase activity and a tendency towards improvement of lipid levels (Ekmekcioglu et al. 2002). Mechanically, spa therapy may favorably affect muscle tone, joint mobility and pain intensity and immersion in spa water at 35°C has been shown to induce diuresis and natriuresis (Sukenik et al. 1999).

The effectiveness of ► **spa treatment** has been evaluated in various musculoskeletal conditions and pain syndromes. The results of these studies are summarized by Sukenik et al. (1999) and Verhagen et al. (1997). Balneotherapy was found to be effective in the treatment of inflammatory arthritides and spondylarthropathies, namely rheumatoid arthritis and psoriatic arthritis (Sukenik et al. 1990; Sukenik et al. 1994).

A statistically significant improvement in most of the clinical parameters assessed for the short period of 1 month was observed in patients with rheumatoid arthritis treated with Dead Sea bath salts (Sukenik et al. 1990). In another study, we found that treatment of psoriasis and psoriatic arthritis in the Dead Sea area is very efficacious and that the addition of balneotherapy can have additional beneficial effects on patients with psoriatic arthritis (Sukenik et al. 1994). Furthermore, it was shown that combined spa exercise therapy and standard treatment with drugs and weekly group physical therapy is more effective and shows favorable cost-effectiveness and cost-utility ratios compared with standard treatment alone in patients with ankylosing spondylitis (Van Tubergen et al. 2002).

We have evaluated the effectiveness of Dead Sea salts dissolved in bathtubs in a group of 26 patients suffering from osteoarthritis of the knees (Sukenik et al. 1995). A statistically significant improvement in patients' self-assessment of disease severity was found in the treatment group vs. a control group at the end of the study. Similar results have been reported on the effectiveness of Puspokladany thermal water on osteoarthritis of the knee joints (Szucs et al. 1989). The effectiveness of spa treatment has also been evaluated in pain syndromes. A randomized study has demonstrated that spa treatment was effective in patients with chronic low back pain, immediately and after 6 months, compared with a control group of patients who did not receive this therapy (Constant et al. 1995).

The fibromyalgia syndrome is a chronic disorder of widespread pain or stiffness in the muscles or joints, accompanied by tenderness on examination at specific predictable anatomic sites known as tender points. We found that balneotherapy was effective in alleviating the pain and other symptoms in patients with fibromyalgia

(Buskila et al. 2001). Relief from the severity of pain, fatigue, stiffness and anxiety were reported, especially in patients receiving sulfur baths, as compared with a control group.

Furthermore, we have shown that staying at the Dead Sea spa, in addition to balneotherapy, can transiently improve the quality of life of patients with fibromyalgia as measured by the short form-36 (SF-36) (Neumann et al. 2001). Interestingly, another study has reported meaningful improvements in the quality of life of patients with osteoarthritis treated with spa therapy in France (Guillemin et al. 2001). Although several studies suggest effectiveness of spa treatment in pain syndromes and rheumatic conditions, there still remains a controversy about this treatment modality. Verhagen et al. (1997) provided a systematic review of the literature analyzing the efficacy of balneotherapy in patients with arthritis. It was concluded that because of methodological flaws a conclusion about the efficacy of balneotherapy could not be provided from studies that were reviewed.

In conclusion, spa treatment has been shown to be effective in temporarily relieving pain and arthritis is a variety of pain syndromes and rheumatic conditions. However, well-conducted prospective randomized clinical trials are needed to strengthen these findings.

## References

1. Bellometti S, Cecchetti M, Galzigna L (1997) Mud pack therapy in osteoarthritis. Changes in serum levels chondrocyte markers. *Clin Chim Acta* 268:101–106
2. Bellometti S, Poletto M, Gregotti C et al. (2000) Mud bath therapy influences nitric oxide, myeloperoxidase and glutathione peroxidase serum levels in arthritic patients. *Int J Clin Pharmacol Res* 20:69–80
3. Buskila D, Abu-Shakra M, Neumann L et al. (2001) *Rheumatol Int* 20:105–108
4. Constant F, Collin JF, Guillemin F (1995) Effectiveness of the spa therapy in chronic low back pain: A randomized clinical trial. *J Rheumatol* 22:1315–1320
5. Ekmekcioglu C, Strauss-Blasche G, Holzer F et al. (2002) Effect of sulfur baths on antioxidative defense systems, peroxidase concentrations and lipid levels in patients with degenerative osteoarthritis. *Forsch Komplementarmed Klass Naturheilkd* 9:216–220
6. Guillemin F, Virion JM, Escudier P et al. (2001). Effect on osteoarthritis of spa therapy at Bourbonne-Les-Bain. *Joint Bone Spine* 68:499–503
7. Neumann L, Sukenik S, Bolotin A et al. (2001) The effect of balneotherapy at the Dead Sea on the quality of life of patients with fibromyalgia. *Clin Rheumatol* 20:15–19
8. Pizzoferrato A, Garzia I, Cenni E et al. (2000) Beta-endorphin and stress hormones in patients affected by osteoarthritis undergoing thermal mud therapy. *Minerva Med* 91:239–245
9. Sukenik S, Neumann L, Buskila D et al. (1990) Dead Sea bath salts for the treatment of rheumatoid arthritis. *Clin Exp Rheumatol* 8:353–357
10. Sukenik S, Giryas H, Halevy S et al. (1994) Treatment of psoriatic arthritis at the Dead Sea. *J Rheumatol* 21:1305–1309
11. Sukenik S, Mayo A, Neumann L et al. (1995) Dead Sea bath salts for osteoarthritis of the knees. *Harefuah* 129:100–103
12. Sukenik S, Flusser D, Abu-Shakra M (1999) The role of Spa therapy in various rheumatic diseases. *Rheum Dis Clin North Am* 25:883–897

13. Szucs L, Ratka L, Lesko T (1989) Double-blind trial on the effectiveness of the Puspokladany thermal water on arthrosis of the knee joints. *J R Soc Health* 109:7–14
14. Van Tubergen A, Boonen A, Landewe R et al. (2002) Cost effectiveness of combined spa exercise therapy in ankylosing spondylitis: a randomized controlled trial. *Arthritis Rheum* 47:459–467
15. Verhagen AP, de Vet HCW, de Bie RA et al. (1997) Taking baths: the efficacy of balneotherapy in patients with arthritis. A systematic review. *J Rheumatol* 24:1964–1971

---

## Spared Nerve Injury Model

- ▶ [Neuropathic Pain Model, Spared Nerve Injury](#)

---

## Spasm

### Definition

Involuntary sudden muscle contraction. It is a generic term that does not necessarily indicate a muscle cramp. For example, a facial spasm cannot be included as a muscle cramp because it is not painful. Thus, a muscle cramp is simply a painful spasm.

- ▶ [Muscular Cramps](#)

---

## Spasticity

### Definition

Increased tone or rigidity of muscles as a result of abnormal upper motor neuron function. Spasticity may be differentiated from contractures by its improvement with peripheral nerve blocks or the use of Botulinum toxin.

- ▶ [Spinal Cord Injury Pain](#)

---

## Spatial Summation

### Definition

Spatial summation is when progressively larger numbers of primary afferent (presynaptic) neurons are activated simultaneously, until sufficient neurotransmitter is released to activate an action potential in the spinal cord (postsynaptic) neuron. The term is also used to describe the increase in response that results from stimulation of larger areas or greater amounts of body tissue. Thus, pain increases in intensity as a function of this factor. In the context of nocifensive behaviors, spatial summation is the response that results from simultaneous activation of spatially separated visceral receptors. Because the viscera are generally less densely innervated than most other tissues (e.g. skin), production of nocifensive behaviors (for example, by distending a hollow

organ) typically requires that a larger area of tissue is activated than would be necessary in other tissues. Thus, distension of hollow organs with longer balloons activates more visceral receptors and generally produces nocifensive behaviors at lower distending pressures.

- ▶ [Exogenous Muscle Pain](#)
- ▶ [IB4-Positive Neurons, Role in Inflammatory Pain](#)
- ▶ [Nocifensive Behaviors, Gastrointestinal Tract](#)
- ▶ [Pain in Humans, Electrical Stimulation \(Skin, Muscle and Viscera\)](#)
- ▶ [Pain in Humans, Psychophysical Law](#)

---

## Special Place Imagery

### Definition

This is a very common use of guided imagery. The subject is invited to enter a „special place“ in imagination, which has qualities of comfort, safety and other desirable attributes. The intention is to engender feelings of comfort and safety that can lead to reductions in pain experience.

- ▶ [Therapy of Pain, Hypnosis](#)

---

## Specialist Palliative Care

### Definition

Care provided by professionals whose core activity is limited to palliative care, and who have undergone a high level of training in palliative care, for example, a palliative medicine consultant physician in the UK.

- ▶ [Cancer Pain Management, Interface Between Cancer Pain Management and Palliative Care](#)

---

## Species Differences in Skin Nociception

BRUCE LYNN

Department of Physiology, University College London, London, UK

b.lynn@ucl.ac.uk

### Synonyms

Skin Nociception, Species Differences

### Definition

Differences (and similarities) in how different animals, from the simplest to the most complex, detect noxious stimuli at the body surface.

## Characteristics

The detection of dangerous events or situations at the body surface is of great importance to the survival of an organism. Motile organisms can respond to this information and take avoiding action. It is therefore no surprise to find that, as a result of natural selection, most organisms possess excellent nociceptive systems at the body surface. In this essay, the nociceptive systems of a relatively simple organism, the nematode *C. elegans* will be described. Then the nociceptors in mammalian skin will be looked at and here the focus will be on the differences between species, especially those differences that scale with body size

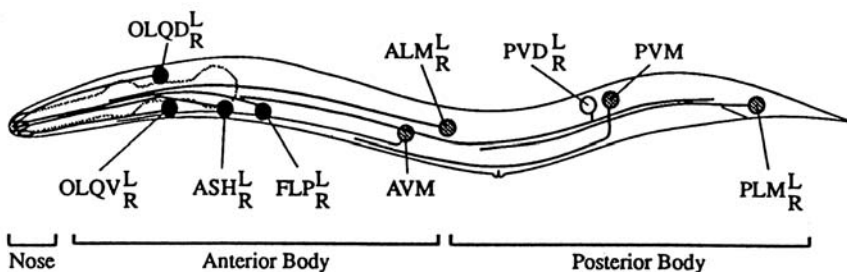
### *Caenorhabditis elegans*

*C. elegans* is a small (1 mm long) ▶ **nematode** worm with a nervous system comprising only 302 neurons. The main sensory neurones linked to the body surface are shown in Fig. 1. There are sensitive mechanoreceptors (ALM, AVM, PLM) that respond to very light contact (<10  $\mu\text{N}$  force) and trigger locomotor responses (Goodman and Schwarz 2003). After destruction of these neurones the worm still responds to stronger contacts (>100  $\mu\text{N}$  force) with avoidance movements. These responses are triggered by the 2 PVD sensory neurones that therefore act like mechanical nociceptive neurones (Kaplan 1996; Goodman and Schwarz 2003). At the anterior end of the worm are 2 other neurones (ASH in Fig. 1) that respond to pressure and also to dangerous chemical states such as high osmotic pressure and acid pH (Goodman and Schwarz 2003). These neurones thus have a polymodal response profile. A similar organisation is seen in many species i.e. separate specialised nociceptive sensory neurones that operate in parallel with specialised mechanoreceptors and, in some species, thermoreceptors. Within the nociceptors, there is a further specialisation into 2 classes, one class “tuned” for mechanical noxious stimuli and one class with broad, polymodal, response properties. As a further example we can consider the rainbow trout. Recent studies of the trigeminal system in the trout have

revealed the presence of ▶ **polymodal nociceptors** in large numbers (approximately 60% of all high threshold, presumed nociceptive, neurones) (Sneddon 2003). Smaller numbers of ▶ **Mechanical Nociceptors** were also found, plus some mechano-heat units that did not respond to the irritant used in this study (acetic acid). Interestingly the trout trigeminal system has few ▶ **C-fibres** (only 5% of all fibres), so the nociceptors are predominantly ▶ **A-fibre** conducting.

### Mammalian Skin

Four major classes of nociceptor have been described in mammalian skin: polymodal nociceptors, mechanical nociceptors, heat nociceptors and sleeping or silent nociceptors. Properties are summarised in Table 1. Polymodal nociceptors with C-fibre axons and mechanical nociceptors with A-fibre axons are present in all species examined. Probably some insensitive “sleeping” units that only respond to irritant chemicals in uninflamed skin are also present in all species. However, heat nociceptors are not always found. They comprise 7–19% of the C-nociceptor population in primate and pig. However, they are rare or absent in rabbit and rodent skin. Conduction velocity varies with species, as does the proportion of A to C fibre nociceptors. In general, conduction velocities increase with body size. For example, A-mechanical nociceptors in the mouse conduct at an average of 7 m/sec (Cain et al. 2001; Koltzenburg et al. 1997) while similar units in the pig average 20 m/sec (Lynn et al. 1995). Similarly C-nociceptors conduct at an average of 0.7 m/sec in the mouse but at 1.2 m/sec in the pig. There are also small differences in the conduction velocities of different classes of nociceptor. Most interesting is the finding of significant numbers of A-fibre nociceptors with polymodal properties in primate skin whereas such units are uncommon in rodents. The mechanical thresholds and receptive field areas of nociceptors vary with body size within the mammals. Average pressure thresholds of C-polymodal nociceptors, determined using fine ▶ **von-Frey type filaments**, increase from 6 mN in the mouse to 70 mN in the pig.

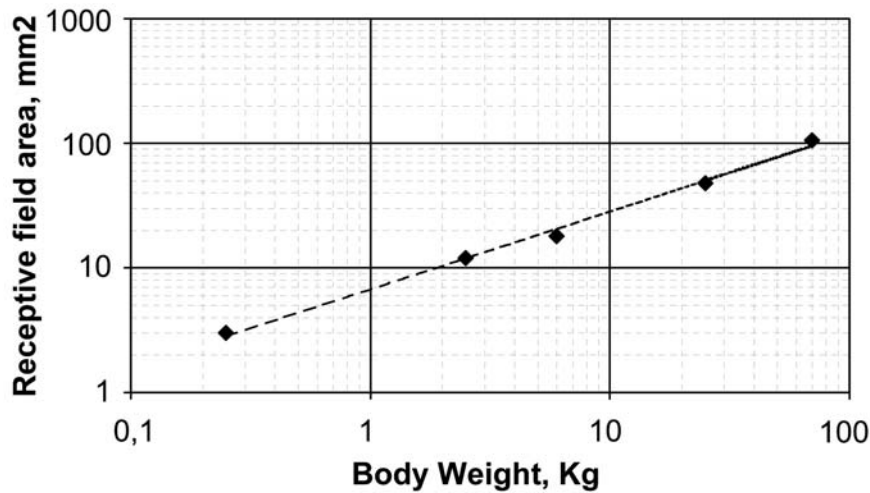
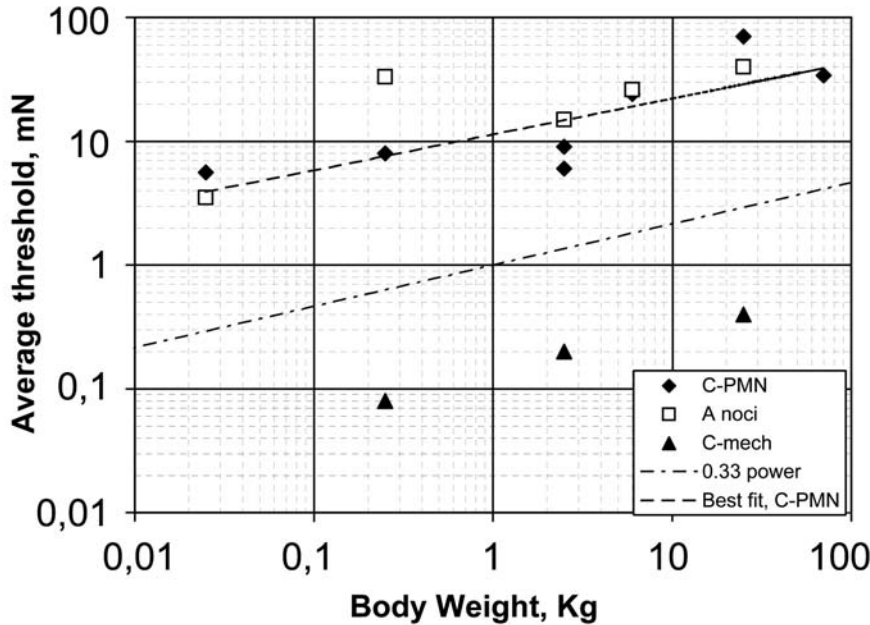


**Species Differences in Skin Nociception, Figure 1** Sensory cells in *C. elegans*. The ASH, FLP and OLQ neurones sense touch to the nose. The ASH cells in addition sense noxious chemicals and so have a polymodal response profile. AVM and ALM neurones sense light touch to the anterior region whereas PLM neurones sense light touch to the posterior region. PVD neurones sense only intense mechanical stimuli, i.e. they have a mechanical nociceptor profile. The anatomical abbreviations are L, left, R, right, D, dorsal, V, ventral. The figure shows the left lateral side of the worm. From (Kaplan and Horvitz 1993).

**Species Differences in Skin Nociception, Table 1** Response profiles to key stimulus modalities of different classes of nociceptor in mammalian skin

Class of nociceptor	Main conduction velocity band	Stimulus		
		Strong mechanical	Strong heat	Irritant chemicals
Polymodal nociceptor	C	+	+	+
Mechanical nociceptor	A	+	0	0
Heat nociceptor	C	0	+	+
Sleeping nociceptor	C	(+)*	(+)*	+

\* Sleeping (or silent) nociceptors show no responses to mechanical or heat stimuli in normal skin, but fire like polymodal nociceptors when the skin becomes inflamed.



**Species Differences in Skin Nociception, Figure 2** Top. Pressure thresholds *versus* body weight for 7 mammalian species on the hairy skin of the limb. Slope of best fit line for C-polymodal nociceptors (C-PMN) is 0.29. A-Noci = A-mechanical nociceptor. C-mech = sensitive C-fibre mechanoreceptors. Bottom. Receptive field area of C-PMN in 5 species. Dotted line, best fit, slope 0.62. Data from the following studies: mouse, Koltzenburg et al. 1997; rat, Lynn 1994; cat, Bessou and Perl 1969, Burgess and Perl 1967; rabbit, Fitzgerald 1978; monkey, Treede et al. 1995; pig, Lynn et al. 1995; man, Schmidt et al. 1997.

If pressure threshold is plotted against body mass, it appears that thresholds increase with the 0.3 power of body mass (Fig. 2, upper part). Interestingly this relation holds for both A-fibre mechanical nociceptors

and for C-polymodal nociceptors. It appears to hold for C-fibre mechanoreceptors as well. Receptive field areas increase approximately with the 0.67 power of body mass, i.e. receptive field area increases roughly



in proportion to total body surface area (Fig. 2, lower part).

Note that the changes in properties with body size described above can lead to problems of definition. A neurone with a pressure threshold at the most sensitive end of the nociceptor range in a mouse would probably be considered a mechanoreceptor in a large species such as the pig. A neurone with conduction velocity of 25 m/sec is a fast fibre in the mouse, but would be firmly in the ► **A-delta**, slow myelinated, band in larger mammalian species.

### Molecular Evolution. Species Differences – but Molecular Similarities

Recent studies into the key proteins involved in sensory transduction in nociceptors have revealed some interesting similarities across the animal kingdom. Two families of ► **ion channel** proteins appear to play a role in nociception in all species, invertebrate and vertebrate, so far studied. These are the TRPv family and the ► **ENaC/DEG** family (Julius and Basbaum 2001). To illustrate this pattern consider the TRPv family. The first mammalian member to be characterised was the ► **capsaicin** receptor (originally designated VR1, now designated TRPV1) that amazingly turns out to be a ligand-gated ion channel that also opens to noxious heat and low pH. Truly a polymodal channel! It plays an important role in noxious heat ► **transduction** and is expressed in most C-polymodal neurones. If expressed artificially in non-sensory cells, then these cells develop chemo- and heat sensitivity. Several other members of the TRP family are also expressed in small sensory ganglion cells. For example, TRPV2 (originally VRL1) is another heat-gated channel, but lacks capsaicin sensitivity (Julius and Basbaum 2001).

In *C. elegans* a ► **homologous gene**, *osm-9* is found in ASH cells and if it is missing, all sensory functions of the ASH cells are lost. However, unlike TRPV1, attempts to generate transduction by expressing the *osm-9* gene in non-sensory cell lines have been unsuccessful. However, this may not indicate that *osm-9* is not involved directly in transduction, but perhaps that other proteins are necessary to get a working channel. Also, noxious heat reactions of *C. elegans* are unaffected in mutants lacking *osm-9*, although there are several other TRPv proteins whose function has yet to be determined and which might therefore turn out to be involved in noxious heat transduction (Wittenburg and Baumeister 1999).

### Summary

Specialised nociceptors sensing mechanical and thermal conditions at the body surface and reacting to noxious chemicals appear to be omnipresent in Metazoa. Commonly, a sub-class of nociceptor sensing just strong mechanical stress is found alongside another “polymodal” sub-class sensing a range of noxious stimuli.

Within the vertebrates, nociceptor pressure thresholds scale with  $1/3^{\text{rd}}$  power of body weight whilst receptive field area scales with body surface area.

Despite many detailed differences between nociceptors in different species, they share a closely related family of molecular transduction proteins. Notable are the TRP family of sensory-gated ion channels that subserve mechano-, thermal- and chemo-transduction in many species.

### References

1. Bessou P, Perl ER (1969) Response of cutaneous sensory units with unmyelinated fibers to noxious stimuli. *J Neurophysiol* 32:1025–1043
2. Burgess PR, Perl ER (1967) Myelinated afferent fibres responding specifically to noxious stimulation of the skin. *J Physiol* 190:541–562
3. Cain DM, Khasabov SG, Simone DA (2001) Response properties of mechanoreceptors and nociceptors in mouse glabrous skin: an in vivo study. *J Neurophysiol* 85:1561–1574
4. Fitzgerald M The sensitization of cutaneous nociceptors (1978) PhD Thesis, University of London
5. Goodman MB, Schwarz EM (2003) Transducing touch in *Caenorhabditis elegans*. *Annu Rev Physiol* 65:429–452
6. Julius D, Basbaum AI (2001) Molecular mechanisms of nociception. *Lancet Neurol* 413:203–210
7. Kaplan JM (1996) Sensory signalling in *Caenorhabditis elegans*. *Curr Opin Neurobiol* 6:494–499
8. Kaplan JM, Horvitz HR (1993) A dual mechanosensory and chemosensory neuron in *Caenorhabditis elegans*. *Proc Natl Acad Sci USA* 90:2227–2231
9. Koltzenburg M, Stucky CL, Lewin GR (1997) Receptive properties of mouse sensory neurons innervating hairy skin. *J Neurophysiol* 78:1841–1850
10. Lynn B (1994) The fibre composition of cutaneous nerves and the classification and response properties of cutaneous afferents, with particular reference to nociception. *Pain Rev* 1:172–183
11. Lynn B, Faulstich K, Pierau FK (1995) The classification and properties of nociceptive afferent units from the skin of the anaesthetized pig. *Eur J Neurosci* 7:431–437
12. Schmidt R, Schmelz M, Ringkamp M et al. (1997) Innervation territories of mechanically activated C nociceptor units in human skin. *J Neurophysiol* 78:2641–2648
13. Sneddon LU (2003) Trigeminal somatosensory innervation of the head of a teleost fish with particular reference to nociception. *Brain Res* 972:44–52
14. Treede RD, Meyer RA, Raja SN et al. (1995) Evidence for two different heat transduction mechanisms in nociceptive primary afferents innervating monkey skin. *J Physiol* 483:747–758
15. Wittenburg N, Baumeister R (1999) Thermal avoidance in *Caenorhabditis elegans*: an approach to the study of nociception. *Proc Natl Acad Sci USA* 96:10477–10482

S

## Specificity

### Definition

Specificity is a statistical decision term equivalent to correct rejection rate. The probability that the test will be negative among patients who do not have the disease.

► **Sacroiliac Joint Pain**

► **Statistical Decision Theory Application in Pain Assessment**

## Specificity Theory

### Definition

Each sensation is coded by the activity in a particular and unique receptor subtype.

- ▶ Somatic Pain

## SPECT

### Definition

SPECT (Single Photon Emission Computed Tomography) is a method of functional brain imaging. The technique involves the injection of a radiopharmaceutical contrast agent into the subject, the distribution of the contrast agent within the brain is detected using gamma rays.

- ▶ Single Photon Emission Computed Tomography
- ▶ Thalamus, Clinical Pain, Human Imaging

## Spike

### Definition

Spike is a synonym for action potential.

- ▶ Nociceptors, Action Potentials and Post-Firing Excitability Changes

## Spike Bursts

### Definition

Spike bursts are action potentials that comprise of the thalamic firing pattern during bursting mode.

- ▶ Central Pain, Human Studies of Physiology
- ▶ Thalamic Bursting Activity, Chronic Pain

## Spillover

### Definition

Spillover refers to the diffusion of a synaptically released neurotransmitter out of the synaptic cleft to neighboring synapses or extrasynaptic receptors.

- ▶ GABA and Glycine in Spinal Nociceptive Processing

## Spinal Analgesia

### Definition

Pain relief obtained by drugs acting directly on the spinal cord, e.g. morphine, local anesthetics, adrenaline (epinephrine), clonidine, or neostigmine.

- ▶ Postoperative Pain, Acute Pain Management, Principles

## Spinal Anesthesia

A form of anesthesia where medication is injected into the subarachnoid space. The subarachnoid space is located between the arachnoid membrane and the pia mater, and contains cerebral spinal fluid that bathes the spinal cord.

- ▶ Analgesia During Labor and Delivery
- ▶ Subarachnoid/Spinal Anesthesia

## Spinal Arthrodesis

### Definition

Another term for spinal fusion.

- ▶ Spinal Fusion for Chronic Back Pain

## Spinal Ascending Pathways

### Definition

The neuronal tracts of spinal origin that project directly upward to supraspinal structures.

- ▶ Spinal Ascending Pathways, Colon, Urinary Bladder and Uterus
- ▶ Spinothalamic Projections in Rat

## Spinal Ascending Pathways, Colon, Urinary Bladder and Uterus

TIMOTHY NESS

Department of Anesthesiology, University of Alabama at Birmingham, Birmingham, AL, USA

loch@uab.edu

### Synonyms

Spinal Dorsal Horn Pathways, Colon, Urinary Bladder and Uterus; visceral spinothalamic tract; visceral spinomesencephalic tract (see spinomesencephalic neurons); visceral spinohypothalamic tract (see spino-

hypothalamic neurons); visceral spinomedullary tract (see spinomedullary neurons); visceral spinoreticular tract; postsynaptic dorsal column pathway (see postsynaptic dorsal column neurons).

### Definition

Spinal dorsal horn neurons receiving excitatory inputs from pelvic viscera, which include the urinary bladder, the colon-rectum and the uterus-vagina, frequently have axonal extensions projecting to supraspinal sites of termination. These sites include the thalamus, the hypothalamus, the midbrain, the pons and the medulla. These axons travel within the white matter of the spinal cord in two main sites: the anterolateral quadrants and the dorsal midline. Decussation of fibers to the contralateral anterolateral white matter occurs for axons projecting to the thalamus and most other brainstem sites, although many axons with sites of termination in “reticular” structures will remain in the ipsilateral anterolateral white matter. Dorsal column pathways have sites of termination in the gracile nucleus of the medulla. Intraspinal pathways have also been demonstrated, as has extensive collateralization of axons with multiple sites of termination. Novel pathways for ascending visceral information may also include dorsolateral spinothalamic pathways related to lamina I neurons.

### Characteristics

#### General

Spinal dorsal horn neurons receiving excitatory visceral inputs from pelvic structures have been demonstrated to be present throughout the dorsal horn, but with particular localization to laminae I, II, V and X. Mapping of primary afferents from visceral structures have demonstrated sites of connectivity that are heaviest in these same laminae. Multisegmental connections of single primary afferents from visceral structures have been demonstrated to travel via lateral (e.g. Lissauer’s tract) and medial tracts, prior to synaptic contact with multiple neurons in multiple laminae (Sugiura et al. 1993). Neurons throughout the dorsal horn receiving visceral inputs have been demonstrated to possess axonal extensions that project to distant (rostral and caudal) sites within the spinal cord and brainstem. No quantitative study has defined the precise percentage of spinal neurons with viscerosensitive input that have axonal projections within any specific portion of spinal white matter, and information related to the importance of specific tracts on subsequent neuronal function has been extrapolated from studies utilizing spinal lesions to reduce or abolish behaviors, reflexes or supraspinal neuronal responses. Inputs from some visceral structures such as the uterus to supraspinal sites such as the nucleus tractus solitarius have been demonstrated to travel by spinal as well as nonspinal pathways, which include the vagus nerve (Berkley and Hubscher 1995).

### Intraspinal (Propriospinal) Pathways

Multiple interconnections occur between spinal neurons. This has been particularly demonstrated in the case of neurons receiving visceral afferent input from pelvic structures. With afferent pathways traveling via the pelvic nerve and in association with sympathetic nerve pathways, the site of entry of afferent information for pelvic organs is split between the lower thoracic-upper lumbar and lower lumbar-sacral segments. McMahon and Morrison (1982) demonstrated clear connectivity between inputs via these two pathways by performing a cordotomy at the midlumbar spinal cord, and demonstrating an abolition of excitatory responses to respective inputs. A more subtle white matter localization of the axonal extensions of **propriospinal neurons** has not been performed, but they are presumed to follow the paths of other propriospinal neurons, which include dorsally located white matter paths and some within-gray matter extensions. Collateral intraspinal extensions of ascending axons located within the ventrolateral white matter have also been demonstrated. Spinocervicothalamic pathways have not been implicated in viscerosensation.

### Anterolateral White Matter

The traditional pain pathways are the spinothalamic and spinoreticular tracts (see **spinoreticular neurons**) located within the anterolateral white matter of the spinal cord. Both ipsilateral and contralateral localization of axon pathways have been demonstrated en route to supraspinal sites, with the predominant path for afferents traveling to the ventrobasal thalamus residing on the contralateral side. Numerous neurons with axonal projections to the thalamus traversing the anterolateral white matter have been demonstrated to receive visceral inputs from pelvic organs (e.g. Milne et al. 1981). Despite these observations, experiments utilizing lesions of the anterolateral spinal white matter have demonstrated reduction/abolition of ventrobasal thalamic neuron responses to noxious cutaneous stimuli, but failed to demonstrate a significant reduction in the responses to colorectal distension in rats and primates (Al Chaer and Willis 1999; Hirshberg et al. 1996; Ness 2000). In contrast, ventrolateral medullary neuronal responses to colorectal distension and the evocation of cardiovascular and visceromotor reflexes to the same stimulus disappeared with ventrolateral white matter lesions (Ness 2000). Neurons with projections to other supraspinal sites such as the hypothalamus, parabrachial nucleus, mesencephalon, pons and other medullary sites have been demonstrated to be excited by pelvic organ stimulation (e.g. Katter et al. 1996). It must be extrapolated that the axonal projections of this specific subset of neurons follows the same spinal white matter pathways as other spinal neurons with similar terminal sites of projection. Hence, the ipsilateral and contralateral ventrolateral white matter pathways are the

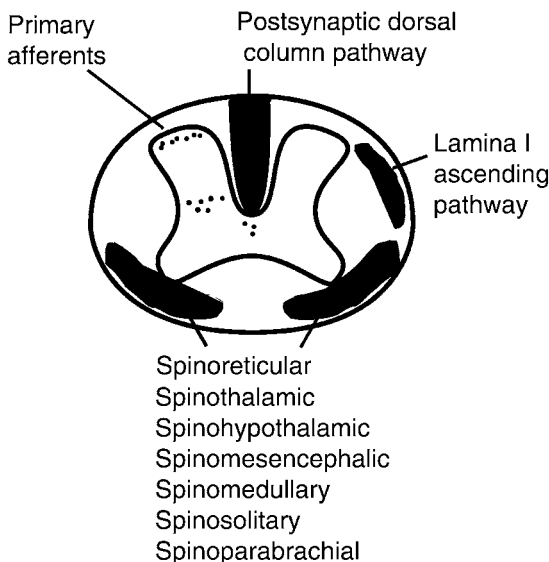
presumed predominant pathway, with an unknown balance between ipsilateral and contralateral localization.

### Lamina I Spinothalamic Pathways

► **Spinothalamic neurons** located within lamina I have been demonstrated to send axonal projections to the contralateral thalamus via a contralateral dorsolateral pathway. As lamina I neurons have also been demonstrated to receive pelvic visceral inputs, it is presumed that similar white matter projections exist for viscerosensitive lamina I neurons.

### Dorsal Column Pathways

One of the most exciting neurophysiological findings related to visceral pain is the demonstration of the existence of a spinal pathway in the midline of the dorsal columns for the rostral transmission of pelvic visceral nociception. Discrete neurosurgical lesions of this portion of the spinal cord have been demonstrated to relieve cancer-related pain in patients with pelvic visceral pathology (Hirshberg et al. 1996; Nauta et al. 2000). Parallel studies in non-human animals have demonstrated that in this area of spinal white matter, there exist axons of post-synaptic dorsal horn neurons receiving noxious excitatory input from the colon, bladder and/or uterus. Excitatory responses of neurons located in the medullary gracile nucleus or ventrobasal thalamus to noxious visceral stimuli are attenuated/abolished with lesions of the dorsal midline region of the spinal cord (Al Chaer et al. 1999; Berkley and Hubscher 1995; Hirshberg et al. 1996; Ness 2000). Inputs from the uterus to medullary gracile nucleus neurons have been demonstrated not to require



**Spinal Ascending Pathways, Colon, Urinary Bladder and Uterus, Figure 1** Schematic diagram of spinal cord cell body localization of neurons receiving pelvic organ visceral inputs (filled circles) and spinal white matter pathways discussed in text (see also ► [spinosolitary neurons](#); ► [spinoparabrachial neurons](#)).

dorsolateral funiculus pathways (Berkley and Hubscher 1995).

### Summary

Spinal dorsal horn neurons excited by stimulation of the colon, urinary bladder and/or uterus have axonal projections to numerous intraspinal and supraspinal sites. Unique to these visceral structures is the suggestion of a role for dorsal column pathways in nociceptive processing. Other pathways appear to be shared with somatic nociceptive pathways.

### References

1. Al Chaer ED, Feng Y, Willis WD (1999) Comparative Study of Viscerosomatic Input onto Postsynaptic Dorsal Column and Spinothalamic Tract Neurons in the Primate. *J Neurophysiol* 82:1876–1882
2. Berkley KJ, Hubscher CH (1995) Are there Separate Central Nervous System Pathways for Touch and Pain? *Nat Med* 1:766–773
3. Hirshberg RM, Al-Chaer ED, Lawand NB et al. (1996) Is there a Pathway in the Posterior Funiculus that Signals Visceral Pain? *Pain* 67:291–305
4. Katter JT, Dado RJ, Kostarczyk E et al. (1996) Spinothalamic and Spinohypothalamic Tract Neurons in the Sacral Spinal Cord of Rats. II. Responses to Cutaneous and Visceral Stimuli. *J Neurophysiol* 75:2606–2628
5. McMahon SB, Morrison JFB (1982) Two Groups of Spinal Interneurons that Respond to Stimulation of the Abdominal Viscera of the Cat. *J Physiol* 322:21–34
6. McMahon SB, Wall PD (1983) A System of Rat Spinal Cord Lamina I Cells Projecting through the Contralateral Dorsolateral Funiculus. *J Comp Neurol* 20:217–223
7. Menetrey D, DePommery J (1991) Origins of Spinal Ascending Pathways that Reach Central Areas Involved in Visceroception and Visceronociception in the Rat. *Eur J Neurosci* 3:249–259
8. Milne RJ, Foreman RD, Giesler GJ Jr et al. (1981) Convergence of Cutaneous and Pelvic Visceral Nociceptive Inputs onto Primate Spinothalamic Neurons. *Pain* 11:163–183
9. Nauta HJ, Soukup VM, Fabian RH et al. (2000) Punctate Midline Myelotomy for the Relief of Visceral Cancer Pain. *J Neurosurg* 92:125–130
10. Ness TJ (2000) Evidence for Ascending Visceral Nociceptive Information in the Dorsal Midline and Lateral Spinal Cord. *Pain* 87:83–88
11. Sugiura Y, Terui N, Hosoya Y et al. (1993) Quantitative Analysis of Central Terminal Projections of Visceral and Somatic Unmyelinated (C) Primary Afferent Fibers in the Guinea Pig. *J Comp Neurol* 15:315–325

## Spinal Block

### Definition

Injection of local anesthetic into the spinal fluid of the lumbar spinal canal; rarely used for diagnostic blocks.

► [Pain Treatment, Spinal Nerve Blocks](#)

## Spinal Cord

### Definition

The spinal cord is part of the central nervous system and connects the brain to the rest of the body. The dorsal horn,



which is the dorsal part of the grey matter, contains the cell bodies of sensory neurons.

- ▶ [Opioid Receptor Localization](#)
- ▶ [Prostaglandins, Spinal Effects](#)

## Spinal Cord Astrocyte

- ▶ [Cord Glial Activation](#)

## Spinal Cord Compression

### Synonyms

SCC

### Definition

Spinal cord compression (SCC) is due to extrinsic compression of the cord from the epidural space secondary to extension of adjacent bony or soft tissue lesions. Less commonly, SCC can be a complication of intramedullary metastases or primary tumors (even benign). Of cancer patients, 5–10% suffer SCC. Most cases of SCC are caused by extension of vertebral bone metastases to the epidural space. Metastases of cancer of breast, lung and prostate are the most common causes of SCC. Pain precedes the neurological symptoms (e.g. paresis) in almost all cases; however, the diagnosis of SCC is always delayed until the onset of a full blown neurological syndrome. The treatment of choice is radiotherapy accompanied by high doses of dexamethasone.

- ▶ [Cancer Pain](#)
- ▶ [Cancer Pain Management, Radiotherapy](#)

## Spinal Cord Injury Pain

D. PAUL HARRIES

Pain Care Center, Samaritan Hospital Lexington, KY, USA

pharries@kypain.com

### Characteristics

#### Incidence

Spinal Cord injury (SCI) occurs at an annual incidence of between 20 and 40 cases per million of the populations. Of those affected 69% suffer from chronic pain, a third of these patients describing their pain as severe. Half of the patients describe primarily neuropathic symptoms, 25% primarily non-neuropathic symptoms and 25% a mixture of pain types. Generally, ▶ [neuropathic pain](#) seems to be worse with distal lesions and in incomplete spinal cord injuries (▶ [incomplete spinal cord injury](#)) (Kirshblum 2002).

### Pain in Relation to Level of Injury

Pain can occur at the site of injury, above the injury and/or below the injury. Somatic and neuropathic pain can occur at each of these levels. It is helpful when evaluating a patient to try and think of pain origin in these terms. Formal classification has been suggested (Bryce and Ragnarsson 2000; Siddall et al. 1997).

### Cranial to Injury

Probably the commonest source of somatic pain cranial to the injury is from the shoulder joint. This joint is particularly vulnerable to repeated trauma in the paraplegic using their arms to propel a wheelchair.

Neuropathic pain cranial to the injury is classically as a result of peripheral nerve compression from wheelchair positioning, lack of padding and as a result of poorly fitting orthotics. Prevention is the best approach. ▶ [Entrapment neuropathies](#) do occur at an increased rate and treatment for these follows conventional guidelines for these syndromes once external compression has been eliminated.

### At the Level of Injury

At the level of injury, pain can be somatic from associated injuries to bony structures and soft tissues; fusion hardware can contribute to this component of the pain. Neuropathic pain can be as a result of either injury to the exiting root at the time of injury or surgery, or from ongoing compression, the latter being potentially amenable to surgical decompression. Neuropathic pain at the level of injury can also arise from within the cord itself. ▶ [Selective nerve root blocks](#) may be helpful in making this distinction.

### Caudal to Injury

Neuropathic pain distal to the level of injury is classically of central origin. Somatic pain can be as a result of acquired musculoskeletal problems and is particularly associated with poorly controlled ▶ [spasticity](#).

### Psychological Factors and Substance Abuse

It is estimated that 50% of patients with SCI in the United States have a prior history of substance abuse. There are a similar percentage of patients with significant pre morbid psychological/psychiatric issues. These clearly affect the patient's suffering after a SCI (Kennedy et al. 1995; Kirshblum 2002).

### Other Factors Causing Pain after SCI

Poorly controlled spasticity is associated with increased pain. Spasticity may result in compromised wheelchair seating, and as a result postural imbalances may develop that increase pain. It is particularly important to evaluate a patient for contractures around the hip joint, as these may result in a cascade of seating related pain generators. ▶ [Syringomyelia](#) can present with new onset of pain years after a SCI. To think of a syrinx is usually enough to make the diagnosis!

► **Heterotopic ossification** develops in up to 50% of SCI patients; this can be painful. NSAIDs (with or without surgical resection) are the mainstay of treatment where tolerated.

#### Management of Particular SCI Pain Syndromes Medications

Gabapentin has become first line therapy for neuropathic symptoms following SCI (Ahn et al. 2003; Levendoglu et al. 2004; Tai et al. 2002). Numerous studies have demonstrated its effectiveness. Carbamazepine and other AEDs have also been utilized. Baclofen and Tizanidine have been used as adjuvant therapy.

Spasticity related pain is controlled using Baclofen, Tizanidine, benzodiazepines or Dantrolene.

Narcotics together with NSAIDs are the mainstay of pharmacologic management of somatic pain. Narcotic management can be very challenging given the 50% rate of substance abuse.

Chronic shoulder pain in the SCI patient who uses their arms for propulsion can be very difficult to treat. Evaluation of scapular stabilizer muscle strength is important, and strengthening exercises may well be necessary. The trade off between using a power chair with improvement in pain vs. loss of exercise and physiological fitness is a difficult balance.

► **Autonomic dysreflexia** is a syndrome that can occur in patients with an SCI above T6. It is characterized by an exaggerated autonomic response to what would normally represent a painful area (e.g. ingrown toenail) or even normal visceral distension (e.g. distended bladder) stimuli. Severe hypertension can occur, which left untreated can be fatal. Optimal treatment starts with removal of the responsible stimulus. Careful clinical evaluation is mandatory.

#### Interventional Pain Techniques

Selective nerve root blocks and ganglion radiofrequency lesions can be performed for segmental neuropathic pain. There are no good outcome studies for these procedures.

Facet joint denervation can be helpful in some patients with facet pain (see ► [Facet Joint Procedures for Chronic Back Pain](#) and ► [Dorsal Root Ganglion Radiofrequency](#)).

Intrathecal infusions of Morphine and Clonidine for pain, and Baclofen for spasticity, have been utilized with success in SCI (Siddall et al. 2000; Sjolund 2002). Spinal Cord Stimulation for neuropathic pain after SCI has generally been disappointing, with the exception of pain following cauda equina lesions (Kirshblum 2002; Midha and Schmitt 1998).

#### Surgical Interventions

Dorsal Root Entry Lesions have been used for severe neuropathic pain at the site of injury with limited success (Werhagen et al. 2004; Young 1990).

Deep Brain Stimulation has been used for chronic pain after SCI, however, there is no evidence to support its use (Kumar 1997).

► [Functional Changes in Sensory Neurons Following Spinal Cord Injury in Central Pain](#)

► [Opioids and Reflexes](#)

► [Spinal Cord Injury Pain Model, Hemisection Model](#)

#### References

- Ahn SH, Park HW, Lee BS et al. (2003) Gabapentin Effect on Neuropathic Pain Compared among Patients with Spinal Cord Injury and Different Durations of Symptoms. *Spine* 28:341–347
- Bryce TN, Ragnarsson KT (2000) Pain after Spinal Cord Injury. *Phys Med Rehabil Clin N Am* 11:157–168
- Kennedy P, Lowe R, Grey N et al. (1995) Traumatic Spinal Cord Injury and Psychological Impact: A Cross-Sectional Analysis of Coping Strategies. *Br J Clin Psychol* 34:627–639
- Kirshblum S (2002) *Spinal Cord Medicine*. Lippincott Williams and Wilkins, pp 389–408
- Kumar K (1997) Deep Brain Stimulation for Intractable Pain: A 15-Year Experience. *Neurosurgery* 40:736–747
- Levendoglu F, Ogun CO, Ozerbil O et al. (2004) Gabapentin is a First Line Drug for the Treatment of Neuropathic Pain in Spinal Cord Injury. *Spine* 29:743–751
- Midha M, Schmitt JK (1998) Epidural Spinal Cord Stimulation for the Control of Spasticity in Spinal Cord Injury Patients Lacks Long-Term Efficacy and is not Cost-Effective. *Spinal Cord* 36:190–192
- Siddall PJ, Taylor DA, Cousins MJ (1997) Classification of Pain following Spinal Cord Injury. *Spinal Cord* 35:69–75
- Siddall PJ, Molloy AR, Walker S et al. (2000) The Efficacy of Intrathecal Morphine and Clonidine in the Treatment of Pain after Spinal Cord Injury. *Anesth Analg* 91:1493–1498
- Sjolund BH (2002) Pain and Rehabilitation after Spinal Cord Injury: The Case of Sensory Spasticity? *Brain Res Brain Res Rev* 40:250–256
- Tai Q, Kirshblum S, Chen B et al. (2002) Gabapentin in the Treatment of Neuropathic Pain after Spinal Cord Injury: A Prospective, Randomized, Double-Blind, Crossover Trial. *J Spinal Cord Med* 25:100–105
- Werhagen L, Budh CN, Hultling C et al. (2004) Neuropathic Pain after Traumatic Spinal Cord Injury – Relations to Gender, Spinal Level, Completeness, and Age at the Time of Injury. *Spinal Cord* 42:665–673
- Young RF (1990) Clinical Experience with Radiofrequency and Laser DREZ Lesions. *J Neurosurg*:715–720

## Spinal Cord Injury Pain Model, Contusion Injury Model

PHILIP J. SIDDALL

Pain Management Research Institute, University of Sydney, Royal North Shore Hospital, Sydney, NSW, Australia

phils@med.usyd.edu.au

#### Synonyms

Contusion injury model

#### Definition

The contusion injury model of spinal cord injury (SCI) pain refers to an animal model of SCI in which a spinal

cord ► **contusion** is produced by dropping a small weight either directly or indirectly onto the exposed surface of the cord. This results in a motor dysfunction and in a proportion of animals is accompanied by altered behavioural responses to peripheral mechanical and thermal stimulation suggestive of pain.

## Characteristics

### Background

The contusion model of spinal cord injury is based on the Allen weight drop method and is sometimes referred to as the modified Allen weight drop method (Wrathall 1992). In humans, most spinal cord injuries occur with a relatively fast application of a force that results in compression and contusion to the spinal cord. The contusion model, therefore, was designed to mimic the impact forces that are sustained in the clinical setting. It has been in use for nearly a century to investigate the sequelae of SCI, particularly in studies that investigate prevention of secondary consequences of cord trauma, regeneration and restoration of function. Although the contusion model has been used for some time in studies of SCI, most studies have focussed on motor effects of SCI and paid little attention to sensory changes. It is only more recently that it has been used to investigate mechanisms of neuropathic pain following SCI (Siddall et al. 1995; Hubscher and Johnson 1999; Mills et al. 2000; Lindsey et al. 2000).

### Description of the Model

To produce a contusion injury, the animal is deeply anaesthetised and a laminectomy is performed to expose the spinal cord, usually at the lower thoracic or upper lumbar levels. A small window is created over the dorsal surface of the spinal cord and the dura mater is left intact. The vertebral processes above and below are clamped to stabilise the spine. A guide tube containing a cylindrical weight (usually 10 g) is positioned directly over the exposed cord. The weight is then dropped from a fixed height (approximately 5–25 mm) in a guide tube by removing a pin inserted through holes at fixed intervals through the tube. Several devices are available that produce a standardised lesion such as the New York University (NYU) impactor. The weight drops through the guide tube and the tip, 2–2.5 mm diameter, impacts either directly onto the cord surface or against a plastic device with the same configuration resting on the cord surface.

Another technique for producing a contusion injury has also been described by Hubscher and Johnson (1999). Rather than using an impact device, a contusion injury is induced by rapidly compressing the cord using a probe connected to a displacement-controlled device.

Following the contusion injury, the wound is closed and the animal is allowed to recover from the anaesthetic with antibiotic and analgesic cover. The contusion results in weakness of the hind limbs that is apparent im-

mediately on recovery from anaesthesia. The severity of hindlimb weakness is proportional to the height of the weight drop. A 12.5–20 mm drop typically results in a transient hindlimb paralysis immediately following injury. However, depending on the severity of the injury, most animals regain motor function with a gradual improvement over the 2–4 weeks following injury (Siddall et al. 1995; Hulsebosch et al. 2000; Lindsey et al. 2000). Although motor function improves following the contusion injury, a proportion of rats develop mechanical and ► **thermal allodynia** following spinal cord contusion. This ► **allodynia** may be present almost immediately following the injury (Siddall et al. 1995) but may also develop later and persist for more than 10 weeks post injury (Lindsey et al. 2000). Interestingly, in the study by Lindsey et al. (2000) in which animals were assessed for 10 weeks following injury, after an initial increase in responsivity in the first 2 weeks, animals displayed a decrease in responsivity which then reappeared at 8–10 weeks following injury. This suggests a biphasic onset pattern of allodynia which has also been noted in the ischaemic SCI pain model.

Allodynia and ► **hyperalgesia** are most commonly assessed by a change in vocalisation threshold to peripheral stimuli but other responses such as orientation and escape behaviors may also be observed. ► **Mechanical allodynia** is evidenced by a decreased vocalisation threshold to mechanical stimulation. This is usually assessed by the application of graded ► **Von Frey monofilaments** onto the skin surface, noting the calibre and force of the filament that results in consistent vocalisation (Siddall et al. 1995; Mills et al. 2000; Lindsey et al. 2000). Thermal allodynia or hyperalgesia may be assessed by application of a radiant heat stimulus (Mills et al. 2000) or by application of an ice probe (Lindsey et al. 2000). Stimuli are applied most commonly in the dermatomes close to the level of injury (trunk) (Siddall et al. 1995; Hubscher and Johnson 1999; Hulsebosch et al. 2000; Lindsey et al. 2000) as well as the forelimbs and hindlimbs (Hulsebosch et al. 2000; Mills et al. 2000; Lindsey et al. 2000).

As well as these evoked responses, changes in behaviour suggestive of spontaneous pain have also been observed. Animals exhibit a reduction in exploratory behaviors including rearing and other activities that were independent of locomotor ability and may be indicative of the presence of spontaneous neuropathic pain (Mills et al. 2001).

Behavioural changes suggestive of evoked pain appear to occur most commonly in those animals that have moderate injuries. Most studies suggest that an injury of between 12 and 25 mm results in the most consistent expression of allodynia (Siddall et al. 1997; Lindsey et al. 2000). Although the development of allodynia appears to be related to the severity of injury, it does not appear to correspond with the location of injury or the spinal cord structures that are affected.

Histologically, the extent of cell loss corresponds to the severity of injury. A 12–25 mm injury, which is most commonly used in SCI pain studies, results in cell loss which predominantly affects the spinal grey matter and dorsal columns. Cystic cavitation is evident in the central region of the spinal cord with a spared rim of white matter (Siddall et al. 1995; Lindsey et al. 2000). The lesion mainly involves the injured segment but extends rostrally and caudally for a distance of approximately 1 segment in each direction with a mean cavity length of 4.2 mm following a 25 mm injury (Lindsey et al. 2000).

### Clinical relevance

One of the issues confronting any animal model is its relevance to the clinical situation. The nature of the SCI following a contusive injury is very similar to the clinical situation in which most injuries are due to high impact trauma to the cord. Contusive trauma results in secondary biochemical changes, through to cell death and necrosis similar to that seen in the spinal cord of humans who have had a high impact SCI. A weight drop from a relatively low height (6–25 mm depending on the device used) results in a lesion predominantly affecting the dorsal columns and central grey matter with relative preservation of lateral and anterior fibre tracts. This is similar to the pathology evident in people with central cord injuries.

Allodynia and hyperalgesia typically occur and are strongest in the dermatomes close to the level of injury although changes in responsiveness with stimulation of hindlimbs and forelimbs have also been noted. Most studies have focussed on relatively early (<4 weeks) changes. The combination of these characteristics (damage to central structures, early onset, allodynia in the segments close to the level of injury) suggests that the model mimics the acute segmental allodynia and hyperalgesia that is sometimes a feature of central cord injuries (Siddall et al. 1999). A later onset form of this type of pain may also be indicated by the findings of Lindsey et al. (2000) and is also apparent clinically (Siddall et al. 1999). Thus the model appears to correspond well with a recognised pattern of ► [at-level neuropathic pain](#) that is observed following SCI (Siddall et al. 2002). This means that any observations on the underlying mechanisms and potential treatments are more likely to relate to at-level neuropathic SCI pain with allodynia and hyperalgesia.

### Findings

The model has been used in a number of studies to investigate the mechanisms underlying neuropathic pain following spinal cord injury. Using this model, it has been demonstrated that animals with allodynia following a contusion injury have higher levels of basal and evoked neuronal activity in the spinal cord close to the level of injury as measured by ► [Fos](#) immunoreactivity (Siddall et al. 1999). Single cell recordings in this model

also demonstrate an increased responsiveness of some neurons in the spinal cord close to the damaged segment (Drew et al. 2001). It has also been demonstrated that an increase in neuronal responsiveness is not confined to spinal neurons. Neurons in the caudal brain stem show a decreased threshold to mechanical stimulation of the trunk (Hubscher and Johnson 1999). Evoked responses of thalamic neurons were also exaggerated in allodynic animals with a contusion injury with a higher proportion of cells exhibiting ► [afterdischarges](#) (Gerke et al. 2003). The receptor changes that may underlie these changes in behaviour and neuronal responsiveness have been examined in a series of experiments investigating alterations in metabotropic glutamate expression following contusive SCI. These experiments indicate that contusion results in an increase in the group I metabotropic glutamate receptor (mGluR1) in the spinal cord (Mills et al. 2001) and that this increase in expression occurs on spinothalamic tract cells both just rostral to the site of the lesion and on cells in the cervical enlargement (Mills and Hulsebosch 2002).

Thus, findings from this model suggest that neuropathic pain following spinal cord injury is associated with abnormal responsiveness of spinal and supraspinal neurons with both an increased rate of firing and prolonged firing beyond the period of stimulation. The cellular mechanisms underlying this increased neuronal responsiveness are still unclear but may include receptor changes such as alterations in metabotropic glutamate receptors.

### References

1. Drew GM, Siddall PJ, Duggan AW (2001) Responses of Spinal Neurons to Cutaneous and Dorsal Root Stimuli Following Contusive Spinal Cord Injury in the Rat. *Brain Res* 893:59–69
2. Gerke MB, Xu L, Duggan AW, Siddall PJ (2003) Ventrobasal Thalamic Neuronal Activity in Rats with Mechanical Allodynia Following Contusive Spinal Cord Injury. *Neuroscience* 117:715–722
3. Hubscher CH, Johnson RD (1999) Changes in Neuronal Receptive Field Characteristics in Caudal Brain Stem Following Chronic Spinal Cord Injury. *J Neurotrauma* 16:533–541
4. Hulsebosch CE, Xu GY, Perez-Polo JR, Westlund KN, Taylor CP, McAdoo DJ (2000) Rodent Model of Chronic Central Pain after Spinal Cord Contusion Injury and Effects of Gabapentin. *J Neurotrauma* 17:1205–1217
5. Lindsey AE, LoVerso RL, Tovar CA, Hill CE, Beattie MS, Bresnahan JC (2000) An Analysis of Changes in Sensory Thresholds to Mild Tactile and Cold Stimuli after Experimental Spinal Cord Injury in the Rat. *Neurorehabil. Neural Repair* 14:287–300
6. Mills CD, Xu GY, Johnson KM, McAdoo DJ, Hulsebosch CE (2000) AIDA Reduces Glutamate Release and Attenuates Mechanical Allodynia after Spinal Cord Injury. *Neuroreport* 11:3067–3070
7. Mills CD, Fullwood SD, Hulsebosch CE (2000) Changes in Metabotropic Glutamate Receptor Expression Following Spinal Cord Injury. *Exp Neurol* 170:244–257
8. Mills CD, Grady JJ, Hulsebosch CE (2001) Changes in Exploratory Behavior as a Measure of Chronic Central Pain Following Spinal Cord Injury. *J Neurotrauma* 18:1091–1105
9. Mills CD, Hulsebosch CE (2002) Increased Expression of Metabotropic Glutamate Receptor Subtype 1 on Spinothalamic



- Tract Neurons Following Spinal Cord Injury in the Rat. *Neurosci Lett* 319:59–62
10. Mills CD, Johnson KM, Hulsebosch CE (2002) Role of Group II and Group III Metabotropic Glutamate Receptors in Spinal Cord Injury. *Exp Neurol* 173:153–167
  11. Siddall PJ, Xu CL, Cousins MJ (1995) Allodynia Following Traumatic Spinal Cord Injury in the Rat. *Neuroreport* 6:1241–1244
  12. Siddall PJ, Yeziarski RP, Loeser J D (2002) Taxonomy and Epidemiology of Spinal Cord Injury Pain. In: Yeziarski RP, Burchiel K (eds) *Spinal Cord Injury Pain: Assessment, Mechanisms, Management, Progress in Pain Research and Management*, vol 23. IASP Press, Seattle, pp 9–23
  13. Siddall PJ, Xu CL, Floyd N, Keay KA (1999) C-fos Expression in the Spinal Cord in Rats Exhibiting Allodynia Following Contusive Spinal Cord Injury. *Brain Res* 851:281–286
  14. Siddall PJ, Taylor DA, McClelland JM, Rutkowski SB, Cousins MJ (1999) Pain Report and the Relationship Between Physical Factors and the Development of Pain in the First Six Months Following Spinal Cord Injury. *Pain* 81:187–197
  15. Wrathall JR (1992) Spinal Cord Injury Models. *J Neurotrauma* 9:129–134

## Spinal Cord Injury Pain Model, Cordotomy Model

ALAN R. LIGHT<sup>1</sup>, CHARLES J. VIERCK JR.<sup>2</sup>

<sup>1</sup>Department of Anesthesiology, University of Utah, Salt Lake City, UT, USA

<sup>2</sup>Department of Neuroscience and McKnight Brain Institute, University of Florida College of Medicine, Gainesville, FL, USA

alan.light@hsc.utah.edu, vierck@mbi.ufl.edu

### Definition

► **Cordotomy** (originally ► **anterolateral cordotomy**—referring to the geometric term “chord” to indicate interruption of white matter) was developed as a surgical procedure to sever the spinothalamic tract at a spinal level above dermatomes to which extreme chronic pain is referred. However, physicians noted early on that, while pain was initially reduced or eliminated contralateral and below the level of cordotomy, pain often recurred, even 6 months or more after the lesion. Other studies have reported a strong correlation between development of chronic pain after traumatic ► **spinal cord injury** (SCI) and interruption of the spinothalamic tract. This prompted investigations of evidence in animal models for recurrence of pain sensitivity following anterolateral spinal lesions, in order to understand mechanisms for chronic pain caudal to the level of the lesion following spinal cord injury.

### Characteristics

Spinal cord injury produces loss of motor and sensory functions below the ► **dermatomal level** of the lesion, as a predictable consequence of interrupting long pathways descending from and ascending to the brain. If the spinal cord is transected (e.g. at a thoracic level), consciously initiated motor activities of the legs and sensations from stimulation of the lower limb are permanently

lost. However, spontaneous sensations that are referred to the legs (perceived as if they originated in the legs) are commonly experienced after ► **spinal transection**, and these can be painful (Defrin et al. 2001; Finnerup et al. 2003).

Numerous investigations of human patients following incomplete spinal cord injuries or vascular strokes that affect ascending somatosensory pathways, have shown that chronic pain can also develop with these partial lesions. Interestingly, in these patients, the body region from which the chronic, spontaneous pain originates often has reduced, or no sensitivity to noxious stimuli or temperature, yet mild stimuli of these same regions can enhance or trigger the chronic pain (e.g. Boivie et al. 1989). These results implicate interruption of the lateral spinothalamic tract as necessary for development and maintenance of chronic, below-level pain.

Thus, paradoxically, interruption of the ascending pathways considered most important for ascending conduction of nociceptive input can result in chronic pain. However, spontaneous pain does not always develop after transection of the spinothalamic tract (see ► **Cordotomy Effects on Humans and Animal Models**). Therefore, this lesion may represent a necessary condition but does not represent a sufficient condition for chronic, below-level pain. Possibly, the extent of a lesion that involves the spinothalamic tract (i.e. partial interruption, total interruption or inclusion of another critical pathway) is the determining feature. Alternatively, excitatory influences at the lesion site could have important influences on rostral sites that have been partially deafferented by the spinothalamic lesion. These factors have been evaluated in laboratory animal models of spinal cord injury.

Two approaches have been used to study chronic pain in laboratory animals after spinal lesions. The first is observation of spontaneous behaviors that might be elicited by pain. For example, Levitt and Levitt (1981) observed episodes of self-injurious behavior directed towards regions caudal and contralateral to anterolateral cordotomy. The episodic nature of these behaviors is consistent with reports of pain episodes experienced by humans after spinal cord injury. However, the qualities of spontaneous sensations experienced by a laboratory animal cannot be deduced from self-injurious behavior, which could be elicited by non-noxious sensations such as itching, or tickle. Animals might persist in such behavior, even when they severely injure the body part, because scratching or biting the region of sensory referral would not be painful (or would be minimally painful) after interruption of the spinothalamic tract.

The second approach to study the development of chronic pain caused by an incomplete spinal lesion such as cordotomy is to evaluate sensitivity to nociceptive stimulation before and after surgery. When chronic pain develops after cordotomy in humans, sensitivity to noxious stimulation recovers for stimulation within the

region of pain referral and can be heightened outside the region of referral (e.g. ipsilateral to the lesion) (Nagaro et al. 2001).

Testing of operant escape from noxious stimulation in monkeys has demonstrated that restricted, superficial lesions of the anterolateral tract result in long-lasting contralateral hypoalgesia, similar to the effects of superficially located cordotomy in humans (Nathan and Smith 1979; Vierck et al. 1990). In contrast, medially extensive lesions often resulted in recovery of pain sensitivity and even the development of hyperalgesia (Vierck et al. 1990). This result suggests that lesion extent is a critical feature of anterolateral cordotomy, a hypothesis that is difficult to evaluate in humans, because histological confirmation of lesion extent has rarely been possible. Because mechanisms of recovery of behavioral responses to nociceptive stimulation were difficult to study in monkeys, a rat model was developed to determine if similar results would be obtained (Vierck et al. 1995). This study demonstrated that, like monkeys and humans, rats with medially extensive anterolateral spinal lesions showed initial contralateral hypoalgesia, which recovered in some animals over time.

Overall, the monkey and rat studies showed a remarkable correspondence to human patients with cordotomy, in that animals with medially extensive lesions recovered pain sensitivity in approximately 50% of the cases, very similar to the percentage of patients with cordotomy who have recurrence of their pain (White and Sweet 1969). Thus, another apparently paradoxical finding was confirmed: that larger, more medially extensive lesions resulted in the recurrence of pain, while smaller, more restricted lesions resulted in permanent pain reduction.

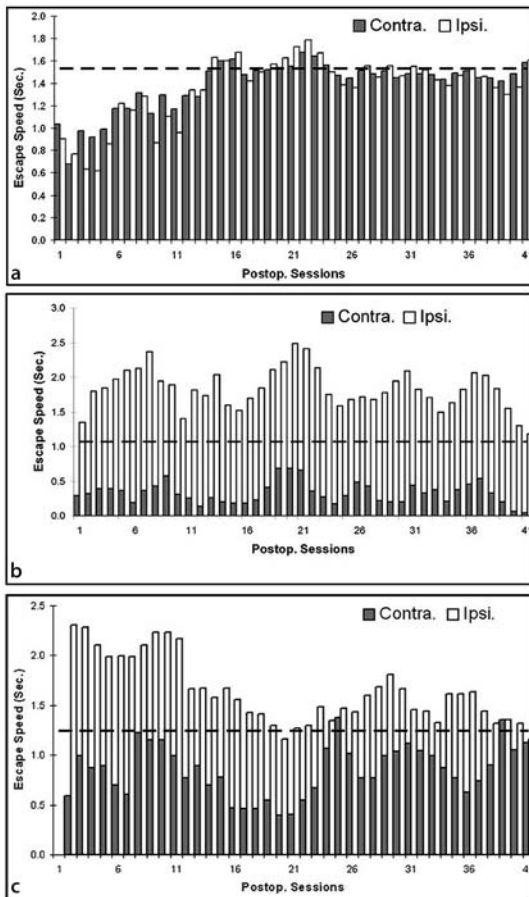
The explanation for less doing more, in terms of reducing pain following cordotomy, may lie in reactions to the injury in the spinal gray, rather than in the tracts lesioned. For example, Vierck and Light (1999) observed ipsilateral hyperalgesia when hemotoxic ischemia was intentionally introduced within the gray matter at the cordotomy lesion sites of rats (Fig. 1).

Other investigations of neuronal activity within spinal segments bordering a variety of spinal lesion models have shown conclusively that some neurons exhibit abnormal spontaneous activity and hyperexcitable responses to somatosensory input and abnormal afterdischarge. The lesion models include lateral hemisection (Hains et al. 2003), contusion injury (Gerke et al. 2003), photochemical ischemia (Hao et al. 1992) and excitotoxicity (Yeziarski and Park 1993). These demonstrations of neuronal hyperexcitability are most clearly related mechanistically to ► [dysesthesias](#) and pain, which can be experienced within dermatomes bordering a spinal lesion (► [at-level phenomena](#)). In addition, they may provide evidence for a determining factor in development of below-level pain after interruption of the spinothalamic tract. Thus, it may be that

ischemia/excitotoxicity establishes abnormal activity of sufficient magnitude in neurons bordering a spinal lesion that propagates via diffuse spinal projection systems and influences spontaneous and evoked activity of rostral projection sites, particularly including those partially deafferented, by interruption of the spinothalamic tract.

Evidence for propagation of excitatory influences along the propriospinal system of diffuse spinal projections has been provided by assessment of nociceptive reflexes, and by psychophysical observations of humans after SCI. Excitotoxic injury to the spinal gray matter of rats enhances reflexes elicited by mechanical and thermal stimuli delivered to segments caudal to the lesion (Yeziarski et al. 1998), and thoracic lateral hemisection of rats has this effect on forelimb and hindlimb reflex responses to mechanical and thermal stimulation (Christensen et al. 1996). In monkeys, SCI can transform the valence of intersegmental modulation from inhibitory to excitatory, using a condition-test paradigm (Vierck et al. 2002), and nociceptive flexion reflexes can recover from an initial depression following anterolateral cordotomy, similar to the return of contralateral pain sensitivity (Vierck et al. 1990). Thus, modulation of segmental spinal reflexes in laboratory animals is affected rostral and caudal to a spinal lesion, and this effect can change over time after SCI. Similarly, exaggeration of flexion reflexes caudal to SCI is well documented in humans as a component of the spastic syndrome (Dimitrijevic and Nathan 1967), and autonomic and somatic reflexes rostral to a lesion can be enhanced in humans (Calancie 1991; Curt et al. 1997). In addition, psychophysical tests of humans after SCI have shown that pain sensitivity can be exaggerated for stimulation rostral to a spinal lesion (Vierck et al. 2002).

Both laboratory animal and human studies have implicated combined contributions of spinal hyperexcitability and rostral deafferentation for establishment of chronic pain after SCI. Following anterolateral cordotomy and more extensive spinal lesions in rats, monkeys and humans, abnormal spontaneous activity is present in a primary thalamic termination site of the spinothalamic tract (nucleus ventralis posterolateralis: VPL) (Weng et al. 2000). Clearly, sufficient spontaneous activity in a pain transmission system could produce sensations of pain, but the pattern or intensity of this activity that elicits pain is difficult to determine. An investigation with rats after contusion injury of the spinal cord, however, has shown that spontaneous and elicited activity in partially deafferented thalamic nucleus VPL is greater in animals with exaggerated reflex responses to at-level stimulation than for animals with comparable lesions but no reflex enhancement (Gerke et al. 2003). Also, a study of humans with incomplete spinal lesions has thoroughly characterized the sensitivity to below-level stimulation of those with and without chronic pain



**Spinal Cord Injury Pain Model, Cordotomy Model, Figure 1** Three examples of effects of spinal lesions on nociceptive sensitivity of rats. Each lesion cavity was filled with blood to produce hemotoxicity within the spinal gray matter. Each graph presents the speed of operant escape responses to electrocutaneous stimulation (ordinate) within successive postoperative testing sessions (abscissa; 5 sessions per week). (a) A large lesion involving both lateral white columns and the gray matter produced a bilateral reduction of nociceptive sensitivity that recovered to preoperative levels (dashed line). (b) In contrast, a small superficial lesion of anterolateral white matter on the right produced a substantial and enduring contralateral reduction of escape speed, accompanied by an ipsilateral hypersensitivity. (c) A large unilateral lesion produced a moderate contralateral reduction of escape speed that episodically recovered to preoperative levels (dashed line). Ipsilateral sensitivity for this animal was increased, particularly early.

(Finnerup et al. 2003). Absence of below-level thermal sensitivity was present for all subjects, indicating that interruption of the spinothalamic tract was common to all lesions. However, regions of below-level allodynia were unique to subjects with pain, and the abnormally sensitive regions corresponded to locations of referred pain. These studies indicate that spinal hyperexcitability is a contributing factor to abnormal thalamic activity and chronic pain for incomplete spinal lesions. It remains to be determined if this is the case for complete spinal transections that result in below-level central pain.

In summary, interruption of the spinothalamic tract is a necessary condition for development of below-level pain following SCI. In addition, abnormal discharge within the gray matter bordering a lesion appears to be a necessary condition for development of increased pain sensitivity over time, an accompaniment of chronic pain following incomplete spinal lesions. Neither of these factors represents a sufficient condition for chronic pain or increased nociceptive sensitivity. Therefore, attenuation or prevention of abnormal activity within the spinal gray matter bordering a spinal lesion has the potential to reduce the probability that a chronic pain condition will become established.

## References

- Boivie J, Leijon G, Johansson I (1989) Central Post-Stroke Pain - A Study of the Mechanisms Through Analyses of the Sensory Abnormalities. *Pain* 37:173-185
- Calancie B (1991) Interlimb Reflexes Following Cervical Spinal Cord Injury in Man. *Exp Brain Res* 85: 458-469
- Christensen MD, Everhart AW, Pickelman JT, Hulsebosch CE (1996) Mechanical and Thermal Allodynia in Chronic Central Pain Following Spinal Cord Injury. *Pain* 68:97-107
- Curt A, Nitsche B, Rodic B, Schurch B, Dietz V (1997) Assessment of Autonomic Dysreflexia in Patients with Spinal Cord Injury. *J Neurol Neurosurg Psychiatry* 62:473-477
- Defrin R, Ohry A, Blumen N, Urca G (2001) Characterization of Chronic Pain and Somatosensory Function in Spinal Cord Injury Subjects. *Pain* 89:253-263
- Dimitrijevic MR, Nathan PW (1967) Studies of Spasticity in Man. I. Some Features of Spasticity. *Brain* 90:1-30
- Finnerup NB, Johannesen IL, Fuglsang-Frederiksen A, Bach FW, Jensen TS (2003) Sensory Function in Spinal Cord Injury. Patients With and Without Central Pain. *Brain* 126:57-70
- Gerke MB, Duggan AW, Siddall PJ (2003) Thalamic Neuronal Activity in Rats with Mechanical Allodynia Following Contusive Spinal Cord Injury. *Neurosci* 117:715-722
- Hains BC, Willis WD, Hulsebosch CE (2003) Temporal Plasticity of Dorsal Horn Somatosensory Neurons After Acute and Chronic Spinal Cord Hemisection in Rat. *Brain Res* 970:238-241
- Hao JX, Xu X-J, Seiger A, Wiesenfeld-Hallin Z (1992) Transient Spinal Cord Ischemia Induces Temporary Hypersensitivity of Dorsal Horn Wide Dynamic Range Neurons to Myelinated, but not Unmyelinated Fiber Input. *J Neurophysiol* 68:384-391

11. Levitt M, Levitt J (1981) The Deafferentation Syndrome in Monkeys: Dysesthesias of Spinal Origin. *Pain* 10:129–147
12. Nagaro T, Adachi N, Tabo E, Kimura SAT, Dote K (2001) New Pain Following Cordotomy: Clinical Features, Mechanisms, and Clinical Importance. *J Neurosurg* 95:425–431
13. Nathan PW, Smith MC (1979) Clinico-Anatomical Correlation in Anterolateral Cordotomy. *Adv Pain Res Ther* 3:921–926
14. Vierck CJ, Jr., Greenspan JD, Ritz LA (1990) Long-Term Changes in Purposive and Reflexive Responses to Nociceptive Stimulation in Monkeys Following Anterolateral Chordotomy. *J Neurosci* 10:2077–2095
15. Vierck CJ, Jr., Lee CL, Willcockson HH, Kitzmiller A, DiRuggiero D, Bullitt E, Light AR (1995) Effects of Anterolateral Spinal Lesions on Escape Responses of Rats to Hindpaw Stimulation. *Somatosens Motor Res* 12:163–174
16. Vierck CJJ, Cannon RL, Stevens KA, Wirth ED (2002) Mechanisms of Increased Pain Sensitivity Within Dermatomes Remote from an Injured Segment of the Spinal Cord. In: *Yeziarski RP, Rurchiel KJ (eds) Spinal Cord Injury Pain: Assessment, Mechanisms, Management*. IASP Press, Seattle, pp 155–173
17. Vierck CJ, Light A (1999) Effects of Combined Hemotoxic and Anterolateral Spinal Lesions on Nociceptive Sensitivity. *Pain* 82:1–11
18. Weng H-R, Lee J, Lenz F, Schwartz A, Vierck C, Rowland L, Dougherty P (2000) Functional Plasticity in Primate Somatosensory Thalamus Following Chronic Lesion of the Ventral Lateral Spinal Cord. *Neuroscience* 101:393–401
19. White JC, Sweet WH (1969) Pain and the Neurosurgeon: A Forty-Year Experience. CC Thomas, Springfield
20. Yeziarski RP, Liu S, Ruenes GL, Kajander KJ, Brewer KL (1998) Excitotoxic Spinal Cord Injury: Behavioral and Morphological Characteristics of a Central Pain Model. *Pain* 75:141–155
21. Yeziarski RP, Park S-H (1993) The Mechanosensitivity of Spinal Sensory Neurons Following Intraspinal Injections of Quisqualic Acid in the rat. *Neurosci Lett* 157:115–119

## Spinal Cord Injury Pain Model, Hemisection Model

CLAIRE E. HULSEBOSCH  
 Spinal Cord Injury Research, University of Texas  
 Medical Branch, Galveston, TX, USA  
 cehulseb@utmb.edu

### Synonyms

Spinal cord injury; Hemisection Model; Central neuropathic pain; Chronic Central Pain Models

### Definition

Spinal Hemisection Model of Chronic Central Pain is a surgical lesion in the rat to the low thoracic spinal cord, between the dorsal root entry zones of T13 and L1, in which the spinal cord is cut, unilaterally, from dorsal to ventral. The surgical cut includes unilateral lesions of the dorsal column system, dorsal corticospinal tract, Lissauer's tract, lateral and ventral funiculi, (including the dorsal lateral fasciculus, spinothalamic, spinocerebellar, and ventral corticospinal tracts) and the grey matter on one side of the cord. ► **Mechanical allodynia** develops over two to three weeks bilaterally in the dermatome of the segment of lesion, as well as bilaterally in both the

forelimbs and hindlimbs; while ► **thermal allodynia** (allodynia - since lower temperature than that of presurgery, evokes response after surgery) develops in these same regions but a week or so later than mechanical allodynia. The mechanical and thermal allodynia persist for the life of the animal.

### Characteristics

Spinal cord injury (SCI), with the development of various pain states, continues to present a significant challenge to physicians treating these disease entities. It is disturbing that embarrassingly little is known concerning the pathophysiology of pain following CNS trauma. Clearly, the attention devoted to the treatment of chronic central pain is underrepresented in terms of research, and thus treatment options. The definition of central pain, according to the International Association for the Study of Pain, is “pain initiated or caused by a primary lesion or dysfunction in the central nervous system”, for example, as occurs following SCI. Chronic pain is pain that persists beyond the period of wound healing. Thus, chronic central pain (CCP) after SCI is pain that persists long after the SCI healing has occurred.

Central pain syndromes and ► **dysesthesias** can be divided into two broad categories based on the dependency of the pain on peripheral stimuli: 1) persistent pain - occurs independent of peripheral stimuli, occurs spontaneously, increases intermittently and is described as numbness, burning, cutting, piercing or electric-like; and 2) peripherally evoked pain - occurs in response to either normally nonnoxious or noxious stimuli. In the case where the peripherally evoked pain is in response to normally nonnoxious stimuli, the pain state developed is considered to be allodynia. In the case where the peripherally evoked stimulus is in response to a normally noxious stimuli but the response is exaggerated, the pain state developed is considered to be hyperalgesia. A subtle but important definition is the state of increased sensitivity to stimulation, which may or may not be painful which is considered to be hyperesthesia. Chronic central pain syndromes are characterized by the presence of persistent pain with concomitant changes in peripheral somatosensory responses. Recently, The International Association for the Study of Pain proposed clear classifications in the case of CCP (or central neuropathic pain, CNP) after spinal cord injury, since there are clear differences with regard to kinds of pain presented in the clinic.

An understanding of the pathophysiological bases for these differences can aid therapeutic strategies used to treat the pain. Essentially, there are two general classes of pain after SCI: nociceptive and neuropathic. Nociceptive pain is abnormal pain arising from stimulation of somatic or visceral nociceptors, while neuropathic pain is abnormal pain initiated or caused by a primary lesion or dysfunction in the nervous system. In SCI patients, examples of nociceptive pain include dam-



age of skeletal structures and ligaments of the spine, overuse of muscles, and decubitus. Non-steroidal anti-inflammatory drugs and physical therapy are effective treatment strategies for nociceptive pain. Neuropathic pain, however, remains a therapeutic challenge. If the lesion is in the peripheral nervous system, the pain state is described as peripheral neuropathic pain; if it is in the central nervous system, the pain state is central neuropathic pain. Within the central neuropathic pain class, specifically in spinal cord lesions, there are three further subdivisions which describe the location of neuropathic pain relative to the location of the lesion: above-level, at-level, and below-level neuropathic pain. At-level pain is pain located in dermatomes immediately adjacent (typically rostrally) to the level of injury, most commonly described as a “girdle” of pain to mechanical stimuli. Below-level pain occurs in dermatomes or structures below the level of lesions, commonly described by SCI patients as “their legs hurt.” Above-lesion pain is abnormal pain sensations that occur above the lesion, such as increased sensitivity to tactile stimulation to the face of paraplegics and quadriplegics and increased sensitivity to cold. All three of these classifications, while described by location, are certainly products of different pathophysiological conditions, which, when understood, can be treated effectively. The spinal hemisection model allows investigators to explore all three subdivisions of neuropathic pain: above-level, at level and below-level.

Another barrier in the failure of therapeutic strategies to treat dysesthesias of SCI is largely due to the difficulty in modeling SCI in mammalian models with similar pathophysiological mechanisms to the clinical symptomatology.

There are several animal models of chronic pain after SCI:

1. The ischemic model developed in Z. Wiesenfeld-Hallin & laboratory, an intravascular photochemical reaction occludes blood vessels in the thoracic cord, thereby producing spinal cord ischemia with a resultant band of mechanical allodynia on the trunk at the lesion site (“girdle” region, at level).
2. Unilateral single quisqualate injections into the spinal dorsal horn of T10 to L4 spinal segments described by R. Yeziarski, which eventually results in overgrooming and mechanical allodynia in the peripheral dermatome of the segment that received the injection (at level).
3. The spinal contusion model that results in changes in spontaneous activity (Mills et al. 2001b), as well as thermal and mechanical allodynia in both forelimbs and hindlimbs (above-level, below level), and demonstrates the development of mechanical allodynia at the segment of injury that extends rostral for several dermatomes, “girdle” allodynia (at level, Hulsebosch et al. 2000a).
4. Selective surgical lesions done in C. Vierck’s laboratory, which included anterolateral lesions of white matter, and both white and grey matter in monkeys and rats, that produces overgrooming and mechanical allodynia in both rostral (above level) and caudal segments (below level).
5. A clip compression model developed in L. Weaver’s laboratory, in which a 35 g or 50 g clip compresses the lower thoracic spinal cord, and the development of mechanical allodynia in the hindlimbs (below level) is demonstrated by rats.
6. A spinal hemisection model in rats in which the spinal cord is unilaterally cut dorso-ventrally, with the development over time of “girdle” pattern of mechanical allodynia (at level), thermal and mechanical allodynia in both forelimbs and hindlimbs (above and below level, Christensen and Hulsebosch 1997) and alterations in spontaneous activity (Hulsebosch 2002).

There are several advantages of the spinal hemisection (HS) model over other models of CCP after SCI:

1. HS avoids the variability of vascular-dependent lesions.
2. Responses to a variety of somatic stimuli are examined, since pharmacological interventions may selectively alter one quality of sensation (e.g., thermal and not tactile).
3. Changes in locomotion are assessed using the Basso, Beattie and Bresnahan (BBB) open field test scale developed in the laboratory of M. Basso, to control for alterations in motor control that might affect the nociceptive tests.
4. Most animals develop allodynia [only a subset (44%) of the spinal ischemic rats, 50% of the quisqualate spinally injected rats and 80% of the spinal contused rats (Mills et al. 2001a) develop mechanical allodynia].
5. Both spontaneous and evoked components of central neuropathic pain occur (Hulsebosch 2002).
6. Surgical ease and reproducibility, i.e., this is a relatively low technical approach that does not require an expensive contusion weight drop apparatus, and finally,
7. While spinal contusion lesions may better parallel the injury profile described in human spinal cord injury (Hulsebosch et al. 2000a), we have determined empirically that the hemisection model has several advantages over the contusion model such as, no “twice daily” bladder expressions for up to two weeks, no accompanying bladder infections, better hindlimb recovery for spontaneous and evoked testing allowing below-level testing of “pain-like” behavior and, importantly, more animals develop allodynia in this model than other models (Mills et al. 2001a; Hulsebosch 2002).

To approach this concept at the single cell level, if one focuses on a pain projection neuron, such as a spinothalamic tract neuron, input from primary afferents, interneurons and descending inputs can either facilitate or inhibit the excitability of the projection neuron by receptor-mediated alterations in membrane potential. Equally important in projection neuron excitability, is the presence of ion channels and a variety of second messenger and trans-synaptic signaling cascades. Thus, by pharmacological interventions using antagonists of excitatory receptors, or agonists of inhibitory receptors, or appropriate manipulation of ion channel permeability, it is possible to alter the hyperexcitability that is present after SCI (Hains et al. 2003). The spinal hemisection allows easy interpretation of whole animal behavior in response to pharmacological intervention, since the hindlimbs are not compromised. For example, it has been demonstrated by our laboratory and others that calcitonin gene-related peptide (CGRP) is a putative nociceptive transmitter. Thus, blocking CGRP receptor activation with a neutralizing peptide fragment that binds in the CGRP ligand binding site, but does not activate the G-protein coupled activation of adenyl cyclase. This results in attenuation of evoked responses in the forelimbs and the hindlimbs that are consistent with mechanical and thermal allodynia (above-level and below-level pain) (Bennett et al. 2000a). Similarly, inhibition of excitatory amino acid (EAA) receptors by the NMDA antagonist D-AP 5, and a non-NMDA antagonist that is specific for the AMPA/kianate receptor (NBQX) (Bennett et al. 2000b), attenuates mechanical allodynia but has no effect on thermal allodynia in both the forelimbs and hindlimbs. Furthermore, application of exogenous catecholamines (Hains et al. 2000a) or serotonin (Hains et al. 2000b) attenuate the mechanical and thermal allodynia both above and below level, presumably subserving the descending inputs that provide tonic inhibition of projection neurons that were severed in the hemisection. In another example, evoked and spontaneous allodynia behaviors are attenuated with an L-type Ca channel blocker (gabapentin, see Hulsebosch 2002) with the rat spinal hemisection model, after development of mechanical and thermal allodynia in both forelimbs and hindlimbs. Behavioral measures of both mechanical and thermal allodynia are described in detail elsewhere (Christensen et al. 1996). It is important to note that the measures (frequency or latency) of brisk paw withdrawals are accompanied by active attention of the rat to the stimulus by head turning and stimulus attack, whole body posturing to avoid a repeated stimulus in response to stimuli. The inclusion of these complex behaviors excludes simple hyperreflexia, which is a segmental response. Briefly, all the above interventions resulted in attenuation of both mechanical and thermal allodynia with the exception of the NMDA antagonist (D-AP5) and the non-NMDA antagonist (NBQX), which atten-

uated mechanical but not thermal allodynia, in both above level and below level subclassifications of CNP. To summarize, there are many models of CNP after spinal cord injury and each have advantages and disadvantages. The above discussion focuses on the spinal hemisection model as a useful model of clinical CNP.

## References

1. Bennett AD, Chastain KM, Hulsebosch CE (2000a) Alleviation of Mechanical and Thermal Allodynia by CGRP<sub>8-37</sub> in a Rodent Model of Chronic Central Pain. *Pain* 86:163–175
2. Bennett AD, Everhart AW, Hulsebosch CE (2000b) Intrathecal Administration of an NMDA or a Non-NMDA Receptor Antagonist Reduces Mechanical but not Thermal Allodynia in a Rodent Model of Chronic Central Pain after Spinal Cord Injury. *Brain Res* 859:72–82
3. Christensen AD, Everhart AW, Pickelmann JT, Hulsebosch CE (1996) Mechanical and Thermal Allodynia in Chronic Central Pain Following Spinal Cord Injury. *Pain* 68:97–107
4. Christensen MD, Hulsebosch CE (1997) Chronic Central Pain after Spinal Cord Injury. *J Neurotrauma* 14:517–537
5. Hains BC, Chastain KM, Everhart AW, McAdoo DJ, Hulsebosch CE (2000a) Transplants of Adrenal Medullary Chromaffin Cells Reduce Forelimb and Hindlimb Allodynia in a Rodent Model of Chronic Central Pain after Spinal Cord Hemisection Injury. *Exp Neurol* 164:426–437
6. Hains BC, Johnson KA, Eaton MJ, Hulsebosch CE (2000b) Transplantation of Immortalized Serotonergic Neurons Attenuates Chronic Central Pain after Spinal Hemisection Injury in Rat. *Neurosci Abstr* 26:2303
7. Hains BC, Willis WD, Hulsebosch CE (2003) Serotonin Receptors 5-HT<sub>A1</sub> and 5-HT<sub>3</sub> Reduce Hyperexcitability of Dorsal Horn Neurons after Chronic Spinal Cord Hemisection Injury in Rat. *Brain Res* 149:174–186
8. Hulsebosch CE (2002) Pharmacology of Chronic Pain after Spinal Cord Injury: Novel Acute and Chronic Intervention Strategies. In: Yezierski RP, Burchiel KJ (eds) *Spinal Cord Injury Pain: Assessment, Mechanisms, Management*. Progress in Pain Research and Management. vol 23. IASP Press, Seattle, pp 189–204
9. Hulsebosch CE (2002) Recent Advances in Pathophysiology and Treatment of Spinal Cord Injury. *Adv Physiol Edu* 26:238–255
10. Hulsebosch CE, Hains BC, Waldrep K, Young W (2000a) Bridging the Gap: From Discovery to Clinical Trials in Spinal Cord Injury. *J Neurotrauma* 17:1117–1128
11. Mills CD, Grady JJ, Hulsebosch CE (2001a) Changes in Exploratory Behavior as a Measure of Chronic Central Pain Following Spinal Cord Injury. *J Neurotrauma* 18:1091–1105
12. Mills CD, Hains BC, Johnson KM, Hulsebosch CE (2001b) Strain and Model Differences in Behavioral Outcomes after Spinal Cord Injury in Rat. *J Neurotrauma* 18:743–756

## Spinal Cord Injury Pain Model, Ischemia Model

XIAO-JUN XU, JING-XIA HAO,  
ZSUZSANNA WIESENFELD-HALLIN  
Karolinska Institute, Stockholm, Sweden  
zsuzsanna.wiesenfeld-hallin@labmed.ki.se

## Synonyms

Photochemical Model; Central Pain Model; Ischemia Model

## Definition

A photochemical technique was developed to induce ischemia in nervous tissue (Dietrich et al. 1986), which results from a reaction between a photosensitizing dye circulating in the blood stream and a focused light source, producing singlet oxygen, leading to damage of the endothelial layer of the vessel. The developing thrombosis causes localized ischemia. Spinal cord injury can be produced in rats following intravenous injection of the red dye erythrosin B, and subsequent irradiation with an argon ion laser (Hao et al. 1991; Hao et al. 1992). By varying the duration of laser irradiation, the extent of ischemia and consequent injury can be controlled (Hao et al. 1991; Hao et al. 1994). In this series of studies ischemia was induced in lower thoracic to midlumbar segments in Sprague-Dawley rats.

## Characteristics

### Acute Pain-Like Behaviors, Underlying Physiological Mechanisms and Pharmacology

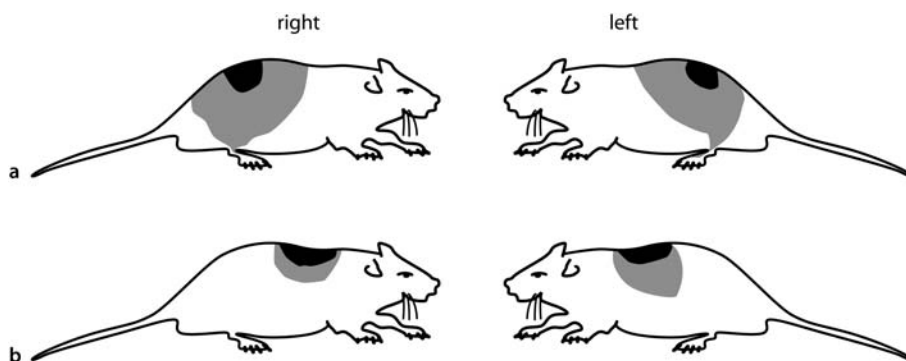
Within 24 h following spinal ischemia about 90% of rats develop hypersensitivity to mechanical stimuli (Hao et al. 1991; Hao et al. 1992a). The acute allodynia is present in animals with both mild and severe ischemic injury. Following transient ischemia motor deficits are minor, accompanied by little or no morphological damage in the spinal cord at the light microscopic level (Hao et al. 1991; Hao et al. 1992). A similar acute hypersensitivity follows severe ischemia, producing severe motor deficit, including bladder paralysis for about 1 week, and extensive injury to the dorsal spinal cord. In these cases, the acute phase is often followed by a chronic phase of allodynia.

The behavioral abnormalities during the acute phase include mechanical hypersensitivity to brushing and pressure and cold hypersensitivity, but no increased responsiveness to heat. The allodynic area is usually fairly large, including the flanks and the whole back region (Figure 1a).

To study the underlying physiological mechanisms of acute allodynia, the characteristics of wide dynamic range (WDR) neurons in the dorsal horn were compared in normal and allodynic animals (Hao et al. 1992). The receptive field sizes and background activity were similar in the two groups. Cutaneous stimuli that activated both A and C afferents evoked a biphasic response, with a short latency A-fiber mediated and a long latency C-fiber mediated response in normal animals. In allodynic animals, the stimulus evoked a prolonged burst, with no separation between A- and C-fiber mediated activity. The overall response magnitude was increased, but the A-fiber mediated response especially was much greater than normal. The response of the WDR neurons to mechanical stimulation with calibrated von Frey hairs in normal animals increased linearly with increased pressure. In allodynic animals, the cells had a significantly lower threshold than normal and the response magnitude increased exponentially, reaching maximal discharge frequencies at lower stimulus intensities than in normal animals. In contrast, the neuronal responses to noxious thermal stimuli applied with a CO<sub>2</sub> laser were indistinguishable in normal and allodynic animals. Thus, the responses of single neurons clearly reflected the behavioral abnormalities, where allodynia to mechanical, but not to heat, stimulation was observed.

The pharmacological basis of acute allodynia was also examined (Table 1).

Systemic or intrathecal administration of the GABA-B receptor agonist baclofen alleviated the allodynia and normalized the response pattern of WDR neurons recorded from allodynic rats, indicating an important role for activation of the GABA-B receptors in controlling the expression of mechanical allodynia. The GABA-A agonist muscimol had no effect. We have subsequently demonstrated that the number of dorsal horn neurons exhibiting GABA-like immunoreactivity was temporarily decreased after spinal cord ischemia, during the period when the acute allodynia was observed (Zhang et al. 1994). These results suggest that



**Spinal Cord Injury Pain Model, Ischemia Model, Figure 1** Spinal Cord Injury Pain Models / Ischemia Model. Illustration of typical area exhibiting mechanical allodynia in an acute (a) and a chronic (b) allodynic rat. In (a) injury is at spinal segments L3-4. In (b) injury is at spinal segment T11-12. The vocalization threshold in the acutely allodynic rat is 27.5 g in the shaded area and 13.0 g at black area. In the rat with chronic allodynia the vocalization threshold in the shaded area is 2.6 g and in the black area 0.6 g. The normal vocalization threshold is 80 g.

**Spinal Cord Injury Pain Model, Ischemia Model, Table 1** Summary of the effect of drugs applied systemically or intrathecally on acute and chronic allodynia in spinally injured rats. The drug's mechanism of action and side effects are indicated in parentheses

Drug	Acute Allodynia		Chronic allodynia	
	Systemic	Intrathecal	Systemic	Intrathecal
Morphine ( $\mu$ -opioid agonist)	-	$\pm$	- (sedation)	+
DAMGO ( $\mu$ -opioid agonist)	nt	nt	nt	+
CI977, U50488 ( $\kappa$ -opioid agonist)	nt	nt	- (sedation)	- (increased pain)
CI988 (CCK-B receptor antagonist)	nt	nt	+	nt
DPDPE ( $\delta$ -opioid agonist)	nt	nt	nt	+
Clonidine ( $\alpha$ -2 adrenergic agonist)	nt	$\pm$	- (sedation)	+
R-PIA (adenosine 1 receptor agonist)	nt	$\pm$	nt	+
Baclofen (GABA-B agonist)	+	+	-	nt
Muscimol, THIP (GABA-A agonist)	-	-	-	nt
Diazepam (benzodiazepine)	nt	nt	- (sedation)	nt
Tocainide, mexiletine ( $\text{Na}^+$ -channel blocker)	+	nt	+	nt
Carbamazepine (tricyclic antidepressant)	nt	nt	- (sedation)	nt
Gabapentin ( $\text{Ca}^{++}$ current inhibitor)	nt	nt	+	nt
NBQX (AMPA antagonist)	+	nt	- (sedation)	nt
MK-801, CGS 19755 (NMDA antagonist)	+	nt	$\pm$ (stereotypy)	-
Dextromethorphan (NMDA antagonist)	nt	nt	+	nt
F 13640 (5-HT $A_1$ receptor agonist)	-	nt	+	nt

+ = good effect,  $\pm$  = moderate effect, - = no effect, nt = not tested

the acute allodynia is predominantly mediated by abnormal input from myelinated afferents. The sensory abnormality is primarily due to disinhibition, involving a loss of GABAergic presynaptic control of input via myelinated afferents, which may result from a high susceptibility of GABAergic neurons to excitotoxicity.

### Chronic Allodynia, Its Underlying Physiological Mechanisms and Pharmacology

A chronic syndrome, with sensory abnormalities more severe than in the acute condition, develops in a subgroup of animals following severe, irreversible spinal cord ischemia (Xu et al. 1992). The main symptoms of this chronic syndrome are mechanical and cold allodynia referred to zones rostral to the damaged spinal cord segments (Fig. 1b).

Injury to dorsal gray matter is necessary for the development of chronic allodynia, which appears after a delay of 2–8 weeks following the injury. Once present, the allodynia persists without signs of remission. Not all rats with a similar degree of spinal cord injury developed chronic allodynia, which may be due to different levels of endogenous inhibitory control exerted by opioids. Thus,

systemic or intrathecal naloxone, or selective  $\mu$ -opioid receptor antagonists, can trigger the appearance of typical allodynia-like responses in non-allodynic, spinally injured rats (Hao et al. 1998). Finally, the level of endogenous inhibitory control may be set by anti-opioid systems, such as the neuropeptide cholecystokinin (CCK) (Xu et al. 1994).

Several abnormalities were found in the distribution and response characteristics of dorsal horn neurons in the chronic allodynic rats (Xu et al. 2002). In the allodynic rats, 17% of the units vs. 0% in controls had no receptive field. Most of these units were located at or close to the lesioned spinal segment and they discharged spontaneously at high frequencies. Furthermore, allodynic rats showed a significant change in the relative proportion of low threshold (LT), WDR or high threshold (HT) neurons recorded, with fewer LT and more WDR cells in allodynic rats than in normal rats. The rate of ongoing activity of HT neurons was significantly higher, and the responses to mechanical stimulation were increased in allodynic rats. In allodynic rats, the WDR neurons responded with higher discharge rates to innocuous mechanical stimuli compared to controls, and the percentage of WDR and HT neurons showing afterdischarges



to noxious pinch was also significantly increased. Finally, the proportion of WDR and HT neurons responding to innocuous cold stimulation increased from 53 and 25%, respectively, in control rats to 91 and 83% in allodynic animals. Neurons located up to 3 segments rostral to the lesion exhibited mechanical and cold hypersensitivity, which supports the presence of allodynia-like behavior to mechanical and cold stimuli applied in these dermatomes.

A large number of drugs have been tested in the chronic allodynic model (Table 1). Systemic or intrathecal morphine has a weak effect on acute allodynia, which may be related to a reduction in the density of  $\mu$ -opioid receptors in the spinal cord after ischemia (Hao et al. 1991; Yu et al. 1999). In contrast, during chronic allodynia intrathecal, but not systemic, morphine was highly effective. The potency of the anti-allodynic effect of intrathecal morphine was, however, reduced compared to its antinociceptive effect, and there was a rapid development of tolerance to the effects of intrathecal morphine in spinally injured rats. Thus it is unclear whether monotherapy with intrathecal morphine could provide long-term pain relief in patients with spinal cord injury pain, as tolerance development may present a problem.

Adenosine is an endogenous purine nucleotide which is extensively distributed intra- and extracellularly in the nervous system. Activation of spinal adenosine A1 receptors has been shown to produce antinociception. In a recent series of studies, we have shown that intrathecal R-phenylisopropyladenosine (R-PIA), an adenosine A1 receptor agonist, effectively alleviated chronic allodynia in spinally injured rats. The antiallodynic effect of R-PIA persisted considerably longer than that of morphine upon repetitive administration, and there was a synergistic interaction between R-PIA and morphine (von Heijne et al. 2000). Interestingly, i. t. R-PIA has only limited effect against acute allodynia, possibly indicating that the strong antiallodynic effect of R-PIA against chronic allodynia depends on structural and/or functional plasticity after injury.

There are several other interesting differences between the pharmacology of acute and chronic allodynia (Table 1). While baclofen is effective in treating acute allodynia (Hao et al. 1991), it is ineffective in chronic allodynia (Xu et al. 1992), suggesting that GABAergic mechanisms may not play as important a role in the pathophysiology of chronic allodynia as they do immediately after injury. Moreover, acute allodynia is sensitive to blockade of the AMPA receptor for glutamate (Xu et al. 1993), but not the NMDA receptor, whereas the opposite is true for chronic allodynia (Hao and Xu 1996). Again, this suggests the involvement of central nervous system plasticity in the mechanisms of chronic pain, for which the activation of NMDA receptors may play an important role. Systemically applied local anesthetics, such as tetracaine and mexiletine, are effective in both conditions (Xu et al. 1992).

Two drugs were recently tested that may offer new approaches to treat central pain following spinal cord injury (Table 1). One is the highly selective 5-HT<sub>1A</sub> receptor agonist F 13640, which was effective in reversing chronic allodynia, possibly through the mechanism of inverse tolerance. The second is gabapentin, a drug that has been shown to be useful in treating some neuropathic pain conditions. Thus, the ischemic spinal injury model may be useful for testing the efficacy of potential analgesics for the treatment of neuropathic central pain.

## References

1. Dietrich WD, Ginsberg MD, Busto R, Watson BD (1986) Photochemically Induced Cortical Infarction in the Rat. 1. Time Course of Hemodynamic Consequences. *J Cereb Blood Flow Metab* 6:184–194
2. Hao J-X, Xu X-J, Aldskogius H, Seiger Å, Wiesenfeld-Hallin Z (1991) Allodynia-Like Effect in Rat After Ischemic Spinal Cord Injury Photochemically Induced by Laser Irradiation. *Pain* 45:175–185
3. Hao J-X, Xu X-J, Aldskogius H, Seiger Å, Wiesenfeld-Hallin Z (1992) Photochemically Induced Transient Spinal Ischemia Induces Behavioral Hypersensitivity to Mechanical and Cold, but not to Noxious Heat, Stimuli in the Rat. *Exp Neurol* 118:187–194
4. Hao J-X, Herregodts P, Lind G, Meyerson B, Seiger Å, Wiesenfeld-Hallin Z (1994) Photochemically Induced Spinal Cord Ischaemia in Rats: Assessment of Blood Flow by Laser Doppler Flowmetry. *Acta Physiol Scand* 151:209–215
5. Hao J-X, Xu X-J, Yu Y-X, Seiger Å, Wiesenfeld-Hallin Z (1992) Transient Spinal Cord Ischemia Induces Temporary Hypersensitivity of Dorsal Horn Wide Dynamic Range Neurons to Myelinated, but not Unmyelinated, Fiber Input. *J Neurophysiol* 68:384–391
6. Zhang A-L, Hao J-X, Seiger Å, Xu X-J, Wiesenfeld-Hallin Z, Grant G, Aldskogius H (1994) Decreased GABA Immunoreactivity in Spinal Cord Dorsal Horn Neurons after Transient Spinal Cord Ischemia in the Rat. *Brain Res* 656:187–190
7. Xu X-J, Hao J-X, Aldskogius H, Seiger Å, Wiesenfeld-Hallin Z (1992) Chronic Pain-Related Syndrome in Rats after Ischemic Spinal Cord Lesion: A Possible Animal Model for Pain in Patients with Spinal Cord Injury. *Pain* 48:279–290
8. Hao J-X, Yu W, Xu X-J (1998) Evidence that Spinal Endogenous Opioidergic Systems Control the Expression of Chronic Pain-Related Behaviors in Spinally Injured Rats. *Exp Brain Res* 118:259–268
9. Xu X-J, Hao J-X, Seiger Å, Hughes J, Hökfelt T, Wiesenfeld-Hallin Z (1994) Chronic Pain-Related Behaviors in Spinally Injured Rats: Evidence for Functional Alterations of the Endogenous Cholecystokinin and Opioid Systems. *Pain* 56:271–277
10. Xu X-J, Hao J-X, Wiesenfeld-Hallin Z (2002) Physiological and Pharmacological Characterization of a Rat Model of Spinal Cord Injury Pain after Ischemic Spinal Cord Injury. In: Yezierski R and Burchiel K (eds) *Spinal Cord Injury Pain*. IASP Press, Seattle, pp 175–187
11. Yu W, Hao J-X, Xu X-J, Hökfelt T, Wiesenfeld-Hallin Z (1999) Spinal Cord Ischemia Reduces  $\mu$ -Opioid Receptor in Rats: Correlation with Morphine Insensitivity. *NeuroReport* 10:87–91
12. von Heijne M, Hao J-X, Sollevi A, Xu X-J, Wiesenfeld-Hallin Z (2000) Marked Enhancement of Anti-Allodynic Effect by Combined Intrathecal Administration of the Adenosine A-1 Receptor Agonist R-phenylisopropyladenosine and Morphine in a Rat Model of Central Pain. *Acta Anaesthesiol Scand* 44: 665–671
13. Xu X-J, Hao J-X, Seiger Å, Wiesenfeld-Hallin Z (1993) Systemic Excitatory Amino Acid Receptor Antagonist of the  $\alpha$ -amino-3-hydroxy-5-methyl-4-isoxazolepropionic acid (AMPA) Receptor, but not of N-methyl-D-aspartate (NMDA) Receptor, Relieves the Mechanical Hypersensitivity in Rats after Transient Spinal Cord Ischemia. *J Pharmacol Exp Therap* 267:140–144

14. Hao J-X, Xu X-J (1996) Treatment of Chronic Allodynia-Like Symptoms in Rats after Spinal Cord Injury: Effects of Systemic Glutamate Receptor Antagonists. *Pain* 66:279–286
15. Xu X-J, Hao J-X, Seiger Å, Arnér S, Lindblom U, Wiesenfeld-Hallin Z (1992) Systemic Mexiletine Relieves Chronic Allodynia-Like Symptoms in Rats with Ischemic Spinal Cord Injury. *Anesth Analg* 74:694–652

## Spinal Cord Injury Pain Models

- ▶ Spinal Cord Injury, Excitotoxic Model
- ▶ Spinal Cord Injury Pain Model, Contusion Injury Model
- ▶ Spinal Cord Injury Pain Model, Cordotomy Model
- ▶ Spinal Cord Injury Pain Model, Hemisection Model
- ▶ Spinal Cord Injury Pain Model, Ischemia Model

## Spinal Cord Injury, Excitotoxic Model

ROBERT P. YEZIERSKI  
Comprehensive Center for Pain Research and the  
McKnight Brain Institute, University of Florida,  
Gainesville, FL, USA  
ryezierski@dental.ufl.edu

### Synonym

Excitotoxic Model

### Definition

Loss of sensory and motor function are considered the most significant consequences of spinal cord injury (SCI). The condition of pain, however, is also associated with SCI and has a direct relationship with the ability of spinal injured patients to regain their optimal level of activity. Pain associated with SCI is typically perceived in anesthetic regions below the level of injury and is usually bilateral. It is often referred to as deafferentation pain, dysesthetic pain or central dysesthesia syndrome. The significance of SCI pain was revealed in a postal survey, in which 11% of those responding reported pain, rather than loss of motor function, stopped them from working (Rose et al. 1988). The functional impact of pain following SCI is demonstrated by results of a study, reporting 37% of SCI patients with high thoracic and cervical lesions would be willing to trade pain relief for loss of bladder, bowel or sexual function (Nepomuceno et al. 1979). The difficulty of dealing with SCI pain was examined by Widerstrom-Noga et al. (1999), and they found that the difficulty of dealing with chronic pain was only surpassed by the decreased ability to walk or move, loss of sexual function and decreased ability to control bladder and bowel function.

Although it is difficult in many studies to allocate pain types to specific categories, it appears that of all the types of SCI pain, below-level neuropathic pain is the

most common and the most difficult to treat (Finnerup et al. 2002). Other types of pain associated with SCI include at-level and above-level pain syndromes (Siddall et al. 2000).

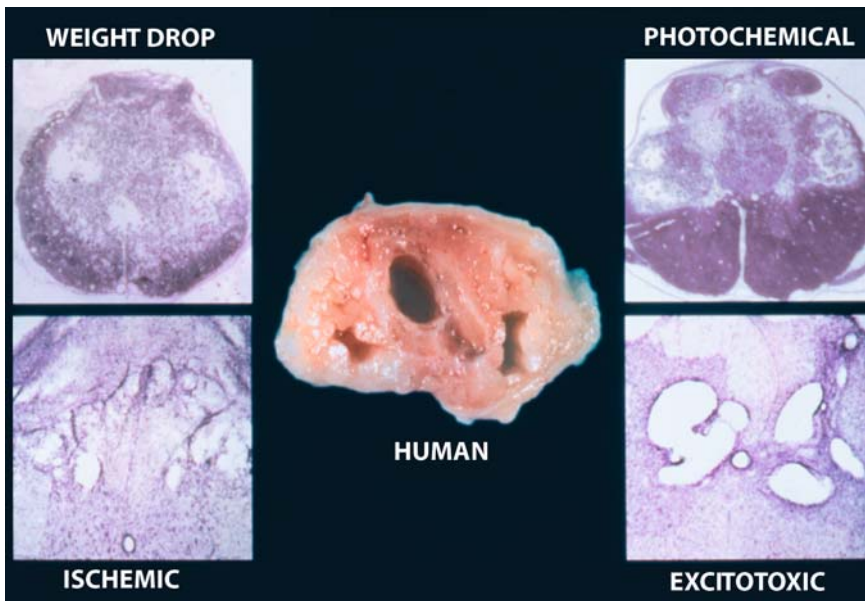
Simulation of injury-induced elevations of excitatory acids (EAA) can be achieved by intraspinal microinjection of EAA receptor agonists. These injections initiate a cascade of neurochemical, excitotoxic, inflammatory, and physiological events leading to the onset of spontaneous and evoked pain behaviours. These behavioural and pathophysiological events characterize the excitotoxic model of spinal injury.

### Experimental Models of Spinal Cord Injury

In recent years a number of experimental models have been used to study spinal cord injury (SCI) (Yezierski 2002). All of these models have distinctive characteristics related to a critical component of the primary injury (e.g., trauma or ischemia). In studies related to mechanisms of injury induced abnormal sensation, including pain, the photochemical (Xu et al. 2002) and hemisection (Hulsebosch 2002) models have provided important information regarding the pathophysiology and pharmacology of these sensory changes. The weight drop or contusion model, which is the oldest and most widely used model of SCI, has also been used in studies related to altered sensation following injury (Siddall et al. 1995). A final approach in the study of injury-induced abnormal sensation, involves the use of selected spinal lesions simulating the mechanical damage to ascending and descending pathways associated with spinal injury (Vierck and Light 2002). These different experimental strategies all produce pathological and/or behavioral changes associated with human SCI, and, therefore, provide an opportunity to study the spinal and supraspinal mechanisms responsible for the condition of injury-induced pain. Examples of the pathological changes observed with different models of SCI compared to the human condition are shown in Figure 1.

### The Excitotoxic Model of Spinal Cord Injury

In recent years, substantial evidence has been reported supporting the involvement of glutamate as a major contributor to the tissue damaging effects of SCI. For this reason, glutamate is viewed as one of several putative chemical mediators contributing to a 'central cascade' of secondary pathological changes following spinal injury. In an effort to evaluate the contribution of different glutamate receptor subtypes to the pathophysiology of SCI, a series of studies was undertaken in which NMDA and non-NMDA receptor agonists were microinjected into the rat spinal cord (Yezierski 2002). In these studies the intraspinal injection of quisqualic acid (QUIS) resulted in cell death and the formation of spinal cavities; similar results have been obtained with injections of NMDA. From these initial observations the excitotoxic



**Spinal Cord Injury, Excitotoxic Model, Figure 1** Examples of histological sections from spinal cords that underwent contusion (WEIGHT DROP), vasoconstriction (ISCHEMIC), ischemia (PHOTOCHEMICAL), and chemical (EXCITOTOXIC) injuries. The objective of each of these experimental models is to simulate different components of the human condition using features (e.g. trauma, vascular, chemical) known to be involved in producing primary and/or secondary tissue damage. Sections from the rat spinal cords were taken 3–6 weeks after injury, while the human sample was obtained 15 years after contusion injury. (Reprinted with permission from Yeziarski 2002).

model of SCI was developed, in an effort to study the well documented injury induced elevation of EAAs. The precision of the intraspinal injection technique makes it possible to evaluate the physiological and behavioral consequences of simulating small elevations in the concentration of specific glutamate agonists. Importantly, initial studies with this model also revealed a significant relationship between excitotoxic cell loss and the emergence of spontaneous and evoked pain behaviors, commonly associated with models of chronic neuropathic pain. Over the past 10 years the excitotoxic model has been used to investigate the pathophysiological, molecular and behavioral consequences initiated by the transient increase in spinal levels of EAAs (Yeziarski 2002). The clinical relevance of this model is supported by the fact that all of the pathological changes associated with it are part of the sequella associated with human SCI, and similar to those described following ischemic and traumatic injury in rats.

Initial studies using the excitotoxic model showed pathological findings following QUIS injections believed to be initiated by cellular events associated with ► **excitotoxicity**; overstimulation of glutamate receptors. More recent studies, however, have revealed that contributions from other components of a *central injury cascade* associated with SCI cannot be ignored. For example, a detailed study of the inflammatory component of the QUIS injury model has also shown that, following QUIS injections, there is an upregulation of mRNA for cytokines (IL-1 $\beta$ , TNF- $\alpha$ ), COX-2, iNOS as well as the death inducing ligands TRAIL and CD-95 (Plunkett et al. 2001). Therefore, the excitotoxic model, originally developed to study the temporal profile of pathological consequences following injury-induced elevations of EAAs, led to the discovery of an interre-

lationship between excitotoxic and other components of a secondary injury cascade, as well as a link with the spinal mechanisms responsible for the onset of injury-induced abnormal sensation and pain related behaviors (Fig. 2).

## Characteristics

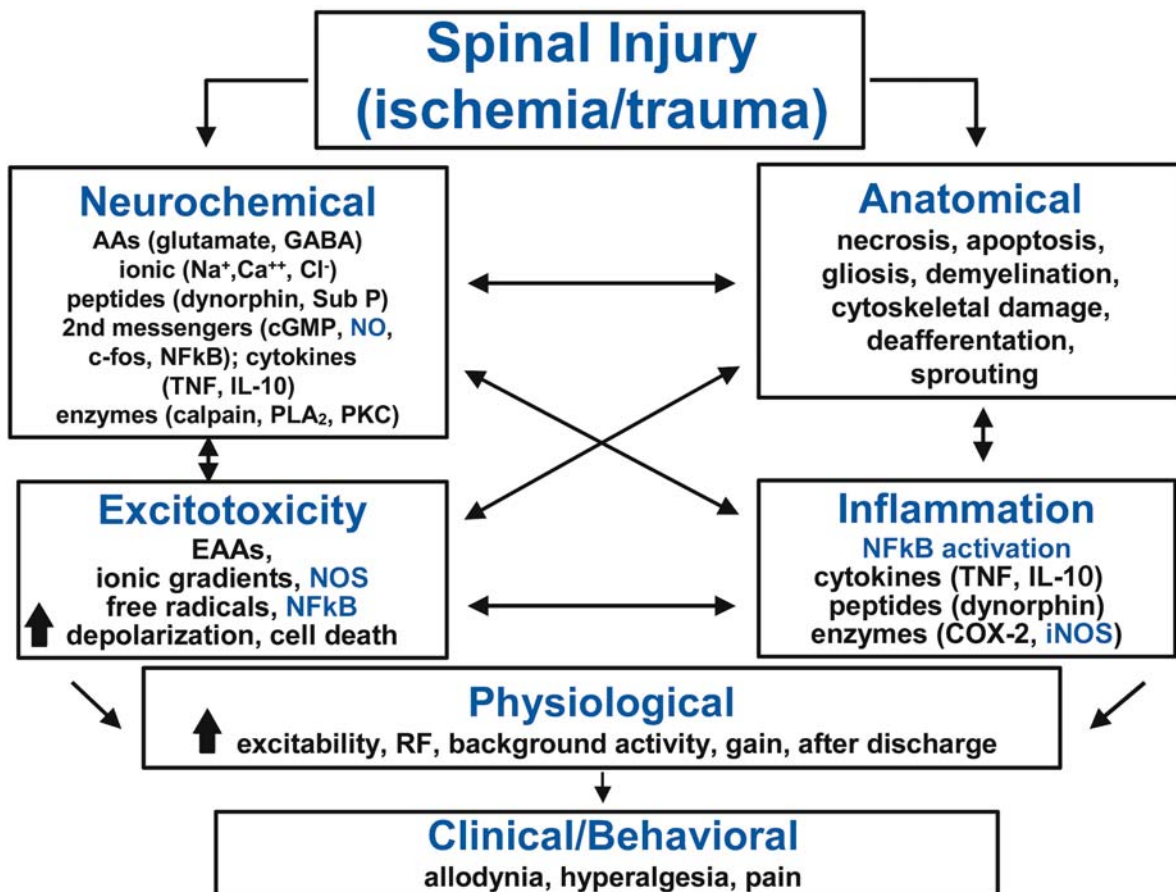
### Behavioral Consequences of Excitotoxic Spinal Injury

#### Mechanical and Thermal Hypersensitivity

A significant observation following QUIS injections is the onset of mechanical and thermal allodynia. In this evaluation baseline responses were elicited by stimulus intensities of 10–35g (mean baseline value 21.0 $\pm$ 9.8g). Following QUIS injections, stimulus intensities were significantly lower (1.5–8.0g) than pre-injection values (Fig. 3). The time course for the onset of mechanical allodynia was 10–12 days. The fact that significant effects (relative to baseline) were observed throughout the post-injury evaluation period (with no signs of recovery), underscores the chronic nature of the behavioral effect (Yeziarski et al. 1998).

Responses to a thermal detection task were evaluated in the same animals undergoing mechanical testing. Differences in responses to thermal stimulation were found starting approximately 10–12 days post-QUIS injections, and lasted throughout the evaluation period of 34 days (Fig. 3). As with mechanical stimulation, thermal stimuli were delivered to the glabrous skin of the hind paws in animals receiving QUIS injections in spinal segments T12–L2. Thus, responses reflecting a hypersensitivity to thermal stimulation were observed in dermatomes remote from those represented by segments receiving QUIS injections (Yeziarski et al. 1998).





**Spinal Cord Injury, Excitotoxic Model, Figure 2** Summary of the major components of the spinal *central injury cascade* that are believed to be responsible for the onset and progression of *at-level* and *below-level* pain following ischemic or traumatic spinal injury. Evidence supporting the basic concept of this cascade follows from results of clinical studies, as well as those obtained from the use of ischemic, lesion, contusion, and excitotoxic models of spinal cord injury. The four major components of the cascade (neurochemical, excitotoxicity, anatomical and inflammation) are represented as being interactive, and collectively lead to changes in the physiological state of spinal and supraspinal neurons. The end result of this cascade is the onset of clinical symptoms, e.g. allodynia, hyperalgesia, and pain. Abbreviations: EAAs, excitatory amino acids; Sub P, substance P; cGMP, cyclic guanine monophosphate; NO, nitric oxide; NF- $\kappa$ B, nuclear factor kappa B; PKC, protein kinase C; TNF, tumor necrosis factor; IL-1 $\beta$ , interleukin-1 $\beta$ ; PLA<sub>2</sub>, phospholipase A<sub>2</sub>; NOS, nitric oxide synthase; COX-2, cyclooxygenase-2; RF, receptive field. (Reprinted with permission from Yeziarski 2000).

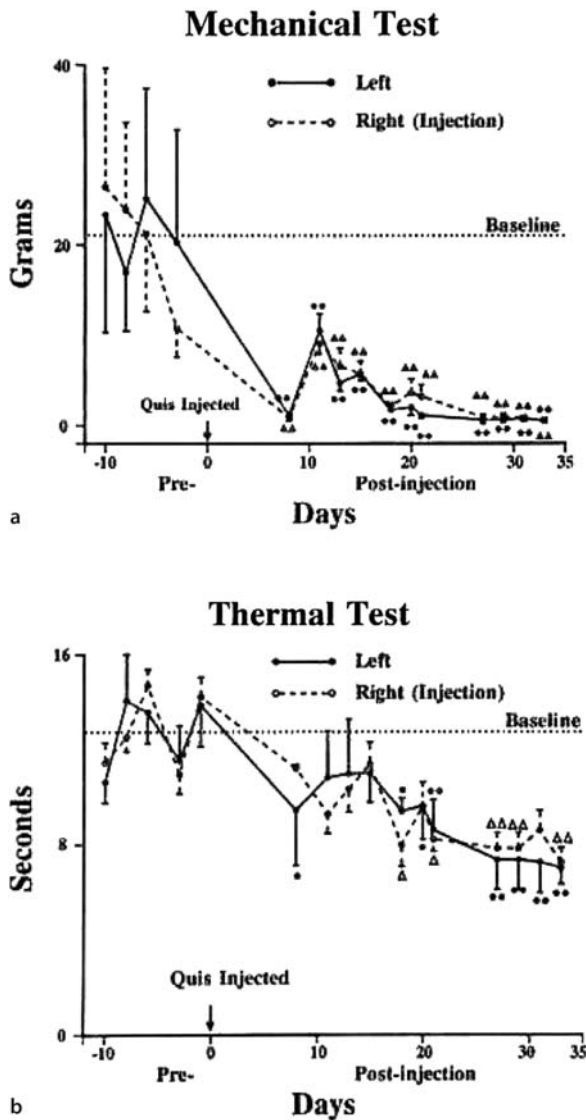
### Excessive Grooming Behavior

Excessive grooming behavior is a self-directed behavior that begins 10–15 days post-injury, with excessive biting and scratching of the skin, continues with removal of hair, and can progress to the extent where there is damage to the superficial layers of skin. Excessive grooming behavior is a progressive condition, and therefore a classification scheme for different phases of this behavior was developed: (a) Class I: hair removal over contiguous portions of a dermatome; (b) Class II: extensive hair removal combined with signs of damage to the superficial layers of skin; (c) Class III: hair removal and damage to dermal layers of skin; and (d) Class IV: subcutaneous tissue damage (experiment terminated). It is of interest that clinically, pain in paraplegia is also referred to peripheral dermatomes corresponding to spinal segments at or below the site of injury. Of special interest in QUIS injected animals is the parallel between the de-

layed onset of excessive grooming and a similar temporal profile of **central pain** in patients with SCI. Injury induced changes following QUIS injections are therefore believed to be part of a progression of altered sensations related to the clinical condition of central pain. Excessive grooming behavior has been proposed as a model of **at-level pain** associated with SCI (Yeziarski 2002).

Excessive grooming behavior is correlated with a lesion sparing the superficial lamina of the dorsal horn, and is viewed as a variant of the well described “deafferentation autotomy” (Yeziarski et al. 1998). Support for the conclusion that ectopic activity in the superficial dorsal horn may contribute to this behavior, was found in animals with injections selectively eliminating different regions of the gray matter. Figure 4A shows a cord where the superficial region and neck of the dorsal horn on the side of injection were eliminated, and this animal did not

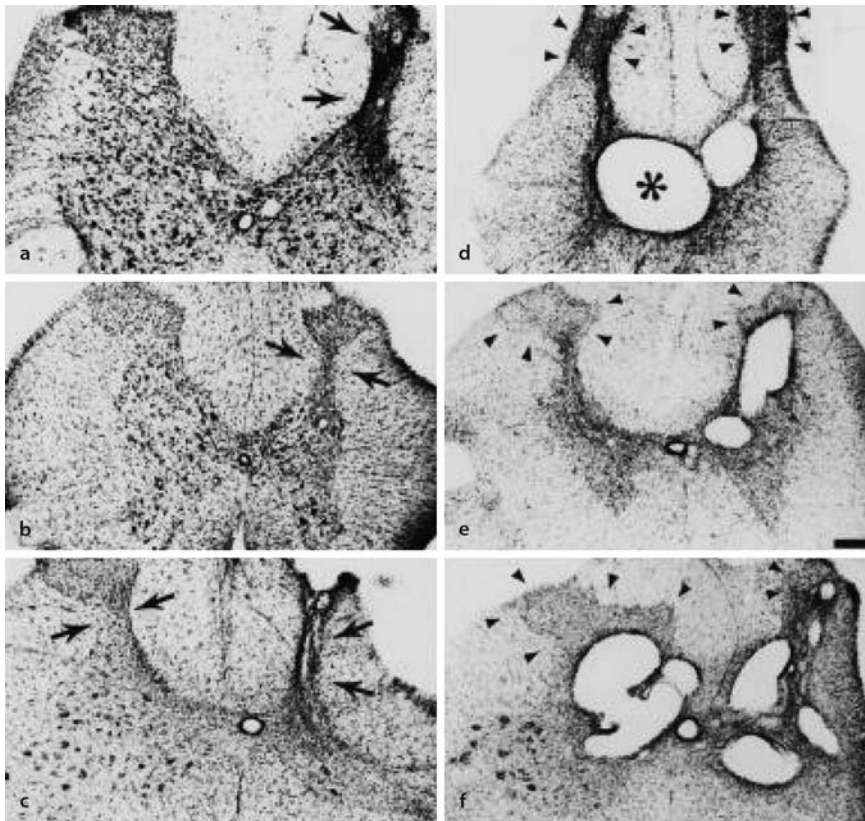




**Spinal Cord Injury, Excitotoxic Model, Figure 3** Responses to mechanical and thermal stimuli delivered to the hind paws. Animals were pre-tested over a period of 7–10 days prior to receiving intraspinal injections of 125mM quisqualic acid (QUIS). Animals received unilateral injections (1.2 $\mu$ l) directed at the dorsal horn and intermediate gray (right side) in spinal segments ranging from T12–L2. Post-injection testing commenced 10 days after surgery, and continued for a period of 34 days. (a) Results of testing with mechanical stimuli delivered to the hind paws ipsilateral and contralateral to the side of QUIS injections. During post-injection testing there was a significant decrease in stimulus intensity required to elicit withdrawal responses (bilaterally). Each point on the graph represents the mean threshold for all animals (n=10) on each day of testing. Error bars represent standard errors around the mean. Stimulus intensity in grams is represented on the y-axis and days pre- and post-injection on the x-axis. Statistical comparisons were made between the mean pre-injection baseline value and data obtained on each day of post-injection testing: \*, triangle =  $P < 0.05$  and \*\*, double triangle =  $P < 0.01$ . (b) Results of the Paw Flick test assessing the sensitivity to a radiant heat stimulus delivered to the hind paws (same group of animals as tested in (a)). During post-injection testing there was a significant decrease in withdrawal latencies to the thermal stimulus (bilaterally). Each point on the graph represents the mean of all trials (n=3) for all animals (n=10) on each day of testing. Error bars represent standard errors around the mean. Time in seconds is represented on the y-axis and days on the x-axis. Statistical comparisons were made between the mean pre-injection baseline value and data obtained on each day of post-injection testing: \*, triangle =  $P < 0.05$  and \*\*, double triangle =  $P < 0.01$ . (Reprinted with permission from Yeziarski et al. 1998).

exhibit excessive grooming behavior. By contrast, the pattern of neuronal loss in Figure 4B included the neck of the dorsal horn, with sparing of the superficial region. This animal exhibited excessive grooming behavior ipsilateral to the side of injury. This pattern of neuronal loss is referred to as: "grooming-type damage". Examples of grooming-type damage are also shown in Figure 4C–F. Efforts to systematically characterize events contributing to the onset and progression of excessive grooming were carried out in three different strains of male rats (Gorman et al. 2001): Sprague-Dawley (SDM); Long Evans (LEM); and Wistar Furth (WFM) rats. Differences in grooming characteristics between male and female rats, and the modulatory effects of female gonadal hormones were also evaluated in Sprague-Dawley females (SDF); bilaterally ovariectomized Sprague-Dawley females (OVX); and SDM's treated

with either 17- $\beta$ -estradiol (SDM-Est) or progesterone (SDM-Pro). The results showed that the development of excessive grooming behavior in males and ovariectomized females is related to the rostrocaudal spread of a specific pattern of neuronal loss. The onset, severity, and progression of excessive grooming in OVX females, was similar to that found in SDM's. Furthermore, estradiol treated SDM's developed severe grooming characterized by early onset, while progesterone treatment delayed the onset of grooming and attenuated its severity and progression. Strain-related differences were also observed with WFM's exhibiting more aggressive grooming than SDM's or LEM's. The results of this study showed that gender, strain and gonadal hormones influence the onset and progression of excessive grooming behavior following excitotoxic SCI (Gorman et al. 2001).



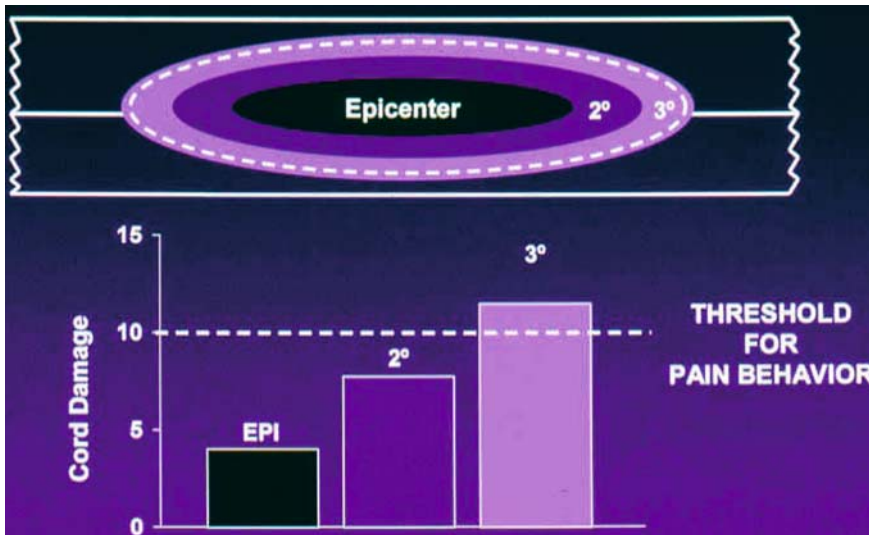
**Spinal Cord Injury, Excitotoxic Model, Figure 4** Patterns of neuronal loss following intraspinal injection of 125mM quisqualic acid (QUIS). All injections were made on the right side of the spinal cord. (a) Neuronal loss throughout the dorsal horn following injection of 0.6 $\mu$ l of QUIS at a depth of 300  $\mu$ m in spinal segment L2 (survival period 30 days). (b) Grooming-type damage represented by neuronal loss in the neck of the dorsal horn (arrows) following injection of 0.6  $\mu$ l of QUIS at a depth of 900 $\mu$ m in spinal segment T13 (survival period 32 days). (c) Neuronal loss throughout the dorsal horn (ipsilateral to injection) and in the neck of the dorsal horn (arrows) contralateral to injection site (L4) where 1.2  $\mu$ l of QUIS was injected at depths of 600  $\mu$ m and 1200  $\mu$ l (survival period 18 days). The pattern of neuronal loss contralateral to injection represents grooming-type damage. (d) Bilateral grooming-type damage represented by neuronal loss in the dorsal horn partially sparing the superficial lamina (arrowheads) following injection of 1.2  $\mu$ l of QUIS at depths of 600  $\mu$ m and 1200  $\mu$ m in spinal segment T13 (survival period 34 days). (e) Bilateral grooming-type damage represented by neuronal loss throughout the neck of the dorsal horn following injection of 1.2  $\mu$ l of QUIS at depths of 600  $\mu$ m and 1200  $\mu$ m in spinal segment L1 (survival period 27 days). Note partial and complete sparing of the superficial lamina (arrowheads) ipsilateral and contralateral, respectively, to injection site. (f) Bilateral grooming-type damage represented by neuronal loss below the superficial lamina ipsilateral and contralateral following injection of 1.2  $\mu$ l of QUIS at depths of 600  $\mu$ m and 1200  $\mu$ m in spinal segment L3 (survival period 28 days). Note: sparing of superficial lamina (arrowheads) contralateral and ipsilateral to the site of injection. Scale bar in (e) equals 190  $\mu$ m in a–c, e–f and 320  $\mu$ m in d. (Reprinted with permission from Yeziarski et al. 1998).

In conclusion there are three important similarities between excessive grooming behavior, and the well documented clinical condition of at-level pain in patients with spinal injury: (a) delayed onset; (b) spontaneous nature; and (c) dermatomal distribution relative to site of injury. The delayed onset of excessive grooming behavior suggests the neural mechanism is not simply an inhibitory release phenomenon, but instead requires significant changes (over time) in the functional state of spinal (and possibly supraspinal) sensory neurons. It is hypothesized that this behavior may be due to a loss of spinal inhibitory neurons, thus creating an imbalance between normal gating and biasing mechanisms within spinal and supraspinal somatosensory pathways (Vierck et al. 2000). Combined with a loss of segmental and/or supraspinal inhibitory influences, spinal neurons become hyperactive, and these focal pattern

generators are responsible for producing paraesthetic and/or dysesthetic sensations referred to the affected dermatome.

#### Spatial Profile of Spinal Cord Damage Required for the Onset of Pain Behaviors following Excitotoxic Spinal Injury

Initial studies evaluating the behavioral consequences of QUIS-induced spinal injury gave little attention to the longitudinal extent of neuronal loss required to produce these behaviors. While it is acknowledged that the cellular and molecular events accompanying injury are undoubtedly important in inducing pain behaviors, the question was asked if the longitudinal extent over which neurons are affected by the injury process is also important. To answer this question, an analysis of the longitudinal distribution of grooming-type damage was carried out in animals with and without excessive



**Spinal Cord Injury, Excitotoxic Model, Figure 5** Hypothetical progression of the *central injury cascade* from the epicenter (EPI) of an ischemic, traumatic or excitotoxic insult to the spinal cord. In this model, the extent of injury and/or the area of cord influenced by different components of the injury cascade expand to include 2° and 3° areas of injury. If left untreated the amount of cord damage will continue to expand until it exceeds the threshold required for the onset of pain behavior. (Reprinted with permission from Yeziarski 2000).

grooming behavior. The results demonstrated a clear relationship between a critical extent of damage along the rostrocaudal axis of the cord, and the onset of this spontaneous pain behavior. In animals with injury induced grooming behavior, grooming-type damage was in excess of 5000 $\mu$ m. By contrast, damage in non-grooming animals was less than 4000 $\mu$ m. Based on these data, a hypothetical model of tissue damage versus pain behavior was proposed (Fig. 5). In this model there is a gradual progression of cord damage away from the injury epicenter. As the injury evolves, the extent of tissue damage exceeds a critical threshold, triggering the onset of pain behaviors. This model suggests that it is not only the secondary injury cascade that is responsible for the onset of central pain following spinal injury, but also important is the longitudinal extent over which events in this cascade spread throughout the cord.

The above hypothesis was tested in a study where QUIS injured animals were administered intraperitoneal injections of the NMDA antagonist and NOS inhibitor agmatine (Yu et al. 2003). Following administration of agmatine, administered at the time of QUIS injury, there was a significant delay in the onset of excessive grooming behavior. Furthermore, following a 14 day treatment with agmatine after the onset of excessive grooming behavior, the final area of skin involvement targeted for excessive grooming was significantly reduced, and the severity of grooming behavior was significantly lower. Interestingly, the longitudinal extent of grooming type damage was also significantly less than in animals treated with saline. Neuroprotective effects similar to those with agmatine have also been obtained with the potent anti-inflammatory IL-10 (Yu et al. 2003). The results of this evaluation showed that IL-10 significantly reduced the onset time and area of excessive grooming behavior following QUIS injections. The

fact that agmatine and IL-10 can be used effectively as preventive treatments for injury-induced pain behaviors, underscores the importance of this intervention as a preemptive strategy of pain management for patients predisposed to progressive tissue damage in the spinal cord (e.g. syringomyelia, spinal cord injury).

Further studies related to evaluating the “neuroprotective hypothesis” of preventing the onset of spinal injury pain behaviors was evaluated using the immunosuppressant cyclosporin A. In a ‘prevention protocol’ beginning thirty minutes post-injection of QUIS, rats were divided into three groups: (1) QUIS+saline; and (2) QUIS+CsA. In a ‘treatment protocol’ beginning after the onset of QUIS-induced excessive grooming, animals were randomly divided into three groups: (1) grooming+saline; and (2) grooming+CsA. The results of this study showed in the ‘prevention protocol’ CsA delayed the onset of excessive grooming, reduced grooming area, reduced grooming severity, and reduced neuronal loss in the spinal cord compared to saline-treated animals (Yu et al. 2003). Treatment of excessive grooming behavior with CsA significantly reduced grooming area, grooming severity, and neuronal loss in the spinal cord compared to saline treatment. The conclusion from this study was that systemic administration of CsA significantly delayed the onset and reduced the progression of a spontaneous pain-related behavior. The results of the above studies have shown that there is a critical distance of neuronal loss along the longitudinal axis of the cord, which when exceeded, leads to the expression of a pain related behavior. Interventions which limit the spread of neuronal loss result in the prevention or delayed onset of these behaviors. The above studies support the “neuroprotective hypothesis” of SCI pain, and point to the possibility that using neuroprotective strategies, targeting specific components of the spinal injury cascade that interfere with death inducing events,

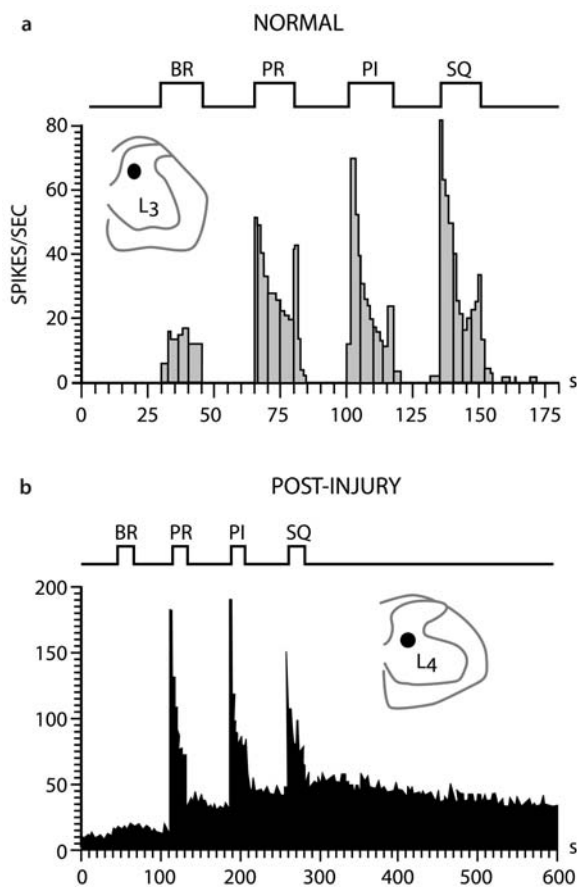


may be useful in the prevention or treatment of pain conditions associated with SCI.

### Functional Correlates of Behavioral Changes following Excitotoxic Spinal Cord Injury

Evaluation of the neural correlate of QUIS induced behavioral changes was undertaken by examining the functional properties of dorsal horn neurons, including cells belonging to the projection system from the spinal cord to the mesencephalon, i.e. spinomesencephalic tract (SMT). Supportive of a spinal mechanism for the evoked and spontaneous behavioral changes following QUIS injections, was the finding that spinal wide dy-

namic range neurons adjacent to the injury site undergo significant functional changes, including a shift to the left in the stimulus-response function, an increase in the level of background activity, and an increase in the duration of afterdischarge responses following removal of a stimulus (Yeziarski and Park 1993). These changes appeared within 3–7 days of injury, and were especially prevalent in animals following the onset of excessive grooming behavior. Afterdischarges lasting 5–15 minutes, and “wind-up” of background discharges with repeated stimulation, were novel characteristics of neurons in QUIS injected animals (Fig. 6). The fact that these changes were observed in cells belonging to the SMT, support the notion of a possible supraspinal component to the observed pain behaviors. Changes in the response characteristics of spinal neurons, similar to those observed following QUIS injuries, have been reported for cells following ischemic and hemisection injury of the spinal cord. The increased excitability, bursting discharges, and long afterdischarge responses of neurons in QUIS-injected animals, are reminiscent of the abnormal functional characteristics of neurons recorded in patients with chronic pain following SCI. Elimination of this activity by computer assisted DREZ (dorsal root entry zone) results in a significant reduction of spontaneous pain (Falci et al. 2003).



**Spinal Cord Injury, Excitotoxic Model, Figure 6** Post-stimulus time histograms showing the responses of two WDR neurons to graded intensities of mechanical stimuli. Cells were recorded in uninjected (a) and quisqualic acid-injected (b) animals. (a) Response profile of a WDR neuron recorded in the dorsal horn of spinal segment L3 (inset). Mechanical stimuli delivered to the receptive field on the foot included brush (BR), light pressure (PR), pinch (PI), and noxious squeeze (SQ). Note increased magnitude of response with increased intensity of stimulation. This cell had no spontaneous activity or afterdischarge response following removal of a stimulus. (b) Response profile of a WDR neuron recorded in the dorsal horn of spinal segment L4 (inset) caudal to an excitotoxic injury site located in L1–2. Note the presence of background activity, response magnitude to each stimulus condition (compared to cell in a), and the afterdischarge responses that continued following removal of each stimulus. Time in seconds is represented on the x-axis and spikes/sec on the y-axis. (Reprinted with permission from Yeziarski 1996).

### Supraspinal Changes associated with Excitotoxic Spinal Cord Injury

Efforts to evaluate supraspinal changes associated with excitotoxic injury were carried out, to evaluate whether injury induced changes extend to sites remote from the site of injury. Changes at supraspinal sites could potentially contribute to the central mechanism responsible for the onset and progression of injury induced pain behaviors. The studies carried out included an evaluation of changes in forebrain blood flow (Morrow et al. 2000), and evaluation of opiate transmitters in selected supraspinal sites (Abraham et al. 2001). In the study by Morrow et al. (2000), significant increases in regional cerebral blood flow were found in 7/22 supraspinal structures examined, including the arcuate nucleus, hindlimb region of S1 cortex, parietal cortex and the thalamic posterior, ventral posterior medial and lateral nuclei. Work from Brewer and colleagues focused on an examination of changes in peptidergic transmitter systems at spinal and supraspinal levels following excitotoxic SCI (Abraham et al. 2001). Preproenkephalin (PPE) and prodynorphin (PPD) expression was shown to increase in cortical regions associated with nociceptive function; PPE in the cingulate cortex and PPD in the parietal cortex, both ipsilateral and contralaterally at various time-points following injury. The increases in PPD were significant in animals that developed excessive grooming behaviors versus those that did not. PPE expression in the anterior cingulate cortex and PPD expression in the contralateral



parietal cortex were significantly higher in grooming versus non-grooming animals. All of these structures are associated with the processing of somatosensory information. The important conclusion from these reports is that following injury to the spinal cord there are significant changes at selected supraspinal sites, including somatosensory structures putatively involved in pain processing. These results are consistent with a recent report in humans using proton magnetic resonance spectroscopy, showing changes in the concentration of selected metabolites in SCI patients with pain (Pattany et al. 2002).

In conclusion, the results of the excitotoxic model described above support the general scheme that, following spinal injury, there are neurochemical, anatomical, molecular, and physiological changes that collectively constitute a *central injury cascade* responsible for the development of clinical symptoms, i.e. altered sensory (and motor) function. It is noteworthy, that many of the changes described following excitotoxic injury parallel descriptions of events thought to be responsible for the development of neurogenic pain following peripheral nerve and tissue injury. Although there may be subtle differences in specific components of the central cascade responsible for neurogenic versus central pain, it is difficult to ignore the similarities between the end result, i.e. pain, and the involvement of neurochemical, excitotoxic, anatomical, and physiological changes proposed for both central and peripheral pain. These similarities suggest that the central responses brought on by peripheral injury, and which underlie the onset of neurogenic pain, should not be overlooked in the search for a central mechanism of pain following spinal injury.

#### Acknowledgements

The work related to the excitotoxic model of spinal injury was supported by NS40096. The author would like to thank the collaborative assistance of Drs. Shanliang Liu, Kori Brewer, Chen-Guang Yu, Jeffery Plunkett and Laurel Gorman.

#### References

1. Abraham KE, McGinty JF, Brewer KL (2001) Spinal and Supraspinal Changes in Opioid mRNA Expression are related to the Onset of Pain Behaviors following Excitotoxic Spinal Cord Injury. *Pain* 90:181–190
2. Falci S, Best L, Bayles R, Lammertse D, Starnes C (2002) Dorsal Root Entry Zone Microcoagulation for Spinal Cord Injury – Related Central Pain: Operative Intramedullary Electrophysiological Guidance and Clinical Outcome. *J Neurosurg* 97:193–200
3. Finnerup NB, Johannesen IL, Sindrup SH, Bach FW, Jensen TS (2002) Pharmacological Treatment of Spinal Cord Injury Pain. In: Yeziarski RP and Burchiel K (eds) *Spinal Cord Injury Pain: Assessment, Mechanisms, Management*; IASP Press, Seattle, pp 341–351
4. Gorman AL, Yu CG, Sanchez D, Ruenes GR, Daniels L, Yeziarski RP (2001) Conditions Affecting the Onset, Severity, and Progression of a Spontaneous Pain-like Behavior after Excitotoxic Spinal Cord Injury. *J Pain* 2:229–240
5. Hulsebosch CE (2002) Pharmacology of Chronic Pain after Spinal Cord Injury: Novel Acute and Chronic Intervention Strategies. In: Yeziarski RP and Burchiel K (eds) *Spinal Cord Injury Pain: Assessment, Mechanisms, Management*. IASP Press, Seattle, pp 189–204
6. Morrow TJ, Paulson PE, Brewer KL, Yeziarski RP, Casey KL (2000) Chronic, Selective Forebrain Responses to Excitotoxic Dorsal Horn Injury. *Expt Neurol* 161:220–226
7. Nepomuceuno C, Fine PR, Richards JS, Gowens H, Stover SL et al. (1979) Pain in Patients with Spinal Cord Injury. *Arch Phys Med Rehabil* 60:605–609
8. Pattany PM, Yeziarski RP, Widerstrom-Noga EG, Bowen BC, Martinez-Arizala A, Garcia BR, Quencer RM (2002) Proton Magnetic Resonance Spectroscopy of the Thalamus: Evaluation of Patients with Chronic Neuropathic Pain following Spinal Cord Injury. *Am J Neuroradiology* 23:901–905
9. Plunkett JA, Yu C-G, Bethea JR, Yeziarski RP (2001) Effects of Interleukin-10 (IL-10) on Pain Behavior and Gene Expression following Excitotoxic Spinal Cord Injury in the Rat. *Exp Neurol* 169:144–154
10. Rose M, Robinson JE, Ellis P, Cole JD (1988) Pain following Spinal Injury: Results from a Postal Survey. *Pain* 34:101–102
11. Siddall PJ, Xu CL, Cousins MJ (1995) Allodynia following Traumatic Spinal Cord Injury in the Rat. *Neuroreport* 6:1241–1244
12. Siddall PJ, Yeziarski RP, Loeser J (2000) Pain following Spinal Cord Injury: Clinical Features, Prevalence, and Taxonomy. *IASP Newsletter* 3:3–7
13. Vierck CJ, Siddall PJ, Yeziarski RP (2000) Pain following Spinal Cord Injury: Animal Models and Mechanistic Studies. *Pain* 89:1–5
14. Vierck CJ and Light AR (2002) Assessment of Pain Sensitivity in Dermatomes Caudal to Spinal Cord Injury in Rats. In: Yeziarski RP and Burchiel K (eds) *Spinal Cord Injury Pain: Assessment, Mechanisms, Management*. IASP Press, Seattle, pp 137–154
15. Widerstrom-Noga EG, Cuevo EF, Broton JG, Duncan RC, Yeziarski RP (1999) Perceived Difficulty in Dealing with Consequences of SCI. *Arch Phys Med Rehab* 80:580–586
16. Xu X-J, Hao J-X, Wiesenfeld-Hallin Z (2002) Physiological and Pharmacological Characterization of a Rat Model of Spinal Cord Injury Pain after Spinal Ischemia. In: Yeziarski RP and Burchiel K (eds) *Spinal Cord Injury Pain: Assessment, Mechanisms, Management*; IASP Press, Seattle, pp 175–187
17. Yeziarski RP (2002) Pathophysiology and Animal Models of Spinal Cord Injury Pain. In: Yeziarski RP and Burchiel K (eds) *Spinal Cord Injury Pain: Assessment, Mechanisms, Management*; IASP Press, Seattle, pp 117–136
18. Yeziarski RP, Liu S, Ruenes GL, Kajander KJ, Brewer KL (1998) Excitotoxic Spinal Cord Injury: Behavioral and Morphological Characteristics of a Central Pain Model. *Pain* 75:141–155
19. Yeziarski RP, Park SH (1993) The Mechanosensitivity of Spinal Sensory Neurons following Intraspinal Injections of Quisqualic Acid in the Rat. *Neurosci Lett* 157:115–119
20. Yu CG, Fairbanks CA, Wilcox GL, Yeziarski RP (2003) Effects of Agmatine, Interleukin-10 and Cyclosporin on Spontaneous Pain Behavior following Excitotoxic Spinal Cord Injury in Rats. *J Pain* 4:129–140

## Spinal Cord Laminae

### Definition

Cytoarchitecturally differentiated regions of the spinal cord (described by Rexed).

► [Stimulation-Produced Analgesia](#)

## Spinal Cord Nociception and CGRP

► [CGRP and Spinal Cord Nociception](#)

## Spinal Cord Nociception, Encoding of Noxious Stimuli

### ► Encoding of Noxious Information in the Spinal Cord

## Spinal Cord Nociception, Glutamate Receptor (Metabotropic)

### ► Metabotropic Glutamate Receptors in Spinal Nociceptive Processing

## Spinal Cord Nociception, Neurotrophins

MARZIA MALCANGIO

Wolfson CARD King's College London, London, UK  
marzia.malcangio@kcl.ac.uk

### Synonym

Spinal nociceptive processing, neurotrophins; Neurotrophins in Spinal Cord Nociception

### Definition

The ► **neurotrophins** are a family of polypeptides, namely nerve growth factor (► **NGF**), neurotrophin 3 (► **NT-3**), NT-4 and brain derived neurotrophic factor (► **BDNF**). Peripheral sensory neurones require the neurotrophins produced by peripheral target tissue for survival during embryonic life. Then in adulthood, the neurotrophins can influence the morphology, excitability and synaptic plasticity of sensory neurones expressing their high affinity receptors. These receptors are tropomyosin receptor kinases (Trk's) coupled to a tyrosine kinase domain, TrkA, TrkB and TrkC and bind NGF, BDNF and NT4/5 and NT-3, respectively.

### Characteristics

The first pain synapse is formed between the central terminal of primary sensory neurones (pre-synaptic element) and second order neurones in the dorsal horn of spinal cord (post-synaptic element). The strength of this synapse is plastic and modifiable and it is now well established that neurotrophic factors are strong regulators of synaptic efficacy.

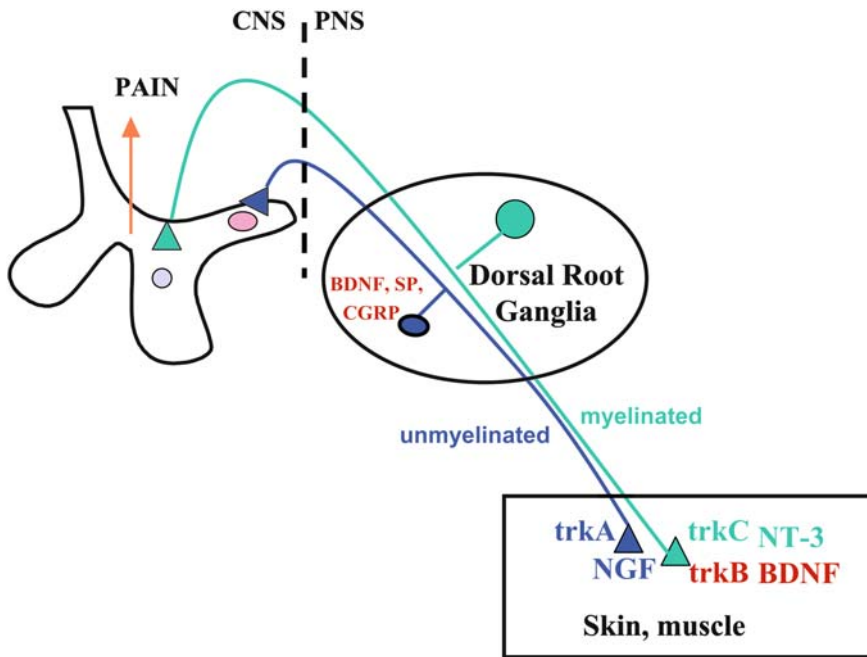
Primary sensory neurones are pseudo-unipolar cells that have cell bodies in the dorsal root ganglia (► **DRG**) and send their axons centrally to the dorsal horn of the spinal cord and peripherally to the skin and internal tissues. Sensory neurones can be broadly divided into two groups. First, neurones with a large cell body diameter and large myelinated axons. These respond to low threshold innocuous stimuli applied to peripheral tissues and their central axons terminate in the deeper laminae of the spinal cord. These neurones mainly

express TrkC and TrkB receptors and do not express peptides under normal circumstances. The second group includes neurones with a small cell body diameter and mostly unmyelinated axons. These cells are nearly all nociceptors and the central axons terminate in the superficial layers of the spinal cord. Many of these neurones contain peptides and a subpopulation of these small diameter sensory neurones expresses the TrkA receptor for NGF and expresses neurotrophins (McMahon et al. 1994; Michael et al. 1997) (Fig. 1).

Neurotrophic factors can regulate spinal nociceptive processing at the first synapse in the dorsal horn in two main ways. Firstly, if synthesised and released by primary sensory neurones they will directly modulate synaptic efficacy. Secondly, neurotrophins can indirectly modulate synaptic strength by regulating the expression and release of transmitters/ modulators of the first pain synapse.

### Nerve Growth Factor

NGF indirectly regulates the synaptic function of sensory neurone terminals in the dorsal horn by maintaining or stimulating the expression of excitatory peptides, receptors and neurotrophins in TrkA-expressing neurones. The high affinity receptor for NGF, TrkA, is expressed in the superficial laminae of the dorsal horn where it is found on the central terminals of some unmyelinated fibres that also express ► **substance P** (SP), calcitonin gene-related peptide (► **CGRP**) and BDNF. However, NGF does not directly modulate the activity of the central terminals of sensory neurones (Malcangio et al. 1997). Intrathecally-injected NGF does not modify the rat nociceptive threshold unless administered for 6–9 days, when it induces thermal hyperalgesia and increases sensory neurone transmitter content and consequently activity-induced release (Malcangio et al. 2000). In contrast, systemically administered NGF induces thermal hyperalgesia in rats very rapidly (Lewin and Mendell 1993). Endogenous NGF produced peripherally in the skin can sensitise the peripheral terminals of sensory neurones (e.g. in inflammation). Exogenous NGF induces hypersensitivity to thermal and mechanical noxious stimuli and sensitises the response of sensory neurones to capsaicin. Thermal hyperalgesia develops quickly and is maintained for days. It is sympathetically maintained and depends on peripheral mechanisms involving degranulation of mast cells and spinal cord mechanisms involving the ► **NMDA** receptor as well as the regulation of the content/release of nociceptive neuromodulators from sensory neurones. NGF-induced mechanical hyperalgesia seems to be independent of mast cell degranulation or central NMDA receptor sites. Endogenous NGF levels rise in inflammatory conditions. Reduction in endogenous NGF levels following systemic treatment with ► **TrkA-IgG**, which sequesters peripherally produced NGF, induces hypoalgesia and reduces inflammatory pain (McMahon



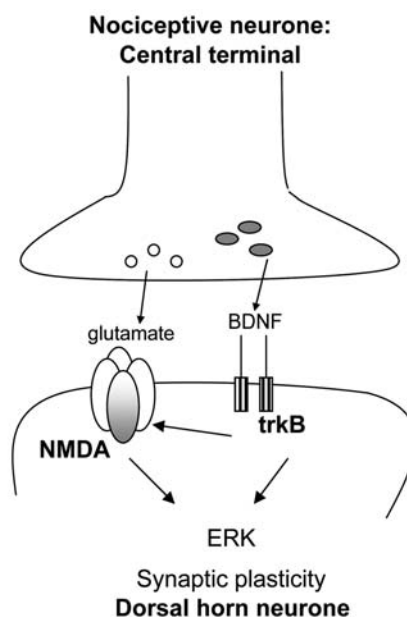
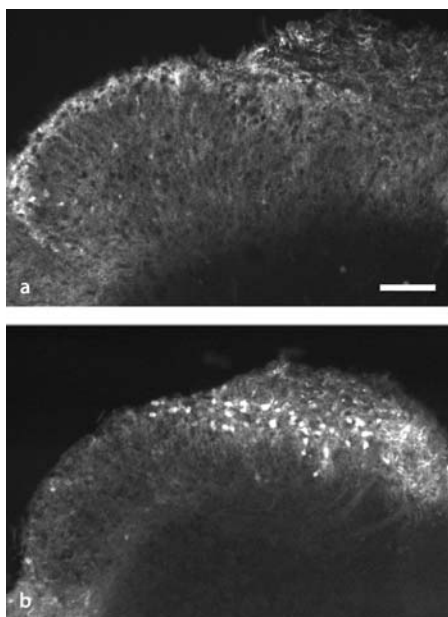
**Spinal Cord Nociception, Neurotrophins, Figure 1** Peripherally produced neurotrophins are retrogradely transported to the dorsal root ganglia by sensory neurons expressing Trk receptors. BDNF is also expressed by nociceptive neurons along with SP and CGRP.

et al. 1995). However, endogenous NGF levels decrease in peripheral neuropathies (e.g. diabetic neuropathy) and NGF supplementation can be anti-hyperalgesic in neuropathic pain conditions (McMahon and Priestley 1995).

**Neurotrophin 3**

Unlike NGF, NT-3 can acutely modulate sensory neuron transmission in the dorsal horn, where NT-3 inhibits activity-induced neuropeptide release from sensory neurons

terminals. This effect is mainly indirect since trkC receptors are not found in peptidergic neurons. NT-3 intrathecally or intraplantarly delivered does not modify thermal thresholds (Shu et al. 1999; Malcangio et al. 2000). The effects of systemic NT-3 on nociceptive thresholds include short-lasting thermal and mechanical hyperalgesia (Malcangio et al. 1997). However, activation of more than one Trk receptor by NT-3 makes it difficult to interpret the effect of this neurotrophin on sensory mechanisms.



**Spinal Cord Nociception, Neurotrophins, Figure 2** pERK labelling increases in mouse dorsal horn after application of BDNF-releasing stimulus to the attached dorsal roots. (a) control tissue. (b) stimulated tissue (300~pulses at 100~Hz, 10~mA, 0.5~ms). Scale bar =122~µm. (c) In the dorsal horn, BDNF released by nociceptive neurone terminals binds trkB postsynaptically and contributes to synaptic plasticity. TrkB activation promotes activation of **ERK** MAP kinase) directly and *via* NMDA receptor facilitation (Lever et al. 2003).

### Brain Derived Neurotrophic factor

BDNF is unique amongst the neurotrophins in that it is constitutively synthesised by sensory neurones. Unlike NGF, BDNF can directly modulate nociceptive processing in the dorsal horn (Pezet et al. 2002; Malcangio and Lessmann 2003).

Although peripherally produced BDNF can be retrogradely transported by sensory neurones expressing TrkB receptors, target-derived BDNF represents a small fraction of the total BDNF within the DRG. BDNF is found along with SP and CGRP in a subpopulation of sensory neurones that is sensitive to NGF (Michael et al. 1997). BDNF is synthesized in the dorsal root ganglia, packaged in vesicles and anterogradely transported to the central terminals of sensory neurones in the superficial laminae of the dorsal horn. Here BDNF can be released by certain noxious stimuli that produce bursting activity in nociceptive fibres (Lever et al. 2001) and binds its high affinity TrkB receptors, functioning to modulate nociceptive transmission (Garraway et al. 2003; Lever et al. 2003) (Fig. 2). BDNF content in sensory neurons is up-regulated in inflammatory states, and the activation of TrkB receptors in the dorsal horn by endogenous BDNF appears to contribute to the hyperalgesia associated with peripheral inflammation *via* facilitation of NMDA receptor activation (Kerr et al. 1999, Garraway et al. 2003). In neuropathic rat models, BDNF undergoes changes in injured and uninjured sensory neurons. Whether *de novo* expressed/up-regulated endogenous BDNF contributes to spinal nociceptive processing has not been definitively proved (Malcangio and Lessmann, 2003). However, intrathecal injection of BDNF in neuropathic rats transiently reversed thermal hyperalgesia *via* release of **GABA** in the dorsal horn and over-expression of BDNF in the spinal cord of neuropathic rats can alleviate chronic neuropathic pain (Eaton et al. 2002).

Therefore BDNF may be pro- or anti-nociceptive depending on circumstances e.g. inflammatory *versus* neuropathic pain conditions.

### References

- Eaton MJ, Blits B, Ruitenbergh MJ et al. (2002) Amelioration of chronic neuropathic pain after partial nerve injury by adeno-associated viral (AAV) vector-mediated over-expression of BDNF in the rat spinal cord. *Gene Ther* 9:1387–1395
- Garraway SM, Petruska JC, Mendell LM (2003) BDNF sensitizes the responses of lamina II neurons to high threshold primary afferent inputs. *Eur J Neurosci* 18:2467–2476
- Kerr BJ, Bradbury EJ, Bennett DLH et al. (1999). Brain-derived neurotrophic factor modulates nociceptive sensory inputs and NMDA-evoked responses in the rat spinal cord. *J Neurosci* 19:5138–5148
- Lewin GR, Mendell LM (1993) Nerve growth factor and nociception. *Trends Neurosci* 16:353–359
- Lever IJ, Bradbury EJ, Cunningham JR et al. (2001) Brain-derived neurotrophic factor is released in the dorsal horn by distinctive patterns of afferent fiber stimulation. *J Neurosci* 21:4469–4477

- Lever IJ, Pezet S, McMahon SB et al. (2003) The signalling components of sensory fiber transmission involved in the activation of ERK MAP kinase in the mouse dorsal horn. *Mol Cell Neurosci* 24:259–270
- Malcangio M, Lessmann V (2003) A common thread for pain and memory synapses? Brain-derived neurotrophic factor and TrkB receptors. *Trends Pharmacol Sci* 24:116–121
- Malcangio M, Garrett NE, Cruwys S et al. (1997) Nerve growth factor- and neurotrophin-3- induced changes in nociceptive threshold and the release of substance P from the rat isolated spinal cord. *J Neurosci* 17:8459–8467
- Malcangio M, Ramer MS, Boucher TJ et al. (2000) Intrathecally injected neurotrophins and the release of substance P from the rat isolated spinal cord. *Eur J Neurosci* 12:139–144
- McMahon SB, Priestley JV (1995) Peripheral neuropathies and neurotrophic factors: animal models and clinical perspectives. *Curr Opin Neurobiol* 5:616–624
- McMahon SB, Armanini MP, Ling LH et al. (1994) Expression and co-expression of Trk receptors in subpopulations of adult primary sensory neurones projecting to identified peripheral targets. *Neuron* 12:1161–1171
- McMahon SB, Bennett DL, Priestley JV et al. (1995) The biological effects of endogenous NGF on adult sensory neurones revealed by a TrkA-IgG fusion molecule. *Nat Med* 1:774–780
- Michael GJ, Averill S, Nitkunan A et al. (1997) Nerve growth factor treatment increases brain-derived neurotrophic factor selectively in tyrosine kinase A expressing dorsal root ganglion cells and their central terminations in the dorsal horn. *J Neurosci* 17:8476–8490
- Pezet S, Malcangio M, McMahon SB (2002) BDNF: a neuro-modulator in nociceptive pathways? *Brain Res Rev* 40:240–249
- Shu, X-Q, Llinas A, Mendell LM (1999) Effects of TrkB and TrkC neurotrophin receptor agonists on thermal nociception: a behavioural and electrophysiological study. *Pain* 80:463–470

## Spinal Cord Segmental Level

### Definition

A certain part of the spinal cord supplying a segment of the body with sensory nerves (conducting e.g. pain impulses).

- ▶ [Cancer Pain Management, Anesthesiologic Interventions, Neural Blockade](#)

## Spinal Cord Stimulation

### Definition

Chronic electrical stimulation of the spinal cord through an epidural electrode attached to an implanted pulse generator, a common minimally invasive technique for treatment of chronic pain.

- ▶ [Cancer Pain Management, Anesthesiologic Interventions, Spinal Cord Stimulation, and Neuraxial Infusion](#)
- ▶ [Complex Regional Pain Syndrome and the Sympathetic Nervous System](#)
- ▶ [Deep Brain Stimulation](#)
- ▶ [Pain Treatment, Motor Cortex Stimulation](#)
- ▶ [Pain Treatment, Spinal Cord Stimulation](#)



## Spinal Dorsal Horn

### Definition

Spinal structure mediating sensory inputs from the somatic distributions to the spinal cord.

- ▶ Calcium Channels in the Spinal Processing of Nociceptive Input
- ▶ DREZ Procedures
- ▶ NMDA Receptors in Spinal Nociceptive Processing

## Spinal Dorsal Horn Pathways, Colon, Urinary Bladder and Uterus

- ▶ Spinal Ascending Pathways, Colon, Urinary Bladder and Uterus

## Spinal Dorsal Horn Pathways, Dorsal Column (Visceral)

WILLIAM D. WILLIS  
Department of Neuroscience and Cell Biology,  
University of Texas Medical Branch, Galveston, TX,  
USA  
wdwillis@utmb.edu

### Synonyms

Posterior horn; posterior column; Visceral Nociceptive Tracts

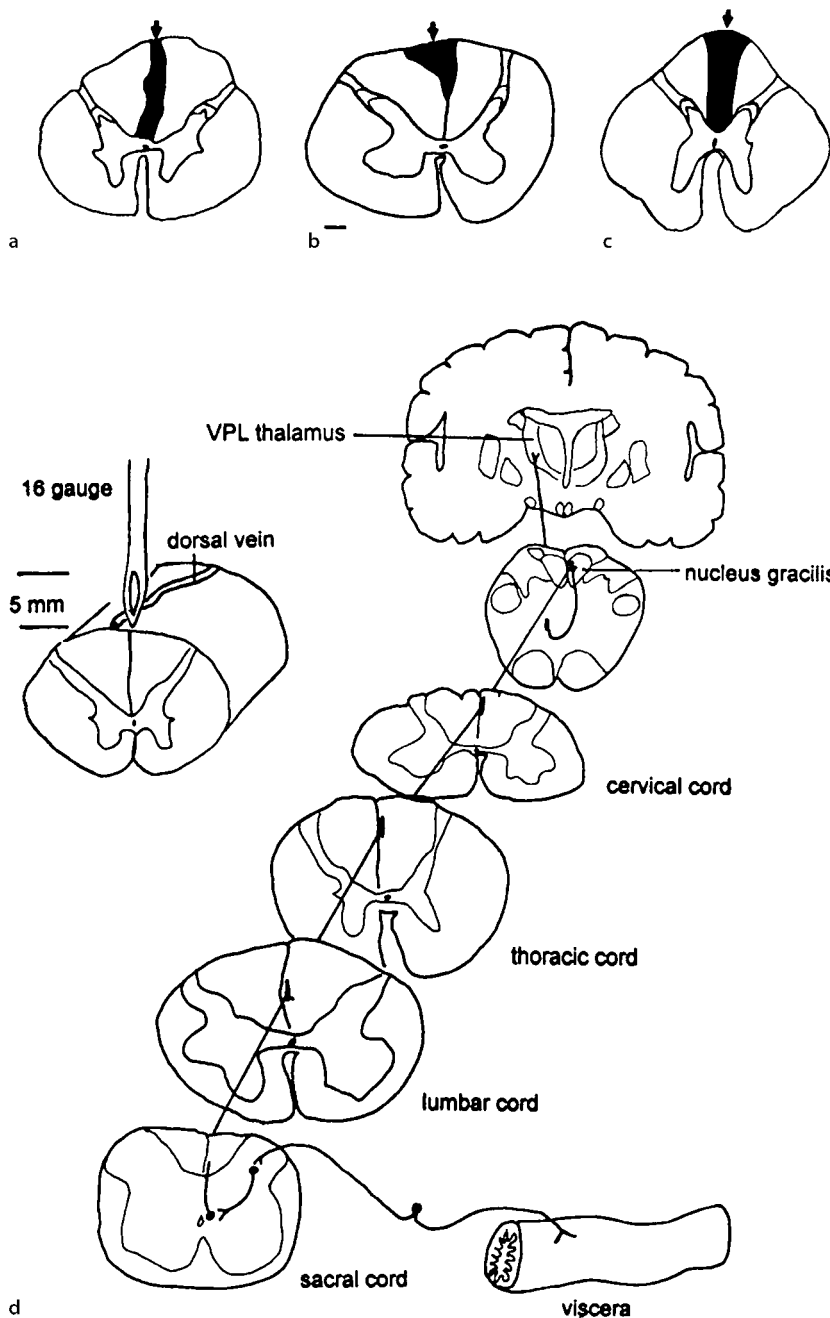
### Definition

The dorsal column visceral nociceptive pathway originates from postsynaptic dorsal column (PSDC) neurons (▶ Postsynaptic Dorsal Column Neurons). Although most previous work has emphasized the cutaneous input to PSDC neurons, it has now been shown that at least some of these neurons respond to noxious visceral stimuli, as well as to cutaneous stimuli. The cell bodies of PSDC neurons are concentrated in the nucleus proprius of the spinal cord dorsal horn, but some are located in the central gray matter. The axons of some of these neurons convey visceral nociceptive information through the dorsal column to the dorsal column nuclei of the medulla oblongata. The dorsal column nuclei transmit visceral nociceptive information to the contralateral ventral posterior lateral (VPL) thalamic nucleus, which in turn relays the information to the somatosensory cerebral cortex.

### Characteristics

A number of spinal cord ascending pathways convey visceral nociceptive information to the brain. These pathways include the spinothalamic, spinoreticular, spinoparabrachial, spinohypothalamic, spinoamygdalar and other spinolimbic tracts, which ascend in the lateral and ventral funiculi (Willis and Coggeshall 2004) (see ▶ Spinal Ascending Pathways, Colon, Urinary Bladder and Uterus). However, clinical observations have shown that midline lesions of the human posterior columns at a midthoracic level (Fig. 1) can relieve the pain of pelvic cancer and reduce the need for analgesic drugs (▶ analgesics) (Hirshberg et al. 1996; Nauta et al. 2000; Kim and Kwon 2000). For example, the lesions shown in Fig. 1a–c were made in patients with cancer pain. The lesion in Fig. 1a was made at T10 in a patient with colon cancer (Hirshberg et al. 1996). After the surgery, this patient spent the remaining 3 months of his life pain-free, without the need for strong analgesics. The lesion in Fig. 1b was made at T7 in a patient with lung cancer. This was the least successful lesion in relieving cancer pain in a series of cases (Nauta et al. 2000), perhaps because the lesion was largely unilateral or because the lesion was not placed sufficiently rostrally in this patient, who had lung cancer. Pelvic cancer pain was relieved for a period of several years by the lesion shown in Fig. 1c in another patient (Nauta et al. 2003). A technique for making a punctate midline myelotomy (Nauta et al. 2000) is shown in Fig. 1d (drawing at the left). The postsynaptic dorsal column pathway that was proposed to convey visceral nociceptive signals to the brain based on animal experiments (see below) is shown at the right in Fig. 1d.

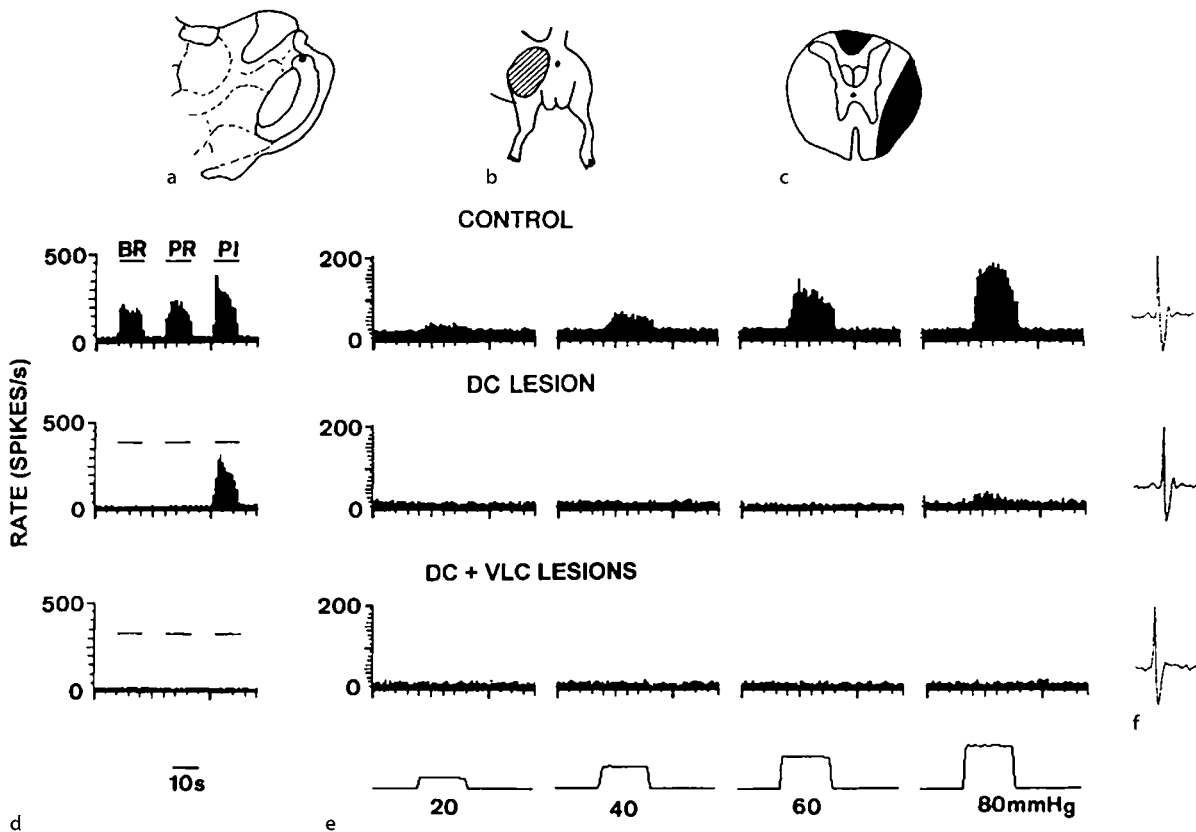
The rationale for performing a ▶ midline myelotomy for pelvic cancer pain was the previous success of midline myelotomies performed by Hitchcock and other neurosurgeons at the upper cervical level in relieving visceral and other forms of pain (Gybels and Sweet 1989). However, placement of a midline myelotomy at a mid-thoracic level rostral to afferent input from pelvic viscera is a safer procedure (Hirshberg et al. 1996). The interruption of a nociceptive pathway in the posterior columns of humans could also account for neurosurgical reports that commissural myelotomies can produce pain relief in much more caudal parts of the body than would be suggested by the segmental levels of the commissural myelotomy (Gybels and Sweet 1989). The presence of a visceral nociceptive path in the dorsal columns has now been demonstrated in animal experiments. For example, in rats the responses of neurons in the *ventral posterior lateral* (VPL) thalamic nucleus to noxious ▶ colorectal distension were found to be reduced by about 80% following a lesion restricted to the dorsal columns (Fig. 2), whereas similar responses in other rats were reduced by only about 20% after a lesion confined to the ventrolateral quadrant



**Spinal Dorsal Horn Pathways, Dorsal Column (Visceral), Figure 1** (a–d) The dorsal column visceral pain pathway in humans. (a–c) Lesions made in the dorsal columns of patients in an effort to relieve cancer pain. (a) Lesion at T10 completely relieved the pain of colon cancer. (b) Lesion at T7 was only partially effective in relieving pain from lung cancer, perhaps because the lesion did not extend sufficiently laterally on one side. (c) A lesion that relieved pelvic cancer pain for several years after the surgery. (d) The different levels of the dorsal column visceral pain pathway, including visceral nociceptive afferents, spinal cord processing circuits, postsynaptic dorsal column neurons projecting through the dorsal column to the dorsal column nuclei, and nucleus gracilis neurons projecting through the medial lemniscus to the VPL thalamic nucleus. (From Willis and Westlund 2004).

of the spinal cord (Al-Chaer et al. 1996a). Visceral nociceptive responses could also be recorded from neurons of the gracile nucleus, and these were blocked by ► [microdialysis](#) administration of morphine or of the non-N-methyl-D-aspartate antagonist, CNQX, into the sacral spinal cord, after restricting the afferent input from the colon to the sacral cord to the pelvic nerves by sectioning the hypogastric nerves prior to the experiment (Al-Chaer et al. 1996b). The ability of these drugs to block the visceral responses in the gracile nucleus is consistent with a synaptic action,

presumably at synapses of visceral primary afferent neurons on PSDC neurons. Recordings from individual antidromically identified PSDC neurons confirmed that their responses to visceral stimuli were in fact blocked by microdialysis administration of morphine or CNQX into the sacral spinal cord. Furthermore, the responses of VPL neurons to colorectal distention were greatly reduced by a small lesion placed in the gracile nucleus (Al-Chaer et al. 1997). Thus, the visceral responses in the gracile and VPL nuclei depend on a synaptic relay in the sacral spinal cord, and on subsequent transmission



**Spinal Dorsal Horn Pathways, Dorsal Column (Visceral), Figure 2** (a–f) Reduction in the responses of a neuron in the VPL thalamic nucleus in a rat to cutaneous and visceral stimulation following successive lesions of the dorsal column (DC) and the ventrolateral column (VLC). (a) Recording site, (b) cutaneous receptive field, (c) maximum extent of lesions of DC and VLC, (d) responses to brush (BR), pressure (PR) and pinch (PI) stimuli applied to the receptive field, (e) responses to graded colorectal distention (20, 40, 60 and 80 mm Hg), (f) action potential of VPL neuron. The DC lesion eliminated the responses to BR and PR, but not PI, and it nearly eliminated the responses to colorectal distention. The VLC lesion eliminated the remaining responses. The action potential remained consistent, indicating that the recording was unchanged throughout the experiment. (From Al-Chaer et al. 1996).

of visceral signals through the dorsal columns and dorsal column nuclei (Fig. 1d). Midthoracic dorsal column lesions were also observed to block changes in regional blood flow in the brains of monkeys at the level of the thalamus, using functional magnetic resonance imaging (Willis et al. 1999), indicating that there is a dorsal column visceral nociceptive pathway in primates, as well as in rats.

An anatomical study using the anterograde tracer, (▶ **anterograde axonal tracer (anterograde labeling)**) *Phaseolus vulgaris* leucoagglutinin, showed that PSDC neurons in the sacral spinal cord project their axons through the midline dorsal column to the gracile nucleus (Wang et al. 1999). However, the axons of PSDC neurons in the mid-thoracic spinal cord were found in the dorsal column, near the dorsal intermediate septum, between the gracile and cuneate fasciculi, and the axons terminated in the border area between the gracile and cuneate nuclei (Wang et al. 1999). Thus, the visceral component of the PSDC pathway has a viscerotopic organization, similar to the somatotopic organization of the cutaneous component of this pathway. Due to

this viscerotopic organization, dorsal column lesions to reduce visceral pain arising from abdominal organs would need to be placed more laterally than the midline lesions that are used to alleviate pelvic visceral pain. Evidence confirming that responses to noxious visceral stimuli applied to abdominal viscera are blocked by lesions of the dorsal columns placed at the border between the fasciculus gracilis and fasciculus cuneatus, has been obtained in experiments using recordings from VPL neurons before, during and after duodenal distention (Feng et al. 1998). In such animals, midline dorsal column lesions were ineffective. Similar laterally placed dorsal column lesions in rats were also needed to reduce the responses of VPL neurons to noxious stimulation of the pancreas using ▶ **bradykinin** applications (Houghton et al. 2001).

Behavioral studies have underlined the importance of the visceral pathway in the dorsal column for responses to noxious visceral stimuli. For example, dorsal column lesions reduce the writhing responses of rats to duodenal distention (Feng et al. 1998), as well as some of the changes in exploratory activity that result from noxious

stimulation of the pancreas (Houghton et al. 2001). Furthermore, dorsal column lesions prevent or disrupt the ► **visceromotor reflexes**, recorded as electromyographic responses from the external abdominal oblique muscle in rats, following noxious colorectal distention in animals in which the colon had been inflamed by injection of mustard oil, but not in non-inflamed control animals (Palecek and Willis 2003). The effect of a combination of colon inflammation and colorectal distention in reducing exploratory behavior of rats is partially reversed by bilateral dorsal column lesions at an upper cervical level, but not by a lesion of the ventrolateral funiculus (Palecek et al. 2002).

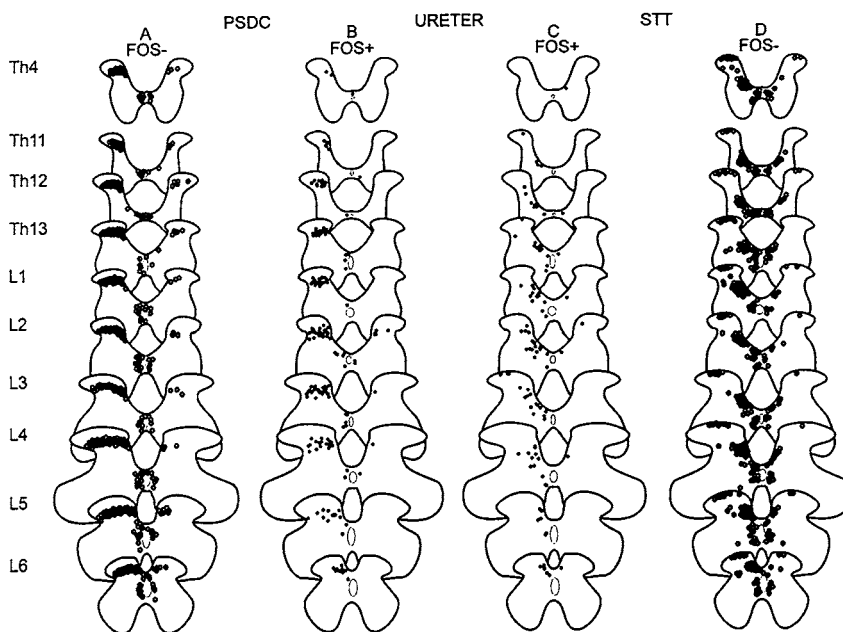
Another approach that has been used to demonstrate the role of the PSDC pathway, as well as of the spinothalamic tract, in signaling nociceptive visceral activity is a demonstration of the expression of ► **Fos protein** in response to ureter distention (Palecek et al. 2003). Retrograde labeling from the nucleus gracilis and the contralateral VPL nucleus, respectively, was used to identify neurons of the PSDC pathway and of the spinothalamic tract. A substantial fraction of neurons belonging to each pathway was found to express Fos protein after noxious distention of the ureter (Fig. 3). The leftmost column of Fig. 3 shows drawings of histological sections taken at various levels of the spinal cord. The locations of retrogradely labeled PSDC neurons are plotted on the drawings. The second column of drawings shows the locations of PSDC neurons that were immunoreactive for Fos protein following distention of the ureter. Some of the Fos-labeled PSDC neurons were in the central gray matter of the spinal cord, an area known to process visceral information. Other Fos-positive PSDC neurons were in the nucleus proprius. Similarly, the rightmost column

in Figure 3 shows the locations of retrogradely labeled spinothalamic tract (STT) cells, and the third column shows those STT cells that were immunoreactive for Fos protein after ureter distention.

Although not rigorously proven as yet, there is a plausible explanation for why a dorsal column lesion can interrupt nociceptive behavior in response to visceral stimuli, despite the fact that many spinothalamic and other ascending tract cells also respond to noxious visceral stimuli. It is well established that visceral responses in the spinal cord depend on the activation of an excitatory pathway that descends from the brain stem to activate spinal cord viscerosensitive neurons (Zhuo and Gebhart 2002; see also Willis and Coggeshall 2004). It seems likely that activity ascending in the dorsal column is not only transmitted by way of the dorsal column nuclei to the thalamus, but that this information also serves to activate this descending excitatory pathway (Palecek and Willis 2003). The brainstem excitation would normally help activate spinothalamic and other ascending tracts that convey visceral nociceptive information to higher centers. Interruption of the dorsal column could interfere with transmission, not only in the postsynaptic dorsal column path, but also in the other ascending viscerosensitive tracts, such as the spinothalamic tract.

## References

1. Al-Chaer ED, Lawand NB, Westlund KN, Willis WD (1996a) Visceral Nociceptive Input into the Ventral Posterolateral Nucleus of the Thalamus: A New Function for the Dorsal Column Pathway. *J Neurophysiol* 76:2661–2674
2. Al-Chaer ED, Lawand NB, Westlund KN, Willis WD (1996b) Pelvic Visceral Input into the Nucleus Gracilis is Largely Medi-



**Spinal Dorsal Horn Pathways, Dorsal Column (Visceral), Figure 3** Fos protein expression in postsynaptic dorsal column (PSDC) and spinothalamic tract (STT) neurons following noxious distention of the ureter in rats. PSDC and STT neurons were labeled retrogradely from the nucleus gracilis and thalamus, respectively. The filled circles in the leftmost column of drawings of spinal cord sections from Th4 to L6 indicate the locations of PSDC neurons that did not express Fos protein, and those in the next column of drawings show the positions of neurons that did express Fos protein after ureter distention. The third column shows STT cells that expressed Fos protein and the rightmost column those that did not. (From Palecek et al. 2003).



- ated by the Postsynaptic Dorsal Column Pathway. *J Neurophysiol* 76:2675–2690
3. Al-Chaer ED, Westlund KN, Willis WD (1997) Nucleus Gracilis: An Integrator for Visceral and Somatic Information. *J Neurophysiol* 78:521–527
  4. Feng Y, Cui M, Al-Chaer ED, Willis WD (1998) Epigastric Antinociception by Cervical Dorsal Column Lesions in Rats. *Anesthesiology* 89:411–420
  5. Gybels JM and Sweet WH (1989) *Neurosurgical Treatment of Persistent Pain*. Karger, Basel.
  6. Hirshberg RM, Al-Chaer ED, Lawand NB, Westlund KN, Willis WD (1996) Is there a Pathway in the Posterior Funiculus that Signals Visceral Pain? *Pain* 67:291–305
  7. Houghton AK, Wang CC, Westlund KN (2001) Do Nociceptive Signals from the Pancreas Travel in the Dorsal Column? *Pain* 89:207–220
  8. KimYS, Kwon SJ (2000) High Thoracic Midline Dorsal Column Myelotomy for Severe Visceral Pain due to Advanced Stomach Cancer. *Neurosurgery* 46:85–90
  9. Nauta HJW, Soukup VM, Fabian RH, Lin JT, Grady JJ, Williams CGAS, Campbell GA, Westlund KN, Willis WD (2000) Punctate Mid-Line Myelotomy for the Relief of Visceral Cancer Pain. *J Neurosurgery (Spine 1)* 92:6989–6997
  10. Palecek J, Paleckova V, Willis WD (2002) The Roles of Pathways in the Spinal Cord Lateral and Dorsal Funiculi in Signaling Nociceptive Somatic and Visceral Stimuli in Rats. *Pain* 96:297–307
  11. Palecek J, Paleckova V, Willis WD (2003) Fos Expression in Spinothalamic and Postsynaptic Dorsal Column Neurons following Noxious Visceral and Cutaneous Stimuli. *Pain* 104:249–257
  12. Palecek J, Willis WD (2003) The Dorsal Column Pathway Facilitates Visceromotor Responses to Colorectal Distention after Colon Inflammation in Rats. *Pain* 104:501–507
  13. Wang CC, Willis WD, Westlund KN (1999) Ascending Projections from the Area around the Spinal Cord Central Canal: A *Phaseolus Vulgaris* Leucoagglutinin Study in Rats. *J Comp Neurol* 415:341–367
  14. Willis WD, Al-Chaer ED, Quast MJ, Westlund KN (1999) A Visceral Pain Pathway in the Dorsal Column of the Spinal Cord. In: *The Neurobiology of Pain, NAS Colloquium*. PNAS USA 96:7675–7679
  15. Willis WD, Coggeshall RE (2004) *Sensory Mechanisms of the Spinal Cord*, 3<sup>rd</sup> edn. Kluwer Academic/Plenum Publishers, New York
  16. Willis WD, Westlund KN (2004) Pain System. In: Paxinos G, Mai JK (eds) *The Human Nervous System*, 2nd edn. Elsevier Academic Press, San Diego, pp 1125–1170
  17. Zhuo M, Gebhart GF (2002) Facilitation and Attenuation of a Visceral Nociceptive Reflex from the Rostroventral Medulla in the Rat. *Gastroenterology* 122:1007–1019

## Spinal Dorsal Horn Pathways, Muscle and Joint

SIEGFRIED MENSE<sup>1</sup>, HANS-GEORG SCHAIBLE<sup>2</sup>  
<sup>1</sup>Institute for Anatomy and Cell Biology III, University Heidelberg, Heidelberg, Germany  
<sup>2</sup>Department of Physiology, Friedrich Schiller University of Jena, Jena, Germany  
 mense@urz.uni-heidelberg.de,  
 hans-georg.schaible@mti.uni-jena.de

### Synonyms

Deep Somatic Pain; Muscle and Joint Pain; Small-Caliber Afferent Fibers; group III and IV fibers

### Definitions

- ▶ **Deep Somatic Pain**: pain from muscle, fascia, tendons and joint capsules
- ▶ **Receptive field**: those regions of the body from which a second order (or higher order) neuron can be excited or inhibited

### Characteristics

In contrast to cutaneous pain, which is usually well localized, deep somatic pain is rather diffuse and has a greater tendency to spread and to be referred. Moreover, deep pain is often associated with more marked autonomic reactions such as sweating and an increase in heart rate.

### Spinal Terminations

#### Primary Afferents from Muscle

Transganglionic labeling of afferent fibers from the cat gastrocnemius-soleus (GS) muscle has shown that small-diameter fibers terminate in laminae I and IV–VI (Mense and Craig 1988). Intraaxonal staining of single group IV fibers from muscle in the guinea-pig demonstrated spinal terminations mainly in lamina I and II (Ling et al. 2003). Thus, not only the superficial laminae – but also laminae of the deep dorsal horn – appear to be the main targets of small-caliber muscle afferent fibers, many of which are nociceptive.

#### Primary Afferents from Joint

Articular nerves supplying the knee or elbow joint of rat, cat and monkey project to several spinal segments. Staining of whole nerves with horseradish peroxidase showed dense projections of joint afferents to lamina I and to deep laminae IV, V, and VI (and VII) in cat, but other studies found projections mainly in lamina II and III (Schaible and Grubb 1993).

#### Dorsal Horn Laminae Containing Second Order Neurons Involved in Muscle and Joint Pain

In the past, pain research was focused on cutaneous pain, and dorsal horn neurons that were described as mediating skin pain were not tested for additional receptive fields (RFs) in deep somatic tissues. In recent years, it became clear that most dorsal horn neurons – particularly in the deep dorsal horn – have convergent input from joint, muscle, and skin. Neurons with exclusive input from muscle or joint are extremely rare.

#### Second Order Neurons Involved in Nociception from Muscle

Lamina I: In cat, most lamina I cells with input from the GS muscle were found to respond only to noxious stimuli and were driven by group III fibers (Craig and Kniffki 1985). Interestingly, those cells that projected to the contralateral thalamus had no additional group IV-fiber input. However, neurons not projecting to the

thalamus exhibited responses to electrical stimulation of group IV fibers. Apparently, lamina I is a rather specific target for muscle nociceptors with thinly myelinated fibers.

**Laminae IV–VI:** In these laminae, a marked convergence from deep somatic tissues and skin is present, and all functional types of cell can be found; low-threshold mechanosensitive (LTM, presumably non-nociceptive), high-threshold mechanosensitive (HTM or nociceptive specific (NS), presumably nociceptive), and wide-dynamic range or multireceptive (WDR or MR, presumably nociceptive) cells.

### Spread of Muscle-Induced Excitation of Dorsal Horn Neurons under Pathologic Conditions

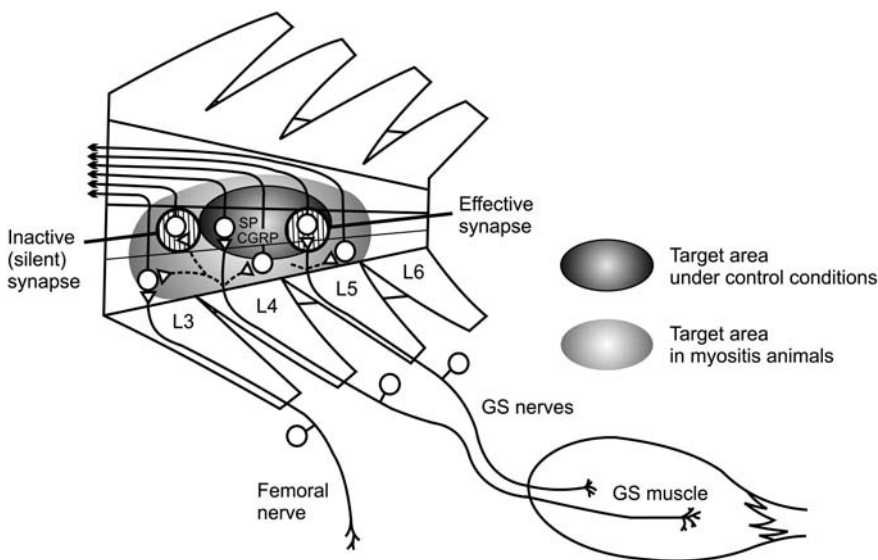
Input from muscle is known to be more effective in inducing spinal neuroplastic changes than input from the skin (Wall and Woolf 1984). In the rat, an experimental myositis induced marked changes in the connections between the afferents of the inflamed muscle and dorsal horn neurons (a lesion-induced “functional reorganization” of the spinal cord). One aspect of this reorganization was an expansion of the target region of the muscle nerve, i.e. input from inflamed muscle excited a larger population of spinal neurons than input from normal muscle (Hoheisel et al. 1994) (Fig. 1). This expansion was mainly due to activation of NMDA channels (binding glutamate) and NK1 receptors (binding substance P); AMPA/kainate receptors were not involved. The expansion is an expression of dorsal horn hyperexcitability (► **central sensitization**). Under the influence of nociceptive input from an inflamed muscle, formerly silent or ineffective synapses become effective, and the target area of the muscle nerve expands. Clinically, these findings could explain the subjective spread and referral of muscle pain.

### Glia-Neuron-Interaction

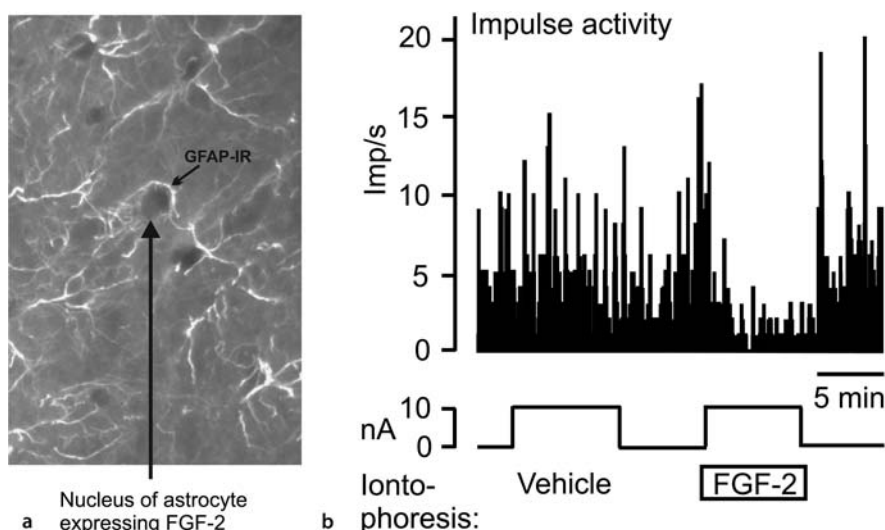
The great majority of cells in the CNS are glial cells (astrocytes, microglia, oligodendrocytes). Only recently has the role of glial cells in pain been acknowledged (Watkins et al. 2001). In rats with an experimental chronic myositis, astrocytes exhibit an increased synthesis of the cytoskeletal protein GFAP and of the basic fibroblast factor (FGF-2) (Tenschert et al. 2004) (Fig. 2a). Activation of central nervous system glial cells by a peripheral lesion, and the ensuing release of cytokines and other pro-inflammatory substances, are assumed to be important for the transition to chronic pain. However, glial cells also synthesize agents (e.g. FGF-2) that inhibit neuronal activity (Blum et al. 2001) (Fig. 2b).

### Second Order Neurons Involved in Nociception from Joint

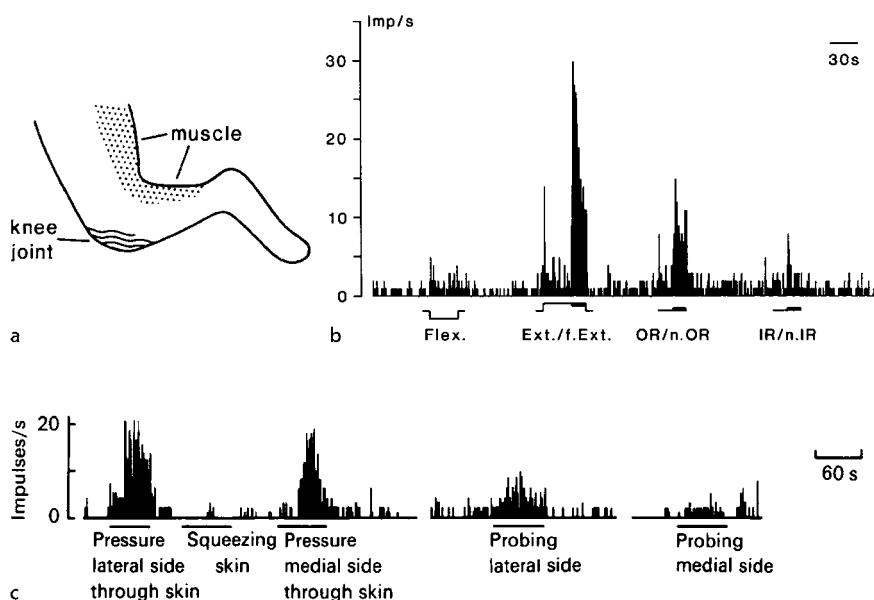
The spinal cord contains neurons that respond to pressure applied to the knee joint, but not to stimulation of the skin overlying the knee (Fig. 3c). Typically, these neurons also respond to stimulation of adjacent muscles (Fig. 3a). NS neurons with joint input are only excited by noxious pressure onto the joint and/or muscle, and twisting of the joint against resistance of the tissue. WDR neurons with joint input respond to light pressure onto the joint and to movements in the working range, and show greater responses to noxious stimuli (Fig. 3b). Most WDR neurons exhibit convergent inputs from skin and deep tissue, whereas many NS neurons in the deep dorsal horn have only deep input. The cat spinal cord contains neurons with cell bodies in the ventral horn and axons in the spinoreticular tract, which are only driven by noxious stimulation of deep tissue (Schaible 2005; Schaible and Grubb 1993).



**Spinal Dorsal Horn Pathways, Muscle and Joint, Figure 1** Expansion of the target area of a muscle nerve after an acute myositis (duration 8 h). The target area is that region of the dorsal horn in which neurons can be excited by standard electrical stimulation of the GS muscle nerves. Dark shading, target area of rats with intact muscle (control); light shading, target area of myositis animals. For further explanation, see text.



**Spinal Dorsal Horn Pathways, Muscle and Joint, Figure 2** Activation of astrocytes by a chronic myositis (a), and the effect of FGF-2 on neuronal activity (b). (a) Astrocytes were double-labeled with antibodies to glial fibrillary acidic protein (GFAP; white spider-like structures) and basic fibroblast growth factor (FGF-2; dark nuclei of the astrocytes). (b) Upper panel, resting activity of a dorsal horn neuron during iontophoresis of FGF-2 and vehicle, respectively. Lower panel, recording of the iontophoresis current used for depositing the FGF-2 solution close to the neuron. FGF-2 was ejected at a concentration of 5 nM through a glass microelectrode with 3 barrels, one of which was used for recording of the neuron's activity.



**Spinal Dorsal Horn Pathways, Muscle and Joint, Figure 3** Receptive field and responses of spinal cord neurons with input from the knee joint. (a) Receptive field of a neuron in the deep dorsal horn with input from the knee and adjacent muscles. (b) Responses of an ascending WDR neuron in lamina VIII of cat spinal cord with input from the knee joint, adjacent muscles and skin over the ankle joint. The neuron responded weakly to innocuous movements of the knee (flexion, extension, outward rotation, OR), and showed pronounced responses to forced extension (f. ext) and noxious outward rotation (n.OR) of the knee. (c) Responses of a lamina I neuron in L7 with joint input in cat spinal cord. The neuron was activated by pressure applied to the lateral and medial side of the knee joint through the skin and by probing the exposed lateral and medial side of the knee but not by squeezing the skin overlying the joint.

### Inflammation-Evoked Hyperexcitability of Spinal Neurons with Joint Input

During knee joint inflammation, NS and WDR neurons with knee input develop pronounced hyperexcitability. Responses to innocuous and noxious mechanical stimulation of the inflamed knee increase, and NS neu-

rons show a drop of threshold to the innocuous range. Responses to pressure onto non-inflamed muscles in the limb and to the ankle joint show a similar increase, and the receptive field often expands towards the paw. Thus, the spinal sensitization results from increased input from sensitized joint afferents and from an in-

traspinal increase of the gain (Schaible 2005; Schaible et al. 1987).

### Central Sensitization can persist during Chronic Inflammation

During chronic inflammation spinal neurons were more sensitive than in normal rats, and had expanded receptive fields in deep tissue and skin (Men trety and Besson 1982; Schaible and Grubb 1993), and numerous neurons in lamina I, and in the deep dorsal and ventral horn of several segments expressed the activity marker c-Fos. Particularly during chronic inflammation, c-Fos was mainly elevated in the deep dorsal horn, and only marginally in the superficial dorsal horn (Abbadie and Besson 1992; Men trety et al. 1989).

### Transmitters Involved in Activation and Sensitization of Spinal Neurons with Joint Input

Spinal application of antagonists at AMPA/kainate (non-NMDA) receptors reduced the responses of spinal neurons to innocuous and noxious pressure onto the knee joint, whereas NMDA receptor antagonists reduced only the responses to noxious pressure. During acute joint inflammation the intraspinal release of glutamate is enhanced, and antagonists at AMPA/kainate and NMDA receptors prevented the development of hyperexcitability. These antagonists also reduced the responses of the neurons to joint stimulation after established inflammation. Thus, glutamate receptors play a key role in the generation and maintenance of inflammation-evoked spinal hyperexcitability.

Noxious but not innocuous compression of the normal joint enhanced the intraspinal release of substance P, neurokinin A and CGRP. During acute inflammation, release of these mediators was even evoked by innocuous mechanical stimulation. Spinal application of antagonists at neurokinin 1, neurokinin 2 and CGRP receptors reduced the responses of spinal cord neurons to noxious compression of the normal joint, and attenuated the inflammation-evoked hyperexcitability (Schaible 2005).

During joint inflammation, PGE<sub>2</sub> was released within the dorsal and ventral horn. Topical application of PGE<sub>2</sub> to the spinal cord surface facilitated the responses of spinal cord neurons to pressure onto the normal joint. Topical spinal application of the COX inhibitor indomethacin before inflammation attenuated the development of hyperexcitability. Thus, spinal PGs are also involved in the generation of inflammation-evoked spinal hyperexcitability (Vasquez et al. 2001).

### References

- Abbadie C, Besson J-M (1992) C-fos Expression in Rat Lumbar Spinal Cord during the Development of Adjuvant-Induced Arthritis. *Neuroscience* 48:985–993
- Blum T, Hoheisel U, Unger T et al. (2001) Fibroblast Growth Factor-2 Acutely Influences the Impulse Activity of Rat Dorsal Horn Neurons. *Neurosci Res* 40:115–123
- Craig AD, Kniffki KD (1985) Spinothalamic Lumbosacral Lamina I Cells Responsive to Skin and Muscle Stimulation in the Cat. *J Physiol* 365:197–221
- Hoheisel U, Koch K, Mense S (1994) Functional Reorganization in the Rat Dorsal Horn during an Experimental Myositis. *Pain* 59:111–118
- Ling LJ, Honda T, Shimada Y et al. (2003) Central Projection of Unmyelinated (C) Primary Afferent Fibers from Gastrocnemius Muscle in the Guinea Pig. *J Comp Neurol* 461:140–150
- Men trety D, Besson J-M (1982) Electrophysiological Characteristics of Dorsal Horn Cells in Rats with Cutaneous Inflammation. *Pain* 13:343–364
- Men trety D, Gannon A, Levine JD et al. (1989) Expression of c-fos Protein in Interneurons and Projection Neurons of the Rat Spinal Cord in Response to Noxious Somatic, Articular, and Visceral Stimulation. *J Comp Neurol* 285:177–195
- Mense S, Craig AD (1988) Spinal and Supraspinal Termination of Primary Afferent Fibers from the Gastrocnemius-Soleus Muscle in the Cat. *Neuroscience* 26:1023–1035
- Schaible H-G (2005) Basic Mechanisms of Deep Somatic Pain. In: McMahon SB, Koltzenburg M (eds) *Wall and Melzack's Textbook of Pain*. Elsevier, Churchill, Livingston, pp 621–633
- Schaible H-G, Grubb BD (1993) Afferent and Spinal Mechanisms of Joint Pain. *Pain* 55:5–54
- Schaible H-G, Schmidt RF, Willis WD (1987) Enhancement of the Responses of Ascending Tract Cells in the Cat Spinal Cord by Acute Inflammation of the Knee Joint. *Exp Brain Res* 66:489–499
- Tenschert S, Reinert A, Hoheisel U et al. (2004) Effects of a Chronic Myositis on Structural and Functional Features of Spinal Astrocytes in the Rat. *Neurosci Lett* 361:196–199
- Vasquez E, B r K-J, Ebersberger A et al. (2001) Spinal Prostaglandins are Involved in the Development but not the Maintenance of Inflammation-Induced Spinal Hyperexcitability. *J Neurosci* 21:9001–9008
- Wall PD, Woolf CJ (1984) Muscle but not Cutaneous C-Afferent Input Produces Prolonged Increases in the Excitability of the Flexion Reflex in the Rat. *J Physiol* 356:443–458
- Watkins LR, Milligan ED, Maier SF (2001) Spinal Cord Glia: New Players in Pain. *Pain* 93:201–205

## Spinal Effects of Prostaglandins

### ► Prostaglandins, Spinal Effects

## Spinal Flattened Neuron

### Definition

Spinal lamina I neuron with a disk-shaped horizontal cell body and a roughly circular sparsely ramified aspiny dendritic tree confined to lamina I.

### ► Spinothalamic Tract Neurons, Morphology

## Spinal Fusiform Neuron

### Definition

Spinal lamina I neuron with a spindle-shaped cell body oriented rostrocaudally, and a narrow longitudinal dendritic tree with numerous short pedicled dendritic spines.

### ► Spinothalamic Tract Neurons, Morphology



## Spinal Fusion for Chronic Back Pain

VIVEKANANDA GONUGUNTA<sup>1</sup>,  
EDWARD C. BENZEL<sup>1, 2</sup>

<sup>1</sup>The Cleveland Clinic Foundation, Department of  
Neurosurgery, Cleveland, OH, USA

<sup>2</sup>The Cleveland Clinic Foundation, Cleveland Clinic  
Spine Institute, Cleveland, OH, USA  
benzele@ccf.org

### Synonyms

Spinal arthrodesis

### Definition

Elimination of movement between various elements of spinal column at one or more segmental levels, with or without instrumentation, is termed spinal fusion or arthrodesis. ► [Spinal arthrodesis](#) may be a more appropriate term, since it involves removing the articular surfaces and securing bony union. The origin of spinal fusion stems from the vast orthopedic literature supporting fusion for painful joints. Hippocrates first observed fusion of the facet joints in a patient with spinal tuberculosis and described it as nature's attempt to halt the progression of the deformity. Hibbs is credited for the first spinal fusion performed; in 1911 he surgically fused the posterior spinal elements in young patients with spinal tuberculosis.

### Indications

Spinal fusion is indicated in a variety of disorders causing back pain that are not responding to various conservative and less invasive measures. These conditions include Degenerative Disc Disease (DDD) causing discogenic low-back pain, spondylolisthesis, recurrent lumbar disc herniation with significant mechanical back pain or radiculopathy, and psuedoarthrosis.

### Investigations

Before embarking on a surgical fusion procedure, it is imperative that the surgeon establishes an anatomic explanation for the patient's symptoms, and then a realistic estimation should be made of the likelihood that the spinal fusion procedure would significantly improve the symptoms. In order to determine which patients are appropriate candidates for a fusion procedure and to decide which levels should be fused, all relevant investigations should be performed. These include plain radiographs, which show the disc height, any introsseous pathology, osteoporosis, and overall sagittal and coronal alignment. Flexion and extension views are used to help identify excessive segmental motion/instability. In non-traumatic settings, the extent to which this excessive motion represents instability is poorly defined (Nachemson et al. 1991), but generally 4–5 mm of translation and 15° of relative angulation is considered instability in degenerative disease (Spratt et al. 1993).

MRI is very sensitive regarding degenerative changes in discs and the surrounding soft tissue structures, spawning the concept of "black disc disease." Black disc disease is a loss of bright signal on T2 weighted images due to age-related loss of water content in the disk. High intensity zones confined to the annulus fibrosus, annular tears of various configurations and various endplate abnormalities of degenerative disc disease (Modic et al. 1988) are identified on MRI. It is precarious to attribute low back pain to these MRI abnormalities, as these are found in a fairly high percentage of asymptomatic individuals. Borenstein et al. (2001) demonstrated that the presence of such MRI findings of disc degeneration in healthy subjects does not predict the subsequent development of lumbar spine symptomatology.

Provocative discography has thus been proposed to identify the painful disc (see chapter on ► [Discogenic Back Pain](#)). The most useful aspect of the procedure in the context of determining levels for surgical fusion is the subjective pain response, with the reproduction of the patient's low back pain symptoms during the injection of the contrast agent representing a "concordant" pain response. However, the natural history of low back pain in patients with positive discography is uncertain. Smith et al. (1995) observed that approximately two thirds of patients with positive discography, who were considered operative candidates but did not have surgery, had satisfactory relief with non-operative therapy.

From this description of various diagnostic tools, it is obvious that our ability to delineate the exact cause of back pain, and then to predict the outcome of surgical fusion based on these findings, is far from perfect. However, the ideal surgical candidate for fusion would be a patient with chronic low back pain who has isolated single disc degeneration on MRI. This patient should have concordant discographic pain and evidence of instability after a failed, prolonged course of non-operative therapy.

### Characteristics

The primary objective of lumbar spinal fusion is not to achieve fusion between two vertebrae but to improve pain, disability, quality of life and the working capacity of the patient, or to alter an unfavorable natural course (M. Krismer). A solid bony union does not necessarily correlate with symptom relief.

Types of fusion:

1. Interlaminar fusion
2. Postero-lateral fusion
3. LIF: Lumbar interbody fusion (► [ALIF](#)-Anterior LIF, ► [PLIF](#)-Posterior LIF and ► [TLIF](#)-transforaminal LIF)

Fusion procedures are often combined with spinal instrumentation in the form of pedicle screw fixation. The latter is used not only to correct the deformity, but also to compress the bone graft between the articular surfaces to promote union. The full details of surgical technique are

beyond the scope of this chapter, but a brief description of each fusion procedure, along with expected results, follows.

Postero-lateral fusion involves decortication of facet joints, transverse processes and pars-articularis, with the onlay of bone graft to encompass the exposed bony surfaces. Although the fusion rates are better with a lower pseudoarthrosis rate (5%–10% with addition of pedicle screws (Zdeblick 1993), good to excellent relief of back pain was reported in only 39%–57% of the patients (France et al. 1999; Zdeblick 1993). One of the reasons for these disappointing clinical outcomes is due to the biomechanical inability of posterolateral fusion alone to impart rigid immobilization of the spinal column, without additionally providing anterior column support. Rigid posterolateral fusion might allow micromotion anteriorly through the “pain generating” intervertebral disk. This was demonstrated by Weatherley et al. (1986) in 5 patients with persisting discogenic back pain despite solid posterolateral fusion.

Lumbar Interbody Fusion (LIF) thus became popular since it has multiple theoretical advantages over posterolateral fusion. Interbody fusion places the bone graft in the load bearing position of anterior and middle spinal columns (which support 80% of spinal loads and provide 90% of the osseous surface area), thereby enhancing the potential for fusion. This procedure also helps to restore the disc space height, lumbar lordosis, and coronal and sagittal balance of the spine, whereas a posterolateral fusion has limited potential to do this (Mummaneni et al. 2004). As this procedure involves complete discectomy, it theoretically eliminates discogenic pain if the lumbar disc is the pain generator in that particular patient. Three different approaches for LIF are widely practiced:

- ALIF: Anterior Lumbar Interbody Fusion - where discectomy and fusion is performed by ventral approach and fusion is often supplemented with posterior instrumentation. Advantages include direct access for reconstruction of anterior spinal column, ability to improve sagittal balance, and ability to avoid paraspinal muscle trauma and denervation. Drawbacks include risk of deep venous thrombosis and vascular injury due to retraction of iliac vessels, retrograde ejaculation from hypogastric plexus injury, and muscular atony of abdominal wall leading to hernias.
- PLIF: Posterior Lumbar Interbody Fusion (Fig. 1a, b) – where a laminectomy is performed and thecal sac is retracted to access the disc space, and to perform discectomy and placement of interbody cages filled with bone graft. Simultaneous posterolateral fusion is performed to achieve circumferential fusion. Since this technique requires significant bilateral retraction of the thecal sac and nerve roots, risks include cerebrospinal fluid leakage, dysesthetic nerve

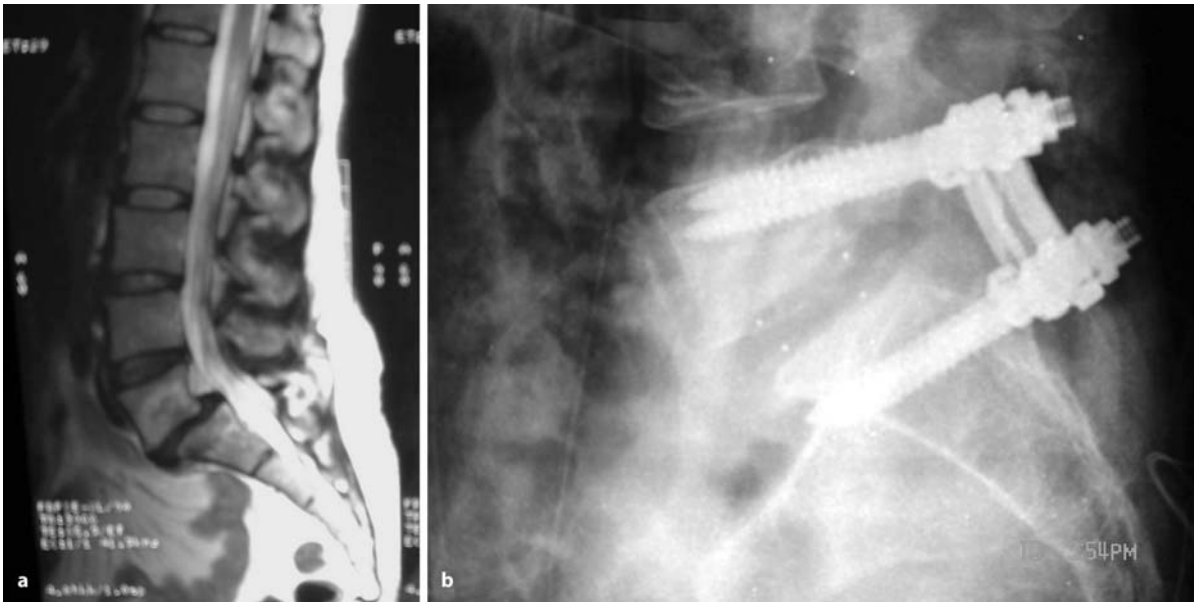
root pain syndromes, nerve root injury, epidural fibrosis and potential injury to conus medullaris if performed above L3 level.

- TLIF: Transforaminal Lumbar Interbody Fusion - where hemilaminectomy and hemifacetectomy is performed and discectomy and bone graft/cages are placed through a posterior transforaminal approach, thus avoiding undue retraction of the thecal sac. Thus, it avoids all the risks associated with ALIF and TLIF, and can be used safely even above L3 level.

Autogenous iliac crest is the gold standard graft material for interbody fusion, but various titanium and carbon fiber implants filled with autogenous bone are widely available to replace the disc space and to achieve solid fusion.

Minimally Invasive Lumbar Fusion: the methods are associated with varying degrees of paraspinal muscle injury due to retraction induced intramuscular pressure and ischemia. Gejo et al. (1999) showed that the incidence of low back pain after open lumbar surgery was significantly increased in patients who had long muscle retraction times. Rantanen et al. (1993) demonstrated that patients with poor outcomes after lumbar surgery were more likely to have persistent pathologic changes in their paraspinal muscles. Minimally invasive lumbar fusion technology has evolved to obviate these risks associated with open surgeries. Foley et al. (2003) reported that in 39 patients, who had percutaneous minimally invasive lumbar fusion, two thirds had excellent outcome and one third had good outcome, as determined by the modified Mac Nab criteria, with 100% solid fusion by radiographic criteria. Technology is also evolving to replace the disc with an artificial prosthetic disc, to preserve the motion segment with the potential avoidance of adjacent segment degeneration. Contraindications for LIF: Relative contraindications for interbody fusion are greater than 3 level degenerative disc disease (except for scoliosis), severe osteoporosis and single level disc disease causing radiculopathy without symptoms of mechanical back pain or instability.

Outcomes after Lumbar Fusion: Spinal immobilization and fusion are obviously indicated for spinal instability due to trauma or tumor, but huge controversy exists about the role of fusion as treatment for low back pain secondary to degenerative disc disease and spondylolisthesis. There is a definitive trend towards increasing use of spinal instrumentation and fusion over the past 20 years, despite the lack of evidence that surgery can positively influence the course of degenerative spine disorders (Bono et al. 2004). The reader should also be cognizant of the potential complications of invasive spinal surgery, occurring in up to 33% of patients (Mayer et al. 2002), which include implant failure, non-union, graft related morbidity, sexual dysfunction etc. A Cochrane review by Gibson et al. (1999) came



**Spinal Fusion for Chronic Back Pain, Figure 1** (a) MRI of lumbar spine showing L5-S1 spondylolisthesis in a patient with mechanical back pain. (b) Post-operative x-ray of Posterior lumbar interbody fusion (PLIF)-position of the cages between the vertebral bodies is identified by the radio-opaque markers.

to the following conclusions: 1) There is no acceptable evidence of the efficacy of any form of fusion for degenerative lumbar spondylosis, back pain or instability. 2) There is strong evidence that instrumented fusion may produce a higher rate of fusion, but does not improve clinical outcome. The same observations can be made about non-surgical therapeutic options like peridural injections, catheters, intradiscal electrothermal therapy (▶ IDET) etc. Until randomized prospective blinded clinical trials are performed, controversy will persist regarding spinal fusion. Suffice it to say, fusion for backache is not an alternative to expert rehabilitation with muscle retraining and exercises.

### Summary

Lumbar spinal fusion is an effective surgical option for chronic back pain secondary to degenerative spinal disorders when a patient has failed optimal conservative and less invasive management. Randomized clinical trials are necessary to study the efficacy of spinal fusion on clinical outcomes. Emerging technology as alternative to spinal fusion include total disc replacement with prosthetic discs (like SBIII Charite Disc or ProDisc II) in order to preserve the segmental motion of the involved spine.

### References

1. Bono CM, Lee CK (2004) Critical Analysis of Trends in Fusion for Degenerative Disc Disease over the Past 20 Years. Influence of Technique on Fusion Rate and Clinical Outcome. *Spine* 29:455–463
2. Borenstein DG, O'Mara Jr JW, Boden SD et al. (2001) The Value of Magnetic Resonance Imaging of the Lumbar Spine to Pre-

- dict Low-Back Pain in Asymptomatic Subjects; A Seven-Year Follow-Up Study. *J Bone Joint Surg* 83:1305–1311
3. Foley KT, Holly Langston TH, Schwender JD (2003) Minimally Invasive Lumbar Fusion. *Spine*:28:26–35
4. France JC, Yaszemski MJ, Laueran WC et al. (1999) A Randomized Prospective Study of Posterolateral Lumbar Fusion. Outcomes With and Without Pedicle Screw Instrumentation. *Spine* 24:553–560
5. Gejo R, Matsui H, Kawaguchi Y et al. (1999) Serial Changes in Trunk Muscle Performance after Posterior Lumbar Surgery. *Spine* 24:1023–1028
6. Gibson JN, Grant IC, Wadell G (1999) The Cochrane Review of Surgery for Lumbar Disc Prolapse and Degenerative Lumbar Spondylosis. *Spine* 24:1820–1832
7. Krismer M (2002) Fusion of the Lumbar Spine. A Consideration of the Indications. *J Bone Joint Surg (Br)* 84:783–794
8. Mayer HM, Korge A (2002) Non-Fusion Technology in Degenerative Lumbar Spinal Disorders: Facts, Questions, Challenges. *Eur Spine J* 11 85–91
9. Modic MT, Steinberg PM, Ross JS et al. (1988) Degenerative Disk Disease: Assessment of Changes in Vertebral Body Marrow with MR Imaging. *Radiology* 166:193–199
10. Mummaneni PV, Haid RW, Rodts GE (2004) Lumbar Interbody Fusion: State of the Art Technical Advances. *J Neurosurg Spine* 1:24–30
11. Nachemson AL (1991) Instability of the Lumbar Spine. Pathology, Treatment, and Clinical Evaluation. *Neurosurg Clin N Am* 2:785–790
12. Rantanen J, Hurme M, Falck B et al. (1993) The Lumbar Multifidus Muscle Five Years after Surgery for a Lumbar Intervertebral Disc Herniation. *Spine* 1993:18:568–574
13. Smith SE, Darden BV, Rhyne AL et al. (1995) Outcome of Unoperated Discogram-Positive Low Back Pain. *Spine* 20:1997–2000
14. Spratt KF, Weinstein JN, Lehmann TR et al. (1993) Efficacy of Flexion and Extension Treatment Incorporating Braces for Low-Back Pain Patients with Retrodisplacement, Spondylolisthesis, or Normal Sagittal Translation. *Spine* 18:1839–1849
15. Weatherley CR, Prickett CF, O'Brien JP (1986) Discogenic Pain Persisting Despite Solid Posterior Fusion. *J Bone Joint Surg (Br)* 68:142–143
16. Zdeblick TA (1993) A Prospective, Randomized Study of Lumbar Fusion. Preliminary results. *Spine* 18:983–991

## Spinal Injection

### ► Intrathecal Injection

## Spinal Manipulation, Characteristics

BENGT H. SJÖLUND

Rehabilitation and Research Centre for Torture Victims, South Danish University, Copenhagen, Denmark  
bsj@rct.dk

### Synonyms

Chiropractics; osteopathy

### Definition

Manual manipulation of near vertebral column structures to relieve pain.

### Characteristics

Originally based on anecdotal non-scientific observations (the “subluxation theory” see Jarvis 2001), spinal manipulative therapy has been used to a varying extent in the western world, both as a separate modality outside and inside traditional medical practice and as part of physical and rehabilitation medicine. As part of complementary medicine, it has received great popularity in the general population (Ernst et al. 2001).

The most common types of spinal manipulative therapy are high velocity, low amplitude thrust manipulation, low velocity, small or large amplitude mobilization, manual traction (see ► [Lumbar Traction](#)) and so called cranio-sacral therapy. While there are controlled data that acute back pain may in fact be temporarily relieved by manipulation (e.g. Koes et al. 1992), the results in chronic back pain are ambiguous. Furthermore, to be clinically relevant, the long-term pain relief after a limited series of manipulation sessions should last at least 3–6 (12) months and be reproducible with additional spinal manipulation sessions at a later stage. In addition, the risk of serious side effects after initial or subsequent manipulations should be negligible.

At present there are several systematic reviews available on the effects of spinal manipulative therapy in chronic low back pain. Ferreira et al. (2002) included 9 randomized controlled trials (RCTs) of mostly moderate quality in their review. The patients were adult and had low back pain of at least 3 months duration. The outcome measures in the studies had to include at least one of pain, disability, quality of life, adverse events, return to work, global perceived effect or patient’s satisfaction with therapy. The mean duration of pain was 28.1 months. The mean reduction in pain intensity was

7 (95%CI 1–14) mm on a 100 mm VAS scale at 1 month when compared with placebo and the disability score was reduced by 6 (95%CI 1–40) points on a 100 point disability questionnaire, indicating no relevant clinical effects from the therapy.

In a periodically updated Cochrane analysis of spinal manipulative therapy in low back pain, Assendelft et al. (2004) aimed to analyze comparative studies between spinal manipulative therapy and other therapies and to include recent RCTs up to September 2003. They have found 39 RCTs. In acute low back pain, the effect of spinal manipulation was superior to sham therapy with a pain VAS reduction of 10 (95% CI 2–17) mm short term and 19 (95% CI 3–35) mm after more than 6 weeks. The improvement at the same point in time on the Rivermead disability questionnaire was 2.6 (95%CI 0.5–4.8) points, i.e. of little clinical importance. Spinal manipulation was not more effective than general practice care, analgesics, physiotherapy in general, exercise or back schools. The results for chronic low back pain were similar and the authors conclude that there is at present no evidence that spinal manipulation is superior to standard treatments for acute or chronic low back pain.

The so called cranio-sacral therapy is based on bizarre mechanistic speculations (see Hartman and Norton, 2002) and has not been shown to relieve pain in controlled studies (e.g. Vendtegodt et al, 2004).

An additional factor is the risk of side effects with manipulation, which is very low with lumbar manipulation but not with cervical manipulation, where many clinical reports have been published of vascular deficiency to structures of the posterior part of the brain. Recently, a case control study (Smith et al. 2003) of 150 patients with vertebral artery dissection and ischemic stroke or transient ischemic attacks compared with 300 matched controls could demonstrate that spinal manipulative therapy is an independent risk factor for vertebral artery dissection (odds ratio 6.62, 95% CI 1.4–30). Hence, it can be considered entirely inappropriate to perform cervical spinal manipulative therapy for the symptomatic treatment of pain.

### References

1. Assendelft WJJ, Morton SC, Yu EI et al. (2004) Spinal manipulative therapy for low back pain. The Cochrane Database of Systematic Reviews, Issue 1, Art NoCD 000447.pub2
2. Ernst E, Pittler MH, Eisenberg D et al. (2001) The Desktop Guide to Complementary and Alternative Medicine. Mosby, Edinburgh
3. Ferreira MF, Ferreira PH, Latimer L et al. (2002) Does spinal manipulative therapy help people with chronic low back pain? *Austral J Physiother* 48:277–284
4. Hartman SE, Norton JM (2002) Craniosacral therapy is not medicine. *Physical Ther* 82:1146–1147
5. Jarvis WT (2001) Fact sheet on chiropractic. National Council against Health Fraud, USA, <http://www.ncahf.org/articles/c-d/chiro.html>
6. Koes BW, Bouter LM, van Mameren H et al. (1992) The effectiveness of manual therapy, physiotherapy and treatment by the general practitioner for non-specific back and neck complaints. *Spine* 17:28–36



7. Smith WS, Johnston SC, Skalabrin EJ et al. (2003) Spinal manipulative therapy is an independent risk factor for vertebral artery dissection. *Neurology* 60:1424–1428
8. Ventegodt S, Merrick J, Andersen NJ, Bendix T (2004) A combination of gestalt therapy, Rosen Body Work, and Cranio Sacral therapy did not help in chronic whiplash-associated disorders (WAD)—results of a randomized clinical trial. *Scientific World J* 4:1055-1068

## Spinal Manipulation, Pain Management

ROBERT GASSIN  
Musculoskeletal Medicine Clinic, Frankston, VIC,  
Australia  
rgassin@pen.hotkey.net.au

### Synonyms

High velocity thrust manipulation (HVTM); Mobilisation With Thrust; Mobilisation With Impulse

### Definition

Spinal manipulation is a treatment that involves the application of a mechanical force to the spine, with the aim of moving one or more spinal joints beyond the physiological range and towards the anatomical limit of motion. Spinal manipulation is described as ‘long lever’ when the force is applied some distance from the area where it is expected to have its effect, and ‘short lever’ when the force is applied to a specific spinal segment.

### Characteristics

#### Mechanism

The mechanism of action of spinal manipulation remains unclear. The major theories include:

- The reduction of disc bulging or prolapse.
- Stretching of adhesions in the zygapophyseal joint capsules or freeing of an entrapped meniscoid from a zygapophyseal joint.
- Correction of spinal misalignment.
- Inducing muscle relaxation.
- Stretching of the vertebral ligaments.
- Release of endogenous opioids.
- Normalisation of local or regional reflex activity.
- Normalisation of blood flow.
- Normalisation of CSF flow.
- Activation of a central control mechanism.
- A placebo effect.

None of these theories is strongly supported by scientific evidence.

#### Applications

The indications for spinal manipulation depend on what the practitioner has been trained to regard as a “manipulable lesion”, i.e. a condition that invites treatment by manipulation. The practitioner decides if the

patient has such a lesion on the basis of ► [medical history](#), ► [musculoskeletal examination](#), and perhaps investigations such as ► [plain radiography](#).

Spinal manipulation may be used as an isolated treatment, or as part of a multimodal management strategy for the management of many musculoskeletal conditions.

### Efficacy

#### Low Back Pain

An early systematic review found that patients with uncomplicated, acute low-back pain, treated with spinal manipulation, had a 17% greater chance of recovery at 3 weeks (Shekelle et al. 1992). No other ► [Attributable Effect](#) was demonstrated. Since that review, further studies have been published, and have been subjected to a meta-analysis (Assendelft et al. 2003).

For patients with acute low back pain, spinal manipulation was superior only to sham therapy and therapies judged to be ineffective or even harmful. Spinal manipulation had no statistically or clinically significant advantage over general practitioner care, analgesics, physical therapy, exercises, or back school.

Results for patients with chronic low back pain were similar. Radiation of pain, study quality, profession of manipulator, and use of manipulation alone or in combination with other therapies did not affect these results.

The authors concluded that there is no evidence that spinal manipulation is superior to other standard treatments for patients with acute or chronic low back pain (Assendelft et al. 2003). This conclusion is consistent with that of previous systematic reviews (Koes et al. 1996; van Tulder et al. 1997).

#### Thoracic Pain

Scientific data on the efficacy of spinal manipulation for thoracic pain is sparse. A recent randomized controlled trial, comparing spinal manipulation to non-functional ultrasound, has demonstrated significant improvement in lateral flexion, and reductions in numerical pain ratings at the conclusion of a 2 to 3 week treatment period. At one month follow-up, the changes were maintained but were no longer better than in the placebo group (Schiller 2001). These results suggest that spinal manipulation has greater short-term benefits than placebo treatment in the management of thoracic pain, but offers no sustained benefit.

#### Neck Pain

The effectiveness of spinal manipulation for neck pain remains unproven. In one review (Hurwitz et al. 1996), the combination of three of the randomized controlled trials for patients with subacute or chronic neck pain, showed an improvement on a 100 mm visual analogue scale of pain at 3 weeks of 12.6 mm (95% confidence interval, -0.15, 25.5) for manipulation, compared with muscle relaxants or usual medical care. This suggests that cervical spinal manipulation, at best, provides

marginal benefit for some patients with subacute and chronic neck pain.

The most recent systematic review found that manipulation used as a sole treatment consistently showed effects similar to those of placebo, wait period, or control (Gross et al. 2002). It was only if combined with exercises, as part of a multimodal treatment package, that there was any detectable benefit of manipulation for neck pain. However, in that context, the attributable effects of manipulation cannot be distinguished from those of exercise.

In a randomized trial of chiropractic manipulation and mobilisation for patients with neck pain, both modalities were found to yield comparable clinical outcomes in terms of mean reductions in pain and disability (Hurwitz et al. 2002).

### Cervicogenic Headaches

In one controlled trial, the active and control interventions consisted of 6 sessions over 3 weeks (Nilsson et al. 1997). The active intervention group received spinal manipulation at each session, whereas the control intervention group received deep friction massage to the posterior muscles of the shoulder girdle, the upper thoracic and lower cervical regions, plus treatment with a laser light in the upper cervical region. One week following the final treatment, statistically significant improvement was evident in the active intervention group compared to the control group, with respect to: decreased use of analgesia (36% vs. 0%,  $p = 0.04$ ), decreased number of headache hours per day (69% vs. 37%,  $p = 0.03$ ), decreased headache intensity per episode (36% vs. 17%,  $p = 0.04$ ). Evidence of any longer-lasting effect was not provided.

### Migraine

One controlled trial of spinal manipulation in the management of migraine consisted of: 2 months of data collection (before treatment), 2 months of treatment, and a further 2 months of data collection (after treatment) (Tuchin et al. 2000). The active treatment consisted of a maximum of 16 sessions of HVTM administered by a chiropractor. The control group received detuned interferential therapy. The average response of the treatment group showed statistically significant improvement in migraine frequency, duration, disability, and medication use, when compared to the control.

A prospective, randomised, parallel-group comparison of spinal manipulation, amitriptyline, and a combination of both therapies for the prophylaxis of migraine (Nelson et al. 1998), revealed clinically important, but not statistically significant, improvement in a headache index score, in all 3 study groups, compared to baseline. The headache index score represents the weekly sum of the patient's daily headache pain score. The authors claim that the study shows that HVTM is as effective as a well-established and efficacious treatment, amitripty-

line. These results suggest that spinal manipulation is an option for certain migraine patients who have failed trials of proven conventional treatments.

### Contraindications

Although certain conditions are almost universally acknowledged as contraindications to spinal manipulation, others are seen by some and not others as contraindications (Gassin and Masters 2001).

Universally acknowledged contraindications to spinal manipulation include: neoplasia (benign or malignant), active infection, active inflammation, neurological disorders, instability following trauma, acute spondylolysis/spondylolithesis, and vertebral or rib fracture. Widely accepted contraindications to spinal manipulation are: osteoporosis, bleeding disorders, anticoagulation therapy, radicular pain, radiculopathy, vertebral-basilar insufficiency, rheumatoid arthritis of the upper cervical spine, abnormal spinal anatomy, severe pain or distress, past adverse effect from spinal manipulation, and hypermobility (including pregnancy).

### Adverse Effects

Most adverse effects following spinal manipulation are benign and of short duration. Local discomfort or pain is by far the most common, accounting for approximately two-thirds of the total adverse effects (Senstad et al. 1997). The possible adverse effects of spinal manipulation, ranked in order of decreasing incidence, are: local discomfort, headache, fatigue, discomfort outside area of treatment, dizziness, nausea, intervertebral joint injury, triggering or exacerbation of neurological symptoms, vertebral and rib fracture, vertebral artery injury, carotid artery injury, and spinal cord injury.

Vertebral and internal carotid artery injuries results from manipulation of the cervical spine above the C6 spinal segment. Most published data suggest an incidence of 0.5 – 1 per 1,000,000 manipulations (Hurwitz et al. 1996; Haldeman et al. 2002).

In a review of case reports of accidents due to cervical spine manipulation published between 1925 and 1997, the most frequently reported injuries involved arterial dissection or spasm, lesions of the brain stem, and Wallenberg syndrome. Death occurred in 18% of cases (Di Fabio 1999). The incidence of death following cervical spinal manipulation has been estimated at 0.3 per 1,000,000 (Hurwitz et al. 1996).

### References

1. Assendelft WJ, Morton SC, Yu EI, Suttrop MJ, Shekelle PG (2003) Spinal Manipulative Therapy for Low Back Pain. A Meta-Analysis of Effectiveness Relative to other Therapies. *Ann Intern Med* 138:871–81
2. Di Fabio RP (1999) Manipulation of the Cervical Spine: Risks and Benefits. *Phys Ther* 79:50–65
3. Gassin R, Masters S (2001) Spinal Manual Therapy – The Evidence. *Australasian Musculoskeletal Medicine* 6:26–31
4. Gross AR, Kay T, Hondras M, Goldsmith C, Haines T, Peloso P, Kennedy C, Hoving J (2002) Manual Therapy for Mechanical Neck Disorders: A Systematic Review. *Man Ther* 7:131–149

5. Haldeman S, Carey P, Townsend M, Papadopoulos C (2002) Clinical Perceptions of the Risk of Vertebral Artery Dissection after Cervical Manipulation: The Effect of Referral Bias. *Spine J* 2:334–42
6. Hurwitz EL, Aker PD, Adams AH, Meeke WC, Shekelle PG (1996) Manipulation and Mobilization of the Cervical Spine. A Systematic Review of the Literature. *Spine* 21:1746–1759
7. Hurwitz EL, Morgenstern H, Harber P, Kominski GF, Yu F, Adams AH (2002) A Randomized Trial of Chiropractic Manipulation and Mobilization for Patients with Neck Pain: Clinical Outcomes from the UCLA Neck-Pain Study. *American Journal of Public Health* 92:1634–1641
8. Koes BW, Assendelft WJ, van der Heijden GJ, Bouter LM (1996) Spinal Manipulation for Low Back Pain. An Updated Systematic Review of Randomized Clinical Trials. *Spine* 21:2860–2871
9. Nelson CF, Bronfort G, Evans R, Boline P, Goldsmith C, Anderson AV (1998) The Efficacy of Spinal Manipulation, Amitriptyline and the Combination of Both Therapies for the Prophylaxis of Migraine Headache. *J Manipulative Physiol Ther* 21:511–519
10. Nilsson N, Christensen HW, Hartvigsen J (1997) The Effect of Spinal Manipulation in the Treatment of Cervicogenic Headache. *J Manipulative Physiol Ther* 20:326–330
11. Schiller L (2001) Effectiveness of Spinal Manipulative Therapy in the Treatment of Mechanical Thoracic Spinal Pain. *J Manipulative Physiol Ther* 24:394–401
12. Senstad O, Leboeuf-Yde C, Borchgrevink C (1997). Frequency and Characteristics of Side Effects of Spinal Manipulative Therapy. *Spine* 22:435–441
13. Shekelle PG, Adams AH, Chassin MR, Hurwitz EL, Brooks RH (1992) Spinal Manipulation for Low-Back Pain. *Ann Int Med* 117:590–598
14. Tuchin PJ, Pollard H, Bonello R (2000) A Randomized Controlled Trial of Chiropractic Spinal Manipulative Therapy for Migraine. *J Manipulative Physiol Ther* 23(2):91–95
15. van Tulder MW, Koes BW, Bouter LM (1997) Conservative Treatment of Acute and Chronic Non-Specific Low Back Pain. A Systematic Review of Randomized Controlled Trials of the Most Common Interventions. *Spine* 2:2128–2156

## Spinal Modulatory Impulses

### Definition

Nerve impulses generated inside the spinal cord or at supraspinal centers that modulate the transmission of primary impulses through projection spinal neurons.

- ▶ [Spinothalamic Tract Neurons, Morphology](#)

## Spinal Multipolar Neuron

### Definition

Spinal lamina I neuron with an ovoid cell body and dendritic tree oriented rostrocaudally and ventrally, highly ramified near the cell body and covered by numerous multishaped, often long pedicled spines.

- ▶ [Spinothalamic Tract Neurons, Morphology](#)

## Spinal Nerve Block

- ▶ [Pain Treatment, Spinal Nerve Blocks](#)

## Spinal Nerve Ligation Model

### Synonyms

Chung Model; SNL

### Definition

Spinal nerve ligation, also known as the “Chung” model, is currently one of the most frequently used models for nerve injury and neuropathic pain behavior in animals (rats/mice; Kim and Chung, 1992). The lumbar 5 spinal nerve is ligated with silk suture just distal to the L5 DRG. Usually, the spinal nerve is then cut just distal to the ligation. In some cases, the lumbar 6 spinal nerve is also ligated and cut. In non-injured animals, the distal axons of L4 and L5 neurons co-mingle in the sciatic nerve and innervate overlapping territories in the skin. After L5 spinal nerve ligation, the distal axons of the L5 nerve degenerate within the sciatic nerve. It is thought that inflammatory and immune processes involved in the degeneration of the distal L5 fibers then affect the adjacent “uninjured” L4 nerve fibers, causing functional changes in the L4 neurons. The advantage of this model, compared to other nerve injury models, is that all L5 DRG neurons are directly injured whereas the adjacent L4 DRG neurons remain intact. This allows anatomical and functional analyses to be performed on injured and adjacent DRG neurons separately.

- ▶ [Immunocytochemistry of Nociceptors](#)
- ▶ [Neuropathic Pain Model, Partial Sciatic Nerve Ligation Model](#)
- ▶ [Neuropathic Pain Model, Spinal Nerve Ligation Model](#)
- ▶ [Peptides in Neuropathic Pain States](#)
- ▶ [Purine Receptor Targets in the Treatment of Neuropathic Pain](#)

### Reference

Kim SH, Chung JM (1992) An Experimental Model for Peripheral Neuropathy Produced by Segmental Spinal Nerve Ligation in the Rat. *Pain* 50: 355-363.

## Spinal (Neuraxial) Opioid Analgesia

### Definition

For selected patients, the spinal route of drug delivery may be used for opioid analgesics. Opioids are administered via catheters placed in the epidural or intrathecal (subarachnoid) space. The spinal route of administration allows the drug to be delivered in close proximity to opioid receptors in the dorsal horn of the spinal cord, often permitting effective analgesia at considerably lower doses than would be required if a systemic route of drug administration were used.

- ▶ [Cancer Pain Management, Opioid Side Effects, Uncommon Side Effects](#)

## Spinal Pyramidal Neuron

### Definition

Spinal lamina I neuron with a triangular prism-shaped cell body partly encased in the overlying white matter by its dorsal portion, and a dendritic tree occupying a similarly shaped domain with branches oriented rostro-caudally, mediolaterally and dorsally.

- ▶ [Spinothalamic Tract Neurons, Morphology](#)

## Spinal Radicular Arteries

### Definition

Small arterial branches that course through the intervertebral foramina adjacent to the exiting spinal nerve roots. In the cervical region, the radicular arteries arise from the vertebral artery and supply the spinal cord via the anterior and posterior spinal arteries.

- ▶ [Cervical Transforaminal Injection of Steroids](#)

## Spinal Reflex

### Definition

A reflex with the reflex center in the spinal cord. The nociceptive tail-flick reflex is a spinal reflex that is present after a transaction of the spinal cord above the lumbar level, however, it has been suggested that for longer tail-flick latencies supraspinal structures may be involved.

- ▶ [Tail-Flick Test](#)

## Spinal Root Disease

### Definition

A radiculopathy caused by compression, inflammation, ischemia, or tumor.

- ▶ [Radiculopathies](#)

## Spinal Segment

### Definition

Morphological division of the spinal cord based on the dorsal root ganglia and ventral roots. The cervical, thoracic, lumbar and sacral cord have 8, 12, 5, and 5 pairs of roots, respectively. They are arranged rostro-caudally,

and their length or width is correlated with the nerve function innervating the peripheral tissue.

- ▶ [Morphology, Intraspinal Organization of Visceral Afferents](#)

## Spinal Sensitization

### Definition

Central sensitization refers to a state of increased synaptic efficacy, established in spinal dorsal horn neurons following intense peripheral noxious stimulation, a tissue injury, inflammation or nerve damage. ▶ [Central sensitization](#) is associated with spontaneous DH neuron activity, the recruitment of responses from neurons that normally only respond to low-intensity stimuli (i.e. altered neural connections), and expansion of DH neuron receptive fields.

- ▶ [Nick Model of Cutaneous Pain and Hyperalgesia](#)
- ▶ [Peptides in Neuropathic Pain States](#)

## Spinal Stenosis

### Definition

Narrowing of the anterior-posterior dimension of the spinal canal.

- ▶ [Chronic Back Pain and Spinal Instability](#)
- ▶ [Sacroiliac Joint Pain](#)

## Spinal Subarachnoid Space

### Definition

The space surrounding the spinal cord and containing the cerebrospinal fluid.

- ▶ [Cancer Pain Management, Anesthesiologic Interventions, Neural Blockade](#)

## Spinal Tract of the Trigeminal Nerve

### Definition

The central processes of trigeminal ganglion cells that descend in the lateral brainstem to terminate in the caudal spinal trigeminal nucleus. The spinal tract of the trigeminal nerve gives off collaterals to provide input for trigeminal reflexes, and convey nociceptive information from the head and face to the subnucleus caudalis.

- ▶ [Trigeminothalamic Tract Projections](#)



## Spinal Transection

### Definition

Spinal Transection is a surgical procedure in which the spinal cord is severed.

- ▶ [Opioids and Reflexes](#)

## Spinal Trigeminal Complex

The Spinal Trigeminal Complex consists of the spinal trigeminal tract, which contains the primary sensory afferents, descending from the trigeminal root entry into the pons to the first cervical segments, and the spinal trigeminal nucleus, which mediates thermal-pain sensitivity and consists of three subnuclei, oral (in the pons), interpolaris (in the upper medulla), and caudalis (in the lower medulla and first cervical segments).

- ▶ [Jaw-Muscle Silent Periods \(Exteroceptive Suppression\)](#)

## Spinoannular

### Definition

The projection from the spinal cord to the periaqueductal gray (PAG) is known as the spinoannular pathway.

- ▶ [Spinomesencephalic Tract](#)

## Spinothalamic Neurons

### Definition

Neurons with cell bodies in the spinal cord and axonal projections with sites of termination in the hypothalamus.

- ▶ [Spinal Ascending Pathways, Colon, Urinary Bladder and Uterus](#)

## Spinothalamic Tract, Anatomical Organization and Response Properties

XIJING ZHANG

Department of Neuroscience, University of Minnesota, Minneapolis, MN, USA

zhang036@umn.edu

### Definition

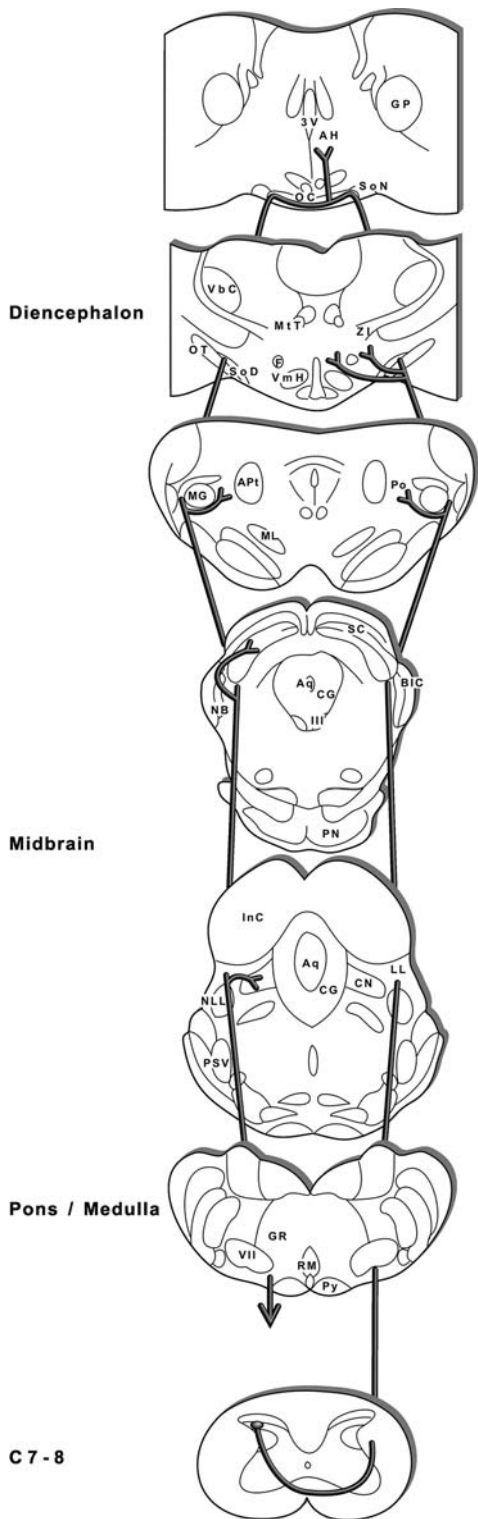
Neuron whose cell body and dendrites are located in the spinal cord, and whose axon projects to or through

the hypothalamus, decussates in the posterior optic chiasm, turns posteriorly and descends in the other side of the brain. The axon or collateral branches of the spinothalamic neuron terminate in both sides of the hypothalamus, thalamus, superior colliculus, and reticular formations in the midbrain, pons, and medulla (Fig. 1). The axons of spinothalamic neurons form a nociceptive tract that is responsible for conveying information to the brain that mainly contributes to the affective component of pain, including various reflexes, endocrine adjustments, and emotional changes caused by pain.

### Characteristics

Spinothalamic neurons are a type of sensory projection neuron. The axons of spinothalamic neurons form the spinothalamic tract, which is one of several sensory pathways that transmit nociceptive signals from the spinal cord to the brain (Giesler et al. 1994). Locations of the spinothalamic neurons in the spinal cord have been determined using ▶ [retrograde labeling](#) (Burstein et al. 1990) and ▶ [antidromic activation](#) techniques (Burstein et al. 1991; Zhang et al. 1995). Spinothalamic neurons are found throughout the length of the spinal cord, and are concentrated in three main regions: the marginal zone; the lateral reticulated area; and the area surrounding the central canal. These three areas receive direct input from primary afferent ▶ [nociceptors](#), contain many nociceptive neurons, and contribute large numbers of neurons to other ascending nociceptive tracts. It was estimated that the total number of spinothalamic and spinothalamic neurons are similar in rats (Burstein et al. 1990; Burstein et al. 1990) suggesting that the spinothalamic tract is large, and it may also make important contributions to nociceptive processing.

The trajectory and termination of the axons of the spinothalamic neurons have been examined using antidromic activation (Zhang et al. 1995; Dado et al. 1994a; Kostarczyk et al. 1997) and ▶ [anterograde labeling](#) techniques (Cliffer et al. 1991; Newman et al. 1996). The axons cross the midline and ascend in the lateral funiculus on the side contralateral to the cell body (Dado et al. 1994b). In the brainstem, the axons ascend through the lateral reticular formation to the level of the contralateral thalamus (Kostarczyk et al. 1997). Within the thalamus, spinothalamic axons ascend within the supraoptic decussation, a small area of white matter medially adjacent to the optic tract, to the rostral ventral hypothalamus (Cliffer et al. 1991). In the rostral ventral hypothalamus the axons cross the midline in the posterior optic chiasm, enter the ipsilateral hypothalamus, turn caudally and descend along the identical path in which they ascended in the contralateral brain (Zhang et al. 1995). Axons descend and terminate in the ipsilateral hypothalamus, thalamus, midbrain, pons, and some axons project as far as caudally the rostral



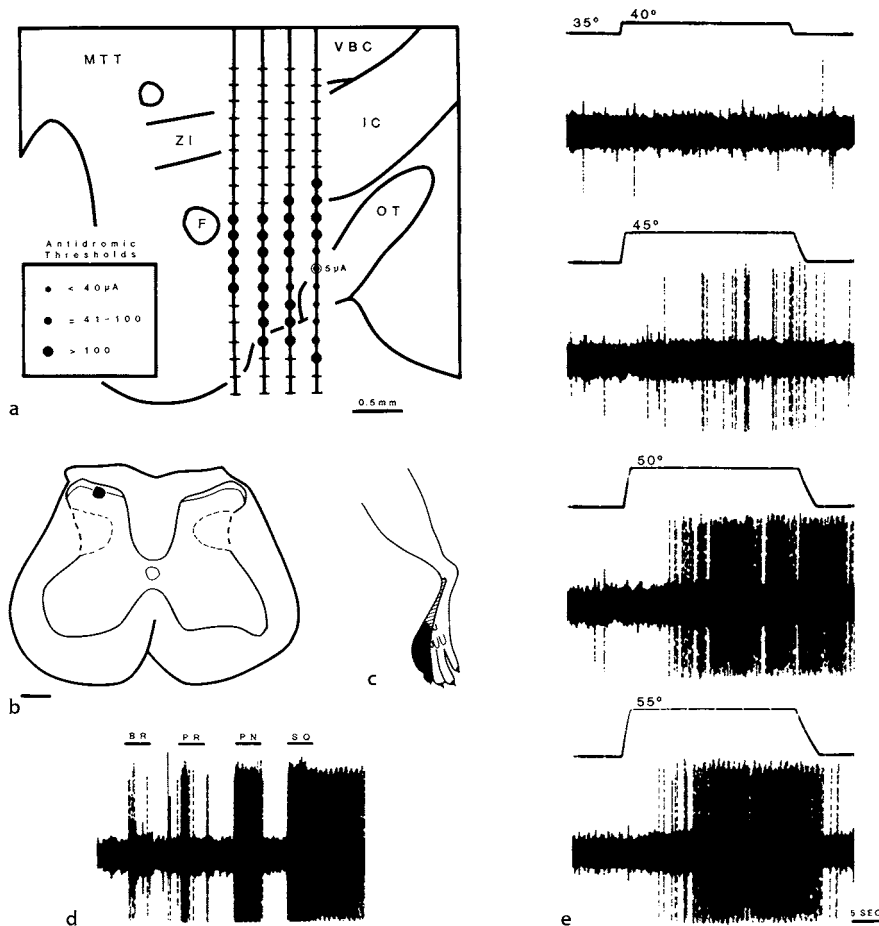
**Spinal Fusion for Chronic Back Pain, Figure 1** Schematic drawing of the spinothalamic neuron with its axon projecting trajectory in the brain. From Zhang et al. (1995). Abbreviations: 3V, third ventricle; AH, anterior hypothalamus area; Apt, anterior pretectal nucleus; Aq, aqueduct; BIC, brachium inferior colliculus; CG, central gray; CN, cuneiform nucleus; F, fornix; GP, globus pallidus; GR, gigantocellular reticular nucleus; Ill, oculomotor nucleus; InC, inferior colliculus; LL, lateral lemniscus; MG, medial geniculate nucleus; ML, medial lemniscus; MlT, mammillothalamic tract; NB, nucleus brachium inferior colliculus; NLL, nucleus of the lateral lemniscus; OC, optic chiasm; OT, optic tract; PN, pontine nucleus; Po, posterior thalamic nucleus; PSV, principal sensory nucleus of the trigeminal nerve; Py, pyramidal tract; RM, nucleus raphe magnus; SC, superior colliculus; SoD, supraoptic decussation; SoN, supraoptic hypothalamic nucleus; VII, facial nucleus; VbC, ventrobasal complex; VmH, ventromedial hypothalamic nucleus; ZI, zona incerta.

Through this long and complex projection, the axons of the spinothalamic neurons are capable of carrying nociceptive information bilaterally to many areas in the diencephalon and brainstem, which are involved in the production of various responses to noxious stimuli.

Responses of the spinothalamic neurons to noxious somatic and visceral stimuli have been described (Burstein et al. 1991; Dado et al. 1994c; Katter et al. 1996; Zhang et al. 2002). The overwhelming majority of the spinothalamic neurons responded strongly to noxious mechanical stimuli applied to the skin. Many were also powerfully activated by noxious thermal stimuli. Spinothalamic neurons also respond to noxious visceral stimuli such as rectal, vaginal and bile duct distension. Fig. 2 shows that a spinothalamic neuron responded to noxious mechanical and thermal stimuli applied to the skin. This spinothalamic neuron was located in the marginal zone of the lumbar spinal cord (Fig. 2b), its axon projected to the contralateral hypothalamus (Fig. 2a). The neuron had a small cutaneous receptive field located in the ipsilateral hindpaw (Fig. 2c). The neuron responded to innocuous brushing of the skin, but responded much more vigorously to noxious stimuli applied to the skin (Fig. 2d). The neuron also responded with increasing intensity to a series of ascending heat stimuli applied to the receptive field (Fig. 2e).

Spinothalamic neurons are likely to contribute mainly to **▶ affective responses**, although they may also contribute to **▶ sensory discrimination** through collateral branches within the thalamus. Through the terminations and collateral branches in the hypothalamus, spinothalamic neurons carry information to the hypothalamus that is likely to be involved in pain-related endocrine adjustments or emotional reactions, while the terminations and collateral branches in the brainstem reticular formation and superior colliculus may be involved in pain related somatic and visceral reflexes. Thus, spinothalamic neurons, with their long and complicated axonal projections on both sides of the brain, may directly affect the activity in many areas in the brain that are known to be involved in the production of autonomic, neuroendocrine, and affective responses to noxious stimuli.

medulla. The axons of the spinothalamic neurons and their collateral branches terminate bilaterally in many nuclei within hypothalamus, thalamus, superior colliculus, and reticular formation of the brainstem.



**Spinothalamic Tract, Anatomical Organization and Response Properties, Figure 2** Characterization of a spinothalamic neuron. (a) Locations of tracks of a stimulating electrode in the hypothalamus, showing thresholds for antidromic activation and a low-threshold point in the supraoptic decussation (circled). (b) Drawing of lesion marking the recording location. (c) receptive field. (d) Oscillographic tracing of responses to brush (BR), pressure (PR), pinch (PN), and squeeze (SQ) of the receptive field. (e) Responses to noxious heat. Temperature tracings are presented above responses. From Burstein et al. (1991). Abbreviations: (f) fornix; IC, internal capsule; MTT, mammillothalamic tract; OT, optic tract; VBC, ventrobasal complex; ZI, zona incerta.

## References

- Burstein R, Cliffer KD, Giesler GJ Jr (1990) Cells of Origin of the Spinothalamic Tract in the Rat. *J Comp Neurol* 291:329–344
- Burstein R, Dado RJ, Cliffer KD, Giesler GJ Jr (1991) Physiological Characterization of Spinothalamic Tract Neurons in the Lumbar Enlargement of Rats. *J Neurophysiol* 66:261–284
- Burstein R, Dado RJ, Giesler GJ Jr (1990) The Cells of Origin of the Spinothalamic Tract of the Rat: A Quantitative Re-examination. *Brain Res* 511:329–337
- Cliffer KD, Burstein R, Giesler GJ Jr (1991) Distributions of Spinothalamic, Spinothalamic and Spinothalamic Fibers Revealed by Anterograde Transport of PHA-L in Rats. *J Neurosci* 11:852–868
- Dado RJ, Katter JT, Giesler GJ Jr (1994a) Spinothalamic and Spinothalamic Tract Neurons in the Cervical Enlargement of Rats. I. Locations of Antidromically Identified Axons in the Thalamus and Hypothalamus. *J Neurophysiol* 71:959–980
- Dado RJ, Katter JT, Giesler GJ Jr (1994b) Spinothalamic and Spinothalamic Tract Neurons in the Cervical Enlargement of Rats. III. Locations of Antidromically Identified Axons in the Cervical Cord White Matter. *J Neurophysiol* 71:1003–1021
- Dado RJ, Katter JT, Giesler GJ Jr (1994c) Spinothalamic and Spinothalamic Tract Neurons in the Cervical Enlargement of Rats. II. Responses to Innocuous and Noxious Mechanical and Thermal Stimuli. *J Neurophysiol* 71:981–1002
- Giesler GJ Jr, Katter JT, Dado RJ (1994) Direct Spinal Pathways to the Limbic System for Nociceptive Information. *TINS* 17(6):244–250
- Katter JT, Dado RJ, Kostarczyk E, Giesler GJ Jr (1996) Spinothalamic and Spinothalamic Tract Neurons in the Sacral Spinal Cord of Rats. II. Responses to Cutaneous and Visceral Stimuli. *J Neurophysiol* 75:2606–2628
- Kostarczyk E, Zhang X, Giesler GJ Jr (1997) Spinothalamic Tract Neurons in the Cervical Enlargement of Rats: Locations of Antidromically Identified Ascending Axons and their Collateral Branches in the Contralateral Brain. *J Neurophysiol* 77:435–451
- Newman HM, Stevens RT, Apkarian AV (1996) Spinal-Suprathalamic Projections from the Upper Cervical and the Cervical Enlargement in Rat and Squirrel Monkey. *J Comp Neurol* 365:640–658
- Zhang X, Gokin AP, Giesler GJ Jr (2002) Responses of Spinothalamic Tract Neurons in the Thoracic Spinal Cord of Rats to Somatic Stimuli and to Graded Distention of the Bile Duct. *Somatosens. Mot. Res* 19(1):5–17
- Zhang X, Kostarczyk E, Giesler GJ Jr (1995) Spinothalamic Tract Neurons in the Cervical Enlargement of Rats: Descending Axons in the Ipsilateral Brain. *J Neurosci* 15:8393–8407

## Spinomedullary Neurons

### Definition

Neurons with cell bodies in the spinal cord and axonal projections with sites of termination in the medulla.

- ▶ Spinal Ascending Pathways, Colon, Urinary Bladder and Uterus

## Spinomesencephalic Neurons

### Definition

Neurons with cell bodies in the spinal cord and axonal projections with sites of termination in the midbrain.

- ▶ [Spinal Ascending Pathways, Colon, Urinary Bladder and Uterus](#)

## Spinomesencephalic Tract

ROBERT P. YEZIERSKI

Comprehensive Center for Pain Research and Department of Neuroscience, McKnight Brain Institute, Gainesville, FL, USA  
ryezierski@dental.ufl.edu

### Synonyms

SMT

### Definition

The spinomesencephalic tract (SMT) with its varied origins, spinal trajectories and sites of termination is often described as having a prominent role in nociception. This ascending projection is a collection of pathways originating throughout all levels of the spinal cord and terminating in different targets throughout the midbrain. Three prominent pathways represent the spinomesencephalic projection system, including the spinotectal, spinoannular and spinoparabrachial tracts that project respectively to the superior colliculus, periaqueductal and parabrachial regions.

### Characteristics

Although there are some variations among species, the majority of cells belonging to the spinomesencephalic tract (SMT) are found in laminae I, III-V, VII and X at all levels of the cord (Menetrey et al. 1982; Wiberg and Blomqvist 1984). Many cells belonging to the SMT have collateral, including bilateral, projections to the thalamus and medullary reticular formation and some have ascending as well as descending projections (Yeziarski and Mendez 1991). In the primate, neurons classified as SMT- spinothalamic tract (STT) are located primarily in laminae I, V, VII and X. In general, fewer SMT-STT neurons are found in the lumbar compared to the cervical segments. The number of SMT cells in the monkey was estimated to be approximately 10,000 with 75% having projections to the contralateral midbrain (Zhang et al. 1990). Chemically, a subpopulation of SMT cells stain for the enzyme glutaminase; thus the excitatory amino acid glutamate may be a transmitter in this pathway (Willis and Coggeshall 2004). ▶ [Lamina I](#) SMT cells projecting to the parabrachial region stain

positive for dynorphin or enkephalin, implicating these peptides as transmitter candidates in this component of the SMT. ▶ [Substance P](#) (sub P) receptors are located on this same population of SMT neurons. The presence of ▶ [serotonin](#) (5-HT) immunoreactive contacts suggests that these cells are influenced by descending pathways from the medulla. The spinal trajectory of SMT axons includes the ventral lateral funiculus, although there is evidence that the lamina I component of this pathway ascends in the dorsal part of the lateral funiculus (Hylden et al. 1986; Swett et al. 1985).

The primary projection targets of the SMT include three prominent regions of the mesencephalon: (1) the caudal midbrain, including the nucleus cuneiformis, parabrachial nucleus and ▶ [periaqueductal gray](#) (PAG), (2) the intercollicular region, including the nucleus cuneiformis, PAG, intercollicular nucleus and deep layers of the superior colliculus and (3) the rostral midbrain, including the PAG, the nucleus of Darkschewitsch and the anterior and posterior pretectal nuclei. The majority of ascending projections terminate contralateral to the site of origin (Wiberg and Blomqvist 1984; Yeziarski 1988).

One of the principal targets of the spinomesencephalic projection is the PAG. Originating from cells in all laminae of the gray matter and at all levels of the spinal cord, the spino-PAG component of the SMT is well suited to relay afferent information throughout the midbrain. Although the functional significance of this input is unknown, the PAG is involved in the control of blood pressure, defense reactions, respiration and vocalization, reproductive behavior, stomach and bladder motility, grooming and analgesic mechanisms (Depaulis and Bandler 1991). The SMT may, therefore, represent an important component of afferent systems contributing input to neural substrates directly or indirectly involved in carrying out these functions.

The response properties of SMT cells have been studied in rat, cat and monkey (Hylden et al. 1986; Menetrey et al. 1980; Yeziarski and Broton 1991; Yeziarski and Schwartz 1986; Yeziarski et al. 1987). Functional properties include a range of complex and restricted excitatory RF's, often including complex inhibitory components. Some neurons have prolonged afterdischarges. Consistent with the SMT projection having a prominent role in nociception, cells belonging to this pathway respond to noxious mechanical and thermal stimuli, including inputs from cutaneous and/or deep structures (e.g. joints, muscles and viscera) (Hylden et al. 1986; Menetrey et al. 1980; Yeziarski and Schwartz 1986; Yeziarski and Broton 1991; Yeziarski et al. 1987; Yeziarski 1990). These observations, as well as the varied functions associated with SMT projection targets, support a role of the SMT in sensory, motor and visceral functions. The varied conduction velocities of axons belonging to the SMT reflect the fact that SMT cells vary in size. Cells located in the superficial laminae



routinely have slower axons compared with cells in deeper laminae.

Based on responses to mechanical stimuli and input from deep structures (muscles and joints), the response profiles of SMT cells in the lumbosacral and upper cervical spinal can be divided into three major categories: (a) wide dynamic range (WDR), (b) high threshold (HT) and (c) deep/tap (D). Responses to peripheral stimuli include both excitatory and inhibitory effects (McMahon and Wall 1985; Yeziarski 1990; Yeziarski and Broton 1991; Yeziarski and Schwartz 1986; Yeziarski et al. 1987). Although the functional properties of SMT cells in different laminae have been most frequently studied in the cat (Hylden et al. 1986; Yeziarski 1990; Yeziarski and Schwartz 1986; Yeziarski and Broton 1991), similar cell types are described in the rat (Menetrey et al. 1980) and monkey (Yeziarski et al. 1987; Zhang et al. 1990). SMT neurons in the monkey projecting to the PAG may evoke components of the systemic response to neurogenic hyperalgesia, as evidenced by responses to intradermal capsaicin. The functional heterogeneity of SMT cells is exemplified by the three patterns of response of primate SMT cells to intradermal capsaicin, which appear to be dependent on the functional regions of the PAG to which they project. (Dougherty et al. 1999). The lamina I component of the SMT projecting to the parabrachial region is made up of high-threshold neurons believed to be part of a pathway that contributes to the ► **motivational-affective** aspects of pain.

The heterogeneity of the SMT cell population is exemplified by the responses and receptive field (RF) organization of cells belonging to this pathway. Cells with complex RFs that include the hind limbs, forelimbs and/or oral-facial structures have been described (Menetrey et al. 1980; Yeziarski 1990; Yeziarski and Broton 1991; Yeziarski and Schwartz 1986). SMT cells in the upper cervical cord are a heterogeneous mix and often have collateral projections to midbrain and thalamus and complex receptive fields involving muscle, cornea, dura, testicles and skin. In the primate SMT, cells projecting to midbrain have complex fields, while those projecting to thalamus and midbrain have restricted excitatory RF's. SMT cells, regardless of segmental location, receive input from large portions of the body. Because of this, it is unlikely that these cells are important in stimulus localization. Since the complex RFs of SMT cells are due, in part, to descending influences (Yeziarski 1990), these cells may constitute a component of the SMT involved in a positive feedback loop responsible for autonomic and motor reflexes in the spinal cord. Alternatively, these cells may provide input compatible with the known arousal functions of the reticular activating system. Consistent with this are reactions commonly associated with the delivery of noxious stimuli, including changes in motor behavior, respiration and alterations in cardiovascular function, changes in blood pressure, heart rate and resistance in

peripheral vascular beds (Bandler et al. 1991). Lamina I cells belonging to the parabrachial projection largely reflect the functional properties of parabrachial neurons suggesting an involvement in the autonomic and emotional/aversive aspects of pain. The spinoparabrachial component of the SMT, which further relays input to the amygdala, hypothalamus and bed nucleus of the stria terminalis provide afferent input to a major integration site for the autonomic and emotional/aversive aspects of pain.

Although the responses of SMT cells have been most commonly evaluated with mechanical and thermal stimuli, chemical agents including intramuscular injection of hypertonic saline and intravenous serotonin (i. v. 5HT) have also been described (Yeziarski and Broton 1991). SMT cells have been proposed to contribute to the spinal mechanism responsible for the development of pain associated with spinal injury. Following injury, cells belonging to this pathway have increased spontaneous activity, expanded RF's, increased responses to mechanical and thermal stimuli and long afterdischarge responses (Yeziarski and Park 1993). These changes in functional state of SMT cells correlate with increased behavioral responses to mechanical and thermal stimuli following injury.

In order to gain a thorough appreciation of the potential functional importance of the SMT, one must acknowledge the varied functions associated with different regions of the midbrain. For example, if one considers the autonomic and somatomotor responses elicited by noxious stimuli and couples this with the control of blood pressure, respiration and vocalization and defense reactions associated with midbrain regions overlapping the SMT projection, what emerges is a functional relationship between SMT input to the midbrain and behavioral responses to noxious stimuli. Similarly, the relationship between responses of SMT cells to stimulation of the genitals and perineal region and the role of PAG in reproductive behavior suggests a functional role of the SMT in this behavior.

The functional significance of the SMT would not be complete without consideration of the descending control system. To this end, the spinomesencephalic projection overlaps with sites producing analgesia and the inhibition of nociceptive spinal neurons (Hammond 1986; Gerhart et al. 1984). The distribution of midbrain neurons projecting to medullary raphespinal and reticulospinal neurons also overlaps with the terminal domain of the SMT. Consistent with a feedback loop between SMT projection targets and descending control pathways are reports that stimulation at midbrain sites used to antidromically activate SMT cells also inhibits evoked responses of these cells (Yeziarski and Schwartz 1986; Yeziarski 1990). The effects of PAG stimulation on SMT cells in the lumbosacral spinal cord are not limited to inhibition. Given the distribution of PAG sites producing analgesia and aversive reactions, it is

not surprising that excitatory and mixed effects can be obtained with PAG stimulation. Descending excitatory, inhibitory or mixed effects may be exerted on cells at different levels of the cord for reflex, e.g. autonomic and motor control, or for purposes of stimulus localization. The fact that the SMT is involved in the relay of somatosensory input to a region with complex functional significance supports the notion that this pathway is an integral part of a supraspinal control center. Although the emphasis of effects produced by PAG stimulation has been on analgesia and inhibition, it is important to point out that the PAG stimulation effects are not limited to inhibition and probably have a functional significance much broader than the analgesic effects that have been described. For example, the excitatory effects of PAG stimulation may facilitate segmental reflex activity. It is also possible that there are different functional compartments within the PAG that exert varied effects on different populations of tract cells and interneurons in different spinal laminae.

### Conclusions

The results of anatomical investigations (anterograde and retrograde studies) have provided definitive proof for the existence of a spinal projection to different regions of the midbrain. The spinal distribution of cells responsible for this projection and the response properties of SMT cells are all consistent with an involvement in conveying information related to the modalities of touch, pressure, pain and temperature to supraspinal targets. Although the functional relevance of these studies provides the basis for the clinical significance of the SMT projection, any assessment of these functions cannot be made without acknowledging the functional organization of the midbrain. To this end, discussions related to cardiovascular and reproductive function, respiration, vocalization and analgesic mechanisms must be considered. Somatosensory input to different regions of the midbrain may not alone trigger any of these functions, but in concert with other afferent systems it may be involved in producing a repertoire of behaviorally appropriate responses to different stimulus conditions.

### References

- Bandler R, Carrive P, Zhang SP (1991) Interaction of somatic and autonomic reactions within the midbrain periaqueductal gray: viscerotopic, somatotopic and functional organization. *Prog Brain Res* 87:269–305
- Depaulis A, Bandler R (1991) The midbrain periaqueductal gray matter: functional, anatomical and neurochemical organization. NATO ASI Series, vol 213. Plenum Press, New York
- Dougherty PM, Schwartz A, Lenz FA (1999) Responses of primate spinomesencephalic tract cells to intradermal capsaicin. *Neuroscience* 90:1377–1392
- Gerhart KD, Yeziarski RP, Wilcox TK et al. (1984) Inhibition of primate spinothalamic tract neurons by stimulation in periaqueductal gray or adjacent midbrain reticular formation. *J Neurophysiol* 51:450–466
- Hammond DL (1986) Control systems for nociceptive afferent processing: The descending inhibitory pathways. In: Yaksh T (ed) *Spinal afferent processing*. Plenum, New York, pp 363–390
- Hyliden J, Hayashi H, Bennett G (1986) Physiology and morphology of the lamina I spinomesencephalic projection. *J Comp Neurol* 247:505–515
- Menetrey D, Chaouch A, Besson JM (1980) Location and properties of dorsal horn neurons at origin of spinoreticular tract in lumbar enlargement of the rat. *J Neurophysiol* 44:862–877
- Menetrey D, Chaouch A, Binder D et al. (1982) The origin of the spinomesencephalic tract in the rat: an anatomical study using the retrograde transport of horseradish peroxidase. *J Comp Neurol* 206:193–207
- Swett JE, McMahon SB, Wall PD (1985) Long ascending projections to the midbrain from cells of lamina I and nucleus of the dorsolateral funiculus of the rat spinal cord. *J Comp Neurol* 238:401–416
- Wiberg M, Blomqvist A (1984) The spinomesencephalic tract in the cat: its cells of origin and termination pattern as demonstrated by the intraxonal transport method. *Brain Res* 291:1–18
- Willis WD, Coggeshall RE (2004) *Sensory mechanisms of the spinal cord*, vol 2. Plenum, New York
- Yeziarski RP (1988) The spinomesencephalic tract: projections from the lumbosacral spinal cord of the rat, cat and monkey. *J Comp Neurol* 267:131–146
- Yeziarski RP (1990) The effects of midbrain and medullary stimulation on spinomesencephalic tract cells in the cat. *J Neurophysiol* 63:240–255
- Yeziarski RP, Broton JG (1991) Functional properties of spinomesencephalic tract (SMT) cells in the upper cervical spinal cord of the cat. *Pain* 45:187–196
- Yeziarski RP, Mendez CM (1991) Spinal distribution and collateral projections of rat spinomesencephalic tract cells. *Neurosci* 44:113–130
- Yeziarski RP, Park, SH (1993) Mechanosensitivity of spinal sensory neurons following intraspinal injections of quisqualic acid. *Neurosci Letters* 157:115–119
- Yeziarski RP, Schwartz RH (1986) Response and receptive field properties of spinomesencephalic tract cells in the cat. *J Neurophysiol* 55:76–96
- Yeziarski RP, Sorkin LS, Willis WD (1987) Response properties of spinal neurons projecting to midbrain or midbrain and thalamus in the monkey. *Brain Res* 437:165–170
- Zhang D, Carlton SM, Sorkin LS et al. (1990) Collaterals of primate spinothalamic tract neurons to the periaqueductal gray. *J Comp Neurol* 296:277–290

## Spinoparabrachial Neurons

### Definition

Neurons with cell bodies in the spinal cord and axonal projections with sites of termination in the parabrachial nucleus.

► [Spinal Ascending Pathways, Colon, Urinary Bladder and Uterus](#)

## Spinoparabrachial Pathway

### Definition

The projection from the spinal cord to the parabrachial region in the caudal midbrain is known as the spinoparabrachial pathway.

► [Spinomesencephalic Tract](#)

## Spinoparabrachial Tract

ALAN R. LIGHT

Department of Anesthesiology, University of Utah,  
Salt Lake City, UT, USA  
alan.light@hsc.utah.edu

### Synonyms

Part of the spinoreticular tract

### Definition

Neurons in the spinal cord, and their axons that project and terminate in the parabrachial nuclei of the brain. Many of these neurons are found in the most superficial regions of the dorsal horn (Rexed's lamina 1) and respond best to nociceptive inputs (Bester et al. 2000; Hylden et al. 1985; Light et al. 1993). The parabrachial nuclei are at the junction between the midbrain and the pons and are found immediately adjacent to the brachium conjunctivum (the superior cerebellar peduncle) as it ascends from the pons, through the midbrain. The function of these neurons in the perception of pain is unknown (for more information on the function of this pathway see ► [parabrachial hypothalamic and amygdaloid projections](#) and Bernard and Besson 1990).

### Characteristics

Nociceptive neurons (neurons capable of encoding information discriminating between tissue damaging and non-damaging stimuli) are concentrated in the most superficial layers of the spinal cord (laminae 1 and 2) and the neck of the dorsal horn (lamina 5). Laminae 1 and 5 contain many neurons that project

to supraspinal regions of the brain, including the thalamus and brainstem (see ► [spinohypothalamic tract, anatomical organization and response properties](#) and other entries on spinothalamic tracts).

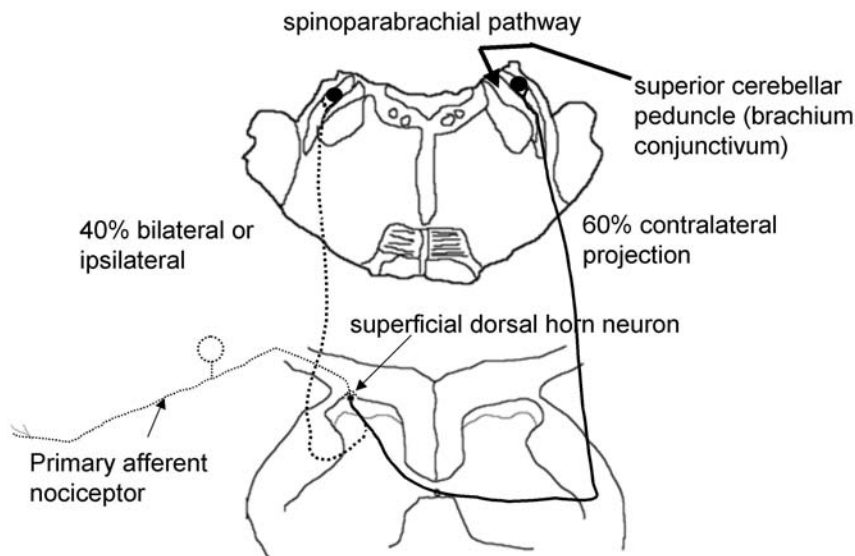
One region of the brainstem that receives many projections from lamina 1 is the region at the junction of the pons and midbrain adjacent to the superior cerebellar peduncle called the parabrachial region (see Fig. 1).

This projection is more prominent contralaterally than ipsilaterally (Blomqvist et al. 1989; Cechetto et al. 1985; Craig 1995; Kitamura et al. 1993; Panneton and Burton 1985; Slugg and Light 1994). As many as 50% of the projection neurons in lamina 1 project to this region *via* very slowly conducting axons (<4 M/sec). The neurons mostly respond only to nociceptive stimuli or to innocuous cooling, with only a few responding to both innocuous and noxious stimuli (Bester et al. 2000; Hylden et al. 1985; Light et al. 1993). Figure 2 shows some responses. The pathway has been identified in rats, cats, monkeys and other species. Its prominence in man is unknown.

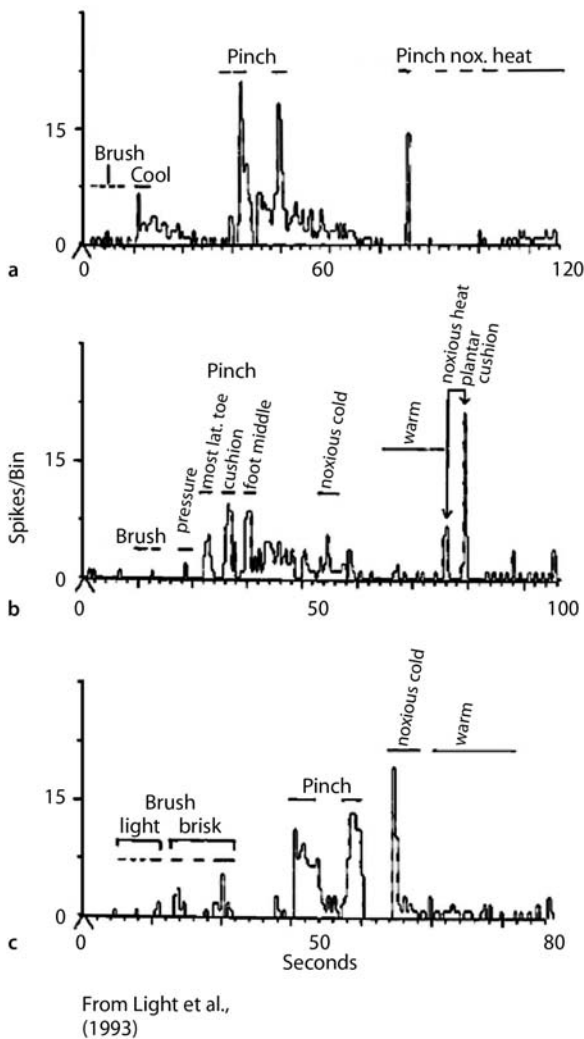
The parabrachial region to which the lamina 1 neurons project, itself projects to the amygdala, thalamus and hypothalamus (e.g. Bernard and Besson 1990), allowing the possibility that information from this pathway may reach higher brain centers, especially those centers involved in emotional and hormonal responses to pain (see entry described above for more information).

The parabrachial region also receives inputs from visceral centers, thus leaving open the possibility that visceropain interactions may occur at this level of the CNS (Cechetto et al. 1985, Menetrey and de Pommery 1991; Saper 1995).

Lesions of the parabrachial region have been associated with increased pain behavior, leading some to postulate



**Spinoparabrachial Tract, Figure 1** Diagram of the Spinoparabrachial Tract. Nociceptive primary afferent axons synapse on superficial dorsal horn neurons. Superficial dorsal horn cell (bottom panel) projects through the contralateral white matter to the lateral parabrachial region to terminate on cells in this region. Most of the projections are contralateral (indicated by 60% in the diagram) while some are ipsilateral or bilateral (indicated by 40% in the diagram).



**Spinoparabrachial Tract, Figure 2** Responses of 3 different spinoparabrachial neurons from cat. Action potential rate (action potentials per second) is on the Y axis while time in seconds is on the X axis. The indicated stimuli were applied during the bars. Brush is innocuous brush with a camel's hair brush; Cool is applying cool water (10 – 15 °C), Pinch is pinching the skin with flat forceps, nox. Heat is applying 55 °C heat with a heat probe. Warm is applying 37°C heat with a heat probe. Noxious cold is applying ethyl chloride spray. All units were identified by antidromic stimulation of the contralateral parabrachial region.

that this region may be involved in the descending control of pain (Wall et al. 1988). Still other researchers have stressed the role of the spinoparabrachial pathway in the enhanced pain induced by inflammation and neuropathy (Bester et al. 1997; Buritova et al. 1998; Nahin et al. 1992).

## References

1. Bernard JF, Besson JM (1990) The spino(trigemino)pontoamygdaloid pathway: electrophysiological evidence for an involvement in pain processes. *J Neurophysiol* 63:473–490
2. Bester H, Matsumoto N, Besson JM et al. (1997) Further evidence for the involvement of the spinoparabrachial pathway in

- nociceptive processes: a c-Fos study in the rat. *J Comp Neurol* 383:439–458
3. Bester H, Chapman V, Besson JM et al. (2000) Physiological properties of the lamina I spinoparabrachial neurons in the rat. *J Neurophysiol* 83:2239–2259
4. Blomqvist A, Ma W, Berkley KJ (1989) Spinal input to the parabrachial nucleus in the cat. *Brain Res.* 480:29–36
5. Buritova J, Besson JM, Bernard JF (1998) Involvement of the spinoparabrachial pathway in inflammatory nociceptive processes: a c-Fos protein study in the awake rat. *J Comp Neurol* 397:10–28
6. Cechetto DF, Standaert DG, Saper CB (1985) Spinal and trigeminal dorsal horn projections to the parabrachial nucleus in the rat. *J Comp Neurol* 240:153–160
7. Craig AD (1995) Distribution of brainstem projections from spinal lamina I neurons in the cat and the monkey. *J Comp Neurol* 361:225–428
8. Hylden JL, Hayashi H, Bennett GJ et al. (1985) Spinal lamina I neurons projecting to the parabrachial area of the cat midbrain. *Brain Res* 336:195–198
9. Kitamura T, Yamada J, Sato H et al. (1993) Cells of origin of the spinoparabrachial fibers in the rat: a study with fast blue and WGA-HRP. *J Comp Neurol* 328:449–461
10. Light AR, Sedivec MJ, Casale EJ et al. (1993) Physiological and morphological characteristics of spinal neurons projecting to the parabrachial region of the cat. *Somatosens Mot Res* 10:309–325
11. Menetrey D, De Pommery J (1991) Origins of spinal ascending pathways that reach central areas involved in viscerosensation and viscerosensation in the rat. *Eur J Neurosci* 3:249–259
12. Nahin RL, Hylden JL, Humphrey E (1992) Demonstration of dynorphin A 1-8 immunoreactive axons contacting spinal cord projection neurons in a rat model of peripheral inflammation and hyperalgesia. *Pain* 51:135–143
13. Panneton WM, Burton H (1985) Projections from the paratrigeminal nucleus and the medullary and spinal dorsal horns to the parabrachial area in the cat. *Neuroscience* 15:779–797
14. Saper CB (1995) The spinoparabrachial pathway: shedding new light on an old path. *J Comp Neurol* 353:477–479.
15. Slugg RM, Light AR (1994) Spinal cord and trigeminal projections to the pontine parabrachial region in the rat as demonstrated with Phaseolus vulgaris leucoagglutinin. *J Comp Neurol* 339:49–61
16. Wall PD, Bery J, Saade N (1988) Effects of lesions to rat spinal cord lamina I cell projection pathways on reactions to acute and chronic noxious stimuli. *Pain* 35:327–339

## Spinopetal Modulation of Pain

- [Descending Facilitation and Inhibition in Neuropathic Pain](#)

## Spinoreticular Neurons

### Definition

Neurons with cell bodies in the spinal cord and axonal projections with sites of termination in supraspinal reticular structures.

- [Spinal Ascending Pathways, Colon, Urinary Bladder and Uterus](#)



## Spinosolitary Neurons

### Definition

Neurons with cell bodies in the spinal cord and axonal projections with sites of termination in the nucleus tractus solitarius.

- ▶ Spinal Ascending Pathways, Colon, Urinary Bladder and Uterus

## Spinotectal

### Definition

The projection from the spinal cord to the superior colliculus, especially the deep layers, is known as the spinotectal pathway.

- ▶ Spinomesencephalic Tract

## Spinothalamic Input, Cells of Origin (Monkey)

WILLIAM D. WILLIS

Department of Neuroscience and Cell Biology,  
University of Texas Medical Branch, Galveston, TX,  
USA

wdwillis@utmb.edu

### Synonyms

Spinothalamic neurons; Spinothalamic Tract Cells

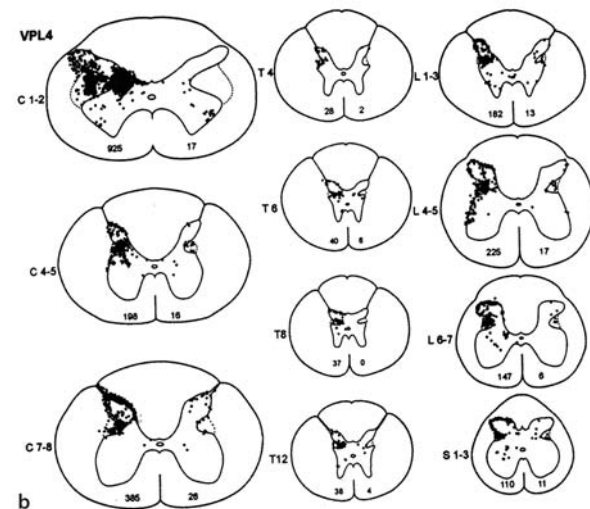
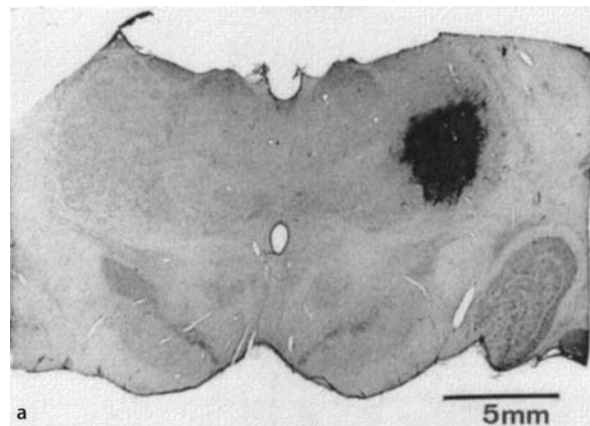
### Definition

A spinothalamic tract cell is a neuron whose cell body and dendrites are located in the spinal cord and whose axon projects to and terminates in the thalamus, usually on the side contralateral to the cell body. The spinothalamic tract is a major pathway by which nociceptive information is conveyed to the thalamus and from there to the cerebral cortex, leading to the perception of pain as well as to motivational-affective responses to painful stimuli.

### Characteristics

The locations of the cells of origin of the primate spinothalamic tract have been mapped anatomically using the ▶ retrograde tracing technique (Apkarian and Hodge 1989; Willis et al. 1979; Willis et al. 2001) and electrophysiologically by ▶ antidromic microstimulation within the thalamus while recording from spinal cord neurons (Applebaum et al. 1979; Giesler et al. 1981; Zhang et al. 2000).

Figure 1 illustrates the distribution of spinothalamic tract cells that were retrogradely labeled following the injection of cholera toxin subunit B into the ▶ ventral posterior lateral (VPL) nucleus of the thalamus of a monkey (Willis et al. 2001). The injection site is shown in Fig. 1a. In the cervical and lumbosacral enlargements, numerous labeled neurons were observed in laminae I, V and VI (Fig. 1b). A few labeled cells were found in laminae II–IV and in the ventral horn. Spinothalamic tract cells in the thoracic and upper lumbar spinal cord had similar locations as in the enlargements, but the density of labeled cells was smaller.



**Spinothalamic Input, Cells of Origin (Monkey), Figure 1** Distribution of retrogradely labeled spinothalamic tract cells in a monkey. (a) shows the site of injection of cholera toxin subunit B in the ventral posterior lateral nucleus of the thalamus. The injection spread into several adjacent nuclei that do not receive spinal projections, but not into the ventral posterior inferior nucleus, posterior complex or central lateral nuclei. In (b) are drawings of representative transverse sections through the spinal cord at different segmental levels from C1-2 through S1-3. The locations of retrogradely labeled spinothalamic tract cells are indicated. The total counts of cell profiles for different levels are indicated on the drawings for the side of the cord contralateral (left) and ipsilateral (right) to the injection. (From Willis et al. 2001).

In the uppermost cervical spinal cord, there was a large population of labeled neurons in the ► **lateral cervical nucleus**; these give rise to the cervicothalamic tract (Willis and Coggeshall 2003). There were also large numbers of labeled neurons in the neck of the dorsal horn at C1–2.

The antidromic mapping technique reveals a comparable distribution of spinothalamic tract cells in the lumbar enlargement of monkeys, as shown in Fig. 2 (Zhang et al. 2000). In these experiments, all of the microstimulation sites were in the ventral posterior lateral thalamic nucleus (Fig. 2a), except for one site that was in the supragenicular nucleus (Fig. 2b). The antidromically activated spinothalamic tract cells were concentrated in laminae I and IV–V. An advantage of this approach is that the response properties of the recorded spinothalamic cells can be determined. The cells whose locations are shown in Fig. 2c were classed as ► **wide dynamic range (WDR)**, ► **high threshold (HT)** or ► **low threshold (LT)**, according to their responsiveness to graded mechanical stimuli applied to their receptive fields. WDR cells respond to innocuous and noxious stimuli, but best to noxious intensities. HT cells respond essentially only to noxious stimuli. LT cells respond to innocuous and not to noxious stimuli.

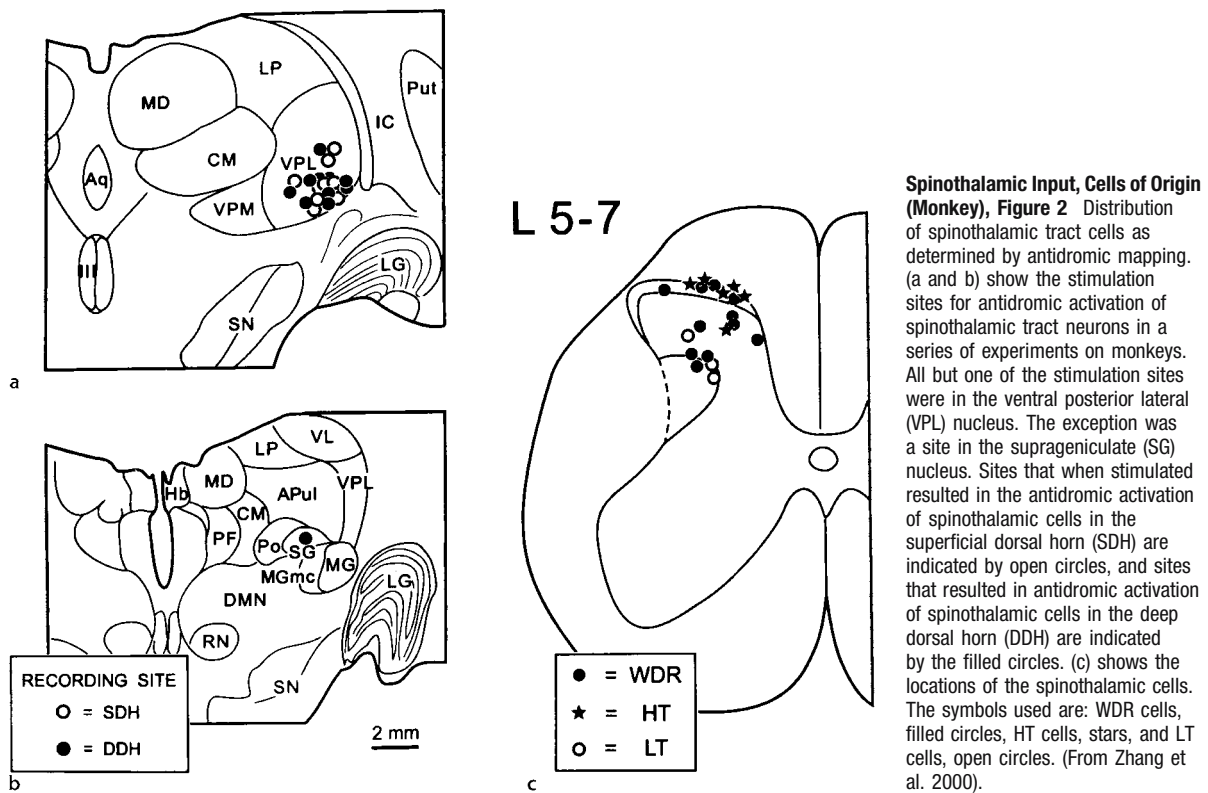
The dendrites of spinothalamic tract cells in lamina I are oriented longitudinally, as shown in Fig. 3a in a horizontal section of the spinal cord after retrograde labeling from the thalamus using cholera toxin subunit B (Zhang

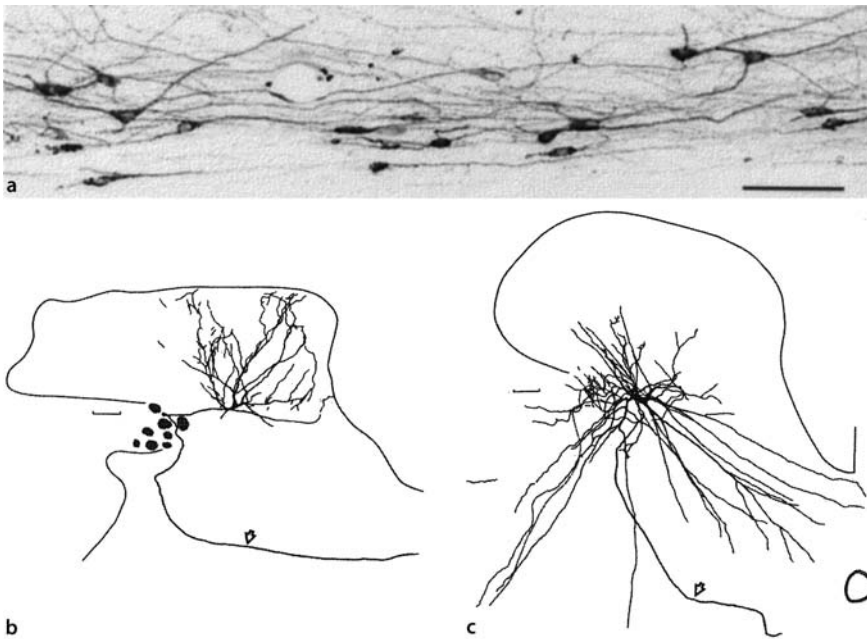
and Craig 1997). Based on the configuration of the dendrites, lamina I spinothalamic cells could be subdivided into fusiform (47%), pyramidal (27%) and multipolar (22%) types (Zhang and Craig 1997).

By contrast, the dendrites of spinothalamic tract cells in the deep dorsal horn are oriented transversely, as illustrated in Fig. 3b and c in histological reconstructions of antidromically identified spinothalamic cells that were injected intracellularly with horseradish peroxidase (Surmeier et al. 1988). In some cases, the dendrites extended dorsally as far as to lamina I (Fig. 3b); in other cases the dendrites spread chiefly ventrally (Fig. 3c). The classification of the spinothalamic tract cell in Fig. 3B was WDR and that of the neuron shown in Fig. 3c was HT.

In recordings from 53 lamina I spinothalamic tract cells in monkeys, 69% were of the WDR type and 29% of the HT type; only 2% were LT (Owens et al. 1992). Of 155 spinothalamic tract cells in laminae IV–VI, 59% were classified as WDR, 22% HT and 20% as LT cells.

The receptive fields of spinothalamic neurons that terminate in the ventral posterior lateral nucleus of the thalamus can be quite small, or they may be medium sized or even large, but they are usually limited to a single limb (Giesler et al. 1981). Spinothalamic tract cells in lamina I are more likely to have small receptive fields than are spinothalamic cells in laminae IV–VI (Willis and Coggeshall 2003). In addition, the receptive fields of lamina I spinothalamic tract cells have a ► **somatotopic**





**Spinothalamic Input, Cells of Origin (Monkey), Figure 3** Orientation of the dendrites of spinothalamic tract cells in the monkey. (a) shows the cell bodies and dendrites of retrogradely labeled monkey spinothalamic cells following injection of cholera toxin subunit B into the contralateral thalamus. The lumbosacral spinal cord was sectioned horizontally, and the section shown was taken through lamina I. Note that the dendrites are oriented longitudinally. Cells having fusiform, pyramidal or multipolar configurations can be recognized. (b and c) illustrate the cell bodies and dendrites of two spinothalamic tract cells in the deep dorsal horn of monkey spinal cord. Intracellular recordings were made from these neurons, which were identified by antidromic activation from the ventral posterior lateral nucleus of the thalamus. The responses to graded intensities of mechanical stimuli showed that the neuron in (b) was a WDR cell and that in (c) a HT cell. After the recordings were completed, the cells were injected with horseradish peroxidase through the microelectrode. The injected cells were later reacted histochemically and then reconstructed from serial sections. The dendrites of the cell in (b) extended mostly dorsally and reached lamina I. By contrast, the dendrites of the cell in (c) extended mostly ventrally. The open arrows indicate the axons of these neurons as they neared the point at which they crossed the midline in the anterior white commissure. ((a) is from Zhang and Craig 1997); (b and c) are from Surmeier et al. 1988).

**organization** (Willis and Coggeshall 2003). These observations suggest that lamina I spinothalamic cells are able to contribute to the accurate localization of painful stimuli.

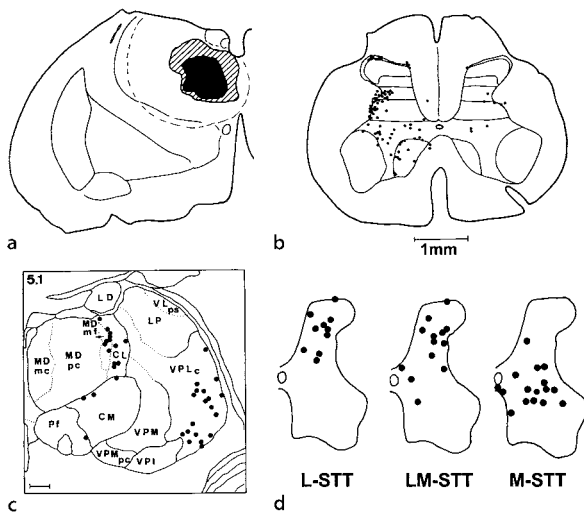
No studies have been done in which spinothalamic neurons have been retrogradely labeled in a selective way by injections of tracer into the ► **ventral posterior inferior nucleus** or the posterior complex or by antidromic activation from these nuclei. However, the response properties of thalamic neurons in these nuclei have been described in the squirrel monkey (Apkarian and Shi 1994). Half of the neurons sampled in the ventral posterior inferior nucleus and more than a third of those recorded in the posterior complex were nociceptive. Presumably, a major source of the nociceptive input to these thalamic neurons was by way of the spinothalamic tract.

In general, spinothalamic cells that terminate in the ventral posterior lateral nucleus, the ventral posterior inferior nucleus and the near-by posterior complex appear to be suited to mediate the ► **sensory-discriminative aspects of pain** sensation (Willis and Coggeshall 2003). Cortical projections from the ventral posterior lateral nucleus are to the ► **SI** and ► **SII** areas of the somatosensory cortex (Jones 1985). The ventral posterior inferior nucleus and the posterior complex may also

project to the SII cortex (Apkarian and Shi 1994; Jones 1985). Functional imaging studies provide evidence that the SI and SII cortices play a major role in sensory-discrimination of painful stimuli (Ploner et al. 1999; Rainville et al. 2000).

Some spinothalamic tract cells can be retrogradely labeled (Fig. 4a, b) or antidromically activated from the medial thalamus, in particular from the region of the central lateral nucleus of the intralaminar complex and the adjacent region of the medial dorsal nucleus (Fig. 4c, d) (Giesler et al. 1981). In contrast to spinothalamic tract cells that project only to the ventral posterior lateral nucleus of the lateral thalamus (L-STT cells), some spinothalamic tract cells can be activated both from the lateral thalamus and the medial thalamus (LM-STT cells), whilst others project only to the medial thalamus (M-STT cells). The locations of L-STT and LM-STT cells (Fig. 4d) are similar to those shown in Figs. 1 and 2. However, the medially projecting spinothalamic cells tend to be located more ventrally, mostly in laminae VII and VIII (Fig. 4d, M-STT).

The response properties of the spinothalamic cells that just project to the ventral posterior lateral nucleus or to both that nucleus and the medial thalamus are similar. However, spinothalamic tract cells that project only to



**Spinothalamic Input, Cells of Origin (Monkey), Figure 4** Spinothalamic tract cells that project to the vicinity of the central lateral nucleus in monkeys. (a) shows an injection site in the medial thalamus of a monkey. The retrograde tracer was horseradish peroxidase. In (b) are plotted the retrogradely labeled spinothalamic tract cells in the same animal. Many of the labeled cells are in the ventral horn contralateral to the injection site in the thalamus. Many others are in the deep dorsal horn, and some are in lamina I. (c) shows the stimulation sites for antidromic activation of primate spinothalamic tract cells. Most of the stimulation sites were in the lateral thalamus in the caudal part of the ventral posterior lateral nucleus (VPLc) or in the medial thalamus, especially in the central lateral (CL) nucleus and perhaps in the adjacent part of the medial dorsal (MD) nucleus. D shows the locations of spinothalamic tract cells that could be activated antidromically from just the lateral thalamus (L-STT cells), both the lateral and medial thalamus (LM-STT cells) or just the medial thalamus (M-STT cells). Note that spinothalamic tract cells that project just to the medial thalamus are located chiefly in the intermediate region and ventral horn, whereas those that project to the lateral thalamus, with or without collateralizing to the medial thalamus, are mostly in the superficial or deep dorsal horn. ((a and b) are from Willis et al. 1979; (c and d) are from Giesler et al. 1981).

the medial thalamus tend to be of the HT type and often have very large receptive fields that may include the entire surface of the body and head (Giesler et al. 1981). These spinothalamic cells are unlikely to contribute to sensory-discrimination. Instead, they presumably participate in the [motivational-affective aspects of pain](#). They may be especially important for attention and arousal.

## References

1. Apkarian AV, Hodge CJ (1989) The primate spinothalamic pathways: I. A quantitative study of the cells of origin of the spinothalamic pathway. *J Comp Neurol* 288:447–473
2. Apkarian AV, Shi T (1994) Squirrel monkey lateral thalamus. I. Somatic nociresponsive neurons and their relation to spinothalamic terminals. *J Neurosci* 14:6779–6795
3. Applebaum AE, Leonard RB, Kenshalo DR et al. (1979) Nuclei in which functionally identified spinothalamic tract neurons terminate. *J Comp Neurol* 188:575–586
4. Giesler GJ, Yezierski RP, Gerhart KD et al. (1981) Spinothalamic tract neurons that project to medial and/or lateral thalamic nuclei: evidence for a physiologically novel population of spinal cord neurons. *J Neurophysiol* 46:1285–1308
5. Jones EG (1985) *The Thalamus*. Plenum Press, New York
6. Owens CM, Zhang D, Willis WD (1992) Changes in the response states of primate spinothalamic tract cells caused by mechanical damage of the skin or activation of descending controls. *J Neurophysiol* 67:1509–1527
7. Ploner M, Freund HJ, Schnitzler A (1999) Pain affect without pain sensation in a patient with a postcentral lesion. *Pain* 81:211–214
8. Rainville P, Bushnell MC, Duncan GH (2000) PET studies of the subjective experience of pain. In: Casey KL, Bushnell MC (eds) *Pain Imaging*. Progress in Pain Research and Management, vol 18. IASP Press, Seattle, pp 123–156
9. Surmeier DJ, Honda CN, Willis WD (1988) Natural groupings of primate spinothalamic neurons based on cutaneous stimulation. Physiological and anatomical features. *J Neurophysiol* 59:833–860
10. Willis WD, Coggeshall RE (2004) *Sensory Mechanisms of the Spinal Cord*, 3rd edn, Kluwer Academic/Plenum Publishers, New York
11. Willis WD, Kenshalo DR, Leonard RB (1979) The cells of origin of the primate spinothalamic tract. *J Neurophysiol* 188:358–372
12. Willis WD, Zhang X, Honda CN et al. (2001) Projections from the marginal zone and deep dorsal horn to the ventrobasal nuclei of the primate thalamus. *Pain* 92:267–276
13. Zhang ET, Craig AD (1997) Morphology and distribution of spinothalamic lamina I neurons in the monkey. *J Neurosci* 17:3274–3284
14. Zhang X, Honda CN, Giesler GJ (2000) Position of spinothalamic tract axons in upper cervical spinal cord of monkeys. *J Neurophysiol* 84:1180–1185

## Spinothalamic Neuron

WILLIAM D. WILLIS

Department of Neuroscience and Cell Biology,  
University of Texas Medical Branch, Galveston, TX,  
USA

wdwillis@utmb.edu

## Definition

Neuron whose cell body and dendrites are located in the spinal cord and whose axon projects to and terminates in the thalamus, usually on the side contralateral to the cell body. The axons of spinothalamic neurons form a major nociceptive tract that is responsible for conveying to the brain the information that is required for the perception of the sensory-discriminative components of pain. The spinothalamic tract also contributes to the affective component of pain.

## Characteristics

Spinothalamic neurons are a class of sensory projection neurons. They form one of several different sensory pathways that transmit nociceptive signals from the level of the spinal cord to the brain (reviewed in Willis and Coggeshall 2004; Willis and Westlund 1997). The nociceptive signals depend on input to the spinal cord from peripheral [nociceptors](#) in skin, muscle, joints and viscera. The signals are processed in the spinal cord and then are transmitted to the thalamus and, after a synaptic relay, to the SI and SII somatosensory cortices and other regions of the cerebral cortex (anterior cingulate gyrus, insula). Other pathways, as well as

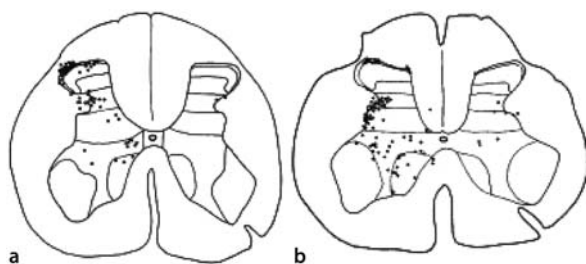


collaterals of spinothalamic tract axons, project to the reticular formation, hypothalamus, limbic system, (including the amygdala) and structures usually identified with the motor system, such as the cerebellum and basal ganglia. Different brain structures are thought to be involved in the parallel processing of the nociceptive signals, resulting in different components of the overall pain response, including ► **sensory discrimination** (quality, duration, location and intensity of the pain) and ► **affective responses**, as well as reflex and endocrine adjustments. The role of spinothalamic neurons in pain includes contributions to both sensory discrimination and affective responses (Willis et al. 1974; Giesler et al. 1981). Sensory discrimination is thought to depend on the activation of neurons in the lateral thalamus by the spinothalamic tract, especially neurons in the ventral posterior lateral nucleus, the ventral posterior inferior nucleus and the posterior complex, whereas terminations of the spinothalamic tract and of a spinoreticulothalamic pathway in the medial thalamus, including the central lateral and parafascicular nuclei of the intralaminar complex and several midline nuclei, are believed to contribute to the affective aspects of pain, as well as to attention and arousal (Willis 1997). The distribution of the cell bodies of spinothalamic neurons in the spinal cord of monkeys has been mapped using the ► **antidromic activation** (Trevino et al. 1973; Giesler et al. 1981) and the ► **retrograde labeling** techniques (Willis et al. 1979; Willis et al. 2001). Spinothalamic neurons that send projections to the lateral thalamus are concentrated in ► **Rexed's laminae I and IV–VI** of the dorsal horn (Fig. 1a). Some of those that project to the medial thalamus are found in the same laminae, but others are concentrated in laminae VII and VIII (Fig. 1b). The fact that the cell body of a spinothalamic neuron is located in a particular lamina does not rule out the possibility of synaptic input to that neuron by synaptic connections formed in other laminae. For example, the dendritic tree of a primate spinothalamic tract neuron is shown in Fig. 2a. This neuron was identified by antidromic activation from

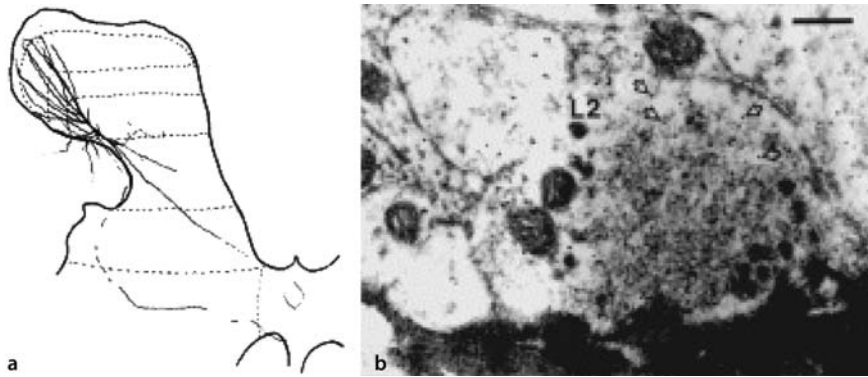
the ventral posterior lateral nucleus of the thalamus and then injected intracellularly with horseradish peroxidase. Although the cell body was in lamina IV, some of its dendrites extended dorsally through laminae III and II to reach lamina I. Other dendrites were directed ventrally and reached lamina VI. Thus, this neuron could receive synaptic connections from synaptic terminals in any lamina of the dorsal horn.

Most spinothalamic neurons send their axonal projections to the contralateral thalamus through the spinothalamic tract, which crosses the midline in the anterior white commissure of the spinal cord (Willis et al. 1979; Willis and Coggeshall 2004). However, there are also some uncrossed projections to the ipsilateral thalamus. The axon of the spinothalamic neuron shown in Fig. 2a can be seen to cross just ventral to the central canal. It is instructive that the cell body and the crossing axon are at the same level of the spinal cord. This contrasts with the suggestion in the literature that spinothalamic axons cross several segments rostral to their cell bodies. The spinothalamic tract ascends in the lateral and anterior funiculi of the spinal cord and then through the lateral brain stem to its destinations in the thalamus (Willis and Coggeshall 1991). Collateral branches of spinothalamic axons may terminate in the reticular formation, midbrain periaqueductal gray, hypothalamus or other brain structures (Lu and Willis 1999). Interruption of the spinothalamic and associated tracts by ► **anterolateral cordotomy** has been used successfully to relieve pain on the side of the body contralateral to the cordotomy (Willis and Coggeshall 1991). It has been especially helpful for cancer pain.

Responses of spinothalamic neurons to noxious stimuli applied to the skin, muscle, joints and viscera have been described (Willis et al. 1974; Foreman et al. 1979; Milne et al. 1981; Dougherty et al. 1992). Peripheral sensitization of primary afferent nociceptors, including ► **silent nociceptors**, can lead to enhanced responses. Such a change is thought to be responsible for ► **primary hyperalgesia**. The responsiveness of spinothalamic neurons can also be altered by intense noxious stimulation (Simone et al. 1991), after which these neurons may become sensitized through the activation of intracellular signal transduction pathways, a process known as ► **central sensitization** (Willis 2001). Central sensitization of spinothalamic tract cells is initiated by synaptic release of excitatory amino acids and peptides, which in turn activate signal transduction pathways in dorsal horn neurons, including spinothalamic neurons. Fig. 2b shows a synaptic ending on a spinothalamic tract cell that was labeled by an intracellular injection of horseradish peroxidase. The synaptic terminal was immunolabelled for glutamate, using the immunogold technique. The terminal also contains dense core vesicles that are likely to contain one or more peptides. Presumably, activation of this and other terminals by intense peripheral stimulation would result in the release of glutamate and



**Spinothalamic Neuron, Figure 1** (a), (b) Locations of the cell bodies of spinothalamic tract (STT) neurons in the monkey spinal cord, as determined by retrograde labeling from the thalamus using horseradish peroxidase. (a) Locations of STT neurons that project to the lateral thalamus. (b) Locations of STT neurons that project to the medial thalamus. (Modified from Willis et al. 1979).



**Spinothalamic Neuron, Figure 2** (a) Drawing of an STT neuron that was identified in an anesthetized monkey by antidromic activation from the ventral posterior lateral nucleus of the thalamus. After the cell was impaled by a microelectrode, horseradish peroxidase was injected intracellularly to label the cell body, dendrites and axon. The spinal cord tissue containing the cell was processed so that the HRP could be visualized in a light microscope and drawn. (b) Thin sections were made and an immunogold procedure was used to demonstrate the localization of glutamate. Gold particles, some of which are indicated by the open arrows, indicate that the presynaptic terminal at the center is glutamatergic. The terminal also contained dense core vesicles, which presumably contain peptides. A part of the labeled STT cell is shown at the bottom and the active zone of an asymmetrical synapse made by the glutamate-containing terminal is shown to be in contact with the STT cell. Scale bar in D = 0.29  $\mu$ m. (Westlund et al. 1992).

peptide. With strong synaptic input by such terminals and release of sufficient glutamate and peptide, a state of central sensitization might ensue. It has been suggested that central sensitization of spinothalamic tract neurons helps account for ► [secondary mechanical allodynia](#) and secondary mechanical hyperalgesia.

► [Spinal Ascending Pathways, Colon, Urinary Bladder and Uterus](#)

► [Spinothalamic Tract Neurons, Descending Control by Brainstem Neurons](#)

► [Vagal Input and Descending Modulation](#)

## References

- Dougherty PM, Sluka KA, Sorkin LS et al. (1992) Neural changes in acute arthritis in monkeys. I. Parallel enhancement of responses of spinothalamic tract neurons to mechanical stimulation and excitatory amino acids. *Brain Res Rev* 176:1–13
- Foreman RD, Schmidt R, Willis WD (1979) Effects of mechanical and chemical stimulation of fine muscle afferents upon primate spinothalamic tract cells. *J Physiol* 286:215–231
- Giesler GJ, Yezierski RP, Gerhart KD et al. (1981) Spinothalamic tract neurons that project to medial and/or lateral thalamic nuclei: evidence for a physiologically novel population of spinal cord neurons. *J Neurophysiol* 46:1285–1308
- Lu G-W, Willis WD (1999) Branching and/or collateral projections of spinal dorsal horn neurons. *Brain Res Rev* 29:50–82
- Milne RJ, Foreman RD, Giesler GJ et al. (1981) Convergence of cutaneous and pelvic visceral nociceptive inputs onto primate spinothalamic neurons. *Pain* 11:163–183
- Simone DA, Sorkin LS, Oh U et al. (1991) Neurogenic hyperalgesia: central neural correlates in responses of spinothalamic tract neurons. *J Neurophysiol* 66:228–246
- Trevino DL, Coulter JD, Willis WD (1973) Location of cells of origin of spinothalamic tract in lumbar enlargement of the monkey. *J Neurophysiol* 36:750–761
- Westlund KN, Carlton SM, Zhang D et al. (1992) Glutamate-immunoreactive terminals synapse on primate spinothalamic tract cells. *J Comp Neurol* 322:519–527
- Willis WD (1997) Nociceptive functions of thalamic neurons. In: Steriade M, Jones EG, McCormick DA (eds) *Thalamus*, vol II, Experimental and Clinical Aspects. Elsevier, Amsterdam, pp 373–424
- Willis WD (2001) Mechanisms of central sensitization of nociceptive dorsal horn neurons. In: Patterson MM, Gray JW (eds) *Spinal Cord Plasticity: Alterations in Reflex Function*, Kluwer Acad Publishers, Boston, pp 127–183
- Willis WD, Coggeshall RE (2004) *Sensory Mechanisms of the Spinal Cord*, 3rd edn. Kluwer Academic/Plenum Publishers, New York
- Willis WD, Westlund KN (1997) Neuroanatomy of the pain system and of the pathways that modulate pain. *J Clin Neurophysiol* 14:2–31
- Willis WD, Trevino DL, Coulter JD et al. (1974) Responses of primate spinothalamic tract neurons to natural stimulation of hindlimb. *J Neurophysiol* 37:358–372
- Willis WD, Kenshalo DR, Leonard RB (1979) The cells of origin of the primate spinothalamic tract. *J Comp Neurol* 188:543–574
- Willis WD, Zhang X, Honda CN et al. (2001) Projections from the marginal zone and deep dorsal horn to the ventrobasal nuclei of the primate thalamus. *Pain* 92:267–276

## Spinothalamic Projections in Rat

DANIEL MENÉTREY

CNRS, Université René Descartes, Biomédicale, Paris, France

menetrey@biomedicale.univ-paris5.fr

### Definition

The spinal ascending pathway that transmits somesthetic inputs from the level of the spinal cord directly to the thalamus in rat.

### Characteristics

The spinothalamic tract (STT) of the rat is a moderately developed pathway comprising 6000 to 9500 spinal neurons according to evaluations based on different tracing techniques (Burstein et al. 1990). This is less than half of the number estimated in macaque monkeys. Spinal segments are unevenly represented (Giesler et al. 1979; Granum, 1986; Kemplay and Webster 1986). Half of the

neurons lie in the first four cervical segments, the cervical enlargement contains less than 5%, the lumbar enlargement 33% and the thoracic, sacral and coccygeal segments all together about 10% (Fig. 1). This indicates that, as for somatosensory information conveyed by dorsal column systems towards the ► **thalamus**, different parts of the body are not represented to the same extent, thus reflecting the relative importance of various body regions in somatic sensibility. The rat's STT development requires a short postnatal maturation period of a few days, during which small-diameter peripheral afferent fiber activities are essential. Its maturation is complete two weeks after birth. The STT has a trigeminal counterpart, the trigeminothalamic tract, issuing from neurons lying ahead in the spinal trigeminal nucleus pars caudalis.

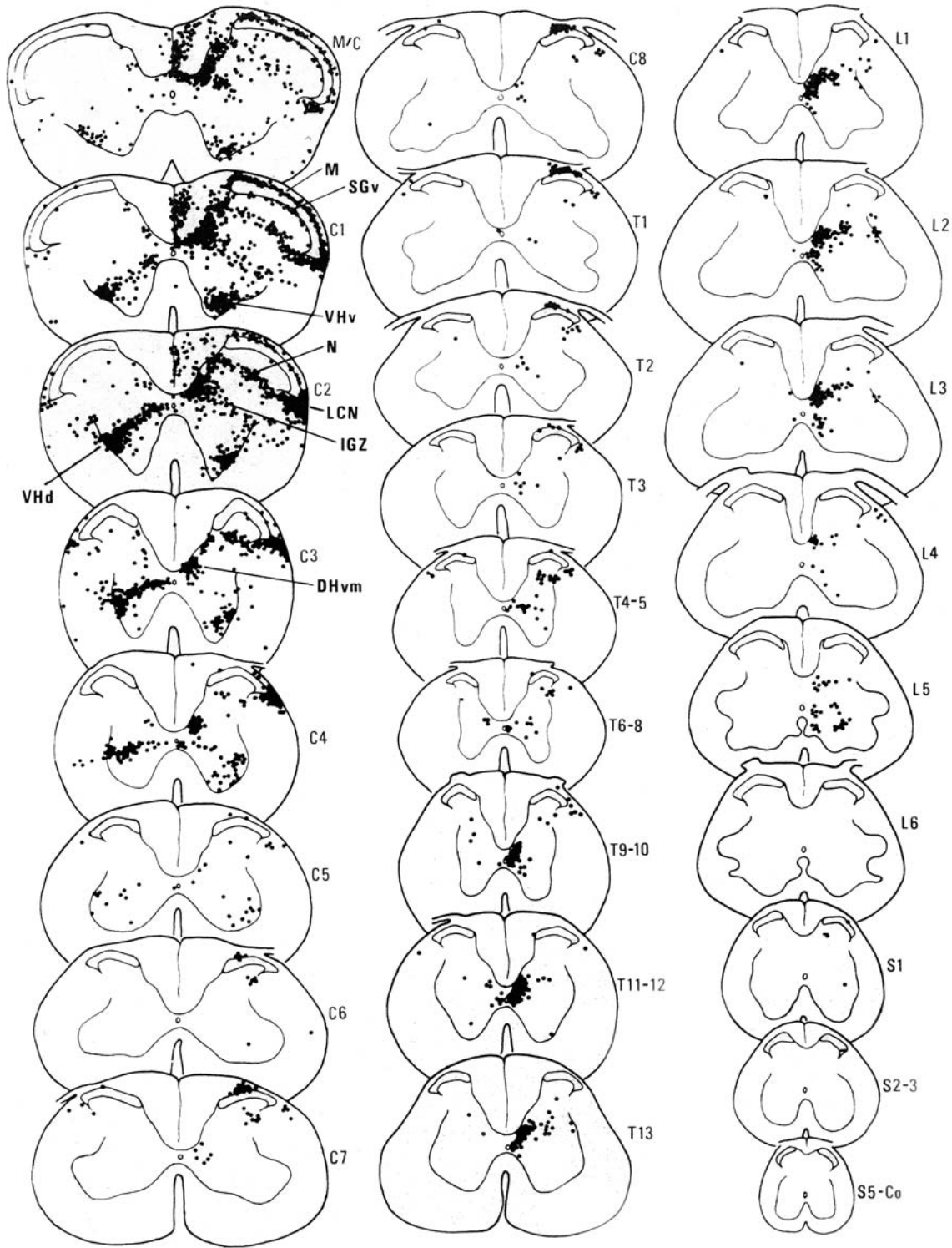
The rat's STT is a crossed pathway except for an ipsilateral contingent taking its origin from neurons located deep in the ventral horn of the upper cervical cord. Two main subdivisions have been recognized that differ in the distribution of their cells of origin in the gray matter, the ► **funiculus** of the cord in which their axons ascend and the thalamic nuclei where they project (Giesler et al. 1981). Axons issuing from neurons located within the dorsal-most two thirds of the dorsal horn and the ventral gray matter ascend within the ventrolateral funiculus and project to the lateral thalamus. Axons issuing from neurons lying deep in the dorsal horn and in the intermediate horn ascend within the ventral funiculus and project to the medial thalamus (Giesler et al. 1981). A third subdivision located within the dorsolateral funiculus comprises axons from neurons located in the marginal layer of the dorsal horn (Zemlan et al. 1978). Axon collaterals to extrathalamic targets have been examined, but with large discrepancies between results. Three to five % of cervical STT cells give rise to descending propriospinal collaterals. Rat STT neurons containing neuropeptides have been described for a variety of substances (bombesin, cholecystokinin, dynorphin, enkephalin, galanin, nitric oxide synthase, substance P, somatostatin, vasoactive intestinal polypeptide) that all form very minor subgroups, so that the main neurotransmitter(s) in the rat's STT remain(s) to be identified. The lumbar galanin-containing subgroup is sexually dimorphic with males containing more of these neurons than females. Anatomical evidence has been given in support of rat STT neurons' responsiveness to glutamatergic, GABAergic, serotonergic, thyrotropin-releasing hormone and substance P inputs.

Terminations of the STT have been reported in a variety of discrete thalamic nuclei sometimes overlapping with those of other somatosensory pathways, the ► **medial lemniscus** (ML) or axon terminals from the ► **lateral cervical nucleus** (LCN). Both main and sparser projection zones have been recognized (Lund and Webster 1967; Mehler 1969; Zemlan et al. 1978). In all, their cells of

origin are mostly contralateral. Main targets include the rostral part of the ventroposterolateral nucleus (VPL) where they overlap with those of ML, the intralaminar nuclei, primarily the central lateral nucleus (CL) and the dorsomedial region of the posterior thalamic group (PO). VPL projections are organized in two segregated zones, which are transitional between the ventral lateral nucleus (VL) rostrally and the PO caudally. Terminations in all these main areas share the following features. They have a patchy distribution and terminate in the form of large terminals that contain round synaptic vesicles and make asymmetrical synaptic contacts with large dendrites or dendritic protrusions. STT synaptic profiles cannot be distinguished on a morphological basis from those of ML terminals. However, as ML terminals tend to contact more proximal dendrites as well as cell somata, they probably have greater influence on cell activities (McAllister and Wells 1981; Peschanski et al. 1985; Ma et al. 1987a, 1987b). Since the VPL in rats virtually lacks interneurons, making it simpler than in cat and monkey, its neurons receiving STT synaptic contacts are all ► **thalamocortical neurons**. Sparser targets include the epithalamus, the dorsal portion of the nucleus submedius (gelatinosus) and areas medially bordering the medial geniculate body (Menétrey et al. 1984; Ledoux et al. 1987). This latter area is also a convergent field for projections from the LCN and the inferior colliculus. A role in pairing of acoustic and somesthetic inputs is consequently highly probable in this case.

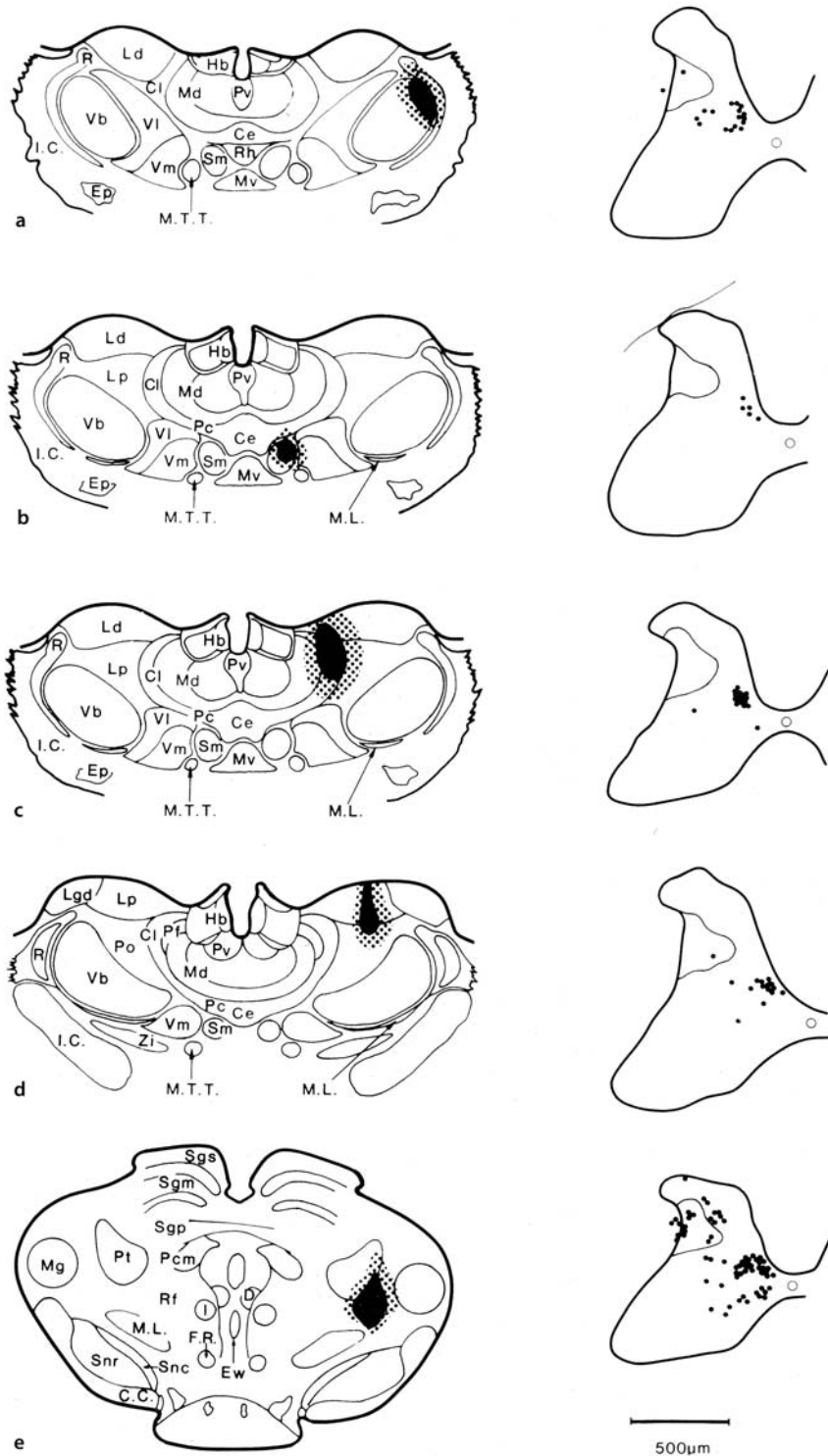
Cells of origin of the rat's STT have been reported in marginal layer (lamina I), neck of the dorsal horn (nDH, lateral lamina V), ► **lateral spinal nucleus** (LSN), ventromedial portion of the dorsal horn (vmDH, laminae V/VI) and intermediate and ventral gray zones (medial portions of laminae VII/VIII and lamina X). The population of neurons reaching the medial thalamus is distributed preferentially deep in the dorsal horn and intermediate region. With the sole exceptions of the vmDH and LSN groups, the great majority of these cells are confined to the most rostral spinal levels. The vmDH group is a unique feature of the rat's lumbar STT extending from vertebral levels T9 to L4 and projecting to all the identified spinothalamic targets (Fig. 2). Two groups of neurons have been identified electrophysiologically, each constituting a homogeneous population of cells (Menétrey et al. 1984). Both groups comprise cells supplying the thalamus with integrated hind limb proprioceptive information about limb position in passive postural changes and locomotion, along with the different phases of the ongoing ► **step cycle** (Fig. 3). The LSN constitutes a specific entity in certain mammals including the rat, the guinea pig, the rabbit and the ferret. Its participation in the STT is moderate compared to other ► **spinal ascending pathways**. LSN neurons have very particular electrophysiological properties. Their axons have slow conduction velocities, sometimes in the un-





**Spinothalamic Projections in Rat, Figure 1** Cells of origin of the rat's spinothalamic tract. Abbreviations: Co, coccygeal segments; C1 to C8, cervical segments; DHvm, ventromedial portion of the dorsal horn; IGZ, intermediate grey zone; LCN, lateral cervical nucleus; L1 to L6, lumbar segments; M, marginal layer; M/C, medulla/cord junction; N, neck of the dorsal horn; SGv, ventral portion of the substantia gelatinosa; S1 to S5, sacral segments; T1 to T13, thoracic segments; Vhd and VHv, dorsal and ventral portions of the ventral horn. From Granum (1986).



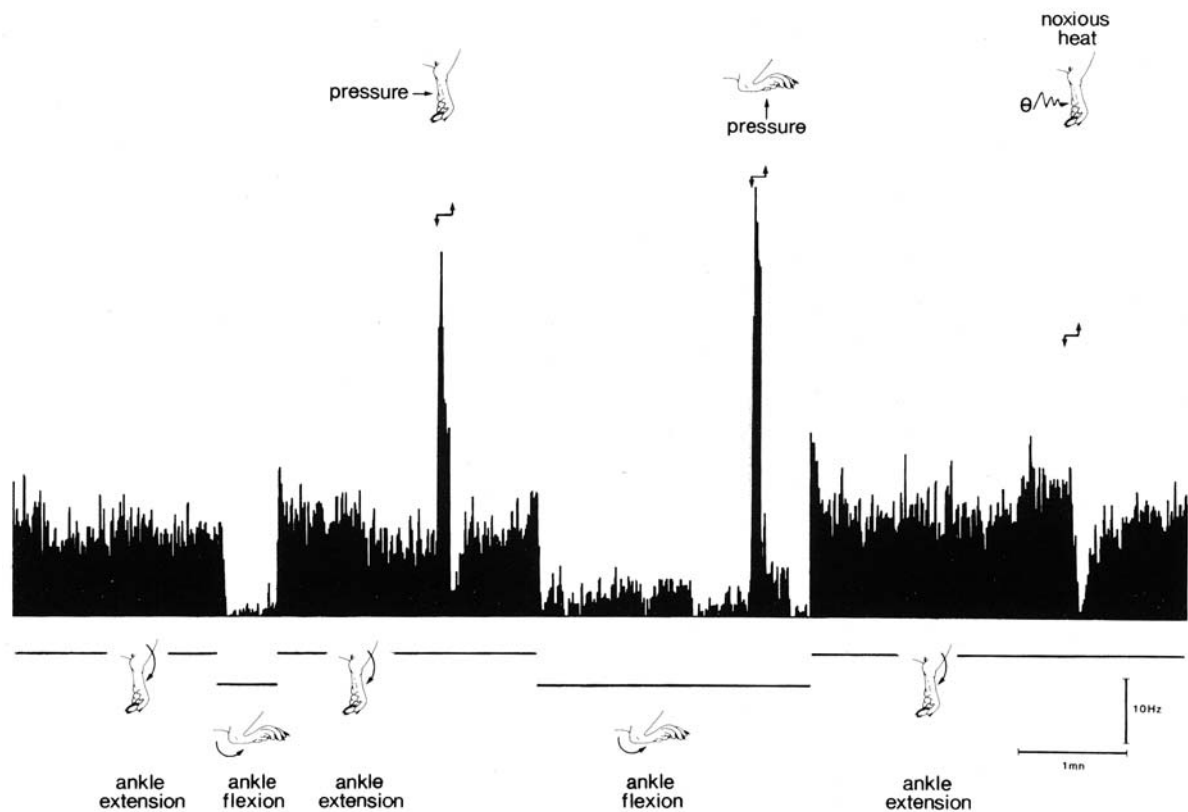


S

**Spinothalamic Projections in Rat, Figure 2** Spinal labeling in the lumbar enlargement resulting from discrete horseradish peroxidase injections into five spinothalamic target regions. (a) anterior portion of the VPL as part of the ventrobasal complex (Vb), (b) nucleus submedialis (Sm), (c) central lateral nucleus (CL), (d) dorsal portion of the posterior group (PO), (e) areas medially bordering the medial geniculate body (Mg). From Menétrey et al. (1984).

myelinated range. They do not usually have spontaneous firing or a defined peripheral excitatory receptive field. Receptive fields seem to be located in deep tissues and responses are inconstant. Their exact role in sensory trans-

mission remains to be studied. The LSN and marginal layer receive identical neuropeptidergic afferents of peripheral origin. The LSN and lamina X contain most of the neuropeptidergic ascending tract cells.



**Spinothalamic Projections in Rat, Figure 3** An example of a vmDH STT cell. This cell had a high ongoing activity directly related to the resting position of the ankle (extension increased it, whereas flexion inhibited it). Innocuous cutaneous stimuli (pressure) excited it, whereas noxious ones (radiant heat) inhibited it. Foot diagrams show the different stages of the application periods for peripheral stimuli, durations of which are indicated by black lines (lower lines for the ankle manipulation, upper lines for cutaneous stimulations). From Men trety et al. (1984).

Evidence has been given that the rat's STT transmits nociception. It contains dorsal horn cells responding most vigorously to noxious cutaneous stimuli, either marginal layer cells responding solely to noxious stimuli or wide dynamic range cells of nDH responding to both innocuous and noxious stimuli with an increased discharge when the stimulus strength becomes noxious (Giesler et al. 1976). Nociceptive rat STT neurons receive inputs from unmyelinated fibers and develop hypersensitivity in painful pathological conditions (intra-dermal capsaicin injection, nerve ligature, diabetic neuropathy, spinal cord injury) and are subject to analgesic effects of morphine and brain and vagal stimulation. In spite of these observations, it is however clear that the rat's STT transmits nociception in a way that conflicts with traditional concepts of the STT system as it is regarded from human observations or other animal studies. In fact anatomical data demonstrate that spinal areas that relay peripheral nociceptive inputs are underrepresented, especially the marginal layer, and exclude some targets such as nucleus submedius, contrary to cat and monkey (Men trety et al. 1984). The role of the rat's STT in transmission of visceral pain has also been questioned. In fact the rat's STT lacks projections

from spinal autonomic columns, as do some other ascending pathways, spinosolitary, lateral spinoreticular, spinoparabrachial and spinomesencephalic tracts.

Heterogeneity in the functional roles of the rat's STT has thus been established. Since the beginning of the 20<sup>th</sup> century, the STT has unequivocally been considered as the main pathway for transmitting information about pain and temperature in all species studied but with a prejudice against the notion that this pathway could assume other putative functions and that other pathways could be involved in pain transmission. Studies in the rat balance this concept.

## References

1. Burstein R, Dado RJ, Giesler GJ Jr (1990) The cells of origin of the spinothalamic tract of the rat: a quantitative reexamination. *Brain Res* 511:329-337
2. Giesler GJ Jr, Men trety D, Guilbaud G et al. (1976) Lumbar cord neurons at the origin of the spinothalamic tract in the rat. *Brain Res* 118:320-324
3. Giesler GJ Jr, Men trety D, Basbaum AI (1979) Differential origins of spinothalamic tract projections to medial and lateral thalamus in the rat. *J Comp Neurol* 184:107-126
4. Giesler GJ Jr, Spiel HR, Willis WD (1981) Organization of spinothalamic tract axons within the rat spinal cord. *J Comp Neurol* 195:243-252

5. Granum SL (1986) The spinothalamic system of the rat. I. Locations of cells of origin. *J Comp Neurol* 247:159–180
6. Kemplay SK, Webster KE (1986) A qualitative and quantitative analysis of the distributions of cells in the spinal cord and spinomedullary junction projecting to the thalamus of the rat. *Neuroscience* 17:769–789
7. Ledoux JE, Ruggiero DA, Forest R et al. (1987) Topographic organization of convergent projections to the thalamus from the inferior colliculus and spinal cord in the rat. *J Comp Neurol* 264:123–146
8. Lund RD, Webster KE (1967) Thalamic afferents from the spinal cord and trigeminal nuclei. An experimental anatomical study in the rat. *J Comp Neurol* 130:313–328
9. Ma W, Peschanski M, Ralston HJ 3rd (1987a) The differential synaptic organization of the spinal and lemniscal projections to the ventrobasal complex of the rat thalamus. Evidence for convergence of the two systems upon single thalamic neurons. *Neuroscience* 22:925–934
10. Ma W, Peschanski M, Ralston HJ 3rd (1987b) Fine structure of the spinothalamic projections to the central lateral nucleus of the rat thalamus. *Brain Res* 414:187–191
11. McAllister JP, Wells J (1981) The structural organization of the ventral posterolateral nucleus in the rat. *J Comp Neurol* 197:271–301
12. Mehler WR (1969) Some neurological species differences – *A posteriori*. *Ann NY Acad Sci* 167:424–468
13. Menétrey D, de Pommery J, Roudier F (1984) Properties of deep spinothalamic tract cells in the rat, with special reference to ventromedial zone of lumbar dorsal horn. *J Neurophysiol* 52:612–624
14. Peschanski M, Roudier F, Ralston HJ 3rd et al. (1985) Ultrastructural analysis of the terminals of various somatosensory pathways in the ventrobasal complex of the rat thalamus: an electron-microscopic study using wheatgerm agglutinin conjugated to horseradish peroxidase as an axonal tracer. *Somatosens Res* 3:75–87
15. Zemlan FP, Leonard CM, Kow LM et al. (1978) Ascending tracts of the lateral columns of the rat spinal cord: a study using the silver impregnation and horseradish peroxidase techniques. *Exp Neurol* 62:298–334

## Spinothalamic Terminations, Core and Matrix

EDWARD JONES  
Center for Neuroscience, University of California,  
Davies, CA, USA  
ejones@ucdavis.edu

### Synonyms

Core and Matrix; lateral thalamic nuclei and STT; Laminae I/II Inputs to the Thalamus

### Definition

The ventral posterior complex can be subdivided into two compartments, based on differential staining with different calcium binding proteins, a core and a matrix. The spinothalamic terminations from superficial laminae of the spinal cord terminate in both compartments and in multiple other nuclei.

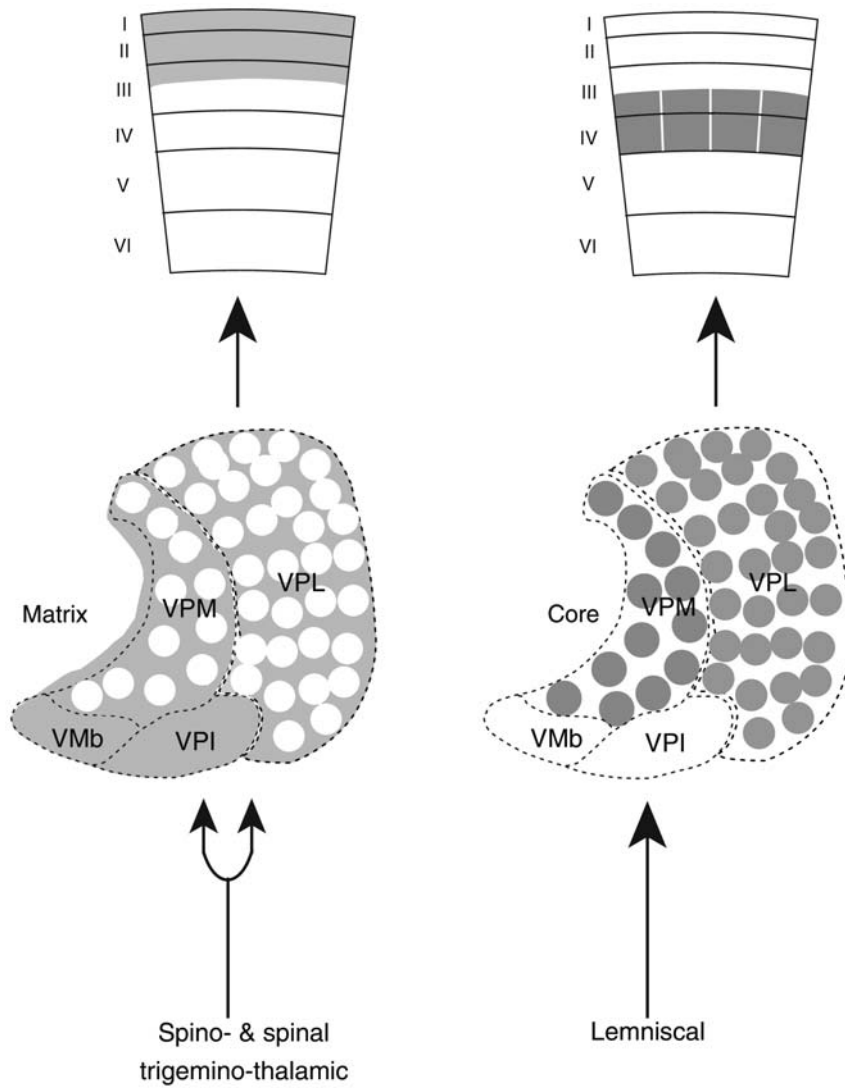
### Characteristics

The most direct of the central pain pathways arise in the spinal and medullary dorsal horns and project directly to

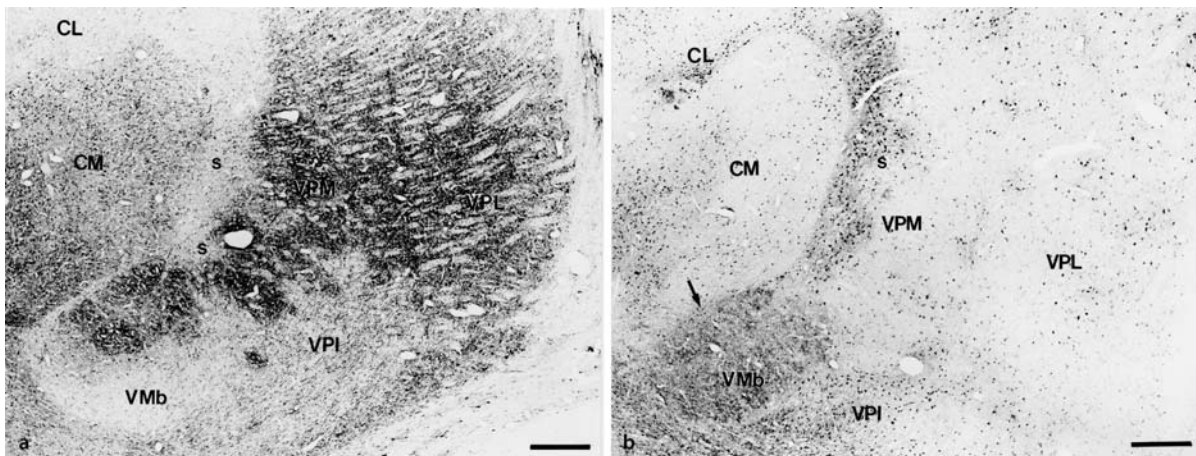
the thalamus and from thence to the cerebral cortex. The greatest numbers of pain-related fibers in these pathways arise from superficial laminae of the dorsal horn of the spinal and medullary gray matter. For the purposes of this essay, we will not consider to any extent the fibers arising in deep parts of the spinal central gray and we will not consider at all the various brainstem targets of these pathways that may secondarily relay pain information to the thalamus and cerebral cortex.

In monkeys, spinothalamic fibers, whether labeled *en masse* or labeled specifically from the superficial laminae of the spinal dorsal horn, terminate extensively in the thalamus and not exclusively in the ► **ventral posterior nucleus**, which is the relay for the dorsal column-lemniscal pathway to the primary somatosensory cortex (Rausell et al. 1992; Graziano and Jones 2004). Thalamic nuclei in which spinal terminations have been identified include the ► **ventral posterior**, ► **ventral lateral**, ► **intralaminar** and ► **posterior**. Terminations are often identified in the caudal part of the mediodorsal nucleus as well, but this is a matter of nomenclature, for most, if not all, of these are actually in the caudal part of the intralaminar system in a part of the central lateral nucleus often misidentified as the ► **densocellular subnucleus of the mediodorsal nucleus** (Jones 2006). The terminations in and around the ► **ventral posterior nucleus** are particularly interesting on account of their relationships to a chemically specified part of the thalamus and their complementarity with the terminations of lemniscal fibers. This is where we come to consider the core and matrix of the primate thalamus.

The *ventral posterior complex* of monkeys and other primates, including humans, is made up of the ► **ventral posterior lateral (VPL)** and ► **ventral posterior medial (VPM)** nuclei and two subsidiary nuclei the ventral posterior inferior nucleus (VPI) and the basal ventral medial nucleus (VMb) (Fig. 1). The basal ventral medial nucleus is a modern name for a nucleus formerly called the parvocellular division of the ► **VPM**. In humans, the ► **VMb** and ► **VPI** together make up the greater part of a nucleus called by Hassler (1959) *ventralis caudalis parvicellularis (v.c.p.c.)*. Within the four-nucleus complex, two histo- and immunocyto-chemically defined compartments can be identified (Fig. 2) (Rausell and Jones 1991a; Rausell and Jones 1991b). A *matrix* compartment is found throughout all four nuclei; it stains weakly for ► **cytochrome oxidase** and other oxidative enzymes but contains thalamocortical relay neurons identified by specific immunostaining for the 28 kD calcium binding protein, ► **calbindin**. On the matrix is imposed, but only in the VPL and VPM, a core compartment which stains densely for ► **cytochrome oxidase** and is filled with relay cells that stain specifically for a different calcium binding protein, ► **parvalbumin**. The core compartment in the VPL and VPM is fragmented, with zones of dense ► **parvalbumin** immunostaining separated by other zones in which the ► **calbindin** immunostained



**Spinothalamic Terminations, Core and Matrix, Figure 1** Schematic view of the background matrix (left) of the ventral posterior complex, with its input from the spinothalamic and spinal trigeminothalamic systems and widespread projection to superficial layers of the cerebral cortex, contrasted with the core, restricted to the VPM and VPL nuclei, with its input from the lemniscal system and topographically-organized projection to middle layers of the primary somatosensory cortex. Based on Jones (2005). Abbreviations: VMb, basal ventral medial nucleus; VPI, ventral posterior inferior nucleus; VPL, ventral posterior lateral nucleus; VPM, ventral posterior medial nucleus.



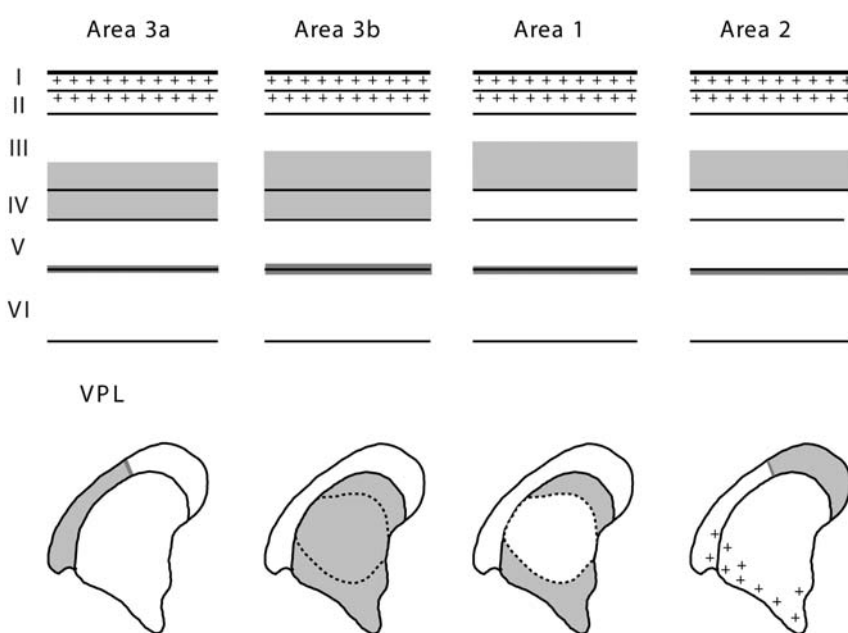
**Spinothalamic Terminations, Core and Matrix, Figure 2** Photomicrographs of adjacent frontal sections through the thalamus of a macaque monkey, showing the parvalbumin immunoreactive core of the ventral posterior nucleus (a) and the calbindin immunoreactive matrix (b). Bar 500  $\mu$ m. s, enhanced matrix region of VPM; CL, central lateral nucleus; CM, centre median nucleus; other abbreviations as in Fig 1. Arrow indicates region of parvalbumin and calbindin overlap in medial VPM. From Jones (2005).



matrix is exposed. The VMb and VPI lack a core compartment and are made up exclusively of the calbindin matrix; fingers of this matrix extend up from the VPI into the VPL and there is a large zone of matrix (the S region) along the medial edge of the VPM. The matrix regions of the overall ventral posterior complex extend posteriorly as an enlarged, calbindin-rich, ► **cytochrome oxidase-weak** and ► **parvalbumin-deficient** region that is coextensive with nuclei lying posterior and postero-medial to the ventral posterior complex, the ► **posterior nucleus** and the ► **anterior pulvinar nucleus** (Jones et al. 2001). The significance of the matrix and core compartments is that they represent the selective termination sites of spino- and spinal trigeminothalamic fibers and of lemniscal fibers respectively (Rausell et al. 1992; Graziano and Jones 2004). Moreover, the cells of the two compartments project differentially upon the cerebral cortex (Fig. 1).

Large regions of the thalamic matrix such as the S region, VMb, VPI and the posterior/anterior pulvinar nuclear region are sufficiently far removed from the core compartment in which lemniscal fibers terminate to represent regions in which spino- and spinal trigeminothalamic fibers exclusively terminate. In them there is unlikely to be convergence of the pain and lemniscal systems upon the same thalamocortical relay cells. Segregation of the two systems is maintained at a relatively coarse level even within the heart of the VPL and VPM where both the spino- and spinal trigeminothalamic and the lemniscal pathways terminate, but it cannot be ruled out that extension of dendrites of parvalbumin core cells into a calbindin matrix region and *vice versa* might provide a basis for some convergence. This has been pro-

posed from electron microscopical studies, although terminals of the two systems were not specifically shown to converge on the same cell (Ralston and Ralston 1994). The parvalbumin immunoreactive cells of the core project in a well-known topographic order on the first somatosensory area of the postcentral gyrus, those receiving proprioceptive inputs ending specifically in area 3a and those receiving cutaneous inputs in areas 3b and 1 (Fig. 3). In all areas, the terminations of the parvalbumin immunoreactive fibers are concentrated in the middle layers of the cortex (layer IV and deep layer III) (Rausell et al. 1992). The topography in this parvalbumin-defined, dorsal column-lemniscal projection clearly underlies the representational map in the primary somatosensory cortex as commonly defined by multiunit recording of responses to peripheral stimuli. The calbindin-defined cells of the matrix have quite a different pattern of thalamocortical projection. Their fibers branch more extensively than the fibers of the core and can extend over two or more adjacent cytoarchitectonic areas of the somatosensory cortex and even across the somatosensory and motor areas without a high degree of topographic order; in these areas they terminate in superficial layers of the cortex (layers I, II and upper III) (Fig. 1). There is, thus, a basis for parallel lemniscal and spinothalamic pathways passing through the ventral posterior complex and reaching the cortex of the primary somatosensory cortex in a complementary manner. If, as appears likely, the parvalbumin fibers target not only cortical intrinsic neurons in the middle layers but also the basal and oblique apical side branches of layers III and V pyramidal cells and the calbindin fibers, the apical tufts of these same cells,



**Spinothalamic Terminations, Core and Matrix, Figure 3** Laminar and areal projections of neurons in the ventral posterior nucleus of monkeys. Core regions (gray) receiving inputs from different classes of peripheral mechanoreceptors project to middle layers of specific cortical fields. Matrix regions (crosses) receiving inputs from the spinothalamic and spinal trigeminothalamic systems project to superficial layers of all fields. From Jones (2006).

then the arrangement seems to form an ideal basis for a coincidence detecting circuit (Jones 2001). However, the spinothalamic and spinotrigeminothalamic pathway running through the thalamic matrix is more diffuse than that of the core, spreading without topographic order across several areas. Moreover, fibers arising in the matrix, especially that of the VMb and VPI nuclei, project beyond the primary somatosensory cortex into gustatory, visceral and peri-insular regions of the cortex (Krubitzer and Kaas 1992; Qi et al. 2002).

## References

1. Graziano A, Jones EG (2004) Widespread thalamic terminations of fibers arising in the superficial medullary dorsal horn of monkeys and their relation to calbindin immunoreactivity. *J Neurosci* 24:248–256
2. Hassler R (1959) Anatomy of the Thalamus. In: Schaltenbrand G, Bailey P (eds) *Introduction to Stereotaxis with an Atlas of the Human Brain*. Thieme, New York, pp 230–290
3. Jones EG (2001) The thalamic matrix and thalamocortical synchrony. *Trends Neurosci* 24:595–601
4. Jones EG (2006) *The Thalamus – Revisited*. Cambridge University Press, Cambridge
5. Jones EG, Lensky KM, Chan VH (2001) Delineation of thalamic nuclei immunoreactive for calcium-binding proteins in and around the posterior pole of the ventral posterior complex. *Thalamus and Related Systems* 1:213–224
6. Krubitzer LA, Kaas JH (1992) The somatosensory thalamus of monkeys: cortical connections and a redefinition of nuclei in marmosets. *J Comp Neurol* 319:123
7. Qi HX, Lyon DC, Kaas JH (2002) Cortical and thalamic connections of the parietal ventral somatosensory area in marmoset monkeys (*Callithrix jacchus*). *J Comp Neurol* 443:168–182
8. Ralston HJ III, Ralston DD (1994) Medial lemniscal and spinal projections to the macaque thalamus: An electron microscopic study of differing GABAergic circuitry serving thalamic somatosensory mechanisms. *J Neurosci* 14:2485–2502
9. Rausell E, Jones EG (1991a) Chemically distinct compartments of the thalamic VPM nucleus in monkeys relay principal and spinal trigeminal pathways to different layers of the somatosensory cortex. *J Neurosci* 11:226–237
10. Rausell E, Jones EG (1991b) Histochemical and immunocytochemical compartments of the thalamic VPM nucleus in monkeys and their relationship to the representational map. *J Neurosci* 11:210–225
11. Rausell E, Bae CS, Viñuela A et al. (1992) Calbindin and parvalbumin cells in monkey VPL thalamic nucleus: distribution, laminar cortical projections, and relations to spinothalamic terminations. *J Neurosci* 12:4088–4111

## Spinothalamic Tract Cells

### ► Spinothalamic Input, Cells of Origin (Monkey)

## Spinothalamic Tract Neurons, Central Sensitization

DONALD A. SIMONE  
Department of Diagnostic and Biological Sciences,  
University of Minnesota, School of Dentistry,  
Minneapolis, MN, USA  
simon003@umn.edu

## Definition

Central sensitization refers to an increase in excitability of dorsal horn neurons following tissue injury and inflammation. The sensitization is typically characterized by an increase in a) spontaneous activity, b) responses evoked by mechanical and thermal stimuli applied to the ► **receptive field** and c) receptive field area.

## Characteristics

Many studies have demonstrated alterations in response properties of spinothalamic tract (STT) neurons following tissue damage. Early studies showed that repeated heating of the skin with heat stimuli from 43–50°C produced an increase in spontaneous activity of STT neurons in monkeys and enhanced their responses to heat stimuli applied to the same site (Kenshalo et al. 1979). The sensitization to heat was characterized by a decrease in response threshold and increased response to suprathreshold stimuli. Additional studies showed that repeated noxious heating of the skin decreased the heat response threshold of STT neurons by approximately 5°C and also increased responses to innocuous cold and mechanical stimuli (Kenshalo et al. 1982; Ferrington et al. 1987). These studies suggested that sensitization of STT neurons may contribute to the ► **hyperalgesia** that occurs at the site of injury (primary hyperalgesia). Other injuries that produce behavioral measures of hyperalgesia, such as joint inflammation and nerve injury, also enhanced the responses of STT neurons. For example, inflammation following intra-articular injection of kaolin and carrageenan enhanced responses of STT neurons to joint flexion, to mechanical stimuli applied to the skin and to iontophoretic application of excitatory amino acids, suggesting a role for amino acids and their receptors in central sensitization and demonstrating that STT neurons are more sensitive to amino acid neurotransmitters released into the dorsal horn (Dougherty et al. 1992). Similarly, experimental neuropathy produced by spinal nerve ligation in monkeys (Palecek et al. 1992) or by diabetes (streptozotocin model) in rats (Chen and Pan 2002) also resulted in increased responses of STT neurons to mechanical and/or thermal stimuli. Collectively, these studies suggest that sensitization of STT neurons contributes to hyperalgesia produced by inflammation and by nerve injury.

Sensitization of STT neurons that occurs at a site of injury or inflammation may in part be due to sensitization of peripheral nociceptors that project to STT neurons. However, sensitization of STT neurons following a small, localized injury can occur throughout their receptive fields and include areas of the receptive field that are uninjured. Hyperalgesia that extends outside an area of injury is referred to as secondary (Lewis 1942; Hardy et al. 1950) and the contribution of STT neurons to secondary hyperalgesia has been investigated. A role for STT neurons in secondary hyperalgesia was first

described by Kenshalo et al. (1982) who reported that responses of STT neurons to innocuous mechanical stimuli, such as brushing the skin, following repeated noxious heating of the skin were enhanced at the stimulation site and also in other areas of the receptive field. To further determine the contribution of STT neurons to secondary hyperalgesia, direct comparisons were made between psychophysical measures of cutaneous hyperalgesia produced by intradermal injection of capsaicin in humans and responses of STT neurons in monkey. In humans, injection of capsaicin (100  $\mu$ g in 10  $\mu$ l) produces burning pain, hyperalgesia to heat at the injection site and secondary mechanical hyperalgesia to stroking the skin with a cotton swab or to poking the skin with punctate stimuli (von Frey monofilaments) within a large area surrounding the injection site (Simone et al. 1989; LaMotte et al. 1991). Injection of capsaicin into the receptive field of STT neurons caused excitation with a time course similar to the capsaicin evoked pain in humans. In addition, responses of STT to heat stimuli applied to the capsaicin injection site were enhanced and responses to stroking the skin and to stimulation with von Frey monofilaments were increased through the receptive field (Simone et al. 1991a). Responses of STT neurons to iontophoretic application of excitatory amino acids were also increased (Dougherty and Willis 1992).

Sensitization of STT neurons was also found after application of a ► **pruritic stimulus** to the skin (Andrew and Craig 2001). Iontophoretic application of histamine excited a subpopulation of STT neurons in cats and increased their responses to mechanical stimuli. Excitation and sensitization of this unique group of STT neurons may contribute to the sensation of itch as well as to ► **alloknesis** (► **mechanically evoked itch**) that occurs in humans after application of histamine to the skin (Simone et al. 1991b).

Collectively, these data demonstrate that STT neurons develop enhanced responses following tissue injury and inflammation and that the sensitization of STT neurons is not only a reflection of increased input from sensitized nociceptors at the site of injury, but also reflects a general increase in STT neuronal excitability.

## References

- Andrew D, Craig AD (2001) Spinothalamic lamina I neurons selectively sensitive to histamine: A central neural pathway for itch. *Nat Neurosci* 4:72–77
- Chen SR, Pan HL (2002) Hypersensitivity of spinothalamic tract neurons associated with diabetic neuropathic pain in rats. *J Neurophysiol* 87:2726–2733
- Dougherty PM, Willis WD (1992) Enhanced responses of spinothalamic tract neurons to excitatory amino acids accompany capsaicin-induced sensitization in the monkey. *J Neurosci* 12:883–894
- Dougherty PM, Sluka KA, Sorkin LS et al. (1992) Neural changes in acute arthritis in monkeys: I. Parallel enhancement of responses of spinothalamic tract neurons to mechanical stimulation and excitatory amino acids. *Brain Res Rev* 17:1–13
- Ferrington DG, Sorkin LS, Willis WD (1987) Responses of spinothalamic tract cells in the superficial dorsal horn of the primate lumbar spinal cord. *J Physiol* 388:681–703
- Hardy JD, Woolf HG, Goodell H (1950) Experimental evidence on the nature of cutaneous hyperalgesia. *J Clin Invest* 29:115–140
- Kenshalo DR, Leonard RB, Chung JM et al. (1979) Responses of primate spinothalamic neurons to graded and to repeated noxious heat stimuli. *J Neurophysiol* 42:1370–1389
- Kenshalo DR, Leonard RB, Chung JM et al. (1982) Facilitation of the responses of primate spinothalamic cells to cold and to tactile stimuli by noxious heating of the skin. *Pain* 12:141–152
- LaMotte RH, Shain CN, Simone DA et al. (1991) Neurogenic hyperalgesia: Psychophysical studies of underlying mechanisms. *J Neurophysiol* 66:190–211
- Lewis T (1942) *Pain*, Macmillan, London
- Palacek J., Dougherty PM, Kim SH et al. (1992) Responses of spinothalamic tract neurons to mechanical and thermal stimuli in an experimental model of peripheral neuropathy in primates. *J Neurophysiol* 68:1951–66
- Simone DA, Baumann TK, LaMotte RH (1989) Dose-dependent pain and mechanical hyperalgesia in humans after intradermal injection of capsaicin. *Pain* 38:99–107
- Simone DA, Sorkin LS, Oh U et al. (1991a) Neurogenic hyperalgesia: Central neural correlates in responses of spinothalamic tract neurons. *J Neurophysiol* 66:228–246
- Simone DA, Alreja M, LaMotte RH (1991b) Psychophysical studies of the itch sensation and itchy skin ("alloknesis") produced by intracutaneous injection of histamine. *Somatosens Mot Res* 8:271–279

## Spinothalamic Tract Neurons, Descending Control by Brainstem Neurons

WILLIAM D. WILLIS

Marine Biochemical Institute, 2.104 Medical Research Building, Galveston, TX, USA  
wdwillis@utmb.edu

S

### Synonyms

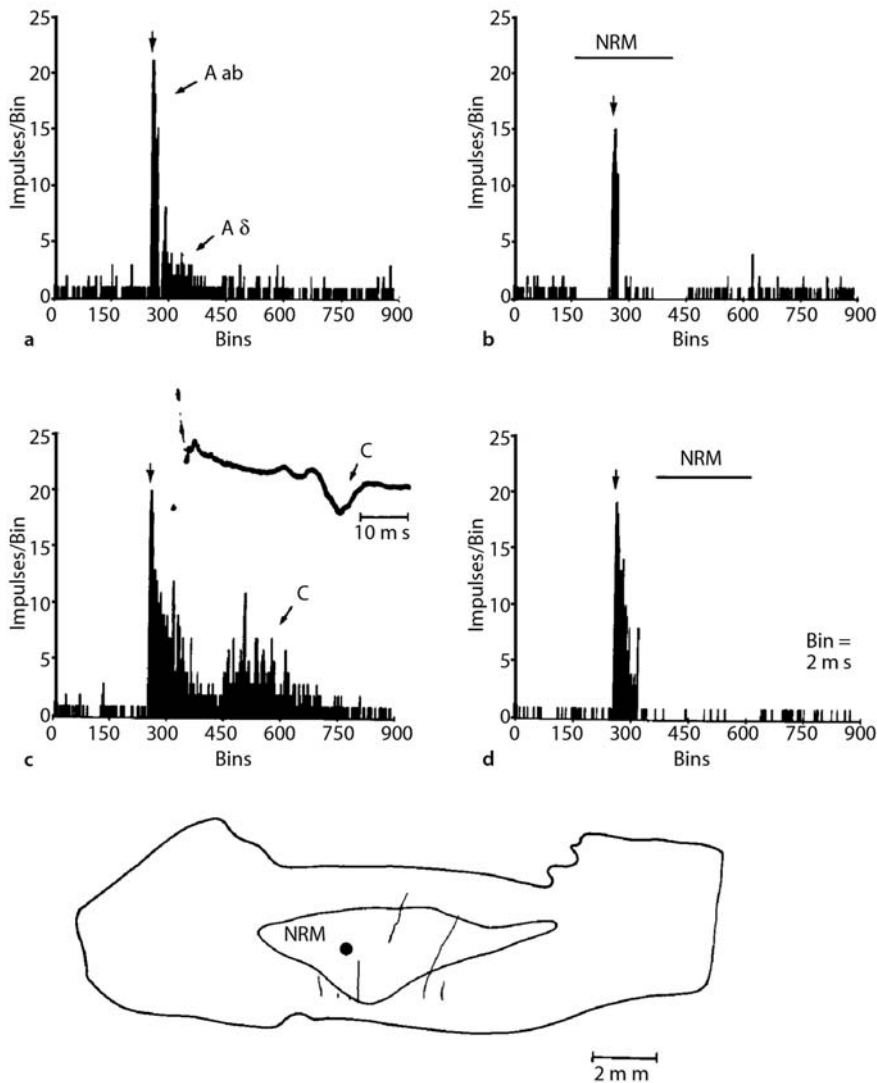
Centrifugal Control of Nociceptive Processing; Supraspinal Regulation; endogenous analgesia system

### Definition

A number of descending pathways to the spinal cord that originate from brainstem neurons have been shown either to inhibit or to excite spinothalamic (STT) and other nociceptive neurons. It is generally accepted that such modulatory actions are likely to affect the processing of nociceptive signals by neural circuits of the spinal cord dorsal horn, as well as of the trigeminal sensory nuclei and hence the experience of pain. Collectively, the descending inhibitory pathways are often referred to as the endogenous analgesia system. By contrast, the descending excitatory pathways are presumed to enhance pain.

### Characteristics

Most ► **spinothalamic neurons** transmit nociceptive signals from relatively restricted cutaneous receptive fields. These cells can usually be activated by volleys in A $\alpha$  $\beta$ ,



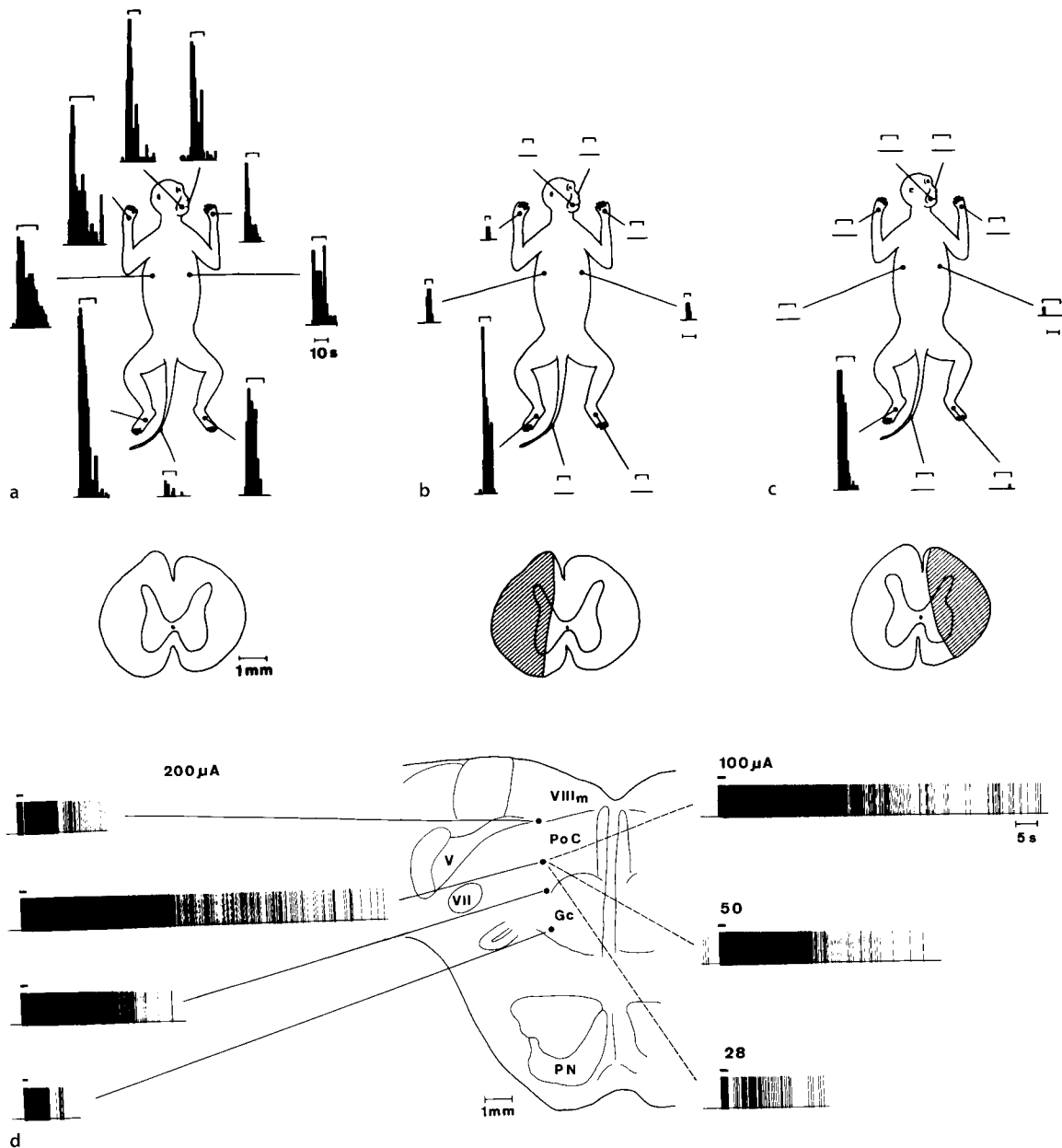
**Spinothalamic Tract Neurons, Descending Control by Brainstem Neurons, Figure 1** Inhibition of the responses of a primate spinothalamic neuron following stimulation in the nucleus raphe magnus (NRM). The peristimulus time histogram in (a) shows the response to stimulation of the sural nerve (arrow) at a strength that activated  $A_{\alpha\beta}$  and  $A_{\delta}$  fibers. (b) shows that stimulation in the NRM reduced the response dramatically, especially that to  $A_{\delta}$  fibers. In (c) is the response to stimulation of A and C fibers. The inset shows a recording of the C fiber volley from the sural nerve. In (d), stimulation in the NRM eliminated the response to the C-fiber volley. The stimulation site in the NRM is indicated below on a drawing of a midsagittal section through the brainstem. The NRM is outlined, and some of the midline blood vessels are indicated on the drawing. (From (Gerhart et al. 1981).

$A_{\delta}$  and C fibers in the appropriate cutaneous nerve (Fig. 1a, b). The axons of these neurons project directly to the ventral posterior lateral (VPL) nucleus of the contralateral thalamus (Willis and Coggeshall 2004). Some STT cells that project to the contralateral VPL nucleus also convey nociceptive signals from muscles, joints or viscera (Willis and Coggeshall 2004). The VPL nucleus of the thalamus in turn transmits somatosensory information derived from the spinothalamic tract input to the somatosensory cerebral cortex. Presumably, this information is used for ► [sensory discrimination](#) of nociceptive stimuli. Many of these same spinothalamic tract cells also project to the contralateral central lateral nucleus, a part of the thalamic intralaminar complex. Some nociceptive STT cells have very large cutaneous receptive fields, often including the entire body and face, and project to the medial part of the thalamus, ending in the contralateral central lateral nucleus of the intralaminar complex (Fig. 2) (Giesler et al. 1981). The

sensory information conveyed by these STT cells to the intralaminar complex is unlikely to relate to sensory discrimination but instead may play a role in ► [arousal](#), ► [attentional mechanisms](#) or ► [motivational-affective responses](#) to painful stimuli (Giesler et al. 1981; Price 1988).

The nociceptive signals conveyed to the brain by STT cells and other ascending ► [nociceptive pathways](#) are necessary for signaling pain. As in other sensory systems, the brain can exert a ► [centrifugal control](#) of the somatosensory information that it receives (Willis 1982). For example, neurons located in the brainstem can modulate nociceptive signals by way of pathways that descend into the spinal cord (Willis 1982; Besson and Chaouch 1987). These brainstem neurons are in turn under the influence of neurons in the cerebral cortex and other areas of the forebrain. In addition, corticospinal projections affect the activity of STT cells. The analgesia that can be produced by stimula-





S

**Spinothalamic Tract Neurons, Descending Control by Brainstem Neurons, Figure 2** An excitatory spino-bulbospinal loop is responsible for the very large receptive fields of primate spinothalamic tract (STT) cells that project to the central lateral thalamic nucleus. In (a) is shown the excitation of a medially projecting STT cell following stimulation anywhere on the body or face. (b) interruption of the dorsal and lateral funiculi on one side of the spinal cord reduced the responses from most of the receptive field except from one hind limb. (c) a lesion of the other dorsal and lateral funiculi restricted the receptive field to one hind limb, that which corresponded to the location of the STT cell in the lumbar enlargement. (d) shows sites within the reticular formation that when stimulated caused a powerful excitation of a medially projecting STT cell. (From Giesler et al. 1981).

tion of pathways descending from the brainstem has been termed “stimulation-produced analgesia.” The descending neural pathways that cause analgesia release endogenous opioid substances, as well as other inhibitory neurotransmitters, such as norepinephrine and serotonin, in the spinal cord dorsal horn (Fields and Besson 1988; Akil and Lewis 1987). The descending

pathways that inhibit the processing of nociceptive information are often called the ► **endogenous analgesia system**. The action of morphine on opiate receptors contained in nociceptive neurons explains the ability of morphine and other opiates to produce an effective analgesia. Similarly, other exogenous drugs can affect pain transmission through action on other receptors.

Brainstem regions that have been found to inhibit the activity of spinothalamic neurons include the midbrain ► **periaqueductal gray matter**, the ► **rostral ventral medulla** (which includes the nucleus raphe magnus and adjacent parts of the reticular formation) and the ► **dorsolateral pons** (which includes the locus coeruleus, subcoeruleus and parabrachial nuclei). Stimulation in the periaqueductal gray or in the nucleus raphe magnus in primates (Fig. 1) can produce a powerful inhibition of spinothalamic neurons (Hayes et al. 1979) (Willis et al. 1977; Gerhart KD et al. 1981). This occurs in part through an opioid mechanism and in part by the release of serotonin in the spinal cord. Another region that when stimulated causes the inhibition of spinothalamic tract neurons is the dorsolateral pons (Girardot et al. 1987). This inhibition can be attributed to the release of norepinephrine in the spinal cord. Stimulation of forebrain areas, such as the ventrobasal thalamus and the postcentral gyrus, can also result in the inhibition of STT cells (Gerhart et al. 1983; Yeziarski et al. 1983). On the other hand, primate STT cells can be excited following stimulation in the primary motor cortex or the medullary pyramid (Yeziarski et al. 1983). Another site that when stimulated can result in the excitation of STT cells is the medullary reticular formation (Haber et al. 1980). However, it is unclear if this excitation is due to activation of reticular formation neurons or of fibers of passage coming from more rostral levels of the brainstem.

The very large cutaneous receptive fields of STT cells that project to the central lateral thalamic nucleus depend on an excitatory loop from the spinal cord to the brainstem and back to the spinal cord, since transection of the spinal cord at a rostral level reduces the receptive fields of such neurons to a restricted area on a single limb (Fig. 2a-c) (Giesler et al. 1981). Stimulation within the pontine reticular formation can produce a long-lasting excitation of such neurons (Fig. 2d) (Giesler et al. 1981). An excitatory loop through the brainstem is also very important for visceral nociceptive signals (Cervero and Wolstencroft 1984). Although some of the responses of spinal cord neurons to noxious visceral stimuli are mediated by local interneuronal circuits, a major part of these responses depends on the transmission of information to the brainstem and subsequent activation of a descending excitatory projection. This excitatory feedback can be considered a means for amplification of the visceral nociceptive signals.

## References

- Akil H, Lewis JW (1987) Neurotransmitters and pain control. Karger, Basel
- Besson JM, Chaouch A (1987) Peripheral and spinal mechanisms of nociception. *Physiol Rev* 67:67–186
- Cervero F, Wolstencroft JH (1984) A positive feedback loop between spinal cord nociceptive pathways and antinociceptive areas of the cat's brain stem. *Pain* 20:125–138
- Fields HL, Besson JM (1988) Pain modulation. *Progress in brain research*, vol 77. Elsevier, Amsterdam
- Gerhart KD, Yeziarski RP, Fang ZR et al. (1983) Inhibition of primate spinothalamic tract neurons by stimulation in ventral posterior lateral (VPL<sub>c</sub>) thalamic nucleus: possible mechanisms. *J Neurophysiol* 49:406–423
- Gerhart KD, Wilcox TK, Chung JM et al. (1981) Inhibition of nociceptive and nonnociceptive responses of primate spinothalamic cells by stimulation in medial brain stem. *J Neurophysiol* 45:121–136
- Giesler GJ, Yeziarski RP, Gerhart KD et al. (1981) Spinothalamic tract neurons that project to medial and/or lateral thalamic nuclei: evidence for a physiologically novel population of spinal cord neurons. *J Neurophysiol* 46:1285–1325
- Girardot MN, Brennan TJ, Ammons WS et al. (1987) Effects of stimulating the subcoeruleus-parabrachial region on the non-noxious and noxious responses of T2–T4 spinothalamic tract neurons in the primate. *Brain Res* 409:19–30
- Haber LH, Martin RF, Chung JM et al. (1980) Inhibition and excitation of primate spinothalamic tract neurons by stimulation in region of nucleus reticularis gigantocellularis. *J Neurophysiol* 43:1578–1593
- Hayes RL, Price DD, Ruda MA et al. (1979) Suppression of nociceptive responses in the primate by electrical stimulation of the brain or morphine administration: behavioral and electrophysiological comparisons. *Brain Res* 167:417–421
- Price DD (1988) Psychological and neural mechanisms of pain. Raven Press, New York
- Willis WD (1982) Control of nociceptive transmission in the spinal cord. In: Ottoson D (ed) *Progress in sensory physiology* 3. Academic Press, New York
- Willis WD, Coggeshall RE (2004) Sensory mechanisms of the spinal cord, 3<sup>rd</sup> edn. Kluwer/Plenum, New York
- Willis WD, Haber LH, Martin RF (1977) Inhibition of spinothalamic tract cells and interneurons by brain stem stimulation in the monkey. *J Neurophysiol* 40:968–981
- Yeziarski RP, Gerhart KD, Schrock BJ et al. (1983) A further examination of effects of cortical stimulation in primate spinothalamic tract cells. *J Neurophysiol* 49:424–441

## Spinothalamic Tract Neurons, Glutamatergic Input

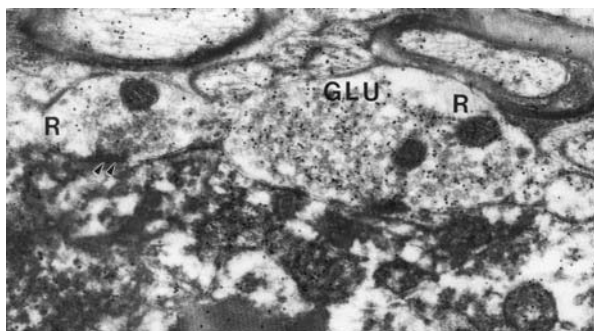
SUSAN M. CARLTON

Marine Biomedical Institute, University of Texas Medical Branch, Galveston, TX, USA  
smcarlto@utmb.edu

### Characteristics

#### Anatomical Evidence for Glutamatergic Input

Anatomical evidence that ► **glutamate**-containing terminals synapse on spinothalamic tract (STT) cells is derived from immunohistochemical studies in primate and rat spinal cord. Analysis of high threshold or wide dynamic range primate STT cells demonstrates that glutamate-labeled terminals constitute 46% of the terminal population apposed to the STT cell body, and 50% of the profiles apposed to STT dendrites (see Fig. 1; also see ► **Spinothalamic Neuron**, Fig. 2b) (Westlund et al. 1992). In terms of surface length, this constitutes 54% of the soma surface length and 50% of the dendritic surface length. In the rat, type I and II STT cells in laminae I and II of the dorsal horn have been analyzed. Type I STT cells have a pyramidal (triangular) soma



**Spinothalamic Tract Neurons, Glutamatergic Input, Figure 1** Immunogold staining for glutamate (GLU) in an "R" type terminal (contains round, clear vesicles) apposing an HRP-labeled STT neuron. (From Westlund et al. 1992).

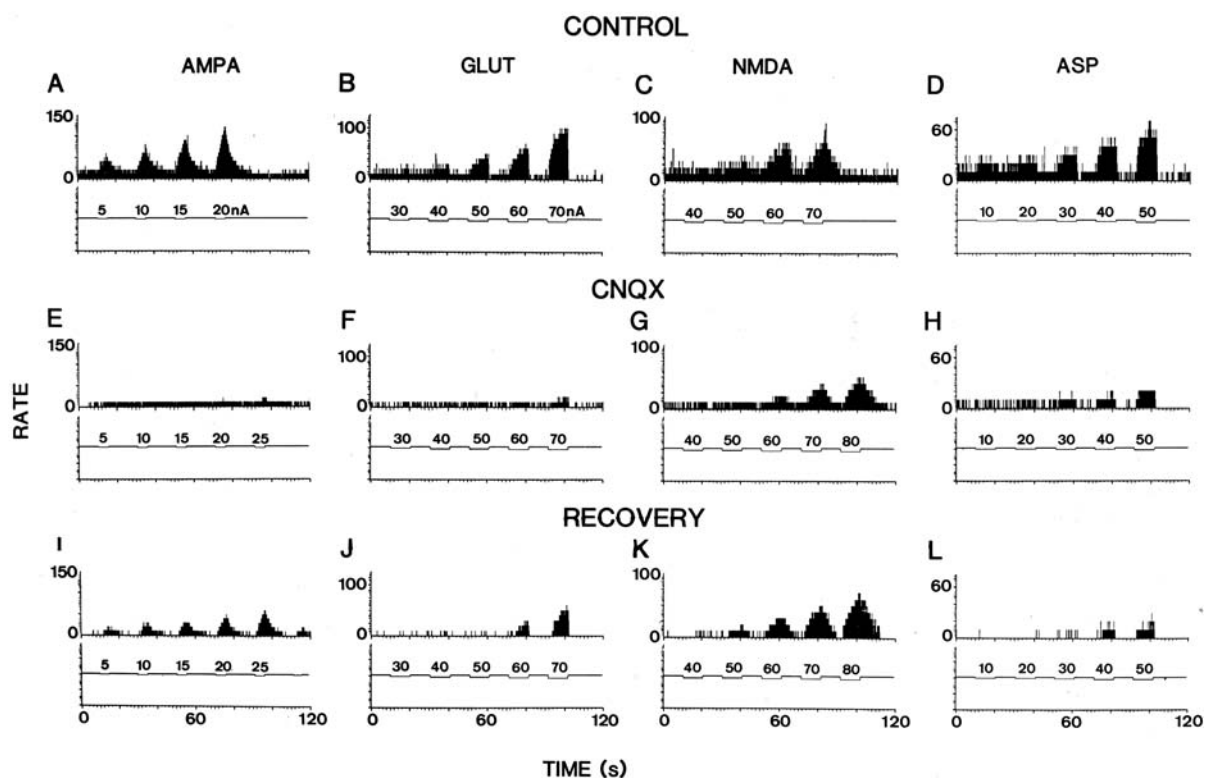
with dendrites oriented along the rostro-caudal axis of the cord; type II STT cells have a rounded soma, with numerous primary dendrites extending in all directions (Lima and Coimbra 1988). Glutamatergic input composed 37% of the terminal population on the 15 STT cells analyzed, and this percentage remains uniform for the soma and dendrites (Lekan and Carlton 1995). There is no significant difference among the 15 STT cells analyzed, suggesting that type I and type II STT

cells of the superficial dorsal horn have similar synaptic organizations in relation to glutamatergic input.

A variety of glutamate receptor subunits have been anatomically localized on STT cells including the NMDA receptor subunit NMDAR1 and non-NMDA (AMPA) subunits GluR1 and GluR2/3 (Ye and Westlund 1996). Based on the pharmacological studies discussed below, it is highly likely that metabotropic Glu receptor subunits are also expressed by STT cells.

#### Pharmacological Evidence for Glutamatergic Input

Several lines of pharmacological evidence indicate that STT cells are modulated by glutamate. Initial studies demonstrated that microiontophoresis of glutamate, or its agonists, in the vicinity of STT cells, excite the cells (Jordan et al. 1978) in a dose-dependent manner (Fig. 2) (Willcockson et al. 1984, Dougherty et al. 1992). Glutamate also participates in the **▶ sensitization** of STT neurons, a phenomenon where responses of STT neurons to the glutamate agonist **▶ N-methyl-D-aspartate** (NMDA) are potentiated following a single combined application of NMDA + Substance P. The potentiation usually out-lasts the co-administration of drugs by as much as several hours, and is accompanied by an increase in the response of STT cells to mechanical



**Spinothalamic Tract Neurons, Glutamatergic Input, Figure 2** Rate histograms of the responses of a representative wide dynamic range STT cell to iontophoretic release of excitatory amino acids (EAAs) before, during, and following dialysis of the spinal cord with CNQX. (a-d) shows the control responses of the cell to graded iontophoretic current pulses of AMPA, GLUT, NMDA and aspartate (ASP). (e-h) shows the responses of the cell to the EAAs following infusion of CNQX. (i-l) shows the responses to the EAAs 4 hr after termination of the CNQX. Bin widths are 100 msec. (Dougherty et al. 1992).

stimulation of the skin. These results provide a cellular model for ► **secondary hyperalgesia** (Dougherty and Willis 1991, Dougherty et al. 1993). Blockade of glutamatergic non-NMDA receptors results in a nearly complete elimination of responses of STT cells to noxious and non-noxious stimuli, while blockade of NMDA receptors attenuates responses to noxious input only (Dougherty et al. 1992). NMDA (Dougherty et al. 1992; Dougherty et al. 1993) and Group I metabotropic glutamate (mGlu) receptor (Neugebauer and Willis 1999) antagonists, or Group II and III mGlu receptor agonists (Neugebauer et al. 2000), can prevent or reverse STT sensitization that develops after intradermal injection of ► **capsaicin**. Taken together, these results indicate that glutamate is involved in the normal transmission of sensory input from primary afferent fibers to STT cells, and the sensitization of STT cells to peripheral input.

### Sources of Glutamate in the Dorsal Horn

There are three possible sources of the glutamate-containing terminals that contact STT cells. Many arise from primary afferent fibers, since it is known that the majority of primary sensory neurons contain glutamate (Battaglia and Rustioni 1988), and that STT cells receive input from primary afferents (Carlton et al. 1989). Spinal interneurons contain glutamate and are likely to synapse onto STT cells. Finally, descending systems originating from the cerebral cortex (Coulter et al. 1974) and reticular formation (Haber et al. 1978) can excite STT neurons, probably through glutamate release.

### References

- Battaglia G, Rustioni A (1988) Coexistence of Glutamate and Substance P in Dorsal Root Ganglion Neurons of the Rat and Monkey. *J Comp Neurol* 277:302–312
- Carlton SM, Westlund KN, Zhang D et al. (1990) Calcitonin Gene-Related Peptide Containing Primary Afferent Fibers Synapse on Primate Spinothalamic Tract Cells. *Neurosci Lett* 109:76–81
- Coulter JD, Maunz R, Willis WD (1974) Effects of Stimulation of Sensorimotor Cortex on Primate Spinothalamic Neurons. *Brain Res* 65:351–356
- Dougherty PM, Palecek J, Paleckova V, Sorkin LS, Willis WD (1992) The Role of NMDA and Non-NMDA Excitatory Amino Acid Receptors in the Excitation of Primate Spinothalamic Tract Neurons by Mechanical, Chemical, Thermal, and Electrical Stimuli. *J Neurosci* 12:3025–3041
- Dougherty PM, Palecek J, Zorn S et al. (1993) Combined Application of Excitatory Amino Acids and Substance P Produces Long-Lasting Changes in Responses of Primate Spinothalamic Tract Neurons. *Brain Res Rev* 8:227–246
- Dougherty PM, Willis WD (1991) Enhancement of Spinothalamic Neuron Responses to Chemical and Mechanical Stimuli following Combined Micro-Iontophoretic Application of N-methyl-D-aspartic Acid and Substance P. *Pain* 47:85–93
- Haber LH, Martin RF, Chatt AB et al. (1978) Effects of Stimulation in Nucleus Reticularis Gigantocellularis on the Activity of Spinothalamic Tract Neurons in the Monkey. *Brain Res* 153:163–168
- Jordan LM, Kenshalo, Jr. D, Martin RF et al. (1978) Depression of Primate Spinothalamic Tract Neurons by Iontophoretic Application of 5-Hydroxytryptamine. *Pain* 5:135–142
- Lekan HA, Carlton SM (1995) Glutamatergic and GABAergic Input to Rat Spinothalamic Tract Cells in the Superficial Dorsal Horn. *J Comp Neurol* 361:417–428
- Lima D, Coimbra A (1988) The Spinothalamic System of the Rat: Structural Types of Retrogradely Labeled Neurons in the Marginal Zone (lamina I). *Neurosci* 27:215–230
- Neugebauer V, Chen P-S, Willis WD (2000) Groups II and III Metabotropic Glutamate Receptors Differentially Modulate Brief and Prolonged Nociception in Primate STT Cells. *J Neurophysiol* 84:2998–3009
- Neugebauer V, Willis WD (1999) Role of Metabotropic Glutamate Receptor Subtype mGluR1 in Brief Nociception and Capsaicin-Induced Central Sensitization of Primate STT Cells. *J Neurophysiol* 82:272–282
- Westlund KN, Carlton SM, Zhang D et al. (1992) Glutamate-Immunoreactive Terminals Synapse on Primate Spinothalamic Tract Cells. *J Comp Neurol* 322:519–527
- Willcockson WS, Chung, JM, Hori Y et al. (1984) Effects of Iontophoretically Released Amino Acids and Amines on Primate Spinothalamic Tract Cells. *J Neurosci* 4: 732–740
- Ye Z, Westlund KN (1996) Ultrastructural Localization of Glutamate Receptor Subunits (NMDAR1, AMPA GluR1 and GluR2/3) on Spinothalamic Tract Cells. *NeuroReport* 7:2581–2585

## Spinothalamic Tract Neurons, in Deep Dorsal Horn

DONALD D. PRICE

Department of Oral and Maxillofacial Surgery,  
University of Florida, Gainesville, FL, USA  
dprice@dental.ufl.edu

### Definition

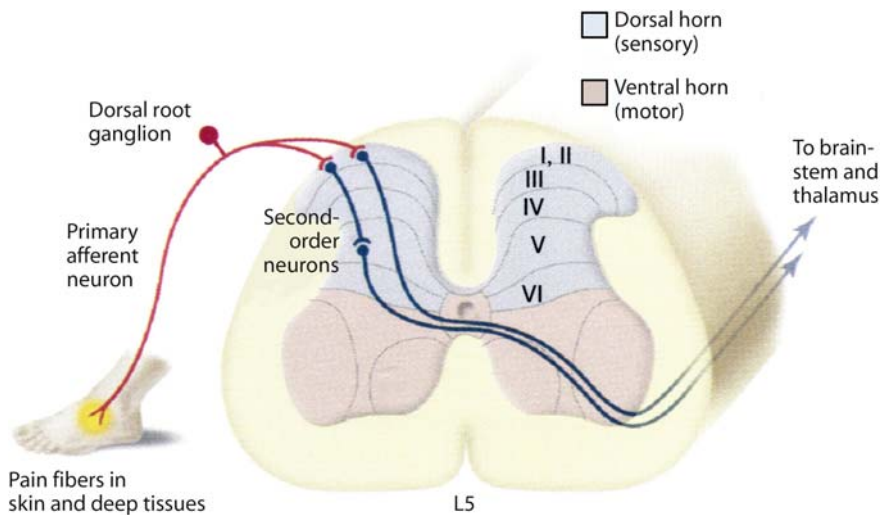
The principle ascending pathways for pain (e.g. spinothalamic and trigeminothalamic tracts) originate partly within deep or most ventral layers (IV–VI of Rexed) of the dorsal horn of the spinal cord and medulla, wherein neurons receive synaptic input from primary afferent neurons that supply ► **nociceptors** in tissue (Fig. 1). These second order neurons within the deep dorsal horn are mainly ► **wide dynamic range (WDR) neurons** and to a lesser extent nociceptive-specific (NS) neurons, and these two types of neurons have functional significance for processing both exteroceptive and interoceptive information associated with pain (Willis 1985; Price and Dubner 1977; Dubner et al. 1986).

### Characteristics

#### Wide Dynamic Range (WDR) Neurons (Figure 2)

WDR neurons are present in both superficial and deep layers of the dorsal horn (Willis 1985; Price and Dubner 1977). However, NS neurons occur in highest percentages in the superficial layers (layers I–II), and the deep layers contain mostly WDR neurons. Thus, WDR neurons will be extensively described in this section. Although they receive synaptic input from primary ► **A-delta** and ► **C-nociceptive afferent neurons** innervating cutaneous, visceral, muscular, or other tissues, they are





**Spinothalamic Tract Neurons, in Deep Dorsal Horn, Figure 1** Schematic of dorsal horn showing superficial (I-II) and deep (V-VI) layers. Both regions contain sensory projection neurons and interneurons and interconnections exist between both regions. Neurons of the deeper layers tend to be larger than those of the superficial layers. Superficial neurons (layers I and II) and deep dorsal horn neurons (light stippled zone in layers V-VI) tend to be NS and WDR, respectively.

classified on the basis of their responses to cutaneous stimuli (Willis 1985; Price and Dubner 1977). WDR neurons have several distinct and defining characteristics. First, they respond differentially over a broad range of stimulus intensity, extending from very gentle to distinctly painful levels of stimulation; noxious stimuli delivered to the most sensitive portion of their receptive fields evoke a higher impulse frequency than any form of innocuous stimulation. Second, based on multiple tests, WDR neurons also receive synaptic input from ► **A-beta primary afferent neurons** that supply sensitive mechanoreceptors in the skin (Willis 1985; Price and Dubner 1977; Price et al. 1976; Price et al. 1978). The demonstration of A-beta input prior to testing with nociceptive stimuli shows that WDR neurons in layer I are not misidentified nociceptive-specific, or neurons that respond mainly to heat, pinch, and cold, as has been claimed previously (Craig 2003). WDR neurons have a very distinct receptive field organization that contains a central cutaneous zone differentially responsive to non-noxious and noxious stimuli, and a larger surrounding zone that responds mainly to nociceptive stimuli. This receptive field organization provides a critical basis whereby populations of WDR neurons could encode the distinction between non-noxious and noxious stimulation. Multiple lines of evidence show that, in comparison to non-noxious stimuli, noxious stimuli activate higher impulse frequencies and a larger number of WDR neurons (Price and Dubner 1977; Dubner et al. 1986; Price et al. 1976; Price et al. 1978; Coghill et al. 1993). Consideration of the number of neurons activated is important in explaining encoding mechanisms because populations are what respond during non-noxious and noxious stimulation. Beyond these defining characteristics, several features of WDR neurons are highly consistent with their role in ► **exteroceptive pain**. First, they respond in a graded fashion to several forms of noxious stimuli that re-

flect contact of external objects with the skin. To a major extent, their responses to these stimuli represent characteristics of the objects themselves. Their impulse frequency increases with sharper or hotter objects (above about 45°C), and in a manner that closely parallels psychophysical responses (Dubner et al. 1986; Price et al. 1978; Coghill et al. 1993). Similar to pain ratings in human psychophysical experiments, their responses to contact heat stimuli in the nociceptive range (45–51°C) are positively accelerating power functions. WDR neurons have a very high discriminative capacity, as demonstrated in studies of WDR neurons in conscious monkeys trained in a discrimination task (Dubner et al. 1986). Consistent with both human and monkeys' ability to detect very small shifts within the noxious temperature range, WDR neurons responded to temperature shifts as small as 0.2°–0.4°C. NS neurons were much less sensitive to these small differences, and their discriminative capacity was not sufficient to account for psychophysical discriminations of either humans or monkeys. Deep dorsal horn WDR neurons have this discriminative capacity (Dubner et al. 1986). This feature of WDR neurons shows that they are a class of neurons that are part of an ascending exteroceptive pathway that is critical for discrimination of small differences in temperature of external objects. The functional role of such refined discrimination is related to the fact that mammals actually utilize refined nociceptive discrimination to acquire information about properties of external objects. A monkey picking berries out of a thorny bush or an animal stalking prey across hot rocks pursues these tasks in order to eat. The animal must carefully weigh the painfulness of thorns or hot rocks against its need for food. In making such decisions, it must assess whether different objects in the environment or movements in different directions will result in *more* or *less* pain. This high discriminative capacity of the pain system also has an extremely

important implication in pain measurement, because it suggests that there are many more discriminative levels of pain than would be implied by simple category scales or numerical rating scales.

A second reason that WDR neurons are involved in exteroceptive pain is that they are somatotopically organized within the dorsal horn, thereby providing the basis for locating the external source of contact between objects and the body (Price and Dubner 1977; Price et al. 1976; Price et al. 1978; Yokota and Nishikawa 1980; Yokota 1985). Their [▶ somatotopic organization](#) is a relatively unrecognized feature, and it has recently been claimed that they have only large receptive fields and, therefore, do not display somatotopic organization (Craig 2003). Yet their receptive field sizes range from very small (< 2 cm<sup>2</sup>), to medium (e.g. a portion of a foot or part of one trigeminal division) to large (larger than the foot or one trigeminal division) in monkeys (Willis 1985; Price and Dubner 1977; Price et al. 1976; Price et al. 1978), and they are even smaller in cats (Yokota and Nishikawa 1980; Yokota 1985). Moreover, they are somatotopically organized in medio-lateral fashion within the trigeminal (Price et al. 1976; Yokota and Nishikawa 1980; Yokota 1985) and spinal dorsal horns (Willis 1985).

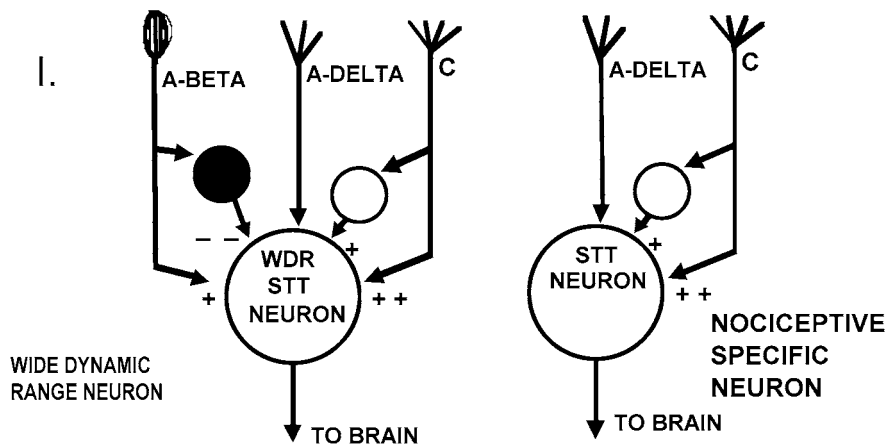
A third reason that WDR neurons are involved in exteroceptive pain is that their responses can distinguish between different forms of externally applied somatic stimulation, including the distinction between tactile stimuli and noxious stimuli. Monkey WDR spinothalamic tract neurons consistently increase their firing frequency (e.g. from below 10 Hz to 15–20 Hz) when a camel-hair brush is dragged gently across the glabrous skin of the foot (Price et al. 1978). They continue to respond at about this frequency for more than 20 seconds, and as long as 56 seconds after termination of this stimulus. This phenomenon parallels tactile after-sensations in humans evoked by the same type of stimulus (Melzack and Eisenberg 1968). For example, both human tactile after-sensations and WDR neuron after-responses abruptly terminate when the affected skin is rubbed (Price et al. 1978; Melzack and Eisenberg 1968). Since WDR neurons are the only class of spinal cord neurons that respond with tactile-after-responses, these responses are likely to be sufficient for this form of tactile sensation. Yet the same WDR neurons inevitably respond with a higher impulse frequency to noxious stimulation of the most sensitive portion of their receptive fields (Price and Dubner 1977; Price et al. 1976; Price et al. 1978; Coghill et al. 1993). Thus, WDR neurons respond differentially to several forms of somatosensory stimulation, particularly when population factors are considered as factors in encoding (Coghill et al. 1993). They encode nociceptive intensity and the distinction between non-noxious and noxious stimuli with exquisite precision (Price and Dubner 1977; Coghill et al. 1993).

### Nociceptive-Specific Neurons (Figure 2)

Although dorsal horn NS neurons may be somewhat more common within superficial layers of the dorsal horn, they are less commonly found within the deep layers of the dorsal horn (Price and Dubner 1977; Price et al. 1976; Price et al. 1978; Yokota and Nishikawa 1980; Yokota 1985). NS deep dorsal horn neurons receive synaptic input from the same types of primary nociceptive afferents that contact WDR neurons (Willis 1985; Price and Dubner 1977; Yokota and Nishikawa 1980). Unlike WDR neurons, however, they do not receive input from A-beta mechanoreceptors, and therefore respond predominantly to nociceptive stimuli. There are at least two types of NS, those receiving exclusive input from A-delta mechanical nociceptive afferents, and those receiving input from different types of A-delta and C nociceptive afferents. At least some of the latter respond to intense cold and have been termed “heat-pinch-cold” or HPC neurons (Craig 2003). Similar to WDR neurons, they are somatotopically organized within the dorsal horn (Craig 2003). NS appear to encode stimulus location with precision as a result of their small receptive field sizes. The majority of NS neurons have input from multiple types of nociceptive afferent neurons. Thus, the encoding of stimulus submodality within the nociceptive domain (e.g. heat, chemical, and mechanical stimuli) is likely to depend heavily on composition of activated populations of neurons, a composition that includes both WDR and NS neurons. NS neurons may fine-tune the capacity to localize stimulus location as a result of their relatively small receptive fields. A small minority of NS neurons may also fine-tune the ability to detect stimulus submodality as a result of the fact that they respond to input from only one type of primary nociceptive afferent (Willis 1985; Price and Dubner 1977; Price et al. 1976; Craig 2003; Yokota and Nishikawa 1980; Yokota 1985). These functions are exteroceptive because they deal with detection of the location and physical nature of the object that is in contact with the skin (e.g. pinprick).

### The Coordination of Superficial and Deep Dorsal Horn Neurons

The physiological characteristics of WDR and NS neurons and the differences between them are found at all levels of the [▶ spinothalamocortical pathway](#), including the deep dorsal horn where they are intermingled. They are likely to function in concert to encode the sensory discriminative features of noxious stimuli. Indeed, there is a long history of evidence that WDR and NS neurons function together as an integrated system within the dorsal horn (Price and Dubner 1977; Yokota and Nishikawa 1980; Yokota 1985; Khasabov et al. 2002; Suzuki et al. 2002). Recent studies show that destruction of some superficial dorsal horns containing the substance P receptor, some of which are likely to be nociceptive-specific, leads to widespread changes throughout the dorsal horn, particularly of WDR neu-



**Spinothalamic Tract Neurons, in Deep Dorsal Horn, Figure 2** Schematics of wide dynamic range (WDR) and nociceptive-specific neurons (NS). WDR neurons receive synaptic convergence from A-beta mechanoreceptive afferents, A-delta nociceptive afferents, and C-nociceptive afferents, and NS neurons receive synaptic input only from nociceptive afferents. Local inhibitory and excitatory interneurons serve to control the input-output relationships of WDR neurons.

rons (Khasabov et al. 2002; Suzuki et al. 2002). In particular, windup and responses indicative of **central sensitization** do not develop in the deep dorsal horn after destruction of neurons in the superficial layers. Thus, after this treatment, WDR neurons of the deep dorsal horn respond normally to innocuous mechanical stimuli and to brief forms of noxious stimulation to some extent, but they no longer display progressive increases in response to repeated C-fiber stimulation, termed windup (Khasabov et al. 2002; Suzuki et al. 2002). Consistent with this change in windup, they also display a large reduction in the capacity to become sensitized (Khasabov et al. 2002; Suzuki et al. 2002). For example, they respond less intensely to intradermal capsaicin and do not show a delayed response to intradermal formalin (i.e. second phase is attenuated). Clearly, superficial and deep dorsal horn neurons are interactive, particularly during persistent pain conditions.

#### Convergence of Cutaneous, Muscular, and Visceral Primary Afferents on Deep Dorsal Horn Neurons

Primary afferent nociceptive neurons that innervate muscle, skin, and viscera have synaptic terminals on deep dorsal horn nociceptive neurons. These primary afferent neurons from divergent tissue sources often converge on and synaptically activate the same dorsal horn neuron, thereby providing part of the basis of referred pain from these tissues (Willis 1985; Foreman 1977). A common pattern of convergence occurs on these neurons wherein the location of cutaneous, visceral, and muscular “receptive fields” is expected on the basis of known patterns of referred pain. For example, stimulation of cardiac sympathetic nerve axons excites WDR and NS spinothalamic tract neurons that are located at upper thoracic segmental levels of monkeys’ spinal cords (Foreman 1977). These same neurons often have a cutaneous receptive field that extends along the inner aspect of the forearm, the pattern of pain referral in angina pectoralis. Similarly, spinothalamic neurons of upper lumbar segments can be excited both by noxious stimulation of the testicle and by noxious and

non-noxious stimulation of the upper flank and lower abdominal skin areas, areas of pain referral in testicular injury (Willis et al. 1981). Some of these same neurons can also be excited by over-distension of the urinary bladder. The convergence of inputs from different tissue sources onto the same deep dorsal horn neurons provides confirmation of the convergence theory of referred pain, and indicates that deep dorsal horn neurons are involved in interoceptive as well as exteroceptive pain.

#### Central Projections of Deep Dorsal Horn Neurons

Both WDR and NS neurons of the deep dorsal horn have axons that project to multiple levels of the brain, and the same WDR or NS neuron often has collateral axonal branches projecting to several brainstem sites (Willis 1985; Price et al. 1978). Thus, neurons of the deep dorsal horn receive synaptic input from multiple types of primary nociceptive and non-nociceptive primary afferent neurons, both directly and from superficial neurons. They convey tactile and nociceptive information to multiple brain sites and are related to several functions. Inasmuch as many neurons of ascending spinal pathways origin are WDR neurons, and NS of the deep dorsal horn, these pathways must convey information about a wide variety of somatosensory events, including those related to touch, pain, and possibly innocuous temperature sensibility. This view contrasts sharply with that of “labeled lines” which proposes separate neuron types encode each form of somatosensation such as touch, warmth, itch, first pain, and second pain (Craig 2003).

#### References

1. Coghill RC, Mayer DJ, Price DD (1993) Spinal Cord Coding of Pain: The Role of Spatial Recruitment and Discharge Frequency in Nociception. *Pain* 53:295–309
2. Craig AD (2003) Pain Mechanisms: Labeled Lines versus Convergence in Central Processing. *Annu Rev Neurosci* 26:1–30
3. Dubner R, Bushnell MC, Duncan GH (1986) Sensory-Discriminative Capacities of Nociceptive Pathways and their Modulation by Behavior. In: Yaksh TL (ed) *Spinal Afferent Processing*. Plenum Press, New York, pp 331–342

4. Foreman RD (1977) Viscerosomatic Convergence onto Spinal Neurons Responding to Afferent Fibers Located in the Inferior Cardiac Nerve. *Brain Res* 137:164–168
5. Khasabov SG, Rogers SD, Ghilardi JR, Peters CM, Mantyh PW, Simone D (2002) Spinal Neurons that Possess the Substance P Receptor are required for the Development of Central Sensitization. *J Neurosci* 22:9086–9098
6. Melzack R, Eisenberg H (1968) Skin Sensory Afterglows. *Science* 351:445–449
7. Milne RJ, Foreman RD, Giesler GJ, Willis WD (1981) Convergence of Cutaneous and Pelvic Visceral Nociceptive Inputs onto Primate Spinothalamic Tract Neurons. *Pain* 11:63–183
8. Price DD, Dubner R (1977) Neurons that Subserve the Sensory-Discriminative Aspects of Pain. *Pain* 3:307–338
9. Price DD, Dubner R, Hu JW (1976) Trigeminothalamic Neurons in Nucleus Caudalis Responsive to Tactile, Thermal, and Nociceptive Stimulation of Monkey's Face. *J Neurophysiol* 39:936–953
10. Price DD, Hayes RL, Ruda MA, Dubner R (1978) Spatial and Temporal Transformations of Input to Spinothalamic Tract Neurons and their Relation to Somatic Sensation. *J Neurophysiol* 41:933–947
11. Suzuki R, Morcuende S, Webber M, Hunt SP, Dickenson AH (2002) Superficial NK-1<sup>-</sup> Expressing Neurons Control Spinal Excitability through Activation of Descending Pathways. *Nat Neurosci* 5:1319–1326
12. Willis WD (1985) *The Pain System*. Karger, Basel
13. Yokota T (1985) Neural Mechanisms of Trigeminal Pain. In: Fields HL (ed) *Advances in Pain Research and Therapy*, vol 9. Raven Press, New York, pp 211–232
14. Yokota T, Nishikawa N (1980) Reappraisal of Somatotopic Tactile Representation within Trigeminal Subnucleus Caudalis. *J Neurophysiol* 43:700–712

## Spinothalamic Tract Neurons, Morphology

DEOLINDA LIMA

Instituto de Histologia e Embriologia, Faculdade de Medicina da Universidade do Porto, Porto, Portugal  
limad@med.up.pt

### Synonyms

Spinothalamic neurons; spinal neurons projecting to the thalamus; Neuronal Structure; Neuronal Architecture

### Definition

Structural characteristics of spinal neurons that distribute axonal terminals to the thalamus

### Characteristics

The structural features of a neuron are likely to give important insights on how it processes and integrates incoming signals and the kind of responses it generates. This applies to the ► [dendritic topography](#), which determines to which ► [axonal arborizations](#) different portions of the ► [dendritic tree](#) have access, as well as to the various morphological features that characterize the dendritic tree. Electrical responsiveness of a neuron depends on the density and distribution of a large variety of ionic channels, as well as on multiple variables,

which together define the dendritic morphology. Little is known about how and to what extent firing properties are influenced by structural features, as, for example, the branching pattern of the dendritic arbor, thickness of dendrites at various segments, or shape, density and distribution of ► [dendritic spines](#). A few studies on the spinal cord (Grudt and Perl 2002; Prescott and De Koninck 2002; Szucs et al. 2003) have recently addressed the question of whether the firing pattern of a neuron is determined by its dendritic structure. Although not clear cut, some correlations were pointed out, but the structural aspects accounting for the various types of responses were not established. Only the extent of dendritic arborization, expressed as the ratio of axosomatic area to dendritic membrane area, was shown to correlate with specific firing patterns in computational models of cortical neurons (Mainen and Sejnowski 1996). Understanding how structural features influence the biophysical properties of neurons will hopefully enable us to predict the kind of neuronal signals that are conveyed in the spinothalamic tract for particular stimulation conditions.

The spinothalamic tract differs from several projecting systems, in that neurons contributing ► [axons](#) to it do not present a unique and particular morphology. Such diversity cannot be linearly correlated with the occurrence of multiple terminal areas in the thalamus, since, in spite of overall differences, there is a large overlap of the spinal laminae that project to each thalamic target (see ► [spinothalamic neuron](#)). The contribution of various spinal laminae to each spinothalamic ascending pathway is in itself a source of heterogeneity of the participating neurons. Not only that the nature of primary and modulatory impulses that impinge upon neurons in each lamina is different, but also several structural aspects, including the size of ► [soma](#) and dendritic trees, vary considerably from lamina to lamina. The spinothalamic tract, as well as each one of its components on its own, is thus likely to carry an array of various signals that differ as to the peripheral inputs that generate them, the local and supraspinal actions modulating them and their electrical properties. The spinothalamic system must, therefore, be considered to be fitted particularly to integrate several kinds of information arriving from the periphery, and filtered in multiple ways in the spinal cord.

Structural differences between the neuronal populations at the various laminar sources of spinothalamic fibers were evaluated, taking into account the size and shape of the soma and the orientation of the soma and proximal dendritic arbors (Kobayashi 1998). Neurons in the marginal zone (lamina I) and the lateral spinal nucleus are smaller than neurons in deeper spinal grey areas. In the marginal zone they are oriented parallel to the dorsal surface of the dorsal horn when viewed in the transverse plane, whereas in the lateral spinal nucleus no precise orientation was depicted. In the deep dorsal horn (lami-



nae IV–VI), perikarya are larger and either fusiform or multipolar in shape. However, in what was called the deep dorsal horn-neck (lamina IV and dorsal part of lamina V), neurons tended to be oriented parallel to the laminar borders, whereas in the deep dorsal horn-base (ventral lamina V and lamina VI) neurons did not present any particular orientation. In the internal basilar group (medial portion of lamina V), perikarya range in size from small to very large, but in any case are multipolar in shape and present dendritic arbors oriented parallel to the lateral edge of the dorsal funiculus. In the ventral horn (laminae VII and VIII), large soma prevail. In its medial portion they are all multipolar and oriented horizontally, whereas in the lateral portion they are either multipolar or fusiform, the latter being oriented vertically to the dorsal surface of the spinal cord.

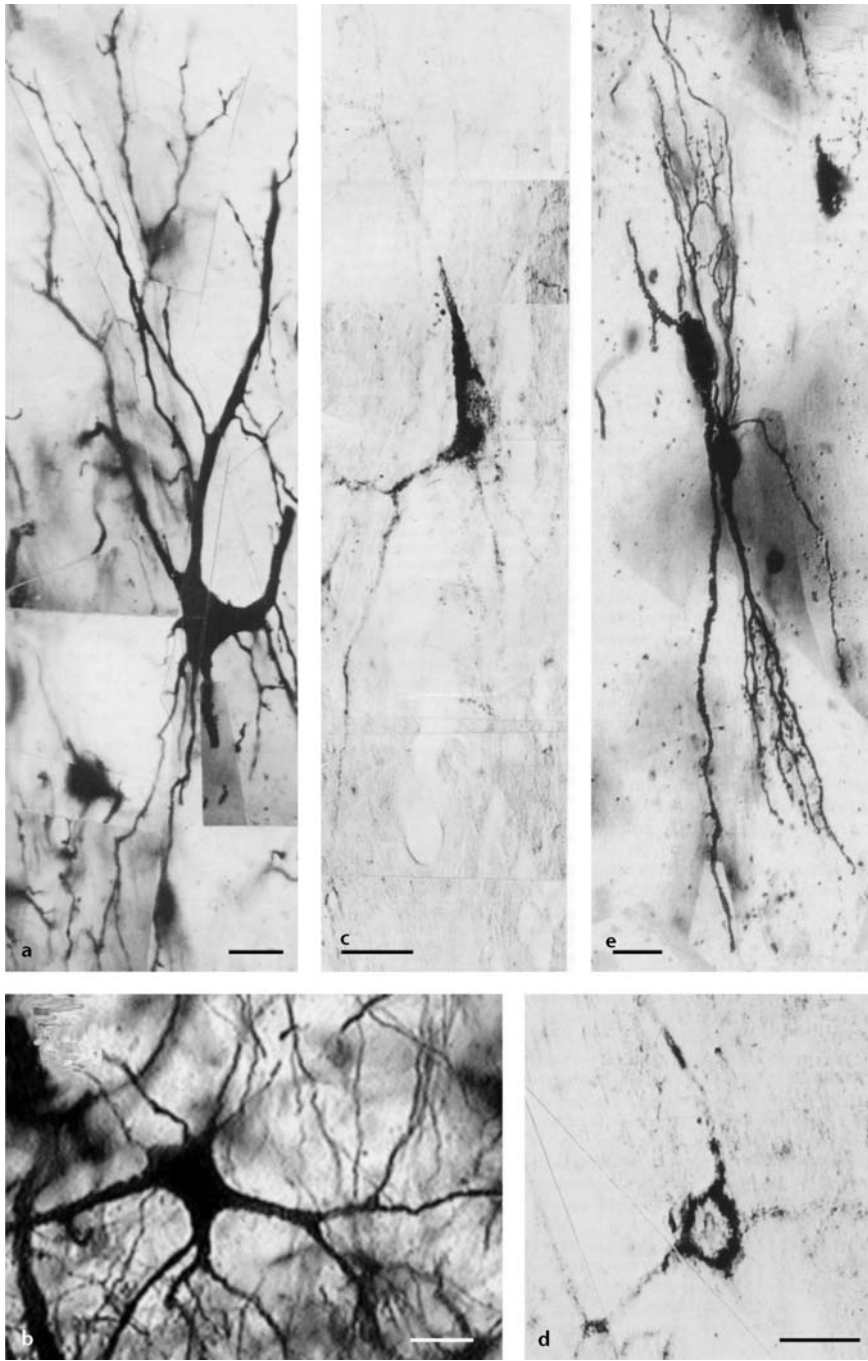
A more detailed description of the morphology of the spinothalamic neurons is only liable for the marginal zone (Galhardo et al. 2000; Lima and Coimbra 1986). In all the other areas of origin of the spinothalamic tract, both staining by retrograde tracing and Golgi impregnations are inconclusive as to neuronal structural systematization. In the spinal cord lamina I, neurons are distributed through four morphological groups: ► (spinal) pyramidal (Fig. 1a), ► (spinal) flat tened (Fig. 1b), ► (spinal) fusiform (Fig. 1e), and ► (spinal) multipolar. These four groups are present in similar proportions in species as different as the pigeon (Galhardo and Lima 1999), rat (Galhardo et al. 2000), cat (Lima et al. 2002), and monkey (Puskár et al. 2001), fusiform neurons accounting for almost 50% of the entire population. They all have dendritic arbors elongated along the rostrocaudal axis, but the mediolateral extent is also considerable in the pyramidal and flattened groups, whereas in the multipolar group ventrally oriented dendrites are characteristically present. In the rat, their soma and dendritic arbors average 25  $\mu\text{m}$  and 300  $\mu\text{m}$ , respectively, along the rostrocaudal axis (Galhardo et al. 2000). In the cat and monkey, perikarya and dendritic arbors are slightly larger, averaging respectively, 30  $\mu\text{m}$  and 320  $\mu\text{m}$  rostrocaudally (Lima et al. 2002; Puskár et al. 2001). There are no differences between the sizes of the various cell groups, but, in all the species studied, each group comprises a few cells (around 6%) that are twice to three times larger than the remaining. Some of these so called “giant” lamina I cells (flattened and pyramidal) receive a particularly important inhibitory GABAergic input (Lima and Coimbra 1988). They present nuclei completely devoid of heterochromatin and abundant cytoplasm with particularly extensive rough endoplasmic reticulum (unpublished data). Both small and giant cells participate in the spinothalamic tract (Lima and Coimbra 1986), as well as in other spinofugal pathways.

Of the four neuronal groups present in lamina I, only two, the pyramidal and the flattened, project to the ventrobasal complex of the thalamus (Lima and Coim-

bra 1986; Kobayashi 1998). Similar amounts of flattened and pyramidal cells are involved in the lateral spinothalamic tract. As to the medial thalamus, studies based on tracer injections confined to medial thalamic spinal targets did not discriminate the neuronal groups involved. However, in the cat (Zhang et al. 1996) and monkey (Zhang and Craig 1997), retrograde tracing from injections that encompassed both the lateral and medial thalamus revealed labeling of fusiform cells, in addition to pyramidal and flattened cells (the latter misleadingly called multipolar by the authors). It is possible, therefore, that fusiform cells alone, or together with pyramidal and flattened cells, take part in the medial spinothalamic system. In this respect it should be noted that, although species differences between the rat on one side and the cat and monkey on the other, have been claimed to account for the participation of fusiform cells in the spinothalamic tract of the two latter species, the fact that the injection sites are not comparable, but rather include spinal thalamic targets that were not injected in the rat, does not allow this sort of conclusion. Moreover, data showing that some spinofugal nociceptive pathways in the pigeon completely match those described in the rat as to the types and relative amounts of lamina I neurons involved, point to a high preservation of the structural characteristics of the ascending nociceptive pathways.

Although distinct in several respects, pyramidal and flattened neurons do share a few characteristics, namely the mediolateral expansion of the dendritic tree and the scarcity of dendritic spines (Fig. 1a, b) (Galhardo et al. 2000; Lima et al. 2002; Puskár et al. 2001). Pyramidal cells, in addition, have dendritic branches that course inside the white matter overlying the dorsal and dorsolateral surface of lamina I. The dendritic arbor of pyramidal cells ramifies at regular intervals, tracing the direction defined by the primary dendritic trunks (Fig. 1a, c). The dendritic field extends rostrocaudally, mediolaterally and dorsally as a triangular pyramid protruding into the dorsal funiculus or the dorsolateral fasciculus. In the rat, a few sessile pointed dendritic spines accumulate in proximal dendritic segments, near the soma (Galhardo et al. 2000). This feature, however, cannot be observed in the cat and monkey (Lima et al. 2002; Puskár et al. 2001). Axons are of the ► myelinated type, as revealed by the confinement of silver impregnation to the initial segment. In a few pyramidal neurons, axons were followed to the contralateral spinal gray (Grudt and Perl 2002). Flattened cells have disk-shaped soma flattened across the dorsoventral axis, and aspiny, sparsely ramified dendritic arbors that extend as a roughly circular horizontal sheet inside lamina I (Fig. 1b, d) (Galhardo et al. 2000; Lima et al. 2002; Puskár et al. 2001). Axons are of the myelinated type.

Fusiform cells differ completely from pyramidal and flattened cells as to the strictly longitudinal orientation



**Spinothalamic Tract Neurons, Morphology, Figure 1** Photomicrographs of spinal cord lamina I neurons silver-impregnated by the Golgi method (a, b, e) or retrogradely labeled with CTb from the ventrobasal complex of the thalamus (c, d). (a), (c) Pyramidal neurons from the rat, in horizontal view; (b), (d) Flattened neurons from the monkey (b) and rat (d), in horizontal view; (e) Fusiform neurons from the cat, in horizontal view.

of the dendritic arbor and the abundance of dendritic spines (Fig. 1e) (Galhardo et al. 2000; Lima et al. 2002; Puskár et al. 2001). The soma is flame-shaped and longitudinally oriented, elongated rostrally and caudally by thick primary dendritic trunks that ramify profusely, but at relatively large distances from the perikarya. Dendritic branches narrow progressively, the more distal ones being extremely thin. Dendritic spines are all of the pedicled type, with round knobs connected to the dendritic shaft by short pedicles of similar length.

They are absent from primary dendritic trunks and particularly abundant in the distal portion of the dendritic arbor. Axons are of the ► **unmyelinated** type. They run longitudinally along with the dendritic arbor, with numerous boutons en passant and a few longitudinal collaterals.

The majority of lamina I cells immunoreactive for met-enkephalin belong in the pyramidal group, while immunoreactivity for dynorphin is observed in similar amounts of pyramidal, flattened and fusiform neurons

(Lima et al. 1993). Most lamina I cells immunoreactive for substance P belong in the flattened group (Lima et al. 1993). A large number of fusiform cells are immunoreactive for GABBA (Lima et al. 1993). Flattened cells immunoreactive for substance P were shown to project to the ventrobasal complex of the thalamus (Battaglia and Rustioni 1992). Neither enkephalin nor dynorphin have been observed in spinothalamic cells. Several attempts to detect immunoreactivity for GABA in projecting fusiform cells have also failed. According to these data, the possibility that each lamina I morphological group participating in the spinothalamic tract has a counterpart of ► **local circuit interneurons**, has to be taken into account.

In *in vitro* studies, pyramidal neurons were shown to fire in high frequency bursts of variable duration (phasic neurons) in response to injection of depolarizing current, although neurons generating tonic and single spike responses were also recorded (Prescott and De Koninck 2002; Grudt and Perl 2002). In contrast, almost all fusiform neurons fired continuously at low frequency throughout depolarization (tonic neurons) (Prescott and De Koninck 2002; Grudt and Perl 2002). Flattened cells were not included in the sample. Although no causal relation between dendritic morphology and firing pattern has been established, it was speculated that long sparsely branching dendrites may promote electrotonic filtering of synaptic events. Neurons with phasic responses, such as pyramidal neurons, would be optimally excited by short stimulation and would not rely on summation of inputs for spike generation. Fusiform neurons, which responded tonically, seemed particularly fitted to promote temporal summation and integration.

## References

- Battaglia G, Rustioni A (1992) Substance P Innervation of the Rat and Cat Thalamus. II. Cells of Origin in the Spinal Cord. *J Comp Neurol* 315:473–486
- Galhardo V, Lima D (1999) Structural Characterization of Marginal (Lamina I) Spinal Cord Neurons in the Cat. A Golgi study. *J Comp Neurol* 414:315–333
- Galhardo V, Lima D, Necker R (2000) Spinomedullary Pathways in the Pigeon (*Columba Livia*): Differential Involvement of Lamina I Cells. *J Comp Neurol* 423:631–645
- Grudt TJ, Perl ER (2002) Correlations between Neuronal Morphology and Electrophysiological Features in the Rodent Superficial Dorsal Horn. *J Physiol* 540:189–207
- Kobayashi Y (1998) Distribution and Morphology of Spinothalamic Tract Neurons in the Rat. *Anat Embryol* 197:51–67
- Lima D, Avelino A, Coimbra A (1993) Morphological Characterization of Marginal (Lamina I) Neurons Immunoreactive for Substance P, Enkephalin, Dynorphin and Gama-Aminobutyric Acid in the Rat Spinal Cord. *J Chem Neuroanat* 6:43–52
- Lima D, Castro AR, Castro-Lopes JM, Galhardo V (2002). Differential Expression of GABA<sub>B</sub> Receptors in Monkey Lamina I Neuronal Types; A Golgi and Immunocytochemical Study. *Soc Neurosci Abstract Viewer*, 258.4. Society for Neuroscience, Washington, DC
- Lima D, Coimbra A (1986) A Golgi Study of the Neuronal Population of the Marginal Zone (Lamina I) of the Rat Spinal Cord. *J Comp Neurol* 244:53–71
- Lima D, Coimbra A (1988) The Spinothalamic System of the Rat: Structural Types of Retrogradely Labelled Neurons in the Marginal Zone (Lamina I). *Neuroscience* 27:215–230
- Mainen ZF, Sejnowski TJ (1996) Influence of Dendritic Structure on Firing Pattern in Model Neocortical Neurons. *Nature* 382:363–366
- Prescott SA, De Koninck Y (2002) Four Cell Types with Distinctive Membrane Properties and Morphologies in Lamina I of the Spinal Dorsal Horn of the Adult Rat. *J Physiol* 539:817–836
- Puskár Z, Polgár E, Todd AJ (2001). A Population of Large Lamina I Projection Neurons with Selective Inhibitory Input in Rat Spinal Cord. *Neuroscience* 102:167–176
- Szucs P, Odeh F, Szokol K, Antal M. (2003) Neurons with Distinctive Firing Patterns, Morphology and Distribution in Laminae V–VII of the Neonatal Rat Lumbar Spinal Cord. *Europ J Neurosci* 17:537–544
- Zhang E-T, Craig AD (1997) Morphology and Distribution of Spinothalamic Lamina I Neurons in the Monkey. *J Neurosci* 17:3274–3284
- Zhang E-T, Han Z-S, Craig AD (1996) Morphological Classes of Spinothalamic Lamina I Neurons in the Cat. *J Comp Neurol* 367:537–549

## Spinothalamic Tract Neurons, Peptidergic Input

VIRGINIA S. SEYBOLD

Department of Neuroscience, University of Minnesota, Minneapolis, MN, USA  
vseybold@umn.edu

### Synonyms

Neuropeptides; co-transmission; neuromodulators

### Definition

Peptides are short sequences of amino acids that are clipped from larger precursor proteins during synthesis. Peptides are packaged into large, dense core vesicles within the cell body and transported to the nerve terminal. The majority of primary afferent neurons of small and intermediate size contain one or more peptides. Peptides released from the central terminals of primary afferent neurons contribute to ► **central sensitization** and release from the peripheral terminals facilitates the inflammatory response and wound healing. In addition to primary afferent neurons, peptidergic input to spinothalamic neurons arises from neurons within the spinal cord as well as projections from the brainstem.

### Characteristics

Peptides occur in primary afferent neurons that innervate somatic and visceral targets (Table 1). Several aspects of peptidergic neurotransmission are important in understanding the contribution of peptides to the processing of nociceptive information by spinothalamic neurons (Hökfelt et al. 2000). 1) Peptides are released with small-molecule neurotransmitters such as glutamate, forming the basis for the concept of “► **co-transmission**.” 2) Peptides activate receptors that couple to ► **G-proteins** and G-proteins initiate the generation

**Spinothalamic Tract Neurons, Peptidergic Input, Table 1** Peptides expressed in mammalian primary afferent neurons

Peptide	Normal Occurrence	Plasticity
Calcitonin gene-related peptide (CGRP)	Most abundant, occurs primarily in small neurons that give rise to A $\delta$ - and C-fibers	↑ with inflammation ↓ in injured neurons
Substance P	Primarily in small neurons that give rise to C-fibers; extensive co-existence with CGRP	↑ with inflammation ↓ in injured neurons
Vasoactive intestinal polypeptide (VIP)	Primarily in visceral afferents	↑ in injured, small diameter somatic afferents
Galanin	Low expression	↑ in injured, small diameter somatic afferents
Neuropeptide Y (NPY)	Low expression	↑ in injured, large diameter somatic afferents
Enkephalin	Primarily in small neurons within superficial dorsal horn	↑ in intrinsic neurons with inflammation
Dynorphin	Primarily in small neurons within superficial dorsal horn	↑ in intrinsic neurons with inflammation

of the intracellular messengers that may ultimately enhance or inhibit excitability of spinothalamic neurons depending on the G-protein. 3) The expression of peptides by primary afferent neurons changes with disease states. Although a variety of peptides have been localized to primary afferent neurons in many species, the two peptides that have received considerable attention in the study of nociception are ► **substance P** and ► **calcitonin gene-related peptide (CGRP)**. Both of these peptides have been localized to ► **nociceptors** (Lawson 2002), both are released in response to intense, persistent peripheral thermal, mechanical and chemical stimuli (Duggan et al. 1988) and both have been localized to terminals that make synaptic contacts onto spinal neurons in regions that give rise to spinothalamic neurons (DeKoninck et al. 1992). Effects of peptides on nociceptive behaviors and spinal cord physiology have been extensively explored, but less is known about their effects on spinothalamic neurons. Therefore, these two peptides will illustrate potential consequences of peptidergic input to spinothalamic neurons.

### Co-Transmission

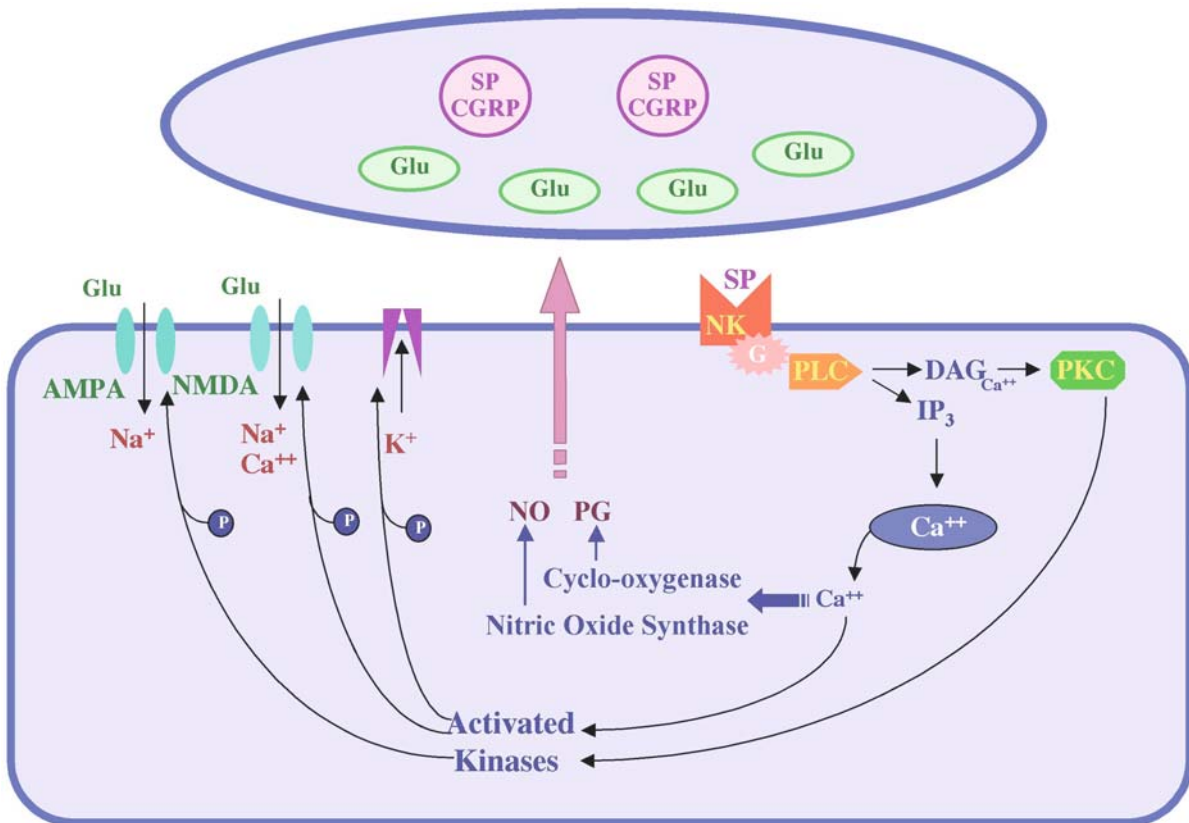
The concept of co-transmission stems from the fact that peptides are released with small-molecule neurotransmitters and sometimes other peptides that may also be contained within the same vesicle (e.g. substance P and CGRP). Peptides are synthesized in the neuronal cell body and stored in large dense-core vesicles in the nerve terminal. In contrast, the small molecule neurotransmitter glutamate is recovered from the synaptic space and stored in small synaptic vesicles. Glutamate is believed to be the universal transmitter of mammalian primary afferent neurons and is the transmitter responsible for activation of spinothalamic neurons in response to acute stimuli. Whereas brief stimuli are sufficient to release glutamate from small synaptic vesicles that cluster at a pre-synaptic density, persistent stimuli that generate higher firing frequencies of longer duration are required to evoke the release of peptides. The differential release

of peptides and glutamate in response to neuronal firing may be due to a number of factors including the greater distance of large dense-core vesicles from the synapse, differences in the vesicle-membrane fusion proteins associated with large dense-core vesicles and small synaptic vesicles and differences in the intracellular calcium gradients generated by different types of stimuli. Consequently, peptide release encodes the intensity of noxious stimuli. Furthermore, because of differences in signaling mechanisms of receptors for peptides compared to receptors for glutamate, antagonists for peptidergic receptors do not modulate acute nociceptive responses; however central sensitization and hyperalgesia are decreased with both antagonists and gene deletion of peptidergic receptors (Parsons et al. 1996; Laird et al. 2001).

### G-Protein Coupled Receptors

Direct effects of peptides on spinal neurons are mediated by ► **metabotropic receptors** that couple to G-proteins. In contrast to ► **ionotropic receptors** for glutamate, in which glutamate binding sites are part of a cation channel that produces depolarization of the neuron on opening (e.g. AMPA receptors), effects of metabotropic receptors are mediated by intracellular messengers, resulting in a longer latency between receptor activation and physiological effect compared to ionotropic receptors. Metabotropic receptors may also activate multiple intracellular signaling pathways and the down-stream effects may or may not include modulation of ion channels. Furthermore, there are families of metabotropic receptors that are activated by peptides as well as glutamate. For example, substance P is a member of a family of peptides that includes ► **neurokinin A** (which is synthesized in primary afferent neurons as part of the same precursor molecule as substance P) and neurokinin B (synthesized by spinal neurons). These peptides activate a family of receptors, neurokinins (NK) 1, 2, and 3, that are differentiated by the relative potency of the three peptides. All of the neurokinin receptors facilitate nociception, but most is known about the NK1 receptor. Substance P has the





**Spinothalamic Tract Neurons, Peptidergic Input, Figure 1** Post-synaptic events resulting from the release of glutamate (glu) and substance P (SP) from primary afferent terminals in the spinal cord. Glutamate activates the ionotropic receptors AMPA and NMDA. Influx of Na<sup>+</sup> through these channels results in depolarization of the neuron within milliseconds of glutamate binding to the receptors. Substance P, however, activates neurokinin (NK) receptors, which are metabotropic receptors that couple to the activation of phospholipase C (PLC). Activation of PLC results in the generation of intracellular messengers diacylglycerol (DAG) and inositol triphosphate (IP<sub>3</sub>) as well as release of Ca<sup>2+</sup> from intracellular stores. These intracellular messengers activate kinases, including protein kinase C (PKC), which can phosphorylate AMPA and NMDA receptors to increase their responses to glutamate. Kinases can also phosphorylate K<sup>+</sup> channels, closing them and thereby increasing the excitability of the neuron. Increases in intracellular Ca<sup>2+</sup> from influx through NMDA receptors and release of Ca<sup>2+</sup> from intracellular stores can activate cyclo-oxygenase and nitric oxide synthase, which produce the membrane permeable messengers nitric oxide (NO) and prostaglandins (PG), respectively.

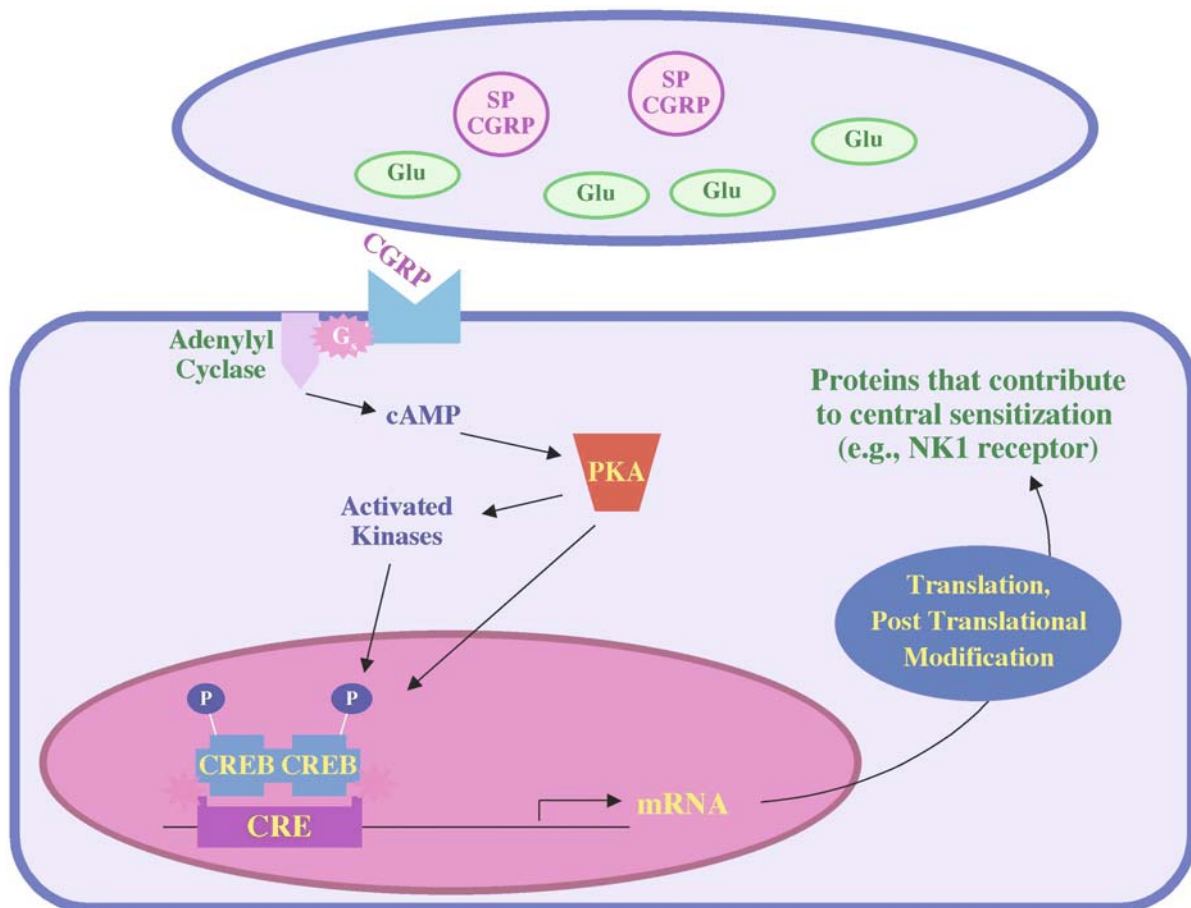
S

greatest potency at NK1 receptors. NK1 receptors occur at the highest density within the dorsal horn of the spinal cord and have been localized to spinothalamic neurons. Neurokinin-1 receptors in the spinal cord couple to activation of phospholipase C resulting in the activation of protein kinase C and release of calcium from intracellular stores (Fig. 1). SP contributes directly to central mechanisms of hyperalgesia by increasing the excitability of spinal neurons (Henry 1976) and indirectly, by facilitating the activation of NMDA receptors (Urban et al. 1994). Neurons in superficial laminae of the spinal cord that express NK1 receptors are required for sensitization of spinal neurons to mechanical and thermal stimuli following treatment with capsaicin (Khasabov et al. 2002). Because of the time required for intracellular events, effects of peptides do not contribute to sensation of acute stimuli. However, they contribute to central sensitization and secondary hyperalgesia.

Peptidergic input to spinal neurons has broader consequences than changing the excitability of the spinotha-

lamic neurons. For example, activation of spinal neurokinin receptors has also been linked to the generation of prostaglandins (Yaksh et al. 1999) and nitric oxide (Linden et al. 1999). Both of these messengers diffuse across cell membranes and can act back on terminals of primary afferent neurons, thus they are referred to as retrograde messengers. Prostaglandins and nitric oxide contribute to hyperalgesia by facilitating the release of neurotransmitters from presynaptic terminals.

Increasing neuronal excitability and the generation of retrograde messengers are postsynaptic consequences of peptides that occur over seconds to minutes. However, the same pathways that mediate these effects also interface with pathways for regulation of gene expression. For example, CGRP has no overt behavioral effects when injected intrathecally and does not depolarize spinal neurons. However, ▶ **secondary hyperalgesia** is blocked in  $\alpha$ -CGRP knockout mice (Zhang et al. 2001). Long-term effects of CGRP on hyperalgesia accompanying peripheral inflammation are likely to



**Spinothalamic Tract Neurons, Peptidergic Input, Figure 2** CGRP activates metabotropic receptors that couple to the generation of cyclic AMP (cAMP). Cyclic AMP activates protein kinase A (PKA), which can activate other kinases through phosphorylation. PKA and other kinases can phosphorylate the transcription factor cAMP response element binding protein (CREB) within the nucleus. When phosphorylated CREB forms a complex with other proteins at the cAMP response element (CRE) site within the promoter region of a gene, transcription is initiated. Several proteins that contribute to central sensitization have CRE binding sites in the promoter region of their genes. Other peptides, such as vasoactive intestinal polypeptide (VIP) may have similar effects because receptors for VIP also couple to the generation of cAMP. Peptides that activate receptors that couple to different G-proteins may regulate gene expression through different transcription factors.

include regulation of gene expression (Fig. 2). CGRP receptors on spinal neurons couple to the generation of cyclic-AMP (cAMP), which activates an intracellular pathway that results in phosphorylation and activation of the transcription factor cAMP-response element binding protein (CREB). Several proteins that contribute to central sensitization and are increased in conjunction with peripheral inflammation have CRE-binding sites in the promoter region of their genes (e.g. ► [NK1 receptors](#), cyclo-oxygenase 2, ► [nitric oxide synthase](#), dynorphin). Treatment of rat spinal neurons with CGRP increases CRE-dependent gene expression and substance P binding to spinal neurons (Seybold et al. 2003). As our understanding of pathways that contribute to the regulation of gene expression expands, it is likely that peptides will assume greater prominence in shaping long term changes in synaptic plasticity that contribute to chronic pain.

### Phenotypic Changes

Just as peptidergic neurotransmission may modulate the expression of proteins in spinal neurons, the expression of peptides by primary afferent neurons and spinal neurons changes with disease states. For example, peripheral inflammation increases levels of mRNA for substance P and CGRP in dorsal root ganglia, the site of cell bodies of primary afferent neurons. Peptide synthesis is increased in neurons that already express the peptides and novel expression is evoked in larger, non-nociceptive neurons that give rise to myelinated fibers (Neumann et al. 1996). The increase in mRNA contributes to increased release of substance P and CGRP from terminals in response to peripheral stimuli; the increased release contributes to enhanced effects of these peptides on central sensitization. Conversely, the expression of substance P and CGRP in small neurons within dorsal root ganglia decreases in models of neu-

ropathic pain, and the expression of other peptides, such as vasoactive intestinal polypeptide (VIP), ► **galanin** and ► **neuropeptide Y** (NPY), increases (Hökfelt et al. 1994). These peptides activate receptors on primary afferent and spinal neurons that promote hyperalgesia through some of the same intracellular signaling pathways described for substance P and CGRP. However, VIP, galanin and NPY will activate their own receptors that are distributed among a unique pattern of spinal neurons.

#### Other Sources of Peptidergic Input

Descending projections from the brainstem and neurons intrinsic to the spinal cord are additional sources of peptidergic input to spinothalamic tract neurons. ► **Opioid peptides** (met-enkephalin, leu-enkephalin, dynorphin, endomorphin) are noteworthy because they activate opioid receptors ( $\mu$ ,  $\delta$  and  $\kappa$ ) that mediate inhibitory effects on spinothalamic neurons. Synaptic contacts of terminals containing these peptides onto spinothalamic neurons have been described (Ruda 1982). Opioid analgesia is effective because it mimics neurotransmission of these endogenous substances.

#### References

- De Koninck Y, Ribeiro-da-Silva A, Henry JL et al. (1992) Spinal neurons exhibiting a specific nociceptive response receive abundant substance P-containing synaptic contacts. *Proc Natl Acad Sci USA* 89:5073–5077
- Duggan AW, Hendry IA, Morton CR et al. (1988) Cutaneous stimuli releasing immunoreactive substance P in the dorsal horn of the cat. *Brain Res* 451:261–273
- Henry JL (1976) Effects of substance P on functionally identified units in cat spinal cord. *Brain Res* 114:439–451
- Hökfelt T, Zhang X, Wiesenfeld-Hallin Z (1994) Messenger plasticity in primary sensory neurons following axotomy and its functional implications. *Trends Neurosci* 17:22–30
- Hökfelt T, Broberger C, Xu ZQ et al. (2000) Neuropeptides—an overview. *Neuropharmacology* 39:1337–1356
- Khasabov SG, Rogers SD, Ghilardi JR et al. (2002) Spinal neurons that possess the substance P receptor are required for the development of central sensitization. *J Neurosci* 22:9086–9098
- Laird JM, Roza C, De Felipe C et al. (2001) Role of central and peripheral tachykinin NK1 receptors in capsaicin-induced pain and hyperalgesia in mice. *Pain* 90:97–103
- Lawson SN (2002) Phenotype and function of somatic primary afferent nociceptive neurones with C-,  $\delta$ - or  $\alpha$ / $\beta$ -fibres. *Exp Physiol* 87:239–244
- Linden DR, Jia YP, Seybold VS (1999) Spinal neurokinin3 receptors facilitate the nociceptive flexor reflex via a pathway involving nitric oxide. *Pain* 80:301–308
- Neumann S, Doubell TP, Leslie T et al. (1996) Inflammatory pain hypersensitivity mediated by phenotypic switch in myelinated primary sensory neurons. *Nature* 384:360–364
- Parsons AM, Honda CN, Jia YP et al. (1996) Spinal NK1 receptors contribute to the increased excitability of the nociceptive flexor reflex during persistent peripheral inflammation. *Brain Res* 739:263–275
- Ruda MA (1982) Opiates and pain pathways: demonstration of enkephalin synapses on dorsal horn projection neurons. *Science* 215:1523–1525
- Seybold VS, McCarson KE, Mermelstein PG et al. (2003) Calcitonin gene-related peptide regulates expression of neurokinin1 receptors by rat spinal neurons. *J Neurosci* 23:1816–1824
- Urban L, Thompson SW, Dray A (1994) Modulation of spinal excitability: co-operation between neurokinin and excitatory amino acid neurotransmitters. *Trends Neurosci* 17:432–438
- Yaksh TL, Hua XY, Kalcheva I et al. (1999) The spinal biology in humans and animals of pain states generated by persistent small afferent input. *Proc Natl Acad Sci USA* 96:7680–7686
- Zhang L, Hoff AO, Wimalawansa SJ et al. (2001) Arthritic calcitonin/alpha calcitonin gene-related peptide knockout mice have reduced nociceptive hypersensitivity. *Pain* 89:265–273

## Spinothalamic Tract Neurons, Responses to Chemical Stimulation

DONALD A. SIMONE

Department of Diagnostic and Biological Sciences,  
University of Minnesota, School of Dentistry,  
Minneapolis, MN, USA  
simon003@umn.edu

#### Definition

Discharge of spinothalamic tract neurons in response to chemical stimulation of the receptive field. The receptive field may be located in skin or in deep tissues.

#### Characteristics

Many studies have demonstrated that spinothalamic tract (STT) neurons are excited by noxious chemical stimulation of deep tissues as well as skin. Early studies showed that STT neurons in monkeys were excited by injection of bradykinin into the femoral artery (Levante et al. 1975). Although intra-arterial injection of bradykinin in humans produces pain, which suggests that activation of STT neurons contributed to the bradykinin evoked pain, it is unclear in which tissues the bradykinin receptors were activated, since several different types of tissue receive blood supply from the injected artery. In subsequent studies, responses of STT neurons were determined following noxious chemical stimulation of identified tissues. For example, Foreman et al. (1979) examined responses of STT neurons produced by intra-arterial injection in preparations in which all nerves of the distal hind limb were denervated except for those innervating the triceps surae muscles. Thus, activation of STT neurons following intra-arterial injection was due to excitation of receptors and primary afferent fibers in muscle. It was found that injection of bradykinin, serotonin or KCL produced strong excitation of STT neurons. Many of the neurons excited were located in the deep dorsal horn. The time course of response and responses to repeated injections of the same chemical differed for the different chemicals used. For example, excitation by bradykinin had a slower time course than serotonin or KCL and, whereas repeated injections of bradykinin produced similar responses, tachyphylaxis occurred for responses to serotonin. The effect of chemical stimulation of the heart on responses of STT neurons has also been determined. In

initial studies, it was found that occlusion of a coronary artery often produced a delayed excitation of STT neurons, perhaps corresponding to the development of ischemia (and pain) in cardiac muscle (Blair et al. 1984). Since bradykinin excites small afferent fibers that innervate the heart and which may contribute to pain associated with angina, it was determined whether intracardiac injection of bradykinin excited STT neurons (Ammons et al. 1985; Blair et al. 1982, 1984). In one study (Blair et al. 1982) it was found that bradykinin (0.3–3.5  $\mu\text{g}$ ) excited approximately 75% of STT neurons located in the superficial and deep dorsal horn in C8 to T5 spinal segments and the average discharge rate after bradykinin was about twice that of the spontaneous activity prior to injection. In addition, chemical stimulation of cardiac or pericardiac tissue with a chemical mixture containing adenosine, bradykinin, prostaglandin, serotonin and histamine excited STT neurons in the C1–C2 spinal segments (Chandler et al. 2000). Thus, activation of STT neurons that receive input from small caliber cardiac afferent fibers is likely to contribute to anginal pain. STT neurons are also excited by chemical stimulation of joints. For example, intra-articular injection of kaolin and carrageenan, which has been used as a model of inflammation, increased spontaneous activity of STT neurons (Dougherty et al. 1992). Chemical stimulation of the skin also excites STT neurons. Intradermal injection of capsaicin (100  $\mu\text{g}$ ) produced a robust excitation of STT neurons located in the superficial and deep dorsal horn in monkeys (Simone et al. 1991a; Simone et al. 2004). The magnitude and time course of excitation of STT neurons was similar to the time course of pain in humans following similar injection of capsaicin (Simone et al. 1989; LaMotte et al. 1991). These STT neurons, which were also sensitive to mechanical stimuli, exhibited weak responses to intradermal injection of histamine (Simone et al. 2004). However in cats, iontophoretic application of histamine produced a greater excitation in STT neurons that were not sensitive to mechanical stimulation of their receptive field (Andrew and Craig 2001). Since histamine evokes a sensation of itch in humans (Magerl et al. 1990; Simone et al. 1991b), these studies indicate that a unique subgroup of mechanically insensitive STT neurons may contribute to the sensation of itch.

## References

- Ammons WS, Girardot MN, Foreman RD (1985) Effects of intracardiac bradykinin on T2–T5 medial spinothalamic cells. *Am J Physiol* 249:R147–152
- Andrew D, Craig AD (2001) Spinothalamic lamina I neurons selectively sensitive to histamine: A central neural pathway for itch. *Nat Neurosci* 4:72–77
- Blair RW, Ammons WS, Foreman RD (1984) Responses of thoracic spinothalamic and spinoreticular cells to coronary artery occlusion. *J Neurophysiol* 51:636–648
- Blair RW, Weber RN, Foreman RD (1982) Responses of thoracic spinothalamic neurons to intracardiac injection of bradykinin in the monkey. *Circ Res* 51:83–94
- Chandler MJ, Zhang J, Qin C et al. (2000) Intrapericardiac injections of algogenic chemicals excite primate C<sup>1</sup>–C<sup>2</sup> spinothalamic tract neurons. *Am J Physiol* 279:R560–568
- Coffman JD (1966) The effect of aspirin on pain and hand blood flow responses to intra-arterial injection of bradykinin in man. *Clin Pharmacol Therap* 7:26–37
- Dougherty PM, Sluka KA, Sorkin LS et al. (1992) Neural changes in acute arthritis in monkeys: I. Parallel enhancement of responses of spinothalamic tract neurons to mechanical stimulation and excitatory amino acids. *Brain Res Rev* 17:1–13
- Foreman RD, Schmidt RF, Willis WD (1979) Effects of mechanical and chemical stimulation of fine muscle afferents upon primate spinothalamic tract cells. *J Physiol* 286:215–231
- LaMotte RH, Shain CN, Simone DA et al. (1991) Neurogenic hyperalgesia: Psychophysical studies of underlying mechanisms. *J Neurophysiol* 66:190–211
- Levante A, Lamour Y, Guilbaud G et al. (1975) Spinothalamic cell activity in the monkey during intense nociceptive stimulation: intra-arterial injection of bradykinin into the limbs. *Brain Res* 88:560–564
- Magerl W, Westerman RA, Mohner B et al. (1990) Properties of transdermal histamine iontophoresis: differential effects of season, gender, and body region. *J Invest Dermatol* 94:347–352
- Simone DA, Baumann TK, LaMotte RH (1989) Dose-dependent pain and mechanical hyperalgesia in humans after intradermal injection of capsaicin. *Pain* 38:99–107
- Simone DA, Zhang X, Li J et al. (2004) Comparison of responses of primate spinothalamic tract neurons to pruritic and algogenic stimuli. *J Neurophysiol* 91:213–222
- Simone DA, Sorkin LS, Oh U et al. (1991a) Neurogenic hyperalgesia: Central neural correlates in responses of spinothalamic tract neurons. *J Neurophysiol* 66:228–246
- Simone DA, Alreja M, LaMotte RH (1991b) Psychophysical studies of the itch sensation and itchy skin ("alloknesis") produced by intracutaneous injection of histamine. *Somatosens Mot Res* 8:271–279

## Spinothalamic Tract Neurons, Role of Nitric Oxide

WILLIAM D. WILLIS

Department of Neuroscience and Cell Biology,  
University of Texas Medical Branch, Galveston, TX,  
USA  
wdwillis@utmb.edu

### Definition

Nitric oxide is a diffusible gas that may be released in nervous tissue during activity. Nitric oxide plays an important role in the ► **central sensitization** of spinothalamic tract neurons that occurs following strong noxious stimuli. The initiation of central sensitization involves the release of synaptic transmitters, including glutamate and the excitatory neuropeptides, ► **substance P** and ► **calcitonin gene-related peptide**. The actions of these transmitters on glutamate and peptide receptors lead to increased intracellular calcium concentration and the activation of a number of signal transduction cascades. One of these signal transduction cascades involves the activation of ► **nitric oxide synthase**, leading to the synthesis and release of nitric oxide within the spinal cord. Nitric oxide in turn activates guanylyl cyclase, resulting



in increased production of cyclic GMP. The cGMP activates protein kinase G, which can then phosphorylate proteins important for central sensitization.

### Characteristics

► **Central sensitization** of the responses of nociceptive neurons in the spinal cord, including spinothalamic tract cells, can occur following acute inflammation or as a contributor to other painful conditions, such as neuropathic pain. ► **Peripheral sensitization** of nociceptive afferents may occur, as well, but the demonstration of central sensitization is independent of peripheral sensitization. For example, stimulation of an undamaged or un-inflamed area of the body adjacent to the damaged area can produce an enhanced activation of spinal neurons that have undergone central sensitization (Simone et al. 1991; Dougherty and Willis 1992). For this reason, it is thought that central sensitization can help explain the development of ► **secondary mechanical allodynia** and ► **hyperalgesia** in the area of skin that surrounds a site of damage (Hardy et al. 1967).

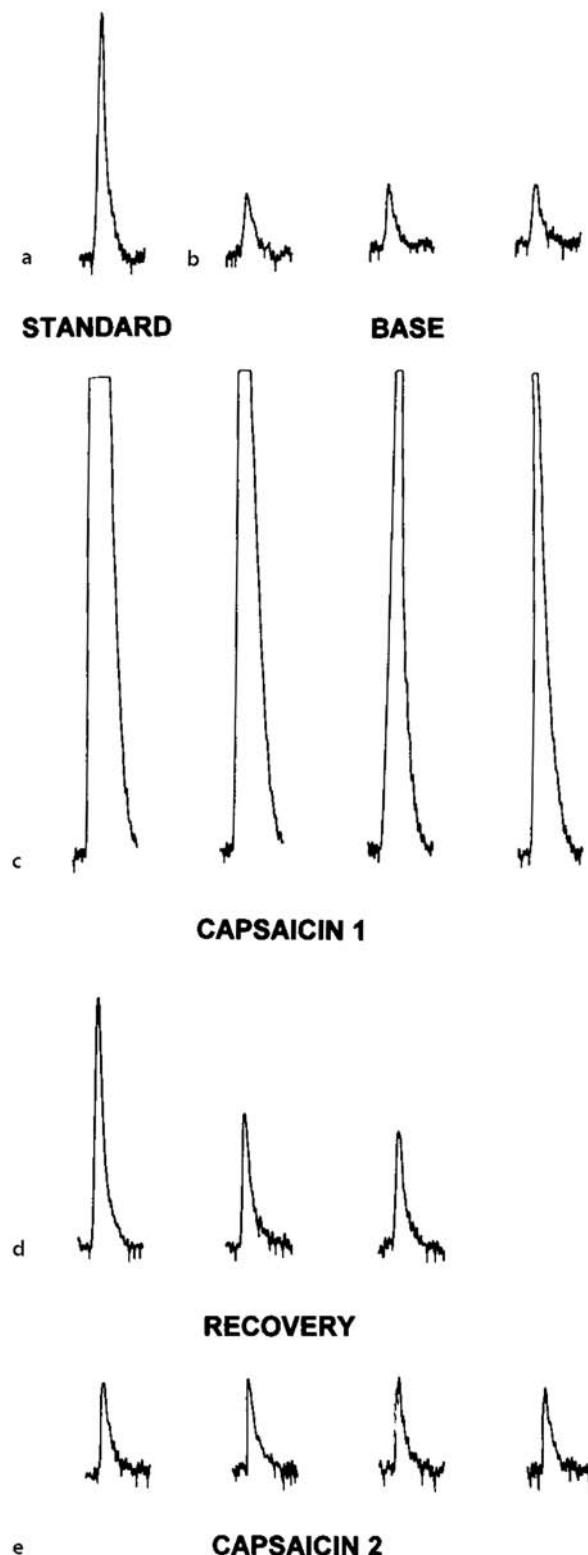
Central sensitization is a form of ► **activity-dependent plasticity** and resembles in many details the process of ► **long-term potentiation (LTP)** that is observed in brain areas, such as the hippocampal formation (Willis 2002). A number of laboratories have described a form of LTP that occurs in the spinal cord (see Willis 2002), so the findings of similarities between central sensitization and LTP are not surprising.

A consistent procedure for evoking central sensitization in primate spinothalamic tract cells is to inject ► **capsaicin** intradermally within the receptive field (Simone et al. 1991) (Dougherty and Willis 1992). This generally leads to a powerful activation of the spinothalamic tract cell and an enhanced responsiveness of the neuron to innocuous and sometimes noxious mechanical stimulation of an area of skin surrounding the injection site. Recordings from primary afferent fibers that innervate the same region of skin show that the responsiveness of the peripheral nerve fibers is unchanged (Baumann et al. 1991; LaMotte et al. 1992). Despite this, the responses of the spinothalamic tract cell can be elevated for a period of hours.

Experiments in which antagonists of various neurotransmitter receptors are introduced into the spinal cord near

### Spinothalamic Tract Neurons, Role of Nitric Oxide,

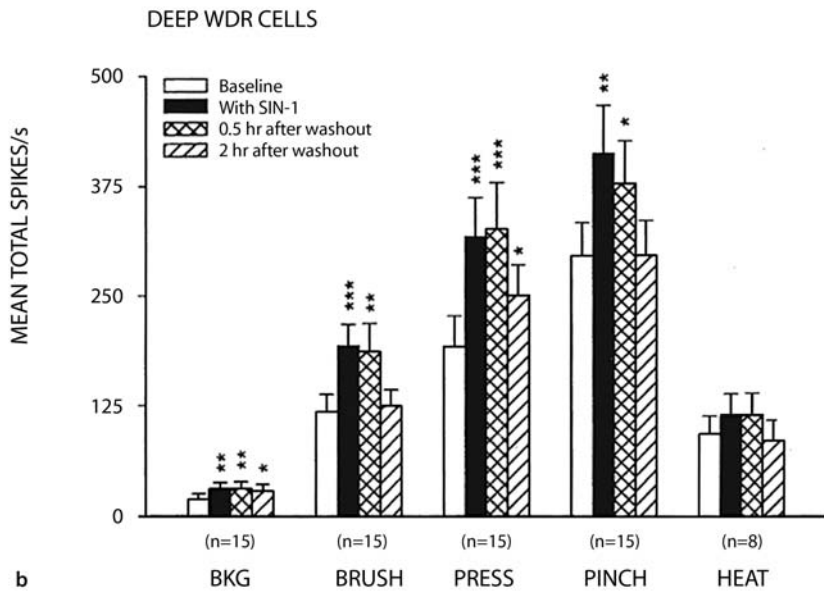
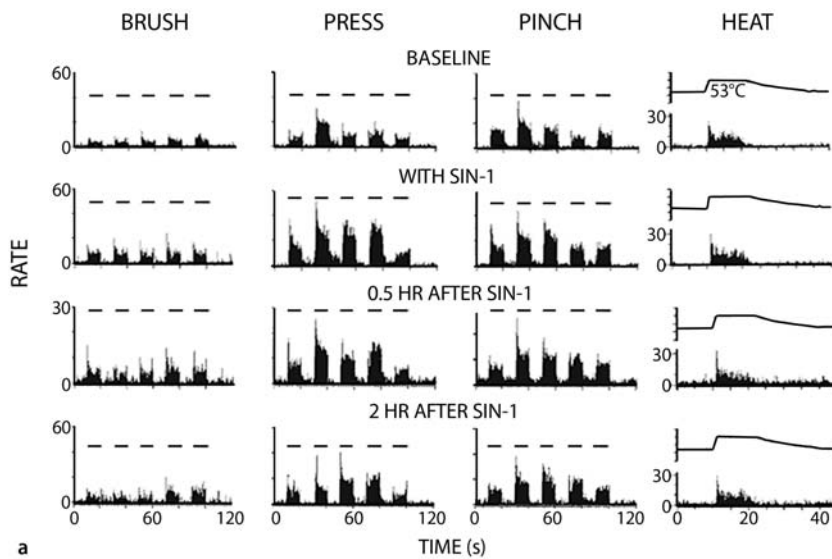
**Figure 1** Absorbance peaks for  $\text{NO}_2^-$  measured by high performance liquid chromatography using a UV detector. ( $\text{NO}_3^-$  was reduced to  $\text{NO}_2^-$  so that the measurements represent the combination of both NO metabolites.) (a) Peak produced by a 25  $\mu\text{M}$  standard. (b) Baseline peaks produced by 3 samples taken from the lumbar spinal cord by microdialysis over a period of 1 h after surgery. (c) Peaks from samples taken following intradermal injection of capsaicin. (d) Peaks showing recovery from the first capsaicin injection. Between (d) and (e), a nitric oxide synthase inhibitor was administered through the microdialysis fiber for 40 min. (e) Peaks showing lack of response to a second injection capsaicin. (From Wu J et al. 1998).



a spinothalamic tract neuron by ► **microdialysis** have shown that the initiation of central sensitization depends on the activation of several kinds of ► **neurotransmitter receptors**, including non-N-methyl-D-aspartate, N-methyl-D-aspartate and metabotropic glutamate receptors, as well as neurokinin-1 receptors (Willis 2002). Calcitonin gene-related peptide receptors (CGRP receptors) are also involved in the initiation of central sensitization in dorsal horn nociceptive neurons, since spinal cord administration of a CGRP receptor antagonist blocks central sensitization of nociceptive dorsal horn neurons by intradermal injection of capsaicin (Sun et al. 2003). The duration of central sensitization is much longer than would be expected for the normal synaptic actions of glutamate or peptides. This leads to the suggestion that cen-

tral sensitization depends on the activation of ► **second messenger cascades**. One such cascade that has been investigated involves the synthesis and release of ► **nitric oxide** in the spinal cord following intradermal injection of capsaicin. Fig. 1 shows the enhanced level of nitrite (and nitrate that was reduced to nitrite) in dialysate collected from the dorsal horn of a rat spinal cord by microdialysis following an intradermal injection of capsaicin (Wu et al. 1998). The increase in nitrite, which is a metabolite of nitric oxide, was the result of the action of ► **nitric oxide synthase**, since the increase was prevented by administration of a nitric oxide synthase inhibitor.

Several additional lines of evidence suggest a role of nitric oxide in the central sensitization of spinothalamic



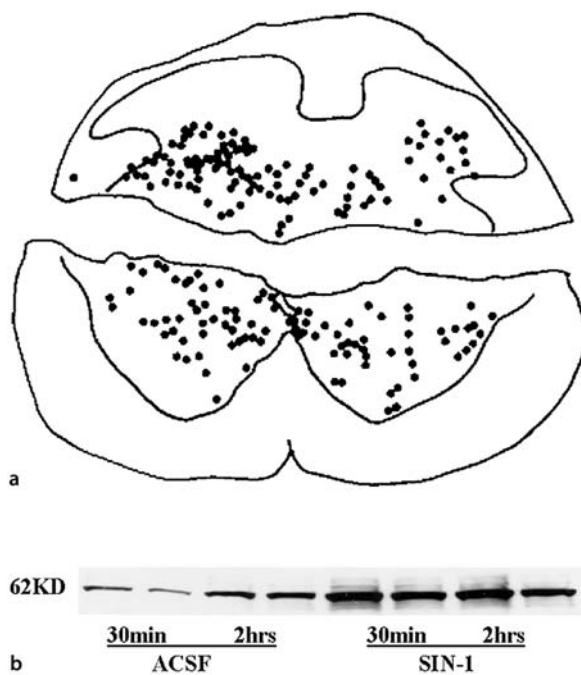
**Spinothalamic Tract Neurons, Role of Nitric Oxide, Figure 2** Effects of microdialysis administration of a nitric oxide donor (3-morpholinosydnonimine, SIN-1) into the dorsal horn of the spinal cord of a monkey while recordings were made from a spinothalamic tract neuron. (a) responses are shown to stimulation of different parts of the receptive field using weak (Brush), intermediate strength (Press) and strong (Pinch) mechanical stimuli, as well as a noxious thermal stimulus (Heat). The horizontal bars over the left 3 columns of peristimulus time histograms indicate when the mechanical stimuli were applied. A temperature monitor is shown over the histograms in the rightmost column of histograms of the heat responses. The top row of histograms shows the control responses. Following these recordings, SIN-1 was infused through the microdialysis fiber. The lower two rows are the responses 0.5 h and 2 h after the infusion. (b) grouped data for 15 spinothalamic tract neurons show the enhancement of the responses to mechanical but not heat stimuli during SIN-1 infusions and for 0.5 h afterwards. Background activity (BKG) was also increased. (From Lin Q et al. 1999).

tract cells. Administration of a nitric oxide donor causes an enhancement of the responses of spinothalamic tract cells to mechanical stimuli (Fig. 2), and microdialysis administration of a nitric oxide synthase inhibitor prevents central sensitization (Lin et al. 1997). Nitric oxide often has its primary effect by activation of guanylyl cyclase, which results in an increased intracellular synthesis of cyclic GMP and as a consequence the activation of protein kinase G. For this reason, the effects of agents affecting the protein kinase G cascade have been examined. Microdialysis administration of 8-bromo-cyclic GMP enhances the excitability of spinothalamic tract cells, whereas a guanylyl cyclase inhibitor, ODQ, prevents central sensitization by intradermal capsaicin injection (Lin et al. 1999a; Lin et al. 1999b). Glutamate and aspartate are released into the dorsal horn following intradermal injection of capsaicin, and this release is blocked after administration of a protein kinase G inhibitor, but not after administration of a protein kinase A inhibitor (Sluka and Willis 1998).

Other signal transduction cascades have also been shown to be involved in central sensitization, including the calcium/calmodulin kinase II, protein kinase C and protein kinase A pathways (Willis 2002).

It is as yet unclear what the action of protein kinase G might be in central sensitization. Protein kinase C and protein kinase A are involved in the phosphorylation of glutamate receptors, including the NR1 subunits of N-methyl-D-aspartate receptors and the GluR1 subunits of AMPA receptors (Willis 2002). It is thought that phosphorylation of these receptors makes them more responsive to the effects of glutamate released at synapses on spinothalamic tract cells. Additionally or alternatively, phosphorylation of glutamate receptors may assist in the insertion of more receptor molecules into the neuronal membrane. In addition, the responses of spinothalamic tract cells to inhibitory amino acids are reduced during central sensitization (Lin et al. 1999). It is not known if this is the result of phosphorylation of inhibitory amino acid receptors.

Two other roles of nitric oxide have been observed in studies of central sensitization following intradermal capsaicin administration. One role of nitric oxide is to trigger the expression of ► **Fos protein** in the spinal cord dorsal horn (Wu et al. 2000). Administration of a nitric oxide donor results in Fos expression (Fig. 3), whereas administration of a nitric oxide synthase inhibitor reduces the expression of Fos following capsaicin injection. The immediate-early gene, c-Fos, is thought to act on the nucleus of neurons through expression of Fos protein, with a consequent regulation of gene expression related to nociception. Another action of nitric oxide is to promote the phosphorylation of ► **cyclic adenosine monophosphate-responsive element-binding protein** (CREB) in the spinal cord (Wu et al. 2002). CREB is also a transcription factor, and its activation by phosphorylation also leads to changes



**Spinothalamic Tract Neurons, Role of Nitric Oxide, Figure 3** Administration of a nitric oxide donor increases the expression of Fos protein in the spinal cord. (a) Section of the spinal cord of a rat at the level of placement of a microdialysis fiber. The nitric oxide donor, SIN-1, was infused through the microdialysis fiber for 30 min. Spinal cord tissue was removed at 2 h and immunostained for Fos protein. Labeled neurons are plotted dorsal and ventral to the gap made by the microdialysis fiber. There was very little labeling when artificial cerebrospinal fluid was infused instead of SIN-1 (data not shown). Evidently, SIN-1 triggered the expression of Fos. The increase in Fos labeling spread about 400  $\mu\text{m}$  from the edges of the microdialysis fiber. (b) Western blot showing the expression of Fos protein when the spinal cord was removed 30 min or 2 h after infusion of artificial cerebrospinal fluid or SIN-1. Fos expression was greatly increased following SIN-1 administration. (From Wu J et al. 2000).

S

in gene expression. Phosphorylation of CREB is seen after either intradermal capsaicin injection or after spinal cord administration of a nitric oxide donor. The phosphorylation is blocked by a nitric oxide synthase inhibitor.

## References

1. Baumann TK, Simone DA, Shain CN et al. (1991) Neurogenic hyperalgesia: The search for the primary cutaneous afferent fibers that contribute to capsaicin-induced pain and hyperalgesia. *J Neurophysiol* 66:212–227
2. Dougherty PM, Willis WD (1992) Enhanced responses of spinothalamic tract neurons to excitatory amino acids accompany capsaicin-induced sensitization in the monkey. *J Neurosci* 12:883–894
3. Hardy JD, Wolff HG, Goodell H (1967) In: Pain sensations and reactions. Hafner Publishing Co., New York (reprint of 1952 edn published by Williams and Wilkins)
4. LaMotte RH, Lundberg LER, Torebjörk HE (1992) Pain, hyperalgesia and activity in nociceptive C units in humans after intradermal injection of capsaicin. *J Physiol* 448:749–764
5. Lin Q, Peng YB, Wu J et al. (1997) Involvement of cGMP in nociceptive processing by and sensitization of spinothalamic neurons in primates. *J Neurosci* 17:3293–3302

6. Lin Q, Palecek J, Paleckova V et al. (1999a) Nitric oxide mediates the central sensitization of primate spinothalamic tract neurons. *J Neurophysiol* 81:1075–1085
7. Lin Q, Wu J, Peng YB et al. (1999b) Inhibition of primate spinothalamic tract neurons by spinal glycine and GABA is modulated by guanosine 3',5'-cyclic monophosphate. *J Neurophysiol* 81:1095–1103
8. Lin Q, Wu J, Peng YB et al. (1999c) Nitric oxide-mediated spinal disinhibition contributes to the sensitization of primate spinothalamic tract neurons. *J Neurophysiol* 81:1086–1094
9. Simone DA, Sorkin LS, Oh U et al. (1991) Neurogenic hyperalgesia: central neural correlates in responses of spinothalamic tract neurons. *J Neurophysiol* 66:228–246
10. 40:202–214
11. Sluka KA, Willis WD (1998) Increased spinal release of excitatory amino acids following intradermal injection of capsaicin is reduced by a protein kinase G inhibitor. *Brain Res* 798:281–286.
12. Sun R-Q, Lawand NB, Lin Q et al. (2003) Capsaicin-induced sensitization of dorsal horn neurons is prevented or reversed by CGRP<sub>8-37</sub>, a specific CGRP 1 receptor antagonist. *Neurosci Abstracts*
13. Willis WD (2002) Long-term potentiation in spinothalamic neurons. *Brain Res Brain Res Rev* 40:202–214
14. Wu J, Lin Q, McAdoo DJ et al. (1998) Nitric oxide contributes to central sensitization following intradermal injection of capsaicin. *NeuroReport* 9:589–592
15. Wu J, Fang L, Lin Q et al. (2000) Fos expression is induced by increased nitric oxide release in rat spinal cord dorsal horn. *Neuroscience* 96:351–357
16. Wu J, Fang L, Lin Q et al. (2002) The role of nitric oxide in the phosphorylation of cyclic adenosine monophosphate-responsive element-binding protein in the spinal cord after intradermal injection of capsaicin. *J Pain* 3:190–198

## Spinothalamic Tract Neurons, Visceral Input

ROBERT D. FOREMAN, CHAO QIN  
 Department of Physiology, College of Medicine,  
 University of Oklahoma Health Sciences Center,  
 Oklahoma City, OK, USA  
 robert-foreman@ouhsc.edu

### Synonyms

“Pain” pathway; Nociceptive Projecting Neurons; visceral pain; angina pectoris

### Characteristics

#### Spinothalamic tract cells - Spinal cord processing

The spinothalamic tract originates from cells in the dorsal gray matter, ascends in the contralateral anterolateral funiculus and terminates in the thalamus. The dorsal and intermediate gray matter of the spinal dorsal is made up of cells serving as interneurons and as the origin of ascending pathways that transmit visceral information to areas of the brain processing sensory information and participating in pain perception (Fig. 1) (reviewed in Willis and Westlund 1997). Of the ascending pathways, the STT is the most studied system for transmitting visceral afferent information to the brain. Axons of STT cells generally cross over in the white commissure to the

contralateral side within one or two segments and then ascend generally in the anterolateral quadrant. Recent studies, however, have shown that some axons remain on the ipsilateral side and some are in the dorsolateral quadrant (Apkarian and Hodge 1989). Visceral information from the upper thoracic segments usually converges with input from somatic structures and ascends to the lateral and medial thalamus (reviewed in Foreman 1997; Foreman 1999).

#### Neurophysiological Mechanisms of Visceral Pain and Spinothalamic Tract Cells

Patients with angina pectoris express three main clinical characteristics to describe their symptoms: (a) pain from the heart is generally referred to somatic structures innervated by the same spinal segments that innervate the heart (Ruch 1961); (b) the pain of angina pectoris is referred to proximal and axial body areas but generally not to distal limbs (Bonica 1990) and (c) angina pectoris is generally felt as deep and not superficial or cutaneous pain (Lewis 1942). In this section, neurophysiological mechanisms are described to support the patient observations of the referred pain associated with myocardial ischemia and other cardiac diseases. The principles of the mechanisms discussed below can also be used to describe referred pain associated with diseases of the esophagus, gall bladder, stomach, colon and rectum, urinary bladder and reproductive organs.

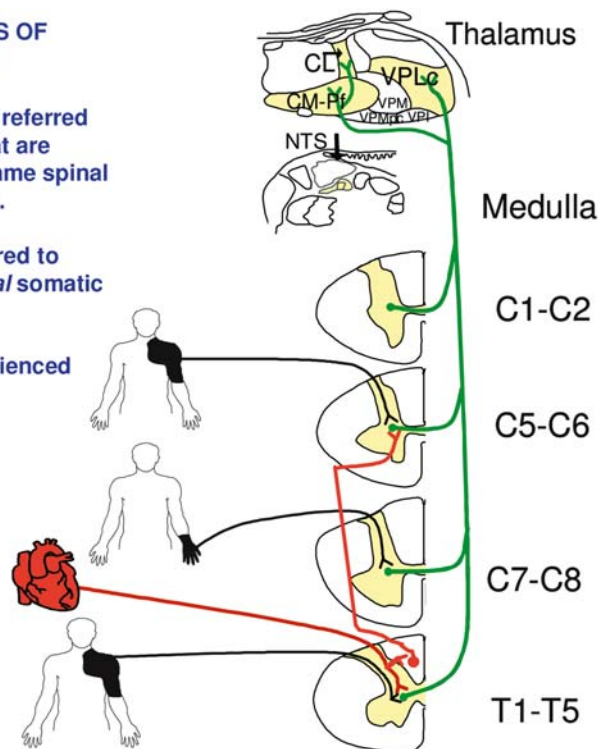
#### Viscerosomatic Convergence

Electrophysiological studies show that electrical stimulation of cardiopulmonary afferent fibers excites STT cells in the T1 to T6 segments of the spinal cord (Hobbs et al. 1992). Approximately 80% of the cells recorded in these segments are strongly activated with cardiopulmonary afferent stimulation, and all these cells receive convergent input from somatic structures. It is interesting that cardiopulmonary afferent stimulation has little effect on the activity of cells in the C7 and C8 segments, where the major innervation is to the distal forelimb and hand. This fits with the clinical observations that anginal pain is usually not referred to the hand and distal forelimb (Harrison and Reeves 1968; Sampson and Cheitlin 1971). Thus, the lack of responsiveness of these cells agrees with clinical observations. Once past the cervical enlargement, STT cells of the C5–C6 segments are again primarily excited by cardiopulmonary sympathetic afferent and somatic stimulation. Somatic fields for these cells are primarily from the chest. An interesting feature of these segments is that they do not receive cardiac input directly from their dorsal root ganglion cells; in fact, the afferent input is a few segments away. Some evidence suggests that cardiopulmonary afferent fibers may activate cell bodies of a propriospinal path where it directly or indirectly makes synaptic connection with STT cells in the cervical region (Nowicki and Szulczyk 1986). It is also possible that afferent branches of the T2



### CHARACTERISTICS OF REFERRED PAIN

1. Pain of visceral origin referred to somatic regions that are innervated from the same spinal segments as the heart.
2. Pain is generally referred to proximal, but not distal somatic structures
3. Referred Pain is experienced as deep pain



**Spinothalamic Tract Neurons, Visceral Input, Figure 1** Schematic diagram of the neural mechanisms that explain the characteristics of referred pain resulting from angina pectoris. The green solid line represents the spinothalamic tract with the cells located in the spinal gray matter in each segment and the axons projecting to the lateral (caudal ventral posterior lateral nucleus [VPLc] and the medial (central lateral [CL] and central median-parafascicular nucleus [CM-Pf]). The black areas on the figurines are representative somatic fields. The red line from the heart to the spinal cord represents the sympathetic afferent fibers from the heart. The red line from the T1-T5 spinal segments to the C5-C6 segments is that intraspinal pathway transmitting cardiac afferent information that bypasses the C7-C8 segments and projects to the mid cervical segments. NTS, Nucleus Tract

and T3 sympathetic fibers may travel in the zone of Lissauer for several segments (Sugiura et al. 1989). Thus, convergence of visceral and somatic input onto a common pool of STT cells provides a substrate for explaining the referral of pain to somatic structures.

#### Proximal And Axial Somatic Involvement

Neurophysiological mechanisms also provide a basis for the proximal nature of the referred pain of angina pectoris. Electrophysiological studies of the STT show that cardiopulmonary afferent input most commonly excites cells with proximal somatic receptive fields (Hobbs et al. 1992). Cardiopulmonary input strongly excites approximately 80% of the STT cells with proximal somatic receptor fields but only weakly excites 35% of the cells with distal somatic input. Thus, the relationship of cells with excitatory visceral input and proximal axial fields is highly significant. These neurophysiological observations support the human studies that angina pectoris is most commonly felt in the proximal and axial regions of the left arm and chest. The frequency distribution of angina pectoris shows that the chest is involved more than 95% of the time, the pain radiates 30–60% of the time to the left proximal shoulder and less involvement occurs down the arm (Sampson and Cheitlin 1971). Proximal and axial pain is common for all forms of visceral pain.

#### Deep, Dull, Diffuse, Aching Pain

The final characteristic of angina pectoris is the deep, diffuse, dull nature of the symptoms. These sensations

are comparable to muscle pain. That is, the pain is typically deep and aching and is often associated with referred muscle hyperalgesia. The similarity of muscle pain and visceral pain was shown in patients who suffer frequently from angina pectoris referred unilaterally to the chest and radiating down the inner aspect of the left arm (Lewis 1942). These patients could not distinguish their anginal pain from pain they experienced when hypertonic saline solution was injected into the interspinous ligament of the left eighth cervical or first thoracic spinal segment. The pain is diffuse, continuous, and difficult to describe, although it can be identified as causing suffering (Lewis 1942).

#### Visceral Pain and Hyperalgesia

Human studies show that referred muscle hyperalgesia resulting from a diseased visceral organ is a common presentation in the clinic (Giamberardino et al., 1993). Although this section focuses on the results of hyperalgesia from different visceral organs, the possibility of hyperalgesia resulting from angina pectoris should also be considered. Patients suffering pain caused by calculosis of the upper urinary tract experience muscular hyperalgesia with less involvement of overlying cutaneous structures (Giamberardino et al. 1994; Vecchiet et al. 1989). Experimental studies also show that stimulation of the ureter results in muscular hyperalgesia and ▶ central sensitization of dorsal horn cells (Giamberardino et al. 1997; Laird et al. 1996). Their results show that muscle and deep structures contribute to referred pain resulting from visceral diseases, while

cutaneous pain plays a much smaller role. Evidence exists to suggest that the STT plays a role in processing sensations associated with muscle changes resulting from visceral pain. This evidence is based on studies showing that STT cells responding to nociceptive cardiac information received the most potent somatic inputs from muscle in the proximal structures. In contrast, cells with distal cutaneous input received very little if any noxious cardiac input (Hobbs et al. 1992). Thus, converging input from deep tissue and visceral afferent fibers onto STT cells may provide a basis for explaining why visceral pain, such as that resulting from myocardial ischemia, is felt predominantly as a deep or localized suffering pain, generally in proximal structures such as muscles, tendons and ligaments. It also supports the idea that some hyperalgesia may remain after episodes of angina pectoris.

## References

1. Apkarian AV, Hodge CJ Jr (1989) Primate spinothalamic pathways II. The cells of origin of the dorsolateral and ventral spinothalamic pathways. *J Comp Neurol* 288:474–492
2. Bennet JR, Atkinson M (1966) The differentiation between oesophageal and cardiac pain. *Lancet* 2:1123–1127
3. Bonica JJ (1990) Management of pain. Lea & Febiger, London, pp 133–179
4. Foreman RD (1997) Organization of visceral input. In: Yaksh TL et al. (eds) *Anesthesia: biologic foundations*. Lippincott-Raven, Philadelphia, pp 663–683
5. Foreman RD (1999). Mechanisms of cardiac pain. *Ann Rev Physiol* 61:143–167
6. Giamberardino MA, Valente R, Vecchiet L (1993) Muscular hyperalgesia of renal/ureteral origin. In: Vecchiet L, Albe-Fessard D, Lindblom L (eds) *New trends in referred pain and hyperalgesia*. Elsevier, New York, pp 149–160
7. Giamberardino MA, de Bigotina P, Martegiani C et al. (1994) Effects of extracorporeal shock-wave lithotripsy on referred hyperalgesia from renal/ureteral calculosis. *Pain* 56:77–83
8. Giamberardino MA, Valente R, Affaitati G et al. (1997) Central neuronal changes in recurrent visceral pain. *Int J Clin Pharmacol Res* 17:63–66
9. Harrison TR, Reeves TJ (1968) Patterns and causes of chest pain. In: *Principles and problems of ischemic heart disease*. Year Book Med, Chicago, pp 197–204
10. Hobbs SF, Chandler MJ, Bolser DC et al. (1992) Segmental organization of visceral and somatic input onto C<sub>3</sub>-T<sub>6</sub> spinothalamic tract cells of the monkey. *J Neurophysiol* 68:1575–1588
11. Laird JMA, Roza C, Cervero F (1996) Spinal dorsal horn neurons responding to noxious distension of the ureter in anesthetized rats. *J Neurophysiol* 76:3239–3248
12. Lewis T (1942) *Pain*. Macmillan, New York
13. Nowicki D, Szulczyk P (1986) Longitudinal distribution of negative cord dorsum potentials following stimulation of afferent fibres in the left inferior cardiac nerve. *J Auton Nerv Syst* 18:185–197
14. Ruch TC (1961) Pathophysiology of pain. In: Ruch TC, Patton HD, Woodbury JW et al (eds) *Neurophysiology*. Saunders, Philadelphia, pp 350–368
15. Sampson JJ, Cheitlin MD (1971) Pathophysiology and differential diagnosis of cardiac pain. *Prog Cardiovasc Dis* 23:507–531
16. Sugiura Y, Terul N, Hosoya Y (1989) Difference in distribution of central terminals between visceral and somatic unmyelinated (C) primary afferent fibers. *J Neurophysiol* 62:834–40
17. Vecchiet L, Giamberardino MA, Dragani L et al. (1989) Pain from renal/ureteral calculosis: evaluation of sensory thresholds in the lumbar area. *Pain* 36:289–95
18. Willis WD, Westlund KN (1997) Neuroanatomy of the pain system and of the pathways that modulate pain. *J Clin Neurophysiol* 14:2–31

## Spinothalamocortical Pathway

### Definition

The spinothalamocortical pathway is the somatosensory pathway that originates mainly in the dorsal horn and projects to various nuclei within the thalamus that, in turn, project to various regions within the cerebral cortex.

► [Spinothalamic Tract Neurons, in Deep Dorsal Horn](#)

## Spinothalamocortical Projections from SM

VJEKOSLAV MILETIC

School of Veterinary Medicine, University of Wisconsin-Madison, Madison, WI, USA  
vam@svm.vetmed.wisc.edu

### Synonyms

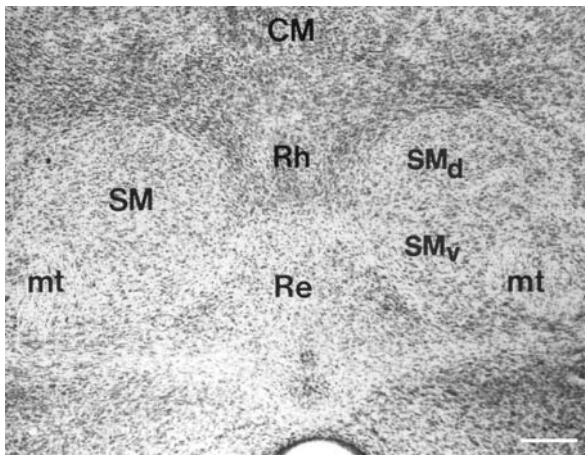
Nucleus Gelatinosus

### Definition

The ► [nucleus submedius \(SM\)](#) is a small oblong nucleus that is located ventromedial to the internal medullary lamina of the thalamus and is bounded by the nucleus reuniens medioventrally, the rhomboid and central medial nuclei mediodorsally and the mammillothalamic tract ventrolaterally (Fig. 1). In the cat, the dorsal portion of the SM receives topographically organized projections exclusively from neurons located in ► [lamina I](#) of both the medullary (trigeminal) and spinal ► [dorsal horn](#) (Craig and Burton 1981). In the rat, the trigeminal, and especially spinal, afferent projections are substantially smaller than in the cat. Those rat spinal neurons that do send their axons to the SM are located in deeper spinal laminae, rather than lamina I (Dado and Giesler 1990). Based on their data, Craig and Burton (1981) proposed that the SM might play an important role in ► [nociception](#).

### Characteristics

Coffield et al. (1992) employed the fluorescent tracers Fluoro-Gold and 1,1'-Diiodo-3,3,3,3-tetramethyl indocarbocyanine perchlorate (DiI) as retrograde markers to examine the organization of reciprocal connections between the SM and the ► [ventrolateral orbital cortex \(VLO\)](#) and to investigate the connections of both of these areas with the midbrain in the rat.



**Spinothalamocortical Projections from SM, Figure 1** Photomicrograph of a cresyl violet-stained section representative of the rat ventromedial thalamus in the coronal plane (50  $\mu\text{m}$  thick section; magnification = 10 $\times$ ). The SM is bounded dorsomedially by the rhomboid (Rh) and central medial (CM) nuclei, ventromedially by the reuniens nucleus (Re) and ventrolaterally by the mammillothalamic tract (mt). The dorsal part of the SM (SM<sub>d</sub>) is separated from the ventral part (SM<sub>v</sub>) by a thin fiber lamina extending mediolaterally. Dorsal is up. Scale bar = 200  $\mu\text{m}$ .

#### VLO Neurons Retrogradely Labeled from the SM (Fig. 2)

► **Retrogradely labeled** neurons were observed bilaterally throughout the rostrocaudal extent of the VLO, with the majority of labeled cells located ipsilaterally. Most of the labeled neurons were confined to cortical layers 5 and 6. Densely packed cells were found in layer 5, with more diffuse labeling present in layer 6. In general, when the dye injection filled the whole SM, labeled neurons were concentrated in a narrow band bordering the medial edge of the VLO, curving ventrally toward the olfactory cortex. This was especially evident in the caudal aspect of the VLO. Fewer labeled neurons were noted in layers 5 and 6 of the lateral edge of the VLO and lateral orbital cortex (LO). This distribution of labeled cells was consistent from rat to rat. More diffusely located, labeled neurons were noted in layers 5/6 of the medial prefrontal cortex (medial orbital cortex, cingulate cortex areas 1 and 3, frontal cortex area 2).

Variations in labeling were noted when different regions of the SM were injected. When the injection was centered in the dorsal SM (with little or no dye spread into the ventral SM), the retrogradely labeled neurons extended from the lateral VLO rostrally to the medial VLO caudally. Conversely, when the dye injection included mostly the ventral SM, the greatest number of retrogradely labeled cells extended from the medial VLO rostrally to the lateral VLO caudally. The number of retrogradely labeled neurons in the medial prefrontal cortex increased with the spread of the injection site into the rhomboid and reuniens nuclei. Injection sites centered dorsal to the SM (e.g., in central medial, interanterodorsal and mediodorsal nuclei) or medial to the SM (rhomboid and reuniens nuclei) resulted in

decreased labeling in the VLO and a corresponding increase in labeling in the medial prefrontal cortex.

Retrogradely labeled neurons were also seen in other areas of the prefrontal cortex. These included a limited bilateral focus in area 2 of the frontal cortex and diffuse labeling in the ► **contralateral** VLO, LO and cingulate cortical areas 1 and 3. Diffusely located, retrogradely labeled neurons were also noted in the somatosensory cortex, the amygdaloid nuclei and the globus pallidus (not illustrated).

#### SM Neurons Retrogradely Labeled from the VLO (Fig. 2)

The greatest number of retrogradely labeled SM neurons was noted when the injection site was centered around or encompassed the ventrolateral and rostral aspect of the VLO, including the medial aspect of the LO. The label in the SM was invariably ► **ipsilateral** with few SM neurons labeled ► **contralateral** to the injection site.

Different areas of the SM were labeled differently depending on the placement of the dye in the VLO. When the VLO injection was located medially, retrogradely labeled neurons were noted in the anteroventral, but not dorsal, SM. The dorsal SM was labeled when the injection was situated more laterally and ventrally in cortical layers 1–3. In addition, when the injection site was centered more medially to include the medial and ventral orbital cortices, other thalamic nuclei (mediodorsal, central medial, anteromedial) contained labeled neurons. When the injection spread more ventrally to include the dorsal and medial parts of the rhinal sulcus (layer 1), then the thalamic ventromedial nucleus was labeled. When the injection site was located in the medial and caudal aspect of the VLO, no label was noted in the SM. Injection into the olfactory cortex (just ventral to VLO) or the claustrum (just caudal to VLO) did not lead to labeling in the SM.

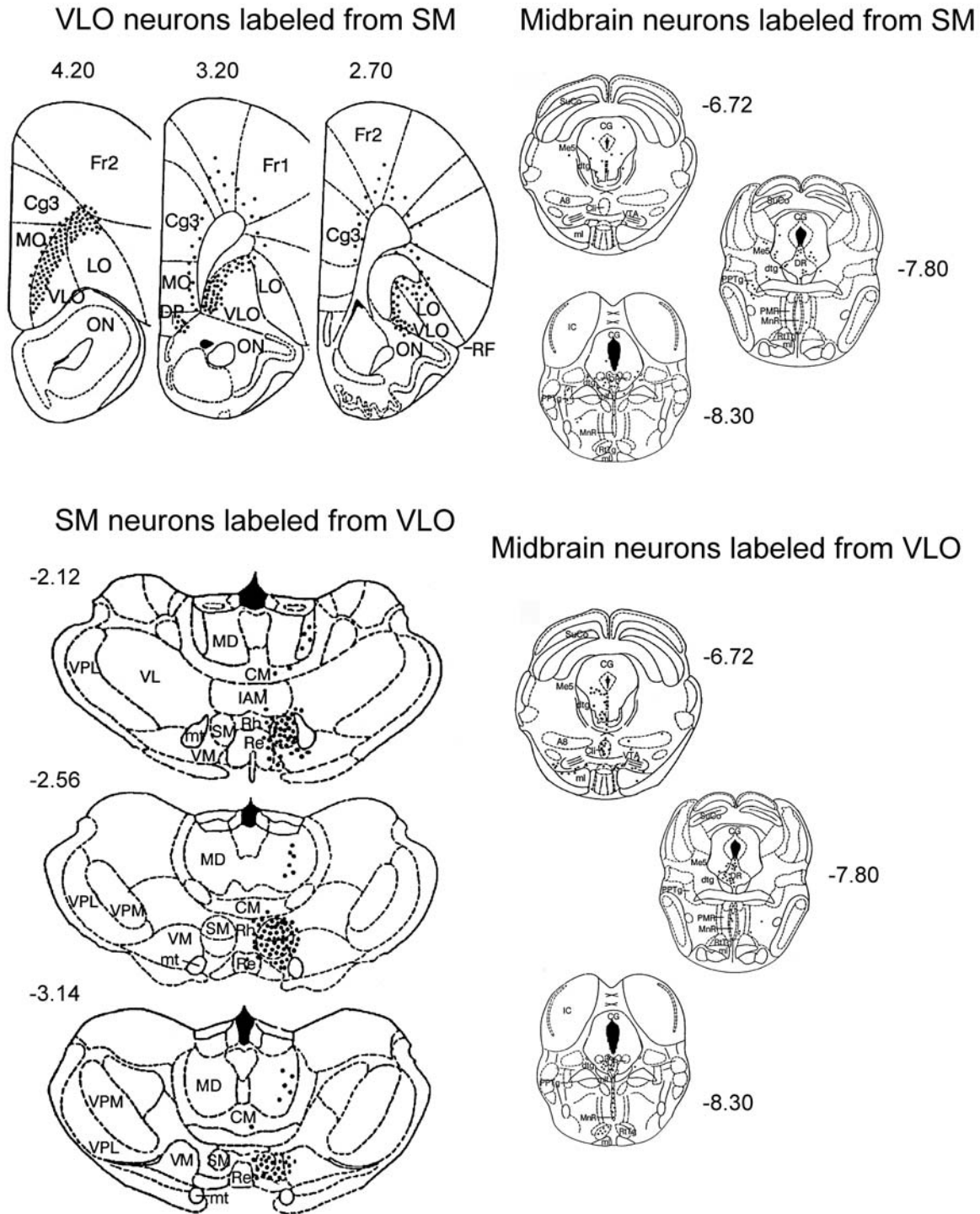
#### Midbrain Neurons Retrogradely Labeled from the VLO (Fig. 2)

Labeled neurons were found throughout the rostrocaudal extent of the ventral ► **periaqueductal gray** (PAG). Most of the labeled neurons were seen in the contralateral caudal 3/4 of the PAG, although some ipsilateral labeling was also noted. No labeled neurons were seen in the dorsal PAG. Many of the labeled neurons were found along the ventral midline of the PAG, in the dorsal raphe nucleus as well as deeper midline nuclei including the caudal linear and median raphe nuclei. A few neurons were seen in the raphe magnus. Labeled neurons were also found in the substantia nigra (mostly contralateral; not illustrated). Occasionally, neurons were found scattered in the mesencephalic reticular formation and the tectal nuclei.

#### Midbrain Neurons Retrogradely Labeled from the SM (Fig. 2)

The number of midbrain neurons labeled from the SM was smaller than those labeled from the VLO. The location of neurons in the ventral PAG and dorsal raphe





labeled from the SM overlapped with those labeled from the VLO, although they appeared more scattered in their distribution. In experiments in which other mid-line thalamic nuclei were included in the injection site, increased labeling occurred in the ventral and dorsal PAG and the raphe nuclei.

These data provide anatomical evidence for the existence of a neural circuit between the SM, VLO and the midbrain PAG. In the prefrontal cortex, input from the SM terminates rostrally within the lateral and ventral areas of the VLO. Conversely, the cortical input to the SM originates from the medial and dorsal parts of the



◀ **Spinothalamocortical Projections from SM, Figure 2** Schematic illustrations of the distribution of retrogradely labeled neurons (black dots). The dots are meant to indicate only density and distribution, and not actual numbers of neurons. The numbers represent rostrocaudal coordinates from the bregma expressed in mm (negative is caudal, positive is rostral). These drawings are slightly modified copies of appropriate sections from the atlas of Paxinos and Watson (1986). Only selected nuclei are labeled. Abbreviations: A8, dopaminergic cells; Cg3, cingulate cortex area 3; CG, central gray; Cli, caudal linear raphe nucleus; CM, central medial thalamic nucleus; DP, dorsal peduncular cortex; DR, dorsal raphe nucleus; dtg, dorsal tegmental bundle; Fr1, frontal cortex; area 1; Fr2, frontal cortex; area 2; IAM, interanterodorsal thalamic nucleus; IC, inferior colliculus; LO, lateral orbital cortex; MD, medial dorsal thalamic nucleus; Me5, mesencephalic trigeminal nucleus; ml, medial lemniscus; mlf, medial longitudinal fasciculus; MnR, median raphe nucleus; MO, medial orbital cortex; mt, mammillothalamic tract; ON, olfactory nuclei; PAG, periaqueductal gray; PMR, paramedian raphe nuclei; PPTg, pedunculo-pontine tegmental nucleus; Re, reuniens thalamic nucleus; RF, rhinal fissure; Rh, rhomboid thalamic nucleus; RMg, raphe magnus nucleus; RTg, reticulotegmental nucleus pons; SM, nucleus submedius or nucleus gelatinosus; SuCo, superior colliculus; VL, ventral lateral thalamic nucleus; VLO, ventral lateral orbital cortex; VM, ventral medial thalamic nucleus; VPL, ventral posterolateral thalamic nucleus; VPM, ventral posteromedial thalamic nucleus; VTA, ventral tegmental area.

VLO. In addition, neurons from the ventrolateral PAG and the raphe nuclei project to the midline nuclei of the thalamus, including a small projection to the SM. Regions within the ventrolateral PAG and raphe nuclei project to the VLO and these regions overlap with those that project to the SM.

These data suggest that the SM may provide another link between peripheral noxious input and the limbic, motor and autonomic systems. The PAG is both the origin and recipient of a diverse array of ascending and descending neural input (Beitz 1982). In particular, the ventral PAG appears strategically situated to transmit or modulate nociceptive inputs between the lower brainstem, thalamus and cortex. Hence, the connections of the SM with the VLO and the ventral PAG may allow SM neurons to be part of neural circuits involved in both pain and analgesia.

## References

1. Beitz AJ (1982) The organization of afferent projections to the midbrain periaqueductal grey of the rat. *Neuroscience* 7:133–159
2. Coffield JA, Bowen KK, Miletic V (1992) Retrograde analysis of reciprocal projections between the rat ventrolateral orbital cortex and the nucleus submedius, and their connections to the midbrain. *J Comp Neurol* 321:488–499
3. Craig AD Jr, Burton H (1981) Spinal and medullary lamina I projection to nucleus submedius in medial thalamus: A possible pain center. *J Neurophysiol* 45:443–466
4. Dado RJ, Giesler GJ Jr (1990) Afferent input to nucleus submedius in rats: Retrograde labeling of neurons in the spinal cord and caudal medulla. *J Neurosci* 10:2672–2686
5. Paxinos G, Watson C (1986) *The Rat Brain in Stereotaxic Coordinates*, 2nd edn. Academic Press, New York

## Spinothalamocortical Projections to Ventromedial and Parafascicular Nuclei

LENAÏC MONCONDUIT, LUIS VILLANUEVA  
INSERM, University of Clermont-Ferrand, Clermont-Ferrand, France  
luis.villanueva@u-clermont1.fr

### Definition

Spinoreticulothalamic networks convey nociceptive signals from the whole body to widespread areas of the neocortex, *via* the ▶ **ventromedial nuclei** and parafascicular thalamic nuclei. This pathway allows any painful

stimuli to modify cortical activity in a widespread manner, thus altering behavioral levels of attention and / or the planning of programmed movements.

### Characteristics

It has been known for a long time that the majority of ascending axons located in the anterolateral quadrant of the spinal white matter, which contains the pain pathways in mammals, terminate within the medullary ▶ **reticular formation** (Bowsher 1976; Villanueva et al. 1996). Interestingly, the notion of a receptive centre (centrum receptorium or sensorium) within the reticular formation was introduced by Kohnstamm and Quensel (1908) for bulbar reticular areas receiving spinal afferents. In a study of retrograde cellular reactions in the bulbar reticular formation to high mesencephalic lesions, the same authors demonstrated ascending pathways connecting the centrum receptorium with higher levels of the brain. They postulated that reticulo-thalamic projections might be part of a polysynaptic path responsible for the conduction of pain and temperature to higher brain levels.

Thus, in addition to spinal pathways that carry nociceptive information directly to the diencephalon, some nociceptive information is relayed to the thalamus *via* the medullary reticular formation. Widespread areas throughout the brainstem reticular formation contain neurons that are responsive to noxious stimuli. Among these medullary areas, the ▶ **subnucleus reticularis dorsalis** (SRD) contains neurons that respond and encode selectively noxious stimuli from any part of the body (Villanueva et al. 1996).

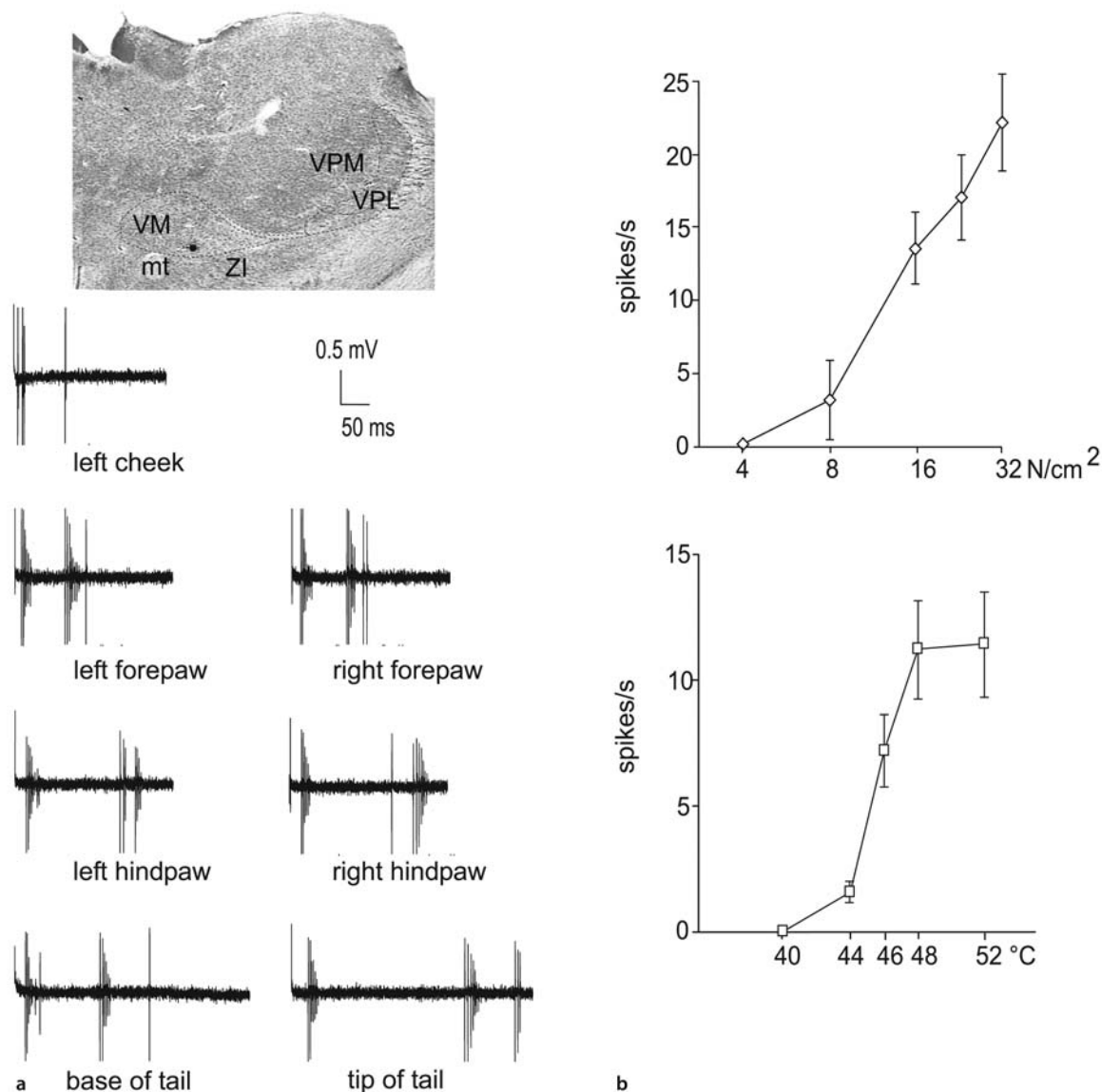
Diencephalic projections from the SRD are essentially contralateral and terminate primarily in the lateral half of the ventromedial thalamus (VMI), almost throughout its rostro-caudal extent. Moreover, dense terminals are also located in the lateral aspect of the parafascicular nucleus (PF) (Desbois and Villanueva 2001; Villanueva et al. 1998). Reticulo-PF projections also originate from the ▶ **gigantocellular reticular nucleus**, an area situated rostrally to the SRD, which has also been implicated in nociceptive processing (see refs. in Bowsher 1976).

PF units respond to both cutaneous and visceral noxious stimuli in the rat (Berkley et al. 1995). These neurons are driven from large cutaneous receptive fields and respond to intense, frankly noxious cutaneous and vis-

ceral stimuli. Noxious-responding units recorded in the PF thalamic nucleus of alert monkeys also display large receptive fields and some discriminate changes in the intensity of noxious stimuli (Bushnell and Duncan 1989). The lateral PF projects to the dorsolateral part of the caudate-putamen, the lateral subthalamic nucleus, which itself has reciprocal projections with pallidal and nigral motor relays and the sensorimotor cortex (Groenewegen and Berendse 1994). In addition to its striatal afferents, the lateral PF area projects mainly to the lateral agranular field of motor cortex and the rostral parietal cortex. Thus, as most lateral PF projections are

related to brain structures involved in motor processing, SRD-PF connections could mediate some motor reactions following noxious stimulation.

VM/ thalamic neurons are exclusively driven by activities in A $\delta$ - and C-cutaneous **▶ polymodal nociceptors** from the entire body surface (Monconduit et al. 1999). These neurons present **▶ whole body receptive fields**, which are activated by graded stimuli. A linear relationship exists between the evoked firing rate and the intensities of both thermal and mechanical stimuli only within noxious ranges (Fig. 1). In some cases, VM/ neurons develop residual activity and / or after-discharges

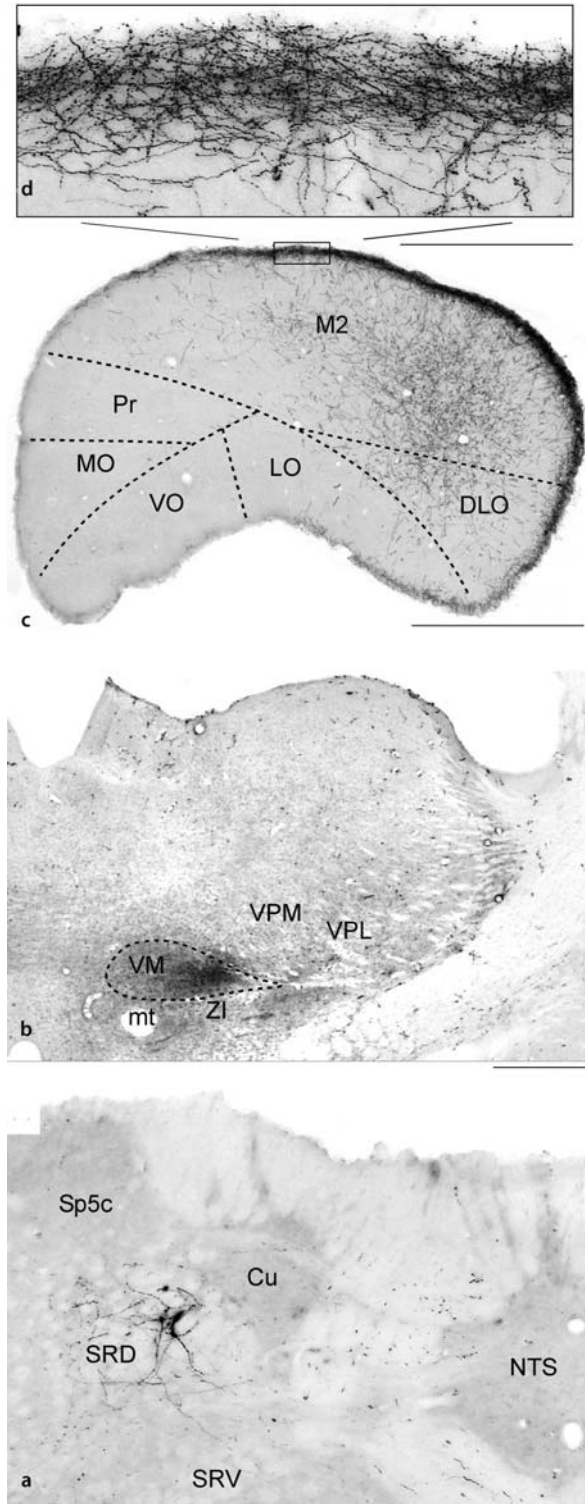


**Spinothalamic Projections to Ventromedial and Parafascicular Nuclei, Figure 1** (a) Single sweep recordings showing A $\delta$ - and C-fiber evoked responses of a VM/ neuron (black dot) following supramaximal percutaneous electrical stimulation (2 ms duration square-wave pulses) of different parts of the body. (b) Cumulative results showing the magnitudes of the responses of VM/ neurons to graded mechanical ( $n = 7$ ) or thermal ( $n = 16$ ) stimulation of the ipsilateral hind paw. (Adapted from Monconduit et al. 1999).

following strong noxious stimulations. Systemic morphine depresses VMI neuronal activities evoked by A $\delta$ - and C-fibers and by thermal noxious stimuli, in a dose-dependent and naloxone-reversible fashion (Monconduit et al. 2002). Similar reductions in the C-fiber and noxious thermal evoked activities were obtained with equivalent doses of morphine, suggesting that morphine selectively depresses inputs to the VMI that arise from cutaneous polymodal nociceptors. By contrast, these neurons did not respond to levels of distension that could be considered to be innocuous or noxious of the intact and inflamed colon and rectum. Moreover, following inflammation induced by subcutaneous injections of mustard oil, VMI neurons developed responses to both thermal and mechanical innocuous skin stimulation (Monconduit et al. 2003). Nociceptive activity in the VMI arises primarily from monosynaptic inputs from the medullary SRD, since a strong reduction in VMI responses was obtained following blockade of the contralateral SRD.

VMI neurons in turn relay the widespread nociceptive inputs from the SRD to the whole layer I of the dorsolateral neocortex. VMI projections are organized as a widespread dense band, covering mainly layer I of the dorsolateral anterior-most aspect of the cortex (Fig. 2; Desbois and Villanueva 2001). This band diminishes progressively as one moves caudally, disappearing completely at 1 mm caudal to bregma level. This reticulo-thalamo-cortical network could allow any painful stimuli to modify cortical activity in a widespread manner, since thalamocortical interactions in layer I are assumed to be a key substrate for the ► **synchronization** of large ensembles of neurons across extensive cortical territories and have been associated with changes in states of consciousness. In this respect, layer I inputs may act as a “mode switch”, by activating a spatially restricted low-threshold zone in the apical dendrites of layer V pyramidal neurons and evoking regenerative potentials propagating toward their soma, which in turn could switch layer V neurons into the ► **burst firing mode** (Larkum and Zhu 2002). This hypothesis fits with the facts that painful stimuli can elicit widespread cortical activation in human beings and that

increasing stimulus intensity increases the number of brain regions activated, including ventral posterior and medial thalamic regions and prefrontal, premotor and motor cortices (Porro 2003).



**Spinothalamocortical Projections to Ventromedial and Parafascicular Nuclei, Figure 2** Bright field images showing an example of the main connections from the nociceptive (lateral) region of the ventromedial thalamus, the VMI (b). VMI was labeled following an electrophoretic ejection of 3000 molecular weight lysine-fixable dextran, a compound conveyed by both anterograde and retrograde axonal transport and revealed by immunohistochemistry. VMI cortical efferents terminated as a dense band in layer I of the dorsolateral neocortex (c). They appeared as dense clusters of terminal fibers with small varicosities (d). Afferents to VMI appeared as Golgi-like labeled cells (a) that were confined to the dorsal aspect of the medullary subnucleus reticularis dorsalis (SRD). Scale bars: a, b, c = 1 mm, d = 100  $\mu$ m. Other abbreviations: DLO, dorsolateral orbital cortex; LO, lateral orbital cortex; M2, secondary motor cortex; MO, medial orbital cortex; PrL, prelimbic cortex; SRV, subnucleus reticularis ventralis.

VM/ neurons cannot be clearly assigned to the clear-cut described ► [medial pain system](#) or the ► [lateral pain system](#). They have fine discriminative properties, as shown by their selective responsiveness to noxious stimuli and their ability to encode precisely different kinds of cutaneous stimuli within noxious ranges. Their activation by innocuous stimuli occurs only under conditions of experimental allodynia. However, they lack topographical discrimination, as illustrated by their whole body receptive fields and their ability to respond to widespread noxious stimuli of cutaneous, muscular or visceral origins. The VM/ may constitute an important thalamic nociceptive branch of what was originally termed the “ascending reticular activating system” (Herkenham 1986; Jasper 1961).

## References

1. Berkley K, Benoist JM, Gautron M et al. (1995) Responses of neurons in the caudal intralaminar thalamic complex of the rat to stimulation of the uterus, vagina, cervix, colon and skin. *Brain Res* 695:92–95
2. Bowsher D (1976) Role of the reticular formation in responses to noxious stimulation. *Pain* 2:361–378
3. Bushnell MC, Duncan GH (1989) Sensory and affective aspects of pain perception: is medial thalamus restricted to emotional issues? *Exp Brain Res* 78:415–418
4. Desbois C, Villanueva L (2001) The organization of lateral ventromedial thalamic connections in the rat: a link for the distribution of nociceptive signals to widespread cortical regions. *Neuroscience* 102:885–898
5. Groenewegen HJ, Berendse HW (1994) The specificity of the “non-specific” midline and intralaminar thalamic nuclei. *TINS* 17:52–57
6. Herkenham M (1986) New perspectives on the organization and evolution of nonspecific thalamocortical projections. In: Jones EG, Peters A (eds) *Cerebral Cortex*, vol 5, sensory-motor areas and aspects of cortical connectivity. Plenum, New York, pp 403–445
7. Jasper HH (1961) Thalamic reticular system. In: Sheer DE (ed) *Electrical stimulation of the brain*. University of Texas, Austin, pp 277–287
8. Kohnstamm O, Quensel F (1908) Das centrum receptorium (sensorium) der formatio reticularis. *Neurol Zbl* 27:1046–1047
9. Larkum ME, Zhu JJ (2002) Signaling of layer 1 and whisker-evoked  $Ca^{2+}$  and  $Na^{+}$  action potentials in distal and terminal dendrites of rat neocortical pyramidal neurons *in vitro* and *in vivo*. *J Neurosci* 22:6991–7005
10. Monconduit L, Bourgeois L, Bernard JF et al. (1999) Ventromedial thalamic neurons convey nociceptive signals from the whole body surface to the dorsolateral neocortex. *J Neurosci* 19 9063–9072
11. Monconduit L, Bourgeois L, Bernard JF et al. (2002) Systemic morphine selectively depresses a thalamic link of widespread nociceptive inputs in the rat. *Eur J Pain* 6:81–87
12. Monconduit L, Bourgeois L, Bernard JF et al. (2003) Convergence of cutaneous, muscular and visceral noxious inputs onto ventromedial thalamic neurons in the rat. *Pain* 103:83–91
13. Porro CA (2003) Functional imaging and pain: behavior, perception, and modulation. *Neuroscientist* 9:354–369
14. Villanueva L, Bouhassira D, Le Bars D (1996) The medullary subnucleus reticularis dorsalis (SRD) as a key link in both the transmission and modulation of pain signals. *Pain* 67:231–240
15. Villanueva L, Desbois C, Le Bars D et al. (1998) Organization of diencephalic projections from the medullary subnucleus reticularis dorsalis and the adjacent cuneate nucleus: a retrograde and anterograde tracer study in the rat. *J Comp Neurol* 390:133–160

## Spiral CT

- [CT Scanning](#)

## Spiritual Problems

### Definition

Deeper concerns such as life after death, guilt regarding certain life events, the meaning of existence, or the perception of disease as punishment.

- [Cancer Pain Management, Interface Between Cancer Pain Management and Palliative Care](#)

## Splice Variants

### Definition

Different forms of a protein that result from the alternative splicing of the mRNA before translation.

- [Opioid Receptors at Postsynaptic Sites](#)

## Spondyloarthropathy

### Definition

Spondyloarthropathies are a group of related inflammatory joint diseases associated with the MHC class I molecule HLA-B27. Subgroups (with increased HLA-B27 frequency) are: ankylosing spondylitis (AS, 90%), reactive arthritis (ReA)/Reiter’s syndrome (RS, 80%), enteropathic arthritis associated with inflammatory bowel disease (IBD, 70%), Psoriatic arthritis (60%), isolated acute anterior uveitis (AAU, iritis or iridocyclitis, 50%), and undifferentiated SpA (USpA, 20–25%).

- [Chronic Low Back Pain, Definitions and Diagnosis](#)
- [Sacroiliac Joint Pain](#)

## Spondylolisthesis

### Definition

Spondylolisthesis is a defect in the construct of bone between the superior and inferior facets with varying degrees of displacement, so that the vertebra with the defect and the spine above that vertebra are displaced forward in relationship to the vertebrae below. It is usually due to a developmental defect or the result of a fracture.

- [Chronic Low Back Pain, Definitions and Diagnosis](#)
- [Lower Back Pain, Physical Examination](#)



## Spontaneous Aliquorhea

- ▶ Headache Due to Low Cerebrospinal Fluid Pressure

## Spontaneous Cerebrospinal Fluid (CSF) Leak

### Synonyms

CSF Leak

### Definition

A syndrome in which a positional headache occurs after a non-lumbar puncture induced CSF leak. Headache will occur out of the blue, normally with no inciting event (although repetitive valsalva maneuvers, cough, sneeze, strain, may induce leak). Headache will be better or absent in a supine position and severe in an upright position. Most common location of spontaneous CSF leaks is at the cervical-thoracic junction.

- ▶ New Daily Persistent Headache
- ▶ Orthostatic Headache
- ▶ Post-Lumbar Puncture Headache
- ▶ Primary Exertional Headache

## Spontaneous Dissection

### Definition

There is no obvious trauma involved; no trauma preceding the onset of symptoms, such as e.g. a car accident or a heavy hit to the neck.

- ▶ Headache due to Dissection

## Spontaneous Ectopia

- ▶ Ectopia, Spontaneous

## Spontaneous Intracranial Hypotension

- ▶ Headache Due to Low Cerebrospinal Fluid Pressure

## Spontaneous Nociceptive Behaviors

### Definition

Behaviors exhibited by animals, in response to a nociceptive stimulus (typically chemical), which are persistent in nature, and not simply a withdrawal reflex. In the formalin test, these behaviors include favoring, elevation, shaking or flinching, or licking/biting of the injected paw.

- ▶ Formalin Test

## Spontaneous Onset

### Definition

Pain that occurs for no apparent reason and cannot be attributable to a specific cause.

- ▶ Pain in the Workplace, Risk Factors for Chronicity, Job Demands

## Spontaneous Pain

### Definition

Pain without any obvious external stimuli, e.g. constant deep aching pain, constant superficial burning pain and paroxysms of brief lancinating pain. Spontaneous pain is thought to be elicited by epitopic discharge generated along axons of involved neurons.

- ▶ Antidepressants in Neuropathic Pain
- ▶ Causalgia, Assessment
- ▶ Diabetic Neuropathy, Treatment
- ▶ Dysesthesia, Assessment
- ▶ Neuropathic Pain Model, Partial Sciatic Nerve Ligation Model
- ▶ Nocifensive Behaviors, Muscle and Joint

S

## Spouse, Role in Chronic Pain

ROBERT D. KERNS, ALICIA A. HEAPY  
VA Connecticut Healthcare System and Yale University, Westhaven, CT, USA  
robert.kerns@va.gov, alicia.heapy@va.gov

### Synonyms

Social support; pain-relevant communication; significant others; pain behaviors; Solicitousness; distracting responding; Negative Responding

## Definition

► **Family systems theories** espouse that the patterns of family functioning play a dominant role in determining health and illness among family members. ► **Social support** generally refers to the availability or provision of instrumental and/or emotional assistance from ► **significant others**. The ► **operant conditioning model of chronic pain** hypothesizes that pain and pain-related disability may be maintained by environmental contingencies for overt, observable demonstrations of pain. ► **Pain-relevant communication** involving significant others refers to verbal and non-verbal exchanges in the context of a person's expressions of pain. These expressions of pain are often referred to as ► **pain behaviors**, and include distorted ambulation (i.e. use of a prosthesis, limping), facial/audible expressions of pain (e.g. verbal complaints of pain, grimacing), expressions of affective distress (e.g. sighing, crying), and seeking help (e.g. asking for assistance, taking pain medications). ► **Sollicitous responses** are defined as a set of positive responses (e.g. expressions of sympathy, taking over of duties and responsibilities) delivered by significant others, including the spouse or family members, contingent on the display of pain behaviors. ► **Distracting responses** refer to cues from significant others intended to encourage alternative, presumably more adaptive, well behaviors (e.g. increased activity, use of distraction to cope with pain) on the part of the person experiencing pain. ► **Negative or punishing responses** (e.g. expressions of irritation, ignoring) represent a third category of responses to the expression of pain. The ► **cognitive-behavioral transactional model of family functioning** emphasizes the role of cognitions and beliefs in the appraisal of pain and pain-related behavioral interactions.

## Characteristics

The influence of the social context, and particularly the family environment, on health and illness issues has been widely recognized and studied (Ramsey 1989; Schmaling and Sher 2000). Dominant models for understanding and explaining these influences, and for the development of family-based interventions, include family systems theories (Patterson 1988) and operant behavioral and cognitive-behavioral perspectives (Kerns and Weiss 1994). Within the chronic pain literature, there has been a similar call for attention to the role of the family and social context in studies of patient adjustment and adaptation (Nicassio and Radojevic 1993; Roy 1989).

The importance of the family's role can be traced, in part, to the dominance of behavioral and cognitive behavioral theories in chronic pain related research and practice (Fordyce 1976). Whereas social support has generally been accepted as having a positive, moderating or mediating role on health and recovery or adaptation to

illness, the operant conditioning model of chronic pain hypothesizes that the specific pattern of pain-relevant communication involving significant others, including family members, may either have positive, or negative, influences on important aspects of the chronic pain experience. According to the operant conditioning model of chronic pain, pain and pain-related disability may be maintained by environmental contingencies for overt expressions of pain, termed pain behaviors, even in the absence of continued nociception (Fordyce 1976). In particular, positive or solicitous responses from spouses and family members, contingent on pain behaviors, may serve to reinforce these maladaptive behaviors and encourage the development and maintenance of pain and pain-related disability. Examples of solicitous behavior include expressions of sympathy or concern for the spouse, physical assistance or performance of a task and encouraging rest and discouraging activity.

Recent reviews of the empirical literature informed by this model concluded that, in general, spouse solicitousness is significantly related to greater pain intensity, greater frequency of pain behavior, higher levels of disability, and increased help-seeking behaviors (Kerns and Otis 2003; Newton-John 2002). Interestingly, responses from significant others categorized as distracting responses, although likely intended to cue more adaptive behavior, have been found to be reliably positively related to poor outcomes. In contrast, frequency of negative or punishing responses has most often been found to be positively associated with increased activity in persons with chronic pain (Flor et al. 1987). Mood and global marital satisfaction appear to mediate these relationships (Newton-John 2002). Several studies have found that solicitousness only results in poorer pain outcomes in the context of a globally satisfying relationship. Higher rates of punishing responses, in the context of well-adjusted marriages, have been found to be associated with lower levels of pain intensity, but negative responses have been associated with greater pain intensity when marital satisfaction is low (Weiss and Kerns 1995). Marital satisfaction has also been identified as a significant predictor of depressive symptoms, and higher rates of punishing responses from spouses have been shown to be associated with higher levels of depression among persons with chronic pain (Turk et al. 1992). Further, one study found that the link between solicitousness and increased physical disability was only present among depressed patients (Romano et al. 1995). Overall, pain-related outcomes and spouse responses most closely reflect those predicted by operant principles in the context of higher levels of marital satisfaction, and depressive symptom severity appears to influence pain-related outcomes (Newton-John 2002).

The inclusion of cognitive factors in theoretical models has been advocated as a way to better understand this pattern of findings. The cognitive-behavioral trans-

actional model of family functioning emphasizes the role of cognitions and beliefs in the appraisal of pain and pain-related behavioral interactions (Kerns 1995; Kerns and Otis 2003). This model also promotes a more sophisticated understanding of the reciprocal influence among spousal interactions, the perceived effectiveness of those exchanges, and adaptation to pain. More sophisticated models, like the cognitive-behavioral transactional model, may be needed to untangle the complex relationships present among spouse behavior, marital satisfaction, mood and pain-related outcomes. In addition to examining how the behavior of the well spouse affects the adaptation of the person experiencing chronic pain, the effect on the well spouse of living with someone with chronic pain has also been examined. Although estimates vary, high rates of depression have been shown to exist in spouses of persons with chronic pain (Flor et al. 1987). However, studies investigating the consequences of living with someone with chronic pain have not demonstrated consistently negative outcomes. Although several studies have found that persons with chronic pain and their spouses report lower levels of marital and sexual satisfaction than spouses with chronic pain, several studies have found normal levels of marital satisfaction (Kerns and Otis 2003; Romano and Schmaling 2001).

Empirical investigations of the efficacy of pain treatments involving the spouse of the person with chronic pain have not demonstrated incremental efficacy beyond treatment of the individual alone (Kerns and Otis 2003). Unfortunately, the number of empirical studies has been small, and many studies have been marked by methodological shortcomings. For example, although controlled trials have examined treatments that included couples treatment components, the specific contribution of this component has not been extensively examined (Kerns and Otis 2003). Despite the wealth of studies that have demonstrated a link between spouse behavior and chronic pain, these findings have not been translated into the development of efficacious and theory-based interventions. Increased attention to the role of the spouse in treatment for chronic pain and methodologically rigorous studies are needed to advance pain treatment, and to fully realize the benefits of the increased knowledge of the role of the spouse in chronic pain outcomes.

## References

1. Flor H, Kerns RD, Turk DC (1987) The Role of Spouse Reinforcement, Perceived Pain, and Activity Levels of Chronic Pain Patients. *J Psychosom Res* 31:251–259
2. Fordyce WE (1976) *Behavioral Methods in Chronic Pain and Illness*. Mosby, St. Louis, MO
3. Kerns RD (1995) Family Assessment and Intervention. In: Nicassio PM and Smith TW (eds) *Managing Chronic Illness*. American Psychological Association, Washington, DC, pp 207–244
4. Kerns RD, Otis J (2003) Family Therapy for Persons Experiencing Pain: Evidence for its Effectiveness. *Sem Pain Med* 1:79–89
5. Kerns RD, Weiss LH (1994) Family Influences on the Course of Chronic Illness: A Cognitive–Behavioral Transactional Model. *Ann Behav Med* 16:116–130
6. Newton-John TRO (2002) Solicitousness and Chronic Pain: A critical review. *Pain Reviews* 9:7–27
7. Nicassio P, Radojevic V (1993) Models of Family Functioning and their Contribution to Patient Outcomes in Chronic Pain. *Motivation and Emotion* 17:349–356
8. Patterson JM (1988) Families Experiencing Stress: The Family Adjustment and Adaptation Response Model. *Family Systems in Medicine* 5: 202–237
9. Ramsey CN (1989) *Family Systems in Medicine*. Guilford Press, New York
10. Romano JM, Turner JA, Jensen MP et al. (1995) Chronic Pain Related Patient-Spouse Behavioral Interactions Predict Patient Disability. *Pain* 63:227–233
11. Romano JM, Schmaling KB (2001) Assessment of Couples and Families with Chronic Pain. In: Turk DC and Melzack R (eds) *Handbook of Pain Assessment*. Guilford Press, New York, pp 346–361
12. Roy R (1989) *Chronic Pain and the Family: A Problem-Centered Perspective*. Human Sciences Press, New York
13. Schmaling KB, Sher TG (2000) *The Psychology of Couples and Illness: Theory, Research and Practice*. American Psychological Association, Washington
14. Turk DC, Kerns RD, Rosenberg R (1992) Effects of Marital Interaction on Chronic Pain and Disability: Examining the Downside of Social Support. *Rehab Psychol* 37:259–274
15. Weiss LH, Kerns RD (1995) Patterns of Patient-Relevant Social Interactions. *Int J Behav Med* 2:157–171

## Sprained Ankle Pain Model

SUNG TAE KOO WONKWANG<sup>1</sup>, JIN MO CHUNG<sup>2</sup>

<sup>1</sup>Korea Institute of Oriental Medicine, Seoul, Korea

<sup>2</sup>Department of Neuroscience and Cell Biology, University of Texas Medical Branch, Galveston, TX, USA

stkoo@klom.re.kr, jmchung@utmb.edu

S

### Definition

Ankle sprain commonly occurs during participation in various strenuous sports, as well as during routine locomotive activity, and is a common source of persistent pain and reduction of mobility. The rat model of sprained ankle pain is produced by manually over-extending the lateral ligaments, without breaking them, to imitate a lateral ankle sprain in a human. The ankle sprain rat subsequently showed swelling of the ankle and a reduced stepping force of the affected limb for the next several days. The amount of reduction of foot stepping force is used as an index of the degree of pain generated by ankle sprain.

### Characteristics

The typical ankle sprain is caused by a combination of forces that tend to adduct, invert and plantar flex the talus beyond its physiological limit (Connolly 1981). Such motion causes avulsion of lateral ligaments, rupture of the adjacent capsule, and soft tissue hemorrhage and edema, resulting in severe discomfort and talar instabil-

ity (Cotler 1984; Liu and Nguyen 1999). Examination of the sprained ankle of the rat indicated that there was stretching of ligaments without a macroscopic tear. Such a condition is classified as a mild or grade 1 ankle sprain in humans (Brier 1999; Patel and Warren 1999). Grade 1 can be further subdivided into grade 1 and grade 1+, and rats in the present study displayed behaviors similar to human patients with the latter grade, in that they showed a mild loss of function, which recovered in 2–5 days (Brier 1999).

#### Procedure for Ankle Sprain Pain Model

Under general anesthesia, ankle sprain is produced by manually over-extending the lateral ligaments, without breaking them, to imitate a lateral ankle sprain in a human. As originally described by Koo et al. (2002), the right hind foot was repeatedly bent in the direction of simultaneous inversion and plantar flexion 60 times during a 1-minute period with gradually increasing force, so that the foot could eventually be bent to a position of 90° inversion and 90° plantar flexion from the resting position. During the next 1-minute period, the foot was further inverted so that it eventually reached 180° inversion (paw facing completely upward). Both of the above-mentioned 1-minute procedures were repeated one more time; therefore, the total procedure took 4 minutes.

#### Anatomical Observation

Careful observation of the ligaments around the ankle joint in normal rats revealed that the calcaneofibular, calcaneocuboid, and talonavicular ligaments are stretched during plantar flexion. During inversion, on the other hand, the talocalcaneal ligament was stretched along with the calcaneofibular and calcaneocuboid ligaments. Therefore, the ankle sprain procedure, which was the combination of the forceful plantar flexion and inversion, most likely induced stretching of four ligaments: calcaneofibular, calcaneocuboid, talonavicular, and talocalcaneal ligaments. Careful examination, under a dissecting microscope, of those four ligaments immediately after the sprain procedure indicated that there were no obvious signs of tearing of any ligaments. However, those ligaments were elongated and thus gaps between bones were widened. In addition, there was minor hemorrhaging on the retinaculum surrounding the extensor tendons (Koo et al. 2002).

#### Behavioral Changes

The rat subsequently showed swelling of the ankle and a reduced stepping force of the affected limb for the next several days. Measuring the amount of weight bearing force by the foot (Min et al. 2001; Koo et al. 2002) is employed as a behavioral test method to estimate the level of pain in the sprained ankle. The average weight bearing by the hind limb during normal gait is 60% of total body weight, which is reduced to less than 10% after ankle sprain.

Systemically injected morphine improved the stepping force in a dose dependent manner. The reduced stepping force of the hind limb after the induction of ankle sprain was nearly restored one hour after an intraperitoneal injection of morphine, at a dose of 5 mg/kg (Koo et al. 2002). The fact that morphine restored the reduced foot stepping force, suggests that measuring foot stepping force can be used as an index for ankle sprain pain.

Changes in foot stepping force were measured before and after induction of ankle sprain. Figure 1a shows the pattern of force generated by the stepping of the forelimb, and then the hind limb of one side, during locomotion in a normal rat.

The weight bearing on the forelimb was followed by the hind limb, with the latter being a little stronger, so that it reached about 60% of the rat's total body weight at the peak point. Immediately after the induction of ankle sprain, the rat started limping on the affected foot. To quantify the limping, the stepping force of the limb was measured. As shown in Figure 1b, for example, the stepping force was greatly reduced one day after induction of ankle sprain. Figure 1c shows average values of stepping force of the hind limb in a group of rats before, and at various times after, ankle sprain.

The stepping force was maximally reduced at the 12<sup>th</sup> hour after ankle sprain, and then gradually recovered afterward, so that it was fully recovered by the 5<sup>th</sup> day after the induction of ankle sprain.

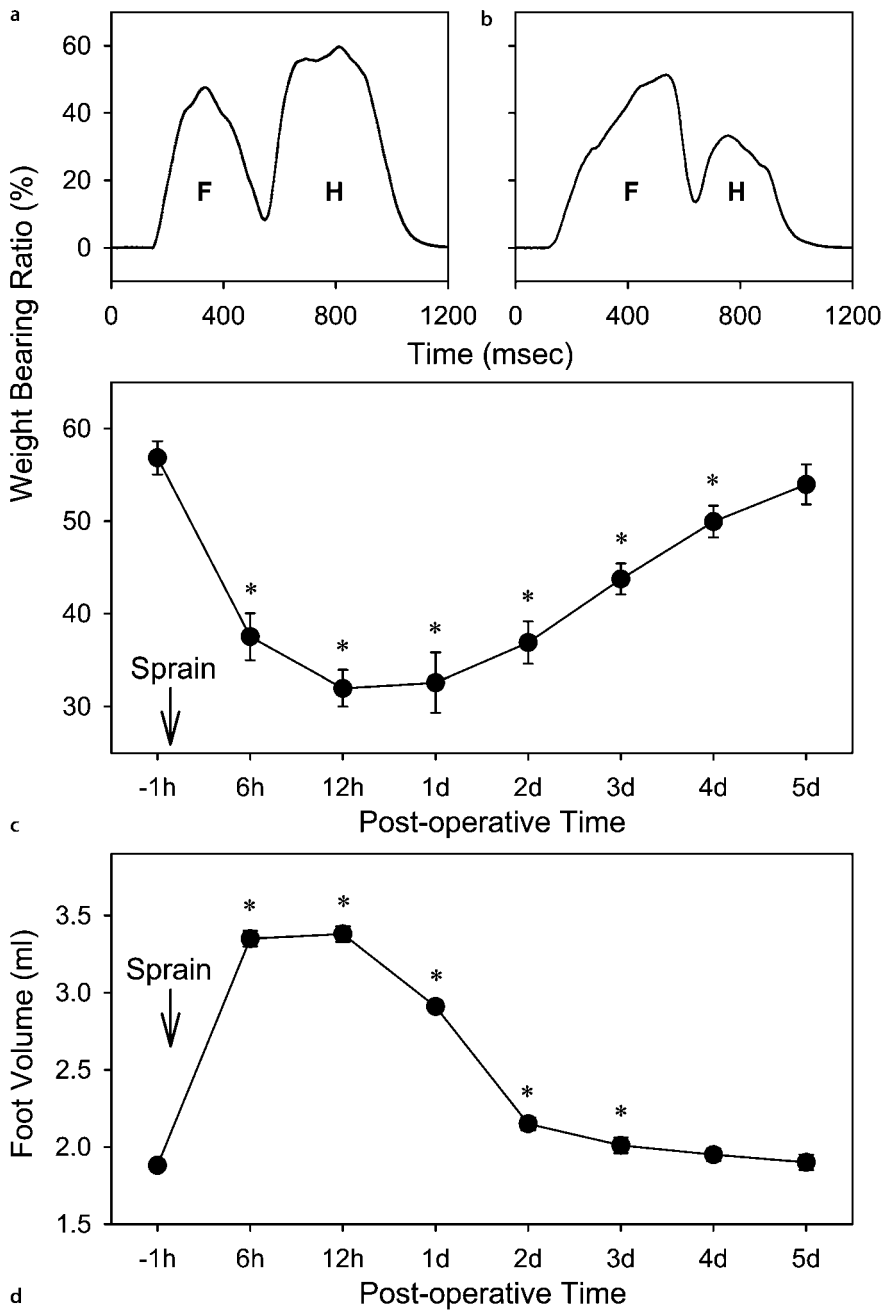
Daily measurements of weight bearing of the hind limb on the side contralateral to the sprained ankle revealed that there was a small increase (~5%) in weight bearing over the next 3 days, as compared to the preoperative control value (Koo et al. 2002). The reduced weight bearing on the foot after induction of ankle sprain, is because the rats are trying to avoid bearing weight on the affected foot due to pain associated with the sprained ankle.

The swelling of the ankle roughly paralleled the reduction in weight bearing. As shown in Figure 1d, the average volume of the foot was just below 2 ml before the induction of ankle sprain.

However, the ankle swelled rapidly after the sprain operation, so that it had almost doubled its volume in 6–12 hours. After that, the swelling rapidly subsided so that the foot volume was almost restored to normal volume by 2 days.

There is a certain level of endogenous opioid activity in the ankle sprain model, and blocking it further reduces the foot stepping force. Peritoneal injection of naltrexone, a non-selective long lasting opioid antagonist (Crabtree 1984), further reduced foot stepping force one hour after injection (Koo et al. 2002). The effect of naltrexone on the weight bearing suggests that the ankle sprain pain model triggers the release of endogenous opioids, so that the level of pain is maintained at a partially reduced state





**Sprained Ankle Pain Model, Figure 1** Changes in weight bearing of the limb and foot volume after ankle sprain. Foot stepping force was measured and expressed as weight bearing ratio to body weight. (a) Shows the pattern of the foot stepping force of both the forelimb (F) and hind limb (H) on one side of a normal rat. This rat weighed 230 g and stepping on the forelimb and hind limb bore about 45 and 60% of the body weight respectively when the rat walked at a normal pace. (b) Shows the pattern of foot stepping force of the same rat 1 day after ankle sprain. The amount of weight bearing of the hind limb was reduced to about half. (c) Shows the average values ( $\pm$  SEM) of peak foot stepping force of the hind limb of a group of nine rats 1 h before (-1 h) and at various times after induction of ankle sprain. (d) Shows the average volume ( $\pm$  SEM) of the foot 1 h before (-1 h) and various times after induction of ankle sprain. Foot volume increased rapidly due to swelling of the ankle after the sprain procedure. For both (c) and (d), post-operative time is expressed as h for hours and d for days. Asterisks indicate values significantly different ( $P < 0.05$ ) from the preoperative value (-1 h) (Koo et al. 2002).

S

## References

- Brier SR (1999) Primary Care Orthopedics. Mosby, St. Louis, pp 380–386
- Connolly JF (1981) De Palma's the Management of Fractures and Dislocations. W.B. Saunders Company, Philadelphia, pp 1806–1808
- Cotler JM (1984) Lateral Ligamentous Injuries of the Ankle. In: Hamilton WC (ed) Traumatic Disorders of the Ankle. Springer-Verlag, New York, pp 113–123
- Crabtree BL (1984) Review of Naltrexone, a Long-Acting Opiate Antagonist. Clin Pharm 3:273–280
- Koo ST, Park YI, Lim KS, Chung K, Chung JM (2002) Acupuncture Analgesia in a New Rat Model of Ankle Sprain Pain. Pain 99:423–431
- Liu SH, Nguyen TM (1999) Ankle Sprains and Other Soft Tissue Injuries. Curr Opin Rheumatol 11:132–137
- Min SS, Han JS, Kim YI, Na HS, Yoon YW, Hong SK, Han HC (2001) A Novel Method for Convenient Assessment of Arthritic Pain in Voluntarily Walking Rats. Neurosci Lett 308:95–98
- Patel DV, Warren RF (1999) Ankle Sprain: Clinical Evaluation and Current Treatment Concepts. In: Ranawat CS, Positano RG (eds) Disorders of the Heel, Rearfoot, and Ankle. Churchill Livingstone, Philadelphia, pp 323–340

## Spray and Stretch

### Definition

Spray and stretch is a technique used by manual therapists to treat trigger points associated with myofascial pain syndrome. The technique involves stretching muscles after first producing a superficial anesthesia with a coolant spray.

- ▶ Stretching

## Spreading Depression

### Definition

Very brief spreading wave of neuronal and glial depolarization, followed by a long-lasting suppression of neural activity, which is easily evoked in lissencephalic brains by mechanical or chemical stimuli of the brain surface (Leão 1944). As spreading depression invades the cortex at a speed (4–6mm/min) similar to that of spreading visual aura symptoms and the oligemia found to be associated with them in functional imaging studies, it is thought to be the pathophysiologic event underlying the migraine aura.

- ▶ Clinical Migraine without Aura
- ▶ Post-Seizure Headache

## SQUID

- ▶ Superconducting Quantum Interference Device

## SRD

- ▶ Subnucleus Reticularis Dorsalis

## SSDI

- ▶ Social Security Disability Insurance

## sSNI Model

- ▶ Neuropathic Pain Model, Spared Nerve Injury

## SNRIs

- ▶ Serotonin Norepinephrine Reuptake Inhibitors

## SSR

- ▶ Sympathetic Skin Response

## SSRIs

- ▶ Selective Serotonin Reuptake Inhibitors

## Static Allodynia

### Definition

Gentle pressure on skin evokes pain.

- ▶ Hyperpathia, Assessment

## Statistical Decision Making

### Definition

Statistical decision making is the only mathematical model that yields separate measures for discrimination and response bias.

- ▶ Statistical Decision Theory Application in Pain Assessment

## Statistical Decision Theory Application in Pain Assessment

W. CRAWFORD CLARK  
College of Physicians and Surgeons, Columbia  
University, New York, NY, USA  
clarkcr@pi.cpmc.columbia.edu

### Synonyms

Decision Theory; thresholds; pain; sensory decision theory; pain memory

### Definition

This article reviews recent developments in the application of the statistical decision making model (SDM) to problems in pain perception, pain report bias, pain memory and questionnaire construction as well as diagnosis and treatment outcomes. More generally, it applies to decisions made on the basis of evidence that is less than perfect. The general model quantifies correct decisions (hits and correct rejections) and incorrect decisions (misses and false affirmatives) concerning two objectively definable but confusable events A and B (Table 1). SDM determines two variables, the discrimination parameter quantifies the decision maker's ability to distinguish Event A from Event B, independently of response bias, while the criterion parameter quantifies

**Statistical Decision Theory Application in Pain Assessment, Table 1** Stimulus – Response Matrix for the Binary Decision Task

	Responses	
	“Pain” or “High” or “A” Occurred	“No Pain” or “Low” or “B” Occurred
Higher Intensity Stimulus or Event A	Hit (▶ Sensitivity)	Miss
Lower Intensity Stimulus (“blank”) or Event B	False Alarm	▶ Correct Rejection (▶ Specificity)

Statistical decision-making is the only mathematical model that yields separate measures for discrimination and for response bias

response bias, the decision maker’s tendency to favor, consciously or unconsciously, the reporting of one event over the other. Depending upon its various implementations, the model is known as ▶ **sensory decision theory** or ▶ **signal detection theory**, i.e. decisions about discrimination between a weaker or an absent sensory stimulus and a more intense stimulus, ▶ **memory decision theory**, i.e. discrimination between previously reported symptom descriptors and those not previously reported, the ▶ **situational pain questionnaire** decision model, i.e. discrimination between defined sets of less painful and more painful situations or scenarios, and the ▶ **medical decision-making model**, i.e. accuracy and risk/benefit payoffs of diagnostic and treatment decisions. A more detailed review of the SDM approaches to pain assessment appears elsewhere (Clark 2003).

**Characteristics**

**Introduction to Decision Theory**

There are various mathematical SDM models depending on the type of distributions assumed to be generated by Events A and B along the decision continuum. The discrimination and criterion measures  $d'$  and  $L_x$  assume Gaussian distributions,  $d_L$  and  $B_L$  assume logistic distributions, while the indices  $P(A)$  and  $B$  are non-parametric. The discrimination indices have been demonstrated to be relatively uninfluenced by differences in subjects’ response bias, while the criterion indices have been shown to be altered by changes in the decision-maker’s expectations, mood, motivation and other essentially attitudinal variables.

Excellent introductions to the parametric (Green and Swets 1966) and the non-parametric (McNicol 1972) approaches are available. There are two SDT models and data collection procedures. In the ▶ **single interval procedure** a response is obtained from a yes-no or a verbal category scale after each stimulus presentation; in the ▶ **forced choice procedure** a decision is made after two or more observation intervals concerning which interval contained the more intense stimulus. The forced choice model does not involve a response criterion because it is based on perceived intensity

alone; subjective qualities, e.g. whether it is painful or not, are irrelevant. The forced choice procedure provides the most sensitive and hence the most valid measure of neurosensory function that can be achieved. However, it does not determine the report criterion, an essential parameter in pain research. A data collection procedure which combines single interval and forced choice methods offers the best of both techniques.

**The Gaussian Model**

Statistical decision theory has spawned a number of mathematical models. Although the Gaussian model has now been eclipsed by McNicol’s nonparametric model, it is presented first because it provides a simple introduction to SDT in general and most studies in the early literature used it. If the underlying noise (N) and signal-plus-noise (SN) distributions are unit normal probability density functions of equal variance, the distance between the means of these distributions in terms of Z, the standard deviate, indexes discrimination,  $d'$ . If  $Z_n$  and  $Z_{sn}$  are the standardized distances of the criterion from the means of the N and SN distributions, then

$$d' = Z_n - Z_{sn}$$

Thus, to determine  $d'$  from the false alarm and hit probabilities, one proceeds to a published table that relates areas under the normal curve to values of the standard deviate, Z. If a rating scale is used instead of a binary decision, then there is one value of  $d'$  for each boundary between categories; accordingly, an eight-category scale would yield seven  $d'$ s.

The criterion, one value of  $L_x$  for each category boundary, is the logarithm of the likelihood ratio, that is, the ratio of the ordinate of the SN distribution to the ordinate of the N distribution at the criterion locus defined by hit and false alarm probabilities.

$$L_x = f_{SN}(y)/f_N(y)$$

Accordingly, to determine  $L_x$  from the false alarm and hit probabilities, one consults a table that relates areas under the normal curve to values of the ordinate. Further details and the requisite tables for  $d'$  and  $L_x$  are available in statistics texts.

**The Logistic Model**

In contrast to the Gaussian model, the logistic model assumes underlying logistic distributions. The logistic discrimination measure is computed from hit (H) and false alarm (FA) rates,

$$dL = \log n \{ [H(1-FA)] / [(1-H)FA] \}$$

The criterion, which is independent of  $dL$ , is

$$cL = 0.5 [ \log n \{ [(1-FA)(1-H)] / [(H)(FA)] \} ]$$

**Area Under the ROC Curve, the Nonparametric Model**

The nonparametric SDT makes no assumptions about the shapes of the underlying N and SN distributions. Here,  $P(A)$ , the area under the ROC curve indexes discrimination. Because  $P(A)$  is typically based on more than a single point on the ROC rating curve, the set



of points from a rating scale are integrated into the area measure,  $P(A)$ , making it superior to a series of single points obtained with the parametric measures,  $d'$  and  $dL$ . Because  $P(A)$  integrates all of the data points, the nonparametric model is useful in clinical research where time with a patient is limited. To compute  $P(A)$ , the points on the ROC curve, including (0,0) and (1,1), are joined by straight lines and the areas of the trapezoids beneath are summed. The area under the curve varies from 1.0, perfect discrimination of SN from N, to 0.5, chance level, that is the hit rates and false affirmative rates are equal. The criterion measure  $B$  integrates all of the data from the ROC curve and locates the median response category, that is, the rating scale criterion at which half the responses to both stimulus intensities are equal to categories above the criterion and half are equal to those below.

#### The Influence of Response Bias on the Traditional Threshold

Reduction in the amount of information reaching higher centers by an analgesic would be expected to decrease the discriminability index; thus  $d'$  has been shown to decrease following administration of morphine (Yang et al. 1979) or a carbocaine local nerve block (Clark and Yang 1974). A number of SDT studies have demonstrated that the traditional sensory threshold is strongly influenced by changes in the report criterion. Yang et al. (1985) determined that compared to healthy controls, back pain patients set a more stoical criterion, higher  $B$ , probably because they found the painful heat stimuli relatively innocuous compared to their clinical pain. However, when the traditional method of constant stimuli threshold was computed from the same data, the threshold was highly correlated with the psychological variable, the pain report criterion  $B$ , but not at all with the sensory parameter  $P(A)$ . Clearly, the belief that the traditional threshold is a pure measure of sensory sensitivity uninfluenced by the subject's attitude is a myth without any empirical support.

#### SDT Investigations of Cross-Cultural Differences

Cultural, gender and age based attitudes also influence the pain criterion (Clark 2003). In a study conducted in the Himalayas, Clark and Bennett Clark (1980) found that compared to Western trekkers the Nepalese porters reported far less pain (high criterion) to a series of noxious electrical stimuli of increasing intensity. However, the two groups did not differ in their ability to discriminate (same  $d'$ ) among the various stimulus intensities. This finding demonstrated that there were no neurosensory differences between the groups, and thus eliminated the possibility that a neurosensory deficit was responsible for the fewer pain reports by the Nepalese. Since the Nepalese porters and Westerners did not differ in sensory sensitivity, the Nepalese's higher traditional pain threshold was caused by a more stoical attitude or higher report criterion and not to a

sensory difference. Age and gender also influence the criterion for reporting pain (Clark 2003).

#### Psychiatric and Physical Illnesses

Kemperman et al. (1997) demonstrated that those female patients with borderline personality disorder who did not experience pain during self-injury discriminated more poorly among noxious heat stimuli, low  $P(A)$ , and set a more stoical report criterion, high  $B$ , than patients who experienced pain during self-injury. Dworkin et al. (1993) found that schizophrenic patients had significantly poorer sensory discrimination  $d'$ , of painful heat stimuli than healthy volunteers and also set a more stoical response criterion, which was associated with greater affective flattening. Gil et al. (1995) compared the responses of patients with sickle cell disease and healthy controls to noxious pressure stimuli and found no difference in discriminability,  $P(A)$ . However patients who scored high on her Negative Thoughts in Response to Pain Questionnaire tended to report more pain, lower  $B$ . Glusman et al. (1996) demonstrated that cardiac patients who experienced angina ("symptomatic") did not differ from those who reported no symptoms ("silents"), since SDT analysis of responses to electrical stimuli revealed no significant differences between the two groups for either discrimination,  $P(A)$ , or report bias,  $B$ . Contrary to a commonly held view, it was concluded that the "silents" were not setting a high report criterion and denying a painful experience. These findings suggested that the "silent" patients suffered a loss of painful cardiac sensations. This view was confirmed by Clark et al. (2000), who monitored EKG responses while the cardiac patients ran on a treadmill. The patients were asked a number of times whether or not they felt "anything" both when, according to the EKG, ST-segment depression was present (a stimulus) and when it was absent (a blank). The symptomatic myocardial ischemia patients were found to be good discriminators, high  $P(A)$ , between the presence and absence of the sensations produced by ST-segment depression. In contrast, the "silent" patients were unable to discriminate between the presence and absence of ST-segment depressions, very low  $P(A)$ . This study demonstrated that silent myocardial ischemia patients are silent because they suffer a severe sensory loss, not because they are denying their anginal symptoms.

#### Situational Pain Questionnaire (SPQ)

The Situational Pain Questionnaire (SPQ) consists of descriptions of two sets of possible situations or scenarios that differ in their degree of painfulness. Yang et al. (1983) found no difference between chronic pain patients and healthy controls for the SPQ discrimination measure,  $P(A)$ . However, chronic pain patients rated more situations as painful (lower  $B$ ). Using the SPQ, Noël-Jorand et al. (2001) found that the discriminability index for imaginary painful situations,  $P(A)$ , did



not differ significantly among various exercise groups. However, groups who exercised in a dangerous environment, such as mountain climbing, were far more stoical (higher pain report criterion) than those who exercised in a safe environment.

### Memory for Pain

A patient's description of previous pains is important for diagnosis and treatment. Recognition memory, the ability to discriminate between old and new material, is the most sensitive way to determine the amount of information that has been retained. In the SDM approach, a set of pain descriptors previously used by the patient to describe the experience (stimuli) are randomly mixed with related words not previously reported (blanks). The patient's task is to identify each word as old or new.  $P(A)$  is a pure measure of how much remains in memory and the report criterion,  $B$ , measures the extent to which the patient is biased toward reporting "old" or reporting "new." In a study by Hunter et al. (1979) patients checked relevant sensory and affective pain descriptors from a list immediately following a painful diagnostic procedure, then 5 days later attempted to discriminate the descriptors they had checked (stimuli) from those they had not (blanks). Hunter and colleagues examined only the **hit rates** and concluded that the recall of pain was surprisingly accurate and that memory is the same for both the sensory and emotional pain descriptors. However, re-analysis of these data by SDM (Clark and Bennett Clark 1993) demonstrated that the patients' recall of pain was relatively poor, low  $d'$ , and that recall for the affect words was significantly better (higher  $d'$ ) than for sensory words.

### Diagnostic and Treatment Decisions

SDM has been used to compare the abilities of various diagnostic tests, chemical profiles, x-rays and CT scans to discriminate between the presence and the absence of disease. In these applications, the goal is to improve diagnostic accuracy by segregating the decision criterion from the discrimination parameter. Clark (2003) used SDM to examine the ability of various symptoms to discriminate between migraine and tension headaches. First, experts diagnosed patients as having migraine or tension type headaches. Symptoms experienced by migraine headache patients were labeled "stimuli" and tension headache symptoms were "blanks." The presence of a symptom in a migraine patient was a hit; the presence of the same symptom in a tension headache patient was a false affirmative. A subsequent study then determined the frequency of the headache symptoms in another group of patients. SDM analysis of hit and false affirmative rates demonstrated that the unilateral vs. bilateral locus of the headache was the best discriminator between the two types of headaches, followed by the symptoms of prodroma, throbbing and vomiting, while duration, age of onset and (surprisingly) family history

were relatively poor discriminators. The customary diagnostic approach based only on the presence of a symptom (hit rate alone) failed to identify the most important discriminatory symptoms.

### Conclusions

A common argument against the application of the signal and **sensory decision theory** model to the study of calibrated noxious stimuli is that a mathematical model designed to extract weak signals from noise cannot possibly be used to study pain. This view, held by those who are but superficially acquainted with the model, is seriously flawed. As this paper has emphasized, from its inception the application of the SDM model to sensory measurement has been but one of the many applications of statistical decision theory. Statistical decision theory applies to the discrimination of any objectively definable event A from event B. If it is acceptable to use SDT to study the ability to discriminate between many kinds of quantifiable events including non-noxious visual, auditory and warm stimuli, why should it become controversial to study noxious intensities? As Green and Swets (1996) point out, the objectivity of SDT depends only upon the experimenter objectively knowing the intensity of the stimuli and blanks being presented. The investigator cannot score the subject as right or wrong when measuring a transition from not painful to painful, but can score the subject's ability to discriminate between the two stimulus intensities and thus obtain a pure measure of sensory function regardless of criterion variability. In addition, a quantitative measure of the subject's response bias, which has been demonstrated to be closely related to the traditional threshold, is obtained. Some have argued that  $d'$  and  $P(A)$  are unimportant because they measure discrimination, not pain. But a pure measure of the level of sensory functioning is critical for the understanding of pain. Moreover, the location of the pain report criterion provides additional quantitative information about the individual's subjective pain experience.

S

### Acknowledgments

This essay and much of the research reported here was supported by NIDR 20248 and NICDR 12725, and by the Nathaniel Wharton Fund for Research and Education in Brain, Body and Behaviour.

### References

1. Clark WC (2003) Somatosensory and pain measurement by signal detection theory. In: Adelman G, Smith B (eds) Encyclopedia of Neuroscience, 3rd edn (CD-Rom). Elsevier, Amsterdam
2. Clark WC, Bennett Clark S (1980) Pain responses in Nepalese porters. *Science* 209:410–412
3. Clark WC, Bennett Clark S (1993) Remembrance of pains past? A commentary on: Salovey P et al. The accuracy of memory for pain: not so bad most of the time. *Am Pain Soc J* 2:195–200
4. Clark WC, Yang JC (1974) Acupunctural analgesia? Evaluation by signal detection theory. *Science* 184:1096–1098
5. Clark WC, Glusman M, Janal MN et al. (2000) Sensory decision theory analysis of silent myocardial ischemia: sensory deficit or stoical attitude? *Psychosom Med* 62:134

6. Dworkin RH, Clark WC, Lipsitz JD et al. (1993): Affective deficits and pain insensitivity in schizophrenia. *Motivat Emot* 17:245–276
7. Gil KM, Phillips G, Webster DA et al. (1995) Experimental pain sensitivity and reports of negative thoughts in adults with sickle cell disease. *Behav Ther* 26:273–294
8. Glusman M, Clark WC, Coromilas J et al. (1996) Pain sensitivity in silent myocardial ischemia. *Pain* 64:477–483
9. Green DM, Swets JA (1966) *Signal Detection Theory and Psychophysics* Wiley, New York
10. Hunter M, Phillips C, Rachman S (1979) Memory for pain. *Pain* 6:35–46
11. Kemperman I, Russ MJ, Clark WC et al. (1997) Pain assessment in self-injurious patients with borderline personality disorder using signal detection theory. *Psychiatry Res* 70:175–183
12. McNicol DA (1972) *A Primer of Signal Detection Theory*. Allen and Unwin, London
13. Noël-Jorand MC, Joulia F, Braggard D (2001) Personality factors, stoicism and motivation in subjects under hypoxic stress in extreme environments. *Aviat Space Environ Med* 72:391–399
14. Swets JA (1996) *Signal Detection Theory and ROC Analysis in Psychology and Diagnostics*. Erlbaum Press, Mahwah, NJ
15. Yang JC, Clark WC, Ngai SH et al. (1979) Analgesic action and pharmacokinetics of morphine and diazepam in man: an evaluation by sensory decision theory. *Anesthesiology* 51:495–502
16. Yang JC, Richlin D, Brand L et al. (1985) Thermal sensory decision theory indices and pain threshold in chronic pain patients and healthy volunteers. *Psychosom Med* 47:461–468
17. Yang JC, Wagner JM, Clark WC (1983) Psychological distress and mood in chronic pain and surgical patients: a sensory decision analysis. In: Bonica JJ, Lindblom U, Iggo A (eds) *Advances in Pain Research and Therapy*. Raven Press, New York, pp 901–906

---

## Step Cycle

### Definition

The various temporally organized activity phases that give rise to locomotion.

- ▶ [Spinothalamic Projections in Rat](#)

---

## Stepwise Approach

### Definition

An approach to psychosocial evaluation that proceeds from assessment of more global indices of emotional distress and disturbance, to more detailed evaluations of specific diagnoses of psychopathology when warranted.

- ▶ [Disability Assessment, Psychological / Psychiatric Evaluation](#)

---

## Stereological Techniques

### Definition

An objective (unbiased) way to calculate, e.g. the number of neurons in a dorsal root ganglion or in a nucleus in the CNS.

- ▶ [Retrograde Cellular Changes after Nerve Injury](#)

---

## Stereotactic Cingulotomy

### Definition

Ablation of the cingulum (part of the limbic system in the brain), most often using electrodes heated via radiofrequency energy.

- ▶ [Cancer Pain Management, Neurosurgical Interventions](#)

---

## Stereotactic Medial Thalamotomy

### Definition

Precise ablation of the medial thalamus.

- ▶ [Cancer Pain Management, Neurosurgical Interventions](#)

---

## Stereotactic Radiosurgery

### Definition

Precise delivery of multiple beams of radiation so that they overlap and sum to ablate a target area in the brain.

- ▶ [Cancer Pain Management, Neurosurgical Interventions](#)

---

## Stereotactic Sacroiliac Joint Denervation

- ▶ [Sacroiliac Joint Radiofrequency Denervation](#)

---

## Stereotactic Surgery

### Definition

The branch of neurosurgery that involves the use of a precision apparatus to carry out x-ray guided operations on the nervous system.

- ▶ [Pain Treatment, Intracranial Ablative Procedures](#)

---

## Stereotaxy

### Definition

A system of three-dimensional coordinates that help to locate a center inside the brain, based on its relative location with reference to the planes of the ears bars (anterior-posterior), the mid line (lateral), and the depth into the skull (vertical).

- ▶ [Post-Stroke Pain Model, Thalamic Pain \(Lesion\)](#)

## Steroid Injections

NIKOLAI BOGDUK

Department of Clinical Research, Royal Newcastle Hospital Newcastle, University of Newcastle, Newcastle, NSW, Australia  
nik.bogduk@newcastle.edu.au

### Synonyms

Injections of Steroids; Injections of Corticosteroids; Corticosteroid Injections

### Definition

Steroid injections are a treatment for pain, in which a corticosteroid is injected into a site of tenderness that is ostensibly the source of pain. Steroid injections differ from ► **intra-articular steroids** in that the target tissues are not cavities of synovial joints. Instead, they are typically sites of attachment of tendons, ligaments, or muscles.

### Characteristics

It is difficult to obtain the rationale for steroid injections from the literature. They seem to be used as if in the belief that steroids have an undisclosed healing property in areas that are tender and seemingly the source of pain. Although the anti-inflammatory effect of steroids might be invoked as grounds for the injections, there is no evidence that the conditions treated involve inflammation. Indeed, such evidence as is available indicates that degeneration, but not inflammation, is the underlying pathology.

### Technique

Steroid injections simply require inserting a needle into the area or point that appears to be tender. Through the needle, a quantity of corticosteroid preparation is injected, typically mixed with a local anaesthetic. The volume injected differs between operators and for different sites. It may be a fraction of a millilitre or between 1, 2, and 5 ml. The agents used are based on triamcinolone, dexamethasone, betamethasone, or methylprednisolone, usually as a depot preparation designed for slow release of the active steroid.

### Application

In practice, almost any tender site might be a target for steroid injections. For most sites, however, there is little scientific literature. The sites for which the greatest number of controlled trials has been published are the lateral elbow and the low back. These sites have a common feature. The target is a region where over a short distance muscles become tendons, which insert into bone.

### Lateral Elbow

Lateral elbow pain is classically known as “tennis elbow” or “lateral epicondylalgia”. It is the archetypical

condition for which steroid injections have been used. The literature is not consistent as to the exact target point for injection. It ranges from the apex of the lateral epicondyle, to the enthesis of the extensor tendons arising from this eminence, to the terminal tendons themselves, and even the myotendinous junctions of the extensor muscles.

The pathology of lateral elbow pain does not involve inflammation. Biopsy studies have shown that the extensor tendons exhibit partial rupture, hyaline degeneration, fibro-fatty change, vascular proliferation, fibroblastic proliferation, glycosaminoglycan infiltration, fibrocartilage formation, calcification, and new bone formation, to various extents (Chard et al. 1994; Regan et al. 1992).

An early controlled study found no difference in outcome between patients treated with steroid injections or saline injections (Saartok and Eriksson 1986). A later study found that steroid injections gave better relief shortly after injection than did lignocaine alone, but by 24 weeks differences were no longer apparent (Price et al. 1991). Another study found steroid injections to be more effective than physiotherapy for lateral elbow pain (Verhaar et al. 1996). The most recent controlled trial found that steroid injections provided greater relief of pain than either naproxen or placebo at 4 weeks follow-up, but thereafter there was no difference in outcome (Hay et al. 1999). A systematic review, published in 1996 (Assendelft et al.), found that the pooled odds ratio for benefit at less than 6 weeks was 0.15 (95%CI 0.10–0.23), indicating a statistically significant benefit for corticosteroid injections; but there was no statistically significant benefit at periods in excess of 6 weeks.

### Low Back Pain

In patients with low back pain, a site that is commonly tender lies against the iliac crest, supermedial to the posterior superior iliac spine. This site has attracted a variety of injection therapies, mostly with local anaesthetic alone, but sometimes with steroids. According to a systematic review, the published studies favour an effect of injection therapy, but the small sample sizes used prevent the pooled outcome data from achieving statistical significance. The 95% confidence intervals of the pooled relative risk cross the critical value of 1.0 (Nelemans et al. 2001). One controlled study showed that methylprednisolone mixed with lignocaine was more effective than normal saline in securing “improvement” in pain, when assessed at two weeks (Sonne et al. 1985).

Other data apply to the injection of steroids at various tender sites in the back. An old study reported that a greater proportion of patients achieve complete relief of pain (odds ratio: 7.7) when corticosteroids are used rather than lignocaine alone (Bourne 1984). This encouraging report, however, has not been replicated.

## Discussion

Despite the popularity of steroid injections as a treatment for musculoskeletal pain, the literature offers little support for this intervention. These injections do appear to have an effect in some patients, but the benefit is short-lived.

## References

1. Assendelft WJJ, Hay EM, Adshead R et al. (1996) Corticosteroid Injection for Lateral Epicondylitis: A Systematic Overview. *Brit J Gen Prac* 46:209–216
2. Bourne IH (1984) Treatment of Chronic Back Pain. Comparing Corticosteroid-Lignocaine Injections with Lignocaine Alone. *Practitioner* 228:333–338
3. Chard MD, Cawston TE, Riley GP et al. (1994) Rotator Cuff Degeneration and Lateral Epicondylitis: A Comparative Histological Study. *Ann Rheum Dis* 53:30–34
4. Hay EM, Paterson SM, Lewis M et al. (1999) Pragmatic Randomised Controlled Trial of Local Corticosteroid Injection and Naproxen for Treatment of Lateral Epicondylitis of Elbow in Primary Care. *BMJ* 319:964–968
5. Nelemans PJ, de Bie RA, deVet HCW et al. (2001) Injection Therapy for Subacute and Chronic Benign Low Back Pain. *Spine* 26:501–515
6. Price R, Sinclair H, Heinrich I et al. (1991) Local Injection Treatment of Tennis Elbow-Hydrocortisone, Triamcinolone and Lignocaine Compared. *Br J Rheumatol* 30:39–44
7. Regan W, Wold LE, Coonrad R et al. (1992) Microscopic Histopathology of Chronic Refractory Lateral Epicondylitis. *Am J Sports Med* 20:746–749
8. Saartok T, Eriksson E (1986) Randomized Trial of Oral Naproxen or Local Injection of Betamethasone in Lateral Epicondylitis of the Humerus. *Orthopedics* 9:191–194
9. Sonne M, Christensen K, Hansen SE et al. (1985) Injection of Steroids and Local Anaesthetics as Therapy for Low Back Pain. *Scand J Rheum* 14:343–345
10. Verhaar JA, Walenkamp GH, van Mameren H et al. (1996) Local Corticosteroid Injection versus Cyriax-Type Physiotherapy for Tennis Elbow. *J Bone Joint Surg* 78B:128–132

## Steroids

### Definition

Long-lasting therapy with glucocorticosteroids may be complicated by muscle weakness.

- ▶ **Muscle Pain in Systemic Inflammation (Polymyalgia Rheumatica, Giant Cell Arteritis, Rheumatoid Arthritis)**

## Stimulant

### Definition

A stimulant is a laxative whose principal mode of action is the stimulation of gut wall muscular contraction (i.e. peristalsis), which pushes the gut contents forward more forcefully.

- ▶ **Cancer Pain Management, Gastrointestinal Dysfunction as Opioid Side Effects**

## Stimulation-Produced Analgesia

GREGORY W. TERMAN

Department of Anesthesiology and the Graduate Program in Neurobiology and Behavior, University of Washington, Seattle, WA, USA  
gwt@u.washington.edu

### Synonyms

Brain stimulation analgesia; electrical stimulation induced analgesia

### Definition

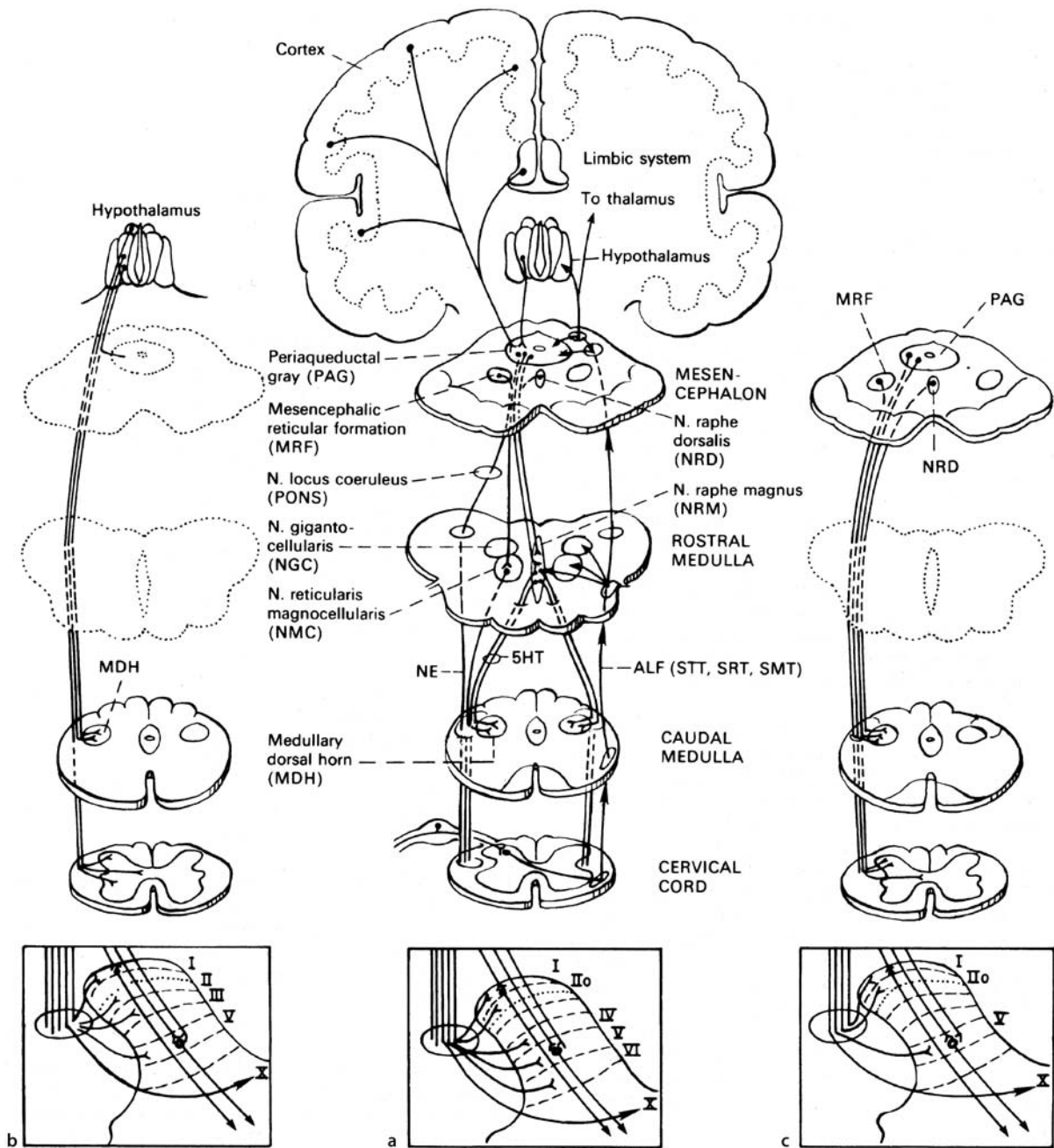
Although the concept of descending pain modulation goes back to Sherrington in the early 1900s and was an important part of Melzack and Wall's gate control theory of pain (Melzack and Wall 1965) there was little direct evidence until 1970 for ▶ **endogenous** neural systems descending from brain to spinal cord whose normal function was the inhibition of pain. Reynolds in 1969 reported that focal electrical stimulation of the ▶ **periaqueductal gray** (PAG) resulted in sufficient analgesia to perform laparotomy in rats. These observations were soon confirmed and extended by Liebeskind and his students (e.g. Mayer et al. 1971) who labeled the phenomenon "▶ **stimulation-produced analgesia**" (SPA).

### Characteristics

These early studies by Liebeskind and associates found SPA to be specifically ▶ **antinociceptive** – producing no generalized sensory, attentional, emotional, or motoric deficits. They also showed that SPA could outlast the period of brain stimulation and that it occurred in a restricted peripheral field such that noxious stimuli applied outside that field elicited normal defensive reactions. They reported that during stimulation the sensation of light touch was intact, there was no indication of seizure activity, and animals were still capable of eating. Furthermore, rats could be trained to self-administer brain stimulation in the presence of noxious stimuli, and this self-administration did not recur when the noxious stimuli were terminated. The analgesia produced by electrical stimulation of the PAG was of rapid onset and as potent as high doses of morphine; completely inhibiting withdrawal responses to even the most severe noxious stimuli. These findings demonstrated the existence of a potent and selective natural ▶ **pain-inhibitory system** in the PAG.

SPA's effects depend on descending mechanisms (rather than primarily supraspinal mechanisms) as evidenced by the inhibition of both spinal nociceptive reflexes and responses of spinal cord dorsal horn nociceptive cells to noxious stimuli (Dubner and Bennett 1983). SPA eliminates behavioral responses to such varied noxious somatic and visceral stimuli as electric shocks





S

**Stimulation-Produced Analgesia, Figure 1** Descending endogenous pain inhibitory systems activated in stimulation produced analgesia. (a) The periaqueductal gray (PAG) receives input from such rostral structures as the frontal and insular cortex and other parts of the cerebrum involved in cognition, and from the limbic system, thalamus, and hypothalamus. The PAG sends axons that project to nucleus raphe magnus (NRM) and nucleus reticularis gigantocellularis (NGC). Here, they synapse with neurons that are primarily serotonergic, whose axons project to the medullary dorsal horn or descend in the dorsolateral funiculus to all laminae of the spinal gray matter. Noradrenergic fibers from locus coeruleus also descend in the dorsolateral funiculus to the spinal gray. (b) Direct hypothalamospinal descending control system, which originates in the medial and paraventricular hypothalamic nuclei. The inset shows sites of termination in the spinal cord. (c) Direct PAG-spinal projection system, which bypasses the medullary nuclei and projects directly to the medullary dorsal horn or spinal gray matter. The inset shows sites of termination in the spinal cord. (Reprint with permission from Loeser et al 2001).

applied to the tooth pulp and limbs, heating of the skin, and injection of irritants into the skin and abdominal cavity. Subsequent demonstrations that stimulation of homologous brain regions in humans could relieve

chronic pain provided even greater interest in this phenomenon (Hosobuchi 1980). Within 10 years of Reynolds' initial SPA paper, more than 150 reports of stimulation-produced analgesia had been published,

including 2 major reviews (Basbaum and Fields 1978; Mayer and Price 1976) of the anatomical and biochemical substrates of SPA.

Perhaps the most important finding concerning SPA, in these early studies, was that analgesia induced by brain stimulation shared several characteristics with analgesia from opiate drugs. Areas of the brain from which SPA could be elicited were rich in opiate receptors and microinjection of morphine into these brain regions produced analgesia, indicating that common brain sites support both SPA and opiate analgesia. Like opiate analgesia, ► **tolerance** develops to the analgesic effects of repeated brain stimulation. Moreover, cross-tolerance is observed between opiate analgesia and SPA suggesting a common underlying mechanism. Finally, opiate antagonists such as naloxone antagonize SPA, a finding which was influential in suggesting the existence of and subsequent sequencing of the endogenous ► **opioid peptides** (Hughes et al. 1975). Ironically, the naloxone-sensitivity of SPA has proven controversial, and it is now clear that not all SPA is mediated by opioid peptides. Indeed, differential production of “opioid” and “nonopioid” forms of SPA have been found to rely on the distinct region of the PAG stimulated.

Additional work clarifying the circuitry of descending pain inhibitory systems activated by electrical stimulation of the central nervous system (Gebhart 2004) has focused on four tiers of CNS processing.

#### Cortical and Diencephalic Descending Systems

Stimulation of S1 and S2 cortex inhibits spontaneous activity of wide dynamic range spinothalamic tract (STT) neurons, as well as responses to C-fiber volleys in sural nerve and to noxious thermal and mechanical stimuli. Efferents from sensory cortex run with the corticospinal tract, descending contralaterally in the ► **dorsolateral funiculus** before terminating in laminae I–VII of the spinal gray matter. Corticospinal fibers in laminae I and II exert direct postsynaptic control on dorsal horn neurons, although the neurotransmitters involved are unknown. Despite these direct connections, the many S1 and S2 cortical projections to striatum, thalamus, and mesencephalon are likely to mediate many of the analgesic effects of somatosensory cortex stimulation.

Similarly, the specific descending influence of limbic structures (such as amygdala and cingulate cortex) on nociception are difficult to identify because of the complex brain circuitry these structures are involved in. Nonetheless, stimulation of limbic structures can cause analgesia and it is likely that activation of these structures mediate analgesia associated with such diverse phenomena as hypnosis, placebo, learned helplessness and uncontrollable stress.

Diencephalic structures such as the periventricular gray, the medial and lateral hypothalamus, the medial preoptic/basal forebrain region, and the somatosensory nuclei of the thalamus can all support SPA, albeit by differing

mechanisms. Stimulation of the ventroposterolateral and medial nuclei of the thalamus, for example, can inhibit evoked responses of identified spinal nociceptive neurons. There is no evidence for a direct projection of thalamic neurons to the spinal cord, however. It is likely instead that stimulation of the thalamus produces antidromic activation of spinothalamic tract collaterals, which synapse in medullary reticular formation or periaqueductal gray, and which, in turn activate neurons which do project to the spinal cord to exert inhibition. A direct, predominantly ipsilateral projection to the spinal cord from the medial hypothalamic nuclei, and to a lesser extent, the lateral nuclei of the hypothalamus, travels principally in the dorsolateral funiculus and may mediate the antinociceptive effect of hypothalamic stimulation. Although the ► **Spinal Cord Laminae** in which these projections terminate have not been identified, it is known that oxytocin- and vasopressin-containing neurons of the hypothalamus terminate predominantly in laminae I and X, and that there are sparse inputs in laminae II, III, and V. Both oxytocin and vasopressin have been reported to produce analgesia at the level of the spinal cord (although the effects of the latter, at least, may be confounded by paralytic motor effects). Another neurochemical possibly involved in such hypothalamic stimulation produced analgesia is dopamine. Dopaminergic innervation terminates in laminae I and particularly laminae III and IV of the spinal cord and dopamine has been found to reduce spinal nociception both electrophysiologically and behaviorally. This is one of three major ► **monoamines** thought to mediate some forms of SPA. As in cortical SPA, SPA from the hypothalamus may be mediated by indirect projections to the spinal cord via midbrain and hindbrain relay nuclei.

#### Mesencephalic Descending Systems

The PAG receives inputs from such rostral structures as the frontal and insular cortex, limbic system, septum, amygdala, and hypothalamus. Input from caudal structures includes those from nucleus cuneiformis, the pontomedullary reticular formation, locus coeruleus, and the spinal cord. Moreover, the PAG has descending connections to the rostral medulla, particularly its ventromedial part (RVM), the medullary reticular nuclei, and the ► **nucleus raphe magnus** (known, as we will see, to be a major source of projections to the medullary and spinal dorsal horns) as well as ascending projections to diencephalon. Thus the PAG is ideally positioned to integrate information from sensory systems in the brainstem/spinal cord with information from higher processing in the forebrain and is thought to modulate a number of homeostatic processes including fear, anxiety, cardiovascular tone, and vocalization. The descending nociceptive modulation from PAG activated by SPA appears to be normally under tonic ► **GABA** inhibitory control such that GABA<sub>A</sub> antagonists can

produce reliable antinociception when microinjected into the PAG in the absence of electrical stimulation. Endogenous and exogenous opiates likely produce analgesia within the PAG via inhibition of inhibitory GABA containing interneurons and thereby activate (disinhibit) PAG output neurons.

### Pontine and Medullary Descending Systems

The ► **serotonergic**-rich raphe nuclei in the brainstem, particularly the nucleus raphe magnus (NRM), were implicated early on in mediating SPA. Raphe-spinal neurons were excited by PAG opiate microinjection or PAG electrical stimulation. Stimulation of the NRM produced analgesia, whereas lesions of this structure inhibited SPA from PAG. Consequently, the NRM appeared to be a relay station that received descending input from the PAG and modulated spinal and medullary dorsal horn. Subsequent findings suggest other important alternative descending paths are activated by PAG opiates and electrical stimulation. In order to abolish SPA from PAG, lesions of the NRM had to be extended into the adjacent magnocellular reticular field. Electrical stimulation or lesions in the medullary reticular core activate or interfere with, respectively, multiple descending pathways including rubrospinal, tectospinal, pontine reticulospinal and noradrenergic fibers in the pons -all of which can influence dorsal horn nociceptive activity. In addition to fibers of passage, the reticular formation in the rostral medulla and caudal pons also includes several nuclei which have been implicated in pain modulation (including the reticularis gigantocellularis (NGC) and reticularis paragigantocellularis lateralis (RPGL) in the rat). These nuclei and the NRM have been grouped together by Fields and labeled the ► **rostromedullary** (RVM). All of the nuclei in this region receive projections from the PAG, contain cells which can be activated by PAG stimulation, send axons to the spinal cord, and can support SPA. Microinjection of opiates into RVM, like into the PAG, can produce descending pain inhibition (although via a different mechanism than observed in PAG as detailed by Fields and colleagues (Pan et al. 1997). Nicotinic acetylcholine and endogenous cannabinoid (e.g. anandamide) mechanisms have also been implicated in RVM mediated pain inhibitory substrates.

### Descending Fibers from Supraspinal Nuclei Terminate in Spinal Dorsal Horn and Selectively Inhibit Nociceptive Neurons

In the mid 1970s, Basbaum and associates (Basbaum et al. 1977) lesioned various quadrants of the spinal cord to determine the spinal tracts containing fibers descending from brain stem to dorsal horn which inhibit nociception. They found that lesions of the dorsal part of the lateral funiculus (DLF) markedly reduced or abolished SPA (opiate analgesia was also blocked by these lesions). The neurochemicals underlying this descend-

ing inhibition have been much studied but have primarily focused on monoaminergic systems because of the importance of the medullary raphe and reticular nuclei in mediating SPA:

Cell bodies containing ► **serotonin** (5HT) are located in the nucleus raphe magnus (NRM), n. raphe dorsalis (NRD), and several other raphe nuclei in the medulla and pons and are absent in spinal cord. Most NRM-5HT neurons project to spinal cord via the dorsolateral funiculus to terminate predominantly in laminae I, IIo, IV, and V of the spinal dorsal horn and near the central canal. Early studies of SPA from a number of brainstem sites (as well as systemic opiate analgesia) supported a role for 5HT in mediating endogenous pain inhibition (Basbaum and Fields 1978). Inhibition of synthesis of 5HT, destruction of spinal 5HT terminals and lesions of 5HT producing cells in the medullary raphe all inhibited SPA. Moreover, an intrathecal serotonin antagonist blocked analgesia produced by microinjection of morphine into the raphe nuclei. Application of 5HT to the spinal cord was most commonly reported to inhibit the response of dorsal horn neurons to noxious stimulation, and produced analgesia. Dubner, Ruda and associates examined sites of interaction between descending 5HT axons and lamina I and II neurons in a series of experiments (Dubner et al. 1984). The majority of spinal 5HT terminals form axosomatic and axodendritic synapses with neurons of the dorsal horn including STT neurons. Stimulation of NRM inhibited all nociceptive-specific (NS) or wide-dynamic-range (WDR) neurons identified, including STT cells, and all of these lamina I neurons exhibited many 5HT immunoreactive contacts. Thus, the 5HT neurons of the nucleus raphe magnus and other nuclei are presumed to provide the serotonergic link in the pain-inhibitory controls exerted by SPA. Unfortunately, activation of serotonin containing neurons also has pro-nociceptive effects (e.g. Calejesan et al. 1998) and serotonin's pro- or antinociceptive effects in the spinal cord may depend on the specific 5HT receptors activated (of which there are many sub-types) and the location of those receptors. Although this does not negate the results of previous SPA studies it has limited the clinical relevance of, for example, serotonin re-uptake inhibitors where it is difficult to predict the magnitude or even the direction of the effect on pain.

A second neurochemically distinct monoamine descending system involves ► **noradrenergic** neurons whose cell bodies are in A5, A6 and A7 cell groups in the brainstem and whose axons descend in dorsolateral, ventrolateral, and ventral funiculi to end in all of the laminae of the spinal cord. Several studies indicate that a descending norepinephrine (NE) system can mediate analgesia and dorsal horn inhibition and that the NE descending system is critical for opiate-induced analgesia. Adrenergic blockers can attenuate the analgesia produced by systemic morphine administration,



microinjection of morphine into the PAG or magnocellular tegmental field, and SPA of magnocellularis. Blockade of PAG SPA by intrathecal  $\alpha_2$  adrenergic antagonists (Budai et al. 1998) emphasizes the importance of noradrenergic systems in descending nociceptive modulation. Intrathecal  $\alpha_2$  adrenergic agonists, of which clonidine is the prototype, produce analgesia in animals, including man, although such analgesia is associated with hemodynamic and sedative side effects. Much ongoing work is attempting to identify  $\alpha_2$  adrenergic receptor subtypes which might mediate analgesia without inducing undesirable side effects to provide targets for development of new analgesics, thus far without success.

The opioid peptide enkephalin and 5-HT coexist in some RVM neurons and based on the overlap between opiate and SPA mechanisms it seems reasonable to assume an importance of enkephalins in descending pain inhibitory systems. Nonetheless, there is surprisingly little evidence suggesting the importance of spinal opioids in descending inhibition of nociception. Budai and Fields reported that descending inhibition of heat responses in dorsal horn cells from PAG is antagonized by direct application of mu antagonists on the spinal cord although many others have failed to see inhibition of SPA by spinally administered opiate antagonists. The anatomy and physiology of SPA as revealed in the laboratory have been complementary to the many clinical reports that electrical stimulation of the thalamus, septum, caudate nucleus, medial forebrain bundle, lateral hypothalamus, and internal capsule can all produce analgesia in humans (Richardson 1990). The invasive nature of such human stimulation-produced analgesia and the resultant risks involved in such therapy make such reports of more scientific than therapeutic value. The long term benefit of SPA in humans has not been demonstrated due to tolerance to SPA, inadequate electrode placement or innumerable other physiological or clinical reasons. Nonetheless, although the similarities between SPA in humans and laboratory animals does not imply that such stimulation is recommended for either, an understanding of the neurochemical basis of SPA in animals may one day help identify new therapeutic drugs in man. Moreover, identification of less invasive ways of activating the endogenous pain-inhibitory substrates mediating SPA (by placebo, acupuncture, or exercise, for example) may help us harness these systems for therapeutic benefit in the years to come.

► [Forebrain Modulation of the Periaqueductal Gray](#)

## References

1. Basbaum AI, Fields HL (1978) Endogenous Pain Control Mechanisms: Review and Hypothesis. *Ann Neurol* 4:451–462
2. Basbaum AI, Marley NJ, O'Keefe J, Clanton CH (1977) Reversal of Morphine and Stimulus-Produced Analgesia by Subtotal Spinal Cord Lesions. *Pain* 3:43–56
3. Budai D, Harasawa I, Fields HL (1998) Midbrain Periaqueductal Gray (PAG) Inhibits Nociceptive Inputs to Sacral Dorsal Horn

4. Calejesan AA, Ch'ang MH, Zhuo M (1998) Spinal Serotonergic Receptors Mediate Facilitation of a Nociceptive Reflex by Subcutaneous Formalin Injection into the Hindpaw in Rats. *Brain Res* 798:46–54
5. Dubner R et al. (1984) Neural Circuitry Mediating Nociception in the Medullary and Spinal Dorsal Horn. In: Kruger L, Liebeskind JC (eds) *Advances in Pain Research and Therapy*, vol 6. New York, Raven Press, pp 151–166
6. Dubner R, Bennett GJ (1983) Spinal and Trigeminal Mechanisms of Nociception. *Annu Rev Neurosci* 6:381–418
7. Gebhart GF (2004) Descending Modulation of Pain. *Neurosci Biobehav Rev* 27:729–737
8. Hosobuchi Y (1980) The Current Status of Analgesic Brain Stimulation. *Acta Neurochir Suppl (Wien)* 30:219–227
9. Hughes J, Smith TW, Kosterlitz HW, Fothergill LA, Morgan BA, Morris HR (1975) Identification of Two Related Pentapeptides from the Brain with Potent Opiate Agonist Activity. *Nature* 258:577–580
10. Loeser JD, Butler SF, Chapman CR, Tunk DC (2001) *Bonica's Management of Pain*. 3rd edn. Lippincott Williams and Wilkins
11. Mayer DJ, Price DD (1976) Central Nervous System Mechanisms of Analgesia. *Pain* 2:379–404
12. Mayer DJ, Wolfe TL, Akil H, Carder B, Liebeskind JC et al. (1971) Analgesia from Electrical Stimulation in the Brainstem of the Rat. *Science* 174:1351–1354
13. Melzack R, Wall PD (1965) Pain Mechanisms: A New Theory. *Science* 150:971–979
14. Pan ZZ, Tershner SA, Fields HL (1997) Cellular Mechanism for Anti-Analgesic Action of Agonists of the Kappa-Opioid Receptor. *Nature* 389:382–385
15. Reynolds DV (1969) Surgery in the Rat during Electrical Analgesia Induced by Focal Brain Stimulation. *Science* 164:444–445
16. Richardson DE (1990) Central Stimulation-Induced Analgesia in Humans – Modulation by Endogenous Opioid Peptides. *Crit Rev Neurobiol* 6:33–37

## Stimulation Treatments of Central Pain

ANTONIO OLIVIERO, ELISA LOPEZ-DOLADO,  
VINCENCO DI LAZZARO  
FENNSI Group, National Hospital of Paraplégicos,  
SESCAM Finca “La Peraleda” Toledo, Toledo, Spain  
antonioo@sescam.jccm.es

### Synonyms

Neurostimulation; neuromodulation

### Definition

Nervous system stimulation is a pain treatment that uses low voltage electrical or magnetic stimulation, delivered to the central or peripheral nervous systems, to inhibit or block the sensation of pain.

### Characteristics

Chronic pain is an important cause of physical and emotional suffering, interference in family and social life, reduced quality of life, disability, work absenteeism and an increased need for health care. Injury to the nervous system represents a risk for the development of chronic pain, having a mayor impact on patients as well as society. The IASP (International Association for the Study



of Pain) defines “neuropathic pain” as a pain initiated or caused by a primary lesion or dysfunction of the nervous system. Peripheral neuropathic pain occurs when the lesion or dysfunction affects the peripheral nervous system. Damage to the central nervous system (CNS) can also cause chronic pain. The IASP defines “central pain” as a “pain initiated or caused by a primary lesion or dysfunction in the central nervous system”.

Treatment of central pain (CP) is often difficult and it is not known if different CP conditions respond differently to different treatments. Despite the discovery of multiple mechanisms causing chronic pain, the handling of central pain is still insufficient.

### Central Nervous System Stimulation

CNS electrical stimulation has been used to treat various pains. Investigation has been done into the use of stimulation on well-defined targets including cortex, sensory thalamus, midbrain periaqueductal or periventricular gray and spinal cord.

CP is caused by a heterogeneous group of aetiologically different diseases (traumatic, vascular, degenerative, inflammatory, tumoural, etc.), of different damage locations (spinal cord, brainstem, thalamus and cortex), and of both rapidly and slowly developing lesions. It seems that every lesion affecting structures involved in somatic sensibility can produce CP. The physiopathology of central pain is still poorly understood, but the thalamus seems to play a pivotal role in the generation of central pain. Thalamic neurons are hyperactive and cells spontaneously fire (bursting cells) in patients with central pain. Intraoperative stimulation of the lateral thalamus in patients with CP (with symptoms of hyperpathia or allodynia) elicited a painful sensation, while control patients (patients operated for dyskinesias or tremor) did not. Furthermore, an altered somatotopy and displaced and/or reorganized receptive fields have been observed in the thalamus of patients with CP. In addition, an unbalanced transmission between sensory-motor cortex and the sensory thalamus has also been hypothesized in the generation of CP. All these considerations suggest that a form of plasticity is present in the thalamus and the cortex, and also probably in other locations of the CNS (Brown and Barbaro 2003).

The sensory cortex could be thought of as a primary target for stimulation to obtain pain relief, but the usefulness of the stimulation of this target is still under debate. Stimulation of the sensory cortex in animal models did not produce conclusive evidence of effective pain management. In humans, when the sensory cortex has been stimulated, pain was either exacerbated or remained unchanged. However, contradictory results of sensory cortex stimulation have recently been reported (Bonicalzi and Canavero 2004; Brown and Barbaro 2003). White and Sweet (1955) performed post-central gyrectomy and obtained pain relief in only a few (13 %) of the treated patients, whereas the surgical removal of both the post

and the precentral gyri produced long-term relief from pain. These results are suggestive of the importance of motor cortex removal in providing pain relief, due to the fact that precentral gyrus ablation was performed in a second surgical operation, given that the previous post-central ablation had not been effective.

Tsubokawa and his co-workers described their first clinical experience using motor cortex stimulation to treat central pain syndromes in 1991. They reported “excellent or good” pain relief, and a long-term efficacy of motor cortex stimulation in most of the patients. Since then many other patients have been treated with motor cortex stimulation with similar, interesting results (Brown and Barbaro 2003). How motor cortex stimulation (MCS) works in producing pain relief is still poorly understood. It is still not clear if MCS acts at cortical level or through the activation of descending axons. An intact corticospinal tract originating from motor cortex would seem to be required to obtain pain relief, while an intact somatosensory system does not appear to be necessary to receive benefit from MCS. Pain relief is achieved at a stimulus intensity below the threshold for muscular movement, and the efficacy of MCS seems to have a somatotopic organization. The corticospinal tract could be activated by motor cortex stimulation below the threshold for muscle movement (Di Lazzaro et al. 1998). The necessity to have an intact corticospinal tract to obtain pain relief, and the possibility to stimulate it with stimulus intensity below the threshold for muscular movement, could suggest that an activation of projecting axons is required. Moreover, MCS seems to activate the thalamus. Positron emission tomography studies during MCS show activation in the ipsilateral thalamus, cingulate gyrus, orbitofrontal-cortex and brainstem; some of these structures could be related to the suffering component of chronic pain, and the removal of this component could be one of the ways in which MCS is effective in providing pain relief (Garcia-Larrea et al. 1999).

► **Transcranial magnetic stimulation (TMS)** was introduced in 1985 and permits a non-invasive stimulation of the cerebral cortex. TMS has been used in evaluation of the motor system, the functional study of several cerebral regions, and the physiological study of several neuropsychiatric illnesses. ► **Repetitive transcranial magnetic stimulation (rTMS)** has become a useful tool for investigating and even modulating human brain function. rTMS of the human motor cortex can produce changes in cortical excitability that outlast the period of stimulation. In addition, it has been postulated that rTMS could be a therapeutic tool in some psychiatric disorders.

rTMS of the motor cortex has also been demonstrated as useful in alleviating acute pain (induced by capsaicin) and chronic pain (neuropathic pain of central and peripheral origin). High frequency rTMS seems effective in alleviating neuropathic pain, and this effect seems capable of predicting the efficacy of invasive

MCS (Lefaucheur et al. 2004). How motor cortex rTMS works to provide pain relief is still not clear. rTMS can modulate cortical excitability, promote a short term change in inhibitory cortical activity, modify corticocortical connections functionally, and produce a net change in synaptic cortical activity. Sensory functions are modulated by rTMS of the sensorimotor cortex. Tactile threshold was increased for a short duration after low-frequency rTMS of the sensorimotor cortex, and thermal perception was reduced after high-frequency rTMS of the same cortical area (unpublished personal observations). rTMS activates a network of primary and secondary cortical motor regions (using a suprathreshold intensity), supplementary motor area, dorsal premotor cortex, cingulate motor area, as well as the putamen and thalamus (using both supra and subthreshold intensity) (Bestmann et al. 2004). In conclusion, rTMS of the motor cortex and invasive MCS seem to activate overlapping cerebral regions, and activation of the thalamus again seems to be important to obtain pain relief. Moreover, it has recently been observed that invasive MCS and rTMS activate the motor cortex in a similar (though not exactly the same) way (Di Lazzaro et al. 2004). Future studies will clarify the role of rTMS; whether this non-invasive technique could be useful for treatment of CP and predict the efficacy of invasive MCS.

Thalamus has long been known to be involved in the processing of pain in normal and pathological conditions, and it seems to play an important role in the way therapeutic cortical stimulation works. Stimulation of the somatosensory thalamus has been used for many years in the treatment of chronic pain. More recently, the centre median-parafascicular complex has also been targeted in order to obtain relief from neuropathic pain. However, despite clinical reports of successful results, little is known about the way this form of analgesia is achieved. Thalamic stimulation activates ipsilateral insula and the anterior cingulate cortex, and only produces a slight effect on the somatosensory cortex (Duncan et al. 1998). For these reasons and others, the gate control theory, which is based on the idea of stimulation of low threshold somatosensory pathways inhibiting pain (Melzack and Wall 1965), as a basic mechanism of how stimulation works, has been thrown into doubt. An alternative hypothesis is that thalamic stimulation may activate thalamocortical circuits involved in thermal as well as tactile processing, and in this way could provide analgesia. Whichever mechanism is hypothesized, it seems that the cortex and thalamus represent two sites within a pain related circuit, and pain relief can be achieved wherever you stimulate within this circuit.

Spinal cord stimulation (SCS) has been widely used in the management of pain. It emerged as a clinical application of the gate-control theory. Later, the therapeutic properties of SCS were considered to be due to a sympatholytic effect. This effect is considered to be responsi-

ble for the effectiveness of SCS in peripheral ischemia, cardiac ischemia, and at least some cases of pain syndromes (► [Complex Regional Pain Syndromes, General Aspects](#) Types I and II). The sympatholytic effect has also been considered effective in the treatment of other chronic pain states such as failed back surgery syndrome, diabetic neuropathy, post-herpetic neuralgia, and multiple sclerosis. It is surprising that almost forty years after the first attempt to modulate pain through SCS only few large-scale trials of its effectiveness have been published, and at present there is limited evidence that spinal cord stimulators are effective in the management of pain.

### Peripheral Nervous System Stimulation

The basic idea of using local application of electricity for pain treatment is ancient, and in ancient Greece the electrical properties of animals have been used for pain relief in pain conditions of the upper and lower limbs.

► [Transcutaneous electrical nerve stimulation](#) (TENS) is widely believed to be an effective, safe and relatively non-invasive intervention which can be used to alleviate many different types of pain, including labour pain, surgical pain, back pain, arthritis, neuropathic pain, menstrual pain, migraine and headache. However, controversy still surrounds TENS and its effectiveness has not been proven conclusively. A Cochrane review recently concluded that it is not possible to provide useful evidence-based information for the use of TENS for CP (Carroll et al. 2004). The gate-control theory could provide a possible means of understanding the way in which TENS works. Peripheral stimulation could activate large myelinated nerve fibres and local inhibitory circuits within the dorsal horn of the spinal cord, regulating the flow of pain information, and thus reducing the perception of pain. Peripheral mechanisms of pain relief have also been hypothesized, but microneurographic studies failed to demonstrate an impulse transmission failure during TENS administration to nerves. TENS could also provide pain relief neurochemically. Contradictory data are present in literature where opioid systems are or are not stimulated by TENS. It seems that low frequency of stimulation is capable of activating opioid endogenous systems, while high frequency TENS does not. This would suggest that the frequency of stimulation is critical in achieving successful pain management. Opioid endogenous system activation should work in a similar way to that of acupuncture analgesia.

### References

1. Bestmann S, Baudewig J, Siebner HR et al. (2004) Functional MRI of the Immediate Impact of Transcranial Magnetic Stimulation on Cortical and Subcortical Motor Circuits. *Eur J Neurosci* 19:1950–1962
2. Bonicalzi V, Canavero S (2004) Motor Cortex Stimulation for Central and Neuropathic Pain. *Pain* 108:199–200
3. Brown JA, Barbaro NM (2003) Motor Cortex Stimulation for Central and Neuropathic Pain: Current Status. *Pain* 104:431–435

4. Carroll D, Moore RA, McQuay HJ et al. (2004) Transcutaneous Electrical Nerve Stimulation (TENS) for Chronic Pain (Cochrane Review). In: The Cochrane Library, Issue 2. John Wiley & Sons, Ltd, Chichester, UK
5. Di Lazzaro V, Oliviero A, Pilato F et al. (2004) Comparison of Descending Volleys Evoked by Transcranial and Epidural Motor Cortex Stimulation in a Conscious Patient with Bulbar Pain. *Clin Neurophysiol* 115:834–838
6. Di Lazzaro V, Restuccia D, Oliviero A et al. (1998) Effects of Voluntary Contraction on Descending Volleys Evoked by Transcranial Stimulation in Conscious Humans. *J Physiol* 508:625–33
7. Duncan GH, Kupers RC, Marchand S et al. (1998) Stimulation of Human Thalamus for Pain Relief: Possible Modulatory Circuits Revealed by Positron Emission Tomography. *J Neurophysiol* 80:3326–3330
8. Garcia-Larrea L, Peyron R, Mertens P (1999) Electrical Stimulation of Motor Cortex for Pain Control: A Combined PET-Scan and Electrophysiological Study. *Pain* 83:259–73
9. Lefaucheur JP, Drouot X, Menard-Lefaucheur I (2004) Neurogenic Pain Relief by Repetitive Transcranial Magnetic Cortical Stimulation Depends on the Origin and the Site of Pain. *J Neurol Neurosurg Psychiatry* 75:612–616
10. Melzack R, Wall PD (1965) Pain Mechanisms: A New Theory. *Science* 150:971–979

## Stimulus-Dependent Pain

### Definition

Pain that is evoked by stimulation.

- ▶ [Diagnosis and Assessment of Clinical Characteristics of Central Pain](#)

## Stimulus-Evoked Pain

### Definition

Pain elicited by external stimulation.

- ▶ [Antidepressants in Neuropathic Pain](#)

## Stimulus-Independent Pain

### Definition

Pain that occurs spontaneously, not dependent on stimuli applied to the skin.

- ▶ [Diagnosis and Assessment of Clinical Characteristics of Central Pain](#)

## Stimulus Quality

### Definition

The categorical subjective experience evoked by activation of either primary afferents or central nervous system neurons. Such experiences could be burning, aching, pricking, warm, cool, etc.

- ▶ [Encoding of Noxious Information in the Spinal Cord](#)

## Stimulus Response Functions

RICHARD H. GRACELY

Ann Arbor Veterans Administration Medical Center, Departments of Medicine-Rheumatology and Neurology, and the Chronic Pain and Fatigue Research Center, University of Michigan Health System, Ann Arbor, MI, USA  
rgracely@umich.edu

### Characteristics

#### Pain Threshold and Pain Tolerance

The pain threshold is the minimum amount of noxious stimulation that reliably evokes a report of pain. Pain tolerance is similarly defined as the time that a continuous stimulus is endured or the maximally tolerated stimulus intensity. The popularity of threshold and tolerance measures are due in part to their ease of use and a response that is expressed in physical units of stimulus intensity or time, avoiding the problems with developing a subjective scale of pain. Both threshold and tolerance measures are often confounded with time or increasing intensity and thus consistent data or analgesic effects can be simulated by responding after a specific number of stimuli or after a specific elapsed time. External factors can bias a subject to respond sooner or later or to a lower or higher intensity. Tolerance of a painful stimulus has been shown to be related to a separate endurance factor that is not associated with sensory intensity (Cleeland et al. 1996; Timmermans and Steinbach 1974; Wolff 1971). Although these simple methods may be useful in specific situations, at best they only assess the extremes of the perceptual pain range.

#### Assessing the Range between Pain Threshold and Tolerance: Suprathreshold Scaling

Rather than determine pain sensitivity at specific endpoints, suprathreshold scaling methods evaluate the range of pain intensity from low to those deemed tolerable by the subject. Since tolerance is not a measure of pain sensitivity, these scaling methods provide critical information about the pain processing system that are more relevant to the magnitudes of pain experienced in clinical conditions. In addition, these measures are not always associated; in the example of hyperalgesia and in other less extreme conditions, the function may rotate, resulting in higher pain thresholds but increased suprathreshold sensitivity. In these cases the pain threshold is not only irrelevant but actually misleading.

Although there are many types of direct scaling methods, the most common method is to select a set of 5–7 stimulus intensities that 1) cover the range from above pain threshold to that tolerated by the subject and 2) are spaced close enough to be confused with one another. This latter property is important to avoid artefactual reliability (e.g. “that is the third stimulus from the bottom

that I call a 5"). Once the stimulus set is chosen, a random sequence is determined to deliver each stimulus at least 2 or 3  $\times$ ; thus 7 stimuli delivered 3  $\times$  each would result in 21 trials. After each stimulus, the subject uses a response scale to rate some aspect, usually sensory intensity, of the evoked pain sensation. There is a large and sometimes lively literature about choice of response scale and the appropriate analysis, addressed only briefly below.

The random sequence of stimulus presentation theoretically controls for psychophysical biases. This feature is not usually included in necessarily fast clinical methods because of the enormity of modalities and areas that have to be tested in a short time and because many clinical abnormalities are distinct and adequately captured by these simple methods. Recent empirical evidence supports the theoretical advantage of the random methods. **Fibromyalgia** is diagnosed in part by applying 4 kg of manual pressure to 18 defined tender points and recording a report of pain from at least 11 of these sites. The method can be objectified somewhat by using one of several types of pressure algometer to deliver a pressure stimulus that increases at a constant rate and the subject indicates the point at which the evoked sensation becomes painful (termed the pain pressure threshold or PPT). Petzke et al. (2003), in a population with both healthy controls and with fibromyalgia patients with a normal spread of pressure sensitivities, observed that the tender point count, and to a lesser extent the PPT, was significantly associated with psychological distress while a random method was not. Giesecke et al. (2003) replicated this study with a cohort of fibromyalgia patients. Although the use of simple clinical measures may be warranted and sufficient in many cases, in this case one of the diagnostic criteria is probably an unknown mix of somatic sensitivity and psychological distress.

The scaling method described above was used extensively before the age of computers and has been adapted to computer administration. However, computers allow for new, interactive methods that take advantage of the ability to adjust the levels of stimulation based on the subject's responses (Duncan et al. 1992; Gracely et al. 1988). These "second generation" methods are able to overcome a number of problems with conventional direct scaling. For example, in many cases and especially when comparing patient groups to controls, the maximum level of stimulation must be determined for each individual with direct scaling, while newer methods determine this automatically. Also, a successful analgesic intervention may be obvious with direct scaling because all of the evoked sensations seem less intense. An interactive method can increase the stimulus intensities to evoke the same responses (and presumably similar sensation levels) as those produced before the analgesic intervention. Interactive methods express sensitivity in terms of stimulus intensity, providing a common measure across time and subjects.

There are a number of other advanced scaling techniques that have been applied to pain measurement. Stimulus integration methods require subjects to rate some combination of two stimuli or two stimulus characteristics, which are varied independently. Both a non-parametric method termed conjoint measurement and a parametric method termed functional measurement have been applied to pain assessment. In a typical application, subjects are presented with two stimuli and asked to rate the average pain of the two. The two stimuli can be from the same pain modality (Jones 1980), different modalities, a pain modality and an aversive non-painful modality (Algom 1986) or even a pain modality and words symbolizing pain (Gracely and Wolskee 1983; Heft and Parker 1984). The analysis treats scaling as an experiment that either indicates that subjects can perceive, combine and reliably rate the concept being measured or indicates a failure at one or more of these three stages. This promising method has only been used in a small number of studies.

#### Issues Concerning the Choice of Response

As mentioned above, pain scaling can use a number of response measures such as verbal (none, mild, moderate, intense) or numerical (0–10) categories (Brennum et al. 1992; Max and Laska 1991). Probably the most widely used is the visual analog scale (VAS), commonly displayed as a 10 cm horizontal line labeled at the ends with extreme descriptors such as "no pain" and "pain as bad as it could be." Subjects indicate the magnitude of pain by marking the line. This method has been shown to be sensitive (Price 1988) and is useful in multi-center international trials, avoiding the problems of translating and validating verbal scale in multiple languages. On the other hand, verbal category scales may increase face validity by anchoring judgments to specific levels of pain. The author favors category scales in which the position of descriptors is determined in previous experiments, and different scales display words of a particular pain dimension, such as mild, moderate and intense for pain intensity and unpleasant, distressing or very distressing for pain unpleasantness (Gracely et al. 1979). There is some evidence that the use of language may help to facilitate discrimination of different pain dimensions, although it is also likely that sufficient training will result in adequate discrimination with any scale. In addition, the issues about the type of response are dependent on other facets of the experimental situation, such as the goal of the measurement. If the goal is to provide baseline measurement and compare the responses between different groups of subjects, methods with increased face validity, possibly by the use of multiple verbal categories, may be advantageous. If the goal is to address the efficacy of a fast-acting analgesic, sensitivity to change in pain is more important than categorizing initial pain.

If subjects make repeated responses to a number of stimuli, all of the responses and methods above are influenced



by biases, such as the desire to spread responses along the entire response continuum. This bias can be controlled by the use of responses with an unlimited range (number use, duration of a button press) or by presenting quantified verbal descriptors in a random sequence, forcing choices based on semantic content rather than the position in a list. A few studies have addressed these biases with scales such as the VAS (Fernandez et al. 1991) but generally these effects have not been investigated in any detail. In many cases they would tend to diminish analgesic effects, making the many such demonstrations of analgesia more convincing.

### The Use of Experimental Pain Scaling in the Assessment of Clinical Pain

In addition to the goals of determining differences in pain sensitivities between groups and assessing the action of interventions, the stimulus-response function can be used to characterize the function of the pain sensory system under normal conditions, under experimental conditions such as slow temporal summation and under pathophysiological conditions such as nerve injury or inflammation. Indeed, the growth of clinical studies employing quantitative sensory testing (QST) is an excellent example of the successful merging of experimental procedures and clinical evaluation. An additional application is the interesting concept that responses to an experimental pain stimulus can aid the often problematic process of measuring the subjective experience of clinical pain.

One approach to assisting clinical pain measurement is the use of triangular validation in which the vertices represent a scaling method, clinical pain experience and the experience of experimentally evoked pain. The sides of the triangle represent the three possible comparisons of two vertices. One side is using a scale to clinical pain. Another is using the same scale to establish the stimulus-response function described above. The third is a variant of magnitude matching (Feine et al. 1991) in which subjects perform the novel task of comparing their clinical pain experience directly with an experimental pain experience. In theory the combination of any two legs predicts the third leg; for example the combination of stimulus-response functions and clinical-experimental pain matching provides a second measure of clinical pain magnitude that can be compared to the direct scaling of clinical pain experience. Experimental studies using acute dental pain, chronic orofacial pain and chronic low back pain confirm the theoretical agreement (Gracely 1979; Heft et al. 1980; Price et al. 1984).

Finally, while not using painful stimulation, another approach applies the principles of scaling to clinical pain assessment. Scaling methods collect multiple stimulus-evoked responses in relation to a single subjective standard. A clinical application of scaling turns this process around by using quantified categories to compare a single "clinical stimulus" to multiple subjective

standards. The descriptor differential scale (DDS) uses this approach by presenting 12 quantified descriptors and instructing subjects to rate whether their clinical pain is equal to that implied by the descriptors or how much less or greater on a +10 -10 scale. The DDS has demonstrated adequate reliability, internal consistency, validity and sensitivity (Doctor et al. 1994; Gracely and Kwilosz 1988). The use of multiple measures also provides a measure of scaling consistency. Preliminary studies have shown generally high consistency that improves from the first to the second administration (Gracely and Kwilosz 1988). These consistency measures can be used to identify subjects who are obviously not attending to the scaling task. The use of multiple items also allows the construction of alternative forms, each with different descriptor items. Validated alternative forms of the DDS demonstrated accurate memory of acute post surgical pain over a 1 week period (Kwilosz et al. 1984). The use of alternative forms in such studies increases confidence that the demonstrated recall is of previous pain and not of a previous response. An additional advantage of scaling methods in clinical pain assessment is that the use of multiple items decreases the influence of random scaling errors. The reliability and homogeneity of the overall score of the DDS is improved in comparison to analyses of individual items (Gracely and Kwilosz 1988); an effect consistent with the concept that averages of multiple responses to a single-item pain diary are superior to single responses or to the mean of only a few responses (Jensen and McFarland 1993).

Critics point out that pain evoked by experimental methods cannot duplicate the sensory, emotional and cognitive dimensions of clinical pain. Perfect duplication of all these features is not a requirement for utility and scaling methods have provided and continue to provide a wealth of information about the mechanisms of pain and pain control, about normal and abnormal pain processing, about the influence of clinical pain on pain perception and about clinical pain magnitude. Future studies of pain genetics will be as good as the ability to phenotype individuals accurately and scaling methods that have been shown to be purer measures of factors such as tenderness will probably contribute to such investigations. Despite advances in neuroimaging and human neurophysiology, pain is still defined only by human subjective experience. Clearly, methods that systematically assess this experience are critical for studies that will ultimately lead to improved diagnosis and treatment.

These experiments will probably provide important parts of the puzzle of the multiple mechanisms of pain perception. They will also probably continue to approach one of the most elusive goals: a physiological signature associated with what is otherwise an unobservable and private event.

## References

1. Algom D, Raphaeli N, Cohen-Raz L (1986) Integration of noxious stimulation across separate somatosensory communications systems: A functional theory of pain. *J Experimental Psychol: Human Perception and Performance* 12:92–102
2. Brennum J, Arendt-Nielsen L, Secher NH et al. (1992) Quantitative sensory examination during epidural anesthesia in man: Effects of lidocaine. *Pain* 51:27–34
3. Cleeland CS, Nakamura Y, Howland EW et al. (1966) Effects of oral morphine on cold pressor tolerance time and neuropsychological performance. *Neuropsychopharmacology* 15:252–262
4. Doctor JN, Slater MA, Atkinson JH (1995) The Descriptor Differential Scale of Pain Intensity, an evaluation of item and scale properties. *Pain* 61:251–60
5. Duncan GH, Miron D, Parker SR (1992) Yet another adaptive scheme for tracking threshold. Meeting of the International Society for Psychophysics, Stockholm
6. Feine JS, Bushnell MC, Miron D et al. (1991) Sex differences in the perception of noxious heat stimuli. *Pain* 44:255–262
7. Fernandez E, Nygren TE, Thorn BE (1991) An “open-transformed scale” for correcting ceiling effects and enhancing retest reliability: The example of pain. *Perception and Psychophysics* 49:572–578
8. Giesecke T, Gracely RH, Harris RE et al. (2003) Factor analysis of various measures of tenderness, clinical pain, and psychological distress, in patients with fibromyalgia. *Arthritis and Rheumatism (abstract supplement)* 48:86
9. Gracely RH (1979) Psychophysical assessment of human pain. In: Bonica JJ, Liebeskind JC, Albe-Fessard D (eds) *Advances in Pain Research and Therapy*, vol 3. Raven Press, New York, pp 805–824
10. Gracely RH, Kwilosz DM (1988) The Descriptor Differential Scale: applying psychophysical principles to clinical pain assessment. *Pain* 35:279–288
11. Gracely RH, Wolskee PJ (1983) Semantic functional measurement of pain: integrating perception and language. *Pain* 15:389–398
12. Gracely RH, Dubner R, McGrath PA (1979) Narcotic analgesia: Fentanyl reduces the intensity but not the unpleasantness of painful tooth pulp stimulation. *Science* 203:1261–1263
13. Gracely RH, Lota L, Walther DJ et al. (1988) A multiple random staircase method of psychophysical pain assessment. *Pain* 32:55–63
14. Heft MW, Parker SR (1984) An experimental basis for revising the graphic rating scale. *Pain* 19:153–161
15. Heft MW, Gracely RH, Dubner R et al. (1980) A validation model for verbal descriptor scaling of human clinical pain. *Pain* 9:363–373
16. Jensen MP, McFarland CA (1993) Increasing the reliability and validity of pain intensity measurement in chronic pain patients. *Pain* 55:195–203
17. Jones B (1980) Algebraic models for integration of painful and nonpainful electric shocks. *Perception and Psychophysics* 28:572–576
18. Kwilosz DM, Gracely RH, Torgerson WS (1984) Memory for post-surgical dental pain. *Pain* 2:426
19. Max MB, Laska EM (1991) Single-dose analgesic comparisons. In: Max MB, Portenoy RK, Laska EM (eds) *Advances in Pain Research and Therapy*, vol 18. The Design of Analgesic Clinical Trials. Raven Press, New York, pp 55–95
20. Petzke F, Gracely RH, Park KM et al. (2003) What do tender points measure? Influence of distress on 4 measures of tenderness. *J Rheumatol* 30:567–574
21. Price DD (1988) *Psychological and Neural Mechanisms of Pain*. Raven Press, New York
22. Price DD, Rafii A, Watkins LR et al. (1984) A psychophysical analysis of acupuncture analgesia. *Pain* 19:27–42
23. Timmermans G, Sternbach RA (1974) Factors of human chronic pain: an analysis of personality and pain reaction variables. *Science* 184:806–808
24. Wolff BB (1971) Factor analysis of human pain responses: pain endurance as a specific pain factor. *J Abnorm Psychol* 78:292–298

---

## Stomatodynia

- ▶ [Atypical Facial Pain, Etiology, Pathogenesis and Management](#)

---

## STP Syndromes

- ▶ [Soft Tissue Pain Syndromes](#)

---

## Straight-Leg-Raising Sign

- ▶ [Lower Back Pain, Physical Examination](#)

---

## Strain

### Definition

Traumatic injury to the muscle.

- ▶ [Opioids and Muscle Pain](#)

---

## Stratum Corneum

### Definition

The stratum corneum is the uppermost layer of skin and consists of cells containing keratin. Old and dead cells on the surface are continuously shed off, and are replaced by new cells formed at the stratum germinativum.

- ▶ [Opioid Therapy in Cancer Pain Management, Route of Administration](#)

---

## Strength (Efficiency) of Chemical Synapses

Action potentials invading pre-synaptic nerve terminals trigger release of one or more fast neurotransmitters, which activate postsynaptic ionotropic neurotransmitter receptors such as AMPA-, kainate- or NMDA-receptors for glutamate (usually excitatory), or GABA<sub>A</sub> or glycine receptors for  $\gamma$ -amino-buturic acid and glycine (usually inhibitory), respectively. Ligand binding leads to excitatory inward currents or inhibitory outward currents and increased membrane conductance. Synaptic strength is defined as the magnitude of postsynaptic currents elicited by a single pre-synaptic action potential. Action potential firing of the postsynaptic cells

depends on spatial and temporal summation of excitatory and inhibitory synaptic input, level of resting membrane potential, pacemaker potentials and membrane excitability of the post-synaptic cell. Thus, action potential firing of a post-synaptic neuron in response to pre-synaptic stimulation is not a direct measure of excitatory synaptic strength.

- ▶ [Long-Term Potentiation and Long-Term Depression in the Spinal Cord](#)

## Streptozotocin

### Definition

An antibiotic made by *Streptomyces achromogenes*, which is a selective toxin of the  $\beta$  cells of the pancreas. It enters the  $\beta$  cell via glucose transporters and induces DNA damage. Cells undergo necrosis, rupture and release stored insulin. The result is a transient period of hypoglycemia caused by release of insulin into the blood, followed by progression to hyperglycemia as cells such as muscle and fat fail to take up glucose from the blood due to the lack of insulin to activate their glucose transport mechanisms.

- ▶ [Neuropathic Pain Model, Diabetic Neuropathy Model](#)

## Streptozotocin-Induced Diabetic Neuropathy

### Definition

Streptozotocin is a chemical that destroys the beta islet cells of the pancreas, and can therefore be given as an intra-peritoneal injection in the animal model to create diabetes mellitus.

- ▶ [Ulceration, Prevention by Nerve Decompression](#)

## Stress

### Definition

Any environmental or life event perceived by the individual as threatening to his or her physical or psychological well being and exceeding his or her capacities to cope. It causes bodily or mental tension and may be a factor in disease causation.

- ▶ [Pain as a Cause of Psychiatric Illness](#)
- ▶ [Pain in the Workplace, Risk Factors for Chronicity, Psychosocial Factors](#)
- ▶ [Stress and Pain](#)

## Stress and Pain

HEATHER L. ROGERS<sup>1</sup>, MICHAEL FEUERSTEIN<sup>1, 2, 3</sup>

<sup>1</sup>Department of Medical and Clinical Psychology, Uniformed Services University of the Health Sciences, Bethesda, MD, USA

<sup>2</sup>Department of Preventive Medicine & Biometrics, USUHS, Bethesda, MD, USA

<sup>3</sup>Georgetown University Medical Center, Washington, DC, USA

mfeuerstein@usuhs.mil

### Synonyms

Psychosocial factors; Biobehavioral Factors; Occupational Stressors; Family Stressors; Social Stressors; Physical Stressors; Physiological Pathways

### Definition

Stress has been defined as a state of threatened homeostasis, or a disturbance of the body's physiological processes that are normally maintained at a predetermined, optimal set point. While homeostasis suggests that there is a single set point for any physiological measure that is adjusted by some local mechanism, a common principle in the area of stress (i.e. ▶ [allostasis](#)) emphasizes that different situations require variations in set points, for which regulatory changes throughout the body are necessary in order to maintain optimal levels of biological function (McEwen 1998). Many theories and models hypothesize that exposure to environmental stimuli (referred to as "stressors") initiates the stress response. In a physiological context, a ▶ [stressor](#) can be something physical (i.e. frequent lifting) or psychological (i.e. time demands at work) that disrupts the body's allostatic balance. The ▶ [stress response](#) is the body's attempt to maintain stability, or homeostasis, through change (McEwen 1998).

An early cognitive model of stress (Lazarus 1966) suggests that the physiological stress response may be affected by the degree and intensity of the perceived stress, or a person's ▶ [cognitive appraisal](#) (evaluation) of the actual environmental stimuli. As any stimuli could potentially be interpreted as harmful, it is the cognitive appraisal or perception of a given situation that labels the stimuli as threatening or as "stressors", thus eliciting the stress response. Appraisal can be modified by attention, past experiences, and various psychological coping styles. According to Lazarus, when making an appraisal, people consider the resources they have available to cope with the potential stressor and their ability to offset the threatening stimuli. A person's vulnerability to the stressor can be mediated by variables such as social support, perception of predictability and controllability, problem solving, skill-building and/or learning, as well as personal factors, genotype, and lifestyle. Some of these variables can be categorized as ▶ [Coping](#)

**Strategy/Style** (e.g. problem solving, recruiting social support). These mediating variables have been reported to impact the stress-pain relationship in a number of recurrent chronic pain disorders. Haufler et al. (2000) found an association between job stress, response to work demands, and upper extremity pain and function. It is important to note that stressors can impact the severity of pain, tolerance of pain, and the behavioral disability associated with the pain (Wall and Melzack 1999).

Any stimulus deemed threatening through the person's cognitive appraisal of the situation can disturb the body's allostasis, and consequently evoke a stress response which can involve acute and longer term physiological, hormonal, immune, cognitive and behavioral changes. Over the years, many researchers have proposed that the stress response involves the activation of a number of different systems that each interact with one another. For example, the hypothalamic-pituitary-adrenal (HPA) system is activated and produces CRH, which activates ACTH, which results in the production of cortisol (humans) or corticosterone (animals). The locus coeruleus-norepinephrine-sympathetic (LC-NE) system in the brainstem has both descending and ascending projections. Both of these systems interact with the immune, opioid and limbic-cortical systems to determine the degree of stress-regulation, and whether or not pain will be experienced or suppressed (Chrousos and Gold 1992).

The speed, magnitude and duration of these changes depend on the stressor, its perceived severity, and attenuating or exacerbating conditions. The prolonged activation of the stress response, specifically the stress-regulation systems, can potentially initiate, exacerbate, and/or maintain certain pain states and illness related to pain (Melzack 1999; Watkins and Maier 2000).

### Characteristics

In examining the characteristics of the stress-pain link, it is important to consider the biobehavioral changes that can occur, underlying its plausibility in both acute and chronic stages. Animal and human research has shown that the acute stress response can result in analgesia, or a suppression of pain. A variety of stressful environmental stimuli can elicit pain suppression, including electric shock, cold water, swims, aggression, the sight of a cat by a rat, and military combat. Studies examining the possible neural pathways and neurochemistry mediating analgesia, suggest that the brain sends signals to the spinal cord where pain signals are inhibited. Endogenous opioid compounds are synthesized and released by the parts of the brain that regulate pain perception. These natural painkillers circulate in the bloodstream and bind to opiate receptors, effectively blunting the perception of pain (Wall and Melzack 1999). However, some stressors can result in analgesia through unknown nonopioid-mediated pathways. Thus, after a severe acute injury, it is well known that some people may not feel pain until

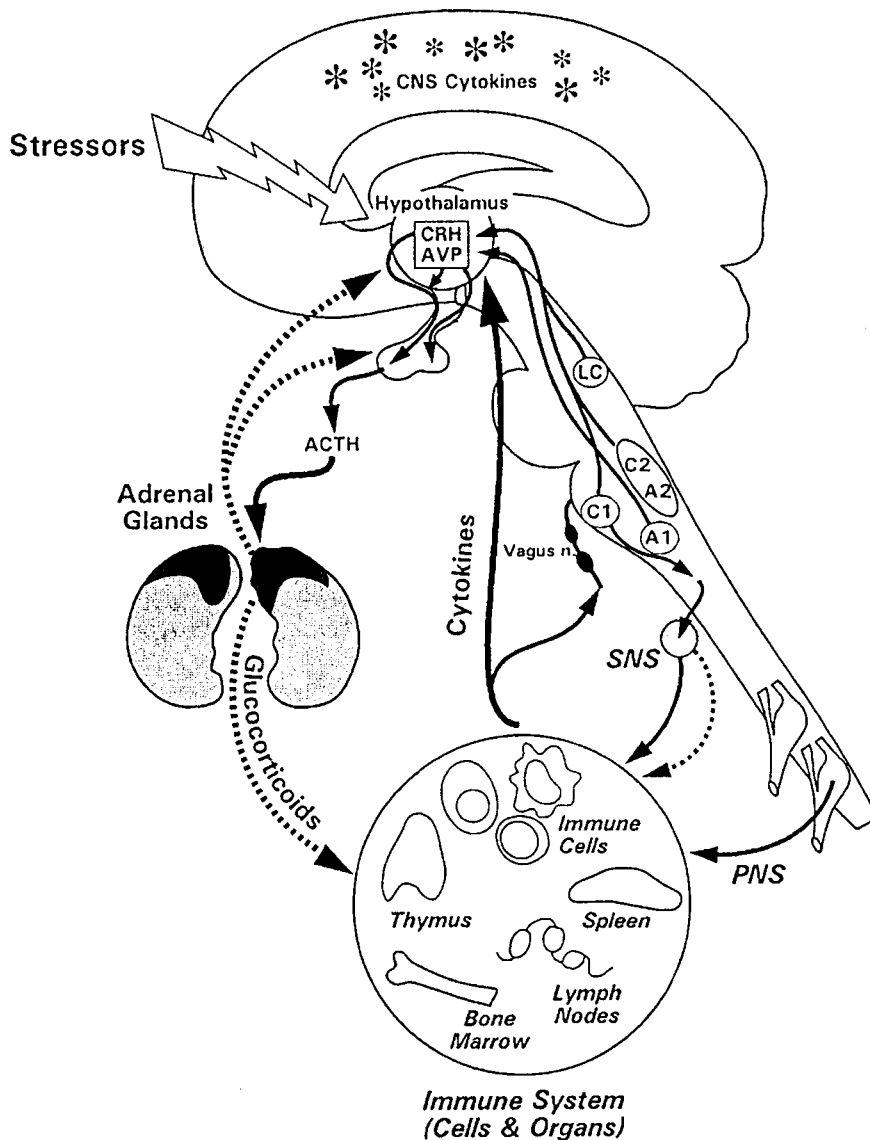
hours, or even days, later (e.g. during the excitement of a sports match).

The biological mechanisms responsible for the stress-pain link are complicated and at present not well delineated. Eriksen et al. (1999) have examined the temporal dimension of the stress response, and provided evidence that it develops in phases. According to his model, the stimulus first produces increased brain activity, which leads to behavioral changes (i.e. goal-directed behavior). Within seconds, the sympathetic and parasympathetic nervous systems are activated. Then slower acting systems, like the endocrine system, respond. Its effects are more systemic. Changes in the immune system occur last, some as a response to the peak levels of hormones generated by the endocrine response. However, if a stressor is constant, such as prolonged exposure to time demands at one's job, with persistent recurring thoughts at home and few opportunities for recovery, there can be sustained activation of the systems involved in the stress response. Hormone and immune levels can rise dramatically and stay high for long periods of time. Receptors may up-regulate and neurons can become sensitized. Normal somatic signals may be over-interpreted and the sensations from the body may be evaluated as danger signals, further enhancing the stress response (Eriksen et al. 1999). Figure 1 (Webster et al. 2002) illustrates the communication pathways among the systems as delineated in Maier (2003).

Melzack views pain as a multi-dimensional experience produced by many influences (e.g. sensory input, somatic input, cytokines, cultural experience). Melzack (1999) proposed a ► **body-self neuromatrix** model, which consists of three parallel neural networks that contribute to the sensory-discriminative, affective-motivational, and evaluative-cognitive dimensions of the pain experience. The neuromatrix receives input from many sources, including somatic, visual, cognitive and emotional, and the stress-regulation systems (including endocrine, immune, opioid, HPA and LC-NE). In the neuromatrix model, the input, which includes either acute or long-term stress responses, modulates the pain experience.

Extended activation of these stress-regulation systems, which are proposed to be partly responsible for determining the body's pain response, impacts muscle, bone, joints, and neural tissue, and may set the stage for a number of persistent pain disorders such as persistent back pain and arthritis. Any site of inflammation or immune response cytokine activity, which can include strain or muscle spasm, could become a target for cortisol. Barr (2002) proposes that a "vicious cycle" can be initiated as cytokines released during acute inflammation activate macrophages, which then in turn produce even more cytokines that further stimulate inflammation and a further release of cortisol. Through this process, direct tissue damage can occur, with the end result being chronic inflammation and pain.





**Stress and Pain,**  
**Figure 1** Diagram of the routes of communication between the brain and immune system, including the HPA axis, sympathetic nervous system, and cytokine feedback to the brain (from Webster JI, Tonelli L, Sternberg EM (2002) Neuroendocrine regulation of immunity, *Annual Review of Immunology* 20:125–163).

S

Proinflammatory cytokines, such as IL-1, IL-6 and TNF- $\alpha$ , appear to play a pathogenic role in various diseases associated with disability among the elderly, including arthritis; elevated levels of IL-6 predict future disability in older adults (Ferrucci et al. 1999). Research also shows that both acute and chronic stressful experiences can increase the production of proinflammatory cytokines. Kiecolt-Glaser and colleagues (2003) studied spousal dementia caregivers, and found that caregivers had an average rate of increase of IL-6 approximately four times that of non-caregivers. Moreover, stress may permanently alter the responsiveness of the immune system. The same study reports that the caregivers' mean annual IL-6 levels did not change, even 3 years after the death of the impaired spouse (Kiecolt-Glaser et al. 2003). Women may be especially vulnerable to stress and pain. A study of female managers at an in-

surance company found that, although no significant differences were found during the workday compared to male colleagues, the women had significantly higher norepinephrine levels after work, while the males' levels returned to normal (Lundberg and Frankenhaeuser 1999).

Furthermore, pain itself can be a powerful stressor. Many studies have shown that severity of pain during an injury or infection is a major determinant of chronic pain after healing has occurred. Patients with post herpetic neuralgia were found more likely to develop persistent pain after the infection had healed if they had experienced greater activation of their stress-regulation systems, either in the acute stage of the illness or over the course of the disease, i.e. greater severe pain, nerve infection, sensory dysfunction, or immune response (Dworkin and Portenoy 1996).

Exposure to a variety of types of stressors can evoke a complex cognitive, behavioral and physiological response. The biological response can have many systemic consequences. This, in turn, can trigger, exacerbate, or maintain many types of pain. The transition from acute to recurrent or chronic pain following repeated exposure to stress is complex and not well documented at this point. The biological plausibility of the impact of stressors on daily life, and the experience of pain, is becoming clearer as models based on physiological and biochemical research begin to clarify these pathways. The clinical implications of this stress-pain link relates to the use of various medications (anti-inflammatories, anxiolytics, and anti-depressants), environmental interventions such as modifying work organization, and cognitive-behavioral approaches that can help reduce pain and/or its impact on function (National Institutes of Health 1995).

The opinions and assertions contained herein are the private views of the authors, and are not to be construed as being official or as reflecting the views of the Uniformed Services University of the Health Sciences or the Department of Defense.

## References

- Barr (2002) Pathophysiological Tissue Changes Associated with Repetitive Movement: A Review of the Evidence. *Phys Ther* 82:173–187
- Dworkin RH, Portenoy RK (1996) Pain and its Persistence in Herpes Zoster. *Pain* 67:241–251
- Eriksen HR, Olf M, Murison R et al. (1999) The Time Dimension in Stress Response: Relevance for Survival and Health. *Psych Res* 85:39–50
- Ferrucci L, Harris TB, Guralnik JM et al. (1999) Serum IL-6 Level and the Development of Disability in Older Persons. *J Am Geriatr Soc* 47:639–646
- Haufler AJ, Feuerstein M, Huang GD (2000) Job Stress, Upper Extremity Pain and Functional Limitation in Symptomatic Computer Users. *Am J Indust Med* 38:507–515
- Kiecolt-Glaser JK, Preacher KJ, MacCallum RC et al. (2003) Chronic Stress and Age-Related Increases in the Proinflammatory Cytokine IL-6. *Proc Natl Acad Sci USA* 100:9090–9095
- Lazarus RS (1966) *Psychological Stress and the Coping Process*. McGraw-Hill, New York
- Lundberg U, Frankenhaeuser M (1999) Stress and Workload of Men and Women in High Ranking Positions. *J Occup Health Psychol* 4:142–152
- Maier SF (2003) Bi-Directional Immune-Brain Communication: Implications for Understanding Stress, Pain, and Cognition. *Brain Behav Immun* 17:69–85
- McEwen BS (1998) Protective and Damaging Effects of Stress Mediators. *N Engl J Med* 338:171–179
- Melzack R (1999) Pain and stress: A New Perspective. In: Gatchel RJ, Turk DC (eds) *Psychosocial Factors in Pain: Critical Perspectives*. Guilford Press, New York, pp 89–106
- National Institutes of Health (1995) Integration of Behavioral and Relaxation Approaches into the Treatment of Chronic Pain and Insomnia: Technology Assessment Conference Statement. [http://consensus.nih.gov/ta/017/017ta\\_statement.pdf](http://consensus.nih.gov/ta/017/017ta_statement.pdf)
- Wall P, Melzack R (1999) *Textbook of Pain*, 4<sup>th</sup> edn. Churchill Livingstone, Edinburgh
- Watkins LR, Maier SF (2000) The Pain of Being Sick: Implications of Immune-to-Brain Communication for Understanding Pain. *Ann Rev Psychol* 51:29–57
- Webster JI, Tonelli L, Sternberg EM (2002). Neuroendocrine Regulation of Immunity. *Ann Rev Immunol* 20:125–163

## Stress Headache

- ▶ Headache, Episodic Tension Type

## Stress-Induced Analgesia

### Definition

Inhibition of pain by environmental stressors.

- ▶ Pain Modulatory Systems, History of Discovery

## Stress Management

- ▶ Psychological Treatment of Headache
- ▶ Relaxation Training

## Stress Metabolism

- ▶ Postoperative Pain, Pathophysiological Changes in Metabolism in Response to Acute Pain

## Stress Profile

- ▶ Psychophysiological Assessment of Pain

## Stress Response

### Definition

The cognitive, behavioral and/or physiological changes that occur in response to a stressor as the body attempts to maintain allostasis.

- ▶ Postoperative Pain, Pathophysiological Changes in Neuro-Endocrine Function in Response to Acute Pain
- ▶ Stress and Pain

## Stressor

### Definition

A stimulus of a physical (i.e. frequent lifting) or psychological (i.e. time demands at work) nature that disrupts the body's allostatic balance.

- ▶ Stress and Pain

## Stretching

ROBERT D. HERBERT  
School of Physiotherapy, University of Sydney,  
Sydney, NSW, Australia  
r.herbert@fhs.usyd.edu.au

### Definition

Stretching involves positioning a joint or joints so that muscles or other structures are placed under passive tension. Stretches may be brief and repetitive (dynamic stretching) or sustained (static stretching). The muscles may remain relaxed as they are stretched (passive stretching) or agonist or antagonist muscles may be made to actively contract (active stretching).

### Characteristics

Physiotherapists, chiropractors and osteopaths (collectively referred to here as manual therapists) often stretch soft tissues. The purpose may be to prevent or treat stiff joints (adaptive shortening of soft tissues that prevents normal joint motion) or to prevent or treat pain. This essay is concerned with the use of soft tissue stretching to prevent or treat pain of presumed musculoskeletal origin.

A cursory inspection of the literature reveals a remarkable diversity in proposed indications for therapeutic stretching of muscles. Equally remarkable is the diversity of theories about mechanisms by which stretching is thought to produce its therapeutic effects. Establishing the effect of muscle stretching is difficult because most research has investigated stretching as part of a combination of therapies, an approach that reflects contemporary clinical practice.

This essay will consider three putative indications for stretching muscles, treatment of musculoskeletal pain, prevention and treatment of malalignment syndromes and prevention of delayed onset muscle soreness. These indications were chosen because they provide scenarios where stretching is used as the main or sole component of therapy.

### Treatment of Musculoskeletal Pain

A range of conditions is associated with pain of presumed musculoskeletal origin. One school of thought holds that a prevalent cause of pain is the ► **myofascial pain syndrome**, characterised by the presence of ► **trigger points**, focal muscle lesions tender to palpation (Travell and Simons 1983). Trigger points are thought to be regions of muscle containing sensitised nerve fibres (Hong and Simons 1998; Travell and Simons 1983).

Trigger point therapists stretch muscles because they believe that stretching “inactivates” trigger points and relieves pain (Travell and Simons 1983). A popular technique (► **spray and stretch**) involves first spraying the

skin overlying the muscles with a vapocoolant spray to produce a superficial local anaesthesia. But soft tissue stretching is not solely the domain of trigger point therapy; manual therapists who do not subscribe to the trigger point theory may also stretch soft tissues to relieve pain.

There have been relatively few randomised investigations of stretching for treatment of pain. Hou and colleagues (2002) randomly allocated 31 subjects with active trigger points in the upper trapezius muscle to receive either spray and stretch or a control condition. Pain levels were measured immediately after the stretch. The effect of spray and stretch procedures was to reduce pain by approximately one-third of initial levels. This study shows that spray and stretch produces an immediate reduction in pain, but it is not clear if the effects are sustained, or whether the effects are due to the spray or the stretch. Khalil et al. (1992) randomly allocated 28 subjects with low back pain to receive four sessions of muscle stretching over a 2 week period or a control condition. All subjects had been diagnosed with myofascial syndrome. After the last stretching session, subjects reported mean pain levels (in cm on a 10 cm VAS scale) of 5.3 (SD 2.0) in the control group and 1.6 (1.4) in the treated group, suggesting that stretching reduced pain by 3.7 cm on a 10 cm VAS scale. Again, it is not clear if this effect was sustained for a clinically useful duration. Hanten and colleagues (2000) randomised 40 subjects with trigger points in the neck or back to receive either self-administered pressure and stretch treatment (10 sessions over 5 days) or a control condition. They measured pain levels 2 days after the last treatment and found modest reductions in pain (VAS pain 1.3 cm (SD 1.6) compared to 2.5 cm (SD 2.1)). Together these studies provide some evidence that stretching can produce short-term reductions in pain of people with myofascial pain syndromes.

### Malalignment Syndromes

Mainstream medical texts often label conditions such as tendinoses, periostitis, stress fractures, compartment syndromes, impingement syndromes and even osteoarthritis as diseases of “overuse”. Historically there has been little attempt to distinguish why some people develop a particular condition while others, even those who experience high degrees of use, do not.

A view held by many manual therapists is that the causes of some musculoskeletal pain conditions can be understood in biomechanical terms. According to this view, abnormalities of body alignment place excessive stresses on specific anatomical structures, causing pain. Thus, it is believed, particular pain conditions can be prevented or treated by altering body alignment. Therapists who hold to this view assess body alignment with an aim to identifying ► **malalignment syndromes**. In-

tervention often involves stretching muscles, provision of orthoses or splints or specific exercises to correct the malalignment.

One example may suffice. Various lower limb conditions, such as plantar fasciitis, are thought to be due to tightness of the soleus muscle (Pfeffer et al. 1999). Thus patients with plantar fasciitis may be advised to perform “heel cord stretches” (self-administered calf muscle stretches) or to wear night splints that stretch the ankle into dorsiflexion. The expectation is that stretching of calf muscles will cause the rearfoot to be less supinated, causing less stress on painful structures and less pain. Similar theories are used to explain other sorts of foot pain, as well as back and neck pain, shoulder pain and knee pain. Manual therapists may stretch muscles to treat any of these conditions. If interventions such as muscle stretching are to be generally effective in preventing and treating pain due to malalignment, then there must be a strong causal relationship between body alignment and the development of pain. To what extent is this condition satisfied?

It is difficult to establish if there is a causal relationship between body alignment and the development of pain. The only satisfactory approach involves prospective monitoring of large cohorts, using multivariate statistical techniques to control for potentially confounding factors. The largest studies investigating the relationship between body alignment and development of low back pain (Bigos et al. 1992; Diek et al. 1985) found no association, suggesting that body alignment does not have an important influence on risk of developing back pain. Some relatively small studies have investigated the relationship between lower limb alignment and risk of lower limb overuse injuries and these studies provide inconsistent evidence of a relationship (e.g. Cowan et al. 1996; Wen et al. 1998). It has not been established if the observed relationship between lower limb alignment and subsequent development of painful overuse injuries in the lower limb is causal.

Many studies have investigated the effects of stretching as part of a combination of therapies. For example, stretching has been incorporated into many exercise programs that have been shown to be effective for reducing back pain, neck pain or pain due to hip or knee osteoarthritis. This makes sense because it is not usual clinical practice to apply stretch as a sole treatment for musculoskeletal pain. Nonetheless it is difficult to extract effects of stretching from other components of exercise programs. The few studies that specifically examined effects of muscle stretching on musculoskeletal pain were trials designed to see if night splints (which provide a sustained stretch to the calf muscles) can reduce pain in plantar fasciitis. The three relevant trials provide only limited support for the effectiveness of night splints (Crawford and Thomson 2003).

### Muscle Soreness

Unaccustomed exercise can produce muscle soreness that develops 1 or 2 days after the exercise is completed. This type of muscle soreness is called ► **delayed-onset muscle soreness**. Many people stretch before or after exercise in the belief that this will prevent or minimise delayed-onset muscle soreness. The origin of the belief that stretching of muscles can prevent muscle soreness may lie with physiological studies conducted in the 1960s. De Vries (1966) hypothesised that unaccustomed exercise induced muscle spasm. He believed that spasm impaired blood flow, causing ischaemic pain and further spasm (the pain-spasm-pain cycle) and that stretching interrupted this cycle. De Vries’ early model of the pain-spasm-pain cycle was probably a precursor of the contemporary theories about mechanisms of trigger points.

The spasm theory of muscle soreness is almost certainly wrong. Moderate isometric muscle contractions are required to prevent blood flow to muscles, but sore muscles do not exhibit this level of spasm and may not exhibit any increase in resting activity (Bobbert et al. 1986). Instead it is likely that muscle soreness is caused by a series of events beginning with damage to the contractile elements in muscle fibres (Proske and Morgan 2001). This mechanism leaves little room for a role of stretching.

What evidence is there that stretching before or after unaccustomed exercise prevents or reduces delayed onset muscle soreness? A systematic review of the relevant literature identified five randomised studies of the effects of stretching on muscle soreness (Herbert and Gabriel 2002). Three studies evaluated stretching after exercising, and two evaluated stretching before exercising. As there was no evidence of heterogeneity in the outcomes of the studies, the findings of all studies were combined in a meta-analysis. The pooled estimate of the mean effect of stretching on muscle soreness 48 h after exercising was just 0.3 mm (95% CI -4.0 mm to 4.5 mm) on a 100 mm scale, where negative values indicate a beneficial effect of stretching. These data clearly indicate that stretching before or after exercise does not produce worthwhile reductions in muscle soreness.

### Conclusion

A number of theories have been put forward about how stretching could prevent or treat pain. Stretch has been used to reduce pain of presumed musculoskeletal origin and there is some evidence from several small studies that these techniques are helpful. Many therapists stretch muscles to correct postural malalignment thought to cause overuse injury, but there is little evidence of a causal relationship between abnormal alignment and development of overuse injury and the few relevant trials are equivocal. The practice of stretching immediately before or after exercise does not prevent delayed onset muscle soreness.



## References

1. Bigos SJ, Battie MC, Spengler DM et al. (1992) A longitudinal, prospective study of industrial back injury reporting. *Clin Orthop Relat Res* 279:21–34
2. Bobbert MF, Hollander AP, Huijing PA (1986) Factors in delayed onset muscular soreness of man. *Med Sci Sports Exerc* 18:75–81
3. Crawford F, Thomson C (2003) Interventions for treating plantar heel pain. In: *The Cochrane Library, Issue 4*. Wiley, Chichester
4. Cowan DN, Jones BH, Frykman PN et al. (1996) Lower limb morphology and risk of overuse injury among male infantry trainees. *Med Sci Sports Exerc* 28:945–952
5. De Vries HA (1966) Quantitative electromyographic investigation of the spasm theory of muscle pain. *Am J Physl Med* 45:119–134
6. Dieck GS, Kelsey JL, Goel VK et al. (1985) An epidemiologic study of the relationship between postural asymmetry in the teen years and subsequent back and neck pain. *Spine* 10:872–877
7. Hanten WP, Olson SL, Butts NL et al. (2000) Effectiveness of a home program of ischemic pressure followed by sustained stretch for treatment of myofascial trigger points. *Phys Ther* 80:997–1003
8. Herbert RD, Gabriel M (2002) Effects of stretching before and after exercising on muscle soreness and risk of injury: systematic review. *BMJ* 325:468
9. Hong C, Simons DG (1998) Pathophysiological and electrophysiological mechanisms of myofascial trigger points. *Arch Phys Med Rehab* 79:863–872
10. Hou C-R, Tsai L-C, Cheng K-F et al. (2002) Immediate effects of various physical therapeutic modalities on cervical myofascial pain and trigger-point sensitivity. *Arch Phys Med Rehab* 83:1406–1414
11. Khalil TM, Asfour SS, Martinez LM et al. (1992) Stretching in the rehabilitation of low back pain patients. *Spine* 17:311–318
12. Pfeffer G, Bacchetti P, Deland J et al. (1999) Comparison of custom and prefabricated orthoses in the initial treatment of proximal plantar fasciitis. *Foot Ankle Int* 20:214–221
13. Proske U, Morgan DL (2001) Muscle damage from eccentric exercise: mechanism, mechanical signs, adaptation and clinical applications. *J Physiol* 537:333–345
14. Travell JG and Simons DG (1983) *Myofascial Pain and Dysfunction. The Trigger Point Manual*. Williams & Wilkins, Baltimore
15. Wen DY, Puffer JC, Schmalzried TP (1998) Injuries in runners: a prospective study of alignment. *Clin J Sport Med* 8:187–194

## Stria Terminalis (ST)

### Definition

A curved fiber bundle that accompanies the caudate nucleus and reciprocally connects the amygdala and the medial hypothalamus.

- ▶ [Nociceptive Processing in the Amygdala, Neurophysiology and Neuropharmacology](#)

## Stroke

### Definition

A sudden disruption of blood flow to the brain, either by a clot or a leak in a blood vessel.

- ▶ [Central Pain, Outcome Measures in Clinical Trials](#)
- ▶ [Headache Due to Arteritis](#)

## Structural Lesion

### Definition

In relation to low back pain, a structural lesion is an abnormality in the structure of the spine that is thought to cause an individual's back pain. Many physicians assume that the most appropriate strategy for treating low back pain is to identify and correct the structural lesion underlying it.

- ▶ [Compensation, Disability and Pain in the Workplace](#)
- ▶ [Disability, Effect of Physician Communication](#)

## Struggle

### Definition

Struggle is a centrally processed reaction (the rat attempts to escape).

- ▶ [Randall-Selitto Paw Pressure Test](#)

## Strychnine

### Definition

Strychnine is a blocker of inhibitory glycine receptors.

- ▶ [GABA and Glycine in Spinal Nociceptive Processing](#)

## STT

- ▶ [Spinothalamic Tract](#)

## Stump Pain

### Definition

Stump pain is a normal consequence of amputation surgery. In most patients, stump pain subsides within a week after amputation, but 5–10% of patients continue to have severe pain localized to the amputation stump. Pain may be accompanied by sensory disturbances such as allodynia and hyperalgesia. Chronic stump pain may be difficult to treat.

- ▶ [Postoperative Pain, Postamputation Pain, Treatment and Prevention](#)

## Subacute Pain

- ▶ [Acute Pain, Subacute Pain and Chronic Pain](#)
- ▶ [Postoperative Pain, Persistent Acute Pain](#)

## Subarachnoid Drug Administration

- ▶ Postoperative Pain, Intrathecal Drug Administration

## Subarachnoid Space

### Definition

The space between the arachnoidea and pia mater membranes surrounding the spinal cord, traversed by delicate fibrous trabeculae and filled with cerebrospinal fluid. This space is especially large around the lumbar level of the human spinal cord.

- ▶ Cell Therapy in the Treatment of Central Pain

## Subarachnoid/Spinal Anesthesia

### Definition

A form of regional anesthesia that involves the injection of anesthetic into the cerebrospinal fluid (CSF), at a predetermined space along the spinal canal, to produce anesthesia to all body regions that are supplied by nerves that arise below the anatomic region of the block.

- ▶ Epidural Infusions in Acute Pain

## Subchondral Bone

### Definition

A portion of bone that lies beneath the cartilage, typically the ends of bones that form joints.

- ▶ Arthritis Model, Osteoarthritis

## Subclinical Forehead Sweating

### Definition

Subclinical Forehead Sweating refers to increased sweating not evident by observation.

- ▶ Sunct Syndrome

## Subcutaneous Mechanoreception

### Definition

Subcutaneous Mechanoreception refers to neuronal responses to mechanical stimuli impacting tissue under the skin, which is transduced by specialized receptive endings of afferent nerve fibers.

- ▶ Postsynaptic Dorsal Column Projection, Anatomical Organization

## Subdural

### Definition

The area between the dura mater and the arachnoid mater.

- ▶ Epidural Infusions in Acute Pain

## Subdural Drug Pumps

- ▶ Pain Treatment, Implantable Pumps for Drug Delivery

## Subdural Hematoma

- ▶ Headache Due to Intracranial Bleeding

## Subject Weights

### Definition

Subject weights are the coordinates of an individual in the source space with respect to the dimensions found in the group stimulus space.

- ▶ Multidimensional Scaling and Cluster Analysis Application for Assessment of Pain

## Subjective Factors

### Definition

Subjective factors are individual's experiences that make it difficult for them to carry out various activities. Since examiners cannot directly observe subjective factors, they must rely on reports by claimants about them.

- ▶ Impairment, Pain-Related

## Subjective Judgment

### Definition

Conclusions drawn about another's pain based on personal feeling or interpretation; not objective. While it is impossible to avoid subjective judgment entirely, it can be minimized through the use of standardized and validated pain assessment tools.

- ▶ Pain Assessment in Neonates

## Subjective Pain Experience

### Definition

The multidimensional perceptual qualities that are categorized by people as pain.

- ▶ McGill Pain Questionnaire

## Sublenticular Extended Amygdala

### Synonyms

SLEA

### Definition

Neurons that represent an extension of the central and medial nucleus of the amygdala.

- ▶ Amygdala, Functional Imaging

## Subliminal Receptive Fields

### Definition

Receptive fields detected after removal of dominant inputs to the neuron.

- ▶ Thalamic Plasticity and Chronic Pain

## Submaximum Effort Tourniquet Technique

- ▶ Tourniquet Test

## Subnucleus Caudalis and Interpolaris

### Definition

The two most caudal subnuclei of the trigeminal sensory nuclear complex. The subnucleus caudalis is a laminated structure that resembles the dorsal horn of the spinal cord. Integrative processing of nociceptive input from facial cutaneous and deep orofacial tissues principally occurs in the subnucleus caudalis. For these reasons, the subnucleus caudalis is often referred to as the medullary dorsal horn.

- ▶ Nociceptors in the Orofacial Region (Temporo-mandibular Joint and Masseter Muscle)

## Subnucleus Reticularis Dorsalis

### Synonyms

SRD

### Definition

These neurons selectively convey nociceptive information from all parts of the body to the thalamocortical system.

- ▶ Spinothalamocortical Projections to Ventromedial and Parafascicular Nuclei

## Subnucleus Reticularis Ventralis

### Definition

The ventral portion of the subnucleus reticularis dorsalis (SRD).

- ▶ Brainstem Subnucleus Reticularis Dorsalis Neuron

## Substance Abuse

### Definition

The intentional misuse of a medication; either over-use or taken for a purpose not prescribed (i.e. mood alteration).

- ▶ Cancer Pain, Evaluation of Relevant Comorbidities and Impact
- ▶ Opioid Therapy in Cancer Patients with Substance Abuse Disorders, Management

## Substance P

### Definition

Substance P is an 11 amino acid neuropeptide that is a member of the tachykinin neuropeptide family and functions as a neurotransmitter and neuromodulator. It is present in both primary afferent neurons and in neurons within the spinal cord and higher brain levels. The endogenous receptor for substance P is the neurokinin 1 receptor, a G-protein coupled receptor. Release of substance P from peripheral terminals of DRG neurons is a major mediator of neurogenic inflammation, causing vasodilation of blood vessels, plasma extravasation and degranulation of mast cells. Release of substance P from central terminals contributes to enhanced function of nociceptive spinal cord neurons, in part by facilitating the actions of glutamate at the N-Methyl-D-Aspartate (NMDA) receptor.

- ▶ Alternative Medicine in Neuropathic Pain
- ▶ Fibromyalgia
- ▶ Immunocytochemistry of Nociceptors
- ▶ Neuropeptide Release in the Skin
- ▶ Nociceptor, Categorization
- ▶ Opioids in the Periphery and Analgesia
- ▶ Opioid Modulation of Nociceptive Afferents In Vivo

- ▶ Somatic Pain
- ▶ Spinomesencephalic Tract

## Substance P Regulation in Inflammation

JANET WINTER

Novartis Institute for Medical Science, London, UK  
janet.winter@novartis.com

### Synonyms

Substance P Tachykinin; neurokinin; NK

### Definition

Substance P is an eleven amino acid neuropeptide associated with pain transmission and is expressed at high levels in ▶ dorsal root ganglia and in sensory afferent terminals in the spinal cord, as well as in the sensory innervation of peripheral tissues such as skin and viscera. Electrical stimulation causes release of substance P from spinal cord, but it can also be released from peripheral endings; in fact the majority of this neuropeptide is transported peripherally, not centrally from the DRG. Peripheral release of substance P is thought to have a pro-inflammatory role (neurogenic inflammation).

### Characteristics

#### Peptide Family

Substance P is part of the tachykinin family along with neurokinin A and neurokinin B; all share the same carboxy terminal sequence (Phe-X-Gly-Leu-X-NH<sub>2</sub>), see Table 1.

There are 3 genes encoding tachykinins, PPT-A (prepro-tachykinin-A), PPT-B and PPT-C. Mammalian substance P is encoded by the PPT-A gene (Severini et al. 2002). This gene also encodes other tachykinins, including NKA and the two N terminally extended forms of NKA, neuropeptide K (NPK) and neuropeptide  $\gamma$  (NP $\gamma$ ). NKB is derived from a separate gene, PPT-B. The endokinins are encoded by PPT-C. There are 4 splice variants of PPT-A, ( $\alpha\beta\gamma\delta$ ) with  $\beta$  PPT-A mRNA containing all seven exons of the corresponding gene. Substance P can be expressed alone ( $\alpha\delta$ ), whereas NKA expression is always accompanied by substance P expression ( $\beta\gamma$ ).

In neurones, substance P is released from its precursor (preprotachykinin) by the action of converting enzymes and is then COOH- terminally amidated, packed into storage vesicles and transported to terminals for final enzymatic processing.

Substance P is expressed predominantly in the nervous system (although other tissue types have recently been shown to express it, e.g. endothelial cells, inflammatory cells, airway smooth muscle cells etc.). All vertebrate tissues are innervated by networks of tachykinergic fibres. Some of the new members of the tachykinin family, the hemokinins and endokinins are primarily expressed in non-neuronal tissues.

▶ Neuron restrictive silencer factor (NRSF) is a repressor that is predominantly expressed in non-neuronal cells. NRSF silences neuronal genes in non-neuronal cells by binding to the NRSE (neurone restrictive silencer element) motif. These neuronal genes include type II sodium channel, synapsin 1, M4 muscarinic acetylcholine receptor and certain adhesion molecules. The NRSE motif is also found at the major transcrip-

**Substance P Regulation in Inflammation, Table 1** Amino acid sequence of mammalian tachykinins

tachykinin	sequence
Substance P	Arg-Pro-Lys-Pro-Gln-Gln-Phe-Phe-Gly-Leu-Met-NH <sub>2</sub>
Neurokinin A	His-Lys-Thr-Asp-Ser-Phe-Val-Gly-Leu-Met-NH <sub>2</sub>
Neurokinin B	Asp-Met-His-Asp-Phe-Phe-Val-Gly-Leu-Met-NH <sub>2</sub>
Hemokinin-1 (m/r)	Arg-Ser-Arg-Thr-Arg-Gln-Phe-Tyr-Gly-Leu-Met-NH <sub>2</sub>
Hemokinin-1 (h)	Thr-Gly-Lys-Ala-Ser-Gln-Phe-Phe-Gly-Leu-Met-NH <sub>2</sub>
Endokinin A and B <sup>1</sup>	-Gly-Lys-Ala-Ser-Gln-Phe-Phe-Gly-Leu-Met-NH <sub>2</sub>
C14TKL-1 <sup>2</sup>	Arg-His-Arg-Thr-Pro-Met-Phe-Tyr-Gly-Leu-Met-NH <sub>2</sub>
Virokinin (viral origin)	Gly-Ile-Pro-Glu-Leu-Ile-His-Tyr-Thr-Arg-Asn-Ser-Thr-Lys-Lys-Phe-Tyr-Gly-Leu-Met-NH <sub>2</sub>
<i>Tachykinin gene-related peptides</i>	
Endokinin C	Lys-Lys-Ala-Tyr-Gln-Leu-Glu-His-Thr-Phe-Gln-Gly-Leu-Leu-NH <sub>2</sub>
Endokinin D	Val-Gly-Ala-Tyr-Gln-Leu-Glu-His-Thr-Phe-Gln-Gly-Leu-Leu-NH <sub>2</sub>

<sup>1</sup>The C-terminal decapeptidic fragment common to endokinin A (47 amino acids) and endokinin B (41 amino acids) is shown. <sup>2</sup>Chromosome 14 tachykinin-like peptide 1. m/r ; mouse/rat; h, human. Modified from (Patacchini et al. 2004)



tional start site of the PPT-A gene, and when promoter constructs expressing NRSF are introduced into cultured DRG neurones, there is a marked down-regulation of PPT-A transcription (Quinn et al. 2002). This important silencer may therefore be responsible for the inhibition of expression of substance P in non-neuronal cells in normal tissues.

### Receptors

Substance P and the other tachykinins act *via* G protein coupled, 7 transmembrane domain, neurokinin (NK) receptors (Severini et al. 2002). There are (at least) 3 of these, NK1, NK2 and NK3, with highest affinities for substance P, NKA and NKB respectively, although endogenous tachykinins are not highly selective and can act at all 3 receptors under certain conditions. A multistate model of GPCR activation has been proposed whereby ligands can specifically stabilize receptor conformations, enabling one receptor to activate one or more G proteins in a ligand specific manner.

The main substance P receptor, NK1, will be described here. NK1 is a single copy gene (mapped to human chromosome 2) that has a high degree of sequence homology between species. There is a cAMP/calcium response element in the 5' untranslated region.

Recent papers suggest that NK1 receptors are expressed both on DRG neurones and terminals and postsynaptically in the spinal cord. Presence on DRG neurones suggests that substance P may regulate its own release. Following substance P application, either exogenously applied to the spinal cord or released from afferent terminals during intense stimulation, there is a dramatic internalisation of NK1 receptor expressed on dorsal horn lamina I neurones from the usual cell membrane localisation. Substance P sensitises NMDA receptors in the spinal cord.

However, this review will focus on the peripheral roles of substance P and NK1 in inflammation.

### Neurogenic inflammation

► **Neurogenic inflammation** is the collective term for the effects produced by neuropeptides released from (mainly capsaicin-sensitive) sensory neurones and include vasodilatation (flare), plasma protein extravasation (PPE) and leukocyte adhesion to vascular endothelial cell receptors (Patacchini et al. 2004; Severini et al. 2002).

In the skin, some substance P positive terminals are found near the epidermal basal membrane, but the majority innervate blood vessels. Substance P released from cutaneous sensory nerves binds to NK1 receptors on endothelial cells, resulting in plasma leakage and increased blood flow, dilatation of the arteriole (although CGRP is probably the main vasodilator released) and wheal and flare (Brain and Williams 1988; Holzer 1998; Green et al. 1992). Substance P can also cause itch. These outcomes are due, not only to direct

action of substance P on blood vessels, but also indirectly to mast cell activation. Substance P released by neurogenic inflammation can also promote angiogenesis *via* NK1 receptors (Seegers et al. 2003). Vascular responses to substance P in the skin are very species dependent, however. These proinflammatory actions of substance P may potentiate nociceptive responses, although neurogenic inflammation alone evoked by antidromic stimulation of primary afferents is not sufficient to sensitize nociceptor terminals *in vivo*, at least acutely.

Mice with a targeted disruption of either the PPT-A gene or the NK1 receptor gene show a complex pattern of responses to noxious stimuli. PPT-A *-/-* mice which lack substance P (SP) and neurokinin A (NKA), exhibit reduced behavioral responses to intense somatic stimuli, but the behavioral hypersensitivity following injury is unaltered. From NK1 *-/-* mice studies, it seems that NK1 receptors have an essential role in mediating central nociceptive and peripheral inflammatory responses to noxious stimuli that provoke neurogenic inflammation (e.g. carageenan), but no role in non-neurogenic stimuli (such as turpentine or ► **CFA**). A much higher percentage of visceral (80%) than skin (25%) afferents express substance P and NK1 *-/-* mice show profound deficits in spontaneous behavioural reactions to an acute visceral chemical stimulus (intracolonic capsaicin) and fail to develop referred hyperalgesia or tissue oedema. However, responses (hyperalgesia and oedema) to mustard oil are intact. Two separate hyperalgesia pathways may exist, one that is NK1 receptor dependent and one that is independent (Laird et al. 2000). The lack of neurogenic inflammation in NK1 *-/-* mice probably does not account for the blunted pain response and lack of hyperalgesia, as NK1 antagonists that do not cross the blood-brain barrier do not affect behavioural nociceptive responses to capsaicin or formalin, but completely block neurogenic inflammation.

In the periphery, density of substance P fibres innervating skeletal muscle increases in inflammation and substance P expression and transport down the sciatic nerve increases following inflammation of the hind paw, though substance P expression in the paw declines, probably due to decreased storage and increased release. NGF may be an important factor in regulation of substance P in inflammation (Woolf 1996). NGF produced in peripheral targets is ► **retrogradely** transported to the cell bodies of sensory neurones innervating that tissue, where it can regulate substance P production. NGF injection into the paw can cause increase in substance P and hyperalgesia. Anti-NGF can block the *in vivo* inflammation-induced increases in substance P as well as hyperalgesia. Substance P injection or neurogenic inflammation activates NK1 receptors on keratinocytes and causes increased NGF production, which is blocked by an NK1 receptor antagonist (Amann et al. 2000). So substance P induced NGF up-regulation can feed-

back to further increases in substance P production. After inflammation, there is a phenotypic switch so that some of the large A fibres now also express substance P (Woolf 1996). These may be A fibre nociceptors. Substance P receptors are expressed on sensory fibres innervating skin (Ruocco et al. 2001) and are also up-regulated in inflamed tissues. The proportion of NK1-expressing sensory fibres in the ► [glabrous](#) skin of the hindpaw increases 2 days after CFA inflammation (Coggeshall and Carlton 2003). PGE2 (prostaglandin E2) production increases in inflammation and may influence NK1 expression levels; NK1 receptor levels are up-regulated by PGE2 in adult sensory neuron cultures. There is also a probable role for substance P in inflammation in man, where psoriatic skin shows a large increase in substance P and other neuropeptides and an increase in substance P receptors. In the clinic, levels of substance P in dental pulp tissue increased in patients with irreversible ► [pulpitis](#) (Bowles et al. 2003).

### Antagonists

NK1 antagonists can inhibit PPE and oedema in rodent skin. They are also potent anti-hyperalgesics in animal models of inflammation and neuropathic pain (Campbell et al. 2000). In the clinic, an NK1 antagonist was effective for acute pain following dental surgery; however, clinical trials of NK1 antagonists in chronic pain have failed to exhibit efficacy (Hill 2000). No clinical trials have yet been carried out on visceral pain, where NK1 antagonists may be more effective (Laird 2001); antagonists acting at visceral afferents have been effective in the clinic against nausea and vomiting.

### References

- Amann R, Egger T, Schuligoi R (2000) The tachykinin NK(1) receptor antagonist SR140333 prevents the increase of nerve growth factor in rat paw skin induced by substance P or neurogenic inflammation. *Neuroscience* 100:611–615
- Bowles WR, Withrow JC, Lepinski AM et al. (2003) Tissue levels of immunoreactive substance P are increased in patients with irreversible pulpitis. *J Endod* 29:265–267
- Brain SD, Williams TJ (1988) Substance P regulates the vasodilator activity of calcitonin gene-related peptide. *Nature* 335:73–75
- Campbell EA, Gentry C, Patel S et al. (2000) Oral anti-hyperalgesic and anti-inflammatory activity of NK(1) receptor antagonists in models of inflammatory hyperalgesia of the guinea-pig. *Pain* 87:253–263
- Coggeshall RE, Carlton SM (2003) Control of postganglionic sympathetic efferent fibers by neurokinin 1 receptors in rats. *Neurosci Lett* 353:197–200
- Green PG, Basbaum AI, Levine JD (1992) Sensory neuropeptide interactions in the production of plasma extravasation in the rat. *Neuroscience* 50:745–749
- Hill R (2000) NK1 (substance P) receptor antagonists—why are they not analgesic in humans? *Trends Pharmacol Sci* 21:244–246
- Holzer P (1998) Neurogenic vasodilatation and plasma leakage in the skin. *Gen Pharmacol* 30:5–11
- Laird J (2001) Gut feelings about tachykinin NK1 receptor antagonists. *Trends Pharmacol Sci* 22:169
- Laird JM, Olivar T, Roza C et al. (2000) Deficits in visceral pain and hyperalgesia of mice with a disruption of the tachykinin NK1 receptor gene. *Neuroscience* 98:345–352
- Patacchini R, Lecci A, Holzer P et al. (2004) Newly discovered tachykinins raise new questions about their peripheral roles and the tachykinin nomenclature. *Trends Pharmacol Sci* 25:1–3
- Quinn JP, Bubbs VJ, Marshall-Jones ZV et al. (2002) Neuron restrictive silencer factor as a modulator of neuropeptide gene expression. *Regul Pept* 108:135–141
- Ruocco I, Cuello AC, Shigemoto R et al. (2001) Light and electron microscopic study of the distribution of substance P-immunoreactive fibers and neurokinin-1 receptors in the skin of the rat lower lip. *J Comp Neurol* 432:466–480
- Seegers HC, Hood VC, Kidd BL et al. (2003) Enhancement of angiogenesis by endogenous substance P release and neurokinin-1 receptors during neurogenic inflammation. *J Pharmacol Exp Ther* 306:8–12
- Severini C, Improta G, Falconieri-Erspamer G et al. (2002) The tachykinin peptide family. *Pharmacol Rev* 54:285–322
- Woolf CJ (1996) Phenotypic modification of primary sensory neurons: the role of nerve growth factor in the production of persistent pain. *Philos Trans R Soc Lond B Biol Sci* 351:441–448

## Substance P Tachykinin

- [Substance P Regulation in Inflammation](#)

## Substantia Gelatinosa

### Synonyms

Rexed's Lamina II

### Definition

A narrow, dense, vertical band of gelatinous grey matter forming the dorsal part of the posterior horn of the spinal cord, and serving to integrate the sensory stimuli that give rise to the sensations of heat and pain. It is also referred to as Rexed's lamina II. Many afferent synapse on the second order neuron here.

- [Nociceptor, Categorization](#)
- [Opioid Therapy in Cancer Pain Management, Route of Administration](#)
- [Psychiatric Aspects of Visceral Pain](#)
- [Somatic Pain](#)
- [Visceral Nociception and Pain](#)

## Substantial Gainful Activity

### Definition

Work that involves doing significant and productive physical or mental duties, which is done (or intended) for pay or profit. Work may be substantial even if done on a part-time basis or if the person does less, gets paid less, or has less responsibility than when he or she worked before.

- [Disability Evaluation in the Social Security Administration](#)

## Sudeck's Atrophy

- ▶ Complex Regional Pain Syndromes, General Aspects
- ▶ Neuropathic Pain Models, CRPS-I Neuropathy Model

## Sudomotor

### Definition

Regulation of sweat secretion (perspiration) is one of the functions of the sympathetic nervous system. This function is known as sudomotor function. Abnormalities in sudomotor function may lead to either excessive sweating (hyperhidrosis) or decreased or absent sweating (anhidrosis). Such abnormalities may be seen in patients with CRPS and in patients with diabetic neuropathy.

- ▶ Sympathetically Maintained Pain in CRPS II, Human Experimentation

## Sudomotor Dysfunction

### Definition

Affecting the sweating-mechanisms.

- ▶ Causalgia, Assessment

## Sudomotor Function

### Definition

Evaluated by:

- 1.) Resting sweat output of non-stimulated skin.
  - 2.) Quantitative sudomotor axon reflex test (QSART). Measures the sympathetic response to a somatic stimulus (electrical current); and the axon reflex sweat response provoked by cutaneous application of acetylcholine.
- ▶ Postoperative Pain, Acute Presentation of Complex Regional Pain Syndrome

## Suffering

### Definition

Suffering is the clash arising from an attack to our person's integrity, to its desire of happiness and health, produced or not produced by pain.

- ▶ Cancer Pain Management, Interface Between Cancer Pain Management and Palliative Care
- ▶ Ethics of Pain in the Newborn Human

## Suggestibility

### Definition

The degree to which an individual is likely to respond to suggestion. This may vary within an individual person depending upon context and state of mind. Group pressure may increase suggestibility to conform to the mores of the group. Hypnosis is considered a state of mind that enhances suggestibility.

- ▶ Therapy of Pain, Hypnosis

## Sulci

### Definition

Sulci are grooves on the surface of the brain, often used as landmarks to identify areas with a distinct function.

- ▶ Clinical Migraine with Aura

## Sulfur Bath

### Definition

Bathing in a sulfur pool heated to 34-37°C.

- ▶ Spa Treatment

## Sunburn

### Definition

Sunburn is a colloquial term for the damage to the skin caused by acute over-exposure to ultraviolet light from the sun.

- ▶ UV-Erythema, a Model for Inducing Hyperalgesias
- ▶ UV-Induced Erythema

## Sunburn as a Model of Cutaneous Hyperalgesia

- ▶ UV-Induced Erythema

## Sunct Status

### Definition

Continuous flow of SUNCT attacks for more than 24 hours.

- ▶ Sunct Syndrome

## SUNCT Syndrome

JUAN A. PAREJA

Department of Neurology, Fundación Hospital Alcorcón, Madrid, Spain  
jpg03m@saludalia.com

### Synonyms

Short-lasting Unilateral Neuralgiform Headache attacks with Conjunctival injection and Tearing

### Definition

The acronym SUNCT (Short-lasting Unilateral Neuralgiform Headache attacks with Conjunctival injection and Tearing) (Sjaastad et al. 1989) summarizes the clinical features of this syndrome.

SUNCT (Sjaastad et al. 1989) is a primary disorder characterized by intermittent short-lived (10–120 s), moderate to severe, paroxysms of orbital/periocular pain, accompanied by ipsilateral, rapidly developing, dramatic, conjunctival injection and lacrimation. Less frequently there may also be rhinorrhea or nasal stuffiness. Attacks are usually precipitated from trigeminal and extratrigeminal innervated areas.

### Characteristics

SUNCT is a male predominant disorder, with the mean age of onset around 50 years (Matharu et al. 2003; Pareja and Sjaastad 1997). Although available epidemiological data is lacking, the low number of reported cases indicates it is a rare disorder.

### Localization

Symptoms and signs are strictly unilateral, generally with the pain persistently confined to the ocular/periocular area (Pareja and Sjaastad 1997; Sjaastad et al. 1989). An occasional spread beyond the midline, or a co-involvement of the opposite side, has been observed in SUNCT (Matharu et al. 2003; Pareja and Sjaastad 1997), with the pain still predominating in the originally symptomatic side. Shifting side attacks have been reported in two patients (e.g. Matharu et al. 2003).

### Intensity and Character of Pain (Intensity of Pain)

Most attacks are characterized by moderate to severe pain. Excruciatingly severe pain (► [excruciating pain](#)) is rarely reported. The pain is frequently described as burning, stabbing, or electric in character (Pareja and Sjaastad 1997). SUNCT attacks start and cease abruptly. The solitary attacks usually have a “plateau-like” pattern (Sjaastad et al. 1989), but also other patterns have been noted (Pareja and Sjaastad 1994): “repetitive” (short-lasting attacks in rapid succession), “saw-tooth-like” (and its variant “staccato-like”, in which consecutive spike-like paroxysms occur without reaching the pain

free baseline), and “plateau-like plus exacerbations” (admixture of 1–2 s jabs superimposed on top of the conventional plateau-like pattern).

### Duration of Attacks

The mean duration of paroxysms is ca. 1 min, with a usual range of 10–120 s. Objectively, measurements of 348 attacks in 11 patients rendered a mean duration of 49 s, with a range of 5–250 s (Pareja et al. 1996c). Very rarely, a few patients reported relatively long-lasting attacks, lasting 1–2 h (Pareja et al. 1996b). However, this atypical duration of SUNCT should be taken as a rare variant since, even in these patients, the vast majority of attacks were almost invariably typical.

In between attacks the patients are completely free of symptoms. Very rarely, however, patients may report very low-grade background pain or discomfort in the symptomatic area during symptomatic periods (Pareja et al. 1996b). This background pain or discomfort could be rather durable, fluctuating or intermittent.

### Temporal Distribution of Attacks

The attacks predominate during daytime. There seems to be a tendency for attacks to occur in the morning and afternoon/evening in a bimodal fashion. Nocturnal attacks are rare, but may occur either during the worst periods or as an occasional feature (Pareja et al. 1996c). The reduction in attacks during the night seems to concern patients exhibiting both exclusively spontaneous attacks and those with mostly precipitated attacks. The reduction in precipitating stimuli during sleep does, therefore, not seem critical for the nocturnal break in the flow of attacks.

The temporal pattern is irregular, with symptomatic periods, alternating with remissions in an unpredictable fashion. Symptomatic periods last from a few days to several months, but may persist for up to five years, in the exceptional case. Remissions may last from 1 week to several years, but usually last for several months (Pareja and Sjaastad 1997; Sjaastad et al. 1989). The chronic pattern seems to be much less typical than the remitting form in SUNCT (Matharu et al. 2003). During active periods, the usual frequency of attacks may vary, from a few attacks/day to >30 attacks/h (Sjaastad et al. 1989). Objective assessment of the frequency of 585 attacks in 4 patients rendered a mean of 16 attacks per day, with a range of 1 to 86 daily (Pareja et al. 1996c). At the peak of an attack series, a 1 to 3 day long clinical “status” has been witnessed in several patients (Pareja et al. 1996a) (► [SUNCT status](#)).

### Accompaniments

Attacks are regularly accompanied by prominent, ipsilateral conjunctival injection and lacrimation, both signs appearing in tandem from the onset of symptoms (Pareja and Sjaastad 1997; Sjaastad et al. 1989). Rhinorrhea and/or nasal obstruction is found in approx-



imately 2/3 of the SUNCT cases (Pareja and Sjaastad 1997; Sjaastad et al. 1989). In addition there is – subclinical – increased forehead sweating (▶ **subclinical forehead sweating**), increased intraocular pressure, and corneal temperature (Sjaastad et al. 1992). During periods with a marked attack tendency, there may be swelling of the eyelids on the symptomatic side owing to vascular engorgement and eyelid edema, but such ▶ **pseudoptosis** is not parietic in nature. Otherwise, no changes in pupil diameter have been observed (Zhao and Sjaastad 1993).

During SUNCT attacks there may be increased systemic blood pressure with heart rate decrement. It has been demonstrated during attacks, and less markedly in between attacks, that SUNCT patients hyperventilate (e.g. Pareja and Sjaastad 1997).

### Precipitating Mechanisms

In SUNCT, numerous mechanical precipitating factors within the trigeminal and extratrigeminal areas have been described (Pareja and Sjaastad 1997; Sjaastad et al. 1989). Although most SUNCT attacks probably are precipitated, a minority of patients seemingly may exhibit exclusively spontaneous attacks. The apparent spontaneous attacks in genuine SUNCT may have “subclinical triggers”. ▶ **Refractory periods** that are a typical feature of genuine, neuralgic pain seem to be lacking in SUNCT patients (Lain et al. 2000; Matharu et al. 2003; Pareja and Sjaastad 1994; Pareja and Sjaastad 1997).

### Symptomatic SUNCT

In the vast majority of SUNCT cases etiology and pathogenesis are unknown. Symptomatic SUNCT has been described in some patients with documented intracranial structural lesions (Bussone et al. 1991; Matharu et al. 2003; Pareja and Sjaastad 1997). The majority were posterior fossa disorders, mostly vascular disturbances/malformations, either extraaxial (cerebellopontine angle arteriovenous malformations) or intraaxial (cavernous angioma of the brainstem, ischemic brainstem infarction). Other documented structural lesions include: basilar impression associated to osteogenesis imperfecta, cranesynostosis, and prolactinomas. A single case of SUNCT syndrome associated with microvascular compression of the trigeminal nerve, and two cases of SUNCT in patients with HIV (one of them with a posterior fossa lesion) have also been reported (for a complete review see Matharu et al. 2003). Such findings make neuroimaging examination of the brain mandatory, as part of the diagnostic work-up.

### Treatment

In SUNCT, there is a lack of persistent, convincingly beneficial effect of drugs or anesthetic blockades generally effective in cluster headache (CH), chronic paroxysmal hemicrania (CPH), trigeminal neuralgia,

primary stabbing headache (PSH), and other headaches more faintly resembling SUNCT (Matharu et al. 2003; Pareja and Sjaastad 1997). Single reports have claimed that carbamazepine, lamotrigine (D’Andrea et al. 2001), gabapentin, topiramate, or surgical procedures may be of help. Absolute improvement of a symptomatic form of SUNCT after surgical removal of a cerebellopontine vascular malformation (Bussone et al. 1991) may indicate that excitation of the trigeminal nerve by such a structural disorder may be pathogenetically important. Conversely, such a posterior fossa intervention may just simply have removed hidden intracranial triggers (▶ **hidden triggers**).

Improvement of symptoms have been reported in a few cases by invasive procedures such as percutaneous, symptomatic side trigeminal ganglion compression, microvascular decompression of the trigeminal root (Jannetta procedure), retrogasserian glycerol rhizolysis, ballon compression of the trigeminal nerve root, or local opioid blockade of the superior cervical ganglion. It should be mentioned that the long-term outcome of some of these patients is unknown. However, negative results of several surgical procedures such as glycerol rhizotomy, gammaknife radiosurgery, and microvascular decompression of the trigeminal nerve, have also been reported. Therefore, at this stage of development, surgical treatment of SUNCT has not been sufficiently validated (Matharu et al. 2003; Pareja et al. 2002)

### Differential Diagnosis

SUNCT syndrome should mainly be considered when encountering a case of orbital/periorbital pain with prominent autonomic accompaniments and/or when the orbital pain paroxysms are short-lasting. The differential diagnostic possibilities seem to be limited, and mainly consist of CH, CPH, first branch (V-1) trigeminal neuralgia, and PSH.

Diagnostic criteria of SUNCT Syndrome (The International Headache Society Classification, 2<sup>nd</sup> edn, in press):

- a) Attacks of unilateral orbital, supraorbital, temporal, stabbing, or throbbing pain lasting from 5–240 s.
- b) Attack frequency from 3 to 200 daily
- c) Pain is accompanied by ipsilateral conjunctival injection and lacrimation
- d) Not attributed to another disorder
- e) At least 20 attacks that fulfill A through D

SUNCT syndrome differs clearly from CH as regards a number of clinical variables such as duration, intensity, frequency, and nocturnal preponderance of attacks. The two syndromes also differ markedly as regards precipitation of attacks, the usual age of onset, and efficacy of various treatment alternatives. Laboratory investigations have disclosed differences as regards presence/absence of Horner-like picture. All

**SUNCT Syndrome, Table 1** CPH and SUNCT syndrome. Differences

	CPH	SUNCT
Sex predominance	Female	Male
Usual age of onset	<40 years	>40 years
Duration of attacks	2–30 min.	10–120 s
Severity of pain	Excruciating	Moderate-severe
Frequency of attacks	Above 5/day (up to 30/day)	16 (1–86)/day (up to 30/h)
Nocturnal attacks	Frequent	Very rare
Mechanical precipitation of attacks	Infrequent	Frequent
Response to indomethacin	Absolute	None

In a minority (12%) of CPH patients attacks may be precipitated by neck movements

Modified from: Pareja JA, Caminero AB, Sjaastad O. SUNCT syndrome. Diagnosis and treatment. *CNS Drugs* 2002; 16:373-383 (Pareja et al. 2002)

in all, these differences seem sufficiently ponderous to make it likely that SUNCT syndrome and CH differ essentially.

SUNCT and PSH are topographically antagonistic in that SUNCT is typically confined to the same orbital/periorbital localization, whereas PSH is characterized by a multidirectional, chaotic, sequence of paroxysms. Such a lack of topographic organization of the symptoms could be the expression of a presumed multi-origin, most probably in the terminal sensitive fibers of the pericranial nerves. However, the pain may be felt within the V-1 territory, frequently in the orbit. Otherwise, PSH is a predominantly female disorder with ultra short (typically lasting 1 s) spontaneous attacks not accompanied by autonomic features.

Short-lasting attacks of CPH may overlap with long-lasting SUNCT attacks. Indeed, CPH may rarely be precipitated by spontaneous or provoked neck movements. These features may pose extra difficulties in its differentiation from SUNCT. The absolute responsiveness of CPH to indomethacin is diagnostically crucial, but there are other differentiating features (Table 1). SUNCT syndrome should be differentiated from V-1 trigeminal neuralgia. It is worth noting that only 5% of trigeminal neuralgia primarily originate in its first division.

V-1 trigeminal neuralgia attacks are much shorter than SUNCT attacks, and are regularly followed by a refractory period. V-1 trigeminal neuralgia attacks may be accompanied by local autonomic signs, but contrary

**SUNCT Syndrome, Table 2** First division (V-1) trigeminal neuralgia, and SUNCT syndrome - differences

	V-1 neuralgia	SUNCT
Sex predominance	Male = Female	Male > female
Usual attack duration	5-10 s	60 s
Usual range of duration	1–30 s	10–120 s
Autonomic phenomena during attacks		
Conjunctival injection	Absent	
Lacrimation	Absent or slight	Constant/Prominent
Rhinorrhoea/nasal stuffiness	Absent	Frequent
Severity of pain	Excruciating	Moderate-severe
Spreading of pain from V-1 to V-2, V-3	Yes	No
Nocturnal attacks	Rare	Very rare
Refractory periods	Constant	May lack
Carbamazepine effect	Excellent	Partial

Modified from: Pareja JA, Caminero AB, Sjaastad O. SUNCT syndrome. Diagnosis and treatment. *CNS Drugs* 2002; 16:373-383 (Pareja et al. 2002)

to what is the case in SUNCT, autonomic accompaniments in V-I trigeminal neuralgia are not constant, tend to appear after years of headache, and have a modest dimension. In SUNCT, attacks are regularly accompanied by dramatic lacrimation and conjunctival injection, both signs appearing in tandem, whereas the minority of V-1 trigeminal neuralgia patients with autonomic accompaniments of attacks show modest lacrimation without conjunctival injection. Other remarkable differential features are set forth in Table 2.

### Pathophysiology

Pathophysiology of SUNCT is mostly unknown. Based on the clinical features there seems to be an activation of the V-I trigeminal system but the “ignition” process is unknown. Since SUNCT attacks are longer, and refractory periods may be lacking, the pain modulating system may seem to behave differently in SUNCT as compared with e.g. trigeminal neuralgia. In SUNCT parasympathetics could be either strongly activated or hypersensitive, bringing about an impressive set of local autonomic signs. The reported activation of the ipsilateral hypothalamic gray during a SUNCT attack (May et al. 1999) has been claimed as pathogenically relevant, as the hypothalamus has connections to the pain modulating system and the superior salivary nucleus and is, therefore, anatomically positioned to influence both the pain and the autonomic accompaniments (Goadsby and Lipton 1997; May et al. 1999).

- ▶ Paroxysmal Hemicrania
- ▶ Primary Stabbing Headache

### References

1. Bussone G, Leone M, Volta GD et al. (1991) Short-Lasting Unilateral Neuralgiform Headache Attacks with Tearing and Conjunctival Injection: The First ‘Symptomatic’ Case. *Cephalalgia* 11:123–127
2. D’Andrea G, Granella F, Ghiotto N et al. (2001) Lamotrigine in the Treatment of SUNCT Syndrome. *Neurology* 57:1723–1725
3. Goadsby PJ, Lipton RB (1997) A Review of Paroxysmal Hemicranias, SUNCT Syndrome and Other Short-Lasting Headaches with Autonomic Features Including New Cases. *Brain* 120:193–209
4. Laín AH, Caminero AB, Pareja JA (2000) SUNCT Syndrome: Absence of Refractory Periods and Modulation of Attack Duration by Lengthening of the Trigger Stimuli. *Cephalalgia* 20:671–673
5. Matharu MS, Cohen AS, Boes CJ et al. (2003) Short-Lasting Unilateral Neuralgiform Headache with Conjunctival Injection and Tearing Syndrome: A Review. *Curr Pain Headache Rep* 7:308–318
6. May A, Bahra A, Buchel C et al. (1999) Functional MRI in Spontaneous Attacks of SUNCT: Short-lasting Neuralgiform Headache with Conjunctival Injection and Tearing. *Ann Neurol* 46:791–793
7. Pareja JA, Sjaastad O (1994) SUNCT Syndrome in the Female. *Headache* 34:217–220
8. Pareja JA, Sjaastad O (1997) SUNCT Syndrome: A Clinical Review. *Headache* 37:195–202
9. Pareja JA, Caballero V, Sjaastad O (1996a) SUNCT Syndrome. Status-Like Pattern. *Headache* 36:622–624
10. Pareja JA, Joubert J, Sjaastad O (1996b) SUNCT Syndrome. Atypical Temporal Patterns. *Headache* 36:108–110
11. Pareja JA, Shen JM, Kruszewski P et al. (1996c) SUNCT Syndrome. Duration, Frequency, and Temporal Distribution of Attacks. *Headache* 36:161–165
12. Pareja JA, Caminero AB, Sjaastad O (2002) SUNCT Syndrome. Diagnosis and Treatment. *CNS Drugs* 16:373–383
13. Sjaastad O, Kruszewski P, Fostad K et al. (1992) SUNCT Syndrome. VII. Ocular and Related Variables. *Headache* 32:489–495
14. Sjaastad O, Saunte C, Salvesen R et al. (1989) Short-lasting, Unilateral, Neuralgiform Headache Attacks with Conjunctival Injection, Tearing, Sweating, and Rhinorrhea. *Cephalalgia* 9:147–156
15. Zhao JM, Sjaastad O (1993) SUNCT Syndrome: VIII. Pupillary Reaction and Corneal Sensitivity. *Funct Neurol* 8:409–414

## Superconducting Quantum Interference Device

- ▶ Magnetoencephalography in Assessment of Pain in Humans

## Superficial Dorsal Horn

### Definition

The spinal cord is arranged in such a way that primary afferent fibers originating in the periphery display specific somatotopic organization upon entry into the cord. Classically, the spinal cord can be divided into the white matter and grey matter, and the latter can be further divided into 10 different laminae, each layer being composed of functionally distinct cells. Laminae I and II make up the superficial dorsal horn, and this area of the spinal cord represents the point at which nociceptive peripheral inputs first synapse.

- ▶ Opioids in the Spinal Cord and Modulation of Ascending Pathways (*N. gracilis*)
- ▶ Spinoparabrachial Tract

S

## Superficial Dry Needling

### Definition

This is a technique of dry needling developed by Baldry. The acupuncture needle is applied subcutaneously, but does not penetrate the muscle tissue.

- ▶ Dry Needling

## Superficial Dyspareunia

### Definition

Entry dyspareunia.

- ▶ Gynecological Pain and Sexual Functioning

## Superior Hypogastric Plexus

### Definition

Nerves to and from internal organs of the lower abdomen.

- ▶ Cancer Pain Management, Anesthesiologic Interventions, Neural Blockade

## Supersensitivity

### Definition

Increased response to a drug, presumably due to an increase in the number of receptors activated by the drug (upregulation) or by a functional increase in receptor reactivity.

- ▶ Opioids and Reflexes

## Supplemental Security Income

- ▶ Disability Evaluation in the Social Security Administration

## Supplemental Security Income Disability Program

### Definition

Means-tested national program administered by the Social Security Administration that provides monthly payments to needy disabled adults and disabled children (individuals under age 18).

- ▶ Disability Evaluation in the Social Security Administration

## Supportive Care

### Definition

Part of palliative care but does not include disease modifying therapy with palliative intent, and like hospice care, does not have as broad a scope as palliative care.

- ▶ Cancer Pain Management, Interface Between Cancer Pain Management and Palliative Care

## Supraspinal Anti-Nociceptive Mechanisms

- ▶ Extrasegmental Anti-Nociceptive Mechanisms

## Supraspinal Pain Control Systems

- ▶ Descending Modulation of Nociceptive Processing

## Supraspinal Regulation

- ▶ GABA Mechanisms and Descending Inhibitory Mechanisms
- ▶ Spinothalamic Tract Neurons, Descending Control by Brainstem Neurons

## Suprathreshold Stimuli

### Definition

These are stimuli whose intensity lies above the subject's pain threshold. It is important to use such stimuli, as opposed to threshold or subthreshold stimuli, to understand true nociceptive processing.

- ▶ Quantitative Sensory Testing

## Sural Nerve Biopsy

### Definition

The traditional method of observing and quantitating small sensory axons involving partial or total surgical removal of the sural nerve above the ankle and electron microscopic analysis. Complications include numbness of the foot, infection, and persistent pain.

- ▶ Diabetic Neuropathies

## Sural Spared Nerve Injury Model

- ▶ Neuropathic Pain Model, Spared Nerve Injury

## Surgery in the DREZ

### Definition

Ablative Pain Surgery in the Dorsal Root Entry Zone.

- ▶ Brachial Plexus Avulsion and Dorsal Root Entry Zone

## Surgical Denervation

### Definition

To cut a peripheral nerve with the surgeon's knife.

- ▶ Cancer Pain Management, Anesthesiologic Interventions, Neural Blockade



## Survivin

### Definition

Survivin is a member of the inhibitor of apoptosis protein (IAP) family.

- ▶ NSAIDs and Cancer

## Swaddling

### Definition

An infant is wrapped in a light cloth to keep limbs close to the trunk and prevent the child from moving around excessively.

- ▶ Acute Pain Management in Infants

## Swedish Massage

- ▶ Massage and Pain Relief Prospects

## Switching

### Definition

Pharmacological technique used to improve the balance between analgesia and adverse effects in clinical conditions of poor opioid response. The prior opioid is discontinued and an alternative one is administered at doses substantially lower than those provided by equianalgesic tables. The rationale is based on the asymmetric tolerance and differences in efficacies among opioids. Equivalence tables are only indicative, as patients who are highly tolerant and receiving high doses of opioids should be carefully monitored, particularly when switching from morphine to methadone, which has a higher potency than expected in patients taking high doses of morphine.

- ▶ Opioid Responsiveness in Cancer Pain Management

## Sylvian Fissure

### Synonyms

Lateral Sulcus

### Definition

Also called lateral sulcus, one of the largest fissures of the brain, the Sylvian fissure separates the temporal lobe from the frontal and parietal lobes. The insula is located deep inside the Sylvian fissure, which is separated from

the frontal, parietal, and temporal operculum by the circular sulcus of the insula.

- ▶ Insular Cortex, Neurophysiology and Functional Imaging of Nociceptive Processing
- ▶ Nociceptive Processing in the Secondary Somatosensory Cortex
- ▶ SII

## Sympathectomy

### Definition

Sympathectomy refers to interruption of the function of the sympathetic chain, either by local anesthetic blockade (a reversible process) or by sectioning the chain and excising the sympathetic ganglia surgically for treatment of SMP (sympathetically maintained pain) or hyperhidrosis (excessive sweating).

- ▶ Complex Regional Pain Syndrome and the Sympathetic Nervous System
- ▶ Sympathetically Maintained Pain in CRPS II, Human Experimentation

## Sympathetic-Afferent Coupling in the Afferent Nerve Fiber, Neurophysiological Experiments

HEINZ-JOACHIM HÄBLER<sup>1</sup>, MATTHIAS RINGKAMP<sup>2</sup>  
<sup>1</sup>FH Bonn-Rhein-Sieg, Rheinbach, Germany  
<sup>2</sup>Department of Neurosurgery, School of Medicine, Johns Hopkins University, Baltimore, MD, USA  
 heinz-joachim.haebler@fh-bonn-rhein-sieg.de, platelet@jhmi.edu

### Synonyms

Sympathetic-Sensory Coupling; Coupling of Sympathetic Postganglionic Neurons onto Primary Afferent Nerve Fibers; sympathetic-sensory coupling distal to the dorsal root ganglion (DRG); peripheral sympathetic-afferent coupling

### Definition

In animal models of neuropathic pain (models of CRPS II), lesioned and/or unlesioned afferents show ectopic activity, which is thought to be involved in initiating and maintaining neuropathic pain behavior. Ectopic activity arises from the somata of primary afferent neurons in the dorsal root ganglion (DRG) (see ▶ [Sympathetic-afferent coupling in the dorsal root ganglion, neurophysiological experiments](#)), and is also generated at different sites along the axon of the primary afferent neuron including its receptive terminal. Similar to experiments on sympathetic-afferent coupling in the DRG, *in vivo* neurophysiological recordings in reduced animal

models under general anesthesia can be used to study coupling between efferent sympathetic postganglionic fibers and nociceptive afferents. Coupling may develop after various types of experimental nerve lesions and could provide a mechanism of SMP in patients. To test for sympathetic-afferent coupling, the sympathetic supply is either activated by natural stimuli (e.g. hypoxia), or directly by electrical stimulation while the ectopic activity in decentralized primary afferent fibers is measured. In addition, pharmacological tools (application of adrenoceptor agonists and antagonists) are applied to block or mimic the effects of sympathetic-sensory coupling on ectopic activity in nociceptive afferents. Sympathetic-afferent coupling may be direct, i.e. the primary afferent neuron is activated by noradrenaline released by sympathetic axons, and/or indirect via effects, for example, on the vascular bed. Results from reduced *in vivo* animal models have to be correlated with the results obtained in behavioral animal models and findings in patients.

### Characteristics

Following nerve injury, sympathetic noradrenergic neurons may influence afferent neurons in several ways. Experiments in reduced *in vivo* animal models of nerve injury have shown that in addition to coupling at the dorsal root ganglion, coupling may also occur along the afferent axon. Coupling could occur at or close to the injury site as well as proximal to the lesion or distal at the afferent terminal. Furthermore, it may involve lesioned, intact or regenerating afferents.

That peripheral sympathetic-afferent coupling is a mechanism for SMP is consistent with the finding that intradermal administration of adrenergic agents rekindles pain in patients who underwent a sympathetic block for the treatment and/or diagnosis of SMP (Ali et al. 2000; Torebjörk et al. 1995).

### Coupling between Sympathetic Fibers and Afferent Endings in Neuromas Following Nerve Lesion

Sympathetic-afferent coupling in neuromas is rare, at least in cats and particularly in old neuromas, taking into account the relatively low proportion of lesioned afferents showing ectopic activity (Blumberg and Jänig 1984). It may be more common in rat neuromas, which generate higher rates of ectopically active afferents in the first two weeks after lesion (Devor and Jänig 1981). In the early phase after lesion, coupling to myelinated and unmyelinated fibers occurs in the cat, but mainly to myelinated fibers in rats. In old sciatic nerve neuromas of the rat, sympathetic-afferent coupling occurs mainly in unmyelinated afferents (Jänig 1990). Lesioned afferents with ectopic activity can be activated by epinephrine/norepinephrine and by electrical stimulation of the sympathetic trunk, and this activation is mediated by  $\alpha$ -adrenoceptors. However, high stimulation frequencies of  $\geq 10$  Hz are needed to elicit discharges

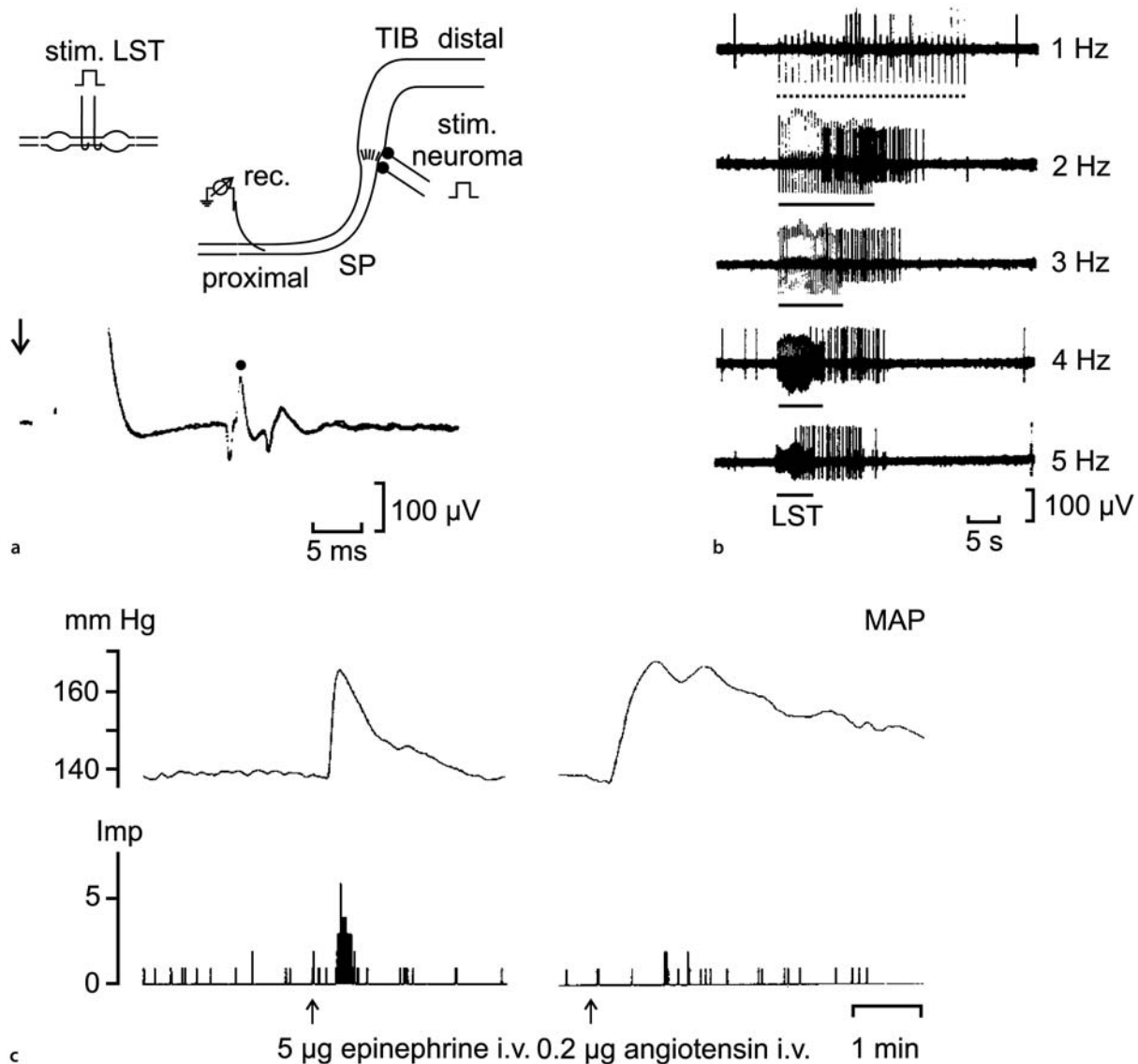
in afferent neurons from the neuroma (Devor and Jänig 1981; Blumberg and Jänig 1984). Such frequencies never occur in sympathetic neurons under physiological *in vivo* conditions. Furthermore, there is no evidence that the ongoing ectopic activity in neuroma fibers is generated by ongoing sympathetic activity. Likewise, there is no evidence that postganglionic sympathetic fibers ephatically couple to afferents from the neuroma. It is possible that the observed sympathetic-afferent coupling in neuromas was mediated indirectly through changes in blood flow.

### Sympathetic-Afferent Coupling after Nerve Lesion with Subsequent Regeneration of Afferent and Sympathetic Fibers to the Target Tissue

More than one year after an inappropriate cross-union between the proximal stump of either the sural or the superficial peroneal nerve and the distal stump of the tibial nerve of the cat, unmyelinated afferent fibers exhibiting a low level of ectopic activity could be vigorously excited by low frequency electrical stimulation of the sympathetic chain (frequencies of  $\geq 0.5$  Hz) and/or by intravenous injection of epinephrine (Häbler et al. 1987) (Fig. 1). Physiological stimulation of the sympathetic neurons by systemic hypoxia also activated some unmyelinated afferent fibers. The sympathetically and epinephrine-induced discharges were blocked by the  $\alpha$ -adrenoceptor antagonist phentolamine, indicating an  $\alpha$ -adrenoceptor-mediated coupling. These effects were unlikely to be mediated indirectly via the vascular bed in the lesioned nerve, because angiotensin-induced vasoconstriction did not activate afferent neurons. This is as yet the only experimental study showing that stimulation of sympathetic neurons at physiological frequencies is able to elicit impulses in unmyelinated, probably nociceptive, afferents after nerve lesion.

### Coupling between Unlesioned Postganglionic and Afferent Nerve Terminals Following Partial Nerve Lesion.

After partially cutting the great auricular nerve in rabbits, a subset of spared C-fiber polymodal nociceptors, and also a few spared A $\delta$ -nociceptors, developed sensitivity to electrical stimulation of the cervical sympathetic trunk and to close-arterial injection of norepinephrine or epinephrine. In addition, they were sensitized to heat stimuli by this sympathetic stimulation 4–148 days after lesion. These effects were preferentially mediated by  $\alpha_2$ -adrenoceptors (O'Halloran and Perl 1997; Sato and Perl 1991). Indirect effects mediated via the vascular bed were unlikely, because vasopressin did not affect nociceptors. However, sympathetic-afferent coupling leading to activation and sensitization of nociceptors required sympathetic stimulation at high, non-physiological frequencies. It was proposed that circulating epinephrine might act via  $\alpha_2$ -adrenoceptors that are up-regulated on afferent terminals after nerve lesion (Birder and Perl 1999). However, the epinephrine



**Sympathetic-Afferent Coupling in the Afferent Nerve Fiber, Neurophysiological Experiments, Figure 1** Sympathetic-afferent coupling after nerve lesion with subsequent fiber regeneration. Excitation of unmyelinated afferent units by electrical stimulation of sympathetic fibers following nerve injury. Unmyelinated primary afferents were recorded in cats 11–20 months following a nerve lesion. The central cut stump of a cutaneous nerve innervating hairy skin (sural or superficial peroneal nerve) had been imperfectly adapted to the distal stump of a transected mixed nerve (tibial nerve). There was a 'neuroma-in-continuity' at the site of the lesion and cutaneous nerve fibers had regenerated into skin and deep somatic tissue supplied by the mixed nerve. (a) Experimental set-up. LST, lumbar sympathetic trunk; TIB, tibial nerve; SP, superficial peroneal nerve. Lower record: The afferent fibers were identified as unmyelinated by electrical stimulation of the neuroma with single impulses. The signal indicated by dot was the same as in (b); the afferent fiber conducted at 1.3 m/s. Record from a single unmyelinated afferent unit. Supramaximal stimulation of the LST with trains of 30 pulses at 1–5 Hz (trains and stimulation artifacts indicated by bars). Note that the afferent unit had some low rate of ongoing activity (impulses before the trains at 1 and 4 Hz). (c) Adrenaline (5 μg injected i.v.) activated the fiber. Angiotensin (0.2 μg injected i.v.) generated a large increase of blood pressure (MAP, mean arterial blood pressure) but did not activate the afferent fiber. Modified from Häbler et al. 1987.

concentrations used to mimic sympathetic-afferent coupling were much higher than plasma concentrations under physiological conditions.

*In vitro* experiments in non-human primates revealed that cutaneous C-fiber afferents spared by the nerve lesion can acquire sensitivity to sympathetic agonists. After partial denervation of the skin resulting from an L6 spinal nerve lesion, uninjured C-fiber nociceptors

showed spontaneous activity, and displayed a higher incidence of responses to both  $\alpha_1$ - and  $\alpha_2$ -adrenergic agonists than controls (Ali et al. 1999). However, the rate of spontaneous activity and the response magnitudes were generally low.

In the absence of any direct injury to afferent nerve fibers, a similar sensitivity to norepinephrine was found in C-fiber polymodal nociceptors following surgical

sympathectomy (Bossut et al. 1996). This finding was suggested to be a correlate of postsympathectomy neuralgia, which in some cases is observed in patients who underwent sympathectomy.

#### Sympathetic-Afferent Coupling in the Nerve Proximal to the Nerve Lesion

A nerve lesion is also followed by dramatic changes along the nerve proximal to the lesion. Many neurons with unmyelinated axons die with time after nerve lesion (Jänig and McLachlan 1984). Peptidergic and nonpeptidergic afferents and postganglionic fibers start to sprout retro- and anterogradely, and there are signs of inflammation and angiogenesis and changes in the innervation of blood vessels supplying the nerve (see ► [Sympathetic and Sensory Neurons after Nerve Lesions, Structural Basis for Interactions](#)). In view of these and other changes, it is possible that sympathetic-afferent coupling occurs in the nerve proximal to the lesion. However, this possibility has not yet been investigated.

#### Significance of Sympathetic Coupling onto the Afferent Nerve Fiber

Sympathetic-afferent coupling after nerve lesion can occur in the peripheral nerve at different sites. In neuromas coupling involves mostly myelinated fibers, and since most of them are probably low-threshold mechanoreceptors, its significance for neuropathic pain is doubtful. This is consistent with clinical experience showing that pain from neuromas is usually independent of the sympathetic nervous system. With the exception of experiments on inappropriate cross-union of two hindlimb nerves, a general problem is that un-physiologically high stimulation frequencies of the sympathetic trunk are necessary to activate afferent fibers. Similar to sympathetic-afferent coupling in the dorsal root ganglion, the exact mechanism of the sympathetic coupling onto afferent nerve fibers remains unclear. While it is an attractive idea that afferent neurons are excited by norepinephrine acting on up-regulated, neuronal  $\alpha_2$ -adrenoceptors, it has to be reconciled with the well-established finding that intact nociceptors possess presynaptic  $\alpha_2$ -adrenoceptors which are inhibitory (e.g. Li and Eisenach 2001). Furthermore, there is evidence indicating that  $\alpha_2$ -adrenoceptors also remain inhibitory after partial sciatic nerve ligation (Lavand'homme et al. 2002).

#### Conclusion

The functional significance of sympathetic-afferent coupling at the level of the afferent nerve fiber is still largely unclear. The assumption that it represents an animal model for SMP in patients should be considered with caution.

#### Acknowledgement

Supported by the Deutsche Forschungsgemeinschaft.

#### References

1. Ali Z, Raja SN, Wesselmann U et al. (2000) Intradermal Injection of Norepinephrine Evokes Pain in Patients with Sympathetically Maintained Pain. *Pain* 88:161–168
2. Ali Z, Ringkamp M, Hartke TV et al. (1999) Uninjured C-Fiber Nociceptors Develop Spontaneous Activity and  $\alpha$ -adrenergic Sensitivity Following L<sub>6</sub> Spinal Nerve Ligation in Monkey. *J Neurophysiol* 81:455–466
3. Birder LA, Perl ER (1999) Expression of  $\alpha_2$ -adrenergic Receptors in Rat Primary Afferent Neurons after Peripheral Nerve Injury or Inflammation. *J Physiol* 515:533–542
4. Blumberg H, Jänig W (1984) Discharge Pattern of Afferent Fibers from a Neuroma. *Pain* 20:335–353
5. Bossut DF, Shea VK, Perl ER (1996) Sympathectomy Induces Adrenergic Excitability of Cutaneous C-Fiber Nociceptors. *J Neurophysiol* 75:514–517
6. Devor M, Jänig W (1981) Activation of Myelinated Afferents Ending in a Neuroma by Stimulation of the Sympathetic Supply in the Rat. *Neurosci Lett* 24:43–47
7. Häbler HJ, Jänig W, Koltzenburg M (1987) Activation of Unmyelinated Afferents in Chronically Lesioned Nerves by Adrenaline and Excitation of Sympathetic Efferents in the Cat. *Neurosci Lett* 82:35–40
8. Jänig W (1990) Activation of Afferent Fibers Ending in an Old Neuroma by Sympathetic Stimulation in the Rat. *Neurosci Lett* 111:309–314
9. Jänig W, McLachlan EM (1984) On the Fate of Sympathetic and Sensory Neurons Projecting into a Neuroma of the Superficial Peroneal Nerve in the Cat. *J Comp Neurol* 225: 302–311
10. Lavand'homme PM, Ma W, De Kock M et al. (2002) Perineural Alpha(2A)-adrenoceptor Activation Inhibits Spinal Cord Neuroplasticity and Tactile Allodynia after Nerve Injury. *Anesthesiology* 97:972–980
11. Li X, Eisenach JC (2001) Alpha2A-adrenoceptor Stimulation Reduces Capsaicin-Induced Glutamate Release from Spinal Cord Synaptosomes. *J Pharmacol Exp Ther* 299:939–944
12. O'Halloran KD, Perl ER (1997) Effects of Partial Nerve Injury on the Responses of C-Fiber Polymodal Nociceptors to Adrenergic Agonists. *Brain Res* 759:233–240
13. Sato J, Perl ER (1991) Adrenergic Excitation of Cutaneous Pain Receptors Induced by Peripheral Nerve Injury. *Science* 251:1608–1610
14. Torebjörk E, Wahren L, Wallin G et al. (1995) Noradrenaline-Evoked Pain in Neuralgia. *Pain* 63:11–20

## Sympathetic-Afferent Coupling in the Dorsal Root Ganglion, Neurophysiological Experiments

HEINZ-JOACHIM HÄBLER<sup>1</sup>, WILFRID JÄNIG<sup>2</sup>

<sup>1</sup>FH Bonn-Rhein-Sieg, Rheinbach, Germany

<sup>2</sup>Institute of Physiology, Christian Albrechts University Kiel, Kiel, Germany

heinz-joachim.haebler@fh-bonn-rhein-sieg.de,

w.janig@physiologie.uni-kiel.de

#### Synonyms

Sympathetic-Sensory Coupling; coupling between sympathetic postganglionic neurons and primary afferent neurons (in the dorsal root ganglion)

#### Definition

Under physiological conditions, there is no coupling between sympathetic neurons and nociceptive primary



afferent neurons at any site in the peripheral nervous system, i.e. activity in sympathetic postganglionic neurons does not activate nociceptors, and thus does not elicit pain under any condition. In rat models of neuropathic pain, nerve lesions lead to the generation of ectopic activity in lesioned afferents, part of which arises from the somata of primary afferent neurons in the dorsal root ganglion (DRG). It is believed that the ectopic activity is involved in initiating and maintaining neuropathic pain behavior in these animals. Using neurophysiological recordings in reduced animal models *in vivo* under general anesthesia or *in vitro*, allows the study of whether there is a coupling between efferent sympathetic postganglionic neurons and afferent nociceptive neurons within the DRG, which may develop after various types of experimental nerve lesion (i.e., whether this could be a model of SMP). Under these conditions, controlled physiological or electrical stimulation of the sympathetic supply and controlled pharmacology (application of adrenoceptor agonists and antagonists) can be applied, and changes of the ectopic activity in axotomized primary afferent neurons can be measured. Furthermore, changes of blood flow resulting from sympathetic stimulation can be measured on the surface of the DRG by laser Doppler flowmetry, to investigate the question of whether sympathetic-afferent coupling may be a direct activation of primary afferent neurons by sympathetic transmitters, or indirectly mediated by changes in DRG blood flow. Results obtained in these reduced *in vivo* animal models have to be correlated with the results obtained in behavioral animal models and in patients.

### Characteristics

Following transection and/or ligation of the sciatic nerve or the L5/L6 spinal nerve (spinal nerve ligation model) in rats, perivascular catecholamine-containing axons start to invade the DRGs, which contain somata with lesioned axon and form baskets around sensory somata (McLachlan et al. 1993) (see ► [Sympathetic and Sensory Neurons after Nerve Lesions, Structural Basis for Interactions](#)). Furthermore, following both types of nerve lesion  $\alpha_{2A}$ -adrenoceptors were found to be upregulated, particularly in medium-sized and large diameter DRG cells (Birder and Perl 1999; Shi et al. 2000). There was evidence that this happened not only in axotomized but also in uninjured neurons (Birder and Perl 1999). Therefore, the hypothesis has been put forward that the baskets, which form around primary afferent somata in DRGs corresponding to the lesioned nerve and which consist of postganglionic sprouts, may mediate sympathetic-afferent coupling. According to this hypothesis, norepinephrine released from these postganglionic sprouts could then directly bind to  $\alpha_{2A}$ -adrenoceptors upregulated on the DRG somata, and activate neurons involved in the generation and maintenance of neuropathic pain behavior. Thus, these

morphological changes in the DRG would represent the morphological correlate of sympathetically maintained pain (SMP).

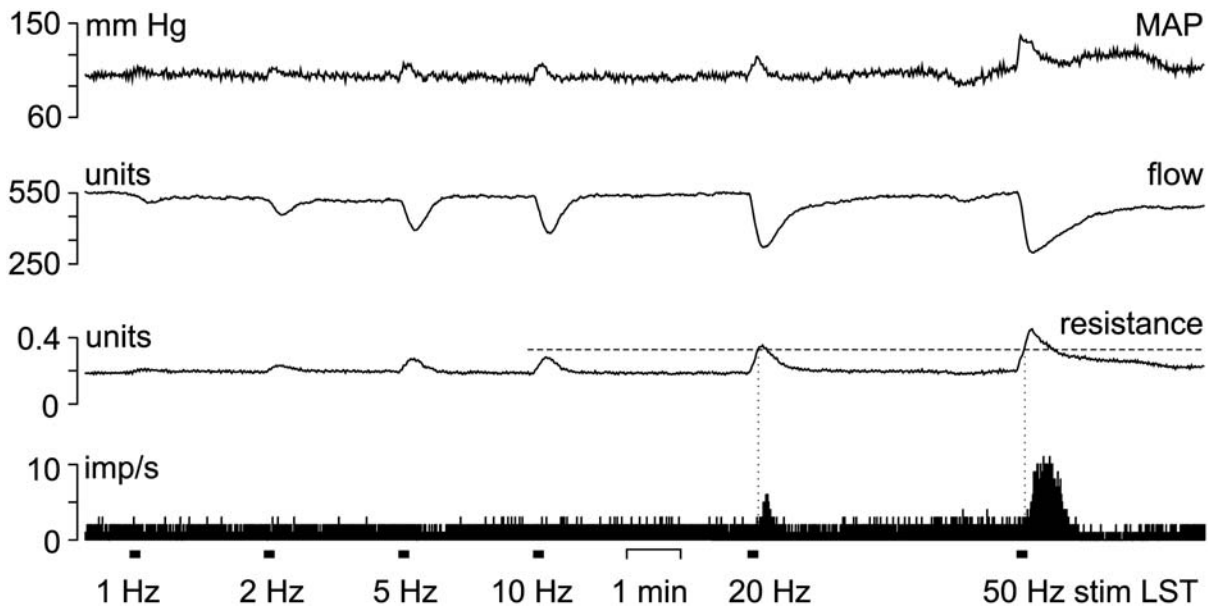
### In Vivo Neurophysiological Experiments after Sciatic Nerve Lesion

After tight ligation and section of the sciatic nerve in Sabra rats many afferent neurons in L4 and L5 DRGs, almost all with myelinated (A-) fibers, develop ectopic activity originating from within these ganglia (Devor et al. 1994; Michaelis et al. 1996). Electrical stimulation of the sympathetic supply of the L4 and L5 DRGs at unphysiologically high frequencies ( $\geq 5$  Hz), or systemic application of epinephrine, changed the ectopic activity of 55–60% of the afferent axotomized neurons via coupling within the DRG. Early after lesion (4–22 days) the predominant response was excitation, whereas later-on the predominant response was depression of activity. A few silent afferent A-neurons were recruited by sympathetic stimulation. Only few DRG cells with unmyelinated (C-) fibers were spontaneously active (0.1–8.7% of neurons with ectopic activity) and most responded to sympathetic stimulation with inhibition. Responses were mediated by  $\alpha_2$ -adrenoceptors in 65% of cases, by  $\alpha_1$ -adrenoceptors in 13% and by  $\alpha_1$  and  $\alpha_2$ -adrenoceptors in 10% of cases (Chen et al. 1996).

### In Vivo Neurophysiological Experiments after Spinal Nerve Lesion

In the spinal nerve lesion (SNL) model, only axotomized neurons with A-fibers develop ectopic activity (Liu et al. 2000). Most lesioned afferent neurons with ectopic activity originally probably supplied skeletal muscle rather than skin (Michaelis et al. 2000).

The incidence of axotomized afferent neurons with ectopic activity which were responsive to electrical stimulation of the sympathetic chain at high stimulation frequencies of  $\geq 5$  Hz was significantly lower (17.6%) than after sciatic nerve lesion (Häbler et al. 2000). Almost all neurons responding to sympathetic stimulation were excited 3–56 days after lesion, while almost all of the 26.3% neurons responsive to systemic application of norepinephrine were inhibited. Registration of blood flow on the surface of the L5 DRG with laser Doppler flowmetry in parallel to recording neural responses revealed that electrical stimulation of the sympathetic chain leads to frequency-dependent vasoconstriction in the DRG (Häbler et al. 2000). When sympathetic stimulation excited axotomized afferent neurons, the activation occurred once a critical threshold of vascular resistance in the DRG was exceeded, and subsided after vasoconstriction had fallen below the critical threshold (Fig. 1). Pre-constriction of the vascular bed with the potent vasoconstrictor drug  $N^G$ -nitro-L-arginine methyl ester (L-NAME), an unspecific inhibitor of the nitric oxide (NO) synthase, significantly enhanced the incidence and magnitude of excitatory



**Sympathetic-Afferent Coupling in the Dorsal Root Ganglion, Neurophysiological Experiments, Figure 1** Activation of an axotomized afferent neuron following lesion of the spinal nerve L5 (performed 35 days prior to the experiment) to electrical stimulation of the lumbar sympathetic trunk (LST, trains of 10 s at 1–50 Hz) in an anesthetized rat. The axon was isolated from the dorsal root L5. Mean arterial blood pressure (MAP), relative blood flow through the dorsal root ganglion (DRG) L5 (measured by laser-Doppler flowmetry) and resistance to flow in the DRG were recorded in parallel to the neural activity. The axotomized afferent neuron responded only to the highest frequencies used (20 Hz and 50 Hz). The activation occurred in parallel with increase in vascular resistance exceeding a critical threshold value (broken and stippled lines). Fiber activation mirrored the magnitude and time course of vascular resistance above this critical level. When the vascular bed was precontracted by L-NAME the axotomized afferent neurons already responded to stimulation frequencies of the LST at  $\geq 5$  Hz (not shown here). From Häbler et al. (2000) with permission.

responses in axotomized DRG neurons with ectopic activity induced by sympathetic stimulation (from 17.6% to 76% of neurons), while the effective stimulation frequency necessary to excite the afferent neurons decreased significantly. In this way many axotomized neurons originally unresponsive even to prolonged sympathetic stimulation could be converted to responders after L-NAME. Both the DRG vasoconstriction and the neuronal responses to sympathetic stimulation were antagonized by both  $\alpha_1$ - and  $\alpha_2$ -adrenoceptor antagonists.

Pre-constriction of the DRG vascular bed also increased the incidence of axotomized afferents responding to systemic application of norepinephrine from 23% to 75%; all responses were excitatory, and previously inhibitory responses were converted into excitatory ones. Similar to norepinephrine, non-sympathetic vasoconstrictor agents like angiotensin II and vasopressin also induced excitatory responses of axotomized afferent neurons with ectopic activity, and a recruitment of some previously silent afferent neurons. Systemic asphyxia was also capable of activating lesioned afferent neurons. These experiments suggest that sympathetic-afferent coupling in the DRG after spinal nerve lesion and, by analogy, also after sciatic nerve lesion is indirect. It occurs mainly when perfusion of the DRG is impaired, and the effective stimulus which activates axotomized afferent neurons is likely to be transient ischemia.

#### In Vitro Neurophysiological Experiments on Axotomized DRG Neurons

In *in vitro* experiments, lesioned afferent neurons after chronic constriction or L5 spinal nerve injury showed excitatory responses to norepinephrine or epinephrine. However, the doses used were relatively high. In similar *in vitro* experiments on acutely isolated DRG neurons, small depolarizations in both intact and lesioned somata in response to norepinephrine or other sympathomimetics could not be blocked by adrenoceptor antagonists (de Armentia et al. 2003), indicating that the observed effects were non-specific.

#### Significance of Sympathetic-Afferent Coupling in the DRG

The critical question is whether sympathetic-afferent coupling in the DRG, as observed after spinal nerve lesion and sciatic nerve lesion, is a neurophysiological correlate of sympathetically maintained pain. This question is directly linked to the question of whether or not the ectopic activity arising in axotomized afferent neurons after nerve lesion is responsible for the development and/or maintenance of neuropathic pain behavior. This issue is controversially discussed. Earlier experiments in the spinal nerve lesion model indicated that sectioning the corresponding dorsal roots before spinal nerve lesion prevented the development of neuropathic pain behavior, while sectioning the corresponding dorsal roots after spinal nerve lesion abolished

neuropathic pain behavior (Kinnman and Levine 1995; Yoon et al. 1996), suggesting that the signal generating neuropathic pain behavior arose from the lesioned segment. However, recent studies found that mechanical allodynic and hyperalgesic behavior after L5 spinal nerve lesion was unchanged by an additional L5 dorsal root section before or after spinal nerve lesion. Furthermore, transection of the dorsal root L5 alone was followed by mechanical allodynic and hyperalgesic behavior, which was undistinguishable from that after spinal nerve lesion (Eschenfelder et al. 2000; Li et al. 2000). In view of these conflicting results, it appears doubtful that ectopic activity in lesioned afferents is responsible for the neuropathic pain behavior in the spinal nerve ligation model.

Another major problem is that ectopic activity in the spinal nerve lesion model arises in axotomized afferent A- but not, or almost not, in C-fibers. At present, there is no conclusive explanation how A-fiber activity in the absence of C-fiber discharge can generate neuropathic pain in the early time period after lesion. A possible explanation in the more chronic state after lesion might be that nerve lesion entails the death of primary afferent neurons with C-fibers (mostly those to the skin but not those to skeletal muscle, see ► [Sympathetic and Sensory Neurons after Nerve Lesions, Structural Basis for Interactions](#) and Hu and McLachlan 2003), and that this leads to central reorganization. Now activity in afferent neurons with A-fibers may be involved in the generation of pain or pain-like behavior.

Finally, according to behavioral experiments, it is at best controversial whether spinal nerve lesion is a model for SMP, first, since surgical sympathectomy alleviated neuropathic pain behavior only in a limited number of rat species, but had no effect in others, and second, since in a given rat strain the results produced by different laboratories were opposite (see ► [Sympathetic Nervous System in the Generation of Pain, Animal Behavioral Models](#)).

### Conclusion

The generation of neuropathic pain, allodynia and hyperalgesia by pathophysiological mechanisms acting within the DRG, and a contribution to these symptoms by the sympathetic nervous system via sympathetic-afferent coupling in the DRG, is at present an attractive possibility, but a number of open questions have to be clarified, until firm conclusions can be drawn.

### Acknowledgements

Supported by the Deutsche Forschungsgemeinschaft and the German Ministry of Research and Education, German Research Network on Neuropathic Pain.

### References

1. Birder LA, Perl ER (1999) Expression of  $\alpha_2$ -adrenergic Receptors in Rat Primary Afferent Neurons after Peripheral Nerve Injury or Inflammation. *J Physiol* 515:533–542

2. Chen Y, Michaelis M, Jänig W et al. (1996) Adrenoceptor Subtype Mediating Sympathetic-Sensory Coupling in Injured Sensory Neurons. *J Neurophysiol* 76:3721–3730
3. De Armentia LM, Leeson AH, Stebbing MJ et al. (2003). Responses of Sympathomimetics in Rat Sensory Neurons after Nerve Transection. *Neuroreport* 14:9–13
4. Devor M, Jänig W, Michaelis M (1994) Modulation of Activity in Dorsal Root Ganglion (DRG) Neurons by Sympathetic Activation in Nerve-Injured Rats. *J Neurophysiol* 71:38–47
5. Eschenfelder S, Häbler HJ, Jänig W (2000) Dorsal Root Section Elicits Signs of Neuropathic Pain Rather than Reversing them in Rats with Spinal Nerve Injury. *Pain* 87:213–219
6. Häbler HJ, Eschenfelder S, Liu XG et al. (2000) Sympathetic-Afferent Coupling after L5 Spinal Nerve Lesion in the Rat and its Relation to Changes in Dorsal Root Ganglion Blood Flow. *Pain* 87:335–345
7. Hu P, McLachlan EM (2003) Selective reactions of cutaneous and muscle afferent neurons to peripheral nerve transection in rats. *J Neurosci* 23:10559–10567
8. Kinnman E, Levine JD (1995) Sensory and Sympathetic Contributions to Nerve Injury-Induced Sensory Abnormalities in the Rat. *Neuroscience* 64:751–767
9. Li Y, Dorsi MJ, Meyer RA et al. (2000) Mechanical Hyperalgesia after an L5 Spinal Nerve Lesion is not Dependent on Input from Injured Nerve Fibers. *Pain* 85:493–502
10. Liu XG, Eschenfelder S, Blenk KH et al. (2000) Spontaneous Activity of Axotomized Afferent Neurons after L5 Spinal Nerve Injury in the Rat. *Pain* 84:309–318
11. McLachlan EM, Jänig W, Devor M et al. (1993) Peripheral Nerve Injury Triggers Noradrenergic Sprouting within Dorsal Root Ganglia. *Nature* 363:543–546
12. Michaelis M, Devor M, Jänig W (1996) Sympathetic Modulation of Activity in Dorsal Root Ganglion Neurons Changes Over Time Following Peripheral Nerve Injury. *J Neurophysiol* 76:753–763
13. Shi TJS, Winzer-Serhan U, Leslie F et al. (2000) Distribution and Regulation of  $\alpha_2$ -adrenoceptors in Rat Dorsal Root Ganglia. *Pain* 84:319–330
14. Yoon YW, Na HS, Chung JM (1996) Contributions of Injured and Intact Afferents to Neuropathic Pain in an Experimental Rat Model. *Pain* 64:27–36

## Sympathetic-Afferent Interaction

S

- [Sympathetic and Sensory Neurons after Nerve Lesions, Structural Basis for Interactions](#)

## Sympathetic Afferents

- [Angina Pectoris, Neurophysiology and Psychophysics](#)

## Sympathetic and Sensory Neurons after Nerve Lesions, Structural Basis for Interactions

ELSPETH M. MCLACHLAN  
 Prince of Wales Medical Research Institute, Randwick,  
 University of New South Wales, Sydney, NSW,  
 Australia  
 e.mclachlan@unsw.edu.au

## Synonyms

Sympathetic-Afferent Interaction; Axonal Sprouting; Perineuronal Terminals; Vascular Hypertrophy

## Definition

After nerve injury, some people develop spontaneous pain and allodynia that is alleviated by sympathetic blockade. Injury-induced retrograde reactions within dorsal root ganglia lead to the ingrowth of sympathetic axons and collateral sprouting of afferent axons, as well as the influx of macrophages and lymphocytes from the blood. These changes are associated with the local production of neurotrophins and cytokines, which raise excitability of sensory neurones. Although some sensory somata express alpha2-adrenoceptors after lesions, there is no clear evidence that noradrenaline released by sympathetic activity can access these receptors. Rather, activation may follow excessive neurogenic vasoconstriction, leading to excitation of hyperexcitable afferents by ischaemia. There is no structural evidence to support sympathetic-sensory interaction within the neuroma, but there may be a site in the periphery, where noradrenaline released from sympathetic nerves accesses adrenoceptors leading to excitation of nociceptors.

## Characteristics

In normal individuals, neurotransmitters such as noradrenaline released by sympathetic nerve activity have no direct effect on nociceptive terminals in skin, although these may be sensitive to changes in the environment mediated by sympathetic effector responses (Roberts 1997). For example, experimentally-induced intense vasoconstriction may lead to ischaemic pain after metabolites have accumulated near nociceptive endings. A few sensory receptors are specifically supplied by sympathetic terminals e.g. the neck of hair follicles (Gibbins 1997).

Blockade of alpha-adrenoceptors can alleviate neuropathic pain in a proportion of patients with peripheral nerve injuries, indicating that pain and sympathetic activity are not always independent (see ► [Symptomatically maintained pain, clinical pharmacological tests](#) ► [Symptomatically maintained pain in CRPS I, human experimentation](#) ► [Symptomatically maintained pain in CRPS II, human experimentation](#)). This has led to the idea that a link can develop after nerve injury, such that noradrenaline released during sympathetic activation excites nociceptive neurones or their peripheral terminals. Because, in normal individuals, sites where sympathetic nerve terminals lie close to nociceptive ones are lacking, the mechanism must involve some form of anatomical or functional plasticity. Is there evidence that neuropathic pain can result from the direct interaction between noradrenaline (NA) released from

nerve terminals and alpha-adrenoceptors on nociceptive neurones?

## What is the Physical Relationship between Sympathetic and Sensory Neurons in the Somatic Domain?

Sympathetic postganglionic neurones in the paravertebral chain send their axons in a virtually exclusive bundle (the grey ramus) to join the spinal nerve, immediately distal to the dorsal root ganglion (DRG). The axons then run in bundles along the peripheral nerve trunks to supply vessels in skin, muscle and joints, and piloerector muscles and sweat glands in some regions of skin. In several species, including cats and rats, the only sympathetic axons that normally turn towards the DRG are those that innervate small blood vessels in the perineurium or around the nerve roots. Terminals are normally not present between or around the somata within the DRG itself.

The small diameter neurones that make up the nociceptive population tend to lie deep in the DRG. They send their unmyelinated axons to the periphery in the same nerve bundles as sympathetic axons. Within muscle nerves,  $\approx 50\%$  of axons are sympathetic and  $\approx 20\%$  are unmyelinated afferents. Within skin nerves, these proportions are reversed. Sympathetic axons form varicose terminal plexuses around deep or sub-dermal arterial vessels, more than 1 mm below the epidermis in humans (Gibbins 1997). In some regions, a few peptidergic afferent terminals lie amongst these sympathetic perivascular terminals, but the majority of unmyelinated afferents form endings in the sub-epidermal plexus and within the epidermis itself, where sympathetic terminals are not found. Deep pain is subserved by C and A $\delta$  axons with endings in muscle and joints, but again close associations with sympathetic terminals are unusual.

## Neuronal Plasticity Following Nerve Injury

Following nerve injuries that transect unmyelinated axons, or after a neuroinflammatory response such as follows a chronic constriction injury, this arrangement is changed. Distal to the injury, unmyelinated axons degenerate, whereas proximally they retract back along the nerve trunk if they cannot regenerate through the scar. After transection with ligation, very few axons containing NA or peptides are present within the neuroma, although many are associated with the surrounding scar tissue. Thus, it is unlikely that sympathetic-afferent coupling occurs within the neuroma.

Within sympathetic ganglia and DRGs, the lesioned cell bodies show typical ► [axotomy](#) responses, and satellite glia are activated and proliferate. Within a few days, resident macrophages become activated and lymphocytes and other types of macrophage invade the ganglia (Hu and McLachlan 2003a). The DRG somata down-regulate synthesis and start to express proteins associated with survival and regeneration. However, if regeneration is impeded,  $\approx 50\%$  of the small sensory neurones in the lesioned DRG, and a similar number of



sympathetic neurones, die over the ensuing weeks. This neuronal death is not entirely dependent on axotomy (Hu and McLachlan 2003b).

Over the next few weeks, collateral sprouts from the main axon close to the axotomized sympathetic somata (Ramer et al. 1999), and sprouts from the perivascular terminals near the DRG (McLachlan et al. 1993), invade the DRG, probably triggered by the release of neurotrophins from activated glia, which also begin to express ► [p75](#) (Ramer et al. 1999; Zhou et al. 1999). The expression of p75, by proliferating glia around larger diameter somata, i.e. low-threshold mechanoreceptors, would be expected to concentrate neurotrophins around these somata.

Not only sympathetic but also trkA-positive peptidergic afferent axons form collateral sprouts after axotomy. A variety of peptidergic terminals arising from small diameter somata grow through the DRG. Both types of sprouts form ► [perineuronal baskets](#) or rings of terminals, which may contain NA or calcitonin-gene-related-peptide (CGRP), Substance P, galanin or vasoactive intestinal polypeptide. Both sympathetic and peptidergic terminals elaborate around the larger diameter neurones, probably in response to neurotrophins concentrated there. Gene deletion in mice has revealed that the production of NGF is necessary for sprouting, while the formation of perineuronal baskets is dependent on p75 expression in perineuronal glia (Walsh et al. 1999). NT3 or other neurotrophins may be equally important. The proportion of neurones bearing rings is low – < 5% of DRG neurones – and is maximal after 8–10 weeks. Both axotomised and uninjured neurones can have associated rings. Terminals of more than one type of axon sometimes co-mingle around the same cell, or they may form independent rings around adjacent cells. However, most of the ► [varicosities](#) lie amongst the perineuronal glia (Shinder et al. 1999), and synaptic contacts or signs of release sites have rarely been identified.

Expression of alpha 2A adrenoceptors increases in medium to large DRG somata after sciatic injury (Birder and Perl 1999). However, the upregulated receptors disappear over several weeks as perineuronal rings develop. Further, direct application of NA has generally been unsuccessful in exciting larger diameter (A) neurones, even when high concentrations are applied. However, high concentrations of NA depolarise a few somata in both control and lesioned DRGs via a non-adrenoceptor-mediated mechanism. This depolarization might be adequate to elicit discharge in somata rendered hyperexcitable after a lesion (Lopez de Armentia et al. 2003). Isolated small somata can be excited by NA via alpha2-adrenoceptors (Abdulla and Smith 1997), but these neurones are not associated with sympathetic terminals. It, therefore, seems unlikely that, even if NA is released from ectopic sprouts, it can activate neuronal alpha2-adrenoceptors within a lesioned DRG.

### Vascular Changes after Nerve Injury

Activation of sympathetic pathways that project to lesioned DRGs leads to increased discharge of muscle afferents that show spontaneous ectopic activity. However, this only results when high stimulation frequencies produce extreme vasoconstriction within the DRG, with markedly reduced blood flow (see ► [Sympathetic afferent coupling in the dorsal root ganglion, neurophysiological experiments](#)). Perhaps the enhanced metabolic activity of macrophages and glia in the lesioned DRG provides an environment where intense vasoconstriction further compromises the supply of nutrients and oxygen, causing excitation of the hyperexcitable DRG somata.

A structural basis for this observation may be the hypertrophy of some arterial vessels in the lesioned nerve trunks. In the rat sciatic nerve, endoneurial vessels are normally uninnervated capillaries. However, proximal to a ligation and transection, enlarged endoneurial vessels appear over several weeks after the lesion. These vessels develop muscle layers and become densely innervated by varicose sympathetic terminals. Similar enlarged vessels are found around and occasionally within the DRG. As constriction of these arterial vessels during sympathetic activity is likely to restrict endoneurial and ganglionic blood flow, it may lead to ischaemic excitation of hyperexcitable afferents. Such a scenario could explain why neuropathic pain is sensitive to adrenoceptor blockade, and would be consistent with observations in patients where sympathetic block by antagonists that are not very effective on alpha2-adrenoceptors can reduce sympathetically-mediated pain.

### Potential Interaction in the Periphery

If damaged unmyelinated axons can regenerate through the lesion site, they grow quickly along the nerve trunk. However, when they reach distal vascular targets, regenerating sympathetic axons reinnervate them very poorly (Jobling et al. 1992). Nevertheless, the peripheral vessels respond to this sparse innervation with exaggerated and prolonged vasoconstriction (Koltzenburg et al. 1995), implying that denervation hyperreactivity persists despite reinnervation. Similarly, regenerated peptidergic afferents are extremely sparse within the dermis (McLachlan et al. 1994). While regenerating unmyelinated axons of both types do not readily reinnervate their denervated targets, they might interact within the subdermal nerves.

Neuropathic pain is more common when nerve damage leaves intact axons in partially denervated territory. After such lesions, stimulation of intact sympathetic axons activates nociceptor endings in skin, which appear to develop sensitivity to alpha 2-adrenoceptors (Sato and Perl 1991). Injection of NA into the skin of patients rekindles neuropathic pain (Torebjörk et al. 1995). Further, both vasoconstriction and the symptoms of neuropathic pain can be attenuated by decreasing sympathetic activity in

patients (Baron et al. 2002). This suggests the periphery may be the site of sympathetic-sensory interaction, but the location for this interaction is not known.

## References

1. Abdulla FA, Smith PA (1997) Ectopic Alpha2-Adrenoceptors Couple to N-type  $Ca^{2+}$  Channels in Axotomized Rat Sensory Neurons. *J Neurosci* 17:1633–1641
2. Baron R, Schattschneider J, Binder A et al. (2002) Relation between Sympathetic Vasoconstrictor Activity and Pain and Hyperalgesia in Complex Regional Pain Syndromes: A Case-Control Study. *Lancet* 359:1655–1660
3. Birder LA, Perl ER (1999) Expression of Alpha2-Adrenergic Receptors in Rat Primary Afferent Neurons after Peripheral Nerve Injury or Inflammation. *J Physiol* 515:533–542
4. Gibbins IL (1997) Autonomic Pathways to Cutaneous Effectors. In: Morris JL, Gibbins IL (eds) *Autonomic Innervation of the Skin*. Harwood Academic Publishers, Amsterdam, pp 1–56
5. Hu P, McLachlan EM (2003a) Distinct Functional Types of Macrophage in Dorsal Root Ganglia and Spinal Nerve Proximal to Sciatic and Spinal Nerve Transections in the Rat. *Exp Neurol* 184:590–605
6. Hu P, McLachlan EM (2003b) Selective reactions of cutaneous and muscle afferent neurons to peripheral nerve transection in rats. *J Neurosci* 23:10559–10567
7. Jobling P, McLachlan EM, Jänig W et al. (1992) Electrophysiological Responses in the Rat Tail Artery during Reinnervation Following Lesions of the Sympathetic Supply. *J Physiol* 454:107–128
8. Koltzenburg M, Häbler H-J, Jänig W (1995) Functional Reinnervation of the Vasculature of the Adult Cat Paw Pad by Axons Originally Innervating Vessels in Hairy Skin. *Neuroscience* 67:245–252
9. Lopez de Armentia M, Leeson AH, Stebbing MJ et al. (2003) Responses to Sympathomimetics in Rat Sensory Neurons after Nerve Transection. *Neuro Report* 14:9–13
10. McLachlan EM, Jänig W, Devor M et al. (1993) Peripheral Nerve Injury Triggers Noradrenergic Sprouting within Dorsal Root Ganglia. *Nature* 363:543–546
11. McLachlan EM, Keast JR, Bauer M (1994) SP- and CGRP-Immunoreactive Axons Differ in their Ability to Reinnervate the Skin of the Rat Tail. *Neurosci Lett* 176:147–151
12. Michaelis M, Devor M, Jänig W (1996) Sympathetic Modulation of Activity in Rat Dorsal Root Ganglion Neurons Changes Over Time Following Peripheral Nerve Injury. *J Neurophysiol* 76:753–763
13. Michaelis M, Liu X, Jänig W (2000) Axotomized and Intact Muscle Afferents but no Skin Afferents Develop Ongoing Discharges of Dorsal Root Origin after Peripheral Nerve Lesion. *J Neurosci* 20:2742–2748
14. Ramer MS, Thompson SWN, McMahon SB (1999) Causes and Consequences of Sympathetic Basket Formation in Dorsal Root Ganglia. *Pain* 6:S111–S120
15. Roberts WJ (1997) Sympathetic Modulation of Cutaneous Sensory Receptors. In: Morris JL, Gibbins IL (eds) *Autonomic Innervation of the Skin*. Harwood Academic Publisher, Amsterdam, pp 269–290
16. Sato J, Perl ER (1991) Adrenergic Excitation of Cutaneous Pain Receptors Induced by Peripheral Nerve Injury. *Science* 251:1608–1610
17. Shinder V, Govrin-Lippmann R, Cohen S et al. (1999) Structural Basis of Sympathetic-Sensory Coupling in Rat and Human Dorsal Root Ganglia Following Peripheral Nerve Injury. *J Neurocytol* 28:743–761
18. Torebjörk E, Wahren L, Wallin G et al. (1995) Noradrenaline-Evoked Pain in Neuralgia. *Pain* 63:11–20
19. Walsh GS, Krol KM, Kawaja MD (1999) Absence of the p75 Neurotrophin Receptor Alters the Pattern of Sympathosensory Sprouting in the Trigeminal Ganglia of Mice Overexpressing Nerve Growth Factor. *J Neurosci* 19:258–273
20. Zhou X-F, Deng Y-S, Chie E et al. (1999) Satellite Cell-Derived Nerve Growth Factor and Neurotrophin-3 are Involved in Noradrenergic Sprouting in the Dorsal Root Ganglia Following Peripheral Nerve Injury in the Rat. *Eur J Neurosci* 11:1711–1722

## Sympathetic Arousal

### Definition

Sympathetic arousal is a physiological process associated with a relative activation of the sympathetic nervous system and mediated by adrenalin, resulting in responses such as increased heart rate, faster and shallower breathing, increased sweating, and increased muscle tension.

► [Relaxation in the Treatment of Pain](#)

## Sympathetic Blockade

### Definition

The peripheral sympathetic nervous system begins as efferent preganglionic fibers in the intermediolateral column of the spinal cord, passing out in the ventral roots from T1 to L2 to form the sympathetic chain at the side of the vertebral bodies. The preganglionic fibers pass a variable distance to reach ganglia in the chain, and postganglionic fibers are widely distributed. The sympathetic ganglia consist of efferent sympathetic fibers and afferent visceral fibers conducting to and from the head, neck and upper extremity (cervicothoracic or stellate ganglion), abdominal viscera (coeliac plexus), lower limbs and lower abdominal viscera (lumbar sympathetic ganglia), pelvic organs (hypogastric plexus), and perineum (ganglion impar). As the sympathetic ganglia are separated from somatic nerves (except in the thoracic region), it is possible to achieve selective blockade of sympathetic fibers at these sites without effects on sensory and motor function. The use of sympathetic blocks as diagnostic procedures is hampered by false positive results due to: spread of local anesthetic to somatic nerve roots or the epidural space; blockade of sensory fibers from many deep somatic elements that traverse the sympathetic rami and chain; or interruption of visceral afferent signals. False negative results may result from an incorrectly performed block, or failure to block all sympathetic supply fibers from the contralateral ganglia or other ganglia in the chain. For example, blockade of all sympathetic fibers to the upper arm may not be achieved with a stellate ganglion block at C6, which has been shown to produce a Horner's syndrome in 84–100%, but ipsilateral hand warming in only 27–75% of subjects.

► [Postoperative Pain, Acute Presentation of Complex Regional Pain Syndrome](#)

## Sympathetic Blocks

ANDREW JEFFREYS

Department of Anaesthesia, Western Health,  
Melbourne, NSW, Australia  
andrew.jeffreys@wh.org.au

### Synonyms

Sympathetic Nerve Block; Chemical Sympathectomy

### Definition

Sympathetic blocks are procedures designed to produce temporary or permanent interruption of activity in sympathetic neurons.

### Characteristics

#### Principles

Sympathetic blockade can be produced temporarily by injecting ► **local anaesthetic** onto sympathetic nerves. Typically, the nerves are blocked where they form the sympathetic trunks and ganglia, or plexuses, in front of the vertebral column. Sympathetic nerves are most concentrated in these regions (Breivik et al. 1998; Kopacz and Thompson 1998). The objective of the block may be to interrupt efferent output to a target region, afferent output from that region, or both. The site of the block used depends on the region targeted (Table 1).

#### Techniques

Blind techniques using anatomical landmarks can be performed, but fluoroscopic or CT guidance allows for safer and more accurate placement of needles. The injection of a test-dose of contrast medium allows confirmation that the agent to be used will spread safely and appropriately.

#### Stellate Ganglion Block

The patient lies supine with their neck slightly extended and mouth open. Upon palpating the transverse process of C6, the operator inserts a needle until it contacts the junction of the transverse process and body of C6.

Between 10 and 15 ml of local anaesthetic is injected slowly. Spread of solution to the midthoracic segments is required to completely block sympathetic efferents to the upper limb.

#### Thoracic Sympathetic Block

The needle is introduced from behind, and is directed to pass ventrally and medially, through the costotransverse ligament, until its tip lies beside the vertebral column at the depth of the sympathetic trunk.

#### Celiac Plexus Block

A bilateral approach uses two needles, inserted from behind, and directed to the anterior aspect of the body of L1 adjacent to the aorta. CT scanning greatly facilitates this block. The insertion points and needle direction can be determined; the pleura and kidneys can be avoided; and the spread of injectate can be ascertained with contrast medium.

#### Lumbar Sympathetic Block

A needle is introduced from behind, and is directed under fluoroscopic guidance through the psoas muscle, until its tip emerges from the psoas fascia immediately adjacent to the vertebral bodies of L2, L3, or L4. A linear spread of 1 ml of contrast medium, with no lateral extension, indicates appropriate positioning. Small volume injections of the active agent can then be made at L2 and L4, or a single injection of a larger volume (15–20 ml) at L3.

#### Hypogastric Plexus Block

This block is performed in a similar fashion to the lumbar plexus block, save that a bilateral approach is used, and the target lies at L5–S1.

#### Ganglion Impar Block

A needle is passed from below the tip of the coccyx to follow its anterior curvature, until it reaches the anterior surface of the sacrococcygeal junction. An alternative is to pass the needle from behind, through the sacrococcygeal ligament.

#### Agents Used

##### Local Anaesthetics

For prolonged block, an agent such as bupivacaine or ropivacaine is commonly used. Clinical experience, and some research evidence, suggests that analgesic effects can continue for significantly longer than the described duration of action of these agents (6–12 hours) (Price et al. 1998). Volumes in the range of 10–20 ml are used, keeping in mind the total dose being administered to the patient.

##### Neurolytic Agents

Neurolytic agents have the advantage of producing a prolonged 'chemical sympathectomy'. The major disadvantage is that unwanted effects on neurological structures, such as somatic nerves, may not recover. The

**Sympathetic Blocks, Table 1** The variety of sympathetic blocks and the regions that they target

BLOCK	TARGET REGION
Stellate ganglion	head, neck, and upper limb
Thoracic sympathetic trunk	upper limb and heart
Coeliac plexus	upper abdominal viscera
Lumbar sympathetic trunk	lower limb
Hypogastric plexus	pelvic viscera
Ganglion impar	perineum

most widely used agents are 50–100% alcohol or 6–7% phenol in water.

### Validity

The accuracy of a sympathetic block is confirmed by signs of venodilatation, increased capillary blood flow and perfusion, and an increase in skin surface temperature. A temperature increase of 1–3°C is indicative of a successful block, but this method is ineffective if skin is warm to begin with (Fisher et al. 1997). Patients with significant vascular disease may not demonstrate these signs.

### Complications

The risk of major complications appears to be acceptably low. The published case reports pertain largely to neurolytic blocks.

Systematically, the potential complications of sympathetic blocks include: the inadvertent puncture of adjacent structures or injection of agents into them, spread of agents to somatic nerves, and the physiological effects of sympathetic blockade, such as postural hypotension or ejaculatory failure.

### Indications and Applications

#### Rest Pain Due to Chronic Vascular Insufficiency

Chemical lumbar sympathectomy has been used for several decades to treat patients with occlusive vascular disease who suffer ischemic rest pain of the distal lower limbs. Its use has declined significantly in latter years due to the development of successful reconstructive surgical techniques.

Since muscle blood flow is largely regulated by autoregulatory mechanisms, sympathectomy is not effective in the treatment of the pain of claudication. (Breivik et al. 1998; Gordon et al. 1994).

The role of sympathectomy in the treatment of peripheral vascular disease has come under scrutiny and its long-term effectiveness questioned (Gordon et al. 1994). Nevertheless, its major application remains for patients for whom surgery is not possible or has failed (Alexander 1994).

#### Chronic Malignant Pain

Neurolysis of visceral nociceptive afferents is an effective treatment for the pain of visceral malignancy. Diagnostic blocks are usually performed to establish efficacy prior to neurolysis.

The most widely used and best studied of these blocks is celiac plexus block, for pain due to malignancy arising from the upper abdomen. Properly performed blocks can provide pain relief lasting for more than one month in 70–85% of patients (Butler and Charlton 2001). Best responses occur in those suffering carcinoma of the pancreas.

The most feared complication is damage to spinal cord or somatic nerves. One retrospective question-

naire based study detected four cases of permanent paraplegia in 2730 neurolytic celiac plexus blocks (Davies 1993).

#### Sympathetically Maintained Neuropathic Pain

The prominence of signs suggesting autonomic dysfunction in ► [Complex Regional Pain Syndromes, General Aspects](#) prompted the widespread use of sympathetic blocks in their treatment. In recent years, however, the role and efficacy of sympathetic blocks in these conditions has been questioned (Cepada et al. 2002).

The exact role that the sympathetic nervous system plays in the maintenance of chronic neuropathic pain remains unclear (Fisher et al. 1997). Evidence of sympathetic nervous system dysfunction in these conditions does exist, but a link between this evidence and the appropriate use of sympathetic blocks has not been established (Baron et al. 2002).

Patients who respond to sympathetic blocks are said to have sympathetically maintained pain. This concept has been criticised, due to the variable efficacy of injection techniques in achieving sympathetic blockade, and because sympathetic blocks can have effects on pathways other than sympathetic nerves (Fisher et al. 1997).

Clinical trials have suffered from differences in inclusion/exclusion criteria, treatment methods, outcome measurements and the use of controls (Perez et al. 2001). Convincing evidence confirming the efficacy of sympathetic blocks in the treatment of neuropathic pain has not been produced. However, some evidence suggests that the use of sympathetic blocks soon after injury may prevent the development of CRPS (Reuben et al. 2000).

Since the placebo effect is powerful in this situation, the use of appropriate controls is vital when conducting studies of this nature. The use of control blocks in routine clinical practice has also been strongly advocated (Bogduk 2002).

Apparent relief of pain with local anaesthetic blocks has led to the use of neurolytic blocks, surgical sympathectomy or radiofrequency denervation in the treatment of CRPS. However neuro-ablative sympathectomy seems to have, at best, a temporary analgesic effect. A significant risk of these techniques is post sympathectomy neuralgia, whereby the patient may be left with a worse pain problem than existed at the outset (Anastasios et al. 2003).

Overall, whereas clinical experience suggests that, when used appropriately, sympathetic blocks can be a useful component of a multidisciplinary treatment regimen, questions regarding their use in the treatment of CRPS remain unanswered. The use of control blocks, where possible, in order to properly assess response is to be recommended. Continuing a series of sympathetic blocks in the face of no improvement is futile and potentially harmful.

► [Epidural Steroid Injections for Chronic Back Pain](#)



## References

- Alexander JP (1994) Chemical Lumbar Sympathectomy in Patients with Severe Lower Limb Ischemia. *Ulster Med J* 63:137–143
- Anastasios T et al. (2003) Characteristics and Associated Features of Persistent Post-Sympathectomy Pain. *Clin J Pain* 19:192–199
- Baron R et al. (2002) National Institutes of Health Workshop: Reflex Sympathetic Dystrophy/Complex Regional Pain Syndromes – State of the Science. *Anesthes Analges* 95:1812–1816
- Bogduk N (2002) Diagnostic Nerve Blocks in Chronic Pain. *Best Prac Res Clin Anaesth.* 16:565–578
- Breivik H, Cousins MJ, Lofstrom JB (1998) Sympathetic Neural Blockade of Upper and Lower Extremity. In: Cousins MJ, Bridenbaugh PO (eds) *Neural Blockade in Clinical Anesthesia and Management of Pain*. Lippincott, Philadelphia, pp 411–450
- Butler SH, Charlton JE (2001) Neurolytic Blockade and Hypophysectomy. In: Loeser J (ed) *Bonica's Management of Pain*. Lippincott, Philadelphia, pp 1967–2006
- Cepada SM et al (2002) Defining the Therapeutic Role of Local Anesthetic Sympathetic Blockade in Complex Regional Pain Syndrome: A Narrative and Systematic Review. *Clin J Pain* 18:216–233
- Davies DD (1993) Incidence of Major Complications of Neurolytic Coeliac Plexus Block. *J Roy Soc Med* 86:264–266
- Fisher DM, Abram SE, Hogan QH (1997) Neural Blockade for Diagnosis and Prognosis: A Review. *Anesthesiology* 86:216–241
- Gordon A, Zechmeister K, Collin J. (1994) The Role of Sympathectomy in Current Surgical Practice. *Eur J Vasc Surg* 8:129–137
- Kopacz DJ, Thompson G (1998) Celiac and Hypogastric Plexus, Intercostal, Interpleural, and Peripheral Neural Blockade of the Thorax and Abdomen. In: Cousins MJ, Bridenbaugh PO (eds) *Neural Blockade in Clinical Anesthesia and Management of Pain*. Lippincott, Philadelphia, pp 451–488
- Perez RS et al. (2001) Treatment of Reflex Sympathetic Dystrophy (CRPS Type 1): A Research Synthesis of 21 Randomized Clinical Trials. *J Pain Symptom Manage* 21:511–526
- Price DD, Long S, Wilsey B, Rafii A (1998) Analysis of Peak Magnitude and Duration of Analgesia Produced by Local Anesthetics Injected into Sympathetic Ganglia of Complex Regional Pain Syndrome Patients. *Clin J Pain* 14:216–226
- Reuben SS et al. (2000) Surgery on the Affected Upper Extremity of Patients with a History of Complex Regional Pain Syndrome: A Retrospective Study of 100 Patients. *J Hand Surg* 25A:1147–1151

## Sympathetic Component

### Definition

Group of visceral responses driven by the sympathetic nervous system. This motor autonomic system is one of the two antagonistic visceral controls (the other being parasympathetic). It includes, schematically, a first neuron preganglionic (cholinergic) located in the intermediolateral spinal horn and a second neuron (adrenergic) located in the paravertebral ganglion, the axon of which innervates the smooth muscles of viscera and blood vessels, the heart and the glandular tissue including notably the suprarenal gland. For example, within the cardiovascular sphere, this system triggers an increase of blood pressure and a tachycardia.

- ▶ Hypothalamus and Nociceptive Pathways

## Sympathetic Fiber Sprouting

### Definition

Abnormal growth of sympathetic nerve fiber at the injury site, within affected dorsal root ganglia and in denervated skin, is induced by peripheral nerve injury.

- ▶ Neuropathic Pain Model, Tail Nerve Transection Model

## Sympathetic Ganglia

### Definition

The autonomic or involuntary nervous system consists of sensory and motor neurons that run between the central nervous system (e.g., hypothalamus and medulla oblongata) and various internal organs such as the heart, lungs, gut, and glands, as well as peripheral tissues such as the blood vessels. The two main subdivisions of the autonomic nervous system are the sympathetic and the parasympathetic nervous systems. The sympathetic nervous system consists of preganglionic motor neurons that arise in the spinal cord and communicate with postganglionic neurons in sympathetic ganglia. The ganglia are primarily organized as two chains that run parallel to, and on either side of, the spinal cord.

- ▶ Sympathetically Maintained Pain in CRPS II, Human Experimentation

S

## Sympathetic Ganglionectomy

### Definition

Excision of ganglia (a mass of neural cell bodies found alongside the vertebral column) of the sympathetic nervous system (along with the parasympathetic nervous system, one of the two components of the autonomic nervous system, which control involuntary bodily functions).

- ▶ Cancer Pain Management, Neurosurgical Interventions

## Sympathetic Nerve Block

- ▶ Sympathetic Blocks

## Sympathetic Nervous System and Pain

WILFRID JÄNIG<sup>1</sup>, RALF BARON<sup>2</sup>

<sup>1</sup>Physiology Institute, Christian Albrechts University Kiel, Kiel, Germany

<sup>2</sup>Department of Neurological Pain Research and Therapy, Neurological Clinic, Christian Albrechts University Kiel, Kiel, Germany  
w.janig@physiologie.uni-kiel.de,  
r.baron@neurologie.uni-kiel.de

### Introduction

Research on the relationship between the autonomic nervous system and pain is a developing field with many facets that are interesting from the biological, pathobiological and clinical point of view. The terms biology and pathobiology are preferred to physiology and pathophysiology, because they include physiological, morphological, biochemical and molecular aspects. This field will be briefly reviewed in a broad context, with focus on the sympathetic nervous system. The peripheral sympathetic noradrenergic neuron will be argued to have, in addition to its conventional function to transmit signals generated in the brain to peripheral target cells (e.g. smooth muscle cells, secretory epithelia, heart cells, neurons of the enteric nervous system etc.), quite different functions that are directly or indirectly related to protection of body tissues and pain. Some of these functions have not been studied as extensively as the function to regulate autonomic target

cells (Jänig 2006). The parasympathetic nervous system is not involved in the generation of pain, yet may also be important in protection of body tissues (e.g. the gastrointestinal tract). Vagal afferents are involved in integrative aspects of pain, hyperalgesia and inflammation. This is discussed elsewhere (Jänig 2005; Jänig and Levine 2005).

The table "Sympathetic nervous system and pain" lists different functions of the sympathetic nervous system related to pain and protection of body tissues in biological and pathobiological conditions. The table clearly shows that peripheral as well as central mechanisms have to be considered and that the topic not only encompasses pain and hyperalgesia, but has a broader context including neural and neuroendocrine regulation of inflammation and the immune system. Often biology and pathobiology are not clearly separated.

As shown above, this brief review will distinguish three aspects of the topic sympathetic nervous system and pain:

1. Reactions of the sympathetic nervous system in pain. This addresses the autonomic reactions during pain and includes reflexes to noxious stimulation and adaptive reactions during pain.
2. Peripheral mechanisms underlying coupling (crosstalk) from sympathetic (noradrenergic) neurons to afferent neurons in the generation of pain. This consists of two types of coupling, coupling related to excitation of the sympathetic postganglionic neurons and release of noradrenaline and coupling independent of excitation and noradrenaline release.

**Sympathetic Nervous System and Pain, Table 1** Sympathetic Nervous System and Pain

1. Reactions of the sympathetic nervous system in pain	Protective spinal reflexes
	Fight, flight and quiescence organized at the level of the periaqueductal gray
2. Role of the sympathetic nervous system in the generation of pain <i>Sympathetic-afferent coupling in the periphery</i>	Coupling after nerve lesion (noradrenaline, $\alpha$ -adrenoceptors)
	Coupling <i>via</i> the micromilieu of the nociceptor and the vascular bed
	Sensitization of nociceptors mediated by sympathetic terminals independent of excitation and release of noradrenaline
	Sensitization of nociceptors initiated by cytokines or nerve growth factor and mediated by sympathetic terminals
3. Sympathetic nervous system and central mechanisms <i>Control of inflammation and hyperalgesia by sympathetic and neuroendocrine mechanisms</i>	Sympatho-adrenal system and nociceptor sensitization
	Sympathetic nervous system and CRPS
	Sympathetic nervous system and immune system
	Sympathetic nervous system and rheumatic diseases

References for 1. Bandler and Shipley (1994), Bandler et al (2000a,b)

for 2. Baron and Jänig 2001, Jänig (2005), Jänig and Häbler (2000), Jänig and Koltzenburg (1991), Jänig and Levine (2005)

for 3. Jänig and Baron (2002, 2003, 2004), Jänig and Häbler (2000a), Jänig et al (2000), Jänig and Levine (2005), Straub and Härle (2005), Straub et al (2005)

3. Central aspects of the role of the sympathetic nervous system in the generation of pain. This aspect includes the sympathetic-afferent coupling discussed before. However, based on observations on patients and animal experimentation, whether change of activity in sympathetic noradrenergic neurons or of the sympatho-adrenal system generated in the brain contributes directly or indirectly to hyperalgesia and inflammation will be considered.

The role of the sympathetic nervous system and its transmitters in chronic inflammation (such as rheumatoid arthritis) and its interaction with the peptidergic afferent innervation as well as the hypothalamo-pituitary-adrenal system will not be discussed. The experimental investigation of these control mechanisms is just beginning (Straub and Härle 2005; Straub et al. 2005).

### Biology of the Sympathetic Nervous System

The peripheral sympathetic nervous system is by definition an efferent system, consisting in the periphery of many functionally distinct pathways that transmit the impulse activity from the spinal cord to the effector cells. These pathways are separate from each other and functionally distinct with respect to the effector cells, as is the impulse transmission in the sympathetic ganglia and at the neuroeffector junctions to the effector cells. Each peripheral sympathetic pathway is connected to distinct neuronal networks in the spinal cord, brain stem and hypothalamus that generate the typical discharge patterns in the sympathetic neurons and are responsible for the precise regulation of the target organs (cardiovascular regulation, thermoregulation, regulation of pelvic organs, regulation of gastrointestinal tract and so forth). The autonomic regulation in which the sympathetic nervous system is involved is represented in these central networks (Jänig 2006; Jänig and McLachlan 2002). The precise anatomical, histochemical and functional organization of the sympathetic nervous system, in the periphery and in the brain, often receives insufficient attention in studies of the functioning of this system under pathobiological conditions.

Although primary afferent neurons innervating visceral organs are indispensable to understanding autonomic regulations, they are neither sympathetic nor parasympathetic nor autonomic, but simply visceral afferents (specified as spinal or vagal). Biological criteria to label these afferents specifically as sympathetic or parasympathetic are lacking (Jänig 2006).

### Reactions of the Sympathetic Nervous System in Pain

Any acute, but possibly also chronic, tissue damaging stimulus affects the sympathetic nervous system.

Neurons of sympathetic systems exhibit generalized and specific reactions to these stimuli. The generalized reactions probably only occur in certain types of sympathetic system (e.g. muscle vasoconstrictor, visceral vasoconstrictor, sudomotor neurons or sympathetic cardiomotor neurons) but are weak or absent in other systems (e.g., sympathetic systems to pelvic organs). They are organized in spinal cord, brain stem (medulla oblongata, mesencephalon) and hypothalamus and are probably best understood as components of the different patterns of defense behavior, such as “confrontational defense” “flight” and “quiescence” Confrontational defense and flight are typical of an active defense strategy when animals encounter threatening stimuli which are potentially injurious for the body, confrontational defense leading potentially to fight and flight to forward avoidance. Both patterns are represented in the lateral and dorsolateral periaqueductal grey of the mesencephalon, activated from the body surface or cortex and associated with endogenous non-opioid analgesia, hypertension and tachycardia. Quiescence is similar to the natural reactions of mammals to serious injury and chronic pain occurring particularly in the deep and visceral body domains. It is represented in the ventrolateral periaqueductal grey, activated from the deep (somatic and visceral) body domains and consists of hyporeactivity, hypotension, bradycardia and an endogenous opioid analgesia. These stereotyped preprogrammed elementary behaviors and their association with the endogenous control of analgesia enable the organism to cope with dangerous situations that are always accompanied by pain or impending pain. The dorsolateral, lateral and ventrolateral columns of the periaqueductal grey have distinct reciprocal connections with the autonomic centers in the lower brain stem and hypothalamus that differentially regulate the activity in neurons of the sympathetic pathways. They are under differential control of the medial and orbital prefrontal cortex (Bandler and Shipley 1994; Bandler et al. 2000a; Bandler et al. 2000b; Keay and Bandler 2004).

There are also more localized and distinct reactions of the sympathetic nervous system to noxious stimuli that are organized within the spinal cord and trigeminal nucleus and in the periphery, i.e. somato-sympathetic, viscerosympathetic and viscerovisceral reflexes. For example, cutaneous vasoconstrictor neurons exhibit distinct inhibitory reflexes to noxious stimuli of the territories innervated by these neurons. The hypothalamo-mesencephalic and the spinal level of integration are presumably protective under normal biological conditions and are associated with activation of the adreno-cortical system by the hypothalamo-hypophyseal axis (Jänig 2006).

### Role of the Sympathetic Nervous System in the Generation of Pain

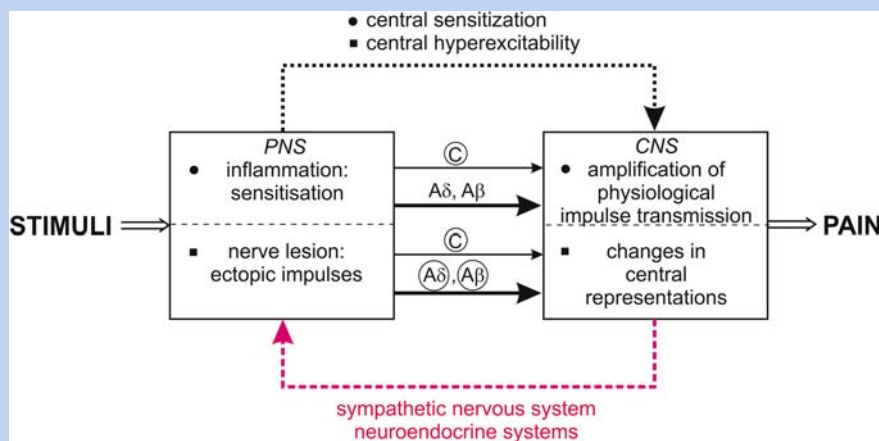
In this section mechanisms will be discussed by way of which sympathetic noradrenergic neurons may be coupled directly or indirectly to primary afferent neurons in the periphery leading to their excitation and / or change of their excitability. This sympathetic-afferent coupling is either dependent on the activity in the sympathetic neurons, but not necessarily on an increase of this centrally generated activity or entirely independent of activity and release of noradrenaline. The latter function of the sympathetic noradrenergic neuron is entirely different from its function to transmit impulses to target cells.

### Physiological Conditions

Under physiological conditions there exists almost no influence of sympathetic activity on sensory neurons projecting to skin and deep somatic tissues in mammals. The effects that have been measured under experimental conditions on receptors with myelinated and unmyelinated axons were weak and can in part be explained by changes in the effector organs (erector pili muscles, blood vessels) induced by the activation of sympathetic neurons. These rather negative results do not rule out that noradrenaline or co-localized substances released by the postganglionic terminals have secondary long-term effects on the excitability of sensory receptors, although there is no experimental evidence for this (Jänig and Koltzenburg 1991).

### Sympathetic-afferent Coupling Dependent on Activity in Sympathetic Neurons

Pain being dependent on activity in sympathetic neurons is called sympathetically maintained pain (SMP) (Stanton-Hicks et al. 1995). SMP is a symptom and includes generically spontaneous pain and pain evoked by mechanical or thermal stimuli. It may be present in the complex regional pain syndromes (CRPS) type I and type II and in other neuropathic pain syndromes (Stanton-Hicks et al. 1995). The idea about the involvement of the (efferent) sympathetic nervous system in pain is based on various clinical observations, which have been documented in the literature for tens of years (Harden et al. 2001). Representative of these multiple observations on patients with SMP are quantitative experimental investigations (Ali et al. 2000; Baron et al. 2002; Price et al. 1998; Torebjörk et al. 1995). These experiments demonstrate that (1) sympathetic postganglionic neurons can be involved in the generation of pain, (2) blockade of the sympathetic activity can relieve the pain, (3) noradrenaline injected intracutaneously is able to rekindle the pain (► [sympathetically maintained pain, clinical pharmacological tests](#); ► [sympathetically maintained pain in CRPS I, human experimentation](#); ► [sympathetically maintained pain in CRPS II, human experimentation](#)) and (4)  $\alpha$ -adrenoceptor blockers or guanethidine (which depletes noradrenaline from its stores) may relieve the pain (Arnér 1991) (see ► [sympathetically maintained pain in CRPS II, human experimentation](#)).



**Sympathetic Nervous System and Pain, Figure 1** Concept of generation of peripheral and central hyperexcitability during inflammatory pain and neuropathic pain. The upper interrupted arrow indicates that the central changes are generated (and possibly maintained) (a) by persistent activation of nociceptors with C-fibers (e.g. during chronic inflammation) called here "central sensitization" and (b) after trauma with nerve lesion by ectopic activity and other changes in lesioned afferent neurons called here "central hyperexcitability". The lower interrupted arrow indicates the efferent feedback *via* the sympathetic nervous system and neuroendocrine systems (e.g. the sympatho-adrenal system). Primary afferent nociceptive neurons (in particular those with C-fibers) are sensitized during inflammation. After nerve lesion, all lesioned primary afferent neurons (unmyelinated as well as myelinated ones) undergo biochemical, physiological and morphological changes which become irreversible with time. These peripheral changes entail changes in the central representation (of the somato-sensory system), which become irreversible if no regeneration of primary afferent neurons to their target tissue occurs. The central changes, induced by persistent activity in afferent nociceptive neurons or after nerve lesions are also reflected in the efferent feedback systems that may establish positive feedback to the primary afferent neurons.

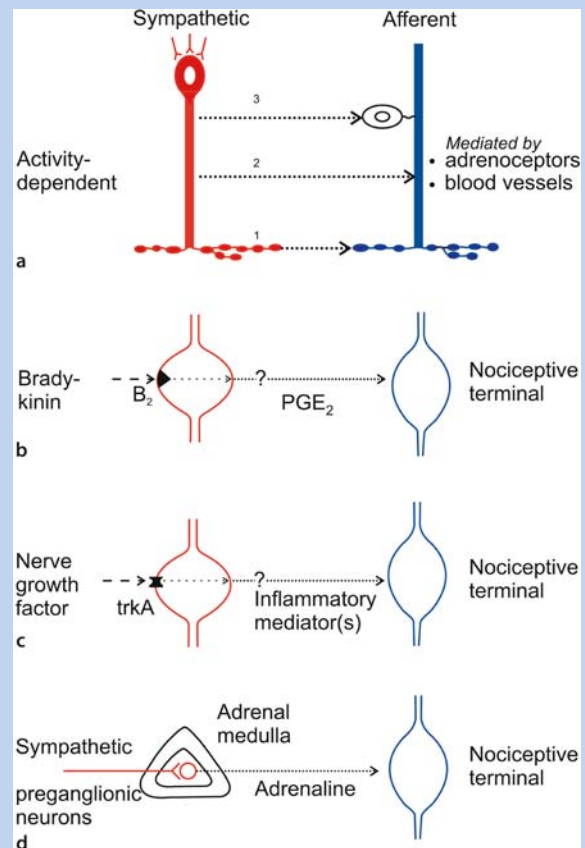


The interpretation of these data is that nociceptors are excited and possibly sensitized by noradrenaline released by the sympathetic fibers. Either the nociceptors have expressed adrenoceptors and/or the excitatory effect is generated indirectly, e.g. *via* changes in blood flow. Sympathetically maintained activity in nociceptive neurons may generate a state of ► **central sensitization** / hyperexcitability, leading to spontaneous pain and secondary evoked pain (mechanical and possibly cold allodynia) (Jänig and Baron 2001; Jänig and Baron 2002) (Fig. 1).

#### Coupling after Nerve Lesion via Noradrenaline and $\alpha$ -Adrenoceptors

The coupling between sympathetic postganglionic neurons and primary afferent neurons following trauma with nerve lesion that underlies SMP may occur in several ways (Fig. 2a), at the lesion site, along the nerve or in the dorsal root ganglion. The afferent activation is mediated by noradrenaline released by the postganglionic axons and by  $\alpha$ -adrenoceptors expressed by the afferent neurons. Primary afferent nociceptive as well as non-nociceptive neurons may be affected (► **sympathetic-afferent coupling in the afferent nerve fiber, neurophysiological experiments**). Coupling in the dorsal root ganglion occurs almost exclusively to large diameter afferent cell bodies. The underlying mechanisms are change of blood flow (generating hypoxia?) and possibly a direct effect by release of noradrenaline. It is debatable whether this coupling is important in patients with SMP following trauma with nerve lesion. Coupling along the lesioned nerve is still hypothetical. However, in view of the experimental observation showing that peptidergic (afferent) and postganglionic (noradrenergic) neurons undergo continuous sprouting in a lesioned nerve proximal to the nerve lesion over >100 days (Barrett and McLachlan 1999) this mechanism is a realistic possibility and needs to be examined. The coupling may also occur indirectly by changes in the micromilieu of the lesioned primary afferent neurons (e.g. by changes of blood flow in the dorsal root ganglion or in the lesioned nerve; see also ► **sympathetic-afferent coupling in the afferent nerve fiber, neurophysiological experiments**).

Experiments supporting these ideas have been performed on human models, on animal behavioral models and on reduced animal models *in vivo* and *in vitro* (► **sympathetically maintained pain in CRPS I, human experimentation** ► **sympathetic nervous system in the generation of pain, animal behavioral models**) (Jänig and Häbler 2000; Harden et al. 2001; Jänig and Baron 2001; Jänig and Baron 2002).



**Sympathetic Nervous System and Pain, Figure 2** Ways hypothesized to couple sympathetic and primary afferent neurons following peripheral nerve lesion (a) or during inflammation (b to d). (a) These types of coupling depend on the activity in the sympathetic neurons and on the expression of functional adrenoceptors by the afferent neurons or mediation indirectly *via* the blood vessels (blood flow). It can occur in the periphery, in the dorsal root ganglion or possibly also in the lesioned nerve. (b) The inflammatory mediator bradykinin acts at B<sub>2</sub> receptors in the membrane of the sympathetic varicosities or in cells upstream of these varicosities, inducing release of prostaglandin E<sub>2</sub> (PGE<sub>2</sub>) and sensitization of nociceptors. This way of coupling is probably not dependent on activity in the sympathetic neurons. (c) Nerve growth factor released during an experimental inflammation reacts with the high affinity receptor for trkA in the membrane of the sympathetic varicosities, inducing release of an inflammatory mediator or inflammatory mediators and sensitization of nociceptors. This effect is possibly not dependent on activity in the sympathetic neurons. (d) Activation of the adrenal medulla by sympathetic preganglionic neurons leads to release of adrenaline, which generates sensitization of nociceptors. The ? in (b) and (c) indicates that PGE<sub>2</sub> or other inflammatory mediators may be released by cells other than the sympathetic varicosities. Modified from Jänig and Häbler (2000).

#### Coupling via the Micromilieu of the Nociceptor

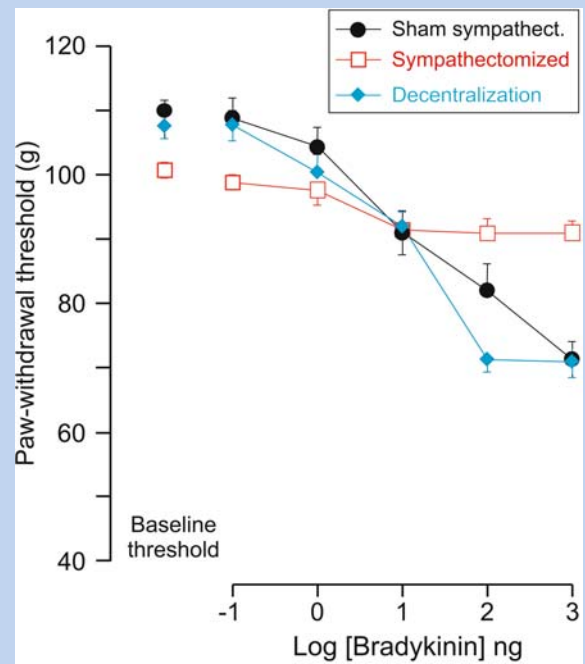
After trauma without nerve lesion, the sympathetic activity may be mediated indirectly to the afferent neurons (i.e., by way of the vascular bed or other mechanisms). The most convincing experiment supporting this idea was conducted by Baron et al. (2002) on CRPS type I patients with SMP. These patients show that SMP

in the skin is enhanced if activity in cutaneous vasoconstrictor neurons is increased (e.g., generated by central cooling). However, the difference in SMP between the states of whole body cooling and whole body warming is significantly smaller than the decrease of SMP following sympathetic block. This important observation argues that the coupling between sympathetic and nociceptive afferent neurons mainly occurs in the deep somatic tissues ([▶ sympathetically maintained pain in CRPS I, human experimentation](#)). An animal model to study this important way of coupling does not exist and has to be designed.

#### Sensitization of Nociceptors Mediated by Sympathetic Terminals Independent of Excitation and Release of Noradrenaline

In the rat, the withdrawal threshold to stimulation of the hind paw with a linearly increasing mechanical stimulus applied to the dorsum of the paw decreases dose dependently after intradermal injection of the inflammatory mediator bradykinin (an octapeptide cleaved from plasma  $\alpha_2$ -globulins by kallikreins circulating in the plasma) (Figs. 2b, 3). Following a single injection of bradykinin, this decrease lasts for more than 1 hour for mechanical stimulation. This type of mechanical hyperalgesic behavior is mediated by the B<sub>2</sub> bradykinin receptor (Khasar et al. 1995) and is not present when bradykinin is injected subcutaneously (Khasar et al. 1993). Bradykinin-induced hyperalgesic behavior is blocked by the cyclooxygenase inhibitor indomethacin and therefore mediated by a prostaglandin (probably PGE<sub>2</sub>) that sensitizes nociceptors for mechanical stimulation (Fig. 3). However, in vagotomized rats in which the bradykinin-induced mechanical hyperalgesia is significantly enhanced (probably due to adrenaline released by the activated adrenal medulla; Khasar et al. 1998a; Khasar et al. 1998b) (see [▶ sympatho-adrenal system and mechanical hyperalgesic behavior, animal experimentation](#)), indomethacin has almost no effect on bradykinin-induced hyperalgesia. This failure is not related to a switch from B<sub>2</sub>- to B<sub>1</sub>-receptor subtype because the selective B<sub>1</sub>-receptor agonist des-Arg<sup>9</sup>-BK failed to produce hyperalgesia in vagotomized rats (Khasar et al. 1998a). This shows that bradykinin-induced hyperalgesia may not be mediated by prostanoids in vagotomized rats. This novel and interesting finding needs to be followed up experimentally.

The decrease in paw withdrawal threshold provided by bradykinin is significantly reduced after surgical sympathectomy. This shows that the sympathetic innervation of the skin is involved in the sensitization of nociceptors for mechanical stimulation. Interestingly, decentralization of the lumbar paravertebral sympathetic ganglia (denervating the postganglionic neurons by cutting the preganglionic sympathetic axons) does



**Sympathetic Nervous System and Pain, Figure 3** Mechanical hyperalgesic behavior and sympathetic innervation. Bradykinin-induced hyperalgesia in sympathectomized (squares;  $n = 12$  hind paws) and sham sympathectomized (circles;  $n = 6$  hind paws) rats and in rats with decentralized lumbar sympathetic chains (preganglionic axons in lumbar sympathetic chain interrupted 8 days before, diamonds;  $n = 10$  paws). Sham sympathectomy and sympathetic decentralization were both significantly different from the sympathectomy groups ( $P < 0.01$ ).

not abolish bradykinin-induced mechanical hyperalgesic behavior (Fig. 3). This indicates that the sensitizing effect of bradykinin is not dependent on activity in the sympathetic neurons innervating skin and therefore not dependent on release of noradrenaline (Jänig and Häbler 2000; Khasar et al. 1998a). It is believed that bradykinin stimulates the release of prostaglandin from the sympathetic terminals (Gonzales et al. 1989). However this release could also occur from other cells in association with the sympathetic terminals in the skin. Evidence for sensitization of cutaneous nociceptors to mechanical stimulation by bradykinin is poor or absent (Treede et al. 1992). Some sensitization to mechanical stimulation by bradykinin has been demonstrated for afferents from the knee joint (Neugebauer et al. 1989) and from skeletal muscle (Mense and Meyer 1988).

Mechanical hyperalgesic behavior generated by intracutaneous injection of bradykinin is an interesting phenomenon. However, the conventional explanation that this mechanical hyperalgesia is due to prostanoids sensitizing nociceptors since indomethacin prevents it appears to be too simple. The reasons are (1) the novel finding that sympathetic fibers mediate this hyperalgesia independent of neural activity and release

of noradrenaline, (2) indomethacin does not block this behavior under certain conditions (e.g., when the adrenal medullae are activated after vagotomy; Khasar et al. 1998a) and (3) sensitization of nociceptors by bradykinin is weak or absent. Thus this phenomenon has to be reinvestigated using a rigorous experimental approach.

#### **Sensitization of Nociceptors Initiated by Cytokines or Nerve Growth Factor Possibly Mediated by Sympathetic Terminals**

##### **Nerve Growth Factor**

Systemic injection of nerve growth factor (NGF) is followed by a transient thermal and mechanical hyperalgesia in rats (Lewin et al. 1993, 1994) and humans (Petty et al. 1994). During experimental inflammation (evoked by Freund's adjuvant in the rat hind paw), NGF increases in the inflamed tissue in parallel with the development of thermal and mechanical hyperalgesia (Donnerer et al. 1992; Woolf et al. 1994). Both are prevented by anti-NGF antibodies (Lewin et al. 1994; Woolf et al. 1994). The mechanisms responsible are sensitization of nociceptors *via* high affinity NGF-receptors (trkA receptors) and an induction of increased synthesis of calcitonin gene related peptide (CGRP) and substance P in the afferent cell bodies by NGF taken up by the afferent terminals and transported to the cell bodies. The NGF-induced sensitization of nociceptors also seems to be mediated indirectly by the sympathetic postganglionic terminals. Heat and mechanical hyperalgesic behavior generated by local injection of NGF into the skin is prevented or significantly reduced after chemical or surgical sympathectomy (Andreev et al. 1995; Woolf et al. 1996). These experiments suggest that NGF released during inflammation by inflammatory cells acts on the sympathetic terminals *via* high affinity trkA receptors, inducing the release of inflammatory mediators and subsequently sensitization of nociceptors to mechanical and heat stimuli (Fig. 2c) (Jänig and Häbler 2000; McMahon 1996; Woolf 1996). It is unclear whether this sensitization of nociceptors mediated by terminal sympathetic nerve fibers (1) is dependent on activity in the sympathetic neurons, release of noradrenaline and adrenoceptors expressed in the nociceptive afferent neurons or (2) is independent of activity and release of noradrenaline.

##### **Proinflammatory Cytokines**

Based on behavioral experiments conducted on rats (studying mechanical and heat hyperalgesia), it has been shown that tissue injury, injection of the bacterial cell wall endotoxin lipopolysaccharide or injection of carrageenan (a plant polysaccharide) stimulates tissue inflammation and leads to sensitization of nociceptors. Systematic pharmacological interventions

using blockers or inhibitors of the various mediators demonstrated that the proinflammatory cytokines, tumor necrosis factor  $\alpha$  (TNF $\alpha$ ), interleukin (IL)-1, IL-6 and IL-8 may be involved in this process of sensitization and therefore in the generation of hyperalgesia (Poole et al. 1999; Sachs et al. 2002; Woolf et al. 1996; Woolf et al. 1997). Pathogenic stimuli lead to activation of resident cells, the release of the inflammatory mediator bradykinin and other mediators. The inflammatory mediators and the pathogenic stimuli themselves activate macrophages, monocytes and other immune related cells. These cells release TNF $\alpha$ , which generates sensitization of nociceptors by two possible pathways (Fig. 4). (1) It induces production of IL-6 and IL-1 $\beta$  by immune cells; IL-6 enhances the production of IL-1 $\beta$ . These interleukins stimulate cyclooxygenase 2 (COX 2) and the production of prostaglandins (PGE<sub>2</sub>, PGI<sub>2</sub>), which in turn react with the nociceptive terminal *via* E-type prostaglandin receptors. (2) It induces the release of IL-8 from endothelial cells and macrophages. IL-8 reacts with the sympathetic terminals that are supposed to mediate sensitization of nociceptive afferent terminals by release of noradrenaline to act *via*  $\beta_2$ -adrenoceptors. These two peripheral pathways involving cytokines, by which nociceptive afferents can be sensitized, are under the inhibitory control of circulating glucocorticoids (indicated by asterisks in Fig. 4) and of other, anti-inflammatory, interleukins (e.g. IL-4 and IL-10 indicated by # in Fig. 4).

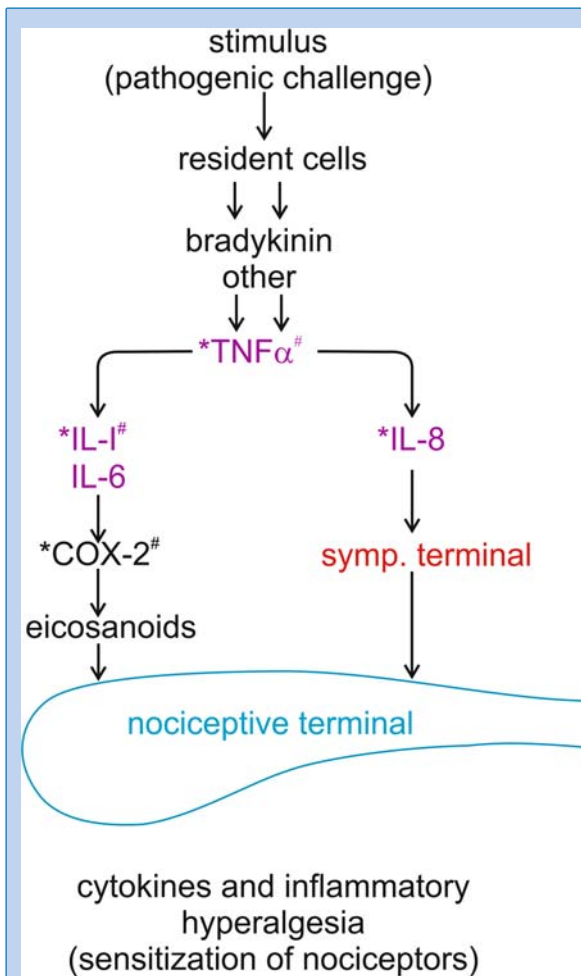
It is important to emphasize that the mechanisms involving NGF, proinflammatory cytokines and noradrenergic sympathetic postganglionic fibers in the sensitization of nociceptive afferents have been deduced on the basis of behavioral and pharmacological experiments. Proof of such interaction by directly assessing the activity of nociceptors with electrophysiological techniques and of the effect of noradrenergic nerve fibers on the afferent nerve fibers are lacking. These experiments have to be done.

#### **Sympathetic Nervous System and Central Mechanisms in the Control of Hyperalgesia and Inflammation**

The question to be addressed here is can centrally generated signals channeled through peripheral sympathetic pathways modulate sensitivity of nociceptors and inflammation? The hypothetical mechanisms involved may include and overlap with the peripheral mechanisms discussed in the foregoing section.

##### **Sympatho-adrenal System and Nociceptor Sensitization**

Activation of the sympatho-adrenal system (adrenal medulla, e.g. by release of the central sympathetic circuits from vagal inhibition), but not of the sympatho-neural system generates mechanical hyperalgesia and



**Sympathetic Nervous System and Pain, Figure 4** Role of cytokines in sensitization of nociceptors during inflammation and the underlying putative mechanisms leading to hyperalgesia. Pathogenic stimuli activate resident cells and lead to release of inflammatory mediators (such as bradykinin). Pro-inflammatory cytokines are synthesized and released by macrophages and other immune or immune related cells. Nociceptors are postulated to be sensitized by two pathways involving the cytokines: (1) Tumor necrosis factor  $\alpha$  ( $\text{TNF}\alpha$ ) induces synthesis and release of interleukin 1 ( $\text{IL-1}$ ) and  $\text{IL-6}$  which, in turn, induce the release of eicosanoids (prostaglandin  $\text{E}_2$  and  $\text{I}_2$  [ $\text{PGE}_2$ ,  $\text{PGI}_2$ ]) by activating the cyclo-oxygenase-2 ( $\text{COX-2}$ ). (2)  $\text{TNF}\alpha$  induces synthesis and release of  $\text{IL-8}$ .  $\text{IL-8}$  activates sympathetic terminals that sensitize nociceptors *via*  $\beta_2$ -adrenoceptors. Glucocorticoids inhibit the synthesis of the cytokines and the activation of  $\text{COX-2}$  (indicated by asterisks). Anti-inflammatory cytokines (such as  $\text{IL-4}$  and  $\text{IL-10}$ ) that are also synthesized and released by immune cells inhibit the synthesis and release of pro-inflammatory cytokines (indicated by #). This scheme is entirely dependent on behavioral experiments and pharmacological interventions. The different steps will need to be verified experimentally using neurophysiological experiments. Modified from Poole et al. (1999).

enhances bradykinin-induced mechanical hyperalgesia (decrease of paw withdrawal threshold to mechanical stimulation of the skin). Both develop over 7 to 14 days following activation of the adrenal medullae and reverse slowly after denervation of the adrenal medullae (Khasar et al. 1998a; Khasar et al. 1998b).

Application of adrenaline through a minipump over days enhances the slow development of mechanical hyperalgesia. Furthermore, continuous application of a  $\beta_2$ -adrenoceptor blocker by way of a minipump prevents the enhancement of bradykinin-induced hyperalgesic behavior generated by activation of the adrenal medullae (Khasar et al. 2003) (see ► [sympatho-adrenal system and mechanical hyperalgesic behavior, animal experimentation](#)).

The results of this experiment are interpreted in the following way. Adrenaline released by persistent activation of the adrenal medullae sensitizes cutaneous nociceptors to mechanical stimuli. This sensitization of nociceptors and its reversal are slow and take days to develop. The slow time course implies that the nociceptor sensitization cannot be acutely blocked by an adrenoceptor antagonist given intracutaneously. Adrenaline probably does not act directly on the cutaneous nociceptors, but on cells in the microenvironment of the nociceptors, inducing slow changes which result in nociceptor sensitization. Candidate cells may be mast cells, macrophages or keratinocytes, which then release substances that generate sensitization (Jänig and Häbler 2000; Jänig et al. 2000; Khasar et al. 1998b). The change in sensitivity of a population of nociceptors generated by adrenaline released by the adrenal medullae, which is regulated by the brain would be a novel mechanism of sensitization. This novel mechanism would be different from mechanisms that lead to activation and / or sensitization of nociceptors by sympathetic-afferent coupling as discussed above (Fig. 2).

This novel mechanism of pain and hyperalgesia involving the sympatho-adrenal system may operate in ill-defined pain syndromes such as irritable bowel syndrome, functional dyspepsia, fibromyalgia, chronic fatigue syndrome, etc. (Clauw and Chrousos 1997; Mayer et al. 1995; Wolfe et al. 1990). The conclusions on long-term sensitization of nociceptors for mechanical stimulation by adrenaline are indirect and rest entirely on behavioral experiments. Neurophysiological experiments *in vivo* on primary afferent nociceptive neurons are required to test whether all or only a subpopulation of nociceptors are sensitized (► [sympatho-adrenal system and mechanical hyperalgesic behavior, animal experimentation](#)).

#### Sympathetic Nervous System and Complex Regional Pain Syndrome Type I

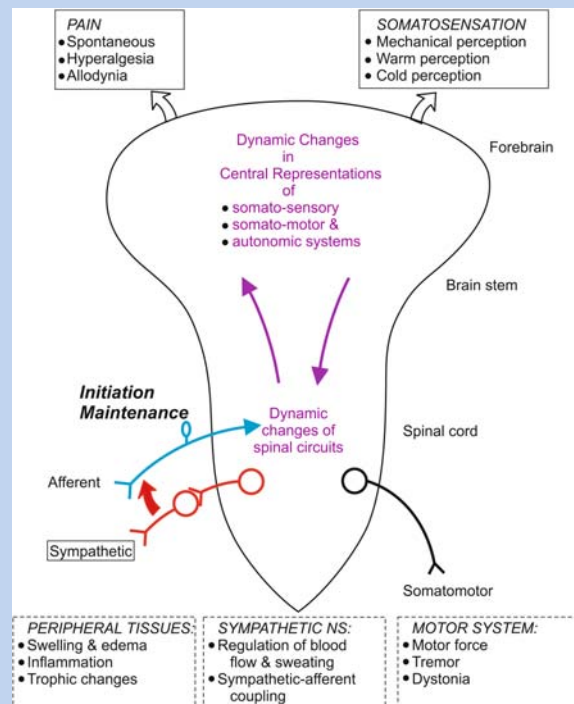
Complex regional pain syndromes (CRPS) are painful disorders that may develop as a consequence of trauma typically affecting the limbs. Clinically they are characterized by pain (spontaneous, hyperalgesia, allodynia), active and passive movement disorders including



an increased physiological tremor, abnormal regulation of blood flow and sweating, edema of skin and subcutaneous tissues and trophic changes of skin, appendages of skin and subcutaneous tissues (Harden et al. 2001; Jänig and Baron 2002, 2003; Jänig and Stanton-Hicks 1996; Stanton-Hicks et al. 1995). CRPS type I (previously called reflex sympathetic dystrophy) usually develops after minor trauma with a small or no obvious nerve lesion in an extremity (e.g. bone fracture, sprains, bruises or skin lesions, surgery) and rarely after remote trauma in the visceral domain or after a CNS lesion (e.g. stroke). An important feature of CRPS I is that the severity and combination of clinical symptoms are disproportionate to the severity and type of trauma with a tendency to spread in the affected distal limb. The symptoms are not confined to the innervation zone of an individual nerve. CRPS type II (previously called causalgia) develops after trauma usually with a large nerve lesion (Harden et al. 2001; Jänig and Stanton-Hicks 1996; Stanton-Hicks et al. 1995).

Recently, it was proposed, on the basis of clinical observations and research on humans and animals that CRPS (in particular type I) is a systemic disease involving the central and peripheral nervous system (Fig. 5). Various traumas can trigger variable combinations of clinical phenomena in which the somatosensory system, the sympathetic nervous system, the somatomotor system and peripheral (vascular, inflammatory) systems are involved (Harden et al. 2001; Jänig and Baron 2002; Jänig and Baron 2003). These authors proposed that the central representations of the sensory, motor and sympathetic systems are changed. The central changes are reflected in changes of somatic sensations (changes of detection thresholds for mechanical, cold, warm and heat), of motor performances and of autonomically regulated effector systems (vasculature, sweat glands, inflammatory cells etc.). The peripheral changes cannot be seen independently of the central ones; both interact with each other *via* afferent and efferent signals. Furthermore, the mechanisms that underlie CRPS cannot be reduced to one system or to one mechanism only (e.g., to sympathetic-afferent coupling, to an adrenoceptor disease, to a peripheral inflammatory disease or to a psychogenic disease) (Harden et al. 2001; Jänig and Baron 2002; Jänig and Baron 2003).

The centrally generated activity in sympathetic neurons may be involved in various ways in the pathogenesis of CRPS type I, the main argument being that these changes are reversed or aggravated after intervention in the peripheral sympathetic nervous system (Fig. 5). Three points that are relevant in the present context of sympathetic nervous system, pain and body protection need to be emphasized for CRPS type I with SMP:



**Sympathetic Nervous System and Pain, Figure 5** Schematic diagram summarizing the sensory, autonomic and somatomotor changes in complex regional pain syndrome I (CRPS I) patients. The figure symbolizes the CNS (forebrain, brain stem and spinal cord). Changes occur in the central representations of the somatosensory, the motor and the sympathetic nervous systems (which include the spinal circuits) and are reflected in changes in the sensory painful and non-painful perceptions, in cutaneous blood flow and sweating and in motor performances. They are triggered and possibly maintained by the nociceptive afferent input from the somatic and visceral body domains. It is unclear whether these central changes are reversible in chronic CRPS I patients. These central changes possibly also affect the endogenous control system of nociceptive impulse transmission. Coupling between the sympathetic neurons and the afferent neurons in the periphery (see bold closed arrow) is one component of the pain in CRPS I patients with sympathetically maintained pain (SMP). However, it seems to be unimportant in CRPS I patients without SMP. Modified from Jänig and Baron (2002, 2003).

- In a subgroup of CRPS I patients, pain or a component of pain is obviously dependent on activity in sympathetic neurons and related to activation or sensitization of nociceptors by noradrenaline released by the sympathetic fibers (sympathetically maintained pain, SMP). Either the nociceptors have expressed adrenoceptors (► **sympathetic-afferent coupling in the dorsal root ganglion, neurophysiological experiments** ► **sympathetic-afferent coupling in the afferent nerve fiber, neurophysiological experiments**) and / or the excitatory effect is generated indirectly, e.g. by way of changes in blood flow in deep somatic tissues of an extremity (Baron et al. 2002). Sympathetically maintained activity in nociceptive neurons may generate a state of cen-

tral sensitization / hyperexcitability that is responsible for spontaneous pain and secondary evoked pain (mechanical and cold allodynia).

- Generation of swelling (edema) and inflammation may be due to sympathetic and peptidergic afferent fibers interacting at the arteriolar site (influencing blood flow) and the venular site (influencing plasma extravasation) of the vascular bed. Sympathetic fibers are supposed to influence inflammatory cells (macrophages, mast cells) by way of noradrenaline and adrenoceptors on the inflammatory cells (Fig. 5) (Jänig and Baron 2002; Jänig and Baron 2003).
- Trophic changes in skin, appendages of skin and subcutaneous tissues (including joints and so forth) are believed to be dependent, at least in part, on the sympathetic innervation. The nature of this neural influence on the tissue structure is unknown (Harden et al. 2001; Jänig and Baron 2003; Jänig and Stanton-Hicks 1996).

These three groups of observation made on patients with CRPS I (who have no nerve lesion and by definition therefore no neuropathic pain) argue that the change of activity in sympathetic neurons entails peripheral changes, which in turn may result in secondary activation and / or sensitization of primary afferent nociceptive neurons. The underlying mechanism(s) of this activation / sensitization of nociceptive afferent neurons may involve short- and long-term processes as discussed above.

An important observation, in CRPS I patients with SMP (but possibly also in CRPS II patients with SMP) is that pain relief following conduction block of sympathetic neurons by a local anesthetic applied to the sympathetic chain usually outlasts the conduction block by at least an order of magnitude (days). This has been measured quantitatively by Price et al. (1998). The long-lasting pain relieving effect of sympathetic blocks suggests that activity in sympathetic neurons, which is of central origin maintains a positive feedback circuit *via* the primary afferent neurons that are probably nociceptive in function. Activity in sympathetic neurons maintains a central state of hyperexcitability (e.g., of neurons in the spinal dorsal horn) (Fig. 1), *via* excitation of afferent neurons started by an intense noxious event. The persistent afferent activity needed to maintain such a state of central hyperexcitability is switched off during temporary block of conduction in the sympathetic chain lasting only a few hours and cannot be immediately switched on again when the block wears off and the activity in the sympathetic postganglionic neurons (and therefore probably also the sympathetically induced activity in afferent neurons) returns. It is hypothesized that the afferent activity has to act over

a long time to initiate and maintain the central state of hyperexcitability (*via* the positive feedback). This important and interesting phenomenon needs to be studied experimentally in patients with SMP as well as in animal models that still have to be designed.

#### Sympathetic Nervous System and Immune System

The hypothalamus can influence the immune system by way of the sympathetic nervous system and therefore control protective mechanisms of the body at the cellular level (Besedovsky and del Rey 1995; Hori et al. 1995; Madden and Felten 1995; Madden et al. 1995). The parameters of the immune tissues potentially controlled are proliferation, trafficking and circulation of lymphocytes, functional activity of lymphoid cells (e.g. activity of natural killer cells) and cytokine production, hematopoiesis of bone marrow, mucosal immunity and thymocyte development etc. (for details of potential mechanisms see Elenkov et al. 2000). The mechanisms of this influence remain largely unsolved (Ader and Cohen 1993; Besedovsky and del Rey 1995; Saphier 1993). It is unknown whether there exists a functionally distinct sympathetic system from the brain to the immune system or whether the modulation of the immune system is a general function of the sympathetic nervous system. The more likely hypothesis favored by one of the present authors is that the immune system is modulated by the brain by way of a functionally distinct sympathetic pathway (for discussion see Jänig and Häbler 2000; Jänig 2006). In both cases, it is hypothesized that activity in the sympathetic neurons supplying the immune system entails indirect modulation of the sensitivity of nociceptors, involving various types of immune related cells and their signaling molecules (e.g. cytokines, see above and Jänig and Levine 2005).

#### Conclusions

Clinical observations, experimentation on humans and animal experimentation indicate that the sympathetic nervous system is potentially involved in the generation of pain, hyperalgesia and inflammation, which should conceptually be seen in the frame of protection of body tissues. These functions of the sympathetic nervous system are different from its conventional functions, namely to transmit impulses from the brain to peripheral effector cells by distinct pathways. They include:

- Sympathetic-afferent coupling following trauma with or without nerve lesion;
- Sensitization of nociceptors independent of action potential generation and noradrenaline release;
- Sensitization of nociceptors by nerve growth factor and cytokines;

- Sensitization of nociceptors involving the sympatho-adrenal system;
- Neurogenic inflammation (e.g. in the knee joint and its control by neuroendocrine systems);
- Modulation of the immune system by the sympathetic innervation;
- Central changes in sympathetic pathways, which in turn constitute positive feedback circuits influencing the vasculature, tissue swelling and trophic structure of tissues.

Multiple mechanisms are at the base of these effects of the sympathetic nervous system. Some have been studied in animal models, but have no equivalent in clinical reality yet. Research on the role of the sympathetic nervous system in the generation of pain, hyperalgesia and inflammation is a developing field. In future insight will be gained into these new mechanisms that probably underlie various pain diseases.

### Acknowledgement

Supported by the Deutsche Forschungsgemeinschaft, the German Ministry of Research and Education, German Research Network on Neuropathic Pain and an unrestricted educational grant from Pfizer, Germany.

### References

1. Ader A, Cohen N (1993) Psychoneuroendocrinology: conditioning and stress. *Annu Rev Physiol* 44:53–85
2. Ali Z, Raja SN, Wesselmann U et al. (2000) Intradermal injection of norepinephrine evokes pain in patients with sympathetically maintained pain. *Pain* 88:161–168
3. Andreev NY, Dimitrieva N, Koltzenburg M et al. (1995) Peripheral administration of nerve growth factor in the adult rat produces a thermal hyperalgesia that requires the presence of sympathetic post-ganglionic neurones. *Pain* 63:109–115
4. Arnér S (1991) Intravenous phentolamine test: diagnostic and prognostic use in reflex sympathetic dystrophy. *Pain* 46:17–22
5. Bandler R, Shipley MT (1994) Columnar organization in the midbrain periaqueductal gray: modules for emotional expression? *Trends Neurosci* 17:379–389
6. Bandler R, Price JL, Keay KA (2000a) Brain mediation of active and passive emotional coping. *Prog Brain Res* 122:333–349
7. Bandler R, Keay KA, Floyd N et al. (2000b) Central circuits mediating patterned autonomic activity during active vs. passive emotional coping. *Brain Res Bull* 53:95–104
8. Baron R, Schattschneider J, Binder A et al. (2002) Relation between sympathetic vasoconstrictor activity and pain and hyperalgesia in complex regional pain syndromes: a case-control study. *Lancet* 359:1655–1660
9. Barrett HLG, McLachlan EM (1999) Long-term changes in peripheral nerve trunks following nerve ligation in rats. *Proc Austr Neurosci Soc* 10:116
10. Besedovsky HO, del Rey A (1995) Immune-neuroendocrine interactions: facts and hypotheses. *Endocr Rev* 17:64–102
11. Clauw DJ, Chrousos GP (1997) Chronic pain and fatigue syndromes: overlapping clinical and neuroendocrine features and potential pathogenic mechanisms. *Neuroimmunomodulation* 4:134–153
12. Donnerer J, Schuligoi R, Stein C (1992) Increased content and transport of substance P and calcitonin gene-related peptide in sensory nerves innervating inflamed tissue: evidence for a regulatory function of nerve growth factor *in vivo*. *Neurosci* 49:693–698
13. Elenkov IJ, Wilder RL, Chrousos GP et al. (2000) The sympathetic nerve –an integrative interface between two super-systems: the brain and the immune system. *Pharmacol Rev* 52:595–638
14. Gonzales R, Goldyne ME, Taiwo YO et al. (1989) Production of hyperalgesic prostaglandins by sympathetic postganglionic neurones. *J Neurochem* 53:1595–1598
15. Harden RN, Baron R, Jänig W (eds) (2001) Complex regional pain syndrome. IASP Press, Seattle
16. Hori T, Katafuchi T, Take S et al. (1995) The autonomic nervous system as a communication channel between the brain and the immune system. *Neuroimmunomodulation* 2: 203–215
17. Jänig W (2005) Vagal afferents and visceral pain. In: Udem B, Weinreich D (eds) *Advances in Vagal Afferent Neurobiology*. CRC Press, Boca Raton, pp 461–489
18. Jänig W (2006) *Integrative Action of the Autonomic Nervous System. Neurobiology of Homeostasis*. Cambridge University Press, Cambridge, New York
19. Jänig W, Baron R (2001) The role of the sympathetic nervous system in neuropathic pain: clinical observations and animal models. In: Hansson PT, Fields HL, Hill RG et al. (eds) *Neuropathic Pain: Pathophysiological and Treatment*. IASP Press, Seattle
20. Jänig W, Baron R (2002) Complex regional pain syndrome is a disease of the central nervous system. *Clin Auton Res* 12:150–164
21. Jänig W, Baron R (2003) Complex regional pain syndrome: mystery explained? *Lancet Neurol* 2:687–697
22. Jänig W, Häbler HJ (2000) Sympathetic nervous system: contribution to chronic pain. *Prog Brain Res* 129:451–468
23. Jänig W, Koltzenburg M (1991) What is the interaction between the sympathetic terminal and the primary afferent fiber? In: Basbaum AI, Besson J-M (eds) *Towards a New Pharmacotherapy of Pain*. Dahlem Workshop Reports. John Wiley & Sons, Chichester, pp 331–352
24. Jänig W, Levine JD (2005) Autonomic-endocrine-immune responses in acute and chronic pain. In: McMahon SB, Koltzenburg M (eds) *“Wall and Melzack’s Textbook of Pain”*, 5th edn. Churchill Livingstone, Edinburgh
25. Jänig W, McLachlan EM (2002) Neurobiology of the autonomic nervous system. In: Mathias CJ, Bannister R (eds) *Autonomic Failure*, 4<sup>th</sup> edn. Oxford University Press, New York, Oxford
26. Jänig W, Stanton-Hicks M (1996) Reflex sympathetic dystrophy –a reappraisal. IASP Press, Seattle
27. Jänig W, Khasar SG, Levine JD et al. (2000) The role of vagal visceral afferents in the control of nociception. *Prog Brain Res* 122:273–287
28. Keay KA, Bandler R (2004) Periaqueductal gray. In: Paxinos G (ed) *The Rat Nervous System*, 3rd edn. Academic Press, San Diego, pp 243–257
29. Khasar SG, Green PG, Levine JD (1993) Comparison of intradermal and subcutaneous hyperalgesic effects of inflammatory mediators in the rat. *Neurosci Lett* 153:215–218
30. Khasar SG, Miao FJP, Levine JD (1995) Inflammation modulates the contribution of receptor-subtypes to bradykinin-induced hyperalgesia in the rat. *Neurosci* 69:685–690
31. Khasar SG, Miao FJP, Jänig W et al. (1998a) Modulation of bradykinin-induced mechanical hyperalgesia in the rat by activity in abdominal vagal afferents. *Eur J Neurosci* 10:435–444
32. Khasar SG, Miao FJP, Jänig W et al. (1998b) Vagotomy-induced enhancement of mechanical hyperalgesia in the rat is sympathoadrenal-mediated. *J Neurosci* 18:3043–3049
33. Khasar SG, Green PG, Miao FJP et al. (2003) Vagal modulation of nociception is mediated by adrenomedullary epinephrine in the rat. *Eur J Neurosci* 17:909–915

34. Lewin GR, Ritter AM, Mendell LM (1993) Nerve growth factor-induced hyperalgesia in the neonatal and adult rat. *J Neurosci* 13:2136–2148
35. Lewin GR, Rueff A, Mendell LM (1994) Peripheral and central mechanisms of NGF-induced hyperalgesia. *Eur J Neurosci* 6:1903–1912
36. Madden KS, Felten DL (1995) Experimental basis for neural-immune interactions. *Physiol Rev* 75:77–106
37. Madden KS, Sanders K, Felten DL (1995) Catecholamine influences and sympathetic modulation of immune responsiveness. *Rev Pharmacol Toxicol* 35:417–448
38. Mayer EA, Munakata J, Mertz H et al. (1995) Visceral hyperalgesia and irritable bowel syndrome. *Visceral pain*. IASP Press, Seattle, pp 429–468
39. McMahon SB (1996) NGF as a mediator of inflammatory pain. *Philos Trans R Soc Lond B Biol Sci* 351:431–440
40. Mense S, Meyer H (1988) Bradykinin-induced modulation of the response behaviour of different types of feline group III and IV muscle receptors. *J Physiol* 398: 49–63
41. Neugebauer V, Schaible HG, Schmidt RF (1989) Sensitization of articular afferents to mechanical stimuli by bradykinin. *Pflügers Arch* 415:330–335
42. Petty BG, Cornblath DR, Adornato BT et al. (1994) The effect of systemically administered recombinant human nerve growth factor in healthy human subjects. *Ann Neurol* 36:244–246
43. Poole S, Woolf CJ (1999) Cytokine-nerve growth factor interactions in inflammatory hyperalgesia. In: Watkins LR, Maier SF (eds) *Cytokines and Pain*. Birkhäuser Verlag, Basel Boston Berlin, pp 89–132
44. Price DD, Long S, Wilsey B et al. (1998). Analysis of peak magnitude and duration of analgesia produced by local anesthetics injected into sympathetic ganglia of complex regional pain syndrome patients. *Clin J Pain* 14:216–226
45. Sachs D, Cunha FQ, Poole S et al. (2002) Tumour necrosis factor- $\alpha$ , interleukin-1 $\beta$  and interleukin-8 induce persistent mechanical nociceptor hypersensitivity. *Pain* 96: 89–97
46. Saphier D (1993) Psychoimmunology: the missing link. In: Schulkin J (ed) *Hormonally induced changes in mind and brain*. Academic Press, San Diego, pp 191–224
47. Stanton-Hicks M, Jänig W, Hassenbusch S et al. (1995) Reflex sympathetic dystrophy: changing concepts and taxonomy. *Pain* 63:127–133
48. Straub RH, Härle P (2005) Sympathetic transmitters in joint inflammation. *Rheum Dis Clin North Am* 31: 43–59
49. Straub RH, Baerwald C, Wahle M et al. (2005) Autonomic dysfunction in rheumatic diseases. *Rheum Dis Clin North Am* 31:61–75
50. Torebjörk HE, Wahren LK, Wallin BG et al. (1995) Noradrenaline-evoked pain in neuralgia. *Pain* 63:11–20
51. Treede RD, Meyer RA, Raja SN et al. (1992) Peripheral and central mechanisms of cutaneous hyperalgesia. *Prog Neurobiol* 38:397–421
52. Wolfe F, Smythe HA, Yunus MB et al. (1990) The American College of Rheumatology 1990 Criteria for the Classification of Fibromyalgia. Report of the Multicenter Criteria Committee. *Arthritis Rheum* 33:160–172
53. Woolf CJ (1996) Phenotypic modification of primary sensory neurons: the role of nerve growth factor in the production of persistent pain. *Phil Trans R Soc Lond B* 351:441–448
54. Woolf CJ, Safieh-Garabedian B, Ma Q-P et al. (1994) Nerve growth factor contributes to the generation of inflammatory sensory hypersensitivity. *Neurosci* 62:327–331
55. Woolf CJ, Ma Q-P, Allchorne A et al. (1996) Peripheral cell types contributing to the hyperalgesic action of nerve growth factor in inflammation. *J Neurosci* 16:2716–2723
56. Woolf CJ, Allchorne A, Safieh-Garabedian B et al. (1997) Cytokines, nerve growth factor and inflammatory hyperalgesia: the contribution of tumour necrosis factor  $\alpha$ . *Br J Pharmacol* 121:417–424

## Sympathetic Nervous System in the Generation of Pain, Animal Behavioral Models

HEINZ-JOACHIM HÄBLER<sup>1</sup>, WILFRID JÄNIG<sup>2</sup>

<sup>1</sup>FH Bonn-Rhein-Sieg, Rheinbach, Germany

<sup>2</sup>Institute of Physiology, Christian Albrechts University Kiel, Kiel, Germany

heinz-joachim.haebler@fh-bonn-rhein-sieg.de,  
w.janig@physiologie.uni-kiel.de

### Definition

Behavioral animal models are designed to test quantitatively physiological as well as pathological (e.g. neuropathic) pain resulting from defined interventions, in intact animals or in animals subjected to defined intentional lesions, under conditions that are known to cause pain in humans. As pain cannot be measured directly in animals for obvious reasons, basic behavioral responses that are known normally to accompany pain are taken as an indicator of pain in non-anesthetized animals. Most often simple motor reflexes, e.g. paw withdrawal, or in some cases more complex motor responses, e.g.

guarding behavior of the affected limb, are used to test stimulation-induced pain. To assess spontaneous pain in an animal, spontaneous abnormal motor behavior after an experimental intervention is quantified within a given time interval. To determine the presence of allodynia and/or hyperalgesia, noxious and innocuous stimuli of different modality at defined strengths (e.g. mechanical with calibrated von Frey hairs, graded heat stimuli) are applied to the body region of interest, and paw withdrawal latency or paw withdrawal threshold are determined. However, as motor responses are not specific for painful stimulation, one has to keep in mind that the validity of animal models of pain critically rests on the interpretation that the observed motor behavior is indeed a correlate of the animal experiencing pain. Several behavioral animal models have been developed of ► [complex regional pain syndrome \(CRPS\)](#) which may arise in humans with (CRPS II, formerly causalgia) or without (CRPS I, formerly reflex sympathetic dystrophy) nerve lesion (see below). In a number of CRPS patients the pain is entirely or in part dependent on the sympathetic nervous system (sympathetically maintained pain, SMP). The behavioral animal models for CRPS allow the testing of the role of the sympathetic nervous system in these pathological pain states. To



this end, pain behavior is assessed before and after interventions that target the sympathetic nervous system. These interventions include surgical sympathectomy, chemical sympathectomy with 6-hydroxy-dopamine, systemic application of adrenoceptor agonists or antagonists or systemic application of guanethidine (which is taken up by the noradrenergic terminals and depletes norepinephrine), the most straightforward procedure being surgical sympathectomy.

## Characteristics

### Models of CRPS I (With no Apparent Nerve Lesion)

As the conditions underlying CRPS I in humans are still completely unknown, there is no animal model available on which the pathophysiological mechanisms and the potential involvement of the sympathetic nervous system could be studied. However, rat models of inflammatory pain and/or hyperalgesia may, in the future, also prove to be of relevance for the pathophysiological mechanisms underlying CRPS I. Several rat behavioral models of hyperalgesia have been propagated in which the sympathetic nervous system is supposed to be involved: (i) Cutaneous mechanical hyperalgesia elicited by the inflammatory mediator bradykinin, (ii) Cutaneous hyperalgesia induced by intradermal injection of capsaicin, (iii) Cutaneous hyperalgesia generated by nerve growth factor (► [Sympathetic nervous system and pain](#)).

### Models of CRPS II (After Nerve Lesion)

In several established rat models of neuropathic pain (believed to be models of CRPS II) behavioral experiments have been performed before and after interventions on the sympathetic supply: Autotomy model (Wall et al. 1979), partial sciatic nerve lesion (Seltzer et al. 1990), chronic constriction injury (CCI) of the sciatic nerve (Bennett and Xie 1988) and spinal nerve ligation (SNL) (Kim and Chung 1992):

#### Autotomy Model

Ligation and transection of the sciatic and saphenous nerves in rats leads to autotomy behavior (self-mutilation), which is considered to be due to pain arising in the denervated part of the hindlimb (anesthesia dolorosa). Repeated intraperitoneal application of guanethidine prevented or significantly reduced the autotomy behavior (Wall et al. 1979). The decrease of self-mutilation was interpreted to mean that activity in sympathetic neurons maintains ectopic activity in lesioned afferent neurons, which in turn triggers the autotomy behavior. However, the effects of surgical sympathectomy on the autotomy behavior were never tested.

#### Partial Sciatic Nerve Lesion

Partial ligation ( $1/3$ – $1/2$ ) of the sciatic nerve leads to signs of spontaneous pain, thermal hyperalgesia, mechanical

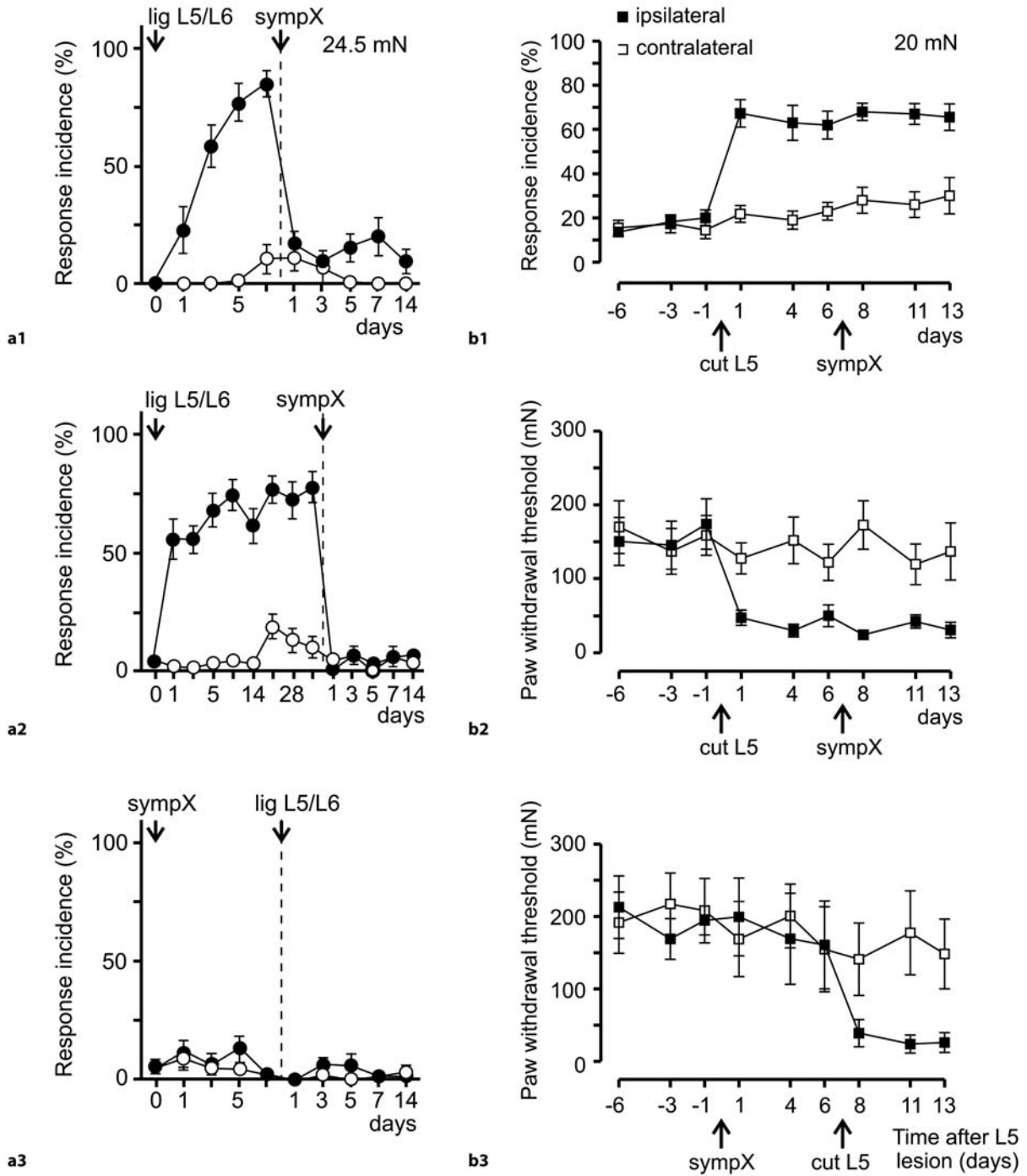
allodynia and mechanical hyperalgesia (Seltzer et al. 1990), which partly also extended to the contralateral non-lesioned side. Chemical sympathectomy with repeated intraperitoneal injection of guanethidine prior to nerve injury prevented thermal hyperalgesia from occurring, but changed mechanical hyperalgesia only little (Shir and Seltzer 1991). When performed months after nerve lesion, sympathectomy by guanethidine alleviated all sensory disorders (Shir and Seltzer 1991). Consistent results were obtained by Tracey et al. (1995), who found that noradrenaline injected locally into the affected paw exacerbated, while the  $\alpha_2$ -adrenoceptor antagonist yohimbine significantly relieved, mechanical and thermal hyperalgesia, which was abolished by chemical sympathectomy with 6-hydroxy-dopamine. However, thermal and mechanical hyperalgesia were not enhanced by the  $\alpha_2$ -adrenoceptor agonist clonidine. Conflicting evidence came from Kim et al. (1997) who found only small and non-significant effects of surgical sympathectomy, performed one week after partial sciatic nerve lesion on mechanical and cold allodynia and ongoing pain.

#### Chronic Constriction Injury of the Sciatic Nerve

Chronic constriction injury of the sciatic nerve generates mechanical and thermal hyperalgesic behavior (Bennett and Xie 1988). Guilbaud and collaborators (Desmeules et al. 1995) found that surgical sympathectomy or depletion of sympathetic transmitters by guanethidine both resulted in a reduction of thermal hyperalgesia, while mechanical hyperalgesia was slightly affected. Self-mutilating behavior and spontaneous pain behavior were not changed after guanethidine and surgical sympathectomy, respectively. However, only a small non-significant reduction of mechanical and cold allodynia was found after surgical sympathectomy in the model by Kim et al. (1997). Rats with cryoneurolysis of the sciatic nerve also developed signs of mechanical allodynia but no thermal hyperalgesic behavior. Surgical sympathectomy performed prior to or after the cryoneurolysis did not influence the development or the maintenance of the mechanical allodynic behavior (Willenbring et al. 1995).

#### Spinal Nerve Ligation

Ligation and transection of the spinal nerves L5 and L6, or only the spinal nerve L5, is followed by behavioral signs of mechanical hyperalgesia and allodynia as well as thermal hyperalgesia (Blenk et al. 1997; Kim and Chung 1992). Some authors found that these pain behaviors were permanently reversed by surgical lumbar sympathectomy (Kim et al. 1993; Kim et al. 1997; Kinnman and Levine 1995) (Fig. 1a), prevented from developing by surgical sympathectomy prior to spinal nerve lesion (Kim et al. 1993), and temporarily reversed by intraperitoneal injection of the  $\alpha$ -adrenoceptor antagonist phentolamine or guanethi-



dine (Kim et al. 1993). These findings suggested that a coupling between sympathetic noradrenergic neurons and afferent neurons is critical for the development and maintenance of the behavioral changes. However, there were considerable differences between rat strains and substrains in the development of signs of mechanical

allodynia and heat hyperalgesia (Yoon et al. 1996), and in the dependence of mechanical allodynic behavior on adrenoceptors. Completely discrepant observations were made by Ringkamp et al. (1999) (Fig. 1b) who found that surgical sympathectomy performed prior to or after spinal

◀ **Sympathetic Nervous System in the Generation of Pain, Animal Behavioral Models, Figure 1** Effect of surgical sympathectomy on mechanical allodynic behavior in Sprague-Dawley rats (a) and Wistar rats (b) following ligation and section of spinal nerves L5&L6 (a) or spinal nerve L5 (b). Experiments in (a) from Kim et al. (1993) and experiments in (b) from Ringkamp et al. (1999). Mechanical allodynic behavior was tested by measuring response incidence and response threshold to stimulation of the plantar skin of the hindpaw ipsilateral to the spinal nerve lesion (filled symbols) and of the contralateral hindpaw (open symbols) with von Frey hairs. For testing the incidence of paw withdrawal the von Frey hair was applied repetitively 6–8 × within a period of 2–3 s (a) or 8 × (b1) with a frequency of about two per second to the plantar test area. Five or 10 trials were performed on each hindpaw and the number of trials with a withdrawal response was noted. The ordinate scale (in a and b1) shows the percentage of positive responses in groups of rats. The threshold of paw withdrawal (b2, b3) was measured using the up-down testing paradigm (for details see Ringkamp et al. 1999). Surgical sympathectomy (bilateral removal of lumbar paravertebral ganglia L1 to L6 or L2-L4) was performed either after spinal nerve lesion (a1, a2, b1, b2) or before spinal nerve lesion (a3, b3) using a medial or lateral approach. a1, a2, b1, b2. Sympathectomy performed 7 days or 35 days (a2) after spinal nerve lesion. a3, b3. Sympathectomy performed 7 days prior to spinal nerve lesion. Values are means ± 1SEM in groups of 13 (a1), 18 (a2), 9 (a3), 10 (b1) or 4 rats (b3). Increase of response incidence and decrease in paw withdrawal threshold following spinal nerve lesion on the ipsilateral side were significant at  $p < 0.05$  (a1, a2),  $p < 0.001$  (b1, b2) or  $p < 0.01$  (B3, Friedman ANOVA). Note that sympathectomy alleviated or prevented the development of the mechanical allodynic behavior in the experiments of Kim et al. (1993) but had no effect in the experiments of Ringkamp et al. (1999).

nerve lesion had no effect on mechanical allodynic and hyperalgesic behavior in two different rat strains.

### Conclusion

The controversial results, with respect to an involvement of the sympathetic nervous system in neuropathic pain, allodynia and hyperalgesia, obtained on the aforementioned four animal behavioral models, indicate that at present we have no animal model that mimics SMP in patients with neuropathic pain (CRPS II) as defined by the clinical situation of patients.

### Acknowledgements

Supported by the Deutsche Forschungsgemeinschaft and the German Ministry of Research and Education, German Research Network on Neuropathic Pain.

### References

- Bennett GJ, Xie YK (1988) A Peripheral Mononeuropathy in Rat Produces Disorders of Pain Sensation Like those Seen in Man. *Pain* 33:87–107
- Blenk KH, Häbler HJ, Jänig W (1997) Neomycin and Gadolinium Applied to an L5 Spinal Nerve Lesion Prevent Mechanical Allodynia-Like Behaviour in Rats. *Pain* 70:155–165
- Desmeules JA, Kayser V, Weil-Fuggaza J et al. (1995) Influence of the Sympathetic Nervous System in the Development of Abnormal Pain-Related Behaviours in a Rat Model of Neuropathic Pain. *Neuroscience* 67:941–951
- Kim SH, Chung JM (1992) An Experimental Model for Peripheral Neuropathy Produced by Segmental Spinal Nerve Ligation in the Rat. *Pain* 50:355–363
- Kim SH, Na HS, Sheen K et al. (1993) Effects of Sympathectomy on a Rat Model of Peripheral Neuropathy. *Pain* 55:85–93
- Kim KJ, Yoon YW, Chung JM (1997) Comparison of Three Rodent Neuropathic Pain Models. *Exp Brain Res* 113:200–206
- Kinnman E, Levine JD (1995) Sensory and Sympathetic Contributions to Nerve Injury-Induced Sensory Abnormalities in the Rat. *Neuroscience* 64:751–767
- Koltzenburg M, Kress M, Reeh PW (1992) The Nociceptor Sensitization by Bradykinin does not Depend on Sympathetic Neurons. *Neuroscience* 46:465–473
- Ringkamp M, Eschenfelder S, Grethel EJ et al. (1999) Lumbar Sympathectomy Failed to Reverse Mechanical Allodynia- and Hyperalgesia-Like Behavior in Rats with L5 Spinal Nerve Injury. *Pain* 79:142–153
- Seltzer Z, Dubner R, Shir Y (1990) A Novel Behavioral Model of Neuropathic Pain Disorders Produced in Rats by Partial Sciatic Nerve Injury. *Pain* 43:205–218
- Shir Y, Seltzer Z (1991) Effects of Sympathectomy in a Model of Causalgiform Pain Produced by Partial Sciatic Nerve Injury in Rats. *Pain* 45:309–320
- Tracey DJ, Cunningham JE, Romm MA (1995a) Peripheral Hyperalgesia in Experimental Neuropathy: Mediation by Alpha 2-adrenoreceptors on Post-Ganglionic Sympathetic Terminals. *Pain* 60:317–327
- Wall PD, Devor M, Inbal R et al. (1979) Autotomy Following Peripheral Nerve Lesions: Experimental Anaesthesia Dolorosa. *Pain* 7:103–113
- Willenbring S, Beuprie IG, DeLeo JA (1993) Sciatic Cryoneurolysis in Rats: A Model of Sympathetically Independent Pain. Part 1: Effects of Sympathectomy. *Anesth Analg* 81:544–548
- Yoon YW, Lee DH, Lee BH et al. (1996) Different Strains and Substrains of Rat Show Different Levels of Neuropathic Pain Behaviors. *Exp Brain Res* 129:167–171

## Sympathetic Postganglionic Neurons in Neurogenic Inflammation of the Synovia

PAUL G. GREEN<sup>1</sup>, WILFRID JÄNIG<sup>2</sup>

<sup>1</sup>NIH Pain Center (UCSF), University of California, San Francisco, CA, USA

<sup>2</sup>Physiology Institute, Christian Albrechts University Kiel, Kiel, Germany

paul@itsa.ucsf.edu, w.janig@physiologie.uni-kiel.de

S

### Definition

Sympathetic postganglionic neurons (SPGNs) are the final motor neurons of the autonomic nervous system and it has recently been appreciated that the sympathetic postganglionic nervous system plays a key role in the regulation of the inflammatory response. In particular, the SPGN mediates inflammation produced in the synovia by the potent inflammatory mediator, bradykinin. The synovium may be unique in regards to the dependence on the SPGN in neurogenic inflammation, possibly due to the density of SPGN innervation which accounts for between half and two-thirds of the nerve fibers in the synovium (Hildebrand et al. 1991; Langford and Schmidt 1983).

The role of the SPGN has been extensively studied in the control of plasma extravasation, a primary component of the inflammatory response. This has established the SPGN as a constituent part of a multifaceted integrated system that also includes primary afferent neurons, mast cells, infiltrating leukocytes and blood vessels.

## Characteristics

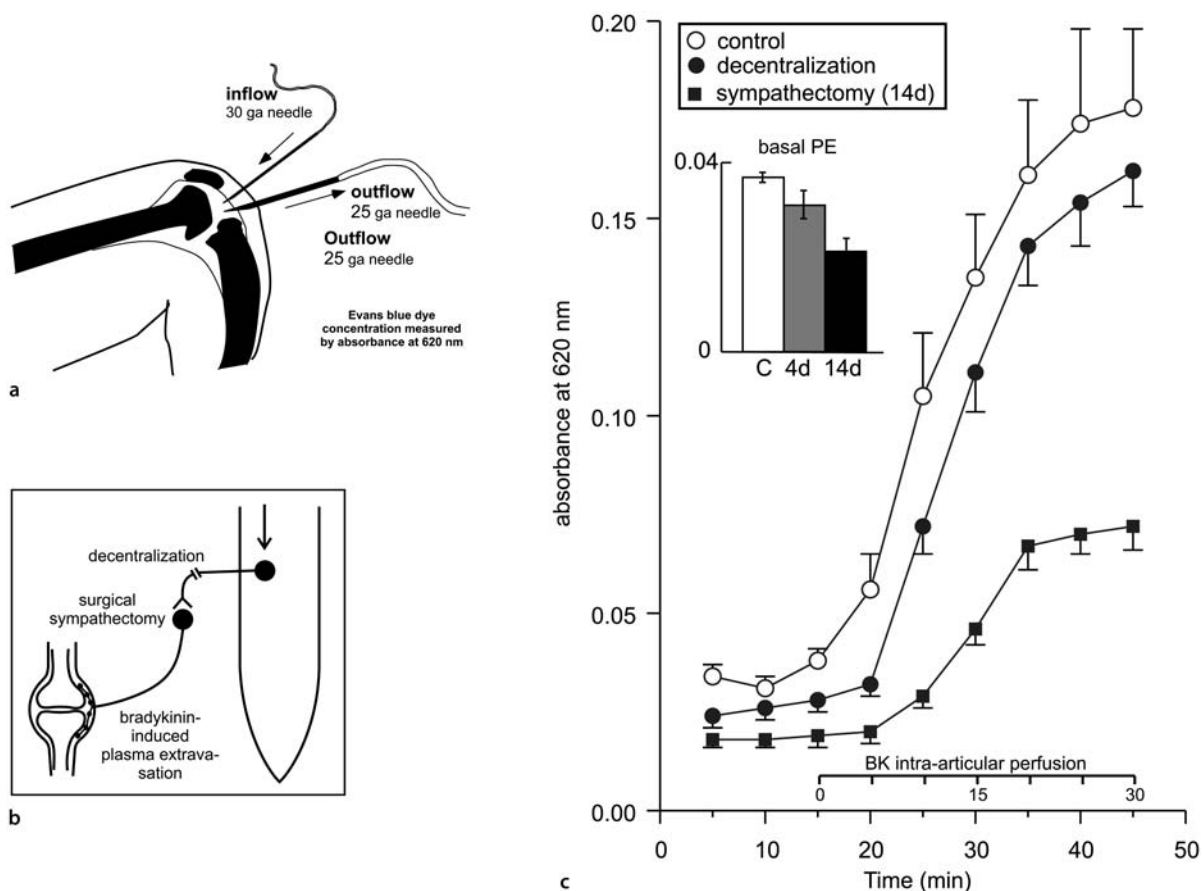
### SPGNs Are Involved in Synovial Inflammation

The inflammatory mediator bradykinin produces a marked increase in plasma extravasation in the rat knee joint. Evidence over the past 20 years has demonstrated a role for the SPGN in synovial inflammation; specifically, either chemically ablating the sympathetic nervous system with guanethidine or 6-hydroxy-dopamine or surgical excision of postganglionic neurons (Coderre et al. 1989; Levine et al. 1985) attenuates the magnitude of baseline extravasation as well as plasma extravasation produced by bradykinin infused into the knee joint. Bradykinin-induced synovial plasma extravasation is reduced by 60–70% 7–14 days following surgical sym-

pathectomy (Fig. 1c; Miao et al. 1996a; Miao et al. 1996b). Importantly, at close to physiological levels (3–300 nM), bradykinin-induced increase in plasma extravasation is SPGN-dependent, while at  $>1 \mu\text{M}$ , the increase in plasma extravasation is independent of the SPGN (Fig. 2).

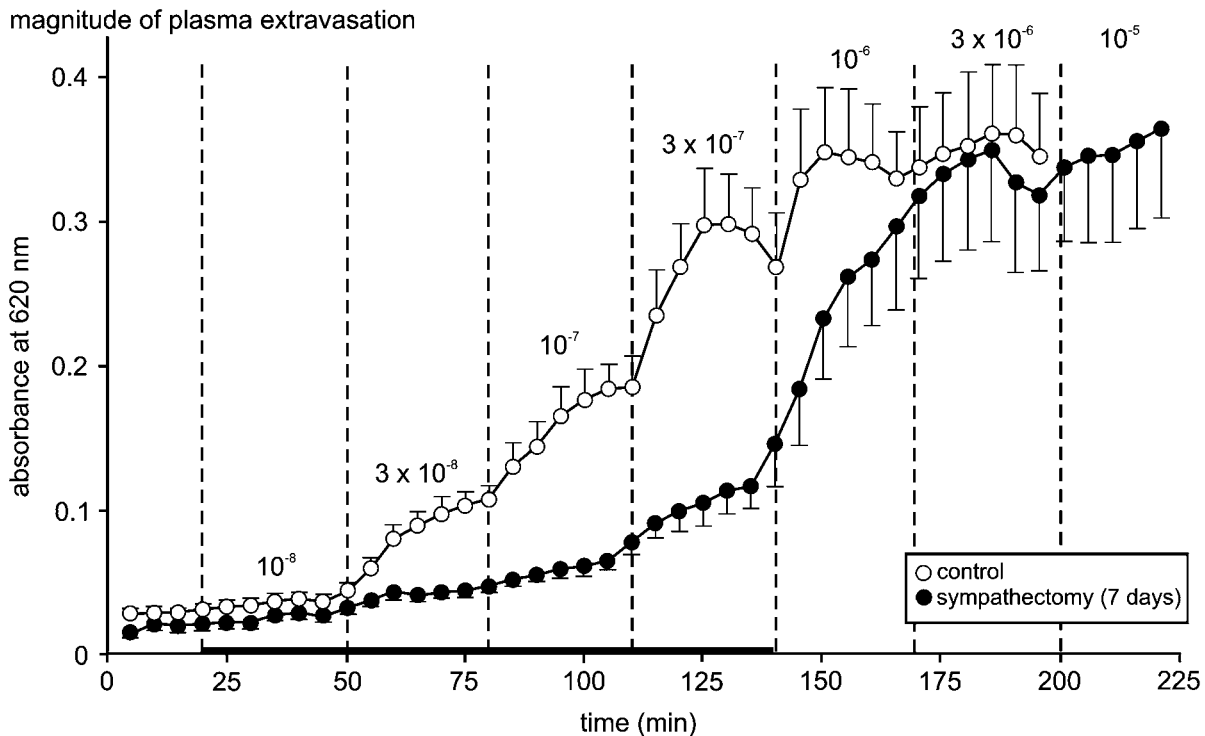
### Mechanism of SPGN Synovial Inflammation

The contribution of the SPGN to synovial inflammation is independent of classical vesicular neurotransmitter release, since bradykinin-induced plasma extravasation is unaffected by decentralization of the lumbar sympathetic chain (ablating preganglionic axons that innervate the postganglionic neurons to the hind limb; closed circle in Fig. 1c), acute interruption of the lumbar



**Sympathetic Postganglionic Neurons in Neurogenic Inflammation of the Synovia, Figure 1** Bradykinin-induced plasma extravasation in the synovia of the knee joint is largely dependent on the sympathetic innervation but not on activity in the sympathetic neurons. (a) The knee joint was perfused with saline in an anesthetized rat at a constant rate of  $250 \mu\text{l} / \text{min}$ . Rats were pretreated with Evans blue dye given i.v. (Evans Blue binds to albumin and does not normally leave the vascular space). Plasma extravasation of the synovia into the knee joint cavity was determined by measuring Evans blue dye extravasation into the perfusate in 5 min samples. The concentration of Evans blue, determined spectrophotometrically at a wavelength of 620 nm, is proportional to the degree of extravasation (ordinate scale in (c)). Bradykinin (BK,  $160 \text{ ng} / \text{ml}$ ,  $1.5 \times 10^{-7} \text{ M}$ ), an inflammatory mediator, was added to the perfusate 15 min after the beginning of the perfusion and the perfusion lasted for another 30 min. (b) Three preparations were used: intact lumbar sympathetic system; decentralized lumbar sympathetic system (preganglionic axons interrupted 7 days before the experiment by sectioning the white rami); surgical sympathectomy 14 days before the experiment (removal of the paravertebral ganglia (Baron et al. 1988)). (c) Increase of plasma extravasation induced by BK in control rats (open circles,  $N = 12$  knees). This increase was significantly smaller 14 days after sympathectomy (closed squares,  $N = 12$  knees) but was not significantly different from control after decentralization (closed circles,  $N = 12$  knees). Inset: Baseline plasma extravasation over 15 min preceding infusion of BK was also lower in animals 4 days and 14 days after sympathectomy than in control animals (C). (c) modified from Miao et al. (1996a); (a) from Paul Green.





**Sympathetic Postganglionic Neurons in Neurogenic Inflammation of the Synovia, Figure 2** Concentration-dependent bradykinin-induced plasma extravasation in control rats and in sympathectomized rats. For experimental procedure, see legend to Fig. 1. Bradykinin was added cumulatively from  $10^{-8}$ – $10^{-5}$  M to the perfusate. The bradykinin concentrations that have been measured in inflamed tissue (Hargreaves et al. 1993; Swift et al. 1993) are indicated in bold on the abscissa scale. In sympathectomized rats the extravasation is significantly reduced at  $3 \times 10^{-8}$  to  $3 \times 10^{-7}$  M bradykinin. At higher (pharmacological) concentrations sympathectomy has no effect because the effect of bradykinin is generated *via* other than the sympathetic-mediated pathways. Modified from Miao et al. (1996b).

sympathetic chain, or perfusion of tetrodotoxin through the knee joint synovial cavity (Miao et al. 1996a). This indicates that mediators released in response to inflammatory agents, such as bradykinin, are not dependent on the excitability of the SPGN, thus not on generation of action potentials and vesicular release of noradrenaline. These inflammatory agents rather are synthesized and released either from the SPGN terminal or from other cells in association with the SPGN terminal. Release of noradrenaline from the SPGN attenuates the increased magnitude of plasma extravasation. Activation of the sympathetic postganglionic neurons by electrical stimulation of the lumbar sympathetic chain reduces both resting and bradykinin-induced plasma extravasation because of a reduction of blood flow through the synovia (Miao et al. 1996a).

These types of experiments suggest that sympathetic postganglionic neurons innervating the joint capsule and its synovium have two functions, to regulate blood flow (vasoconstrictor function) and to mediate vascular permeability. The latter function is a newly described component of neurogenic inflammation. The first occurs at the precapillary resistance vessels by vesicular release of transmitter(s), which induces vasoconstriction and which is regulated by action potentials in the

vasoconstrictor neurons. The second function occurs at the postcapillary venules by non-vesicular release of a chemical substance (or more than one substance, possibly prostaglandin  $E_2$  and / or related substances) that is independent of the electrical activity in the sympathetic neurons. Whether these substance(s) are released by the sympathetic terminals or by other cells in association with these terminals is unknown (Gonzales et al. 1989). This sympathetically mediated component of neurogenic inflammation is an entirely peripheral function of the sympathetic terminals. Whether both functions of the sympathetic postganglionic neurons are represented in the same class of neuron or in distinct ones remains to be studied.

#### Primary Afferent Neuron–SPGN Integration in Neurogenic Inflammation

In the rat knee joint, stimulation of peptidergic (unmyelinated) primary afferents generates neurogenic inflammation (precapillary vasodilation and venular plasma extravasation) involving substance P and calcitonin gene-related peptide (CGRP) (Ferrell and Russell 1986; Green et al. 1992). This afferent-induced neurogenic inflammation seems to be independent of the bradykinin-induced synovial plasma extravasation that

is mediated by the sympathetic terminals. In fact, chemical destruction of unmyelinated primary afferents (by pretreating the rats on neonatal day 2 with capsaicin) does not affect the SPGN-mediated plasma extravasation (Coderre et al. 1989). However, it is unclear in which way plasma extravasation mediated by the sympathetic terminals and plasma extravasation mediated by peptidergic afferents in the synovia work together. To study this potential interaction requires a controlled selective activation of the afferents supplying the synovia, e.g. by electrical stimulation of the corresponding dorsal roots (Häbler et al. 1997). Sensory-sympathetic neuron coupling has been well documented in pathophysiological conditions underlying sympathetically maintained pain (e.g. in complex regional pain syndromes; see ► [Sympathetic nervous system and pain](#)).

#### Endocrine-SPGN Integration in Neurogenic Inflammation

We have demonstrated that the SPGN mediates a negative feedback control of inflammatory response. There are two, independent neuroendocrine circuits which are activated by noxious stimulation. Repetitive transcutaneous electrical stimulation of unmyelinated afferents of plantar skin activates the hypothalamic-pituitary-adrenal axis to release corticosterone, which inhibits the SPGN-dependent plasma extravasation produced by bradykinin. This inhibitory endocrine circuit appears to affect specifically the SPGN-dependent component of the inflammatory response and does not appear to be a vascular effect since, following surgical sympathectomy, the residual (i.e. SPGN-independent) plasma extravasation produced by bradykinin is not inhibited by the noxious stimulation-induced feedback inhibition and neither is the SPGN-independent plasma extravasation produced by platelet activating factor. Corticosterone infused intravenously also depressed bradykinin-induced plasma extravasation with a time course similar to that during reflex activation of the hypothalamo-pituitary axis. In addition, this inhibitory effect of i.v. infused corticosterone was no longer present in sympathectomized joints (Green et al. 1995; Green et al. 1997).

The effect of corticosterone, whether released from the adrenal cortex or injected intravenously, does not appear to be due to a direct action of glucocorticoids on the SPGN, since corticosterone administered in the synovium does not itself inhibit bradykinin-induced plasma extravasation. However, the peptide annexin I (lipocortin I), which is released from many tissues by corticosterone, co-infused with bradykinin in the rat knee joint does inhibit bradykinin-induced plasma extravasation (Green et al. 1998). By the same token, the depression of bradykinin-induced synovial plasma extravasation generated by electrical noxious stimulation or by corticosterone infused i.v. is attenuated by annexin I antibody infused into the knee joint (Green et al. 1998). The source for annexin I released by corticosterone has

not been determined, although polymorphonuclear leukocytes (PMNs), which are a rich source of annexin I, are required for bradykinin-induced synovial plasma extravasation (Bjerknes et al. 1991).

The other endocrine-SPGN anti-inflammatory circuit is activated by noxious somatic or visceral stimulation with capsaicin (Miao et al. 2000). In this circuit, the sympatho-adrenal axis mediates the inhibition of bradykinin-induced plasma extravasation, since it is abolished following denervation of the adrenal medulla. The depression of bradykinin-induced plasma extravasation in the synovia by adrenaline released by the adrenal medulla is not caused by vasoconstriction in the synovia. Its mechanisms of action are unknown but may involve  $\beta$ -adrenoceptors (Jänig et al. 2000; Miao et al. 2000; Miao et al. 2001).

These results raise the question of the biological significance of two independent anti-inflammatory neuroendocrine pathways. There are differences in the pattern of noxious stimulation that activate these circuits; while capsaicin selectively activates primary afferent C-fibers and a sub-population of A $\delta$ -afferents, electrical stimulation at the intensities used in these studies synchronously activates all C-, A $\delta$ - and A $\beta$ -fibers. This differential pattern of activation of nociceptive afferents could be responsible for specific encoding of nociceptive signals to selectively activate specific neuroendocrine circuits. The differential activation of either the hypothalamo-pituitary-adrenal system or the sympatho-adrenal system during stimulation of nociceptive afferents, by transcutaneous electrical impulses or by capsaicin respectively, may turn out to be a valuable tool in the experimental investigation of the effects of both neuroendocrine systems on inflammation. However, it has yet to be determined which physiological stimuli (e.g. chronic inflammatory pain or traumatic injury pain) activate either the hypothalamo-pituitary system or the sympatho-adrenal system.

#### Conclusions

Experimental inflammation in the rat knee joint generated by the inflammatory mediator bradykinin is largely dependent on the sympathetic innervation. Sympathetic terminals mediate synovial plasma extravasation, possibly by release of a prostanoid either from the sympathetic terminal or from other cells, independent of their excitability and of vesicular release of noradrenaline. This peripheral mechanism is under inhibitory control of the hypothalamo-pituitary-adrenal system (corticosterone) and the sympatho-adrenal system. The sympathetic terminal mediates the action of corticosterone on bradykinin-induced plasma extravasation, with the intermediary substance probably being the peptide annexin I. These experiments show that the sympathetic terminal nerve fiber is in a strategic position to integrate local inflammatory signals and remote neuroendocrine signals (e.g. corticosterone, adrenaline)

in the modulation of venular plasma extravasation. This is a novel function of the sympathetic terminal that is independent of its excitability and release of noradrenaline.

## References

1. Baron R, Jänig W, Kollmann W (1988) Sympathetic and afferent somata projecting in hindlimb nerves and the anatomical organization of the lumbar sympathetic nervous system of the rat. *J Comp Neurol* 275:460–468
2. Bjerknes L, Coderre TJ, Green PG et al. (1991) Neutrophils contribute to sympathetic nerve terminal-dependent plasma extravasation in the knee joint of the rat. *Neuroscience* 43:679–686
3. Coderre TJ, Basbaum AI, Levine JD (1989) Neural control of vascular permeability; interactions between primary afferents, mast cells, and sympathetic efferents. *J Neurophysiol* 62:48–58
4. Ferrell WR, Russell NJ (1986) Extravasation in the knee induced by antidromic stimulation of articular C fibre afferents of the anaesthetized cat. *J Physiol* 379:407–416
5. Gonzales R, Goldyne ME, Taiwo YO et al. (1989) Production of hyperalgesic prostaglandins by sympathetic postganglionic neurons. *J Neurochem* 53:1595–1598
6. Green PG, Basbaum AI, Levine JD (1992) Sensory neuropeptide interactions in the production of plasma extravasation in the rat. *Neuroscience* 50:745–749
7. Green PG, Miao FJ-P, Jänig W et al. (1995) Negative feedback neuroendocrine control of the inflammatory response in rats. *J Neurosci* 15:4678–4686
8. Green PG, Jänig W, Levine JD (1997) Negative feedback neuroendocrine control of inflammatory response in the rat is dependent on the sympathetic postganglionic neuron. *J Neurosci* 17:3234–3238
9. Green PG, Strausbaugh HJ, Levine JD (1998) Annexin I is a local mediator in neural-endocrine feedback control of inflammation. *J Neurophysiol* 80:3120–3126
10. Hargreaves KM, Roszkowski MT, Swift JQ (1993) Bradykinin and inflammatory pain. *Agents Actions Suppl* 41:65–73
11. Hildebrand C, Oqvist G, Brax L et al. (1991) Anatomy of the rat knee joint and fibre composition of a major articular nerve. *Anat Rec* 229:545–555
12. Häbler HJ, Wasner G, Jänig W (1997) Interaction of sympathetic vasoconstriction and antidromic vasodilatation in the control of skin blood flow. *Exp Brain Res* 113:402–410
13. Jänig W, Khasar SG, Levine JD et al. (2000) The role of vagal visceral afferents in the control of nociception. *Prog Brain Res* 122:271–285
14. Langford LA, Schmidt RF (1983) Afferent and efferent axons in the medial and posterior articular nerves of the cat. *Anat Rec* 206:71–78
15. Levine JD, Dardick SJ, Basbaum AI et al. (1985) Reflex neurogenic inflammation. I. Contribution of the peripheral nervous system to spatially remote inflammatory responses that follow injury. *J Neurosci* 5:1380–1386
16. Miao FJ-P, Jänig W, Levine JD (1996a) Role of sympathetic postganglionic neurons in synovial plasma extravasation induced by bradykinin. *J Neurophysiol* 75:715–724
17. Miao FJ-P, Green P, Coderre TJ et al. (1996b) Sympathetic-dependence in bradykinin-induced synovial plasma extravasation is dose-related. *Neurosci Lett* 205:165–168
18. Miao FJ-P, Jänig W, Levine JD (2000) Nociceptive neuroendocrine negative feedback control of neurogenic inflammation activated by capsaicin in the rat paw: role of the adrenal medulla. *J Physiol* 527:601–610
19. Miao FJ-P, Jänig W, Jasmin L et al. (2001) Spino-bulbo-spinal pathway mediating vagal modulation of nociceptive-neuroendocrine control of inflammation in the rat. *J Physiol* 532:811–822
20. Swift JQ, Garry MG, Roszkowski MT et al. (1993) Effect of flurbiprofen on tissue levels of immunoreactive bradykinin and acute postoperative pain. *J Oral Maxillofac Surg* 51:112–116

## Sympathetic-Sensory Coupling

- ▶ Sympathetic-Afferent Coupling in the Afferent Nerve Fiber, Neurophysiological Experiments
- ▶ Sympathetic-Afferent Coupling in the Dorsal Root Ganglion, Neurophysiological Experiments

## Sympathetic Skin Response

### Synonyms

SSR

### Definition

The sympathetic skin response (SSR) reflects the integrity of sympathetic sudomotor fibers and the activation of sweat glands. The response is recorded with superficial skin electrodes from palms and soles, with a reference electrode on the dorsum of the hands and feet, and results from a transient and interacting electrical activity of sympathetic sudomotor nerves, sweat glands and adjacent epidermal tissue induced by any stimulus that elicits arousal (Hilz MJ, Axelrod FB, Schweibold G, Kolodny EH (1999a) Sympathetic skin response following thermal, electrical, acoustic, and inspiratory gasp stimulation in familial dysautonomia patients and healthy persons. *Clin Auton Res* 9:165–177).

- ▶ Congenital Insensitivity to Pain with Anhidrosis

S

## Sympathetic Vasoconstrictor Neurons

### Definition

Sympathetic Vasoconstrictor Neurons are postganglionic sympathetic nerve fibers innervating the vasculature. Neuronal activity leads to vasoconstriction, e.g. due to release of norepinephrine acting on adrenoceptors.

- ▶ Sympathetically Maintained Pain and Inflammation, Human Experimentation
- ▶ Sympathetically Maintained Pain in CRPS I, Human Experimentation

## Sympathetically Dependent Pain

- ▶ Sympathetically Maintained Pain and Inflammation, Human Experimentation

## Sympathetically Maintained Pain

### Synonyms

SMP

### Definition

The sympathetic nervous system is normally the part of the nervous system that is involved in control of body temperature, blood pressure, heart rate and regulation of normal body functions. However, in certain special circumstances this part of the nervous system is involved in the maintenance of a chronic pain condition (sympathetically maintained pain). In such cases, interruption or blockade of the sympathetic nerves with a local anesthetic nerve block or drugs that antagonize the chemicals released by the sympathetic nerves can result in alleviation of the pain. A subset of patients with CRPS may have a sympathetically maintained pain state. The proportion of sympathetically maintained pain may vary between patients, or with time in an individual patient, and the residual pain is termed sympathetically independent pain (SIP).

- ▶ [Complex Regional Pain Syndrome and the Sympathetic Nervous System](#)
- ▶ [Complex Regional Pain Syndromes, General Aspects](#)
- ▶ [Postoperative Pain, Acute Presentation of Complex Regional Pain Syndrome](#)
- ▶ [Sympathetically Maintained Pain and Inflammation, Human Experimentation](#)
- ▶ [Sympathetically Maintained Pain, Clinical Pharmacological Tests](#)
- ▶ [Sympathetically Maintained Pain in CRPS I, Human Experimentation](#)
- ▶ [Sympathetically Maintained Pain in CRPS II, Human Experimentation](#)

## Sympathetically Maintained Pain and Inflammation, Human Experimentation

FRANK BIRKLEIN<sup>1</sup>, JÖRN SCHATTSCHNEIDER<sup>2</sup>, RALF BARON<sup>2</sup>

<sup>1</sup>Department of Neurology, University of Mainz, Mainz, Germany

<sup>2</sup>Department of Neurological Pain Research and Therapy, Neurological Clinic, Christian Albrechts University Kiel, Kiel, Germany

birklein@neurologie.klinik.uni-mainz.de,

j.schattschneider@neurologie.uni-kiel.de,

r.baron@neurologie.uni-kiel.de

### Synonyms

Sympathetically Dependent Pain; Sympatho-Nociceptive Coupling

### Definition

There is strong evidence that some neuropathic pain states are characterized by an inflammatory reaction. In some patients sympatholytic procedures can ameliorate pain as well as inflammation and edema.

### Characteristics

#### Sympathetic Influence on Neurogenic Inflammation in Human Pain Models

When sympathetic cutaneous vasoconstrictor activity is modulated in physiological ranges by thermoregulatory stress, it does not measurably influence ▶ [capsaicin-induced ▶ neurogenic inflammation](#), i.e. pain and axon reflex vasodilatation (Fig. 1c) (Baron et al. 1999). Accordingly, activation of skin sympathetic vasoconstrictor neurons (▶ [sympathetic vasoconstrictors](#)) does not change the irritant induced discharge of single microneurographically (▶ [microneurography](#)) recorded cutaneous C-nociceptors (Elam et al. 1999). Furthermore, sympathetic blocks were ineffective in reducing pain in the capsaicin model (Pedersen et al. 1997).

In normal tissue, physiological activity in postganglionic sympathetic efferents or the injection of catecholamines does not produce pain. However, some activation of mechanoreceptors might occur. Since it has been shown that subthreshold-for-pain activation of C-fibers is already sufficient to induce axon reflexes, flare vasodilatation could be a sensitive marker for sympathetically induced C-fiber activation. However, intradermal application of catecholamines, even at supraphysiological doses, does not induce axon reflexes (Fig. 1a, b) (Zahn et al. 2004).

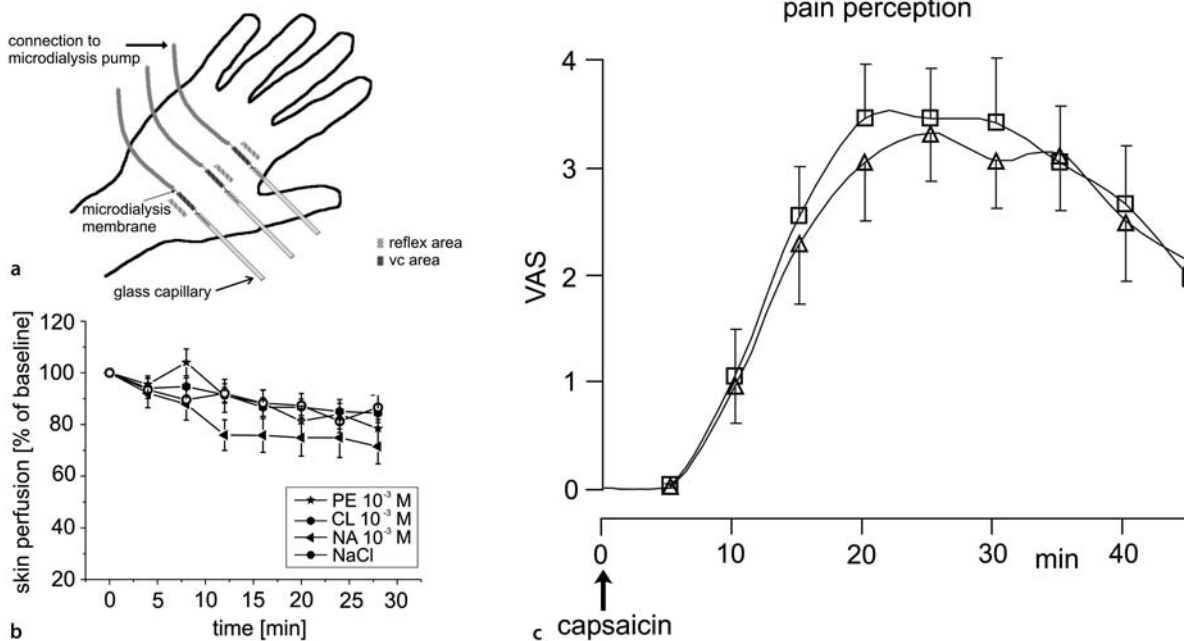
Similar negative results were reported when sympathetic muscle vasoconstrictor activity was altered physiologically by CO<sub>2</sub> stress, and the intensity of pain after capsaicin injection into the muscle was quantified. The muscle pain did not change in this experiment (Wasner et al. 2002).

On the other hand, thermal hyperalgesia, which frequently occurs after capsaicin injection, was enhanced if norepinephrine was co-applied by iontophoresis or injection. This effect was reversed by combined blockade of  $\alpha^1$ - and  $\alpha^2$ -adrenoceptors. However, enhancement of capsaicin induced ▶ [heat hyperalgesia](#) was also found for other vasoconstrictive agents like vasopressin, angiotensin or the occlusion of blood flow, and it was antagonized by vasodilators like nitroprusside (Drummond 1999; Drummond and Lipnicki 1999). These findings indicate that at least a part of catecholamine amplification of capsaicin-induced heat sensitization must be mediated by local vasoconstriction, which is induced by supraphysiological doses of catecholamines.

#### Neurogenic Inflammation in CRPS

In patients with ▶ [Complex regional pain syndrome \(CRPS\)](#), axon reflex vasodilatation was significantly





**Sympathetically Maintained Pain and Inflammation, Human Experimentation, Figure 1** (a, b) Microdialysis has the advantage that a variety of substances can be applied intradermally without simultaneous C-fiber stimulus. The fibers were inserted, and rested in the skin for at least one hour before catecholamines were perfused. (a) Changes of skin blood flow have been monitored by taking repeated pictures covering the whole back of the hand from a laser Doppler perfusion monitor. Even supraphysiological doses of catecholamines (phenylephrine, PE; clonidine CL; norepinephrine NE) did not induce axon reflex-like vasodilatation. With permission from Zahn et al. (2004). (c) Effects of sympathetic activity on capsaicin-evoked cutaneous pain in 12 individuals. Experimental pain was evoked by topical application of 0.6 % capsaicin at the volar forearm (arrow). Pain was measured on a visual analogue scale (VAS) at 5-minute intervals. High cutaneous vasoconstrictor activity (open squares) was experimentally induced by whole-body cooling, and low sympathetic activity (triangles) by whole-body warming. The local skin temperature at the application site was kept constant with a feedback-controlled heating device set to 35°C. There was no difference in capsaicin-evoked pain between high and low activity in cutaneous vasoconstrictor neurons. Modified from Baron et al. (1999).

increased on the affected side, as measured with laser Doppler flowmetry after electrical C-fiber stimulation. Accordingly, systemic CGRP levels were found to be increased in acute CRPS, but not in chronic stages (Birklein et al. 2001)

In acute untreated CRPS I patients, axon reflex activation was elicited by strong transcutaneous electrical stimulation of peptidergic unmyelinated afferents via intradermal ► **microdialysis** capillaries. Protein extravasation that was simultaneously assessed by the microdialysis system was only provoked on the affected extremity as compared with the normal side. The time course of electrically induced protein extravasation in the patients resembled the one observed following application of exogenous substance P (SP) (Weber et al. 2001).

Plasma extravasation could also be demonstrated with other experimental techniques: Bone scintigraphy demonstrated periarticular tracer up-take in acute CRPS and analysis of joint fluid, and synovial biopsies in CRPS patients have shown an increase in protein concentration and synovial hypervascularity. Furthermore, synovial effusion is enhanced in affected joints as measured with MRI (Graif et al. 1998). Scintigraphic investigations with radiolabeled immunoglobulins show extensive plasma extravasation (Oyen et al. 1993; Baron 2006).

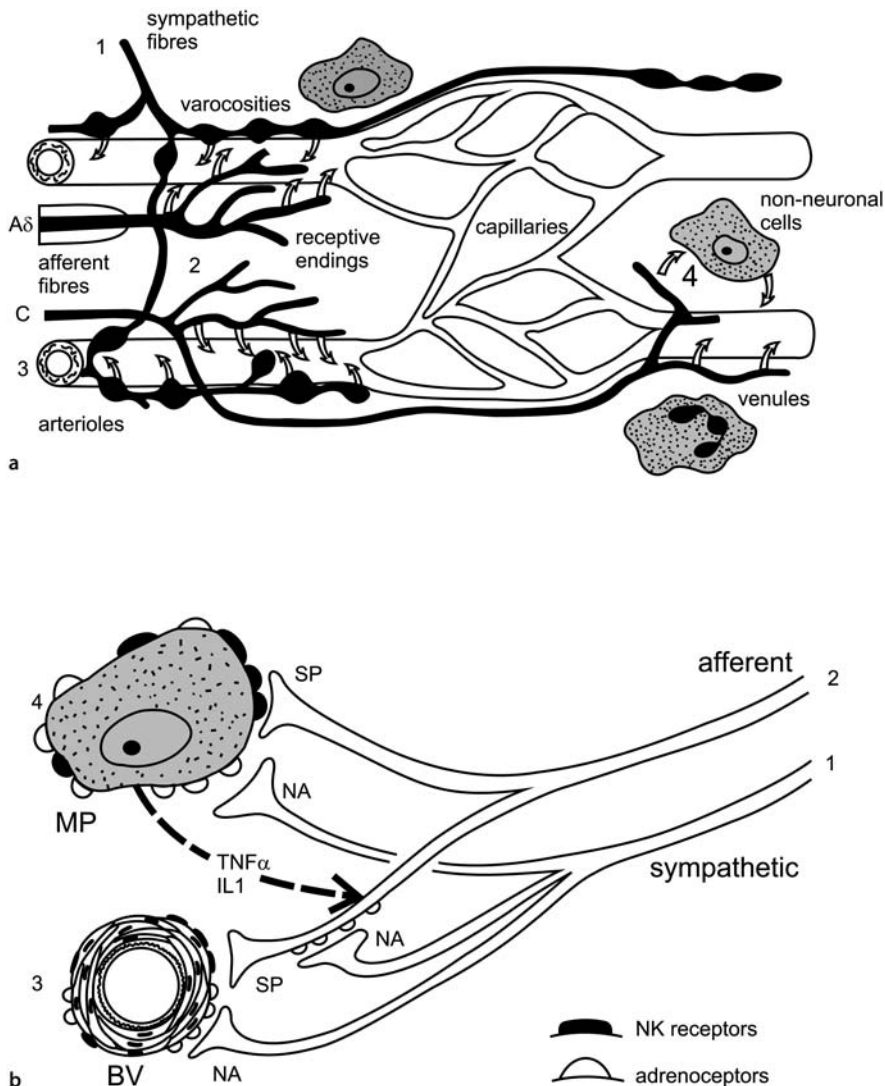
#### Immune Cell Mediated Inflammation and Cytokine Release in CRPS

Skin biopsies in CRPS patients showed a striking increase in the number of Langerhans cells that can release immune cell chemoattractants and proinflammatory cytokines. In accordance, in the fluid of artificially produced skin blisters, significantly higher levels of IL-6 and TNF-alpha were observed in the involved extremity as compared with the uninvolved extremity (Huygen et al. 2002).

The patchy osteoporosis that is found in more advanced CRPS cases may also be consistent with a regional inflammatory process in deep somatic tissues. Both IL-1 and IL-6 cause proliferation and activation of osteoclasts and suppress the activity of osteoblasts. Changes in hair growth can also be created by proinflammatory cytokines. TNF and IL-1 directly inhibit hair growth. Keratocyte-derived TNF and IL-6 cause retarded hair growth, signs of fibrosis, and in turn immune infiltration of the dermis, all present in CRPS patients (Suzuki et al. 1995).

#### The Link between Immune Cell Mediated Inflammation and Neurogenic Inflammation in CRPS

An extensive release of SP would provide a new hypothesis linking immune cell mediated and neurogenic inflam-



**Sympathetically Maintained Pain and Inflammation, Human Experimentation, Figure 2** (a) The microenvironment of nociceptors. The microenvironment of primary afferents is thought to affect the properties of the receptive endings of myelinated (A) and unmyelinated (C) afferent fibers. This has been particularly documented for inflammatory processes, but one may speculate that pathological changes in the direct surroundings of primary afferents may contribute to other pain states as well. The vascular bed consists of arterioles (directly innervated by sympathetic and afferent fibers), capillaries (not innervated and not influenced by nerve fibers) and venules (not directly innervated but influenced by nerve fibers). The microenvironment depends on several interacting components: Neural activity in postganglionic noradrenergic fibers (1) supplying blood vessels (3, BV) causes release of noradrenaline (NA) and possibly other substances and vasoconstriction. Excitation of primary afferents (A $\delta$ - and C-fibers) (2) causes vasodilation in precapillary arterioles and plasma extravasation in postcapillary venules (C-fibers only) by the release of substance P (SP) and other vasoactive compounds (e.g. calcitonin gene-related peptide, CGRP). Some of these effects may be mediated by non-neuronal cells such as mast cells and macrophages (4) Other factors that affect the control of the microcirculation are the myogenic properties of arterioles (3) and more global environmental influences such as a change of the temperature and the metabolic state of the tissue (modified from Jänig and Koltzenburg 1991). (b) Hypothetical relation between sympathetic noradrenergic nerve fibers (1), peptidergic afferent nerve fibers (2), blood vessels (3) and macrophages (4). The activated and sensitized afferent nerve fibers activate macrophages (MP), possibly via substance P release. The immune cells start to release cytokines, such as tumor necrosis factor  $\alpha$  (TNF- $\alpha$ ) and interleukin 1 (IL1) which further activate afferent fibers. Substance P (and CGRP) released from the afferent nerve fibers reacts with neurokinin 1 (NK1) receptors in the blood vessels (arteriolar vasodilation, venular plasma extravasation; neurogenic inflammation). The sympathetic nerve fibers interact with this system on three levels: (1) via adrenoceptors (mainly alpha) on the blood vessels (vasoconstriction), (2) via adrenoceptors (mainly beta) on macrophages (further release of cytokines), and (3) via adrenoceptors (mainly alpha) on afferents (further sensitization of these fibers). Modified from Jänig and Baron (2003).

mation. It has been shown that SP also potently activates immune cells in the human skin. They start to release cytokines, such as TNF- $\alpha$  and IL-1, which, in turn, further activate nociceptive fibers by enhancing sodium influx into the cells. The activated and sensitized afferent nerve fibers again activate macrophages (via SP release).

### The Link between Sympathetic Activity and Inflammation in CRPS

In some CRPS patients, sympatholytic procedures can ameliorate pain as well as inflammation and edema. The question arises whether the sympathetic nervous system

might be involved in the inflammatory process in CRPS, and whether it might interact with immune cells.

Under normal conditions, catecholamines act via  $\beta$ 2-adrenoceptors on immune cells to inhibit the production and release of proinflammatory cytokines. These cells do not express  $\alpha$ -adrenoceptors under basal conditions. However, the situation can dramatically change in chronic inflammation. Then, immune cells downregulate their expression of  $\beta$ 2-adrenoceptors and upregulate their expression of  $\alpha$ 1-adrenoceptors over time (Gazda et al. 2001). In contrast to  $\beta$ 2-adrenoceptors,  $\alpha$ 1-adrenoceptors stimulate the production and release of proinflammatory cytokines. If  $\alpha$ 1-adrenoceptors were to become expressed by the resident and/or recruited immune or immunocompetent cells of the affected CRPS extremity, then sympathetic activation would be predicted to cause pain and other inflammatory signs via cytokine release.

Summarizing the hypothetical ideas described above, Fig. 2 illustrates the possible interactions between sympathetic fibers, afferent fibers, blood vessels and nonneural cells related to the immune system (e.g. macrophages), theoretically leading to the inflammatory changes observed in CRPS patients.

#### Sympathetically Maintained Pain in other Inflammatory Pain States

There are some reports that sympathetic blocks might relieve pain in inflammatory diseases. In rheumatoid arthritis, a randomized controlled trial (RCT) study of intravenous sympathetic block with guanethidine has been effective in 24 patients (Levine et al. 1986). However, recent human histological data has revealed contradictory results – an inhibitory effect of sympathetic innervation on synovial inflammation (Straub et al. 2002).

#### Conclusion

Weighing all information, there seems to be a sympathetic component of chronic human inflammatory pain. However, controlled quantitative studies are needed to verify this assumption.

#### Acknowledgements

Supported by the Deutsche Forschungsgemeinschaft, the German Ministry of Research and Education, German Research Network on Neuropathic Pain and an unrestricted educational grant from Pfizer, Germany.

#### References

- Baron R (2006) Complex Regional Pain Syndromes In: McMahon SB, Koltzenburg M (eds) Wall and Melzack's Textbook of Pain, 5<sup>th</sup> edn. Elsevier, pp 1011–1028
- Baron R, Wasner G, Borgstedt R et al. (1999) Effect of Sympathetic Activity on Capsaicin-Evoked Pain, Hyperalgesia, and Vasodilatation. *Neurology* 52:923–932
- Birklein F, Schmelz M, Schifter S (2001) The Important Role of Neuropeptides in Complex Regional Pain Syndrome. *Neurology* 57:2179–2184
- Drummond PD (1999) Nitroprusside Inhibits Thermal Hyperalgesia Induced by Noradrenaline in Capsaicin-Treated Skin. *Pain* 80:405–412
- Drummond PD, Lipnicki DM (1999) Noradrenaline Provokes Axon Reflex Hyperaemia in the Skin of the Human Forearm. *J Auton Nerv Syst* 77:39–44
- Elam M, Olausson B, Skarphedinsson JO et al. (1999). Does Sympathetic Nerve Discharge Affect the Firing of Polymodal C-Fibre Afferents in Humans? *Brain* 122:2237–2244
- Gazda LS, Milligan ED, Hansen MK et al. (2001) Sciatic Inflammatory Neuritis (SIN): Behavioral Allodynia is Paralleled by Peri-Sciatic Proinflammatory Cytokine and Superoxide Production. *J Peripher Nerv Syst* 6:111–112
- Graif M, Schweitzer ME, Marks B, et al. (1998) Synovial effusion in reflex sympathetic dystrophy: an additional sign for diagnosis and staging. *Skeletal Radiol* 27:262–265
- Huygen FJ, De Bruijn AG, De Bruin MT et al. (2002) Evidence for Local Inflammation in Complex Regional Pain Syndrome Type 1. *Mediators Inflamm* 11:47–51
- Jänig W, Baron R (2003) Complex Regional Pain Syndrome: Mystery Explained? *Lancet Neurol* 2:687–697
- Jänig W, Koltzenburg M (1991) What is the Interaction between the Sympathetic Terminal and the Primary Afferent Fibre? In: Basbaum AI, Besson JM (eds) Towards a New Pharmacotherapy of Pain. Dahlem Workshop Reports. John Wiley & Sons, Chichester, pp 331–352
- Levine JD, Fye K, Heller P et al. (1986) Clinical Response to Regional Intravenous Guanethidine in Patients with Rheumatoid Arthritis. *J Rheumatol* 13:1040–1043
- Oyen WJ, Arntz IE, Claessens RM et al. (1993) Reflex sympathetic dystrophy of the hand: an excessive inflammatory response? *Pain* 55:151–157
- Pedersen JL, Rung GW, Kehlet H (1997) Effect of Sympathetic Nerve Block on Acute Inflammatory Pain and Hyperalgesia. *Anesthesiology* 86: 293–301
- Straub RH, Gunzler C, Miller LE et al. (2002) Anti-Inflammatory Cooperativity of Corticosteroids and Norepinephrine in Rheumatoid Arthritis Synovial Tissue *In Vivo* and *In Vitro*. *FASEB J* 16:93–1000
- Suzuki Y, Tanihara M, Ichikawa Y et al. (1995) Periarticular osteopenia in adjuvant induced arthritis: role of interleukin-1 in decreased osteogenic and increased resorptive potential of bone marrow cells. *Ann Rheum Dis* 54:484–490
- Wasner G, Brechot A, Schattschneider J et al. (2002) Effect of Sympathetic Muscle Vasoconstrictor Activity on Capsaicin-Induced Muscle Pain. *Muscle Nerve* 26:113–121
- Weber M, Birklein F, Neundorfer B (2001) Facilitated Neurogenic Inflammation in Complex Regional Pain Syndrome. *Pain* 91:251–257
- Zahn S, Leis S, Schick C et al. (2004) No  $\alpha$ -adrenoreceptor-Induced C-Fiber Activation in Healthy Human Skin. *J Appl Physiol* 96:1380–1384

S

### Sympathetically Maintained Pain in CRPS I, Human Experimentation

GUNNAR WASNER<sup>1, 2</sup>, RALF BARON<sup>1</sup>

<sup>1</sup>Department of Neurological Pain Research and Therapy, Neurological Clinic, Kiel, Germany

<sup>2</sup>Prince of Wales Medical Research Institute, University of New South Wales, Randwick, NSW, Australia

g.wasner@neurologie.uni-kiel.de,

r.baron@neurologie.uni-kiel.de

## Synonyms

CRPS I; Complex Regional Pain Syndrome Type I; Reflex Sympathetic Dystrophy; Algodystrophy; Morbus Sudeck; SMP

## Definition

► **Sympathetically maintained pain (SMP)** is a symptom of neuropathic pain conditions defined as the pain component that is relieved by specific sympatholytic procedures. If sympatholytic procedures have no influence on the pain, the symptom is called “sympathetically independent pain” (SIP). SMP is most frequently found in ► **Complex Regional Pain Syndrome Type I (CRPS I)**, which develops as a disproportionate consequence of an extremity trauma without any nerve lesion. CRPS I is clinically characterized by spontaneous pain, allodynia, hyperalgesia, autonomic, trophic and motor dysfunction in a distal generalized distribution (see ► **Sympathetic Nervous System and Pain**). There is no clinical feature allowing a distinction between patients with SMP and with SIP. The only possibility to differentiate between SMP and SIP is the efficacy of a correctly applied sympatholytic intervention. Furthermore, there are no animal data for investigation of the pathophysiological mechanisms underlying SMP without nerve lesion like in CRPS I. Therefore, human experiments for investigation of SMP in CRPS I are essential for the understanding of the pathological interaction between the sympathetic nervous system and pain pathways. In these studies the influence of increasing activity in sympathetic neurons, of blocking the sympathetic activity, and of externally applied adrenoceptor agonists in experimental pain models and CRPS patients were tested.

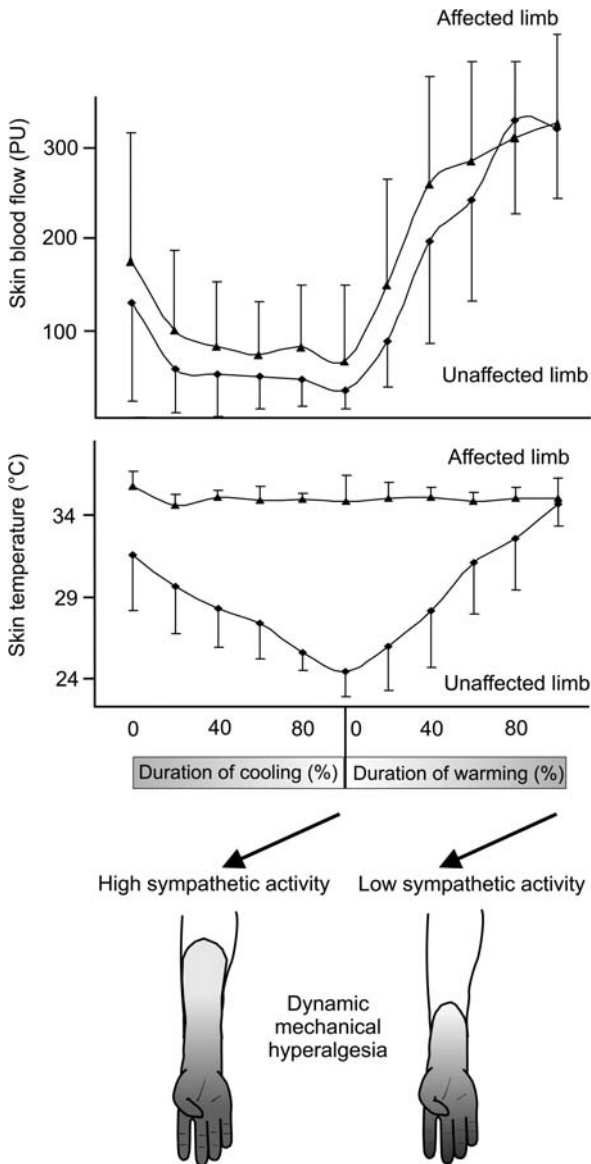
## Characteristics

Physiologically, sympathetic preganglionic neurons that are involved in the regulation of effector cells in somatic tissues, project to the paravertebral ganglia of the sympathetic trunk and synapse with postganglionic neurons that innervate the effector cells. These preganglionic sympathetic neurons are under central control, and the pattern of ongoing and reflex discharges is characteristic for each type of sympathetic pathway, e.g. skin vasoconstrictor, muscle vasoconstrictor and sudomotor neurons, and varies according to the innervated target cells (Jänig and McLachlan 2005; Jänig 2006). Under normal conditions, sympathetic activity has no influence on nociceptive and other primary afferent neurons leading to pain. However, the clinical picture of CRPS I with autonomic dysfunction including changes in skin blood flow, temperature and sweating, as well as the symptom of sympathetically maintained pain, suggests that the sympathetic nervous system is involved in the pathophysiology of CRPS (Stanton-Hicks et al. 2005).

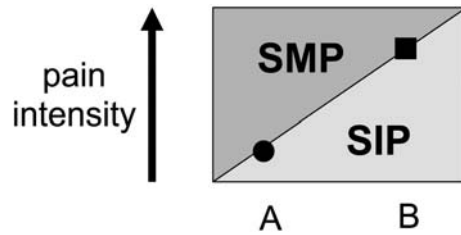
## SMP in CRPS I

Contrasting the results in human experimental pain models, several studies have demonstrated an influence of the sympathetic nervous system on pain in CRPS I patients, from which possible underlying pathophysiological mechanisms can be derived. Drummond et al. (2001, 2004) investigated the effect of sympathetic arousal on pain in CRPS patients. They found that pain ratings increased in over 70% of CRPS patients during forehead cooling and/or after being startled, e.g. by mental arithmetic. This pain-increasing effect of such phasic cutaneous sympathetic activation was most pronounced in patients suffering from cold or punctate hyperalgesia. In another study, the technique of controlled alterations of sympathetic activity by changing environmental temperature that was applied to investigate sympathetic-nociceptive coupling was used in CRPS I patients (Baron et al. 2002): Cutaneous sympathetic vasoconstrictor outflow to the painful limb was activated by whole-body cooling. During the thermal challenge, local skin temperature at the affected region was fixed at 35°C to avoid thermal effects at the nociceptor level. The intensity of spontaneous pain, the area of mechanical hyperalgesia, and the heat pain thresholds, were measured and compared with the results of diagnostic sympathetic blocks that were performed to identify patients with SMP (pain relief >50% after sympathetic block) and SIP (pain relief <50%). The results showed that in patients with SMP the intensity of spontaneous pain significantly increased by 22%, and the spatial distribution of mechanical dynamic and punctate hyperalgesia increased by 42% and 27%, respectively, during high compared with low sympathetic activity (Fig. 1). On the other hand, heat pain thresholds did not change, indicating that specific heat-sensitive primary afferent neurons are not, or are only marginally, affected by sympathetic activity. This observation also lends support to an alternative idea that low threshold A $\beta$  afferent neurons, which are associated with mechanical allodynia, might be implicated in sympathetic-afferent coupling. Interestingly, pain relief after sympathetic blockade correlated with augmentation of spontaneous pain after experimental stimulation of cutaneous vasoconstrictor activity in all patients (both SMP and SIP). This suggests that the sympathetically maintained pain component in CRPS I might form a continuum. Also, in patients classified as SIP (pain relief <50% after sympathetic block), there might be a pain component that depends on sympathetic activity (Fig. 2). In conclusion, the study data (Baron et al. 2002; Drummond et al. 2001) gives strong evidence for a pathological coupling between skin ► **sympathetic vasoconstrictor neurons** and cutaneous afferents in CRPS. The question arises where this coupling might be located. In CRPS and posttraumatic neuralgias, intracutaneous application of noradrenaline into the symptomatic area





**Sympathetically Maintained Pain in CRPS I, Human Experimentation, Figure 1** Experimental modulation of cutaneous sympathetic vasoconstrictor neurons by physiological thermoregulatory reflex stimuli in 13 CRPS patients. With the help of a thermal suit, whole-body cooling and warming was performed to alter sympathetic skin nerve activity. The subjects lay in a suit supplied by tubes, in which running water of 12°C and 50°C, respectively (inflow temperature) was used to cool or warm the whole body. By these means, sympathetic activity could be switched on and off. Top: High sympathetic vasoconstrictor activity during cooling induces considerable drop in skin blood flow on the affected and unaffected extremity (laser Doppler flowmetry). Measurements were taken at 5 min intervals. Middle: On the unaffected side a secondary decrease of skin temperature was documented. On the affected side, the forearm temperature was clamped at 35°C by a feed-back-controlled heat lamp to exclude temperature effects on the sensory receptor level. Measurements were taken at 5 min intervals. Bottom: Effect of cutaneous sympathetic vasoconstrictor activity on dynamic mechanical allodynia in one CRPS patient with sympathetically maintained pain (SMP). Activation of sympathetic neurons (during cooling) leads to a considerable increase of the area of dynamic mechanical allodynia. From (Baron et al. 2002) with permission.



**Sympathetically Maintained Pain in CRPS I, Human Experimentation, Figure 2** A graphic representation of the relative contribution of SMP to overall pain in a given patient. Point A represents an individual whose pain is predominantly sympathetically-maintained, whereas point B represents a situation in which the pain is only slightly responsive to sympatholytic intervention. Points A and B may represent different patients or the same patient at two different times. Adapted from Stanton-Hicks et al. (1995).

rekindled spontaneous pain and mechanical hyperalgesias that had been relieved by sympathetic blockade (Torebjörk et al. 1995). Ali et al. (2000) also found in patients with SMP during local anesthetic sympathetic blockade that intracutaneous injections of naradrenaline in physiologically relevant doses induced pain and mechanical hyperalgesias in the affected region, but not on the contralateral side and not in controls. This effect was blocked in most patients by systemic administration of the  $\alpha$ -adrenoceptor-antagonist phentolamine. Accordingly, results of autoradiographic studies showed that the number of  $\alpha$ -<sup>1</sup> adrenoceptors in hyperalgesic skin in CRPS I patients is substantially larger than in the pain free skin of the patients (Drummond et al. 1996). These findings support a role for adrenoceptors in cutaneous primary afferent neurons in the mechanisms of sympathetically maintained pain. Interestingly, development of adrenergic supersensitivity is suggested to be involved in vasomotor abnormalities in CRPS I (Wasner et al. 2001). Evidence from animal experiments favors the idea that sympathetic activity can sensitize nociceptors chemically, via naradrenaline released from sympathetic fibers, acting directly on adrenoceptors expressed on afferent fibers (see ► [Sympathetic-Afferent Coupling in the Dorsal Root Ganglion, Neurophysiological Experiments](#) ► [Sympathetic-Afferent Coupling in the Afferent Nerve Fiber, Neurophysiological Experiments](#)). Furthermore, amplified excitability of nociceptors might be generated indirectly –i.e. via the vascular bed (e.g. change of blood flow), or by other components such as inflammatory cells around nociceptive neurons, which might have a permissive effect on sympathetic to nociceptive coupling, or they might be modulated directly by molecules released from sympathetic post-ganglionic neurons (► [Sympathetic nervous system and pain](#)). However, the exact mechanism of sympathetic-afferent coupling in CRPS remains unclear, the more so since results from animal experiments are mainly based on nerve lesion models that did not account for CRPS. In addition, Drummond and Finch (2004) demonstrated that in some CRPS patients with SMP, stimuli arousing

sympathetic activity still increased pain even during sympathetic blockade, indicating a central component of sympathetic-afferent interaction that has not been considered in animal work so far. Furthermore, nearly all human and animal studies have focused on the skin as the region of interest for sympathetic-afferent coupling. However, it has been clearly demonstrated that relief of spontaneous pain after sympathetic blockade was more pronounced than changes in spontaneous pain that could be induced experimentally by activation of cutaneous sympathetic vasoconstrictor neurons (Baron et al. 2002). One explanation for this discrepancy might be that a complete sympathetic block affects all sympathetic outflow channels projecting to the affected limb. In addition to coupling in the skin, a sympathetic-afferent interaction is likely to happen in other tissues, particularly, in deep somatic domains such as bone, muscle or joints (Schattschneider et al. 2006). These structures are especially painful in some CRPS I patients, which lends support to this notion.

### Conclusion

There is strong evidence from human experiments for a sympathetic-afferent interaction in CRPS I. It is suggested that adrenoceptors are involved in the coupling in the skin. Furthermore, there is indirect evidence that a pathological sympathetic-afferent interaction also happens in deep somatic tissues contributing to the symptoms of SMP.

### Acknowledgements

This work was supported by the Alexander von Humboldt-Stiftung, the Deutsche Forschungsgemeinschaft (DFG Ba 1921/1-3), the German Ministry of Research and Education within the German Research Network on Neuropathic Pain (BMBF, 01EM0504) and Pfizer Deutschland (unrestricted educational grant).

### References

1. Ali Z, Raja SN, Wessellmann U et al. (2000) Intradermal Injection of Norepinephrine Evokes Pain in Patients with Sympathetically Maintained Pain. *Pain* 88:161–168
2. Baron R, Schattschneider J, Binder A et al. (2002) Relation between Sympathetic Vasoconstrictor Activity and Pain and Hyperalgesia in Complex Regional Pain Syndromes: A Case-Control Study. *Lancet* 359:1655–1660
3. Drummond PD, Finch PM (2004) Persistence of Pain Induced by Startle and Forehead Cooling after Sympathetic Blockade in Patients with Complex Regional Pain Syndrome. *J Neurol Neurosurg Psychiatry* 75:98–102
4. Drummond PD, Finch PM, Skipworth S et al. (2001) Pain Increases during Sympathetic Arousal in Patients with Complex Regional Pain Syndrome. *Neurology* 57:1296–1303
5. Drummond PD, Skipworth S, Finch PM (1996) Alpha<sup>1</sup>-adrenoceptors in Normal and Hyperalgesic Human Skin. *Clin Sci (Colch)* 91:73–77
6. Fuchs PN, Meyer RA, Raja SN (2001) Heat, but not Mechanical Hyperalgesia, following Adrenergic Injections in Normal Human Skin. *Pain* 90:15–23
7. Jänig W (2006) Integrative Action of the Autonomic Nervous System. *Neurobiology of Homeostasis*. Cambridge University Press, Cambridge, New York
8. Jänig W, McLachlan EM (2005) Neurobiology of the Autonomic Nervous System. In: Mathias CJ, Bannister R (eds) *Autonomic Failure*, 5<sup>th</sup> edn. Oxford University Press, New York, Oxford
9. Schattschneider J, Binder A, Siebrecht D et al. (2006) Complex Regional Pain Syndrome: the Influence of Cutaneous and Deep Somatic Sympathetic Innervation on Pain. *Clin J Pain* (in press)
10. Stanton-Hicks M et al. (2005) CRPS: Current diagnosis and therapy. IASP Press, Seattle
11. Stanton-Hicks M, Jänig W, Hassenbusch S et al. (1995) Reflex Sympathetic Dystrophy: Changing Concepts and Taxonomy. *Pain* 63:127–33
12. Torebjörk E, Wahren L, Wallin G et al. (1995) Noradrenaline-Evoked Pain in Neuralgia. *Pain* 63:11–20
13. Wasner G, Drummond P, Birklein F et al. (2001) The Role of the Sympathetic Nervous System in Autonomic Disturbances and “Sympathetically Maintained Pain” in CRPS. In: Harden RN, Baron R, Jänig W (eds) *Progress in Pain Research and Management*, vol 22, Complex Regional Pain Syndrome. IASP Press, Seattle, pp 89–118

## Sympathetically Maintained Pain in CRPS II, Human Experimentation

SRINIVASA N. RAJA<sup>1</sup>, ADAM CARINCI<sup>1</sup>, RALF BARON<sup>2</sup>

<sup>1</sup>Department of Anesthesiology and Critical Care Medicine, Johns Hopkins University School of Medicine, Baltimore, MD, USA

<sup>2</sup>Department of Neurological Pain Research and Therapy, Department of Neurology, Christian Albrechts University Kiel, Kiel, Germany  
sraja@jhmi.edu, r.baron@neurologie.uni-kiel.de

### Synonyms

Causalgia; CRPS II; complex regional pain syndrome II

### Definition

Complex regional pain syndromes, ► **CRPS I** and ► **CRPS II** (formerly known as reflex sympathetic dystrophy and causalgia, respectively), are pain disorders that commonly develop as a consequence of trauma with or without an associated nerve lesion. These disorders are most common in the limbs and are characterized by pain disproportionate to the trauma, ► **allodynia**, ► **hyperalgesia**, ► **sudomotor**, ► **vasomotor** and trophic skin changes, as well as active and passive movement disorders (Jänig and Baron 2003). CRPS II, in contrast to CRPS I, occurs following a nerve injury, and is commonly caused by high velocity or partial injuries to peripheral nerves such as those occurring in gunshot wounds, stab wounds, or automobile accidents. Studies in humans with CRPS II have focused on two broad areas; (1) studies aimed at understanding the mechanisms of pain and other associated features, and (2) studies to examine the efficacy of treatment strategies. In this essay, we summarize the salient observations related to each of these significant areas.

## Characteristics

### Mechanisms

Numerous studies have explored the role of the sympathetic nervous system (SNS) in CRPS II. The SNS appears to contribute to pain in certain patients after nerve or tissue injury in an extremity. The sympathetic component of pain is often investigated clinically by blocking sympathetic activity in the symptomatic limb or by administering an adrenergic receptor agonist or antagonist. Several lines of clinical evidence support the hypothesis that ► **Alpha( $\alpha$ )-Adrenoceptors** develop in peripheral tissues in ► **sympathetically maintained pain (SMP)**, such that the release of noradrenaline (NA) from the sympathetic terminals activates the nociceptors and leads to the sensation of pain. The perineuromal administration of adrenaline or NA results in increased pain in patients with ► **neuromas** after amputations (Chabal et al. 1992; Katz 1997; Lin 2006). In CRPS II patients with SMP rendered pain-free by a sympathetic block or surgical ► **sympathectomy**, NA injected into the skin restores the hyperalgesia (Davis et al. 1991; Torebjörk et al. 1995; Wallin et al. 1976). In addition, intravenous phentolamine (an  $\alpha$ -adrenoceptor blocker), but not propranolol (a  $\beta$ -adrenoceptor blocker), relieves SMP (Raja et al. 1991).

A potential criticism of the previous studies is that the doses of NA used were much higher than are likely to exist *in vivo*. However, Ali et al. recently concluded that NA in physiologically relevant doses resulted in pain in patients with SMP (Ali et al. 2000). Thus, adrenoceptor mechanisms play a critical role in the maintenance of the pain in a subset of patients with chronic pain that is sympathetically maintained.

Other studies have investigated the effect of sympathetic arousal on pain and vasomotor responses in patients with CRPS. One such study examined sensitivity to heat, cold, and mechanical stimulation, and concluded that pain decreased during sympathetic arousal in healthy subjects, whereas pain often increased and abnormal sensations sometimes developed in the symptomatic limb of patients with CRPS during the same procedures (Drummond et al. 2001). The authors suggest that a mechanism that normally inhibits pain during sympathetic arousal is compromised in the majority of patients with CRPS.

### Treatments

Experimental studies in the treatment of CRPS II have touched on a variety of interventional, pharmacological and behavioral modalities. However, few of these studies have been placebo-controlled trials.

In one such analysis, a comparison of the pain relieving effects of lidocaine/bupivacaine (LA) vs. saline (S) blocks of the ► **sympathetic ganglia** was investigated (Price et al. 1998). Both LA and S blocks produced large reductions in pain intensity 30 minutes after the

block, with no statistically significant difference in peak pain reducing effect. However, the mean duration of pain relief was significantly longer in the case of the LA block. The authors conclude that the duration of pain relief is affected by injection of LA into the sympathetic ganglia, and suggest that both magnitude and duration of pain reduction should be closely monitored to provide optimal efficacy in patients undergoing such interventions.

Muizelaar et al. (1997) explored the use of nifedipine and/or phenoxybenzamine in the treatment of CRPS II, and concluded that both are effective first-line treatments for the acute stage of CRPS with a cure rate of 92%. However, in the chronic stage of CRPS, treatment with these drugs was much less successful, with a documented cure rate of only 40%, thus underscoring the importance of early recognition and intervention in CRPS II patients. Surgical sympathectomy for CRPS II has also been investigated (Singh et al. 2003). In this study, 42 patients with CRPS II of the upper extremity were categorized into one of two groups based upon duration of symptoms, with group I consisting of patients with symptoms less than three months, and group II consisting of patients with symptoms greater than three months. Following sympathectomy, all 42 patients demonstrated improved pain scores (VAS), with the patients in group I showing significantly greater improvement than those in group II. However, long-term results in most cases are disappointing with a high recurrence rate of the pain. Therefore, surgical sympathectomy should not be recommended as the treatment option of choice.

### Conclusions

CRPS II is a multifaceted and complicated neuropathic pain disorder that develops as a consequence of a traumatic nerve lesion. The mechanisms of, and treatment modalities for, CRPS II have been explored by a multitude of investigators and have shed light on the pathophysiology of this syndrome. However, many aspects of this chronic pain state remain obscure.

### Acknowledgements

Supported by the Deutsche Forschungsgemeinschaft, the German Ministry of Research and Education, German Research Network on Neuropathic Pain and an unrestricted educational grant from Pfizer, Germany, and a grant from the National Institute of Neurological Disorders and Stroke, National Institutes of Health, USA.

### References

1. Ali Z, Raja SN, Wesselmann U et al. (2000) Intradermal Injection of Norepinephrine Evokes Pain in Patients with Sympathetically Maintained Pain. *Pain* 88:161–168
2. Chabal C, Jacobson L, Russell LC et al. (1992) Pain Response to Perineuromal Injection of Normal Saline, Epinephrine, and Lidocaine in Humans. *Pain* 49:9–12



3. Davis KD, Treede RD, Raja SN et al. (1991) Topical Application of Clonidine Relieves Hyperalgesia in Patients with Sympathetically Maintained Pain. *Pain* 47:309–317
4. Drummond PD, Finch PM, Skipworth S et al. (2001) Pain Increases during Sympathetic Arousal in Patients with Complex Regional Pain Syndrome. *Neurology* 57:1296–1303
5. Jänig W, Baron R (2003) Complex Regional Pain Syndrome: Mystery Explained? *Lancet Neurol* 2:687–697
6. Katz J (1997) Central Nervous System Correlates and Mechanisms of Phantom Pain. In: Sherman RA (ed) *Phantom Pain*. Plenum, New York, pp 89–109
7. Lin EE, Horasek S, Agarwal S et al. (2006) Local administration of norepinephrine in the stump evokes dose-dependent pain in amputees. *Clin J Pain* 22: 482–486
8. Muizelaar JP, Kleyer M, Hertogs IA et al. (1997) Complex Regional Pain Syndrome (RSD and Causalgia): Management with Calcium Channel Blocker Nifedipine and/or the Alpha-Sympathetic Blocker Phenoxybenzamine in 59 Patients. *Clin Neurol Neurosurg* 99:26–30
9. Price DD, Long S, Wilsey B et al. (1998) Analysis of Peak Magnitude and Duration of Analgesia Produced by Local Anesthetics Injected into Sympathetic Ganglia of Complex Regional Pain Syndrome Patients. *Clin J Pain* 14:216–226
10. Raja SN (1998) Peripheral Modulatory Effects of Catecholamines in Inflammatory and Neuropathic Pain. *Adv Pharmacol* 42:567–571
11. Raja SN, Treede RD, Davis KD et al. (1991) Systemic Alpha-Adrenergic Blockade with Phentolamine: A Diagnostic Test for Sympathetically Maintained Pain. *Anesthesiology* 74:691–698
12. Singh B, Moodley J, Shaik AS et al. (2003) Sympathectomy for Complex Regional Pain Syndrome. *J Vasc Surg.* 37:508–511
13. Torebjörk E, Wahren L, Wallin G et al. (1995) Noradrenaline-Evoked Pain in Neuralgia. *Pain* 63:11–20
14. Wallin BG, Torebjörk E, Hallin RG (1976) Preliminary Observations on the Pathophysiology of Hyperalgesia in the Causalgic Pain Syndrome. In: Zotterman Y (ed) *Sensory Functions of the Skin of Primates with Special Reference to Man*. Pergamon, Oxford, pp 489–499

## Sympathetically Maintained Pain, Clinical Pharmacological Tests

PETER D. DRUMMOND<sup>1</sup>, JÖRN SCHATTSCHEIDER<sup>2</sup>

<sup>1</sup>School of Psychology, Murdoch University, Perth, WA, Australia

<sup>2</sup>Department of Neurology, University Hospital Schleswig-Holstein, Kiel, Germany  
p.drummond@murdoch.edu.au,  
j.schattschneider@neurologie.uni-kiel.de

### Synonyms

SMP; sympathetically maintained pain; CRPS; complex regional pain syndrome

### Definition

Neuropathic pain patients can be divided into groups based on their response to selective sympathetic blockade or antagonism of  $\alpha$ -adrenoceptor mechanisms (Price et al. 1998). The component of spontaneous and evoked pain (hyperalgesia) which is relieved by specific sympatholytic procedures is termed sympathetically maintained pain (SMP). Hyperalgesia can be defined as a leftward shift of the stimulus response function

that relates the magnitude of pain to the intensity of a noxious stimulus. An increased sensitivity to painful heat is termed thermal hyperalgesia. Hyperalgesia can also be evoked by application of different mechanical stimuli; for instance, punctate stimuli (e.g. firm von Frey hairs) can evoke punctate hyperalgesia, whereas gently stroking sensitized skin with a cotton swab can provoke dynamic hyperalgesia (also termed mechanical allodynia).

Intradermal injection or iontophoresis of **adrenergic agonists** such as noradrenaline increases thermal hyperalgesia, but does not normally evoke spontaneous pain or mechanical hyperalgesia. However, in certain neuropathic pain syndromes, intradermal injection of noradrenaline into the affected region exacerbates pain and mechanical hyperalgesia, and can rekindle pain after effective treatment with sympathetic blockade or sympathectomy.

### Characteristics

#### Adrenergic Hyperalgesia in a Human Pain Model

Transcutaneous iontophoresis of noradrenaline and drugs that release neural stores of noradrenaline (e.g. tyramine) (Drummond 1998) exacerbate thermal hyperalgesia in skin made sensitive to heat by the topical application of capsaicin. Similarly, intradermal injection of the  $\alpha$ -adrenergic agonists noradrenaline, phenylephrine, and brimonidine induces thermal but not mechanical hyperalgesia in the skin of normal human subjects (Fuchs et al. 2001). Intradermal injection of the non-adrenergic vasoconstrictors angiotensin II and vasopressin does not increase sensitivity to painful heat, despite producing comparable decreases in blood flow to adrenergic vasoconstrictors (Fuchs et al. 2001). The adrenergic component of thermal hyperalgesia persists after arterial occlusion, indicating that thermal hyperalgesia is independent of blood flow.

When administered in capsaicin-treated skin, the  $\alpha$ -adrenoceptor antagonist (see **adrenergic antagonist**) phenoxybenzamine blocks thermal hyperalgesia to the adrenergic releasing agent tyramine (Drummond 1998). In contrast, phenoxybenzamine administered before the topical application of capsaicin does not inhibit thermal hyperalgesia to tyramine. The blood-nerve barrier weakens during inflammation, thus allowing substances to diffuse more readily than usual from the extracellular fluid to the local environment of nerve fascicles. Hence, enhanced access to neural or perineural  $\alpha$ -adrenoceptors during inflammation might account for the inhibitory influence of phenoxybenzamine on thermal hyperalgesia to tyramine after capsaicin treatment.

#### Adrenoceptor Subtypes

In animal experiments, different adrenoceptor blockers (e.g. phentolamine;  $\alpha_1$  and  $\alpha_2$ ), prazosin ( $\alpha_1$ ) or yohimbine ( $\alpha_2$ ) or adrenoceptor agonists (e.g. cloni-



dine;  $\alpha_2$ ) have been used to examine the role of the sympathetic nervous system in neuropathic pain. In animal neuropathic pain models, sympathetic-sensory coupling is primarily mediated by  $\alpha_2$  adrenoreceptors, whereas  $\alpha_1$  adrenoreceptors play a minor role (Chen et al. 1996).

In humans, topical application of the  $\alpha_2$  receptor agonist clonidine relieves hyperalgesia at the site of application in patients with SMP, presumably because activation of presynaptic adrenergic autoreceptors inhibits the release of noradrenaline (Davis et al. 1991). Davis et al. (1991) reported that a subsequent injection of noradrenaline and the  $\alpha_1$  receptor agonist phenylephrine in the clonidine treated area rekindled hyperalgesia. Quantitative autoradiographic studies indicate that the number of  $\alpha_1$  adrenoreceptors in hyperalgesic skin of patients with CRPS is significantly greater than in the skin of normal subjects (Drummond et al. 1996). In contrast to the data obtained in animal experiments, it seems that in humans sympathetic-sensory coupling is mediated via  $\alpha_1$  adrenoreceptors.

#### Identifying Patients with a Peripheral Adrenergic Component of Pain

The adrenergic component of pain is often investigated clinically with regional sympathetic blockade. However, there are several difficulties with this approach. For example, pain reduction may be due to placebo effects, parallel decreases in anxiety and pain, inadvertent somatic blockade, or systemic uptake of the local anaesthetic agent. The phentolamine test was developed to overcome these difficulties. This procedure typically involves intravenous injection of the  $\alpha$ -adrenoceptor antagonist phentolamine or saline in a double blind manner. A major challenge to the validity of this procedure and, indeed, to the concept of SMP, was mounted by Verdugo and Ochoa (1994). They reported that the frequency of pain reduction did not differ between phentolamine and placebo conditions in CRPS patients. However, adrenergic blockade may not have been complete in this study, because only a low dose (35 mg) of phentolamine was infused over a 20-minute interval. Furthermore, phentolamine administered by intravenous injection might not block adrenergic receptors protected by a blood-nerve barrier.

An alternative to the phentolamine test is to inject adrenergic agonists intradermally in the affected region. Ali et al. (2000) reported that 1  $\mu$ M and 10  $\mu$ M of noradrenaline, at the threshold for producing vasoconstriction, rekindled pain in the affected limb of CRPS patients whose pain had decreased during sympathetic blockade with a local anesthetic agent. Similar doses did not induce pain on the unaffected side or in control subjects, indicating that this test might be useful for identifying patients with an adrenergic component of pain.

Intravenous regional blockade with guanethidine is sometimes used clinically to identify and treat sym-

pathetically maintained pain. Guanethidine occupies adrenergic varicosities in sympathetic nerve fibres, thereby abolishing noradrenaline release and preventing sympathetic vasoconstrictor activity. Controlled trials show that intravenous regional blockade with guanethidine is ineffective for treating the pain of unselected patients with CRPS (Kingery 1997), presumably due to variation of sympathetic involvement in CRPS. However, certain patients may benefit from the guanethidine treatment, particularly those with thermal hyperalgesia and allodynia to cold and vibration (Wahren et al. 1991).

#### Acknowledgements

Supported by the Deutsche Forschungsgemeinschaft, the German Ministry of Research and Education, German Research Network on Neuropathic Pain and an unrestricted educational grant from Pfizer, Germany.

#### References

1. Ali Z, Raja S, Wesselmann U et al. (2000) Intradermal Injection of Norepinephrine Evokes Pain in Patients with Sympathetically Maintained Pain. *Pain* 88:161–168
2. Chen Y, Michaelis M, Jänig W et al. (1996) Adrenoreceptor Subtype Mediating Sympathetic-Sensory Coupling in Injured Sensory Neurons. *J Neurophysiol* 76:3721–3730
3. Davis KD, Treede RD, Raja SN et al. (1991) Topical Application of Clonidine Relieves Hyperalgesia in Patients with Sympathetically Maintained Pain. *Pain* 47:309–317
4. Drummond PD, Skipworth S, Finch PM (1996) Alpha- $1$ -adrenoreceptors in Normal and Hyperalgesic Human Skin. *Clin Sci* 91:73–77
5. Drummond PD (1998) Enhancement of Thermal Hyperalgesia by Alpha-Adrenoreceptors in Capsaicin-Treated Skin. *J Auton Nerv Syst* 69:96–102
6. Fuchs PN, Meyer RA, Raja SN (2001) Heat, but not Mechanical Hyperalgesia, following Adrenergic Injections in Normal Human Skin. *Pain* 90:15–23
7. Kingery WS (1997) A Critical Review of Controlled Clinical Trials for Peripheral Neuropathic Pain and Complex Regional Pain Syndromes. *Pain* 73:123–139
8. Price DD, Long S, Wilsey B et al. (1998) Analysis of Peak Magnitude and Duration of Analgesia Produced by Local Anesthetics into Sympathetic Ganglia of Complex Regional Pain Syndrome Patients. *Clin J Pain* 14:216–226
9. Verdugo RJ, Ochoa JL (1994) 'Sympathetically Maintained Pain.' I. Phentolamine Block Questions the Concept. *Neurology* 44:1003–1010
10. Wahren LK, Torebjörk E, Nystrom B (1991) Quantitative Sensory Testing Before and After Regional Guanethidine Block in Patients with Neuralgia in the Hand. *Pain* 46:23–30

S

### Sympatho-Adrenal System and Mechanical Hyperalgesic Behavior, Animal Experimentation

WILFRID JÄNIG

Institute of Physiology, Christian Albrechts University  
Kiel, Kiel, Germany

w.janig@physiologie.uni-kiel.de

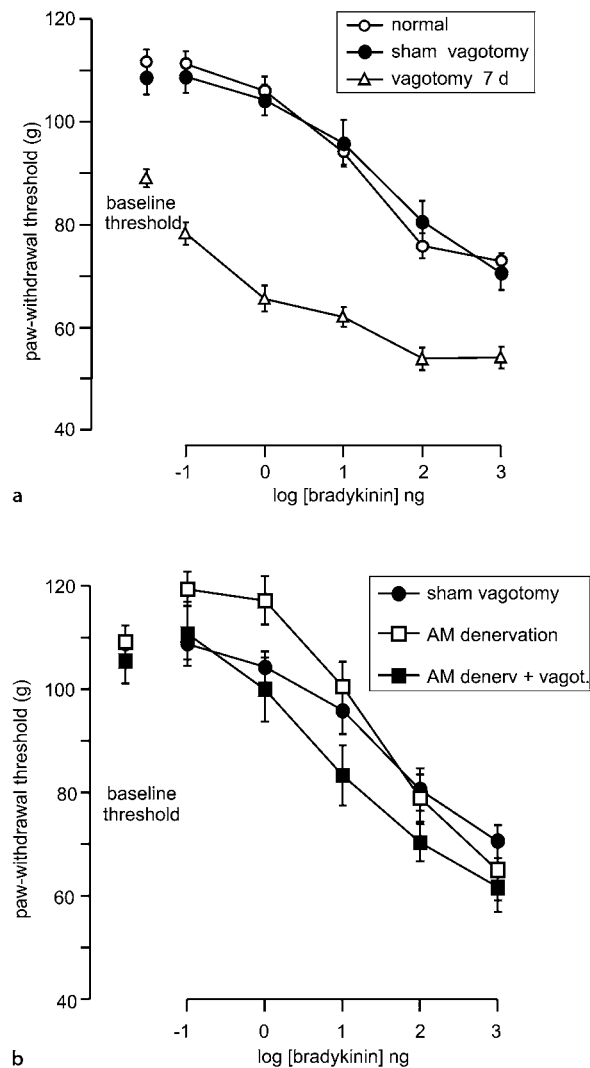
## Definition

The adrenal medullae release both adrenaline and noradrenaline, regulated by activity in preganglionic sympathetic neurons that project from the thoracic spinal cord through the splanchnic nerves to this gland. Histological and immunohistochemical studies show that adrenaline and noradrenaline are synthesized by different cells, which are also innervated by different groups of preganglionic neurons (Edwards et al. 1996). These data suggest that there are two separate sympathetic pathways to the adrenal medulla, one mediating the release of adrenaline and the other noradrenaline (Vollmer 1996). This idea is supported by functional studies implying that the release of adrenaline and noradrenaline from the adrenal medulla can be regulated differentially by the brain (see Folkow 1955 for early studies; Folkow and von Euler 1954; Vollmer 1996). Morrison and Cao (2000) showed in the rat that preganglionic neurons, which innervate adrenergic cells of the adrenal medulla, are not affected by arterial baroreceptor reflexes and respiratory reflexes but are strongly excited by hypoglycemia. In contrast, preganglionic neurons that innervate noradrenergic cells of the adrenal medulla behave like muscle vasoconstrictor neurons. In humans under resting conditions, the concentration of noradrenaline in the blood plasma is 1–1.5 pmol/ml (0.17–0.25  $\mu\text{g/L}$ ) and of adrenaline about 0.25 pmol/ml (0.05  $\mu\text{g/L}$ ) (Kopin 1989). Furthermore, under almost all physiological conditions, the concentration of circulating noradrenaline is 3–5  $\times$  higher than the concentration of adrenaline (Cryer 1980). In humans, only about 2–8% of the circulating noradrenaline is released by the adrenal medulla, and the rest is released by sympathetic nerve endings (Esler et al. 1990). Under physiological conditions adrenaline may be involved in the following functions: (1) regulation of metabolism such as catalyzing the mobilization of glucose and lactic acid from glycogen and probably of fatty acids from adipose tissue; (2) modulation of sensitivity of nociceptors; (3) modulation of inflammation (see [► Sympathetic Postganglionic Neurons in Neurogenic Inflammation of the Synovia](#); Miao et al. 2000; 2001) (4) consolidation of memory (via vagal afferents and the nucleus tractus solitarii [NTS]); and (5) probably not support responses of target organs elicited by activation of other sympathetic pathways except under strong emergency conditions (Jänig 2006).

## Characteristics

### Effect of Subdiaphragmatic Vagotomy on Mechanical Hyperalgesic Behavior

Withdrawal threshold to stimulation of the rat hind paw with a linearly increasing mechanical stimulus, applied to the dorsum of the paw, decreases dose-dependently after intradermal injection of bradykinin (open circles and closed circles in Fig. 1a; bradykinin-induced mechanical hyperalgesic behavior). If inhibition main-



**Sympatho-Adrenal System and Mechanical Hyperalgesic Behavior, Animal Experimentation, Figure 1** (a) Decrease of paw-withdrawal threshold to mechanical stimulation of the dorsum of the rat hind paw induced by bradykinin (bradykinin-induced behavioral mechanical hyperalgesia) in normal control (open circles,  $n = 26$ ), vagotomized (triangles,  $n = 16$ ) and sham vagotomized (closed circles,  $n = 18$ ) rats. Experiments conducted 7 days after vagotomy. Post hoc test shows significant differences between vagotomized and normal ( $P < 0.05$ ) as well as between vagotomized and sham vagotomized ( $P < 0.05$ ) rats, in response to bradykinin. Cutaneous mechanoreceptors in the hairy skin are stimulated by a linearly increasing mechanical force using a Basile Algesimeter (Stoelting, Chicago, IL). Threshold is defined as the minimum force (g) at which the paw is withdrawn by a rat. Ordinate scale expresses paw-withdrawal threshold in grams. The abscissa scale is the log dose of BK (in ng) injected in a volume of 2.5  $\mu\text{L}$  saline into the dermis of the skin of the dorsal aspect of the hind paw. Data from Khasar et al. (1998a) with permission. (b) Role of denervation of adrenal medullae on bradykinin-induced behavioral mechanical hyperalgesia and its enhancement after subdiaphragmatic vagotomy. Data from experiments in which the adrenal medullae are denervated: rats with denervated adrenal medullae (AM denervation, open squares,  $n = 6$ ); vagotomized rats with denervated adrenal medullae (AM denerv plus vagotomy, closed squares;  $n = 10$ ). Experiments were conducted 7 days after surgery. Paw-withdrawal thresholds of vagotomized rats in which the adrenal medullae were denervated are significantly higher than those of rats which are only vagotomized (see open triangles in a;  $P < 0.05$ ). Paw-withdrawal thresholds of rats in which the adrenal medullae are denervated are significantly higher than those of rats which were additionally vagotomized ( $P < 0.05$ ; compare open with closed squares). Modified from Khasar et al. (1998b).

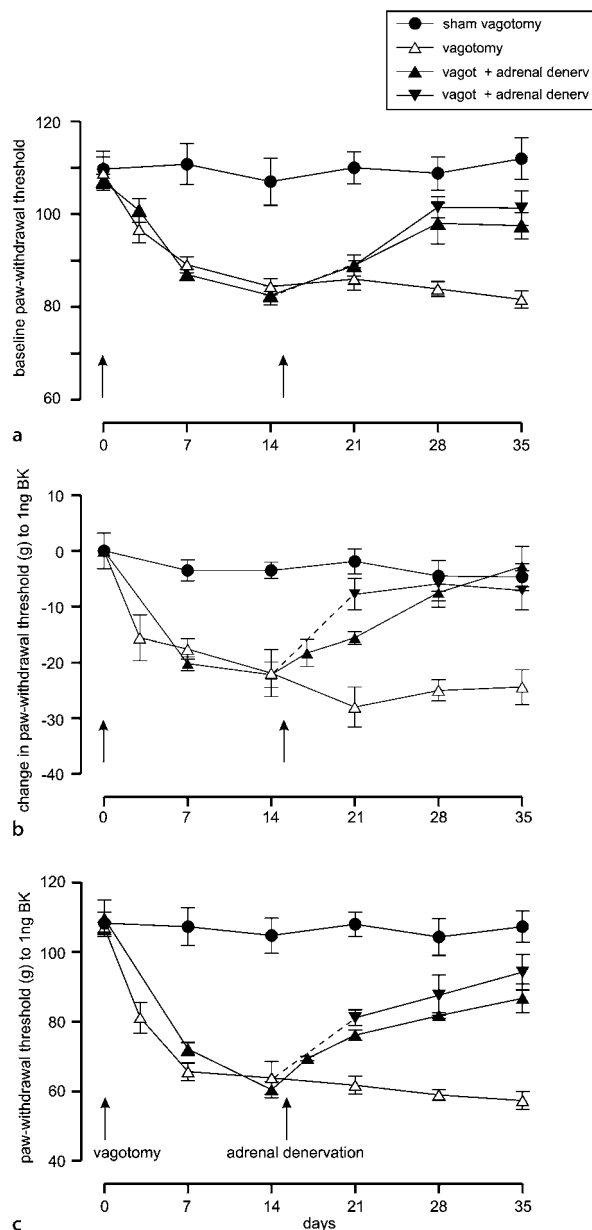
tained by activity in vagal afferents acts continuously on the central nociceptive pathway, one would expect, on the basis of studies reported by Gebhart, Randich and coworkers (Foreman 1989; Gebhart and Randich 1992; Randich and Gebhart 1992), that subdiaphragmatic vagotomy might enhance the mechanical hyperalgesic behavior, irrespective of the way the nociceptive afferents have been sensitized (e.g. by bradykinin or another hyperalgesic agent), and lower baseline threshold to mechanical stimulation. Baseline paw-withdrawal threshold (normal rats:  $109 \pm 2.1$  g [mean  $\pm$  SEM]; sham-vagotomized rats:  $107 \pm 2.8$  g; open and closed circles in Fig. 1a) is significantly decreased 7 days after vagotomy ( $89 \pm 1.7$  g; triangles in Fig. 1a). Bradykinin-induced hyperalgesia is significantly enhanced 7 days after subdiaphragmatic vagotomy (triangles in Fig. 1a). There are three important characteristics of the effect of vagotomy on mechanical baseline threshold and on bradykinin-induced decrease of paw-withdrawal threshold to mechanical stimulation:

1. The dramatic enhancement of bradykinin-induced mechanical hyperalgesic behavior also occurs when only the celiac vagal branches are interrupted, but not when the gastric and/or hepatic branches of the abdominal vagus nerves are interrupted. Thus, the vagal afferents involved project through the celiac branches of the abdominal vagus nerves, which innervate the small intestine and proximal part of the large intestine, and not through the hepatic or gastric branches. Surprisingly, the baseline paw-withdrawal threshold to mechanical stimulation does not decrease when only the celiac vagal branches are interrupted (Khasar et al. 1998a).

2. Both vagotomy-induced changes (decrease in baseline paw-withdrawal threshold, bradykinin-induced hyperalgesic behavior) take about 1 to 2 weeks to reach maximum and remain stable over 5 weeks (Fig. 2) (Khasar et al. 1998a; Khasar et al. 1998b).
3. Subdiaphragmatic vagotomy does not have a significant effect on cutaneous mechanical hyperalgesic behavior produced by intradermal injection of prostaglandin E<sub>2</sub> (which is supposed to act directly to sensitize nociceptors) (Khasar et al. 1998a).

Thus, the effect of vagotomy is not a general effect of all abdominal vagal afferents, and cannot readily be explained by an immediate removal of inhibition from the central nociceptive system (e.g. acting in the dorsal

**Sympatho-Adrenal System and Mechanical Hyperalgesic Behavior, Animal Experimentation, Figure 2** Long-term enhancement of bradykinin-induced behavioral mechanical hyperalgesia after vagotomy and its disappearance after denervation of the adrenal medullae. Baseline paw-withdrawal threshold (a), difference between baseline paw-withdrawal threshold and paw-withdrawal threshold in response to 1 ng BK injected intradermally (b), and total change of paw-withdrawal threshold in response to intradermal injection of 1 ng bradykinin (c) in rats before and 7 to 35 days after vagotomy (open triangles, n = 6), in rats before and 7 to 35 days after sham-vagotomy (closed circles, n = 8) and in rats which are first vagotomized and whose adrenal medullae (AM) are denervated 14 days after vagotomy and measurements taken up to 35 days after initial surgery. The latter group of animals consists of two subgroups: rats which are tested after vagotomy and after additional denervation of the adrenal medullae (closed normal triangles, n = 6) and rats which are only tested after additional denervation of the adrenal medullae (closed inverted triangles, n = 4). Ordinate scale is threshold in grams. Data of the sham-vagotomy and the vagotomy group of rats are significantly different 7 days after vagotomy ( $P < 0.01$ ). Data of vagotomized rats with denervated AM and rats that are only vagotomized are significantly different on days 28 and 35 ( $P < 0.01$ ). Data between sham-vagotomized rats and vagotomized rats in which the adrenal medullae are denervated are not significantly different on days 28 and 35 ( $P > 0.05$ ). Modified from Khasar et al. (1998b).



horn), as predicted by the experiments of Foreman, Gebhart, Randich and coworkers (see above).

#### Effect of Denervation or Removal of the Sympatho-Adrenal System

Bilateral removal or selective denervation of the adrenal medullae (cutting the sympathetic preganglionic axons) generates a small increase in both baseline paw-withdrawal threshold and paw-withdrawal threshold to intradermal injection of bradykinin compared to the controls (open squares vs. closed circles in Fig. 1b). Under this condition of defunctionalized adrenal medullae (i.e. when the effect of adrenaline described below has been removed), subdiaphragmatic vagotomy is followed by only a small decrease in paw-withdrawal threshold (compare open and closed squares in Fig. 1b), but not by the large changes seen in animals with functioning adrenal medullae. These small changes are significant, with the exception of the change of baseline threshold in animals with denervated adrenal medullae. They can be fully explained by removal of central inhibition of nociceptive impulse transmission probably occurring in the dorsal horn (Gebhart and Randich 1992; Randich and Gebhart 1992).

#### Effect of Denervation of the Adrenal Medullae 14 Days Following Vagotomy

The data obtained on vagotomized rats argue that the decrease of baseline mechanical paw-withdrawal threshold and the enhanced decrease of paw-withdrawal threshold to mechanical stimulation, generated by intradermal injection of bradykinin, are generated by adrenaline released from the adrenal medullae. Therefore, it is postulated that these changes seen in vagotomized rats are reversed when the adrenal medullae are denervated, that adrenaline administered chronically simulates the effects, and that a chronic  $\beta$ -adrenoceptor-blockade prevents or attenuates the effect of vagotomy. Groups of rats were repeatedly tested over 5 weeks for their mechanical paw-withdrawal threshold to 1 ng bradykinin injected intracutaneously (a dose that does not decrease the threshold to mechanical stimulation in normal rats with intact vagus nerves) (Fig. 1a, b): (1) Rats in which the vagus nerves were severed subdiaphragmatically followed 14 days later by denervation of the adrenal medullae. (2) Rats which were only vagotomized and repeatedly tested. (3) Control rats which were repeatedly tested without any surgical intervention. Figure 2 demonstrates the results of these experiments for the baseline paw-withdrawal threshold (a), for the decrease in paw-withdrawal threshold to intradermal injection of 1 ng bradykinin alone (b), and for both effects together (c). After vagotomy the paw-withdrawal threshold slowly decreases, reaching its lowest values after 7–14 days. The reversal of the vagotomy effect after additional denervation of the adrenal medullae also has a similar slow time course

(closed triangles in Fig. 2). Repeated testing of sham-vagotomized control rats over the same time period did not reveal a decrease in paw-withdrawal threshold produced by 1 ng bradykinin (closed circles in Fig. 2). The paw-withdrawal thresholds, 14 and 21 days after denervation of the adrenal medullae, are significantly higher than those measured in the animals that are only vagotomized (closed triangles vs. open triangles in Fig. 2). The paw-withdrawal thresholds in response to 1 ng bradykinin at 14 and 21 days after denervation of the adrenal medullae in vagotomized animals are not significantly different from those in sham-vagotomized (control) animals (closed triangles vs. closed circles in Fig. 2).

Chronic administration of adrenaline (10.8  $\mu$ g/h; using a subcutaneously implanted microosmotic pump) generates the same effect as vagotomy: The bradykinin-induced paw-withdrawal threshold to mechanical stimulation significantly decreases. This decrease is delayed and reaches its peak effect 14 days after start of epinephrine infusion. After chronic infusion of the  $\beta_2$ -adrenoceptor blocker ICI 118,551, the decrease of bradykinin-induced paw-withdrawal threshold following vagotomy is significantly attenuated. The plasma levels of adrenaline following vagotomy significantly increase 3, 7 and 14 days after subdiaphragmatic vagotomy compared to sham-vagotomized animals (Khasar et al. 2003).

#### Interpretation of the Results

These results suggest that vagotomy does not only remove ongoing inhibition of nociceptive impulse transmission in the dorsal horn (which is small in the rat model of bradykinin-induced mechanical hyperalgesia), but triggers the activation of sympathetic preganglionic neurons innervating the adrenal medullae, probably by removing central inhibition acting at this sympathetic pathway. This leads to an increased release of adrenaline from the adrenal medullae, with an increased adrenaline level in the plasma. Interruption of the sympathetic preganglionic axons innervating the adrenal glands stops the release of adrenaline, and, therefore, prevents or reverses the decrease of baseline mechanical paw-withdrawal threshold and the enhancement of bradykinin-induced decrease of paw-withdrawal threshold to mechanical stimulation. This novel finding implies that the sensitivity of nociceptors to mechanical stimulation is potentially under the control of the sympatho-adrenal system, and that nociceptor sensitivity can be regulated from remote body domains by way of the brain and this neuroendocrine pathway. The novel mechanism has several implications and raises several interesting questions and problems (Jänig et al. 2000):

- The vagal afferents that are involved in modulation of hyperalgesic behavior project through the celiac



branches of the abdominal vagus nerves and supply the small and large intestines, but probably not liver and stomach. These vagal afferents may monitor toxic and other events at the inner defense line of the body (the „gut associated lymphoid tissue“, GALT). The physiological stimuli activating these vagal afferents are unknown (Jänig 2005).

- The changes following vagotomy (decreased mechanical baseline threshold and enhanced bradykinin-induced mechanical hyperalgesic behavior; Khasar et al. 1998a, b) are generated by the interruption of vagal afferents. Thus, the vagal afferents involved must be tonically active.
- The mechanism of the slow time course of the changes of paw-withdrawal threshold is unknown. Adrenaline obviously has to act over a long period of time to induce changes in the microclimate of the nociceptor population, which in turn leads to their sensitization (Khasar et al. 2003). It most likely does not act directly on the nociceptors but on other cells (e.g. macrophages, mast cells, keratinocytes), which then release substances that generate the sensitization. This is consistent with the finding that prostaglandin E<sub>2</sub>-induced mechanical hyperalgesic behavior is not changed after vagotomy (Khasar et al. 1998a).
- The change of sensitivity of a population of cutaneous nociceptors generated by adrenaline, which is regulated by the brain, would be a novel mechanism of sensitization. This novel mechanism of nociceptor sensitization would be different from mechanisms that lead to activation and/or sensitization of nociceptors by sympathetic-afferent coupling under pathophysiological conditions (see ► [Sympathetic nervous system and pain](#) ► [Sympathetic Nervous System in the Generation of Pain: Animal Behavioral Models](#) ► [Sympathetic-Afferent Coupling in the Dorsal Root Ganglion, Neurophysiological Experiments](#) ► [Sympathetic-Afferent Coupling in the Afferent Nerve Fiber, Neurophysiological Experiments](#)).
- Which central pathways are involved in leading to the activation of preganglionic sympathetic neurons that innervate the adrenal medullae after subdiaphragmatic vagotomy? Are only sympathetic neurons that innervate the adrenal medullae activated after vagotomy or also other functional types of sympathetic neuron (Jänig and McLachlan 2002; Jänig 2006)? Experimental investigations performed on rats show that sympathetic preganglionic neurons, innervating cells of the adrenal medullae that release adrenaline, are connected to distinct neuronal circuits in the neuraxis, which are different from those connected to preganglionic neurons involved in regulating other autonomic functions (Morrison and Cao 2000; Morrison 2001).

## Conclusions

The experiments imply that adrenaline released by the adrenal medullae can sensitize nociceptors. This sensitization is a long-term effect and requires continuous activation of the adrenal medullae. Are all or only subgroups of nociceptors sensitized? Are nociceptors innervating deep somatic tissues or viscera also sensitized?

## References

1. Cryer PE (1980) Physiology and Pathophysiology of the Human Sympathoadrenal Neuroendocrine System. *New England J Med* 303:436–444
2. Edwards SL, Anderson CR, Southwell BR et al. (1996) Distinct Preganglionic Neurons Innervate Noradrenaline and Adrenaline Cells in the Cat Adrenal Medulla. *Neurosci* 70:825–832
3. Esler M, Jennings G, Lambert G et al. (1990) Overflow of Catecholamine Neurotransmitters to the Circulation: Source, Fate, and Functions. *Physiol Rev* 70:963–985
4. Folkow B (1955) The Control of Blood Vessels. *Physiol Rev* 35:629–663
5. Folkow B, Euler USv (1954) Selective Activation of Norepinephrine and Adrenaline Producing Cells in the Cat's Adrenal Gland by Hypothalamic Stimulation. *Circ Res* 2:191–195
6. Foreman RD (1989) Organization of the Spinothalamic Tract as a Relay for Cardiopulmonary Sympathetic Afferent Fiber Activity. *Prog Sensory Physiol* 9:1–51
7. Gebhart GF, Randich A (1992) Vagal Modulation of Nociception. *Am Pain Soc J* 1:26–32
8. Jänig W (2005) Vagal Afferents and Visceral Pain. In: Udem B, Weinreich D (eds) *Advances in Vagal Afferent Neurobiology*. CRC Press, Boca Raton, pp 461–489
9. Jänig W, McLachlan EM (2002) Neurobiology of the Autonomic Nervous System. In: Mathias CJ, Bannister R (eds) *Autonomic Failure*, 4<sup>th</sup> edn. Oxford University Press, Oxford
10. Jänig W (2006) *The Integrative Action of the Autonomic Nervous System: Neurobiology of Homeostasis*. Cambridge University Press, Cambridge, New York
11. Jänig W, Khasar SG, Levine JD et al. (2000) The Role of Vagal Visceral Afferents in the Control of Nociception. *Prog Brain Res* 122:273–287
12. Khasar SG, Miao F-JP, Jänig W et al. (1998a) Modulation of Bradykinin-Induced Mechanical Hyperalgesia in the Rat Skin by Activity in the Abdominal Vagal Afferents. *Eur J Neurosci* 10:435–444
13. Khasar SG, Miao F-JP, Jänig W et al. (1998b) Vagotomy-Induced Enhancement of Mechanical Hyperalgesia in the Rat is Sympathoadrenal-Mediated. *J Neurosci* 18:3043–3049
14. Khasar SG, Green PG, Miao F-JP et al. (2003) Vagal Modulation of Nociception is Mediated by Adrenomedullary Epinephrine in the Rat. *Eur J Neurosci* 17:909–915
15. Kopin IJ (1989) Plasma Levels of Catecholamines and Dopamine-Beta-Hydroxylase. In: Trendelenburg U, Weiner N (eds) *Catecholamines II. Handbook of Experimental Pharmacology*, vol 90/II. Springer-Verlag, Berlin, pp 211–275
16. Miao F-JP, Jänig W, Levine JD (2000) Nociceptive-Neuroendocrine Negative Feedback Control of Neurogenic Inflammation Activated by Capsaicin in the Skin: Role of the Adrenal Medulla. *J Physiol (Lond)* 527:601–610
17. Miao F-JP, Jänig W, Jasmin L, Levine JD (2001) Spino-bulbo-spinal pathway mediating vagal modulation of nociceptive-neuroendocrine control of inflammation in the rat. *J Physiol* 532:811–22
18. Morrison SF (2001) Differential Control of Sympathetic Outflow. *Am J Physiol Regul Integr Comp Physiol* 281:683–698
19. Morrison SF, Cao WH (2000) Different Adrenal Sympathetic Preganglionic Neurons Regulate Epinephrine and Norepinephrine Secretion. *Am J Physiol Regul Integr Comp Physiol* 279:1763–1775

20. Randich A, Gebhart GF (1992) Vagal Afferent Modulation of Nociception. *Brain Res Rev* 17:77–99
21. Vollmer RR (1996) Selective Neural Regulation of Epinephrine and Norepinephrine Cells in the Adrenal Medulla – Cardiovascular Implications. *Clin Exp Hypertens* 18:731–751

## Sympathomimetic Amines

### Definition

Amines that mimic effects of agents that activate the sympathetic nervous system.

- ▶ Cytokines, Effects on Nociceptors

## Sympatho-Nociceptive Coupling

- ▶ Sympathetically Maintained Pain and Inflammation, Human Experimentation

## Symphysis Pubis Dysfunction

### Definition

Separation of the symphysis pubis is a complication of pregnancy, with an increasing prevalence from 1 in 36 at worst [Owens, Pearson & Mason 2002]. In the past it has largely been ignored as a cause of painful morbidity after delivery. It is characterized by suprapubic pain and tenderness with radiation to the backs of the legs, difficulty in walking and occasionally bladder dysfunction. A clinical history is usually adequate to make the diagnosis, but confirmation by ultrasound or radiography may be required. It is a condition associated with multiparity but the underlying etiology has not been fully investigated. Conservative therapy is usual with rest, binders and mild analgesics and complete recovery is expected up to two months after delivery.

- ▶ Postpartum Pain

## Symptom Magnifier

### Definition

A claimant whose verbal or nonverbal communications suggest a degree of incapacitation that appears to be excessive compared to his or her medical findings, or to the communications of other individuals with similar medical findings.

- ▶ Impairment, Pain-Related

## Symptomatic Annular Tear

- ▶ Discogenic Back Pain

## Symptomatic Cramps

### Definition

Cramps due to several diseases such as central and peripheral nervous system disorders, muscular diseases, vascular diseases, endocrine-metabolic diseases, electrolyte imbalance, toxic and pharmacological substances, and psychiatric disorders.

- ▶ Muscular Cramps

## Symptomatic Intracranial Hypotension

- ▶ Headache Due to Low Cerebrospinal Fluid Pressure

## Symptomatic Trigeminal Neuralgia

- ▶ Trigeminal Neuralgia, Etiology, Pathogenesis and Management

## Symptoms

### Definition

Symptoms are sensations that patients experience and interpret as warnings that something is out of balance or wrong within their bodies, and those experiences are communicated to clinicians. The US Social Security Administration holds that no symptom can be the basis for a finding of disability, no matter how genuine the person's complaints may appear to be, unless there is objective medical evidence that demonstrates the existence of a physical or mental impairment(s) that could reasonably be expected to produce the symptom.

- ▶ Disability Evaluation in the Social Security Administration
- ▶ Hypoalgesia, Assessment
- ▶ Hypoesthesia, Assessment

## Synapse

### Definition

The junction where a signal is transmitted from one nerve cell to another, to a muscle cell or to a gland cell usually by a neurotransmitter (chemical synapse) but sometimes electrically (electrical synapse).

- ▶ Amygdala, Pain Processing and Behavior in Animals

## Synaptic Glomerulus

### Definition

Synaptic glomerulus is a complex synaptic arrangement representing a central terminal from primary afferents surrounded with many neural elements such as axon terminals and dendrites.

- ▶ [Trigeminal Brainstem Nuclear Complex, Anatomy](#)

## Synaptic Organization

### Definition

Synaptic organization is usually used as a morphological characteristic of synaptic contacts. The synapse is composed of different elements, which include a terminal axon, dendrite, dendritic spine and pre-synaptic axon. The number of elements varies according to the function of inputs and the output information to secondary neurons.

- ▶ [Morphology, Intraspinal Organization of Visceral Afferents](#)

## Synaptic Organization of Afferent Fibers from Viscera in the Spinal Cord

- ▶ [Morphology, Intraspinal Organization of Visceral Afferents](#)

## Synchronization

### Definition

Large ensembles of neurons firing at the same time.

- ▶ [Spinothalamocortical Projections to Ventromedial and Parafascicular Nuclei](#)

## Syndrome X

### Definition

Syndrome X is a condition characterized by angina-like chest pain and ST depression on stress ECG in patients that have normal coronary arteries on angiography.

- ▶ [Thalamus and Visceral Pain Processing \(Human Imaging\)](#)

## Synergistic

### Definition

The action of two or more substances achieving an effect greater than that possible with any of the individual components, i.e. the sum is greater than the parts. In medicine, this refers to the potentiation of one drug by one or more additional agents when administered together, or by a single drug at two separate sites.

- ▶ [Opioids and Reflexes](#)
- ▶ [Postoperative Pain, Appropriate Management](#)

## Synergy

### Definition

Synergy refers to the combined action of two agents that produce an effect that neither agent could produce alone, or an effect that is greater than the total of those produced by the individual agents.

- ▶ [Drugs with Mixed Action and Combinations, Emphasis on Tramadol](#)

## Synovial Joints

### Definition

A specialized joint that is characterized by opposing bone surfaces covered with cartilage and enveloped by a synovial membrane, which serves to secrete synovial fluid as a lubricant for the joint. Synovial joints typically allow unrestricted motion and are most commonly found in the arms and legs. These joints are the most common joints to be affected by osteoarthritis.

S

## Syntenic

### Definition

Syntenic refers to a conserved region of chromosomal DNA in which two or more genes are found adjacent in the chromosomes of two species.

- ▶ [TRPV1 Receptor, Species Variability](#)

## Syringomyelia

### Definition

A chronic progressive disease of the spinal cord in which cavities form in the gray matter.

- ▶ [Central Pain, Outcome Measures in Clinical Trials](#)
- ▶ [Spinal Cord Injury Pain](#)

---

## Systematic

### Definition

Characterized by a series of orderly actions that are planned and deliberate: not haphazard.

- ▶ [Pain Assessment in Neonates](#)

---

## Systematic Review

### Definition

A review of the literature, in which there is a clearly formulated question, and systematic and explicit methods are used to identify, select and critically appraise relevant research, and to collect and analyze data from the original studies that are included in the review. (Petitti, 1994).

- ▶ [Lumbar Traction](#)

---

## Systemic Lupus Erythematosus

### Synonyms

SLE

### Definition

Systemic Lupus Erythematosus (SLE) is a systemic autoimmune disease with antinuclear antibodies and multilocular manifestations, caused by a thrombotic vasopathy or antibodies interacting with cell membrane function.

- ▶ [Headache Due to Arteritis](#)

---

## Systemic Morphine Effects on Evoked Pain

- ▶ [Opioids, Effects of Systemic Morphine on Evoked Pain](#)

---

## Systems Theory

### Definition

Principles, models, and laws applied to the interrelationships and interdependencies of sets of linked components that form a system.

- ▶ [Assessment of Pain Behaviors](#)



---

## Tabes Dorsalis

### Definition

A late complication of neurosyphilis. It results in gait impairment, joint deformity, pain, lack of coordination, sensory loss, as well as autonomic dysfunction and ocular symptoms. Pain is felt mostly in the legs and is described as lightning and lancinating. Abdominal colicky pain is also reported.

- ▶ [Central Nervous System Stimulation for Pain](#)

---

## Tachykinin

### Definition

Tachykinins are a family of structurally-related peptides, widely scattered in vertebrate and invertebrate tissues. Mammalian tachykinins are substance P (SP), neurokinin A (NKA), and neurokinin B (NKB). All mammalian tachykinins share a common C-terminal amino acid sequence, i.e. Phe-x-Gly-Leu- MetNH, which is the minimal structural motif for the activation of tachykinin receptors (NK1, NK2 and NK3). Pharmacologically, they all cause hypotension in mammals, contraction of gut and bladder smooth muscle, and secretion of saliva.

- ▶ [Neuropeptide Release in the Skin](#)
- ▶ [NGF, Regulation during Inflammation](#)
- ▶ [Visceral Nociception and Pain](#)

---

## Tachyphylaxis

- ▶ [Nociceptor, Fatigue](#)

---

## Tactile Allodynia

### Definition

Tactile allodynia refers to touch-evoked pain, i.e. pain due to a mechanical stimulus that does not normally provoke pain.

- ▶ [Opioids in the Spinal Cord and Modulation of Ascending Pathways \(N. gracilis\)](#)

---

## Tactile Allodynia Test

### Definition

The plantar aspects of intact and neuropathic legs of rats are probed with Von Frey hairs of different calibers or strengths. The number of paw withdrawals per 10 trials is counted. In general, a number of 5/10 withdrawals is observed with hairs of strength  $\geq 20$  g in rats with intact legs, and in rats with mononeuropathy, a hair of 2 g can produce a score of  $\geq 5/10$  withdrawals.

- ▶ [Thalamotomy, Pain Behavior in Animals](#)

---

## Tactile Stimuli

### Definition

Stimuli of light touch applied to the skin.

- ▶ [Causalgia, Assessment](#)
- ▶ [Dysesthesia, Assessment](#)

---

## Tail Immersion

### Definition

Submersion of the tail in hot water may be used as the nociceptive stimulus in the Tail-Flick Test.

- ▶ [Tail-Flick Test](#)

---

## Tail Skin Temperature Recording

### Definition

Thermocouples, thermistors or infrared sensors may be used.

- ▶ [Tail-Flick Test](#)

## Tail-Flick Latency

### Definition

Tail-Flick latency is the time from the start of the noxious stimulus until the animal flicks its tail.

► [Tail-Flick Test](#)

## Tail-Flick Latency Correction

### Definition

The tail-flick latency may be corrected for influences of tail skin temperature using a regression analysis or analysis of covariance. Linearity of the data can be assumed only for a limited range of skin temperatures. In some experiments preheating of the tail to a certain temperature may be used.

► [Tail-Flick Test](#)

## Tail Flick Test

KJELL HOLE, ARNE TJØLSEN  
University of Bergen, Bergen, Norway  
kjell.hole@fys.uib.no, arne.tjolsen@fys.uib.no

### Definition

The tail-flick test is a test of nociception used in rats and mice. The noxious stimulus is usually ► [radiant heat](#) on the tail or ► [tail immersion](#) in hot water, and the response is a flick of the tail.

### Characteristics

The tail-flick test is an extensively used test of nociception in rats and mice, and is the nociceptive test most frequently used in animals (Le Bars et al. 2001), first described in 1941 (D'Amour and Smith 1941). In the standard method, radiant heat is focused on the tail, and the time it takes until the animal flicks the tail away from the beam is measured. This ► [tail-flick latency](#) is a measure of the nociceptive sensitivity of the animal, and is prolonged by opioid analgesics, for instance. A spinal transection above the lumbar level does not block the tail-flick response. Thus, in this test, a spinal nociceptive reflex is measured, and pain is not measured directly. Still, this is considered a very useful test of "phasic pain", both in basic pain research and in pharmacological investigations of analgesic drugs. The relevance of the test as a measure of pain has been discussed (Le Bars et al. 2001). The test stimulus is noxious heat. In addition to the test with radiant heat (e.g. focused light from a light bulb), the stimulus may be applied by e.g. direct contact with a heated surface, such as a Peltier element, or by submersion of part of the tail in hot water. The test may be

performed in lightly anaesthetized rats or mice, as well as in animals that are awake.

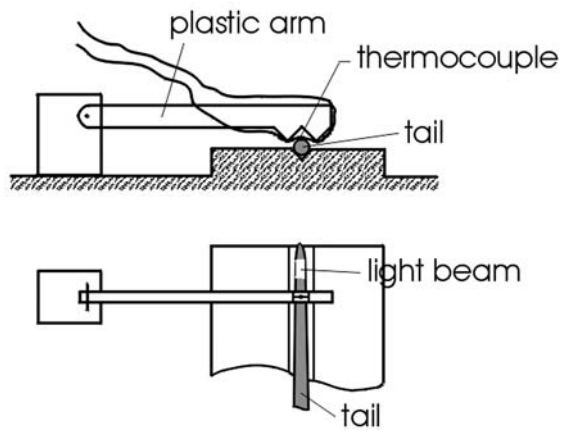
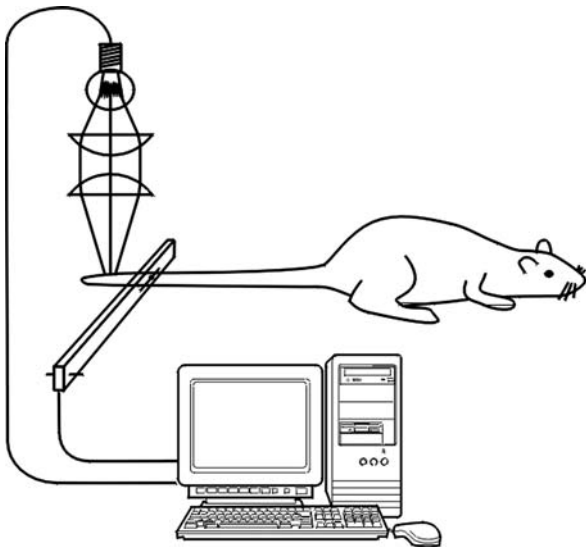
Several tail-flick apparatuses are commercially available, and many laboratories have made their own apparatus. The main requirements are stable functioning and proper focus of the light beam on the tail. The tail-flick latency may be recorded by means of a photocell, which is activated when the animal flicks the tail. When a photocell is used, one should be aware that the reflex response may involve retracting the tail, without immediately removing the tail from the light beam. Thus the rats' behaviour should always be observed.

The tail-flick test may be a good and useful test of nociception, but only if it is carefully performed and possible sources of error are taken into account. One requirement, particularly in rats, is that the animals are well handled. This may require daily handling for up to a week, including adaptation to the test apparatus. Some researchers confine the animals in a plastic tube during testing. If this is used, it is necessary that the animals are so well handled that they freely walk in and out of the tube. We find it better and faster not to use a tube, but to hold the well-adapted animal by hand.

A particular problem with tests that use thermal stimulation is the possible confounding influence of the skin temperature. In electrophysiological studies in animals, it has been reported that changes in the temperature or blood flow of the skin (Duggan et al. 1978) alter the response to cutaneous heat stimulation. More recently, it has been found that the tail skin temperature affects the tail-flick latency as well. This has been described using radiant heat stimulation (Ren and Han 1979; Berge et al. 1988; Roane et al. 1998; Sawamura et al. 2002) as well as with hot water immersion of the tail (Milne and Gamble 1989). For an extensive review see Le Bars et al. (2001). However, in many laboratories the tail-flick test is still performed without taking the tail skin temperature into account. This is probably a main confounding factor, and therefore needs special consideration in the following.

We have investigated the relationship between skin surface temperature and tail-flick latency in rats in a setup with a radiant heat apparatus, stimulating the distal part of the tail (10–15 mm from the tip), with a stimulated area of 15–20 mm<sup>2</sup> (Fig. 1). Using control latencies of approximately 4s, we regularly find a clear and reproducible relationship between tail skin temperature and tail-flick latency, with a slope of the regression equation of  $-0.3 - 0.4s/^{\circ}C$  (Tjølsen et al. 1989). With similar methodology, the same relationship has been found in mice, with a very similar slope (Eide et al. 1988).

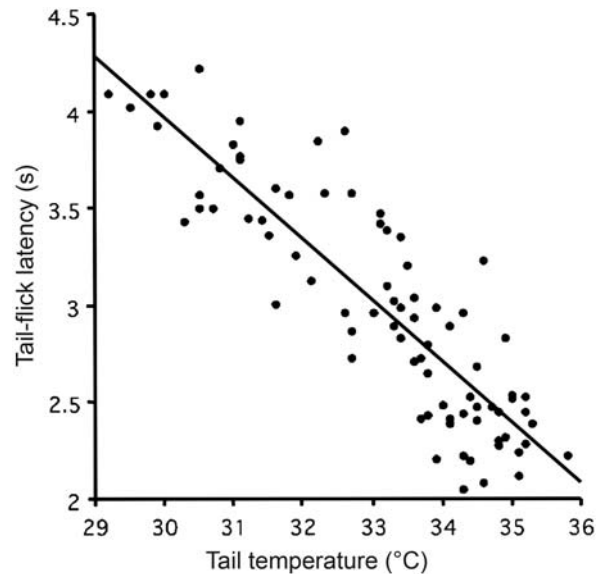
The tail is the most important thermoregulatory organ of the rat. The heat loss is regulated by an on-off regulation of blood flow in the tail, which leads to rapid variations in skin temperature (Milne and Gamble 1989, Tjølsen and Hole 1992). The amount and duration of vasodilation is partly determined by the relationship between the am-



**Tail Flick Test, Figure 1** Simple test equipment for concomitant recording of tail skin temperatures and tail-flick latencies. A standard tail-flick apparatus can easily be modified to enable recording of tail skin temperatures. The temperature is measured by means of a small thermocouple mounted on a plastic arm, 65 mm long, which rests on the tail with a force corresponding to approximately 1g. For a thorough description see Tjølsen et al. (1989).

bient temperature and the acclimatization temperature. In rats at rest, the ambient temperature where vasodilation occurs is lower after acclimatization to cold, than after acclimatization to a warmer environment. When animals are lightly stressed and activated due to experimental procedures, a considerable increase in tail skin temperature is regularly observed (Tjølsen et al. 1989). Rats restrained in tubes for a short time may show a considerable increase in the temperature of the tail (Tjølsen and Hole 1992), probably due to vasodilation.

The relationship between skin temperature and response latency (Fig. 2) would be expected to vary with different experimental conditions. The most reliable values for the slope are obtained in experiments where data from repeated measures are not pooled, but analysed separately



**Tail Flick Test, Figure 2** The relationship between tail-flick latency and tail skin temperature. Data were obtained from eight measurements in each of 12 rats. Tail skin temperature was controlled by means of a heating blanket. Adapted from Sawamura et al. (2002), with permission.

for each time point (Tjølsen et al. 1989). In fact, if repeated measures on the same animals are pooled in a regression analysis, an error in the calculated slope may be introduced. A possible cause of error is the effect of repeated testing on nociception itself, whether due to stress or to local effects in the skin if the same site is stimulated repeatedly. The time required for heating the tissue to a critical response temperature will depend on the initial skin temperature, which is determined by local blood flow within the limits given by deep body and ambient temperatures. Measuring subcutaneous tissue temperatures during a radiant heat stimulus, we found that the rate of increase in tissue temperature was independent of initial skin temperature, and the time required to reach a hypothetical threshold temperature was strongly dependent on the initial temperature (Hole and Tjølsen 1993). As a consequence, the tail-flick latency is negatively correlated to the ambient temperature (Berge et al. 1988) and to skin temperature when the heating intensity is kept constant.

The temperature of the tail skin of rats during an experiment may rise as much as 8°C in untreated animals (Tjølsen and Hole 1992). It is reasonable to consider this is the maximal possible difference in skin temperature due to changes in vasodilation. With a change in tail-flick latency of 0.3–0.4 s/°C, it would imply a potential difference in tail-flick latency of up to approximately 3s. In a group of rats, not all animals would show this degree of vasodilation, and hence the mean difference in latency would be somewhat smaller. However, this shows that increased vasoconstriction or inhibition of vasodilation may cause differences in

tail–flick latency that easily could be misinterpreted as analgesia.

The potential for treatment–induced vasodilation to cause reduction of the tail–flick latencies is approximately the same size. Under circumstances when control animals are relatively vasoconstricted, vasodilation may lead to an increase in tail skin temperature from about ambient temperature to above 30°C. The effect of vasodilation is particularly important, as smaller changes in the tail–flick latency are required to interpret the results as hyperalgesia than as analgesia. Even a modest increase in the mean tail skin temperature of about 3.5°C, due to lesioning of descending serotonergic systems, leads to a reduction of the tail–flick latency from 4–4.5s to about 3s (Hole and Tjølsen 1993). If the change in skin temperature were not taken into consideration, a reduction of the tail–flick latency of this size would have been considered an indication of a hyperalgesic state.

Many experimental treatments affect blood flow and thereby the tail skin temperature. This may by itself influence the tail–flick latency, and lead to erroneous conclusions with regard to nociception. An increase in tail skin temperature may shorten tail–flick latencies and may be interpreted as hyperalgesia (Urban and Smith 1994; Roane et al. 1998; Sawamura et al. 2002). Even a reduction in tail skin temperature compared to untreated animals may occur, and may be interpreted as analgesia. Desipramine reduced tail skin temperature and increased tail–flick latencies at an ambient temperature of 24–25°C, while no significant change was observed at 21–22°C (Hole and Tjølsen 1993). This difference in temperature is well within the variation in ambient temperature between laboratories, and even within the range of ambient temperatures that may occur in a laboratory with insufficient control of room temperature. In the experiments at 24–25°C, desipramine inhibited vasodilation so that the skin temperatures in the drug–treated group were close to the ambient temperature, while control animals showed higher skin temperatures and hence shorter response latencies.

Stress, due to a new environment, handling or injection procedures, may influence peripheral blood flow and tail temperature. In rats, stress causes motor activation, increased heat production, increased core temperature and an increased frequency and duration of the periods of vasodilation and increase in skin temperature of the tail. It has been shown (Tjølsen et al. 1992) that immobilization may cause a considerable increase in core temperature and tail vasodilation, while small doses of morphine (0.5–1mg/kg) completely abolish the vasodilation.

The importance of the skin temperature for the ordinary use of the tail–flick test has been discussed (Roane et al. 1998). Clearly, when high doses of potent analgesics like opioids are used, the relative influence of the skin temperature may be small. However, when the temperature influence is not known, this will always be an un-

predictable confounding factor. As discussed above, this has, in several instances, lead to erroneous conclusions.

### Possible Remedies

The temperature of the tail skin should always be considered a possible confounding factor when performing the tail–flick test. A minimal requirement should be that the tail skin temperature is measured before testing, e.g. by means of thermocouples (Fig. 1), thermistors or infrared sensors, and the possible influence of the temperature evaluated.

It is obviously necessary to take the effects of skin temperature into account when investigating factors, or using drugs that may influence autonomic activity and thermo – or cardiovascular regulation. Recording the tail skin temperature and correcting the tail–flick latency data for changes in the temperature may reduce the problem. In some cases, a regression analysis or an analysis of covariance may be performed for this purpose. Methods for tail–flick testing with measurement of skin temperature and for correction of tail–flick data (see ► [tail–flick latency correction](#)) have been described (Tjølsen et al. 1989; Roane et al. 1998; Sawamura et al. 2002). However, there are some limitations when using this type of statistical analysis on tail–flick data. In these statistical methods, linearity of the relationship is supposed. It seems to be a reasonable approximation to suppose linearity over a normal, limited range of skin temperatures in untreated animals, e.g. 20–30°C. In studies where drug administration causes a large increase in tail–flick latency due to changes in nociception, the assumption of linearity may not be correct. Above all, these methods for statistical evaluation cannot adequately handle cut-off values for tail–flick latencies. This should be considered in each experiment, and even when limitations as above are applicable, the temperature of the skin of the tail should be measured and the possible influence on the results should be evaluated.

As a number of factors may possibly influence the relationship between skin temperature and response latency, it seems ideal to adjust data from one experiment according to the regression slope calculated from that experiment. However, this will not always be possible, in that a regression analysis requires an adequate number of measurements to allow calculation of a reliable regression coefficient, and the spread of the independent variable (skin temperature) must be sufficiently large. If these requirements are not fulfilled, the results of the regression analysis will be inconclusive. With an increasing number of measurements in the analysis, there is an increasing probability that a reliable regression coefficient may be calculated. In many cases, it may be a problem to obtain a reliable correction of tail–flick data based on the same experiment, due to a limited number of animals measured. An alternative method for correction of latencies is to establish the relationship between skin temperature and tail–flick latency in an adequate number of



animals under similar experimental conditions, and subsequently to correct tail–flick latencies according to the calculated regression factor (Ren and Han 1979). This method should be used with caution, because it must be assumed that the experiment is performed under the same conditions as when the correction factor was determined. This is of course an approximation.

Another alternative that has been used is local preheating of the tail to a certain temperature before measuring the tail–flick latency. If the temperatures of the skin and subcutaneous tissue in the stimulated area are constant before the start of stimulation, this may abolish the confounding effect of varying tissue temperatures. In electrophysiological experiments in anaesthetized cats, preheating has been used with a heating lamp and a feedback control system, with a thermocouple on the area of skin to be heated (Duggan et al. 1978). This procedure seemed to reduce the confounding effect of differences in blood flow. For tail–flick reflex recordings, this technique may be used in experiments in lightly anaesthetized animals for instance (Haws et al. 1990), or when the rat is placed in a restrainer and the tail is fixed (Carstens and Douglass 1995). It may probably be more difficult to use this method in animals that are awake when little restraint of the animal is required to minimize stress.

When performed as described here, the tail–flick test is a reliable and useful test of nociception in rodents.

## References

- Berge O-G, Garcia-Cabrera I, Hole K (1988) Response Latencies in the Tail–Flick Test Depend on Tail Skin Temperature. *Neurosci Lett* 86:284–288
- Carstens E, Douglass DK (1995) Midbrain Suppression of Limb Withdrawal and Tail–Flick Reflexes in the Rat: Correlates with Descending Inhibition of Sacral Spinal Neurons. *J Neurophysiol* 73:2179–2194
- D'Amour FE, Smith DL (1941) A Method for Determining Loss of Pain Sensation. *J Pharmacol Exp Ther* 72:74–79
- Duggan AW, Griersmith BT, Headley PM, Maher JB (1978) The Need to Control Skin Temperature when Using Radiant Heat in Tests of Analgesia. *Exp Neurol* 61:471–478
- Eide PK, Berge O-G, Tjølsen A, Hole K (1988) Apparent Hyperalgesia in the Mouse Tail–Flick Test due to Increased Tail Skin Temperature after Lesioning of Serotonergic Pathways. *Acta Physiol Scand* 134:413–420
- Haws CM, Heinricher MM, Fields HL (1990)  $\alpha$ -Adrenergic Receptor Agonists, but not Antagonists, Alter the Tail–Flick Latency when Microinjected into the Rostral Ventromedial Medulla of the Lightly Anesthetized Rat. *Brain Res* 533:192–195
- Hole K, Tjølsen A (1993) The Tail–Flick and Formalin Tests in Rodents: Changes in Skin Temperature as a Confounding Factor. *Pain* 53:247–254
- Le Bars D, Gozariu M, Cadden SW (2001) Animal Models of Nociception. *Pharmacol Rev* 53:597–652
- Milne RJ, Gamble GD (1989) Habituation to Sham Testing Procedures Modifies Tail–Flick Latencies: Effects on Nociception rather than Vasomotor Tone. *Pain* 39:103–107
- Ren MF, Han JS (1979) Rat Tail–Flick Acupuncture Analgesia Model. *Chin Med J* 92:576–582
- Roane DS, Bounds JK, Ang C-Y, Adloo AA (1998) Quinpirole-Induced Alterations of Tail Temperature Appear as Hyperalgesia in the Radiant Heat Tail–Flick Test. *Pharmacol Biochem Behav* 59:77–82
- Sawamura S, Tomioka T, Hanaoka K (2002) The Importance of Tail Temperature Monitoring during Tail–Flick Test in Evaluating the Antinociceptive Action of Volatile Anesthetics. *Acta Anaesthesiol Scand* 46:451–454
- Tjølsen A, Hole K (1992) The Effect of Morphine on Core and Skin Temperature in Rats. *NeuroReport* 3:512–514
- Tjølsen A, Lund A, Berge O-G, Hole K (1989) An Improved Method for Tail–Flick Testing with Adjustment for Tail–Skin Temperature. *J Neurosci Meth* 26:259–265
- Urban MO, Smith DJ (1994) Nuclei within the Rostral Ventromedial Medulla Mediating Morphine Antinociception from the Periaqueductal Gray. *Brain Res* 652:9–16

## Talairach Coordinates

### Definition

Initially developed for a specific stereotactic frame; based on one single brain; frequently used as a common coordinate system; X: left-right, Y: anterior-posterior, Z: superior-inferior; the reference point (0, 0, 0) is the anterior commissure (Talairach and Tournoux 1988).

- [Nociceptive Processing in the Secondary Somatosensory Cortex](#)

## Tampa Scale for Kinesiophobia

### Synonyms

TSK

### Definition

The Tampa Scale for Kinesiophobia is a questionnaire aimed at the assessment of fear of (re)injury due to movement, consisting of 17 items with 4–point likert-scales.

- [Disability, Fear of Movement](#)

## Tapotement

- [Massage and Pain Relief Prospects](#)

## Targeting

- [Trafficking and Localization of Ion Channels](#)

T

## Tarsal Tunnel

### Definition

The anatomic structures that the tibial nerve passes through at the medial ankle are termed the tarsal tunnel. Within this tunnel, the tibial nerve divides into the medial and lateral plantar and the calcaneal nerves, each of which has its own separate tunnel as it goes from the ankle to its final destination. These tunnels represent sites of anatomic narrowing in which nerves can become entrapped, and which can give symptoms of chronic nerve compression in the foot. These can be present in the patient with a systemic neuropathy, such as that due to diabetes.

- ▶ Painful Scars
- ▶ Ulceration, Prevention by Nerve Decompression

## Task Force on Promotion and Dissemination of Psychological Procedures

### Definition

In 1993, Division 12 (Clinical Psychology) of the American Psychological Association appointed a Task Force, with the goal of identifying and disseminating psychological interventions that could be considered as empirically validated. In its 1995 report, this Task Force published criteria that allowed the classification of psychological treatments as “well-established” and “probably efficacious” In 1999, for its special issue on empirically validated treatments in pediatric psychology, the *Journal of Pediatric Psychology* defined an additional category of “promising interventions” A treatment was considered to be well-established if there were at least two good between-group design experiments (or well-controlled single case studies) by at least two different investigators that demonstrated the treatment’s efficacy over placebo, or at least equal efficacy as compared to an already established treatment. In addition, a treatment manual or a well defined treatment protocol needed to be available. A treatment was considered as “probably efficacious” if there were at least two experiments showing its superiority to a wait-list control, or if there was at least one study (or a small series of single-case designs) that met the well-established treatment criteria. Finally, an intervention was considered “promising” if there was at least one well-controlled and another less well controlled study by separate investigators, or a small number of single case experiments, or at least two well-controlled studies by the same investigator.

- ▶ [Modeling, Social Learning in Pain](#)
- ▶ [Psychological Treatment of Pain in Children](#)

## Task Force on Vicarious Instigation

### Definition

Vicarious instigation describes the phenomenon that, possibly mediated by empathy, mere observation of another person’s response to a stimulus or a situation (e.g. a pain response) can induce a similar response in the observer in the absence of any direct experience with the eliciting stimulus or situation. In the context of pain, it is still a matter of debate whether observing another person in pain can induce a pain-like vicarious response in the observer or whether it elicits a more generalized emotional response in the observer.

- ▶ [Modeling, Social Learning in Pain](#)

## TAUT

### Definition

TAUT is a plasma membrane GABA transporter, which transports taurin with higher affinity than GABA.

- ▶ [GABA and Glycine in Spinal Nociceptive Processing](#)

## Taut Band

### Definition

A taut band is a string- or cord-like structure in striated muscle that extends the length of the muscle fibers. It consists of a number of fascicles that are most palpable across (at a right angle to) the fiber direction in the region of fiber midpoints, where the myofascial trigger point is located. The taut band is the responsive part of the muscle in a local twitch response.

- ▶ [Myofascial Trigger Points](#)

## Taxonomy

NIKOLAI BOGDUK

Royal Newcastle Hospital, Department of Clinical Research, University of Newcastle, Newcastle, NSW, Australia

nbogduk@mail.newcastle.edu.au

### Synonyms

Classification; Catalogue; List of Diagnoses and their Definitions

## Definition

A ► **taxonomy** is a catalogue that lists and classifies entities and provides definitions of them. It is like a dictionary restricted to a particular field of scholarship. It is designed to standardize the meaning and use of particular terms. In relation to pain medicine, a taxonomy lists, classifies, and defines terms used to describe pain, and provides criteria for the use of diagnostic labels.

## Characteristics

Two taxonomies have been produced for use in pain medicine. One, developed by the International Association for the Study of Pain (IASP), covers pain in general (Merskey and Bogduk 1994). The other, developed by the International Headache Society, relates exclusively to headache (Headache Classification Subcommittee of the International Headache Society 2004). A related taxonomy – the Diagnostic and Statistical Manual of Mental Disorders (► **DSM**, **DSM-IV**, **DSM-IVR**), was developed by the American Psychiatric Association and is designed to cover mental disorders, but includes some entries that potentially relate to pain (American Psychiatric Association 2000).

### IASP Taxonomy

The taxonomy of the IASP (Merskey and Bogduk 1994) consists of a short, introductory section devoted to the definition of terms used to describe pain, its different forms, (such as ► **somatic pain**, ► **Visceral Nociception and Pain**, ► **referred pain**, and ► **radicular pain**), and its associated clinical features, such as ► **hyperalgesia**, ► **allodynia**, and ► **hyperpathia**). The longer, more substantive section lists various entities that constitute possible diagnoses for patients with ► **chronic pain**. For each entity, criteria for making the ► **diagnosis** are stipulated. The entities are catalogued and listed according to the region of the body that they affect. Conditions that affect the whole body, or which may occur in any region of the body, are described first, followed by conditions that affect the head, the neck and cervical spine, the upper limbs, the thoracic region and thoracic spine, the abdomen and pelvis, the lumbar spine, and the lower limbs.

The IASP Taxonomy was developed because it was recognized that particular terms were being used indiscriminately by practitioners. Different practitioners were using the same term to apply to different conditions, and different terms were used to apply to the same condition. Practitioners were also applying different diagnostic labels to what were essentially the same patients, or were applying labels to patients that were not appropriate. In effect, the use of terms and diagnostic labels was arbitrary. In 1979, Bonica likened the terminology for pain syndromes in use at that time to the “tower of Babel” (Bonica 1979).

The first edition of the Taxonomy of the IASP (Merskey 1986) listed common and rare conditions associated with

chronic pain, and provided defining descriptions of each. It allowed each condition to be described along five axes: The axis system, however, pertained mainly to the six-digit alphanumeric code ascribed to each condition. The conditions themselves were classified largely according to Axis I, with only parenthetical mention of pathology, aetiology and other features, if these were known.

The first edition of the Taxonomy was not intended to be, or expected to be, comprehensive or fixed. Indeed, readers were invited to submit revisions (Merskey 1986). The second edition of the Taxonomy (Merskey and Bogduk 1994) addressed many of the shortcomings of the first edition. Some descriptions were modernized, and involved a name change, e.g. ► **Reflex Sympathetic Dystrophy** and ► **causalgia** became ► **complex regional pain syndrome** Type I and Type II. Some entries were deleted (e.g. prolapsed disc, osteophyte, spondylolysis, arachnoiditis, acute low back strain, recurrent low back strain, and chronic mechanical low back pain) and were replaced by more generic or alternative entries. Some new entries were added, e.g. cervicogenic headache, xiphoidalgia, carcinoma of the lung, proctalgia fugax, piriformis syndrome, and peroneal muscular atrophy. The greatest revision pertained to entries on spinal pain. Some 96 new entries replaced all previous entries on neck pain, back pain, and other spinal pain. Moreover, the new entries were systematic and rigorous. They were designed to eliminate the problems of content validity and of former entries.

The new entries covered standard conditions such as spinal pain attributable to tumour, infection, metabolic disease, and arthritis. Radicular pain, due to osteophyte, disc prolapse, cysts, tumours, etc, was strictly distinguished and segregated from spinal pain on the grounds that, although radicular pain might have a spinal aetiology, it was pain perceived in the limbs or trunk wall rather than in the spinal region.

Perhaps the most comprehensive change was the introduction of the rubric – “spinal pain of unknown origin”. Users were invited, if not directed, to use this rubric wherever an alternative could not be legitimately, or honestly, applied. Providing this rubric encouraged physicians to avoid other poorly defined, invalid, or arbitrary rubrics, in an effort to reduce confusion and false labelling of patients.

Nevertheless, other rubrics were offered. They covered emerging entities, such as discogenic pain and zygapophysial joint pain, as well as classical entities, such as ligament strain and muscle strain, and allopathic entities such as segmental dysfunction. In providing these entries, however, the Taxonomy stipulated stringent, essential diagnostic criteria, in order to avoid the rubrics being applied on intuitive or presumptive grounds.

Thus, for “ligament strain” the ligament had to be specified, and the diagnosis had to be proven with a test that explicitly showed that the ligament in question was the

**Taxonomy, Table 1** Taxonomy

Axis I	Region	Referred to the anatomical region in which the pain was perceived (e.g., head, abdomen, lower limb).
Axis II	System	Referred to the body system that ostensibly was affected by pathology to produce pain (e.g. nervous system, vascular system, musculoskeletal system)
Axis II	Temporal	Described whether the pain was continuous, recurring, paroxysmal, etc.
Axis IV	Intensity and Duration	Stated if the pain was mild, medium or severe; and lasted less than one month, between one and six months, or longer than six months.
Axis V	Aetiology	Stated the nature of the cause of the pain (e.g. infectious, inflammatory, and neuropathic).

source of pain. Similar criteria were applied for “muscle strain”. For “segmental dysfunction” the essential criteria required clinical tests of proven reliability, and established validity to implicate the specified segment as the source of pain.

These rigorous criteria were stipulated quite deliberately in the full knowledge that the tests required to make the diagnosis did not (yet) exist. In effect, therefore, it was impossible to make the diagnosis in practice; yet it appeared in the Taxonomy. The purpose of this action was to indicate to proponents of specific, but ill-defined, yet perhaps popular, diagnoses, that research was required in order for the entity to satisfy the standards of a responsible Taxonomy, and for the diagnosis to be reliable, valid and, therefore, respectable.

#### IHS Taxonomy

The taxonomy for headache catalogues the many forms of ► [headache](#) according to mechanism or cause. Diagnostic criteria are stipulated for each form of headache. These are designed to ensure that practitioners use a particular diagnostic label only in those patients who exhibit the prescribed criteria.

The taxonomy describes and defines those headaches whose mechanism is not known but which have well-defined clinical features, such as ► [migraine](#), ► [cluster headache](#), and ► [paroxysmal hemicrania](#). It continues with descriptions and definitions of headaches associated with particular circumstances (such as the headaches of analgesic abuse, and rebound headache), headaches due to particular causes (such as raised or lowered pressure of cerebrospinal fluid, cerebral tumours, aneurysms, infections and granulomas), and headaches associated with other disorders (such as disorders of the ear, nose, and throat, or the cervical spine) (see essay ► [headache](#)).

The headache taxonomy is complemented by a textbook, now in its second edition (Olesen et al. 2000), with a third edition in preparation. The textbook follows the format of the taxonomy, but provides descriptions, in detail, of the entities and their diagnosis and treatment.

#### References

1. American Psychiatric Association (2000) DSM-IV-TR. Diagnostic and Statistical Manual of Mental Disorders, 4<sup>th</sup> edn, Text Revision. American Psychiatric Association, Washington DC

2. Bonica JJ (1979) The Need for a Taxonomy. *Pain* 6:247–252
3. Headache Classification Subcommittee of the International Headache Society (2004) The International Classification of Headache Disorders, 2<sup>nd</sup> edn. *Cephalalgia* 24 Suppl 1:1–160
4. Merskey H (ed) (1986) Classification of Chronic Pain. Descriptions of Chronic Pain Syndromes and Definition of Pain Terms. *Pain Suppl* 3:S1–S225
5. Merskey H, Bogduk N (1994) Classification of Pain. Descriptions of Chronic Pain Syndromes and Definitions of Pain Terms, 2<sup>nd</sup> edn. International Association for the Study of Pain, Seattle, pp 64–65
6. Olesen J, Tfelt-Hansen P, Welch KM (2000) *The Headaches*, 2<sup>nd</sup> edn. Lippincott Williams & Wilkins, Philadelphia

## Taxonomy, Orofacial Pain

- [Orofacial Pain, Taxonomy/Classification](#)

## TCA's

- [Tricyclic Antidepressants](#)

## TCD

- [Thalamocortical Dysrhythmia](#)

## Team Approach

- [Physical Medicine and Rehabilitation, Team-Oriented Approach](#)

## Technique of Ultrasound Application

### Definition

The most common technique is the stroking technique.

- [Ultrasound Therapy of Pain from the Musculoskeletal System](#)



## Tegretol

### Synonyms

Generic carbamazepine

### Definition

Tegretol (Generic Carbamazepine) is an anti-epileptic drug acting at non-voltage dependent sodium channels, which is so effective in the treatment of cranial neuralgias that lack of a (at least transient) response to this medication raises a significant question about the diagnosis.

- ▶ Trigeminal, Glossopharyngeal, and Geniculate Neuralgias

## Telemetric

### Definition

Telemetric means the transmission of data by radio or other means from a remote source.

- ▶ Opioid Therapy in Cancer Pain Management, Route of Administration

## Temperament

- ▶ Personality and Pain

## Temporal Arteritis

### Definition

Temporal arteritis is an arterial disease with inflammation of the temporal arteries characterized by fever, anorexia, loss of weight, leukocytosis, and tenderness over the scalp and along the temporal vessels. The giant cell arteritis most often attacks the external arteries in the anterior skull region – branches from the *arteria cerebri externa*.

- ▶ Cancer Pain, Assessment in the Cognitively Impaired
- ▶ Muscle Pain in Systemic Inflammation (Polymyalgia Rheumatica, Giant Cell Arteritis, Rheumatoid Arthritis)

## Temporal Association

### Definition

Temporal association between two disorders or clinical problems refers to their hypothesized relationship in terms of time of onset, most often inferring a causal or contributory relationship.

- ▶ Depression and Pain

## Temporal Resolution

### Definition

The value indicates how reliable the results are in terms of the time period. The higher, the better, and EEG and MEG are much higher than fMRI and PET.

- ▶ Magnetoencephalography in Assessment of Pain in Humans

## Temporal Summation (Windup)

### Definition

When synaptic potentials overlap in time, they add together. In this case, repeated administration of the same stimulus, at a given interval of time, produces a progressively increased painful response. Temporal summation is probably the initial part of wind-up, which is the increased neuronal firing to a train of stimuli recorded in animals.

- ▶ Encoding of Noxious Information in the Spinal Cord
- ▶ Exogenous Muscle Pain
- ▶ Opioids and Muscle Pain
- ▶ Opioids, Effects of Systemic Morphine on Evoked Pain
- ▶ Pain in Humans, Electrical Stimulation (Skin, Muscle and Viscera)

## Temporomandibular Disorder

### Synonyms

TMD

### Definition

A collective term embracing a number of clinical problems that involve the masticatory musculature, the temporomandibular joint and associated structures, or both. Temporomandibular disorders have been identified as a major cause of nondental pain in the orofacial region, and are considered to be a subclassification of musculoskeletal disorders.

- ▶ Orofacial Pain, Movement Disorders
- ▶ Orofacial Pain, Taxonomy/Classification
- ▶ Psychological Aspects of Pain in Women

## Temporomandibular Joint

### Definition

The jaw joint. The joint formed between the condylar process of the mandible and the mandibular fossa and articular tubercle of the temporal bone.

- ▶ Nociceptors in the Orofacial Region (Temporomandibular Joint and Masseter Muscle)
- ▶ Psychiatric Aspects of Pain and Dentistry
- ▶ Temporomandibular Joint Disorders

## Temporomandibular Joint and Muscle Pain Dysfunction

- ▶ Temporomandibular Joint Disorders

## Temporomandibular Joint Disorders

CHRISTIAN S. STOHLER  
Baltimore College of Dental Surgery, University of Maryland, Baltimore, MD, USA  
cstohler@dental.umaryland.edu

### Synonyms

Temporomandibular joint disorders (TMJDs); Temporomandibular disorders (TMDs); Craniomandibular Disorders; Previously used diagnostic labels; Temporomandibular Joint and Muscle Pain Dysfunction; TMJD

### Definition

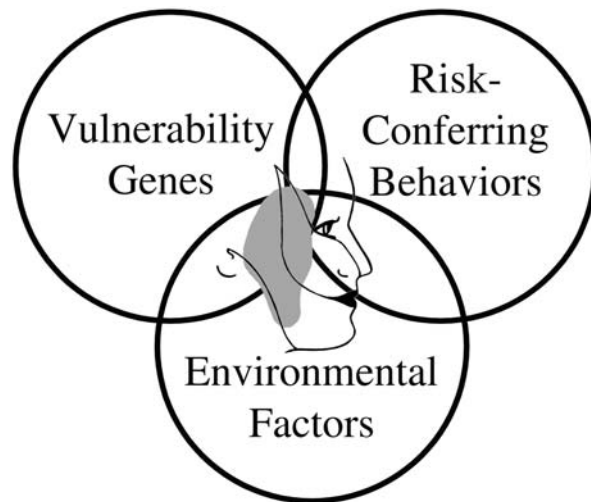
Temporomandibular disorders (TMJDs) comprise of a family of musculoskeletal conditions that involve deep ache or pain in the area of the temporomandibular joint(s) and/or adjacent tissue structures. These conditions constitute a major source of non-dental pain in the craniofacial complex.

### Characteristics

#### Etiology and Pathogenesis

Although the etiology of these musculoskeletal pain disorders is not established and various pathogenetic constructs have been proposed, these conditions are believed to develop from the combined action of many genes, risk-conferring behaviors and environmental factors. The fact that pain originates in deep tissue appears to be relevant to understanding the clinical phenomenon because, unlike superficial pain, deep pain is poorly localized and frequently associated with pronounced autonomic reactions. Genetic vulnerability is attributed to differences in the genetic makeup that enhance, directly or indirectly, pro-nociceptive and/or attenuate anti-nociceptive signalling (Fig. 1).

Earlier etiological constructs have placed significant weight on the dental occlusion as a causal factor in the etio-pathogenesis of TMJDs. However, low strengths



Temporomandibular Joint Disorders, Figure 1 Etiological construct.

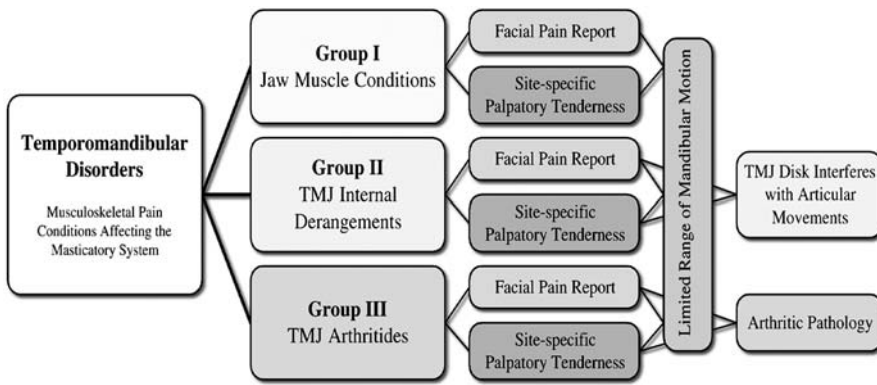
of association between occlusal features and TMJDs, inconsistent findings from study to study regarding the role of a given occlusal attribute, and the absence of any gradient effect of occlusal factors put these earlier theories in question.

#### Case Assignment

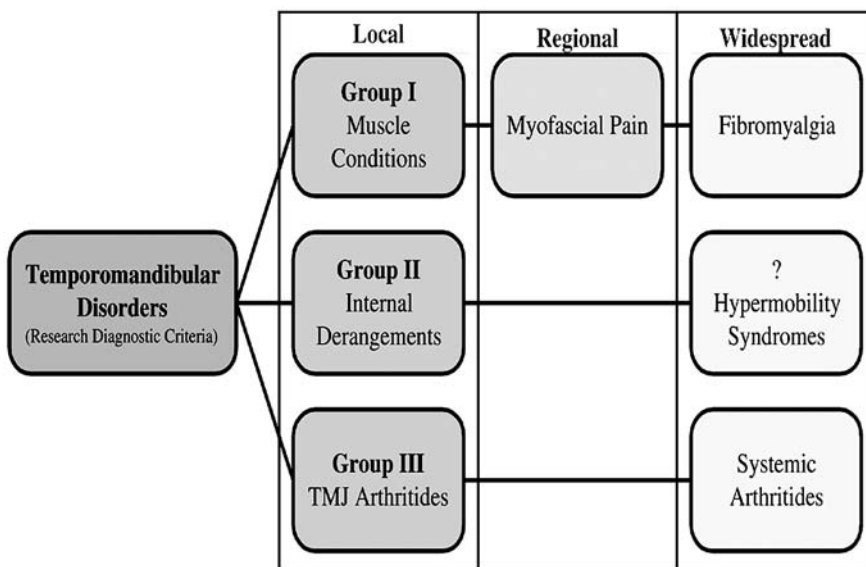
Although research in this subject matter has been intensified in recent years, no biomarkers of exposure or effect are established for valid and reliable TMJD case ascertainment. TMJD case assignment occurs on the basis of clinical features, which consist of symptoms like pain and limited range of mandibular motion. Facial pain reports focus on anatomical regions such as the temples, cheeks, pre-auricular area, or inside the ear and vary in intensity and spatial distribution, both inter-individually and intra-individually, with time. With respect to corresponding clinical signs, allodynia in the form of tenderness to palpation is linked to painful topographical sites. Limited range of motion is often noted and attributed to factors such as the articular disc preventing smooth gliding movement of the mandibular condyle along the articular eminence, constraining mandibular excursion, and/or the recruitment of jaw closing muscles during their function as antagonists, limiting mandibular side-to-side excursions and the capacity to open the jaw fully. However, under no circumstances should observable signs be used in isolation to define a TMJD case, because of insufficient diagnostic validity due to high sensitivity and low specificity.

#### Classification Systems

Important in directing clinical research in the past decade were efforts to produce a dual axes taxonomy for the major types of TMJDs (Dworkin and LeResche 1992). Focusing on the craniofacial domain, Axis I distinguishes three main diagnostic subsets (Fig. 2):



**Temporomandibular Joint Disorders, Figure 2** Overview of the diagnostic construct adopted by the Research Diagnostic Criteria for temporomandibular disorders. (For detail see Dworkin and LeResche 1992).



**Temporomandibular Joint Disorders, Figure 3** Overlap of TMJDs with regional and systemic disorders.

1. Group I: Masticatory myofascial pain
2. Group II: TMJ internal derangements
3. Group III: TMJ arthritides

Axis II criteria assess pain intensity, pain-related disability, and the presence and severity of depressive and anxiety symptoms. Using this classification scheme, about half of all TMJD cases are identified as Group I disorders (List and Dworkin 1996).

Due to the overlap with regional myofascial pain, tension-type headache, fibromyalgia, polyarthritides and possibly connective tissue disorders with impaired collagen makeup, shortcomings of available TMJD taxonomies are becoming increasingly recognized (Fig. 3). The fact that persistent TMJDs are rarely limited to a single topographical domain underscores the need to assess these conditions in the broader context.

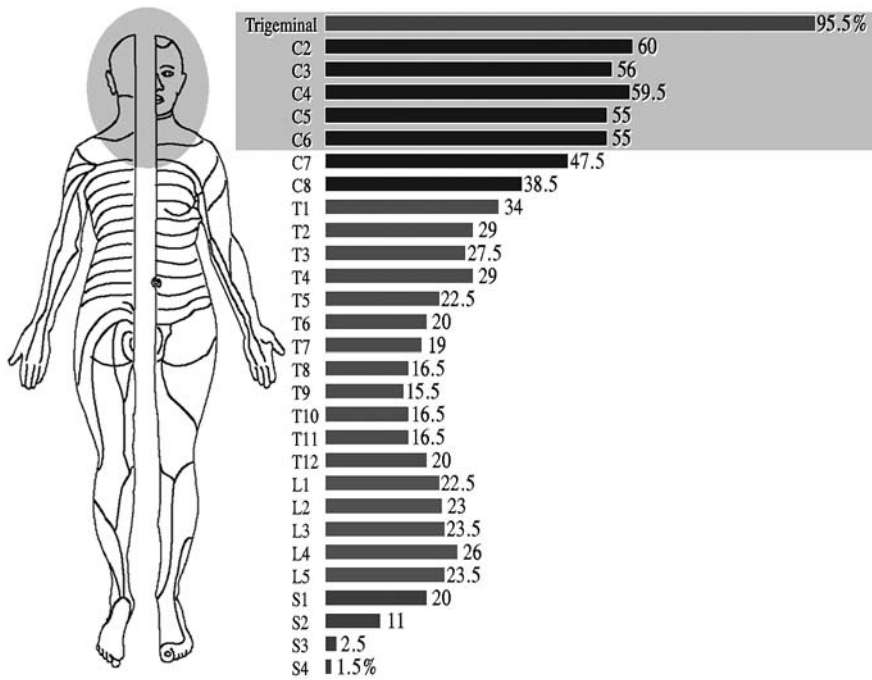
**Phenomenology**

**General Characteristics**

Poorly localizable ache or pain unrelated to dental pathology, constitute the chief complaint of all major

forms of TMJDs. The sensory experience is captured by pain descriptors, such as “aching”, “tight”, “throbbing” and “tender” (Turp et al. 1997). Besides pain, (a) inability to freely move the jaw due to pain and/ or soft or hard tissue interference, (b) sounds originating from the jaw joint, and (c) the disturbing perception of teeth not fitting properly constitute the other shared concerns. With respect to clinically observable signs, pressure allodynia, the experience of pain in response to defined pressure that is rarely identified as painful by subjects without TMJDs, represents the clinical hallmark feature of this family of pain conditions. Inability to move the jaw freely is determined by measurements of the mandibular range of motion and expressed by the clinically observable maximum mandibular excursions in all directions. Joint sounds are often linked to mechanical events between moving articular structures, such as the temporal component of the TMJ, the articular disc and the condyle. With respect to age, prevalence rates are lower among older subjects, and initial care-seeking in both men and women is more likely to occur before age 50 than later in life.





**Temporomandibular Joint Disorders, Figure 4** Cases (in %) reporting pain in a given dermatome. Adapted from (Turp, Kowalski, O'Leary, and Stohler, 1998).

### Spatial Characteristics

Not only can temporomandibular joint (TMJ) arthritides be part of an existing polyarthritis that affects additional joints other than the TMJs, those TMJDs that involve muscle differ in the extent of their bodily involvement as well. Distinction of local and widespread phenomena is important, because cases with widespread pain are more likely in pain on follow-up examination than cases with localized pain (Raphael et al. 2000).

In contrast to TMJD, muscle pain conditions that involve the face and adjacent head or neck regions, fibromyalgia (FMS) is understood as a clinical entity characterized by persistent widespread pain and tenderness to 4 kilograms of pressure at 11 of 18 anatomically defined body sites (Wolfe et al. 1990). Overlap between TMJDs and FMS has been demonstrated in a number of studies (Plesh et al. 1996; Hedenberg-Magnusson et al. 1997; Korszun et al. 1998). According to Plesh and coworkers, 75% of their FMS patients had TMJDs, while, on the other hand, 18% of cases with TMJDs met the diagnostic criteria for FMS. Epidemiological studies also report high associations between TMJDs and the two most common types of headache, tension-type headache and migraine headache (Agerberg and Carlsson 1973). In fact, persistent TMJD pain is associated with co-morbid pain in body parts other than the face at much greater rates than the condition is limited to the face (Fig. 4) (Turp et al. 1998).

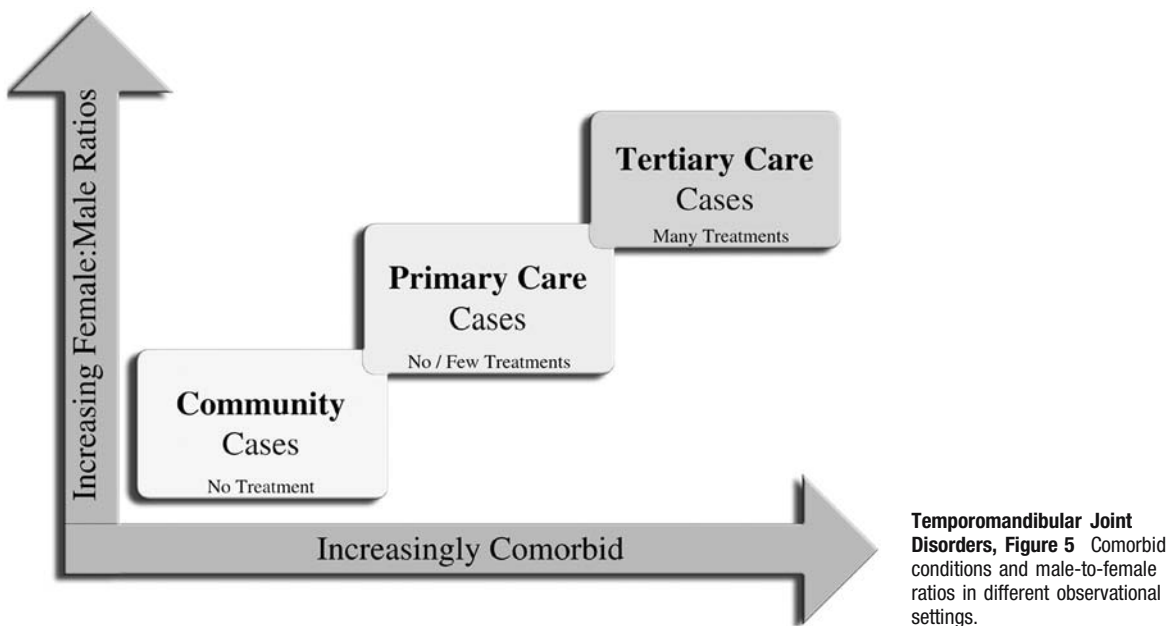
### Temporal Characteristics

Complaints of pain range from a local response to simple injury to complaints of persistent widespread bodily involvement without obvious cause. From a

phenomenological point of view, it needs to be emphasized that the overwhelming case majority seen in the primary care setting exhibits episodic forms, while cases encountered in the tertiary care environment are more likely affected by persistent conditions. The fact that the personally most devastating and clinically most challenging TMJD presentations occur in females in greater numbers than males, results in up to 90% of tertiary care cases being women (Figure 5). Among women, prevalence rates are higher for subjects of reproductive age than those in postmenopausal years without hormone replacement therapy (LeResche et al. 1997).

TMJD pain is characterized as non-progressive and fluctuating in intensity, which is often translated into "good" and "bad" days. What is applicable to a wide range of pain disorders seems also to be the case for TMJDs. As a generalization, infrequent pains of even high intensity are more likely perceived as a nuisance when compared to persistent pain of lesser intensity. On the other hand, persistent pain disrupts the lifestyle, causing functional limitations and restrictions in daily activities. In this context, it is increasingly understood that time in pain influences the subject's physiological state and response behavior. Initial pain constitutes a warning signal, causing the subject to stop the ongoing activity and to take actions to alleviate the pain. If pain persists, longer lasting effects on neuronal excitability, such as the up-regulation of NMDA-mediated effects and changes in the CNS "hardwiring" occur via a series of events and involve alterations in intermediate and late gene expressions. Binding of c-fos and c-jun to DNA alters the transcription of intermediate and even-





tually late effector genes, which in turn affect enzymes, growth factors, peptides, and even the phenotype.

#### Pain Affect

Prolonged and persistent pain can induce significant pain affect, which in itself constitutes an integral part of the TMJDs. Pain affect is captured by pain descriptors, such as “tiring”, “exhausting”, “frightening” and “fearful”. Great variations are observed with respect to the degree to which pain affect is expressed from patient to patient, even within a given TMJD subset (Ohrbach and Dworkin 1998). Much of the variability in response to pain is believed to be of genetic origin. Consequently, intense research is beginning to identify the allelic variants that underlie these response differences. For example, a 3- to 4-fold reduction in the activity due to a valine-methionine polymorphism of catechol-O-methyltransferase (COMT), an enzyme that catalyzes the O-methylation of compounds with a catechol structure, results in less or greater than normal availability of catecholamines at the site of neurotransmission, which in turn significantly shapes the sensory and affective experience of facial pain (Zubieta et al. 2003).

#### Management

Because the causal sequence of events that leads to pain and dysfunction is not known, therapeutic interventions focus on symptom management rather than on the elimination of the cause. Patients who seek care for the first time, report symptom relief of TMJD by 65–95%. Treatments include thermal packs, non-steroidal anti-inflammatory drugs (NSAIDs) and/or muscle relaxants, inter-occlusal appliances, physical therapy, relaxation and stress management, and acupuncture

and diet counselling to mention the most common interventions. There are little differences among the various types with respect to symptom relief. Those patients that do not get a satisfactory outcome, which happen to constitute a clear case minority in the primary care setting, are characterized by persistent pain and dysfunction for which all current forms of treatment fall short. Given the questionable superiority of one type of intervention over another, the choice of care is more influenced by unwanted effects attributable to the intervention, and/or the greater cost for care that does not translate into a justifiable improvement of the therapeutic efficacy. Consequently, case management tends to be “conservative” and “reversible”.

#### References

1. Agerberg G, Carlsson GE (1973) Functional Disorders of the Masticatory System. II. Symptoms in Relation to Impaired Mobility of the Mandible as Judged from Investigation by Questionnaire. *Acta Odontol Scand* 31:337–347
2. Dworkin SF, LeResche L (1992) Research Diagnostic Criteria for Temporomandibular Disorders: Review, Criteria, Examinations and Specifications, Critique. *J Craniomandib Disord* 6:301–355
3. Hagberg C, Hagberg M, Kopp S (1994) Musculoskeletal Symptoms and Psychosocial Factors Among Patients with Craniomandibular Disorders. *Acta Odontol Scand* 52:170–177
4. Hedenberg-Magnusson B, Ernberg M, Kopp S (1997) Symptoms and Signs of Temporomandibular Disorders in Patients with Fibromyalgia and Local Myalgia of the Temporomandibular System. A comparative study. *Acta Odontol Scand* 55:344–349
5. Korszun A, Papadopoulos E, Demitrack M, Engleberg C, Crofford L (1998) The Relationship Between Temporomandibular Disorders and Stress-Associated Syndromes. *Oral Surg Oral Med Oral Pathol Oral Radiol Endod* 86:416–420
6. LeResche L, Saunders K, Von KM, Barlow W, Dworkin SF (1997) Use of Exogenous Hormones and Risk of Temporomandibular Disorder Pain. *Pain* 69:153–160
7. List T, Dworkin SF (1996) Comparing TMD Diagnoses and Clinical Findings at Swedish and US TMD Centers using Research

- Diagnostic Criteria for Temporomandibular Disorders. *J Orofac Pain* 10:240–253
8. Ohrbach R, Dworkin SF (1998) Five-Year Outcomes in TMD: Relationship of Changes in Pain to Changes in Physical and Psychological Variables. *Pain* 74:315–326
  9. Plesh O, Wolfe F, Lane N (1996) The Relationship Between Fibromyalgia and Temporomandibular Disorders: Prevalence and Symptom Severity. *J Rheumatol* 23:1948–1952
  10. Raphael KG, Marbach JJ, Klausner J (2000) Myofascial Face Pain. Clinical Characteristics of those with Regional vs. Widespread Pain. *J Am Dent Assoc* 131:161–171
  11. Turp JC, Kowalski CJ, O’Leary TJ, Stohler CS (1998) Pain Maps from Facial Pain Patients Indicate a Broad Pain Geography. *J Dent Res* 77:1465–1472
  12. Turp JC, Kowalski CJ, Stohler CS (1997) Pain Descriptors Characteristic of Persistent Facial Pain. *J Orofacial Pain* 11:285–290
  13. Wolfe F (1997) The Relation Between Tender Points and Fibromyalgia Symptom Variables: Evidence that Fibromyalgia is not a Discrete Disorder in the Clinic. *Ann Rheum Dis* 56:268–271
  14. Wolfe F, Smythe HA, Yunus MB, Bennett RM, Bombardier C, Goldenberg DL, Tugwell P, Campbell SM, Abeles M, Clark P et al. (1990) The American College of Rheumatology 1990 Criteria for the Classification of Fibromyalgia. Report of the Multicenter Criteria Committee [see comments]. *Arthritis Rheum* 33:160–172
  15. Zubieta JK, Heitzeg MM, Smith YR, Bueller JA, Xu K, Xu Y, Koeppe RA, Stohler CS, Goldman D (2003) Genotype Affects Mu-Opioid Neurotransmitter Responses to a Pain Stressor. *Science* 299:1240–1243

## Temporomandibular Pain

### Definition

Chronic pain in the jaw muscles and TM joint, often associated with malocclusion; also referred to as cranio-mandibular or temporo-mandibular dysfunction.

- ▶ **Jaw-Muscle Silent Periods (Exteroceptive Suppression)**

## Tender Points

MICHAEL SPAETH  
Friedrich-Baur-Institute, University of Munich,  
Munich, Germany  
spaeth.m5@t-online.de  
michael.spaeth@lrz.uni-muenchen.de

### Synonyms

TePs  
Formerly often used as synonymous: trigger points (but nowadays clearly discriminated)

### Definition

If an individual reports local pain when a site is palpated with standardized pressure, this is considered a positive “tender point” (TP).

## Characteristics

### Anatomy

The anatomic TP sites do not appear to represent a single type of anatomical structure, but rather can include ligaments, tendons, skeletal muscles and bursae. The TP hurts at the site where pressure is applied, only, whereas pain induced by pressure at a myofascial pain syndrome (MPS) “trigger point” causes both local pain and pain at a more distant area of reference (“referred pain”). Several efforts have been made to find a primary origin of fibromyalgia (FM) pain at the anatomic sites themselves (Bengtsson et al. 1986; Drewes et al. 1993; Henriksson et al. 1982; Yunus and Kalyan Raman 1989). In fact, most of these investigations studied skeletal muscle exclusively and did not report any findings on other anatomical structures composing the TP regions. Morphological findings in skeletal muscle tissue specimens from FM patients are rather non-specific and presumably secondary to pain-related reduction of activity. Results of image analysis quantification of substance P immunoreactivity in the trapezius muscle of patients with fibromyalgia and myofascial pain syndrome pointed to a peripheral hyperactivity of the peptidergic nervous system in FM as well as in MPS (De Stefano et al. 2000). Recently reported ultrastructural changes in fibromyalgic muscle fibers may contribute to the induction and / or chronicity of nociceptive transmission from muscle to the central nervous system (Sprott et al. 2004). But, these alterations could not be identified as a primary cause of hyperalgesia in FM TP areas.

### Clinical Characteristics

Application of pressure on each of the TPs often induces patient’s involuntary withdrawal. After the examination of all 18 TPs, patients may report a persisting “deep ache”, similar to that of bone pain. Some patients may show the symptoms with either one half (upper or lower) or one side (right or left) of the body preponderating. For standardization and for research purposes, pressure gauges are available. A dolorimeter is commonly used and can further help to standardize the amount of pressure (e.g. 4 kg) applied by the examining finger of each investigator.

### Recent Objections

Despite the lack of information on what TPs really do measure, research over the last few years has brought up some interesting findings about these points. There is evidence from different studies, that FM patients are tenderer in both TP and non-TP regions than healthy control subjects and that these TP regions represent areas, where anyone is tenderer. TPs were revealed not to be specific to FM (Granges and Littlejohn 1993b; Tunks et al. 1995).

TPs were studied in a random sample from adults in the general population. As a result, tenderness to pressure

was found to occur both in people without widespread pain and in people without any pain. The investigators found that TP counts were increased in people who had other symptoms (i.e. poor sleep and / or fatigue), even if they did not complain about pain at all (MacFarlane et al. 1996). Data suggest that TP counts can discriminate between tender and non-tender individuals and can therefore be considered as a clinically useful measure of tenderness (Gracely et al. 2003). From another study, it was concluded that the tender point count was associated not only with the extent of rheumatic pain, but also independently with the extent of bodily complaints (Schochat and Raspe 2003). Significant correlations were found between TP count and psychological distress, evaluated by analyzing somatic and depressive symptoms (Croft et al. 1994). Another study found that TP pain severity ratings produced higher correlations with symptoms of FM and predicted distress better than TP counts (McCarberg et al. 2003).

Since the TP count seems to be a composite measure of at least tenderness and psychological distress, it is of limited value in research settings but useful in a clinical setting in order to recognize the tenderness-distress nature of FM (Gracely et al. 2003). Furthermore, the TP count does not reflect differences in distress or pressure-pain sensitivity or provide help in subgrouping FM patients (Giesecke et al. 2003). Another study replicated previous findings in population-based samples showing that dolorimeter determinations are less influenced by psychological factors than TP counts (Croft et al. 1994; Granges and Littlejohn 1993a), but there was still an impact of distress even on dolorimetry results (Petzke et al. 2003).

Most of these data-based objections were followed by recommendations: (1) to re-consider the current definition of FM, (2) to be aware of the tenderness-distress nature of both FM and TPs and (3) to re-evaluate chronic widespread pain (CWP) in further population-based studies both to potentially discriminate between CWP and FM and to emphasize FM characteristics.

► [Muscle Pain, Fibromyalgia Syndrome \(Primary, Secondary\)](#)

## References

- Bengtsson A, Henriksson KG, Larsson J (1986) Muscle biopsy in primary fibromyalgia. Light-microscopical and histochemical findings. *Scand J Rheumatol* 15:1–6
- Croft P, Schollum J, Silman A (1994) Population study of tender point counts and pain as evidence of fibromyalgia. *Bmj* 309:696–699
- De Stefano R, Selvi E, Villanova M et al. (2000) Image analysis quantification of substance P immunoreactivity in the trapezius muscle of patients with fibromyalgia and myofascial pain syndrome. *J Rheumatol* 27:2906–2910
- Drewes AM, Andreassen A, Schroder HD et al. (1993) Pathology of skeletal muscle in fibromyalgia: a histo-immuno-chemical and ultrastructural study. *Br J Rheumatol* 32:479–483
- Giesecke T, Williams DA, Harris RE et al. (2003) Subgrouping of fibromyalgia patients on the basis of pressure-pain thresholds and psychological factors. *Arthritis Rheum* 48:2916–2922
- Gracely RH, Grant MA, Giesecke T (2003) Evoked pain measures in fibromyalgia. *Best Pract Res Clin Rheumatol* 17:593–609
- Granges G, Littlejohn G (1993a) Pressure pain threshold in pain-free subjects, in patients with chronic regional pain syndromes, and in patients with fibromyalgia syndrome. *Arthritis Rheum* 36:642–646
- Granges G, Littlejohn GO (1993b) A comparative study of clinical signs in fibromyalgia / fibrositis syndrome, healthy and exercising subjects. *J Rheumatol* 20:344–351
- Henriksson KG, Bengtsson A, Larsson J et al. (1982) Muscle biopsy findings of possible diagnostic importance in primary fibromyalgia (fibrositis, myofascial syndrome). *Lancet* 2:1395
- MacFarlane GJ, Croft PR, Schollum J et al. (1996) Widespread pain: is an improved classification possible? *J Rheumatol* 23:1628–1632
- McCarberg B, Barkin RL, Wright JA et al. (2003) Tender points as predictors of distress and the pharmacologic management of fibromyalgia syndrome. *Am J Ther* 10:176–192
- Petzke F, Gracely RH, Park KM et al. (2003) What do tender points measure? Influence of distress on 4 measures of tenderness. *J Rheumatol* 30:567–574
- Schochat T, Raspe H (2003) Elements of fibromyalgia in an open population. *Rheumatology (Oxford)* 42:829–835
- Sprott H, Salemi S, Gay RE et al. (2004) Increased DNA fragmentation and ultrastructural changes in fibromyalgic muscle fibres. *Ann Rheum Dis* 63:245–251
- Tunks E, McCain GA, Hart LE et al. (1995) The reliability of examination for tenderness in patients with myofascial pain, chronic fibromyalgia and controls. *J Rheumatol* 22:944–952
- Yunus MB, Kalyan Raman UP (1989) Muscle biopsy findings in primary fibromyalgia and other forms of nonarticular rheumatism. *Rheum Dis Clin North Am* 15:115–134

## Tenderness

### Definition

Tenderness describes a feeling of discomfort or pain caused by pressure that would normally be insufficient to cause such sensations.

► [Headache, Episodic Tension Type](#)

T

## Tendinitis

### Definition

Tendinitis is a painful tendon, usually resulting from unaccustomed physical activity. Classified as a localized STP. Fraying and thickening of the tendon may be observed.

► [Ergonomics Essay](#)

► [Muscle Pain, Fibromyalgia Syndrome \(Primary, Secondary\)](#)

## Tendon Sheath Inflammation

### Definition

Tendon sheaths have synovial lining cells, which are included in the inflammation in rheumatoid arthritis.

- ▶ [Muscle Pain in Systemic Inflammation \(Polymyalgia Rheumatica, Giant Cell Arteritis, Rheumatoid Arthritis\)](#)

## Tenosynovitis

### Definition

Tenosynovitis refers to inflammation of the tendon sheaths, through which the tendons slide when the muscle length changes. Excessive fluid accumulation can cause swelling and pain in the affected areas.

- ▶ [Ergonomics Essay](#)

## TENS

- ▶ [Transcutaneous Electrical Nerve Stimulation](#)

## TENS, Mechanisms of Action

KATHLEEN A. SLUKA

Physical Therapy and Rehabilitation Science Graduate Program, University of Iowa, Iowa City, IA, USA  
kathleen-sluka@uiowa.edu

### Synonyms

PES; electrical stimulation analgesia; transcutaneous electrical nerve stimulation

### Definition

Electrical stimulation applied to the skin for pain relief.

### Characteristics

The mechanisms of action of ▶ [TENS](#) primarily involve central mechanisms and have been extensively reviewed (see Sluka and Walsh 2003 for more details and references). There are generally two types of TENS applied clinically, low frequency (<10 Hz) and high frequency (>50 Hz). These can be applied at either a sensory intensity that produces a tapping or tingling sensation or at motor intensity that produces an additional motor contraction. The mechanisms of action for TENS appear to be frequency, not intensity, dependent.

### High Frequency (50–100 Hz) TENS

#### Effects on Behavior and Dorsal Horn Neurons

Early studies utilizing acute pain tests show that high frequency, motor intensity TENS increases the tail flick latency to heat (i.e. analgesia) and decreases the flexion reflex response to noxious stimuli (reviewed in Sluka and Walsh 2003). Recording from spinothalamic tract cells, stimulation at an intensity activating A $\beta$  fibers (3  $\times$  the threshold) has no effect on the spontaneous firing

rate. However, increasing the intensity so as to also activate A $\delta$  nociceptors reduces spontaneous activity and responses to noxious heat or pinch (Lee et al. 1985). Similarly, studies by Garrison and Foreman (1997) and by Sjolund (1985) both show that increasing intensity increases inhibition of dorsal horn neurons and the flexion reflex response to noxious stimuli. These data suggest that high and low frequency TENS are effective and that increasing intensity increases inhibition.

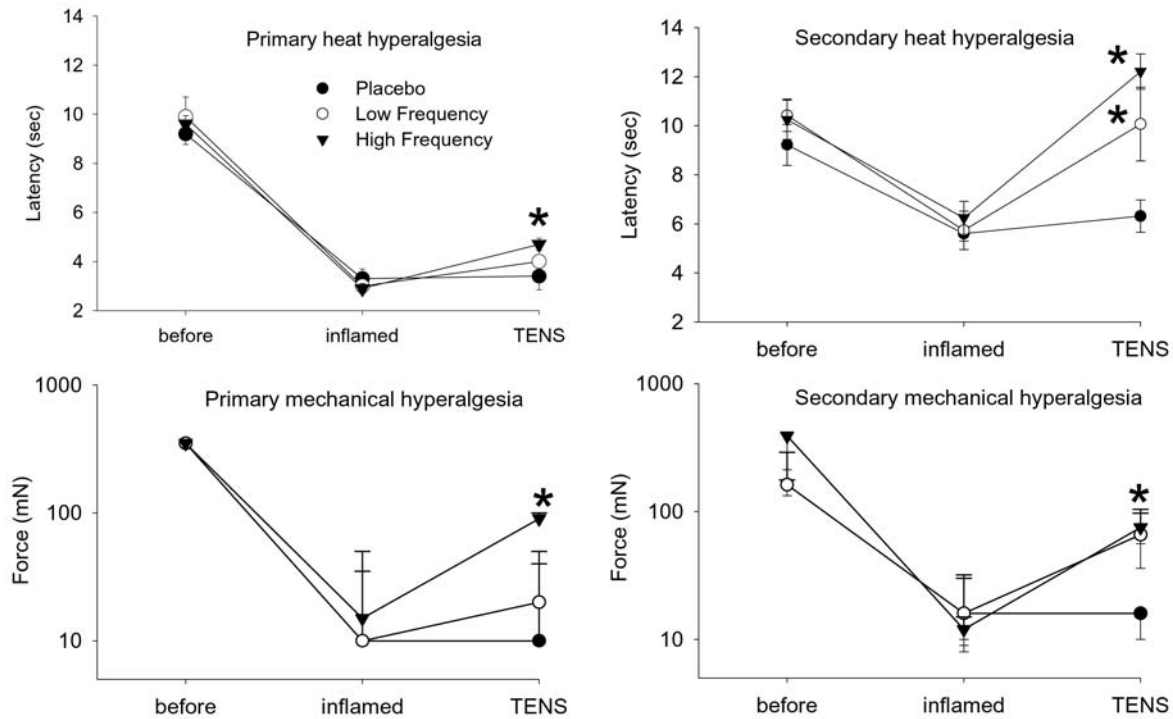
Utilizing an animal model of joint inflammation reveals that high frequency, sensory intensity TENS has long-lasting effects on both primary and secondary heat and mechanical ▶ [hyperalgesia](#) (reviewed in Sluka and Walsh 2003) (Fig. 1). In fact, these studies show that high frequency, sensory intensity partially reverses the primary hyperalgesia and completely reverses the secondary hyperalgesia associated with ▶ [carrageenan inflammation](#) for 24 h. Importantly, modulation of frequency (4 Hz vs. 100 Hz), intensity (sensory vs. motor) or pulse duration (100  $\mu$ s vs. 250  $\mu$ s) shows a frequency, but not intensity or pulse duration, dependent effect on primary hyperalgesia to mechanical and heat stimuli in animals with carrageenan paw inflammation. The increased responsiveness of dorsal horn neurons to innocuous and noxious mechanical stimuli that occurs after inflammation is completely reduced following high frequency, sensory intensity TENS treatment applied to the inflamed paw (Ma and Sluka 2001). Utilizing a ▶ [model of neuropathic pain](#), Somers and Clemente (1998) demonstrated that high frequency, sensory intensity TENS stimulation over the paraspinal musculature reduced the heat but not the mechanical hyperalgesia that normally occurs in this model. This inhibition of heat hyperalgesia only occurs if TENS was started the first day after injury but not if it was started 3 days after injury.

### Pharmacology

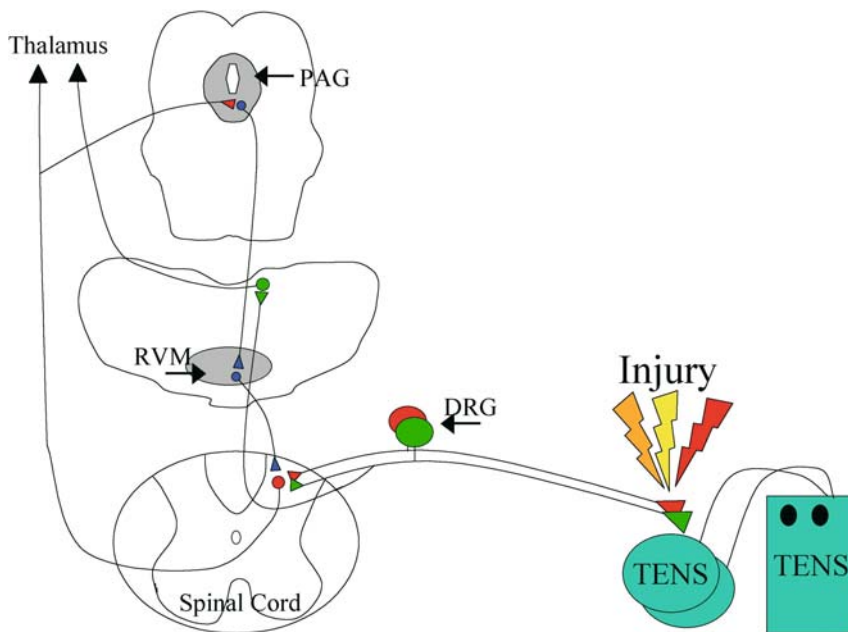
In animals that were spinalized to remove descending inhibitory pathways (Fig. 2), inhibition of the tail flick by high frequency, motor intensity TENS still occurs but is reduced by about 50% (Woolf et al. 1980). Thus, these studies suggest both spinal and ▶ [descending inhibition](#) are involved in the analgesia produced by high frequency, motor intensity TENS. Later studies prevented the antihyperalgesia, by blockade of  $\delta$ -opioid receptors in the rostral ventral medial medulla (RVM), further supporting a role for descending inhibitory systems in the inhibition produced by TENS.

Pharmacologically, opioid peptides mediate the effects of high frequency TENS. Concentrations of beta-endorphins increase in the bloodstream and cerebrospinal fluid and methionine-enkephalin increases in the cerebrospinal fluid of human subjects, following administration of high frequency, sensory intensity TENS (reviewed in Sluka and Walsh 2003). High frequency, motor intensity TENS is blocked by systemic block-





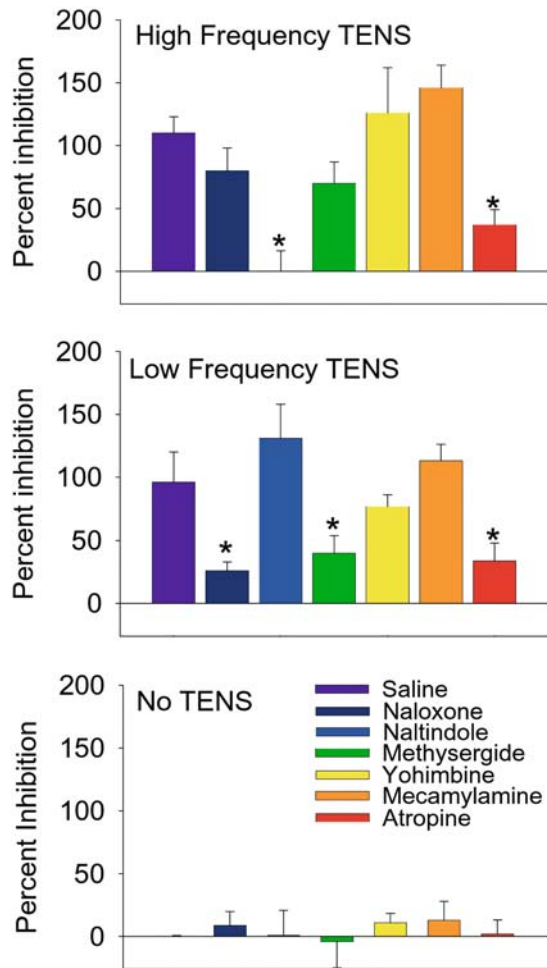
**TENS, Mechanisms of Action, Figure 1** Effects of TENS on primary and secondary, mechanical and heat hyperalgesia induced by carrageenan inflammation. High, but not low, frequency TENS partially reverses primary hyperalgesia to heat and mechanical stimuli induced by carrageenan paw inflammation (left panels). In contrast, both high and low frequency TENS reverse secondary hyperalgesia induced by carrageenan knee joint inflammation (right panels).



**TENS, Mechanisms of Action, Figure 2** Schematic drawing demonstrating that TENS applied to the periphery at the site of injury activates primary afferent fibers. This information is transmitted to the spinal cord and results in inhibition both locally and from descending inhibitory pathways. Descending inhibition from the rostral ventral medial medulla (RVM) involves 5-HT and opioids and can be activated by the periaqueductal gray (PAG). Previous studies show that opioid receptors in the spinal cord and RVM and serotonergic and muscarinic receptors in the spinal cord mediate the reduction in hyperalgesia by TENS.

ade of opioid receptors with naloxone and systemic depletion of serotonin (reviewed in Sluka and Walsh 2003). Blockade of  $\delta$ -opioid receptors in the spinal cord or the rostral ventral medial medulla (RVM) reverses the antihyperalgesia produced by high frequency

sensory intensity TENS in animals with carrageenan knee joint inflammation (Fig. 3) (Kalra et al. 2001; Sluka et al. 1999). Similarly, spinal  $\delta$ -opioid receptors are implicated in the antihyperalgesic effects of high frequency motor intensity TENS, since repeated



**TENS, Mechanisms of Action, Figure 3** Summary bar graph of the effects of blockade of spinal receptors on the antihyperalgesia produced by low and high frequency TENS. Approximately 100% inhibition of hyperalgesia occurs after treatment with either high or low frequency TENS (saline, purple). Blockade of  $\mu$ -opioid (naloxone, dark blue) and muscarinic (atropine, red) receptors prevents the antihyperalgesia produced by high frequency TENS. Blockade of spinal  $\delta$ -opioid (naltindole, blue), serotonin (methysergide, green) or muscarinic (atropine, red) receptors prevents the antihyperalgesia produced by low frequency TENS. Spinal blockade of  $\alpha$ -2 adrenergic (yohimbine, yellow) or nicotinic (mecamylamine, orange) receptors has no effect on the effects of either high or low frequency TENS.

application of high frequency, motor intensity TENS produces tolerance (reduced effectiveness) to the antihyperalgesic effects of TENS and at spinal  $\delta$ -opioid receptors (Chandran and Sluka 2003).

Further, blockade of muscarinic receptors (M1 and M3, but not M2) in the spinal cord also partially reverses the antihyperalgesia produced by high frequency, sensory intensity TENS (Radhakrishnan and Sluka 2003). However, blockade of serotonin or noradrenergic receptors in the spinal cord has no effect on the reversal of hyperalgesia produced by high frequency, sensory intensity TENS (Radhakrishnan et al. 2003) (Fig. 3).

### Autonomic and Peripheral Effects

TENS could have effects on autonomic function, blood flow and peripheral afferent fibers (reviewed in Sluka and Walsh 2003). However, high frequency, sensory intensity TENS stimulation at intensities just above or below motor threshold does not affect local blood flow. In contrast, utilizing laser Doppler imaging, increases in blood flow were observed with high frequency TENS, at an intensity "that was felt but not painful (10–15 mA). In human subjects, after application of high frequency TENS at the threshold for discomfort (strong motor intensity applied to a digit), subjects report numbness and cooling just distal to the stimulation (on the digit). This is associated with decreased temperature and loss of color in the skin suggesting effects on the autonomic nervous system. The primary afferent neuropeptide, substance P, is reduced in dorsal root ganglia neurons and spinal cord dorsal horn by high frequency, sensory intensity TENS in animals injected with the inflammatory irritant, formalin. Thus, evidence is beginning to emerge that some of the analgesic effects of TENS may be mediated through actions on primary afferent fibers and modulation of autonomic activity.

### Low Frequency (<10 Hz) TENS

#### Effects on Behavior and Dorsal Horn Neuron Activity

In primates without tissue injury, low rate burst TENS (3 bursts per second and 7 pulses per burst with an internal frequency of 85 Hz) at an intensity that activates  $A\beta$  (presumable sensory intensity,  $3 \times$  sensory threshold) fibers has no effect on either the spontaneous activity or responses to noxious stimuli of spinothalamic tract cells. Increasing intensity to activate  $A\delta$  fibers reduces spontaneous activity and responses to noxious stimuli of spinothalamic tract cells (Lee et al. 1985). Similarly, low frequency TENS at an intensity that activates  $A\delta$  fibers reduces the ventral root reflex in response to C-fiber stimulation (Sjolund 1985).

Low frequency TENS, regardless of intensity has no effect on the primary mechanical or heat hyperalgesia produced by carrageenan inflammation. However, low frequency, sensory intensity TENS fully reverses secondary heat hyperalgesia and partially reverses secondary mechanical hyperalgesia (reviewed in Sluka and Walsh 2003). Importantly, in these studies, increasing intensity to twice the motor threshold does not further reduce the secondary mechanical hyperalgesia. The increased responsiveness of dorsal horn neurons to innocuous and noxious mechanical stimuli that occurs after inflammation is equally and completely reduced following low frequency, sensory intensity TENS treatment applied to the inflamed paw (Ma and Sluka 2001). Following spinal nerve ligation, TENS reduces the responsiveness to noxious mechanical stimulation of dorsal horn neurons in both normal and neuropathic animals. However, the responsiveness of spinal neurons

to innocuous mechanical stimulation is only inhibited by TENS in neuropathic animals (Leem et al. 1995). Behaviorally, low frequency, motor intensity TENS reduces mechanical hyperalgesia and cold allodynia induced by nerve injury (Nam et al. 2001).

### Pharmacology

Low frequency, sensory intensity, TENS antihyperalgesia is prevented by blockade of  $\mu$ -opioid receptors in the spinal cord or the RVM (Fig. 3) (Kalra et al. 2001; Sluka et al. 1999). Studies utilizing carrageenan knee joint inflammation suggest that  $\mu$ -opioid receptors are also activated by low frequency, motor intensity TENS since repeated application of TENS produces tolerance (reduced effectiveness) to the antihyperalgesic effects of TENS and of spinal  $\mu$ -opioid receptors (Chandran et al. 2003). Low frequency, sensory intensity TENS is also reduced by blockade of serotonin 5-HT<sub>2A</sub> and 5-HT<sub>3</sub> and muscarinic M<sub>1</sub> and M<sub>3</sub> receptors in the spinal cord (Fig. 3) (Radhakrishnan et al. 2003; Radhakrishnan and Sluka 2003). Taken together, these studies suggest a role of opioid, serotonin and muscarinic receptors in the spinal cord and supraspinal opioid mechanisms in the action of low frequency, sensory intensity TENS.

### Autonomic Effects of Low Frequency TENS

The effect of low frequency, motor intensity TENS on cold allodynia, but not mechanical hyperalgesia, is reduced by systemic phentolamine to block  $\alpha$ -adrenergic receptors, suggesting activation of sympathetic noradrenergic receptors may mediate TENS effects (Nam et al. 2001). However, phentolamine could block central receptors. Transient increases in blood flow with low frequency, burst-mode (2 Hz) TENS were observed at the area of stimulation, if intensity was 25% above the motor threshold, but not just below (sensory intensity) or just above motor threshold (Sherry et al. 2001).

### References

- Chandran P, Sluka KA (2003) Development of opioid tolerance with repeated TENS administration. *Pain* 101:195–201
- Garrison DW, Foreman RD (1997) Effects of prolonged transcutaneous electrical nerve stimulation (TENS) and variation of stimulation variables on dorsal horn cell activity. *Eur J Phys Med Rehabil* 6:87–94
- Kalra A, Urban MO, Sluka KA (2001) Blockade of opioid receptors in rostral ventral medulla prevents antihyperalgesia produced by transcutaneous electrical nerve stimulation (TENS). *J Pharmacol Exp Ther* 298:257–263
- Lee KH, Chung JM, Willis WD (1985) Inhibition of primate spinothalamic tract cells by TENS. *J Neurosurg* 62:276–287
- Leem JW, Park ES, Paik KS (1995) Electrophysiological evidence for the antinociceptive effect of transcutaneous electrical nerve stimulation on mechanically evoked responsiveness of dorsal horn neurons in neuropathic rats. *Neurosci Lett* 192:197–200
- Ma YT, Sluka KA (2001) Reduction in inflammation-induced sensitization of dorsal horn neurons by transcutaneous electrical nerve stimulation in anesthetized rats. *Exp Brain Res* 137:94–102
- Nam TS, Choi Y, Yeon DS et al. (2001) Differential antinociceptive effect of transcutaneous electrical stimulation on pain behavior sensitive or insensitive to phentolamine in neuropathic rats. *Neurosci Lett* 301:17–20
- Radhakrishnan R, Sluka KA (2003) Spinal muscarinic receptors are activated during low or high frequency TENS-induced antihyperalgesia in rats. *Neuropharmacology* 45:1111–1119
- Radhakrishnan R, King EW, Dickman J et al. (2003) Spinal 5-HT<sub>2</sub> and 5-HT<sub>3</sub> receptors mediate low, but not high, frequency TENS-induced antihyperalgesia in rats. *Pain* 105:205–213
- Sherry JE, Oehrlein KM, Hegge KS et al. (2001) Effect of burst-mode transcutaneous electrical nerve stimulation on peripheral vascular resistance. *Phys Ther* 81:1183–1191
- Sjolund BH (1985) Peripheral nerve stimulation suppression of C-fiber evoked flexion reflex in rats. Part 1: Parameters of continuous stimulation. *J Neurosurg* 63:612–616
- Sluka KA, Walsh D (2003) Transcutaneous electrical nerve stimulation: Basic science mechanisms and clinical effectiveness. *J Pain* 4:109–121
- Sluka KA, Deacon M, Stibal A et al. (1999) Spinal blockade of opioid receptors prevents the analgesia produced by TENS in arthritic rats. *J Pharmacol Exp Ther* 289:840–846
- Somers DL, Clemente FR (1998) High-frequency transcutaneous electrical nerve stimulation alters thermal but not mechanical allodynia following chronic constriction injury of the rat sciatic nerve. *Arch Phys Med Rehabil* 79:1370–1376
- Woolf CJ, Mitchell D, Barrett GD (1980) Antinociceptive effect of peripheral segmental electrical stimulation in the rat. *Pain* 8:237–252

## TENS Outcomes

- ▶ Transcutaneous Electrical Nerve Stimulation Outcomes

## Tension Headache

- ▶ Headache, Episodic Tension Type

## Tension Type Headache

T

### Definition

Tension Type Headache in SLE patients is associated with personality changes, emotional conflicts, depression, and higher disease activity scores. In some cases, tension type headache is associated with tonic contraction of the cranial muscles. Many patients with tension type headache do not exhibit increased EMG activity in these muscles, but have the feeling of a tight ring around the head.

- ▶ Headache Due to Arteritis
- ▶ Headache, Episodic Tension Type
- ▶ Sensitization of Muscular and Articular Nociceptors

## TePs

- ▶ Tender Points

## Tertiary Gain

### Definition

Gains sought or obtained by others from a patient's illness.

- ▶ Malingering, Primary and Secondary Gain

## TES

- ▶ Transcutaneous Electrical Stimulation

## Testosterone

### Definition

Testosterone is normally produced in the testes in men, the ovaries in women, and in the adrenal cortex of both men and women. In men, testosterone is primarily responsible for normal growth and development of male sex and reproductive organs, including the penis, testicles, scrotum, prostate, and seminal vesicles. It facilitates the development of secondary male sex characteristics such as musculature, bone mass, fat distribution, hair patterns, laryngeal enlargement, and vocal chord thickening. In women, testosterone strengthens bone and ensures the nipples and clitoris are sensitive to sexual pleasure. In both men and women, normal testosterone levels maintain energy level, healthy mood, muscle mass, fertility, and sexual desire. Decreased levels of testosterone, induced by aging, disease, surgery, and medications (including opioids), lead to loss of libido and decreased sexual function.

- ▶ Cancer Pain Management, Opioid Side Effects, Endocrine Changes and Sexual Dysfunction

## Tetrodotoxin

### Synonyms

TTX

### Definition

Tetrodotoxin (anhydrotetrodotoxin 4-epitetrodotoxin, tetrodonic acid, TTX) is a potent neurotoxin found in the tissues of the puffer fish. It has a complex structure, with the active part of the molecule being a positively charged guanidinium moiety. The molecule can block sodium channels from the outside (in contradistinction to clinically used local anesthetic agents that must first permeate the neuron and then act from the inside). Tetrodotoxin is used by neurophysiologists to categorize various types of sodium channel.

- ▶ Acute Pain Mechanisms
- ▶ Membrane Stabilizing Drugs
- ▶ Nociceptors, Action Potentials and Post-Firing Excitability Changes
- ▶ Tetrodotoxin

## Tetrodotoxin (TTX)-Resistant Sodium Channel

### Definition

A type of voltage-gated sodium channel that is not inhibited by the highly potent neurotoxin, tetrodotoxin, which is extracted from the puffer fish. Tetrodotoxin (TTX)-resistant sodium channels are found on the membrane of many DRG neurons that have nociceptive response properties, and contribute to the excitability of the neurons and generation of action potentials.

- ▶ IB4-Positive Neurons, Role in Inflammatory Pain
- ▶ Nociceptor Generator Potential

## Thalamic Bursting Activity

- ▶ Burst Activity in Thalamus and Pain
- ▶ Thalamic Bursting Activity, Chronic Pain

## Thalamic Bursting Activity, Chronic Pain

A. TAGHVA, S.H. PATEL, A. FERNANDEZ,  
NIRIT WEISS, FRED A. LENZ  
Department of Neurosurgery, Johns Hopkins Hospital,  
Baltimore, MD, USA  
flenzi1@jhmi.edu

### Synonyms

Spike bursting

### Definition

Spontaneous thalamic cellular activity is often categorized as either bursting activity (▶ [spike bursts](#), bursting mode) or as tonic firing (tonic mode) (Steriade et al. 1990). Many studies have suggested that increased ▶ [spike bursting](#) occurs in the thalamus of patients with chronic pain (Lenz et al. 1994; Lenz et al. 1988; Rinaldi et al. 1991; Jeanmonod et al. 1993; Lenz et al. 1998).



## Characteristics

### The Thalamic Region of Vc and its Importance in Pain Processing

Several lines of evidence demonstrate that the ventral caudal nucleus of the human sensory thalamus (► Vc), the human analog of monkey ventral posterior (VP) nucleus (Hirai and Jones 1989), is important in human pain-signaling pathways. Studies of patients at autopsy following lesions of the ► spinothalamic tract (STT) show the most dense STT termination in the Vc region including the posterior and inferior subnuclei of Vc, suprageniculate and posterior subnuclei (Mehler 1962; Walker 1943). In monkeys, STT terminations are found in the Vmpo of Craig, which may, by immunohistochemistry and physiology, have a human analog (Craig et al. 1994).

### Is Thalamic Functional Mode Altered in Chronic Pain States?

► Spike bursting activity refers to a particular pattern of ► interspike intervals (ISI) between action potentials, such that a ► spike burst begins after a relatively long ISI and is comprised of a series of action potentials with short ISIs (typically < 6 ms) (Lenz et al. 1989). Thereafter, the ISIs progressively lengthen so that the cell's firing decelerates throughout the spike burst. When the period of the bursting is completed, the cell is said to fire in tonic mode when the firing rate is relatively constant and bursts do not occur.

In patients with spinal transection, the highest rate of bursting occurs in cells that do not have peripheral ► receptive fields and that are located in the representation of the anesthetic part of the body. These cells also have the lowest firing rates in the interval between bursts (Lenz et al. 1994). The low firing rates suggest that these cells have decreased tonic excitatory drive and are ► hyperpolarized, perhaps due to loss of excitatory input from the ► STT (Eaton and Salt 1990; Dougherty et al. 1996). Therefore the available evidence suggests that affected thalamic cells in patients with spinal transection were dominated by spike bursting consistent with membrane hyperpolarization (1990; Steriade and Llinas 1988; Lenz et al. 1998; Davis et al. 1998).

Spike bursting activity is maximal in the region posterior and inferior to the core nucleus of Vc (Table 4 in Lenz et al. 1994). Stimulation in this area evokes the sensation of pain more frequently than does stimulation in the core of Vc (Lenz et al. 1993; Hassler 1970). Thus, increased spike bursting activity may be correlated with some aspects of the abnormal sensations (e.g. ► dysesthesia or pain) that these patients experience. However, in patients with spinal transection, the painful area and the area of sensory loss overlap (Lenz et al. 1994). Thus, the bursting activity might be related to sensory loss, rather than to pain.

These findings about spike bursting activity in spinal patients have been called into question by a recent study in patients with chronic pain (Radhakrishnan et al. 1999).

It has been reported that the number of bursting cells per trajectory in patients with movement disorders (controls) is not different from that in patients with chronic pain. However, there are significant differences between the two studies (Lenz et al. 1994; Radhakrishnan et al. 1999) in terms of patient population (spinal cord injury vs mixed chronic pain), location of cells studied (Vc vs anterior and posterior to Vc) and analysis methods (incidence of bursting cells vs bursting parameters). Clearly, the increase in bursting activity demonstrated in the earlier study is more applicable to the region of the principal somatic sensory nucleus of patients with central pain from spinal transection (Lenz et al. 1994).

Further support for increased spike bursts occurring in spinal cord transected patients is found in thalamic recordings from monkeys with thoracic anterolateral cordotomies (Weng et al. 2000). Some of these animals showed increased responsiveness to electrocutaneous stimuli and thus may represent a model of central pain (Vierck 1991). The most pronounced changes in firing pattern were found in thalamic ► multi-receptive cells, which respond to both cutaneous brushing and compressive stimuli with activity that is not graded into the noxious range. In comparison with normal controls, multi-receptive cells in the monkeys with cordotomies showed significant increases in the number of bursts occurring spontaneously or in response to brushing or compressive stimuli. The changes in bursting behavior were widespread, occurring in the thalamic representation of upper and lower extremities, both ipsilateral and contralateral to the cordotomy.

Although there is an increase in spike burst activity in chronic pain states, there does not appear to be a direct relationship between spike burst firing and pain. Spike bursts are also found in the thalamic representation of the monkey upper extremity and of the representation of the arm and leg ipsilateral to the ► cordotomy (Weng et al. 2000). Pain is not typically experienced in these parts of the body in patients with thoracic spinal cord transection or cordotomy (Beric et al. 1988). Spike bursts are increased in frequency during slow wave sleep in all mammals studied (Steriade and Llinas 1988) including man (Zirh et al. 1997). However, such bursting could cause pain if stimulation in the vicinity of the bursting cell produced the sensation of pain. This finding has been reported in two recent studies of sensations evoked by stimulation of the region of Vc in patients with chronic pain secondary to neural injury (Davis et al. 1996; Lenz et al. 1998).

Thus, there is evidence from both human and animal studies for a correlation between chronic pain states and an altered thalamic neuronal action potential firing pattern. It appears that there is an increase in spike burst firing in chronic pain conditions. The exact physiological relationships that link the pattern of thalamic firing to the human perception of chronic pain have yet to be elucidated.

## References

- Beric A, Dimitrijevic MR, Lindblom U (1988) Central dysesthesia syndrome in spinal cord injury patients. *Pain* 34:109–116
- Craig AD, Bushnell MC, Zhang ET et al. (1994) A thalamic nucleus specific for pain and temperature sensation. *Nature* 372:770–773
- Davis KD, Kiss ZHT, Luo L et al. (1998) Phantom sensations generated by thalamic microstimulation. *Nature* 391:385–387
- Davis KD, Kiss ZHT, Tasker RR et al. (1996) Thalamic stimulation-evoked sensations in chronic pain patients and non-pain (movement disorder) patients. *J Neurophysiol* 75:1026–1037
- Dougherty PM, Li YJ, Lenz FA et al. (1996) Evidence that excitatory amino acids mediate afferent input to the primate somatosensory thalamus. *Brain Res* 278:267–273
- Eaton SA, Salt TE (1990) Thalamic NMDA receptors and nociceptive sensory synaptic transmission. *Neurosci Lett* 110:297–302
- Hassler R (1970) Dichotomy of facial pain conduction in the diencephalon. In: Walker AE (ed) *Trigeminal neuralgia*. Saunders, Philadelphia, pp 123–138
- Hirai T, Jones EG (1989) A new parcellation of the human thalamus on the basis of histochemical staining. *Brain Res Rev* 14:1–34
- Jeanmonod D, Magnin M, Morel A (1993) Thalamus and neurogenic pain: physiological, anatomical and clinical data. *Neurorep* 4:475–478
- Lenz FA, Dostrovsky JO, Kwan HC et al. (1988) Do calcium spikes account for the bursts of action potentials which occur in sensory thalamus of central pain patients? Society For Neuroscience Abstract 561
- Lenz FA, Gracely RH, Baker FH et al. (1998) Reorganization of sensory modalities evoked by stimulation in the region of the principal sensory nucleus (ventral caudal - Vc) in patients with pain secondary to neural injury. *J Comp Neurol* 399:125–138
- Lenz FA, Kwan HC, Martin R et al. (1994) Characteristics of somatotopic organization and spontaneous neuronal activity in the region of the thalamic principal sensory nucleus in patients with spinal cord transection. *J Neurophysiol* 72:1570–1587
- Lenz FA, Seike M, Richardson RT et al. (1993) Thermal and pain sensations evoked by microstimulation in the area of human ventrocaudal nucleus. *J Neurophysiol* 70:200–212
- Lenz FA, Zirh AT, Garonzik IM et al. (1998) Neuronal activity in the region of the principle sensory nucleus of human thalamus (ventralis caudalis) in patients with pain following amputations. *Neurosci* 86:1065–1081
- Mehler WR (1962) The anatomy of the so-called “pain tract” in man: an analysis of the course and distribution of the ascending fibers of the fasciculus anterolateralis. In: French JD, Porter RW (eds) *Basic Research in Paraplegia*. Thomas, Springfield, pp 26–55
- Radhakrishnan V, Tsoukatos J, Davis KD et al. (1999) A comparison of the burst activity of lateral thalamic neurons in chronic pain and non-pain patients. *Pain* 80:567–575
- Rinaldi PC, Young RF, Albe-Fessard DG et al. (1991) Spontaneous neuronal hyperactivity in the medial and intralaminar thalamic nuclei in patients with deafferentation pain. *J Neurosurg* 74:415–421
- Steriade M, Jones EG, Llinas RR (1990) *Thalamic Oscillations and Signaling*. Wiley, John & Sons, New York
- Steriade M, Llinas RR (1988) The functional states of the thalamus and the associated neuronal interplay. *Physiol Rev* 68:649–742
- Vierck CJ (1991) Can mechanisms of central pain syndromes be investigated in animal models? In: Casey KL (ed) *Pain and central nervous system disease: the central pain syndromes*. Raven Press, New York, pp 129–141
- Walker AE (1943) Central representation of pain. *Res Publ Assoc Res Nerv Ment Dis* 23:63–85
- Weng HR, Lee JJ, Lenz FA, Vierck CJ, Rowland LH, Dougherty PM (2000) Functional plasticity in primate somatosensory thalamus following chronic lesion of the ventral lateral spinal cord. *Neuroscience* 101:393–401
- Zirh AT, Lenz FA, Reich SG et al. (1997) Patterns of bursting occurring in thalamic cells during parkinsonian tremor. *Neuroscience* 83:107–121

## Thalamic Neurotransmitters and Neuromodulators

KARIN N. WESTLUND, BRIDGET E. HAWKINS  
Department of Anatomy and Neurosciences, University of Texas Medical Branch, Galveston, TX, USA  
kwhigh@utmb.edu, behawkin@utmb.edu

### Synonyms

Signaling Molecules of Thalamic Regions; thalamic neurotransmitters and neurochemical effector molecules

### Definition

The thalamus, a heterogeneous structure located in the dorsal diencephalic region of the brain, processes both sensory and motor input signals prior to transmission to higher cortical areas. ► **Neuromodulators** are chemical effector molecules that determine the neural activity enabling this process. While the microcircuitry and content of neuromodulators in the thalamus can be partially detailed at this point in time, the precise role of transmitters of the sensory thalamus in the transmission and generation of what is perceived as “pain” is still largely undefined. More recent observations suggest that neuromodulation occurs throughout the excitatory and the inhibitory neurocircuitry of the thalamus. It is clear that the chemical neuromodulation occurring in the thalamus permits a significantly more important role for the thalamus than simply as a “relay station”. Rather, the thalamus is an integration site where filtering and consolidation of sensory information occurs through chemical neurotransmission.

### Characteristics

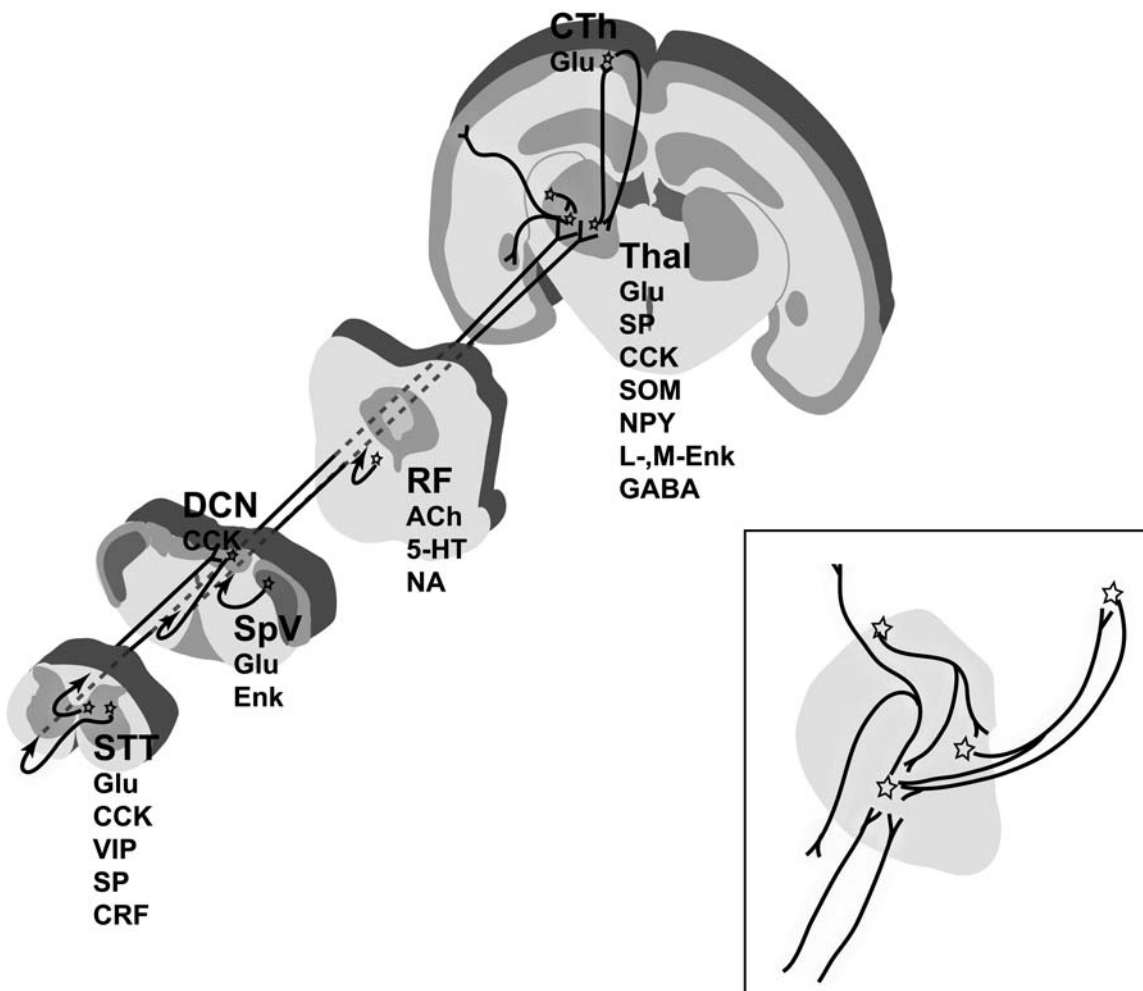
Neuromodulation in the sensory thalamus can best be described in terms of whether the neurochemicals are the content of input fibers, intrinsic interneurons or output components (Table 1; Fig. 1). The primary integrative sites in the thalamus for nociception are located medially and laterally in the posterior thalamus. The ventral posterior lateral thalamus is chiefly responsible for determining the intensity and location of the painful stimulus before relaying that information to the appropriate higher cortical regions of the brain. The medial thalamus is involved with emotional responses to nociceptive input.

### Thalamic Input

The primary sources of sensory information provided to the thalamus are the incoming spinothalamic, spinotrigeminal and medial lemniscal pathways.

**Thalamic Neurotransmitters and Neuromodulators, Table 1** Nociceptive Processing in the Thalamus

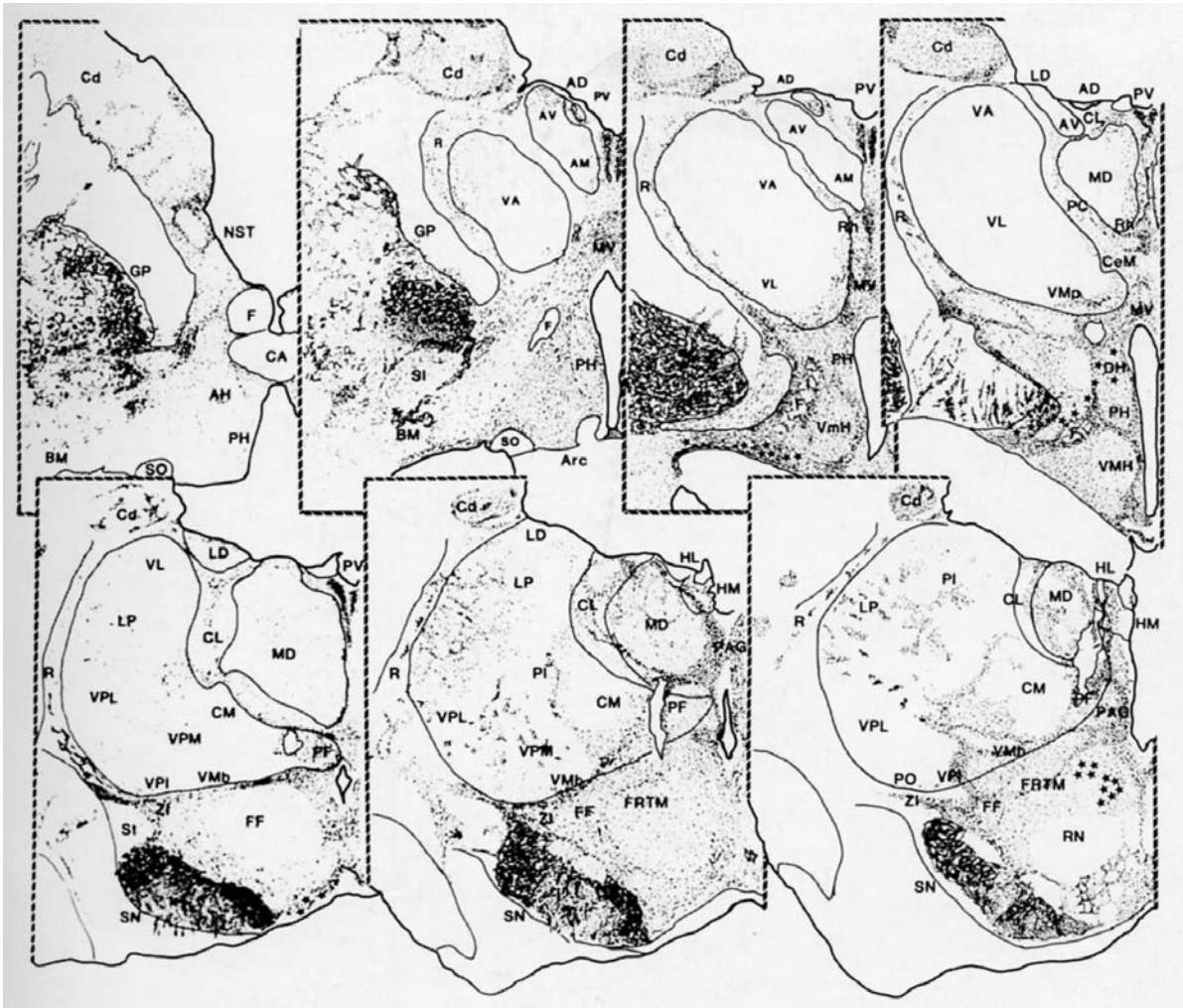
Thalamic Transmitters and Neuromodulators	
Thalamic Input	
Spinothalamic Tract and Medial Lemniscus	GLU, CCK
Corticothalamic Tract	GLU
Central Tegmental Field and Reticular Activation Systems	ACH (ChAT), 5-HT, NA, (TH, DBH), CGRP
Input to Intralaminar and Ventral Thalamic nuclei (from hypothalamus, basal telencephalon, and lateral midbrain)	ENK, SOM, CCK, SP, NPY
Intrinsic Interneurons and Reticular nucleus	GABA, ACH, SOM
Thalamic Output	
Thalamocortical Projections	GLU
Thalamoamygdalar Projections	CGRP



T

**Thalamic Neurotransmitters and Neuromodulators, Figure 1** Sensory input to the thalamus is transmitted by glutamatergic (GLU) spinothalamic (STT), spinal trigeminal (SpV), dorsal column nucleus (DCN) and reticular formation (RF) neurons. The information, modulated by neuropeptides, is relayed to the medial and lateral thalamus (Thal) where it is influenced by intrinsic GABAergic (GABA) interneurons. The integrated information is routed by glutamatergic thalamic projection neurons to sites including the cerebral cortex (CTh) and amygdala. Reciprocal input back to the thalamus from the cortex is also glutamatergic. Abbreviations: ACh, acetylcholine; CCK, cholecystokinin; CRF, corticotrophin releasing factor; Enk, leu- or met-enkephalin; Glu, glutamate; 5-HT, serotonin; NA, norepinephrine; NPY, neuropeptide Y; SOM, somatostatin; SP, substance P; VIP, vasoactive intestinal polypeptide.





**Thalamic Neurotransmitters and Neuromodulators, Figure 2** Schematic diagram illustrating the distribution of substance P immunoreactive fibers (dots) and cell somata (stars) in the monkey diencephalon (Jones 1988).

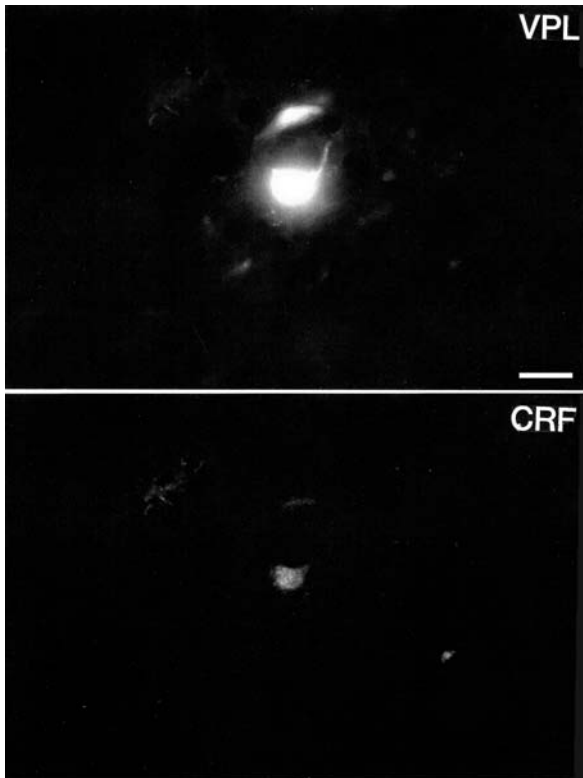
The corticothalamic tract, from cortical areas SI and SII, also provides a large contribution of incoming axonal fibers to the thalamus. Glutamate, the classical excitatory amino acid, is believed to be the primary transmitter of these fiber tracts, based on physiological and anatomical data. In other brain regions, increased release of glutamate and activation of neurons by glutamate is typically enhanced by the modulatory effects of ► **neuropeptides**, such as substance P (SP), CGRP and vasoactive intestinal polypeptide (VIP). Neuromodulators such as SP are found in abundance and probably function in a similar manner in the sensory thalamus (Fig. 2). The neuropeptide content of neuronal terminals in the thalamus is believed to be partially from thalamic input sources (Jones 1988).

#### Spinothalamic Tract

Glutamate has been observed in the spinothalamic projection neurons by electron microscopy (Westlund et al. 1992) (Fig. 1). Most spinothalamic neurons are

also believed to contain at least one neuropeptide, such as SP, cholecystinin (CCK), bombesin, dynorphin, enkephalin, galanin, corticotrophin releasing hormone (CRH) (Fig. 3) and / or vasoactive intestinal polypeptide (VIP) (Coffield and Miletic 1987; Leah et al. 1988; Nahin 1988). In fact, some have been shown to contain multiple neuropeptides (Ju et al. 1987). Lamina X STT cells have been shown to predominantly contain bombesin, enkephalin, CCK, somatostatin (SOM), CRF, neuropeptide Y and SP (Battaglia et al. 1988; Leah et al. 1988). The SP seems to function as a slow intermediary for transmission of noxious stimuli as well as a fast excitatory neurotransmitter modulator (Battaglia et al. 1988). Most of the terminals staining for SP are located in the medial rather than the lateral thalamus (Fig. 2). Enkephalin has also been identified in spinothalamic neurons (Nahin 1988). These findings are supported by both tract tracing / immunocytochemical studies and negative staining after spinal hemisection.





**Thalamic Neurotransmitters and Neuromodulators, Figure 3** After fluorescent tracer is injected into the ventral thalamus, spinothalamic tract cells containing peptides such as corticotrophin releasing factor (CRF) can be identified in the sacral spinal cord, lamina V. The panel labeled VPL illustrates two cells retrogradely labeled after injection of fluorescent tracer into ventral thalamus. One of these cells also stained for CRF. Scale bar = 15  $\mu$ m. (Westlund et al., unpublished).

### Medial Lemniscus

Input to the thalamus from the dorsal column nuclei is less well studied. Neuropeptide CCK content in the ventral posterolateral (VPL) nucleus is, however, reduced upon lesion of the contralateral dorsal column nucleus, suggesting that this modulator is involved in the relay of sensory information by the medial lemniscus (Jones 1988).

### Spinoreticular Pathways

Innervation by brainstem cholinergic, serotonergic and noradrenergic neurons is also present in the thalamus (Jones 1988; Westlund et al. 1990) (Fig. 4). Sparse innervation by **serotonin** fibers from the raphe nucleus and adjacent periaqueductal gray region has been demonstrated by dual labeling in monkeys. Similarly, in the same studies, norepinephrine was found sparsely innervating the VPL. However, innervation by serotonergic, noradrenergic and **acetylcholine** terminals is found more prominently in the reticular and dorsal lateral geniculate nuclei (as reviewed in McCormick 1992). The purpose of these classical neurotransmitters in the thalamus remains unclear, though iontophoretic application of acetylcholine results in marked inhibition

of the activity of reticular nucleus neurons, which, if it persists, can shift reticular nucleus cells into bursting activity. Iontophoresis of norepinephrine or serotonin markedly activates the reticular nucleus neurons through  $\alpha_1$  and 5-HT<sub>2</sub> (and possibly, 5-HT<sub>1C</sub>) receptors, due to the decrease in resting potassium conductance. The net result is facilitation of single spike activity and marked inhibition of the rhythmic bursting activity normally promoted by the slow release of norepinephrine in this nucleus. It is assumed that these processes are part of the general arousal system throughout the neuraxis in which these transmitters participate. The highest levels of 5-HT<sub>7</sub> receptors are found on the intralaminar and midline thalamic neurons. Stimulation of the raphe nuclei can alter the responses of these neurons to nociceptive input (Goaillard and Vincent 2002).

### Corticothalamic Input

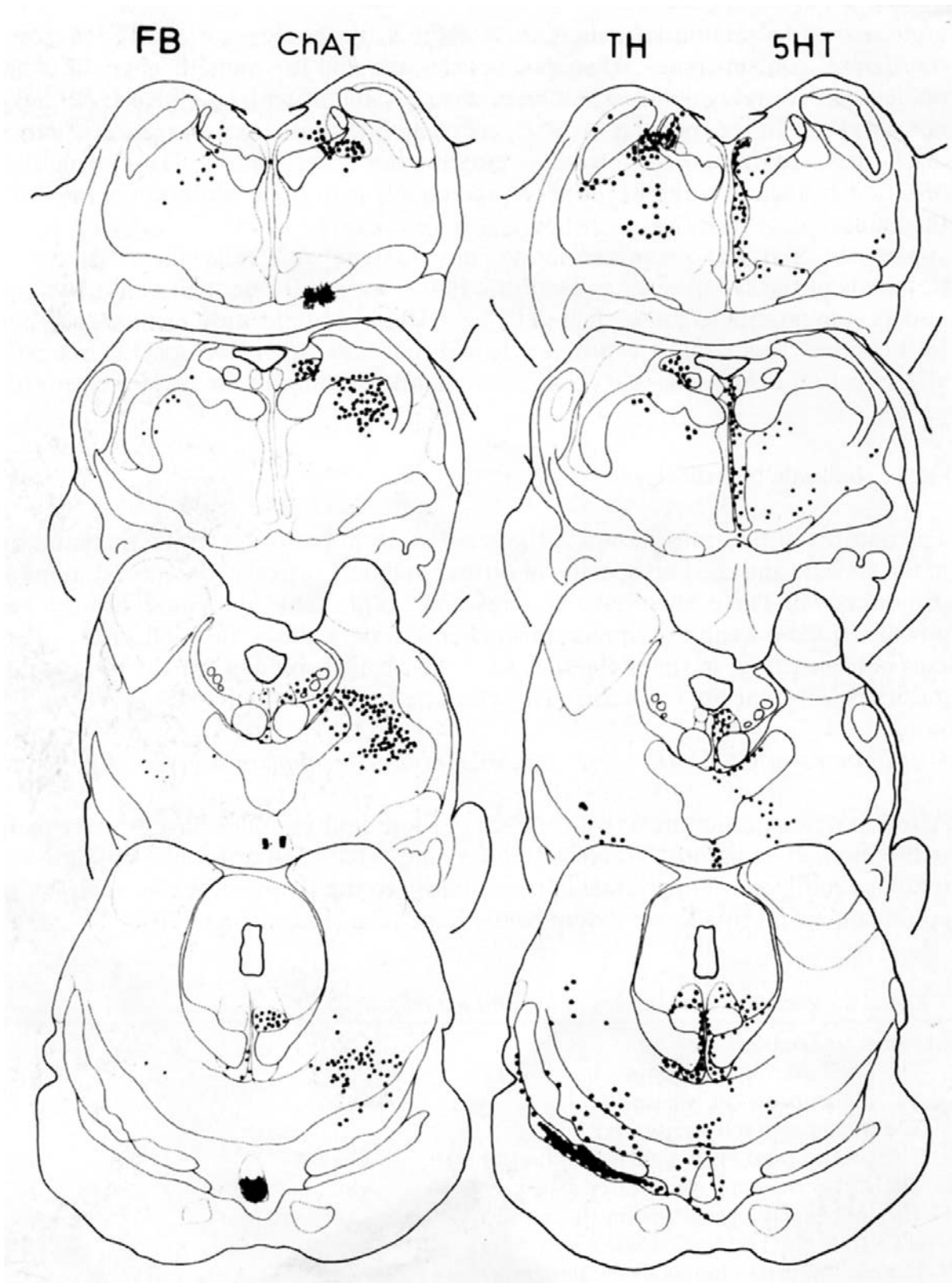
Corticothalamic input to the thalamus is also glutamatergic since there is dense staining of both glutamate and aspartate in cells in layers IV and III of SI sensory cortex and many of these cortical cells can be double labeled with tract tracers injected into the thalamus (Guiffreda and Rustioni 1988; Rustioni et al. 1988) Only a small population of neurons is labeled with both glutamate and aspartate. The corticofugal fibers utilizing glutamate as the primary neurotransmitter terminate as small endings containing round vesicles primarily contacting fine caliber (distal) dendrites of thalamic neurons and are particularly dense in the reticular nucleus (Guiffreda and Rustioni 1988; McCormick 1992).

### Intrinsic Interneurons

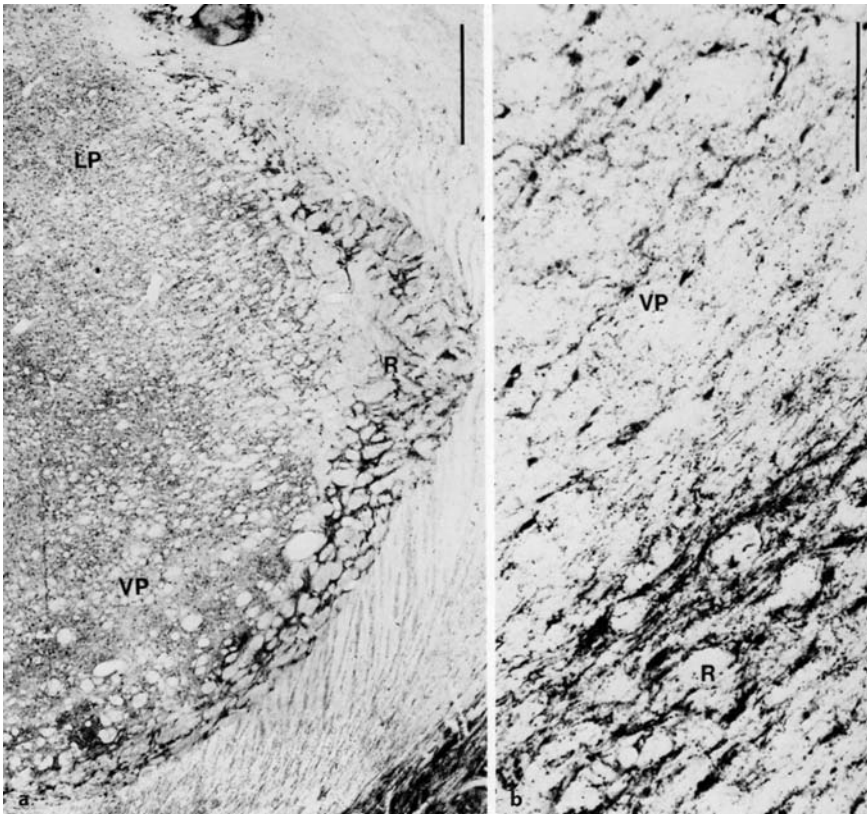
The inhibitory neurotransmitter, gamma amino butyric acid (**GABA**), has been well characterized in the thalamus, particularly in the reticular nucleus of the thalamus where it is the predominant feature (Fig. 5). It has been determined that GABA is present in the interneurons of the ventral posterior thalamus only in carnivorous animals (i.e. present in primates and cats, but not in rats) (Rustioni et al. 1988). Intrinsic substance P interneurons have also been described in the thalamus in regions receiving spinothalamic tract input as demonstrated by anterograde tracing (Battaglia et al. 1988).

### Thalamic Output

Information regarding the sensory-discriminative aspect of pain is sent to parts of the cortex involved in somatosensory processing, such as precisely localized areas I (SI), II (SII) and area 4, for further site specific association, in order that pain appropriate response instructions can be dispatched *via* the motor systems. The thalamocortical efferent pathways (Fig. 1) were identified as glutamate positive neurons with collaterals to the reticular nucleus (Guiffreda and Rustioni 1988; as reviewed in McCormick 1992). Thalamic output to the cortex is activated by glutamate NMDA and non-NMDA receptors, since specific antagonists applied



**Thalamic Neurotransmitters and Neuromodulators, Figure 4** Transverse sections of the brainstem of a monkey showing retrograde labeling of neurons (FB) after injection of Fast Blue in the ipsilateral ventral posterolateral nucleus of the thalamus, and the distribution of choline acetyltransferase (ChAT)-, tyrosine hydroxylase (TH)- and serotonin (5HT)-immunoreactive cells (Jones 1988).



**Thalamic Neurotransmitters and Neuromodulators, Figure 5** (a) Immunocytochemical staining of GABAergic neurons in the reticular nucleus (R) of a cat, identified using antiserum to glutamic acid decarboxylase (GAD). Fine dots in the dorsal thalamus are GAD-positive somata of interneurons. (b) Higher-power photomicrograph of GAD-positive cells in reticular nucleus (R) and ventral posterior (VP) nucleus of a cat. Bars = 1 mm (a), 250  $\mu\text{m}$  (b). (Jones 1985)

to the thalamus can block transmission of thalamic outflow. The glutamatergic input to the thalamocortical neurons probably arises from the input sources detailed above.

There is also an affective component to pain perception, which contributes to the emotional responses generated in response to the stimulus. This aids in memory development for future avoidance of the painful situation. These functions are relegated to the mediodorsal (ventrocaudal) (MDvc) and intralaminar thalamic regions which receive input mainly from laminae I and X of the spinal cord and send projections to the cingulate cortex (in primates). The ventral posterior inferior nuclei send signals directly to the somatosensory area of the parietal cortex (SII) and indirectly to the insula (Millan 1999). Both may be joined by additional ipsilateral input. A thin layer of CGRP neurons is found just ventral to the thalamus near to the meso-diencephalic junction (Kruger et al. 1988) and is associated with the thalamus and the somatosensory pathways, as are all CGRP components of the nervous system. These CGRP neurons have been shown to provide a thalamoamygdalar projection which may also be important in generating the emotional responses to painful stimuli.

Calcium calmodulin-dependent protein kinase (CaM kinase II) has been found in thalamic dendrites apposed by glutamate terminals, suggesting that this major postsynaptic activity regulator may assist in modulating synaptic strength, transmitter release and / or vesicle

movement in thalamic neurons (Liu and Jones 1996). The CaM kinase II terminals in the cerebral cortex are thought to be terminals of thalamocortical neurons.

## References

1. Battaglia G, Spreafico R, Rustioni A (1988) Substance P-immunoreactive fibers in the thalamus from ascending somatosensory pathways. In: Bentivoglio M, Spreafico R (eds) *Cellular Thalamic Mechanisms*. Elsevier Science Publishers, Amsterdam
2. Coffield JA, Miletic V (1987) Immunoreactive enkephalin is contained within some trigeminal and spinal neurons projecting to the rat medial thalamus. *Brain Res* 425:380–383
3. Goauillard JM, Vincent P (2002) Serotonin suppresses the slow afterhyperpolarization in rat intralaminar and midline thalamic neurones by activating 5-HT(7) receptors. *J Physiol* 541:453–465
4. Guiffrida R, Rustioni A (1988) Glutamate and aspartate immunoreactivity in corticothalamic neurons of rats. In: Bentivoglio M, Spreafico R (eds) *Cellular Thalamic Mechanisms*. Elsevier Science Publishers, Amsterdam, pp 311–320
5. Jones EG (1985) Transmitters, receptors, and related compounds in the thalamus. In: Jones EG (ed) *The Thalamus*. Plenum Press, New York, pp 225–256
6. Jones EG (1988) Modern views of cellular thalamic mechanisms. In: Bentivoglio M, Spreafico R, (eds) *Cellular Thalamic Mechanisms*. Elsevier Science Publishers, pp 1–22
7. Ju G, Melander T, Ceccatelli S et al. (1987) Immunohistochemical evidence for a spinothalamic pathway co-containing cholecystokinin- and galanin-like immunoreactivities in the rat. *Neuroscience* 20:439–456
8. Kruger L, Stermini C, Brecha NC et al. (1988) The thalamic region of calcitonin gene-related peptide (CGRP) immunoreactivity and its relation to somatosensory pathways. In: Bentivoglio M, Spreafico R (eds) *Cellular Thalamic Mechanisms*. Elsevier Science Publishers, Amsterdam, pp 375–386



9. Leah J, Menetrey D, de Pommery J (1988) Neuropeptides in long ascending spinal tract cells in the rat: evidence for parallel processing of ascending information. *Neuroscience* 24:195–207
10. Liu XB, Jones EG (1996) Localization of alpha type II calcium calmodulin-dependent protein kinase at glutamatergic but not gamma-aminobutyric acid (GABAergic) synapses in thalamus and cerebral cortex. *Proc Natl Acad Sci USA* 93:7332–7336
11. McCormick DA (1992) Neurotransmitter actions in the thalamus and cerebral cortex and their role in neuromodulation of thalamocortical activity. *Prog Neurobiol* 39:337–388
12. Millan MJ (1999) The induction of pain: an integrative review. *Prog Neurobiol* 57:1–164
13. Nahin RL (1988) Immunocytochemical identification of long ascending, peptidergic lumbar spinal neurons terminating in either the medial or lateral thalamus in the rat. *Brain Res* 443:345–349
14. Rustioni A, Battaglia G, De Biasi S et al (1988) Neuromediators in somatosensory thalamus: an immunocytochemical overview. In: Bentivoglio M, Spreafico R (eds) *Cellular Thalamic Mechanisms*. Elsevier Science Publishers, Amsterdam, pp 271–296
15. Westlund KN, Sorkin LS, Ferrington DG, Carlton SM, Willcockson HH, Willis WD (1990) Serotonergic and noradrenergic projections to the ventral posterolateral nucleus of monkey thalamus. *J Comp Neurol* 295:197–207
16. Westlund KN, Carlton SM, Zhang D et al. (1992) Glutamate-immunoreactive terminals synapse on primate spinothalamic tract cells. *J Comp Neurol* 322:519–527

## Thalamic Nociceptive Neurons

- ▶ Human Thalamic Nociceptive Neurons

## Thalamic Nociceptive System

- ▶ Thalamic Nuclei Involved in Pain, Cat and Rat

## Thalamic Nuclei

### Definition

The thalamus, which is located in the centre of the cerebral cortex, is comprised of many nuclei. The thalamus relays information to and from the cerebral cortex, and also plays a part in modulating sensory information.

- ▶ Central Pain, Diagnosis

## Thalamic Nuclei Involved in Pain, Cat and Rat

CHRISTIANE VAHLE-HINZ

Institute of Neurophysiology and Pathophysiology,  
University Hospital Hamburg-Eppendorf, Hamburg,  
Germany

vahle-hinz@uke.uni-hamburg.de

### Synonyms

Thalamic Nociceptive System; Lateral and Medial Thalamic Nociceptive System

### Definition

Nuclei of the dorsal thalamus whose neurons receive inputs from ascending nociceptive pathways and project to cortical nociceptive areas. The neurons respond to stimulation of ▶ **nociceptors** in skin, muscles, joints and viscera. The different thalamic regions process and transmit information subserving the ▶ **sensory-discriminative** and the ▶ **motivational-affective components of pain**.

### Characteristics

A distinction is generally made in all species between a lateral and a medial thalamic system, the lateral with neurons encoding stimulus quality, duration, intensity and location on the body and thus subserving the ▶ **sensory-discriminative component of pain**, the medial system with neurons activated from large areas of the body and/or internal organs and involved in the motivational-affective component of pain. The different response properties reflect ascending inputs dominated by the spinothalamic and spinal trigeminothalamic tracts (STT) and projection to the SI and SII somatosensory cortices (lateral system) *versus* STT and spinoreticulothalamic tract and widespread cortical projections including limbic areas (medial system).

In contrast to other sensory nuclei in the thalamus, nociceptive “nuclei” cannot be delineated histologically. Rather, nociceptive neurons are found within nuclei primarily subserving other functions like the mediodorsal or intralaminar nuclei or the ventral posterior complex (VP). Thus, “thalamic nuclei involved in pain” have been identified by neuroanatomical tracing of terminations of ascending tracts carrying nociceptive signals or by ▶ **electrophysiological mapping** of neurons responsive to noxious stimuli. The latter is hindered further by the problems of applying painful stimuli in awake animals or the inherent ▶ **antinociceptive effects of general anesthetics** when studies are done under ▶ **anesthesia** (Vahle-Hinz and Detsch 2002; Vahle-Hinz et al. 2002). At the spinal cord level, the majority of nociceptive somatic and visceral neurons in addition have low-threshold somatic receptive fields (RFs), which may be preserved in the thalamus while their nociceptive components are abolished by the anesthetic. These difficulties are reflected in the heterogeneous picture of thalamic nociception in the literature (for review see Willis 1997) and it still awaits clarification whether species differences originate from principally different organizations or a unifying picture may emerge.

### Lateral Thalamus

Nociceptive neurons are found in regions of terminations of the STT that are patchy and dispersed in and around the VP and the posterior complex (PO) in the rat while they are confined to the PO and the margins of the VP in



the cat. These regions are further characterized by small neurons and may correspond to the small-celled matrix regions in and around the VP of monkeys. Thus, although the location of nociceptive neurons may differ between species (outside *versus* inside VP), this may result from a different degree of invasion of this small-celled matrix into the VP.

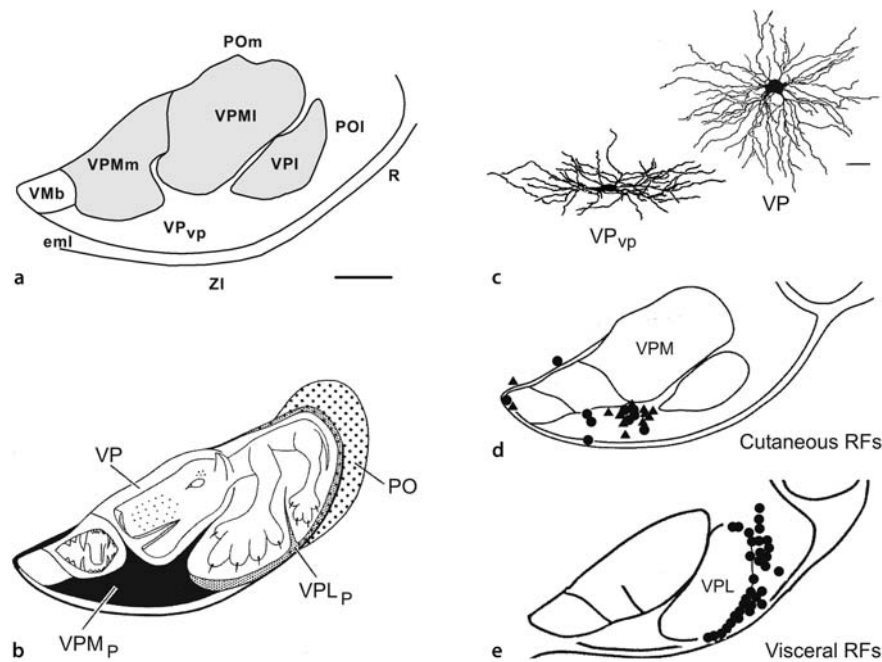
### Region of the Ventral Posterior Complex (VP)

The VP is characterized by input from the medial and trigeminal lemnisci carrying a somatotopic representation of low-threshold mechanoreceptors of the contralateral half of the body surface including the furry buccal pad (rat) or a bilateral representation of intraoral structures (cat) (Vahle-Hinz and Gottschaldt 1983). The cartoon in Fig. 1B shows the approximate proportions in the cat's VP in a frontal plane, while in fact the complex extends caudomedially to rostrolaterally with the hind limb area rostral to the face in both rat and cat. The subnuclei of the VP holding the representations of the different parts of the body stand out from adjacent regions histologically by denser packing and larger somata of neurons (Fig. 1a). Interspersed are smaller **GABAergic cells** with local axonal arbors (interneurons, about 25% of the neurons) in the cat; these are virtually absent in the rat. The projection neurons of the VP have large round so-

mata with dense radial dendritic arbors (Fig. 1c) (Kniffki et al. 1993).

Nociceptive neurons occur in the periphery of the VP ( $VP_p$ ) in the cat (Kniffki and Vahle-Hinz 1987; Vahle-Hinz et al. 1987). This peripheral region is characterized by scattered neurons with small, spindle-shaped somata and few primary dendrites giving rise to sparse dendritic arbors oriented within the confines of the region, i.e. mediolaterally along its borders (Fig. 1c) (Kniffki et al. 1993). The narrow sheath of cells wraps around the VP dorsally and laterally, extending towards the external medullary lamina on its ventral border, thus widening to a sizeable area ventral to the ventral posterior medial nucleus (VPM). This part resembles the ventral posterior inferior nucleus (VPI) of the monkey. Most of the neurons in the  $VPM_p$  have somatic RFs and the majority are located on the head (Fig. 1d). The lateral part of the  $VP_p$  ( $VPL_p$ ) is a narrow band surrounding the ventral posterior lateral nucleus (VPL) ventrally, laterally and dorsally. It merges with the lateral and medial parts of the PO and its RFs are located on the fore- and hindlimbs as well as on visceral organs (Fig. 1e). Thus with respect to somatic RFs, a coarse somatotopy is present running parallel to that of the VP proper.

While no nociceptive neurons are found inside the VP of the cat, they may invade the laminae between subnu-



**Thalamic Nuclei Involved in Pain, Cat and Rat, Figure 1** Locations of nociceptive neurons in the lateral thalamus of the cat. (a, b) Subnuclei of the ventral posterior complex and adjacent regions as determined by histology (a), Nissl stain, coronal section, medial to the left, scale bar: 1 mm) and electrophysiological mapping of neuronal receptive fields (b). (c) Examples of neurons from the  $VP_{vp}$  and the VP (camera lucida drawings from Golgi-stained tissue, scale bar: 50  $\mu$ m). (d) Recording sites in  $VP_p$  of nociceptive neurons with cutaneous receptive fields. Nociceptive-specific (dots) and multireceptive neurons (triangles). (e) Recording sites of visceroreceptive neurons in  $VP_p$  and PO determined by electrical stimulation of the pelvic nerve. Eml, external medullary lamina; POl, m, medial and lateral parts of the posterior complex; R, thalamic reticular nucleus; VMb, basal ventral medial nucleus (gustatory relay); VP, ventral posterior complex;  $VP_p$ , periphery of VP;  $VP_{vp}$ , ventral periphery of VP; VPMm, l, medial (intraoral RFs) and lateral (face RFs) parts of the ventral posterior medial nucleus; VPL, ventral posterior lateral nucleus (postcranial body RFs); ZI, zona incerta; scale bar: 1 mm. Modified from Vahle-Hinz et al. 1995 (b), Kniffki et al. 1993 (c), Kniffki and Vahle-Hinz 1987 (e), Brüggenmann et al. 1994 (e).

clei of the VP as shown in Fig. 1b. In the rat, clustering of VP cells with similar RFs is even more pronounced and thus laminae with nociceptive cells are more numerous interspersed, contributing to the appearance of a mixed representation of mechanoreceptive and nociceptive neurons described in the literature (for review see Willis 1997). Most of the somatic nociceptive neurons in the rat, however, are found in the PO.

### Posterior Complex (PO)

The somatosensory parts of PO adjoin VPL laterally and dorsally and VPM dorsally (POm). The nuclear and subnuclear boundaries are not discernible histologically. PO receives inputs from the STT, the lateral cervical nucleus, the dorsal column, the nucleus of the solitary tract and the parabrachial area. These afferents carry nociceptive somatic and visceral signals. In the cat, the VPL<sub>p</sub> and adjoining PO were found to hold visceroreceptive neurons with inputs from thoracic and pelvic visceral organs (Brüggemann et al. 1993; Brüggemann et al. 1994; Horn et al. 1997; Horn et al. 1999; Vahle-Hinz et al. 1995). Also in the rat, a concentration of visceroreceptive neurons in the region immediately surrounding the VP was found (Berkley et al. 1993). No viscerotopic organization is discernible but the response properties indicate that this region may be involved in the encoding, localization and referral of visceral pain.

The somatic low-threshold RFs of PO neurons are often large and bilateral and include deep structures like muscles and joints. In the rat, somatic nociceptive neurons with small RFs and stimulus encoding properties similar to those of the cat's VP<sub>p</sub> are found in the POM.

### Medial Thalamus

Nociceptive somatic and visceral neurons are found in a number of nuclei of the medial thalamus, including the central lateral and parafascicular nucleus of the intralaminar complex, the mediodorsal nucleus and the nucleus submedius (for review see Willis 1997). The RFs are usually large, often bilateral, with convergent input from skin, muscles, joints and viscera. There is no somatotopic or viscerotopic organization; thus these regions may not be involved in the spatial localization of a painful stimulus. In contrast, intensity is encoded in graded responses, a property important for the affective component of pain. The nociceptive responses are particularly sensitive to the kind and depth of anesthesia. NS, WDR and multireceptive neurons occur in the mediodorsal and intralaminar nuclei. The nucleus submedius receives a dense projection from ► lamina I of the spinal cord in cats and nociceptive-specific somatic neurons here are more abundant than WDR neurons in both rats and cats.

### References

1. Berkley KJ, Guilbaud G, Benoist J-M, Gautron M (1993) Responses of neurons in and near the thalamic ventrobasal complex

of the rat to stimulation of uterus, vagina, colon, and skin. *J Neurophysiol* 69:557–568

2. Brüggemann J, Vahle-Hinz C, Kniffki K-D (1993) Representation of the urinary bladder in the lateral thalamus of the cat. *J Neurophysiol* 70:482–491
3. Brüggemann J, Vahle-Hinz C, Kniffki K-D (1994) Projections from the pelvic nerve to the periphery of the cat's thalamic ventral posterolateral nucleus and adjacent regions of the posterior complex. *J Neurophysiol* 72:2237–2245
4. Horn AC, Vahle-Hinz C, Petersen M et al. (1997) Projections from the renal nerve to the cat's lateral somatosensory thalamus. *Brain Res* 736:47–55
5. Horn AC, Vahle-Hinz C, Brüggemann J et al. (1999) Responses of neurons in the lateral thalamus of the cat to stimulation of urinary bladder, colon, esophagus, and skin. *Brain Res* 851:164–174
6. Kniffki K-D, Vahle-Hinz C (1987) The periphery of the cat's ventroposteromedial nucleus (VPM<sub>p</sub>): Nociceptive neurones. In: Besson J-M, Guilbaud G, Peschanski M (eds) *Thalamus and Pain*. Elsevier, Amsterdam, pp 245–257
7. Kniffki K-D, Pawlak M, Vahle-Hinz C (1993) Scaling behavior of the dendritic branches of thalamic neurons. *Fractals* 1:171–178
8. Vahle-Hinz C, Brüggemann J, Kniffki K-D (1995) Thalamic processing of visceral pain. In: Bromm B, Desmedt J (eds) *Pain and the Brain. From Nociception to Cognition*. Advances in Pain Research and Therapy, vol 22. Raven Press, New York, pp 125–141
9. Vahle-Hinz C, Detsch O (2002) What can *in vivo* electrophysiology in animal models tell us about mechanisms of anesthesia? *Br J Anaesth* 89:123–142
10. Vahle-Hinz C, Freund I, Kniffki K-D (1987) Nociceptive neurons in the ventral periphery of the cat thalamic ventroposteromedial nucleus. In: Schmidt RF, Schaible H-G, Vahle-Hinz C (eds) *Fine Afferent Nerve Fibers and Pain*. VCH Verlagsgesellschaft, Weinheim, pp 440–450
11. Vahle-Hinz C, Gottschaldt K-M (1983) Principal differences in the organization of the thalamic face representation in rodents and felids. In: Macchi G, Rustioni A, Spreafico R (eds) *Somatosensory Integration in the Thalamus*. Elsevier, Amsterdam, pp 125–145
12. Vahle-Hinz C, Reeker W, Detsch O et al (2002) Antinociceptive effects of anesthetics *in vivo*: Neuronal responses and cellular mechanisms. In: Urban BW, Barann M (eds) *Molecular and Basic Mechanisms of Anesthesia*. Pabst Sci Publ, Lengerich, pp 516–524
13. Willis WD (1997) Nociceptive functions of thalamic neurons. In: Steriade M, Jones EG, McCormick DA (eds) *Thalamus*, Vol. II, Experimental and Clinical Aspects. Elsevier, Amsterdam, pp 373–424

## Thalamic Nuclei Involved in Pain, Human and Monkey

EDWARD JONES

Center for Neuroscience, University of California,  
Davies, CA, USA

eJones@ucdavis.edu

### Synonyms

Nociceptive Coding in Lateral Thalamus; Lateral thalamus encodes pain

### Description

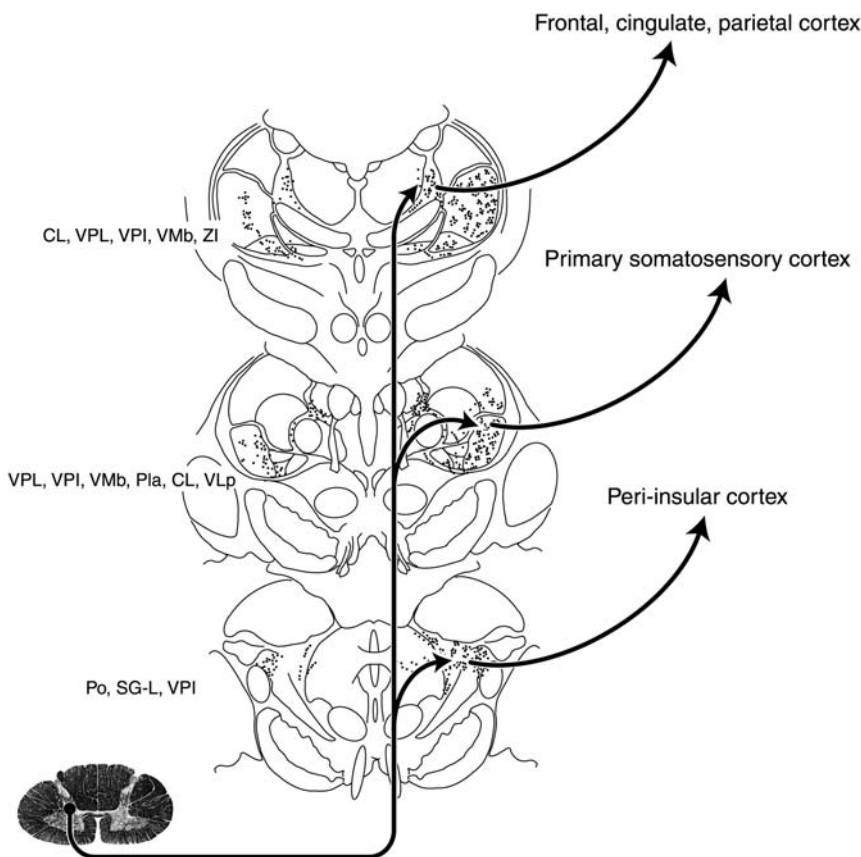
Based on anatomical considerations, afferent inputs, cortical projections and electrophysiological evidence, the core of the ventral posterior nuclei must be involved in transmitting nociceptive information to the cortex.

## Characteristics

It is likely that many thalamic nuclei and therefore their projection areas in the cerebral cortex are “involved” in pain. However, despite many attempts to discredit it, it remains apparent that the ventral posterior nuclear complex is that part of the thalamus that possesses the appropriate input connections and the relevant cellular machinery for relaying the qualitative features and peripheral localization of a painful stimulus. A necessary corollary of this is that the cortical projection target of the ventral posterior complex, the post central gyrus, is a central element in the onward pathways to the perception of pain.

The essay ▶ [Spinothalamic Terminations, Core and Matrix](#) summarizes the newer connection tracing studies that demonstrate not only the widespread terminations of the ▶ [central pain pathways](#) in the primate thalamus but also their relationships to cells within the heart of the ventral posterior nucleus, the ▶ [ventral posterior medial \(VPM\)](#) and ▶ [ventral posterior lateral \(VPL\)](#) nuclei. Here they appear to terminate preferentially on the *matrix* cells of the two nuclei, extending these terminations beyond the confines of ▶ [VPM](#) and ▶ [VPL](#) into and surrounding nuclei that are also characterized by the presence of ▶ [calbindin-immunoreactive matrix cells](#).

Single unit recordings both within and around the perimeter of the ventral posterior nucleus of the thalamus in monkeys and humans reveal the presence of neurons with both nociceptive-specific and ▶ [wide dynamic range](#) properties akin to those found in dorsal horn neurons (e.g. Bushnell et al. 1993; Craig et al. 1994; Lee et al. 1999; Ohara and Lenz 2003; Willis and Coggeshall 2004). Unfortunately, these have never been satisfactorily identified as exclusively within the matrix, but it is clear that many of these recordings have come not just from the matrix regions surrounding VPM and VPL but also from within the heart of these nuclei themselves. From what we have described in the essay on spino- and spinal trigeminothalamic terminations mentioned above, it is unlikely (although some have considered it controversial) that noci- or thermo-specific neurons of spinal lamina I project only to neurons outside the confines of the ventral posterior nucleus, although their projections may be concentrated there in the matrix domain in monkeys and humans (and in comparable regions in cats). Of special note is the presence of neurons with nociceptive specific properties within the heart of the ventral posterior nucleus. This carries the implication that these neurons project to the primary somatosensory cortex and that has indeed



**Thalamic Nuclei Involved in Pain, Human and Monkey, Figure 1** Schematic view of the distribution of spinothalamic tract fibers in the thalamus of the macaque monkey and the cortical projections of the receiving nuclei. CL, central lateral nucleus; Po, posterior nucleus; Pla, anterior pulvinar nucleus; SG-L, limitans-supragenulate nucleus; VLp, posterior ventral lateral nucleus; VMb, basal ventral medial nucleus; VPI, ventral posterior inferior nucleus; VPL, ventral posterior lateral nucleus; VPM, ventral posterior medial nucleus; ZI, zona incerta.

been directly demonstrated in a small number of cases (Kenshalo et al. 1980).

The presence of neurons with properties appropriate for relaying the details of the modality, location and intensity of a painful stimulus within the heart of the thalamic nucleus that projects to the primary somatosensory cortex should not be taken to imply that these neurons are found only therein. They are indeed found within all or most of the other sites of termination of the spinothalamic tracts as a whole and within those sites outside the ventral posterior nucleus to which neurons specifically located in the superficial dorsal horn project (reviewed in Willis et al. 2002). The cortical targets of these other parts of the thalamus, which include the ► **ventral posterior inferior** and ► **basal ventral medial nuclei** of the ventral posterior complex, the adjacent matrix-filled domains of the ► **posterior nucleus** and ► **anterior pulvinar nucleus** and the caudal intralaminar nuclei, are diverse and include the second somatosensory area, other peri-insular areas and parts of the prefrontal and possibly anterior cingulate cortex. The broad implication is the classical one that the multi-dimensional character of that sensation that we call pain is reflected in inputs to regions of cortex whose known or conjectured functional connotations are appropriate for each of these dimensions. But there is still no reason to rule out the belief that the primary somatosensory cortex is the primary route to the centers for perception of the quality, location and intensity of a painful stimulus. This is not the place to consider all the data that imply the dissociation of the sensory discriminative and affective-motivational dimensions of pain in relation to different cortical areas but there is a growing literature (often misinterpreted or misrepresented) in this field that is covered in other essays in this encyclopedia.

Functional imaging studies in humans support the view of widespread thalamocortical projections in the central pain system. Most of the areas referred to in the preceding paragraph show functional activation in response to application of painful stimuli to the skin or stimuli engendered in deeper tissues. Areas of the cortex reportedly activated during the appreciation of a painful stimulus include the first and second somatosensory areas, the insula and the anterior cingulate gyrus (e.g. Coghill et al. 1994; Davis et al. 1998; Gelnar et al. 1999). Trying to correlate these observations with electrophysiological reports from monkeys and the effects of stimulation or lesions in humans presents a confusing picture from which workers committed to any point of view about the cortical representation of pain, however eccentric, can derive sustenance.

When we look at the results of recording or imaging of the postcentral gyrus after presentation of painful stimuli to human subjects, it is difficult to escape the conclusion that the primary somatosensory cortex is at the heart of the territory involved in nociception but more lateral areas are likely to be involved as well (Treede et al. 2000;

Ohara et al. 2004a, 2004b). These imaging results, moreover, tend to be supported by the results of single unit studies in monkeys (Robinson and Burton 1980; Kenshalo et al. 2000). The role of the lateral areas has been adduced mainly from lesion studies in humans, but these have been variously interpreted.

My own view is that lesions involving the parietal operculum (which might mean involvement of the second somatosensory area alone but could equally undercut fibers approaching the postcentral gyrus) seem to alter the sensory-discriminative aspects of pain appreciation, while those affecting regions located in insular and postinsular regions tend to alter affective and motivational aspects and can result in pain asymbolia (see, for example, Greenspan et al. 1999; Ostrowsky et al. 2002). This still leaves out, however, the prefrontal and cingulate areas. Perhaps it is their activation in pain states that represents the inputs from thalamic nuclei such as the caudal intralaminar?

## References

1. Bushnell MC, Duncan DH, Tremblay N (1993) Thalamic VPM nucleus in the behaving monkey. I. Multimodal and discriminative properties of thermosensitive neurons. *J Neurophysiol* 69:739–752
2. Coghill RC, Talbot JD, Evans AC et al. (1994) Distributed processing of pain and vibration by the human brain. *J Neurosci* 14:4095–4108
3. Craig AD, Bushnell MC, Zhang E-T et al. (1994) A thalamic nucleus specific for pain and temperature sensation. *Nature* 372:770–773
4. Davis KD, Kwan CL, Crawley AP et al. (1998) Functional MRI study of thalamic and cortical activations evoked by cutaneous heat, cold, and tactile stimuli. *J Neurophysiol* 80:1533–1546
5. Gelnar PA, Krauss BR, Sheeche PR et al. (1999) A comparative fMRI study of cortical representations for thermal painful, vibrotactile, and motor performance tasks. *Neuroimage* 10:460–482
6. Greenspan JD, Lee RR, Lenz FA (1999) Pain sensitivity alterations as a function of lesion location in the parasyllvian cortex. *Pain* 81:273–282
7. Kenshalo DR Jr, Giesler GJ Jr, Leonard RB et al. (1980) Responses of neurons in primate ventral posterior lateral nucleus to noxious stimuli. *J Neurophysiol* 43:1594–1614
8. Kenshalo DR, Iwata K, Sholas M, Thomas DA (2000) Response properties and organization of nociceptive neurons in area 1 of monkey primary somatosensory cortex. *J Neurophysiol* 84:719–729
9. Lee J-I, Dougherty PM, Antezana D et al (1999) Responses of neurons in the region of human thalamic principal somatic sensory nucleus to mechanical and thermal stimuli graded into the painful range. *J Comp Neurol* 410:541–555
10. Ohara S, Lenz FA (2003) Medial lateral extent of thermal and pain sensations evoked by microstimulation in somatic sensory nuclei of human thalamus. *J Neurophysiol* 90:2367–2377
11. Ohara S, Crone NE, Weiss N et al. (2004a) Cutaneous painful laser stimuli evoke responses recorded directly from primary somatosensory cortex in awake humans. *J Neurophysiol* 91:2734–2746
12. Ohara S, Crone NE, Weiss N et al. (2004b) Attention to pain is processed at multiple cortical sites in man. *Exp Brain Res* 156:513–517
13. Ostrowsky K, Magnin M, Ryvlin P et al. (2002) Representation of pain and somatic sensation in the human insula: a study of responses to direct electrical cortical stimulation. *Cereb Cortex* 12:376–385



14. Robinson CJ, Burton H (1980) Somatic submodality distribution within the second somatosensory (SII), 7b, retroinsular, postauditory and granular insular cortical areas of *M. fascicularis*. *J Comp Neurol* 192:93–108
15. Treede RD, Apkarian AV, Bromm B et al. (2000) Cortical representation of pain: functional characterization of nociceptive areas near the lateral sulcus. *Pain* 87:113–119
16. Willis WD Jr, Coggeshall RE (2004) *Sensory Mechanisms of the Spinal Cord*, 3rd edn. Plenum, New York
17. Willis WD Jr, Zhang X, Honda CN et al. (2002) A critical review of the role of the proposed VMpo nucleus in pain. *J Pain* 3:79–94

## Thalamic Pain

- ▶ Central Pain, Diagnosis

## Thalamic Physiology Changes Occurring in Patients with Chronic Pain

- ▶ Thalamus, Receptive Fields, Projected Fields, Human

## Thalamic Plasticity and Chronic Pain

JONATHAN O. DOSTROVSKY<sup>1</sup>,  
DOUGLAS RASMUSSEN<sup>2</sup>

<sup>1</sup>Department of Physiology, University of Toronto, Toronto, ON, Canada

<sup>2</sup>Department of Physiology and Biophysics, Dalhousie University, Halifax, NS, Canada  
j.dostrovsky@utoronto.ca

### Synonyms

Functional Changes in Thalamus; Chronic Pain, Thalamic Plasticity

### Definition

Long term changes in processing of somatosensory inputs in thalamus as a result of ▶ [deafferentation](#) and/or chronic pain.

### Characteristics

Most of the information regarding ▶ [plasticity](#) in the somatosensory system at supraspinal levels concerns the processing and representation of non-nociceptive tactile inputs. This is mainly because it is difficult to determine a clear map of the body representation of neurons responding to nociceptive inputs. However, it is likely that there are at least some common mechanisms between plasticity of innocuous information and nociceptive information processing, and thus the first section will deal with

findings regarding plasticity in processing of tactile information.

In contrast to the hundreds of papers that have described reorganization of the primary somatosensory cortex after deafferentation, relatively few have studied changes at the thalamic level. However, the variables that affect thalamic and cortical reorganization are the same: the age of the animal at the time of the damage; the extent and location of the damage; and the time that has expired since the damage. Neonatal damage, or even trimming of whiskers from birth to decrease sensory experience, can produce dramatic changes in the somatotopic map within the rodent thalamus (e.g. Nicolelis et al. 1997; Simons and Land 1994). These developmental changes are reflected in morphological changes in the structural representation of whiskers in the rodent thalamus, the “▶ [barreloids](#)”. In particular, the separation between affected barreloids is lost, suggesting a profound interference with the migration of thalamic neurons. The critical period for the thalamus is intermediate between the earlier developing brainstem and the later developing cortex.

In the adult animal, immediate reorganization of the ▶ [ventral posterior lateral nucleus](#) (VPL) thalamus, by reversibly blocking afferent inputs from the skin following local anesthetic injections, has been demonstrated in several species including man (Nicolelis et al. 1993; see Dostrovsky 1999 for other references). This results in the appearance of new and/or enlargement of the RFs of individual neurons. Of particular interest is a study that found that this unmasking was greatly reduced if the somatosensory cortex was inactivated at the time of peripheral deafferentation, suggesting that ▶ [Cortical Feedback](#) plays an important role in these immediate changes (Krupa et al. 1999).

Longer-term plasticity of the thalamus (requiring several months) has been demonstrated after a variety of different types of peripheral nerve damage. These include transection of median and ulnar nerves in squirrel monkeys (Garrahy and Kaas 1991), digit amputation in raccoons (Rasmusson 1996), dorsal rhizotomies in primates (Jones and Pons 1998), as well as central lesions affecting the ascending branch of peripheral afferents in the dorsal columns (Pollin and Albe-Fessard 1979). Thalamic reorganization also results from destruction of the dorsal column nuclei, which provide the major, direct input to VPL and to the spinothalamic tract. Lesioning the gracile nucleus in rats results in expansion of upper limb and shoulder representations (Parker et al. 1998; Wall and Egger 1971). In all these cases, the major effect is an expansion of intact adjacently represented regions into the region that has been deafferented. In addition, spinothalamic tract lesions in sub-human primates have been shown to increase the spontaneous firing rate and responses to mechanical stimulation of the skin, and increase the degree of ▶ [bursting activity](#) in low threshold slowly adapting neurons (Weng et al. 2003).

T

Recordings and stimulation in human thalamus of chronic pain patients suffering spinal cord damage or amputation reveal an expansion of the intact regions into deafferented regions, and the existence of neurons firing spontaneously in bursts. Stimulation in such regions usually evokes sensations referred to the deafferented region or phantom limb. Some of these alterations may also be involved in mediating the patients' pain (see references in Dostrovsky 1999; Weng et al. 2003).

Few studies have examined the mechanisms responsible for thalamic plasticity. Electron microscopic evidence for synaptogenesis, presumably resulting from sprouting of surviving axons, has been found in the rat after dorsal column nuclei lesions (Wells and Tripp 1987). Of potential interest is the decrease in **GABAA receptors** that follows dorsal **rhizotomy** in primates (Rausell et al. 1992). In addition, other studies have revealed changes in the morphology of **GABA terminals** following dorsal column lesions. Decreased inhibitory control could contribute directly or indirectly to the plasticity mechanisms responsible for thalamic reorganization, and may also result in increased RF sizes and lowered thresholds of nociceptive neurons in thalamus (see references in Weng et al. 2003). There is also electrophysiological evidence that many cells in VPL have **subliminal receptive fields**, and these may provide an important substrate for the expansion of **receptive fields** following deafferentation (Dostrovsky 1999).

There have been several studies in animals showing greatly increased responses, receptive field sizes, and decreased thresholds of nociceptive neurons in medial and lateral (VPL) thalamus following peripheral damage, inflammation, or central damage. Although it is likely that some of these alterations were due to changes at the thalamic level, it is difficult to assess to what extent these were due to neuroplastic changes occurring at spinal and trigeminal levels (e.g. Dostrovsky and Guilbaud 1990; see references in Weng et al. 2003).

Several studies have reported that following deafferentation and **CNS damage** leading to chronic pain, there is an increase in bursting activity of neurons in and near the deafferented region in human thalamus, and have suggested that this may be related to the development of central pain. Bursting cells have also been observed in chronic pain patients (see **Thalamic Bursting Activity** and references in Weng et al. 2003).

Of considerable interest are observations in humans on the incidence of stimulation-evoked pain. In non-pain patients the incidence of evoking pain by stimulation within **ventral basal nucleus (VB)** is very low. However, in some types of pain patients, and in particular in **post-stroke central pain** patients, the incidence is much higher, suggesting that neuroplastic changes have occurred in the thalamocortical system in these cases that are causing pain to be perceived by thalamic stimuli that

normally elicit only non-painful parasthesia (see references in Dostrovsky 1999; Weng et al. 2003).

► **Thalamus, Dynamics of Nociception**

## References

1. Dostrovsky JO (1999) Immediate and Long-Term Plasticity in Human Somatosensory Thalamus and its Involvement in Phantom Limbs. *Pain* 6:37–43
2. Dostrovsky JO, Guilbaud G (1990) Nociceptive Responses in Medial Thalamus of the Normal and Arthritic Rat. *Pain* 40:93–104
3. Garraghty P, Kaas J (1991) Functional Reorganization in Adult Monkey Thalamus after Peripheral Nerve Injury. *NeuroReport* 2:747–750
4. Jones EG, Pons TP (1998) Thalamic and Brainstem Contributions to Large-Scale Plasticity of Primate Somatosensory Cortex. *Science* 282:1121–1125
5. Krupa DJ, Ghazanfar AA, Nicolelis MA (1999) Immediate Thalamic Sensory Plasticity Depends on Corticothalamic Feedback. *Proc Natl Acad Sci USA* 96:8200–8205
6. Nicolelis MA, Lin RCS, Chapin JK (1997) Neonatal Whisker Removal Reduces the Discrimination of Tactile Stimuli by Thalamic Ensembles in Adult Rats. *J Neurophysiol* 78:1691–1706
7. Nicolelis MAL, Lin RCS, Woodward DJ et al. (1993) Induction of Immediate Spatiotemporal Changes in Thalamic Networks by Peripheral Block of Ascending Cutaneous Information. *Nature* 361:533–536
8. Parker JL, Wood ML, Dostrovsky JO (1998) A Focal Zone of Thalamic Plasticity. *J Neurosci* 18:548–558
9. Pollin L, Albe-Fessard D (1979) Organization of Somatic Thalamus in Monkeys with and without Section of Dorsal Spinal Tracts. *Brain Res* 173:431–449
10. Rasmusson DD (1996) Changes in the Organization of the Ventroposterior Lateral Thalamic Nucleus after Digit Removal in Adult Raccoon. *J Comp Neurol* 364:92–103
11. Rausell E, Cusick CG, Taub E et al. (1992) Chronic Deafferentation in Monkeys Differentially Affects Nociceptive and Nonnociceptive Pathways Distinguished by Specific Calcium-Binding Proteins and Down-Regulates  $\gamma$ -Aminobutyric Acid Type A Receptors at Thalamic Levels. *Proc Natl Acad Sci USA* 89:2571–2575
12. Simons DJ, Land PW (1994) Neonatal Whisker Trimming Produces Greater Effects in Nondeprived than Deprived Thalamic Barreloids. *J Neurophysiol* 72:1434–1447
13. Wall PD, Egger MD (1971) Formation of New Connexions in Adult Rat Brains after Partial Deafferentation. *Nature* 232:542–545
14. Wells J, Tripp LN (1987) Time Course of Reactive Synaptogenesis in the Subcortical Somatosensory System. *J Comp Neurol* 255:466–475
15. Weng HR, Lenz FA, Vierck C et al. (2003) Physiological Changes in Primate Somatosensory Thalamus Induced by Deafferentation are Dependent on the Spinal Funiculi that are Sectioned and Time following Injury. *Neuroscience* 116:1149–1160

---

## Thalamic Projections

► **Corticothalamic and Thalamocortical Interactions**

---

## Thalamic Reorganization

► **Thalamus, Dynamics of Nociception**

## Thalamic Response to Experimental Pain in Humans

- ▶ Human Thalamic Response to Experimental Pain (Neuroimaging)

## Thalamic Reticular Nucleus

### Synonyms

TRN

### Definition

A nucleus that surrounds the thalamus. It receives inputs from the cortex and thalamus and projects back to the thalamus with inhibitory connections. Neurones in this thalamic nucleus are inhibitory GABAergic neurones that provide inhibition onto thalamic relay neurones. TRN neurones do not project to the cerebral cortex.

- ▶ Thalamocortical Loops and Information Processing
- ▶ Thalamus, Metabotropic Glutamate Receptors
- ▶ Thalamus, Nociceptive Neurotransmission

## Thalamo-Amygdala Interactions and Pain

GEORGE S. BORSZCZ<sup>1</sup>, S. E. HARTE<sup>2</sup>

<sup>1</sup>Department of Psychology, Wayne State University, Detroit, MI, USA

<sup>2</sup>Department of Internal Medicine, Chronic Pain and Fatigue Research Center, Rheumatology University of Michigan Health System, Ann Arbor, MI, USA  
borszcz@wayne.edu, seharte@umich.edu

### Synonyms

Affective analgesia; affective pain processing; Limbic Forebrain Matrix; pain asymbolia

### Definition

Processing the ▶ **affective-motivational dimension of pain** experience. Suppression of nociceptive transmission through this limbic forebrain matrix produces selective inhibition of the affective reaction to pain (affective analgesia). Interactions between limbic forebrain sites and the midbrain periaqueductal gray is one mechanism through which morphine acts to produce affective analgesia.

### Characteristics

W. H. Sweet (1980), the eminent neurosurgeon and pain researcher, observed the critical need to evaluate the neural mechanisms that generate and suppress the affective-motivational dimension of pain. In reviewing the extant

human neurosurgical data, he noted that ablation of several limbic forebrain sites proved effective in reducing the ‘agonizing’ pain associated with advanced cancer. These areas include the anterior cingulate cortex (ACC), medial thalamic nuclei (centromedian and parafascicular nuclei), amygdala, and prefrontal cortex. Damage of these structures produced no loss of the ▶ **sensory-discriminative dimension of pain**, but was efficacious in alleviating its affective-motivational dimension. Sweet pointed out that the mechanisms responsible for this dissociative analgesia were poorly understood, and called for the development of animal models and systematic research programs that could provide insights into the neurobiology of the affective dimension of pain.

Subsequent research provided convergent evidence in support of the involvement of the limbic-forebrain in processing the affective-motivational dimension of human pain. Additional human neurosurgical observations confirmed the involvement of the ▶ **medial thalamus** and ACC in pain perception. Ablations of these areas remain an effective treatment in alleviating chronic intractable pain (Hassenbusch et al. 1990; Whittle and Jenkinson 1995). The chronic pain state appears to be mediated by sustained abnormal neural activity within the limbic forebrain. High frequency spontaneous neural activity was recorded from medial thalamic nuclei in patients with deafferentation pain (Rinaldi et al. 1991). High frequency stimulation of the medial thalamus produced reports of intense pain in human subjects, which was suppressed by treatment with the  $\mu$ -opiate agonist fentanyl (Velasco et al. 1998). Neuroimaging studies of the human pain, experimental and clinical, also revealed a limbic-forebrain matrix that underlies the processing of the affective-motivational dimension of pain (see review Derbyshire 2000). These studies consistently report activation of the amygdala, ACC, insula, prefrontal cortex, and medial thalamus.

Following the ▶ **parallel pain processing** model of Melzack and Casey (1968), the results of these neurosurgical and neuroimaging studies have been interpreted as reflecting the processing of noxious stimulation by the ‘▶ **medial pain system**’ (Vogt and Sikes 2000). The medial pain system is proposed to process noxious stimulation transmitted by medially projecting spinothalamic pathways (i.e. spinoreticulothalamic tract). This projection system terminates in medial thalamic nuclei that project to limbic forebrain structures that underlie processing of the affective-motivational dimension of pain. The ACC, insula, and prefrontal cortex are principal forebrain targets of medial thalamic projections (Vogt and Sikes 2000). The medial thalamus also projects to the amygdala that is reciprocally interconnected with the medial thalamus, ACC, and insula. The amygdala and medial thalamus also receive nociceptive afferents from the spinal dorsal horn, relayed via the parabrachial nucleus (Bernard and Besson 1990; Bourgeois et al. 2001). The processing of noxious

stimulation by this limbic-forebrain matrix generates the emotional reaction to pain, coordinates relevant motor activity, and supports the development of fear conditioning and avoidance responding (Derbyshire 2000).

Alternately, the '► lateral pain system' processes noxious stimulation transmitted by laterally projecting spinothalamic and trigeminothalamic pathways that terminate in lateral thalamic nuclei (i.e. VPL and VPM). Projections of the lateral thalamic nuclei to the primary and secondary somatosensory cortices are proposed to underlie the processing of the sensory-discriminative dimension of the pain experience. This dimension of pain signals the location, intensity, and physical properties of a noxious stimulus.

Systemic administration of morphine preferentially suppresses the affective reaction of humans and animals to noxious stimulation (Borszcz et al. 1994; Price et al. 1985). This effect is mediated by the inhibition of pain transmission through limbic forebrain structures that process the affective dimension of pain (Casey et al. 2000). The ventrolateral division of the midbrain periaqueductal gray (vPAG) is a major site through which morphine acts to suppress pain transmission. Through its descending projections to the rostral ventromedial medulla, the vPAG inhibits pain transmission at the level of the spinal dorsal horn. The vPAG also contributes ascending projections that suppress pain transmission directly within the limbic forebrain (Borszcz 1999). The vPAG and adjacent dorsal raphe nucleus provide ascending serotonergic projections to the medial thalamus (parafascicular nucleus) and amygdala, and the microinjection of morphine into the vPAG increases the release and metabolism of serotonin in these sites (Munn and Borszcz 2002; Tao and Auerbach 1995). Moreover, the suppression of rats' affective reaction to noxious stimulation following injection of morphine into vPAG is reversed by bilateral administration of serotonin antagonists into either the parafascicular nucleus or amygdala (Borszcz 1999).

The parafascicular nucleus and amygdala appear to interact in the production of affective analgesia following the injection of morphine into the vPAG. The unilateral administration of serotonin antagonists into the parafascicular nucleus or amygdala failed to alter the antinociceptive action of vPAG-administered morphine. However, the combined unilateral administration of serotonin antagonists into the parafascicular nucleus and amygdala was as effective as their bilateral administration into either site in reversing the antinociceptive action of morphine injected into the vPAG (Borszcz and Streltsov 2000). These findings suggest that a functional interaction exists between the medial thalamus, amygdala, and vPAG in mediating affective analgesia. Evidence also exists for the interaction between the vPAG and other limbic forebrain sites (nucleus accumbens, habenula) in mediating the antinociceptive

action of vPAG-administered morphine (Ma and Han 1991).

## References

1. Bernard JF, Besson JM (1990) The Spino(trigemino)pontoamygdaloid Pathway: Electrophysiological Evidence for an Involvement in Pain Processes. *J Neurophysiol* 63:473–490
2. Borszcz GS (1999) Differential Contributions of Medullary, Thalamic, and Amygdaloid Serotonin to the Antinociceptive Action of Morphine Administered into the Periaqueductal Gray: A Model of Morphine Analgesia. *Behav Neurosci* 113:612–631
3. Borszcz GS, Johnson CP, Fahey KA (1994) Comparison of Motor Reflex and Vocalization Thresholds following Systemically Administered Morphine, Fentanyl, and Diazepam in the Rat: Assessment of Sensory and Performance Variables. *Pharmacol Biochem Behav* 49:827–834
4. Borszcz GS, Streltsov NG (2000) Amygdaloid-Thalamic Interactions Mediate the Antinociceptive Action of Morphine Microinjected into the Periaqueductal Gray. *Behav Neurosci* 114:574–584
5. Bourgeois L, Monconduit L, Villanueva L et al. (2001) Parabrachial Internal Lateral Neurons Convey Nociceptive Messages from the Deep Laminas of the Dorsal Horn to the Intralaminar Thalamus. *J Neurosci* 21:2159–2165
6. Casey KL, Svensson P, Morrow TJ, Raz J, Jone C, Minoshima S (2000) Selective Opiate Modulation of Nociceptive Processing in the Human Brain. *J Neurophysiol* 84:525–533
7. Derbyshire SWG (2000) Exploring the Pain 'Neuromatrix'. *Curr Rev Pain* 4:467–477
8. Hassenbusch SJ, Pillay PK, Barnett GH (1990) Radiofrequency Cingulotomy for Intractable Cancer Pain using Stereotaxis Guided by Magnetic Resonance Imaging. *Neurosurgery* 27:220–223
9. Ma QP, Han JS (1991) Neurochemical Studies on the Mesolimbic Circuitry of Antinociception. *Brain Res* 566:95–102
10. Munn EM, Borszcz GS (2002) Increases in the Release and Metabolism of Serotonin in Nucleus Parafascicularis Thalami following Systemically Administered Morphine in the Rat. *Neurosci Lett* 332:151–154
11. Price DD, Von der Gruen A, Miller J et al. (1985) A Psychophysical Analysis of Morphine Analgesia. *Pain* 22:261–269
12. Rinaldi PC, Young RF, Albe-Fessard D et al. (1991) Spontaneous Neuronal Hyperactivity in the Medial and Intralaminar Thalamic Nuclei of Patients with Deafferentation Pain. *J Neurosci* 74:415–421
13. Sweet WH (1980) Mechanisms of Chronic Pain (Neuralgias and Certain Other Neurogenic Pain). In: Bonica JJ (ed) *Pain*. Raven Press, New York, pp 287–303
14. Tao R, Auerbach SB (1995) Involvement of the Dorsal Raphe but not Median Raphe Nucleus in Morphine-Induced Increases in Serotonin Release in the Rat Forebrain. *Neuroscience* 68:553–561
15. Velasco M, Brito F, Jimenez F et al. (1998) Effect of Fentanyl and Naloxone on a Thalamic Induced Painful Response in Intractable Epileptic Patients. *Stereotact Funct Neurosurg* 71:90–102
16. Vogt BA, Sikes RW (2000) The Medial Pain System, Cingulate Cortex, and Parallel Processing of Nociceptive Information. *Prog in Brain Res* 122:223–235
17. Whittle IR, Jenkinson JL (1995) CT-Guided Stereotactic Antero-Medial Pulvinotomy and Centromedian-Parafascicular Thalamotomy for Intractable Malignant Pain. *Br J Neurosci* 9:195–200

## Thalamocortical and Corticothalamic Interactions

### ► Corticothalamic and Thalamocortical Interactions



## Thalamocortical Dysrhythmia

### Synonyms

TCD

### Definition

A pathophysiological chain reaction at the origin of neurogenic pain. It consists of: 1) a reduction of excitatory inputs onto thalamic cells, which results in cell membrane hyperpolarization, 2) the production of low-threshold calcium spike bursts by deinactivation of calcium T-channels, discharging at low (theta) frequency, 3) a progressive increase of the number of thalamocortical modules discharging at theta frequency, and 4) a cortical high frequency activation through asymmetric corticocortical inhibition. These events have been documented by thalamic and cortical recordings in patients suffering from peripheral and central neurogenic pain.

- ▶ [Thalamotomy for Human Pain Relief](#)
- ▶ [Thalamus, Dynamics of Nociception](#)

## Thalamocortical Fibers

### Definition

Axons with cell bodies located in the thalamus and terminations in the cortex.

- ▶ [Corticothalamic and Thalamocortical Interactions](#)

## Thalamocortical Loops and Information Processing

S. MURRAY SHERMAN

Department of Neurobiology, State University of New York, Stony Brook, NY, USA  
s.sherman@sunysb.edu

### Synonyms

Cortical Information Flow; Corticocortical Pathways

### Definition

Until recently, communication among related cortical areas (e.g., those for somatosensation and pain) was thought to involve direct connections. We (Sherman and Guillery 2001; Sherman and Guillery 2002; Guillery and Sherman 2002a; Guillery and Sherman 2002b) suggest a radically new view in which many and perhaps all corticocortical communications involve a cortico-thalamo-cortical route.

### Characteristics

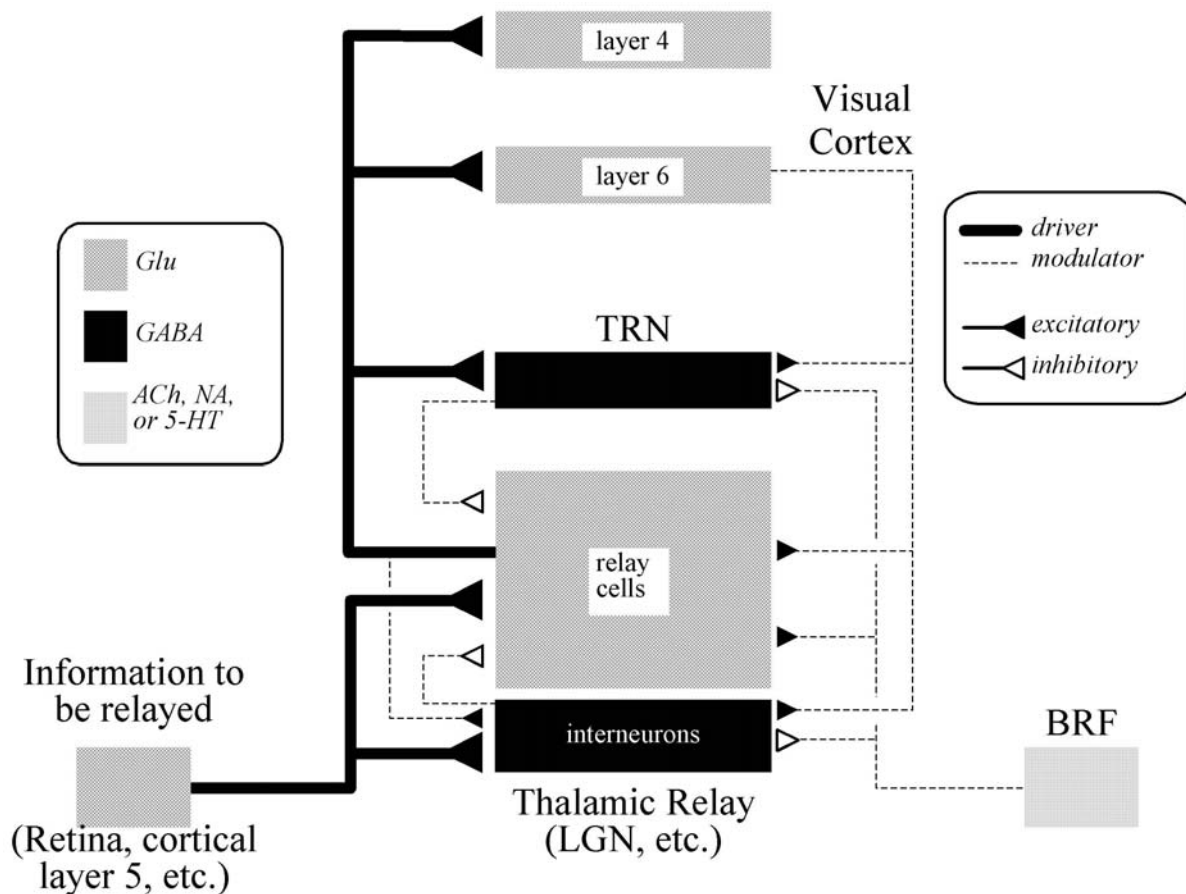
To understand how information is processed in a thalamocortical system, it is important to identify and follow the route of information transfer. A recent suggestion based on thalamic circuitry is that not all pathways are equivalent, but instead can be divided into “drivers” which are the information bearing pathways and “modulators” which serve to modulate the flow of information rather than transmitting it. How this might apply to cortical processing in general and cortical processing of pain more specifically is best explained by considering how this idea has led to important changes in our thinking of thalamic circuitry.

### Drivers and Modulators

Figure 1 shows the basic circuit of the thalamus, which varies only slightly among thalamic relays. As argued previously, the inputs to relay cells can be divided into two basic types, “drivers” and “modulators” and these differ on a number of different morphological and functional grounds that are briefly summarized in Table 1 (for details, see Sherman and Guillery 2001, 2002; Guillery and Sherman 2002a). The first pair of listed differences are properties limited to thalamus, but the remainder represent criteria that can be applied anywhere in the central nervous system. The drivers are the input that brings the information to be relayed. Examples are retinal input to the lateral geniculate nucleus, medial lemniscal input to the ▶ [ventral posterior nucleus](#) and, as noted below for some thalamic relays, layer 5 input from cortex. The modulators are everything else and their main function is to control the level and type of information relayed from drivers through thalamus to cortex. Examples are the local ▶ [GABAergic cells](#) (i.e., interneurons and cells of the thalamic reticular nucleus), feedback from cortical layer 6 and a projection from the brainstem reticular formation. Drivers represent relatively few of the synaptic inputs to relay cells (only about 5–10%), but their synapses are relatively powerful. The other 90–95% of synapses onto relay cells are divided roughly equally among modulatory inputs from local GABAergic cells, from cortical layer 6 and from the brainstem. The modulators require the vast majority of inputs for many subtle roles that affect the relay of driver inputs (Sherman and Guillery 2001, 2002; Guillery and Sherman 2002a).

The main difference between thalamic relays is the origin of the driver input; the modulators are basically similar throughout thalamus, although there is some variation (Jones 1985; Sherman and Guillery 2001).

The understanding that inputs to relay cells can be divided into drivers and modulators and that the former largely define the function of a thalamic relay has implications that may extend beyond thalamus (see also below). Thus the ▶ [lateral geniculate nucleus](#) is largely defined as a relay of retinal information. It is important to understand that consideration of anatomical information



**Thalamocortical Loops and Information Processing, Figure 1** Schema of inputs to thalamic relay cells. Abbreviations: 5-HT, serotonin; ACh, acetylcholine; BRF, brainstem reticular formation; GABA, gamma-aminobutyric acid; Glu, glutamate; LGN, lateral geniculate nucleus; NA, noradrenalin; TRN, thalamic reticular nucleus.

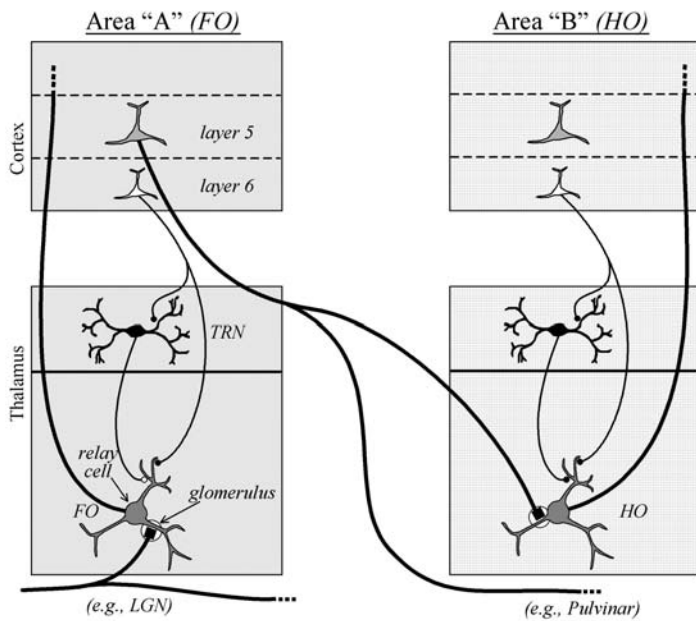
alone can obscure this. For the lateral geniculate nucleus for instance, only 5-10% of synapses onto relay cells derive from retina and roughly one third derive from brainstem. If we had only these anatomical data, most of us would conclude that the lateral geniculate nucleus relayed brainstem information and that retinal input provided some obscure, minor function. In other words, we would badly misconstrue this thalamic relay.

### First and Higher Order Relays

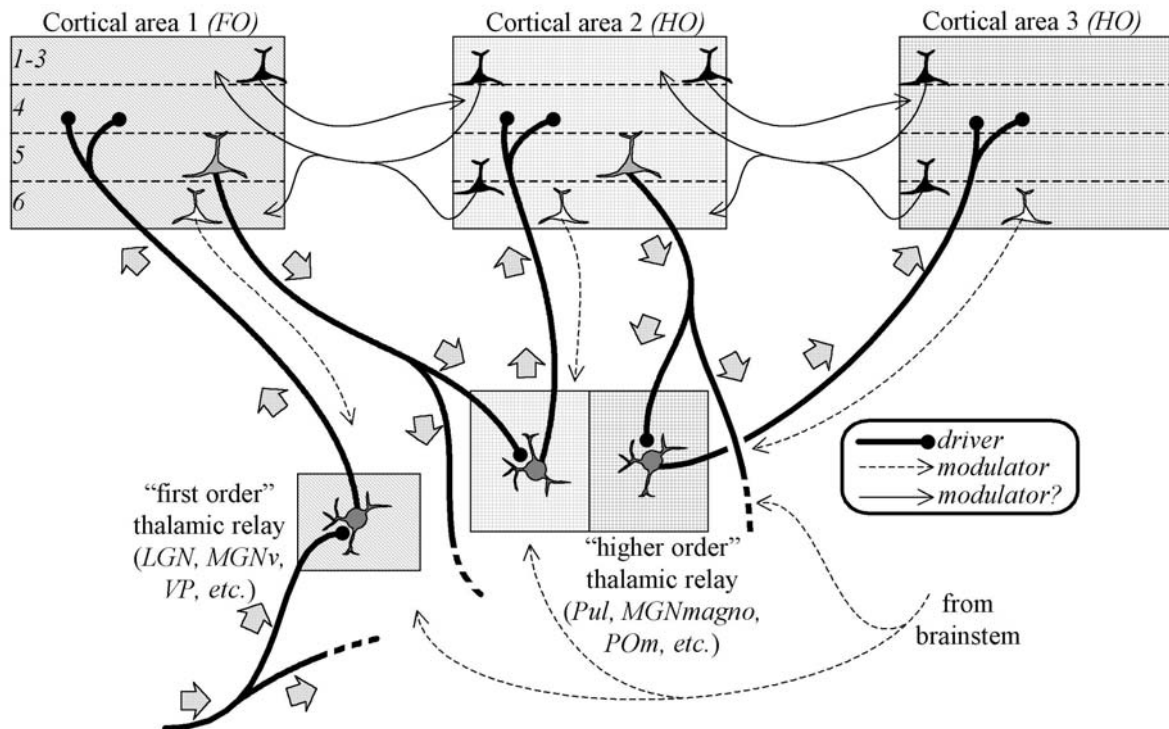
Thus identifying the driver is a major key in determining the role played by a thalamic relay. For instance, we define the role of the ► lateral geniculate nucleus based on its relay of retinal axons and that of the ventral posterior nucleus based on its relay of ► medial lemniscus axons. However, until recently, the role played by many thalamic relays remained a mystery, because it was not clear what was being relayed. We used to think that the role of the thalamus was to relay subcortical information to cortex and for large regions of thalamus, such as much of the pulvinar, it was not clear what was the subcortical source being relayed.

However, the recent realization that drivers for many thalamic relays originate in layer 5 of cortex led to a division of thalamus into “first order” and “higher order” relays, and this is summarized in Fig. 2 (Sherman and Guillery 2001, 2002; Guillery and Sherman 2002a). First order relays transmit to cortex a particular type of information (e.g. retinal) for the first time, whereas higher order relays are involved in further transmission of such information between cortical areas. The higher order relay can be between a first order and higher order cortical area (as shown in Fig. 2) or between two higher order cortical areas (not shown). Higher order relays have been identified for the major sensory systems, the pulvinar for vision, the posterior medial nucleus for somatosensation (and thus for pain) and the magnocellular division of the medial geniculate nucleus for hearing. Other examples of higher order relays have also been identified (see Sherman and Guillery 2001, 2002).

Several features from Fig. 2 bear further emphasis. All thalamic relays receive a modulatory input from layer 6 of cortex that is mainly feedback, whereas only the higher order relays receive in addition a layer 5 cortical input and this is feedforward. Note also that the driver



**Thalamocortical Loops and Information Processing, Figure 2** First order (FO; left) and higher order (HO; right) thalamic relays. For simplicity, connections to relay cells from interneurons and brainstem are omitted. "Glomerulus" refers to a complex synaptic zone that is ubiquitous to thalamus and that is often associated with driver input.



**Thalamocortical Loops and Information Processing, Figure 3** Involvement of higher order thalamic relays in corticocortical communication. For simplicity inputs from interneurons and cells of the thalamic reticular nucleus omitted. Abbreviations as in Fig. 1 plus: MGNv, ventral region of medial geniculate nucleus; MGNmagn; magnocellular region of medial geniculate nucleus; POm, posterior medial nucleus; VP, ventral posterior nucleus.

afferents, both subcortical to first order relays and from layer 5 for higher order relays, are branches of axons that also innervate an extrathalamic target, which tends to be "motor" in nature; this is true for many and perhaps all driver inputs (for details, see Guillery and Sherman 2002 a, b; Guillery 2003). For instance, many or all retinal af-

ferents to the lateral geniculate nucleus branch to also innervate midbrain structures associated with control of pupil size, eye movements, etc and many layer 5 afferents to higher order thalamic relays also innervate many levels of the brainstem and may extend input to spinal levels. It is as if the information relayed to cortex through

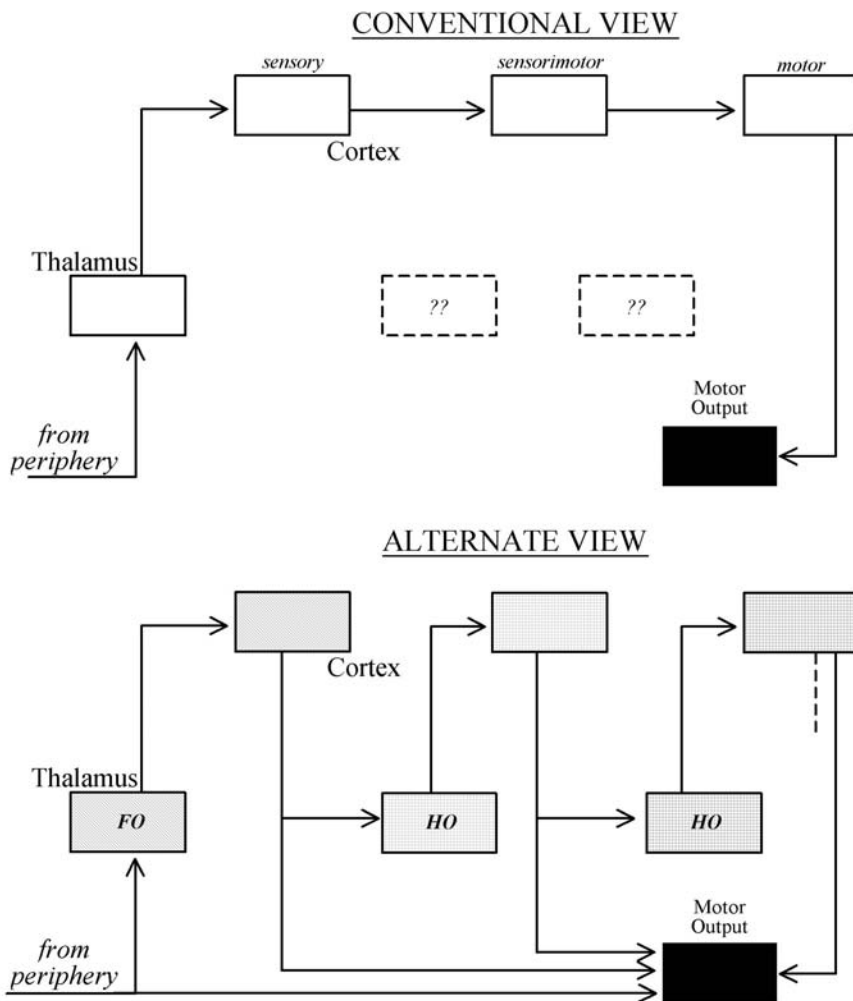
thalamus is a corollary of motor commands and it is these motor commands that serve as the basis of perceptual information acted upon and further elaborated by cortex (Guillery and Sherman 2002 a, b; Guillery 2003). It is also worth noting that, as sufficient information regarding various thalamic relays develops regarding the division into first order and higher order, the large majority of thalamus seems to be devoted to higher order relays.

**Role of Thalamus in Corticocortical Communication**

Figure 3 summarizes the major implication of this division of thalamic relays into first order and higher order for cortical functioning. Information of a particular sort first reaches cortex *via* a first order relay; this can apply to primary information about vision, sounds, pain, etc. Further cortical processing of this primary information is based on cortico-thalamo-cortical pathways involving higher order thalamic relays. This view of corticocortical processing has the interesting feature that any new information reaching a cortical area, whether initiated subcortically or in another cortical area, benefits from a

thalamic relay. Such benefits are beyond the scope of this essay to cover, but the reader can learn more of this from other sources (Sherman and Guillery 2001; Guillery and Sherman 2002a).

To place this scheme in the proper perspective, it is important to appreciate that most prevailing conceptions about functioning of cortical areas are based on direct connections between areas. For instance, the best studied is visual cortex, which is divided into more than 30 discrete areas in humans and the detailed scheme of functional organization is based almost entirely on the pattern of direct corticocortical connections, with no place for thalamus (Van Essen et al. 1992; Kandel et al. 2000). A similar view dominates thinking about the organization of somatosensory cortical areas responsible for the cortical processing of pain. Understanding how cortical areas process information requires first identifying the routes of information and, if the driver/modulator distinction holds for cortical pathways as it seems to in thalamus, it then becomes essential to distinguish among the direct corticocortical pathways those that are drivers from those that are modulators. As it happens, the cur-



**Thalamocortical Loops and Information Processing, Figure 4** Conventional (upper) versus alternate (lower) views of cortical processing.



rent views of cortical organization consider only direct corticocortical connections that have been identified almost entirely with anatomical techniques and an implied assumption that needs to be made explicit is that all more or less contribute equally, in a sort of anatomical democracy, to information flow. This same logic applied to the thalamus would produce the misconception that the lateral geniculate nucleus relayed brainstem, not retinal, inputs to cortex (see above).

Given the nature of thalamocortical inputs, which have the morphological and functional characteristics of drivers, it seems very likely that the cortico-thalamocortical pathways shown in Fig. 3 are important information routes. It follows that understanding the relationships of cortical areas in various functional zones (e.g. visual, somatosensory and auditory among others) will require mapping out of all of the cortico-thalamocortical pathways involving higher order thalamic relays.

What, then is the function of the direct corticocortical pathways? An answer to this important question requires identifying these pathways, one by one if necessary, for function as driver or modulator. One extreme possibility is that all of these pathways are modulators. However, even if some are drivers, there is an important distinction to be made between such putative information routes and those involving higher order thalamic relays. That is, the former involve information that remains strictly within cortex, whereas the latter involve information, perhaps involving motor commands, that is shared with various subcortical centers.

### Summary and Conclusions

To understand the implications of the proposal put forward here for the role of thalamus in corticocortical communication, it might be helpful to contrast it with the conventional view, and this is done in Fig. 4. In the conventional view (Fig. 4, upper), sensory information is relayed from the periphery by thalamus to a primary sensory cortical area. From there, the information is processed strictly within cortex, eventually *via* sensorimotor areas to motor areas and finally this leads to a motor output. Note that, in this view, the only role for thalamus is to get raw information to cortex in the first place and that most of thalamus, which we call higher order relays, has no specific role to play. In the alternate view (Fig. 4, lower) offered here, information relayed to cortex is, from the very beginning, corollary to motor commands and further corticocortical processing involves higher order thalamic relays of continuously elaborated and updated motor commands. Thus thalamus not only gets information to cortex in the first place but also continues to play an essential role in corticocortical communication.

This has important implications for cortical functioning generally and also for cortical processing of pain information more specifically. That is, the higher order tha-

lamic relays involved in pain processing could be key. The best candidate for the higher order thalamic relay of pain information would be the posterior medial nucleus, which lies mostly medial to the ventral posterior nucleus, most of which is the first order somatosensory relay. We clearly need a better understanding of how pain is processed by somatosensory cortex and the purpose of this essay is to provide a different theoretical framework that might fruitfully guide further research through this topic.

### References

1. Guillery RW (2003) Branching thalamic afferents link action and perception. *J Neurophysiol* 90:539–548
2. Guillery RW, Sherman SM (2002a) Thalamic relay functions and their role in corticocortical communication: Generalizations from the visual system. *Neuron* 33:1–20
3. Guillery RW, Sherman SM (2002b) Thalamocortical pathways as monitors of ongoing motor instructions. *Philos Trans R Soc Lond (Biol)* 357:1809–1821
4. Jones EG (1985) *The Thalamus*. Plenum Press, New York
5. Kandel ER, Schwartz JH, Jessell TM (2000) *Principles of Neural Science*. McGraw Hill, New York
6. Sherman SM, Guillery RW (2001) *Exploring the Thalamus*. Academic Press, San Diego
7. Sherman SM, Guillery RW (2002) The role of thalamus in the flow of information to cortex. *Philos Trans R Soc Lond (Biol)* 357:1695–1708
8. Van Essen DC, Anderson CH, Felleman DJ (1992) Information processing in the primate visual system: an integrated systems perspective. *Science* 255:419–423

## Thalamocortical Module

### Definition

Anatomofunctional entity comprising of thalamic cells and their cortical partners, interconnected by thalamocortical and corticothalamic projections and sustaining perceptual, motor and cognitive hemispheric functions. The thalamocortical loop is accompanied by a shorter thalamoreticulothalamic loop. Every module may be subdivided in a specific, or content subpart, providing the substrate for the integration of a given function, and a non-specific, or context subpart, dealing with the interactions between functional domains.

► [Thalamotomy for Human Pain Relief](#)

T

## Thalamocortical Neurones

### Definition

Neurones located within the thalamus and projecting directly to the cerebral cortex.

► [Spinothalamic Projections in Rat](#)

## Thalamotomy

### Definition

A neurosurgical procedure in which a therapeutic lesion is made in a specific subnucleus of the thalamus.

- ▶ Pain Treatment, Intracranial Ablative Procedures
- ▶ Thalamotomy for Human Pain Relief
- ▶ Thalamotomy, Pain Behavior in Animals
- ▶ Thalamus, Receptive Fields, Projected Fields, Human

## Thalamotomy for Human Pain Relief

DANIEL JEANMONOD<sup>1</sup>, JOHANNES SARNTHEIN<sup>1</sup>,  
JAIR STERN<sup>1</sup>, MICHEL MAGNIN<sup>2</sup>,  
CHRISTOPH AUFENBERG<sup>1</sup>, ANNE MOREL<sup>1</sup>  
<sup>1</sup>Functional Neurosurgery, Neurosurgical Clinic,  
University Hospital, Zürich, Switzerland  
<sup>2</sup>INSERM, Neurological Hospital, Lyon, France  
daniel.jeanmonod@usz.ch

### Synonyms

Stereotactic operation with thalamic target. First order subtype: medial thalamotomy. Second order subtype: central lateral thalamotomy.

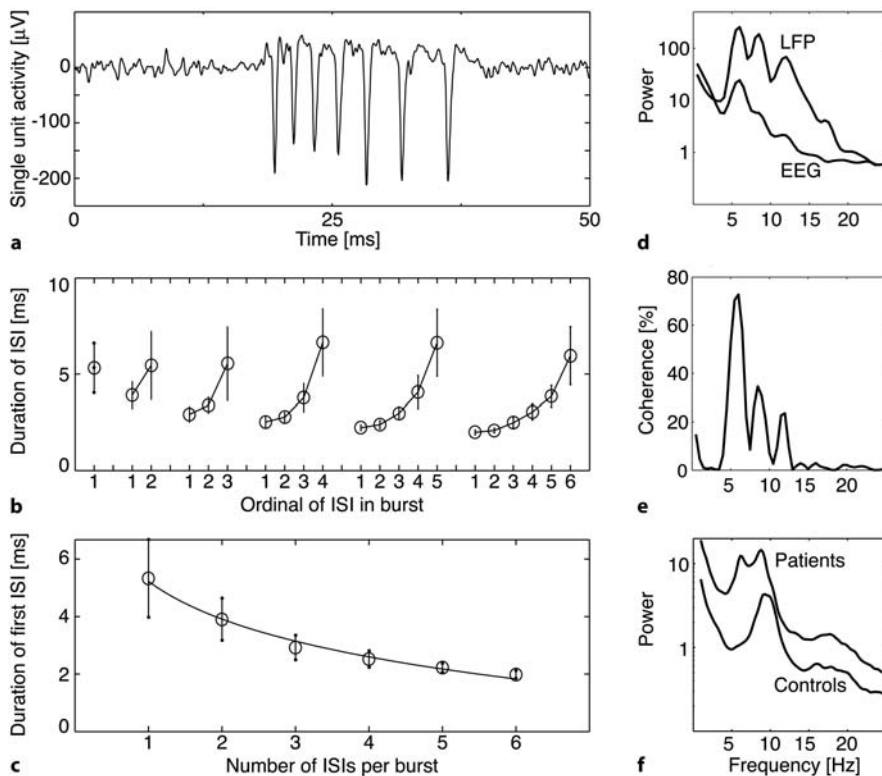
### Definition

Neurophysiological studies at the cellular level (▶ [single unit activity](#) and ▶ [local field potentials](#) or LFP) as well as ▶ [electroencephalographic](#) (EEG) and ▶ [magnetoencephalographic](#) (MEG) recordings provide converging evidence for a thalamocortical dysregulation at the origin of chronic ▶ [neurogenic pain](#) of both peripheral and central origin. These data suggest an increase of low frequency thalamocortical rhythmicity originating in disfacilitation of thalamic relay neurons, followed by cortical activation due to asymmetries of corticocortical inhibition. The process, called ▶ [thalamocortical dysrhythmia](#) (TCD) may become self-sustained and thus chronic, due to recurrent thalamoreticulothalamic and corticoreticulothalamic feedback inhibition. The surgical approach presented here is centered on a re-establishment of a normal thalamocortical oscillatory activity using a strategically placed medial thalamic lesion, which reduces or abolishes the TCD *via* low frequency desamplification and provides long term therapeutic efficiency coupled with sparing of the specific ▶ [thalamocortical modules](#). This physiopathological framework underscores the risks run by any surgical procedure aiming at further reducing the activation of specific thalamic relay cells and thus increasing thalamic disfacilitation and dysrhythmic pain mechanisms. The present essay is thus focused on ▶ [medial thalamotomies](#), more specifically on central lateral thalamotomy (CLT).

In 1989, Lenz and collaborators (Lenz et al. 1989) provided the first evidence for the presence of ▶ [low-threshold calcium spike \(LTS\) bursts](#) in the thalamus of patients suffering from neurogenic pain. They found them in the somatosensory ▶ [ventral posterior \(VP\) complex](#), localized in and around the portion of VP representing the deafferented and thus painful body part (Lenz et al. 1994). The presence of the same activities was also described widely spread in and around the posterior part of the ▶ [central lateral nucleus](#) (CL) of the medial thalamus (Jeanmonod et al. 1993; Jeanmonod et al. 1994; Jeanmonod et al. 1996). An example of such LTS bursting activity in CL is shown in Fig. 1 a–c), with the typical progressive increase in duration of each successive interspike interval and the inverse relationship between the duration of the first interspike interval and the number of spikes in a burst. Furthermore, it was shown that: 1) half of the recorded neurons presented LTS bursting activity, 2) only a minority (less than 1 %) had somatosensory receptive fields, 3) LTS bursts displayed a theta rhythmicity, with a mean interburst discharge rate of 4 Hz, and 4) there were no significant differences between recordings performed in patients suffering from peripheral and central neurogenic pain. A recent analysis (Sarnthein et al., 2003) of thalamic LFP recordings in CL showed the presence of a high ▶ [theta](#) (4–8 Hz) power (Fig. 1d), correlating closely with the theta rhythmicity displayed by LTS bursts. In addition, an increase in the cortical theta power was recorded by EEG (Fig. 1d) and a high coherence between EEG and thalamic theta activities was found (Fig. 1e). This underscores the expected high level of functional coupling between thalamus and cortex. In Fig. 1f, EEG power spectra of patients have been averaged and compared with those of controls, confirming the existence of a disease-related increase in theta power.

Based on converging evidence from experimental and clinical data over the last 20 years (Llinás and Jahnsen 1982; Steriade et al. 1990; Jeanmonod et al. 1993; Jeanmonod et al. 1996; Jeanmonod et al. 2001; Steriade et al. 1997; Llinás et al. 1999; Llinás et al. 2001), a thalamocortical concept of chronic neurogenic pain was initially proposed at the thalamic level (Jeanmonod et al. 1993), and extended to the cortical level, with the denomination of thalamocortical dysrhythmia (Llinás et al. 1999). It is characterized by the following sequential set of events.

1. Bottom-up or top-down disfacilitation by deafferentation of excitatory inputs onto thalamic relay cells through a somatosensory lesion, either peripheral or central, is at the source of the neurogenic pain syndrome. This results in cell membrane hyperpolarization.
2. In this hyperpolarized state, deinactivation of calcium T-channels causes thalamic relay neurons to fire LTS bursts at theta frequency.



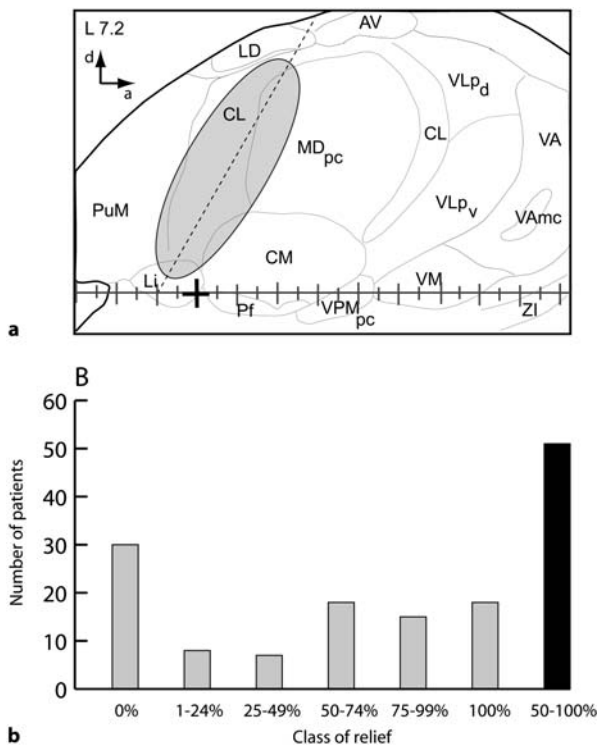
### Thalamotomy for Human Pain Relief, Figure 1

(a, b, c) LTS bursts. (a) LTS bursting cell recorded in the posterior part of CL. Note the progressive increase in duration of each successive interspike interval (ISI). (b) Progressive increase of the ISI within the burst. (c) Logarithmic decrease of the length of the first ISI as a function of the number of spikes in the burst. (d, e, f) Spectral analysis of LFP and EEG. (d) LFP and EEG power spectra of one neurogenic pain patient (power units:  $\mu\text{V}^2/\text{Hz}$ ). (e) Coherence between EEG and LFP in the same patient. (f) Power spectra of scalp EEG recordings in 11 patients (mean age 59  $\pm$  13 years) and 12 healthy controls (mean age 56  $\pm$  10 years). Spectra were averaged over subjects.

- These thalamic neurons impose a theta rhythmicity to the thalamocortical modules they are part of, as demonstrated by theta power increases in both LFP and EEG recordings. The tight functional coupling between thalamus and cortex is confirmed by the high theta coherence between the two. This coupling is not only sustained by thalamocorticothalamic, but also by thalamoreticulothalamic and corticoreticulothalamic recurrent projections.
- Divergent thalamocortical, corticothalamic and reticulothalamic projections provide the anatomical basis for the coherent diffusion of low frequencies to an increasing number of neighboring thalamocortical modules. This phenomenon may explain the frequently observed delay between the occurrence of the causal insult and the beginning of pain.?
- The final step consists in the activation of high frequency (beta and gamma) cortical domains in the vicinity of low frequency theta areas: constraining corticocortical GABAergic inhibitory interneurons to theta rhythmicity may indeed reduce lateral inhibitory drive. This leads to disinhibition and thus activation of neighboring thalamocortical modules (edge effect), with production of pain sensation. MEG (Llinás et al. 1999) and LFP power correlation studies as well as LFP bicoherence data (Sarnthein et al. 2003) provide evidence for such a phenomenon, showing an increased interfrequency coherence between theta and beta domains and thus indicating a coupling of low and high frequency activities.

### Characteristics

Exploration of the human medial thalamus allowed the identification of a zone located in the posterior part of the CL, which harbored a large majority of the recorded LTS bursts (Jeanmonod et al. 1993; Jeanmonod et al. 1994). Considering in addition the evidence for low frequency recruitment by CL stimulation (Morison and Dempsey 1942) and surgical experience in the medial thalamus, a medial thalamic target was redefined, centered in the posterior part of the CL (for review, see Jeanmonod et al. 2001). This target aims at rendering the low frequency thalamocortical power increase subcritical by reducing theta overamplification and oversynchronization, without reducing the specific and remaining unaffected non-specific thalamocortical loops. A magnetic resonance- and microelectrode-guided stereotactic thalamotomy in the posterior part of the CL (central lateral thalamotomy or CLT, Fig. 2a) was implemented in 96 patients (Jeanmonod et al. 2001) suffering from chronic therapy-resistant peripheral or central neurogenic pain (mean age 56 years; mean pain duration before surgery 7.5 years). At a mean follow-up of 3 years 9 months, 53% of the patients benefited from a relief of more than 50% (Figure 2b). Patients with continuous pain showed only a mean relief of 20% in contrast to the 66% obtained for patients with phasic or intermittent pain manifestations. Allodynia was suppressed in 57% of the patients. There was only a trend for better relief in patients with peripheral neurogenic



**Thalamotomy for Human Pain Relief, Figure 2** (a) Sagittal atlas section (Morel et al., 1997) 7.2 mm distant from the ventricular border. The horizontal scale line is aligned to the intercommissural plane, with a cross indicating the level of the posterior commissure. Scale: 1 mm between graduations. The shaded area displays the position and extent of CLT, centered on the penetration track (dashed line). Abbreviations: AV, anteroventral; CL, central lateral; CM, centre médian; LD, lateral dorsal; Li, limitans; MDpc, parvocellular part of the mediodorsal nucleus; Pf, parafascicular; PuM, medial pulvinar; VAmc, magnocellular part of the ventral anterior (VA) nucleus; VLP<sub>d</sub> and VLP<sub>v</sub>, dorsal and ventral divisions of the ventral lateral posterior nucleus; VM, ventral medial; VPM<sub>pc</sub>, parvocellular part of the ventral posterior medial nucleus. ZI, zona incerta. (b) Histogram displaying the clinical results of the CL thalamotomy for 96 patients with a mean follow-up of 3 years and 9 months.

pain. An increase of continuous pain relief from 14 to 49% was observed when CLT was performed bilaterally instead of only contralaterally. The CLT procedure produced no somatosensory deficits and entailed no risk of pain increase, but only the usual vascular risk related to the stereotactic procedure. The localization and expanse of the posterior part of the CL, away from neurologically eloquent areas, allow the placing of the therapeutic lesion with minimal risks for neurological functions. Extension of bleeding into adjacent structures, such as the centre médian-parafascicular complex, posterior complex or medial pulvinar, does not correlate with observable deficits and could even contribute to pain relief. The medial location of the CL target guarantees a good distance away from the VP and lateral spinothalamic tract and its anteroposterior coordinate is posterior enough to avoid a significant encroachment on the mediodorsal nucleus. At the ventral limit of the target, 1–2 mm may be left intact in the area

of the limitans nucleus to avoid any intrusion into the pretectum below.

From a review of the literature (Jeanmonod et al. 2001), relief percentages between 50 and 100% were obtained in averages of 53, 47 and 53% after dorsal column stimulation, VP stimulation and motor cortex stimulation respectively. These results thus come close to those obtained after CLT. In our study, all patients selected clinically as having a neurogenic pain diagnosis are included in the results. To compare with stimulation studies, it is necessary to include in the failure percentages of these studies those patients who received only a temporary unsatisfactory stimulation test, thus showing an immediate resistance to stimulation. In many studies, quoted success rates are based only on the patients who underwent permanent implantation. A correction integrating all patients with and without permanent implantation reduces pain relief percentages very significantly.

The fact that CLT does not produce clinically relevant deficits suggests that the posterior part of the CL is no longer normally functional, i.e. only serves as a generator of low frequencies. This is supported by the unresponsiveness of 99% of the recorded cells (see above) and implies a redistribution of its functions to other thalamic nuclei. Such a transfer may be all the more complete in our patients who have been operated on after years of suffering. CLT being restricted to the medial thalamic area harboring LTS activities and exhibiting a widespread functional block leaves other medial thalamic nuclei, all potential candidates for the redistribution of CL functions, intact. We are thus facing the paradoxical and conceptually intriguing situation where a lesion not only produces no or only clinically irrelevant deficits but also results in beneficial effects by the suppression of a dysfunctional area (Welsh 1998).

The therapeutic possibilities of other medial thalamic targets, particularly the posterior complex, the medial pulvinar and the centre médian-parafascicular complex seem, in our experience, to be inferior to those of the CLT. We have, however, not explored these areas sufficiently to make a definitive statement.

## References

- Jeanmonod D, Magnin M, Morel A (1993) Thalamus and neurogenic pain: physiological, anatomical and clinical data. *Neuroreport* 4:475–478
- Jeanmonod D, Magnin M, Morel A (1994) A thalamic concept of neurogenic pain. In: Gebhart GF, Hammond DL, Jensen TS (eds) *Progress in Pain Research and Management*. IASP Press, Seattle, pp 767–787
- Jeanmonod D, Magnin M, Morel A (1996) Low-threshold calcium spike bursts in the human thalamus. Common physiopathology for sensory, motor and limbic positive symptoms. *Brain* 119:363–375
- Jeanmonod D, Magnin M, Morel A et al. (2001) Surgical control of the human thalamocortical dysrhythmia: I. Central lateral thalamotomy in neurogenic pain. *Thalamus Related Syst* 1:71–79
- Lenz FA, Kwan HC, Dostrovsky JO et al. (1989) Characteristics of the bursting pattern of action potentials that occurs in the thalamus of patients with central pain. *Brain Res* 496:357–360



6. Lenz FA, Kwan HC, Martin R et al. (1994) Characteristics of somatotopic organization and spontaneous neuronal activity in the region of the thalamic principal sensory nucleus in patients with spinal cord transection. *J Neurophysiol* 72:1570–1587
7. Llinás R, Jahnsen H (1982) Electrophysiology of mammalian thalamic neurones in vitro. *Nature* 297:406–408
8. Llinás RR, Ribary U, Jeanmonod D et al. (1999) Thalamocortical dysrhythmia: A neurological and neuropsychiatric syndrome characterized by magnetoencephalography. *Proc Natl Acad Sci USA* 96:15222–15227
9. Llinás R Ribary U, Jeanmonod D et al. (2001) Thalamocortical dysrhythmia I. Functional and imaging aspects. *Thalamus Related Syst* 1:237–244
10. Morel A, Magnin M, Jeanmonod D (1997) Multiarchitectonic and stereotactic atlas of the human thalamus. *J Comp Neurol* 387:588–630
11. Morison R, Dempsey E (1942) A study of thalamo-cortical relations. *Am J Physiol* 135:281–292
12. Sarnthein J, Morel A, von Stein A et al. (2003) Thalamic theta field potentials and EEG: high thalamocortical coherence in patients with neurogenic pain, epilepsy and movement disorders. *Thalamus Related Syst* 2:231–238
13. Steriade M, Jones EG, Llinas R (1990) *Thalamic oscillations and signalling*. Wiley, New York
14. Steriade M, Jones EG, McCormick DA (1997) *Thalamus: Organisation and Function*. Elsevier, Oxford
15. Welsh JP (1998) Systemic harmaline blocks associative and motor learning by the actions of the inferior olive. *Eur J Neurosci* 10:3307–3320

## Thalamotomy, Pain Behavior in Animals

NAYEF E. SAADÉ, SUHAYL J. JABBUR  
Neuroscience Program, Faculty of Medicine, American University of Beirut, Beirut, Lebanon  
nesaade@aub.edu.lb

### Definition

Textbooks of neurology continue to regard the thalamus as an obligatory relay station for all sensory pathways (except olfaction) on their way to the cerebral cortex. Moreover, the thalamus has been considered to be a most important brain center for the perception of pain (Head and Holmes 1911). Over the last century, several clinical reports described disturbed sensations and spontaneous pain produced by thalamic lesion, a pathology labeled “thalamic syndrome” (Dejerine and Roussy 1906). Therefore, clinical and experimental investigations have been devoted to the understanding of the mechanisms underlying sensory disturbances following thalamic lesions.

### Characteristics

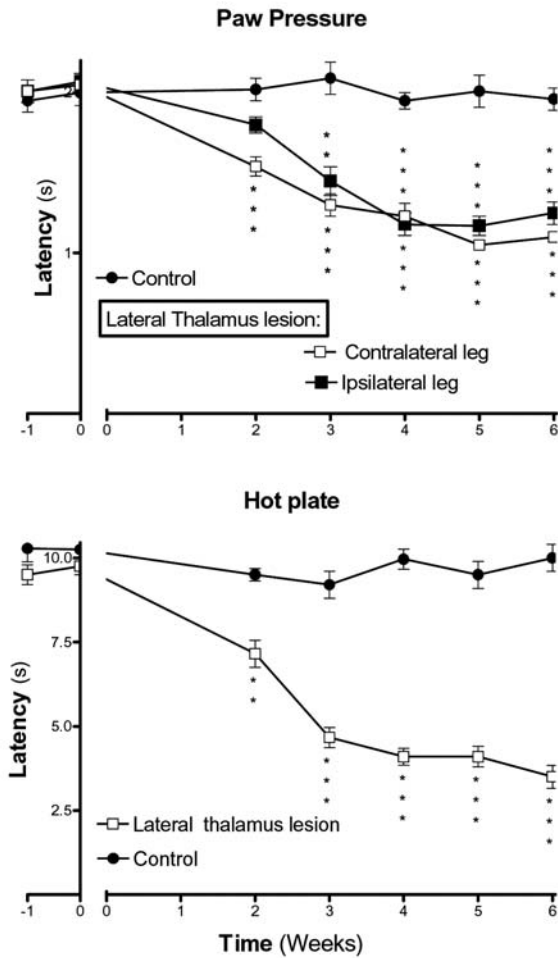
The work of Roussy (Roussy 1907) was among the first attempts to reproduce the “thalamic syndrome” in animals by controlled thalamic lesions (thalamotomies). The stereotaxic method and the techniques used for the placement of small or large experimental lesions in the thalamus are explained in ► [Post-stroke pain model, thalamic pain \(lesion\)](#) (lesion).

Placement of a controlled lesion in the human thalamus cannot be performed for experimental purposes. Therefore, studies involving partial or total thalamotomies can only be performed on experimental animals under controlled conditions and with strict adherence to ethical guidelines for pain experimentation on animals. The experimental protocol should take into consideration the effects of lesions placed in different thalamic nuclear groups known to be involved in the processing of various aspects of pain. These areas can be classified under two major headings, the lateral and the medial nuclear groups. The protocol should also be based on special animal models simulating different pain conditions (including acute and chronic pain) and using appropriate tests that allow the assessment of the different qualities of nociception (such as mechanonociception or thermonociception etc.).

Despite abundant clinical literature on the thalamic syndrome (about 820 studies, listed in a recent Pub Med search), few studies have been devoted to the investigation of the effects of various thalamic lesions on nociceptive behavior in animals. The early work by Delacour and Borst (Delacour and Borst 1972) showed that lesions of centromedian and parafascicular nuclei of the thalamus did not interfere with the escape reaction to noxious stimuli, but suppressed learning and avoidance conditioning. Mitchell and Kaelber (Mitchell and Kaelber 1967) also showed that lesion of more than 50% of the same (plus adjacent) thalamic nuclei in cats is necessary to block the escape reaction to grid electrical shock stimulation. More recently, Casey and Morrow (Casey and Morrow 1983) showed that bilateral medial thalamic lesions increased nociceptive responses in cats. This finding received further confirmation by the reported effects of lesions of the nucleus submedius in rats (Roberts and Dong 1994). A more recent study by Norrsell and Craig (Norrsell and Craig 1999) however, reported a mild thermosensory deficiency in cats subjected to ► [electrolytic lesions](#) placed in the various medial nuclear groups (nucleus submedius, posterior medial nucleus, basal ventral medial nucleus). It is important to note that the electrolytic lesions used can involve neuronal cell bodies in addition to passing fibers, which can have a functional role different from that of the lesioned centers.

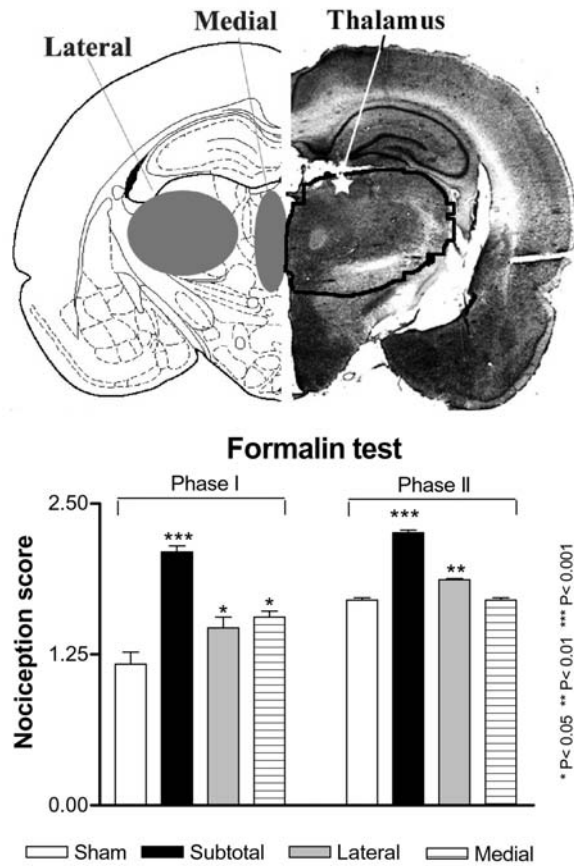
Recent work from our laboratory has aimed at studying the effects of lesions of various sizes and locations in the thalamus on the nociceptive behavior in rats. These lesions were performed by injecting either electrical current (electrolytic) or excitotoxic substances (for selective lesion of cell bodies). Their effects were assessed on acute nociceptive reactions and on a rat ► [animal model for mononeuropathy](#) (Saadé et al 1999).

Chronic unilateral lesions, which were either subtotal or placed in the lateral or the medial thalamus produced significant and persistent decreases in the mechanical and thermal nociceptive thresholds as assessed by the ► [paw pressure test](#) (PP) and ► [hot plate](#) (HP) tests, re-



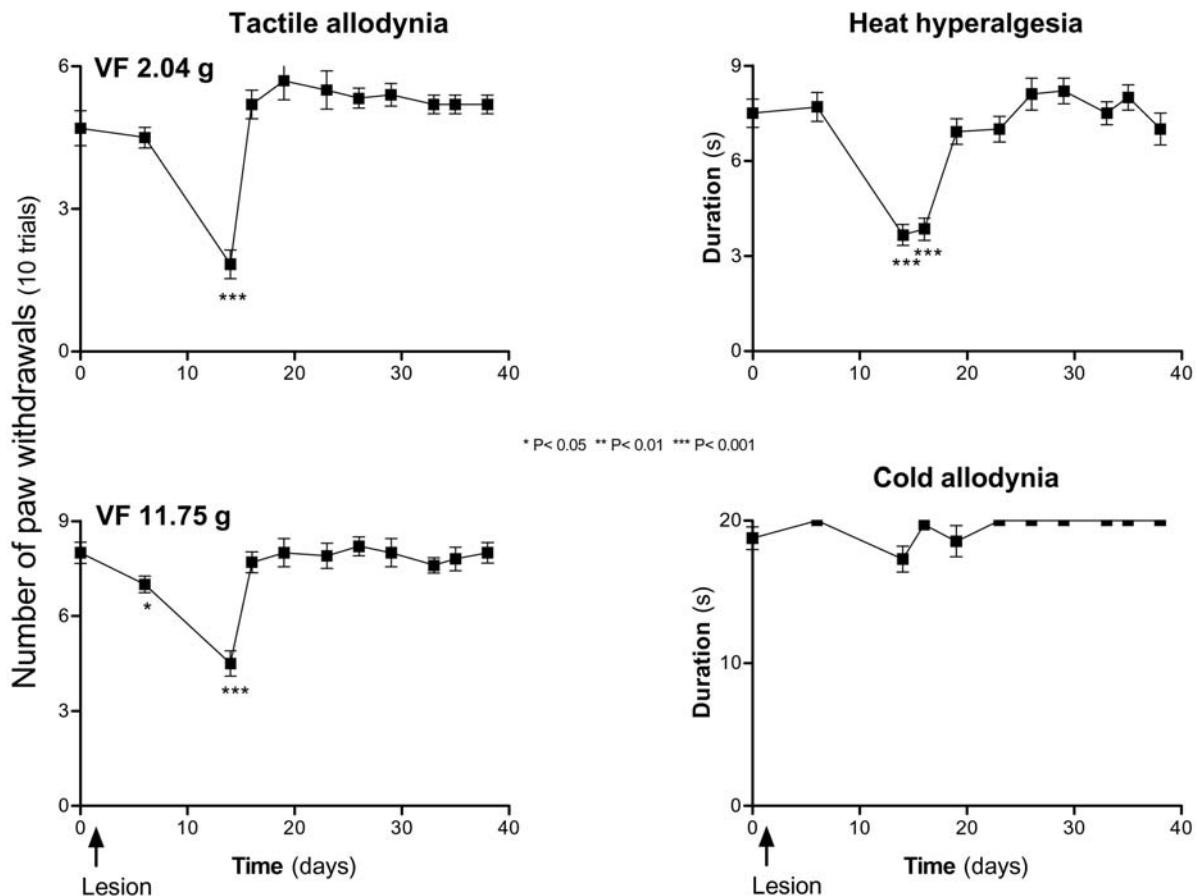
**Thalamotomy, Pain Behavior in Animals, Figure 1** Temporal evolution of the effects of lesions placed in the lateral thalamus of rats. Mechanical (paw pressure) and thermal (hot plate) nociceptive thresholds. The latencies of the nociceptive tests elicit a significant decrease (hyperalgesia) after the lesion (time 0) when compared to the latencies of the same test observed in intact rats (control).

spectively (Fig. 1). No significant differences were noticed between the effects of electrolytic and excitotoxic lesions. Furthermore, the increased nociception was bilateral (Fig. 1) and more pronounced on supraspinally coordinated nociceptive tests such as the HP. Thalamic lesions also exerted differential effects on the aversive behavior induced by intraplantar injection of 0.05 ml of formalin 2.5%, known as the ► **formalin test** (Dubuisson and Dennis 1977). The most pronounced effect, observed as increases in the nociceptive scores, was obtained with subtotal thalamic lesion (Fig. 2). The effects of either lateral or medial thalamic lesions on the neuropathic behavior observed in a rat ► **animal model for mononeuropathy** were also examined. Neuropathy was induced by selective lesion of two components (peroneal and tibial nerves) of the sciatic nerve supplying the hind leg and sparing the third



**Thalamotomy, Pain Behavior in Animals, Figure 2** Summary of the effects of different types of thalamic lesions on the formalin tests performed on three groups of rats subjected to thalamic lesions as compared to a fourth intact group (sham). (top) A composite drawing showing a microscopic view of a transverse section of a rat brain (right) and schematic drawing (left) illustrating the placement of lesions in the thalamus. (bottom) Each bar represents the average nociceptive score measured during a period of 12 min in phase I (early phase 3–15 min), or phase II (late or tonic phase 30–42 min) in the various groups of rats.

component (the sural). This model is characterized by a persistent ► **allodynia** (nociceptive reaction induced by non-noxious stimulus) and ► **hyperalgesia** (increased reactivity to a noxious stimulus). Both electrolytic or excitotoxic lesions placed either in the lateral or medial thalamic sensory nuclei produced transient decreases in neuropathic manifestations, which recovered their levels before thalamotomy within one or two weeks (Fig. 3). However, when mononeuropathy was induced 1 or 2 weeks after thalamic lesions, allodynia and hyperalgesia developed without any significant differences (in intensity or temporal evolution) from those observed in animals with an intact thalamus. Although it is difficult to produce exact simulation of clinical syndromes such as spontaneous pain by animal models, the batteries of tests employed appear to reflect significant changes in nociceptive reactivity in animals



**Thalamotomy, Pain Behavior in Animals, Figure 3** Transient attenuation of neuropathic manifestations by electrolytic lesions in the lateral thalamic nuclei. Each lesion was performed at day zero on a group of rats subjected to mononeuropathy. Tactile allodynia and heat hyperalgesia were decreased during the first 2 weeks, after which they recovered to their pre-lesion levels. Cold allodynia was not affected (Saadé et al., unpublished data).

subjected to thalamic lesions. Starting with the earliest animal experiments by Roussy in 1907, the outcome of lesions in sensory thalamic nuclei often resulted in either a decrease or no change in the nociceptive thresholds. It becomes necessary, therefore, to explain the resulting paradox as to how a function of a center can be either unaffected or exaggerated when that center is ablated? Possible answers to this question include the fact that a lesion to a nervous center can either affect, in varying proportions, inhibitory and excitatory mechanisms or lead to plastic changes that adjust and compensate for the insult or injury.

#### ► Lateral Thalamic Lesions, Pain Behavior in Animals

#### References

- Casey KL, Morrow TJ (1983) Supraspinal pain mechanisms in the cat. In: Kitchell KL, Erickson HH (eds) *Animal Pain Perception and Alleviation*. American Physiological Society, Bethesda, Maryland, USA, pp 63–82
- Dejerine J, Roussy G (1906) Le syndrome thalamique. *Rev Neurol* 14:521–532
- Delacour J, Borst A (1972) Failure to find homology in rat, cat, and monkey for functions of a subcortical structure in avoidance conditioning. *J Comp Physiol Psychol* 80:458–468
- Dubuisson D, Dennis SG (1977) The formalin test: a quantitative study of the analgesic effects of morphine, meperidine and brain stem stimulation in rats and cats. *Pain* 4:161–174
- Head H, Holmes G (1911) Sensory disturbances from cerebral lesions. *Brain* 34:102–254
- Mitchell CL, Kaelber WW (1967) Unilateral vs bilateral medial thalamic lesions and reactivity to noxious stimuli. *Arch Neurol* 17:653–660
- Norrnell U, Craig AD (1999) Behavioral thermosensitivity after lesions of thalamic target areas of a thermosensory spinothalamic pathway in the cat. *J Neurophysiol* 82:611–625
- Roberts VJ, Dong WK (1994) The effect of thalamic nucleus submedialis lesions on nociceptive responding in rats. *Pain* 57:341–349
- Roussy G (1907) *Le syndrome thalamique*. In: G. Steinheil: *La Couche Optique*. Paris
- Saadé NE, Kafrouni AI, Saab CY et al. (1999) Chronic thalamotomy increases pain-related behavior in rats. *Pain* 83:401–409

## Thalamus

### Definition

The thalamus is derived from the Greek word ‘Thálamos’ (bedroom, chamber). It represents the biggest structure

of the diencephalon. Its two hemispheres are located in the center of the brain next to the third ventricle. It has reciprocal connections with the cerebral cortex and relays sensory signals from all senses except that of olfaction to the cerebral cortex, and is also involved in motor, arousal and mood functions.

- ▶ Angina Pectoris, Neurophysiology and Psychophysics
- ▶ Deep Brain Stimulation
- ▶ Lateral Thalamic Pain-Related Cells in Humans
- ▶ Pain Treatment, Intracranial Ablative Procedures
- ▶ Prefrontal Cortex, Effects on Pain-Related Behavior
- ▶ Spinothalamic Projections in Rat

---

## Thalamus and Cardiac Pain

- ▶ Thalamus, Clinical Visceral Pain, Human Imaging

---

## Thalamus and Gastrointestinal Pain

- ▶ Thalamus, Clinical Visceral Pain, Human Imaging

---

## Thalamus and Pain

### Definition

Thalamic structures (including intralaminar nuclei, principle sensory nucleus, nuclei posterior to it including supra-geniculate, posterior, ventral medial-posterior nucleus) that have pain-related activity, as identified by anatomic and physiologic studies in primates.

- ▶ Pain Treatment, Motor Cortex Stimulation

---

## Thalamus and Visceral Pain (Positron Emission Tomography or Functional Magnetic Resonance Imaging)

- ▶ Thalamus, Clinical Visceral Pain, Human Imaging

---

## Thalamus and Visceral Pain Processing (Human Imaging)

ANTHONY R. HOBSON, QASIM AZIZ  
Section of GI Sciences, Hope Hospital, University of Manchester, Manchester, UK  
ahobson@fs1.ho.man.ac.uk

### Definition

Whilst there is ample evidence from animal studies to support the role of the thalamus in visceral pain

processing (Al-Chaer et al. 1998; Willis and Westlund 1997), studies in humans have, until recently, been limited to intra-operative observations from patients with implanted deep brain stimulating electrodes (Lenz et al. 1994). However, the availability of ▶ **functional brain imaging** techniques (FBI) such as ▶ **positron emission tomography (PET)** and ▶ **functional magnetic resonance imaging (fMRI)**, has allowed visceral pain researchers to confirm that the thalamus is not only an important relay station for visceral pain transmission, but may also be pivotal in the generation of symptoms in several visceral pain conditions.

### Characteristics

To date, information regarding the brain processing of visceral sensations and pain has been obtained following stimulation of the esophagus, stomach, rectum, bladder and vagina, in addition to that acquired during ▶ **dobutamine** induced chest pain (Aziz et al. 1997; Hobday et al. 2001; Ladabaum et al. 2001; Matsuura et al. 2002; Rosen et al. 1996; Whipple and Komisaruk 2002). In healthy subjects, thalamic activity has only been reported in approximately 50% of studies, and this has been predominantly in response to noxious rather than innocuous visceral stimulation.

Strigo et al. have compared the processing of visceral and cutaneous pain in the human brain using fMRI (Strigo et al. 2003). In this study, esophageal distension and contact heat stimulation of the anterior chest wall were matched for subjective intensity and applied to healthy subjects in a counterbalanced order. Analysis revealed that whilst differences were seen in cortical regions such as the anterior insula, a common pain neural network was activated encompassing the second somatosensory cortex, posterior parietal cortex, basal ganglia and thalamus. The authors concluded that the similar activations seen within these regions implicate their function in the identification of a stimulus as painful, rather than in the differentiation between the nature of painful stimuli (Strigo et al. 2003).

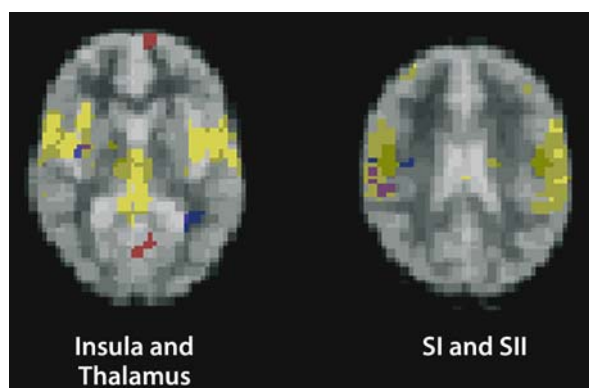
In a PET study that examined the effect of increasing intensity of gastric distension on cortical and sub-cortical activation, Ladabaum et al. reported significant thalamic activity only at the highest distension volumes, which produced a noxious stimulus. Peak activations were noted bilaterally in the ventral posterolateral (VPL) nuclei and in the left dorsomedial nuclei (Ladabaum et al. 2001) leading the authors to conclude that noxious gastric stimulation activates both the lateral and medial pain systems.

The ability to non-invasively map the neuroanatomy of the visceral pain matrix has led to several researchers embarking on clinical studies in patients with ▶ **functional gastrointestinal disorders**, predominantly in patients with ▶ **irritable bowel syndrome (IBS)**. Patients with IBS commonly report heightened perception of rectal distension (▶ **visceral hypersensi-**



tivity), and the aim of these studies has been to identify objective neural correlates of visceral hypersensitivity. Whilst the heterogeneity of the IBS population has meant that results from group imaging data have been inconsistent, several groups have shown increased thalamic activation in response to noxious rectal distension (Mertz et al. 2000; Verne et al. 2003; Yuan et al. 2003). The thalamic regions of interest identified in these studies encompassed the VPL and dorsomedial nuclei. The limited spatial resolution of the fMRI imaging techniques used in these studies meant that it was not possible to comment on activation of specific thalamic nuclei, and thus no comment could be made on the specific contribution of the sensory and affective dimensions of pain. Future clinical studies using high resolution imaging of the thalamus may be able to provide more information regarding the contribution of different thalamic regions to aberrant visceral pain processing in IBS.

Perhaps the most dramatic evidence to support the role of the thalamus in aberrant visceral pain processing comes from studies by Rosen et al. in patients with various forms of ► **angina pectoris** (Rosen et al. 1996, 2002). A previous case report from 1994 had reported that microstimulation of the VPL induced angina like symptoms in a single patient, which was not coincident with changes in cardiovascular function, strongly implicating the VPL in visceral and referred pain (Lenz et al. 1994). Rosen followed this up with a PET study in which he measured brain activity during intravenous dobutamine infusion in patients with coronary artery disease and active angina (Rosen et al. 1994). These data revealed that dobutamine induced angina was associated with bilateral activation of the thalamus, in addition to activation of a number of higher cortical structures. Following the cessation of dobutamine infusion, symptoms ceased and no cortical activity



**Thalamus and Visceral Pain Processing (Human Imaging), Figure 1** This image shows bilateral activation of the thalamus following painful esophageal balloon distension. In addition, activity is also seen in the primary / secondary somatosensory cortex and insula. These four regions are robustly activated following noxious visceral stimulation.

was seen; however, thalamic activity was still evident. The authors concluded that the thalamus acted as a gateway for afferent visceral pain signals; however, cortical activity was needed to bring this to a level of conscious perception. Further evidence to support this has been provided by additional studies in patients with silent ischemia and ► **syndrome X** (Rosen et al. 1996, 2002).

In summary, painful visceral stimuli produce bilateral activation of the thalamus incorporating the regions of the VPL and dorsomedial nuclei. Heightened activation of these regions has been associated with aberrant pain processing in patients with gastrointestinal and cardiac disease. As the spatial resolution of fMRI techniques improves, it will be possible to study the thalamus in greater detail shedding further light on its role in visceral pain processing.

## References

1. Al-Chaer ED, Feng Y, Willis WD (1998) A Role for the Dorsal Column in Nociceptive Visceral Input into the Thalamus of Primates. *J Neurophysiol* 79:3143–3150
2. Aziz Q, Andersson JL, Valind S et al. (1997) Identification of Human Brain Loci Processing Esophageal Sensation using Positron Emission Tomography. *Gastroenterology* 113:50–59
3. Hobday DI, Aziz Q, Thacker N et al. (2001) A Study of the Cortical Processing of Ano-Rectal Sensation using Functional MRI. *Brain* 124:361–368
4. Ladabaum U, Minoshima S, Hasler WL et al. (2001) Gastric Distention Correlates with Activation of Multiple Cortical and Subcortical Regions. *Gastroenterology* 120:369–376
5. Lenz FA, Gracely RH, Hope EJ et al. (1994) The Sensation of Angina can be Evoked by Stimulation of the Human Thalamus. *Pain* 59:119–125
6. Matsuura S, Kakizaki H, Mitsui T et al. (2002) Human Brain Region Response to Distention or Cold Stimulation of the Bladder: A Positron Emission Tomography Study. *J Urol* 168:2035–2039
7. Mertz H, Morgan V, Tanner G et al. (2000) Regional Cerebral Activation in Irritable Bowel Syndrome and Control Subjects with Painful and Non-Painful Rectal Distension. *Gastroenterology* 118:842–848
8. Rosen SD, Paulesu E, Frith CD et al. (1994) Central Nervous Pathways Mediating Angina Pectoris. *Lancet* 344:147–150
9. Rosen SD, Paulesu E, Nihoyannopoulos P et al. (1996) Silent Ischemia as a Central Problem: Regional Brain Activation Compared in Silent and Painful Myocardial Ischemia. *Ann Intern Med* 124:939–949
10. Rosen SD, Paulesu E, Wise RJ et al. (2002) Central Neural Contribution to the Perception of Chest Pain in Cardiac Syndrome X. *Heart* 87:513–519
11. Strigo IA, Duncan GH, Boivin M et al. (2003) Differentiation of Visceral and Cutaneous Pain in the Human Brain. *J Neurophysiol* 89:3294–3303
12. Verne GN, Himes NC, Robinson ME et al. (2003) Central Representation of Visceral and Cutaneous Hypersensitivity in the Irritable Bowel Syndrome. *Pain* 103:99–110
13. Whipple B, Komisaruk BR (2002) Brain (PET) Responses to Vaginal-Cervical Self-Stimulation in Women with Complete Spinal Cord Injury: Preliminary Findings. *J Sex Marital Ther* 28:79–86
14. Willis WD, Westlund KN (1997) Neuroanatomy of the Pain System and of the Pathways that Modulate Pain. *J Clin Neurophysiol* 14:2–31
15. Yuan YZ, Tao RJ, Xu B et al. (2003) Functional Brain Imaging in Irritable Bowel Syndrome with Rectal Balloon-Distention by using fMRI. *World J Gastroenterol* 9:1356–1360

## Thalamus, Clinical Pain, Human Imaging

A. VANIA APKARIAN

Feinberg School of Medicine, Department of Physiology, Northwestern University, Chicago, IL, USA

a-apkarian@northwestern.edu

### Synonyms

Chronic pain; BOLD activity; voxel-based morphometry; Gray Matter Density

### Definition

Non-invasive human brain imaging provides the opportunity to examine central processes that may be critically involved in the induction and/or maintenance of clinical chronic pain conditions. Such studies point to the notion that the thalamus shows reduced signaling and reduced gray matter, suggesting that the region is at least an active player in chronic pain conditions.

### Characteristics

The advent of non-invasive brain imaging technologies affords a unique opportunity for unraveling brain processes that may be critical in induction and/or maintenance of clinical chronic pain conditions. Such studies have the potential for replacing speculations, psychosocial interpretations and accusations of patients by dubbing them malingers and other such labels, by physiological parameters that characterize these conditions and then hopefully lead to new, more science based development of therapies. Here we briefly discuss the current understanding of the role of the thalamus in clinical pain states based on human brain imaging studies.

Brain activity as determined by ► PET or ► fMRI has established a reproducible pattern of cortical activity associated with acute or experimental painful conditions. A recent meta-analysis, of such studies over the last 15 years estimated that the incidence of reporting of thalamic activity in experimental pain conditions is 84% (16/19 studies) in PET studies and 81% (13/16 studies) in fMRI studies (Apkarian et al. 2005) (incidence here is the ratio of the number of studies where the area was investigated in contrast to the number of studies where the area was reported to be activated). In contrast to this value, when the incidence of thalamic activity is examined in brain imaging studies in clinical pain conditions the incidence is 59% (16/27 PET, ► SPECT and fMRI studies combined). The conditions included in the clinical cases are cancer pain, cluster headache, migraine, cardiac pain, irritable bowel syndrome, fibromyalgia, CRPS, phantom pain and mono- or poly-neuropathies (Apkarian et al. 2005). Contrasting the incidence of thalamic activity in normal subjects to clinical pain conditions indicates a borderline significant decrease in clinical conditions ( $p = 0.09$ , Fisher's exact test).

The result seems paradoxical since one would naturally associate decreased thalamic activity with decreased pain and not the other way. We argue below that this observation is consistent with the notion that chronic pain conditions are more emotional states and hence less sensory; as a result they may involve less spinothalamic activation and enhanced activations through pathways more directly accessing emotional regions of the brain. The first clinical pain study was done in 5 patients with chronic cancer pain, where brain activity as determined by PET was compared between them and normal subjects before and after high cervical cordotomies that resulted in significant pain relief (Di Piero et al. 1991). The main outcome of the study was the observation that thalamic activity was low in the patients during chronic pain and normalized after the cordotomy. At least another 5 studies report that chronic clinical pain conditions are associated with decreased baseline activity or decreased stimulus related activity in the thalamus. A SPECT blood flow study (Fukumoto et al. 1999) has shown a strong relationship between time of onset of CRPS symptoms and thalamic activity. The ratio between contralateral and ipsilateral thalamic perfusion was larger than 1.0, indicating hyperperfusion, for patients with symptoms for only 3–7 months and smaller than 1.0, indicating hypoperfusion, for patients with longer-term symptoms (24–36 months), with a correlation coefficient of 0.97 (normal subjects had a thalamic perfusion ratio of about 1.0). These results strongly imply that the thalamus undergoes adaptive changes in the course of CRPS. Thus, it can be asserted that thalamic activity for pain in chronic clinical conditions is different from that for acute painful stimuli in normal subjects.

Proving long-term reorganization of the CNS is hard with functional imaging, since one cannot disentangle reorganization from modulation of responses due to the presence of the condition, for example in chronic pain. On the other hand, examination of brain chemistry by ► MRS indicates changes in various metabolites, most of which are not affected by the current cognitive state of the person. Thus, such measures document long-term changes more readily. The limitation of the technique regards the specific chemicals that can be detected (the specific functions of many of which remain unclear), and the need for regional imaging which limits the spatial extent of the measurement (Salibi and Brown 1998). One such study examined thalamic metabolites in chronic back pain patients and observed no changes in comparison to healthy subjects, although there were decreased measures for multiple metabolites in the prefrontal cortex (Grachev et al. 2000). Another similar study examined thalamic metabolites (Pattany et al. 2002) in patients with chronic neuropathic pain after spinal cord injury and did see decreased metabolites in the thalamus and observed a negative correlation between pain intensity and concentration in the thalamus.

Since a decreased concentration of N-acetyl-aspartate has been reported in most neurodegenerative conditions, it is reasonable to conclude that the observation of decreased N-acetyl-aspartate in the chronic spinal cord injury patients suggests that the condition is associated with a neurodegenerative process in the thalamus. This idea was tested directly in a morphometric study. The gray matter density of chronic back pain patients was contrasted with age and gender matched normal subjects using high resolution anatomical MRI. The results indicate that the thalamus gray matter density, mainly on the right, is significantly lower in density in the chronic back pain patients (Apkarian et al. 2004). The mechanisms inducing this atrophy remain to be determined, as well as the extent of its reversibility and its impact on information processing in the thalamus. However, the observation clearly implies that the thalamus is undergoing long-term reorganization due to the presence of the pain condition. It is also possible that some of this reorganization has a genetic component that may predispose these subjects to develop chronic pain. Thus, there are more questions raised than answered. Fortunately, these questions can be answered in future studies and should provide a more accurate understanding of the role of the thalamus in chronic pain conditions.

Decreased brain responses to painful stimuli in clinical pain conditions have been observed in other meta-analyses of the literature (Derbyshire 1999; Peyron et al. 2000), and interpreted as evidence for a generalized decrease in brain activity in such patients. However, when the incidence of prefrontal cortical activity is examined, one observes increased incidence of activating this region in chronic pain patients in contrast to normal subjects. In normal subjects, prefrontal cortex is activated in 55% (23/42) of functional imaging studies for pain, while in pain patients this rate increases to 81% (21/26,  $p = 0.04$ , Fisher's exact statistics). Thus, in chronic pain patients, decreased thalamic activity seems to be accompanied by increased prefrontal cortical activity. This implies a switch of nociceptive inputs away from spinothalamic afferents and enhanced nociceptive inputs through brainstem prefrontal cortical regions. This has been suggested in animal models of neuropathic pain (Hunt and Mantyh 2001), based on the response changes observed in spinal cord neurons following neuropathic injury. The shift suggests that chronic clinical pain conditions are more emotional/cognitive than sensory. Whether the thalamic atrophy observed in back pain patients directly contributes to this shift remains to be determined. It is at least consistent with the model.

Overall, multiple lines of investigations regarding the involvement of the thalamus in clinical pain conditions imply that the region actively reorganizes in such conditions. It should be emphasized that most probably the details of this reorganization are specific to differ-

ent types of clinical pains. The extent to which this reorganization contributes to such conditions remains unclear. More importantly, these observations strongly suggest that at least part of this reorganization may be a consequence of neuronal death and hence irreversible, pointing to the urgency for further elaborating these details and for more effective therapeutic approaches for these conditions.

## References

1. Apkarian AV, Sosa Y, Sonty S et al. (2004) Chronic back pain is associated with decreased prefrontal and thalamic gray matter density. *J Neurosci* 24:10410–10415
2. Apkarian AV, Bushnell MC, Treede RD et al. (2005) Human brain mechanisms of pain perception and regulation in health and disease. *Eur J Pain* 9:463–84
3. Derbyshire SW (1999) Meta-Analysis of Thirty-Four Independent Samples Studied Using PET Reveals a Significantly Attenuated Central Response to Noxious Stimulation in Clinical Pain Patients. *Curr Rev Pain* 3:265–280
4. Di Piero V, Jones AK, Iannotti F et al. (1991) Chronic pain: a PET study of the central effects of percutaneous high cervical cordotomy. *Pain* 46:9–12
5. Fukumoto M, Ushida T, Zinchuk VS et al. (1999) Contralateral thalamic perfusion in patients with reflex sympathetic dystrophy syndrome. *Lancet* 354:1790–1791
6. Grachev ID, Fredrickson BE, Apkarian AV (2000) Abnormal brain chemistry in chronic back pain: an in vivo proton magnetic resonance spectroscopy study. *Pain* 89:7–18
7. Hunt SP, Mantyh PW (2001) The molecular dynamics of pain control. *Nat Rev Neurosci* 2:83–91
8. Pattany PM, Yezierski RP, Widerstrom-Noga EG et al. (2002) Proton magnetic resonance spectroscopy of the thalamus in patients with chronic neuropathic pain after spinal cord injury. *AJNR Am J Neuroradiol* 23:901–905
9. Peyron R, Laurent B, Garcia-Larrea L (2000) Functional imaging of brain responses to pain. A review and meta-analysis (2000). *Neurophysiol Clin* 30:263–288
10. Salibi N, Brown MA (1998) *Clinical MR spectroscopy*. Wiley-Liss, New York

## Thalamus, Clinical Visceral Pain, Human Imaging

T

URI LADABAUM

Division of Gastroenterology, University of California, San Francisco, CA, USA  
uri.ladabaum@ucsf.edu

## Synonyms

Thalamus and Cardiac Pain; Thalamus and Gastrointestinal Pain; Thalamus and Visceral Pain (Positron Emission Tomography or Functional Magnetic Resonance Imaging)

## Definition

Visceral pain arises from the internal organs, such as the heart and the gastrointestinal tract. In contrast, somatic pain arises from the skin and deeper tissues, including muscle. The central nervous system regions activated by visceral pain in humans, including the thalamus, have

been studied non-invasively with ► [positron emission tomography](#) (PET) and ► [functional magnetic resonance imaging](#) (fMRI), functional imaging techniques that measure increased regional cerebral blood flow as a marker of neuronal activation.

### Characteristics

Thalamic activation (defined as a statistically significant increase in regional blood flow during the condition of interest) has been reported in many but not all functional cerebral imaging studies of visceral pain in humans. The cerebral representation of visceral pain was first studied by inducing angina in humans, and later by distending gastrointestinal viscera to induce pain. A recent systematic review that included inspection of published images by the author in addition to the results explicitly reported by investigators found evidence for thalamic activation with angina, noxious esophageal stimulation, gastric distension and noxious lower gastrointestinal distension in healthy volunteers and patients with ► [irritable bowel syndrome](#) (IBS) (Derbyshire 2003).

### Cardiac Ischemia and Angina

A pioneering ► [PET](#) study reported the central nervous system pathways mediating ► [dobutamine](#)-induced angina in patients with coronary artery disease (Rosen et al. 1994). Compared to the resting state, regional blood flow increased during angina in a number of cerebral structures, including increases of 2.7% in the left thalamus and 3.7% in the right thalamus. After the resolution of angina, thalamic activity remained significantly increased, whereas the cortical activity associated with angina was no longer detected. The authors suggested that the thalamus receives input from the heart during angina and continues to receive such input even when angina is no longer felt, with this less intense signal not being transmitted to the cerebral cortex and therefore not associated with conscious perception.

Cerebral PET imaging was then used to gain insight into the problem of ► [silent myocardial ischemia](#) (Rosen et al. 1996). Cerebral activation patterns were compared between patients with stress-induced angina and patients with stress-induced myocardial ischemia but no angina. During myocardial ischemia, significant left thalamic activation was detected in patients with angina and bilateral thalamic activation was detected in patients with silent ischemia. However, much more extensive cortical activation was seen in those with angina. Because thalamic activation was seen in both groups of patients, the authors concluded that ► [silent myocardial ischemia](#) cannot be explained by peripheral nerve dysfunction. They proposed that abnormal central processing of afferent pain signals (possibly abnormal gating at the level of the thalamus), may contribute to the pathophysiology of silent myocardial ischemia.

### Esophageal Stimulation

An early PET study of the cerebral regions involved in esophageal sensation found bilateral activations along the central sulcus, insulae, and frontal and parietal operculum during non-painful esophageal distension and more intense activations in these regions as well as additional activation in the right anterior insular cortex and the anterior cingulate gyrus during painful distension (Aziz et al. 1997). Thalamic activation was not detected.

Subsequently, a fMRI study examined the cerebral cortical response to esophageal distension or acid perfusion (Kern et al. 1998). Acidification and distension generally resulted in activations of Brodmann's areas 7, 23, 30, 32, insula, operculum and anterior cingulate cortex. Although the activated regions were similar, the temporal characteristics of the activation were different (slower for acidification). Significant thalamic activation was again not detected.

The cortical processing of distal and proximal esophageal sensation has been compared using fMRI (Aziz et al. 2000). Among other differences, proximal distension was localized precisely to the upper chest and activated the left primary somatosensory cortex, whereas distal distension was perceived diffusely over the lower chest and activated the junction of the primary and secondary somatosensory cortices bilaterally. Significant thalamic activation was not reported.

The cerebral processing of visceral and cutaneous pains were compared using distal esophageal distension and application of heat to the chest during cerebral fMRI scanning (Strigo et al. 2003). Painful esophageal distension and painful heat stimulation both induced statistically significant thalamic activation on the left and non-significant activation on the right. Overall, a similar neural network was activated with visceral and somatic stimulation, but notable differences were also apparent that probably relate to the differences in the experience of visceral and cutaneous pain.

The different results among these studies probably relate to differences in experimental design, study population and chance. Regional cerebral blood flow changes with "activation" are generally small (a few percent). Because the thalamus is a major relay and processing station between the periphery and the cortex and basal ganglia and because thalamic activation has been reported in a substantial proportion of all available visceral pain studies in humans, it is likely that the lack of significant thalamic activation in the first three studies reflects the limitations of the available techniques.

### Gastric Stimulation

Cerebral PET imaging during increasing levels of gastric distension detected progressive increases in activation in multiple cortical and subcortical regions, including the thalami, insulae, anterior cingulate cortex, periaqueductal gray matter and cerebellum (Ladabaum



et al. 2001). Statistically significant activation centered in the right ventral posterolateral (VPL) nucleus of the thalamus was detected with distension producing threshold pain as well as distension producing moderate pain. Statistically significant activations centered in the VPL and dorsomedial (DM) nuclei of the left thalamus were detected with distension producing moderate pain. The VPL nucleus is a key component of the lateral pain system, which is believed to subserve the sensory-discriminative component of pain and the DM nucleus is part of the medial pain system, which is believed to mediate the affective-motivational component of pain. The identification of precise thalamic nuclei as the regions of peak activation must be interpreted with caution given the spatial resolution limits of PET.

### Rectosigmoid Stimulation

A pioneering PET study of visceral sensation in healthy volunteers and patients with IBS found thalamic activation of borderline significance during rectal distension in healthy volunteers (Silverman et al. 1997). An early fMRI study detected activation in numerous regions including the anterior cingulate, prefrontal, insular and sensorimotor cortices during rectal distension in healthy volunteers, but no thalamic activation was detected (Baciu et al. 1999).

A larger study of healthy volunteers (16) and IBS patients (18) using fMRI during rectal distension reported increased activity in the anterior cingulate, prefrontal, and insular cortices, as well as increased thalamic activity in nearly all subjects (Mertz et al. 2000). In contrast to earlier results (Silverman et al. 1997), this study found comparable patterns of activation in healthy volunteers and IBS patients, but greater activation of the anterior cingulate cortex during painful compared to non-painful stimulation only in IBS patients.

An intriguing study examined cerebral activation during subliminal visceral stimulation caused by rectal distension (Kern and Shaker 2002). Cerebral activation during subliminal distension was generally bilateral in regions including the sensory/motor, parieto-occipital, anterior cingulate, prefrontal and insular cortices. Distension to liminal (threshold sensation) and supraliminal (above threshold sensation) levels activated regions similar to those activated with subliminal stimulation, but the volume of cortical activity increased with the stimulus intensity. In contrast to studies of myocardial ischemia in which thalamic activity was detected even after resolution of angina (Rosen et al. 1994; Rosen et al. 1996), thalamic activation was not detected in this study of subliminal rectal sensation.

Some subsequent studies involving rectal distension have reported significant thalamic activation (Verne et al. 2003; Yuan et al. 2003), including greater activation in the thalamus and multiple other regions in IBS patients compared to healthy volunteers during

both rectal and somatic stimulation (Verne et al. 2003). However, thalamic activation has not been detected in all subsequent studies (Berman et al. 2002). As with the esophageal stimulation studies that failed to detect thalamic activation, it seems likely that the lack of significant thalamic activation in some rectal distension studies reflects the limitations of the available technology.

### Summary

The thalamus is a major relay and processing station between the peripheral nervous system and higher centers in the central nervous system. It would be anticipated that cerebral functional imaging studies using PET or fMRI in humans would detect thalamic activation during visceral pain. Many such studies have indeed detected thalamic activation. The results include thalamic activation during myocardial ischemia with or without angina and after the resolution of angina and thalamic activation during distal esophageal distension, gastric distension and rectal distension. However, not all studies of functional cerebral imaging during gastrointestinal visceral distension have detected thalamic activation. These seemingly inconsistent results are probably due to limitations in the sensitivity of the available technology.

### References

1. Aziz Q, Andersson JL, Valind S et al. (1997) Identification of human brain loci processing esophageal sensation using positron emission tomography. *Gastroenterology* 113:50–59
2. Aziz Q, Thompson DG, Ng VW et al. (2000) Cortical processing of human somatic and visceral sensation. *J Neurosci* 20:2657–2663
3. Baciu MV, Bonaz BL, Papillon E et al. (1999) Central processing of rectal pain: a functional MR imaging study. *AJNR Am J Neuroradiol* 20:1920–1924
4. Berman SM, Chang L, Suyenobu B et al. (2002) Condition-specific deactivation of brain regions by 5-HT<sub>3</sub> receptor antagonist Alosetron. *Gastroenterology* 123:969–977
5. Derbyshire SW (2003) A systematic review of neuroimaging data during visceral stimulation. *Am J Gastroenterol* 98:12–20
6. Kern MK, Shaker R (2002) Cerebral cortical registration of subliminal visceral stimulation. *Gastroenterology* 122:290–298
7. Kern MK, Birn RM, Jaradeh S et al. (1998) Identification and characterization of cerebral cortical response to esophageal mucosal acid exposure and distention. *Gastroenterology* 115:1353–1362
8. Ladabaum U, Minoshima S, Hasler W et al. (2000) Gastric distention correlates with activation of multiple cortical and subcortical regions. *Gastroenterology* 120:369–376
9. Mertz H, Morgan V, Tanner G et al. (2000) Regional cerebral activation in irritable bowel syndrome and control subjects with painful and nonpainful rectal distention. *Gastroenterology* 118:842–848
10. Rosen SD, Paulesu E, Frith CD et al. (1994) Central nervous pathways mediating angina pectoris. *Lancet* 344:147–150
11. Rosen SD, Paulesu E, Nihoyannopoulos P et al. (1996) Silent ischemia as a central problem: regional brain activation compared in silent and painful myocardial ischemia. *Ann Intern Med* 124:939–949
12. Silverman DH, Munakata JA, Ennes H et al. (1997) Regional cerebral activity in normal and pathological perception of visceral pain. *Gastroenterology* 112:64–72

13. Strigo IA, Duncan GH, Boivin M et al. (2003) Differentiation of visceral and cutaneous pain in the human brain. *J Neurophysiol* 89:3294–3303
14. Verne GN, Himes NC, Robinson ME et al. (2003) Central representation of visceral and cutaneous hypersensitivity in the irritable bowel syndrome. *Pain* 103:99–110
15. Yuan YZ, Tao RJ, Xu B et al. (2003) Functional brain imaging in irritable bowel syndrome with rectal balloon-distention by using fMRI. *World J Gastroenterol* 9:1356–1360

## Thalamus, Dynamics of Nociception

VASCO GALHARDO

Institute of Histology and Embryology, Faculty of Medicine of Porto, University of Porto, Porto, Portugal  
galhardo@med.up.pt

### Synonyms

Thalamic plasticity; Thalamic Reorganization; sensitization

### Definition

The dynamics of the thalamic responses to noxious stimuli are the signature of neural mechanisms that make the responses not rigid and immutable, since they reflect both the nature of the incoming afferent signal and the internal state of the neuronal populations that process nociceptive signals.

### Characteristics

Somatosensory noxious information is processed by the thalamus in a complex manner that is still little understood. Far from being a simple relay station for painful stimuli on their way from the periphery to the cortex, thalamic neurons integrate and modulate the pain signals in a dynamic way. This implies that the modulation itself is the result of the instantaneous status of the thalamic neuronal network. By addressing the topic of the dynamics of thalamic responses we acknowledge the fact that the arriving nociceptive information will not always be processed by the thalamic neural networks in exactly the same manner, since the functional properties of the processing neural networks will change over time, reflecting the history of the incoming signals.

The factors that affect the status of the processing neural networks may be *extrinsic* to the thalamus – meaning that they are caused by the qualities of the past and immediate afferent information - or *intrinsic* – meaning that they are the result of the status of the thalamus, namely the occurrence of population ► **oscillations**.

This brief essay will review four key aspects of nociceptive information processing dynamics within the thalamus.

### Sensitization of the Thalamus

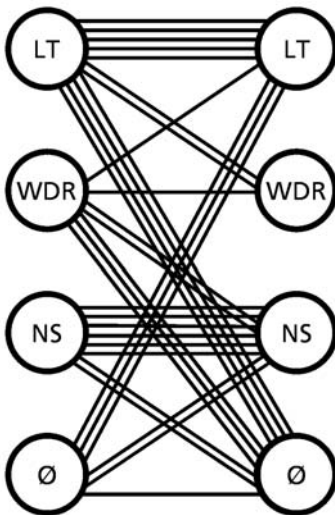
The most basic aspect of thalamic somatosensory dynamics is the change in the response properties of

thalamic neurons induced by states of peripheral persistent pain. Several studies have shown that in conditions of ► **hyperalgesia** or ► **allodynia** the neurons in the ventrobasal complex of the lateral thalamus have enhanced responsiveness, i.e. they have lower activation thresholds for both thermal and mechanical stimuli and larger peripheral receptive fields and continue to discharge spontaneously for long periods after cessation of the noxious stimulation (Guilbaud et al. 1990; Sherman et al. 1997). Ultimately, it is difficult to determine to what extent this functional plasticity corresponds to a change within the thalamic networks or if the enhanced thalamic activity is instead simply a consequence of the enhanced somatosensory information generated at spinal levels during chronic pain. One strong piece of evidence for the occurrence of plasticity at the thalamic level is that painful sensations are evoked more frequently by microstimulation of the lateral thalamus in patients with chronic neuropathic pain than in patients with non-painful movement disorders (Davis et al. 1996). Further microstimulation studies suggest that in neuropathic pain patients, thalamic areas usually signaling thermal non-painful discrimination are now evoking painful sensations when stimulated (Lenz et al. 1998).

It is very tempting to assume that the enhanced sensory activity corresponds to a progressive change of thalamic nociceptive-specific neurons into the wide-dynamic range category, as was implied in some studies (Guilbaud et al. 1990). However, multielectrode recordings lasting several hours in the rat somatosensory thalamus (Brueggemann et al. 2001) showed that immediately after a nerve lesion no rigid pattern of change between cell types could be found (Fig. 1). Although the results from multielectrode studies show immediate fluctuations in response properties, they do not show a clear net increase in nociceptive responses in the affected portion of the lateral thalamus.

### Deafferentation-Induced Plasticity

Paradoxically, just as the enhanced somatosensory information leads to a sensitization of thalamic networks, the decrease in somatosensory information arriving at the thalamus due to peripheral nerve lesions also leads to higher levels of pain sensitivity. This is probably due to the fact that both the functional loss of afferents by peripheral lesions and the functional gain of afferents by peripheral ► **hyperalgesia** lead to similar net effects; some regions of the thalamus are suddenly more active than their neighbors and this spatial imbalance causes a regional peak of activity that leads to somatosensory hypersensitivity. ► **Deafferentation** studies also reveal a crosstalk between somatosensory modalities in which both the disruption of thick myelinated non-nociceptive fibers leads to altered pain perception and the disruption of unmyelinated high-threshold ► **C Fiber** leads to altered tactile perception. A recent multielectrode study



**Thalamus, Dynamics of Nociception, Figure 1** Changes in classification of lateral thalamic neurons at the beginning (Before, before sciatic nerve ligation) and at the end of the experiments (After, after nerve ligation). Horizontal lines indicate no change; diagonal lines indicate changes in neuronal class. Abbreviations:  $\emptyset$ , unresponsive neurons; LT, Low-threshold neurons; WDR, wide-dynamic range neurons; NS, nociceptive-specific neurons (Figure taken from Brueggemann et al. 2001).

in the rat lateral thalamus (Katz et al. 1999) showed that the silencing of **c-fibers** after perioral capsaicin injections changed the pattern of sensitivity to tactile deflection of the whiskers, resulting in “unmasking” of new tactile responses.

#### Spatiotemporal Dynamics in the Thalamus

Several studies have shown novel properties in the thalamic integration of nociceptive signals, in both space and time domains. Finding spatiotemporal patterns of coherence in the activity of neuronal populations in the thalamus during the processing of pain will help unravel the intrinsic organization of the processing units within the lateral thalamus. The use of multielectrode arrays with precise spatial arrangements showed that the functional connectivity between pairs of neurons depends on the distance separating them; neighboring nociceptive neurons tend to be positively correlated, while most negative correlations in evoked spike timings occur between neurons separated by more than 50  $\mu\text{m}$  (Apkarian et al. 2000). Interestingly, the spatial maps of evoked spike coherence between pairs of neurons were different for noxious and non-noxious stimulations, with tactile stimuli inducing almost no inhibitory spatial effects. The results of that study also suggest that in the primate thalamus, nociceptive and non-nociceptive neurons are clustered separately in a lattice manner. This spatial arrangement of the lateral thalamus would have profound implications for the spatiotemporal dynamics of thalamic function, since nociceptive clusters would receive spinothalamic afferents while non-nociceptive clusters would receive mainly dorsal column afferents and both

have distinct velocity and synchrony characteristics that would result in complex spatiotemporal patterns, difficult to interpret and predict.

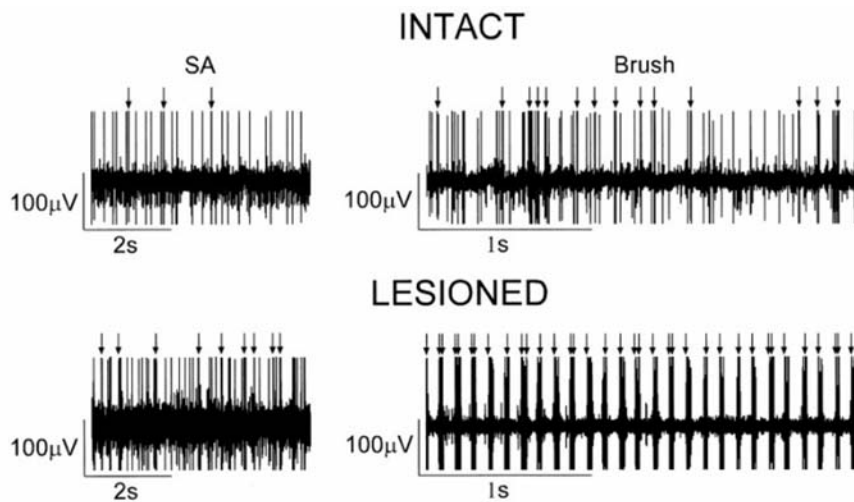
By the same token, it has been conclusively shown that for fine tactile discrimination also, the spatiotemporal maps are complex to determine and reorganize after peripheral **deafferentation** and that distributed coherent activity in the thalamus plays a key role in the encoding of somatosensory signals (Nicoletis 1997).

#### Thalamic Oscillations and Pain Processing

The thalamus is known to have two modes of firing: tonic mode, in which neurons fire single action potentials and bursting mode, in which neurons fire in rhythmic rapid bursts of several action potentials. Traditionally, thalamic bursts were associated with non-aware states, while tonic mode was associated with alert states, although this simple scheme has been questioned in recent studies (Nicoletis and Fanselow 2002). High-frequency spike bursts are one of the most characteristic features observed in the thalamus following **deafferentation** by lesion of peripheral nerves, dorsal roots or the spinal cord (Albe-Fessard et al. 1985; Guilbaud et al. 1990). In the thalamus, spike bursts have been described with very specific membrane physiology and have been shown to function normally to synchronize activity of neurons both within and between thalamic nuclei as well as between the thalamus and cortex. In human thalamic recordings performed during surgery (Lenz et al. 1989), a characteristic series of spontaneous short high frequency spike trains (3–8 action potentials occurring at 60–160 Hz) or spike bursts was found in long-term para- and tetraplegics. These bursts repeat themselves in low-frequency **oscillations** in pain patients and the clinical condition has been termed **thalamocortical dysrhythmia** (Llinás et al. 1999).

Significance has been assigned to changes in the temporal patterns of activity in thalamic neurons following deafferentation because spike bursts in pain patients are especially concentrated in regions of the lateral thalamus representing the painful part of the body. In Fig. 2 we present an example of such a burst activity. The figure is taken from Weng et al. (2000) where the authors report that thalamic wide-dynamic range neurons (but not the low-threshold neurons) of monkeys partially deafferented by spinal cord lesions showed enhanced activity compared with the same types of cells in thalamus with intact innervation; both the spontaneous and evoked discharges of the cells were altered, so that there was an increased incidence of spike-bursts in cells of deafferented thalamus.

Recently, the importance of this abnormal thalamic firing for the genesis of chronic central pain has been challenged by the finding of no differences between the number of oscillating neurons in the thalamus of allodynic *versus* non-allodynic rats with spinal cord injury (Gerke et al. 2003), suggesting that **thalamic**



**Thalamus, Dynamics of Nociception, Figure 2** Brush stimuli evoke oscillatory activity in the lateral thalamus of animals with complete sectioning of the anterolateral spinal quadrant (Figure taken from Weng et al. 2000).

dysrhythmia is linked to cord injury but not to the presence of ► **allodynia**. However this study was performed in anaesthetized animals, raising the question of its applicability to awake thalamic processing. By the same token, Radhakrishnan et al. (1999) showed that the incidence of thalamic bursting was similar between painful and non-painful neurological injuries. Hence, the role of the internal oscillatory states of the thalamus in pain processing is still to be clarified.

## References

- Albe-Fessard D, Berkley KJ, Kruger L et al. (1985) Diencephalic mechanisms of pain sensation. *Brain Res* 356:217–296
- Apkarian AV, Shi T, Brueggemann J et al. (2000) Segregation of nociceptive and non-nociceptive networks in the squirrel monkey somatosensory thalamus. *J Neurophysiol* 84:484–494
- Brueggemann J, Galhardo V, Apkarian AV (2001) Immediate reorganization of the rat somatosensory thalamus following peripheral partial nerve ligation. *J Pain* 2:220–228
- Davis KD, Kiss ZHT, Tasker RR et al. (1996) Thalamic stimulation-evoked sensations in chronic pain patients and non-pain (movement disorder) patients. *J Neurophysiol* 75:1026–1037
- Gerke M, Duggan A, Xu L et al. (2003) Thalamic neuronal activity in rats with mechanical allodynia following contusive spinal cord injury. *Neuroscience* 117:715–722
- Guilbaud G, Benoist JM, Jazat F et al. (1990) Neuronal responsiveness in the ventrobasal thalamic complex of rats with an experimental peripheral mononeuropathy. *J Neurophysiol* 64:1537–1554
- Katz DB, Simon SA, Moody A et al. (1999) Simultaneous reorganization in thalamocortical ensembles evolves over several hours after perioral capsaicin injections. *J Neurophysiol* 82:963–977
- Lenz FA, Kwan HC, Dostrovsky JO et al. (1989) Characteristics of the bursting pattern of action potentials that occurs in the thalamus of patients with central pain. *Brain Res* 496:357–360
- Lenz FA, Gracely RH, Baker FH et al. (1998) Reorganization of sensory modalities evoked by microstimulation in region of the thalamic principal sensory nucleus in patients with pain due to nervous system injury. *J Comp Neurol* 399:125–138
- Llinas RR, Ribary U, Jeanmonod D et al. (1999) Thalamocortical dysrhythmia: A neurological and neuropsychiatric syndrome characterized by magnetoencephalography. *Proc Natl Acad Sci USA* 96:15222–15227
- Nicolelis MAL (1997) Dynamic and distributed somatosensory representations as the substrate for cortical and subcortical plasticity. *Semin Neurosci* 9:24–33
- Nicolelis MAL, Fanselow EE (2002) Thalamocortical optimization of tactile processing according to behavioral state. *Nat Neurosci* 5:517–523
- Radhakrishnan V, Tsoukatos J, Davis KD et al. (1999) A comparison of the burst activity of lateral thalamic neurons in chronic pain and non-pain patients. *Pain* 80:567–575
- Sherman SE, Luo L, Dostrovsky JO (1997) Altered receptive fields and sensory modalities of rat VPL thalamic neurons during spinal strychnine-induced allodynia. *J Neurophysiol* 78:2296–2308
- Weng HR, Lee JI, Lenz FA et al. (2000) Functional plasticity in primate somatosensory thalamus following chronic lesion of the ventral lateral spinal cord. *Neuroscience* 101:393–401

## Thalamus Lesion

- [Lateral Thalamic Lesions, Pain Behavior in Animals](#)

## Thalamus, Metabotropic Glutamate Receptors

- [Metabotropic Glutamate Receptors in the Thalamus](#)

## Thalamus, Nociceptive Cells in VPI, Cat and Rat

CHRISTIANE VAHLE-HINZ  
 Institute of Neurophysiology and Pathophysiology,  
 University Hospital Hamburg-Eppendorf, Hamburg,  
 Germany  
 vahle-hinz@uke.uni-hamburg.de

## Synonyms

High-threshold neurons; nociceptive-specific neurons (NS); wide-dynamic range (WDR) neurons; multireceptive neurons (MR)



## Definition

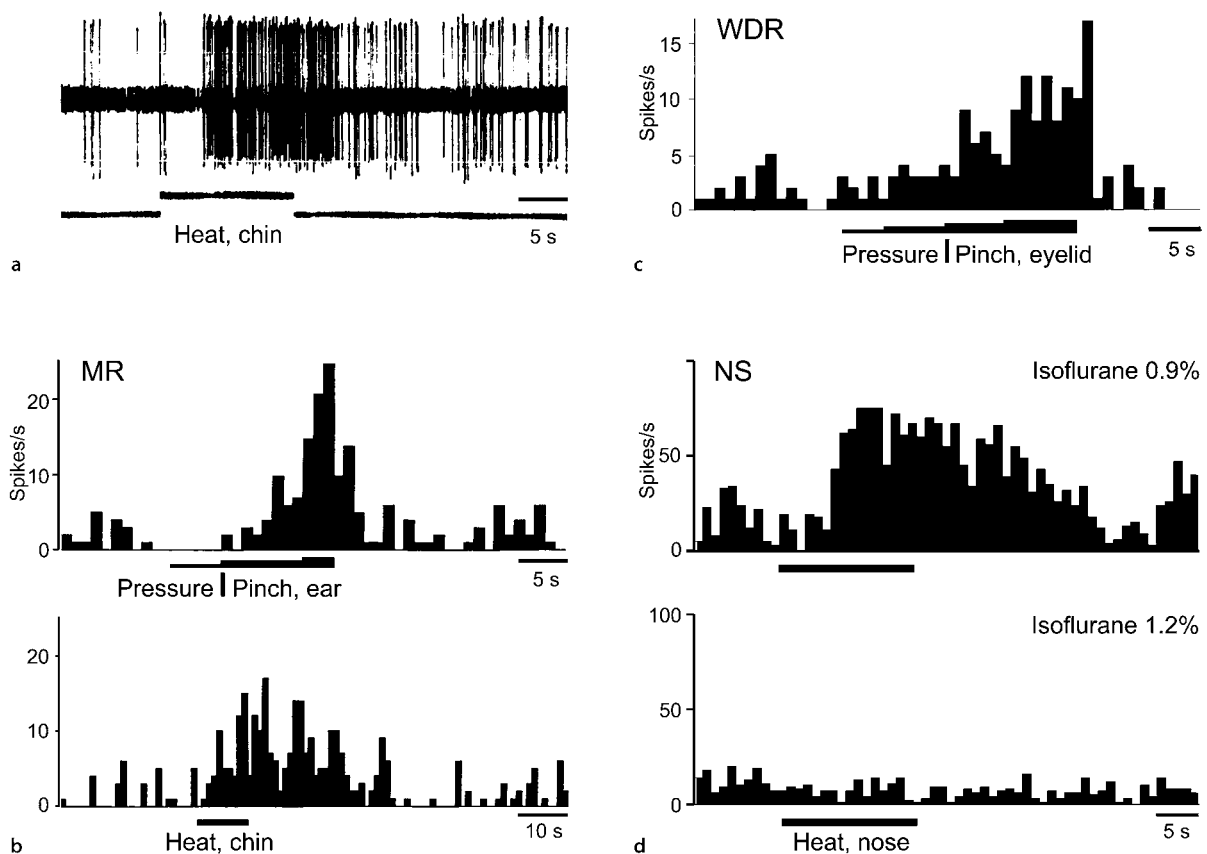
Neurons of the lateral thalamus encoding stimulus quality, duration, intensity and location on the body and thus subserving the ► **sensory-discriminative component of pain**.

The neurons respond with an increase or decrease of discharge activity to noxious stimuli exclusively (► **nociceptive-specific neurons**, NS) or with a higher discharge to noxious mechanical than to innocuous mechanical stimuli (► **wide-dynamic range (WDR) neurons**) or to both noxious and innocuous mechanical as well as thermal stimuli (multireceptive neurons). As defined in “Thalamic Nuclei Involved in Pain, cat and rat” the region termed ► **ventral posterior inferior nucleus (VPI)** in monkeys may correspond to the small celled region of the ventral periphery of the ventral posterior medial nucleus (VPMvp) in cats, the extensions of which surround the ventral, lateral and dorsal periphery of the ► **ventral posterior complex (VP)**. In rats, nociceptive neurons are also found within and around the VP, but most are concentrated in the adjoining

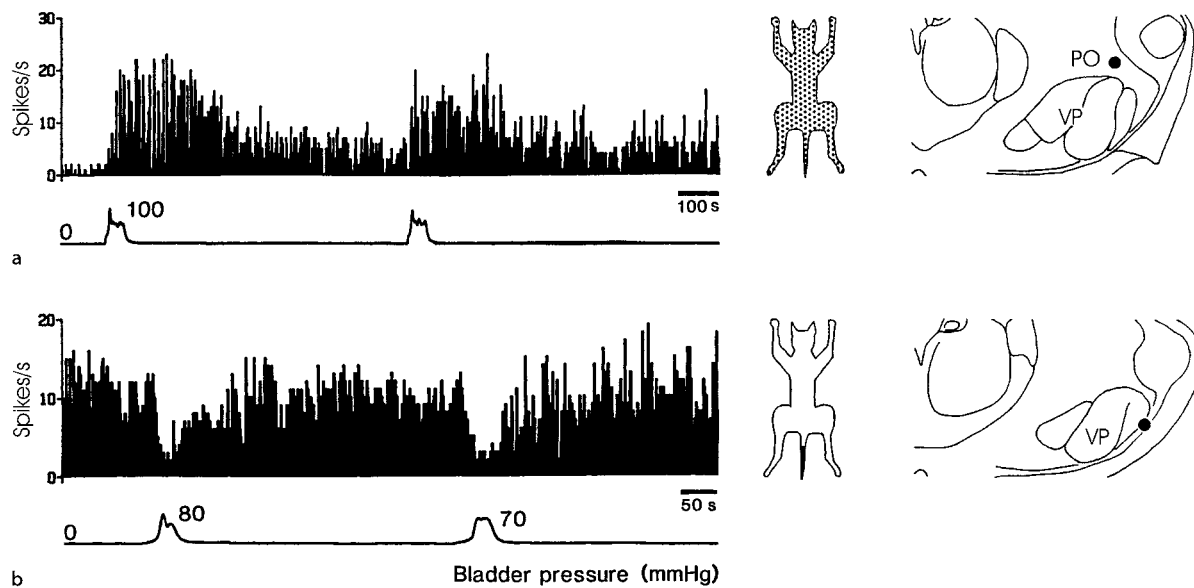
► **medial part of the posterior complex (POm)**. Since these have similar ► **receptive field (RF)** and response properties, it appears that these regions in the lateral thalamus of rats and cats are involved in processing and transmission of nociceptive signals in a similar way.

## Characteristics

Nociceptive neurons in the VPp have a less precise somatotopic organization than neurons of the VP proper, largely due to numerous neurons with larger and complex RFs consisting of discontinuous areas on the body surface. However, a coarse mediolateral sequence of head, forelimb and hind limb ► **RFs** is present, running parallel to that of the VP proper, thus forming a second representation of the body. Due to a lower ongoing activity and a sparser packing of neurons, even low impedance electrodes hardly pick up any background activity in contrast to the noisy “hash” characteristic of the VP (Kniffki and Vahle-Hinz 1987; Vahle-Hinz et al. 1987).



**Thalamus, Nociceptive Cells in VPI, Cat and Rat, Figure 1** Response characteristics of nociceptive neurons of the cat's VP<sub>p</sub> (a, b, c) and the rat's POm (d). (a) Spike record of a heat-evoked response. The elevated activity representing stimulus duration is followed by a lower afterdischarge for about 30 s before return to prestimulus activity. (b) Multireceptive neuron responding to noxious pressure and heat stimuli in different parts of the receptive field. (c) Wide-dynamic range neuron with graded responses to innocuous pressure and two intensities of noxious pressure. (d) The response elicited by a radiant heat stimulus is abolished by an increase of isoflurane concentration from 0.9% to 1.2%. Spike histograms, bin width 1 s; the bar below each histogram represents the duration of the stimulus (modified from Vahle-Hinz et al. 1987 (a); 2002 (b); Kniffki and Vahle-Hinz 1987 (c)).



**Thalamus, Nociceptive Cells in VPI, Cat and Rat, Figure 2** Excitatory responses of a PO neuron (a) and inhibitory responses of a  $VP_p$  neuron (b) to noxious distension of the bladder. Peristimulus-time histograms (bin width 1 s) and intravesical pressure (lower traces), with baseline and peak values indicated, are shown on the left. The low-threshold cutaneous RFs of the respective neuron (b, black area) or of the background activity (a, stippled area) are delineated in the figurines. The locations of the recording sites are shown in the line drawings made from the histological sections. (Modified from Brüggemann et al. 1993).

In both cats and rats, the neurons respond to graded noxious mechanical and/or heat stimuli (for review see Willis 1997). Responses to noxious heat stimuli characteristically occur after long latencies (several seconds), which may result from receptor activation time and transmission by C fibers. The discharge increase in many neurons encodes stimulus duration, often followed by a lower but still increased afterdischarge for several tens of seconds (Fig. 1a, b, d). A threshold temperature and a stimulus-response function resembling psychophysical heat pain in humans are found. All types of nociceptive neurons are present, nociceptive-specific (Fig. 1a, d), multireceptive (Fig. 1b) and WDR neurons (Fig. 1c). NS and WDR/MR neurons occur in about equal proportions in the cat, while the majority in the rat is of the NS-type. Thalamic nociceptive neurons are sensitive to anesthetics; the response to a noxious stimulus may be abolished by a slight increase of anesthetic dose without a marked suppression of the neuron's ongoing discharge activity (Fig. 1d). Different classes of anesthetic agents appear to block nociceptive signal transmission at different subthalamic/thalamic sites within the ascending pathways. The low-threshold mechanoreceptive responses in contrast are more robust (Vahle-Hinz and Detsch 2002; Vahle-Hinz et al. 2002).

As with noxious somatic stimuli and also with visceral stimulation, both excitation and inhibition of thalamic neuronal discharges can be elicited (Fig. 2). In contrast to the spinal cord level, where the majority of visceroreceptive neurons have convergent somatic inputs of the WDR type, visceroreceptive-specific neurons are found in

the thalamus of both rats and cats. Some of the additional somatic RFs of viscerosomatic convergent neurons in the rat are nociceptive (Berkley et al. 1993), while in the cat most are of the low-threshold type. The majority of these somatic low-threshold RFs are located in areas including dermatomes to which pain is referred from the respective visceral organs (Brüggemann et al. 1993; Horn et al. 1999; Vahle-Hinz et al. 1995).

The neuronal responses in the lateral thalamus indicate that distinct response properties are segregated (e.g. somatic and visceral nociceptive-specific), thus increasing the diversity of response characteristics contained in the population of nociceptive neurons. Excitatory and inhibitory interactions between inputs from different somatic sources (mechanoreceptive/nociceptive) or visceral organs may help to focus the activity and hence the sensation to a certain stimulus or organ.

## References

1. Brüggemann J, Vahle-Hinz C, Kniffki K-D (1993) Representation of the urinary bladder in the lateral thalamus of the cat. *J Neurophysiol* 70:482–491
2. Berkley KJ, Guilbaud G, Benoist J-M et al. (1993) Responses of neurons in and near the thalamic ventrobasal complex of the rat to stimulation of uterus, vagina, colon, and skin. *J Neurophysiol* 69:557–568
3. Horn AC, Vahle-Hinz C, Brüggemann J et al. (1999) Responses of neurons in the lateral thalamus of the cat to stimulation of urinary bladder, colon, esophagus, and skin. *Brain Res* 851:164–174
4. Kniffki K-D, Vahle-Hinz C (1987) The periphery of the cat's ventroposteromedial nucleus ( $VPM_p$ ): Nociceptive neurons. In: Besson J-M, Guilbaud G, Peschanski M (eds) *Thalamus and Pain*. Elsevier, Amsterdam, pp 245–257
5. Vahle-Hinz C, Brüggemann J, Kniffki K-D (1995) Thalamic processing of visceral pain. In: Bromm B, Desmedt J (eds) *Pain and*

- the Brain. From Nociception to Cognition. Advances in Pain Research and Therapy, vol 22. Raven Press, New York, pp 125–141
6. Vahle-Hinz C, Detsch O (2002) What can *in vivo* electrophysiology in animal models tell us about mechanisms of anesthesia? *Br J Anaesth* 89:123–142
  7. Vahle-Hinz C, Freund I, Kniffki K-D (1987) Nociceptive neurons in the ventral periphery of the cat thalamic ventroposteromedial nucleus. In: Schmidt RF, Schaible H-G, Vahle-Hinz C (eds) *Fine Afferent Nerve Fibers and Pain*. VCH Verlagsgesellschaft, Weinheim, pp 440–450
  8. Vahle-Hinz C, Reeker W, Detsch O et al (2002) Antinociceptive effects of anesthetics *in vivo*: Neuronal responses and cellular mechanisms. In: Urban BW, Barann M (eds) *Molecular and Basic Mechanisms of Anesthesia*. Pabst Sci Publ, Lengerich, pp 516–524
  9. Willis WD (1997) Nociceptive functions of thalamic neurons. In: Steriade M, Jones EG, McCormick DA (eds) *Thalamus*, Vol. II, Experimental and Clinical Aspects. Elsevier, Amsterdam, pp 373–424

## Thalamus, Nociceptive Inputs in the Rat (Spinal)

JEAN-FRANÇOIS BERNARD  
 Institut National de la Santé et de la Recherche  
 Médicale, INSERM U-677, Paris, France  
 jfbernar@ext.jussieu.fr

### Definition

#### Layers of the Spinal Cord

The gray matter of the spinal cord is divided, from dorsal to ventral, into 10 laminae on the basis of cytoarchitectonic criteria. The dorsal horn includes the laminae I to VI; the lamina VII is an intermediate area; the ventral horn includes the laminae VIII and IX (motoneurons); the region around the central canal corresponds to the lamina X.

#### Thalamus

The caudal portion of the thalamus is an important brain center for somatosensory and nociceptive processing. This caudal region is often divided into the lateral and the medial thalamus. 1) The lateral thalamus is primarily a relay that includes chiefly, for somatosensory functions, the ventral posterolateral (VPL), the ventral posteromedial (VPM), the posterior group (Po) and the triangular posterior group (PoT) thalamic nuclei. 2) The medial thalamus might be regarded as a more integrative region that includes intralaminar [chiefly the central lateral (CL), paracentral (PC), central medial (CM) and parafascicular (Pf) nuclei], paralaminar [notably the ventral medial (VM) nucleus] and median thalamic nuclei.

### Characteristics

#### The Spinal Relay

Noxious messages are conveyed from the periphery (trunk and limbs) to the thalamus *via* a primary relay, the dorsal horn of the spinal cord. Two individualized

regions of the dorsal horn, the superficial and the deep laminae, have key roles in the processing of nociceptive messages.

The superficial laminae (I and II) have a major role in nociceptive processing because this region is the main recipient for peripheral nociceptive inputs conveyed by A $\delta$  and C fibers. Whereas both the laminae I and II receive nociceptive inputs, only the lamina I neurons project to supraspinal centers. These neurons are the main output of this superficial region. The lamina I neurons are primarily nociceptive, a majority of them being nociceptive specific (Christensen and Perl 1970). In addition, a lower proportion of lamina I neurons can encode specifically innocuous thermal stimuli (Light et al. 1993).

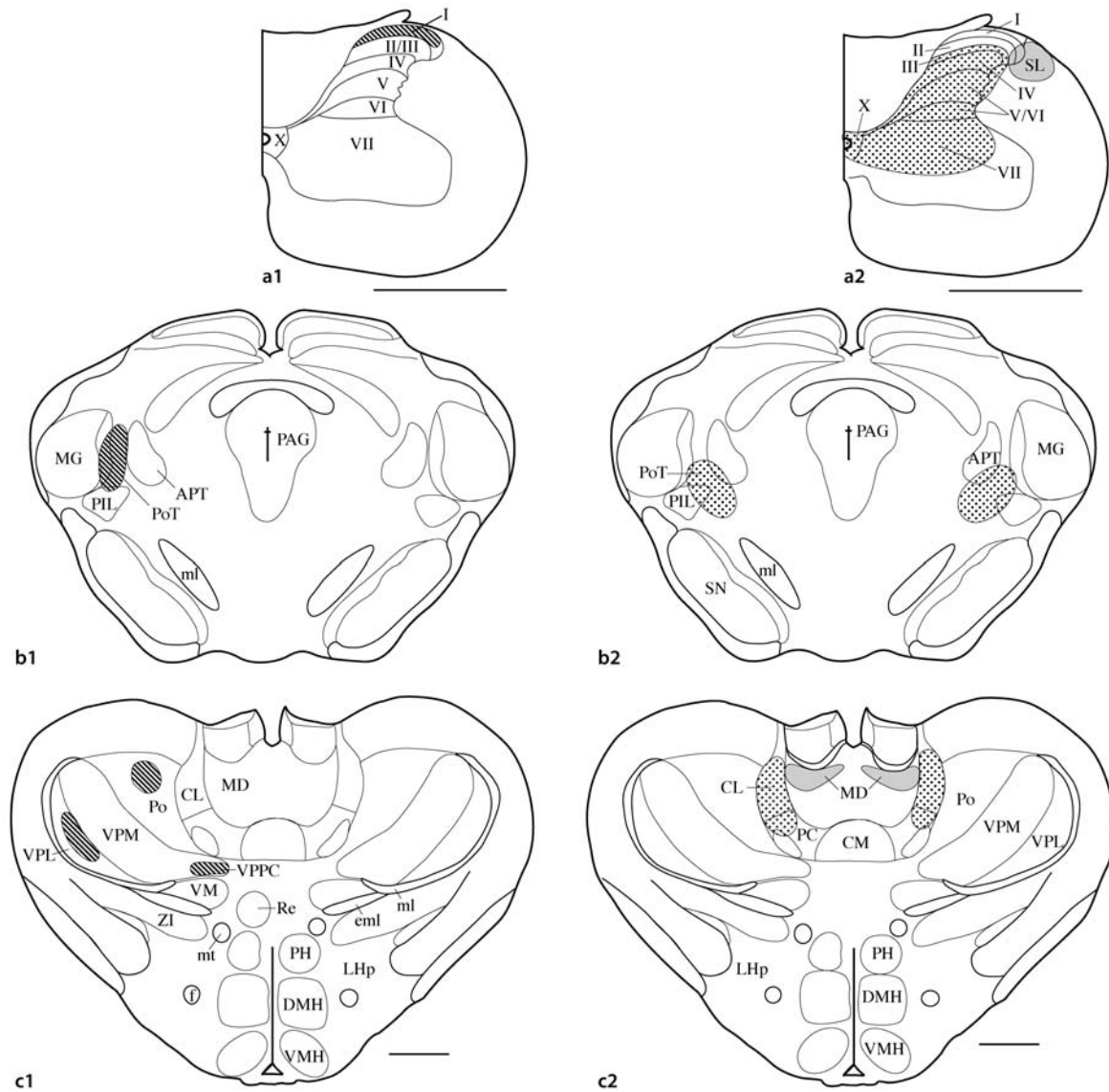
The second area of the dorsal horn, which processes nociceptive messages, includes the deep laminae V, VI and the adjacent portion of the lamina VII. The involvement of deep laminae in nociceptive processing was chiefly demonstrated by electrophysiology; this region contains numerous wide dynamic range neurons that have a great ability to encode noxious stimuli but from a clearly innocuous range (Besson and Chaouch 1987). The anatomical link of this region with peripheral A $\delta$  and C nociceptive fibers is less clear; deep laminae neurons receive some collateral projections from A $\delta$  and C fibers, but the main nociceptive input might be conveyed indirectly *via* superficial laminae.

The caudal thalamus is a primary brain center for pain processing. Nociceptive information is conveyed to the thalamus from nociceptive neurons in lamina I and deep laminae of the spinal cord 1) directly *via* the spino-thalamic tract and 2) indirectly *via* relay nuclei in the brainstem.

#### Spinal Nociceptive Inputs to the Thalamus

Retrograde tracing studies show that neurons projecting to the thalamus are located in lamina I and in deep laminae of the spinal cord (Burstein et al. 1990). Thalamic projecting superficial spinal neurons are clearly concentrated in lamina I of the dorsal horn, only very few are located in lamina II. Lamina I neurons are evenly distributed along the spinal cord, with higher concentrations at the levels of cervical and lumbar enlargements. On the other hand, thalamic projecting deep laminae neurons are scattered in deep laminae of the spinal cord (III to VIII and X) although they are more numerous around the laminae IV – VI. These thalamic projecting deep laminae neurons are not evenly distributed in the spinal cord, since almost half of them are concentrated in the two first spinal segments (C1, 2). In the cervical enlargement (C5 – 8), which relays nociceptive messages from the forelimb, one spino-thalamic neuron in lamina I and one in the deep lamina were counted on average per 50  $\mu$ m section (Burstein et al. 1990).

Anterograde tracing studies, using a high-resolution tracer such as the *Phaseolus vulgaris* leucoagglutinin (PHA-L), allowed the demonstration of separate pro-



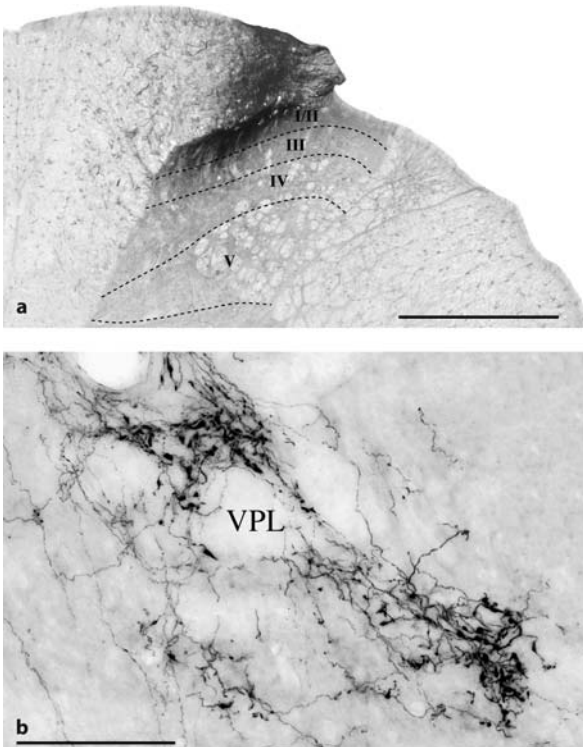
**Thalamus, Nociceptive Inputs in the Rat (Spinal), Figure 1** Summary diagram of spinal projections to the thalamus. (a1) Lamina I (hatching) projecting area in the cervical enlargement of the spinal cord. (b1) Projection in the PoT (hatching) from lamina I. (c1) Projection to VPL, Po and VPPC thalamic nuclei (hatching) from lamina I. (a2) Deep laminae (black points) and SL nucleus (gray) projecting area in the cervical enlargement. (b2) Projection to PoT thalamic nucleus (points) from the deep laminae. (c2) Projection to CL (points) and MD (gray) thalamic nuclei from deep laminae and SL nucleus, respectively. Scale bars = 1 mm. Abbreviations: I-X, laminae I-X of the spinal cord; APT, anterior pretectal nucleus; CL, central lateral thalamic nucleus; CM, central medial thalamic nucleus; DMH, dorsomedial hypothalamic nucleus; eml, external medullary lamina; f, fornix; LHp, lateral hypothalamus posterior; MD, mediodorsal nucleus; MG, medial geniculate nucleus; ml, medial lemniscus; mt, mammillothalamic tract; PAG, periaqueductal gray matter; PC, paracentral thalamic nucleus; PH, posterior hypothalamus; PIL, posterior intralaminar thalamic nucleus; Po, posterior thalamic group; PoT, posterior thalamic group, triangular part; Re, reuniens nucleus; SL, spinal lateral nucleus; SN, substantia nigra; VM, ventromedial thalamic nucleus; VMH, ventromedial hypothalamic nucleus; VPL, ventral posterolateral thalamic nucleus; VPM, ventral posteromedial thalamic nucleus; VPPC, ventral posterior parvocellular thalamic nucleus; ZI, zona incerta.

jections from lamina I and deeplaminae of the spinal cord upon the thalamus (Gauriau and Bernard 2003). The projections from lamina I are markedly different from those of deep laminae (Fig. 1).

Lamina I neurons project primarily to restricted portions of the VPL and rostral Po (Fig. 1a1–c1). In these areas,

axonal endings have large varicosities (Fig. 2). Other substantial projections with small varicosities were observed in the PoT and the ventral posterior parvocellular nucleus (VPPC). Only a moderate number of projections are observed in a few additional thalamic targets such as the periventricular, the subparafascicular, the reuniens





**Thalamus, Nociceptive Inputs in the Rat (Spinal), Figure 2** Photomicrographs of the projection from lamina I to the thalamus. (a) PHA-L injection site in laminae I/II of the cervical enlargement. (b) Extensive terminal labeling with large varicosities in the VPL thalamic nucleus resulting from the injection in (a). Scale bars = 500  $\mu\text{m}$  in A, 100  $\mu\text{m}$  in (b). Abbreviations: I-X, laminae I-X of the spinal cord; VPL, ventral posterolateral thalamic nucleus.

and the mediodorsal nuclei; no projection is observed to the submedius nucleus. Lamina I projections to the thalamus are almost exclusively contralateral. Because the VPL/Po system is also known to be the thalamic relay conveying somatotopically tactile messages from gracile and cuneate nuclei to somatosensory SI and SII cortex, it appears likely that the lamina I – VPL/Po system is devoted to somatosensory discriminative aspects of nociception. The role of the lamina I – PoT/VPPC system is less clear, it could participate to the recognition of the “painful” nature of nociceptive stimuli.

Deep laminae neurons project chiefly to the central lateral intralaminar and the PoT thalamic nuclei on both sides (Fig. 1 a2–c2). Very few projections are observed to other thalamic nuclei. In fact, it appears that deep laminae neurons project as much to the thalamus as to extrathalamic targets, such as the substantia innominata, the globus pallidus, the posterior and lateral hypothalamus and the central amygdaloid nucleus. These recent findings clearly question the projections of deep laminae to the VPL, suggesting strongly that the main nociceptive inputs to the VPL originate primarily from the lamina I neurons, in the rat.

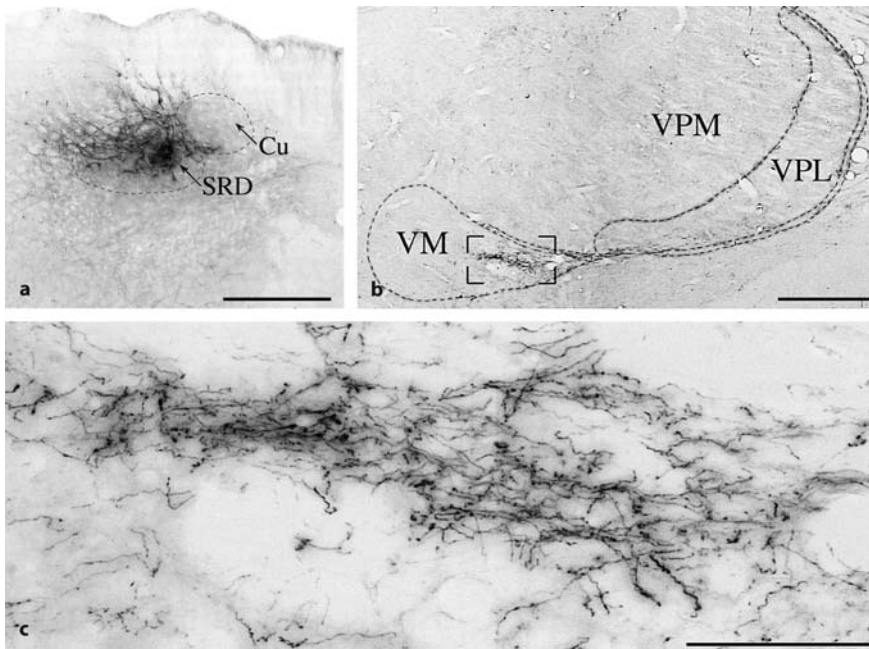
A last notable projection is from the spinal lateral neurons to the caudal portion of the mediodorsal nucleus (Fig. 1 a2–c2).

### Brainstem Nociceptive Inputs to the Thalamus

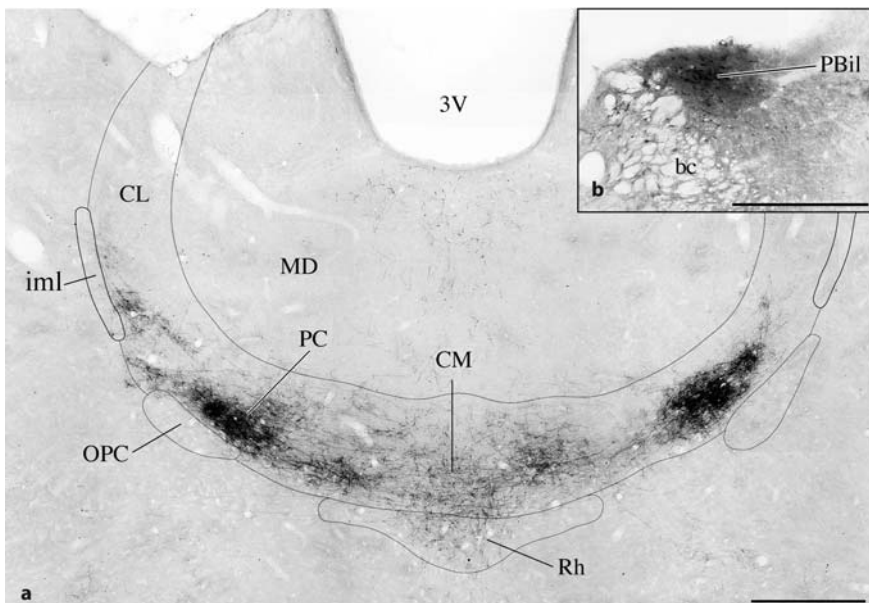
The spino-thalamic tract is often considered to be the primary pathway conveying nociceptive messages from the spinal cord to the thalamus. In fact, the number of spino-thalamic neurons (9500 is the higher estimation in the rat; Burstein et al. 1990) is substantial but represents only a very small proportion of dorsal horn neurons. Furthermore, anterograde studies in primate (Mehler et al. 1960) as well as in the rat (Gauriau and Bernard 2003) indicate that spinal projections are clearly more extensive upon the brainstem than to the thalamus. These data strongly suggest that the brainstem should have an important role in conveying nociceptive input from the spinal cord to the thalamus and the other brain centers.

The gigantocellular reticular (Gi) nucleus, located in the center of the medulla, was the first candidate to fulfill this role (Casey 1971; Bowsler 1976). This nucleus receives an extensive projection from deep laminae of the spinal cord, it contains numerous nociceptive neurons and its stimulation produces aversive reactions. However, the portion of the Gi that receives the densest spinal projection projects primarily to the locus coeruleus and the spinal cord and only weakly to the thalamus.

The subnucleus reticularis dorsalis (SRD), a very caudal reticular area of the medulla, located just ventral to the cuneate nucleus, now appears to be the best candidate to convey nociceptive messages from the spinal cord to the thalamus. Indeed, the SRD receives an extensive projection from deep laminae of the spinal cord (Raboisson et al. 1996). Electrophysiological studies demonstrate the involvement of this reticular region in nociceptive processing. Indeed, most of the SRD neurons are strongly excited by noxious stimuli from a low spontaneous activity and do not respond to multisensory (visual and auditory) stimuli. SRD neurons encode the intensity of thermal, mechanical and visceral noxious stimuli. They respond exclusively to the activation of peripheral A $\delta$ - or A $\delta$ - and C-fibers. Such responses are depressed by intravenous morphine in a dose-dependent and naloxone-reversible fashion (Villanueva et al. 1996). The receptive fields of SRD neurons are very large; they often include the whole body. The main thalamic targets of the SRD are the lateral portions of the VM nucleus, (Fig. 3) and, to a lesser extent, of the Pf nucleus (Villanueva et al. 1998). The internal lateral parabrachial (PBil) nucleus, located in a dorsal position at the ponto-mesencephalic junction, is another candidate for conveying nociceptive messages from the spinal cord to the thalamus. The PBil should not be mixed up with the lateral parabrachial area, which receives an extensive projection from lamina I and does not project substantially to the thalamus. In fact, the PBil specifically receives a dense projection from deep laminae of the spinal cord (especially from the reticular por-



**Thalamus, Nociceptive Inputs in the Rat (Spinal), Figure 3** Photomicrographs of the projection from the SRD to the thalamus. (a) PHA-L injection site in the SRD. (b) High density of labeled terminals in the lateral portion of the VM. (c) Higher magnification of the labeled terminals in the region delineated in (b). Note the numerous terminals with small varicosities. Scale bars = 500  $\mu\text{m}$  in (a), (b), 100  $\mu\text{m}$  in (c). Abbreviations: Cu, cuneate nucleus; SRD, subnucleus reticularis dorsalis; VM, ventromedial thalamic nucleus; VPL, ventral posterolateral thalamic nucleus; VPM, ventral posteromedial thalamic nucleus.



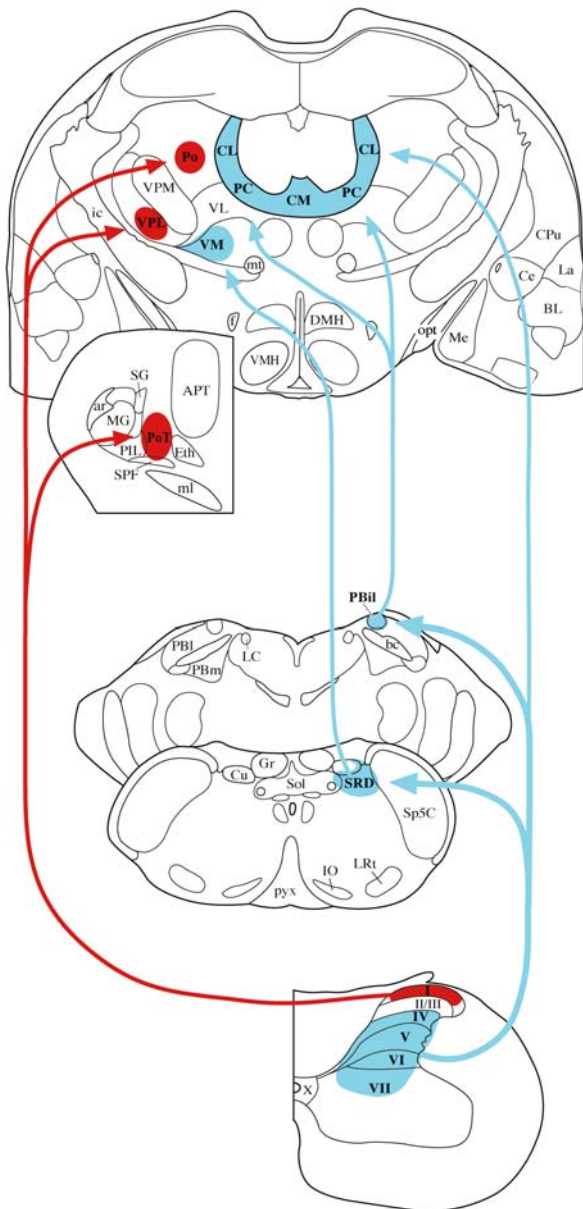
**Thalamus, Nociceptive Inputs in the Rat (Spinal), Figure 4** Photomicrographs of the projection from the PBil to the thalamus. Note the high density of labeled terminals concentrated in the PC (black area on both sides) with a lower density of labeling in the CM (a) resulting from the PHA-L injection covering the PBil (b). Scale bars = 500  $\mu\text{m}$ . Abbreviations: 3V, third ventricle; bc, brachium conjunctivum; CL, central lateral thalamic nucleus; CM, central medial thalamic nucleus; iml, internal medullary lamina; MD, mediodorsal thalamic nucleus; OPC, oval paracentral thalamic nucleus; PBil, internal lateral parabrachial nucleus; PC, paracentral thalamic nucleus; Rh, rhomboid thalamic nucleus.

tion of laminae IV and V) (Bernard et al. 1995). The PBil neurons project primarily to the PC thalamic nucleus (Fig. 4) and, to a lesser extent, to the CM and the Pf thalamic nuclei (Bester et al. 1999). Electrophysiological studies demonstrate the involvement of thalamic projecting PBil neurons in nociceptive processing. Indeed, most of them respond to thermal and noxious stimuli, with a maximum response in the mid-nociceptive scale ( $48^{\circ}\text{C}$  and  $16 \text{ N/cm}^2$ ). The PBil neurons exhibit strong “wind up” and long lasting after-discharge in response to noxious stimuli (Bourgeois et al. 2001). With regard to the deep laminae system, the brainstem clearly has an important complementary role to the

spino-thalamic tract. Indeed, deep laminae neurons send nociceptive messages to the medial thalamus directly *via* the spino-thalamic tract, as well as indirectly *via* SRD and PBil neurons. Thus this system could deal with alertness and emotional and motor aspects of pain through a general arousal of the prefrontal and frontal (motor) cortices (the cortical targets of the medial thalamus).

### Synthesis

Nociceptive inputs to the thalamus can be classified in the two different systems summarized in Fig. 5 as follows:



**Thalamus, Nociceptive Inputs in the Rat (Spinal), Figure 5** Schematic representation of the main nociceptive inputs to the thalamus, in the rat. Red: Main inputs to the lateral thalamus from the lamina I of the spinal cord. Blue: Main inputs to the medial thalamus originating from the deep laminae of the spinal cord, directly *via* the spino-thalamic tract, and indirectly *via* the SRD and the PBil nuclei. Abbreviations: I-X, laminae I-X of the spinal cord; APT, anterior pretectal nucleus; ar, acoustic radiation; bc, brachium conjunctivum; BL, basolateral amygdaloid nucleus; Ce, central amygdaloid nucleus; CL, central lateral thalamic nucleus; CM, central medial thalamic nucleus; CPu, caudate putamen (striatum); Cu, cuneate nucleus; DMH, dorsomedial hypothalamic nucleus; Eth, ethmoid thalamic nucleus; f, fornix; Gr, gracilis nucleus; ic, internal capsule; IO, inferior olive; La, lateral amygdaloid nucleus; LC, locus coeruleus; LRt, lateral reticular nucleus; Me, medial amygdaloid nucleus; MG, medial geniculate nucleus; ml, medial lemniscus; mt, mammillothalamic tract; opt, optic tract; PBil, internal lateral parabrachial nucleus; PBI, lateral parabrachial nucleus; PBm, medial parabrachial nucleus; PC, paracentral thalamic nucleus; PIL, posterior intralaminar thalamic nucleus; Po, posterior thalamic group; PoT, posterior thalamic group, triangular part; pyx, pyramidal decussation; SG, supragenicular thalamic nucleus; Sol, solitary tract nucleus; Sp5C, spinal trigeminal nucleus caudal part; SPF, subparafascicular nucleus; SRD, subnucleus reticularis dorsalis; VL, ventrolateral thalamic nucleus; VM, ventromedial thalamic nucleus; VMH, ventromedial hypothalamic nucleus; VPL, ventral posterolateral thalamic nucleus; VPM, ventral posteromedial thalamic nucleus.

1. The lamina I – (lateral) thalamic system, which could be chiefly responsible for sensory discrimination of nociceptive stimuli *via* thalamic projections to somatosensory cortices (SI, SII, Insular).
2. The deep laminae – (medial) thalamic system, which includes two subsystems: a direct deep laminae – medial thalamic pathway and an indirect deep laminae – SRD/PBil – medial thalamic pathway. This system could be involved in motor and alertness/arousal emotional features of pain *via* the medial thalamic projections to the frontal motor and the prefrontal medial (cingulate) cortices.

The spinal ascending axons of all these systems are located around the same region of the spinal lat-

eral/ventrolateral quadrant in the rat. Thus, it appears clear that the strikingly acute effectiveness of ventrolateral cordotomy is due to the interruption of both a direct spino-thalamic tract and a strong spino-brainstem-thalamic pathway.

An additional nociceptive pathway to the thalamus (not illustrated) was proposed by the group of Willis. The visceral (colorectal) nociceptive information, after a relay in laminae X and VII of the lumbo-sacral spinal cord, would be conveyed *via* the medial portion of the dorsal column and the gracile nucleus to the VPL thalamic nucleus. The key point in the demonstration of this pathway is the strong effect of a medial commissurotomy (in the middle of dorsal column fasciculus) upon the response of VPL neurons to visceral noxious stimuli and visceral



pain (Willis et al. 1999). However, the existence of such a pathway remains difficult to reconcile with previous clinical and experimental data.

## References

- Bernard JF, Dallel R, Raboisson P et al. (1995) Organization of the efferent projections from the spinal cervical enlargement to the parabrachial area and periaqueductal gray: a PHA-L study in the rat. *J Comp Neurol* 353:480–505
- Besson JM, Chaouch A (1987) Peripheral and spinal mechanisms of nociception. *Physiol Rev* 67:67–186
- Bester H, Bourgeois L, Villanueva L et al. (1999) Differential projections to the intralaminar and gustatory thalamus from the parabrachial area: A PHA-L study in the rat. *J Comp Neurol* 405:421–449
- Bourgeois L, Monconduit L, Villanueva L et al. (2001) Parabrachial internal lateral neurons convey nociceptive messages from the deep laminae of the dorsal horn to the intralaminar thalamus. *J Neurosci* 21:2159–2165
- Bowsher D (1976) Role of the reticular formation in responses to noxious stimulation. *Pain* 2:361–378
- Burstein R, Dado RJ, Giesler GJ Jr (1990) The cells of origin of the spinothalamic tract of the rat: a quantitative reexamination. *Brain Res* 511:329–337
- Casey KL (1971) Somatosensory responses of bulboreticular units in awake cat: relation to escape-producing stimuli. *Science* 173:77–80
- Christensen BN, Perl ER (1970) Spinal neurons specifically excited by noxious or thermal stimuli: marginal zone of the dorsal horn. *J Neurophysiol* 33:293–307
- Gauriau C, Bernard JF (2003) A comparative reappraisal of projections from the superficial laminae of the dorsal horn in the rat: the forebrain. *J Comp Neurol* 468:24–56
- Light AR, Sedivec MJ, Casale EJ et al. (1993) Physiological and morphological characteristics of spinal neurons projecting to the parabrachial region of the cat. *Somatosens Mot Res* 10:309–325
- Mehler WR, Feferman ME, Nauta W (1960) Ascending axon degeneration following anterolateral cordotomy. An experimental study in the monkey. *Brain* 83:718–751
- Raboisson P, Dallel R, Bernard JF et al. (1996) Organization of efferent projections from the spinal cervical enlargement to the medullary subnucleus reticularis dorsalis and the adjacent cuneate nucleus: a PHA-L study in the rat. *J Comp Neurol* 367:503–517
- Villanueva L, Bouhassira D, Le Bars D (1996) The medullary subnucleus reticularis dorsalis (SRD) as a key link in both the transmission and modulation of pain signals. *Pain* 67:231–240
- Villanueva L, Desbois C, Le Bars D et al. (1998) Organization of diencephalic projections from the medullary subnucleus reticularis dorsalis and the adjacent cuneate nucleus: A retrograde and anterograde tracer study in the rat. *J Comp Neurol* 390:133–160
- Willis WD, Al-Chaer ED, Quast MJ et al. 1999 A visceral pain pathway in the dorsal column of the spinal cord. *Proc Natl Acad Sci USA* 96:7675–7679

## Thalamus, Nociceptive Neurotransmission

### ► Nociceptive Neurotransmission in the Thalamus

## Thalamus, Receptive Fields, Projected Fields, Human

NIRIT WEISS, SHINJI OHARA, STAN ANDERSON, FRED A. LENZ

Departments of Neurosurgery, Johns Hopkins University, Baltimore, MD, USA

flenzl@jhmi.edu

### Synonyms

Thalamic Physiology Changes Occurring in Patients with Chronic Pain

### Definition

Physiologic changes in the thalamus seen in patients with chronic pain syndromes. These changes are reflected in alterations in the properties of neurons and assemblies of neurons in patients who suffer from chronic pain.

### Characteristics

Studies of the ► [plasticity](#) of the somatosensory system in non-human primates have focused on maps of cortical function determined by examining neuronal ► [receptive fields](#) (RFs) (Kaas 1991). Studies in humans can explore both maps determined from RFs (RF maps) and maps of the locations and quality of sensations evoked by stimulation of the brain (► [projected field](#) or PF maps) (Lenz et al. 1994). While RF maps are a reflection of the organization of inputs to the ► [central nervous system](#), PF maps give an indication of the image of the body contained in the thalamus and cortex. There are numerous studies of cortical plasticity secondary to injuries of the nervous system (Kaas 1991). Although much of the reorganization of cortical maps may reflect underlying changes in thalamic organization (Pons et al. 1991), there are relatively few direct studies of thalamic plasticity (Rasmusson 1996).

Medically intractable chronic pain due to nervous system injury or medically intractable movement disorders may be surgically treated by implantation of deep brain stimulating electrodes in the principal sensory nucleus of the thalamus (► [ventral caudal – Vc](#)) (Hosobuchi, 1986) or by ► [thalamotomy](#) (Tasker et al. 1988). During such operations, microelectrode recordings may be used to confirm the target predicted by the radiological studies. The physiological studies of Vc in patients with chronic pain syndromes are compared with the recordings of Vc in patients with movement disorders and thus plasticity of pain-related neuronal activity in the human thalamus can be studied directly.

The region of the principal sensory nucleus of thalamus (Vc) was explored during stereotactic surgical procedures for treatment of patients with pain following spinal cord transection and compared to results from patients with movement disorders (Lenz et al. 1994).



Many cells in the expected representation of the anesthetic part of the body did not have RFs. However, in the border zone/anesthetic zone between the anesthetic and innervated areas of the thalamus, there was frequently a mismatch between the location of RFs and PFs. Often RFs were located on the chest and abdominal wall, above the level of the spinal transection, while PFs were located in the lower extremity, below the spinal transection.

Border zone/anesthetic areas of thalamus often exhibited increased representations of the border of the anesthetic part of the body. Two sites were said to have a consistent RF if the RF of both sites included the same part of the body. The length of a trajectory with consistent RFs is the distance along the trajectory where each RF continues to include the same part of the body (Lenz et al. 1988). The maximal distance along a trajectory over which the RF or the PF stays consistent is longer for body parts with larger representations (Lenz et al. 1994). Lengths of trajectory with a consistent RF in a particular part of the body were significantly longer in border zone/anesthetic zones than in control areas with apparently normal input. Neurons with RFs adjacent to the area of sensory loss in amputation patients ( $n=3$ ) occupied a larger part of the thalamic homunculus (Lenz et al. 1998) than found for the same part of the body in patients with movement disorders (Lenz et al. 1988; Lenz et al. 1994). This result is consistent with somatotopic reorganization of afferent inputs from the limb. Similarly the large area over which PFs include the stump (Lenz et al. 1994; Lenz et al. 1993) suggest that there has been reorganization of the perceptual image of the limb in the central nervous system (Jensen and Rasmussen 1994). It has also been reported that phantom sensations can be evoked by stimulation of the region where stump RFs are located in the region of Vc (Davis et al. 1998). Thus, in the case of amputations and spinal cord injury, the alteration in the image of the body in the thalamus is less than that of the inputs from that part of the body.

In primates there are well-documented alterations in thalamic anatomy and physiology after peripheral nerve injury. The distributions of thalamic regions with characteristic histology are altered (Rausell et al. 1992) in monkeys with a C2-T4 dorsal rhizotomy (Sweet 1981). In the affected arm area of rhizotomized animals, there is a reduction in the density of large cells and of **▶ parvalbumin** and **▶ CO staining**, all characteristic of the terminal zone for dorsal column inputs. There is a corresponding increase in the **▶ calbindin** staining in the arm area, characteristic of the terminal zone for STT inputs.

After cervical dorsal rhizotomy, large numbers of cells without RFs are encountered (Albe-Fessard and Lombard 1983) in the forelimb region of the monkey VP. Following adult digit amputation, increased representation of the stump is found, with large RFs including adjacent digits (Rasmusson 1996). The thalamic representation

of the border of the anesthetic part is increased in monkeys with nerve sections (Garraghty and Kaas 1991). Studies have shown that stimulation of the somatic sensory thalamus is more likely to evoke pain in patients with chronic pain after nervous system injury than in patients without somatic sensory abnormalities (patients with movement disorders) (Lenz et al. 1998). The region of Vc was divided on the basis of projected fields into areas representing the part of the body where the patients experienced chronic pain (pain affected) or did not experience chronic pain (pain unaffected) and into a control area located in the thalamus of patients with movement disorders and no experience of chronic pain. In both the core and posterior inferior regions of the thalamic sensory nucleus, the proportion of sites where threshold microstimulation evoked pain was larger in pain affected and unaffected areas than in control areas. The number of sites where thermal (warm or cold) sensations were evoked was correspondingly smaller, so that the total of pain plus thermal sites was not significantly different across all areas (Lenz et al. 1998). Therefore, sites where stimulation evoked pain in patients with neuropathic pain may correspond to sites where thermal sensations were evoked by stimulation in patients without somatic sensory abnormality. In the posterior inferior region, the number of sites where cold was evoked by stimulation decreased significantly, while the number of sites where pain was evoked increased significantly.

These results suggest that pain is evoked in patients with neuropathic pain by stimulation at sites where thermal sensations would normally be evoked. Therefore, the present data suggest that the STT, or elements to which the STT projects, signal pain rather than thermal sensations in patients with neuropathic pain. This is consistent with the finding that stimulation of the STT evokes pain in patients with neuropathic pain but evokes nonpainful thermal sensations in patients who do not have neuropathic pain (Tasker 1988). Cordotomy relieves pain in a much greater proportion of patients with somatic pain than it does in patients with neuropathic pain (Sweet et al. 1994). The failure of cordotomy to relieve neuropathic pain might be anticipated from the occurrence of central pain in patients with impaired function of the STT (Cassinari and Pagni 1969; Boivie et al. 1989). These results suggest that the generator for pain in patients with central pain is the terminus of the STT.

In patients with central pain, anatomic evidence of damage to STT is a common finding (Cassinari and Pagni 1969) and loss of STT function, indicated by impaired thermal and pain sensibility, is a uniform finding (Boivie 1994). In patients with central pain, pain is more common than in controls, while threshold microstimulation-evoked cold sensations are correspondingly less common. These findings suggest that there has been a reorganization, so that cold modalities

are relabeled to signal pain in the thalamus of patients with central pain (Ralston et al. 1996). The relationship between thalamic stimulation-evoked cold and pain in patients with central pain may explain the perception of cold as pain (cold hyperalgesia) that can occur in these patients (Boivie 1994).

Similar changes are observed after central nervous system injury. In patients with spinal transection, the numbers of cellular RFs representing the border of the anesthetic part of the body are increased (Lenz et al 1994). Following transection of the dorsal columns at the T3-T5 level, activity in simian VP (Pollin and Albe-Fessard 1979) shows a decrease in the percentage of cells with hind limb RFs and an increase in the percentage of cells with forelimb RFs. Many cells have large RFs and respond to high threshold inputs, consistent with inputs from STT. Therefore, loss of input due to peripheral or central nervous system injury leads to significant reorganization of the thalamic representation of inputs from different parts of the body.

Studies of the thalamus in monkeys and humans with a nervous system injury demonstrate large changes in the perceptual representation of the body in the thalamus, as revealed by somatotopic maps of projected fields (Lenz et al. 1994; Lenz et al. 1998). Patients with amputations show increases in the thalamic area from which stimulation evokes sensations in the part of a limb that has become the stump (Lenz et al. 1998). In patients with spinal transections, the incidence of mismatches between neuronal RFs and threshold microstimulation-evoked PFs at the same sites is much higher than in patients with movement disorders (Lenz et al. 1994). In patients with spinal transection, these mismatches occur because sensations in the anesthetic part are evoked by stimulation at sites where cellular RFs represent parts of the body proximal to the anesthetic part. In these patients, stimulation in the thalamic area where the representation of the anesthetic part of the body is usually located evokes sensations in the anesthetic part (Lenz et al. 1994). These results suggest that the perceptual representation of the body in the thalamus reorganizes less than the representation of inputs to the thalamus. Although the central image of the body is relatively constant in the face of altered input, our studies show that changes in the modality organization of this image can change dramatically (Lenz et al. 1998). This plasticity of modality organization may contribute to the development of chronic pain in patients with nervous system injury.

## References

- Albe-Fessard DG, Lombard MC (1983) Use of an animal model to evaluate the origin of and protection against deafferentation pain. *Adv Pain ResTher* 5:691–700
- Boivie J (1994) Central pain. In: Wall PD, Melzack R (eds) *Textbook of Pain*. Churchill Livingstone, Edinburgh, pp 871–902
- Boivie J, Leijon G, Johansson I (1989) Central post-stroke pain – a study of the mechanisms through analyses of the sensory abnormalities. *Pain* 37:173–185
- Cassinari V, Pagni CA (1969) *Central Pain*. A neurosurgical survey. Harvard University Press, Cambridge, Massachusetts
- Davis KD, Kiss ZHT, Luo L et al. (1998) Phantom sensations generated by thalamic microstimulation. *Nature* 391:385–387
- Garraghty PE, Kaas JH (1991) Functional reorganization in adult monkey thalamus after a peripheral nerve injury. *Neuroreport* 2:747–750
- Hosobuchi Y (1986) Subcortical electrical stimulation for control of intractable pain in humans. *J Neurosurg* 64:543–553
- Jensen TS, Rasmussen P (1994) Phantom pain and related phenomena after amputation. In: Wall PD, Melzack R (eds) *Textbook of Pain*. Churchill Livingstone, New York, pp 651–665
- Kaas JH (1991) Plasticity of sensory and motor maps in adult mammals. *Annu Rev Neurosci* 14:137–167
- Lenz FA, Dostrovsky JO, Tasker RR et al. (1988) Single-unit analysis of the human ventral thalamic nuclear group: somatosensory responses. *J Neurophysiol* 59:299–316
- Lenz FA, Tasker RR, Kwan HC et al. (1988) Single unit analysis of the human ventral thalamic nuclear group: correlation of thalamic “tremor cells” with the 3-6 Hz component of parkinsonian tremor. *J Neurosci* 8:754–764
- Lenz FA, Seike M, Lin YC et al. (1993) Thermal and pain sensations evoked by microstimulation in the area of the human ventrocaudal nucleus (Vc). *J Neurophysiol* 70:200–212
- Lenz FA, Kwan HC, Martin R et al. (1994) Characteristics of somatotopic organization and spontaneous neuronal activity in the region of the thalamic principal sensory nucleus in patients with spinal cord transection. *J Neurophysiol* 72:1570–1587
- Lenz FA, Gracely RH, Baker FH et al. (1998) Reorganization of sensory modalities evoked by stimulation in the region of the principal sensory nucleus (ventral caudal – Vc) in patients with pain secondary to neural injury. *J Comp Neurol* 399:125–138
- Lenz FA, Zirh AT, Garonzik IM et al. (1998) Neuronal activity in the region of the principal sensory nucleus of human thalamus (ventralis caudalis) in patients with pain following amputations. *Neurosci* 86:1065–1081
- Pollin B, Albe-Fessard DG (1979) Organization of somatic thalamus in monkeys with and without section of dorsal spinal tracts. *Brain Res* 173:431–449
- Pons TP, Garraghty PE, Ommaya AK et al. (1991) Massive cortical reorganization after sensory deafferentation in adult macaques. *Science* 252:1857–1860
- Ralston HJ, Ohara PT, Meng XW et al. (1996) Transneuronal changes in the inhibitory circuitry of the macaque somatosensory thalamus following lesions of the dorsal column nuclei. *J Comp Neurol* 371:325–335
- Rasmusson DD (1996) Changes in the response properties of neurons in the ventroposterior lateral thalamic nucleus of the raccoon after peripheral deafferentation. *J Neurophysiol* 75:2441–2450
- Rausell E, Cusick CG, Taub E et al. (1992) Chronic Deafferentation in monkeys differentially affects nociceptive and non-nociceptive pathway distinguished by specific calcium-binding proteins and down-regulates gamma-aminobutyric acid type A receptors at thalamic levels. *Proc Natl Acad Sci USA* 89:2571–2575
- Sweet WH (1981) Animal models of chronic pain: their possible validation from human experience with posterior rhizotomy and congenital analgesia. *Pain* 10:275–295
- Sweet WH, Poletti CE, Gybels GM (1994) Operations in the brainstem and spinal canal with an appendix on the relationship of open and percutaneous cordotomy. In: Wall PD, Melzack R (eds) *Textbook of Pain*. Churchill and Livingstone, New York, pp 1113–1136
- Tasker RR (1988) Percutaneous Cordotomy: The Lateral High Cervical Technique. In: Schmidek HH, Sweet WH (eds) *Operative Neurosurgical Techniques Indications, Methods, and Results*. Saunders WB, Philadelphia, pp 1191–1205
- Tasker RR, Doorly T, Yamashiro K (1988) Thalamotomy in Generalized Dystonia. *Adv Neurol* 50:615–631

## Thalamus, Visceral Representation

A. VANIA APKARIAN

Feinberg School of Medicine, Department of Physiology, Northwestern University, Chicago, IL, USA

a-apkarian@northwestern.edu

### Synonyms

Interoception; Visceral Modulation; Visceral Representation; referred pain

### Definition

Stimulation of visceral organs distinctly activates different populations of neurons in the thalamus. Neurons located in ► **parvocellular VP** (VPpc) are described as visceral-specific, while neurons located in other medial and lateral thalamic nuclei respond to multiple viscera and to somatic inputs convergently. Other thalamic nuclei do not receive visceral inputs.

### Characteristics

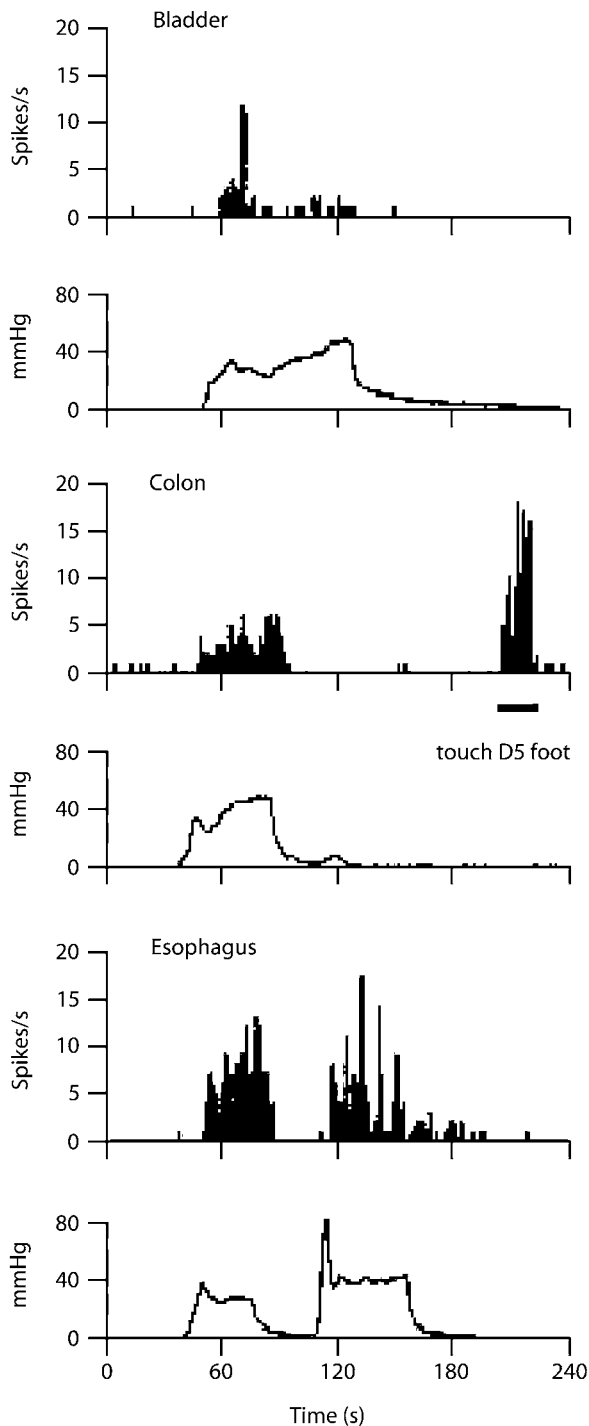
In contrast to somatic stimuli, visceral stimuli may or may not be accompanied by perception and the perceptions show distinct properties. For example, baro- and chemo-receptor activation do not give rise to sensations/perceptions, although they are represented in visceral specific portions of the thalamus and in insular cortex. On the other hand, distension of most hollow viscera is associated with ill-defined sensations. Visceral nociceptive stimuli in such organs are generally characterized by a sense of malaise or discomfort, with no clear ability to localize the source of the stimulus. Moreover, visceral pains are usually associated with pain referred on the skin, the location of which is characteristic for different viscera, an association used since antiquity to pinpoint specific viscera as the source of injury or inflammation. Thus, the contrast between visceral and somatic representation and associated differences in perception provides an opportunity for dissecting conscious perceptions from unconscious modulation, in relationship to thalamocortical connectivity. Unfortunately very little effort has been invested in this direction. It should also be added that visceral stimuli that do not evoke any conscious sensations and are represented at the level of the thalamus and cortex, most probably play a modulatory role in emotional responses to the environment and exert emotionally driven modulatory control over somatic and visceral responses. This notion, however, remains mainly a speculation, since direct studies on the topic are minimal (Gebhart 1995). Here we concentrate on thalamic neuronal response properties from the viewpoint of coding visceral stimuli and being modulated by visceral stimuli. All the available data are from

anesthetized preparations; thus they should be regarded as examples of responses undoubtedly stunted due to anesthesia.

The earliest evidence for visceral inputs to the thalamus and cortex used electrical stimulation of the vagus (Bailey and Bremer 1938; Dell and Olson 1951) and demonstrated a relay from the lateral thalamus to the ► **insular cortex** from visceral organs. More recent anatomic studies have elucidated that the visceral inputs through vagal afferents terminate in the solitary tract, second order neurons then project ipsilaterally to the parabrachial nucleus and third order neurons travel contralaterally to the ventroposterior parvocellular nucleus of the thalamus (VPpc) and then project to the insula. A separate projection from parabrachial regions directly accesses the insula too, see chapter by Cechetto in Gebhart (1995). ► **Calcitonin gene related peptide** (CGRP) seems to label this pathway in rats as well as in man. Using a combination of physiological recordings from insular cortex and tracing techniques, it was demonstrated that the most medial portion of the VPpc projects to the insular region with gustatory responses, while a more lateral portion projects to part of the insula with gastric mechanoreceptor responsive neurons and the most lateral portion projects to an area with cardiopulmonary responses; parabrachial inputs to the thalamus seem to have a parallel organization as well (Cechetto and Saper 1987; Gebhart 1995). More recent studies in the rat confirm the parabrachial inputs and also show inputs from spinal cord and trigeminal lamina I (Bester et al. 1999; Gauriau and Bernard 2004). Thus, the VPpc portion of the thalamus seems to be viscerotopically organized, where gustatory responses have been shown physiologically (Ganchrow and Erickson 1972).

Inputs from pelvic viscera to the cat lateral thalamus have been mapped with electrical stimulation and natural stimulation of the urinary bladder (Brüggemann et al. 1993; Brüggemann et al. 1994). Identified neurons were all found located outside the ► **VPL**, either just in its periphery or in the adjacent ► **posterior nucleus (PO)**. All visceral responsive neurons also responded to low-threshold stimuli applied to the skin. A similar study examined renal nerve stimulus responses to map kidney representation in and around the ► **VPL** in the cat (Horn et al. 1997). Most responsive units were located in the periphery of the VPL, dorsal PO or lateral PO; none were found within the VPL. Response latency suggested large and small myelinated afferent fibers mediating kidney inputs. The somatic receptive fields of the cells with renal nerve inputs showed minimal correspondence with the dermatomes of the renal nerve. A subsequent study mapped the same region of the thalamus in the cat for bladder, colon and esophagus inputs and again found the majority of cells localized to either the periphery of the VPL or the ► **PO** and no indication of segregation of neurons based on responses

T



**Thalamus, Visceral Representation, Figure 1** Visceral responses of a VPL neuron with low-threshold somatic response (touching digit 5, D5 on the foot contralateral to the recording) in the anesthetized squirrel monkey. Intraluminal pressures are shown for each viscus distended. The neuron responds by increased activity to noxious distension of the bladder, colon, and esophagus (Bruggemann, Shi and Apkarian 1994).

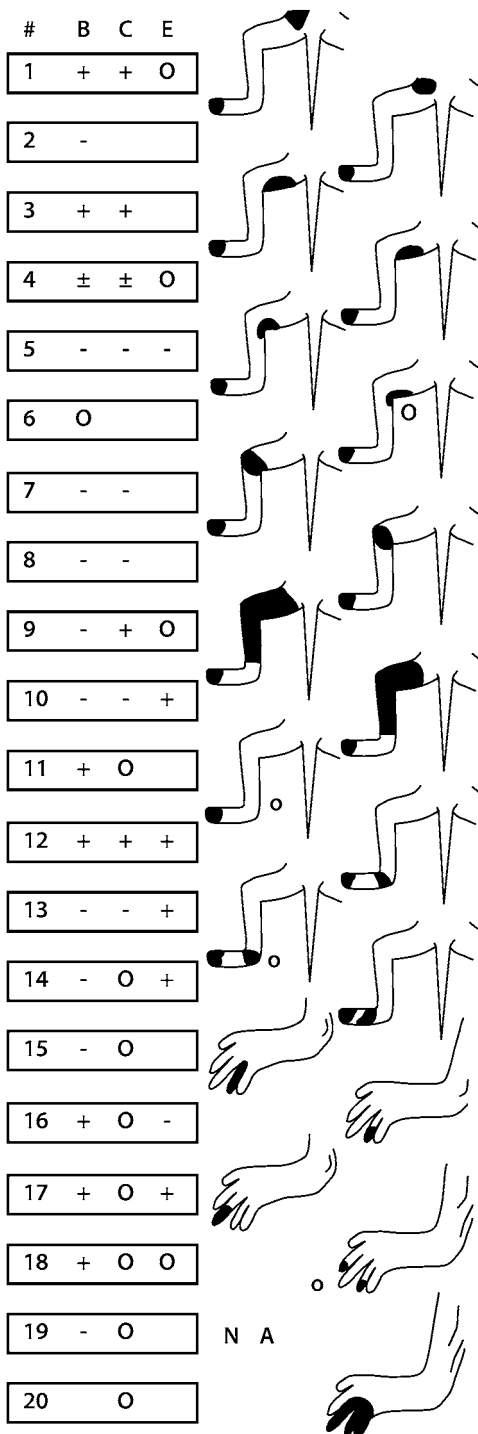
to any particular viscus (Ganchrow and Erickson 1972; Horn et al. 1999). Visceral responsive cells have been studied in the medial thalamus of the cat (1995) and

localized within the ► **mediodorsal (MD)**, ► **central medial (CM)**, ► **central lateral (CL)**, periphery of the VPL and ► **ventral posterior medial (VPM)** nuclei as well as in the ► **zona incerta (ZI)**. More than 23% responded to esophagus (of 120 neurons examined), 8% to bladder and 6% to colon distension. In contrast to the lateral thalamic neurons, all medial thalamic visceral responsive cells had nociceptive inputs from the skin. In the squirrel monkey, lateral thalamus responses to distending the urinary bladder, distal colon and lower esophagus, as well as to noxious and innocuous somatic stimuli have been mapped (Bruggemann et al. 1994). Eighty-five percent (of 106 neurons studied) responded to at least one of the viscera. Most viscerceptive cells had somatic low-threshold responses and convergent multivisceral responses. Figure 1 is an example of a neuron located in the VPL, it responds to all three viscera by excitation and has a somatic tactile receptive field on foot digit 5. The visceral responsive cells showed increased or decreased firing for distensions in the noxious range and some also coded distensions in the innocuous and noxious ranges. Figure 2 shows visceral and somatic properties of 20 VPL neurons identified in a single electrode penetration. The extent of unpredictability between adjacent neurons, regarding specific visceral inputs and their excitatory or inhibitory responses is evident. Modulatory effects of visceral stimulation have been examined in squirrel monkey VPL (Bruggemann et al. 1998) and indicate that noxious distensions of urinary bladder, distal colon or lower esophagus decrease responses to somatic stimuli by about 50%. The high incidence of visceral responsive cells in the VPL implies that this information must be transmitted to the cortex and such visceral responsive neurons have in fact been reported in the monkey primary somatosensory cortex (Bruggemann et al. 1997).

Neuronal responses to uterus, cervix, vagina, colon and skin have been examined in the rat thalamus (Berkley et al. 1993; Berkley et al. 1995; Guilbaud et al. 1993). In the lateral thalamus, most neurons responded to multiple viscera and most were located in and around the border of ventrobasal complex (VB). Like results seen in the cat medial thalamus, most neurons in the caudal intralaminar thalamic nuclei (IL) with visceral responses also responded to noxious somatic stimuli, and most had inputs from multiple viscera (Berkley et al. 1995). The lateral portion of ventral medial nucleus (VM<sub>l</sub>) has recently been established as a region important in signaling nociceptive information from the brainstem to the cortex (see chapter in this encyclopedia by Villanueva). Cells in this region respond to noxious mechanical and thermal stimuli applied anywhere on the body, yet surprisingly these neurons do not respond to visceral stimuli (Monconduit et al. 2003).

Overall, thalamic nuclei can be differentiated into three kinds: nuclei with visceral specific inputs, nuclei with visceral convergent inputs and nuclei with no visceral





**Thalamus, Visceral Representation, Figure 2** Visceral and somatic responses of 20 neurons identified in a single track by an electrode traversing VPL dorso-ventrally. Cell 1 (#) is located most dorsally. Somatic receptive fields are either low-threshold tactile (unmarked) or wide-dynamic range type marked next to the receptive fields (open circle). Visceral responses are: O, no response, -, inhibition, +, excitation, ±, mixed; due to distension of the urinary bladder (B), colon (C), or lower esophagus (E) (missing symbols, not tested; N.A. somatic receptive field not found) (From Brüggemann, Shi and Apkarian 1994).

inputs. Surprisingly this differentiation does not follow the organization of the thalamus regarding somatic nociceptive and non-nociceptive responses, which was a primary hypothesis for most of the studies in the topic. The region of the thalamus presumed to be organized viscerotopically has not been adequately studied, especially physiologically and, although it is commonly referred as the visceral specific part of the thalamus, its detailed response properties remain unknown. However, it is possible that the observations in the cat VPL periphery and PO are actually part of the same visceral specific nucleus (VPPc) extending laterally and dorsally. There are important species differences in the visceral organization of the thalamus. In the cat, there is good reproducible evidence that the VPL proper, and most likely also the VPM proper, do not receive visceral inputs, while the VPL and VPM in rat and monkey do. In fact, in the squirrel monkey there is good evidence that all neurons in the VPL and VPM receive visceral inputs, non-viscerotopically. There is also good agreement between studies and across species for medial visceroreceptive cells having convergent somatic nociceptive inputs, while lateral visceroreceptive cells have mainly innocuous somatic inputs. Given the widely convergent viscerovisceral inputs on somatic responsive cells in the monkey lateral thalamus, it has been proposed that the visceral inputs through dorsal column inputs provide the signal for poorly localized visceral perceptions and that the spinothalamic inputs (presumed to be more specific and more dominantly somatic) may then lead to the perception of referred pain on the skin; see chapter by Apkarian in (Gebhart 1995). Undoubtedly, visceral inputs to the medial thalamus would complement this model by providing modulation of affect. The distinct visceral organizational rules of the thalamus, coupled with unique perceptions should provide the opportunity for studying the brain circuitry regarding different types of perceptions, yet current research in this field remains limited.

## References

1. Bailey P, Bremer F (1938) A sensory cortical representation of the vagus nerve with a note on the effects of the low blood pressure on the cortical electrogram. *J Neurophysiol* 1:405-412
2. Berkley KJ, Guilbaud G, Benoist JM et al. (1993) Responses of neurons in and near the thalamic ventrobasal complex of the rat to stimulation of uterus, cervix, vagina, colon, and skin. *J Neurophysiol* 69:557-568
3. Berkley KJ, Benoist JM, Gautron M et al. (1995) Responses of neurons in the caudal intralaminar thalamic complex of the rat to stimulation of the uterus, vagina, cervix, colon and skin. *Brain Res* 695:92-95
4. Bester H, Bourgeois L, Villanueva L et al. (1999) Differential projections to the intralaminar and gustatory thalamus from the parabrachial area: a PHA-L study in the rat. *J Comp Neurol* 405:421-449
5. Brüggemann J, Vahle-Hinz C, Kniffki KD (1993) Representation of the urinary bladder in the lateral thalamus of the cat. *J Neurophysiol* 70:482-491
6. Brüggemann J, Shi T, Apkarian AV (1994) Squirrel monkey lateral thalamus. II. Viscerosomatic convergent representation of urinary bladder, colon, and esophagus. *J Neurosci* 14:6796-6814

7. Brüggemann J, Vahle-Hinz C, Kniffki KD (1994) Projections from the pelvic nerve to the periphery of the cat's thalamic ventral posterolateral nucleus and adjacent regions of the posterior complex. *J Neurophysiol* 72:2237–2245
8. Brüggemann J, Shi T, Apkarian AV (1997) Viscero-somatic neurons in the primary somatosensory cortex (SI) of the squirrel monkey. *Brain Res* 756:297–300
9. Brüggemann J, Shi T, Apkarian AV (1998) Viscerosomatic interactions in the thalamic ventral posterolateral nucleus (VPL) of the squirrel monkey. *Brain Res* 787:269–276
10. Cechetto DF, Saper CB (1987) Evidence for a viscerotopic sensory representation in the cortex and thalamus in the rat. *J Comp Neurol* 262:27–45
11. Dell P, Olson R (1951) Projections thalamiques, corticales et cerebelleuses des afferences viscerales vagagles. *Soc Biol (Paris)* 145:1084–1088
12. Ganchrow D, Erickson RP (1972) Thalamocortical relations in gustation. *Brain Res* 36:298–305
13. Gauriau C, Bernard JF (2004) A comparative reappraisal of projections from the superficial laminae of the dorsal horn in the rat: the forebrain. *J Comp Neurol* 468:24–56
14. Gebhart GF (1995) Visceral pain. IASP Press, Seattle
15. Guilbaud G, Berkley KJ, Benoist JM et al. (1993) Responses of neurons in thalamic ventrobasal complex of rats to graded distension of uterus and vagina and to uterine suprafusion with bradykinin and prostaglandin F2 alpha. *Brain Res* 614:285–290
16. Horn AC, Vahle-Hinz C, Petersen M et al. (1997) Projections from the renal nerve to the cat's lateral somatosensory thalamus. *Brain Res* 763:47–55
17. Horn AC, Vahle-Hinz C, Brüggemann J et al. (1999) Responses of neurons in the lateral thalamus of the cat to stimulation of urinary bladder, colon, esophagus, and skin. *Brain Res* 851:164–174
18. Monconduit L, Bourgeois L, Bernard JF et al. (2003) Convergence of cutaneous, muscular and visceral noxious inputs onto ventromedial thalamic neurons in the rat. *Pain* 103:83–91

---

## Thalassotherapy

### Definition

Bathing in the sea.

- ▶ [Spa Treatment](#)

---

## Tolosa-Hunt Syndrome (Painful Ophthalmoplegia)

- ▶ [Headache Due to Dissection](#)

---

## Therapeutic Acupuncture

### Definition

Therapeutic Acupuncture refers to the clinical use of acupuncture for the more long-term relief of different symptoms after a course of treatments.

- ▶ [Acupuncture Mechanisms](#)

---

## Therapeutic Alliance

- ▶ [Chronic Pain, Patient-Therapist Interaction](#)

---

## Therapeutic Cold

- ▶ [Therapeutic Heat, Microwaves and Cold](#)

---

## Therapeutic Drug Monitoring

### Definition

The use of serum drug concentrations to guide dosing of the drug in order to obtain optimum treatment effect and avoid toxicity.

- ▶ [Antidepressants in Neuropathic Pain](#)

---

## Therapeutic Exercise

### Definition

Exercise as part of a treatment program designed to improve an individual's ability to move, balance and coordination, endurance, flexibility, muscle tone, posture, and strength.

- ▶ [Chronic Pain in Children: Physical Medicine and Rehabilitation](#)

---

## Therapeutic Gain

### Definition

Therapeutic gain is the difference between the therapeutic response to the verum and the placebo in a randomized controlled trial, in migraine prophylaxis, between the percentage of „responders“, i.e. of patients with a 50% reduction of attack frequency, to the active drug and the percentage of responders to placebo.

- ▶ [Clinical Migraine without Aura](#)

---

## Therapeutic Gene Transfer

- ▶ [Opioids and Gene Therapy](#)

---

## Therapeutic Heat

- ▶ [Therapeutic Heat, Microwaves and Cold](#)

## Therapeutic Heat, Microwaves and Cold

JEFFREY R. BASFORD

Department of Physical Medicine and Rehabilitation,  
Mayo Clinic and Mayo Foundation, Rochester, MN,  
USA

basford.jeffrey@mayo.edu

### Synonyms

Physical agent; modality; diathermy; Therapeutic Cold;  
Therapeutic Heat; Cold Therapy; Microwaves

### Definition

The use of heat and cold to lessen pain, promote healing or obtain other therapeutic goals.

### Characteristics

The body is sensitive to its environment. Temperatures above 42°C or below 13°C produce discomfort and those only a few degrees higher or lower may actually injure it. Furthermore, temperature changes easily obtained in the clinic alter enzymatic activity, nerve conduction and tissue viscosity (Oosterveld and Rasker 1994). While heat and cold may be used to alleviate the cause of pain or to produce analgesia, the latter is far more common.

Thermal agents achieve their effects as the result of changing the temperature of a tissue. Specifically, most heat-based treatments attempt to warm tissues to by 3–8°C and most cold therapies attempt to reduce tissue temperatures by a similar amount. As a result, the overlap between their indications and contraindications is surprisingly broad (Tables 1 and 2). It should be remembered that many of the contraindications of heat and cold are relative, i.e. localized heating might be acceptable in a patient with cardiac disease, while systemic heating might place unacceptable demands on his cardiac function (Keast and Adamo 2000).

### Mechanism of Action

Tissue can be heated or cooled by conduction, convection or the conversion of a different form of energy into heat. Hot packs epitomize conductive heating, hydrotherapy convection and ultrasound conversion, due to its reliance on the conversion of sound into heat.

### Superficial Heat

The physiological effects of the superficial heating agents differ little and choice depends on the situation and patient / therapist preference.

### Hot Packs

Hot packs are typically constructed of porous bags filled with a hygroscopic material. They are either kept in 70–80°C water baths or warmed in a microwave before being covered with an absorbent wrap and placed on the body. Treatments may last for 30 min with the packs slowly cooling. Alternatives such as electrically heated

pads that do not cool spontaneously are convenient but may increase the risk of burns.

### Heat Lamp

Heat lamp use may be declining but is still common. Skin temperatures are controlled by adjusting the distance between the lamp and the patient. The precautions in Table 1 apply to these agents but it should also be noted that chronic use of superficial heat can produce a permanent mottling of the skin (erythema *ab igne*).

### Hydrotherapy

Hydrotherapy uses a fluid medium to produce heating, cooling, massage and debridement. Neither agitation nor water is necessary and solutes in the medium (e.g. NaCl for wound care) may be a significant factor in treatment. Hydrotherapy may also be performed with substances such as finely ground solid materials suspended by jets of hot air. The benefits of this dry heat ‘fluidotherapy’ approach over conventional water-based hydrotherapy are unestablished.

### Whirlpool Baths

Whirlpool baths range in size from those intended to treat a single extremity to others in which the entire body is immersed. Temperatures of 33–36°C are usually well tolerated, although for a healthy patient, elevations to 43°C are possible on limited portions of the body. Treatment with stationary mediums may be beneficial. Sitz baths, for example, are beneficial in the treatment of anorectal pain and research demonstrates that bathing at 40–50°C is not only comfortable but also lessens anal tone (Pinho et al. 1993). Agitation increases the efficiency of thermal transfer and it should be remembered that a temperature that is comfortable with a motionless medium might become painfully hot or cold with agitation.

### Contrast Bathing

Contrast bathing involves the patient shifting their treated extremities alternatively between a warm (38–40°C) and a cool (13–16°C) bath about ten times. These baths are frequently used in the treatment of complex regional pain syndrome with benefits thought to result from reflex hyperemia and desensitization.

### Paraffin Baths

Paraffin baths consist of a basin filled with a 1:7 mixture of mineral oil and paraffin. Temperatures (45–54°C) are higher than those of water-based hydrotherapy and are tolerated due to the lack of agitation, the insulation provided by wax as it solidifies on the treated area and the low heat capacity of the medium. Treatment is usually performed by dipping the involved extremity in the bath about ten times, covering it and then allowing it to cool slowly in an insulated wrap. An alternative approach in which the treated extremity is dipped once and then kept in the bath permits more vigorous heating. 30 min treatments may produce increases in the intramuscular tem-

**Therapeutic Heat, Microwaves and Cold, Table 1** Indications and Precautions for the Use of Therapeutic Heat

Indications	Precautions and Contraindications
Pain	Acceleration of metabolic processes
Acute inflammation, trauma or hemorrhage	Malignancy
Muscle spasm	Chronic Hematoma
Bleeding dyscrasias	Edema
Contractures	Bursitis/Tenosynovitis
Insensitivity	Ischemia
Fibromyalgia	Superficial thrombophlebitis
Inability to communicate or respond to pain	Atrophic skin/scar tissue
Hyperemia	Unstable angina or blood pressure
Poor thermal regulation (systemic heating situation)	Decompensated heart failure/recent myocardial infarction

**Therapeutic Heat, Microwaves and Cold, Table 2** Indications and Precautions for the Use of Therapeutic Cold

Indications	Precautions and Contraindications
Acute musculoskeletal trauma	Spasticity
Ischemia	Severe cold pressor responses
Pain	Reduction of metabolic activity
Cold intolerance/urticaria	Inability to communicate or respond to pain
Muscle spasm	Poor thermal regulation
Raynaud's phenomenon and disease	Insensitivity

perature of superficial muscles of about 3°C (Abramson et al. 1964).

### Diathermy

► **Diathermy** can be performed with short waves (SWD), microwaves (MWD) or ultrasound (USD). USD is the most frequently used agent (Lindsay et al. 1995) but as it is discussed in another chapter will be only summarized here. Discussion here will emphasize SWD which is still in relatively widespread use and to a lesser extent, MWD whose medical use is now quite restricted.

### Ultrasound

Ultrasound has both thermal and ► **non-thermal effects**. The production and effects of heat are well understood. The benefits of non-thermal processes, which include such phenomena as cavitation (the production and destruction of small bubbles), tissue micro-streaming and mechanical deformation remain to be established. Treatment usually involves stroking an USD applicator over the treated tissue for 5–7 min. Intensities range from mWs to 1.5 + W per cm<sup>2</sup>. Continuous waves are employed when the goal is heating and pulsed treatments are chosen to emphasize non-thermal effects. Temperature elevations of 5°C are easily possible and may be particularly large at bone:soft tissue interfaces. USD phonophoresis is also used to introduce topical medication (e.g. lidocaine) through the skin. USD used as a treatment for conditions ranging from contractures, sprains, muscle strains, wounds, tendinitis and non-healing fractures to carpal tunnel syndrome. Benefits are controversial and in some situations may be no more effective than placebos or anti-inflammatories (Basford 1998). Precautions include those for heat in general, as well as avoidance of fluid-filled cavities,

the gravid or mensurating uterus, the heart, brain, cervical ganglia, tumors, laminectomy sites, and acutely inflamed joints.

### Short Wave Diathermy

Short wave diathermy uses radio waves to heat tissue. Use is restricted to a limited range of frequencies (27.12 MHz, 13.56 MHz and 40.68 MHz in the U.S.). In one approach, the body acts as an antenna and the SWD machine induces eddy currents that produce heat as they flow through the body. This method delivers the most energy to water-rich conductive tissues such as muscles. In the second approach, the body serves as the dielectric of a capacitor that is charged by the SWD machine. In this case, the tissues are in series and heating may be most marked in water-poor, high resistance tissues, such as fat and ligaments. Applicators range from inductive pads that are placed on the patient to the flat plates of a simple capacitor. Although now rarely done, specialized heating can be performed by wrapping coils around a patient's limb or with rectal or vaginal probes. Continuous waveforms are used when the goal is heating while pulsed waves are used when non-thermal effects are desired. SWD can increase subcutaneous fat temperatures by 15°C and 3–5 cm deep intramuscular temperatures by 4–6°C (Draper et al. 1999). A SWD device is, in effect, a radio transmitter that is used to produce heat in two ways. As is true for US, the benefits of SWD non-thermal phenomena (such as possible frequency dependent effects on cell function) remain to be established.

### Microwaves

Microwaves (915 MHz and 2,456 MHz) do not penetrate tissue as deeply as SWD. In fact, their absorption is so rapid that fat overlying a site of interest will absorb a sig-



nificant portion of the beam. Thus, microwave diathermy (MWD) may increase subcutaneous fat temperatures by 10 to 12°C, while the underlying muscles will be warmed only a third as much (Basford 1998). Microwaves have been replaced in therapy by US and SWD. Today MSD use in medicine appears to be restricted to the production of local hyperthermia and the potentiation of cancer chemotherapy and radiation treatment.

SW and MW diathermy are both subject to the general precautions for heat outlined in Table 1. However, both are electromagnetic in nature and metal implants / devices, pacemakers, stimulators, contact lenses and the menstruating or pregnant uterus should be avoided. Risks are real; diathermy treatment of the jaw resulted in severe brain damage in a man with a deep brain stimulator (Nutt et al. 2001).

### Cold Therapy

Cold decreases metabolic activity, slows nerve conduction, produces analgesia, lessens muscle tone, inhibits spasticity and increases gastrointestinal motility (Basford 1998; Denys 1991). The application of ice to the body decreases skin temperature by 20°C in about 10 min. Subcutaneous temperatures decrease 3–5°C over the same period. If cooling is continued, forearm intramuscular temperature may decrease by 6–16°C and muscle blood flow by as much as 30% (Oosterveld and Rasker 1994). Although chemical and refrigerated agents may have temperatures below 0°C and can produce frostbite, ice treatments of healthy people for periods of less than 30 min do not seem to cause injury.

### Technique

Ice has a high heat capacity; ice packs, massage, compression wraps and slushes all cool tissues rapidly. Treatments tend to last 10–20 min and a slightly damp, thin towel may be placed between the ice and the skin. Iced whirlpools provide particularly rapid cooling. However, they are poorly accepted by most people. Insulated foot coverings or fabric socks and gloves may lessen discomfort and increase acceptance. Ice massage produces rapid cooling over a limited area. Treatment involves rubbing ice (often pre-frozen in a paper cup) over the painful area. Analgesia can be achieved in 7–10 min.

There are a number of other cooling agents. Vapocoolant sprays can reduce skin temperature by 20°C (Oosterveld and Rasker 1994) and are used for local skin analgesia and the “spray and stretch” techniques. Chemical ice packs cool *via* the production of an endothermic reaction and while convenient tend to be expensive. Refrigerated and pressurized water pressure cuffs are also available. Frozen juice and vegetable packages are convenient for home use.

The application of superficial cold appears to lessen hypoxic damage, edema and compartmental pressures after injury (Bert et al. 1991), but the magnitude of its ben-

efits in the ultimate recovery remain debatable despite its ability to lessen metabolic activity and blood flow (Ho et al. 1995). In practice, ice is typically used in conjunction with rest, compression and elevation (RICE) in the treatment of many musculoskeletal injuries. A common regimen, such as for an ankle sprain, consists of using ice acutely for about 20 min every 2 h for 6–24 h. Although icing is almost the automatic response to acute soft-tissue injury, it may not be a panacea in that studies of the postsurgical knee (Daniel et al. 1994) and cesarean sections (Amin-Hanjani et al. 1992) may not show benefit.

After the first day or two, the choice between ice-based therapy and heat appears to depend on personal choice. Many find heat more comfortable and use it unless there is a worsening of edema or pain. Others find a combination of icing and active exercising a more effective way to speed recovery. In any case, long-term recovery depends on mobilization and exercise. Heat and cold are only important as the agents used to assist in gaining it. Patients with long-standing trochanteric bursitis and lateral epicondylitis may find ice in combination with friction massage extraordinarily effective. Ice massage and transcutaneous electrical nerve stimulation (TENS) may be equally beneficial in low back pain (Basford 1998). The precautions of Table 2 should be heeded. Elevation of blood pressure as well as the effects of cold-induced vasoconstriction in people with ischemia and Raynaud’s phenomenon may be important considerations.

In summary, there is little evidence that heat and cold alone are of much benefit except for the temporary reduction of pain. As a result, they are usually prescribed in conjunction with a program of education, activity modification and exercise. Preference plays a role in agent choice but there are some guidelines that are appropriate. Thus, acute musculoskeletal conditions are usually initially treated with ice. In addition, hydrotherapy or SWD are used to treat large areas of the body while USD is used for more focal conditions. Deep heat may appear physiologically appealing, but at times the comforting effects of superficial heat may prove as beneficial.

### References

1. Abramson DI, Tuck S, Chu LSW et al. (1964) Effect of paraffin bath and hot fomentations on local tissue temperatures. *Arch Phys Med Rehabil* 45:87–94
2. Amin-Hanjani S, Corcoran J, Chatwani A (1992) Cold therapy in the management of postoperative cesarean section pain. *J Obstet Gynecol* 167:108–109
3. Basford JR (1998) Physical Agents. *Rehabilitation Medicine: Principles and Practice*, 2nd edn. Lippincott-Raven, Philadelphia, pp 483–504
4. Beenakker EA, Oparina TI, Teelken A et al. (2001) Cooling garment treatment in MS: clinical improvement and decrease in leukocyte NO production. *Neurology* 57:892–894
5. Bert JM, Stark JG, Maschka K et al. (1991) The effect of cold therapy on morbidity subsequent to arthroscopic lateral retinacular release. *Orthop Rev* 20:755–758

6. Daniel DM, Stone ML, Arendt DL (1994) The effect of cold therapy on pain, swelling, and range of motion after anterior cruciate ligament reconstructive surgery. *Arthroscopy* 10:530–533
7. Denys EH (1991) AAEM minimonograph #14: the influence of temperature in clinical neurophysiology. *Muscle Nerve* 14:795–811
8. Draper DO, Knight K, Fujiwara T et al. (1999) Temperature change in human muscle during and after pulsed short-wave diathermy. *J Orthop Sports Phys Ther* 29:13–8; discussion 19–22
9. Ho SSW, Illgen RL, Meyer RW et al. (1995) Comparison of various icing times in decreasing bone metabolism and blood flow in the knee. *Am J Sports Med* 23:74–76
10. Keast ML, Adamo KB (2000) The Finnish sauna bath and its use in patients with cardiovascular disease. *J Cardiopulm Rehabil* 20:225–230
11. Lindsay DM, Dearness J, McGinley CC (1995) Electrotherapy usage trends in private physiotherapy practice in Alberta. *Physiother Can* 47:30–34
12. Nutt JG, Anderson VC, Peacock JH et al. (2001) DBS and diathermy interaction induces severe CNS damage. *Neurology* 56:1384–1386
13. Oosterveld FG, Rasker JJ (1994) Effects of local heat and cold treatment of surface and articular temperature of arthritic knees. *Arthritis Rheum* 31:1578–1582
14. Pinho M, Correa JCO, Furtado A et al. (1993) Do hot baths promote anal sphincter relaxation? *Dis Colon Rectum* 36:273–274

## Therapeutic Relationships

- ▶ Chronic Gynaecological Pain, Doctor-Patient Interaction

## Therapeutic Ultrasound

- ▶ Modalities

## Therapy of Pain, Hypnosis

ROBERT G. LARGE  
The Auckland Regional Pain Service, Auckland  
Hospital, Auckland, New Zealand  
boblarge@actrix.co.nz

### Synonyms

Hypnotism; Mesmerism; Hypnotherapy

### Definition

Hypnosis refers to the “state” of consciousness associated with the phenomenon in question.

Hypnotism refers to the science and art of inducing and utilising this phenomenon. This term is now less used in current research literature.

Mesmerism is a term associated with the controversial work of Franz Anton Mesmer (1734–1815) and replaced his concept of “animal magnetism”. Modern accounts occasionally use the term to describe the non-verbal “mesmeric passes” used in some contexts.

Hypnotherapy is a term used to describe various forms of psychotherapy utilizing hypnosis as the major ingredient.

Hypnosis has been notoriously difficult to define. The British Medical Association (1955) introduced the following operational definition:

Hypnosis is a temporary condition of altered perception in the subject which may be induced by another person and in which a variety of phenomena may appear spontaneously or in response to verbal or other stimuli. These phenomena include alterations in consciousness and memory, increased susceptibility to suggestion, and the production in the subject of responses and ideas unfamiliar to him in his normal state of mind. Further phenomena such as anaesthesia, paralysis and the rigidity of muscles, and vasomotor changes can be produced and removed in the hypnotic state.

Most investigators emphasise one or more of four characteristics: expectations and the hypnotist-subject interaction; ▶ **suggestibility**; a cognitive dimension related to relaxation and/or ▶ **imagery**; and ▶ **dissociation** (Evans 2001).

### Characteristics

Of the wide range of phenomena associated with hypnosis, hypnotic analgesia is obviously the most useful in treating pain. Clinicians have typically used one or more of the following approaches: direct suggestion of pain reduction or insensitivity; suggestions aimed at altering the experience of pain; or suggestions directing attention away from pain and its source.

Social role theorists have proposed that hypnotic analgesia is simply a consequence of compliance with the ▶ **demand characteristics** of the experimental or clinical situation. In other words, subjects respond in the way they expect the hypnotist wishes them to respond. However, hypnotic analgesia shows a moderately strong correlation with measured hypnotic susceptibility (0.5), and there is a marked difference in the subjective experience of subjects simulating hypnosis compared with authentic hypnosis (Hilgard and Hilgard 1975). Many studies have shown that pain reduction in response to suggestion can occur without any apparent hypnotic induction. Nevertheless, accumulating evidence suggests that a hypnotic induction at least facilitates more profound analgesia. Price (1999) proposes that the sense of ease, absorption of attention and lack of monitoring and censoring that are characteristic of hypnosis, lays the foundation for an increased responsiveness to suggestion. Modern brain imaging techniques show differences in brain activity between normal waking and hypnotic states. Furthermore, specific analgesia suggestions are accompanied by specific brain changes; e.g. suggestions to enhance or reduce pain unpleasantness, with no change in pain sensation, are accompanied by changes in the anterior cingulate cortex and not in the primary sensory cortex. Similarly, suggestions of sensory reduc-

tion produce parallel changes in subjective ratings and in activity in the primary somatosensory cortex. There is now some evidence that hypnotic analgesia also involves descending brain-to-spinal cord inhibitory mechanisms and can inhibit spinal nociceptive reflexes. Our emerging understanding of the nature of hypnotic analgesia is that it relates to a wide range of cognitive variables, such as placebo/nocebo, attention, distraction and emotional tone which modulate pain through changes in neural activity in many brain structures involved in nociception and pain (Large et al. 2003).

#### Treatment for Acute Pain

Clinicians over many years have reported remarkable success in using hypnosis to manage acute pain. Mesmer's explorations of "animal magnetism" seemed often to precipitate pain in his patients as an indication of the healing process (Bloch 1980). His followers, such as John Elliotson (1791–1868), reported surgical operations performed under "mesmeric sleep". James Esdaile (1808–1859) described 345 operations performed in India with mesmerism as the sole anaesthetic. Modern day accounts of major surgery performed under hypnotic analgesia continue to be collected (Hilgard and Hilgard 1975). Rapid induction techniques have been developed for use in managing the acute pain of trauma and the imposed pain of procedures (Barber 1982). Despite its long history and the experience of many clinicians and patients, good outcome research has been somewhat sparse. A recent meta-review concluded that hypnosis had been shown to be effective in controlling the pain of procedures in children with cancer. It is also effective in reducing the acute pain of burns and childbirth (Hawkins 2001).

#### Treatment for Chronic Pain

The persistent and relapsing nature of chronic pain presents a challenge to the therapist to develop strategies that will endure beyond the laboratory or consultation room. Hypnotic analgesia in the therapy session may offer some respite from pain but not a long-term cure. Clinicians have therefore turned to developing self-management techniques and the teaching of self-hypnosis (Eimer 2002). A typical clinical approach is to work with the patient in exploring hypnotic responsiveness, emphasizing what is possible rather than what is not possible. Techniques are explored and developed in collaboration between therapist and patient. These may range from simple ▶ [relaxation](#), to ▶ ["special place" imagery](#), to inducing hypnotic analgesia in a hand (▶ [glove anaesthesia](#)) and transferring this to the site of pain, to using ▶ [post-hypnotic suggestion](#) with or without specific cues. The patient's own sense of control is enhanced and encouraged.

A review of clinical trials of hypnosis for chronic pain, where there has been some attempt at systemisation and control, suggests that hypnosis is effective in a variety of

pain conditions. It has not been shown to be consistently superior to relaxation or other psychological interventions, however.

Hypnosis proved superior to propranolol in children with migraine, but few other comparisons with drug treatments have been made. In studies with adults, hypnosis and ▶ [autogenic training](#) appear to be equally efficacious for migraine.

Studies in irritable bowel syndrome have shown not only a reduction in pain and distension, but also changes in rectal sensitivity assessed by balloon manometry. This finding hints at some basic psychophysiological change induced by hypnosis. However, a similar effect on tender points in fibromyalgia was looked for, but not found. Work adherence was also improved in a hypnosis group treated for irritable bowel syndrome, suggesting an important shift in social and occupational functioning. Large and James (1988) found that patients trained in self-hypnosis changed their ▶ [self-constructs](#) as they gained mastery over their pain. From viewing themselves as physically ill people, they moved closer to their construction of their ideal self. This and other studies suggest that one of the major gains that can be made through hypnosis is the enhancement of the patient's sense of control and ▶ [self-efficacy](#). Price (1999) points out that unlike placebo suggestion, which implies an external authoritative agent, hypnotic suggestion refers to a more innate, internal and self-directed capacity to alter experience.

Overall, the outcome research on hypnosis is promising, but there is a difficulty in relating current clinical approaches to the results of randomized controlled trials. Rigorous experimental design favours standardized approaches to hypnosis, with the use of scripts and prepared tape recordings. In contrast, many clinicians use sophisticated and individualized techniques that are difficult to replicate across subjects. (Large et al. 2003) For example, some anecdotal reports have described using hypnosis as a means of returning to a presumed crucial traumatic event, so-called ▶ [age regression](#). These reports suggest that resolution of the trauma can lead to a dramatic resolution of a chronic pain problem (e.g. Gainer 1992). It is difficult to evaluate the importance of such reports in the absence of reports of failures, which are seldom, if ever, published.

As noted, ▶ [hypnotisability](#) is correlated with hypnotic analgesia in laboratory studies. A number of studies using hypnosis in chronic pain management have found better results in higher hypnotizable subjects. However, it would seem that high hypnotizable subjects are also more likely to respond to relaxation techniques in general. This suggests that there are some commonalities in the various forms of psychological interventions that utilize relaxation. It is possible that highly hypnotisable subjects begin to access the hypnotic state in response to relaxation training in general. Hilgard's research in the laboratory has suggested that the simple induction of

hypnosis without analgesic suggestions does not induce hypnotic analgesia. Specific analgesic suggestions are required. Many relaxation scripts, however, do include suggestions for comfort and pain reduction, so that there is considerable crossover between strategies labelled “hypnosis” and those not labelled “hypnosis”!

### Conclusion

Hypnosis has waxed and waned in popularity since the days of Mesmer. Systematic research in cognitive psychology and physiological psychology has improved our understanding of the nature of hypnotic responding and hypnotic analgesia. The introduction of modern neuroimaging techniques has begun to validate the construct of hypnosis as a phenomenon that has both subjective and objective reality. Clinical research continues to encourage the development of effective strategies utilising hypnosis. Hypnosis continues to pose important questions in our understanding of pain, consciousness and cognitive influences on brain processes, as well as challenging us to refine therapeutic strategies utilizing the full potential of hypnotic analgesia.

### References

1. Barber J (1982) Managing Acute Pain. In: Barber J, Adrian C (eds) *Psychological Approaches to the Management of Pain*. Brunner/Mazel Publishers, New York, pp 168–185
2. Bloch G (1980) *Mesmerism. A Translation of the Original Scientific and Medical Writings of F.A. Mesmer*. William Kaufmann, Inc, Los Altos
3. British Medical Association Report (1955) Medical Use of Hypnotism. *BMJ* 1 Supplement 190
4. Eimer BN (2002) *Hypnotize Yourself Out of Pain Now!* New Harbinger Publications, Inc, Oakland
5. Evans FJ (2001) Hypnosis in Chronic Pain Management. In: Burrows GD, Stanley RO, Bloom PB (eds) *International Handbook of Clinical Hypnosis*. John Wiley and Sons, Ltd, Chichester, pp 247–260
6. Gainer MJ (1992) Hypnotherapy for Reflex Sympathetic Dystrophy. *Am J Clin Hypn* 34:227–232
7. Hawkins RMF (2001) A Systemic Meta-Review of Hypnosis as an Empirically Supported Treatment for Pain. *Pain Rev* 8:47–73
8. Hilgard ER, Hilgard JR (1975) *Hypnosis in the Relief of Pain*. William Kaufmann, Inc, Los Altos
9. Large RG, James FR (1988) Personalised Evaluation of Self-Hypnosis as a Treatment of Chronic Pain: A Repertory Grid Analysis. *Pain* 35:155–169
10. Large RG, Price DD, Hawkins R (2003) Hypnotic Analgesia and its Applications in Pain Management. In: Dostrovsky JO, Carr DB, Koltzenburg M (eds) *Proceedings of the 10<sup>th</sup> World Congress on Pain*. Progress in Pain Research and Management, vol 24. IASP Press, Seattle, pp 839–851
11. Price DD (1999) Mechanisms of Hypnotic Analgesia. In: Price DD (ed) *Psychological Mechanisms of Pain and Analgesia*. Progress in Pain Research and Management vol 15. IASP Press, Seattle, pp 183–204

## Thermal Allodynia

### Definition

Allodynia evoked by a thermal stimulus.

- ▶ [Cognitive Behavioral Treatment of Pain](#)

- ▶ [Spinal Cord Injury Pain Model, Contusion Injury Model](#)

## Thermal Effects of Ultrasound

### Definition

The thermal effects on the target tissue result in an increased local metabolism, circulation, extensibility of connective tissue, tissue regeneration and bone growth.

- ▶ [Ultrasound Therapy of Pain from the Musculoskeletal System](#)

## Thermal Hyperalgesia

### Definition

Thermal Hyperalgesia is a condition of altered perception of temperature. Describes heightened sensitivity to noxious heat.

- ▶ [Neuropathic Pain Model, Chronic Constriction Injury](#)
- ▶ [Opioids in the Spinal Cord and Modulation of Ascending Pathways \(N. gracilis\)](#)
- ▶ [TRPV1, Regulation by Nerve Growth Factor](#)
- ▶ [TRPV1, Regulation by Protons](#)

## Thermal Hyperalgesia Test

- ▶ [Thermal Nociception Test](#)

## Thermal Neuroablation

- ▶ [Radiofrequency Neurotomy, Electrophysiological Principles](#)

## Thermal Nociception Test

KENNETH M. HARGREAVES<sup>1</sup>,  
CHRISTOPHER M. FLORES<sup>2</sup>

<sup>1</sup>Department of Endodontics, University of Texas Health Science Center at San Antonio, San Antonio, TX, USA

<sup>2</sup>Drug Discovery, Johnson and Johnson Pharmaceutical Research and Development, Spring House, PA, USA  
hargreaves@uthscsa.edu



## Synonyms

Plantar Test; Thermal Hyperalgesia Test; Radiant Heat Test; Hargreaves Test

## Definition

The thermal hyperalgesia test permits highly reproducible evaluation of paw withdrawal thresholds of animals to a beam of radiant heat applied to the plantar surface of the paw. The endpoint is detected automatically thereby removing an important potential source of observer bias. The test can be used to measure normal nociceptive thresholds and to quantify hyperalgesia and allodynia in models of inflammatory or neuropathic pain (Hargreaves et al. 1988).

## Characteristics

### Overview

Our understanding of the chemical and anatomical substrates that underlie hyperalgesia and allodynia has benefited tremendously from numerous important animal models. Consequently, we have a more profound appreciation for the processes that contribute to the development and maintenance of certain behavioral responses to noxious stimulation and tissue injury. Nonetheless, such models are only as valuable as are the methods employed to detect and quantitate these behavioral responses. Thus, validity, reliability, sensitivity, assay reproducibility and flexibility are all critical determinants of any paradigm by which to assess nociception and its physiological sequelae.

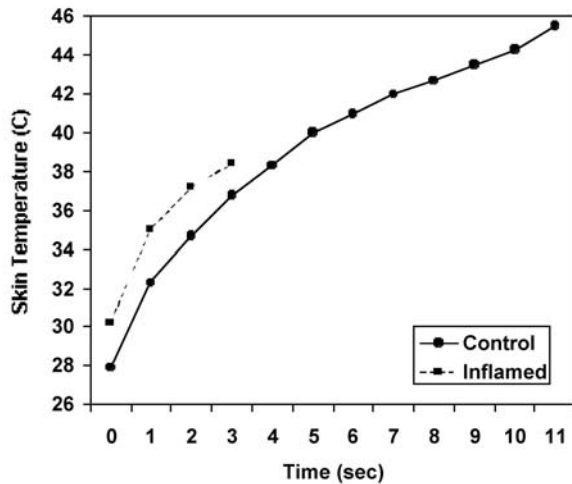
Attempts to assess pain quantitatively in humans and animals dates back to the first half of this century, and there are numerous reports of “pain” measurements in animals responding to thermal, chemical, mechanical or electrical stimuli. However, these methods all suffered from a variety of drawbacks including, but not limited to, a lack of correlation between human clinical and experimental animal studies, a lack of assay sensitivity to pharmacological manipulation, especially with regard to ► [NSAIDs, Survey](#) (NSAIDs), the inability to perform within-subject controls and a virtually uniform reliance on non-complex, reflex behaviors (often involving the uniquely scaly, non-glabrous skin of the rat tail) that are difficult if not impossible to equate with the human sensation of pain.

The plantar test avoids many of these limitations since it measures complex, nociceptive behaviors following thermal stimulation of cutaneous tissues, using a method allowing for not only the determination of thermal nociceptive thresholds but also the quantitation of ► [primary hyperalgesia](#), ► [secondary hyperalgesia](#) and ► [allodynia](#). The test is performed in awake, freely moving and unrestrained animals, thereby avoiding the potential generation of stress responses. In addition, the device is flexible enough to permit the independent

testing of selected, individual receptive fields (e.g., independent assessment of both hind paws), permitting the use of within-subject controls, sophisticated enough to yield a quantifiable, automated end-point, thereby removing most of the potentially confounding observer interaction and sensitive enough to detect relatively small changes in response to relevant perturbations, such as the induction of inflammation and hyperalgesia and/or the administration of drugs. In 1988, after two years of design, development and validation, the plantar test methods paper was published. According to an ISI Web of Science™ analysis of papers published through May 2005, this paper has been cited in more than 1,000 publications, making it one of the most heavily cited articles ever published in the journal *Pain* (Terajima and Aneman 2003).

### Procedure

The device (for detailed description, see Hargreaves et al. 1988) essentially consists of a raised glass floor beneath which is placed a movable case containing a radiant heat source and photoelectric cell that are aimed through an aperture at the top of the case. The method involves placing an animal on top of the glass floor and enclosing it in a small, clear plastic cage. Depending on the size of the floor and the enclosures employed, several animals may be positioned simultaneously in individual cages. Following an acclimation period, at which point the animal has come to rest, the aperture is positioned directly beneath the plantar surface of the animal’s hind paw. The trial is commenced by a switch that simultaneously activates the heat source and an electronic timer. Upon withdrawal of the paw, the resulting interruption of the reflected light is detected by the photoelectric cell, thereby signaling the lamp and timer to turn off and a tone to be emitted. The electronic clock circuit is wired to a microcomputer and LED readout. The paw withdrawal latency (PWL), measured as the time to the nearest 0.1 sec between points at which the switch is turned on and the beam of light is interrupted, is taken as a measure of the thermal nociceptive threshold of the animal and is displayed on the readout. The test may then be repeated on the same or the other paw. Owing to the fact that the procedure is carried out on unrestrained, freely moving animals, this method also allows for the concurrent measurement of complex, organized behaviors in addition to the PWL, including the duration and rapidity of withdrawal as well as various locomotor activities such as licking, each a separate measure of hyperalgesia (defined as an exaggerated response to a noxious stimulus). To measure duration of paw withdrawal, a stopwatch is started when the device emits the tone and is stopped when the paw is returned to the glass floor. Similarly, the duration of licking or other complex behavior can be measured. Changes in latency correspond to thermal allodynia, since latency is directly correlated with cutaneous temperature (Fig. 1). In contrast, changes in du-



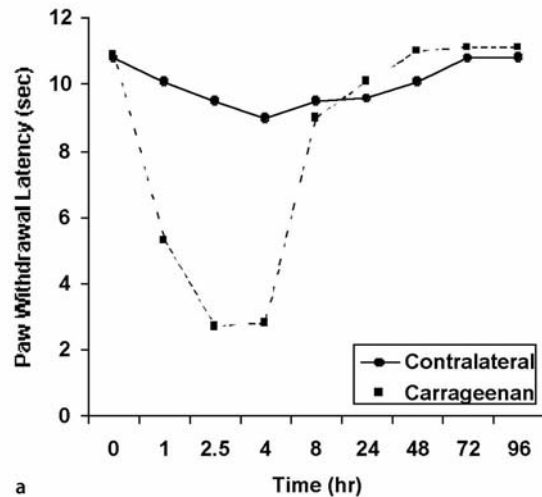
**Thermal Nociception Test, Figure 1** Effects of radiant heat on the cutaneous temperature of rat hind paws. Reproduced with permission from: Hargreaves, et al. *Pain* 32:77-88, 1988, Elsevierf.

ration of hind paw elevation following the stimulus may reflect aspects of hyperalgesia (Fig. 2).

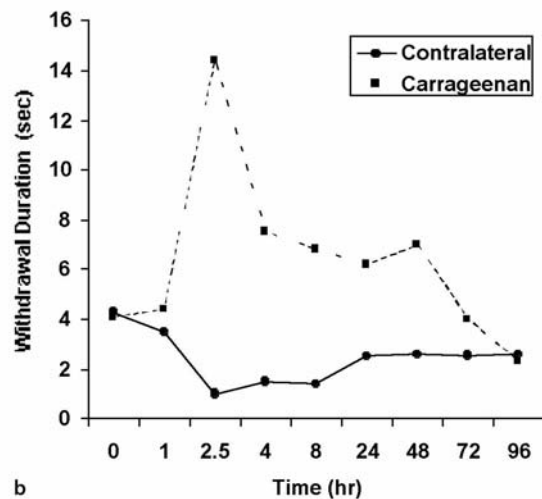
#### Advantages and Disadvantages

Many of the advantages and limitations of this radiant heat method compared with previously existing methods have been summarized (Table 1). Perhaps of greatest importance is that this paradigm conforms to the guidelines for the ethical and responsible use of animals as experimental subjects established by the International Association for the Study of Pain and the Society for Neuroscience. In this regard, it is of profound importance that the noxious stimulus applied during testing of the animals is readily escapable. Thus, the animal itself terminates the experimental session after a brief stimulus and before any thermal injury can occur, even after repeated application of the test. In addition, the capacity to perform the test on an awake, freely moving animal that appears ostensibly calm and comfortable during the acclimation and testing period markedly reduces the concern that any stress-related neuroendocrine circuits will be engaged. Another advantage to the freedom of movement afforded by this method is that a number of more complex behaviors related to an induced hyperalgesic state and occurring secondary to or as a result of the testing can be measured. The ability to quantitate such an array of nociceptive behaviors gives rise to a "hyperalgesia profile" for a given animal that may be compared to other individuals under a variety of experimental conditions. This set-up also readily permits the administration of test articles or other perturbations, on a repeated basis if necessary, in between PWL measurements.

As already alluded to, this method, in addition to measuring thermal nociceptive thresholds in normal animals/hind paws, may also be used to quantitate hyperalgesia, operationally defined as an increased



a



b

**Thermal Nociception Test, Figure 2** (a) Effects of carrageenan on the latency for hind paw withdrawal following injection of carrageenan into one hind paw with measurement of both the ipsilateral injected hind paw and the contralateral control hind paw. (b) Effects of carrageenan on the post-stimulus duration of hind paw elevation above the glass floor in the same animals as (a). Reproduced with permission from: Hargreaves et al. *Pain* 32:77-88, 1988, Elsevierf.

responsiveness to noxious stimulation. It is also theoretically possible to alter the device to deliver a sub-threshold stimulus as a means of measuring allodynia. In the context of this discussion then, it may be appreciated that this method is amenable to measuring hyperalgesia that develops due to inflammation or nerve injury induced by a variety of perturbations. Thus, the method has been applied to several models, including the intraplantar injection of carrageenan (Hargreaves et al. 1988), complete Freund's adjuvant (Iadarola et al. 1988), yeast (Iadarola et al. 1988), nerve growth factor (Andreev et al. 1995) or the induction of a peripheral

**Thermal Nociception Test, Table 1** Methodological Papers Evaluating the Radiant Heat Device

Modification of Parameter Evaluated	Authors
Methods paper: thermal hyperalgesia in a model of inflammation	Hargreaves et al. 1988
Thermal hyperalgesia in a model of peripheral neuropathy	Bennett and Xie 1988
Glass surface acts as a heat sink	Hirata et al. 1990
To avoid heat sink effect, only test a paw when it is in contact with the glass surface	Bennett and Hargreaves 1990
A nylon mesh over the glass surface reduces the heat sink effect	Murphy et al. 1991
Animals restrained during thermal testing	Kerns et al. 1991
Testing thermal thresholds in normal animals	Yamamoto and Yaksh 1991
Heated glass surface using feedback control to avoid a heat sink effect	Yamamoto and Yaksh 1991
Correlation of paw temperature and escape latencies are consistent with measuring nociception	Yeomans et al. 1992
Thermal hyperalgesia in a model of peripheral neuropathy	Kim and Chung 1992
Thermal hyperalgesia following i.t. NMDA	Malmberg and Yaksh 1993
Heated glass floor, joystick control of radiant heat source, illustration of a circuit diagram	Galbraith et al. 1993
Radiant heat device more sensitive than tail flick for detecting thermal hyperalgesia during tolerance	Mao et al. 1994
Frogs as test subject	Willenbring and Stevens 1995
Radiant heat applied to the dorsum of the hindpaw	Tracey et al. 1995
Gerbils as test subject	Rupniak et al. 1995
Evaluated two intensities of radiant heat in the same subjects	Abram and O'Connor 1995

neuropathy by nerve constriction (Bennett and Xie 1988; Kim and Chung 1992; Bennett 1999).

One of the most important advantages of this method compared with previous methods is the ability to have within-subject controls. This may be represented statistically as left *vs* right or baseline *vs* post-perturbation hind paw difference scores. The utility of this transformation of the data is highlighted by the demonstration of Bennett and Xie that 140 normal rats exhibited difference scores that fit a Gaussian distribution with a mean and standard deviation of  $0.04 \pm 0.66$  sec (i.e. a right-left difference score of approximately zero) (Bennett and Xie 1988). This feature of the paradigm has been exploited in myriad, within-animal studies evaluating the mechanisms of hyperalgesia and inflammation and the effects of drugs or other therapeutic interventions used to counteract these processes. Thus, one could design a study to determine whether a given inflammatory agent results in a localized *vs* systemic hyperalgesia. In addition, one could distinguish between peripheral *vs* central mechanisms of action of antinociceptive agents (Jackson et al. 1995), in that PWL measurements can be made in a given paw following injection of a potentially antinociceptive test substance directly into that paw or alternatively into the contralateral paw or some other remote location, usually at a dose that is not sufficient to reach pharmacologically relevant systemic concentrations. Another application of this method is the

ability to correlate somatotopically localized biochemical, cellular and molecular alterations with behavior in the affected limb. Thus, several interesting studies were performed in which carrageenan- or CFA-induced hyperalgesia was correlated with somatotopically appropriate increases in opioid peptide gene expression in the dorsal spinal cord on the side ipsilateral to the inflammation (Iadarola et al. 1988). In addition, *in vivo* microdialysis has been used to measure and correlate the time course of the local production and/or release of inflammatory mediators with nociceptive behavior in parallel groups of animals (Hargreaves and Costello 1990).

Ultimately, the true measure of any method rests on its sensitivity, in other words, the ability to detect changes in the dependent measurement when in fact they occur. In this respect, it is significant that in the periphery, the sensitivity to detect hyperalgesia is greater for thermal *vs* mechanical stimuli in several tests (Handwerker et al. 1987). Consistent with this concept, the radiant heat device was shown to be more sensitive than the Randall and Selitto mechanical test in detecting hyperalgesia in response to a subcutaneous injection of carrageenan, which was manifested as an increase in signal-to-noise ratios, as indicated by improved ANOVA *F* ratios and increased carrageenan dose-response curve slopes (Hargreaves et al. 1988). Moreover, the radiant heat device has been used to evaluate several hundred compounds, rep-

representing at least 20 distinct classes for their ability to alter nociception and nociceptive behaviors, highlighting its utility as a tool not only for investigating the neurochemistry of pain but also for the development of novel analgesic therapeutics.

The most obvious limitation of the current method is that it does not measure mechanical nociceptive thresholds, allodynia or hyperalgesia. Moreover, the extent to which thermal hypersensitivity, as measured by this method, accurately predicts the efficacy of clinically useful drugs (based on type 1 and type 2 errors) or reliably mimics one or more than one clinically relevant pain condition/symptom remains to be determined (although the test reliably demonstrates the efficacy of a variety of currently marketed NSAID and opioid analgesics with reasonably appropriate rank order potency). Notwithstanding these *caveats*, the combination of the thermal method with mechanical tests, such as the use of von Frey filaments, offers a powerful approach to the study of a variety of nociception-modifying perturbations as well as a means for discriminating potential sensory modality differences between them. The other major disadvantage of the radiant heat method is that the glass surface may act as a heat sink, leading to artifactually short paw withdrawal latencies and a subsequent increase in assay variability (Bennett and Hargreaves 1990; Hirata et al. 1990). This factor will vary with the specific conductive properties of the floor, the ambient temperature in the experimental procedure room and the pressure exerted by the rat on the paw being tested, which last will be affected under conditions of induced inflammation or neuropathy (Bennett and Hargreaves 1990; Murphy et al. 1991). However, several suggestions have been made to counteract this effect, the most important of these being that the skin being irradiated should be in contact with the glass floor (Table 1). Modifications to the device itself include placing a nylon mesh screen between the rat and the glass (Murphy et al. 1991) or heating the floor to maintain it at a constant temperature, either by implanting a heating element within the glass or applying warm air to its underside (Galbraith et al. 1993). The minor inconveniences created by the rats urinating or defecating on the glass floor are easily remedied with a spray bottle of cleanser and a roll of paper towels.

In conclusion, the radiant heat test described here offers a simple, highly reproducible and useful approach to the study of thermal nociception in naïve and injured/inflamed rodents. Accordingly, it may be considered one of several powerful behavioral tools available to pain scientists in the investigation of nociceptive mechanisms and in the search for better and safer analgesic drugs. It is hoped that further improvements in this method, including those mentioned herein, and its use in combination with complementary behavioral assays will lead to a better understanding of the neu-

rophysiological underpinnings of pain in humans and ultimately better treatment options.

## References

1. Andreev NY, Dimitrieva N, Koltzenburg M et al. (1995) Peripheral administration of nerve growth-factor in the adult-rat produces a thermal hyperalgesia that requires the presence of sympathetic postganglionic neurons. *Pain* 63:109–115
2. Bennett GJ (1999) Does a neuroimmune interaction contribute to the genesis of painful peripheral neuropathies? *Proc Natl Acad Sci USA* 96:7737–7738
3. Bennett GJ, Hargreaves KM (1990) A model of peripheral mononeuropathy in the rat – reply. *Pain* 42:255–255
4. Bennett GJ, Xie Y-K (1988) A peripheral mononeuropathy in rat that produces disorders of pain sensation like those seen in man. *Pain* 33:87–107
5. Galbraith JA, Mrosko BJ, Myers RR (1993) A system to measure thermal nociception. *J Neurosci Methods* 49:63–68
6. Handwerker HO, Anton F, Kocher L et al. (1987) Nociceptor functions in intact skin and in neurogenic or non-neurogenic inflammation. *Acta Physiol Hung* 69:333–342
7. Hargreaves KM, Costello A (1990) Glucocorticoids suppress levels of immunoreactive bradykinin in inflamed tissue as evaluated by microdialysis probes. *Clin Pharmacol Ther* 48:168–178
8. Hargreaves KM, Dubner R, Brown F et al. (1988) A new and sensitive method for measuring thermal nociception in cutaneous hyperalgesia. *Pain* 32:77–88
9. Hirata H, Pataky A, Kajander K et al. (1990) A model of peripheral mononeuropathy in the rat. *Pain* 42:253–254
10. Iadarola MJ, Brady LS, Draisci G et al. (1988) Enhancement of dynorphin gene-expression in spinal-cord following experimental inflammation – stimulus specificity, behavioral parameters and opioid receptor-binding. *Pain* 35:313–326
11. Jackson DL, Graff CB, Richardson JD et al. (1995) Glutamate participates in the peripheral modulation of thermal hyperalgesia in rats. *Eur J Pharmacol* 284:321–325
12. Kim SH, Chung JM (1992) An experimental-model for peripheral neuropathy produced by segmental spinal nerve ligation in the rat. *Pain* 50:355–363
13. Murphy LG, Alexander GM, Schwartzman RJ (1991) Improvement to the Hargreaves paw flick method. *Pain* 46:347–347
14. Terajima K, Aneman A (2003) Citation classics in anaesthesia and pain journals: a literature review in the era of the internet. *Acta Anaesth Scand* 47:655–663

## Thermal Receptors

### Definition

Sensory receptors sensitive to thermal stimuli.

- ▶ [Hyperaesthesia, Assessment](#)
- ▶ [Hypoesthesia, Assessment](#)

## Thermal Sensory Testing

- ▶ [Quantitative Thermal Sensory Testing of Inflamed Skin](#)



## Thermal Stimulation (Skin, Muscle, Viscera)

- ▶ Pain in Humans, Thermal Stimulation (Skin, Muscle, Viscera), Laser, Peltier, Cold (Cold Pressure), Radiant, Contact

## Thermal Stimulation (Stimuli)

### Definition

Thermal stimulation (warm and cold stimuli) consists of transferring (adding or subtracting) calorific energy between the skin (or mucosa, muscle, viscera) and its surroundings.

- ▶ Causalgia, Assessment
- ▶ Dysesthesia, Assessment
- ▶ Pain in Humans, Thermal Stimulation (Skin, Muscle, Viscera), Laser, Peltier, Cold (Cold Pressure), Radiant, Contact

## Thermal Therapy

- ▶ Spa Treatment

## Thermal Transduction

- ▶ Polymodal Nociceptors, Heat Transduction

## Thermocoagulation

### Definition

Destroying tissue (e.g. nerves) by heating.

- ▶ Cancer Pain Management, Anesthesiologic Interventions, Neural Blockade
- ▶ Radiofrequency Neurotomy, Electrophysiological Principles

## Thermode

### Definition

A thermode is a device used to apply controlled temperature to the skin of subjects or animals. One surface of the thermode is placed in contact with the skin. The temperature at that surface is controlled with the use of heating elements, Peltier elements, and/or circulating water.

The surface temperature is measured with a thermocouple or thermister, which is used in a feedback manner to regulate the thermode's surface temperature.

- ▶ Threshold Determination Protocols

## Thermography

### Definition

Detects and delineates areas of cutaneous thermal change.

- ▶ Postoperative Pain, Acute Presentation of Complex Regional Pain Syndrome

## Thermoreception

- ▶ Lateral Thalamic Pain-Related Cells in Humans

## Thermoreceptor

### Definition

Cutaneous, oral and visceral receptors responding only or preferentially to temperature within the innocuous or nonpainful range. Thermoreceptors show static and dynamic sensitivity to temperature.

- ▶ Nociceptors, Cold Thermotransduction

## Thermoregulation

### Definition

Rodents regulate body temperature mainly by regulating blood flow in the tail by an on-off mechanism, suddenly changing the tail skin temperature by up to 8–10°C.

- ▶ Tail-Flick Test

## Theta Rhythm

### Definition

Frequency domain of oscillatory hemispheric activity between 4 and 8 Hz. It has been associated with different functional brain states, e.g. somnolence, cognitive activations, altered states of consciousness like meditation, and, relevant here, dysfunctional brain states like neurogenic pain and tinnitus, abnormal movements, epilepsy and neuropsychiatric disorders (see thalamocortical dysrhythmia).

- ▶ Thalamotomy for Human Pain Relief

## Thoracic Epidural Analgesia

### Definition

Pain relief obtained by drugs acting directly on the spinal cord, e.g. morphine, local anesthetics, adrenaline (epinephrine), clonidine, and neostigmine.

- ▶ Postoperative Pain, Acute Pain Management, Principles
- ▶ Postoperative Pain, Acute Pain Team

## Thoracic Epidural Anesthesia

### Definition

For thoracic epidural anesthesia the catheters are inserted dependent on the surgical procedure, between level T4–T12 by a median or paramedian approach and usually with the loss of resistance technique. Postoperatively, the patient has perfect analgesia and can be mobilized.

- ▶ Postoperative Pain, Thoracic and Cardiac Surgery

## Thoracic Medial Branch Blocks and Intra-Articular Blocks

PAUL VERRILLS

Metropolitan Spinal Clinic, Prahran, VIC, Australia  
verrills@bigpond.net.au

### Synonyms

Intra-Articular Blocks and Thoracic Medial Branch Blocks

### Definition

Thoracic medial branch blocks and intra-articular blocks are both diagnostic procedures designed to test if the patient's pain arises from a thoracic zygapophysial joint. They involve anaesthetising the joint or its nerve supply with injections of small volumes of local anaesthetic.

### Characteristics

The thoracic zygapophysial joints may be a cause of posterior thoracic spinal pain. Studies in normal volunteers (Dreyfuss et al. 1994), and in patients (Fukui et al. 1997), have shown that noxious stimulation of these joints produces local and ▶ **somatic referred pain** in a segmental pattern along the posterior chest wall (Fig. 1). There are no means clinically, or by medical imaging, by which pain from these joints can be diagnosed. The

only means of determining if they are a source of pain is to anaesthetise putatively symptomatic joints.

The thoracic zygapophysial joints can be anaesthetised either by injecting local anaesthetic into the joint cavity, or by anaesthetising the medial branches of the dorsal rami that innervate them. Respectively, these procedures are called thoracic intra-articular zygapophysial joint blocks and thoracic medial branch blocks.

### Intra-Articular Block

The thoracic zygapophysial joints are not directly evident on anteroposterior views of the thoracic spine, because their joint cavities are orientated in a coronal plane. Nevertheless, the location of each joint can be inferred. The joint lies opposite the inter-vertebral disc of the segment, between the pedicles of the two vertebrae that contribute to the joint.

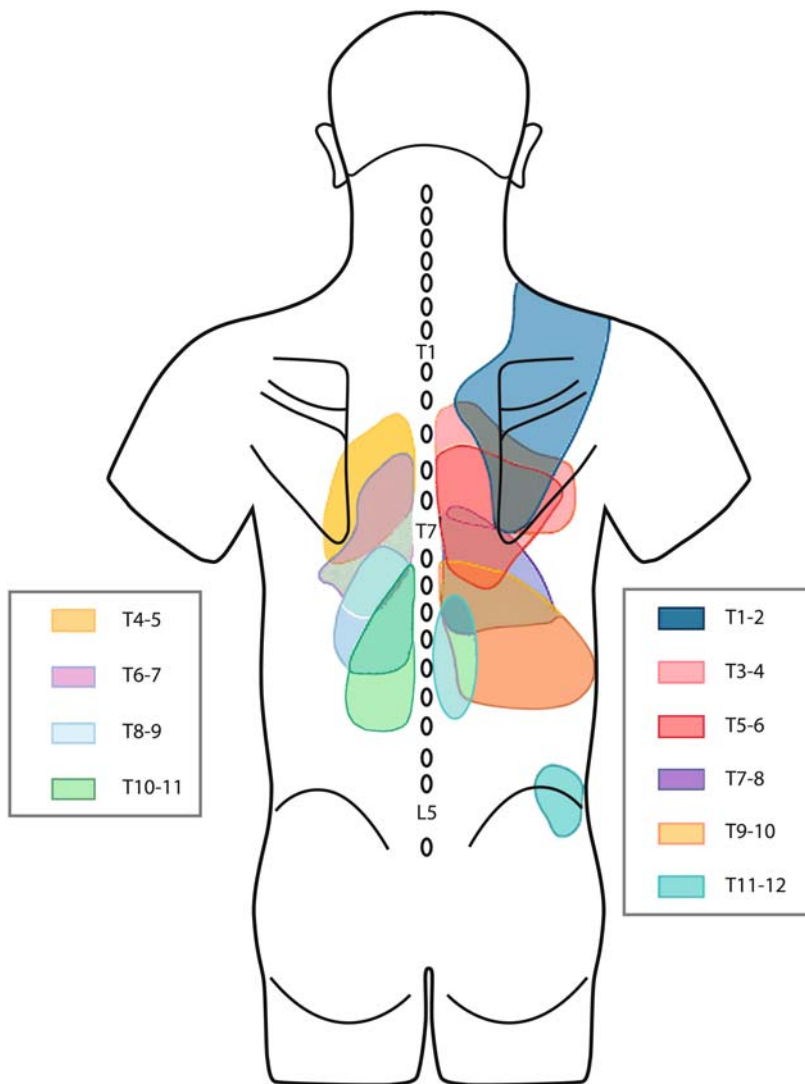
Once the target joint has been identified, a puncture point on the skin is selected, about three-quarters of a segment caudal to the joint, on a caudal extension of the sagittal bisector of the pedicle below the target joint. A spinal needle is introduced at around 60 degrees caudal to the perpendicular, and is advanced towards the lower quarter of the silhouette of the pedicle below the joint (Dreyfuss et al. 1994; International Spinal Intervention Society 2004a). A contra-lateral oblique view can then be used to carefully advance the needle into the inferior margin of the joint (Fig. 2a). Once the needle has entered the joint, an anteroposterior view is used in order to check that the needle has not strayed medially or laterally (Fig. 2b).

Intra-articular placement is verified by injecting 0.1 ml of contrast medium, in order to obtain an arthrogram (Dreyfuss et al. 1994; International Spinal Intervention Society 2004a) (Fig. 3). Subsequently, the joint is anaesthetised by injecting 0.75 ml of local anaesthetic.

### Medial Branch Block

The thoracic medial branches cross the thoracic transverse processes obliquely, passing from the region of the superior lateral corner of the process to its infero-medial corner. At segmental levels T1–4 and T9 and T10, the nerves lie on the posterior surface of the transverse process, slightly below and just medial to the superior lateral corner of the transverse process. This point constitutes the target point for medial branch blocks at these levels (Chua and Bogduk 1995; International Spinal Intervention Society 2004b).

Under postero-anterior fluoroscopic screening, a spinal needle is inserted through the skin of the posterior thorax, and passed towards the target point of the nerve to be blocked (Fig. 4). Once the needle has reached bone, a test-dose of contrast medium is injected under continuous fluoroscopic screening to ensure that there is no vascular uptake, and to determine that the injectate spreads appropriately (International Spinal Intervention Society 2004b). To block the nerve, 0.3 ml



**Thoracic Medial Branch Blocks and Intra-Articular Blocks, Figure 1** The distribution of referred pain from the thoracic zygapophysial joints. Based on Dreyfuss et al. 1994 and Fukui et al. 1997.

T

of local anaesthetic is injected. To anaesthetise a given zygapophysial joint, both the nerves that innervate it are blocked.

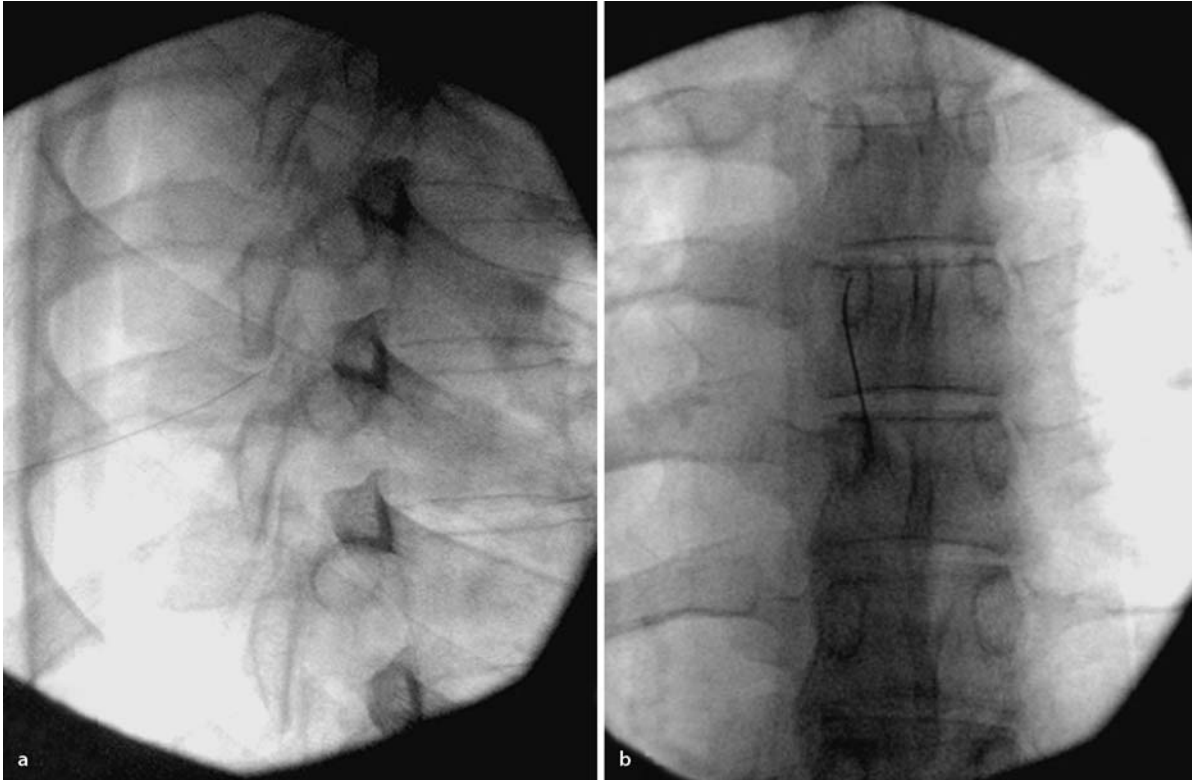
At the T4 to T8 levels, the medial branches do not run on bone. From the intertransverse space, they are suspended dorsal to the depth of the transverse process (Chua and Bogduk 1995). In order to block the nerve, a needle is delivered into the intertransverse space, slightly cranial to the tip of the transverse process (International Spinal Intervention Society 2004b). In this location, a small volume of contrast medium is injected, in order to confirm appropriate spread of injectate. Thereupon, local anaesthetic can be injected to anaesthetise the nerve.

The T11 and T12 medial branches assume a course similar to that of the lumbar medial branches. The target points and technique for these nerves are like those for ► [lumbar medial branch blocks](#).

### Evaluation

The optimal means of reducing error and securing reliable diagnostic information is real time assessment. The response to the diagnostic block is evaluated immediately after the block, and for some time afterwards, at the clinic at which the block was performed, and by an independent observer using validated and objective instruments or tools (Dreyfuss et al. 1994; International Spinal Intervention Society 2004b).

Visual analogue scores are recorded before the block, immediately afterwards, at 30 minutes and then hourly. The patient is instructed to monitor the extent and duration of any relief that ensues. Further, if relief occurs, the patient should carefully attempt movements and activities that are usually restricted by pain to assess their response during the anaesthetic phase.



**Thoracic Medial Branch Blocks and Intra-Articular Blocks, Figure 2** Radiographs of a needle in position for an intra-articular injection of a thoracic zygapophysial joint. (a) Lateral view. (b) AP view. Reproduced courtesy of the International Spinal Intervention Society (2004a).

If the response to the block is negative, then zygapophysial joint pain can effectively be ruled out at the level tested. Adjacent levels may then be blocked based on clinical indication.

If the response to the block is positive, then a control block is undertaken. If the patient has a concordant response to controlled blocks, then the putative diagnosis of zygapophysial joint pain is confirmed.

#### Validity

Single diagnostic blocks of thoracic medial branches carry a false-positive rate of 58% (Manchikanti et al. 2002). Control blocks are, therefore, mandatory (International Spinal Intervention Society 2004b; Manchikanti et al. 2002).

Although placebo controlled blocks could be used, they require three injections, and are not readily implemented in clinical practice. Comparative local anaesthetic blocks, using lignocaine 2%, as a short-acting agent, and bupivacaine 0.5% as a long-acting agent, are a valid alternative (International Spinal Intervention Society 2004b; Manchikanti et al. 2002; Barnsley et al. 1993; Lord et al. 1995). A concordant response would be complete relief of pain for a shorter duration following the short-acting agent, and a longer duration of relief following the long-acting agent (see ► [Peripheral](#)

[Nerve Blocks](#)). Complete relief of pain on each of the two occasions, regardless of duration of relief, increases the positive yield of blocks, but increases the risk of false-positive responses.

Similar controls have not been evaluated for intra-articular blocks. Their validity has not been established.

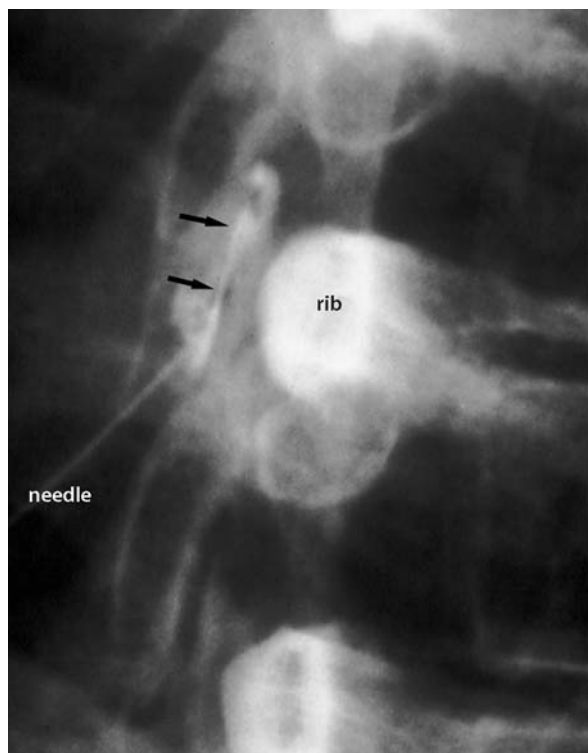
#### Application

Only one study has described the application of thoracic medial branch blocks in clinical practice (Manchikanti et al. 2002). It reported that 48% of patients had their pain relieved with the medial branch blocks. The study thereby established that thoracic zygapophysial joint blocks have a considerable diagnostic utility in clinical practice. However, it did not indicate which segmental levels were most commonly the source of pain.

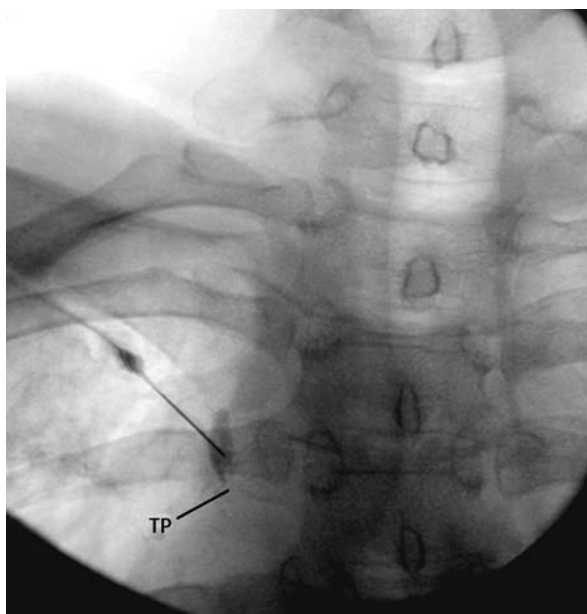
By analogy, with lumbar and cervical spine, one would expect the therapeutic utility of thoracic medial branch blocks would be to select patients for medial branch ► [radiofrequency neurotomy](#). However, there are no publications to describe a valid technique, or to establish the efficacy of such treatment in the thoracic spine. Therefore, the therapeutic utility of thoracic zygapophysial joint blocks is only potential.

Although intra-articular blocks constitute an alternative means of diagnosing thoracic zygapophysial joint pain,





**Thoracic Medial Branch Blocks and Intra-Articular Blocks, Figure 3**  
A lateral radiograph of an arthrogram of a thoracic zygapophysial joint. The arrows point to contrast medium inside the joint. Reproduced courtesy of the International Spinal Intervention Society (2004a).



**Thoracic Medial Branch Blocks and Intra-Articular Blocks, Figure 4**  
An AP radiograph showing a needle in place for a thoracic medial branch block, and an injection of contrast medium to show spread of injectate over the superior lateral corner of the transverse process. The inferior border of the transverse process (TP) is labelled. Reproduced courtesy of the International Spinal Intervention Society 2004a.

no studies have described any results from their use. Some operators administer intra-articular injections of corticosteroids as a treatment for thoracic zygapophysial joint pain, but no studies have reported the efficacy of this treatment.

#### Patient Selection

Thoracic zygapophysial joint blocks are not indicated in acute pain. They are relevant only for patients with persistent thoracic spinal pain, in whom a diagnosis is required. A prerequisite is that serious possible causes of pain such as infection, tumours, vascular disease and metabolic disease have been excluded by careful and thorough history and examination, laboratory tests, and medical imaging if necessary. The working diagnosis should be that of thoracic spinal pain of unknown origin. The minimum criterion should be that the patient has pain in a distribution that resembles that shown to emanate from thoracic zygapophysial joint in normal volunteers (Dreyfuss et al. 1994; Fukui et al. 1997).

#### Contraindications

Absolute contra-indications include bacterial infection, either systemic or localised in the region that blocks are to be performed, bleeding diatheses or possible pregnancy. Relative contraindications include allergy to contrast media or local anaesthetics.

#### References

1. Barnsley L, Lord S, Bogduk N (1993) Comparative Local Anaesthetic Blocks in the Diagnosis of Cervical Zygapophysial Joint Pain. *Pain* 55:99–106
2. Chua WH, Bogduk N (1995) The Surgical Anatomy of Thoracic Facet Denervation. *Acta Neurochir* 136:140–144
3. Dreyfuss P, Tibiletti C, Dreyer SJ (1994) Thoracic Zygapophysial Joint Pain Patterns. A Study in Normal Volunteers. *Spine* 19:807–811
4. Dreyfuss P, Tibiletti C, Dreyer S, Sobel J (1994) Thoracic Zygapophysial Joint Pain: A Review and Description of an Intra-Articular Block Technique. *Pain Digest* 4:46–64
5. Fukui S, Ohseto K, Shiotani M (1997) Patterns of Pain Induced by Distending the Thoracic Zygapophysial Joints. *Regional Anesthesia* 22:332–336
6. International Spinal Intervention Society (2004a). Thoracic Intra-Articular Zygapophysial Joint Blocks. In: Bogduk N (ed). *Practice Guidelines for Spinal Diagnostic and Treatment Procedures*. International Spinal Intervention Society, San Francisco (in press)
7. International Spinal Intervention Society (2004b). Thoracic Medial Branch Blocks. In: Bogduk N (ed) *Practice Guidelines for Spinal Diagnostic and Treatment Procedures*. International Spinal Intervention Society, San Francisco (in press)
8. Lord SM, Barnsley L, Bogduk N (1995) The Utility of Comparative Local Anaesthetic Blocks versus Placebo-Controlled Blocks for the Diagnosis of Cervical Zygapophysial Joint Pain. *Clin J Pain* 11:208–213
9. Manchikanti L, Singh V, Pampati V, Beyer CD, Damron KS (2002) Evaluation of the Prevalence of Facet Joint Pain in Chronic Thoracic Pain. *Pain Physician* 5:354–359

## Thoracic Outlet Syndrome

A. LEE DELLON<sup>1, 2</sup>

<sup>1</sup>Plastic Surgery and Neurosurgery, Johns Hopkins University, Baltimore, MD, USA

<sup>2</sup>Plastic Surgery, University of Arizona, Tucson, AZ, USA

aldellon@erols.com

### Synonyms

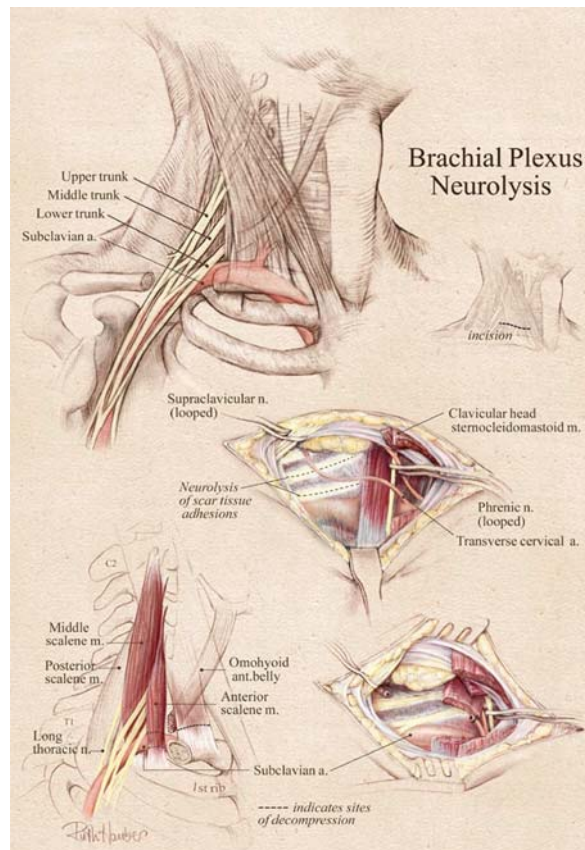
Brachial Plexus Compression; Scalenus Anticus Syndrome; Costoclavicular Syndrome

### Definition

Thoracic Outlet Syndrome is a misnomer for the symptoms caused by compression of the brachial plexus in the thoracic inlet. The symptoms have a wide range that can encompass any manifestation related to the motor or sensory functions of the cervical nerve roots C5, C6, C7, C8, and T1. There can be secondary symptoms related to the cervical plexus and shoulder dysfunction. The most common symptoms are aching in the shoulder, numbness in the fingers, with the symptoms being aggravated or initiated by elevating the arm above the shoulder level. The syndrome most commonly occurs in the setting of neck or shoulder trauma, and is often related to the presence of anatomical congenital anomalies. Due to the inability of traditional electrodiagnostic testing to identify this syndrome, except for the isolated problem with the lower trunk of the brachial plexus, diagnosis and treatment for brachial plexus compression in the thoracic inlet remains a controversial source of neck, shoulder and upper extremity pain.

### Characteristics

The subclavian artery and subclavian vein exit the thorax and enter the upper extremity by a path that takes them into the supraclavicular region, and then between the clavicle and the first rib and into the axilla. The anterior scalene muscle is usually located between these two large blood vessels as it inserts into the first rib. Post-traumatic tightness or anatomic anomalies in this region can cause vascular symptoms such as purplish color and swelling due to venous obstruction, or coldness and digital necrosis due to arterial obstruction and emboli. These vascular forms of the "thoracic outlet syndrome" are responsible for about 5% of the patients with symptoms in this region, and the diagnosis is made by radiologic imaging of these vessels with the arm at rest and the arm elevated. These vessels actually leave the thorax, and pass across the thoracic inlet to reach the axilla (Fig. 1). Relief of obstruction is surgical, requiring resection of the anterior scalene muscle or excision of the first rib. Different anatomic approaches, supraclavicular or transaxillary, are currently in use. These vascular syndromes do not have neurologic symptoms,



Thoracic Outlet Syndrome, Figure 1 Brachial Plexus Neurolysis.

but can be associated with compression of the brachial plexus in this same region (Mackinnon and Dellon 1988; Leffert 1992). The classic physical examination maneuvers related to the disappearance of the radial pulse when the hand is elevated or the head is turned, are best related to the arterial form of compression in this region, but can be present in 33% of the normal population.

When the lower trunk of the brachial plexus, formed from the C8 nerve root and T1 nerve root, are compressed against the posterior border of the first rib by a tumor (Pancoast Syndrome, upper pulmonary lobe bronchogenic carcinoma, or benign neural tumor like Schwannoma or neurofibroma), trauma, or congenital anomaly, the patient experiences symptoms of coldness in the arm, apart from subclavian artery compression (because the sympathetic input from the stellate ganglion enters the lower trunk). They also experience numbness of the little and ring finger, as well as the upper inner arm, and intrinsic muscle weakness, because these are the skin territories innervated by these nerve roots, and all the intrinsic muscles of the hand are innervated by these nerve roots. Note that the compression site is at the thoracic inlet (the thoracic outlet is the diaphragm). Therefore, this is the one form of

thoracic outlet syndrome that can be identified by electrodiagnostic testing (EDT) (Gilliatt et al. 1970). The EDT will demonstrate abnormal electromyography of both median and ulnar nerve innervated intrinsic muscles (typically the abductor digiti minimi, the first dorsal interosseous, and the opponens pollicis and the abductor pollicis brevis), with a decreased sensory amplitude for the little finger while the sensory amplitude remains normal for the index finger. This “true neurogenic” thoracic outlet syndrome is rare, accounting for less than 1% of patients with thoracic outlet syndrome.

The vast majority of patients (94%) have complaints that are often global in nature, which has led some to doubt the existence of this syndrome (Cherington and Cherington 1992; Roos and Wilbourn 1990). Headaches, shoulder pain, diffuse weakness in the upper extremity, numbness in the little and ring finger, but also in all fingers, and these symptoms being made worse by any activity that requires elevation of the shoulder. In some women there is breast pain. In some patients there is upper back or scapular pain. In some patients there is pain in the temporomandibular joint, requiring evaluation by a Dentist or Oral Surgeon. In some there is neck pain. It is critical to appreciate that the brachial plexus does take a course across the thoracic inlet to enter the axilla between the clavicle (which is concave at this location) and the second rib; it does not travel between the clavicle and the first rib. The upper trunk of the brachial plexus does travel beneath the anterior scalene muscle. There is a spectrum of congenital anomalies that course across or through or under the brachial plexus that are responsible for the symptoms of the nerve compression, and depending upon the location of the compression sites, the symptoms will vary. These include:

- Cervical rib
- Fibrous Bands from C7 transverse process
- Extra Origins for Scalene Muscles
- Pre- or Post-fixed Brachial Plexus
- Intra-Plexus anomalous connections
- Elevated position of Subclavian Artery
- Muscle of Albinus (scalenus minimus)
- Fibrous edges of Scalene Muscles
- Anomalous vessels crossing Plexus
- Sibson’s Fascia crossing T1 nerve root
- Proximal junction of T1 to C8

Secondary compression of the cervical plexus by a tight or spasmodic anterior scalene muscle is the cause of the facial pain, and this muscle pulling upon the occiput is the source of the headache (Mackinnon and Dellon 1988). A winging component to the scapula is due to compression of the long thoracic nerve as it exits between the medial and posterior scalene muscles, and this can be corrected by including a neurolysis of this branch of the brachial plexus in the surgical approach (Disa et al. 2001).

Diagnosis of brachial plexus compression in the thoracic inlet has been a challenge. Traditional EDT cannot identify this compression because the site is too close to the spinal nerve roots, because the variation in thickness of the chest wall invalidates amplitude measurements, and because the inability to measure distance variable invalidates nerve conduction measurements. The H-wave is not reliable because as the impulse travels from the finger to the spinal cord and back to the hand, multiple potential sites of entrapment are encountered at the wrist, forearm and elbow. (Wilbourn and Urschel 1984) Since the symptoms are produced or aggravated when the hands are elevated above the head, provocation of the plexus in such a manner has been used to identify patients with thoracic outlet syndrome, a positive Roos sign (Roos 1966). Palpation over the brachial plexus in the thoracic inlet will produce a distally radiating sign when the plexus is compressed beneath anatomic structures in this location, positive Tinel sign or pressure provocative test (Novak et al. 1995). Based upon the assumption that measurement of the cutaneous pressure threshold would change for the index finger (representing the upper trunk) and the little finger (representing the lower trunk), when the threshold was compared between the at rest and the provoked measurement, the Pressure-Specified Sensory Device™ was introduced for diagnosis (Lee et al. 2000). This approach was refined to include measurements of one and two-point static and moving-touch, plus pinch and grip strength (Howard et al. 2003). A sensitivity of 100% and a specificity of 88% were obtained in the diagnosis of severe brachial plexus compression using this approach. Treatment of brachial plexus compression should include stretching of the anterior scalene and strengthening of the upper trapezius, rhomboids, and serratus anterior muscles (Novak et al. 1995). This approach can relieve symptoms in 90% of patients. In those patients who fail to respond to non-operative methods, an exhaustive diagnostic approach must be undertaken to rule out causes that may give similar pain, prior to undertaking a surgical decompression of the plexus. Additional diagnostic testing should include chest X-ray, cervical and shoulder MRI, and evaluation of peripheral nerve entrapments such as carpal and cubital tunnel syndrome, since these entrapments, cervical disc disease and intrinsic shoulder pathology are the commonest causes of these types of pain (Campbell et al. 1991; Levin and Dellon 1992).

The surgical treatment of brachial plexus compression must accomplish a decompression of the brachial plexus from whichever structure or structures are causing the compression. Historically, just the scalenus anterior was resected (Mackinnon and Dellon 1988). In 1966, the transaxillary first rib resection was introduced, with the concept that the plexus was compressed between the first rib and the clavicle (Roos 1966). This is a difficult approach, requiring wide retraction from the axilla in order to reach the posterior border of the first rib. Com-



plications include burning pain in the distribution of the 2<sup>nd</sup> or 3<sup>rd</sup> intercostobrachial nerve due to stretch/traction injury, and injury to the subclavian artery, pneumothorax, and injury to the C8 or T1 nerve roots, as they cross the posterior border of the first rib. Due to persistent upper trunk symptoms following transaxillary first rib resection, an anterior scalene resection often had to be added as a secondary procedure. This gave rise to the supra-clavicular surgical approach through which the anterior (and medial) scalene muscles could be resected, a neurolysis of the brachial plexus could be done under direct vision, the major vessels could be identified and protected, and a cervical or first rib could still be resected if necessary (Dellon 1993; Hempel et al. 1996; Sanders 1991). The results reported by Hempel et al in 1996 are worth noting: During a 28-year period, 637 patients underwent 770 supraclavicular first rib resections and scalenectomies for thoracic outlet syndrome. Following surgery an excellent response was achieved in 59%, good in 27%, fair in 13%, and poor in 1%. One lymphatic leakage and no brachial plexus injuries resulted. Postoperative causalgia requiring subsequent sympathectomy developed in two cases. No vascular or permanent phrenic nerve injuries occurred, and 12 patients (2%) required operative intervention for recurrence. Sanders, in 1991, reported no difference in the outcome whether he resected the first rib, or did not resect it. The author's preferred approach is a supraclavicular anterior scalenectomy and neurolysis of the brachial plexus, preserving the first rib. During fifteen years with this approach, there has not been one pneumothorax, or injury to the brachial plexus or major vessels. There have been two patients with transient phrenic nerve palsy.

## References

- Campbell JN, Naff N, Dellon AL (1991) Thoracic Outlet Syndrome: A Neurosurgical Perspective. *Neurosurg Clin N Am* 2:227–234
- Cherington M, Cherington C (1992) Thoracic Outlet Syndrome Reimbursement Patterns and Patient Profiles. *Neurology* 42:492–495
- Dellon AL (1993) The Results of Supraclavicular Brachial Plexus Neurolysis (without First Rib Resection) in Management of Post-Traumatic "Thoracic Outlet Syndrome". *J Reconstr Microsurg* 9:11–17
- Disa J, Wang B, Dellon AL (2001) Correction of Scapular Winging by Neurolysis of the Long Thoracic Nerve. *J Reconstr Microsurg* 17:79–84
- Gilliatt RW, Le Quesne PM, Logue V et al. (1970) Wasting of the Hand Associated with a Cervical Rib or Band. *J Neurol Neurosurg Psychiatry* 33:615–619
- Hempel GK, Shutze WP, Anderson JF et al. (1996) 770 Consecutive Supraclavicular First Rib Resections for Thoracic Outlet Syndrome. *Ann Vasc Surg* 10:456–463
- Howard M, Lee C, Dellon AL (2003) Documentation of Brachial Plexus Compression in the Thoracic Inlet Utilizing Provocation with Neurosensory and Motor Testing. *J Reconstr Microsurg* 19:303–312
- Lee GW, Massry DR, Kupfer DM et al. (2000) Documentation of Brachial Plexus Compression in the Thoracic Inlet with Quantitative Sensory Testing. *J Reconstr Microsurg* 16:15–20
- Leffert RD (1992) Thoracic Outlet Syndromes. *Hand Clinics* 8:285–291
- Levin LS, Dellon AL (1992) Pathology of the Shoulder as it Relates to the Differential Diagnosis of Thoracic Outlet Compression. *J Reconstr Microsurg* 8:313–317
- Mackinnon SE, Dellon AL (1988) *Surgery of the Peripheral Nerve*, 1<sup>st</sup> edn. Thieme, New York, pp 175–191
- Novak CB, Collins ED, Mackinnon S (1995) Outcome following Conservative Management of Thoracic Outlet Syndrome. *J Hand Surg* 20A:542–548
- Roos D (1966) Transaxillary Approach to the First Rib to Relieve Thoracic Outlet Syndrome. *Ann Surg* 163:354–358
- Roos D, Wilbourn AJ (1990) Thoracic Outlet Syndrome is Under-rated/Overdiagnosed. *Arch Neurol* 47:228–230
- Sanders RJ (1991) Thoracic Outlet Syndrome: A Common Sequelae of Neck Injuries. JB Lippincott Co, Philadelphia
- Wilbourn A, Urschel HC (1984) Evidence for Conduction Delay in Thoracic Outlet Syndrome is Challenged. *New Eng J Med* 310:1052–1053

## Thoracic Surgery

### Definition

Thoracic surgery includes all thoracic surgical procedures performed with lateral thoracotomy or median sternotomy.

- ▶ [Postoperative Pain, Thoracic and Cardiac Surgery](#)

## Thought Suppression

### Definition

The intentional act of excluding certain thoughts from consciousness.

- ▶ [Psychology of Pain, Assessment of Cognitive Variables](#)

## Threat Appraisal

### Definition

The judgment that a stressful event, such as pain, is threatening.

- ▶ [Psychological Aspects of Pain in Women](#)

## Three-Way Scaling Models

### Definition

Three-way scaling models provide, in addition to the group stimulus space, a subject weight space that provides coordinates for the dimensions most salient to each individual.

- ▶ [Multidimensional Scaling and Cluster Analysis Application for Assessment of Pain](#)



## Threshold

### Definition

The threshold is the endpoint for the appearance of a given reaction or behavior.

- ▶ [Randall-Selitto Paw Pressure Test](#)
- ▶ [Statistical Decision Theory Application in Pain Assessment](#)

## Threshold Determination Protocols

JOEL D. GREENSPAN

Department of Biomedical Sciences, University of Maryland Dental School, Baltimore, MD, USA  
jgreenspan@umaryland.edu

### Synonyms

Quantitative Sensory Testing (QST). Although not strictly synonymous, QST refers to a particular set of threshold determination protocols used for both pain and innocuous sensory evaluation.

### Definition

Threshold determination protocols are those psychophysical procedures used to estimate perceptual threshold. These protocols (of which there are several) are defined by the rules by which stimuli are applied, the ways that responses are measured, and how the entire sequence of events is orchestrated.

### Characteristics

There are several protocols in the literature that estimate pain threshold. To a large extent, these protocols are the same as those used to estimate the threshold of other sensory systems. These protocols have been developed and modified over the last 150 years, resulting in many variations (Boring 1942).

One important distinction is between those protocols that depend upon the subject's reaction time (RT), and those that do not (Yarnitsky 1997). The most commonly used RT-dependent protocol is referred to as the Method of Limits. Within this protocol, the stimulus intensity (i.e. temperature with a thermal probe or force with a pressure ▶ [algometer](#)) is gradually increased until the point at which the subject indicates he feels pain, typically by pushing a button. The stimulus level at the time of that report is taken as the pain threshold (Fig. 1, top). One can also use this same approach and have the subject indicate the limits of his tolerance.

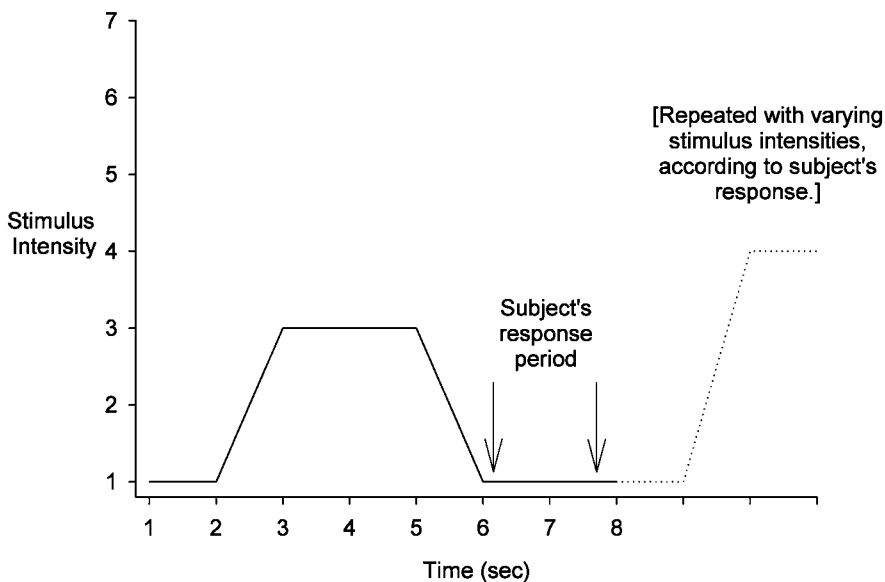
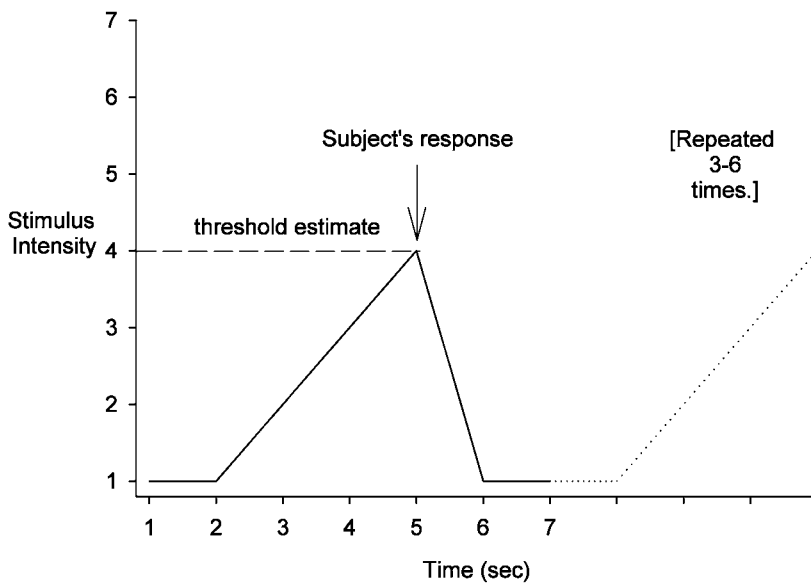
A major reason for its wide use is the simplicity of this protocol, particularly in the clinical environment. However, it has some distinct disadvantages, including the obvious confound of a motor response

embedded in the measure. One must consider, for instance, in comparing two groups of people, whether a group difference in motor reaction time could be large enough to produce different thresholds with this measure. Alternatively, and perhaps more likely, is whether slower decision making in one group vs. another (i.e. aged or patient groups) could account for slower responses, thus leading to higher thresholds.

One of the common variants of this protocol uses a contact ▶ [thermode](#), and runs a series of trials to estimate the threshold for innocuous thermal sensation (warm and cool), and then cold pain and heat pain. In the example provided in Figure 2 (Greenspan 2001), the thermode was placed on the test site (right foot) at an adapting temperature of 32°C. Then, without warning to the subject, the temperature was decreased (cool or cold pain trials) or increased (warm or heat pain trials) at a fixed rate of temperature change (1.0°C/s). The subject depressed a button when she felt the particular sensation for which she was instructed to attend. These trials are repeated typically 3–4 times for each sensory modality, and an average value is calculated for threshold.

A variant of this protocol was referred to as the ▶ [Marstock method](#), and used oscillating temperatures between warm and cool or heat and cold pain thresholds (Fruhstorfer et al. 1976). While somewhat faster than a protocol that separately evaluated warm, cool, heat pain and cold pain thresholds, the Marstock method relied on the subject recognizing the change in temperature direction each time, and knowing which sensation to attend to at any point in time. This may be confusing for a patient with ▶ [paresthesia](#), or those who have completely lost the ability to feel some sensory qualities.

Almost all other pain threshold protocols use fixed duration stimuli of a prescribed intensity, and do not rely on the subject's reaction time (see Fig 1, bottom). The most common protocol of this type is a Staircase protocol, or one of its variants, including the Method of Levels. In this type of method, a series of stimulus intensities is prescribed with a few simple rules. After a single stimulus is applied, the subject reports whether it was painful or not. If it was not painful, the next stimulus is more intense. If it was painful, the next stimulus is less intense. Stimuli are applied according to these rules until a predefined endpoint is reached. That endpoint can be defined in terms of the number of "response reversals" (i.e. going from "painful" to "non painful", or vice versa, from one trial to the next). Variations of this protocol include the way in which stimulus intensity is changed from trial to trial. For instance, it is common to start the protocol with relatively large changes (or "steps") in stimulus intensity from trial to trial (such as 2–4°C steps to derive heat or cold pain), and reduce step size as the session progresses. The initial temperature is typically chosen to be well below pain threshold, so subsequent stimuli

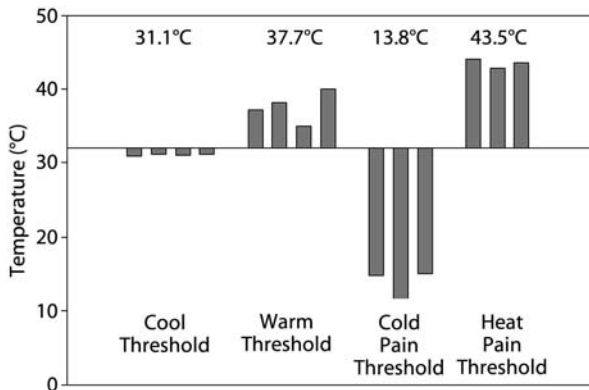


**Threshold Determination Protocols, Figure 1** Representation of a reaction time-dependent (top) and a reaction time independent (bottom) protocol. Top: Stimulus intensity increases until the subject indicates (s) he feels pain (or another specified percept), at which time the stimulus is returned to its baseline level. The stimulus intensity at the time of the report is taken as an estimate of threshold. This process is repeated, and the threshold estimates averaged across trials. Bottom: A prescribed stimulus is presented, and the subject is instructed to provide a response at the end of the stimulus (i.e. "painful" or "not painful"). Depending upon the response, subsequent stimuli are of either greater or lesser intensity. See text for further details.

will be of larger intensity, until the subject reports that one of the stimuli is painful. At that point, the next stimulus is of a lower intensity, but the change in temperature will be less (for instance, half of the step size used to that point). Once a stimulus intensity is reached that is not painful, the next stimulus will be of a greater intensity, but will be yet a smaller step size. In this manner, the stimuli are "titrated" to reach the intensity closest to the painful/non-painful level, ultimately at the smallest step size (resolution) desired. For the Method of Levels, the step sizes are gradually reduced, and the protocol is complete when the minimally desired step size is achieved. In this case, the threshold is the average of the temperature at the last two response reversals. For the Staircase protocol, the step sizes reduce quickly to a minimal value, and

the protocol continues using that step size for several response reversals. In this case, the threshold is calculated as an average of the last few (typically 4–6) response reversal temperatures.

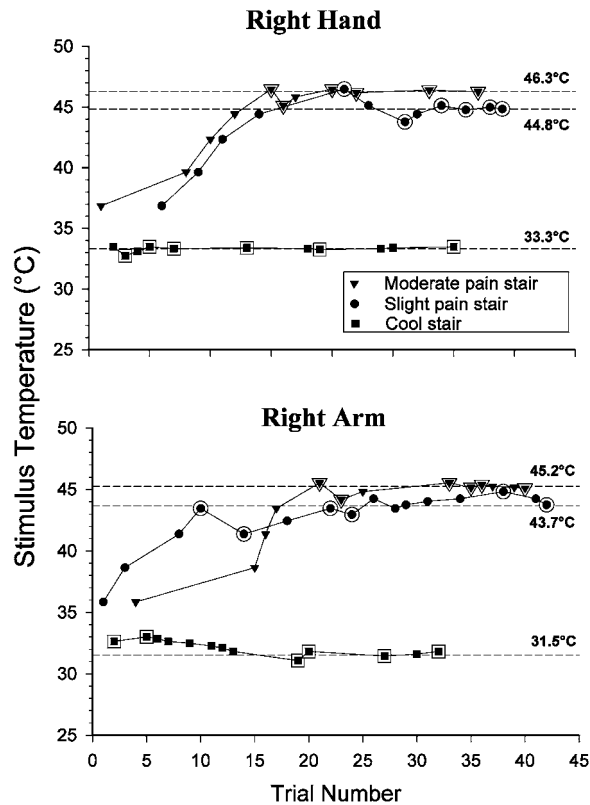
A simpler variant of this type of protocol is to use a series of stimuli in ascending intensity, until a stimulus is given that the subject reports as painful. This protocol is something like the Method of Limits (in terms of increasing stimulus intensity), but uses discrete stimulus trials, to make it a reaction time-independent protocol. The threshold would be estimated as the stimulus intensity between the first painful stimulus and the immediately preceding one. This Ascending Method of Limits would be repeated several times, and threshold estimates averaged. A protocol of this type has been success-



**Threshold Determination Protocols, Figure 2** An example of a threshold data set gathered using the Method of Limits protocol. The bars represent the temperature reached for each trial at the time the subject pressed a button to indicate she felt a particular perception. The particular sensation for any given set of trials is indicated at the bottom of the graph. The threshold for each sensory percept is calculated as the average of each trial, and indicated at the top of the graph (Adapted from data presented in Greenspan 2001).

fully used for mechanical pain thresholds (Greenspan and McGillis 1991) and heat pain thresholds (Dyck et al. 1996).

One problem with these protocols is the subjects' predictability of the stimulus sequence, particularly after some experience with it. One way to thwart such predictability is to include some "out of sequence" stimulus intensities at random times, which are irrelevant to the course of the staircase. Another way is to use a Multiple Staircase protocol. For this protocol, one starts two or more staircases, each operating by the same rules described above. However, from trial to trial, the stimulus may be drawn from any of the staircases, determined randomly. Thus, at the end of the protocol, one has two or more estimates of pain threshold – one derived from each staircase – and the stimulus sequence was unpredictable on a trial by trial basis. Another variation of the multiple staircase protocol allows one to derive thresholds for more than just the pain threshold. If the subject is instructed to report from a list of qualitative descriptors (i.e. "warm", "hot", "slight pain", "moderate pain", etc.), one can prescribe a staircase to titrate to any one of the qualitative percepts. Gracely et al. (1988) used this protocol to derive thresholds for "slight pain", "moderate pain", and "intense pain", in a single test session, with heat stimuli. Taylor et al. (1993) and Greenspan et al. (1993) used a multiple staircase protocol to derive thresholds for "cool"; "slight heat pain" and "moderate heat pain" (see Fig. 3). However, the Greenspan et al. report revealed that mixing of cool and heat stimuli increased the incidence of paradoxical heat sensations, rendering cool threshold estimates problematic in some instances. Thus, it may be preferable to restrict multiple staircases (or any other threshold protocol) to either detection or pain thresholds, within a single modality, for any single block of trials.



**Threshold Determination Protocols, Figure 3** Data from two multiple-staircase sessions using thermal stimuli. Three different staircases were prescribed: one for cool sensation, one for slight heat pain sensation, and one for moderate heat pain sensation. Each filled symbol represents a single temperature presentation (a trial). After each stimulus was presented, the subject chose a descriptor that best represented his sensation from a list of thermal and pain terms. For each staircase, successive stimuli were more intense until the criterion response was elicited. Then, subsequent stimuli were progressively less intense, until a response other than the criterion response was elicited. Thus, the stimulus at which the subject's response changed with respect to the criterion response produced a reversal of the staircase. The trials producing such staircase reversals are marked by the open symbols surrounding the filled symbols. Each staircase was continued until six reversals occurred. The dotted lines denote the calculated threshold for a given staircase, based on the average of its last four reversals. On any given trial, a random process selected one of the three staircase algorithms to determine the temperature, thus preventing any prediction of the stimulus sequence. The adapting temperature was 34.0°C. (Reprinted with permission from Taylor et al. 1993; <http://www.tandf.co.uk/journals>).

T

In principle, one should be able to compare directly threshold data gathered at different times, and by different investigators, using the same protocol. Such comparisons are tenuous, due to the fact that variations in protocol may systematically alter the resulting threshold values. Differences in stimulus area, rate of stimulus change, inter-stimulus interval, and precise body site tested can significantly alter pain thresholds. Furthermore, situational factors such as the subject's general comfort, or the instructions to the subject, can affect threshold values. It is for these reasons that comparisons of threshold values are better made within a given study, rather than across studies (Shy et al. 2003).

## References

1. Boring EG (1942) Sensation and Perception in the History of Experimental Psychology. Appleton-Century-Crofts, New York
2. Dyck PJ, Zimmerman IR, Johnson DM et al. (1996) A Standard Test of Heat-Pain Responses using CASE IV. *J.Neurol.Sci* 136:54–63
3. Fruhstorfer H, Lindblom U, Schmidt WG (1976) Method for Quantitative Estimation of Thermal Thresholds in Patients. *J Neurol Neurosurg Psychiatry* 39:1071–1075
4. Gracely RH, Lota L, Walter DJ et al. (1988) A Multiple Random Staircase Method of Psychophysical Pain Assessment. *Pain* 32:55–63
5. Greenspan JD (2001) Quantitative Assessment of Neuropathic Pain. *Curr Pain Headache Rep* 5:107–113
6. Greenspan JD, McGillis SLB (1991) Stimulus Features Relevant to the Perception of Sharpness and Mechanically Evoked Cutaneous Pain. *Somatosens Mot Res* 8:137–147
7. Greenspan JD, Taylor DJ, McGillis SLB (1993) Body Site Variation of Cool Perception Thresholds, with Observations on Paradoxical Heat. *Somatosens Mot Res* 10:467–474
8. Shy ME, Frohman EM, So YT et al. (2003) Quantitative Sensory Testing: Report of the Therapeutics and Technology Assessment Subcommittee of the American Academy of Neurology. *Neurology* 60:898–904
9. Taylor DJ, McGillis SLB, Greenspan JD (1993) Body Site Variation of Heat Pain Sensitivity. *Somatosens Mot Res* 10:455–466
10. Yarnitsky D (1997) Quantitative Sensory Testing. *Muscle Nerve* 20:198–204

## Thromboembolism

### Definition

A thromboembolism is a blood clot (thrombus) formed in a blood vessel after surgery, which is transported as an embolus to the lungs or brain to cause an infarct.

► [Postoperative Pain, Acute Pain Team](#)

## Thrombosis

### Definition

Thrombosis is the formation of clots inside blood vessels.

► [NSAIDs and their Indications](#)

## Thrombotic Event

### Definition

Thrombotic Event refers to the formation of blood clots in blood vessels e.g. coronary or cerebral arteries.

► [NSAIDs, Adverse Effects](#)

## Thromboxane

### Definition

Thromboxanes are arachidonic acid derived molecules that are involved in platelet aggregation and blood clotting.

- [COX-1 and COX-2 in Pain](#)
- [NSAIDs, Adverse Effects](#)

## Thromboxane A<sub>2</sub>

### Definition

Thromboxane A<sub>2</sub> is a prostaglandin-like material that is synthesized mainly by a COX-1-dependent process in activated platelets. Thromboxane A<sub>2</sub> promotes vasoconstriction and aggregation of platelets, thereby initiating the clotting of blood.

► [NSAIDs and their Indications](#)

## Tic and Cranial Neuralgias

Z. HARRY RAPPAPORT<sup>1</sup>, MARSHALL DEVOR<sup>2</sup>  
<sup>1</sup>Department of Neurosurgery, Rabin Medical Center, Tel-Aviv University, Petah Tikva, Israel

<sup>2</sup>Institute of Life Sciences and Center for Research on Pain, Hebrew University of Jerusalem, Jerusalem, Israel

zhr1@internet-zahav.net, marshlu@vms.huji.ac.il

### Synonyms

Cranial Neuralgias

Neuralgia of Cranial Nerve V; trigeminal neuralgia; tic douloureux; tic douloureux

Neuralgia of Cranial Nerve IX with or without Cranial Nerve X; glossopharyngeal neuralgia; vagoglossopharyngeal neuralgia; Neuralgia of Cranial Nerve VII; geniculate neuralgia

### Definition

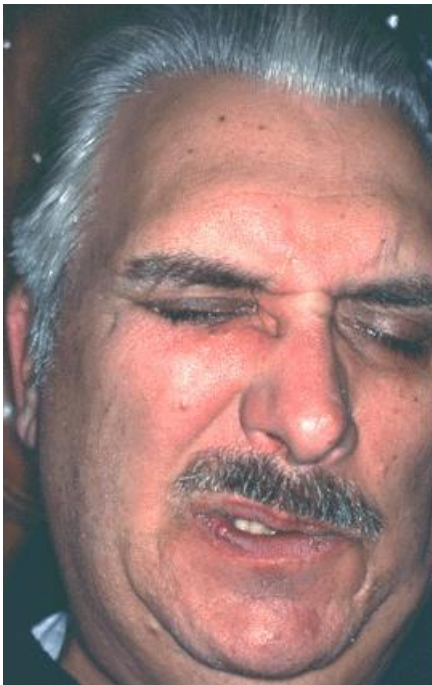
Cranial nerve neuralgia refers to a clinical pain symptom complex that consists of recurrent, intermittent, often paroxysmal pain felt in the head, in the distribution of a specific cranial nerve. By far the most commonly encountered cranial nerve neuralgia is that of the trigeminal nerve and root. This is trigeminal neuralgia (tic douloureux). Neuralgias of the vagoglossopharyngeal nerves and the nervus intermedius branch of the facial nerve are much rarer. Cranial nerve neuralgias are severely painful, but non life-threatening conditions.



## Characteristics

### Clinical Phenomenology

Trigeminal neuralgia is unique among cephalic-facial pain syndromes, both for its dramatic symptomatology as for its susceptibility to both drug and interventional therapy. The incidence is approximately 4 new cases per 100,000 population/year. It is much more common in the elderly than in young patients. There is no definite sex predisposition. Intense, intermittent paroxysms of pain in the distribution of the trigeminal branches are followed by variable pain-free periods. The pain is unilateral and does not cross the midline of the face. There is usually a distinct trigger point, most commonly in the perinasal or perioral area, but sometimes within the oral cavity. When the trigger point is stimulated, after a short latency period, the painful paroxysm begins (Fig. 1). Pain may radiate from the trigger area along the appropriate trigeminal division, sometimes crossing into adjacent divisions. Trigger stimuli are usually quite weak, such as light touch, chewing, talking movement or a puff of wind. Paroxysms may also arise spontaneously. Noxious stimulation of the trigger points is usually ineffective (Kugelberg and Lindblom 1959). The pain onset is usually sudden, and has an electric shock-like quality. A series of attacks, building to a crescendo, is common. Patients describe the pain as “shooting”, “electric”, or “cutting” in quality. While the paroxysms tend to be short, in the order of seconds or occasionally minutes, they can run into each other



**Tic and Cranial Neuralgias, Figure 1** A patient winces during a right-sided trigeminal neuralgia attack.

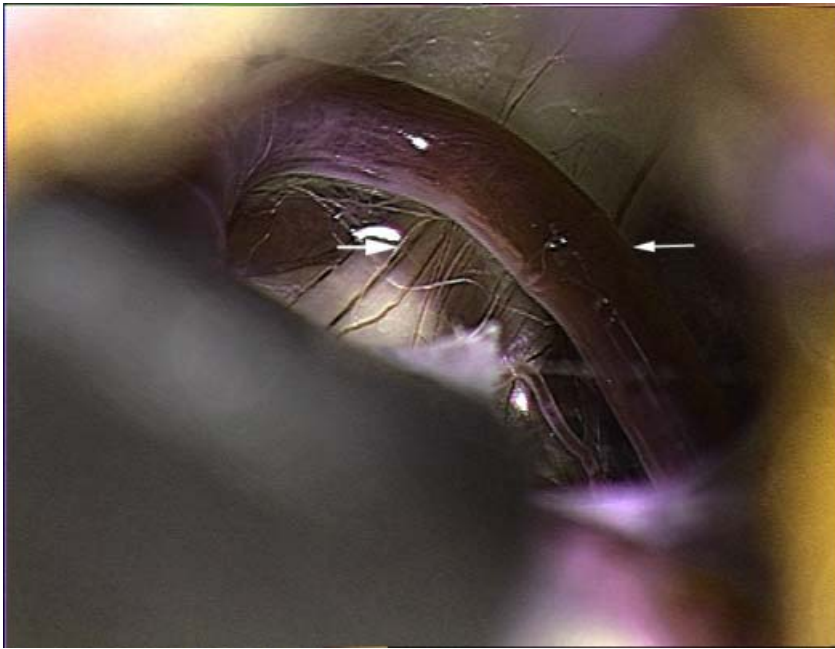
giving the impression of a prolonged attack over hours. Typically, pain attacks come in clusters separated by remissions of days to months, and sometimes even years (Rasmussen (1990). Following an attack the trigger area remains relatively refractory to further pain inducing stimuli for up to 2 minutes (Kugelberg and Lindblom 1959). Routine sensory examination of the face does not usually reveal any changes, but quantitative sensory testing may reveal elevated tactile and thermal detection thresholds in the area surrounding and including the trigger point (Nurmikko 1991). Trigeminal neuralgia is idiopathic; there is rarely any obvious precipitating injury or disease. Prominent hypoesthesia in the presence of typical trigeminal neuralgia symptoms implies the presence of a paratrigeminal space occupying lesion or multiple sclerosis. This is sometimes termed atypical trigeminal neuralgia.

The symptomatology of glossopharyngeal neuralgia is similar to that of trigeminal neuralgia, but pain is felt in the distributions of the ninth (glossopharyngeal) and/or tenth (vagus) cranial nerves (Rushton et al. 1981). ► **Pain paroxysms** are usually triggered during swallowing, talking, or chewing, with the trigger point located unilaterally at the base of the tongue, tonsillar region, or in the ear. Concomitant vagal autonomic involvement probably accounts for episodes of syncope and bradycardia that may accompany pain attacks. In more severe cases, prolonged asystole may be life threatening. The disease is equally distributed between the sexes and is most frequently seen between the fifth and seventh decades of life, with an incidence of 0.8 cases/100,000/year. It is occasionally bilateral in presentation. Pain tends to be less severe than trigeminal neuralgia, and often more steady and burning in quality (Katusic et al. 1991).

Geniculate neuralgia involves the sensory distribution of the seventh cranial nerve (facial nerve) via the nervus intermedius (of Wrisberg). The painful attacks, which are sharp and stabbing, are centered within the ear canal (Pulec 2002). A dull background pain may persist for several hours after an attack. Affected patients tend to be younger than in trigeminal and glossopharyngeal neuralgia. When seen together with hemifacial spasm, the term “tic convulsive” has been used (Yeh and Tew 1984).

### Pathophysiology

Medical and surgical experience in treating tic, combined with pathological findings and laboratory experiments using animal models, sheds light on the etiology of pain paroxysms in the cranial nerve neuralgias. During exploration of the cerebello-pontine angle on the side of the pain, vascular compression of the appropriate nerve root is usually observed (Fig. 2). Following decompression, the patients are relieved of their pain in a high percentage of cases (Yeh and Tew 1984; Sindou et al. 2002; Patel et al. 2002). Ultrastructural examination of post-mortem specimens, and cranial nerve biopsies



**Tic and Cranial Neuralgias, Figure 2**  
 A photomicrograph of a compressed trigeminal root (short arrow) and the compressing blood vessel (long arrow), taken during microvascular decompression surgery in trigeminal neuralgia. Note the discoloration of the root at the compression site.

taken during surgical procedures, show extensive pathological change in the cranial nerve root and ganglion (Devor et al. 2002a; Devor et al. 2002b). Disordering and loss of myelin is seen in the area compressed by the vessel loop, as are signs of axonal sprouting and regions of close membrane contact between adjacent denuded axons. The latter observation is a likely anatomical substrate of ephaptic (electrical, non-synaptic) coupling between axons. These types of structural change can give rise to ectopic pacemaker sites, and the generation of abnormal impulse discharge. Moreover, they facilitate neuron-to-neuron spread of electrical activity through the injured cranial nerve root and its sensory ganglion, by means of neurophysiological mechanisms such as ► **ephaptic coupling** and crossed afterdischarge (Rappaport and Devor 1994). The generation of self-sustaining discharge in the root and ganglion following peripheral triggering, and the rapid spread of this activity, is thought to cause paroxysms of pain. This is the ► **“ignition hypothesis”** of trigeminal neuralgia (Rappaport and Devor 1994). Other properties of cranial nerve neuralgias, such as post-paroxysm refractoriness and pain suppression by membrane stabilizing anticonvulsants, are consistent with this mechanism (Rappaport and Devor 1994). Central changes in signal processing within the trigeminal brainstem have also been proposed as causes of tic pain (Fromm and Sessle–1991).

### Treatment

The hallmark of cranial nerve neuralgias is their response to specific anticonvulsant medications, notably carbamazepine and gabapentin, and to a lesser extent

phenytoin. Barbiturates are not effective, presumably because they act synaptically rather than as ► **membrane stabilizers**. The effectiveness of drug therapy declines over time in nearly one half of cases. When drug therapy no longer controls the pain paroxysms, or its side effects impair quality of life, interventional procedures may be considered (Rappaport 1996). Peripheral nerve blocks or neurectomies have only a short-term effect. Most elderly patients undergo percutaneous partial damage to the trigeminal root and ganglion using radiofrequency coagulation, retro-Gasserian glycerol injection or balloon compression. The initial success rate is in the 80 % range, with recurrence rates of up to 30 % at 1 year and up to 45 % at 5 years. These procedures entail various degrees of facial hypoesthesia. Their efficacy is probably due to lessened triggering and reduction of trigeminal ganglion neuron populations, and hence reduction of the critical mass of electrical activity required for pain ignition. Radiofrequency rhizolysis of the glossopharyngeal nerve is also effective for ninth nerve neuralgia; however, the procedure is technically more demanding.

For patients who can tolerate the surgery, open exposure of the posterior fossa via a retromastoid craniotomy, and ► **microvascular decompression** of the neural complex, optionally combined with partial rhizolysis, is the preferred interventional procedure for all cranial nerve neuralgias. Microvascular decompression has the advantage of treating the root cause of the symptoms without destroying neural tissue and superimposing hypoesthesia. The low morbidity and mortality of this procedure (less than 4 %), and its impressive efficacy at relieving pain with only modest rates of recurrence (80 % still with sig-

nificant pain relief at 5 year follow-up) makes microvascular decompression the surgical treatment of choice, at least in younger patients (Rappaport 1996).

### Acknowledgements

We wish to thank Prof. Yair Sharav of the Hebrew University School of Dentistry for providing us with the photograph of a patient during a trigeminal neuralgia paroxysm used in Figure 1.

### References

1. Devor M, Govrin-Lippmann R, Rappaport ZH (2002a) Mechanism of Trigeminal Neuralgia: An Ultrastructural Analysis of Trigeminal Root Specimens Obtained during Microvascular Decompression Surgery. *J Neurosurg* 96:532–543
2. Devor M, Govrin-Lippmann R, Rappaport ZH, Tasker RR, Dostrovsky JO (2002b) Cranial Root Injury in Glossopharyngeal Neuralgia: Electron Microscopic Observations. *J Neurosurg* 96:603–606
3. Fromm GH, Sessle BJ (1991) Trigeminal Neuralgia: Current Concepts Regarding Pathogenesis and Treatment. Butterworth-Heinemann, Boston, pp 1-230
4. Katusic S, Williams DB, Beard CM, Bergstralh EJ, Kurland LT (1991) Epidemiology and Clinical Features of Idiopathic Trigeminal Neuralgia and Glossopharyngeal Neuralgia Similarities and Differences, Rochester, Minnesota, 1945–1984. *Neuroepidemiology* 10:276–281
5. Kugelberg E, Lindblom U (1959) The Mechanism of the Pain in Trigeminal Neuralgia. *J Neurol Neurosurg Psychiatr* 22:36–43
6. Nurmikko TJ (1991) Altered Cutaneous Sensation in Trigeminal Neuralgia. *Arch Neurol* 48:523–527
7. Patel A, Kassam A, Horowitz M, Chang YF (2002) Microvascular Decompression in the Management of Glossopharyngeal Neuralgia: Analysis of 217 Cases. *Neurosurgery* 50:705–710
8. Pulec JL (2002) Genuate Neuralgia: Long-Term Results of Surgical Treatment. *Ear Nose Throat J* 81:30–33
9. Rappaport ZH (1996) The Choice of Therapy in Medically Intractable Trigeminal Neuralgia. *Isr J Med Sci* 32:1232–1234
10. Rappaport ZH, Devor M (1994) Trigeminal Neuralgia: The Role of Self-Sustaining Discharge in the Trigeminal Ganglion. *Pain* 56:127–138
11. Rasmussen P (1990) Facial Pain: A Prospective Study of 1052 Patients with a View of: Character of the Attacks, Onset, Course, and Character of Pain. *Acta Neurochir* 107:121–128
12. Rushton JG, Stevens JC, Miller RH (1981) Glossopharyngeal (Vaguglossopharyngeal) Neuralgia: A Study of 217 Cases. *Arch Neurol* 38:201–205
13. Sindou M, Howeidly T, Acevedo G (2002) Anatomical Observations during Microvascular Decompression for Idiopathic Trigeminal Neuralgia (with Correlations between Topography of Pain and Site of the Neurovascular Conflict). Prospective Study in a Series of 579 Patients. *Acta Neurochir* 144:1–12
14. Tyler-Kabara EC, Kassam AB, Horowitz MH, Urgo L, Hadjipanayis C, Levy EI, Chang YF (2002) Predictors of Outcome in Surgically Managed Patients with Typical and Atypical Trigeminal Neuralgia: Comparison of Results following Microvascular Decompression. *J Neurosurg* 96:527–531
15. Yeh HS, Tew JM Jr (1984) Tic Convulsive, the Combination of Genuate Neuralgia and Hemifacial Spasm Relieved by Vascular Decompression. *Neurology* 34:682–68

## Tic Douloureux

- ▶ Tic and Cranial Neuralgias
- ▶ Trigeminal, Glossopharyngeal, and Genuate Neuralgias

- ▶ Trigeminal Neuralgia
- ▶ Trigeminal Neuralgia, Diagnosis and Treatment
- ▶ Trigeminal Neuralgia, Etiology, Pathogenesis and Management

## Time Constant

### Definition

For a variable that is an exponential function of time

$$x(t) = x_0 e^{\pm \frac{t}{\tau}}$$

the time constant ( $\tau$ ) is the time after which the variable ( $x$ ) has decreased by  $1/e$  or increased by  $e$ .

- ▶ Mechano-Insensitive C-Fibres, Biophysics

## Time-Contingent Medication

- ▶ Time-Locked Medication

## Time-Locked Medication

### Synonyms

Time-Contingent Medication

### Definition

Time-locked medication refers to medication intake not on an as needed (prn) schedule but at fixed points in time to avoid maladaptive learning processes.

- ▶ Operant Treatment of Chronic Pain

T

## Timing

### Definition

In the context of pre-emptive analgesia: an analgesic treatment can be initiated (or „timed“ to start) before or after the surgical injury.

- ▶ Postoperative Pain, Pre-Emptive or Preventive Analgesia

## Timolol

### Definition

A beta-blocker.

- ▶ Migraine, Preventive Therapy

## Tinel Sign

TURO J. NURMIKKO

Department of Neurological Science and Pain Research Institute, University of Liverpool, Liverpool, UK  
tjn@liv.ac.uk

### Synonyms

Tinel's sign; Hoffman-Tinel sign; sign of fornication

### Definition

Tingling or sensation of pins and needles elicited by an examiner tapping over a nerve. Tingling must be felt in the territory supplied by the nerve.

### Characteristics

The Tinel sign is a simple clinical test to identify local nerve damage or map the progress of nerve regeneration following nerve injury. It was championed in the 1910s by two neuroscientists independently of each other, Dr. Jules Tinel (1879 – 1952), a French Neurologist, and Paul Hoffman (1884 – 1962), a German Neurophysiologist, but there are earlier descriptions of the sign in medical literature. The phenomenon was probably well known to the medical community before their reports. Tinel and Hoffman are, however, credited for highlighting the clinical potential of the sign and giving it a measure of scientific validity (Wilkins et al. 1971).

The Tinel sign is a tingling perceived by a patient with nerve injury when the examiner taps over the trunk of the nerve. Tingling is felt in the skin supplied by the nerve, does not change on repetition, and outlasts the stimulus by no more than a few seconds. Tinel and Hoffman considered this to signal the presence of regenerating ► **axons**, which start to sprout from the proximal part of the nerve after injury. The further the recovery advances, the further away from the site of injury the Tinel sign can be elicited. In this way, the successful progress of nerve recovery can be tracked.

In its classical form, the test is carried out by applying repeated percussions by one's extended finger over the presumed course of the nerve, initially well below the expected target, and continued upwards until the first tingling sensation is elicited. The site where this happens is the maximum distance over which the nerve fibers have regenerated. In order to prevent false results from vibrations induced on the skin, the examiner places his free hand between the percussing finger and the site of injury. In the early years of its popularity, the sign was used to estimate the rate of recovery of the nerve following injury. Large case series were published, mostly involving patients with gun shot wounds who had undergone surgery for their injury. At the time these were the best available

estimates of the recovery times of peripheral nerves, and ranged from 1–3 mm/per day (Sunderland 1968).

Not long after Tinel and Hoffman published their first papers, there were reports by several surgeons that the sign failed to indicate accurately whether or not recovery of the injured nerve was taking place. Reports of patients with a positive Tinel sign, who at operation were found to have total interruption of the nerve with no chance of recovery, were published. It appears that the essential requirement for the sign to be positive – that it was progressing – was overlooked by many. Nevertheless, more criticism toward the sign was generated by observations of good neural recovery in patients in whom the Tinel sign was missing (Napier 1949; David and Chung 2004), and the test fell into disfavor. Later, a few investigators published relatively large case series and concluded that it is, when used critically, of moderate use as a rough guide of nerve recovery (Napier 1949; Nathan and Rennie 1946). There are today other more advanced methods for assessment of such recovery, and the sign is to be regarded more as a curiosity than a valid clinical tool. Despite this, it is always introduced to medical students and regularly appears in surgical and neurological textbooks.

The basis for the test lies in increased excitability of the recovering nerve fibers. Following injury, nerve fibers begin to grow sprouts from the proximal stump. These sprouts are far more sensitive to mechanical stimuli than are mature nerve fibers in intact nerves. As the sprouts go longer, the most distant point of mechanical sensitivity moves further away from the injury. ► **Myelin** breakage and restoration, and recovery of support structures of the nerve trunk, also have an impact on the general excitability of the recovering nerve. In the part of the nerve in which full or near-full recovery of fibers has taken place, the nerve trunk loses its sensitivity to percussion.

Tinel, and later advocates of his method, stressed that tapping should produce tingling, not pain in the reference area. Tinel did acknowledge that at times mechanical compression of the site of injury could cause pain, prominent on the site of compression, with less intense pain referred to the territory of the nerve. To Tinel, the natural explanation for a stationary sign was that nerve degeneration did not take place, and that the regenerating nerves grew aimlessly into a bundle of sprouts, forming a ► **neuroma**. Neuromas are known for their excessive mechanical sensitivity. Inevitably, the sign was soon adopted for diagnosing neuromas, with no evidence that it provides more information than careful manual palpation or compression. It has been suggested that a neuroma can be distinguished from other tender structures at the operation site by using a series of light weight percussion tools (Tucker and Nancarrow 2000), but this method is not in common use. There are sophisticated electrophys-



iological and neuroimaging methods that can be used instead.

In the 1950s, Phalen and co-workers reported that they could frequently elicit the Tinel sign in patients with ▶ [carpal tunnel syndrome](#) and added the test to their other diagnostic criteria (Phalen et al. 1950). In carpal tunnel syndrome, the median nerve is under constant compression, imposing increasing structural damage on nerve fibers. Axonal degeneration and regeneration take place concurrently, and with varying levels of demyelination and remyelination present, the nerve becomes excessively sensitive to mechanical stimuli. However, several studies have been published that show convincingly that the Tinel sign has little to offer for differential diagnosis. It is too crude a test for accurate differentiation between patients with carpal tunnel syndrome from those with other peripheral nerve diseases, or even healthy people (D'Arcy et al. 2000).

The significance of the Tinel sign has faded with time, and these days it remains more a curiosity than a serious clinical tool. It is still used out of its original context in pain research – more as a “neuroma sign”, rather than the sign of a recovering nerve than it was used for in the early part of the 20th century.

- ▶ [Neuroma Pain](#)
- ▶ [Peripheral Neuropathic Pain](#)
- ▶ [Ulceration, Prevention by Nerve Decompression](#)

### References

1. D'Arcy CA, McGee S (2000) Does this Patient have Carpal Tunnel Syndrome? JAMA 283:3110–3117
2. Dellon AL (1984) Tinel or not Tinel. J Hand Surg 9:216
3. David EN, Chung KC (2004) The Tinel Sign: A Historical Perspective. Plast Reconstr Surg 114:494–499
4. Moldaver J (1978) Tinel's Sign. J Bone Joint Surg 60-A:412–413
5. Napier JR (1949) The Significance of Tinel's Sign in Peripheral Nerve Injuries. Brain 72:63–82
6. Nathan PW, Rennie AM (1946) Value of Tinel's Sign. Lancet I:610–611
7. Phalen GS, Gardner WJ, LaLonde AA (1950) Neuropathy of the Median Nerve Due to Compression beneath the Transverse Carpal Ligament. J Bone Joint Surg 32A:109–112
8. Sunderland S (1968) Nerves and Nerve Injuries. E&S Livingstone, Edinburgh
9. Tucker SC and Nancarrow JD (2000) Objective Assessment of Post-Traumatic Nerve Repairs and Neuromas. Br J Plastic Surg 53:694–696
10. Wilkins RH, Brody IA (1971) Neurological Classics XXXIV. Tinel's Sign. 24:573–575
11. Yarnitsky D, Ochoa JL (1991) The Sign of Tinel can be mediated either by Myelinated or Unmyelinated Primary Afferents. Muscle Nerve 14: 379–380

## Tinnitus

### Definition

A ringing sensation in one or both ears.

- ▶ [NSAIDs, Adverse Effects](#)

## Tissue Fatigue

### Definition

Tissue fatigue refers to a decline in the load-bearing capacity of tissue in response to an applied load. This phenomenon is reversible provided that there is sufficient time for recovery.

- ▶ [Ergonomic Counseling](#)

## TLIF

### Synonyms

Transforaminal interbody fusion

### Definition

Graft/cages placed between the vertebral bodies by posterior approach through the neural foramina without retracting the thecal sac.

- ▶ [Spinal Fusion for Chronic Back Pain](#)

## TMD

- ▶ [Temporomandibular Disorder](#)

## TMS

- ▶ [Transcranial Magnetic Stimulation](#)

## TMJD

- ▶ [Temporomandibular Joint Disorders](#)

## TNF Alpha( $\alpha$ )

- ▶ [Tumor Necrosis Factor Alpha\( \$\alpha\$ \)](#)

## TNS

- ▶ [Transcutaneous Electrical Nerve Stimulation Outcomes](#)

## Tolerance

### Definition

Tolerance refers to diminishing susceptibility to the effects of a drug with continued use. The phenomenon of tolerance is characteristic of opioid analgesics. The development of tolerance to the analgesic effects of the opioids means that with continued opioid use, progressively higher doses may be required to maintain the same analgesic effect. Tolerance also develops to the nonanalgesic side effects of opioids, including respiratory depression, nausea, and sedation. The development of tolerance to these effects is desirable as it permits dose titration.

- ▶ Cancer Pain Management, Opioid Side Effects, Uncommon Side Effects
- ▶ CRPS, Evidence-Based Treatment
- ▶ Opiates During Development
- ▶ Opioids and Inflammatory Pain
- ▶ Opioids in the Periphery and Analgesia
- ▶ Opioid Receptors
- ▶ Opioid Responsiveness in Cancer Pain Management
- ▶ Opioid Therapy in Cancer Patients with Substance Abuse Disorders, Management
- ▶ Postoperative Pain, Opioids
- ▶ Purine Receptor Targets in the Treatment of Neuropathic Pain
- ▶ Stimulation-Produced Analgesia

## Tolerance Thresholds

- ▶ Pain in Humans, Thresholds

## Tolosa-Hunt Syndrome

### Definition

Also called: “painful ophthalmoplegia”: a variable combination of periorbital pain, ipsilateral oculomotor nerve palsies, oculosympathetic palsy and trigeminal sensory loss.

- ▶ Headache due to Dissection

## Tonic Firing Mode

### Definition

A pattern of spontaneous action potential firing demonstrated by thalamic neurons, in which no clear pattern of interspike intervals exists.

- ▶ Central Pain, Human Studies of Physiology
- ▶ Thalamic Bursting Activity, Chronic Pain

## Tonic Rebalance

### Definition

Tonic rebalance is a spontaneous, physiological process by which the system tries to restore symmetry at the level of the vestibular nuclei in the acute phase after a vestibular crisis. The process occurs independently of the patient’s activities.

- ▶ Coordination Exercises in the Treatment of Cervical Dizziness

## Toothache

- ▶ Dental Pain, Etiology, Pathogenesis and Management

## Top-Down Control of Pain

### Definition

Neural pathways descending from higher brain structures to lower brain structures modulate ascending pain signals.

- ▶ Descending Modulation and Persistent Pain

## Topical Drug Therapy

CHARLES NG  
Musculoskeletal Medicine Specialist, Australasian Faculty of Musculoskeletal Medicine, Auckland, New Zealand  
cng@xtra.co.nz

### Definition

Topical drug therapy is the application of drugs to the skin over an area of pain. The drug penetrates the skin to act on the underlying painful tissues or the nerves than innervate them.

### Characteristics

The three main groups of topical medications used in treating pain are topical NSAIDs (nonsteroidal anti-inflammatory drugs), topical local anaesthetics and topical capsaicin. These drugs may be formulated as a cream, gel, paste or patch.

## Topical NSAIDs (nonsteroidal anti-inflammatory drugs)

### Mechanisms of Action

Topical NSAIDs have a peripheral action on soft tissue, inhibiting prostaglandin synthesis, inhibiting the lipoxygenase pathway and inhibiting excitatory amino acids. They have effects on G protein-mediated signal transduction (Galer 2001). They also reduce the neurogenic inflammatory response.

Evidence shows that therapeutic concentrations are achieved in soft tissues (Vaile et al. 1998). These tissues can act as a drug reservoir, and thus maintain tissue and plasma concentration after application of the drug has ceased. Systemic redistribution of NSAIDs results in measurable plasma levels. However, plasma, muscle and synovial fluid concentrations have been found to be lower than in subcutaneous fat and soft tissue, and are possibly subtherapeutic. Consequently, topical NSAIDs are more effective for soft tissue complaints than arthropathies.

### Applications and Efficacy

Topical NSAIDs are most effective for soft tissue complaints. Evidence supports the use of ketorolac, flurbiprofen and niflumic acid in acute ankle sprain. Indomethacin and piroxicam are effective in sprains and tendinitis. Naproxen and felbinac are effective in a variety of soft tissue injuries (Vaile et al. 1998). Diclofenac is effective in treating lateral epicondylitis (Burnham et al. 1998).

Moore et al. (1998) showed that topical NSAIDs were significantly more effective than placebo in the treatment of acute sprains and strains, with an **NNT (number needed to treat)** of 3.9; and chronic arthritis and rheumatism, for which the NNT was 3.1. Ketoprofen, felbinac, ibuprofen and piroxicam had similar, significant efficacy.

As the natural history of soft tissue complaints tends to be self-limiting, treatment with topical NSAIDs does not necessarily alter the overall outcome.

Topical NSAIDs are less effective for arthropathies, but have been shown to be effective in treating mild to moderate osteoarthritis (Hosie and Bird 1994). However, evidence supporting their efficacy in osteoarthritis of the knee is not consistent (Vaile et al. 1998).

### Side Effects

Cutaneous adverse reactions like erythema, burning sensation, irritation and contact dermatitis occur in 1 to 2% of patients (Vaile et al. 1998). Asthma, renal and gastrointestinal side-effects have been reported. However, as plasma concentrations of topical NSAIDs are low compared to oral NSAIDs, gastrointestinal side-effects are less severe and less frequent. Therefore, topical NSAIDs are promoted as a safer and more cost-effective alternative.

## Topical Local Anaesthetics

### Mechanisms of Action

Local anaesthetics act through the blockade of sodium channels in sensory afferent neurons. Thereby, topical application reduces ectopic discharge in superficial somatic nerves that are stimulated in neuropathic pain states and acute injuries (Galer 2001).

### Applications and Efficacy

Studies support the efficacy of topical lidocaine, in either the Lidoderm patch or gel formulation, for relieving pain in chronic **postherpetic neuralgia** and for mechanical **allodynia** (Galer 2001, Sawynok 2003). There is anecdotal evidence that topical lidocaine may be useful for diabetic and other peripheral **neuropathic pains** (Galer 2001).

Topical application of EMLA (eutectic mixture of local anaesthetics, 2.5% lidocaine and 2.5% prilocaine) reduces acute pain associated with invasive procedures such as venipuncture (Galer 2001). It also reduces chronic pain in postherpetic neuralgia and chronic post-surgical pain (Towlerton and Rice 2003).

Topical tetracaine provides effective anaesthesia for endotracheal, ocular and invasive skin procedures (Galer 2001). Topical cocaine provides effective anaesthesia for nasal mucosa.

A combination of a low dose of morphine and lidocaine results in analgesic synergy, where the analgesic activity exceeds that from a simple additive effect of the agents (Kolesnikov et al. 2000).

### Side Effects

Application of topical local anaesthetics does not result in clinically significant plasma levels causing side effects (Galer 2001; Towlerton and Rice 2003).

## Topical Capsaicin

### Mechanisms of Action

Capsaicin is an extract of chili peppers. It is formulated as a topical application, which when applied to skin causes an intensely painful burning sensation, by selectively depolarising small diameter sensory afferent neurons. Repeated application causes a desensitising or neurotoxic effect on nociceptors, which results in a prolonged "selective local analgesia" (Sawynok 2003; Towlerton and Rice 2003). Desensitisation of skin results in an analgesia effect. Capsaicin stimulates the release of substance P and calcitonin gene-related peptide from peripheral and central terminals of sensory neurons. Their release is inhibited by the desensitisation effect (Sawynok 2003).

### Applications and Efficacy

Evidence supporting the use of capsaicin in postherpetic neuralgia and painful **diabetic neuropathy** is unconvincing (Galer 2001; Towlerton and Rice 2003). Evidence supports its use in osteoarthritis at a variety of sites, including the hand and knee, and in rheumatoid

arthritis (Galer 2001; Towleron and Rice 2003). It is useful in non-specific neck pain (Mathias et al. 1995), cluster headaches and post-mastectomy pain (Galer 2001). Anecdotal evidence attests to its ► **effectiveness** in a range of other neuropathic pain conditions and facial pain (Galer 2001).

Capsaicin is often not sufficient as monotherapy for treating chronic pain. It appears to be useful only in conjunction with other therapies.

#### Side Effects

Initial application of capsaicin, especially in the first week, causes burning pain at the site of application in 40–80% of patients (Towleron and Rice 2003). This, along with a therapeutic effect time-delay of at least a week, reduces patient compliance and continuation of use.

#### References

1. Burnham R, Gregg R, Healy P, Steadward R (1998) The Effectiveness of Topical Diclofenac for Lateral Epicondylitis. *Clin Journal Sports Med* 8:78–81
2. Galer B (2001) Topical Medications. In: Loeser JD (ed) *Bonica's Management of Pain*, 3<sup>rd</sup> edn. Lippincott Williams & Wilkins, Philadelphia, pp 1736–1742
3. Hosie G, Bird H (1994) The Topical NSAID Felbinac versus Oral NSAIDs: A Critical Review. *Eur J Rheumatol Inflamm* 14:21–28
4. Kolesnikov Y, Chereshev I, Pasternak G (2000) Analgesic Synergy between Topical Lidocaine and Topical Opioids. *J Pharmacol Exp Ther* 295:546–551
5. Mathias B, Dillingham T, Zeigler D, Chang A, Belandres P (1995) Topical Capsaicin for Chronic Neck Pain. *Am J Phys Med Rehab* 74:39–44
6. Moore R, Tramer M, Carroll D, Wiffen P, McQuay H (1998) Quantitative Systematic Review of Topically Applied Non-Steroidal Anti-Inflammatory Drugs. *BMJ* 316:333–338
7. Sawynok J (2003) Topical and Peripherally Acting Analgesics. *Pharmacological Reviews* 55:1–20
8. Towleron G, Rice A (2003) Topical Analgesics for Chronic Pain. In: Jensen T, Wilson P, Rice A (eds) *Clinical Pain Management Chronic Pain*. Arnold, London, 213–226
9. Vaile J, Davis P (1998) Topical NSAIDs for Musculoskeletal Conditions. *Adis International Limited* 56:783–799

## Topiramate

#### Definition

Anticonvulsant medication.

- **Migraine, Preventive Therapy**

## Topographical

#### Definition

Topographical refers to the arrangement or reference to regions of the body or of a body part, especially the regions of a definite and limited area of the surface.

- **Postsynaptic Dorsal Column Projection, Anatomical Organization**

## Topography

- **Magnetoencephalography in Assessment of Pain in Humans**

## Total Pain

#### Definition

Expression of suffering, particularly the expression of psychological distress as pain.

- **Cancer Pain Management, Interface between Cancer Pain Management and Palliative Care**

## Touch Evoked Pain

- **Allodynia (Clinical, Experimental)**

## Tourniquet Ischemia

- **Tourniquet Test**

## Tourniquet Pain Ratio

#### Definition

It is calculated as follows:  $\text{Ongoing Clinical Pain Match Time/Tolerance Time} \times 100$  where the Ongoing Clinical Pain Match time is the time point, since the beginning of the Tourniquet Test, at which the patient reports a pain intensity that matches the clinical pain intensity; the Tolerance Time is the time the patient can tolerate the ischemia in the Tourniquet Test.

- **Tourniquet Test**

## Tourniquet Test

GIANCARLO CARLI

Department of Physiology, University of Siena, Siena, Italy  
carlig@unisi.it

#### Synonyms

Ischemic Test; Submaximum Effort Tourniquet Technique; Forearm Ischemia Procedure; Acute Ischemia Test; Forearm Occlusion Pain; Ischemic pain; Tourniquet Ischemia



## Definition

Ischemic ► **pain** is elicited by having the subject squeeze a handspring exerciser 20 times after a tourniquet is inflated around his upper arm. The quality of sensation is dull-aching or stinging ► **muscular pain**, which closely resembles most types of ► **pathologic pain**, but increases progressively after cessation of squeezing. Test performance is measured in terms of elapsed time between cessation of squeezing and report of slight (threshold) and unbearable (tolerance) pain. Muscular pain from ischemic contractions, which is due to transient stimulation of peripheral ► **nociceptors** (LaMotte and Campbell 1978), is based on the ► **algogenic actions of protons** (Issberner et al. 1996). Noxious forearm ischemia also evokes substantial elevations in arterial blood pressure (Maixner et al. 1990) and activation of endogenous opioid systems (Goldstein and Grevert 1978), thus representing a ► **diffuse noxious inhibitory controls** (DNIC) paradigm (Willer et al. 1989).

A pneumatic tourniquet cuff connected to a computer controlled air compressor has been used recently to produce pressure pain (Polianskis et al. 2001). Computerized cuff algometry may continuously control stimulus or adjust the pressure to maintain the programmed pain level. This set up, which elicits an increasing pain immediately after tourniquet cuff application around the gastrocnemius-soleus muscle, represents a highly configurable tool for assessment of pain sensitivity by pressure, but does not involve the ischemic mechanisms as does the classical tourniquet test described in this chapter.

## Characteristics

The need for a dependable experimental method to test new analgesics in man was one of the main motivations to modify the earlier techniques of producing ► **Ischemic Pain/Test** (Lewis et al. 1931, Hewer and Keele 1948), by changing from maximum to submaximum squeezing effort.

Originally, the ► **submaximum tourniquet test** (Smith et al. 1966; Smith et al. 1968) was suggested with the following order (see Fig. 1a, b, c).

The subject, reclining on a bed, is asked to comply with the following procedure:

1. to extend his non-dominant arm toward the ceiling and, with the arm raised, an Esmarch bandage is wrapped from the fingers to the elbow to drain the arm of venous blood (see Fig. 1a)
2. to apply a tourniquet bandage around the upper arm and inflate it to obtain a pressure of 250 mm Hg, to abolish arterial supply and to render the arm hypoxic
3. to lower the arm, remove the band and, after a pause of 60 sec, to squeeze a hand spring exerciser 20 times while his arm is rested. Each squeeze is timed to last 2 sec followed by a 2 sec rest, so that the whole ex-

ercise time lasts 80 sec. The schedule is presented to the subject by means of tape-recorded signals

4. after completing the squeezes, to remain in a reclining position and rest his arm at his side with the tourniquet still inflated, not to move his arm until the pressure has been released (see Fig. 1c)
5. to rate, when asked at irregularly spaced intervals, the incoming sensations of pain according to a predetermined scale, which includes the following categories of experience: 0 = none; 1 = slight; 2 = moderately distressing; 3 = very distressing; 4 = unbearable. Irregular intervals should be used to minimize the cues to the subject regarding the time he had tolerated the pain.

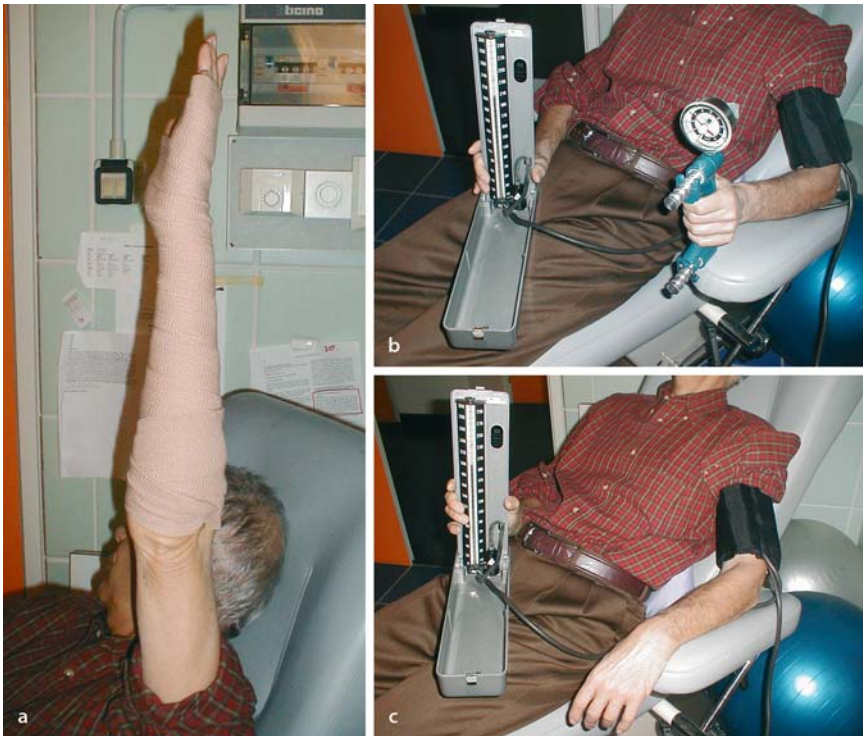
► **Pain threshold** (slight pain) occurs after about 3–6 min, while unbearable pain (tolerance) varies from 7 to 53 min (Smith et al. 1966; Smith et al. 1968). The latency of unbearable pain is usually called ► **pain tolerance**, but formally it represents ischemia tolerance, i.e. the measurement of time elapsed since exercise termination (beginning of ischemia) and not since pain onset. When the cuff is released, pain intensity and numbness sensations sharply decrease, but their time course, as not included in the formal test, have not been systematically investigated.

Several authors have modified the test, but the main changes that have improved the test have been proposed by Moore et al. (1979). According to new suggestions, the individual maximal grip strength of the non-dominant arm has to be assessed using an isometric exerciser equipped with a force gauge (Fig. 1b). After lowering the arm, the squeeze exercise must start immediately after the cuff has been inflated to 200 mm Hg, instead of 250, avoiding a pause of 60 sec. as suggested by Smith et al. (1966). The individual grip strength should be kept at the fixed percentage (50 %) of the maximum grip strength, in order to avoid fatigue and to reduce inter-subject differences. The measurement of elapsed time should begin at the time of blood pressure cuff inflation, i.e. at the beginning of the ischemia, rather than at exercise termination. In addition, the rating must be in a visual analog scale from 0 (no pain) to 100 (pain so severe that you would commit suicide if you had to bear it for more than a few minutes).

In the same research (Moore et al. 1979), it was observed that the amount of exercise used during the submaximal effort tourniquet test significantly affected the level of reported pain intensity versus time elapsed: in fact, by increasing the duration of each contraction from 0.6 sec. to 2 sec, the threshold pain intensity was reached much more rapidly.

## Tourniquet Pain Ratio: A Method to Evaluate Clinical Pain

Sternback et al. (1974) originally suggested that the experimental pain generated by ischemic exercise could be used to evaluate the severity of the ongoing clinical



**Tourniquet Test, Figure 1** Main phases of the tourniquet test. (a) elevation of the bandaged forearm; (b) squeezes of isometric exerciser while the pneumatic tourniquet remains inflated to block forearm circulation; (c) arm at rest while the tourniquet is still inflated.

pain. This method, called ► **Tourniquet Pain Ratio**, requires the patients to report when their arm pain intensity matches the clinical pain intensity: this time point is then used to measure the subjective severity of patient's clinical pain and is calculated as follows: (Ongoing Clinical Pain Match Time / Tolerance Time) X 100. This method has several limitations, mainly because the Tourniquet Pain Matching Score is significantly lower than the patient's own pain estimate (Moore et al. 1979). As for the relationship between pain intensity and elapsed time, the data indicate that the pain ratings produced by the test are not a linear function of elapsed time but rather a sigmoid shaped curve. Nonetheless, the Tourniquet Pain Ratio is still used to provide an additional index of clinical pain modulation (Sigurdsson and Maixner 1994).

#### **Tourniquet Test in the Diagnosis of Altered Nociceptive Transmission**

Both threshold and tolerance to ischemic pain has been repetitively tested in clinical syndromes such as localized musculoskeletal pain, ► **fibromyalgia**, peripheral neuralgias, bulimia, hypertension and other conditions in which a dysfunction in the excitability of the nociceptive system is expected.

#### **Tourniquet Test and DNIC**

The efficacy of DNIC, the neurophysiological mechanism that underlines the long established clinical phenomenon of ► **counterirritation** (Wand-Tetley 1956), has been successfully tested in healthy subjects following the procedure of the submaximum tourniquet test,

in electrical threshold to evoke muscle pain (Pantaleo et al. 1988), cutaneous warming pain threshold (Pertovara et al. 1982) and in other sensory modalities. In patients with ongoing pain, it has been established that pain by clinical origin does not stimulate DNIC on ischemic or thermal pain perception (Ekbloom and Hansson 1987; Hansson et al. 1988). On the contrary, forearm ischemia elicited by the procedure of the submaximum tourniquet test elicits a generalized non-segmental inhibition of tooth pain, resulting from acute irreversible pulpitis (Sigurdsson and Maixner 1994). The latter effects remain for at least 5 minutes after removal of the tourniquet, while the arm is free from pain. It has to be underlined that the mechanisms of DNIC are not univocal since, for instance, the tourniquet test elicits inhibition of static mechano-allodynia sensations, triggered by pressure stimuli, but has no effect on dynamic mechano-allodynia sensations, elicited by brushing (Bouhassira et al. 2003). In fibromyalgia and painful osteoarthritis patients the procedure of the submaximum tourniquet test does not elicit modulation of pressure pain, as opposed to controls (Kosek et al. 1966), while the DNIC is still effective in patients suffering from long-term trapezius myalgia.

#### **Tourniquet Test and Drug Screening**

It has been repeatedly established that placebo and suggestions of analgesia, both in subjects who are awake and during hypnosis, can reduce pain elicited by the tourniquet test. Similarly, small doses of opiates (morphine, dipipanone, codeine) and the NMDA-receptor

antagonist ketamine display analgesic effects. On the contrary, the NMDA-receptor antagonist dextromethorphan, diazepam and anti-inflammatory drugs such as aspirin or indomethacin do not affect ischemic pain. Finally, adenosine, which mediates ischemic pain in humans, at low doses exerts analgesic effects on the tourniquet pain by membrane-bound peripheral adenosine receptors (Eriksson et al. 2000).

### Concluding Remarks

In conclusion, the tourniquet test can provide useful indications about individual reactivity and tolerance to deep ischemic stimuli, both in healthy subjects and in patients. There are, however, some limitations to be underlined. First of all, in patients suffering from deep pressure pain or other deep pains in the forearms, unbearable pain can occur following the application and/or inflation of the bandage. Moreover, the tourniquet procedure has shown a considerable between subjects and between session variability (Sigurdsson and Maixner 1994), and the sensitivity displayed may be inadequate to assess the analgesic effects of some pharmacological agents (Sternbach et al. 1977).

### References

- Bouhassira D, Danziger N, Atta N et al. (2003) Comparison of the Pain Suppressive Effects of Clinical and Experimental Painful Conditioning Stimuli. *Brain* 126:1068–1078
- Eriksson BE, Sadig B, Svedenhag J et al. (2000) Analgesic Effects of Adenosine in Syndrome X are Counteracted by Theophylline: A Double-Blind Placebo-Controlled Study. *Clin Sci* 98:15–20
- Eklblom A, Hansson P (1987) Thermal Sensitivity is not Changed by Acute Pain or Afferent Stimulation. *J Neurol Neurosurg Psychiatr* 50:1216–1220
- Goldstein A, Grevert P (1978) Placebo Analgesia, Endorphins and Naloxone. *Lancet* 2:1385
- Hansson P, Eklblom A, Lindblom U et al. (1988) Does Acute Intraoral Pain Alter Cutaneous Sensibility? *J Neurol Neurosurg Psychiatr* 51:10032–1036
- Hewer AJ, Keele CA (1948) A Method of Testing Analgesics in Man. *Lancet* 2:683–688
- Issberner U, Rehe PW, Steen KH (1996) Pain due to Tissue Acidosis: A Mechanism for Inflammatory and Ischemic Myalgia? *Neurosci Lett* 208:191–194
- Kosek E, Ekholm J, Hansson P (1966) Sensory Dysfunction in Fibromyalgia Patients with Implications for Pathogenic Mechanisms. *Pain* 68:375–383
- LaMotte RH, Campbell JN (1978) Comparison of Responses of Warm and Nociceptive C-Fiber Afferents in Monkey with Human Judgements of Thermal Pain. *J Neurophysiol* 41:509–528
- Lewis D, Pikerling GW, Rothschild P (1931) Observations upon Muscular Pain in Intermittent Claudication. *Heart* 15:359–383
- Maixner W, Gracely RH, Zuniga JR et al. (1990) Cardiovascular and Sensory Responses to Forearm Ischemia and Dynamic Hand Exercise. *Am J Physiol* 259:R1156–R1163
- Moore PA, Duncan GH, Scott DS et al. (1979) The Submaximal Effort Tourniquet Test: Its use in Evaluating Experimental and Chronic Pain. *Pain* 6:375–382
- Pantaleo T, Duranti R, Bellini F (1988) Effects of Heterotopic Ischemic Pain on Muscular Pain Threshold and Blink Reflex in Humans. *Neurosci Letter* 85:56–60
- Pertovara A, Kempainen P, Johansson G et al. (1982) Ischemic Pain Nonsegmentally Produces a Predominant Reduction of Pain and Thermal Sensitivity in Man: A Selective Role for Endogenous Opioids. *Brain Res* 251:82–93
- Polianskis R, Graven Nielsen T, Arendt-Nielsen (2002) Spatial and Temporal Aspects of Deep Tissue Pain Assessed by Cuff Algometry. *Pain* 100:19–26
- Sigurdsson A, Maixner W (1994) Effects of Experimental and Clinical Noxious Counterirritants on Pain Perception. *Pain* 57:265–275
- Smith GM, Egbert LD, Markowitz RA et al. (1966) An Experimental Pain Method Sensitive to Morphine in Man: The Submaximum Effort Tourniquet Technique. *J Pharmacol Exp Ther* 154:324–332
- Smith GM, Lowenstein E, Hubbard JH et al. (1968) Experimental Pain Produced by the Submaximum Effort Tourniquet Technique: Further Evidence and Validity. *J Pharmacol Exp Ther* 163:468–474
- Sternbach RA, Deems LM, Timmermans G et al. (1977) On the Sensitivity of the Tourniquet Pain Test. *Pain* 3:105–110
- Wand-Tetley JI (1956) Historical Methods of Counter-Irritation. *Ann Phys Med* 3:90–98
- Willer JC, DeBroucker T, LeBars D (1989) Encoding of Nociceptive Thermal Stimuli by Diffuse Noxious Inhibitory Controls in Humans. *J Neurophysiol* 62:1028–1038
- Williams MW (1959) Ischemic Arm Pain and Non-Narcotic Analgesics. *Toxicol Appl Pharmacol* 1:590–597

## Toxic Neuropathies

SUNG-TSANG HSIEH

Department of Anatomy and Cell Biology and  
Department of Neurology, National Taiwan University,  
Taipei, Taiwan  
sthsieh@ha.mc.ntu.edu.tw

### Definition

Toxic neuropathies are peripheral nerve disorders due to acute or chronic adverse effects of chemicals or medications which occur in individuals or as an outbreak in a certain population after occupational exposure or environmental contamination.

### Characteristics

#### Neurons, Axons and Neuropathy

► **Neuropathies** are diseases of the peripheral nervous system from various etiologies, including metabolic disorders, such as ► **diabetic neuropathy** due to ► **diabetes mellitus** (Vinik AI et al. 2000), and toxic effects of chemotherapy for cancer. In the peripheral nervous system, the length of ► **axons** is much greater than the diameter of the neuronal cell body. This results in a much larger cytoplasmic volume in the entire axon compared to the volume of the neuronal cell body, often by several orders of magnitude. As an example, take a motor neuron of an adult human. The diameter of a motor neuron in the lumbar spinal cord is up to 100  $\mu\text{m}$ ; in contrast, the length of a motor axon from this motor neuron innervating the foot muscles is up to 1 m in length. This greatly differs from other cells in the body, such as fibroblasts, which have a cellular extension of only a limited length.

To maintain such unusual structural requirements, axons possess a rather complicated cytoskeletal system



(Griffin et al. 1995). Components of the ► **cytoskeleton** include microtubules (> 24 nm), intermediate filaments (10 nm), and microfilaments (6–8 nm) according to their diameters and composition. These cytoskeletal proteins interact with each other through associated proteins, such as microtubule-associated proteins, to form a three-dimensional interlacing structure. In addition, the metabolic demands of axons heavily depend on the neuronal cell body, and an ► **axoplasmic transport** system has developed to transport materials both to and from neuronal cell bodies. Some cytoskeleton-associated proteins, such as the kinesin and dynein superfamily, are also responsible for transporting organelles and neurotransmitter-containing vesicles (Hirokawa 1998). Peripheral nerves, particularly those in nerve terminal regions, are distributed throughout the entire body, and are thus the most vulnerable part of the nervous system during toxin exposure and metabolic derangement. Consequences of these insults, including dysregulated cytoskeletal maintenance or blockade of ► **axonal transport**, may impair the functioning of axons, and eventually result in ► **axonal degeneration**. Alternatively, neurons are vulnerable to toxins via systemic absorption. Toxins directly act on neuronal cell bodies, resulting in neuronal cell death and subsequent axonal degeneration.

#### **Structural Organization of Peripheral Nerves and Pathology of Toxic Neuropathies**

The structural organization of peripheral nerves includes two major cellular components: neurons with cytoplasmic extensions and axons, and ensheathing glia (► **Schwann cells**) with myelin sheaths, modified membranous insulating materials. Nerve injury in toxic neuropathies occurs at different levels along the neural axis through different mechanisms. Toxins can act on neuronal components (neuronal cell bodies, axons, and nerve terminals) and glial components (Schwann cells and myelin sheaths). Neuronal degeneration results in subsequent nerve fiber degeneration. Most frequently, the major target site is at axons, either proximally or distally along the nerve fibers, while neuronal cell bodies largely remain intact. The common outcome is axonal degeneration, or Wallerian-like degeneration, and secondary demyelination. The pathology of most toxic neuropathies is axonal degeneration, particularly of the distal axons, such as with ► **acrylamide** (Schaumburg et al. 1974). Only rare experimental toxins, such as  $\beta,\beta'$ -iminodipropionitrile, act on proximal axons (Griffin et al. 1983). If a toxin selectively damages Schwann cells or impairs myelin organization, neuropathies of primary demyelination will develop. Because of conduction failure in primary ► **demyelination**, the major electrophysiological abnormality of ► **demyelinating neuropathy** is the marked slowing of nerve conduction. This type of toxic neuropathy is relatively rare compared to neuropathies of the primarily axonal degeneration

type. An example of a primarily demyelinating neuropathy is tellurium-induced toxic neuropathy (Bouldin et al. 1988).

#### **Clinical Applications**

Peripheral neuropathies are common neurological disorders of the community with an annual incidence of 100–200 per 100,000 people. Toxic neuropathies account for a minor proportion of etiology (~5%) depending on economical and medical factors and geographic distribution. In the 1950–1970's, most toxic neuropathies have been related to outbreaks of industrial chemicals, such as acrylamide and organic solvents (hexacarbons). The list of these etiologies depends on the industrial development of different countries. Over the past decades, major outbreaks of toxic neuropathy have decreased to a great extent due to stricter regulation of chemicals used in industry.

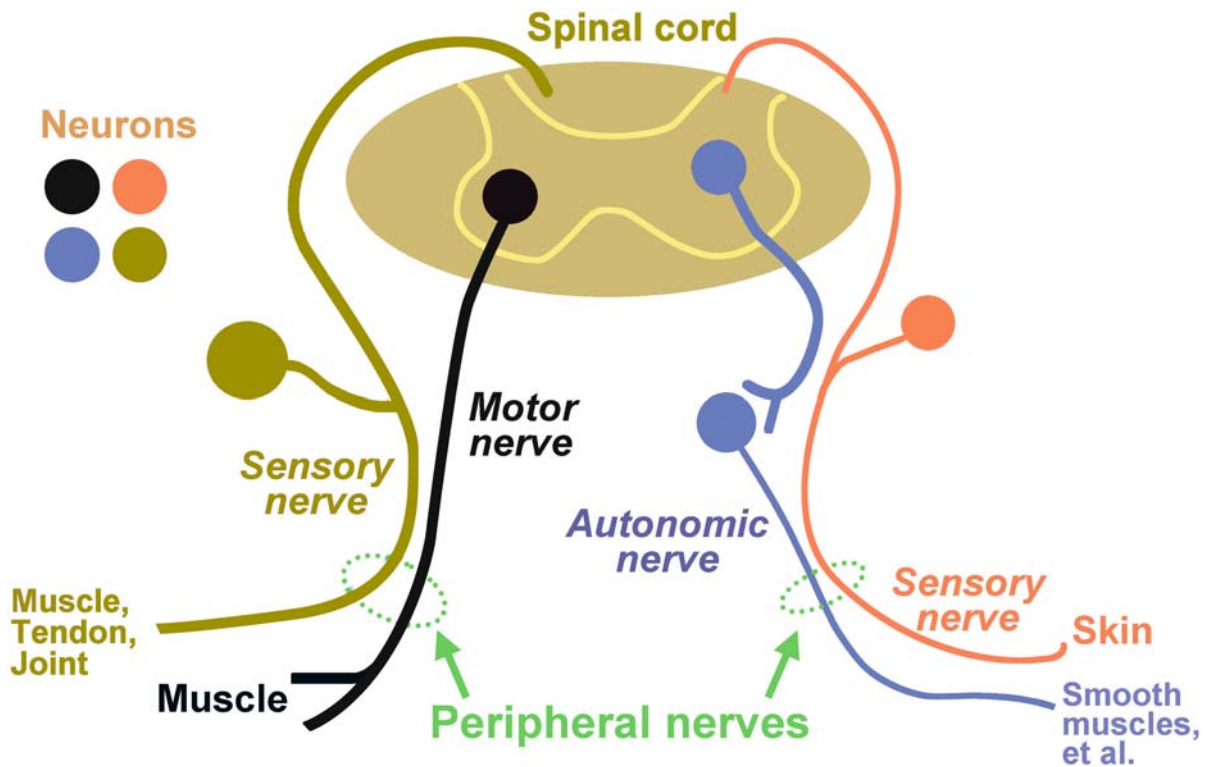
In recent years, most reported toxic neuropathies have been due to side effects of medications or from accidental exposure. Common chemotherapeutic agents causing toxic neuropathies include cis-platinum, taxol, and thalidomide. Thus, toxic neuropathies are relatively uncommon compared to other etiologies, such as diabetes mellitus, genetic neuropathies and inflammatory disorders. Nevertheless, toxic neuropathies have great impact on environmental and industrial regulation, and serve as important models for investigating mechanisms of nerve injury and the correlation between pathology and clinical manifestations.

#### **Clinical Manifestations of Toxic Neuropathies**

Functionally, the peripheral nervous system consists of motor, sensory, and autonomic nerve fibers (Fig. 1). Motor nerves and proprioceptive nerves, which convey sensory information from bones, muscles, and joints, are large ► **myelinated nerves** (large-diameter nerves or ► **large fibers**). Nociceptive, thermal, and autonomic nerves belong to small myelinated nerves or unmyelinated nerves (small-diameter nerves or ► **small fibers**). All of these nerve fibers have different cytoskeletal organizations, origins, and terminals (Chen et al. 1999). The severity of neurological deficits depends on several factors, including the vulnerability of each nerve fiber type, the duration of toxin exposure, the total dose of toxins, and the extent of nerve degeneration. A major factor in determining clinical presentations is the differential susceptibility of neurons to toxins or pathological processes, a characteristic of neurological diseases: for example, motor neurons in amyotrophic lateral sclerosis (Lou Gehrig's disease), cortical neurons in Alzheimer's disease, and substantia nigra neurons in Parkinson's disease. Each disease has a distinct pattern of clinical presentation because certain parts of the nervous system are selectively damaged.

Clinical manifestations of neuropathies, therefore, depend on the damage to different fiber types (Thomas





**Toxic Neuropathies, Figure 1** Structural organization of peripheral nerves. Peripheral nerves consist of: (1) motor nerves from ventral horn motor neurons of the spinal cord (black), (2) proprioceptive nerves from large-diameter sensory neurons of dorsal root ganglia which terminate in skeletal muscles, tendons, and joints (olive), and (3) nociceptive and thermal nerves from small-diameter sensory neurons of dorsal root ganglia which terminate in the skin (pink) and autonomic nerves from autonomic ganglia innervating smooth muscles and glands (blue).

and Ochoa 1993). When motor nerve fibers are injured, neurological deficits range from mild weakness of distal limb muscles to marked paralysis of all four limbs. When sensory nerves responsible for joint movements are injured, unsteadiness during walking may develop. This type of neuropathy is sometimes called ► **Large Fiber Neuropathy**. On the other hand, in patients with damaged sensory nerves, neuropathic pain, such as tingling or electric-shock sensations can be experienced. Various autonomic complaints, such as tachycardia, constipation, or diarrhea can be presenting symptoms in patients with damaged autonomic nerves. Sensory neuropathy with painful features and loss of nociceptive functions and autonomic neuropathy are termed as ► **small-fiber neuropathy**. Often, neurological presentations are combined effects due to deficits of different fibers types: for example, a patient with motor, sensory, and autonomic neuropathy may have manifestations of weakness, sensory disturbances, and dysautonomia. Various etiologies of toxic neuropathies with their pathologic mechanisms and manifestations are summarized below. This list is not intended to be a comprehensive catalogue, and readers can refer to various sources for detailed information (Spencer and Schaumburg 2000).

#### Classification of Toxic Neuropathies: Sources

- Environmental contaminants: lead
- Occupational outbreaks: *n*-hexane
- Adverse effects of medications: cisplatin
- Accidental exposure or ingestion: lead
- Experimental uses: e.g. hexacarbonyl, 2,5-hexanediol, acrylamide, capsaicin

#### Functional components

- Motor neuropathy: lead
- Sensory neuropathies
  - Proprioceptive type: cis-platinum, vincristine, isoniazid
  - Nociceptive type: capsaicin
- Autonomic neuropathy: acrylamide, alcoholic, arsenic (inorganic), diphtheritic toxin

#### Clinical presentations

- Weakness
- Sensory disturbances: neuropathic pain, hypesthesia
- Dysautonomia

### Structural components

- Large myelinated nerves
  - Motor nerves: acrylamide
  - Sensory nerves (proprioception): *n*-hexane
- Small myelinated nerves
  - Sensory nerves (thermal sense, nociception): capsaicin
  - Autonomic nerves: acrylamide, alcoholic, arsenic (inorganic), diphtheritic toxin
- Unmyelinated nerves
  - Sensory nerves (thermal senses, nociception): capsaicin
  - Autonomic nerves: acrylamide, alcoholic, arsenic (inorganic), diphtheritic toxin

### Sites of actions and mechanisms

- Proximal axons: filamentous swelling
  - $\beta,\beta'$ -iminodipropionitrile
- Terminal portion: swelling and degeneration
  - Neuromuscular junctions: 2,5-hexanediol, acrylamide
  - Pacinian corpuscles: 2,5-hexanediol
  - Epidermal nerves of the skin: acrylamide, cisplatin

### Pathology

- Primarily axonal degeneration: hexacarbon
- Primarily demyelination: tellurium

The terminals of the longest nerves are the most susceptible part during toxin exposure, and clinical symptoms usually develop in the corresponding innervated areas of these damaged nerves in the early phase of toxic neuropathy. In addition, clinical symptoms and signs are usually more severe in regions with early-onset symptoms than in regions with late-onset symptoms. For example, numbness and neuropathic pain may appear in the toes and feet earlier than in the legs and thighs. Similarly, symptoms in the fingers and hands are earlier than those in the forearms. Neurological deficits are usually more severe in the lower limbs than in the upper limbs. This “glove-stocking” type of distribution is characteristic of length-dependent neuropathies, particularly for the majority of toxic neuropathies, although exceptions may exist in certain types of toxic neuropathies.

### Therapeutic Consequences

#### Evolution of Pathology in Toxic Neuropathies

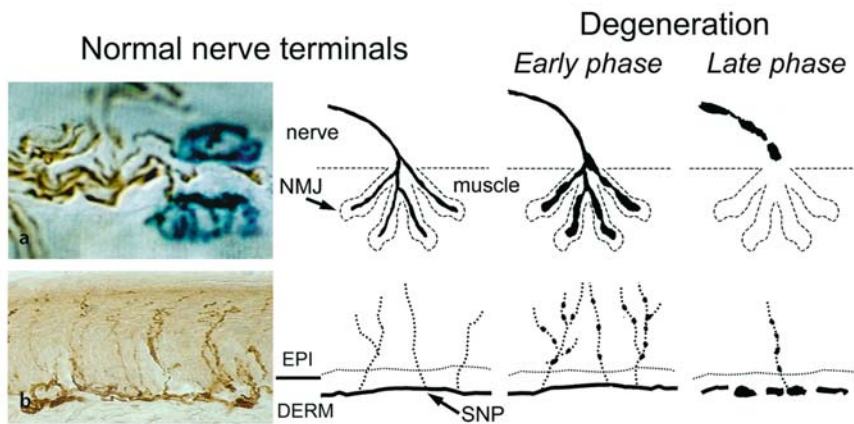
The typical pathology of toxic neuropathies of large-diameter motor and sensory nerves has been demon-

strated in both humans and experimental animals over the past few decades: for example, neuropathies due to exposure to hexacarbons, particularly the active components, 2,5-hexanediol, acrylamide, and carbon disulfide. The longest and largest nerves are affected earlier, with the major pathology in the terminal parts of axons, i.e. ► [distal axonopathy](#). Intoxication results from absorption of organic solvents in poorly ventilated environments. Fig. 2 illustrates the scenario of pathology in neuromuscular junctions after hexacarbon and acrylamide intoxication (Ko et al. 1999). In animals intoxicated with such compounds as, for example, acrylamide, there is no visible weakness or ataxia during the early phase. At that stage, however, motor nerve terminals have already begun to swell up. Obvious weakness and ataxia of hind limbs gradually develops. The weakness and unsteadiness progress at variable speeds, and eventually the forelimbs are affected, resulting in quadriparesis at the late stage. As intoxication proceeds, axonal swelling extends from junctional folds into the intramuscular nerves, which results in Wallerian-like degeneration of motor nerves and denervation of neuromuscular junctions (Fig. 2a). Similar changes also develop in the central terminals of long axons, such as terminals of the posterior column at the brainstem, the central axons of dorsal root ganglia, thus the term, ► [central-peripheral distal axonopathy](#), or ► [dying-back neuropathy](#) (LoPachin 2000).

#### Nociceptive Nerves in Toxic Neuropathies

Nociceptive nerves subserving thermal sensations are A $\delta$  or C fibers based on physiological classification, with diameters in the range of 1–5  $\mu$ m. These axons, with ► [free nerve endings](#), are peripheral processes of small neurons in ► [dorsal root ganglia](#), and terminate in the most-superficial layer of the skin, the epidermis (Fig. 1). Their central processes end in the dorsal horn and synapse with spinothalamic and other nociceptive neurons. Due to their small size, these nerve fibers have traditionally been studied with high-resolution ► [electron microscopy](#). The application of sensitive ► [immunohistochemistry](#) with various neuronal markers has enabled the evaluation of skin innervation at a global scale (Hsieh et al. 2000). Among these neuronal proteins, protein gene product 9.5, an ubiquitin C-terminal hydrolase, is particularly useful for demonstrating the rich innervation of the epidermis (Fig. 2b). Based on technical improvements, it is now possible to address the issue of neuropathy of small-diameter nerves due to toxin exposure.

► [Capsaicin](#) is an active compound from hot peppers, which is known to activate the vallinoid receptor. A major use of capsaicin ointment is to treat neuropathic pain; its efficacy probably occurs through damage to sensory nerve endings. Systemic injection of capsaicin in neonatal rats abolishes primary afferent terminals in the dorsal horn of the spinal cord (Wall et al. 1982). In human stud-



**Toxic Neuropathies, Figure 2** Diagram of the progression of toxic neuropathy. The diagram illustrates degeneration of nerve terminals in neuromuscular junctions (a) and in the epidermis of the skin (b) during the evolution of toxic neuropathy with acrylamide-induced neuropathy as an example. Axons and nerve terminals were immunostained with protein gene product 9.5 (dark brown), and neuromuscular junctions with substrates of cholinesterase (blue). (a) In normal muscles, motor nerve terminals travel into every fold of the neuromuscular junction (NMJ) with quite-uniform thickness. In the early phase of degeneration, focal swelling of nerve terminals in the neuromuscular junctions develops, and axonal swelling extends into the motor nerve trunks. Finally in the late stage, neuromuscular junctions are denervated, and motor nerves become degenerated with a segmented appearance. (b) Bundles of nerve fibers form subepidermal nerve plexuses (SNP) in the dermis (DERM) below the epidermis (EPI) in normal skin. Epidermal nerves arise from the subepidermal nerve plexuses, and ascend vertically in the epidermis with a varicose appearance. In the early phase of degeneration, epidermal nerves become swollen, and branching increases. During the late phase, epidermal nerves disappear, and the epidermis becomes denervated. Subepidermal nerve plexuses have a fragmented appearance, indicating that they are undergoing degeneration.

ies, capsaicin causes degeneration of nerve terminals in the epidermis after local application, with corresponding loss of thermal sensations in the application area (Simone et al. 1998). A certain degree of epidermal nerve regeneration can later be observed, suggesting that the major target of capsaicin-induced nerve damage by local treatment is at the terminal portion, instead of at the neuronal cell body.

Traditionally, acrylamide and cisplatin have been considered to cause neuropathy of large-diameter nerves. The development of staining for cutaneous nerve terminals allowed the influence of acrylamide on small-diameter sensory nerves in the skin to be assessed (Fig. 2b). At the initial stage of intoxication, ► **epidermal nerves** show two major changes: terminal swelling and increased branching (Ko et al. 2002). There is a progressive reduction in epidermal nerve density thereafter. At the late stage, there is significant dermal nerve degeneration with ultrastructural demonstration of vacuolar changes. These findings have established the pathological consequences of acrylamide neurotoxicity in cutaneous sensory nerves for studying the “dying-back” pathology of nociceptive nerves. These phenomena are quite similar to the pathology of cutaneous nerves in human skin, including epidermal nerve swelling, increased branching points of epidermal nerves, and fragmentation of dermal nerve fibers.

Neuropathic pain is an important manifestation of some toxic neuropathies, such as cis-platinum and vincristine-induced neuropathies. The exact mechanisms remain obscure. Responses to nerve injury include neuronal and glial responses at the levels of transcription and post-translation, re-organization of neuronal and ax-

onal structures and changes in synaptic plasticity. For example, different subtypes of sodium channels are up-regulated or down-regulated in animals with neuropathic pain. In damaged nerves, sodium channels are re-distributed along the entire axons or accumulate in the neuroma, instead of clustering around the node of Ranvier in normal axons. Many of these changes may contribute to the generation and maintenance of neuropathic pain.

Our knowledge of toxic neuropathies has broadly expanded over the past decade because many new investigative techniques have been developed, particularly toxic neuropathies of nociceptive nerves, whose dysfunctions cause diverse manifestations of neuropathic pain. The identification of environmental toxins as etiologies of neuropathies provides new insights into mechanisms of nerve degeneration and its consequent neuropathic pain. A good example is 2,5-hexanedione, the active metabolic product of organic solvents containing hexacarbons. The recognition of hexacarbon-induced central-peripheral distal axonopathy has provided a new model and opened a new field to understand nerve degeneration. The causes of a considerable proportion (10–20%) of peripheral neuropathies have not yet been identified. Among these neuropathies, toxin-exposure has rarely been explored. Detailed investigation of exposure history is mandatory, and may offer a new look at some neuropathies of unknown etiology.

## References

1. Bouldin TW, Samsa G, Earnhardt TS, Krigman MR (1988) Schwann Cell Vulnerability to Demyelination is Associated with Internodal Length in Tellurium Neuropathy. *J Neuropathol Exp Neurol* 47:41-47

2. Chen WP, Chang YC, Hsieh ST (1999) Trophic Interactions between Sensory Nerves and the Targets. *J Biomed Sci* 6:79-85
3. Griffin JW, Fahnstock KE, Price DL, Cork LC (1983) Cytoskeletal Disorganization Induced by Local Application of beta, beta'-iminodipropionitrile and 2,5-hexanedione. *Ann Neurol* 14:55-61
4. Griffin JW, George EB, Hsieh ST, Glass JD (1995) Axonal Degeneration and Disorders of the Axonal Cytoskeleton. In: Waxman SG, Kocsis JD, Stys PK (eds) *The Axon*, Oxford University Press, New York, pp 375-390
5. Hirokawa N (1998) Kinesin and Dynein Superfamily Proteins and the Mechanism of Organelle Transport. *Science* 279:519-526
6. Hsieh ST, Chiang HY, Lin WM (2000) Pathology of Nerve Terminal Degeneration in the Skin. *J Neuropathol Exp Neurol* 59:297-307
7. Ko MH, Chen WP, Hsieh ST (2002) Neuropathology of Skin Denervation in Acrylamide-Induced Neuropathy. *Neurobiol Dis* 11:155-165
8. Ko MH, Chen WP, Lin-Shiau SY, Hsieh ST (1999) Age-Dependent Acrylamide Neurotoxicity in Mice: Morphology, Physiology, and Function. *Exp Neurol* 158:37-46
9. LoPachin RM (2000) Redefining Toxic Distal Axonopathies. *Toxicol Lett* 112-113:23-33
10. Schaumburg HH, Wisniewski HM, Spencer PS (1974) Ultrastructural Studies of the Dying-Back Process. I. Peripheral Nerve Terminal and Axon Degeneration in Systemic Acrylamide Intoxication. *J Neuropathol Exp Neurol* 33:260-284
11. Simone DA, Nolano M, Johnson T, Wendelschafer-Crabb G, Kennedy WR (1998) Intradermal Injection of Capsaicin in Humans Produces Degeneration and Subsequent Reinnervation of Epidermal Nerve Fibers: Correlation with Sensory Function. *J Neurosci* 18:8947-8959
12. Spencer PS, Schaumburg HH (2000) *Experimental and Clinical Neurotoxicology*. Oxford University Press, New York
13. Thomas PK, Ochoa J (1993) Clinical Features and Differential Diagnosis. In: Dyck PJ, Thomas PK, Griffin JW, Low PA, Poduslo JF (eds) *Peripheral Neuropathy*, W.B.Saunders, Philadelphia, pp 749-774
14. Vinik AI, Park TS, Stansberry KB, Pittenger GL (2000) Diabetic Neuropathies. *Diabetologia* 43:957-973
15. Wall PD, Fitzgerald M, Nussbaumer JC, Van der Loos H, Devor M (1982) Somatotopic Maps are Disorganized in Adult Rodents Treated Neonatally with Capsaicin. *Nature* 295:691-693

## Traction

SUSAN MERCER

School of Biomedical Sciences, University of Queensland, Brisbane, QLD, Australia  
susan.mercer@stonebow.otago.ac.nz

### Synonyms

Intermittent; progressive adjustive; manual or continuous traction; autotraction; gravity-assisted traction; self traction; unloading

### Definition

Traction is a treatment for spinal pain. It involves applying a pulling force to the lower limbs or to the head, in order to separate the vertebrae of the spine and / or to stretch the surrounding muscles and ligaments. The traction force may be delivered manually, or *via* weights, pulleys or mechanical devices as a continuous, sustained, intermittent or intermittent pulsed force.

## Characteristics

### Mechanism

No mechanism has been established whereby traction might relieve pain. Nevertheless, proponents of traction believe that it works, and have speculated on its mechanism of effect (Krause et al. 2000).

There is clear evidence that spinal traction does separate vertebral bodies. However, in the lumbar spine much of the separation observed arises from flattening of the lumbar lordosis (Twomey 1985). In the cervical spine, 30 pounds of traction achieves only fractions of a millimetre separation between vertebral bodies, amounting to 2 mm total elongation anteriorly and 6 mm posteriorly between C2 and T1 (Colachis and Strohm 1969). The purported benefit of this separation is, however, ambiguous.

When traction is used to treat radicular pain, the implicit mechanism is decompression of the affected spinal nerve. However, separation of vertebrae increases the longitudinal dimension of the intervertebral foramina but longitudinal compression of spinal nerves is an uncommon phenomenon. Most commonly, spinal nerves are affected in the sagittal dimension, anteriorly by disc herniations or osteophytes or posteriorly by osteophytes of the zygapophysial joints. Longitudinal separation does not relieve encroachment in the sagittal dimension. Moreover, upon the patient resuming the upright posture, any benefit of traction is immediately lost, as gravity restores the compression load on the spine. Indeed, it has been shown that, without rising, after simply resting on the traction table for 20 min, the effects of cervical traction are all but lost (Colachis and Strohm 1969).

Another conjecture is that traction reduces disc herniations. The available data, however, are limited and conflicting. In one small study, although traction did reduce disc herniations in two of three patients, the protrusions reappeared within 14 min after release of the force (Matthews 1968).

In the absence of firm evidence for a mechanical effect of traction, some authorities have pursued alternative rationales, such as silencing ectopic impulse generators and normalisation of conduction in spinal nerves (Krause et al. 2000). These speculations, however, nevertheless presuppose that traction reverses compression of the spinal nerve by separating the vertebral bodies. They also require that relatively brief traction somehow achieves lasting reversal of the pathophysiology that causes pain.

There is even less of a physiological rationale for traction when it is applied for spinal pain, as opposed to radicular pain. In the first instance, nerve root irritation causes pain in the limbs, not in the back or in the neck. The rationale for traction for spinal pain, therefore, cannot involve decompression of spinal nerves. Instead, it has been proposed that perhaps spinal pain might be relieved by “in-



creasing non-nociceptive input and recruitment of descending inhibition” (Krause et al. 2000). While perhaps attractive as a conjecture, such a statement falls short of actually constituting evidence of how traction might relieve spinal pain. Another proposition is that traction serves to stretch spinal tissues (Krause et al. 2000), but in that event it is questionable whether elaborate and passive traction offers any advantage over simple stretching exercises that the patients can undertake themselves. The proposition that traction reduces intervertebral disc pressures is confounded not only by the lack of experimental data that demonstrate this effect, but also by the lack of a cogent theory as to how raised disc pressure causes back pain and why that pain should stay relieved once the traction is released and the patient resumes an upright posture.

### Applications

Traction has been used to treat neck pain, cervical radicular pain and radiculopathy, back pain and lumbar radicular pain and radiculopathy. Some practitioners use it to treat thoracic spinal pain, but there is no literature on its efficacy for this condition.

Traction can be applied manually by the therapist (manual traction), by a motorized pulley (motorised lumbar or cervical traction), by the patients themselves providing the pulling force (autotraction) or by suspension from a device (gravitational traction) (Twomey 1985).

### Efficacy

Systematic reviews have been confounded by the irregular and inconsistent diagnostic criteria used in the studies reviewed. It has not always been evident if the patients had somatic pain, somatic referred pain or radicular pain. Although some earlier reviews offered open or encouraging conclusions, these have been supplanted by subsequent studies and reviews.

No randomized controlled trials have shown if traction is effective for neck pain (Aker et al. 1996; Harms-Ringdahl and Nachemson 2000). The available studies indicated that it is not effective for acute neck pain (Bogduk and McGuirk 2006). For chronic neck pain, traction has not been subjected to scientific studies. For cervical radicular pain, studies have shown that traction is no more effective than sham traction or placebo treatment (British Association of Physical Medicine 1966; Goldie and Landquist 1970; Klaber et al. 1990). The same conclusions apply for the treatment of lumbar radicular pain (Coxhead et al. 1981; Matthews and Hickling 1975; Pal et al. 1986). For non-specific low back pain, traction is no more effective than a placebo treatment (Beursken et al. 1997).

### Indications

In the face of the available scientific evidence, there are no legitimate indications for traction in the modern era. It

is a treatment, steeped in tradition but devoid of evidence.

### ► Lumbar traction

### References

1. Aker PD, Gross AR, Goldsmith CH et al. (1996) Conservative management of mechanical neck pain: systematic overview and meta-analysis. *BMJ* 313:1291–1296
2. Beurskens AJ, de Vet HC, Koke AJ et al. (1997) Efficacy of traction for non-specific low back pain: 12-week and 6-month results of a randomized clinical trial. *Spine* 22:2756–2762
3. Bogduk N, McGuirk B (2006) *Medical Management of Acute and Chronic Neck Pain. An Evidence-Based Approach*. Elsevier, Amsterdam (in press)
4. British Association of Physical Medicine (1966) Pain in the neck and arm: a multicentre trial of the effects of physiotherapy. *BMJ* 1:253–258
5. Colachis SC, Strohm BR (1969) Effects of intermittent traction on separation of lumbar vertebrae. *Arch Phys Med Rehabil* 44:251–258
6. Coxhead CE, Inskip H, Meade TW et al. (1981) Multicentre trial of physiotherapy in the management of sciatic symptoms. *Lancet* 1:1065–1068
7. Goldie I, Landquist A (1970) Evaluation of the effects of different forms of physiotherapy in cervical pain. *Scand J Rehab Med* 2-3:117–121
8. Harms-Ringdahl K, Nachemson A (2000) Acute and subacute neck pain: nonsurgical treatment. In: Nachemson A, Jonsson E (eds) *Neck and Back Pain: The Scientific Evidence of Causes, Diagnosis, and Treatment*. Lippincott Williams & Wilkins, Philadelphia, pp 327–338
9. Harte AA, Baxter GD, Gracey JH (2203) The efficacy of traction for back pain: a systematic review of randomized controlled trials. *Arch Phys Med Rehabil* 84:1542–1553
10. Klaber Moffett JA, Hughes GI, Griffiths P (1990) An investigation of the effects of cervical traction. Part 1: clinical effectiveness. *Clin Rehab* 4:205–211
11. Krause M, Refshauge KM, Dessen M et al. (2000) Lumbar spine traction: evaluation of effects and recommended application for treatment. *Manual Therapy* 5:72–81
12. Matthews JA (1968). Dynamic discography: a study of lumbar traction. *Ann Phys Med* 9:275–279
13. Matthews JA, Hickling J (1975) Lumbar traction: a double-blind controlled study for sciatica. *Rheumatol Rehabil* 14:222–225
14. Pal B, Mangion P, Hossain MA et al. (1986) A controlled trial of continuous lumbar traction in the treatment of back pain and sciatica. *Brit J Rheumatol* 25:181–183
15. Twomey LT (1985) Sustained lumbar traction. An experimental study of long spine segments. *Spine* 10:146–149

T

## Tractus Trigeminothalamicus

### ► Trigeminothalamic Tract Projections

## Traditional Pharmacological Pain Relief

### Definition

Pain relieved by oral and subcutaneous injections of analgesic drugs when the patient demands pain relief. Often ineffective in that doses are too low and dosing intervals are too long.

### ► Postoperative Pain, Acute Pain Team

## Trafficking

### Definition

Trafficking refers to synthesis and targeting of proteins to specific locations within the cell.

- ▶ [Opioid Receptor Trafficking in Pain States](#)
- ▶ [Trafficking and Localization of Ion Channels](#)

## Trafficking and Localization of Ion Channels

PETER SHRAGER<sup>1</sup>, MATTHEW N. RASBAND<sup>2</sup>

<sup>1</sup>Department of Neurobiology and Anatomy, University of Rochester Medical Center, Rochester, NY, USA

<sup>2</sup>University of Connecticut Health Center, Farmington, CT, USA

pshr@mail.rochester.edu, rasband@uchc.edu

### Synonyms

Voltage-Dependent Pores; Clustering; Targeting; Ion Channel Trafficking

### Definition

- ▶ **Ion channels** are pore-forming proteins in the surface membrane through which electrical charges move to establish and alter the membrane potential. These channels must be synthesized and inserted into the membrane in the proper locations within the neuron in order for signaling to occur normally.

### Characteristics

Neurons are highly polarized cells, and during development individual neurites become either dendrites or axons. An essential element in this polarization is the proper **trafficking** of proteins to these processes, and, in particular, the targeting of ion channels to specific locations. In dendrites, ligand-gated channels must accumulate at postsynaptic regions. In axons, Na<sup>+</sup> channels are clustered at the initial segment, which is the site of integration of postsynaptic potentials and of initiation of the action potential. Na<sup>+</sup> and **K<sup>+</sup> channels** are distributed at low density throughout the remainder of the fiber and, if the axon is myelinated, they are also clustered within specific zones in the region of the node of Ranvier. Ectopic localization of these channels can lead to repetitive or spontaneous firing, and can thus contribute to pain. Localization may be controlled by domains within the protein that direct transport or insertion to specific sites, or by differential rates of endocytosis. For example, a protein may be axonal because its endocytotic removal rate is much higher in dendrites. There has been much progress recently in uncovering these mechanisms.

Multiple targeting domains have been discovered that direct K<sup>+</sup> channels to different sites within the neuron. The differential targeting of Kv2.1 and Kv2.2 to alternative dendritic regions is governed, at least in part, by a 26 amino acid **motif** on the cytoplasmic tail of Kv2.1. Manganas et al. (2001) have found that specific residues within the pore region of Kv1.x control surface expression of those channels. Voltage-dependent ion channels are typically heteromultimers consisting of a pore-forming alpha subunit and one or more beta subunits that modulate gating. Kv channel beta subunits are bound at the cytoplasmic surface of the channel. It was recently found that beta subunits also participate in localization. Axonal targeting of Kv1.2 in hippocampal neurons is driven by the tetramerization domain on the N-terminus, at a site that binds Kvbeta2 (Gu et al. 2003). Kvbeta subunits have a binding pocket for NADP<sup>+</sup>, and mutation of this site eliminates their axonal targeting capability (Campomanes et al. 2002). Nodal regions have 3 major zones: the nodal gap; paranodes in which axoglial junctions link the paranodal loops to the axolemma; and the juxtaparanodes, zones that flank the paranodes, begin the internode, and have no special morphological characteristics. At nodal regions KCNQ2 and KCNQ3, slowly activating channels that can be modulated by neurotransmitters, are found within the nodal gap (Devaux et al. 2004). Kv1.1 and Kv1.2 are clustered in the juxtaparanodes in both the PNS and CNS. The localization of Kv1.x is dependent on the integrity of the axoglial paranodal junctions. When the latter are disrupted, these K<sup>+</sup> channels are found in the paranodes and diffusely throughout the internode.

At both axon initial segments and **nodes of Ranvier**, voltage-dependent **Na<sup>+</sup> channels** are linked to the spectrin-actin cytoskeleton by the adapter protein ankyrinG. AnkyrinG also serves to link Na<sup>+</sup> channels in a large molecular complex that includes the L1-family proteins NrCAM and neurofascin. The beta subunits of Na<sup>+</sup> channels are membrane proteins and they, along with NrCAM, neurofascin, and contactin (a GPI-anchored protein) are all members of the immunoglobulin superfamily, implicating them in intercellular (perhaps neuron-glia) signaling. The link to ankyrinG also appears to be important in targeting. In spinal motor neurons in culture, Na<sup>+</sup> channels are normally synthesized in the soma, but are inserted in the surface membrane only at the axon initial segment (Alessandri-Haber et al. 1999). Nav1.2 has a C-terminal motif that is involved in axonal targeting. It has also recently been demonstrated that the intracellular linker between domains II and III serves as a localization signal to the initial segment (Garrido et al. 2003). Of particular interest, Lemaillet et al. (2003) showed that this latter loop contains an ankyrinG binding motif. Thus, establishment of these regions of high Na<sup>+</sup> channel density appears to involve targeting to the axon and insertion in

the surface membrane, followed by cytoskeletal immobilization via ankyrinG. In the case of nodes of Ranvier, there is an additional requirement for glial modeling of the axonal surface. Myelinating Schwann cells in the PNS direct the clustering of Na<sup>+</sup> channels, perhaps by reorganizing the low density of these channels present throughout the axon prior to myelin formation (Dugandzija-Novakovic et al. 1995). The neuron-glial communication involved in this trafficking may involve the other members of the Na<sup>+</sup> channel complex mentioned above (Custer et al. 2003). In the CNS, some early aspects of clustering may involve soluble factors released by oligodendrocytes, but final node formation seems to be contact dependent, as in the PNS (Kaplan et al. 2001). Finally, there is a developmentally regulated progression in Na<sup>+</sup> channel subtype in axons. Nav1.2 is expressed early, and is later replaced by Nav1.6 (Boiko et al. 2001). The physiological consequences of this shift are not known, but Nav1.6 has a unique resurgent current (Raman and Bean 1997), which could render axons more susceptible to re-entry excitation that may contribute to pain, if other regulatory zones of nodes are compromised. For example, loss of juxtaparanodal Kv1.x can lead to instabilities.

Turnover rates of ion channels in myelinated axons have not been measured directly, but some data are available. Nodal Na<sup>+</sup> channels are particularly stable, and clusters can be detected up to 9 days after myelin disruption (Custer et al. 2003). This is undoubtedly due to the cytoskeletal link via ankyrinG. The stabilization of these channels seems to occur gradually after their initial clustering, and may involve the formation of large complexes through the multiple binding sites of ankyrinG (Custer et al. 2003). Juxtaparanodal Kv1.x channel clusters are significantly less stable, and break up within 1–2 days after initiating demyelination (Rasband et al. 1998).

There is considerable evidence that altered ion channel trafficking, localization, and turnover are involved in painful neuropathies, although the precise mechanisms remain to be determined. Painful neuromas develop within peripheral nerves after axonal injury, and the spontaneous discharge at these sites is thought to result from an accumulation of Na<sup>+</sup> channels (Devor et al. 1989). Further, there is evidence that specific subtypes of Na<sup>+</sup> channels are involved, including PN1 and PN3. The Na<sup>+</sup> channels accumulating at neuromas are colocalized with ankyrinG (Kretschmer et al. 2002), and the increased levels of both proteins, may reflect dysregulation of trafficking and/or turnover rates. As more information becomes available on the neurobiological mechanisms regulating ion channel biosynthesis, trafficking, and targeting, it will be interesting to apply these principles to models of neuropathic pain. For example, if some forms of neuropathic pain are a consequence of altered Na<sup>+</sup> channel trafficking, then therapeutic strategies designed to disrupt or perturb the trafficking

of these proteins may prove useful in the treatment of these disorders.

## References

- Alessandri-Haber N, Paillart C, Arzac C, Gola M, Couraud F, Crest M (1999) Specific Distribution of Sodium Channels in Axons of Rat Embryo Spinal Motoneurons. *J Physiol* 518:203–214
- Boiko T, Rasband MN, Levinson SR, Caldwell JH, Mandel G, Trimmer JS, Matthews G (2001) Compact Myelin Dictates the Differential Targeting of Two Sodium Channel Isoforms in the Same Axon. *Neuron* 30:91–104
- Campomanes CR, Carroll KI, Manganas LN, Hershberger ME, Gong B, Antonucci DE, Rhodes KJ, Trimmer JS (2002) Kv Beta Subunit Oxidoreductase Activity and Kv1 Potassium Channel Trafficking. *J Biol Chem* 277:8298–8305
- Custer AW, Kazarinova-Noyes K, Sakurai T, Xu X, Simon W, Grumet M, Shrager P (2003) The Role of the Ankyrin-Binding Protein NrCAM in Node of Ranvier Formation. *J Neurosci* 23:10032–10039
- Devaux JJ, Kleopa KA, Cooper EC, Scherer SS (2004) KCNQ2 is a Nodal K<sup>+</sup> Channel. *J Neurosci* 24:1236–1244
- Devor M, Keller CH, Deerinck TJ, Levinson SR, Ellisman MH (1989) Na<sup>+</sup> Channel Accumulation on Axolemma of Afferent Endings in Nerve End Neuromas in Apterionotus. *Neurosci Lett* 102:149–154
- Dugandzija-Novakovic S, Koszowski AG, Levinson SR, Shrager P (1995) Clustering of Na Channels and Node of Ranvier Formation in Remyelinating Axons. *J Neurosci* 15:492–502
- Garrido JJ, Giraud P, Carlier E, Fernandes F, Moussif A, Fache MP, Debanne D, Dargent B (2003) A Targeting Motif Involved in Sodium Channel Clustering at the Axonal Initial Segment. *Science* 300:2091–2094
- Gu C, Jan YN, Jan LY (2003) A Conserved Domain in Axonal Targeting of Kv1 (Shaker) Voltage-Gated Potassium Channels. *Science* 301:646–649
- Kaplan MR, Cho MH, Ullian EM, Isom LL, Levinson SR, Barres BA (2001) Differential Control of Clustering of the Sodium Channels Na(v)1.2 and Na(v)1.6 at Developing CNS Nodes of Ranvier. *Neuron* 30:105–119
- Kretschmer T, England JD, Happel LT, Liu ZP, Thouron CL, Nguyen DH, Beuerman RW, Kline DG (2002b) Ankyrin G and Voltage Gated Sodium Channels Co-Localize in Human Neuroma-Key Proteins of Membrane Remodeling after Axonal Injury. *Neurosci Lett* 323:151–155
- Lemaitre G, Walker B, Lambert S (2003) Identification of a Conserved Ankyrin-Binding Motif in the Family of Sodium Channel Alpha Subunits. *J Biol Chem* 278:27333–27339
- Manganas LN, Wang Q, Scannevin RH, Antonucci DE, Rhodes KJ, Trimmer JS (2001) Identification of a Trafficking Determinant Localized to the Kv1 Potassium Channel Pore. *Proc Natl Acad Sci USA* 98:14055–14059
- Raman IM, Bean BP (1997) Resurgent Sodium Current and Action Potential Formation in Dissociated Cerebellar Purkinje Neurons. *J Neurosci* 17:4517–4526
- Rasband MN, Trimmer JS, Schwarz TL, Levinson SR, Ellisman MH, Schachner M, Shrager P (1998) Potassium Channel Distribution, Clustering, and Function in Remyelinating Rat Axons. *J Neurosci* 18:36–47

## Trafficking of Proteins

### Definition

Proteins are synthesized on ribosomes in the cell body, packaged into vesicles in the Golgi apparatus, and then transported along cytoskeletal structures to their final lo-

cation in the cell. The process of targeted transport is trafficking.

- ▶ [Peripheral Neuropathic Pain](#)
- ▶ [Trafficking and Localization of Ion Channels](#)

## Training by Quotas

WILBERT E. FORDYCE

Department of Rehabilitation, University of Washington School of Medicine, Seattle, WA, USA  
wfordyce@msn.com

### Synonyms

Exercise; quotas; contingency management

### Definition

Training by quota describes methods for increasing exercise and activity level by use of the quota system, a form of contingency management based on behavioral science. The methods make use of sensitivity to our environments to improve our state. Review of the theoretical and conceptual background can be found in texts by Fordyce (1976, 1990). “How” to do it will be described. PINPOINT the ▶ [behavior](#) to be changed (i.e. specify in ▶ [movement cycles](#), walking-steps, exercise repetitions), RECORD the pre-intervention rate of the behavior and CONSEQUATE, i.e. spell out the rate of reinforcement and by whom, always with the patient’s informed consent.

### Characteristics

The term chronic pain encompasses many conditions. Increasing exercise and/or activity level is not indicated for all of them. Evaluation of a problem of chronic pain (ideally a multi-disciplinary, multi-modal process) indicating increased exercise or activity is clearly to the patient’s benefit points to using these methods. Quota methods help patients increase exercise or activity levels. They are not methods for treating pain. Increases in activity level help restore patient access to activities usually engaged in. When target levels of activity or exercise are reached, the program can be faded to maintenance levels or stopped altogether. Re-entry into sustaining activities should be achieved before halting or reducing exercise levels.

- ▶ [Reinforcers](#) are usually simple to define and apply in the practical case, using the Premack Principle (Premack 1959). This states that high strength behaviors reinforce low strength behaviors; paraphrased as, what a person does a lot of can be used to reinforce activities or movements targeted to be increased. Observing the consequences of what the person does a lot can usually readily identify effective reinforcers. To a restless person frequently on the move, activity,

a high strength behavior, is likely to be an effective reinforcer. If programmed or scheduled carefully, it can serve to enhance or reinforce exercise. To an inactive person, one who moves relatively little, activity is unlikely to be reinforcing but rest or “time out” from activity is. In the context of pain management, rest or “time out” from activity and attention or encouragement of important others around the person (e.g. the therapist) usually suffice as reinforcers, when programmed appropriately.

### Baseline

Baseline is the starting point or rate (i.e. number of repetitions) at which the target behavior is occurring, e.g. number of steps walked before weakness, pain or fatigue causes stopping. If the target behavior is not in the person’s present repertoire, establishing it by teaching or “shaping” is indicated (Fordyce 1976).

Walking, performing selected exercises, engaging in activities intended to diminish reclining time and increasing activity are common targets for behavior change. Talking about pain, grimacing, asking for and/or taking analgesics are less frequently targets for change and should become so only with careful consideration of appropriateness to the patient’s condition and with full informed consent.

### Quota

Once baseline performance is identified, set quotas to be applied for each trial. The initial quota should be approximately  $\frac{2}{3}$  or  $\frac{1}{2}$  of baseline, e.g. laps walked = 7, initial quota = 4 or 5, baseline of an exercise repetition = 5, initial quota = 2 or 3. Initial quota level should be determined by confidence that it is an amount well within the patient’s current repertoire, ensuring successes at early trials. It is better to have too low an initial quota and be sure of success than too high and a risk of failure. Quotas are then incremented at a rate driven mainly by an ascending performance curve confidently expected to provide several early succeeding trials before initial baseline is reached. In short, “success breeds success.”

### Quota Increment Rates

Most commonly, incrementing by 1 repetition per trial or session is appropriate. In cases of marginally adequate ability to increment, a slower rate (e.g. 1 × each 2 or 3 trials) may suffice. An amount easily performed may indicate increments of 2 or more with each trial, but do that only if confident that several successful sessions are achieved prior to reaching baseline. In all cases, full informed consent prior to performance is indicated. Quota increment rates should be spelled out to the patient following their determination, including the expected endpoint.

### Quota Endpoints

Within physiological limits, quota endpoints or targets are defined mainly by practical considerations. Target



levels must consider time to permit achieving current quota levels, as well as overall fatigue considerations if there is an array of exercises to be performed. Quota increments and endpoints are also moderated by patient access to monitoring. For example, for a patient for whom 3 weeks of daily trials is the logistical limit, quota endpoints may be limited by the time available to reach them using the quota increments selected, unless surrogate monitoring is available, e.g. family.

### Examples

#### Walking

##### Pinpoint

Lay out the course to be walked (e.g. a 25 m lap in a hospital corridor or distance in meters from the front door of home to a selected landmark).

##### Baseline

The initial baseline should be within expected patient tolerance. The patient is asked to walk laps (start-end-return to start) until “pain, weakness or fatigue cause you to want to stop. You decide when to stop.” If the patient is unable to do at least one lap, shorten the lap distance until two or more repetitions are within starting tolerance. Theoretically, baseline is defined by a stabilizing performance curve. Usually, however, in the exercise context, 2–3 baseline trials suffice. Each trial is spaced to provide ample rest between trials.

##### Record

Record laps walked each trial. A graph on the wall at the bedside or in a folder carried by the patient is adequate. By making recorded results “visible”, an element of social support or reinforcement is also provided.

##### Quota

One lap increments per trial usually suffices.

##### Consequence

Reinforcement from rest (i.e. time out from the activity) and social approval of contextual personnel usually suffice. Resort to some form of tangible reinforcement is rarely needed. See Fordyce (1976, 1990) for more on this.

#### Exercise: (e.g. Hip Abduction, Deep Knee Bends, Arm Extension)

##### Pinpoint

The patient is asked to perform the assigned exercise (always with full informed consent) and instructed as to how to do it.

##### Baseline

The patient is asked to perform the assigned exercise “until pain, weakness or fatigue cause you to want to stop. You decide when to stop.” Amounts performed across 2–3 trials, spaced appropriately, are recorded.

##### Quota

Usually one repetition per trial suffices. Increment rates of >1 repetition per trial could be designated if there is ample confidence that performance will succeed, particularly if access to monitoring is limited by the calendar.

##### Consequence

Rest or time out from the exercise, plus therapist attention and regard suffice.

##### Quota Failures (see also Fordyce 1976, 1990)

The options re failure divide into (a) problems of patient status and access and (b) performance.

##### Status

If opportunity to perform was not the problem, ask the patient why failure? If change in health or status of pain is the problem, clarify with the attending physician whether to proceed with quotas, change exercises, etc. Scheduling problems or access to equipment with which to perform can be dealt with directly.

##### Performance

Your value as a source of reinforcement should not be expended carelessly. Admonitions or urging better performance lets your attention become contingent on failure. Instead, convey that you hope and expect he / she will be able to resume meeting quotas and leave it at that. If on subsequent trials success is achieved, be quick to praise.

If the patient is not invested in getting better, the patient should choose whether to proceed or to halt the program. Discussions with significant others to the patient may also help.

### References

1. Fordyce WE (1976) Behavioral methods in chronic pain and illness. C.V. Mosby, St. Louis, pp 236
2. Fordyce WE (1990) Contingency Management. In: Bonica JJ Management of Pain, vol 2, 2nd edn. Lea & Febiger, Philadelphia, pp 1702–1710 (also in: Bonica JJ (2001) Management of Pain, 3rd edn. Lippincott, Williams & Wilkins, Philadelphia, pp 1745–1750)
3. Premack D (1959) Toward Empirical Behavior Laws: I Positive Reinforcement. Psychol Rev 66:219–233

T

## Trait

- Personality and Pain

## Trajectory

### Definition

The path of pain expression over time.

- Pain Assessment in Neonates

## Tramadol

### Definition

Tramadol is a synthetic, centrally acting analgesic agent that is structurally related to codeine and morphine; it is a racemic mixture, and the 2 enantiomers function in a complementary manner to enhance analgesic actions. It also acts as a weak opioid agonist and inhibits the serotonin release and reuptake of norepinephrine and serotonin. The analgesic effects of oral tramadol (100mg) peak at 1–2 hrs and last for 3–6 hours after drug administration.

- ▶ Acute Pain in Children, Post-Operative
- ▶ Drugs with Mixed Action and Combinations, Emphasis on Tramadol
- ▶ Post-Operative Pain, Tramadol
- ▶ Tramadol Hydrochloride

## Tramadol Hydrochloride

JAYANTILAL GOVIND

Department of Anaesthesia, Pain Clinic, University of New South Wales, Liverpool Hospital, Sydney, NSW, Australia

jaygovind@bigpond.com

### Synonyms

Tramadol; Tramal<sup>®</sup>; Zydol

### Definition

An analogue of codeine, tramadol hydrochloride is a centrally acting analgesic. It is not derived from natural sources, and structurally is not related to opioids; but does exhibit certain opioid characteristics.

### Characteristics

#### Mechanism

Animal and in-vitro studies suggest that in addition to its mu-opioid effect, tramadol synergistically inhibits the reuptake of norepinephrine (NE) and serotonin, and simultaneously stimulates the pre-synaptic release of serotonin (Raffa and Fridericks 1996; Bamigbade et al. 1997). It has a weak affinity for opioid receptors and is less potent than morphine. The analgesic effect is apportioned between the opioid and monoaminergic components (Desmoules et al. 1996). The response is dose-dependent but the relationship between analgesic effect and serum concentration varies considerably between individuals.

#### Pharmacokinetics

After oral administration, tramadol is rapidly and almost completely absorbed with a mean bio-availability of 68%–72%. The drug is widely distributed and 20% is bound to plasma proteins. The peak serum level is reached within two hours (range 1–3 hours) (Tramal 2004).

Tramadol is metabolized, via the CYP2D6 isoenzyme of cytochrome P450, to eleven metabolites of which only O-desmethyltramadol (M1) is active. M1 has a greater affinity for opioid receptors and exerts greater analgesia than tramadol. About 7%–8% of Caucasians lack this isoenzyme. Tramadol has a half-life of about 6–7 hours and is principally excreted via the kidneys. At least 30% remains unchanged (Tramal 2004).

### Routes of Administration

Tramadol can be administered orally, rectally and parenterally. For formulations and dosing schedules readers should consult the product information pertinent to their respective jurisdictions.

### Applications

The agent is indicated for the treatment of mild to moderate pain. It is less effective than morphine for severe pain (Kaye 2004; Pang et al. 1999; Osipova et al. 1991).

### Efficacy

When administered to post-surgical and post-traumatic patients, 100 mg injectable tramadol is equivalent to 5–10mg of morphine. As an oral dose, 100 mg tramadol is as effective as 1000 mg paracetamol (Moore and McQuay 1997). For achieving 50% reduction of pain, tramadol has an NNT of 4.6 (Moore and McQuay 1997). For 150 mg the NNT is 2.9 (Drugdex Drug Evaluations. Micromedex<sup>®</sup> Healthcare series).

Tramadol has been shown to be effective for the relief of neuropathic pain (Duhmke 2004). Patients with chronic painful neuropathy reported relief of their pain, paraesthesia and touch evoked allodynia by 2 median points on a 10-point scale (Sindrup 1999). To achieve a 50% reduction in pain level, the ▶ NNT is between 3 and 6, using a daily dose of 200 mg – 400 mg. Studies investigating the efficacy of tramadol for the treatment of pain of diabetes neuropathy (Harati 1998) and ▶ post-herpetic neuralgia have been inconclusive (Wareham DW 2004).

The safety and efficacy of tramadol in patients under the age of 16 years has not been established (Drugdex Drug Evaluations. Micromedex<sup>®</sup> Healthcare series).

### Contraindications

Tramadol is contraindicated in patients with: porphyria; known hypersensitivity to tramadol, opioids or any excipients; acute intoxication with alcohol, opioids, hypnotics, analgesics, or psychotropic drugs; who use monoamine oxidase inhibitors, or have used them in the last 14 days. Tramadol must not be used for opioid dependency, addiction or for opioid withdrawal treatment (Kaye 2004; Pang et al. 1999; Drugdex Drug Evaluations. Micromedex<sup>®</sup> Healthcare series).

### Side effects and complications

Adverse reactions are common and patients must be given guidance about appropriate action. The potential for serious side effects including anaphylaxis should

not be underestimated. Either the monoaminergic or opioid effects may predominate. The adverse effects of tramadol may be difficult to distinguish or recognize in patients taking multiple medications. Even with therapeutic doses opioid side-effects can occur, except respiratory depression and inhibition of smooth muscle, which are usually less pronounced (Kaye 2004; Drugdex Drug Evaluations. Micromedex® Healthcare series).

Central effects include seizures, hallucinations, euphoria, ataxia, and suicidal ideation. Co-administration with alcohol, general anaesthetics, or other respiratory depressants can precipitate profound respiratory decompensation. Dizziness can cause at-risk patients to fall.

Gastrointestinal side effects are very common, including nausea, vomiting, and constipation. Dyspepsia, diarrhoea and increased flatulence have been reported (Kaye 2004).

Although uncommon, cardiovascular side-effects such as hypertension, palpitations, tachycardia, bradycardia, other ECG abnormalities, and orthostatic dysregulation do occur and can be serious.

Additional reported side effects include urinary retention, erythema, hypertonia, hyponatraemia, itch, rhabdomyolysis and diaphoresis.

#### Drug interactions

Tramadol is known to interact with at least 72 other drugs, some with serious consequences (Kaye 2004; Drugdex Drug Evaluations. Micromedex® Healthcare series). Carbamazepine reduces tramadol's analgesic effect by increasing its metabolism. Drugs that inhibit CY2D6 activity (e.g. Selective Serotonin Reuptake Inhibitors [SSRI], or quinidine) will prevent conversion to its active metabolite, M1.

Serotonin syndrome is a potentially serious toxic state caused mainly by excess serotonin within the central nervous system (Hall and Buckley 2003). It manifests as a dose-related range of toxic symptoms due to a variety of mental, autonomic and neuromuscular changes. The clinical features are highly variable and the onset could be insidious or dramatic. It is nearly always caused by a drug interaction involving two or more 'serotonergic' drugs including SSRIs, MAOI, pethidine, tricyclic antidepressants, St John's wort and lithium. Severe hyperthermia, rhabdomyolysis, disseminated intravascular coagulation and adult respiratory distress syndrome are potentially life-threatening (Hall and Buckley 2003).

#### Reproduction

Tramadol is embryotoxic and fetotoxic but not tetratoxic in animal studies (Drugdex Drug Evaluations. Micromedex® Healthcare series).

#### Precautions

Tramadol is best avoided in patients with epilepsy, and in patients who are at risk of developing respiratory depression. Because of miosis and its central effects, it is inadvisable to prescribe tramadol for patients with a head injury or raised intracranial pressure. Elderly patients and patients with renal or hepatic decompensation, myxoedema, hypothyroidism, hypoadrenalism are particularly vulnerable to severe side effects and complications. Its administration may complicate the clinical assessment of patients with acute abdominal conditions (Kaye 2004; Drugdex Drug Evaluations. Micromedex® Healthcare series).

#### Pregnancy and lactation

Tramadol has been detected in breast milk. It is best avoided during pregnancy and whilst breast-feeding (Kaye 2004).

#### Overdose

Treatment is symptomatic. The effects are not completely reversed by naloxone (Kaye 2004), and the latter may increase the risk of seizure (Drugdex Drug Evaluations. Micromedex® Healthcare series).

#### References

- Raffa RB, Fridericks E (1996) The basic science aspect of tramadol hydrochloride. *Pain Rev* 3:249–271
- Bamigbade TA, Davidson C, Langdord RM, Stamford JA (1997) Actions of tramadol: its enantiomers and principle metabolite, O-desmethyltramadol on serotonin (5-HT) efflux and uptake in the rat dorsal raphe nucleus. *Br J Anaesth* 79:352–356
- Desmoules JB, Piquet R, Collart L, Dayer P (1996) Combination of monoaminergic modulation to the analgesic effect of tramadol. *Br J Clin Pharmacol* 41:7–12
- Tramal (2004) Product information. CSL Limited. Parkville, VIC, Australia
- Kaye K (2004) Trouble with tramadol (editorial) *Australian Prescriber* 27:26–27
- Pang, WW, Mok MS, Lin CH, et al. (1999) Comparison of patient controlled analgesia (PCA) with tramadol or morphine. *Can J Anesth* 46:1030–1035
- Osipova NA, Novikov GA, Beresnev VA et al. (1991) Analgesic effect of tramadol in cancer patients with chronic pain: a comparison with prolonged action morphine sulfate. *Curr Ther Res* 50:812–821
- Moore RA, McQuay HJ (1997) Single-patient data meta-analysis of 3453 postoperative patients: oral tramadol versus placebo, codeine and combination analgesics. *Pain* 69:287–294
- Drugdex Drug Evaluations. Micromedex® Healthcare series. ▶ <http://micromedex.hen.net.au/mde-3261/display.exe?CTL=apache/products/micromede>. Accessed 13.10.04
- Duhmke RM, Cornblath DD, Hollingshead JR (2004) Tramadol for neuropathic pain. *Cochrane Database Syst Rev*: CD003726
- Sindrup SH, Andersen G, Madsen C, Smith T, Broesen K, Jensen TS (1999) Tramadol relieves pain and allodynia in polyneuropathy: a randomised double blind controlled trial. *Pain* 83:85–90
- Harati Y, Gooch C, Swenson M et al. (1998) Double blind randomized trial of tramadol for the treatment of the pain of diabetic neuropathy. *Neurology* 50:1842–1846
- Wareham DW (2004) Postherpetic Neuralgia. In: Godlee F (ed) *Clinical Evidence*. edn
- Hall M, Buckley N (2003) Serotonin Syndrome. *Australian Prescriber* 26:62–63

## Tramal®

- ▶ Postoperative Pain, Tramadol
- ▶ Tramadol Hydrochloride

## Transcranial Magnetic Stimulation

### Synonyms

TMS

### Definition

Transcranial Magnetic Stimulation refers to stimulation of the cerebral cortex by an electromagnetic field, generated by a magnetic stimulator placed over the scalp without the need for surgery or external electrodes. Magnetic stimuli can also activate the peripheral nervous system.

- ▶ Clinical Migraine without Aura
- ▶ Motor Cortex, Effect on Pain-Related Behavior
- ▶ Stimulation Treatments of Central Pain

## Transcription Factor

### Definition

A protein, product of gene transcription and translation, which enters the nucleus where it binds to a nucleotide sequence in the regulatory regions of responsive genes, and has the effect of either enhancing or repressing the expression of one or more genes downstream of the binding site. Expression of one gene is normally controlled by several transcription factors.

- ▶ Central Changes after Peripheral Nerve Injury
- ▶ COX-1 and COX-2 in Pain
- ▶ Cytokines, Effects on Nociceptors
- ▶ NSAIDs and Cancer

## Transcutaneous Electrical Nerve Stimulation

JAMES WATT  
North Shore Hospital, Auckland, New Zealand  
jameswatt@clear.net.nz

### Synonyms

TENS; AL-TENS (Acupuncture like TENS); Electrical Therapy.

### Definition

Transcutaneous electrical nerve stimulation (TENS) is a means of relieving pain. It entails delivering an electrical stimulus through electrodes to the skin overlying or near the region in which pain is perceived. The stimulus is delivered from a battery-driven generator.

### Characteristics

TENS is a commonly used non-invasive modality that provides an alternative to medication for pain relief. It has been used for more than 30 years, but its effectiveness remains controversial.

### Mechanism

TENS was developed on the basis of the gate control theory of pain proposed by Melzack and Wall (Melzack and Wall 1965). This theory predicted that stimulation of large-diameter primary afferent fibres (A fibres) would have an inhibitory effect on transmission from the small-diameter, unmyelinated afferent fibres (C fibres). Accordingly, pain should be relieved if cutaneous afferents from a region of pain could be artificially stimulated using an electrical current.

A battery-operated, transistorised unit generates the electrical stimulus. There are usually three separate controls. The first varies the amplitude or intensity, and allows for administration of a range from low (2–4Hz) to high (100–250 Hz) frequency stimulation. A second varies pulse width, usually from 0.04–0.1 ms, and a third controls the mode to select continuous or pulsed  $\pm$  ramped,  $\pm$  random stimulus. The stimulus is delivered through pads attached to the skin surface. The electrical field generated has to be of sufficient magnitude to excite the adjacent afferent nerve fibres without damaging the local skin, producing dysaesthesia or producing painful muscle contractions.

The mechanism of action of TENS has not been explicitly or directly demonstrated. However, it is believed that low frequency stimulation releases mu opioids ( $\beta$ -endorphins), while high frequency stimulation releases delta opioids (met-enkephalin and leu-enkephalin) in the central nervous system. The mu receptor antagonist – naloxone, inhibits the effects of low frequency stimulation, but not those of high frequency stimulation (Sjolund and Eriksson 1979; Freeman et al. 1983). Rats develop opioid tolerance after 4 days when treated with TENS for 20 min. a day (Chandran and Sluka 2003).

Due to the development of tolerance, treatment is more effective when TENS is used intermittently. Daily administration lessens the analgesic effect. The short duration of benefit (260 minutes) (Cheing et al. 2003), however, encourages frequent application in chronic conditions; but this in turn reduces pain relief.

### Applications

TENS is used for the control of pain of various types in various regions of the body. The portability, safety and



low cost of the transistorised impulse generator have all contributed to its wide and varied use in the field of pain medicine.

A number of factors need to be considered when offering TENS as a treatment option. The aim is to produce the optimal tolerable stimulus. Application is critical to the success of the treatment. The site of stimulation should be chosen to produce maximal input in the segment where the pain originates, and should be proximal to it. It is often not possible to predict the optimal placement or type of electrodes, or the stimulus that will produce maximal pain relief. Consequently, with guidance, the patient should be encouraged to experiment with amplitude, frequency and pulse width, as well as electrode placement and duration of stimulus, in order to maximize their relief of pain. Most choose frequencies from 40–70 Hz; with a pulse-width of 0.1–0.5 ms. Stimulation at lower frequencies requires higher intensity of stimulus, which tends to produce painful muscle contractions.

Maximal comfortable stimulus is more effective in relieving pain than stimulation that is barely detectable. However, the theoretical argument of providing a sufficiently powerful stimulus to activate both small myelinated A-delta fibres and large A-beta fibres is negated by the difficulty patients have in tolerating continuous high-intensity stimulation.

### Efficacy

Two Cochrane reviews, one of chronic pain (Carroll et al. 2002), and the other of chronic low back pain (Milne et al. 2002), demonstrate lack of effectiveness. There were wide variations in the parameters of type, site and frequency of application, treatment duration, intensity and frequency of the electrical impulse in both reviews.

Many studies show lack of evidence of benefit. There was no evidence that TENS was any more effective than other conservative treatments for acute and chronic non-specific low back pain (van Tulder et al. 1997) or for chronic pain (McQuay et al. 1997). TENS was found not to be effective in relieving labour pain (Carroll et al. 1997).

In contrast, a Cochrane Review by Proctor (Proctor et al. 2002) showed high frequency TENS to be more effective than placebo in relieving primary dysmenorrhoea, while low frequency TENS showed no difference. A review by Osiri (Osiri et al. 2001) on knee osteoarthritis showed TENS provided significantly better pain relief and improved movement, compared with placebo. The effect had previously been shown in three randomised controlled trials reviewed in a paper by Puett and Griffin (Puett and Griffin 1994). However, Osiri's review showed that TENS only differed from placebo when treatment continued for more than 4 weeks in duration. The efficacy of TENS in acute situations is attested in a meta-analysis of studies of reduction of analgesic use in post-operative patients. Bjordal (Bjordal et al. 2003)

reviewed 21 randomised placebo-controlled trials with a total of 1350 patients, and demonstrated a mean reduction in analgesic consumption after TENS/AL-TENS of 26.5% (range –6 to +51%). Eleven of these trials, covering 964 patients, reported that a strong sub-noxious electrical impulse of adequate stimulus frequency was administered. These trials demonstrated a reduction in analgesic consumption of 35.5% (range 1–51%). In comparison, the nine trials that did not confirm sufficient current intensity or adequate frequency, demonstrated a reduction of only 4.1% (range –10 to +29%).

The short-term analgesic efficacy of TENS was demonstrated in a trial using distension arthrography (a moderately painful procedure) for frozen shoulder. There was a 50% reduction using high intensity TENS, and 38% reduction using low intensity TENS, compared to controls (Morgan et al. 1996).

Thus, the evidence is mixed. This is due, in part, to the poor quality of studies available, and the lack of clear definition of the treatment given. The effect has been shown to differ depending on a number of variables in the treatment application. These are frequency, intensity and waveform of the stimulus, site and duration of its application, and conduction medium. All need to be recorded clearly for every subject in a trial of the efficacy of TENS.

### Side-Effects

Opioid tolerance can develop with repeated daily use. There are few other side effects from the administration of TENS, probably due to the application generally being under the patient's control. There is the theoretical risk that too high a stimulus could damage the skin by electrical burn, but it is unusual for patients to achieve such damage. The range of machine settings, and the noxious stimulus produced by painful muscle contraction at the higher stimulus range, affords protection. Side effects really only occur in the presence of excessive zeal.

- ▶ [Acupuncture Mechanisms](#)
- ▶ [Chronic Pain in Children, Physical Medicine and Rehabilitation](#)
- ▶ [Complex Chronic Pain in Children, Interdisciplinary Treatment](#)
- ▶ [McGill Pain Questionnaire](#)
- ▶ [Pain in Humans, Electrical Stimulation \(Skin, Muscle and Viscera\)](#)
- ▶ [Postoperative Pain, Appropriate Management](#)
- ▶ [Transcutaneous Electrical Nerve Stimulation Outcomes](#)
- ▶ [Transcutaneous Electrical Nerve Stimulation \(TENS\) in Treatment of Muscle Pain](#)

### References

1. Bjordal JM, Johnson MI, Ljunggreen AE (2003) Transcutaneous Electrical Nerve Stimulation (TENS) can Reduce Postoperative Analgesic Consumption. A Meta-Analysis with Assessment of Optimal Treatment Parameters for Postoperative Pain. *Eur J Pain* 7:181–188

- Carroll D, Moore RA, McQuay HJ, Fairman F, Tramer M, Leijon G (2002) Transcutaneous Electrical Nerve Stimulation (TENS) for Chronic Pain (Cochrane Review). The Cochrane Library, Issue 2
- Carroll D, Moore RA, Tramer MR, McQuay HJ (1997) Transcutaneous Electrical Nerve Stimulation Does Not Relieve Labour Pain: Updated Systematic Review. Contemporary Reviews in Obstetrics and Gynaecology: 195–205
- Chandran P, Sluka KA (2003) Development of Opioid Tolerance with Repeated Transcutaneous Electrical Nerve Stimulation Administration. Pain 102(1–2):195–201
- Cheing GL, Tsui AY, Lo SK, Hui-Chan CW (2003) Optimal Stimulation Duration of TENS in the Management of Osteoarthritic Knee Pain. J Rehabil Med 35(2):62–68
- Freeman TB, Campbell JN, Long DM (1983) Naloxone Does Not Affect Pain Relief Induced by Electrical Stimulation in Man. Pain 17:189–195
- McQuay HJ, Moore RA, Eccleston C, Morley S, DeC Williams AC (1997) Systematic Review of Outpatient Services for Chronic Pain Control. Health Technology Assessment 1(6):1–137
- Melzack R, Wall PD (1965) Pain Mechanisms: A New Theory. Science 15:971–979
- Milne S, Welch V, Brosseau L, Saginur M, Shea B, Tugwell P, Wells G (2002) Transcutaneous Electrical Nerve Stimulation (TENS) for Chronic Low Back Pain (Cochrane Review). The Cochrane Library, Issue 1
- Morgan B, Jones AR, Mulcahy KA, Finlay DB, Collett B (1996) Transcutaneous Electrical Nerve Stimulation (TENS) during Distension Shoulder Arthrography: A Controlled Trial. Pain 64:265–267
- Osiri M, Welch V, Brosseau L, Shea B, McGowan J, Tugwell P, Wells G (2001) Transcutaneous Electrical Nerve Stimulation for Knee Osteoarthritis (Cochrane Review). The Cochrane Library, Issue 1
- Proctor ML, Smith CA, Farquhar CM, Stones RW (2002) Transcutaneous Electrical Nerve Stimulation and Acupuncture for Primary Dysmenorrhoea (Cochrane Review). The Cochrane Library, Issue 1
- Puett DW, Griffin MR (1994) Published Trials of Non-Medicinal and Non-Invasive Therapies for Hip and Knee Osteoarthritis. Ann Int Med 121:133–140
- Sjolund BH, Eriksson MBE (1979) The Influence of Naloxone on Analgesia Produced by Peripheral Conditioning Stimulation. Brain Res 173:295–301
- van Tulder MW, Koes BW, Bouter LM (1997) Conservative Treatment of Acute and Chronic Non-Specific Low Back Pain: A Systematic Review of Randomised Controlled Trials of the Most Common Interventions. Spine 22:2128–2156

## Transcutaneous Electrical Nerve Stimulation (TENS) in Treatment of Muscle Pain

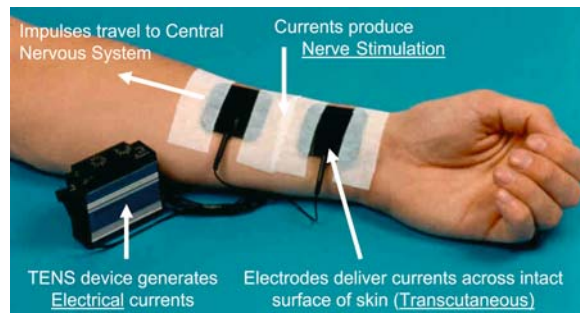
MARK I. JOHNSON

Faculty of Health, Leeds Metropolitan University,  
Leeds, UK

m.johnson@leedsmet.ac.uk

### Synonyms

Transcutaneous Nerve Stimulation (TNS); Transcutaneous Electrical Stimulation; (TES) Electrical Stimulation Therapy (EST); Percutaneous Electrical Nerve Stimulation; Electroanalgesia



**Transcutaneous Electrical Nerve Stimulation (TENS) in Treatment of Muscle Pain, Figure 1** An electrical pulse generator delivers currents via conducting electrodes attached to the intact surface of the skin. Traditionally, carbon rubber electrodes smeared with conducting gel and attached to the skin using self-adhesive tape were used to deliver the electrical currents. Nowadays, self-adhesive electrodes are used.

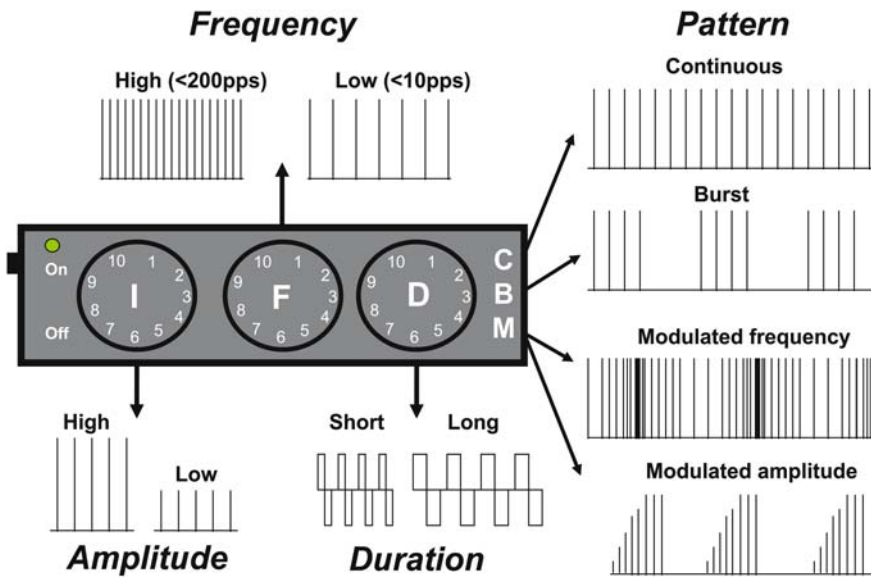
### Definition

► **Transcutaneous electrical nerve stimulation (TENS)** is a non-invasive analgesic intervention, which delivers electrical currents across the intact surface of the skin to stimulate the underlying nerves (see Fig. 1). TENS is used extensively for the symptomatic relief of all types of pain, including pains of musculoskeletal origin. The purpose of TENS is to activate selectively those populations of nerve fibres that are concerned with ► **segmental** and ► **extrasegmental anti-nociceptive mechanisms**. The two main TENS techniques are ► **conventional TENS** and ► **acupuncture-like TENS (AL-TENS)**.

### Characteristics

TENS is popular because patients can administer TENS themselves and can titrate the dosage of treatment as required. TENS effects are often rapid in onset and there are few side effects and no potential for toxicity or overdose. The technical specifications of TENS devices vary according to manufacturer, although most utilise biphasic pulsed currents that may be either symmetrical or non-symmetrical square waves. Pulse durations lie between 50  $\mu$ s–1000  $\mu$ s, pulse frequencies between 1–200 pulses per second (pps) and pulse amplitudes between 1–60 mA. Most devices offer continuous, burst (used for AL-TENS) and modulated pulse patterns. Factors that influence the success of TENS include the patient, the condition and the appropriateness of the TENS technique employed (see Fig. 2).

TENS is commonly used to treat chronic pains, including those of musculoskeletal origin. Systematic reviews on TENS and chronic pain have been inconclusive due to the low methodological quality of RCTs (Reeve et al. 1996; McQuay and Moore 1998; Carroll et al. 2003). However, meta-analyses have demonstrated that TENS is beneficial for knee osteoarthritis (Osiri et al. 2000) and rheumatoid arthritis in the hand (Brosseau et al. 2003). Meta-analysis on TENS for low back pain are

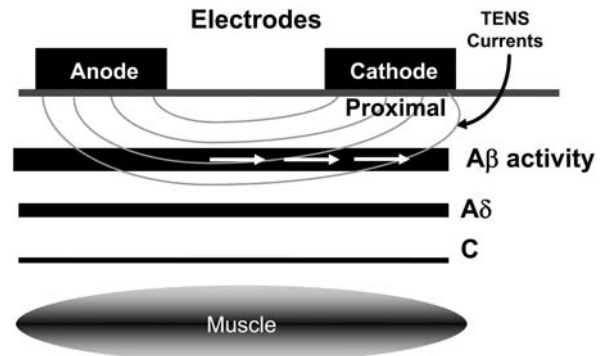


**Transcutaneous Electrical Nerve Stimulation (TENS) in Treatment of Muscle Pain, Figure 2** The output characteristics of a typical TENS device (topographic view). The amplitude, frequency, duration and pattern of electrical pulses can be controlled by the end user (I, intensity; F, frequency; D, duration; C, continuous; B, burst; M, modulation; pps, pulses per second).

conflicting (Flowerdew and Gadsby 1997; Brosseau et al. 2002). Under dosing of TENS and the use of inappropriate TENS techniques in some RCTs have influenced the findings of systematic reviews (Bjordal et al. 2003).

There have been no systematic reviews on TENS and muscle pain because of a lack of randomised controlled clinical trials. TENS is used extensively for reducing localised muscle pain, especially in the neck and shoulder, arising from muscle tension. TENS is also used to treat acute traumatic muscle pain that results from physical injury from sport and minor accidents, and to treat post-exertional muscle pain. Reports suggest that TENS is helpful for myofascial pain syndrome (Graff-Radford et al. 1989; Hou et al. 2002) and localised pain in fibromyalgia (Offenbacher and Stucki 2000), although in practice, TENS reduces pain in some of these patients and aggravates it in others. It is unlikely that TENS will be helpful in widespread pain in fibromyalgia, because it is difficult to direct TENS currents into the painful area.

In clinical practice, conventional TENS is used in the first instance for most pains, including those of musculoskeletal origin. The purpose of conventional TENS is to activate selectively large diameter non-nociceptive cutaneous afferents ( $A\beta$ ) without concurrently activating small diameter nociceptive afferents ( $A\delta$  and C), which would cause pain, or muscle efferents, which would cause muscle contractions. TENS-induced  $A\beta$  activity has been shown to inhibit ongoing activity in second order nociceptive neurones in the dorsal horn of the spinal cord (Garrison and Foreman 1994). In practice, large diameter non-nociceptive cutaneous afferent activity is recognised by a ‘strong but comfortable’ non-painful electrical paraesthesia beneath the electrodes, and patients are trained to titrate current amplitude to achieve this outcome (see Fig. 3).



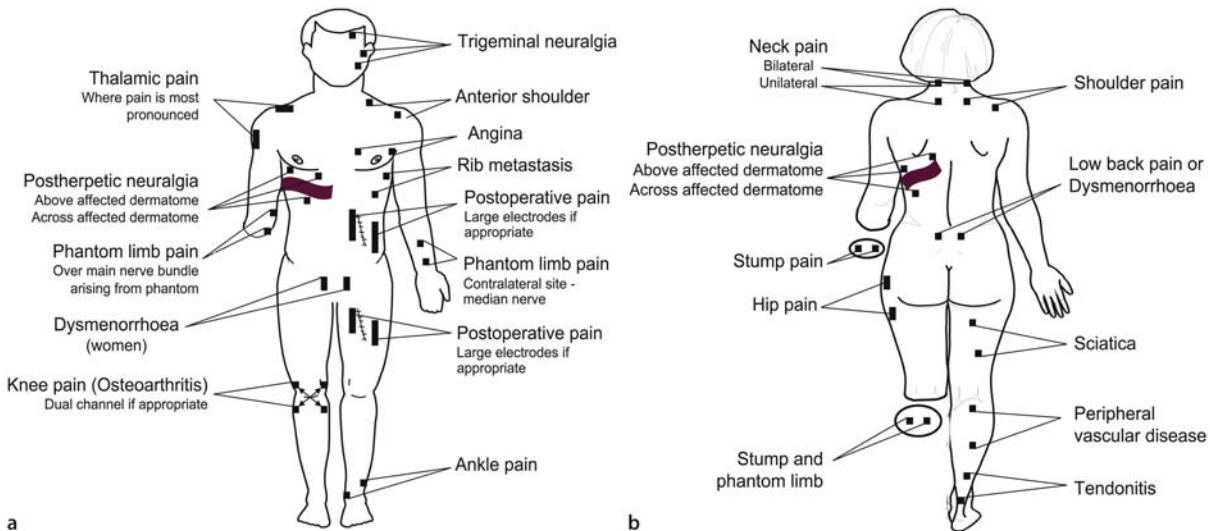
**Transcutaneous Electrical Nerve Stimulation (TENS) in Treatment of Muscle Pain, Figure 3** The purpose of conventional TENS is to activate non-nociceptive cutaneous afferents ( $A\beta$ ) without concurrent activation nociceptive ( $A\delta/C$ ) or muscle afferents. Arrows indicate impulses travelling towards the central nervous system.

T

During conventional TENS electrodes are applied to healthy skin, at the site of pain, to stimulate large diameter non-nociceptive cutaneous afferents which enter the same spinal segment as the nociceptive fibres associated with the origin of the pain. When it is not possible to apply electrodes at the site of pain, for example when the skin is damaged and/or sensitive to touch, electrodes can be applied proximally over the main nerve trunk that innervates the skin at the site of pain. Alternatively, electrodes can be placed over the spinal cord at a level segmentally related to the site of origin of the pain, or at a site which is contralateral (mirror image) to the site of pain. Dual channel devices using 4 electrodes can be used for pains covering large areas such as in a gluteal region or lower limb, and for multiple pains such as low back pain and sciatica (see Fig. 4).

For conventional TENS, maximum pain relief is achieved when the TENS device is switched on. There-

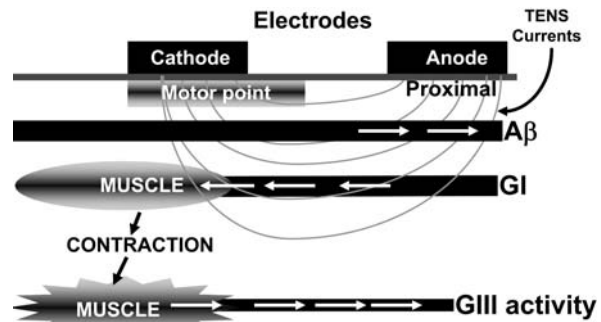




**Transcutaneous Electrical Nerve Stimulation (TENS) in Treatment of Muscle Pain, Figure 4** (a) Electrode positions for common pain conditions – anterior view. (b) Electrode positions for common pain conditions – posterior view.

fore, patients should be encouraged to use conventional TENS whenever the pain is present, although it is wise to instruct the patient to monitor their skin condition under the electrodes on a regular basis, and perhaps take regular (although short) breaks from stimulation. Dosing regimens of 20 minutes at daily, weekly or monthly intervals is likely to be ineffective for conventional TENS. Some patients report post-stimulation analgesia following conventional TENS, although reports of the duration of this effect varies widely and may reflect natural fluctuations in symptoms rather than specific TENS-induced effects. The relationship between the pulse frequency, duration and pattern of TENS and the magnitude of analgesia for different pain conditions has not been fully confirmed in the clinical setting as much available evidence is conflicting, inconclusive or methodologically flawed. Encouraging patients to experiment with all TENS settings while they maintain a strong but comfortable electrical paraesthesia within the site of pain may be the most effective approach for conventional TENS (Johnson 2001).

AL-TENS is a variant of conventional TENS and has been successfully used for pains of musculoskeletal origin. The purpose of AL-TENS is to stimulate axons of muscle efferent neurons ( $\alpha$  motor axons) to generate a forceful but non-painful phasic muscle twitch. This muscle twitch generates activity in small diameter Group III muscle afferent neurons, which trigger extrasegmental anti-nociceptive mechanisms, which lead to the release of opioid peptides in a manner similar to that suggested for acupuncture. AL-TENS is helpful for radiating neurogenic pain and for patients who have decreased skin sensitivity from damage to cutaneous afferents in the painful region. AL-TENS has been used successfully for muscle pain by stimulating the painful muscles and



**Transcutaneous Electrical Nerve Stimulation (TENS) in Treatment of Muscle Pain, Figure 5** The purpose of AL-TENS is to elicit a non painful muscle twitch by activating large diameter motor efferents. The muscle twitch generates activity in ergoreceptors and small diameter group III (GIII) muscle afferents which initiates extrasegmental antinociceptive mechanisms.  $A\beta$  afferents may also become active as currents pass through the skin. Arrows indicate direction of relevant impulse information.

trigger points. However, some patients report that that this aggravates their pain. In such circumstances AL-TENS can be administered on the contralateral myotome (Sjölund et al.1990; Johnson 1998) (see Fig. 5). AL-TENS is administered over muscles and motor points using low frequency burst patterns of pulse delivery. Currents are delivered at high but non-painful intensities, to generate a forceful but non-painful phasic muscle twitch. Currents delivered during AL-TENS will also activate  $A\beta$  fibers during their passage through the skin leading to segmental analgesia. AL-TENS is administered intermittently for 20–30 minutes at a time to reduce excessive muscle fatigue. The general impression of users is that post-TENS analgesia is longer for AL-TENS than conventional TENS, and this is supported by initial findings in experimental studies.



For this reason, AL-TENS is useful for patients who obtain brief after-effects from conventional TENS, or who are resistant to conventional TENS.

TENS should not be administered to patients fitted with cardiac pacemakers or women in the first trimester of pregnancy. TENS should not be used while operating vehicles or potentially hazardous equipment, and electrodes should not be positioned over the anterior part of the neck, over areas of broken skin or directly over a pregnant uterus (although it is safe when applied to the lower back to treat labour pains). Patients should be tested for normal skin sensation prior to using TENS. Patients should be warned not to use TENS in the shower or bath and to keep TENS appliances out of the reach of children.

## References

1. Bjordal JM, Johnson MI, Ljunggreen AE (2003) Transcutaneous Electrical Nerve Stimulation (TENS) can Reduce Postoperative Analgesic Consumption. A Meta-Analysis with Assessment of Optimal Treatment Parameters for Postoperative Pain. *Eur J Pain* 7:181–188
2. Brosseau L, Milne S, Robinson V et al. (2002) Efficacy of the Transcutaneous Electrical Nerve Stimulation for the Treatment of Chronic Low Back Pain: A Meta-Analysis. *Spine* 27:596–603
3. Brosseau L, Yonge KA, Robinson V et al. (2003) Transcutaneous Electrical Nerve Stimulation (TENS) for the Treatment of Rheumatoid Arthritis in the Hand (Cochrane Review). *The Cochrane Library* Oxford: Update Software Issue 3:1–19
4. Carroll D, Moore RA, McQuay HJ et al. (2003) Transcutaneous Electrical Nerve Stimulation (TENS) for Chronic Pain. In: *The Cochrane Library*, Issue 3. Update Software, Oxford
5. Flowerdew M, Gadsby G (1997) A Review of the Treatment of Chronic Low Back Pain with Acupuncture-Like Transcutaneous Electrical Nerve Stimulation and Transcutaneous Electrical Nerve Stimulation. *Complement Ther Med* 5:193–201
6. Garrison DW, Foreman RD (1994) Decreased Activity of Spontaneous and Noxiously Evoked Dorsal Horn Cells during Transcutaneous Electrical Nerve Stimulation (TENS). *Pain* 58:309–315
7. Graff-Radford SB, Reeves JL, Baker RL et al. (1989) Effects of Transcutaneous Electrical Nerve Stimulation on Myofascial Pain and Trigger Point Sensitivity. *Pain* 37:1–5
8. Hou CR, Tsai LC, Cheng KF et al. (2002) Immediate Effects of Various Physical Therapeutic Modalities on Cervical Myofascial Pain and Trigger-Point Sensitivity. *Arch Phys Med Rehabil* 83:1406–1414
9. Johnson M (1998) The Analgesic Effects and Clinical Use of Acupuncture-Like TENS (AL-TENS). *Phys Ther Rev* 3:73–93
10. Johnson MI (2001) Transcutaneous Electrical Nerve Stimulation. In: Kitchen S (ed) *Electrotherapy: Evidence-Based Practice*. Churchill Livingstone, Edinburgh, pp 259–286
11. McQuay H, Moore A (1998) TENS in Chronic Pain. In: McQuay H, Moore A (eds) *An Evidence-Based Resource for Pain Relief*. Oxford University Press, Oxford, pp 207–211
12. Offenbacher M, Stucki G (2000) Physical Therapy in the Treatment of Fibromyalgia. *Scand J Rheumatol* 113:78–85
13. Osiri M, Welch V, Brosseau L et al. (2003) Transcutaneous Electrical Nerve Stimulation for Knee Osteoarthritis. In: *The Cochrane Library*, Issue 3. Update Software, Oxford
14. Reeve J, Menon D, Corabian P (1996) Transcutaneous Electrical Nerve Stimulation (TENS): A Technology Assessment. *Int J Technol Assess Health Care* 12:299–324
15. Sjölund B, Eriksson M, Loeser J (1990) Transcutaneous and Implanted Electric Stimulation of Peripheral Nerves. In: Bonica JJ (ed) *The Management of Pain*, vol 2. Lea & Febiger, Philadelphia, pp 1852–1861

## Transcutaneous Electrical Nerve Stimulation Outcomes

MARK I. JOHNSON

School of Health and Human Sciences, Faculty of Health, Leeds Metropolitan University, Leeds, UK  
m.johnson@leedsmet.ac.uk

### Synonyms

TENS Outcomes; transcutaneous nerve stimulation; TNS; transcutaneous electrical stimulation (TES); electrical stimulation therapy (EST); Percutaneous Electrical Nerve Stimulation; Electroanalgesia

### Definition

► **Transcutaneous electrical nerve stimulation (TENS)** is a non-invasive analgesic intervention that delivers electrical currents across the intact surface of the skin to stimulate the underlying nerves. TENS is used extensively for the symptomatic relief of all types of pain including pains of nociceptive, neuropathic and musculoskeletal origin. The purpose of TENS is to activate selectively those populations of nerve fibres that are concerned with segmental and extrasegmental anti-nociceptive mechanisms. The two main TENS techniques are ► **conventional TENS** and ► **acupuncture-like TENS (AL-TENS)**.

### Characteristics

Clinical experience supports a role for TENS in the management of acute and chronic pain. Clinical research on TENS also reports beneficial effects for a wide range of chronic pain conditions including back pain, neck pain, headache, osteoarthritis, rib fracture, orofacial pain, post-herpetic neuralgia, trigeminal neuralgia, post-stroke pain, phantom limb and stump pain, brachial plexus avulsion, causalgia, angina pectoris, myalgia, postoperative pain, labour pain, dental pain and cancer pain (Hansson and Lundberg 1999). However, many clinical trials lack appropriate controls and / or randomisation leading to overestimation of treatment effects. In recent years, systematic reviews and meta-analyses have challenged the effectiveness of TENS.

Many clinical trials on TENS and chronic pain suffer methodological inadequacies and fail to meet the inclusion criteria for systematic reviews. Systematic reviewers report that the lack of good quality RCTs makes it difficult to estimate the effectiveness of TENS. Reeve et al. reported that TENS was more effective than sham (dummy) TENS or no treatment in 9 / 20 RCTs on a variety of chronic pain conditions (Reeve et al. 1996). McQuay et al. reported that TENS was better than sham TENS, placebo pills or inappropriate electrode placements in 10 / 24 RCTs on chronic pain (McQuay and Moore 1998). A follow-up review identified 107 reports

**Transcutaneous Electrical Nerve Stimulation Outcomes, Table 1** Physical Medicine, TENS outcomes

Ref.	Patients	Results	Reviewers' Conclusion
Reeve et al. (1996)	Mixed conditions (low back, pancreatitis, arthritis, angina)	TENS > control in 9/20 RCTs	Evidence inconclusive
McQuay and Moore (1998)	Mixed conditions (low back, pancreatitis, osteoarthritis, dysmenorrhoea)	TENS > control in 10/24 RCTs	Evidence inconclusive
Carroll et al. (2003)	Mixed conditions (low back, pancreatitis, osteoarthritis, dysmenorrhoea)	TENS > control in 10/15 RCTs	Evidence inconclusive
Flowerdew and Gadsby (1997)	Low back pain	288 patients (6 RCTs) TENS > sham for pain relief (OR = 2.11)	Evidence of effect
Brosseau et al. (2002)	Low back pain	421 patients (5 RCTs) TENS = sham for pain relief (SMD = -0.207)	Evidence of no effect
Price and Pandyan (2001)	Post-stroke shoulder pain	170 patients (4 RCTs). Any surface electrical stimulation (ES) ES = sham / no treatment control for pain relief (WMD = 0.13) ES > sham / no treatment control for range of movement (WMD = 9.17)	Evidence inconclusive
Proctor et al. (2002)	Primary dysmenorrhoea	213 patients (8 RCTs) HF TENS > sham for pain relief (OR = 7.2) LF TENS = sham for pain relief (OR = 1.3)	Evidence of effect – HF TENS only
Brosseau et al. (2003)	Rheumatoid arthritis of the hand	78 patients (3 RCTs) AL-TENS reduced pain at rest (67% relative benefit versus placebo)	Evidence of effect
Osiri et al. (2003)	Knee osteoarthritis	294 patients (7 RCTs) TENS > sham for pain relief (SMD = -0.448 – although only 2/7 RCTs +ve)	Evidence of effect

Abbreviations: RCT, randomised controlled clinical trial; OR, odds ratio; SMD, standardised mean difference; WMD, weighted mean difference; +ve, positive outcome; HF, high frequency; LF, low frequency

on TENS and chronic pain but only 19 met the inclusion criteria (Carroll et al. 2003). TENS provided better pain relief than sham or no treatment controls in 10/15 RCTs. Evidence for TENS effectiveness in specific chronic pain conditions is also inconclusive or discordant. A meta-analysis of 288 low back pain (LBP) patients (6 RCTs) found that TENS reduced pain and improved the range of motion (Flowerdew and Gadsby 1997). In contrast, a meta-analysis of 321 LBP patients (5 RCTs) found no statistically significant differences between active and sham TENS for pain relief (Brosseau et al. 2002). A meta-analysis of 294 patients (7 RCTs) with knee osteoarthritis found that TENS produced statistically significantly more pain relief and reductions in knee stiffness than placebo (Osiri et al. 2003). A meta-analysis of 78 patients (3 RCTs) with rheumatoid arthritis of the hand found that AL-TENS reduced pain intensity whereas conventional TENS did not, although conventional TENS improved the patient's assessment of their disease state (Brosseau et al. 2003). The beneficial effects of AL-TENS were achieved using particularly low dosage regimens of one 15 min ses-

sion per week for 3 weeks. A meta-analysis of TENS for primary dysmenorrhoea found that high frequency but not low frequency TENS was more effective for pain relief than sham TENS (Proctor et al. 2003). A meta-analysis of any form of surface electrical stimulation (ES) on 170 patients with post-stroke shoulder pain found no significant change in pain incidence or pain intensity after ES compared with control (Price and Pandyan 2001). ES was reported to improve the pain-free range of passive humeral lateral rotation and reduce the severity of glenohumeral subluxation. In summary, the effectiveness of TENS on chronic pain remains uncertain.

The effectiveness of TENS in reducing labour pain has been challenged by systematic reviews. TENS did not improve pain relief when compared to sham TENS or a no treatment control in 3 / 8 RCTs (Reeve et al. 1996) and 10 / 10 RCTs (Carroll et al. 1997). These systematic reviews seem to conflict with clinical experience where midwives and patients report satisfaction with TENS effects. Interestingly, one RCT found significantly more women and midwives favoured active rather than sham

**Transcutaneous Electrical Nerve Stimulation Outcomes, Table 2** Physical Medicine, TENS outcomes

Ref.	Patients	Results	Reviewers' Conclusion
Reeve et al. (1996)	Acute pain (dysmenorrhoea, dental, cervical, orofacial)	TENS >control in 7 / 14 RCTs	Evidence inconclusive
Reeve et al. (1996)	Postoperative pain	TENS >control in 12 / 20 RCTs	Evidence inconclusive
Carroll et al. (1996)	Postoperative pain	TENS >control in 2 / 17 RCTs	Evidence of no effect
Bjordal et al. (2003)	Postoperative pain	1350 patients (21 RCTs) TENS >sham for reducing analgesic consumption (WMD = 35.5%)	Evidence of effect –analgesic sparing
Reeve et al. (1996)	Labour Pain	TENS >control in 3 / 9 RCTs	Evidence inconclusive
Carroll et al. (1997)	Labour Pain	TENS >control in 3 / 10 RCTs	Evidence of no effect

TENS when recorded under double-blind conditions at the end of childbirth (Harrison et al. 1986). This suggests that the point in time that pain relief is recorded may influence the parturient's report of TENS outcome in the clinical trial situation.

Systematic reviews on TENS and postoperative pain are inconclusive or conflicting. TENS has been reported to be no better than no treatment or sham TENS in 12 / 20 RCTs (Reeve et al. 1996) and in 15 / 17 RCTs (Carroll et al. 1996). However, pain relief scores were compromised in some of the included RCTs because patients had free access to analgesic drugs, so they could titrate analgesic consumption to achieve similar levels of pain relief in sham and active TENS groups. Other confounding factors include the difficulty of dichotomising multiple outcome measures, heterogeneous baseline pain measures and sample sizes with insufficient statistical power to detect potential differences between groups. A meta-analysis of 1350 patients (21 RCTs) accounted for some of these issues and found that TENS reduced analgesic consumption when compared to sham TENS (Bjordal et al. 2003). A subgroup analysis of 964 patients (11 RCTs) that used optimal TENS dosage (i.e. a strong, subnoxious electrical stimulation) found a significant improvement in outcome suggesting that adequate TENS technique is necessary in order to achieve an effect.

Often the appropriateness of TENS technique is not accounted for in methodological quality rating scales and / or inclusion criteria used in systematic reviews and meta-analyses. Under-dosing of TENS has occurred in many trials using short duration, single or infrequent TENS interventions. TENS effects are maximal when the device is switched on and in practice users of conventional TENS keep the device switched on whenever they need pain relief. However, many RCTs record pain outcome before and after TENS rather than during stimulation. Conventional TENS and AL-TENS are ill defined in published reports and are often categorised according to the electrical characteristics of TENS rather than the users' intention to stimulate particular types of nerve fibre and whether or not this was achieved during the trial. Analysis of adequate stimulation technique

is absent from the majority of published RCT reports. In future, RCTs on TENS must take these factors into account because they have been shown to alter TENS outcomes.

The low methodological quality of RCTs has created uncertainty in the clinical research evidence for TENS. TENS is a technique based intervention, so outcome is dictated by the appropriateness of TENS technique. The potential number of TENS protocols is vast, as users can alter the characteristics of the electrical currents (i.e. the output characteristics), the application procedure (i.e. electrode type and location) and the dosing regimen. Attempts to improve clinical effectiveness by searching for optimal TENS settings have largely been unsuccessful. Nevertheless, an increasing number of non-standard TENS-like devices have appeared on the market (e.g. interferential therapy (IFT), microcurrent electrical therapy (MET), transcranial electrical stimulation and transcutaneous spinal electroanalgesia (TSE)). Manufacturers overstate the potential effects of these TENS-like devices and often similar levels of pain relief can be achieved using a standard TENS device (Johnson 2003).

Health care professionals should not dismiss the use of TENS for any condition until the issues in clinical trial design and review methodology have been resolved.

## References

1. Bjordal JM, Johnson MI, Ljunggreen AE (2003) Transcutaneous electrical nerve stimulation (TENS) can reduce postoperative analgesic consumption. A meta-analysis with assessment of optimal treatment parameters for postoperative pain. *Eur J Pain* 7:181–188
2. Brosseau L, Milne S, Robinson V et al. (2002) Efficacy of the transcutaneous electrical nerve stimulation for the treatment of chronic low back pain: a meta-analysis. *Spine* 27:596–603
3. Brosseau L, Yonge KA, Robinson V et al. (2003) Transcutaneous electrical nerve stimulation (TENS) for the treatment of rheumatoid arthritis in the hand (Cochrane Review). In: *The Cochrane Library*, Issue 3. Update Software, Oxford
4. Carroll D, Tramer M, McQuay H et al. (1996) Randomization is important in studies with pain outcomes: systematic review of transcutaneous electrical nerve stimulation in acute postoperative pain. *Br J Anaesth* 77:798–803

5. Carroll D, Moore A, Tramer M et al. (1997) Transcutaneous electrical nerve stimulation does not relieve in labour pain: updated systematic review. *Contemporary Reviews in Obstetrics and Gynecology* September 1997:195–205
6. Carroll D, Moore RA, McQuay HJ et al. (2003) Transcutaneous electrical nerve stimulation (TENS) for chronic pain. In: *The Cochrane Library*, Issue 3. Update Software, Oxford
7. Flowerdew M, Gadsby G (1997) A review of the treatment of chronic low back pain with acupuncture-like transcutaneous electrical nerve stimulation and transcutaneous electrical nerve stimulation. *Complement Ther Med* 5:193–201
8. Hansson P, Lundeberg T (1999) Transcutaneous electrical nerve stimulation, vibration and acupuncture as pain-relieving measures. In: PD Wall, R Melzack (eds) *Textbook of Pain*. Churchill Livingstone, Edinburgh, pp 1341–1351
9. Harrison R, Woods T, Shore M et al. (1986) Pain relief in labour using transcutaneous electrical nerve stimulation (TENS). A TENS / TENS placebo controlled study in two parity groups. *Br J Obstet Gynaecol* 93:739–746
10. Johnson M (2003) Transcutaneous Electrical Nerve Stimulation (TENS) and TENS-like devices. Do they provide pain relief? *Pain Rev* 8:121–128
11. McQuay H, Moore A (1998) TENS in chronic pain. In: McQuay H, Moore A (eds) *An evidence-based resource for pain relief*. Oxford University Press, Oxford, pp 207–211
12. Osiri M, Welch V, Brosseau L et al. (2003) Transcutaneous electrical nerve stimulation for knee osteoarthritis. In: *The Cochrane Library*, Issue 3. Update Software, Oxford
13. Price CI, Pandyan AD (2001) Electrical stimulation for preventing and treating post-stroke shoulder pain: a systematic Cochrane review. *Clin Rehab* 15:5–19
14. Proctor ML, Smith CA, Farquhar CM et al. (2003) Transcutaneous electrical nerve stimulation and acupuncture for primary dysmenorrhoea. (Cochrane Review). *The Cochrane Library*, Issue 3. Update Software, Oxford
15. Reeve J, Menon D, Corabian P (1996) Transcutaneous electrical nerve stimulation (TENS): a technology assessment. *Int J Technol Assess Health Care* 12:299–324

## Transcutaneous Electrical Stimulation

- ▶ [Transcutaneous Electrical Nerve Stimulation Outcomes](#)
- ▶ [Transcutaneous Electrical Nerve Stimulation \(TENS\) in Treatment of Muscle Pain](#)

## Transdermal

### Definition

The route of analgesic action is through transdermal application for systemic effect.

- ▶ [Analgesic Guidelines for Infants and Children](#)

## Transduction

### Definition

Transduction is the conversion of one form of signal to another. For example, in sensory endings, the conversion

of the stimulus (e.g. pressure or cold) into an electrical signal.

- ▶ [Somatic Pain](#)
- ▶ [Species Differences in Skin Nociception](#)
- ▶ [Visceral Nociception and Pain](#)

## Transduction Channel

### Definition

Ionic channel gated (i.e. open or closed) by a physical or chemical stimulus applied to the membrane of a peripheral sensory cell.

- ▶ [Nociceptor Generator Potential](#)

## Transduction Sites

### Definition

Membrane patches of sensory receptor terminals where sensory transduction takes place.

- ▶ [Nociceptor Generator Potential](#)

## Transfected Cells

### Definition

Transfection refers to the introduction of exogenous genetic material encoding a gene of interest into cells. Transfected cells are used as model systems to study functional and structural properties of the transfected protein.

- ▶ [Purine Receptor Targets in the Treatment of Neuro-pathic Pain](#)

## Transfer and Generalization

### Definition

Transfer refers to the maintenance of learned behavior change in the patient's environment outside the treatment context; generalization refers to the extension of learned behaviors to similar problems.

- ▶ [Operant Treatment of Chronic Pain](#)

## Transforaminal Injection of Steroids

- ▶ [Epidural Steroid Injections](#)



## Transduction and Encoding of Noxious Stimuli

CARLOS BELMONTE, FÉLIX VIANA  
 Instituto de Neurociencias de Alicante, Universidad Miguel Hernández-CSIC, San Juan de Alicante, Spain  
 carlos.belmonte@umh.es

### Sensory Transduction

Sensory transduction is the process by which external physical changes are transformed into internal biochemical and/or electrical signals that are propagated and processed through different levels of the central nervous system to elicit a sensation. Despite the specialized design of sensory receptors for the different sensory modalities, the cellular and molecular mechanisms involved in sensory transduction have certain common basic principles that can be outlined in a unified scheme (Fig. 1) (Block 1992; Belmonte 1996). This process involves sequential detection, amplification and filtering of the incoming signal. In nociceptor neurons, as in other types of receptor neurons, the transformation of physical and chemical stimuli into electrical signals normally takes place at the peripheral nerve terminals, where the transduction machinery is located. This machinery is formed by a variety

of specialized proteins called receptors. Activation of these receptors by the different stimuli leads to a conformational change in the protein, forming pores in the membrane that allow the flow of ions (ion channels).

### Stimulating Energy

Nociceptors were defined by Charles Sherrington as sensory receptors activated by stimuli that potentially lead to tissue injury (noxious stimuli). Nociceptors, as in the case of other sensory receptors, are directly activated by a limited number of the various forms of energy that are continuously impinging upon the external surface and internal organs of the body and only within a narrow range of intensities (noxious stimuli). Effective stimuli include mechanical forces as well as temperature and a relatively large number of chemical substances. The largest part of the electromagnetic spectrum goes undetected by nociceptors. Only when the action of these otherwise unnoticed forces leads to cell damage may indirect stimulation of nociceptors follow, due to release of chemical mediators by injured cells located nearby. This is the case, for instance, in ultraviolet light or nuclear radiation exposure. What distinguishes nociceptors from low threshold sensory receptors is not the physical nature of the adequate stimuli but the required threshold intensity for their activation (Belmonte 1996).

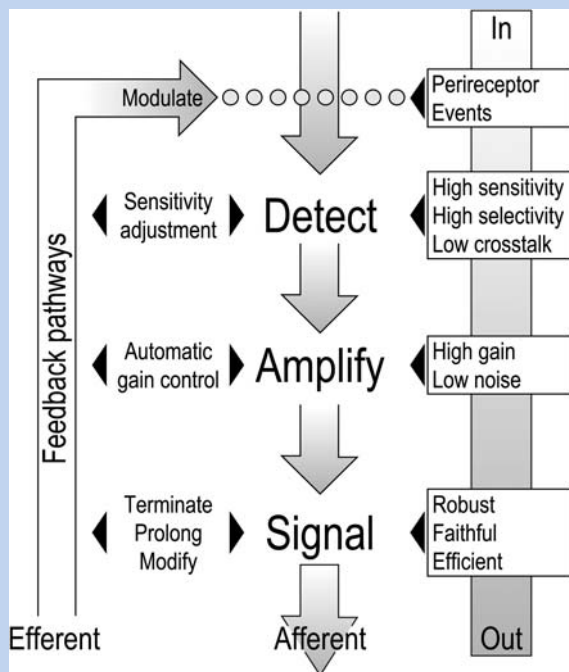
### Perireceptor Elements

Nociceptors are naked (or free) nerve terminals embedded in an intercellular matrix that contains collagen fibrils and proteoglycans and devoid of specialized structures (perireceptor elements) that in other receptors act as filters for the transmission of forces to the transduction sites. Receptive areas in the nociceptor membrane appear to be discontinuous patches of bare axolemma, covered only by the basal lamina of the nerve fiber and thus exposed to the direct action of stimuli. However, macromolecules present in the intercellular matrix surrounding nociceptive nerve endings may play a role in the filtering of noxious stimuli reaching the receptive membrane.

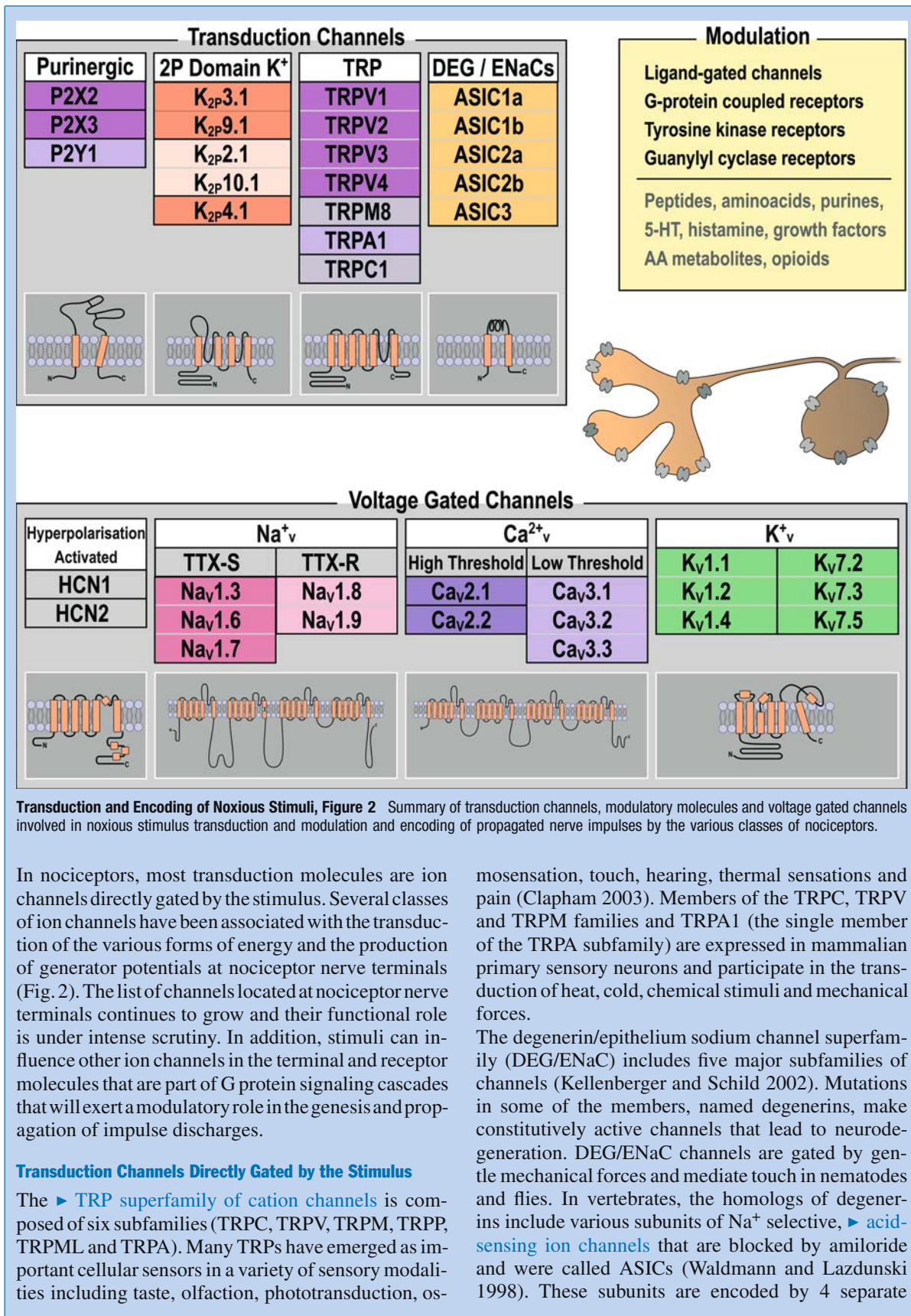
### Transduction Molecules

The diversity of forces that selectively activate nociceptor endings suggests that nociceptive neurons are equipped with separate transduction mechanisms for each of the stimulating energies. Nevertheless, some of the transducer molecules are multimodal and can be activated by more than one class of stimulus.

The detection of stimuli by nociceptor neurons is based on membrane signaling molecules that convert the stimulus energy into an allosteric molecular change, leading ultimately to the gating of membrane ion channels and depolarization of the nerve terminal.



**Transduction and Encoding of Noxious Stimuli, Figure 1** Schematic diagram for sensory transduction steps. Adapted from Belmonte (1996) and Block (1992).



genes and are processed in different splice variants. Some subunits, such as ASIC1b and ASIC3, are expressed almost exclusively in the peripheral nervous system. Others, like ASIC2a, are expressed in specialized mechanosensory structures. These channels have two transmembrane domains and are thought to ensemble into homomeric and heteromeric combinations of 4 subunits (i.e. tetramers). They are gated by protons and give rise to transient inward currents with fast activating and variable desensitizing kinetics. In addition to activation by low pH, some of these channels are activated by mechanical forces and temperature and could play important roles in nociception (Waldmann and Lazdunski 1998).

The ► **two-pore domain superfamily of K<sup>+</sup> channels (K<sub>2p</sub>)** is a class of voltage insensitive, K<sup>+</sup> selective channels that are open at rest. From this property they are also known as background or leak K<sup>+</sup> channels. They control neuronal excitability by changing the resting membrane potential and membrane resistance (Talley et al. 2003). Activity of these channels is regulated by a variety of signaling molecules, including protons, O<sub>2</sub> tension polyunsaturated fatty acids and phospholipids (Patel et al. 2001). They are also modulated by physical variables such as mechanical stretch and temperature, making them candidates for sensory transduction channels. Various K<sub>2p</sub> subunits have been identified in primary sensory neurons. However, very little information is available regarding the expression pattern in specific subpopulations of somatosensory afferents. K<sub>2p</sub>2.1 (TREK-1), K<sub>2p</sub>10.1 (TREK-2) and K<sub>2p</sub>4.1 (TRAAK) may play a role in mechanosensory and thermal transduction (Patel et al. 2001; Kang et al. 2005). Some of these channels, such as members of the TASK subfamily, are closed by extracellular acidic solutions leading to depolarization and could be involved in pH sensing by nociceptors (Talley et al. 2003). Several types of Ligand-gated ion channels are also present in nociceptor neurons and may play a role in transduction of stimuli. These channels open in response to a variety of chemical substances, some of which are released locally following tissue injury. A prominent example is offered by the family of ionotropic ► **purinergic receptors (P2X)**. These are ATP gated, cation selective ion channels. Of the seven P2X channels identified so far, all except P2X<sub>7</sub> are expressed in sensory neurons (Burnstock 2000). Only the P2X<sub>3</sub> subunit is selectively expressed in nociceptors (Chen et al. 1995). Also, some members of the Cys-loop family of transmitter-gated ion channels are present in nociceptive terminals. These include the cation permeable nicotinic ACh receptors and the 5-HT<sub>3</sub> serotonin receptors, which are non-selective cation channels, gated respectively by acetylcholine and serotonin, substances that are released in inflamed

tissues. Recently, ionotropic receptors for excitatory amino acids have been reported in nociceptive terminals, associated with their excitation during injury.

#### Remote Sensors and Modulators of the Stimulus

Activation of metabotropic membrane receptor proteins by endogenous substances released locally in the environment of nociceptive nerve endings plays an important role in modulating their activity and responsiveness following injury. These substances include peptides, kinins, purines and excitatory amino acids. In this case, the effects on nociceptor membrane excitability are not exerted directly on an ion channel. Rather, the presence of an agonist substance causes the activation of second messenger cascades that will finally lead to the opening or closure of ion channels. The effects can be immediate or be the consequence of long-term changes in gene expression that include variations in the number of ion channels and then sustained modifications of neuronal excitability. Receptors of this type include the superfamily of G-protein coupled receptors (GPCR); a large number of G-protein coupled receptors have been shown to be present in sensory nerve endings and up- and down-modulate their excitability following application of the specific ligand. Very often sensitization is specific to a certain type of stimulus (mechanical *versus* thermal). The list of pro-algesic substances includes acetylcholine, bradykinin (BK), noradrenaline, histamine, serotonin, PGE<sub>2</sub> and nerve growth factor (NGF). Among the GPCRs capable of acutely sensitizing nociceptors, we count B1 and B2 BK receptors and alpha-1, alpha-2 and beta-2 adrenergic receptors. Histamine H1 receptors also sensitize nociceptors. The sensitization of nociceptors produced by bradykinin through the activation of B2 and B1 receptors involves the phospholipase C and protein kinase C signaling pathways that lead ultimately to the modulation of the TRPV1 (capsaicin) ion channel (Chuang et al. 2001; Vellani et al. 2001).

In contrast, M2 muscarinic receptors participate in the depression of nociceptive responsiveness to heat and mechanical stimulation produced by the acetylcholine liberated during injury by skin keratinocytes and other local cells. Activation of somatostatin sst<sub>2</sub> receptors, present in about 10% of cutaneous afferent terminals, also has antinociceptive effects. Intradermal injection of metabotropic glutamate receptor type 5 antagonists produces full reversal of thermal hyperalgesia in animal models of neuropathic pain. Opiates also exert a peripheral antinociceptive activity and these unconventional effects of opioids appear to be mediated by opening of K<sup>+</sup>-ATP channels following activation of the arginine/NO/cGMP pathway by protein kinase G. Tyrosine kinase receptors, another superfamily of membrane receptor proteins, also participate in the

modulation of nociceptor excitation. This group includes trkA receptors that are activated by nerve growth factor (NGF) released by injury in the environment of nociceptive terminals. The effect of NGF appears to be mediated in part by the same mechanism that is activated by BK, namely PLC stimulation with subsequent hydrolysis of membrane phosphatidylinositol-4,5-bisphosphate (PIP<sub>2</sub>) yielding inositol 1,4,5-trisphosphate (IP<sub>3</sub>) and diacylglycerol. One final target of this cascade is the TRPV1 channel, which is modulated both by PKC dependent and independent mechanisms (Vellani et al. 2001; Chuang et al. 2001).

► **Proteinase-activated receptors** (PARs) are also members of the superfamily of G-protein coupled receptors. They initiate intracellular signaling by the proteolytic activity of extracellular serine proteases that cleave the N-terminus of the receptor. PAR-1 and PAR-2 are expressed in many peptidergic sensory neurons and their activation induces neurogenic inflammation and mediates peripheral sensitization of nociceptors (Vergnolle et al. 2003).

Membrane lipids are emerging as a new class of ion channel modulators, with important implications in nociceptor activation. A growing list of ion channels are modulated directly by interactions with phosphatidylinositol 4,5-bisphosphate (PIP<sub>2</sub>) (Suh and Hille 2005). As already mentioned, a number of agonists exert their actions by their ability to activate the phospholipase C (PLC) signaling pathway, which stimulates phosphoinositide hydrolysis. The end result is a reduction in the concentrations of plasma membrane phosphoinositides to produce IP<sub>3</sub>. In the case of TRPV1, a reduction in membrane PIP<sub>2</sub> levels, as occurs when PLC is stimulated by NGF or BK, leads to channel activation (Chuang et al. 2001). The opposite appears to occur for TRPM8 channels, inhibited by low PIP<sub>2</sub> levels.

### Transduction Mechanisms for the Different Stimuli

Ion channels and receptor proteins of the different superfamilies exhibit a variable sensitivity to mechanical forces, chemical substances, heat or cold. The characteristic expression patterns of these proteins in the various subtypes of nociceptor neurons confer on them their specific transduction capabilities for the different forms of stimulating energy.

#### Mechanotransduction

Propagated impulse responses to mechanical forces are prominent in the peripheral endings of nociceptor neurons exclusively activated by mechanical stimuli (► **mechano-nociceptors**); they also appear in ► **polymodal nociceptor** neurons that are additionally excited by chemical and thermal stimuli. Mechanically evoked nerve impulse discharges are absent in

► **'silent' nociceptor** nerve fibers but they are obtained following local tissue inflammation. Ion channels directly gated by mechanical stimuli were first recognized in the 1980s but the identification of the molecular entities involved in the transduction of mechanical forces remained elusive until recently.

Mechanical distortion, like stretch or pressure, produces the opening of mechanically sensitive channels (mechanosensitive channels, MSCs). MSCs are a heterogeneous population of channels with differences in sensitivity, type of response, pharmacology and biophysical properties like ionic selectivity conductance and adaptation. They are present in a great variety of cell types and, in addition to stimulus detection, participate in a variety of other cell functions, such as volume regulation, cell movement, cell division, osmosensation and contraction. The effect of mechanical force on a channel can be direct, leading to gating by tension exerted directly on the channel proteins or indirect, involving second messengers controlled by mechanosensitive enzymes. However, the precise mechanism coupling the supply of energy provided by the mechanical stimulus to the gating of the channels is still unresolved in nociceptors.

The molecular identity of ion channels involved in the transduction of low intensity mechanical forces by specific mechanosensory cells has been partly elucidated in ciliated mechanosensory cells of invertebrates and in the hair cells of the auditory, vestibular and lateral line organs of vertebrates (reviewed by Corey 2003). With the application of genetic screens, Deg/ENaC channels and TRP channels have been identified as essential for mechanosensation in different types of mechanosensors in flies and worms. In most cases however, it remains uncertain whether they are the transduction channels themselves and what are the specific mechanisms of activation. The fact that mechanosensation requires the concerted function of several proteins acting in an ensemble (► **transduction apparatus**) make these studies especially difficult.

In the nematode *C. elegans*, gentle touch mechanosensation depends on members of the DEG/ENaC family. In particular, mutations in the channel subunits MEC-4 and MEC-10 led to loss of responses to touch and abolished mechanotransduction currents. OSM-9 and OCR-2, two related TRPV channels are also required for touch sensitivity in the nose region in *C. elegans*. In flies, TRPN1 (previously known as NompC) is essential for mechanotransduction in sensory bristles. This channel is also at the core of mechanotransduction in zebra fish hair cells. Surprisingly, no TRPN-like genes could be found in higher vertebrates. Also in flies, a TRPV-like channel protein, NAN, is expressed selectively in chordotonal neurons and is essential for hearing. No ortho-



logues of *nanchung* have been identified in vertebrates, suggesting that, in this case, hearing is mediated by different transducers. Genetic screens in *Drosophila* larvae for mutations that alter responses to noxious mechanical and thermal stimuli identified *Painless*, a TRPA channel (Tracey Jr et al. 2003). Recently, TRPA1 channels have been located on apical hair bundles (i.e. the mechanotransduction site) of vertebrate hair cells. Furthermore, inhibition of TRPA1 expression inhibits transduction currents generated by the movement of the cilia (Corey et al. 2004).

In contrast to this knowledge, the nature of the channels directly involved in the transduction of mechanical stimuli by mammalian somatosensory endings is largely ignored. Moreover, the differences in threshold and adaptation characteristics found between low- and high-threshold mechanoreceptor neurons are still unexplained at the cellular level. These differences may simply lie in the density of mechanosensory channels in the transducing areas, be due to the presence of different types of mechanosensory transduction channels or to other factors like variations in the arrangement or composition of the mechanotransduction apparatus, cytoskeleton organization and/or second messenger pathways.

Several channels with apparent mechanosensitivity have been identified in primary sensory neurons of mammals but evidence for their direct mechanical activation is slim in all cases. Candidate transducer molecules for mechanotransduction include TRP channels and members of the acid-sensing ion channel (ASIC) family. Modulatory roles have been assigned to other channels like  $K_{2P}$  channels and purinergic receptors.

Within the TRP superfamily of ion channels, TRPC1 and TRPV4 appear to be sensitive to membrane stretch. TRPC1 is highly expressed in frog oocyte membranes and opens in response to tension exerted within the lipid bilayer (Maroto et al. 2005). TRPC1 is also found in visceral sensory neurons, including fine nerve terminals within the carotid body. TRPV4 opens in response to osmotic cell swelling when expressed in mammalian cultured cells. TRPV4 is a multifunctional channel that is also activated by warm temperatures and lipoxigenase metabolites (Patapoutian et al. 2003). Perception of noxious pressure is reduced in *trpv4*<sup>-/-</sup> mice, while gentle touch detection is unimpaired. However, TRPV4 doesn't appear to be directly mechanosensitive; rather, its activation appears to depend on a second messenger cascade. Finally, TRPA1 channels are present in a large proportion of mammalian DRG neurons and may be activated by mechanical forces, as occurs in hair cells.

Among channels of the DEG/ENaCs superfamily, ASIC1, ASIC2 and ASIC3 subunits are expressed

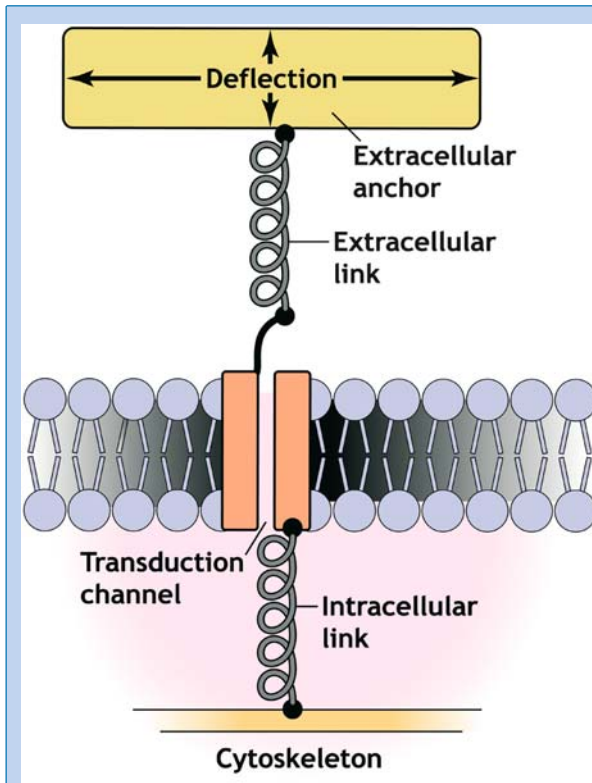
in somas and peripheral terminals of primary sensory neurons (reviewed by Kellenberger and Schild 2002). Nonetheless, assigning a functional role to specific subunits is complicated by the fact that, in most cases, functional channels *in vivo* are heteromultimeric. Somewhat predictably, knockout of individual ASIC subunits in mice only leads to modest deficits in touch sensitivity. The existence of numerous touch receptors with overlapping mechanical sensitivities and intermixed receptive fields limits the possibility of marked functional deficits in the case of single gene disruptions. In addition, properties of human subunits are not identical to those displayed by homologs in other species. So far, there is no definitive evidence for a major role of a particular ASIC subunit in somatosensory mechanotransduction. Early studies suggested that loss of ASIC2a reduced the sensitivity of low threshold rapidly adapting A $\beta$  mechanoreceptors to touch. Deletion of ASIC3, also known as DRASIC, increased the sensitivity of mechanoreceptors detecting light touch, but reduced the sensitivity of A $\delta$  nociceptors responding to noxious pinch. However, other studies indicate that lack of ASIC1, ASIC2 or ASIC3 does not impair cutaneous or visceral mechanosensation nor does it reduce mechanogated currents in the soma of DRG neurons (Roza et al. 2004).

The role of the lipid sensitive, mechano-gated  $K^+$  channels TREK-1, TREK-2 and TRAAK of the  $K_{2P}$  channel family in nociceptor mechanotransduction is still open to discussion (Patel et al. 2001).

P2 purinergic receptors also seem to participate indirectly in mechanotransduction, possibly modulating the opening probability of other classes of mechanosensory channels. Expression of P2Y<sub>1</sub> receptors in oocytes determines the development of ionic responses to the application of light mechanical stimuli. These stimuli appear to release intracellular ATP that in turn activates P2Y<sub>1</sub> receptors (Nakamura and Strittmatter 1996). Similarly, release of ATP from damaged cells following mechanical injury may stimulate P2X receptors present in small unmyelinated fibers and may be involved in mechanical sensitivity of nociceptors (Cook and McCleskey 2002).

Finally, mechanical stretching modifies the activity of voltage dependent  $Ca^{2+}$  channels but not of  $Na^+$  and  $K^+$  channels or  $K^+$  leakage channels. The mechanosensitivity of  $Ca^{2+}$  channels may contribute to modulating the neuron response to mechanical stimuli through changes in intracellular  $Ca^{2+}$ .

Extracellular matrix attachments have been proposed as the general mechanism involved in transmitting external mechanical forces to the neuron surface and subsequently to MSCs. In turn, MSCs are tethered to the internal cytoskeleton. Relative displacement of these structures would transmit tension to



**Transduction and Encoding of Noxious Stimuli, Figure 3** Hypothetical arrangement for the different elements of the mechanotransduction apparatus. External mechanical forces are transmitted by extracellular matrix molecules and cytoskeleton proteins to mechanotransduction channels, causing an ion current flow through the open channel.

the gate of the mechanosensory channel. Altogether they form a functional unity called the mechanosensory apparatus (Fig. 3). It has been suggested that transmembrane integrins act as a molecular linker between the extracellular mechanical signal and the cytoskeleton, because they bind actin associated proteins and therefore physically link the extracellular matrix with the microfilaments. Other cellular elements, such as certain enzymes, can be directly sensitive to stress and act additionally as mechanotransducers. However, the low sensitivity and slow time course of the evoked responses make their direct responsibility in sensory mechanotransduction dubious.

#### Chemotransduction

A great variety of molecules, either exogenous or endogenous, act on nociceptive terminals, producing a change in membrane potential and eventually a discharge of nerve impulses (Belmonte 1996; Julius and Basbaum 2001). Sensitivity to chemicals is present to a variable degree in all subpopulations of nociceptors. In some cases (polymodal nociceptors, silent nociceptors) chemical mediators activate the nerve terminals directly. In others (mechano-nociceptors), chemical mediators may alter the excitability of nerve ter-

minals without producing a propagated discharge, by changing their responsiveness to further stimuli. Endogenous compounds that influence the excitability of nociceptors include protons, low oxygen (i.e. hypoxia), arachidonic acid and metabolites (e.g. prostaglandins), kinins, amines like serotonin and histamine, cytokines (e.g. tumor necrosis factor  $\alpha$ , IL-1 $\beta$  and IL-8), acetylcholine, amino acids, NO, opioids, ATP, adenosine, endocannabinoids and other neuropeptides (e.g. endothelin-1). Many of these substances are released as part of the injury/inflammatory response caused by noxious stimuli and will trigger or modulate the transduction process. In addition, a number of growth factors influence nociceptor excitability either directly or by regulating gene transcription, resulting in altered ion channel expression. These types of substances include nerve growth factor (NGF), brain derived neurotrophic factor (BDNF), glial cell derived neurotrophic factor (GDNF) and related factors. Considering the diverse physicochemical properties of exogenous sensory irritants, it is doubtful that all of them act through a specific receptor molecule. It is more likely that some of the compounds that stimulate nociceptive nerve endings partition in the membrane according to their liposolubility and alter membrane and cellular properties, including surface charge, gating of ion channels and metabolic state of the cell. The net result of these actions is a depolarization of nerve terminals and a discharge of nerve impulses, whose firing frequency may be proportional to the concentration of the irritant substance within certain limits. In contrast, many other exogenous and endogenous chemicals and protons directly or indirectly gate members of the various superfamilies of ion channels, leading to changes in membrane potential (Julius and Basbaum 2001).

TRPV1 (originally named VR1), a member of the TRPV subfamily, is a receptor for capsaicin, the pungent compound found in hot peppers, and appears to play a central role in the sensitization of nociceptors to many endogenous substances (Caterina et al. 1997). This channel is also activated by protons and noxious heat (over 42°C). TRPV1 is a non-selective cation channel with a very high permeability to  $\text{Ca}^{2+}$ . Sensory neurons expressing native TRPV1 receptors and oocytes or mammalian cells transfected with TRPV1 exhibit robust membrane currents in response to capsaicin that are desensitized by repeated exposures to the agonist and blocked by the competitive vanilloid receptor antagonist capsazepine and by the non-competitive antagonists ruthenium red and peptoids. The channel is also activated by various endogenous lipids, such as anandamide, the ligand for cannabinoid receptor 1. Moreover, the endogenous inflammatory mediator bradykinin (BK) that is known to sensitize polymodal

nociceptor endings through activation of the G-protein-coupled receptor BK2 also enhances capsaicin currents. A similar effect is produced by nerve growth factor (NGF), which also sensitizes polymodal nerve endings to noxious stimuli by activation of the tyrosine kinase receptor TrkA. In addition, GDNF up-regulates B1 receptor expression in small non-peptidergic nociceptive neurons. Furthermore, activation of B1 receptor causes a marked increase in the amplitude of the heat-activated current in these neurons. BK2 and TrkA receptors act through the stimulation of phospholipase C (PLC), which enhances both basal TRPV1 activity and capsaicin-evoked responses. PLC catalyzes the hydrolysis of membrane PIP2 to form IP3 and diacylglycerol. PIP2 inhibits TRPV1 channels directly and its hydrolysis results in TRPV1 potentiation (Chuang et al. 2001). In contrast, potentiation of TRPV1 by B2 and P2Y<sub>2</sub> receptors appears to be mediated by protein kinase C (PKC) activation.

It has been claimed that ATP released by injured cells excites nearby nociceptive terminals. Impulse responses to ATP have been evoked in the soma and neurites of tooth pulp cultured nociceptive neurons labeled retrogradely (Cook et al., 1997). This effect is mediated by P2X3 ionotropic channels. Also, in mammalian cells expressing cloned TRPV1 channels and in DRG neurons, ATP enhances the responses to capsaicin, to heat and to protons (Moriyama et al. 2003). This effect seems to be secondary to activation of the metabotropic purinergic receptor P2Y<sub>2</sub>, that activates phospholipase C through a G-protein (G<sub>q/11</sub>), leading to the production of IP3 and diacylglycerol.

Among 2-pore domain K<sup>+</sup> channels, TREK-1, TREK-2 and TRAAK are gated by different biolipids like arachidonic acid and lysophosphatidic acid (Patel et al. 2001).

### Acid Sensing

Intradermal injection of acidic solutions induces pain. Furthermore, tissue acidosis is a common occurrence following inflammation, ischemia and tissue injury. This acidosis, to pH values as low as 5, is known to activate and sensitize polymodal nerve terminals (Belmonte et al. 1991). In fact, most acid sensing neurons have small diameters, typical for nociceptors. The excitatory effects of protons could be mediated by a variety of ion channels including TRPV1, ASICs and TASK channels that are sensitive to pH changes. These findings are of great significance in explaining the pain and primary hyperalgesia that appear during inflammation and ischemia.

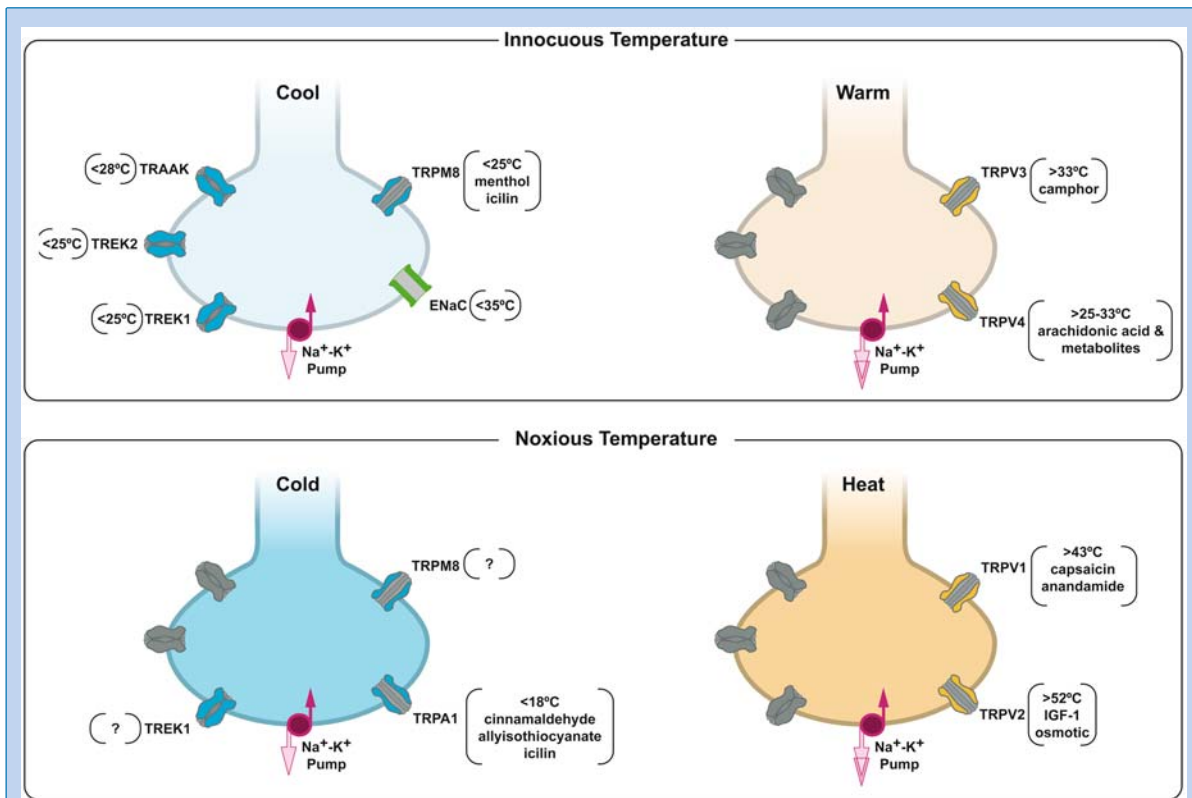
In TRPV1-transfected cells, protons evoke distinct inward currents and enhance the response to capsaicin up to five times over control values (Caterina et al. 1997). Single channel activity in outside-out mem-

brane patches of TRPV1-transfected cells also increases when the external pH is reduced. The acid sensing ion channels (ASIC), members of the DEG/ENaC superfamily, are also activated by extracellular protons and are over-expressed during inflammation. The contribution of different DEG/ENaC channel subunits to pH sensitive currents in DRG neurons has been investigated with targeted disruption of the various subunits. Deletion of any one subunit did not abolish proton-gated currents, suggesting that two or more ASIC subunits coassemble as heteromultimers. As mentioned above, ASIC3 is present in presumed primary nociceptive neurons of the mouse and possibly participates in the detection of strong local pH reductions accompanying ischemia or inflammation. This channel is probably involved in the sensation of cardiac pain (Sutherland et al. 2001). The ASIC3 knockout mouse exhibits a lowered sensitivity to intramuscular injection of acid. Furthermore, DRG neurons respond less to low pH solution. Psychophysical and pharmacological data in humans suggest that ASIC channels have a more important role than TRPV1 channels in the sensation of moderate cutaneous acid induced pain.

Among the K<sub>2P</sub> channels, TASK subunits (TASK-1, TASK-2, TASK-3) represent background outward rectifiers that are constitutively active at all voltages and are inhibited by extracellular acidic pH values. Closure of these channels depolarizes the membrane potential. TASK channels have been found in some sensory neurons with nociceptive properties but their role in pH-induced pain has not been firmly established yet.

### Thermal Transduction

Extremely low or high temperatures evoke distinct pain sensations that are mediated by activation of subpopulations of sensory afferents. Heat activates polymodal nociceptor fibers, which respond to temperatures greater than 41–42°C. For the sensation of pain evoked by cold, it was suggested that a specific group of cold-activated sensory fibers might exist. However, there is also evidence favoring the view that the sensation of cold pain rather results from the concomitant activation by low temperatures of non-nociceptive cold thermoreceptors and a fraction of polymodal nociceptors (Campero et al. 1996). The transduction mechanisms for heat and cold in primary sensory neurons appear to be different at the cellular and molecular levels (Fig. 4). Several receptor molecules have been identified recently that seem to be involved in the detection of temperature changes greater than normal values (Patapoutian et al. 2003). In contrast, the cellular and molecular mechanisms involved in the detection of innocuous *versus* noxious temperature decreases are still incompletely understood.



**Transduction and Encoding of Noxious Stimuli, Figure 4** Diagram of ion channels hypothetically involved in transduction of innocuous and noxious temperatures by peripheral sensory receptor terminals.

### Heat

Temperature elevations influence ionic pumps and conductances in all cell types including nociceptive terminals. However, polymodal nociceptor nerve fibers, unlike thermal sensory fibers that detect innocuous warming, begin to discharge nerve impulses when the tissue temperature increases over 40°C. Moreover, they become sensitized by repeated thermal stimulation in the noxious range. Based on threshold, latency and peak discharges to controlled heat pulses, two types of impulse responses were identified in separate groups of A $\delta$  nociceptors. One had a high threshold (over 53°C), a slow build-up and latencies measured in seconds; the second type was characterized by a lower threshold (46°C), latencies measured in milliseconds and rapid peak discharges. In turn, C nociceptors begin to respond at around 41°C, giving a peak discharge near the stimulus onset. Overall, these observations suggest that various transduction mechanisms may contribute to the final activation of nociceptors by heat. Changes in responsiveness of polymodal nociceptive terminals to heat often go in parallel with a modified chemosensitivity. Thus, thermo- and chemosensitivities were simultaneously altered by capsaicin and exhibited cross-sensitization (Belmonte et al. 1991). These observations suggested that in polymodal

neurons the specific transduction mechanisms for heat were closely associated with chemosensitivity to capsaicin.

Cesare and McNaughton (Cesare and McNaughton 1996) first described an inward current in a subpopulation of small dorsal root ganglion neurons that was activated by noxious heat, sensitized by bradykinin and presumably mediated by a non-selective cation channel. Identification and cloning of the 'capsaicin receptor' TRPV1 (Caterina et al. 1997) proved that heat is a stimulus for this channel as well as for other channels of the TRPV family. Heat induced currents in membrane patches of TRPV1 transfected cells showed the same outwardly rectifying current-voltage relations as those evoked with capsaicin. Both were blocked by capsazepine and displayed analogous ionic selectivities. However, in transgenic mice where the TRPV1 gene was disrupted, sensitivity to capsaicin was lost, while responses to noxious heat still persisted. Also, a fraction of cultured primary sensory neurons respond to heat but not to capsaicin. A candidate molecule for the additional sensitivity to noxious heat is another vanilloid receptor-like channel named TRPV2 that is 50% identical to TRPV1, responds to heat over 52°C and is insensitive to capsaicin, being inhibited by the non-competitive antagonist ruthenium red (Caterina et al. 1999).



Finally, sensitivity to rising temperatures has been shown in two more members of the TRPV family. TRPV3 is structurally analogous to TRPV1 and is expressed in the skin keratinocytes, the brain and other tissues. When transfected into mammalian cells, this channel responds to temperature with a threshold around 33°C but not to capsaicin or pH changes, showing an activation profile closely similar to that of TRPV1 (reviewed by Patapoutian et al. 2003). TRPV3 is also activated by camphor. Although no immunoreactivity to this channel can be found in the neurons of peripheral sensory ganglia, TRPV3 null mice have strong deficits in responses to innocuous and noxious heat, indicating that it participates in thermosensation (Moqrich et al. 2005). TRPV4, a cation channel that has been implicated in hypo-osmolality sensing by neurons of the anterior hypothalamus, is also temperature sensitive when expressed in oocytes and HEK 293 cells, with an activation threshold of 25°C and maximal responses around 40°C (Guler et al. 2002). Thus, transduction of heat by primary sensory neurons appears to be mediated by several ion channel proteins that cover different temperature ranges and may explain the differences in heat threshold among nociceptors. Formation of heteromeric channel assemblies by the members of the TRPV subfamily in nociceptive neurons is an additional possibility for explaining the presence of a range of receptors with a wide spectrum of responses to temperature.

### Cold

The identification of the cellular mechanisms involved in the transduction of cold stimuli by low- and high-threshold cold thermal receptors has been quite elusive. Low-threshold (innocuous) cold sensory fibers increase their firing frequency with changes of skin temperature as small as 0.01°C (Gallar et al. 2003). On the other hand, high-threshold cold fibers responding specifically to cutaneous cold below 27°C have been reported (reviewed by Reid 2005). Finally, a fraction of polymodal nociceptor afferents discharge when they are exposed to very low temperatures (Campero et al. 1996; Acosta et al. 2001).

The unifying hypothesis originally proposed to explain the sensitivity of primary sensory neurons to low temperatures was that the electrogenic Na<sup>+</sup>-K<sup>+</sup> pump was highly temperature dependent, so that temperature decreases cause a reduction in pump activity, leading to depolarization. The differential temperature sensitivity of sodium and potassium ion channels would additionally contribute to a depolarized membrane potential during cooling. However, blockers of the Na<sup>+</sup>-K<sup>+</sup> pump do not eliminate the sensitivity of cold sensory fibers to temperature decreases. More recently, it has been proposed that cold selectively activates an

ion channel of the TRP family, TRPM8 (originally named CMR1 because of its cold and menthol sensitivity, McKemy et al. 2002; Peier et al. 2002) that is found in about 15% of primary sensory neurons. In heterologous expression systems, TRPM8 channels activate at temperatures below 25°C, a temperature notably lower than the activity threshold of cold thermoreceptors (de la Pena et al. 2005). However, this mechanism is possibly not sufficient to explain the firing characteristics of cold receptors and the differences in sensitivity to temperature of the various types of thermal receptors. Cold also closes a background K<sup>+</sup> current in the soma of cultured cold sensitive neurons (Viana et al. 2002; Reid 2005), producing a net inward current ( $I_{\text{cold}}$ ) that leads to depolarization and impulse firing. This effect is partly counteracted by the prominent inwardly rectifying  $I_h$  current present in these cells that tends to depolarize the neuron at the basal membrane potential but decreases progressively with depolarization as well as as a consequence of the direct action of cold. Depolarization by cold occurs in other types of primary sensory neuron but they are less sensitive than cold specific neurons, because they express a slowly inactivating, transient, outward current named  $I_{\text{KD}}$  that reduces their excitability during cooling and prevents the impulse discharge. Low concentrations of 4-AP selectively block this current and render cold insensitive neurons responsive to cold (Viana et al. 2002).

### Noxious Cold

The reduction of cutaneous surface temperature below 15°C elicits a sensation of cold pain. The discovery of TRPA1, a TRP channel that is expressed in a fraction of primary sensory neurons, some of which also harbor TRPV1 channels, and the fact that TRPA1 is activated by temperatures below 18°C made it a good candidate for the transduction of noxious cold (Story et al. 2003). However, TRPA1 is also gated by a number of pungent compounds like cinnamaldehyde, mustard oil and allicin that, when applied to the skin, evoke a burning rather than a cold sensation (Namer et al. 2005). These findings and the disputed activation of TRPA1 by low temperature leave the specific role of TRPA1 in the transduction of noxious cold temperatures unsettled. In neuropathic pain models, the time course of cold hyperalgesia matches the expansion of a population of TRPA1 expressing neurons, but only in the uninjured ganglion (Obata et al. 2005). Cultured primary sensory neurons responding to cold have a wide range of temperature thresholds from 32°C to 18°C, but exhibit homogeneous membrane properties and firing characteristics and the great majority are sensitive to the TRPM8 activator, menthol. About 50% of them are also activated by capsaicin (Viana et al. 2002). Therefore, the possibility that noxious cold is signaled

by a fraction of cold sensitive neurons biophysically analogous to those responding to innocuous cold but with different central connections cannot be excluded. In that respect, it is interesting that topical application of menthol, the specific agonist of TRPM8 channels, can also induce sensations of irritation and pain (Acosta et al. 2001; Wasner et al. 2004). Nonetheless, there is experimental evidence that noxious cooling also activates identified polymodal nociceptor fibers in animals and humans. Thus, it is also possible that noxious cold sensations are evoked through the parallel excitation of polymodal nociceptor and innocuous cold receptor fibers by very low temperatures.

### Generation and Encoding of Nerve Impulses

In nociceptors, the change in local membrane conductance caused by physical and chemical stimuli is expected to produce a generator potential (see generator current), whose magnitude and duration will reflect the intensity, duration and time course of the stimulus. These generator potentials associated with gating of transduction channels in nociceptive terminals have never been recorded, due to technical limitations imposed by the small size of nociceptive endings. The generator potential will in turn propagate electrotonically and initiate, at the closest point of the axonal membrane endowed with regenerative properties, a discharge of propagated nerve impulses, whose frequency of discharge is also proportional to the amplitude of the stimulus. The various ion channels associated with the stimulus transduction and the generation of electrical activity in primary nociceptive neurons appear to be distributed unevenly among the peripheral terminal arborizations, the parent axon and the cell body, thus conferring different electrical properties on the different portions of the neuron.

### Voltage-gated Channels and the Encoding Noxious Stimuli

Primary sensory neurons also express ion channels that gate in response to changes in membrane potential and whose primary role in terms of stimulus detection is not transduction but propagation and modulation of the impulse discharge. They belong to the superfamily of ► **voltage-gated channels** that includes a large variety of  $K^+$ ,  $Na^+$  and  $Ca^{2+}$  channels,  $Cl^-$  channels and non-selective cation channels like the HCN channels (hyperpolarization activated cyclic nucleotide gated  $K^+$  channels) (Hille 2001). Nociceptors have characteristic electrophysiological properties (Koerber and Mendell 1992) and many different voltage gated ion channels contribute to their cellular excitability. Abnormal excitability of injured neurons has been linked to alterations in the expression and functional characteristics of many types of voltage gated ion channels (Cummins et al. 2000). Given the diversity of ion

channels in nerve terminals and their opposite effects on cell firing, the net change in excitability may not always correspond to that predicted by disturbances in a single class of voltage gated ion channel.

### $Na^+$ Channels

Pharmacologically, ► **voltage-gated  $Na^+$  channels** have been broadly separated into two groups; one class is blocked by nanomolar concentrations of the natural marine toxin tetrodotoxin (tetrodotoxin-sensitive, TTXs) while the other group of  $Na^+$  channels is resistant to tetrodotoxin (► **tetrodotoxin resistant, TTXr**). The results of various molecular approaches indicate that nine of the ten alpha subtypes of sodium channels are present in sensory neurons. Some of these channels are found in virtually all sensory neurons, while others, specially the TTXr subtypes, show a more restricted expression pattern. The expression profile also changes during development.

Propagation of action potentials along all sensory axons is mediated by TTXs channels. In contrast, some of the TTXr  $Na^+$  channels subtypes ( $Na_v1.8$  and  $Na_v1.9$ ) are selectively found in small diameter, primarily nociceptive neurons (Akopian et al. 1996; McCleskey and Gold 1999).  $Na_v1.8$  channels are particularly abundant in polymodal nociceptive terminals, where they can sustain propagated action potentials that may contribute to local release of ► **neuropeptides** (Brock et al. 1998).

Expression of  $Na^+$  channels is up- or down-regulated following local inflammation and injury of peripheral sensory axons (Lai et al. 2004). Functional properties are also affected by injury. These factors possibly contribute to the changes in sensitivity and the ectopic activity found in damaged sensory nerves that may give rise to ► **neuropathic pain**. The role of  $Na^+$  channels in hyperalgesia is further substantiated by the effectiveness of use-dependent sodium channel blockers for the treatment of various types of chronic pain. It must be noted that abnormal activity in uninjured primary afferents may also be critical for the observed hypersensitivity to sensory input in animal pain models (Lai et al. 2004).

### $K^+$ Channels

Potassium channels form a diverse superfamily of ion channels. On the basis of their structure and functional properties they can be separated into voltage gated ( $K_v$ ), calcium activated ( $K_{Ca}$ ), inward rectifier ( $K_{ir}$ ) and two-pore domain  $K_{2P}$  channels. They are involved in a variety of neuronal functions including maintenance of membrane potential, action potential repolarization and regulation of firing frequency and are critical regulators of neuronal excitability (Hille 2001). Because  $K^+$  ions have a negative equi-

librium potential across the plasma membrane, activation of these channels tends to dampen excitation.

#### Voltage Gated K<sup>+</sup> Channels (Kv)

A large number of Kv channels are expressed in nociceptors (McCleskey and Gold 1999). A variable combination of rapidly inactivating A-type ( $I_A$ ) and slowly or non-inactivating ( $I_K$ ) K<sup>+</sup> currents are observed in the various types of nociceptor neurons. These functional currents can be further subdivided into several types with distinct kinetic and pharmacological components. Pharmacological, functional and genetic studies confirm that K<sup>+</sup> channels play a role in nociceptor excitability. Furthermore, several Kv channel genes are down-regulated in sensory neurons following axotomy or chronic constriction of peripheral nerves, suggesting that, together with Na<sub>v</sub> channels, they participate in the alteration of axonal excitability that accompanies peripheral nerve injury (Rasband et al. 2001). Substances like PGE<sub>2</sub> can sensitize nociceptive sensory neurons by reducing activity in Kv channels.

K<sub>v</sub>1.4, an A-type K<sup>+</sup> channel, is expressed in sensory neurons of small size, that co-express the capsaicin channel TRPV1 and the TTX-R Na<sup>+</sup> channel Na<sub>v</sub>1.8 and are presumably polymodal nociceptor neurons (Rasband et al. 2001). Kv1.1 and Kv1.2 channels are also expressed in small DRG neurons and genetic studies have linked the lack of Kv1.1 channels with thermal hyperalgesia. K<sub>v</sub>7 (also named KCNQ) channels, responsible for M-type K<sup>+</sup> currents, are also present in nociceptive sensory neurons and pharmacological activation of these channels inhibits responses to algogenic substances in animal models of pain (Passmore et al. 2003). Finally, activation of small conductance calcium activated K<sup>+</sup> channels and ATP sensitive K<sup>+</sup> channels has been also implicated in antinociception. Kir3.2 knockout and Kir3.3 knockout mice display hyperalgesia to elevated temperatures (>50°C) suggesting implication of G-protein-gated K<sup>+</sup> channels in thermal nociception. These modulatory effects appear to be occurring at the level of the spinal cord rather than at the periphery.

#### Two-pore Domain K<sup>+</sup> Channels (KCNK)

In addition to their role as cellular sensors, these channels, responsible for leak K<sup>+</sup> currents, are key elements in the regulation of background excitability. As such, they are thought to play an important role in triggering ectopic discharges associated with chronic pain conditions.

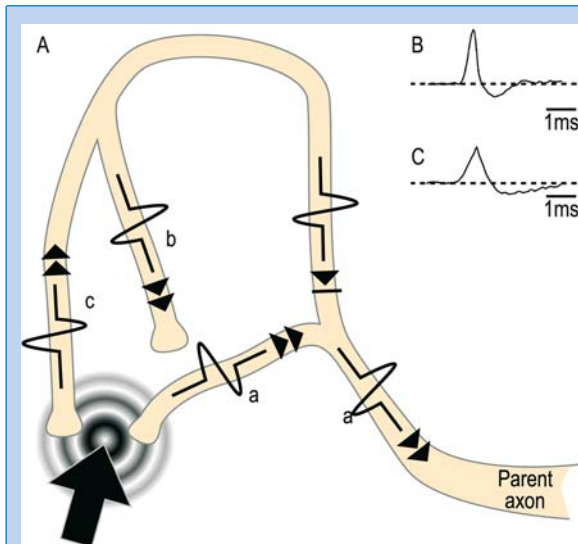
#### Ca<sup>2+</sup> Channels

Voltage activated Ca<sup>2+</sup> channels are channels with steeply voltage dependent gates that open in response

to membrane depolarization. They have the special role of translating electrical signals into chemical signals through their control of the flow of Ca<sup>2+</sup> ions into the cytoplasm, thereby regulating a variety of Ca<sup>2+</sup> dependent intracellular events (Hille 2001). Functional and pharmacological studies followed by cloning and genetic analysis have led to the identification of a large number of voltage gated Ca<sup>2+</sup> channels. Subpopulations of primary sensory neurons exhibit differences in their functional type of Ca<sup>2+</sup> channels and some subunits are selectively expressed in nociceptors (Bell et al. 2004). The properties of voltage-gated Ca<sup>2+</sup> channels are modulated directly and indirectly by a number of endogenous mediators released during injury, thereby changing the excitability and responsiveness of nociceptive neurons. The expression of voltage gated Ca<sup>2+</sup> channel subunits is also altered in conditions such as peripheral nerve injury, contributing to abnormal nerve activity and neuropathic pain. In addition, Ca<sup>2+</sup> channels also play a key role in the function of central neurons involved in nociceptive processing. The end result of these findings is that C<sub>av</sub>2.1 (P/Q-type), C<sub>av</sub>2.2 (N-type), and C<sub>av</sub>3.x (T-type) calcium channels have been validated as useful targets for the treatment of pain (reviewed by Bourinet and Zamponi 2005).

#### HCN Channels

The currents carried by hyperpolarization activated, cyclic nucleotide gated channels (HCN) have been termed I<sub>f</sub>, I<sub>h</sub> or I<sub>q</sub> and are poorly selective K<sup>+</sup> currents activated by membrane hyperpolarization. The current reverses at membrane potentials of about -25 mV and is inwardly directing at rest. I<sub>h</sub> currents contribute to the resting membrane potential, input conductance and subthreshold membrane oscillations in many types of neurons (Robinson and Siegelbaum 2003). HCN channels, particularly HCN1 and HCN2, are abundantly expressed in sensory neurons. Inflammatory mediators, such as serotonin, raise intracellular cAMP levels, which, in turn, increase I<sub>h</sub> current by binding to the HCN channel, shifting its voltage dependent activation to less negative potentials (reviewed by Robinson and Siegelbaum 2003). Likewise, the amplitude of I<sub>h</sub> currents in DRG neurons increases markedly following spinal nerve ligation or chronic compression of the ganglion (Yao et al. 2003). Furthermore, pharmacological blockade of HCN activity with the specific inhibitor ZD7288 reduces the spontaneous ectopic activity secondary to nerve injury and reverses abnormal hypersensitivity to light touch. These results suggest that abnormal expression of HCN channels may be an important factor in the hyperexcitability secondary to peripheral nerve injury.



**Transduction and Encoding of Noxious Stimuli, Figure 5** (A) Propagation of nerve impulses at the peripheral branches of nociceptor fibers. The stimulus extends to various branches where it generates propagated action potentials that travel centripetally. These action potentials may collide at the branching points and this determines the final firing frequency in the parent axon (Modified from Weidner et al. 2003). (B, C) Nerve terminal impulses recorded from nociceptors endings in the cornea, before (B) and after (C) local application of lidocaine. The local anesthetic blocks the regenerative nerve impulse that normally occurs in the terminal (transducing) region of the branch (b) and only impulses passively propagated from neighbor endings are recorded (c).

#### Electrical Activity in Peripheral Terminal Arborizations

Parent sensory axons of nociceptors branch extensively in the peripheral territory. The distribution of the various transduction and voltage gated channels is presumably non-homogeneous among the terminal branches of the various subclasses of nociceptor fibers and perhaps even between branches of a single neuron. It is conceivable that in nociceptors, each terminal branch of an axonal arborization acts as an independent site for transduction and generation of action potentials. Action potentials of nociceptor branches travel centripetally at a conduction velocity that is below that of the parent axon (Weidner et al. 2003). When arriving at a branching point, impulses of the fastest branches will usually travel antidromically and invade the slower branch, transiently changing its excitability or even occluding the generation of action potentials (Fig. 5). In polymodal nociceptors, antidromic action potentials invade the terminals due to the high density of TTXr  $\text{Na}^+$  channels present in their membrane (Brock et al. 1998).

#### Impulse Firing in Parent Axons and Soma

Impulses generated at the endings progress centrally through terminal branches of different length, conduction velocity and possibly duration of their refractory and supernormal periods, becoming finally integrated

in the parent axon. This integration will determine the frequency and firing pattern of the discharge of propagated nerve impulses traveling to the CNS along the complete axonal path of the sensory ganglion neuron. The differences in membrane properties between subclasses of nociceptive neurons are reflected in the conduction velocity and the shape of propagated action potentials at the parent axon and soma, far away from the peripheral endings. C nociceptive axons have longer duration APs and AP undershoot durations than low threshold mechanosensory axons (Koerber and Mendell 1992). Further differences in axonal spike duration and post-spike excitability are noticed between classes of nociceptors (Lawson 2002), possibly influencing the pattern and frequency of their impulse discharge. The soma of the various classes of nociceptive neurons also possesses a number of specific membrane characteristics. Neurons tentatively identified as polymodal have slow somatic action potentials with a hump in the falling phase and do not present inward rectification in response to hyperpolarizing pulses, while low-threshold mechanosensory neurons produce short-lasting action potentials and have a prominent inward rectification (Lawson 2002). These data further suggest that nociceptive neurons possess a specific set of voltage activated  $\text{Na}^+$ ,  $\text{K}^+$  and  $\text{Ca}^{2+}$  channels that confer distinct electrical properties on them and ultimately determine their excitability and pattern of impulse firing in response to peripheral stimuli.

It is worth noticing that the electrical behavior of nociceptor neurons is profoundly influenced by previous history. Repeated stimulation can transiently modify their excitability, through changes in some of the ionic mechanisms associated with the codification and propagation of nerve impulses, contributing to fatigue and/or sensitization (Serra et al. 1999). Similar changes have been observed after nerve damage. This plasticity is important in understanding the altered excitability of nociceptor neurons following injury.

#### Conclusions

Electrophysiological, pharmacological and molecular evidence suggests that nociceptor neurons possess multiple mechanisms for detection, amplification and encoding of input signals. These mechanisms will mediate transduction of the various forms of stimulating energy and also modulate the input signal at the successive steps of the transduction and encoding processes. Different types of stimuli may interact at threshold or subthreshold levels to produce propagated responses. Short- and long-term modulatory mechanisms will further modify the final response characterized by a discharge of nerve impulses of a given frequency, time course and firing pattern.



The interplay of transduction and modulatory mechanisms also defines other characteristics of the impulse response such as ongoing activity, post-discharge, sensitization, fatigue and inactivation.

From the perspective that several molecular mechanisms may co-exist in nociceptive endings for the transduction and amplification of various forms of stimulating energy, a sharp categorization of nociceptors based only on the dominant presence of a given transduction molecule appears to be somewhat simplistic. Many of the 'specific' transduction molecules for a particular form of energy are also present in sensory neurons that respond preferentially to other modalities of stimulus, as is the case of TRPV1 channels in cold receptor neurons. Nonetheless, it is also incomplete to distinguish nociceptors according only to the type of stimulus that evokes a propagated impulse response. Nociceptor functional subtypes categorized by this criterion may in fact represent cases where the transducer mechanism for a given form of energy is prevalent over the others, so that under normal circumstances only this form of stimulus will elicit a propagated response. When changes in excitability and/or summation of the effects of other subthreshold stimuli take place, as is probably the case following inflammation and axonal injury, propagated responses evoked by other forms of energy may become apparent, as occurs for example with 'silent' nociceptors. In spite of their biophysical specialization for certain stimuli, most nociceptor neurons appear to be potentially polymodal and endowed with a high degree of plasticity to modify their response according to the characteristics of the stimulus and its temporal course.

## References

- Acosta MC, Belmonte C, Gallar J (2001) Sensory experiences in humans and single-unit activity in cats evoked by polymodal stimulation of the cornea. *J Physiol* 534:511–525
- Akopian AN, Sivilotti L, Wood JN (1996) A tetrodotoxin-resistant voltage-gated sodium channel expressed by sensory neurons. *Nature* 379:257–262
- Bell TJ, Thaler C, Castiglioni AJ et al. (2004) Cell-specific alternative splicing increases calcium channel current density in the pain pathway. *Neuron* 41:127–138
- Belmonte C (1996) Signal transduction in nociceptors: general principles. In: Belmonte C, Cervero F (eds) *Neurobiology of Nociceptors*. Oxford University Press, New York, pp 243–257
- Belmonte C, Gallar J, Pozo MA et al. (1991) Excitation by irritant chemical substances of sensory afferent units in the cat's cornea. *J Physiol* 437:709–725
- Block S (1992) Biophysical principles of sensory transduction. In: Corey D, Roper SD (eds) *Sensory Transduction*. The Rockefeller University Press, New York, pp 1–17
- Bourinet E, Zamponi GW (2005) Voltage gated calcium channels as targets for analgesics. *Curr Top Med Chem* 5:539–546
- Brock JA, McLachlan EM, Belmonte C (1998) Tetrodotoxin-resistant impulses in single nociceptor nerve terminals in guinea-pig cornea. *J Physiol* 512:211–217
- Burnstock G (2000) P2X receptors in sensory neurones. *Br J Anaesth* 84:476–488
- Campero M, Serra J, Ochoa JL (1996) C-polymodal nociceptors activated by noxious low temperature in human skin. *J Physiol* 497:565–572
- Caterina MJ, Schumacher MA, Tominaga M et al. (1997) The capsaicin receptor: a heat-activated ion channel in the pain pathway. *Nature* 389:816–824
- Caterina MJ, Rosen TA, Tominaga M et al. (1999) A capsaicin-receptor homologue with a high threshold for noxious heat. *Nature* 398:436–441
- Cesare P, McNaughton P (1996) A novel heat-activated current in nociceptive neurons and its sensitization by bradykinin. *Proc Natl Acad Sci USA* 93:15435–15439
- Chen CC, Akopian AN, Sivilotti L et al. (1995) A P2X purinoceptor expressed by a subset of sensory neurons. *Nature* 377:428–431
- Chuang HH, Prescott ED, Kong H et al. (2001) Bradykinin and nerve growth factor release the capsaicin receptor from PtdIns(4,5)P<sub>2</sub>-mediated inhibition. *Nature* 411:957–962
- Clapham DE (2003) TRP channels as cellular sensors. *Nature* 426:517–524
- Cook SP, McCleskey EW (2002) Cell damage excites nociceptors through release of cytosolic ATP. *Pain* 95:41–47
- Cook SP, Vulchanova L, Hargreaves KM et al. (1997) Distinct ATP receptors on pain-sensing and stretch-sensing neurons. *Nature* 387:505–508
- Corey DP (2003) New TRP channels in hearing and mechanosensation. *Neuron* 39:585–588
- Corey DP, Garcia-Anoveros J, Holt JR et al. (2004) TRPA1 is a candidate for the mechanosensitive transduction channel of vertebrate hair cells. *Nature* 432:723–730
- Cummins TR, Dib-Hajj SD, Black JA et al. (2000) Sodium channels and the molecular pathophysiology of pain. *Prog Brain Res* 129:3–19
- de la Pena E, Malkia A, Cabedo H et al. (2005) The contribution of TRPM8 channels to cold sensing in mammalian neurones. *J Physiol* 567:415–426
- Gallar J, Acosta MC, Belmonte C (2003) Activation of scleral cold thermoreceptors by temperature and blood flow changes. *Invest Ophthalmol Vis Sci* 44:697–705
- Guler AD, Lee H, Iida T et al. (2002) Heat-evoked activation of the ion channel, TRPV4. *J Neurosci* 22:6408–6414
- Hille B (2001) *Ion Channels of Excitable Membranes*. Sinauer Associates, Sunderland, MA
- Julius D, Basbaum AI (2001) Molecular mechanisms of nociception. *Nature* 413:203–210
- Kang D, Choe C, Kim D (2005) Thermosensitivity of the two-pore domain K<sup>+</sup> channels TREK-2 and TRAAK. *J Physiol* 564:103–116
- Kellenberger S, Schild L (2002) Epithelial sodium channel/degnerin family of ion channels: a variety of functions for a shared structure. *Physiol Rev* 82:735–767
- Koerber HR, Mendell LM (1992) Functional heterogeneity of dorsal root ganglion cells. In: Scott SA (ed) *Sensory Neurons Diversity, Development, and Plasticity*. Oxford University Press, New York, pp 77–96
- Lai J, Porreca F, Hunter JC et al. (2004) Voltage-gated sodium channels and hyperalgesia. *Annu Rev Pharmacol Toxicol* 44:371–397
- Lawson SN (2002) Phenotype and function of somatic primary afferent nociceptive neurones with C-, Aδ- or Aα/beta-fibres. *Exp Physiol* 87:239–244
- Maroto R, Raso A, Wood TG et al. (2005) TRPC1 forms the stretch-activated cation channel in vertebrate cells. *Nat Cell Biol* 7:179–185
- McCleskey EW, Gold MS (1999) Ion channels of nociception. *Annu Rev Physiol* 61:835–856
- McKemy DD, Neuhauser WM, Julius D (2002) Identification of a cold receptor reveals a general role for TRP channels in thermosensation. *Nature* 416: 52–58

35. Moqrich A, Hwang SW, Earley TJ et al. (2005) Impaired thermosensation in mice lacking TRPV3, a heat and camphor sensor in the skin. *Science* 307:1468–1472
36. Moriyama T, Iida T, Kobayashi K et al. (2003) Possible involvement of P2Y2 metabotropic receptors in ATP-induced transient receptor potential vanilloid receptor<sup>1</sup>-mediated thermal hyper-sensitivity. *J Neurosci* 23:6058–6062
37. Nakamura F, Strittmatter SM (1996) P2Y1 purinergic receptors in sensory neurons: contribution to touch-induced impulse generation. *Proc Natl Acad Sci USA* 93:10465–10470
38. Namer B, Seifert F, Handwerker HO et al. (2005) TRPA1 and TRPM8 activation in humans: effects of cinnamaldehyde and menthol. *Neuroreport* 16:955–959
39. Obata K, Katsura H, Mizushima T et al. (2005) TRPA1 induced in sensory neurons contributes to cold hyperalgesia after inflammation and nerve injury. *J Clin Invest* 115:2393–2401
40. Passmore GM, Selyanko AA, Mistry M et al. (2003) KCNQ/M currents in sensory neurons: significance for pain therapy. *J Neurosci* 23:7227–7236
41. Patapoutian A, Peier AM, Story GM et al. (2003) ThermoTRP channels and beyond: mechanisms of temperature sensation. *Nat Rev Neurosci* 4:529–539
42. Patel AJ, Lazdunski M, Honore E (2001) Lipid and mechano-gated 2P domain K(+) channels. *Curr Opin Cell Biol* 13:422–428
43. Peier AM, Moqrich A, Hergarden AC et al. (2002) A TRP channel that senses cold stimuli and menthol. *Cell* 108:705–715
44. Rasband MN, Park EW, Vanderah TW et al. (2001) Distinct potassium channels on pain-sensing neurons. *Proc Natl Acad Sci USA* 98:13373–13378
45. Reid G (2005) ThermoTRP channels and cold sensing: what are they really up to? *Pflugers Arch* 451:250–263
46. Robinson RB, Siegelbaum SA (2003) Hyperpolarization-Activated Cation Currents: From Molecules to Physiological Function. *Ann Rev Physiol* 65:453–480
47. Roza C, Puel JL, Kress M et al. (2004) Knockout of the ASIC2 channel in mice does not impair cutaneous mechanosensation, visceral mechanonociception and hearing. *J Physiol (Lond)* 558:659–669
48. Serra J, Campero M, Ochoa J et al. (1999) Activity-dependent slowing of conduction differentiates functional subtypes of C fibres innervating human skin. *J Physiol* 515:799–811
49. Story GM, Peier AM, Reeve AJ et al. (2003) ANKTM1, a TRP-like channel expressed in nociceptive neurons, is activated by cold temperatures. *Cell* 112:819–829
50. Suh BC, Hille B (2005) Regulation of ion channels by phosphatidylinositol 4,5-bisphosphate. *Curr Opin Neurobiol* 15:370–378
51. Sutherland SP, Benson CJ, Adelman JP et al. (2001) Acid-sensing ion channel 3 matches the acid-gated current in cardiac ischemia-sensing neurons. *Proc Natl Acad Sci USA* 98:711–716
52. Talley EM, Sirois JE, Lei Q et al. (2003) Two-pore-Domain (KCNK) potassium channels: dynamic roles in neuronal function. *Neuroscientist* 9:46–56
53. Tracey WD, Jr., Wilson RI, Laurent G et al. (2003) Painless, a Drosophila gene essential for nociception. *Cell* 113:261–273
54. Vellani V, Mapplebeck S, Moriondo A et al. (2001) Protein kinase C activation potentiates gating of the vanilloid receptor VR1 by capsaicin, protons, heat and anandamide. *J Physiol* 534:813–825
55. Vergnolle N, Ferazzini M, D'Andrea MR et al. (2003) Proteinase-activated receptors: novel signals for peripheral nerves. *Trends Neurosci* 26:496–500
56. Viana F, de la Pena E, Belmonte C (2002) Specificity of cold thermotransduction is determined by differential ionic channel expression. *Nat Neurosci* 5: 254–260
57. Waldmann R, Lazdunski M (1998) H(+)-gated cation channels: neuronal acid sensors in the NaC/DEG family of ion channels. *Curr Opin Neurobiol* 8:418–424
58. Wasner G, Schattschneider J, Binder A et al. (2004) Topical menthol—a human model for cold pain by activation and sensitization of C nociceptors. *Brain* 127:1159–1171
59. Weidner C, Schmidt R, Schmelz M et al. (2003) Action potential conduction in the terminal arborisation of nociceptive C-fibre afferents. *J Physiol (Lond)* 547:931–940
60. Yao H, Donnelly DF, Ma C et al. (2003) Upregulation of the hyperpolarization-activated cation current after chronic compression of the dorsal root ganglion. *J Neurosci* 23:2069–2074

## Transforaminal Interbody Fusion

- ▶ TLIF

## Transforaminal Steroids

- ▶ Lumbar Transforaminal Injection of Steroids

## Transformed Migraine

- ▶ Chronic Daily Headache in Children
- ▶ Transformed Migraine Headache

## Transformed Migraine Headache

### Definition

Classification proposed by Silberstein et al (1994), describing a subtype of chronic daily or near daily

headache (> 15 days per month) that developed gradually over time from a pre-existing, well-defined migraine headache. Headache is longer than 4 hours per day, can include a mixture of autonomic and tension-type symptoms, and symptoms have progressed with increasing frequency and decreasing severity over at least three months.

- ▶ Chronic Daily Headache in Children

## Transganglionic Transport

### Definition

One of the tract tracing methods, e.g. a neural tracer taken up by a peripheral axon or branches of primary afferents is transported centripetally and then centrifugally to their central terminals.

- ▶ Trigeminal Brainstem Nuclear Complex, Anatomy

## Transgene

### Definition

Any gene inserted into a vector that is expressed in cells *in vitro* or animals *in vivo* following vector-mediated transduction.

- ▶ Opioids and Gene Therapy

## Transgenic Knockout Mice

### Definition

Genetically engineered null mutant mice. Via blastocyst microinjection of transgenic (i.e. possessing an altered DNA sequence) embryonic stem cells, mice can be created that lack all expression of a particular gene. These mice can be evaluated for their altered pain sensitivity compared to „wild-type“ mice, and the function of the missing gene/protein inferred.

- ▶ Heritability of Inflammatory Nociception
- ▶ Nerve Growth Factor Overexpressing Mice as Models of Inflammatory Pain

## Transgenic Mice

- ▶ Nerve Growth Factor Overexpressing Mice as Models of Inflammatory Pain

## Transient Headache and CSF Lymphocytosis

ZAZA KATSARAVA, HANS-CHRISTOPH DIENER  
Department of Neurology, University Hospital of Essen, Essen, Germany  
zaza.katsarava@uni-essen.de

### Synonyms

Migraine With Pleocytosis, Pseudomigraine With Lymphocytic Pleocytosis

### Definition

The International Headache Society proposed the following diagnostic criteria for HaNDL (IHS 2003):

- Moderate or severe ▶ [headache](#)
- Cerebrospinal fluid pleocytosis with lymphocytic predominance (greater than 15 cells/ $\mu$ l) and normal neuroimaging, CSF culture and other tests for etiology
- Headache occurs at time of CSF pleocytosis
- Episodes of headache and neurological deficits last < 3 months.

### Characteristics

HaNDL is a transient syndrome characterized by severe headache, focal neurological symptoms and CSF lymphocytosis (IHS 2003; for review see Pascual and Valle 2003).

The HaNDL syndrome was first described by Bartleson et al. (Bartleson et al. 1981). Until now about 100 cases of HaNDL have been published. Fifty patients have been reported by Gomez-Aranda et al. (Gomez-Aranda et al. 1997). Berg and Williams presented a series of 7 patients, as well as a systemic review of the literature (Berg and Williams 1995).

Age of onset of HaNDL ranges between 7 and 50 years, with a mean of 27 years. HaNDL is more frequent in men, with a male to female ratio of 3:1 (Berg and Williams 1995; Gomez-Aranda et al. 1997).

Approximately 25–30% of patients report a viral-like illness 2–3 weeks before the onset of HaNDL. Typical symptoms are cough, rhinitis, diarrhea and fatigue (Gomez-Aranda et al. 1997).

The timing between the headache and neurologic deficit is variable. In some patients the initial symptom is headache, in others neurologic deficits occur first. In some patients neurologic deficits with CSF lymphocytosis can occur without a severe headache (Oldani et al. 1998).

Headache is moderate to severe, pulsating or throbbing and mostly bilateral. In some patients the headache is unilateral and localized contralateral to the neurologic symptoms. Duration of headache ranges between 1 h and 1 week, on average 19 h (Gomez-Aranda et al. 1997). Accompanying symptoms are nausea and vomiting, photo- and phonophobia.

Neurologic signs usually consist of hemiparesis, hemisensory symptoms or aphasia. Sensory symptoms are more frequent than motor signs. Pure motor aphasia is the most frequent speech disorder followed by global aphasia and pure sensory aphasia (Gomez-Aranda et al. 1997). Visual symptoms are rare. The focal neurologic symptoms usually evolve progressively, in some cases, however, suddenly. The deficits are transient, lasting from 5 minutes to hours and at most 3 days. Atypical cases with longer duration up to a week have been described. The recovery is always complete. Routine blood and immunological tests are usually normal. Two exceptional cases associated with a cytomegalovirus infection have been reported (Ferrari et al. 1983; Richert et al. 1987). The examination of cerebrospinal fluid reveals a lymphocytic pleocytosis (range 10–760/ $\mu$ l) and increased total protein. In 50% of the cases an elevated CSF pressure has been measured (Berg and Williams 1995; Gomez-Aranda et al. 1997). Immunological, bacterial and viral studies produce normal results.

Electroencephalography reveals a unilateral focal slowing during the acute HaNDL phase in up to 70% of the

patients (Berg and Williams 1995; Gomez-Aranda et al. 1997). In 10% ► EEG slowing was observed bilaterally (Gomez-Aranda et al. 1997). The changes normalized again after the symptomatic period.

Cranial computed tomography, as well as cranial magnetic resonance imaging, is usually normal. In a few patients nonspecific small areas of high signal in T2-weighted images have been observed (Berg and Williams 1995; Gomez-Aranda et al. 1997). Very recently, in one patient, a diffusion weighted MRI could be performed during acute HaNDL, which did not reveal diffusion changes (Gekeler et al. 2002).

Single photon emission computed tomography has been suggested to be the most informative neuroimaging technique. A focus of decreased tracer uptake has been detected during the acute phase, which becomes normal several days after recovery (Caminero et al. 1997; Fuentes et al. 1998).

Cerebral angiography is usually not informative. In the vast majority of patients studied no changes could be found. In some patients inflammation like processes in the wall of the opercular arteries have been detected, and in some patients new episodes of HaNDL were triggered by the angiography, therefore it has to be avoided.

The pathophysiology of HaNDL is still unclear. There are some obvious similarities to ► migraine with aura. However, only few patients with HaNDL report a history of migraine. The duration of the focal neurological symptoms in HaNDL is longer than in migraine with aura. The most important difference between the HaNDL and migraine is the CSF pleocytosis. HaNDL has also been separated from other diseases such as familial hemiplegic migraine or progressive cerebellar ataxia.

There are several infectious diseases that can cause headache, focal neurologic symptoms and CSF pleocytosis. Mollaret's meningitis is characterized by recurrent episodes of aseptic meningitis with headache and symptoms of meningeal irritation. However, focal neurological symptoms are not typical for Mollaret's meningitis. Furthermore, the pleocytosis in Mollaret's meningitis is a mixture of lymphocytes, polymorphonuclear- and large 'Mollaret's' cells.

HaNDL has to be separated from further infectious conditions such as Lyme disease (Pal et al. 1987), neurosyphilis (Berg and Williams 1995), neurobrucellosis (Roldan-Montaud et al. 1991), mycoplasma infection (Dalton and Newton 1991), granulomatous meningitis (Mayer et al. 1993), and secondary cytomegalovirus encephalitis associated with human immunodeficiency virus (HIV) infection (Richert et al. 1987).

HaNDL is always a self-limiting disorder. Therefore, the therapy is restricted to symptomatic treatment with analgesics and antiemetics. No preventive treatment is needed.

## References

1. Bartleson JD, Swanson JW, Whisnant JP (1981) A Migrainous Syndrome with Cerebrospinal Fluid Pleocytosis. *Neurology* 31:1257–1262
2. Berg M, Williams L (1995) The Transient Syndrome of Headache with Neurologic Deficits and CSF Lymphocytosis. *Neurology* 45:1648–1954
3. Caminero AB, Pareja JA, Arpa J et al. (1997) Migrainous Syndrome with CSF Pleocytosis. SPECT Findings. *Headache* 37:511–515
4. Dalton M, Newton RW (1991) Aseptic Meningitis. *Dev Med Child Neurol* 33:446–451
5. Ferrari MD, Buruma OJ, van Laar-Ramaker M et al. (1983) A Migrainous Syndrome with Pleocytosis. *Neurology* 33:813
6. Fuentes B, Diez Tejedor E, Pascual J et al. (1998) Cerebral Blood Flow Changes in Pseudomigraine with Pleocytosis Analyzed by Single Photon Emission Computed Tomography. A Spreading Depression Mechanism? *Cephalalgia* 18:570–573, discussion 531
7. Gekeler F, Holtmannspotter M, Straube A et al. (2002) Diffusion-Weighted Magnetic Resonance Imaging during the Aura of Pseudomigraine with Temporary Neurologic Symptoms and Lymphocytic Pleocytosis. *Headache* 42:294–296
8. Gomez-Aranda F, Canadillas F, Marti-Masso JF et al. (1997) Pseudomigraine with Temporary Neurological Symptoms and Lymphocytic Pleocytosis. A Report of 50 Cases. *Brain* 120:1105–1113
9. IHS (2003) Headache Classification Committee of the International Headache Society. Classification and Diagnostic Criteria for Headache Disorders, Cranial Neuralgias and Facial Pain. *Cephalalgia* (in press)
10. Mayer SA, Yim GK, Onesti ST et al. (1993) Biopsy-Proven Isolated Sarcoid Meningitis. Case Report. *J Neurosurg* 78:994–996
11. Oldani A, Marcone A, Zamboni M et al. (1998) The Transient Syndrome of Headache with Neurologic Deficits and CSF Lymphocytosis. Report of a Case without Severe Headache. *Headache* 38:135–137
12. Pal GS, Baker JT, Humphrey PR (1987) Lyme Disease Presenting as Recurrent Acute Meningitis. *Br Med J (Clin Res Ed)* 295:367
13. Pascual J, Valle N (2003) Pseudomigraine with Lymphocytic Pleocytosis. *Curr Pain Headache Rep* 7:224–228
14. Richert JR, Potolicchio S Jr, Garagusi VF et al. (1987) Cytomegalovirus Encephalitis Associated with Episodic Neurologic Deficits and OKT-8+ Pleocytosis. *Neurology* 37:149–152
15. Roldan-Montaud A, Jimenez-Jimenez FJ, Zancada F et al. (1991) Neurobrucellosis Mimicking Migraine. *Eur Neurol* 31:30–32

## Transient Receptor Potential

### Definition

Transient change in electrical potential across the cell membrane, for example, induced by activation of a TRP receptor.

► TRPV1 Receptor, Species Variability

## Transient Receptor Potential Family of Ion Channels

### Definition

The mammalian transient receptor potential (TRP) ion channels are named after the role of these channels in *Drosophila* phototransduction. They are encoded by



at least 21 different channel genes. The TRP channel primary structures predict six transmembrane domains, with a pore domain between the fifth and sixth segments, and both the C- and N-termini are located intracellularly. The mammalian TRP channel family is comprised of three subfamilies, including TRPC, TRPV and TRPM. The family members are at least 25% homologous within their amino acid sequences. Most of the channels are non-selective to cations, allowing sodium and calcium to flow in and depolarize neurons. The most well-characterized TRP channels in DRG neurons are the vanilloid family of TRPV1–4 channels, which are activated by a range of heat and/or warm temperatures. TRPV1 is the prototype vanilloid channel and is activated by noxious heat, acidic pH and the alkaloid irritant capsaicin. Additional TRP channels in DRG neurons are TRPM8, which is activated by cool temperatures and menthol, and ANKTM1, which is activated by mustard oil derivatives and may be activated by cold.

- ▶ Immunocytochemistry of Nociceptors
- ▶ TRPV1 Receptor, Species Variability

## Transient Receptor Potential Vanilloid 1 (TRPV1 or VR1) Receptor

- ▶ TRPV1

## Transition from Acute to Chronic Pain

SARAH J. HARPER, STEPHAN A. SCHUG  
Royal Perth Hospital and University of Western  
Australia, Perth, WA, Australia  
schug@cyllene.uwa.edu.au

### Synonyms

Pain Progression; Pain Chronification; Central sensitisation

### Definition

It is now well established that chronic pain can develop as the consequence of repeated or severe episodes of acute pain, e.g. in the context of trauma, surgery or acute painful illness. This progression is most likely to be the consequence of central nervous processes, commonly called central ▶ **neuroplasticity** or sensitisation.

### Characteristics

It is well recognised that chronic pain states often follow an acutely painful stimulus such as surgery or trauma. A large study of over 5000 patients referred to chronic pain clinics in the UK, revealed that 22.5% of these patients had developed their pain after surgery, and 18.7% after trauma (Crombie et al. 1998). Similar observations

have been made when following patients after surgery or trauma; and severe early pain after thoracotomy (Katz et al. 1996) and orthopaedic trauma (Gehling et al. 1999) predicts development of chronic pain states.

### Risk Factors for Transition to Chronic Pain States

In 2000, Perkins and Kehlet published a ▶ **meta-analysis** of the predictive factors of chronic pain after surgery (Perkins and Kehlet 2000). They identified a number of significant risk factors for this transition, which include type of surgery, preoperative, intraoperative and postoperative factors:

#### Type of Surgery

After lower limb amputation phantom limb pain occurs in 30–81% and stump pain in >50%. Post-thoracotomy pain syndrome (PTPS) occurs in >50% of patients. Breast surgery can give rise to chest wall, scar, breast or shoulder pain in 11–57% of patients, and phantom breast pain in 13–24%; post-mastectomy pain syndrome (PMPS) has an overall incidence of 50% at one year (Kwekkeboom 1996). Gallbladder surgery carries a risk between 3 and 56% of post-cholecystectomy syndrome (PCS).

#### Preoperative Factors

Intense preoperative pain increases the incidence of phantom limb pain (from 33% to 72%) (Nikolajsen et al. 1997; Krane and Heller 1995). Preoperative risk factors for PCS include ‘psychologic vulnerability’, female gender and long-standing preoperative symptoms. Other factors are repeat surgery and issues of compensation. Preoperative epidural pain control may decrease the risk of chronic pain after amputation (Schug 2004, Bach et al. 1988).

#### Intraoperative Factors

Technical issues of the surgery, including the surgical approach and the risk of nerve injury, are important here. Video-assisted-thoracoscopic lung surgery reduces the risk of PTPS compared to open lung resection. Position of the incision for thoracotomy may influence the incidence of PTPS. Intraoperative epidural analgesia seems to reduce the risk of PTPS. The incidence of PMPS may be increased by: breast-conserving surgery, immediate insertion of implants, extent of axillary dissection and damage to the intercostobrachial nerve.

#### Early Postoperative Factors

Stump pain at one week post amputation correlates with the risk of phantom pain. Intensity of acute postoperative pain is an independent predictor for PTPS and PMPS. Intercostal nerve dysfunction (loss of the superficial abdominal reflex) is associated with more acute, subacute and chronic pain. Adjuvant postoperative radiotherapy to the breast increases the risk of development of PMPS.

### Late Postoperative Factors

Long-term stump pain predicts long-term phantom limb pain (Nikolajsen et al. 1997). More severe or prolonged acute pain in the postoperative period as well as postoperative complications, commonly leading to increased ► **nociception**, significantly predict the development of chronic pain after surgery (Katz et al. 1996, Gehling et al. 1999). Other relevant factors are radiotherapy and neurotoxic chemotherapy, but also psychological factors such as anxiety, depression, neuroticism and psychological vulnerability.

### Mechanisms for the Transition from Acute to Chronic Pain

The development of chronic pain is based on the phenomenon of central neuroplasticity. Disruption of the normal specialisation of the somatosensory system leads to increasing mismatch between stimulus and response. The underlying mechanisms are not fully elucidated yet, however, the physiological principles have been reviewed in detail (Pockett 1995). The implications for the development of chronic pain as a separate disease entity have been summarised recently by Siddall and Cousins (Siddall and Cousins 2004). Some of these mechanisms are presented in the following:

#### Wind Up

A progressive increase in the number of action potentials elicited per stimulus occurs in dorsal and ventral horn neurons when the stimulus exceeds 0.5 Hz. Above this frequency, the post-synaptic depolarising responses summate to produce a cumulative ► **depolarisation**, resulting in a burst of action potentials, instead of a single action potential, in response to each stimulus. It is mediated via N-methyl-D-aspartic acid (NMDA) glutamate receptors and therefore blocked and reversed by NMDA antagonists. ► **Wind-up** lasts as long as ventral horn cell depolarisation, i.e. about 60 seconds.

#### Long Term Potentiation

Repeated episodes of wind-up may trigger ► **long-term potentiation** (LTP). It was first studied in the hippocampus and is now known to occur in visual, sensorimotor and pre-frontal cortex, as well as in the spinal cord. Its mechanism is complex, but in essence high-frequency pre-synaptic activity causes a pre-synaptic glutamate release, which activates  $\alpha$ -amino-3-hydroxy-5-methyl-4-isoxazole propionic acid (AMPA) receptors. AMPA receptor activation opens ion channels allowing post-synaptic depolarisation. If the depolarisation reaches a certain threshold, a magnesium-dependent block of NMDA receptors is released, and these then open their associated ion channels. There is an overall influx of calcium ions which triggers additional calcium release from intracellular calcium stores. The intracellular calcium rise triggers a complex chain of events, which includes the release of one or more retrograde factors

by the post-synaptic cell. By diffusing back to the pre-synaptic membrane, these cause an increased transmitter release in response to each pre-synaptic action potential. Subsequently, calcium-dependent enzymes are activated, such as protein kinases A and C (PKA, PKC) and calcium/calmodulin kinase, leading to phosphorylation of membrane proteins including receptors and ion channels. This makes the post-synaptic cell more excitable, and upregulation of AMPA receptors and growth of dendrites/spines on the post-synaptic cell occurs.

The overall result is LTP, which can last from one hour to several months. It can be slowed or prevented from occurring *in vitro* by NMDA antagonists, early cooling or PKC inhibitors, but in contrast to wind up cannot be reversed.

#### Recruitment

Chronic inflammation and nerve injury have an effect on the presence and distribution of voltage-gated sodium channels, which can become concentrated in areas of injury and produce ectopic discharges. Studies have shown that neurone-specific sodium channels become concentrated in neurones proximal to a site of nerve injury, and play a role in the ► **hyperalgesia** and ► **allodynia** of chronic pain states. Not all sensory neurons are active all the time, and this ► **peripheral sensitisation** will 'recruit' dormant nociceptors, thus increasing the receptive fields of dorsal horn neurons and increasing the intensity and area of pain (Mannion and Woolf 2000).

#### Immediate Early Gene Expression

Immediate early genes are a family of genes (e.g. *c-fos*, *c-jun*) that share the characteristic of having their expression rapidly and transiently induced upon stimulation of neuronal and non-neuronal cells (Caputto and Guido 2000). Damaged sensory neurones may undergo altered gene expression, such that they release a different type of neurotransmitter. The release of neurotransmitters usually associated with noxious stimuli, such as substance P, may contribute to ► **central sensitisation**.

A change in gene expression can also lead to up or down-regulation of ion channels leading to changes in cellular excitability.

#### Excitotoxicity

► **Excitotoxicity** is a phenomenon that was first described by Olney in the seventies (Olney et al. 1972). It involves the activation of glutamate receptors in the central nervous system (CNS). Glutamate, an excitatory amino acid, activates different types of ion channel forming receptors to develop their essential role in the functional activity of the brain. However, high concentrations of glutamate or neurotoxins acting at the same receptors, cause cell death by apoptosis through the excessive activation of these receptors.

The physiological role of the NMDA receptor seems to be related to synaptic plasticity and learning. In addition, working together with G-protein coupled glutamate receptors, it ensures the establishment of the long-term potentiation phenomenon (LTP) described above. Research into the phenomenon has focused on finding clinically useful NMDA receptor antagonists, for use in both chronic pain conditions and neurodegenerative disorders in which excitotoxicity plays a part, such as ► [Parkinson's disease](#) and Alzheimer's disease (Sureda 2000).

### Conclusion

These mechanisms imply that chronic pathological pain may persist long after the initial noxious insult has ceased and tissue damage has healed. The process of synaptic plasticity and learning begins early and is difficult to reverse. It seems that untreated acute pain persisting for long periods of time can imprint memory-like processes into the central nervous system (Schug 2004). Currently the recommendation is that an extended, balanced, multi-modal approach to pain management should begin in the preoperative period and continue postoperatively.

### References

- Bach S, Noreng MF, Tjellden NU (1988) Phantom Limb Pain in Amputees during the First 12 Months following Limb Amputation, After Preoperative Lumbar Epidural Blockade. *Pain* 33:297–301
- Caputto BL, Guido ME (2000) Immediate early gene expression within the visual system: light and circadian regulation in the retina and the suprachiasmatic nucleus. *Neurochem Res* 25:153–162
- Crombie IK, Davies HT, Macrae WA (1998) Cut and Thrust: Antecedent Surgery and Trauma amongst Patients Attending a Chronic Pain Clinic. *Pain* 76:167–171
- Gehling M, Scheidt C-E, Neibergall H et al. (1999) Persistent Pain after Elective Trauma Surgery. *Acute Pain* 2:110–114
- Katz J, Jackson M, Kavanaugh B, Sandler A (1996) Acute Pain after Thoracic Surgery Predicts Long-Term Post-Thoracotomy Pain. *Clin J Pain* 12:50–55
- Krane EJ, Heller LB (1995) The Prevalence of Phantom Limb Sensation and Pain in Pediatric Amputees. *J Pain Symptom Management* 10:21–29
- Kwekkeboom K (1996) Postmastectomy Pain Syndromes. *Cancer Nurs* 19:37–43
- Mannion RJ, Woolf CJ (2000) Pain mechanisms and management: A central perspective. *Clin J Pain* 16(3 suppl):S144–156
- Nikolajsen L, Ilkjaer S, Kroner K et al. (1997) The Influence of Preamputation Pain on Postamputation Stump and Phantom Pain. *Pain* 72:393–405
- Olney JW, Sharpe LG, Feigin RD (1972) Glutamate-induced brain damage in infant primates. *J Neuropathol Exp Neurol* 31:464–488
- Perkins FM, Kehlet H (2000) Chronic Pain as an Outcome of Surgery – A Review of Predictive Factors. *Anesthesiology* 93:1123–1133
- Pockett S (1995) Spinal Cord Synaptic Plasticity and Chronic Pain. *Anesth Analg* 80:173–179
- Schug SA (2004) Acute Pain Management – Its Role in the Prevention of Chronic Pain States. *ASEAN J Anaesthesiol* 5:166–169
- Siddall PJ, Cousins MJ (2004) Persistent pain as a disease entity: implications for clinical management. *Anesth Analg* 99:510–520
- Sureda FX (2000) Excitotoxicity and the NMDA receptor. From EUROSIVA meeting Vienna. [www.eurosiva.org/Archive/Vienna/abstracts/Speakers](http://www.eurosiva.org/Archive/Vienna/abstracts/Speakers)

## Transition from Parenteral to Oral Analgesic Drugs

- Postoperative Pain, Transition from Parenteral to Oral

## Translaminar Epidural Steroid Injection

- Epidural Steroid Injections for Chronic Back Pain

## Transmitters in the Descending Circuitry

- Descending Circuitry, Transmitters and Receptors

## Transmucosal

### Definition

Absorption across the buccal mucosa.

- Pain Control in Children with Burns

## Transmucosal Fentanyl

### Definition

Transmucosal fentanyl is also available as a lollipop preparation (transmucosal preparation) that has been successfully used in children.

- Postoperative Pain, Fentanyl

## Transmural

### Definition

Passing through a wall, as of the body or of a cyst or any hollow structure.

- Animal Models of Inflammatory Bowel Disease

## Transsynaptic Changes after Peripheral Nerve Injury

- Central Changes after Peripheral Nerve Injury

T

## Traumatic Angiospasm

- ▶ Complex Regional Pain Syndromes, General Aspects

## Traumatic Nerve Endbulb Pain

- ▶ Neuroma Pain

## Treating Pediatric Burns

- ▶ Pain Control in Children with Burns

## Treatment Adherence

### Definition

The extent to which patients or clients follow treatment recommendations made by the clinician, or treatment goals negotiated with the clinician.

- ▶ Chronic Pain, Patient-Therapist Interaction

## Treatment Alliance

### Definition

The extent to which patients and clinicians agree on treatment goals and hold each other in positive regard.

- ▶ Chronic Pain, Patient-Therapist Interaction

## Treatment Matching

### Definition

Prescribing treatments based on specific features of patients that are believed to be important to outcomes. Treatments may be matched on the basis of physical, behavioral, or any unique individual differences associated with pain and disability.

- ▶ Psychological Assessment of Pain

## Treatment of Neuropathic Pain

- ▶ Phantom Limb Pain, Treatment

## Treatment of Phantom Pain

- ▶ Phantom Limb Pain, Treatment

## Treatment Outcome

- ▶ Psychological Treatment of Chronic Pain, Prediction of Outcome

## Treatment Outcome Research

- ▶ Psychology of Pain, Efficacy

## Treatment-Related Neutropenia

### Definition

Low white blood counts that develops after chemotherapy or radiation therapy.

- ▶ Cancer Pain Management, Orthopedic Surgery

## Tremor

- ▶ Orofacial Pain, Movement Disorders

## Tricyclic Antidepressants

MARK JOHNSTON

Musculoskeletal Physician, Hibiscus Coast Highway,  
Orewa, New Zealand

markjohn@ihug.co.nz

### Synonyms

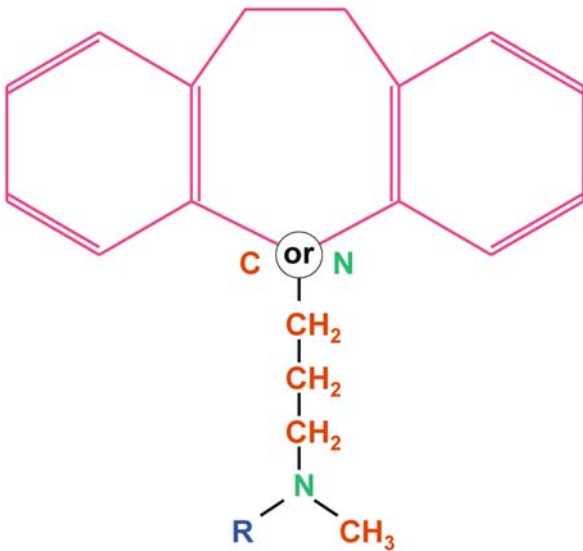
TCAs; tricyclics

### Definition

Tricyclic antidepressants are a group of drugs developed and prescribed primarily as antidepressants. It was discovered in the 1960s that they had an analgesic effect, which was separate from their antidepressant effect. They have since been used increasingly as an analgesic in managing chronic pain.

TCAs consist of a 3 ring central core (Fig. 1). Their properties are related to the degree of saturation of the terminal amine. Tertiary amines available at present include; amitriptyline, clomipramine, doxepine, imipramine and trimipramine. Some of these compounds are metabolised to active secondary amine tricyclic compounds e.g. imipramine to desipramine and nortriptyline from amitriptyline.





**Tricyclic Antidepressants, Figure 1** The core chemical structure of the tricyclic antidepressants, showing the three-ring structure. Individual agents differ in their substitution of carbon or nitrogen in the central ring, and in the radicle on the amine chain.

## Characteristics

### Mechanisms

Whereas their antidepressant action takes about 2–3 weeks to develop, the analgesic effect of TCAs occurs in 3–7 days. For many years, the most appealing hypothesis was that the analgesic and antidepressant effects are related to the block of reuptake of norepinephrine and serotonin (5-HT) at spinal dorsal horn synapses. Presynaptically, TCAs inhibit the reuptake of serotonin, norepinephrine, and to a lesser degree, dopamine. Postsynaptic activity is variable. Amitriptyline blocks cholinergic, histamine, alpha adrenergic, muscarinic, N-methyl-D-aspartate (NMDA), substance P, and various subsets of serotonergic receptors. Recent evidence from animal studies has shown that other mechanisms may also be having antinociceptive effects. These include: modulation of the sympathetic nervous system, blockade of sodium channels, some anti-inflammatory effects, and mechanisms involving GABA or opioid receptors (Cohen and Abdi 2001).

### Routes of Administration

TCAs are only administered orally. However, intravenous preparations can be obtained.

### Applications

TCAs have been recommended and used in many pain conditions, but this is not supported by the evidence. Evidence supports their use only for:

- diabetic neuropathy
- postherpetic neuralgia
- tension-type headache
- prevention of migraine and tension-type headache

There is no evidence, or no more than dubious evidence, for the use of TCA in: acute or chronic low back pain, 'rheumatologic pain' (including fibromyalgia), and chronic facial pain.

Combining TCAs with other analgesics has been recommended in patients with chronic pain, but there are no good studies to support this practice.

## Side Effects

### Cardiovascular

The most serious side effects of TCAs are on the cardiovascular system, where they can cause heart block, arrhythmias, and postural hypotension.

TCAs slow conduction through the heart. The effect is more marked in patients with pre-existing cardiac conduction disease, particularly bundle branch block. Ischemic heart disease is frequently associated with conduction defects. Some 18% of depressed patients with ischemic heart disease, treated with nortriptyline, developed potentially dangerous sinus tachycardia or complex arrhythmias, compared with 2% in those treated with paroxetine (Roose et al. 1998). Treating the elderly is a problem, as ischemic heart disease is common, and as many episodes may be silent it may not be obvious from the history that the patient is suffering from ischemic heart disease.

Postural hypotension is a result of  $\alpha$ -adrenergic receptor blockade. Syncope can occur at any age, but it is more serious in the elderly. The elderly are more prone to syncope, as part of the normal aging process. Other diseases (congestive heart failure etc.) and medication (vasodilators, diuretics etc.) may intensify the normal postural blood pressure drop. The consequences of falls are also more serious in the elderly.

### Sedation

Sedation can be a useful side effect if the patient has insomnia. Sedation is caused by blockade of H1 receptors. Different TCAs produce different degrees of sedation. The sedative effects may diminish after several weeks.

### Sexual Dysfunction

TCAs have all been reported to delay or prevent orgasm in both sexes.

### Psychiatric

Manic episodes may be triggered in patients with bipolar disease. A greater concern is that of a possible suicide attempt using TCAs, in someone who has severe depression. In large doses the cardiovascular effects can be lethal.

### Withdrawal Syndromes

Sudden or gradual discontinuation of TCAs may cause a number of symptoms. These include: nausea, vomiting, headache, malaise, sleep disturbance, akathisia, or paradoxical behavioural activation resulting in hypomanic symptoms. These effects may start within 24 to 48 hours

of the last dose and last up to 1 month. To reduce withdrawal symptoms, the dose should be tapered gradually; if symptoms are upsetting, the dose may even be increased a little.

### Serotonin Syndrome

Combining TCAs with selective serotonin re-uptake inhibitors or monoamine reuptake inhibitors may precipitate a “serotonin overload syndrome”, characterised by myoclonus, hyperreflexia, tremor, increased muscle tone, fever, shivering, sweating, diarrhoea, delirium, coma or death (Bodner et al. 1995). The condition is usually reversible if the drugs involved are stopped.

### Efficacy

For the treatment of chronic low back pain, a systematic review (van Tulder et al. 1997) found moderate evidence that TCAs are not effective for chronic LBP. There is no evidence of efficacy in acute low back pain.

For ► **neuropathic pain**, TCAs are considered ‘adjuvant analgesics’. A systematic review (McQuay et al. 1996) concluded that TCA are effective for the treatment of neuropathic pain: “of 100 patients . . . 30 will obtain more than 50% pain relief” Evidence is strongest for pain relief with amitriptyline and desipramine.

For ► **fibromyalgia**, TCAs provide pain relief and improve sleep (O’Malley et al. 2000). The ► **NNT** was 4 for the outcome ‘to obtain significant benefit’.

A meta-analysis (Tomkins et al. 2001) of the outcomes from TCAs for the treatment of chronic headache showed an NNT of 3.2, for ‘improvement in headaches’. The effect was the same for TCA and serotonin antagonists, and for both tension-like headaches and migraines.

### Selection

When deciding which TCA to use, the broader spectrum ones, such as amitriptyline, imipramine and nortriptyline, have greater efficacy than the selective re-uptake blockers. Nortriptyline may be the best as it has less sedation, less postural hypotension and less anticholinergic effects.

- **Antidepressants in Neuropathic Pain**
- **Drugs Targeting Voltage-Gated Sodium and Calcium Channels**
- **Drugs with Mixed Action and Combinations, Emphasis on Tramadol**
- **Postoperative Pain, Postamputation Pain, Treatment and Prevention**

### References

1. Bodner RA, Lynch T, Lewis L, Kahn D (1995) Serotonin Syndrome. *Neurology* 45:219–223
2. Cohen SP, Abdi S (2001) New Developments in the Use of Tricyclic Antidepressants for the Management of Pain. *Curr Opin Anaesthesiol* 14:505–511
3. McQuay HJ, Tramer M, Nye BA, Carroll D, Wiffen J, Moore RA (1996) A Systematic Review of Antidepressants in Neuropathic Pain. *Pain* 68:217–227

4. O’Malley PG, Balden E, Tompkins G, Santoro J, Kroenke K, Jackson JL (2000) Treatment of Fibromyalgia with Antidepressants: A Meta-Analysis. *J Gen Inter Med* 15:659–666
5. Roose SP, Laghrissi-Thode F, Kennedy JS, Nelson JC, Bigger JT, Pollock BG, Gaffney A, Narayan M, Finkel MS, McCafferty J, Gergel I (1998) Comparison of Paroxetine and Nortriptyline in Depressed Patients with Ischemic Heart Disease. *JAMA* 279:287–291
6. Tomkins GE, Jackson JL, O’Malley PG, Balden E, Santoro JE (2001) Treatment of Chronic Headache with Antidepressants: A Meta-Analysis. *Am J Med* 111:54–63
7. van Tulder MW, Koes BW, Bouter LM (1997) Conservative Treatment of Acute and Chronic Non-Specific Low Back Pain. *Spine* 22:2128–2156

## Tricyclic-Type Antidepressants

- **Antidepressant Analgesics in Pain Management**

## Tricyclics

- **Tricyclic Antidepressants**

## Trigeminal Brainstem Nuclear Complex, Anatomy

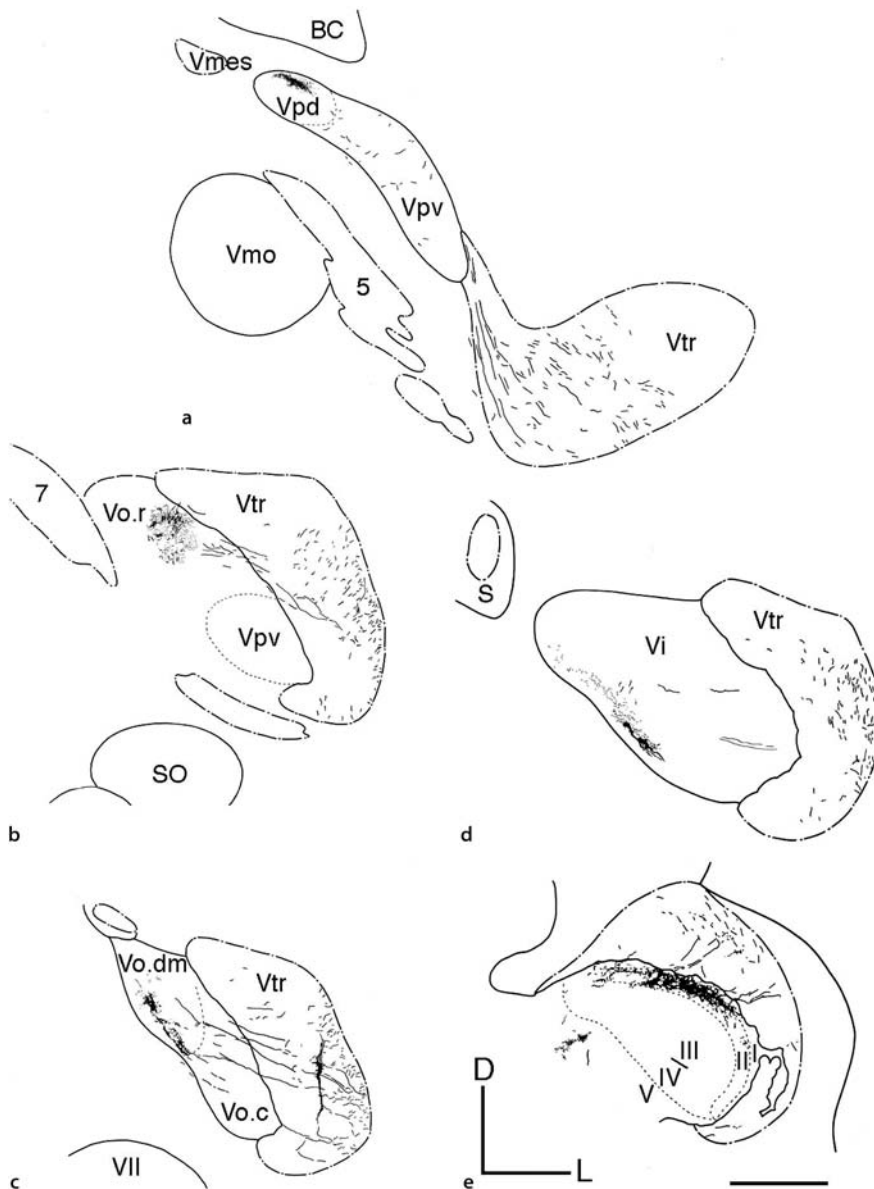
YOSHIO SHIGENAGA, ATSUSHI YOSHIDA  
Department of Oral Anatomy and Neurobiology,  
Osaka University, Osaka, Japan  
sigenaga@dent.osaka-u.ac.jp,  
yoshida@dent.osaka-u.ac.jp

### Definition

The trigeminal brainstem nuclear complex in mammals is generally recognized to include the principal nucleus (Vp), the spinal nuclear complex (Vsp; sometimes also termed the spinal tract nucleus), and the ► **mesencephalic nucleus** (Vmes). It extends through the pons and medulla from the C2 spinal segment and upward through the mesencephalon. In a caudorostral direction, these nuclei are the Vsp, Vp, and Vmes (Fig. 1). Three further divisions of the Vsp are differentiated (Olszewski 1950): the subnuclei caudalis (Vc) (Fig. 1e), interpolaris (Vi) (Fig. 1d), and oralis (Vo) (Fig. 1b, c). The Vmes differs from the other nuclei in that it contains cell bodies of primary afferents innervating jaw muscle spindles or periodontal ligaments.

### Characteristics

The Vp and Vsp integrate the trigeminal afferent system that is organized to serve the ► **exteroceptive**, interoceptive, and proprioceptive sensory functions of the oral and craniofacial structures, but also receive projections from



**Trigeminal Brainstem Nuclear Complex, Anatomy, Figure 1** Camera lucida drawings illustrating the distribution of horseradish peroxidase (HRP) reactions produced at different levels of the trigeminal brainstem nuclear complex after injections of HRP into the lower tooth pulps. (a) to (e) are arranged rostrocaudally. BC, brachium conjunctivum; S, nucleus of solitary tract; SO, superior olivary nucleus; Vtr, spinal trigeminal tract; VII, facial nucleus; 5, trigeminal motor nerve; 7, facial nerve. D-L, dorsal-lateral. Scale bar = 0.5 mm. (Modified from Fig. 1 in Shigenaga et al., 1986c).

the facial, glossopharyngeal and vagus nerves and upper cervical nerves.

The trigeminal spinal tract (Vtr) is somatotopically organized, with fibers of the ophthalmic, maxillary, and mandibular divisions lying successively more dorsally. This dorsoventral arrangement is also applicable to the facial region of the Vp and Vsp, while the intraoral representation is organized in a complex manner (see below) (Shigenaga et al. 1986a; Shigenaga et al. 1986b; Shigenaga et al. 1989b).

Primary afferent projections are not identical at each level, as the density of terminals varies along different nuclei, or in different parts of the same nucleus (Tsuru et al. 1989). The individual nuclei are connected by ascending and descending internuclear pathways (Nasution and Shigenaga 1987).

### Nucleus Principalis (Vp)

This is divided into a subnucleus dorsomedialis (Vpd) and a subnucleus ventrolateralis (Vpv; Fig. 1a). The Vpv extends further caudally than the Vpd, to the rostral pole of the facial nucleus. The caudal limit of Vpd corresponds to the caudal pole of the trigeminal motor nucleus (Vmo). The neurons are densely packed and have a uniform appearance, with small and medium-sized, round or oval cell bodies. The Vpd is distinguished by the compact aggregation of its cells, although caudally it becomes loosely arranged (Shigenaga et al. 1986b).

The central projections of primary afferents have been examined using the techniques of [▶ transganglionic transport](#) and intraaxonal labeling of horseradish peroxidase (HRP). The Vpd receives a projection from

trigeminal primary afferents innervating intraoral structures, but both the intraoral and facial afferents project to the Vpv (Shigenaga et al. 1986b). Both the subnuclei receive mesencephalic afferent projections (Shigenaga et al. 1988; Shigenaga et al. 1989a). Tooth pulp afferents terminate in the Vpd in the cat (Shigenaga et al. 1989b; Westrum et al. 1981), and in the Vpd and Vpv in the rat (Marfurt and Turner 1984).

Intraaxonal labeling shows that stained axons (central processes) of primary afferents in the Vtr ascend and descend (bifurcating fibers), or descend without bifurcation (descending non-bifurcating fibers) (Tsuru et al. 1989; Hayashi 1985). The ascending fiber and the descending fiber give off axon collaterals mainly in the Vp and the Vsp, respectively.

At the electron microscopic level (Bae et al. 2003), all pulpal afferent boutons in rats contain clear, round vesicles (S-type), and make synaptic contact with non-primary dendrites with ► **asymmetric junctions**. Approximately one-third of the boutons show characteristic glomeruli, in which synaptic contact is made with small dendrites as well as with other axon terminals. The ► **synaptic glomerulus** has an important role to activate multiple second-order neurons at the same time. The presynaptic axon terminals contain ► **pleomorphic vesicles** and form symmetric contacts with the postsynaptic membrane. The presynaptic boutons are immunoreactive for GABA. These ultrastructural features are also common in axon terminals from low-threshold mechanoreceptive afferents.

The distribution of cell bodies of trigeminothalamic neurons has been mapped in cats with the ► **retrograde labeling** technique (Shigenaga et al. 1983). It was found that most Vpv neurons project of the contralateral thalamus to the nucleus ventralis posteromedialis (VPM) via the crossed ventral tract, while most Vpd neurons project to the ipsilateral VPM via the uncrossed dorsal tract. Thus sensory information from the intraoral structures is mediated through both crossed (via Vpv) and uncrossed (via Vpd) pathways, whereas facial sensory information is mediated via Vpv by a single crossed pathway, although in the rat most Vpd neurons project into the crossed pathway. The axons of the crossed pathway give off collaterals in the central lateral nucleus (CL) of the intralaminar complex (Shigenaga et al. 1983). An ► **intracellular labeling** study in cats (Yoshida et al. 1998) has shown that the Vp also contains ► **local-circuit cells** whose axon collaterals terminate in the jaw-closing region of the Vmo and the lateral reticular formation.

#### Subnucleus Oral (Vo)

This extends from the caudal tip of the facial nucleus to the level a little posterior to the caudal end of Vmo and thus, the rostral half of the Vo (termed Vo.r) is situated in the region dorsomedial to the Vpv (Fig. 1b). Its caudal limit corresponds to the rostral pole of the facial nucleus.

The Vo.r is characterized by large ► **multipolar cells** and merges medially with the lateral reticular formation. More caudally, two regions represent subgroupings, a ventrolateral region (Vo.c) and a dorsomedial region (Vo.dm, Fig. 1c). The Vo.dm is composed mainly of small, compactly arranged cells and merges with the ventrolateral border of the solitary nucleus. In the cat, this subdivision is present between the levels corresponding to the facial nucleus, whereas in the rat it continues without change of structure caudally into the Vi. The Vo.c is composed of oval- or spindle-shaped small cells, triangular or fusiform medium-sized cells, and large multipolar cells. The large cells are sparsely scattered throughout this subdivision (Shigenaga et al. 1986b). The Vo.r and Vo.dm receive projections from primary afferents innervating intraoral structures as well as from mesencephalic primary afferents (Shigenaga et al. 1989a), while facial afferents project to the Vo.c. A dorsoventral organization is not apparent in the Vo.r and Vo.dm. In cats, pulpal afferents terminate in the Vo.r and Vo.dm, where the upper and lower teeth are represented in a mediolateral sequence, and projections from the anterior to posterior teeth are organized in a ventrolateral to dorsomedial sequence, with an extensive overlap in projections from adjoining teeth (Shigenaga et al. 1989b).

At the electron microscopic level (Bae et al. 2003), synaptic organization of rat pulpal afferent boutons in the Vo differs from that in Vp, in that the number of postsynaptic elements per bouton and the frequency of axoaxonic contacts are lower in the Vo, indicating less frequent synaptic glomeruli. These ultrastructural features are common to those of low-threshold mechanoreceptive afferent terminals in the Vp and Vo in cats.

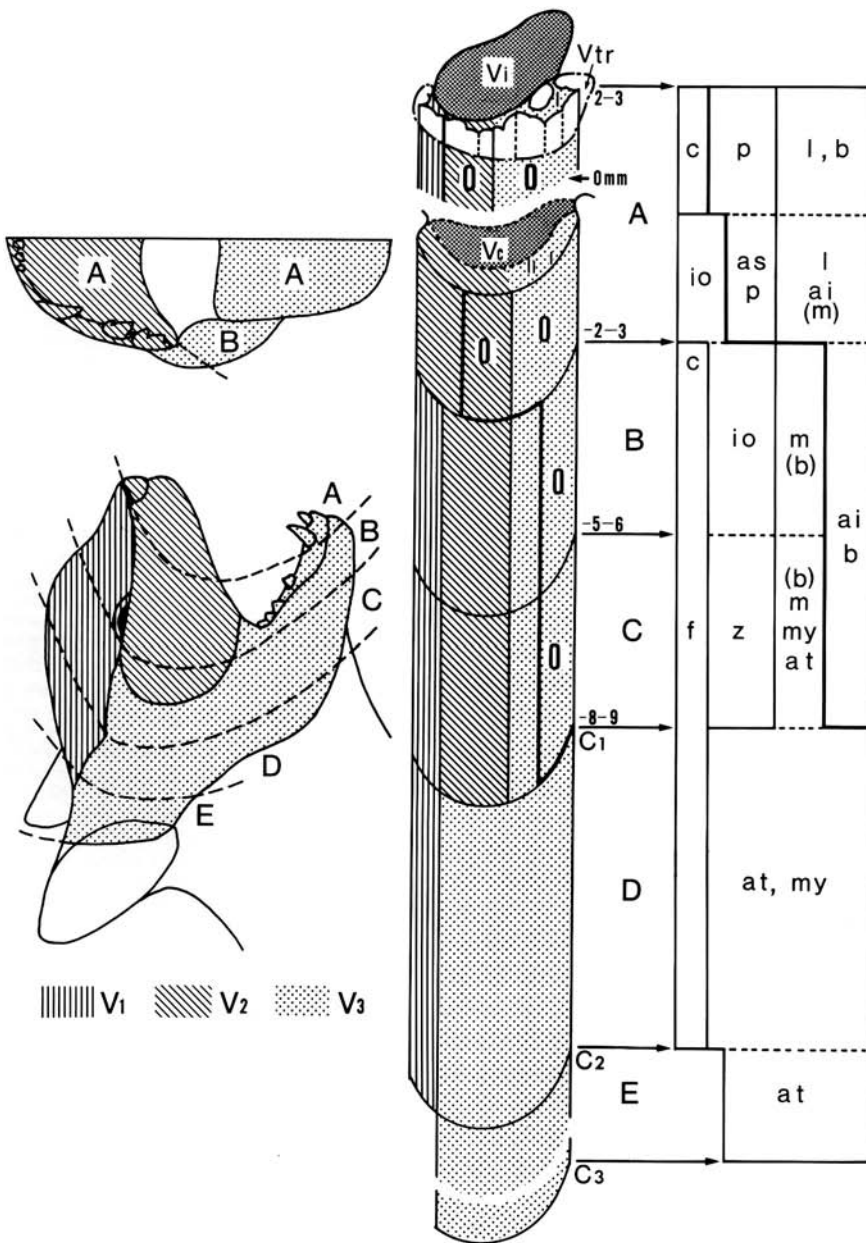
Vo neurons, especially in Vo.r and Vo.dm, send few axons to the VPM in cats (Shigenaga et al. 1983), while a considerable number of Vo.r neurons project to the CL of the intralaminar complex.

There are, however, species differences, and a significant projection to VPM might exist in the rat (see ► **Trigeminal Brainstem Nuclear Complex, Physiology**). In addition, the Vo.r and Vo.dm contain premotoneurons projecting to either jaw-closing or jaw-opening regions of the motor nucleus (Yoshida et al. 1994). Although many neurons respond to light mechanical stimulation of intraoral structures, some are activated by noxious stimuli. These nociceptive neurons send their axon collaterals to the jaw-closing region of the V motor nucleus, suggesting that they may be involved in a reflex circuit that modulates jaw-closing alpha-motoneurons.

#### Subnucleus Interpolaris (Vi)

This lies between the Vo and Vc and ends a little caudal to the obex, and is composed of three neural populations with small, medium, and large cells. Its dorsome-





**Trigeminal Brainstem Nuclear Complex, Anatomy, Figure 2** Schematic drawings of the oral and facial representation in laminae I and II of the medullary and upper cervical dorsal horns. A series of concentric bands (a)-(e) depicting the "onionskin" representation is shown in the drawing of a cat's face and mouth. In a three-dimensional diagram of the medullary and upper cervical dorsal horns, intraoral divisions are marked by O and numbers indicated on the right side show distance in millimeters rostral or caudal (-) to the obex. Each terminal zone of the trigeminal afferent branches examined is filled in in the right column, where b and m indicate presumed terminal zones of the facial branch of the buccal nerve and the most anterior branch of the mental nerve, respectively. The ophthalmic (V1), maxillary (V2), mandibular (V3) divisions of the trigeminal nerve are illustrated by straight lines, oblique lines, and black dots, respectively. ai, inferior alveolar nerve; as, superior alveolar nerve; at, auriculotemporal nerve; b, buccal nerve; c, cornea; f, frontal nerve; io, infraorbital nerve; l, lingual nerve; m, mental nerve; my, mylohyoid nerve; p, palatine nerve; z, zygomatic nerve. (Adapted from figure 13 in Shigenaga et al. 1986a).

T

dial margin, however, contains ovoid- or spindle-shaped small or medium-sized cells, where pulpal afferents terminate in cats (Shigenaga et al. 1986b).

The projection pattern of primary afferents in the Vi is organized in a similar fashion to that in the Vpv, with the exception of lingual and pulpal afferents, which do not terminate in the Vpv in the cat (Shigenaga et al. 1986b; Shigenaga et al. 1989b).

The pulpal projections from the cat's upper and lower teeth are represented in the medial Vi (Fig. 1d) with a topographic fashion, similar to that found in the Vo.r and Vo.dm (Shigenaga et al. 1989b). In addition, the Vi receives projections of primary afferents, with the cell bodies in the trigeminal ganglion, from jaw-closing and -opening muscles (Shigenaga et al. 1988). Their pro-

jection sites are confined to the caudal levels of Vi. They are in the most lateral part of the nucleus, with an extensive overlap in projections, save for the deep temporal nerve, which projects to the interstitial nucleus (see below).

Similar to the Vpv, the Vi neurons project to the contralateral VPM, but not to the CL (Shigenaga et al. 1983). The Vi neurons in Vi/Vc transition zone in rats project to the nucleus submedius (Sm) of the thalamus (Yoshida et al. 1991).

**Subnucleus Caudalis (Vc)**

This extends from the obex to the level of the pyramidal decussation or the C2 segment. The structure resembles closely the spinal dorsal horn, thus it is often termed

the medullary dorsal horn. Olszewski (1950) divided the Vc into three laminar zones: marginalis, gelatinosus, and magnocellularis. The Rexed lamination scheme of the spinal dorsal horn is also applicable to the Vc, and the marginalis, gelatinosus, and magnocellularis correspond to lamina I, lamina II, and laminae III/IV, respectively (Fig. 1e). In the most rostral part, cell islands of lamina I (termed interstitial nucleus) are seen intercalated in the dorsal, lateral and ventral parts of the Vtr at the caudal levels of Vi. The detailed morphology of cells in the different laminae has been reported by several studies (Gobel et al. 1981; Renehan et al. 1986). In cats, laminae I, outer II and V (the lateral parts of medullary reticular formation) receive inputs from small A-delta fibers and c-fibers, which convey information about pain or thermal sensation. In contrast, low-threshold mechanoreceptive afferents (A-beta) terminate throughout inner lamina II to lamina V. However, rat laminae III/IV also receive input from nociceptive primary afferents (Jacquin et al. 1988). Pulpal afferent boutons in the superficial layers in rats can be classified into those with clear, round (S-type) vesicles and dense-cored vesicles, in contrast to pulpal boutons in the rostral nuclei (Bae et al. 2003). Unmyelinated nociceptive primary afferents have been found to bear terminal varicosities that contain a large number of dense-cored vesicles as well as clear, round vesicles (Bae et al. 2003). In addition, the occurrence of synaptic glomeruli and of axoaxonic contacts is much less frequent in the Vc than in the Vp.

The projection patterns of primary afferents in the Vc have also been examined in cats using the technique of transganglionic transport of HRP (Shigenaga et al. 1986a; Shigenaga et al. 1988; Shigenaga et al. 1989b). All three trigeminal divisions terminate throughout laminae I-V, with the exception of tooth pulp, jaw muscle and corneal afferents, which terminate in laminae I, outer II, and V. However, the mediolateral arrangements and caudal extensions differ between the different nerves or branches.

The intraoral and facial structures are arranged as a series of concentric semicircular rings that are centered around the midline of the most anterior face and mouth, and are represented, especially in laminae I/II, in a consecutive order. In this way, the midline of the mouth and the most anterior face are represented most rostrally, while more lateral or posterior structures are represented at successively more caudal levels in the medullary and upper cervical dorsal horns (Fig. 2). The fact that neurons in laminae I, outer II and V receive inputs from nociceptive or thermoreceptive afferents, and that lamina I neurons project to the VPM (Shigenaga et al. 1983), Sm (Yoshida et al. 1991) and in monkey, the posterior ventral medial nucleus (VMpo) (Beggs et al. 2003), support the concept that the onion-skin-like organization of pain and thermal sensations is defined by the arrangement of the sensory projections to lamina I and outer lamina II. An anatom-

ical substrate for referred pain phenomena may be provided by the extensive mediolateral overlap in projections from different nerve branches. Neurons in laminae III and IV project to the rostral nuclei (Nasution and Shigenaga 1987) and medullary reticular formation.

## References

1. Bae YC, Kim JP, Choi BJ et al. (2003) Synaptic Organization of Tooth Pulp Afferent Terminals in the Rat Trigeminal Sensory Nuclei. *J Comp Neurol* 463:13–24
2. Beggs J, Jordan S, Ericson AC et al. (2003) Synaptology of Trigemino- and Spinothalamic Lamina I Terminations in the Posterior Ventral Medial Nucleus of the Macaque. *J Comp Neurol* 459:334–354
3. Gobel S, Hockfield S, Ruda MA (1981) An Anatomical Analysis of the Similarities between Medullary and Spinal Dorsal Horns. In: Kawamura Y and Dubner R (eds) *Oral-Facial Sensory and Motor Functions*. Quintessence, Tokyo, pp 211–223
4. Hayashi H (1985) Morphology of Terminations of Small and Large Myelinated Trigeminal Primary Afferent Fibers in the Cat. *J Comp Neurol* 240:71–89
5. Jacquin MF, Stennett RA, Renehan WE et al. (1988) Structure-Function Relationships in the Rat Brainstem Subnucleus Interpolaris: II. Low and High Threshold Trigeminal Primary Afferents. *J Comp Neurol* 267:107–130
6. Marfurt CF, Turner DF (1984) The Central Projections of Tooth Pulp Afferent Neurons in the Rat as Demonstrated by the Transganglionic Transport of Horseradish Peroxidase. *J Comp Neurol* 223:535–547
7. Nasution ID, Shigenaga Y (1987) Ascending and Descending Internuclear Projections within the Trigeminal Sensory Nuclear Complex. *Brain Res* 425:234–247
8. Olszewski J (1950) On the Anatomical and Functional Organization of the Spinal Trigeminal Nucleus. *J Comp Neurol* 92:402–413
9. Renehan WE, Jacquin MF, Mooney RD, Rhoades RW (1986) Structure-Function Relationships in Rat Medullary and Cervical Dorsal Horns. II. Medullary Dorsal Horn Cells. *J Neurophysiol* 55:1187–1201
10. Shigenaga Y, Chen IC, Suemune S et al. (1986a) Oral and Facial Representation within the Medullary and Upper Cervical Dorsal Horns in the Cat. *J Comp Neurol* 243:388–408
11. Shigenaga Y, Doe K, Suemune S et al. (1989a) Physiological and Morphological Characteristics of Periodontal Mesencephalic Trigeminal Neurons – Intra-Axonal Staining with HRP. *Brain Res* 505:91–110
12. Shigenaga Y, Nakatani Z, Nishimori T et al. (1983) The Cells of Origin of Cat Trigeminothalamic Projections: Especially in the Caudal Medulla. *Brain Res* 277:201–222
13. Shigenaga Y, Nishimura M, Suemune S et al. (1989b) Somatotopic Organization of Tooth Pulp Primary Afferent Neurons in the Cat. *Brain Res* 477:66–89
14. Shigenaga Y, Okamoto T, Nishimori T et al. (1986b) Oral and Facial Representation in the Trigeminal Principal and Rostral Spinal Nuclei of the Cat. *J Comp Neurol* 244:1–18
15. Shigenaga Y, Sera M, Nishimori T et al. (1988) The Central Projection of Masticatory Afferent Fibers to the Trigeminal Sensory Nuclear Complex and Upper Cervical Spinal Cord. *J Comp Neurol* 268:489–507
16. Shigenaga Y, Suemune S, Nishimura T et al. (1986c) Topographic Representation of Lower and Upper Teeth Within the Trigeminal Sensory Nuclei of Adult Cat as Demonstrated by the Transganglionic Transport of Horseradish Peroxidase. *J Comp Neurol* 251:299–316
17. Tsuru K, Otani K, Kajiyama K et al. (1989) Central Terminations of Periodontal Mechanoreceptive and Tooth Pulp Afferents in the Trigeminal Principal and Oral Nuclei of the Cat. *Brain Res* 485:29–61

18. Westrum LE, Canfield RC, O'Conner TA (1981) Each Canine Tooth Projects to all Brain Stem Trigeminal Nuclei in Cat. *Exp Neurol* 74:787-799
19. Yoshida A, Dostrovsky JO, Sessle BJ et al. (1991) Trigeminal Projections to the Nucleus Submedius of the Thalamus in the Rat. *J Comp Neurol* 307:609-625
20. Yoshida A, Hiraga T, Moritani Met et al. (1998) Morphologic Characteristics of Physiologically Defined Neurons in the Cat Trigeminal Nucleus Principalis. *J Comp Neurol* 401:308-328
21. Yoshida A, Yasuda K, Dostrovsky JO et al. (1994) Two Major Types of Premotoneurons in the Feline Trigeminal Nucleus Oralis as Demonstrated by Intracellular Staining with Horseradish Peroxidase. *J Comp Neurol* 347:495-514

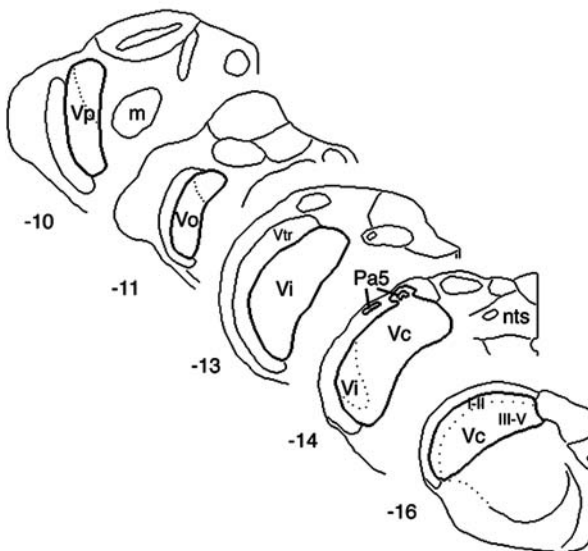
## Trigeminal Brainstem Nuclear Complex, Immunohistochemistry and Neurochemistry

DAVID A. BEREITER  
Department of Surgery, Brown Medical School,  
Providence, RI, USA

### Definition

The trigeminal brainstem nuclear complex (TBNC) is comprised of the principal or main sensory nucleus and spinal trigeminal nucleus.

The spinal trigeminal nucleus is further subdivided, from rostral to caudal, into subnucleus oralis (Vo), subnucleus interpolaris (Vi) and subnucleus caudalis (Vc), which is



**Trigeminal Brainstem Nuclear Complex, Immunohistochemistry and Neurochemistry, Figure 1** Trigeminal brainstem nuclear complex of the rat. Abbreviations: I-II, laminae I-II; III-V, laminae III-V; m, trigeminal motor n.; nts, n. tractus solitarius; Pa5, paratrigenal islands; Vc, subnucleus caudalis; Vi, subnucleus interpolaris; Vi/Vc, interpolaris/caudalis transition region; Vo, subnucleus oralis; Vp, principal sensory nucleus; Vtr, spinal trigeminal tract. Numbers below each outline indicate approximate distance in mm caudal to bregma, a skull surface landmark.

often referred to as the medullary dorsal horn since it displays several features, such as a laminated organization, similar to the spinal dorsal horn.

### Characteristics

The role of the different subnuclei of the TBNC in mediating the various aspects of pain remains controversial, since injurious stimuli can excite neurons throughout the TBNC (Sessle 2000), and orofacial tissues are represented somatotopically at multiple, but interconnected, levels of the TBNC (Bereiter et al. 2000). The neurochemical organization of the TBNC has shed additional light on possible contributions of different portions of the TBNC to pain processing.

Immunohistochemical approaches have identified two broad classes of small-diameter myelinated or unmyelinated nerve fibers: i) fibers stained positive for the neuropeptides substance P, calcitonin gene-related peptide and ▶ **neurotrophins** and ii) fibers stained positive for the cell-surface marker, ▶ **isolectin B4**, and negative for neuropeptides. As summarized in Table 1, both classes of small-diameter fibers terminate densely in laminae I-II of Vc and the paratrigenal islands and weaker, but significant, labeling in deep laminae of Vc and dorso-medial portions of rostral regions of the TBNC (Sugimoto et al. 1997a; Sugimoto et al. 1997b). Immunoreactivity for NK1, the substance P receptor, and TrkA, the high affinity-receptor for nerve growth factor, are consistent generally with the distribution of substance P- and nerve growth factor-positive fibers, respectively, within the TBNC (Krol et al. 2001; Nakaya et al. 1994).

Markers associated with opioid analgesia such the ▶ **endogenous opioid peptide**, endomorphin 2 (Martin-Schild et al. 1999), and the mu opioid receptor subtype, MOR1 (Ding et al. 1996), display moderate to dense immunoreactivity in laminae I-II of Vc, paratrigenal islands and at the Vi/Vc transition region, while deeper laminae of Vc and more rostral regions of the TBNC display weak or no staining. Physiological studies reveal that cornea-responsive neurons at the Vi/Vc transition region, i.e., the most rostral pole of Vc, are often enhanced by increasing doses of morphine, suggesting a role for this region in recruitment of endogenous pain controls (Hirata et al. 2000).

Receptors for monoamine transmitters (catecholamines and serotonin) display diffuse staining throughout most rostral regions of the TBNC; however, the superficial laminae of Vc display moderate to dense levels of immunoreactivity (Day et al. 1997; Wright et al. 1995). Staining for choline acetyltransferase (ChAT), the biosynthesis enzyme for acetylcholine, is weak in most rostral regions of TBNC, while the superficial laminae of Vc display moderate levels, consistent with the distribution of nicotinic receptors (Wada et al. 1989). Neurons that contain the inhibitory amino acid transmitter, GABA, are found in all regions of the TBNC, with the highest density in laminae I-II of Vc (Ginestal



**Trigeminal Brainstem Nuclear Complex, Immunohistochemistry and Neurochemistry, Table 1** Summary of the distribution of immunohistochemical markers associated with nociceptive processing in different portions of the trigeminal brainstem nuclear complex

	Vp		Vo		Vi	Vi/Vc	Pa5	Vc	
	dm	vl	dm	vl				I-II	III-V
IB4	+	-	+	-	+	-	++	+++	-
SP	+	-	+	-	+	++	++	+++	+
CGRP	++	-	++	-	+	++	++	+++	+
TrkA	+	-	+	-	+	+	+	+++	-
ChAT	+	-	+	-	+	+	-	++	+
NR1	++	++	++	++	++	++	+++	+++	+
GABA	++	+	++	+	+	++	+	+++	++
AR $\alpha/\beta$	+	-	+	-	+	+	+	++	+
5HT <sub>1/2</sub>	+	-	+	-	+	+	+	++	+
Endo2	+	-	+	-	+	+	++	+++	-
MOR1	-	-	-	-	-	+	++	+++	-
EP3	-	-	-	-	-	-	+	+++	-
P2X <sub>2</sub>	+	+	+	+	+	+	++	++	+
ER $\alpha$	-	-	-	-	-	-	-	+++	-

Symbols and abbreviations: - = very weak or no staining; +, ++, +++ = weak, moderate and dense staining; AR  $\alpha/\beta$ , adrenergic receptor subtypes; CGRP, calcitonin gene-related peptide; ChAT, choline acetyltransferase; dm, dorsomedial; Endo2, endomorphin 2; EP3, prostaglandin receptor; ER  $\alpha$ , estrogen receptor alpha subtype; GABA, gamma aminobutyric acid; 5HT<sub>1/2</sub>, serotonin receptor subtypes; IB4, isolectin B4; MOR1, mu opioid receptor; NR1, NMDA receptor subunit; P2X<sub>2</sub>, ATP receptor; Pa5, paratrigeminal islands; SP, substance P; TrkA, tyrosine kinase A receptor subtype; Vc, subnucleus caudalis; Vi, subnucleus interpolaris; Vi/Vc, interpolaris/caudalis transition region; Vo, subnucleus oralis; Vp, principal sensory nucleus; vl, ventrolateral

and Matute 1993) in agreement with the distribution of subunits for the GABA<sub>A</sub> receptor (Fritschy and Mohler 1995).

Immunoreactivity for EP3, a subtype of the prostaglandin receptor, and well associated with inflammatory pain, occurs only in laminae I-II of Vc and the paratrigeminal islands (Nakamura et al. 2000). By contrast, the purinergic receptor, P2X<sub>2</sub>, an ATP-gated ion channel, (Kanjhan et al. 1999) and NR1, a subunit of the NMDA receptor (Petrulia et al. 1994), receptors that are upregulated during inflammation and associated with **neuroplasticity**, are widely distributed throughout the TBNC, although they have a higher density in Vc. Several orofacial pain conditions (e.g., migraine headache, temporomandibular disorders) display a significant sex-related prevalence. The basis for these sex differences is not certain. However, the distribution of ER $\alpha$ , a major subtype of estrogen receptor, occurs mainly in lamina II of Vc and not in more rostral regions of the TBNC (Bereiter et al. 2005).

The neurochemical organization of the TBNC is consistent with the notion that, laminae I-II of Vc and the paratrigeminal islands receive direct input from small-diameter nerve fibers, and play an essential role in the processing and modulation of trigeminal pain. Although rostral regions of the TNBC receive only sparse direct

input from small-diameter nerve fibers, the appearance of selected markers for nociceptors and neuroplasticity in the dorsomedial portions of the principal sensory nucleus and Vo, suggest that these regions also contribute to the integration of specific forms of trigeminal pain.

## References

1. Bereiter DA, Cioffi IL, Bereiter DF (2005) Oestrogen receptor-immunoreactive neurons in the trigeminal sensory system of male and cycling female rats. *Arch Oral Biol* 50:971-9
2. Bereiter DA, Hirata H, Hu JW (2000) Trigeminal Subnucleus Caudalis: Beyond Homologies with the Spinal Dorsal Horn. *Pain* 88:221-224
3. Day HE, Campeau S, Watson SJ, Akil H (1997) Distribution of  $\alpha$ 1a,  $\alpha$ 1b, and  $\alpha$ 1d-Adrenergic Receptor mRNA in the Rat Brain and Spinal Cord. *J Chem Neuroanat* 13:115-139
4. Ding Y-Q, Kaneko T, Nomura S, Mizuno N (1996) Immunohistochemical Localization of  $\mu$ -opioid Receptors in the Central Nervous System of the Rat. *J Comp Neurol* 367:375-402
5. Fritschy J-M, Mohler H (1995) GABA<sub>A</sub>-Receptor Heterogeneity in the Adult Rat Brain: Differential Regional and Cellular Distribution of Seven Major Subunits. *J Comp Neurol* 359:154-194
6. Ginestal E, Matute C (1993) Gamma-Aminobutyric Acid-Immunoreactive Neurons in the Rat Trigeminal Nuclei. *Histochemistry* 99:49-55
7. Hirata H, Takeshita S, Hu JW, Bereiter DA (2000) Cornea-Responsive Medullary Dorsal Horn Neurons: Modulation by Local Opioid Agonists and Projections to Thalamus and Brainstem. *J Neurophysiol* 84:1050-1061
8. Kanjhan R, Housley GD, Burton LD, Christie DL, Kippenberger A, Thorne PR, L.Luo, Ryan AF (1999) Distribution of the P2X<sub>2</sub>



- Receptor Subunit of the ATP-gated Ion Channels in the Rat Central Nervous System. *J Comp Neurol* 407:11–32
9. Krol KM, Stein EJ, Elliot J, Kawaja MD (2001) TrkA-Expressing Trigeminal Sensory Neurons Display both Neurochemical and Structural Plasticity Despite a Loss of p75 NTR Function: Responses to Normal and Elevated Levels of Nerve Growth Factor. *Eur J Neurosci* 13:35–47
  10. Martin-Schild S, Gerall AA, Kastin AJ, Zadina JE (1999) Differential Distribution of Endomorphin<sup>1</sup>- and Endomorphin<sup>2</sup>-like Immunoreactivities in the CNS of the Rodent. *J Comp Neurol* 405:450–471
  11. Nakamura K, Kaneko T, Yamashita Y, Hasegawa H, Katoh H, Negishi M (2000) Immunohistochemical Localization of Prostaglandin EP3 Receptor in the Rat Nervous System. *J Comp Neurol* 421:543–569
  12. Nakaya Y, Kaneko T, Shigemoto R, Nakanishi S, Mizuno N (1994) Immunohistochemical Localization of Substance P Receptor in the Central Nervous System of the Adult Rat. *J Comp Neurol* 347:249–274
  13. Petralia RS, Yokotani N, Wenthold RJ (1994) Light and Electron Microscope Distribution of the NMDA Receptor Subunit NR1 in the Rat Nervous System using a Selective Anti-Peptide Antibody. *J Neurosci* 14:667–696
  14. Sessle BJ (2000) Acute and Chronic Craniofacial Pain: Brainstem Mechanisms of Nociceptive Transmission and Neuroplasticity, and their Clinical Correlates. *Crit Rev Oral Biol Med* 11:57–91
  15. Sugimoto T, Fujiyoshi Y, He Y-F, Xiao C, Ichikawa H (1997a) Trigeminal Primary Projection to the Rat Brain Stem Sensory Trigeminal Nuclear Complex and Surrounding Structures Revealed by Anterograde Transport of Cholera Toxin B Subunit-Conjugated and Bandeiraea Simplicifolia Isolectin B4-Conjugated Horseradish Peroxidase. *Neurosci Res* 28:361–371
  16. Sugimoto T, Fujiyoshi Y, Xiao C, He Y-F, Ichikawa H (1997b) Central Projection of Calcitonin Gene-Related Peptide (CGRP)- and Substance P (SP)-Immunoreactive Trigeminal Primary Neurons in the Rat. *J Comp Neurol* 378:425–442
  17. Wada E, Wada K, Boulter J, Deneris E, Heinemann S, Patrick J, Swanson LW (1989) Distribution of alpha2, alpha3, alpha4, and beta2 Neuronal Nicotinic Receptor Subunit mRNAs in the Central Nervous System: A Hybridization Histochemical Study in the Rat. *J Comp Neurol* 284:314–335
  18. Wright DE, Seroogy KB, Lundgren KH, Davis BM, Jennes L (1995) Comparative Localization of Serotonin 1A, 1C and 2 Receptor Subtype mRNAs in Rat Brain. *J Comp Neurol* 351:357–373

## Trigeminal Brainstem Nuclear Complex, Physiology

JAMES W. HU<sup>1</sup>, ALAIN WODA<sup>2</sup>

<sup>1</sup>Faculty of Dentistry, University of Toronto, Toronto, ON, Canada

<sup>2</sup>Faculté de Chirurgie Dentaire, University Clermont-Ferrand, Clermont-Ferrand, France  
james.hu@utoronto.ca, alain.woda@u-clermont1.fr

### Definition

Trigeminal (V) Brainstem Nuclear Complex (VBNC, Fig. 1) is the site of the first synapse of most V sensory primary afferents and of considerable sensory processing and modulation. Its anatomy and physiology, although generally similar to the spinal sensory system, display several differences. These differences, and the existence of specialized organs and tissues, are

important features that have prompted the study of V nociception, and may be manifested clinically in the unique trigeminal pain conditions, such as toothache, migraine, V neuralgia, temporomandibular disorders and other idiopathic orofacial pains.

### Characteristics

#### Trigeminal Brainstem Nuclear Complex (VBNC) Organization

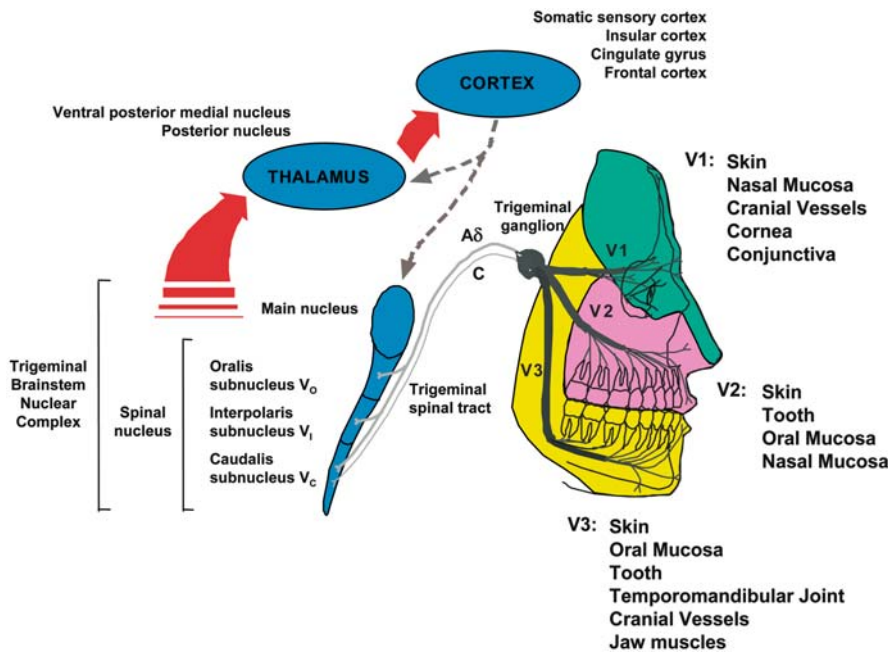
Most V primary afferents have their cell bodies in the V ganglion and project centrally to the VBNC, where they ascend to the main (or principal, V<sub>p</sub>) sensory nucleus and/or descend to the spinal tract nucleus, which includes subnuclei oralis (V<sub>o</sub>), interpolaris (V<sub>i</sub>) and caudalis (V<sub>c</sub>); see essay by Shigenaga and Yoshida (Fig. 1). The most caudal, V<sub>c</sub>, is a laminated structure that extends caudally into the dorsal horn of the cervical spinal cord with which it is homologous. For this reason, it is also called the medullary dorsal horn (Gobel et al. 1981). Almost all nociceptive ► **C Fiber** afferents from the V nerve have their central terminals distributed in the V<sub>c</sub> and V<sub>i</sub>/V<sub>c</sub> transition zone. Terminals of the A-δ fiber afferents are also found in V<sub>c</sub>; however some, mostly from the oral and perioral area, are found rostral to V<sub>c</sub>; in particular, A-δ fibers from the dental pulp have been described to be in the rostral divisions, V<sub>p</sub>, V<sub>o</sub>, V<sub>i</sub>, (see essay by Shigenaga and Yoshida). The somatotopic organization of VBNC is also described in the essay by Shigenaga and Yoshida.

#### General Features of Nociceptive Processing in Subnucleus Caudalis

In 1938, Sjöqvist reported that ► **trigeminal tractotomy**, which interrupts the inputs to the V<sub>c</sub> by severing the V spinal tract at the upper level of V<sub>c</sub>, was an efficient treatment for ► **trigeminal neuralgia**. The effect of V<sub>c</sub> deafferentation by tractotomy has repeatedly been confirmed by neurosurgeons and animal researchers, and it has therefore long been considered that V<sub>c</sub> is the crucial brainstem center for orofacial nociceptive processing. However, this procedure has little effect on tactile sensation and intraoral pain. These results indicate the involvement of the rostral nuclei, such as the V<sub>o</sub>, in toothache or other pain sensations from the oral area (Young 1982). Thus neurons in V<sub>o</sub>, as well as V<sub>c</sub>, are involved in ascending pathways contributing to orofacial pain (also see below). In the case of autonomic responses to noxious stimuli, such as cardiovascular and secretory reflexes (e.g. lacrimation and salivation), the trigeminal brainstem regions that mediate these evoked responses include the V<sub>i</sub>/V<sub>c</sub> transition zone and medial regions of the VBNC that border the reticular formation.

The fact that V<sub>c</sub> is critical for V nociception is supported by 7 pieces of evidence:

1. V<sub>c</sub> receives A-δ and C nociceptive afferents that terminate in laminae I and II



**Trigeminal Brainstem Nuclear Complex, Physiology, Figure 1** Schema of nociceptive somatosensory organization of the orofacial area. The trigeminal nerve is made up of three divisions, ophthalmic (V1), maxillary (V2) and mandibular (V3), which supply a wide variety of tissues; note that V2 and V3 as well as V1 also supply part of the meninges. The primary afferent neurons mediating nociceptive messages (A-delta and C) project to the spinal tract nucleus. Ascending pathways arise from spinal tract nucleus to reach suprasegmental levels such as the thalamus and cerebral cortex. There are also important pathways descending from the suprasegmental centers to modulate the afferent messages, such as the cerebral cortex. Modified with permission from Dallel et al. 2003 *Medicine/sciences* 19: 567–574.

- Vc is a laminated structure with a substantia gelatinosa (lamina II) region, which is known to be associated with pain processing and a high concentration of neuropeptide markers for nociception
- Vc contains nociceptive neurons, either ► **wide-dynamic-range** (WDR) or nociceptive-specific (NS). These nociceptive neurons predominate in the laminae I, V and VI, and display positive stimulus-response functions to various afferent inputs, and can therefore code the intensity of different types of noxious stimuli, including those arising from specialized orofacial structures (Price et al. 1976; Sessle 2000). In addition, these Vc nociceptive neurons also receive a wide range of inputs (see Table 1)
- Some Vc nociceptive neurons send their axons into ascending nociceptive pathways that reach the thalamus (Price et al. 1976)
- Some Vc neurons serve as reflex interneurons in reflex responses to noxious orofacial stimuli (see Sessle 2000)
- Vc nociceptive neurons are subject to several afferent and descending antinociceptive modulatory influences, as well as pharmacological antinociceptive modulations (Sessle 2000; Ren and Dubner 2002)
- In certain conditions (e.g. inflammation or nerve injury), these nociceptive neurons manifest some neuroplastic changes, such as increase in spontaneous activity, reduction of activation threshold, increase response magnitude to noxious stimuli and receptive field expansion (Hu et al. 1992). Induction of these neuroplastic changes is an NMDA receptor-dependent process (Chiang et al. 1998) (Fig. 2). These neuroplastic changes in the nociceptive neu-

**Trigeminal Brainstem Nuclear Complex, Physiology, Table 1** Convergence of Nociceptive Afferent Inputs to Nociceptive Neurons in Trigeminal Subnucleus Caudalis of Cats

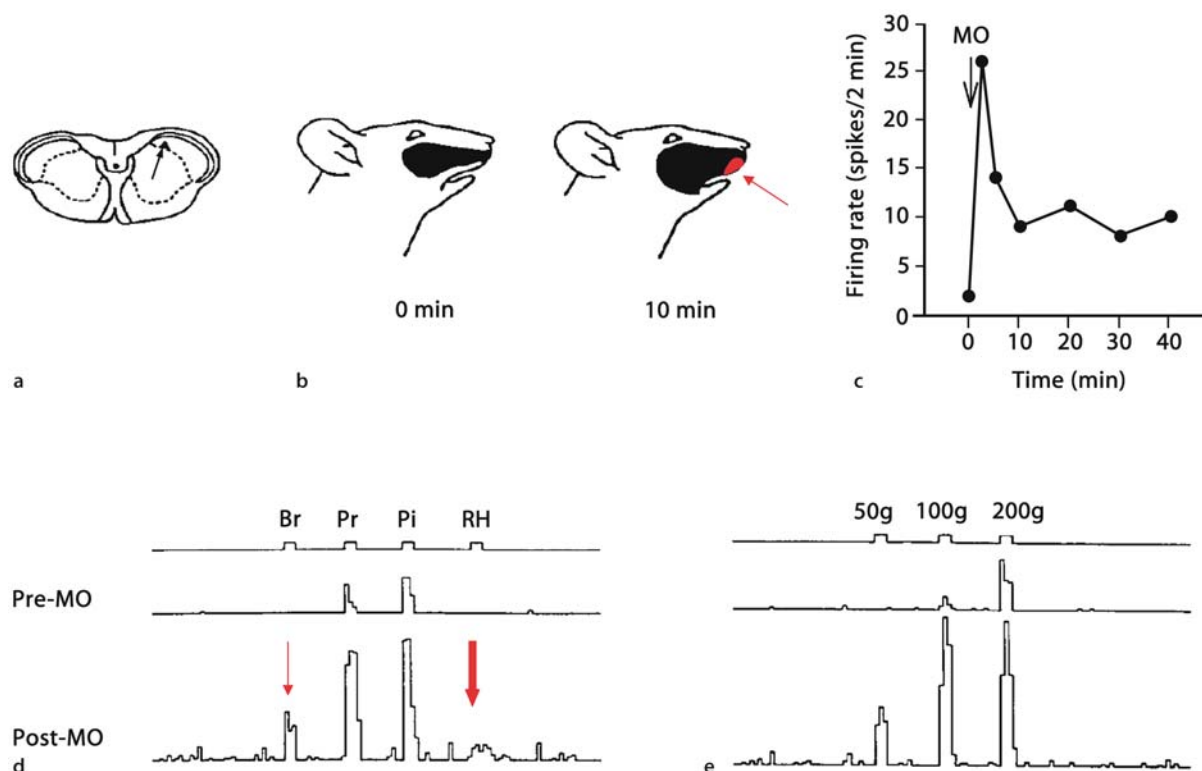
Facial Skin/Oral Mucosa	100%
Tooth pulp	66%
Muscle (jaw or tongue)	55%
Temporomandibular joint (TMJ)	35%
Laryngeal mucosa (Viscera)	55%
Upper cervical nerves	50%

Based upon a sample of approximately 100 WDR and NS neurons with cutaneous or intraoral mechanoreceptive fields; from Sessle et al. 1986

rons correlate well with the clinical observation of allodynia and hyperalgesia associated with inflammatory (Chiang et al. 1998) or nerve injury-induced neuropathic (Iwata et al. 2001) pain conditions.

### Special Features of Trigeminal Brainstem Nociceptive Processing

1. Nociceptive processing in VBNC is not restricted to Vc: Nociceptive neurons activated from the orofacial area are also observed rostrally in Vo and Vi (Dallel et al. 1990; Sessle 2000). Vo convergent neurons share all the properties of other neurons of the deep spinal dorsal horn, or of deep layers of Vc, (Dallel et al. 1990; Hu et al. 1992) including plasticity (Sessle 2000). These neurons may play a role in reflex responses to noxious orofacial stimulation (see Shigenaga and Yoshida essay), but results of V tractotomy (see above) indicate that oral



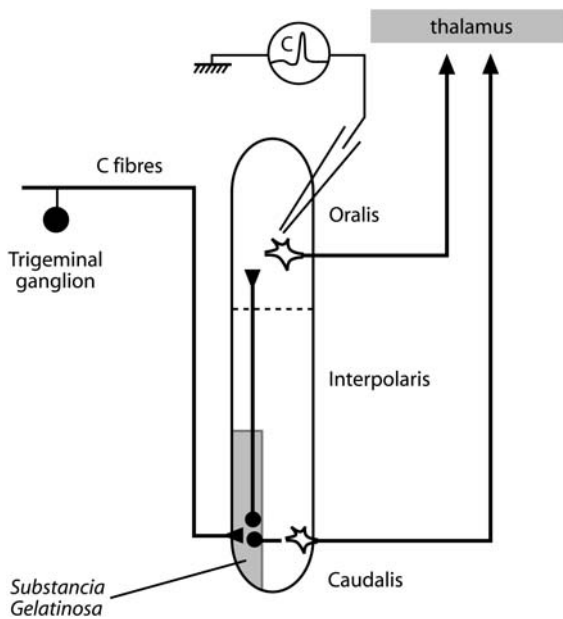
**Trigeminal Brainstem Nuclear Complex, Physiology, Figure 2** Rat caudalis nociceptive-specific (NS) neuron showing neuroplastic changes in neuronal properties after small-fiber excitant, and inflammatory irritant mustard oil (MO) application to the maxillary right molar pulp. In (a), histologically retrieved recording site and the arrow indicates the neuronal recording site in caudalis and in (b), mechanoreceptive field (RF) sizes before (0 min.) and 10 min. after MO application (i.e. solid area represents pinch RF and 'Red' area, with a thin red arrow, represents a newly defined tactile RF that also responded to pinch stimulus after MO application). In (b), blackened area indicates the RF location and size, which only noxious pinch stimulation activated, before MO application. The RF expansion 10 minutes after MO application and a small striped area that appeared only after the application of MO, indicated by a thin arrow, that a brush (low-threshold mechanical) stimulus can also activate this NS neuron that previously was unable to respond to this brush stimulus. In (c), MO-induced a brief burst of discharges followed by higher firing rate than the baseline level (0 min). This response represents an input from the maxillary tooth pulp. In (d), neuronal responses to mechanical and thermal stimuli applied to the cutaneous RF. Top trace: marker of brush (Br), pressure (Pr), pinch (Pi) and radiant heat (RH). Middle trace: neuronal responses in control conditions (i.e. Pre-MO before MO application). Bottom trace: neuronal responses to same stimuli 20 min after MO application (i.e. Post-MO after MO application). In (e), neuronal responses to graded mechanical stimuli (50, 100, and 200 g). Each stimulus lasts for 3 s, and the y-axis scale (omitted) is the same for middle and bottom traces in a and b. Binwidth is 1 s. Note that after MO application this NS neuron became responsive to light brushing (thin arrow) and radiant heating (thick arrow) of the cutaneous RF, and strongly responsive to graded pinch stimuli. Modified with permission from Chiang et al. (1998).

T

and perioral pain sensation also depends on  $V_0$ . Another indication of a sensory role for  $V_0$  as well as  $V_c$  is the presence of a similar density of anatomical projections from these two subnuclei to higher levels of the brain. In addition, nociceptive thalamic neurons can still be recorded after stimulation of oral and perioral areas, in spite of the deafferentation of  $V_c$  by trigeminal tractotomy (Raboisson et al. 1989). In  $V_0$ , the C-fiber primary afferent endings are scarce and a substantia gelatinosa is lacking. However, C-fiber evoked activities recorded in  $V_0$  relay in the substantia gelatinosa of  $V_c$  (Dallel et al. 1998). The influence on the properties of  $V_0$  neurons of the substantia gelatinosa of  $V_c$  constitutes a unique feature, which can be used as an experimental model (Fig. 3), since it offers the possibility of recording from deep layer nociceptive neurons, i.e. in  $V_0$ , while injecting neurochemicals in the  $V_c$  substantia gelatinosa. Indeed, it has been shown that plastic changes observed

in nociceptive neurons of  $V_0$  can be modulated, either facilitated or inhibited, by neurochemicals injected into the  $V_c$  substantia gelatinosa (Dallel et al. 1998; Woda et al. 2001; Hu et al. 2002).

2. Some specialized orofacial tissues receive innervation patterns unique to the trigeminal system. Unlike the skin, specialized V structures, such as the tooth pulp, meninges and cornea are innervated mainly by A- $\delta$  and C nociceptive afferents, since very few or no A- $\beta$  afferents can be found. Single unit-recording studies have shown that the VBNC nociceptive neurons activated from these specialized tissues often receive convergent inputs from a wide range of structures including facial skin. The distribution of V neurons that encode nociceptive information from these specialized orofacial tissues display a complex pattern, which is characterized by their occurrence at different rostrocaudal levels of the VBNC.



**Trigeminal Brainstem Nuclear Complex, Physiology, Figure 3** Schematic dorsal view of the spinal tract nucleus of VBNC that illustrates the subnucleus oralis-subnucleus caudalis experimental model. The subnucleus oralis is activated only indirectly by primary afferent C-fibers. A relay in the substantia gelatinosa in subnucleus caudalis is mandatory, since there is no direct C fiber projection to Vo. This allows for recordings from nociceptive neurons while injecting chemicals into the substantia gelatinosa.

3. The VBNC also offers the possibility of extending the knowledge base relevant to spinal neuronal properties from anaesthetized to awake conditions. Taking advantage of the unique location of the medullary dorsal horn (Vc), Dubner and his colleagues recorded Vc single neurons in conscious monkeys while performing behavioral tasks relevant to nociception (Hoffman et al. 1981). While the properties of WDR and NS neurons in Vc observed in anaesthetized animals during recordings were confirmed in the conscious monkeys, these experiments also showed that many of these Vc neurons could be modulated through attentional and motivational factors.

#### References

1. Bereiter DA, Hirata H, Hu JW (2000) Trigeminal Subnucleus Caudalis: Beyond Homologies with the Spinal Dorsal Horn. *Pain* 88:221–224
2. Chiang CY, Park SJ, Kwan CL, Hu JW, Sessle BJ (1998) NMDA Receptor Mechanisms Contribute to the Trigeminal Nociceptive Neuronal Plasticity Induced by Mustard Oil Application to the Rat Molar Tooth Pulp. *J Neurophysiol* 80:2621–2631
3. Dallel D, Duale C, Molat JL (1998) Morphine Administered in the Substantia Gelatinosa of the Spinal Trigeminal Nucleus Caudalis Inhibits Nociceptive Activities in the Spinal Trigeminal Nucleus Oralis. *J Neurosci* 18:3529–3536
4. Dallel R, Raboisson P, Woda A, Sessle BJ (1990). Properties of Nociceptive and Non-Nociceptive Neurons in Trigeminal Subnucleus Oralis of the Rat. *Brain Res* 521:95–106
5. Gobel S, Hockfield S, Ruda MA (1981) Anatomical Similarities between Medullary and Spinal Dorsal Horns. In: Kawamura Y, Dubner R (eds) *Oral-Facial Sensory and Motor Functions*. Quintessence Publishing Co, Tokyo, Berlin, pp 211–223

6. Hoffman DS, Dubner R, Hayes RL, Medlin TP (1981) Neuronal Activity in Medullary Dorsal Horn of Awake Monkeys Trained in a Thermal Discrimination Task. I. Responses to Innocuous and Noxious Thermal Stimuli. *J Neurophysiol* 46:409–427
7. Hu B, Chiang CY, Hu JW, Dostrovsky JO, Sessle BJ (2002) P2X Receptors in Trigeminal Subnucleus Caudalis Modulate Central Sensitization in Trigeminal Subnucleus Oralis. *J Neurophysiol* 88:1614–1624
8. Hu JW, Sessle BJ, Raboisson P, Dallel R, Woda A (1992). Stimulation of Craniofacial Muscle Afferents Induces Prolonged Facilitatory Effects in Trigeminal Nociceptive Brain-STEM Neurons. *Pain* 48:53–60
9. Iwata K, Imai T, Tsuboi Y, Tashiro A, Ogawa A, Morimoto T, Masuda Y, Tachibana Y, Hu J (2001) Alteration of Medullary Dorsal Horn Neuronal Activity Following Inferior Alveolar Nerve Transection in Rats. *J Neurophysiol* 86:2868–2877
10. Price DD, Dubner R, Hu JW (1976) Trigeminothalamic Neurons in Nucleus Caudalis Responsive to Tactile, Thermal, and Nociceptive Stimulation of Monkey's Face. *J Neurophysiol* 39:936–953
11. Raboisson P, Dallel R, Woda A (1989) Responses of Neurons in the Ventrobasal Complex of the Thalamus to Orofacial Noxious Stimulation after Large Trigeminal Tractotomy. *Exp Brain Res* 77:569–576
12. Ren K, Dubner R (2002) Descending Modulation in Persistent Pain: An Update. *Pain* 100:1–6
13. Sessle BJ (2000) Acute and Chronic Craniofacial Pain: Brainstem Mechanisms of Nociceptive Transmission and Neuroplasticity, and their Clinical Correlates. *Crit Rev Oral Biol Med* 11:57–91
14. Woda A, Molat JL, Luccarini P (2001) Low Doses of N-methyl-D-aspartate Antagonists in Superficial Laminae of Medulla Oblongata Facilitate Wind-Up of Convergent Neurons. *Neuroscience* 107:317–327
15. Young RF (1982) Effect of Trigeminal Tractotomy on Dental Sensation in Humans. *J Neurosurg* 56:812–818

## Trigeminal Ganglion

### Definition

A nerve ganglion where the cell bodies of the afferent neurones innervating the orofacial area are located.

► [Nociceptors in the Dental Pulp](#)

## Trigeminal Lemniscus

### Definition

Trigeminal cutaneous projection to the thalamus, in contrast to the spinal lemniscus.

► [Parafascicular Nucleus, Pain Modulation](#)

## Trigeminal Motor Nucleus

### Definition

Also called masticatory nucleus, it is located in the dorsal mid-pons, close to the trigeminal principal sensory nucleus, and contains motoneurons for both jaw-closing and jaw-opening muscles.

► [Jaw-Muscle Silent Periods \(Exteroceptive Suppression\)](#)



## Trigeminal Nerve

### Definition

The trigeminal nerve is the largest cranial nerve and innervates much of the cutaneous craniofacial regions. The trigeminal nerve also innervates the muscles of mastication. The three major divisions of the trigeminal nerve are ophthalmic, maxillary and mandibular nerves. An extremely painful condition, tic douloureux, occurs in the territory of the trigeminal nerve and likely involves primary afferent fibers of the trigeminal nerve.

- ▶ Amygdala, Pain Processing and Behavior in Animals
- ▶ Nociception in Nose and Oral Mucosa
- ▶ Trigeminothalamic Tract Projections

## Trigeminal Neuralgia

### Synonyms

Tic douloureux

### Definition

Trigeminal neuralgia is an idiopathic, episodic severe pain condition of the orofacial region often described as electric-shock-like sensations that can be triggered by innocuous stimuli, associated with injury or dysfunction of the fifth cranial nerve (trigeminal nerve) or its ganglion and felt in the distribution of this nerve. It is considered as a prototype of neuropathic pain. Trigeminal neuralgia (tic douloureux) may have no apparent cause or be associated with neurovascular conflict between the trigeminal root and an anomalous vascular loop (classical trigeminal neuralgia), or be secondary to benign tumors of the cerebellopontine angle or multiple sclerosis.

- ▶ Central Pain in Multiple Sclerosis
- ▶ Demyelination
- ▶ Jaw-Muscle Silent Periods (Exteroceptive Suppression)
- ▶ Neuralgia, Assessment
- ▶ Neuralgia, Diagnosis
- ▶ Pain Paroxysms
- ▶ Paroxysmal Hemicrania
- ▶ Primary Stabbing Headache
- ▶ Tic and Cranial Neuralgias
- ▶ Trigeminal Brainstem Nuclear Complex, Physiology
- ▶ Trigeminal Neuralgia, Etiology, Pathogenesis and Management

## Trigeminal Neuralgia, Aims of Surgical Management

### Definition

Surgical management of trigeminal neuralgia can provide complete pain relief for periods ranging from a year to 10 years.

- ▶ Trigeminal Neuralgia, Etiology, Pathogenesis and Management

## Trigeminal Neuralgia, Diagnosis and Treatment

DONALD R. NIXDORF

Department of Diagnostic and Biological Sciences,  
School of Dentistry, University of Minnesota,  
Minneapolis, MN, USA  
nixdorf@umn.edu

### Synonyms

Tic douloureux

### Definition

Trigeminal neuralgia is an excruciating pain felt in the distribution of the trigeminal or fifth cranial nerve and is classically described as a brief sharp shooting pain (Kitt et al. 2000). Trigeminal neuralgia has been defined by the International Headache Society's classification subcommittee as (IHS 2004):

- A) ▶ **Paroxysmal** attacks of pain lasting from a fraction of a second to 2 minutes, affecting one or more divisions of the trigeminal nerve and fulfilling criteria B and C.
- B) Pain has at least one of the following characteristics:
  1. intense, sharp, superficial or stabbing
  2. precipitated from trigger areas or by trigger factors
- C) Attacks are stereotyped in the individual patient
- D) There is no clinically evident neurological deficit
- E) Not attributed to another disorder

Although this definition has never been tested for reliability and proven to be valid, either it, or a derivation, are widely accepted and utilized extensively for both research and patient care purposes.

Note: the terms classical trigeminal neuralgia and idiopathic trigeminal neuralgia are used when a secondary cause for this pain is not readily identifiable. Symptomatic trigeminal neuralgia is used when a secondary cause for this pain has been identified, such as an aneurysm, tumor or stroke.

### Characteristics

Trigeminal neuralgia occurs in approximately 4 per 100,000 people and has an onset later in life, with the median age of diagnosis being 67 years old. It occurs about twice as often in women as in men (Katusic et al. 1990), but this may be from sampling error, since good prevalence data do not exist (Zakrzewska and Hamlyn 1999). This severe pain is described by patients as having an electric or lightning bolt quality and being brief in duration, lasting less than 30 seconds. Sometimes

patients describe a dull, burning or throbbing pain that occurs between attacks of intense pain. Trigeminal neuralgia pain is most commonly felt in the maxillary division and to a lesser extent in the mandibular division. Pain is infrequently felt only in the ophthalmic division of the trigeminal nerve. It is almost always unilateral, especially on initial presentation and does not cross the midline. There may be predilection for right-sided pain (Zakrzewska and Hamlyn 1999), which would suggest an anatomical correlation. Paroxysms of pain may be spontaneous, occurring without a known reason or triggered by non-painful stimuli such as light touch or wind on the face, eating and grooming. The triggering area may be the area where the pain is felt or different, but it is always on the same side as the pain and is often perioral. Local anesthetic applied to the triggering area will abate the ability to trigger the pain. Once pain is triggered it is self-sustaining and frequent triggering often results in a decrease in pain intensity in the later bouts of pain. Interestingly, even though this pain is one of the worst pains imaginable, it is not triggerable during unconsciousness and rarely wakes people from sleep. Also, trigeminal neuralgia is characterized as having periods of spontaneous remission, which may last days, months or even years.

#### Diagnostic Process

The diagnosis of trigeminal neuralgia is based strictly on clinical data, i.e. a history and physical examination, since there are no laboratory tests or imaging studies that can either confirm or refute its presence (Merskey and Bogduk 1994; IHS 2004). Brain imaging is frequently ordered to ensure that trigeminal neuralgia is not caused by an intracranial space-occupying lesion or ► **demyelinating** process. Trigeminal neuralgia is 20 times more common in people with multiple sclerosis (Katusic et al. 1990), so when it occurs in young patients, the appropriate evaluative measures should be performed.

Patients sometimes present to their dentist first, because this pain is frequently felt in the jaws and teeth. Often their description is of a continuous dull ache, similar to toothache. There is controversy about this pain because it may actually be a prodrome to the classically described trigeminal neuralgia, occurring days to years before the more recognizable symptoms occur. This prodrome pain has been termed pre-trigeminal neuralgia and corresponds to the initial presentation features of trigeminal neuralgia. This concept is supported by patient reporting and by clinical experience that this prodrome pain responds to pharmacotherapy like classic trigeminal neuralgia does (Fromm et al. 1990). The opposing opinion is that the continuous dull ache pain is really of odontogenic origin. Dental interventions, like root canals and tooth extractions, employed to address pathology result in peripheral nerve injury and this cumulative injury leads, in part, to the formation of trigeminal neuralgia.

#### Etiology and Pathophysiology

The etiology of trigeminal neuralgia is not established and little is truly understood about the underlying pain mechanisms, since a valid animal model does not exist. Trigeminal nerve root compression, at the entry zone into the ► **pons**, has been observed in patients with trigeminal neuralgia (Dandy 1934). The anatomical arrangement of blood vessel impingement on the nerve root has also been described in patients after surgical exploration (Jannetta 1967), but it is not present in all patients with trigeminal neuralgia and sometimes it is noted in imaging of non-trigeminal neuralgia patients (Majoie et al. 1997). It has been hypothesized that the presence of ► **ectopic** action potentials arising from peripheral nerves and the failure of central inhibition within the trigeminal system occur simultaneously to produce paroxysmal pain. This explains why certain medications are beneficial and others are not in the treatment of trigeminal neuralgia (Fromm et al. 1984). Currently, the phenomenon of ephaptic cross talk is used to explain how non-painful stimuli are translated into painful ones and crossed ► **afterdischarge** has been cited as the mechanism implicated in further pain amplification and prolongation. These two assumptions have been collectively termed the ‘ignition hypothesis’, which defines trigeminal neuralgia as a peripheral nerve disorder (Devor et al. 2002). This hypothesis explains why people with demyelinating disorders, such as multiple sclerosis, frequently experience trigeminal neuralgia. It may also account for the clinical observation that trigeminal neuralgia seems to start after recent dental interventions. The continuous dull burning background pain sometimes felt by patients would best be explained by the development of central sensitization secondary to a lack of inhibition, akin to deafferentation pain and other continuous neuropathic pains.

#### Treatment

##### Overview

Whenever possible, treatment should be directed at the etiological factors or tailored to the mechanisms involved. Since these are largely unknown, current treatments have developed from empiric practice. Data exist regarding pharmacological and surgical treatment options, but little or nothing is published about psychological interventions. In my opinion, as with other chronic pains, some trigeminal neuralgia patients may benefit from a cognitive behavioral approach to care that also includes stress reduction and coping strategies. The following is a summation of the best available research published.

##### Pharmacological Treatment Options

Pharmacotherapy, also known as medication or drug therapy, is considered the first-line treatment for trigeminal neuralgia (Kitt et al. 2000). Anticonvulsant medications or drugs that have membrane-stabilizing prop-

erties, meaning that they reduce spontaneous nerve activity, are typically used for the treatment of trigeminal neuralgia. These medications have been shown in animal experiments to suppress the response of mechanoreceptors and augment presynaptic afferent inhibition within the maxillary nerve; this has been correlated with clinical drug efficacy (Fromm et al. 1981). Therefore, the goal of pharmacotherapy is to augment inhibitory pathways and reduce ectopic and ▶ ephaptic neuronal firing. Randomized placebo controlled trials for the treatment of trigeminal neuralgia are rare. The low prevalence in the population and the occurrence of spontaneous symptom remission make it difficult to study.

Carbamazepine is an older anticonvulsant medication that has been studied the most and clinically utilized often. Three randomized controlled studies have evaluated carbamazepine for the treatment of trigeminal neuralgia and have found that it reduces pain severity, frequency and trigger sensitivity. Up to 75% of patients taking carbamazepine find it effective for long-term pain reduction (Sindrup and Jensen 2002). Sodium channel blockade is the accepted mechanism of action for carbamazepine; this results in a reduction of nerve excitation and axonal firing. Dosing is by titration to the clinical effect of pain reduction, initiating at 200 mg a day, increasing at a maximum rate of 200 mg per day to a maximum dosage of 1200 mg per day in divided doses. Most patients respond between 400–800 mg per day, which corresponds to serum levels between 20 and 40  $\mu\text{mol/L}$  (Sindrup and Jensen 2002). Side effects of carbamazepine include hepatic induction and toxicity, hematopoietic suppression, electrolyte imbalances, multiple drug interactions and cognitive impairment. These side effects can be serious; therefore, laboratory monitoring to ensure early detection of potential problems is required. Side effects are often very limiting for patients and can cause them to discontinue use, even when profound pain reduction is achieved.

Phenytoin and valproic acid are two other older anticonvulsant medications that have not been systematically studied. Both phenytoin and valproic acid block sodium channels, while valproic acid also increases gamma-aminobutyric acid (GABA) and enhances glutamate decarboxylase. Case series information suggests that doses of 300 mg per day of phenytoin and 1200 mg per day of valproic acid are effective for pain reduction (Sindrup and Jensen 2002). Both drugs are becoming used less often because they are hampered by similar side effects and monitoring issues as carbamazepine. Also, clinical experience suggests that they do not produce the same robust reduction in pain symptoms. Clonazepam, a GABA<sub>A</sub> agonist, and baclofen, a GABA<sub>B</sub> agonist, are labeled as muscle relaxants and are being used for the treatment of trigeminal neuralgia. One small, uncontrolled trial suggested that clonazepam, at doses of 6–8 mg per day, may be helpful. In a small controlled study of baclofen, as an add-on therapy

to carbamazepine, pain frequency was reduced with dosages of up to 80 mg per day (Sindrup and Jensen 2002).

Newer anticonvulsant medications have shown some potential for successful future use based primarily on their lower side effect profile, as well as on some limited research data. Lamotrigine has been studied in one small controlled trial as an add-on medication. Its mechanism of action has not been totally elucidated, but it has been reported to block sodium channels and inhibit presynaptic glutamate release. At doses of 400 mg per day it has been shown to reduce trigeminal neuralgia pain (Zakrzewska et al. 1997). Topiramate has been studied in a very small controlled trial as an add-on medication. The exact mechanisms of action are also not known, but it is thought to block sodium channels, inhibit glutamate binding and act as a GABA<sub>A</sub> agonist. At doses of up to 600 mg per day, it reduced trigeminal neuralgia pain intensity, duration and frequency (Gilron et al. 2001). Gabapentin, which is thought to cause calcium channel blockade, has been reported to be helpful in case reports in dosages of up to 2700 mg per day (Sist et al. 1997). Its side effect profile tends to be the most favorable of all anticonvulsant medications but dizziness, fatigue, ataxia and weight gain can occur. Oxcarbazepine was evaluated in a small, uncontrolled study of patients with refractory trigeminal neuralgia; patients reported pain relief on doses around 1200 mg per day (Zakrzewska and Patsalos 2002). Oxcarbazepine is chemically related to carbamazepine and also blocks sodium channels. It is reported to have far fewer side effects and does not require monitoring with laboratory testing, but dose dependent ▶ hyponatremia has been reported.

The utility of other medications typically used in chronic pain, such as tricyclic antidepressants and opioid analgesics for the treatment of trigeminal neuralgia has not been systematically researched. Conceptually, most clinicians agree that these medications have a role in the management of trigeminal neuralgia when it is refractory to previous treatment or when it has an atypical presentation, such as concurrent continuous pain.

### Surgical Treatment Options

Surgical treatment is usually reserved for patients who fail first line drug therapy due to uncontrollable pain or intolerable side effects. The target for surgery is the peripheral nerve, with either nerve ablation or decompression the goal. There are no randomized controlled trials that investigate the effects of surgical treatment options; thus the advantages and disadvantages of the various procedures are based on personal opinion (Kitt et al. 2000). Historically, peripheral ▶ neurectomy was the preferred procedure for trigeminal neuralgia, using either mechanical or chemical means. This procedure has been replaced by other surgical options that result in reduced sensory deficits and higher success. Dental treatments, which result in peripheral nerve ablation, usually

result in a short-term remission, but pain usually reoccurs in 3 to 6 weeks.

Gasserian or trigeminal ganglion ► **rhizotomy** is a neuroablative procedure performed by inserting a needle within the trigeminal cistern. Several neurolytic methods have been developed and are routinely employed, each of them having relative advantages and disadvantages. They all provide immediate pain relief in more than 90% of patients. Radiofrequency thermocoagulation can be directed to a specific division of the trigeminal nerve and therefore has the advantage of providing a limited and well-controlled lesion. Correct positioning of the needle tip can be verified by electrical stimulation of the awakened patient prior to lesioning. Disadvantages of this technique include a potentially higher risk for anesthesia dolorosa and corneal anesthesia. Also, other techniques may be superior and more practical when large areas of the trigeminal nerve are involved, since multiple lesions will be required. Injection of glycerol as a neurolytic agent is another possible approach. Glycerol is thought to affect unmyelinated nerve fibers selectively, thereby sparing ► **proprioception**, touch and motor functions of the trigeminal nerve. Anatomic variations in nerve ablation are achieved by altering the patient's head position and adjusting the volume of glycerol injected. The major disadvantages are the relatively imprecise technique, with the potential of glycerol spreading into the brain, as well as the moderate risk for anesthesia dolorosa and corneal anesthesia. Balloon compression is the newest technique and has the lowest reported complications of anesthesia dolorosa and corneal anesthesia (Tekkök and Brown 1996). This procedure has the advantage of not requiring patient participation, but it has the highest incidence of muscle weakness and bradycardia requiring pacing has been reported during balloon inflation. Overall, all three techniques provide comparable pain relief and differ mostly in their potential advantages and disadvantages (Slavin and Burchiel 2002).

Stereotactic radiosurgery or gamma knife is a procedure performed using radiation to cause nerve injury. The target of treatment is along the trigeminal nerve about 2 to 4 mm after it exits the brainstem at the level of the pons. Advantages of this technique are that pain relief percentages are comparable to rhizotomy and it has a low risk for anesthesia dolorosa and corneal anesthesia. Disadvantages include a potential for delayed onset of pain relief and high rates of pain recurrence (Slavin and Burchiel 2002).

Microvascular decompression, also known by the acronym MVD, is an open surgical procedure of the brain. The goal is the alleviation of existing vascular pressure on the trigeminal nerve root. Touted as being potentially curative, this procedure has initial success rates in pain elimination comparable to those of rhizotomy, but it has less pain recurrence and a much lower chance of anesthesia dolorosa, corneal anesthesia and

muscle weakness. The potential disadvantage is a less than 1% mortality rate. Other possible complications include stroke, meningitis, cerebrospinal fluid leak and various ipsilateral cranial nerve deficits, such as hearing loss (Slavin and Burchiel 2002). As surgical microvascular decompression techniques become less invasive, such as with endoscopic assistance, it is likely that it will become more commonly practised and with favorable research published, it may even become a first-line treatment option.

Due to the varied presentation of trigeminal neuralgia and the reported relapse of positive treatment effects, long-term follow-up and management is essential in providing the best possible patient care.

## References

1. Dandy WE (1934) Concerning the cause of trigeminal neuralgia. *Am J Surg* 24
2. Devor M, Amir R, Rappaport ZH (2002) Pathophysiology of Trigeminal Neuralgia: The Ignition Hypothesis. *Clin J Pain* 18:4–13
3. Fromm GH, Chattha AS, Terrence CF et al. (1981) Role of inhibitory mechanisms in trigeminal neuralgia. *Neurology* 31:683–687
4. Fromm GH, Terrence CF, Maroon JC (1984) Trigeminal neuralgia: current concepts regarding etiology and pathogenesis. *Arch Neurol* 41:1204–1207
5. Fromm GH, Graff-Radford SB, Terrence CF et al. (1990) Pre-trigeminal neuralgia. *Neurology* 40:1493–1495
6. Gilron I, Booher SL, Rowan JS et al. (2001) Topiramate in trigeminal neuralgia: a randomized, placebo-controlled multiple crossover pilot study. *Clin Neuropharmacol* 24:109–112
7. International Headache Society Classification of Headache Disorders (2004) Cranial neuralgia, central and primary facial pain, and other headache disorders. *Cephalalgia Suppl* 1:125–135
8. Jannetta PJ (1967) Arterial compression of the trigeminal nerve at the pons in patients with trigeminal neuralgia. *J Neurosurg* 26:159–162
9. Katusic S, Beard CM, Bergstrath E et al. (1990) Incidence and clinical features of trigeminal neuralgia, Rochester, Minnesota, 1945–1984. *Ann Neurol* 27:80–95
10. Kitt CA, Gruber K, Davis M et al. (2000) Trigeminal neuralgia: opportunities for research and treatment. *Pain* 85:3–7
11. Majoie CB, Hulsmans FJ, Verbeeten B Jr et al. (1997) Trigeminal neuralgia: comparison of two MR imaging techniques in the demonstration of neurovascular contact. *Radiology* 204:455–460
12. Merskey H, Bogduk N (1994) Relatively localized syndromes of the head and neck. In: Merskey H, Bogduk N (eds) *Classification of chronic pain*. IASP Press, Seattle, pp 59–92
13. Sindrup SH, Jensen TS (2002) Pharmacotherapy of trigeminal neuralgia. *Clin J Pain* 18:22–27
14. Sist T, Filadora V, Miner M et al. (1997) Gabapentin for idiopathic trigeminal neuralgia: report of two cases. *Neurology* 48:1467
15. Slavin KV, Burchiel KJ (2002) Surgical options for facial pain. In: Burchiel KJ (ed) *Surgical management of pain*. Thieme, New York, pp 849–864
16. Tekkök IH, Brown JA (1996) Trigeminal neuralgia. *Neurosurg Quart* 6:267–288
17. Zakrzewska JM, Hamlyn PJ (1999) Facial pain. In: Crombie IK, Croft PR, Linton SJ et al (eds) *Epidemiology of pain*. IASP Press, Seattle, pp 171–202
18. Zakrzewska JM, Patsalos PN (2002) Long-term cohort comparing medical (oxcarbazepine) and surgical management of intractable trigeminal neuralgia. *Pain* 95:259–266
19. Zakrzewska JM, Chaudhry Z, Nurmikko TJ et al. (1997) Lamotrigine (Lamictal) in refractory trigeminal neuralgia: results from a double-blind placebo controlled crossover trial. *Pain* 73:223–230



## Trigeminal Neuralgia, Diagnostic Method

### Definition

Diagnosis of trigeminal neuralgia is made principally on history as there are no diagnostic tests to validate the diagnosis.

► [Trigeminal Neuralgia, Etiology, Pathogenesis and Management](#)

## Trigeminal Neuralgia, Etiology, Pathogenesis and Management

JOANNA M. ZAKRZEWSKA

Clinical Diagnostic and Oral Sciences, Institute of Dentistry, University of London, Barts and the London Queen Mary's School of Medicine & Dentistry, London, UK

j.m.zakrzewska@qmul.ac.uk

### Synonyms

Trigeminal neuralgia; tic douloureux; Secondary Trigeminal Neuralgia; Symptomatic Trigeminal Neuralgia; Atypical Trigeminal Neuralgia

### Definition

The International Association for the Study of Pain (IASP) defines trigeminal neuralgia as "A sudden, usually unilateral, severe, brief, stabbing, recurrent pain in the distribution of one or more branches of the fifth cranial nerve" (Merskey and Bogduk 1994).

### Characteristics

#### Epidemiology

The incidence of ► [trigeminal neuralgia](#) is 4.3/100,000 (2.96 male, 3.47 female/100,000 based on data from the US). The point prevalence is 0.1%. The peak incidence is in the age group 60–69, and it is rare in patients under the age of 40. There is a strong link between multiple sclerosis and trigeminal neuralgia, and hypertension may also be a risk factor. There are little data on the natural history and prognostic features (► [trigeminal neuralgia, features](#)), but data from the US suggests that it does not affect survival, although attacks get more severe with time (Zakrzewska and Hamlyn 1999).

#### Etiology and Pathogenesis

As there are no satisfactory animal models of trigeminal neuralgia, it still remains difficult to elucidate fully the aetiology and pathogenesis of trigeminal neuralgia. The ignition hypothesis by Devor et al. (2002) (► [trigeminal neuralgia, ignition theory](#)) is accepted by many, although direct support of it from trigeminal electrophysiological studies is very limited. According to this theory, chronic

irritation of the trigeminal nerve leads to focal demyelination, which results in the generation of ectopic action potentials and impaired segmental inhibition. This leads to hyper-excitability of the afferents that give rise to pain paroxysms as a result of synchronised after-discharge activity. This theory is supported by clinical observations that patients with trigeminal neuralgia in the majority of cases are found to have blood vessels compressing the trigeminal nerve, either at the nerve root entry zone or less commonly the brain stem. Electron microscopic examination of nerve roots taken from patients with such compressions has revealed focal demyelination in the region of the compression, with close apposition of demyelinated axons and an absence of intervening glial processes. A process of re-myelination does occur, and this could be responsible for the spontaneous remission of the neuralgia. The most effective drugs are anti-convulsants, and they probably work by suppressing ectopic hyper-excitability in the nerve or central neurons.

### Clinical History

The following list provides the diagnostic criteria as suggested by the International Headache Society (Anon 1988) (► [trigeminal neuralgia, diagnostic method](#)):

1. Paroxysmal attacks of facial or frontal pain last a few seconds to less than two minutes.
2. Pain has at least 4 of the following characteristics:
  - Distribution along one or more divisions of trigeminal nerve
  - Sudden, intense, sharp, superficial, stabbing or burning in quality
  - Pain intensity severe
  - Precipitation from trigger areas, or by certain daily activities such as eating, talking, washing the face or cleaning the teeth
  - Between paroxysms entirely asymptomatic
3. No neurological deficit.
4. Attacks are stereotyped in individual patients.
5. Exclusion of other causes of facial pain.

It is essential to take a very careful history, as this is the only reliable method of making the diagnosis. It is especially important to elucidate the sharpness and paroxysmal quality of this pain, which differentiates it from most other facial pains. A particular feature of trigeminal neuralgia is that it is usually precipitated from one or more trigger areas (especially in the second or third trigeminal divisions), upon tactile stimulation or daily activities such as eating, talking, washing or shaving the face or cleaning the teeth. Each bout of pain is very quick (seconds), but patients may get many of these in quick succession, and so the pain may seem to be lasting longer. The nerve eventually becomes refractory and there is a period when the patient is pain free. Classically, there are also periods of complete pain remission which last for weeks or months. These pain remissions gradually

**Trigeminal Neuralgia, Etiology, Pathogenesis and Management, Table 1** Medical management of trigeminal neuralgia, most drugs need to be escalated and withdrawn slowly

Drug	Daily dosage range	Outcome Number needed to treat NNT (95% CI)	Side effects, Number needed to harm NNH(95% CI)	Comments
Baclofen	50–80 mg	NNT 1.4 (1–2.6) only 10 patients, possibly effective	Ataxia, lethargy, fatigue, nausea	Useful as add on therapy
Carbamazepine	300–1200 mg	NNT 2.6 ( 2–4) , effective	Ataxia, dizziness, diplopia, lethargy NNH 3.4 (2.5–5.2) for side effects, NNH for withdrawal 24 (13–110)	Reduced white cell count, hyponatraemia higher doses
Lamotrigine	200–400 mg	NNT 2.1 ( 1.3–6.1) as add on medication	dizziness, drowsiness, constipation, ataxia, diplopia, irritability	Rapid dose escalation increases incidence of rashes
Pimozide	4–12 mg	NNT 2 (2–3)	Extrapyramidal e.g. tremor, rigidity NNH 2.9 (2–4)	Side effects too severe to recommend routine use
Proparcarine	2 drops of 0.5% solution	Not effective	Toxic keratopathy in long term use	Short lasting even if given repeatedly
Tizanidine	6–18 mg	May be effective	Nil reported	Effect is short lasting
Tocainide	60 mg/kg	Not effective	Nausea, parasthesia, rash	Risk of aplastic anaemia precludes its routine use
Drugs evaluated in case reports only none over 25 patients				
Capsaicin topical on skin	mg for 21–28 days	Little benefit	Burning sensation	Temporary relief ,avoid contact with the eye
Clonazepam	2–8 mg	May be effective	Lethargy in 60%, fatigue, dizziness, personality change	Thrombocytopenia can occur
Gabapentin	1200–3600 mg	May be effective	Ataxia, dizziness, drowsiness, nausea, headache	Better tolerated than carbamazepine
Oxcarbazepine	300–1200 mg	Effective	Ataxia, dizziness, diplopia, lethargy which may be related to hyponatraemia dose dependent	Better tolerated than with carbamazepine
Phenytoin	200 – 300 mg	Effective	Ataxia, lethargy, nausea, headache, behavioural changes , folate deficiency in prolonged use, gingival hypertrophy	Small margin for dose escalation
Valproic acid	600 – 2000 mg	May be effective	Irritability, restlessness, tremor, confusion, nausea, rash, weight gain	

get shorter and shorter. The most common divisions to be affected are the second and third, and it is rare for the first division alone to be affected. In about 3% of patients the pain becomes bilateral, but it is unusual for both sides to be active at the same time.

Other features that need to be assessed include the quality of life and the level of anxiety and depression. Most patients with severe trigeminal neuralgia find it impossible to socialise because of fear of developing an attack of pain while eating. These patients will often lose weight and become depressed. Ideally, patients should be evaluated with standard assessment measures such as the McGill Pain Questionnaire, some form of anxiety or depression scale such as the Hospital Anxiety and Depression Scale, and a quality of life assessment such as the Brief Pain Inventory or SF36. Some patients

will have, what are termed, atypical features and will report a constant, dull, aching background pain, exhibit no paroxysmal features, or have no pain free periods. Some of these symptoms may be related to stress and anxiety. Although 70% of patients will gain relief of pain from the use of carbamazepine, this is not always diagnostic.

#### Examination

In most patients, neurological examination will be negative but some subtle sensory changes may be present. In some cases, this could indicate that there is a secondary cause for trigeminal neuralgia. It is important to examine the oral cavity to exclude any dental causes for pain, especially if the patient reports intra-oral pain. Assessment of hearing may be important if patients wish to undergo an operation that carries a risk of causing hearing loss.

### Investigation

There are no diagnostic tests for trigeminal neuralgia. A CT scan can be used to look for evidence of secondary causes such as benign or malignant tumours or cysts. MRI scans will also show whether there is a compression of the nerve by blood vessels. However, their specificity and sensitivity in being able to predict operative findings still remain under investigation.

### Management

Trigeminal neuralgia is a rare condition, and although it can be treated in its initial phases in primary care, most of these patients benefit from being referred to the secondary care sector, to clinicians who specialise in the management of this condition. Patients, themselves, should be well-informed about the condition since compliance and satisfaction have been shown to be improved in those patients who have a better understanding of their condition, and are given an opportunity to express their wishes in terms of treatment. The ► [expert patient](#) is also able to give truly informed consent to treatment. Most patients will initially be managed medically and then surgery will be offered as a secondary procedure. There remains considerable debate as to the best timing of surgery.

#### Medical management (trigeminal neuralgia, medical management)

The mainstay of treatment for this condition is the use of anti-convulsants, and carbamazepine is the only drug that has been the subject of three randomised, controlled trials (McQuay et al. 1995; Wiffen et al. 2005; Zakrzewska and Lopez 2005). It therefore remains the gold standard against which other drugs are evaluated.

Table 1 gives an indication of the drugs that are in use. Patients should be encouraged to keep pain diaries so they learn to take control of their medication. Once the patient has become pain free for a month, the drugs should be slowly tapered off in the hope that the patient has gone into a natural remission period. Patients, however, need to be warned that they should re-start their medication as soon as they develop new paroxysms of pain.

### Surgery

Major indications for referring patients for surgery include inability to control the pain, poor quality of life, and side effects from medication. Surgery can be carried out at three levels, at the peripheral level where treatments are aimed at the trigger points, at the level of the Gasserian ganglion which involves ablative procedures, and at the level of the posterior fossa where one procedure is ablative whereas the other, that of microvascular decompression (► [trigeminal neuralgia, microvascular decompression](#)), is non-ablative. All ablative surgery (► [trigeminal neuralgia, types of ablative surgery](#)) is likely to result in sensory loss in the area of the trigeminal nerve as tactile, thermal and pain fibres may be destroyed. There are no randomised controlled trials of surgical treatments, and the quality of data reporting outcomes after surgical treatments is relatively poor (Zakrzewska and Lopez 2003). However, there is general consensus that the more central the procedure, the more likely patients are to gain long-term pain relief and high satisfaction rates (Zakrzewska 2002). Table 2 provides data on different surgical procedures (Burchiel 1999; Maesawa et al. 2001; Nurmikko and Eldridge 2001).

T

**Trigeminal Neuralgia, Etiology, Pathogenesis and Management, Table 2** Surgical management of trigeminal neuralgia (► [trigeminal neuralgia, aims of surgical management](#)), data on 5 years not available for some procedures, sensory loss common in all Gasserian ganglion\* procedures

Procedure	% Probability of being pain free	Mortality	Morbidity
Peripheral neurectomy, cryotherapy, alcohol, injection, acupuncture	Two years: 22	Nil	Low, sensory loss, transient haematoma, oedema
Radiofrequency thermorhizotomy (RFT) *	Two years: 68 Five years: 48	Low	28% complications mainly relating to trigeminal nerve, dysesthesia, anesthesia dolorosa, eye problems, masseteric problems
Percutaneous glycerol rhizotomy*	Two years: 63 Five years: 45	Low	25% complications as for RFT
Balloon microcompression*	Two years: 79	Low	10% complications as for RFT
Microvascular decompression	Two years: 81 Five years: 76 Ten years: 71	0.5%	Overall 75% no complications, 14% peri-operative complications, 5% transient cranial nerve 4 <sup>th</sup> , 6 <sup>th</sup> , 8 <sup>th</sup> dysfunction, 2% permanent deafness
Gamma Knife surgery	Two years: 58	Nil	Late onset of relief, may only be partial, 8% sensory loss up to two years post treatment

### Patient Information and Support (trigeminal neuralgia, patient information)

There is now a considerable amount of literature on trigeminal neuralgia for patients in the English language. The information is in the form of printed articles as well as a book (Weigel and Casey 2000), and there is a considerable body of data on the internet produced by patient support groups ([www.tna-uk.org.uk](http://www.tna-uk.org.uk); [www.tna-support.org](http://www.tna-support.org)). Patients need to be aware that continuing care may be necessary and not everyone can be cured.

### References

1. Anonymous (1988) Classification and Diagnostic Criteria for Headache Disorders, Cranial Neuralgias and Facial Pain. Headache Classification Committee of the International Headache Society. *Cephalalgia* 8:1–96
2. Devor M, Amir R, Rappaport ZH (2002) Pathophysiology of Trigeminal Neuralgia: the Ignition Hypothesis. *Clin J Pain* 18:4–13
3. Burchiel KJ (1999) (ed) Trigeminal Neuralgia in Techniques in Neurosurgery 5:200–266 Series of Articles by variety of authors
4. Maesawa S, Salame C, Flickinger JC et al. (2001) Clinical Outcomes after Stereotactic Radiosurgery for Idiopathic Trigeminal Neuralgia. *J Neurosurg* 94:14–20
5. McQuay H, Carroll D, Jadad AR et al. (1995) Anticonvulsant Drugs for Management of Pain: A Systematic Review. *BMJ* 311:1047–1052
6. Merskey H, Bogduk N (1994) Classification of Chronic Pain. Descriptors of Chronic Pain Syndromes and Definitions of Pain Terms. IASP Press, Seattle
7. Nurmikko TJ, Eldridge PR (2001) Trigeminal Neuralgia – Pathophysiology, Diagnosis and Current Treatment. *Br J Anaesth* 87:117–132
8. Weigel G, Casey KF (2004) Striking Back – The Trigeminal Neuralgia and Face Pain Handbook. Whitehall Printing Company, Naples, Florida
9. Wiffen PJ, McQuay HJ, Moore RA (2005) Carbamazepine for acute and chronic pain. The Cochrane Database of Systematic Reviews: Reviews 2005. Issue 3 John Wiley & Sons, Ltd. Chichester, UK DOI:10.1002/14851858.CD005451
10. Zakrzewska JM (2002) Trigeminal Neuralgia. In: Zakrzewska JM, Harrison SD (eds) Assessment and Management of Orofacial Pain. Elsevier Sciences, Amsterdam, pp 267–370
11. Zakrzewska JM, Hamlyn PJ (1999) Facial Pain. In: Crombie IKCPR, Linton SJ, LeResche L et al. (eds) Epidemiology of Pain. IASP Press, Seattle, pp 171–202
12. Zakrzewska JM, Lopez BC (2003) Quality of Reporting in Evaluations of Surgical Treatments of Trigeminal Neuralgia: Recommendations for Future Reports. *Neurosurgery* 53:110–122
13. Zakrzewska JM, Lopez BC (2005) Trigeminal Neuralgia. *Clin Evid* 14:1669–1677

## Trigeminal Neuralgia, Ignition Theory

### Definition

Trigeminal neuralgia is thought to be caused by chronic irritation of the trigeminal nerve, which leads to ectopic hyperexcitability, and this is the basis of the ignition hypothesis.

- ▶ [Trigeminal Neuralgia, Etiology, Pathogenesis and Management](#)

## Trigeminal Neuralgia, Medical Management

### Definition

Medical management of trigeminal neuralgia is principally with the use of anticonvulsant drugs, few of which have undergone evaluation under randomized controlled trial conditions.

- ▶ [Trigeminal Neuralgia, Etiology, Pathogenesis and Management](#)

## Trigeminal Neuralgia, Microvascular Decompression

### Definition

Microvascular decompression is a major neurosurgical procedure that involves gaining entry into the posterior fossa of the skull, and identifying and decompressing the trigeminal nerve in order to provide pain relief without sensory loss.

- ▶ [Trigeminal Neuralgia, Etiology, Pathogenesis and Management](#)

## Trigeminal Neuralgia, Patient Information

### Definition

There is a considerable amount of information, both written and electronic, on trigeminal neuralgia for both healthcare workers and patients, which would aid in management.

- ▶ [Trigeminal Neuralgia, Etiology, Pathogenesis and Management](#)

## Trigeminal Neuralgia, Types of Ablative Surgery

### Definition

Ablative surgery for trigeminal neuralgia involves selective destruction of the trigeminal nerve, and many of these procedures can be done in elderly medically unfit patients, but most result in facial sensory loss. These procedures include radiofrequency thermocoagulation (electrically heating the Gasserian ganglion), percutaneous glycerol injection (injecting glycerol round the Gasserian ganglion) or balloon microcompression (applying pressure on the Gasserian ganglion for a few seconds).

- ▶ [Trigeminal Neuralgia, Etiology, Pathogenesis and Management](#)



## Trigeminal Nucleus Caudalis

### Definition

Part of the trigeminal nuclei that relays intracranial nociceptive information to higher integrative centers.

► [Brainstem Subnucleus Reticularis Dorsalis Neuron](#)

## Trigeminal Subnucleus Caudalis

### Definition

Trigeminal subnucleus caudalis is the most caudal component of the trigeminal system, continuous with the dorsal horn of the spinal cord.

► [Dental Pain, Etiology, Pathogenesis and Management](#)

## Trigeminal Tractotomy

### Definition

A surgical procedure to sever the V spinal tract. The lesion also involves some lateral part of Vc. When performed in humans, the purpose is to deprive Vc of the inputs from the primary afferents, and therefore to provide relief to patients from the excruciating pain of V neuralgia.

► [Trigeminal Brainstem Nuclear Complex, Physiology](#)

## Trigeminal Transition Zone

### Definition

A region at the obex level where the subnuclei interpoplaris (Vi) and caudalis (Vc) of the spinal trigeminal nucleus converge. The ventral portion of the laminated Vc is pushed dorsomedially by Vi. The substantia gelatinosa is still identifiable but often interrupted. Neurons in the trigeminal transition zone project to the thalamus, and are involved in processing of nociceptive information from the orofacial regions.

► [Trigeminothalamic Tract Projections](#)

## Trigeminal, Glossopharyngeal, and Geniculate Neuralgias

WILLIAM S. ANDERSON, CAROL JAMES,  
BENJAMIN S. CARSON SR.  
Department of Neurological Surgery, Johns Hopkins  
Hospital, Baltimore, MD, USA  
wanderso@jhmi.edu

### Synonyms

Trigeminal neuralgia: tic douloureux, Fothergill's disease, epileptiform neuralgia

Glossopharyngeal neuralgia: vagoglossopharyngeal neuralgia

Nervus Intermedius, Primary Otagia

### Definitions

Cranial neuralgias are idiopathic chronic pain conditions characterized by sudden, often short-lived, episodes of pain that may result from non-painful cutaneous stimulation, and that involve the distributions of the involved trigeminal, glossopharyngeal, or geniculate nerve branches.

### Characteristics

Epidemiology is challenged by the lack of consistently applied diagnostic criteria, the absence of objective measures, and the variety of facial pain syndromes encountered by the clinician (Kitt 2000). Trigeminal neuralgia (TN) is the most common cranial neuralgia. Studies in Minnesota report a TN incidence rate of approximately 5/100,000 population (Katusic et al. 1991). Rates are higher in women, 5.9 vs 3.4. The ratio of glossopharyngeal neuralgia (GN) has been reported to be from 5 to 200-fold less than TN. Geniculate neuralgia (GenN) is considered rare, with experienced neurosurgeons report seeing 10–15 GenN cases among several thousand cases of cranial neuralgias.

Cranial neuralgias are usually diseases of seniors (IHS 1997). The median age of diagnosis in the Minnesota series was 67 (Katusic et al. 1991), although the range is wide and younger patients are common, especially in multiple sclerosis (see ► [Central Pain in Multiple Sclerosis](#)). A few series and case reports have described familial occurrences of TN, although no specific genetic defects have been identified, and no linkage studies of these families have been performed. An aggregation of the case reports shows that family members tend to be afflicted on the same side of the face, have a tendency to develop bilateral TN, have a younger age of onset (44.4 years), and tend to demonstrate an autosomal dominant mode of transmission with reduced penetrance (Fleetwood 2001).

The known causes of TN include demyelinating diseases such as multiple sclerosis, infiltration of the root or Gasserian ganglion by tumor or amyloid deposition, or small pontine or medullary infarcts (Love and Coakham 2001). About 4% of TN patients have multiple sclerosis, and 1–5% of multiple sclerosis patients develops TN (Nurmikko and Eldridge 2001). The majority of cases are believed to be due to nerve compression effects, usually by vascular structures (80–90%) (Love and Coakham 2001). A recent operative series of microvascular decompression procedures showed that

90% of first operations revealed compression of the nerve root by either an artery or vein, while in the rest of the cases compression of the root was caused by arachnoid thickening, or angulation or torsion of the root axis (Ishikawa et al. 2002). Approximately 70% of this series had arterial compression, of which 82% were caused by the superior cerebellar artery (SCA). More than 9% had demonstrable venous compression. Herpes zoster is commonly associated with outbreaks. The causes of GN and GenN may be similar to that of TN because effective therapies are similar, but direct evidence is lacking. Several groups have studied the pathologic consequences of trigeminal nerve root compression. Devor et al. describe areas of axonal loss and demyelination close to the compressing vessel with an increase in number of astrocytic processes, a froth of liposomes (the residual myelin sheaths) as well as large and small diameter denuded axons (Devor et al. 2002). Clumps of pure collagen are found in the demyelination zone, as well as regions of dysmyelination in the root adjacent to the offending vessel. The length of a given ► **cranial nerve central nervous system** (CNS) portion may be associated with the incidence of neuralgia affecting that cranial nerve (De Ridder et al. 2002). For instance, TN has a higher incidence than hemifacial spasm (CN VII), which has a higher incidence than GN, covarying with the central segment of the involved nerve identified by oligodendroglial cell derived myelin. The CNS portion of the nerve may be subject to injury by compression because it lacks the strong fascicular structure of the peripheral nerve system portion (De Ridder et al. 2002). The relief many patients feel immediately after decompressive surgery is too short for remyelination to be a mechanism. More likely, relief may relate to a decrease in ectopic pulse generation, to an increase in fiber separation brought about by the decompression, and to the rapid reversal of conduction blockade in the remaining myelinated fibers (Love and Coakham 2001).

### Clinical Features

TN is characterized by a painful sensation in the face, characterized by paroxysms of electric shock like pain within one or more of the trigeminal nerve divisions. The pain can occur spontaneously, or be elicited by non-noxious stimuli such as touch, talking, eating, or wind. The pain is acute in onset and termination, and may show periods of remission (IHS 1997). Pain is usually unilateral, but bilateral cases are observed. Neurologic deficits are generally absent. Case reports of atypical TN are common.

Severe paroxysmal pain in the sensory domain of the glossopharyngeal nerve is similar to TN, except for the position within the distribution of the auricular and pharyngeal branches of the vagus nerve and that of the glossopharyngeal nerve: the posterior part of the tongue, tonsillar fossa, pharynx, beneath the angle of the lower jaw, or in the ear (Loeser 1990). GN may be mistaken for

mandibular division TN. The trigger can be swallowing, yawning, clearing the throat, or talking. GN, like TN, is generally unilateral although there are reports of bilateral GN, GN with TN, and atypical cases.

GenN is a very rare condition, which is characterized by deep pain affecting the distribution of the nervus intermedius: inner ear with radiation to parts of the face with the pinna of the ear being the most common spot. Unlike trigeminal neuralgia, the pain can last for hours at a time, but like trigeminal neuralgia spontaneous remissions can occur. Pain can be triggered by non-noxious stimuli of the ear canal, swallowing, or talking (Loeser 1990).

### Pharmacological Treatments

Patients who present with TN are initially treated with medication, and the first line drug therapy is carbamazepine, with typical maintenance doses of 1500–2000 mg/day (Sindrup and Jensen 2002). Carbamazepine was shown to be effective at reducing pain severity, number of paroxysms, and number of triggers in approximately 75% of patients. Side effects include sedation, rash, hyponatremia, and rarely agranulocytosis. Many clinicians have switched their patients to oxcarbamazepine, a keto-derivative of carbamazepine with a lower side-effect profile, and less chance of hematologic problems.

Phenytoin is often used as a second-line agent, but few controlled trials have been performed with this drug; typical maintenance doses are 300–400 mg/day (Sindrup and Jensen 2002). Baclofen has also been used for pain control in these syndromes. Newer anti-epileptic drugs have also been investigated. Lamotrigine, as an add-on drug to either carbamazepine or Phenytoin, was shown to be effective.

The relative roles of pharmacotherapy and surgery (see below) for TN are in a state of flux, although certainly medically refractory patients tend to progress to surgery more quickly. A few authors have argued that surgery should be utilized earlier, before the typical TN features evolve into the atypical features of constant background pain and sensory disturbances, while others question this theory of disease progression. Many reports observe that the pharmacotherapy of GN and the rare GenN are the same as TN.

### Surgical Treatment

Surgical therapy of TN includes an assortment of treatments, ranging from relatively low invasive therapies such as stereotactic radiosurgery, peripheral nerve branch procedures including peripheral neurectomy, foraminal neurectomy and occlusion, or cryotherapy, percutaneous ganglion level procedures including RF thermocoagulation, glycerolysis, balloon compression, and ► **microvascular decompression** (MVD) procedures. These latter procedures involve a suboccipital craniectomy to reverse vascular compressive of the

nerve. Jannetta and coworkers described the largest series of cranial neuralgias treated with MVD, including TN and GN (McLaughlin et al. 1997).

Reviews of the various surgical treatments have generally found that ganglion level procedures tended to be more effective than peripheral procedures; however, neither group produced long-term pain relief. For instance, RF thermocoagulation by itself provided initial pain relief rates of 91–99% with subsequent recurrence rates of 10–25% over the various study times (25% at 14 years), while peripheral neurectomy by itself had a success rate of only 64% at one year, which fell to 26% by 4 years (Peters and Nurmikko 2002).

An emerging treatment for TN is stereotactic radiosurgery. Pollock et al. published a series of 117 patients with an average age of 67.8 years, 58% of whom had a previous surgical treatment. An excellent outcome overall (complete pain relief without medication) was achieved of 57% at 1 year, and 55% at 3 years. Factors associated with a good outcome were normal preoperative facial sensation, increased radiation dosage, no prior surgery, and trigeminal dysfunction/numbness. Negative factors included multiple sclerosis and atypical pain features. These authors stress that since the long term effects of radiation therapy close to the brainstem is unknown, first line treatment for young healthy patients should continue to address the vascular compressive lesion via an MVD procedure (Pollock et al. 2002).

Patel et al. (2002) reviewed the experience of 217 patients who underwent MVD for GN neuralgia between 1973 and 2000. In this group, immediate relief (no pain, and no medication) was obtained by 67% and partial relief by 25%, while the long-term results showed complete relief 58% and partial relief 18%. Complications of the procedure were few and included intracranial hematoma, brainstem infarction, cranial nerve palsy, CSF leak, operative death (none since 1987), and dysphagia, and seemed to decrease over time (Patel et al. 2002).

Surgery for GenN is based on the concept that pain is mediated through the nervous intermedius and the geniculate ganglion. In general, rare conditions such as this should be referred to individuals who have had significant experience with them, since historically morbidity associated with surgical treatment of this condition is relatively high. The surgical treatment involves dissecting out the nervous intermedius from the seventh cranial nerve in the cerebellar pontine angle and sectioning it. Variable results have been reported with MVD. One of the major problems with GenN is distinguishing it from GN or even from TN, which affects the third division of the nerve. This confusion has led some to advocate not only cutting the nervous intermedius, but also the glossopharyngeal nerve and the upper third of the vagus nerve. Unfortunately, there are no specific tests that are guaranteed to predict surgical success, although some otolaryngologists feel that it is useful to do pha-

ryngeal cocaine blocks prior to attempting nerve sectioning. Long-term results for surgical treatment of GenN in 64 patients have been reviewed by Pulec (Pulec 2002).

## References

1. De Ridder D, Møller A, Verlooy J, Cornelissen M, De Ridder L (2002) Is the Root Entry/Exit Zone Important in Microvascular Compression Syndromes? *Neurosurgery* 51:427–434
2. Devor M, Govrin-Lippmann R, Rappaport ZH (2002a) Mechanism of Trigeminal Neuralgia: An Ultrastructural Analysis of Trigeminal Root Specimens Obtained During Microvascular Decompression Surgery. *J Neurosurg* 96:532–543
3. Fleetwood IG, Innes AM, Hansen SR, Steinberg GK (2001) Familial Trigeminal Neuralgia: Case Report and Review of the Literature. *J Neurosurg* 95:513–517
4. International Headache Society (IHS) (1997) Member's Handbook 1997/98: Classification and Diagnostic Criteria for Headache Disorders, Cranial Neuralgias, and Facial Pain. Scandinavian University Press, Oslo, pp 102–103
5. Ishikawa M, Nishi S, Aoki T, Takase T, Wada E, Ohwaki H, Katsuki T, Fukuda H (2002) Operative Findings in Cases of Trigeminal Neuralgia Without Vascular Compression: Proposal of a Different Mechanism. *J Clin Neurosci* 9:200–204
6. Kastusic S, Williams DB, Beard CM, Bergstrahl EJ, Kurland LT (1991) Epidemiology and Clinical Features of Idiopathic Trigeminal Neuralgia and Glossopharyngeal Neuralgia: Similarities and Differences, Rochester, Minnesota, 1945–1984. *Neuroepidemiology* 10:276–281
7. Loeser JD (1990) In: The Management of Pain, vol 1, 2<sup>nd</sup> edn. Cranial Neuralgias, Lea & Febiger, Philadelphia
8. Love S, Coakham HB (2001) Trigeminal Neuralgia: Pathology and Pathogenesis. *Brain* 124:2347–2360
9. McLaughlin MR, Jannetta PJ, Clyde BL, Subach BR, Comey CH, Resnick DK (1997) Microvascular Decompression of Cranial Nerves: Lessons Learned after 4400 Operations. *J Neurosurg* 90:1–8
10. Nurmikko TJ, Eldridge PR (2001) Trigeminal Neuralgia: Pathophysiology, Diagnosis and Current Treatment. *Br J Anaesth* 87:117–132
11. Patel A, Kassam A, Horowitz M, Chang Y-F (2002) Microvascular Decompression in the Management of Glossopharyngeal Neuralgia: Analysis of 217 Cases. *Neurosurgery* 50:705–711
12. Peters G, Nurmikko TJ (2002) Peripheral and Gasserian Ganglion-Level Procedures for the Treatment of Trigeminal Neuralgia. *Clin J of Pain* 18:28–34
13. Pollock BE, Phuong LK, Gorman DA, Foote RL, Stafford SL (2002) Stereotactic Radiosurgery for Idiopathic Trigeminal Neuralgia. *J Neurosurg* 97:347–353
14. Pulec JL (2002) Geniculate Neuralgia: Long-Term Results of Surgical Treatment. *Ear Nose Throat J* 81:30–33
15. Sindrup SH, Jensen TS (2002) Pharmacotherapy of Trigeminal Neuralgia. *Clin J of Pain* 18:22–27

## Trigemincervical Complex

### Definition

Neurons in the trigeminal nucleus caudalis and dorsal horn of spinal cord segments C<sub>1</sub> and C<sub>2</sub>, which act together as a functional relay for pain input from intracranial structures, and overlap with input from the front and back of the head.

► **Migraine, Pathophysiology**

## Trigeminothalamic Tract

XIJING J. ZHANG

Department of Neuroscience, University of Minnesota,  
Minneapolis, MN, USA  
zhang036@umn.edu

### Definition

The trigeminothalamic tract is a bundle of nerve fibers originating from all of the subnuclei of the trigeminal brainstem nuclear complex and the gray matter of upper cervical spinal cord segments (C1–2), and projecting to or through the hypothalamus. The trigeminothalamic tract is responsible for conveying sensory information, especially nociceptive information, from facial skin, cornea, oral mucosa, and intracranial dura to the hypothalamus, a brain area that regulates homeostasis and other hormonal responses required for survival of the organism.

### Characteristics

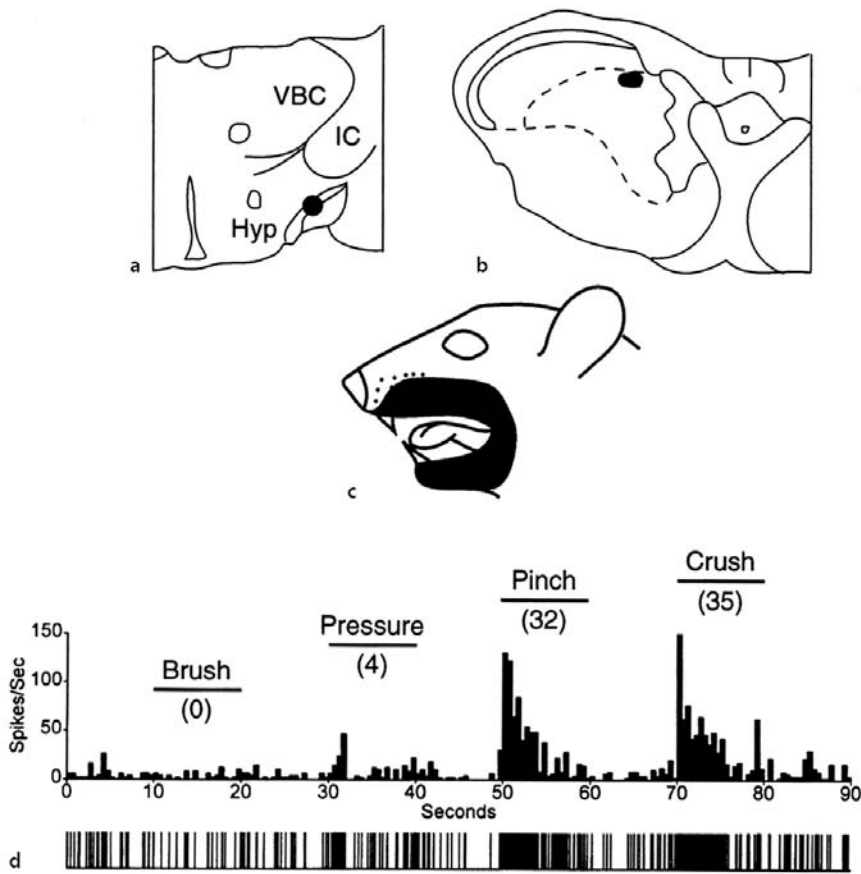
Anatomical retrograde labeling and physiological antidromic activation techniques have identified the locations of the trigeminothalamic neurons in the trigeminal brainstem nuclear complex and the gray matter of upper cervical spinal cord segments (Malick and Burstein 1998; Malick et al. 2000). After the retrograde tracer Fluoro-Gold injection into the hypothalamus, trigeminothalamic neurons are found throughout all of the subnuclei of the trigeminal brainstem nuclear complex (56%) and upper cervical spinal cord segment (44%) (Malick and Burstein 1998). Within the trigeminal brainstem nuclear complex, over 75% of the neurons were distributed caudal to the obex; most of the neurons were located in the nucleus caudalis. Over 90% of the neurons in the nucleus caudalis were distributed in laminae I, II and V. The nucleus caudalis is the subnucleus in the trigeminal brainstem nuclear complex that processes nociceptive information arising in oral and facial organs (Sessle 1987; Jacquin et al. 1986). In cervical cord segments 1 and 2, approximately 85% of the neurons were found in laminae I, II and V. These areas receive direct input from trigeminal primary afferent fibers and contain neurons that respond to mechanical or thermal stimulation of the cornea, oral mucosa, temporomandibular joint, facial skin, and intracranial dura (Lu et al. 1993; Broton et al. 1988, Burstein et al. 1998). Trigeminothalamic neurons were also recorded in laminae I, II and IV, V of the nucleus caudalis, and upper cervical (C1) spinal cord by physiological antidromic activation studies (Malick et al. 2000). Most of the trigeminothalamic neurons that were recorded responded maximally or exclusively to noxious mechanical or thermal stimulation to the head and orofacial receptive fields innervated by the trigeminal nerve.

The trajectory and termination of the trigeminothalamic tract have been examined using antidromic activation (Malick et al. 2000). The trigeminothalamic axons cross the midline and ascend on the contralateral side of the brainstem to the level of the contralateral thalamus. Within the thalamus, trigeminothalamic axons shift through the optic tract, internal capsule, and supraoptic decussation and reach the rostral ventral hypothalamus. In the rostral ventral hypothalamus more than half of the axons cross the midline again at the posterior optic chiasm to the ipsilateral hypothalamus, turn caudally and descend along the identical path in which they ascended in the contralateral hypothalamus (Malick et al. 2000). The axons of the trigeminothalamic neurons and their collateral branches terminate bilaterally in many nuclei within hypothalamus, such as the lateral, perifornical, dorso-medial, suprachiasmatic, and supraoptic hypothalamic nuclei (Malick et al. 2000). Through this complex projection, the axons of the trigeminothalamic neurons are capable of carrying nociceptive information bilaterally to many nuclei in the hypothalamus that are involved in the production of various responses to noxious stimuli.

Responses of the trigeminothalamic neurons to noxious stimuli have been described (Malick et al. 2000). The overwhelming majority of the trigeminothalamic neurons responded strongly to noxious mechanical and thermal stimuli applied to the skin. The receptive fields of the trigeminothalamic neurons included the skin of the head and neck, as well as orofacial organs such as the oral mucosa, tongue, lips, cornea, and intracranial dura. Laminae I-II neurons generally exhibited small to medium receptive fields, while those located in deeper layers had medium to large receptive fields. Over 80% of the recorded trigeminothalamic neurons were nociceptive. Among them, 42% were wide dynamic range, and 38% were high-threshold neurons. The remaining 20% were low-threshold neurons (Malick et al. 2000). Figure 1 shows that a high-threshold trigeminothalamic neuron responded to noxious mechanical stimulus applied to its receptive field. The neuron was located in dorso-medial lamina V of the nucleus caudalis (b), and its axon projected to the contralateral hypothalamus (a). The neuron had a small cutaneous receptive field located around the ipsilateral side of the mouth (c), and only responded to noxious mechanical stimuli applied to the skin (d).

The majority of nociceptive neurons responded primarily to noxious intensities of thermal stimulation. In contrast, all low-threshold neurons responded to both heat and cold stimuli at innocuous and noxious intensities, a phenomenon that has not been reported for other populations of spinal or trigeminal low-threshold neurons (Malick et al. 2000). Thus, trigeminothalamic neurons can transmit innocuous and primarily noxious me-





**Trigeminohypothalamic Tract, Figure 1** Response property of a high-threshold trigeminohypothalamic neuron. (a) Location of low-threshold point for antidromic activation in the hypothalamus. (b) Recording site in dorsomedial lamina V. (c) Receptive field. (d) Peristimulus histogram and record of window discriminator output (below histogram) illustrating the response to mechanical stimuli applied to the receptive field. Numbers in parentheses depict mean response (spikes/sec) to each stimulus. (From Malick et al. 2000). Hyp, hypothalamus; IC, internal capsule; VBC, ventrobasal complex.

chanical and thermal information from facial skin directly to the hypothalamus.

Many trigeminohypothalamic neurons were also powerfully activated by electrical and mechanical stimuli of the oral mucosa, tongue, lips, cornea, and intracranial dura mater (Malick et al. 2000). Most (85%) oral-sensitive trigeminohypothalamic neurons encoded the intensity of the noxious mechanical and thermal stimuli. Since pain is the only sensation that can be evoked by stimulating the cornea and intracranial dura and sinuses, regardless of whether the stimulus is electrical, mechanical, or chemical (Lele and Weddell 1959, Ray and Wolff 1940), the cornea- and dura-sensitive neurons were considered nociceptive. Therefore, trigeminohypothalamic neurons can transmit nociceptive information from these specific organs in the head to the hypothalamus.

The hypothalamus plays an important role in regulating body temperature, food and water intake, sleep and circadian rhythms, endocrine adjustments, and a wide range of behavior (Swanson 1987). Through the terminations and collateral branches in the hypothalamus, the trigeminohypothalamic tract is likely to bring noxious and innocuous sensory signals from orofacial skin and organs to the hypothalamus, and is involved in pain-

related autonomic responses, endocrine adjustments, or emotion reactions.

## References

1. Broton JG, Hu JW, Sessle BJ (1988) Effects of Temporomandibular Joint Stimulation on Nociceptive and Non-Nociceptive Neurons of the Cat's Trigeminal Subnucleus Caudalis (Medullary Dorsal Horn). *J Neurophysiol* 59:1575–1589
2. Burstein R, Yamamura H, Malick A, Strassman AM (1998) Chemical Stimulation of the Intracranial Dura Induces Enhanced Responses to Facial Stimulation in Brainstem Trigeminal Neurons. *J Neurophysiol* 79:964–982
3. Jacquin MF, Renehan WE, Mooney RD, Rhoades RW (1986) Structure-Function Relationships in Rat Medullary and Cervical Dorsal Horns. I. Trigeminal Primary Afferents. *J Neurophysiol* 55:1153–1186
4. Lele PP, Weddell G (1959) Sensory Nerves of the Cornea and Cutaneous Sensibility. *Exp Neurol* 1:334–359
5. Lu J, Hathaway CB, Bereiter DA (1993) Adrenalectomy Enhances Fos-Like Immunoreactivity within the Spinal Trigeminal Nucleus Induced by Noxious Thermal Stimulation of the Cornea. *Neuroscience* 54:809–818
6. Malick A, Burstein R (1998) Cells of Origin of the Trigeminohypothalamic Tract in the Rat. *J Comp Neurol* 400:125–144
7. Malick A, Strassman AM, Burstein R (2000) Trigeminohypothalamic and Reticulohypothalamic Tract Neurons in the Upper Cervical Spinal Cord and Caudal Medulla of the Rat. *J Neurophysiol* 84:2078–2112

8. Ray BS, Wolff HG (1940) Experimental Studies on Headache. Pain-Sensitive Structures of the Head and their Significance in Headache. *Arch Surg* 41:813–856
9. Sessle BJ (1987) The Neurobiology of Facial and Dental Pain: Present Knowledge, Future Directions. *J Dent Res* 66:617–626
10. Swanson LW (1987) The Hypothalamus. In: Hökfelt T and Swanson LW (eds) *Handbook of Chemical Neuroanatomy*, vol 5, Integrated Systems of the CNS, Part I. Elsevier, Amsterdam, pp 1–124

## Trigeminothalamic Tract Projections

KE REN

Department of Biomedical Sciences, University of Maryland, Baltimore, MD, USA  
kren@umaryland.edu

### Synonyms

Tractus Trigeminothalamicus; Lemnicus Trigeminalis

### Definition

The axon bundles of the secondary sensory neurons in the spinal trigeminal nucleus and principal sensory nucleus of the ► [trigeminal nerve](#), which carry somatosensory information from the head and face and terminate in the ventral posterior part of the opposite thalamus. As the counterpart of the spinothalamic tract, the trigeminothalamic axons from the spinal trigeminal nucleus, mainly the subnucleus caudalis, convey nociceptive input. The trigeminothalamic axons from the principal sensory nucleus, equivalent to the medial ► [lemniscal fibers](#), transmit discriminative tactile as well as proprioceptive impulses.

### Characteristics

The somesthetic information from orofacial regions is conveyed via the fifth cranial nerve, the trigeminal nerve, to the two major trigeminal sensory nuclei, the spinal trigeminal and the principal sensory nuclei. Populations of neurons in the trigeminal sensory nuclei then send their axons to the thalamus via trigeminothalamic projections. The pattern and functions of trigeminothalamic projections are specifically related to the individual subnuclei of the spinal trigeminal nucleus and the thalamus (Fukushima and Kerr 1979; Rausell and Jones 1991). For the purpose of completeness, the following discussion will go beyond the projection to the ventrobasal thalamus, to also include trigeminal projections to other nuclei of the thalamus that are related to pain processing.

### Spinal Trigeminal Nucleus

The spinal trigeminal nucleus is further divided rostrocaudally into the subnuclei oralis, interpolaris and caudalis. Cytoarchitecturally, the general classification of the subnuclei for humans is applicable to lower animals such as the rat.

The subnucleus caudalis appears at approximately the level of the obex and continues caudally to merge with

the upper cervical spinal dorsal horn. The caudal portion of the subnucleus caudalis is analogous to the spinal dorsal horn both histologically and physiologically. The Rexed classification of the dorsal horn can be applied to its outer layers. Thus, the subnucleus caudalis is regarded as a laminated structure, and is sometimes referred to as the ► [medullary dorsal horn](#). After entering the central nervous system at the middle of the pons, small-diameter primary afferent (nociceptive) fibers in the trigeminal nerve turn caudally, then descend in the spinal trigeminal tract, and finally terminate in the subnucleus caudalis. Nociceptive neurons, both nociceptive specific and wide dynamic range types, can be recorded from the subnucleus caudalis. The thalamic-projecting axons of subnucleus caudalis neurons carry pain and temperature information to the thalamus.

The subnucleus interpolaris appears gradually from a transition region at the level of the obex, where the subnuclei caudalis and interpolaris coexist in the same transverse plane for a small distance (the ► [trigeminal Vi/Vc transition zone](#)). The subnucleus interpolaris neurons have a well-defined and extensive projection to the medial ventroposterior thalamic nucleus (VPM, the medial part of the ventrobasal complex) (Phelan and Falls 1991). Nociceptive thalamic projecting neurons have been identified in subnucleus interpolaris. However, most thalamic projecting subnucleus interpolaris neurons respond to deflection of mystacial vibrissae and are low-threshold mechanoreceptive (Jacquin et al. 1986; Hayashi et al. 1984). Two types of thalamic ascending fibers have been identified in the subnucleus interpolaris: fast-conducting thick fibers terminate in the posterior nucleus of the thalamus, and slow-conducting thin fibers project to VPM (Veinante et al. 2000).

The subnucleus oralis is the most rostral subnucleus of the spinal trigeminal nucleus. Fukushima and Kerr (1979) found that the subnucleus oralis had no projections to the thalamus in the rat. Using fluorescent dye tracers, however, subnucleus oralis neurons have been shown to project to the thalamus in rodents (Bruce et al. 1987). The neurons of the subnucleus oralis may project to the contralateral thalamus via a relay in the juxtatrigenial nucleus and principal sensory nucleus (Zhang and Yang 1999).

### Principal Sensory Nucleus of the Trigeminal Nerve, Trigeminal Nucleus Principalis

The principal sensory nucleus (main sensory nucleus) can be traced caudally to the level of the rostral tip of the facial nucleus and contiguous obliquely with subnucleus oralis. The principal sensory nucleus mainly receives large-diameter primary afferents and contributes to discriminative sensations. In the rat, the principal sensory nucleus thalamic projecting axons arise from small- and medium-sized neurons; large neurons (20–42  $\mu\text{m}$ ) of the principal sensory nucleus do not project to the thalamus (Fukushima and Kerr 1979). The ascending fibers

from the ventral and dorsal principal sensory nucleus project to the contralateral and ipsilateral VPM, respectively.

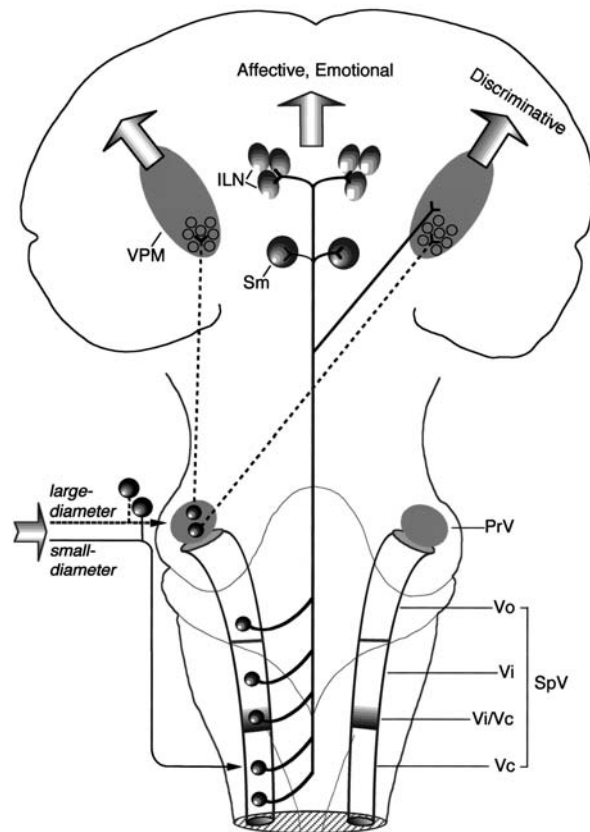
### Subnuclei of the Thalamus

The ascending trigeminal projections terminate in several thalamic subnuclei including the VPM, posterior thalamic nucleus, nucleus submedialis and intralaminar nuclei centralis medialis and lateralis and parafascicular nucleus. The principal sensory nucleus and spinal trigeminal nucleus have complementary projection foci in the thalamus (Rausell and Jones 1991, Williams et al. 1994). The principal sensory nucleus input enters the barreloid portion of VPM that contains ▶ **parvalbumin**-immunoreactive cells. The ascending fibers from spinal trigeminal nucleus terminate in non-barreloid VPM, which contains another calcium-binding protein, ▶ **calbindin-D28k**. Calbindin D-28k and parvalbumin belong to calcium binding protein families and can be used as selective neural markers of central neurons. The trigeminal inputs to the posterior thalamic nucleus are mainly from the principal sensory nucleus and subnucleus interpolaris (Waite and Tracey 1995). The parafascicular nucleus of the thalamus receives input from subnuclei caudalis and interpolaris, but not from principal sensory nucleus and subnucleus oralis (Krout et al. 2002). The nucleus submedialis receives a major input from the Vi/Vc transition zone, as well as from the subnucleus caudalis (Yoshida et al. 1991, Craig and Dostrovsky 2001).

Most trigeminothalamic projections are contralateral, except that the subnucleus caudalis projects to bilateral ▶ **intralaminar thalamic nuclei** (Peschanski 1984), and the principal sensory nucleus has an ipsilateral projection to VPM (Fukushima and Kerr 1979) (Fig. 1). Although the major trigeminothalamic projections are the inputs to VPM and posterior thalamic nucleus from the principal sensory nucleus and subnucleus interpolaris (Waite and Tracey 1995), they are generally not concerned with nociceptive transmission, or at least do not play a major role. Most VPM neurons relay precisely organized tactile information from the face and mouth. Neurons in the posterior nucleus and medial thalamus including nucleus submedialis, intralaminar nuclei and parafascicular nucleus are less somatotopically organized in relaying sensory information than is the VPM nucleus.

### Trigeminothalamic Projection and Pain

Trigeminothalamic neurons are involved in transmitting pain information from the craniofacial region. The trigeminothalamic projection involved in pain is mainly from the subnucleus caudalis, where small-diameter trigeminal primary afferents terminate. Specifically, neurons in the marginal layer (lamina I) of the subnucleus caudalis project to VPM and posterior thalamic nucleus (Shigenaga et al. 1979). Neurons in the sub-



**Trigeminothalamic Tract Projections, Figure 1** Major thalamic projections from the trigeminal sensory nuclei. Sensory inputs from the head and face are relayed in the trigeminal brain stem nuclear complex, including the principal sensory nucleus (PrV) and spinal trigeminal nucleus (SpV). The spinal trigeminal nucleus is further divided into subnuclei oralis (Vo), interpolaris (Vi) and caudalis (Vc). The most caudal subnucleus interpolaris and rostral caudalis merge to form a transition zone (Vi/Vc) at the obex level. Large-diameter myelinated primary afferents mainly synapse in the principal sensory nucleus, and small-diameter A-delta and C-fibers travel caudally to terminate in the subnucleus caudalis. Neurons in the spinal trigeminal nucleus, primarily the subnucleus caudalis, project to contralateral medial ventroposterior nucleus of the thalamus (VPM), posterior thalamic nucleus (not shown), as well as bilateral intralaminar nuclei (ILN) and nucleus submedialis (Sm). The trigeminal projection to the submedialis is predominantly contralateral. The principal sensory nucleus and the subnucleus caudalis project to the barreloid and non-barreloid regions (open circles in VPM) of the VPM, respectively. Note that discriminative and affective components of pain may be relayed by distinct pathways. Dashed lines indicate transmission of discriminative tactile information from the head and face.

nuclei interpolaris and oralis are also involved in the orofacial pain process, although limited information is available on their ascending thalamic projections related to pain. One characteristic of the nociceptive trigeminothalamic projection is that a relatively small number of nociceptive neurons in the subnucleus caudalis projects to the VPM. This is in sharp contrast with the principal sensory nucleus, where a vast majority of cells are connected to VPM. However, nociceptive trigeminothalamic neurons also project to the posterior thalamic nucleus, nucleus submedialis and intralaminar thalamic nuclei.

Most lamina I trigeminothalamic nociceptive neurons in the subnucleus caudalis project to nucleus submedius, but not VPM. In contrast, most thermoreceptive trigeminothalamic cells project to VPM (Craig and Dostrovsky 2001). Subnucleus caudalis nociceptive neurons are antidromically activated by stimulation of the posterior nucleus of the thalamus (Hirata et al. 1999).

Using combined retrograde tracing and nuclear Fos protein expression techniques, it has been shown that a population of nucleus submedius-projecting neurons in the Vi/Vc transition zone is activated by inflammation of the masseter muscle (Ikeda et al. 2003). In contrast, corneal responsive units in the Vi/Vc transition zone do not appear to project to the nucleus submedius (Hirata et al. 1999). Thus, the Vi/Vc-submedius projection may be selectively activated by injury of deep orofacial structures. The trigeminal nociceptive input to the VPM is further relayed to the somatosensory cerebral cortex and related to discriminative information of pain. In contrast, information about affective and emotional aspects of pain from the head and face is likely to be related through the thalamic nucleus submedius and intralaminar nuclei (Fig. 1).

#### Trigeminothalamic Projection and Discriminative Sensations

Information related to discriminative sensations from the head and face is relayed in the VPM through trigeminothalamic projections. Neurons in the principal sensory nucleus receive synaptic contact from large-diameter primary afferent terminals of the trigeminal nerve and send axons ascending to VPM. This pathway corresponds to the spinal dorsal column/medial lemniscal system, and is highly somatotopically organized. In rodents, distinct clusters of VPM cells receive inputs from designated whiskers, mediated by corresponding aggregates of neurons in the principal sensory nucleus. Neurons in the principal sensory nucleus, VPM and the somatosensory cortex are grouped into rows (rods, cellular cylinders) to give topographical representation of the whisker pad. This specific array of cells is named “barrels” in cortex, “barreloids” in VPM and “barrelets” in the principal sensory nucleus (Waite and Tracey 1995; Hendry and Hsiao 2003). Information related to discriminative pain from the head and face is relayed in the non-barreloid thalamic regions of the VPM, complementary to those mediating tactile sensations, or the barreloid areas (Rausell and Jones 1991; Williams et al. 1994).

#### References

- Bruce LL, McHaffie JG, Stein BE (1987) The Organization of Trigeminothalamic and Trigeminothalamic Neurons in Rodents: A Double-Labeling Study with Fluorescent Dyes. *J Comp Neurol* 262: 315–330
- Craig AD, Dostrovsky JO (2001) Differential Projections of Thermoreceptive and Nociceptive Lamina I Trigeminothalamic and Spinothalamic Neurons in the Cat. *J Neurophysiol* 86: 856–870
- Fukushima T, Kerr FW (1979) Organization of Trigeminothalamic Tracts and Other Thalamic Afferent Systems of the Brainstem in the Rat: Presence of Gelatinosa Neurons with Thalamic Connections. *J Comp Neurol* 183: 169–184
- Hayashi H, Sumino R, Sessle BJ (1984) Functional Organization of Trigeminal Subnucleus Interpolaris: Nociceptive and Innocuous Afferent Inputs, Projections to Thalamus, Cerebellum, and Spinal Cord, and Descending Modulation from Periaqueductal Gray. *J Neurophysiol* 51:890–905
- Hendry SH, Hsiao SS (2003) The Somatosensory System, In: Squire LR, Bloom FE, McConnell SK, Roberts JL, Spitzer NC, Zigmond MJ (eds) *Fundamental neuroscience*. 2nd ed. Academic Press, London, pp 667–697
- Hirata H, Hu JW, Bereiter DA (1999) Responses of Medullary Dorsal Horn Neurons to Corneal Stimulation by CO<sub>2</sub> Pulses in the Rat. *J Neurophysiol* 82:2092–2107
- Ikeda T, Terayama R, Jue SS et al. (2003) Differential Rostral Projections of Caudal Brainstem Neurons receiving Trigeminal Input after Masseter Inflammation. *J Comp Neurol* 465:220–233
- Jacquin MF, Mooney RD, Rhoades RW (1986) Morphology, Response Properties, and Collateral Projections of Trigeminothalamic Neurons in Brainstem Subnucleus Interpolaris of Rat. *Exp Brain Res* 61:457–468
- Krout KE, Belzer RE, Loewy AD (2002) Brainstem Projections to Midline and Intralaminar Thalamic Nuclei of the Rat. *J Comp Neurol* 448:53–101
- Peschanski M (1984) Trigeminal Afferents to the Diencephalon in the Rat. *Neuroscience* 12:465–487
- Phelan KD, Falls WM (1991) A Comparison of the Distribution and Morphology of Thalamic, Cerebellar and Spinal Projection Neurons in Rat Trigeminal Nucleus Interpolaris. *Neuroscience* 40:497–511
- Rausell E, Jones EG (1991) Chemically Distinct Compartments of the Thalamic VPM Nucleus in Monkeys Relay Principal and Spinal Trigeminal Pathways to Different Layers of the Somatosensory Cortex. *J Neurosci* 11:226–237
- Shigenaga Y, Takabatake M, Sugimoto T et al. (1979) Neurons in Marginal Layer of Trigeminal Nucleus Caudalis Projecting to Ventrobasal Complex (VB) and Posterior Nuclear Group (PO) Demonstrated by Retrograde Labeling with Horseradish Peroxidase. *Brain Res* 166:391–396
- Veinante P, Jacquin MF, Deschenes M (2000) Thalamic Projections from the Whisker-Sensitive Regions of the Spinal Trigeminal Complex in the Rat. *J Comp Neurol* 420: 233–243
- Waite Phil ME, Tracey DJ (1995) Trigeminal Sensory System. In: Paxinos G (ed) *The rat nervous system*, 2nd edn. Academic Press, San Diego, pp 705–724
- Williams MN, Zahm DS, Jacquin MF (1994) Differential Foci and Synaptic Organization of the Principal and Spinal Trigeminal Projections to the Thalamus in the Rat. *Eur J Neurosci* 6:429–453
- Yoshida AK, Dostrovsky JO, Sessle BJ et al. (1991) Trigeminal Projections to the Nucleus Submedius of the Thalamus in the Rat. *J Comp Neurol* 307:609–625
- Zhang JD, Yang XL (1999) Projections from Subnucleus Oralís of the Spinal Trigeminal Nucleus to Contralateral Thalamus via the Relay of Juxtatrigeminal Nucleus and Dorsomedial Part of the Principal Sensory Trigeminal Nucleus in the Rat. *J Hirnforsch* 39:301–310

## Trigeminovascular System

### Definition

The trigeminovascular system designates the visceral terminals of the 1<sup>st</sup> division of the trigeminal nerve surrounding vessels in the meninges. It is the major pain-signaling structure of the visceral organ brain.

- ▶ [Clinical Migraine without Aura](#)
- ▶ [Migraine, Pathophysiology](#)



## Trigger Point

### Definition

A trigger point is a spot of localized tenderness in a palpable taut band of muscle. Pressure stimulation or palpation on trigger points evoke a characteristic pattern of referred pain and typically a local twitch response. There are also scar, skin, and connective tissue sensitive spots that, when stimulated, mechanically refer pain and are sometimes called trigger points.

- ▶ [Chronic Pelvic Pain, Musculoskeletal Syndromes](#)
- ▶ [Muscle Pain, Fibromyalgia Syndrome \(Primary, Secondary\)](#)
- ▶ [Myofascial Trigger Points](#)
- ▶ [Psychophysiological Assessment of Pain](#)
- ▶ [Referred Muscle Pain, Assessment](#)
- ▶ [Stretching](#)

## Trigger Point Pain

- ▶ [Myofascial Pain](#)

## Trigger Point Pressure Release

### Definition

Trigger point pressure release is a simple, often effective, manual technique for the treatment of myofascial trigger points. Slowly increasing, gentle, digital pressure is applied to the trigger point until a barrier of tissue resistance is encountered. Constant pressure is maintained until the resistance of the barrier tension decreases. Then pressure is slowly increased to reach a new barrier. The term ischemic compression has previously been used to describe this treatment approach, but a different concept of the treatment mechanism was attributed to it, and the procedure was unnecessarily painful.

- ▶ [Myofascial Trigger Points](#)

## Triple Response

### Definition

The triple response consists of three components. In response to an intradermal histamine injection, there is a local erythema (reddening reaction) occurring within 10 seconds due to a direct histamine induced capillary dilatation at the injection site. Then, there is a local swelling, a „wheal“, due to locally increased permeability of capillaries and postcapillary venules with consecutive fluid extravasation. Finally, there is a „flare“, i.e. an erythema occurring within 30 seconds

in neighboring skin areas due to axon reflex activation. Histamine activates nociceptive, unmyelinated C-fibers at the injection site. Their impulses travel orthodromically. As soon as they have reached axon branching points, impulses also propagate antidromically down other neighboring branches of the sensory nerve fibers. The antidromic impulses reach axon terminals and induce release of vasodilating and itching neuropeptides, such as calcitonine gene related peptide (CGRP) or substance P, which also causes fluid extravasation (Ganong WF (1997) Review of Medical Physiology. Appleton & Lange; Stamford, CT p581-582).

- ▶ [Congenital Insensitivity to Pain with Anhidrosis](#)

## Triptans

### Definition

Serotonin, 5-HT<sub>1B/1D</sub>, receptor agonist, i.e. compounds that activate or turn on both these receptor sub-types. These compounds are highly effective in the treatment of acute migraine.

- ▶ [Clinical Migraine without Aura](#)
- ▶ [Migraine, Pathophysiology](#)

## trkA

- ▶ [Tyrosine Kinase A](#)

T

## TrkA Receptor(s)

### Definition

TrkA is a member of the trk family of tyrosine kinase receptors and is the high affinity receptor for nerve growth factor found on NGF-dependent sensory neurons. When trkA binds NGF, the receptor autophosphorylates on tyrosine residues, leading to activation of multiple downstream effector proteins, including the Ras-MAP kinase signaling cascade and PI<sub>3</sub>-kinase activation.

- ▶ [Congenital Insensitivity to Pain with Anhidrosis](#)
- ▶ [IB4-Positive Neurons, Role in Inflammatory Pain](#)
- ▶ [Immunocytochemistry of Nociceptors](#)
- ▶ [Nerve Growth Factor, Sensitizing Action on Nociceptors](#)
- ▶ [TRPV1, Regulation by Nerve Growth Factor](#)

## TrkA-IgG

### Definition

NGF sequestering molecule.

- ▶ Spinal Cord Nociception, Neurotrophins

## TRN

- ▶ Thalamic Reticular Nucleus

## Trochanteric Bursitis

### Definition

Inflammation of the bursa near the greater trochanter of the hip. This condition can produce pain in the thigh.

- ▶ Sciatica

## Trophic Factors

### Definition

Molecules that cause growth/regeneration of various parts of a cell/neuron; more recently some trophic factors have also been shown to have transmitter-like actions.

- ▶ Retrograde Cellular Changes after Nerve Injury

## Tropism

### Definition

Movement or growth of an organism in response to an external stimulus.

- ▶ Hansen's Disease

## TRP Channels

### Definition

Denominates ion channels of the Transient Receptor Potential (TRP) family. The first member of this ion channel family was identified by localization of a gene that caused deficiencies in signaling in the visual system of the model organism *Drosophila melanogaster* (fruit fly). Mammals have more than 14 TRP channel genes. TRP channels play important roles in the regulation of neural excitability and in sensory systems, such as vision, olfaction, and pheromone sensation. TRP channels serve

as receptors for temperature and irritant chemicals (capsaicin, mustard oil) in the pain pathway, and play important functional roles in neurogenic inflammation and hyperalgesia.

- ▶ Nociceptors, Cold Thermotransduction
- ▶ TRPV1, Regulation by Nerve Growth Factor
- ▶ TRPV1, Regulation by Protons

## TRPA1

### Definition

Temperature-sensitive, non-selective cation channel activated near 17°C. The channel is insensitive to menthol but is activated by natural pungent compounds like cinnamon and mustard oil. The transcripts are expressed in a small percentage (4%) of primary sensory neurons. Found exclusively in neurons expressing TRPV1 and peptidergic markers of nociceptors, such as calcitonin gene-related peptide (CGRP). Suggested as the molecular transducer of noxious cold temperatures.

- ▶ Nociceptors, Cold Thermotransduction

## TRPM8 Channel

### Definition

Calcium permeable, voltage-gated, non-selective cation channel that is activated by temperature (threshold 25°C) and natural cooling compounds like menthol and eucalyptol. Expressed in around 10% of primary sensory neurons of small diameter. A crucial element in the transduction of temperature signals by low-threshold peripheral and visceral thermoreceptors.

- ▶ Nociceptors, Cold Thermotransduction

## TRPV1

### Synonyms

Transient Receptor Potential Vanilloid Type 1

### Definition

The TRPV1 receptor is a member of the transient receptor vanilloid subfamily. It is sensitive to capsaicin and has a well defined temperature threshold of about 43°C, similar to the threshold for thermal nociception. The response of this receptor can be sensitized to NGF and other proinflammatory mediators providing a basis for thermal hyperalgesia. Other TRP subfamily members are not sensitive to capsaicin, and have different temperature thresholds (e.g. TRPV2 – 52°C; TRPV3 – 35°C). Still other members of this subfamily appear to respond to other stimuli, e.g. TRPV4 – osmoreceptors. TRPV1

is the charter member of a family of TRP channels identified in mammalian sensory neurons that are activated by temperatures ranging from cold to warm to intense heat.

- ▶ Capsaicin Receptor
- ▶ ERK Regulation in Sensory Neurons during Inflammation
- ▶ IB4-Positive Neurons, Role in Inflammatory Pain
- ▶ Muscle Pain Model, Ischemia-Induced and Hypertonic Saline-Induced
- ▶ Nerve Growth Factor, Sensitizing Action on Nociceptors
- ▶ NGF, Regulation during Inflammation
- ▶ Nociceptor, Categorization
- ▶ Satellite Cells and Inflammatory Pain
- ▶ Species Differences in Skin Nociception
- ▶ TRPV1 Modulation by p2Y Receptors
- ▶ TRPV1 Receptor, Species Variability
- ▶ TRPV1, Regulation by Nerve Growth Factor
- ▶ TRPV1, Regulation by Protons
- ▶ Visceral Pain Model, Esophageal Pain

## TRPV1 Modulation by p2Y Receptors

MAKOTO TOMINAGA

Department of Cellular and Molecular Physiology,  
Mie University School of Medicine, Tsu Mie, Japan  
tominaga@doc.medic.mie-u.ac.jp

### Synonyms

TRPV1 Receptor, Modulation by P2Y Receptors

### Definition

▶ Capsaicin receptor ▶ TRPV1 is a non-selective cation channel expressed in a subset of sensory neurons, ▶ nociceptors. ▶ P2Y receptor activation potentiates or sensitizes TRPV1 activity through a ▶ PKC-dependent pathway. In the presence of ▶ ATP released in the context of tissue damage, the temperature threshold for TRPV1 activation is reduced to less than 35°C, so that body temperature is capable of activating TRPV1, leading to the sensation of pain.

### Characteristics

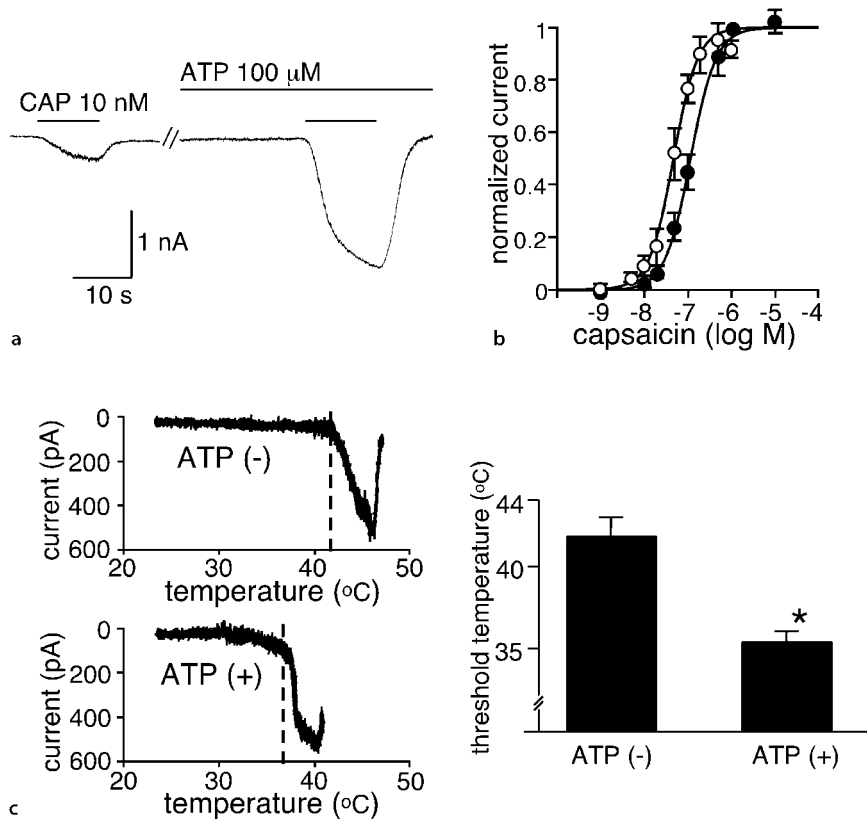
Pain is initiated when noxious thermal, mechanical, or chemical stimuli excite the peripheral terminals of specialized primary afferent neurons called nociceptors. Many different kinds of ionotropic and metabotropic receptors are known to be involved in this process (McCleskey and Gold 1999). ▶ Vanilloid receptors are nociceptor-specific cation channels that serve as the molecular target of capsaicin, the pungent ingredient in hot chili peppers (Szallasi and Blumberg 1999). A gene encoding a capsaicin receptor was isolated using an

expression-cloning method and the receptor protein was found to be an ion channel with six transmembrane domains having high Ca<sup>2+</sup> permeability (Caterina et al. 1997). When expressed in heterologous systems, the cloned capsaicin receptor TRPV1 can also be activated by noxious heat (with a thermal threshold > 43°C) or protons (acidification), both of which cause pain *in vivo* (Caterina et al. 1997; Tominaga et al. 1998; Caterina and Julius 2001). Furthermore, analyses of mice lacking TRPV1 have shown that TRPV1 is essential for selective modalities of pain sensation and for tissue injury-induced thermal hyperalgesia (Caterina et al. 2000; Davis et al. 2000).

Tissue damage associated with infection, inflammation or ischemia produces an array of chemical mediators that activate or sensitize nociceptor terminals to elicit pain at the site of injury. One important component of this pro-algesic response is adenosine triphosphate (ATP) released from different cell types (North and Barnard 1997; Burnstock and Williams 2000). Extracellular ATP excites the nociceptive endings of nearby sensory nerves, evoking a sensation of pain. In these neurons, the most widely studied targets of extracellular ATP have been ionotropic ATP ▶ (P2X) receptors. Indeed, several P2X receptor subtypes have been identified in sensory neurons, including one (P2X<sub>3</sub>) whose expression is largely confined to these cells (North and Barnard 1997). The importance of widely distributed metabotropic ATP (P2Y) receptors in nociception has been recently reported (Molliver et al. 2002; Zimmermann et al. 2002). In particular, the functional interaction between P2Y receptors and TRPV1 has received much attention because TRPV1 is one of the key molecules detecting nociceptive stimuli and because the signaling pathway downstream of P2Y receptor activation can be applicable for other G<sub>q</sub>-protein coupled receptor activation.

Pretreatment with 100 μM extracellular ATP (an attainable concentration in the context of tissue damage) causes more than 6 times the potentiation of capsaicin (low doses)-evoked current responses in HEK293 cells heterologously expressing TRPV1 channels (Fig. 1a) (Tominaga et al. 2001). A similar potentiating effect of extracellular ATP is observed on proton-evoked activation of TRPV1. The dose-response curves for capsaicin in the presence or absence of ATP demonstrate that ATP enhances capsaicin and proton action on TRPV1 by lowering ▶ EC50 values without altering maximal responses (Fig. 1b). Extracellular ATP also lowers the threshold temperature for TRPV1 activation significantly (from about 43°C to about 35°C) (Fig. 1c). Thus, in the presence of ATP, normally non-painful thermal stimuli (even body temperature) are capable of activating TRPV1. These data show that TRPV1 currents evoked by any of three different stimuli (capsaicin, proton or heat) are potentiated or sensitized by extracellular ATP. Activation of protein kinase C (PKC) by

T



**TRPV1 Modulation by p2Y Receptors, Figure 1** (a) Extracellular ATP (100  $\mu$ M) potentiates capsaicin (CAP)-activated currents in HEK293 cells expressing TRPV1. Whole-cell patch-clamp recordings were carried out with holding potential of -60 mV. Cells were perfused for 2 min with solution containing ATP before re-exposure to capsaicin. (b) Capsaicin dose-response curves for TRPV1 in the absence ( $\lambda$ ) and presence ( $\mu$ ) of 100  $\mu$ M extracellular ATP. Currents were normalized to the currents maximally activated by 1  $\mu$ M capsaicin in the absence of ATP. Figure shows averaged data fitted with the Hill equation.  $EC_{50}$  = 114.7 nM and Hill coefficient = 1.48 in the absence of ATP.  $EC_{50}$  = 49.3 nM and Hill coefficient = 1.56 in the presence of ATP. Values represent the mean  $\pm$  SEM. (c) Reduction of the threshold temperature for TRPV1 activation by extracellular ATP. Representative temperature-response profiles in the absence and presence of 100  $\mu$ M extracellular ATP. Dashed lines show the threshold temperature for heat activation of VR1. Temperature threshold for activation of TRPV1 in the presence of ATP ( $35.3 \pm 0.7^\circ\text{C}$ ) was significantly lower than that in the absence of ATP ( $41.7 \pm 1.1^\circ\text{C}$ ). \*,  $p < 0.001$  (Tominaga et al. 2001).

diacylglycerol (DAG) downstream of P2Y<sub>1</sub> receptors is found to be a mechanism for the ATP-induced potentiation from various pharmacological analyses in HEK293 cells (Fig. 2a), consistent with the report that PKC- $\epsilon$  is specifically involved in sensitization of heat-activated channels by ► bradykinin in dorsal root ganglion (DRG) neurons.

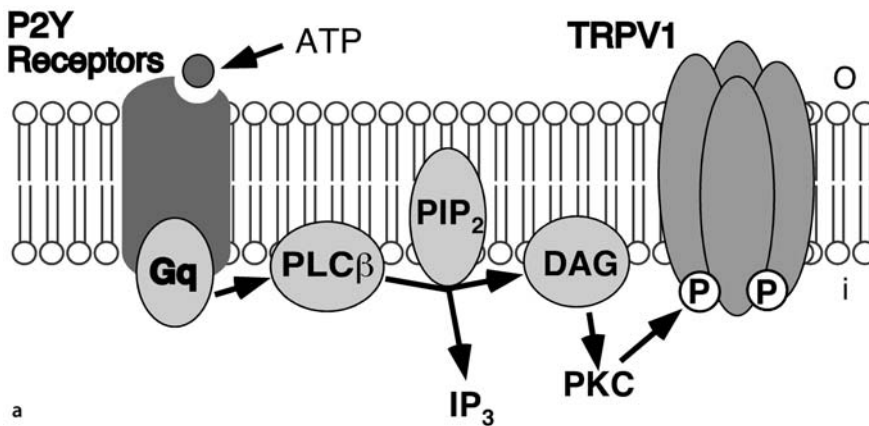
The interaction between ATP and TRPV1 in the context of ATP-induced hyperalgesia *in vivo* is confirmed by a behavioral analysis using wild type mice and TRPV1<sup>-/-</sup> deficient mice (Moriyama et al. 2003). A significant reduction in paw withdrawal latency to radiant paw heating is observed for 5 to 30 min following ATP injection in wild type mice. On the other hand, TRPV1<sup>-/-</sup> deficient mice develop no such thermal hypersensitivity in response to ATP injection, suggesting a functional interaction between ATP and TRPV1 (Fig. 2b). Mice lacking P2Y<sub>1</sub> receptors, a subtype proved to be involved in ATP-induced potentiation of TRPV1 currents in HEK293 cells, showed similar thermal hyperalgesia to wild type mice, indicating that other

P2Y subtypes are involved in ATP-induced thermal hyperalgesia in mice.

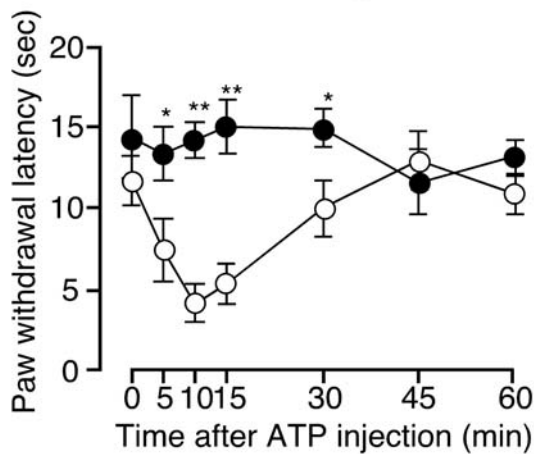
Electrophysiological and pharmacological analyses using DRG neurons of mice revealed that P2Y<sub>2</sub> is a subtype involved in ATP-induced potentiation of TRPV1 currents and ATP-induced thermal hyperalgesia in mice (Moriyama et al. 2003). UTP, a potent P2Y<sub>2</sub> receptor agonist, potentiates the capsaicin-evoked current responses and causes thermal hyperalgesia to a similar extent as ATP in mice, further confirming the involvement of P2Y<sub>2</sub> receptors. P2Y<sub>2</sub> receptor mRNA but not P2Y<sub>1</sub> mRNA is found to be co-expressed with TRPV1 mRNA in the rat lumbar DRG using double *in situ* hybridization, suggesting that P2Y<sub>2</sub>, not P2Y<sub>1</sub> receptors, can functionally interact with TRPV1 in DRG neurons

The data described above suggest that direct phosphorylation of TRPV1 or a closely associated protein by PKC changes the agonist sensitivity of this ion channel. The *in vivo* phosphorylation of TRPV1 by PKC is confirmed in HEK293 cells expressing TRPV1 (Numazaki et al.





a



b

### TRPV1 Modulation by p2Y Receptors, Figure 2

(a) Regulation mechanisms of TRPV1 by P2Y receptors. G<sub>q</sub>-coupled P2Y receptor activation leads to production of IP<sub>3</sub> and DAG through PLCβ. PKC activation by DAG causes phosphorylation of TRPV1, leading to functional potentiation. PLCβ, phospholipase Cβ; DAG, diacylglycerol; IP<sub>3</sub>, inositol 1,4,5-trisphosphate; P, phosphorylation; o and i, outside and inside of cell, respectively. (b) TRPV1 is essential for the development of ATP-induced thermal hypersensitivity *in vivo*. Wild type (γ) or TRPV1<sup>-/-</sup> mice (γ) were injected intraplantarly with ATP (100 nmol), and the response latency to radiant heating of the hind paw was measured at various time points after injection. \* p < 0.05 and \*\* p < 0.01 vs. wild type mice. (Moriyama et al. 2003).

2002). Furthermore, two serine residues as substrates for PKC-dependent phosphorylation, S502 in the first intracellular loop and S800 in the C-terminus, were identified using an *in vitro* kinase assay (Numazaki et al. 2002). A mutant lacking substrates for PKC-dependent phosphorylation (S502A/S800A) exhibited almost no potentiation effects of capsaicin- or proton-evoked current responses by PMA (a direct activator of PKC). Furthermore, the double mutant showed no reduction in temperature threshold for TRPV1 activation, suggesting that the two serine residues are the major substrates for PKC-dependent phosphorylation.

Inflammatory pain is initiated by tissue damage/inflammation and is characterized by hypersensitivity both at the site of damage and in adjacent tissue. One mechanism underlying these phenomena is the modulation (sensitization) of ion channels, such as TRPV1, that detect noxious stimuli at the nociceptor terminal. Sensitization is triggered by extracellular inflammatory mediators that are released *in vivo* from surrounding damaged or inflamed tissue and from nociceptive neurons themselves. Among the mediators, ATP not only potentiates capsaicin- or proton-evoked currents but also lowers the temperature threshold for heat activation of TRPV1, such that normally non-painful thermal stimuli (i.e. normal body temperature) are capable of activating TRPV1,

making ATP act like a direct activator of TRPV1. This represents a novel mechanism through which extracellular ATP may cause inflammatory pain. Most attention in the pain field has focused on the role of ionotropic ATP receptors in ATP-evoked nociception. The above findings suggest that P2Y<sub>2</sub> is also involved in this process and may represent a fruitful target for the development of drugs that blunt nociceptive signaling through capsaicin receptors. P2Y<sub>2</sub> receptors confer responsiveness to uridine triphosphate (UTP) and ATP to a similar extent, suggesting a possible role for UTP as an important component of pro-algesic response in the context of tissue injury. UTP was indeed found to potentiate capsaicin-activated currents and cause thermal hyperalgesia in mice (Moriyama et al. 2003).

These results suggest that activation of similar PKC-dependent events might underlie certain nociceptive effects of other G<sub>q</sub>-coupled metabotropic receptors. Indeed, bradykinin is found to potentiate or sensitize TRPV1 in a similar PKC-dependent pathway through the activation of B<sub>2</sub> receptors (Sugiura et al. 2002).

### References

1. Burnstock G, Williams M (2000) P2 purinergic receptors: modulation of cell function and therapeutic potential. *J Pharmacol Exp Ther* 295:862–869

- Caterina MJ, Schumacher MA, Tominaga M et al. (1997) The capsaicin receptor: a heat-activated ion channel in the pain pathway. *Nature* 389:816–824
- Caterina MJ, Leffler A, Malmberg AB et al. (2000) Impaired nociception and pain sensation in mice lacking the capsaicin receptor. *Science* 288:306–313
- Caterina MJ, Julius D (2001) The vanilloid receptor: a molecular gateway to the pain pathway. *Annu Rev Neurosci* 24:487–517
- Davis, J.B., Gray, J., Gunthorpe, M.J et al. (2000) Vanilloid receptor-1 is essential for inflammatory thermal hyperalgesia. *Nature* 405:183–187
- McCleskey EW, Gold MS (1999) Ion channels of nociception. *Annu Rev Physiol* 61:835–856
- Molliver DC, Cook SP, Carlsten JA et al. (2002) ATP and UTP excite sensory neurons and induce CREB phosphorylation through the metabotropic receptor, P2Y<sub>2</sub>. *Eur J Neurosci* 16:1850–1860
- Moriyama T, Iida T, Kobayashi K et al. (2003) Possible involvement of P2Y<sub>2</sub> metabotropic receptors in ATP-induced transient receptor potential vanilloid receptor<sup>1</sup>-mediated thermal hypersensitivity. *J Neurosci* 23:6058–6062
- North AN, Barnard EA (1997) Nucleotide receptors. *Curr Opin Neurobiol* 7:346–357
- Numazaki M, Tominaga T, Toyooka H et al. (2002) Direct phosphorylation of capsaicin receptor VR1 by PKC $\epsilon$  and identification of two target serine residues. *J Biol Chem* 277:13375–13378
- Sugiura T, Tominaga M, Katsuya H et al. (2002) Bradykinin lowers the threshold temperature for heat activation of vanilloid receptor 1. *J Neurophysiol* 88:544–548
- Szallasi A, Blumberg PM (1999) Vanilloid (capsaicin) receptors and mechanisms. *Pharmacol Rev* 51:159–211
- Tominaga M, Caterina MJ, Malmberg AB et al. (1998) The cloned capsaicin receptor integrates multiple pain-producing stimuli. *Neuron* 21:531–543
- Tominaga M, Wada M, Masu M (2001) Potentiation of capsaicin receptor activity by metabotropic ATP receptors as a possible mechanism for ATP-evoked pain and hyperalgesia. *Proc Natl Acad Sci USA* 98:6951–6956
- Zimmermann K, Reeh PW, Aeverbeck B (2002) ATP can enhance the proton-induced CGRP release through P2Y receptors and secondary PGE(2) release in isolated rat dura mater. *Pain* 97:259–265

## TRPV1 Modulation by PKC

PETER A. MCNAUGHTON  
Department of Pharmacology, University of  
Cambridge, Cambridge, UK  
pam42@cam.ac.uk

### Synonyms

VR1; PKC; protein kinase C; TRPV1 Modulation by PKC

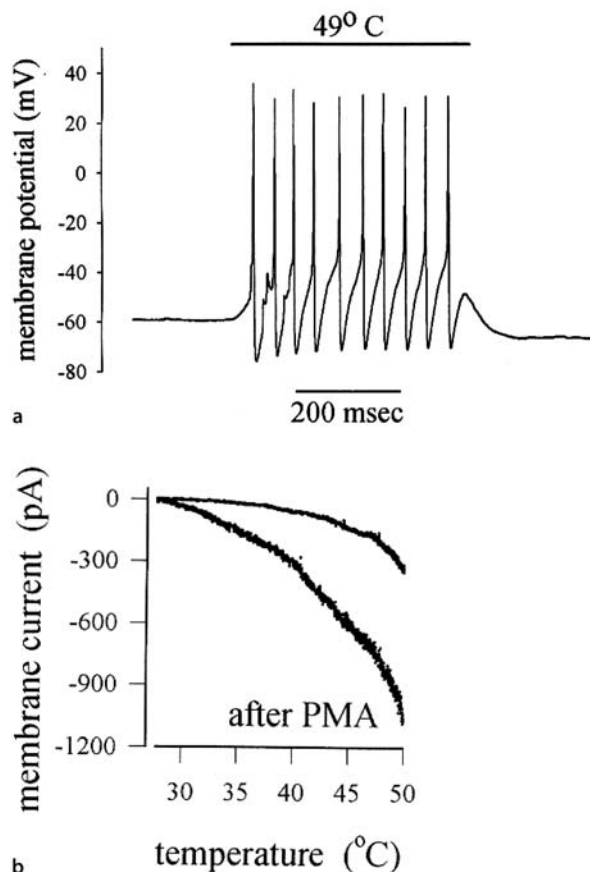
### Definition

TRPV1 is an ion channel located in the surface membrane of pain-sensitive nerve terminals or nociceptors, which is activated by capsaicin, heat and protons. TRPV1 when open conducts electric charge, in the form of cations (mainly Na<sup>+</sup> and Ca<sup>2+</sup>) and therefore makes the interior of the nociceptor more positive, leading to the generation of action potentials. The temperature threshold of TRPV1 is lowered when inflammatory mediators such as bradykinin or ATP interact with surface membrane receptors on nociceptive nerve terminals and

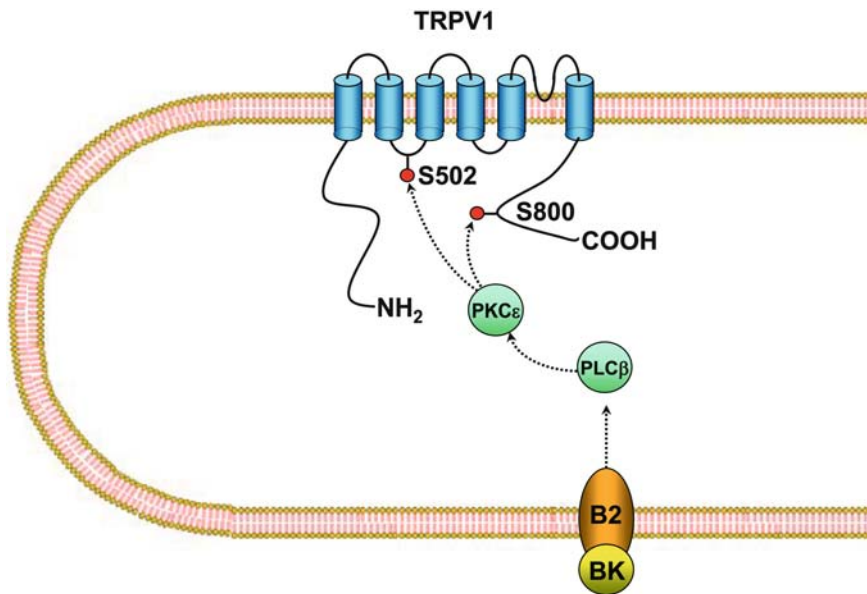
so the nerve terminal becomes hyperalgesic (hypersensitive to heat pain). Many inflammatory mediators act by stimulating an intracellular enzyme known as protein kinase C (a member of the large kinase family of enzymes), which attach phosphate groups to specific locations on the portion of the TRPV1 protein exposed to the intracellular milieu of the nociceptor terminal.

### Characteristics

A role for PKC in nociceptor sensitization was first suspected in studies of the potent sensitizing agent bradykinin, a pro-inflammatory nonapeptide which is released from a larger precursor protein by proteolytic cleavage following tissue damage (Dray and Perkins 1993). Bradykinin is one of the most potent pain-producing substances known, and as well as causing pain directly, it acts as a sensitising agent which lowers the temperature threshold for the activation of heat pain



**TRPV1 Modulation by PKC, Figure 1** Action potentials and generator currents elicited in a nociceptive neuron by a noxious heat stimulus. (a) Application of a 49°C heat stimulus depolarizes a nociceptive neuron to threshold and elicits a train of action potentials. This temperature did not damage the neuron as repeated application of the stimulus gave similar results. (b) Dependence of the membrane current on temperature in a heat-sensitive neuron before and after activation of PKC by phorbol myristate acetate (PMA), a PKC-specific activator. After activation of PKC the activation threshold shifts to lower temperatures and the magnitude of the current increases.



**TRPV1 Modulation by PKC, Figure 2** Pathways leading to heat hyperalgesia. Binding of bradykinin to its receptor activates PLC $\beta$ , which in releases DAG from PIP $_2$ , leading to activation of PKC $\epsilon$ , which in turn phosphorylates TRPV1 at two serine residues, leading to the lowering of heat threshold shown in Fig. 1b.

*in vivo* (Mizumura and Kumazawa 1996). In isolated nociceptive neurons action potentials are elicited by heat stimuli (Fig. 1a), just as they are *in vivo*, and the inward membrane current responsible can be recorded using the whole-cell voltage clamp technique (Fig. 1b). The properties of the heat-gated ion current, such as its threshold and dependence on temperature, closely correspond to those of heat pain *in vivo* (Cesare and McNaughton 1996). Bradykinin is a potent agonist at the G-protein coupled B2 receptor, leading to activation of G $_q$  and phospholipase C  $\beta$  (PLC $\beta$ ), followed by metabolism of phosphatidylinositol bisphosphate (PIP $_2$ ) and release of diacylglycerol (DAG) and inositol trisphosphate (IP $_3$ ). These two products have different actions: DAG activates protein kinase C (PKC) while IP $_3$  releases calcium from intracellular organelles. The critical member of this cascade which is responsible for causing sensitization of the heat-gated membrane current is PKC, because the sensitising effects of bradykinin are mimicked by direct PKC activation (Fig. 1b), are antagonized by PKC inhibitors such as staurosporine and are promoted by phosphatase inhibitors such as calyculin A (Cesare and McNaughton 1996; Cesare and McNaughton 1997).

TRPV1 is activated by heat stimuli, and is the molecule responsible for the heat hyperalgesia caused by inflammation, because no heat hyperalgesia is seen in animals from which TRPV1 has been genetically deleted (Davis et al. 2000; Caterina et al. 2000). Two main models have been proposed for the molecular basis of this hyperalgesia. In experiments on isolated neurons (see above) PKC has been identified as a critical mediator of heat hyperalgesia. PKC acts by phosphorylating serine or threonine residues on its target proteins and phosphorylation sites relevant for the process of sensitisation have been identified by the use of site-directed mutagenesis

of individual serine or threonine residues, followed by expression of the mutant TRPV1 in a heterologous expression system (Numazaki et al. 2002). Mutation of two serines to alanine, which cannot be phosphorylated, abolished sensitization following PKC activation (Fig. 2). The isoform of PKC responsible has also been identified (Cesare et al. 1999). Of the eleven known isoforms of PKC only five, namely PKC $\beta$ I,  $\beta$ II,  $\delta$ ,  $\epsilon$  and  $\zeta$ , are expressed to any significant extent in sensory neurons and of these only PKC $\epsilon$  is translocated to the membrane following exposure to bradykinin, suggesting that it is this isoform which is responsible for sensitization of TRPV1. A central role for PKC $\epsilon$  in sensitization was confirmed by showing that constitutively active PKC $\epsilon$  incorporated into the cell was indeed capable of sensitising the heat-gated current, and that the incorporation of a specific PKC $\epsilon$  inhibitor into the cell largely abolished sensitisation (Cesare et al. 1999). A specific role for PKC $\epsilon$  in nociceptor sensitization is also suggested by the reduced heat hyperalgesia seen in studies using PKC $\epsilon$  knockout mice (Khasar et al. 1999). The model of specific phosphorylation of TRPV1 by PKC $\epsilon$  is shown in outline in Fig. 2.

In an alternative model (Chuang et al. 2001) TRPV1 is proposed to be tonically inhibited by PIP $_2$  in the neuronal cell membrane. Removal of PIP $_2$ , when bradykinin activates PLC $\beta$ , is then proposed to release TRPV1 from inhibition. This model is supported by experiments in which application of PLC $\beta$  to isolated membrane patches in order to break down PIP $_2$ , or removal of PIP $_2$  with an antibody, potentiated gating of TRPV1 (Chuang et al. 2001). The proposal also draws on work carried out on other ion channels, particularly on inward rectifier potassium channels, where a modulation of ion channel function by PIP $_2$  is well established (Hilgemann 2003). It has yet to be clearly established

whether this mechanism plays an important role in TRPV1 sensitization, but the observations cited above suggest that it plays at most a minor role by comparison with the PKC $\epsilon$  pathway summarized in Fig. 2.

## References

1. Caterina MJ, Leffler A, Malmberget AB et al. (2000) Impaired nociception and pain sensation in mice lacking the capsaicin receptor. *Science* 288:306–313
2. Cesare P, McNaughton PA (1996) A novel heat-activated current in nociceptive neurons, and its sensitization by bradykinin. *Proc Natl Acad Sci USA* 93:15435–15439
3. Cesare P, McNaughton PA (1997) Peripheral pain mechanisms. *Curr Opin Neurobiol* 7:493–499
4. Cesare P, Dekker LV, Sardini A et al. (1999) Specific involvement of PKC-epsilon in sensitization of the neuronal response to painful heat. *Neuron* 23:617–624
5. Chuang HH, Prescott ED, Kong H et al. (2001) Bradykinin and nerve growth factor release the capsaicin receptor from PtdIns(4,5)P2-mediated inhibition. *Nature* 411:957–962
6. Davis JB, Gray J, Gunthorpe MJ et al. (2000) Vanilloid receptor-1 is essential for inflammatory thermal hyperalgesia. *Nature* 405:183–187
7. Dray A, Perkins M (1993) Bradykinin and inflammatory pain. *Trends Neurosci* 16:99–104
8. Hilgemann DW (2003) Getting ready for the decade of the lipids. *Annu Rev Physiol* 65:697–700
9. Khasar SG, Lin Y-H, Martin A et al. (1999) A novel nociceptor signaling pathway revealed in protein kinase c epsilon mutant mice. *Neuron* 24:253–260
10. Mizumura K, Kumazawa T (1996) Modification of nociceptor responses by inflammatory mediators and second messengers implicated in their action – A study in canine testicular polymodal receptors. *Prog Brain Res* 113:115–141
11. Numazaki M, Tominaga T, Toyooka H et al. (2002) Direct phosphorylation of capsaicin receptor VR1 by protein kinase C $\epsilon$  and identification of two target serine residues. *J Biol Chem* 277:13375–13378

## TRPV1 Modulation by PKC

- ▶ TRPV1 Modulation by PKC

## TRPV1-Null Mice

### Definition

Mice that have a disruption of the TRPV1 gene. These mice lack expression of the TRPV1 protein and have no response to capsaicin.

- ▶ IB4-Positive Neurons, Role in Inflammatory Pain

## TRPV1 Receptor

- ▶ TRPV1

## TRPV1 Receptor, Modulation by P2Y Receptors

- ▶ TRPV1 Modulation by p2Y Receptors

## TRPV1 Receptor, Species Variability

PETER MCINTYRE

Department of Pharmacology, University of Melbourne, Melbourne, VIC, Australia  
pmci@unimelb.edu.au

### Synonyms

Transient receptor potential cation channel, subfamily V, member 1; TRPV1; Capsaicin receptor; Vanilloid Receptor Subtype 1; VR1

### Definition

TRPV1 is a non-specific cation channel of the ▶ [transient receptor potential](#) protein family, which is expressed in ▶ [polymodal sensory neurons](#) in the peripheral sensory nervous system and is activated by noxious heat (>43°C), pH below 6.5, capsaicin, the pungent ingredient of chili peppers, resiniferatoxin and a number of other vanilloid, phorbol-related compounds as well as the endogenous activators anandamide and some products of lipoxygenase action on arachidonic acid.

### Characteristics

#### Relatives of TRPV1

TRPV1 is a non-selective cation channel with high calcium permeability. It has a long cytoplasmic N-terminal tail with 3 ankyrin repeats and 6 hydrophobic domains (termed S1–S6 here) which may be transmembrane domains and a putative pore-forming region between S5 and S6. It is a member of the superfamily of ion channels with six hydrophobic transmembrane domains and a putative pore-forming loop between the last two hydrophobic domains. This superfamily includes the voltage activated potassium channels, hyperpolarization and cyclic nucleotide gated channels (HCN) and the transient receptor potential (TRP) ion channels, which are involved in many sensory processes.

#### Splice Variants

TRPV1 was first isolated by expression cloning from rat sensory neurons (Caterina et al. 1997) and has subsequently been isolated from human (McIntyre et al. 2001; Cortright et al. 2001; Hayes et al. 2000), guinea pig (Savidge et al. 2002), mouse (Accession number AJ620495), rabbit (Accession number AY487342) and chicken (Jordt and Julius 2002) sources and partial se-



quences are available from gene predictions from dog and zebrafish. Cloning and sequencing of the human and mouse genes has shown that the *trpv1* gene has 16 exons in mouse and human predicted by Ensembl with 15 coding exons and that there are four splice variants of mRNA. The TRPV1 gene is found at position 17p13.2 in the human genome and in a highly **▶ syntenic** region on chromosome 10 in the rat genome (Xue et al. 2001) and chromosome 11 in the mouse genome (Caterina et al. 2000). The predicted protein size is 839 amino acids in human, guinea pig and mouse (~95 kD), 838 amino acids in rat, 842 in the rabbit and 843 (96.5 kD) in chicken. The rat protein can be glycosylated at asparagine 604, migrates with a higher apparent molecular mass in its glycosylated form and can form tetramers that are likely to be the functional form of the channel (Kedei et al. 2001).

An N-terminal splice variant, with most of the ankyrin domains and the cytoplasmic tail missing, has been observed (Schumacher et al. 2000b). The transcript termed VR.5'sv is not functional but the protein is expressed in rat kidney and this splice variant is expressed at low levels in dorsal root ganglia compared to TRPV1 (Sanchez et al. 2001). The importance of this transcript, if any, is still not understood but it appears that an intact N-terminus is essential for TRPV1 to be functional. An earlier report of a TRPV1 transcript termed stretch-inhibited channel (SIC) with differences at both C- and N-termini (Schumacher et al. 2000a) seems to be derived from two independent genes and is unlikely to be a functional TRPV1 transcript (Xue et al. 2001).

#### Single Nucleotide Polymorphism

One non-synonymous **▶ single nucleotide polymorphism** resulting in the amino acid substitution from valine to isoleucine at position 585 has been reported in the human TRPV1 sequence (Hayes et al. 2000). Genotyping of DNA from 123 randomly selected, mixed race individuals, showed that 51% of the population are heterozygous, the homozygous valine-encoding allele occurs in 15% and the homozygous isoleucine-encoding allele occurs in 34% of the population. These

TRPV1 alleles both give rise to functional channels with no reported differences in pharmacology (Hayes et al. 2000).

#### Protein Sequence Alignment

Alignment of the predicted proteins using Clustal W shows that the highest variation occurs at the N- and C-terminal regions of the protein and within the putative pore region. Overall homology scores (Table 1) show that rat and mouse sequences have most identity (94.9%) and that apart from these closely related sequences, the mammalian proteins determined so-far share between 85.7% and 88.5% identity. The mammalian proteins have between 64% and 66% identity to the chicken protein.

#### Pharmacological Differences

##### Agonists

The most extreme example of variation in pharmacological characteristics of TRPV1 is between the rat and chicken **▶ orthologues**. Primary sensory neurons from chicks are responsive to heat (~45°C) and low pH (pH 4) but not capsaicin (Marin-Burgin et al. 2000). The cloned chicken TRPV1 has these properties when expressed in *Xenopus* oocytes or mammalian cells (Jordt and Julius 2002). Jordt and Julius showed, using chimeric receptors, that the molecular determinants for this difference lay in sequence within the S3 and S4 regions; specifically residues responsible for capsaicin sensitivity are tyrosine 511 and serine 512, whereas arginine 491 was shown to modulate the ratio of capsaicin-evoked current to pH-evoked current in electrophysiological experiments. Differences in agonist sensitivity have been found within TRPV1 from mammalian species. The rabbit TRPV1 is unresponsive to capsaicin and substitution of threonine 553 for isoleucine is largely responsible for this phenotype (Gavva et al. 2003). Rat TRPV1 responds well to the agonist phorbol 12-phenylacetate 13-acetate 20-homovanillate (PPAHV) but the human (McIntyre et al. 2001) and guinea pig (Savidge et al. 2002) channels do not. This difference has been mapped to a single conservative amino acid change. Mutation of leucine 457

T

**TRPV1 Receptor, Species Variability, Table 1** TRPV1 percent amino acid identity (top triangle) and divergence (lower triangle) calculated using Clustal W

	rat	mouse	rabbit	human	guinea pig	chicken
rat	***	94.9	86.9	85.7	88.0	65.8
mouse	5.1	***	88.0	86.3	88.5	66.0
rabbit	14.2	13.0	***	88.0	87.5	65.2
human	15.4	14.5	13.0	***	86.5	64.0
guinea pig	12.6	12.3	13.6	14.3	***	66.0
chicken	41.0	40.9	41.3	43.1	40.7	***

```

rat          -----MEQRASLDSEES---ESPPQENSCLDPPDRDPNCKPPVVKPHIFTT-RSRTR
mouse       -----MEKwasLSDSDS---EPPAQENSCDPPDRDPNSKPPPAKPHIFAT-RSRTR
guinea pig  -----MKKRASVDSKES---EDPPQEDYSLDTLDVDANSKTPPAKPHITFSVSKSRNR
rabbit      -----MKRWVSLDSGES---EDPLPEDTCDPLLDGDSNAKPPPAKPHIFSTAKSRSR
human       -----MKKWSSTDLGAA---ADPLQKDTCPDPLDGPNSRPPPAKP-QLSTAKSRTR
chicken     MSSILEKMKKFGSSDIEESEVTDEHTDGEDSALETADNLQGTFSNKVQPSKSNIFARRGR
           *:: * * : . :: : * . . .:* * *

rat          LFGKGDSEEA SPLDCPYEEGGLASCPIITVSSVLTIQRPDGPASVRPSSQDSVSAG--E
mouse       LFGKGDSEEA SPMDCPYEEGGLASCPIITVSSVVTLQRSVDGPTCLRQTSQDSVSTG-VE
guinea pig  LFGKSDLEESSPIDCSFREGEAASCPTITVSSVVTSPRPADGPTSTRQLTQDSIPTSAE
rabbit      LFGKGDSEETS PMDCSYEEGELAPCPAITVSSVIIVQRSGDGPFCARQLSQDSVAAAGAE
human       LFGKGDSEEA FVDCPHEEGELDSCPTITVSPVITIQRPDGPFGARLLSQDSVAAS-TE
chicken     FVMGDCDKDMPMSDFYQMD-----HLMAPSVIKFHANMERGKLLKLLSTDSITGC-SE
           :. : : * : . . . : . . * : : : * : * : * : * : *

rat          KPRLYDRRSIFDAVAQSNQCQELSLPFLQSKKRLTDFEFDKDPETGKTCLLKAMLNLH
mouse       TPRLYDRRSIFDAVAQSNQCQELSLPFLQSKKRLTDFEFDKDPETGKTCLLKAMLNLH
guinea pig  KPLKFYDRRSIFDAVAQNNCQDLSDLPFLQSKKRLTDFEFDKDPETGKTCLLKAMLNLH
rabbit      KPLKLYDRRSIFDAVAQNNCQELSLPFLQSKKRLTDFEFDKDPETGKTCLLKAMLNLH
human       KTLRLYDRRSIFDAVAQNNCQDLSDLPFLQSKKRLTDFEFDKDPETGKTCLLKAMLNLH
chicken     KAFKFYDRRSIFDAVARGSTKDLDDL LYLNR LTKHLTDFEFDKDPETGKTCLLKAMLNLH
           .. : : * * * * : : * : * : * : * : * : * : * : * : * : * : *

rat          NGQNDTIALLLDVARKTDSLKQFVNASYTDSYKQGTALHIAIERRNMTLVTLVENGAD
mouse       NGQNDTIALLLDIARKTDSLKQFVNASYTDSYKQGTALHIAIERRNMTLVTLVENGAD
guinea pig  NGQNDTISLLLDIARQTNLSLKEFVNASYTDSYKQGTALHIAIERRNMTLVTLVENGAD
rabbit      SGQNDTIPLLLEIARQTNLSLKEFVNASYTDSYKQGTALHIAIERRNMTLVTLVENGAD
human       DGQNTTIPLLLEIARQTNLSLKEFVNASYTDSYKQGTALHIAIERRNMTLVTLVENGAD
chicken     DGKNDTIPLLLDIAKKTGTLKEFVNAEYTDNYYKQGTALHIAIERRNMTLVTLVQNGAD
           . * : * * * * : : * : * : * : * : * : * : * : * : * : * : *

rat          VQAAANGDFPFKKTGRPGFYFGELPLSLAACTNQLAIVKFLQNSWQPADISARDSVGNT
mouse       VQAAANGDFPFKKTGRPGFYFGELPLSLAACTNQLAIVKFLQNSWQPADISARDSVGNT
guinea pig  VQAAANGDFPFKKTGRPGFYFGELPLSLAACTNQLAIVKFLQNSWQPADISARDSVGNT
rabbit      VQAAANGDFPFKKTGRPGFYFGELPLSLAACTNQLAIVKFLQNSWQPADISARDSVGNT
human       VQAAAHGDFPFKKTGRPGFYFGELPLSLAACTNQLGIVKFLQNSWQPADISARDSVGNT
chicken     VHARACGEFFRKKIKGKPGFYFGELPLSLAACTNQLCIVKFLLENPYQAADIAAEDSMGNM
           * : * * * : * * * : * : * : * : * : * : * : * : * : * : * : *

rat          VLHALVEADVNTKFDVNTSMYNEILILGAKLHPTLKLEELTNKGLTPLALAASSGKI
mouse       VLHALVEADVNTADNTKFDVNTSMYNEILILGAKLHPTLKLEELTNKGLTPLALAASSGKI
guinea pig  VLHALVEADVNTADNTKFDVNTSMYNEILILGAKLYPTLKLEELTNKGLTPLALAASSGKI
rabbit      VLHALVEADVNTADNTKFDVNTSMYNEILILGAKLHPTLKLEELTNKGLTPLALAASSGKI
human       VLHALVEADVNTADNTKFDVNTSMYNEILILGAKLHPTLKLEELTNKGLMPLALAAGTGKI
chicken     VLHTLVEIADNTKFDVNTSMYNEILILGAKINPILKLEELTNKGLTPLTAAKTGKI
           * * : * * : * * * : * * * : * : * : * : * : * : * : * : *

rat          GVLAYILQREIHEPECRHLSRKFTWAYGPHVSSLYDLSCIDTCEKNSVLEVIAYSSSET
mouse       GVLAYILQREIHEPECRHLSRKFTWAYGPHVSSLYDLSCIDTCEKNSVLEVIAYSSSET
guinea pig  GVLAYILQREIPEPECRHLSRKFTWAYGPHVSSLYDLSCIDTCEKNSVLEVIAYSSSET
rabbit      GVLAYILQREIHEPECRHLSRKFTWAYGPHVSSLYDLSCIDTCEKNSVLEVIAYSSSET
human       GVLAYILQREIQEPECRHLSRKFTWAYGPHVSSLYDLSCIDTCEKNSVLEVIAYSSSET
chicken     GIFAYILRREIKDPECRHLSRKFTWAYGPHVSSLYDLSCIDTCEKNSVLEVIAYSS-ET
           * : : * * * : * * * : * * * : * * * : * * * : * * * : * * * : * *

rat          PNRHDMLLVEPLNRLLDQKWDKRVKRIFYFNFFVYCLYMIIFTAAAYRVEG--LPPYK
mouse       PNRHDMLLVEPLNRLLDQKWDKRVKRIFYFNFFVYCLYMIIFTAAAYRVEG--LPPYK
guinea pig  PNRHDMLLVEPLNRLLDQKWDKRVKRIFYFNFFVYCLYMIIFTAAAYRVPVDG--LPPYK
rabbit      PNRHDMLLVEPLNRLLDQKWDKRVKRIFYFNFFVYCLYMIIFTAAAYRVPVDG--LPPYK
human       PNRHDMLLVEPLNRLLDQKWDKRVKRIFYFNFLVYCLYMIIFTAAAYRVPVDG--LPPFK
chicken     PNRHEMLLVEPLNRLLDQKWDKRVKHLFYFNFFVYAIHISILTTAAAYRVPVQKGDKPPFA
           * * * : * * * : * * * : * : * : * : * : * : * : * : * : * : *
    
```

S1

**TRPV1 Receptor, Species Variability, Figure 1** Alignment of the available predicted full-length proteins using Clustal W (DNASTar). Predicted ankyrin repeat regions are shaded grey and hydrophobic transmembrane domains are underlined and marked S<sup>1</sup>–S6. The most conserved regions are the hydrophobic domains which are thought to be buried in the membrane and the least conserved regions are the N-terminal and C-terminal regions and the proximal part of the putative pore region between S5 and S6.

to methionine enables the human TRPV1 to respond to PPAHV (Phillips et al. 2004).

**Antagonists**

There is a pharmacological difference in the ability of capsaizepine to antagonize the low pH and heat activation of the rat TRPV1 (McIntyre et al. 2001). Whereas it blocks these modalities well in human and guinea pig TRPV1, it has little or no effect on these modalities in rat

TRPV1. The residues responsible for this change were mutated to the human equivalents and restored the phenotype and thus the difference was mapped to amino acids isoleucine 514, valine 518 and methionine 547 in the rat TRPV1.

In summary, several groups have shown that residues between hydrophobic domains S2 and S4 are important in recognition of agonists and antagonists and that small variations in sequence can have significant effects on the pharmacology of this ion channel.



```

rat          -----MEQRASLDSEES----ESPPEQENSCLDPPDRDPNCKPPPVKPHIFTT-RSRTR
mouse       -----MEKWASLDSDDES----EPPAQENSCLDPPDRDPNCKPPPVKPHIFAT-RSRTR
guinea pig  -----MKKRASVDSKES----EDPPQEDYSLDTLVDVANSKTPPAKPHTFVSVKSRNR
rabbit      -----MKRWVSLDSGES----EDPLPEDTCDPLLDGDSNAKPPPAPKPHIFSTAKSRSR
human       -----MKKWSSTDLGAA----ADPLQKDTCPDPLDGDPSNRPPPAPK-QLSTAKSRTR
chicken     MSSILEKMKKFGSSDIEESEVTDEHTDGEDSALEATADNLQGTFSNKVQPSKSNIFARRGR
           *:: ** : . :: : * . . :.* **

rat          LFGKGDSEASPLDCPYEEGGLASCPITVSSVLTIQRPDGPASVRPSSQDSVSAG--E
mouse       LFGKGDSEASPMDCPYEEGGLASCPITVSSVLTQRSVDGPTCLRQTSQDSVSTG-VE
guinea pig  LFGKSDLEESSPIDCSFREGEAASCPTITVSSVVTSPRPADGPTSTRQLTQDSIPT- AE
rabbit      LFGKGDSEETS PMDCSYEEGELAPCPAITVSSVIIVQRSGDGPTCARLQSDSVAAAGAE
human       LFGKGDSEEAFPVDCPHEEGELDSCPTITVSPVITIQRPDGPARGARLLSQDSVAAS-TE
chicken     FVMGDCKDMAPMDSFYQMD-----HLMAPSVIKPHANMERGKHLKLLSTDSITGC-SE
           .. . :: *:*.. . : ...* : : : **.. *

rat          KPPRLYDRRSIFDAVAQSNQCQELLESLLPFLQRSKKRLTDFEFDKDPETGKTCLLKAMNLH
mouse       TPPRLYDRRSIFDAVAQSNQCQELLESLLPFLQRSKKRLTDFEFDKDPETGKTCLLKAMNLH
guinea pig  KPLKFDYRRSIFDAVAQNNCQDLDSLLPFLQRSKKRLTDFEFDKDPETGKTCLLKAMNLH
rabbit      KPLKLYDRRSIFDAVAQNNCQELLESLLPFLQRSKKRLTDFEFDKDPETGKTCLLKAMNLH
human       KTLRLYDRRSIFDAVAQNNCQDLLESLLPFLQRSKKRLTDFEFDKDPETGKTCLLKAMNLH
chicken     KAFKFDYRRSIFDAVARGSTKDLDDLLLYLNRTLKHLTDFEFDKDPETGKTCLLKAMNLH
           .. :***** **:*:*.. :*:** :*:: *:* ** *:*:*****

rat          NGQNDTIALLLDVARKTDSLKQFVNASYTDSYKQGQ TALHIAIERRNMTLVTLVENGAD
mouse       NGQNDTIALLLDIARKTDSLKQFVNASYTDSYKQGQ TALHIAIERRNMTLVTLVENGAD
guinea pig  NGQNDTIALLLDIARQTNLSLKEFVNASYTDSYRQGQ TALHIAIERRNMTLVTLVENGAD
rabbit      SGQNDTIALLLDIARQTNLSLKEFVNASYTDSYKQGQ TALHIAIERRNMTLVTLVENGAD
human       DGQNTTIALLLDIARQTNLSLKEFVNASYTDSYKQGQ TALHIAIERRNMTLVTLVENGAD
chicken     DGKNDTIALLLDIARQTNLSLKEFVNASYTDSYKQGQ TALHIAIERRNMTLVTLVENGAD
           .:* * **:*:*:*.::*:*:*:*:*:*:*:*:*:*:*:*:*:*:*:*:*:*:*:*

rat          VQAAANGDFFKTKGRPGFYFGEPLSLAACTNQLAIVKFLQNSWQPADISARDSVGN
mouse       VQAAANGDFFKTKGRPGFYFGEPLSLAACTNQLAIVKFLQNSWQPADISARDSVGN
guinea pig  VQAAANGDFFKTKGRPGFYFGEPLSLAACTNQLAIVKFLQNSWQPADISARDSVGN
rabbit      VQAAANGDFFKTKGRPGFYFGEPLSLAACTNQLAIVKFLQNSWQPADISARDSVGN
human       VQAAANGDFFKTKGRPGFYFGEPLSLAACTNQLGIVKFLQNSWQPADISARDSVGN
chicken     VHARACGDFFRKIKGKPGFYFGEPLSLAACTNQLCIVKFLLENPYQAADIAEDSMGNM
           *:* * **:*:*:*.::*:*:*:*:*:*:*:*:*:*:*:*:*:*:*:*:*:*:*:*

rat          VLHALVEADNTVDNPKFVTSMYNEILILGAKLHPTLKLEELTNKGLTPLALAASSGKI
mouse       VLHALVEADNTADNPKFVTSMYNEILILGAKLHPTLKLEELTNKGLTPLALAASSGKI
guinea pig  VLHALVEADNTADNPKFVTSMYNEILILGAKLYPTLKLEELTNKGLTPLALAASSGKI
rabbit      VLHALVEADNTADNPKFVTSMYNEILILGAKLHPTLKLEELTNKGLTPLALAASSGKI
human       VLHALVEADNTADNPKFVTSMYNEILILGAKLHPTLKLEELTNKGLTPLALAASSGKI
chicken     VLHTLVEADNTADNPKFVTKMYNNILILGAKINPILKLEELTNKGLTPLALAASSGKI
           ***:*:*:* **:*:*:*:*:*:*:*:*:*:*:*:*:*:*:*:*:*:*:*:*

rat          GVLAYILQREIHEPECRHLSRKFTWEAYGPVHSSLYDLSCIDTCEKNSVLEVIAYSSSET
mouse       GVLAYILQREIHEPECRHLSRKFTWEAYGPVHSSLYDLSCIDTCEKNSVLEVIAYSSSET
guinea pig  GVLAYILQREIHEPECRHLSRKFTWEAYGPVHSSLYDLSCIDTCEKNSVLEVIAYSSSET
rabbit      GVLAYILQREIHEPECRHLSRKFTWEAYGPVHSSLYDLSCIDTCEKNSVLEVIAYSSSET
human       GVLAYILQREIHEPECRHLSRKFTWEAYGPVHSSLYDLSCIDTCEKNSVLEVIAYSSSET
chicken     GIFAYILRREIKDPECRHLSRKFTWEAYGPVHSSLYDLSCIDTCEKNSVLEVIAYSS-ET
           *:*:*:*:* **:*:*:*:*:*:*:*:*:*:*:*:*:*:*:*:*:*:*:*:*

rat          PNRHDMLLVEPLNRLQDKWDRFVKRIFYFNFFVYCLYMIIFTAAAYRPVGG--LPPYK
mouse       PNRHDMLLVEPLNRLQDKWDRFVKRIFYFNFFVYCLYMIIFTAAAYRPVGG--LPPYK
guinea pig  PNRHDMLLVEPLNRLQDKWDRFVKRIFYFNFFVYCLYMIIFTAAAYRPVGG--LPPYK
rabbit      PNRHDMLLVEPLNRLQDKWDRFVKRIFYFNFFVYCLYMIIFTAAAYRPVGG--LPPYK
human       PNRHDMLLVEPLNRLQDKWDRFVKRIFYFNFFVYCLYMIIFTAAAYRPVGG--LPPYK
chicken     PNRHDMLLVEPLNRLQDKWDRFVKHLYFNFFVYAIHISILTTAAAYRPVQKGDKPPFA
           ****:*:*:*:* **:*:*:*:*:*:*:*:*:*:*:*:*:*:*:*:*:*:*:*:*

```

S1

TRPV1 Receptor, Species  
Variability, Figure 1 (continued)

## References

- Caterina MJ, Schumacher M, Tominaga M et al. (1997) The capsaicin receptor: a heat-activated ion channel in the pain pathway. *Nature* 389:816–824
- Caterina MJ, Leffler A, Malmberg AB et al. (2000) Impaired nociception and pain sensation in mice lacking the capsaicin receptor. *Science* 288:306–313
- Cortright DN, Crandall M, Sanchez JF et al. (2001) The tissue distribution and functional characterization of human VR1. *Biochem Biophys Res Commun* 281:1183–1189
- Gavva NR, Klionsky L, Qu Y et al. (2003) Molecular determinants of capsaicin sensitivity in rabbit TRPV1. *Society for Neuroscience Abstracts* 811.12
- Hayes P, Meadows HJ, Gunthorpe MJ et al. (2000) Cloning and functional expression of a human orthologue of rat vanilloid receptor-1. *Pain* 88:205–215
- Jordt SE, Julius D (2002) Molecular basis for species-specific sensitivity to “hot” chili peppers. *Cell* 108:421–430
- Kedei N, Szabo T, Lile JD et al. (2001) Analysis of the native quaternary structure of vanilloid receptor 1. *J Biol Chem* 276:28613–28619

T

8. Marin-Burgin A, Reppenhagen S, Klusch A et al. (2000) Low-threshold heat response antagonized by capsazepine in chick sensory neurons, which are capsaicin-insensitive. *Eur J Neurosci* 12:3560–3566
9. McIntyre P, McLatchie LM, Chambers A et al. (2001) Pharmacological differences between the human and rat vanilloid receptor 1 (VR1). *Br J Pharmacol* 132:1084–1094
10. Phillips E, Reeve A, Bevan S et al. (2004) Identification of species-specific determinants of the action of the antagonist capsazepine and the agonist PPAHV on TRPV1. *J Biol Chem* 279:17165–17172
11. Sanchez JF, Krause JE, Cortright DN (2001) The distribution and regulation of vanilloid receptor VR1 and VR1 5' splice variant RNA expression in rat. *Neuroscience* 107:373–381
12. Savidge J, Davis C, Shah K et al. (2002) Cloning and functional characterization of the guinea pig vanilloid receptor 1. *Neuropharmacology* 43:450–456
13. Schumacher MA, Jong BE, Frey SL et al. (2000a) The stretch-inactivated channel, a vanilloid receptor variant, is expressed in small-diameter sensory neurons in the rat. *Neurosci Lett* 287:215–218
14. Schumacher MA, Moff I, Sudanagunta SP et al. (2000b) Molecular cloning of an N-terminal splice variant of the capsaicin receptor. Loss of N-terminal domain suggests functional divergence among capsaicin receptor subtypes. *J Biol Chem* 275:2756–2762
15. Xue Q, Yu Y, Trilk SL et al. (2001) The genomic organization of the gene encoding the vanilloid receptor: evidence for multiple splice variants. *Genomics* 76:14–20

## TRPV1, Regulation by Acid

### ▶ TRPV1, Regulation by Protons

## TRPV1, Regulation by Nerve Growth Factor

SVEN-ERIC JORDT

Department of Pharmacology, Yale University School of Medicine, New Haven, CT, USA  
sven.jordt@yale.edu

### Synonyms

TRPV1, regulation by NGF; Capsaicin receptor, regulation by NGF; VR1, Regulation by NGF; Vanilloid Receptor, Regulation by NGF

### Definition

▶ **TRPV1**, the receptor for ▶ **capsaicin**, the pungent ingredient in chili peppers, is a polymodal receptor for physical (heat) and chemical painful stimuli in sensory neurons. The neuropeptide ▶ **nerve growth factor** (NGF), which is generated during injury or inflammation, causes ▶ **thermal hyperalgesia**, an increased sensitivity to thermal stimuli. NGF binds to its receptor, TrkA, which activates intracellular signaling pathways that shift the thermal dependence of TRPV1 activation to lower temperatures.

## Characteristics

Tissue damage produces a variety of mediators that activate or sensitize nociceptor terminals and elicit pain. These mediators include peptides such as bradykinin or nerve growth factor (NGF) that bind to their receptors on the nociceptor membrane and activate intracellular signaling pathways that lead to neural activation or sensitization.

NGF is the prototypical member of the neurotrophin family. During mammalian development NGF is essential for the survival of sensory neurons and contributes to the maintenance of their phenotypes within the first two weeks after birth. In the adult NGF is not required for cell survival.

The NGF peptide consists of three subunits, alpha, beta and gamma. The active neurotrophic peptide is the beta subunit that is processed by proteases and contains 118 amino acids. NGF binds to a specific high-affinity receptor, ▶ **TrkA**, on the cell membrane (Kaplan and Miller 2000). TrkA belongs to the receptor tyrosine kinase family of membrane receptors. This peptide receptor protein family has > 50 members and includes the receptors for other neurotrophins and epidermal growth factor (EGF), platelet-derived growth factor (PDGF) and insulin. The TrkA protein consists of an extracellular ligand binding domain, a single transmembrane domain that transmits the extracellular signal and an intracellular domain that is responsible for intracellular signaling and for the formation of a signaling complex with other proteins.

While the role of NGF in the developing nervous system is firmly established, the concept of NGF as a nociceptive signaling molecule is relatively new. NGF has been shown to contribute to inflammation and inflammatory pain in numerous studies. During injury and inflammation the concentration of NGF in the affected tissue is increased (Constantinou et al. 1994; Donnerer et al. 1992; Woolf et al. 1994). For example, inflammatory interleukins that are produced by macrophages and mast cells have been found to trigger the release of NGF from keratinocytes in the skin. NGF release is also activated by tumor necrosis factor (TNF $\alpha$ ), a potent inflammatory peptide. When NGF is injected into rats the animals develop reduced paw withdrawal thresholds for mechanical and thermal stimuli (Lewin et al. 1993). After injection of NGF, mechanical and thermal hyperalgesia develop with different time courses. Thermal hyperalgesia can be observed within minutes and is thought to be mediated through a peripheral mechanism, whereas mechanical hyperalgesia has a longer onset and is believed to be caused by ▶ **central sensitization** on the level of the spinal cord (Lewin et al. 1993; Lewin et al. 1994).

The capsaicin receptor, TRPV1, is an ion channel that is activated by heat and by painful chemical stimuli such as acid (Caterina et al. 1997). Activation of TRPV1 by capsaicin does not only induce acute pain but it also causes thermal hyperalgesia. Heat hyperalgesia



is absent in mice deficient in TRPV1 (Caterina et al. 2000; Davis et al. 2000). In addition, injection of NGF does not result in thermal hyperalgesia in these mice, indicating that TRPV1 might be the downstream target of NGF signaling in nociceptors. Indeed, when TrkA and TRPV1 were co-expressed in a heterologous expression system, activation of TrkA by NGF resulted in a pronounced sensitization of TRPV1 currents towards temperature, with channels already active below body temperature (Chuang et al. 2001).

Recent studies revealed the signaling mechanisms that are involved in the sensitization of TRPV1 by NGF. The initial signaling event after NGF binding is the dimerization of TrkA, followed by autocatalytic phosphorylation of tyrosine residues within the intracellular domain of the receptor (Kaplan and Miller 2000). This results in the activation of phospholipase C (PLC) that catalyses the hydrolysis of the membrane phospholipid phosphoinositol-4,5-bisphosphate (PIP<sub>2</sub>), yielding inositol-1,4,5-trisphosphate (IP<sub>3</sub>) and diacylglycerol (DAG). PIP<sub>2</sub> has been shown to inhibit TRPV1 through interaction with a C-terminal domain in the protein (Chuang et al. 2001; Prescott and Julius 2003). Hydrolysis of PIP<sub>2</sub> relieves this inhibition and leads to sensitization of TRPV1 (Chuang et al. 2001). Biochemical studies revealed that TrkA, TRPV1 and PLC proteins interact *in vitro* and may form a signaling complex. If this interaction occurs *in vivo* remains to be determined (Chuang et al. 2001).

In addition to PIP<sub>2</sub> hydrolysis by PLC, TrkA activates intracellular kinase pathways that play important roles in the sensitization of TRPV1 in sensory neurons. One of the kinases involved is phosphoinositide-3-kinase (PI3K), a kinase that phosphorylates membrane phospholipids. PI3K contributes to TRPV1 sensitization by reducing PIP<sub>2</sub> levels in the membrane. In addition, PI3K activates downstream kinases such as ► ERK that may induce long-term sensitization of the neuron (Bonnington and McNaughton 2003; Zhuang et al. 2004).

## References

- Bonnington JK, McNaughton PA (2003) Signalling pathways involved in the sensitisation of mouse nociceptive neurones by nerve growth factor. *J Physiol* 551:433–446
- Caterina MJ, Schumacher MA, Tominaga M et al. (1997) The capsaicin receptor: a heat-activated ion channel in the pain pathway. *Nature* 389:816–824
- Caterina MJ, Leffler A, Malmberg AB et al. (2000) Impaired nociception and pain sensation in mice lacking the capsaicin receptor. *Science* 288:306–313
- Chuang, HH, Prescott ED, Kong H et al. (2001) Bradykinin and nerve growth factor release the capsaicin receptor from PtdIns(4,5)P<sub>2</sub>-mediated inhibition. *Nature* 411:957–962
- Constantinou J, Reynolds ML, Woolf CJ et al. (1994) Nerve growth factor levels in developing rat skin: upregulation following skin wounding. *Neuroreport* 5:2281–2284
- Davis JB, Gray J, Gunthorpe MJ et al. (2000) Vanilloid receptor-1 is essential for inflammatory thermal hyperalgesia. *Nature* 405:183–187
- Donnerer J, Schuligoi R, Stein C (1992) Increased content and transport of substance P and calcitonin gene-related peptide in sensory nerves innervating inflamed tissue: evidence for a regulatory function of nerve growth factor *in vivo*. *Neuroscience* 49:693–698
- Kaplan DR, Miller FD (2000) Neurotrophin signal transduction in the nervous system. *Curr Opin Neurobiol* 10:381–391
- Lewin GR, Ritter AM, Mendell LM (1993) Nerve growth factor-induced hyperalgesia in the neonatal and adult rat. *J Neurosci* 13:2136–2148
- Lewin GR, Rueff A, Mendell LM (1994) Peripheral and central mechanisms of NGF-induced hyperalgesia. *Eur J Neurosci* 6:1903–1912
- Prescott ED, Julius D (2003) A modular PIP<sub>2</sub> binding site as a determinant of capsaicin receptor sensitivity. *Science* 300:1284–1288
- Woolf CJ, Safieh-Garabedian B, Ma QP et al. (1994) Nerve growth factor contributes to the generation of inflammatory sensory hypersensitivity. *Neuroscience* 62:327–331
- Zhuang ZY, Xu H, Clapham DE et al. (2004) Phosphatidylinositol 3-kinase activates ERK in primary sensory neurons and mediates inflammatory heat hyperalgesia through TRPV1 sensitization. *J Neurosci* 24:8300–8309

## TRPV1, Regulation by Protons

SVEN-ERIC JORDT

Department of Pharmacology, Yale University School of Medicine, New Haven, CT, USA

sven.jordt@yale.edu

### Synonyms

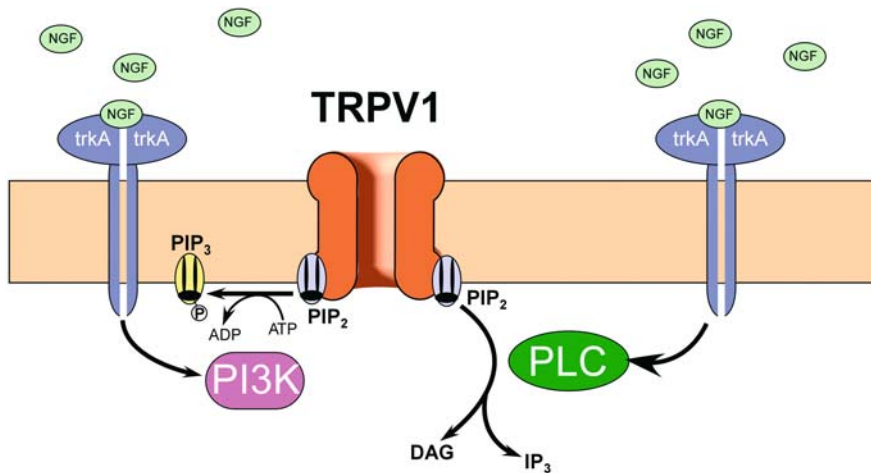
TRPV1, Regulation by Acid; Capsaicin receptor, regulation by protons; VR1, Regulation by Protons; Vanilloid Receptor, Regulation by Protons

### Definition

► **TRPV1**, the receptor for ► **capsaicin**, the pungent ingredient in chili peppers, is a polymodal receptor for physical (heat) and chemical painful stimuli in sensory neurons. Extracellular acidification, caused by inflammation or tissue injury, increases TRPV1 activation through interaction with glutamate residues in the channel protein.

### Characteristics

Tissue damage produces a variety of chemical mediators that activate or sensitize nociceptor terminals to elicit pain. An important component of this proalgesic response is local ► **acidosis**, namely, a reduction in extracellular pH to levels below the physiological norm of ~7.4 (Reeh and Steen 1996). Tissue acidosis has been observed in many painful clinical disorders, which include inflammation, skeletal muscle and cardiac ► **ischemia**, ► **arthritis**, hematoma and bone cancer. In chronic cough and asthma, acidification is thought to contribute to the induction of cough through sensitization of sensory neurons. Tissue acidification is perceived as painful by humans. Test subjects report a significant correlation of the perceived intensity of pain



**TRPV1, Regulation by Nerve Growth Factor, Figure 1** Sensitization of TRPV1 by nerve growth factor – activated signaling pathways. The capsaicin receptor, TRPV1, is coexpressed with the receptor for nerve growth factor (NGF), TrkA, in the plasma membrane of many sensory neurons. Binding of NGF to TrkA leads to TrkA dimerization and subsequent activation of intracellular signaling. TrkA activates phospholipase C (PLC) and phosphoinositide-3-kinase (PI3K). Both enzymes catalyze reactions that reduce the concentration of the phospholipid phosphoinositol-(4,5)-bisphosphate (PIP<sub>2</sub>) in the plasma membrane. Whereas PLC hydrolyses PIP<sub>2</sub>, yielding inositol-triphosphate (IP<sub>3</sub>) and diacylglycerol (DAG), PI3K phosphorylates PIP<sub>2</sub>, thereby generating PIP<sub>3</sub>. PIP<sub>2</sub> inhibits TRPV1 currents by direct interaction with the receptor protein. PIP<sub>2</sub> removal leads to sensitization of TRPV1, resulting in thermal hyperalgesia.

with decreasing pH when acidic solution is perfused into the forearm muscle (Issberner et al. 1996).

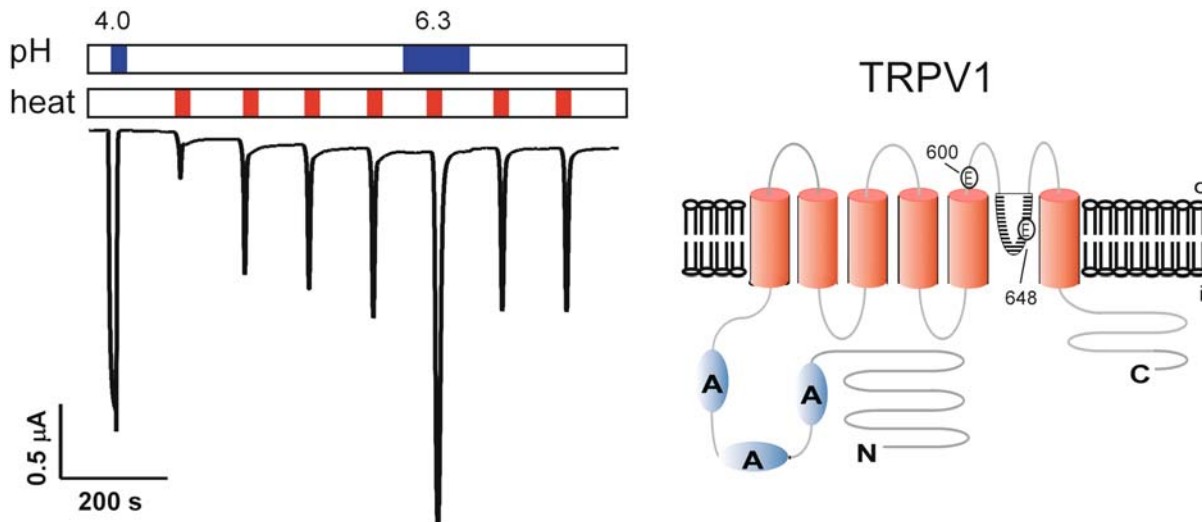
Protons cause excitation or sensitization of sensory neurons by activating ionic currents across the neural membrane. Two different proton-activated inward cationic currents have been described (Bevan and Yeats 1991). One current is sustained and non-desensitizing. The other current is a transient, rapidly activating and desensitizing current. In concert with these currents, a proton-dependent reduction in background potassium conductances has been observed in some neurons that may contribute to an increase in neural excitability.

Protons are capable of modulating the activity of a number of cloned receptors and ion channels expressed by primary afferent nociceptors. Pharmacological, electrophysiological and genetic evidence suggest that the capsaicin receptor, TRPV1, is underlying the sustained proton-activated current, whereas different combinations of ► **ASICs** (acid sensitive ion channels of the degenerin family) may give rise to transient acid-sensitive currents (Krishtal 2003). In addition, ATP-gated channels (P<sub>2</sub>X-receptors) and background potassium channels (TASK-channels) have been shown to be modulated by protons.

The capsaicin receptor, TRPV1, is a nociceptor-specific cation channel that serves as the molecular target for capsaicin, the main pungent ingredient in “hot” chili peppers (Caterina et al. 1997). TRPV1 is a member of the transient receptor potential (TRP) ion channel gene family that includes several other channels involved in sensory transduction, such as ► **TRPM8**, the receptor for cold temperature and ► **menthol**, and ► **TRPV2**, a channel activated at high temperatures (Jordt et al. 2003).

In addition to being sensitive to capsaicin and protons, TRPV1 is also activated by noxious heat and is essential for ► **bradykinin**- or ► **nerve growth factor**-dependent ► **thermal hyperalgesia** (Caterina and Julius 2001).

TRPV1 is predominantly expressed in small diameter unmyelinated neurons. In these neurons, measurements of capsaicin-activated currents correlate with the presence of the sustained proton-activated current (Bevan and Geppetti 1994; Petersen and LaMotte 1993). The sustained current can be reduced by the TRPV1 antagonists capsazepine (Liu and Simon 1994) and iodo-resiniferatoxin, indicating that capsaicin and protons use the same target to activate neural excitation. The effectiveness of TRPV1 antagonists, especially ► **capsazepine**, is strongly dependent on the species used in the individual studies. Whereas proton-induced fiber responses in guinea pigs are strongly reduced by capsazepine, responses in rodents are less affected. However, new high-affinity TRPV1 antagonists such as BCTC (N-(4-tertiarybutylphenyl)-4-(3-chloropyridin-2-yl)-tetrahydropyrazine-1(2H)-carboxamide) are very effective at blocking proton-induced fiber responses in rats at nanomolar concentrations. Capsaicin-activated currents in sensory neurons show sensitivity to extracellular acidification. For example, a decrease in extracellular pH from 7.3 to 6.3 leads to a seven-fold potentiation of the capsaicin-activated current (300 nM) in dissociated rat sensory neurons (Petersen and LaMotte 1993). Single ion channel recordings from sensory neurons show that acidification leads to a dramatic increase in the open probability of capsaicin-activated channels, whereas the single channel conductance is slightly diminished (Baumann and Martenson 2000).



**TRPV1, Regulation by Protons, Figure 1** Activation and modulation of TRPV1 by protons (left): TRPV1 currents recorded from a TRPV1<sup>-</sup>-expressing *Xenopus* oocyte are shown, recorded at a membrane voltage of -40 mV. TRPV1 channels were first activated for 20 s by acidic solution (pH 4.0) at room temperature, inducing a rapidly activating inward current. To record heat-activated currents, the bath temperature was then elevated from room temperature to 47°C within 10 s (red bar). This procedure was repeated seven times in 2 min. intervals. During the fifth heat application, the bath pH was decreased from 7.6 to 6.3. Heat activated currents are potentiated >2-fold by the drop in pH. Localization of proton-sensing residues in the TRPV1 channel (right): TRPV1 has a transmembrane moiety with six putative transmembrane domains and a P-loop structure between transmembrane domains 5 and 6 that contributes to the ion permeation pathway. The N- and C-termini are localized intracellularly. Two glutamate residues (E) are essential for regulation by protons (E600) and activation by protons (E648). Both residues are in or near the putative pore domain of the channel protein.

The analysis of mice with a targeted deletion in the gene encoding for TRPV1 provided further evidence for an important role of TRPV1 in proton-dependent signaling in sensory neurons. In these mice, proton-activated sustained currents in DRG neurons were absent and proton-activated Ca<sup>2+</sup>-uptake was greatly diminished (Caterina et al. 2000). In addition, recordings in the skin-nerve-preparation showed a dramatic reduction in the prevalence of proton-sensitive C-fibers.

In heterologous systems, TRPV1 channels are activated by extracellular protons in the absence of other activating stimuli, such as capsaicin or heat. When expressed in cultured mammalian cells, protons activate TRPV1 starting at pH around 6.5, with a half maximal activation at pH 5.4 (Tominaga et al. 1998). These currents are inhibited by TRPV1 antagonists. Like the situation in the native neuron, the degree of inhibition depends on the individual antagonist and differs between TRPV1 species homologs. For example, proton activated human and guinea pig TRPV1 channels are more strongly inhibited by capsazepine than rat TRPV1 channels.

The potentiation of capsaicin-activated currents by protons in sensory neurons can be recapitulated with cloned TRPV1 channels. More importantly, it was found that protons also potentiate heat-activated TRPV1 currents, effectively lowering the temperature activation threshold of TRPV1 channels during persistent activation and increasing current amplitudes (Tominaga et al. 1998). This indicates that at body temperature, and especially in inflammatory situations with elevated concentrations

of other sensitizing factors (e.g. bradykinin or **nerve growth factor**), even moderate acidification can lead to strong activation of TRPV1.

The capsaicin receptor is a non-selective cation channel with a central ion pore. The channel is formed by four homomeric protein subunits. Each monomer has a transmembrane moiety with six predicted transmembrane domains and extended cytosolic N-terminal and C-terminal domains. The transmembrane moiety contains a region, the P-loop between the fifth and sixth transmembrane domains, that contributes to the ion conduction pathway of the central pore. Extensive site-directed mutagenesis studies pinpointed putative proton interaction sites to regions near or within the pore domain of the channel (Jordt et al. 2000; Welch et al. 2000). In particular, two glutamate residues, at positions E600 and E648 in the rat protein, were identified as essential for the regulation and activation of TRPV1 by protons. Negatively charged glutamate residues can serve as acceptors for protons. In addition, glutamate residues may interact with permeating cations near or in the conduction pathway. These mutagenesis studies also provided further evidence that protons play a dual role in the activation of TRPV1. Mutations introduced at position E600 dramatically shifted or eliminated the pH-dependence of heat- and capsaicin-activated TRPV1 currents. On the other hand, mutations at position E648 led to a significant reduction in proton-activated currents, whereas heat- and capsaicin-activated currents maintained their pH-dependence. These results indicated that the modulation of TRPV1 currents by protons

and direct channel gating by protons can be separated at the structural level.

## References

1. Baumann TK, Martenson ME (2000) Extracellular protons both increase the activity and reduce the conductance of capsaicin-gated channels. *J Neurosci* 20:RC80
2. Bevan S, Geppetti P (1994) Protons: small stimulants of capsaicin-sensitive sensory nerves. *Trends Neurosci* 17:509–512
3. Bevan S, Yeats J (1991) Protons activate a cation conductance in a sub-population of rat dorsal root ganglion neurones. *J Physiol (Lond)* 433:145–161
4. Caterina MJ, Julius D (2001) The vanilloid receptor: a molecular gateway to the pain pathway. *Annu Rev Neurosci* 24:487–517
5. Caterina MJ, Schumacher MA, Tominaga M et al. (1997) The capsaicin receptor: a heat-activated ion channel in the pain pathway. *Nature* 389:816–824
6. Caterina MJ, Leffler A, Malmberg AB et al. (2000) Impaired nociception and pain sensation in mice lacking the capsaicin receptor. *Science* 288:306–313
7. Issberner U, Reeh PW, Steen KH (1996) Pain due to tissue acidosis: a mechanism for inflammatory and ischemic myalgia? *Neurosci Lett* 208:191–194
8. Jordt SE, Tominaga M, Julius D (2000) Acid potentiation of the capsaicin receptor determined by a key extracellular site. *Proc Natl Acad Sci USA* 97:8134–8139
9. Jordt SE, McKemy DD, Julius D (2003) Lessons from peppers and peppermint: the molecular logic of thermosensation. *Curr Opin Neurobiol* 13:487–492
10. Krishtal O (2003) The ASICs: signaling molecules? Modulators? *Trends Neurosci* 26:477–483
11. Liu L, Simon SA (1994) A rapid capsaicin-activated current in rat trigeminal ganglion neurons. *Proc Natl Acad Sci USA* 91:738–741
12. Petersen M, LaMotte RH (1993) Effect of protons on the inward current evoked by capsaicin in isolated dorsal root ganglion cells. *Pain* 54:37–42
13. Reeh PW, Steen KH (1996) Tissue acidosis in nociception and pain. *Prog Brain Res* 113:143–151
14. Tominaga M, Caterina MJ, Malmberg AB et al. (1998) The cloned capsaicin receptor integrates multiple pain-producing stimuli. *Neuron* 21:531–543
15. Welch JM, Simon SA, Reinhart PH (2000) The activation mechanism of rat vanilloid receptor 1 by capsaicin involves the pore domain and differs from the activation by either acid or heat. *Proc Natl Acad Sci USA* 97:13889–13894

## TSK

- ▶ Tampa Scale for Kinesiophobia

## TTX

- ▶ Tetrodotoxin

## Tuberculoid Leprosy

### Definition

The relatively benign and least infectious type of leprosy, which is characterized by early severe damage to

the nerves and by the presence of one to a few sharply defined, anesthetic, hypopigmented skin lesions.

- ▶ Hansen's Disease

## Tube-Ovarian Complex

- ▶ Chronic Pelvic Pain, Pelvic Inflammatory Disease and Adhesions

## Tumor (National Cancer Institute Terminology – Neoplasm)

### Definition

An abnormal mass of tissue that results when cells divide more than they should or do not die when they should. Tumors may be benign (not cancerous), or malignant (cancerous).

- ▶ Cancer Pain Management, Treatment of Neuropathic Components

## Tumor Necrosis Factor Alpha( $\alpha$ )

### Synonyms

TNF Alpha( $\alpha$ )

### Definition

TNF $\alpha$  is a pro-inflammatory cytokine and member of the 'TNF-superfamily', with algescic actions. It participates in inflammation, wound healing and remodeling of tissue.

- ▶ Cytokines as Targets in the Treatment of Neuropathic Pain
- ▶ Inflammatory Neuritis
- ▶ Wallerian Degeneration

## Twin Studies

### Definition

The comparison of traits among pairs of monozygotic (MZ; identical) versus dizygotic (DZ; fraternal) twins. MZ twins are clones, sharing 100% of their DNA sequence, whereas DZ twins share only 50% (no more than any other siblings). If a painful pathology occurs more often in both individuals in a MZ twin pair than a DZ twin pair, it can be said to be *heritable*. A caveat is that this analysis is dependent on the assumption of equal environments of MZ and DZ twins, which may not be realistic.

- ▶ Heritability of Inflammatory Nociception
- ▶ Heritable



## Twitch-Obtaining Intramuscular Stimulation

### Definition

This is a technique of dry needling developed by Chu, using an EMG needle to perform dry needling.

- ▶ [Dry Needling](#)

## Two Pore Domain K<sup>+</sup> Channels

### Definition

A large, structurally related, class of K<sup>+</sup> channels that provide a large fraction of the background conductance in many neurons. They are modulated by a variety of physical (temperature, mechanical) and chemical stimuli (pH, anesthetics, lipids).

- ▶ [Nociceptors, Cold Thermotransduction](#)

## Two-Way Scaling Models

### Definition

Two-way scaling models yield only the group stimulus space; individual differences are lost.

- ▶ [Multidimensional Scaling and Cluster Analysis Application for Assessment of Pain](#)

## Type-1 Reaction (Leprosy)

### Synonyms

Reversal reaction

### Definition

A leprosy reaction usually occurring during chemotherapy in borderline leprosy, representing a delayed hypersensitivity reaction with upgrading of cell-mediated immunity to *Mycobacterium leprae*. It is characterized by erythema, edema, and tenderness of preexisting skin lesions, neuritis with nerve damage, and fever.

- ▶ [Hansen's Disease](#)

## Type-2 Reaction (Leprosy)

### Synonyms

Erythema Nodosum Leprosum

### Definition

A leprosy reaction resembling an Arthus reaction and representing humoral hypersensitivity. It is due to an antigen-antibody reaction with the formation of immune complexes at the site of antigen deposits in various tissues and gives rise to acute inflammatory foci. It is characterized by painful red nodules or plaques, and distributes especially on the face and limbs. It may be associated with severe systemic and visceral symptoms.

- ▶ [Hansen's Disease](#)

## Type-II Receptors

### Definition

Type II receptors are G-protein coupled receptors with 7 transmembrane domains.

- ▶ [Opioid Modulation of Nociceptive Afferents In Vivo](#)

## Tyrosine Kinase A

### Synonyms

trkA

### Definition

The biological actions of neurotrophins are mediated by specific neurotrophin receptor tyrosine kinases (trks). The proto-oncogene trkA is now recognized as the primary high affinity receptor for nerve growth factor (NGF), while two related tyrosine kinase receptors, trkB and trkC, mediate the biological functions of brain-derived neurotrophic factor (BDNF) and neurotrophin-3 (NT-3), respectively.

- ▶ [ERK Regulation in Sensory Neurons during Inflammation](#)



## U-1 Type Units

### Definition

Small population of mechanosensitive units identified in the guinea-pig's ureter (*in-vitro* preparation), which are low-threshold mechanoreceptors concerned with the regulation of ureteric motility [all sensitive to peristaltic contractions of the ureter, responding to imposed distensions with a short latency and a low threshold (mean: 8 mmHg), and not displaying spontaneous activity or afterdischarges] (Cervero and Sann 1989, *J Physiol* 412:245).

► [Visceral Pain Model, Kidney Stone Pain](#)

## U-2 Type Units

### Definition

Large population of mechanosensitive units identified in the guinea-pig's ureter that have the characteristics of nociceptors [not sensitive to peristaltic contractions of the ureter, all responding to imposed distensions with a latency greater than 3 s and a high threshold (mean: 34 mmHg), showing spontaneous activity and afterdischarges to mechanical stimuli lasting up to several minutes]. These units are also sensitive to strong local distensions imposed with an artificial kidney stone, to hypoxia of the ureteric mucosa and to intraluminal application of bradykinin, capsaicin and potassium (Cervero and Sann, 1989, *J. Physiol.* 412:245). The proportion of U-2 units is virtually identical to the proportion of visceral afferent fibers from the guinea-pig's ureter that contain substance P, calcitonin gene-related peptide (CGRP), or both peptides (Semenenko and Cervero 1992, *Neuroscience* 47:1197).

► [Visceral Pain Model, Kidney Stone Pain](#)

## UAB Pain Behavior Scale

### Definition

The UAB Pain Behavior Scale is an instrument where pain behavior is assessed by a trained clinician, who ob-

serves a series of behaviors demonstrated by the patient. It consists of 10 target behaviors, each of which contributes equally to a total score.

► [Pain Inventories](#)

## Ulceration

### Definition

Ulceration refers to a circumscribed inflammatory and often suppurating lesion on the skin or an internal mucous surface resulting in necrosis of tissue.

► [NSAIDs and Cancer](#)

## Ulceration, Prevention by Nerve Decompression

A. LEE DELLON

Johns Hopkins University, Baltimore, MD, USA  
aldellon@starpower.net

### Synonyms

Diabetic neuropathy; large fiber neuropathy; sensibility; chemotherapy-induced neuropathy

### Definition

Ulceration in the lower extremities occurs in the presence of neuropathy, which usually implies loss of protective sensation and absence of pain. The magnitude of the problem may be envisioned by considering ► [diabetic neuropathy](#); there are about 20 million diabetics in the United States, and 60% will develop neuropathy, and one in 6 diabetics with neuropathy will develop an ulcer. The neuropathy that produces the loss of sensibility, however, can be associated with significant pain. While the mechanism of pain in neuropathy is not well-understood, strategies are now available to identify the presence of neuropathy at an early stage, document progression of the neuropathy, and document improvement in sensibility after treatment. For those neuropathies that have an increased susceptibility to chronic nerve compression, such as the diffuse, distal, symmetrical form of diabetic neuropathy, or ► [chemotherapy-induced neuropathy](#), decompres-

sion of the peroneal and tibial nerves at known sites of anatomic narrowing can relieve pain, restore sensibility, and, therefore prevent ulceration and amputation.

### Characteristics

Ulceration in the foot is due to pressure applied to the skin between some external object and the underlying foot skeleton. Painful small-fiber neuropathy is not associated with ulceration, because the normal functioning large-fiber populations of the peripheral nerve permit perception of pressure against the skin. Small fiber neuropathy is best documented by cutaneous thermal threshold testing and skin biopsy, with histologic measurement of intra-epidermal nerve fiber density (Hallik et al. 1998; Boulton and Malik 1998). Electrodiagnostic testing (EDT) is normal in the patient with small-fiber neuropathy, because EDT measures impulse generation in the fastest conducting (large-fiber) population.

Neuropathy that involves both the small-fiber and large-fiber nerve populations creates the clinical conditions in which a patient can have both pain and the large-fiber symptoms of numbness, with associated loss of the perception of touch and vibration. The large-fiber population generates impulses due to ischemia, which can themselves be perceived as painful. Such patients typically complain of burning pain in their feet, shooting hot or sometimes cold flashes, while having an underlying heaviness and tightness in their feet. The disturbing buzzing and tingling sensations are termed paresthesias. The most common cause of this type of problem is the neuropathy in diabetics that is termed diffuse, distal, or symmetrical, and affects primarily sensory, but can also affect motor, function (Boulton and Malik 1998). More recently, with the use of cisplatin and taxol for the treatment of cancer, a similar chemotherapy-induced neuropathy is being increasingly seen (Mollman 1990; Rowinsky et al. 1993). Documentation of large-fiber neuropathy can be obtained with EDT, or the measurement of the cutaneous vibratory or pressure threshold. Recently, with the addition of thalidomide to the chemotherapy regimen, a new chemotherapy-induced neuropathy has been documented with the ► [Pressure-Specified Sensory Device](#), a painless method for evaluation of the large-fiber population for touch (Marx et al. 2001).

The approach to treatment involves neuropathic pain medication, such as tramadol and gabapentin, since the underlying cause of the neuropathy still cannot be treated (Harati et al. 1998; Backonja et al. 1998). Continued investigation of non-operative modalities continue, such as that recently reported for low intensity laser light (Bril et al. 2003), but this too failed to offer hope for clinical relief. In contrast, a source of optimism was first reported more than fifteen years ago, related to the concept that in some neuropathies, like diabetes, the increased intraneural water content (Jakobsen 978) and the decrease in the slow component of anterograde

axoplasmic flow (Jakobsen and Sidenius 980), render the nerve susceptible to chronic compression (Dellon et al. 1988): the ► [streptozotocin-induced diabetic rat](#) was more likely to develop sciatic nerve compression to a more profound degree than the banded non-diabetic control group of rats. Decompression of the tarsal tunnel in streptozotocin-induced diabetic rats, prevented them from developing the typical neuropathic walking track pattern observed in diabetic rats (blood sugar of 400) with an intact tarsal tunnel. This normal walking pattern in the diabetic rats without a site of anatomic compression continued for the one year of the study, half the rat's expected lifetime (Dellon et al. 1994). This research approach was then applied to a model of cisplatin chemotherapy-induced neuropathy, and the study demonstrated that the established neuropathy could be reversed by decompression of the tibial nerve in the tarsal tunnel (Tassler et al. 2000). This research has recently been confirmed for the diabetic rat model, with the documentation that adding an internal neurolysis to the sciatic nerve relieves the increased intraneural pressure, and further improves peripheral nerve function, as demonstrated by walking track analysis (Kale et al. 2003).

In 1992, Dellon reported the first clinical series of patients with diabetic neuropathy who had decompression of multiple peripheral nerves, to treat the symptoms of stocking- and glove-type sensory symptoms; there was an overall 80% improvement in function, not only for the median and ulnar nerves in the upper extremity, but also for the peroneal and tibial nerves in the lower extremity. Motor function was also improved. In the lower extremity, this approach incorporated the anatomic knowledge that the tarsal tunnel was not the homologue of the carpal tunnel, but rather represented the forearm, and therefore, the traditional ► [tarsal tunnel](#) decompression did not address the site of anatomic narrowing that was responsible for the pressure upon the tibial nerve branches. Instead, Dellon demonstrated that the medial plantar tunnel was the homologue of the carpal tunnel. Dellon's approach decompresses four medial ankle tunnels. In 1995, independent confirmation of Dellon's approach to lower extremity nerve decompression was reported for the relief of painful neuropathy in the feet of diabetics by Wieman and Patel (see Table 1). The most recent review of this subject demonstrates that relief of pain may be expected in 90% of patients, improvement in sensibility may be expected in 70% of patients, existing ulcerations will heal and future ulcerations and amputations will be prevented by this approach (Dellon 2002). The most up to date information on this subject is available at [dellonipns.com](http://dellonipns.com), and [neuropathyregistry.com](http://neuropathyregistry.com), public information websites that track reports of peripheral nerve decompressions for relief of pain, restoration of sensation, and prevention of ulceration and amputation. This surgery is now being done in 40 states within the U.S.A. and 12 other countries.



**Ulceration, Prevention by Nerve Decompression, Table 1** Results of Peripheral Nerve Decompression in Diabetic Neuropathy

Study	Number of: Nerves	Patients	Pre-Operative: Ulcers	Amput	Results: Improved	Recurrent Ulceration
Dellon 1992	31	22	0	0	Pain 85%, 2PD 72%	0%
Wieman 1995	33	26	13	0	Pain 92%, 2PD 72%, Ulcer 83%	7%
Chaffe 2000	58	36	11	6	Pain 86%, Touch 50%, Ulcer n/a	0%
Aszmann 2000	16	12	0	0	2PD 69%	0%
Wood 2003	33	33	0	0	Pain 90%, 2PD 67%	0%
Biddinger 2004	15	22	0	0	Pain 90%, 2PD 80%	0%

Posterior Tibial Nerve: Tarsal Tunnel Syndrome

Selection of the patient with symptoms of neuropathy for surgical decompression is based upon: 1) failure to improve with medical treatment of the cause of the neuropathy, e.g. achieve euglycemia for a diabetic, achieve euthyroid for hypothyroid, 2) failure to achieve pain relief with neuropathic medication either due to ineffectiveness or complications of the medications, 3) documented large-fiber neuropathy with axonal loss either with electrodiagnostic testing or testing with the Pressure-Specified Sensory Device, and 4) presence of a positive **Tinel sign** over the site of known anatomic narrowing, e.g. the median nerve at the wrist, the tibial nerve at the medial ankle. Patients with neuropathy of unknown etiology have the same possibility of relief of pain and recovery of sensibility as those with known etiology, like diabetic or chemotherapy-induced neuropathy, if there is a positive Tinel sign at the site of the proposed nerve decompression.

## References

- Aszmann OA, Kress KM, Dellon AL (2000) Results of Decompression of Peripheral Nerves in Diabetics: A Prospective, Blinded Study. *Plast Reconstr Surg* 106:816–821
- Backonja M, Beydoun A, Edwards KR, for the Gabapentin Diabetic Neuropathy Study Group (1998) Gabapentin for Symptomatic Treatment of Painful Neuropathy in Patients with Diabetes Mellitus: A Randomized Controlled Trial. *JAMA* 380:1831–1836
- Biddinger K, Amend MA (2004) The Role of Surgical Decompression for Diabetic Neuropathy. *Foot Ankle Clinics N Amer* 9:239–254
- Boulton AJ, Malik RA (1998) Diabetic Neuropathy. *Med Clin N Amer* 82:909–929
- Bril V, Ngo M, Ng E, New P, Gogov S, Skandarajah S (2003) The Results of Low-Intensity Laser Therapy for Painful Diabetic Sensorimotor Polyneuropathy. *J Periph Nerv Syst* 8:1–78
- Chafee H (2000) Decompression of Peripheral Nerves for Diabetic Neuropathy. *Plast Reconstr Surg* 106:813–815
- Dellon AL (1992) Treatment of Symptoms of Diabetic Neuropathy by Peripheral Nerve Decompression. *Plast Reconstr Surg* 89:689–697
- Dellon AL (2002) Prevention of Foot Ulceration and Amputation by Decompression of Peripheral Nerves in Patients with Diabetic Neuropathy. *Ostomy Wound Management* 48:36–45
- Dellon AL, Dellon ES, Seiler WA (1994) Effect of Tarsal Tunnel Decompression in the Streptozotocin-Induced Diabetic Rat. *Microsurg* 15:265–268
- Dellon AL, Mackinnon SE, Seiler WA (1988) Susceptibility of the Diabetic Nerve to Chronic Compression. *Ann Plast Surg* 20:117–119
- Harati Y, Gooch C, Swenson M, Edelman S, Greene D, Raskin P, Donofrio P, Cornblath D, Sachdeo R, Siu CO, Kamin M (1998) Double-Blind Randomized Trial of Tramadol for the Treatment of the Pain of Diabetic Neuropathy. *Neurology* 50:1842–184
- Holland NR, Crawford TO, Hauer P, Cornblath DR, Griffin JW, McArthur JC (1998) Small-Fiber Sensory Neuropathies: Clinical Course and Neuropathology of Idiopathic Cases. *Ann Neurol* 44:47–59
- Jakobsen J (1978) Peripheral Nerves in Early Experimental Diabetes. Expansion of the Endoneurial Space as a Cause of Increased Water Content. *Diabetologia* 14:113–119
- Jakobsen J, Sidenius P (1980) Decreased Axonal Transport of Structural Proteins in Streptozotocin Diabetic Rats. *J Clin Invest* 66:292–296
- Kale B, Yuksel F, Celikoz B, Sirvanci S, Ergun O, Arbak S (2003) Effect of Various Nerve Decompression Procedures on the Functions of Distal Limbs in Streptozotocin-Induced Diabetic Rats: Further Optimism in Diabetic Neuropathy. *Plastic Reconstr Surg* 111:2265–2272
- Marx, GM, Pavlakis N, McCowatt S, Boyle FM, Levi JA, Bell DR, Cook R, Biggs M, Little N, Wheeler HR (2001) Phase II Study of Thalidomide in the Treatment of Recurrent Glioblastoma Multiforme. *J Neuro-Oncology* 54:31–38
- Mollman JE (1990) Cisplatin Neurotoxicity. *N Eng J Med* 322:126–129
- Rowinsky EK, Eisenhauer EA, Chaudhry V, Griffin J, Cornblath D (1993) Clinical Toxicities Encountered with Paclitaxel (Taxol). *Semin Oncol* 20:1–14
- Tassler PL, Dellon AL, Lesser G, Grossman S (2000) Utility of Decompressive Surgery in the Prophylaxis and Treatment of Cisplatin Neuropathy in Adult Rats. *J Reconstr Surg* 16:457–463
- Wieman TJ, Patel VG (1995) Treatment of Hyperesthetic Neuropathic Pain in Diabetics; Decompression of the Tarsal Tunnel. *Ann Surg* 221:660–665
- Wood WA, Wood MA (2003) Decompression of Peripheral Nerve for Diabetic Neuropathy in the Lower Extremity. *J Foot Ankle Surg* 42:268–275

## Ulcerative Colitis

### ► Animal Models of Inflammatory Bowel Disease

## Ultrasonography

### ► Ultrasound

## Ultrasound

PETER LAU

Royal Newcastle Hospital, Department of Clinical Research, University of Newcastle, Newcastle, NSW, Australia  
petercplau@hotmail.com

### Synonyms

Ultrasonography; sonography

### Definition

Diagnostic ultrasound is a means of obtaining images of the internal structure of the body by recording the pattern of echoes obtained when high frequency acoustic waves are beamed at a selected region of the body.

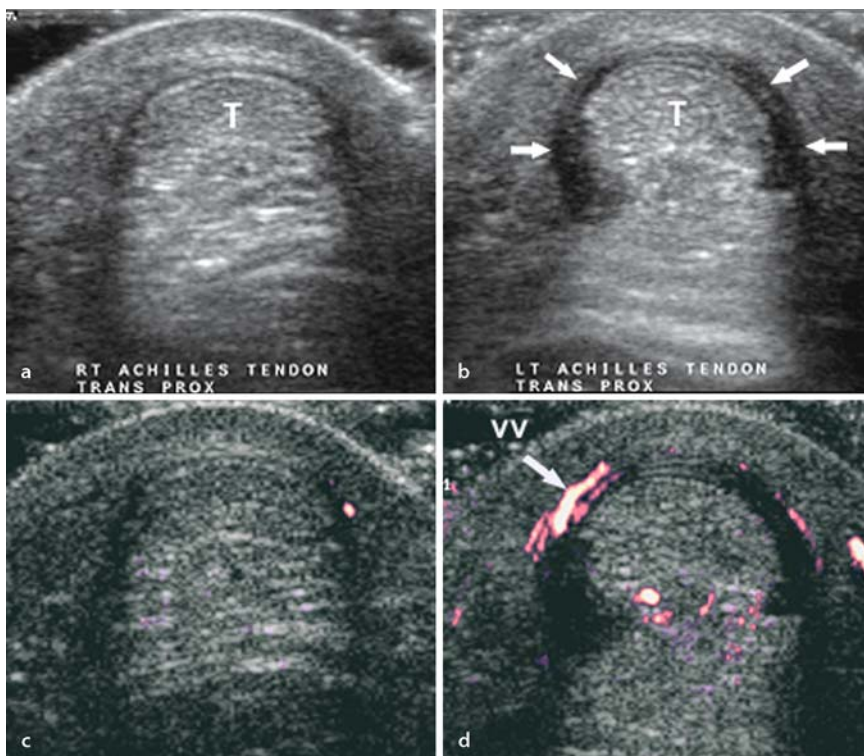
### Characteristics

#### Principles

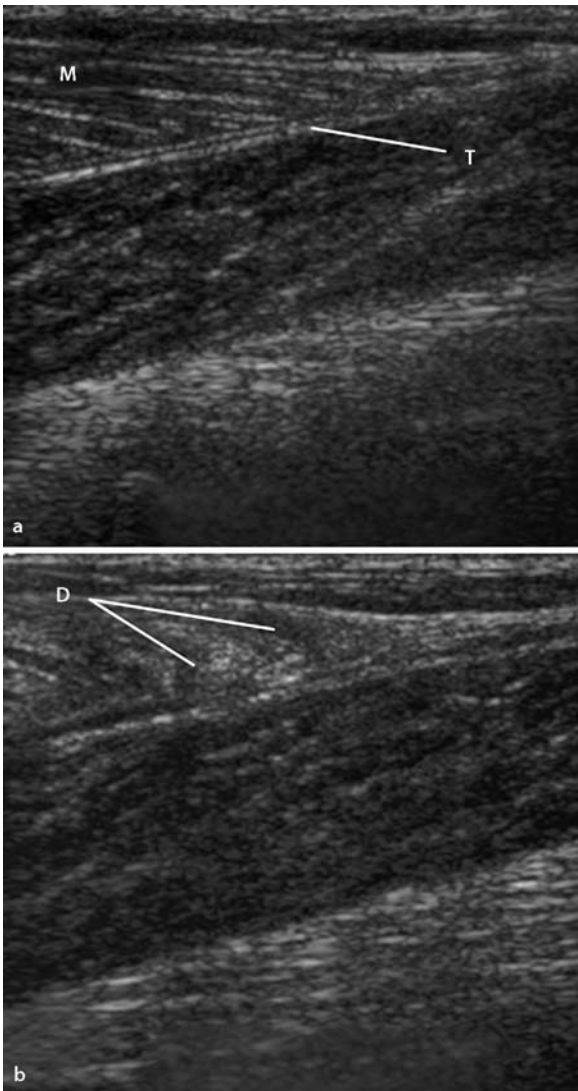
Ultrasound does not depict tissues. Rather, it depicts the boundaries between tissues of different density. The identity of the tissues depicted, however, can be inferred from a knowledge of the anatomy of the region.

Ultrasound is particularly useful for demonstrating hollow organs or cystic pathology, because there is a major difference in density between the wall of the organ or lesion and its lumen. Ultrasound also depicts well-laminated structures, such as muscles and tendons arranged in parallel layers. In such structures, it can reveal swelling, displacement and discontinuities. It has, therefore, been applied in the pursuit of tendonitis (Figs. 1, 2), tendonopathy and tears of tendons, muscle tears (Fig. 3), plantar fasciitis (Fig. 4) and Morton's neuroma (Fig. 5). Advances in technology, such as higher frequency transducers and colour and power Doppler capability, allow modern ultrasound scanners to provide high-tech facilities such as 3-D and 4-D scans. Using the power Doppler facility, increased vascularity due to inflammation can be directly visualized (Figs. 1, 2). 3-D ultrasound allows for more rapid acquisition of reproducible scans, particularly when ultrasound is used as a screening test (Blohmer et al. 1996). Under harmonic scanning, the ultrasound machine scans images at twice the frequency transmitted. This technique improves resolution but has the limitation of restricted depth of penetration, unless newer broadband harmonic imaging techniques are used.

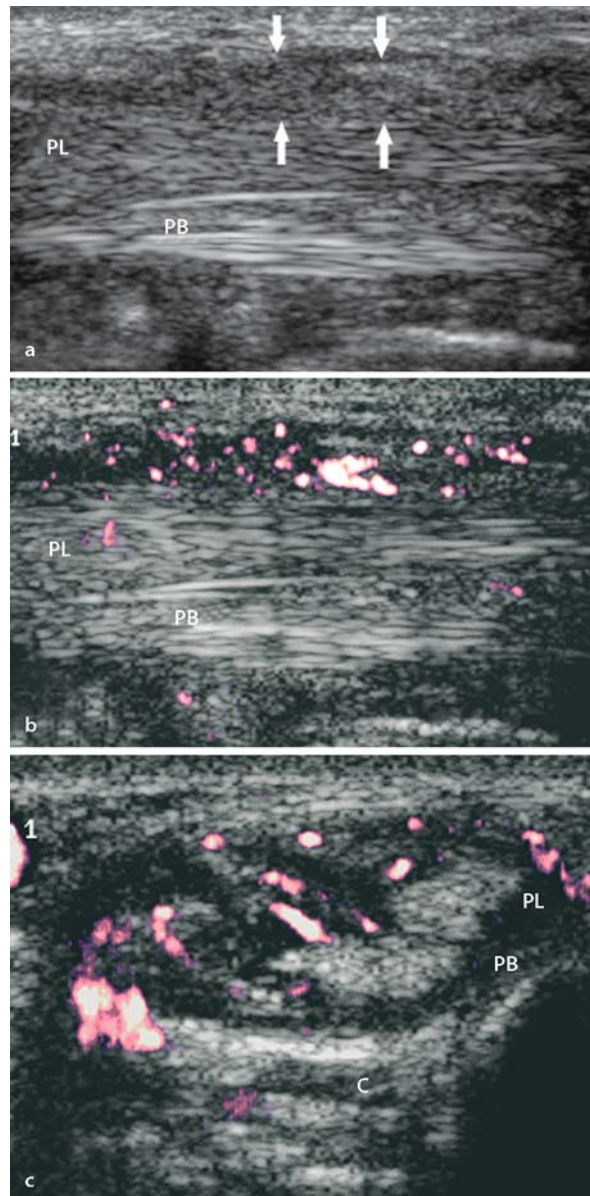
A particular advantage of ultrasonography is that it allows the examiner to interact with the patient. Scanning can be directed by and correlated with the precise anatomic location of the suspected lesion and features such as tenderness on palpation and aggravation of pain upon movement. Since ultrasonography is an innocuous



**Ultrasound, Figure 1** Ultrasonography of peritendinitis of an Achilles tendon. (a) Conventional transverse scan of a normal Achilles tendon. (b) Conventional transverse scan showing oedema of the peritendinous tissues (arrows). (c) Colour Doppler vascular scan of the normal tendon shown in (a). (d) Colour Doppler vascular scan of the peritendinitis shown in (b). The dilated peritendinous vessels (vv) appear pink. Images provided by courtesy of Dr J Linklater, Sonic Health, Australia.



**Ultrasound, Figure 2** Ultrasound images of peritendinitis of the peroneal tendons. (a) Conventional longitudinal scan of peroneus longus (PL) and peroneus brevis (PB) with swollen peritendinous tissues (arrows). (b) Colour Doppler vascular scan showing dilated vessels in the swollen peritendinous tissues. (c) Transverse vascular scan showing dilated vessels around the peroneus longus (PL) and peroneus brevis (PB) lateral to the calcaneus (C). Images provided by courtesy of Dr J Linklater, Sonic Health, Australia.



**Ultrasound, Figure 3** Ultrasound images of a tear of the myotendinous junction of the gastrocnemius. (a) Normal muscle (M) inserting into the intramuscular tendon (T). (b) Muscle sprain, showing disruption (D) of the muscle where it approaches its tendon. Images provided by courtesy of Dr J Linklater, Sonic Health, Australia.

U

procedure, scanning of the opposite side of the body can readily be undertaken in order to provide a comparison between symptomatic and asymptomatic sides (Figs. 1, 3). This allows abnormalities on the symptomatic side to be checked for normal variants or age changes that might otherwise constitute false-positive findings.

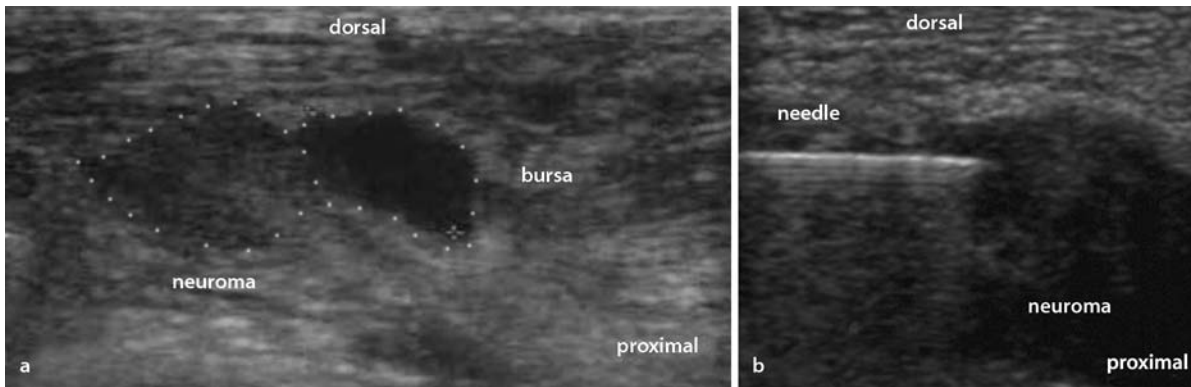
The main disadvantages of ultrasonography are questionable reliability and validity. Technical artefacts are easily produced by ultrasound and can be misconstrued as lesions. Consequently there is a steep learning curve. For this reason, authorities recommend that ultrasound be performed only by experienced operators (Tyson 1995). However, no one has defined what the crite-

ria for “experienced” are and while this may secure reliability, it does not guarantee validity.

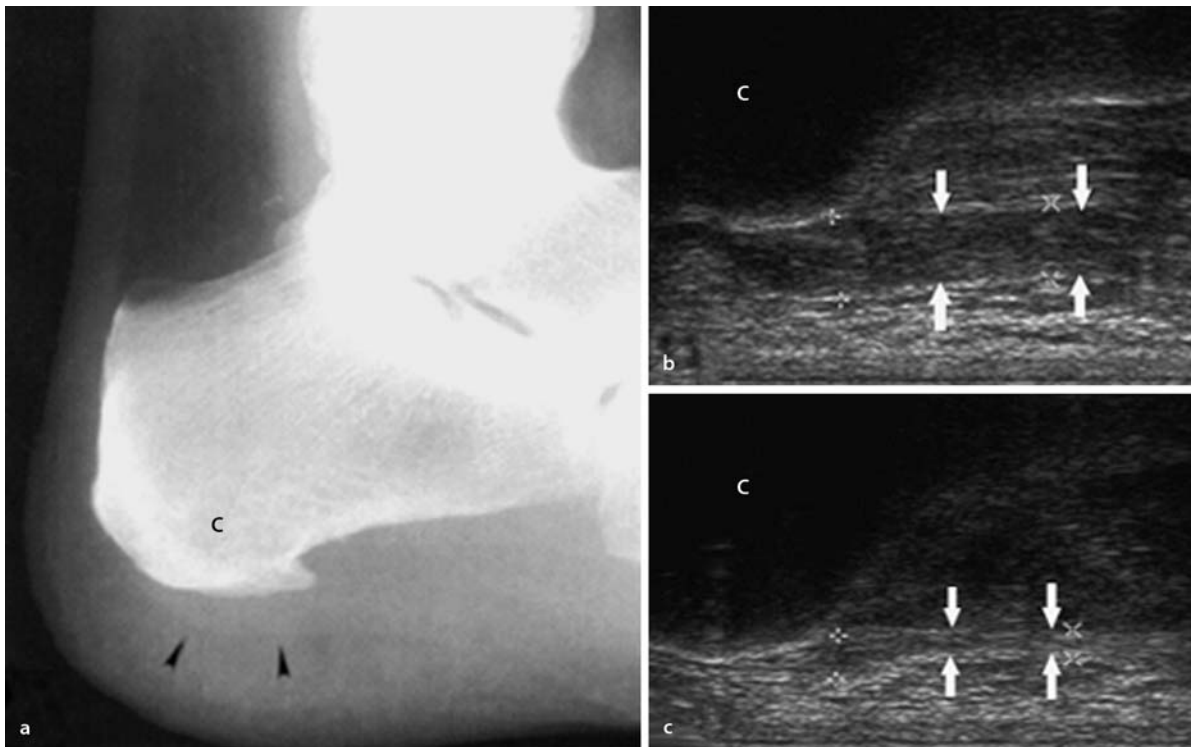
**Validity**

In the evaluation of chronic shoulder pain, when compared with arthrography and operative findings, the sensitivity and specificity of ultrasound for the detection of rotator cuff tears ranges from 60–100% (Stiles and Otte 1993). Missing, however, are the data that such tears are the cause of pain or that repairing such tears guarantees relief of pain. In orthopaedic circles, it has been





**Ultrasound, Figure 4** Plantar fasciitis. (a) A lateral plain radiograph showing the swollen plantar fascia as a thickened soft-tissue density (arrowheads) beneath the calcaneus (C). (b) Longitudinal ultrasound scan showing the thickened plantar fascia (arrows). (c) The normal plantar fascia from the asymptomatic side (arrows). Images provided by courtesy of Dr J Linklater, Sonic Health, Australia.



**Ultrasound, Figure 5** Morton's neuroma. (a) Longitudinal ultrasound scan of a Morton's neuroma and bursa in the 3-4 intermetatarsal space. (b) Longitudinal scan of a needle being directed onto the neuroma. Images provided by courtesy of Dr J Linklater, Sonic Health, Australia.

assumed that tears in the rotator cuff seen on ultrasound must be the cause of pain. The validity of this assumption is fatally challenged when ultrasound demonstrates the same findings in the contra-lateral, but asymptomatic, shoulder. Tears of the rotator cuff occur in totally asymptomatic individuals and with increasing frequency with age (Needell et al. 1996; Sher et al. 1995). Tears are not a surrogate for shoulder pain. For the detection of acute and chronic inflammation, such as in rheumatoid arthritis, ultrasound can detect humeroscapular erosions, synovitis and bursitis better than plain radiography but is less effective than MRI

In about 1995, there was a wave of enthusiasm in spinal sonography for assessing soft tissue trauma, spinal canal stenosis and nerve root pathology. Claims were made that ultrasound measurements could demonstrate reductions in the size of the vertebral canal in patients with back pain and significant reductions in patients with neurogenic claudication and nerve root symptoms. Lesions were supposedly confirmed at surgery in over 80% of cases. Consequently, ultrasound was promoted as a safe, non-invasive, atraumatic method of spinal imaging. Further claims were made that ultrasound showed a correlation of at least 90% with MRI, plain radiography and



orthopaedic and neurological examination. Alarmed by the unbridled application of ultrasound that these claims invited, the American Institute of Ultrasound Medicine (AIUM) issued the following official statement:

“There is insufficient evidence in the peer-reviewed medical literature establishing the value of diagnostic spinal ultrasound. Therefore, the AIUM states that, at this time, the use of diagnostic spinal ultrasound (for study of facet joints and capsules, nerve and fascial oedema and other subtle paraspinal abnormalities) for diagnostic evaluation, for evaluation of pain or radiculopathy syndromes and monitoring of therapy has no proven clinical utility.

Diagnostic spinal ultrasound should be considered investigational. The AIUM urges investigators to perform proper double-blind research projects to evaluate the efficacy of these diagnostic spinal ultrasound examinations.”

In other regions of the body, ultrasound is increasingly used to demonstrate inflamed or swollen tendons in patients with soft-tissue pain. While this is attractive, it is arguably superfluous to do so. Tendonopathy is readily diagnosed on the basis of local tenderness on clinical examination and does not require ultrasound confirmation. Exercise may be prescribed and local anaesthetic or corticosteroids can be injected, without recourse to ultrasound. Nevertheless, ultrasound can be used to guide injection therapy in a variety of sports injuries, such as “tennis elbow”, “jumper’s knee” and Achilles tendonopathy. Ultrasound is used to better visualize the abnormal tendons and to direct the needle accurately to the lesion (Lin et al. 1999).

Similarly, groin pain and hip pain are amendable to ultrasound evaluation. The common causes are adductor tendon lesions, osteitis pubis and inguinal canal lesions, such as sports hernia or inguinal canal posterior wall deficiency. Ultrasound has previously been shown to be of value in diagnosing adductor tendon pathology. The ability to identify pathology of the abdominal muscular wall is of value too in directing further clinical management. However, data are still lacking that these lesions are the cause of pain. There is only a weak correlation between abdominal wall deficiency and groin pain and a temporal relationship between the lesion and symptoms has not been established (Orchard et al. 1998).

Ultrasound has been used to assess carpal tunnel syndrome. One study has claimed that it is a more reliable method than nerve conduction testing (El Miedany et al. 2004), but nerve conduction itself may not be a valid criterion standard. A large proportion of the asymptomatic population exhibits abnormal conduction velocities through the carpal tunnel (Atroshi et al. 1999).

Ultrasound is particularly useful in the evaluation of visceral disorders. Accordingly it has a particular application in the assessment of acute pelvic pain in women. It has an established reputation for detecting gynaecolog-

ical disease, but it is also a useful modality for assessing non-gynaecological pains due to diverticulitis, urinary tract calculi, appendicitis or incarcerated hernia.

### Summary

Ultrasound is an attractive imaging modality because it does not involve ionizing radiation, it allows for real-time assessment and it is relatively portable. It has an established reputation for the assessment of visceral disorders and is promoted as the investigation of choice for soft-tissue musculoskeletal disorders. Sorely lacking, however, are data that establish the validity of ultrasound as a means of establishing sources and causes of musculoskeletal pain or show that such establishment makes a significant difference to management.

► [Ultrasound Therapy of Pain from the Musculoskeletal System](#)

### References

1. Atroshi I, Gummesson C, Johnsson R et al. (1999) Prevalence of carpal tunnel syndrome in a general population. *JAMA* 282:153–158
2. BlohmerJU, Bollmann R, Heinrich G et al. (1996) Three-dimensional ultrasound study of the female breast. *Geburtshilfekd* 56:161–165
3. El Miedany YM, Aty SA, Ashour S (2004) Ultrasonography versus nerve conduction study in patients with carpal tunnel syndrome: substantive or complementary tests? *Rheumatology* 43:887–895
4. Lin EC, Middleton WD, Teefey SA (1999) Extended field of view sonography in musculoskeletal imaging. *J Ultrasound Med* 18:147–152
5. Needell SD, Zlatkin MB, Sher JS et al. (1996) MR imaging of the rotator cuff: peritendinous and bone abnormalities in an asymptomatic population. *AJR Am J Roentgenol* 166:863–867
6. Orchard JW, Read J, Neophyton J et al. (1998) Groin pain associated with ultrasound findings of inguinal canal posterior wall deficiency in Australian Rules footballers. *Br J Sport Med* 32:134–139
7. Sher JS, Uribe JW, Posada A et al. (1995) Abnormal findings on magnetic resonance images of asymptomatic shoulders. *J Bone Joint Surg* 77A:10–15
8. Stiles RG, Otte MT (1993) Imaging of the shoulder. *Radiology* 188:603–613
9. Tyson LL (1995) Imaging of the painful shoulder. *Curr Probl Diag Radiol* 24:110–140



## Ultrasound Delivery

### Definition

Ultrasound delivery may be continuous or pulsed. Pulsed delivery results in less heating than continuous-wave.

► [Ultrasound Therapy of Pain from the Musculoskeletal System](#)

## Ultrasound Therapy

► [Ultrasound Therapy of Pain from the Musculoskeletal System](#)

## Ultrasound Therapy of Pain from the Musculoskeletal System

VERONIKA FIALKA-MOSER  
 Department of Physical Medicine and Rehabilitation,  
 University Vienna, Vienna, Austria  
 Pmr.office@meduniwien.ac.at

### Synonyms

Ultrasound; Ultrasound Therapy; Ultrasound Treatment

### Definition

► **Ultrasound (US)** is defined as acoustic vibration with frequencies above the audible range (i.e. greater than 20,000 Hz). Medical uses of US can be diagnostic or therapeutic. Therapeutic US involves the use of high-frequency acoustic energy to produce thermal and non-thermal effects in tissue.

Ultrasound selectively heats interfaces between tissues of different acoustic impedance because of reflection, formation of shear waves and the high selective absorption in the superficial layers of tissue with a high coefficient of absorption (Table 1). It is characteristic of ultrasound that a selective increase in temperature may occur at the interface between tissues of different acoustic impedance (Fig. 1) (Lehmann et al. 1968).

### Characteristics

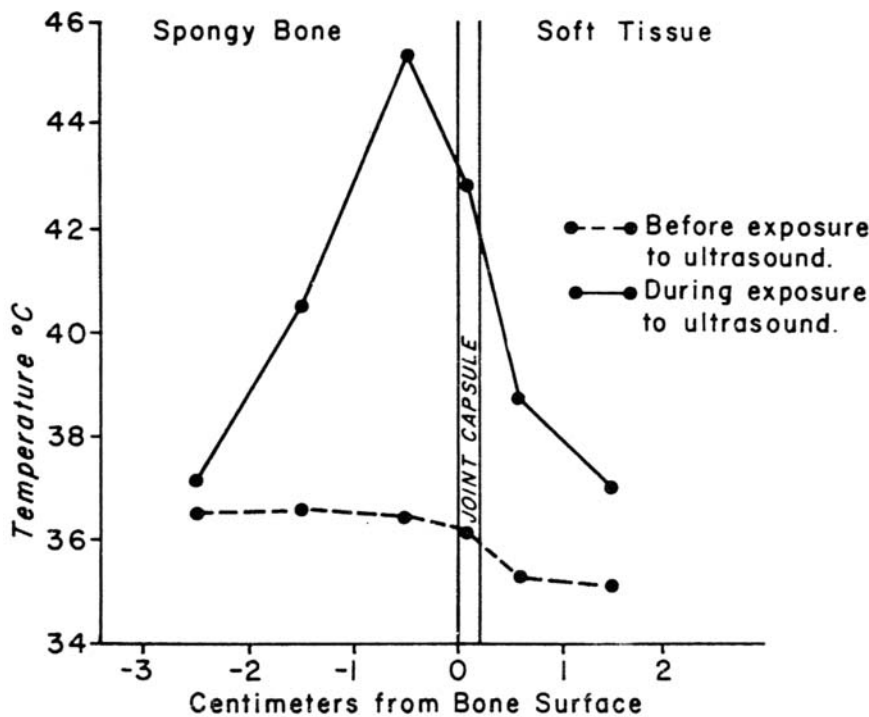
Parameters for therapeutic US are:

Ultrasound Therapy of Pain from the Musculoskeletal System, Table 1 Ultrasound penetration into tissues.

Half value depth of ultrasound	
Muscle	3.0 cm
Fatty tissue	8.0 cm
Bones	0.5 cm

- Frequency
- Power
- Effective radiating area
- Intensity
- Duration
- Additional parameters for pulsed ultrasound (“time on” and “time off”)
- Pulse repetition frequency
- Duty factor

Frequency (► **Frequency of ultrasound treatment**): the most commonly used frequencies are in the range of 0.8–1.1 MHz, although frequencies around 3.0 MHz are also fairly common. Power (► **Power of ultrasound**) is total energy per unit time. Intensity (► **Intensity of ultrasound**) is power per unit area. The World Health Organization and the International Electrical Commission both recommend limiting spatial average intensity to 3 W / cm<sup>2</sup>. Most clinically used intensities of therapeutic US are in the 0.5–2.0 W / cm<sup>2</sup> range. Temperatures of up to 46°C (114.8°F) in deep tissues (e.g. bone-muscle interface) are easily achieved with



Ultrasound Therapy of Pain from the Musculoskeletal System, Figure 1 Temperature distribution 2 cm proximal to the joint space (Lehmann et al. 1968)

**Ultrasound Therapy of Pain from the Musculoskeletal System, Table 2** Parameters for therapeutic ultrasound dependent on the target tissue and on the stage of the disease

Depth of the target from the surface	Superficial	⇒	Deep
Frequency	3 MHz		0.75 MHz
Intensity	0.1 W/cm <sup>2</sup>		3 W/cm <sup>2</sup>
Size of the target area to be treated	Small	⇒	Large
Time	3 min		15 min
Condition	Acute	⇒	Chronic
Intensity	0.1 W/cm <sup>2</sup>		3 W/cm <sup>2</sup>
Time	3 min		15 min
Pattern	Pulsed		Continuous
Heating required	No heat	⇒	Heat
Intensity	0.1 W/cm <sup>2</sup>		3 W/cm <sup>2</sup>
Time	3 min		15 min
Pattern	Pulsed		Continuous

US. Duration (► [Duration of ultrasound treatment](#)): 1–15 min, usually the duration should be at least 3 min. ► [Ultrasound delivery](#) may be continuous or pulsed. Pulsed delivery results in less heating than continuous-wave.

Coupling media (► [Coupling media of ultrasound](#)) like mineral oil and several commercially available coupling gels have similar transmissivities to the reference standard of distilled degassed water (Warren et al. 1976). Predictable and controlled dosages of ultrasound in water can be reliably calculated using dosage correction factors. Those factors enable the user to compensate for applying ultrasound at different skin-to-applicator distances. However, dosage correction is not recommended at distances above 3 cm because gas bubble formation during treatment could seriously impede energy transmission. The dosage correction factors are easily remembered as 0 cm = 0 change, 1 cm = increase by 30%, 2 cm = increase by 55% and 3 cm = increase by 80%.

The most common ► [technique of ultrasound application](#) is the stroking technique. The applicator is moved slowly over an area of approximately 25 cm<sup>2</sup> (4 in<sup>2</sup>) in a circular or longitudinal manner. The applicator size (usually 5–10 cm<sup>2</sup>) limits the size of the area that can be treated. The stationary technique should generally be avoided because of the potential for standing waves and the production of hot spots.

### Indications

Thermal effects (► [Thermal effects of ultrasound](#)) and mechanical effects (► [mechanical effects of ultrasound](#)) on the target tissue result in an increased local metabolism, circulation, extensibility of con-

nective tissue, tissue regeneration and bone growth. The non-thermal effects of ultrasound include cavitation and microstreaming. Beneficial effects for the patient with musculoskeletal disorders should include improvements in pain, swelling and range of motion.

The indication for ultrasound therapy is wide and covers many chronic and acute disorders. Ultrasound therapy with an intensity ranging from 0.5–2.0 W per square centimetre of body-surface area is widely used for the treatment of painful musculoskeletal disorders. However, the clinical efficacy of this approach for most such applications has not been confirmed (Gam and Johannsen 1995). Weak evidence for effectiveness of ultrasound was found for lateral epicondylitis (van der Windt et al. 1999). Gam and Johannsen (1995) hypothesized that ultrasound therapy might augment the effect of exercise therapy. In patients with symptomatic calcific tendinitis of the shoulder, ultrasound treatment helped resolve calcifications and was associated with short-term clinical improvement (Ebenbichler et al. 1999). Patients received 24 15 min sessions of either pulsed ultrasound (frequency 0.89 MHz, intensity 2.5 W per square centimetre, pulsed mode 1:4) or sham treatment to the area over the calcification. The first 15 treatments were given daily and the remainder were given three times a week for 3 weeks. Criteria for the adequate use of ultrasound have recently been proposed by Roebroek et al. (1998); ultrasound should be used primarily 1) for soft-tissue injuries, in particular of the shoulder and elbow, 2) in recent injuries and in the first phases of treatment, 3) to treat signs of inflammation (pain, swelling, restricted range of motion) and 4) in combination with other forms of therapy, especially exercise therapy.

Experiments on the stimulation of nerve regeneration (Hong et al. 1988) and on nerve conduction by ultrasound treatment (Currier et al. 1978; Kramer 1989) and findings of an anti-inflammatory effect of such treatment (El Hag et al. 1985) support the concept that ultrasound treatment might facilitate recovery from nerve compression (Hong et al. 1988). However, few studies report a benefit of ultrasound treatment in carpal tunnel syndrome under clinical conditions (Edel and Bergmann 1970). Results suggest there are satisfying short to medium term effects due to ultrasound treatment in patients with mild to moderate idiopathic carpal tunnel syndrome. In the study by Ebenbichler et al. (1998), twenty sessions of ultrasound treatment showed good short and medium term efficacy in patients with mild to moderate forms of idiopathic carpal tunnel syndrome. Serial ratings by patients of overall improvement suggest that ultrasound treatment would be best administered every day. Frequent treatment is time consuming, but ultrasound treatment could be performed by compliant patients at home. Findings need to be confirmed and ultrasound treatment will have to be compared with standard conservative and invasive treatment options.

#### Ultrasound Precautions (See General Heat Precautions)

Deep heating over an open epiphysis could result in either increased growth (from hyperaemia) or decreased growth (from thermal injury). Avoiding US near pacemakers is reasonable because of potential thermal or mechanical injury to the pacemaker. Ultrasound over laminectomy sites could theoretically result in spinal cord heating (McLeod and Fowlow 1989; Oakley 1978; Ter Haar et al. 1987). Metal *per se* should not be a contraindication to US. However, Lehmann (1990) cautions against the use of US near methyl methacrylate or high-density polyethylene because of their high coefficients of absorption.

#### General heat precautions

- Near brain, eyes, reproductive organs
- Pregnant or menstruating uterus
- Near pacemaker
- Near spine, laminectomy sites
- Malignancy
- Skeletal immaturity
- Arthroplasties?
- Methyl methacrylate or high-density polyethylene?

#### References

1. Currier DP, Greathouse D, Swift T (1978) Sensory nerve conduction: effect of ultrasound. *Arch Phys Med Rehabil* 59:181–185
2. Ebenbichler GR, Resch KL, Nicolakis P et al. (1998) Ultrasound treatment for treating the carpal tunnel syndrome: randomised “sham” controlled trial. *BMJ* 316:731–735
3. Ebenbichler GR, Erdogmus CB, Resch KL et al. (1999) Ultrasound therapy for calcific tendinitis of the shoulder. *N Engl J Med* 340:1533–1538

4. Edel H, Bergmann P (1970) Studies on the effect of ultrasonics in different dosage on the neural conduction velocity in man. *Arch Phys Ther Leipz* 22:255–259
5. El Hag M, Coghlan K, Christmas P et al. (1985) The anti-inflammatory effects of dexamethasone and therapeutic ultrasound in oral surgery. *Br J Oral Maxillofac Surg* 23:17–23
6. Gam AN, Johannsen F (1995) Ultrasound therapy in musculoskeletal disorders: a meta-analysis. *Pain* 63:85–91
7. Hong CZ, Liu HH, Yu J (1988) Ultrasound thermotherapy effect on the recovery of nerve conduction in experimental compression neuropathy. *Arch Phys Med Rehabil* 69:410–414
8. Kramer JF (1989) Effect of therapeutic ultrasound intensity on subcutaneous tissue temperature and ulnar nerve conduction velocity. *Am J Phys Med* 64:1–9
9. Lehmann JF (1990) *Therapeutic heat and cold*, 4th edn. Williams & Wilkins, Baltimore
10. Lehmann JF, de Lateur BJ, Warren CG et al. (1968) Heating of joint structures by ultrasound. *Arch Phys Med Rehabil* 49:28–30
11. McLeod DR, Fowlow SB (1989) Multiple malformation and exposure to therapeutic ultrasound during organogenesis. *Am J Med Genet* 34:317–319
12. Oakley EM (1978) Dangers and contraindication of therapeutic ultrasound. *Physiotherapy* 64:173–174
13. Roebroek ME, Dekker J, Oostendorp RAB (1998) The use of therapeutic ultrasound in physical therapy: practice patterns in Dutch primary health care. *Phys Ther* 78:470–478
14. Van der Windt DAWM, van der Heijden GJMG, van den Berg SGM et al. (1999) Ultrasound therapy for musculoskeletal disorders: a systematic review. *Pain* 81:257–271
15. Warren CG, Koblanski JN, Sigelmann RA (1976) Ultrasound coupling media: their relative transmissivity. *Arch Phys Med Rehabil* 57:218–222

## Ultrasound Treatment

- ▶ [Ultrasound Therapy of Pain from the Musculoskeletal System](#)

## Ultrastructure

### Definition

Ultrastructure refers to a fine structure; structures seen using an electron microscope.

- ▶ [Opioid Receptor Trafficking in Pain States](#)

## Ultraviolet Light

### Synonyms

UV Light

### Definition

Ultraviolet (UV) radiation is classified in wave bands of UV-A (320–400nm), UV-B (280–320nm), and UV-C (below 280nm). UV-A is of low energy and penetrates the skin up to the dermis, UV-B is absorbed by the dermis, UV-C is of the highest energy and is completely absorbed by the epidermis. UV-C should not reach the earth's surface as it is fully abolished by the ozone layer.

- ▶ [UV-Erythema, a Model for Inducing Hyperalgesias](#)



## Ultraviolet Radiation

- ▶ UV-Erythema, a Model for Inducing Hyperalgesias

## Unconventional Medicine

- ▶ Alternative Medicine in Neuropathic Pain

## Underdiagnosing of Pain

### Definition

Therapists tend to overlook pain in elderly individuals because of several reasons: accepting the pain as a natural consequence of old age, holding the misconception that treatment options are less effective with increasing age, and misunderstanding the clinical relevance of laboratory studies about elevated pain thresholds in the elderly.

- ▶ Psychological Treatment of Pain in Older Populations

## Underreporting of Pain

### Definition

The elderly have a tendency to underreport pain, frequently for fear of having their negative expectations verified by further diagnostic procedures, or for fear of the procedures themselves, or just for the reason of accepting pain as a concomitant of old age.

- ▶ Psychological Treatment of Pain in Older Populations

## Undertreated Pain in Children

- ▶ Evolution of Pediatric Pain Treatment

## Unidimensional

### Definition

A pain assessment tool that includes measurement of a single indicator of newborn pain (behavioral or physiological or biochemical (hormonal)).

- ▶ Pain Assessment in Neonates

## Unilateral

### Definition

On either the right or left side, but not crossing the midline.

- ▶ Hemicrania Continua

## Unloading

- ▶ Lumbar Traction

## Unmyelinated Axon

### Definition

Small diameter axon that is just enveloped by glial cytoplasm. Axons of this type conduct at low velocities and frequently present boutons en passant and numerous collaterals near the dendritic tree of the neuron of origin. Unmyelinated nerves are bundles of unmyelinated nerve fibers

- ▶ Spinothalamic Tract Neurons, Morphology
- ▶ Toxic Neuropathies

## Unpleasant Sensation

### Definition

A sensation that is not agreeable.

- ▶ Dysesthesia, Assessment

## Unrecognized Pain in Children

- ▶ Evolution of Pediatric Pain Treatment

## Up-Regulated

### Definition

A state whereby a physiologic feedback loop causes a substance to increase the production or action of another substance.

- ▶ Cancer Pain Management, Orthopedic Surgery

## Upregulation

### Definition

Upregulation refers to an increase in the amount of mRNA and/or protein of a certain gene in a cell or tissue. It may be mediated by an increase of transcription or decrease of metabolism

- ▶ COX-1 and COX-2 in Pain
- ▶ NSAIDs, Adverse Effects

## Ureteral Nociceptors

### Definition

- ▶ U-2 Type Units
- ▶ Visceral Pain Model, Kidney Stone Pain

## Urethral Dyssynergia

### Definition

This is the contraction of the bladder against a contracting rather than relaxing internal sphincter.

- ▶ Clitoral Pain

## Urinary Bladder

### Definition

The urinary bladder is a hollow smooth muscle organ consisting of the bladder body and the bladder base. Its inside is lined by a mucous membrane and its outside is partly covered by peritoneal serosa and partly by fascia.

- ▶ Opioids and Bladder Pain/Function

## Urinary Bladder Nocifensive Behaviors

- ▶ Nocifensive Behaviors of the Urinary Bladder

## Urogenital Pain

- ▶ Dyspareunia and Vaginismus

## Urticaria

### Definition

Urticaria refers to an itchy skin eruption; usually the result of an allergic response to insect bites or food or drugs.

- ▶ NSAIDs, Adverse Effects

## UV Erythema

- ▶ UV-Erythema, a Model for Inducing Hyperalgesias
- ▶ UV-Induced Erythema

## UV-Erythema, a Model for Inducing Hyperalgesias

ROMAN RUKWIED

Department of Anaesthesiology and Intensive Care Medicine, Faculty of Clinical Medicine Mannheim, University of Heidelberg, Heidelberg, Germany  
roman.rukwied@anaes.ma.uni-heidelberg.de

### Synonyms

Sunburn; Ultraviolet Radiation; UV-B erythema

### Definition

Dependent on the wavelength, solar **▶ ultraviolet (UV) light** is classified into UV-A (320–400 nm), UV-B (280–320 nm) and UV-C (below 280 nm) wave bands. Of the UV band, the long wave UV-A is of lowest energy and penetrates the skin up to the dermis. UV-B is of higher energy, penetrates the epidermis and is completely absorbed by the superficial layers of the dermis. UV-C radiation is completely absorbed by the epidermis. Noteworthy, both UV-B and UV-C are potentially detrimental to living cells and effective promoters of skin cancer, probably due to their damaging effect on the DNA.

Sunburnt skin shows tenderness to heat and mechanical stimuli. Increased supra-threshold responses and reduced thresholds correspond to mechanical and heat hyperalgesias. Hyperalgesias developing in the damaged area, the primary zone, are termed **▶ primary hyperalgesias**; those occurring in the area surrounding the injured site – the secondary zone – are called **▶ secondary hyperalgesia**. The nature of the eliciting stimulus differentiates **▶ thermal hyperalgesia** from **▶ mechanical hyperalgesia**. The former develops in the primary hyperalgesic zone only, whereas the latter may occur in both primary and secondary hyperalgesic areas. Mechanical hyperalgesia to non-painful stimuli, for instance touch or light stroking, is termed **▶ allodynia** and differentiated from 'pinprick hyperalgesia'.

UV-A irradiation of the skin may cause pronounced long-lasting tanning of the skin. At higher energy levels UV-A irradiation leads to increasing heat pain and accompanying dermal changes, including vascular damage, blisters, endothelial cell enlargement, extravasation of red blood cells and extravascular fibrin deposition. However, apart from the consequences of possible heating trauma, no specific mechanical or thermal hyperalgesia occurs after UV-A irradiation. In contrast, exposure of the skin to UV-B induces a localized skin reddening – an **▶ erythema** – and subacute primary hyperalgesias to mechanical and thermal stimuli. **▶ Sensitization of nociceptive afferents** at the UV-treated site is most likely the underlying mechanism leading to primary hyperalgesia. If large skin areas are irradiated, even sensitization processes of dorsal horn

neurons of the spinal cord may develop – probably due to an ongoing activity of C-nociceptors that induce and maintain secondary hyperalgesia. In addition, UV-B irradiation causes the release of various endogenous inflammatory mediators, many of which can promote or facilitate neuronal sensitization.

### Characteristics

A plethora of experiments have been performed over the last decades to study the release of inflammatory mediators following UV radiation of the skin. It has been postulated that these mediators are considerably involved in the development of UV-B induced erythema and primary hyperalgesia respectively. Increased levels of cytokines, such as interleukins (IL) IL-1, IL-6, IL-8, and TNF $\alpha$ , have been analyzed during the first few hours after UV-B treatment. Moreover, the level of histamine and prostaglandins (PG), particularly PGD<sub>2</sub>, PGE<sub>2</sub> and PGF<sub>2</sub> $\alpha$ , increased 4–8 h and with maximum levels 18–24 h after UV-exposure. Onset of the UV-B erythema paralleled the mediator production; administration of acetylsalicylic acid or indomethacin reduced the erythema development during 24 h by about 50%. These findings suggest an enhanced cyclooxygenase activity after UV-B irradiation and an augmented arachidonic acid turnover with elevated prostanoid release, which is supported by the finding of an up-regulation of inducible cyclooxygenase (COX2) after UV-B irradiation. However, PGE<sub>2</sub> levels returned to baseline concentrations within 48 h after UV-B treatment, even though the erythema reaction was still 1.5 fold higher than at control sites (Hoffmann and Schmelz 1999). Apparently, prostanoids are not crucially involved in the late phase of a UV-B erythema; however, systemic (oral) treatment with non-steroidal anti-inflammatory drugs (NSAIDs) significantly attenuated the erythema and primary hyperalgesias to heat and pinprick after UV-B skin irradiation (Bickel et al. 1998).

Obviously, there is an interaction between the mediators released upon UV-B irradiation that induce the erythema reaction and neuronal sensitization. Inflammatory mediators like PGE<sub>2</sub> or bradykinin (BK) are known to sensitize nociceptors, particularly to thermal stimuli (Schmelz et al. 2003). Moreover, prostaglandins sensitize bradykinin-B<sub>2</sub>-receptor responses and cause an increase in BK-induced pain. In UV-B irradiated skin, administration of both des-Arg<sup>10</sup>-kallidin (B<sup>1</sup>-receptor agonist) and BK (B<sub>2</sub>-receptor agonist) induced an increased pain sensation, augmented erythema and enhanced axon reflex vasodilatation (Eisenbarth et al. 2004). Higher pain ratings and enlarged axon reflexes indicate a stronger activation of primary afferent nociceptors. This reaction might be promoted by the sensitization of nociceptors, either due to UV-B-induced release of prostaglandins with subsequently altered BK-responses or due to an enhanced BK-receptor expression and stimulation. Cytokines released after UV-B radi-

ation, for example interleukin 1 (IL-1), can induce an up-regulation and *de novo* synthesis of B<sup>1</sup>-receptors, and it remains uncertain whether augmented B<sup>1</sup>-receptor responses in UV-B irradiated skin are attributable to increased receptor expression or receptor sensitization. In recent years, the controlled exposure of the skin to UV light has been investigated as a novel method for the induction and investigation of hyperalgesias. Several comparative experiments have been performed to reveal the dose-dependency and time course of UV-induced erythema and hyperalgesias in humans (Gustorff et al. 2004a; Harrison et al. 2004; Bickel et al. 1998; Hoffmann and Schmelz 1999). The investigators found that UV-B exposed skin areas reveal an increased blood flow that peaks at 12–24 h after irradiation and lasts at least 48 h. At irradiated skin sites, pronounced primary hyperalgesias to mechanical and thermal stimuli develop dose dependently after UV-B irradiation. Thermal hyperalgesia occurs within 6–24 h and remains persistent even 96 h following UV-B exposure (Bickel et al. 1998; Hoffmann and Schmelz 1999). A distinct primary hyperalgesia to mechanical impact stimuli develops 6–48 h after UV-B irradiation, which gradually declines within 5 days post UV-B treatment. Compared to the development of UV-B induced primary hyperalgesias, no secondary hyperalgesia to mechanical stimuli was determined in the vicinity of UV-B treated skin (Harrison et al. 2004). However, a recent investigation demonstrated stable secondary hyperalgesia to pinprick that continued over 10 h (Gustorff et al. 2004a). Notably, Gustorff et al. irradiated skin areas covering 5 cm in diameter, whereas UV-B irradiation of a skin patch either 1.5 cm in diameter (Hoffmann and Schmelz 1999) or a ring 6 cm in diameter and a 2 cm un-irradiated zone (Harrison et al. 2004) does not provoke any secondary hyperalgesia to mechanical (pinprick) stimuli. Apparently, induction of UV-B-evoked secondary pinprick hyperalgesia requires widespread irradiation of rather large skin areas in order to induce a continuous ongoing activity of nociceptive afferent units to facilitate a ► **central sensitization**. It is well accepted that secondary (mechanical) hyperalgesia is based on sensitization processes of dorsal horn neurons of the spinal cord promoting enhanced efficacy of synaptic transmission in the central nervous system. Capsaicin insensitive A-fiber nociceptors (A-delta fibers) play a major role in the conveyance of pain and secondary hyperalgesia to pinprick (Magerl et al. 2001). However, no evidence could be provided to demonstrate the involvement of peripheral sensitization e.g. of “sleeping” capsaicin-sensitive mechano-insensitive C-nociceptors in the secondary zone (Magerl et al. 2001), even though some data might suggest a peripheral component of secondary hyperalgesia (Serra et al. 2004). Employing the UV-B irradiation model, Gustorff and colleagues demonstrated that systemic (intravenous) administration of the  $\mu$ -opioid receptor agonist remifentanyl reduced the

area of secondary pinprick hyperalgesia (Gustorff et al. 2004b). This study suggests an opioid sensitive pathway of central sensitization in the mediation of secondary pinprick hyperalgesia. However, given that irradiation of large skin areas with UV-B comprise apparently both central sensitization processes and peripheral neuronal components to induce secondary hyperalgesia, antihyperalgesic effects of the investigated drug are difficult to attribute to either a peripheral or a central mode of action of the pharmaceutical.

The UV-B erythema model has been used to assess the peripheral antihyperalgesic and analgesic effects of drugs following the induction of primary hyperalgesias. A recent study, for instance, revealed that systemic (oral) administration of the kappa-opioid agonist EMD 61753 had no impact on thermal and mechanical hyperalgesia that had been induced experimentally in UV-B irradiated skin spots (Bickel et al. 1998). In contrast, regionally administered morphine (IV regional anesthesia; "Bier block") significantly increased heat pain thresholds in UV-B irradiated skin, whereas pain ratings after mechanical impact stimulation were not affected (Koppert et al. 1999). These studies indicate that primary mechanical hyperalgesia is differentially mediated from heat hyperalgesia, of which polymodal nociceptive afferents are the most likely target. Moreover, these studies suggest that  $\mu$ -opioid and delta-opioid receptors may play a predominant role in thermal hyperalgesia, which corroborates the fact that once inflammation is induced, opioid receptors are newly expressed, producing an up-regulation in the nerve ending by their axonal transport to the peripheral terminal. In a recent experiment, Koppert and colleagues demonstrated that an intravenous bolus injection of the local anesthetic lidocaine significantly reduced repetitive mechanical hyperalgesia at the site of UV-B irradiated skin (Koppert et al. 2004). The authors concluded that systemically administered lidocaine exerts its antihyperalgesic effect on mechanical stimuli *via* a peripheral mechanism.

Few experimental models have been developed that reliably induce hyperalgesias in humans. Available models include electrically, chemically and thermally induced hyperalgesias (Moiniche et al. 1993; Kilo et al. 1994; Koppert et al. 2001). The administration of chemicals, for instance the injection of capsaicin, the pungent ingredient of chili peppers, or the topical application of mustard oil, induce an instant burning pain. Subsequently an acute primary hyperalgesia to thermal or mechanical stimuli occurs and, with a delay of a few minutes, a secondary mechanical hyperalgesia to punctate pressure (pinprick hyperalgesia) and light touch (allodynia) develops. Chemically, as well as electrically induced hyperalgesias represent acute nociceptive responses that gradually decline with time, usually within a few hours. Thus, they are inadequate models to assess the time dependent dose response of analgesic drugs, which require rather persistent areas

of hyperalgesia. Only recently, a heat/capsaicin sensitization model has been established that synergistically combines repetitive thermal and chemical stimuli to induce stable areas of secondary hyperalgesias for 4 h and a persistent erythema lasting up to 12 h (Petersen and Rowbotham 1999). Thermal stimuli on their own may induce sustained and sub-acute ("chronic") hyperalgesias, as demonstrated in a freeze lesion model (Kilo et al. 1994) and after burn injury (Moiniche et al. 1993). These models induce a clear primary hyperalgesia to thermal and mechanical stimuli; burn injury, in addition, evokes a secondary hyperalgesia to pinprick and touch that lasts up to 72 h. However, burn injuries cause acute pain and provoke considerable tissue damage, whereas freeze lesions induce a persistent pigmentation of the skin. Given these limitations, only the UV-erythema model meets the requirements of a reliable experimental method that induces a sustained and sub-acute primary hyperalgesia. Even better, UV-B irradiation is non-painful and may induce a secondary hyperalgesia, provided a large skin area had been irradiated. Therefore, the UV-B erythema represents a model of first choice to explore the efficacy of newly developed antihyperalgesic drugs.

## References

1. Bickel A, Dorfs S, Schmelz M et al. (1998) Effects of antihyperalgesic drugs on experimentally induced hyperalgesia in man. *Pain* 76:317–325
2. Eisenbarth H, Rukwied R, Petersen M et al. (2004) Sensitization to bradykinin B1 and B2 receptor activation in UV-B irradiated human skin. *Pain* 110:197–204
3. Gustorff B, Anzenhofer S, Sycha T et al. (2004a) The sunburn pain model: the stability of primary and secondary hyperalgesia over 10 hours in a crossover setting. *Anesth Analg* 98:173–177
4. Gustorff B, Hoechtl K, Sycha T et al. (2004b) The effects of remifentanyl and gabapentin on hyperalgesia in a new extended inflammatory skin pain model in healthy volunteers. *Anesth Analg* 98:401–407
5. Harrison GI, Young AR, McMahon SB (2004) Ultraviolet radiation-induced inflammation as a model for cutaneous hyperalgesia. *J Invest Dermatol* 122:183–189
6. Hoffmann RT, Schmelz M (1999) Time course of UVA- and UVB-induced inflammation and hyperalgesia in human skin. *Eur J Pain* 3:131–139
7. Kilo S, Schmelz M, Koltzenburg M, Handwerker HO (1994) Different patterns of hyperalgesia induced by experimental inflammation in human skin. *Brain* 117:385–396
8. Koppert W, Likar R, Geisslinger G et al. (1999) Peripheral antihyperalgesic effect of morphine to heat, but not mechanical, stimulation in healthy volunteers after ultraviolet-B irradiation. *Anesth Analg* 88:117–122
9. Koppert W, Dern SK, Sittl R et al. (2001) A new model of electrically evoked pain and hyperalgesia in human skin: the effects of intravenous alfentanil, S(+)-ketamine, and lidocaine. *Anesthesiology* 95:395–402
10. Koppert W, Brueckl V, Weidner C et al. (2004) Mechanically induced axon reflex and hyperalgesia in human UV-B burn are reduced by systemic lidocaine. *Eur J Pain* 8:237–244
11. Magerl W, Fuchs PN, Meyer RA et al. (2001) Roles of capsaicin-insensitive nociceptors in cutaneous pain and secondary hyperalgesia. *Brain* 124:1754–1764
12. Moiniche S, Dahl JB, Kehlet H (1993) Time course of primary and secondary hyperalgesia after heat injury to the skin. *Br J Anaesth* 71:201–205



13. Petersen KL, Rowbotham MC (1999) A new human experimental pain model: the heat/capsaicin sensitization model. *NeuroReport* 10:1511–1516
14. Schmelz M, Schmidt R, Weidner C et al. (2003) Chemical response pattern of different classes of C-nociceptors to pruritogens and algogens. *J Neurophysiol* 89:2441–2448
15. Serra J, Campero M, Bostock H et al. (2004) Two types of C nociceptors in human skin and their behavior in areas of capsaicin-induced secondary hyperalgesia. *J Neurophysiol* 91:2770–2781

## UV-Induced Erythema

THOMAS BISHOP

King's College London, University of London,  
London, UK

thomas.bishop@kcl.ac.uk

### Synonyms

UV Erythema; UV-Induced Erythema as a Model of Inflammatory Pain; Sunburn as a Model of Cutaneous Hyperalgesia

### Definitions

► **Sunburn** is the commonly experienced cutaneous inflammation that occurs in response to acute over-exposure of the skin to ultraviolet radiation (UVR). Along with the classical characteristics of inflammation (► **erythema**, oedema and increased tissue temperature) very marked increased sensitivities to both thermal and mechanical stimuli emerge in response to ultraviolet radiation within the burn and are typically present for several days. Several characteristics of these sensory changes make sunburn an interesting and useful model for the study of pain.

### Characteristics

#### UVR-Induced Inflammation in Humans

Virtually all Caucasians are acquainted with the effects of excessive cutaneous exposure to UV radiation resulting in sunburn. The associated sensory changes are readily appreciable to anyone who has taken a hot shower with a sunburnt back.

Many different UV sources have been used in the study of pain, including UVA, UVB and solar simulated radiation (SSR) sources. All appear to share similar gross patterns of inflammation and sensory changes (Benrath et al. 2001; Harrison et al. 2004; Gustorff et al. 2004a), providing appropriate doses are used.

This inflammatory response is dependent on the wavelength of the ultraviolet radiation. In humans, UVB (280–320 nm) is 2–4 orders of magnitude more effective at inducing erythema compared to UVA (320–400 nm) (Young et al. 1998). In SSR induced inflammation the UVB component of the spectrum accounts for approximately 90% of the erythema.

Individual responses to UV radiation vary greatly and as a result are largely expressed and normalised in terms

of the biological effect generated. Doses are given in terms of the erythema that is generated (minimal erythema dose, MED; the minimal dose required to produce a clearly demarcated area of erythema assessed at 24 hours) and are tailored to the individual subject. Doses of 1–3 MEDs of SSR are obtainable clinically and are equivalent to exposure of an hour or less of summer sun at temperate latitudes.

Well-demarcated erythema (with no surrounding flare) emerges soon after exposure to a SSR source and peaks at between 24 and 48 h. It has been demonstrated that during this time the blood flow to the skin is increased (Benrath et al. 2001; Harrison et al. 2004). The blood flow to the skin remains significantly raised for 72 h but is gradually falling from its peak (24–48 h) and has returned to normal within a week to ten days.

#### Human Models of UVR-Induced Pain

Doses of 2 MED produce significant ► **hyperalgesia** to both thermal and mechanical stimuli in skin exposed to the UVR (Benrath et al. 2001; Harrison et al. 2004; Gustorff et al. 2004a) though the irradiation is painless. The sensory changes are dose dependent with the magnitude of hyperalgesia positively correlating with the increasing biologically active dose (MED, level of inflammation) (Benrath et al. 2001; Harrison et al. 2004; Gustorff et al. 2004a).

The hyperalgesia develops in parallel with the erythema and also peaks at approximately 24 h. The magnitude of hyperalgesia produced by UVR is surprising; with modest clinically achievable doses of UVR producing large reductions in thermal thresholds and mechanical pain thresholds to levels where brushing the burnt skin can be painful.

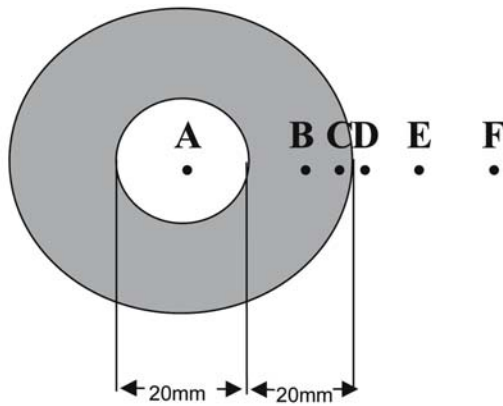
The sensory changes return to normal over several days at a rate dependent on the initial dose. Though the erythema may be biphasic the sensory changes appear to be monophasic.

Burns created by these clinically relevant doses of UVR (1–3 MEDs) do not produce blistering or breakdown of the skin and are not associated with ongoing spontaneous pain.

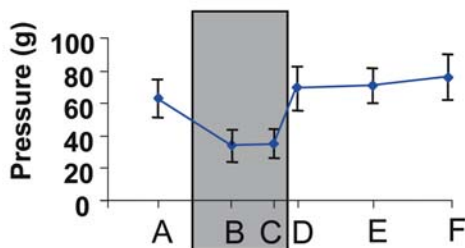
#### Primary vs. Secondary Sensory Changes

Many conventional models of inflammatory pain produce an area of ► **primary hyperalgesia** associated with the area of noxious stimuli and an adjacent area of ► **secondary hyperalgesia**. The neural correlates of these sensory changes are thought to differ between the areas of primary and secondary hyperalgesia.

► **Sensitisation** of the receptive terminals of ► **nociceptors** is thought to underpin a large proportion of primary hyperalgesia. Activity dependent changes in the central processing of sensory stimuli are thought to account for the secondary hyperalgesia. Peripheral neuronal inputs converge on the topographical map in the spinal cord, re-



Site	A	B	C	D	E	F
Distance from centre (mm)	0	20	28.5	31.5	40	60



**UV-Induced Erythema, Figure 1** UVR-Induced Changes in Sensitivity to Mechanical Pain Are Localised. The investigators exposed an annulus shaped region of skin to 3 MED worth of UVR, which produced a ring of burnt skin surrounding a circle of unburnt skin (A). Mechanical pain thresholds were assessed 24 h after irradiation inside (A), within (B, C) and at varying distances outside (D-F) the ring of burnt skin. The thresholds are shown for each point as mean  $\pm$  SEM. Taken from Harrison et al. 2004.

resulting in these central changes affecting uninjured areas adjacent to the primary area of insult.

One of the key points of debate surrounding the UV model is that despite clear evidence of changes in primary mechanical sensitivity there are contrasting reports concerning the emergence of secondary mechanical hyperalgesia surrounding UV irradiated skin. One group elegantly investigated the distribution of primary and secondary changes in mechanical pain thresholds and observed that increased mechanical sensitivity was restricted to the exact area of UVR inflammation without any alterations in secondary hyperalgesia (see Fig. 1) (Harrison et al. 2004).

A second group using different mechanical stimulation protocols demonstrated significant and stable secondary mechanical hyperalgesia (Gustorff et al. 2004a). Further work is needed to clarify these findings, though a working model with decreased primary mechanical pain thresholds superimposed on an area of secondary

mechanical hyperalgesia (mediated by changes in the central responses) may provide a starting point. It must be noted that neither group could demonstrate secondary brush evoked pain surrounding irradiated skin.

The power of this model may reside in the opportunities to study the mechanistic basis of mechanical hyperalgesia, which is a feature of many clinical states. Whereas many substances have been shown to sensitise the peripheral terminals of nociceptors to thermal stimuli, very few substances or conditions produce sensitisation of mechanical response profiles.

#### Mediators Raised in the Skin

Very few studies have looked at the mechanisms that subserve the altered sensation in this model. There is however a large body of work looking at the inflammatory mediators that are produced in the skin by UVR, some of which are algogenic.

There is some evidence that there is a degree of neurogenic inflammation which results from and causes the release of substance P and calcitonin gene-related peptide. Both of these neuropeptides are reported to contribute to the hyperalgesia (Seiffert and Granstein 2002).

The cyclooxygenase (COX) pathway may yield mediators which contribute to the development of the hyperalgesia. COX inhibitors applied topically to irradiated skin can reduce the hyperalgesia (Beyerl et al. 1998). Moreover several members of the prostaglandin family are produced during the time course of the erythema and hyperalgesia in sunburned skin (Rhodes et al. 2001). PGE<sub>2</sub>, one of the prostaglandins produced, is known to sensitise peripheral nociceptors to thermal stimuli.

Many other inflammatory mediators, some of which have established roles in modulating nociceptor and neuronal function, are also up-regulated and released. Histamine, bradykinin, cytokines (IL-1 and IL-10) TNF- $\alpha$  and NGF are all up-regulated in the skin after UV exposure (Barr et al. 1999; Seiffert and Granstein 2002) and all have been implicated in altering pain sensations and nociceptor function. It has recently been demonstrated that bradykinin B1 and B2 receptor activation is sensitised in UV-B irradiated human skin (Eisenbarth et al. 2004). The B1 receptor is thought to require inflammation to induce its expression in nociceptors. *De novo* up-regulation of the receptor can also be produced by exposure to IL-1 which is produced in UV irradiated skin. Bradykinin has been strongly implicated in the sensitisation of several properties of nociceptors, increasing responses to heat as well as other  $\blacktriangleright$  [Allogene](#) and inflammation associated chemicals.

#### Animal Models of UV Inflammation and Pain

The use of UV-induced inflammation as a model of pain in animals is not well established or clearly characterised. The UV sources and dosing regimens used at present do not correlate easily with the clinically

relevant protocols that have been used in human pain studies.

Some authors have used this stimulus as a surrogate for chronic inflammatory pain states by producing frank tissue damage. However, it is hard to see the benefit of these protocols employing very large doses of UVR, over conventional models produced by other inflammatory stimuli.

Recently two groups have characterised rat UVR-induced models of pain using dosing regimens which are more analogous to the human protocols (Davies et al. 2005; Themistocleous et al. 2006). The sensory phenotypes produced are equivalent to the changes seen in the established human models.

### Analgesic Interventions in Human Models

There are very few experimental models of subacute inflammatory pain. The UVR based models offer a quantifiable stimulus which provokes little discomfort during or after the irradiation. While the skin becomes tender, there is no evidence of spontaneous tissue injury or pain. Multiple sites can be exposed. Sensory changes are extremely robust and subjects are easily blinded with respect to treatments.

As UVR inflammatory models have been shown to be sensitive to several established analgesics they are emerging as a valuable tool for pain and pharmaceutical researchers. Acute UVR-induced cutaneous inflammation is sensitive to both topical and systemic ► **NSAIDs** (Sycha et al. 2003). Morphine and other opioids (Koppert et al. 1999; Gustorff et al. 2004b) have been shown to reduce the hyperalgesia caused by UVR. Interestingly it has been reported that peripherally acting morphine may differentially reduce thermal hyperalgesia pointing to different effector pathways in UV inflamed skin (Koppert et al. 1999). Gabapentin (a treatment for neuropathic pain) does not seem to have any analgesic effect in this model though it has been seen to affect the secondary component of some other inflammatory pain models (Gustorff et al. 2004b; Werner et al. 2001).

### Summary

Taken together, work in humans and animals raises the prospect of 'sunburn' (UVR-induced inflammation) becoming a translational model of cutaneous inflammatory pain. Moreover, the changes in responses to mechanical stimuli (magnitude of reduction in thresholds and significant primary hypersensitivity component) suggest that skin exposure to clinically relevant doses of UVR represents a powerful model of mechanical sensitisation of nociceptors.

### References

1. Barr RM, Walker SL, Tsang W et al. (1999) Suppressed alloantigen presentation, increased TNF-alpha, IL-1, IL-1Ra, IL-10, and modulation of TNF-R in UV-irradiated human skin. *J Invest Dermatol* 112:692-698

2. Bayerl C, Pagung R, Jung EG (1998) Meloxicam in acute UV dermatitis—a pilot study. *Photodermatol Photoimmunol Photomed* 14:167-169
3. Benrath J, Gillardon F, Zimmermann M (2001) Differential time courses of skin blood flow and hyperalgesia in the human sunburn reaction following ultraviolet irradiation of the skin. *Eur J Pain* 5:155-167
4. Davies SL, Siao C, Bennett GJ (2005) Characterization of a model of cutaneous inflammatory pain produced by an ultraviolet irradiation-evoked sterile injury in the rat. *J Neurosci Methods* 148:161-166
5. Eisenbarth H, Rukwied R, Petersen M et al. (2004) Sensitization to bradykinin B1 and B2 receptor activation in UV-B irradiated human skin. *Pain* 110:197-204
6. Gustorff B, Anzenhofer S, Sycha T et al. (2004a) The sunburn pain model: the stability of primary and secondary hyperalgesia over 10 hours in a crossover setting. *Anesth Analg* 98:173-7
7. Gustorff B, Hoechtel K, Sycha T et al. (2004b) The effects of remifentanyl and gabapentin on hyperalgesia in a new extended inflammatory skin pain model in healthy volunteers. *Anesth Analg* 98:401-7
8. Harrison GI, Young AR, McMahon SB (2004) Ultraviolet radiation-induced inflammation as a model for cutaneous hyperalgesia. *J Invest Dermatol* 122:183-189
9. Koppert W, Likar R, Geisslinger G et al. (1999) Peripheral antihyperalgesic effect of morphine to heat, but not mechanical, stimulation in healthy volunteers after ultraviolet-B irradiation. *Anesth Analg* 88:117-122
10. Rhodes LE, Belgi G, Parslew R et al. (2001) Ultraviolet-B-induced erythema is mediated by nitric oxide and prostaglandin E2 in combination. *J Invest Dermatol* 117:880-885
11. Seiffert K, Granstein RD (2002) Neuropeptides and neuroendocrine hormones in ultraviolet radiation-induced immunosuppression. *Methods* 28:97-103
12. Sycha T, Gustorff B, Lehr S et al. (2003) A simple pain model for the evaluation of analgesic effects of NSAIDs in healthy subjects. *Br J Clin Pharmacol* 56:165-172
13. Themistocleous A, Fick L, Plessis ID et al. (2006) Exposure of the rat tail to ultraviolet A light produces sustained hyperalgesia to noxious thermal and mechanical challenges. *J Neurosci Methods* 152:267-73
14. Werner MU, Perkins FM, Holte K et al. (2001) Effects of gabapentin in acute inflammatory pain in humans. *Reg Anesth Pain Med* 26:322-328
15. Young AR, Chadwick CA, Harrison GI et al. (1998) The similarity of action spectra for thymine dimers in human epidermis and erythema suggests that DNA is the chromophore for erythema. *J Invest Dermatol* 111:982-988

U

## UV-Induced Erythema as a Model of Inflammatory Pain

► UV-Induced Erythema

### UV Light

► Ultraviolet Light





## Vagal Input and Descending Modulation

CINDY L. THURSTON-STANFIELD<sup>1</sup>,  
ALAN RANDICH<sup>2</sup>

<sup>1</sup>University of South Alabama, Mobile, AL, USA

<sup>2</sup>University of Alabama, Birmingham, AL, USA  
cthursto@usouthal.edu, arandich@uab.edu

### Synonyms

Vagal Stimulation Produced Antinociception; Vagally-Mediated Analgesia; Vagally-Mediated Hyperalgesia

### Definition

Input from vagal afferents to neurons in the brain that control spinal nociceptive transmission. The vagus nerve (cranial nerve X) contains both afferent and efferent fibers that innervate viscera throughout the body. Activation of certain vagal afferents produces ► **antinociception**, whereas activation of others produces ► **hyperalgesia**. Both the antinociception and hyperalgesia result from altering neural activity in certain areas of the brain. These brain regions, through a descending pathway, then alter communication between ► **primary afferent neurons** and ► **spinothalamic neurons**.

### Characteristics

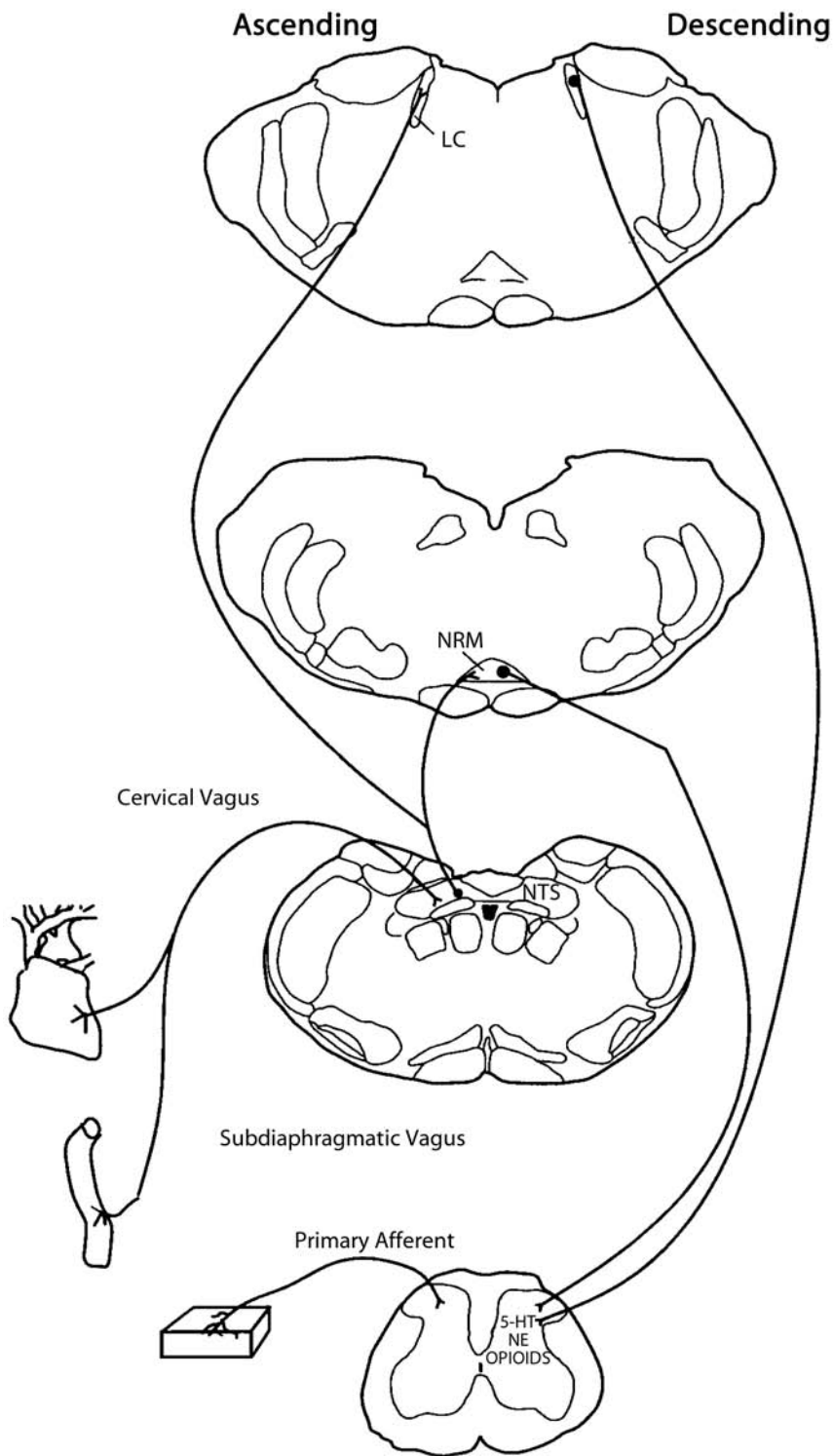
Activation of a number of regions in the brainstem produces antinociception, as evidenced by either the attenuation/absence of behavioral responses to noxious stimuli, or decreases in the responses of spinal/trigeminal dorsal horn neurons to noxious stimuli. Studies that are more recent indicate that some of these same regions can also produce hyperalgesia, when activated by either different types of stimuli or different intensities of electrical stimulation. These descending inhibitory and facilitatory pain-modulating systems are affected by a variety of input, including signals generated by visceral stimuli and transmitted to the central nervous system by vagal afferents. Vagal afferents transmit signals from the esophagus, lower airways, heart, gastrointestinal tract, liver, gallbladder, and pancreas to the ► **nucleus tractus solitarius** in the medulla oblongata.

Electrical, pharmacological, and physiological activation of either cervical or subdiaphragmatic vagal affer-

ents alters nociception, by activating these central descending pain modulatory systems. Analogous to central stimulation, activation of vagal afferents can either facilitate or inhibit nociception. For example, electrical stimulation of vagal afferents has been shown to both facilitate and attenuate nociception, depending on the intensity of stimulation.

In rats, low intensity electrical stimulation of cervical vagal afferents facilitates the nociceptive tail flick reflex, and enhances noxious heat-evoked responses in spinal cord dorsal horn neurons (Randich and Gebhart 1992). High intensity electrical stimulation of cervical or subdiaphragmatic vagal afferents has the opposite effect, inhibiting the tail flick reflex, decreasing formalin-induced nociceptive behavior, attenuating heat-evoked responses in spinal cord dorsal horn neurons, and decreasing formalin-induced Fos expression in trigeminal nuclei (Bohotin et al. 2003; Randich and Gebhart 1992; Ren et al. 1993; Tanimoto et al. 2002, Thurston and Randich 1992). In humans, electrical stimulation of the cervical vagus has been shown to either decrease the thermal pain threshold (Ness et al. 2000), or have no effect on thermal pain and decrease the intensity of tonic pressure pain perception (Kirchner et al. 2000). Pharmacological activation of vagal afferents, with intravenous administration of serotonin or low dose opioids, also inhibits spinal nociceptive reflexes and the response of spinothalamic neurons to noxious stimuli (Meller et al. 1992; Randich et al. 1993). The opioids that support a vagally-induced antinociception include morphine, (D-Ala<sub>2</sub>)-methionine enkephalinamide, and DAGO, all mu agonists (Randich et al. 1993).

Certain stimuli that reproduce normal physiological activation of vagal afferents produce either antinociception or hyperalgesia. Volume expansion produces a vagally-mediated attenuation of nociceptive reflexes and inhibition of trigeminal neuronal responses to a noxious stimulus (Takeda et al. 2002). In a model of inflammation, bradykinin-induced plasma extravasation and hyperalgesia are enhanced by subdiaphragmatic vagotomy, indicating that subdiaphragmatic vagal afferent activity normally suppresses these inflammatory responses (Miao et al. 2001). In these same studies, subdiaphragmatic vagotomy decreased paw withdrawal thresholds in untreated rats, also indicating an attenuation of nociception by tonic vagal activity. In terms of



**Vagal Input and Descending Modulation, Figure 1** Vagal input to descending pain inhibitory systems in the nucleus raphe magnus and locus coeruleus. Ascending pathways are shown on the left. Vagal afferents terminate in the nucleus tractus solitarius (NTS). Pathways from the NTS to the nucleus raphe magnus (NRM) and locus coeruleus (LC) are unknown, but both regions are necessary for vagally-mediated antinociception. Descending pathways are shown on the right. Activation of vagal afferents results in the spinal release of serotonin (5-HT), norepinephrine (NE), and opioids, which inhibits transmission between the primary afferent and spinothalamic neurons (not shown).

hyperalgesia, both lipopolysaccharide-induced illness and fasting produce a hyperalgesia that is reversed by subdiaphragmatic vagotomy (Khasar et al. 2003; Watkins et al. 1995). The illness-induced hyperalgesia can also be attenuated by the more selective resection of the hepatic branch of the vagus (Watkins et al. 1995).

Much of the circuitry, whereby activation of vagal afferents attenuates nociception, has been established (see Fig. 1). Attenuation of nociception requires activation of vagal **C Fiber**, possibly associated with **Visceral Nociception and Pain** (Ren et al. 1993). Some of the neural substrates mediating vagally-induced attenua-

tion of nociception include the nucleus tractus solitarius (NTS), the ► **nucleus raphe magnus** (NRM), the ► **locus coeruleus** (LC), and a descending spinal pathway in the ► **dorsolateral funiculus** (Miao et al. 2001; Randich and Gebhart 1992; Thurston and Randich 1992; Thurston-Stanfield et al. 1999). Neurons descending from the nucleus raphe magnus and locus coeruleus are hypothesized to release serotonin (5-HT) and norepinephrine (NE), respectively, and cause the local release of opioids (Randich and Gebhart 1992). These actions block the transmission of a nociceptive signal between the primary afferent neuron and the spinothalamic neuron. The neural substrates that mediate vagal afferent-induced facilitation of nociception are not as well established, and tend to vary according to the stimulus that activates the vagus. For example, electrical stimulation-induced hyperalgesia likely requires thinly-myelinated A fibers, forebrain structures, and the spinal ► **ventrolateral funiculus**, but not the nucleus raphe magnus, or locus coeruleus (Randich and Gebhart 1992; Ren et al. 1993). Studies suggest that vagal stimulation facilitates nociception through spinal actions of opioids and serotonin, acting at kappa opioid and 5-HT<sub>1</sub> receptor types, respectively (Ren et al. 1991). In contrast, illness-induced hyperalgesia requires the nucleus raphe magnus and dorsolateral funiculus (Watkins et al. 1995).

Clearly, vagal input has complex influences on descending pain modulation. The complexity is partly related to the numerous visceral terminal fields innervated by the vagus, the diversity of functions served by those viscera, and the need to understand both visceral pain and modulation of visceral pain in general. The importance of these findings is a better understanding of natural stimuli that can activate the endogenous analgesia systems, and how these systems work under normal and pathological conditions.

## References

- Bohotin C, Scholsem M, Multon S et al. (2003) Vagus Nerve Stimulation in Awake Rats Reduces Formalin-Induced Nociceptive Behavior and Fos-Immunoreactivity in Trigeminal Nucleus Caudalis. *Pain* 101:3–12
- Khasar SG, Reichling DB, Green PG et al. (2003) Fasting is a Physiological Stimulus of Vagus-Mediated Enhancement of Nociception in the Female Rat. *Neurosci* 119:215–221
- Kirchner A, Birklein F, Stefan H et al. (2000) Left Vagus Nerve Stimulation Suppresses Experimentally Induced Pain. *Neurology* 55:1167–1171
- Meller ST, Lewis SJ, Brody MJ et al. (1992) Vagal Afferent-Mediated Inhibition of a Nociceptive Reflex by I.V. Serotonin in the Rat. II. Role of 5-HT receptor subtypes. *Brain Res* 585:71–86
- Miao, FJ-P, Janig W, Jasmin L et al. (2001) Spino-Bulbo-Spinal Pathway Mediating Vagal Modulation of Nociceptive-Neuroendocrine Control of Inflammation in the Rat. *J Physiol* 532:811–822
- Ness TJ, Fillingim RB, Randich A, Backensto EM, Faught E (2000) Low Intensity Vagal Nerve Stimulation Lowers Human Thermal Pain Thresholds. *Pain* 86:81–85
- Randich A, Gebhart GF (1992) Vagal Afferent Modulation of Nociception. *Brain Res Rev* 17:77–99
- Randich A, Robertson JD, Willingham T (1993) The Use of Specific Opioid Agonists and Antagonists to Delineate the Vagally Mediated Antinociceptive and Cardiovascular Effects of Intravenous Morphine. *Brain Res* 603:186–200
- Ren K, Randich A, Gebhart GF (1991) Spinal Serotonergic and Kappa Opioid Receptors Mediate Facilitation of the Tail Flick Reflex Produced by Vagal Afferent Stimulation. *Pain* 45:321–329
- Ren K, Zhuo M, Randich A, Gebhart GF (1993) Vagal Afferent Stimulation-Produced Effects on Nociception in Capsaicin-Treated Rats. *J Neurophysiol* 69:1530–1540
- Takeda M, Tanimoto T, Nashikawa T et al. (2002) Volume Expansion Suppresses the Tooth-Pulp Evoked Jaw-Opening Reflex Related Activity of Trigeminal Neurons in Rats. *Brain Res Bull* 58:83–89
- Tanimoto T, Takeda M, Matsumoto S (2002) Suppressive Effect of Vagal Afferents on Cervical Dorsal Horn Neurons Responding to Tooth Pulp Electrical Stimulation in the Rat. *Exp. Brain Res* 145:468–479
- Thurston CL, Randich A (1992) Electrical Stimulation of the Subdiaphragmatic Vagus in Rats: Inhibition of Heat-Evoked Responses of Spinal Dorsal Horn Neurons and Central Substrates Mediating Inhibition of the Nociceptive Tail Flick Reflex. *Pain* 51:349–365
- Thurston-Stanfield CL, Ranieri JT, Vallabhapurapu R et al. (1999) Role of Vagal Afferents and the Rostral Ventral Medulla in Intravenous Serotonin-Induced Changes in Nociception and Arterial Blood Pressure. *Physiol Behav* 67:753–767
- Watkins LR, Maier SF, Goehler LE (1995) Immune Activation: The Role of Pro-Inflammatory Cytokines in Inflammation, Illness Responses and Pathological Pain States. *Pain* 63:289–302

## Vagal Stimulation Produced Antinociception

- Vagal Input and Descending Modulation

## Vagally-Mediated Analgesia

- Vagal Input and Descending Modulation

## Vagally-Mediated Hyperalgesia

- Vagal Input and Descending Modulation

## Vaginal Hyperalgesia Model

- Visceral Pain Models, Female Reproductive Organ Pain

## Vaginismus and Dyspareunia

- Dyspareunia and Vaginismus

## Vague, Strange Feeling

### Definition

Responses in the bowel without pain, these include discomfort, weak feelings.

- Morphology, Intraspinal Organization of Visceral Afferents

## Valdecoxib

### Definition

(trade name: Bextra). Valdecoxib is a COX-2 inhibitor that is more selective for COX-2 than celecoxib. In addition to the risk of myocardial infarction, it carries the risk of serious skin reactions and its sales have been suspended.

- Cyclooxygenases in Biology and Disease

## Validity

DAVID VIVIAN

Metro Spinal Clinic, Caulfield, VIC, Australia  
dvivian@metrospinal.com.au

### Definition

► **Validity** is the measure of the extent to which a diagnostic test actually does what it is supposed to do, i.e. how well it actually detects the condition it is supposed to detect. The term is derived from the Latin – *validus*, meaning strong or robust.

### Characteristics

Validity is determined by correlating the results of a test with those of a reference standard, known as the criterion standard, or formerly known as the “gold standard”. The criterion standard differs according to the test whose validity is being sought. The essential feature of a criterion standard is that, by consensus, it provides a more direct observation of the abnormality in question than the test in question and is, therefore, less susceptible to error. Moreover, the criterion standard must use methods independent of those used by the test in question. For clinical tests, such as those that rely on palpation, the criterion standard may be a radiographic finding, a post-mortem finding, or an observation at surgery, for these standards are less susceptible to error than palpation through skin and muscle, and rely on vision rather than touch.

Sometimes, when a criterion standard is not available, investigators have used a consensus view of a panel of experts, who determine whether or not the index condition is present, as the criterion standard. However, if

**Validity, Table 1** The structure of a  $2 \times 2$  contingency table comparing the results of a diagnostic test with those of a criterion standard.

Result of Test	Criterion Standard	
	Positive	Negative
Positive	a	b
Negative	c	d

those experts establish their diagnosis using the same or similar tests as the one in question, they are not assessing validity. Rather, theirs is a test of ► **reliability**, for they are measuring the extent to which two observers using the same test agree on the results.

Validity is determined by subjecting the same sample of patients to the test in question and to the criterion standard. The results of this exercise can be summarised in a  $2 \times 2$  contingency table, from which numerical indices of validity can be calculated (Table 1). Four cells are generated, in which ‘a’ is the number of cases in which the test and the criterion standard are both positive (i.e. both tests agree that the condition was present); ‘b’ is the number of cases in which the test was positive but the criterion standard was negative (i.e. the condition was not present despite the test being positive); ‘c’ is the number of cases in which the test was negative but the criterion standard was positive (i.e. the condition was present but the test missed it); and ‘d’ is the number of cases in which the test and the criterion standard were both negative (i.e. both tests agreed that the condition was absent).

Clearly, the ‘a’ and ‘d’ cases are correct results of the test, but the ‘b’ and ‘c’ cases are mistakes. In the ‘b’ cases, the test was positive but should not have been. Those results are false-positive. In the ‘c’ cases the test was negative, but should not have been (false-negative). A good test is one that carries few, if any, false-positive and false-negative results. From the contingency table, two fundamental values can be derived. These stem from the columns under criterion standard.

The ► **sensitivity** of the test measures how well it detects the condition when the condition is present (Sackett et al. 1991). It is derived down the first column. Numerically it is the ratio:  $a / (a+c)$ . Idiomatically, it is the ratio between the number of true-positive results and all positive cases. This ratio constitutes the true-positive rate. The ► **specificity** of the test measures how well it excludes the condition when the condition is absent (Sackett et al. 1991). It is derived up the second column. Numerically it is the ratio:  $d / (b+d)$ . Idiomatically it is the ratio between the number of true negative results and all negative cases, and constitutes the true-negative rate. Its complement,  $b / (b+d)$ , i.e.  $[1 - \text{specificity}]$ , is the false-negative rate.

A valid test is one with high sensitivity and high specificity. The validity of the test is compromised if either of these indices are low.



From the sensitivity and the specificity, a single measure of the validity of a test can be derived. It is the positive likelihood ratio, which indicates how often positive results of the test are truly positive. Idiomatically, the positive likelihood ratio is the true-positive rate discounted by the false-positive rate, and is defined as (true-positive rate) / (false-positive rate). Numerically it is (sensitivity) / (1 – specificity) (Sackett et al. 1991).

The virtue of the positive likelihood ratio is that it reveals the extent to which confidence in diagnosis is increased by a positive result of the diagnostic test. This can be quantified from the relationship:

(prevalence odds) × (positive likelihood ratio) = (diagnostic confidence odds)

where prevalence odds are the pre-test likelihood that the condition is present, expressed as odds; and diagnostic confidence odds is the post-test likelihood that the condition is present, expressed as odds (Sackett et al. 1991). Odds, instead of percentages, are used in order for the equation to work mathematically (Bogduk 1999). If the prevalence of a condition is 40%, the odds that it is present are 40:60, i.e. 40:(100-40). If the diagnostic confidence odds are 8:2, the diagnostic confidence is 80%, i.e. 8 / (8+2).

If a diagnostic test has a positive likelihood ratio of 1.0, the test has no validity. From the equation it can be seen that applying the test does not improve diagnostic confidence. The odds after the test are the same as before the test.

For a test to be valid, the positive likelihood ratio must be substantially greater than 1.0. Exactly by how much greater it has to be depends on the prevalence of the condition and the diagnostic confidence required. As a rule, if the condition is common, the positive likelihood ratio needs only to be modestly large. If the condition is rare, the positive likelihood ratio must be extremely large. If greater diagnostic confidence is required or desired, the test must have a proportionately larger positive likelihood ratio.

If the natural prevalence of a condition is, say, 40%, and one wants to be 80% confident in the diagnosis, the value required of the positive likelihood ratio (PLR) can be derived:

$$40:60 \times \text{PLR} = 80:20$$

$$\text{PLR} = 6$$

Thus, for a condition with a prevalence of 40%, if the desired diagnostic confidence is 80%, a test is sufficiently valid if its positive likelihood ratio is 6 or more. A test whose positive likelihood ratio is less than 6 lacks sufficient validity to serve the purpose required.

If the natural prevalence of a condition is, say 10%, and one wants to be 80% confident in the diagnosis, the value required of the positive likelihood ratio is different:

$$10:90 \times \text{PLR} = 80:20$$

$$\text{PLR} = 36$$

Thus, in this example, a much larger positive likelihood ratio is required. This arises because of the lower prevalence of the condition being sought.

When the condition in question is uncommon, patients who do not have the condition, but who might nevertheless generate a positive result, outnumber those patients who do have the condition. This increases the chances of a false-positive result. To overcome this false-positive rate, a large positive likelihood ratio is required.

As a general rule, tests that have a positive likelihood ratio with a magnitude of the order of 1.0 or 2.0 have little or no useful validity. Few clinical tests in pain medicine exceed these values. Consequently, few tests are valid.

- ▶ [Disability Assessment, Psychological / Psychiatric Evaluation](#)
- ▶ [Multiaxial Assessment of Pain](#)
- ▶ [Oswestry Disability Index](#)
- ▶ [Pain Assessment in Children](#)
- ▶ [Pain Assessment in Neonates](#)
- ▶ [Pain Inventories](#)
- ▶ [Whiplash](#)

## References

1. Bogduk N (1999) Truth in Musculoskeletal Medicine. Truth in Diagnosis – Validity. *Australasian Musculoskeletal Medicine* 4:32–39
2. Sackett DL, Haynes RB, Guyatt GH, Tugwell P (1991) *Clinical Epidemiology. A Basic Science for Clinical Medicine*, 2<sup>nd</sup> edn. Little, Brown & Co, Boston, pp 119–139

## Valsalva Maneuver

### Definition

The Valsalva Maneuver consists of a forced expiration against a closed glottis and nasal airway. This obstructs venous return to the heart and increases intrathoracic and intra-cranial pressure.

- ▶ [Primary Cough Headache](#)
- ▶ [Primary Exertional Headache](#)

V

## Valsalva Manoeuvre Headache

- ▶ [Primary Cough Headache](#)

## Vanilloid Receptor, Regulation by NGF

- ▶ [TRPV1, Regulation by Nerve Growth Factor](#)

## Vanilloid Receptor, Regulation by Protons

- ▶ [TRPV1, Regulation by Protons](#)

## Vanilloid Receptor Subtype 1

- ▶ Capsaicin Receptor
- ▶ TRPV1
- ▶ TRPV1 Receptor, Species Variability

## Vanilloids

### Definition

Vanilloids are a group of compounds containing a vanillyl residue. Most data exists about capsaicin, the pungent substance in hot pepper varieties. Vanilloids act by stimulating certain transient receptor potentials (TRPV1) on nociceptive afferent neurons, cation channels that are also opened by noxious heat or acidic pH.

- ▶ Neuropeptide Release in the Skin

## VAP

- ▶ Ventral Amygdaloid Pathway

## Varicosities

### Definition

The terminals of unmyelinated axons bear a number of swellings called varicosities that contain accumulations of mitochondria, small and large synaptic vesicles and other organelles. The small vesicles contain neurotransmitter agents, while the large vesicles also contain neuropeptides. The varicosities are the sites of transmitter release, although the probability of release of the contents of one vesicle from a single varicosity is normally very low (<0.001).

- ▶ Sympathetic and Sensory Neurons after Nerve Lesions, Structural Basis for Interactions

## VAS

- ▶ Visual Analog Scale

## Vasa Nervorum

### Definition

Blood vessels supplying, and located within, a nerve trunk.

- ▶ Neuropathic Pain Model, Diabetic Neuropathy Model

## Vascular Compression Syndromes

### Definition

Vascular compression of the cranial nerves leading to syndromes characterized by increased neuronal activity such as spontaneous pain (this entry) or muscle spasm, i.e. hemifacial spasm or twisting neck movements known as torticollis.

- ▶ Trigeminal, Glossopharyngeal, and Geniculate Neuralgias

## Vascular Hypertrophy

- ▶ Sympathetic and Sensory Neurons after Nerve Lesions, Structural Basis for Interactions

## Vascular Neuropathies

CLAUDIA SOMMER

Department of Neurology, University of Würzburg, Würzburg, Germany  
sommer@mail.uni-wuerzburg.de

### Synonyms

Ischemic Neuropathies; vasculitic neuropathies

### Definition

Neuropathies caused by malfunction of nerve blood vessels.

### Characteristics

#### Neuropathies in Peripheral Arterial Occlusive Disease (PAOD)

Peripheral nerve function depends on an adequate blood supply. Since peripheral nerves have a dual blood supply (an intrinsic system consisting of longitudinal microvessels within the endoneurium and an extrinsic system of regional arteries, arterioles, venules, and epineurial vessels, in addition, extensive anastomosing), peripheral nerves are relatively protected from ischemic injury (Nukada et al. 1993). However, acute ischemia leads to axonal nerve damage (Wilbourn et al. 1983). In chronic endoneurial ischemia, histological studies of nerves show signs of axonal pathology, and signs of ▶ [demyelination](#) have been reported (Chalk and Dyck 1993). Furthermore, there is a correlation between the severity of nerve damage and the stage of the vascular insufficiency (Laghi Pasini et al. 1996). By definition, activity-induced or resting pain is a prevalent symptom in patients with PAOD. Few studies have tried to distinguish between ischemic and neuropathic pain in these patients. In one study, paresthesias, indicating neuropathic pain, were present in about 50% of patients with ▶ [Peripheral Arterial Occlusive Disease \(PAOD\)](#).

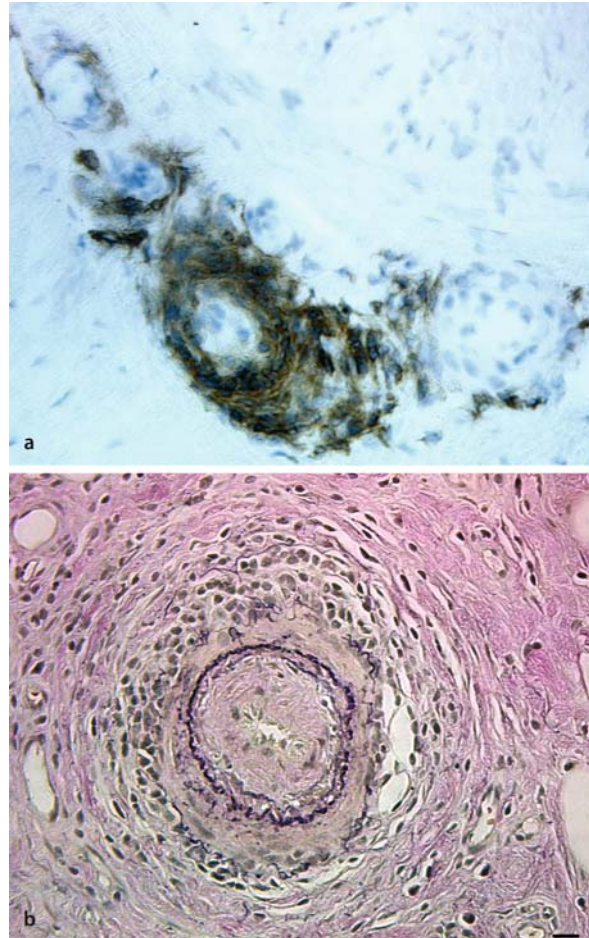
Since the patients' symptoms are usually dominated by activity-dependent pain, and restrictions in activity are associated with vascular ► **claudication**, the neuropathic component receives less attention and often does not require separate treatment (Weber and Ziegler 2002). In a study of 19 patients with PAOD, equally non-neuropathic and local causes of pain (superficial skin ulceration, osteomyelitis, and claudication) dominated the patient's concern and attention. Pain symptoms attributed to the neuropathy were rest pain in the toes or foot (58%), numbness (58%), burning (42%), and paresthesias (37%) (Weinberg et al. 2001). Trophic skin changes may be caused by both the arterial disease itself and by the neuropathy. Treatment is aimed at improvement of blood flow.

Diabetes being the most common cause of small vessel disease in industrialized societies, PAOD is often caused by or associated with diabetic complications. Diabetes leads to a multifactorial neuropathy by itself (see ► **diabetic neuropathies**), which may be enhanced by ischemia due to small vessel occlusion.

### Vasculitic Neuropathies

Vasculitic neuropathies are immune mediated diseases of the peripheral nervous system, in which inflammation of the blood vessels causes damage to the nerves. ► **Vasculitis** may be part of a systemic disease in primary systemic vasculitis or in ► **connective tissue diseases**, or may be an isolated phenomenon in peripheral nerves, called non-systemic vasculitic neuropathy (NSVN). The typical clinical picture consists of an asymmetric or multifocal, painful sensorimotor neuropathy with an acute, subacute or chronic course and acute relapses. However, vasculitis can also cause a rather unspecific syndrome of distal symmetric, sensorimotor neuropathy. Systemic vasculitis has an incidence of 4/100,000 per year and, untreated, has a poor prognosis, which is greatly improved by the use of immunosuppressive treatment. The prognosis of NSVN is generally better, although many patients need long-term ► **immunosuppression**.

Primary systemic vasculitis and secondary vasculitis in connective tissue diseases has been classified in different ways, the latest generally accepted classification being the one of the Chapel Hill Consensus Conference in 1994 (Jennette et al. 1994), which groups diseases according to the size of the affected arteries. Neuropathies are a frequent manifestation in polyarteritis nodosa, in Wegener's granulomatosis and Churg-Strauss-syndrome, in Sjögren's syndrome, and in rheumatoid arthritis. Stage II and III borreliosis may also lead to vasculitic neuropathy. Hepatitis B and C may be associated with cryoglobulinemic vasculitic neuropathy. Malignant tumors may rarely cause vasculitic neuropathy as a paraneoplastic syndrome. One third of the patients coming to attention with vasculitic neuropathy have isolated peripheral nerve vasculitis.



**Vascular Neuropathies, Figure 1** (a) Frozen section from a sural nerve biopsy specimen from a patient with isolated peripheral nerve vasculitis, immunostained for T-cells. Note dense infiltration of the vessel wall. (b) Paraffin section from a sural nerve biopsy specimen from a patient with isolated peripheral nerve vasculitis, elastica-van-Gieson stain. Note narrowing of vessel lumen and perivascular infiltrates. Bar = 10  $\mu$ m.

A diagnosis of definite vasculitis can be made with evidence of vasculitis in a biopsy specimen (Fig. 1); histologic criteria for this diagnosis have been defined (Collins et al. 2000).

The neuropathy in vasculitis is partially caused by ischemia, partially due to direct inflammatory damage of the nerves. Endothelial cells have antigen presenting capacities, they express adhesion molecules which then recruit inflammatory cells. Immunoglobulin complex deposits in the vessel walls may trigger the activation of the complement system, and generate chemotactic factors attracting granulocytes. These further produce ► **cytokines**, prostaglandins, ► **metalloproteases** and perforin, leading to tissue damage and sensitization of nerve fibers (Kissel 2001; Sato et al. 1998). The expression of proinflammatory cytokines in peripheral nerves is increased in most vasculitic neuropathies, and in particular in specimens from patients in whom pain is a prominent symptom (Lindenlaub and Sommer



2003). Nerve growth factor (NGF) has also been implied as a pain-inducing factor in vasculitic neuropathies (Yamamoto et al. 2003).

Thus, in the vasculitic neuropathies, pain is thought to be induced by a combination of axonal injury and inflammatory changes. Changes induced directly through axonal injury are, for example, the altered distribution of sodium channels. In addition, the release of inflammatory mediators in the vicinity of the nerve fibers is increased. Inflammatory mediators, in particular in combination ('inflammatory soup'), are known to increase the excitability of nociceptors, and even more so of those that have suffered an injury (Michaelis et al. 1998; Schäfers et al. 2003). This may be a reason why pain and paresthesias are usually the first symptoms to respond to treatment with corticosteroids in patients with vasculitic neuropathies. However, many patients still need symptomatic treatment for pain, at least temporarily.

Treatment of the underlying disorders consists of immunosuppression, to which most patients respond. Depending on the severity of the disorder and on general organ involvement, treatment may consist of a combination of corticosteroids with ► cyclophosphamide or methotrexate. After achievement of remission, in general after 6–12 months, cyclophosphamide is substituted by ► azathioprine or methotrexate (Jayne 2001). NSVN can sometimes be treated with corticosteroids alone. If the neuropathy progresses, when these are tapered, azathioprine may be necessary, or even temporarily cyclophosphamide (Dyck et al. 1987; Kissel 2001; Kissel and Mendell 1992). Pain in isolated peripheral nerve vasculitis is treated according to the general rules of treatment of neuropathic pain.

## References

- Chalk CH, Dyck PJ (1993) Ischemic Neuropathy. In: Dyck PJ, Thomas PK, Griffin JW et al. (eds) *Peripheral Neuropathy*. WB Saunders, Philadelphia, pp 980–989
- Collins MP, Mendell JR, Periquet MI et al. (2000) Superficial Peroneal Nerve/Peroneus Brevis Muscle Biopsy in Vasculitic Neuropathy. *Neurology* 55:636–643
- Dyck PJ, Benstead TJ, Conn DL et al. (1987) Nonsystemic Vasculitic Neuropathy. *Brain* 110:843–854
- Jayne D (2001) Update on the European Vasculitis Study Group trials. *Curr Opin Rheumatol* 13:48–55
- Jennette JC, Falk RJ, Andrassy K et al. (1994) Nomenclature of Systemic Vasculitides. Proposal of an International Consensus Conference. *Arthritis Rheum* 37:187–192
- Kissel J (2001) Vasculitic Neuropathies. In: Gilman S (ed) *MedLink Neurology*. MedLink Corporation, San Diego
- Kissel JT, Mendell JR (1992) Vasculitic Neuropathy. *Neurol Clin* 10:761–781
- Laghi Pasini F, Pastorelli M, Beermann U et al. (1996) Peripheral Neuropathy Associated with Ischemic Vascular Disease of the Lower Limbs. *Angiology* 47:569–577
- Lindenlaub T, Sommer C (2003) Cytokines in Sural Nerve Biopsies from Inflammatory and Non-Inflammatory Neuropathies. *Acta Neuropathol* 105:593–602
- Michaelis M, Vogel C, Blenk KH et al. (1998) Inflammatory Mediators Sensitize Acutely Axotomized Nerve Fibers to Mechanical Stimulation in the Rat. *J Neurosci* 18:7581–7587
- Nukada H, Powell HC, Myers RR (1993) Spatial Distribution of Nerve Injury after Occlusion of Individual Major Vessels in Rat Sciatic Nerves. *J Neuropathol Exp Neurol* 52:452–459
- Satoi H, Oka N, Kawasaki T et al. (1998) Mechanisms of Tissue Injury in Vasculitic Neuropathies. *Neurology* 50:492–496
- Schäfers M, Lee DH, Brors D et al. (2003) Increased Sensitivity of Injured and Adjacent Uninjured Rat Primary Sensory Neurons to Exogenous Tumor Necrosis Factor-Alpha after Spinal Nerve Ligation. *J Neurosci* 23:3028–3038
- Weber F, Ziegler A (2002) Axonal Neuropathy in Chronic Peripheral Arterial Occlusive Disease. *Muscle Nerve* 26:471–476
- Weinberg DH, Simovic D, Isner J et al. (2001) Chronic Ischemic Monomelic Neuropathy from Critical Limb Ischemia. *Neurology* 57:1008–1012
- Wilbourn AJ, Furlan AJ, Hulley W et al. (1983) Ischemic Monomelic Neuropathy. *Neurology* 33:447–451
- Yamamoto M, Ito Y, Mitsuma N et al. (2003) Pain-Related Differential Expression of NGF, GDNF, IL-6, and their Receptors in Human Vasculitic Neuropathies. *Intern Med* 42:1100–1103

## Vascular Orofacial Pain

### Synonyms

VOP

### Definition

Vascular orofacial pain (VOP) shares many of the signs and symptoms of other vascular-type craniofacial pains. It is confined to the oral cavity, the perioral region and lower part of the face. When affecting a tooth it may mimic pulpitis.

- [Atypical Facial Pain, Etiology, Pathogenesis and Management](#)
- [Atypical Odontalgia](#)

## Vascularization

### Definition

Vascularization is a physiological process to form new blood vessels. The tissue becomes vascular and develops capillaries.

- [NSAIDs and Cancer](#)

## Vascular-Type Craniofacial Pain

### Definition

This is a unilateral, periodic, pulsatile, severe pain in the craniofacial region that may wake from sleep, accompanied by autonomic phenomena. This includes pain syndromes such as migraine, cluster headache and paroxysmal hemicrania.

- [Atypical Facial Pain, Etiology, Pathogenesis and Management](#)
- [Atypical Odontalgia](#)



## Vasculitic

### Definition

Pertaining to vasculitis.  
 ▶ Hansen's Disease

## Vasculitic Neuropathy

### Definition

Neuropathy caused by vasculitis of the nerve.  
 ▶ Diabetic Neuropathies  
 ▶ Vascular Neuropathies

## Vasculitis

### Definition

Inflammation within and around the walls of blood vessels that can deprive nearby tissues of normal blood flow and lead to secondary damage or cell death. Axons are vulnerable to damage from vasculitis.  
 ▶ Diabetic Neuropathies  
 ▶ Headache Due to Arteritis  
 ▶ Vascular Neuropathies  
 ▶ Viral Neuropathies

## Vasoactive Intestinal Polypeptide

### Synonyms

VIP

### Definition

Vasoactive intestinal polypeptide (VIP), a 28–amino acid peptide, was isolated as a vasodilator peptide from lung and intestine, and was later also localized to nervous tissue. VIP acts as an anti-inflammatory peptide, but is itself also produced by immune cells. In the nervous system, it modulates pain sensation as well as other neuronal processes. Apart from its involvement in brain metabolism, it relaxes smooth muscle and stimulates secretory glands. In postganglionic fibers of the autonomic nervous system it is a co-transmitter of acetylcholine.  
 ▶ Neuropeptide Release in the Skin  
 ▶ Peptides in Neuropathic Pain States  
 ▶ Postsynaptic Dorsal Column Projection, Anatomical Organization

## Vasodilator

### Definition

An agent that causes dilation of the blood vessels.  
 ▶ Headache Attributed to a Substance or its Withdrawal

## Vasomotor

### Definition

One of the important functions of the sympathetic nervous system is control of blood flow to tissues. This is achieved by narrowing or widening of the blood vessels depending on the need for oxygen and other nutrients for optimal tissue function. This function of the sympathetic nervous system is known as vasomotor function. Vasomotor dysfunction may occur in CRPS resulting in abnormally warm or cold limbs.  
 ▶ Sympathetically maintained pain in CRPS II, human experimentation

## Vasomotor Dysfunction

### Definition

Affecting blood perfusion.  
 ▶ Causalgia, Assessment

## Vasovagal Response

### Definition

Vasovagal response refers to an exaggerated response by the autonomic nervous system. During the vasovagal response, heart rate and blood pressure decrease rapidly, which reduces blood flow to the brain. This reduction of blood flow leads to feelings of warmth, lightheadedness, and dimming of vision and hearing. If the vasovagal response progresses, further reducing blood flow to the brain, the individual may faint (vasovagal syncope). Frequent triggers of fainting include pain, trauma, fatigue, blood loss or prolonged, motionless standing.  
 ▶ Experimental Pain in Children

## VDCCs

▶ Calcium Channels in the Spinal Processing of Nociceptive Input

## Vector

### Definition

Gene delivery is accomplished through the use of “vectors”. These may be derived from viruses (viral vectors) or constructed using non-viral elements (nonviral vectors). In *ex vivo* applications, cells removed from the body are cultured in a dish, transduced with the vector of choice, and after determining that the transgene is expressed appropriately are transplanted back into the body to achieve the desired therapeutic effect. *In vivo* applications of gene therapy rely on the use of vectors to deliver the therapeutic transgene to an intact organism by injection into a blood vessel or directly into a target tissue.

- ▶ Opioids and Gene Therapy

## Vein Thrombosis

- ▶ Postoperative Pain, Venous Thromboembolism

## Venereal Arthritis

- ▶ Reiter’s Syndrome

## Ventral Amygdaloid Pathway

### Synonyms

VAP

### Definition

A collection of fibers that reciprocally connect the amygdala with the lateral hypothalamus and brainstem areas such as the parabrachial area.

- ▶ Nociceptive Processing in the Amygdala, Neurophysiology and Neuropharmacology

## Ventral Basal Complex of the Lateral Thalamus

### Definition

Human nomenclature (VC), VP or VB in monkeys or cats, includes VPL & VPM.

- ▶ Thalamus, Dynamics of Nociception

## Ventral Basal Nucleus (VB)

### Definition

VPL and VPM nuclei in the cat thalamus.

- ▶ Thalamic Plasticity and Chronic Pain

## Ventral Caudal Nucleus (Vc)

### Definition

Human nomenclature for VP or VB in monkeys or cats, includes VPL and VPM.

- ▶ Burst Activity in Thalamus and Pain
- ▶ Human Thalamic Nociceptive Neurons
- ▶ Thalamic Bursting Activity, Chronic Pain
- ▶ Thalamus, Receptive Fields, Projected Fields, Human

## Ventral Lateral Nucleus

### Definition

It is the ventral nucleus anterior to VP. The region is heavily connected with the motor cortex.

- ▶ Spinothalamic Terminations, Core and Matrix

## Ventral Medial Nucleus

### Synonyms

Vmpo

### Definition

The posterior part (Vmpo) of the ventral medial nucleus of the thalamus. The region is claimed to be the main spinothalamic termination site for lamina I neurons in humans and in the monkey.

- ▶ Human Thalamic Nociceptive Neurons

## Ventral Posterior Complex (VP)

### Definition

A group of nuclei in the ventral tier of the thalamus, receiving the different somatosensory inputs from the whole body. The complex is organized in a topological way, the head being placed medially (ventral posterior medial nucleus), and the foot laterally close to the internal capsule (ventral posterior lateral nucleus). Nociceptive cells have been found in the different parts of the complex, but more specifically in the ventral posterior inferior nucleus, where a pain homunculus

was described. The complex projects mainly to cortical areas SI, SII and the insula.

- ▶ [Thalamotomy for Human Pain Relief](#)

## Ventral Posterior Inferior Nucleus

### Synonyms

VPI

### Definition

The VPI nucleus is part of the somatosensory thalamus. It is located just ventral to the ventral posterior lateral and medial nuclei. Many of the neurons in the VPI nucleus are nociceptive. One source of input to the VPI nucleus is the spinothalamic tract. The thalamocortical output probably includes SII.

- ▶ [Spinothalamic Input, Cells of Origin \(Monkey\)](#)
- ▶ [Spinothalamic Terminations, Core and Matrix](#)
- ▶ [Thalamic Nuclei Involved in Pain, Human and Monkey](#)
- ▶ [Thalamus, Nociceptive Cells in VPI, Cat and Rat](#)

## Ventral Posterior Lateral Nucleus

### Synonyms

VPL

### Definition

The VPL nucleus is a part of the somatosensory thalamus. As the name implies, this nucleus is located in the ventral part of the posterior thalamus. It is lateral to another part of the somatosensory thalamus, the ventral posterior medial (VPM) nucleus. The VPL nucleus is concerned with somatosensory input from the body, whereas the VPM nucleus receives information concerning the head. In primates, the VPL nucleus receives synaptic input from both the dorsal column-medial lemniscus pathway, spino-cervicothalamic pathway and the spinothalamic tract. Some VPL neurons are nociceptive, although most are mechanoreceptive. The VPL nucleus projects to, and thus conveys somatosensory information to, the SI and SII regions of the cerebral cortex.

- ▶ [Burst activity in Thalamus and Pain](#)
- ▶ [Lateral Thalamic Lesions, Pain Behavior in Animals](#)
- ▶ [Spinothalamic Input, Cells of Origin \(Monkey\)](#)
- ▶ [Spinothalamic Terminations, Core and Matrix](#)
- ▶ [Thalamic Nuclei Involved in Pain, Human and Monkey](#)
- ▶ [Thalamic Plasticity and Chronic Pain](#)
- ▶ [Thalamus, Visceral Representation](#)

## Ventral Posterior Medial

### Synonyms

VPM

### Definition

Medial portion of VP. Neurons in this nucleus respond mainly to touch and proprioception applied to the head.

- ▶ [Burst activity in Thalamus and Pain](#)
- ▶ [Human Thalamic Response to Experimental Pain \(Neuroimaging\)](#)
- ▶ [Spinothalamic Terminations, Core and Matrix](#)
- ▶ [Thalamic Nuclei Involved in Pain, Human and Monkey](#)
- ▶ [Thalamus, Visceral Representation](#)

## Ventral Posterior Nuclear Group of the Thalamus

### Definition

Ventral Posterior Nuclear Group of the Thalamus is a summary term for the specific somatosensory nuclei of the thalamus. Most commonly used taxonomy is for monkey thalamus: VPL (ventro-postero-lateral), VPM (ventro-postero-medial), VPI (ventro-postero-inferior). In humans: Vc (ventro-caudal).

- ▶ [Nociceptive Processing in the Secondary Somatosensory Cortex](#)

## Ventral Posterior Nucleus (Human Ventral Caudal)

### Definition

The principle somatic sensory nucleus of thalamus, which receives projections from the spinothalamic tract. Other nuclei receiving such input are posterior and inferior to VP including the posterior nucleus, the ventral posterior inferior nucleus, and the ventral medial nucleus - posterior part (VMpo).

- ▶ [Angina Pectoris, Neurophysiology and Psychophysics](#)
- ▶ [Lateral Thalamic Pain-Related Cells in Humans.](#)

## Ventral Tegmental Area

### Definition

Region of the midbrain containing dopaminergic neurons that project to cortical and limbic structures.

- ▶ [Nociceptive Processing in the Nucleus Accumbens, Neurophysiology and Behavioral Studies](#)

V

## Ventricular Collapse

- ▶ Headache Due to Low Cerebrospinal Fluid Pressure

## Ventrolateral Funiculus

### Definition

White matter of the ventral and lateral aspects of the spinal cord.

- ▶ Vagal Input and Descending Modulation

## Ventrolateral Orbital Cortex

### Synonyms

VLO

### Definition

The VLO is a region of the frontal cortex that envelops the rhinal fissure at its medial limits, and is respectively bounded by the lateral and medial orbital regions. Its location in the so-called limbic (emotional) areas of the cortex, and its interconnections with the SM and PAG, suggest that VLO neurons may process motivational-affective aspects of nociception.

- ▶ Spinothalamocortical Projections from SM

## Ventromedial Nucleus

### Definition

The most medial portion of the ventrobasal or ventral posterior nucleus.

- ▶ Brainstem Subnucleus Reticularis Dorsalis Neuron
- ▶ Spinothalamocortical Projections to Ventromedial and Parafascicular Nuclei

## Ventroposterior Lateral Nucleus

### Synonyms

VPL

### Definition

Lateral portion of VP. Neurons in this nucleus respond mainly to touch and proprioception applied to the lower body and lower limbs.

- ▶ Human Thalamic Response to Experimental Pain (Neuroimaging)

## Verapamil

### Definition

Calcium channel blocker.

- ▶ Migraine, Preventive Therapy

## Vertebro-Basilar Arterial Disease

### Definition

This causes obstruction of flow in the vertebral arteries or the basilar artery that they join to form. This system supplies the hindbrain and brainstem with blood.

- ▶ Primary Cough Headache

## Vertigo

### Definition

An illusory sensation of motion (rotational, translational, or tilting of the visual environment) of either the self or the surrounding.

- ▶ Coordination Exercises in the Treatment of Cervical Dizziness

## Vesical

### Definition

Of the bladder.

- ▶ Nocifensive Behaviors of the Urinary Bladder
- ▶ Visceral Pain Model, Urinary Bladder Pain (Irritants or Distension)

## Vesical Pain Models

- ▶ Visceral Pain Model, Urinary Bladder Pain (Irritants or Distension)

## Vesicular Inhibitory Amino Acid Transporter

### Synonyms

VIAAT

### Definition

A transporter protein that transports GABA and glycine into presynaptic vesicles.

- ▶ GABA and Glycine in Spinal Nociceptive Processing



## Vestibulectomy

### Definition

A vestibulectomy is a minor surgical procedure involving the excision of a portion of the vestibular area in women with vulvar vestibulitis to treat vulvar pain.

- ▶ Dyspareunia and Vaginismus
- ▶ Vulvodynia

## Vestibulodynia

### Definition

A localized form of vulvodynia (pain is localized to the vulvar vestibule); this definition has been introduced to replace the term vulvar vestibulitis, since it was felt that the suffix „-itis,, in vestibulitis might incorrectly suggest an inflammatory etiology.

- ▶ Vulvodynia

## VIAAT

- ▶ Vesicular Inhibitory Amino Acid Transporter

## Viagra

- ▶ Sildenafil

## Vibration

### Definition

Oscillating movements of body parts or of the whole body relative to a midposition. These movements are generated by constantly alternating forces or moments. In most cases these forces are produced outside the body by a motor. Mainly whole-body and hand-arm vibrations are distinguished, during which the whole body or only the hand-arm unit, respectively, are exposed to vibrations. The measure for the magnitude of a mechanical vibration is the mean effective acceleration, expressed in  $m/s^2$ .

- ▶ Ergonomic Counseling
- ▶ Massage and Pain Relief Prospects

## Vicarious Experience

### Definition

Observing another individual enacting a particular behavior or responding to particular environmental conditions.

- ▶ Psychology of Pain, Self-Efficacy

## Vicarious Instigation

### Definition

Vicarious instigation describes the phenomenon that, possibly mediated by empathy, mere observation of another person's response to a stimulus or a situation (e.g. a pain response) can induce a similar response in the observer, in the absence of any direct experience with the eliciting stimulus or situation. In the context of pain, it is still a matter of debate whether observing another person in pain can induce a pain-like vicarious response in the observer, or whether it elicits a more generalized emotional response in the observer.

- ▶ Modeling, Social Learning in Pain

## Vicarious Learning

- ▶ Modeling, Social Learning in Pain

## VIP

- ▶ Vasoactive Intestinal Polypeptide

## Viral Meningitis

- ▶ Headache in Aseptic Meningitis

## Viral Neuropathies

CATHERINE CHO, LYDIA ESTANISLAO,  
DAVID SIMPSON  
Clinical Neurophysiology Laboratories, Mount Sinai  
Medical Center, New York, NY, USA  
david.simpson@mssm.edu

### Synonyms

Virus-Induced Nerve Dysfunction; Nerve Viral Infection

## Definition

Viruses may directly infect neurons or nerve fibers (nerve viral infection) or trigger ► **neuroinflammation** and ► **neuroimmune activation**. These mechanisms result in virus-induced nerve dysfunction or viral neuropathy.

## Characteristics

*Herpes zoster* or *Varicella zoster* virus causes a condition called shingles (Kost and Straus 1996). After primary infection, the virus becomes latent in the dorsal root ganglia and sensory ganglia of the cranial nerves. As ► **cell-mediated immunity** wanes, the virus is reactivated, causing hemorrhagic inflammation. The infection subsequently spreads to the skin, which is also inflamed and partially denervated. Ipsilateral segmental ► **myelitis** and ► **leptomeningitis** with involvement of the adjacent spinal levels may occur and have been documented in post-mortem studies. Pathologically, there is hemorrhagic necrosis in the peripheral nerve and dorsal root ganglion, which is accompanied by neuronal loss. In the central nervous system, the dorsal horn also undergoes ► **neurodegeneration**. Inflammation in both the peripheral nerve and central nervous system can persist for months. Peripherally, there is scarring of the skin, demyelination of the nerve, ► **wallerian degeneration**, and fibrosis of both the nerve and the dorsal root ganglion. In some cases, there is atrophy of the dorsal horn.

Human immunodeficiency virus (HIV) may cause neuropathy in over 30% of infected patients in the form of distal symmetric polyneuropathy (DSP). While the mechanism of HIV DSP is uncertain, there is *in vitro* evidence that the gp120 subunit of HIV may act as a cofactor in the pathogenesis of DSP (Herzberg and Sagen 2001); (Keswani et al. 2003). Tumor necrosis factor alpha (TNF- $\alpha$ ), interleukin-1 (IL-1), and other cytokines have been identified in peripheral nerve and dorsal root ganglia, after exposure of the peripheral nerve to gp120. In one study using a rat model, transient axonal swelling developed after the sciatic nerve was exposed to gp120 (Herzberg et al. 2001). A second phase of astrocytic and microglial activation in the spinal cord persisted after exposure. The latter finding correlated with rat neuropathic pain behavior.

In a study using cell culture, Schwann cells secreted proinflammatory cytokines after ligation of gp120 to the CXCR4 chemokine receptors (Keswani et al. 2003). These cofactors might mediate gp120 neurotoxicity via a cascade of interactions with cytokines. Pathology reveals degeneration of myelinated and unmyelinated axons in nerve biopsies of nearly all patients with AIDS. Mild epineurial and endoneurial perivascular mononuclear inflammation is present in two-thirds of patients. Suppressor/cytotoxic cells (CD8) are more prevalent in the endoneurial infiltrate, while the ratio between CD8 and helper/inducer (CD4) cells is about equal in

the epineurial infiltrate. Activated macrophages are also detected among the inflammatory cells. In autopsy studies, dorsal root ganglion cells and the gracilis tract show inflammatory and neurodegenerative changes, but these are mild in comparison to those found in distal peripheral nerves.

Of all the human herpes viruses, cytomegalovirus (CMV) is the most consistently reactivated, and causes the most severe clinical consequences, particularly in immunocompromised patients such as those with AIDS. CMV infection in AIDS patients causes progressive ► **polyradiculopathy** by both direct infection of the dorsal root ganglia (ganglionitis) and immune-mediated neuronal damage. Pathologic changes include necrosis and inflammation of ventral and dorsal roots, with giant cells and inclusion bodies in Schwann cells, endothelial cells, and within the nerve. Features consistent with vasculitis are also present. Focal myelitis adjacent to the involved nerve roots is common.

Among the several forms of viral hepatitis, hepatitis C virus (HCV) has emerged as the most clinically important virus (Lange and Tolunsky 2002). The pathogenesis of HCV-associated neuropathies is unclear. A necrotizing vasculitis associated with HCV infection is one mechanism of neuropathy. Although neuropathies associated with HCV are presumed to be immune-mediated, evidence for direct infection causing neuropathy was demonstrated, with localization of HCV RNA in nerve and muscle biopsies (Authier et al. 2003). However, replicative RNA was not detected, raising doubt of the role of direct infection in neuropathy.

All of the viral neuropathies discussed have pain as a prominent clinical manifestation. Acute Herpes zoster is manifested by pain, which may precede the rash by days to weeks (Geraci et al. 2002). The eruption starts as patches of erythema that progress to form grouped vesicles. Usually one or two dermatomes are involved. The lesions pustulate and crust over the next 7–10 days. This is followed by a period of pain, anesthesia, and changes in pigmentation that lasts 4–6 weeks after the crusting of the lesions. The thoracic levels are most commonly involved, followed by the ophthalmic division of the trigeminal nerve. Reactivation of zoster in the geniculate ganglion leads to Ramsay-Hunt syndrome. Zoster infection may occur without a characteristic cutaneous rash, a condition called zoster sine herpette. In some cases, the pain may last more than 4–6 weeks, and even years, after the rash has resolved, termed postherpetic neuralgia (PHN). The risk of PHN is increased in the elderly.

Pain in the feet is the most common symptom of HIV-DSP. Patients often have an antalgic gait due to ► **dysesthesia** in the distal lower extremities. The pain can be so intense that light contact can be perceived as excruciating. A significant proportion of AIDS patients with neuropathy may be asymptomatic (Keswani et al. 2003). The distal upper extremities may be af-

ected later in the course of DSP. Numbness may also be present, but muscle weakness is usually absent. Absent or depressed muscle stretch reflexes in the ankles and ► **hypesthesia** to all sensory modalities are the most common signs of DSP. Weakness, if present, is usually confined to the intrinsic foot muscles.

Asymptomatic CMV is common in the general population, but symptomatic and severe disease may develop in patients who are immunocompromised, particularly in AIDS. Progressive polyradiculopathy (PP) presents as severe radiating pain and paresthesias, hyporeflexia, progressive flaccid paraparesis, and sphincter dysfunction (Anders and Goebel 1998). Early recognition is critical, as the majority of untreated patients have severe neurological sequela or die. In the presence of neurologic CMV infection, cerebrospinal fluid studies show a polymorphonuclear pleocytosis, elevated protein, and low glucose. CMV is difficult to culture from CSF, and polymerase chain reaction (PCR) analysis is a far more sensitive assay (Anders et al. 1998). Electrodiagnostic studies reflect axonal loss in a radicular pattern. Imaging studies may show nodular thickenings of multiple roots with leptomeningeal enhancement.

Mixed ► **cryoglobulinemia**, present in 56% of patients with HCV, is the most common extrahepatic immunologic manifestation of chronic HCV infection (Cacoubet et al. 2000). Approximately 9% of HCV-infected patients have peripheral neuropathy. The most common type of neuropathy is painful distal sensory polyneuropathy in the presence of vasculitis and mixed cryoglobulinemia (Authier et al. 2003).

Despite similarities in the pathogenesis and clinical manifestations of pain among the different viral neuropathies, therapy has to be individualized because success varies between patients. In the treatment of acute zoster, acyclovir, famciclovir, and valacyclovir significantly reduce the duration and intensity of pain if initiated within 72 hours of rash (Kost et al. 1996). If there is no contraindication to corticosteroid treatment, combination with prednisone therapy may improve the quality of life and reduce pain. Topical analgesics or narcotics may provide additional pain relief. Some studies suggest that nerve blocks provide some acute benefit. Non-narcotic analgesics are usually ineffective. The management of PHN presents a challenge, and many patients continue to suffer despite the available treatments. Of the topical therapies, aspirin with ether, indomethacin with ether, lidocaine, and lidocaine with prilocaine may be useful. Lidocaine and capsaicin have both been studied in controlled trials for PHN and were proven effective for short-term analgesia. However, the burning experienced when using currently available formulations of low concentration capsaicin is poorly tolerated, limiting its use. An experimental high concentration capsaicin patch has shown efficacy in preliminary trials of PHN (Backonja, *Neurology*, 2003; AAN abstract). Narcotics can be helpful in the

treatment of PHN but are limited by the side effects experienced at effective doses (Kost et al. 1996). Neuroleptics, lorazepam, and dopamine agonists have been used with varying success (Mendell and Sahenk 2003). Some norepinephrine-selective tricyclics (maprotiline and desipramine) have also been shown to reduce pain as compared with placebo, maprotiline less so than amitriptyline. Serotonin reuptake inhibitors have not been useful in the treatment of PHN. Gabapentin has been compared with amitriptyline and has been shown to be equally efficacious in the treatment of zoster neuropathic pain.

Other nonpharmacological therapies can be used alone or as adjuncts (Mendell et al. 2003). Skin excision and neurosurgical interventions, including electrostimulation of the thalamus, anterolateral cordotomy, cingulotomy, and dorsal root entry zone lesions, have shown some benefit. These are treatments of last resort for intractable pain and only anecdotal evidence supports these modalities. Sympathetic nerve blocks are helpful for the pain in acute zoster, but do not seem to have benefit in PHN. Transcutaneous electrical nerve stimulation and ethyl chloride spray have shown partial benefit in PHN. There is no evidence supporting the efficacy of acupuncture.

Treatment of HIV DSP is directed towards lowering HIV viral load and alleviating symptoms. Plasma HIV viral load may serve as a predictor of the occurrence of HIV neuropathy, and correlates with the severity of pain (Simpson et al. 2002). HIV RNA levels that are greater than 10,000 copies/ml predispose an individual to a 2.3-fold greater risk of sensory neuropathy (Childs et al. 1999). It is not clear if the HIV viral load will continue to be predictive of HIV DSP in the current post-HAART era (Highly Active Anti-Retroviral Therapy). Effective virologic suppression with HAART improves quantitative sensory function of HIV DSP (Martin et al. 2000), although its effect on symptoms is unknown.

Guidelines established by the World Health Organization for the management of cancer pain can be applied to DSP treatment. Nonopioid analgesics are first line therapy for mild to moderate pain. Adjuvant agents, such as tricyclic antidepressants, may help in more disabling pain, although amitriptyline and mexiletine did not demonstrate superior pain relief as compared to placebo in a study of painful HIV DSP (Mendell et al. 2003). Of the anticonvulsants used in managing pain, lamotrigine has shown significant pain reduction in HIV-associated DSP in a placebo-controlled study, although this benefit was limited to the subgroup treated with neurotoxic antiretroviral agents. Gabapentin has not been sufficiently studied in randomized controlled trials in HIV neuropathy, but has proven to have some benefit in controlled studies of other painful neuropathies (Rosner et al. 1996; Mendell et al. 2003). A new related compound, pregabalin, is being developed for the treat-

ment of several painful neuropathies, including diabetic, PHN and HIV. Topical agents, including lidocaine and capsaicin, are emerging as potential treatments in HIV neuropathy. An open label study of a high concentration capsaicin patch demonstrated substantial pain relief, lasting three months, after a single application (Simpson et al. 2004). Larger placebo-controlled trials of this agent are underway. When pain is refractory to these treatments, narcotics may be required. Long-acting agents, such as sustained-release morphine or oxycodone, may be preferable in these patients.

CMV-induced PP is fatal if untreated. When CMV is clinically suspected, antiviral therapy should be immediately initiated. While no controlled studies in AIDS-associated PP have been undertaken, agents may include ganciclovir, foscarnet, or cidofovir, alone or in combination. Neurologic stabilization and improvement may follow effective therapy. HAART is essential for immune recovery.

Treatment in HCV neuropathy is directed towards HCV infection and cryoglobulinemia. Corticosteroids, cyclophosphamide, plasma exchange and cryopheresis have been used with varying success. Interferon- $\alpha$  has been helpful, presumably by resolution of HCV-associated cryoglobulinemia. There are no studies of analgesics in the treatment of HCV neuropathy. In clinical practice, it is reasonable to use agents with demonstrated efficacy in other forms of painful neuropathy for the treatment of HCV neuropathy.

Research is continuing to develop treatment based on the molecular mechanisms of the various types of pain. For now, the approach to the treatment of pain in viral neuropathies largely relies on treatment of the underlying viral disease, together with symptomatic relief through trials of different pharmacologic agents and non-pharmacologic modalities.

## References

- Anders H, Goebel F (1998) Cytomegalovirus Polyradiculopathy in Patients with AIDS. *Clin Infect Dis* 27:345–352
- Authier F, Bassez G, Payan C et al. (2003) Detection of Genomic Viral RNA in Nerve and Muscle of Patients with HCV Neuropathy. *Neurology* 60:808–812
- Backonja et al. (2003) Pilot study of High-Dose Capsaicin Patches to Treat Postherpetic Neuralgia Pain. AAN 55<sup>th</sup> Annual Meeting Abstract SLB 003
- Cacoub P, Renou C, Rosenthal E et al. (2000) Extrahepatic Manifestations Associated with Hepatitis C Virus Infection: A Prospective Multicenter Study of 321 Patients. *Medicine* 79:47–56
- Childs EA, Lyles RH, Selnes OA et al. (1999) Plasma Viral Load and CD4 Lymphocytes Predict HIV-Associated Dementia and Sensory Neuropathy. *Neurology* 52:607–613
- Geraci A, Wulff E, Simpson D (2002) Infectious and Granulomatous Neuropathies. In: Katirji B, Kaminski H, Preston D et al. (eds) *Neuromuscular Disorders in Clinical Practice*. Butterworth-Heinemann, Woburn
- Herzberg U, Sagen J (2001) Peripheral Nerve Exposure to HIV Viral Envelope Protein gp120 Induces Neuropathic Pain and Spinal Gliosis. *J Neuroimmunol* 116:29–39
- Keswani S, Polley M, Pardo C et al. (2003) Schwann Cell Chemokine Receptors Mediate HIV-1 gp120 Toxicity to Sensory Neurons. *Ann Neurol* 54:287–296
- Kost R, Straus S (1996) Postherpetic Neuralgia – Pathogenesis, Treatment, and Prevention. *N Engl J Med* 335:32–42
- Lange D, Tolunsky E (2002) Infections and Peripheral Neuropathy. In: Brown W, Bolton C, Aminoff M (eds) *Neuromuscular Function and Disease: Basic, Clinical, and Electrodiagnostic Aspects*. WB Saunders Company, Philadelphia, pp 1251–1262
- Martin C, Solders G, Sonnerborg A et al. (2000) Antiretroviral Therapy may Improve Sensory Function in HIV-Infected Patients: A Pilot Study. *Neurology* 54:2120–2127
- Mendell J, Sahenk Z (2003) Painful Sensory Neuropathy. *N Engl J Med* 348:1243–1255
- Newsham G (1998) HIV Neuropathy Treated with Gabapentin. *AIDS* 12:219–221
- Rosner H, Rubin L, Kestenbaum A (1996) Gabapentin Adjunctive Therapy in Neuropathic Pain States. *Clin J Pain* 12: 56–58
- Simpson D, Brown S, Sampson J et al. (2004) A Single Application of High Concentration Trans-Capsaicin Leads to 12 Weeks of Pain Relief in HIV DSP: Results of an Open Label Trial. Platform Presentation. 56<sup>th</sup> American Academy of Neurology Annual Meeting, San Diego
- Simpson D, Olney R, McArthur J et al. (2000) A Placebo-Controlled Trial of Lamotrigine for Painful HIV-Associated Neuropathy. *Neurology* 54:2115–2119
- Simpson DM, Haidich AB, Schifitto G et al. (2002) Severity of HIV-Associated Neuropathy is Associated with Plasma HIV-1 RNA Levels. *AIDS* 16:407–412

## Viral Vectors

- ▶ Opioids and Gene Therapy

## Virus-Induced Nerve Dysfunction

- ▶ Viral Neuropathies

## Visceral

### Definition

Pertaining to any organ within the great cavities of the body, mainly describing the soft internal abdominal organs, particularly the intestines.

- ▶ Recurrent Abdominal Pain in Children

## Visceral Afferent

### Definition

Afferent fibers from the viscera to the central nervous system. These fibers originate from dorsal root ganglion cells and vagal (nodose) ganglion cells.

- ▶ Morphology, Intraspinal Organization of Visceral Afferents



## Visceral Hyperalgesia

- ▶ Descending Modulation of Visceral Pain
- ▶ Visceral Pain Model, Esophageal Pain

## Visceral Hypersensitivity

### Definition

Heightened perception of visceral events both physiological and experimental.

- ▶ Descending Modulation of Visceral Pain
- ▶ Thalamus and Visceral Pain Processing (Human Imaging)
- ▶ Visceral Pain Model, Irritable Bowel Syndrome Model

## Visceral Inflammation

- ▶ Visceral Pain Model, Pancreatic pain

## Visceral Modulation

- ▶ Thalamus, Visceral Representation

## Visceral Nociceptive Tracts

- ▶ Postsynaptic Dorsal Column Projection, Functional Characteristics
- ▶ Spinal Dorsal Horn Pathways, Dorsal Column (Visceral)

## Visceral Nociception and Pain

PAUL M. MURPHY

Department of Anaesthesia and Pain Management,  
Royal North Shore Hospital, St Leonard's, NSW,  
Australia  
drpmurphy@hotmail.com

### Definition

▶ **Visceral Nociception and Pain** originates from body organs. Visceral ▶ **nociceptors** are located within body organs and internal cavities. The relative scarcity of nociceptors in these areas results in a pain that is often of a vague cramping/aching quality, diffuse, poorly localised and of a longer duration than somatic pain.

**Visceral Nociception and Pain, Table 1** Comparison of Somatic Versus Visceral Pain

	<i>Somatic</i>	<i>Visceral</i>
Stimuli	Mechanical Thermal Inflammatory	Ischaemia Distension Inflammatory
Localisation	Precise	Poor, Referred to somatic structures
Autonomic Symptoms	Yes	No

### Characteristics

To date most fundamental basic scientific research has focused on ▶ **somatic pain** rather than visceral pain states. In part, this is due to the relative ease with which somatic pain can be evoked in both animal and human volunteer models. Despite this, visceral pain is an important clinical problem, which differs from somatic nociception in many fundamental respects.

Phylogenetically, somatic and visceral nociceptive processes subserve different biological functions and thus it is unsurprising that the systems respond to different stimuli. Mechanical and thermal stimuli, which have been demonstrated to evoke somatic nociceptive responses when applied to the skin, often fail to produce pain when applied experimentally to the viscera. Indeed, application of thermal and mechanical stimuli to healthy viscera often evokes no sensory response. Alternative stimuli such as inflammation, ischaemia or distension of hollow organs are however demonstrated to evoke pain.

### Visceral Nociception

It is a subject of controversy as to whether specific visceral nociceptors or an alteration in electrophysiological parameters, such as signal pattern or intensity, in non-specific afferent receptors normally involved in regulatory visceral reflexes (“pattern” theory) is responsible for the ▶ **transduction** of visceral pain. Recent evidence suggests that in hollow viscera such as the urinary bladder, a homogenous group of visceral afferents respond in a graded manner to distensile stimulation. Increasing distension beyond the biological range results in altered neuronal firing patterns and the perception of visceral pain. Animal studies (Sengupta and Gebhart 1995) have demonstrated the presence of both low threshold “intensity encoding” and high threshold ▶ **afferent neurons** in the cat colon. Low threshold neurons respond to colonic distension across both the biological and noxious range, while high threshold neurons respond only to noxious distension. It appears that both afferent fibre types play an important role in visceral pain encoding. High threshold afferents have been demonstrated in the gastrointestinal system (colon, small bowel and biliary tree), the

genitourinary system (ureter, bladder) and in the uterus. Intensity encoding afferents have been demonstrated in the heart, oesophagus, colon, bladder and testes. A third subtype of nociceptor, the “silent receptor” has been described. This receptor appears to be “sensitized” by alterations, such as hypoxia, acidosis or hyperkalaemia, in the local tissue environment that are associated with tissue damage. Initial studies estimated that some 80–90% of all visceral nociceptors were of this “silent” type, although this has been subsequently revised to approximately 40–45% (Cervero 1994; McMahon et al. 1995).

### Spinal Processing

The dorsal horn of the spinal cord is the first relay point for conveying sensory information from the periphery to the brain. Somatic nociceptive inputs terminate on projection neurons and inhibitory/excitatory ► [interneurons](#) in ► [Rexed’s laminae I](#) (marginal zone) and II (► [substantia gelatinosa](#)). Some fibres also project more deeply into lamina V. Visceral nociceptive inputs terminate in laminae I and V, where they converge with somatic inputs, although they are less well somatotopically represented. Somatovisceral afferents also end in lamina X. Visceral inputs are predominantly of the peptidergic subtype (substance P, CGRP). NK-1 receptor (Sub P) knockout mice fail to develop primary ► [hyperalgesia](#) or ► [referred pain](#) after visceral injury. Blockade of ► [tachykinin](#) (NK-2) receptors in animal models of colonic distension does not alter the pain response; however if the animal colon is inflamed prior to distension, NK-2 blockade inhibits visceral pain transmission. It has been suggested that this response may be important in conditions such as irritable bowel syndrome. Unlike somatic spinal neurons, “► [wind-up](#)” is not identified in visceral neurons. Interaction between the viscerosomatic neurons and supraspinal centres may result in enhanced autonomic and motor responsiveness characteristic of visceral pain (Gebhardt 1995, Beaulieu and Rice 2003; Laird et al. 2000; Laird et al. 2001).

### Referred Pain

Three theories exist regarding the phenomenon of referred visceral pain.

1. Axon divergence: A bifurcating primary afferent from visceral and cutaneous structures terminates on a spinal projection neuron.
2. Axon convergence:
  - a) Projection: Somatic and visceral afferents terminate on the same spinal projection neuron. Electrophysiological activity in the projection neuron is perceived as somatic pain.
  - b) Facilitation: Visceral afferent input to the spinal projection neuron reduces the threshold for stimulation from somatic afferent input.

3. Thalamic: The presence of specific visceral pain projection fibres in the thalamus supports this theory although it cannot account for referred hyperalgesia (McMahon 1994).

### Supraspinal Visceral Pain Pathways

Three separate visceral pain pathways have been identified:

1. Spino-hypothalamic
2. Spino-amygdaloid
3. Dorsal column

Traditionally, the dorsal column-medial lemniscus system has not been considered to be involved in pain perception. Recent clinical and experimental data suggest that this pathway may play an important role in relaying visceral nociceptive information (Houghton et al. 2001). Clinical studies indicate that small ► [dorsal column](#) lesions relieve pain and decrease analgesic requirements in the setting of visceral cancer pain (Al-Chaer et al. 1998).

### Role of Supraspinal Structures

Various imaging and electrophysiological techniques have been utilised to study the perception of visceral pain. Thalamic stimulation has been demonstrated to evoke visceral pain sensations analogous to angina or labour pain in patients, often years after the original pain. This suggests a potential integrative role for the thalamus in visceral “pain memory”.

The cortical representation of visceral pain of enteric origin has been assessed by means of positron emission tomography (PET). Rectal stimulation in normal subjects is associated with activation of the anterior cingulate cortex, a region associated with affective components of the pain experience. The activated areas are quite different to the cingulate cortical areas activated by somatic pain and correspond to areas typically involved in visceromotor reactions. In patients suffering from irritable bowel syndrome, the same stimulus did not activate the anterior cingulate cortex but rather activation of the dorsolateral prefrontal cortex was identified *in anticipation* of the stimulus. This appears to indicate that persistent visceral pain states are associated with ► [hypervigilance](#) to visceral events. Functional magnetic resonance imaging (fMRI) studies on distension of the proximal (somatic) and distal (visceral) oesophagus demonstrate differential cortical activation patterns (Aziz et al. 2000). Differences in perception of somatic and visceral pain are thus partly dependent upon differential cortical representation (Treede et al. 1999).

- [Animal Models and Experimental Tests to Study Nociception and Pain](#)
- [Cancer Pain Management, Overall Strategy](#)
- [Chronic Pelvic Pain, Musculoskeletal Syndromes](#)
- [Postsynaptic Dorsal Column Projection, Functional Characteristics](#)
- [Rest and Movement Pain](#)

- ▶ Spinothalamic Tract Neurons, Visceral Input
- ▶ Vagal Input and Descending Modulation
- ▶ Visceral Pain and Nociception
- ▶ Visceral Pain Model, Pancreatic Pain
- ▶ Visceral Referred Pain

## References

1. Al-Chaer ED, Feng Y, Willis WD (1998) A role for the dorsal column in nociceptive visceral input into the thalamus of primates. *J Neurophysiol* 79:3143–3150
2. Aziz Q, Thompson DG, Ng VWK et al. (2000) Cortical Processing of human somatic and visceral sensation. *J Neurosci* 20:2657–63
3. Beaulieu P, Rice ASC (2003) Applied Physiology of Nociception. In: Rowbotham DJ, Macintyre PE (eds) *Clinical Pain Management: Acute Pain*. Oxford University Press Inc, New York
4. Cervero F (1994) Sensory innervation of the viscera: Peripheral basis of visceral pain. *Physiol Rev* 75:95–134
5. Gebhart GF (1995) Visceral Pain. In: Gebhart GF (ed) *Progress in Pain Research and Management*, vol 5. IASP Press, Seattle
6. Houghton AK, Wang CC, Westlund KN (2001) Do nociceptive signals from the pancreas travel in the dorsal column? *Pain* 89:207–20
7. Laird JMA, Olivar T, Lopez-Garcia JA et al. (2001) Responses of rat spinal neurons to distension of inflamed colon: role of tachykinin NK2 receptors. *Neuropharmacology* 40:696–701
8. Laird JMA, Olivar T, Roza C et al. (2000) Deficits of visceral pain and hyperalgesia of mice with a disruption of the tachykinin NK1 receptor gene. *Neuroscience* 98:345–52
9. McMahon SB (1994) Mechanisms of cutaneous deep and visceral pain. In: Wall PD, Melzack R (eds) *Textbook of Pain*. Churchill Livingstone, Edinburgh, pp 129–151
10. McMahon SB, Dmitrieva N, Koltzenberg M (1995) Visceral pain. *Br J Anaesth* 75:132–44
11. Treede R-D, Kenshalo DR, Gracely RH et al. (1999) The cortical representation of pain. *Pain* 79:105–11

## Visceral Nociceptors, Sensitization

- ▶ Sensitization of Visceral Nociceptors

## Visceral Pain and Nociception

JAMES BOROWCZYK

Department of Orthopaedics and Musculoskeletal Medicine, Christchurch School of Medicine, Christchurch, New Zealand  
jmbor@clear.net.nz

### Definition

Visceral pain is pain that is caused by nociceptive information arising from the organs (viscera) of the body, e.g. the heart, stomach, intestine, bladder, and uterus.

### Characteristics

Of all the different pain types that have undergone increasingly intensive study in the past ten to twenty years, visceral pain is the poor cousin (Cervero and Laird 1999). Due to recent developments in imaging

(Hobson and Aziz 2003), and the development of improved animal models with a focus on gastrointestinal tract pain (Al-Chaer et al. 2000), this deficiency is being addressed.

Lewis distinguished two types of visceral pain: true visceral pain arising from a viscus, or part of a viscus; and pain arising from the parietal peritoneum or pleura (Lewis and T 1942). More recently, Cervero and Laird (1999) ascribed five cardinal characteristics to visceral pain.

1. Visceral pain may not be evoked from all organs, either because they are not innervated, or because the stimulus is inappropriate.
2. Visceral pain is not always linked to injury.
3. Visceral pain is referred to the body wall.
4. Visceral pain is diffuse and poorly localised.
5. Visceral pain is often accompanied by accentuated motor and autonomic reflexes (Cervero and Laird 1999).

### Mechanisms

In terms of mechanism, visceral pain can be caused by (Procacci et al. 1991):

- spasm of smooth muscle in the hollow viscera;
- contraction of smooth muscle in the gastrointestinal or genitourinary tracts against obstruction;
- sudden, abnormal stretching, distension or tearing;
- rapid stretching of the capsule of solid viscera;
- rapidly developing ischemia;
- inflammation of the lining of hollow viscera;
- mechanical or chemical stimulation of inflamed mucous membranes;
- traction compression or twisting of the mesentery, organ ligaments or their blood vessels; and necrosis of viscera such as the pancreas or myocardium.
- Stimuli that tend not to produce visceral pain, when applied, include cutting, pressure and burning.

The viscera are innervated by either or both of two sets of primary afferent fibres that project to separate regions of the neuraxis (Al-Chaer and Traub 2002), and which constitute approximately 10 % of all afferent input into the spinal cord. Firstly, the heart, lungs, and the gastrointestinal tract, from the level of the oesophagus to the transverse colon, are innervated by the vagus nerve, with central projection to the nucleus of the solitary tract. The remainder of the colon and the pelvic viscera are supplied by pelvic splanchnic nerves, whose afferent fibres project centrally to the sacral spinal cord. Secondly, all the viscera of the chest, abdomen, and pelvis are innervated by splanchnic nerves from the thoracolumbar, sympathetic trunk (Berkley et al. 1993). Their afferents terminate in the dorsal grey column between T1 and L2.

These two separate systems seem to serve a different purpose. Vagal nerves do not directly convey nociceptive

signals, but vagal activity does modify nociceptive processing in the spinal cord (Ness et al. 2000). Nociceptive afferents are conveyed by the sympathetic splanchnic nerves. Centrally, they terminate in the dorsal grey column between T1 and L2.

Visceral sensory afferent fibres innervate all layers of a given viscus. They are exclusively small diameter, myelinated A-delta, or unmyelinated C fibres. They have no end organs or any evidence of morphological specialisation. They exhibit chemosensitivity, thermosensitivity and/or mechanosensitivity.

Evidence suggests that there are two physiological populations of these receptors (Sengupta and Gebhart 1994). The first are 'high threshold' receptors that respond to stimuli only within the noxious range, and are found predominantly in organs in which pain is the dominant sensation (heart, ureter). The second are 'low-threshold' receptors, which respond to the intensity of a stimulus by increasing their frequency of discharge from the innocuous, into the noxious range. They are found predominantly in viscera such as bowel and bladder, which respond to both innocuous and noxious stimuli such as filling and distension. In addition, there is evidence to support a third population of 'silent' nociceptive afferents that are sensitised by ischemia and inflammation (McMahon et al. 1995; Gebhart 2000).

As in the somatic nociceptive system, the visceral nociceptive system exhibits both ► [peripheral](#) and ► [central sensitisation](#). The mechanisms of peripheral sensitisation contain elements in common with that of the somatic system. Low and high threshold receptors signal acute pain. So called silent nociceptors are activated by the pathophysiological processes as described above, and inflammatory mediators released at the site of tissue damage lower receptor firing thresholds, therefore facilitating the central transmission of noxious stimuli (Cervero and Laird 1999). In the gut, it is thought that this is mediated by increased activity in a particular sub-population of sodium channels found in all colon and bladder afferents (Al-Chaer and Traub 2002). Furthermore, as compared with the somatic system, visceral afferents contain a greater percentage of neuropeptides, particularly substance P, but also including CGRP, somatostatin and vasoactive intestinal peptide.

It is likely that the mechanism of central sensitisation in the visceral system differs from that in the somatic system. Cardinal to this difference is the observation that NMDA receptor antagonists inhibit primary afferent and spinal responses to both innocuous and acute noxious colonic stimuli (McRoberts et al. 2001), suggesting that NMDA receptors have a role in the transmission of both types of stimuli. This is in stark contrast to the somatic system, where NMDA receptors are thought to contribute mainly to the development of central sensitisation, and do not operate under acute or innocuous situations.

In the visceral system, it is possible that excessive NMDA receptor activity in the absence of noxious stimuli or inflammation could explain phenomena such as irritable bowel syndrome (Ji and Traub 2001). With respect to neurokinin receptors, NK-1 receptors have been shown to signal neurogenic inflammation, but not non-neurogenic inflammation (Laird et al. 2000), whereas a different inflammagen is thought to work through NK-3 and NMDA receptors (Kamp et al. 2001). All of this points to a probable different pathophysiology for the two systems.

### Future Developments

Combinations of traditional therapeutic agents remain the mainstay of treatment for visceral pain management. More recent studies focusing on the role of kappa opioid receptors, sodium channels, and neurokinin and NMDA receptors, promise new interventions in pain management. This, combined with improved models of study, and improved imaging of pain pathways, are likely to provide the discipline with exciting research tools, and novel pharmacological approaches to the treatment of visceral pain.

- [Animal Models and Experimental Tests to Study Nociception and Pain](#)
- [Cancer Pain Management, Overall Strategy](#)
- [Chronic Pelvic Pain, Musculoskeletal Syndromes](#)
- [Postsynaptic Dorsal Column Projection, Functional Characteristics](#)
- [Rest and Movement Pain](#)
- [Spinothalamic Tract Neurons, Visceral Input](#)
- [Vagal Input and Descending Modulation](#)
- [Visceral Nociception and Pain](#)
- [Visceral Pain Model, Pancreatic Pain](#)
- [Visceral Referred Pain](#)

### References

1. Al-Chaer ED, Kawasaki M, Pasricha PJ (2000) A New Model of Chronic Visceral Hypersensitivity in Adult Rats Induced by Colon Irritation during Postnatal Development. *Gastroenterology* 119:1276–1285
2. Al-Chaer ED, Traub RJ (2002) Biological Basis of Visceral Pain: Recent Developments. *Pain* 96:221–225
3. Berkley KJ, Hubscher CH, Wall PD (1993) Neuronal Responses to Stimulation of the Cervix, Uterus, Colon, and Skin in the Rat Spinal Cord. *J Neurophysiol* 69:545–556
4. Cervero F, Laird JM (1999) Visceral Pain. *Lancet* 353:2145–2148
5. Gebhart GF (2000) Physiology, Pathophysiology, and Pharmacology of Visceral Pain. *Reg Anesth Pain Med* 25:632–638
6. Hobson AR, Aziz Q (2003) Central Nervous System Processing of Human Visceral Pain in Health and Disease. *News Physiol Sci* 18:109–114
7. Ji Y, Traub RJ (2001) Spinal NMDA Receptors Contribute to Neuronal Processing of Acute Noxious and Non-Noxious Colorectal Stimulation in the Rat. *J Neurophysiol* 86:1783–1791
8. Kamp EH, Beck DR, Gebhart GF (2001) Combinations of Neurokinin Receptor Antagonists Reduce Visceral Hyperalgesia. *J Pharmacol Exp Ther* 299:105–113
9. Laird JM, Olivar T, Roza C, De Felipe C, Hunt SP, Cervero F (2000) Deficits in Visceral Pain and Hyperalgesia of Mice with a Disruption of the Tachykinin NK1 Receptor Gene. *Neuroscience* 98:345–352



10. Lewis T (1942) Pain. Macmillan, New York
11. McMahon SB, Dmitrieva N, Koltzenburg M (1995) Visceral Pain. *Br J Anaesth* 75:132–144
12. McRoberts JA, Coutinho SV, Marvizon JC, Grady EF, Tognetto M, Sengupta JN, Ennes HS, Chaban VV, Amadesi S, Creminon C, Lanthorn T, Geppetti P, Bunnett NW, Mayer EA (2001) Role of Peripheral N-methyl-D-aspartate (NMDA) Receptors in Visceral Nociception in Rats. *Gastroenterology* 120:1737–1748
13. Ness TJ, Fillingim RB, Randich A, Backensto EM, Faught E (2000) Low Intensity Vagal Nerve Stimulation Lowers Human Thermal Pain Thresholds. *Pain* 86:81–85
14. Procacci P, Maresca M, Cersosimo RM (1991) Visceral Pain: Pathophysiology and Clinical Aspects. *Adv Exp Med Biol* 298:175–181
15. Sengupta, JN, Gebhart GF (1994) Characterization of Mechanosensitive Pelvic Nerve Afferent Fibers Innervating the Colon of the Rat. *J Neurophysiol* 71:2046–2060

## Visceral Pain from the Bladder

### Definition

Visceral pain from the bladder is evoked from distension, chemicals, inflammation or trauma. It is often diffuse and poorly located. It may be felt in the midline above the symphysis, and can also be referred to the inner thighs, the groin or even to the knees. Bladder pain may be accompanied by sweating, nausea or dizziness.

► [Opioids and Bladder Pain/Function](#)

## Visceral Pain Model, Angina Pain

ROBERT D. FOREMAN, CHAO QIN  
University of Oklahoma Health Sciences Center,  
Oklahoma City, USA  
robert-foreman@ouhsc.edu

### Synonyms

Angina pectoris; chest pain; Coronary Artery Disease; Coronary Insufficiency; Heart Pain; ischemic heart disease; Myocardial Ischemia

### Characteristics

#### Adequate Stimulus for Angina Pectoris

► [Mechanosensitive](#) ► [sympathetic afferent fibers](#) and ► [chemosensitive sympathetic afferent fibers](#) innervate the heart. Both classes of cardiac afferent fibers respond to ► [bradykinin](#); however, only chemosensitive endings are sensitized by prostaglandins, especially PGE<sub>1</sub> (Baker et al. 1980; Nerdrum et al. 1986). After sensitization, bradykinin increases the magnitude and duration of the afferent impulses being transmitted in the chemosensitive endings, but does not affect mechanosensitive endings. It appears, however, that the chemical effects of these neurons are far more dramatic than are the mechanical effects for producing pain of ► [angina pectoris](#). Thus, chemosensitive endings are

better candidates for carrying information that leads to angina pectoris resulting from ► [ischemic heart disease](#). Often the environment around receptors leads to sensitization because the release of chemicals changes the responsiveness of the afferent endings.

Debates about mechanical and chemical mechanisms to activate sensory receptors generating cardiac pain symptoms have persisted for years. The mechanical hypothesis centered on the idea that distension of the ventricular wall resulted in pain (Cobeck 1903). Clinical studies showing that painful and painless episodes of transient ischemia are produced by similar patterns of ventricular dilation do not support this hypothesis (Davies et al. 1988). In addition, acute ventricular failure, valvuloplasty, and myocardial biopsy all produce non-painful ventricular dilation. Thus, the general sense is that mechanical stimulation does not play a major role in the pain associated with myocardial ischemia (Davies et al. 1988).

### Chemical Stimulation of Sensory Endings

Unmyelinated sympathetic afferent fibers respond vigorously to chemical substances such as bradykinin, potassium, adenosine, acids, and veratridine when applied to the epicardial surface or injected directly into coronary arteries (Foreman 1999). Several chemicals have been examined for their role in activating afferent fibers during myocardial ischemia; however, bradykinin has long been used as a chemical of choice to produce nociceptive responses. Although some disagreements exist, bradykinin is increased in the effluent of the coronary sinus following coronary artery occlusion (Hashimoto et al. 1977; Kimura et al. 1973), and intracoronary infusions of bradykinin lead to angina-like pain (Gaspardone et al. 1999). An important observation about angina pectoris and ischemic heart disease is that patients may experience significant ischemic episodes, as demonstrated by ECG changes, but no pain is experienced. These episodes are called silent ischemia. Thus, the variability of the pain sensation and its lack of direct relationship with myocardial ischemia, shows that a complex system may be operating in a way not yet discovered. This lack of understanding is due to the fact that little information is available about the characteristics of sensory receptors in the heart, and how the interstitial environment surrounding the receptors influences their processing of information.

Adenosine may also be an important component of the chemicals contributing to cardiac pain. Intracoronary infusions of adenosine cause angina-like pain in healthy volunteers (Sylvén 1986) and in patients who suffer from ischemic heart disease and experience angina pectoris (Sylvén et al. 1988; Crea et al. 1990) without expressing any electrocardiographic changes. This pain most likely originates from the sympathetic afferent fibers innervating the heart, because similar doses of adenosine infused

into the right atrium did not evoke any pain, and afferent activity is increased.

#### Methods of Chemical Stimulation of Cardiac Receptors

**Intracardiac Injections** (Blair et al. 1982; Ammons et al. 1985): – In cats and monkeys, the left thoracic cavity is exposed by removing the second through the fifth ribs and the anterior lobe of the lung. A small hemostat is used to grip the tip of the left atrial appendage. A small incision is made into the tip and then a cannula (PE-90) with a small flanged end is inserted into the left atrial appendage. A purse string is used to clasp the atrial tissue tightly against the cannula. This ligation prevents leakage of blood chemicals into the thoracic cavity. Commonly, another cannula (PE-90) is inserted into the left femoral artery and is moved up the aorta, until the tip is placed just above the coronary ostia. Chemical injections are made through this cannula to serve for control measurements.

**Intracoronary Injections:** – In dog studies, several routes of anesthesia administration and techniques for intracoronary implantation can be used. The anesthesia and techniques described here will serve as a prototype for administering intracoronary injections of chemicals. Healthy mongrel dogs, generally weighing between 20 and 30 kg, are tranquilized with morphine sulfate (2 mg/kg I.P) and anesthetized with pentobarbital sodium (30 mg/kg), intubated, and placed on a Harvard apparatus room air ventilator. During the course of the experiment additional doses of anesthesia are administered as needed (5 mg/kg I.V.). The appropriate level of anesthesia is checked by making sure the withdrawal reflex is absent when the forepaw is pinched with a small hemostat and the jaw tension is low. Access to the right femoral artery is obtained by inserting an 8F sheath. An 8F hockey stick guide catheter is then passed via the femoral sheath and positioned in the ostium of the left coronary artery. The chemicals can then be injected directly into the coronary artery.

**Intrapericardial Injections** (Euchner Wamser et al. 1994; Qin et al. 2001; commonly used procedure in rats): – A midline thoracotomy is used to place a silicone catheter (0.020 ID, 0.037 OD, 14–16 cm length) into the pericardial sac over the left ventricle. Individual chemicals such as bradykinin, capsaicin, or adenosine or a mixture of algescic compounds can be injected into the pericardial sac to stimulate both vagal and sympathetic afferent endings. Solutions are injected and withdrawn via a 1 ml syringe connected to the catheter. The protocol is to inject 0.2 ml of warm saline into the sac and then withdraw the saline after 60 sec. This is followed by the injection of 0.2 ml of the algescic mixture, which is also withdrawn after 60 sec. The pericardial sac is then flushed twice or three times with warm saline. It is important to make the injection in at least 15 minute intervals to prevent tachyphylaxis

**Coronary artery occlusion** (Blair et al. 1984): – To expose the left coronary artery, the chest is opened at the fourth or fifth intercostal space on the left side of the chest. The ribs are retracted and the lungs are reflected to expose the heart. For cats and monkeys, tissue surrounding the left anterior descending branch of the left main coronary artery is dissected, while carefully avoiding damage to the pericoronary nerves. The hearts of cats and monkeys are large enough to place occluders around both the left circumflex and left anterior descending branch of the left coronary artery. For rats, the heart is exteriorized by pressing gently on the right chest wall. For all species, a silk ligature (2–0 – 4–0) is placed around the left coronary artery, approximately 2–3 mm from its origin. The ends of the sutures are slipped through a small polyethylene tube. For the occlusion, the tubing is moved until it touches the artery and then the suture strings are pulled to collapse the vessel. The ECG is monitored via Lead II on an oscilloscope and stored on a data acquisition system. We have shown that repeated occlusions can be done without diminishing the cellular responses. This technique can be adapted for the rat, cat, monkey and dog. Another approach for the dog is to introduce balloon catheters in closed chest preparations.

#### References

1. Ammons WS, Girardot M-N, Foreman RD (1985) Effects of Intracardiac Bradykinin on T2–T5 Medial Spinothalamic Cells. *Am J Physiol* 249:R147–52
2. Baker DG, Coleridge HM, Coleridge JCG, Nerdrum T (1980) Search for a Cardiac Nociceptor: Stimulation by Bradykinin of Sympathetic Afferent Nerve Endings in the Heart of Cat. *J Physiol* 306:519–36
3. Blair RW, Ammons WS, and Foreman RD (1984) Responses of Thoracic Spinothalamic and Spinoreticular Cells to Coronary Artery Occlusion. *J Neurophysiol* 51:636–648
4. Blair RW, Weber RN and Foreman RD (1982) Responses of Thoracic Spinothalamic Neurons to Intracardiac Injection of Bradykinin in the Monkey. *Circ Res* 51:83–94
5. Colbeck EH (1903) Angina Pectoris: A Criticism and a Hypothesis. *Lancet* 1:793–95
6. Crea F, Pupita G, Galassi AR, El-Tammi H, Kaski JC et al. (1990) Role of Adenosine in Pathogenesis of Anginal Pain. *Circulation* 81:164–7
7. Davies G, Bencivelli W, Chierchia S, Fragasso G, Crea F et al. (1988) Sequence and Magnitude of Ventricular Volume Changes in Painful and Painless Myocardial Ischemia. *Circulation* 78:310–19
8. Euchner-Wamser I, Meller ST, Gebhart GF (1994) A Model of Cardiac Nociception in Chronically Instrumented Rats: Behavioral and Electrophysiological Effects of Pericardial Administration of Algogenic Substances. *Pain* 58:117–28
9. Gaspardone A, Crea F, Tomai F, Versaci F, Pellegrino A, Chiariello L, Gioffre PA (1999) Effect of Acetylsalicylate on Cardiac and Muscular Pain Induced by Intracoronary and Intra-Arterial Infusion of Bradykinin in Humans. *J Am Coll Cardiol* 34:216–222
10. Hashimoto K, Hirose M, Furukawa S, Hayakawa H, Kimura E (1977) Changes in Hemodynamics and Bradykinin Concentration in Coronary Sinus Blood in Experimental Coronary Artery Occlusion. *Jpn Heart J* 18:679–89
11. Kimura E, Hashimoto K, Furukawa S, Hayakawa H (1973) Changes in Bradykinin Level in Coronary Sinus Blood after

- the Experimental Occlusion of Coronary Artery. *Am Heart J* 85:635–47
12. Nerdrum T, Baker DG, Coleridge HM, Coleridge JCG (1986) Interaction of Bradykinin and Prostaglandin E1 on Cardiac Pressor Reflex and Sympathetic Afferents. *Am J Physiol* 250:R815–22
  13. Sylvé C, Beermann B, Jonzon B, Brandt R (1986) Angina Pectoris-Like Pain Provoked by Intravenous Adenosine in Healthy Volunteers. *Br Med J* 293:227–30
  14. Sylvé C, Beermann B, Edlund A, Lewander R, Jonzon B, Mogensén L (1988) Provocation of Chest Pain in Patients with Coronary Insufficiency using the Vasodilator Adenosine. *Eur Heart J* 9:6–10
  15. Qin C, Chandler MJ, Miller KE, Foreman RD (2001) Responses and Afferent Pathways of Superficial and Deeper C<sub>1</sub>–C<sub>2</sub> Spinal Cells to Intrapericardial Allogenic Chemicals in Rats. *J Neurophysiol* 85:1522–1532

## Visceral Pain Model, Esophageal Pain

JYOTI N. SENGUPTA, REZA SHAKER,  
ADRIAN MIRANDA  
Division of Gastroenterology and Hepatology and  
Pediatric Gastroenterology, Medical College of  
Wisconsin, Milwaukee, WI, USA  
sengupta@mcw.edu

### Synonyms

Esophageal Pain, Non-Cardiac Chest Pain; gastroesophageal reflux disease; Central Hyperexcitability; Visceral Hyperalgesia

### Definition

Recurrent chest pain without demonstrable cardiac abnormalities is often referred to as ► **non-cardiac chest pain** (NCCP). In many cases, such pain can originate from the esophagus as a result of ► **gastroesophageal reflux disease** (GERD) or motor dysfunction of the esophagus. Pain which results from abnormal sensory perception in the esophagus, known as “functional” pain, can also result in NCCP, and is characterized as pain in the absence of biochemical, endoscopic, histologic or manometric abnormalities.

### Characteristics

Non-cardiac chest pain (NCCP) is most often presumed to be of esophageal origin, and is characterized by episodes of unexplained pain that are usually localized in the mid-sternal region, and may often radiate to the back, neck, jaw and arms. Pain of esophageal origin can be easily confused with that of cardiac angina, since there is common convergence of cardiac and esophageal sensory afferents on the thoracic and cervical spinal dorsal horn neurons (Euchner et al. 1994; Garrison et al. 1992). However, the vast majority of patients suffering from chest pain do not have a cardiac etiology to explain their pain. Other potential etiologies of chest pain include GERD, esophageal spasm, musculoskeletal pain, and even psychiatric disorders such

as panic attacks. The annual prevalence of NCCP is approximately 25%, imposing a substantial economic burden on healthcare resources in the United States. Despite this significant burden, the natural history and underlying pathophysiology of NCCP remains poorly understood. Most of the available clinical information has been derived from patients who have sought treatment only after the development of symptoms. As a result, the inciting events can only be evaluated retrospectively, making it difficult to establish a direct cause-and-effect relationship. It is thought however, that gastroesophageal reflux (GER) plays a major role in the pathogenesis of NCCP.

Acid reflux can stimulate pH-sensitive receptors in the esophagus resulting in acute pain often referred to as “heartburn”. However, there is poor correlation between discrete episodes of acid reflux and pain as demonstrated by intraesophageal pH monitoring. Fewer than 20% of reflux episodes have been found to correlate with complaints (Richter 1998). In a subset of patients, sensory perception in the esophagus can be altered, resulting in a reduced threshold for pain. It is speculated that poor acid clearance from the esophagus may stimulate and sensitize primary sensory neurons of the vagus and spinal nerves, to ultimately sensitize the neurons in the spinal cord and brainstem. However, the relative contribution of vagal and spinal afferents to pain perception is not clearly known, and no systematic behavioral study has been performed to evaluate the role of vagal and spinal nerves in esophageal pain.

The majority of human studies evaluating esophageal pain sensation have been carried out by scoring pain perception, and/or by imaging cortical brain activity in response to different stimuli. Unfortunately, no behavioral model has been developed to evaluate esophageal pain perception in intact animals. Animal studies evaluating esophageal pain are mostly restricted to recordings of neuronal activity from the primary sensory afferents, spinal cord and/or brainstem neurons in the acutely anesthetized setting.

### Psychophysical Studies

Human studies have demonstrated that patients with NCCP have lower thresholds for pain in response to esophageal balloon distension. In addition, prolonged (~15 minutes) acid infusion into the esophagus of healthy human subjects produces hyperalgesia to mechanical distension (Richter et al. 1998; Sarkar et al. 2001; Wayne et al. 2000). Recently, a multimodal pain assessment model has been developed in humans by using a probe that can deliver mechanical, electrical and thermal stimuli (Drewes et al. 2002). Healthy subjects reported increased pain intensity and expansion of the referred pain area with increased stimulus intensity. However, the type of pain sensation to different modes of stimulation varied, which suggests the recruitment of different types of sensory neurons and pathways to

different stimuli (Drewes et al. 2002). A subsequent study, reported that 15 minutes of acid exposure in the esophagus produces mechanical and thermal hyperalgesia and a significant expansion of referred pain areas (Drewes et al. 2003). This type of multimodal probe can be effectively used in NCCP patient to evaluate the altered sensory perception to different modalities of stimuli. Since the altered sensory perception of NCCP patients is generally not associated with tissue pathology or motility disorders, it has been speculated that the etiology of NCCP involves either hypersensitivity of the primary sensory neurons (► [peripheral sensitization](#)) and/or the central nervous system (► [central sensitization](#)). However, the underlying mechanism that triggers the esophageal hypersensitivity is not known. Psychophysical studies in humans clearly indicate that acid plays a key role in altering the sensation in the esophagus. It is conceivable that frequent GER may produce a change in the response properties of sensory neurons, which in turn may sensitize the neurons in the spinal cord and brainstem.

### Electrophysiological Studies in Animals

#### Primary Sensory Afferents

The esophagus is primarily innervated by vagal and spinal sensory neurons, which are pseudounipolar cells with their cell bodies located either in the ► [nodose ganglia](#) (for vagal afferents), or in the thoracic and cervical ► [dorsal root ganglia](#) (DRG) for spinal afferents. The sensory neurons in the vagal and spinal pathways primarily innervate the mucosa and muscles of the esophagus. The majority of these sensory neurons in the vagus and the spinal nerves are unmyelinated C-fibers or thinly myelinated A $\delta$ -fibers. Both mucosal and muscle afferent fibers have also been sub-classified on the basis of sensory modality as mechano-, chemo- or thermo-receptors. However, recent studies have shown that many of the vagal sensory afferents respond to multiple stimuli (i.e. polymodal). With almost all vagal afferent fibers having low thresholds for response exhibit spontaneous firing and response to changes in intraluminal pressure, a behavior likely to be related to their role in the regulation of peristalsis. Spinal muscle afferent fibers can have either low ( $\leq 5$  mmHg, 63%) or high thresholds ( $\geq 40$  mmHg, 37%) for response to esophageal distension (Sengupta and Gebhart 1994). Their response characteristics to graded distension differ from vagal afferent fibers. Most of the vagal afferent fibers exhibit a steep increase in firing within a narrow range of distending pressures (5–40 mmHg), but with increasing distension pressures of nociceptive intensities, ( $>40$  mmHg) the firing frequency reaches a plateau. Unlike vagal afferents, spinal afferents continue to exhibit a positive increase in firing in response to increasing distension pressure (Sengupta and Gebhart 1994). This linear encoding property of spinal sensory afferents makes them suitable for nociceptive transmission. The

vagal sensory neurons possibly regulate motor function and other non-painful sensations. Interestingly, a recent study documents that a proportion of vagal sensory neurons supplying the thoracic esophagus project to the upper cervical (C1–C2) spinal cord (Qin et al. 2004). However, it is not known whether this vagal pathway via the spinal cord is involved in esophageal pain.

The existing data on mucosal afferents are exclusively from the vagus nerve, and to date no study has been conducted on spinal mucosal afferent fibers. Mucosal afferent endings are mostly located in the mucosa and are extremely sensitive to light touch of the mucosal surface, but are generally insensitive to peristaltic contractions. Unlike muscle afferents, mucosal afferent fibers do not always exhibit spontaneous firing. These fibers are pH sensitive, and many of them also exhibit a response to other chemicals (Page et al. 2000). It has been shown that chronic acid exposure changes the chemosensitive properties of the mucosal afferent fibers (Page et al. 2000). The afferent fibers, which are initially insensitive or less sensitive to chemicals, (e.g.  $\alpha$ , $\beta$ -methylene ATP and capsaicin) become extremely sensitive after chronic acid exposure.

Although the thermosensitivity of primary sensory afferents in the esophagus has not been examined in electrophysiology experiments, it is very likely that vagal and spinal afferent fibers are capable of sensing temperature. A recent study documented the existence of thermosensitive transient receptor potential channels (TRPV<sub>1-4</sub>, TRPN1 and TRPM8) in the nodose cell body (Ward et al. 2003; Patterson et al. 2003; Zhang et al. 2004). In addition, human studies have documented pain perception to hot (50°C) and cold (7°C) temperatures in the esophagus (Drewes et al. 2002; Drewes et al. 2003).

#### Spinal Cord and Brainstem

Animal studies involving electrophysiologic recordings from the spinal cord complement many of the human psychophysical studies. For example, spinal neurons receiving synaptic projections from the esophagus have been shown to exhibit sensitization to esophageal distension, and expansion of the somatic receptive area following acid infusion into the esophagus (Garrison et al. 1992). Acid exposure of the distal esophagus produces a secondary hyperalgesia distant from the area of acid exposure, suggesting sensitization of spinal neurons that may receive projections from distant areas (Sarkar et al. 2001). In the rat, approximately 26% of thoracic (T3–T4) dorsal horn neurons respond to cervical and thoracic esophageal distension (Qin et al. 2003), which suggests that viscerovisceral convergence plays a major role in the development of secondary visceral hyperalgesia in the esophagus. In addition, it has been reported that 42% of thoracic spinal dorsal horn neurons in the rat respond to esophageal distension and pericardial administration of the algogenic substance



bradykinin (Euchner-Wamser et al. 1994). As a result of this viscerovisceral convergence from the heart and esophagus, pain originating from the esophagus often mimics that of cardiac angina.

#### A Possible Mechanism of NCCP of Esophageal Origin

A prolonged esophageal insult can result in neuronal sensitization and a reduced threshold for pain in the esophagus. As a result, chronic acid reflux could potentially lead to sensitization of either primary afferents and/or central neurons. It has been shown that frequent acid exposure initiates over expression of many of the ion channels (Page and Blackshaw 2000). ► **Acid-sensing ion channels** (ASICs) and transient receptor potential vanilloid type 1 (► **TRPV1**) channels may play primary and secondary roles in sensitization of the sensory afferent fibers. Activation of these channels by acid leads to Na<sup>+</sup> and Ca<sup>++</sup> influx and excitation of the neuron (a primary function), which leads to the release of neuropeptides including glutamate, substance P and CGRP (a secondary function). These neurotransmitters may cause a neuroplastic change in the primary sensory neurons and ultimately in central neurons. There is growing evidence that activation of glutamate receptors, especially n-methyl D-aspartic acid (NMDA) receptors, causes long-term sensitization of spinal dorsal horn neurons. In the acute setting, both preemptive and post emptive administration of the NMDA channel blocker ketamine, can prevent esophageal acid-induced hypersensitivity in humans (Willert et al. 2004).

In conclusion, human psychophysical models have consistently shown that acid reflux can induce hypersensitivity in the esophagus, a possible factor contributing to the development of NCCP. However, the exact mechanism remains poorly understood. Experimental pain models are based on neurophysiological and behavioral reactions, and are sometimes difficult to extrapolate to humans. Although great advances have been made in understanding the pathophysiology of esophageal pain, newer models are required to further understand the complexity and to target newer pharmacological therapies.

#### References

1. Drewes AM, Schipper K-P, Dimcevski G, Petersen P, Andersen OK, Gregersen H, Nielsen LA (2002) Multimodal Assessment of Pain in the Esophagus: A New Experimental Model. *Am J Physiol* 283:G95–G103
2. Drewes AM, Schipper K-P, Dimcevski G, Petersen P, Andersen OK, Gregersen H, Nielsen LA (2003) Multi-Modal Induction and Assessment of Allodynia and Hyperalgesia in the Human Esophagus. *Eur J Pain* 7:539–549
3. Euchner-Wamser I, Meller ST, Gebhart GF (1994) A Model of Cardiac Nociception in Chronically Instrumented Rats: Behavioral and Electrophysiological Effects of Pericardial Administration of Allogenic Substances. *Pain* 58:117–128
4. Garrison DW, Chandler MJ, Foreman RD (1992) Viscerosomatic Convergence onto Feline Neurons from Esophagus, Heart and Somatic Fields: Effects of Inflammation. *Pain* 49:373–382
5. Page AJ, O'Donnell TA, Blackshaw LA (2000) P2X Purinoceptor-Induced Sensitization of Ferret Vagal Mechanoreceptors in Esophageal Inflammation. *J Physiol* 523:403–411
6. Patterson LM, Zheng H, Ward SM, Berthoud HR (2003) Vanilloid Receptor (VR1) Expression in Vagal Afferent Neurons Innervating the Gastrointestinal Tract. *Cell Tissue Res* 311:277–287
7. Qin C, Chandler MJ, Foreman RD (2003) Afferent Pathways and Responses of T3–T4 Spinal Neurons to Cervical and Thoracic Esophageal Distensions in Rats. *Auton Neurosci* 109:10–20
8. Qin C, Chandler MJ, Jou CJ, Foreman RD (2004) Response and Afferent Pathways of C1–C2 Spinal Neurons to Cervical and Thoracic Esophageal Stimulation in Rats. *J Neurophysiol* 91:2227–2235
9. Richter JE (1998) Dysphagia, Odynophagia, Heartburn and Other Esophageal Symptoms. In: Feldman M, Scharschmidt BF, Sleisenger M, Zorab R (eds) *Gastrointestinal and Liver Disease*. W.B. Saunders Company, Philadelphia, pp 97–105
10. Sarkar S, Hobson AR, Furlong PL, Woolf CJ, Tomson DG, Aziz Q (2001) Central Neural Mechanisms Mediating Human Visceral Hypersensitivity. *Am J Physiol* 281:G1196–G1202
11. Sengupta JN, Gebhart GF (1994) Gastrointestinal Afferents Fibers and Sensation. In: Johnson LR (ed) *Physiology of the Gastrointestinal Tract* Raven Press, New York, pp 483–519
12. Ward SM, Bayguinov J, Won KJ, Grundy D, Berthoud HR (2003) Distribution of the Vanilloid Receptor (VR1) in the Gastrointestinal Tract. *J Comp Neurol* 465:121–235
13. Hu WH, Martin CJ, Talley NJ (2000) Intraesophageal Acid Perfusion Sensitizes the Esophagus to Mechanical Distension: A Barostat Study. *Am J Gastro* 95:2189–2194
14. Willert PR, Woolf CJ, Hobson AR, Delaney C, Thomson D, Aziz Q (2004) The Development and Maintenance of Human Visceral Pain Hypersensitivity is Dependent on the N-methyl-D-aspartate Receptor. *Gastroenterology* 126:683–692
15. Zhang L, Jones S, Brody K, Costa M, Brookes SJH (2004) Thermosensitive Transient Receptor Potential Channels in Vagal Afferent Neurons of the Mouse. *Am J Physiol* 286:G983–G991

## Visceral Pain Model, Irritable Bowel Syndrome Model

ELIE D. AL-CHAER

Neurobiology and Developmental Sciences College of Medicine, University of Arkansas for Medical Sciences, Center for Pain Research, Pediatrics, Little Rock, AR, USA  
ealchaer@uams.edu

V

#### Synonyms

Irritable Bowel Syndrome Model; IBS; Functional Abdominal Pain; Non-Structural Disorders; visceral hypersensitivity; Chronic Neural Sensitization; Neonatal Pain; Neonatal Inflammation

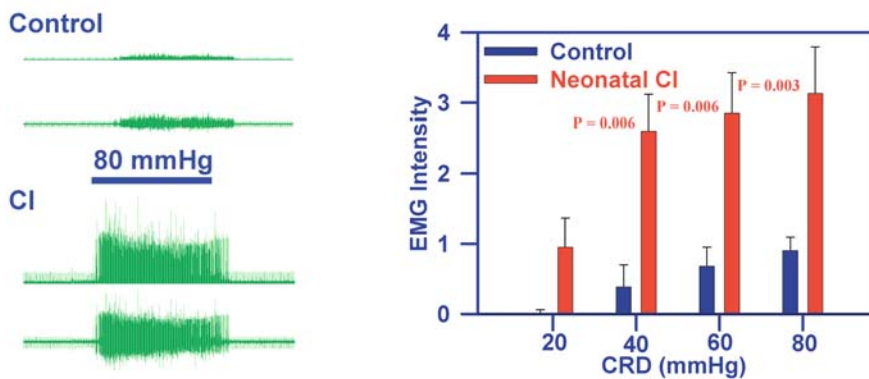
#### Definition

► **Irritable bowel syndrome** (IBS) is a functional disorder of the large and small intestines, which causes abdominal pain or discomfort in the absence of identifiable physical pathology such as inflammation or tumors. The pain occurs along with constipation or diarrhea. Other common symptoms are bloating, passing mucus in the stools, or a sense that the bowels have not been completely emptied. The exact cause of irritable bowel



## Sensitization of EMG Responses to CRD

*EMG responses were recorded from the external oblique muscle.  
The responses were larger in CI rats than in controls*



**Visceral Pain Model, Irritable Bowel Syndrome Model, Figure 2** Sensitization of EMG Responses to CRD. Left Panel: Waveforms (traces 2 and 4) showing the responses to CRD (80 mmHg) recorded in the external oblique muscles of a control rat and a rat with neonatal colon irritation. The upper traces (1 and 3) show the rectified signal used to measure the area under the curve. Right Panel: Bar graphs showing the average EMG responses (+/- SEM), quantified by measuring the area under the curve, to graded colorectal distension measured in control rats (dark) or rats with neonatal CI (light).

newborn gut may well be exposed to a variety of factors resulting in mucosal inflammation and tissue irritation. These factors include inflammation resulting from food allergies, viral infections and acid reflux, all of which are common in early life. Given the immature neonatal nervous system (e. g. underdeveloped endogenous pain inhibition systems), this may result in permanent neuroplastic alterations, manifesting as an altered pain response to visceral stimuli in adults.

In an animal model of neonatal colon injury, Al-Chaer et al. reported that exposing newborn rat pups (days 8–21) to painful ► colorectal distension (CRD, using angioplasty balloon; 2×60 s distensions separated by 30 min) - a painful stimulus but arguably a reproducible experimental form of physical abuse - or colon inflammation (daily intracolonic injection of mustard oil) during pre-adolescence can cause long-term visceral and somatic hypersensitivity, which lingers beyond the age of 4 months in the adult rat and long after the initial injury has resolved (Al-Chaer et al. 2000) (Fig. 1). Behavioral pain responses to CRD are significantly increased in the neonatally irritated rats when assessed at postnatal week 5 and persist up to postnatal week 12 (Fig. 2), while colon histology is not different from controls (Al-Chaer et al. 2000).

This hypersensitivity is associated with central and peripheral neural sensitization (Al-Chaer ED et al. 2000, Lin and Al-Chaer 2003) and functional changes in pain processing pathways (Saab CY et al. 2004). Electrophysiologic recordings of the responses of viscerosensitive primary afferent fibers converging onto the L6-S1 or T13-L2 segments of the spinal cord, and of individual viscerosensitive dorsal horn neurons at L6-S1 or T13-L2 spinal segments, show increased baseline firing rates, as well as increased responses, to graded CRD and somatic stimuli applied to the same dermatome (Lin and Al-Chaer 2003). Evidence of central (spinal) sensitization is further demonstrated

by increased expression of c-Fos in spinal segments receiving colorectal input.

Adult rats exposed to neonatal colon irritation show disturbances in colon motility in the form of altered fecal output (Ma et al. 2002), symptoms commonly seen in patients with IBS. Furthermore, exposure to neonatal colon pain can cause adult rats of both sexes to reduce their exploratory activity and confine themselves to a limited area of an open field. The decrease in exploratory activity is aggravated by stress (Hinze et al. 2002).

### Other Animal Models

These include: 1) Neonatal maternal separation stress model, in which the normal mother-infant interaction is compromised. Daily separation of the litter from their mothers for 180 min. each day during postnatal days 4–18 results in an alteration of maternal behavior, with significantly reduced times of the licking/grooming behavior. Adult maternally separated rats show evidence of alterations in stress-induced visceral and somatic pain sensitivity, consistent with compromised stress induced engagement of opioid systems. Additionally, colonic motor function in response to stress is also enhanced in these animals (Coutinho et al. 2001). 2) Post-traumatic stress disorder model, which uses daily sessions of brief electric footshock, or other interventions such as repeated injections of psychostimulants or corticotropin releasing factor (CRF), to induce a sensitized state in the adult rat. Evidence suggests that such animals also show increased visceral afferent responses to colonic distension (Stam et al. 2000), in addition to postinfectious or post-inflammatory models (Collins et al. 1996).

### References

1. Al-Chaer ED, Kawasaki M, Pasricha PJ (2000) A New Model of Chronic Visceral Hypersensitivity in Adult Rats Induced by Colon Irritation During Postnatal Development. *Gastroenterology* 119:1276–1285



2. Blanchard EB, Scharff L (2002) Psychosocial Aspects of Assessment and Treatment of Irritable Bowel Syndrome in Adults and Recurrent Abdominal Pain in Children. *Journal of Consulting and Clinical Psychology* 70:725–738
3. Collins SM, McHugh K, Jacobson K, Khan I, Riddell R, Murase K, Weingarten HP. (1996) Previous Inflammation Alters the Response of the Rat Colon to Stress. *Gastroenterology* 111:1509–1515
4. Coutinho S, Plotsky P, Sablad M, Miller J, Zhou H, Bayati A, McRoberts JA, Mayer EA (2001) Neonatal Maternal Separation Alters Stress-Induced Responses to Viscerosomatic Nociceptive Stimuli in the Adult Rat. *Am J Physiol Gastrointest Liver Physiol* 282:G307–316
5. Drossman DA, Talley NJ, Leserman J, Olden KJ, Barreiro M (1995) Sexual and Physical Abuse and Gastrointestinal Illness: Review and Recommendations. *Ann Intern Med* 123:782–794
6. Hinze CL, Lin C, Al-Chaer ED (2002) Estrous Cycle and Stress Related Variations of Open Field Activity in Adult Female Rats with Neonatal Colon Irritation (CI). Program No. 155.14. 2002 Abstract Viewer/Itinerary Planner. Society for Neuroscience, Washington, DC, CD-ROM
7. Hyams JS, Hyman PE, Rasquin-Weber A (1999) Childhood Recurrent Abdominal Pain and Subsequent Adult Irritable Bowel Syndrome. *J Develop Behav Ped* 20:318–319
8. Lin C, Al-Chaer ED (2003) Long-Term Sensitization of Primary Afferents in Adult Rats Exposed to Neonatal Colon Pain. *Brain Res* 971:73–82
9. Ma H, Park Y, Al-Chaer ED (2002) Functional Outcomes of Neonatal Colon Pain Measured in Adult Rats. *American Pain Society, J Pain* 3 Supp.1: p 27, #707.
10. Saab CY, Arai Y-CP, Al-Chaer ED (2004) Modulation of Visceral Nociceptive Processing in the Lumbar Spinal Cord Following Thalamic Stimulation or Inactivation and after Dorsal Column Lesion in Rats with Neonatal Colon Irritation. *Brain Res* 1008:186–192
11. Stam R, Bruijnzeel AW, Wiegant VM (2000) Long-Lasting Stress Sensitization. *Eur J Pharmacol* 405:217–224
12. Thompson WG, Longstreth G, Drossman DA, Heaton K, Irvine EJ, Muller-Lissner S (2000) Functional Bowel Disorders and Functional Abdominal Pain. In: Drossman DA, Corazziari E, Talley NJ, Thompson WG, Whitehead WE (eds) *Rome II: The Functional Gastrointestinal Disorders: Diagnosis, Pathophysiology and Treatment: A Multinational Consensus 2<sup>nd</sup> edn*. Degnon Associates, McLean VA, USA, pp 351–375

## Visceral Pain Model, Kidney Stone Pain

MARIA ADELE GIAMBERARDINO  
 Dipartimento di Medicina e Scienze  
 dell'Invecchiamento, University of Chieti,  
 Chieti, Italy  
 mag@unich.it

### Definition

Animal model (rat) of urinary colic and referred lumbar muscle hyperalgesia from an artificial ureteric calculus.

### Characteristics

Renal/ureteral colic, evoked by the passage of kidney stones, is intensely painful in humans (Bihl and Meyers 2001). Calculosis of one upper urinary tract typically produces pain in the ipsilateral lumbar region (L1), which radiates downward on the anterior flank towards the groin, and ► **referred hyperalgesia** in the ipsilat-

eral oblique musculature. The hyperalgesia is already detectable after a few colic episodes, is accentuated in extent by the repetition of the colic and is long-lasting, i. e., it outlasts not only the spontaneous pain (it is detectable in the pain-free interval) but often also the presence of the stone in the urinary tract (it can persist long after the stone is expelled through the urine) (Giamberardino et al. 1994; Vecchiet et al. 1989).

Rats with an artificial stone in one upper ureter present characteristics closely mimicking the clinical condition. They display both repeated “crises” of abnormal behavior (direct visceral pain/colic) and hypersensitivity of the ipsilateral oblique musculature (referred hyperalgesia), whose extent and temporal evolution are in parallel with those of patients (see below). Spontaneous behavior is monitored, post-stone formation, through non-stop video-tape recordings, and referred hyperalgesia is measured as a decrease in the ► **vocalization threshold to electrical muscle stimulation** in the post-stone period, with respect to the pre-stone formation period (Giamberardino et al. 1990; Giamberardino et al. 1995). This model has been developed to investigate pathophysiological mechanisms of visceral pain/referred phenomena from the urinary tract in standardized conditions.

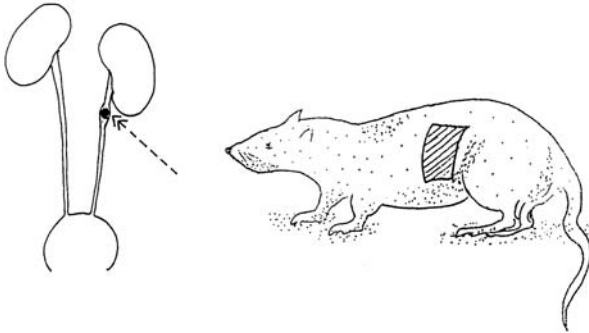
### Operation

Under general anesthesia (pentobarbital or halothane) (Giamberardino et al. 1990; Roza et al. 1998) the obliquus externus muscle (L1) of both sides is implanted with bipolar wire electrodes (insulated nichelchrome wires), 1 cm apart. The wires are passed under the skin to reach the skull, where connectors are fixed into the parietal bones via small screws and dental cement, to form a small device. This permits testing of muscle sensitivity in the awake, freely moving rats, for many days after implantation. On the third day after electrode implantation, a second general anesthesia is induced for ureteral stone formation. The left ureter is approached via a suprapubic vertical incision and 0.02 ml of dental lamell resin cement is injected, while still fluid, in the upper third of the lumen, using an insulin syringe with a 0.4 mm-diameter needle. The cement hardens quickly and forms a small stone (Fig. 1, left) (Giamberardino et al. 1995).

### Behavior in Stone Rats

Ureteral “crises”: Ninety-eight percent of stone rats show spontaneous nocifensive behavior over several days post-operatively, i.e., repeated “crises” similar in nature to the writhing behavior typical with noxious visceral stimulation (Le Bars et al. 2001). These crises, which never appear after non-noxious ureteral procedures (sham intervention, i.e., injection of saline in the lumen, ligation of the lowest ureter) or interventions on somatic structures (e.g., muscle implantation), are significantly and dose-dependently reduced in number and





**Visceral Pain Model, Kidney Stone Pain, Figure 1** Sites of ureteral stone formation (left) and referred lumbar muscle hyperalgesia (right) in the rat model of artificial ureteric calculosis.

duration by chronic treatment with morphine, tramadol or metamizol (Affaitati et al. 2002, Giamberardino et al. 1995, Laird et al. 1998). All these observations strongly support their being an index of perceived visceral pain, and thus the equivalent of urinary colic in humans.

During ► [continuous video-tape recordings](#), the typical movements of a ureteral “crisis” are:

- Hump-backed position
- Licking of lower abdomen and/or ipsilateral flank
- Repeated waves of contraction of flank muscles with inward movements of ipsilateral hind limb
- Body stretching
- Squashing of lower abdomen against the floor
- Supine position with ipsilateral hind-limb adducted and compressed against the abdomen.

A “crisis” is a sequence of at least 3 of the above movements for a minimum duration of 2 minutes. A lesser number of movements (1 or 2) and/or duration of the sequence (< 2 min) is termed “subcrisis” Complexity of crises is estimated via a 4-point arbitrary scale: a sequence of 3 movements is scored 1, and sequences of 4, 5 or 6 movements are scored 2, 3 or 4, respectively. From one rat to another, the crises vary from very few to a very high number (~ 60), last a few min. to over 45 min. and are of variable complexity. In each rat, they predominate in the dark phase of the day; their number and duration decrease progressively with time after stone formation, so that they are concentrated mostly during the first 3–4 days (Giamberardino et al. 1995). In female rats, the percentage of time spent in crisis is significantly higher during the metestrus/diestrus than during the proestrus/estrus phases of the estrus cycle (Affaitati et al. 2002), in parallel with the clinical evidence of urinary colics prevailing during the premenstrual/menstrual phases in fertile women (Giamberardino et al. 2001).

#### Oblique Muscle Hyperalgesia

Calculosis rats develop hypersensitivity of the left oblique musculature (Fig. 1, right), revealed by vocal-

ization to slight digital pressure and pinching of the muscle. The hypersensitivity is quantified in terms of a decrease in the vocalization threshold to electrical muscle stimulation, with respect to values preceding stone formation (thresholds are measured daily for 3 days before and 7–10 days after stone implantation). The decrease starts from the 1st post-stone implantation day, is maximal (peak hyperalgesia) on the 2<sup>nd</sup>–3<sup>rd</sup> day and lasts over a week, i.e., it outlasts the presence of ureteral crises (which cease after 4 days), and even the presence of the stone in the urinary tract. In fact, it is still detectable in rats that, at autopsy, appear to have spontaneously eliminated the stone. The muscle threshold lowering is significantly and directly correlated to the number and duration of “crises” displayed over the first 4 days (Giamberardino et al. 1995). Referred muscle hyperalgesia in calculosis rats has, therefore, the same characteristics as in humans, i.e., early phenomenon, accentuated in extent by the repetition of visceral “crises” and long-lasting (Giamberardino et al. 1994). It is also significantly reduced in extent and duration by chronic administration of NSAIDs (ketoprofen), spasmolytics (hyoscine-N-butylbromide) or both compounds in combination, similar to that observed in the clinical setting (Affaitati et al. 2002).

#### Destiny of the Stone

The destiny of the stone in rats is variable, just as it is in patients. Autopsy shows different patterns: stone spontaneously eliminated through the urine, or stone still present in the ureter, either in the original position or lower, with or without signs of urinary tract occlusion (proximal ureter dilated, kidney enlarged) (Affaitati et al. 2002, Giamberardino et al. 1990, Giamberardino et al. 1995).

#### Generation of Ureteral Pain

Pain from urinary calculosis is thought to derive mainly from acute pelvis dilatation, due to stone impact in the ureteral lumen. When a stone moves into the renal collecting system, the resulting increase in intraluminal pressure stretches nerve endings in the mucosa. Ureteric obstruction furthermore causes increased synthesis and release of prostaglandins, which in turn both increase glomerular filtration and renal pelvic pressure and sensitize nociceptors locally. An important algogenic role is also played by ureteral wall contractility, i.e. hypermotility taking place above the obstacle (Bihl and Meyers 2001).

► [Abnormal ureteric peristalsis](#) has been demonstrated in calculosis rats (Laird et al. 1997), which may contribute to the pain behavior, although the mechanisms producing the change in peristalsis are unknown. One possibility is that damage and inflammation of the ureteral wall caused by the stone induced cyclooxygenase activity (endogenous prostaglandins have been shown to enhance the activity of the pacemaker in the

renal pelvis *in vitro*). Another possibility is that stimulation of ureteric nociceptors by the stone provokes axon reflexes, with consequent release of neuropeptides such as tachykinins (affecting ureteric motility) from the nociceptive terminals (Laird et al. 1997).

The ► **ureteral nociceptors** stimulated in the calculosis rat model are presumably ► **U-2 type units**. These are a large population of high threshold units originally identified in the guinea pig's ureter. Unlike the ► **U-1 type units**, they respond to intense distensions but not to peristalsis (Cervero 1996).

### Generation of Referred Hyperalgesia

Electrophysiology in the calculosis model has shown changes in activity and excitability of spinal sensory neurons with convergent input from the ureter and the somatic area of referral (Giamberardino et al. 1996; Laird et al. 1998; Roza et al. 1998). Central mechanisms, i.e., sensitization of convergent neurons, are thus likely to be involved in the increased pain response to stimulation of the referred area.

Based on the clinical observation that the hyperalgesic muscle is often contracted, a reflex arc mechanism has also been hypothesized; the afferent visceral barrage would trigger activation of somatic efferents to the muscle, generating sustained contraction, which, in turn, would be responsible for sensitization of nociceptors locally (Vecchiet et al. 1989). Recent studies in the calculosis rat model provide some experimental support to this theory. In specimens of the ipsilateral (hyperalgesic) vs contralateral (non-hyperalgesic) oblique musculature, significant changes were found in several ► **parameters indicative of skeletal muscle contraction**. These changes were directly proportional to the number of ureteral crises, which in turn was proportional to the degree of the hyperalgesia (Giamberardino et al. 2003).

### Pros and Cons of the Ureteral Stone Model

Ideal requisites for pain modeling (Gebhart et al. 1993; Le Bars et al. 2001) are: natural, minimally invasive, reproducible and reliable stimulus, quantifiable responses, unanesthetized animals. In the calculosis model, the mechanical stimulus exerted by the stone can be regarded as "natural" being similar to that occurring spontaneously in humans with urinary stones. Though the procedure for stone formation is invasive, the stimulus per se is scarcely so, as the stone can even be eliminated spontaneously. The behavioral responses are quantifiable in terms of number/duration/complexity of ureteral crises, and changes in vocalization thresholds to muscle stimulation, with a mathematical relationship between the amount of ureteral behavior and the extent of muscle hyperalgesia. All responses are observed in the unanesthetized animal. The requisite "reproducible and reliable stimulus" is only satisfied in part. Though the technique for stone formation is standardized and easily reproducible, and the stimulus is reliably "nociceptive"

(nocifensive behavior observed in almost 100% of the cases), the outcome in terms of extent of noxious stimulation of the ureter is not predictable. The amount of pain behavior varies considerably from rat to rat, probably due to the different destiny of the stone. This variability renders the experiments with calculosis rats more elaborate, with high numbers of animals often being required for reliable statistical evaluations. However, an identical variability is seen in patients with urinary stones (different number/duration of colics for calculosis of similar characteristics). Due to the close similarity to the clinical condition, the calculosis model offers more advantages than ► **alternative rat models of ureteric nociceptive stimulation** *in vivo*.

### References

- Affaitati G, Giamberardino MA, Lerza R, Lapenna D, De Laurentis S, Vecchiet L (2002) Effects of Tramadol on Behavioural Indicators of Colic Pain in a Rat Model of Ureteral Calculosis. *Fundam Clin Pharmacol* 16:23–30
- Bihl G, Meyers A (2001) Recurrent Renal Stone Disease - Advances in Pathogenesis and Clinical Management. *Lancet* 358:651–656
- Cervero F (1996) Visceral Nociceptors. In: Belmonte C, Cervero F (eds) *Neurobiology of nociceptors*. Oxford University Press, Oxford, New York, Tokyo, pp 220–240
- Gebhart GF, Meller ST, Euchner-Wamser I, Sengupta JN (1993) Modeling Visceral Pain. In: Vecchiet L, Albe-Fessard D, Lindblom U (eds) *New Trends in Referred Pain and Hyperalgesia*. Elsevier, Amsterdam, pp 129–148
- Giamberardino MA, Vecchiet L, Albe-Fessard D (1990) Comparison of the Effects of Ureteral Calculosis and Occlusion on Muscular Sensitivity in Rats. *Pain* 43:227–234
- Giamberardino MA, de Bigontina P, Martegiani C, Vecchiet L (1994) Effects of Extracorporeal Shock-Wave Lithotripsy on Referred Hyperalgesia from Renal/Ureteral Calculosis. *Pain* 56:77–83
- Giamberardino MA, Valente R, de Bigontina P, Vecchiet L (1995) Artificial Ureteral Calculosis in Rats: Behavioural Characterization of Visceral Pain Episodes and their Relationship with Referred Lumbar Muscle hyperalgesia. *Pain* 61:459–469
- Giamberardino MA, Dalal A, Valente R, Vecchiet L (1996) Changes in Activity of Spinal Cells with Muscular Input in Rats with Referred Muscular Hyperalgesia from Ureteral Calculosis. *Neurosci Lett* 203:89–92
- Giamberardino MA, De Laurentis S, Affaitati G, Lerza R, Lapenna D, Vecchiet L (2001) Modulation of Pain and Hyperalgesia from the Urinary Tract by Algogenic Conditions of the Reproductive Organs in Women. *Neurosci Lett* 304:61–64
- Giamberardino MA, Affaitati G, Lerza R, Fanò G, Fulle S, Belia S, Lapenna D, Vecchiet L (2003) Evaluation of Indices of Skeletal Muscle Contraction in Areas of Referred Hyperalgesia from an Artificial Ureteric Stone in Rats. *Neurosci Lett* 338:213–216
- Laird JMA, Roza C, Cervero F (1997) Effects of Artificial Calculosis on Rat Ureter Motility: Peripheral Contribution to the Pain of Ureteric Colic. *Am J Physiol* 272:1409–1416
- Laird JMA, Roza C, Olivar T (1998) Antinociceptive Activity of Metamizol in Rats with Experimental Ureteric Calculosis: Central and Peripheral Components. *Inflamm Res* 47:389–395
- Le Bars D, Gozariu M, Cadden SW (2001) Animal Models of Nociception. *Pharmacol Rev* 53:597–652
- Roza C, Laird JMA, Cervero F (1998) Spinal Mechanisms Underlying Persistent Pain and Referred Hyperalgesia in Rats with an Experimental Ureteric Stone. *J Neurophysiol* 79:1603–1612
- Vecchiet L, Giamberardino MA, Dragani L, Albe-Fessard D (1989) Pain from Renal/Ureteral Calculosis: Evaluation of Sensory Thresholds in the Lumbar Area. *Pain* 36:289–295

## Visceral Pain Model, Lower Gastrointestinal Tract Pain

WILLIAM D. WILLIS

University of Texas Medical Branch, Galveston, TX, USA

wdwillis@utmb.edu

### Synonyms

Lower Gastrointestinal Tract Pain Models

### Definition

Animal models of lower gastrointestinal tract pain include graded ► [colorectal distension](#) and experimental ► [colitis](#).

### Characteristics

#### Methods

#### Distension of the Lower Gastrointestinal Tract

The effects of graded colorectal distension have been studied both in human subjects (Ness et al. 1990) and in animals (Ness and Gebhart 1987; Ness and Gebhart 1988a; Ness and Gebhart 1988b; Ness and Gebhart 1989; Traub et al. 1993; Al-Chaer et al. 1996; Al-Chaer et al. 1998). A device for controlling the pressure of distension stimuli has been described (Anderson et al. 1987). Humans report distinct sensations of pressure and of pain with different intensities of colorectal distension. Repeated distensions result in a greater intensity of pain and a greater area of pain referral (Ness et al. 1990).

#### Construction of Balloon for Colorectal Distension in Rats

For colorectal distension in rats, an inflatable balloon is inserted through the anus into the rectum and lower colon for a distance of about 7 cm. The balloon can be made from a finger from a latex surgical glove attached to tygon tubing. The wall tension of the balloon is reduced by inflating the balloon and leaving it inflated overnight (Al-Chaer et al. 1998). Before inserting the balloon, the tubing is connected by way of a T connector to a manual pump and to a pressure transducer. The latter is used to monitor stimulus intensity. Distensions that result in pressures ranging from 20 to 80 mmHg are used. Pressures that are above 30–40 mmHg are aversive to rats, as shown by a ► [passive avoidance test](#) (Ness and Gebhart 1988b). Care needs to be taken not to apply pressures in excess of 100 mmHg, since the colon is ruptured by pressures of 120 mmHg or greater (Ness and Gebhart 1987). Even pressures of 80 mmHg produce some damage to the colon (Traub et al. 1993).

#### Methods for Determining the Effects of Colorectal Distension in Rats

Experiments using a passive avoidance paradigm in rats have provided evidence that colorectal distension

to 80 mmHg for 20 s is aversive (Ness and Gebhart 1988b). A more convenient behavioral response that can be used to demonstrate the effects of colorectal distension in rats is the recording of ► [visceromotor reflexes](#) from the external abdominal oblique muscle, using electromyography (Ness and Gebhart 1988b). Usually, there is no response when the distension pressure is 30 mmHg, but graded responses are evoked by pressures of 60 and 80 mmHg (Palecek et al. 2002). Other techniques for detecting responses to colorectal distension in animals include electrophysiological recordings from visceromotor-responsive neurons in the spinal cord or brain (Ness and Gebhart 1987; Ness and Gebhart 1988a; Ness TJ and Gebhart 1989; Al-Chaer et al. 1996; Al-Chaer et al. 1998) and the demonstration of Fos expression following colorectal distension (Traub et al. 1993). Still another technique is the demonstration of the internalization of substance P receptors (NK-1 receptors) in spinal cord neurons following colorectal distension (Honore et al. 2002).

#### Methods for Inducing Experimental Colitis

An irritant, such as mustard oil (0.5 ml of 2.5% mustard oil) or zymosan (1 ml of a 25 mg/ml solution) is injected into the colon at a distance of 7–8 cm from the anus. The inflammation provoked by mustard oil results in enhanced activity of visceromotor-responsive neurons in the thalamus within about 30 minutes and a maximum change in about an hour (Al-Chaer et al. 1996). Zymosan colitis has a slower time course. Its effects are maximal at 3–6 hours post-treatment (Coutinho et al. 1996; Honore et al. 2002).

The effects of experimental colitis can be demonstrated by changes in the responses to colorectal distension or by observations of changes in the electrophysiological activity of neurons in the spinal cord or brain, as described above.

#### Advantages and Disadvantages of Colorectal Distension and Colitis Models

Important advantages of the colorectal distension model are that the lower gastrointestinal tract is readily accessible and can be stimulated in both animal models and in human subjects. The pressures that result in human reports of visceral pain from strong colorectal distension exceed the pressures that evoke pseudoaffective responses in animals, but the pseudoaffective responses can still be used as an index of nociception. (Ness et al. 1990) These models do not represent chronic visceral pain states.

#### Acknowledgments

Work in the Willis laboratory is supported by NIH grants NS 09743 and NS 11255.

#### References

1. Al-Chaer ED, Lawand NB, Westlund KN et al. (1996) Visceral nociceptive input into the ventral posterolateral nucleus of the



- thalamus: a new function for the dorsal column pathway. *J Neurophysiol* 76:2661–2674
- Al-Chaer ED, Feng Y, Willis WD (1998) A role for the dorsal column in nociceptive visceral input into the thalamus of primates. *J Neurophysiol* 79:3143–3150
  - Anderson R, Ness TJ, Gebhart GF (1987) A distension control device useful for studies of hollow organ sensation. *Physiol Behav* 41: 635–638
  - Coutinho SV, Meller ST, Gebhart GF (1996) Intracolonic zymosan produces visceral hyperalgesia in the rat that is mediated by spinal NMDA and non-NMDA receptors. *Brain Res* 736:7–15
  - Honore P, Kamp EH, Rogers SD et al. (2002) Activation of lamina I spinal cord neurons that express the substance P receptor in visceral nociception and hyperalgesia. *J Pain* 3:3–11
  - Ness TJ, Gebhart GF (1987) Characterization of neuronal responses to noxious visceral and somatic stimuli in the medial lumbosacral spinal cord of the rat. *J Neurophysiol* 57:1867–1892
  - Ness TJ, Gebhart GF (1988a) Colorectal distension as a noxious visceral stimulus: physiologic and pharmacologic characterization of pseudoaffective reflexes in the rat. *Brain Res* 450:153–169
  - Ness TJ, Gebhart GF (1988b) Characterization of neurons responsive to noxious colorectal distension in the T13-L2 spinal cord of the rat. *J Neurophysiol* 60:1419–1438
  - Ness TJ, Gebhart GF (1989) Characterization of superficial dorsal horn neurons encoding for colorectal distension in the rat: comparison with neurons in deep laminae. *Brain Res* 486:301–309
  - Ness TJ, Metcalf AM, Gebhart GF (1990) A psychophysiological study in humans using phasic colonic distension as a noxious visceral stimulus. *Pain* 43:377–386
  - Palecek J, Paleckova V, Willis WD (2002) The roles of pathways in the spinal cord lateral and dorsal funiculi in signaling nociceptive somatic and visceral stimuli in rats. *Pain* 96:297–307
  - Traub RJ, Pechman P, Iadarola MJ et al. (1993) Fos-like proteins in the lumbosacral spinal cord following noxious and non-noxious colorectal distension in the rat. *Pain* 49:393–403

## Visceral Pain Model, Pancreatic pain

KARIN N. WESTLUND HIGH<sup>1</sup>,  
LOUIS VERA-PORTOCARRERO<sup>2</sup>

<sup>1</sup>Department of Neuroscience and Cell Biology,  
University of Texas Medical Branch, Galveston, TX,  
USA

<sup>2</sup>Department of Pharmacology, College of Medicine,  
University of Arizona, Tucson, AZ, USA

kwhigh@utmb.edu, loverapo@email.arizona.edu

### Synonyms

Pancreatitis pain; pancreatalgia; Visceral Inflammation; Epigastric Pain; Alcohol-Induced Pancreatitis; visceral pain; Acinar Cell Injury

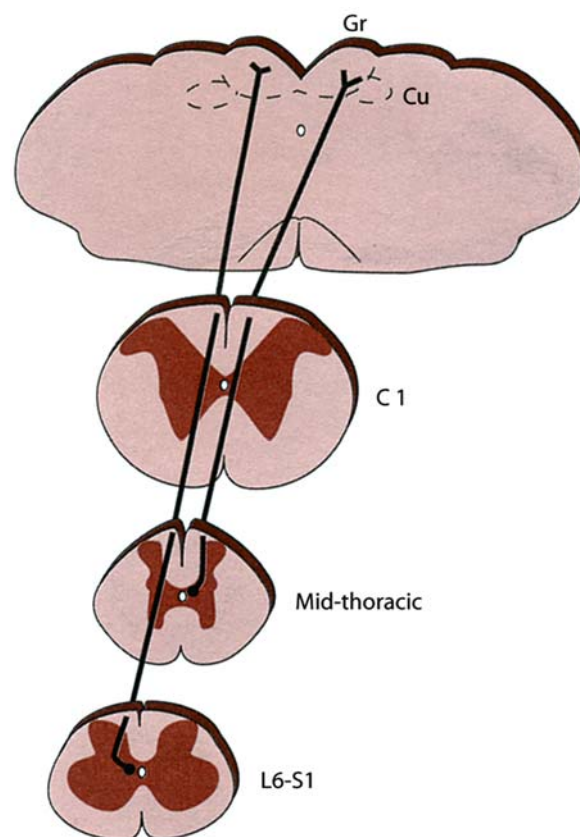
### Definition

► **Pancreatic pain** (► **pancreatalgia**) is a clinical indicator of an inflammatory or malignant condition involving the pancreas. Pancreatitis is inflammation of the pancreas. Clinically ► **pancreatitis** is defined by sudden severe abdominal pain, nausea, fever and leukocytosis accompanied by high levels of pancreatic enzymes, such as  $\alpha$ -amylase and lipase in blood serum.

## Characteristics

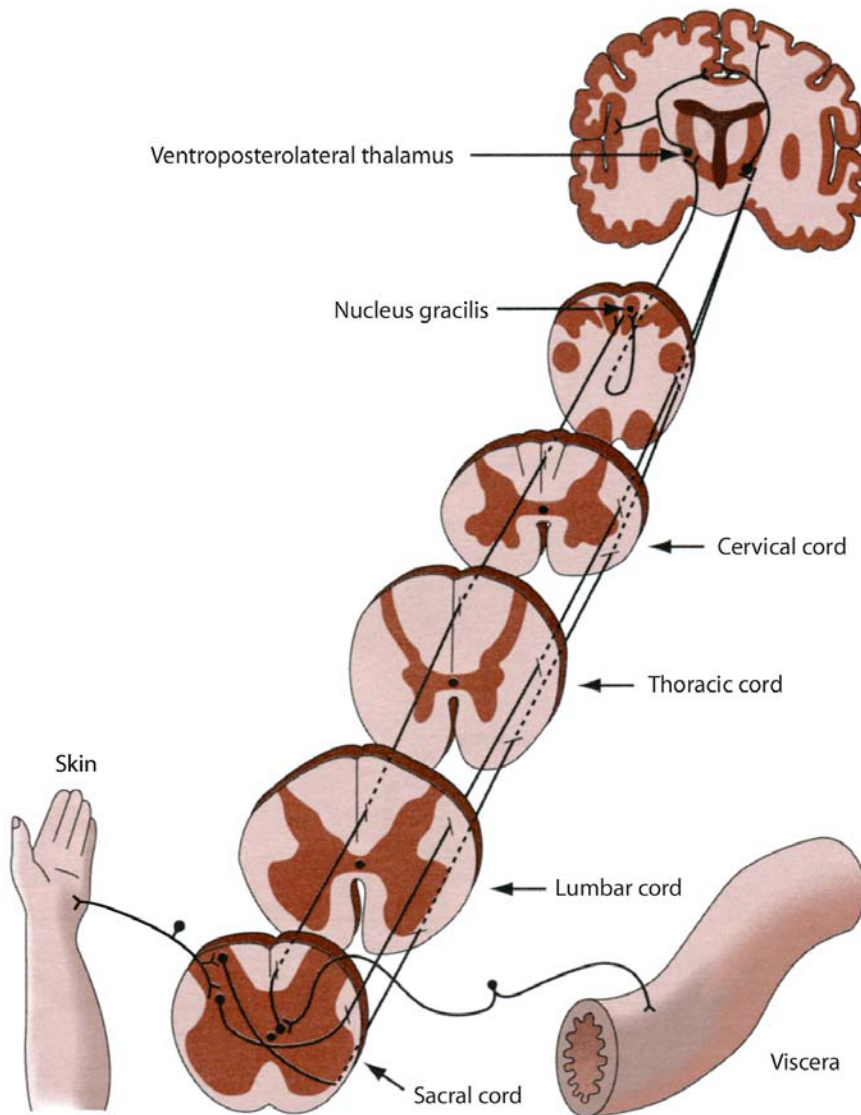
### Pancreatitis and Pancreatic Pain

The pancreas is a roughly triangular organ in the ► **retroperitoneal** area of the upper abdomen. Pain is the only sensation that can be elicited from the pancreas (Cervero 1994), and ► **visceralgia** is the major complaint bringing patients with pancreatitis to the clinic. Pancreatitis pain is usually ► **epigastric** in nature, felt in the right and /or left upper quadrant and may radiate to the back. The etiology of this referred pain can be from several diseases affecting the pancreas, including pancreatitis in its acute and chronic forms. While some patients are afflicted with an idiopathic pancreatitis such as with blockage of the biliary duct, most pancreatitis is the result of chronic alcohol abuse and/or industrial chemical, paint or solvent expo-



**Visceral Pain Model, Pancreatic pain, Figure 1** The visceral nociceptive pathway arises from post-synaptic dorsal column projection neurons located around the central canal. The pathway was visualized after small injections of anterograde transporter *Phaseolus vulgaris leucoagglutinin* were made in the gray matter near the central canal (Wang et al. 1999). The visceral pathway arising from the lumbosacral cord travels in the dorsal column midline. The ascending fibers from thoracic levels travel between the gracile and cuneate fasciculi. Many of the postsynaptic dorsal column neurons send their axons through the dorsal column to relay their information at the dorsal column nuclei. The information then travels with the lemniscal system to the thalamus. Axons from the region around the spinal cord are also seen crossing to travel in the ventral medial white matter. (Reprinted with permission from Westlund 2000).





**Visceral Pain Model, Pancreatic pain, Figure 2** The summary diagram depicts the two routes taken by axons ascending as separate pathways in the dorsal column and the ventrolateral spinal white matter depending on whether they are transmitting somatic or visceral pain. Two separate pathways to higher brain centers are taken by cutaneous and visceral pain information. It is well known that cutaneous inputs are relayed in the spinal cord onto spinothalamic tract cells sending their axons up the ventrolateral white matter on the opposite side. Clinical and basic studies have shown that visceral pain is transmitted through the dorsal spinal white matter. (Reprinted with permission from Westlund, 2000).

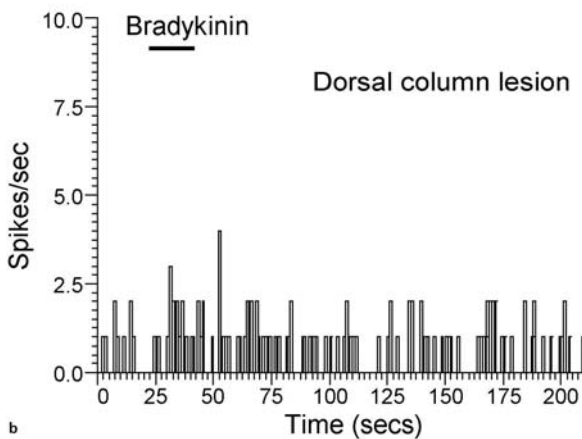
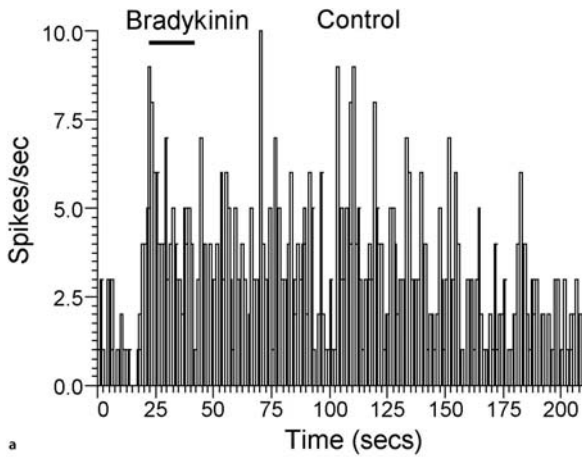
tures. Inflammation of the pancreas is defined clinically by sudden severe abdominal pain, nausea, fever and leukocytosis. Pancreatitis is characterized by severe histopathological changes, such as the presence of inflammatory mediators, acinar atrophy, fatty necrosis, intraductal hemorrhage, periductal fibrosis and stromal proliferation (Schmidt et al. 1995) and elevated levels of  $\alpha$ -amylase and lipase in the serum. Acute pancreatitis ranges from a mild edematous condition that is self-limited to severe hemorrhagic necrotizing inflammation that is often fatal over a period of days as patients succumb to abdominal sepsis and multi-organ failure. Persistent pancreatitis is typically characterized by unremitting pain and progressive destructive fibrosis. The ► **Visceral Nociception and Pain** can be severe and become intractable, resistant even to morphine. In patient surveys, 32% of patients with chronic pancre-

atic pain report being willing to try any new therapy for relief and some may resort to suicide for this intractable pain state.

#### Animal Models of Pancreatitis Pain

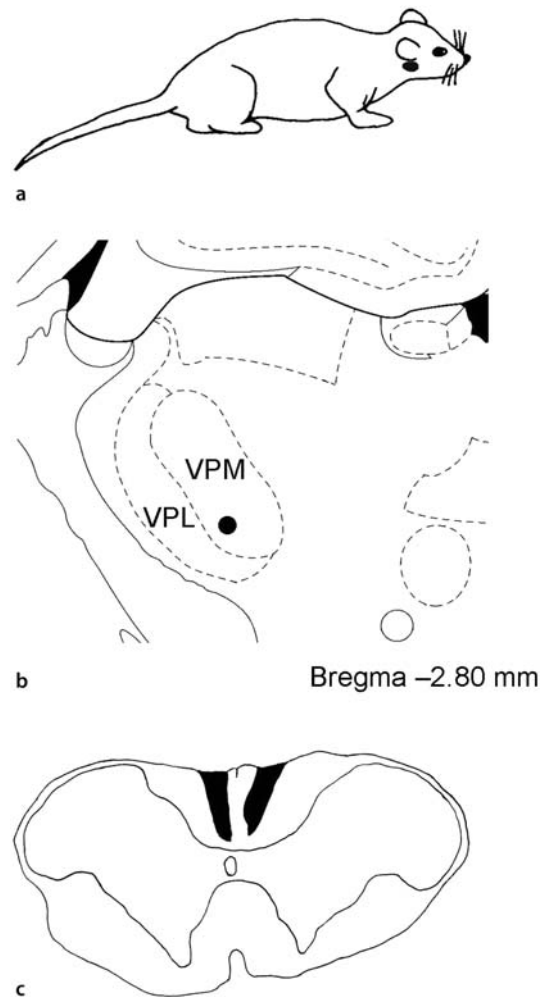
##### Anatomy and Function of Pancreatic Innervation

Much of the present knowledge about pancreatic pain has come from clinical work. For example, the effectiveness of blocks or sectioning of the sympathetic innervation, but not the vagus, indicates that primary afferent fibers traveling with the sympathetic nerves are involved in transmitting nociceptive information from the pancreas. Experimental anatomical studies, however, have been useful in showing that pancreatic afferent fibers reach the spinal cord through Lissauer's tract where they may terminate in the spinal segment in which they enter the spinal cord or within one or two



**Visceral Pain Model, Pancreatic pain, Figure 3** Rate histograms showing the responses of a thalamic cell to bradykinin ( $10^{-5}$  M, 20 sec) application to the pancreas both before (a) and (b) after DC lesions. (Reprinted with permission from Westlund 2000).

segments rostrally or caudally (Sugiura et al. 1989). Small caliber visceral afferent fibers have a wide, diffuse termination pattern extending over more than two segments with some terminating bilaterally in laminae V and X. This diffuse termination in contrast to clearly defined terminal fields for somatic afferent fibers may contribute to the diffuse and difficult to localize nature of this visceral pain state. Direct stimulation of the pancreas with bradykinin in anesthetized rats induces FOS expression most abundantly in segments T7-T10 of the spinal cord, indicating that nociceptive information from the pancreas is mainly processed in those segments (Wang and Westlund, unpublished). With bradykinin-induced noxious stimulation of the pancreas, evidence is provided that spinal cord cells are activated in the region around the central canal, which is known to be involved in visceral processing. The visceral (pancreatic) nociceptive information travels in the dorsal column pathway with relays in the dorsal column nuclei and the thalamus (Figs. 1 and 2)



**Visceral Pain Model, Pancreatic pain, Figure 4** (a) The dark area delineates the cutaneous receptive field of a thalamic cell on the shoulder of a rat. (b) The cell was responsive to bradykinin activation of the pancreas and was located at the border between the ventral posterolateral (VPL) and ventromedial (VPM) thalamus. Responses ceased after the dorsal column was lesioned. (c) Camera lucida reconstruction from several spinal cord sections located the lesion as shown in the blackened areas in the dorsal columns. (Reprinted with permission from Westlund 2000).

(Wang et al. 1999; Houghton et al. 2001; Wang and Westlund 2001; Westlund 2000). Rate histograms show decreased activity after dorsal column lesions (Figs. 3 and 4). Thus, animal models have shown that much of the visceral pain is relayed to the thalamus through a dorsal column pathway separate from that relaying information about somatosensation (Fig. 2).

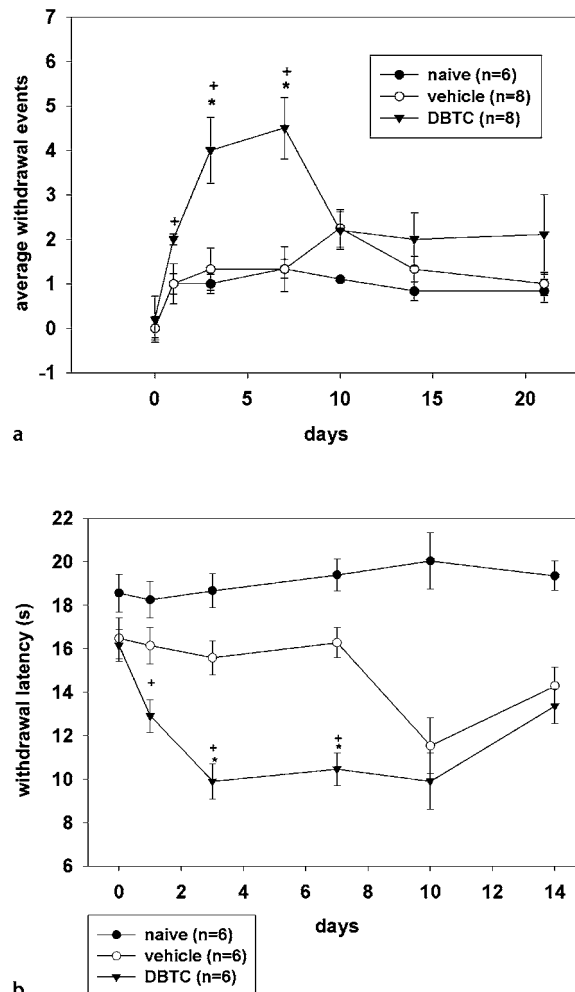
Animal models of pancreatic pain have also been useful in determining functional aspects of pancreatitis as an example of visceral pain. All of the animal models described below have been shown histologically to be confined to the pancreas with limited or no involvement of the liver or other organs. Direct intraductal stimulation (distension) of the pancreas with bradykinin (0.5 ml of  $10^{-5}$  M in lactated Ringer's solution) has been used,

as has intraductal distension with another chemical irritant, glycodeoxycholic acid, combined with intraperitoneal caerulean (Schmidt et al. 1992). With these distension/irritation models, pancreatic hypersensitization behavior has been observed acutely in conscious animals (Houghton et al. 2001; Lu et al. 2003; Zhang et al. 2004; Smiley et al. 2004). Decreases in cage crossing and rearing exploratory behavior are noted in open field-testing. Hind limb extensions, a specific pain-related behavior, are observed in this model. Restoration of behavior is noted after treatment with specific neurotransmitter receptor blockers and modulators as described below.

A model of more persistent pancreatic pain develops after a tail vein injection of dibutyltin dichloride (DBTC) in commercially available Lewis rats (Vera-Portocarrero et al. 2003). This model is clinically relevant in that both histological and immunological responses resemble human pancreatitis and involvement is limited to the pancreas without significant involvement of the liver. The symptoms persist for up to 3 weeks and are maximal at 1 week. The method was originally described by Merkord and colleagues (1989), and is described as chronic when applied to their highly inbred strain of rats. The method involves a tail vein injection of dibutyltin dichloride (8 mg/kg body weight). Dibutyltin dichloride is an active component of some paint thinners, a stabilizer in plastics manufacturing and is used as a biocide in agriculture. The damage induced after tail vein injection in rats occurs slowly in the pancreas over the subsequent 2 weeks. Extreme care must be taken to ensure that the compound remains in the vessel, as it is most caustic upon leakage. Animals are fed with a low soy content diet, such as Harlan TekLad Diet 8626 and provided with 10% grain ethanol in their drinking water. Serum parameters that serve as markers of pancreatitis remain elevated during the first week and histopathological changes occur throughout the observation period of 21 days. Nociceptive characterization of this animal model of persistent visceral pain has determined that the animals have ► **central sensitization**, ► **Secondary mechanical allodynia** and ► **thermal hyperalgesia** present along the abdomen are persistent during the first week after tail vein injection in rats (Fig. 5) (Vera-Portocarrero et al. 2003; Westlund 2000).

### Pharmacological Characterization of Pancreatitis Pain in Animal Models

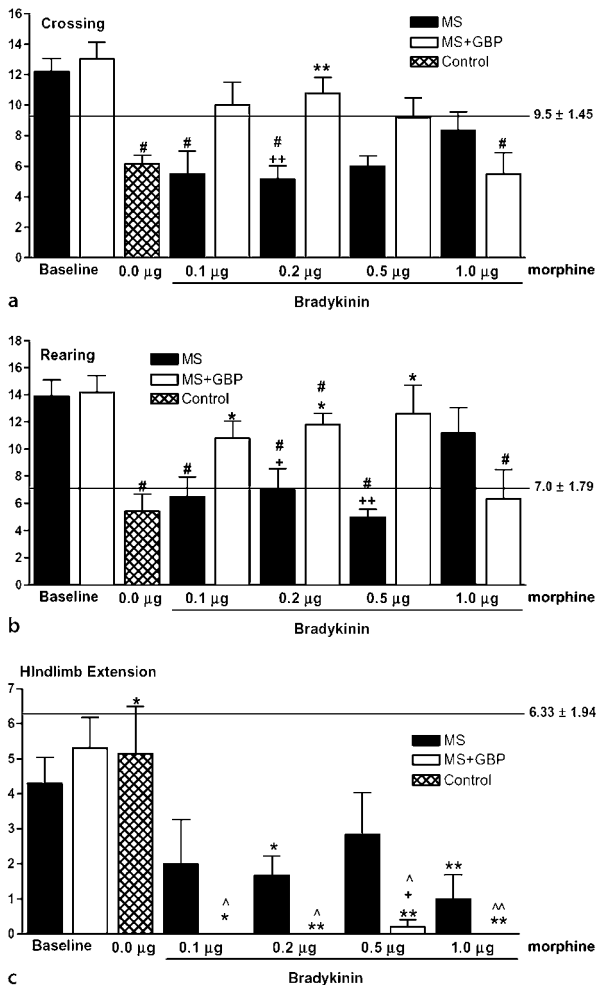
Behavioral studies using these pancreatitis models in Lewis rats have examined the role of specific receptors in the maintenance of a nociceptive state in this model (Vera-Portocarrero et al. 2003; Portocarrero et al. 2004; Lu et al. 2003; Zhang et al. 2004; Smiley et al. 2004). Thus far, studies have shown that blockers of neurokinin NK-1, opiate and NMDA receptors (CP99,994, morphine and AP-5, respectively) can significantly reduce the pain related behaviors in these pancreatitis rats.



**Visceral Pain Model, Pancreatic pain, Figure 5** Time course of nociceptive behaviors. (a) Secondary mechanical hypersensitivity. The y-axis indicates the average number of reflexive withdrawals from von Frey stimuli applied to the abdominal surface of rats (AWE). Rats with an injection of dibutyltin dichloride, DBTC, demonstrate a greater sensitivity to von Frey stimuli (204.1 mN) compared to naive animals and vehicle-injected animals at time points 3 and 7 days after dibutyltin dichloride injection. + Denotes  $p < 0.05$  when comparing the respective animal group behavior to its baseline measure at time point 0. \* denotes  $p < 0.05$  when compared to corresponding controls (naive and vehicle-injected groups). Error bars denote standard error of the mean. (b) Secondary heat hyperalgesia. Time course for the withdrawal latencies of rats injected with DBTC. The rats receiving the injection of DBTC demonstrated a significantly more rapid reflexive withdrawal to abdominal stimulation with a radiant heat source on days 1–7 after injection compared with the vehicle-injected and naive groups. (\*  $p < 0.05$  compared to vehicle control; +  $p < 0.05$  compared to baseline (time point 0). Error bars denote standard error of the mean. (Reprinted with permission from Vera-Portocarrero et al. 2003).

V

Block of the  $\alpha_2\delta_1$  subunit of N-type voltage activated calcium channels with gabapentin (Neurontin), or protein kinase C inhibition (GF 109302X) is also highly effective. The restoration of open field behavior and reduction of pain related behaviors observed in these pancreatitis models after treatment with the NMDA antagonist or gabapentin can be potentiated with sub-



**Visceral Pain Model, Pancreatic pain, Figure 6** Bar chart illustrating the anti-nociceptive effects of intrathecal co-administration of a single ineffective dose of gabapentin (300 µg) when combined with various low doses of morphine (0.1, 0.2, 0.5, 1.0 µg) (white bar) during bradykinin infusion of the pancreatic duct. Measures examined included cage crossing, rearing, and hind limb extension activities in rats with acute pancreatitis ( $n = 5$  per dose) or for morphine alone ( $n=6$  per dose). Values are represented as the mean  $\pm$  SEM for the initial ten minutes of activity in a novel cage experience. Surgical baseline behaviors were tested for each of the animals in the drug studies for comparison to its own behavior after a single drug treatment (total  $n=20$  for the combined morphine plus gabapentin groups and total  $n = 24$  for the morphine alone doses). The 0 µg dose (hatched bar) represents the aCSF vehicle treated control group in animals with intrathecal and intraductal catheters after bradykinin infusion ( $n = 6$ ) used as controls combined for both studies. The dotted line illustrates the values for gabapentin alone (300 µg) from Fig. 1A ( $9.5 \pm 1.45$  for crossing;  $7.0 \pm 1.79$  for rearing; and  $6.33 \pm 1.94$  for hind limb extension). Black bars indicate treatment with morphine alone for comparisons. Comparisons were made between surgical baseline and combined drug groups using the Wilcoxon test (#  $p < 0.05$ ; ##  $p < 0.01$ ). Comparisons were made to the combined gabapentin and morphine treatment groups using Mann-Whitney U tests versus the 0 µg aCSF vehicle treated control group (\* $p < 0.05$ ; \*\* $p < 0.01$ ); vs morphine alone (+  $p < 0.05$ ; ++ $p < 0.01$ ); and vs gabapentin alone (^  $p < 0.05$ ; ^^  $p < 0.01$ ). MS= morphine sulfate; GBP= gabapentin. (Reprinted with permission from Smiley et al., 2004).

therapeutic doses of morphine (Fig. 6) (Lu et al. 2003; Smiley et al. 2004).

## References

- Cervero F (1994) Sensory innervation of the viscera: peripheral basis of visceral pain. *Physiol Rev* 74:95–138
- Houghton AK, Wang C-C, and Westlund KN (2001) Do nociceptive signals from the pancreas travel in the dorsal column? *Pain* 89:207–220
- Lu Y, Vera-Portocarrero LP, Westlund KN (2003) Intrathecal co-administration of D-APV and morphine is maximally effective in a rat experimental pancreatitis model. *Anesthesiology* 98:734–740
- Merkord J, Hennighausen G (1989) Acute pancreatitis and bile duct lesions in rat induced by dibutyltin dichloride. *Exp Pathol* 36:59–62
- Schmidt J, Compton CC, Rattner DW et al. (1995) Late histopathological changes and healing in an improved rodent model of acute necrotizing pancreatitis. *Digestion* 56:246–252
- Schmidt J, Rattner DW, Lewandrowski K et al. (1992) A better model of acute pancreatitis for evaluating therapy. *Annals of Surgery* 215: 44–56
- Smiley MM, Lu Y, Vera-Portocarrero LP et al. (2004) Intrathecal gabapentin enhances the analgesic effects of subtherapeutic-dose morphine in a rat experimental pancreatitis model. *Anesthesiology* 101:759–765
- Sugiura Y, Terui N, Hosoya Y (1989) Difference in distribution of central terminal between visceral and somatic unmyelinated primary afferent fibers. *J Neurophysiol* 62:834–840
- Vera-Portocarrero LP, Lu Y, Westlund KN (2003) Nociception in Persistent Pancreatitis in Rats: The Effects of Morphine and Neuropeptide Alterations. *Anesthesiology* 98:474–84
- Vera-Portocarrero LP, Westlund KN (2004) Attenuation of nociception in a model of acute pancreatitis by an NK-1 antagonist. *Pharmacol Biochem Behav* 77:631–640
- Wang C-C, and Westlund KN (2001) Responses of rat dorsal column neurons to pancreatic nociceptive stimulation. *NeuroReport* 12:2527–2530
- Wang C-C, Willis WD, Westlund KN (1999) Ascending projections from the area around the spinal cord central canal: A PHA-L study in rats. *J Comp Neurol* 415:341–367
- Westlund KN (2000) Visceral nociception. *Curr Rev Pain* 4:478–487
- Zhang L, Zhang X, Westlund KN (2004) Restoration of spontaneous exploratory behaviors with an intrathecal NMDA receptor antagonist or a PKC inhibitor in rats with acute pancreatitis. *Pharmacol Biochem Behav* 77:145–153

## Visceral Pain Model, Small Intestinal Bowel Distension Pain

YI FENG

Department of Anesthesiology, Peking University People's Hospital, Peking, P.R. China  
yifeng65@263.net

### Definition

The small intestinal distension pain model is an abdominal mechanical visceral pain model induced by intermittent small intestinal distention, utilizing a balloon catheter that is implanted in the small intestine.

### Characteristics

Clinical studies in patients and healthy volunteers have consistently documented that human experimental pain evoked by distention of the gastrointestinal tract is similar to the sensation of pathologic pain. Inflation of a bal-



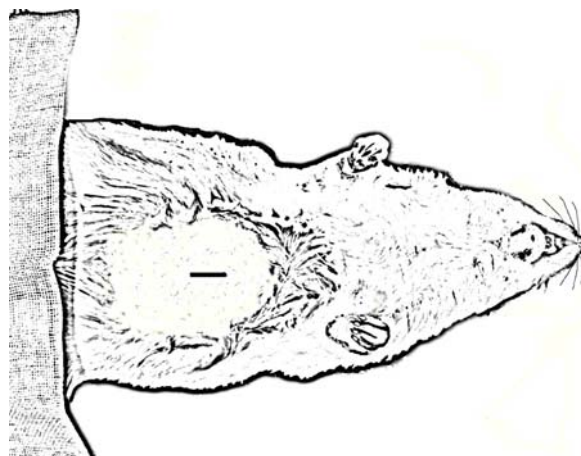
loon inserted into the small intestine produces an intense pain, and the sites of pain referral are predominantly epigastric and periumbilical. In rats, responses elicited by distension of the small intestine are considered to be indicative of visceral nociception, as they are blocked by morphine (Colburn et al. 1989) and abolished by capsaicin (Lembeck and Skofitsch 1982). Small intestinal distension in animals induces a range of nociceptive responses, including writhing-like responses and pseudo-affective reflexes, which have been used as indexes of visceral nociception (Lembeck and Skofitsch 1982; Colburn et al. 1989; Feng et al. 1998; McLean et al. 1998; Timar-Peregrin et al. 2001). The proximal part of the small intestine, the duodenum or jejunum, are often chosen because gastric or pyloric distention and/or obstruction are frequently fatal to the rats. The duodenum is found to be more sensitive to distention than more distal sections of the small intestine (Jänig and Morrison 1986). Here, we are going to put more emphasis on the duodenal distention model. This model was first created by Dr. Colburn and his colleagues in 1988 and was later modified by several investigators.

This model has some advantages over other visceral pain models. The stimulus (distention) is reversible and repeatable. A quantifiable nociceptive behavior can be induced and used as a bioassay intended for repetitive use. This repeatable visceral pain model has many of the study design advantages found in somatic pain models, such as serial tail-flick or hot plate tests. It allows for paired observations in small animal populations with a minimum of discomfort to the animals. The model can reproduce duplicate visceral symptoms without serious tissue injury, and permit repetitive testing of potential antinociceptive agents in awake or anesthetized rats.

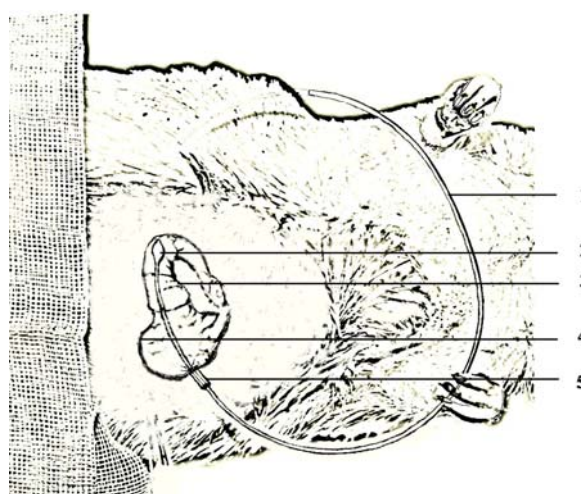
The model can be used to study the pharmacology and mechanisms of visceral pain including anatomical pathways and physiological processing of nociceptive signals.

### Experimental Model Preparation

As experimental animals, adult Sprague-Dawley rats, weighing 200–350 g, are acceptable. Under halothane inhalation anesthesia (2–2.5%), the rats are positioned supine, the abdomen is shaved and prepped with iodine. A 1.5 cm laparotomy is made at the midline of the upper abdomen (see Fig. 1) and the gastro-duodenal junction is exposed. A purse string is accomplished with 4.0 silk on the greater curvature of the stomach, at least 10 mm from the pylorus. The stomach wall is punctured with an 18 gauge needle and a latex rubber balloon catheter (15 cm long epidural or PE50 catheter with an attached 8 mm-long balloon distensible to a 2 ml fluid volume) is introduced and advanced through the pylorus into the first portion of the duodenum (see Fig. 2, area marked “2” and Fig. 3, area marked “4”). The purse string is tied properly affecting a gastrostomy closure around the catheter. A 5 mm long silicone rubber sleeve (the inner

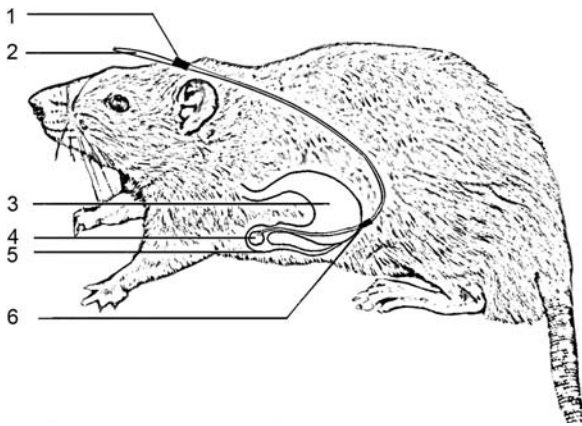


**Visceral Pain Model, Small Intestinal Bowel Distension Pain, Figure 1** The rat is placed in a supine position. The solid line represents the incision (1–1.5 cm).



**Visceral Pain Model, Small Intestinal Bowel Distension Pain, Figure 2** Schematic drawing of surgical implantation of the balloon catheter. 1, the distal end of catheter; 2, the balloon; 3, the duodenum; 4, the greater curvature of the stomach; 5, the internal silicon sleeve at the gastrostomy site.

diameter is slightly larger than the outer diameter of the catheter) is advanced over the protruding gastrostomy catheter to the closure purse string (see Fig. 2, area marked “5” and Fig. 3, area marked “6”). The free end of the purse string is tied to anchor the silicone sleeve and the enclosed catheter. A tangential tunnel is made through the abdominal musculature in the left upper quadrant, and the distal end of the catheter is drawn through using an 18 gauge Touhy epidural needle and tunneled subcutaneously to the base of the skull, externalized, and anchored to the dermis with another silicone sleeve and super glue (see Fig. 3, area marked “1”). The distal external catheter length is trimmed to 2–3 cm (see Fig. 3, area marked “2”). The wound is closed in two layers and the animals are allowed 5–7 days to recover before any experimental manipulation.



**Visceral Pain Model, Small Intestinal Bowel Distension Pain, Figure 3** Schematic drawing of implanted balloon catheter. 1, the silicone sleeve at the exit site; 2, the balloon catheter; 3, the stomach; 4, the balloon; 5, the first portion of the duodenum; 6, the silicone sleeve at the gastrostomy site.

### Post-Implantation Care

The intraduodenal balloon catheter implantation will not affect the rats' normal diet or behavior. The weight of the rats usually decreases 5–20 g during the initial 3–5 days after implantation surgery and then gradually increases. Except for slight acute inflammation, there is no severe mucosal injury 7–12 days after the balloon catheter implantation. The balloon catheter may be lost in some rats, either because it backs into the stomach or passes through the rectum. This lost catheter problem can be solved by careful application of silastic sleeves and ligatures. The incidence of intestinal rupture will increase if the intra-balloon volume is greater than 0.75 ml. Duodenal dilation at the site of the balloon may occur in some rats for several weeks (>4 weeks) post-implantation.

### Nociceptive Behavioral Response

Rats will show unconditioned responses to noxious duodenal distension, which are characterized by repeated contractions of the abdominal muscles accompanied by extension of the hind limbs. The intraduodenal balloon can be distended by saline using a 1 ml syringe for 1–2 min. at a 15 min. interval. Upon increasing the intra-balloon volume, the rats display uniform behavioral responses within a discrete volume range. Behavioral responses can be scored on a 0–4 scale:

- 0: normal body position and exploratory behavior
- 1: halt in activity, “wet dog” shaking, excessive facial grooming, and teeth chattering
- 2: hunching, abdominal nipping, hind paw biting, and immobility of hind limbs
- 3: stretching of the hind limbs, arching, and dorsoflexion of the hind paws

- 4: stretching of the body, extension of the hind limbs, squatting of the body to the floor of the test box, or rotation of the pelvis sideways

The most exaggerated level is characterized by contraction of abdominal muscles followed by a stretch of the body with hind limb extension (the classic writhing behavior). The greater the volume of balloon inflation, the higher the score that is seen. The threshold volume to elicit classic writhing behavior is around 0.5–0.8 ml, depending on the weight of the rat.

### References

1. Colburn RW, Coombs DW, Degnan CC, Rogers L (1989) Mechanical Visceral Pain Model: Chronic Intermittent Intestinal Distention in the Rat. *Physiol Behav* 45:191–197
2. DeLeo JA, Colburn RW, Coombs DW, Ellis MA (1989) The Differentiation of NSAIDs and Prostaglandin Action using a Mechanical Visceral Pain Model in the Rat. *Pharmacol Biochem Behav* 33:253–255
3. Feng Y, Cui M, Al-Chaer ED, Willis WD (1998) Epigastric Antinociception by Cervical Dorsal Column Lesions in Rats. *Anesthesiology* 89:411–420
4. Jänig W, Morrison JF (1986) Functional Properties of Spinal Visceral Afferents Supplying Abdominal and Pelvic Organs with Special Emphasis on Visceral Nociception. In: Cervero F, Morrison JFB (eds) *Progress in Brain Research*. Elsevier, Amsterdam, pp 87–144
5. Lembeck F, Skofitsch G (1982) Visceral Pain Reflex after Pretreatment with Capsaicin and Morphine. *Naunyn Schmiedeberg Arch Pharmacol* 321:116–122
6. McLean PG, Garcia-Villar R, Fioramonti J, Bueno L (1998) Effects of Tachykinin Receptor Antagonists on the Rat Jejunal Distension Pain Response. *Eur J Pharmacol* 26:247–252
7. Timar-Peregrin A, Kumano K, Khalil Z, Sanger GJ, Furness JB (2001) The Relationship Between Propagated Contractions and Pseudoaffective Changes in Blood Pressure in Response to Intestinal Distension. *Neurogastroenterol Motil* 13:575–584

## Visceral Pain Model, Urinary Bladder Pain (Irritants or Distension)

TIMOTHY NESS

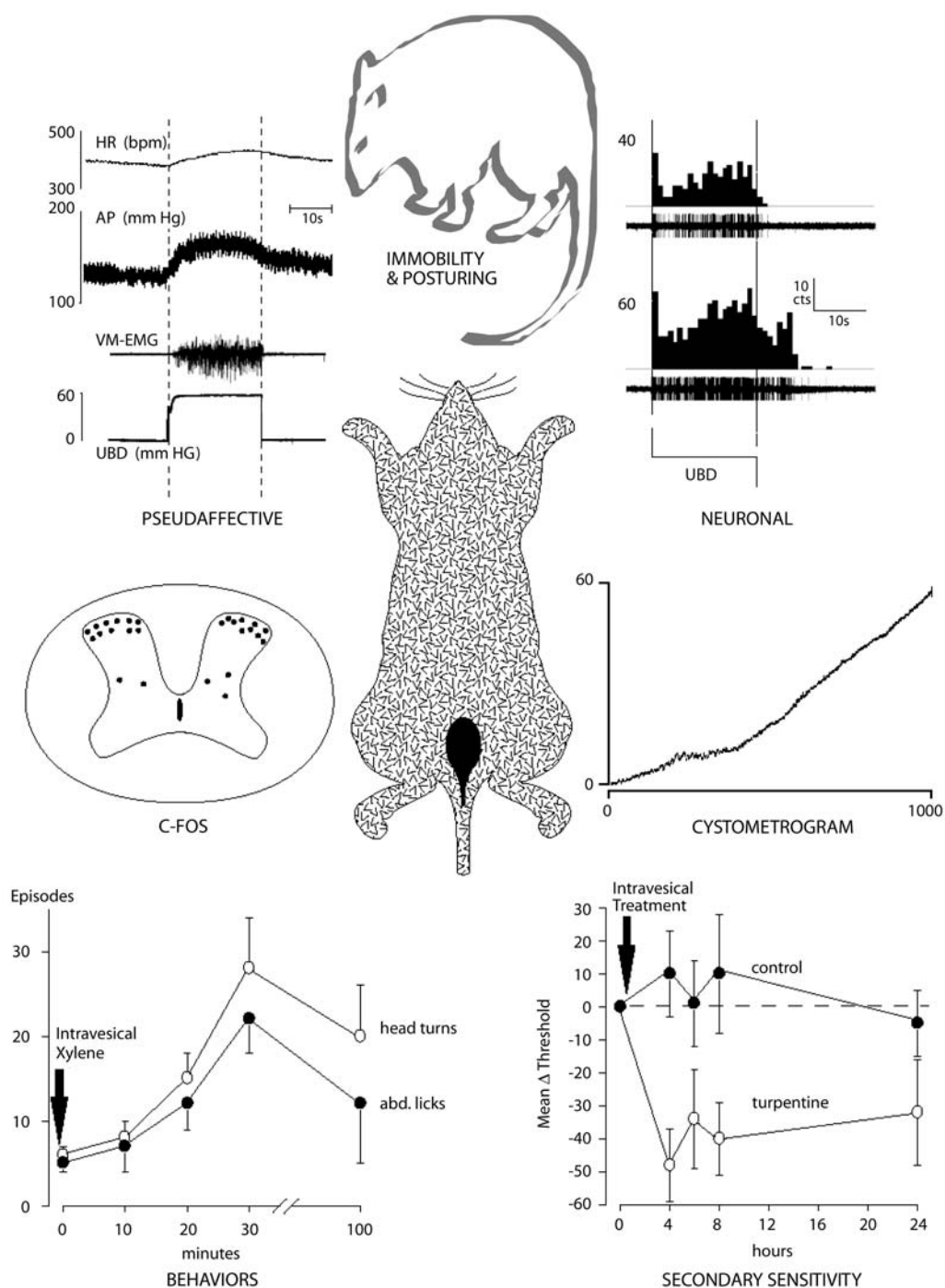
Department of Anesthesiology, University of Alabama at Birmingham, Birmingham, AL, USA  
loch@uab.edu

### Synonyms

Vesical Pain Models; Cystitis Models

### Definition

The urinary bladder is a common site of visceral pain generation and/or localization. Numerous animal models of pain exist utilizing a bladder stimulus to evoke responses, which are summarized in Figure 1. These models can be broadly stratified into those that use mechanical stimuli to activate afferents arising in the bladder (typically by air or fluid distension using a catheter), and those that chemically activate/sensitize afferents arising in the bladder using irritants. These irritants may be administered directly into the bladder using a catheter, or



V

**Visceral Pain Model, Urinary Bladder Pain (Irritants or Distension), Figure 1** Examples of responses to urinary bladder stimulation using mechanical or chemical stimuli. Urinary bladder distension (UBD) can evoke pseudoaffective reflexes (top left-data adapted from Ness et al. 2001) and neuronal responses (top right-data adapted from Ness and Castroman 2001) in addition to cystometrograms (middle right-data adapted from Ness et al. 2001). Pseudoaffective reflexes are typically visceromotor responses that can be measured by direct visualization or by electromyographically (VM-EMG), or as autonomic responses such as alterations in heart rate (HR in beats per minute, bpm) and alterations in arterial pressure (AP measured in mm Hg). Neuronal responses have been demonstrated to be graded in response to graded UBD (40 or 60 mm Hg in this example), and can be quantified as activity per unit time (peristimulus time histograms with one second bins are indicated above oscillographic tracings demonstrating neuronal action potentials). Bladder irritants have been demonstrated to induce c-fos in central nervous system structures (Lanteri-Minet et al. 1995) (stylized spinal cord slice of immunohistochemical localization – middle left), to evoke behaviors such as abdominal licking and head turns (data adapted from Abelli et al. 1989), to produce immobility with characteristic postures (Lanteri-Minet et al. 1995, Vizzard et al. 1996) (top-middle) or secondary hyperalgesia of the hindlimbs (indicated as a decrease in the thermal threshold/latency for hindlimb withdrawal [Mean  $\Delta$  Threshold] (data adapted from Jaggar et al. 1999). In all of these models, pharmacological manipulation with analgesic drugs such as morphine leads to reduced responses. Total figure is adapted from Ness and Gebhart 2001.



indirectly by the renal excretion of irritating urinary constituents.

### Characteristics

#### Adequate, Appropriate and Useful Stimuli

There are many considerations related to the development of models for the study of visceral pain (Cervero and Laird 1999; AlChaeer and Traub 2002; Ness and Gebhart 2001), but the most important considerations must be whether the stimulus is an ► “adequate” stimulus, and whether the models using the stimulus are appropriate to the organ system and useful. By Sherrington’s definition, an adequate noxious stimulus is one which damages or threatens to damage the organism. Whereas this definition is valid for stimulating skin, mechanical, thermal and chemical stimuli that produce pain when applied to skin may not produce pain in humans when applied to their viscera. Mechanical distension and the inflammation of hollow viscera are stimuli that are reliably associated with pain in humans and with behaviors in non-human animals consistent with nociception, and so these stimuli have been viewed as adequate.

To determine whether models of visceral pain are appropriate and useful in the study of visceral pain mechanisms, additional important criteria need to be considered. To the extent possible, the stimulus should reproduce a natural stimulus for the tissue or organ. Distension and inflammation of the urinary bladder meet this criterion. Ideally, the stimulus should be reproducible in terms of onset, intensity and duration and the responses produced in animals should be quantifiable, reliable and ideally reproducible. Models which meet these criteria are presented here.

It should be noted that models of bladder pain may or may not be models of a specific disease state. In this particular case, models of bladder pain are often viewed as models of interstitial cystitis, a chronic painful bladder syndrome (Westropp and Buffington 2002). In some cases there may be some validity to this extrapolation, particularly when an attempt to mimic pathophysiological events is undertaken (e.g. Chuang et al. 2003), but in general, data gathered from animal studies must be narrowly interpreted as indicative of a type of pain processing and not necessarily representative of a specific pathophysiological process.

#### Urinary Bladder Distension (UBD)

A limited number of studies have formally utilized the stimulus of UBD in models of nociception. One might expect more pain-related studies, since classic ► **Pseudoaffective Response** responses to UBD (vigorous cardiovascular and visceromotor reflexes) have been demonstrated in numerous species including rats, mice, rabbits, cats, dogs and monkeys. Instead, most existent studies have focused upon the evocation of micturition reflexes and their modulation by pharmacological and surgical manipulations. The intensity

of the distending stimulus and its rate of delivery are often chosen based upon the planned measure: for micturition-related studies, a cystometrogram can be produced by the slow infusion of fluid into the bladder with a simultaneous measure of the ► **intravesical pressure**; studies related to nociception have more commonly used a much more rapid UBD stimulus through the use of a rapid infusion of air or saline. In anesthetized female rats, vigorous neuronal responses can be evoked (e.g. Ness and Castroman 2001) which are inhibited by opioids, local anesthetics and NMDA receptor antagonists. Reliable and reproducible pressor responses and contractions of the abdominal musculature (a visceromotor response measured by electromyogram) can also be evoked by UBDs (Ness et al. 2001). Gender differences and hormonal influences are apparent. Genetic models of painful bladder disorders such as the feline interstitial cystitis model have also noted increased sympathoneural activation associated with bladder stimulation (Westropp and Buffington 2002.) Intravesical treatment with sensitizing chemicals such as those associated with inflammation lead to more vigorous responses to UBD, particularly at low intensities of stimulation (Dmitrieva and McMahon 1996). This phenomenon will be discussed further in the next section.

#### Direct Instillation of Inflammatory Compounds

Even without an evocative stimulus such as distension, inflammation of the bladder commonly produces reports of pain and urgency in patients suffering from a urinary tract infection. Experiments in non-human animals have artificially inflamed or sensitized the bladder with the intravesical administration of numerous irritants. Such irritation leads to altered micturition reflexes, alterations in the spontaneous activity of primary afferent neurons (e.g. Dmitrieva and McMahon 1996) and spontaneous behavioral responses. Most reflex studies have been performed in rats, although behavioral and neurophysiological studies have been performed in primates and cats. McMahon and Abel (1987) performed an extensive characterization of visceromotor and altered micturition reflexes in chronically decerebrate rats following inflammation of the bladder with 25% turpentine, 2.5% mustard oil or 2% croton oil administered directly into the bladder via a urethral cannula. Subsequently, the bladder was slowly filled with saline through the urethral cannula and intravesical pressures measured, thereby generating a cystometrogram. Following administration of an irritant, increased responses to urinary bladder filling correlated with measures of inflammation such as tissue edema, plasma extravasation and leukocyte infiltration. Rats became hypersensitive to noxious stimuli applied to the lower abdomen, perineum and tail as measured by the number of “kicks” evoked by a given stimulus. This model has also been modified for use in both anesthetized and unanesthetized rat prepa-



rations (e.g. Jagger et al. 1999). In those models, the focus of study has been novel mechanisms related to visceral hyper-reflexia (altered cystometrograms) or secondary hyperalgesia (decreased thresholds to heat stimuli in hindlimbs). Intact female rats are anesthetized and a 25% solution of turpentine is instilled into the bladder for one hour using a transurethral angiocatheter. Subsequently, repeat cystometrograms or thermal/mechanical testing of the hindpaws is performed 1–24 hours after the intravesical treatment in awake or anesthetized preparations. Modulatory effects of glutamate-receptor antagonists, nitric oxide synthase inhibitors and bradykinin receptor antagonists have all been noted.

### Direct Application of Irritants

Another model of bladder pain using intravesical irritant administration is that described by Abelli et al. (1989), which was modified by Craft et al. (1993). This model examines immediate effects of the irritants on animal behaviors. In this preparation a midline laparotomy is performed 24 hours prior to testing, and a 1 mm diameter polyethylene cannula is inserted through the dome of the bladder. The cannula is held in place by a purse string suture and the opposite end is tunneled subcutaneously to the midline upper back, where it is externalized and anchored by a skin button. On the day of testing, rats receive an injection through the cannula of 0.3 cc of xylene (30% in silicone oil vehicle), capsaicin or its related compound resiniferatoxin (0.1 or 3.0 nmoles). Immediate behavioral responses are evoked which consist of abdominal/perineal licking, headturns, hindlimb hyperextension, head grooming, biting, vocalization, defecation, scratching and salivation. The time to onset, incidence and number of individual behavioral responses are recorded for fifteen or more minutes following intravesical drug administration. Baclofen, mu, kappa and delta opioid receptor agonists and intravesical tetracaine have all been demonstrated to inhibit these behavioral responses. Pretreatment with systemic capsaicin as adults or neonates abolishes the licking of the lower abdomen/perineum, but does not block hindlimb hyperextension. Bladder denervation abolishes all behavioral responses. This model of acute urinary bladder pain is methodologically simple and only requires a minimally invasive surgical preparation a day prior to testing. The noxious stimulus is normally intermediate in duration (15 minutes), but is not escapable. There is no parallel human literature related to intravesical xylene application, but there is an increasing anecdotal literature related to the painful nature of intravesical capsaicin instillation in humans. Numerous analgesic manipulations have been demonstrated to be inhibitory in this model and no nonspecific effects of non-analgesics have been noted. A recent addition to the bladder irritant models is that of Chuang et al. (2003) who have demonstrated that the intravesical ad-

ministration of protamine, which disrupts the urothelial barrier, makes the bladder easily irritated by physiological concentrations of urinary potassium. This model has a pathophysiological correlate in that defects in the urothelial lining of the bladder have been observed in patients with interstitial cystitis.

### Cyclophosphamide-Induced Cystitis

An additional, distinctly different, model of subacute, irritant-induced urinary bladder pain mimics clinically-noted pain that occurs due to cystitis that is secondary to antineoplastic treatments. In this model in rats, the cancer chemotherapeutic agent cyclophosphamide (CP) is administered intraperitoneally and subsequently metabolized and excreted as urinary acrolein, a potent irritant of the bladder (Lanteri-Minet et al. 1995). Beginning approximately one hour after systemic administration of CP and continuing for approximately four hours, unanesthetized rats demonstrate decreased locomotion coupled with altered postures and “crises” (sudden alterations in postures). These behaviors are scored and a cumulative sum for relevant time periods assigned. Measures of bladder inflammation correlate with some behaviors and with the induction of c-fos and Krox-24 proteins within the spinal cord. There is the ethical concern that the stimulus is inescapable and of four hours duration. Chronic (2 week) treatments with CP have also been described with numerous physiological and biochemical alterations (e.g. Vizzard et al. 1996). Olivari and Laird (1999) have characterized responses to acutely administered CP in mice, noting a 53% reduction in spontaneous locomotion and intermittent crises, similar to those observed in rats. Subsequent use of the CP model in transgenic mice have suggested a role for NK1 receptor activation and altered Nav1.8 sodium channel activity.

### Comparison of Models

As noted above, numerous models of urinary bladder pain have been developed because of the clinical importance of this type of pain. Species and technique differences have occasionally resulted in apparently contradictory results related to the efficacy of novel analgesics. However, to date, all traditional analgesics (i.e. opioids) have been demonstrated to have efficacy in the different model systems. Subsequent translation of laboratory data into clinical trials will determine which model systems are best predictive of the human condition, and therefore the most useful.

### References

1. Abelli L, Conte B, Somme V, Maggi CA, Girliani S, Meli A (1989) A Method for Studying Pain Arising from the Urinary Bladder in Conscious, Freely-Moving Rats. *J Urol* 141:148–151
2. Al-Chaer ED, Traub RJ (2002) Biological Basis of Visceral Pain: Recent Developments. *Pain* 96:221–225
3. Cervero F, Laird JM (1999) Visceral Pain. *Lancet* 353:2145–2148
4. Chuang YC, Chancellor MB, Seki S, Yoshimura N, Tyagi P, Huang L, Lavelle JP, DeGroat WC, Fraser MO (2003) Intraves-

- ical Protamine Sulfate and Potassium Chloride as a Model for Bladder Hyperactivity. *Urology* 61:664–670
5. Craft RM, Carlisi VJ, Mattia A, Herman RM, Porreca F (1993) Behavioral Characterization of the Excitatory and Desensitizing Effects of Intravesical Capsaicin and Resiniferatoxin in the Rat. *Pain* 55:205–215
  6. Dmitrieva N, McMahon SB (1996) Sensitisation of Visceral Afferents by Nerve Growth Factor in the Adult Rat. *Pain* 66:87–97
  7. Jaggar SI, Scott HCF, Rice ASC (1999) Inflammation of the Rat Urinary Bladder is Associated with a Referred Hyperalgesia which is NGF Dependent. *Br J Anaesth* 83:442–448
  8. Lanteri-Minet M, Bon K, de Pommery J, Michiels JF, Menetrey D (1995) Cyclophosphamide Cystitis as a Model of Visceral Pain in Rats: Model Elaboration and Spinal Structures Involved as Revealed by the Expression of c-fos and Krox-24 Proteins. *Exp Brain Res* 105:220–232
  9. McMahon SB, Abel C (1987) A Model for the Study of Visceral Pain States: Chronic Inflammation of the Chronic Decerebrate Rat Urinary Bladder by Irritant Chemicals. *Pain* 28:109–127
  10. Ness TJ, Castroman PJ (2001) Evidence for Two Populations of Rat Spinal Dorsal Horn Neurons Excited by Urinary Bladder Distension. *Brain Res* 932:147–156
  11. Ness TJ, Gebhart GF (2001) Methods in Visceral Pain Research. In: Kruger L (ed) *Methods in Pain Research*. CRC Press, New York, pp 93–108
  12. Ness TJ, Lewis-Sides A, Castroman PJ (2001) Characterization of Pseudoaffective Responses to Urinary Bladder Distension in the Rat: Sources of Variability and Effect of Analgesics. *J Urol* 165:968–974
  13. Olivar T, Laird JM (1999) Cyclophosphamide Cystitis in Mice: Behavioral Characterization and Correlation with Bladder Inflammation. *Eur J Pain* 3:141–149
  14. Vizzard MA, Erdman SL, de Groat WC (1996) Increased Expression of Neuronal Nitric Oxide Synthetase in Bladder Afferent Pathways following Chronic Bladder Irritation. *J Comp Neurol* 370:191–202
  15. Westropp JL, Buffington CAT (2002) *In Vivo* Models of Interstitial Cystitis. *J Urol* 167:694–702

## Visceral Pain Models, Female Reproductive Organ Pain

KAREN J. BERKLEY

Program in Neuroscience, Florida State University,  
Tallahassee, FL, USA  
kberkley@darwin.psy.fsu.edu

### Synonyms

Female Reproductive Organ Pain Model; Gynecological Pain Model; Endometriosis Model; Labor Pain Model; Dyspareunia Model; Vaginal Hyperalgesia Model; Chronic Pelvic Pain Model

### Definition

A “model” of pain refers to a non-human animal treated in a manner that mimics a painful human condition or disease. The model can then be used both to improve knowledge of mechanisms that might underlie the condition/disease and its relation to pain and to develop better treatments. Models of visceral pain usually refer to animals that currently have or have had some type of pathophysiology of an internal organ. For female reproductive organs, the models would have been treated in ways that

can mimic pain associated with female reproductive organs; i.e. gynecological pain. Of utmost importance in interpreting results from studies using animal models is recognition of limitations inherent in translating results to humans.

### Characteristics

In general, there are five main procedural steps for developing and using models of painful conditions/diseases:

1. To mimic in animals the pathophysiological conditions and signs/symptoms associated with a particular painful condition/disease in humans.
2. To develop the means to assess the model.
3. To validate the model and understand its interpretative limitations.
4. To use the model to study mechanisms underlying the pain or changes in nociceptive sensitivity associated with it.
5. To use the model to assess potential treatments and their efficacy.

Of particular importance for gynecological pain models in all steps is to consider the animal’s reproductive and hormonal status.

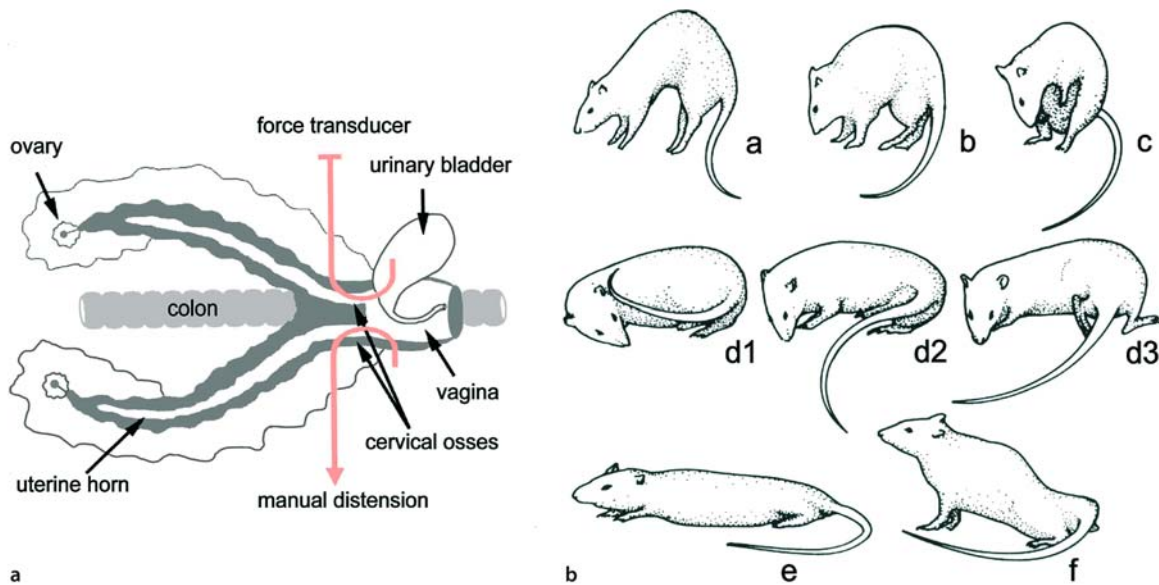
Despite the rather large number of painful gynecological conditions/diseases, there are only a few published models, all using rats. Thus, models currently exist for:

1. labor pain, assessed by distending the cervix and measuring reflex abdominal contractions and neuronal activation patterns (Fig. 1a) (Sandner-Kiesling et al. 2002a; Tong et al. 2003);
2. uterine inflammation (e.g. endometritis) – assessed by videotaping spontaneous ‘pain behaviors’ (Fig. 1b) (Wesselmann et al. 1998) and neurogenic plasma extravasation in the skin (as an indirect measure of referred nociception) (Wesselmann and Lai 1997);
3. post-menopausal-induced ▶ **dyspareunia**; and
4. ▶ **endometriosis**-induced dyspareunia (Fig. 2d; Fig. 3a). Models 3 and 4 are assessed using behavioral methods to measure vaginal nociception (Fig. 2) (Cason et al. 2003; Bradshaw and Berkley 2002); neuronal activation patterns (Bradshaw and Berkley 2003).

Although these models have only recently been developed, and none has yet been studied using all five procedural steps, results so far are beginning to provide insights into mechanisms of gynecological pain and some potential clinical applications.

### Labor Pain (Cervix Distention)

In an attempt to mimic the cervical distention that occurs during parturition, Gintzler and Komisaruk (1991) and Eisenach and colleagues (Sandner-Kiesling et al. 2002, Shin et al. 2003, Tong et al. 2003) developed similar methods that allowed them to mechanically dis-



**Visceral Pain Models, Female Reproductive Organ Pain, Figure 1** (a) Diagram of apparatus designed to distend the rat cervix as a model for labor pain (adapted from Sandner-Kiesling et al. 2002). (b) Diagram of abnormal body positions used to quantify pain behaviors in a rat model of uterine inflammation (adapted from Wesselmann et al. 1998).

tend the rat's uterine cervix (UCD) with known force (Fig. 1a). Gintzler and Komisaruk used the technique in adult, non-pregnant, nulliparous rats of unspecified estrous stage to study the analgesic effects of cervix stimulation. They found that UCD activated neurons in the deep dorsal horn of spinal segments T12–L2 and produced an increase in tail flick latency (analgesia), which was abolished by ► **pelvic neurectomy**, but not ► **hypogastric neurectomy**. Interestingly, combined pelvic and hypogastric neurectomy decreased tail flick latencies, indicating hyperalgesia. They suggested that the relative influence of activity in the hypogastric and pelvic nerve routes could be relevant to individual differences in labor pain.

Eisenach and his colleagues, also using adult, non-pregnant, nulliparous rats of unspecified estrous stage, applied different forces of cervical distention, and found that UCD produced a force-dependent increase in hypogastric nerve activity and evoked abdominal muscle contractions. They have now begun a series of studies investigating how systemic opioids, and systemic (intravenous) or intrathecal cyclooxygenase inhibitors (ketorolac), influence these effects in rats that have been ovariectomized (OVX) or ovariectomized and given estradiol replacement (OVX+E2). So far, their results indicate that systemic delivery of mu and kappa opioids and systemic, but not intrathecal, delivery of ketorolac reduce the inhibition of responses to UCD. Estrogen reduces the efficacy of the mu opioid inhibition, but not of the kappa opioid or intrathecal ketorolac. The authors conclude that, whereas morphine acts at estrogen-influenced spinal and supraspinal sites, the cyclooxygenase inhibitor acts at an estrogen-independent,

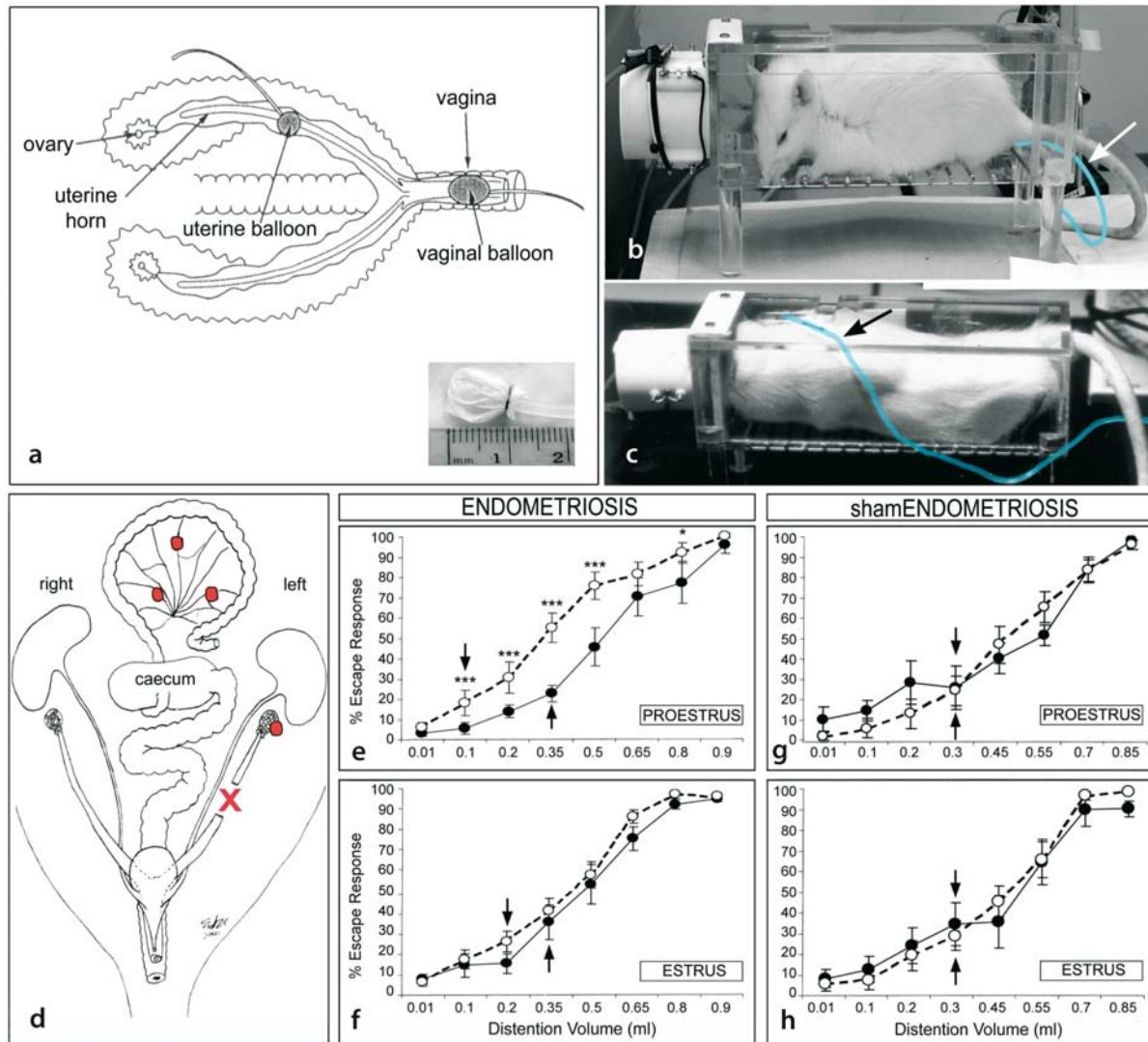
non-spinal site(s). Neither of these two groups has yet used their model to study pregnant or parturient rats, so, although interesting with respect to pain associated with cervix stimulation, it is yet to be determined how these results might relate to labor pain.

#### Uterine Inflammation

To mimic the several painful clinical conditions in women that involve uterine inflammation, Wesselmann and her colleagues (Wesselmann et al. 1998; Wesselmann and Lai 1997) developed a model in which they inflamed the left uterine horn of adult, non-pregnant, nulliparous rats in unspecified estrous stages with mustard oil. To validate the model, they used methods developed by Giamberardo et al. (1995) to videotape and quantify pain behaviors for seven days afterwards. To assess referred hyperalgesia, they examined whether this manipulation produced plasma extravasation of Evans Blue dye in the skin, and increased vocalization thresholds to stimulation of the left flank musculature. They found that in most but not all rats (72%), the inflammation resulted in clear-cut and quantifiable pain behaviors that persisted for 2–4 days post treatment. The treatment also reduced muscle nociceptive vocalization thresholds and induced dye extravasation in flank skin, indicating the presence of referred hyperalgesia. The authors concluded that their behavioral model closely resembles pain exhibited by women who suffer from inflammatory uterine conditions, and therefore will be of value for future studies of mechanisms and potential treatment.

Using a different approach, our group has created a method that permits behavioral assessment of uterine





**Visceral Pain Models, Female Reproductive Organ Pain, Figure 2** (a) Diagram showing location of distensible balloons placed in either the rat uterus or vagina. The inset is a close-up photograph of the vaginal balloon. (b), (c) Photographs showing rat in testing chamber. To escape a stimulus, the rat must extend her head or nose into the white tube at the front of the chamber. Uterine or vaginal nociception is quantified by measuring the probability of an escape response at different volumes of distention [(e)–(h)]. (b) shows a rat in the chamber not making an escape response. This rat has an uninflated balloon in her vaginal canal (note blue catheter exiting her vaginal canal, white arrow). (c) shows a rat making an escape response to distention of a balloon that has been implanted into one uterine horn (note blue catheter that had been threaded from the uterus under the skin to exit at the nape of neck, black arrow). (a)–(c) are adapted from Berkley et al. 1995; Bradshaw and Berkley 2002. (d) Diagram of surgical model of endometriosis. The red X shows region where a partial hysterectomy has been performed. The red ovals show locations of the uterine autotransplants which form cysts. (In the sham surgery, only fat is transplanted. The fat transplants do not form cysts.) (e)–(h) These graphs show the probability of escape responses before and after either endometriosis [(e), (f)] or sham endometriosis [(g), (h)], when the rats are in either proestrus [high estradiol levels, (e), (g)] or estrus [low estradiol levels, (f), (h)]. Arrow in (e)–(h) show volumes at which the percent escape was significantly greater than to the control (0.01 ml) volume. Asterisks in E indicate the volumes at which escape percentages after endometriosis surgery were significantly greater than those before surgery. (d)–(h) are adapted from Cason et al. 2003.

nociception in rats (Berkley et al. 1995). The method is identical to that used for behavioral assessment of vaginal nociception (shown in Fig. 2a, b, e, h), except that the distending balloon is permanently implanted in the left uterine horn (Fig. 2c). Using this method we found that ~70% of rats would learn to perform operant **▶ escape responses** to uterine distention, and that the probability of escape increased as distention volume (and pressure) increased. The responses depended on

estrous stage (rats exhibited fewer escape responses during periovulatory stages than in other stages) (Berkley et al. 1999). These responses were eliminated by hypogastric neurectomy (a procedure similar to presacral neurectomy in women; Temple et al. 1999). However, the neurectomy was ineffective if the uterine horn exhibited signs of inflammation (or inflammation was induced by prostaglandin 2 $\alpha$ -containing tablets). As discussed in the report, these results support clinical



evidence indicating the limited efficacy of presacral neurectomies for severe ▶ [dysmenorrhea](#) in women.

### Post-Menopausal Dyspareunia

Using behavioral methods shown in Fig. 2a, b, e, h to assess vaginal nociception, our group has examined whether surgical menopause (▶ [ovariectomy](#)) increased escape responding, which would indicate OVX-induced vaginal hyperalgesia, and thus serve as a model for post-menopausal dyspareunia in women (Bradshaw and Berkley 2002). We found that OVX did indeed produce vaginal hyperalgesia in all rats. Furthermore, in most but not all rats (87%), the vaginal hyperalgesia was alleviated by estradiol replacement, a situation similar to the individual differences in efficacy of estrogen replacement on post-menopausal dyspareunia in women.

Because these results indicated that this model could help improve our understanding of mechanisms of post-menopausal dyspareunia, we examined the influence of OVX and OVX+E2 on neural responses of neurons in the gracile nucleus in the brainstem to stimulation of the vaginal canal and other pelvic organs, and of the skin of the hindquarters. We found that OVX reduced responses to skin stimulation and estradiol replacement partially restored responses to skin stimulation. Importantly, moreover, OVX enhanced excitatory responses to vaginal distention and estradiol replacement reversed this effect. Thus, it seems likely that activity of gracile nucleus neurons contributes to the effects of surgically-induced reproductive senescence and estrogen replacement on vaginal nociception.

### Endometriosis-Induced Dyspareunia

Nearly 20 years ago, a rat model of endometriosis was developed mainly to assess mechanisms of the reduced fertility and fecundity associated with endometriosis (Vernon and Wilson 1985). The model involves removal of a small part of one uterine horn, followed by autotransplantation of small pieces of the excised uterus (or fat in sham-controls) on abdominal mesenteric arteries and/or ovary. The uterine, but not the fat autotransplants, form cysts that grow rapidly during the first month, then stabilize in size by the second month, and remain for at least the following 8 months. Like the situation for women, reducing hormone levels causes the cysts to disappear (via GnRH agonists in women; via OVX in rats), whereas estradiol replacement causes them to return. We replicated this model in our laboratory (Fig. 2d) and used our behavioral methods for assessing vaginal nociception, to determine if the model also gave rise to vaginal hyperalgesia (i.e. dyspareunia). We found that the surgical induction of endometriosis (but not the sham surgery) gave rise to vaginal hyperalgesia, whose severity increased rapidly during the first month, after which it stabilized (Cason et al. 2003). Furthermore, once stabilized, its severity varied with

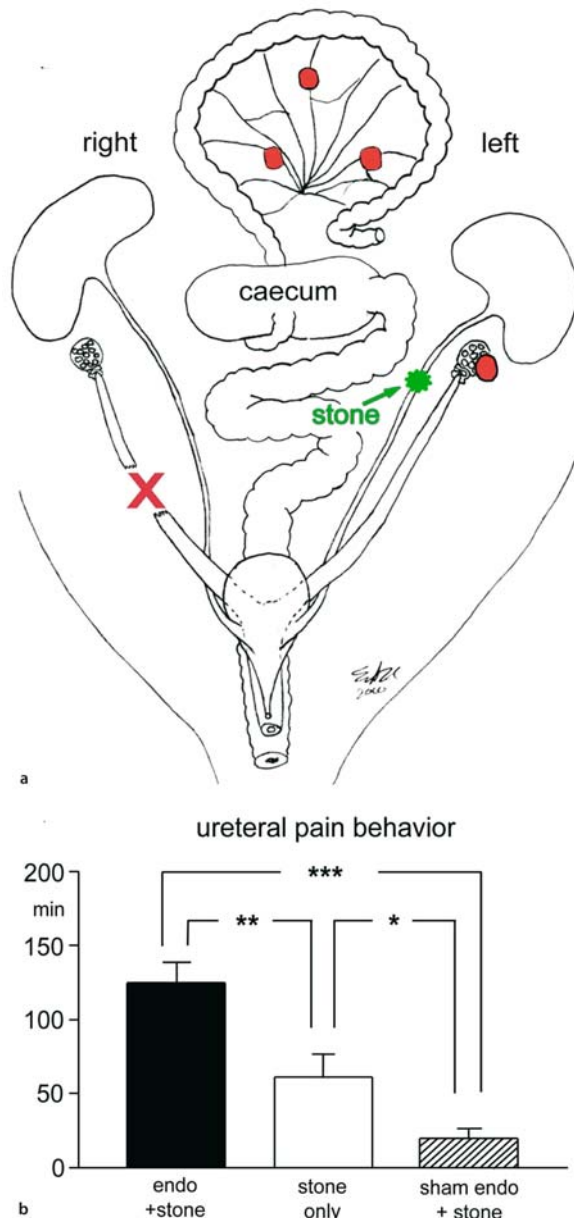
the rat's ▶ [estrous cycle](#), in a manner that correlated with circulating levels of estradiol (Fig. 2e–h). These results not only further validated surgical endometriosis as a useful model for improving our understanding of endometriosis-related symptoms (reduced fertility and pelvic pain), but it also helped support the clinical concept that endometriosis (along with its associated symptoms) is “estrogen-dependent.”

### Cross-System, Viscero-Visceral Interactions (Example: Endometriosis and Chronic Ureteral Calculosis)

One of the clinical features of endometriosis and its associated chronic pelvic pain is that the condition surprisingly frequently *co-occurs* with other chronic painful disorders such as interstitial cystitis, irritable bowel disorder, migraine headaches, vulvodynia, fibromyalgia, and repetitive ureteral calculosis (kidney/ureteral stones). Little is understood about the mechanisms underlying such co-occurrences. In order to investigate potential mechanisms (see ▶ [Gynecological Pain, Neural Mechanisms](#)), we combined the endometriosis model discussed above with a second rat model of ureteral calculosis (stone). In this second model, rats are videotaped for 7 days after implanting an artificial stone into the left ureter, and their pain behaviors are quantified (Giamberardino et al. 1995). The combined model (Fig. 3a) involved several steps: First the endometriosis surgery (or the control surgery) was performed and the rat's videotaped pain behaviors (if any) were quantified. About three weeks later, a ureteral stone was implanted and the rat's videotaped pain behaviors quantified again. The results were then compared with pain behaviors after only a stone had been implanted. Vocalization thresholds to stimulation of the oblique musculature (L1 dermatome) were also measured. The results showed that whereas endometriosis increased pain behaviors and referred muscle hyperalgesia associated with a ureteral stone, the control surgical procedures *reduced* them. We called this latter effect “silent stones.” As discussed in the article, the findings indicate the existence of cross-system interactions within the CNS, which can produce powerful effects on symptoms, not only to exacerbate them, but also, importantly, to reduce them. This situation has obvious implications for diagnosis as well as therapy, and warrants further study not only in animal models but also in the clinic; i.e. translational research in both directions: not only from animal to clinic, but from clinic to animal.

### Challenges for the Future

It seems evident that more models of gynecological pain are needed, among them conditions/diseases such as dysmenorrhea, ovarian cysts, gynecological cancers, mastitis (painful inflammation of the breast), and post-mastectomy pain to name just a few. Of value may be concurrent development of visceral pains unique to males (e.g. prostatitis, testicular pain, etc), because



**Visceral Pain Models, Female Reproductive Organ Pain, Figure 3** (a) Diagram showing surgical model of combining endometriosis (or sham endometriosis) with a ureteral stone. (See Fig. 2 for explanation of the endometriosis and sham endometriosis surgeries.) The endometriosis and sham endometriosis surgeries were carried out 2–3 weeks before the stone was implanted. (b) This graph depicts videotaped ureteral pain behaviors in three groups: after the stone only surgery (stone only), the combined endometriosis and stone surgeries (endo+stone), and the combined sham endometriosis and stone surgeries (sham endo+stone). Note that the endo surgery exacerbated the ureteral pain behaviors, whereas the sham endo surgery reduced them. (No pain behaviors were observed after either the endo or sham endo alone.) This figure was adapted from Giamberardino et al. 2002.

comparisons between females and males could produce meaningful insights. Also needed are studies that incorporate into their design analyses of how reproductive and hormonal status can influence signs/symptoms. Of

clear value also would be more studies aimed at understanding how interactions across organ systems can influence pain symptoms and therapy. And finally, of perhaps greatest importance, is that there are currently no models of clinical conditions that, surprisingly, *fail to produce pain* when in fact the pain could save lives; e.g. early stage gynecological cancers.

## References

- Berkley KJ, Wood E, Scofield SL, Little M (1995) Behavioral Responses to Uterine or Vaginal Distension in the Rat. *Pain* 61:121–131
- Bradshaw HB, Berkley KJ (2002) Estrogen Replacement Reverses Ovariectomy-Induced Vaginal Hyperalgesia in the Rat. *Maturitas* 41:157–165
- Bradshaw HB, Berkley KJ (2003) The Influence of Ovariectomy with or without Estrogen Replacement on Responses of Rat Gracile Nucleus Neurons to Stimulation of Hindquarter Skin and Pelvic Viscera. *Brain Res* 986:82–90
- Bradshaw HB, Temple JL, Wood E, Berkley KJ (1999) Estrous Variations in Behavioral Responses to Vaginal and Uterine Distension in the Rat. *Pain* 82:187–197
- Cason AM, Samuelsen CL, Berkley KJ (2003) Estrous Changes in Vaginal Nociception in a Rat Model of Endometriosis. *Horm Behav* 44:123–131
- Giamberardino MA, Berkley KJ, Affaitati G, Lerza R, Centurione L, Lapenna D, Vecchiet L (2002) Influence of Endometriosis on Pain Behaviors and Muscle Hyperalgesia Induced by a Ureteral Calculus in Female Rats. *Pain* 95:247–257
- Giamberardino MA, Valente R, de Bigontina P, Vecchiet L (1995) Artificial Ureteral Calculus in Rats: Behavioural Characterization of Visceral Pain Episodes and their Relationship with Referred Lumbar Muscle Hyperalgesia. *Pain* 61:459–469
- Gintzler AR, Komisaruk BR (1991) Analgesia is Produced by Uterocervical Mechanostimulation in Rats: Roles of Afferent Nerves and Implications for Analgesia of Pregnancy and Parturition. *Brain Res* 566:299–302
- Sandner-Kiesling A, Pan HL, Chen SR, James RL, DeHaven-Hudkins DL, Dewan DM, Eisenach JC (2003) Effect of Kappa Opioid Agonists on Visceral Nociception Induced by Uterine Cervical Distension in Rats. *Pain* 96:13–22
- Shin SW, Sandner-Kiesling A, Eisenach JC (2003) Systemic, but not Intrathecal Ketorolac is Antinociceptive to Uterine Cervical Distension in Rats. *Pain* 105:109–114
- Temple JL, Bradshaw HB, Wood E, Berkley KJ (1999) Effects of Hypogastric Neurectomy on Escape Responses to Uterine Distention in the Rat. *Pain Suppl* 6:S13–S20
- Tong C, Ma W, Shin SW, James RL, Eisenach JC (2003) Uterine Cervical Distension Induces cFos Expression in Deep Dorsal Horn Neurons of the Rat Spinal Cord. *Anesthesiology* 99:205–211
- Vernon MW, Wilson EA (1985) Studies on the Surgical Induction of Endometriosis in the Rat. *Fertil Steril* 44:684–694
- Wesselmann U, Czakanski PP, Affaitati G, Giamberardino MA (1998) Uterine Inflammation as a Noxious Visceral Stimulus: Behavioral Characterization in the Rat. *Neurosci Lett* 246:73–76
- Wesselmann U, Lai J (1997) Mechanisms of Referred Visceral Pain: Uterine Inflammation in the Adult Virgin Rat Results in Neurogenic Plasma Extravasation in the Skin. *Pain* 73:309–317

## Visceral Pain Pathway

- ▶ Postsynaptic Dorsal Column Projection, Anatomical Organization
- ▶ Postsynaptic Dorsal Column Projection, Functional Characteristics

## Visceral Referred Pain

JAMES BOROWCZYK  
Department of Orthopaedics and Musculoskeletal  
Medicine, Christchurch School of Medicine,  
Christchurch, New Zealand  
jmbor@clear.net.nz

### Synonyms

Referred pain; visceral pain

### Definition

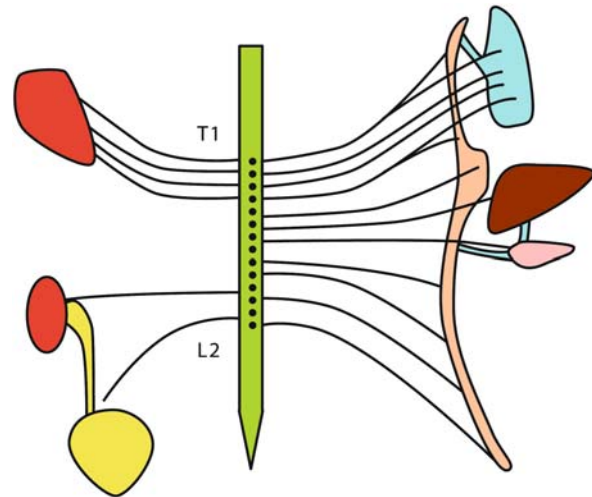
Referred pain is pain perceived in a region innervated by nerves other than those that innervate the source of the pain (Merskey and Bogduk 1994). ► **Visceral referred pain** is explicitly ► **Visceral Nociception and Pain** that becomes referred.

### Characteristics

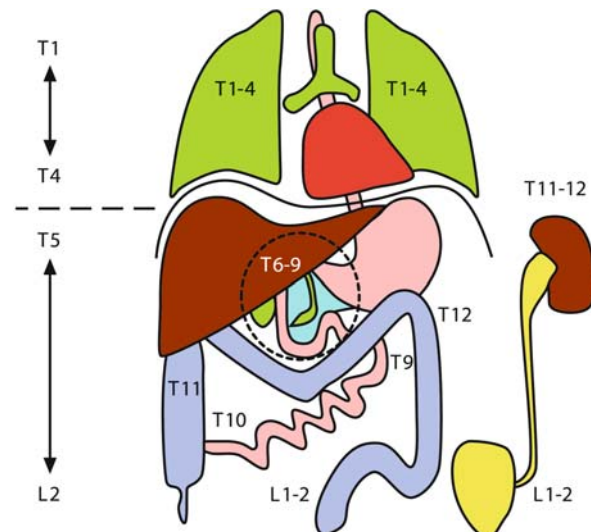
Visceral pain is not perceived locally. Viscera are diffusely innervated, and the central pathways of visceral pain are poorly organized somatotopically. This means that the nervous system is not “wired” in a manner to localize visceral pain accurately. Consequently, patients with visceral pain are not aware of its precise source. Instead, they experience a sensation whose location is attributed within and throughout the territory subtended by the same spinal cord segment, or segments, that innervate the source of pain. Typically, the pain is perceived in the body wall surrounding the viscus, or in other territories with the same segmental innervation. As this perception is in an area remote from the viscus, it has been interpreted as an example of ► **referred pain**.

The viscera are innervated by the thoracolumbar outflow of the sympathetic nervous system, between spinal cord segments T1 and L2. Their segmental innervation is established early during development, before the viscera are fully differentiated and before they assume their final topographic positions. In this state, the systematic pattern of innervation is apparent (Fig. 1). Within this pattern, the progenitors of proximal viscera receive their innervation from proximal segments, and progressively more caudal viscera are innervated by progressively more caudal segments. The gastrointestinal tract is innervated by segments T1 to L2. The heart is innervated by T1–4, and the urinary system by T11 to L2.

As the viscera grow, and the gastrointestinal tract rotates and migrates, the viscera draw their nerve supply with them. The final location of viscera bears little resemblance to their original, embryonic location. Consequently, the segmental innervation of the viscera is dissonant with the innervation of those parts of the chest and abdominal wall under which they lie (Fig. 2). For example, in the upper abdomen lie viscera innervated by T5, 6, T6–9, and T11–12.



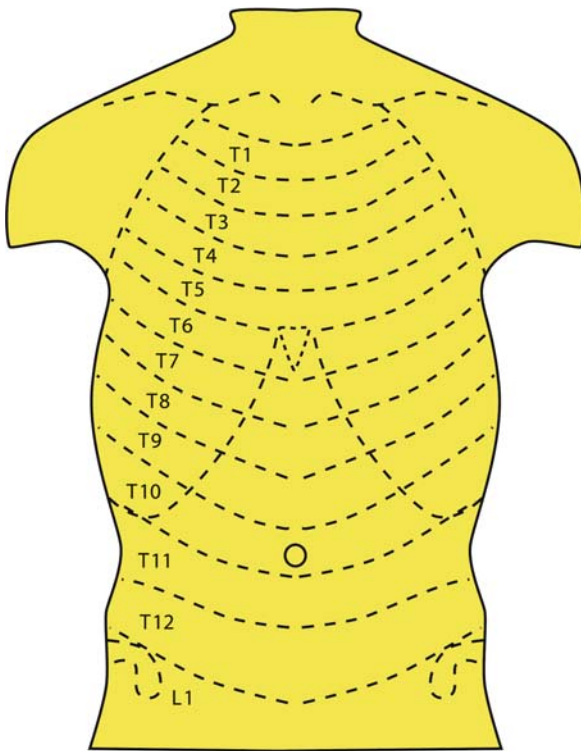
**Visceral Referred Pain, Figure 1** A sketch of the systematic pattern of innervation of the viscera during early embryonic development. From proximal to distal sites, the gastrointestinal tract progressively receives its innervation from segments T1 to L2.



**Visceral Referred Pain, Figure 2** A sketch of the relative topographic disposition of the thoracic and abdominal viscera, with the segmental innervation of each organ labelled. Above the diaphragm, all the thoracic viscera are innervated by T1–4. Below the diaphragm, the abdominal viscera are serially innervated from T5 to L2, along the length of the gastrointestinal tract.

The site to which visceral pain is referred is dictated by its segmental innervation. It will be perceived in those segments of the body wall that have the same segmental innervation as the viscus (Fig. 3). Thus, gastric pain is perceived in the epigastrium, not because the stomach lies in the epigastrium but because the abdominal wall of the epigastrium is innervated by the same segments (T5, 6) as innervate the stomach. The transverse colon may lie in the epigastrium, but its segmental innervation is T11. Its pain is therefore perceived in the lower abdominal wall. Pain from the urinary tract is felt in the loin





**Visceral Referred Pain, Figure 3** The segmental pattern of innervation of the chest and abdominal wall. Pain will be referred from viscera with the same segmental innervation into these areas.

and groin, because the abdominal wall spanning these regions is innervated by T12 and L1. Pain from the appendix is perceived in the umbilical region, because this region is innervated by T10. Cardiac pain is perceived in the central chest wall, because the central chest is innervated by T1–4.

Referral to the anterior chest wall, and to the anterior abdominal wall, is the classical pattern of behaviour of visceral pain with which most physicians will be familiar; but other patterns of referral may occur. For example, viscera may refer pain posteriorly, where it is perceived in regions of the spine with the same segmental innervation of the viscus. However, although such patterns of referral are known by anecdote and experience, no studies have formally addressed its incidence. Nevertheless, posterior referral of visceral pain is an important differential diagnosis of spinal pain. Cardinal examples include uterine pain, and the pain of abdominal aortic aneurysm presenting as low back pain.

At a neurological level, the mechanism underlying pain referral is generally held to be due to convergence. Afferents from viscera and from the body wall converge onto common neurons in the dorsal horn. Evidence for this was first presented in 1968 (Pomeranz et al. 1968), and further evidence was presented in the 1980's (Cervero 1983). This convergence occurs mainly at the spinal level, but also occurs at higher

levels, such as the thalamus and even in the cortex. Some 50% of all neurons at the termination of the spinothalamic tract in the thalamus can be excited by both cutaneous and noxious visceral input.

Due to convergence, the brain cannot determine the exact peripheral origin of information arriving to it from the spinal cord. It cannot determine if the information was initiated in an organ, or in that part of the body wall with the same segmental innervation as the organ. Being more accustomed to stimuli from the body wall, the brain attributes the origin of visceral pain to the body wall.

Convergence also allows for referred hyperalgesia. If dorsal horn neurons are facilitated by ongoing nociceptive input from an organ, areas of skin supplied by the same spinal segment may exhibit hyperalgesia or hyperaesthesia. This explains certain phenomena that, in the surgery literature, were classically described as “oddities” amongst the features of visceral disease. A good example is ‘Boas’ sign, where superficial cutaneous hyperalgesia may be found on the postero-inferior chest wall and flank in acute cholecystitis (Cervero 1982).

#### Reflex Muscle Contraction

An accompanying feature of visceral pain is reflex muscle contraction. In response to pain in an abdominal organ, muscles of the anterolateral abdominal wall contract. The particular muscles involved depend on both the spinal segments supplying the viscera, and the intensity of the stimulus. The degree of muscle spasm ranges from mild to intense, and if prolonged can cause muscle pain and prolonged muscle tenderness (McLellan and Goodell 1943). If the noxious stimulus is extreme, such as in pancreatitis, muscles above and below the initially involved spinal segments may also be recruited. This muscle spasm also prolongs and aggravates the initial condition, and may lead to ongoing or chronic pain that confounds further diagnosis and therapy (Zimmerman and Mayer-Rivera 1979). Associated phenomena include deep hyperalgesia and tenderness that may outlast the actual muscle spasm.

#### Distinctions

Visceral pain and its referral must be distinguished from other types of pain that may be associated with disorders of viscera. Some disorders may initially affect the organ intrinsically, but subsequently they extend to involve tissues adjacent to the organ. That secondary involvement of adjacent structures can become a second source of pain. Typical examples include, the spread of infection or inflammation to involve the parietal peritoneum of the abdomen, inflammation or haemorrhage over the posterior abdominal wall, and invasion of visceral nerve plexuses by spreading tumours.

These secondary sources of pain have their own mechanisms and patterns of behaviour, distinct from those of intrinsic visceral pain. Inflammation may be felt locally



or may itself become referred. This underlies classical examples of so-called visceral pain, but become examples of primary and secondary visceral pain, when properly understood.

Intrinsic pain from the appendix will be perceived in the central abdominal wall, because the appendix and the umbilical region are both innervated by T10. If, and once, the inflammation spreads to involve the overlying parietal peritoneum, a new (second and additional) pain occurs. It is felt locally in the iliac region of the abdominal wall, under which the appendix lies. Technically, this latter pain is not pain of the appendix, but pain caused by the inflammation of the appendix spreading to involve the abdominal wall. Similarly, an inflamed retrocaecal appendix may irritate the posterior abdominal wall, and present with pain in the back.

The inflammation of cholecystitis may spread to involve the parietal peritoneum of the diaphragm. In this condition, the intrinsic pain of the organ will be perceived in the epigastric region, because it is innervated by the same segments (T6–8) as innervate the gall bladder (T6–9); but the diaphragm is innervated by C3, 4, 5. The secondary pain of cholecystitis will therefore be perceived in the C3, 4, 5 segments. This territory includes the diaphragm and also the supraclavicular region. Hence, the pain of cholecystitis may eventually be referred to the shoulder.

If visceral diseases extend from their organ and invade nerve plexuses, the resultant pain is no longer visceral pain. It becomes an example of ► **neuropathic pain**.

► **Spinothalamic Tract Neurons, Visceral Input**

## References

1. Cervero F (1982) Afferent Activity Evoked by Natural Stimulation of the Biliary System in the Ferret. *Pain* 13:137–51
2. Cervero F (1983) Mechanisms of Visceral Pain. In: Lipton S (ed) *Persistent Pain*. Grune and Stratton, New York, pp 1–19
3. McLellan A Goodell H (1943) Pain from the Bladder, Ureter and Kidney Pelvis. *Proc Assoc Res Nerv Ment Dis* 23:252–262
4. Merskey H, Bogduk N (1994) Classification of Chronic Pain. Descriptions of Chronic Pain Syndromes and Definitions of Pain Terms, 2<sup>nd</sup> edn. IASP Press, Seattle, pp 11–16
5. Pomeranz B, Wall PD, Weber WV (1968) Cord Cells Responding to Fine Myelinated Afferents from Viscera, Muscle and Skin. *J Physiol* 199:511–32
6. Zimmerman M, Mayer–Rivera F (1979) Peripheral and Central Nervous Mechanisms of Nociception, Pain and Pain Therapy: Facts and Hypotheses. In: Bonica JJ (ed) *Advances in Pain Research and Therapy*. Raven Press, New York, pp 3–32

## Visceral Representation

► **Thalamus, Visceral Representation**

## Visceral Sensation

► **Angina Pectoris, Neurophysiology and Psychophysics**

## Visceral Sympathetic Blocks

### Definition

Blocking nerve impulses in nerves to and from internal organs.

► **Cancer Pain Management, Anesthesiologic Interventions, Neural Blockade**

## Visceralgia

### Definition

Pain may arise under certain conditions from the viscera, the organs of splanchnic origin.

► **Animal Models and Experimental Tests to Study Nociception and Pain**  
 ► **Visceral Pain Model, Pancreatic Pain**

## Visceromotor Reflex

### Definition

Visceromotor Reflex is a reflex response to noxious stimulation of a visceral organ. An example is the reflex contraction of the external abdominal oblique muscle in response to colorectal distention. In the case of colon or bladder distension, the abdominal muscles will contract. The visceromotor response requires a spino-bulbar-spinal loop, distinguishing it from a simple nociceptive withdrawal reflex organized within the spinal cord. The reflex may be recorded by electromyography.

► **Hypothalamus and Nociceptive Pathways**  
 ► **Nocifensive Behaviors, Gastrointestinal Tract**  
 ► **Nocifensive Behaviors of the Urinary Bladder**  
 ► **Spinal Dorsal Horn Pathways, Dorsal Column (Visceral)**  
 ► **Visceral Pain Model, Lower Gastrointestinal Tract Pain**  
 ► **Visceral Pain Model, Urinary Bladder Pain (Irritants or Distension)**

## Visceroreception

### Definition

Nociceptive awareness of visceral structures may be referred to as visceroreception. Visceral afferents are normally silent, but sensitization of afferent input can lead to heightened awareness or increased responsiveness to visceral afferent input.

► **Postsynaptic Dorsal Column Projection, Anatomical Organization**

## Viscerosensation

### Definition

Sensory input derived from the internal organs or viscera.

- ▶ Amygdala, Pain Processing and Behavior in Animals

## Viscerosomatic Pain Syndrome

### Definition

A syndrome in which related visceral and body wall pain interact with each other, as interstitial cystitis is related to suprapubic body wall pain.

- ▶ Chronic Pelvic Pain, Musculoskeletal Syndromes
- ▶ Myalgia

## Viscerotome

### Definition

The visceral area innervated by the spinal segment.

- ▶ Central Nervous System Stimulation for Pain

## Viscoelastic Elements

### Definition

Molecules that exhibit properties combining the elastic behavior of a gel and the viscous behavior of a solution.

- ▶ Perireceptor Elements

## Viscosupplementation

- ▶ Hyaluronan

## Visual Analog Scale

### Synonyms

VAS

### Definition

The Visual Analog Scale is often used for ratings of pain intensity in experimental studies. It is a scale that is comprised of a horizontal or vertical line and anchored at both ends by words indicative of extremes of magnitude, such as “no pain” to “most intense pain sensation imaginable” For children, a 10 cm vertical VAS is typically used to represent a continuum from no pain at all (at the bottom) to the worst pain imaginable (at the top of the VAS scale). To enhance comprehension in children, the VAS may include visual cues. For example, the VAS may employ color cues, graded from white at the bottom to dark red at the top, as well as a neutral face at the bottom and a negative facial expression at the top.

- ▶ Central Pain, Outcome Measures in Clinical Trials
- ▶ Experimental Pain in Children
- ▶ Magnetoencephalography in Assessment of Pain in Humans
- ▶ Pain in Humans, Psychophysical Law
- ▶ Quantitative Sensory Testing

## Visual Evoked Potentials

### Definition

The retina is stimulated with stroboscopic flashes or an alternating chequered board pattern. A signal is then obtained using electroencephalogram electrodes over the occipital region.

- ▶ Metabolic and Nutritional Neuropathies

## Vitamin Neuropathy

- ▶ Metabolic and Nutritional Neuropathies

## VLO

- ▶ Ventrolateral Orbital Cortex

## VM, VMb

- ▶ Basal Ventral Medial Nuclei

## Vmpo

- ▶ Posterior Part of the Ventromedial Nucleus
- ▶ Ventral Medial Nucleus

## Vocalization

### Definition

Vocalization is a centrally processed reaction.

- ▶ Randall-Selitto Paw Pressure Test

## Vocalization Threshold to Electrical Muscle Stimulation

### Definition

The minimal current intensity (in mA) corresponding to the first vocalization of the animal upon electrical stimulation of a skeletal muscle. Vocalization, being a highly integrated test, is regarded as a reliable index of perceived pain in animals (Le Bars et al. 2001); vocalization thresholds can thus be considered as an equivalent of pain thresholds in humans. In normal rats, electrical muscle thresholds are stable and reproducible over long periods of time (Giamberardino et al. 1990). In rats with uterine stones, the vocalization test is adopted to assess changes in sensitivity of the oblique muscles (L1 level) chronically implanted with nickelchrome wires. The stimuli employed are 250 ms trains of 1 ms square waves, frequency 200/s, delivered automatically every 2 s by a constant current electrical stimulator. The intensity of the current is gradually increased in 0.3 mA steps/2 s. Thresholds are measured by the method of the limits. The intensity is increased in 0.3 mA steps until vocalization occurs, then decreased in 0.1 mA steps until it disappears, and then re-increased at the latter rate until vocalization returns, noting the corresponding values in mA. The threshold is calculated as the mean of these values.

- ▶ Referred hyperalgesia in rats with uterine stones is evidenced as a percentage decrease in thresholds of the ipsilateral oblique musculature after stone implantation with respect to pre-stone implantation values.
- ▶ Visceral Pain Model, Kidney Stone Pain

## Vocational Appraisal

- ▶ Vocational Assessment in Chronic Pain

## Vocational Aptitudes

### Definition

Vocational aptitudes refers to a client's natural ability, other characteristics and necessary skills. Aptitude tests assess a client's abilities (general learning ability, verbal, numerical, spatial, form perception, clerical perception,

motor co-ordination, finger and manual dexterity), and are designed to reveal whether the client is suitable for a particular type or course of training or occupation.

- ▶ Vocational Counselling

## Vocational Assessment

- ▶ Disability, Functional Capacity Evaluations

## Vocational Assessment in Chronic Pain

KURT L. JOHNSON

Department of Rehabilitation Medicine, School of Medicine, University of Washington Seattle, WA, USA  
kjohnson@u.washington.edu

### Synonyms

Vocational Appraisal; Career Assessment; Employment Assessment; Vocational Evaluation

### Definition

Vocational assessment is a dynamic, interactive process of data collection and analysis to assist individuals in determining their preferences, strengths, limitations, and barriers with respect to education and employment.

### Characteristics

Among people 45 years of age or younger, back pain is the most common, and most expensive, cause of work-related disability (Deyo and Weinstein 2001). About 50% of working-age people surveyed report back pain symptoms each year (Sternbach 1986). About 2% of the work force in the U.S. may be expected to report a compensable back injury during any given year (Snook 1987; Andersson 1999). Of those, approximately 10% are limited in their ability to work at three months, and these few workers, whose recovery takes longest and suffer the most, use up to 80% of the total costs of back pain care (Bigos et al. 1986), or 88% of wage compensation and medical costs (Volinn et al. 1991). For people with chronic low back pain, and those with other chronic musculoskeletal pain without history of traumatic injury or clear objective findings, return to work after extended pain related disability can be very difficult.

Individuals with chronic pain seeking to return to employment face significant obstacles related to their own de-conditioning and self-perception of competence and capacity for employment, often in the context of an adversarial relationship with their worker's compensation or other disability insurance carrier, and psychosocial variables such as changes in family roles. Many individuals may need to change careers due to their functional limitations or changes in the labor market. Vocational as-

assessment is a process that provides a framework to assist individuals in understanding their preferences for various aspects of work, strengths and aptitudes, limitations, and barriers they may confront as they seek to re-enter employment.

Vocational assessment is a global term describing the appraisal of an individual's entire educational and employment background, and characteristics of temperament, medical issues, critical behaviors, skills, and abilities necessary to obtain and retain employment. A more narrow appraisal of specific occupational interests, specific job skills, would be termed a vocational evaluation, which is now considered one element of vocational assessment (Wesolek and McFarlane 1992). It is not sufficient simply to assess the individual with chronic pain. One must also have a mechanism to evaluate the characteristics of various workplaces. The Minnesota Theory of Work Adjustment (MTWA) (Dawes 1987) provides a scaffold that includes both the individual and the work environment. The MTWA has served as the basis for the way the U.S. Dept. of Labor codes the characteristics of workers and jobs.

Under the MTWA, successful work adjustment is determined by two factors, job satisfaction on the part of the employee, and the satisfactoriness of job performance as perceived by the employer. A person who is able to satisfy his or her needs in terms of temperament, work values, compensation, and preferred activities, is likely to continue employment. Similarly, if the employer perceives the performance of the employee as satisfactory, and if the economy supports the position, the employment is likely to be continued. The MTWA does not include a focus on factors that may moderate satisfaction and satisfactoriness, nor does it include consideration of cognitive variables, such as perceived competence and self-efficacy, with respect to various elements of employment (Tinsley 1993).

Satisfaction includes a variety of factors that must be assessed. These include preferences for reinforcers including ability utilization, achievement, activity, advancement, authority, company policies and practices, compensation, co-workers, creativity, independence, moral values, recognition, responsibility, security, social service, social status, supervision-human relations, supervision-technical, variety, and working conditions. There are a variety of paper and pencil inventories that can be used to assess sub-groups of these elements.

Holland's theory of occupational choice is currently the most widely used, to help people consider the relationship between their career interests and various occupations (Holland 1997). Under Holland's theory, career choice is an extension of one's personality, and vocational personality can be categorized by the degree to which one shares characteristics of six behavioral styles: Realistic, Investigative, Artistic, Social Service, Enterprising, and Conventional. The most widely used inventory for career decision-making, the Strong

Interest Inventory, is based on Holland's model. Respondents can see from the results of the Strong the pattern of their interests (e.g. their dominant behavioral style or styles), how their interests compare with men and women in general, and the degree to which their interests conform to those in large criterion groups in a variety of occupations. Holland contends that, when people share interest patterns or vocational personality styles with others in the occupation, they are more likely to be satisfied and successful. The Strong is primarily geared toward respondents with some college education, but other similar instruments, such as the Career Assessment Inventory are appropriate for respondents with high school or vocational technical training.

Job Satisfactoriness involves those attributes of the person with chronic pain that are necessary for general employability and specific employability with reference to the performance requirements of various occupations. General employability may encompass characteristics common to many jobs such as personal hygiene, grooming, punctuality, stamina, tolerance of frustration, ability to get along with co-workers, tolerance for supervision, etc. These factors are evaluated by interview of the individual with chronic pain, review of employment records, interviews with past employers or co-workers, and/or observation.

Specific employability refers to those characteristics necessary to perform various specific occupations such as intelligence, aptitude, temperament, physical capacity, etc. These may be evaluated through the use of psychometric testing using instruments such as the Wechsler Adult Intelligence Scale III, Minnesota Multiphasic Personality Inventory 2, General Aptitude Test Battery, Wide Range Achievement Test, etc. More frequently they are evaluated less formally through interview, observation, and record review. Physical capacity is often estimated using a physical capacities evaluation, where the subject is asked to perform a number of tasks such as lifting, reaching, kneeling, etc. From a practical perspective, simply asking the person with chronic pain his or her capacity in each area is likely to give a valid indicator of physical capacity, since it is the individual's perception of his or her capacity that is relevant.

In the United States, it is important to frame vocational evaluations in the context of the American's with Disabilities Act. Many people with chronic pain will be qualified as individuals with disabilities under the Act, so the question becomes, "...can this individual do the essential functions of this job with or without accommodation."

#### **Who Conducts Vocational Assessment**

Typically, vocational assessment would be conducted by someone with at least a master's degree in rehabilitation counseling or counseling, who has had training at graduate level in career assessment, functional assessment,



and job placement. Here, the assessor will be referred to as the “counselor.”

### Strategies for Vocational Assessment

Although some of the psychometric instruments described above are often used diagnostically, the vocational assessment process is decidedly not diagnostic in the traditional sense. Rather, the vocational assessment involves collaboration between the assessor and the subject. The counselor works with the individual with chronic pain to guide or facilitate an empirical process, where the individual gathers data about him- or herself around the factors described above, and gathers data about the characteristics and demands of various jobs. To have a successful outcome (e.g. re-entering employment), it is critical that the subject invests in the process and takes responsibility for the results. Vocational assessment is also dynamic. Hypotheses are developed, tested, and refined through experience.

Most frequently, the vocational assessment may include interviews with the subject and various key informants (e.g. previous employer, co-worker, or spouse), a review of history including education and employment, and a review of relevant medical information. In some cases, the addition of paper and pencil tests may be helpful. For example, it may be important to establish a literacy level, or a subject may not have a clear understanding of his or her ability to profit from higher education, or what his or her interests are. In these cases, using interest inventories, achievement tests, intelligence tests, personality inventories, or other tools may help the subject gain a better understanding of these variables. As part of the assessment, the counselor will identify with the subject a set of transferable skills, that is, skills that the subject has acquired or demonstrated in the past that may be applied to other employment areas. This also allows for planning for education and training, which may be necessary to expand the skill set so that more occupational choices are available.

Situational assessment can also play a key role for some people with chronic pain. Situational assessment involves the subject performing real or simulated work. For example, a 48 year old man has previously worked at finishing concrete and cannot return to that job. He has a high school education and reads at the tenth grade level. He reports that he enjoys working with people and “helping” people, but is not aware of what sorts of jobs are available and how they would suit him. He also is not certain he has the stamina for an eight hour day. For situational assessment, the counselor could set up an opportunity for him to work four hours a day, three days a week, for two weeks at a patient reception counter in a medical center. At the end of the assessment, the counselor and the man could discuss various aspects of that job, his endurance, and could get feedback on performance from the site supervisor. These data would then become part of the career counseling process.

Job Analysis is another key component of vocational assessment. In a job analysis, the counselor evaluates the various demands of a particular job. It is important to evaluate not only the physical demands, but also the social and cognitive demands. The U.S. Department of Labor has cataloged job analyses of representative jobs in the national economy. While these generic job analyses are useful for career counseling, they rarely describe adequately the requirements of a specific job. Job analyses can be conducted by interviewing workers or supervisors, but are best conducted by also conducting observations in the workplace.

The outcome of the vocational assessment is a synthesis of the variables related to satisfaction and satisfactoriness, an exposition of the subject’s strengths, limitations, barriers, and strategies to enhance success, including potential accommodations. There should also be examples of potential jobs that would be a good fit, and issues that should be considered in job placement.

### References

1. Andersson GBJ (1999) Epidemiological Features of Chronic Low-Back Pain. *Lancet* 354:581–585
2. Bigos S, Spengler D, Martin N et al. (1986) Back Injuries in Industry: A Retrospective Study II. Injury Factors. *Spine* 11:121–130
3. Dawes R (1987) A Theory of Work Adjustment. In: Bolton B (ed) *A Handbook on the Measurement and Evaluation in Rehabilitation*, 2<sup>nd</sup> edn. Paul Brooks, Baltimore
4. Deyo R, Weinstein JN (2001) Low Back Pain. *N Engl J Med* 344:363–370
5. Holland J (1997) *Making Vocational Choices: A Theory of Vocational Personalities and Work Environments*. Psychological Assessment Resources, Odessa, FL
6. Snook SH (1987) The Costs of Back Pain in Industry. In: Deyo RA (ed) *Occupational Back Pain: State of the Art Reviews*. Hanley and Belfus, Philadelphia, pp 1–5
7. Sternbach R (1986) Survey of Pain in the United States: The Nuprin Pain Report. *Clin J Pain* 2:49–53
8. Tinsley, D (1993) Extensions, Elaboration, and Content Validation of the TWA. *Journal of Vocational Behavior* 43:67–74
9. Volinn E, Van Koeveering D, Loeser J (1991) Back Sprain in Industry: The Role of Socioeconomic Factors in Chronicity. *Spine* 16:542–548
10. Wesolek J, McFarlane F (1992) Vocational Assessment and Evaluation: Some Observations for the Past and Anticipation for the Future. *Vocational Evaluation and Work Adjustment Bulletin* 25:51–54

V

## Vocational Counselling

INGRID SÖDERBACK  
Department of Public Health and Caring Sciences,  
Uppsala University, Uppsala, Sweden  
ingrid.soderback@pubcare.uu.se

### Definition

In the context of physical medicine and rehabilitation, vocational counselling is the process of giving professional advice to people with long-term (>3 months) musculoskeletal pain impairments regarding the needs

of a particular job. The information is aimed at assisting the client to understand vocational assets and liabilities for a suitable occupation. Vocational counselling comprises vocational assessment and vocational rehabilitative measures.

Through vocational assessment, a client's vocational readiness and potential for an optimal return to work outcome are identified. Vocational assessment is a comprehensive, interdisciplinary and systematic process where real or simulated occupational tasks are used. The results reveal the contents of a client's job tasks and his / her individual characteristics (i.e. physical, mental and emotional aptitudes / limitations, education and work tolerance). The assessment serves as the basis for planning vocational rehabilitation measures. The goal of return to work implies full- or part-time work at the previous workplace or another, performing job tasks adjusted to the rehabilitee's aptitude and skill and using adaptive equipment.

Vocational counselling for people with long-term pain impairments is based on the idea of ► **work fitness** and comprises measures for maximising the client's ► **vocational aptitudes** and skills and / or functional capacity that promote return to work.

### Characteristics

The prevalence rate of long-term pain impairments varies according to nation-wide population studies between 11% and 66%, with a predominance among people with brief education and among women aged 50–58 years. Activity limitations and participation restrictions (World Health Organisation 2006) (prevalence 26%; incidence 0.07), e.g. inability to perform employed work (93.1%) due to long-term / recurrent pain were self-reported by a Swedish population (n = 6419) (Müllersdorf and Söderback 2000). Factors indicating need for multidisciplinary rehabilitative measures, e.g. vocational counselling, were feelings of insufficiency such as irresolution and gnawing or searing pain.

### Predictors for Return to Work

The main goals of medical rehabilitation for people with long-term musculoskeletal pain impairments are to attain work fitness and to return to work. Variables of the biopsychosocial model (Hanson and Gerber 1990) significantly predict return to work and therefore partly constitute the components of a vocational assessment. These variables are:

The disability factor (World Health Organisation 2006), which consists of a low or average impairment sensation of pain (<5.4 score on a 10 degree VAS scale).

The contextual factors (World Health Organisation 2006), which consist of:

- **Personal factors** (World Health Organisation 2006): possessing (a) vocational training, (b) a strong intention to come back to and remain at one's previ-

ous work, (c) a positive perception of one's previous employment status, a moderate or high level of self-perceived capacity for work, general satisfaction with present life value and job and a feeling that one's job tasks are meaningful;

- **Environmental factors** (World Health Organisation 2006): (a) availability of suitable job tasks that are (b) comparable to one's vocational aptitude, (c) early referral to vocational counselling and (d) less than 1 month elapsing between completed vocational rehabilitation and returning to work (Fishbain et al. 1997; Schult 2002; van der Giezen et al. 2000).

Predictors of non-return to work are older age, language barriers and the emotional impairment of depression (>16 scores on the Beck depression scale).

Variables that do not significantly predict return to work are the client's medical history, physical capacity status, range of motion and findings from biomechanical tests (Hunt et al. 2002).

In conclusion, psychosocial aspects of health and work in combination with economic aspects have a significantly larger impact on return to work than medical and physical aspects. People work because they need to earn money to survive or to establish a career and/or because the work itself gives them satisfaction and membership in a social group that may increase their meaning of life.

### Goals and Assessment Methods of Vocational Counselling

The goals of vocational counselling are (a) to facilitate a client's knowledge of available occupational opportunities and resources, (b) to identify a client's present vocational aptitudes, (c) to identify environmental occupational barriers (World Health Organisation 2001), (d) to identify a vocational goal consistent with identified individual vocational aptitudes and preferences and (e) to outline a rehabilitative plan for vocational assessment and vocational rehabilitation measures (Leahy 1995).

Vocational counselling assessment methods include (a) an ► **evaluation of vocational capacity**, (b) a ► **functional capacity evaluation** and (c) a ► **Vocational Assessment**. However, the client's return to work potential is determined by the results of a vocational assessment. Vocational assessment is a multi-professional investigation. It is performed for several days and based on the main principle of using ► **criterion-referenced assessments**, meaning that the vocational skills required of the worker in a specific work environment are compared with the ► **personal characteristics**, personal factors and vocational aptitudes the worker brings to a job. These influence optimal healthy performance and work productivity (Spenner 1990). Assessors systematically use multidimensional assessment tools and methods, e.g. interviews, self-reports and behavioural observation. A vocational assessment contains an intake interview, a general medical examination, a ► **job analysis** and an evaluation of the client's characteristics.

### Methods for Performing a Vocational Assessment

A vocational assessment may be based on the following methods (Stein et al. 2006):

- Analyzing the actual job: Information about the ► **job requirements** of a client's actual occupation is available from electronic sources (US Department of Labor 1996, 2003) which combine information from the ► **Dictionary of Occupational Titles** (US Department of Labor 1991a), the Worker Traits Data Book (US Department of Labor 1994) on the O\*NET database (US Department of Labor, 2006). These databases contain variables that represent descriptors of work and worker characteristics, including skill requirements. Selecting from the electronic sources the occupation that is the most comparable to the client's present circumstances is determined by (a) structured interviews with the worker, workmates and manager and (b) a ► **situational assessment** or an ► **on the job site evaluation**. These observations are video-recorded and systematically analysed according to the Revised Handbook of Analyzing Jobs (US Department of Labour 1991b), and ergonomics. The key characteristic of an occupation (job substantive complexity, physical demands and circumstances of physical environmental factors) is numerically determined using an index.
- Assessing the client's occupational performance. Worker traits, i.e., the client's vocational aptitudes and skills that contribute to performance of his / her actual occupation are determined by (a) observing the client's ► **occupational behaviour** (b) observing the client's performance of real and / or ► **simulated job tasks** and / or (c) ► **work samples**. The VAL PAR component work samples (VCWS) (Christopherson and Hayes 1992) is an example of a commonly used work sample. The job analysis constitutes the base for the choice of a, b or c as being the most appropriate occupational tasks for assessing the client's behaviour. The client's results when performing at least two VCWS samples give a worker qualification profile (WQP) (VAL PAR 1998), which demonstrates whether the client's achievement corresponds to (a) the required DOT variables and (b) the standard criterion of the methods-time measurement (MTM) score. Self-reported assessments of the client's capability to perform daily occupations may contribute valuable information (Schult 2002). The client's performance of the chosen job tasks is systematically observed and video-recorded. The analysis focuses on the client's biomechanical and ergonomic work technique with the aim of preventing adverse health.
- Assessing the client's personal behaviour. The client's personal behaviour as affected by internal strengths, perception of present life values and coping style regarding the work-mates and manager

and by pain-associated problems, such as fear, avoidance behaviour, depression and negative orientation to life are assessed using client reported, reliable and valid assessment questionnaires (Schult 2002).

- Analysing and assessing the work environment. The physical work environment, e.g. exposure / no exposure to weather, noise intensity level and vibration, is determined by systematic observation of the real work conditions according to the Worker Traits Data Book. The ergonomic and biomechanical conditions at the workplace are observed and video-recorded. The psychological work environment that has an impact on the worker's satisfaction is related to organisational risk factors for job stress, psychological work demands, employee control over the work process, on the job social supports, uncertainly on the job and on the job conflict. These factors are estimated with client reported assessment instruments. The Demand-Control-Support Questionnaire (Theorell et al. 1990) estimates how the actual work organisation, which may be characterised by e.g. high levels of psychological demands, a low level of decision latitude or poor social support, affects the worker's health adverse. The Job Diagnostic Survey estimates the worker's need for workplace re-design to increase the positive personal outcome of high internal motivation, work satisfaction, quality performance and low absenteeism (Schult and Söderback 2000).

### The Validity of Vocational Assessments

The criterion-referenced multidimensional job-related vocational assessment (CMVA) model seeks to assess the client's ► **work capacity**. It addresses the variables; "Work demands" derived from the DOT variables, i.e. physical demands, substantive complexity and physical environmental factors, "Occupational performance" i.e. the individual's results on two VCWS, "Personal" i.e. individual perception of capacity for occupational performance of work tasks and the difference between desired values of work and attained values and "Environment" i.e. the individual's perception of how much social support he or she receives. With the CMVA model it is possible to predict a long-term pain sufferer's capacity for work, as demonstrated by the multivariate linear regression model with the forward selection of variables. The result explains 78% of the variance. Further studies may demonstrate the value of the CMVA for preventing people from becoming sick listed or out of work. Among the variables in the CMVA model, "occupational performance" (self-perceived ability and satisfaction with the performance of a daily occupation) is the strongest predictor. This is shown by the fact that the results of logistic regression analysis correctly classified 88% of participants who were out of work due to long-term pain impairments (Söderback et al. 2000; Stein et al. 2006).

## Conclusion

- There seems to be a need for vocational counselling assessment, especially among people with long-term gnawing or searing pain and those who perceive themselves as incapable of performing daily occupations.
- Vocational counselling assessment methods include evaluation of vocational capacity, evaluation of functional capacity and vocational assessment. Of these, vocational assessment is judged the most valid for assessing capacity for work among people with long-term pain. This is because these assessment results demonstrate the client's capacity for work compared to the job requirements.

## References

1. Christopherson BB, Hayes PD (1992) VAL PAR Component Work Samples uses in allied health. VAL PAR International Corporation, Tucson
2. Fishbain DA, Cutler RB, Rosomoff HL et al. (1997) Impact of chronic pain patient's job perception variables or actual return to work. *Clin J Pain* 13:197–206
3. Hanson R., Gerber K (1990) Coping with chronic pain. A guide to patient self-management. The Guilford Press, New York
4. Hunt DG, Zuberbier OA, Kozlowski AJ et al. (2002) Are components of a comprehensive medical assessment predictive of work disability after an episode of occupational low back trouble? *Spine* 27:156–129
5. Leahy MJ (1995) Assessment of vocational interests and aptitudes in rehabilitation setting. In: Scherer MJ (ed) *Psychological Assessment in Medical Rehabilitation*. American Psychological Association, Easton, pp 299–324
6. Müllersdorf M, Söderback I (2000) Assessing health care needs. The actual state of self-perceived activity limitation and participation restrictions due to pain in a national-wide Swedish population. *Int J Rehabil Research* 23:201–207
7. Occupational Information network (O\*NetOnLine) The O\*NET database. <http://www.online.onetcenter.org> . 10/03/2006
8. Schult M-L (2002) Multidimensional assessment of people with chronic pain. A critical appraisal of the person, environment, occupation model. Acta Dissertations of Uppsala university, Uppsala, Sweden
9. Schult M-L, Söderback I (2000) A method for 'diagnosing' jobs before re-design in chronic-pain patients. Preliminary Findings. *J Occup Rehabil* 10:295–307
10. Söderback I, Schult M-L, Jacobs K (2000) A criterion-referenced multidimensional job-related model predicting capability to perform occupations among persons with chronic pain. *Work* 15:25–39
11. Spenner K (1990) Skill. Meanings, methods and measurements. *Work and Occupations*. 17:399–421
12. Stein F, Söderback I, Cutler SK, and Larson B (2006) *Occupational Therapy and Ergonomics. Applying Ergonomics Principles to Everyday Occupation in the Home and at the Work* (1st ed.). London/Philadelphia: Whurr Publisher/John Wiley & Sons, Ltd
13. Theorell T, Ahlberg-Hultén G, Härenstam A (1990) A psychosocial and biomedical comparison between men in six contrasting service occupations. *Work and Stress* 4:51–53
14. US Department of Labor (1991a) Dictionary of Occupational Titles. JIST Works, Inc Indianapolis
15. US Department of Labor (1991b) The revised handbook for analyzing jobs. JIST Works, Inc Indianapolis
16. US Department of Labor (1994) Worker Traits Data Book. JIST Works, Inc Indianapolis
17. US Department of Labor (1996) Jist's Electronic Enhanced Dictionary of Occupational Titles (Jist's DOT). Computer Program. JIST Works, Inc Indianapolis
18. VAL PAR Component Work Samples (1998) Worker Qualification Profile. Computer program: S 2000. VAL PAR International Corporation, Tucson
19. van der Giezen AM, Bouter LM, Nijuhuis FJ (2000) Prediction of return-to-work of low back pain patients sick-listed for 3–4 months. *Pain* 87:285–294
20. World Health Organisation (2006) International Classification of Functioning, Disability and Health (ICF). <http://www.who.int/classifications/icf/en> 10/03/2006

## Vocational Evaluation

- ▶ Vocational Assessment in Chronic Pain

## Voltage-Dependent Calcium Channels

- ▶ Calcium Channels in the Spinal Processing of Nociceptive Input

## Voltage-Dependent Pores

- ▶ Trafficking and Localization of Ion Channels

## Voltage-Gated Calcium Channel

### Definition

Voltage-gated calcium channels represent a range of membrane ion channels that are selectively permeable to calcium ions. Permeation of calcium into nerve terminals and cell bodies through these channels is gated by membrane depolarization to produce calcium entry and excitation. The major protein classes are N- ( $Ca_v$  2.2), P/Q ( $Ca_v$  2.1), R ( $Ca_v$  2.3), T ( $Ca_v$  3.X) and L ( $Ca_v$  1.X).

- ▶ Opioid Electrophysiology in PAG

## Voltage-Gated Channel

### Definition

A pore in the cell membrane that allows passage of a substance dependent upon the voltage across the cell membrane.

- ▶ Drugs Targeting Voltage-Gated Sodium and Calcium Channels
- ▶ Migraine, Pathophysiology

## Voltage-Gated Potassium Channels

### Definition

Voltage-gated  $K_v$  channels represent a large family of membrane ion channels that are selectively perme-



able to potassium ions. Activation of these channels by changes in membrane voltage produces membrane hyperpolarization to control action potential repolarization, frequency and firing patterns.

- ▶ Opioid Electrophysiology in PAG

## Voltage-Gated Sodium Channel

### Definition

A pore in the neuronal cell membrane that permits the influx of sodium ions, which is opened by a change in membrane potential.

- ▶ Molecular Contributions to the Mechanism of Central Pain

## Volume of Distribution (Vd)

### Definition

The volume of distribution (Vd) is a hypothetical volume. It is the volume that would be required to dissolve the administered amount of drug (A) at the measured drug concentration (C):

$$Vd = \frac{A}{C}$$

- ▶ NSAIDs, Pharmacokinetics

## Volume Transmission

### Definition

The term volume transmission is used to describe a mechanism whereby a neurotransmitter diffuses through the neurophil to reach the receptors on which it acts, rather than merely crossing a synaptic cleft. Both neuropeptides and monoamines are thought to act through volume transmission.

- ▶ Nociceptive Circuitry in the Spinal Cord

## Von Frey Hair

### Definition

Von Frey hairs (named after the German physiologist Max von Frey, 1852-1932) are nylon monofilaments with increasing diameters, each of them mounted at right angles to the end of a plastic handle. The diameter determines the flexibility of the monofilament and thereby determines the amount of force applied by each instrument. Each filament is placed at right angle to

the skin with a constant strength until it bends. It stays bent for 1.5 seconds and is then removed with constant decreasing strength. Each of the filaments is numbered and represents a force expressed in grams.

- ▶ Cognitive Behavioral Treatment of Pain
- ▶ Hyperaesthesia, Assessment
- ▶ Hypoesthesia, Assessment
- ▶ Muscle Pain Model, Inflammatory Agents-Induced
- ▶ Neuropathic Pain Model, Tail Nerve Transection Model
- ▶ Species Differences in Skin Nociception
- ▶ Spinal Cord Injury Pain Model, Contusion Injury Model

## Von Frey Monofilaments

- ▶ Von Frey Hair

## VOP

- ▶ Vascular Orofacial Pain

## Voxel-Based Morphometry

### Definition

A computational approach to neuroanatomy, which measures differences in local concentrations of brain tissue through a voxel-wise comparison of multiple brain images.

- ▶ Thalamus, Clinical Pain, Human Imaging

## VP

- ▶ Lateral Thalamic Pain-Related Cells in Humans
- ▶ Ventral Posterior Nucleus (Human Ventral Caudal)

V

## VPI

- ▶ Ventral Posterior Inferior Nucleus

## VPL

- ▶ Ventral Posterior Lateral Nucleus
- ▶ Ventroposterior Lateral Nucleus

## VPM

- ▶ Ventral Posterior Medial

## VPpc

- ▶ Parvocellular VP

## VR1

- ▶ TRPV1 Modulation by PKC
- ▶ TRPV1 Receptor, Species Variability

## VR1, Regulation by NGF

- ▶ TRPV1, Regulation by Nerve Growth Factor

## VR1, Regulation by Protons

- ▶ TRPV1, Regulation by Protons

## VR1, VRL1, TRPV1, TRPV2

### Definition

The transient receptor potential (TRP) family of proteins assemble to form a variety of ligand and thermally gated ion channels. Some of these were originally designated vanilloid receptors (VR). TRPV1 and TRPV2 assemble to form heat sensitive ion channels with thresholds near 45 and 50 degrees, respectively. TRPV1 is also proton sensitive and can also be gated by a number of pro-inflammatory lipids.

- ▶ [Nociceptors in the Orofacial Region \(Skin/Mucosa\)](#)

## Vulvar Dysesthesia

### Definition

An unpleasant abnormal sensation in the vulva.

- ▶ [Dysesthesia, Assessment](#)
- ▶ [Dyspareunia and Vaginismus](#)
- ▶ [Vulvodynia](#)

## Vulvar Vestibulitis

### Definition

A subset of vulvodynia characterized by: (1) presence of severe pain on vestibular touch or attempted vaginal entry, (2) tenderness to pressure localized within the vulvar vestibule, and (3) physical findings confined to vestibular

erythema of various degrees. Common form of dyspareunia (painful intercourse) with significant interference with sex lives.

- ▶ [Dyspareunia and Vaginismus](#)
- ▶ [Gynecological Pain and Sexual Functioning](#)
- ▶ [Gynecological Pain, Neural Mechanisms](#)
- ▶ [Pudendal Neuralgia in Women](#)
- ▶ [Vulvodynia](#)

## Vulvodynia

URSULA WESSELMANN

Departments of Neurology, Neurological Surgery and Biomedical Engineering, The Johns Hopkins University School of Medicine, Baltimore, MD, USA  
pain@jhmi.edu

### Synonyms

Vulvar dysesthesia; dysesthetic vulvodynia; essential vulvodynia; vulvar vestibulitis; vestibulodynia; idiopathic vulvar pain

### Definition

Vulvar pain in the absence of an infectious, dermatological, metabolic, autoimmune or neoplastic disease has been recognized as a common clinical problem. Hyperesthesia of the vulva was already described in American and European gynecological textbooks more than 100 years ago (Thomas 1880). Surprisingly, despite early detailed reports, chronic vulvar dysesthesia disappeared to a large extent from the medical literature until the mid 1970s. In 1976 the International Society for the Study of Vulvovaginal Disease (ISSVD) identified idiopathic vulvar pain as a unique entity and introduced the term “burning vulva syndrome”, based on the observation that most women describe the pain as a hot-burning sensation. The ISSVD subsequently coined the term ▶ [vulvodynia](#) (defined as chronic vulvar discomfort especially that characterized by the patient’s complaint of burning, and sometimes stinging, irritation, or rawness) to describe this disorder (see Moyal-Barracco and Lynch 2004 for review). The ISSVD stated that vulvodynia was a symptom rather than a diagnosis and that multiple etiologies might be possible. Subsequently, two subsets of vulvodynia were identified. One subgroup of patients complained about entrance dyspareunia (pain with tampon insertion and pain at vaginal penetration during sexual intercourse), rather than diffuse vulvar pain. The term “▶ [vulvar vestibulitis](#)” was introduced for this subset of vulvodynia and the following diagnostic criteria were established: (1) presence of severe pain on vestibular touch or attempted vaginal entry, (2) tenderness to pressure localized within the vulvar vestibule, (3) physical findings confined to vestibular erythema of various degrees (Friedrich 1987).

The other main subgroup of patients with vulvodynia presented with generalized, spontaneous vulvar pain occurring in the absence of physical findings. The term ► **dysesthetic (or essential) vulvodynia** was suggested for this symptom complex. Clinically, two different groups of patients with vulvar vestibulitis have been described: ► **Primary vulvar vestibulitis** is defined as dyspareunia from the first attempt of sexual intercourse, whereas in ► **secondary vulvar vestibulitis** the dyspareunia appears after a period of pain-free sexual intercourse. Based on the concern that the suffix “-itis” in vulvar vestibulitis incorrectly implies an inflammatory etiology, the term vestibulodynia has been suggested (see Moyal-Barracco and Lynch 2004 for review). The most recent revision of the ISSVD of the terminology of vulvodynia was published in 2004 (Moyal-Barracco and Lynch 2004). This classification suggests categorizing a generalized and a localized (► **vestibulodynia**, clitorodynia, hemivulvodynia etc.) form of vulvodynia, and to differentiate subgroups within those 2 categories based on the observation whether the vulvar pain is provoked, unprovoked or mixed (provoked and unprovoked). As the knowledge about the etiology and treatment of idiopathic vulvar pain is advancing, the definitions of vulvodynia will probably be modified, based on emerging knowledge of the underlying pathophysiological mechanisms. In a broader view, vulvodynia can be grouped with the chronic non-malignant syndromes of urogenital origin occurring in both sexes (Wessellmann et al. 1997). In addition to vulvodynia, these pain syndromes include: urethral syndrome, coccygodynia, generalized perineal pain, orchialgia, prostatodynia (chronic pelvic pain syndrome in men), chronic penile pain and interstitial cystitis.

### Characteristics

Women, who present with persistent vulvar pain, typically described as a burning pain, are diagnosed with vulvodynia, after other diseases that can result in vulvar pain have been excluded. The differential diagnosis is wide and can include vulvar candidiasis, herpetic infections, lichen planus, Paget’s disease, squamous cell carcinoma, postherpetic neuralgia or spinal nerve compression (Moyal-Barracco and Lynch 2004). Thus, vulvodynia is a diagnosis of exclusion. Community studies suggest that vulvar pain is common, and prevalence rates as high as 18% have been reported (Harlow et al. 2001). Vulvar vestibulitis has been described in up to 15% of gynecological outpatients (Goetsch 1991). While initial reports postulated that vulvodynia affects primarily Caucasian women, a recent survey of ethnically diverse women showed similar life-time prevalences of chronic vulvar burning pain or pain on contact (Harlow and Stewart 2003).

There is experimental evidence from several psychophysical studies indicating that the pain sensitivity

to mechanical and thermal stimuli in the vulvar area is altered in women with vulvodynia (Bohm-Starke et al. 2001; Pukall et al. 2002). The results are compatible with the hypothesis that patients with vulvodynia suffer from a sensitization of thermoreceptors and nociceptors in their vestibular mucosa. Histological studies of vulvar biopsy specimens from women with vulvar vestibulitis, as compared to pain-free controls, have shown a significant increase in the number of intra-epithelial nerve endings in women with vulvar vestibulitis. When using immunohistochemical methods to detect neuropeptides normally found in various types of nerve fibers, calcitonin gene-related peptide, which is known to exist in nociceptive afferent nerves, was the only neuropeptide detected in the superficial nerves of the vestibular mucosa (Bohm-Starke et al. 1999). In addition, an increased vanilloid receptor VR1 innervation has recently been reported (Tympanidis et al. 2004). These findings suggest that the increase of free nerve endings within the vulvar vestibular mucosa of women with vulvar vestibulitis is due to an increase in nociceptors. It has been hypothesized based on these results, that the erythema observed in these patients at the vulvar vestibule might be of neurogenic rather than of inflammatory origin.

In addition to the ► **peripheral sensitization** demonstrated in the vulvar area in women with vulvodynia, there is evidence of ► **central sensitization**. Women with vulvar vestibulitis report experiencing a higher incidence of non-vulvar pain problems. Psychophysical studies have shown lowered mechanical and thermal thresholds in non-genital body areas, indicating a generalized sensory dysregulation (Granot et al. 2004; Pukall et al. 2002). Recent MRI studies of the brain indicated that women diagnosed with vulvar vestibulitis syndrome have significantly higher activation levels in the insular and frontal cortical regions than did control women during pressure applied to the posterior portion of the vulvar vestibule (Pukall et al. 2005). These results imply that women with vulvar vestibulitis exhibit an augmentation of genital sensory processing which is similar to that observed for a variety of syndromes causing hypersensitivity, including fibromyalgia, irritable bowel syndrome and neuropathic pain.

There is evidence of a possible genetic component in the etiology of vulvodynia. As is common for inflammatory conditions, allele 2 in the interleukin-1 beta gene was more common in women with vulvar vestibulitis syndrome than in other women. Susceptibility to the vulvar vestibulitis syndrome might be influenced by carriage of this polymorphism (Gerber et al. 2003).

Recent studies have demonstrated that a subgroup of women with vulvodynia displayed clinically significant broad-based psychological distress that warranted psychological assessment and treatment (Brotto et al. 2003). Adult-onset vulvodynia has been shown to be strongly associated with abuse as a child more than a

few times physically or sexually. When abused women were compared with those with no history of abuse, the association was largely confined to those harmed by a primary family member (Harlow and Stewart 2005). Since the limited research studies to this date indicate that vulvodynia is a heterogeneous, multisystem and multifactorial disorder, a multidimensional and multidisciplinary treatment approach is recommended (Weijmar Schultz et al. 2005). The first step in the treatment of vulvodynia is to identify and eliminate local irritants and potential allergens. Oral medications recommended for the treatment of neuropathic pain management including antidepressants, anticonvulsants, membrane-stabilizing agents and opioids have been considered. In patients with localized vulvodynia, where a small area is painful, topical treatment regimens such as creams with local anesthetics, aspirin, steroids or estrogen might reduce the pain. Glazer (2000) has reported significant pain relief in patients with vulvodynia using electromyographic biofeedback of the pelvic floor musculature. Surgical procedures have been advocated to remove the hyperalgesic skin area in patients with vulvar vestibulitis (Bergeron et al. 1997; Foster et al. 1995). The most commonly used procedure is ► **vestibulectomy**. A simplified surgical revision, as an alternative to this extensive surgical intervention, has been advocated by Goetsch (1996), where the painful area is excised under local anesthesia. A larger study (Bergeron et al. 2001) comparing different treatment approaches found that vaginal biofeedback, cognitive behavioral therapy and vestibulectomy have similar treatment outcomes. Further basic science studies to define the etiology of vulvodynia and its subgroups are urgently needed, to identify rational treatment approaches based on the pathophysiological mechanisms of this genital pain disorder in women.

### Acknowledgements

Ursula Wesselmann is supported by NIH grants DK57315 (NIDDK), DK066641 (NIDDK), HD39699 (NICHD, Office of Research for Women's Health) and the National Vulvodynia Association.

- **Chronic Pelvic Pain, Physical and Sexual Abuse**
- **Dyspareunia and Vaginismus**
- **Gynecological Pain and Sexual Functioning**
- **Pudendal Neuralgia in Women**

### References

1. Bergeron S, Binik YM, Khalife S et al. (2001) A Randomized Comparison of Group Cognitive-Behavioral Therapy, Surface Electromyographic Biofeedback, and Vestibulectomy in the Treatment of Dyspareunia Resulting from Vulvar Vestibulitis. *Pain* 91:297–306
2. Bergeron S, Bouchard C, Fortier M et al. (1997) The Surgical Treatment of Vulvar Vestibulitis Syndrome: A Follow-Up Study. *J Sex Marital Ther* 23:317–325
3. Bohm-Starke N, Hilliges M, Brodda-Jansen G et al. (2001) Psychophysical Evidence of Nociceptor Sensitization in Vulvar vestibulitis Syndrome. *Pain* 94:177–183
4. Bohm-Starke N, Hilliges M, Falconer C et al. (1999) Neurochemical Characterization of the Vestibular Nerves in Women with Vulvar Vestibulitis Syndrome. *Gynecol Obstet Invest* 48:270–275
5. Brotto LA, Basson R, Gehring D (2003) Psychological Profiles among Women with Vulvar Vestibulitis Syndrome: A Chart Review. *J Psychosom Obstet Gynaecol* 24:195–203
6. Foster D, Butts C, Shah K et al. (1995) Long-Term Outcome of Perineoplasty for Vulvar Vestibulitis. *J Women's Health* 4:669–675
7. Friedrich EG (1987) Vulvar Vestibulitis Syndrome. *J Reprod Med* 32:110–114
8. Gerber S, Bongiovanni AM, Ledger WJ et al. (2003) Interleukin-1Beta Gene Polymorphism in Women with Vulvar Vestibulitis Syndrome. *Eur J Obstet Gynecol Reprod Biol* 107:74–77
9. Glazer HI (2000) Dysesthetic Vulvodynia. Long-Term Follow-Up after Treatment with Surface Electromyography-Assisted Pelvic Floor Muscle Rehabilitation. *J Reprod Med* 45:798–802
10. Goetsch MF (1991) Vulvar Vestibulitis: Prevalence and Historic Features in a General Gynecologic Practice Population. *Am J Obstet Gynecol* 164:1609–1616
11. Goetsch MF (1996) Simplified Surgical Revision of the Vulvar Vestibule for Vulvar Vestibulitis. *Am J Obstet Gynecol* 174:1701–1705
12. Granot M, Friedman M, Yarnitsky D et al. (2004) Primary and Secondary Vulvar Vestibulitis Syndrome: Systemic Pain Perception and Psychophysical Characteristics. *Am J Obstet Gynecol* 191:138–142
13. Harlow BL, Stewart EG (2005) Adult-Onset Vulvodynia in Relation to Childhood Violence Victimization. *Am J Epidemiol* 161:871–880
14. Harlow BL, Stewart EG (2003) A Population-Based Assessment of Chronic Unexplained Vulvar Pain: Have We Underestimated the Prevalence of Vulvodynia? *J Am Med Womens Assoc* 58:82–88
15. Harlow BL, Wise LA, Stewart EG (2001) Prevalence and Predictors of Chronic Lower Genital Tract Discomfort. *Am J Obstet Gynecol* 185:545–550
16. Moyal-Barracco M, Lynch PJ (2004) 2003 ISSVD Terminology and Classification of Vulvodynia: A Historical Perspective. *J Reprod Med* 49:772–777
17. Pukall CF, Strigo IA, Binik YM et al. (2005) Neural Correlates of Painful Genital Touch in Women with Vulvar Vestibulitis Syndrome. *Pain* 115:118–127
18. Pukall CF, Binik YM, Khalife S et al. (2002) Vestibular Tactile and Pain Thresholds in Women with Vulvar Vestibulitis Syndrome. *Pain* 96:163–175
19. Thomas T (1880) *Practical Treatise on the Diseases of Woman*. Henry C & Lea's Son, Philadelphia, pp 145–147
20. Tympanidis P, Casula MA, Yiangou Y et al. (2004) Increased Vanilloid Receptor VR1 Innervation in Vulvodynia. *Eur J Pain* 8:129–133
21. Weijmar Schultz W, Basson R, Binik Y et al. (2005) Women's Sexual Pain and its Management. *J Sex Med* 2:301–316
22. Wesselmann U, Burnett AL, Heinberg LJ (1997) The Urogenital and Rectal Pain Syndromes. *Pain* 73:269–294

## Vulvo-Vaginal Atrophy

### Definition

Vulvo-vaginal atrophy is a manifestation of tissue aging and the cytological and chemical transformations within the internal and external genitalia, resulting from declining levels of endogenously produced estrogens.

- **Dyspareunia and Vaginismus**



## Waddell Signs

- ▶ Non-Organic Symptoms and Signs

## Wage Replacement

### Definition

The wage replacement benefit is the ratio of the expected disability benefit to the preinjury wage.

- ▶ Pain in the Workplace, Risk Factors for Chronicity, Workplace Factors

## Walking Epidural

### Definition

Walking epidural is a term used to describe an epidural technique whereby a woman in labor has analgesia but is also able to ambulate. The medication used to confer epidural analgesia typically causes lower extremity motor weakness. With the “walking epidural” technique, a small concentration of local anesthetic with an opioid

is used to achieve analgesia while maintaining lower extremity motor function. There is no scientific evidence demonstrating a benefit with respect to obstetric outcome, but women are more satisfied when they can move their legs during labor.

- ▶ Analgesia During Labor and Delivery

## Wallerian Degeneration

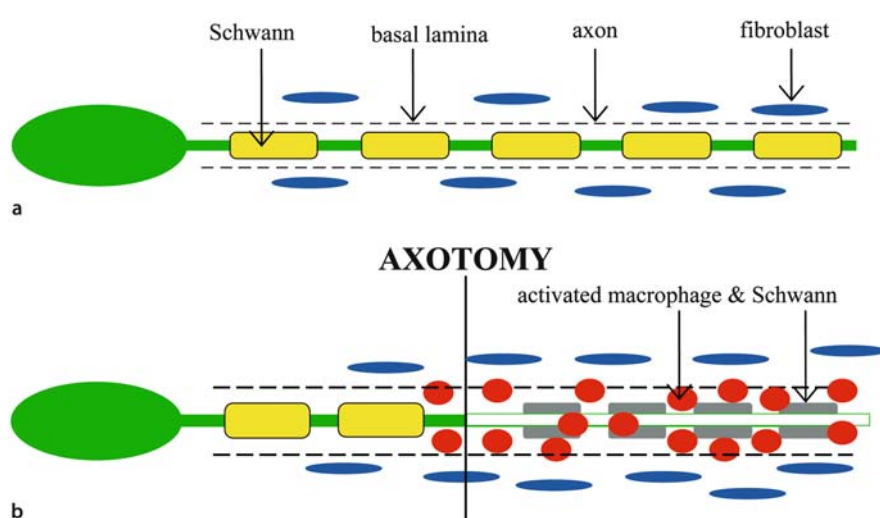
SHLOMO ROTSHENKER

Department of Anatomy & Cell Biology, Faculty of Medicine, Hebrew University of Jerusalem, Jerusalem, Israel

rotsh@md.huji.ac.il

### Definition

▶ **Wallerian degeneration (WD)** defines the array of cellular events that follow injury to peripheral nervous system (PNS) ▶ axons (Waller 1850). They take place throughout the nerve segment situated distal to a lesion site: anterograde degeneration. Notably, the term WD is sometimes used in reference to injury to central nervous system (CNS) axons, although cell types and cellular events differ substantially.

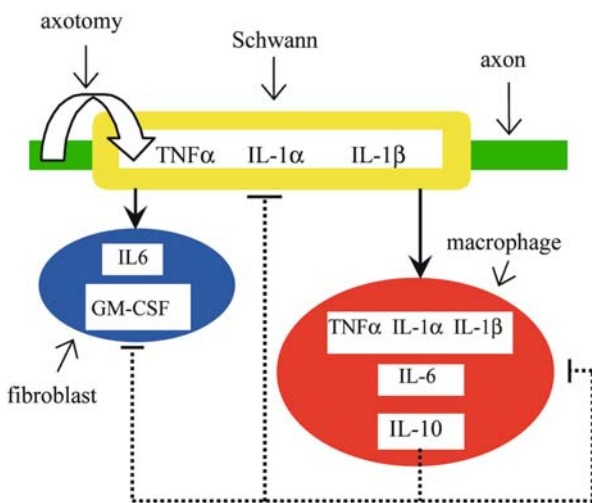


### Wallerian Degeneration,

**Figure 1** Intact (a) and injured (b) PNS. (a) Intact axons are surrounded by myelin forming Schwann cells, and fibroblasts are scattered between nerve fibers. (b) Axotomy is followed by rapid-WD throughout distal to and remote from the lesion site. Amongst others, axons degenerate, Schwann cells reject their myelin, macrophages are recruited, and macrophages and Schwann cells are activated to phagocytose myelin. In complete PNS injury all axons undergo rapid-WD. In partial PNS injury, lesioned axons and non-neuronal cells participating in rapid-WD are situated next to intact axons and their associated non-neuronal cells and receptors (envisage axons a and b next to each other).

## Characteristics

In intact PNS (Fig. 1a), ► **Schwann cells** surround axons and form myelin sheaths around the larger diameter sensory and motor axons. In between intact nerve fibers, ► **fibroblasts** and a few mast cells and macrophages are scattered. Endothelial cells are present within walls of capillaries that nourish the PNS tissue. In WD (Fig. 1b), amongst others, axons disintegrate, Schwann cells reject the myelin portion of their membrane and proliferate, fibroblasts proliferate, and as of the third day after injury numerous monocytes/macrophages are recruited from the circulation. Activated macrophages and Schwann cells complete the removal of degenerated myelin by phagocytosis within 8 to 12 days, which is significant to successful regeneration since myelin contains molecules that inhibit axonal growth. The simplistic view that WD emanates from the loss of metabolic support of axons due to disconnection from their cell bodies, is at most partial since in mutant C57/BL/Wld mice axon/myelin degeneration, ► **monocyte/macrophage** recruitment and myelin removal are delayed for many days after the injury. Thus, C57/BL/Wld mice display abnormal slow progression of WD (slow-WD) compared to the normal rapid progression of WD displayed, for example, by normal strain C57/BL mice described above (Brown et al. 1991, Reichert et al. 1994). Normal WD will be referred to as WD or rapid-WD.



**Wallerian Degeneration, Figure 2** The cytokine-network of WD. The cellular elements depicted are a resident Schwann cell surrounding an axon, a resident fibroblast and a recruited monocyte/macrophage. Solid lines represent induction/up-regulation and dotted lines represent production down-regulation of cytokine proteins. Axotomy induces the production of TNF $\alpha$  and IL-1 $\alpha$  in resident Schwann cells first. Sequentially thereafter follow IL-6 and GM-CSF production in resident fibroblasts and IL-1 $\beta$  production in resident Schwann cells. Monocytes/macrophages, which are recruited as of the third day after injury, produce the inflammatory cytokines TNF $\alpha$ , IL-1 $\alpha$ , IL-1 $\beta$  and IL-6, and the anti-inflammatory cytokine IL-10. IL-10 down-regulates the production of all inflammatory cytokines and itself in all non-neuronal cells. Monocytes/macrophages, which are recruited as of the third day after injury, produce the inflammatory cytokines TNF $\alpha$ , IL-1 $\alpha$ , IL-1 $\beta$  and IL-6, and the anti-inflammatory cytokine IL-10. IL-10 down-regulates the production of all inflammatory cytokines and itself in all non-neuronal cells. Not shown are low functionally insignificant levels of IL-10 produced by fibroblasts, and the ability IL-6 to down-regulate TNF $\alpha$  production. After Shamash et al. 2002.

WD can be viewed as the inflammatory response of the PNS to injury. The production of cytokines, the mediator molecules of inflammation, and the involvement of monocytes/macrophages, which are inflammatory/immune cells, indicate this. Detailed examinations of cytokine-mRNA expression and cytokine-protein synthesis and secretion in C57/BL mice, which display rapid-WD, indicate that cytokine production is orchestrated in time and magnitude, thereby forming the cytokine-network of WD (Fig. 2) (Rotshenker et al. 1992; Reichert et al. 1996; Saada et al. 1996; Be'eri et al. 1998; Shamash et al. 2002; Mirski et al. 2003). The producing of non-neuronal cell types, their spatial distribution in the PNS tissue, and the timing of monocyte/macrophage recruitment determine timing and magnitude. Schwann cells are the first to respond rapidly to axotomy, by producing the inflammatory cytokines ► **TNF Alpha( $\alpha$ )** followed by IL-1 $\alpha$ . The rapid response of Schwann cells is possible since: (1) they form intimate contact with axons and are thus the first among the non-neuronal cells to "sense" axonal injury, (2) they normally express TNF $\alpha$  and IL-1 $\alpha$  mRNAs, and (3) they normally contain low levels of TNF $\alpha$  protein. Fibroblasts follow by producing IL-6 and GM-CSF within 2 and 4-hours after injury, respectively. IL-6 and GM-CSF production can be induced by diffusible TNF $\alpha$  and IL-1 $\alpha$  synthesized and secreted by Schwann cells. IL-1 $\beta$ , whose onset of production by Schwann cells is delayed by 5 to 10-hours after injury, can further contribute to IL-6 and GM-CSF production. Schwann cell-derived TNF $\alpha$ , IL-1 $\alpha$  and IL-1 $\beta$  contribute to monocyte/macrophage recruitment directly and indirectly by inducing monocyte chemoattractant protein-1 (MCP-1) production in Schwann cells, fibroblasts and mast cells (Subang and Richardson 2001). These cytokines further induce recruited monocytes/macrophages to synthesize mostly IL-6, but also TNF $\alpha$ , IL-1 $\alpha$  and IL-1 $\beta$ . TNF $\alpha$ , IL-1 $\alpha$  and IL-1 $\beta$  further induce the production of anti-inflammatory cytokine IL-10 in fibroblasts and recruited monocytes/macrophages. Indeed, the onset of IL-10 production by fibroblasts is rapid, but levels of production are low and insignificant. High levels of IL-10 are produced by, and therefore concomitant with, monocyte/macrophage recruitment from the fourth day of WD. IL-10 then down-regulates the production of the inflammatory cytokines and itself, thereby down-regulating the inflammatory aspects of WD. Remarkably, all cytokines augment myelin phagocytosis by macrophages. The inflammatory nature of WD and the role of cytokines are supported by observations of deficient cytokine production in slow-WD in mutant C57/BL/Wld mice. Notably, TNF $\alpha$  and IL-1 $\alpha$  protein production fails in injured PNS of C57/BL/Wld mice, although their mRNAs are expressed, which suggests differential regulation between mRNA expression and protein synthesis. It is likely, therefore, that TNF $\alpha$  and IL-1 $\alpha$  play a critical role in setting the

normal cytokine-network and rapid-WD in-motion, and the failure of their production results in an abnormal deficient cytokine-network and slow-WD.

► **Neurotrophic factors** are an additional class of molecules whose expression is altered after PNS injury (e. g. reviewed in (Terenghi 1999)). For example, ► **nerve growth factor** (NGF), brain-derived neurotrophic factor (BDNF), neurotrophin-4 (NT-4), glial-derived neurotrophic factor (GDNF), and leukemia inhibitory factor (LIF) expressions are up-regulated in WD. In contrast, ciliary neurotrophic factor (CNTF) and NT-3 expressions are down-regulated in WD.

Cytokines and neurotrophic factors are closely associated. For example, NGF production up-regulation is integrated into the cytokine-network of WD. NGF mRNA expression and protein synthesis is efficient in rapid-WD but deficient in slow-WD (Brown et al. 1991). This discrepancy can be partially explained by: (1) efficient versus deficient TNF $\alpha$ , IL-1 $\alpha$  and IL-1 $\beta$  production in rapid- and slow-WD, respectively (see above), and (2) the induction of NGF production in fibroblasts by these cytokines (Hattori et al. 1994). Furthermore, some molecules display both neurotrophic factor and cytokine properties; for example, IL-6, LIF and CNTF (Patterson 1994, Stahl and Yancopoulos 1994).

Delayed and reduced neuropathic pain in C57/BL/Wld mice that display slow-WD (Myers et al. 1996), and the ability to provoke neuropathic pain by inducing inflammation without axonal injury (Safieh-Garabedian et al. 1995, Woolf et al. 1997, Eliav et al. 2001), suggest that the molecular events associated with WD play a major role in the development of neuropathic pain (e. g. IL-1 $\beta$ , TNF $\alpha$ , and NGF). There are several potential sites of action for molecules produced in WD. First, secreted/diffusible molecules may act upon the producing and neighboring non-neuronal cells in an autocrine/paracrine fashion. For example, TNF $\alpha$  and IL-1 $\alpha$  secreted from Schwann cells may induce productions, amongst others, of IL-6, GM-CSF, MCP-1 and NGF in nearby fibroblasts. Second, in instances of partial PNS injury, some axons are cut but others remain intact (Fig. 1; envisage axons a and b next to each other). Molecules (e. g. TNF $\alpha$  and NGF) secreted from the non-neuronal cells that participate in WD may affect neighboring intact axons, myelinated and non-myelinated, their surrounding Schwann cells and sensory receptors/endings to alter electrical properties and thresholds, mechanisms suggested to be instrumental in the pathophysiology of neuropathic pain (e. g. Wu et al. 2002). Third, at the neuroma site, the region immediately proximal to the injury site (<1 mm in length), non-neuronal cells may produce cytokines and neurotrophic factors (e. g. documented for IL-1 $\alpha$ , IL-6, IL-10, and NGF), which, in turn, may affect properties of lesioned axons and surrounding non-neuronal cells (Zimmermann 2001). Fourth, secreted molecules (e. g.

NGF, BDNF, NT-3/4, CNTF and LIF, Curtis et al. 1998) can be taken up by lesioned axons, and reach sensory and motor nerve cell bodies by retrograde axonal transport, where they may affect cell survival and phenotype. It is unclear to what extent this mechanism replaces target-derived retrograde transport of neurotrophic factors occurring under normal conditions.

- **Cytokines, Upregulation in Inflammation Neuropathic Pain Model, Chronic Constriction Injury**
- **Dorsal Root Ganglionectomy and Dorsal Rhizotomy**
- **Neuropathic Pain Model, Diabetic Neuropathy Model**
- **Painless Neuropathies**
- **Viral Neuropathies**

## References

1. Be'eri H, Reichert F, Saada A, Rotshenker S (1998) The Cytokine Network of Wallerian Degeneration: IL-10 and GM-CSF. *Eur J Neurosci* 10:2707–2713
2. Brown MC, Perry VH, Lunn ER, Gordon S, Heumann R (1991) Macrophage Dependence of Peripheral Sensory Nerve Regeneration: Possible Involvement of Nerve Growth Factor. *Neuron* 6:359–370
3. Curtis R, Tonra JR, Stark JL, Adryan KM, Park JS, Cliffer KD, Lindsay RM, DiStefano PS (1998) Neuronal Injury Increases Retrograde Axonal Transport of the Neurotrophins to Spinal Sensory Neurons and Motor Neurons via Multiple Receptor Mechanisms. *Mol Cell Neurosci* 12:105–118
4. Eliav E, Benoliel R, Tal M (2001) Inflammation with No Axonal Damage of the Rat Saphenous Nerve Trunk Induces Ectopic Discharge and Mechanosensitivity in Myelinated Axons. *Neurosci Lett* 311:49–52
5. Hattori A, Iwasaki S, Murase K, Tsujimoto M, Sato M, Hayashi K, Kohno M (1994) Tumor Necrosis Factor is Markedly Synergistic with Interleukin 1 and Interferon-Gamma in Stimulating the Production of Nerve Growth Factor in Fibroblasts. *FEBS Lett* 340:177–180
6. Mirski R, Reichert F, Klar A, Rotshenker S (2003) Granulocyte Macrophage Colony Stimulating Factor (GM-CSF) Activity is Regulated by a GM-CSF Binding Molecule in Wallerian Degeneration Following Injury to Peripheral Nerve Axons. *Journal of Neuroimmunology* 140:88–96
7. Myers RR, Heckman HM, Rodriguez M (1996) Reduced Hyperalgesia in Nerve-Injured WLD Mice: Relationship to Nerve Fiber Phagocytosis, Axonal Degeneration, and Regeneration in Normal Mice. *Exp Neurol* 141:94–101
8. Patterson PH (1994) Leukemia Inhibitory Factor, a Cytokine at the Interface Between Neurobiology and Immunology. *Proc Natl Acad Sci USA* 91:7833–7835
9. Reichert F, Levitzky R, Rotshenker S (1996) Interleukin 6 in Intact and Injured Mouse Peripheral Nerves. *Eur J Neurosci* 8:530–535
10. Reichert F, Saada A, Rotshenker S (1994) Peripheral Nerve Injury Induces Schwann Cells to Express Two Macrophage Phenotypes: Phagocytosis and the Galactose-Specific Lectin MAC-2. *J Neurosci* 14:3231–3245
11. Rotshenker S, Aamar S, Barak V (1992) Interleukin-1 Activity in Lesioned Peripheral Nerve. *J Neuroimmunol* 39:75–80
12. Saada A, Reichert F, Rotshenker S (1996) Granulocyte Macrophage Colony Stimulating Factor Produced in Lesioned Peripheral Nerves Induces the Up-Regulation of Cell Surface Expression of MAC-2 by Macrophages and Schwann Cells. *J Cell Biol* 133:159–167
13. Safieh-Garabedian B, Poole S, Allchorne A, Winter J, Woolf CJ (1995) Contribution of Interleukin-1 Beta to the Inflammation-Induced Increase in Nerve Growth Factor Levels and Inflammatory Hyperalgesia. *Br J Pharmacol* 115:1265–1275
14. Shamash S, Reichert F, Rotshenker S (2002) The Cytokine Network of Wallerian Degeneration: Tumor Necrosis Factor-

- alpha, Interleukin-1alpha, and Interleukin-1beta. *J Neurosci* 22:3052–3060
15. Stahl N, Yancopoulos GD (1994) The Tripartite CNTF Receptor Complex: Activation and Signaling Involves Components Shared with Other Cytokines. *J Neurobiol* 25: 1454–1466
  16. Subang MC, Richardson PM (2001) Influence of Injury and Cytokines on Synthesis of Monocyte Chemoattractant Protein-1 mRNA in Peripheral Nervous Tissue. *Eur J Neurosci* 13:521–528
  17. Terenghi G (1999) Peripheral Nerve Regeneration and Neurotrophic Factors. *J Anat* 194 (Pt 1):1–14
  18. Waller A (1850) Experiments on the Section of the Glossopharyngeal and Hypoglossal Nerves of the Frog. Observations of the Alterations Produced Thereby in the Structure of their Primitive Fibers. *Phil Transact Royal Soc London* 140:423–429
  19. Woolf CJ, Allchorne A, Safieh-Garabedian B, Poole S (1997) Cytokines, Nerve Growth Factor and Inflammatory Hyperalgesia: The Contribution of Tumour Necrosis Factor Alpha. *Br J Pharmacol* 121:417–424
  20. Wu G, Ringkamp M, Murinson BB, Pogatzki EM, Hartke TV, Weerahandi HM, Campbell JN, Griffin JW, Meyer RA (2002) Degeneration of Myelinated Efferent Fibers Induces Spontaneous Activity in Uninjured C-Fiber Afferents. *J Neurosci* 22:7746–7753
  21. Zimmermann M (2001) Pathobiology of Neuropathic Pain. *Eur J Pharmacol* 429:23–37

## Warm Allodynia

### Definition

Allodynia evoked by a warm stimulus.

- ▶ [Neuropathic Pain Model, Tail Nerve Transection Model](#)

## WDR Neurons

- ▶ [Wide Dynamic Range Neuron](#)

## Wegener's Granulomatosis (WG)

### Definition

A rare systemic necrotizing vasculitis associated with antineutrophil cytoplasm antibodies (c-ANCA) leading to affections of the lung and kidney.

- ▶ [Headache Due to Arteritis](#)

## Weighted Scores Technique

### Definition

The weighted scores technique identifies four distinct categories (0 = injected paw is not favored, 1 = injected paw has little or no weight on it, 2 = injected paw is elevated and not in contact with any surface, 3 = injected paw is licked, bitten or shaken). A weighted pain score (which ranges from 0 to 3) is calculated by multiplying the time spent in each category by the category weight,

summing these products and dividing by the total time in a given time interval.

- ▶ [Formalin Test](#)

## Weight-Lifter's Headache

- ▶ [Primary Exertional Headache](#)

## Well Behaviours

### Definition

Behaviors that are pain-incompatible and related to health.

- ▶ [Operant Treatment of Chronic Pain](#)

## Wernicke-Korsakoff Syndrome

### Definition

This consists of two distinct syndromes caused by the same pathology. Wernicke syndrome describes ophthalmoparesis, ataxia and global confusion. Korsakoff syndrome affects cognitive function, and is dominated by both anterograde and retrograde amnesia often associated with confabulation and impaired insight.

- ▶ [Metabolic and Nutritional Neuropathies](#)

## West Haven-Yale Multidimensional Pain Inventory

### Synonyms

WHYMPI

### Definition

The West Haven-Yale Multidimensional Pain Inventory (WHYMPI) is a multidimensional self-report instrument that consists of 52 questions, and is designed to measure psychosocial and behavioral aspects of chronic pain across a variety of clinical populations.

- ▶ [Pain Inventories](#)

## WGA-HRP

### Definition

Wheat germ agglutinine coupled with horseradish peroxidase. This protein is extracted from wheat and coupled to an enzyme that has a high affinity for the soma and axon of a neuron. It migrates in both retrograde (antidromic) and anterograde (orthodromic) directions. It



labels somata of afferent projections and, less effectively than PHA-L, efferent axonal projections.

► **Parabrachial Hypothalamic and Amygdaloid Projections**

## Whiplash

MICHELE CURATOLO<sup>1</sup>, NIKOLAI BOGDUK<sup>2</sup>

<sup>1</sup>Department of Anesthesiology, Division of Pain Therapy, University Hospital of Bern Inselspital, Bern, Switzerland

<sup>2</sup>Department of Clinical Research, Royal Newcastle Hospital, Newcastle, NSW, Australia  
michele.curatolo@insel.ch

### Synonyms

Whiplash syndrome; acceleration-deceleration injury; Whiplash-Associated Disorders

### Definition

The term ► **whiplash**, is used to describe both an event and an injury. The whiplash event is the movement experienced by the head and neck during a motor vehicle accident in which no force is directly exerted onto the head. The whiplash injury is the injury that may occur to the neck as a result of this movement. The symptoms that arise from either the event or the injury are described as a whiplash-associated disorder (WAD).

### Characteristics

#### Aetiology

Classically, whiplash occurs during a rear-end collision. However, only about 45 % of cases of WAD arise from rear-end collisions. The remainder occur in front-end, side-impact, and combined collisions (Bogduk 2000).

#### Clinical Features

Not all patients involved in a whiplash event suffer, or seek treatment for, symptoms. In those that do, the symptoms typically arise within 24 hours of the event. Patients who do develop symptoms in this period are three times more likely to suffer chronic neck pain than members of the general community, or individuals who do not develop symptoms after a motor vehicle accident (Berglund et al. 2000).

In the acute phase, the most frequent symptoms are neck pain and headache. Other features that can occur in a minority of patients include anxiety, sleep disturbances, back pain, visual disturbances, dizziness, inability to concentrate, and other cognitive disturbances (Barnsley et al. 2002). In patients who do not recover, these same symptoms persist, but with greater prevalence in affected individuals, together with psychological distress (Radanov et al. 1995). In the chronic phase, patients display ► **hyperalgesia** to stimuli applied to

both painful and non-painful areas of the body (Banic et al. 2004).

### Natural History and Prognostic Factors

Most patients who suffer a whiplash-associated disorder recover. Two years after injury, 82 % of patients are asymptomatic (Radanov et al. 1995). For those who do not recover, increasing age, injury-related cognitive disturbances, and the severity of initial neck pain predict the persistence of symptoms at 6 months (Radanov et al. 1991). The chance of spontaneous recovery after two years is minimal.

### Mechanisms

During the whiplash event, the torso is thrust upwards and forwards, and compresses the neck from below. Initially, the cervical spine undergoes a sigmoid deformation, but subsequently the head drops into extension, and later rebounds into flexion (Bogduk and Yoganandan 2001). At no time does the head and neck exceed normal physiologic range of motion. The offending insult is the initial compression and sigmoid deformation of the cervical spine. During this motion, the lower vertebrae undergo an abnormal pattern of extension, in which anteriorly, the intervertebral discs are strained; and posteriorly, the zygapophysial joints are impacted (Bogduk and Yoganandan 2001). Injury to these structures may or may not occur, depending on the severity of impact, and the morphology and strength of the vertebrae and their joints and ligaments.

Most patients suffer no substantive or lasting injury, but a minority does. Tears of the ► **annulus fibrosus** and contusion or small fractures of the zygapophysial joints have been demonstrated in postmortem studies, but these defy resolution by current medical imaging techniques (Yoganandan et al. 2001); giving the false impression that no injury is present.

The frequent absence of evident tissue damage has led to the hypothesis that psychosocial factors are the main determinants of symptoms. However, psychological disturbances do not predict the clinical course of whiplash patients (Radanov et al. 1991), and there is no evidence that therapies aiming at correcting these disturbances consistently produce resolution of symptoms. The persistence of pain, and the legal and economic consequences that often follow a whiplash-associated disorder, may cause psychological distress, which may contribute to the pain complaints. However, there is no evidence that psychological factors *per se* cause persistent pain.

Hypersensitivity of central nociceptive pathways in chronic whiplash patients has been demonstrated objectively using electrophysiological measurements (Banic et al. 2004). This central hyperexcitability may amplify the nociceptive signal arising from areas of minimal and undetectable tissue damage, which could partly explain the discrepancy between objective clinical

cal findings and extent of pain and disability that occurs in these patients. Importantly, these data indicate that increased pain sensitivity at non-painful areas does not necessarily imply hysteria, a conclusion that is still made by too many physicians.

In summary, the most likely cause of persistent pain and disability after a whiplash trauma is an occult injury to a zygapophysial joint or an intervertebral disc, caused by the acute distortion of the spine. The resulting psychological distress, as well as central neural hypersensitivity, is likely to amplify symptoms.

### Physical Examination

Both in the acute phase and in patients with chronic pain, physical examination may detect areas of tenderness and impaired range of movement of the neck. These signs, however, are not reliable, lack ► **validity** (Bogduk 2003), and do not permit a patho-anatomic diagnosis to be made.

Neurological examination is usually normal, but a small proportion of patients may suffer cervical disc prolapse and nerve root compression as a result of whiplash. These patients will exhibit signs of ► **radiculopathy**.

### Investigations

Medical imaging is not indicated for patients with just neck pain after whiplash. According to the Canadian C-Spine Rule, radiography is not justified in a patient who has been in a motor-vehicle collision and can rotate their neck at least 45° to the left and right (Stiell et al. 2001). Magnetic resonance imaging is of no diagnostic value for most patients (Bogduk 2003). It is indicated only in those patients with neurological signs.

In patients with chronic neck pain after whiplash, the zygapophysial joints are the single most common source of pain (Lord et al. 1996), but zygapophysial joint pain cannot be diagnosed by physical examination or medical imaging (Bogduk 2003). It requires controlled diagnostic blocks performed under fluoroscopic guidance. Even if performed correctly, these diagnostic blocks cannot pinpoint the painful joint (or joints) in over 50 % of patients (Bogduk 2003).

### Treatment

Given the favourable prognosis of acute pain after whiplash, the first imperative is for the physician to reassure the patient of the high likelihood of complete recovery. Passive therapy is not indicated and, indeed, the evidence shows that conventional interventions do not work (Bogduk 2003). The evidence supports only reassuring the patient, encouraging them to resume normal activities, and to keep the neck moving through simple exercises that the patient can do regularly, themselves, at home (Bogduk 2003). Analgesics may be prescribed to reduce pain, but no evidence supports their efficacy.

For patients with acute neurological symptoms, one study has shown that high-dose intravenous ► **methyl-prednisolone** was effective in reducing the number of sick days (Pettersson and Toolanen 1998); but this treatment may not apply for patients who do not have radiculopathy.

For patients with chronic neck pain after whiplash, few treatments have been vindicated by controlled studies. There are no data on the efficacy of short-wave diathermy, collars, traction, transcutaneous electrical nerve stimulation (TENS), laser therapy, neck school, spray and stretch or trigger point therapy. Magnetic necklaces, acupuncture, and physiotherapy are no better than sham therapy (Bogduk 2003). Manual therapy is no more effective than using salicylates while on a waiting list. Intensive exercises are no more effective than less intensive exercises; both achieve only modest improvements (25 %) in pain and disability (Bogduk 2003). Intra-articular injections of corticosteroids for cervical zygapophysial joint pain offer no long-term and little short-term benefit (Barnsley et al. 1994).

Multidisciplinary biopsychosocial rehabilitation programs are widely used. However, these treatment programs are expensive and still lack convincing evidence of effectiveness (Karjalainen et al. 2001). One uncontrolled study attests to the efficacy of a four-week, multimodal treatment program involving graded return to activity, abolishing pain behavior, and restoring muscle strength and endurance (Vendrig et al. 2000). At six months follow-up, cognitive and behavioral complaints were eliminated in some 90 %; 65 % of patients returned to work, 58 % ceased to use drugs; and 81 % ceased to pursue medical care; pain was reduced to “healthy” levels in 46 % of patients; disabilities were reduced to normal levels in 38 %.

A further option for pain-relief may be the long-term use of analgesics. Unfortunately, however, there is no evidence of their efficacy. Opioids may be required for severe, persistent pain; but these need to be prescribed and monitored carefully.

► **Radiofrequency denervation** of painful zygapophysial joints is the only treatment that has been vindicated by a randomized, double-blind, placebo-controlled trial (Lord et al. 1996), and subsequent, long-term follow-up studies (Bogduk 2003). This procedure is indicated only in those patients in whom controlled diagnostic blocks have identified the joint responsible for the patient's pain. Successful treatment of the pain also results in resolution of the psychological distress suffered by these patients (Bogduk 2003).

### Discussion

Pain after whiplash injury is a temporary experience for most patients: spontaneous healing is almost the rule. Patients with persistent symptoms, however, constitute an important medical and social problem.

As patients with persisting pain lack conventional, objective signs of organic lesions, they are often treated in a pejorative manner. Resources, such as zygapophysial joint blocks, by which the source of pain can be determined, are not readily available or are not implemented. Conventional therapies have been found to have little or no effect, and few practitioners are able to implement those few interventions that have been shown to be effective. As a result of these factors, patients continue to suffer pain and disability. Beyond the misfortune of getting an illness that changes their life, patients are confronted with the new experience of having to fight insurance companies, employers and doctors, to convince them that they really “do have something wrong with their neck.” The resulting psychological distress is an obvious consequence of this state of affairs, but is not the cause of the problem.

Patients with acute neck pain after whiplash have the advantage of a favorable prognosis. Being reassured and resuming normal activities is all that they may require for recovery. For patients with persisting pain after whiplash, two main problems apply. First is the lack of reliable diagnostic tools to identify the source of pain. The most honest approach by the physician is to declare and explain this deficiency, as opposed to insisting that there is nothing wrong. The second problem is the lack of proven treatments. This too should be explained, rather than causing unrealistic hopes. Radiofrequency denervation is the only proven treatment, but is provided by very few practitioners.

## References

1. Banic B, Petersen-Felix S, Andersen OK, Radanov BP, Villiger PM, Arendt-Nielsen L, Curatolo M (2004) Evidence for Spinal Cord Hypersensitivity in Chronic Pain after Whiplash Injury and in Fibromyalgia. *Pain* 107:7–15
2. Barnsley L, Lord SM, Bogduk N (2002) The Pathophysiology of Whiplash. In: Malanga GA, Nadler SF (eds) *Whiplash*. Hanley & Belfus, Philadelphia, pp 41–77
3. Barnsley L, Lord SM, Wallis BJ et al. (1994) Lack of Effect of Intraarticular Corticosteroids for Chronic Pain in the Cervical Zygapophysial Joints. *N Engl J Med* 330:1047–1050
4. Berglund A, Alfredsson L, Cassidy JD et al. (2000) The Association between Exposure to a Rear-End Collision and Future Neck or Shoulder Pain: A Cohort Study. *J Clin Epidemiol* 53:1089–1094
5. Bogduk N (2000) An overview of whiplash. In: Yoganandan N, Pintar FA (eds) *Frontiers in Whiplash Trauma*. IOS Press, Amsterdam, pp 3–9
6. Bogduk N (2003) Neck Pain and Whiplash. In: Jensen TS, Wilson PR, Rice ASC (eds) *Clinical Pain Management: Chronic Pain*. Arnold, London, pp 504–519
7. Bogduk N, Yoganandan N (2001) Biomechanics of the Cervical Spine Part 3: Minor Injuries. *Clinical Biomechanics (Bristol, Avon)* 16:267–275
8. Karjalainen K, Malmivaara A, van Tulder M et al. (2001) Multidisciplinary Biopsychosocial Rehabilitation for Neck and Shoulder Pain among Working Age Adults: A Systematic Review within the Framework of the Cochrane Collaboration Back Review Group. *Spine* 26:174–181
9. Lord SM, Barnsley L, Wallis BJ et al. (1996) Percutaneous Radiofrequency Neurotomy for Chronic Cervical Zygapophysial Joint Pain. *N Engl J Med* 335:1721–1726
10. Pettersson K, Toolanen G (1998) High-Dose Methylprednisolone Prevents Extensive Sick Leave after Whiplash Injury. A Prospective, Randomized, Double-Blind Study. *Spine* 23:984–989
11. Radanov BP, Di Stefano G, Schnidrig A et al. (1991) Role of Psychosocial Stress in Recovery from Common Whiplash. *Lancet* 338:712–715
12. Radanov BP, Sturzenegger M, Di Stefano G (1995) Long-Term Outcome after Whiplash Injury. A 2-Year Follow-Up Considering Features of Injury Mechanism and Somatic, Radiologic, and Psychosocial Findings. *Medicine* 74:281–297
13. Stiell IG, Wells GA, Vandemheen KL et al. (2001) The Canadian C-Spine Rule for Radiography in Alert and Stable Trauma Patients. *Jama* 286:1841–1848
14. Vendrig AA, van Akkerveeken PF, McWhorter KR (2000) Results of a Multimodal Treatment Program for Patients with Chronic Symptoms after a Whiplash Injury of the Neck. *Spine* 25:238–244
15. Yoganandan N, Cusick JF, Pintar FA et al. (2001) Whiplash Injury Determination with Conventional Spine Imaging and Cryomicrotomy. *Spine* 26:2443–2448

## Whiplash-Associated Disorders

### ► Whiplash

## WHO Analgesic Ladder

### ► World Health Organization (WHO) Analgesic Ladder

## WHO System on Impairment and Disability

JENNY STRONG

University of Queensland, Brisbane, QLD, Australia  
j.strong@uq.edu.au

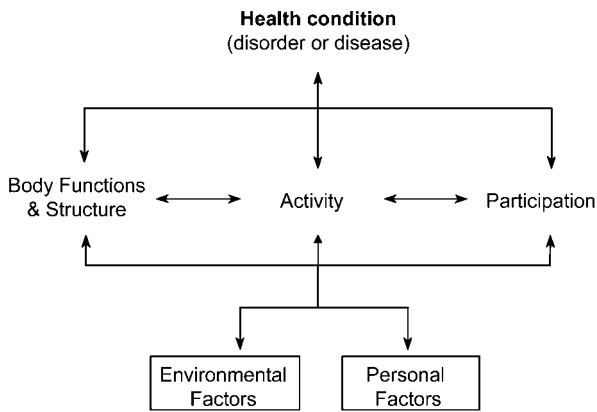
### Synonym

World Health Organisation International Classification of Functioning; Disability and Health (ICF)

### Definition

The World Health Organisation’s (WHO) International Classification of Functioning, Disability and Health (ICF) (WHO 2001), replaces the earlier WHO International Classification of Impairments, Disabilities and Handicaps (WHO 1980). The ICF provides a framework for health practitioners to evaluate the impact of health conditions upon particular individuals. Against the background of contextual, personal and environmental factors, the impact of the health condition upon the person is considered in terms of the interaction between body structures and functions, activities, and participation (Gibson and Strong 2003; WHO 2001). The ICF model conceptualizes the functional aspects of health, moving from an impairment focused or deficit focused framework to a participative framework. This is in contrast to the old ICIDH (WHO 1980) that focused upon impairments, activity limitations, and handicaps.

W



**WHO System on Impairment and Disability, Figure 1** Interaction of Concepts ICF 2001 (World Health Organisation 2001), reproduced with permission.

The WHO ICF model is illustrated in Figure 1. Instead of focusing on impairments, which are problems in body function such as significant deviation or loss, attention is given to not only the difficulties the person may have in executing activities but also to the problems the person has being involved in life situations.

**Characteristics**

The ICF (<http://www.who.int>) was developed to provide a unified and universally understood language to describe the outcomes of all health conditions (Gray and Hendershot 2000). It provides a useful framework for considering the impacts of chronic pain upon the individual client or patient. It is also suggested as a useful framework for considering the outcomes of pain rehabilitation programs. The ICF particularly directs the health practitioner to be clear as to the level at which they are measuring outcomes, viz, are they confining their outcome assessment to body structures and impairment based systems (e.g. active and passive range of motion, allodynia and presence of vasomotor and sudomotor changes); or are they considering outcomes in terms of activity limitations or participation restrictions (e.g. ADLs, and life roles) (Unsworth 2000). Furthermore, are the individual patient’s particular personal and environmental factors being considered in such outcome measurement (e.g. financial pressures upon the family unit, and fear of failure).

Personal factors to be considered may include sex, age, co-morbidities, usual coping style, social background and education, job, past experiences, and type of personality. Patients with chronic pain are embedded within contexts that can facilitate or hinder their rehabilitation. Environmental factors may be familial, work-related, cultural, political, societal, or of the built environment (WHO 2001).

Use of the ICF framework can assist in the measurement of outcomes of relevance for the individual client/patient, the health care provider and the insurer or employer. The patient will most probably be concerned with the elimination of pain, an increase in function, and a return to work. The health care professional will be concerned with pain control, assisting the patient to gain an increase in function, and a decrease in suffering. The insurer or employer will primarily be concerned with return to work.

The value of the ICF framework is illustrated by considering the case of a 42-year old man who sustained a soft tissue injury at work, and developed complex regional pain syndrome Type I (CRPSI). The patient was a miner and sole provide for the family. He was married with 2 children. Assessment using a body structures and impairment framework revealed he had no active range of motion of his right hand (guarding), a reduced passive range of motion of his right hand, allodynia, and marked vasomotor and sudomotor changes.

Considering the patient’s ability to engage in activities, he reported limitations in all functional activities that required bilateral upper limb involvement, including personal activities of daily living, e.g. pushing, lifting, using controls (driving), handling, and carrying tasks. He was fearful of increased pain, and therefore self-limited many of his instrumental activities such as walking near other people, or going out of the house to shop or socialize. He reported reduced participation in all home-based activities, and was currently off work. There were significant financial pressures upon his family. This was combined with self-esteem problems he faced, having been ‘transformed’ from a strong, independent, successful miner to a weak, disabled person. His employer and fellow workers did not understand his pain problem, and suspected he was malingering. His current problems with body function would preclude him from working with heavy machinery in an underground mine.

**WHO System on Impairment and Disability, Table 1** Assessment Matrix, based upon the WHO ICF 2001

Body function and structures	Activities	Participation
Muscle testing	ADL assessment	Home assessment
Range of Motion testing	Functional Capacity Evaluation	Work-place assessment*
NB Psychosocial assessment of personal factors		

\* Ergonomic assessment of environmental factors



The ICF provides a useful framework for evaluating such patients with chronic pain, and highlights the multidimensional nature of assessment, enabling a matrix of outcome measurements to be identified for use in a pain rehabilitation program. A possible matrix is illustrated in Table 1.

By using an assessment matrix such as the one in Table 1, which is based upon the WHO ICF, it is easier for health practitioners working with patients with pain, and pain clinics in general, to ensure that the focus of assessment is not only focused upon the impairment, or body function and structures level. Good outcomes for pain treatments should be focused upon the activities and participation levels as indicated by the WHO ICF classification. It is the outcome at these levels that are of most salience to patients and to insurers, and surely to health practitioners.

### References

1. Gibson L, Strong J (2003) A Conceptual Framework of Functional Capacity Evaluation for Occupational Therapy in Work Rehabilitation. *Australian Occupational Therapy Journal* 50:64–71
2. Gray DB, Hendershot GE (2000) The ICDH-2: Developments for a New Era of Outcomes Research. *Arch Phys Med Rehabil* 81 (Suppl 2):S10–S14
3. Unsworth C (2000) Measuring of Outcome of Occupational Therapy: Tools and Resources. *Australian Occupational Therapy Journal* 47:147–158
4. World Health Organisation (1980) *International Classification of Impairments, Disabilities, and Handicaps*. World Health Organisation, Geneva
5. World Health Organisation (2001) *The International Classification of Functioning, Disability and Health (ICF)*. World Health Organisation, Geneva

## Whole Body Receptive Fields

### Definition

Stimulation anywhere on the body activates these neurons.

- ▶ Spinothalamocortical Projections to Ventromedial and Parafascicular Nuclei

## Whole-Brain/Partial Brain Coverage

### Definition

The most common forms of functional imaging employ whole-brain coverage. This means that signal changes are measured throughout the whole brain. However, to achieve greater spatial resolution, e.g. for a study of differences between hippocampus and entorhinal cortex processing (or if faster acquisition of data is required), one option is to acquire a signal from a smaller section of the brain only (partial brain coverage).

- ▶ Hippocampus and Entorhinal Complex, Functional Imaging

## Whole Cell Patch Clamp Recordings

### Definition

Recording of membrane currents in an intact cell by applying gentle suction to a micropipette patched onto the cell membrane to create an opening.

- ▶ Amygdala, Pain Processing and Behavior in Animals

## WHYMPI

- ▶ West Haven-Yale Multidimensional Pain Inventory

## Wide Dynamic Range Neuron

### Synonym

WDR neuron

### Definition

Wide dynamic range (WDR) neurons are nociceptive neurons that respond with small responses to innocuous pressure to deep tissue, and stronger and graded responses to noxious mechanical stimulation of peripheral tissues. They often also respond to noxious, thermal and chemical stimuli. This type of neuron is defined physiologically by its response properties and can be found at spinal thalamic and cortical sites important in the processing of noxious information.

- ▶ Alternative Medicine in Neuropathic Pain
- ▶ Arthritis Model, Kaolin-Carrageenan Induced Arthritis (Knee)
- ▶ Encoding of Noxious Information in the Spinal Cord
- ▶ Freezing Model of Cutaneous Hyperalgesia
- ▶ Functional Changes in Sensory Neurons Following Spinal Cord Injury in Central Pain
- ▶ Human Thalamic Nociceptive Neurons
- ▶ Lateral Thalamic Pain-Related Cells in Humans
- ▶ Nick Model of Cutaneous Pain and Hyperalgesia
- ▶ Referred Muscle Pain, Assessment
- ▶ Spinothalamic Input, Cells of Origin (Monkey)
- ▶ Thalamic Nuclei Involved in Pain, Human and Monkey
- ▶ Thalamus, Nociceptive Cells in VPI, Cat and Rat
- ▶ Trigeminal Brainstem Nuclear Complex, Physiology
- ▶ Wind-Up of Spinal Cord Neurons

## Wide Field Radiation

### Definition

Radiation of a large area.

- ▶ Cancer Pain Management, Radiotherapy

## Wind-Up (Phenomenon)

### Definition

Repetitive stimulation of unmyelinated C-fibers can result in prolonged discharge of dorsal horn cells, termed “wind-up” It is characterized by a progressive increase in the number of action potentials elicited, per stimulus, which occurs in dorsal horn neurons. “Wind-up” is a short-lived process, however, repetitive episodes may precipitate long-term potentiation (LTP), which involves a long lasting increase in the efficacy of synaptic transmission and thus alters synaptic plasticity. Both “wind-up” and LTP are believed to be important components of central sensitization.

- ▶ [Acute Pain Mechanisms](#)
- ▶ [Brainstem Subnucleus Reticularis Dorsalis Neuron](#)
- ▶ [Encoding of Noxious Information in the Spinal Cord](#)
- ▶ [Hyperpathia, Assessment](#)
- ▶ [Neuropathic Pain Models, CRPS-I Neuropathy Model](#)
- ▶ [Opioids in the Spinal Cord and Central Sensitization](#)
- ▶ [Opioid Modulation of Nociceptive Afferents In Vivo](#)
- ▶ [Postoperative Pain, Pre-Emptive or Preventive Analgesia](#)
- ▶ [Psychiatric Aspects of Pain and Dentistry](#)
- ▶ [Quantitative Sensory Testing](#)
- ▶ [Somatic Pain](#)
- ▶ [Spinothalamic Tract Neurons, in Deep Dorsal Horn](#)
- ▶ [Visceral Nociception and Pain](#)
- ▶ [Wind-Up of Spinal Cord Neurons](#)

## Wind-Up of Spinal Cord Neurons

JUAN F. HERRERO

Department of Physiology, Edificio de Medicina,  
University of Alcalá, Madrid, Spain  
juanf.herrero@uah.es

### Synonyms

Frequency-Dependent Nociceptive Facilitation

### Definition

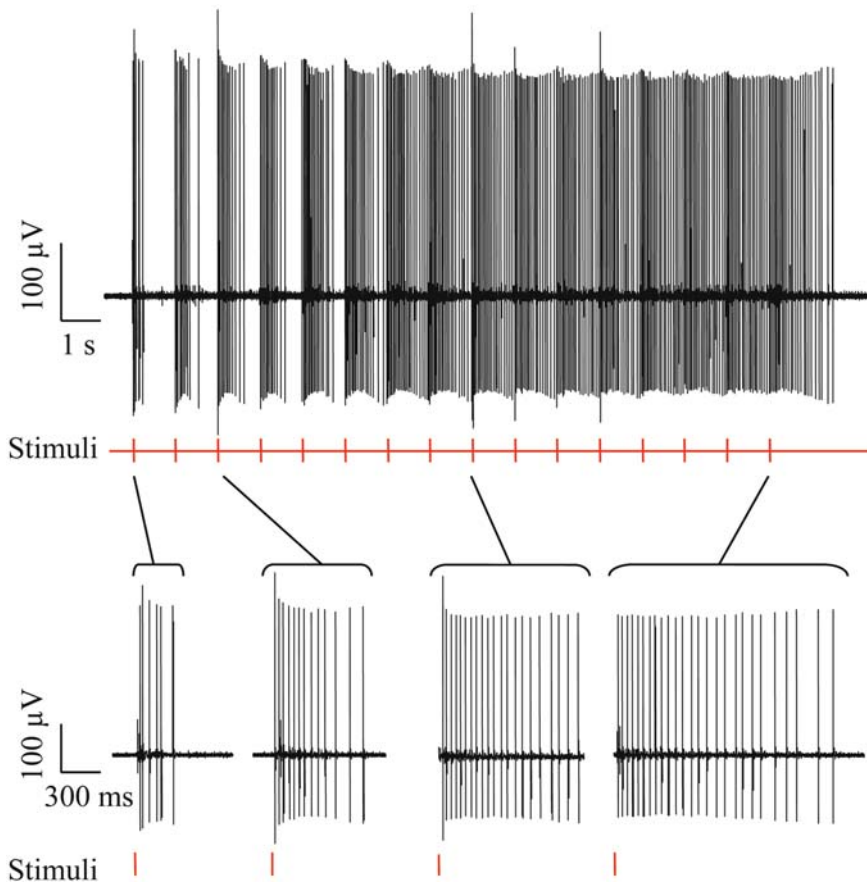
Progressive and frequency-dependent facilitation of the responses of a spinal cord neuron observed on the application of constant and high intensity repetitive electrical stimuli. It is a phenomenon that shares some common mechanisms with central sensitization and is mediated by ▶ [NMDA receptors](#) and ▶ [NK1 receptors](#), although cyclooxygenases, nitric oxide, TRH, adenosine and other systems are also involved in its generation or maintenance.

### Characteristics

Wind-up is a phenomenon described in terms of neuronal responses to repetitive electrical stimulation. It can be defined as a progressive and frequency-dependent facilitation of the responses of a spinal cord neuron observed on the application of constant and high intensity repetitive electrical stimuli. It was first described by Lorne Mendell (Mendell and Wall 1965) as a frequency-dependent facilitation of spinal cord neuronal responses mediated by afferent C-fibers, suggesting that it might be due to a reverberatory activity evoked by C-fibers in interneurons of the spinal cord. Systematic studies of the *in vivo* activity of spinal cord neurons (Schouenborg and Sjölund 1983) established that under normal conditions, wide dynamic range or class 2 neurons showed the most pronounced wind-up, whereas classes 1 and 3, equivalent to low threshold and high threshold neurons, showed a very weak response. Wind-up is also observed in nociceptive withdrawal reflexes recorded as single motor units (SMU), spinal cord field potentials, isolated *in vitro* spinal recordings from immature rats (see for review Herrero et al. 2000) or even dorsal horn neurons in cell culture (Vikman et al. 2001). The generation of wind-up depends critically on the frequency of stimulation of afferent C-fibers. The greatest wind-up is seen at frequencies of around 1–2 Hz. It is not observed below frequencies of 0.2–0.3 Hz. Above frequencies of 20 Hz, rather than observing wind-up, the usual observation is a habituation of the response or wind-down. This is due to a progressive slowing of the conduction velocity of afferent C-fibers when stimulated at high frequency, resulting in a conduction blockade and a reduction in the number of impulses reaching the spinal cord with sufficiently high frequencies.

The generation of wind-up does not only depend on the frequency of stimulation, it also depends on other parameters such as the duration and the intensity of the stimuli used. The level of excitability of spinal cord neurons and the integrity of spinal cord connections to the brain are also crucial in the generation of wind-up. Prolonged noxious stimulation, peripheral injury and inflammation evoke an enhancement of the excitability of spinal cord neurons and an increase in the degree of wind-up, as well as a reduction in the threshold for the generation of wind-up, which has been interpreted as a result of loss of inhibitory modulation.

In hyperalgesic states induced by peripheral injury or inflammation, wind-up is also evoked by stimulation of A $\beta$ -fibers. This new phenomenon has been described either in isolated preparations of the spinal cord from newborn rats (Thompson et al. 1995) or in adult *in vivo* preparations (Herrero and Cervero 1996). Reflex wind-up facilitation and a novel A-fiber mediated wind-up evoked in arthritic animals were, however, only observed in intact, not in spinalized, preparations (Herrero and Cervero 1996). The enhancement of the



**Wind-Up of Spinal Cord Neurons, Figure 1** Wind-up of a single motor unit recorded in an *in vivo* preparation. Sixteen stimuli of 2 ms of duration, at an intensity of 6 mA, twice the threshold for C-fiber activation, were applied at 1 Hz frequency in the cutaneous receptive field. Note how the number of spikes recorded increase progressively despite a constant stimulus intensity.

reflex wind-up observed during hyperalgesia, therefore required an intact spinal cord and might be explained as the consequence of a direct descending excitatory influence on spinal cord neurons. Supraspinal modulation is also evidenced by the reduction of wind-up in deep dorsal horn class 2 neurons observed after applying a remote noxious mechanical stimulation to the nose of the rat (Schouenborg and Dickenson 1985), showing that wind-up is also affected by diffuse noxious inhibitory controls (DNIC).

The mechanisms underlying the generation of wind-up are still unresolved. Multiple factors may contribute to wind-up: network properties, pre-synaptic mechanisms, post-synaptic receptors and post-synaptic membrane properties. Glutamate NMDA receptors are intimately involved in the generation of wind-up, as demonstrated by experiments showing that the administration of NMDA antagonists, such as ketamine, D-AP5 (2-amino-5-phosphonopentanoate) or kynurenic acid, abolished wind-up (Davies and Lodge 1987, Dickenson and Sullivan 1987). At normal resting membrane potential, NMDA receptors are blocked by  $Mg^{2+}$  ions. During repetitive stimulation, each stimulus leaves the neuron at a more depolarized membrane potential, which in turn may contribute to the removal of the  $Mg^{2+}$  block from the NMDA receptors. The progressive release

of the  $Mg^{2+}$  block would act as an amplifier mechanism, boosting the summation of EPSPs and hence potentiating subsequent afferent input. Furthermore, as a consequence of NMDA receptor over-activity, an increase in intracellular  $Ca^{2+}$  may activate protein kinase C and this, in turn, would increase the probability of NMDA receptor channel opening and reduce the voltage-dependence of the  $Mg^{2+}$  block of the receptor (Chen and Huang 1992).

Blockade of wind-up by NMDA receptor antagonists is, however, only partial and, based on this observation, other modulators have been proposed to contribute to the long latency depolarization and to the hyperactivity observed during wind up. Substance P, a member of the tachykinin family of peptide neurotransmitters, was proposed to be involved in wind-up and this was confirmed in NK1 knockout mice by De Felipe et al. (1998). Some **Cyclooxygenases** inhibitors, especially nitric oxide derivatives such as nitroparacetamol, are very effective inhibitors of wind-up (for review see Herrero et al. 2000); two complementary mechanisms of action have been proposed to explain this effect. On the one hand, nitric oxide seems to inhibit the reuptake of some monoamines like serotonin. The enhancement of the amount of monoamines in the synaptic space would reduce the release of glutamate (Kiss and Vizi 2001).

On the other hand, the cyclooxygenase inhibition would reduce the level of circulating prostaglandins, which have been shown to enhance the release of glutamate and aspartate in the spinal cord (Nishihara et al. 1995). Wind-up results from a synchronous electrical (and therefore artificial) stimulation of a peripheral nerve, producing a pattern of input distinct from the asynchronous discharge evoked by natural stimulation. Thus, it is not clear if this represents a genuine physiological response or is simply an artificially generated phenomenon. However, since nociceptive neurons respond in a very characteristic way to this specific pattern of artificial stimulation, it seems probable that there is a physiological correlate. Further, repetitive natural stimuli in human subjects can induce a temporal summation of pain sensation very similar, if not identical, to that induced by repetitive electrical stimuli. Wind-up is also similar in many respects to the process that evokes short-term potentiation, i.e. an increase in hippocampal excitability that lasts for a few seconds to up to an hour. Wind-up may underlie the continuation of pain sensation in response to prolonged or repetitive stimuli, despite a reduction in the number of action potentials in afferent C-fibers and may represent an amplification mechanism or even a 'pain memory' in spinal cord neurons. In addition, wind-up-inducing stimuli evoke some of the manifestations of ► [central sensitization](#) in spinal neurons, such as enlarged receptive fields and enhanced responses to input from afferent C-fibers. NMDA receptors are involved in the generation of both phenomena. However, it has been shown that whilst stimuli that evoke wind-up may be sufficient to induce central sensitization, wind-up is not essential for the induction of central sensitization (Woolf 1996). There is no doubt that wind-up is a useful tool in the study of spinal cord-processing of somatosensory information and provides an experimental correlate of spinal cord hyperexcitability, sharing some common mechanisms with central sensitization or hyperalgesia.

## References

- Chen L, Huang LYM (1992) Protein kinase C reduces Mg block of NMDA-receptor channels as a mechanism of modulation. *Nature* 356:521–523
- Davies SN, Lodge D (1987) Evidence for the involvement of N-methylaspartate receptors in 'wind-up' of class 2 neurons in the dorsal horn of the rat. *Brain Res* 424:402–406
- De Felipe C, Herrero JF, O'Brien JA et al. (1998) Altered nociception, analgesia and aggression in the mice lacking the substance P receptor. *Nature* 392:394–397
- Dickenson AH, Sullivan AF (1987) Evidence for a role of the NMDA receptor in the frequency dependent potentiation of deep rat dorsal horn nociceptive neurons following C fiber stimulation. *Neuropharmacol* 26:1235–1238
- Herrero JF, Cervero F (1996) Supraspinal influences on the facilitation of rat nociceptive reflexes induced by carrageenan monoarthritis. *Neurosci Lett* 209:21–24
- Herrero JF, Laird JMA, Lopez-Garcia JA (2000) Wind-up of spinal cord neurons and pain sensation: much ado about something? *Prog Neurobiol* 61:169–203
- Kiss JP, Vizi ES (2001) Nitric oxide: a novel link between synaptic and nonsynaptic transmission. *TINS* 24:211–215
- Mendell L M, Wall PD (1965) Responses of single dorsal cells to peripheral cutaneous unmyelinated fibers. *Nature* 206:97–99
- Nishihara I, Minami T, Watanabe Y et al. (1995) Prostaglandin E2 stimulates glutamate release from synaptosomes of rat spinal cord. *Neurosci Lett* 196:57–60
- Schouenborg J, Dickenson AH (1985) The effects of a distant noxious stimulation on A and C fiber evoked flexion reflexes and neuronal activity in the dorsal horn of the rat. *Brain Res* 328:23–32
- Schouenborg J, Sjölund BH (1983) Activity evoked by A- and C-afferent fibers in rat dorsal horn neurons and its relation to a flexion reflex. *J Neurophysiol* 50:1108–1121
- Thompson SWN, Dray A, McCarron KE et al. (1995) Nerve growth factor induces mechanical allodynia associated with novel A fiber-evoked spinal reflex activity and enhanced neurokinin-1 receptor activation in the rat. *Pain* 62:219–231
- Vikman KS, Kristensson K, Hill RH (2001) Sensitization of dorsal horn neurons in a two-compartment cell culture model: wind-up and long-term potentiation-like responses. *J Neurosci* 21:RC169
- Woolf CJ (1996) Windup and central sensitization are not equivalent. *Pain* 66:105–108

## Winging Scapula

### Definition

Winging of the scapula is a protrusion of the scapula away from the thorax when the patient attempts to raise the arm above the shoulder level. The serratus anterior muscle keeps the scapula close to the ribs while stabilizing the scapula for shoulder abduction, overhead use of the hand, and push-up type work. Any injury or compression of the long thoracic nerve, which innervates this muscle, will cause scapular winging. A neurolysis of the long thoracic nerve in the thoracic inlet can resolve this problem.

► [Thoracic Outlet Syndrome](#)

## Withdrawal

### Definition

Withdrawal is a reflex reaction (the rat withdraws its limb or tail).

► [Randall-Selitto Paw Pressure Test](#)

## Withdrawal Symptoms

### Definition

Withdrawal symptoms are a result of abrupt discontinuation of a drug, and in the case of opioid analgesics can include diarrhea, sweating, insomnia and goosebumps.

► [Opioids, Clinical Opioid Tolerance](#)



## Work Capacity

### Definition

Work capacity is the client's ability to experience, understand and learn to perform job tasks/occupations resulting in production that is at least comparable with the industrial standard for that product or service. In choosing a suitable occupation, work capacity is understood as the client's valuable and useful quality and skills, indicating that he/she is specially matched for a certain type of work.

- ▶ Vocational Counselling

## Work Fitness

### Definition

Work fitness is a capacity to successfully meet the present and potential challenges of work requirements with vigor, and to demonstrate the traits and capacities that will prevent occupational injuries.

- ▶ Vocational Counselling

## Work Samples

### Definition

Work samples are designed to appraise whether an individual's ability to perform actual work matches the job description and skills required for that job. The client's vocational aptitudes (physical and mental), skills and occupational behavior are exposed. In a therapeutic environment, the client performs well-defined simulated work activities, involving tasks, materials and tools resembling those in actual job tasks, occupations or cluster of occupations. A work sample simulates factors that are required in thousands of specific jobs. One example is the VALPAR Component Work Sample (VCWS), which covers 21 individual criterion-referenced work samples. Each VCWS job requirement corresponds to the classification and analysis system of the Dictionary of Occupational Titles (DOT) and the Worker Qualification Profile (WQP). Ability to perform a cluster of VCWS demonstrates whether the client has met the WQP. The WQP is rated in a time-standard known as Methods-Time Measurement (MTM) scores. MTMs represent the standards of time a well-trained worker would be expected to perform tasks like those of the Valpar's VCWS within a typical industrial setting during an eight-hour working day.

- ▶ Disability Functional Capacity Evaluations
- ▶ Vocational Counselling

## Worker Compensation

### Definition

Benefits paid to a worker injured during the conduct of his or her job based on a proportion of their preinjury salary.

- ▶ Impairment Rating, Ambiguity
- ▶ Impairment Rating, Ambiguity, IAIABC System
- ▶ Pain in the Workplace, Risk Factors for Chronicity, Workplace Factors
- ▶ Rating Impairment Due to Pain in a Worker's Compensation System

## Working Alliance

The degree to which a bond exists between the patient and clinician, and also the extent to which the patient and clinician agree on the treatment goals and the steps needed to reach those goals.

- ▶ Chronic Pain, Patient-Therapist Interaction

## Work-Related Musculoskeletal Disorder

### Synonyms

WRMD

### Definition

This collective term is used to define the whole of muscle, bone, tendon, nerve and fascia disorders which are presumed to be work-related.

- ▶ Ergonomic Counseling

## World Health Organisation International Classification of Functioning

- ▶ WHO System on Impairment and Disability

W

## World Health Organization (WHO) Analgesic Ladder

### Definition

The World Health Organization Analgesic Ladder is a structured approach to cancer pain management, proposed by an expert committee convened by the Cancer and Palliative Care Unit of the World Health Organization, which focuses on selecting analgesics on the basis of pain intensity.

- ▶ Cancer Pain Management, Nonopioid Analgesics
- ▶ Cancer Pain Management, Principles of Opioid Therapy, Drug Selection



---

## Xanthochromic

### Definition

Yellowish color of the cerebrospinal fluid, due to intracranial bleeding or blood-brain-barrier defects.

- ▶ [Headache due to Low Cerebrospinal Fluid Pressure](#)





## Yellow Flags

CHRIS J. MAIN

University of Manchester, Manchester, UK  
cjm@fs1.ho.man.ac.uk

### Synonyms

Psychosocial risk factors; Psychosocial Obstacles to Recovery

### Definition

Yellow Flags are psychosocial factors associated with risk of the development of chronicity in patients/employees with low back pain. The increasing costs of chronic low back pain, despite advances in technological medicine, stimulated the search for new solutions to the problem of low back disability.

### Characteristics

In New Zealand, increasing costs of chronic non-specific low back pain had become an unmanageable burden. This fuelled a new initiative designed to complement a slightly modified set of acute back pain management guidelines, with a psychosocial assessment system designed systematically to address the psychosocial risk factors that had been shown in the scientific literature to be predictive of chronicity (Kendall et al. 1997). The stated purposes of assessment of Yellow flags were to:

- Provide a method for screening for psychosocial factors
- Provide a systematic approach to the assessment of psychosocial factors
- Suggest better strategies for better management for those with back pain who appear at a higher risk of chronicity

Focus on a number of key psychological factors:

- Belief that back pain is harmful or severely disabling
- Fear-avoidance behaviour patterns with reduced activity levels
- Tendency to low mood and withdrawal from social interaction
- Expectation that passive treatments rather than active participation will help

The Yellow flags consisted of integration into an assessment system, which included a screening questionnaire, interview guidelines and recommendations for early behavioural management in individuals with low back pain. They consisted of both psychological and socio-occupational risk factors. The main categories of the Yellow flags are:

- Attitudes and beliefs about back pain
- Behaviours
- Compensation issues
- Diagnostic and treatment issues
- Emotions
- Family
- Work

They also included a number of specific guidelines for behavioural management, including:

1. Provide a positive expectation that the individual will return to work
2. Be directive in scheduling regular reviews of progress
3. Keep the individual active and at work
4. Acknowledge difficulties of daily living
5. Help maintain positive co-operation
6. Communicate that having more time off work reduces the likelihood of successful return
7. Beware of expectations of “total cure” or expectation of simple “techno-fixes”
8. Promote self-management and self-responsibility
9. Be prepared to say “I don’t know”
10. Avoid confusing the report of symptoms with the presence of emotional distress
11. Discourage working at home
12. Encourage people to recognise that pain can be controlled
13. If barriers are too complex, arrange multidisciplinary referral

(Kendall et. al1997)

Examination of this list reveals that, in addition to current management, there are clear preventative components within the guidelines.

### Beyond Yellow Flags: The Blue Flags and Black Flags

Traditionally, clinical rehabilitation had focused primarily on clinical outcomes, with relatively little attention directed specifically at work. Although designed origi-

**Yellow Flags, Table 1** Selected Psychosocial Work factors and their Facets

Job demands	Quantitative workload Variance in workload Work pressure Cognitive demands
Job content	Repetitiveness Challenge Utilisation and development of skills
Job control	Task/instrumental control Decision/organisational control Control over the physical environment Resource control Control over workplace: machine-pacing
Social interactions	Social support from supervisor and colleagues Supervisor complaint, praise, monitoring Dealing with (difficult) clients/customers
Role factors	Role ambiguity Role conflict
Job future and career issues	Job future ambiguity Fear of job loss
Technology issues	Computer-related problems Electronic performance monitoring Fear of job loss
Organisational and management	Issues Participation Management style

(Adapted from Table 15.2 in Carayon and Lim (1999), p 278)

nally for a case-management system, the original Yellow Flags focused primarily on perceptions of health. Initially, the prime reason for development of the flags was to offer a complementary analysis to the ► **Red Flags** (based exclusively on a medical model of illness). It was decided that the collective importance of psychosocial factors was such that it made sense to integrate them under a single heading. It became clear, however, that implicit within the Yellow Flag initiative was the possibility of a range of different solutions, involving both health-care providers and occupational personnel. Main and Burton (1998), Burton and Main (2000) decided that insufficient attention had been given to specific occupational factors, and it was therefore decided to subdivide the yellow flags into clinical Yellow Flags and occupationally focused Blue Flags.

The ► **Blue Flags** have their origins in the work stress literature and can be viewed in terms of characteristics of the working environment, physiological stress, or as a consequence of interaction between the individual and their environment. Some of the more important factors, according to Carayon and Lim (1999), are shown in Table 1.

The relationships between stress, well-being, and health is not as yet fully understood, but Griffiths (1998) identified a large number of work organizational factors associated with poor health and well-being. The available evidence provides most support for influence of the following factors (Bongers et al. 1993; Vinggaard and Nachemson 2000):

- High demand and low control
- Time pressure/monotonous work
- Lack of job satisfaction
- Unsupportive management style
- Low social support from colleagues
- High perceived workload

In fact, it has been suggested, that workers' reactions to psychosocial aspects of work may be more impor-

tant than the actual requirements of the job themselves (Davies and Heaney 2000), with stress acting as an intermediary (Bongers et al. 1993).

These perceived features of work, generally associated with higher rates of symptoms, ill health and work loss have been termed Blue flags. In the context of injury, these factors may delay recovery or constitute a major obstacle to it; and for those at work there may be major contributory factors to sub-optimal performance or "Presenteeism" (Shamansky 2000). They are characterised by features such as high demand/low control, unhelpful management style, poor social support from colleagues, perceived time pressure and lack of job satisfaction. Individual workers may differ in their perception of the same working environment.

Blue flags incorporate not only issues related to the perception of job characteristics, such as job demand, but also perception of social interactions (whether with management or fellow-workers). From a work retention or work rehabilitation perspective, however, a further distinction has been made between two types of occupational risk factors: those concerning the perception of work (Blue Flags) and organisational obstacles to recovery, including objective work characteristics and conditions of employment (Black flags) (Main and Burton 1998; Burton and Main 2000). The distinction is similar to the distinction between intrinsic and extrinsic factors by Herzberg (1974), but with a focus on obstacles to recovery (i.e. potential targets for some sort of biopsychosocial intervention).

► **Black Flags** are not a matter of perception, and affect all workers equally. They include both nationally established policy concerning conditions of employment and sickness policy and working conditions specific to a particular organisation. Some examples are shown in Table 2.

It is not always possible to make an absolute distinction between Black and Blue flags, since there are also specific objective job characteristic aspects of work, which

**Yellow Flags, Table 2** Occupational Black Flags I: Job context and working conditions

National	Rates of pay Nationally negotiated entitlements Sick certification Benefit system Wage re-imbursement rate
Local	Sickness Policy Entitlements to sick leave Role of occupational health in “signing off” (?) and “signing on” Requirement for full fitness Possibility of sheltered work Restricted duties
Management style	
Trades Union support/involvement	
Organisational size and structure	

are associated with higher rates of illness, injury or work loss. They are shown in Table 3.

The features of work following injury may require a higher level of working capacity for successful work retention. After certain types of injury, such jobs may be specifically contra-indicated and therefore constitute an absolute obstacle to return-to-work. It might be hoped that many such risk factors could be “designed” out of the working environment, but such factors certainly need to be evaluated in the context of work retention or rehabilitation. Specifically, in terms of prevention they are a matter primarily for legislation, establishment of satisfactory job design, and adherence to recommended work practices, in negotiation, where appropriate, between employers and employee organizations.

The Yellow Flag initiative has been important in two major ways:

Firstly, in promulgation of a “systems approach”, involving all key stakeholders, in addressing issues of clinical and occupational rehabilitation, with emphasis on the need for better clinical-occupational interfaces, and secondly in attempting to identify and reduce risk factors for chronic incapacity, whether in health-care or in occupational settings.

Arguably, the strength of the Yellow Flags initiative has been the fact that it has offered a conceptual alternative to the bio-medical model of low back pain disability. The development of the Blue and Black Flags, has offered a more detailed conceptual framework within which a range of initiatives may be linked. At the core of the “flag” construct is a conceptual shift from risks (many of which may be immutable), to obstacles, to recovery. This may be individual clinical factors or perceptions of work or organization, which in turn require a range of solutions from individual clinical interventions and work re-integration strategies to fundamental redesign of the individual-organization interface.

**Yellow Flags, Table 3** Occupational Black Flags II: Content-specific aspects of work

Ergonomic	Job heaviness Lifting frequency Postures Sitting/standing postural requirements
Temporal characteristics	Number of working hours shift pattern

The conceptual framework of the “Flags” approach now needs to be supported by further empirical research in five key areas:

- The statistical construction and validation of screening strategies
- Refinement of cognitive-behavioural strategies appropriate for different contexts
- Identification of appropriate competencies for the delivery of psychosocial interventions
- Integration of sickness/disability management strategies with the development and enhancement of positive/adaptive coping strategies
- Developing an evidence-base of context-specific interventions; including bench-marking of successful initiatives

In conclusion, the Yellow Flags initiative has offered a way of understanding and addressing psychosocial obstacles to recovery (or to optimal function). In its more recent conceptual development (incorporating both Blue and Black Flags) it may also offer a framework within which to consider opportunities for change.

**References**

1. Bongers PM, de Winter CR, Kompier MAJ, Hildebrandt VH (1993) Psychosocial Factors at Work and Musculoskeletal Disease. *Scand J Work Environ Health* 19:297–312
2. Burton AK, Main CJ (2002) Obstacles to Recovery from Work-related Musculoskeletal Disorders In: Karwowski W (ed) *International Encyclopedia of Ergonomics and H Factors*. Taylor and Francis, London, pp 1542–1544
3. Carayon P, Lim S-Y (1999) Psychosocial Work Factors. In: Karwowski W, Marras W (eds) *The Occupational Ergonomics Handbook*. Boca Raton, CRC, pp 275–283
4. Davis KG, Heaney CA (2000). The Relationship between Psychosocial Work Characteristics and Low Back Pain: Underlying Methodological Issues. *Clin Biomech* 15:389–406
5. Griffiths A (1998) The Psychosocial Work Environment. In McCaig R, Harrington M (eds) *The Changing Nature of Occupational Health*. HSE Books, Sudbury Suffolk, pp 213–232
6. Herzberg E (1974) The Wise Old Turk. *Harvard Business Rev Sep/Oct*:70–80
7. Kendall NAS, Linton SJ, Main CJ (1997) Guide to Assessing Psychosocial Yellow Flags in Acute Low Back Pain: Risk Factors for Long Term Disability and Work Loss. Accident Rehabilitation and Compensation Insurance Corporation of New Zealand and the National Health Committee. Wellington, NZ
8. Linton SJ (2000) A Review of Psychological Risk Factors in Back Pain and Neck Pain. *Spine* 25:1148–1156
9. Main CJ, Burton AK (1998) Pain Mechanisms. In: McCaig R, Harrington M (eds) *The Changing Nature of Occupational Health*, HSE Books, Sudbury Suffolk, pp 233–254



10. Shamansky SL (2000) Editorial: Presenteeism. Or When Being There is Not Being There. *Public Health Nurs* 19:79–80
11. Vingard E, Nachemson (2000) A Work Related Influences on Neck and Low Back Pain. In: Nachemson A, Jonsson E (eds). *Neck Pain and Back Pain: The Scientific Evidence of Causes, Diagnosis and Treatment*. Lippincott Williams and Wilkins, Philadelphia
12. Waddell G (1998) *The Back Pain Revolution*. Churchill-Livingstone, Edinburgh
13. Waddell G, Aylward M, Sawney P (2002) *Back Pain, Incapacity for Work and Social Security Benefits: an International Literature Review and Analysis*. Royal Society of Medicine Press, London



---

## Z Joint

- ▶ Zygapophyseal Joint

---

## Z Joint Blocks

- ▶ Cervical Medial Branch Blocks

---

## Zidovudine (AZT)-Induced Headache

- ▶ Pain in Human Immunodeficiency Virus Infection and Acquired Immune Deficiency Syndrome

---

## Zona Incerta

### Definition

A region just ventral to the thalamus and dorsal hypothalamus. Receives inputs from the sensory motor areas, ventral lateral geniculate, trigeminal complex and the spinal cord.

- ▶ Brainstem Subnucleus Reticularis Dorsalis Neuron
- ▶ Thalamus, Visceral Representation

---

## Zoster-Associated Pain

### Definition

Pain occurring before, during or after acute herpes zoster. This does not discriminate between acute zoster pain and postherpetic neuralgia.

- ▶ Postherpetic Neuralgia, Etiology, Pathogenesis and Management

---

## Zydol

- ▶ Tramadol Hydrochloride

---

## Zygapophyseal Joint

### Synonyms

Apophysial joint; posterior intervertebral joint; Z joint

### Definition

The facet joint, bridging the vertebrae behind the vertebral foramina. May also be known as the apophysial joint, posterior intervertebral joint, or Z joint.

- ▶ Cervical Transforaminal Injection of Steroids
- ▶ Chronic Low Back Pain, Definitions and Diagnosis

---

## Zygapophysial Joint Pain, Sciatica

- ▶ Facet Joint Pain

---

## Zygapophysis

### Definition

One of the articular processes of a vertebra, of which there are usually four, two anterior and two posterior.

- ▶ Facet Joint Pain

---

## Zygapophyseal Joint Injection

- ▶ Facet Joint Procedures for Chronic Back Pain

---

## Zymosan

### Definition

Zymosan is an insoluble carbohydrate from the cell wall of yeast that leads to immune activation after peri-sciatic application.

- ▶ Amygdala, Pain Processing and Behavior in Animals



---

## List of Entries

Essays are shown in bold

- ▶ A Afferent Fibers (Neurons)
- ▶ A Fibers (A-Fibers)
- ▶ A Beta( $\beta$ ) Afferent Fibers
- ▶ A Delta( $\delta$ ) Afferent Fibers (Axons)
- ▶ A Delta( $\delta$ )-Mechanoheat Receptor
- ▶ A Delta( $\delta$ )-Mechanoreceptor
- ▶ AAV
- ▶ Abacterial Meningitis
- ▶ Abdominal Skin Reflex
- ▶ Abduction
- ▶ Aberrant Drug-Related Behaviors
- ▶ Ablation
- ▶ Abnormal Illness Affirming States
- ▶ Abnormal Illness Behavior
- ▶ Abnormal Illness Behaviour of the Unconsciously Motivated, Somatically Focussed Type
- ▶ Abnormal Temporal Summation
- ▶ Abnormal Ureteric Peristalsis in Stone Rats
- ▶ Abscess
- ▶ Absolute Detection Threshold
- ▶ Absorption
- ▶ ACC
- ▶ Accelerated Recovery Programs
- ▶ Acceleration-Deceleration Injury
- ▶ Accelerometer
- ▶ Accommodation (of a Nerve Fiber)
- ▶ Acculturation
- ▶ Accuracy and Reliability of Memory
- ▶ ACE-Inhibitors, Beta( $\beta$ )-Blockers
- ▶ Acetaminophen
- ▶ Acetylation
- ▶ Acetylcholine
- ▶ Acetylcholine Receptors
- ▶ Ach, ACh
- ▶ Acidosis
- ▶ **Acid-Sensing Ion Channels**  
NICOLAS VOILLEY, MICHEL LAZDUNSKI
- ▶ Acinar Cell Injury
- ▶ Acrylamide
- ▶ Acting-Out
- ▶ Action
- ▶ Action Potential
- ▶ Action Potential Conduction of C-Fibres
- ▶ Action Potential in Different Nociceptor Populations
- ▶ Actiq<sup>®</sup>
- ▶ Activa<sup>®</sup>
- ▶ Activation Threshold
- ▶ **Activation/Reassurance**  
GEOFFREY HARDING
- ▶ Active
- ▶ Active Inhibition
- ▶ Active Locus
- ▶ Active Myofascial Trigger Point
- ▶ Activities of Daily Living
- ▶ Activity
- ▶ Activity Limitations
- ▶ Activity Measurement
- ▶ Activity Mobilization
- ▶ Activity-Dependent Plasticity
- ▶ Acupuncture
- ▶ **Acupuncture Efficacy**  
EDZARD ERNST
- ▶ **Acupuncture Mechanisms**  
CHRISTER P.O. CARLSSON
- ▶ Acupuncture-Like TENS
- ▶ Acute Backache
- ▶ Acute Experimental Monoarthritis
- ▶ Acute Experimental Synovitis
- ▶ Acute Inflammatory Demyelinating Polyneuropathy

- ▶ Acute Ischemia Test
- ▶ Acute Knee Joint Inflammation
- ▶ Acute Lumbago
- ▶ **Acute Pain**  
ROSS MACPHERSON, MICHAEL J. COUSINS
- ▶ **Acute Pain in Children, Post-Operative**  
JOLENE D. BEAN-LIJEWSKI
- ▶ **Acute Pain in Children, Procedural**  
CHRISTINA LIOSI
- ▶ **Acute Pain Management in Infants**  
REBECCA PILLAI RIDDELL, BONNIE J. STEVENS
- ▶ **Acute Pain Mechanisms**  
PAUL M. MURPHY
- ▶ Acute Pain Service
- ▶ Acute Pain Team
- ▶ **Acute Pain, Subacute Pain and Chronic Pain**  
WADE KING
- ▶ Acute Painful Diabetic Neuropathy
- ▶ Acute Pelvic Pain
- ▶ Acute Phase Protein
- ▶ Acute Post-Operative Pain in Children
- ▶ Acute Postoperative Pain Therapy
- ▶ Acute Procedural Pain in Children
- ▶ Acute Salpingitis
- ▶ Acute Sciatica
- ▶ Acute Stress Disorder
- ▶ Acute-Recurrent Pain
- ▶ Adaptation
- ▶ Adaptation Phase
- ▶ Adaptive Equipment
- ▶ ADD Protocol
- ▶ Addiction
- ▶ Adduction
- ▶ Adenoassociated Virus Vectors
- ▶ Adenoma
- ▶ Adenomyosis
- ▶ Adenosine 5' Triphosphate
- ▶ Adenoviral Vectors
- ▶ Adequate Stimulus
- ▶ Adherence
- ▶ Adhesion Molecules
- ▶ Adjunctive Drugs
- ▶ Adjusted Odds Ratio
- ▶ Adjustment Disorder
- ▶ Adjuvant
- ▶ Adjuvant Analgesic
- ▶ **Adjuvant Analgesics in Management of Cancer-Related Bone Pain**  
KERI L. FAKATA, ARTHUR G. LIPMAN
- ▶ **Adjuvant Analgesics in Management of Cancer-Related Neuropathic Pain**  
DAVID LUSSIER, RUSSELL K. PORTENOY
- ▶ Adjuvant Arthritis
- ▶ ADLs
- ▶ Adrenergic Agonist
- ▶ Adrenergic Antagonist
- ▶ Adrenoceptors
- ▶ Adult Respiratory Distress Syndrome
- ▶ Adverse Effects
- ▶ Adverse Neural Tension
- ▶ Adverse Selection
- ▶ Aerobic Exercise
- ▶ Affective
- ▶ Affective Analgesia
- ▶ Affective Component (Aspekt, Dimension) of Pain
- ▶ Affective Responses
- ▶ Affective-Motivational
- ▶ Affective-Motivational Dimension of Pain
- ▶ Afferent Fiber / Afferent Neuron
- ▶ Afferent Projections
- ▶ Afferent Signal
- ▶ Afterdischarge(s)
- ▶ Afterhyperpolarisation
- ▶ After-Pains, Postnatal Pain
- ▶ Age and Chronicity
- ▶ Age Regression
- ▶ Age-Related Pain Diagnoses
- ▶ Aggression
- ▶ Agonist
- ▶ Agreed Medical Examination
- ▶ AHP
- ▶ AIDS and Pain
- ▶ Alcock's Canal
- ▶ Alcohol-Induced Pancreatitis
- ▶ Alcoholism
- ▶ Alfentanil
- ▶ Algesia
- ▶ Algesic Agent / Algesic Chemical
- ▶ Algodystrophy
- ▶ Algogen
- ▶ Algogenic Actions of Protons
- ▶ Algometer
- ▶ Alice-in-Wonderland Syndrome



- ▶ ALIF
- ▶ Allele Dosage Study
- ▶ Alleles
- ▶ Allocortex
- ▶ Allodynia
- ▶ **Allodynia (Clinical, Experimental)**  
ROLF-DETLEF TREEDE
- ▶ **Allodynia and Alloknesis**  
ROBERT H. LAMOTTE
- ▶ Allodynia in Fibromyalgia
- ▶ **Allodynia Test, Mechanical and Cold Allodynia**  
KYUNGSOON CHUNG
- ▶ Alloknesis
- ▶ Alloknesis and Allodynia
- ▶ Allostasis
- ▶ Alpha( $\alpha$ ) 1-Adrenergic Receptor
- ▶ Alpha( $\alpha$ ) 2-Adrenergic Agonist
- ▶ Alpha( $\alpha$ ) 2-Adrenergic Receptor Agonists
- ▶ Alpha( $\alpha$ ) 2-Adrenoceptor Agonists
- ▶ Alpha( $\alpha$ ) 2-Adrenoceptors
- ▶ **Alpha( $\alpha$ ) 2-Adrenergic Agonists in Pain Treatment**  
CARSTEN BANTEL, MERVYN MAZE, LAURA STONE, GEORGE WILCOX
- ▶ Alpha( $\alpha$ ) 2-Agonists
- ▶ Alpha( $\alpha$ )-Adrenoceptors
- ▶ Alpha( $\alpha$ )-Delta( $\delta$ ) Sleep
- ▶ Alpha( $\alpha$ )-D Galactose
- ▶ Alpha( $\alpha$ ) EEG Wave Intrusion
- ▶ Alpha( $\alpha$ )-I-Acid Glycoprotein
- ▶ AL-TENS
- ▶ Alternative Medicine
- ▶ **Alternative Medicine in Neuropathic Pain**  
MILES J. BELGRADE
- ▶ Alternative Rat Models of Ureteric Nociceptive Stimulation In Vivo
- ▶ Alternative Therapies
- ▶ Ambiguity
- ▶ Amelioration
- ▶ Amenorrhea
- ▶ American Society of Anesthesiologists' Status Category
- ▶ Amide Anesthetic
- ▶ Amide Local Anesthetic
- ▶ Aminobisphosphonate
- ▶ Aminomethyl-Cyclohexane-Acetic Acid
- ▶ Amitriptyline
- ▶ AMPA Glutamate Receptor (AMPA Receptor)
- ▶ Amphibian Peptides
- ▶ Amphipathic
- ▶ Amygdala
- ▶ **Amygdala, Functional Imaging**  
UTE HABEL, FRANK SCHNEIDER
- ▶ Amygdala, Nociceptive Processing
- ▶ **Amygdala, Pain Processing and Behavior in Animals**  
BARTON H. MANNING
- ▶ Amygdaloid Complex
- ▶ Anaerobic Glycolysis
- ▶ Analgesia
- ▶ **Analgesia During Labor and Delivery**  
YAAKOV BEILIN
- ▶ Analgesia for Labor and Delivery
- ▶ Analgesic Effect of Oxycodone
- ▶ Analgesic Gap
- ▶ **Analgesic Guidelines for Infants and Children**  
STEPHEN C. BROWN
- ▶ Analgesic Ladder
- ▶ Analgesic Tolerance
- ▶ Analgesic Treatment
- ▶ Analgesics
- ▶ Analgesics, History
- ▶ Analysis of Pain Behavior
- ▶ Anaphylactic Reaction
- ▶ Anaphylaxis
- ▶ Anesthesia
- ▶ Anesthesia Dolorosa
- ▶ Anesthesia Dolorosa Due to Plexus Avulsion
- ▶ **Anesthesia Dolorosa Model, Autotomy**  
MARSHALL DEVOR
- ▶ Anesthesiological Interventions
- ▶ Anesthesiologist
- ▶ Anesthetic Block
- ▶ Anesthetic Blockade
- ▶ Aneurysm
- ▶ **Anger and Pain**  
AKIKO OKIFUJI
- ▶ Anger-In
- ▶ Angiitis of the CNS
- ▶ Angina Pectoris
- ▶ **Angina Pectoris, Neurophysiology and Psychophysics**  
STAN ANDERSON, SHINJI OHARA, NIRIT WEISS, FRED A. LENZ
- ▶ Angiogenesis
- ▶ Angiography

- ▶ **Animal Models and Experimental Tests to Study Nociception and Pain**  
JIN MO CHUNG
- ▶ Animal Models for Mononeuropathy
- ▶ **Animal Models of Inflammatory Bowel Disease**  
JULIE A. CHRISTIANSON, BRIAN DAVIS
- ▶ Animal Models of Inflammatory Muscle Pain
- ▶ Animal Models of Inflammatory Myalgia
- ▶ Ankylosing Spondylitis
- ▶ Ankylosis
- ▶ Annulus Fibrosus
- ▶ Anorexia
- ▶ Antecedents and Consequences of Behaviour
- ▶ Anterior Cingulate Cortex
- ▶ Anterior Lumbar Interbody Fusion
- ▶ Anterior Primary Ramus
- ▶ Anterior Pulvinar Nucleus
- ▶ Anterior Spinothalamic Tract
- ▶ Anterograde Axonal Tracer (Anterograde Labeling)
- ▶ Anterograde Transport
- ▶ Anterolateral Cordotomy
- ▶ Antiarrhythmics
- ▶ Anticholinergics
- ▶ Anticipatory Anxiety
- ▶ Anticonvulsant (Agent)
- ▶ **Antidepressant Analgesics in Pain Management**  
PETER N. WATSON, HAROLD MERSKEY
- ▶ Antidepressant Drugs
- ▶ **Antidepressants in Neuropathic Pain**  
SØREN H. SINDRUP, TROELS S. JENSEN
- ▶ Antidromic Activation/Invasion
- ▶ Antidromic Microstimulation Mapping
- ▶ Antiepileptic Drugs (Agents)
- ▶ Antihyperalgesic Effect
- ▶ Anti-Inflammatories
- ▶ Anti-Inflammatory Cytokines
- ▶ Antinociception
- ▶ Antinociceptive Effects of General Anesthetics
- ▶ Antinociceptive Models
- ▶ Antiphospholipid Syndrome
- ▶ Antipyretic Analgesics
- ▶ Antisense Oligonucleotide
- ▶ Anxiety
- ▶ Anxiety Sensitivity
- ▶ Anxiolysis
- ▶ Apamin
- ▶ Apoplexy
- ▶ Apoptosis
- ▶ Apoptotic Degeneration
- ▶ Appraisal
- ▶ APS
- ▶ APT
- ▶ Arachadonic Acid
- ▶ Arachnoid Membrane
- ▶ Archispinothalamic Tract
- ▶ ARDS
- ▶ Area Postrema
- ▶ Area under the Curve
- ▶ Arousal
- ▶ Arterial Spasm
- ▶ Arthralgias
- ▶ Arthritis
- ▶ **Arthritis Model, Adjuvant-Induced Arthritis**  
LUCY F. DONALDSON, NAOMI L. CHILLINGWORTH
- ▶ **Arthritis Model, Kaolin-Carrageenan Induced Arthritis (Knee)**  
VOLKER NEUGEBAUER
- ▶ **Arthritis Model, Osteoarthritis**  
JAMES D. POMONIS
- ▶ Arthritis Urethritica
- ▶ Arthritogenic Pain
- ▶ Articular
- ▶ **Articular Afferents, Morphology**  
KARL MESSLINGER
- ▶ **Articular Nociceptors**  
HANS-GEORG SCHAIBLE
- ▶ Articular Nociceptors, Sensitization
- ▶ Articular Sensory Receptors
- ▶ As Needed Dosage Regimen
- ▶ **Ascending Nociceptive Pathways**  
GLENN J. GIESLER JR
- ▶ Aseptic Meningitis
- ▶ ASICs
- ▶ ASO
- ▶ Aspartate
- ▶ Aspirin-Like Drugs
- ▶ Assessment
- ▶ Assessment of Discomfort in Dementia Protocol
- ▶ Assessment of Hypoalgesia
- ▶ **Assessment of Pain Behaviors**  
FRANCIS J. KEEFE, REBECCA W. PRYOR
- ▶ Assimilation
- ▶ Association Study
- ▶ Astrocytes
- ▶ Asymmetric Junctions

- ▶ Ataxia
- ▶ Atenolol
- ▶ At-Level Neuropathic Pain
- ▶ At-Level Phenomena
- ▶ ATP
- ▶ ATP-Dependent Na<sup>+</sup>K<sup>+</sup> Pump
- ▶ ATrP
- ▶ Attachment Trigger Point
- ▶ Attentional Bias
- ▶ Attentional Mechanisms
- ▶ Attributable Effect
- ▶ **Attributable Effect and Number Needed to Treat**  
NIKOLAI BOGDUK
- ▶ Atypical Antidepressants
- ▶ Atypical Facial Neuralgia
- ▶ **Atypical Facial Pain, Etiology, Pathogenesis and Management**  
YAIR SHARAV
- ▶ **Atypical Odontalgia**  
YAIR SHARAV
- ▶ Atypical Trigeminal Neuralgia
- ▶ AUC
- ▶ Audit Report
- ▶ Aura
- ▶ Autacoids
- ▶ Autobiographical Memory
- ▶ Autogenic Feedback
- ▶ Autogenic Training
- ▶ Autologous Graft
- ▶ **Autologous Thrombocyte Injection as a Model of Cutaneous Pain**  
JAMES A. BLUNK, MARTIN SCHMELZ
- ▶ Autonomic
- ▶ Autonomic Dominant Cramping Disease
- ▶ Autonomic Dysreflexia
- ▶ Autonomic Features
- ▶ Autonomic Functions
- ▶ Autonomic Nervous System
- ▶ Autonomic Phenomena
- ▶ Autonomic Reactions/Symptoms
- ▶ Autoregulation of the Cerebral Vessels
- ▶ Autotomy
- ▶ Autotraction
- ▶ Avocado-Soybean-Unsaponifiables
- ▶ Avoidance Behavior
- ▶ Avulsion
- ▶ Avulsion Fracture
- ▶ Awakening
- ▶ Awareness
- ▶ Axillary Block
- ▶ Axolemma
- ▶ Axon
- ▶ Axon Reflex
- ▶ Axonal Arborization
- ▶ Axonal Degeneration
- ▶ Axonal Sprouting
- ▶ Axonal/Axoplasmic Transport
- ▶ Axotomy
- ▶ Azathioprine
- ▶ Back Pain
- ▶ **Back Pain in the Workplace**  
JOHN D. LOESER
- ▶ Back Schools
- ▶ Background Activity / Firing
- ▶ Background Infusion
- ▶ Baclofen
- ▶ Bad Back
- ▶ Balanced Analgesia
- ▶ Balanced Analgesic Regime
- ▶ Balneotherapy
- ▶ Baricity
- ▶ Barotraumas
- ▶ Barrelioids
- ▶ Basal Ganglia
- ▶ Basal Lamina
- ▶ Basal Ventral Medial Nuclei
- ▶ Baseline Phase
- ▶ Basic Body Awareness Therapy
- ▶ Basic Work Activities
- ▶ Basilar-Type Migraine
- ▶ Bcl-2
- ▶ BDNF
- ▶ Bed Nucleus of the Stria Terminalis
- ▶ Behçet's Disease
- ▶ Behavior
- ▶ Behavior Modification
- ▶ Behavior Therapies
- ▶ Behavioral
- ▶ Behavioral Assessment
- ▶ Behavioral Descriptions of Symptoms
- ▶ Behavioral Experiments
- ▶ Behavioral Pain Scale
- ▶ Behavioral Responses to Examination
- ▶ Behavioral Self-Management

▶ **Behavioral Therapies to Reduce Disability**

MICHAEL J.L. SULLIVAN

- ▶ Behavioral Treatment
  - ▶ Behavioral/Cognitive Perspective
  - ▶ Below-Level Neuropathic Pain
  - ▶ Benign Cough Headache
  - ▶ Bennett Model
  - ▶ Beri Beri Disease
  - ▶ Beta( $\beta$ ) Blockers
  - ▶ Beta( $\beta$ )-Adrenergic Sympathetic System
  - ▶ Beta( $\beta$ )-Endorphin
  - ▶ Beta( $\beta$ )-Thromboglobulin
  - ▶ BFB
  - ▶ BGT
  - ▶ Bias
  - ▶ Bicuculline
  - ▶ Binding Medical Examination
  - ▶ Binding Studies
  - ▶ Bioavailability
  - ▶ Biobehavioral Factors
  - ▶ Biobehavioral Model
  - ▶ BiobraneRx
  - ▶ Biofeedback
  - ▶ **Biofeedback in the Treatment of Pain**
- FRANK ANDRASIK, BEVERLY E. THORN
- ▶ Biogenic Amine Theory
  - ▶ Biological Clock
  - ▶ Biological Rhythms
  - ▶ Biomagnetometer
  - ▶ Biopsy
  - ▶ Biopsychosocial
  - ▶ Biopsychosocial Model
  - ▶ Biopsychosocial Perspective
  - ▶ Bischof Myelotomy
  - ▶ **Bisphosphonates**
- NIKOLAI BOGDUK
- ▶ BK
  - ▶ Black Disc Disease
  - ▶ Black Flags
  - ▶ Blink Reflex
  - ▶ Block Design
  - ▶ Blocking Threshold
  - ▶ Blood Brain Barrier
  - ▶ Blood Clot
  - ▶ Blood Clot in Brain
  - ▶ Blood Nerve Barrier

- ▶ Blood Oxygenation Level Dependent

- ▶ Blood Patch
  - ▶ Blood Platelets
  - ▶ Blue Flags
  - ▶ BMS
  - ▶ Body Awareness
  - ▶ **Body Awareness Therapies**
- ALICE KVÅLE, ANNE ELISABETH LJUNGGREN

- ▶ Body Awareness Training
  - ▶ Body Dysmorphic Disorder
  - ▶ Body Functions
  - ▶ Body of the Clitoris
  - ▶ Body Structures
  - ▶ Body-Mind Approaches
  - ▶ Body-Self Neuromatrix
  - ▶ BOLD
  - ▶ Bone Marrow
  - ▶ Bone Metastases
  - ▶ Bone Pain
  - ▶ **Bone Scan**
- PETER LAU
- ▶ Bone Scintigraphy
  - ▶ Borderline Leprosy
  - ▶ Botox<sup>®</sup>
  - ▶ Bottom of Form
  - ▶ **Botulinum Toxin**
- JAYANTILAL GOVIND
- ▶ Boxcar Design
  - ▶ Brachial and/or Lumbal Plexopathy
  - ▶ Brachial Plexus
  - ▶ Brachial Plexus Avulsion
  - ▶ **Brachial Plexus Avulsion and Dorsal Root Entry Zone**
- MARC SINDOU
- ▶ Brachial Plexus Avulsion Injury
  - ▶ Brachial Plexus Compression
  - ▶ Brachial Plexus Injury
  - ▶ Brachialgia
  - ▶ Bradykinin
  - ▶ Bradykinin Receptors
  - ▶ Brain Derived Neurotrophic Factor
  - ▶ Brain Electrode
  - ▶ Brain Sodium Channel 2 (BNC2, BNaC2)
  - ▶ Brain Stimulation Analgesia
  - ▶ Brain-Gut Axis
  - ▶ Brainstem
  - ▶ Brainstem Respiratory Centers



- ▶ **Brainstem Subnucleus Reticularis Dorsalis Neuron**  
LENAIC MONCONDUIT, LUIS VILLANUEVA
- ▶ Breakthrough Pain (BP)
- ▶ Brennan Pain Model
- ▶ Brodmann Areas
- ▶ Bruxism
- ▶ Bulbospinal Modulation of Nociceptive Inputs
- ▶ Bulbospinal Pathways
- ▶ Buprenorphine
- ▶ Burn Pain Control in Children
- ▶ Burning Feet Syndrome
- ▶ **Burning Mouth Syndrome**  
YAIR SHARAV
- ▶ Burning Pain
- ▶ Bursitis
- ▶ **Burst Activity in Thalamus and Pain**  
JONATHAN O. DOSTROVSKY
- ▶ Burst Firing Mode
- ▶ Bursting Activity
- ▶ Butterfly Erythema
- ▶ By the Ladder, by the Clock, by the Child and by the Mouth
- ▶ C Afferent Axons/Fibers
- ▶ C and A Fibers
- ▶ Cachexia
- ▶ CACNA1A
- ▶ Calbindin
- ▶ Calbindin D–28k
- ▶ Calbindin-Immunoreceptive Matrix Cells
- ▶ Calcitonin Gene-Related Peptide
- ▶ **Calcitonin Gene-Related Peptide and Migraine Headaches**  
KIRSTEN ARNDT, STEFAN JUST, HENRI DOODS
- ▶ Calcium Channel Blockers
- ▶ **Calcium Channels in the Spinal Processing of Nociceptive Input**  
HORACIO VANEGAS
- ▶ Calcium Spike Bursts
- ▶ Calculosis
- ▶ CAMs
- ▶ **Cancer Pain**  
ZBIGNIEW ZYLICZ, MAŁGORZATA KRAJNIK
- ▶ **Cancer Pain and Pain in HIV / AIDS**  
RUSSELL K. PORTENOY
- ▶ **Cancer Pain, Animal Models**  
MARY ANN C. SABINO, PATRICK W. MANTYH
- ▶ **Cancer Pain, Assessment in Children**  
GARY A. WALCO
- ▶ **Cancer Pain, Assessment in the Cognitively Impaired**  
WENDY M. STEIN
- ▶ **Cancer Pain, Assessment of Cultural Issues**  
TERRY ALTILIO
- ▶ **Cancer Pain, Epidemiology**  
CIELITO C. REYES-GIBBY, CHARLES S. CLEELAND
- ▶ **Cancer Pain, Evaluation of Relevant Comorbidities and Impact**  
MYRA GLAJCHEN
- ▶ **Cancer Pain, Goals of a Comprehensive Assessment**  
PAULINE LESAGE
- ▶ **Cancer Pain, Palliative Care in Children**  
STEPHEN C. BROWN
- ▶ Cancer Pain Management
- ▶ **Cancer Pain Management, Adjuvant Analgesics in Management of Pain Due To Bowel Obstruction**  
PAUL C. ROUSSEAU
- ▶ **Cancer Pain Management, Anesthesiologic Interventions**  
PAUL A. SLOAN
- ▶ **Cancer Pain Management, Anesthesiologic Interventions, Neural Blockade**  
HARALD BREIVIK
- ▶ **Cancer Pain Management, Anesthesiologic Interventions, Spinal Cord Stimulation, and Neuraxial Infusion**  
MUTHUKUMAR VAIDYARAMAN, PETER S. STAATS
- ▶ **Cancer Pain Management, Cancer-Related Breakthrough Pain, Therapy**  
GIOVAMBATTISTA ZEPPESELLA
- ▶ **Cancer Pain Management, Chemotherapy**  
RONALD H. BLUM
- ▶ **Cancer Pain Management, Gastrointestinal Dysfunction as Opioid Side Effects**  
NIGEL P. SYKES
- ▶ **Cancer Pain Management, Interface between Cancer Pain Management and Palliative Care**  
PETER G. LAWLOR
- ▶ **Cancer Pain Management, Neurosurgical Interventions**  
RICHARD B. NORTH, SAMUEL J. HASENBUSCH
- ▶ **Cancer Pain Management, Nonopioid Analgesics**  
ALISON MURRAY, JOSE PEREIRA
- ▶ **Cancer Pain Management, Opioid Responsiveness**

- ▶ **Cancer Pain Management, Opioid Side Effects, Cognitive Dysfunction**  
S. YENNURAJALINGAM, EDUARDO BRUERA
- ▶ **Cancer Pain Management, Opioid Side Effects, Endocrine Changes and Sexual Dysfunction**  
JUDITH A. PAICE
- ▶ **Cancer Pain Management, Opioid Side Effects, Uncommon Side Effects**  
CHRISTOPHER J. WATLING
- ▶ **Cancer Pain Management, Orthopedic Surgery**  
JOHN H. HEALEY
- ▶ **Cancer Pain Management, Overall Strategy**  
GILBERT J. FANCIULLO
- ▶ Cancer Pain Management, Palliation of Upper GI Cancer
- ▶ **Cancer Pain Management, Patient-Related Barriers**  
CIELITO REYES-GIBBY
- ▶ **Cancer Pain Management, Principles of Opioid Therapy, Dosing Guidelines**  
JAMES F. CLEARY
- ▶ **Cancer Pain Management, Principles of Opioid Therapy, Drug Selection**  
MARIE FALLON
- ▶ **Cancer Pain Management, Radiotherapy**  
EDWARD CHOW, STEPHEN LUTZ, NORA JANJAN
- ▶ **Cancer Pain Management, Rehabilitative Therapies**  
ANDREA CHEVILLE
- ▶ **Cancer Pain Management, Treatment of Neuropathic Components**  
PAUL W. WACNIK, RICHARD L. BOORTZ-MARX
- ▶ **Cancer Pain Management, Undertreatment and Clinician-Related Barriers**  
SEAN O'MAHONY
- ▶ Cancer Pain Model
- ▶ **Cancer Pain Model, Bone Cancer Pain Model**  
DARRYL T. HAMAMOTO, DONALD A. SIMONE
- ▶ Cancer Survivorship
- ▶ Cancer Therapy
- ▶ Cannabinoid
- ▶ Cannabinoid Receptors
- ▶ Capacity
- ▶ Capitated Care
- ▶ Capsaicin
- ▶ **Capsaicin Receptor**  
ANTONIO VICENTE FERRER-MONTIEL
- ▶ Capsazepine
- ▶ Carbenoxolone
- ▶ Cardiac Stress Response
- ▶ Cardiac Surgery
- ▶ Career Assessment
- ▶ Caregiver
- ▶ Carotid Arteries
- ▶ Carotidynia
- ▶ Carpal Tunnel Syndrome
- ▶ **Carpal Tunnel Syndrome**  
A. LEE DELLON
- ▶ Carrageenan
- ▶ Carrageenan Inflammation
- ▶ Cartilage
- ▶ Case Control Study
- ▶ Case Rate
- ▶ Caspases
- ▶ CAT Scan
- ▶ Catabolism, Destructive Metabolism
- ▶ Catalogue
- ▶ Catastrophic Cognitions
- ▶ Catastrophic Thinking
- ▶ **Catastrophizing**  
MICHAEL J.L. SULLIVAN, HEATHER ADAMS
- ▶ Categorization of Nociceptors
- ▶ Cauda Equina
- ▶ Caudal Analgesia or Anesthesia
- ▶ Caudal Epidural Blocks
- ▶ Caudal Epidural Steroids
- ▶ Caudal Injection
- ▶ Caudate Nucleus
- ▶ Causalgia
- ▶ **Causalgia, Assessment**  
ELLEN JØRUM
- ▶ Cawthorne and Cookseys' Eye-Head Exercises
- ▶ CBT
- ▶ CCI
- ▶ CCK
- ▶ CDH
- ▶ Celiac Plexus Block
- ▶ Cell Adhesion
- ▶ Cell Grafts
- ▶ Cell Minipumps
- ▶ **Cell Therapy in the Treatment of Central Pain**  
MARY J. EATON
- ▶ Cell Transplantation
- ▶ Cell-Mediated Immunity
- ▶ Cellular Adhesion Molecules
- ▶ Cellular Targets of Substance P
- ▶ Cementum

- ▶ **Central Changes after Peripheral Nerve Injury**  
MARSHALL DEVOR
- ▶ Central Gray/Central Grey
- ▶ Central Hyperexcitability
- ▶ Central Lateral Nucleus (CL)
- ▶ Central Lobe
- ▶ Central Medial Nucleus (CM)
- ▶ Central Nervous System Map
- ▶ Central Nervous System Portion of a Cranial Nerve
- ▶ **Central Nervous System Stimulation for Pain**  
LUC JASMIN, PETER T. OHARA
- ▶ **Central Neuropathic Pain**  
DAVID BOWSHER
- ▶ **Central Neuropathic Pain from Spinal Cord Injury**  
PHILIP SIDDALL
- ▶ Central Pain
- ▶ **Central Pain and Cancer**  
PAOLO L. MANFREDI, GILBERT R. GONZALES
- ▶ **Central Pain, Diagnosis**  
DAVID VIVIAN
- ▶ Central Pain, Diagnosis and Assessment of Clinical Characteristics
- ▶ Central Pain, Functional Changes in Sensory Neurons Following Spinal Cord Injury
- ▶ **Central Pain, Human Studies of Physiology**  
A. TAGHVA, S.H. PATEL, A. FERNANDEZ, N. WEISS, FREDERICK A. LENZ
- ▶ **Central Pain in Multiple Sclerosis**  
JÖRGEN BOIVIE
- ▶ Central Pain Mechanisms, Molecular Contributions
- ▶ Central Pain Model
- ▶ **Central Pain, Outcome Measures in Clinical Trials**  
EVA WIDERSTRÖM-NOGA
- ▶ Central Pain Pathways
- ▶ **Central Pain, Pharmacological Treatments**  
NANNA BRIX FINNERUP, SØREN HEIN SINDRUP
- ▶ Central Pain Syndrome
- ▶ Central Pattern Generator
- ▶ Central Sensitization
- ▶ Central Sulcus
- ▶ Central Trigger Point
- ▶ Centralization
- ▶ Central-Peripheral Distal Axonopathy
- ▶ Centrifugal Control of Nociceptive Processing
- ▶ Centrifugal Control of Sensory Inputs
- ▶ Cephalalgia
- ▶ Ceramide
- ▶ Cerebellum
- ▶ Cerebral Cortex
- ▶ Cerebrospinal Fluid
- ▶ Cervical Discogram
- ▶ **Cervical Discography**  
DAVID DIAMANT
- ▶ Cervical Facet Blocks
- ▶ Cervical Facet Denervation
- ▶ Cervical MBBs
- ▶ **Cervical Medial Branch Blocks**  
JAYANTILAL GOVIND
- ▶ **Cervical Medial Branch Neurotomy**  
JAYANTILAL GOVIND
- ▶ Cervical Periradicular Epidural Steroid Injection
- ▶ Cervical Radiofrequency Neurotomy
- ▶ Cervical Root Avulsion
- ▶ Cervical Selective Nerve Root Injection
- ▶ Cervical Transforaminal Injection of Corticosteroids
- ▶ **Cervical Transforaminal Injection of Steroids**  
TIMOTHY R. LAIR, JAMES P. RATHMELL
- ▶ Cervical Zygapophysial Joint Blocks
- ▶ CFA
- ▶ C Fiber
- ▶ c-Fos
- ▶ c-Fos Immediate-Early Gene Expression
- ▶ CFS
- ▶ CGRP
- ▶ **CGRP and Spinal Cord Nociception**  
ANDREA EBERSBERGER
- ▶ Channel Inactivation
- ▶ Channelopathies
- ▶ Charcot-Marie-Tooth Disease
- ▶ C-Heat Receptor
- ▶ Chemesthesis
- ▶ Chemical Lesion
- ▶ Chemical Sympathectomy
- ▶ Chemical Transmitter
- ▶ Chemoattractants
- ▶ Chemokines
- ▶ Chemosensation
- ▶ Chemosensitive Sympathetic Afferent Fibers
- ▶ Chemotactic
- ▶ Chemotactic Cytokines
- ▶ Chemotherapy
- ▶ Chemotherapy-Induced Neuropathy
- ▶ Chest Pain

- ▶ Chiari Type I Malformation
- ▶ Childhood Migraine
- ▶ Childhood Sexual Abuse
- ▶ Chiropractic
- ▶ Chloride Transporter
- ▶ Chloro-phenyl-2-methylaminocyclohexanone-hydrochloride
- ▶ Cholecystokinin
- ▶ Chondrocytes
- ▶ Chromosomes
- ▶ Chronic Abdominal Pain of Childhood
- ▶ **Chronic Back Pain and Spinal Instability**  
KENE UGOKWE, AJIT KRISHNANEY, MICHAEL STEINMETZ, EDWARD BENZEL
- ▶ Chronic Central Pain Models
- ▶ Chronic Constriction Injury Model
- ▶ Chronic Daily Headache
- ▶ **Chronic Daily Headache in Children**  
PATRICIA A. MCGRATH
- ▶ **Chronic Gynaecological Pain, Doctor-Patient Interaction**  
R. WILLIAM STONES
- ▶ Chronic Illness Problem Inventory
- ▶ Chronic Inflammatory Demyelinating Polyneuropathy
- ▶ **Chronic Low Back Pain, Definitions and Diagnosis**  
CHRISTOPHER J. WINFREE
- ▶ Chronic Migraine
- ▶ Chronic Neural Sensitization
- ▶ Chronic Neuropathic Pain
- ▶ Chronic Pain
- ▶ Chronic Pain Disorder Prevalence in Children
- ▶ **Chronic Pain in Children, Physical Medicine and Rehabilitation**  
JOYCE M. ENGEL, DEBORAH A. O'ROURKE
- ▶ **Chronic Pain, Patient-Therapist Interaction**  
MARK P. JENSEN
- ▶ Chronic Pain, Thalamic Plasticity
- ▶ Chronic Paroxysmal Hemicrania
- ▶ Chronic Pelvic Inflammatory Disease
- ▶ Chronic Pelvic Pain
- ▶ **Chronic Pelvic Pain, Endometriosis**  
FRED M. HOWARD
- ▶ Chronic Pelvic Pain, Epidemiology
- ▶ Chronic Pelvic Pain, Interstitial Cystitis
- ▶ **Chronic Pelvic Pain, Laparoscopic Pain Mapping**  
FRED M. HOWARD
- ▶ Chronic Pelvic Pain Model
- ▶ **Chronic Pelvic Pain, Musculoskeletal Syndromes**  
ROBERT D. GERWIN
- ▶ **Chronic Pelvic Pain, Pelvic Inflammatory Disease and Adhesions**  
FRED M. HOWARD
- ▶ **Chronic Pelvic Pain, Physical and Sexual Abuse**  
BEVERLY J. COLLETT, CHRISTINE CORDLE
- ▶ **Chronic Pelvic Pain, Physical Therapy Approaches and Myofascial Abnormalities**  
RHONDA K. KOTARINOS
- ▶ Chronic Postoperative Pain
- ▶ Chronic Post-Surgical Neuralgia
- ▶ Chronic Post-Surgical Pain Syndromes
- ▶ Chronic Relapsing Polyneuropathy
- ▶ Chronic Tension-Type Headache
- ▶ Chronic Vulvar Pain
- ▶ Chronic Widespread Allodynia
- ▶ Chronic Widespread Pain
- ▶ **Chronicity, Prevention**  
MICHAEL K. NICHOLAS
- ▶ Chung Model
- ▶ CIDP
- ▶ Cingulate Cortex
- ▶ Cingulate Cortex, Effect on Pain-Related Behavior in Humans
- ▶ **Cingulate Cortex, Functional Imaging**  
PIERRE RAINVILLE
- ▶ **Cingulate Cortex, Nociceptive Processing, Behavioral Studies in Animals**  
PERRY N. FUCHS, VERNE C. COX
- ▶ Cingulotomy
- ▶ CIPA
- ▶ Circadian Rhythms/Variations
- ▶ Circadian Variations in Pain Level
- ▶ Circumventricular Brain Structures
- ▶ Cl<sup>-</sup> Transporter
- ▶ Classical Conditioning
- ▶ Classical Massage
- ▶ Classical Migraine
- ▶ Classification
- ▶ Claudication
- ▶ Clearance
- ▶ **Clinical Migraine With Aura**  
F. MICHAEL CUTRER
- ▶ Clinical Migraine Without Aura
- ▶ Clinical Pain
- ▶ Clinical Signs
- ▶ Clinical Trial



- ▶ **Clitoral Pain**  
ALLAN GORDON
- ▶ Clofazimine
- ▶ Clonidine
- ▶ Cluster Analysis
- ▶ Cluster Headache
- ▶ Clustering
- ▶ C-Mechanoheat Receptor
- ▶ C-Mechanoreceptor
- ▶ CM-PF Complex
- ▶ CMT
- ▶ CNS Changes after Peripheral Nerve Injury
- ▶ CNS Stimulation in Treatment of Neuropathic Pain
- ▶ CNV
- ▶ CO Staining
- ▶ CO<sub>2</sub> Laser
- ▶ Cochlea
- ▶ Cognition
- ▶ Cognitive
- ▶ Cognitive Appraisal
- ▶ Cognitive Aspect of Pain
- ▶ Cognitive Assessment
- ▶ Cognitive-Behavior Modification
- ▶ Cognitive-Behavioral Model
- ▶ Cognitive-Behavioral Model of Chronic Low Back Pain
- ▶ **Cognitive-Behavioral Perspective of Pain**  
DENNIS C. TURK
- ▶ Cognitive-Behavioral Programs
- ▶ Cognitive-Behavioral Theories
- ▶ Cognitive-Behavioral Therapy
- ▶ Cognitive-Behavioral Transactional Model of Family Functioning
- ▶ **Cognitive-Behavioral Treatment of Pain**  
DENNIS C. TURK
- ▶ Cognitive Coping Training
- ▶ Cognitive Dysfunction
- ▶ Cognitive Error
- ▶ Cognitive Factors
- ▶ Cognitive Impairment
- ▶ Cognitive Model of Pain
- ▶ Cognitive Modulation of Pain
- ▶ Cognitive Restructuring
- ▶ Cognitive Schemata
- ▶ Cognitive Tasks
- ▶ Cognitive Therapy
- ▶ Cohort
- ▶ Cohort Study
- ▶ Coital Pain
- ▶ Cold Allodynia
- ▶ Cold Allodynia Test
- ▶ Cold Hyperalgesia
- ▶ Cold Nociception
- ▶ **Cold Nociceptors**  
DONALD A. SIMONE
- ▶ Cold Pressor Test
- ▶ Cold Therapy
- ▶ Cold Thermoreceptor
- ▶ Cold Thermotransduction
- ▶ Cold-Induced Hyperalgesia
- ▶ Colitis
- ▶ Collateral Sprouting
- ▶ Colorectal Distension
- ▶ Colposcopy
- ▶ Combined Spinal Epidural (CSE) Technique
- ▶ Common Fears
- ▶ Common Migraine
- ▶ Common Toxicity Criteria
- ▶ Communication Limitations or Neurological Impairment
- ▶ Comorbid Headache
- ▶ Comorbidity
- ▶ Compartmental Syndrome
- ▶ **Compensation, Disability, and Pain in the Workplace**  
JAMES P. ROBINSON, DENNIS C. TURK
- ▶ Competitive Agonist or Antagonist
- ▶ Complement
- ▶ Complementary Medicine
- ▶ Complementary Therapies
- ▶ Complete Freund's Adjuvant
- ▶ Complex Adaptive System
- ▶ **Complex Chronic Pain in Children, Interdisciplinary Treatment**  
JENNIFER N. STINSON
- ▶ Complex Migraine
- ▶ Complex Regional Pain Syndrome
- ▶ **Complex Regional Pain Syndrome and the Sympathetic Nervous System**  
JAMES N. CAMPBELL
- ▶ Complex Regional Pain Syndrome Type I
- ▶ Complex Regional Pain Syndrome Type I (CRPS I) and Type II (CRPS II)
- ▶ **Complex Regional Pain Syndromes, General Aspects**  
KOK E. KHOR

- ▶ **Complex Regional Pain Syndromes, Clinical Aspects**  
RALF BARON
- ▶ Compliance
- ▶ Complicated Migraine
- ▶ Comprehensive Assessment
- ▶ Compression Fracture
- ▶ Computed Radiography
- ▶ Computerised Axial Tomography
- ▶ Conditioned Analgesia
- ▶ Conditioned Place Avoidance
- ▶ Conditioning
- ▶ Conductance
- ▶ Conduction Velocity
- ▶ Confidence in Coping Abilities
- ▶ Confusional Migraine
- ▶ Congener
- ▶ Congenital Hypomyelinating Neuropathy
- ▶ **Congenital Insensitivity to Pain with Anhidrosis**  
MAX J. HILZ
- ▶ Congenital Sensory Neuropathy with Anhidrosis
- ▶ Conjunctival Injection
- ▶ Connective Tissue Disease
- ▶ Connective Tissue Manipulation
- ▶ Conscious Laparoscopic Pain Mapping
- ▶ Conscious Pain Mapping
- ▶ **Consciousness and Pain**  
C. RICHARD CHAPMAN, YOSHIO NAKAMURA
- ▶ Consolidated Standards of Reporting Trials Statement
- ▶ CONSORT Statement
- ▶ Constitutive Gene
- ▶ Construction of Consciousness
- ▶ Contact Stimulator
- ▶ Contemplation
- ▶ Contextual Factors
- ▶ Contingencies
- ▶ Contingencies of Reinforcement
- ▶ Contingency Management
- ▶ Contingent Negative Variation
- ▶ Continuous Video-Tape Recordings
- ▶ Contract-Release
- ▶ Contracture
- ▶ Contralateral
- ▶ Controlled Trial
- ▶ Contusion
- ▶ Conus medularis DREZ
- ▶ Conventional TENS
- ▶ Convergent
- ▶ Conversion Disorder
- ▶ **Coordination Exercises in the Treatment of Cervical Dizziness**  
KJERSTI WILHELMSEN, ANNE E. LJUNGGREN
- ▶ Coping
- ▶ **Coping and Pain**  
JENNIFER A. HAYTHORNTHWAITE
- ▶ Coping Repertoire
- ▶ Coping Strategy/Style
- ▶ Coprevalence
- ▶ **Cord Glial Activation**  
JULIE WIESELER-FRANK, ERIN D. MILLIGAN, STEVEN F. MAIER, LINDA R. WATKINS
- ▶ Cordotomy
- ▶ **Cordotomy Effects on Humans and Animal Models**  
CHARLES J. VIERCK, ALAN R. LIGHT
- ▶ Core and Matrix
- ▶ Coronary Artery Disease
- ▶ Coronary Insufficiency
- ▶ Corpus Callosum
- ▶ Correct Rejection
- ▶ Correlation
- ▶ Cortex and Pain
- ▶ **Cortical and Limbic Mechanisms Mediating Pain and Pain-Related Behavior**  
KENNETH L. CASEY
- ▶ Cortical Feedback
- ▶ Cortical Information Flow
- ▶ Cortical Plasticity
- ▶ Cortical Projections
- ▶ Cortical Reorganization
- ▶ Cortical Spreading Depression
- ▶ Cortical Stimulation for Relief of Pain
- ▶ Corticolimbic Circuits
- ▶ Corticocortical Pathways
- ▶ Corticospinal Tract
- ▶ Corticosteroid Injections
- ▶ **Corticothalamic and Thalamocortical Interactions**  
EDWARD JONES
- ▶ Corticothalamic Fibers
- ▶ Cortisol
- ▶ Cost Shifting
- ▶ Costoclavicular Syndrome
- ▶ Co-Transmission

- ▶ Cotrimoxazol
- ▶ Cotunnus Disease
- ▶ Counterirritation
- ▶ Coupling Media of Ultrasound
- ▶ Coupling of Sympathetic Postganglionic Neurons onto Primary Afferent Nerve Fibers
- ▶ COX
- ▶ COX Isozymes
- ▶ COX-1
- ▶ **COX-1 and COX-2 in Pain**  
IRMGARD TEGEDER
- ▶ COX-1 Inhibitor
- ▶ COX-2
- ▶ COX-2 Inhibitor
- ▶ Coxibs
- ▶ **Coxibs and Novel Compounds, Chemistry**  
STEFAN A. LAUFER
- ▶ CPH
- ▶ Cranial Arteritis
- ▶ Cranial Nerve Neuralgia
- ▶ Cranial Nerves
- ▶ Cranial Neuralgias
- ▶ Craniomandibular Disorders
- ▶ Cranium
- ▶ CRD
- ▶ CREB
- ▶ Credibility Finding
- ▶ **Credibility, Assessment**  
KENNETH D. CRAIG
- ▶ Creep
- ▶ Criterion-Referenced Assessment
- ▶ Crohn's Disease
- ▶ Cross Excitation
- ▶ Cross Sectional Study
- ▶ Cross-Excitatory Discharge
- ▶ Cross-System Viscero-Visceral Interactions
- ▶ Cross-System Viscero-Visceral or Viscero-Somatic Convergence
- ▶ CRPS
- ▶ **CRPS, Evidence-Based Treatment**  
ANNE LOUISE OAKLANDER
- ▶ CRPS Type-I
- ▶ CRPS Type-II
- ▶ **CRPS-1 in Children**  
GUNNAR L. OLSSON
- ▶ Cura of Clitoris
- ▶ Cryoablation
- ▶ Cryoglobulinemia
- ▶ Cryotherapy
- ▶ CSF
- ▶ CSF Examination
- ▶ CSF Leak
- ▶ CT Myelography
- ▶ **CT Scanning**  
PETER LAU
- ▶ CT Scans
- ▶ CTDs
- ▶ CTrP
- ▶ Cuban Neuropathy Fabry's Disease
- ▶ Cumulative Trauma Disorders
- ▶ Cuneate Nucleus
- ▶ Cutaneous
- ▶ Cutaneous Allodynia
- ▶ **Cutaneous Field Stimulation**  
JENS SCHOUENBORG
- ▶ Cutaneous Freeze Trauma
- ▶ Cutaneous Hyperalgesia
- ▶ Cutaneous Mechanoreception
- ▶ Cutaneous Pain Model
- ▶ Cutaneous Stimulation
- ▶ CWP
- ▶ Cyclic Adenosine Monophosphate-Responsive Element-Binding Protein
- ▶ Cyclic Alternating Pattern
- ▶ Cyclic Pain
- ▶ Cyclooxygenase Inhibitors
- ▶ Cyclooxygenase Inhibitors, Chemistry
- ▶ Cyclooxygenase-2 Inhibitors
- ▶ Cyclooxygenases
- ▶ **Cyclooxygenases in Biology and Disease**  
REGINA M. BOTTING
- ▶ Cyclophosphamide
- ▶ Cyclosporin, Methotrexate
- ▶ Cystitis Models
- ▶ Cytoarchitectural
- ▶ Cytochrome Oxidase Staining
- ▶ **Cytokine Modulation of Opioid Action**  
VASUDEVA RAGHAVENDRA, JOYCE A. DELEO
- ▶ Cytokines
- ▶ **Cytokines as Targets in the Treatment of Neuropathic Pain**  
CLAUDIA SOMMER, LINDA S. SORKIN
- ▶ **Cytokines, Effects on Nociceptors**  
VICTORIA C. J. WALLACE

**▶ Cytokines, Regulation in Inflammation**

VICTORIA WALLACE

- ▶ Cytoprotection
- ▶ Cytoskeleton
- ▶ Daily Persistent Headache
- ▶ DAMGO
- ▶ Dapsone
- ▶ Dark Disc Disease
- ▶ Data
- ▶ Data Auditing/Collection/Gathering/Management/Security
- ▶ DBS
- ▶ Deactivation
- ▶ Dead Sea
- ▶ Deafferentation
- ▶ Deafferentation Pain
- ▶ Deception
- ▶ Decerebrated
- ▶ Decidualization
- ▶ Decision Theory
- ▶ Deconditioned
- ▶ **Deep Brain Stimulation**  
N. WEISS, I. GARONZIK, A. SAMDANI, S. OHARA, F. A. LENZ
- ▶ Deep Dysparuenia
- ▶ Deep Sedation
- ▶ Deep Somatic Pain
- ▶ Deep Venous Thrombosis
- ▶ Default Value
- ▶ Definition of Disability (Adults)
- ▶ Definition of Disability for Individuals under Age 18 (SSI Program Only)
- ▶ Degenerative Disease
- ▶ Degenerative Joint Disease
- ▶ Dejerine-Roussy Syndrome
- ▶ Dejerine-Sottas Syndrome (Neuropathy)
- ▶ Delayed Muscle Soreness
- ▶ **Delayed Onset Muscle Soreness**  
JAN FRIDÉN
- ▶ Delayed Severe Respiratory Depression
- ▶ Delirium
- ▶ Delta( $\delta$ ) Opioid Receptor(s)
- ▶ Delta( $\delta$ ) Sleep
- ▶ Demand Characteristics
- ▶ Dementia
- ▶ Demographic

**▶ Demyelination**

MATTHEW N. RASBAND, PETER SHRAGER

- ▶ Dendrite
- ▶ Dendritic Spines
- ▶ Dendritic Topography
- ▶ Dendritic Tree
- ▶ Dendrogram
- ▶ Denervation
- ▶ Denervation Model of Neuropathic Pain
- ▶ Densocellular Subnucleus of the Mediodorsal Nucleus
- ▶ **Dental Pain, Etiology, Pathogenesis and Management**  
GRAHAM R. HOLLAND
- ▶ Dental Pulp
- ▶ Dentin
- ▶ Dentinal Tubules
- ▶ Dependence
- ▶ Depolarisation
- ▶ Depression
- ▶ **Depression and Pain**  
ROBERT D. KERNS, ALICIA A. HEAPY
- ▶ Depression, Major Depressive Disorder
- ▶ Depressive Symptom Severity
- ▶ Dermatomal Level
- ▶ Dermatomes
- ▶ Dermatomyositis
- ▶ Descending Anti-Analgesic Systems
- ▶ **Descending Circuitry, Molecular Mechanisms of Activity-Dependent Plasticity**  
KE REN
- ▶ **Descending Circuitry, Opioids**  
DONNA L. HAMMOND, HERBERT K. PROUDFIT
- ▶ **Descending Circuitry, Transmitters and Receptors**  
ALVIN J. BEITZ
- ▶ **Descending Circuits in the Forebrain, Imaging**  
ELIZABETH ROY FELIX
- ▶ Descending Control
- ▶ Descending Control of Hyperalgesia
- ▶ Descending Excitatory Modulation
- ▶ Descending Facilitation
- ▶ **Descending Facilitation and Inhibition in Neuropathic Pain**  
MICHAEL H. OSSIPOV, FRANK PORRECA
- ▶ **Descending Facilitatory Systems**  
MIN ZHUO
- ▶ Descending Inhibition
- ▶ Descending Inhibition/Facilitation



- ▶ Descending Inhibitory Fibers
- ▶ Descending Inhibitory Mechanisms and GABA Mechanisms
- ▶ Descending Inhibitory Noradrenergic Pathways
- ▶ Descending Inhibitory Pathway for Pain
- ▶ **Descending Modulation and Persistent Pain**  
ANTTI PERTOVAARA
- ▶ **Descending Modulation of Nociceptive Processing**  
RONALD DUBNER
- ▶ **Descending Modulation of Nociceptive Transmission during Persistent Damage to Peripheral Tissues**  
HORACIO VANEGAS
- ▶ Descending Modulation of Pain
- ▶ **Descending Modulation of Visceral Pain**  
ELIE D. AL-CHAER
- ▶ Descending Noradrenergic Pathways
- ▶ Descending Pain Control
- ▶ Descending Pain Modulatory Pathways, Sex Differences
- ▶ Desensitization
- ▶ Desensitizing Toothpastes
- ▶ Desmin
- ▶ Detection Threshold
- ▶ Developmental Level
- ▶ Dexamethasone
- ▶ Diabetes Mellitus
- ▶ Diabetes Mellitus Type I
- ▶ Diabetes Mellitus Type II
- ▶ Diabetic Amyotrophy
- ▶ Diabetic Autonomic Polyneuropathy
- ▶ Diabetic Cranial Mononeuropathy
- ▶ Diabetic Mononeuritis
- ▶ **Diabetic Neuropathies**  
ANNE LOUISE OAKLANDER
- ▶ **Diabetic Neuropathy, Treatment**  
ANNE KJØRSVIK BERTELSEN, JOHN W. GRIFFIN
- ▶ Diabetic Polyneuropathy
- ▶ Diagnosis
- ▶ **Diagnosis and Assessment of Clinical Characteristics of Central Pain**  
ELLEN JØRUM
- ▶ **Diagnosis and General Pain Management**  
NIKOLAI BOGDUK
- ▶ **Diagnosis of Pain, Epidural Blocks**  
NIKOLAI BOGDUK
- ▶ **Diagnosis of Pain, Neurological Examination**  
NIKOLAI BOGDUK
- ▶ **Diagnostic and Statistical Manual of Mental Disorders**  
NIKOLAI BOGDUK
- ▶ Diagnostic Block
- ▶ Diaphragmatic Breathing
- ▶ Diaries
- ▶ Diathermy
- ▶ Diathesis
- ▶ Diathesis Stress
- ▶ **Diathesis-Stress Model of Chronic Pain**  
HERTA FLOR
- ▶ Diazepam
- ▶ Dictionary of Occupational Titles
- ▶ **Diencephalic Mast Cells**  
DANIEL MENÉTREY
- ▶ Diencephalic Nociceptive Neurons in the Human
- ▶ **Dietary Variables in Neuropathic Pain**  
JASENKA BORZAN, SRINIVASA N. RAJA,  
YORAM SHIR
- ▶ Differentiation
- ▶ Difficulty to Disengage
- ▶ Diffuse Noxious Inhibitory Controls
- ▶ Diffusion
- ▶ Diffusion Tensor Imaging
- ▶ Digital Nerve Blocks
- ▶ Digital Radiography
- ▶ Dimension
- ▶ Dimethylsulfoxide
- ▶ Dihypogastric Nerve Block
- ▶ Dioinguinal and Dihypogastric Nerve Block
- ▶ Direct Suggestion
- ▶ Disability
- ▶ Disability and Health (ICF)
- ▶ **Disability and Impairment Definitions**  
GEROLD STUCKI, THOMAS EWERT
- ▶ **Disability Assessment, Psychological / Psychiatric Evaluation**  
ROBERT J. GATCHEL
- ▶ Disability Determination
- ▶ **Disability, Effect of Physician Communication**  
JAMES P. ROBINSON
- ▶ **Disability Evaluation in the Social Security Administration**  
VICTORIA DORF
- ▶ **Disability, Fear of Movement**  
MAAIKE LEEUW, JOHAN W. S. VLAEYEN,  
GEERT CROMBEZ
- ▶ **Disability, Functional Capacity Evaluations**  
MICHELE C. BATTIÉ, DOUGLAS P. GROSS

- ▶ **Disability in Fibromyalgia Patients**  
ROBERT BENNETT
- ▶ Disability Insurance Benefits
- ▶ Disability Management
- ▶ **Disability Management in Managed Care System**  
BILL MCCARBERG
- ▶ Disability Prevention
- ▶ Disability Rating
- ▶ **Disability, Upper Extremity**  
J. MARK MELHORN
- ▶ Disability-Litigation System
- ▶ Disc Displacement
- ▶ Discharge Frequency
- ▶ Discharge Pattern
- ▶ **Discogenic Back Pain**  
VIVEKANANDA GONUGUNTA, EDWARD C. BENZEL
- ▶ Discogenic Pain
- ▶ Discordant Illness Behaviour
- ▶ Discriminability
- ▶ Discriminative Information
- ▶ Disease Modifying Antirheumatic Drugs
- ▶ Disinhibition
- ▶ Disinhibition of Nociceptive Neurons
- ▶ Displacement
- ▶ Disposition
- ▶ Disruption
- ▶ Dissection
- ▶ Dissociation
- ▶ Dissociative Imagery
- ▶ Dissociative Sedation
- ▶ Distal Axonopathy
- ▶ Distractibility
- ▶ Distracting Responses
- ▶ Distraction
- ▶ Distraction Signs
- ▶ Distribution
- ▶ Disuse Syndrome
- ▶ **Diurnal Variations of Pain in Humans**  
GASTON LABRECQUE
- ▶ Divalproex Sodium
- ▶ Diver's Headache
- ▶ Dizziness
- ▶ DMARDs
- ▶ DMSO
- ▶ DNA Recombination
- ▶ DNIC
- ▶ Dobutamine
- ▶ Doctor-Patient Communication
- ▶ DOMS
- ▶ DOP
- ▶ DOP Receptor
- ▶ Dopamine
- ▶ DOR-1
- ▶ Dorsal Column
- ▶ Dorsal Column Nuclei
- ▶ Dorsal Column Stimulators
- ▶ Dorsal Horn
- ▶ Dorsal Horn Neurons
- ▶ Dorsal Horn Opiate Systems
- ▶ Dorsal Rhizotomy
- ▶ Dorsal Root Entry Zone
- ▶ Dorsal Root Entry Zone Lesioning
- ▶ Dorsal Root Ganglion
- ▶ **Dorsal Root Ganglion Radiofrequency**  
WAY YIN, NIKOLAI BOGDUK
- ▶ **Dorsal Root Ganglionectomy and Dorsal Rhizotomy**  
MICHAEL J. DORSI, ALLAN J. BELZBERG
- ▶ Dorsal Root Reflexes
- ▶ Dorsolateral Fasciculus
- ▶ Dorsolateral Pons
- ▶ Dorsomedial Nucleus (DM)
- ▶ Dose Titration
- ▶ Dosing Interval
- ▶ Dosing Regimen
- ▶ DOT
- ▶ Double Depression
- ▶ Double-Blind
- ▶ Down-Regulated
- ▶ DREZ
- ▶ **DREZ Procedures**  
KENNETH M. LITTLE, ALLAN H. FRIEDMAN
- ▶ DREZ Lesions
- ▶ DRG
- ▶ Drug Guidelines
- ▶ **Drugs and Procedures to Treat Neuropathic Pain**  
GEORGE L. WILCOX
- ▶ **Drugs Targeting Voltage-Gated Sodium and Calcium Channels**  
ANNE K. BERTELSEN, MISHA-M. BACKONJA
- ▶ **Drugs with Mixed Action and Combinations, Emphasis on Tramadol**  
ROBERT B. RAFFA

- ▶ **Dry Needling**  
CHANG-ZERN HONG
- ▶ DSM, DSM-IV, DSM-IVR
- ▶ DSPN
- ▶ DTI
- ▶ Dual Matrix (Agro Contin System)
- ▶ Ductus Arteriosus
- ▶ Dummy
- ▶ Dura Mater
- ▶ Dural Puncture
- ▶ Dural Receptors
- ▶ Duration of Ultrasound Treatment
- ▶ Duration Requirement
- ▶ Durogesic®
- ▶ Dyesthesias
- ▶ Dying-Back Neuropathy
- ▶ Dying Child
- ▶ Dynamic Allodynia
- ▶ Dynamic Ensemble
- ▶ Dynamic Mechanical Allodynia
- ▶ Dynamic Mechanical Hyperalgesia
- ▶ Dynamic Pain
- ▶ Dynorphins
- ▶ Dysaesthesia (Dysesthesia)
- ▶ Dysautonomic
- ▶ Dyschezia
- ▶ **Dysesthesia, Assessment**  
ELLEN JØRUM
- ▶ Dysesthetic Vulvodinia
- ▶ **Dysfunctional Pain and the International Classification of Function**  
BENGT H. SÖLUND
- ▶ Dysfunctional Segmental Motion
- ▶ Dysmenorrhea
- ▶ Dysnosognosia
- ▶ Dyspareunia
- ▶ **Dyspareunia and Vaginismus**  
MARIE ANDREE LAHAIE, YITZCHAK M. BINIK
- ▶ Dyspareunia Model
- ▶ Dyspepsia
- ▶ Dysphagia
- ▶ Dysraphism
- ▶ Dysthesia
- ▶ Dysthymia
- ▶ Dystonia
- ▶ EAE
- ▶ Early Mobilization
- ▶ ECD
- ▶ **Ectopia, Spontaneous**  
ROBERT H. LAMOTTE
- ▶ Ectopic Activity (Ectopic Discharge)
- ▶ Ectopic Excitability
- ▶ Ectopic Mechanosensitivity
- ▶ Ectopic Nerve Impulses
- ▶ Edema
- ▶ EDT
- ▶ Education
- ▶ Education and Chronicity
- ▶ EEG
- ▶ **Effect Size**  
NIKOLAI BOGDUK
- ▶ Effective Analgesia
- ▶ Effectiveness
- ▶ Effectiveness Measure
- ▶ Efficacy
- ▶ Efficacy of Drugs
- ▶ Efficacy Study
- ▶ Effleurage
- ▶ Effort Headache
- ▶ Eicosanoids
- ▶ Electrical Stimulation Induced Analgesia
- ▶ Electrical Stimulation Therapy
- ▶ Electrical Therapy
- ▶ Electro-Acupuncture (EA)
- ▶ Electroanalgesia
- ▶ **Electrodiagnosis and EMG**  
D. PAUL HARRIES
- ▶ Electrodiagnostic Testing (Studies)
- ▶ Electroencephalogram/Electroencephalography
- ▶ Electrolytic Lesion
- ▶ Electromyography
- ▶ Electron Microscopy
- ▶ Electrophysiological Mapping
- ▶ Electrophysiology
- ▶ Electrotherapy
- ▶ Eligibility
- ▶ Elimination
- ▶ Elimination Half-Life ( $t_{1/2}$ )
- ▶ Elmiron®
- ▶ Embolism
- ▶ Emergence
- ▶ EMG-Assisted Relaxation
- ▶ Emotional Factors/Reactions
- ▶ Empathic
- ▶ Employment Assessment

- ▶ ENaC/DEG
- ▶ Enamel
- ▶ Enantiomer of Tramadol
- ▶ Encephalopathy
- ▶ **Encoding of Noxious Information in the Spinal Cord**  
ROBERT C. COGHILL
- ▶ **Encoding of Noxious Stimuli**  
MARTIN SCHMELZ
- ▶ End of Life Care
- ▶ Endocannabinoids
- ▶ Endogenous
- ▶ Endogenous Analgesia System
- ▶ Endogenous Opiate/Opioid System
- ▶ Endogenous Opioid Peptides
- ▶ Endogenous Opioid Receptors
- ▶ Endogenous Opioids/Opiates
- ▶ Endogenous Pain Control Pathway
- ▶ Endometriosis
- ▶ Endometriosis Externa
- ▶ Endometriosis Model
- ▶ Endomorphin 1 and Endomorphin 2
- ▶ Endone<sup>®</sup>
- ▶ Endorphins
- ▶ Endoscopic Sympathectomy
- ▶ Endothelins
- ▶ Endovanilloid
- ▶ Endplate Noise
- ▶ Endurance Exercise
- ▶ Enforced Mobilisation
- ▶ Enkephalin
- ▶ Enteric Coating
- ▶ Enterohepatic Recirculation (Biliary Recycling)
- ▶ Enthesis
- ▶ Enthesopathy
- ▶ Entorhinal Cortex and Hippocampus, Functional Imaging
- ▶ Entrapment Neuropathies
- ▶ Entrapment Neuropathies, Carpal Tunnel Syndrome
- ▶ Environmental Factors
- ▶ Ephaptic Coupling
- ▶ Epicondylitis
- ▶ Epicritic
- ▶ Epidemiology
- ▶ **Epidemiology of Chronic Pelvic Pain**  
STEPHEN KENNEDY, KRINA ZONDERVAN
- ▶ **Epidemiology of Work Disability, Back Pain**  
ERNEST VOLINN
- ▶ Epidermal Nerves
- ▶ Epidural
- ▶ Epidural Analgesia
- ▶ Epidural Block
- ▶ Epidural Diagnostic Blocks
- ▶ Epidural Drug Pumps
- ▶ Epidural Hematoma
- ▶ **Epidural Infusions in Acute Pain**  
ANNE JAUMEEES
- ▶ Epidural Injection of Corticosteroids
- ▶ Epidural Space
- ▶ Epidural Spinal Electrical Stimulation
- ▶ **Epidural Steroid Injections**  
NIKOLAI BOGDUK
- ▶ **Epidural Steroid Injections for Chronic Back Pain**  
DAVID M. SIBELL, BRETT R. STACEY
- ▶ Epigastric
- ▶ Epigastric Pain
- ▶ Epilepsy
- ▶ Epileptiform Neuralgia
- ▶ Episode Tension Type Headache
- ▶ Episodic Pain
- ▶ Episodic Paroxysmal Hemicrania
- ▶ Episodic Tension-Type Headache (Frequent and Infrequent)
- ▶ EPN
- ▶ EPSC
- ▶ Equianalgesic Dose
- ▶ Equianalgesic Dose Ratios
- ▶ Equianalgesic Dose Table
- ▶ Equivalent Current Dipole
- ▶ Ergonomic Approach
- ▶ **Ergonomic Counseling**  
JOHN DE CLERCQ, GUY VANDERSTRAETEN
- ▶ Ergonomics
- ▶ **Ergonomics Essay**  
PEREGRIN O. SPIELHOLZ
- ▶ **ERK Regulation in Sensory Neurons during Inflammation**  
KOICHI OBATA, YI DAI, KOICHI NOGUCHI
- ▶ Error of Measurement
- ▶ Erythema
- ▶ Erythema Nodosum
- ▶ Erythema Nodosum Leprosum
- ▶ Erythropoietin



- ▶ ES Stimulation
- ▶ Escape Response
- ▶ ESES
- ▶ Esophageal Pain, Non-Cardiac Chest Pain
- ▶ Essential Vulvodynia
- ▶ Estrous Cycle
- ▶ Etanercept
- ▶ **Ethics of Pain Control in Infants and Children**  
GARY A. WALCO
- ▶ **Ethics of Pain, Culture and Ethnicity**  
DAVID B. MORRIS
- ▶ **Ethics of Pain, Human Dignity and the Ethical Management of Pain and Suffering**  
DARYL PULLMAN
- ▶ **Ethics of Pain in the Newborn Human**  
CARLO VALERIO BELLINI
- ▶ **Ethics of Pain-Related Disability Evaluations**  
MARK D. SULLIVAN
- ▶ Ethnic Group
- ▶ Ethnicity
- ▶ Etomidate
- ▶ **Evaluation of Pain in Humans**  
LARS ARENDT-NIELSEN
- ▶ Evaluation of Pain-Related Thought, Psychological Aspects of Pain
- ▶ Evaluation of Permanent Impairment
- ▶ Evaluation of Vocational Capacity
- ▶ Event-Related Potential
- ▶ Evidence-Based Treatments
- ▶ Evoked Activity
- ▶ **Evoked and Movement-Related Neuropathic Pain**  
LOIS J. KEHL
- ▶ Evoked Pain
- ▶ Evoked Pain and Morphine
- ▶ Evoked Potentials
- ▶ **Evolution of Pediatric Pain Treatment**  
NEIL SCHECHTER
- ▶ Excitatory Amino Acids
- ▶ Excitatory Post-Synaptic Current
- ▶ Excitotoxic
- ▶ Excitotoxic Lesion
- ▶ Excitotoxic Model
- ▶ Excruciating Pain
- ▶ **Exercise**  
SUSAN MERCER
- ▶ Exercise-Induced Muscle Soreness
- ▶ Exertional Activity
- ▶ Exertional Capability
- ▶ Exertional Limitations and Restrictions
- ▶ Existential Distress
- ▶ Exocytosis
- ▶ **Exogenous Muscle Pain**  
THOMAS GRAVEN-NIELSEN
- ▶ Exon
- ▶ Exorphins
- ▶ Expectancies
- ▶ Expectation
- ▶ Experimental Allergic Encephalitis
- ▶ Experimental Diabetic Neuropathy
- ▶ Experimental Endpoint
- ▶ Experimental Jaw Muscle Pain
- ▶ Experimental Muscle Pain
- ▶ Experimental Pain
- ▶ **Experimental Pain in Children**  
JENNIE C. I. TSAO, LONNIE K. ZELTZER
- ▶ Expert Patient
- ▶ Explanatory Model
- ▶ Exposure In Vivo
- ▶ Exposure Techniques for Reducing Activity Avoidance
- ▶ Exposure Treatment
- ▶ Extension Exercises
- ▶ Extensive First Pass Metabolism
- ▶ Exteroception
- ▶ Exteroceptive
- ▶ Exteroceptive Suppression
- ▶ Exteroreceptive
- ▶ Extinction
- ▶ Extracellular Signal-Regulated Protein Kinase
- ▶ Extradural Infusions
- ▶ Extralemniscal Myelotomy
- ▶ Extrasegmental Analgesia
- ▶ Extrasegmental Anti-Nociceptive Mechanisms
- ▶ Extrusion
- ▶ Eye Nociceptors
- ▶ Eye Pain Receptors
- ▶ F2 Intercross
- ▶ Faces Pain Scale
- ▶ Facet Denervation
- ▶ Facet Joint
- ▶ Facet Joint Injection
- ▶ **Facet Joint Pain**  
ALFRED T. OGDEN, CHRISTOPHER J. WINFREE

- ▶ **Facet Joint Procedures for Chronic Back Pain**  
DAVID M. SIBELL
- ▶ Facet Rhizolysis
- ▶ Facet Syndrome
- ▶ Facial Ganglion Neuralgia
- ▶ Facial Pain
- ▶ Facial Pain Associated with Disorders of the Cranium
- ▶ Facilitative Tucking
- ▶ Factor Analysis
- ▶ Factor Loading
- ▶ Factors Associated with Low Back Pain
- ▶ Failed Back
- ▶ Failed Back Surgery Syndrome
- ▶ False Affirmative Rate
- ▶ Familial Adenomatous Polyposis
- ▶ Familial Dysautonomia Type II
- ▶ Familial Factors
- ▶ Familial Hemiplegic Migraine
- ▶ Familial Polyposis Coli
- ▶ Family Centered Care
- ▶ Family Environment
- ▶ Family Stressors
- ▶ Family Systems Theories
- ▶ FAP
- ▶ Fascia Iliaca Compartment Block
- ▶ Fasciculus Cuneatus
- ▶ Fasciculus Gracilis
- ▶ Fast Track Surgery
- ▶ Fatigue
- ▶ FCA
- ▶ FCA-Induced Arthritis
- ▶ FCE
- ▶ Fear
- ▶ **Fear and Pain**  
MAAIKE LEEUW, JOHAN W. S. VLAEYEN
- ▶ Fear-Anxiety-Avoidance Model
- ▶ Fear Avoidance
- ▶ Fear Avoidance Beliefs
- ▶ Fear-Avoidance Model
- ▶ Fear Hierarchy
- ▶ Fear of Movement/(Re)Injury
- ▶ Fear of Pain
- ▶ **Fear Reduction through Exposure In Vivo**  
JEROEN R. DE JONG, JOHAN W. S. VLAEYEN
- ▶ Feasible
- ▶ Feedback Control of Pain
- ▶ Fee-for-Service
- ▶ Female Reproductive Organ Pain Model
- ▶ Femoral Nerve Block
- ▶ Fentanyl
- ▶ Fibroblast
- ▶ Fibroblast-Like Satellite Cells
- ▶ Fibrocartilage
- ▶ **Fibromyalgia**  
DAVID VIVIAN, NIKOLAI BOGDUK
- ▶ **Fibromyalgia, Mechanisms and Treatment**  
ALICE A. LARSON, KATALIN J. KOVÁCS
- ▶ Fibromyalgia Syndrome
- ▶ Fibromyositis
- ▶ Fibrositis
- ▶ Fibrositis Syndrome
- ▶ Field Block
- ▶ Fifth Lobe
- ▶ Firing of Suburothelial Afferent Nerves
- ▶ **First and Second Pain Assessment (First Pain, Pricking Pain, Pin-Prick Pain, Second Pain, Burning Pain)**  
DONALD D. PRICE
- ▶ First Pain
- ▶ First Pain Assessment
- ▶ First-Pass Metabolism
- ▶ Fit of Pain
- ▶ Fitness Training
- ▶ Flare
- ▶ Flare, Flare Response
- ▶ Flexion Exercise
- ▶ Flexion Withdrawal Reflex
- ▶ Flinching
- ▶ Flip-Flop Isoform of AMPA Receptors
- ▶ Flunarizin
- ▶ Fluorocitrate
- ▶ Flurbiprofen
- ▶ fMRI
- ▶ fMRI Imaging and PET in Parietal Cortex
- ▶ FMS
- ▶ Focal Pain
- ▶ Focused Analgesia
- ▶ Follicular Phase
- ▶ Forced Choice Procedure
- ▶ Forearm Ischemia Procedure
- ▶ Forearm Occlusion Pain
- ▶ Forebrain

- ▶ **Forebrain Modulation of the Periaqueductal Gray**  
MATTHEW ENNIS, YI-HONG ZHANG, ANNE Z. MURPHY
- ▶ **Formalin Test**  
TERENCE J. CODERRE, FRANCES V. ABBOTT, JANA SAWYNOK
- ▶ Forty Hz Oscillations
- ▶ Fos Expression
- ▶ Fos Protein
- ▶ Fothergill's Disease
- ▶ Fractalkine
- ▶ Fractional Receptor Occupancy
- ▶ Free from Bias
- ▶ Free Magnitude Estimation
- ▶ Free Nerve Endings
- ▶ Freeze Lesion
- ▶ **Freezing Model of Cutaneous Hyperalgesia**  
SUSANNE K. SAUER
- ▶ French Energetic Acupuncture
- ▶ Frequency-Dependent Nociceptive Facilitation
- ▶ Frequency of Low Back Pain
- ▶ Frequency of Ultrasound Treatment
- ▶ Freund's Complete Adjuvant
- ▶ FRO
- ▶ Frontal-Posterior Neck Electromyographic Sensor Placement
- ▶ Frustration
- ▶ Fulcrum
- ▶ Full and Partial Opioid Receptor Agonists
- ▶ Functional
- ▶ Functional Abdominal Pain
- ▶ Functional Abilities Evaluation
- ▶ Functional Aspects of Visceral Pain
- ▶ Functional Bowel Disorder
- ▶ Functional Brain Imaging
- ▶ Functional Capacity
- ▶ Functional Capacity Assessment
- ▶ Functional Capacity Battery
- ▶ Functional Capacity Evaluation
- ▶ **Functional Changes in Sensory Neurons Following Spinal Cord Injury in Central Pain**  
JING-XIA HAO, XIAO-JUN XU
- ▶ Functional Changes in Thalamus
- ▶ Functional Gastrointestinal Disorders
- ▶ Functional Health
- ▶ Functional Imaging
- ▶ **Functional Imaging of Cutaneous Pain**  
JÜRGEN LORENZ
- ▶ Functional Imaging of Descending Modulation
- ▶ Functional Loss
- ▶ Functional Magnetic Resonance Imaging
- ▶ Functional Restoration
- ▶ Fundamental Fears
- ▶ Funiculus
- ▶ G Protein
- ▶ G Protein Coupling
- ▶ G Protein-Coupled Receptor
- ▶ **GABA and Glycine in Spinal Nociceptive Processing**  
HANNS ULRICH ZEILHOFER
- ▶ **GABA Mechanisms and Descending Inhibitory Mechanisms**  
WILLIAM D. WILLIS
- ▶ GABA Transporter
- ▶ GABA<sub>A</sub> Receptors
- ▶ GABA<sub>B</sub> Receptors
- ▶ GABAergic
- ▶ GABAergic Cells (Inhibitory Interneurones)
- ▶ GABAergic Inhibition
- ▶ Gabapentin
- ▶ GAD
- ▶ Gainful Work Activity
- ▶ Galactorrhea
- ▶ Galanin
- ▶ Gamma Knife
- ▶ Gamma( $\gamma$ )-Aminobutyric Acid
- ▶ **Ganglionopathies**  
JOHN W. GRIFFIN
- ▶ Gap Junctions
- ▶ Gastroesophageal Reflux Disease
- ▶ Gastrointestinal Tract, Nocifensive Behaviors
- ▶ GAT 1, GAT 2, GAT 3
- ▶ Gate Control Theory
- ▶ Gazelius Model
- ▶ GBS
- ▶ GDNF
- ▶ GDNF-Dependent Neurons
- ▶ Gender
- ▶ **Gender and Pain**  
ANITA M. UNRUH
- ▶ Gender Differences in Opioid Analgesia
- ▶ Gender Role Expectation of Pain Scale
- ▶ Gender Role Theories in Pain

- ▶ Gene
- ▶ Gene Array
- ▶ Gene Therapy and Opioids
- ▶ Gene Transcription
- ▶ General Adaptation Syndrome
- ▶ General Anesthesia
- ▶ Generator Currents
- ▶ Generic Carbamazepine
- ▶ Genetic Correlation
- ▶ Genetic Factors Contributing to Opioid Analgesia
- ▶ Genetic Linkage
- ▶ Geniculate Neuralgia
- ▶ Genital Mucosa, Nociception
- ▶ Genome
- ▶ Genotype
- ▶ Genotypic Influences on Opioid Analgesia
- ▶ GERD
- ▶ Geriatric Medicine
- ▶ GFR $\alpha$ 1 or GFR $\alpha$ 2
- ▶ Giant Cell Arteritis (Arthritis)
- ▶ Gigantocellular Reticular Nucleus
- ▶ GIRK Channel
- ▶ Glabrous
- ▶ Glabrous Skin
- ▶ Glans Clitoris
- ▶ Glia
- ▶ Glial Activation
- ▶ Glial Cell Line-Derived Neurotrophic Factor
- ▶ Glial Proliferation
- ▶ Glomerulations
- ▶ Glossopharyngeal Neuralgia
- ▶ Glove Anesthesia
- ▶ Glucocorticosteroid
- ▶ Glucosamine
- ▶ Glucose Intolerance
- ▶ Glucuronide Metabolites of Morphine
- ▶ Glutamate
- ▶ Glutamate Homeostasis
- ▶ **Glutamate Homeostasis and Opioid Tolerance**  
JIANREN MAO
- ▶ Glutamate Neurotoxicity
- ▶ Glutamate Receptors
- ▶ Glutamate Regulation
- ▶ Glutamate Transporter
- ▶ Glutamatergic
- ▶ Glutamic Acid Decarboxylase
- ▶ Gluteus Medius
- ▶ Glycerol Rhizotomy
- ▶ Glycine Transporter
- ▶ Glycolysis
- ▶ Glycosaminoglycan
- ▶ Glycyrrhizic Acid
- ▶ GlyT-1
- ▶ GlyT-2
- ▶ Goals for Pain Treatment in the Elderly
- ▶ gp120
- ▶ GPCR
- ▶ GPI (Guinea Pig Ileum) and MVD (Mouse Vas Deferens)
- ▶ Gracile Nucleus
- ▶ Graded Activity Approaches to Chronic Pain
- ▶ Graded Exposure in Vivo with Behavioral Experiments
- ▶ Gradiometer
- ▶ Granulocyte Colony Stimulating Factor
- ▶ Granulocytopenia
- ▶ Granulomas
- ▶ Gravity-Assisted Traction
- ▶ Gray Matter Density
- ▶ GREP Scale
- ▶ Grip Force
- ▶ Group Health
- ▶ Group III/Group IV Afferent Fibers
- ▶ Group Stimulus Space
- ▶ Group-Oriented Practice
- ▶ Growth Factor
- ▶ Growth Hormone
- ▶ Guarding
- ▶ Guided Imagery/Guided Mental Imagery
- ▶ **Guillain-Barré Syndrome**  
JOHN W. SCADDING
- ▶ Gynecological Cancer
- ▶ **Gynecological Pain and Sexual Functioning**  
PH. TH. M. WEIJENBORG, M. M. TER KUILE
- ▶ Gynecological Pain Model
- ▶ **Gynecological Pain, Neural Mechanisms**  
KAREN J. BERKLEY, NATALIA DMITRIEVA
- ▶ Habituation
- ▶ Hamstring Muscle Strain
- ▶ Handicap
- ▶ **Hansen's Disease**  
AKI J. HIETAHARJU, MAIJA HAANPÄÄ
- ▶ Hargreaves Test
- ▶ Head Pain



- ▶ **Headache**  
NIKOLAI BOGDUK
- ▶ **Headache, Acute Post-Traumatic**  
MIGUEL JA LÁINEZ-ANDRÉS, ANA M. PASCUAL-LOZANO
- ▶ Headache Associated with Disorders of the Cranium
- ▶ Headache Associated with Psychotic Disorder
- ▶ Headache Associated with Somatisation Disorder
- ▶ **Headache Attributed to a Substance or its Withdrawal**  
STEPHEN D. SILBERSTEIN
- ▶ **Headache Due to Arteritis**  
PETER BERLIT
- ▶ Headache Due to Brain Metastases
- ▶ **Headache Due to Dissection**  
MATHIAS STURZENEGGER
- ▶ **Headache Due to Hypertension**  
JOHN EDMEADS
- ▶ **Headache Due to Intracranial Bleeding**  
SEYMOUR SOLOMON
- ▶ **Headache Due to Low Cerebrospinal Fluid Pressure**  
ANDREAS R. GANTENBEIN, PETER S. SÁNDOR
- ▶ **Headache Due to Sinus-Venous Thrombosis**  
VOLKER LIMMROTH, HANS-CHRISTOPH DIENER
- ▶ **Headache Due to Somatoform Disorder**  
RETO M. AGOSTI
- ▶ **Headache, Episodic Tension Type**  
ANDREAS R. GANTENBEIN, PETER S. SÁNDOR
- ▶ **Headache from Cranial Bone**  
HARTMUT GÖBEL
- ▶ **Headache in Aseptic Meningitis**  
K. RAVISHANKAR
- ▶ Health Informatics
- ▶ Heart Pain
- ▶ Heat Hyperalgesia
- ▶ Heat Lesion
- ▶ Heat Sensor
- ▶ Heightened Attention
- ▶ Heightened Vigilance
- ▶ Helical CT
- ▶ Helicobacter Pylori
- ▶ Heliotherapy
- ▶ Helplessness
- ▶ Hemianesthesia
- ▶ Hemibody Radiation
- ▶ **Hemicrania Continua**  
LAWRENCE C. NEWMAN
- ▶ Hemicrania Continua Headache
- ▶ Hemicrania Simplex
- ▶ Hemipain
- ▶ Hemisection Model
- ▶ Hemisphere
- ▶ Hemorrhagic Stroke
- ▶ Hereditary Motor and Sensory Neuropathy
- ▶ **Hereditary Neuropathies**  
WILLIAM N. KELLEY, STEVEN S. SCHERER
- ▶ Hereditary Neuropathy with Liability to Pressure Palsies
- ▶ Hereditary Sensory and Autonomic Neuropathy Type IV, HSAN IV, HSAN 4
- ▶ Hereditary Sensory Neuropathy
- ▶ **Heritability of Inflammatory Nociception**  
JEFFREY S. MOGIL
- ▶ Heritable
- ▶ Herpes Simplex Virus Vectors
- ▶ Herpes Virus
- ▶ Herpes Zoster
- ▶ Herpes Zoster Pain
- ▶ Heteromeric Channels
- ▶ Heterotopic Ossification
- ▶ Heterozygosity
- ▶ Heterozygous Carriers
- ▶ Hidden Triggers
- ▶ High Dependency or Intensive Care Units
- ▶ High Thoracic Epidural Anesthesia
- ▶ High Threshold Mechanoreceptor
- ▶ High-Threshold Mechanosensitive Muscle Receptors
- ▶ High Threshold Neurons
- ▶ High-Threshold VDCCs
- ▶ High Velocity Thrust Manipulation
- ▶ High-Voltage Calcium Channels
- ▶ Hindlimb Flexor Reflex
- ▶ Hippocampal Formation or Hippocampal Region
- ▶ Hippocampus
- ▶ **Hippocampus and Entorhinal Complex, Functional Imaging**  
SIRI LEKNES, IRENE TRACEY
- ▶ Histamine
- ▶ Histopathological
- ▶ **History of Analgesics**  
KAY BRUNE, BURKHARD HINZ
- ▶ Hit Rate or Sensitivity
- ▶ HIV and Pain
- ▶ HMSN
- ▶ HNPP

- ▶ Hoffman-Tinel Sign
- ▶ Holistic Medicine
- ▶ Homeopathy
- ▶ Homeostasis
- ▶ Homeostatic Adaptations
- ▶ Homework
- ▶ Homologous Gene
- ▶ Homomeric Channels
- ▶ Homozygous Carriers
- ▶ Horsley-Clarck Apparatus or Stereotaxic Frame
- ▶ Hospice Care
- ▶ Hostility
- ▶ Hot Plate Test (Assay)
- ▶ Hot Tooth Syndrome
- ▶ Household Income and Chronicity
- ▶ HPA Axis
- ▶ HT Neurons
- ▶ Human Factors Engineering
- ▶ Human Infant Pain Neurophysiology
- ▶ **Human Models of Inflammatory Pain**  
LOUISE HARDING
- ▶ **Human Thalamic Nociceptive Neurons**  
KAREN D. DAVIS, JONATHAN O. DOSTROVSKY
- ▶ **Human Thalamic Response to Experimental Pain (Neuroimaging)**  
ALEXANDRE F. M. DASILVA, NOUCHINE HADJIKHANI
- ▶ Hunner's Ulcer
- ▶ HVTM
- ▶ Hyaline Cartilage
- ▶ **Hyaluronan**  
BRIAN MCGUIRK
- ▶ Hyaluronic Acid (HA)
- ▶ Hydrodistention
- ▶ Hydroperoxides
- ▶ Hydrotherapy
- ▶ Hydroxy-7.8-Dihydrocodeinone
- ▶ Hypalgesia
- ▶ Hypalgia
- ▶ Hyperaesthesia
- ▶ **Hyperaesthesia, Assessment**  
KRISTINA B. SVENDSEN, TROELS S. JENSEN, F. W. BACH
- ▶ **Hyperalgesia**  
ROLF-DETLEF TREEDE
- ▶ Hyperalgesia, Primary and Secondary
- ▶ Hyperemia
- ▶ Hyperesthesia
- ▶ Hyperexcitability
- ▶ Hyperglycemic Neuropathy
- ▶ Hyperhidrosis
- ▶ Hyperknesis
- ▶ **Hyperpathia**  
JOHN W. SCADDING
- ▶ **Hyperpathia, Assessment**  
ASTRID J. TERKELSEN, TROELS S. JENSEN
- ▶ Hyperpolarization
- ▶ Hyperresponsiveness
- ▶ Hypersensitivity
- ▶ Hypersensitivity Maintained Pain
- ▶ Hyperstimulation Analgesia
- ▶ Hypertensive Encephalopathy
- ▶ Hypertensive Headaches
- ▶ Hypertonic Saline
- ▶ Hypervigilance
- ▶ **Hypervigilance and Attention to Pain**  
GEERT CROMBEZ, STEFAAN VAN DAMME, CHRISTOPHER ECCLESTON
- ▶ Hypesthesia
- ▶ Hypnic Alarm Clock Headache Syndrome
- ▶ **Hypnic Headache**  
JAMES W. LANCE
- ▶ Hypnosis
- ▶ Hypnotherapy
- ▶ **Hypnotic Analgesia**  
DONALD D. PRICE, PIERRE RAINVILLE
- ▶ Hypnotic Relaxation
- ▶ Hypnotism
- ▶ Hypnotizability
- ▶ Hypoaesthesia
- ▶ **Hypoalgesia, Assessment**  
MISHA-MIROSLAV BACKONJA
- ▶ Hypochondriaca
- ▶ Hypochondriasis
- ▶ **Hypochondriasis, Somatoform Disorders and Abnormal Illness Behaviour**  
ISSY PILOWSKY
- ▶ **Hypoesthesia, Assessment**  
MISHA-MIROSLAV BACKONJA
- ▶ Hypogastric Neurectomy
- ▶ Hyponatremia
- ▶ Hypophysectomy
- ▶ Hypotension of Spinal Fluid
- ▶ Hypothalamic Pituitary Axis
- ▶ Hypothalamus
- ▶ **Hypothalamus and Nociceptive Pathways**  
JEAN-FRANÇOIS BERNARD

- ▶ Hypothalamus-Anterior Pituitary-Gonadal Axis
- ▶ Hypoxia
- ▶ IAIABC System
- ▶ **Iatrogenic Causes of Neuropathy**  
PAOLO MARCHETTINI
- ▶ Iatrogenic Effect/Response
- ▶ Iatrogenic Neuropathy
- ▶ IB4-Binding Neurons
- ▶ **IB4-Positive Neurons, Role in Inflammatory Pain**  
CHERYL L. STUCKY
- ▶ IB4-Positive Nociceptors
- ▶ IBS
- ▶ IC<sub>50</sub> Value
- ▶ Ice-Pick Pain
- ▶ Ice-Water Bucket Test
- ▶ ICF
- ▶ ICSI
- ▶ IDET
- ▶ Idiopathic
- ▶ Idiopathic Ataxic Neuropathy
- ▶ Idiopathic Cramps
- ▶ Idiopathic Headache
- ▶ Idiopathic Myalgia
- ▶ Idiopathic Orofacial Pain
- ▶ Idiopathic Stabbing Headache
- ▶ Idiopathic Vulvar Pain
- ▶ IEGs
- ▶ iGluRs
- ▶ Ignition Hypothesis
- ▶ IL-1beta
- ▶ IL-4
- ▶ IL-6
- ▶ IL-10
- ▶ Ilium
- ▶ Illness Behaviour
- ▶ Illusory Cramp
- ▶ Imagery
- ▶ IME
- ▶ Imitation Learning
- ▶ Immediate Early Genes
- ▶ Immortalization
- ▶ Immune Cell Recruitment
- ▶ Immune Cells
- ▶ Immunocompetent Cells
- ▶ Immunocytochemistry
- ▶ **Immunocytochemistry of Nociceptors**  
CHERYL L. STUCKY
- ▶ Immunocytokines
- ▶ Immunodeficient
- ▶ Immunoglobulin Therapy
- ▶ Immunohistochemistry
- ▶ Immuno-Inflammatory Muscle Pain
- ▶ Immunoisolation
- ▶ Immunoreactivity
- ▶ Immunostaining
- ▶ Immunosuppression
- ▶ **Impact of Familial Factors on Children's Chronic Pain**  
LINDSAY S. UMAN, CHRISTINE T. CHAMBERS
- ▶ Impact on Activities of Daily Living
- ▶ Impairment
- ▶ Impairment Due to Pain
- ▶ Impairment Evaluation
- ▶ Impairment, Functions Loss
- ▶ **Impairment, Pain-Related**  
JAMES P. ROBINSON
- ▶ Impairment Rating
- ▶ **Impairment Rating, Ambiguity**  
ALAN L. COLLEDGE, GREGORY KROH
- ▶ **Impairment Rating, Ambiguity, IAIABC System**  
ALAN L. COLLEDGE, GREGORY KROH
- ▶ Impartial Medical Evaluation
- ▶ In Vitro
- ▶ In Vitro CCK Release
- ▶ In Vivo
- ▶ In Vivo CCK Release by Microdialysis
- ▶ Inactive Agent
- ▶ Inappropriate Symptoms and Signs
- ▶ Inbred Strains
- ▶ INCB
- ▶ Incentive
- ▶ Incidence
- ▶ Incidence of Low Back Pain
- ▶ Incident Pain
- ▶ Incision Model for Postoperative Pain
- ▶ Inclusion Body Myositis
- ▶ Incomplete Cross Tolerance
- ▶ Incomplete Spinal Cord Injury
- ▶ Inconsistent Symptoms and Signs
- ▶ Indemnity Costs
- ▶ Independent Medical Evaluation

- ▶ **Independent Medical Examinations**  
CHRISTOPHER R. BRIGHAM
- ▶ Indirect Suggestion
- ▶ Individual Differences
- ▶ Indomethacin
- ▶ Induration
- ▶ Inert Agent
- ▶ Infant Composite Pain Measures
- ▶ Infant Pain
- ▶ Infant Pain Instruments
- ▶ **Infant Pain Mechanisms**  
KATHARINE ANDREWS CAMPBELL
- ▶ Infant Pain Reduction/Therapy/Treatment
- ▶ Inflammation
- ▶ **Inflammation, Modulation by Peripheral Cannabinoid Receptors**  
ISOBEL LEVER
- ▶ Inflammation, Neuropeptide Release
- ▶ **Inflammation, Role of Peripheral Glutamate Receptors**  
SUSAN M. CARLTON
- ▶ Inflammatory
- ▶ Inflammatory Bowel Disease, n Animal Models
- ▶ Inflammatory Hyperalgesia by Skin Freezing
- ▶ Inflammatory Mediators
- ▶ Inflammatory Myopathies
- ▶ **Inflammatory Neuritis**  
LINDA S. SORKIN
- ▶ Inflammatory Neuropathy
- ▶ Inflammatory Nociception, Genetic Factors
- ▶ Inflammatory Nociception, Heritability
- ▶ **Inflammatory Nociceptor Sensitisation, Prostaglandins and Leukotrienes**  
BLAIR D. GRUBB
- ▶ Inflammatory Pain
- ▶ **Inflammatory Pain and NGF**  
DAVID BENNETT
- ▶ Inflammatory Pain and Opioids
- ▶ Inflammatory Pain, Human Models
- ▶ Inflammatory Pain Models
- ▶ Inflammatory Syndrome
- ▶ Infliximab
- ▶ Inflow Artefacts
- ▶ **Information and Psychoeducation in the Early Management of Persistent Pain**  
STEVEN J. LINTON
- ▶ Infraclavicular Block
- ▶ Infusion
- ▶ Inherited Factors Implicated in the Mechanisms of Migraine
- ▶ Inherited Variability of Drug Response
- ▶ Inhibitory Synaptic Transmission
- ▶ Injection Acupuncture
- ▶ Injections of Corticosteroids
- ▶ Injections of Steroids
- ▶ Injury Discharge
- ▶ Injury Memory
- ▶ Innervation of the Urinary Bladder
- ▶ Innocuous Input/Stimulus
- ▶ Instability
- ▶ Installation Block
- ▶ Instrumental Conditioning
- ▶ Insula
- ▶ Insula/Insular Cortex
- ▶ **Insular Cortex, Neurophysiology and Functional Imaging of Nociceptive Processing**  
TUAN DIEP TRAN, KENNETH L. CASEY
- ▶ Insulin Neuropathy
- ▶ Insurance Incentives
- ▶ Intensity of Pain
- ▶ Intensity of Ultrasound
- ▶ Intentionality
- ▶ Intercostal Space
- ▶ Interdisciplinary
- ▶ Interdisciplinary Pain Management Programs
- ▶ **Interdisciplinary Pain Rehabilitation**  
CHRIS J. MAIN
- ▶ Interlaminar Epidural Steroid Injection
- ▶ Interleukin(s) (IL)
- ▶ Intermittent Claudication
- ▶ Internal Capsule
- ▶ Internal Disc Disruption
- ▶ Internal Neurolysis
- ▶ Internal Validity
- ▶ Internalization
- ▶ Internalization of Receptors
- ▶ International Narcotics Control Board
- ▶ Interneuron
- ▶ Interoception
- ▶ **Interpersonal Pain Behaviour**  
PAUL J. WATSON
- ▶ Interprofessional Approach
- ▶ Interscalene
- ▶ Interscalene Block
- ▶ Interspike Interval



- ▶ **Interstitial Cystitis and Chronic Pelvic Pain**  
ELLIOT M. PAUL, EVAN R. EISENBERG, ROBERT M. MOLDWIN
- ▶ Interventional Therapies
- ▶ Intervertebral Disc
- ▶ Intervertebral Foramen, Cervical
- ▶ Intra-Articular Blocks and Thoracic Medial Branch Blocks
- ▶ **Intra-Articular Injections of Steroids**  
NIKOLAI BOGDUK
- ▶ Intra-Articular Morphine
- ▶ Intra-Articular Sacroiliac Joint Block
- ▶ Intra-Articular Steroid Injections
- ▶ Intra Discal Electrothermal Therapy
- ▶ Intracellular Labeling
- ▶ Intracerebral Hematoma Apoplexy
- ▶ Intracerebroventricular Drug Pumps
- ▶ Intracerebroventricular, Intracerebral and Intrathecal
- ▶ Intracranial
- ▶ Intracranial Ablative Procedures
- ▶ Intracranial Nociceptors
- ▶ Intractable
- ▶ Intracutaneous Injection Pain
- ▶ Intradental Nociceptors
- ▶ Intradermal
- ▶ Intradiscal Electrothermal Anuloplasty
- ▶ **Intradiscal Electrothermal Therapy**  
KEVIN PAUZA, NIKOLAI BOGDUK
- ▶ Intralaminar Thalamic Nuclei
- ▶ Intramuscular Sensory Nerve Stimulation
- ▶ Intramuscular Stimulation
- ▶ Intraoperative Awareness
- ▶ Intraperitoneal
- ▶ Intrathecal
- ▶ Intrathecal Drug Pumps
- ▶ Intrathecal Injection
- ▶ Intrathecal Space
- ▶ **Intravenous Infusions, Regional and Systemic**  
JOHN ROBINSON
- ▶ Intravenous Regional Analgesia/Block
- ▶ Intravenous Tramadol
- ▶ Intraventricular
- ▶ Intraventricular Drug Pumps
- ▶ Intravesical
- ▶ Invasive
- ▶ Inverse Agonist
- ▶ Inverse Problems
- ▶ Ion Channel
- ▶ Ion Channel Blockers
- ▶ Ion Channel Trafficking
- ▶ Ionotropic Glutamate Receptors
- ▶ Ionotropic Receptor
- ▶ Ipsilateral
- ▶ Irritable Bowel Syndrome
- ▶ Irritable Bowel Syndrome Model
- ▶ Irritant
- ▶ Ischemia
- ▶ Ischemia Model
- ▶ Ischemic Heart Disease
- ▶ Ischemic Neuropathies
- ▶ Ischemic Pain/Test
- ▶ ISH
- ▶ ISI
- ▶ Island of Reil
- ▶ Isolectin B4
- ▶ **Itch/Itch Fibers**  
MARTIN SCHMELZ
- ▶ ITCH MAN
- ▶ Itchy Skin
- ▶ IUPHAR
- ▶ Jab-Like and Jolt-Like Headache
- ▶ Jabs and Jolts Syndrome
- ▶ Japanese Meridian Therapy
- ▶ Jaw Claudication
- ▶ **Jaw-Muscle Silent Periods (Exteroceptive Suppression)**  
GIORGIO CRUCCU
- ▶ Job Analysis
- ▶ Job Capacity Evaluation
- ▶ Job Demands
- ▶ Job Requirements
- ▶ Job Satisfaction
- ▶ Job Site Evaluation
- ▶ Joint Deformities
- ▶ Joint Nociceptors
- ▶ JRA
- ▶ Junctional DREZ Coagulation
- ▶ Just-Noticeable-Difference
- ▶ Juvenile Rheumatoid Arthritis
- ▶ Juxtaglomerular Apparatus
- ▶ K/C Arthritis
- ▶ K<sup>+</sup> Channel

- ▶ Kainate-Induced Lesion
- ▶ Kainate Receptor
- ▶ Kaolin
- ▶ Kaolin-Carrageenan Induced Arthritis
- ▶ Kapanoll
- ▶ Kappa( $\kappa$ ) Opiate/Opioid Receptors
- ▶ Keratinocytes
- ▶ Ketalar
- ▶ Ketamine
- ▶ Kidney Stone Pain
- ▶ Kinesiophobia
- ▶ Kinesthesia
- ▶ Knee Joint Nociceptors
- ▶ Knockout Mice
- ▶ KOP Receptor
- ▶ KOR-1
- ▶ Kyphotic
- ▶ La Belle Indifference
- ▶ Labor Pain
- ▶ Labor Pain Model
- ▶ Laboratory Findings
- ▶ Laboratory Pain
- ▶ Lacrimation
- ▶ Laminae I and V Neurones
- ▶ Laminae II<sub>outer</sub> and Lamina II<sub>inner</sub>
- ▶ Lamina Propria
- ▶ Laminae I/II Inputs to the Thalamus
- ▶ Laminae IV-IV, X
- ▶ Laminectomy
- ▶ Lancinating Pain
- ▶ Langerhans Cells
- ▶ Laparoscopic Pain Mapping
- ▶ Laparoscopy
- ▶ Laparoscopy (for Pain) under Local Anesthesia
- ▶ Large Fibers
- ▶ Large Fiber Neuropathy
- ▶ **Laser**  
BENGT H. SJÖLUND
- ▶ Laser Acupuncture
- ▶ Laser-Doppler Flowmetry
- ▶ Laser Evoked Field
- ▶ Laser-Evoked Potential
- ▶ Laser Heat Stimulator
- ▶ Laser Silent Period
- ▶ Laser Speckle Imaging
- ▶ Latent Myofascial Trigger Point
- ▶ Lateral and Dorsal Funiculi
- ▶ Lateral and Medial Thalamic Nociceptive System
- ▶ Lateral Cervical Nucleus
- ▶ Lateral Division (of the Spinal Dorsal Root)
- ▶ Lateral Geniculate Nucleus
- ▶ Lateral Pain System
- ▶ Lateral Spinal Nucleus
- ▶ Lateral Sulcus
- ▶ **Lateral Thalamic Lesions, Pain Behavior in Animals**  
PERRY N. FUCHS, YUAN BO PENG
- ▶ Lateral Thalamic Nuclei
- ▶ **Lateral Thalamic Pain-Related Cells in Humans**  
ANDRES FERNANDEZ, SHINJI OHARA, NIRIT WEISS, STAN ANDERSON, FRED A. LENZ
- ▶ Laughing Gas
- ▶ Law of Bell and Magendie
- ▶ LCN
- ▶ Learned Helplessness
- ▶ LEF
- ▶ Lemington 5 Element Acupuncture
- ▶ Lemnicus Trigeminalis
- ▶ Lemniscal Fibers
- ▶ LEP
- ▶ Lepromatous Leprosy
- ▶ Leprosy
- ▶ Leprosy Reaction
- ▶ Leptomeninges
- ▶ Leptomeningitis
- ▶ Lesion
- ▶ Leucoencephalopathy
- ▶ Leukocytes
- ▶ Leukotrienes
- ▶ Leukotrienes in Inflammatory Nociceptor Sensitisation
- ▶ Levator Ani Syndrome
- ▶ Level of the Measurement Scale
- ▶ LFP
- ▶ Liberation
- ▶ Libido
- ▶ Lichen Sclerosis
- ▶ Lidocaine
- ▶ Lifetime Prevalence
- ▶ Ligands
- ▶ Lightning Pain
- ▶ Lignocaine
- ▶ Likert Scale
- ▶ Limb Amputation

- ▶ Limbic Forebrain Matrix
- ▶ Limbic Forebrain/System
- ▶ Linkage Disequilibrium
- ▶ Lipophilic
- ▶ Lissauer's Tract
- ▶ List of Diagnoses and their Definitions
- ▶ LLLT
- ▶ Load
- ▶ Load-Bearing Capacity
- ▶ **Local Anaesthetics**  
MARK JOHNSON, NIKOLAI BOGDUK
- ▶ Local Anesthetic Agents/Drugs
- ▶ Local Anesthetic Motor Blockade
- ▶ Local Anesthetics/Antiarrhythmics
- ▶ Local-Circuit Cells
- ▶ Local Circuit Interneuron
- ▶ Local Field Potential
- ▶ Local Twitch Response
- ▶ Local-Twitch-Response Locus
- ▶ Localized Muscle Pain
- ▶ Locus Coeruleus
- ▶ Locus of Control
- ▶ Longitudinal Myelotomy
- ▶ Longitudinal Study
- ▶ Long-Lasting Acute Pain
- ▶ Long-Term Depression in the Spinal Cord
- ▶ **Long-Term Effects of Pain in Infants**  
RUTH ECKSTEIN GRUNAU
- ▶ Long-Term Potentiation
- ▶ **Long-Term Potentiation and Long-Term Depression in the Spinal Cord**  
JÜRGEN SANDKÜHLER
- ▶ Long-Term Potentiation in the Spinal Cord
- ▶ Loss of Consciousness Associated with Fentanyl
- ▶ Loss of Olfactory Function
- ▶ Low Back Pain
- ▶ **Low Back Pain, Epidemiology**  
J. MOCCO, RICARDO J. KOMOTAR,  
CHRISTOPHER J. WINFREE
- ▶ **Low Back Pain Patients, Imaging**  
PRAMIT PHAL, DANIEL RIRIE, GARY NESBIT
- ▶ Low First Pass Metabolism
- ▶ Low Frequency Oscillations
- ▶ Low Intracranial Pressure Headache
- ▶ Low Threshold Calcium Spike
- ▶ Low Threshold Calcium Spike Burst
- ▶ Low Threshold Neuron
- ▶ **Lower Back Pain, Acute**  
T. SHAH, STEPHAN A. SCHUG
- ▶ **Lower Back Pain, Physical Examination**  
PATRICK B. SENATUS, CHRISTOPHER J.  
WINFREE
- ▶ Lower Gastrointestinal Tract Pain Models
- ▶ Low-Level Laser Therapy
- ▶ Low-Threshold Calcium Channels
- ▶ Low-Threshold VDCCs
- ▶ Low-Voltage Calcium Channels
- ▶ LSN
- ▶ LSP
- ▶ LT Neurons
- ▶ LTP
- ▶ LTR
- ▶ LTR Locus
- ▶ LTS
- ▶ LTS Burst
- ▶ Lumbago
- ▶ Lumbar Disc Stimulation
- ▶ Lumbar Discogram
- ▶ **Lumbar Discography**  
DAVID DIAMANT
- ▶ Lumbar Epidural Steroids
- ▶ Lumbar Facet Denervation
- ▶ Lumbar Facet Rhizolysis
- ▶ Lumbar Lordosis
- ▶ **Lumbar Medial Branch Blocks**  
PAUL VERRILLS
- ▶ **Lumbar Medial Branch Neurotomy**  
PAUL DREYFUSS
- ▶ Lumbar Pain
- ▶ Lumbar Plexus
- ▶ Lumbar Puncture
- ▶ Lumbar Radiofrequency Neurotomy
- ▶ **Lumbar Traction**  
JUDY CLARKE, ANDREA D. FURLAN, MAURITS  
VAN TULDER
- ▶ **Lumbar Transforaminal Injection of Steroids**  
JAMES M. BOROWCZYK
- ▶ Lumbosacral Radiculitis
- ▶ Luteal Phase
- ▶ Luxation
- ▶ LVCCs
- ▶ Lymphokines
- ▶ Lysis of Adhesions
- ▶ MI

- ▶ MAC
- ▶ **Magnetic Resonance Imaging**  
PETER LAU
- ▶ Magnetoencephalography
- ▶ **Magnetoencephalography in Assessment of Pain in Humans**  
RYUSUKE KAKIGI, KOJI INUI, MINORU HOSHIYAMA, SHOKO WATANABE, DAISUKE NAKA, KENSAKU MIKI, HIROSHI YAMASAKI, DIEP TUAN TRAN, YUNHAI QIU, XIAOHONG WANG
- ▶ Magnetometer
- ▶ Magnification
- ▶ Magnocellular Neurons
- ▶ Maintenance
- ▶ Maitland Mobilisation
- ▶ Major Depressive Disorder
- ▶ Maladaptive Coping
- ▶ Maladaptive Thoughts
- ▶ Malalignment Syndromes
- ▶ Malignant Bone Pain
- ▶ Malignant Bowel Obstruction
- ▶ Malignant Pain
- ▶ Malingering
- ▶ Malingering
- ▶ **Malingering, Primary and Secondary Gain**  
DAVID A. FISHBAIN
- ▶ Malnutrition
- ▶ Managed Care
- ▶ Management of Postoperative Pain
- ▶ Mandibular Dysfunction
- ▶ Manipulation Without Impulse
- ▶ Manipulation Without Thrust, Oscillatory Mobilisation
- ▶ Manual or Continuous Traction
- ▶ Manual Therapy
- ▶ MAO
- ▶ MAPK
- ▶ Marital Status and Chronicity
- ▶ Marstock Method
- ▶ **Massage and Pain Relief Prospects**  
MICHAEL QUITTAN
- ▶ **Massage, Basic Considerations**  
SUSAN MERCER
- ▶ Masseter Inhibitory Reflex
- ▶ Masseter Muscle
- ▶ Masseter Silent Periods
- ▶ Mast Cells
- ▶ Mastery Experience
- ▶ Mastitis
- ▶ Matrix Metalloproteinases
- ▶ **McGill Pain Questionnaire**  
RONALD MELZACK , JOEL KATZ
- ▶ MCID
- ▶ McI-1
- ▶ MDD
- ▶ MDdc
- ▶ Measuring Tools
- ▶ Mechanical Allodynia
- ▶ Mechanical Allodynia Test
- ▶ Mechanical Effects of Ultrasound
- ▶ Mechanical Hyperalgesia
- ▶ Mechanical Low Back Pain
- ▶ Mechanical Nociceptors
- ▶ Mechanical Stimuli
- ▶ Mechanical Syndrome
- ▶ Mechanically-Evoked Itch
- ▶ Mechanism-Based Approaches to Pain and Nociception
- ▶ Mechanoheat Nociceptor
- ▶ **Mechano-Insensitive C-Fibres, Biophysics**  
CHRISTIAN WEIDNER
- ▶ Mechano-Insensitive Nociceptor
- ▶ **Mechanonociceptors**  
ELVIRA DE LA PEÑA GARCÍA
- ▶ Mechanoreceptive/Mechanosensitive Visceral Receptors
- ▶ Mechanoreceptor Afferents
- ▶ Mechanosensitive
- ▶ Mechanosensitive Sympathetic Afferent Fibers
- ▶ Mechanosensitivity
- ▶ MED
- ▶ Medial Branch Block
- ▶ Medial Lemniscus (ML)
- ▶ Medial Pain System
- ▶ Medial Part of the Posterior Complex
- ▶ Medial Thalamotomies
- ▶ Medial Thalamus
- ▶ Median Branch Block
- ▶ Median Nerve Compression at the Wrist
- ▶ Mediate
- ▶ Medical Decision-Making Model
- ▶ **Medical History**  
WADE KING
- ▶ Medical Hydrology



- ▶ Medical Misadventures
- ▶ Medical Mishaps
- ▶ Medical Outcomes Study 36-Item Short-Form Health Survey (SF-36)
- ▶ Medical Signs
- ▶ Medically Incongruent Symptoms and Signs
- ▶ Medication-Induced Headaches
- ▶ Mediodorsal Nucleus (MD)
- ▶ Mediolongitudinal Myelotomy
- ▶ Meditation
- ▶ Medullary Dorsal Horn
- ▶ Medullary Lateral Reticular Formation
- ▶ MEG
- ▶ Meissner Receptor
- ▶ Melanotic
- ▶ Melatonin
- ▶ Membrane Capacitance
- ▶ Membrane Potential
- ▶ Membrane Resistance
- ▶ Membrane Stabilising Agents
- ▶ Membrane Stabilizers
- ▶ Membrane-Stabilizing Drugs
- ▶ Memory Decision Theory
- ▶ Meningeal Afferents
- ▶ Meningeal Carcinomatous
- ▶ Meningeal Layer
- ▶ Meningeal Nociceptors
- ▶ Meningoencephalitis
- ▶ Meniscus
- ▶ Mensendieck System
- ▶ Menstrual Suppression
- ▶ Mental Disorders, Diagnostics and Statistics
- ▶ Mental Pain
- ▶ Menthol
- ▶ Meralgia Paresthetica
- ▶ Merkel Receptor
- ▶ Mesencephalic Nucleus
- ▶ Mesencephalic Tractotomy
- ▶ Mesencephalon
- ▶ Mesencephalotomy
- ▶ Mesmerism
- ▶ Meta-Analysis
- ▶ **Metabolic and Nutritional Neuropathies**  
ALEX BARLING, JOHN B. WINER
- ▶ Metabolic Neuropathies
- ▶ Metabolism
- ▶ Metabotropic Glutamate Receptors
- ▶ **Metabotropic Glutamate Receptors in Spinal Nociceptive Processing**  
VOLKER NEUGEBAUER
- ▶ **Metabotropic Glutamate Receptors in the Thalamus**  
THOMAS E. SALT
- ▶ Metabotropic Receptor
- ▶ Metalloproteases
- ▶ Metastasis
- ▶ Methadone
- ▶ Method of Adjustments
- ▶ Method of Constant Stimuli
- ▶ Method of Limits
- ▶ Methotrexate
- ▶ Methyl-2-(2,6-Xylyloxy)-Ethylamine-Hydrochloride
- ▶ Methylprednisolone
- ▶ Methysergide
- ▶ Metopropol
- ▶ Mexiletine/Mexitol
- ▶ mGlu Receptors/mGluRs
- ▶ MH, HTM, PMN
- ▶ Micro-Arousal
- ▶ Microdialysis
- ▶ Microglia
- ▶ Microglia Activation
- ▶ Microinjection
- ▶ Microiontophoresis
- ▶ Microneurography and Intraneural Microstimulation
- ▶ Microneuroma
- ▶ Microstimulation
- ▶ Microsurgical DREZotomy
- ▶ Microswitch
- ▶ Microvascular Decompression
- ▶ Microwaves
- ▶ Midazolam
- ▶ Midline Commissural Myelotomy
- ▶ Midline Epidural Steroid Injection
- ▶ **Midline Myelotomy**  
H. J. W. NAUTA
- ▶ Migraine
- ▶ Migraine Accompanee
- ▶ Migraine Aphasic
- ▶ **Migraine, Childhood Syndromes**  
ERIC M. PEARLMAN
- ▶ **Migraine Epidemiology**  
RICHARD B. LIPTON, MARCELO E. BIGAL

- ▶ **Migraine, Genetics**  
ANNE DUCROS
- ▶ Migraine Hemiparesthetic
- ▶ Migraine Hemiplegic
- ▶ Migraine Ophthalmic
- ▶ Migraine Optical
- ▶ **Migraine, Pathophysiology**  
PETER J. GOADSBY
- ▶ **Migraine, Preventive Therapy**  
STEPHEN D. SILBERSTEIN
- ▶ Migraine Type Headache
- ▶ Migraine Variants of Childhood
- ▶ Migraine With Aura
- ▶ Migraine With Pleocytosis, Pseudomigraine With Lymphocytic Pleocytosis
- ▶ **Migraine Without Aura**  
ARNAUD FUMAL, JEAN SCHOENEN
- ▶ Minimal Alveolar Concentration
- ▶ Minimal Clinically Important Difference
- ▶ Minimal Sedation
- ▶ Minimum Effective Analgesic Serum Concentrations of Fentanyl
- ▶ Minimum Erythema Dose
- ▶ Minocycline
- ▶ Miss Rate
- ▶ Mitogen-Activated Protein Kinase
- ▶ Mittelschmerz
- ▶ Mixed-Acting Analgesics
- ▶ Mixed Forms of Diabetic Neuropathy
- ▶ MMP
- ▶ Mnemonic Function
- ▶ Mobilisation/Mobilization
- ▶ Mobilisation Following Surgery
- ▶ Mobilisation With Impulse
- ▶ Mobilisation With Thrust
- ▶ **Modalities**  
ALISON THOMAS
- ▶ Model of Neuropathic Pain
- ▶ Model of Spontaneous Neuropathic Pain
- ▶ **Modeling, Social Learning in Pain**  
CHRISTIANE HERMANN
- ▶ Moderate Sedation
- ▶ Modifications of Treatment for the Elderly
- ▶ Modifying Factors
- ▶ **Molecular Contributions to the Mechanism of Central Pain**  
BRYAN C. HAINS
- ▶ Monoamine Oxidase Inhibitors
- ▶ Monoamines
- ▶ Monocyte/Macrophage
- ▶ Monosynaptic
- ▶ Mood
- ▶ MOP Receptor
- ▶ MOR-1
- ▶ Moral Hazard
- ▶ Morbus Sudeck
- ▶ Morning Stiffness
- ▶ Morphine
- ▶ Morphine and Muscle Pain
- ▶ Morphine Sulphate
- ▶ Morphine Tolerance
- ▶ **Morphology, Intraspinous Organization of Visceral Afferents**  
YASUO SUGIURA
- ▶ Morris Water Maze
- ▶ Morton's Neuroma
- ▶ Motif
- ▶ Motivation
- ▶ Motivational-Affective
- ▶ Motivational-Affective Aspects/Components of Pain
- ▶ **Motivational Aspects of Pain**  
MARK P. JENSEN
- ▶ Motivational Components
- ▶ Motivational Reactions
- ▶ Motor Cortex
- ▶ **Motor Cortex, Effect on Pain-Related Behavior**  
LUC JASMIN, PETER T. OHARA
- ▶ Movement Cycles
- ▶ Movement-Related Pain
- ▶ MPQ
- ▶ MPS
- ▶ MRI
- ▶ MRS
- ▶ MS Contin<sup>®</sup>
- ▶ MS Contin<sup>®</sup> Controlled (Slow) Release Morphine Sulphate
- ▶ MSDs/MSPs
- ▶ MTrP
- ▶ MTrP Circuit
- ▶ MTrP Locus
- ▶ Mu( $\mu$ )- and Kappa( $\kappa$ )-Opioids
- ▶ Mucosa
- ▶ Mucosa of Sexual Organs, Nociception
- ▶ Mucositis
- ▶ Mud Therapy

- ▶ **Multiaxial Assessment of Pain**  
DENNIS C. TURK
- ▶ Multichannel CT
- ▶ Multidimensional
- ▶ Multidimensional Model
- ▶ **Multidimensional Scaling and Cluster Analysis Application for Assessment of Pain**  
W. CRAWFORD CLARK
- ▶ Multidisciplinary
- ▶ Multidisciplinary Assessment
- ▶ **Multidisciplinary Pain Centers, Rehabilitation**  
DENNIS C. TURK
- ▶ Multidisciplinary Pain Treatment for the Elderly
- ▶ Multidisciplinary Treatment Program
- ▶ Multimodal
- ▶ Multimodal Analgesia
- ▶ **Multimodal Analgesia in Postoperative Pain**  
EDWARD A. SHIPTON
- ▶ Multimodal Analgesics
- ▶ **Multimodal Rehabilitation Treatment and Psychiatric Aspects of Multimodal Treatment for Pain**  
DAVID A. FISHBAIN
- ▶ Multimodal Treatment
- ▶ Multiple Sclerosis (MS)
- ▶ Multipolar Cells
- ▶ Multiprofessional
- ▶ Multireceptive Neuron (MR)
- ▶ Multisensory Perceptions
- ▶ Munchausen's by Proxy
- ▶ Mu( $\mu$ )-Opioid Receptor
- ▶ Muscle and Joint Pain
- ▶ Muscle Contraction Headache
- ▶ Muscle Cramp
- ▶ Muscle Discrimination
- ▶ Muscle Hyperactivity
- ▶ Muscle Nociceptor
- ▶ **Muscle Nociceptors, Neurochemistry**  
SIEGFRIED MENSE
- ▶ Muscle Pain
- ▶ **Muscle Pain, Fear-Avoidance Model**  
GEERT CROMBEZ, JOHAN W.S. VLAEYEN,  
LIESBET GOUBERT
- ▶ **Muscle Pain, Fibromyalgia Syndrome (Primary, Secondary)**  
I. JON RUSSELL
- ▶ **Muscle Pain in Systemic Inflammation (Polymyalgia Rheumatica, Giant Cell Arteritis, Rheumatoid Arthritis)**  
HENNING BLIDDAL
- ▶ **Muscle Pain Model, Inflammatory Agents-Induced**  
DARRYL T. HAMAMOTO, DONALD A. SIMONE
- ▶ **Muscle Pain Model, Ischemia-Induced and Hypertonic Saline-Induced**  
SIEGFRIED MENSE
- ▶ **Muscle Pain, Referred Pain**  
MARIA ADELE GIAMBERARDINO
- ▶ **Muscle Relaxants**  
MARK JOHNSON, NIKOLAI BOGDUK
- ▶ Muscle Scanning
- ▶ Muscle Spasm
- ▶ Muscle Tension
- ▶ **Muscular Cramps**  
MARIANO SERRAO
- ▶ Muscular Nociceptors, Sensitization
- ▶ Muscular Rheumatism
- ▶ Musculoskeletal Disorders
- ▶ **Musculoskeletal Examination**  
WADE KING
- ▶ **Musculoskeletal Pain**  
LARS ARENDT-NIELSEN
- ▶ Musculoskeletal Transferred Pain
- ▶ Musculoskeletal Type of Pain
- ▶ MVD
- ▶ **Myalgia**  
ROBERT D. GERWIN
- ▶ Mycobacterium Lepae
- ▶ Mycobacterium Species
- ▶ Myelin
- ▶ Myelinated
- ▶ Myelination
- ▶ Myelitis
- ▶ Myelopathy
- ▶ Myelotomy
- ▶ Myenteric Plexus
- ▶ Myocardial Ischemia
- ▶ Myoclonus
- ▶ Myofascial
- ▶ Myofascial Manipulation
- ▶ **Myofascial Pain**  
ROBERT BENNETT
- ▶ Myofascial Pain Syndrome
- ▶ Myofascial Release

- ▶ **Myofascial Trigger Points**  
DAVID G. SIMONS
- ▶ Myofibrositis
- ▶ Myogelosis
- ▶ **Myositis**  
DIETER PONGRATZ
- ▶ Myotomal Pain
- ▶ N/O/FQ
- ▶ N<sub>2</sub>O
- ▶ Na<sup>+</sup> Channel
- ▶ Na<sup>+</sup>K<sup>+</sup>Cl<sup>-</sup> Cotransporter
- ▶ NAcc
- ▶ nAChr
- ▶ Nadolol
- ▶ Naloxone
- ▶ Narcolepsy
- ▶ Narcotic Bowel Syndrome
- ▶ Narcotics, Major Analgesics
- ▶ Natural History
- ▶ NCCP
- ▶ Near-Infrared Spectroscopy
- ▶ Neck Pain
- ▶ Necrosis
- ▶ Negative Affectivity
- ▶ Negative Mucosal Potential
- ▶ Negative or Punishing Responses
- ▶ Negative Reinforcement
- ▶ Negative Responding
- ▶ Negative Sensory Phenomenon
- ▶ Nematode
- ▶ Neocortical
- ▶ Neonatal Inflammation
- ▶ Neonatal Pain
- ▶ Neonate
- ▶ Neospinothalamic Tract
- ▶ Nerve Blocks by Local Anesthetic Drugs
- ▶ Nerve Compression
- ▶ Nerve Conduction
- ▶ Nerve Growth Factor
- ▶ **Nerve Growth Factor Overexpressing Mice as Models of Inflammatory Pain**  
DEREK C. MOLLIVER, KATHRYN M. ALBERS
- ▶ **Nerve Growth Factor, Sensitizing Action on Nociceptors**  
LORNE M. MENDELL
- ▶ Nerve Inflammation
- ▶ Nerve Injury
- ▶ Nerve Lesion
- ▶ Nerve Ligation
- ▶ Nerve Pain
- ▶ Nerve Pain of Joint and Muscle Origin
- ▶ Nerve Stump Pain
- ▶ Nerve Terminals
- ▶ Nerve Viral Infection
- ▶ Nervus Intermedius, Primary Otagia
- ▶ Neural Blockade
- ▶ Neural Compressive Syndrome
- ▶ Neural Foramen
- ▶ Neural Plasticity
- ▶ Neuralgia
- ▶ **Neuralgia, Assessment**  
RALF BARON
- ▶ **Neuralgia, Diagnosis**  
JAYANTILAL GOVIND
- ▶ Neuralgia of Cranial Nerve V
- ▶ Neuralgia of Cranial Nerve VII
- ▶ Neuralgia of Cranial Nerve IX with or without Cranial Nerve X
- ▶ Neuraxial Blocks
- ▶ Neuraxial Infusion
- ▶ Neuraxial Morphine
- ▶ Neuraxis
- ▶ Neurectomy
- ▶ Neuritis
- ▶ Neuroablation
- ▶ Neuroactive Substance
- ▶ Neuroaxial
- ▶ Neuro-Behçet
- ▶ Neurobehavioral Scores
- ▶ Neurochemical Markers
- ▶ Neurochemistry
- ▶ Neurodegeneration
- ▶ Neurodynia
- ▶ Neurofilament Protein NF200
- ▶ Neurogenic Claudication
- ▶ Neurogenic Inflammation
- ▶ **Neurogenic Inflammation and Sympathetic Nervous System**  
HEINZ-JOACHIM HÄBLER
- ▶ **Neurogenic Inflammation, Vascular Regulation**  
HEINZ-JOACHIM HÄBLER
- ▶ Neurogenic Pain
- ▶ Neurogenic Pain of Joint and Muscle Origin
- ▶ Neurogenic Pain, Painful Neuropathy



- ▶ Neurogenic Vasodilation
- ▶ Neuroglial Cells
- ▶ Neuroimaging
- ▶ Neuroimmune Activation
- ▶ Neuroimmune Interaction
- ▶ Neuroinflammation
- ▶ Neurokinin
- ▶ Neurological Deficit
- ▶ Neurolytic Drugs
- ▶ Neuroma
- ▶ Neuroma Endbulb
- ▶ Neuroma Model of Neuropathic Pain
- ▶ **Neuroma Pain**  
JAMES N. CAMPBELL
- ▶ Neuroma-in-Continuity
- ▶ Neuromatrix
- ▶ Neuromodulation
- ▶ Neuromodulator(s)
- ▶ Neuron
- ▶ Neuron Restrictive Silencer Factor
- ▶ Neuronal Architecture
- ▶ Neuronal Dysfunction
- ▶ Neuronal Hyperexcitability
- ▶ Neuronal Release
- ▶ Neuronal Structure
- ▶ Neuronavigation
- ▶ Neuropathic Pain
- ▶ **Neuropathic Pain, Diagnosis, Pathology and Management**  
ROBERT GASSIN
- ▶ **Neuropathic Pain, Joint and Muscle Origin**  
MARTIN MICHAELIS
- ▶ Neuropathic Pain Model, Anesthesia Dolorosa Model
- ▶ **Neuropathic Pain Model, Chronic Constriction Injury**  
CLAUDIA SOMMER
- ▶ **Neuropathic Pain Model, Diabetic Neuropathy Model**  
NIGEL A. CALCUTT, SANDRA CHAPLAN
- ▶ **Neuropathic Pain Model, Neuritis/Inflammatory Neuropathy**  
ERIN D. MILLIGAN, STEVEN F. MAIER, LINDA R. WATKINS
- ▶ **Neuropathic Pain Model, Partial Sciatic Nerve Ligation Model**  
JIN MO CHUNG
- ▶ **Neuropathic Pain Model, Spared Nerve Injury**  
ISABELLE DECOSTERD
- ▶ **Neuropathic Pain Model, Spinal Nerve Ligation Model**  
JIN MO CHUNG, KYUNGSOON CHUNG
- ▶ **Neuropathic Pain Model, Tail Nerve Transection Model**  
H. S. NA, H. J. KIM, S. K. BACK, B. SUNG, Y. I. KIM, Y. W. YOON, H. C. HAN, S. K. HONG
- ▶ **Neuropathic Pain Models, CRPS-I Neuropathy Model**  
JEAN-JACQUES VATINE, JEANNA TSENTER, ZE'EV SELTZER
- ▶ **Neuropathic Pain of Central Origin**  
ROBERT P. YEZIERSKI
- ▶ Neuropathic Syndrome
- ▶ Neuropathy
- ▶ Neuropathy Due to HAART
- ▶ **Neuropeptide Release in Inflammation**  
BEATE AVERBECK
- ▶ **Neuropeptide Release in the Skin**  
ULRIKE HOLZER-PETSCHKE
- ▶ Neuropeptide Y
- ▶ Neuropeptides
- ▶ Neuropeptides in Neuropathic Pain States
- ▶ Neuropile
- ▶ Neuroplasticity
- ▶ Neurosecretion
- ▶ Neurosensory Testing
- ▶ Neurosteroids
- ▶ Neurostimulation
- ▶ Neurosurgery for Pain
- ▶ Neurosurgery for Pain in the DREZ
- ▶ **Neurosurgical Treatment of Pain**  
FRED A. LENZ
- ▶ Neurotomy
- ▶ Neurotransmitter
- ▶ Neurotransmitter Receptors
- ▶ Neurotrophic Factors
- ▶ Neurotrophic Support
- ▶ Neurotrophin
- ▶ Neurotrophin Receptors
- ▶ Neurotrophins in Spinal Cord Nociception
- ▶ Neutral Cell (RVM)
- ▶ Neutral Medical Examination
- ▶ **Neutrophils in Inflammatory Pain**  
RAINER AMANN
- ▶ **New Daily Persistent Headache**  
TODD D. ROZEN
- ▶ Newborn
- ▶ NGF

- ▶ NGF -/- Mice
- ▶ NGF-OE mice
- ▶ **NGF, Regulation during Inflammation**  
RAINER AMANN
- ▶ **NGF, Sensitization of Nociceptors**  
DAVID BENNETT
- ▶ **Nick Model of Cutaneous Pain and Hyperalgesia**  
ESTHER M. POGATZKI-ZAHN
- ▶ Nicotinic receptors
- ▶ NIRS
- ▶ Nitric Oxide (NO)
- ▶ Nitric Oxide Synthase
- ▶ **Nitrous Oxide Antinociception and Opioid Receptors**  
LINDA K. VAUGHN, RAYMOND M. QUOCK
- ▶ NK-1 Blockers
- ▶ NK-1 Receptor
- ▶ NMDA
- ▶ NMDA Glutamate Receptor(s)
- ▶ **NMDA Receptors in Spinal Nociceptive Processing**  
HORACIO VANEGAS, HANS-GEORG SCHAIBLE
- ▶ N-methyl-D-aspartate
- ▶ N-methyl-D-aspartate (NMDA) Antagonist
- ▶ N-methyl-D-aspartate (NMDA) Receptor
- ▶ NMR
- ▶ NNT
- ▶ Nocebo
- ▶ Nocebo Effect
- ▶ Nociceptin
- ▶ Nociception
- ▶ Nociception in Genital Mucosa
- ▶ **Nociception in Mucosa of Sexual Organs**  
MARITA HILLIGES
- ▶ **Nociception in Nose and Oral Mucosa**  
THOMAS HUMMEL, BARRY GREEN
- ▶ Nociception Induced by Injection of Dilute Formaldehyde
- ▶ Nociceptive
- ▶ Nociceptive Afferents
- ▶ **Nociceptive Circuitry in the Spinal Cord**  
ANDREW J. TODD
- ▶ Nociceptive Coding in Lateral Thalamus
- ▶ Nociceptive Masseter Muscle Afferents
- ▶ Nociceptive Nerve Endings
- ▶ Nociceptive Neuroplasticity
- ▶ **Nociceptive Neurotransmission in the Thalamus**  
THOMAS E. SALT
- ▶ Nociceptive Pain
- ▶ Nociceptive Pathways
- ▶ Nociceptive Primary Afferents
- ▶ **Nociceptive Processing in the Amygdala, Neurophysiology and Neuropharmacology**  
VOLKER NEUGEBAUER
- ▶ **Nociceptive Processing in the Brainstem**  
JONATHAN O. DOSTROVSKY, BARRY J. SESSLE
- ▶ Nociceptive Processing in the Cingulate Cortex, Behavioral Studies in Animals
- ▶ Nociceptive Processing in the Cingulate Cortex, Behavioral Studies in Human
- ▶ **Nociceptive Processing in the Hippocampus and Entorhinal Cortex, Neurophysiology and Pharmacology**  
SANJAY KHANNA
- ▶ **Nociceptive Processing in the Nucleus Accumbens, Neurophysiology and Behavioral Studies**  
LINO BECERRA, MARNIE SHAW, DAVID BORSOOK
- ▶ **Nociceptive Processing in the Secondary Somatosensory Cortex**  
ROLF-DETLEF TREEDE, ULF BAUMGÄRTNER, FREDERICK A. LENZ
- ▶ **Nociceptive Processing in the Spinal Cord**  
HANS-GEORG SCHAIBLE
- ▶ Nociceptive Projecting Neurons
- ▶ Nociceptive Reflex
- ▶ Nociceptive Selective Stimulation
- ▶ Nociceptive Sensory Neurons
- ▶ Nociceptive Specific Neurons
- ▶ Nociceptive System
- ▶ **Nociceptive Processing in the Thalamus**  
A. VANIA APKARIAN
- ▶ Nociceptive Temporomandibular Joint Afferents
- ▶ Nociceptive Threshold
- ▶ Nociceptive Transduction
- ▶ Nociceptive Withdrawal Reflex
- ▶ Nociceptor Accommodation
- ▶ Nociceptor Desensitization
- ▶ **Nociceptor Generator Potential**  
CARLOS BELMONTE
- ▶ Nociceptor Inactivation
- ▶ Nociceptor Sensitization
- ▶ Nociceptor(s)
- ▶ **Nociceptor, Adaptation**  
RICHARD A. MEYER, MATTHIAS RINGKAMP
- ▶ **Nociceptor, Axonal Branching**  
MARTIN SCHMELZ

- ▶ **Nociceptor, Categorization**  
EDWARD PERL
- ▶ **Nociceptor, Fatigue**  
RICHARD A. MEYER, MATTHIAS RINGKAMP
- ▶ **Nociceptors, Action Potentials and Post-Firing Excitability Changes**  
BRUCE LYNN
- ▶ **Nociceptors, Cold Thermotransduction**  
FÉLIX VIANA, ELVIRA DE LA PEÑA
- ▶ Nociceptors, Immunocytochemistry
- ▶ **Nociceptors in the Dental Pulp**  
MATTI V. O. NÄRHI
- ▶ Nociceptors in the Mucosa
- ▶ **Nociceptors in the Orofacial Region (Meningeal/Cerebrovascular)**  
KARL MESSLINGER
- ▶ **Nociceptors in the Orofacial Region (Skin/Mucosa)**  
BRIAN Y. COOPER
- ▶ **Nociceptors in the Orofacial Region (Temporomandibular Joint and Masseter Muscle)**  
BRIAN E. CAIRNS
- ▶ Nociceptors, Perireceptor Elements
- ▶ Nocifensive
- ▶ Nocifensive Behavior
- ▶ Nocifensive Behaviors Evoked by Myositis
- ▶ **Nocifensive Behaviors, Gastrointestinal Tract**  
GERALD F. GEBHART
- ▶ **Nocifensive Behaviors, Muscle and Joint**  
KATHLEEN A. SLUKA, KARIN N. WESTLUND
- ▶ **Nocifensive Behaviors of the Urinary Bladder**  
TIMOTHY NESS
- ▶ Nodes of Ranvier
- ▶ Nodose Ganglia
- ▶ Nomogenic Symptoms and Signs
- ▶ Non-Anatomic Symptoms and Signs
- ▶ Non-Cardiac Chest Pain
- ▶ Non-Competitive Antagonist
- ▶ Non-Corpuscular Sensory Endings
- ▶ Non-Drug Treatment
- ▶ Nonexertional Capability
- ▶ Nonexertional Limitations and Restrictions
- ▶ **Non-Migraine Headaches**  
HANS-CHRISTOPH DIENER
- ▶ Non-Neurogenic Inflammation
- ▶ Non-Nutritive Sucking
- ▶ Nonopioid Analgesia
- ▶ Nonopioid Analgesic Drug
- ▶ Nonorganic Physical Findings (Waddell Signs)
- ▶ **Non-Organic Symptoms and Signs**  
GORDON WADDELL
- ▶ Non-Pharmacologic Pain Management
- ▶ Non-Pharmacological Interventions
- ▶ Non-Pharmacological Treatment
- ▶ Non-Selective COX-Inhibitors
- ▶ Non-Specific Low Back Pain
- ▶ **Non-Steroidal Anti-Inflammatory Drugs (NSAIDs)**  
GERD GEISSLINGER
- ▶ Non-Steroidal Anti-Rheumatic Drugs
- ▶ Non-Structural Disorders
- ▶ Non-Systemic (Isolated) Vasculitic Neuropathy
- ▶ Nonthermal Effects
- ▶ Non-Topographic
- ▶ Non-Traditional Medicine
- ▶ NOP Receptor
- ▶ Noradrenaline
- ▶ Noradrenergic
- ▶ Noradrenergic and Serotonergic Inhibitory Pathways
- ▶ NOS
- ▶ Noxious Cold Receptor
- ▶ Noxious Stimulus
- ▶ Noxious Stimulus Intensity
- ▶ Noxious Stimulus Location
- ▶ NPY
- ▶ NRS
- ▶ NRSF
- ▶ **NSAID-Induced Lesions of the Gastrointestinal Tract**  
JOACHIM MÖSSNER
- ▶ NSAIDs
- ▶ **NSAIDs and Cancer**  
SABINE GRÖSCH, THORSTEN J. MAIER
- ▶ **NSAIDs and Cardio-Vascular Effects**  
KAY BRUNE
- ▶ NSAIDs and Coxibs
- ▶ **NSAIDs and their Indications**  
RICHARD O. DAY, GARRY G. GRAHAM
- ▶ **NSAIDs, Adverse Effects**  
IRMGARD TEGEDER
- ▶ **NSAIDs, Chemical Structure and Molecular Mode of Action**  
STEFAN A. LAUFER
- ▶ **NSAIDs, COX-Independent Actions**  
ELLEN NIEDERBERGER, IRMGARD TEGEDER

- ▶ **NSAIDs, Mode of Action**  
MARIA BURIAN
- ▶ **NSAIDs, Pharmacogenetics**  
CARSTEN SKARKE
- ▶ **NSAIDs, Pharmacokinetics**  
BRUNO OERTEL, JÖRN LÖTSCH
- ▶ NSAIDs, Side Effects
- ▶ **NSAIDs, Survey**  
GIRESH KANJI
- ▶ NSAR
- ▶ NST
- ▶ NT-3 Neurotrophin 3
- ▶ NTT
- ▶ Nuclear Magnetic Resonance
- ▶ Nucleoplasty
- ▶ Nucleotide
- ▶ Nucleotide Receptors
- ▶ Nucleus Accumbens
- ▶ Nucleus Caudalis DREZ
- ▶ Nucleus Gelatinosus
- ▶ Nucleus Gracilis
- ▶ Nucleus Pulposus
- ▶ Nucleus Raphe Magnus
- ▶ Nucleus Submedius (SM)
- ▶ Nucleus Tractus Solitarius
- ▶ Number Needed to Treat
- ▶ Number Needed to Harm
- ▶ Numerical Rating Scale
- ▶ Nursing Home Residents
- ▶ **Nutraceuticals**  
SCOTT MASTERS
- ▶ Nutraceutical
- ▶ Nutritional Neuropathies
- ▶ NVNP
- ▶ Objective Factors
- ▶ Objective Judgment
- ▶ Objective Medical Evidence
- ▶ Observation of Pain Behavior
- ▶ Observational Learning
- ▶ **Obstetric and Gynecological Pain**  
URSULA WESSELMANN
- ▶ Obstetric Brachial Palsy
- ▶ **Obstetric Pain**  
JOHN S. MCDONALD
- ▶ Obstipation
- ▶ Occlusal Force
- ▶ Occupational Behavior
- ▶ Occupational Capacity Evaluation
- ▶ Occupational Pain
- ▶ Occupational Stressors
- ▶ Occupational Therapist
- ▶ Occupational Therapy in Children
- ▶ **Ocular Nociceptors**  
CARLOS BELMONTE
- ▶ Ocular Pain Receptors
- ▶ ODAC
- ▶ Odds Ratio
- ▶ ODI
- ▶ Odorant
- ▶ Off-Cells (RVM)
- ▶ OFQ
- ▶ OFQ/N
- ▶ O'Leary-Sant Interstitial Cystitis Symptom Index
- ▶ Oligonucleotide Array
- ▶ On-Cells (RVM)
- ▶ Oncological Pain
- ▶ Ondansetron
- ▶ On-Demand Analgesia
- ▶ On-Demand Analgesia Computer
- ▶ On-Demand Epidural Analgesia
- ▶ Ondine's Curse
- ▶ Ongoing Pain
- ▶ On-the-Job Site Evaluation
- ▶ Oocyte
- ▶ OP1 Receptors
- ▶ Operant
- ▶ Operant-Behavioral Treatment
- ▶ Operant Conditioning
- ▶ Operant Conditioning Approaches to Chronic Pain
- ▶ Operant Conditioning Model of Chronic Pain
- ▶ Operant Conditioning or Learning Models of Pain
- ▶ Operant Escape
- ▶ **Operant Perspective of Pain**  
MICHAEL K. NICHOLAS
- ▶ Operant Process
- ▶ Operant Treatment
- ▶ **Operant Treatment of Chronic Pain**  
HERTA FLOR
- ▶ Operants
- ▶ Operculum
- ▶ Ophthalmodynia Periodica
- ▶ Ophthalmoplegic Migraine
- ▶ Opiate
- ▶ Opiate Receptors



- ▶ **Opiates - Pharmacology of Pain**  
FRANK PORRECA
- ▶ **Opiates During Development**  
GORDON A. BARR
- ▶ **Opiates, Rostral Ventromedial Medulla and Descending Control**  
MARY M. HEINRICHER
- ▶ Opioid
- ▶ Opioid Adverse Effects
- ▶ Opioid Analgesia
- ▶ Opioid Analgesia and Sex Differences
- ▶ **Opioid Analgesia, Strain Differences**  
JEFFREY S. MOGIL
- ▶ Opioid Analgesic
- ▶ Opioid Analgesic Actions Outside the Central Nervous System
- ▶ Opioid Antagonists
- ▶ Opioid Dose Titration
- ▶ **Opioid Electrophysiology in PAG**  
MACDONALD J. CHRISTIE, P. B. OSBORNE
- ▶ Opioid Hyperexcitability
- ▶ Opioid Hypoalgesia
- ▶ Opioid-Induced Analgesia
- ▶ Opioid-Induced Bowel Dysfunction
- ▶ Opioid-Induced Neurotoxicity
- ▶ **Opioid-Induced Release of CCK**  
CARL-OLAV STILLER
- ▶ Opioid Modulation by Cytokines
- ▶ **Opioid Modulation of Nociceptive Afferents In Vivo**  
DAVID C. YEOMANS, ALEXANDER TZABAZIS
- ▶ Opioid Peptide
- ▶ **Opioid Peptide Co-Localization and Release**  
SARAH V. HOLDRIDGE, NOUFISSA KABLI, CATHERINE M. CAHILL
- ▶ Opioid Peptide Release
- ▶ **Opioid Peptides from the Amphibian Skin**  
LUCIA NEGRI
- ▶ Opioid Pseudo-Pharmacological Ceiling Dose
- ▶ **Opioid Receptor Localization**  
CATHERINE ABBADIE, GAVRIL W. PASTERNAK
- ▶ **Opioid Receptor Trafficking in Pain States**  
CATHERINE M. CAHILL, ANNE MORINVILLE, ALAIN BEAUDET
- ▶ **Opioid Receptors**  
GAVRIL W. PASTERNAK
- ▶ **Opioid Receptors at Postsynaptic Sites**  
ANDREW J. TODD
- ▶ Opioid Responsiveness
- ▶ **Opioid Responsiveness in Cancer Pain Management**  
SEBASTIANO MERCADANTE
- ▶ **Opioid Rotation**  
CHARLES E. INTURRISI
- ▶ **Opioid Rotation in Cancer Pain Management**  
ROSE-ANNE INDELICATO, RUSSELL K. PORTENOY
- ▶ Opioid Switch
- ▶ **Opioid Therapy in Cancer Pain Management, Route of Administration**  
LUKAS RADBRUCH
- ▶ **Opioid Therapy in Cancer Patients with Substance Abuse Disorders, Management**  
STEVEN D. PASSIK, K. L. KIRSH
- ▶ Opioid Tolerance
- ▶ Opioid Tolerance and Glutamate Homeostasis
- ▶ Opioid Tone
- ▶ **Opioids and Bladder Pain/Function**  
DAGMAR WESTERLING, KARL-ERIK ANDERSSON
- ▶ **Opioids and Gene Therapy**  
DAVID J. FINK
- ▶ **Opioids and Inflammatory Pain**  
C. ZÖLLNER, M. SCHÄFER
- ▶ **Opioids and Muscle Pain**  
KATHLEEN A. SLUKA
- ▶ Opioids and Nucleus Gracilis
- ▶ Opioids and Opioid Receptor Function in Inflammation
- ▶ **Opioids and Reflexes**  
CLAIRE D. ADVOKAT
- ▶ **Opioids, Clinical Opioid Tolerance**  
MISHA-MIROSLAV BACKONJA
- ▶ **Opioids, Effects of Systemic Morphine on Evoked Pain**  
CHARLES J. VIERCK JR
- ▶ **Opioids in Geriatric Application**  
PERRY G. FINE
- ▶ Opioids in Sympathetically Maintained Pain
- ▶ **Opioids in the Management of Complex Regional Pain Syndrome**  
SRINIVASA N. RAJA, SHEFALI AGARWAL
- ▶ Opioids in the Modulation of Ascending Pathways
- ▶ **Opioids in the Periphery and Analgesia**  
CHRISTOPH STEIN
- ▶ **Opioids in the Spinal Cord and Central Sensitization**  
ANTHONY H. DICKENSON
- ▶ **Opioids in the Spinal Cord and Modulation of Ascending Pathways (N. gracilis)**  
RIE SUZUKI, ANTHONY H. DICKENSON

- ▶ **Opioids, Kappa Receptors and Visceral Pain**  
PIERRE J. M. RIVIÈRE
- ▶ **Oral Opioids**  
KOK KHOR
- ▶ Ordinary Cramp
- ▶ Ordinary Headache
- ▶ Ordine<sup>®</sup>-morphine-hydrochloride
- ▶ Organ or Body Part Dysfunction
- ▶ **Orofacial Pain**  
BARRY J. SESSLE, JONATHAN O. DOSTROVSKY
- ▶ **Orofacial Pain, Movement Disorders**  
PETER SVENSSON
- ▶ **Orofacial Pain, Sleep Disturbance**  
GILES J. LAVIGNE
- ▶ **Orofacial Pain, Taxonomy/Classification**  
ANTOON F. C. DE LAAT
- ▶ Orphan G Protein-Coupled Receptor
- ▶ **Orphanin FQ**  
DAVID K. GRANDY
- ▶ Orthodromic Activation
- ▶ Orthologues
- ▶ Orthostatic Component of Pain
- ▶ Orthostatic Hypotension
- ▶ Oscillations (Neuronal)
- ▶ Osmolysis
- ▶ Osmosensitive
- ▶ Osmotic
- ▶ Osteoarthritic Pain
- ▶ Osteoarthritis
- ▶ Osteoarthritis Model
- ▶ Osteoblast
- ▶ Osteoblastoma
- ▶ Osteoclast
- ▶ Osteolysis
- ▶ Osteolytic Fibrosarcoma
- ▶ Osteopathy
- ▶ Osteophyte
- ▶ **Oswestry Disability Index**  
OLE HAEGG
- ▶ Oswestry Disability Questionnaire
- ▶ Oswestry Low Back Pain Disability Questionnaire
- ▶ **Outcome Measures**  
VICTOR WILK
- ▶ Outcome Questionnaires
- ▶ Outcomes Assessment Tools
- ▶ Ovariectomy
- ▶ Over the Counter Analgesics
- ▶ Overalertness
- ▶ Overlap Syndrome
- ▶ Oxidative Stress
- ▶ Oxycodone
- ▶ Oxycodone and its Metabolites
- ▶ Oxycontin
- ▶ P/Q Type Calcium Channel
- ▶ P1 Receptors
- ▶ P2X Receptor
- ▶ P2X3 Receptor
- ▶ P2Y Receptors
- ▶ p38 MAP Kinase
- ▶ p75 Receptor
- ▶ PACAP
- ▶ Pachymeningeal Enhancement
- ▶ Pachymeningeal Enhancement in MRI with Gadolinium
- ▶ Paediatric Chronic Pain Management
- ▶ Paediatric Pain Measures
- ▶ Paediatric Pain Scales
- ▶ Paediatric Procedural Analgesia
- ▶ Paediatric Sedation
- ▶ PAG
- ▶ Paget's Disease
- ▶ Pain
- ▶ Pain Affect
- ▶ Pain Amplification Disability Syndrome
- ▶ **Pain and Sedation of Children in the Emergency Setting**  
SUZAN SCHNEEWEISS
- ▶ **Pain as a Cause of Psychiatric Illness**  
TIPU AAMIR, ROBERT G. LARGE
- ▶ Pain as a Stressor
- ▶ Pain Assessment
- ▶ **Pain Assessment in Children**  
PATRICIA A. MCGRATH
- ▶ **Pain Assessment in Neonates**  
FAY WARNOCK
- ▶ **Pain Assessment in the Elderly**  
ROBERT D. HELME, BARBARA WALKER
- ▶ Pain Associated with Traumatic Nerve Injury
- ▶ Pain Asymbolia
- ▶ Pain Attacks
- ▶ Pain Behavior
- ▶ Pain Belief
- ▶ Pain Catastrophizing
- ▶ Pain Centralization

- ▶ Pain Chronification
- ▶ Pain Cocktail
- ▶ **Pain Control in Children with Burns**  
WALTER J. MEYER III, LEE WOODSON
- ▶ Pain Control in Children with Cancer
- ▶ Pain Coping Skills
- ▶ Pain Detection and Pain Tolerance Thresholds
- ▶ Pain Diaries
- ▶ Pain Disability
- ▶ Pain Disability Index
- ▶ Pain Disorder
- ▶ Pain Disorder in Children
- ▶ Pain Drawings
- ▶ Pain Due to Cancer
- ▶ Pain Evaluation
- ▶ **Pain Evaluation, Psychophysical Methods**  
LEON PLAGHKI
- ▶ Pain-Facilitatory Systems
- ▶ Pain Flares
- ▶ Pain Generator
- ▶ Pain History
- ▶ **Pain in Children**  
PATRICIA A. MCGRATH
- ▶ Pain in Children with Cognitive Impairment
- ▶ **Pain in Children with Disabilities**  
TIM F. OBERLANDER, KENNETH D. CRAIG
- ▶ Pain in Ganglionopathy
- ▶ Pain in HIV / AIDS
- ▶ **Pain in Human Immunodeficiency Virus Infection and Acquired Immune Deficiency Syndrome**  
FRANCINE RAINONE, PETER SELWYN
- ▶ **Pain in Humans, EEG Documentation**  
ANDREW C. N. CHEN
- ▶ **Pain in Humans, Electrical Stimulation (Skin, Muscle and Viscera)**  
OLE K. ANDERSEN
- ▶ **Pain in Humans, Psychophysical Law**  
DONALD D. PRICE
- ▶ **Pain in Humans, Sensory-Discriminative Aspects**  
RICHARD H. GRACEY
- ▶ **Pain in Humans, Sleep Disturbances**  
HARVEY MOLDOFSKY
- ▶ **Pain in Humans, Thermal Stimulation (Skin, Muscle, Viscera), Laser, Peltier, Cold (Cold Pressure), Radiant, Contact**  
LEON PLAGHKI
- ▶ **Pain in Humans, Thresholds**  
JOEL D. GREENSPAN
- ▶ Pain in Radiculopathy
- ▶ **Pain in Superficial Tissues**  
HERMANN O. HANDWERKER
- ▶ Pain in the Workplace
- ▶ **Pain in the Workplace, Compensation and Disability Management**  
PATRICK LOISEL
- ▶ **Pain in the Workplace, Risk Factors for Chronicity, Demographics**  
DENNIS C. TURK
- ▶ **Pain in the Workplace, Risk Factors for Chronicity, Job Demands**  
GREG MCINTOSH
- ▶ **Pain in the Workplace, Risk Factors for Chronicity, Psychosocial Factors**  
DENNIS C. TURK
- ▶ **Pain in the Workplace, Risk Factors for Chronicity, Workplace Factors**  
DENNIS C. TURK
- ▶ Pain-Inhibitory System
- ▶ **Pain Inventories**  
MARC J. SHULMAN, ROBERT D. KERNS
- ▶ Pain-Killers
- ▶ Pain Management
- ▶ Pain Management in Infants
- ▶ Pain Management, Pharmacotherapy
- ▶ Pain Management Programs
- ▶ Pain Mapping
- ▶ Pain Measurement
- ▶ **Pain Measurement by Questionnaires, Psychophysical Procedures and Multivariate Analysis**  
W. CRAWFORD CLARK
- ▶ Pain Measurement in the Elderly
- ▶ Pain Mechanisms Investigation in Human Infants
- ▶ **Pain Memory**  
STEPHEN MORLEY
- ▶ Pain Modulation
- ▶ Pain Modulatory Circuitry and Endogenous Pain Control
- ▶ Pain Modulatory Pathways
- ▶ **Pain Modulatory Systems, History of Discovery**  
GREGORY W. TERMAN
- ▶ Pain Nurse(s)
- ▶ Pain of Recent Origin
- ▶ Pain Ombudsman-Nurses

- ▶ **Pain Paroxysms**  
RON AMIR, Z. HARRY RAPPAPORT, MARSHALL DEVOR
- ▶ Pain Pathway
- ▶ Pain Prevention
- ▶ **Pain Processing in the Cingulate Cortex, Behavioral Studies in Humans**  
SERGE MARCHAND, PHILIPPE GOFFAUX
- ▶ Pain Progression
- ▶ **Pain Prone Patients**  
ROLF H. ADLER
- ▶ Pain Prone Personality
- ▶ **Pain, Psychiatry and Ethics**  
MARK D. SULLIVAN
- ▶ Pain Questionnaire
- ▶ Pain Rehabilitation
- ▶ Pain-Related Anxiety
- ▶ Pain-Related Disability
- ▶ Pain-Related Fear
- ▶ Pain-Related Impairment
- ▶ Pain-Relevant Communication
- ▶ Pain Scale
- ▶ Pain Schema
- ▶ Pain Schools
- ▶ Pain System
- ▶ Pain Tension Cycle
- ▶ Pain Therapy, Biofeedback in the Treatment of Pain
- ▶ Pain Threshold
- ▶ Pain Tolerance
- ▶ **Pain Treatment, Implantable Pumps for Drug Delivery**  
KHAN W. LI, FREDERICK A. LENZ
- ▶ **Pain Treatment, Intracranial Ablative Procedures**  
PHILIP L. GILDENBERG
- ▶ **Pain Treatment, Motor Cortex Stimulation**  
JEFFREY A. BROWN
- ▶ **Pain Treatment, Spinal Cord Stimulation**  
BJÖRN A. MEYERSON
- ▶ **Pain Treatment, Spinal Nerve Blocks**  
RICHARD B. NORTH
- ▶ **Painful Channelopathies**  
STEPHEN G. WAXMAN
- ▶ Painful Disc Syndrome
- ▶ Painful Scars
- ▶ Painful Tonic Seizure
- ▶ **Painless Neuropathies**  
MARCO LACERENZA, PAOLO MARCHETTINI
- ▶ Paleospinothalamic Tract
- ▶ Palliative Care
- ▶ Palliative Care and Cancer Pain Management
- ▶ Palliative Care in Children
- ▶ Palliative Medicine
- ▶ Palliative Radiotherapy
- ▶ **Palliative Surgery in Cancer Pain Management**  
ANNE M. HEFFERNAN, KEVIN C. CONLON
- ▶ Pancreas
- ▶ Pancreatalgia
- ▶ Pancreatitis
- ▶ Pancreatitis Pain
- ▶ Panic Attacks
- ▶ Pannus
- ▶ PAOD
- ▶ Papillae
- ▶ Papilloedema
- ▶ PAR
- ▶ **Parabrachial Hypothalamic and Amygdaloid Projections**  
JEAN-FRANÇOIS BERNARD
- ▶ Parabrachial/PAG
- ▶ Paracetamol
- ▶ Paracetamol in Postoperative Pain
- ▶ Paracrine
- ▶ Paradoxical Cold Sensation
- ▶ Paradoxical Heat
- ▶ Paraesthesia
- ▶ Parafascicular Nucleus (PF)
- ▶ **Parafascicular Nucleus, Pain Modulation**  
ERIK ASKENASY, NACHUM DAFNY
- ▶ Parahippocampal Region
- ▶ Parahippocampal Region, Neuroimaging
- ▶ Parallel Pain Processing
- ▶ Parameters Indicative of Skeletal Muscle Contraction
- ▶ Paraneoplastic Syndrome
- ▶ Paraphysiological Cramps
- ▶ Paraproteinemic Neuropathies
- ▶ Paraspinal
- ▶ Parasylyvian
- ▶ Parasympathetic Component
- ▶ Paravertebral Muscle
- ▶ Parental Response
- ▶ **Paresthesia**  
TURO J. NURMIKKO
- ▶ Parietal Cortex, PET and fMRI Imaging
- ▶ Parity



- ▶ Parkinson's Disease
- ▶ Paroxysmal
- ▶ **Paroxysmal Hemicrania**  
MARGARITA SANCHEZ DEL RIO
- ▶ Paroxysmal Hypertension
- ▶ Paroxysmal Hypertensive Headaches
- ▶ Partial Agonist
- ▶ Partial Sciatic Nerve Ligation
- ▶ Participation
- ▶ Participation Restrictions
- ▶ Parvalbumin
- ▶ Parvocellular Neurons
- ▶ Parvocellular VP
- ▶ Passive
- ▶ Passive Avoidance
- ▶ Passive Relaxation
- ▶ **Passive Spinal Mobilisation**  
ROBERT GASSIN
- ▶ Patch-Clamp
- ▶ Pathogen
- ▶ Pathological Fracture
- ▶ Pathophysiological Pain
- ▶ Patient Assisted Laparoscopy
- ▶ Patient-Centered
- ▶ Patient Controlled Analgesia
- ▶ Patient Controlled Epidural Analgesia
- ▶ Patient Controlled Intravenous Analgesia
- ▶ **Patient Education**  
GEOFFREY HARDING
- ▶ Patient Information
- ▶ Patient-Therapist Interaction
- ▶ Pavlovian Conditioning
- ▶ Paw Pressure Test
- ▶ PCA
- ▶ PCA Pump
- ▶ PCEA
- ▶ PCM
- ▶ PDPH
- ▶ Pediatric Burns
- ▶ Pediatric Dosing Guidelines
- ▶ Pediatric Integrated Care for Painful Procedures
- ▶ Pediatric Migraine
- ▶ Pediatric Pain Management
- ▶ Pediatric Pain Treatment, Evolution
- ▶ Pediatric Pharmacological Interventions
- ▶ Pediatric Physical Therapy
- ▶ Pediatric Physiotherapy
- ▶ Pediatric Post-Surgical Pain
- ▶ Pediatric Psychological Interventions
- ▶ Peltier
- ▶ Pelvic Inflammatory Disease
- ▶ Pelvic Neurectomy
- ▶ Pelvic Pain Syndrome
- ▶ Pelvic Pain Syndrome of Bladder Origin
- ▶ Penile Block
- ▶ PENS
- ▶ **Peptides in Neuropathic Pain States**  
TODD W. VANDERAH, CARL-OLAV STILLER,  
FRANK PORRECA
- ▶ Per Capita Morphine Consumption
- ▶ **Percutaneous Cordotomy**  
RONALD R. TASKER
- ▶ Percutaneous Electrical Nerve Stimulation
- ▶ Performance
- ▶ Periaqueductal Gray
- ▶ Pericranial Muscles
- ▶ Peridural Infusions
- ▶ Perikarya
- ▶ Perineural Catheters
- ▶ Perineural Injection
- ▶ Perineuronal Basket
- ▶ Perineuronal Cells
- ▶ Perineuronal Terminals
- ▶ Periodic Disorders of Childhood that are Precursors to Migraine
- ▶ Peripheral Arterial Occlusive Disease
- ▶ Peripheral Glutamate Receptors, Role in Inflammation
- ▶ Peripheral Mechanisms of Opioid Analgesia
- ▶ Peripheral Modulation of Nociceptors
- ▶ **Peripheral Nerve Blocks**  
JOHN ROBINSON
- ▶ Peripheral Neuralgia
- ▶ Peripheral Neurogenic Pain
- ▶ **Peripheral Neuropathic Pain**  
MARSHALL DEVOR
- ▶ Peripheral Neuropathies
- ▶ Peripheral Opioid Analgesia
- ▶ Peripheral Opioid Receptors (OR)
- ▶ Peripheral Sensitization
- ▶ Peripheral Sensitization in Muscle and Joint
- ▶ Peripheral Vascular Disease
- ▶ Periphery of the Ventral Posterior Complex (VPp)

- ▶ **Perireceptor Elements**  
ANA GOMIS
- ▶ Perireceptor Events
- ▶ Perispinal Infusions
- ▶ Periventricular Gray
- ▶ Permanent Partial Disability
- ▶ Permanent Partial Impairment
- ▶ Permanent Restrictions
- ▶ Persistent Acute Pain
- ▶ Persistent Pain and Descending Modulation
- ▶ Persisting Pain
- ▶ Person
- ▶ Personal Characteristics
- ▶ Personal Factors
- ▶ Personality
- ▶ **Personality and Pain**  
JENNIFER A. HAYTHORNTHWAITE
- ▶ Personality Disorder
- ▶ **Personality Disorders and Pain**  
MICHAEL R. BOND
- ▶ Personally-Relevant Stressful Situations
- ▶ Persuasion
- ▶ PES
- ▶ PET
- ▶ **PET and fMRI Imaging in Parietal Cortex (SI, SII, Inferior Parietal Cortex BA40)**  
MARIE-CLAIRE ALBANESE, GARY DUNCAN
- ▶ Petrissage
- ▶ PGE2
- ▶ PGHS
- ▶ PGH-Synthase
- ▶ PHA-L
- ▶ **Phantom Limb Pain, Treatment**  
HERTA FLOR, RALF BARON
- ▶ Phantom Sensation
- ▶ Phantom Tooth Pain
- ▶ Pharmacodynamics
- ▶ Pharmacogenetics
- ▶ Pharmacogenetics of NSAIDs
- ▶ Pharmacokinetic Profile of Fentanyl
- ▶ Pharmacokinetics
- ▶ Pharmacokinetics of the NSAIDs
- ▶ Pharmacological Interventions
- ▶ Pharmacotherapy
- ▶ Phase-1 Reactions
- ▶ Phase-2 Reactions
- ▶ Phenadone
- ▶ Phenotype
- ▶ Phentolamine Test
- ▶ Pheromones
- ▶ Phonophobia
- ▶ Photochemical Model
- ▶ Photophobia
- ▶ Photosensitivity
- ▶ Physeptone
- ▶ Physical Abuse
- ▶ Physical Activity
- ▶ Physical Agent
- ▶ Physical Capacity Evaluation
- ▶ **Physical Conditioning Programs**  
EVA SCHONSTEIN
- ▶ Physical Deconditioning
- ▶ Physical Dependence
- ▶ **Physical Exercise**  
KAISA MANNERKORPI
- ▶ **Physical Medicine and Rehabilitation**  
BENGT H. SJÖLUND
- ▶ **Physical Medicine and Rehabilitation, Team-Oriented Approach**  
BENGT H. SJÖLUND
- ▶ Physical Performance Capacity
- ▶ Physical Stressors
- ▶ Physical Therapy
- ▶ Physiological Pain Measure
- ▶ Physiological Pathways
- ▶ Physiotherapist
- ▶ **Physiotherapy**  
CHRISTOPH GUTENBRUNNER
- ▶ Picrotoxin
- ▶ Pin-Prick Pain
- ▶ PIRFT
- ▶ Piriformis
- ▶ Pituitary Adenylate Cyclase Activating Peptide
- ▶ Pituitary Adenylate Cyclase-Activating Polypeptide
- ▶ Pituitary Gland
- ▶ PKA
- ▶ PKC
- ▶ **Placebo**  
SCOTT MASTERS
- ▶ Placebo Analgesia
- ▶ **Placebo Analgesia and Descending Opioid Modulation**  
FABRIZIO BENEDETTI
- ▶ Placebo Analgesic Effect

- ▶ Placebo Analgesic Response
- ▶ Placebo Effect
- ▶ **Plain Radiography**  
PETER LAU
- ▶ Plain X-Ray
- ▶ Plantar Incision Model
- ▶ Plantar Test
- ▶ Plasma Concentration Versus Time Profiles
- ▶ Plasma Extravasation
- ▶ Plasticity
- ▶ Pleomorphic Vesicles
- ▶ Plexopathy
- ▶ **Plexus Injuries and Deafferentation Pain**  
PRAVEEN ANAND
- ▶ PLIF
- ▶ PMS
- ▶ Pneumothorax
- ▶ Point Acupuncture
- ▶ Point Prevalence
- ▶ Polyarteritis Enterica
- ▶ Polyarthritits
- ▶ Polymodal Nociceptor(s)
- ▶ **Polymodal Nociceptors, Heat Transduction**  
CAROLINA ROZA
- ▶ Polymodal Sensory Neurones
- ▶ Polymodality
- ▶ Polymorphism
- ▶ Polymyalgia Rheumatica
- ▶ Polymyositis
- ▶ Polyol Pathway
- ▶ Polyps
- ▶ Polyradiculopathy
- ▶ Polysomnography
- ▶ POM
- ▶ Pons
- ▶ Poor Sleep Quality
- ▶ Population Survey
- ▶ Portacatheters
- ▶ Positioning
- ▶ Positive Reinforcement
- ▶ Positive Sensory Phenomenon
- ▶ Positron Emission Tomography
- ▶ Post Dural Puncture Headache
- ▶ Post Stroke Central Pain
- ▶ Post Surgical Nerve Injury
- ▶ Postamputation Pain
- ▶ Posterior Intervertebral Joint
- ▶ Posterior Nucleus
- ▶ Posterior Part of the Ventromedial Nucleus
- ▶ Posterior Primary Ramus
- ▶ Post-Excitatory Effects of C-Fibres
- ▶ Post-Firing Excitability Changes in Different Nociceptor Populations
- ▶ Postherpetic Neuralgia
- ▶ **Postherpetic Neuralgia, Etiology, Pathogenesis and Management**  
PETER N. WATSON
- ▶ **Postherpetic Neuralgia, Pharmacological and Non-Pharmacological Treatment Options**  
ANNE KØRSVIK BERTELSEN, MILES BELGRADE
- ▶ Post-Hypnotic Suggestion
- ▶ Postictal Headache
- ▶ Post-Infarction Sclerodactyly
- ▶ Post-Lumbar Puncture Headache
- ▶ **Postoperative Pain, Acute Neuropathic Pain**  
PHILIP SIDDALL, MICHAEL COUSINS
- ▶ **Postoperative Pain, Acute Pain Management Principles**  
HARALD BREIVIK
- ▶ **Postoperative Pain, Acute Pain Team**  
HARALD BREIVIK
- ▶ **Postoperative Pain, Acute Presentation of Complex Regional Pain Syndrome**  
SUELLEN M. WALKER
- ▶ **Postoperative Pain, Acute-Recurrent Pain**  
W. A. WILLIAMS, STEPHAN A. SCHUG
- ▶ **Postoperative Pain, Adverse Events (Associated with Acute Pain Management)**  
SARAH J. HARPER, STEPHAN A. SCHUG
- ▶ **Postoperative Pain, Anti-Convulsant Medications**  
ROSS MACPHERSON
- ▶ **Postoperative Pain, Anti-Depressants**  
ROSS MACPHERSON
- ▶ **Postoperative Pain, Appropriate Management**  
PAUL M. MURPHY
- ▶ **Postoperative Pain, Compartment Syndrome**  
E. L. BRANDON, STEPHAN A. SCHUG
- ▶ **Postoperative Pain, COX-2 Inhibitors**  
LESLEY A. COLVIN, IAN POWER
- ▶ **Postoperative Pain, Data Gathering and Auditing**  
KERSI TARAPOREWALLA
- ▶ **Postoperative Pain, Epidural Infusions**  
EDWARD A. SHIPTON
- ▶ **Postoperative Pain, Fentanyl**  
PETER C. A. KAM

- ▶ **Postoperative Pain, Gabapentin**  
ROSS MACPHERSON
- ▶ **Postoperative Pain, Hydromorphone**  
ROSS MACPHERSON
- ▶ **Postoperative Pain, Importance of Mobilisation**  
PETER C. A. KAM
- ▶ **Postoperative Pain, Intrathecal Drug Administration**  
EDWARD A. SHIPTON
- ▶ **Postoperative Pain, Ketamine**  
ROSS MACPHERSON
- ▶ **Postoperative Pain, Lignocaine**  
ROSS MACPHERSON
- ▶ **Postoperative Pain, Local Anaesthetics**  
LAURENCE E. MATHER
- ▶ **Postoperative Pain Management**
- ▶ **Postoperative Pain, Membrane Stabilising Agents**  
ROSS MACPHERSON
- ▶ **Postoperative Pain, Methadone**  
ROSS MACPHERSON
- ▶ **Postoperative Pain, Mexiletine**  
ROSS MACPHERSON
- ▶ **Postoperative Pain Model**
- ▶ **Postoperative Pain, Morphine**  
PETER C. A. KAM
- ▶ **Postoperative Pain, Non Steroidal Anti-Inflammatory Drugs**  
IAN POWER, LESLEY A. COLVIN
- ▶ **Postoperative Pain, Opioids**  
PETER C. A. KAM
- ▶ **Postoperative Pain, Oxycodone**  
PETER C. A. KAM
- ▶ **Postoperative Pain, Paracetamol**  
IAN POWER, LESLEY A. COLVIN
- ▶ **Postoperative Pain, Pathophysiological Changes in Cardiovascular Function in Response to Acute Pain**  
Z. KARIM, STEPHAN A. SCHUG
- ▶ **Postoperative Pain, Pathophysiological Changes in Metabolism in Response to Acute Pain**  
Z. KARIM, STEPHAN A. SCHUG
- ▶ **Postoperative Pain, Pathophysiological Changes in Neuro-Endocrine Function in Response to Acute Pain**  
Z. KARIM, STEPHAN A. SCHUG
- ▶ **Postoperative Pain, Patient Controlled Analgesia Devices, Epidural**  
PER FLISBERG, STEPHAN A. SCHUG
- ▶ **Postoperative Pain, Patient Controlled Analgesia Devices, Parenteral**  
K. M. POLLOCK, STEPHAN A. SCHUG
- ▶ **Postoperative Pain, Persistent Acute Pain**  
EDWARD A. SHIPTON
- ▶ **Postoperative Pain, Postamputation Pain, Treatment and Prevention**  
LONE NIKOLAISEN
- ▶ **Postoperative Pain, Pre-Emptive or Preventive Analgesia**  
JØRGEN B. DAHL
- ▶ **Postoperative Pain, Preoperative Education**  
EDWARD A. SHIPTON
- ▶ **Postoperative Pain, Regional Blocks**  
ANDREW J. FARACI, SPENCER S. LIU
- ▶ **Postoperative Pain, Thoracic and Cardiac Surgery**  
ELMAR BERENDES, HUGO VAN AKEN, THOMAS HACHENBERG
- ▶ **Postoperative Pain, Tramadol**  
PETER C. A. KAM
- ▶ **Postoperative Pain, Transition from Parenteral to Oral Drugs**  
RICHARD BURSTAL
- ▶ **Postoperative Pain, Venous Thromboembolism**  
O. J. TWEEDIE, STEPHAN A. SCHUG
- ▶ **Postpartum Pain**  
ANITA HOLDCROFT
- ▶ **Post-Radiation Plexopathy**
- ▶ **Post-Seizure Headache**  
TOBIAS LENIGER, HANS CHRISTOPH DIENER
- ▶ **Post-Stroke Pain Model, Cortical Pain (Injection of Picrotoxin)**  
JEAN-LOUIS OLIVÉRAS
- ▶ **Post-Stroke Pain Model, Thalamic Pain (Lesion)**  
NAYEF E. SAADÉ, SUHAYL J. JABBUR
- ▶ **Post-Sympathectomy Neuralgia**
- ▶ **Postsynaptic Dorsal Column Neurons**
- ▶ **Postsynaptic Dorsal Column Neurons, Responses to Visceral Input**  
ELIE D. AL-CHAER
- ▶ **Postsynaptic Dorsal Column Projection, Anatomical Organization**  
KARIN N. WESTLUND
- ▶ **Postsynaptic Dorsal Column Projection, Functional Characteristics**  
KARIN N. WESTLUND
- ▶ **Postsynaptic Inhibition**
- ▶ **Postsynaptic Opioid Receptors**
- ▶ **Post-Traumatic Headache**
- ▶ **Post-Traumatic Neuralgia**
- ▶ **Posttraumatic Subdural Hemorrhage**
- ▶ **Postural Position**
- ▶ **Posture**



- ▶ Potassium Sensitivity Testing
- ▶ Potent Opioid Analgesic
- ▶ Pourpre Myelotomy
- ▶ Power Law
- ▶ Power of Ultrasound
- ▶ PPI
- ▶ Preadmission Clinics
- ▶ Preamputation Pain
- ▶ Precontemplation
- ▶ Preidentin
- ▶ Prednisone
- ▶ Pre-Emptive Analgesia
- ▶ **Pre-Emptive or Preventive Analgesia and Central Sensitisation in Postoperative Pain**  
EMMA L. BRANDON, STEPHAN A. SCHUG
- ▶ Preferential Processing
- ▶ Prefrontal Cortex
- ▶ **Prefrontal Cortex, Effects on Pain-Related Behavior**  
JÜREGEN LORENZ
- ▶ Premenstrual Dysphoric Disorder
- ▶ **Premenstrual Syndrome**  
ANDREA J. RAPKIN, JUDITH A. MIKACICH
- ▶ Premenstrual Tension
- ▶ Premorbid Functioning
- ▶ Preoperative Education
- ▶ Preoperative Epidural Blockade
- ▶ Preoperative Nutritional Support
- ▶ Preoperative Patient Education
- ▶ Preoperative Teaching
- ▶ Pre-Paid Care
- ▶ Preparation
- ▶ Preparation Programs
- ▶ Prepuce Clitoris
- ▶ Present Pain Intensity Subscale
- ▶ Pressing/Tightening
- ▶ Pressure Algometer
- ▶ Pressure-Specified Sensory Device
- ▶ Presynaptic
- ▶ Presynaptic Inhibition
- ▶ Presynaptic Reuptake
- ▶ Prevalence
- ▶ **Prevalence of Chronic Pain Disorders in Children**  
ELIZABETH VAN DEN KERKHOF, ADAM VAN DIJK
- ▶ Prevention of Phantom Pain
- ▶ Prevention of Postoperative Pain
- ▶ Preventive Analgesia
- ▶ Preventive Therapy
- ▶ Pricking Pain
- ▶ Primary Afferents/Neurons
- ▶ Primary Afferents of the Urinary Bladder
- ▶ Primary and Secondary Hyperalgesia
- ▶ Primary and Secondary Zones
- ▶ Primary Anorgasmia
- ▶ Primary Cells (RVM)
- ▶ **Primary Cough Headache**  
JAMES W. LANCE
- ▶ Primary Dysmenorrhea
- ▶ **Primary Exertional Headache**  
ANDREAS STRAUBE
- ▶ Primary Hyperalgesia
- ▶ Primary Motor Cortex
- ▶ **Primary Somatosensory Cortex (S1), Effect on Pain-Related Behavior in Humans**  
MARKUS PLONER, ALFONS SCHNITZLER
- ▶ Primary Somatosensory Cortex (SI)
- ▶ **Primary Stabbing Headache**  
JAMES W. LANCE
- ▶ Primary Vulvar Vestibulitis
- ▶ PRM Specialist
- ▶ PRN
- ▶ Pro Re Nata
- ▶ Probability
- ▶ Probable Cause
- ▶ Procedural Distress
- ▶ Prognosis
- ▶ Prognostic Block
- ▶ Programmed Cell Death
- ▶ Progressive Adjustive
- ▶ Progressive Muscle Relaxation
- ▶ **Proinflammatory Cytokines**  
LINDA R. WATKINS, STEVEN F. MAIER
- ▶ Projection Neurons
- ▶ Projective Field (PF)
- ▶ Prolactin
- ▶ Proliferant
- ▶ Prolonged Acute Pain
- ▶ **Prolotherapy**  
MICHAEL YELLAND
- ▶ Promoter
- ▶ Prophylactic Pain Treatment
- ▶ Prophylactic Therapy

- ▶ Propofol
- ▶ Propranolol
- ▶ Proprioception
- ▶ Propriospinal Neurons
- ▶ Prospective Observational Cohort Study
- ▶ Prostacyclin
- ▶ Prostadynia
- ▶ Prostaglandin E2
- ▶ Prostaglandin Endoperoxide Synthase
- ▶ Prostaglandin H Synthase
- ▶ Prostaglandins
- ▶ Prostaglandins in Inflammatory Nociceptor Sensitisation
- ▶ **Prostaglandins, Spinal Effects**  
HORACIO VANEGAS, HANS-GEORG SCHAIBLE
- ▶ Prostanoids
- ▶ Protective Analgesia
- ▶ Protein Kinase A
- ▶ Protein Kinase C
- ▶ Proteinase-Activated Receptors
- ▶ Protein-Calorie Malnutrition
- ▶ Proteoglycan
- ▶ Provocation Discogram
- ▶ Provocative
- ▶ Provocative Maneuver
- ▶ Proximal Diabetic Neuropathy
- ▶ Pruriception
- ▶ Pruriceptive
- ▶ Pruritic Stimulus
- ▶ Pruritus
- ▶ PSDC
- ▶ PSDC Projection
- ▶ Pseudoaffective Response
- ▶ Pseudoaddiction
- ▶ Pseudoptosis
- ▶ Pseudotumor Cerebri
- ▶ PSL Model
- ▶ Psoas Compartment
- ▶ Psoriatic Arthritis
- ▶ **Psychiatric Aspects of Litigation and Pain**  
GEORGE MENDELSON
- ▶ Psychiatric Aspects of Multimodal Treatment for Pain
- ▶ **Psychiatric Aspects of Pain and Dentistry**  
CHARLOTTE FEINMANN
- ▶ **Psychiatric Aspects of the Epidemiology of Pain**  
ELDON TUNKS, JOAN CROOK, ROBIN WEIR
- ▶ **Psychiatric Aspects of the Management of Cancer Pain**  
SANTOSH K. CHATURVEDI
- ▶ **Psychiatric Aspects of Visceral Pain**  
STEPHEN P. TYRER, ANN WIGHAM
- ▶ Psychiatric Disorder
- ▶ Psychiatric Evaluation
- ▶ Psychiatric Illness
- ▶ Psychiatric Management of Cancer Pain
- ▶ Psychiatric Physiotherapy
- ▶ **Psychiatry and Pain Management**  
MICHAEL R. BOND
- ▶ Psychobiological Model
- ▶ Psychoeducation
- ▶ Psychoeducational Intervention
- ▶ Psychogenic
- ▶ Psychogenic Headache
- ▶ Psychogenic Pain
- ▶ Psychogenic Pain Disorder
- ▶ Psychogenic Rheumatism
- ▶ **Psychological Aspects of Pain in Women**  
ELENI G. HAPIDOU
- ▶ **Psychological Assessment of Pain**  
DENNIS C. TURK
- ▶ Psychological Consequences of Pain
- ▶ Psychological Evaluation
- ▶ Psychological Factors
- ▶ Psychological Management of Cancer Pain
- ▶ Psychological Pain Measures
- ▶ **Psychological Predictors of Chronicity**  
MICHAEL K. NICHOLAS
- ▶ Psychological Risk Factors
- ▶ Psychological Strategies
- ▶ Psychological Treatment
- ▶ **Psychological Treatment in Acute Pain**  
ROBERT R. EDWARDS
- ▶ **Psychological Treatment of Chronic Pain, Prediction of Outcome**  
ROBERT J. GATCHEL
- ▶ **Psychological Treatment of Headache**  
BEVERLY E. THORN, FRANK ANDRASIK
- ▶ **Psychological Treatment of Pain in Children**  
CHRISTIANE HERMANN
- ▶ **Psychological Treatment of Pain in Older Populations**  
HEINZ-DIETER BASLER
- ▶ Psychological Treatment of Pain in the Elderly
- ▶ **Psychology of Pain and Psychological Treatment**  
HERTA FLOR, NIELS BIRBAUMER

- ▶ **Psychology of Pain, Assessment of Cognitive Variables**  
MICHAEL J. L. SULLIVAN
- ▶ **Psychology of Pain, Efficacy**  
STEPHEN MORLEY
- ▶ **Psychology of Pain, Self-Efficacy**  
MICHAEL J. L. SULLIVAN
- ▶ **Psychology of Pain, Sensitisation, Habituation and Pain**  
MICHAEL K. NICHOLAS
- ▶ Psychometric Function
- ▶ Psychometrics
- ▶ Psychomotor Physiotherapy
- ▶ Psychomyogenic Headache
- ▶ Psychopathology
- ▶ Psychophysical Law
- ▶ Psychophysical Testing
- ▶ Psychophysics
- ▶ Psychophysiological Model of Pain
- ▶ Psychophysiological Assessment
- ▶ **Psychophysiological Assessment of Pain**  
FRANK ANDRASIK, BEVERLY E. THORN, HERTA FLOR
- ▶ Psychophysiological Reactivity
- ▶ Psychophysiological Stress Profile
- ▶ Psychosocial Factors
- ▶ Psychosocial Interventions
- ▶ Psychosocial Maladjustment and Pain
- ▶ Psychosocial Management of Cancer Pain
- ▶ Psychosocial Obstacles to Recovery
- ▶ Psychosocial Predictors or Risk Factors
- ▶ Psychosocial Treatments for Pain
- ▶ Psychosocioeconomic
- ▶ Psychosocioeconomic Syndrome
- ▶ Psychosomatic and Psychiatric Physiotherapy
- ▶ Psychotherapy
- ▶ Psychotherapy of Older Pain Patients
- ▶ Psychotic
- ▶ Psychotropics
- ▶ Ptosis
- ▶ Pudendal Nerve
- ▶ Pudendal Neuralgia
- ▶ **Pudendal Neuralgia in Women**  
MAURICE F. BENSIGNOR, JEAN-JACQUES LABAT, ROGER ROBERT, MICHEL GUERINEAU
- ▶ Puerperium
- ▶ PUF Scale
- ▶ Pulmonary Embolism (PE)
- ▶ Pulpal Nociceptors
- ▶ Pulpalgia
- ▶ Pulpitis
- ▶ Pulsed Electromagnetic Therapy
- ▶ Punch Skin Biopsies
- ▶ Punctate Hyperalgesia
- ▶ Punctate Midline Myelotomy
- ▶ Punctuate Allodynia
- ▶ Punishment
- ▶ **Purine Receptor Targets in the Treatment of Neuropathic Pain**  
LUCY VULCHANOVA
- ▶ Purinergic Receptors
- ▶ Putamen
- ▶ Pyeloplasty
- ▶ Pyramidal Cells
- ▶ Pyramidal Neuron
- ▶ QOL
- ▶ QST
- ▶ QTL Mapping
- ▶ Quadratus Lumborum
- ▶ Quality of Life
- ▶ Quantal Release Probability
- ▶ **Quantitative Sensory Testing**  
OLIVER H. G. WILDER-SMITH
- ▶ Quantitative Sensory Tests
- ▶ **Quantitative Thermal Sensory Testing of Inflamed Skin**  
LOUISE HARDING
- ▶ Quantitative Trait Locus Mapping
- ▶ Quotas
- ▶ Radial Arm Maze
- ▶ Radiant Heat
- ▶ Radiant Heat Test
- ▶ Radiant Stimulation
- ▶ Radiculalgia
- ▶ Radicular Leg Pain
- ▶ Radicular Nerve Root Pain
- ▶ Radicular Pain
- ▶ **Radicular Pain, Diagnosis**  
JAYANTILAL GOVIND
- ▶ **Radiculopathies**  
PAOLO MARCHETTINI
- ▶ Radiofrequency
- ▶ Radiofrequency Ablation
- ▶ Radiofrequency Denervation
- ▶ Radiofrequency Lesion

- ▶ **Radiofrequency Neurotomy, Electrophysiological Principles**  
JAYANTILAL GOVIND
- ▶ Radiofrequency Rhizotomy
- ▶ Radiography
- ▶ Radioisotope
- ▶ Radio-Ligand Binding
- ▶ Radiopharmaceuticals
- ▶ Radiosurgical Rhizotomy
- ▶ Radiotherapy
- ▶ Raeder's Paratrigeminal Syndrome
- ▶ Ramus
- ▶ **Randall-Selitto Paw Pressure Test**  
VALERIE KAYSER
- ▶ Randomized
- ▶ Randomized Controlled Trial
- ▶ RAP
- ▶ Raphe Nuclei
- ▶ Rapid Eye Movement Sleep
- ▶ Rapidly Adapting Responses
- ▶ **Rating Impairment Due to Pain in a Workers' Compensation System**  
HENRY STOCKBRIDGE
- ▶ Ratio Scale
- ▶ Raynaud's Syndrome
- ▶ Raynaud's Vibration White Finger Syndrome
- ▶ RCT
- ▶ Reactive Arthritis
- ▶ Reactive Hypertension
- ▶ Reactive Tachycardia
- ▶ Reactivity
- ▶ Real Time PCR
- ▶ Reassurance and Activation
- ▶ Recall
- ▶ Receiver Operating Characteristics
- ▶ Receptive Field (RF)
- ▶ Receptor
- ▶ Receptor Affinity
- ▶ Receptor Potential
- ▶ Receptor Selectivity
- ▶ Receptors in the Descending Circuitry
- ▶ Recist
- ▶ Recognition
- ▶ Recognizing Issues Contributing to Pain Secondary to Burn Injury and its Treatment
- ▶ Recollection
- ▶ Recording of Pain Behavior
- ▶ Recovery
- ▶ Recruitment to an Injury Site
- ▶ Rectangular Pulses
- ▶ Recurrent Abdominal Pain
- ▶ **Recurrent Abdominal Pain in Children**  
DAVID S. JONES, LYNN S. WALKER
- ▶ Recurrent Pelvic Pain
- ▶ Red Flags
- ▶ Red Thrombi
- ▶ Re-Entrant Excitation
- ▶ Referred Hyperalgesia
- ▶ Referred Muscle Pain
- ▶ **Referred Muscle Pain, Assessment**  
THOMAS GRAVEN-NIELSEN
- ▶ Referred Pain
- ▶ Reflective Listening
- ▶ Reflex Sympathetic Dystrophy
- ▶ Reflexes and Opioids
- ▶ Refractory Period
- ▶ Regional Anesthesia
- ▶ Regional Blocks
- ▶ Regional Heterogeneity
- ▶ Regional Infusion
- ▶ Regression to the Mean
- ▶ Rehabilitation
- ▶ Rehabilitation Plan
- ▶ Reinforcers
- ▶ Reiter's Syndrome
- ▶ Relationship
- ▶ Relative Potency
- ▶ Relaxation
- ▶ **Relaxation in the Treatment of Pain**  
BEVERLY E. THORN, FRANK ANDRASIK
- ▶ Relaxation Interventions
- ▶ Relaxation-Induced Anxiety
- ▶ Relaxation Therapy
- ▶ **Relaxation Training**  
BENGT H. SJÖLUND
- ▶ **Reliability**  
DAVID VIVIAN
- ▶ REM Sleep
- ▶ Renin
- ▶ Repetitive Strain Injuries
- ▶ Repetitive Transcranial Magnetic Stimulation
- ▶ Repetitiveness of Movement
- ▶ Repriming
- ▶ Rescue Analgesic
- ▶ Residual Functional Capacity



- ▶ Residual Limb Pain
- ▶ Resiniferatoxin
- ▶ Resistance
- ▶ Respiratory Centers
- ▶ Respiratory Depression
- ▶ Respondent Conditioning
- ▶ **Respondent Conditioning of Chronic Pain**  
HERTA FLOR
- ▶ Respondents
- ▶ Response Dependent Method
- ▶ Response Prevention
- ▶ Response to Analgesics
- ▶ Responsive Neurostimulation
- ▶ Responsiveness
- ▶ **Rest and Movement Pain**  
PAUL M. MURPHY
- ▶ Rest Position
- ▶ Resting State Network
- ▶ **Restless Legs Syndrome**  
MICHAEL POLYDEFKIS
- ▶ Reticular Activating System
- ▶ Reticular Formation
- ▶ Reticular Nucleus Inputs from Cortex
- ▶ Retinal Slip
- ▶ Retrograde
- ▶ Retrograde Axonal Tracer
- ▶ **Retrograde Cellular Changes after Nerve Injury**  
TOMAS HÖKFELT, PABLO BRUMOVSKY,  
MARCELO VILLAR
- ▶ Retrograde Labeling
- ▶ Retrograde Tracing Technique
- ▶ Retrograde Transport
- ▶ Retroperitoneal
- ▶ Retrospective
- ▶ Reversal Reaction
- ▶ Reversible Posterior Leucoencephalopathy Syndrome
- ▶ Rexed's Lamina II
- ▶ Rexed's Laminae
- ▶ RFC
- ▶ Rheumatoid Arthritis
- ▶ Rhinorrhea
- ▶ Rhizotomy
- ▶ Risk
- ▶ Risk Factor
- ▶ Risk Factors for Chronicity
- ▶ Risk for Development of a WMSD
- ▶ RLS
- ▶ ROC
- ▶ Rolandic Sulcus
- ▶ Role Modeling
- ▶ Role Plays
- ▶ Root Canal Therapy
- ▶ Root Disease
- ▶ Rostral Ventral Medulla
- ▶ **Rostral Ventromedial Medulla**  
PEGGY MASON
- ▶ **Rostral Ventromedial Medulla Cell Types**  
PEGGY MASON
- ▶ Roxycodone®
- ▶ RSD
- ▶ RSI
- ▶ rTMS
- ▶ RTX
- ▶ Ruffini Receptor
- ▶ Rumination
- ▶ S/N Ratio
- ▶ Sacral Hiatus
- ▶ Sacroiliac Injury
- ▶ Sacroiliac Joint
- ▶ **Sacroiliac Joint Blocks**  
ANTHONY C. SCHWARZER
- ▶ Sacroiliac Joint Denervation
- ▶ Sacroiliac Joint Injection
- ▶ Sacroiliac Joint Neurotomy
- ▶ **Sacroiliac Joint Pain**  
RICARDO J. KOMOTAR, J. MOCCO,  
CHRISTOPHER J. WINFREE
- ▶ **Sacroiliac Joint Radiofrequency Denervation**  
WAY YIN
- ▶ Sacroiliitis
- ▶ Sacrum
- ▶ Saliency
- ▶ Salpingitis-Oophoritis-Peritonitis
- ▶ Sarcomere
- ▶ Satellite Cells
- ▶ **Satellite Cells and Inflammatory Pain**  
REGINALD J. DOCHERTY
- ▶ Satellite Glial Cells
- ▶ Scalenus Anticus Syndrome
- ▶ Scanning
- ▶ SCC
- ▶ Scheduling Reinforcement
- ▶ Schema

- ▶ Schema Activation
- ▶ Schemata
- ▶ Schrober's Test
- ▶ Schwann Cell
- ▶ Sciatic Inflammatory Neuritis
- ▶ Sciatic Inflammatory Neuropathy
- ▶ Sciatic Neuralgia
- ▶ Sciatic Neuropathy
- ▶ Sciatic Notch
- ▶ **Sciatica**  
GABOR B. RACZ, CARL E. NOE
- ▶ SCI-Pain
- ▶ Sclerosant
- ▶ Sclerotherapy
- ▶ Scotoma
- ▶ Screening
- ▶ Second Messenger Cascades
- ▶ Second Order Neurons
- ▶ Second Pain
- ▶ Second Pain Assessment
- ▶ Second Somatosensory Cortex
- ▶ Secondary Cells (RVM)
- ▶ Secondary Dysmenorrhea
- ▶ Secondary Hyperalgesia
- ▶ Secondary Losses
- ▶ Secondary Mechanical Allodynia
- ▶ Secondary Prevention
- ▶ Secondary Somatosensory Cortex
- ▶ **Secondary Somatosensory Cortex (S2) and Insula, Effect on Pain Related Behavior in Animals and Humans**  
ERIC A. MOULTON, JOEL D. GREENSPAN
- ▶ Secondary Trigeminal Neuralgia
- ▶ Secondary Vulvar Vestibulitis
- ▶ Sedentary Work
- ▶ Segmental Analgesia
- ▶ Segmental Anti-Nociceptive Mechanisms
- ▶ Segmental Demyelination
- ▶ Seizure-Associated Headache
- ▶ Seizures
- ▶ Selectins
- ▶ Selection Factors
- ▶ Selective Anesthesia
- ▶ Selective Nerve Root Block
- ▶ Selective Nerve Root Injection
- ▶ Selective Serotonin Reuptake Inhibitors
- ▶ Self-Constructs
- ▶ Self-Efficacy
- ▶ Self-Management
- ▶ Self-Organization
- ▶ Self-Regulation
- ▶ Self-Reinforcement
- ▶ Self-Report Pain Measures
- ▶ Seltzer Model
- ▶ Sense of Control
- ▶ Sensitive Locus
- ▶ Sensitivity
- ▶ Sensitization
- ▶ **Sensitization of Muscular and Articular Nociceptors**  
SIEGFRIED MENSE, HANS-GEORG SCHAIBLE
- ▶ Sensitization of the Nociceptive System
- ▶ **Sensitization of Visceral Nociceptors**  
GERALD F. GEBHART
- ▶ Sensorimotor Integration
- ▶ Sensory Decision Theory
- ▶ Sensory Dimension of Pain
- ▶ Sensory Discrimination
- ▶ Sensory-Discriminative Aspect of Pain
- ▶ Sensory Endings in Joint Tissues
- ▶ Sensory Focusing
- ▶ Sensory Ganglia
- ▶ Sensory Ganglionectomy
- ▶ Sensory Ganglionitis
- ▶ Sensory Impairment
- ▶ Sensory Modalities
- ▶ Sensory Neuronopathy
- ▶ Sensory Receptor
- ▶ Sensory Relay Neurons
- ▶ Sensory Rhizotomy
- ▶ Sensory Saturation
- ▶ Sensory Stimulation-Guided Radiofrequency Neurotomy
- ▶ Sensory Transduction
- ▶ SEPs
- ▶ Sequential Relay
- ▶ Serotonergic
- ▶ Serotonin
- ▶ Serotonin Antagonist
- ▶ Serotonin Blockers
- ▶ Serotonin Norepinephrine Reuptake Inhibitors
- ▶ Serous Meningitis
- ▶ Sex
- ▶ Sex and Chronicity

- ▶ **Sex Differences in Descending Pain Modulatory Pathways**  
ANNE Z. MURPHY, DAYNA R. LOYD
- ▶ **Sex Differences in Opioid Analgesia**  
REBECCA M. CRAFT
- ▶ Sexual Abuse
- ▶ Sexual Activity Headache
- ▶ Sexual Dysfunctions
- ▶ Sexual Pain Disorder
- ▶ Sexual Response
- ▶ SF-36 Health Status Questionnaire
- ▶ SFEMG
- ▶ SF-MPQ
- ▶ Sham
- ▶ Shear Stress
- ▶ Shingles Pain
- ▶ Short-Lasting Unilateral Neuralgiform Headache Attacks with Conjunctival Injection and Tearing
- ▶ Shortwave Diathermy
- ▶ Shoulder Pain
- ▶ Shoulder-Hand Syndrome
- ▶ SI
- ▶ SII
- ▶ SII/PV
- ▶ SIA
- ▶ Sicca-Syndrome
- ▶ Sick Role
- ▶ Sickle Cell Disease
- ▶ Side Effects
- ▶ Sign of Formication
- ▶ Signal Detection Analysis/Theory
- ▶ Signaling
- ▶ Signaling Molecules of Thalamic Regions
- ▶ Signal-to-Noise Ratio
- ▶ Significant Others
- ▶ Significant Others' Responses to Pain
- ▶ Sildenafil
- ▶ Silent Myocardial Ischemia
- ▶ **Silent Nociceptor**  
ROBERT F. SCHMIDT
- ▶ **Simple Analgesics**  
NIKOLAI BOGDUK
- ▶ Simple Nerve Blocks
- ▶ Simple Synapse
- ▶ Simulated Job Tasks
- ▶ SIN
- ▶ Single Fiber Electromyography
- ▶ Single Interval Procedure
- ▶ Single Nucleotide Polymorphisms
- ▶ Single or Straight Form of Terminal Branches
- ▶ **Single Photon Emission Computed Tomography**  
PETER LAU
- ▶ Single Unit Activity
- ▶ Single-Unit Recording
- ▶ Sinus Thrombosis
- ▶ siRNA
- ▶ Situational Assessment
- ▶ Situational Factors
- ▶ Situational Pain Questionnaire
- ▶ Sjögren's Syndrome
- ▶ Sjaastad's Syndrome
- ▶ Skin Conductance-Assisted Relaxation
- ▶ Skin-Nerve Preparation
- ▶ Skin Nociception, Species Differences
- ▶ Skin-to-Skin Contact
- ▶ SLE
- ▶ SLEA
- ▶ Sleep
- ▶ Sleep Disturbance
- ▶ Sleep Fragmentation
- ▶ Sleep Stage
- ▶ Sleeping Nociceptor
- ▶ Small-Caliber Afferent Fibers
- ▶ **Small Fiber Neuropathies**  
JOHN W. GRIFFIN
- ▶ Small Fiber Neuropathy/Polyneuropathy
- ▶ Small Fibers
- ▶ SMP
- ▶ SMT
- ▶ SNI Model
- ▶ SNL
- ▶ SNL Model
- ▶ SNP
- ▶ **Social Dislocation and the Chronic Pain Patient**  
RANJAN ROY
- ▶ Social Learning
- ▶ Social Learning Theory
- ▶ Social Security Disability Insurance
- ▶ Social Stressors
- ▶ Social Support
- ▶ Socioeconomic Factors
- ▶ Sodium Channel
- ▶ Sodium Channel Blockers

- ▶ Sodium Pump
- ▶ Soft Tissue Manipulation
- ▶ Soft Tissue Pain Syndromes
- ▶ Soft Tissue Rheumatism
- ▶ Softener
- ▶ Solicitous
- ▶ Solicitous Responses
- ▶ Solicitousness
- ▶ Soma
- ▶ Somatic Dysfunction
- ▶ **Somatic Pain**  
PAUL M. MURPHY
- ▶ **Somatic Referred Pain**  
DAVID ROSELT
- ▶ Somatic Sensory and Intralaminar Nuclei of Thalamus
- ▶ Somatic Sensory Nucleus of Human Thalamus
- ▶ Somatization
- ▶ **Somatization and Pain Disorders in Children**  
JANET W. M. ELLIS
- ▶ Somatization Disorder
- ▶ Somatoform Disorders
- ▶ Somatoform Pain Disorder
- ▶ Somatosensory
- ▶ Somatosensory Evoked Potentials
- ▶ Somatosensory Nervous System
- ▶ Somatosensory Pain Memories
- ▶ Somatosensory Pathways
- ▶ Somatostatin
- ▶ Somatotopic
- ▶ Somatotopic Organization
- ▶ Somatotopical Location
- ▶ Somatotopy
- ▶ Somatotropin
- ▶ Somatovisceral Convergence
- ▶ Sonography
- ▶ Soul Pain
- ▶ Source Analysis
- ▶ SP1 and SP2 Silent Periods
- ▶ Spa
- ▶ Spa Therapy
- ▶ **Spa Treatment**  
DAN BUSKILA
- ▶ Spared Nerve Injury Model
- ▶ Spasm
- ▶ Spasticity
- ▶ Spatial Summation
- ▶ Special Place Imagery
- ▶ Specialist Palliative Care
- ▶ **Species Differences in Skin Nociception**  
BRUCE LYNN
- ▶ Specificity
- ▶ Specificity Theory
- ▶ SPECT
- ▶ Spike
- ▶ Spike Bursts
- ▶ Spillover
- ▶ Spinal Analgesia
- ▶ Spinal Anesthesia
- ▶ Spinal Arthrodesis
- ▶ Spinal Ascending Pathways
- ▶ **Spinal Ascending Pathways, Colon, Urinary Bladder and Uterus**  
TIMOTHY NESS
- ▶ Spinal Block
- ▶ Spinal Cord
- ▶ Spinal Cord Astrocyte
- ▶ Spinal Cord Compression
- ▶ **Spinal Cord Injury Pain**  
D. PAUL HARRIES
- ▶ **Spinal Cord Injury Pain Model, Contusion Injury Model**  
PHILIP J. SIDDALL
- ▶ **Spinal Cord Injury Pain Model, Cordotomy Model**  
ALAN R. LIGHT, CHARLES J. VIERCK JR.
- ▶ **Spinal Cord Injury Pain Model, Hemisection Model**  
CLAIRE E. HULSEBOSCH
- ▶ **Spinal Cord Injury Pain Model, Ischemia Model**  
XIAO-JUN XU, JING-XIA HAO, ZSUZSANNA WIESENFELD-HALLIN
- ▶ Spinal Cord Injury Pain Models
- ▶ **Spinal Cord Injury, Excitotoxic Model**  
ROBERT P. YEZIERSKI
- ▶ Spinal Cord Laminae
- ▶ Spinal Cord Nociception and CGRP
- ▶ Spinal Cord Nociception, Encoding of Noxious Stimuli
- ▶ Spinal Cord Nociception, Glutamate Receptor (Metabotropic)
- ▶ **Spinal Cord Nociception, Neurotrophins**  
MARZIA MALCANGIO
- ▶ Spinal Cord Segmental Level
- ▶ Spinal Cord Stimulation
- ▶ Spinal Dorsal Horn
- ▶ Spinal Dorsal Horn Pathways, Colon, Urinary Bladder and Uterus



- ▶ **Spinal Dorsal Horn Pathways, Dorsal Column (Visceral)**  
WILLIAM D. WILLIS
- ▶ **Spinal Dorsal Horn Pathways, Muscle and Joint**  
SIEGFRIED MENSE, HANS-GEORG SCHAIBLE
- ▶ Spinal Effects of Prostaglandins
- ▶ Spinal Flattened Neuron
- ▶ Spinal Fusiform Neuron
- ▶ **Spinal Fusion for Chronic Back Pain**  
VIVEKANANDA GONUGUNTA, EDWARD C. BENZEL
- ▶ Spinal Injection
- ▶ **Spinal Manipulation, Characteristics**  
BENGT H. SJÖLUND
- ▶ **Spinal Manipulation, Pain Management**  
ROBERT GASSIN
- ▶ Spinal Modulatory Impulses
- ▶ Spinal Multipolar Neuron
- ▶ Spinal Nerve Block
- ▶ Spinal Nerve Ligation Model
- ▶ Spinal (Neuraxial) Opioid Analgesia
- ▶ Spinal Pyramidal Neuron
- ▶ Spinal Radicular Arteries
- ▶ Spinal Reflex
- ▶ Spinal Root Disease
- ▶ Spinal Segment
- ▶ Spinal Sensitization
- ▶ Spinal Stenosis
- ▶ Spinal Subarachnoid Space
- ▶ Spinal Tract of the Trigeminal Nerve
- ▶ Spinal Transection
- ▶ Spinal Trigeminal Complex
- ▶ Spinoannular
- ▶ Spinohypothalamic Neurons
- ▶ **Spinohypothalamic Tract, Anatomical Organization and Response Properties**  
XIJING ZHANG
- ▶ Spinomedullary Neurons
- ▶ Spinomesencephalic Neurons
- ▶ **Spinomesencephalic Tract**  
ROBERT P. YEZIERSKI
- ▶ Spinoparabrachial Neurons
- ▶ Spinoparabrachial Pathway
- ▶ **Spinoparabrachial Tract**  
ALAN R. LIGHT
- ▶ Spinopetal Modulation of Pain
- ▶ Spinoreticular Neurons
- ▶ Spinosolitary Neurons
- ▶ Spinotectal
- ▶ **Spinothalamic Input, Cells of Origin (Monkey)**  
WILLIAM D. WILLIS
- ▶ **Spinothalamic Neuron**  
WILLIAM D. WILLIS
- ▶ **Spinothalamic Projections in Rat**  
DANIEL MENÉTREY
- ▶ **Spinothalamic Terminations, Core and Matrix**  
EDWARD JONES
- ▶ Spinothalamic Tract Cells
- ▶ **Spinothalamic Tract Neurons, Central Sensitization**  
DONALD A. SIMONE
- ▶ **Spinothalamic Tract Neurons, Descending Control by Brainstem Neurons**  
WILLIAM D. WILLIS
- ▶ **Spinothalamic Tract Neurons, Glutamatergic Input**  
SUSAN M. CARLTON
- ▶ **Spinothalamic Tract Neurons, in Deep Dorsal Horn**  
DONALD D. PRICE
- ▶ **Spinothalamic Tract Neurons, Morphology**  
DEOLINDA LIMA
- ▶ **Spinothalamic Tract Neurons, Peptidergic Input**  
VIRGINIA S. SEYBOLD
- ▶ **Spinothalamic Tract Neurons, Responses to Chemical Stimulation**  
DONALD A. SIMONE
- ▶ **Spinothalamic Tract Neurons, Role of Nitric Oxide**  
WILLIAM D. WILLIS
- ▶ **Spinothalamic Tract Neurons, Visceral Input**  
ROBERT D. FOREMAN, CHAO QIN
- ▶ Spinothalamocortical Pathway
- ▶ **Spinothalamocortical Projections from SM**  
VJEKOSLAV MILETIC
- ▶ **Spinothalamocortical Projections to Ventromedial and Parafascicular Nuclei**  
LENAIC MONCONDUIT, LUIS VILLANUEVA
- ▶ Spiral CT
- ▶ Spiritual Problems
- ▶ Splice Variants
- ▶ Spondyloarthropathy
- ▶ Spondylolisthesis
- ▶ Spontaneous Aliquorhea
- ▶ Spontaneous Cerebrospinal Fluid (CSF) Leak
- ▶ Spontaneous Dissection
- ▶ Spontaneous Ectopia
- ▶ Spontaneous Intracranial Hypotension

- ▶ Spontaneous Nociceptive Behaviors
- ▶ Spontaneous Onset
- ▶ Spontaneous Pain
- ▶ **Spouse, Role in Chronic Pain**  
ROBERT D. KERNS, ALICIA A. HEAPY
- ▶ **Sprained Ankle Pain Model**  
SUNG TAE KOO WONKWANG, JIN MO CHUNG
- ▶ Spray and Stretch
- ▶ Spreading Depression
- ▶ SQUID
- ▶ SRD
- ▶ SSDI
- ▶ sSNI Model
- ▶ SNRIs
- ▶ SSR
- ▶ SSRIs
- ▶ Static Allodynia
- ▶ Statistical Decision Making
- ▶ **Statistical Decision Theory Application in Pain Assessment**  
W. CRAWFORD CLARK
- ▶ Step Cycle
- ▶ Stepwise Approach
- ▶ Stereological Techniques
- ▶ Stereotactic Cingulotomy
- ▶ Stereotactic Medial Thalamotomy
- ▶ Stereotactic Radiosurgery
- ▶ Stereotactic Sacroiliac Joint Denervation
- ▶ Stereotactic Surgery
- ▶ Stereotaxy
- ▶ **Steroid Injections**  
NIKOLAI BOGDUK
- ▶ Steroids
- ▶ Stimulant
- ▶ **Stimulation-Produced Analgesia**  
GREGORY W. TERMAN
- ▶ **Stimulation Treatments of Central Pain**  
ANTONIO OLIVIERO, ELISA LOPEZ-DOLADO,  
VINCENCO DI LAZZARO
- ▶ Stimulus-Dependent Pain
- ▶ Stimulus-Evoked Pain
- ▶ Stimulus-Independent Pain
- ▶ Stimulus Quality
- ▶ **Stimulus Response Functions**  
RICHARD H. GRACEY
- ▶ Stomatodynia
- ▶ STP Syndromes
- ▶ Straight-Leg-Raising Sign
- ▶ Strain
- ▶ Stratum Corneum
- ▶ Strength (Efficiency) of Chemical Synapses
- ▶ Streptozotocin
- ▶ Streptozotocin-Induced Diabetic Neuropathy
- ▶ Stress
- ▶ **Stress and Pain**  
HEATHER L. ROGERS, MICHAEL FEUERSTEIN
- ▶ Stress Headache
- ▶ Stress-Induced Analgesia
- ▶ Stress Management
- ▶ Stress Metabolism
- ▶ Stress Profile
- ▶ Stress Response
- ▶ Stressor
- ▶ **Stretching**  
ROBERT D. HERBERT
- ▶ Stria Terminalis (ST)
- ▶ Stroke
- ▶ Structural Lesion
- ▶ Struggle
- ▶ Strychnine
- ▶ STT
- ▶ Stump Pain
- ▶ Subacute Pain
- ▶ Subarachnoid Drug Administration
- ▶ Subarachnoid Space
- ▶ Subarachnoid/Spinal Anesthesia
- ▶ Subchondral Bone
- ▶ Subclinical Forehead Sweating
- ▶ Subcutaneous Mechanoreception
- ▶ Subdural
- ▶ Subdural Drug Pumps
- ▶ Subdural Hematoma
- ▶ Subject Weights
- ▶ Subjective Factors
- ▶ Subjective Judgment
- ▶ Subjective Pain Experience
- ▶ Sublenticular Extended Amygdala
- ▶ Subliminal Receptive Fields
- ▶ Submaximum Effort Tourniquet Technique
- ▶ Subnucleus Caudalis and Interpolaris
- ▶ Subnucleus Reticularis Dorsalis
- ▶ Subnucleus Reticularis Ventralis
- ▶ Substance Abuse

- ▶ Substance P
- ▶ **Substance P Regulation in Inflammation**  
JANET WINTER
- ▶ Substance P Tachykinin
- ▶ Substantia Gelatinosa
- ▶ Substantial Gainful Activity
- ▶ Sudeck's Atrophy
- ▶ Sudomotor
- ▶ Sudomotor Dysfunction
- ▶ Sudomotor Function
- ▶ Suffering
- ▶ Suggestibility
- ▶ Sulci
- ▶ Sulfur Bath
- ▶ Sunburn
- ▶ Sunburn as a Model of Cutaneous Hyperalgesia
- ▶ Sunct Status
- ▶ **SUNCT Syndrome**  
JUAN A. PAREJA
- ▶ Superconducting Quantum Interference Device
- ▶ Superficial Dorsal Horn
- ▶ Superficial Dry Needling
- ▶ Superficial Dyspareunia
- ▶ Superior Hypogastric Plexus
- ▶ Supersensitivity
- ▶ Supplemental Security Income
- ▶ Supplemental Security Income Disability Program
- ▶ Supportive Care
- ▶ Supraspinal Anti-Nociceptive Mechanisms
- ▶ Supraspinal Pain Control Systems
- ▶ Supraspinal Regulation
- ▶ Suprathreshold Stimuli
- ▶ Sural Nerve Biopsy
- ▶ Sural Spared Nerve Injury Model
- ▶ Surgery in the DREZ
- ▶ Surgical Denervation
- ▶ Survivin
- ▶ Swaddling
- ▶ Swedish Massage
- ▶ Switching
- ▶ Sylvian Fissure
- ▶ Sympathectomy
- ▶ **Sympathetic-Afferent Coupling in the Afferent Nerve Fiber, Neurophysiological Experiments**  
HEINZ-JOACHIM HÄBLER, MATTHIAS RINGKAMP
- ▶ **Sympathetic-Afferent Coupling in the Dorsal Root Ganglion, Neurophysiological Experiments**  
HEINZ-JOACHIM HÄBLER, WILFRID JÄNIG
- ▶ Sympathetic-Afferent Interaction
- ▶ Sympathetic Afferents
- ▶ **Sympathetic and Sensory Neurons after Nerve Lesions, Structural Basis for Interactions**  
ELSPETH M. MCLACHLAN
- ▶ Sympathetic Arousal
- ▶ Sympathetic Blockade
- ▶ **Sympathetic Blocks**  
ANDREW JEFFREYS
- ▶ Sympathetic Component
- ▶ Sympathetic Fiber Sprouting
- ▶ Sympathetic Ganglia
- ▶ Sympathetic Ganglionectomy
- ▶ Sympathetic Nerve Block
- ▶ **Sympathetic Nervous System and Pain**  
WILFRID JÄNIG, RALF BARON
- ▶ **Sympathetic Nervous System in the Generation of Pain, Animal Behavioral Models**  
HEINZ-JOACHIM HÄBLER, WILFRID JÄNIG
- ▶ **Sympathetic Postganglionic Neurons in Neurogenic Inflammation of the Synovia**  
PAUL G. GREEN, WILFRID JÄNIG
- ▶ Sympathetic-Sensory Coupling
- ▶ Sympathetic Skin Response
- ▶ Sympathetic Vasoconstrictor Neurons
- ▶ Sympathetically Dependent Pain
- ▶ Sympathetically Maintained Pain
- ▶ **Sympathetically Maintained Pain and Inflammation, Human Experimentation**  
FRANK BIRKLEIN, JÖRN SCHATTSCHEIDER, RALF BARON
- ▶ **Sympathetically Maintained Pain in CRPS I, Human Experimentation**  
GUNNAR WASNER, RALF BARON
- ▶ **Sympathetically Maintained Pain in CRPS II, Human Experimentation**  
SRINIVASA N. RAJA, ADAM CARINCI, RALF BARON
- ▶ **Sympathetically Maintained Pain, Clinical Pharmacological Tests**  
PETER D. DRUMMOND, JÖRN SCHATTSCHEIDER
- ▶ **Sympatho-Adrenal System and Mechanical Hyperalgesic Behavior, Animal Experimentation**  
WILFRID JÄNIG
- ▶ Sympathomimetic Amines
- ▶ Sympatho-Nociceptive Coupling
- ▶ Symphysis Pubis Dysfunction

- ▶ Symptom Magnifier
- ▶ Symptomatic Annular Tear
- ▶ Symptomatic Cramps
- ▶ Symptomatic Intracranial Hypotension
- ▶ Symptomatic Trigeminal Neuralgia
- ▶ Symptoms
- ▶ Synapse
- ▶ Synaptic Glomerulus
- ▶ Synaptic Organization
- ▶ Synaptic Organization of Afferent Fibers from Viscera in the Spinal Cord
- ▶ Synchronization
- ▶ Syndrome X
- ▶ Synergistic
- ▶ Synergy
- ▶ Synovial Joints
- ▶ Syntenic
- ▶ Syringomyelia
- ▶ Systematic
- ▶ Systematic Review
- ▶ Systemic Lupus Erythematosus
- ▶ Systemic Morphine Effects on Evoked Pain
- ▶ Systems Theory
- ▶ Tabes Dorsalis
- ▶ Tachykinin
- ▶ Tachyphylaxis
- ▶ Tactile Allodynia
- ▶ Tactile Allodynia Test
- ▶ Tactile Stimuli
- ▶ Tail Immersion
- ▶ Tail Skin Temperature Recording
- ▶ Tail-Flick Latency
- ▶ Tail-Flick Latency Correction
- ▶ **Tail Flick Test**  
KJELL HOLE, ARNE TJØLSEN
- ▶ Talairach Coordinates
- ▶ Tampa Scale for Kinesiophobia
- ▶ Tapotement
- ▶ Targeting
- ▶ Tarsal Tunnel
- ▶ Task Force on Promotion and Dissemination of Psychological Procedures
- ▶ Task Force on Vicarious Instigation
- ▶ TAUT
- ▶ Taut Band
- ▶ **Taxonomy**  
NIKOLAI BOGDUK
- ▶ Taxonomy, Orofacial Pain
- ▶ TCAs
- ▶ TCD
- ▶ Team Approach
- ▶ Technique of Ultrasound Application
- ▶ Tegretol
- ▶ Telemetric
- ▶ Temperament
- ▶ Temporal Arteritis
- ▶ Temporal Association
- ▶ Temporal Resolution
- ▶ Temporal Summation (Windup)
- ▶ Temporomandibular Disorder
- ▶ Temporomandibular Joint
- ▶ Temporomandibular Joint and Muscle Pain Dysfunction
- ▶ **Temporomandibular Joint Disorders**  
CHRISTIAN S. STOHLER
- ▶ Temporomandibular Pain
- ▶ **Tender Points**  
MICHAEL SPAETH
- ▶ Tenderness
- ▶ Tendinitis
- ▶ Tendon Sheath Inflammation
- ▶ Tenosynovitis
- ▶ TENS
- ▶ **TENS, Mechanisms of Action**  
KATHLEEN A. SLUKA
- ▶ TENS Outcomes
- ▶ Tension Headache
- ▶ Tension Type Headache
- ▶ TePs
- ▶ Tertiary Gain
- ▶ TES
- ▶ Testosterone
- ▶ Tetrodotoxin
- ▶ Tetrodotoxin (TTX)-Resistant Sodium Channel
- ▶ Thalamic Bursting Activity
- ▶ **Thalamic Bursting Activity, Chronic Pain**  
A. TAGHVA, S. H. PATEL, A. FERNANDEZ, NIRIT WEISS, FRED A. LENZ
- ▶ **Thalamic Neurotransmitters and Neuromodulators**  
KARIN N. WESTLUND, BRIDGET E. HAWKINS
- ▶ Thalamic Nociceptive Neurons
- ▶ Thalamic Nociceptive System
- ▶ Thalamic Nuclei



- ▶ **Thalamic Nuclei Involved in Pain, Cat and Rat**  
CHRISTIANE VAHLE-HINZ
- ▶ **Thalamic Nuclei Involved in Pain, Human and Monkey**  
EDWARD JONES
- ▶ Thalamic Pain
- ▶ Thalamic Physiology Changes Occurring in Patients with Chronic Pain
- ▶ **Thalamic Plasticity and Chronic Pain**  
JONATHAN O. DOSTROVSKY, DOUGLAS RASMUSSEN
- ▶ Thalamic Projections
- ▶ Thalamic Reorganization
- ▶ Thalamic Response to Experimental Pain in Humans
- ▶ Thalamic Reticular Nucleus
- ▶ **Thalamo-Amygdala Interactions and Pain**  
GEORGE S. BORSZCZ, S. E. HARTE
- ▶ Thalamocortical and Corticothalamic Interactions
- ▶ Thalamocortical Dysrhythmia
- ▶ Thalamocortical Fibers
- ▶ **Thalamocortical Loops and Information Processing**  
S. MURRAY SHERMAN
- ▶ Thalamocortical Module
- ▶ Thalamocortical Neurones
- ▶ Thalamotomy
- ▶ **Thalamotomy for Human Pain Relief**  
DANIEL JEANMONOD, JOHANNES SARNTHEIN, JAIR STERN, MICHEL MAGNIN, CHRISTOPH AUFENBERG, ANNE MOREL
- ▶ **Thalamotomy, Pain Behavior in Animals**  
NAYEF E. SAADÉ, SUHAYL J. JABBUR
- ▶ Thalamus
- ▶ Thalamus and Cardiac Pain
- ▶ Thalamus and Gastrointestinal Pain
- ▶ Thalamus and Pain
- ▶ Thalamus and Visceral Pain (Positron Emission Tomography or Functional Magnetic Resonance Imaging)
- ▶ **Thalamus and Visceral Pain Processing (Human Imaging)**  
ANTHONY R. HOBSON, QASIM AZIZ
- ▶ **Thalamus, Clinical Pain, Human Imaging**  
A. VANIA APKARIAN
- ▶ **Thalamus, Clinical Visceral Pain, Human Imaging**  
URI LADABAUM
- ▶ **Thalamus, Dynamics of Nociception**  
VASCO GALHARDO
- ▶ Thalamus Lesion
- ▶ Thalamus, Metabotropic Glutamate Receptors
- ▶ **Thalamus, Nociceptive Cells in VPI, Cat and Rat**  
CHRISTIANE VAHLE-HINZ
- ▶ **Thalamus, Nociceptive Inputs in the Rat (Spinal)**  
JEAN-FRANÇOIS BERNARD
- ▶ Thalamus, Nociceptive Neurotransmission
- ▶ **Thalamus, Receptive Fields, Projected Fields, Human**  
NIRIT WEISS, SHINJI OHARA, STAN ANDERSON, FRED A. LENZ
- ▶ **Thalamus, Visceral Representation**  
A. VANIA APKARIAN
- ▶ Thalassotherapy
- ▶ Tolosa-Hunt Syndrome (Painful Ophthalmoplegia)
- ▶ Therapeutic Acupuncture
- ▶ Therapeutic Alliance
- ▶ Therapeutic Cold
- ▶ Therapeutic Drug Monitoring
- ▶ Therapeutic Exercise
- ▶ Therapeutic Gain
- ▶ Therapeutic Gene Transfer
- ▶ Therapeutic Heat
- ▶ **Therapeutic Heat, Microwaves and Cold**  
JEFFREY R. BASFORD
- ▶ Therapeutic Relationships
- ▶ Therapeutic Ultrasound
- ▶ **Therapy of Pain, Hypnosis**  
ROBERT G. LARGE
- ▶ Thermal Allodynia
- ▶ Thermal Effects of Ultrasound
- ▶ Thermal Hyperalgesia
- ▶ Thermal Hyperalgesia Test
- ▶ Thermal Neuroablation
- ▶ **Thermal Nociception Test**  
KENNETH M. HARGREAVES, CHRISTOPHER M. FLORES
- ▶ Thermal Receptors
- ▶ Thermal Sensory Testing
- ▶ Thermal Stimulation (Skin, Muscle, Viscera)
- ▶ Thermal Stimulation (Stimuli)
- ▶ Thermal Therapy
- ▶ Thermal Transduction
- ▶ Thermocoagulation
- ▶ Thermode
- ▶ Thermography
- ▶ Thermoreception

- ▶ Thermoreceptor
- ▶ Thermoregulation
- ▶ Theta Rhythm
- ▶ Thoracic Epidural Analgesia
- ▶ Thoracic Epidural Anesthesia
- ▶ **Thoracic Medial Branch Blocks and Intra-Articular Blocks**  
PAUL VERRILLS
- ▶ **Thoracic Outlet Syndrome**  
A. LEE DELLON
- ▶ Thoracic Surgery
- ▶ Thought Suppression
- ▶ Threat Appraisal
- ▶ Three-Way Scaling Models
- ▶ Threshold
- ▶ **Threshold Determination Protocols**  
JOEL D. GREENSPAN
- ▶ Thromboembolism
- ▶ Thrombosis
- ▶ Thrombotic Event
- ▶ Thromboxane
- ▶ Thromboxane A<sub>2</sub>
- ▶ **Tic and Cranial Neuralgias**  
Z. HARRY RAPPAPORT, MARSHALL DEVOR
- ▶ Tic Douloureux
- ▶ Time Constant
- ▶ Time-Contingent Medication
- ▶ Time-Locked Medication
- ▶ Timing
- ▶ Timolol
- ▶ **Tinel Sign**  
TURO J. NURMIKKO
- ▶ Tinnitus
- ▶ Tissue Fatigue
- ▶ TLIF
- ▶ TMD
- ▶ TMS
- ▶ TMJD
- ▶ TNF Alpha( $\alpha$ )
- ▶ TNS
- ▶ Tolerance
- ▶ Tolerance Thresholds
- ▶ Tolosa-Hunt Syndrome
- ▶ Tonic Firing Mode
- ▶ Tonic Rebalance
- ▶ Toothache
- ▶ Top-Down Control of Pain
- ▶ **Topical Drug Therapy**  
CHARLES NG
- ▶ Topiramate
- ▶ Topographical
- ▶ Topography
- ▶ Total Pain
- ▶ Touch Evoked Pain
- ▶ Tourniquet Ischemia
- ▶ Tourniquet Pain Ratio
- ▶ **Tourniquet Test**  
GIANCARLO CARLI
- ▶ **Toxic Neuropathies**  
SUNG-TSANG HSIEH
- ▶ **Traction**  
SUSAN MERCER
- ▶ Tractus Trigeminothalamicus
- ▶ Traditional Pharmacological Pain Relief
- ▶ Trafficking
- ▶ **Trafficking and Localization of Ion Channels**  
PETER SHRAGER, MATTHEW N. RASBAND
- ▶ Trafficking of Proteins
- ▶ **Training by Quotas**  
WILBERT E. FORDYCE
- ▶ Trait
- ▶ Trajectory
- ▶ Tramadol
- ▶ **Tramadol Hydrochloride**  
JAYANTILAL GOVIND
- ▶ Tramal<sup>®</sup>
- ▶ Transcranial Magnetic Stimulation
- ▶ Transcription Factor
- ▶ **Transcutaneous Electrical Nerve Stimulation**  
JAMES WATT
- ▶ **Transcutaneous Electrical Nerve Stimulation (TENS) in Treatment of Muscle Pain**  
MARK I. JOHNSON
- ▶ **Transcutaneous Electrical Nerve Stimulation Outcomes**  
MARK I. JOHNSON
- ▶ Transcutaneous Electrical Stimulation
- ▶ Transdermal
- ▶ Transduction
- ▶ **Transduction and Encoding of Noxious Stimuli**  
CARLOS BELMONTE, FÉLIX VIANA
- ▶ Transduction Channel
- ▶ Transduction Sites
- ▶ Transfected Cells
- ▶ Transfer and Generalization

- ▶ Transforaminal Injection of Steroids
- ▶ Transforaminal Interbody Fusion
- ▶ Transforaminal Steroids
- ▶ Transformed Migraine
- ▶ Transformed Migraine Headache
- ▶ Transganglionic Transport
- ▶ Transgene
- ▶ Transgenic Knockout Mice
- ▶ Transgenic Mice
- ▶ **Transient Headache and CSF Lymphocytosis**  
ZAZA KATSARAVA, HANS-CHRISTOPH DIENER
- ▶ Transient Receptor Potential
- ▶ Transient Receptor Potential Family of Ion Channels
- ▶ Transient Receptor Potential Vanilloid 1 (TRPV1 or VR1) Receptor
- ▶ **Transition from Acute to Chronic Pain**  
SARAH J. HARPER, STEPHAN A. SCHUG
- ▶ Transition from Parenteral to Oral Analgesic Drugs
- ▶ Translaminar Epidural Steroid Injection
- ▶ Transmitters in the Descending Circuitry
- ▶ Transmucosal
- ▶ Transmucosal Fentanyl
- ▶ Transmural
- ▶ Transsynaptic Changes after Peripheral Nerve Injury
- ▶ Traumatic Angiospasm
- ▶ Traumatic Nerve Endbulb Pain
- ▶ Treating Pediatric Burns
- ▶ Treatment Adherence
- ▶ Treatment Alliance
- ▶ Treatment Matching
- ▶ Treatment of Neuropathic Pain
- ▶ Treatment of Phantom Pain
- ▶ Treatment Outcome
- ▶ Treatment Outcome Research
- ▶ Treatment-Related Neutropenia
- ▶ Tremor
- ▶ **Tricyclic Antidepressants**  
MARK JOHNSTON
- ▶ Tricyclic-Type Antidepressants
- ▶ Tricyclics
- ▶ **Trigeminal Brainstem Nuclear Complex, Anatomy**  
YOSHIO SHIGENAGA, ATSUSHI YOSHIDA
- ▶ **Trigeminal Brainstem Nuclear Complex, Immunohistochemistry and Neurochemistry**  
DAVID A. BEREITER
- ▶ **Trigeminal Brainstem Nuclear Complex, Physiology**  
JAMES W. HU, ALAIN WODA
- ▶ Trigeminal Ganglion
- ▶ Trigeminal Lemniscus
- ▶ Trigeminal Motor Nucleus
- ▶ Trigeminal Nerve
- ▶ Trigeminal Neuralgia
- ▶ Trigeminal Neuralgia, Aims of Surgical Management
- ▶ **Trigeminal Neuralgia, Diagnosis and Treatment**  
DONALD R. NIXDORF
- ▶ Trigeminal Neuralgia, Diagnostic Method
- ▶ **Trigeminal Neuralgia, Etiology, Pathogenesis and Management**  
JOANNA M. ZAKRZEWSKA
- ▶ Trigeminal Neuralgia, Ignition Theory
- ▶ Trigeminal Neuralgia, Medical Management
- ▶ Trigeminal Neuralgia, Microvascular Decompression
- ▶ Trigeminal Neuralgia, Patient Information
- ▶ Trigeminal Neuralgia, Types of Ablative Surgery
- ▶ Trigeminal Nucleus Caudalis
- ▶ Trigeminal Subnucleus Caudalis
- ▶ Trigeminal Tractotomy
- ▶ Trigeminal Transition Zone
- ▶ **Trigeminal, Glossopharyngeal, and Geniculate Neuralgias**  
WILLIAM S. ANDERSON, CAROL JAMES, BENJAMIN S. CARSON SR.
- ▶ Trigemino-cervical Complex
- ▶ **Trigeminohypothalamic Tract**  
XIJING J. ZHANG
- ▶ **Trigeminohypothalamic Tract Projections**  
KE REN
- ▶ Trigeminovascular System
- ▶ Trigger Point
- ▶ Trigger Point Pain
- ▶ Trigger Point Pressure Release
- ▶ Triple Response
- ▶ Triptans
- ▶ trkA
- ▶ TrkA Receptor(s)
- ▶ TrkA-IgG
- ▶ TRN
- ▶ Trochanteric Bursitis
- ▶ Trophic Factors
- ▶ Tropism

- ▶ TRP Channels
- ▶ TRPA1
- ▶ TRPM8 Channel
- ▶ TRPV1
- ▶ **TRPV1 Modulation by p2Y Receptors**  
MAKOTO TOMINAGA
- ▶ **TRPV1 Modulation by PKC**  
PETER A. MCNAUGHTON
- ▶ TRPV1 Modulation by PKC
- ▶ TRPV1-Null Mice
- ▶ TRPV1 Receptor
- ▶ TRPV1 Receptor, Modulation by P2Y Receptors
- ▶ **TRPV1 Receptor, Species Variability**  
PETER MCINTYRE
- ▶ TRPV1, Regulation by Acid
- ▶ **TRPV1, Regulation by Nerve Growth Factor**  
SVEN-ERIC JORDT
- ▶ **TRPV1, Regulation by Protons**  
SVEN-ERIC JORDT
- ▶ TSK
- ▶ TTX
- ▶ Tuberculoid Leprosy
- ▶ Tubo-Ovarian Complex
- ▶ Tumor (National Cancer Institute Terminology – Neoplasm)
- ▶ Tumor Necrosis Factor Alpha( $\alpha$ )
- ▶ Twin Studies
- ▶ Twitch-Obtaining Intramuscular Stimulation
- ▶ Two Pore Domain K<sup>+</sup> Channels
- ▶ Two-Way Scaling Models
- ▶ Type-1 Reaction (Leprosy)
- ▶ Type-2 Reaction (Leprosy)
- ▶ Type-II Receptors
- ▶ Tyrosine Kinase A
- ▶ U-1 Type Units
- ▶ U-2 Type Units
- ▶ UAB Pain Behavior Scale
- ▶ Ulceration
- ▶ **Ulceration, Prevention by Nerve Decompression**  
A. LEE DELLON
- ▶ Ulcerative Colitis
- ▶ Ultrasonography
- ▶ **Ultrasound**  
PETER LAU
- ▶ Ultrasound Delivery
- ▶ Ultrasound Therapy
- ▶ **Ultrasound Therapy of Pain from the Musculoskeletal System**  
VERONIKA FIALKA-MOSER
- ▶ Ultrasound Treatment
- ▶ Ultrastructure
- ▶ Ultraviolet Light
- ▶ Ultraviolet Radiation
- ▶ Unconventional Medicine
- ▶ Underdiagnosing of Pain
- ▶ Underreporting of Pain
- ▶ Undertreated Pain in Children
- ▶ Unidimensional
- ▶ Unilateral
- ▶ Unloading
- ▶ Unmyelinated Axon
- ▶ Unpleasant Sensation
- ▶ Unrecognized Pain in Children
- ▶ Up-Regulated
- ▶ Upregulation
- ▶ Ureteral Nociceptors
- ▶ Urethral Dyssynergia
- ▶ Urinary Bladder
- ▶ Urinary Bladder Nocifensive Behaviors
- ▶ Urogenital Pain
- ▶ Urticaria
- ▶ UV Erythema
- ▶ **UV-Erythema, a Model for Inducing Hyperalgesias**  
ROMAN RUKWIED
- ▶ **UV-Induced Erythema**  
THOMAS BISHOP
- ▶ UV-Induced Erythema as a Model of Inflammatory Pain
- ▶ UV Light
- ▶ **Vagal Input and Descending Modulation**  
CINDY L. THURSTON-STANFIELD, ALAN RANDICH
- ▶ Vagal Stimulation Produced Antinociception
- ▶ Vagally-Mediated Analgesia
- ▶ Vagally-Mediated Hyperalgesia
- ▶ Vaginal Hyperalgesia Model
- ▶ Vaginismus and Dyspareunia
- ▶ Vague, Strange Feeling
- ▶ Valdecocixib
- ▶ **Validity**  
DAVID VIVIAN
- ▶ Valsalva Maneuver
- ▶ Valsalva Manoeuvre Headache



- ▶ Vanilloid Receptor, Regulation by NGF
- ▶ Vanilloid Receptor, Regulation by Protons
- ▶ Vanilloid Receptor Subtype 1
- ▶ Vanilloids
- ▶ VAP
- ▶ Varicosities
- ▶ VAS
- ▶ Vasa Nervorum
- ▶ Vascular Compression Syndromes
- ▶ Vascular Hypertrophy
- ▶ **Vascular Neuropathies**  
CLAUDIA SOMMER
- ▶ Vascular Orofacial Pain
- ▶ Vascularization
- ▶ Vascular-Type Craniofacial Pain
- ▶ Vasculitic
- ▶ Vasculitic Neuropathy
- ▶ Vasculitis
- ▶ Vasoactive Intestinal Polypeptide
- ▶ Vasodilator
- ▶ Vasomotor
- ▶ Vasomotor Dysfunction
- ▶ Vasovagal Response
- ▶ VDCCs
- ▶ Vector
- ▶ Vein Thrombosis
- ▶ Venereal Arthritis
- ▶ Ventral Amygdaloid Pathway
- ▶ Ventral Basal Complex of the Lateral Thalamus
- ▶ Ventral Basal Nucleus (VB)
- ▶ Ventral Caudal Nucleus (Vc)
- ▶ Ventral Lateral Nucleus
- ▶ Ventral Medial Nucleus
- ▶ Ventral Posterior Complex (VP)
- ▶ Ventral Posterior Inferior Nucleus
- ▶ Ventral Posterior Lateral Nucleus
- ▶ Ventral Posterior Medial
- ▶ Ventral Posterior Nuclear Group of the Thalamus
- ▶ Ventral Posterior Nucleus (Human Ventral Caudal)
- ▶ Ventral Tegmental Area
- ▶ Ventricular Collapse
- ▶ Ventrolateral Funiculus
- ▶ Ventrolateral Orbital Cortex
- ▶ Ventromedial Nucleus
- ▶ Ventroposterior Lateral Nucleus
- ▶ Verapamil
- ▶ Vertebro-Basilar Arterial Disease
- ▶ Vertigo
- ▶ Vesical
- ▶ Vesical Pain Models
- ▶ Vesicular Inhibitory Amino Acid Transporter
- ▶ Vestibulectomy
- ▶ Vestibulodynia
- ▶ VIAAT
- ▶ Viagra
- ▶ Vibration
- ▶ Vicarious Experience
- ▶ Vicarious Instigation
- ▶ Vicarious Learning
- ▶ VIP
- ▶ Viral Meningitis
- ▶ **Viral Neuropathies**  
CATHERINE CHO, LYDIA ESTANISLAO, DAVID SIMPSON
- ▶ Viral Vectors
- ▶ Virus-Induced Nerve Dysfunction
- ▶ Visceral
- ▶ Visceral Afferent
- ▶ Visceral Hyperalgesia
- ▶ Visceral Hypersensitivity
- ▶ Visceral Inflammation
- ▶ Visceral Modulation
- ▶ Visceral Nociceptive Tracts
- ▶ **Visceral Nociception and Pain**  
PAUL M. MURPHY
- ▶ Visceral Nociceptors, Sensitization
- ▶ **Visceral Pain and Nociception**  
JAMES BOROWCZYK
- ▶ Visceral Pain from the Bladder
- ▶ **Visceral Pain Model, Angina Pain**  
ROBERT D. FOREMAN, CHAO QIN
- ▶ **Visceral Pain Model, Esophageal Pain**  
JYOTI N. SENGUPTA, REZA SHAKER, ADRIAN MIRANDA
- ▶ **Visceral Pain Model, Irritable Bowel Syndrome Model**  
ELIE D. AL-CHAER
- ▶ **Visceral Pain Model, Kidney Stone Pain**  
MARIA ADELE GIAMBERARDINO
- ▶ **Visceral Pain Model, Lower Gastrointestinal Tract Pain**  
WILLIAM D. WILLIS
- ▶ **Visceral Pain Model, Pancreatic pain**  
KARIN N. WESTLUND HIGH, LOUIS VERA-PORTOCARRERO

- ▶ **Visceral Pain Model, Small Intestinal Bowel Distension Pain**  
YI FENG
- ▶ **Visceral Pain Model, Urinary Bladder Pain (Irritants or Distension)**  
TIMOTHY NESS
- ▶ **Visceral Pain Models, Female Reproductive Organ Pain**  
KAREN J. BERKLEY
- ▶ Visceral Pain Pathway
- ▶ **Visceral Referred Pain**  
JAMES BOROWCZYK
- ▶ Visceral Representation
- ▶ Visceral Sensation
- ▶ Visceral Sympathetic Blocks
- ▶ Visceralgia
- ▶ Visceromotor Reflex
- ▶ Visceroreception
- ▶ Viscerosensation
- ▶ Viscerosomatic Pain Syndrome
- ▶ Viscerotome
- ▶ Viscoelastic Elements
- ▶ Viscosupplementation
- ▶ Visual Analog Scale
- ▶ Visual Evoked Potentials
- ▶ Vitamin Neuropathy
- ▶ VLO
- ▶ VM, VMb
- ▶ Vmpo
- ▶ Vocalization
- ▶ Vocalization Threshold to Electrical Muscle Stimulation
- ▶ Vocational Appraisal
- ▶ Vocational Aptitudes
- ▶ Vocational Assessment
- ▶ **Vocational Assessment in Chronic Pain**  
KURT L. JOHNSON
- ▶ **Vocational Counselling**  
INGRID SÖDERBACK
- ▶ Vocational Evaluation
- ▶ Voltage-Dependent Calcium Channels
- ▶ Voltage-Dependent Pores
- ▶ Voltage-Gated Calcium Channel
- ▶ Voltage-Gated Channel
- ▶ Voltage-Gated Potassium Channels
- ▶ Voltage-Gated Sodium Channel
- ▶ Volume of Distribution (Vd)
- ▶ Volume Transmission
- ▶ Von Frey Hair
- ▶ Von Frey Monofilaments
- ▶ VOP
- ▶ Voxel-Based Morphometry
- ▶ VP
- ▶ VPI
- ▶ VPL
- ▶ VPM
- ▶ VPpc
- ▶ VR1
- ▶ VR1, Regulation by NGF
- ▶ VR1, Regulation by Protons
- ▶ VR1, VRL1, TRPV1, TRPV2
- ▶ Vulvar Dysesthesia
- ▶ Vulvar Vestibulitis
- ▶ **Vulvodynia**  
URSULA WESSELMANN
- ▶ Vulvo-Vaginal Atrophy
- ▶ Waddell Signs
- ▶ Wage Replacement
- ▶ Walking Epidural
- ▶ **Wallerian Degeneration**  
SHLOMO ROTSHENKER
- ▶ Warm Allodynia
- ▶ WDR Neurons
- ▶ Wegener's Granulomatosis (WG)
- ▶ Weighted Scores Technique
- ▶ Weight-Lifter's Headache
- ▶ Well Behaviours
- ▶ Wernicke-Korsakoff Syndrome
- ▶ West Haven-Yale Multidimensional Pain Inventory
- ▶ WGA-HRP
- ▶ **Whiplash**  
MICHELE CURATOLO, NIKOLAI BOGDUK
- ▶ Whiplash-Associated Disorders
- ▶ WHO Analgesic Ladder
- ▶ **WHO System on Impairment and Disability**  
JENNY STRONG
- ▶ Whole Body Receptive Fields
- ▶ Whole-Brain/Partial Brain Coverage
- ▶ Whole Cell Patch Clamp Recordings
- ▶ WHYMPI
- ▶ Wide Dynamic Range Neuron
- ▶ Wide Field Radiation
- ▶ Wind-Up (Phenomenon)
- ▶ **Wind-Up of Spinal Cord Neurons**  
JUAN F. HERRERO
- ▶ Winging Scapula

- 
- ▶ Withdrawal
  - ▶ Withdrawal Symptoms
  - ▶ Work Capacity
  - ▶ Work Fitness
  - ▶ Work Samples
  - ▶ Worker Compensation
  - ▶ Working Alliance
  - ▶ Work-Related Musculoskeletal Disorder
  - ▶ World Health Organisation International Classification of Functioning
  - ▶ World Health Organization (WHO) Analgesic Ladder
  - ▶ Xanthochromic
  - ▶ **Yellow Flags**  
CHRIS J. MAIN
  - ▶ Z Joint
  - ▶ Z Joint Blocks
  - ▶ Zidovudine (AZT)-Induced Headache
  - ▶ Zona Incerta
  - ▶ Zoster-Associated Pain
  - ▶ Zydol
  - ▶ Zygapophyseal Joint
  - ▶ Zygapophysial Joint Pain, Sciatica
  - ▶ Zygapophysis
  - ▶ Zygapophyseal Joint Injection
  - ▶ Zymosan